

Quantum Theory: Concepts and Methods

by

Asher Peres

Kluwer Academic Publishers

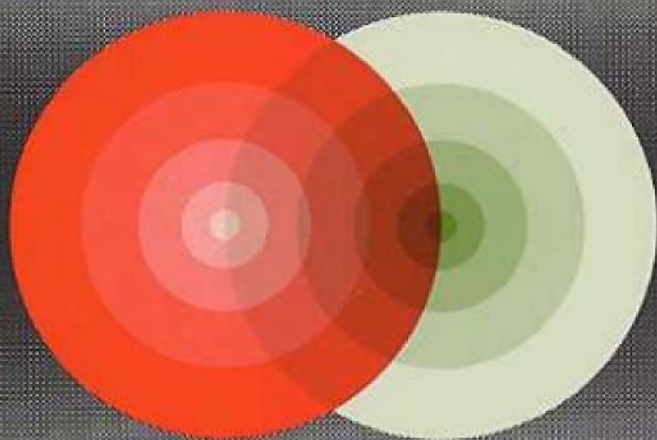

Fundamental Theories of Physics

Quantum Theory: Concepts and Methods

Fundamental Theories of Physics

*An International Book Series on The Fundamental Theories of Physics:
Their Clarification, Development and Application*

Editor: ALWYN VAN DER MERWE
University of Denver, U. S. A.

Editorial Advisory Board:

L. P. HORWITZ, *Tel-Aviv University, Israel*
BRIAN D. JOSEPHSON, *University of Cambridge, U.K.*
CLIVE KILMISTER, *University of London, U.K.*
GÜNTER LUDWIG, *Philipps-Universität, Marburg, Germany*
A. PERES, *Israel Institute of Technology, Israel*
NATHAN ROSEN, *Israel Institute of Technology, Israel*
MENDEL SACHS, *State University of New York at Buffalo, U.S.A.*
ABDUS SALAM, *International Centre for Theoretical Physics, Trieste, Italy*
HANS-JÜRGEN TREDER, *Zentralinstitut für Astrophysik der Akademie der
Wissenschaften, Germany*

Quantum Theory: Concepts and Methods

by

Asher Peres

Department of Physics,

Technion-Israel Institute of Technology,

Haifa, Israel

KLUWER ACADEMIC PUBLISHERS

NEW YORK, BOSTON, DORDRECHT, LONDON, MOSCOW

eBook ISBN: 0-306-47120-5

Print ISBN 0-792-33632-1

©2002 Kluwer Academic Publishers
New York, Boston, Dordrecht, London, Moscow

All rights reserved

No part of this eBook may be reproduced or transmitted in any form or by any means, electronic, mechanical, recording, or otherwise, without written consent from the Publisher

Created in the United States of America

Visit Kluwer Online at: <http://www.kluweronline.com>
and Kluwer's eBookstore at: <http://www.ebooks.kluweronline.com>

To Aviva

Peres has given us a clear and fully elaborated statement of the epistemology of quantum mechanics, and a rich source of examples of how ordinary questions can be posed in the theory, and of the extraordinary answers it sometimes provides. It is highly recommended both to students learning the theory and to those who thought they already knew it.

A. Sudbery, *Physics World* (April 1994)

Asher Peres has produced an excellent graduate level text on the conceptual framework of quantum mechanics . . . This is a well-written and stimulating book. It concentrates on the basics, with timely and contemporary examples, is well-illustrated and has a good bibliography . . . I thoroughly enjoyed reading it and will use it in my own teaching and research . . . it is a beautiful piece of real scholarship which I recommend to anyone with an interest in the fundamentals of quantum physics.

P. Knight, *Contemporary Physics* (May 1994)

Peres's presentations are thorough, lucid, always scrupulously honest, and often provocative . . . the discussion of chaos and irreversibility is a gem—not because it solves the puzzle of irreversibility, but because Peres consistently refuses to take the easy way out . . . This book provides a marvelous introduction to conceptual issues at the foundations of quantum theory. It is to be hoped that many physicists are able to take advantage of the opportunity.

C. Caves, *Foundations of Physics* (Nov. 1994)

I like that book and would recommend it to anyone teaching or studying quantum mechanics . . . Peres does an excellent job of reviewing or explaining the necessary techniques . . . the reader will find lots of interesting things in the book . . .

M. Mayer, *Physics Today* (Dec. 1994)

Setting the record straight on the conceptual meaning of quantum mechanics can be a perilous task . . . Peres achieves this task in a way that is refreshingly original, thought provoking, and unencumbered by the kind of doublethink that sometimes leaves onlookers more confused than enlightened . . . the breadth of this book is astonishing: Peres touches on just about anything one would ever want to know about the foundations of quantum mechanics . . . If you really want to be proficient with the theory, an honest, “no-nonsense” book like Peres's is the perfect place to start; for in so many places it supplants many a standard quantum theory text.

R. Clifton, *Foundations of Physics* (Jan. 1995)

This book provides a good introduction to many important topics in the foundations of quantum mechanics . . . It would be suitable as a textbook in a graduate course or a guide to individual study . . . Although the boundary between physics and philosophy is blurred in this area, this book is definitely a work of physics. Its emphasis is on those topics that are the subject of active research and on which considerable progress has been made on recent years . . . To enhance its use as a textbook, the book has many problems embedded throughout the text . . . [The chapter on] information and thermodynamics contains many interesting results, not easily found elsewhere . . . A chapter is devoted to quantum chaos, its relation to classical chaos, and to irreversibility. These are subjects of ongoing current research, and this introduction from a single, clearly expressed point of view is very useful . . . The final chapter is devoted to the measuring process, about which many myths have arisen, and Peres quickly dispatches many of them . . .

L. Ballentine, *American Journal of Physics* (March 1995)

Table of Contents

Preface	x <i>i</i>
PART I: GATHERING THE TOOLS	
Chapter 1: Introduction to Quantum Physics	3
1-1. The downfall of classical concepts	3
1-2. The rise of randomness	5
1-3. Polarized photons	7
1-4. Introducing the quantum language	9
1-5. What is a measurement?	14
1-6. Historical remarks	18
1-7. Bibliography	21
Chapter 2: Quantum Tests	24
2-1. What is a quantum system?	24
2-2. Repeatable tests	27
2-3. Maximal quantum tests	29
2-4. Consecutive tests	33
2-5. The principle of interference	36
2-6. Transition amplitudes	39
2-7. Appendix: Bayes's rule of statistical inference	45
2-8. Bibliography	47
Chapter 3: Complex Vector Space	48
3-1. The superposition principle	48
3-2. Metric properties	51
3-3. Quantum expectation rule	54
3-4. Physical implementation	57
3-5. Determination of a quantum state	58
3-6. Measurements and observables	62
3-7. Further algebraic properties	67

3-8. Quantum mixtures	72
3-9. Appendix: Dirac's notation	77
3-10. Bibliography	78
Chapter 4: Continuous Variables	79
4-1. Hilbert space	79
4-2. Linear operators	84
4-3. Commutators and uncertainty relations	89
4-4. Truncated Hilbert space	95
4-5. Spectral theory	99
4-6. Classification of spectra	103
4-7. Appendix: Generalized functions	106
4-8. Bibliography	112
 PART II: CRYPTODETERMINISM AND QUANTUM INSEPARABILITY	
Chapter 5: Composite Systems	115
5-1. Quantum correlations	115
5-2. Incomplete tests and partial traces	121
5-3. The Schmidt decomposition	123
5-4. Indistinguishable particles	126
5-5. Parastatistics	131
5-6. Fock space	137
5-7. Second quantization	142
5-8. Bibliography	147
Chapter 6: Bell's Theorem	148
6-1. The dilemma of Einstein, Podolsky, and Rosen	148
6-2. Cryptodeterminism	155
6-3. Bell's inequalities	160
6-4. Some fundamental issues	167
6-5. Other quantum inequalities	173
6-6. Higher spins	179
6-7. Bibliography	185
Chapter 7: Contextuality	187
7-1. Nonlocality versus contextuality	187
7-2. Gleason's theorem	190
7-3. The Kochen-Specker theorem	196
7-4. Experimental and logical aspects of contextuality	202
7-5. Appendix: Computer test for Kochen-Specker contradiction	209
7-6. Bibliography	211

PART III: QUANTUM DYNAMICS AND INFORMATION

Chapter 8: Spacetime Symmetries	215
8-1. What is a symmetry?	215
8-2. Wigner's theorem	217
8-3. Continuous transformations	220
8-4. The momentum operator	225
8-5. The Euclidean group	229
8-6. Quantum dynamics	237
8-7. Heisenberg and Dirac pictures	242
8-8. Galilean invariance	245
8-9. Relativistic invariance	249
8-10. Forms of relativistic dynamics	254
8-11. Space reflection and time reversal	257
8-12. Bibliography	259
Chapter 9: Information and Thermodynamics	260
9-1. Entropy	260
9-2. Thermodynamic equilibrium	266
9-3. Ideal quantum gas	270
9-4. Some impossible processes	275
9-5. Generalized quantum tests	279
9-6. Neumark's theorem	285
9-7. The limits of objectivity	289
9-8. Quantum cryptography and teleportation	293
9-9. Bibliography	296
Chapter 10: Semiclassical Methods	298
10-1. The correspondence principle	298
10-2. Motion and distortion of wave packets	302
10-3. Classical action	307
10-4. Quantum mechanics in phase space	312
10-5. Koopman's theorem	317
10-6. Compact spaces	319
10-7. Coherent states	323
10-8. Bibliography	330
Chapter 11: Chaos and Irreversibility	332
11-1. Discrete maps	332
11-2. Irreversibility in classical physics	341
11-3. Quantum aspects of classical chaos	347
11-4. Quantum maps	351
11-5. Chaotic quantum motion	353

11-6. Evolution of pure states into mixtures	369
11-7. Appendix: POST SCRIPT code for a map	370
11-8. Bibliography	371
Chapter 12: The Measuring Process	373
12-1. The ambivalent observer	373
12-2. Classical measurement theory	378
12-3. Estimation of a static parameter	385
12-4. Time-dependent signals	387
12-5. Quantum Zeno effect	392
12-6. Measurements of finite duration	400
12-7. The measurement of time	405
12-8. Time and energy complementarity	413
12-9. Incompatible observables	417
12-10. Approximate reality	423
12-11. Bibliography	428
Author Index	430
Subject Index	435

Preface

There are many excellent books on quantum theory from which one can learn to compute energy levels, transition rates, cross sections, etc. The theoretical rules given in these books are routinely used by physicists to compute observable quantities. Their predictions can then be compared with experimental data. There is no fundamental disagreement among physicists on how to *use* the theory for these practical purposes. However, there are profound differences in their opinions on the ontological meaning of quantum theory.

The purpose of this book is to clarify the *conceptual meaning* of quantum theory, and to explain some of the mathematical methods which it utilizes. This text is not concerned with specialized topics such as atomic structure, or strong or weak interactions, but with the very foundations of the theory. This is not, however, a book on the philosophy of science. The approach is pragmatic and strictly instrumentalist. This attitude will undoubtedly antagonize some readers, but it has its own logic: quantum phenomena do not occur in a Hilbert space, they occur in a laboratory.

The level of the book is that of a graduate course. Since most universities do not offer regular courses on the foundations of quantum theory, this book was also designed to be suitable for independent study. It contains numerous exercises and bibliographical references. Most of the exercises are “on line” with the text and should be considered as part of the text, so that the reader actively participates in the derivation of results which may be needed for future applications. Usually, these exercises require only a few minutes of work. The more difficult exercises are denoted by a star \star . A few exercises are rated $\star\star$. These are little research projects, for the more ambitious students.

It is assumed that the reader is familiar with classical physics (mechanics, optics, thermodynamics, etc.) and, of course, with elementary quantum theory. To remedy possible deficiencies in these subjects, textbooks are occasionally listed in the *bibliography* at the end of each chapter, together with general recommended reading. Any required notions of mathematical nature, such as elements of statistics or computer programs, are given in *appendices* to the chapters where these notions are needed.

The mathematical level of this book is not uniform. Elementary notions of linear algebra are explained in minute detail, when a *physical meaning* is

attributed to abstract mathematical objects. Then, once this is done, I assume familiarity with much more advanced topics, such as group theory, angular momentum algebra, and spherical harmonics (and I supply references for readers who might lack the necessary background).

The general layout of the book is the following. The first chapters introduce, as usual, the formal tools needed for the study of quantum theory. Here, however, the primitive notions are not vectors and operators, but *preparations and tests*. The aim is to define the operational meaning of these physical concepts, rather than to subordinate them to an abstract formalism. At this stage, a “measurement” is considered as an ideal process which attributes a numerical value to an observable, represented by a self-adjoint operator. No detailed dynamical description is proposed as yet for the measuring process. However, physical procedures are defined as precisely as possible. Vague notions such as “quantum uncertainties” are never used. There also is a brief chapter devoted to dynamical variables with continuous spectra, in which the mathematical level is a reasonable compromise, neither sloppy (as in some elementary textbooks) nor excessively abstract and rigorous.

The central part of this book is devoted to cryptodeterministic theories, *i.e.*, extensions of quantum theory using “hidden variables.” Nonlocal effects (related to Bell’s theorem) and contextual effects (due to the Kochen-Specker theorem) are examined in detail. It is here that quantum phenomena depart most radically from classical physics. There has been considerable progress on these issues while I was writing the book, and I have included those new developments which I expect to be of lasting value.

The third part of the book opens with a chapter on spacetime symmetries, discussing both nonrelativistic and relativistic kinematics and dynamics. After that, the book penetrates into topics which belong to current research, and it presents material having hitherto appeared only in specialized journals: the relationship of quantum theory to thermodynamics and to information theory, its correspondence with classical mechanics, and the emergence of irreversibility and quantum chaos. The latter differs in many respects from the more familiar classical deterministic chaos. Similarities and differences between these two types of chaotic behavior are analyzed.

The final chapter discusses the measuring process. The measuring apparatus is now considered as a *physical system*, subject to imperfections. One no longer needs to postulate that observable values of dynamical variables are eigenvalues of the corresponding operators. This property follows from the dynamical behavior of the measuring instrument (typically, if the latter has a pointer moving along a dial, the final position of the pointer turns out to be *close* to one of the eigenvalues). The thorny point is that the measuring apparatus must accept two irreconcilable descriptions: it is a quantum system when it interacts with the measured object, and a classical system when it ultimately yields a definite reading. The *approximate* consistency of these two conflicting descriptions is ensured by the irreversibility of the measuring process.

This book differs from von Neumann's classic treatise in many respects. von Neumann was concerned with "measurable quantities." This is a neo-classical attitude: supposedly, there are "physical quantities" which we measure, and their measurements disturb each other. Here, I merely assume that we perform macroscopic operations called *tests*, which have stochastic outcomes. We then construct *models* where these macroscopic procedures are related to microscopic objects (e.g., atoms), and we use these models to make statistical predictions on the stochastic outcomes of the macroscopic tests. This approach is not only conceptually different, but it also is more general than von Neumann's. The measuring process is not represented by a complete set of orthogonal projection operators, but by a non-orthogonal *positive operator valued measure* (POVM). This improved technique allows to extract more information from a physical system than von Neumann's restricted measurements.

These topics are sometimes called "quantum measurement theory." This is a bad terminology: there can be no quantum measurement theory—there is only quantum mechanics. Either you use quantum mechanics to describe experimental facts, or you use another theory. A measurement is not a supernatural event. It is a physical process, involving ordinary matter, and subject to the ordinary physical laws. Ignoring this obvious truth and treating a measurement as a primitive notion is a distortion of the facts and a travesty of physics.

Some authors, perceiving conceptual difficulties in the description of the measuring process, have proposed new ways of "interpreting" quantum theory. These proposals are *not* new interpretations, but radically different theories, without experimental support. This book considers only standard quantum theory—the one that is actually used by physicists to predict or analyze experimental results. Readers who are interested in deviant mutations will not be able to find them here.

While writing this book, I often employed colleagues as voluntary referees for verifying parts of the text in which they had more expertise than me. I am grateful to J. Avron, C. H. Bennett, G. Brassard, M. E. Burgos, S. J. Feingold, S. Fishman, J. Ford, J. Goldberg, B. Huttner, T. F. Jordan, M. Marinov, N. D. Mermin, N. Rosen, D. Saphar, L. S. Schulman, W. K. Wootters, and J. Zak, for their interesting and useful comments. Special thanks are due to Sam Braunstein and Ady Mann, who read the entire draft, chapter after chapter, and pointed out numerous errors, from trivial typos to fundamental misconceptions. I am also grateful to my institution, Technion, for providing necessary support during the six years it took me to complete this book. Over and above all these, the most precious help I received was the unflinching encouragement of my wife Aviva, to whom this book is dedicated.

ASHER PERES

June 1993

This page intentionally left blank.

Part I

GATHERING
THE TOOLS

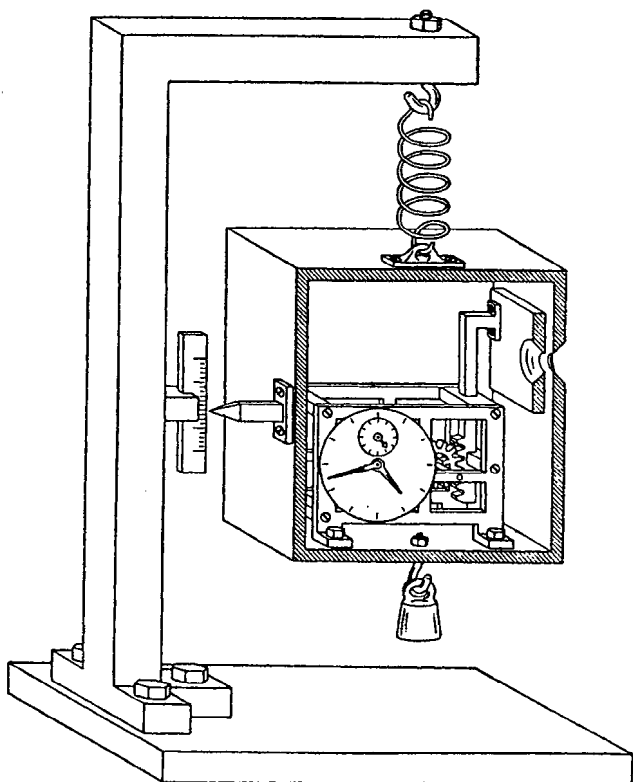

Plate I. This pseudorealistic instrument, designed by Bohr, records the moment at which a photon escapes from a box. A spring-balance weighs the box both before and after its shutter is opened to let the photon pass. It can be shown by analyzing the dynamics of the spring-balance that the time of passage of the photon is uncertain by at least $\hbar/\Delta E$, where ΔE is the uncertainty in the measurement of the energy of the photon. (Reproduced by courtesy of the Niels Bohr Archive, Copenhagen.)

Chapter 1

Introduction to Quantum Physics

1-1. The downfall of classical concepts

In classical physics, particles were assumed to have well defined positions and momenta. These were considered as objective properties, whether or not their values were explicitly known to a physicist. If these values were not known, but were needed for further calculations, one would make reasonable (statistical) assumptions about them. For example, one would assume a uniform distribution for the phases of harmonic oscillators, or a Maxwell distribution for the velocities of the molecules of a gas. Classical statistical mechanics could explain many phenomena, but it was considered only as a pragmatic approximation to the true laws of physics. Conceptually, the position \mathbf{q} and momentum \mathbf{p} of each particle had well defined, objective, numerical values.

Classical statistical mechanics also had some resounding failures. In particular, it could not explain how the walls of an empty cavity would ever reach equilibrium with the electromagnetic radiation enclosed in that cavity. The problem is the following: The walls of the cavity are made of atoms, which can absorb or emit radiation. The number of these atoms is *finite*, say 10^{25} ; therefore the walls have a finite number of degrees of freedom. The radiation field, on the other hand, can be Fourier analyzed in orthogonal modes, and its energy is distributed among these modes. In each one of the modes, the field oscillates with a fixed frequency, like a harmonic oscillator. Thus, the radiation is dynamically equivalent to an *infinite* set of harmonic oscillators. Under these circumstances, the law of equipartition of energy ($E = kT$ per harmonic oscillator, on the average) can never be satisfied: The vacuum in the cavity, having an infinite heat capacity, would absorb all the thermal energy of the walls. Agreement with experimental data could be obtained only by modifying, *ad hoc*, some laws of physics. Planck¹ assumed that energy exchanges between an atom and a radiation mode of frequency ν could occur only in integral multiples of $h\nu$, where h was a new universal constant. Soon afterwards, Einstein²

¹ M. Planck, *Verh. Deut. Phys. Gesell.* 2 (1900) 237; *Ann. Physik* 4 (1901) 553.

² A. Einstein, *Ann. Physik* (4) 17 (1905) 132; 20 (1906) 199.

sharpened Planck's hypothesis in order to explain the photoelectric effect—the ejection of electrons from materials irradiated by light. Einstein did not go so far as to explicitly write that light consisted of particles, but this was strongly suggested by his work.

Circa 1927, there was ample evidence that electromagnetic radiation of wavelength λ sometimes appeared as if it consisted of localized *particles*—called photons³—of energy $E = h\nu$ and momentum $p = h/\lambda$. In particular, it had been shown by Compton⁴ that in collisions of photons and electrons the total energy and momentum were conserved, just as in elastic collisions of ordinary particles. Since Maxwell's equations were not in doubt, it was tempting to identify a photon with a pulse (a wave packet) of electromagnetic radiation. However, it is an elementary theorem of Fourier analysis that, in order to make a wave packet of size Δx , one needs a minimum bandwidth $\Delta(1/\lambda)$ of the order of $1/\Delta x$. When this theorem is applied to photons, for which $1/\lambda = p/h$, it suggests that the location of a photon in phase space should not be described by a point, but rather by a small volume satisfying $\prod \Delta q^i \Delta p_i \gtrsim h^3$ (a more rigorous bound is derived in Chapter 4). This fact by itself would not have been a matter of concern to a classical physicist, because the latter would not have considered a “photon” as a genuine particle anyway—this was only a convenient name for a bunch of radiation. However, it was pointed out by Heisenberg⁵ that if we attempt to *look* (literally) at a particle, that is, if we actually bombard it with photons in order to ascertain its position \mathbf{q} and momentum \mathbf{p} , the latter will not be determined with a precision better than the \mathbf{q} and \mathbf{p} of the photons used as probes. Therefore any particle observed by optical means would satisfy $\prod \Delta q^i \Delta p_i \gtrsim h^3$. This limitation, together with the experimental discovery of the wave properties of electrons,⁶ led to the conclusion that the classical concept of particles which had precise \mathbf{q} and \mathbf{p} was pure fantasy.

This naive classical description was then replaced by another one, involving a state vector ψ , commonly represented by a function $\psi(\mathbf{q}_1, \dots, \mathbf{q}_n; t)$. Our intuition, rooted in daily experience with the macroscopic world, utterly fails to visualize this complex function of $3n$ configuration space coordinates, and time. Nevertheless, some physicists tend to attribute to the wave function ψ the objective status that was lost by \mathbf{q} and \mathbf{p} . There is a temptation to believe that each particle (or system of particles) *has* a wave function, which is its objective property. This wave function might not necessarily be *known* to any physicist; if its value is needed for further calculations, one would have to make reasonable assumptions about it, just as in classical statistical physics. However, conceptually, the state vector of any physical system would have a well defined, objective value.

Unfortunately, there is no experimental evidence whatsoever to support this

³ G. N. Lewis, *Nature* 118 (1926) 874.

⁴ A. H. Compton, *Phys. Rev.* 21 (1923) 207, 483, 715.

⁵ W. Heisenberg, *Z. Phys.* 43 (1927) 172; *The Physical Principles of the Quantum Theory*, Univ. of Chicago Press (1930) [reprinted by Dover] p. 21.

⁶ C. Davisson and L. H. Germer, *Phys. Rev.* 30 (1927) 705.

naive belief. On the contrary, if this view is taken seriously, it leads to many bizarre consequences, called “quantum paradoxes” (see for example Fig. 6.1 and the related discussion). These so-called paradoxes originate solely from an incorrect interpretation of quantum theory. The latter is thoroughly pragmatic and, when correctly used, never yields two contradictory answers to a well posed question. It is only the *misuse* of quantum concepts, guided by a pseudorealistic philosophy, which leads to these paradoxical results.

1-2. The rise of randomness

Heisenberg’s uncertainty principle may seem to be only a bit of fuzziness which blurs classical quantities. A much more radical departure from classical tenets is the intrinsic *irreproducibility* of experimental results. The tacit assumption underlying classical physical laws is that if we exactly duplicate all the conditions for an experiment, the outcome must turn out to be exactly the same. This doctrine is called *determinism*. It is not compatible, however, with the known behavior of photons in some elementary experiments, such as the one illustrated in Fig. 1.1. Take a collimated light source, a birefringent crystal such as calcite, and a filter for polarized light, such as a sheet of polaroid. Two spots of light, usually of different brightness, appear on the screen. As the sheet of polaroid is rotated with respect to the crystal through an angle α , the intensities of the spots vary as $\cos^2 \alpha$ and $\sin^2 \alpha$.

This result can easily be explained by *classical* electromagnetic theory. We know that light consists of electromagnetic waves. The polaroid absorbs the waves having an electric vector parallel to its fibers. The resulting light beam

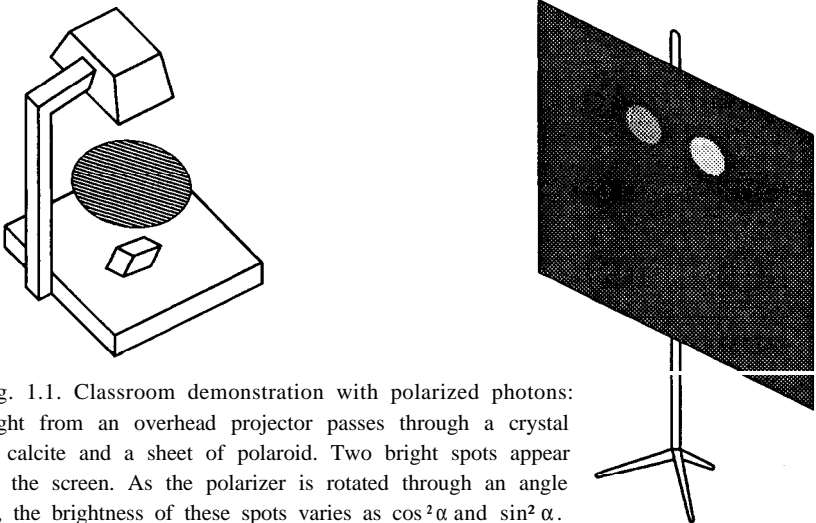
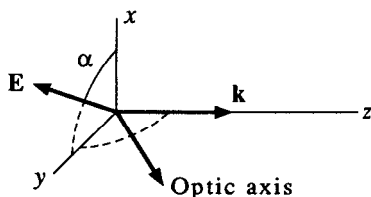

Fig. 1.1. Classroom demonstration with polarized photons: Light from an overhead projector passes through a crystal of calcite and a sheet of polaroid. Two bright spots appear on the screen. As the polarizer is rotated through an angle α , the brightness of these spots varies as $\cos^2 \alpha$ and $\sin^2 \alpha$.

Fig. 1.2. Coordinates used to describe double refraction: The incident wave vector \mathbf{k} is along the z -axis; the electric vector \mathbf{E} is in plane xy ; and the optic axis of the crystal is in plane yz .



is therefore polarized. It now passes through the calcite crystal, which has an anisotropic refraction index. In order to compute the path of the light beam in that crystal, it is convenient to set a coordinate system as shown in Fig. 1.2: the z -axis along the incident wave vector \mathbf{k} , the x -axis perpendicular to \mathbf{k} and to the optic axis of the crystal, and the y -axis in the remaining direction. Then, the x and y components of the electric vector \mathbf{E} propagate *independently* (with different velocities) in the anisotropic crystal. They correspond to the ordinary and extraordinary rays, respectively. These components are proportional to $\cos\alpha$ and $\sin\alpha$ (where α is the angle between \mathbf{E} and the x -axis). The *intensities* (Poynting vectors) of the refracted rays are therefore proportional to $\cos^2\alpha$ and $\sin^2\alpha$. This is what classical theory predicts and what we indeed see.

However, this simple explanation breaks down if we want to restate it in our modern language, where light consists of particles—photons—because each photon is *indivisible*. It does not split. We do not get in each beam photons with a reduced energy $h\nu\cos^2\alpha$ or $h\nu\sin^2\alpha$ (this would correspond to reduced frequencies). Rather, we get *fewer* photons with the *full* energy $h\nu$. To further investigate how this happens, let us improve the experimental setup, as shown in Fig. 1.3. Assume that the light intensity is so weak and the detectors are so fast that individual photons can be registered. Their arrivals are recorded by printing $+$ or $-$ on a tape, according to whether the upper or the lower detector was triggered, respectively. Then, the sequence of $+$ and $-$ appears *random*. As the total numbers of marks, N_+ and N_- , become large, we find that the corresponding *probabilities*, that is, the ratios $N_+/(N_+ + N_-)$ and $N_-/(N_+ + N_-)$ tend to limits which are $\cos^2\alpha$ and $\sin^2\alpha$. We can see that empirically, this can also be explained by quantum theory, and moreover this

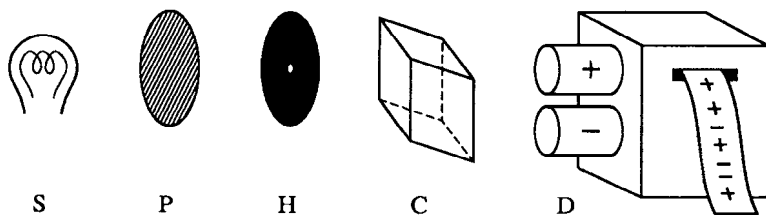

Fig. 1.3. Light from a thermal source S passes through a polarizer P , a pinhole H , a calcite crystal C , and then it triggers one of the detectors D . The latter register their output in a device which prints the results.

agrees with the classical result, all of which is very satisfactory. On the other hand, when we consider *individual events*, we cannot predict whether the next printout will be + or -. We have no explanation why a particular photon went one way rather than the other. We can only make statements on *probabilities*.

Once you accept the idea that polarized light consists of photons and that the latter are indivisible entities, physics cannot be the same. Randomness becomes fundamental. Chance must be elevated to the status of an essential feature of physical behavior.⁷

Exercise 1.1 Consider a beam of photons having a wave vector \mathbf{k} along the z -axis, and linear polarization initially along the x -axis. These photons pass through N consecutive identical calcite crystals, with gradually increasing tilts: the direction \mathbf{O} of the optic axis of the m th crystal ($m = 1, \dots, N$) is given, with respect to the fixed coordinate system defined above, by $O_x = \sin(\pi m / 2N)$ and $O_y = \cos(\pi m / 2N)$. Show that there are 2^N outgoing beams. What are their polarizations? What are their intensities (neglecting absorption)? Show that, as $N \rightarrow \infty$, nearly all the outgoing light is found in one of the beams, which is polarized in the y -direction. ★

Exercise 1.2 Generalize these results to arbitrary initial linear polarizations.

1-3. Polarized photons

The experiment sketched in Fig. 1.3 requires the calcite crystal to be thick enough to separate the outgoing beams by more than the width of the beams themselves. What happens if the crystal is made thinner, so that the beams partly overlap? In classical electromagnetic theory, the answer is straightforward. In the separated (non-overlapping) parts of the beams, the electric field is

$$\mathbf{E} = \mathbf{E}_x \cos(kz - \omega t + \delta_x), \quad (1.1)$$

for the ordinary ray, and

$$\mathbf{E} = \mathbf{E}_y \cos(kz - \omega t + \delta_y), \quad (1.2)$$

for the extraordinary ray. Here, the coordinates are labelled as in Fig. 1.2; \mathbf{E}_x and \mathbf{E}_y are vectors along the x and y directions; and δ_x and δ_y are the phase shifts of the ordinary and extraordinary rays, respectively, due to their passage in the birefringent crystal. The photons in the non-overlapping parts of the light beams are said to be *linearly polarized* in the x and y directions, respectively.

In the overlapping part of the beams, classical electromagnetic theory gives

⁷ Well, this claim is not yet proved at this stage. In fact, it will be seen in Chapter 6 that determinism can be restored for very simple systems, such as polarized photons, by introducing additional "hidden" variables which are then treated statistically. However, this leads to serious difficulties for more complicated systems.

$$\mathbf{E} = \mathbf{E}_x \cos(kz - \omega t + \delta_x) + \mathbf{E}_y \cos(kz - \omega t + \delta_y). \quad (1.3)$$

For arbitrary $\delta = \delta_x - \delta_y$, the result is called *elliptically polarized* light [the ellipse is the orbit drawn by the vector $\mathbf{E}(t)$ for fixed z]. This is the most general kind of polarization. In the special case where $\delta = \pm\pi/2$ and $|\mathbf{E}_x| = |\mathbf{E}_y|$, one has *circularly polarized* light. On the other hand, if $\delta = 2\pi n$ (with integral n), one has, in the overlapping region, light which is linearly polarized along the direction of $\mathbf{E}_x + \mathbf{E}_y$, exactly as in the incident beam. This is true, in particular, when the thickness of the crystal tends to zero, so that both δ_x and δ_y vanish.

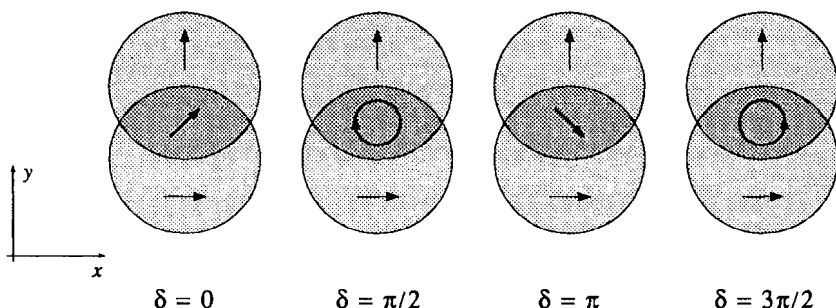

Fig. 1.4. Overlapping light beams with opposite polarizations. For simplicity, the beams have been drawn with sharp boundaries and they are supposed to have equal intensities, uniformly distributed within these boundaries. According to the phase difference δ , one may have, in the overlapping part of the beams, linearly, circularly or, in general, elliptically polarized photons.

How shall we describe in terms of photons the *overlapping* part of the beams? There can be no doubt that, in the limiting case of a crystal of vanishing thickness, we have linearly polarized light, with properties identical to those of the incident beam. This must also be true whenever $\delta = 2\pi n$. We then have photons which are linearly polarized in the direction of the original \mathbf{E} . We do *not* have a mixture of photons polarized in the x and y directions. If you have doubts about this,⁸ you may test this claim by using a second (thick) crystal as a polarization analyzer. The intensities of the outgoing beams will behave as $\cos^2 \alpha$ and $\sin^2 \alpha$, exactly as for the original beam.

In the general case represented by Eq. (1.3), we likewise obtain in the overlapping beams *elliptically polarized photons*—not a mixture of linearly polarized photons. The special case where $|\mathbf{E}_x| = |\mathbf{E}_y|$ and $\delta = \pm\pi/2$ gives *circularly polarized photons*. The latter can be produced by placing a quarter wave plate (qwp) with its optic axis perpendicular to \mathbf{k} and making a 45° angle with \mathbf{E} , so that $E_x = E_y$ in Fig. 1.2. Conversely, if circularly polarized light falls on a

⁸You *should* have doubts about any claim of that kind, unless it can be supported by experimental facts. You will see in Chapter 6 how intuitively obvious, innocent looking assumptions turn out to be experimentally wrong.

qwp, it will become linearly polarized in a direction at $\pm 45^\circ$ to the optic axis of the qwp; the sign \pm depends on the helicity of the circular polarization, *i.e.*, whether the vector $\mathbf{E}(t)$ moves clockwise or counterclockwise.

Exercise 1.3 Design an optical system which converts photons of given linear polarization into photons of given elliptic polarization (*i.e.*, with specified values for δ and $|E_x/E_y|$). ★

Exercise 1.4 Show that a device consisting of a qwp, followed by a thick calcite crystal with its optic axis at 45° to that of the qwp, followed in turn by a second qwp orthogonal to the first one, is a **selector** of circular polarizations: Circularly polarized incident photons emerge from it with their original circular polarization, but in two separate beams, depending on their helicity. What happens if the optic axes of the qwp are parallel, rather than orthogonal? ★

Exercise 1.5 Design a selector of elliptic polarizations with properties similar to those of the device described in the preceding exercise: All incoming photons emerge in one of two beams. If the incoming photon has a specified elliptic polarization (*i.e.*, given values of δ and $|E_x/E_y|$) it will always emerge in the upper beam, and will retain its initial polarization (that means, it would again emerge in the upper beam if made to pass in a subsequent, similar selector). Likewise, a photon emerging in the lower beam of the first selector will again emerge in the lower beam of a subsequent, similar selector. What is the polarization of the photons in the lower beam? **Ans.:** They have the inverse value of $|E_x/E_y|$ and the opposite value of $e^{i\delta}$ (these two elliptic polarizations are called **orthogonal**). ★

Exercise 1.6 Redesign the system requested in Exercise 1.3 in such a way that if two incident photons have given orthogonal linear polarizations, the outgoing photons will have given orthogonal elliptic polarizations (see the definition in Exercise 1.5). Does this requirement completely specify the optical properties of that system? **Ans.:** No, a phase factor remains arbitrary. ★

Exercise 1.7 Design a device to measure the polarization parameters δ and $|E_x/E_y|$ of a single, elliptically polarized photon of unknown origin. **Hint:** First, try the simpler case $\delta = 0$: the polarization is known to be linear. It is only its direction that is unknown. How would you determine that direction, for a single photon?

1-4. Introducing the quantum language

Have you solved Exercise 1.7? You should try very hard to solve this exercise. Don't give up, until you are fully convinced that an instrument measuring the polarization parameters of a single photon *cannot exist*. The question "What is

the polarization of that photon?" cannot be answered and has no meaning. A legitimate question, which can be answered experimentally by a device such as those described above, is whether or not a photon has a *specified* polarization. The difference between these two questions is essential and is best understood with the help of a geometric analogy. A question such as "In which unit cube is this point?" is obviously meaningless. A legitimate question is whether or not a given point is inside a *specified* unit cube. A point can be inside some cube, and *also* inside some other cube, if these two cubes overlap.

The analogous "overlapping" property for photon polarizations is the following: Suppose that a photon is prepared with a linear polarization making an angle α with the x -axis, and then we test whether it is polarized along the x -axis itself. The answer may well be positive: this will indeed happen with a probability $\cos^2 \alpha$. Thus, if I prepare a sequence of photons with *specified* polarizations, and then I send you these photons without disclosing what are their polarizations, there is no instrument whatsoever by means of which you could sort these photons into bins for polarizations from 0° to 10° , from 10° to 20° , etc., in a way agreeing with my records. In summary, while it is *possible* to measure with good accuracy the polarization parameters δ and $|E_x/E_y|$ of a *classical* electromagnetic wave which contains a huge number of photons, it is *fundamentally impossible* to measure those of a single photon of unknown origin. (The case of a finite number of identically prepared photons is discussed at the end of Chapter 2.)

The notion of "physical reality" thus acquires a new meaning with quantum phenomena, different from its meaning in classical physics. We therefore need a *new language*. We shall still use the same words as in everyday's life, such as "to measure," but the meaning of these words will be different. This is similar to the use, in special relativity, of words borrowed from Newtonian mechanics, such as time, mass, energy, etc. In relativity theory, these words have meanings which are different from those attributed to them in Newtonian mechanics; and some grammatically correct combinations of words are *meaningless*, for example, "these events occurred at the same instant at different places."

We shall now develop a new language to describe the quantum world, and a set of syntactical rules to use that language. In the first chapters of this book, our description of the physical world is a grossly oversimplified model (which will be refined later). It consists of two distinct classes of objects: macroscopic ones, described in classical terms—for example, they may be listed in a catalog of laboratory hardware—and microscopic objects—such as photons, electrons, etc. The latter are represented, as we shall see, by state vectors and the related paraphernalia. This dichotomy was repeatedly emphasized by Bohr:⁹

However far the [quantum] phenomena transcend the scope of classical physical explanation, the account of all evidence must be expressed in classical terms. The argument is simply that by the word 'experiment'

⁹N. Bohr, in *Albert Einstein, Philosopher-Scientist*, ed. by P. A. Schilpp, Library of Living Philosophers, Evanston (1949), p. 209.

we refer to a situation where we can tell others what we have done and what we have learned and that, therefore, the account of the experimental arrangement and the results of the observations must be expressed in unambiguous language with suitable application of the terminology of classical physics.

To underscore this point, Bohr used to sketch caricatures of measuring instruments in a pseudorealistic style, such as robust clocks, built with heavy duty gears, firmly bolted to rigid supports (see for example Plate I, page 2). The message of these caricatures was unmistakable: They vividly illustrated the fact that such a macroscopic instrument was only a mundane piece of machinery, that its workings could completely be accounted for by ordinary mechanics and, in particular, that the clock would *not* be affected by merely *observing* the position of its hands.

There should be no misunderstanding: Bohr never claimed that different physical laws applied to microscopic and macroscopic systems. He only insisted on the necessity of using different *modes of description* for the two classes of objects. It must be recognized that this approach is not entirely satisfactory. The use of a specific language for describing a class of physical phenomena is a tacit acknowledgment that the theory underlying that language is valid, to a good approximation. This raises thorny issues. We may wish to extend the microscopic (supposedly exact) theory to objects of intermediate size, such as a DNA molecule. Ultimately, we must explain how a very large number of microscopic entities, described by an utterly complicated vector in many dimensions, combine to form a macroscopic object endowed with classical properties. These issues will be discussed in Chapter 12.

A geometric analogy

When we study elementary Euclidean geometry—an ancient and noncontroversial science—we first introduce abstract notions (points, straight lines, ...) related by axioms, e.g., two points define a straight line. Intuitively, these abstract notions are associated with familiar objects, such as a long and narrow strip of ink which is called a “line.” Identifications of that kind promote Euclidean geometry to the status of a physical theory, which can then be tested experimentally. For example, one may check with suitable instruments whether or not the sum of the angles of a triangle is 180° . This experiment was actually performed by Gauss,¹⁰ while he was commissioned to make a geodetic survey of the kingdom of Hanover, in 1821–23. With his surveying equipment, Gauss found that space was Euclidean, within the accuracy of his observations (at least, it was Euclidean for distances commensurate with the kingdom of Hanover). Yet, this was not a test the axioms of Euclid: Gauss’s experiment tested the *physical properties of light rays*, and could only confirm that these

¹⁰C. F. Gauss, *Werke*, Teubner, Leipzig (1903) vol. 9, pp. 299–319.

rays were a satisfactory realization of the abstract concept of straight lines. A hundred years later, precise astronomical tests of Einstein's theory of gravitation showed that light rays are deflected by massive bodies: they are *not* faithful realizations of the straight lines of Euclidean geometry. Actually, no material object can precisely mimic these ideal straight lines. Nonetheless, Euclidean geometry is useful for *approximate* calculations in the real world. Likewise, we shall see that the real instruments in a laboratory can only *approximately mimic* the fictitious instruments of the axiomatic quantum ontology.

Preparations and tests

Let us observe a physicist¹¹ in his laboratory. We see him performing two different kinds of tasks, which can be called *preparations* and *tests*. These preparations and tests are the primitive, undefined notions of quantum theory. They are like the points and straight lines in the axioms of Euclidean geometry. Their intuitive meaning can be explained as follows.

A preparation is an experimental procedure that is completely specified, like a recipe in a good cookbook. For example, the hardware sketched in the left half of Fig. 1.3 represents a preparation. Preparation rules should preferably be unambiguous, but they *may* involve stochastic processes, such as thermal fluctuations, provided that the statistical properties of the stochastic process are known, or at least reproducible.

A test starts like a preparation, but it also includes a final step in which *information*, previously unknown, is supplied to an *observer* (i.e., the physicist who is performing the experiment). For example, the right half of Fig. 1.3 represents a sequence of tests, and the resulting information is the one printed on the tape. This information is not trivial because, as seen in the figure, tests that follow identical preparations need not have identical outcomes.

Note that a preparation usually involves tests, followed by a *selection* of specific outcomes. For example, a mass spectrometer can prepare a certain type of particle by measuring the masses of various incoming particles and selecting those with the desired properties.

The foregoing statements have only suggestive value. They do not properly define preparations and tests, as this would require prior definitions for the notion of *information* and for related terms such as *known/unknown*, etc. It is obvious that the distinction between preparations and tests involves a direction for the flow of time. The asymmetry between past and future is fundamental in the axiomatic structure of quantum theory. It is similar to the fundamental asymmetry between the past and future light cones in special relativity. These

¹¹This book sometimes refers to "physicists" who perform various experimental tasks, such as preparing and observing quantum systems. They are similar to the ubiquitous "observers" who send and receive light signals in special relativity. Obviously, this terminology does not imply the actual presence of human beings. These fictitious physicists may as well be inanimate automata that can perform all the required tasks, if suitably programmed. I used everywhere, for brevity, the pronoun "he" to mean "he or she or it."

asymmetries may appear paradoxical because elementary dynamical laws are invariant under time reversal.¹² However, there is no real contradiction here because, at the present stage of the discussion, we have not yet offered a *dynamical description* for preparations and tests, or for the emission and detection of signals. The macroscopic instruments which perform these tasks are considered at this stage as unresolved objects. Therefore, time-reversal invariance is lost, just as it would be in any elementary problem with external time-dependent forces. In the final chapters of this book, this approach will be refined and the macroscopic apparatuses will be considered as dynamical entities. Then, the asymmetry in the flow of time—the irreversibility of preparations and tests—will be explained by arguments similar to those of classical statistical mechanics.

Note that we are free to *choose* the preparations and tests that we perform. As stated by Bohr,¹³ “our freedom of handling the measuring instruments [is] characteristic of the very idea of experiment.” We may even consider the possible outcomes of mutually *incompatible* tests (an example is given in the next section). However, our free will stops there. We are not free to choose the future outcome of a test (unless it is a trivial test that can have only one outcome).

We can now define the scope of quantum theory:

*In a strict sense, quantum theory is a set of rules allowing the computation of **probabilities** for the outcomes of tests which follow specified preparations.*

Here, a probability is defined as usual: If we repeat the same preparation many times, the *probability* of a given outcome is its *relative frequency*, namely the limit of the ratio of the number of occurrences of that outcome to the total number of trials, when these numbers tend to infinity. This ratio *must* tend to a limit if we repeat the *same* preparation (this is the meaning of “same”).

The above strict definition of quantum theory (a set of rules for computing the probabilities of macroscopic events) is not the way it is understood by most practicing physicists. They would rather say that quantum theory is used to compute the properties of microscopic objects, for example the energy-levels and cross-sections of atoms and nuclei. The theory can also explain some properties of bulk matter, such as the specific heat of solids or the electric conductivity of metals—whenever these macroscopic properties can be derived from those of the microscopic constituents. Despite this uncontested success, the epistemological meaning of quantum theory is fraught with controversy, perhaps because it is formulated in a language where familiar words are given unfamiliar meanings. Do these microscopic objects—electrons, photons, etc.—really exist, or are they only a convenient fiction introduced to help our reasoning, by supplying intuitive models in circumstances where ordinary intuition is useless? I shall argue later in this book that the microscopic objects do “exist” in some sense but, depending on circumstances, their existence may be very elusive.¹⁴

¹² Exotic phenomena such as K^0 decay cannot be the cause of macroscopic time asymmetry; nor can the expansion of the Universe explain time asymmetry in local phenomena in an isolated laboratory.

¹³ N. Bohr, *Phys. Rev.* 48 (1935) 696.

¹⁴ An early draft of this book had a Freudian typo here: “illusive” instead of “elusive.”

1-5. What is a measurement?

Science is based on the observation of nature. Most scientists tend to believe that there exists an objective reality, which is partly unknown to us. We acquire knowledge about this reality by means of *measurements*: These are processes in which an apparatus interacts with the physical system under study, in such a way that a property of that system affects a corresponding property of the apparatus. Since there *must* be an interaction between the apparatus and the system, measuring one property of a system necessarily causes a disturbance to some of its other properties. This is true even in classical physics, as we shall see in Sect. 12-2. However, classical physics assumes that the property which is measured objectively *exists* prior to the interaction of the measuring apparatus with the observed system.

Quantum physics, on the other hand, is incompatible with the proposition that measurements discover some unknown but preexisting reality. For example, consider the historic Stern-Gerlach experiment¹⁵ whose purpose was to determine the magnetic moment of atoms, by measuring the deflection of a neutral atomic beam by an inhomogeneous magnetic field. Let us compute the trajectory of such an atom by *classical* mechanics, as Stern and Gerlach would have done in 1922. (The reader who is not interested in the details of this calculation can skip the next page.) The Hamiltonian of the atom is

$$H = \frac{\mathbf{P}^2}{2m} - \boldsymbol{\mu} \cdot \mathbf{B}, \quad (1.4)$$

where m is the mass of the atom, \mathbf{p} its momentum, and $\boldsymbol{\mu}$ its intrinsic magnetic

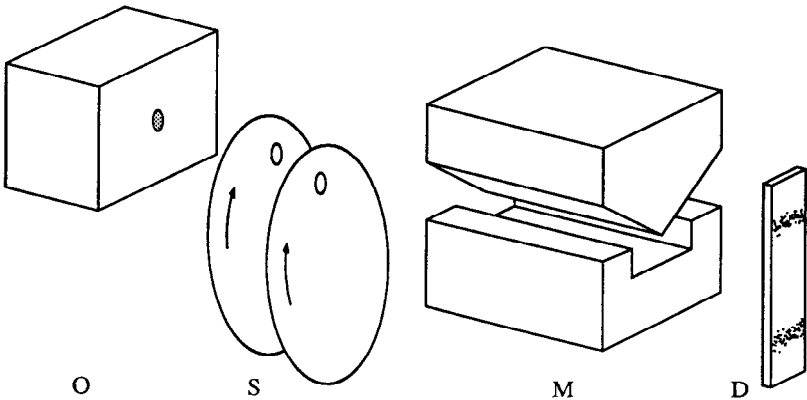

Fig. 1.5. Idealized Stern-Gerlach experiment: silver atoms evaporate in an oven O, pass through a velocity selector S, an inhomogeneous magnet M, and strike a detector D. All the impacts are found in two narrow strips.

¹⁵W. Gerlach and O. Stern *Z. Phys.* 8 (1922) 110; 9 (1922) 349.

moment. If the latter is due to some kind of internal rotational motion around a symmetry axis, we have $\boldsymbol{\mu} = g\mathbf{S}$, where \mathbf{S} is the angular momentum around the center of mass of the atom, and g is a constant—the gyromagnetic ratio—which depends on the mass and charge distribution around the rotation axis. The magnetic field \mathbf{B} is a function of \mathbf{r} , the position of the center of mass of the atom (the variation of \mathbf{B} over the size of the atom is completely negligible).

The classical equations of motion are obtained from the Poisson brackets

$$\dot{\mathbf{r}} = [\mathbf{r}, H]_{\text{PB}} = \mathbf{p}/m, \tag{1.5}$$

$$\dot{\mathbf{p}} = [\mathbf{p}, H]_{\text{PB}} = \nabla(\boldsymbol{\mu} \cdot \mathbf{B}), \tag{1.6}$$

$$\dot{\boldsymbol{\mu}} = [\boldsymbol{\mu}, H]_{\text{PB}} = g(\boldsymbol{\mu} \times \mathbf{B}). \tag{1.7}$$

The last equation follows from $[S_x, S_y]_{\text{PB}} = S_z$ and its cyclic permutations. Note that the internal variables \mathbf{S} have vanishing Poisson brackets with the center of mass variables \mathbf{r} and \mathbf{p} .

Equation (1.7) implies that $\boldsymbol{\mu}$ precesses around the direction of \mathbf{B} . This direction cannot be constant in space, since this would violate Maxwell’s equation $\nabla \cdot \mathbf{B} = 0$. One can however approximately solve (1.7) if $\overline{\mathbf{B}}$, the *mean* value of \mathbf{B} in the magnet gap, is much larger than the *variation* of \mathbf{B} in that gap and if, moreover, the duration of passage of the atom through the magnet is much longer than its precession time $2\pi/gB$. If these conditions hold, the atom will precess many times around the direction of $\overline{\mathbf{B}}$, so that we can neglect, on a *time average*, the components of $\boldsymbol{\mu}$ orthogonal to $\overline{\mathbf{B}}$. Let us write $\overline{\mathbf{B}} = \mathbf{e}_1 B$, where \mathbf{e}_1 is a unit vector and B is a constant. It then follows from (1.7) that $\boldsymbol{\mu} \cdot \mathbf{e}_1$ is a constant, and we can, on a *time average*, replace $\boldsymbol{\mu}$ by $\mu_1 \mathbf{e}_1$, where

$$\mu_1 := \boldsymbol{\mu} \cdot \mathbf{e}_1. \tag{1.8}$$

(The symbol $:=$ means “is defined as”.) From Eq. (1.6) we obtain

$$\frac{d}{dt}(\mathbf{e}_1 \cdot \mathbf{p}) = \mu_1 B', \tag{1.9}$$

where $B' := (\mathbf{e}_1 \cdot \nabla)(\mathbf{e}_1 \cdot \mathbf{B})$ depends only on the construction of the magnet.

The force (1.6) acts during a time L/v , where v is the longitudinal velocity of the atoms, and L is the length of the magnet. The transverse momentum imparted to the atoms by this force is $\mu_1 B'L/v$, and their deflection angle is $\mu_1 B'L/2E$, where $E = \frac{1}{2}mv^2$. All these terms, except μ_1 , are determined by the macroscopic experimental setup (the oven, the velocity selector, the magnet, etc.) and are fixed for a given experiment. The surprising result found by Gerlach and Stern¹⁵ was that μ_1 could take *only two values*, $\pm\mu$.

This result is extremely surprising from the point of view of classical physics, because Gerlach and Stern could have chosen different orientations for their magnet, for example \mathbf{e}_2 and \mathbf{e}_3 , making angles of $\pm 120^\circ$ with \mathbf{e}_1 , as shown in Fig. 1.6. They would have measured then

$$\mu_2 = \boldsymbol{\mu} \cdot \mathbf{e}_2 \quad \text{or} \quad \mu_3 = \boldsymbol{\mu} \cdot \mathbf{e}_3, \quad (1.10)$$

respectively. As the laws of physics cannot be affected by merely rotating the magnet, they would have found, likewise, $\mu_2 = \pm\mu$ or $\mu_3 = \pm\mu$. This creates, however, an apparent contradiction when we add Eqs. (1.8) and (1.10):

$$\mu_1 + \mu_2 + \mu_3 = \boldsymbol{\mu} \cdot (\mathbf{e}_1 + \mathbf{e}_2 + \mathbf{e}_3) \equiv 0. \quad (1.11)$$

Obviously, μ_1 , μ_2 and μ_3 cannot all be equal to $\pm\mu$, and also sum up to zero.

Of course, it is impossible to measure in this way the values of μ_1 and μ_2 and μ_3 of the *same* atom—the magnet can have only one of the three positions. There is no need to invoke “quantum uncertainties” here. This is a purely classical impossibility, inherent in the experiment described by Fig. 1.6. (What

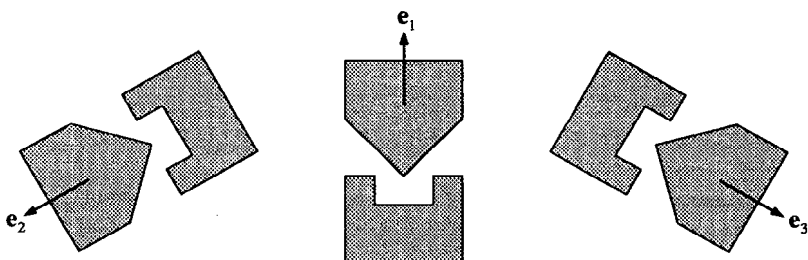

Fig. 1.6. Three possible orientations for the Stern-Gerlach magnet, making 120° angles with each other. The three unit vectors \mathbf{e}_1 , \mathbf{e}_2 and \mathbf{e}_3 sum up to zero.

quantum theory tells us is that this is not a defect of this particular experimental method for measuring a magnetic moment: No experiment whatsoever can determine μ_1 and μ_2 and μ_3 simultaneously.) Yet, even if the three experimental setups sketched in Fig. 1.6 are *incompatible*, it is certainly possible¹⁶ to measure μ_2 , or μ_3 , instead of μ_1 . Thus, if we attribute to the word “measurement” its ordinary meaning, namely the acquisition of knowledge about some objective preexisting reality, we reach a contradiction.

*The contradiction is fundamental. Once we associate **discrete** values with the components of a vector which can be **continuously** rotated, the meaning of these discrete values cannot be that of “objective” vector components, which would be independent of the measurement process.*

¹⁶You may feel uneasy with this *counterfactual* reasoning. While we are free to imagine the possible outcomes of unperformed experiments, Eq. (1.11) goes farther: it involves, simultaneously, the results of three *incompatible* experiments. At most one of the mathematical symbols written on the paper can acquire an actual meaning. The two others then exist only in our imagination. Is that equation legitimate? Can we draw from it reliable conclusions? Moreover, Eq. (1.11) assumes that, in these three possible but incompatible experiments, the magnetic moment of the silver atom has the same orientation. That is, our freedom of choice for the orientation of the magnet does not affect the silver atoms that evaporate from the oven. If you think that this is obvious, wait until after you have read Chapter 6.

A measurement is not a passive acquisition of knowledge. It is an active process, making use of extremely complex equipment, usually involving irreversible amplification mechanisms. (Irreversibility is not accidental, but essential, if we want an objective, indelible *record*. The record must be objective, even if the “physical quantity” to which it refers is not. This point will be discussed in Chapter 12). Moreover, we must *interpret* the experimental outcomes produced by our equipment. We do that by constructing a *theoretical model* whereby the behavior of the macroscopic equipment is described by a few degrees of freedom, interacting with those of the microscopic system under observation. We then call this a “measurement” of the microscopic system. The logical conclusion from this procedure was drawn long ago by Kemble:¹⁷

We have no satisfactory reason for ascribing objective existence to physical quantities as distinguished from the numbers obtained when we make the measurements which we correlate with them. There is no real reason for supposing that a particle has at every moment a definite, but unknown, position which may be revealed by a measurement of the right kind, or a definite momentum which can be revealed by a different measurement. On the contrary, we get into a maze of contradictions as soon as we inject into quantum mechanics such concepts carried over from the language and philosophy of our ancestors... It would be more exact if we spoke of “making measurements” of this, that, or the other type instead of saying that we measure this, that, or the other “physical quantity.”

As a concrete example, consider again the Stern-Gerlach experiment sketched in Fig. 1.5. The theoretical model corresponding to it is given by Eq. (1.4). The microscopic object under investigation is the magnetic moment $\boldsymbol{\mu}$ of an atom—more exactly, its μ_1 component. The macroscopic degree of freedom to which it is coupled in this model is the center of mass position \mathbf{r} (the coupling is in the term $\boldsymbol{\mu} \cdot \mathbf{B}$, since \mathbf{B} is a function of \mathbf{r}). I call this degree of freedom *macroscopic* because different final values of \mathbf{r} can be directly distinguished by macroscopic means, such as the detectors sketched in Fig. 1.5 (see Exercise 1.8). From here on, the situation is simple and unambiguous, because we have entered the macroscopic world: The type of detectors and the details of their functioning are deemed *irrelevant*. No additional theoretical model is needed to interpret the conspicuously macroscopic event which occurs when a particular detector is excited. The use of these detectors is only a convenient amplification of an existing signal, for the benefit of the experimenter.

Nevertheless, if we have doubts about this interpretation, we can displace the arbitrary boundary between the microscopic and the macroscopic worlds. We have the right to consider the numerous atoms in the detectors as additional parts of the observed system, to include all their degrees of freedom in the Hamiltonian (with all the interactions between these atoms and those of

¹⁷E. C. Kemble, *The Fundamental Principles of Quantum Mechanics*, McGraw-Hill, New York (1937) [reprinted by Dover] pp. 243-244.

the atomic beam) and to imagine an additional, larger apparatus observing the whole thing. Consistency requires that the result of observing the detectors by another instrument is the same as if the detectors themselves are considered as the ultimate instrument. This is what is meant by the claim that there is an *objective* record of the experiment. The role of physics is to study relationships between these objective records. Some people prefer to use the word “inter-subjectivity,” which means that all observers agree about the outcome of any particular experiment. Whether or not there exists an objective “reality” beyond the intersubjective reality may be an interesting philosophical problem,¹⁸ but this is *not* the business of quantum theory. As explained at the end of Sect. 1-4, quantum theory, in a strict sense, is nothing more than a set of rules whereby physicists compute probabilities for the outcomes of macroscopic tests.

Exercise 1.8 Show that, in the Stern-Gerlach experiment, the quantum mechanical spreading of the wave packet of a free silver atom is negligible. Therefore the motion of its center of mass can safely be treated by classical mechanics, once the magnetic moment of the atom does not interact with external fields. **Hint:** What is the diffraction angle of a beam with $\lambda = h/p$ and aperture determined by the collimators in the Stern-Gerlach experiment?

Exercise 1.9 Rewrite the Stern-Gerlach calculation in quantum notations, with commutators instead of Poisson brackets, and with \mathbf{S} represented by 2×2 matrices. Is Eq. (1.11) still valid? Where will the classical argument which led to a contradiction break down?

Exercise 1.10 What are the possible values of S_x , S_y and S_z for a particle of spin $S = \frac{3}{2}$? Can you combine these values so that $S_x^2 + S_y^2 + S_z^2 = S(S + 1)$?

1-6. Historical remarks

The interference properties of polarized light were discovered in the early 19th century by Arago and Fresnel.¹⁹ Decades before Maxwell, the phenomenology sketched in Fig. 1.4 was known. The crisis of classical determinism could therefore have erupted already in 1905, as soon as it became apparent from the work of Planck¹ and Einstein² that light consisted of discrete, indivisible entities. But at that time, no one was worried by such difficulties, because too many other facts were unexplained. Nobody knew how to compute the frequencies of spectral lines, nor their intensities. In fact, nobody understood why atoms were stable and could exist at all.

Progress was slow. First, came the “old” quantum theory. In 1913, Bohr²⁰ suggested that the only stable electronic orbits were those for which the angular

¹⁸B. d’Espagnat, *Une incertaine réalité*, Bordas, Paris (1985); English transl.: *Reality and the Physicist*, Cambridge Univ. Press (1989).

¹⁹F. Arago and A. Fresnel, *Ann. de Chimie et Physique* 10 (1819) 288.

²⁰N. Bohr, *Phil. Mag.* 26 (1913) 1, 476, 857.

MÉMOIRE

*Sur l' Action que les rayons de lumière polarisés
exercent les uns sur les autres.*

Par MM. ARAGO et FRESNEL.

AVANT de rapporter les expériences qui font l'objet de ce Mémoire, il ne sera peut-être pas inutile de rappeler quelques-uns des beaux résultats que le D^r Thomas Young avait déjà obtenus en étudiant, avec cette rare sagacité qui le caractérise, l'influence que, dans certaines circonstances, les rayons de lumière exercent les uns sur les autres.

1°. Deux rayons de lumière homogène, émanant d'une même source, qui parviennent en un certain point de l'espace par deux routes différentes et légèrement inégales, s'ajoutent ou se détruisent, forment sur l'écran qui les reçoit un point clair ou obscur, suivant que la différence des routes a telle ou telle autre valeur.

2°. Deux rayons s'ajoutent constamment là où ils ont parcouru des chemins égaux: si l'on trouve qu'ils s'ajoutent de nouveau quand la différence des deux chemins

Fig. 1.7. The historic paper of Arago and Fresnel⁹ on the interference of polarized light starts by recalling “some of the beautiful results already obtained by Dr. Thomas Young on the interference of light rays.”

momentum was an integral multiple of $h/2\pi$. Planck's constant h , originally introduced to explain the properties of thermal radiation, was found relevant to the mechanical properties of atoms too. Unfortunately, Bohr's *ad hoc* hypothesis, which correctly gave the energy levels of the hydrogen atom—the simplest atom—already failed for the next simplest one, helium.

Exercise 1.11 Bohr's model for the helium atom consists of two electrons revolving at diametrically opposed points of a circular orbit, around a point-like nucleus at rest. Find the lowest energy level from the condition that the angular momentum of each electron is \hbar . Compare your result with the experimental ionization energy of helium.

Bohr's hypothesis was generalized by Wilson²¹ and Sommerfeld²² to dynamical systems with several separable degrees of freedom, and then by Einstein²³ to

²¹W. Wilson, *Phil. Mag.* 29 (1915) 795.

²²A. Sommerfeld, *Ann. Physik* 51 (1916) 1.

²³A. Einstein, *Verh. Deut. Phys. Gesell.* 19 (1917) 82.

systems which were not separable, but still were integrable. However, more general aperiodic phenomena, such as the scattering of atoms or their interaction in the formation of molecules, remained practically untouched.

The next progress was due to de Broglie.²⁴ His doctoral thesis, submitted in 1924, was effectively the counterpart of the hypothesis that Einstein had proposed in 1905 to explain the photoelectric effect. Not only were electromagnetic waves endowed with particle-like properties, but material particles such as electrons could display wave-like behavior. The relationship $p = h/\lambda$ was universal, and Bohr's angular momentum postulate simply meant that the length of an electronic orbit was an integral number of electronic wavelengths. This unified view of nature was aesthetically appealing, but it could not yet be considered as a consistent theory.

The following year, Heisenberg²⁵ invented a "matrix mechanics" in which energy levels were the eigenvalues of infinite matrices. Lanczos²⁶ showed that Heisenberg's infinite matrices could be represented as singular kernels in integrals and was able to derive an integral equation whose eigenvalues were the *inverse* energy levels. However, Lanczos's work attracted little attention because it was soon superseded by Schrödinger's "wave mechanics" in which energy levels were the eigenvalues of a *differential* operator (which is notoriously easier to use than an integral operator). Schrödinger, who was led to his theory by a study of de Broglie's work, also proved the mathematical equivalence of his approach and that of Heisenberg.²⁷

The "new" quantum theory became known as quantum mechanics and developed very rapidly. There were important contributions by Born and Jordan²⁸ and especially by Dirac,²⁹ who successfully guessed a relativistic wave equation for the electron. Quantum mechanics was unambiguous and mathematically consistent. It allowed to compute not only the properties of the hydrogen atom, but also those of the helium atom—in principle those of any atom, any molecule, anything for which the potential was known. It would correctly predict the *probabilities* for photons to go one way or the other in a calcite crystal but, on the other hand, it could not predict the path taken by a *particular* photon. Therefore that theory was *essentially statistical*.

Not everyone was happy with this novel feature, in particular Einstein was not. He clearly understood that the meaning of quantum mechanics could only be statistical. He wrote, near the end of his life:³⁰

One arrives at very implausible theoretical conceptions, if one attempts to maintain the thesis that the statistical quantum theory is in principle

²⁴L. de Broglie, *Ann. Physique* (10) 3 (1925) 22.

²⁵W. Heisenberg, *Z. Phys.* 33 (1925) 879.

²⁶K. Lanczos, *Z. Phys.* 35 (1926) 812.

²⁷E. Schrödinger, *Ann. Physik* 79 (1926) 361, 489, 734.

²⁸M. Born and P. Jordan, *Z. Phys.* 34 (1925) 858.

²⁹P. A. M. Dirac, *Proc. Roy. Soc. A* 117 (1928) 610.

³⁰A. Einstein, in *Albert Einstein, Philosopher-Scientist*, ed. by P. A. Schilpp, Library of Living Philosophers, Evanston (1949), pp. 671-672.

capable of producing a complete description of an individual physical system. . . I am convinced that everyone who will take the trouble to carry through such reflections conscientiously will find himself finally driven to this interpretation of quantum-theoretical description (the ψ -function is to be understood as the description not of a single system but of an ensemble of systems). . . There exists, however, a simple psychological reason for the fact that this most nearly obvious interpretation is being shunned. For if the statistical quantum theory does not pretend to describe the individual system (and its development in time) completely, it appears unavoidable to look elsewhere for a complete description of the individual system. . . Assuming the success of efforts to accomplish a complete physical description, the statistical quantum theory would, within the framework of future physics, take an approximately analogous position to the statistical mechanics within the framework of classical mechanics. I am rather firmly convinced that the development of theoretical physics will be of that type; but the path will be lengthy and difficult.

Since the inception of quantum mechanics, many theorists have labored to prove, or disprove, the possible existence of theories with “hidden variables” whereby the quantum wave function would be supplemented by additional data in order to restore a neoclassical determinism. The unexpected result of these investigations were proofs by Bell,³¹ and by Kochen and Specker,³² that hidden variables *could* actually be introduced in such a way that statistical averages over their values reproduced the results of quantum mechanics. There was however a heavy price to pay for this reinstatement of determinism: the hidden variables of two widely separated and noninteracting systems were, in some cases, inseparably entangled. Therefore determinism could be restored only at the cost of abandoning the axiom of separability—the mutual independence of very distant systems—which until that time had been considered as obvious. This *quantum inseparability* will be discussed in Chapter 6. Its philosophical implications are profound. They have been the subject of a lively debate which will probably continue for many years to come.

1-7. Bibliography

The reader of this book is assumed to be reasonably familiar with classical physics. To remedy possible deficiencies, the following textbooks are suggested:

Thermal radiation

L. D. Landau and E. M. Lifshitz, *Statistical Physics*, 2nd ed., Pergamon, Oxford (1969) Chapt. 5.

³¹J. S. Bell, *Physics* 1 (1964) 195; *Rev. Mod. Phys.* 38 (1966) 447.

³²S. Kochen and E. P. Specker, *J. Math. Mech.* 17 (1967) 59.

F. K. Richtmyer, E. H. Kennard, and J. N. Cooper, *Introduction to Modern Physics*, 6th ed., McGraw-Hill, New York (1969) Chapt. 5.

Crystal optics

M. Born and E. Wolf, *Principles of Optics*, 6th ed., Pergamon, Oxford (1980) Chapt. 14.

S. G. Lipson and H. Lipson, *Optical Physics*, 2nd ed., Cambridge U. Press (1981) Chapt. 5.

Poisson brackets

H. Goldstein, *Classical Mechanics*, 2nd ed., Addison-Wesley, Reading (1980) Chapt. 9.

L. D. Landau and E. M. Lifshitz, *Mechanics*, 3rd ed., Pergamon, Oxford (1976) Chapt. 7.

“Old” and “new” quantum theory

M. Born, *The mechanics of the atom*, Bell, London (1927) [reprinted by Ungar, New York (1960)].

This remarkable book was originally published in 1924 under the title “*Atom-mechanik*.” In the preface to the English translation, completed in January 1927, the author wrote:

Since the appearance of this book in German, the mechanics of the atom has developed with a vehemence that could scarcely be foreseen. The new type of theory which I was looking for as the subject matter of the projected second volume has already appeared in the new quantum mechanics, which has been developed from two quite different points of view. I refer on the one hand to the quantum mechanics which was initiated by Heisenberg, and developed by him in collaboration with Jordan and myself in Germany, and by Dirac in England, and on the other hand to the wave mechanics suggested by de Broglie, and brilliantly worked out by Schrödinger. These are not two different theories, but simply two different modes of exposition. Many of the theoretical difficulties discussed in this book are solved by the new theory.

Born’s book is one of the best sources on canonical transformations, action-angle variables and the Hamilton-Jacobi theory. These were the indispensable tools of theorists who practiced the old quantum theory. Curiously, the book does not mention Poisson brackets. The latter became of special interest only at a later stage, with the advent of Heisenberg’s and Dirac’s formulations of the “new” quantum theory.

Another classic reference for the “old” quantum theory is

A. Sommerfeld, *Atomic Structure and Spectral Lines*, Methuen, London (1923).

This is a translation of the third edition of *Atombau und Spektrallinien*, Vieweg, Braunschweig (1922). The fourth German edition (1924) was not translated.

B. L. van der Waerden, editor, *Sources of Quantum Mechanics*, North-Holland, Amsterdam (1967) [reprinted by Dover].

This book contains the English text (original or translated) of 17 historic articles on quantum theory, starting with Einstein's "Quantum Theory of Radiation" (1917), and ending with the works of Heisenberg, Born, Jordan, Dirac, and Pauli. It is remarkable that Schrödinger's work is totally ignored. The inventors of quantum mechanics—in its original matrix form—were dismayed by the success of Schrödinger's "wave mechanics," which promptly superseded matrix mechanics in nearly all applications.

Recommended reading

J. B. Hartle, "Quantum mechanics of individual systems," *Am. J. Phys.* 36 (1968) 704.

This is a lucid explanation that a quantum "state is not an objective property of an individual system, but is that information, obtained from a knowledge of how the system was prepared, which can be used for making predictions about future measurements . . . The 'reduction of the wave packet' does take place in the consciousness of the observer, not because of any unique physical process which takes place there, but only because the state is a construct of the observer and not an objective property of the physical system."

D. Finkelstein, "The physics of logic," in *Paradigms and Paradoxes*, edited by R. C. Colodry, Univ. Pittsburgh Press (1971), Vol. V; reprinted in *Logico-Algebraic Approach to Quantum Mechanics*, edited by C. A. Hooker, Reidel, Dordrecht (1975), Vol. II, pp. 141–160.

J. M. Jauch, *Are Quanta Real? A Galilean Dialogue*, Indiana Univ. Press, Bloomington (1973).

L. E. Ballentine, "The statistical interpretation of quantum mechanics," *Rev. Mod. Phys.* 42 (1970) 358.

H. P. Stapp, "The Copenhagen interpretation," *Am. J. Phys.* 40 (1972) 1098.

The experts disagree on what is meant by "Copenhagen interpretation." Ballentine gives this name to the claim that "a pure state provides a complete and exhaustive description of a single system." The latter approach is called by Stapp the "absolute- ψ interpretation." Stapp insists that "critics often confuse the Copenhagen interpretation, which is basically pragmatic, with the diametrically opposed absolute- ψ interpretation . . . In the Copenhagen interpretation, the notion of absolute wave function representing the world itself is unequivocally rejected." There is therefore no real conflict between Ballentine and Stapp, except that one of them calls Copenhagen interpretation what the other considers as the exact opposite of the Copenhagen interpretation.

Chapter 2

Quantum Tests

2-1. What is a quantum system?

A *quantum system* is a useful abstraction, which frequently appears in the literature, but does not really exist in nature. In general, a quantum system is defined by an *equivalence class of preparations*. (Recall that “preparations” and “tests” are the primitive notions of quantum theory. Their meaning is the set of instructions to be followed by an experimenter.) For example, there are many equivalent macroscopic procedures for producing what we call a photon, or a free hydrogen atom, etc. The *equivalence* of different preparation procedures should be verifiable by suitable tests.

The ambiguity of these notions emerges as soon as we think of concrete examples. Is a hydrogen atom in a $2p$ state the same system as one in a $1s$ state? Or is it the same system as a hydrogen atom in a $1s$ state accompanied by a photon? The answer depends on the problem in which we are interested: energy levels or transition rates. In a Stern-Gerlach experiment, we have seen (page 17) that the “quantum system” is *not* a complete silver atom. It is only the magnetic moment μ of that atom, because the goal of the Stern-Gerlach test is to determine a component of μ . The center of mass of the atom can be treated classically. These examples show that we must be content with a vague “definition”: A quantum system is whatever admits a closed dynamical description within quantum theory.

While quantum systems are somewhat elusive, quantum *states* can be given a clear *operational* definition, based on the notion of *test*. Consider a given preparation and a set of tests, among which some are mutually incompatible, as in Fig. 1.6. If these tests are performed many times, after identical preparations, we find that the statistical distribution of outcomes of each test tends to a limit. Each outcome has a definite probability. We can then define a state as follows: *A state is characterized by the probabilities of the various outcomes of every conceivable test.*

This definition is highly redundant. We shall soon see that these probabilities are not independent. One can specify—in many different ways—a restricted set

of tests such that, if the probabilities of the outcomes of these tests are known, it is possible to predict the probabilities of the outcomes of every other test. (A geometric analogy is the definition of a vector by its projections on *every* axis. These projections are not independent: it is sufficient to specify a *finite* number of them, on a complete, linearly independent set of axes.)

Before we examine concrete examples, the notion of *probability* should be clarified. It means the following. We *imagine* that the test is performed an infinite number of times, on an infinite number of replicas of our quantum system, all identically prepared. This infinite set of experiments is called a *statistical ensemble*. It should be clearly understood that a statistical ensemble is a conceptual notion—it exists only in our imagination, and its use is to help our reasoning.¹ In this statistical ensemble, the occurrence of event A has relative frequency $\mathbf{P}\{A\}$; it is this relative frequency which is called a *probability*. To actually *measure* a probability, the best we can do is to repeat the same experiment a large (but finite) number of times.¹ The more we repeat it, the smaller will be the expected difference between the measured relative frequency and the true probability.

As a simple example of definition of a state, suppose that a photon is said to have right-handed polarization. Operationally, this means that if we subject that photon to a specific test (namely, a quarter wave plate followed by a suitably oriented calcite crystal) we can predict *with certainty* that the photon will exit in a particular channel. For any other test, consisting of arbitrarily arranged calcite crystals and miscellaneous optically active media, we can then predict *probabilities* for the various exit channels. (These probabilities are computed in the same way as the classical beam intensities.) Note that the word “state” does not refer to the photon by itself, but to an entire experimental setup involving macroscopic instruments. This point was emphasized by Bohr²

There can be no unambiguous interpretation of the quantum mechanics symbols other than that embodied in the well-known rules which allow to predict the results to be obtained by a given experimental arrangement described in a totally classical way.

More generally, we may relate a quantum state to a set of equivalent experimental procedures—provided that it is in principle possible to verify that these procedures are indeed equivalent. For instance, we may use quarter wave plates supplied by different manufacturers, or we may devise an altogether different method to analyze circular polarization. Occasionally, we may even renounce the use of any equipment, and consider purely mental experiments, as long as we are sure that a real experiment is possible *in principle*. For example, it is perfectly legitimate to consider the state of an electron located at the center of the Sun. A measurement of a spin component of that electron is undoubtedly

¹Repeating an experiment a million times does *not* produce an ensemble. It only makes *one* very complex experiment, involving a million approximately similar elements. (In this book, the term *assembly* is used to denote a set of almost identical systems.)

²N. Bohr, *Phys. Rev.* 48 (1935) 696.

very difficult, and it is ruled out for sure by budgetary constraints; but it is not ruled out by the laws of physics—as they are known today. Therefore it is legitimate to use quantum mechanics to compute the physical properties of a stellar plasma, just as it is used to discuss metallic conduction, or helium superfluidity, that we observe in our laboratory.

The essence of quantum theory is to provide a mathematical representation of states (that is, of *preparation procedures*), together with rules for computing the probabilities of the various outcomes of any test. Our first task thus is to get acquainted with the phenomenology of quantum tests. I shall start by listing some basic *empirical* facts. The conceptual implications of these facts will be analyzed, and then elevated to the status of “postulates.” However, it will not be possible to derive the complete formal structure of quantum theory from these empirically based postulates. Additional postulates will have to be introduced, with mathematical intuition as our only guide; and the consequences derived from these new postulates will have to be tested experimentally.

Before we enter into these details, the nature of a quantum test must be clearly understood. A test is more than the mere occurrence of an unpredictable event, such as the blackening of a grain in a photographic plate, or an electric discharge in a particle detector. To be interesting to physicists, these macroscopic events must be accompanied by a theoretical interpretation. As explained above, the latter must be partly *classical*.

For example, the firing of one of the photodetectors in Fig. 1.3 is interpreted as the arrival of a polarized photon, because we tacitly use the rules of classical electromagnetic theory, according to which a beam of light is split by a calcite crystal into two beams with opposite polarizations. Likewise, the Stern-Gerlach experiment is interpreted as the measurement of a magnetic moment, because it could indeed be such a measurement if we just sent little compass needles through the Stern-Gerlach magnet, instead of sending silver atoms. When nuclear physicists measure cross sections, they assume that the nuclear fragment trajectories are classical straight lines between the target and the various detectors. Without this assumption, the macroscopic positions of the detectors could not be converted into angles for the differential nuclear cross sections. And when spectroscopists measure wavelengths by means of diffraction gratings, they use classical diffraction theory to convert their data into wavelengths. Quantum theory appears only at the *next* stage, to explain, or predict, the possible values of the magnetic moment, the cross sections, the wavelengths, etc.

Here, you may ask: Why can't we describe the measuring instrument by quantum theory too? We can, and we shall indeed do that later, in order to prove the internal consistency of the theory. However, this only shifts the imaginary boundary between the quantum world—which is an abstract concept—and the mundane, tangible world of everyday. If we quantize the original classical instrument, we need another classical instrument to measure the first one, and to record the permanent data that will remain available to us for further study.

This mental process can be repeated indefinitely. Some authors state that the last stage in this chain of measurements involves “consciousness,” or the

“intellectual inner life” of the observer, by virtue of the “principle of psycho-physical parallelism.”^{3,4} Other authors introduce a wave function for the whole Universe.⁵ In this book, I shall refrain from using concepts that I do not understand. The internal consistency of the theory will simply mean that if an instrument is quantized and observed by another instrument, whose description remains classical, the result obtained by the second instrument must agree with the result that was registered by the first one, when the first one was described classically. More precisely, the probability for obtaining conflicting results must be arbitrarily low. This requirement imposes conditions on what can legitimately be called a measuring apparatus. It will be shown that an apparatus must have enough degrees of freedom to behave *irreversibly* in a thermodynamic sense. This will establish the consistency of our approach.

2-2. Repeatable tests

Consider two consecutive identical tests, following each other with a negligible time interval between them. If these tests always yield identical outcomes, they are called *repeatable*. (The term “repeatable” is used to refer to tests whose outcomes are intrinsically *unpredictable*, except statistically, for most preparations that may precede these tests. The term “reproducible” refers to phenomena having a fully *predictable* behavior.)

For example, consider two identical calcite crystals, arranged for testing the linear polarizations of incoming photons, as in Fig. 2.1. There are three detectors. It is found empirically that only the upper and lower ones may be excited; the central one never is. This is indeed what classical electromagnetic theory predicts for light rays: any trajectory different from those indicated by the dotted lines is impossible to achieve. Note that we *must* tacitly imagine the existence of quasi-classical paths, as indicated by the dotted lines, because this is the only way of interpreting the outcome of the experiment. Without some kind of interpretation, experiments are meaningless.

There is, however, a delicate point here: We also tacitly assume that the route followed by a photon, when it is tested by the first calcite crystal, does not depend on the existence of the second calcite crystal that we placed between the first one and the detectors. We believe that this photon would have followed the same route even if the second crystal had not been present. Such an assumption is needed in order to be able to say that there are *two* consecutive tests here, and to compare their results, in spite of the fact that the result of the first test is not recorded, but only inferred. This assumption is natural, because of our

³J. von Neumann, *Mathematische Grundlagen der Quantenmechanik*, Springer, Berlin (1932) p. 223; transl. by E. T. Beyer: *Mathematical Foundations of Quantum Mechanics*, Princeton Univ. Press, Princeton (1955) p. 418.

⁴E. P. Wigner, *Symmetries and Reflections*, Indiana Univ. Press, Bloomington (1967) p. 177.

⁵J. B. Hartle and S. W. Hawking, *Phys. Rev. D* 28 (1983) 2960.

deeply rooted classical prejudices—we have a tendency to imagine that each photon follows a well defined trajectory. However, this assumption is obviously counterfactual, and it is not verifiable. Counterfactual experiments will further be discussed in Chapter 6, where it will be seen that our intuition is not at all a reliable guide in the quantum domain.

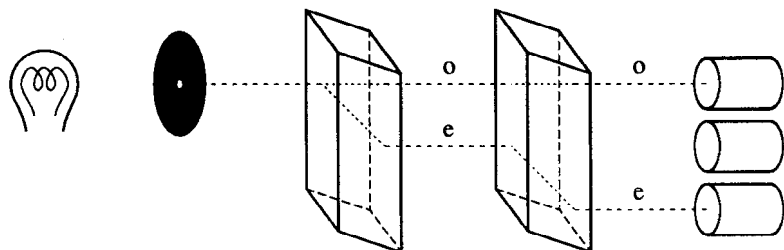

Fig. 2.1. A repeatable test: the second calcite crystal always confirms the result given by the first one.

Not every test is repeatable. For example, if identical quarter wave plates were affixed to the *right* of each calcite crystal in Fig. 2.1, there would be three outgoing rays, rather than two, emerging from the second crystal (the central detector would be excited as frequently as the two others combined). In that case, the photons leaving the first test would be circularly polarized. This is *not* the kind of polarization that is tested by these calcite crystals—therefore the modified tests would not be repeatable.

These tests would also not be repeatable if an optically active fluid were introduced between the two crystals, causing a rotation of the polarization plane. Likewise, two consecutive identical Stern-Gerlach experiments, with their magnetic fields parallel, may yield conflicting results if they are separated by a region where a perpendicular magnetic field causes a precession of the magnetic moment of the atom. The dynamical evolution of quantum systems will be discussed in Chapter 8. In the present chapter, it is assumed that consecutive tests follow each other so rapidly that we can neglect any dynamical evolution between them.

Another example of nonrepeatable test is the standard method for measuring the momentum of a neutron, by observing the recoil of a proton in a photographic emulsion or in a bubble chamber. It is obvious that the momentum of the neutron after the measurement cannot be the same as before it. This example clearly shows that a good measurement is not necessarily repeatable, contrary to careless statements such as⁶

From physical continuity, if we make a second measurement of the same dynamical variable immediately after the first, the result of the second measurement must be the same as that of the first.

⁶P. A. M. Dirac, *The Principles of Quantum Mechanics*, Oxford Univ. Press (1947), p. 36.

This gives the impression that every correctly done test is necessarily repeatable. Actually, repeatable tests are the exception, not the rule. They exist mostly in the imagination of theorists. They are idealizations, like rigid bodies, or Carnot engines; and like them, they are useful in theoretical discussions. The reason will soon be obvious, when we consider consecutive tests that *differ* from each other (see Sect. 2-4).

In most of this book, I shall therefore assume that tests have been designed so as to be repeatable, and the word “test” will mean a *repeatable test*, unless specified otherwise. However, it must be emphasized that nonrepeatable tests are the most common variety. Moreover, they may yield *more information* than ideal repeatable tests, as you will see in Chapter 9.

2-3. Maximal quantum tests

Let N be the maximum number of different outcomes obtainable in a test of a given quantum system. Assume N to be finite, for simplicity (the case of infinite N will be discussed in Chapter 4). Then, any test that has exactly N different outcomes is called *maximal* or *complete*. For example, the Stern-Gerlach experiment sketched in Fig. 1.5 is a complete test for the value of a component of a magnetic moment. It always has, irrespective of the orientation of the magnet, $(2s + 1)$ different outcomes for atoms of spin s . An *incomplete test* is one where some outcomes are lumped together, for example, because the experimental equipment has insufficient resolution. This is not necessarily a defect. We shall see (Chapter 12) that a low resolution may be advantageous in some applications, and that “fuzzy measurements” sometimes are those from which we can extract the most interesting information. They should not be confused with *imperfect tests*, whose outcomes are afflicted by various detector inefficiencies (including false alarms).

The adjective *maximal* or *complete* should not be misunderstood. A linear polarization test, such as the one sketched in Fig. 1.3, is complete only with respect to the polarization of the photon. It yields no information about other properties that the photon may have, such as its position or momentum. Likewise, the Stern-Gerlach experiment (Fig. 1.5) is a complete test for spin, while other degrees of freedom are ignored. In practice, the result of each one of these tests is observed by *correlating* the value of the internal degree of freedom (polarization or spin) which is being tested, to the *position* of the outgoing particle, which can then be detected by macroscopic means.

The notion of completeness of a quantum test is radically different from its counterpart in classical physics. For example, in classical mechanics, it is possible to specify *all* the components of the angular momentum \mathbf{J} of a rotating body. A complete description of the body *must* therefore include all of them. However, when we attempt to measure the components of \mathbf{J} of very small systems such as atoms, we find *empirically* that the measurement of

one of the components of \mathbf{J} not only precludes the measurement of the other components, but it even alters the expected values of these other components in an uncontrollable way. An example was given in Sect. 1-5 when we discussed the Stern-Gerlach experiment. It was shown that the atom had to precess many times around the direction of $\bar{\mathbf{B}}$ —the mean value of the magnetic field—so that the components of \mathbf{J} perpendicular to $\bar{\mathbf{B}}$ were randomized. This result may appear at first as an irrelevant practical difficulty, due to the limitations of the experimental setup chosen by Gerlach and Stern. However, this difficulty becomes a matter of principle in quantum theory. To be precise, if we *choose* to use quantum theory as the tool for interpreting the results of our experiments, it is impossible to *exactly* determine more than one component of the angular momentum.⁷ We can only *choose* the component which we want to determine.

This limitation does not preclude the use of quantum mechanics for computing the motion of a gyroscope, say, if we wish to do so. We shall see that, in the semiclassical limit $J \gg \hbar$, it is in principle possible to reduce the uncertainty in each one of the components of \mathbf{J} to a value of the order of $\sqrt{J\hbar}$. This uncertainty is utterly negligible for macroscopic systems, such as gyroscopes. Quantum limitations, as mentioned above, arise only when we want to reduce the uncertainty in one of the components of \mathbf{J} to less than $\sqrt{J\hbar}$.

It should be clear that the interpretation of raw experimental data always necessitates the use of *some* theory. Concepts such as “angular momentum” are parts of the theory, not of the experiment. Moreover, *correspondence rules* are needed to relate the abstract notions of the theory to our laboratory hardware. It is the theory—together with its correspondence rules—which tells us what can, or cannot, be measured. What does not exist in the theory cannot be observed in any experiment to be described by that theory. Conversely, anything described by the theory is deemed to be observable, unless the theory itself prohibits to observe it. To be acceptable, a theory must have predictive power about the outcomes of the experiments that it describes, so that the theory can eventually *fail*. A “good” theory is one which does not fail in its domain of applicability. Today, in our present state of knowledge, quantum theory is the best available one for describing atomic, nuclear, and many other phenomena.

According to quantum theory, we have a *choice* between different, *mutually incompatible* tests. For example, we may orient the Stern-Gerlach magnet in any direction we please. Why then is such a Stern-Gerlach test called *complete*? The reason can be stated as the following postulate:

A. Statistical determinism. *If a quantum system is prepared in such a way that it certainly yields a predictable outcome in a specified maximal test, the various outcomes of any other test have definite probabilities. In particular, these probabilities do not depend on the details of the procedure used for preparing the quantum system, so that it yields a specific outcome in the given maximal test. A system prepared in such a way is said to be in a pure state.*

⁷ There is one exception: all the components of \mathbf{J} may vanish simultaneously.

The simplest method for producing quantum systems in a given pure state is to subject them to a complete test, and to discard all the systems that did not yield the desired outcome. For example, perfect absorbers may be inserted in the path of the outgoing beams that we do not want. When this has been done, *all the past history of the selected quantum systems becomes irrelevant*. The fact that a quantum system produces a definite outcome, if subjected to a specific maximal test, completely identifies the state of that system, and this is the *most complete description* that can be given of it.⁸

The next definition we need is that of equivalent tests:

B. Equivalence of maximal tests. *Two maximal tests are equivalent if every preparation that yields a **definite** outcome for one of these tests also yields a **definite** outcome for the other test. In that case, any other preparation (namely one that does not yield a predictable outcome for these tests) will still yield the same **probabilities** for corresponding outcomes of both tests.*

For example, a Stern-Gerlach experiment measuring J_z (for arbitrary spin) is equivalent to an experiment measuring $(J_z)^3$, or $1/(J_z - \hbar\sqrt{2})$, or any other single valued function of J_z . It is important to note that postulate B demands that N different preparations yield *definite and different* outcomes for each one of the maximal tests. Equivalence is not guaranteed for tests that merely yield, in some cases, identical *probabilities*. For example, consider two crystals which can test linear polarization. Each one of these crystals, regardless of its orientation, will split an incoming beam of circularly polarized light into two beams of equal intensities, so that both tests always agree, statistically, in the special case of circularly polarized light (for *both* circular polarizations!). This trivial result gives of course no information as to what would happen if a beam of linearly polarized light impinged on one of these crystals, and in particular whether that beam would be split in the same proportions by both crystals.

In real life, most preparations do not yield pure states, but *mixed* ones. After an imperfect preparation, no maximal test has a predictable outcome. For example, photons originating from an incandescent lamp are in a mixed state of polarization. In this particular case, their polarization is completely *random*. Any test for polarization (whether linear, circular or, in general, elliptic) should yield approximately equal numbers of photons with opposite polarizations, if the apparatus has the same efficiency for both outcomes of that test. Such an apparatus is called *unbiased*, and we shall henceforth consider only unbiased tests. This example suggests the following generalization:

C. Random mixtures. *Quantum systems with N states can be prepared in such a way that **every** unbiased maximal test has the same probability, N^{-1} , for each one of its outcomes.*

⁸Any attempt to supplement this description by means of additional "hidden" variables leads to serious difficulties. See discussion in Chapter 6.

A random mixture is the state that corresponds to a *complete* lack of knowledge of the past history of the quantum system. To avoid a possible misunderstanding, I again emphasize that a “quantum system” is defined by *the set of quantum tests under consideration*. For example, if we consider experiments of the Stern-Gerlach type, which test a component of the magnetic moment, the quantum state of a silver atom emerging from the oven involves only the magnetic moment $\boldsymbol{\mu}$ of that atom—its center of mass \mathbf{r} can be treated classically (see p. 17). Obviously, that quantum state is a random mixture.

Postulate C seems innocuous, but it has far reaching consequences. First, we note that, for each quantum system, the state which is a random mixture is *unique* (there cannot be several distinct types of random mixtures). This follows from the very definition of a state, namely the set of probabilities for the various outcomes of every conceivable test. All these probabilities are equal to N^{-1} . Moreover, this unique random mixture is *dynamically invariant*. This can be shown as follows: An unbiased maximal test may include doing nothing but waiting, for a finite time. In that case, a quantum system, initially prepared as a random mixture, and allowed to evolve according to its internal dynamical properties, must remain in the state which is a random mixture. If it weren't so, the “idle test” would yield probabilities different from N^{-1} , contrary to the definition of a random mixture. Postulate C may therefore be called the *law of conservation of ignorance*. We shall see in Chapter 9 that this a special case of the law of conservation of entropy for an isolated system.

Note that true randomness is a much stronger property than mere “disorder,” and that total ignorance is radically different from incomplete knowledge. The distinction is fundamental, as the following exercises show. (Their solution requires a statistical assumption called *Bayes's rule*, which is explained in an appendix at the end of this chapter, for readers who are not familiar with this subject. Additional exercises can be found in that appendix.)

Exercise 2.1 *One million photons, linearly polarized in the x-direction, and one million photons, linearly polarized in the y-direction, are injected into a perfectly reflecting box⁹ where these photons can move (in the $\pm z$ -direction) with no change of their polarizations. No record is kept of the order in which these photons are introduced in the box (only the total numbers are recorded). A second, similar box contains one million photons with clockwise circular polarization, and one million photons with counter-clockwise circular polarization. You are given one of these boxes, but you are not told which one. Can you find out how that box was prepared, by testing each photon, in a way which you choose? What is the probability that you will make a wrong guess? **Ans.:** About $(4\pi \times 10^6)^{-1/2}$, if you have perfect photodetectors (see below). **

Exercise 2.2 *Repeat the preceding exercise, assuming now that the photodetectors have “only” 99% efficiency.*

⁹The size of the box is much larger than the coherence length of the photons, so that you can ignore the consequences of the Bose statistics that photons obey.

Exercise 2.3 Suppose that you have successfully performed an experiment which solves Exercise 2.1: You tested all the photons for one of the types of polarization, and you found unequal numbers of the two possible outcomes of these tests. You now hand on all these photons to another physicist, without telling him the result that you obtained. Can he find out which is the type of polarization that you tested? (Assume that all photodetectors are perfect and allow repeatable tests.)

2-4. Consecutive tests

To be acceptable, a theory must have predictive power about the outcomes of some experiments. We are therefore led to consider *correlations* between the outcomes of consecutive tests. The simplest case, namely identical tests, was discussed in Sect. 2-2. A situation more instructive than identical consecutive tests is that of *different* consecutive tests, such as those illustrated in Fig. 2.2, which represents a double Stern-Gerlach experiment for particles of spin 1.

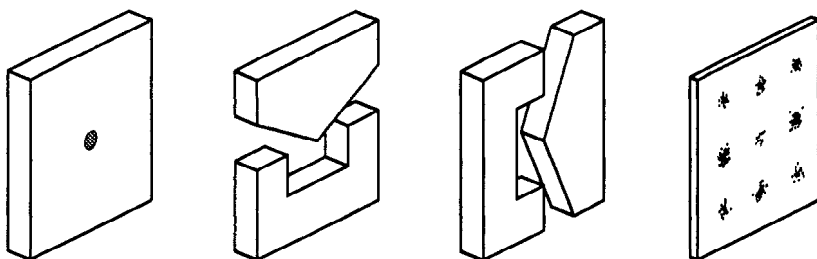

Fig. 2.2. Two consecutive Stern-Gerlach experiments for particles of spin 1. The drawing has been compressed by a factor 10 in the longitudinal direction.

Let I_m denote the intensities of the three beams leaving the first magnet. (If the source of particles is unpolarized, all the I_m are equal, by postulate C, but for our present purpose we need only assume that none of the I_m vanishes.) Let the angular separation of these three beams be sufficient, so that *they do not overlap* when they enter the second magnet. Yet, that separation should not be too large, so that the second magnet performs essentially the same test for each one of the three beams that impinge on it. If these conditions are satisfied, it becomes possible to imagine the existence of quasi-classical trajectories—as we did for Fig. 2.1—in order to give a meaning to the experiment. We want to consider the setup shown by Fig. 2.2 as *two* consecutive tests, rather than a single test with nine possible outcomes. Therefore we imagine that each impact on the detector plate is the end point of a trajectory which is not seen, but which can be calculated semi-classically. The location of the impact point reveals not only the outcome of the final test, but also the outcome of the test performed

with the first magnet. (Moreover, we assume that *if* the second magnet had not been there, the trajectory through the first magnet *would* have remained the same. As explained above, this is a natural, but unverifiable, counterfactual assumption.)

Taking all these assumptions for granted, the nine spots on the detector plate can be unambiguously identified as corresponding to outcomes $a, b,$ and c of the first test, and outcomes $\alpha, \beta,$ and γ of the second test (Latin and Greek letters will be used to label the outcomes of the first and second test, respectively). Let $I_{\mu m}$ be the observed intensities of the nine spots on the detector plate. If no particle is lost in transit, we have $\sum_{\mu} I_{\mu m} = I_m$. Define now a new matrix $P_{\mu m} = I_{\mu m} / I_m$, which therefore satisfies

$$\sum_{\mu} P_{\mu m} = 1. \quad (2.1)$$

(Matrices with nonnegative elements which satisfy the above equation are called “stochastic” in probability theory.)

In the experiment sketched in Fig. 2.2, the first test is not only complete, but also repeatable: its different outcomes are preparations of pure states. Therefore the matrix $P_{\mu m}$ is a probability table for the observation of outcome μ , following the preparation of pure state m . This probability matrix depends solely on the properties of the two tests that are involved in the experimental setup. It does not depend on the properties of the source of particles.

It will now be shown that $P_{\mu m}$ satisfies not only (2.1), but also

$$\sum_m P_{\mu m} = 1. \quad (2.2)$$

Matrices with nonnegative elements satisfying both (2.1) and (2.2) are called “doubly stochastic.” They have remarkable properties which will soon be used.

The proof of Eq. (2.2) is based on the obvious fact that any combination of consecutive tests can be considered as a single test. In general, this combined test may be biased, even if the individual tests are not. For example, in Fig. 2.1, we could *select* one of the outcomes of the first test before performing the second one, by placing an absorber in one of the beams, between the two crystals. Likewise, in Fig. 2.2, we could bias the final result by performing a selection among the beams which leave the first magnet or, more gently, by subjecting them to an additional inhomogeneous magnetic field in order to cause different precessions of the magnetic moments of the atoms. Suppose however that we are careful not to introduce any bias by treating differently the beams which leave the first test. Then, if the quantum systems being tested are prepared as a *random* mixture (see postulate C), the probability for each one of the N distinct outcomes of the second test is $p'_{\mu} = N^{-1}$, just as $p_m = N^{-1}$ was the probability for the m th outcome, in the first part of the combined test. On the other hand, we also have

$$p'_{\mu} = \sum_m P_{\mu m} p_m,$$

because $P_{\mu m}$ is the probability that outcome μ follows preparation m . Comparing these results, we readily obtain Eq. (2.2).

Exercise 2.4 Use your knowledge of quantum mechanics to predict the $P_{\mu m}$ matrix for the experiment sketched in Fig. 2.2. **Ans.:** In the special case of perpendicular magnets, one obtains $P_{\pm 1, 1} = \frac{1}{4}$, $P_{\pm 1, 0} = \frac{1}{2}$, and $P_{00} = 0$. Therefore, there should be no central spot on the detector plate of Fig. 2.2, if the magnets are exactly perpendicular.

Finally, consider the same two complete, repeatable tests executed in reverse order, as sketched in Fig. 2.3. We likewise define a probability table $\Pi_{m\mu}$, for the observation of outcome m , following a preparation of pure state μ . It is found *empirically* that

$$\Pi_{m\mu} = P_{\mu m}. \quad (2.3)$$

This can be stated as the following law:

D. Law of reciprocity. Let ϕ and ψ denote pure states. Then the probability of observing outcome ϕ in a maximal test following a preparation of state ψ , is equal to the probability of observing outcome ψ in a maximal test following a preparation of state ϕ .

This reciprocity law has no classical analogue. The probability of observing blond hair for a person who has blue eyes is not the same as the probability of observing blue eyes for a person who has blond hair. Of course, none of these classical tests (for the color of hair or eyes) is complete. Nor are they mutually incompatible, as complete quantum tests may be.

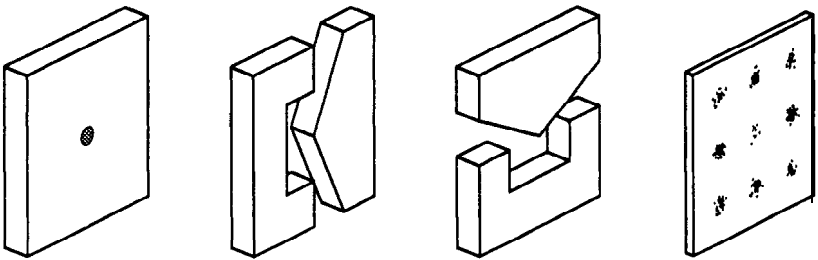

Fig. 2.3. The same tests as in Fig. 2.2, performed in reverse order.

In some instances, it is possible to derive the reciprocity law from symmetry arguments, for example in the case of tests for the linear polarization of photons along different directions: The probability that a photon with one of the polarizations will pass a test for the other polarization can depend only on the angle between the two directions. However, in general, different complete tests are not related by symmetry operations. Consider, for example, the spin state of a hydrogen atom. A complete test could be to measure s_x of the proton, and

s_y of the electron. Another complete test could be to measure the total spin S^2 , and its component S_z . These two complete tests are utterly different and unrelated by any symmetry.

Exercise 2.5 Find the probability matrix relating the four possible outcomes of these two complete tests. *

The heuristic meaning of the law of reciprocity is the following: Suppose that a physical system is prepared in such a way that it will always pass a maximal test for pure state ϕ . Then the probability that it will pass a maximal test for pure state ψ is a measure of the “resemblance” of these two states. Therefore the law of reciprocity simply means that “state ϕ resembles state ψ just as state ψ resembles state ϕ .” An unsuccessful attempt to derive this law from thermodynamic arguments was made by Landé.¹⁰ Here, we accept it as an empirical fact. At a later stage, the law of reciprocity will be derived from the more abstract postulates of quantum theory. However, it is important to note that this law can be experimentally checked in a straightforward way, without invoking *any* theory—that is, insofar as we can identify specific laboratory procedures with maximal tests.

An interesting consequence of the law of reciprocity is that quantum prediction and retrodiction are completely symmetric. In terms of conditional probabilities, pure states satisfy

$$\mathbf{P}\{\phi|\psi\} = \mathbf{P}\{\psi|\phi\}. \quad (2.4)$$

This symmetry between past and future can be extended to any sequence of maximal tests.¹¹ There is no contradiction between this property and the fact that each individual quantum test is a fundamentally irreversible process.¹²

2-5. The principle of interference

One further step will now bring us to the heart of quantum physics. Consider *three* consecutive repeatable maximal tests, as illustrated in Fig. 2.4. It is enough to treat the case where the first and last tests are identical. As before, it is assumed that the beams which leave each magnet are well separated, so that they do not overlap when they pass through the next magnet, but nevertheless their separation is not too large, so that the next magnet performs essentially the same test for each one of the beams that impinge on it. If these conditions are satisfied, and if we use spin $\frac{1}{2}$ particles for simplicity, eight clusters of points

¹⁰ A. Landé, *Foundations of Quantum Theory: A Study in Continuity and Symmetry*, Yale Univ. Press, New Haven (1955).

¹¹ Y. Aharonov, P. G. Bergmann, and J. L. Lebowitz, *Phys. Rev.* 134B (1964) 1410.

¹² Any man carries, on the average, one quarter of the genes of his grandmother. Any grandmother carries, on the average, one quarter of the genes of her grandchild. This does not contradict the fact that procreating is an irreversible process.

appear on the detector plate (there would be 27 such clusters if particles of spin 1 were used, as in the preceding figures). Each cluster can be labelled by three indices, such as $m\mu n$, indicating that the three tests successively performed on each particle gave outcomes m , μ , and n , respectively (the same set of Latin indices can be used to label the outcomes of the first and last tests, since these tests are identical). If the particles are initially unpolarized (e.g., they escaped from an oven) the intensity of cluster $m\mu n$ is proportional to

$$\Pi_{n\mu} P_{\mu m} = P_{\mu n} P_{\mu m}, \quad (2.5)$$

where the right hand side follows from the reciprocity law (2.3).

Exercise 2.6 Show by symmetry arguments that $P_{\mu m} = \frac{1}{2}$ if the second magnet is perpendicular to the first one.

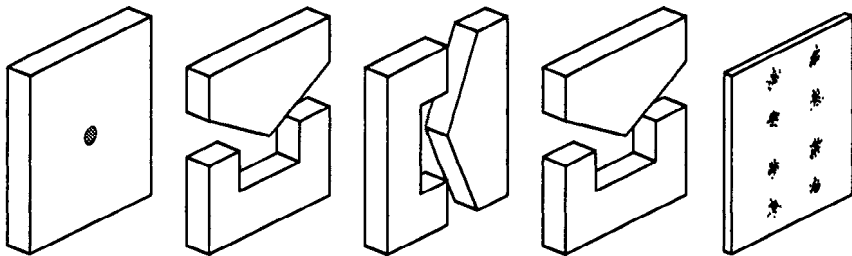

Fig. 2.4. Three consecutive Stern-Gerlach experiments for spin $\frac{1}{2}$ particles. Eight clusters of points appear on the detector plate, corresponding to the two possible outcomes of each test.

Let us now gradually turn off the field of the *second* magnet of Fig. 2.4. The horizontal separation of the clusters on the detector plate will decrease but, as long as these clusters are distinguishable, their intensities remain constant and are given by Eq. (2.5). As the field continues to decrease, each one of the four pairs of clusters begins to coalesce. One could then naively expect to get, when the second magnet is completely turned off, four clusters with intensities proportional to $\sum_{\mu} P_{\mu m} P_{\mu n}$. On the other hand, we know that it cannot be so, because this would violate the *repeatability* property of the first and third tests, which are identical: If the second magnet is inactive, all the particles hitting the detector plate must be concentrated in *two* clusters only, those corresponding to identical outcomes of the initial and final tests. These two clusters are equally populated if the initial preparation is a random mixture (Postulate C).

What actually happens in this experiment is that when the second magnet is gradually turned off, it ceases to satisfy the requirement that the beams which leave it are well separated. As they come to overlap, two of the pairs of beams interfere constructively and reinforce each other, giving the *double* of the sum of their separate intensities, while the two other pairs interfere destructively and

annihilate each other (see Fig. 2.5). This phenomenon is one of the cornerstones of quantum theory:

E. Principle of interference. *If a quantum system can follow several possible paths from a given preparation to a given test, the probability for each outcome of that test is **not** in general the sum of the separate probabilities pertaining to the various paths.*

In the preceding example, the preparation was labelled by m , the various possible paths by μ , and the final outcome by n .

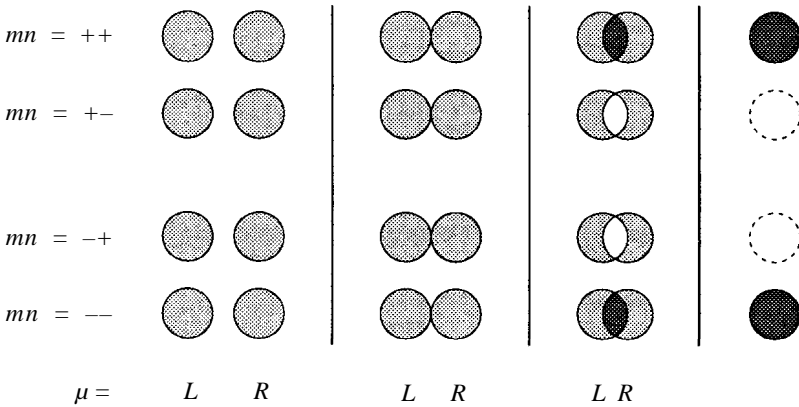

Fig. 2.5. Behavior of the eight beams in the experiment of Fig. 2.4, when the field in the middle magnet is gradually turned off. Interference effects double the amplitude of the beams with $m = n$, and annihilate those with $m \neq n$.

The principle of interference implies that the rule of addition of probabilities¹³

$$P\{A \cup B\} = P\{A\} + P\{B\} - P\{A \cap B\}, \tag{2.6}$$

which is valid for the *occurrence of two events* A and B , does not apply in general to quantum probabilities. This does not mean of course that probability theory is wrong: the passage of a quantum system through an indeterminate path is *not the occurrence of an event*, and therefore Eq. (2.6) is not applicable to it.

In classical mechanics, the situation would be different. Even in the presence of stochastic forces (e.g., in Brownian motion), it is in principle possible to follow the evolution of a dynamical system without in any way disturbing that evolution. Therefore the passage of a system through one of various alternative paths can be considered as a sequence of events which can conceptually be monitored, so that Eq. (2.6) applies. Actually, Eq. (2.6) may be valid for a

¹³W. Feller, *An Introduction to Probability Theory and Its Applications*, Wiley, New York (1968) Vol. I, p. 22.

quantum system too, in situations where it is in principle possible to determine the path which is followed without disturbing the dynamics of that system. However, if that path cannot be determined without such a disturbance, the separate probabilities do not add. What exactly constitutes a “path,” and what is the criterion for deciding whether the evolution of a system is disturbed, will be clearer after we have discussed quantum dynamics.

The experiment sketched in Fig. 1.4 would be difficult to perform, but an analogous one, with polarized photons, is feasible. It has predictable results, because statistical properties of photons, such as the total intensity of a light beam, are adequately treated by classical electromagnetic theory. Instead of the three magnets, let there be three calcite crystals. The first and last crystals test vertical vs horizontal polarization, and the middle crystal tests polarization at $\pm 45^\circ$. If we gradually reduce the thickness of the middle crystal, the eight resulting light beams will behave as shown in Fig. 2.5. When two beams overlap, there is either constructive interference (the amplitude is double and therefore the intensity quadruple of that of a single beam) or destructive interference (the amplitude is zero).

The principle of interference E could be made plausible by simple qualitative arguments, involving only crude conceptual experiments (on the other hand, the law of reciprocity D had to be accepted as an empirical fact). How can such a far reaching principle, which grossly violates our classical intuition, be derived without detailed knowledge of the dynamical laws underlying quantum phenomena? The novel feature of quantum physics which inexorably led us to the principle of interference can be succinctly stated as follows:

Quantum tests may depend on classical parameters which can be varied continuously, and nevertheless these tests have fixed, discrete, outcomes.

Examples of continuous classical parameters which control quantum tests are the angle of orientation of a calcite crystal used to test the linear polarization of a photon, or the angle of orientation of a Stern-Gerlach magnet.

2-6. Transition amplitudes

Interference effects are not peculiar to quantum physics. They also occur in acoustics, optics, and other types of classical wave motion. The *amplitudes* of these waves usually satisfy a set of *linear* differential equations (for instance, Maxwell's equations for the electromagnetic field). Therefore, when several paths are available for the propagation of a wave, the amplitudes combine linearly. On the other hand, the observed *intensity* of these wave phenomena is given by the energy flux, and the latter is *quadratic* in the field amplitudes. Therefore, the intensities—contrary to the amplitudes—are not additive.

In a quantum description of optical interference, the energy flux is proportional to the number of photons per unit area, and therefore to the *probability* of arrival of these photons. The principle of interference E, which applies to

all quantum systems (photons, electrons, atoms, . . .), suggests that transition probabilities such as $P_{\mu m}$ are the squares of *transition amplitudes*, and that the latter combine in a linear fashion. Moreover, we know from classical optics that phase relationships are essential and that polarization states are conveniently described by complex numbers.¹⁴ We are thus led to postulate the existence of a *complex* transition amplitude, $C_{\mu m}$, for obtaining outcome μ in a test that follows preparation m .

The postulated transition amplitude $C_{\mu m}$ satisfies

$$|C_{\mu m}|^2 = P_{\mu m}. \quad (2.7)$$

Likewise, we define, for the inverse transition, an amplitude $\Gamma_{m\mu}$, satisfying

$$|\Gamma_{m\mu}|^2 = \Pi_{m\mu}. \quad (2.8)$$

We know from the reciprocity law, Eq. (2.3), that $|\Gamma_{m\mu}| = |C_{\mu m}|$, but we do not know the phases, as yet. Finding the phases is our next problem.

Consider consecutive tests, as in the above figures, and assume for the moment that a *single* path can lead from the initial preparation to the final outcome. The overall probability for that path is the product of the consecutive probabilities for each step, as in Eq. (2.5). It is therefore natural to define the transition amplitude for a sequence of maximal tests as the *product of the consecutive amplitudes of each step*. For example, in the triple Stern-Gerlach experiment (Fig. 2.4), the amplitude for the path labelled $m\mu n$ is $\Gamma_{n\mu}C_{\mu m}$.

Up to this point, nothing was assumed that had any physical consequence: The phases of the transition amplitudes $C_{\mu m}$ still are irrelevant, and we could as well have stayed with the probabilities $P_{\mu m}$. It is only now that we introduce a new physical hypothesis (borrowed from classical wave theory):

F. Law of composition of transition amplitudes. *The phases of the transition amplitudes can be chosen in such a way that, if several paths are available from the initial state to the final outcome, and if the dynamical process leaves no trace allowing to distinguish which path was taken, the complete amplitude for the final outcome is the **sum** of the amplitudes for the various paths.*

For example, in the triple Stern-Gerlach experiment of Fig. 2.4, if the middle magnet is switched off, the various amplitudes $\Gamma_{n\mu}C_{\mu m}$ have to be summed over μ , which labels the unresolved intermediate path. On the other hand, all we really have in that case is a pair of *identical* maximal tests whose results must always agree. Therefore the overall transition probability, from pure state m (prepared by the first Stern-Gerlach magnet) to pure state n (obtained from the last magnet) is δ_{nm} . Let us assume that the complete transition *amplitude* is δ_{nm} too, without extra phase factor. We then have

¹⁴H. Poincaré, *Théorie mathématique de la lumière*, Carré, Paris (1892) Vol. II, p. 275.

$$\sum_{\mu} \Gamma_{n\mu} C_{\mu m} = \delta_{nm}. \quad (2.9)$$

The matrices C and Γ are the inverses of each other. Moreover, we know from the reciprocity law D that $|\Gamma_{n\mu}| = |C_{\mu n}|$. Therefore, if we could choose phases in such a way that $\Gamma_{n\mu} = \overline{C_{\mu n}}$, we would obtain a nice result:¹⁵

$$\sum_{\mu} \overline{C_{\mu n}} C_{\mu m} = \delta_{nm}. \quad (2.10)$$

Matrices satisfying (2.10) are called *unitary*. They are the generalization to the complex domain of the familiar orthogonal matrices, which represent real Euclidean rotations.

Exercise 2.7 Prove that $\text{Det } C_{\mu m} = 1$.

Exercise 2.8 Prove from (2.10) that

$$\sum_m C_{\mu m} \overline{C_{\nu m}} = \delta_{\mu\nu}. \quad (2.11)$$

Note, however, that Eqs. (2.10) and (2.11) are equivalent only for matrices of **finite order**. A simple counterexample, in an infinite dimensional space, is the shift operator $C_{\mu n} = \delta_{\mu, n+1}$ ($\mu, n = 1, \dots, \infty$).

We are now faced with an algebraic problem: Given $P_{\mu m}$, can we find its “square root,” namely a unitary matrix $C_{\mu m}$ which satisfies Eq. (2.7)? We shall see that this problem has solutions for a *dense* set of $P_{\mu m}$, provided that these $P_{\mu m}$ are *doubly stochastic* matrices, obeying both (2.1) and (2.2). This condition is necessary, but it is not sufficient: the probabilities $P_{\mu m}$ must also satisfy some complicated inequalities. Doubly stochastic matrices that satisfy Eq. (2.7) are called *orthostochastic*.¹⁶ The reader who is not interested in this algebraic problem may skip the next subsection.

Determination of phases of transition amplitudes

The absolute values $|C_{\mu m}|$ being already given, the problem is to assign *phases* to the complex numbers $C_{\mu m}$, in such a way that Eq. (2.10) is valid. Let us count the number of independent equations. It is enough to consider the case $m > n$, because $m < n$ corresponds to the complex conjugate equations, and, if $m = n$, Eq. (2.10) is automatically satisfied by virtue of (2.1). Counting separately real and imaginary parts, there are $N(N-1)$ equations (2.10) to be satisfied. These equations, however, are not independent, because the $|C_{\mu m}|$ given by (2.7) are themselves not independent. They must satisfy the N constraints (2.2),

¹⁵The *complex conjugate* of a number is denoted by a bar. An asterisk will denote the *adjoint* of an operator, to be defined in Chapter 4. This is the standard practice in functional analysis.

¹⁶Y. H. Au-Yeung and Y. T. Poon, *Linear Algebra and Appl.* 27 (1979) 69.

of which only $(N - 1)$ are independent, because the sum of these constraints is automatically satisfied, thanks to (2.1). The final count thus is $(N - 1)^2$ independent algebraic conditions imposed on the phases of $C_{\mu m}$.

This also is the number of unknown *nonarbitrary phases* that have to be determined. Indeed, we may, without affecting the unitary conditions (2.10), choose arbitrarily the phases of an entire row and an entire column of the matrix $C_{\mu m}$. For example, the first row and the first column can be made real by the transformation¹⁷

$$C_{\mu m} \rightarrow C'_{\mu m} = C_{\mu m} \frac{|C_{\mu 1}|}{C_{\mu 1}} \frac{|C_{1 m}|}{C_{1 m}} \frac{C_{11}}{|C_{11}|}. \tag{2.12}$$

We are thereby left with $(N-1)^2$ nontrivial phases, to be determined by $(N-1)^2$ independent nonlinear algebraic conditions. These conditions are algebraic—not transcendental—because we can always replace each unknown phase $e^{i\theta}$ by *two* unknowns, $x = \cos\theta$ and $y = \sin\theta$, subject to the algebraic constraint $x^2 + y^2 = 1$. It is therefore plausible that there is a dense, $(N - 1)^2$ -dimensional domain of values of the $P_{\mu m}$, in which our problem has a *finite* number of solutions, with real x and y .

Exercise 2.9 Show that, if the unitary condition (2.10) holds for $C_{\mu m}$, it also holds for $C'_{\mu m}$, defined by (2.12).

Exercise 2.10 Show that the ratio $C_{\mu m} C_{\nu n} / C_{\nu m} C_{\mu n}$ is invariant under the transformation (2.12).

Exercise 2.11 Solve explicitly Eq. (2.10) for the case $N = 2$.

The case $N = 3$ can be explicitly solved as follows.¹⁷ First, choose phases such that $C_{\mu 1}$ and $C_{1 m}$ are real. Equation (2.10) for $nm = 12$ then gives

$$|C_{11}C_{12}| + e^{i\beta}|C_{21}C_{22}| + e^{i\gamma}|C_{31}C_{32}| = 0, \tag{2.13}$$

where $e^{i\beta} := C_{22}/|C_{22}|$ and $e^{i\gamma} := C_{32}/|C_{32}|$. We thereby obtain a complex equation for the two unknown phases β and γ . A graphical solution can be obtained by drawing a triangle with sides $|C_{\mu 1}C_{\mu 2}|$, as shown in the figure. This can be done if, and only if, all the triangle inequalities such as

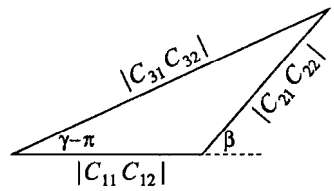

$$|C_{11}C_{12}| \leq |C_{21}C_{22}| + |C_{31}C_{32}|, \tag{2.14}$$

are satisfied by the given values of $|C_{\mu m}| = \sqrt{P_{\mu m}}$. Obviously, if β and γ are a solution of (2.13), $-\beta$ and $-\gamma$ are another solution. This is not, however, the only ambiguity, as seen in the following exercise.

¹⁷If any of the $C_{\mu 1}$ or $C_{1 m}$ vanishes, it may be replaced by an arbitrarily small number.

Exercise 2.12 Show that the $N - 1$ matrices of order N

$$C_{\mu m}^{(k)} = e^{2\pi i k \mu m / N} / N^{1/2} \quad (k = 1, \dots, N-1, \quad m, \mu = 1, \dots, N), \quad (2.15)$$

are unitary. Note that all these matrices correspond to the same $P_{\mu m} = 1/N$. If N is prime, these matrices differ only in the ordering of their rows and columns, but, for composite N , some of them are genuinely different. ★

Exercise 2.13 In the case $N = 3$, write a computer program which generates random values for four of the nine $P_{\mu m}$, computes the five other $P_{\mu m}$ by means of Eqs. (2.1) and (2.2), checks whether all the relations of type (2.14) are satisfied, and finally computes, whenever possible, the phases of the $C_{\mu m}$. ★

Exercise 2.14 Your supplier of pure quantum systems has furnished to you two sets, which he claims originate from two different outcomes of a maximal test, having N outcomes. However, he does not disclose the specific test that was performed. Generalize Eq. (2.14) to the case of maximal tests with N outcomes, and devise a procedure which could disprove the supplier's claim. (If you also suspect that the states are not pure, the situation is more complicated and several tests are needed. See Exercise 3.37, page 77.) ★

Exercise 2.15 Show that if $0 \leq \lambda \leq 1$, and if $P_{\mu m}$ is a 3×3 orthostochastic matrix, the matrix $\lambda P_{\mu m} + (1 - \lambda)/3$ is orthostochastic too.¹⁷ ★★

Amplitudes, not probabilities, are fundamental

Let us proceed to the case $N \geq 4$. The situation then becomes much more complicated.¹⁸ The space of allowed values of $P_{\mu m}$ has a subspace of dimension $< (N - 1)^2$, in which the various algebraic constraints are not independent, so that there is a *continuous* family of solutions for the phases of $C_{\mu m}$.¹⁹ This difficulty indicates that we ought to reverse our approach. The amplitudes $C_{\mu m}$ should be considered as the *primary*, fundamental objects, and the probabilities $P_{\mu m}$ should be derived from them, in spite of the fact that the $P_{\mu m}$ are the only quantities that are directly observable.

We can reach the same conclusion by modifying the triple Stern-Gerlach experiment of Fig. 2.4. Let us orient the last magnet in a direction that is *not* parallel to the first one. The third magnet then provides a *new* test, whose outcomes will be labelled by boldface letters, such as **r**, **s**, etc.²⁰ When, in the modified experiment, the central magnet is turned on, all the paths are distinguishable, and the probability for path $m\mu\mathbf{r}$ is $\Pi_{\mathbf{r}\mu} P_{\mu m}$. We therefore write the transition amplitude for that path as $\Gamma_{\mathbf{r}\mu} C_{\mu m}$, where $|\Gamma_{\mathbf{r}\mu}|^2 = \Pi_{\mathbf{r}\mu}$, as usual. Let us now gradually turn off the central magnet, so that the various μ become indistinguishable. The generalization of the sum over paths (2.9) is

¹⁸M. Roos, *J. Math. Phys.* 5 (1964) 1609; 6 (1965) 1354 (erratum).

¹⁹G. Auberson, *Phys. Letters B* 216 (1989) 167.

²⁰It is good practice to use different sets of labels for characterizing the outcomes of different tests. This helps avoid confusion.

$$\sum_{\mu} \Gamma_{\mathbf{r}\mu} C_{\mu m} = C_{\mathbf{r}m}, \quad (2.16)$$

where $C = \Gamma C$, again is a unitary matrix. Its element $C_{\mathbf{r}m}$ is the transition amplitude from preparation m to outcome \mathbf{r} .

Note that the matrices Γ and C in (2.16) are time ordered: the earliest is on the right, the most recent on the left. This is readily generalized to cases with additional intermediate states, and suggests that the dynamical evolution of a quantum system is represented by a product of unitary matrices. We shall indeed derive that property in Chapter 8.

It follows from Eq. (2.16) that the probability matrix $\mathbf{P}_{\mathbf{r}m} = |C_{\mathbf{r}m}|^2$, which is experimentally observable, cannot be independent of $\Pi_{\mathbf{r}\mu}$ and $P_{\mu m}$. There must be numerous relationships between the elements of these three probability matrices, which can in principle be tested experimentally. These tests have a fundamental, *universal* character. They do not involve any dynamical assumptions, such as those be needed to predict energy levels, cross sections, etc. We can really test the *logical structure* of quantum theory, and not only the validity of this or that Hamiltonian. Here are some examples:

Exercise 2.16 Given the transition probabilities $\Pi_{\mathbf{r}\mu}$ and $P_{\mu m}$ (for any three specified pure states m , μ , and \mathbf{r}), what is the range of admissible values of the transition probability $\mathbf{P}_{\mathbf{r}m}$?

Exercise 2.17 Consider a source of particles, two independent scatterers and a detector. If only scatterer A (or B) is present, the detector registers intensity I_A (or I_B , respectively). If both scatterers are present, the detector registers intensity I_{AB} . Show that

$$(I_{AB} - I_A - I_B)^2 \leq 4 I_A I_B. \quad (2.17)$$

Exercise 2.18 The experimental setup described in the preceding exercise is extended, by the introduction of a third scatterer, C. Define, as before, intensities I_C , I_{BC} and I_{CA} . Further define a dimensionless parameter

$$M_{AB} = (I_{AB} - I_A - I_B)/2\sqrt{I_A I_B}, \quad (2.18)$$

and likewise M_{BC} and M_{CA} . Show that, if the particles emitted by the source are in a pure state,

$$M_{AB}^2 + M_{BC}^2 + M_{CA}^2 - 2 M_{AB} M_{BC} M_{CA} = 1. \quad (2.19)$$

Note that this relationship, which involves the results of six different experiments, does not depend on the properties of the particles (other than their being in a pure state), nor on those of the scatterers.²¹ ★

²¹This result can be used for distinguishing experimentally quaternionic from complex quantum theory: A. Peres, *Phys. Rev. Lett.* 42 (1979) 683.

2-7. Appendix: Bayes's rule of statistical inference

The essence of quantum theory is its ability to predict *probabilities* for the outcomes of tests, following specified preparations. Quantum mechanics is *not* a theory about reality; it is a prescription for making the best possible predictions about the future, if we have certain information about the past.²² The quantum theorist can tell you *what the odds are*, if you wish to bet²³ on the occurrence of various events, such as the firing of this or that detector. Some theorists are indeed employed in predicting probabilities of future events: They calculate cross sections that have not yet been measured, or predict rates of transitions that have not yet been observed.

However, a more common activity is *retrodiction*: the outcomes of tests are given, it is their preparation that has to be guessed. Look at Fig. 1.3, where the two photomultipliers recorded 4 and 3 events, respectively. What can you infer about the orientation of the polarizer? In another commonly performed experiment, you detected and counted some C^{14} decays. How old is the fossil? The “inverse probability” problem is of considerable importance in many aspects of human activity, from intelligence gathering to industrial quality control. A brief account is given below, for the reader who is not familiar with the vast—and sometimes controversial—literature on this subject.

Consider two statistically related events, A and B . For example, B is the outcome of the experiment in Fig. 1.3, where the upper photodetector fired four times, and the lower one three times (note that this is a *single* experiment, not a set of seven experiments). Likewise, A is the positioning of the polarizer at an angle in the interval θ to $\theta + d\theta$, in that experiment. Recall now the notion of *statistical ensemble*, that was introduced in Sect. 2-1: in an ensemble—*i.e.*, an infinite set of conceptual replicas of the same system—the *relative frequencies* of events A and B define the probabilities $\mathbf{P}\{A\}$ and $\mathbf{P}\{B\}$, respectively. Let us further introduce two notions:

$\mathbf{P}\{A \cap B\} = \mathbf{P}\{B \cap A\}$ is the *joint probability* of events A and B . This is the relative frequency of the occurrence of *both* events, in the statistical ensemble under consideration.

$\mathbf{P}\{A|B\}$ is the *conditional probability* of occurrence of A , when B is true; and likewise $\mathbf{P}\{B|A\}$ denotes the converse conditional probability.

Since all these probabilities are defined as the relative frequencies of various combinations of events in the given ensemble, we have

$$\mathbf{P}\{A \cap B\} = \mathbf{P}\{A|B\} \mathbf{P}\{B\} = \mathbf{P}\{B|A\} \mathbf{P}\{A\}, \quad (2.20)$$

²²G. 't Hooft, *J. Stat. Phys.* 53 (1988) 323.

²³No experimental evidence will convince a bad theorist that his statistical predictions are wrong. At most, you may drive him to bankruptcy if he is serious about betting.

whence we obtain Bayes's theorem,^{24,25}

$$\mathbf{P}\{A|B\} = \mathbf{P}\{B|A\} \mathbf{P}\{A\} / \mathbf{P}\{B\}. \quad (2.21)$$

In this equation, $\mathbf{P}\{B|A\}$ is assumed known, thanks to the physical theory that we use. For example, in the experiment of Fig. 1.3, the theory tells us that the probabilities for exciting the upper and lower photodetectors are $\cos^2 \theta$ and $\sin^2 \theta$, respectively. We therefore have, from the binomial distribution,

$$\mathbf{P}\{B|A\} = \frac{7!}{4!3!} \cos^8 \theta \sin^6 \theta. \quad (2.22)$$

Recall that the problem in Fig. 1.3 is to estimate the orientation angle θ of the polarizer. To make use of (2.22), we still need $\mathbf{P}\{A\}$ and $\mathbf{P}\{B\}$. These probabilities cannot be calculated from a theory, nor determined empirically. They solely depend on the statistical ensemble that we have mentally conceived. Let us consider the *complete* set of events of type A , and call them A_1, A_2, \dots , etc. For example, A_j represents the positioning of the polarizer at an angle between θ_j and $\theta_j + d\theta_j$. By completeness, $\sum_j \mathbf{P}\{A_j\} = 1$, and therefore

$$\mathbf{P}\{B\} = \sum_j \mathbf{P}\{B|A_j\} \mathbf{P}\{A_j\}. \quad (2.23)$$

At this stage, it is customary to introduce Bayes's *postulate* (this is not the same thing as Bayes's *theorem*!). This postulate is also called the "principle of indifference," or the "principle of insufficient reason." If we have no reason to expect that the person who positioned the polarizer had a preference for some particular orientation, we assume that all orientations are equally likely, so that $\mathbf{P}\{A\} = d\theta/\pi$ for every θ (we can always take $0 \leq \theta < \pi$, because θ and $\theta + \pi$ are equivalent). We then have, from (2.23),

$$\mathbf{P}\{B\} = \frac{1}{\pi} \int_0^\pi 35 \cos^8 \theta \sin^6 \theta d\theta, \quad (2.24)$$

and we obtain, from Bayes's theorem (2.21),

$$\mathbf{P}\{A|B\} = \frac{35}{\pi} \cos^8 \theta \sin^6 \theta d\theta / \mathbf{P}\{B\} = \frac{2^{11}}{5\pi} \cos^8 \theta \sin^6 \theta d\theta. \quad (2.25)$$

Exercise 2.19 Check this equation and plot its right hand side as a function of θ . Where are the maxima of this function? How sharp are they? ★

²⁴ T. Bayes, *Phil. Trans. Roy. Soc.* 53 (1763) 370; reprinted in *Biometrika* 45 (1958) 293.

²⁵ Joint probabilities exist only for events which are compatible. In particular, no joint probability can be defined for the outcomes of incompatible tests. Therefore Bayes's theorem does not apply to quantum conditional probabilities, like those in Eq. (2.4), because they refer to different experimental setups.

Exercise 2.20 Exactly 10^6 photons, linearly polarized in the same unknown direction, and 10^6 photons, linearly polarized in the orthogonal direction, are injected into a perfectly reflecting box⁹ where they move with no change of their polarizations. No record is kept of the order in which these photons are introduced in the box (only the total numbers are recorded). Can you determine along which directions these photons are polarized? **Hint:** Start with just two oppositely polarized photons, then consider two pairs, and so on. You will quickly realize that if the photons are tested one by one, even with perfect photodetectors, the result is considerably less efficient than a combined test involving the entire set. For further hints, see Exercise 5.27, page 141. ★★

Exercise 2.21 A single photon of energy 1eV arrived from a distant light source. Assume that this source has a thermal spectrum, and give an estimate of its temperature. **Hint:** You must assume some a priori probability distribution for the temperature, and only then deduce the a posteriori probability. ★

Exercise 2.22 A second photon arrived from the source mentioned in the preceding exercise. Its energy is measured as 0.01eV. Can you still believe that the source emits thermal radiation? **Hint:** What is the probability that two photons picked at random from a Planck spectrum have energies which differ by a factor 100 or more? ★★

2-8. Bibliography

A brief account of Bayesian statistics was given in the preceding section. There is a vast literature on the analysis of stochastic data. Two excellent books are

S. L. Meyer, *Data Analysis for Scientists and Engineers*, Wiley, New York (1975).

C. W. Helstrom, *Quantum Detection and Estimation Theory*, Academic Press, New York (1976).

It is interesting to compare the approaches taken in these books. Meyer follows the custom of experimental scientists and shows how to compute the most probable value of a random variable, together with confidence intervals giving the likelihood of deviations from this most probable value. On the other hand, Helstrom presents the problem from the point of view of a communications engineer, who must supply a single, unambiguous output. In that case, detection and estimation errors may occur. An arbitrary "cost" is assigned to each type of error, and the problem then is to minimize the total cost incurred by the recipient of a message, due to unavoidable errors.

Recommended reading

R. T. Cox, "Probability, frequency, and reasonable expectation," *Am. J. Phys.* 14 (1946) 1.

R. Giles, "Foundations for quantum mechanics," *J. Math. Phys.* 11 (1970) 2139.

Chapter 3

Complex Vector Space

3-1. The superposition principle

We have seen that quantum transitions are described by unitary matrices $C_{\mu m}$ which satisfy Eq. (2.10), repeated below for the reader's convenience:

$$\sum_{\mu} \overline{C_{\mu m}} C_{\mu n} = \delta_{mn}. \quad (3.1)$$

This suggests the introduction of complex vectors on which these matrices will act. The physical meaning of the complex vectors, as we shall presently see, is that of *pure quantum states*. We shall use **sans serif** letters to denote these N -dimensional complex vectors, while **boldface** letters will be used, as usual, for the ordinary real vectors in Euclidean three dimensional space.

Let us examine this new kind of vectors. First, we note that, in order to satisfy the summation rules of linear algebra, their complex components must be labelled by indices such as m , or μ , matching those of the unitary matrices. Recall that these indices refer to the outcomes of maximal quantum tests, and therefore to pure quantum states (see Sect. 2-4). On the other hand, Eq. (3.1) shows that unitary matrices are an extension to the complex domain of the familiar orthogonal matrices, which represent real Euclidean rotations. We are therefore led to try the following idea: The choice of a maximal test is analogous to the choice of a coordinate system in Euclidean geometry; and the pure states, which correspond to the various outcomes of a maximal test, are analogous to unit vectors along a set of orthogonal axes.

Let us denote these unit vectors by \mathbf{e}_m , \mathbf{e}_{μ} , etc. This notation is meant to recall that \mathbf{e}_m represents the pure state corresponding to outcome m of the "Latin test," \mathbf{e}_{μ} corresponds to outcome μ of the "Greek test," and so on. An obvious role for the unitary matrices $C_{\mu m}$ would then be to express the transformation law from one basis to the other:

$$\mathbf{e}_{\mu} = \sum_m C_{\mu m} \mathbf{e}_m. \quad (3.2)$$

However, we are not free to postulate arbitrarily the above relationship: The unitary matrix that appears in it represents transition amplitudes which are experimentally accessible. Therefore Eq. (3.2) *has a physical meaning* and is amenable to a consistency check. Let us indeed consider a third maximal test, whose outcomes are labelled by boldface indices. We have, likewise,

$$\mathbf{e}_r = \sum_m \mathbf{C}_{rm} \mathbf{e}_m \quad \text{and} \quad \mathbf{e}_r = \sum_\mu \Gamma_{r\mu} \mathbf{e}_\mu, \quad (3.3)$$

where \mathbf{C}_{rm} and $\Gamma_{r\mu}$ are unitary matrices, representing the transition amplitudes from states m and μ , respectively, to state \mathbf{r} . Consistency of Eqs. (3.2) and (3.3) implies that

$$\mathbf{C}_{rm} = \sum_\mu \Gamma_{r\mu} C_{\mu m}. \quad (3.4)$$

This result is identical to the composition law of transition amplitudes, Eq. (2.16), that was found earlier on purely phenomenological grounds. This agreement indicates that we are on the right track, and that a complex vector formalism is indeed appropriate for describing quantum phenomena.

Exercise 3.1 *Prove that*

$$\mathbf{e}_m = \sum_\mu \mathbf{e}_\mu \overline{C_{\mu m}}. \quad (3.5)$$

Exercise 3.2 *Consider three different Stern-Gerlach experiments for spin $\frac{1}{2}$ particles, with the magnets tilted at an angle of 120° from each other, as in Fig. 1.6. Find the unitary matrices for conversion from one basis to another, and check that Eq. (3.4) is satisfied.*

Exercise 3.3 *Repeat the preceding exercise for particles of spin 1. ★*

Encouraged by the success of Eq. (3.2), we now define a *vector*, in general, as a linear combination

$$\mathbf{v} := \sum_m v_m \mathbf{e}_m. \quad (3.6)$$

The complex coefficients v_m are the *components* of the vector. We shall later see that any vector represents a pure state. However, we first need some formal rules to give a mathematical meaning to expressions like (3.6).

Let $\mathbf{u} := \sum u_m \mathbf{e}_m$ be another vector. The equality $\mathbf{u} = \mathbf{v}$ means that corresponding components of \mathbf{u} and \mathbf{v} are equal, $u_m = v_m$. The *addition* of vectors and their *multiplication* by scalars (*i.e.*, by complex numbers, sometimes called *c-numbers* in the older literature) are defined by the execution of the same operations on the vector components. Therefore vectors form a *linear space*: If \mathbf{u} and \mathbf{v} are vectors, and α and β are complex numbers, $\mathbf{w} = \alpha\mathbf{u} + \beta\mathbf{v}$ is a vector, with components $w_k = \alpha u_k + \beta v_k$. The *null vector* $\mathbf{0}$ is defined as the one that has all its components equal to zero.

A fundamental tenet of quantum theory is the following assumption:

G. Principle of superposition. *Any complex vector, except the null vector, represents a realizable pure state.*

This sweeping declaration does not tell us, unfortunately, how to design the equipment which prepares the pure state represented by a given vector. As explained in Sect. 1-4, quantum theory allows us to compute probabilities for the outcomes of tests following specified preparations. However, the theory does not supply instructions for actually setting up the laboratory procedures that are used as preparations and tests (just as Euclidean geometry does not tell us how to manufacture rulers and compasses). These procedures are conceived by physicists, using whatever supplies are available, and their design can be analyzed, *a posteriori*, with the help of quantum theory.

It is sometimes claimed that the principle of superposition G is not generally valid: Not every vector that can be written by a theorist would be realizable experimentally. It is indeed true that some theoretical desiderata (ultrahigh energies, extremely low temperatures, etc.) appear to lie beyond any foreseeable technology. Our ability to design instruments will always be limited by mundane physical constraints, such as the finite strength of existing materials, or their ability to sustain high voltages without electric breakdown. Moreover, practical limitations on *information storage and processing* make it exceedingly difficult (we say "impossible") to realize pure states of *macroscopic* systems, having numerous degrees of freedom. Nevertheless, there is no convincing argument indicating that the principle of superposition might fail for quantum systems that have a *finite* number of states. One should never underestimate the ingenuity of experimental physicists!

Another problem raised by the principle of superposition is the converse of the preceding one: How can we determine the values of the components v_m that represent a pure state, specified by a given experimental procedure? Here again, the analogy with Euclidean vectors is a helpful guide. Euclidean vectors may have a *physical meaning*, such as displacement, momentum, force, etc. Their components are the values of the projections of these physical quantities on three arbitrary orthogonal axes. A different choice of axes gives different values to the components of the *same* vector. It is only after we choose a set of axes that the components of a vector acquire definite values.

In quantum theory, we can likewise represent the *same* vector by means of different bases. For example, the vector \mathbf{v} , given by Eq. (3.6), can also be written

$$\mathbf{v} = \sum_{\mu} v_{\mu} \mathbf{e}_{\mu}. \quad (3.7)$$

We then obtain, from the transformation laws (3.2) and (3.5),

$$v_m = \sum_{\mu} v_{\mu} C_{\mu m} \quad \text{and} \quad v_{\mu} = \sum_m \overline{C_{\mu m}} v_m. \quad (3.8)$$

Note that the transformation law of vector *components* is the *converse* of the transformation law of basis vectors, Eq. (3.2) or (3.5). It ought to be clear that

the two sets of components, v_m and v_μ , are two different representations of the *same* physical state.

I shall now briefly outline a method for the experimental determination of the components v_m (or v_μ). Recall that a state is defined by the probabilities of outcomes of arbitrary tests. Since the procedure for preparing \mathbf{v} is specified—this was our assumption when the present problem was formulated—we can produce as many replicas as we wish of the quantum system in state \mathbf{v} . Therefore we can measure, with arbitrary accuracy, the probabilities for occurrence of outcomes $\mathbf{e}_m, \mathbf{e}_\mu, \dots$, of various maximal tests that can be performed on a system in state \mathbf{v} . In other words, we can obtain the transition probabilities $P_{m\mathbf{v}}, \dots$, from state \mathbf{v} to states $\mathbf{e}_m, \mathbf{e}_\mu, \dots$. With enough data of that type, we can compute complex amplitudes, such as $C_{m\mathbf{v}}$, from which we finally obtain the coefficients v_m in Eq. (3.6). The execution of this conceptual program requires additional mathematical tools, which are given below.

3-2. Metric properties

Orthogonal transformations in Euclidean space preserve the *length* of a vector, defined by $|\mathbf{A}| = [\sum (A_k)^2]^{1/2}$. We shall likewise introduce a *metric structure* in the complex vector space and define the *norm* of a vector by¹

$$\|\mathbf{v}\| := \left[\sum |v_m|^2 \right]^{1/2}. \quad (3.9)$$

The norm of a vector is always positive, unless it is the null vector $\mathbf{0}$. A vector whose norm is 1 is said to be *normalized*. It is always possible to normalize a nonnull vector by dividing it by its norm, and it is often convenient to do so.

For a linear combination $\alpha\mathbf{u} + \beta\mathbf{v}$, we have

$$\|\alpha\mathbf{u} + \beta\mathbf{v}\|^2 \equiv |\alpha|^2 \|\mathbf{u}\|^2 + |\beta|^2 \|\mathbf{v}\|^2 + \bar{\alpha}\beta \sum_m \bar{u}_m v_m + \alpha\bar{\beta} \sum_m u_m \bar{v}_m. \quad (3.10)$$

The expression²

$$\langle \mathbf{u}, \mathbf{v} \rangle := \sum_m \bar{u}_m v_m, \quad (3.11)$$

is called the *scalar product* (or *inner product*) of the vectors \mathbf{u} and \mathbf{v} . It is the natural generalization of the scalar product of ordinary Euclidean vectors. Note that $\langle \mathbf{v}, \mathbf{v} \rangle \equiv \|\mathbf{v}\|^2$. Two vectors whose scalar product vanishes are called *orthogonal*. Two vectors which satisfy $\alpha\mathbf{u} + \beta\mathbf{v} = \mathbf{0}$, for nonvanishing α and β , are called *parallel*.

It is easily seen that the scalar product $\langle \mathbf{u}, \mathbf{v} \rangle$ is linear in its second argument:

¹ Some authors denote the norm by $|\mathbf{v}|$ instead of $\|\mathbf{v}\|$.

² The notation here is a compromise between the one used by mathematicians, who write scalar products as (\mathbf{u}, \mathbf{v}) , and Dirac's notation $\langle \mathbf{u} | \mathbf{v} \rangle$, which is often convenient and is very popular among physicists, but may be misleading, if improperly used. Dirac's notation is explained in an appendix at the end of this chapter.

$$\langle \mathbf{u}, \alpha \mathbf{v} + \beta \mathbf{w} \rangle \equiv \alpha \langle \mathbf{u}, \mathbf{v} \rangle + \beta \langle \mathbf{u}, \mathbf{w} \rangle. \quad (3.12)$$

It is “antilinear” in its first argument:

$$\langle \alpha \mathbf{u} + \beta \mathbf{v}, \mathbf{w} \rangle \equiv \bar{\alpha} \langle \mathbf{u}, \mathbf{w} \rangle + \bar{\beta} \langle \mathbf{v}, \mathbf{w} \rangle. \quad (3.13)$$

Moreover, the scalar product satisfies

$$\langle \mathbf{u}, \mathbf{v} \rangle \equiv \overline{\langle \mathbf{v}, \mathbf{u} \rangle}. \quad (3.14)$$

Bilinear expressions having this property are called *Hermitian*.

Exercise 3.4 Show that the norm of a vector is invariant under unitary transformations:³

$$\sum_{\mu} |v_{\mu}|^2 = \sum_m |v_m|^2. \quad (3.15)$$

Exercise 3.5 Prove the “law of the parallelogram”:

$$\|\mathbf{u} + \mathbf{v}\|^2 + \|\mathbf{u} - \mathbf{v}\|^2 = 2\|\mathbf{u}\|^2 + 2\|\mathbf{v}\|^2. \quad (3.16)$$

Exercise 3.6 Show that the norm completely determines the scalar product:

$$\|\mathbf{u} + \mathbf{v}\|^2 - \|\mathbf{u} - \mathbf{v}\|^2 + i\|\mathbf{u} - i\mathbf{v}\|^2 - i\|\mathbf{u} + i\mathbf{v}\|^2 = 4\langle \mathbf{u}, \mathbf{v} \rangle. \quad (3.17)$$

This property is very handy and we shall often make use of it. For example, it readily follows from (3.15) and (3.17) that the scalar product $\langle \mathbf{u}, \mathbf{v} \rangle$ is *invariant under unitary transformations* (this is why it is called a *scalar product*).

Schwarz inequality

An important property is the Schwarz inequality

$$|\langle \mathbf{u}, \mathbf{v} \rangle|^2 \leq \|\mathbf{u}\|^2 \|\mathbf{v}\|^2, \quad (3.18)$$

which is easily proved from

$$\mathbf{v} \equiv \mathbf{u} \frac{\langle \mathbf{u}, \mathbf{v} \rangle}{\|\mathbf{u}\|^2} + \left(\mathbf{v} - \mathbf{u} \frac{\langle \mathbf{u}, \mathbf{v} \rangle}{\|\mathbf{u}\|^2} \right). \quad (3.19)$$

The first term on the right hand side is a vector parallel to \mathbf{u} . The other term is orthogonal to \mathbf{u} , as can be seen by taking its scalar product with \mathbf{u} . These two terms are therefore orthogonal to each other and we have

³It is also possible to define complex orthogonal transformations preserving a sum of squares such as $\sum (v_m)^2$, rather than $\sum |v_m|^2$, but these sums have no use in quantum theory.

$$\|\mathbf{v}\|^2 \equiv \frac{|\langle \mathbf{u}, \mathbf{v} \rangle|^2}{\|\mathbf{u}\|^2} + \left\| \mathbf{v} - \mathbf{u} \frac{\langle \mathbf{u}, \mathbf{v} \rangle}{\|\mathbf{u}\|^2} \right\|^2, \quad (3.20)$$

whence (3.18) readily follows. Moreover, the equality sign holds in (3.18) if, and only if, the last term in (3.20) vanishes, *i.e.*, when \mathbf{u} and \mathbf{v} are parallel.

A useful corollary of the Schwarz inequality is the *triangle inequality*,

$$\|\mathbf{u}\| - \|\mathbf{v}\| \leq \|\mathbf{u} + \mathbf{v}\| \leq \|\mathbf{u}\| + \|\mathbf{v}\|. \quad (3.21)$$

The proof is left to the reader.

Orthonormal bases

A *complete orthonormal basis* is a set of N vectors, $\mathbf{e}_a, \mathbf{e}_b, \dots$, satisfying

$$\langle \mathbf{e}_m, \mathbf{e}_n \rangle = \delta_{mn}. \quad (3.22)$$

Recall the physical interpretation of these unit vectors: they represent pure states corresponding to the different outcomes of a maximal test. From the definition of a vector, Eq. (3.6), and from (3.22), it follows that

$$v_m = \langle \mathbf{e}_m, \mathbf{v} \rangle. \quad (3.23)$$

The converse is also true: If v_m is defined by (3.23), and the \mathbf{e}_m are a *complete* basis, we have

$$\|\mathbf{v} - \sum v_m \mathbf{e}_m\|^2 = \|\mathbf{v}\|^2 + \sum |v_m|^2 - \sum \overline{v_m} \langle \mathbf{e}_m, \mathbf{v} \rangle - \sum \langle \mathbf{v}, \mathbf{e}_m \rangle v_m. \quad (3.24)$$

The right hand side of this expression vanishes by virtue of (3.9) and (3.23). It follows that $\mathbf{v} - \sum v_m \mathbf{e}_m$ is the null vector, and therefore Eq. (3.6) holds.

Now let $\mathbf{u}_\alpha, \mathbf{u}_\beta, \dots$, be another orthonormal basis (corresponding to the outcomes of another maximal test), so that

$$\langle \mathbf{u}_\mu, \mathbf{u}_\nu \rangle = \delta_{\mu\nu}. \quad (3.25)$$

We obtain, from the transformation law (3.2),

$$C_{\mu m} = \langle \mathbf{e}_m, \mathbf{e}_\mu \rangle. \quad (3.26)$$

It follows that the transition probability from state m to state μ is

$$P_{\mu m} = |C_{\mu m}|^2 = |\langle \mathbf{e}_m, \mathbf{e}_\mu \rangle|^2. \quad (3.27)$$

In particular, as shown below, it is possible to construct orthonormal bases which satisfy $P_{\mu m} = 1/N$, for all μ and m . These bases are “as different as possible” and are called *mutually unbiased*. For example, in the case of polarized photons, a test for vertical *vs* horizontal linear polarization, a test for the two oblique polarizations at $\pm 45^\circ$, and one for clockwise *vs* counterclockwise circular polarization, are mutually unbiased. A photon, having passed one of these tests, and then submitted to any other one, has equal chances for yielding the two possible outcomes of the second test. Some examples of unbiased bases were given in Exercise 2.12. It can be shown that, if N is prime, it is always possible to find $N+1$ mutually unbiased bases.^{4,5}

The simplest case of unbiased bases results from a discrete Fourier transform:

$$\mathbf{e}_m = N^{-1/2} \sum_{\mu} \mathbf{e}_{\mu} e^{2\pi i \mu m / N} \quad (m, \mu = 1, \dots, N). \quad (3.28)$$

Quantum tests satisfying (3.28) are called *complementary*.⁶ We shall see in Chapter 10 that these tests are the quantum analogs of measurements of classical, canonically conjugate, dynamical variables.

3-3. Quantum expectation rule

The correspondence between complex vectors and physical pure states is not one to one: Quantum theory considers vectors that are *parallel* to each other as representing the *same* physical state. It is often convenient to *normalize* vectors by dividing them by their norm, so that the new norm is 1. There still remains an arbitrariness of the phase, because \mathbf{v} and $e^{i\theta} \mathbf{v}$ have the same norm, for any real θ . This phase arbitrariness is an essential feature of quantum theory. It cannot be eliminated, because of the superposition principle: Given any two states \mathbf{u} and \mathbf{v} , the linear combinations $\mathbf{u} + \mathbf{v}$ and $\mathbf{u} + e^{i\theta} \mathbf{v}$ are physically realizable states, and are *not* equivalent, as shown by the simple example of the polarization states of photons, illustrated in Fig. 1.4.

If parallel vectors represent the same physical state, what is the meaning of *orthogonal* vectors? The latter can be members of an orthogonal basis. This suggests the following extrapolation of the principle of superposition **G**:

G*. **Strong superposition principle.** *Any orthogonal basis represents a realizable maximal test.*

That is, not only can any individual vector, such as \mathbf{v} in Eq. (3.6), be experimentally realized, but any complete set of mutually orthogonal vectors has a physical realization, in the form of a maximal quantum test.

⁴ I. D. Ivanovic, *J. Phys. A* 14 (1981) 3241.

⁵ W. K. Wootters, *Found. Phys.* 16 (1986) 391.

⁶ J. Schwinger, *Proc. Nat. Acad. Sc.* 46 (1960) 570.

Orthogonal states corresponding to different outcomes of a maximal test are the quantum analog of “different states” in classical physics. If we definitely know that a system has been prepared in *one of several given orthogonal states* (not in a linear combination thereof) we can unambiguously identify that state, by the appropriate maximal test.

Non-orthogonal states

The generic case is a pair of vectors that are neither parallel nor orthogonal. These vectors correspond to physical states that are neither identical, nor totally different, but “partly alike.” For example, photons with linear polarizations tilted at an angle α from each other are partly alike. There is a probability $\cos^2 \alpha$ that a photon prepared with one of these linear polarizations will successfully pass a test for the other linear polarization.

This partial likeness is not peculiar to quantum physics. In the classical phase space too, we may have Liouville densities, $f_1(\mathbf{q}, \mathbf{p})$ and $f_2(\mathbf{q}, \mathbf{p})$, which partly overlap. For example, there may be two different methods for releasing a given pendulum. In each one of these methods, the initial coordinates and momenta are not controlled with absolute precision; therefore the phase space domains corresponding to these two different preparation procedures have a finite size. They may be disjoint, or they may partly overlap, as shown in Fig. 3.1. Note that this figure represents our imperfect knowledge of the classical \mathbf{q} and \mathbf{p} of a *single* pendulum. The use of Liouville densities for representing this imperfect knowledge has the following meaning: We imagine the existence of an *infinite set of identical replicas* of our pendulum (that is, we imagine an *ensemble*, as explained in Sect. 2-1). All these conceptual replicas are produced according

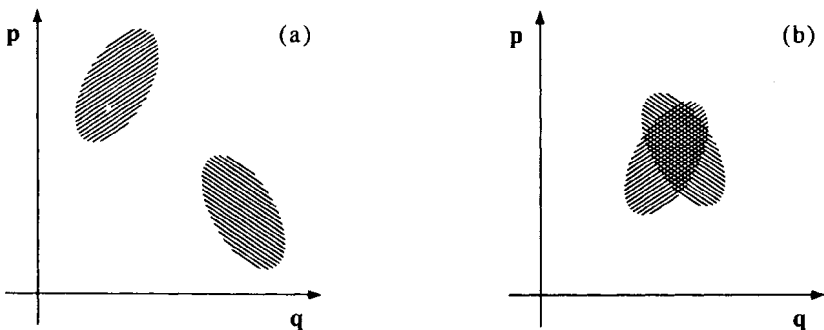

Fig. 3.1. The results of two different classical preparation procedures are shown by hatchings with opposite orientations. The size of the ellipse represents the expected instrumental error. (a) If the ellipses do not overlap, an observer can deduce with certainty which method was used. (b) If there is an overlap, it is only possible to assign probabilities to the two methods.

to one of the two imperfectly controlled preparation procedures, and all the resulting \mathbf{q} and \mathbf{p} are therefore represented by a cloud of points in phase space. The density of points in this cloud is the Liouville density, $f_1(\mathbf{q}, \mathbf{p})$ or $f_2(\mathbf{q}, \mathbf{p})$, which corresponds to the preparation method that was used.

Suppose now that an observer wants to determine which one of the two preparations was actually implemented. Even if that observer is capable of exactly locating \mathbf{q} and \mathbf{p} by means of ideal measurements, he may not be able to tell with certainty to which “cloud” the result belongs. The answer can be stated only in terms of *probabilities*.

The new feature introduced by quantum theory is that the probabilistic nature of the outcome of a measurement is not due to imperfections of the preparing or measuring apparatuses. It is inherent to quantum physics. A *pure* quantum state is similar to a classical *ensemble*.⁷ Therefore, the meaningful questions are not about the values of dynamical variables, but rather about the probability that some particular preparation was used. This is a much sounder approach: quantum dynamical variables are abstract concepts, existing only in our mind. The experimental preparations exist in the laboratory.

Probability interpretation

In general, let us define a “test for state \mathbf{v} ” as one which always succeeds for quantum systems prepared in state \mathbf{v} , and always fails for those prepared in any state orthogonal to \mathbf{v} . This need not be a maximal test, but only one that singles out \mathbf{v} from all the states orthogonal to \mathbf{v} . A fundamental result of quantum theory is the following rule:

H. Quantum expectation rule. *Let \mathbf{u} and \mathbf{v} be two normalized vectors. The probability that a quantum system prepared in state \mathbf{u} will pass successfully a test for state \mathbf{v} is $|\langle \mathbf{u}, \mathbf{v} \rangle|^2$.*

With the notations of Sect. 2-4, this means that

$$P_{\mathbf{v}\mathbf{u}} = |\langle \mathbf{u}, \mathbf{v} \rangle|^2, \quad (3.29)$$

which is an obvious corollary of Eq. (3.27) and of the strong superposition principle \mathbf{G}^* . (If we had not already assumed the validity of \mathbf{G}^* , we would have to consider \mathbf{H} as a new, independent postulate.)⁸

The law of reciprocity \mathbf{D} , expressed by Eq. (2.4), now becomes a trivial consequence of the Hermitian nature of the scalar product (3.14). Conversely, if the reciprocity law \mathbf{D} were experimentally falsified, we would have to reject the expectation rule \mathbf{H} , and then the entire complex vector formalism proposed here would be devoid of physical interpretation.

⁷I. R. Senitzky, *Phys. Rev. Lett.* 47 (1981) 1503.

⁸From postulate \mathbf{G}^* , together with reasonable continuity assumptions, it is possible to derive Gleason's theorem (see Sect. 7-2). That theorem generalizes the quantum expectation rule to states which are not pure.

3-4. Physical implementation

It is the probability rule H which allows us to relate the abstract mathematical formalism of quantum theory to actual observations that may be performed in a laboratory. This rule can be derived from previously proposed postulates. Every step in its derivation is a plausible extension of preceding steps. When we retrace the route that was followed in the derivation of H , the weakest link is the *law of composition of transitions amplitudes* (Postulate F, page 40) which may be no more than an educated guess, influenced by our familiarity with classical field theory.

Quantum theory, for which we are now collecting appropriate tools, may some day be found unsatisfactory, and replaced by a more elaborate theory (just as Newtonian mechanics was superseded by special relativity, and then by general relativity theory). The need to discard—or upgrade—quantum theory may arise when we become able to probe smaller spacetime regions, or stronger gravitational fields, or biological systems, or other phenomena yet unforeseen. However, a more urgent task is to check the theory for internal consistency. All the foregoing discussion involved ideal maximal tests, which can only be roughly *approximated* by real laboratory procedures. The final chapter of this book will be devoted to the “measurement problem.” It will give a more detailed description of the experimenter’s work with quantum systems. At the present stage, I shall only propose another version of the expectation rule, with a mild operational flavor:

I. Quantum expectation rule (operational version). *For any two normalized vectors u and v , it is possible to design experimental testing procedures with the following property: a quantum system which certainly passes the test for state u has a probability $|\langle u, v \rangle|^2$ to pass the test for state v , and vice versa.*

This new version is more explicit than H , but not yet fully satisfactory. A quantum test is not a supernatural event. It is a physical process, involving ordinary matter. Our testing instruments are subject to the ordinary physical laws. If we ignore this obvious fact and treat quantum tests as a primitive notion, as we are presently doing, we are guilty of a gross oversimplification of physics. We shall return to this problem in Chapter 12. Meanwhile, let us note that the consistency of the expectation rule implies that dynamical laws must have specific properties:

J. Dynamical description of quantum tests. *Let U and V denote apparatuses which perform the tests for states u and v , respectively. The dynamical laws which govern the working of these apparatuses must have the following property: If quantum systems are prepared in such a way that apparatus U always indicates a successful test, apparatus V has a probability $|\langle u, v \rangle|^2$ to yield a positive answer, and vice versa.*

It is not obvious that this requirement can be fulfilled for arbitrary \mathbf{u} and \mathbf{v} . Dynamical laws cannot be decreed by whim, without risking a violation of physical principles that we wish to respect, such as conservation of charge, or relativistic invariance, or the second law of thermodynamics. More often than not, it is impossible to satisfy condition J in a rigorous way (as will be seen in Chapter 12), but it still can be satisfied to an arbitrarily good approximation.

In last resort, the fundamental question is: What distinguishes a *quantum test* from any other dynamical process governed by quantum theory? The characteristic property of a genuine test is that it produces a *permanent record*, which can be described by our ordinary language, after having been observed by ordinary means, without the risk of being perturbed by the act of observation. It does not matter whether someone will actually observe this record. It is sufficient to prove, by relying on known physical laws, that an observation is in principle possible and can be repeated at will by several independent physicists without giving rise to conflicting results. In summary, the outcome of a test is an *objective* event (some authors prefer the term *intersubjective*).

The robustness of a macroscopic record—its stability with respect to small perturbations such as those caused by repeated observations—suggests that *irreversible* processes must be involved. This is a complicated issue, not yet fully understood, which will be discussed in Chapter 11.

Having thus warned the reader of the difficulties lying ahead, I now return to the formal and naive approach where a quantum test is an unexplained event, producing a definite and repeatable outcome, in accordance with well defined probability rules given by quantum theory.

3-5. Determination of a quantum state

Suppose that the only information we have about a preparation procedure is that it produces a *pure* state. (The more general case of *mixed* states will be discussed later.) Our task is to determine the components of the corresponding state vector, $\mathbf{v} = \sum v_m \mathbf{e}_m = \sum v_\mu \mathbf{e}_\mu = \dots$. If we can prepare and test an unlimited number of systems, it follows from the expectation rule H that we can measure, with arbitrary accuracy, the *probabilities* of outcomes such as

$$|v_m|^2 = |\langle \mathbf{e}_m, \mathbf{v} \rangle|^2 \quad \text{or} \quad |v_\mu|^2 = |\langle \mathbf{e}_\mu, \mathbf{v} \rangle|^2. \quad (3.30)$$

There are $2(N - 1)$ independent experimental data in (3.30), because of the constraints $\sum |v_m|^2 = \sum |v_\mu|^2 = 1$. This is exactly the number of data that we need to determine the *phases* of these complex numbers. Indeed, let us write

$$v_m = r_m e^{i\phi_m}, \quad (3.31)$$

where r_m and ϕ_m are real. Note that the phases ϕ_m are defined only up to an arbitrary common additive constant. The N moduli r_m are given by the first

set of data in (3.30), and then the $N - 1$ relative phases can be obtained by making use of the transformation law (3.8), which gives

$$|v_\mu|^2 = \left| \sum_m \overline{C_{\mu m}} r_m e^{i\phi_m} \right|^2. \quad (3.32)$$

The solution of (3.32) for the unknowns ϕ_m is an algebraic problem, similar to the one in Sect. 2-6. There are as many independent algebraic equations as there are unknowns. A finite number of solutions should therefore be obtainable, provided that the data satisfy some inequalities, which restrict the domain of admissible values of $|v_m|$ and $|v_\mu|$. These inequalities have the meaning of *uncertainty relations*, as may be seen from the following example.

Uncertainty relations

Consider two complementary bases, as defined by Eq. (3.28), in a two dimensional vector space. We then have $C_{\mu m} = (-1)^{\mu m} / \sqrt{2}$, and Eq. (3.32) gives

$$|v_\mu|^2 = \frac{1}{2} |\pm r_1 e^{i\phi_1} + r_2 e^{i\phi_2}|^2 = \frac{1}{2} [r_1^2 + r_2^2 \pm 2 r_1 r_2 \cos(\phi_1 - \phi_2)], \quad (3.33)$$

whence

$$\frac{1}{2} |r_1 - r_2|^2 \leq |v_\mu|^2 \leq \frac{1}{2} |r_1 + r_2|^2. \quad (3.34)$$

For example, if $v_m = \delta_{m1}$ (if there is no uncertainty in the result of a ‘‘Latin’’ test), we obtain $|v_\mu|^2 = \frac{1}{2}$ for both values of μ (there is maximal uncertainty for the result of a ‘‘Greek’’ test).

Example: photon polarization

Suppose that we receive a strong beam of polarized light (from a laser, say) and we want to determine the polarization properties of the photons in that beam. We have seen, in Sect. 1-3, how polarization is described by *classical* electromagnetic theory. Although Maxwell’s equations cannot apply to individual photons (since they allow no randomness), the description of the polarization of single photons ought to be similar to the classical one, because the simplest *statistical* properties of photons, such as the total intensity of a light beam, agree with the predictions of classical electromagnetic theory. Therefore, an *assembly*⁹ of photons can be treated classically, to a good approximation. Consider now two interfering polarized light beams, as in Fig. 1.4. The experiment sketched in that figure can be performed with very weak beams, in such a way that it

⁹The term *assembly* denotes a large number of identically prepared physical systems, such as the photons originating from a laser. An assembly, which is a real physical object, should not be confused with an *ensemble*, which is an infinite set of *conceptual* replicas of the same system, used for statistical argumentation, as explained in Sect. 2-1.

is unlikely to have at any moment more than one photon in the apparatus; and nevertheless, the total number of photons during the entire experiment is very large, so that the laws of classical optics must be valid. This two-sided situation suggests that we represent the polarization states of a *single* photon by a linear space, like the one used in classical electrodynamics. This conclusion is of course in complete agreement with the superposition principle G.

Note that, in the present discussion, we are concerned only with polarization properties. The number of photons—*i.e.*, the beam intensity—and the location of that beam are not considered. In other words, the “quantum system” that we are testing by calcite crystals and similar devices is only the *polarization* of a photon. (Recall the discussion of the Stern-Gerlach experiment in Sect. 1-5: the “quantum system” was the magnetic moment $\boldsymbol{\mu}$ of a silver atom. The position of the atom could be described classically.)

The linear space describing photon polarization is two-dimensional, because there are two distinct states corresponding to each maximal test; and it is a *complex* space, because phase relationships are essential (see Fig. 1.4). We are thus led to a representation of polarization states by column vectors $\begin{pmatrix} \alpha \\ \beta \end{pmatrix}$, with complex components α and β , satisfying the normalization condition

$$|\alpha|^2 + |\beta|^2 = 1. \quad (3.35)$$

The two outcomes of any maximal test may be taken as a basis for this two-dimensional linear space. Different tests correspond to different bases, as we have seen. For example, the vectors $\mathbf{e}_x = \begin{pmatrix} 1 \\ 0 \end{pmatrix}$ and $\mathbf{e}_y = \begin{pmatrix} 0 \\ 1 \end{pmatrix}$ can be taken to represent linear polarizations in the x - and y -directions, respectively.

The classical superposition principle (1.3) suggests that $\alpha \sim E_x \exp(i\delta_x)$ and $\beta \sim E_y \exp(i\delta_y)$, with a proportionality constant which depends on the units chosen and on the intensity of the beam, and which in any case includes the common phase $e^{i(kz - \omega t)}$. Here, E_x and E_y can be taken as functions of x and y , if we wish to represent beams of finite extent, rather than an infinite plane wave. Note that the polarization of a light beam depends only on the *ratio* of the components E_x and E_y , and on their relative phase. Multiplying both components by the same number does not change the polarization of the light beam, but only its total intensity.

Suppose now that a photon with unknown polarization $\begin{pmatrix} \alpha \\ \beta \end{pmatrix}$ is tested for linear polarization in a direction making an angle θ with the x -axis. We know that a classical electromagnetic wave will pass without reduction of intensity if $E_x/E_y = \cos \theta / \sin \theta$. It follows that photons with that polarization state, $\begin{pmatrix} \alpha \\ \beta \end{pmatrix} = \begin{pmatrix} \cos \theta \\ \sin \theta \end{pmatrix}$, always pass the test. Likewise, those having the orthogonal polarization, namely $\begin{pmatrix} \alpha \\ \beta \end{pmatrix} = \begin{pmatrix} -\sin \theta \\ \cos \theta \end{pmatrix}$, always fail the test. In general, we can write

$$\begin{pmatrix} \alpha \\ \beta \end{pmatrix} = c_1 \begin{pmatrix} \cos \theta \\ \sin \theta \end{pmatrix} + c_2 \begin{pmatrix} -\sin \theta \\ \cos \theta \end{pmatrix}, \quad (3.36)$$

where

$$c_1 = \alpha \cos \theta + \beta \sin \theta = \begin{pmatrix} \cos \theta \\ \sin \theta \end{pmatrix}^\dagger \begin{pmatrix} \alpha \\ \beta \end{pmatrix}, \quad (3.37)$$

and¹⁰

$$c_2 = -\alpha \sin \theta + \beta \cos \theta = \begin{pmatrix} -\sin \theta \\ \cos \theta \end{pmatrix}^\dagger \begin{pmatrix} \alpha \\ \beta \end{pmatrix}. \quad (3.38)$$

Again, from the analogy with the classical electromagnetic wave, we know that the *amplitude* of the wave that has passed through the linear analyzer is proportional to c_1 , and therefore its *intensity* (its energy flux given by the Poynting vector) is proportional to $|c_1|^2$. When this is expressed in terms of photon numbers, this means that $|c_1|^2$ and $|c_2|^2$ are the *probabilities* for any single photon to pass or fail the test, respectively. Note that $|c_1|^2 + |c_2|^2 = 1$, by virtue of (3.35). All these findings are in complete agreement with the expectation rule H.

We can now solve the problem of finding the polarization of an assembly of photons in a pure state—that is, finding the ratio α/β , which is in general complex. A calcite crystal will split the light beam into two parts, with intensities proportional to $|\alpha|^2$ and $|\beta|^2$. In these beams, the photons are in pure states \mathbf{e}_x and \mathbf{e}_y , respectively, with the x - and y -axes defined by the orientation of the optic axis of the crystal (see Fig. 1.2). This still leaves the phase of α/β to be determined. To find that phase, let us rotate the analyzer by 45° around the direction of the light beam. We thus substitute, in (3.37) and (3.38), $\theta = 45^\circ$. The observed probabilities $|c_1|^2$ and $|c_2|^2$ then become $\frac{1}{2}|\alpha \pm \beta|^2$, from which one can obtain the phase of α/β (except for the arbitrary sign of $\pm i$). Note that α and β may still be multiplied by a *common phase factor*. The latter is obviously related to the arbitrariness of the origin of time in the common phase $e^{i(kz - \omega t)}$.

Exercise 3.7 Find explicitly the ratio α/β from the intensities measured in the two experiments described above.

Exercise 3.8 Show that a similar experiment with a quarter wave plate, to test circular polarization, would give the two probabilities $\frac{1}{2}|\alpha \pm i\beta|^2$. Moreover, show that a comparison of the result of this experiment with the two preceding ones is a consistency check for the claim that the incoming light is fully polarized (i.e., that the photons are in a **pure quantum state**).

Exercise 3.9 Find an uncertainty relation similar to Eq. (3.34) for the case of complementary bases in a 3-dimensional vector space. *

¹⁰The dagger \dagger superscript denotes Hermitian conjugation, that is, both transposition and complex conjugation.

Exercise 3.10 Four polarization filters are introduced in a Mach-Zehnder interferometer, as shown in the figure below. The two internal filters allow the passage of light with vertical and horizontal polarization, respectively. The filter near the source is oblique, at 45° . The filter near the observer may be rotated, or removed. Show that no interference fringes will appear if the observer's filter is vertical, or horizontal, or absent. On the other hand, there **will** be fringes if that filter is oblique. How can the existence of these fringes be explained in terms of polarized photons travelling in the interferometer? What happens to these fringes if the filter near the source is removed, or is rotated to the vertical or horizontal position?

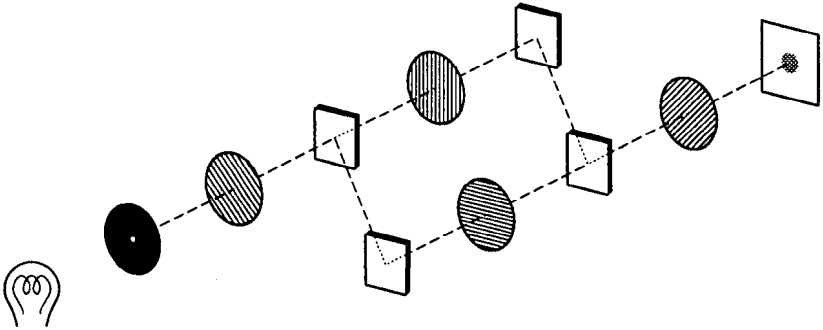

Fig. 3.2. Mach-Zehnder interferometer with four polarization filters. (This experiment was suggested by M. E. Burgos.)

3-6. Measurements and observables

A meaningful quantum test must have a theoretical interpretation, usually formulated in the language of classical physics. For example, if a Stern-Gerlach test is found to have three distinct outcomes for a given atomic beam, we interpret these outcomes as the values μ , 0 , and $-\mu$, which can be taken by a component of the magnetic moment of each atom. In the absence of obvious classical values for the outcomes of a test, we may ascribe arbitrary numerical labels to these outcomes; for example, in Fig. 1.3, the two linear polarizations can be labelled ± 1 . Thus, in general, we associate N real numbers, a_1, \dots, a_N , with the N distinct outcomes of a given maximal test.

Once this has been done, we may say that the result of a quantum test is a real number, and the test becomes similar to a classical measurement, which also yields a number. I shall therefore follow the usage and call that test a "quantum measurement." However, as explained in Sect. 1-5, this new type of measurement is not a passive acquisition of knowledge, as in classical physics. There is no "physical quantity" whose value is unknown before the

measurement, and is then revealed by it. A “quantum measurement” is nothing more than its original definition: It is a quantum *test* whose outcomes are labelled by real numbers.

To complicate things, the same word “measurement” is also used with a totally different meaning, whereby numerous quantum tests are involved in a single measurement. For example, when we measure the lifetime of an unstable nucleus (that is, its *expected* lifetime), we observe the decays of a large number of identically prepared nuclei. Very little information can be obtained from a single decay. Likewise, the measurement of a cross section necessitates the detection of numerous scattered particles: each one of the detection events is a quantum test, whose alternative outcomes correspond to the various detectors in the experiment.

Still another kind of scattering experiment, also called a measurement, is the use of an assembly⁹ of *quantum probes* for the determination of a *classical* quantity. For example, when we measure the distance between two mirrors by interferometry, each interference fringe that we see is created by the impacts of numerous photons. A single photon would be useless in such an experiment. These collective measurements will be discussed in Chapter 12. Here, we restrict our attention to measurements which involve a single quantum test.

Suppose that we perform such a test many times, on an assembly⁹ of quantum systems prepared in a pure state ν . Let \mathbf{e}_r be the vector representing the r th outcome of the test, and a_r be the real number that we have associated with that outcome. (I am using here boldface indices for labelling the outcomes of the test. The reason for this choice will soon be clear.) Since we get *numbers* as the result of this process, we say, rather loosely, that we are observing the value of some physical quantity A , and we call A an *observable*. By its very definition, that observable can take the values a_1, a_2, \dots , only. The quantum expectation rule H asserts that the probability of getting the result a_r is $|\langle \mathbf{e}_r, \nu \rangle|^2$. Therefore, the *mean value* (also called *expectation value*) of the observable A is¹¹

$$\langle A \rangle = \sum_r a_r |\langle \mathbf{e}_r, \nu \rangle|^2 = \sum_r a_r |\nu_r|^2. \quad (3.39)$$

Let $\mathbf{e}_a, \mathbf{e}_b, \dots$, denote the orthonormal basis used to set up the complex vector space of quantum theory. (As usual, this basis is labelled by *italic* indices. Here, it would be more efficient to take the **boldface** basis, $\mathbf{e}_1, \mathbf{e}_2, \dots$, corresponding to the test under consideration, but that choice has not enough generality, because we shall soon be interested in comparing the outcomes of *several* distinct tests.) From the transformation law (3.3), we obtain

¹¹ According to common practice, the same symbols $\langle \text{and} \rangle$ are used to denote the mean value of an observable, and the scalar product of two vectors. This dual usage has no profound meaning and is solely due to a dearth of typographical symbols. It cannot lead to any ambiguity. Some authors prefer to denote an average as \overline{A} , but this may lead to confusion when complex expressions are averaged. A bar is still used in this book to denote a *classical* average (e.g., \overline{B} in Sect. 1-5) because in that case no complex conjugation can be involved and, on the other hand, it is necessary to avoid confusion with *quantum* averages.

$$\langle \mathbf{A} \rangle = \sum_{\mathbf{r}} a_{\mathbf{r}} \left| \sum_{\mathbf{m}} \langle \mathbf{C}_{\mathbf{r}\mathbf{m}} \mathbf{e}_{\mathbf{m}}, \mathbf{v} \rangle \right|^2 = \sum_{\mathbf{r}} a_{\mathbf{r}} \left| \sum_{\mathbf{m}} \overline{\mathbf{C}_{\mathbf{r}\mathbf{m}}} v_{\mathbf{m}} \right|^2. \quad (3.40)$$

This can also be written as

$$\langle \mathbf{A} \rangle = \sum_{\mathbf{m}\mathbf{n}} \overline{v_{\mathbf{m}}} A_{\mathbf{m}\mathbf{n}} v_{\mathbf{n}}, \quad (3.41)$$

clearly showing the distinct roles of the expressions $\overline{v_{\mathbf{m}}} v_{\mathbf{n}}$, which refers solely to the preparation of the quantum system being tested, and

$$A_{\mathbf{m}\mathbf{n}} := \sum_{\mathbf{r}} \mathbf{C}_{\mathbf{r}\mathbf{m}} a_{\mathbf{r}} \overline{\mathbf{C}_{\mathbf{r}\mathbf{n}}}, \quad (3.42)$$

which refers solely to the quantum test defining the basis $\mathbf{e}_{\mathbf{r}}$, and thereby the observable \mathbf{A} .

An observable is therefore represented by a *matrix* in our complex vector space. These matrices will be denoted by capital sans serif letters, such as \mathbf{A} , to distinguish them from ordinary complex numbers, such as their components $A_{\mathbf{m}\mathbf{n}}$. The Hermitian conjugate of a matrix, denoted by a superscript \dagger , is defined as the complex conjugate transposed matrix:

$$(\mathbf{M}^{\dagger})_{\mathbf{r}\mathbf{s}} \equiv \overline{\mathbf{M}_{\mathbf{s}\mathbf{r}}}. \quad (3.43)$$

Since $a_{\mathbf{r}}$ is real, it follows from (3.42) that $A_{\mathbf{m}\mathbf{n}} = \overline{A_{\mathbf{n}\mathbf{m}}}$, so that any observable matrix is Hermitian: $\mathbf{A} = \mathbf{A}^{\dagger}$. It will be shown later that the converse is also true: any Hermitian matrix defines an observable.

Transformation properties

Note that we have now two essentially different types of matrices. There are unitary transformation matrices, such as $C_{\mu\mathbf{m}}$ or $\mathbf{C}_{\mathbf{r}\mathbf{m}}$, whose indices belong to two different alphabets, indicating that they refer to two different orthogonal bases; and there are Hermitian matrices, like $A_{\mathbf{m}\mathbf{n}}$, which represent observable physical properties, described with the use of a *single* basis.

It is natural to ask what is the transformation law of the components of these observable matrices, when we refer them to another basis. For example, we may define, by analogy with (3.42), the expression

$$A_{\mu\nu} := \sum_{\mathbf{r}} \Gamma_{\mathbf{r}\mu} a_{\mathbf{r}} \overline{\Gamma_{\mathbf{r}\nu}}, \quad (3.44)$$

where the transformation matrix Γ is defined by Eq. (3.3). These transformation matrices are not independent (in mathematical parlance, they form a *group*). Inserting the composition law (3.4) into (3.42), we obtain

$$A_{\mathbf{m}\mathbf{n}} = \sum_{\mathbf{r}} \left(\sum_{\mu} \Gamma_{\mathbf{r}\mu} C_{\mu\mathbf{m}} \right) a_{\mathbf{r}} \left(\sum_{\nu} \overline{\Gamma_{\mathbf{r}\nu}} \overline{C_{\nu\mathbf{n}}} \right), \quad (3.45)$$

whence, by comparing with (3.44),

$$A_{mn} = \sum_{\mu\nu} C_{\mu m} A_{\mu\nu} \overline{C_{\nu n}}. \quad (3.46)$$

This is the transformation law for observable matrices. It is similar to the vector transformation law (3.8), but now both $C_{\mu m}$ and its complex conjugate appear, because the transformed elements have two indices.¹²

Exercise 3.11 Derive (3.46) from (3.8) and from the requirement that

$$\langle A \rangle = \sum_{\mu\nu} \overline{v_\mu} A_{\mu\nu} v_\nu, \quad (3.47)$$

gives a result which agrees with Eq. (3.41).

Exercise 3.12 Show that

$$A_{\mu\nu} = \sum_{mn} \overline{C_{\mu m}} A_{mn} C_{\nu n}. \quad (3.48)$$

I shall now show that the N expressions $w_m = \sum_n A_{mn} v_n$ are the components of a *vector* which can be written as $\mathbf{w} = \mathbf{A} \mathbf{v}$. This is not a trivial claim because, in general, N arbitrary numbers are *not* the components of a vector. The characteristic property of a vector is that its components obey a well defined transformation law (the same law for all vectors!) when these components are referred to another basis. Simple examples of non-vectors are shown in the following exercises:

Exercise 3.13 A vector $\{x_1, x_2\}$ in the Euclidean plane is defined by the property that a rotation of the axes by an angle q induces a linear mapping

$$\{x_1, x_2\} \rightarrow \{x_1 \cos \theta + x_2 \sin \theta, -x_1 \sin \theta + x_2 \cos \theta\}. \quad (3.49)$$

Show that the pair of numbers $\{y_1, y_2\} = \{x_1, -x_2\}$ also has a linear mapping law under a rotation of the axes, but that law has not the same form as (3.49) and therefore the pair $\{y_1, y_2\}$ is **not** a vector. On the other hand, show that $\{u_1, u_2\} = \{-x_2, x_1\}$ transforms according to

$$\{u_1, u_2\} \rightarrow \{u_1 \cos \theta + u_2 \sin \theta, -u_1 \sin \theta + u_2 \cos \theta\}, \quad (3.50)$$

and therefore the pair $\{u_1, u_2\}$ is a vector. ★

¹²If you are familiar with general relativistic notations, and in particular with spinor theory in curved spaces, you will want to introduce here lower (covariant) and upper (contravariant) indices, as well as dotted and undotted indices for complex conjugate transformations. I refrain from using these exquisite notations, lest they scare the uninitiated.

Exercise 3.14 Show that the pair of numbers $\{v_1, v_2\} = \{x_1^2 - x_2^2, 2x_1x_2\}$ behaves, under the mapping (3.50), as a vector would have behaved under a rotation of the axes by an angle 2θ , rather than θ . Therefore, v_1 and v_2 are not the components of a vector (they are the components of a tensor). ★

Let us therefore examine whether $w = Av$ is a vector: We must find what happens to the equation $w_m = \sum_n A_{mn} v_n$, when that equation is referred to another orthonormal basis—say e_μ . Shall we then get $w_\mu = \sum_\nu A_{\mu\nu} v_\nu$, with w_μ satisfying the transformation law (3.8)? The answer is positive, as may be seen from the transformation laws (3.8) and (3.46). These give

$$\sum_n A_{mn} v_n = \sum_{n\mu\nu\sigma} C_{\mu m} A_{\mu\nu} \overline{C_{\nu n}} C_{\sigma n} v_\sigma = \sum_{\mu\nu} C_{\mu m} A_{\mu\nu} v_\nu = \sum_\mu C_{\mu m} w_\mu,$$

and this is indeed w_m . This formally proves that the components of w transform like those of a vector. In other words, an observable matrix is a *linear operator* mapping vectors into vectors.

Once this point is established, we can considerably simplify the notation and discard all the indices (Latin, Greek, boldface, etc.) which refer vectors to various orthogonal bases. For example, Eq. (3.41) becomes

$$\langle A \rangle = v^\dagger A v = \langle v, A v \rangle. \quad (3.51)$$

This symbolic notation is not only aesthetically more pleasant; it will be the only possible one for *infinite* dimensional vector spaces, where “indices” take continuous values (see Chapter 4). The index free notation is unambiguous provided that all vectors and matrices are referred to the *same* basis. Explicit indexing is preferable when transformations among several bases are involved.

Projection operators

The simplest observables are those for which all the coefficients a_r are either 0 or 1. These observables correspond to tests which ask yes-no questions (yes = 1, no = 0). They are called *projection operators*, or simply *projectors*, for the following reason: For any normalized vector v , one can define a matrix $P_v = v v^\dagger$, with the properties $P_v^2 = P_v$ and

$$P_v u = v v^\dagger u = v \langle v, u \rangle. \quad (3.52)$$

The last expression is a vector parallel to v , for any u , unless $\langle v, u \rangle = 0$. In geometric terms, $P_v u$ is the *projection* of u along the direction of v . Projectors of a more general type than in Eq. (3.52) will be discussed later.

These projection operators are very handy. In particular, we can write any observable A as a linear combination of projectors on the basis which defines that observable:

$$A = \sum_r a_r e_r e_r^\dagger. \quad (3.53)$$

The matrix elements A_{mn} are then simply given by

$$A_{mn} = \mathbf{e}_m^\dagger \mathbf{A} \mathbf{e}_n = \langle \mathbf{e}_m, \mathbf{A} \mathbf{e}_n \rangle, \quad (3.54)$$

as can be seen from the definitions (3.3) and (3.42). Conversely,

$$\mathbf{A} = \sum_{mn} A_{mn} \mathbf{e}_m \mathbf{e}_n^\dagger. \quad (3.55)$$

The matrix A_{mn} is said to be the *representation* of the observable \mathbf{A} in the basis \mathbf{e}_m . Likewise, the matrix $A_{\mu\nu}$ is the representation of \mathbf{A} in the basis \mathbf{e}_μ , and so on. It readily follows from (3.53) that the representation of \mathbf{A} in the basis \mathbf{e}_r (the basis which corresponds to the quantum test that was used to define \mathbf{A}) is a *diagonal* matrix, with the numbers a_r along the diagonal.

Eigenvalues and eigenvectors

Two more notions are of paramount importance in quantum theory: If there is a number α and a non-null vector \mathbf{u} such that the equation $\mathbf{A}\mathbf{u} = \alpha\mathbf{u}$ holds, then α is called an *eigenvalue* of \mathbf{A} , and \mathbf{u} is the corresponding *eigenvector*.¹³ For example, we have from (3.53),

$$\mathbf{A} \mathbf{e}_s = \sum_r a_r \mathbf{e}_r \mathbf{e}_r^\dagger \mathbf{e}_s = a_s \mathbf{e}_s. \quad (3.56)$$

Exercise 3.15 Show that, in the \mathbf{e}_m representation, Eq. (3.56) becomes

$$\sum_n A_{mn} \mathbf{C}_{sn} = a_s \mathbf{C}_{sm}, \quad (3.57)$$

where \mathbf{C}_{sm} is defined by Eq. (3.3).

Equation (3.57) shows the structure of the unitary transformation matrix which diagonalizes \mathbf{A} : the matrix element \mathbf{C}_{sm} is the m th component of the eigenvector of \mathbf{A} corresponding to the eigenvalue a_s .

3-7. Further algebraic properties

The transformation law (3.46) for the matrix elements of an observable is linear. Therefore observables, like state vectors, form a linear space: If \mathbf{A} and \mathbf{B} are observables, and α and β are real numbers, $\mathbf{D} = \alpha\mathbf{A} + \beta\mathbf{B}$ is an observable too, with components $D_{mn} = \alpha A_{mn} + \beta B_{mn}$. Note that α and β must be real, as otherwise \mathbf{D} would not be Hermitian. The proof of some important theorems is left to the reader, in the following exercises:

¹³The terms *proper* or *characteristic* values and vectors are also used in the older literature.

Exercise 3.16 Show that if C is unitary and A is Hermitian, $C^\dagger A C$ is also Hermitian. Likewise if U is unitary, $C^\dagger U C$ is unitary.

Exercise 3.17 Show that any algebraic relation between matrices, such as $A + B = D$, or $AB = D$, is invariant under a similarity transformation $A \rightarrow S^{-1} A S$, $B \rightarrow S^{-1} B S$ (and in particular under a unitary transformation).

Nonlinear functions of an observable are defined by the natural generalization of Eq. (3.53):

$$f(A) = \sum_{\mathbf{r}} f(a_{\mathbf{r}}) \mathbf{e}_{\mathbf{r}} \mathbf{e}_{\mathbf{r}}^\dagger. \quad (3.58)$$

Their matrix elements are given as in (3.42):

$$(f(A))_{mn} = \langle \mathbf{e}_m, f(A) \mathbf{e}_n \rangle = \sum_{\mathbf{r}} C_{\mathbf{r}m} f(a_{\mathbf{r}}) \overline{C_{\mathbf{r}n}}, \quad (3.59)$$

For the integral powers of an observable, this definition coincides with raising its matrix to the same power. For example,

$$(A^2)_{mn} = \sum_k A_{mk} A_{kn} = \sum_{krs} C_{\mathbf{r}m} a_{\mathbf{r}} \overline{C_{\mathbf{r}k}} C_{\mathbf{s}k} a_{\mathbf{s}} \overline{C_{\mathbf{s}n}}, \quad (3.60)$$

is indeed equal to $\sum_{\mathbf{r}} C_{\mathbf{r}m} (a_{\mathbf{r}})^2 \overline{C_{\mathbf{r}n}}$, by virtue of (3.1). However, the definition (3.58) is also applicable to functions which cannot be expanded into power series, such as $\log A$. Note that if the function f is bijective, the measurements of A and $f(A)$ are equivalent, in the sense of Postulate B (page 31).

Exercise 3.18 Show that if H is Hermitian, e^{iH} is unitary.

Exercise 3.19 Show that if U is unitary, $i(\mathbf{1} - U)/(\mathbf{1} + U)$ is Hermitian. (Here, $\mathbf{1}$ denotes the unit matrix.)

Next, let us consider functions of several observables— A and B , say—which are *not* defined by the same complete test. While A is defined as above by associating real numbers $a_{\mathbf{r}}$ with a set of orthonormal vectors $\mathbf{e}_{\mathbf{r}}$, one defines B by associating real numbers b_{μ} with another set of orthonormal vectors, \mathbf{e}_{μ} , corresponding to a *different* maximal test. (If you want a concrete example, think of A and B as angular momentum components, J_x and J_y .) As before, we refer all the components of vectors and matrices to some fixed orthonormal basis \mathbf{e}_m (for example, the one in which J_z is diagonal). The matrix A_{mn} is given by Eq. (3.42), and likewise we have

$$B_{mn} := \sum_{\mu} C_{\mu m} b_{\mu} \overline{C_{\mu n}}. \quad (3.61)$$

What is then the physical meaning of the observable $D = \alpha A + \beta B$? Clearly, there is some other basis—corresponding to some other maximal test—in which D_{mn} is given by an expression similar to (3.42) or (3.61), with numerical coefficients d_{ν} (instead of a_{τ} and b_{μ}) which then are, by definition, the possible values of the observable D . These d_{ν} and the orthonormal vectors e_{ν} corresponding to them are the eigenvalues and eigenvectors of the matrix D , as in Eq. (3.56).

Conversely, suppose that we have prepared a quantum state v for which it can be predicted with certainty that the measurement of an observable D will yield the value d_{ν} . It then follows that d_{ν} is an eigenvalue of D and v is the corresponding eigenvector. Indeed, the variance

$$\langle (D - d_{\nu})^2 \rangle = v^{\dagger} (D - d_{\nu})^2 v \equiv \| (D - d_{\nu})v \|^2, \quad (3.62)$$

must vanish, and this can happen if, and only if, $Dv = d_{\nu}v$.

Exercise 3.20 *What are the eigenvalues of $J_x + J_y$ for a particle of spin 2? What are the eigenvectors in a representation where J_z is diagonal?*

Exercise 3.21 *Show that the eigenvalues of a matrix are invariant under a unitary transformation (or, more generally, under a similarity transformation).*

To verify the consistency of the physical interpretation, we must still show that the eigenvalues of any Hermitian matrix are real, and that eigenvectors corresponding to different eigenvalues are orthogonal. The first property readily follows from the fact that the diagonal elements of a Hermitian matrix are real—in any representation. The second one too is easily proved: Let $Hu = \alpha u$, and $Hv = \beta v$. We then have

$$v^{\dagger}Hu = \alpha v^{\dagger}u \quad \text{and} \quad u^{\dagger}Hv = \beta u^{\dagger}v. \quad (3.63)$$

Subtract the second equation from the Hermitian conjugate of the first one. The result is $(\alpha - \beta)u^{\dagger}v = 0$, so that u and v are indeed orthogonal if $\alpha \neq \beta$.

Exercise 3.22 *Prove likewise that the eigenvalues of a unitary matrix lie on the unit circle, and that eigenvectors corresponding to different eigenvalues are orthogonal.*

Conversely, if $\langle w, Aw \rangle$ is real for any vector w , then A satisfies

$$\langle u, Av \rangle = \overline{\langle v, Au \rangle}, \quad (3.64)$$

for any two vectors u and v (that is, A is Hermitian). This property is proved in the same way as Eq. (3.17), which showed how all scalar products could be determined from the knowledge of all norms. Here, we have

$$\begin{aligned} & (u + v)^{\dagger}A(u + v) - (u - v)^{\dagger}A(u - v) \\ & + i(u - iv)^{\dagger}A(u - iv) - i(u + iv)^{\dagger}A(u + iv) = 4u^{\dagger}Av. \end{aligned} \quad (3.65)$$

The real part of the left hand side is obviously invariant under the interchange of u and v . The imaginary part, on the other hand, changes its sign, because

$$(\mathbf{v} \pm i\mathbf{u})^\dagger \mathbf{A}(\mathbf{v} \pm i\mathbf{u}) = (\mathbf{u} \mp i\mathbf{v})^\dagger \mathbf{A}(\mathbf{u} \mp i\mathbf{v}), \quad (3.66)$$

and Eq. (3.64) readily follows.

Computation of eigenvalues and eigenvectors

To obtain explicitly the eigenvalues and eigenvectors of a given matrix \mathbf{A} , we have to solve $\sum A_{mn} u_n = \alpha u_n$, or $\sum (A_{mn} - \alpha \delta_{mn}) u_n = 0$. These linear equations have a nontrivial solution if, and only if, $\text{Det} (A_{mn} - \alpha \delta_{mn}) = 0$. This is an algebraic equation of order N , called the *secular equation*. If α is a simple root of this equation, the corresponding eigenvector is obtained by solving a set of linear equations, and it is unique, up to a normalization factor.

If the same eigenvalue occurs more than once, it is called “degenerate,” and it may have several independent eigenvectors. In particular, if \mathbf{A} is Hermitian (or unitary), it is always possible to construct M orthonormal eigenvectors corresponding to an M -fold root of the secular equation. This can be proved as follows. We first find one eigenvector, \mathbf{v} say. We then perform a unitary transformation to a new basis, such that \mathbf{v} is the k th basis vector. This does not affect the eigenvalues of \mathbf{A} (see Exercise 3.21). In the new basis, we have $\sum A_{mn} v_n = \alpha v_m$. However, in that basis, the only nonvanishing component of \mathbf{v} is v_k , whence it follows that $A_{kk} = \alpha$ and all the other $A_{mk} = 0$, and therefore all $A_{km} = 0$ too, because \mathbf{A} is Hermitian. Consider now a new matrix \mathbf{A}' which is the same as \mathbf{A} , but with the k th row and column removed. This matrix is defined in the subspace of all the vectors orthogonal to \mathbf{v} . By construction, its eigenvectors are also eigenvectors of \mathbf{A} , with the same eigenvalues. Repeating this process $M - 1$ times, we can find M orthogonal eigenvectors pertaining to the M -fold eigenvalue. Obviously, any linear combination of these vectors is also an eigenvector, corresponding to the same eigenvalue. Additional information can be found in texts on algebra, such as those listed in the bibliography.

Exercise 3.23 Prove that similar properties hold for unitary matrices.

Exercise 3.24 On the other hand, show that the matrix $\begin{pmatrix} 1 & i \\ i & -1 \end{pmatrix}$, which is neither Hermitian nor unitary, has only a single eigenvector.

Exercise 3.25 Show that the trace (the sum of diagonal elements) of a Hermitian—or unitary—matrix is equal to the sum of its eigenvalues, and the determinant of that matrix is equal to the product of its eigenvalues.

From the definition of $f(\mathbf{A})$ —see Eq. (3.53)—it readily follows that if all the eigenvalues a_r satisfy a relationship $f(a_r) = 0$, then $f(\mathbf{A}) = 0$ too. The converse is also true, as can be seen by considering the representation where \mathbf{A} is diagonal. A simple example is that of *projection operators* (or *projectors*), for which all eigenvalues are either 0 or 1, and which therefore satisfy

$$P^2 = P. \quad (3.67)$$

Exercise 3.26 Prove that any projector P can be used to split any vector v into the sum of two orthogonal terms:

$$v \equiv Pv + (v - Pv). \quad (3.68)$$

Exercise 3.27 Let u and v be normalized vectors. Show that uu^\dagger and vv^\dagger are projectors. Moreover, show that $uu^\dagger + vv^\dagger$ is a projector if, and only if, $\langle u, v \rangle = 0$. Generalize this result to an arbitrary number of vectors.

Exercise 3.28 Let $\{e_\mu\}$ be a complete orthogonal basis. Show that

$$\sum_\mu e_\mu e_\mu^\dagger \equiv \mathbb{1}, \quad (3.69)$$

where $\mathbb{1}$ is the unit matrix.

Commutators

The expression

$$[A, B] := AB - BA, \quad (3.70)$$

is called the *commutator* of the matrices A and B . If $[A, B] = 0$, we say that A and B commute. Obviously, two observables defined by means of the same maximal test commute (there is a representation in which both are diagonal). Conversely, if A and B are Hermitian and commute, it is possible to find a basis where both matrices are diagonal. This can be done as follows: First, let us diagonalize A . We then have

$$[A, B]_{mn} = (A_{mm} - A_{nn})B_{mn} = 0. \quad (3.71)$$

If A is nondegenerate, it follows that $B_{mn} = 0$ whenever $m \neq n$ (i.e., B too is diagonal). If, on the other hand, A is degenerate, B is only block-diagonal. Each one of the blocks corresponds to a set of equal eigenvalues of A (that is, the corresponding block of A is a multiple of the unit submatrix). We can then diagonalize each block of B separately without affecting A , so that, finally, both A and B are diagonal.

In particular, consider two projectors P and Q . If they commute, both can be diagonalized in some basis. In that case, their product $PQ = QP$ has diagonal elements equal to 1 only where *both* P and Q have such diagonal elements. Projection operators which satisfy $PQ = 0$ are said to be *orthogonal*.

Exercise 3.29 Show that if the projection operators P and Q satisfy $PQ = 0$, then $QP = 0$ too.

Exercise 3.30 Show that if P and Q are orthogonal projectors, and v is any vector, $\langle Pv, Qv \rangle = 0$.

Exercise 3.31 Show that if P is a projector, the operator $\mathbf{1} - P$ is also a projector, and it is orthogonal to P .

Normal matrices and polar decomposition

To conclude this brief tour of linear algebra, here are two more definitions. A matrix A is called *normal* if it commutes with its adjoint: $[A, A^\dagger] = 0$. In that case, the Hermitian matrices $A + A^\dagger$ and $i(A - A^\dagger)$ commute and can be simultaneously diagonalized by a unitary transformation. Therefore A itself can be diagonalized.

Consider now a generic matrix A , which is *not* normal, and therefore cannot be diagonalized by a unitary transformation. It may still be possible to write A in *polar* form, like we write a complex number $z = re^{i\theta}$. Indeed, the matrix $A^\dagger A$ is Hermitian, and it has nonnegative eigenvalues, because, for any u ,

$$u^\dagger A^\dagger A u = \|Au\|^2 \geq 0. \quad (3.72)$$

Further assume that $A^\dagger A$ has no zero eigenvalue (*i.e.*, the equation $Au = 0$ has no solution other than $u = 0$). Since $A^\dagger A$ is Hermitian, it is possible to define, thanks to Eq. (3.58), the matrix $(A^\dagger A)^{-1/2}$, where, for definiteness, we choose the positive square root of each eigenvalue of $A^\dagger A$. Then, the matrix product

$$U := A(A^\dagger A)^{-1/2} \quad (3.73)$$

is unitary, because $U^\dagger U = (A^\dagger A)^{-1/2} A^\dagger A (A^\dagger A)^{-1/2} = \mathbf{1}$, and we finally have

$$A \equiv A(A^\dagger A)^{-1/2} (A^\dagger A)^{1/2} = U(A^\dagger A)^{1/2}. \quad (3.74)$$

The reader is invited to work out an explicit example, such as $A = J_x + iJ_y + \epsilon \mathbf{1}$, and to see what happens in the limit $\epsilon \rightarrow 0$.

3-8. Quantum mixtures

Most tests are not maximal and most preparations do not produce pure quantum states. We often have only partial specifications for a physical process. We therefore need a formalism for describing incompletely specified situations.

Imagine a procedure in which we prepare various pure states u_α , with respective probabilities p_α . The vectors u_α are normalized but not necessarily orthogonal to each other. The corresponding projectors are $\rho_\alpha = u_\alpha u_\alpha^\dagger$ (a new symbol ρ_α was introduced here, instead of the former P_α , to avoid confusion with the probabilities p_α).

The average value of an observable A for the pure state u_α is

$$\langle A \rangle_\alpha = u_\alpha^\dagger A u_\alpha = \text{Tr}(\rho_\alpha A), \quad (3.75)$$

where the *trace* of a matrix is defined as the *sum of its diagonal elements*. Traces will frequently occur in our calculations. You should be familiar with their most important properties, which are listed in the following exercises.

Exercise 3.32 Prove that $\text{Tr}(\alpha A + \beta B) = \alpha \text{Tr}(A) + \beta \text{Tr}(B)$.

Exercise 3.33 Prove that $\text{Tr}(AB) = \text{Tr}(BA)$. As a corollary, prove that the trace of a matrix is invariant under similarity transformations $A \rightarrow SAS^{-1}$. In particular, it is invariant under unitary transformations.

Exercise 3.34 Prove that $\text{Tr}(AB)$ is real if A and B are Hermitian.

Returning to our stochastic preparation procedure, where the pure state u_α occurs with probability p_α , we get, as the average value of the observable A :

$$\langle A \rangle = \sum_\alpha p_\alpha \langle A \rangle_\alpha = \text{Tr} \left(\sum_\alpha p_\alpha \rho_\alpha A \right), \quad (3.76)$$

which can be written as

$$\langle A \rangle = \text{Tr}(\rho A), \quad (3.77)$$

where

$$\rho = \sum_\alpha p_\alpha \rho_\alpha \quad (3.78)$$

is the *density matrix* (or *statistical operator*) of the quantum system. It satisfies

$$\text{Tr} \rho = \sum_\alpha p_\alpha \text{Tr}(\rho_\alpha) = \sum_\alpha p_\alpha = 1. \quad (3.79)$$

Note in particular that $\langle \mathbf{1} \rangle = 1$, as it ought to be.

Equation (3.77) can be considered as a generalization of (3.41) when the preparation of a system is not completely specified. The notion of density matrix—just as that of state vector—describes a *preparation procedure*; or, if you prefer, it describes an ensemble of quantum systems, whose statistical properties correspond to the given preparation procedure. A pure state is a special case of Eq. (3.78), when only one of the p_α is 1, and all the other ones vanish. In that case, ρ is a projection operator and satisfies

$$\rho^2 = \rho. \quad (3.80)$$

Conversely, if Eqs. (3.79) and (3.80) are satisfied, ρ is a projector on some pure state w . Indeed, (3.80) implies that the eigenvalues of ρ are 0 and 1, and (3.79) that the sum of these eigenvalues is 1. Therefore, there is a single eigenvector w satisfying $\rho w = w$, and we have $\rho = ww^\dagger$.

Note that any projector satisfies

$$\langle \mathbf{v}, P\mathbf{v} \rangle = \langle \mathbf{v}, P^2\mathbf{v} \rangle = \|P\mathbf{v}\|^2 \geq 0. \quad (3.81)$$

Hence the diagonal elements of a projector are nonnegative, and so are those of any density matrix. This property cannot be affected by choosing another basis. In particular, *the eigenvalues of a density matrix are nonnegative*. Moreover, none of these eigenvalues can exceed 1, because of (3.79).

Exercise 3.35 *A maximal test defines an orthonormal basis \mathbf{e}_μ . Show that the probability of obtaining the μ th outcome of that test, following a preparation ρ , is $\text{Tr}(\rho P_\mu)$, where $P_\mu = \mathbf{e}_\mu \mathbf{e}_\mu^\dagger$.*

Positive operators

A *positive operator* A is defined by the property that $\langle \mathbf{w}, A\mathbf{w} \rangle \geq 0$ for any \mathbf{w} (a more accurate name would have been “nonnegative operator”). Such an operator is always Hermitian, as seen in the proof of Eq. (3.64). It satisfies further interesting inequalities. Consider, for example, a vector \mathbf{v} with only two nonvanishing components, v_m and v_n , say. Since $\mathbf{v}^\dagger A \mathbf{v}$ involves only a submatrix of A with elements labelled by the indices m or n , that submatrix itself must be a positive operator. In particular, its eigenvalues cannot be negative, and therefore—see Exercise (3.25)—the corresponding subdeterminant, $(A_{mm}A_{nn} - |A_{mn}|^2)$, cannot be negative. It follows that if a diagonal element A_{mm} vanishes, the entire m th row and m th column of A must vanish. More generally, if a matrix is positive, then any submatrix, obtained by keeping only the rows and columns labelled by a subset of the original indices, is itself a positive matrix, and in particular it has a nonnegative determinant.

Decomposition of a density matrix

An important corollary is that if we try to decompose a pure state $\rho = \mathbf{u}\mathbf{u}^\dagger$ as

$$\rho = \lambda \rho' + (1 - \lambda) \rho'', \quad (3.82)$$

with $0 < \lambda < 1$, we can obtain only

$$\rho' = \rho'' = \rho. \quad (3.83)$$

Indeed, consider any \mathbf{v} orthogonal to \mathbf{u} . We have

$$\langle \mathbf{v}, \rho \mathbf{v} \rangle = \lambda \langle \mathbf{v}, \rho' \mathbf{v} \rangle + (1 - \lambda) \langle \mathbf{v}, \rho'' \mathbf{v} \rangle = 0. \quad (3.84)$$

Since both λ and $(1 - \lambda)$ are positive, it follows that $\langle \mathbf{v}, \rho' \mathbf{v} \rangle = \langle \mathbf{v}, \rho'' \mathbf{v} \rangle = 0$. Therefore, if we choose a representation in which both \mathbf{u} and \mathbf{v} are basis vectors, the entire row and column belonging to \mathbf{v} must vanish. It follows that the only nonvanishing components of ρ' and ρ'' are $\langle \mathbf{u}, \rho' \mathbf{u} \rangle = \langle \mathbf{u}, \rho'' \mathbf{u} \rangle = 1$, whence we obtain Eq. (3.83).

On the other hand, any density matrix which is *not* a pure state can be decomposed into pure states in infinitely many ways.¹⁴ For example, we have

$$\begin{pmatrix} 0.7 & 0 \\ 0 & 0.3 \end{pmatrix} \equiv 0.7 \begin{pmatrix} 1 & 0 \\ 0 & 0 \end{pmatrix} + 0.3 \begin{pmatrix} 0 & 0 \\ 0 & 1 \end{pmatrix}, \quad (3.85)$$

where the two matrices on the right hand side are projectors on the orthogonal pure states $\begin{pmatrix} 1 \\ 0 \end{pmatrix}$ and $\begin{pmatrix} 0 \\ 1 \end{pmatrix}$, respectively. The *same* diagonal density matrix (3.85) can also be decomposed in an infinity of other ways, such as

$$0.4 \begin{pmatrix} 1 & 0 \\ 0 & 0 \end{pmatrix} + 0.3 \begin{pmatrix} 0.64 & 0.48 \\ 0.48 & 0.36 \end{pmatrix} + 0.3 \begin{pmatrix} 0.36 & -0.48 \\ -0.48 & 0.64 \end{pmatrix}, \quad (3.86)$$

where the last two matrices correspond to pure states $\begin{pmatrix} 0.8 \\ 0.6 \end{pmatrix}$ and $\begin{pmatrix} 0.6 \\ -0.8 \end{pmatrix}$ which are orthogonal to each other, but not to $\begin{pmatrix} 1 \\ 0 \end{pmatrix}$ or $\begin{pmatrix} 0 \\ 1 \end{pmatrix}$

This lack of uniqueness has a remarkable consequence. Given two *different* preparations represented by density matrices ρ_1 and ρ_2 , one can prescribe a third preparation, ρ , as follows: Let a random process have probability λ to “succeed” and probability $(1 - \lambda)$ to “fail.” In case of success, prepare the quantum system according to ρ_1 . In case of failure, prepare it according to ρ_2 . The result is represented by the density matrix

$$\rho = \lambda \rho_1 + (1 - \lambda) \rho_2, \quad (3.87)$$

because, if the above instructions are executed a large number of times, the *average* value obtained for subsequent measurements of any observable A is

$$\langle A \rangle = \lambda \text{Tr}(\rho_1 A) + (1 - \lambda) \text{Tr}(\rho_2 A) = \text{Tr}(\rho A). \quad (3.88)$$

What is truly amazing in this result is that, once ρ is given, it contains *all* the available information, and it is impossible to reconstruct from it the original ρ_1 and ρ_2 ! For example, we may have an experimental setup in which we prepare a large number of polarized photons, and we toss a coin to decide, with equal probabilities, whether the next photon to be prepared will have vertical or horizontal *linear* polarization; or we may have a completely different experimental setup, in which we randomly decide whether the next photon will have right handed or left handed *circular* polarization. In both cases, we shall get the same $\rho = \frac{1}{2} \mathbf{1}$. An observer, receiving megajoules of these photons, will never be able to discover which one of these two methods was chosen for their preparation, notwithstanding the fact that these preparations are *macroscopically* different. (If he were able to do so, he could use this capability for the instantaneous transfer of information to distant observers, in violation of relativistic causality. This will be shown in Chapter 6.)

This property will be expressed as our final fundamental postulate:

¹⁴A quantum mixture is therefore radically different from a chemical mixture, which has a unique decomposition into pure components.

K. Completeness of quantum description. *The ρ matrix completely specifies all the properties of a quantum ensemble.*

Determination of a density matrix

We have seen in Section 3-5 how we can in principle determine an unknown pure state, by testing a large number of identically prepared systems, provided that we are sure that their unknown preparation indeed is that of a *pure* state. This was a simple, but a rather artificial problem. We shall now consider the generic case of an *arbitrary* unknown preparation. How can we determine the corresponding density matrix ρ ? In principle, the method is the same, but we now need to measure the mean values of a larger number of observables.

Consider again the case of polarized light, but allow now *partial* polarization. A test for vertical vs horizontal polarization, which distinguishes the pure states $\begin{pmatrix} 1 \\ 0 \end{pmatrix}$ and $\begin{pmatrix} 0 \\ 1 \end{pmatrix}$, is equivalent to the measurement of an observable

$$\sigma_z = \begin{pmatrix} 1 & 0 \\ 0 & -1 \end{pmatrix}, \quad (3.89)$$

having these pure states as eigenstates, with eigenvalues 1 and -1 . Likewise, a test for linear polarization at $\pm 45^\circ$, corresponding to the pure states

$$\frac{1}{\sqrt{2}} \begin{pmatrix} 1 \\ 1 \end{pmatrix} \quad \text{and} \quad \frac{1}{\sqrt{2}} \begin{pmatrix} 1 \\ -1 \end{pmatrix}, \quad (3.90)$$

can be considered as the measurement of an observable

$$\sigma_x = \begin{pmatrix} 0 & 1 \\ 1 & 0 \end{pmatrix}, \quad (3.91)$$

with eigenstates given by (3.90), and eigenvalues ± 1 .

Finally, a test for circular polarization, corresponding to the pure states

$$\frac{1}{\sqrt{2}} \begin{pmatrix} 1 \\ i \end{pmatrix} \quad \text{and} \quad \frac{1}{\sqrt{2}} \begin{pmatrix} i \\ 1 \end{pmatrix}, \quad (3.92)$$

is equivalent to the measurement of an observable

$$\sigma_y = \begin{pmatrix} 0 & -i \\ i & 0 \end{pmatrix}, \quad (3.93)$$

with eigenstates given by (3.92), and again with eigenvalues ± 1 .

These three measurements, repeated many times—on three disjoint subsets of photons randomly chosen from the light beam—yield average results

$$a_j = \langle \sigma_j \rangle = \text{Tr}(\rho \sigma_j). \quad (3.94)$$

The observed values of these a_j are three experimental data, which, together with the trace condition (3.79), allow us to determine the unknown values of the four elements of the Hermitian matrix ρ . The result is

$$\rho = \frac{1}{2}(\mathbf{1} + \sum_j a_j \sigma_j), \quad (3.95)$$

as can easily be verified by using the identity

$$\sigma_m \sigma_n + \sigma_n \sigma_m \equiv 2 \delta_{mn}. \quad (3.96)$$

Exercise 3.36 Show that (3.94) is a consequence of (3.95).

Exercise 3.37 For quantum systems having N orthogonal states, how many different measurements are needed to determine ρ ? **Ans.:** $N + 1$.

Exercise 3.38 Show that ρ in Eq. (3.95) corresponds to a pure state (that is, to fully polarized light) if $\sum_j (a_j)^2 = 1$.

Exercise 3.39 What are the eigenvalues of ρ in Eq. (3.95)? **Ans.:** The two eigenvalues are $\frac{1}{2}[1 \pm (\sum_j a_j^2)^{1/2}]$. Therefore, if an experimenter finds $\sum_j a_j^2 > 1$, he'd better look for systematic errors.

3-9. Appendix: Dirac's notation

Most notations used in this chapter are the standard ones of linear algebra. They may become awkward when complicated quantum systems have to be described. For example, the state of a free hydrogen atom involves its total momentum \mathbf{p} , the internal quantum numbers n, l, m , one quantum number for the spin of the electron, and perhaps one more for the proton spin, if you wish to discuss the atom hyperfine structure. To avoid unwieldy symbols with multiple subscripts, like $u_{\mathbf{p}nlms_e s_p}$, Dirac introduced the bra-ket notation. The state vector is written as $|\mathbf{p}nlms_e s_p\rangle$; this symbol is called a *ket*, and it has the same algebraic meaning as a column matrix. Its Hermitian conjugate, which is a row matrix, is written $\langle \mathbf{p}nlms_e s_p|$ and is called a *bra* (this has caused not only some bawdy jokes, but also fruitless attempts to attribute different physical meanings to the two types of vectors, such as preparation states and observation states). The scalar product that was hitherto denoted² by $\langle \mathbf{u}, \mathbf{v} \rangle$ then becomes a complete bra-c-ket $\langle \mathbf{u} | \mathbf{v} \rangle$.

The following table is a summary of the various notations. The two last lines show that great care must be exercised with Hermitian conjugation if you use Dirac's notation.

Table 3-1. Equivalent notations for vectors and operators.

	\mathbb{R}^3	Complex vectors	Dirac's notation
Vector (column, ket)	\mathbf{v}	\mathbf{v}	$ v\rangle$
Co-vector (row, bra)	$\mathbf{u}\cdot$	\mathbf{u}^\dagger	$\langle u $
Scalar product	$\mathbf{u}\cdot\mathbf{v}$	$\mathbf{u}^\dagger\mathbf{v} \equiv \langle \mathbf{u}, \mathbf{v} \rangle$	$\langle u v\rangle$
Dyadic	$\mathbf{v}\mathbf{u}\cdot$	$\mathbf{v}\mathbf{u}^\dagger$	$ v\rangle\langle u $
Hermitian conjugate	—	$\mathbf{v} \leftrightarrow \mathbf{v}^\dagger$	$ v\rangle \leftrightarrow \langle v $
Linear operator	$A\mathbf{v}$	$A\mathbf{v}$	$A v\rangle$
Co-vector (linear in A , antilinear in u)	$\mathbf{u}A\cdot$	$\mathbf{u}^\dagger A$	$\langle u A$
Co-vector (antilinear in A and in u)	—	$(A\mathbf{u})^\dagger \equiv \mathbf{u}^\dagger A^\dagger$	$\langle Au \equiv \langle u \bar{A}$
Adjoint of operator	—	$(A\mathbf{u})^\dagger\mathbf{v} \equiv \mathbf{u}^\dagger A^\dagger\mathbf{v}$	$\langle Au v\rangle \equiv \langle u \bar{A} v\rangle$

3-10. Bibliography

Vectors and matrices

G. Fano, *Mathematical Methods of Quantum Mechanics*, McGraw-Hill, New York (1971) Chapt. 1, 2.

P. Lancaster and M. Tismenetsky, *The Theory of Matrices*, Academic Press, Boston (1985).

Quantum mechanics

There are many excellent books on elementary quantum mechanics. Two of them deserve a special mention, because they use matrix algebra, rather than wave functions and differential equations:

H. S. Green, *Matrix Mechanics*, Noordhoff, Groningen (1965).

T. F. Jordan, *Quantum Mechanics in Simple Matrix Form*, Wiley, New York (1986).

Strong superposition principle

The strong superposition principle (p. 54) asserts that any orthogonal basis represents a realizable maximal test, but it does not tell us how to actually perform that test. The following article supplies instructions for the case of multiple optical beams.

M. Reck, A. Zeilinger, H. J. Bernstein, and P. Bertani, *Phys. Rev. Lett.* 73 (1994) 58.

Chapter 4

Continuous Variables

4-1. Hilbert space

Most quantum systems require the use of an *infinite dimensional* vector space, where vectors have an infinity of components u_k . The index k may even take continuous values, and we then write $u(k)$, rather than u_k . It is possible to have indices whose values are discrete in some domain, and continuous in another domain. For example, if a quantum system has both bound states and unbound ones, and if the energy of that system is used as an index for labelling states, that index has both discrete and continuous values.

Physicists usually have a nonchalant attitude when the number of dimensions is extended to infinity. Optimism is the rule, and every infinite sequence is presumed to be convergent, unless proven guilty. The purpose of this chapter is to highlight some of the novel features which appear when vectors and matrices become infinite dimensional. This does not pretend to be an exhaustive treatment. I shall only guide the reader through a grand tour of common pitfalls. The selection of topics reflects my personal taste, shaped by my experience with real problems that I have encountered. More information, at various levels of rigor, can be found in the treatises listed at the end of this chapter.

Quantum theory uses a special kind of infinite dimensional vector space, called “Hilbert space”—usually denoted by H . To qualify as a Hilbert space, a vector space must satisfy three properties. The first one is *linearity*: If u and v are elements of H , and if α and β are complex numbers, $\alpha u + \beta v$ too is an element of H . For example, if the elements of H are represented by functions of x , such as $u(x)$ and $v(x)$, then $\alpha u(x) + \beta v(x)$ is a function of x , and therefore it is an element of H . In particular, H contains a null element, 0 , such that $u + 0 = u$ for any u . Up to this point, there is nothing essentially new.

Inner product and norm

The second property that must be satisfied by a Hilbert space is the existence of a Hermitian inner product: To any pair of elements u and v , corresponds a

complex number $\langle \mathbf{u}, \mathbf{v} \rangle = \overline{\langle \mathbf{v}, \mathbf{u} \rangle}$, the value of which is linear in \mathbf{v} and antilinear in \mathbf{u} . The rule for actually computing $\langle \mathbf{u}, \mathbf{v} \rangle$ need not be specified at this stage. However, that rule *must* be such that

$$\langle \mathbf{u}, \mathbf{u} \rangle \geq 0, \quad (4.1)$$

with the equality sign holding if, and only if, $\mathbf{u} = 0$. If one allows $\langle \mathbf{u}, \mathbf{u} \rangle < 0$, this gives a “pseudo-Hilbert” space. Many theorems which can be proved for Hilbert spaces are not valid in pseudo-Hilbert spaces, and the latter have no legitimate use for representing states in quantum theory. (Spaces endowed with an indefinite metric, such as the Minkowski spacetime of special relativity, have many important uses in theoretical physics. However, the *space of quantum states must have a definite metric.*) If you ignore the requirement (4.1), as some authors brashly do, Schwarz’s inequality (3.18) does not hold, and you will soon encounter negative probabilities, or probabilities larger than 1, and other bizarre results for which I can offer no explanation.

Returning to the case where the elements of H are represented by functions of x , a natural (but by no means unique) choice for the definition of the inner (or scalar) product is

$$\langle \mathbf{u}, \mathbf{v} \rangle = \int \overline{u(x)} v(x) dx. \quad (4.2)$$

This expression is obviously Hermitian, linear in \mathbf{v} and antilinear in \mathbf{u} , as we want. However, there already is a difficulty here: The sum in (4.2) may diverge for some functions $u(x)$ and $v(x)$. In particular, for Eq. (4.1) to make sense, the sum $\int |u(x)|^2 dx$ must exist. Therefore only square integrable functions are admitted in a Hilbert space whose scalar product is defined by (4.2). Again, you may find authors who feel comfortable with vectors of infinite norm. If you want to follow their path, you will do so at your own risk. Here is an example:

Exercise 4.1 *If a monochromatic wave e^{ikx} is an acceptable state, why shouldn't e^{kx} be acceptable too? But if that is acceptable, you will not have **discrete** energy levels in a square well. Show that a wave function $\cos Kx$ inside the well, which corresponds to **any** negative energy E , can always be smoothly joined to a wave function $Ae^{kx} + Be^{-kx}$ outside the well (with the same arbitrary negative E).*

The norm $\|\mathbf{u}\|$ of a vector is defined as usual by

$$\|\mathbf{u}\|^2 := \langle \mathbf{u}, \mathbf{u} \rangle. \quad (4.3)$$

Many of the properties that were proved for the norm of finite dimensional vectors remain valid. In particular, the norm completely defines the scalar product as in Eq. (3.17); and the Schwarz inequality (3.18) and the triangle inequality (3.21) still hold.

Strong and weak convergence

The third property that must be satisfied by a Hilbert space is *completeness*, which means that any strongly convergent sequence of elements u_n has a limit, and that limit too is an element of H (more formally, if $\|u_m - u_n\| \rightarrow 0$ for $m, n \rightarrow \infty$, there is a *unique* $u \in H$, such that $\|u_m - u\| \rightarrow 0$). Note that *strong* convergence, as defined above, is essential. Weak convergence, defined by the property that the sequence $\langle v, u_n \rangle$ tends to a limit $\langle v, u \rangle$ for every v , is not sufficient for completeness. For example, if the u_n are an infinite sequence of orthonormal vectors, the scalar product $\langle v, u_n \rangle$ has a limit, namely zero, while obviously the sequence u_n does not converge to $u = 0$.

Exercise 4.2 Let us try to define the square root of a delta function (there is no such thing, as you will see). Consider the sequence of functions

$$u_n(x) = \begin{cases} \sqrt{n} & \text{if } |x| < 1/2n, \\ 0 & \text{if } |x| > 1/2n. \end{cases} \quad (4.4)$$

Show that, although each function is normalized, the sequence of u_n weakly converges to zero. Moreover, show that this sequence does not strongly converge to anything, because $\|u_m - u_n\|$ has no limit, when m and n tend to infinity.

The completeness requirement has no immediate physical meaning, but it is essential, because the proofs of many theorems about Hilbert spaces require going to some limit, and that limit must also belong to the Hilbert space. If completeness is not satisfied, we don't have a Hilbert space, and some theorems which were proved for Hilbert spaces are no longer valid.

In particular, *continuous* functions do *not* form a Hilbert space, because a sequence of such functions can have, as its limit, a discontinuous function. An elementary example is the Fourier expansion of a square wave: a finite number of terms in this expansion is continuous, but the limit is discontinuous.

Case study: spontaneous generation of a singularity

It is inconsistent to require Schrödinger wave functions to be always continuous and finite, even for free particles. It is not difficult to construct states which are represented, at time $t = 0$, by a continuous function and which evolve into a discontinuous, or even singular, one. Indeed, consider the free particle Schrödinger equation

$$i \frac{\partial \psi}{\partial t} = -\frac{1}{2} \frac{\partial^2 \psi}{\partial x^2}, \quad (4.5)$$

where units are chosen so that $m = \hbar = 1$. The explicit solution of (4.5), for given initial $\Psi(x, 0)$, is¹

¹E. Merzbacher, *Quantum Mechanics*, Wiley, New York (1970) p. 163.

$$\psi(x, t) = \left(\frac{1}{2\pi i t} \right)^{1/2} \int_{-\infty}^{\infty} e^{i(x-y)^2/2t} \psi(y, 0) dy. \quad (4.6)$$

The reader is invited to verify that (4.6) is a solution of (4.5), and that it satisfies $\lim_{t \rightarrow 0} \psi(x, t) = \psi(x, 0)$. This way of writing the Schrödinger equation as an integral equation, rather than a differential one, has the advantage of being valid even if ψ is not a differentiable function.

As an example, let

$$\psi(x, 0) = e^{-ix^2/2} (1+x^2)^{-1/3}, \quad (4.7)$$

which is square integrable, and everywhere continuous and differentiable. We then have

$$\psi(x, t) = \frac{e^{ix^2/2t}}{(2\pi i t)^{1/2}} \int_{-\infty}^{\infty} e^{iy^2(1-t)/2t} e^{-ixy/t} \frac{dy}{(1+y^2)^{1/3}}. \quad (4.8)$$

The integrand falls off only as $|y|^{-2/3}$ for large $|y|$, but the rapid oscillations of the complex exponent make it integrable, *except* for $x = 0$ and $t = 1$. That is, $\psi(0, 1)$ is infinite. Explicitly, we have, at time $t = 1$,

$$\psi(x, 1) = \frac{e^{ix^2/2}}{(2\pi i)^{1/2}} \int_{-\infty}^{\infty} \frac{e^{-ixy} dy}{(1+y^2)^{1/3}}. \quad (4.9)$$

The integral on the right hand side can be evaluated explicitly:²

$$\int_{-\infty}^{\infty} \frac{\cos xy dy}{(1+y^2)^{1/3}} = \frac{2\pi^{1/2}}{\Gamma(1/3)} \left(\frac{|x|}{2} \right)^{1/6} K_{1/6}(|x|), \quad (4.10)$$

where $K_\nu(x)$ is the modified Bessel function of the third kind, which is infinite at $x = 0$, but is nevertheless square integrable.

Exercise 4.3 As a milder example, let

$$\psi(x, 0) = e^{-ix^2/2} x^{-1} \sin x. \quad (4.11)$$

Show that ψ has a finite discontinuity at $t = 1$:

$$\psi(x, 1) = \begin{cases} e^{ix^2/2} (\pi/2i)^{1/2} & \text{if } |x| < 1, \\ 0 & \text{if } |x| > 1. \end{cases} \quad (4.12)$$

² A. Erdélyi, W. Magnus, F. Oberhettinger, and F. G. Tricomi, *Tables of Integral Transforms*, McGraw-Hill, New York (1954) Vol. I, p. 11, Eq. (7).

Separability³

A Hilbert space is *separable* if there exists a *countable* set of vectors $\{e_m\}$ such that any $v \in H$ can be written as in Eq. (3.6),

$$v = \sum v_m e_m, \quad m = 1, 2, \dots, \infty, \tag{4.13}$$

with $\langle e_m, e_n \rangle = \delta_{mn}$, and $\sum |v_m|^2$ finite. This way of writing v as a discrete sum does not preclude the possibility of representing it by means of a function of a continuous variable, such as $v(x)$. As a simple example of a relationship between a discrete basis and a representation by continuous variables, let H consist of all the square integrable functions $v(x)$ on the segment $0 \leq x \leq 2\pi$, with scalar product defined by

$$\langle u, v \rangle = \int_0^{2\pi} \overline{u(x)} v(x) dx. \tag{4.14}$$

Dirichlet's theorem asserts that any $v(x)$ having at most a finite number of maxima, minima, and discontinuities, can be represented, except at isolated points, by a Fourier series

$$v(x) = (2\pi)^{-1/2} \sum_m v_m e^{imx}, \tag{4.15}$$

where

$$v_m = (2\pi)^{-1/2} \int_0^{2\pi} e^{-imx} v(x) dx. \tag{4.16}$$

That is, the function $v(x)$ contains the same information as a *countable* set of Fourier coefficients. Note that $\|v\|^2 \equiv \langle v, v \rangle = \sum_m |v_m|^2$.

If you want a counterexample, a set of functions that do *not* satisfy Dirichlet's conditions is $f(x) = x^2 \sin(a/x)$. These functions are everywhere continuous and differentiable, but they have infinitely many maxima and minima near $x = 0$. Therefore, these $f(x)$ cannot be represented, as in Eq. (4.15), by a countable orthonormal basis, independent of the parameter a .

Nonseparable Hilbert spaces involve mathematical intricacies well beyond the scope of this book. I mentioned them because the quantization of *fields* (that is, of classical dynamical systems with a countable infinity of degrees of freedom) inexorably leads to nonseparable Hilbert spaces.⁴ It also leads to *superselection rules* which restrict the validity of the superposition principle. Fortunately, ordinary quantum mechanics requires only a separable Hilbert space. It may involve discontinuous wave functions, but not "pathological" ones.

³The word "separability" here has a meaning completely different from the "separability" that will be discussed in Chapter 6.

⁴G. Barton, *Introduction to Advanced Field Theory* (Interscience, New York, 1963), Chapt. 13.

4-2. Linear operators

Next, consider infinite dimensional matrices, which map vectors into vectors. As before, I shall mention only the most important new features which result from the infinite dimensionality. It will be no surprise to encounter again convergence problems.

For example, the innocent looking matrix

$$A_{mn} = \delta_{1m} + \delta_{1n}, \quad (4.17)$$

gives, when we expand $v = Au$,

$$v_1 = \sum_n A_{1n} u_n = u_1 + \sum_n u_n, \quad (4.18)$$

and

$$v_m = u_1, \quad (m \neq 1). \quad (4.19)$$

The expression $\sum u_n$ which appears in (4.18) may diverge, even if $\sum |u_n|^2$ is finite (e.g., $u_n = 1/n$). Therefore Au is not defined for every vector u . Moreover, even if $\sum u_n$ is finite, so that v_1 in (4.18) has a meaning, v itself is not an element of Hilbert space, because $\sum |v_m|^2$ diverges (unless $u_1 = 0$).

Exercise 4.4 Show that if A is defined as above, A^2 does not exist.

These convergence problems lead to the notion of *domain of definition* of an operator A : this is a set of elements $u \in H$, such that $v = Au$ also is an element of H . The domain of definition of an operator A can be the entire Hilbert space if, and only if, $\|Au\|$ is bounded, for any normalized u . The *norm* $\|A\|$ of a bounded linear operator is defined by

$$\|A\| = \sup (\|Au\| / \|u\|), \quad (u \neq 0). \quad (4.20)$$

Exercise 4.5 Show that any unitary operator satisfies $\|U\| = 1$.

Exercise 4.6 Show that, for a bounded operator A , and normalized vectors u and v ,

$$|\langle Au, Av \rangle| \leq \|A\|^2 \quad \text{and} \quad |\langle u, Av \rangle|^2 \leq \|A\|^2. \quad (4.21)$$

Local and quasilocal operators

When we use continuous indices, an expression such as $v = Au$ becomes

$$v(x) = \int A(x, y) u(y) dy. \quad (4.22)$$

The analog of a diagonal matrix, $A_{mn} = a_m \delta_{mn}$, becomes

$$A(x, y) = a(x) \delta(x - y), \tag{4.23}$$

where $\delta(x - y)$ is Dirac's delta function, defined for any continuous f by

$$f(x) \equiv \int_{y_1 < x}^{y_2 > x} \delta(x - y) f(y) dy. \tag{4.24}$$

Intuitively, a delta function $\delta(z)$ has an exceedingly high and narrow peak at $z = 0$, satisfying $\int \delta(z) dz = 1$. Actually, its structure may be much more complicated. These generalized functions, called *distributions*, are discussed in an appendix at the end of this chapter.

If Eq. (4.23) holds, Eq. (4.22) becomes $v(x) = a(x)u(x)$. In that case, the operator A is *local*, in the x basis: its meaning simply is multiplication by the function $a(x)$. That function is called the x representation of A .

Likewise, one can define a *quasilocal operator* as the continuous analog of a band matrix $B_{mn} = b_m (\delta_{m,n+1} - \delta_{m,n-1})$. Instead of (4.23), we have

$$B(x, y) = b(x) \delta'(x - y). \tag{4.25}$$

Integration by parts then gives

$$v(x) = \int b(x) \delta'(x - y) u(y) dy = b(x) u'(x). \tag{4.26}$$

This means that the x representation of the observable B is the differential operator $b(x)d/dx$. Higher derivatives of the delta function likewise correspond to higher order differential operators.

These operators are unbounded, even if they are restricted to act only on continuous and differentiable functions. For example, let H consist of all the square integrable functions $v(x)$, on the segment $0 \leq x \leq 2\pi$, with scalar product defined by (4.14). A convenient basis is the set $w_m(x) = e^{imx}/\sqrt{2\pi}$. Equations (4.15) and (4.16) show that this set is complete, if m runs over all the integers from $-\infty$ to ∞ . Now let $A := -i\partial/\partial x$, so that $A w_m = m w_m$. Then $\|A w_m\|^2 = m^2$ is finite for every m . However the sequence $\|A w_m\|^2$ is unbounded, and therefore the operator A is unbounded too.

As a further example, consider the function $\psi = e^{-ix^2/2} x^{-1} \sin x$, with $-\infty < x < \infty$, which appeared in Exercise 4.3. This function is continuous and differentiable. Nevertheless, it does not belong to the domain of definition of $-i\partial/\partial x$, because its derivative is not square integrable. Therefore the free particle Schrödinger equation (4.5) is, strictly speaking, meaningless in this case. However, the equivalent integral equation (4.6) causes no difficulty: Even if H is unbounded, the unitary operator $U = e^{-iHt}$ has unit norm, and its domain of definition is the entire Hilbert space. This unitary evolution operator is therefore more fundamental than the Hermitian operator H .

Further definitions

The product of a linear operator by a number c is defined by $(cA)v = c(Av)$; the sum $A + B$ of two linear operators, by $(A + B)v = Av + Bv$; and their product AB by $(AB)v = A(Bv)$. Note that cA , $A + B$, and AB , also are linear operators. The domain of definition of cA is the same as that of A . The domain of definition of $A + B$ is defined as the *intersection* of those of A and B . The domain of definition of AB consists of the vectors v for which the expression Bv is defined and belongs to the domain of A . It is sometimes possible to extend these domains, in a natural way, beyond the minimal boundaries guaranteed by the preceding definitions.

Obviously, ordinary numbers are a trivial case of bounded linear operators. Therefore I shall often make no distinction between the number 1 and the unit operator $\mathbf{1}$. The null operator $\mathbf{0}$ is defined by the property $\mathbf{0}u = \mathbf{0}$, for every vector u . Some elementary lemmas, which will be useful in the sequel, are listed in the following exercises:

Exercise 4.7 If $\langle u, v \rangle = 0$ for every v , then $u = \mathbf{0}$. **Hint:** Let $v = u$.

Exercise 4.8 If $\langle Au, v \rangle = 0$ for every u and v , it follows that $A = \mathbf{0}$.

Exercise 4.9 Show that if $\langle Av, v \rangle = 0$ for every v , then $A = \mathbf{0}$.

Exercise 4.10 Show that if A is bounded, $\|cA\| = |c| \|A\|$.

Exercise 4.11 Show that, for any two bounded operators A and B ,

$$\|A + B\| \leq \|A\| + \|B\| \quad \text{and} \quad \|AB\| \leq \|A\| \|B\|. \quad (4.27)$$

Adjoint operator

Let an operator A be defined over a *dense set*⁵ of vectors v in Hilbert space. The *adjoint operator*, A^* , is then defined by the relation

$$\langle A^*u, v \rangle = \langle u, Av \rangle. \quad (4.28)$$

This equation determines A^* uniquely, if u also belongs to a dense set. Indeed, if (4.28) has two solutions, A_1^* and A_2^* these satisfy $\langle (A_1^* - A_2^*)u, v \rangle = 0$, whence it follows that $A_1^* - A_2^* = \mathbf{0}$ (this is proved by extending the result of Exercise 4.8 to dense sets). However, there is in general no guarantee that the domain of A^* is dense (possibly, it may contain only the element $\mathbf{0}$).⁶

An operator satisfying $A^* = A$ is called *self-adjoint*. Note that the equality $A^* = A$ implies that both operators have the *same domain of definition*. It is

⁵ A set of vectors is *dense* if every vector in H can be approximated arbitrarily well by some element of that set.

⁶ F. Riesz and B. Sz.-Nagy, *Functional Analysis*, Ungar, New York (1955) pp. 300, 305.

not enough if they act in the same way on the common part of their domains of definition. This requirement is essential, as the following example shows.

Consider again the Hilbert space consisting of square integrable functions on the segment $0 \leq x \leq 2\pi$, with scalar product given by (4.14). An operator $A = -id/dx$ is defined over all the differentiable functions $v(x)$. We shall see that its adjoint A^* is also written $-id/dx$, but A^* has a smaller domain: It is defined only over differentiable functions $u(x)$ which satisfy the boundary condition $u(0) = u(2\pi) = 0$. Indeed, we have

$$\langle u, Av \rangle - \langle A^*u, v \rangle = -i \int_0^{2\pi} [\overline{u(x)} v'(x) + \overline{u'(x)} v(x)] dx, \tag{4.29}$$

$$= -i [\overline{u(2\pi)} v(2\pi) - \overline{u(0)} v(0)], \tag{4.30}$$

and since $v(0)$ and $v(2\pi)$ are arbitrary, the above expression will vanish if, and only if, the function $u(x)$ satisfies $u(0) = u(2\pi) = 0$. Thus, in this example, the domain of A^* (which acts on u) is smaller than that of A (which acts on v). This is written as

$$A \supset A^* \quad \text{or} \quad A^* \subset A, \tag{4.31}$$

and we say that A is an *extension* of A^* , or that A^* is a *restriction* of A . Note that both operators coincide in the common part of their domain of definition.

Closure

An operator A , with domain D_A , is called *closed* if every sequence $v_n \in D_A$ has a limit v which also belongs to D_A , and moreover the sequence Av_n has a limit, which is Av . Even if A is not closed, its adjoint A^* , defined by Eq. (4.28), is always closed, because the scalar product is a continuous function of its arguments. It can be proved⁶ that if A is closed and D_A is dense in H , the domain of A^* is also dense in H , and moreover $A^{**} = A$.

Symmetric operators and self-adjoint extensions

An operator satisfying $\langle u, Bv \rangle = \langle Bu, v \rangle$ in a dense domain of H , is called *symmetric* (another way of saying that is $B \subseteq B^*$). For example, in Eq. (4.29), A^* is symmetric, but A is not. In the physics literature, the term ‘‘Hermitian’’ is often indiscriminately used for either self-adjoint or symmetric.

Exercise 4.12 Prove that, if $A, B, A + B$, and AB , have dense domains,

$$(AB)^* \supseteq B^* A^* \quad \text{and} \quad (\alpha A + \beta B)^* \supseteq \bar{\alpha} A^* + \bar{\beta} B^* \tag{4.32}$$

Also, prove that $(\alpha A)^* = \bar{\alpha} A^*$, for any complex number α . ★

It is sometimes possible to extend the domain of definition of a symmetric operator, so as to make it self-adjoint. A symmetric operator may even have an infinity of *different* self-adjoint extensions. For example, let us define a family of operators $A_\alpha = -id/dx$, whose domains of definition consist of the differentiable functions $v(x)$ which satisfy

$$v(2\pi) = e^{2\pi i\alpha} v(0), \quad (4.33)$$

with $0 \leq \alpha < 1$. All these differential operators are written $-id/dx$ and “look the same,” but actually they are quite different, because their domains of definition are different (they do not even overlap). For each one of these operators, it follows from (4.29) that the adjoint operator A_α^* is again $-id/dx$. Now, however, the domain of definition of A_α^* is the same as that of A_α , because the right hand side of (4.30) vanishes if the boundary condition

$$\overline{u(2\pi)} = e^{-2\pi i\alpha} \overline{u(0)}, \quad (4.34)$$

holds, as well as Eq. (4.33). Therefore $A_\alpha^* = A_\alpha$. These A_α^* are self-adjoint extensions of the symmetric operator A^* which was defined in Eq. (4.29). Each value of α generates a different extension, which represents a *different physical observable*. The difference is clearly seen in the spectra of the various A_α , given by the eigenvalue equation $A_\alpha v = \lambda v$. The latter is, explicitly, $-i dv/dx = \lambda v$, with the boundary condition (4.33). The solutions are $v(x) = e^{i(m+\alpha)x}$, where m is an integer. Therefore the eigenvalues (that is, the observable values) of A_α are $m + \alpha$, and they are different for each α .

Aharonov-Bohm effect

Differential operators like A_α can be given a simple physical interpretation. Consider an infinitely long and narrow solenoid,⁷ carrying a magnetic flux Φ . There is no magnetic field \mathbf{B} outside the solenoid, but nevertheless there must be a magnetic vector potential \mathbf{A} , whose line integral around the solenoid satisfies $\oint \mathbf{A} \cdot d\mathbf{r} = \Phi$. For example, if we take cylindrical coordinates r, θ, z , with the z axis along the solenoid, and if the gauge is appropriately chosen, the vector \mathbf{A} has only an azimuthal component $\Phi/2\pi r$ (note that the flux Φ is gauge invariant). A free particle of mass m and charge q , moving in the region outside the solenoid, is classically described by a Hamiltonian

$$H = \frac{1}{2m} \left(\mathbf{p} - \frac{q}{c} \mathbf{A} \right)^2 = \frac{1}{2m} \left[p_r^2 + \frac{1}{r^2} \left(p_\theta - \frac{q\Phi}{2\pi c} \right)^2 + p_z^2 \right]. \quad (4.35)$$

The classical canonical transformation, $p_\theta \rightarrow p_\theta + q\Phi/2\pi c$, can then completely eliminate the flux term from (4.35), so that the solenoid does not influence the motion of charges outside it. This is the expected classical result, since there is no magnetic field outside the solenoid.

⁷ Y. Aharonov and D. Bohm, *Phys. Rev.* 115 (1959) 485.

In quantum mechanics (where p_θ becomes $-i\hbar\partial/\partial\theta$), there is likewise a unitary transformation, similar to the above canonical transformation, which eliminates Φ from Schrödinger's equation. That transformation is

$$\psi = e^{iq\Phi\theta/2\pi\hbar c} \chi, \quad (4.36)$$

giving

$$\left(-i\hbar\frac{\partial}{\partial\theta} - \frac{q\Phi}{2\pi c}\right)\psi = e^{iq\Phi\theta/2\pi\hbar c} \left(-i\hbar\frac{\partial}{\partial\theta}\right)\chi. \quad (4.37)$$

The Schrödinger equation, when written in terms of χ , then looks exactly like that of a free particle—the flux Φ nowhere appears in it—but, on the other hand, the new wave function χ must satisfy a boundary condition

$$\chi(2\pi) = e^{-iq\Phi/\hbar c} \chi(0), \quad (4.38)$$

instead of simply $\psi(2\pi) = \psi(0)$. It is the *boundary condition* which depends on the external parameter Φ , and gives it physical relevance. In a practical problem, such as a scattering experiment in the region encircling the solenoid, we can *either* work with ψ and the expressions on the left hand side of (4.37), *or* with χ , given by (4.36). In the later case, the presence of the solenoid is taken into account by the boundary condition (4.38), rather than by the wave equation itself. These two alternative ways of representing the physical situation are completely equivalent.

Radial momentum

Not every symmetric operator has a self-adjoint extension. For example, let $\mathbf{p}_r = -i\hbar/dr$ be defined over differentiable and square integrable functions $v(r)$, in the domain $0 \leq r < \infty$, with $v(\infty) = 0$, and inner product

$$\langle \mathbf{u}, \mathbf{v} \rangle = \int_0^\infty \overline{u(r)} v(r) dr. \quad (4.39)$$

A calculation similar to Eq. (4.29) shows that \mathbf{p}_r is symmetric if its domain is restricted by the boundary condition $v(0) = 0$. Then, the domain of \mathbf{p}_r^* need *not* be restricted by $u(0) = 0$. It can be proved that no adjustment similar to Eqs. (4.33) and (4.34) can make the domains of \mathbf{p}_r and \mathbf{p}_r^* coincide.

4.3. Commutators and uncertainty relations

The formal derivation of the quantum uncertainty relations provides instructive examples of the importance of correctly specifying the domains of definition of unbounded operators. However, before we discuss these mathematical issues, it is desirable to clarify the physical meaning of these so-called “uncertainties.”

Classical measurement theory tacitly assumes that physical quantities have objective, albeit unknown, numerical values. Measurement errors are caused by imperfections of the experimental equipment, not to mention those of the observers themselves. Thus, if we repeatedly measure the same physical quantity, such as the length or the weight of a macroscopic object, the resulting values are scattered around some average. The most common and naive approach to data analysis simply is to proclaim this average as the “best” value that was obtained for the physical quantity.

In general, there are many independent sources of instrumental errors. If these errors have finite first and second moments, the central limit theorem⁸ asserts that unbiased experimental values have a Gaussian distribution. A convenient estimate of the uncertainty of a variable X is the standard deviation $\Delta X = (\langle X^2 \rangle - \langle X \rangle^2)^{1/2}$, divided by the square root of the number of experimental data. This uncertainty is usually listed, with a \pm sign, after the “best” value, to indicate the expected accuracy of the latter. For example, the solar luminosity recorded for the year 1990 was $L_{\odot} = (3.826 \pm 0.008) \times 10^{26}$ watts.

In quantum physics too, there are instrumental errors, which, if due to many independent causes, are Gaussian distributed. However, even if we could have perfectly reliable instruments, the results of identical quantum tests, following identical preparations, would not, in general, be identical. For example, if an atomic beam of spin $\frac{1}{2}$ particles, polarized in the z direction, is sent through a Stern-Gerlach magnet oriented along the x direction, the resulting distribution of the observed magnetic moments μ_x may appear as in Fig. 4.1.

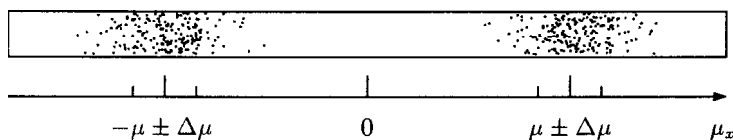

Fig. 4.1. Simulated scatter plot of a Stern-Gerlach experiment (each cluster contains 200 impact points, produced by a random number generator).

A naive application of the “best value” formalism would then yield $\langle \mu_x \rangle \simeq 0$, and give no useful information on the intrinsic magnetic moment of the atoms studied in the experiment. Moreover, the standard deviation from this “best value,” namely $\Delta \mu_x \simeq \langle \mu_x^2 \rangle^{1/2} \simeq \mu$, is not at all the result of instrumental errors. The correct interpretation of the data shown in Fig. 4.1 is that μ_x can take two values, μ or $-\mu$. Each one of the two clusters of impact points must be treated *separately*. The distance between the centers of the two clusters is not due to an instrumental deficiency, but is a genuine, unavoidable quantum effect. It is the spread of points within *each* cluster which is related to experimental imperfections, such as a poor collimation of the atomic beam. The actual

⁸W. Feller, *An Introduction to Probability Theory and Its Applications*, Wiley, New York (1968) Vol. I, p. 244.

uncertainty of the value of μ is given by the width of *each* cluster, divided by the square root of the number of its points.

There are many other instances where a standard deviation is *not* the same thing as an instrumental uncertainty. For example, in a table of elementary particle properties, the $\phi(1020)$ meson is listed as follows:⁹

$$\text{Mass } m = 1019.413 \pm 0.008 \text{ MeV,}$$

$$\text{Full width } \Gamma = 4.43 \pm 0.06 \text{ MeV.}$$

Obviously, Γ , the full width of the mass distribution, is much larger than the mass uncertainty (0.008 MeV). These are two essentially different notions. The mass uncertainty could be reduced by performing more experiments, in order to improve the statistics. The full width Γ is a physical constant which cannot be reduced by performing more experiments—it is only its uncertainty (0.06 MeV) which can be reduced.

Although the standard deviation, $\Delta X = (\langle X^2 \rangle - \langle X \rangle^2)^{1/2}$, cannot in general be a good indicator of the nonuniformity of the results of quantum measurements, the mathematical simplicity of this expression has nevertheless led to its widespread use. The familiar relation¹⁰

$$\Delta A \Delta B \geq \frac{1}{2} |\langle AB - BA \rangle|, \quad (4.40)$$

links the traditional measure of uncertainty (the standard deviation) with the novel feature brought by quantum mechanics (noncommutativity). However, the situation is more complicated than it appears: Eq. (4.40) cannot be valid in general. Let us carefully follow its derivation.

From the Schwarz inequality (3.18), we have

$$\|Au\|^2 \|Bu\|^2 \geq |\langle Au, Bu \rangle|^2, \quad (4.41)$$

where it was assumed that u belongs to the domains of A and of B . The equality sign in (4.41) holds if, and only if, the vectors Au and Bu are parallel. Furthermore, from the definition of the adjoint of an operator, Eq. (4.28), we have

$$\langle Au, Bu \rangle = \langle u, A^*B u \rangle, \quad (4.42)$$

$$= \frac{1}{2} \langle u, (A^*B + B^*A) u \rangle + \frac{1}{2} \langle u, (A^*B - B^*A) u \rangle. \quad (4.43)$$

Note that both $A^*B + B^*A$ and $i(A^*B - B^*A)$ are self-adjoint, or at least symmetric operators in some dense domain. Therefore the first term in (4.43) is real, and the second one is imaginary. It follows that

$$|\langle Au, Bu \rangle|^2 = \frac{1}{4} |\langle A^*B + B^*A \rangle|^2 + \frac{1}{4} |\langle A^*B - B^*A \rangle|^2. \quad (4.44)$$

Moreover, in Eq. (4.41),

⁹Review of Particle Properties, *Phys. Rev. D* 45 (1992) VII.22.

¹⁰H. P. Robertson, *Phys. Rev.* 34 (1929) 163.

$$\|A\mathbf{u}\|^2 = \langle A\mathbf{u}, A\mathbf{u} \rangle = \langle \mathbf{u}, A^*A\mathbf{u} \rangle = \langle A^*A \rangle. \quad (4.45)$$

Combining all these results, we obtain

$$\langle A^*A \rangle \langle B^*B \rangle \geq \frac{1}{4} |\langle A^*B + B^*A \rangle|^2 + \frac{1}{4} |\langle A^*B - B^*A \rangle|^2. \quad (4.46)$$

Exercise 4.13 Show that

$$\langle A^*A + AA^* \rangle \langle B^*B + BB^* \rangle \geq |\langle A^*B \pm BA^* \rangle|^2. \quad (4.47)$$

Hint: The expression $\langle A^*B \rangle = \overline{\langle BA^* \rangle}$ behaves like a scalar product $\langle A, B \rangle$, and in particular it satisfies a Schwarz inequality.¹¹ *

In quantum theory, we are mostly interested in the case where A and B are self-adjoint operators, and (4.46) becomes

$$\langle A^2 \rangle \langle B^2 \rangle \geq \frac{1}{4} |\langle AB + BA \rangle|^2 + \frac{1}{4} |\langle AB - BA \rangle|^2. \quad (4.48)$$

This equation remains valid if A is replaced by $(A - a)$, where a is any number, in particular $a = \langle A \rangle$. We then have

$$\langle (A - \langle A \rangle)^2 \rangle = \langle A^2 \rangle - \langle A \rangle^2 = (\Delta A)^2, \quad (4.49)$$

and likewise for ΔB . The uncertainty relation (4.40) readily follows. Let us now examine the conditions for attaining the equality sign in (4.40): the vectors $(A - \langle A \rangle)\mathbf{u}$ and $(B - \langle B \rangle)\mathbf{u}$ must be parallel and, moreover, the real contribution to (4.43) must vanish. The second requirement can be written as

$$\langle (A - \langle A \rangle)\mathbf{u}, (B - \langle B \rangle)\mathbf{u} \rangle + \langle (B - \langle B \rangle)\mathbf{u}, (A - \langle A \rangle)\mathbf{u} \rangle = 0. \quad (4.50)$$

It follows that, in the condition for parallelism,

$$\alpha(A - \langle A \rangle)\mathbf{u} + \beta(B - \langle B \rangle)\mathbf{u} = 0, \quad (4.51)$$

the ratio α/β is pure imaginary.

Now, for all the foregoing mathematical manipulations to make sense, the state vector \mathbf{u} must belong not only to the domains of A and B , as in Eq. (4.41), but also to those of A^*B , and B^*A , and A^*A , and B^*B . Any vector \mathbf{u} lying outside one of these domains (which may not even overlap!) may cause a violation of the uncertainty relation (4.40).

Let us examine some examples. The simplest case is that of a Cartesian coordinate x and its conjugate momentum. In the x representation, these operators are x and $p = -i\hbar d/dx$, respectively. Their commutator is

$$[x, p] = i\hbar \quad (4.52)$$

¹¹L. Pitaevskii and S. Stringari, *J. Low Temp. Phys.* 85 (1991) 377.

Both operators are self-adjoint if the inner product of two vectors is

$$\langle \mathbf{u}, \mathbf{v} \rangle = \int_{-\infty}^{\infty} \overline{u(x)} v(x) dx. \quad (4.53)$$

We then obtain the standard uncertainty relation

$$\Delta x \Delta p \geq \hbar/2. \quad (4.54)$$

Now, since both x and p are unbounded operators, there are functions lying outside their domains of definition. For example, you may easily verify that the function $(\sin x^2)/x$, which is square integrable, belongs neither to the domain of x , nor to that of p . For such a function, both Δx and Δp are infinite, and Eq. (4.54) is trivially satisfied—if it has any meaning.

Exercise 4.14 Show that the equality sign in (4.54) is attained only for

$$\psi(x) = C e^{-ax^2 - bx}, \quad (4.55)$$

where a is real and positive, and b may be complex. Compute explicitly the normalization constant C , and the values of $\langle x \rangle$ and $\langle p \rangle$ for this “minimum uncertainty wave packet.” Hint: ψ must satisfy $(p - \langle p \rangle)\psi = im\omega(x - \langle x \rangle)\psi$, where $m\omega$ is a real constant with the dimensions of mass/time.

An uncertainty relation such as (4.54) is not a statement about the accuracy of our measuring instruments. On the contrary, its derivation assumes the existence of *perfect* instruments (the experimental errors due to common laboratory hardware are usually much larger than these quantum uncertainties). The only correct interpretation of (4.54) is the following: If the *same* preparation procedure is repeated many times, and is followed either by a measurement of x , or by a measurement of p , the various results obtained for x and for p have standard deviations, Δx and Δp , whose product cannot be less than $\hbar/2$. There never is any question here that a measurement of x “disturbs” the value of p and vice-versa, as sometimes claimed. These measurements are indeed incompatible, but they are performed on *different* particles (all of which were identically prepared) and therefore these measurements cannot disturb each other in any way. The uncertainty relation (4.54), or more generally (4.40), only reflects the intrinsic randomness of the outcomes of quantum tests.

Consider now an angular variable θ , with a range of values $0 \leq \theta \leq 2\pi$, and the conjugate momentum $p_\theta = -i\hbar d/d\theta$. Both are self-adjoint operators if the scalar product is defined as in Eq. (4.14), and the domain of p_θ is restricted to differentiable functions which satisfy $v(2\pi) = v(0)$. Shall we then have an uncertainty relation

$$\Delta\theta \Delta p_\theta \geq \hbar/2? \quad (4.56)$$

This equation is obviously wrong. It is violated by all the eigenfunctions of p_θ , namely $u_m(\theta) = (2\pi)^{-1/2} e^{im\theta}$, which trivially satisfy $\Delta p_\theta = 0$, while their $\Delta\theta$ is about 1.8 (see next Exercise). It is not difficult to find the error. The eigenfunctions $u_m(\theta)$ do not belong to the domain of the product $p_\theta \theta$, because $\theta u_m(\theta)$ does not satisfy the periodicity condition $v(2\pi) = v(0)$, and therefore does not belong to the domain of p_θ .

Exercise 4.15 Show that any eigenfunction of p_θ gives $\Delta\theta = \pi/\sqrt{3}$.

Exercise 4.16 Find three textbooks on quantum mechanics with the wrong uncertainty relation (4.56), and one with the correct version. *

Exercise 4.17 Find three other textbooks with the uncertainty relation $\Delta t \Delta E \geq \hbar/2$ (or $\geq \hbar$). Read carefully how each one of them explains the meaning of this expression. This cannot be a special case of Eq. (4.40). The time t is not an operator (in classical mechanics, it is not a dynamical variable) so that Δt cannot be the standard deviation of the results of measurements of time. (This issue is discussed in Sect. 12-8.) *

Case study: commutator of a product

From the well known identity,

$$[A, BC] \equiv [A, B]C + B[A, C], \quad (4.57)$$

one is tempted to infer that if A commutes with B and C , then A must also commute with the product BC . This conclusion is undoubtedly valid for finite matrices, but it may not be valid in an infinite dimensional Hilbert space, as the following example shows.

Let H consist of square integrable functions of x , with $-\infty \leq x \leq \infty$, and with an inner product given by Eq. (4.53). Let the operators A , B , and C , be given, in the x representation, as follows:

$$A = x/|x|, \quad (4.58)$$

$$B = 1/x, \quad (4.59)$$

$$C = x d/dx. \quad (4.60)$$

Then $AB = BA = 1/|x|$, so that $[A, B] = 0$. Likewise, $AC = |x|d/dx$ and

$$CA = x \left(\frac{d}{dx} \frac{x}{|x|} \right) + |x| \frac{d}{dx}. \quad (4.61)$$

The first term on the right hand side contains the derivative of the discontinuous function $x/|x|$, which is $2\delta(x)$. It is apparently permissible to ignore this term, because $x\delta(x)$ is equal to zero when it multiplies a function $\psi(x)$ which is finite at $x = 0$, or even a function which is *infinite* at the origin, as long as it is

less singular than x^{-1} , for example, $\psi(x) = x^{-0.9}$. Now, any $\psi(x)$ which is square integrable must be less singular than $x^{-1/2}$. Therefore, we can safely write $AC = CA$, when these operators act on functions belonging to H .

Consider now the product $BC = d/dx$. We have

$$[A, BC] = [x/|x|, d/dx] = -2\delta(x), \quad (4.62)$$

and this commutator for sure does not vanish, although A commutes with B and with C separately! Where is the error? A careful check of the foregoing calculations shows that $[A, C] = -2x\delta(x) \neq 0$ was set equal to zero, because $x\delta(x) = 0$ whenever this expression is multiplied by a function belonging to H . But the operator $B = 1/x$, when acting on that function, makes it singular at the origin, and then the resulting product $B[A, C] = -2\delta(x)$ does not vanish.

This example shows the importance of being extremely careful with the domains of definition of unbounded operators. You will find more surprises in the exercises below.

Exercise 4.18 *The scaling operator $D(s)$ is defined by*

$$D(s)\psi(x) = s\psi(s^2x), \quad (4.63)$$

where s is a positive constant. Show that $D(s)$ is a unitary operator, and that it commutes with the sign operator A defined by (4.58). Show moreover that $[A, BD(s)] = 0$, where B is defined by (4.59). *

Exercise 4.19 *From the scaling operator $D(s)$, defined above, one can obtain a new operator,*

$$D'(1) = \lim_{\epsilon \rightarrow 0} \frac{D(1+\epsilon) - D(1)}{\epsilon}. \quad (4.64)$$

Show that $D'(1) = 1 + 2x d/dx = 1 + 2C$, where C is the operator defined by (4.60). Thus, although A commutes with $BD(s)$ for all s , it does not commute with the derivative $BD'(1)$. *

4-4. Truncated Hilbert space

In the preceding chapter, we saw that physical *observables* are represented by Hermitian matrices, according to the following prescription: The eigenvectors of a matrix A form an orthonormal basis, whose elements correspond to the pure states defined by all the possible outcomes of a maximal quantum test; each one of these outcomes corresponds to one of the eigenvalues of A ; that eigenvalue is then said to be the result of a measurement of A , by means of the aforementioned quantum test.

We thus turn our attention to a difficult issue—the *existence* of eigenvalues and eigenvectors of linear operators in a separable Hilbert space H . These operators may be represented by infinite matrices, if H is endowed with a discrete basis, or by differential or integral operators acting on functions of continuous variables, if H is represented by a space of functions. The novel feature here is that, contrary to the case of finite Hermitian matrices, *not every operator has eigenvalues*. For example, consider a Hilbert space consisting of functions of x , defined in the domain $-1 \leq x \leq 1$, and with an inner product

$$\langle \mathbf{u}, \mathbf{v} \rangle = \int_{-1}^1 \overline{u(x)} v(x) dx. \quad (4.65)$$

The linear operator x is perfectly well behaved: it is bounded (its domain of definition is the entire Hilbert space) and it is self-adjoint; but, on the other hand, it has no eigenvalues. Indeed, if we try to solve $x\psi_\xi(x) = \xi\psi_\xi(x)$ to obtain an eigenvalue ξ , we find that $(x - \xi)\psi_\xi(x) = 0$, so that $\psi_\xi(x) = 0$ whenever $x \neq \xi$. You cannot overcome this difficulty by taking, as some authors boldly do, $\psi_\xi(x) = \delta(x - \xi)$, because the delta function is not square integrable, and therefore does not belong to H ; nor can you introduce the square root of a delta function, because there is no such thing (see Exercise 4.2). Other ways must be found to overcome the difficulty.

A possibility worth investigating is the *discretization* of continuous variables, as when we solve numerically a differential equation, or replace an integral by a finite sum. In the present case, we may attempt to replace H by a surrogate, finite dimensional vector space. For example, we may restrict the functions $v(x)$ to be polynomials of degree $\leq N$ (where N is a large integer). We then get a linear space with $N + 1$ dimensions. Truncation methods of this type are commonly used in chemical physics, in order to find the energy levels and transition amplitudes of atomic and molecular systems. They are reasonably successful for Hamiltonians involving smooth anharmonic potentials—which may be good approximations to the true molecular Hamiltonians—because the exact energy eigenfunctions can be closely approximated by linear combinations of a *finite* number of harmonic oscillator eigenfunctions.

Unfortunately, truncation methods fail for operators with continuous spectra (that is, operators lacking a discrete set of eigenvalues). Let us see this in detail for the operator x , defined above. If H is restricted to polynomial functions of degree $\leq N$, a convenient orthonormal basis is the set of normalized Legendre polynomials $u_n(x) = (n + \frac{1}{2})^{1/2} P_n(x)$, with $n = 0, 1, \dots, N$. Everything then seems very simple. The only trouble is that the operator x no longer exists! Indeed $x \check{z}x^N = x^{N+1}$ is outside the truncated Hilbert space.

As an alternative, let us try to *define* an operator equivalent to x by means of its matrix elements. From the identity

$$(2n + 1) x P_n(x) \equiv n P_{n-1}(x) + (n + 1) P_{n+1}(x), \quad (4.66)$$

we obtain

$$(2n+1) \int_{-1}^1 x P_n(x) P_m(x) dx = (n \delta_{n-1,m} + m \delta_{n+1,m}) / (m + \frac{1}{2}), \quad (4.67)$$

whence

$$x_{mn} = \int_{-1}^1 u_m(x) x u_n(x) dx, \quad (4.68)$$

$$= (m \delta_{m,n+1} + n \delta_{n,m+1}) / \sqrt{(2m+1)(2n+1)}. \quad (4.69)$$

This matrix correctly represents the operator x if the indices m and n can run to infinity. Here however, the matrix is *truncated* for m or $n \geq N$. It is this truncation which causes it to have properties different from those of the original operator x . How badly different is it? This can be seen by inspecting the eigenvalues and the eigenfunctions of the operator represented by the band matrix x_{mn} . We first have to solve

$$\sum_n x_{mn} v_n = \xi v_m, \quad (4.70)$$

to find the $N+1$ eigenvalues ξ and the corresponding eigenvectors (this is easily done numerically, since x_{mn} already is in tridiagonal form). Then, for each ξ , we may obtain the x representation of the eigenvector v_n —that is, the eigenfunction $v(x)$ —by

$$v(x) = \sum_n v_n u_n(x) = \sum_n v_n \sqrt{n + \frac{1}{2}} P_n(x). \quad (4.71)$$

The result is shown in Fig. 4.2, for $N = 100$. First, we notice that the eigenvalues are not evenly distributed between -1 and 1 . They are more concentrated toward the extremities. We also see that a typical eigenfunction (the 60th, in this case) has, as intuitively expected, a sharp peak at the corresponding eigenvalue. But it also has fringes all over the domain of x . These fringes are necessary in order to ensure its orthogonality to the other eigenfunctions. Note in particular the overshoot (Gibbs phenomenon) at $x = \pm 1$. These properties are not unexpected. They resemble those of the delta functions which will be discussed in an appendix to this chapter (see Fig. 4.4).

As a further exercise, let us examine the matrix elements of the operator $p = -i\hbar d/dx$. They are

$$p_{mn} = -i\hbar \int_{-1}^1 u_m(x) \frac{du_n(x)}{dx} dx, \quad (4.72)$$

where $u_m(x) = (m + \frac{1}{2})^{1/2} P_m(x)$, as before. Integration by parts gives

$$\int_{-1}^1 P_m(x) P'_n(x) dx = [1 - (-1)^{m+n}] - \int_{-1}^1 P'_m(x) P_n(x) dx, \quad (4.73)$$

because $P_m(\pm 1) = (\pm 1)^m$. The parity and orthogonality properties of Legendre polynomials ensure that the integral on the left hand side vanishes, unless $n = m + 1, m + 3, \dots$; and in that case, it is the integral on the right hand side that must vanish. We therefore obtain

$$p_{mn} = -i\hbar \sqrt{(2m+1)(2n+1)} \quad \text{if } n = m + 1, m + 3, \dots, \quad (4.74)$$

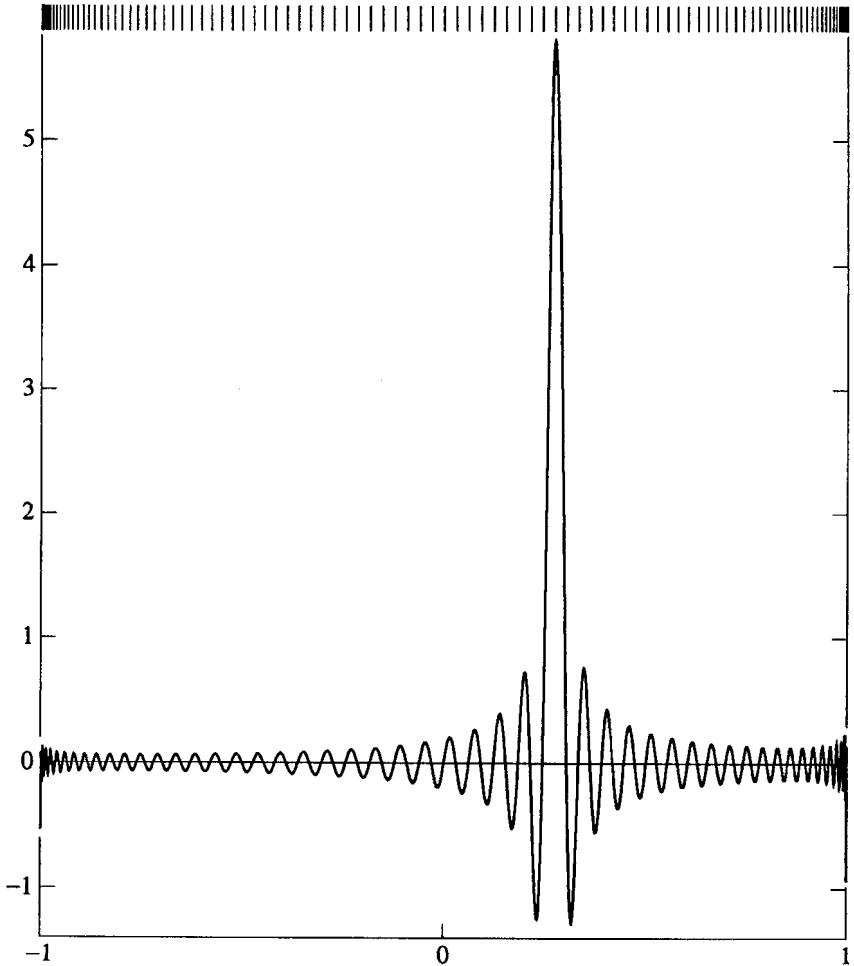

Fig. 4.2. The 101 eigenvalues of the truncated operator x are shown by the bars at the top of the figure. The normalized eigenfunction corresponding to the 60th eigenvalue (which is 0.27497 27848) has a sharp peak there, but is also spread throughout the entire domain of x , from -1 to 1 .

and the other p_{mn} vanish. Obviously, this matrix is not Hermitian. This had to be expected: as we saw earlier, the operator id/dx is not self-adjoint when the domain of x is finite and no boundary conditions are imposed on the wave functions.

Exercise 4.20 Verify that $\sum_s (x_{ms} p_{sn} - p_{ms} x_{sn}) = i\hbar \delta_{mn}$, if the sum is not truncated. What is the result if s runs only from 0 to N ? **

The conclusion to be drawn from this study is that truncation of an infinite dimensional Hilbert space to a finite number of dimensions completely distorts the physical situation. Truncation methods may be justified only for operators with discrete eigenvalues and, moreover, for states that are well represented by linear combinations of a finite number of basis vectors. In all other cases, a radically new approach is needed.

4-5. Spectral theory

The correct mathematical treatment of operators with continuous spectra closely parallels what we actually do, in ordinary life, with mundane tools. For instance, to locate the position of a material object, we take a graduated ruler. We formally consider that physical position as a continuous variable, x . The ruler, however, can only have a finite resolution. An outcome anywhere within its j th interval is said to correspond to the value x_j . Thus, effectively, the result of the position measurement is not the original continuous variable x , but rather a staircase function,

$$x' = f(x) = x_j, \quad \forall \quad x_j \leq x < x_{j+1}. \quad (4.75)$$

This is illustrated in Fig. 4.3.

These considerations are easily transcribed into the quantum language. In the x representation, an operator x' is defined as multiplication by the staircase function $f(x)$. This operator has a finite number of discrete eigenvalues x_j . Each one of these eigenvalues is infinitely degenerate: *any* wave function with support between x_j and x_{j+1} entirely falls within the j th interval of the ruler of Fig. 4.3, and therefore corresponds to the degenerate eigenvalue x_j .

Orthogonal resolution of the identity

An experimental setup for a quantum test described by the above formalism could have, at its final stage, an array of closely packed detectors, labelled by the real numbers x_j . Such a quantum test thus asks, simultaneously, a set of questions "Is $x_j \leq x < x_{j+1}$?" (one question for each j). The answers, "yes" and "no," can be ascribed numerical values 1 and 0, respectively. Each one of these questions therefore corresponds to the measurement of a *projection operator* (or *projector*) P_j , which is itself a function of x :

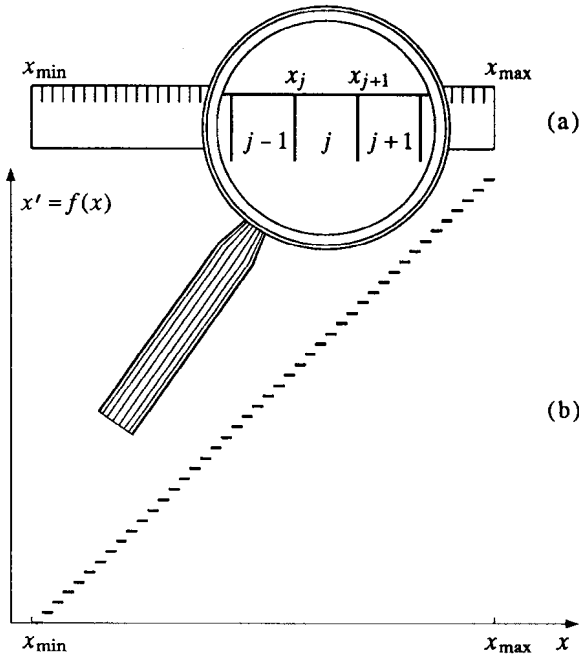

Fig. 4.3. (a) The magnifying glass shows the details of a ruler used to measure the continuous observable x . (b) The result of the measurement is given by the staircase function $f(x)$.

$$P_j(x) = \begin{cases} 1 & \text{if } x_j \leq x < x_{j+1}, \\ 0 & \text{otherwise.} \end{cases} \quad (4.76)$$

These projectors obviously satisfy

$$P_j P_k = \delta_{jk} P_k, \quad (4.77)$$

and

$$\sum_j P_j = 1. \quad (4.78)$$

The staircase operator $x' = f(x)$, defined by Eq. (4.75), can then be written as

$$x' = \sum_j x_j P_j. \quad (4.79)$$

It satisfies

$$\|x' - x\| = \sup(x_{j+1} - x_j), \quad (4.80)$$

so that the operator x' indeed approximates the operator x , as well as allowed by the finite resolution of the ruler in Fig. 4.3.

Exercise 4.21 Prove Eq. (4.80).

How do we proceed to the continuum limit? We could rely on Eq. (4.80), and imagine that we have an infinite sequence of rulers, divided in centimeters, millimeters, and so on, getting arbitrarily close to the abstract notion of a continuous length. However, it is more efficient to proceed as follows.

Let us define a *spectral family* of operators

$$E(x_j) = \sum_{k=0}^{j-1} P_k. \quad (4.81)$$

They obey the recursion relation

$$E(x_{j+1}) = E(x_j) + P_j, \quad (4.82)$$

and the boundary conditions

$$E(x_{\min}) = O \quad \text{and} \quad E(x_{\max}) = \mathbf{1}. \quad (4.83)$$

The physical meaning of the operator $E(x_j)$ is the question “Is $x < x_j$?” with answers yes = 1, and no = 0. As can be seen from Eq. (4.77), these $E(x_j)$ are projectors. They act like a sequence of sieves, satisfying

$$E(x_m)E(x_n) = E(x_n)E(x_m) = \begin{cases} E(x_m) & \text{if } x_m \leq x_n, \\ E(x_n) & \text{if } x_n \leq x_m. \end{cases} \quad (4.84)$$

It is now easy to pass to the continuum limit: We define $E(\xi)$ as the projector which represents the question “Is $x < \xi$?” and which returns, as the answer, a numerical value (yes = 1, no = 0). We can then consider two neighboring values, ξ and $\xi + d\xi$, and define an “infinitesimal” projector,

$$dE(\xi) = E(\xi + d\xi) - E(\xi), \quad (4.85)$$

which represents the question “Is $\xi \leq x < \xi + d\xi$?”. This $dE(\xi)$ thus behaves as an infinitesimal increment P_j in Eq. (4.82). We then have, instead of the staircase approximation (4.79), the exact result

$$x = \int_0^1 \xi dE(\xi). \quad (4.86)$$

Note that the integration limits actually are *operators*, namely $E(x_{\min}) = O$, and $E(x_{\max}) = \mathbf{1}$, in accordance with (4.83).

Equation (4.86) is called the *spectral decomposition*, or *spectral resolution*, of the operator x , and the operators $E(\xi)$ are the *spectral family* (also called *resolution of the identity*) generated by x . We can now define any function of the operator x in a way analogous to Eq. (3.58):

$$f(x) = \int_0^1 f(\xi) dE(\xi). \quad (4.87)$$

The right hand sides of Eqs. (4.86) and (4.87) are called Stieltjes integrals.

Consider now a small increment $d\xi \rightarrow 0$. If the limit $dE(\xi)/d\xi$ exists, the integration step can be taken as the c -number $d\xi$, rather than $dE(\xi)$, which is an operator. We then have an operator valued Riemann integral:

$$\int_0^1 f(\xi) dE(\xi) = \int_{x_{\min}}^{x_{\max}} f(\xi) \frac{dE(\xi)}{d\xi} d\xi. \quad (4.88)$$

It can be shown¹² that any self-adjoint operator generates a *unique* resolution of the identity. A spectral decomposition such as (4.86) applies not only to operators with continuous spectra, but also to those having discrete spectra, or even mixed ones, like the Hamiltonian of the hydrogen atom. For a discrete spectrum, $dE(\xi) = 0$ if ξ lies between consecutive eigenvalues, and $dE(\xi) = P_k$, namely the projector on the k th eigenstate, if the k th eigenvalue lies between ξ and $\xi + d\xi$.

Note that in any case the projector $E(\xi)$ is a bounded operator, which depends on the parameter ξ . It may be a discontinuous function of ξ , but it never is infinite, and we never actually need $dE(\xi)/d\xi$. This is the advantage of the Stieltjes integral over the more familiar Riemann integral: the left hand side of (4.88) is always meaningful, even if the right hand side is not.

Exercise 4.22 Show that, if $f(\xi)$ is a real function, then $f(x)$, defined by Eq. (4.87), is a self-adjoint operator. ★

Exercise 4.23 Show that two operators that have the same spectral family are functions of each other.

Exercise 4.24 Show, directly from Eq. (4.84), that, for a given spectral family $E(\lambda)$,

$$\int f(\xi) dE(\xi) \int g(\eta) dE(\eta) = \int f(\zeta) g(\zeta) dE(\zeta). \quad (4.89)$$

This is an important property, which will be used later. ★

Exercise 4.25 Show that, if $f(\xi)$ is a real function, and x is an operator with the spectral representation (4.86), the expression

$$e^{if(x)} = \int e^{if(\xi)} dE(\xi), \quad (4.90)$$

is a unitary operator. **Hint:** Use the results of the preceding exercises.

¹²M. H. Stone, *Linear Transformations in Hilbert Space*, Amer. Math. Soc., New York (1932) p. 176.

The spectral decomposition of self-adjoint operators allows one to give a rigorous definition of the measurement of a continuous variable. The latter is equivalent to an infinite set of yes-no questions. Each question is represented by a bounded (but infinitely degenerate) projection operator. However, this formal approach is unable to give a meaning to the measurement of operators that are not self-adjoint, such as the radial momentum $-\hbar d/dr$ (with $0 \leq r < \infty$) whose properties were discussed on page 89. Yet, in classical mechanics, p_r is a well defined variable. It thus appears that there can be no strict correspondence between classical mechanics and quantum theory.

4-6. Classification of spectra

Self-adjoint operators may have a discrete spectrum—with well separated eigenvalues and with a *complete* set of normalizable eigenvectors—or a continuous spectrum, or a mixed one. A mixed spectrum may have a finite number of discrete eigenvalues, or even a denumerable infinity of them; typical examples are the bound energy levels of a finite potential well, and those of the hydrogen atom, respectively. In both cases, there is, above the discrete spectrum, a continuous spectrum of unbound states.

Although an operator A with a continuous spectrum has, strictly speaking, no eigenvectors at all, each point λ of that spectrum (that is, each point where $dE(\xi)/d\xi$ exists and is not 0) is “almost an eigenvalue” in the following sense: It is possible to construct states ψ_λ satisfying

$$\|(A - \lambda) \psi_\lambda\| < \epsilon, \tag{4.91}$$

with arbitrarily small positive ϵ . Indeed, let $E(\xi)$ be the spectral family of A . Define a projector

$$P_\lambda = \int_{\lambda-\epsilon}^{\lambda+\epsilon} dE(\xi), \tag{4.92}$$

and let ψ_λ be any eigenstate of P_λ with eigenvalue 1, that is to say,

$$P_\lambda \psi_\lambda = \psi_\lambda. \tag{4.93}$$

Such a ψ_λ is easily constructed by taking any state ϕ for which $P_\lambda \phi \neq 0$. The normalized vector $\psi_\lambda = P_\lambda \phi / \|P_\lambda \phi\|$ will then satisfy (4.93). For example, if $A = x$, the x -representation of ψ_λ is any function $\psi(x)$ with support between $\lambda - \epsilon$ and $\lambda + \epsilon$.

To prove (4.91), we note that, by virtue of (4.89),

$$A \psi_\lambda = A P_\lambda \psi_\lambda = \int_{\lambda-\epsilon}^{\lambda+\epsilon} \xi dE(\xi) \psi_\lambda, \tag{4.94}$$

and we thus have

$$\|(\mathbf{A} - \lambda) \psi_\lambda\|^2 = \left\| \int_{\lambda-\epsilon}^{\lambda+\epsilon} (\xi - \lambda) d\mathbf{E}(\xi) \psi_\lambda \right\|^2, \quad (4.95)$$

$$= \left\langle \psi_\lambda, \int_{\lambda-\epsilon}^{\lambda+\epsilon} (\xi - \lambda)^2 d\mathbf{E}(\xi) \psi_\lambda \right\rangle, \quad (4.96)$$

where (4.89) was used again. The last expression can be transformed into an ordinary integral (that is, into a sum of c -numbers):

$$\int_{\lambda-\epsilon}^{\lambda+\epsilon} (\xi - \lambda)^2 \langle \psi_\lambda, d\mathbf{E}(\xi) \psi_\lambda \rangle \leq \epsilon^2 \int_{\lambda-\epsilon}^{\lambda+\epsilon} \langle \psi_\lambda, d\mathbf{E}(\xi) \psi_\lambda \rangle. \quad (4.97)$$

The integral on the right hand side simply is $\langle \psi_\lambda, f d\mathbf{E}(\xi) \psi_\lambda \rangle = \langle \psi_\lambda, \mathbf{P}_\lambda \psi_\lambda \rangle = 1$. This completes the proof of Eq. (4.91).

More generally, we have

$$\| [f(\mathbf{A}) - f(\lambda)] \psi_\lambda \| = \left\| \int_{\lambda-\epsilon}^{\lambda+\epsilon} [f(\xi) - f(\lambda)] d\mathbf{E}(\xi) \psi_\lambda \right\|. \quad (4.98)$$

If the function f can be expanded into a Taylor series around λ ,

$$f(\xi) = f(\lambda) + (\xi - \lambda) f'(\lambda) + \dots, \quad (4.99)$$

the right hand side of (4.98) becomes

$$\left\| \int_{\lambda-\epsilon}^{\lambda+\epsilon} [(\xi - \lambda) f'(\lambda) + \dots] d\mathbf{E}(\xi) \psi_\lambda \right\| \leq \epsilon |f'(\lambda)| + O(\epsilon^2). \quad (4.100)$$

Therefore, states ψ_λ can be constructed in such a way that, for any smooth function f , the mean value $\langle f(\mathbf{A}) \rangle$ is arbitrarily close to $f(\lambda)$. This is in sharp contrast to the situation prevailing in the *empty* regions between eigenvalues of a *discrete* spectrum: While it is easy to construct superpositions of eigenstates of an operator \mathbf{A} such that, on the average, $\langle \psi, \mathbf{A} \psi \rangle = \mu$ (for any real μ between two discrete eigenvalues), the variance

$$\langle \psi, (\mathbf{A} - \mu)^2 \psi \rangle = \|(\mathbf{A} - \mu) \psi\|^2, \quad (4.101)$$

cannot be made arbitrarily small.

Exercise 4.26 Let λ_m and λ_n be consecutive discrete eigenvalues of \mathbf{A} , and let \mathbf{v}_m and \mathbf{v}_n be the corresponding eigenvectors. Let $\psi = \mathbf{v}_m \cos \theta + \mathbf{v}_n \sin \theta$. Show that θ can be chosen in such a way that $\langle \psi, \mathbf{A} \psi \rangle$ will take any desired value between λ_m and λ_n . What is then the variance $\|(\mathbf{A} - \mu) \psi\|^2$?

Bound states embedded in a continuum

The discrete and continuous parts of a mixed spectrum are not always disjoint. They may also overlap: discrete eigenvalues, which correspond to normalizable eigenvectors, may be embedded in a continuous spectrum (that is, the intervals between these discrete eigenvalues are not empty). For example, consider two hydrogen atoms, far away from each other. Their mutual interaction is negligible. If we also neglect their interaction with the quantized electromagnetic field vacuum, each atom has an infinite number of stable energy levels. The lowest ones are $E_1 = -13.6\text{eV}$ and $E_2 = -3.4\text{eV}$. Each atom also has a continuous spectrum, $E \geq 0$. Therefore the two atoms *together* have, among their discrete eigenvalues, one at $2E_2 = -6.8\text{eV}$, which is *higher* than the threshold of their continuous spectrum, namely $E \geq E_1$.

However, if we take into account the mutual interaction of the two atoms, this discrete eigenvalue (with both atoms in an excited $n = 2$ state) becomes metastable: it actually is a *resonance*. The system will eventually undergo an *autoionization* transition, whereby one of the electrons falls into its $n = 1$ ground state, and the other electron escapes to infinity.

Exercise 4.27 Estimate the mean decay time by autoionization of this H_2 system, as a function of the distance between the atoms. ★★

A similar situation occurs in the Auger effect. An atom can be excited in such a way that an electron from the innermost shell is transferred into a higher, incomplete shell. The result is an eigenstate of the Hamiltonian of the atom,¹³ with all the electrons bound. However, the total energy of that excited atom is compatible with other electronic configurations, where the innermost shell is occupied and one of the electrons is free. The resulting positive ion has, like the neutral atom, discrete energy levels; but, on the other hand, the kinetic energy of the free electron has a continuous spectrum. In this way, discrete energy levels of the neutral atom are embedded in the continuous spectrum of the ion-electron system. Here too, most of these “discrete energy levels” actually are very narrow and long lived resonances, which decay by autoionization. It is only the use of an *approximate* Hamiltonian, where some interactions are neglected, which make these levels appear discrete and stable.

Still another type of spectrum, which at first sight may seem rather bizarre, but which will actually appear in a future application (Sect. 10-5), consists of a *dense* set of *discrete* eigenvalues. As a simple example, consider the Hilbert space of functions $\psi(x, y)$, with $0 \leq x, y < 2\pi$. The scalar product is given by

$$\langle \phi, \psi \rangle = \int_0^{2\pi} \int_0^{2\pi} \overline{\phi(x, y)} \psi(x, y) dx dy. \quad (4.102)$$

¹³The Auger effect is a *nonradiative* rearrangement of the electrons. In the present discussion, the atomic nucleus is assumed fixed, and the Hamiltonian does not include any interaction with the quantized electromagnetic field.

In that space let an operator,

$$A = -i \left(\frac{d}{dx} + \sqrt{2} \frac{d}{dy} \right), \quad (4.103)$$

be defined over the subset of differentiable functions $\psi(x, y)$ which satisfy the boundary conditions

$$\psi(2\pi, y) = \psi(0, y) \quad \text{and} \quad \psi(x, 2\pi) = \psi(x, 0). \quad (4.104)$$

That operator is self-adjoint. Its normalized eigenfunctions are $e^{i(mx+ny)}/2\pi$, corresponding to eigenvalues $m + \sqrt{2}n$, with m and n running over positive and negative integers.

This spectrum looks very simple, but its physical implications are curious. Suppose that a measurement of A yields the result α , with an expected accuracy $\pm\epsilon$. (The estimated error $\pm\epsilon$ is solely due to the finite instrumental resolution, it is *not* a quantum effect.) What can now be said about the corresponding eigenstates (that is, the corresponding quantum numbers m and n)? The latter are obtained from the equation

$$\alpha - \epsilon < m + \sqrt{2}n < \alpha + \epsilon, \quad (4.105)$$

which has, for arbitrarily small positive ϵ , an infinity of solutions m and n .

This is intuitively seen by noting that (4.105) represents a narrow strip in the mn plane. That strip, which has an irrational slope, contains an infinity of points with integral coordinates m and n . The smaller ϵ , the larger the average distance between consecutive values of m and n . While an *exact* measurement of A (for example, $\alpha = 7 - 5\sqrt{2}$, exactly) would yield unambiguous values for m and n , and therefore well defined eigenstates of the commuting operators $-id/dx$ and $-id/dy$, the least inaccuracy ϵ leaves us with an infinite set of widely different m, n pairs.

Finally, one more type of pathological spectrum is worth mentioning: It is a *singular continuous spectrum*, whose support is a Cantor set—an uncountable set which may, but need not, have zero Lebesgue measure. Spectra of this kind may occur for Hamiltonians with an almost periodic potential.¹⁴

4-7. Appendix: Generalized functions

The use of singular δ -functions, originally introduced by Dirac, was criticized by von Neumann, in the preface of his book:¹⁵

¹⁴ J. Avron and B. Simon, *Bull. Am. Math. Soc.* 6 (1982) 81.

¹⁵ J. von Neumann, *Mathematische Grundlagen der Quantenmechanik*, Springer, Berlin (1932); transl.: *Mathematical Foundations of Quantum Mechanics*, Princeton Univ. Press, Princeton (1955).

The method of Dirac, mentioned above, (and this is overlooked today in a great part of quantum mechanical literature, because of the clarity and elegance of the theory) in no way satisfies the requirements of mathematical rigor—not even if these are reduced in a natural and proper fashion to the extent common elsewhere in theoretical physics. For example, the method adheres to the fiction that each self-adjoint operator can be put in diagonal form. In the case of those operators for which this is not actually the case, this requires the introduction of “improper” functions with self-contradictory properties. The insertion of such a mathematical “fiction” is frequently necessary in Dirac’s approach, even though the problem at hand is merely one of calculating numerically the result of a clearly defined experiment. There would be no objection here if these concepts, which cannot be incorporated into the present day framework of analysis, were intrinsically necessary for the physical theory But this is by no means the case It should be emphasized that the correct structure need not consist in a mathematical refinement and explanation of the Dirac method, but rather that it requires a procedure differing from the very beginning, namely, the reliance on the Hilbert theory of operators.

In this chapter, I followed von Neumann’s approach, to give some idea of its flavor. I did not attempt to be mathematically rigorous nor complete; more information can be found in the treatises listed in the bibliography. The purpose of the present appendix is to partly rehabilitate Dirac’s delta functions, and to clarify the conditions under which their use is legitimate.

From the pure mathematician’s point of view, a space whose elements are ordinary functions with regular properties may be embedded in a larger space, whose elements are of a more abstract character. In this larger space, the operations of analysis may be carried out more freely, and the theorems take on a simpler and more elegant form. For example, the theory of *distributions*, developed by Schwartz,¹⁶ is a rigorous version of Dirac’s intuitive delta function formalism.

These distributions can often be obtained as improper limits, that I shall denote by writing “lim” between quotation marks. However, as we shall see, their properties are quite different from those sketched in Dirac’s graphic description:¹⁷

To get a picture of $\delta(x)$, take a function of the real variable x which vanishes everywhere except inside a small domain, of length ϵ say, surrounding the origin $x = 0$, and which is so large inside this domain that its integral over this domain is unity. The exact shape of the function inside this domain does not matter, provided that there are no unnecessarily wild variations (for example, provided that the function is always of order ϵ^{-1}). Then in the limit $\epsilon \rightarrow 0$ this function will go over into $\delta(x)$.

¹⁶L. Schwartz, *Théorie des Distributions*, Hermann, Paris (1950).

¹⁷P. A. M. Dirac, *The Principles of Quantum Mechanics*, Oxford Univ. Press (1947), p. 58.

A simple example will show that things are different from Dirac's intuitive picture. From the properties of Fourier series, Eqs. (4.15) and (4.16), we have

$$v(x) = (2\pi)^{-1} \sum_{m=-\infty}^{\infty} \int_0^{2\pi} e^{im(x-y)} v(y) dy. \quad (4.106)$$

Let us boldly exchange the order of summation. We obtain

$$v(x) = (2\pi)^{-1} \int_0^{2\pi} \left[\sum_{m=-\infty}^{\infty} e^{im(x-y)} \right] v(y) dy, \quad (4.107)$$

whence we infer

$$(2\pi)^{-1} \sum_{m=-\infty}^{\infty} e^{im(x-y)} = \delta(x-y). \quad (4.108)$$

To give a meaning to this infinite sum—when it stands alone, rather than inside an integral as in (4.107)—let us try to consider it as the “limit” of a finite sum, from $-M$ to M , when $M \rightarrow \infty$. This finite sum is a geometric progression which is easily evaluated, with result

$$\frac{1}{2\pi} \sum_{m=-M}^M e^{imz} = \frac{1}{2\pi} \frac{\sin[(2M+1)z/2]}{\sin(z/2)}, \quad (4.109)$$

where z denotes $x-y$, for brevity. For large M , the right hand side is easily seen to have a sharp peak of height M/π at $z = 0$. On each side of the peak, the nearest zeros occur at $z = \pm\pi/M$. Thus, the area of the peak is roughly unity. However, the function (4.109) does not vanish outside that narrow domain. Rather, it rapidly oscillates, with a period $2\pi/M$, and with a *slowly* decreasing amplitude, which is about $1/\pi z$ for $|z| \lesssim 1$. As a consequence of these rapid oscillations, we have, for any smooth function f ,

$$\int_{y_1 < x}^{y_2 > x} \frac{\sin[(2M+1)(x-y)/2]}{2\pi \sin[(x-y)/2]} f(y) dy \simeq f(x). \quad (4.110)$$

This approximation is valid for large M , and for functions f whose variation is much slower than that of the first factor in the integrand of (4.110). Under these conditions, the “limit” of Eq. (4.109) for $M \rightarrow \infty$ satisfies the fundamental property of delta functions:

$$f(x) = \int_{y_1 < x}^{y_2 > x} \delta(x-y) f(y) dy. \quad (4.111)$$

Note that this result is valid only for functions f that are sufficiently smooth in the vicinity of x .

Another example of delta function, showing a different morphology, can be obtained by using the orthogonality and completeness properties of Legendre polynomials, in the domain $-1 \leq x \leq 1$. Formally, we have

$$\sum_{m=0}^{\infty} (2m + 1) P_m(x) P_m(y) = \delta(x - y), \tag{4.112}$$

because, if we multiply this equation by $P_n(y)$ and integrate over y , both sides give the same result, namely $P_n(x)$. As the Legendre polynomials form a complete basis, the same property will hold for any “reasonable” function which can be expanded into a sum of $P_n(x)$. Let us however examine how the “limit” $m \rightarrow \infty$ is attained. We have, from the Christoffel-Darboux formula,¹⁸

$$\sum_{m=0}^n (2m + 1) P_m(x) P_m(y) \equiv (n + 1) [P_{n+1}(x) P_n(y) - P_n(x) P_{n+1}(y)] / (x - y). \tag{4.113}$$

Figure 4.4 show a plot of this expression, as a function of x , for $n = 100$ and $y = \frac{1}{3}$. There is a striking resemblance with Fig. 4.2; even the overshoot (Gibbs phenomenon) at $x = \pm 1$ looks the same. However, the vertical scales in these figures are completely different. The area under the curve in Fig. 4.4 is equal to 1 (see next Exercise). On the other hand, Fig. 4.2 represents a normalized eigenfunction $v(x)$ of the truncated operator x , given by Eq. (4.71), and it is the integral of $|v(x)|^2$ which is equal to 1.

Exercise 4.28 Show that if the left hand side of (4.113) is multiplied by x^k , for any $k \leq n$, and then integrated over x , the result is y^k .

Exercise 4.29 Use the asymptotic expansion of $P_n(x)$ for large n to obtain a simple estimate of the right hand side of (4.113). ★

Exercise 4.30 Show that

$$\text{“lim”}_{\epsilon \rightarrow 0} \frac{1}{x \pm i\epsilon} = \mathcal{P} \frac{1}{x} \mp i\pi\delta(x), \tag{4.114}$$

where \mathcal{P} denotes the principal value. **Hint:** Consider the real and imaginary parts of this equation. ★

We thus see that delta functions (or *tempered distributions*, as they are called in the mathematical literature) can be given rigorous definitions, and are a legitimate computational tool. However, *these are not functions*, in the usual sense of this word, and one must be careful not to misuse them. In particular, they *cannot represent quantum states*, because they are not square integrable, and therefore not members of a Hilbert space; nor can we consistently define the square root of a delta function, as we attempted to do in Exercise 4.2.

An essential property of delta functions is that they can safely be used only when they appear in expressions in which they are multiplied by other, *smooth*

¹⁸I. S. Gradshteyn and I. M. Ryzhik, *Table of Integrals, Series, and Products*, Academic Press, New York (1980) p. 1026.

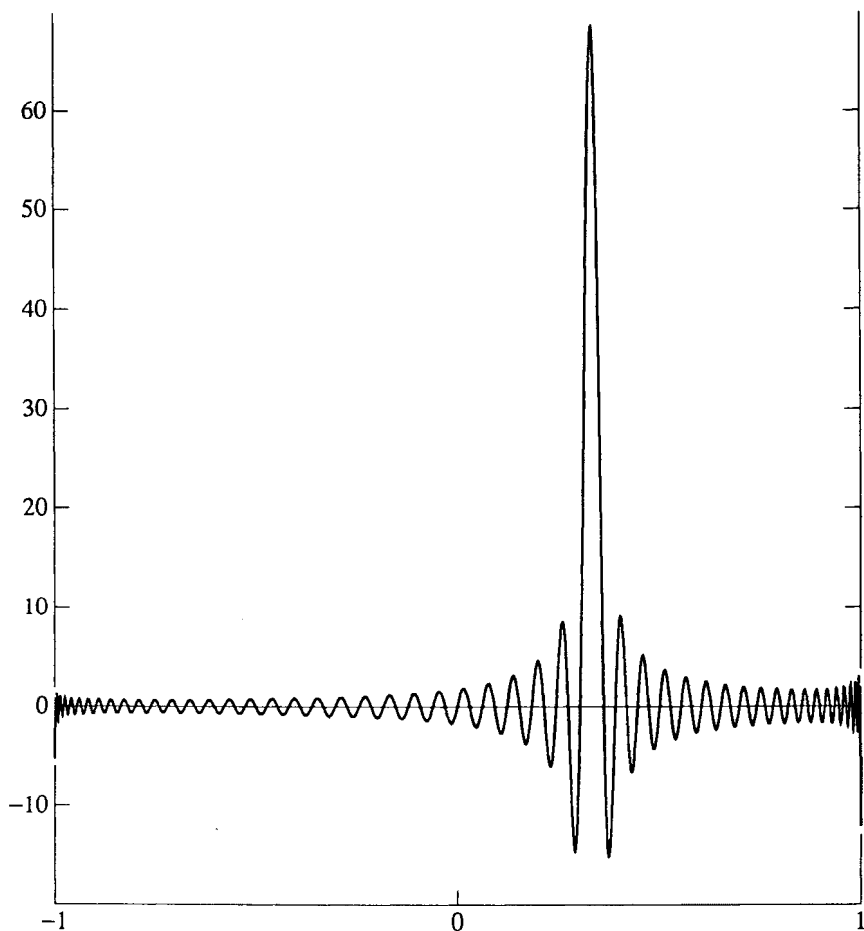

Fig. 4.4. A truncated delta function: The expression in Eq. (4.113) is plotted as a function of x , for $y = \frac{1}{3}$ and $n = 100$.

functions. Only then is the meaning of these expressions unambiguous. In any other case, the result is ill defined.

Quantum fields

However, these other cases do occur—they even play a central role in quantum field theory. The latter is an extension of quantum mechanics, in which the dynamical variables are *fields*, such as $\mathbf{E}(\mathbf{r}, t)$ or $\mathbf{B}(\mathbf{r}, t)$. Here, the symbol \mathbf{r} does *not* represent a dynamical variable; rather, it serves as a continuous index for the set of variables, \mathbf{E} and \mathbf{B} . We thus have an *infinite* number of degrees

of freedom, and this creates new convergence difficulties, over and above those already discussed earlier in this chapter.

As an elementary example, consider the canonical commutation relations,

$$[q_m, p_n] = i\hbar \delta_{mn}. \quad (4.115)$$

Assume that we have an *infinite* set of canonical variables: the indices m and n run over all integers, from $-\infty$ to ∞ . Let us now replace these discrete indices by continuous ones, as we did for Fourier series, in Eqs. (4.15) and (4.16). We thereby produce “field variables”

$$Q(x) = (2\pi)^{-1/2} \sum_{m=-\infty}^{\infty} q_m e^{imx}, \quad (4.116)$$

and

$$P(y) = (2\pi)^{-1/2} \sum_{n=-\infty}^{\infty} p_n e^{-iny}. \quad (4.117)$$

Their commutator is

$$[Q(x), P(y)] = \frac{i\hbar}{2\pi} \sum_{m=-\infty}^{\infty} e^{im(x-y)}, \quad (4.118)$$

and this can be written, by virtue of (4.108), as

$$[Q(x), P(y)] = i\hbar \delta(x - y). \quad (4.119)$$

This singular result shows that the quantum field variables $Q(x)$ and $P(y)$ are not ordinary operators. They were defined by the sums (4.116) and (4.117), and the latter *do not converge*. These quantum field variables are technically known as “operator valued distributions.”

Until now, the singular nature of the commutator (4.119) was only the result of formal definitions, and caused no real difficulty. However, when we extend our considerations to nontrivial problems, involving *interacting* fields, we encounter products of fields *at the same point* of spacetime. For example, there is a term $\gamma^\mu A_\mu(x)\psi(x)$, in the Dirac equation for a charged particle. In the “second quantized” version of that equation, the product of the field operators $A_\mu(x)$ and $\psi(x)$ is ill defined. This gives rise to divergent integrals, if we attempt to obtain a solution by means of an expansion into a series of powers of the coupling constant, $e^2/\hbar c$. In this particular theory—quantum electrodynamics—and also in some other ones, that difficulty can be circumvented by a sophisticated method, called *renormalization*. The latter is, however, beyond the scope of this book.

Exercise 4.31 *In classical field theory too, Poisson brackets between fields are delta functions. Why isn't classical field theory plagued by divergences, like quantum field theory? ★*

4-8. Bibliography

The purpose of this chapter was to highlight some mathematical aspects of quantum theory, which are usually ignored in introductory texts. Only a few selected topics were treated. More complete discussions can be found in the following sources:

T. F. Jordan, *Linear Operators for Quantum Mechanics*, Wiley, New York (1969) [reprinted by Krieger].

This book was specifically written to be a companion to quantum mechanics texts. Its compact presentation clearly shows the logic and simplicity of the mathematical structure of quantum theory. Rigorous proofs are supplied, if they are reasonably short. Long and difficult proofs are replaced by references to more complete treatises, such as

F. Riesz and B. Sz.-Nagy, *Functional Analysis*, Ungar, New York (1955) [reprinted by Dover].

P. Roman, *Some Modern Mathematics for Physicists and Other Outsiders*, Pergamon, New York (1975). Vol. I: Algebra, topology, and measure theory; Vol. II: Functional analysis with applications.

The author, whose previous publications include well known textbooks on particle physics and quantum theory, writes in the preface: “. . . this book may fill the needs of most theoretical physicists (especially of those interested in quantum theory, high energy physics, relativity, modern statistical physics) . . . However, this is a book on mathematics and the student who patiently made his way through it will be able to understand any contemporary mathematical source that is needed to enlarge the knowledge gained from this volume.”

M. Reed and B. Simon, *Methods of Modern Mathematical Physics*, Academic Press, New York. Vol. I: Functional analysis (1980); Vol. II: Fourier analysis, self-adjointness (1975); Vol. III: Scattering theory (1979); Vol. IV: Analysis of operators (1978).

This four volume encyclopedia covers nearly every aspect of mathematics that may be needed by a quantum theorist.

Mathematical paradoxes

C. Zhu and J. R. Klauder, “Classical symptoms of quantum illnesses,” *Am. J. Phys.* 61 (1993) 605.

O. E. Alon, N. Moiseyev and A. Peres, “Infinite matrices may violate the associative law,” *J. Phys. A* 28 (1995) 1765.

Part II

CRYPTODETERMINISM
AND QUANTUM
INSEPARABILITY

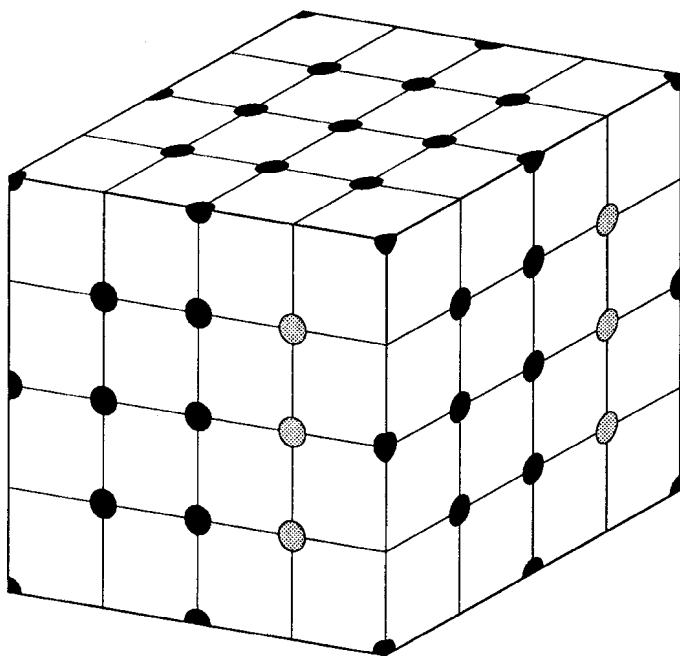

Plate II. The Kochen-Specker theorem, discussed in Chapter 7, is of fundamental importance for quantum theory. Its most “economical” proof makes use of 31 rays, which form 17 orthogonal triads (see Exercise 7.20, page 211). These rays are obtained by connecting the center of the cube to the black dots on its faces and edges (the six gray dots are not used in that proof). This construction should be compared with the cube in Fig. 7.2, on page 198.

Chapter 5

Composite Systems

5-1. Quantum correlations

A composite system is one that includes several quantum objects (for example, a hydrogen atom consists of a proton and an electron). Our problem is to construct a formalism whereby the state of a composite system is expressed in terms of states of its constituents.

The situation is simple if the electron and the proton are widely separated—they may possibly be in different laboratories, where they have been prepared in states u and v , respectively. (This is not, of course, what is commonly called a hydrogen atom.) The vectors u and v belong to different Hilbert spaces. It is possible to represent them by functions $u(\mathbf{r}_e)$ and $v(\mathbf{r}_p)$, where \mathbf{r}_e and \mathbf{r}_p are Cartesian coordinates used to describe the states of the electron and the proton, respectively. However, in order to make our first acquaintance with this problem, it is preferable to use a *discrete* basis, where the components of u and v are u_m and v_ν , with the Hilbert space of electron states labelled by Latin indices, and that of proton states by Greek indices.¹ The state of both particles together can then be represented as a *direct product* (sometimes called “tensor product”) of these two vectors, written as $w = u \otimes v$. The components of w are $w_{m\nu} = u_m v_\nu$. In that expression, one must consider $m\nu$ as a *single* vector index, whose values can conveniently be listed in alphabetical order: $m\nu = a\alpha, a\beta, a\gamma, \dots, b\alpha, b\beta, b\gamma, \dots$, and so on.

Direct products can represent the state of two (or more) systems that have been prepared *independently*. However, the main issue that we want to investigate is the description of *interacting* particles—for example, of a genuine hydrogen atom. Let us tentatively assume that composite systems do not differ in any essential way from “elementary” ones, and in particular that they obey the principle of superposition \mathbb{G} (see page 50). Namely, if u_1 and u_2 are possible states of an electron, and v_1 and v_2 possible states of a proton, the expression $w = \alpha(u_1 \otimes v_1) + \beta(u_2 \otimes v_2)$ is a realizable state of an electron-proton system.

¹ Here, indices taken from different alphabets are used to label different vector spaces. In preceding chapters, they denoted different bases in the same vector space.

Note that, in this combined state w , neither the electron nor the proton is in a pure quantum state: There is no complete test for the electron alone, nor for the proton alone, whose result is predictable with certainty. Only the *pair* of particles has a well defined pure state, in which the electron and the proton are *correlated*. Numerous examples of such situations will be encountered in this chapter and in the following ones.

A simple example of correlated states is produced when a photon passes through a calcite crystal. The photon has two relevant degrees of freedom: its polarization, and the location of the path (the ray) that it follows. Although these two degrees of freedom belong to the same photon, they can formally be treated as if they were two constituents of a composite system.² The Hilbert space describing the state of the photon is the direct product of a polarization space and a location space. Let x and y denote the two orthogonal polarization states defined by the crystal orientation, and let u and v denote the locations of the ordinary and extraordinary rays, respectively. A complete basis for photon states, at this level of description, may thus be: $x \otimes u$, $x \otimes v$, $y \otimes u$, and $y \otimes v$. For example, if we say that a photon state is $x \otimes u$, this means that we can *predict* that if the photon is subjected to a test for polarization x , and if that test is located in the ordinary ray u , the photon will certainly pass the test. Moreover, that photon will not excite a detector located in the extraordinary ray v (for any polarization) and it will not pass a test for polarization y (at any location). These predictions are the only operational meaning of the phrase “the photon has state $x \otimes u$.”

Suppose now that the initial state of the photon, before passing through the crystal, is $(\alpha x + \beta y) \otimes w$, where α and β are known complex numbers satisfying $|\alpha|^2 + |\beta|^2 = 1$, and where w denotes the location of the incident ray. This state is a direct product: the photon can be found only in the incident ray; it will pass with *certainty* a test for polarization state $\alpha x + \beta y$; and it is *certain* to fail a test for the orthogonal polarization $(\bar{\beta}x - \bar{\alpha}y)$. Our calcite crystal, however, does not test these two orthogonal elliptic polarizations—it tests x vs y . Therefore the only predictions that we can make are *statistical*: After a photon passes through the crystal, there are *probabilities* $|\alpha|^2$ and $|\beta|^2$ to find it in the ordinary ray u with polarization x , or in the extraordinary ray v with polarization y , respectively. However, the mere probabilities do not tell us the complete story. According to quantum theory, the state of the photon, after passing through the crystal, can be written as

$$\Psi = \alpha x \otimes u + \beta y \otimes v, \quad (5.1)$$

where an arbitrary phase factor was omitted (it can be included in the definition of the basis vectors). This is called a *correlated* (or “entangled”) state. The corresponding process is sketched in Fig. 5.1.

²In classical physics too, a Hamiltonian $H = (p_1^2 + p_2^2)/2m + V(x_1, x_2)$ can represent a single particle in a plane, or two interacting particles on a line.

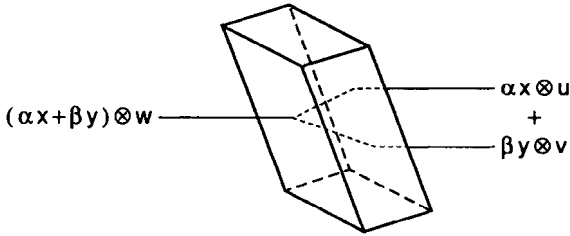

Fig. 5.1. Preparation of a photon in a correlated (or “entangled”) state.

Decorrelation of an entangled state

The superposition principle asserts that Ψ in Eq. (5.1) is a *pure state*. This means that there exists a *maximal* test (having four distinct outcomes) such that a photon prepared in state Ψ will always yield the same, predictable outcome. As we shall presently see, such a test may include either a mirror to reflect the photon through the crystal, or a second crystal which is the mirror image of the first and recombines the two beams. The state of the photon is thereby decorrelated—it again is a direct product—and its polarization can then be tested as usual.

It is instructive to design explicitly a maximal test having the entangled state (5.1) as one of its eigenvectors. The three other eigenvectors can be chosen arbitrarily, provided that all of them are orthogonal. Let them be $\beta x \otimes u - \alpha y \otimes v$, which also is an entangled state, and $x \otimes v$ and $y \otimes u$, which are direct products. A possible experimental setup is sketched in Fig. 5.2.

The first element of the testing apparatus is a calcite crystal, which is the mirror image of the one in Fig. 5.1, and therefore reverses its effect. Ideally, we have

$$\alpha x \otimes u + \beta y \otimes v \rightarrow (\alpha x + \beta y) \otimes w. \tag{5.2}$$

However, to obtain this perfect recurrence of the initial state, one needs a perfect symmetry of the two crystals. If that symmetry is only approximate,

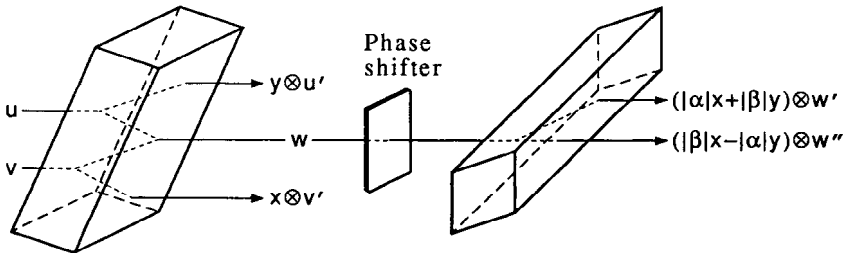

Fig. 5.2. A maximal test with four distinct outcomes, one of which certifies that the incoming photon was prepared in the correlated state given by Eq. (5.1).

any thickness difference generates extra phase shifts, ξ and η , in the ordinary and extraordinary rays, respectively. Instead of (5.2), we then have

$$\alpha \mathbf{x} \otimes \mathbf{u} + \beta \mathbf{y} \otimes \mathbf{v} \rightarrow (\alpha e^{i\xi} \mathbf{x} + \beta e^{i\eta} \mathbf{y}) \otimes \mathbf{w}. \quad (5.3)$$

Note that the right hand side of Eq. (5.3) still is a *pure* state.

We must also find out what happens to a photon prepared in one of the *other* incoming states. First, we notice that Eq. (5.3) is valid for any α and β . On its right hand side, \mathbf{w} , ξ , and η depend on the properties of the crystal, but not on α and β , which refer to the preparation of the photon. We therefore have, separately,

$$\mathbf{x} \otimes \mathbf{u} \rightarrow e^{i\xi} \mathbf{x} \otimes \mathbf{w} \quad \text{and} \quad \mathbf{y} \otimes \mathbf{v} \rightarrow e^{i\eta} \mathbf{y} \otimes \mathbf{w}, \quad (5.4)$$

and

$$\bar{\beta} \mathbf{x} \otimes \mathbf{u} - \bar{\alpha} \mathbf{y} \otimes \mathbf{v} \rightarrow (\bar{\beta} e^{i\xi} \mathbf{x} - \bar{\alpha} e^{i\eta} \mathbf{y}) \otimes \mathbf{w}. \quad (5.5)$$

This result directly follows from (5.3) by substituting $\alpha \rightarrow \bar{\beta}$ and $\beta \rightarrow -\bar{\alpha}$. It could also have been derived from (5.4) by virtue of the linearity of the quantum dynamical evolution, which will be discussed in Chapter 8.

Note that the two orthogonal correlated states on the left hand sides of (5.3) and (5.5) are channeled into the same ray \mathbf{w} . The resulting states are no longer entangled. They are direct products of a location state \mathbf{w} and an elliptic polarization state, which is either $(\alpha e^{i\xi} \mathbf{x} + \beta e^{i\eta} \mathbf{y})$, or $(\bar{\beta} e^{i\xi} \mathbf{x} - \bar{\alpha} e^{i\eta} \mathbf{y})$.

The next element of the testing apparatus is a phase shifter, converting these elliptic polarization states, which are mutually orthogonal, into linear ones. In the special case of circular polarization, this phase shifter would be a quarter wave plate. In the general case, its effect is the same as that of an extra thickness of the crystal. The phase shift has to be adjusted in such a way that

$$\mathbf{x} \rightarrow \mathbf{x} e^{i(\theta-\xi)} \sqrt{\bar{\alpha}/\alpha} \quad \text{and} \quad \mathbf{y} \rightarrow \mathbf{y} e^{i(\theta-\eta)} \sqrt{\bar{\beta}/\beta}, \quad (5.6)$$

where θ is a function of α , β , ξ , and η , which need not be known explicitly for our present purpose.³ We thereby obtain linear polarizations:

$$\alpha e^{i\xi} \mathbf{x} + \beta e^{i\eta} \mathbf{y} \rightarrow e^{i\theta} (|\alpha| \mathbf{x} + |\beta| \mathbf{y}), \quad (5.7)$$

and

$$\bar{\beta} e^{i\xi} \mathbf{x} - \bar{\alpha} e^{i\eta} \mathbf{y} \rightarrow e^{i\theta} \sqrt{\bar{\alpha}\bar{\beta}/\alpha\beta} (|\beta| \mathbf{x} - |\alpha| \mathbf{y}). \quad (5.8)$$

³The only adjustable parameter is the optical length (*i.e.*, the thickness) of the phase shifter. The extra phases in (5.6) are proportional to that thickness. However, it is only the *difference* (not the *sum*) of these phases which turns out to be relevant in the following calculations, and this difference does not depend on the parameter θ .

Exercise 5.1 Check the last two equations and verify that the resulting linear polarizations are orthogonal.

The final step of the test can then be performed by another calcite crystal, with its optic axis oriented in the direction appropriate for distinguishing these two orthogonal linear polarizations, as shown in Fig. 5.2

We still have to examine the result of this test in the case where the initial state of the photon is one of the two remaining orthogonal vectors, $x \otimes v$ or $y \otimes u$. We have already seen in Eq. (5.4) that the first crystal in Fig. 5.2 deflects incoming photons with x polarization downwards (from u to w), and those with y polarization upwards (from v to w). This is indeed the opposite of the effect of the symmetric crystal in Fig. 5.1. We can therefore write

$$x \otimes v \rightarrow x \otimes v' \quad \text{and} \quad y \otimes u \rightarrow y \otimes u', \quad (5.9)$$

where any extra phase factors were absorbed in the definitions of the vectors v' and u' , which represent the locations of the new ordinary and extraordinary rays, respectively. These rays are located, as shown in Fig. 5.2, below and above the w ray, and their distance from the latter is equal to that between the original u and v rays. This completes the construction of a complete (maximal) test, having the *entangled* state (5.1) as one of its eigenstates.

Further algebraic properties

Composite systems have observables which are not trivial combinations of those of their constituents. In general, a system with N states has $N^2 - 1$ linearly independent observables (plus the trivial observable 1, represented by the unit matrix) because a Hermitian matrix of order N has N^2 real parameters. Any other observable is a linear combination of the preceding ones. Now, if systems having M and N states, respectively, are combined into a single composite system, the latter has MN states and therefore $M^2N^2 - 1$ nontrivial linearly independent observables. These are obviously more numerous than the observables of the separate subsystems, whose total number is only $M^2 + N^2 - 2$. Therefore, a composite system involves more information than the sum of its parts. This additional information, which resides in the *quantum correlations*, involves *phases* and has no counterpart in classical physics.

Some of the observables of a composite system may be ordinary sums. For example, if A and B are observables of an electron and a proton, respectively, their sum (classically $A+B$) is

$$(A \otimes \mathbb{1} + \mathbb{1} \otimes B)_{m\mu, n\nu} \equiv A_{mn} \delta_{\mu\nu} + \delta_{mn} B_{\mu\nu}. \quad (5.10)$$

This expression involves *direct products* of matrices (not to be confused with their ordinary products). These direct products follow the standard rules of matrix algebra, once we remember that $m\mu$ is a single index. For example,

$$(\mathbf{A} \otimes \mathbf{1} + \mathbf{1} \otimes \mathbf{B})(\mathbf{u} \otimes \mathbf{v}) = (\mathbf{A}\mathbf{u} \otimes \mathbf{v}) + (\mathbf{u} \otimes \mathbf{B}\mathbf{v}), \quad (5.11)$$

because

$$\sum_{\nu\mu} (A_{m\nu} \delta_{\mu\nu} + \delta_{m\nu} B_{\mu\nu}) u_\nu v_\mu = \sum_{\nu} A_{m\nu} u_\nu v_\nu + \sum_{\nu} u_\nu B_{\mu\nu} v_\nu. \quad (5.12)$$

Likewise

$$\sum_{\nu\mu} (\mathbf{A} \otimes \mathbf{B})_{m\mu, n\nu} (\mathbf{u} \otimes \mathbf{v})_{n\nu} = [(\mathbf{A}\mathbf{u}) \otimes (\mathbf{B}\mathbf{v})]_{m\mu}. \quad (5.13)$$

When no confusion is likely to occur, it is usual to omit the \otimes and $\mathbf{1}$ signs, and to write simply $(\mathbf{A} + \mathbf{B})\mathbf{u}\mathbf{v} = (\mathbf{A}\mathbf{u})\mathbf{v} + \mathbf{u}(\mathbf{B}\mathbf{v})$, etc.

Exercise 5.2 *Let*

$$\mathbf{s}_x = \frac{1}{2} \begin{pmatrix} 0 & 1 \\ 1 & 0 \end{pmatrix}, \quad \mathbf{s}_y = \frac{1}{2} \begin{pmatrix} 0 & -i \\ i & 0 \end{pmatrix}, \quad \mathbf{s}_z = \frac{1}{2} \begin{pmatrix} 1 & 0 \\ 0 & -1 \end{pmatrix},$$

be observables of an electron, and likewise let

$$\mathbf{S}_x = \frac{1}{2} \left[\begin{array}{cc} 0 & 1 \\ 1 & 0 \end{array} \right], \quad \mathbf{S}_y = \frac{1}{2} \left[\begin{array}{cc} 0 & -i \\ i & 0 \end{array} \right], \quad \mathbf{S}_z = \frac{1}{2} \left[\begin{array}{cc} 1 & 0 \\ 0 & -1 \end{array} \right],$$

*be observables of a proton (the latter were written with square brackets, rather than parentheses, to emphasize that they belong to a different linear space). Write explicitly, in the four dimensional combined space of both particles, the 15 matrices $\mathbf{s}_j \otimes \mathbf{1}$, $\mathbf{1} \otimes \mathbf{S}_k$, and $\mathbf{s}_j \otimes \mathbf{S}_k$. **

Exercise 5.3 *With \mathbf{s}_j and \mathbf{S}_k defined as in the preceding exercise, let*

$$\mathbf{J}_x = \sqrt{3} \mathbf{1} \otimes \mathbf{S}_x + 2(\mathbf{s}_x \otimes \mathbf{S}_x + \mathbf{s}_y \otimes \mathbf{S}_y),$$

$$\mathbf{J}_y = \sqrt{3} \mathbf{1} \otimes \mathbf{S}_y + 2(\mathbf{s}_y \otimes \mathbf{S}_x - \mathbf{s}_x \otimes \mathbf{S}_y),$$

$$\mathbf{J}_z = \mathbf{1} \otimes \mathbf{S}_z + 2\mathbf{s}_z \otimes \mathbf{1}.$$

*What are the eigenvalues of these matrices? You should find that none of these eigenvalues is degenerate, so that measuring any one of these observables is a maximal test. Hint: Show that $\mathbf{J}_x \mathbf{J}_y - \mathbf{J}_y \mathbf{J}_x = i\mathbf{J}_z$ (and cyclic permutations) and that $\mathbf{J}_x^2 + \mathbf{J}_y^2 + \mathbf{J}_z^2 = \frac{15}{4}$. **

Exercise 5.4 *With notations similar to those of Exercise 5.2, consider the singlet state*

$$\Psi = \frac{1}{\sqrt{2}} \left\{ \begin{pmatrix} 1 \\ 0 \end{pmatrix} \otimes \begin{bmatrix} 0 \\ 1 \end{bmatrix} - \begin{pmatrix} 0 \\ 1 \end{pmatrix} \otimes \begin{bmatrix} 1 \\ 0 \end{bmatrix} \right\}.$$

Show that $\langle \mathbf{s}_j \rangle = \langle \mathbf{S}_k \rangle = 0$, and $\langle \mathbf{s}_j \otimes \mathbf{S}_k \rangle = -\frac{1}{4} \delta_{jk}$.

5-2. Incomplete tests and partial traces

Consider again the “entangled” pure state (5.1) and suppose that we want to measure a polarization property of the photon, regardless of where the photon is. That property is represented by a second order Hermitian matrix A , acting on the linear space spanned by the vectors x and y which correspond to two orthogonal polarization states. For example, if x and y represent states of linear polarization, the observable $A = \begin{pmatrix} 0 & -i \\ i & 0 \end{pmatrix}$ gets values ± 1 for the two states of circular polarization. Now, a complete description of photon states (including the labels u and v which distinguish the two outgoing rays) requires a four dimensional vector space, as explained above. If the location of the photon is not tested, this “non-test” can be formally represented by the trivial observable $\mathbf{1}$ (the unit matrix) in the subspace spanned by the vectors u and v . This is because the question “Is the photon in one of the rays?” is always answered in the affirmative. We are therefore effectively measuring the observable $A \otimes \mathbf{1}$. This is *not* a maximal test, because $\mathbf{1}$ is a degenerate matrix, and there are only two distinct outcomes, rather than four.

The mean value of A (or, if you prefer, $A \otimes \mathbf{1}$), expected for this incomplete test, is given by the usual rule in Eq. (3.41):

$$\langle A \rangle = \Psi^\dagger A \Psi = (\alpha x \otimes u + \beta y \otimes v)^\dagger (A \otimes \mathbf{1}) (\alpha x \otimes u + \beta y \otimes v). \tag{5.14}$$

This can be written as

$$\langle A \rangle = |\alpha|^2 x^\dagger A x + |\beta|^2 y^\dagger A y. \tag{5.15}$$

The result would be the same if the photon simply had probability $|\alpha|^2$ to be in state x and probability $|\beta|^2$ to be in state y . These probabilities do not depend on the choice of the observable A which is being measured. In other words, if that experiment is repeated many times, everything happens as if we had an ordinary mixture of photons, some of them prepared in state x , and some in state y . The relative phase of x and y is irrelevant.

This result is radically different from the one which would be obtained by measuring A (that is, $A \otimes \mathbf{1}$) on the *incident* beam whose state, $(\alpha x + \beta y) \otimes w$, is an *uncorrelated* direct product. In that case, we would have

$$\begin{aligned} \langle A \rangle_{in} &= (\alpha x + \beta y)^\dagger A (\alpha x + \beta y), \\ &= |\alpha|^2 x^\dagger A x + |\beta|^2 y^\dagger A y + \bar{\alpha}\beta x^\dagger A y + \alpha\bar{\beta} y^\dagger A x. \end{aligned} \tag{5.16}$$

The last two terms involve off-diagonal elements of the matrix A and depend on the relative phase of α and β . That phase did not appear in (5.15) because, in the entangled state Ψ of Eq. (5.1), the states x and y are correlated to the rays u and v , respectively, and the unit matrix $\mathbf{1}$ has no off-diagonal elements connecting u and v .

It is convenient to rewrite (5.15) explicitly in terms of matrix elements:

$$\langle A \rangle = \sum_{mn} (|\alpha|^2 x_m \bar{x}_n + |\beta|^2 y_m \bar{y}_n) A_{nm} = \sum_{mn} \rho_{mn} A_{nm}. \quad (5.17)$$

This has the same form, $\text{Tr}(\rho A)$, as in Eq. (3.77), with ρ given by

$$\rho = |\alpha|^2 \mathbf{x}\mathbf{x}^\dagger + |\beta|^2 \mathbf{y}\mathbf{y}^\dagger. \quad (5.18)$$

Note that $\mathbf{x}\mathbf{x}^\dagger$ and $\mathbf{y}\mathbf{y}^\dagger$ are projection operators on the states \mathbf{x} and \mathbf{y} which are detected with probabilities $|\alpha|^2$ and $|\beta|^2$, respectively.

Irrelevant degrees of freedom

It is of course possible to use (5.14) instead of (5.17), and to consider explicitly the subspace spanned by \mathbf{u} and \mathbf{v} , in which we “measure” the unit matrix. However, it is far more convenient to ignore the irrelevant degrees of freedom and to use directly (5.17). Moreover, we often have no real alternative to the use of (5.17), because the irrelevant data are too numerous, or they are inaccessible. For example, the photons originating from an incandescent source are said to be “unpolarized” because we cannot follow all their correlations with the microscopic variables of the source, which are in thermal motion.

Some further thought will convince you that there is no essential difference between the derivations of Eq. (3.77) on page 73, and Eq. (5.17) here. In the former, we considered a situation where the preparation procedure was incompletely specified: it involved a stochastic process. Here, we deliberately choose to ignore part of the available information, by testing only the photon polarization, irrespective of the ray where the photon is to be found. The final result is given by similar expressions. This is natural, because this result cannot depend on whether the omission of “irrelevant” data was voluntary or not.

In general, let the density matrix of a composite system be $\rho_{m\mu, n\nu}$ where, as usual, Latin indices refer to one of the subsystems and Greek indices to the other one. If we measure only observables of type $A_{mn} \delta_{\mu\nu}$ (that is, if we observe only the Latin subsystem and ignore the Greek one) we have, as in Eq. (5.17),

$$\langle A \rangle = \sum_{mn, \mu\nu} \rho_{n\nu, m\mu} A_{mn} \delta_{\mu\nu} = \sum_{mn} \left(\sum_{\mu} \rho_{n\mu, m\mu} \right) A_{mn}. \quad (5.19)$$

The matrix

$$\rho_{nm} := \sum_{\mu} \rho_{n\mu, m\mu}, \quad (5.20)$$

obtained by a partial trace on the Greek indices, is called the *reduced density matrix* of the Latin subsystem.

Exercise 5.5 With the same notations as in Exercise 5.2, let

$$\Psi = \begin{pmatrix} 1 \\ 1 \end{pmatrix} \otimes \begin{bmatrix} 0.4 \\ 0.3 \end{bmatrix} + \begin{pmatrix} 1 \\ -1 \end{pmatrix} \otimes \begin{bmatrix} 0.3 \\ 0.4 \end{bmatrix}. \quad (5.21)$$

Show that Ψ is normalized. Compute the average values of the 15 observables $\mathbf{s}_j \otimes \mathbb{1}$, $\mathbb{1} \otimes \mathbf{S}_k$, and $\mathbf{s}_j \otimes \mathbf{S}_k$. If we ignore one of the two particles, what is the reduced density matrix of the other one? ★

5-3. The Schmidt decomposition

In Eq. (5.21), the vector Ψ is written as the sum of two terms. The latter are orthogonal, because $\begin{pmatrix} 1 \\ 1 \end{pmatrix}$ and $\begin{pmatrix} 1 \\ -1 \end{pmatrix}$ are. On the other hand, $\begin{bmatrix} 0.3 \\ 0.4 \end{bmatrix}$ is *not* orthogonal to $\begin{bmatrix} 0.4 \\ 0.3 \end{bmatrix}$. It will now be shown that, if a pair of correlated quantum systems are in a pure state Ψ , it is always possible to find preferred bases such that Ψ becomes a sum of *bi-orthogonal* terms. A simple example of bi-orthogonal sum can be seen in Eq. (5.1), where we have both $\langle \mathbf{x}, \mathbf{y} \rangle = 0$ and $\langle \mathbf{u}, \mathbf{v} \rangle = 0$.

The representation of Ψ by a bi-orthogonal sum is called the Schmidt decomposition of Ψ . The appropriate bases can be constructed as follows: let \mathbf{u} and \mathbf{v} be unit vectors pertaining to the first and second subsystems, and let

$$M := \langle \mathbf{u} \otimes \mathbf{v}, \Psi \rangle. \quad (5.22)$$

Since $|M|^2$ is nonnegative and bounded, it attains its maximum value for some choice of \mathbf{u} and \mathbf{v} . This choice is not unique because of a phase freedom, and possibly additional degeneracies, but this nonuniqueness does not impede the construction given below.

Let us choose \mathbf{u} and \mathbf{v} so as to maximize $|M|^2$. Let \mathbf{u}' be any state of the first system, orthogonal to \mathbf{u} . Let ϵ be an arbitrarily small complex number. Then

$$\|\mathbf{u} + \epsilon \mathbf{u}'\|^2 = 1 + O(\epsilon^2), \quad (5.23)$$

so that $\mathbf{u} + \epsilon \mathbf{u}'$ is a unit vector, just as \mathbf{u} , if we neglect terms of order ϵ^2 . We then have

$$\langle (\mathbf{u} + \epsilon \mathbf{u}') \otimes \mathbf{v}, \Psi \rangle = M + \epsilon \langle \mathbf{u}' \otimes \mathbf{v}, \Psi \rangle, \quad (5.24)$$

whence

$$|\langle (\mathbf{u} + \epsilon \mathbf{u}') \otimes \mathbf{v}, \Psi \rangle|^2 = |M|^2 + 2 \operatorname{Re}(\epsilon \langle \mathbf{u}' \otimes \mathbf{v}, \Psi \rangle) + O(\epsilon^2). \quad (5.25)$$

The value of the expression on the left hand side is stationary with respect to any variation of \mathbf{u} , by virtue of the definition of \mathbf{u} . As the phase of \mathbf{v} is arbitrary, it follows that, on the right hand side of (5.25),

$$\langle \mathbf{u}' \otimes \mathbf{v}, \Psi \rangle = 0, \quad \forall \mathbf{u}' \in \mathcal{H}'_{\mathbf{u}}, \quad (5.26)$$

where $\mathcal{H}'_{\mathbf{u}}$ denotes the set of all the states of the first subsystem, which are orthogonal to \mathbf{u} . Likewise, if \mathbf{v}' is a state of the second system, orthogonal to \mathbf{v} , we have, with similar notations,

$$\langle \mathbf{u} \otimes \mathbf{v}', \Psi \rangle = 0, \quad \forall \mathbf{v}' \in \mathcal{H}'_{\mathbf{v}}. \quad (5.27)$$

Consider now the vector

$$\Psi' = \Psi - M \mathbf{u} \otimes \mathbf{v}. \quad (5.28)$$

It is easily seen that Ψ' satisfies the same relationships as Ψ in Eqs. (5.26) and (5.27), and, moreover, it also satisfies

$$\langle \mathbf{u} \otimes \mathbf{v}, \Psi' \rangle = 0, \quad (5.29)$$

by the definition of M . Therefore, if the bases chosen for our two subsystems include \mathbf{u} and \mathbf{v} among their unit vectors, all the components of Ψ' referring to these two unit vectors shall vanish. It follows that

$$\Psi' \in \mathcal{H}'_{\mathbf{u}} \otimes \mathcal{H}'_{\mathbf{v}}. \quad (5.30)$$

We can now repeat the same procedure in the smaller space $\mathcal{H}'_{\mathbf{u}} \otimes \mathcal{H}'_{\mathbf{v}}$, and proceed likewise as many times as needed, until we finally obtain

$$\Psi = \sum_j M_j \mathbf{u}_j \otimes \mathbf{v}_j, \quad (5.31)$$

where the unit vectors \mathbf{u}_j and \mathbf{v}_j belong to the first and second subsystems, respectively, and satisfy

$$\langle \mathbf{u}_i, \mathbf{u}_j \rangle = \langle \mathbf{v}_i, \mathbf{v}_j \rangle = 0. \quad (5.32)$$

Note that the number of nonvanishing coefficients M_j is at most equal to the smaller of the dimensionalities of the two subsystems. The phases of the M_j are arbitrary—because those of \mathbf{u}_j and \mathbf{v}_j are. Moreover, if several $|M_j|$ are equal, the $(\mathbf{u}_j \otimes \mathbf{v}_j)$ corresponding to them can be replaced by linear combinations of each other, as is usual when there is a degeneracy. For example, the singlet state of a pair of spin $\frac{1}{2}$ particles can be written as

$$\frac{1}{\sqrt{2}} \left\{ \begin{pmatrix} 1 \\ 0 \end{pmatrix} \otimes \begin{bmatrix} 0 \\ 1 \end{bmatrix} - \begin{pmatrix} 0 \\ 1 \end{pmatrix} \otimes \begin{bmatrix} 1 \\ 0 \end{bmatrix} \right\} = \frac{1}{\sqrt{8}} \left\{ \begin{pmatrix} 1 \\ i \end{pmatrix} \otimes \begin{bmatrix} i \\ 1 \end{bmatrix} - \begin{pmatrix} i \\ 1 \end{pmatrix} \otimes \begin{bmatrix} 1 \\ i \end{bmatrix} \right\}, \quad (5.33)$$

as well as in an infinity of other equivalent bi-orthogonal forms.

Exercise 5.6 Verify Eq. (5.33) and write two more equivalent forms of the singlet state.

Exercise 5.7 Show that the density matrix of the singlet state (5.33) is

$$\rho = \frac{1}{4} \left(\mathbf{1} \otimes \mathbf{1} - \sum_m \sigma_m \otimes \sigma_m \right). \tag{5.34}$$

Hint: Show that $\text{Tr}(\mathbf{A} \otimes \mathbf{B}) \equiv (\text{Tr} \mathbf{A})(\text{Tr} \mathbf{B})$, that this ρ is a pure state, and that a spin singlet satisfies $(\mathbf{1} \otimes \boldsymbol{\sigma} + \boldsymbol{\sigma} \otimes \mathbf{1})\Psi = 0$.

Exercise 5.8 Find the Schmidt decomposition of Ψ in Exercise 5.5.

Exercise 5.9 Show that the Schmidt decomposition **cannot** in general be extended to more than two subsystems.

The density matrix of a pure state Ψ is, in the Schmidt basis,

$$\rho = \Psi\Psi^\dagger = \sum_{ij} M_i \overline{M_j} \mathbf{u}_i \mathbf{u}_j^\dagger \otimes \mathbf{v}_i \mathbf{v}_j^\dagger. \tag{5.35}$$

The reduced density matrices of the two subsystems therefore are

$$\rho_1 = \sum_j |M_j|^2 \mathbf{u}_j \mathbf{u}_j^\dagger \quad \text{and} \quad \rho_2 = \sum_j |M_j|^2 \mathbf{v}_j \mathbf{v}_j^\dagger. \tag{5.36}$$

These two matrices obviously have the same eigenvalues (except for possibly different multiplicities of the eigenvalue zero) and their eigenvectors are exactly those used in the Schmidt decomposition (5.31). Thanks to this property, it is a straightforward matter to determine the Schmidt basis which corresponds to a pure state, if the latter is given in an arbitrary basis.

Exercise 5.10 Given any density matrix ρ in a Hilbert space H , show that it is always possible to introduce a second Hilbert space H' , in such a way that ρ is the reduced density matrix, in H , of a **pure state** in $H \otimes H'$.

Exercise 5.11 What are the reduced density matrices of the two particles in the singlet state (5.33)?

Exercise 5.12 Two coupled quantum systems, each one having two states, are prepared in a correlated state Ψ , represented by the vector with components 0.1, 0.3 + 0.4i, 0.5i, -0.7. (This 4-dimensional vector is written here in a basis labelled $a\alpha, a\beta, b\alpha, b\beta$, as explained at the beginning of this chapter.) Find the Schmidt decomposition of Ψ . ★

Exercise 5.13 Two coupled quantum systems, having two and three states, respectively, are prepared in a correlated state Ψ , represented by the vector with components 0.1, 0.3 + 0.4i, -0.4, 0.7, 0.3i, 0. (As in the preceding exercise, this vector is written in a basis labelled $a\alpha, \dots, b\gamma$.) Find the Schmidt decomposition of Ψ . ★★

Another way of transforming $\Psi = \sum A_{\mu\nu} x_\nu \otimes y_\mu$ from arbitrary bases x_ν and y_μ to the Schmidt basis, is to diagonalize the Hermitian matrices $A^\dagger A$ and AA^\dagger by unitary transformations: $UA^\dagger AU^\dagger = D'$ and $VAA^\dagger V^\dagger = D''$. We then have $VAU^\dagger D' = D''V AU^\dagger$, so that $V AU^\dagger$ is “diagonal” too: $\sum V_{i\mu} A_{\mu\nu} \overline{U_{j\nu}} = \delta_{ij} \alpha_j$. It follows that $\Psi = \sum \alpha_j \mathbf{u}_j \otimes \mathbf{v}_j$, where $\mathbf{u}_j = \sum U_{j\nu} x_\nu$ and $\mathbf{v}_j = \sum \overline{V_{j\mu}} y_\mu$.

5-4. Indistinguishable particles

A quantum system may include several subsystems of identical nature, which are physically *indistinguishable*. Any test performed on the quantum system treats all these subsystems in the same way, and is indifferent to a permutation of the labels that we attribute to the identical subsystems for computational purposes. For example, the electrons of an atom can be arbitrarily labelled 1, 2, . . . (or John, Peter, and so on) and no observable property of the atom is affected by merely exchanging these labels. The same is true for the protons in an atomic nucleus and also, separately, for the neutrons.⁴

As a simple example, consider a helium atom. The distance between the two electrons, $|\mathbf{r}_1 - \mathbf{r}_2|$, is observable, in principle; but \mathbf{r}_1 , the position of the “first” electron, is a physically meaningless concept. This is true even if the helium atom is partly ionized, with one of its electrons removed far away. Note that it *is* meaningful to ask questions about the electron closest to the nucleus, or about the most distant one—but *not* about the electron labelled 1 or 2.

We have here a *fundamental limitation to the realizability of quantum tests*. One may toy with the idea of devising “personalized” tests, which would be sensitive to individual electrons—and it is indeed easy to write down vector bases corresponding to such tests—but this fantasy cannot be materialized in the laboratory. We are forced to the conclusion that *not every pure state is realizable* (recall that pure states were defined by means of maximal tests—see Postulate A, page 30). Our next task is to characterize the realizable states of a quantum system which includes several indistinguishable subsystems.

Bosons and fermions

First, consider the simple case where only two identical particles are involved. A complete set of orthogonal states for one of them, if it is alone, will be denoted by \mathbf{u}_m ; the *same* states of the other particle will be called \mathbf{v}_m . Then, if these two particles are truly indistinguishable, some states of the pair cannot be realized. For example, the state $\mathbf{u}_m \otimes \mathbf{v}_n$ (for $m \neq n$) cannot, because it is *different* from the state $\mathbf{v}_m \otimes \mathbf{u}_n$, obtained by merely relabelling the two particles (these two states are actually orthogonal). On the other hand, states that are not

⁴ This issue does not occur in classical physics, because classical objects have an inexhaustible set of attributes, and therefore are always distinguishable.

forbidden by indistinguishability are

$$\mathbf{u}_m \otimes \mathbf{v}_n \quad \text{and} \quad (\mathbf{u}_m \otimes \mathbf{v}_n + \mathbf{u}_n \otimes \mathbf{v}_m)/\sqrt{2} \quad (m \neq n), \quad (5.37)$$

and

$$(\mathbf{u}_m \otimes \mathbf{v}_n - \mathbf{u}_n \otimes \mathbf{v}_m)/\sqrt{2} \quad (m \neq n). \quad (5.38)$$

Vectors of type (5.37) are obviously invariant under relabelling of the particles. Those of type (5.38) merely change sign under relabelling, and therefore still represent the *same* physical state.

Now, however, we run afoul of the superposition principle \mathbf{G} (see page 50), because the following linear combination of (5.37) and (5.38),

$$\mathbf{u}_m \otimes \mathbf{v}_n = \frac{1}{2} [(\mathbf{u}_m \otimes \mathbf{v}_n + \mathbf{u}_n \otimes \mathbf{v}_m) + (\mathbf{u}_m \otimes \mathbf{v}_n - \mathbf{u}_n \otimes \mathbf{v}_m)], \quad (5.39)$$

is unphysical, as we have just seen. The only way to salvage linearity is to demand that, for any given type of particles, the allowed state vectors of a pair of particles are either always symmetric, as in (5.37), or always antisymmetric, as in (5.38). Particles that always have symmetric state vectors are called *bosons*; those having always antisymmetric states are called *fermions*. It is customary to say that these particles obey Bose-Einstein or Fermi-Dirac *statistics*, even if only two particles are involved, as here, and we are far from the realm of genuine statistical physics.

From the postulates of relativistic local quantum field theory, it can be shown that bosons have integral spin, and fermions have half-integral spin. The assumptions underlying this theorem, as well as its detailed proof, are beyond the scope of this book.

It is customary to say that “only one fermion can occupy a quantum state.” This statement is not accurate. In a vector such as (5.38), *both* particles are present in *each one* of the two states—this is indeed a trivial consequence of their indistinguishability. However, fermions and bosons have different ways for occupying their states, and that difference can be seen experimentally. The mean value of an observable A involving two identical particles is

$$\begin{aligned} \langle A \rangle &= \frac{1}{2} \langle (\mathbf{u}_m \otimes \mathbf{v}_n \pm \mathbf{u}_n \otimes \mathbf{v}_m), A (\mathbf{u}_m \otimes \mathbf{v}_n \pm \mathbf{u}_n \otimes \mathbf{v}_m) \rangle, \\ &= \frac{1}{2} (A_{mn,mn} + A_{nm,nm} \pm A_{mn,nm} \pm A_{nm,mn}), \end{aligned} \quad (5.40)$$

where the various matrix elements are defined by

$$A_{mn,rs} := \langle \mathbf{u}_m \otimes \mathbf{v}_n, A \mathbf{u}_r \otimes \mathbf{v}_s \rangle. \quad (5.41)$$

Since the particles are indistinguishable, the observable A must be indifferent to any interchange of the particle labels. Therefore, the value of (5.41) is invariant under an exchange of the labels u and v that we use to indicate the “first” and “second” particles, respectively. Hence,

$$A_{mn,rs} = A_{nm,rs}, \quad (5.42)$$

and (5.40) becomes

$$\langle \mathbf{A} \rangle = A_{mn, mn} \pm A_{mn, nm}. \quad (5.43)$$

The \pm sign in the observable mean value differentiates bosons from fermions.

Exercise 5.14 *Two noninteracting identical particles occupy the two lowest energy levels in a one-dimensional quadratic potential $V = \frac{1}{2}kx^2$. Find the mean value of $x_1 x_2$ when these particles are bosons, and when they are fermions. What would be the result for distinguishable particles? ★*

Likewise, if there are three indistinguishable bosons or fermions, a vector involving three orthogonal states can be written as

$$\Psi = [(|mns\rangle + |nsm\rangle + |smn\rangle) \pm (|nms\rangle + |snm\rangle + |msn\rangle)]/\sqrt{6}, \quad (5.44)$$

with Dirac's notation, $|mns\rangle := \mathbf{u}_m \otimes \mathbf{v}_n \otimes \mathbf{w}_s$. (Another notation could be ${}_m \overset{n}{\Delta}_s$, to emphasize the symmetric structure of Ψ .) As in Eq. (5.42), matrix elements of an observable \mathbf{A} are invariant under internal permutations in their composite indices:

$$A_{mns,xyz} = A_{nsm,yzx} = A_{nms,yxz} = \dots \quad (5.45)$$

Therefore the mean value of \mathbf{A} is given, as in (5.43), by

$$\begin{aligned} \langle \mathbf{A} \rangle = & (A_{mns,mns} + A_{mns,nsm} + A_{mns,smn}) \\ & \pm (A_{mns,nms} + A_{mns,snm} + A_{mns,msn}). \end{aligned} \quad (5.46)$$

Exercise 5.15 *Three identical and noninteracting particles occupy the three lowest energy levels in a one-dimensional quadratic potential $V = \frac{1}{2}kx^2$. Find the mean value of $(x_1 + x_2 + x_3)^2$ when these particles are bosons, and when they are fermions. What would be the result for distinguishable particles? ★*

Cluster separability

An immediate consequence of Eqs. (5.37) and (5.38) is that two particles of the same type are always entangled, even if they were prepared independently, far away from each other, in different laboratories. We must now convince ourselves that this entanglement is not a matter of concern: No quantum prediction, referring to an atom located in our laboratory, is affected by the mere presence of similar atoms in remote parts of the universe.

To prove this statement, we first have to define "remoteness." In real life, there are experiments that we elect *not* to perform, because they are too far away. For example, if we consider only quantum tests that can be performed with equipment no bigger than 1 meter, a state \mathbf{w} localized more than 1 meter away is "remote." In general, a state \mathbf{w} is called remote if $\|\mathbf{A}\mathbf{w}\|$ is vanishingly

small, for any operator A which corresponds to a quantum test in a nearby location. It then follows from Schwarz's inequality (3.18) that any matrix element involving w , such as $\langle u, Aw \rangle = \langle Au, w \rangle$, is vanishingly small. (There is no contradiction with $\langle w, \mathbf{1}w \rangle \equiv 1$, because the unit operator $\mathbf{1}$ is not restricted to nearby locations.)

We can now show that the entanglement of a local quantum system with another system in a remote state (as defined above) has no observable effect. Recall that if a quantum system is prepared in a state u , and if we measure an observable A of that system, the mean value of the result predicted by quantum theory is $\langle A \rangle = \langle u, Au \rangle$. Suppose now that there is another identical quantum system, in a remote state w . The state of the pair is entangled:

$$\Psi = (u \otimes w \pm w \otimes u)/\sqrt{2}, \quad (5.47)$$

where the \pm sign is for bosons and fermions, respectively. The operator A , which was used to refer to the "first" system, must now be replaced by a new operator, namely $A \otimes \mathbf{1} + \mathbf{1} \otimes A$, which does not discriminate between the two systems (since the latter are indistinguishable). Yet, we still have

$$\langle \Psi, (A \otimes \mathbf{1} + \mathbf{1} \otimes A) \Psi \rangle = \langle u, Au \rangle, \quad (5.48)$$

as before, because any matrix element involving A and the remote state w must vanish. It follows that all predictions on nearby quantum tests are insensitive to the possible existence of the second particle, far away.

These considerations can be extended to additional particles. Suppose that two particles are nearby, and a third one is far away. This will cause no difficulty for bosons or fermions, as can be seen in the following exercise:

Exercise 5.16 *Show that if the state $|s\rangle$ in Eq. (5.46) is localized far away from the states $|m\rangle$ and $|n\rangle$, the resulting value of $\langle A \rangle$ coincides with that given by Eq. (5.43).*

However, when there are more than two identical particles, new possibilities open up, and symmetries more complicated than those of bosons or fermions become compatible with the indistinguishability principle. These symmetries will be discussed in Section 5-5, where it will be shown that they are *not* compatible with cluster separability. This will leave us with the Bose-Einstein and Fermi-Dirac statistics as the only reasonable alternatives.

Composite bosons and fermions

The remarkable properties of liquid helium are due to the fact that He^4 atoms contain an even number of fermions (two electrons, two protons, and two neutrons) and therefore they behave like elementary bosons, as long as their internal structure is not probed. Likewise, superconductivity is caused by the formation

of Cooper pairs, whereby two loosely bound electrons behave, in some respects, as a boson. At a deeper level, a proton made of three quarks behaves as an elementary fermion, provided that its internal structure is not probed. Other similar examples readily come to the mind.

Let us see why these composite particles act, approximately, as if they were structureless bosons or fermions. As a simple example, consider a crude model of the hydrogen atom, consisting of a pointlike proton (mass M , position \mathbf{R}) and a pointlike electron (mass m , position \mathbf{r}). Assume that the wave function can be factored as

$$\psi(\mathbf{R}, \mathbf{r}) = u(M\mathbf{R} + m\mathbf{r})v(\mathbf{R} - \mathbf{r}), \quad (5.49)$$

where u involves only the center of mass of the atom, and v describes its internal structure. Not every wave function has this form, but this is what we would obtain by a suitable preparation which selects atoms in their ground state, or in a well defined excited state.

If we now have two such atoms, arbitrarily labelled 1 and 2, their combined wave function changes sign whenever one swaps the labels of the electrons *or* those of the protons. It therefore remains invariant if we swap complete atoms. This leads to the following puzzle: If the atoms were structureless bosons, both could be in the same state. What happens when these bosons are made of fermions, which *cannot* be in the same state? To clarify this point, let us write the combined wave function (apart from a normalization factor) as

$$\Psi = \psi_{11} \psi_{22} - \psi_{12} \psi_{21}, \quad (5.50)$$

where

$$\psi_{jk} := u(M\mathbf{R}_j + m\mathbf{r}_k)v(\mathbf{R}_j - \mathbf{r}_k). \quad (5.51)$$

The wave function (5.50) has all the symmetry properties required by the fermionic nature of the protons and electrons. In particular, $\Psi = 0$ when $\mathbf{r}_1 = \mathbf{r}_2$, or when $\mathbf{R}_1 = \mathbf{R}_2$. Yet, Ψ clearly does not vanish in general!

Further consideration of this wave function shows that, if the internal state $v(\mathbf{R} - \mathbf{r})$ is highly localized, the first term on the right hand side of (5.50) dominates when $\mathbf{R}_1 \simeq \mathbf{r}_1$ and $\mathbf{R}_2 \simeq \mathbf{r}_2$, while the second term dominates when $\mathbf{R}_1 \simeq \mathbf{r}_2$ and $\mathbf{R}_2 \simeq \mathbf{r}_1$. These two terms will therefore not interfere, unless the two atoms overlap, *i.e.*, $\mathbf{R}_1 \simeq \mathbf{R}_2 \simeq \mathbf{r}_1 \simeq \mathbf{r}_2$. Such an overlap of the two atoms occurs in a region of their configuration space which is exceedingly small, if v is localized and u is an extended wave function (only if v and u indeed have these properties can our four particles be called “two atoms”).

From (5.50), an observable mean value is

$$\langle \mathbf{A} \rangle = 2 \int (\overline{\psi_{11} \psi_{22}} \mathbf{A} \psi_{11} \psi_{22} - \overline{\psi_{12} \psi_{21}} \mathbf{A} \psi_{12} \psi_{21}) d\mathbf{R}_1 d\mathbf{R}_2 d\mathbf{r}_1 d\mathbf{r}_2. \quad (5.52)$$

The first term in the integrand is just what we would expect for a pair of elementary bosons, both in the same state ψ . The second term is vanishingly small if the extent of u (the "uncertainty" in the position of the center of mass) is much larger than the extent of v (the "size" of each particle). This means that the two hydrogen atoms approximately behave as elementary bosons, as long as they do not appreciably overlap.

Exercise 5.17 *Two identical and noninteracting particles are confined to the segment $0 \leq x \leq 1$. Both have the same state $\psi = e^{ikx}$. What is the mean value of $(x_1 - x_2)^2$? Ans.: 1/6.*

We clearly see in this exercise that two particles in the *same* state may be, on the average, far away from each other.

Note that swapping the fictitious *labels* of two identical particles is not the same as actually swapping their positions and other physical properties. In the first case, we have a *passive* transformation—a mere change of language, like the use of a different coordinate system for describing the same physical situation. In the second case, the transformation is *active*: objects are actually moved around. Even if the final conditions appear to be the same as the initial ones, the swapping process may cause a *phase shift* (called the Berry phase⁵), which is experimentally observable. Pairs of particles whose wave function is multiplied by a nontrivial phase when their positions are swapped have been called *anyons*.⁶

5-5. Parastatistics

The symmetrized expressions on the right hand side of Eq. (5.44) represent two possible configurations of three indistinguishable particles occupying three orthogonal one-particle states, $|m\rangle$, $|n\rangle$, and $|s\rangle$. However, these two configurations do not exhaust all the possible ways of using this set of states. Since there are six orthogonal three-particle states to start with, there must be four other orthogonal combinations. The latter too can be chosen so that they have simple properties under permutations of the fictitious labels that we arbitrarily attach to the particles in order to perform our calculations. It will now be shown that these other possibilities, while mathematically well defined, are unlikely to be realized in nature. Bosons and fermions are the only acceptable types of particles. The reader who is not interested in speculations about the properties of other types of particles may skip the rest of this section.

A complete classification of all possible symmetrized states is the task of group theory, which is the natural mathematical tool for investigating permutations of indistinguishable objects. The group of permutations of n objects is

⁵M. V. Berry, *Proc. Roy. Soc. A* 392 (1984) 45.

⁶F. Wilczek, *Phys. Rev. Lett.* 49 (1982) 957.

called the *symmetric group* and is denoted by S_n . In the following pages, I shall not assume that the reader is conversant with the theory of group representations, and all the necessary concepts and techniques will be explained, as they are needed. Some textbooks on group theory are listed in the bibliography.

Hidden quantum numbers

First, let us put aside a trivial way in which the boson and fermion symmetry rules can be violated. If some physical properties are ignored because they are not discerned by our quantum tests, the states resulting from these incomplete tests are not pure. These states are represented by density matrices of rank larger than 1, and the elementary symmetrization method used in Eq. (5.44) is not applicable. In this case, however, it is always possible to restore the usual symmetry rules by introducing new quantum numbers, even if the latter are (perhaps temporarily) not experimentally accessible.

For example, when the quark model was first introduced in particle physics, it had the unpleasant feature that three identical u -quarks, each one with spin $\frac{1}{2}$, were used to make one Δ^{++} particle, which had spin $\frac{3}{2}$. This implied that the three u -quarks had the *same* spin state, in contradiction to the spin-statistics theorem, which wants spin $\frac{1}{2}$ particles to be *fermions*. Likewise, three d -quarks made one Δ^- , and three s -quarks made one Ω^- , both having spin $\frac{3}{2}$. The puzzle was solved by attributing to quarks a new property, called “color,” with three possible values, and assuming that the three quarks making a baryon always were in an antisymmetric color state—and therefore their spin state had to be symmetric. However, before the concept of colored quarks gained general acceptance, serious consideration was given to the possibility that quarks might satisfy *parastatistics*, that is, permutation rules different from those of bosons and fermions. The simplest example of such rules is discussed below, for the case of three indistinguishable particles.

Three indistinguishable particles

The bosonic state in Eq. (5.44) is invariant under any exchange of the particle labels. The fermionic state is invariant under cyclic permutations of the labels, and it changes sign if any two labels are swapped. These various permutations can be visualized by attaching the fictitious labels to the vertices of an equilateral triangle. Cyclic permutations become *rotations* of the triangle around its center, by angles of $\pm 2\pi/3$, and label swappings are *reflections* of the triangle through one of its three medians. Our next task is to find other quantum states, besides those of Eq. (5.44), having simple transformation properties under these rotations and reflections. Let us introduce the following notations:

$$\begin{aligned}\omega &= e^{2\pi i/3} = (-1 + i\sqrt{3})/2, \\ \bar{\omega} &= \omega^2 = \omega^{-1} = (-1 - i\sqrt{3})/2.\end{aligned}\tag{5.53}$$

Note that $1 + \omega + \bar{\omega} \equiv 0$.

A convenient pair of states, with simple transformation properties, is

$$\begin{aligned}\Psi_+ &= (|mns\rangle + \omega |nsm\rangle + \bar{\omega} |smn\rangle)/\sqrt{3}, \\ \Psi_- &= (|nms\rangle + \omega |snm\rangle + \bar{\omega} |msn\rangle)/\sqrt{3}.\end{aligned}\tag{5.54}$$

Exercise 5.18 Show that Ψ_+ and Ψ_- are normalized, orthogonal to each other, and orthogonal to the boson and fermion states of Eq. (5.44).

Under a cyclic permutation, $|abc\rangle \rightarrow |cab\rangle$, we have $\Psi_+ \rightarrow \Psi'_+ = \omega\Psi_+$ and $\Psi_- \rightarrow \Psi'_- = \bar{\omega}\Psi_-$. These transformations can be written as

$$\Psi \rightarrow \Psi' = \begin{pmatrix} \omega & 0 \\ 0 & \bar{\omega} \end{pmatrix} \Psi,\tag{5.55}$$

where Ψ is a column vector with components Ψ_+ and Ψ_- . On the other hand, an exchange of the first two labels, $|abc\rangle \rightarrow |bac\rangle$, gives $\Psi_+ \leftrightarrow \Psi_-$, or

$$\Psi \rightarrow \Psi' = \begin{pmatrix} 0 & 1 \\ 1 & 0 \end{pmatrix} \Psi.\tag{5.56}$$

Any other permutation of the particle labels can be obtained by combining these two operations, and is therefore represented by products of these two matrices.

The set of matrices that correspond to all these permutations (including the unit matrix for the identity transformation) is called a *representation* of the symmetric group. Note that these matrices are *unitary*, and that the only matrix which commutes with all of them is the unit matrix (or a scalar multiple thereof). The last property characterizes an *irreducible* representation of a group. (Contrariwise, a *reducible* representation consists of block diagonal matrices, all identically structured in submatrices of the same size, so that each set of submatrices is by itself a representation of the group.)

Bosons correspond to a trivial unitary representation of the symmetric group: the transformation matrices are one-dimensional, and all of them are equal to 1. This representation is called $\mathbf{D}^{(0)}$. (The notations used here are those of Wigner's book, listed in the bibliography.) Fermions also correspond to a one-dimensional representation, which is called $\bar{\mathbf{D}}^{(0)}$: the matrices corresponding to even permutations are equal to 1, and those corresponding to odd permutations are -1. The symmetric group has no other one-dimensional representation. It can be shown that all its other representations are multidimensional. Moreover, it can be shown that, for any finite group, the sum of the squares of the dimensions of all the inequivalent irreducible representations is equal to the number of group elements (which is $n!$ for the symmetric group S_n).

In the particular case of S_3 that we are investigating now, we have just found a two-dimensional representation which consists of the matrices in Eqs. (5.55) and (5.56), and all the products of these matrices. This irreducible representation is called $\mathbf{D}^{(1)}$. There can be no further (inequivalent) representation, because

$1 + 1 + 2^2 = 3!$, which is the number of group elements. On the other hand, we have so far used only four orthonormal states: the bosons and fermions given by Eq. (5.44), and the Ψ_+ and Ψ_- states in Eq. (5.54), which form a closed set under all permutations. Therefore there must be another orthonormal pair of states, which also transforms under permutations with the aid of the matrices of the $\mathbf{D}^{(1)}$ representation (but which does not mix with Ψ_{\pm}).

It is not difficult to find the two missing states. They can be taken as

$$\begin{aligned}\Phi_+ &= (|nms\rangle + \bar{\omega}|snm\rangle + \omega|msn\rangle)/\sqrt{3}, \\ \Phi_- &= (|mns\rangle + \bar{\omega}|nsm\rangle + \omega|smn\rangle)/\sqrt{3}.\end{aligned}\quad (5.57)$$

Exercise 5.19 Verify that Φ_+ and Φ_- are orthogonal to the boson, fermion, and Ψ_{\pm} states, and that they behave exactly as Ψ_+ and Ψ_- under permutations of the particle labels.

Exercise 5.20 Show that, for any real α and β , the four states

$$\Xi_{\pm} = \cos \alpha \Psi_{\pm} - e^{i\beta} \sin \alpha \Phi_{\pm}, \quad (5.58)$$

and

$$\Upsilon_{\pm} = e^{i\beta} \sin \alpha \Phi_{\pm} + \cos \alpha \Psi_{\pm}, \quad (5.59)$$

are mutually orthogonal, and that each pair, Ξ_{\pm} and Υ_{\pm} , has the same transformation properties as Ψ_{\pm} and Φ_{\pm} under permutations of the particle labels.

Exercise 5.21 Show that the pair of orthonormal states

$$\Lambda_+ = (\Psi_+ + \Psi_-)/\sqrt{2} \quad \text{and} \quad \Lambda_- = i(\Psi_+ - \Psi_-)/\sqrt{2}, \quad (5.60)$$

transforms according to

$$\Lambda \rightarrow \Lambda' = \begin{pmatrix} 1 & 0 \\ 0 & -1 \end{pmatrix} \Lambda, \quad \text{if } |abc\rangle \rightarrow |bac\rangle, \quad (5.61)$$

and

$$\Lambda \rightarrow \Lambda' = -\frac{1}{2} \begin{pmatrix} 1 & -\sqrt{3} \\ \sqrt{3} & 1 \end{pmatrix} \Lambda, \quad \text{if } |abc\rangle \rightarrow |cab\rangle. \quad \star \quad (5.62)$$

The last exercise shows that all six matrices of the $\mathbf{D}^{(1)}$ representation can be made real by a unitary transformation of the basis. (Different representations of the same group, related by a unitary transformation of the basis, are said to be *equivalent*.) Since the new $\mathbf{D}^{(1)}$ matrices no longer involve i , the coefficients of i and of $-i$ in the vectors Λ_{\pm} are not mixed by these matrices, and therefore they transform independently. You may verify that the two pairs of vectors

$$\left\{ \begin{aligned} & (2|mns\rangle - |nsm\rangle - |smn\rangle + 2|nms\rangle - |snm\rangle - |msn\rangle)/\sqrt{12}, \\ & (\quad \quad - |nsm\rangle + |smn\rangle \quad \quad + |snm\rangle - |msn\rangle)/2, \end{aligned} \right. \quad (5.63)$$

and

$$\left\{ \begin{array}{l} (|nsm\rangle - |smn\rangle + |snm\rangle - |msn\rangle)/2, \\ (2|mns\rangle - |nsm\rangle - |smn\rangle - 2|nms\rangle + |snm\rangle + |msn\rangle)/\sqrt{12}, \end{array} \right. \quad (5.64)$$

are mutually orthogonal, and that each pair transforms, without mixing with the other, as in Eqs. (5.61) and (5.62).

Inequivalent bases can be experimentally distinguished

This wealth of equivalent $\mathbf{D}^{(1)}$ representations raises a fundamental question: Given that the particles cannot be individually identified, are there quantum tests able to distinguish from each other the various states, Ψ_{\pm} , Φ_{\pm} , Ξ_{\pm} , etc.? It is obvious that states which can be transformed into each other by relabelling the particles, such as Ψ_{+} and Ψ_{-} , or any linear combination thereof (for example, Λ_{\pm}) cannot be distinguished by any test. Indeed, the mean value of any observable A is the same,

$$\langle \Psi_{-}, A \Psi_{-} \rangle = \langle \Psi_{+}, A \Psi_{+} \rangle, \quad (5.65)$$

because a relabelling of the particles is represented by a unitary transformation, $\Psi_{\pm} \rightarrow U \Psi_{\pm}$, under which A is invariant: $A = UAU^{\dagger}$.

On the other hand, bases that cannot be converted into each other by merely relabelling the particles, such as Ψ_{\pm} and Φ_{\pm} , are experimentally distinguishable. For instance, the operator

$$P_{\Psi} - P_{\Phi} = \Psi_{+} \Psi_{+}^{\dagger} + \Psi_{-} \Psi_{-}^{\dagger} - \Phi_{+} \Phi_{+}^{\dagger} - \Phi_{-} \Phi_{-}^{\dagger}, \quad (5.66)$$

is invariant under a relabelling of the particles; all linear combinations of the Ψ_{\pm} states are eigenvectors of that operator (with eigenvalue +1); those of Φ_{\pm} states also are eigenvectors (eigenvalue -1); and the boson and fermion states in Eq. (5.44) are eigenvectors too (eigenvalue 0). A physical realization of the operator in (5.66) would therefore allow us to verify whether triads of identical particles are of type Ψ , or Φ , or none of these.

As a concrete example, consider the symmetric expression

$$A = x y (z p_z + p_z z) + z x (y p_y + p_y y) + y z (x p_x + p_x x), \quad (5.67)$$

where x , y and z are the coordinates of three identical particles, and p_x , p_y and p_z are the conjugate momenta. Let the three states, $|m\rangle$, $|n\rangle$, and $|s\rangle$, be those of a harmonic oscillator, with the ground state labelled 0 (not 1). We then have (in natural units, including $\hbar = 1$),

$$\begin{aligned} x_{mn} &= (\sqrt{m} \delta_{m,n+1} + \sqrt{n} \delta_{n,m+1})/\sqrt{2}, \\ p_{mn} &= (\sqrt{m} \delta_{m,n+1} - \sqrt{n} \delta_{n,m+1})i/\sqrt{2}. \end{aligned} \quad (5.68)$$

It follows that $(xp - px)_{mn} = i \delta_{mn}$, as is well known, and

$$(xp + px)_{mn} = i(\sqrt{m(n+1)} \delta_{m,n+2} - \sqrt{n(m+1)} \delta_{n,m+2}). \quad (5.69)$$

Therefore the operator A , given by Eq. (5.67), has a nonvanishing mean value if the states $|m\rangle$, $|n\rangle$ and $|s\rangle$ correspond to three *consecutive* levels—in any order. For example, let us take them as $|0\rangle$, $|1\rangle$ and $|2\rangle$. We have

$$x_{01} = 1/\sqrt{2}, \quad x_{12} = 1, \quad (xp_x + p_x x)_{02} = -i\sqrt{2}, \quad (5.70)$$

and you are invited to verify that

$$\langle \Psi_{\pm}, A \Psi_{\pm} \rangle = -3\sqrt{3} \quad \text{and} \quad \langle \Phi_{\pm}, A \Phi_{\pm} \rangle = +3\sqrt{3}, \quad (5.71)$$

while $\langle A \rangle = 0$ for bosonic and fermionic states.

Exercise 5.22 Find the mean value of the operator A in Eq. (5.67) for the states Ξ_{\pm} , Υ_{\pm} , and Λ_{\pm} , which were defined in the preceding exercises. *

These results show beyond doubt that, if there were particles which obeyed parastatistics rules, that property would have observable consequences.

Suppose now that we have three particles of the Ψ_{\pm} type. That is, we have determined experimentally that they are neither Φ_{\pm} , nor Υ_{\pm} , etc. On the other hand, we have no experimental way of differentiating Ψ_{+} from Ψ_{-} (or from linear combinations thereof, such as Λ_{\pm}) because the particles are indistinguishable. These states can be transformed into each other by relabelling the particles, and all mean values, such as $\langle A \rangle$, are the same for all of them. It follows that the physical state of our three-particle system is an *equal weight mixture* of $\Psi_{+}\Psi_{+}^{\dagger}$ and $\Psi_{-}\Psi_{-}^{\dagger}$. This mixture is represented by a density matrix which is proportional to the unit matrix (in the subspace spanned by Ψ_{+} and Ψ_{-}), and is therefore invariant under the unitary transformations corresponding to permutations of the particles. We have a mixture, rather than a pure state, because of the inaccessibility of some data—namely, the conceptual labels attached to the indistinguishable particles.

Cluster inseparability

The above considerations can be generalized to multidimensional irreducible representations of S_n , for $n > 3$. The latter have the property that, when we descend⁷ from S_n to its subgroup S_{n-1} (for instance if one of the particles is so distant that we ignore it and permute only the labels of the $n-1$ other particles), all the irreducible representations of S_n become *reducible* representations of S_{n-1} . This too has observable consequences, that will now be discussed.

⁷H. Weyl, *Theory of Groups and Quantum Mechanics*, Methuen, London (1931) [reprinted by Dover] p. 390.

Returning to the case of three particles, assume that the $|m\rangle$ and $|n\rangle$ states are localized in our laboratory, while the $|s\rangle$ state is remote, localized on the Moon, say. The question may now be raised: if three particles obey the $\mathbf{D}^{(1)}$ symmetry, what happens when we swap the labels of only two particles of the same species? (More generally, if n particles belong to a given irreducible representation of S_n , what is the representation for a subset of $n - 1$ particles?) We have already investigated a similar question in the case of three *bosons* or *fermions* (see Exercise 5.16) and we then found the intuitively obvious result that if one of the three particles is remote, the two others still behave as bosons or fermions, respectively.

However, for three particles obeying the $\mathbf{D}^{(1)}$ symmetry, the situation is more complicated. For example, if they are of type Ψ_{\pm} , we have, instead of Eq. (5.46),

$$\langle A \rangle = A_{mns, mns} + \omega A_{mns, nsm} + \bar{\omega} A_{mns, smn}. \quad (5.72)$$

Exercise 5.23 Show from Eq. (5.54) that the matrix elements $A_{mns, smn}$ and $A_{mns, nsm}$ are complex conjugate, and verify Eq. (5.72).

On the other hand, for three particles of type Φ_{\pm} , we have a different result, which looks like (5.72), but with $\omega \leftrightarrow \bar{\omega}$. Other bases, which also lead to the same $\mathbf{D}^{(1)}$ representation, or to unitarily equivalent ones, give for the observable mean value $\langle A \rangle$ still other results. None of these results has the desired property of reducing to the boson or fermion symmetry rules, if one of the three occupied states is remote, and only the two others are accessible.

This leads to a paradoxical situation. We know that *two* indistinguishable particles behave either as bosons, or as fermions. On the other hand, if we have such a pair of particles here, we can never be sure that there is no third particle of the same kind elsewhere (e.g., on the Moon). The mere existence of that third particle would make the trio obey $\mathbf{D}^{(1)}$ statistics—which implies, for the two particles in our laboratory, an improperly symmetrized $\langle A \rangle$, unlike that in Eq. (5.43) which was valid for bosons or fermions. Since it is hardly conceivable that observable properties of the particles in our laboratory are affected by the possible existence on the Moon of another particle of the same species, we are forced to the conclusion that only Bose-Einstein or Fermi-Dirac statistics are admissible for indistinguishable systems.

5-6. Fock space

An efficient way of writing completely symmetric or antisymmetric state vectors is the use of a Fock space. This is a new notation, which also allows the introduction of states where the *number* of particles is not definite. Such states naturally occur whenever particles can be produced or absorbed. For example, if an atom is prepared in an excited energy state from which it can decay by emission of a photon, the quantum state after a finite time will be a *linear*

superposition of two components, representing an excited atom, and an atom in its ground state accompanied by a free photon; the number of photons present in that quantum system is *indefinite*. We thus need a mathematical formalism which is able to represent situations of that kind, and is more powerful than ordinary quantum mechanics, which describes only permanent particles.

Raising and lowering operators

Assume for simplicity that there is only one kind of particle, and that the physical system has a nondegenerate *vacuum state*, in which no particles are present.⁸ That state is denoted by Ψ_0 (or $|0\rangle$, in the Dirac notation). It is the *normalized ground state* of the system, and it should not be confused with the null vector 0 , which does not represent a physical state.

We now define a *raising operator* \mathbf{a}_μ^+ by the property that the vector $\mathbf{a}_\mu^+ \Psi_0$ is normalized and represents a single particle in state \mathbf{e}_μ . (The term *creation operator* and the notation \mathbf{a}_μ^\dagger are also commonly used.) The operator which is adjoint to \mathbf{a}_μ^+ is written \mathbf{a}_μ^- and is a *lowering operator*, because

$$\langle \Psi_0, \mathbf{a}_\mu^- \mathbf{a}_\mu^+ \Psi_0 \rangle = \langle \mathbf{a}_\mu^+ \Psi_0, \mathbf{a}_\mu^+ \Psi_0 \rangle = 1, \quad (5.73)$$

and therefore

$$\mathbf{a}_\mu^- \mathbf{a}_\mu^+ \Psi_0 = \Psi_0, \quad (5.74)$$

so that \mathbf{a}_μ^- maps the one particle state \mathbf{e}_μ into the vacuum state. (The terms *destruction*, or *annihilation operator*, and the notation \mathbf{a}_μ , without a superscript, are also commonly used for \mathbf{a}_μ^- .)

We shall henceforth assume that (except for normalization) the operator \mathbf{a}_μ^+ adds a particle in state \mathbf{e}_μ to *any* state (not only to the vacuum state) and therefore its adjoint \mathbf{a}_μ^- removes such a particle. In particular,

$$\mathbf{a}_\mu^- \Psi_0 = 0, \quad (5.75)$$

is the null vector, because removing a particle from the vacuum produces an unphysical state.

Fermions

Two fermions cannot occupy the same state. We therefore write $(\mathbf{a}_\mu^+)^2 \Psi_0 = 0$, since this expression is unphysical. More generally,

$$(\mathbf{a}_\mu^+)^2 = 0, \quad (5.76)$$

even when this operator acts on a non-vacuum state.

⁸This assumption is not as obvious as it may seem. Quantum field theory involves an infinite number of degrees of freedom and allows, in some cases, the existence of degenerate vacua. The Fock space formalism, discussed here, is not applicable to these situations.

We likewise have $(\mathbf{a}_\nu^+)^2 = \mathbf{0}$ for any \mathbf{e}_ν orthogonal to \mathbf{e}_μ , and moreover, for the state represented by the unit vector $(\mathbf{e}_\mu + \mathbf{e}_\nu)/\sqrt{2}$, we have $(\mathbf{a}_\mu^+ + \mathbf{a}_\nu^+)^2 = \mathbf{0}$. Combining all these equations, we obtain

$$\mathbf{a}_\mu^+ \mathbf{a}_\nu^+ + \mathbf{a}_\nu^+ \mathbf{a}_\mu^+ = \mathbf{0}, \quad (5.77)$$

which generalizes Eq. (5.76). The raising operators \mathbf{a}_μ^+ and \mathbf{a}_ν^+ are said to *anti-commute*. The lowering operators, which are their adjoints, also anticommute:

$$\mathbf{a}_\mu^- \mathbf{a}_\nu^- + \mathbf{a}_\nu^- \mathbf{a}_\mu^- = \mathbf{0}. \quad (5.78)$$

The state vector

$$\mathbf{a}_\mu^+ \mathbf{a}_\nu^+ \Psi_0 = -\mathbf{a}_\nu^+ \mathbf{a}_\mu^+ \Psi_0, \quad (5.79)$$

represents two fermions occupying the orthogonal states \mathbf{e}_μ and \mathbf{e}_ν . With this new notation, no fictitious labels need to be attached to the two particles. However, we can still swap the labels μ and ν of the *occupied states*, and then the entire vector changes its sign, as seen in (5.79). This property is readily generalized to three or more fermions: the complete antisymmetrization of the state vector is automatically included in the Fock formalism.

It is convenient to define a *number operator*,

$$\mathbf{N}_\mu = \mathbf{a}_\mu^+ \mathbf{a}_\mu^-. \quad (5.80)$$

It follows from Eqs. (5.75) and (5.74), respectively, that the eigenvalues of \mathbf{N}_μ are 0 and 1, since

$$\mathbf{N}_\mu \Psi_0 = 0 \quad \text{and} \quad \mathbf{N}_\mu \mathbf{a}_\mu^+ \Psi_0 = \mathbf{a}_\mu^+ \Psi_0. \quad (5.81)$$

Exercise 5.24 Show that the operator $\mathbf{a}_\mu^- \mathbf{a}_\mu^+$ has the same eigenvectors as \mathbf{N}_μ , but with eigenvalues 1 and 0, respectively, and therefore

$$\mathbf{a}_\mu^+ \mathbf{a}_\mu^- + \mathbf{a}_\mu^- \mathbf{a}_\mu^+ = \mathbf{1}. \quad (5.82)$$

Show, more generally, that

$$\mathbf{a}_\mu^+ \mathbf{a}_\nu^- + \mathbf{a}_\nu^- \mathbf{a}_\mu^+ = \delta_{\mu\nu} \mathbf{1}. \quad (5.83)$$

Hint: Consider the raising and lowering operators, $\mathbf{a}_\theta^\pm = \cos \theta \mathbf{a}_\mu^\pm + \sin \theta \mathbf{a}_\nu^\pm$, for the normalized state \mathbf{e}_θ , with an arbitrary value of the mixing angle θ .

From (5.83), it follows that

$$[\mathbf{N}_\mu, \mathbf{N}_\nu] = \mathbf{a}_\mu^+ \mathbf{a}_\mu^- \mathbf{a}_\nu^+ \mathbf{a}_\nu^- - \mathbf{a}_\nu^+ \mathbf{a}_\nu^- \mathbf{a}_\mu^+ \mathbf{a}_\mu^- = \mathbf{0}, \quad (5.84)$$

because the exchange of two anticommuting operators involves two changes of sign, and therefore *pairs* of anticommuting operators commute.

Bosons

The treatment of bosons is simpler in some respects, and more complicated in others, than that of fermions. It is simpler because the sign of the state vector does not change when occupied states are swapped. On the other hand, each state can be occupied by an arbitrary number of particles. A complete orthonormal basis can be written as $|n_\alpha n_\beta \dots n_\mu \dots\rangle$, where n_μ is the number of particles in state \mathbf{e}_μ . We may define a number operator N_μ , for that state, by

$$N_\mu |\dots n_\mu \dots\rangle = n_\mu |\dots n_\mu \dots\rangle. \quad (5.85)$$

It then follows from the definition of the raising and lowering operators that

$$N_\mu \mathbf{a}_\mu^\pm |\dots n_\mu \dots\rangle = (n_\mu \pm 1) \mathbf{a}_\mu^\pm |\dots n_\mu \dots\rangle, \quad (5.86)$$

or, more generally,

$$N_\mu \mathbf{a}_\nu^\pm |\dots n_\mu \dots\rangle = (n_\mu \pm \delta_{\mu\nu}) \mathbf{a}_\nu^\pm |\dots n_\mu \dots\rangle. \quad (5.87)$$

The raising and lowering operators for bosons *commute*,

$$[\mathbf{a}_\mu^+, \mathbf{a}_\nu^+] = [\mathbf{a}_\mu^-, \mathbf{a}_\nu^-] = \mathbf{O}, \quad (5.88)$$

instead of anticommuting like those of fermions, because bosonic state vectors do not change sign if state labels are swapped.

Equation (5.87) can also be written as

$$[N_\mu, \mathbf{a}_\nu^\pm] |\dots n_\mu \dots\rangle = \pm \delta_{\mu\nu} \mathbf{a}_\nu^\pm |\dots n_\mu \dots\rangle. \quad (5.89)$$

Since the basis $|\dots n_\mu \dots\rangle$ is complete, this gives the operator equation

$$[N_\mu, \mathbf{a}_\nu^\pm] = \pm \delta_{\mu\nu} \mathbf{a}_\nu^\pm, \quad (5.90)$$

from which it is easily shown that $[N_\mu, \mathbf{a}_\nu^+ \mathbf{a}_\nu^-] = \mathbf{O}$.

We have not yet normalized the raising and lowering operators \mathbf{a}_μ^\pm . The preceding relations only say that, in the basis where N_μ is diagonal, the matrices \mathbf{a}_μ^\pm have their nonvanishing elements in the *adjacent* diagonals:

$$(\mathbf{a}_\mu^+)_{mn} = \lambda_m \delta_{m,n+1} \quad \text{and} \quad (\mathbf{a}_\mu^-)_{mn} = \bar{\lambda}_n \delta_{n,m+1}. \quad (5.91)$$

Therefore, $(\mathbf{a}_\mu^+ \mathbf{a}_\mu^-)_{mn} = |\lambda_m|^2 \delta_{mn}$. It is convenient to choose $\lambda_n = \sqrt{n}$, so that

$$N_\mu = \mathbf{a}_\mu^+ \mathbf{a}_\mu^-, \quad (5.92)$$

has the same form as the number operator for fermions. It also follows from the preceding equations that $\mathbf{a}_\mu^- \mathbf{a}_\mu^+ = \mathbf{N}_\mu + 1$, and therefore, for any pair of orthogonal states,

$$[\mathbf{a}_\mu^-, \mathbf{a}_\nu^+] = \delta_{\mu\nu} \mathbf{1}. \quad (5.93)$$

This is a *commutation* relation, instead of the *anticommutation* relation (5.83) that was valid for the fermionic raising and lowering operators.

It follows from (5.90) and (5.91), with $\lambda_n = \sqrt{n}$, that

$$\begin{aligned} \mathbf{a}_\mu^+ |\dots n_\mu \dots\rangle &= \sqrt{n_\mu + 1} |\dots (n_\mu + 1) \dots\rangle, \\ \mathbf{a}_\mu^- |\dots n_\mu \dots\rangle &= \sqrt{n_\mu} |\dots (n_\mu - 1) \dots\rangle. \end{aligned} \quad (5.94)$$

Therefore, the *normalized* basis states in Fock space are

$$|\dots n_\mu \dots\rangle = \prod_{\mu} (n_\mu!)^{-1/2} (\mathbf{a}_\mu^+)^{n_\mu} \Psi_0. \quad (5.95)$$

Exercise 5.25 Show that

$$[\mathbf{a}_\mu^-, (\mathbf{a}_\nu^+)^n] = \delta_{\mu\nu} n (\mathbf{a}_\nu^+)^{n-1}. \quad (5.96)$$

Exercise 5.26 Show that

$$\mathbf{q}_\mu = (\mathbf{a}_\mu^+ + \mathbf{a}_\mu^-)/\sqrt{2} \quad \text{and} \quad \mathbf{p}_\mu = i(\mathbf{a}_\mu^+ - \mathbf{a}_\mu^-)/\sqrt{2} \quad (5.97)$$

satisfy the canonical commutation relation $[\mathbf{q}_\mu, \mathbf{p}_\nu] = i\delta_{\mu\nu} \mathbf{1}$.

Exercise 5.27 Try again to solve Exercise 2.20 (page 47) by using Fock space methods. **Hint:** Let \mathbf{a}^+ and \mathbf{b}^+ be the creation operators for photons polarized along the x - and y -axes, respectively. The operators corresponding to axes rotated by an angle θ are $\mathbf{a}^+ \cos \theta + \mathbf{b}^+ \sin \theta$ and $-\mathbf{a}^+ \sin \theta + \mathbf{b}^+ \cos \theta$. Therefore the state with N photons polarized along θ , and N photons along $\theta + \pi/2$, is

$$\Phi_\theta = [(\mathbf{a}^+ \cos \theta + \mathbf{b}^+ \sin \theta)(-\mathbf{a}^+ \sin \theta + \mathbf{b}^+ \cos \theta)]^N \Psi_0/N!. \quad (5.98)$$

Show that, if $|\theta' - \theta|$ is small and N is large, we have $|\langle \Phi_\theta, \Phi_{\theta'} \rangle|^2 \simeq e^{-4N(\theta - \theta')^2}$, so that the angular resolution attainable by an ideal measurement is about $1/\sqrt{4N}$. *

Parafermions

The Fock space formalism can be adapted to represent hypothetical particles having a number operator with eigenvalues $0, \dots, M$ (ordinary fermions correspond to $M = 1$.) Indeed, any matrix of order $M + 1$, with nonvanishing elements given by (5.91), is a raising operator \mathbf{a}_μ^+ which satisfies

$$(\mathbf{a}_\mu^+)^{M+1} = 0. \quad (5.99)$$

For example, a smooth interpolation between fermions ($M = 1$) and quasi-bosons ($M \rightarrow \infty$) is obtained from

$$\underline{(\mathbf{a}_\mu^+)_{mn} = (\mathbf{a}_\mu^-)_{nm} = \delta_{m,n+1} [m(M-n)/M]^{1/2}. \quad (5.100)}$$

Exercise 5.28 Show that Eq. (5.99) is satisfied by (5.100), and moreover that $(\mathbf{a}_\mu^+ \mathbf{a}_\mu^-)_{mn} = \delta_{mn} m(M-m+1)/M$, $(\mathbf{a}_\mu^- \mathbf{a}_\mu^+)_{mn} = \delta_{mn} (m+1)(M-m)/M$, and therefore

$$\frac{1}{2} M (\mathbf{a}_\mu^+ \mathbf{a}_\mu^- - \mathbf{a}_\mu^- \mathbf{a}_\mu^+ + \mathbf{1})_{mn} = \delta_{mn} n. \quad (5.101)$$

The expression on the left hand side of this equation is the number operator N_μ , with eigenvalues $0, \dots, M$.

The generalization of Eq. (5.99) to products of raising operators belonging to different states can be obtained by considering transformations to other orthonormal bases. The transformation law (3.2) gives

$$\mathbf{a}_\mu^+ = \sum_m C_{\mu m} \mathbf{a}_m^+, \quad (5.102)$$

where $C_{\mu m}$ is an arbitrary unitary matrix. Because of this arbitrariness, we have, in general,

$$\sum \mathbf{a}_m^+ \mathbf{a}_n^+ \dots \mathbf{a}_s^+ = 0, \quad (5.103)$$

where each term is a product of $M + 1$ raising operators, and the sum includes all the permutations of the indices $mn \dots s$. This relationship—which depends solely on the property of \mathbf{a}_μ^+ postulated in Eq. (5.99), not on its particular implementation in Eq. (5.100)—imposes an antisymmetry property on state vectors, when there are more than M particles. However, this antisymmetry is not restrictive enough for a smaller number of particles.

This alternative approach to parastatistics is just another way of showing the difficulties that were already mentioned in the preceding section.

5-7. Second quantization

Some composite quantum systems contain a *large number* of indistinguishable particles: heavy nuclei, solids, neutron stars, are typical examples. A method called *second quantization*, originally devised for use in quantum field theory, allows us to treat these large assemblies of particles without having to specify how many particles are actually involved. This is made possible by using the Fock basis given by (5.95). We shall now learn to write ordinary operators, like those for kinetic energy, or potential energy, in that new basis.

One-particle operators

Consider an *additive* dynamical variable, such as kinetic energy, or angular momentum, which is represented in quantum mechanics by an operator $A(\mathbf{q}, \mathbf{p})$ when there is a single particle. If there are N indistinguishable particles, the *total* value of that variable is

$$\mathcal{A} := \sum_{k=1}^N A(\mathbf{q}_k, \mathbf{p}_k). \tag{5.104}$$

We are interested in the matrix elements of A between Fock states, which are a complete orthonormal set labelled by occupation numbers n_μ .

In ordinary quantum mechanics, where particles are not allowed to appear or disappear (as they can do in quantum field theory) an operator acting on a state vector may change the occupation numbers n_μ of individual basis states, but it cannot change $\sum n_\mu$. In particular, A does not change the total number of particles. Therefore, the observable A has nonvanishing matrix elements only between Fock states with the same *total* number of particles, because states with different numbers of particles are orthogonal.

Let us now choose a one-particle basis in which $A(\mathbf{q}, \mathbf{p})$ is diagonal. With that basis, even the individual occupation numbers n_μ do not change when the diagonalized operator A acts on a Fock state, and we have

$$\mathcal{A} | \dots n_\mu \dots \rangle = \sum_{\mu} A_{\mu\mu} n_\mu | \dots n_\mu \dots \rangle. \tag{5.105}$$

This can be written as an operator equation $\mathcal{A} = \sum_{\mu} A_{\mu\mu} N_{\mu} = \sum_{\mu} A_{\mu\mu} a_{\mu}^{+} a_{\mu}^{-}$. Recall that this equation holds only in the basis where A is diagonal. Its form in any other basis (denoted as usual by Latin indices) can be obtained from the transformation law (5.102), and its Hermitian conjugate which is

$$a_{\mu}^{-} = \sum_n \overline{C_{\mu n}} a_n^{-}. \tag{5.106}$$

We have

$$\mathcal{A} = \sum_{mn} \left(\sum_{\mu} C_{\mu m} A_{\mu\mu} \overline{C_{\mu n}} \right) a_m^{+} a_n^{-}. \tag{5.107}$$

Since A is diagonal in the Greek basis, the parenthesis on the right hand side of (5.107) can also be written as

$$\sum_{\mu\nu} C_{\mu m} A_{\mu\nu} \overline{C_{\nu n}} = A_{mn} = \langle \mathbf{e}_m, \mathbf{A} \mathbf{e}_n \rangle, \tag{5.108}$$

where use was made of the transformation law for matrices (3.46). Thus, finally,

$$\mathcal{A} = \sum_{mn} A_{mn} a_m^{+} a_n^{-}. \tag{5.109}$$

The remarkable property of this expression for A is that it makes no explicit reference to the total number of particles, while that information was needed for writing Eq. (5.104). This is the advantage of the “second quantized” notation, with respect to the ordinary, “first quantized” one.

Exercise 5.29 Show that the generalization of Eq. (5.105) to a general basis where $A_{\mu\nu}$ is not diagonal is

$$A|\dots n_\mu \dots\rangle = \sum_\mu \left(A_{\mu\mu} n_\mu |\dots n_\mu \dots\rangle + \sum_{\nu \neq \mu} A_{\mu\nu} \sqrt{(n_\mu + 1)n_\nu} |\dots (n_\mu + 1) \dots (n_\nu - 1) \dots\rangle \right). \quad (5.110)$$

It is instructive to verify the agreement of Eq. (5.110) with the result that can be obtained, laboriously, by means of the first quantized formalism. Assume for simplicity that only the two states e_μ and e_ν are occupied. Let $N = n_\mu + n_\nu$. The state vector Ψ is a symmetrized sum of $N!/n_\mu!n_\nu!$ different terms that correspond to inequivalent ways of attributing states e_μ and e_ν to the particles. Since all these terms are orthogonal, the normalization factor is $(n_\mu!n_\nu!/N!)^{1/2}$. From the definition of matrix elements, $Ae_\nu = (A_{\nu\nu}e_\nu + A_{\mu\nu}e_\mu + \text{irrelevant terms})$, we see that the vector $A\Psi$ contains:

- 1) the same terms as in Ψ , with unaltered occupation numbers, but multiplied by a coefficient $(A_{\mu\mu} n_\mu + A_{\nu\nu} n_\nu)$.
- 2) terms with a coefficient $A_{\mu\nu}$, in which one particle switched from e_ν to e_μ . The number of these terms is

$$n_\nu [N!/n_\mu!n_\nu!] = (n_\mu + 1) [N!/(n_\mu + 1)!(n_\nu - 1)!], \quad (5.111)$$

so that each symmetrized set of these new terms occurs $(n_\mu + 1)$ times. The new normalization factor is $[(n_\mu + 1)!(n_\nu - 1)!/N!]^{1/2}$. Comparing the old and new normalizations, we get an extra coefficient $\sqrt{n_\nu/(n_\mu + 1)}$, which, together with the coefficient $(n_\mu + 1)$ on the right hand side of (5.111), exactly gives the square root in Eq. (5.110).

- 3) and likewise for $\mu \leftrightarrow \nu$.

Two-particle operators

A similar treatment applies to additive two-particle operators, such as two-body Coulomb interactions. In the ordinary (first quantized) notation, we have

$$B := \sum_{i < j} B(\mathbf{q}_i, \mathbf{p}_i, \mathbf{q}_j, \mathbf{p}_j). \quad (5.112)$$

When this operator acts on a Fock state, it may change the occupation numbers of at most two one-particle states, and it can therefore be written as

$$B = \frac{1}{2} \sum_{\kappa\lambda\mu\nu} B_{\kappa\lambda,\mu\nu} a_{\kappa}^{\dagger} a_{\lambda}^{\dagger} a_{\mu}^{-} a_{\nu}^{-}. \quad (5.113)$$

Note that the raising operators stand on the left of the lowering operators. This is called a *normal ordering*. Any other ordering can be obtained by using the (anti)commutation relations (5.83) and (5.93); the result differs from (5.113) by terms having only one raising and one lowering operator (or none at all), that is, by a one-particle operator (or a scalar). This ordering arbitrariness is related to a trivial ambiguity in the definition of a two-particle operator: an expression such as $B(\mathbf{q}_i, \mathbf{p}_i, \mathbf{q}_j, \mathbf{p}_j)$ remains a two-particle operator if one adds to it a sum of two one-particle operators.

It will now be shown that the coefficient $B_{\kappa\lambda,\mu\nu}$ in (5.113) is the ordinary two-particle matrix element,

$$B_{\kappa\lambda,\mu\nu} = \pm \langle \mathbf{e}_{\kappa\lambda}, B \mathbf{e}_{\mu\nu} \rangle, \quad (5.114)$$

where the minus sign is for fermions, and where

$$\mathbf{e}_{\mu\mu} := \mathbf{u}_{\mu} \otimes \mathbf{v}_{\mu}, \quad (5.115)$$

and

$$\mathbf{e}_{\mu\nu} := (\mathbf{u}_{\mu} \otimes \mathbf{v}_{\nu} \pm \mathbf{u}_{\nu} \otimes \mathbf{v}_{\mu})/\sqrt{2} \quad (\mu \neq \nu), \quad (5.116)$$

are the symmetrized state vectors given by Eqs. (5.37) and (5.38). Consider for example the effect of B on a two-particle state $\mathbf{e}_{\rho\sigma}$ (with $\rho \neq \sigma$). We have

$$B a_{\rho}^{\dagger} a_{\sigma}^{\dagger} \Psi_0 = \frac{1}{2} \sum_{\kappa\lambda\mu\nu} B_{\kappa\lambda,\mu\nu} a_{\kappa}^{\dagger} a_{\lambda}^{\dagger} a_{\mu}^{-} a_{\nu}^{-} a_{\rho}^{\dagger} a_{\sigma}^{\dagger} \Psi_0. \quad (5.117)$$

Repeated use of the (anti)commutation relations (5.83) and (5.93), together with $a_{\tau}^{-} \Psi_0 \equiv 0$, gives

$$a_{\mu}^{-} a_{\nu}^{-} a_{\rho}^{\dagger} a_{\sigma}^{\dagger} \Psi_0 = (\delta_{\mu\sigma} \delta_{\nu\rho} \pm \delta_{\mu\rho} \delta_{\nu\sigma}) \Psi_0, \quad (5.118)$$

whence

$$\begin{aligned} B a_{\rho}^{\dagger} a_{\sigma}^{\dagger} \Psi_0 &= \frac{1}{2} \sum_{\kappa\lambda} (B_{\kappa\lambda,\sigma\rho} \pm B_{\kappa\lambda,\rho\sigma}) a_{\kappa}^{\dagger} a_{\lambda}^{\dagger} \Psi_0, \\ &= \pm \sum_{\kappa\lambda} B_{\kappa\lambda,\rho\sigma} a_{\kappa}^{\dagger} a_{\lambda}^{\dagger} \Psi_0, \end{aligned} \quad (5.119)$$

which is just another way of writing Eq. (5.114).

Exercise 5.30 Compute explicitly $B(n_{\sigma}!)^{-1/2} (a_{\sigma}^{\dagger})^{n_{\sigma}} \Psi_0$. **Hint:** Use the commutation relation (5.96).

Exercise 5.31 Compute explicitly $B \prod_{\sigma} (n_{\sigma}!)^{-1/2} (a_{\sigma}^{\dagger})^{n_{\sigma}} \Psi_0$. *

Quantum fields

Let the abstract Hilbert space vectors e_μ be represented by functions $u_\mu(\mathbf{r}, t)$, which satisfy the orthonormality and completeness relations

$$\int \overline{u_\mu(\mathbf{r}, t)} u_\nu(\mathbf{r}, t) d\mathbf{r} = \delta_{\mu\nu}, \quad (5.120)$$

and

$$\sum_\mu \overline{u_\mu(\mathbf{r}', t)} u_\mu(\mathbf{r}'', t) = \delta(\mathbf{r}' - \mathbf{r}''). \quad (5.121)$$

Note that the *same* parameter t accompanies both \mathbf{r}' and \mathbf{r}'' .

Under a unitary transformation of the basis e_μ , given by Eq. (3.2), we have

$$u_\mu(\mathbf{r}, t) = \sum_m C_{\mu m} u_m(\mathbf{r}, t). \quad (5.122)$$

It then follows from the transformation law (5.106) that the operators

$$\psi(\mathbf{r}, t) = \sum_\mu u_\mu(\mathbf{r}, t) a_\mu^- \quad \text{and} \quad \psi^*(\mathbf{r}, t) = \sum_\mu \overline{u_\mu(\mathbf{r}, t)} a_\mu^+ \quad (5.123)$$

are invariant under a unitary transformation of the basis, produced by the matrix $C_{\mu m}$. They are *not* invariant, of course, if we choose a different set of orthonormal functions $u_\mu(\mathbf{r}, t)$ for representing the same physical state e_μ .

If all the functions $u_\mu(\mathbf{r}, t)$ happen to satisfy a partial differential equation (the same equation for all μ), the operator $\psi(\mathbf{r}, t)$ also satisfies that partial differential equation. In that respect, it behaves like a field in classical physics, and for that reason it is called a “quantum field.” In particular, if the functions $u_\mu(\mathbf{r}, t)$ obey a Schrödinger equation, the field $\psi(\mathbf{r}, t)$ also obeys that equation. This is the origin of the term “second quantization”: The old quantum wave function (for a single particle) becomes an operator, and the new state vector (for an indefinite number of particles) is given by a combination of Fock states.

The quantum fields ψ and ψ^* have (anti)commutation relations⁹

$$[\psi(\mathbf{r}', t), \psi(\mathbf{r}'', t)]_\pm = [\psi^*(\mathbf{r}', t), \psi^*(\mathbf{r}'', t)]_\pm = 0, \quad (5.124)$$

and

$$[\psi(\mathbf{r}', t), \psi^*(\mathbf{r}'', t)]_\pm = \sum_{\mu\nu} u_\mu(\mathbf{r}', t) \overline{u_\nu(\mathbf{r}'', t)} [a_\mu^-, a_\nu^\pm]_\pm = \delta(\mathbf{r}' - \mathbf{r}''), \quad (5.125)$$

by virtue of Eqs. (5.83), (5.93), and (5.121). The singular nature of this (anti)commutator is related to that of the fields themselves: The sums in (5.123) do not converge, and the quantum fields ψ and ψ^* actually are *operator valued distributions*, as explained at the end of Chapter 4.

Operators that were defined in Fock space, such as A and B , can now be written in terms of fields. We have

⁹ The symbol $[A, B]_\pm$ means $AB \pm BA$.

$$\begin{aligned} \mathcal{A} &= \sum_{\mu\nu} A_{\mu\nu} a_{\mu}^{\dagger} a_{\nu}^{-} = \sum_{\mu\nu} \int \overline{u_{\mu}(\mathbf{r}, t)} \mathbf{A} u_{\nu}(\mathbf{r}, t) d\mathbf{r} a_{\mu}^{\dagger} a_{\nu}^{-}, \\ &= \int \psi^{*}(\mathbf{r}, t) \mathbf{A}(\mathbf{r}) \psi(\mathbf{r}, t) d\mathbf{r}. \end{aligned} \quad (5.126)$$

Likewise,

$$\mathcal{B} = \frac{1}{2} \iint \psi^{*}(\mathbf{r}', t) \psi^{*}(\mathbf{r}'', t) \mathbf{B}(\mathbf{r}', \mathbf{r}'') \psi(\mathbf{r}'', t) \psi(\mathbf{r}', t) d\mathbf{r}' d\mathbf{r}'' \quad (5.127)$$

Exercise 5.32 Take $\mathbf{A} = 1$ and show that the operator for the total number of particles is $\mathcal{N} = \int \psi^{*}(\mathbf{r}, t) \psi(\mathbf{r}, t) d\mathbf{r}$.

Exercise 5.33 Check that the factor ordering in Eq. (5.127) is the correct one for fermions (it is of course irrelevant for bosons). ★

5-8. Bibliography

Group theory

The theory of group representations is an essential mathematical tool in many applications of quantum mechanics. The reader who is not already familiar with this subject is urged to get acquainted with this powerful technique. The classic treatise is

E. P. Wigner, *Group Theory and Its Application to the Quantum Mechanics of Atomic Spectra*, Academic Press, New York (1959).

This book is an expanded translation of *Gruppentheorie und ihre Anwendung auf Quantenmechanik der Atomspektren*, Vieweg, Braunschweig (1931). A more recent introductory text, with applications to molecular and solid state physics, is

M. Tinkham, *Group Theory and Quantum Mechanics*, McGraw-Hill, New York (1964).

Schmidt's theorem

E. Schmidt, "Zur Theorie der linearen und nichtlinearen Integralgleichungen," *Math. Ann.* 63 (1907) 433.

A. Peres, "Higher order Schmidt decompositions," *Phys. Letters A* 202 (1995) 16.

Necessary and sufficient conditions are given for the existence of a Schmidt decomposition involving more than two subspaces.

Many-Body Theory

A. A. Abrikosov, L. P. Gor'kov, and I. Ye. Dzyaloshinskii, *Quantum Field Theoretical Methods in Statistical Physics*, Pergamon, Oxford (1965) [transl. from the Russian].

A. L. Fetter and J. D. Walecka, *Quantum Theory of Many-Particle Systems*, McGraw-Hill, New York (1971).

Chapter 6

Bell's Theorem

6-1. The dilemma of Einstein, Podolsky, and Rosen

The entangled states introduced in Chapter 5 raise fundamental issues, which were exposed by Einstein, Podolsky, and Rosen (hereafter EPR) in a classic article¹ entitled "Can Quantum Mechanical Description of Physical Reality Be Considered Complete?". In that article, the authors define "elements of physical reality" by the following criterion: *If, without in any way disturbing a system, we can predict with certainty . . . the value of a physical quantity, then there exists an element of physical reality corresponding to this physical quantity.* This criterion is then applied by EPR to a composite quantum system consisting of two distant particles, with an entangled wave function

$$\psi = \delta(x_1 - x_2 - L) \delta(p_1 + p_2). \quad (6.1)$$

Here, the symbol δ does not represent a true delta function, of course, but a normalizable function with an arbitrarily high and narrow peak; and L is a large distance—much larger than the range of mutual interaction of particles 1 and 2. The physical meaning of this wave function is that the particles have been prepared in such a way that their relative distance is arbitrarily close to L , and their total momentum is arbitrarily close to zero. Note that the operators $x_1 - x_2$ and $p_1 + p_2$ commute.

In the state ψ , we know nothing of the positions of the individual particles (we only know their distance from each other); and we know nothing of their individual momenta (we only know the total momentum). However, if we measure x_1 , we shall be able to predict with certainty the value of x_2 , without having in any way disturbed particle 2. At this point, EPR argue that "*since at the time of measurement the two systems no longer interact, no real change can take place in the second system in consequence of anything that may be done to the first system.*" Therefore, x_2 corresponds to an "element of physical reality," as defined above.

¹ A. Einstein, B. Podolsky, and N. Rosen, *Phys. Rev.* 47 (1935) 777.

Nathan Rosen, working in his office at Technion, 55 years after he co-authored the famous EPR article.



On the other hand, if we prefer to perform a measurement of p_1 rather than of x_1 , we shall then be able to predict with certainty the value of p_2 , again without having in any way disturbed particle 2. Therefore, by the same argument as above, p_2 also corresponds to an “element of physical reality.” However, quantum mechanics precludes the simultaneous assignment of precise values to both x_2 and p_2 , since these operators do not commute, and thus EPR “*are forced to conclude that the quantum mechanical description of physical reality given by wave functions is not complete.*” However, they prudently leave open the question of whether or not a complete description exists.

Bohr's reply

Soon after its publication, EPR's article was criticized by Bohr.² Let us examine the points of agreement and disagreement. Bohr did not contest the validity of counterfactual reasoning. He wrote: “*our freedom of handling the measuring instruments is characteristic of the very idea of experiment . . . we have a completely free choice whether we want to determine the one or the other of these quantities . . .*” Thus, Bohr too found it perfectly legitimate to consider counterfactual alternatives. He had no doubt that the observer had free will and could arbitrarily choose his experiments.

On the other hand, Bohr disagreed with EPR's interpretation of the notion of locality. He readily conceded that “*there is no question of a mechanical disturbance of the system under investigation*” [due to the measurement of the other, distant system], but he added: “*there is essentially the question of an influence on the very conditions which define the possible types of predictions regarding the future behavior of the system.*”

Bohr gave to his point of view the name “principle of complementarity.” Its meaning is that some types of predictions are possible while others are not, because they are related to mutually incompatible tests. For example, in

²N. Bohr, *Phys. Rev.* 48 (1935) 696.

the situation described by EPR, the choice of the experiment performed on the first system determines the type of prediction that can be made for the results of experiments performed on the second system. On the other hand, no experiment, performed on the second system by an observer ignorant of the above choice, would reveal the occurrence of a "disturbance" to that system, thereby disclosing what the choice of the first experiment had been.

According to Bohr, each experimental setup must be considered separately. In particular, no conclusions can be drawn from the comparison of possible results of mutually incompatible experiments (*i.e.*, those having the property that the execution of any one of these experiments precludes the execution of the others). Bohr's argument did not convince Einstein who later wrote, in his autobiography: ³

. . . it becomes evident that the paradox forces us to relinquish one of the following two assertions:

- (1) the description by means of the ψ -function is *complete*,
- (2) the real states of spatially separated objects are independent of each other.

In Einstein's mind, the second of these assertions was indisputable. He wrote:⁴ "*On one supposition we should, in my opinion, absolutely hold fast: the real factual situation of the system S2 is independent of what is done with the system S1, which is spatially separated from the former.*" This physical principle has received the name Einstein locality.

Spin systems

A simpler example of the same dilemma, involving only discrete variables, was proposed by Bohm,⁵ and became since then the basis of most discussions of the so-called "EPR paradox." Consider the decay of a spinless system into a pair of spin $\frac{1}{2}$ particles, such as $\pi^0 \rightarrow e^+ e^-$ (this decay mode of π^0 is rare, but it actually occurs). After the decay products have separated and are very far apart, we measure a component of the spin of one of them. Suppose that S_x of the electron is measured and found equal to $\hbar/2$. Then, we can be sure that S_x of the positron will turn out equal to $-\hbar/2$, if we measure it; in other words, we know that the positron is in a state with $S_x = -\hbar/2$. Moreover, it must have been in that state from the very instant the positron was free, since it did not interact with other particles.

On the other hand, we *could* have measured S_y of the electron and, by the same argument, S_y of the positron *would* have been definite; and likewise for S_z .

³ A. Einstein, in *Albert Einstein, Philosopher-Scientist*, ed. by P. A. Schilpp, Library of Living Philosophers, Evanston (1949) p. 682.

⁴ A. Einstein, *ibid.*, p. 85.

⁵ D. Bohm, *Quantum Theory*, Prentice-Hall, New York (1951) p. 614.

Therefore, all three components of spin correspond to “elements of reality,” as defined by EPR, because a definite value will be predictable with certainty, for any one of them, if we measure the corresponding spin component of the *other* particle. This claim, however, is incompatible with quantum mechanics, which asserts that at most *one* spin component of each particle may be definite.

Recursive elements of reality

The “paradox” can be sharpened if we further assume that elements of reality which correspond to *commuting* operators can be combined algebraically, and thereby generate new elements of reality, in a recursive manner. The rationale for this assumption is that if operators A and B commute, quantum mechanics allows us in principle to measure both of them simultaneously, together with any algebraic function $f(A, B)$, and the numerical results of these measurements are functionally related like the operators themselves (see Exercise 6.2 below). Therefore, if commuting operators A and B correspond to elements of reality with numerical values α and β , respectively, it is tempting to say that any algebraic function $f(A, B)$ also corresponds to an element of reality, with numerical value $f(\alpha, \beta)$. This is the spirit, if not the letter, of the EPR criterion. One may distinguish *primary* elements of reality (obtained by observations performed on distant systems) from *secondary* ones (obtained recursively), but both kinds are considered equivalent in the present argument. This recursive definition is strongly suggested by the intuitive meaning of “reality.”

Now, consider again our two spin $\frac{1}{2}$ particles, far apart from each other, in a singlet state. We know that measurements of S_{1x} and S_{2x} , if performed, shall yield *opposite* values, that we denote by m_{1x} and m_{2x} , respectively. Likewise, measurements of S_{1y} and S_{2y} , if performed, shall yield *opposite* values, $m_{1y} = -m_{2y}$. Furthermore, since S_{1x} and S_{2y} commute, and both correspond to elements of reality, their product $S_{1x} S_{2y}$ also corresponds to an element of reality (recursively defined, as explained above). The numerical value assigned to the product $S_{1x} S_{2y}$ is the product of the individual numerical values, $m_{1x} m_{2y}$. Likewise, the numerical value of $S_{1y} S_{2x}$ is the product $m_{1y} m_{2x}$. These two products must be *equal*, because $m_{1x} = -m_{2x}$ and $m_{1y} = -m_{2y}$. But, on the other hand, quantum theory asserts that these products have *opposite* values, because the singlet state satisfies

$$(S_{1x} S_{2y} + S_{1y} S_{2x}) \psi = 0. \quad (6.2)$$

This is no longer a paradox, but an algebraic contradiction.⁶ We are thus forced to the conclusion that our recursive definition of elements of reality, which appeared almost obvious, is incompatible with quantum theory.

Exercise 6.1 Show that the operators $S_{1x} S_{2y}$ and $S_{1y} S_{2x}$ commute, and prove Eq. (6.2).

⁶ A. Peres, *Phys. Letters A* 51 (1990) 107.

Exercise 6.2 Show that if a state ψ is prepared in such a way that $A\psi = \alpha\psi$ and $B\psi = \beta\psi$, then $f(A, B)\psi = f(\alpha, \beta)\psi$. Note that this result is valid even if A and B do not commute, but merely happen to have a common eigenvector ψ .

Three particle model

A similar contradiction was derived by Mermin⁷ for a three particle system, without the use of any debatable extension of the EPR criteria. (Mermin's argument is a simplified version of another one, with four particles, due to Greenberger, Horne, and Zeilinger.⁸)

The three spin $\frac{1}{2}$ particles are prepared in an entangled state

$$\psi = f(\mathbf{r}_1, \mathbf{r}_2, \mathbf{r}_3)(\mathbf{u}_1 \mathbf{u}_2 \mathbf{u}_3 - \mathbf{v}_1 \mathbf{v}_2 \mathbf{v}_3), \quad (6.3)$$

where the coordinate space wave function $f(\mathbf{r}_1, \mathbf{r}_2, \mathbf{r}_3)$ has a form ensuring that the particles are widely separated, and where the spin states \mathbf{u} and \mathbf{v} are eigenstates of σ_z , satisfying

$$\begin{array}{lll} \sigma_x \mathbf{u} = \mathbf{v} & \sigma_y \mathbf{u} = i\mathbf{v} & \sigma_z \mathbf{u} = \mathbf{u}, \\ \sigma_x \mathbf{v} = \mathbf{u} & \sigma_y \mathbf{v} = -i\mathbf{u} & \sigma_z \mathbf{v} = -\mathbf{v}. \end{array} \quad (6.4)$$

It is easily seen that ψ is an eigenfunction of several operators:

$$\sigma_{1x} \sigma_{2y} \sigma_{3y} \psi = \sigma_{1y} \sigma_{2x} \sigma_{3y} \psi = \sigma_{1y} \sigma_{2y} \sigma_{3x} \psi = \psi, \quad (6.5)$$

and

$$\sigma_{1x} \sigma_{2x} \sigma_{3x} \psi = -\psi. \quad (6.6)$$

Exercise 6.3 Verify the above equations and show that these four operators commute. Moreover show that

$$(\sigma_{1x} \sigma_{2y} \sigma_{3y})(\sigma_{1y} \sigma_{2x} \sigma_{3y})(\sigma_{1y} \sigma_{2y} \sigma_{3x}) \equiv -(\sigma_{1x} \sigma_{2x} \sigma_{3x}). \quad (6.7)$$

The minus sign in (6.7) is crucial, as will soon be seen.

The EPR argument now runs as follows. We may measure, on each particle, either σ_x or σ_y , without disturbing the other particles. The results of these measurements will be called m_x or m_y , respectively. From (6.6), we can predict with certainty that, if the three σ_x are measured, the results satisfy

$$m_{1x} m_{2x} m_{3x} = -1. \quad (6.8)$$

⁷ N. D Mermin, *Physics Today* 43 (June 1990) 9; *Am. J. Phys.* 58 (1990) 731.

⁸ D. M. Greenberger, M. Horne, and A. Zeilinger, in *Bell's Theorem, Quantum Theory, and Conceptions of the Universe*, ed. by M. Kafatos, Kluwer, Dordrecht (1989) p. 69.

Therefore each one of the operators σ_{1x} , σ_{2x} , and σ_{3x} corresponds to an EPR element of reality, because its value can be predicted with certainty by performing measurements on the two *other*, distant particles.

However, it also follows from (6.5) that we can predict with certainty the value of σ_{1x} by measuring σ_{2y} and σ_{3y} rather than σ_{2x} and σ_{3x} . We have

$$m_{1x} m_{2y} m_{3y} = 1, \tag{6.9}$$

and likewise, by cyclic permutation,

$$m_{1y} m_{2x} m_{3y} = 1, \tag{6.10}$$

and

$$m_{1y} m_{2y} m_{3x} = 1. \tag{6.11}$$

The product of the last four equations immediately gives a contradiction.

There is a tacit assumption in the above argument, that m_{1x} in Eq. (6.8) is the same as m_{1x} in Eq. (6.9), in spite of the fact that these two ways of obtaining m_{1x} involve *mutually exclusive* experiments—measuring σ_{2x} and σ_{3x} , or measuring σ_{2y} and σ_{3y} . This tacit assumption is of *counterfactual nature*, and cannot be experimentally verified. It obviously adheres to the spirit of the EPR article—it is almost forced upon us by the intuitive meaning of the word “reality”—but it is open to the same criticism that Bohr expressed in his response to Einstein, Podolsky, and Rosen.

Einstein locality and other relativistic considerations

The paradoxes—or algebraic contradictions—resulting from the apparently reasonable criteria proposed by EPR, prompt us to reexamine more carefully their argument: *If . . . we can predict with certainty . . .* Who are “we”?

In Bohm’s singlet model, the observer who measures S_{1x} and finds $+\hbar/2$ knows that if the other observer measures (or has measured, or will measure) S_{2x} , she⁹ must find the opposite result, $-\hbar/2$. However, this knowledge is useless (it is devoid of operational meaning) because the two observers are far apart. The only thing that the first observer can do is to send a message to the second one, telling her that she can verify that S_{2x} is $-\hbar/2$, provided that she has not yet disturbed her particle by measuring another component of spin, before she received that message.

Now assume that, unbeknownst to the first observer, she measures S_{2y} and finds the result $+\hbar/2$, say. Can there be any paradox here? Conceptual difficulties may indeed arise if you demand that every physical system, such as our pair of particles, has, at every instant, a well defined quantum state (some authors

⁹ When two observers are involved, I shall call the second one “she” rather than “he” (see footnote on page 12).

would like the entire Universe to have a quantum state). To illustrate this difficulty, let our two observers be attached to *different* Lorentz frames, as shown in Fig. 6.1. They recede from each other, with a constant relative velocity. Thus, in each one of the Lorentz frames, the test performed by the observer who is at rest appears to occur *earlier* than the test performed by the moving observer. If the first observer got a bad education in quantum theory and believes that the pair of particles has, at each instant, a definite wave function, he will say that the singlet state, which existed for $t_1 < 0$, collapsed into an eigenstate of S_{1x} and of S_{2x} , for $t_1 > 0$. In the same vein, the second observer may say that the singlet state held for $t_2 < 0$, and thereafter collapsed into an eigenstate of S_{1y} and of S_{2y} , as a result of her test.

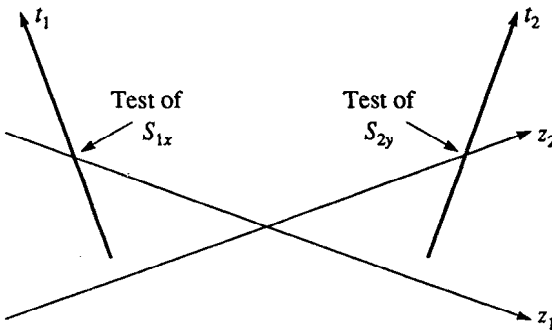

Fig. 6.1. In this spacetime diagram, the origins of the coordinate systems are the locations of the two tests. The t_1 and t_2 axes are the world lines of the observers, who are receding from each other. In each Lorentz frame, the z_1 and z_2 axes are isochronous: $t_1 = 0$ and $t_2 = 0$, respectively.

Statements like those of our fictitious observers are not only contradictory—they are utterly meaningless. There is no disagreement about what was actually observed. However, a situation involving *several* observers cannot be described by a wave function with a relativistic transformation law. No single covariant state history may be defined which properly accounts for all the experimental results.¹⁰

Exercise 6.4 Show that if the two observers cannot communicate to compare their results, the observations of each one of them are statistically consistent with a random preparation, represented by the reduced density matrix $\rho = \frac{1}{2} \mathbb{1}$.

Exercise 6.5 After the first observer performs a repeatable test and finds $S_{1x} = \hbar/2$, the spin state of the pair of particles, as defined by that test, is $\frac{1}{2} \begin{pmatrix} 1 \\ 1 \end{pmatrix} \begin{bmatrix} 1 \\ -1 \end{bmatrix}$. Transform this spin state to the Lorentz frame of the second observer, whose relative velocity is in the z direction. ★

¹⁰ Y. Aharonov and D Z. Albert, *Phys. Rev. D* 24 (1981) 359.

6-2. Cryptodeterminism

The EPR claim that the description of physical reality by means of quantum mechanics is not complete suggests the existence of a more detailed description of nature—perhaps associated with the use of a technology more advanced than the current one—such that all our predictions would be unambiguous, rather than probabilistic. For example, we would be able to predict whether any specified silver atom passing through a Stern-Gerlach magnet will be deflected up or down. This more detailed description would presumably involve additional data on the silver atom, and the Stern-Gerlach magnet, and perhaps also the oven from which the atom originated. These hypothetical additional data have been given the name “hidden variables.” The tentative goal of a hidden variable theory is the following: In the absence of a detailed knowledge of the hidden variables, calculations could be based on an *ensemble average* over their purported statistical distribution, and would then yield the statistical predictions of quantum theory. The probabilistic character of quantum theory would thus be due to an incomplete specification of physical data, just as in classical statistical mechanics; and a quantum average would have a conceptual status similar to that of a classical canonical average.

Photon pairs

There are indeed clues that the randomness of quantum phenomena is only an illusion, and what appears to be a random sequence may actually be fully deterministic. To illustrate this, consider an atom, initially in an excited S state, undergoing two consecutive electric dipole transitions, $(J = 0) \rightarrow (J = 1) \rightarrow (J = 0)$. This process is called an atomic *SPS* cascade. If the two emitted photons are detected in opposite directions, they appear to have the *same polarization*. This is due to a symmetry property explained below.

The initial, excited state of the *atom* is spherically symmetric ($J = 0$). Its decay is due to an electromagnetic interaction, which is rotationally invariant. Therefore, the final state of *the atom and the photon pair* is also spherically symmetric. That final state is *entangled*, the various eigenstates of the atom being correlated to those of the photons. This entanglement can partly be lifted by means of collimators which select photons moving in a given direction. Let us take that direction as the z axis. The resulting state, after collimation, still has rotational symmetry around that axis. Let x and y denote the states of a photon with linear polarization along directions x and y , orthogonal to the z axis. Then, for a *pair* of photons, the four states $x_1 x_2$, $x_1 y_2$, $y_1 x_2$, and $y_1 y_2$, form a complete basis. Of these, only the two *entangled* combinations

$$\psi_+ = (x_1 x_2 + y_1 y_2)/\sqrt{2}, \quad (6.12)$$

and

$$\psi_- = (x_1 y_2 - y_1 x_2)/\sqrt{2}, \quad (6.13)$$

are invariant under rotations around the z axis. The polarization state ψ_+ is even under reflections, while ψ_- is odd. Since the electromagnetic interaction conserves parity, the final state of the photon pair can only be ψ_+ , if the photons originate from an atomic *SPS* cascade. (On the other hand, a pair of gamma rays created by positronium annihilation must be in the antisymmetric state ψ_- , because the positronium ground state has negative intrinsic parity.¹¹)

Exercise 6.6 Write ψ_+ and ψ_- in terms of helicity eigenstates (that is, states of circularly polarized photons).

Let us now improve the experiment sketched in Fig. 1.3 (page 6), and replace our source of photons—the incandescent lamp—by an atomic *SPS* cascade, so as to obtain pairs of photons in state ψ_+ , with correlated polarizations. In the new setup, shown in Fig. 6.2, there are no polarizers, but each beam of photons has its own complete detecting station, with an analyzer (a calcite crystal), two photodetectors, and a printer to record the results.

We are then faced with the following situation. If we consider the output of each printer separately, it appears completely random, with equal numbers of $+$ and $-$. However, if we *compare* these printouts, they are *correlated*. In particular, if the two crystals are parallel, as shown in the figure, their printers will always register identical outputs, because the photons have the same polarization. An observer, having seen the results of the upper printer, can predict with absolute certainty those that are going to appear in the lower printer. The second printout by itself looks like a random sequence, but actually each and everyone of its results is fully deterministic.

A further improvement, shown in Fig. 6.3, is the possibility of rotating one of the two detecting stations—as a whole—by an angle θ around the direction of the photon beam. Let the linear polarization state tested by the *fixed* analyzer be called x (this merely defines the direction of the x axis, in the plane perpendicular to the z axis which coincides with the light ray). Then, the linear polarization tested by the *rotating* analyzer is $x \cos \theta + y \sin \theta$, and the corresponding test is represented by the projector

$$P_\theta := (x \cos \theta + y \sin \theta)(x \cos \theta + y \sin \theta)^\dagger. \quad (6.14)$$

It will be convenient, in the sequel, to work with another operator,

$$\sigma_\theta := 2P_\theta - \mathbb{1} = (x x^\dagger - y y^\dagger) \cos 2\theta + (x y^\dagger + y x^\dagger) \sin 2\theta, \quad (6.15)$$

whose eigenvalues are 1 and -1 , corresponding to the eigenvalues 1 and 0 of P_θ . (This operator is formally similar to $\sigma_x \cos 2\theta + \sigma_y \sin 2\theta$.)

For our *pair* of photons, the product $\sigma_\theta \otimes \sigma_\theta$ also has eigenvalues 1 and -1 . These correspond to identical results, and opposite results, respectively, of the

¹¹J. M. Jauch and F. Rohrlich, *The Theory of Photons and Electrons*, Addison-Wesley, Cambridge (1955) pp. 275–282.

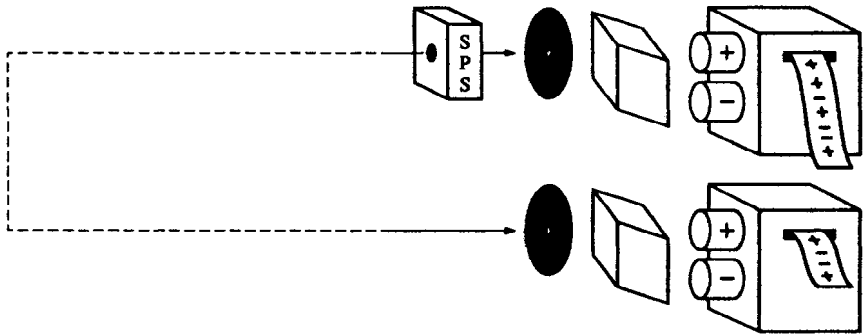

Fig. 6.2. Photons originating in an SPS cascade, with opposite directions, have perfectly correlated linear polarizations. Here, there is a delay in the detection of one of the photons, whose path is reflected by distant mirrors, far to the left (not shown). The lower detecting station is always activated later than the upper one, and its outcomes are predictable with certainty.

two analyzers. The average value of the observable $\sigma_0 \otimes \sigma_\theta$ is the *correlation* of the outcomes of the two analyzers. Its value can be predicted by the standard rule for a quantum average, Eq. (3.41):

$$\langle \sigma_0 \otimes \sigma_\theta \rangle = \frac{1}{2} (\mathbf{x}_1 \mathbf{x}_2 + \mathbf{y}_1 \mathbf{y}_2)^\dagger (\sigma_0 \otimes \sigma_\theta) (\mathbf{x}_1 \mathbf{x}_2 + \mathbf{y}_1 \mathbf{y}_2) = \cos 2\theta. \tag{6.16}$$

We obtain, as expected, a perfect correlation for $\theta = 0$, a perfect anticorrelation for $\theta = \pi/2$, and Malus's law for all the other angles.

Exercise 6.7 What is the correlation that has been measured in the experiment sketched in Fig. 6.3, until the last test recorded on that figure? **Ans.:** $\langle \sigma_0 \otimes \sigma_\theta \rangle = 0.5$.

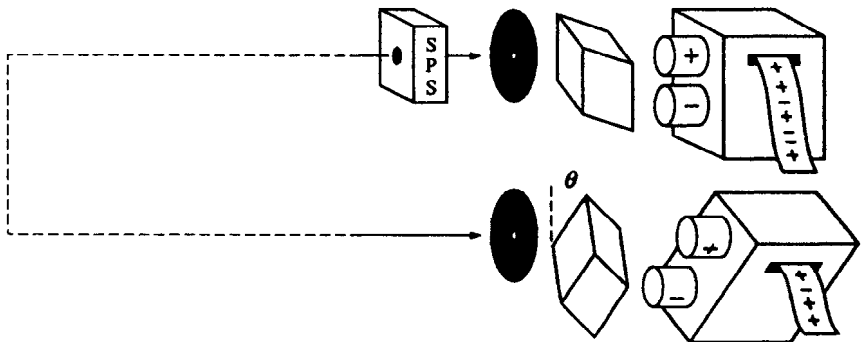

Fig. 6.3. If one of the detecting stations is tilted by an angle θ , the correlation of the outcomes is $\cos 2\theta$.

Exercise 6.8 Show, from Eqs. (6.12) and (6.15), that if two analyzers test linear polarizations at angles α and β from an arbitrary x axis, the correlation of their outcomes is

$$\langle \sigma_\alpha \otimes \sigma_\beta \rangle = \cos 2(\alpha - \beta). \quad (6.17)$$

Bell's model of hidden variables

The perfect correlation of distant and seemingly random events, illustrated in Fig. 6.2, suggests that the fundamental laws of physics are deterministic, and the apparent stochasticity of quantum phenomena is merely due to our imperfect methods of preparing physical systems. Indeed, from the early days of quantum theory, there were attempts to deduce its properties from those of a deterministic, yet unknown, subquantum world; and, on the other hand, there also were numerous attempts to prove that no "hidden variable" theory could reproduce the statistical properties of quantum theory.

In particular, von Neumann's classic book¹² contains a mathematical proof that quantum theory is incompatible with the existence of "dispersion free ensembles." Namely, it is impossible to prepare an ensemble of physical systems in such a way that every observable A satisfies $\langle A^2 \rangle = \langle A \rangle^2$. The assumptions needed for von Neumann's proof are that any observable A is represented by a self-adjoint operator (this is the essence of quantum theory); that if A and B are observables, their sum $A + B$ is also an observable; and moreover that

$$\langle A + B \rangle = \langle A \rangle + \langle B \rangle. \quad (6.18)$$

The last equation could be a trivial consequence of the trace formula (3.77), but von Neumann does not want to use the trace formula in his proof—he rather wants to *derive* it from weaker assumptions.

The difficulty, acknowledged by von Neumann himself, is that there is no physical reason to assume the validity of Eq. (6.18), if the operators A and B do not commute and cannot be measured simultaneously. The three experimental setups needed for measuring A , B , and $A + B$, may be radically different (just think of measuring the kinetic energy, or the potential energy, or the total energy of a physical system). One could therefore argue that a conventional preparation, which produces an ordinary quantum ensemble, satisfies (6.18), but more sophisticated preparation methods, not yet invented by us, could create dispersion free ensembles, violating condition (6.18).

Following von Neumann's questionable proof, there were other unsuccessful attempts to derive the "no hidden variable theorem," from different premises. All these efforts were finally laid to rest by Bell¹³ who explicitly constructed a

¹²J. von Neumann, *Mathematische Grundlagen der Quantenmechanik*, Springer, Berlin (1932) p. 171; transl. by E. T. Beyer: *Mathematical Foundations of Quantum Mechanics*, Princeton Univ. Press, Princeton (1955) p. 324.

¹³J. S. Bell. *Rev. Mod. Phys.* 38 (1966) 447.

deterministic model, generating results whose *averages* were identical to those predicted by quantum theory.

Bell's model involves a spin $\frac{1}{2}$ particle and an observable $A = \mathbf{m} \cdot \boldsymbol{\sigma}$, where the three components of \mathbf{m} are arbitrary real numbers, and those of $\boldsymbol{\sigma}$ are the Pauli spin matrices. According to quantum mechanics, a measurement of A always yields one of its eigenvalues $\pm m$ (where $m = |\mathbf{m}|$) and the average result of an ensemble of measurements is $\langle A \rangle = \psi^\dagger A \psi$. However, quantum mechanics is unable to predict the specific outcome of each test. Bell's model assumes that this outcome is determined by \mathbf{m} (a macroscopic parameter of the measuring apparatus, which we know to control), by ψ (the quantum state preparation, which we can also control), and by an additional, hidden variable called λ . Conceptually, each physical system has a unique λ , but we are unable to know its value. Our present experimental techniques always end up yielding a *uniform* distribution of λ , between -1 and 1 . It is this uniform distribution which characterizes the domain of validity of quantum theory. The model further specifies that, for any given λ , the result of a measurement is:

$+m$ if $-\psi^\dagger A \psi / m < \lambda < +1$ — this occurs with probability $(1 + \psi^\dagger A \psi / m) / 2$,
 $-m$ if $-1 < \lambda < -\psi^\dagger A \psi / m$ — this occurs with probability $(1 - \psi^\dagger A \psi / m) / 2$.

Therefore the *average* result is $m(1 + \psi^\dagger A \psi / m) / 2 - m(1 - \psi^\dagger A \psi / m) / 2 = \psi^\dagger A \psi$, in agreement with quantum mechanics.

Consider now another observable, $B = \mathbf{n} \cdot \boldsymbol{\sigma}$, whose measurement yields $\pm n$, according to the value of λ , by the same rule as for A . Furthermore, define a third observable, $C = A + B = (\mathbf{m} + \mathbf{n}) \cdot \boldsymbol{\sigma}$. Notice that a measurement of C will always yield $\pm |\mathbf{m} + \mathbf{n}|$, and this result is *not* one of the four combinations $m+n$, $m-n$, etc. Therefore, Eq. (6.18) cannot be valid for a particular value of λ , nor in general for an arbitrary distribution of the values of λ . Nonetheless, Eq. (6.18) is valid for *uniformly* distributed λ , because, in that case, Bell's model guarantees agreement with quantum mechanics. We thus see that it is possible to mimic all the statistical properties of quantum theory by a deterministic hidden variable model.

In the same article,¹³ Bell also shows that this model can be extended to higher dimensional Hilbert spaces; and then, he raises a new, cardinal question: If a quantum system consists of several disjoint subsystems, as in the EPR argument, will the hidden variables too fall into disjoint subsets? Bell shows that his model does not satisfy this *separability* requirement, if the state of the quantum system is entangled:

. . . in this theory an explicit causal mechanism exists whereby the disposition of one piece of apparatus affects the results obtained with a distant piece. In fact the Einstein-Podolsky-Rosen paradox is resolved in the way which Einstein would have liked least.⁴

Finally, Bell asks whether it is possible to prove that “*any* hidden variable account of quantum mechanics *must* have this extraordinary character.” The

answer appears in a footnote, added at the end of this article: "Since the completion of this paper such a proof has been found." (An editorial accident caused a two year delay in the publication of Bell's article,¹³ which appeared long after the proof mentioned at its end.^{14,15} That proof is *Bell's theorem* on the nonexistence of *local* hidden variables, discussed below.)

6-3. Bell's inequalities

The title of Bell's second paper is "On the Einstein Podolsky Rosen paradox," but, contrary to the EPR argument, Bell's is *not* about quantum mechanics. Rather, it is a general proof, independent of any specific physical theory, that there is an *upper limit to the correlation of distant events*, if one just assumes the validity of the *principle of local causes*. This principle (also called *Einstein locality*, but conjectured well before Einstein) asserts that events occurring in a given spacetime region are independent of external parameters that may be controlled, at the same moment, by agents located in distant spacetime regions. Bell's proof¹⁴ that the principle of local causes is incompatible with quantum mechanics has momentous implications, and it was hailed as "the most profound discovery of science."¹⁶

Here, you may object that the principle of local causes does not belong to physics, but rather to philosophy, because it is of counterfactual nature. The claim that the occurrence of a particular event does not depend on some external parameters implies a comparison between mutually exclusive scenarios, in which these external parameters have different values. For example, we may imagine the existence of several replicas of the experiment of Fig. 6.3, with different values of the angle θ , and we may reasonably claim that the results displayed by the *upper* printer should not depend on the tilt angle θ given to the *lower* detecting station. Bell's theorem asserts that this claim—obvious as it may appear—is incompatible with the cosine correlation law (6.17). As we shall see, that correlation is *too strong*.

Before discussing these quantum correlations, let us consider an elementary classical analog of the SPS photon cascade:¹⁷ Imagine a bomb, initially at rest, which explodes into two asymmetric parts, carrying angular momenta \mathbf{J}_1 and $\mathbf{J}_2 = -\mathbf{J}_1$. An observer detects the first fragment and measures the dynamical variable $\text{sign}(\alpha \cdot \mathbf{J}_1)$, where α is a unit vector with an arbitrary direction, chosen by that observer. The result of this measurement is called a and can only take the values ± 1 . Likewise, a second observer detects the other fragment and measures $\text{sign}(\beta \cdot \mathbf{J}_2)$, where β is another unit vector, chosen by the second observer. The result is $b = \pm 1$.

¹⁴ J. S. Bell, *Physics* 1 (1964) 195.

¹⁵ M. Jammer, *Found. Phys.* 20 (1990) 1139.

¹⁶ H. P. Stapp, *Nuovo Cimento B* 29 (1975) 270.

¹⁷ A. Peres, *Am. J. Phys.* 46 (1978) 745.

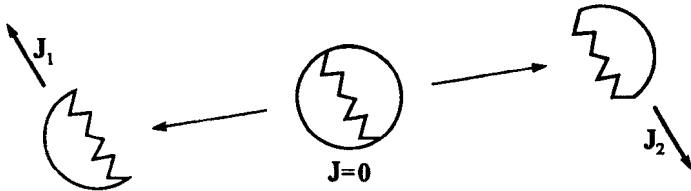

Fig. 6.4. A bomb, initially at rest, explodes into two fragments carrying opposite angular momenta.

This experiment is repeated N times. Let a_j and b_j be the results measured by our observers for the j th bomb. If the directions of \mathbf{J}_1 and \mathbf{J}_2 are randomly distributed, the averages obtained by each observer,

$$\langle a \rangle = \sum_j a_j / N \quad \text{and} \quad \langle b \rangle = \sum_j b_j / N, \tag{6.19}$$

are both close to zero (typically, they are of the order of $1/\sqrt{N}$). However, if the observers *compare* their results, they find a *correlation*,

$$\langle ab \rangle = \sum_j a_j b_j / N, \tag{6.20}$$

which, in general, does not vanish. For instance, if $\alpha = \beta$, they always obtain $a_j = -b_j$, so that $\langle ab \rangle = -1$.

For arbitrary α and β , the expected correlation $\langle ab \rangle$ can be computed as follows: Consider a unit sphere, cut by an equatorial plane perpendicular to α , as shown in Fig. 6.5. We then have $a = 1$ if \mathbf{J}_1 points through one of the hemispheres, and $a = -1$ if it points through the other hemisphere. Likewise, a second equatorial plane, perpendicular to β , determines the regions where $b = \pm 1$. The unit sphere is thereby divided by these two equatorial planes into four sectors, with alternating signs for the product ab . Adjacent sectors have their areas in the ratio of θ to $\pi - \theta$, where θ is the angle between α and β . Thus, if \mathbf{J}_1 is uniformly distributed, we obtain the *classical* correlation

$$\langle ab \rangle = [\theta - (\pi - \theta)] / \pi = -1 + 2\theta / \pi. \tag{6.21}$$

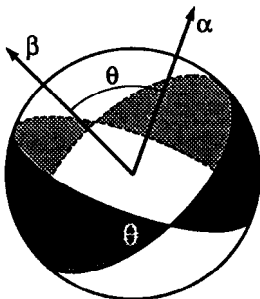

Fig. 6.5. Geometric construction for obtaining the classical correlation (6.21). In the shaded areas, $ab = 1$; in the unshaded ones, $ab = -1$.

Let us now return to quantum mechanics. Consider two spin $\frac{1}{2}$ particles in a singlet state, far away from each other, like those of the Bohm model.⁵ Our observers measure the observables $\alpha \cdot \sigma_1$ and $\beta \cdot \sigma_2$, where σ_1 and σ_2 are the Pauli spin matrices pertaining to the two particles. The unit vectors α and β are freely chosen by the observers. As before, the results are called a and b , and can have values ± 1 . Their mean values are predicted by quantum mechanics as $\langle a \rangle = \langle b \rangle = 0$, and their correlation as

$$\langle ab \rangle = \psi^\dagger (\alpha \cdot \sigma_1) (\beta \cdot \sigma_2) \psi. \quad (6.22)$$

In the singlet state, we have $\sigma_2 \psi = -\sigma_1 \psi$. Hence, with the help of the identity $(\alpha \cdot \sigma)(\beta \cdot \sigma) \equiv \alpha \cdot \beta + i(\alpha \times \beta) \cdot \sigma$, we obtain

$$\langle ab \rangle = -\alpha \cdot \beta = -\cos \theta. \quad (6.23)$$

Figure 6.6 shows the expressions (6.20) and (6.23): *the quantum correlation is always stronger* than the classical one, except in the trivial cases where both are 0 or ± 1 . Are you surprised? If so, this is the result of having been exposed to unfounded quantum superstitions, according to which quantum theory is afflicted by more “uncertainty” than classical mechanics. Exactly the opposite is true: quantum phenomena are more disciplined than classical ones. We shall again see this in Chapter 11, where quantum chaos will be found much tamer than classical chaos.

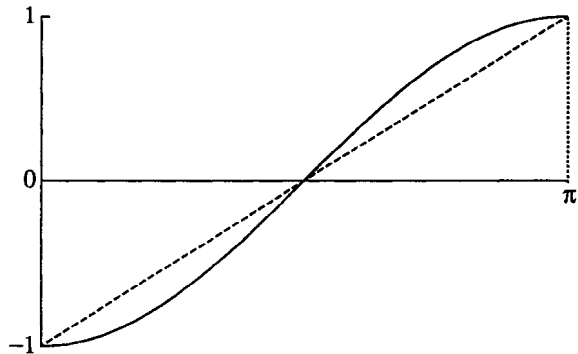

Fig. 6.6. The quantum correlation (solid line) and the classical one (broken line) for a pair of spins, as functions of the angle θ .

Bell's theorem

Bell's theorem is *not* a property of quantum theory. It applies to any physical system with dichotomic variables, whose values are arbitrarily called 1 and -1 . Its proof involves two distant observers and some counterfactual reasoning, just as in the EPR article.¹ However, while EPR merely pointed out a property of quantum theory which they found unsatisfactory, Bell derives *quantitative criteria* for the existence of a realistic interpretation of *any* local theory.

The elementary algebraic proof below involves pairs of polarized photons, because this is the example most easily amenable to experimental verification.

However, the result applies equally well to pairs of correlated spins, or indeed to any correlated systems, whether classical or quantal.

Consider a pair of photons, emitted in opposite directions in an SPS cascade. Two distant observers test their linear polarizations. The first observer has a *choice* between two different orientations of his polarization analyzer, making angles α and γ with an arbitrary axis. For each orientation, his experiment has two possible (and unpredictable) outcomes. The hypothesis that we want to test is that the outcome which actually occurs is causally determined by *local* hidden variables, of unknown nature, but pertaining only to the photon and to the apparatus of the first observer. If he chooses angle α , that outcome is called α and may take values ± 1 . The measured observable thus is the one called σ_α in Eq. (6.15). Likewise, if the first observer chooses γ , he measures σ_γ , and the *same* hidden variables determine the outcome $c = \pm 1$.

Einstein locality asserts that these outcomes cannot depend on parameters controlled by faraway agents. In particular, they do not depend on the orientation of the analyzers used by the *second* observer. The latter also has a choice of two alternative directions, β or γ (the same γ as may be chosen by the first observer). The outcomes of her test are $b = \pm 1$ or $c = \pm 1$, respectively, and are determined by the hidden variables of her photon and her apparatus.⁹

If both observers choose the same direction γ , they find the same result c , as we already know. In any case, the results a , b , and c , identically satisfy

$$a(b - c) \equiv \pm(1 - bc), \tag{6.24}$$

since both sides of this equation vanish if $b = c$, and are equal to ± 2 if $b \neq c$. Note that the various mathematical symbols in (6.24) refer to three tests, of which *any* two, but *only* two, can actually be performed. At least one of the three tests is counterfactual.

Suppose now that the same joint experiment is repeated many times, with many consecutive photon pairs. Then, the three results (actual or imagined) for the j th photon pair satisfy

$$a_j b_j - a_j c_j \equiv \pm(1 - b_j c_j), \tag{6.25}$$

as in the preceding equation. Obviously, the hidden variables, which we do not control, are different for each j . The serial number j can thus be understood as a shorthand notation for the unknown values of these hidden variables. In particular, taking an average over the hidden variables is the same as taking an average over j , and therefore we have

$$|\langle ab \rangle - \langle ac \rangle| \leq 1 - \langle bc \rangle. \tag{6.26}$$

Here, $\langle ab \rangle$ is the sum of all the products $a_j b_j$, divided by the number of photon pairs. In other words, $\langle ab \rangle$ is the *correlation* of the outcomes a and b . The result (6.26) is Bell's inequality. (For perfectly *anticorrelated* pairs, as in Fig. 6.4, the right hand side of the inequality is $1 + \langle bc \rangle$.)¹⁴

Now comes the crux of this argument: Although quantum theory is unable to predict individual values a_j, b_j, c_j , it can very well predict *average* values, and in particular *correlations* like those which appear in (6.26). Moreover, these correlations *can also be measured experimentally, regardless of any theory*. In the case of polarized photons, they are explicitly given by Eq. (6.17), and Bell's inequality (6.26) becomes

$$|\cos 2(\alpha - \beta) - \cos 2(\alpha - \gamma)| + \cos 2(\beta - \gamma) \leq 1. \tag{6.27}$$

For instance, if the three directions $\alpha, \beta,$ and $\gamma,$ are separated by angles of $30^\circ,$ as shown in Fig. 6.7(a), the three cosines are $\frac{1}{2}, -\frac{1}{2},$ and $\frac{1}{2},$ respectively, and the left hand side of (6.27) is $\frac{3}{2}.$ Therefore *Bell's inequality is violated by quantum theory*—and also by experimental evidence, as discussed below. Thus, ironically, Bell's theorem is “the most profound discovery of science”¹⁶ because it is *not* obeyed by the experimental facts.

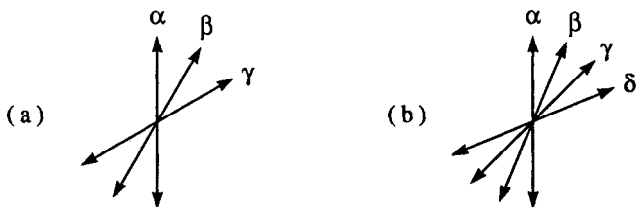

Fig. 6.7. Linear polarization directions giving the maximal violation of (a) Bell's inequality (6.26), and (b) the CHSH inequality (6.30).

A more general inequality

In the above argument, the γ direction was common to both observers. More generally, the two alternative experiments of the second observer may involve directions β and $\delta,$ both of which are different from those of the first observer, who can test along α or $\gamma.$ If a test along δ is performed, it will give a result $d = \pm 1.$ We then have, identically,

$$(a + c) b + (a - c) d \equiv \pm 2, \tag{6.28}$$

because either $a + c = 0$ and $a - c = \pm 2,$ or $a - c = 0$ and $a + c = \pm 2.$ If several photon pairs are tested, we have, for the j th pair

$$a_j b_j + b_j c_j + c_j d_j - d_j a_j \equiv \pm 2, \tag{6.29}$$

and therefore, on the average,

$$|\langle ab \rangle + \langle bc \rangle + \langle cd \rangle - \langle da \rangle| \leq 2. \tag{6.30}$$

This result is called the CHSH inequality.¹⁸ Like Bell's inequality (6.26), it is valid for any set of dichotomic variables. It is an *upper limit to the correlation of distant events*, if the principle of local causes is valid. In the special case of photons with the correlation (6.17), this inequality becomes

$$|\cos 2(\alpha - \beta) + \cos 2(\beta - \gamma) + \cos 2(\gamma - \delta) - \cos 2(\delta - \alpha)| \leq 2. \quad (6.31)$$

For instance, if these various directions are separated by angles of 22.5° , as in Fig. 6.7(b), the first three cosines are $1/\sqrt{2}$, and the fourth one is $-1/\sqrt{2}$. Therefore the left hand side of (6.31) is $2\sqrt{2}$, which is obviously more than 2. We again reached a contradiction: there must be something wrong with our physical interpretation of the identity (6.30).

The theorem itself is not wrong, of course. It is based on Eq. (6.29), which is trivially true. The difficulty lies with the conceptual premises underlying that identity. Its physical interpretation is questionable and involves delicate points of logic, which will be discussed in the next section.

Exercise 6.9 Show that a linear correlation law, $1 - 2\theta/\pi$, as in Eq. (6.21), satisfies both Bell's inequality (6.26) and the CHSH inequality (6.30).

Exercise 6.10 Show that Bell's inequality (6.26) is a special case of the CHSH inequality (6.30).

Exercise 6.11 Show that the maximal violation of Bell's inequality (6.26) for polarized photons occurs when there are three angles of 30° , as in Fig. 6.7. Show likewise that the maximal violation of the CHSH inequality (6.30) occurs when there are three angles of 22.5° .

Experimental tests

Physics is an experimental science, and theoretical predictions like Eqs. (6.26) and (6.30) must be tested in the laboratory. For correlated photons, this means that one must verify the cosine correlation (6.17), which was derived from the wave function ψ_+ in Eq. (6.12), which was itself derived from purported symmetry properties of atomic states and of their electromagnetic interaction. For correlated fermions, it is the cosine correlation (6.23), illustrated in Fig. 6.6, which must be tested. These are difficult experiments, whose interpretation is complicated, because in real life one must take into account finite collimation angles and finite detector efficiencies.¹⁹

A static test like the one in Fig. 6.3, with fixed (or slowly moving) detectors, does not fully implement all the premises of Bell's theorem. The latter involve two disjoint observers, who are free to choose their experiments out of mutually incompatible alternatives. These observers need not, of course, be humans: any

¹⁸J. F. Clauser, M. A. Horne, A. Shimony, and R. A. Holt, *Phys. Rev. Lett.* 23 (1969) 880.

¹⁹J. F. Clauser and A. Shimony, *Rep. Prog. Phys.* 41 (1978) 1881.

automatic devices, acting in a *random* fashion and independently of each other, effectively behave as these fictitious observers, endowed with free will.

An experiment²⁰ simulating these conditions is sketched in Fig. 6.8. The photons, emitted by excited calcium atoms in *SPS* cascades, have wavelengths $\lambda_1 = 422.7\text{nm}$ and $\lambda_2 = 551.3\text{ nm}$. (These photons are therefore distinguishable, contrary to the situation in some more recent experiments^{21,22} which use parametric down conversion in nonlinear crystals.) Each photon that passes through a collimator (not shown in the figure) impinges on an acousto-optical switch, from where it is “randomly” directed toward one of two polarization analyzers. The two switches, which act like rapidly moving mirrors, are not truly random, of course, but rather quasi-periodic. They are driven by different generators, at different frequencies, and it is plausible that they function in uncorrelated ways. The distance between them is 12m, corresponding to a signal transit time of 40ns. This is much larger than the mean time between switchings (about 10 ns), or the mean lifetime of the intermediate level of the calcium atoms (5 ns). Therefore “the experimental settings are changed during the flight of the particles,” a feature that was deemed “crucial” by Bell.¹⁴

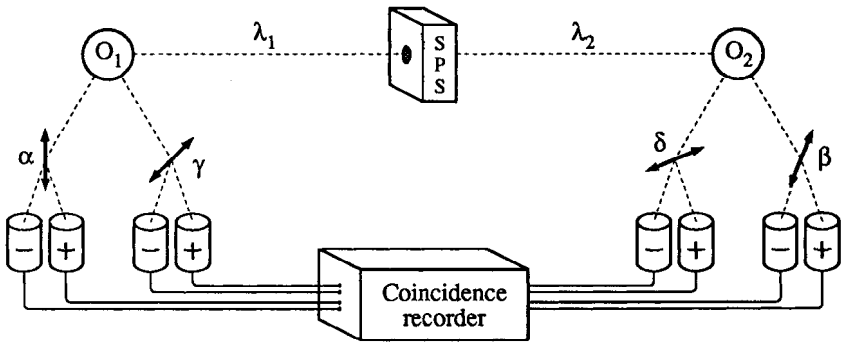

Fig. 6.8. Aspect's experiment: Pairs of photons are emitted in *SPS* cascades. Optical switches O_1 and O_2 randomly redirect these photons toward four polarization analyzers, symbolized by thick arrows. Each analyzer tests the linear polarization along one of the directions indicated in Fig. 6.7(b). The detector outputs are checked for coincidences in order to find correlations between them.

This schematic description of Aspect's experiment cannot do full justice to this technical *tour de force* which took six years to be brought to completion. For the first time in the history of science, a physical process was controlled by two independent agents with a *space-like* separation, rather than a *time-like* one, as in every other experiment hitherto performed. The result was in

²⁰ A. Aspect, J. Dalibard, and G. Roger, *Phys. Rev. Lett.* 49 (1982) 1804.

²¹ Y. H. Shih and C. O. Alley, *Phys. Rev. Lett.* 61 (1988) 2921.

²² J. G. Rarity and P.R. Tapster, *Phys. Rev. Lett.* 64 (1990) 2495.

complete agreement with the quantum mechanical prediction, Eq. (6.17); and it violated the CHSH inequality (6.30) by five standard deviations.

6-4. Some fundamental issues

We must now find out what was wrong with the *identity* (6.29), which led us to conclusions inconsistent with experimental facts. There is no doubt that counterfactual reasoning is involved: the four numbers a_j, b_j, c_j, d_j cannot be simultaneously known. The first observer can measure either a_j or c_j , but not both; the second one—either b_j or d_j . Therefore Eq. (6.29) involves at least two numbers which do not correspond to any tangible data, and it cannot be experimentally verified.

However, we do not normally demand that every number in every equation correspond to a tangible quantity. Counterexamples abound, even in classical physics (the vector potential A_μ , the Hamilton-Jacobi function S , are two familiar instances) Moreover, counterfactual reasoning is not illegitimate per se. It was endorsed by Bohr² in his answer to EPR; it is practiced daily, with no apparent ill effects, by people who ponder over a menu in a restaurant, or over an airline schedule in a travel agency. In the present case (correlated photon pairs) we can always imagine a table as the one below, including both actual and hypothetical results of performed and unperformed experiments. We lack the information needed for filling the blanks in the last two rows of that table, but there are only 2^{2N} different ways of guessing the missing data c_j and d_j . Therefore, there are only 2^{2N} different tables that can be imagined. The point is that *none* of them obeys the cosine correlation (6.17). That correlation (which has been experimentally verified) is *too strong* to be compatible with Table 6-1.

Table 6-1. Actual and hypothetical outcomes of N quantum tests.

The tests were		1	2	3	4	5	6	...	N
actually performed	a_j	+	+	-	+	-	-	...	+
	b_j	+	-	-	+	-	-	...	+
unperformed, just imagined	c_j	?	?	?	?	?	?	...	?
	d_j	?	?	?	?	?	?	...	?

Let us see why a correlation which is too strong prevents the assignment of consistent values to c_j and d_j . Choose the various directions as in Fig. 6.7(b), so as to maximize the experimental violation of the CHSH inequality (6.30). Then, only a fraction $\sin^2(\pi/8) \simeq 1/7$ of the b_j will *not* agree with the corresponding a_j . Likewise, only 1/7 of the unknown c_j will be different from b_j , and only 1/7 of the d_j will differ from the corresponding c_j . Thus, if we discard all the j for which there is any disagreement among the outcomes of the above tests, we still remain with at least a fraction $1 - 3 \sin^2(\pi/8) \simeq 4/7$ of the d_j which

agree with the corresponding a_j . On the other hand, the probability of agreement between a_j and d_j , predicted by Eq. (6.17), is only $\cos^2(3\pi/8) \simeq 1/7$. Therefore at least $3/7$ (more precisely, $\sqrt{2} - 1 \simeq 0.4142$) of the columns of Table 6-1 cannot be consistently filled. This conclusion can be succinctly stated: *unperformed experiments have no results.*¹⁷

Exercise 6.12 Construct a similar table for the original Bell inequality (6.26). If the polarization tests are performed along the directions shown in Fig. 6.7(a), what fraction of the columns cannot be consistently filled? **Ans.:** $1/4$.

Exercise 6.13 Show that a table like the above one is consistent with the weaker linear correlation $1 - 2\theta/\pi$, which satisfies the CHSH inequality.

A 41% discrepancy, as in Table 6-1, is not a small effect, and calls for a full investigation. Here is an exchange of opinions on this problem:²³

Salviati. At the time of these measurements, the two observers are unaware of each other, e.g., they are mutually space-like. There is no possibility of communication between them. It is therefore reasonable to assume, as EPR did, that the actions of one observer do not influence the results of experiments performed by the other one. For example, the result $a = 1$ obtained by the first observer should not depend on whether the second one measures (or has measured, or will measure) the photon polarization along β , or along δ .

Simplicio. This is obvious.

Sagredo. Your statement makes sense only if you assume that all these events are causally determined, even those which are unpredictable and seem to us random. Otherwise, you could not meaningfully compare the results that are obtainable by the first observer under different and mutually exclusive external conditions. I am seriously worried by this deterministic approach, because you have *also* assumed that the observers themselves have a *free choice* among the various experiments. Aren't these observers physical systems too, and therefore subject to deterministic laws? Let us see how you solve this apparent contradiction.

Salviati. Please, don't detract me from my proof. The crucial point in Bell's argument is that although the *individual* results are unpredictable, their *correlations*, which are average values, can be computed by quantum theory, or can simply be *measured experimentally, irrespective of any theory*. The amazing fact is that it is possible to prepare physical systems in such a way that the inequality (6.30) is violated, and therefore the *identity* (6.29) cannot be valid.

Simplicio. An *identity* which is not valid?

Salviati. This is of course impossible, therefore there must be a flaw in this argument. *Either* it is wrong that the observers have a free choice among the alternative experiments (namely, for each pair of particles, only one of the four experimental setups is compatible with the laws of physics—the others are not,

²³ A. Peres, *Found. Phys.* 14 (1984) 1131.

for reasons unknown to us), or it is wrong that each photon can be observed without disturbing the other photon. Take your choice.

Simplicio. Both alternatives are distasteful. I prefer classical physics.²⁴

Salviati. I again insist: This difficulty is not the fault of quantum theory. Only experimental facts are involved here.²⁰ So indeed we have a paradox.

Sagredo. There is a paradox only because you *force* on this physical system a description with two separate photons. These photons exist only in your imagination. The only thing that you have really prepared is a *pair* of photons, in a spin zero state. *That pair is a single, indivisible, nonlocal object.* Now, if you like paradoxes, I can supply to you additional ones, at a greatly reduced cost in labor and parts. You don't have to invoke Einstein, Podolsky, and Rosen. You don't need *two* photons. A *single* photon will do as well, in the standard double slit experiment. You just ask: How can the half-photon passing through one of the slits know the position and shape of the other slit, through which the other half-photon is passing, so that it can interfere with it?

Simplicio. This question is meaningless! There are no half-photons. A photon is a single, indivisible, nonlocal object. This is why it can pass through two widely separated slits and interfere with itself.

Salviati. A single photon can even originate from two different lasers.²⁵ We have been since long familiar with nonlocal photons, electrons, etc.

Sagredo. And yet, you have no moral pangs in asking, in the EPR paradox, how can the first half of the pair (here) be influenced by the apparatus which interacts with the second half of the pair (there). After you know that each particle is stripped by quantum theory of all its classical attributes (it has neither definite position, nor definite momentum, nor definite spin components), you still believe that it retains a well defined "existence," as a separate entity.

Salviati. So, there is no paradox?

Sagredo. The only paradoxical feature that I can see is that *almost* everything happens *as if* there were, at each instant, two distinct particles with reasonably well defined positions and momenta. It is only their polarization states that are inseparably entangled. That's why you may be excused for having had no moral pangs, and EPR are excused too. But there is no paradox.

Nonlocality vs free will

In his opening statement, Sagredo admitted being worried by the fact that free will had been granted to the two observers, in an otherwise deterministic world. Then, at the end of the dialogue, he opted for abandoning Einstein locality, and he left the free will conundrum unsolved. As we shall now see, these two issues are inseparably intertwined.

²⁴G. Galileo, *Discorsi e Dimostrazioni Matematiche, Intorno à Due Nuove Scienze*, Elsevier, Leiden (1638).

²⁵R. L. Pfleeger and L. Mandel, *Phys. Rev.* 159 (1967) 1084.

Let us examine the consequences of nonlocality. Assume that the outcome a_j , obtained by the first observer, depends on whether the second observer chooses to measure the polarization of her photon along β , or along δ . We shall distinguish these two alternatives by means of more detailed notations, such as $a_{j(\beta)}$ and $a_{j(\delta)}$. If Einstein locality does not hold, these two numbers are not necessarily equal. The left hand side of Eq. (6.29) then becomes

$$a_{j(\beta)} b_{j(\alpha)} + b_{j(\gamma)} c_{j(\beta)} + c_{j(\delta)} d_{j(\gamma)} - d_{j(\alpha)} a_{j(\delta)}, \quad (6.32)$$

which can be 0, ± 2 , or ± 4 . The right hand side of the CSHS inequality (6.31) becomes 4, and there is no more any contradiction with experimental facts.

There seems to be, however, a new problem with potentially devastating consequences: Assuming that measurements are instantaneous (that is, very brief), can we use these nonlocal effects to transfer information *instantaneously* between distant observers? For example, can the second observer find out the orientation of the apparatus used by the first one? If this were possible, Einstein's theory of relativity would be in jeopardy. In the present case, there is no such danger, because, as long as the observers do not communicate and compare their results, each one of them only sees a random sequence of + and -, carrying no information.

Exercise 6.14 Let ψ_+ , given by Eq. (6.12), represent the state of a pair of correlated photons, and let $\rho = \psi_+ \psi_+^\dagger$ be the corresponding density matrix. Show that if a partial trace is taken on the polarization states of one of the photons, the other photon is described by a reduced density matrix $\rho = \frac{1}{2} \mathbb{1}$, which corresponds to a random polarization mixture.

Exercise 6.15 Show that if, contrary to postulate K (page 76), it were experimentally possible to distinguish a random mixture of photons with orthogonal linear polarizations from a random mixture of photons with opposite circular polarizations, EPR correlations could be used for the instantaneous transfer of information between arbitrarily distant observers (provided that these EPR correlations would be maintained for arbitrarily large distances).

The question may still be raised whether more sophisticated preparations of correlated quantum systems would allow instantaneous transfer of information. Quantum theory by itself neither imposes nor precludes relativistic invariance. It only guarantees that if the dynamical laws are relativistically invariant (see Chapter 8), the particles used as information carriers cannot propagate faster than light over macroscopic distances—insofar as the macroscopic emitters and detectors of these particles are themselves roughly localized.²⁶ Therefore all the *statistical* predictions (which are the *only* predictions) of relativistic quantum theory necessarily satisfy Einstein locality.²⁷

²⁶A. Peres *Ann. Phys. (NY)* 37 (1966) 179.

²⁷More generally, one can define *weak nonlocality*, which cannot be used for information transfer, and *strong nonlocality*, which could have such a use. For example, quantum correlations are weakly nonlocal; the laws of rigid body motion are strongly nonlocal.

On the other hand, a hidden variable theory which would predict *individual* events must violate the canons of special relativity: there would be no covariant distinction between cause and effect. Yet, it is not inconceivable that a nonlocal and noncovariant hidden variable theory can be concocted in such a way that, after the hidden variables have been averaged out, the theory has only local and covariant consequences. It must be so, indeed, if these average results coincide with those predicted by relativistic quantum theory.

There is nothing unacceptable in the assumption that deterministic hidden variables underlie the statistical features of quantum theory. When Boltzmann created classical statistical mechanics, he assumed the existence of atoms, well before anyone was able to observe—let alone manipulate—individual atoms. Boltzmann's work was attacked by the school of "energeticists" who did not believe in atoms, and wanted to base all of physical science on macroscopic energy considerations only. Later discoveries, relying on new experimental techniques, fully vindicated Boltzmann's work.

One could likewise speculate that future discoveries will some day give us access to a subquantum world, described by these hypothetical hidden variables which are purported to underlie quantum theory. It is here that Bell's theorem comes to put a cap on science fiction. In a completely deterministic theory, which would necessarily be nonlocal, *separate parts of the world would be deeply and conspiratorially entangled, and our apparent free will would be entangled with them.*²⁸ (If you hesitate to include "free will" in the theory, you may replace the human observers by automatons, having random and uncorrelated behaviors. Just imagine two telescopes pointing toward different directions in the sky and counting whether an odd or even number of photons arrive in a predetermined time interval.) A reasonable compromise thus is to abandon Einstein locality for *individual* phenomena, which are fundamentally unpredictable, but to retain it for quantum *averages*, which can be predicted and causally controlled.

However, once we accept this attitude, doubts about the existence of "free will" appear again: Why can't our pair of observers be considered as a single, indivisible, nonlocal entity? Their past histories are undeniably correlated, since they agreed to collaborate in a joint experiment. Consider the similar, but much simpler issue illustrated in Fig. 6.2, where two photons have correlated histories. Each one of the two records appears "random" (each apparatus seems to have "free will") if we disregard the information in the other record. The latter is crucial, because the photon pair is a single, indivisible, nonlocal object. If we ignore the correlation, *every* outcome looks random. Likewise, when people are considered individually, and their past interactions with other people or things are ignored, they appear to behave randomly—to have "free will."²⁹

Can unknown correlations restrict our apparent free will? A similar question also bears on the experiment in Fig. 6.2, in which randomness is not completely

²⁸J. S. Bell, *J. Physique* 42 (1981) C2-41.

²⁹A. Peres, *Found. Phys.* 16 (1986) 573.

eliminated: we can predict the second sequence after seeing the first one, but we cannot predict the first one. Can the remaining randomness be reduced by finding further correlations? This would require to trace back the histories of the atoms that emitted the *SPS* cascades. If the latter were produced by a coherent process, it may be possible to correlate these photon pairs with other observable phenomena. On the other hand, if the excitation process was thermal, further correlations are *practically* lost. Turning now our attention to considerably more complex systems, such as human beings, it is obvious that any EPR correlation between them is swamped by myriads of irreversible processes. The result is that *each one* of us behaves unpredictably, as if endowed with free will; this is why the expression “each one” *can* be used when we talk about people like you and me.

In our daily work as physicists, we are compelled to use only *incomplete* information on the world, because we cannot know everything. The method that we use in physics is the following. We divide the world into three parts, which are the *system* under study, the *observer* (or the observing apparatus), and the *rest of the world* (that is, most of it!) which, we pretend, is unaffected by the two other parts. We further assume that, if the system under observation is sufficiently small, it can be perfectly isolated from everything else,³⁰ except from the observer testing it, if and when it is tested. This makes things *appear* simple. This method is what gives to physics the aura of an exact science. For example, we can compute the properties of the hydrogen atom to umpteen decimal places, because when we do these calculations, there is nothing but a single hydrogen atom in our conceptual world.

We work as if the world could be dissected into small independent pieces. This is an illusion. The entire world is interdependent. We see that in every experiment where Bell's inequality is violated. But we have no other way of working. The practical questions with which we are faced always are of the type: Given a finite amount of information, what are the possible outcomes of the ill-defined experiments that we prepare? The answers must necessarily be probabilistic, by the very nature of the problem.

Is quantum theory universally valid?

The proof of Bell's theorem requires the observed system to be deterministic, while the observers are not. If observers enjoy the privilege of immunity from the laws of a deterministic theory, we still have a logically consistent scheme, but it is not a universal one. (By way of analogy: celestial mechanics is deterministic and puts no restrictions on our ability to measure the positions of planets and asteroids, but celestial mechanics does not explain the functioning of telescopes

³⁰More precisely, a microscopic system can be isolated from any *unknown* effects originating in the rest of the world. That system may still interact with a *perfectly controlled* environment, such as an external magnetic field, which is then treated as a known term in the system's Hamiltonian.

and photographic plates, nor was it intended to.)³¹

On the other hand, we believe that our apparatuses are made of atoms and that their macroscopic behavior is reducible to that of their elementary constituents. There is nothing in quantum theory making it applicable to three atoms and inapplicable to 10^{23} . At this point, it is customary to argue that observers (or measuring apparatuses) are essentially different from microscopic physical objects, such as molecules, because they are very big, and therefore it is impossible to isolate them from unknown and uncontrollable effects originating in the rest of the world. They are *open systems*. However, the mental boundary between our ideal quantum world and tangible reality is arbitrary and fuzzy, just like the boundary between reversible microscopic systems and irreversible macroscopic ones. I shall return to this problem at the end of the book.

Even if quantum theory is universal, it is not *closed*. A distinction must be made between *endophysical* systems—those which are described by the theory—and *exophysical* ones, which lie outside the domain of the theory (for example, the telescopes and photographic plates used by astronomers for verifying the laws of celestial mechanics). While quantum theory can in principle describe *anything*, a quantum description cannot include *everything*. In every physical situation *something* must remain unanalyzed. This is not a flaw of quantum theory, but a logical necessity in a theory which is self-referential and describes its own means of verification.³¹ This situation reminds of Gödel's undecidability theorem:³² the consistency of a system of axioms cannot be verified because there are mathematical statements that can neither be proved nor disproved by the formal rules of the theory; but they may nonetheless be verified by metamathematical reasoning.

In summary, there is no escape from nonlocality. The experimental violation of Bell's inequality leaves only two logical possibilities: *either* some simple physical systems (such as correlated photon pairs) are essentially nonlocal, *or* it is forbidden to consider simultaneously the possible outcomes of mutually exclusive experiments, even though *any one* of these experiments is actually realizable. The second alternative effectively rules out the introduction of exophysical automatons with a random behavior—let alone observers endowed with free will. If you are willing to accept that option, then it is the *entire universe* which is an indivisible, nonlocal entity.

6-5. Other quantum inequalities

The stunning implications of Bell's theorem caused an outbreak of theoretical activity, including wild speculations that I shall not discuss. On the serious side, Bell's work led to a systematic search for other universal inequalities.

³¹ A. Peres and W. H. Zurek, *Am. J. Phys.* 50 (1982) 807.

³² K. Gödel, *Monat. Math. Phys.* 38 (1931) 173 [transl.: *On Formally Undecidable Propositions of Principia Mathematica and Related Systems*, Basic Books, New York (1962)].

Cirel'son's inequality

Cirel'son³³ raised the question whether *quantum* theory imposed an upper limit to correlations between distant events (a limit which would of course be higher than the classical one, given by Bell's inequality).

Let us consider four operators, $\sigma_\alpha, \sigma_\beta, \sigma_\gamma,$ and σ_δ , with algebraic properties similar to those of the observables in the Aspect experiment (Fig. 6.8). These operators satisfy $\sigma_\alpha^2 = \sigma_\beta^2 = \sigma_\gamma^2 = \sigma_\delta^2 = \mathbf{1}$, and

$$[\sigma_\alpha, \sigma_\beta] = [\sigma_\beta, \sigma_\gamma] = [\sigma_\gamma, \sigma_\delta] = [\sigma_\delta, \sigma_\alpha] = \mathbf{0}. \quad (6.33)$$

Define an operator

$$C = \sigma_\alpha \sigma_\beta + \sigma_\beta \sigma_\gamma + \sigma_\gamma \sigma_\delta - \sigma_\delta \sigma_\alpha, \quad (6.34)$$

with the same structure as the combination which appears on the left hand side of the CHSH inequality (6.30). We have identically³⁴

$$C^2 = 4 + [\sigma_\alpha, \sigma_\gamma] [\sigma_\beta, \sigma_\delta]. \quad (6.35)$$

The identities (4.27), page 86, give, for any two bounded operators A and B,

$$\| [A, B] \| \leq \| AB \| + \| BA \| \leq 2 \| A \| \| B \|, \quad (6.36)$$

and therefore, in the present case, $\| [\sigma_\alpha, \sigma_\gamma] \| \leq 2$ and $\| [\sigma_\beta, \sigma_\delta] \| \leq 2$. It thus follows from Eq. (6.35) that $\| C^2 \| \leq 8$, or

$$\| C \| \leq 2\sqrt{2}. \quad (6.37)$$

This is Cirel'son's inequality. Its right hand side is exactly equal to the upper limit that can be attained by the left hand side of the CHSH inequality (6.30). Quantum theory does not allow any stronger violation of the CHSH inequality than the one already achieved in Aspect's experiment.

Further insight in this problem can be gained by choosing a basis which makes both $[\sigma_\alpha, \sigma_\gamma]$ and $[\sigma_\beta, \sigma_\delta]$ diagonal, with eigenvalues λ_n and Λ_μ , respectively.³⁵ In that basis, C^2 is also diagonal, with eigenvalues $4 + \lambda_n \Lambda_\mu$. If it happens that all the λ_n (or all the Λ_μ) vanish, we have $\| C \| = 2$ exactly, and there is no disagreement with the CHSH inequality (6.30). None should indeed be expected, since at least one of the observers is not involved with incompatible tests. However, in general, there are nonvanishing eigenvalues λ_n and Λ_μ . If there is a pair for which $\lambda_n \Lambda_\mu > 0$, the corresponding eigenvectors represent a state which violates the CHSH inequality, because $\| C \| = \sqrt{4 + \lambda_n \Lambda_\mu} > 2$. It can be shown³⁵ that these violations come with both signs: if $\xi > 2$ is an eigenvalue of C, then $-\xi$ also is an eigenvalue of C.

³³B. S. Cirel'son, *Lett. Math. Phys.* 4 (1980) 93.

³⁴L. J. Landau, *Phys. Letters A* 120 (1987) 54.

³⁵S. L. Braunstein, A. Mann, and M. Revzen, *Phys. Rev. Lett.* 68 (1992) 3259.

Chained Bell inequalities

Generalized CHSH inequalities may be obtained by providing more than two alternative experiments to each observer.³⁶ Consider, as usual, a pair of spin 1/2 particles in a singlet state. The first observer can measure a spin component along one of the directions $\alpha_1, \alpha_3, \dots, \alpha_{2n-1}$, and the second observer along one

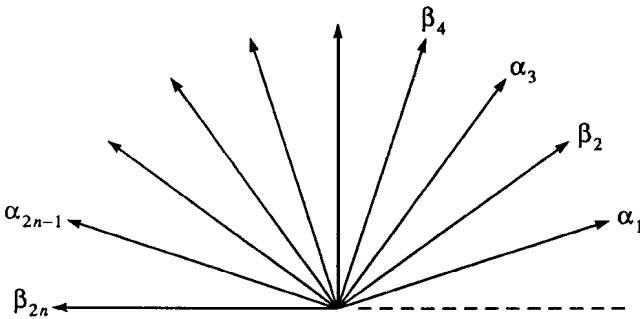

Fig. 6.9. The n alternative directions along which each observer can measure a spin projection.

of the directions $\beta_2, \beta_4, \dots, \beta_{2n}$. The results of these measurements (whether actual or hypothetical) are called a_r and b_s , respectively, and their values are ± 1 (in units of $\hbar/2$). We have, for each pair of particles,

$$|a_1 b_2 + b_2 a_3 + a_3 b_4 + \dots + a_{2n-1} b_{2n} - b_{2n} a_1| \leq 2n - 2, \tag{6.38}$$

because the $2n$ terms in the sum cannot all have the same sign. Taking the average for many pairs of particles, we obtain a generalized CHSH inequality:

$$|\langle a_1 b_2 \rangle + \langle b_2 a_3 \rangle + \dots + \langle a_{2n-1} b_{2n} \rangle - \langle b_{2n} a_1 \rangle| \leq 2n - 2. \tag{6.39}$$

This upper bound is violated by quantum theory, increasingly with larger n . For instance, let the $2n$ observation directions be chosen as in Fig. 6.9, with angles $\pi/2n$ between them. Each one of the correlations $\langle ab \rangle$ in (6.39) is then equal to $-\cos(\pi/2n)$, which tends to $-1 + \pi^2/8n^2$ for $n \rightarrow \infty$. Therefore the sum on the left hand side of (6.39) can be made arbitrarily close to $2n$.

More general entangled states

For any nonfactorable (entangled) state of two quantum systems, it is possible to find pairs of observables whose correlations violate the CHSH inequality.³⁷

³⁶S. L. Braunstein and C. M. Caves, *Ann. Phys. (NY)* 202 (1990) 22.

³⁷N. Gisin and A. Peres, *Phys. Letters A* 162 (1992) 15.

Indeed, any $\psi \in H_1 \otimes H_2$ can be written as a Schmidt bi-orthogonal sum $\psi = \sum_i c_i \mathbf{u}_i \otimes \mathbf{v}_i$, where $\{\mathbf{u}_i\}$ and $\{\mathbf{v}_i\}$ are orthonormal bases in H_1 and H_2 , respectively. It is possible to choose their phases so that all the c_i are real and non-negative, and to label them so that $c_1 \geq c_2 \geq \dots \geq 0$. We shall now restrict our attention to the N -dimensional subspaces of H_1 and H_2 which correspond to nonvanishing c_j . A *nonfactorable* state is one for which $N > 1$.

With orthonormal bases defined as above, let Γ_x and Γ_z be block-diagonal matrices, where each block is an ordinary Pauli matrix, σ_x and σ_z , respectively:

$$\Gamma_x := \begin{pmatrix} \sigma_x & 0 & 0 & \dots \\ 0 & \sigma_x & 0 & \dots \\ 0 & 0 & \sigma_x & \dots \\ \vdots & \vdots & \vdots & \ddots \end{pmatrix}, \quad \Gamma_z := \begin{pmatrix} \sigma_z & 0 & 0 & \dots \\ 0 & \sigma_z & 0 & \dots \\ 0 & 0 & \sigma_z & \dots \\ \vdots & \vdots & \vdots & \ddots \end{pmatrix}. \tag{6.40}$$

If N is odd—which slightly complicates the proof—we take $(\Gamma_z)_{NN} = 0$, and we define still another matrix, Π , whose only nonvanishing element is $\Pi_{NN} = 1$. If N is even, Π is the null matrix. It is also convenient to define a number γ by

$$\gamma := c_N^2 \quad (\text{odd } N) \quad \text{and} \quad \gamma := 0 \quad (\text{even } N). \tag{6.41}$$

With the above notations, consider the observables

$$\begin{aligned} A(\alpha) &:= \Gamma_x \sin \alpha + \Gamma_z \cos \alpha + \Pi, \\ B(\beta) &:= \Gamma_x \sin \beta + \Gamma_z \cos \beta + \Pi. \end{aligned} \tag{6.42}$$

The eigenvalues of $A(\alpha)$ and $B(\beta)$, denoted by a and b respectively, are ± 1 , and the correlation of these observables is

$$\langle ab \rangle = \langle \psi, A(\alpha) \otimes B(\beta) \psi \rangle = (1 - \gamma) \cos \alpha \cos \beta + K \sin \alpha \sin \beta + \gamma, \tag{6.43}$$

where

$$K := 2(c_1 c_2 + c_3 c_4 + \dots) \tag{6.44}$$

is always positive for a nonfactorable state. In particular, if we choose $\alpha = 0$, $\alpha' = \pi/2$, and $\beta = -\beta' = \tan^{-1}[K/(1 - \gamma)]$, we obtain

$$\langle ab \rangle + \langle ab' \rangle + \langle a'b \rangle - \langle a'b' \rangle = 2[(1 - \gamma)^2 + K^2]^{1/2} + 2\gamma, \tag{6.45}$$

$$> 2(1 - \gamma) + 2\gamma, \tag{6.46}$$

which contradicts the CHSH inequality (6.30).

Exercise 6.16 Verify Eqs. (6.43) and (6.45).

Exercise 6.17 Prove that $\gamma \geq 1/N$ and $\gamma < 1 - K$.

Exercise 6.18 *The above definition of $B(\beta)$ is not optimal. Show that, in order to maximize the violation of the CHSH inequality for a given state ψ , there should be different angles β_n associated with each σ_x and σ_z in Eq. (6.40):*

$$\beta_n = -\beta'_n = \tan^{-1}[2 c_{2n-1} c_{2n} / (c_{2n-1}^2 + c_{2n}^2)], \quad 1 \leq n \leq N/2. \quad (6.47)$$

Find the amount of violation achieved in this way. ★

More than two entangled particles

If there are N entangled quantum systems, which are examined by N distant and mutually independent observers, the correlations found by these observers may violate classical bounds by a factor that increases exponentially with N . Recall that the EPR dilemma, that was originally formulated for two entangled particles, turned into an algebraic contradiction for Mermin’s three particle state (6.3). A generalization of that state for N particles is³⁸

$$\psi = f(\mathbf{r}_1, \mathbf{r}_2, \dots, \mathbf{r}_N)(\mathbf{u}_1 \mathbf{u}_2 \cdots \mathbf{u}_N - \mathbf{v}_1 \mathbf{v}_2 \cdots \mathbf{v}_N), \quad (6.48)$$

where \mathbf{u} and \mathbf{v} are the eigenvectors of σ_z , and the function $f(\mathbf{r}_1, \mathbf{r}_2, \dots, \mathbf{r}_N)$ has a form ensuring that the N particles are widely separated. That function is properly symmetrized, and it is normalized so that $\int |f|^2 d\mathbf{r}_1 \cdots d\mathbf{r}_N = \frac{1}{2}$.

Each one of the N observers has a choice of measuring either σ_x or σ_y of his particle, with a result, m_x or m_y respectively, which can be ± 1 . There are therefore 2^N possible (and mutually incompatible) experiments that can be performed. Let us assume that all these experiments, whether or not actually performed, have definite results, and moreover that the results of each observer do not depend on the choice made by the *other* observers. This is the familiar cryptodeterministic hypothesis which bears the name “local realism.” Consider now all the products of the possible results of these experiments:

$$\prod_{n=1}^N m_{nr} = \pm 1, \quad (6.49)$$

where m_{nr} means either m_{nx} or m_{ny} (here, the index n labels the N particles and their observers). Let us multiply by i each m_{ny} appearing in (6.49), and also multiply the right hand side of (6.49) by the appropriate power of i . Having done that, let us add the 2^N resulting equations. This gives

$$\prod_{n=1}^N (m_{nx} + i m_{ny}) = \prod_{n=1}^N (\pm 1 \pm i). \quad (6.50)$$

Since $|\pm 1 \pm i| = \sqrt{2}$, we obtain $|\prod (m_{nx} + i m_{ny})| = 2^{N/2}$, and therefore

³⁸N. D. Mermin, *Phys. Rev. Lett.* 65 (1990) 1838.

$$\left| \operatorname{Re} \prod_{n=1}^N (m_{nx} + im_{ny}) \right| \leq 2^{N/2}. \quad (6.51)$$

Let us compare this classical upper bound with the quantum mechanical prediction. Define an operator

$$\mathbf{A} = \frac{1}{2} \left[\prod_{n=1}^N (\sigma_{nx} + i\sigma_{ny}) + \prod_{n=1}^N (\sigma_{nx} - i\sigma_{ny}) \right]. \quad (6.52)$$

Recall that

$$\begin{aligned} (\sigma_x + i\sigma_y) \mathbf{u} &= \mathbf{0} & (\sigma_x + i\sigma_y) \mathbf{v} &= 2\mathbf{u}, \\ (\sigma_x - i\sigma_y) \mathbf{u} &= 2\mathbf{v} & (\sigma_x - i\sigma_y) \mathbf{v} &= \mathbf{0}. \end{aligned} \quad (6.53)$$

We can readily verify that the entangled state (6.48) satisfies

$$\mathbf{A} \psi = -2^{N-1} \psi. \quad (6.54)$$

On the other hand, if we expand all the products in (6.52), we obtain a sum of 2^{N-1} operators, each one of which is a product of σ_x and σ_y belonging to different particles (with an even number of σ_y). Each one of these 2^{N-1} terms has eigenvalues ± 1 . It follows then from Eq. (4.27), page 86, that all these 2^{N-1} operators commute, because otherwise their sum could not have an eigenvalue as large as the one we find in Eq. (6.54).

Exercise 6.19 Show directly, by using the algebraic properties of the Pauli matrices, that these 2^{N-1} operators commute.

Any one of these 2^{N-1} operators may now be measured by a collaboration of our N distant observers—each observer having to deal with a single particle. The outcomes of all these measurements are combined as in Eq. (6.49) and its corollary (6.50). Therefore, the classical expectation, given by Eq. (6.51), is

$$|\langle \mathbf{A} \rangle| \leq 2^{N/2}. \quad (6.55)$$

This is in flagrant contradiction, for any $N \geq 3$, with the quantum prediction (6.54). Note that the contradiction increases *exponentially* with N , the number of disjoint observers who are collecting these entangled particles.

When N is very large (10^{10} or 10^{25} , say) the vector ψ in (6.48) is a coherent superposition of two *macroscopically distinguishable* states. For example, $|\mathbf{u}\mathbf{u}\mathbf{u}\dots\rangle$ may represent a ferromagnet with all its spins up, and $|\mathbf{v}\mathbf{v}\mathbf{v}\dots\rangle$ the same ferromagnet with all its spins down. It is then exceedingly difficult to adjust the relative phase of the two components (here $e^{i\pi}$) because they may have slightly different energies in an imperfectly controlled environment. These peculiar superpositions, known as “Schrödinger cats,” play an essential role in the measuring process, and will be discussed in Chapter 12.

6-6. Higher spins

It is commonly believed that classical properties emerge in the limit of large quantum numbers. Let us examine whether there is a smooth transition from quantum theory to classical physics. Consider a pair of spin j particles with arbitrarily large j , prepared in a singlet state as usual (rather than spin $\frac{1}{2}$ particles as we considered until now, or polarization components of photons which have similar algebraic properties).

The EPR argument is applicable to our spin j particles, exactly as before. Separate measurements of J_{1z} and J_{2z} by two independent observers must give opposite values, since the value of $J_{1z} + J_{2z}$ is zero. More generally, we are interested in the *correlation* of the results of measurements of J_1 and J_2 along *non-parallel* directions, arbitrarily chosen by the two observers.

We shall need the explicit form of the vector ψ_0 that represents two spin j particles with total angular momentum zero. For each particle, we have

$$J_{1z} \mathbf{u}_m = m \mathbf{u}_m \quad \text{and} \quad J_{2z} \mathbf{v}_m = m \mathbf{v}_m, \quad (6.56)$$

where $m = j, j-1, \dots, -j$, and $\hbar = 1$ for simplicity. In order to satisfy $(J_{1z} + J_{2z})\psi_0 = 0$, the singlet state must have the form $\psi_0 = \sum_m c_m \mathbf{u}_m \otimes \mathbf{v}_{-m}$. This is a Schmidt bi-orthogonal sum, as in Eq. (5.31). Therefore, the data that can be obtained separately by each observer are given by identical density matrices ρ , which are diagonal, with elements $|c_m|^2$ summing up to 1.

Moreover, all the probabilities $|c_m|^2$ are equal. The reason simply is that a zero angular momentum state is spherically symmetric, and the z -axis has no special status. Any other polar axis would yield the same diagonal density matrix ρ , with the same elements $|c_m|^2$. As the choice of another axis is a mere rotation of the coordinates, represented in quantum mechanics by a unitary transformation, $\rho \rightarrow U\rho U^\dagger$, it follows that ρ commutes with all the rotation matrices U . Now, for any given j , these matrices are irreducible.³⁹ Therefore ρ is a multiple of the unit matrix, and $|c_m|^2 = (2j+1)^{-1}$. Only the phase of c_m remains arbitrary (because those of \mathbf{u}_m and \mathbf{v}_m are).

Exercise 6.20 Show that $\langle \psi_0, (\boldsymbol{\alpha} \cdot \mathbf{J}_1) \otimes (\boldsymbol{\beta} \cdot \mathbf{J}_2) \psi_0 \rangle = -\frac{1}{3} j(j+1) (\boldsymbol{\alpha} \cdot \boldsymbol{\beta})$.

Exercise 6.21 Show that for the singlet state ψ_0 , and for half-integral j , Eq. (6.44) gives $K = 1$, causing the maximal violation of the CHSH inequality allowed by Cirel'son's theorem. What happens for integral j ? ★

Exercise 6.22 Show that the standard choice for the matrices J_x (symmetric and real) and J_y (antisymmetric and pure imaginary) gives

$$\psi_0 = (2j+1)^{-1/2} \sum_{m=-j}^j (-1)^{j-m} \mathbf{u}_m \otimes \mathbf{v}_{-m}. \quad (6.57)$$

This result generalizes Eq. (5.33), which was valid for spin $\frac{1}{2}$.

³⁹E. P. Wigner, *Group Theory*, Academic Press, New York (1959) p. 155.

Consider now the following experiment: The two spin j particles, prepared in the singlet state (6.57), fly apart along the $\pm x$ directions (collimators eliminate those going toward other directions). The two distant observers apply to each particle that they collect a torque around its direction of motion, for example by letting the particles pass through solenoids, where each observer can control the magnetic field. The state of the pair thus becomes

$$\psi = e^{-i\theta_1 J_{1x}} e^{-i\theta_2 J_{2x}} \psi_0 = e^{-i(\theta_1 - \theta_2) J_{1x}} \psi_0. \quad (6.58)$$

The last step follows from $J_{2x} \psi_0 = -J_{1x} \psi_0$, which holds for a singlet state.

Each observer then performs a Stern-Gerlach experiment, to measure J_{1z} and J_{2z} , respectively. There is no fundamental limitation to the number of detectors involved in such an experiment ($2j+1 = 10^9$ detectors, say) because it is always possible, at least in principle, to position the detectors so far away from the Stern-Gerlach magnets that the $2j+1$ beams are well separated, and the corresponding m can be precisely known. (An equivalent experiment would be to apply no torque, and to rotate the Stern-Gerlach magnets, together with all their detectors, by angles θ_1 and θ_2 .)

Notice that a Stern-Gerlach experiment measures not only J_z , but also any function $f(J_z) = \sum_m f(m) u_m u_m^\dagger$, as defined by Eq. (3.58), page 68. In particular, a Stern-Gerlach experiment measures the dichotomic variable,

$$\sum_{m=-j}^j (-1)^{(j-m)} u_m u_m^\dagger = e^{i\pi(j-J_z)}, \quad (6.59)$$

which has eigenvalues ± 1 . The *correlation* of the values obtained by the two observers for these dichotomic variables is the mean value of their product:

$$\begin{aligned} C(\theta) &= \langle \psi, e^{i\pi(j-J_{1z})} e^{i\pi(j-J_{2z})} \psi \rangle, \\ &= e^{2\pi i j} \langle e^{-i\theta J_{1x}} \psi_0, e^{-i\pi J_{1z}} e^{-i\pi J_{2z}} e^{-i\theta J_{1x}} \psi_0 \rangle, \end{aligned} \quad (6.60)$$

where $\theta = \theta_1 - \theta_2$, for brevity. Note that $e^{-i\pi J_{2z}}$ and $e^{-i\theta J_{1x}}$ commute; that $e^{-i\pi J_{2z}} \psi_0 = e^{i\pi J_{1z}} \psi_0$ (because ψ_0 is a singlet state); and that $e^{-i\pi J_z}$ generates a rotation by an angle π around the z -axis, so that

$$e^{-i\pi J_{1z}} e^{-i\theta J_{1x}} e^{i\pi J_{1z}} = e^{i\theta J_{1x}}. \quad (6.61)$$

We thus obtain

$$C(\theta) = e^{2\pi i j} \langle \psi_0, e^{2i\theta J_{1x}} \psi_0 \rangle = e^{2\pi i j} \langle \psi_0, e^{2i\theta J_{1x}} \psi_0 \rangle, \quad (6.62)$$

where the last step used rotational invariance. Together with (6.57), this gives

$$\begin{aligned} C(\theta) &= (2j+1)^{-1} e^{2\pi i j} \sum_{m=-j}^j (-1)^{2(j-m)} \langle u_m \otimes v_{-m}, e^{2i\theta m} u_m \otimes v_{-m} \rangle, \\ &= (2j+1)^{-1} (-1)^{2j} \sum_{m=-j}^j e^{2i\theta m}. \end{aligned} \quad (6.63)$$

This sum is an ordinary geometric series, and we finally have

$$C(\theta) = (-1)^{2j} \sin[(2j+1)\theta]/[(2j+1)\sin\theta]. \quad (6.64)$$

We can now apply the CHSH inequality (6.30) in the usual way: If the first observer has a choice between parameters θ_1 and θ_3 , and the second observer between θ_2 and θ_4 , that inequality becomes:

$$|C(\theta_1 - \theta_2) + C(\theta_2 - \theta_3) + C(\theta_3 - \theta_4) - C(\theta_4 - \theta_1)| \leq 2. \quad (6.65)$$

Let us take $\theta_1 - \theta_2 = \theta_2 - \theta_3 = \theta_3 - \theta_4 = x/(2j+1)$. When $j \rightarrow \infty$, the left hand side of (6.65) tends to a constant, whose maximum value is obtained for $x = 1.054$:

$$\frac{3 \sin x}{x} - \frac{\sin 3x}{3x} = 2.481 > 2. \quad (6.66)$$

It is possible to obtain an even stronger violation, up to $2\sqrt{2}$ which is the maximum allowed by Cirel'son's inequality (6.37), by using particles having an electric quadrupole moment besides their magnetic dipole moment.³⁷

In summary, if the resolution of our instruments is sharp enough for discriminating between consecutive values of m , their readings violate the CHSH inequality, and therefore invalidate its classical premises. The conclusion is that *measurements which resolve consecutive values of m are inherently nonclassical*. No matter how large j may be, there is no reason to expect the results of these ideal measurements to mimic classical behavior.⁴⁰

Exercise 6.23 *Generalize the preceding calculations to the case where the torques are applied around axes that are not parallel.* ★

Observations in a noisy environment

There is a serious practical difficulty in the ideal experiment that was just described. The dissemination of all these spin j particles among a multitude of detectors, unless accompanied by a proportional increase of the incoming beam intensity, reduces the statistical significance of the results and makes them highly sensitive to *noise*. In particular, a compromise must be sought between detection failures and false alarms. As the detectors are mutually independent, there are no correlations between the wrong signals that they generate, and the noise has a white spectrum.⁴¹ This means that if we carry out a discrete Fourier transform from the variable m , which labels the outgoing beams, to a frequency-like variable, the power spectrum of the noise is uniform for all frequencies. This situation is familiar in communications engineering. The key to noise reduction is a suitable filtering which retains only the low frequency part of the spectrum.⁴¹

In our example, this filtering can be done as follows. First, we note that, in the absence of noise, the probability amplitude for the pair of results m_1 and m_2 is given by Eqs. (6.57) and (6.58) as

⁴⁰N. D. Mermin and G. M. Schwarz, *Found. Phys.* 12 (1982) 101.

⁴¹J. R. Pierce, *An Introduction to Information Theory: Symbols, Signals and Noise*, Dover, New York (1980).

$$\begin{aligned} \langle \mathbf{u}_{m_1} \otimes \mathbf{v}_{m_2}, \psi \rangle &= (2j+1)^{-1/2} \langle \mathbf{u}_{m_1} \otimes \mathbf{v}_{m_2}, e^{-i\theta J_{1z}} \sum_m (-1)^{j-m} \mathbf{u}_m \otimes \mathbf{v}_{-m} \rangle, \\ &= (2j+1)^{-1/2} \langle \mathbf{u}_{m_1}, e^{-i\theta J_{1z}} (-1)^{j+m_2} \mathbf{u}_{-m_2} \rangle. \end{aligned} \quad (6.67)$$

Therefore the joint probability for the results m_1 and m_2 is

$$\mathbf{P}(m_1, m_2) = (2j+1)^{-1} |\langle \mathbf{u}_{m_1}, e^{-i\theta J_{1z}} \mathbf{u}_{-m_2} \rangle|^2. \quad (6.68)$$

A discrete Fourier transform, from m_1 and m_2 to the frequency-like variables ξ and η , gives

$$\tilde{\mathbf{P}}(\xi, \eta) = \sum_{m_1 m_2} e^{i(\xi m_1 + \eta m_2)} P(m_1, m_2), \quad (6.69)$$

$$= (2j+1)^{-1} \sum_{m_1 m_2} e^{i(\xi m_1 + \eta m_2)} \langle \mathbf{u}_{m_1}, e^{-i\theta J_{1z}} \mathbf{u}_{-m_2} \rangle \langle \mathbf{u}_{-m_2}, e^{i\theta J_{1z}} \mathbf{u}_{m_1} \rangle, \quad (6.70)$$

where the last inner product was obtained thanks to the definition of the adjoint of an operator—see Eq. (4.28). The double sum in (6.70) can be rearranged as

$$\begin{aligned} \text{Tr} \left[\left(\sum_{m_1} e^{i\xi m_1} \mathbf{u}_{m_1} \mathbf{u}_{m_1}^\dagger \right) e^{-i\theta J_{1z}} \left(\sum_{m_2} e^{i\eta m_2} \mathbf{u}_{-m_2} \mathbf{u}_{-m_2}^\dagger \right) e^{i\theta J_{1z}} \right] \\ = \text{Tr} \left[e^{i\xi J_{1z}} e^{-i\theta J_{1z}} e^{-i\eta J_{1z}} e^{i\theta J_{1z}} \right]. \end{aligned} \quad (6.71)$$

To evaluate this trace, we note that each one of the exponents on the right hand side of (6.71) is a rotation operator, and therefore their product also is a rotation operator, by some angle κ that we have to determine. The crucial point here is that κ is a function of the separate rotation angles, ξ , η , and $\pm\theta$, but *not* of the spin magnitude j (the latter affects only the *order* of the rotation matrices, not their geometrical meaning). In order to compute κ , we may simply pretend that $j = \frac{1}{2}$, so as to handle nothing bigger than 2 by 2 matrices. Moreover, we actually need only the absolute value of κ , not the direction of the combined rotation axis. It is easily found that

$$\cos \frac{\kappa}{2} = \cos \frac{\xi}{2} \cos \frac{\eta}{2} + \cos \theta \sin \frac{\xi}{2} \sin \frac{\eta}{2}. \quad (6.72)$$

Exercise 6.24 Verify Eq. (6.72) and show that it can also be written as

$$\sin^2 \frac{\kappa}{4} = \sin^2 \frac{\xi - \eta}{4} + \frac{1}{2} \left(\cos \frac{\xi - \eta}{2} - \cos \frac{\xi + \eta}{2} \right) \sin^2 \frac{\theta}{2}. \quad (6.73)$$

Exercise 6.25 Find the direction of the vector κ (the rotation axis). ★

We can now evaluate the trace in (6.71). As a trace is independent of the basis used in Hilbert space, it is convenient to take the basis that diagonalizes $\kappa \cdot \mathbf{J}$, whose eigenvalues are κj , $\kappa(j-1)$, \dots , $-\kappa j$. We obtain

$$\text{Tr}(e^{-i\kappa \cdot \mathbf{J}}) = e^{i\kappa j} + e^{i\kappa(j-1)} + \dots + e^{-i\kappa j}. \quad (6.74)$$

This again is a geometric series which is readily summed, and we finally have

$$\tilde{\mathbf{P}}(\xi, \eta) = \sin[(2j+1)\kappa/2]/[(2j+1)\sin(\kappa/2)]. \quad (6.75)$$

This expression is *exact* and contains the same information as Eq. (6.70). In particular, if we take $\xi = \eta = \pi$, (that is, alternating signs for consecutive m), Eq. (6.72) gives $\kappa = 2\theta$, and the final result in (6.75) agrees with the one in Eq. (6.64).⁴²

We now turn our attention to the white noise that mars our exact quantum results. Because of it, high frequency components in (6.75)—those with ξ and η of the order of unity—may not be experimentally observable. If only low frequency components are, we may take, instead of Eq. (6.73), its limiting value

$$\lim_{\xi, \eta \rightarrow 0} \kappa^2 = \xi^2 + \eta^2 - 2\xi\eta \cos \theta, \quad (6.76)$$

where the terms that have been neglected are smaller than those which were retained by factors of order $(\xi - \eta)^2$ and $(\xi + \eta)^2 \sin^2(\theta/2)$. It will now be shown that if this expression is used in Eq. (6.75), the result is identical to the Fourier transform of the joint probability for observing given values of two components of the angular momenta of a pair of *classical* particles, whose total angular momentum is zero.

The classical correlation

The classical analog of a pair of spin j particles in a singlet state is a pair of particles with opposite angular momenta $\pm \mathbf{J}$. More precisely, the analog of an *ensemble* of pairs of spin j particles in the singlet state is an *ensemble* of pairs of classical particles with angular momenta $\pm \mathbf{J}$ whose directions are isotropically distributed, so that both ensembles have spherical symmetry. (Recall the discussion in Sect. 2-1. The only meaning of “quantum state” is: a list of the statistical properties of an ensemble of identically prepared systems.)

Let us denote the magnitude of the angular momenta as

$$J = \sqrt{j(j+1)} \simeq j + \frac{1}{2}, \quad (6.77)$$

the last approximation being valid for $j \gg 1$. Instead of the quantum correlation (6.68), we have, for given \mathbf{J} , a classical correlation,

$$\mathbf{P}_{cl}(m_1, m_2; \mathbf{J}) = \delta(m_1 - \boldsymbol{\alpha} \cdot \mathbf{J}) \delta(m_2 + \boldsymbol{\beta} \cdot \mathbf{J}), \quad (6.78)$$

and the Fourier transform (6.69) is replaced by

⁴²The extra factor $(-1)^{2j}$ in (6.64) is due to the factor $(-1)^j$ in the definition of the dichotomic variable that was previously used: $(-1)^{j-m}$.

$$\tilde{\mathbf{P}}_{cl}(\xi, \eta; \mathbf{J}) = \int_{-j}^j \int_{-j}^j e^{i(\xi m_1 + \eta m_2)} \mathbf{P}_{cl}(m_1, m_2) dm_1 dm_2 = e^{i\mathbf{J} \cdot \mathbf{k}}, \quad (6.79)$$

where

$$\mathbf{k} = \xi \boldsymbol{\alpha} - \eta \boldsymbol{\beta}. \quad (6.80)$$

This classical correlation must now be averaged over all possible directions of \mathbf{J} . As the latter are isotropically distributed, we have

$$\tilde{\mathbf{P}}_{cl}(\xi, \eta) = \int e^{i\mathbf{J} \cdot \mathbf{k}} d\Omega / 4\pi, \quad (6.81)$$

where $d\Omega$ is the infinitesimal solid angle element in the direction of \mathbf{J} . To perform the integration, let us take the direction of \mathbf{k} as the polar axis, so that

$$\mathbf{J} \cdot \mathbf{k} = J k u, \quad (6.82)$$

where

$$k := |\xi \boldsymbol{\alpha} - \eta \boldsymbol{\beta}| = (\xi^2 + \eta^2 - 2 \boldsymbol{\alpha} \cdot \boldsymbol{\beta} \xi \eta)^{1/2}, \quad (6.83)$$

and where u is the cosine of the angle between \mathbf{J} and \mathbf{k} . We can then take $d\Omega = 2\pi du$ by virtue of the rotational symmetry of $e^{i\mathbf{J} \cdot \mathbf{k}}$ around the direction of \mathbf{k} , and Eq. (6.81) becomes

$$\tilde{\mathbf{P}}_{cl}(\xi, \eta) = \frac{1}{2} \int_{-1}^1 e^{iJku} du = (\sin Jk) / Jk. \quad (6.84)$$

Since $\boldsymbol{\alpha} \cdot \boldsymbol{\beta} = \cos \theta$ (where θ has the same meaning as before) we find that

$$k = (\xi^2 + \eta^2 - 2 \xi \eta \cos \theta)^{1/2}, \quad (6.85)$$

is exactly the same as the limiting value of κ in Eq. (6.76). We thus finally have, for large j and small k ,

$$\tilde{\mathbf{P}}_{cl}(\xi, \eta) \simeq \sin[(2j+1)k/2] / [(2j+1)k/2], \quad (6.86)$$

in complete agreement with the limiting value of the quantum correlation $\tilde{\mathbf{P}}(\xi, \eta)$ in Eq. (6.75), for large j and small κ .

How coarse should our instruments be, in order to obtain this agreement of classical and quantum results? We have seen, in the derivation of Eq. (6.76), that the error made in approximating κ by its limiting value k is of the order of $(\xi - \eta)^2$ and $(\xi + \eta)^2 \sin^2(\theta/2)$. This error is then multiplied by j , in Eq. (6.75). Therefore $\tilde{\mathbf{P}}$ will be well approximated by $\tilde{\mathbf{P}}_{cl}$ if both $j(\xi - \eta)^2 \ll 1$ and $j(\xi + \eta)^2 \sin^2(\theta/2) \ll 1$ hold. In other words, the noise level must be such that the only detectable "frequencies" ξ and η are those for which both $|\xi - \eta|$ and $(\xi + \eta) \sin(\theta/2)$ are much smaller than $j^{-1/2}$. This high frequency cutoff implies

that different values of m can be experimentally distinguished only if they are separated by much more than \sqrt{j} .

This result had to be expected on intuitive grounds: In order to reduce the quantum correlation to a value similar to that of the weaker classical correlation, the minimum amount of blurring that one needs is obviously larger than the intrinsic "uncertainty" imposed by quantum mechanics on the components of the angular momentum vector. The latter is $[(\mathbf{J} \cdot \mathbf{J}) - \langle \mathbf{J} \rangle \cdot \langle \mathbf{J} \rangle]^{1/2} \geq \sqrt{j}$ (this will be proved in Sect. 10-7). The minimum uncertainty is achieved by *angular momentum coherent states* that satisfy $\mathbf{n} \cdot \mathbf{J} \psi = j \psi$, for some unit vector \mathbf{n} . For example the state u_j , defined by $J_z u_j = j u_j$, gives

$$\langle J_z \rangle = j \quad \text{and} \quad \langle J_x \rangle = \langle J_y \rangle = 0, \quad (6.87)$$

whence $\langle \mathbf{J} \cdot \mathbf{J} \rangle - \langle \mathbf{J} \rangle \cdot \langle \mathbf{J} \rangle = j$. This is the minimal angular dispersion compatible with quantum mechanics. If the angular resolution of our instruments is much poorer than this limit, they cannot detect the effects of quantum nonlocality.

6-7. Bibliography

Collections of reprints

J. S. Bell, *Speakable and Unspeakable in Quantum Mechanics*, Cambridge Univ. Press (1987).

This is a complete anthology of John Bell's published and unpublished articles on the conceptual and philosophical problems of quantum mechanics.

L. E. Ballentine, editor, *Foundations of Quantum Mechanics Since the Bell Inequalities*, Amer. Assoc. Phys. Teachers, College Park (1988).

This book lists 140 recent articles on the foundations of quantum theory, with brief comments on each one. Fifteen of these articles are also reprinted.

N. D. Mermin, *Boojums All the Way Through: Communicating Science in a Prosaic Age*, Cambridge Univ. Press (1990).

This is a collection of essays in which David Mermin's wry humor is combined with his commitment to finding simple ways of presenting complex ideas. The book includes various ways of demonstrating the extraordinary implications of Bell's theorem, as well as amusing anecdotes, such as the adventures that befell the author when he introduced the word "boojum" into the technical lexicon of modern physics.

Conference proceedings

J. T. Cushing and E. McMullin, eds., *Philosophical Consequences of Quantum Theory: Reflections on Bell's Theorem*, Univ. of Notre Dame Press (1989).

M. Kafatos, editor, *Bell's Theorem, Quantum Theory, and Conceptions of the Universe*, Kluwer, Dordrecht (1989).

Gödel's theorem

Kurt Gödel's revolutionary paper³² challenged basic assumptions of mathematical logic. Two nontechnical accounts of Gödel's theorem are:

E. Nagel and J. R. Newman, *Gödel's Proof*, New York Univ. Press (1958).

D. R. Hofstadter, *Gödel, Escher, Bach: an Eternal Golden Braid*, Basic Books, New York (1979).

The latter book won the 1980 Pulitzer Prize for general non-fiction. The author's remarkable achievement is the use of an entertaining style to make one of the most abstract ideas of mathematical logic understandable by the general reader.

G. J. Chaitin, "Gödel's theorem and information," *Int. J. Theor. Phys.* 21 (1982) 941.

Gödel's theorem is demonstrated by arguments with an information-theoretic flavor: if a theorem contains more information than a set of axioms, that theorem cannot be derived from these axioms. This suggests that the incompleteness phenomenon discovered by Gödel's is natural and widespread, rather than pathological and unusual.

Recommended reading

N. Herbert, *Quantum Reality*, Anchor Press-Doubleday, New York (1985).

Herbert's book is a well illustrated narrative of Bell's discovery and its implications.

A. Garg and N. D. Mermin, "Bell's inequalities with a range of violation that does not diminish as the spin becomes arbitrary large," *Phys. Rev. Lett.* 49 (1982) 901, 1294 (E).

Garg and Mermin were the first to show that spin j particles in a singlet state have correlations which violate Bell's inequality for measurements along nearly all directions. However, the magnitude of the violation that they found vanished exponentially for large j because of the use of slowly varying functions of the spin components, which made their method insensitive to the rapidly varying part of the quantum correlations.

W. De Baere, "Einstein-Podolsky-Rosen paradox and Bell's inequalities," *Adv. Electronics and Electron Physics*, 68 (1986) 245.

Recent progress, curiouser and curiouser

D. M. Greenberger, M. A. Horne, A. Shimony, and A. Zeilinger, "Bell's theorem without inequalities," *Am. J. Phys.* 58 (1990) 1131.

L. Hardy, "Nonlocality for two particles without inequalities for almost all entangled states," *Phys. Rev. Lett.* 71 (1993) 1665; "Nonlocality of a single photon revisited," *ibid.* 73 (1994) 2279.

Hardy derives two surprising results: states that are *not* maximally entangled may give stronger effects; and a single particle is enough to violate Einstein causality.

A. Peres, "Nonlocal effects in Fock space," *Phys. Rev. Lett.* (1995) in press.

Chapter 7

Contextuality

7-1. Nonlocality versus contextuality

In the preceding chapter, it was shown that, for any nonfactorable quantum state, it is possible to find pairs of observables whose correlations violate Bell's inequality (see page 176). This means that, for such a state, quantum theory makes statistical predictions which are incompatible with the demand that the outcomes of experiments performed at a given location in space be independent of the arbitrary choice of *other* experiments that can be performed, simultaneously, at distant locations (this apparently reasonable demand is the *principle of local causes*, also called *Einstein locality*).

However, it is not easy to demonstrate experimentally a violation of Bell's inequality. The predicted departure from classical realism appears only at the statistical level. Even formulations of Bell's theorem "without inequalities" cannot be verified by a single event. Therefore, any purported experimental verification is subject to all the vagaries of nonideal quantum detectors.

In the present chapter, we shall encounter another class of "paradoxes" which result from counterfactual logic. These new contradictions between quantum theory and cryptodeterminism do not depend on the choice of a particular quantum state, and therefore they are free from statistical inferences. Operator algebra is the only mathematical tool which is required. On the other hand, postulates *stronger* than the principle of local causes are needed.

Degeneracy and compatible measurements

If a matrix A is not degenerate, there is only one basis in which A is diagonal. That basis corresponds to a maximal quantum test which is equivalent to a *measurement* of the physical observable represented by the matrix A . If, on the other hand, A is degenerate, there are different bases in which A is diagonal. These bases correspond to *inequivalent physical procedures*, that we still call "measurements of A ." Therefore the word "measurement" is *ambiguous*.

If two matrices A and B commute, it is possible to find at least one basis

in which both matrices are diagonal (see page 71). Such a basis corresponds to a maximal test, which provides a measurement of both A and B . It follows that *two commuting operators can be simultaneously measured*. If, on the other hand, A and B do not commute, there is no basis in which both are diagonal, and the measurements of A and B are mutually incompatible.

These properties are readily generalized to a larger number of commuting operators. A set of commuting operators is called *complete* if there is a single basis in which all these operators are diagonal. Therefore, the simultaneous measurement of a complete set of commuting operators is equivalent to the measurement of a single nondegenerate operator, by means of a maximal—*or complete*—quantum test.

Exercise 7.1 Give examples of complete and incomplete sets of degenerate commuting operators.

Exercise 7.2 Show that an operator which commutes with all the operators of a complete set can be written as a function of these operators. ★

Context of a measurement

Let us now assume that, in spite of the ambiguity mentioned above, the result of the measurement of an operator A depends solely on the choice of A and on the objective properties of the system being measured (including “hidden” properties that quantum theory does not describe). In particular, if A commutes with other operators, B and C , so that one can measure A together with B , or together with C , the result of the measurement of A does not depend on its *context*, namely on whether we measure A alone, or A and B , or A and C .

This is assumed here not only for the “obvious” situation where operators B and C refer to some distant physical systems, but also if operators B and C belong to the *same* physical system as A . For example, the square of the angular momentum of a particle, $\mathbf{J}^2 \equiv J_x^2 + J_y^2 + J_z^2$, commutes with the angular momentum components J_x and J_y of the *same* particle, but J_x does not commute with J_y . The present assumption thus is that a measurement of \mathbf{J}^2 shall yield the same value, whether it is performed alone, or together with a measurement of J_x , or one of J_y .

The hypothesis that the results of measurements are independent of their context is manifestly counterfactual (it is not amenable to an experimental test). The nature and connotations of counterfactual reasoning were discussed at great length in the preceding chapter and will not be further debated here.

Functional consistency of results of measurements

If two operators A and B commute, quantum mechanics allows us in principle to measure not only both of them simultaneously, but also any function thereof,

$f(A,B)$. In particular, it is easily shown that if a system is prepared in a state ψ such that $A\psi = \alpha\psi$ and $B\psi = \beta\psi$, then $f(A,B)\psi = f(\alpha,\beta)\psi$. This property holds even if A and B do not commute, but merely happen to have a common eigenvector ψ . We may be tempted to extend this result and to propose the following postulate:

Even if ψ is not an eigenstate of the commuting operators A, B and $f(A, B)$, and even if these operators are not actually measured, one may still assume that the numerical results of their measurements (if these measurements were performed) would satisfy the same functional relationship as the operators.

For example, these results could be α, β , and $f(\alpha, \beta)$, respectively.

Each one of the two above assumptions (independence from context and functional consistency) seems quite reasonable. Yet, taken together, they are incompatible with quantum theory, as the following example readily shows.¹ Consider once more a pair of spin $\frac{1}{2}$ particles, but this time let them be in *any* state, not necessarily a singlet. In the square array

$$\begin{array}{ccc}
 \mathbb{1} \otimes \sigma_z & \sigma_z \otimes \mathbb{1} & \sigma_x \otimes \sigma_z \\
 \sigma_x \otimes \mathbb{1} & \mathbb{1} \otimes \sigma_x & \sigma_x \otimes \sigma_x \\
 \sigma_x \otimes \sigma_z & \sigma_z \otimes \sigma_x & \sigma_y \otimes \sigma_y
 \end{array} \tag{7.1}$$

each one of the nine operators has eigenvalues ± 1 . In each row and in each column, the three operators commute, and each operator is the product of the two others, *except in the third column*, where an extra minus sign is needed.

Exercise 7.3 Show that

$$(\sigma_x \otimes \sigma_z)(\sigma_z \otimes \sigma_x) = \sigma_y \otimes \sigma_y, \tag{7.2}$$

but

$$(\sigma_z \otimes \sigma_z)(\sigma_x \otimes \sigma_x) = -\sigma_y \otimes \sigma_y. \tag{7.3}$$

Exercise 7.4 Construct an array similar to (7.1) for the operators involved in Eq. (6.7). **Hint:** The array has the form of a five-pointed star, with an operator at each intersection of two lines.

Because of the opposite signs in Eqs. (7.2) and (7.3), it is clearly impossible to attribute to the nine elements of (7.1) numerical values, 1 or -1 , which would be the results of the measurements of these operators (if these measurements were performed), and which would obey the same multiplication rule as the operators themselves. We have therefore reached a contradiction. This simple algebraic exercise shows that what we call “the result of a measurement of A ” cannot in general depend only on the choice of A and on the system being measured (unless ψ is an eigenstate of A or, as will be seen below, A is nondegenerate).

¹N. D. Mermin, *Phys. Rev. Lett.* 65 (1990) 3373.

The above proof necessitated the use of a four dimensional Hilbert space. We know, on the other hand, that in a two dimensional Hilbert space, it is possible to construct hidden variable models that reproduce all the results of quantum theory (see page 159). Most of the remaining part of this chapter will be devoted to the case of a three dimensional Hilbert space, which gives rise to challenging algebraic problems, worth being investigated for their own sake.

7-2. Gleason's theorem

An important theorem was proved by Gleason² during the course of an investigation on the possible existence of new axioms for quantum theory, that would be weaker than those of von Neumann, and would give statistical predictions different from the standard rule (see page 73),

$$\langle A \rangle = \text{Tr}(\rho A). \quad (3.77)$$

Gleason's theorem effectively states that there is no alternative to Eq. (3.77) if the dimensionality of Hilbert space is larger than 2.

The premises needed to prove that theorem are the strong superposition principle G^* (namely, any orthogonal basis represents a realizable maximal test, see page 54), supplemented by reasonable continuity arguments. As shown below, these very general assumptions are sufficient to prove that the average value of a projection operator P is given by

$$\langle P \rangle = \text{Tr}(\rho P), \quad (7.4)$$

where ρ is a nonnegative operator with unit trace, which depends only on the preparation of the physical system (it does not depend on the choice of the projector P). This result is then readily generalized to obtain Eq. (3.77) which holds for any operator A . The thrust of Gleason's theorem is that some of the postulates that were proposed in Chapters 2 and 3—in particular the quantum expectation rule H , page 56—can be replaced by a smaller set of abstract definitions and axioms, which may have more appeal to mathematically inclined theorists. The fundamental axioms now are:

- α) *Elementary tests (yes-no questions) are represented by projectors in a complex vector space.*
- β) *Compatible tests (yes-no questions that can be answered simultaneously) correspond to commuting projectors.*
- γ) *If P_u and P_v are orthogonal projectors, their sum $P_{uv} = P_u + P_v$, which is itself a projector, has expectation value*

²A. M. Gleason, *J. Math. Mech.* 6 (1957) 885.

$$\langle P_{uv} \rangle = \langle P_u \rangle + \langle P_v \rangle. \tag{7.5}$$

The last assumption, which is readily generalized to the sum of more than two orthogonal projectors, is not at all trivial. A projector such as P_{uv} , whose trace is ≥ 2 , can be split in infinitely many ways. For example, let $P_u = uu^\dagger$ and $P_v = vv^\dagger$ be projectors on the orthonormal vectors u and v , and let

$$x = (u + v)/\sqrt{2} \quad \text{and} \quad y = (u - v)/\sqrt{2}, \tag{7.6}$$

be another pair of orthonormal vectors. The corresponding projectors $P_x = xx^\dagger$ and $P_y = yy^\dagger$ satisfy

$$P_x + P_y = P_u + P_v. \tag{7.7}$$

This expression is a trivial *identity* in our abstract complex vector space. On the other hand, the assertion that

$$\langle P_x \rangle + \langle P_y \rangle = \langle P_u \rangle + \langle P_v \rangle \tag{7.8}$$

has a nontrivial *physical content* and can in principle be tested experimentally, by virtue of the strong superposition principle G^* .

Experimental verification

As a concrete example, consider a spin 1 particle. Let u, v , and w be eigenstates of J_z , corresponding to eigenvalues 1, -1, and 0, respectively (in natural units, $\hbar = 1$), and likewise let x, y , and w be eigenstates of $(J_x^2 - J_y^2)$, corresponding to eigenvalues 1, -1, and 0. Let us prepare a beam of these spin 1 particles, and send it through a beam splitter (a filter) which sorts out the particles according to the eigenvalues 0 and 1 of the observable

$$J_z^2 = (J_x^2 - J_y^2)^2. \tag{7.9}$$

This can in principle be done in a Stern-Gerlach type experiment, using an inhomogeneous quadrupole field.³

An observer, \mathcal{L} , far away on the left hand side of the beam splitter (see Fig. 7.1), receives the beam with state w which corresponds to the eigenvalue 0 of the matrix J_z^2 . That observer can thus measure the expectation value $\langle P_w \rangle$, which is the fraction of the beam intensity going toward the left.

Meanwhile, the other beam, that corresponds to the degenerate eigenvalue 1 of the observable in Eq. (7.9), impinges on a second filter, which is prepared by another observer, R , far away on the right hand side. That observer has a *choice* of testing the particles either for J_z (thereby obtaining the expectation values $\langle P_u \rangle$ and $\langle P_v \rangle$), or for $J_x^2 - J_y^2$ (to obtain $\langle P_x \rangle$ and $\langle P_y \rangle$). These two choices naturally correspond to different types of beam splitters. The two experimental setups that can be arbitrarily chosen by R are mutually incompatible.

The results recorded by the two observers are not independent. In the first case, \mathcal{L} gets a fraction

³A. R. Swift and R. Wright, *J. Math. Phys.* 21 (1980) 77.

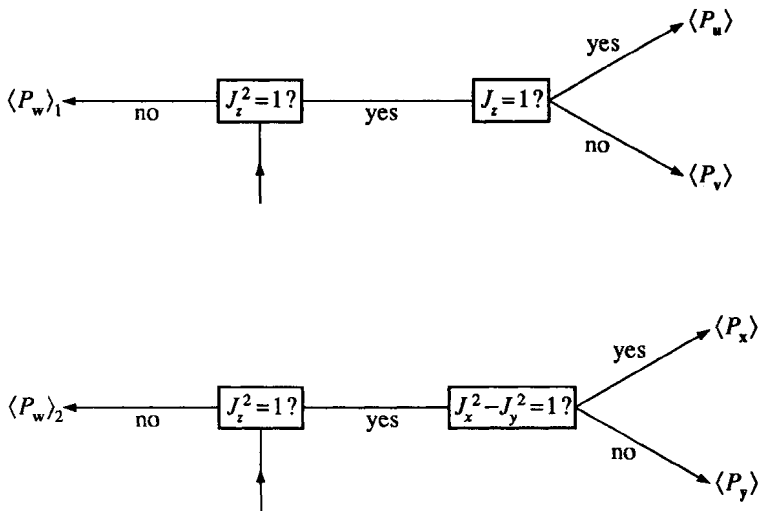

Fig. 7.1. The two alternative experiments testing Eq. (7.8). If that equation does not hold, the values of $\langle P_w \rangle$ are different in these two experiments.

$$\langle P_w \rangle_1 = 1 - \langle P_u \rangle - \langle P_v \rangle \tag{7.10}$$

of the initial beam, while in the second case, he gets

$$\langle P_w \rangle_2 = 1 - \langle P_x \rangle - \langle P_y \rangle. \tag{7.11}$$

If Eq. (7.8) is valid, $\langle P_w \rangle_1 = \langle P_w \rangle_2$, and observer \mathcal{L} cannot discern which one of the two experiments was chosen by R . Contrariwise, if Eq. (7.8) does not hold—which would mean that quantum theory is wrong—a measurement of $\langle P_w \rangle$ will unambiguously indicate to \mathcal{L} which one of the two setups was chosen by the distant observer R . In that case, R would have the possibility of sending messages to \mathcal{L} , that would be “read” instantaneously. They could even be read before they are sent, if the distance from the first filter to R is larger than its distance to \mathcal{L} , and if the particles are slow enough.

The hypothetical situation described above is essentially different from the ordinary quantum nonlocality linked to the violation of Bell’s inequality. Indeed, Bell’s inequality only refers to correlations between the observations of \mathcal{L} and R . In order to test experimentally Bell’s inequality, one must compare the results obtained by the two distant observers, after bringing their records to a common analysis site. Each observer separately is unable to test Bell’s inequality. Therefore the observers have no way of using the Bell nonlocality in order to send messages to each other. On the other hand, if Eq. (7.8) does not hold, the results observed by \mathcal{L} are sufficient to tell him which one of the two setups was chosen (or will be chosen) by his distant colleague R .

Frame functions

Let us now return to Gleason's original problem: Find all the real nonnegative functions $f(u)$ such that, for *any* complete orthonormal basis \mathbf{e}_m , one has

$$\sum_m f(\mathbf{e}_m) = 1. \tag{7.12}$$

The physical meaning of such a function $f(u)$ is the probability of finding a given quantum system in state u . This interpretation of $f(u)$ is in accord with Postulate γ . More generally, Gleason defines a *frame function* by the property that $\sum_m f(\mathbf{e}_m)$ has the same value for any choice of the complete orthonormal frame $\{\mathbf{e}_m\}$, but this value is not necessarily 1.

The solution of Gleason's problem, given below, involves the transformation properties of spherical harmonics under the rotation group $SO(3)$. The reader who is not interested in these details may skip the rest of this section.

Two dimensions

If you haven't followed the above option, consider a two dimensional real vector space. Unit vectors correspond to points on a unit circle, and can be denoted by an angle θ . Equation (7.12) becomes

$$f(\theta) + f(\theta + \pi/2) = 1. \tag{7.13}$$

Let us try a Fourier expansion, $f(\theta) = \sum c_n e^{in\theta}$, with $c_{-n} = \overline{c_n}$. We obtain

$$f(\theta) + f(\theta + \pi/2) = \sum_n c_n e^{in\theta} (1 + e^{in\pi/2}) = \sum_n c_n e^{in\theta} (1 + i^n). \tag{7.14}$$

To have a frame function, this expression must be a constant. Therefore, the only values of n allowed in the Fourier expansion are $n = 0$, and those n for which $i^n = -1$, namely, $n = \pm 2, \pm 6, \pm 10$, etc. There is an infinity of possible forms for frames functions in a two dimensional real vector space. This can also be seen intuitively: an arbitrary function $f(\theta)$ can be chosen along one of the quadrants of the unit circle, and then one takes $(1 - f)$ for the next quadrant.

In more dimensions, there is less freedom, because the orthonormal bases are intertwined: a unit vector \mathbf{u} may belong to more than one basis. However, it must have a single expectation value, $f(\mathbf{u}) = \langle \mathbf{u}\mathbf{u}^\dagger \rangle$, irrespective of the choice of the basis in which it is included. This requirement imposes severe constraints on the possible forms of $f(u)$, as we shall presently see.

Three dimensions

Let us now consider a three dimensional real vector space, which has the same metric properties as our ordinary Euclidean space. The unit vectors correspond to points on a unit sphere, and can be denoted by a pair of angles θ and ϕ . We can therefore write $f(u)$ as $f(\theta, \phi)$ and try an expansion in spherical harmonics:

$$f(\theta, \phi) = \sum_{lm} c_{lm} Y_{lm}(\theta, \phi). \tag{7.15}$$

Lemma. *If $f(\theta, \phi)$ is a frame function, each irreducible l -component of an expansion in spherical harmonics is by itself a frame function.*

Proof. Consider two directions, (θ', ϕ') and (θ'', ϕ'') , orthogonal to (θ, ϕ) and to each other. We then have⁴

$$f(\theta', \phi') = \sum_{lm} c_{lm} Y_{lm}(\theta', \phi') = \sum_{lm} c_{lm} \sum_r \mathcal{D}_{rm}^{(l)'} Y_{lr}(\theta, \phi), \tag{7.16}$$

where the $\mathcal{D}_{rm}^{(l)'}$ are unitary matrices of order $(2l+1)$, representing a rotation which carries (θ, ϕ) into (θ', ϕ') . Likewise,

$$f(\theta'', \phi'') = \sum_{lm} c_{lm} \sum_r \mathcal{D}_{rm}^{(l)''} Y_{lr}(\theta, \phi), \tag{7.17}$$

where the $\mathcal{D}_{rm}^{(l)''}$ matrices represent a rotation which carries (θ, ϕ) into (θ'', ϕ'') . Let us interchange the indices m and r in the last two equations, and add the resulting expressions to Eq. (7.15). After some rearrangement, we obtain

$$f(\theta, \phi) + f(\theta', \phi') + f(\theta'', \phi'') = \sum_{lm} \left[c_{lm} + \sum_r (\mathcal{D}_{mr}^{(l)'} + \mathcal{D}_{mr}^{(l)''}) c_{lr} \right] Y_{lm}(\theta, \phi). \tag{7.18}$$

This must be a constant, if we want f to be a frame function. It follows that

$$c_{lm} + \sum_r (\mathcal{D}_{mr}^{(l)'} + \mathcal{D}_{mr}^{(l)''}) c_{lr} = 0 \quad \text{if} \quad l \neq 0. \tag{7.19}$$

This result must hold for each l separately. Therefore each l -component of the frame function (7.15) is by itself a frame function.

Thanks to this lemma, it is now sufficient to investigate the conditions for

$$f_l(\theta, \phi) = \sum_{m=-l}^l c_m P_l^{|m|}(\cos \theta) e^{im\phi} \tag{7.20}$$

to be a frame function. Note that l cannot be odd, because in that case f_l would change sign when the direction (θ, ϕ) is replaced by its antipode $(\pi - \theta, \pi + \phi)$, and a frame function is not allowed to do that (if one or more of the \mathbf{e}_m are reversed, they still form an orthonormal basis). In general, for antipodes, we have $e^{im\phi} \leftrightarrow e^{im(\pi+\phi)} = (-1)^m e^{im\phi}$, and⁴

$$P_l^m(\cos \theta) = \sin^m \theta \frac{d^m}{d(\cos \theta)^m} P_l(\cos \theta), \tag{7.21}$$

⁴E. P. Wigner, *Group Theory*, Academic Press, New York (1959) p. 154.

which behaves as $(-1)^{l+m}$ when $\theta \leftrightarrow \pi - \theta$.

For even l , it is enough to consider the simple case $\theta = 0$, and $\theta' = \theta'' = \pi/2$. From Eq. (7.21), we obtain

$$P_l^m(1) = 0 \quad \text{if} \quad m \neq 0, \tag{7.22}$$

so that $f_l(0, \phi) = c_0$, which is a constant. Moreover we have, as in Eq. (7.14),

$$f_l(\pi/2, \phi) + f_l(\pi/2, \phi + \pi/2) = \sum_{m=-l}^l c_m P_l^{|m|}(0) e^{im\phi} (1 + i^m), \tag{7.23}$$

and this too ought to be independent of ϕ , if we want to have a frame function. The odd values of m do not contribute to (7.23), because $P_l^m(0) = 0$ if $l + m$ is odd, as can be seen from (7.21). We are therefore left to consider the even values of m . For the latter, one must prevent occurrences of $m = \pm 4, \pm 8, \dots$, if the right hand side of (7.23) is to be constant. It will now be shown that this rules out every l , except $l = 0$ and $l = 2$.

Recall that the representation of the rotation group by spherical harmonics of order l is *irreducible*.⁴ Therefore, for any given $l \geq 4$, the requirement that $c_4 = 0$ in every basis (*i.e.*, with every choice of the polar axis) entails $c_m = 0$ for all m . Indeed, by choosing $2l + 1$ different polar axes, we can obtain $2l + 1$ linearly independent expressions for c_4 , and all of them will vanish if, and only if, every one of the $c_m = 0$.

Exercise 7.5 *Prove that if a given component of a vector vanishes for all bases, that vector is the null vector.* ★

We are thus finally left with spherical harmonics of order 0 and 2. These can be written as bilinear combinations of the Cartesian components of the unit vector \mathbf{u} , so that any frame function has the form

$$f(\mathbf{u}) = \sum_{mn} \rho_{mn} u_m u_n, \tag{7.24}$$

where ρ is a nonnegative matrix with unit trace.

Higher dimensional spaces

Any higher dimensional vector space, possibly a complex one, has an infinity of three dimensional real subspaces. In each one of the latter, frame functions have the form (7.24). It is intuitively obvious, and it can be formally proved, that in the larger space one must have

$$f(\mathbf{u}) = \sum \rho_{mn} \overline{u_m} u_n. \tag{7.25}$$

A rigorous proof of this assertion involves intricate geometrical arguments, for which the interested reader is referred to Gleason's original article.²

Cryptodeterminism

Gleason's theorem is a powerful argument against the hypothesis that the stochastic behavior of quantum tests can be explained by the existence of a subquantum world, endowed with "hidden variables" whose values unambiguously determine the outcome of each test. If it were indeed so, then, for any specific value of the hidden variables, every elementary test (yes-no question) would have a unique, definite answer; and therefore every projector P_u would correspond to a definite value, 0 or 1. And therefore the function $f(u) = \langle P_u \rangle$ too would everywhere be either 0 or 1 (its precise value depending on those of the hidden variables). Such a discontinuous function $f(u)$ is radically different from the smooth distribution (7.25) required by Gleason's theorem. This means that Eq. (7.5) cannot be valid, in general, for an arbitrary distribution of hidden variables; and therefore, a hidden variable theory must violate Postulate γ , as long as the hidden variables have not been averaged over.

This conclusion was first reached by Bell.⁵ Soon afterwards, Kochen and Specker⁶ gave a purely algebraic proof, which used only a *finite* number of operators (117 operators, to be precise). Gleason's continuity argument, which had motivated the work of Bell and of Kochen and Specker, was no longer needed for discussing the cryptodeterminism problem. More recent (and simpler) proofs of the Kochen-Specker theorem are given in the next section.

7-3. The Kochen-Specker theorem

The Kochen-Specker theorem asserts that, in a Hilbert space of dimension $d \geq 3$, it is impossible to associate definite numerical values, 1 or 0, with every projection operator P_m , in such a way that, if a set of *commuting* P_m satisfies $\sum P_m = \mathbb{1}$, the corresponding values, namely $v(P_m) = 0$ or 1, also satisfy $\sum v(P_m) = 1$. The thrust of this theorem is that any cryptodeterministic theory that would attribute a definite result to each quantum measurement, and still reproduce the statistical properties of quantum theory, is inevitably *contextual*. In the present case, if three operators, P_m , P_r , and P_s , have commutators $[P_m, P_r] = [P_m, P_s] = 0$ and $[P_r, P_s] \neq 0$, the result of a measurement of P_m cannot be independent of whether P_m is measured alone, or together with P_r , or together with P_s .

Exercise 7.6 Write three projectors P_m , P_r , and P_s with the above algebraic properties. Explain why this requires a vector space of dimension $d \geq 3$.

⁵J. S. Bell, *Rev. Mod. Phys.* 38 (1966) 447.

⁶S. Kochen and E. Specker, *J. Math. Mech.* 17 (1967) 59.

The proof of the theorem runs as follows. Let u_1, \dots, u_N be a complete set of orthonormal vectors. The N matrices $P_m = u_m u_m^\dagger$ are projection operators on the vectors u_m . These matrices commute and satisfy $\sum P_m = \mathbf{1}$. There are N different ways of associating the value 1 with one of these matrices (that is, with one of the vectors u_m), and the value 0 with the $N - 1$ others. Consider now several distinct orthogonal bases, which may share some of their unit vectors. Assume that if a vector is a member of more than one basis, the value (1 or 0) associated with that vector is the same, irrespective of the choice of the other basis vectors. This assumption leads to a contradiction, as first shown by Kochen and Specker⁶ for a particular set of 117 vectors in \mathbb{R}^3 (the real 3-dimensional vector space). The earlier proof by Bell⁵ involved a *continuum* of vector directions, but it can easily be rewritten in a way using only a finite number of vectors.

As this result has a fundamental importance, many attempts were made to simplify the Kochen-Specker proof, and in particular to use fewer than 117 vectors. The most economical proof known at present is due to Conway and Kochen, who found a set of 31 vectors having the required property. The direction cosines of these vectors have ratios involving only small integers, 0, ± 1 , and ± 2 (see Plate II, page 114). Here however, we shall consider another set, with 33 vectors belonging to 16 distinct bases in \mathbb{R}^3 . That set enjoys many symmetries which greatly simplify the proof of the theorem.⁷ We shall then see an even simpler proof in \mathbb{R}^4 , using only 20 vectors.

In these proofs, I shall use the word *ray*, rather than *vector*, because only directions are relevant. The length of the vectors never plays any role, and it is in fact convenient to let that length exceed 1. This does not affect orthogonality, and the algebra becomes easier. To further simplify the discourse, rays associated with the values 1 and 0 will be called green and red, respectively (as in traffic lights, green = yes, red = no).

Thirty three rays in \mathbb{R}^3

The 33 rays used in the proof are shown in Fig. 7.2. They will be labelled xyz , where x , y , and z can be: 0, 1, $\bar{1}$ (this symbol stands for -1), 2 (means $\sqrt{2}$), and $\bar{2}$ (means $-\sqrt{2}$). For example the ray $\bar{1}02$ connects the origin to the point $(-1, 0, \sqrt{2})$. Opposite rays, such as $\bar{1}02$ and $10\bar{2}$, are counted only once, because they correspond to the same projector.

Exercise 7.7 Show that the squares of the direction cosines of each ray are one of the combinations $0 + 0 + 1 = 0 + \frac{1}{2} + \frac{1}{2} = 0 + \frac{1}{3} + \frac{2}{3} = \frac{1}{4} + \frac{1}{4} + \frac{1}{2}$, and all permutations thereof.

Exercise 7.8 Show that the 33 rays form 16 orthogonal triads (with each ray belonging to several triads). ★

⁷ A. Peres, *J. Phys. A* 24 (1991) L175.

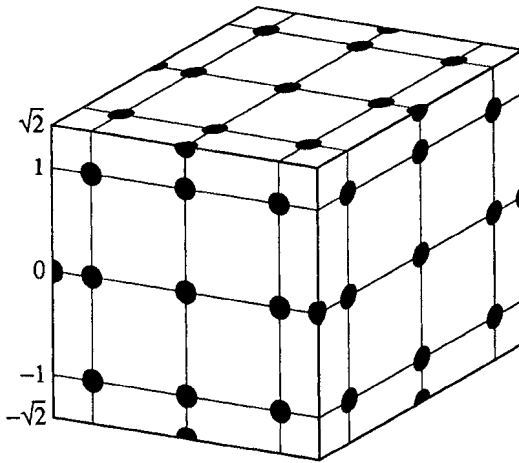

Fig. 7.2. The 33 rays used in the proof of the Kochen-Specker theorem are obtained by connecting the center of the cube to the black dots on its faces and edges. Compare this construction with Plate II, page 114.

An important property of this set of rays is its invariance under interchanges of the x , y and z axes, and under a reversal of the direction of each axis. This allows us to assign arbitrarily—without loss of generality—the value 1 to some of the rays, because giving them the value 0 instead of 1 would be equivalent to renaming the axes, or reversing one of them. For example, one can impose that ray 001 is green, while 100 and 010 are red.

Table 7-1. Proof of Kochen-Specker theorem in 3 dimensions.

Orthogonal triad	Other rays	The first ray is green because of
001 100 010	110 $\bar{1}\bar{1}0$	arbitrary choice of z axis
101 $\bar{1}01$ 010		arbitrary choice of x vs $-x$
011 $0\bar{1}\bar{1}$ 100		arbitrary choice of y vs $-y$
$1\bar{1}\bar{2}$ $\bar{1}\bar{1}2$ 110	$\bar{2}01$ 021	arbitrary choice of x vs y
102 $\bar{2}01$ 010	$\bar{2}\bar{1}\bar{1}$	orthogonality to 2nd and 3rd rays
211 $0\bar{1}\bar{1}$ $\bar{2}\bar{1}\bar{1}$	$\bar{1}02$	orthogonality to 2nd and 3rd rays
201 010 $\bar{1}02$	$\bar{1}\bar{1}\bar{2}$	orthogonality to 2nd and 3rd rays
112 $1\bar{1}0$ $\bar{1}\bar{1}\bar{2}$	021	orthogonality to 2nd and 3rd rays
012 100 $0\bar{2}\bar{1}$	$1\bar{2}\bar{1}$	orthogonality to 2nd and 3rd rays
121 $\bar{1}01$ $1\bar{2}\bar{1}$	$0\bar{1}\bar{2}$	orthogonality to 2nd and 3rd rays

The proof of the Kochen-Specker theorem entirely holds in Table 7-1 (the table has to be read from top to bottom). In each line, the first ray, printed in **boldface** characters, is green. The second and third rays form, together

with the first one, an orthogonal triad. Therefore they are red. Additional rays listed in the same line are also orthogonal to its first ray, therefore they too are red (only the rays that will be needed for further work are listed). When a red ray is printed in *italic* characters, this means that it is an “old” ray, that was already found red in a preceding line. The choice of colors for the new rays appearing in each line is explained in the table itself.

The first, fourth and last lines contain rays 100, 021, and 0 $\bar{1}$ 2, respectively. These three rays are red and mutually orthogonal: this is the Kochen-Specker contradiction. It can be shown that if a single ray is deleted from that set of 33, the contradiction disappears. It is so even if the deleted ray is not explicitly listed in Table 7-1. This is because the removal of one ray breaks the symmetry of the set and therefore necessitates the examination of alternative choices. The proof that a contradiction can then be avoided is not as simple as in Table 7-1 (the computer program in the Appendix may help).⁸

Physical interpretation

Since our present Hilbert space is isomorphic to \mathbb{R}^3 , the abstract vectors u_m behave as ordinary Euclidean vectors. We shall therefore denote them by boldface letters, \mathbf{m}, \mathbf{n} , etc. A simple physical interpretation of the projection operator P_m can be given in terms of the angular momentum components of a spin 1 particle. It is convenient to use a representation where

$$J_x = \begin{pmatrix} 0 & 0 & 0 \\ 0 & 0 & -i \\ 0 & i & 0 \end{pmatrix}, \quad J_y = \begin{pmatrix} 0 & 0 & i \\ 0 & 0 & 0 \\ -i & 0 & 0 \end{pmatrix}, \quad J_z = \begin{pmatrix} 0 & -i & 0 \\ i & 0 & 0 \\ 0 & 0 & 0 \end{pmatrix}, \quad (7.26)$$

in natural units ($\hbar = 1$). These matrices satisfy $[J_x, J_y] = i J_z$, and cyclic permutations thereof. With this representation, we have

$$J_x^2 = \begin{pmatrix} 0 & 0 & 0 \\ 0 & 1 & 0 \\ 0 & 0 & 1 \end{pmatrix}, \quad J_y^2 = \begin{pmatrix} 1 & 0 & 0 \\ 0 & 0 & 0 \\ 0 & 0 & 1 \end{pmatrix}, \quad J_z^2 = \begin{pmatrix} 1 & 0 & 0 \\ 0 & 1 & 0 \\ 0 & 0 & 0 \end{pmatrix}. \quad (7.27)$$

These three matrices commute, so that the corresponding observables can be measured simultaneously. One may actually consider all the J_m^2 as functions of a single nondegenerate operator,

⁸ The proof originally given by Kochen and Specker proceeds in two steps. The first step (which is the difficult one) is a lemma saying that two particular vectors out of a given set of 8 vectors cannot both have the value 1. The second, much easier step is to replicate 15 times that 8-vector set, in a way leading to a contradiction. Three of the vectors appear twice in this construction, making a total of $15 \times 8 - 3 = 117$ distinct vectors. Some authors consider the second step so trivial that they say that the Kochen-Specker proof necessitates only 8 vectors (and then Bell’s earlier proof would have used 10 vectors). However, the purists, including Kochen and Specker themselves, want a complete proof, not only a lemma, and their count is 117 vectors.

$$K = J_x^2 - J_y^2 = \begin{pmatrix} -1 & 0 & 0 \\ 0 & 1 & 0 \\ 0 & 0 & 0 \end{pmatrix}. \tag{7.28}$$

Exercise 7.9 Show that $J_x^2 = \mathbf{1} + (K - K^2)/2$, and write likewise J_y^2 and J_z^2 as functions of K .

Exercise 7.10 Write explicitly the three matrices $J_k J_l + J_l J_k$ (for $k \neq l$) and show that, for any real unit vector \mathbf{m} , the matrix

$$P_{\mathbf{m}} = \mathbf{1} - (\mathbf{m} \cdot \mathbf{J})^2, \tag{7.29}$$

has components $(P_{\mathbf{m}})_{rs} = m_r m_s$, and therefore is a projection operator.

A measurement of the projector $P_{\mathbf{m}}$ is a test of whether the spin component along the unit vector \mathbf{m} is equal to zero. The eigenvalue 1 corresponds to the answer “yes,” and the degenerate eigenvalues 0 to the answer “no.” Note that this test is essentially different from an ordinary Stern-Gerlach experiment which would measure the spin component along \mathbf{m} , because the degenerate matrix $P_{\mathbf{m}}$ makes no distinction between the eigenvalues -1 and $+1$ of $\mathbf{m} \cdot \mathbf{J}$.

A generalization of (7.28), for two orthogonal unit vectors \mathbf{m} and \mathbf{n} , is

$$K(\mathbf{m}, \mathbf{n}) = (\mathbf{m} \cdot \mathbf{J})^2 - (\mathbf{n} \cdot \mathbf{J})^2. \tag{7.30}$$

This operator has eigenvalues $-1, 0$, and 1 . A direct measurement of $K(\mathbf{m}, \mathbf{n})$ is difficult, but it is technically possible,³ and a single operation can thereby determine the “colors” of the triad \mathbf{m}, \mathbf{n} and $\mathbf{m} \times \mathbf{n}$.

The 33 rays that were used in the proof of the Kochen-Specker theorem form 16 orthogonal triads (see Exercise 7.8). These triads correspond to 16 different and *noncommuting* operators of the same type as $K(\mathbf{m}, \mathbf{n})$. Any one of them, but only one, can actually be measured. The results of the other measurements are counterfactual—and mutually contradictory.

Twenty rays in \mathbb{R}^4

Consider again our pair of spin $\frac{1}{2}$ particles. Recall that in array (7.1), each row and each column is a *complete* set of commuting operators. The product of the three operators in each row or column is $\mathbf{1} \otimes \mathbf{1}$, except those of the third column, whose product is $-\mathbf{1} \otimes \mathbf{1}$. It is obviously impossible to associate, with each one of these nine operators, numerical values 1 or -1 , that would obey the same multiplication rule as the operators themselves.

This algebraic impossibility will now be rephrased in the geometric language of the Kochen-Specker theorem. The common eigenvectors of the commuting operators in each row and each column of (7.1) form a complete orthogonal basis. We thus have 6 orthogonal bases, with a total of 24 vectors. The impossible assignment is to “paint” them in such a way that one vector of each basis is

green, while *all* the vectors that are orthogonal to that green vector are red (including any orthogonal vectors that belong to *other* bases).

Suppose that we have painted in this way the vectors of *one* of the bases. Its “green” vector indicates the outcome of the complete test corresponding to that basis—if and when the test is performed—and therefore it attributes definite values, 1 or -1 , to each one of the three commuting operators (the entire row or column) generating that basis. Now, we have just seen that it is impossible to have a consistent set of values for all the elements of array (7.1). Therefore we expect to encounter a geometric incompatibility in our painting job, similar to the one found earlier in \mathbb{R}^3 .

The geometric proof is even simpler in the present case than in \mathbb{R}^3 . With the usual representation of σ_z and σ_x (both real), the eigenvectors too may be taken real. Therefore the discussion can be restricted to \mathbb{R}^4 . With the same notations as above, the 24 rays, labelled $wxyz$, are 1000, 1100, $1\bar{1}00$, 1111, 111 $\bar{1}$, 11 $\bar{1}\bar{1}$, and all permutations thereof (opposite rays are counted only once). This set is invariant under interchanges of the w, x, y and z axes, and under a reversal of the direction of each axis.

Exercise 7.11 Sort out these 24 rays into 6 orthogonal bases, one for each row and column in array (7.1). Show that each one of the 24 rays is orthogonal to 9 other rays and belongs to 4 distinct tetrads. There are 108 pairs of orthogonal rays, and 24 distinct orthogonal tetrads. ★

Exercise 7.12 Show that the 24 rays are orthogonal to the faces of the regular polytope⁹ known as the 24-cell. ★★

Exercise 7.13 Prove the Kochen-Specker theorem in \mathbb{R}^4 by the method used in Table 7-1. ★

It turns out that it is not necessary to use all these 24 rays for proving the Kochen-Specker theorem. A proof with only 20 rays¹⁰ is given by Table 7-2: there are 11 columns, and the four rays in each column are mutually orthogonal. Therefore in each column one ray is green. This makes a total of 11 green rays. However, it is easily seen that each ray in the table appears either twice, or 4 times, so that the total number of green rays must be an even number. The contradiction implies that the 20 rays have no consistent coloring.

Table 7-2. Proof of Kochen-Specker theorem in 4 dimensions.

1000	1000	1000	1000	$\bar{1}111$	$\bar{1}\bar{1}11$	$1\bar{1}11$	$11\bar{1}1$	0110	0011	1010
0100	0100	0010	0001	$1\bar{1}\bar{1}1$	$11\bar{1}\bar{1}$	$11\bar{1}\bar{1}$	$11\bar{1}\bar{1}$	$100\bar{1}$	$1\bar{1}00$	0101
0010	0011	0101	0110	$11\bar{1}\bar{1}$	1010	0110	0011	1111	1111	$11\bar{1}\bar{1}$
0001	001 $\bar{1}$	010 $\bar{1}$	01 $\bar{1}0$	$11\bar{1}\bar{1}$	010 $\bar{1}$	100 $\bar{1}$	$1\bar{1}00$	$1\bar{1}\bar{1}1$	$11\bar{1}\bar{1}$	$1\bar{1}\bar{1}1$

⁹H. S. M. Coxeter, *Regular Polytopes*, Macmillan, New York (1963) [reprinted by Dover].

¹⁰M. Kernaghan, *J. Phys. A* 27 (1994) L829.

7-4. Experimental and logical aspects of contextuality

The Kochen-Specker theorem is a geometrical statement. Like Bell's theorem, it is independent of quantum theory, but it profoundly affects the interpretation of the latter. However, the Kochen-Specker theorem, contrary to Bell's, does not involve statistical correlations in an ensemble of systems. It compares the results of various measurements that can be performed on a *single* system. This is a radical simplification. There is no need of taking averages over unspecified hidden variables, or over fictitious experimental runs, as in the derivation of the CHSH inequality from Eq. (6.29). Moreover, the absence of statistical considerations relieves us of any worries about detector efficiencies.

Yet, the problem cannot be one of pure logic. Any discussion about physics must ultimately make connection with experimental facts. The purpose of this section is to analyze the empirical premises underlying the theorems of Bell and of Kochen and Specker. These premises are formulated as nine distinct propositions. Seven of them are strictly phenomenological. They can be tested experimentally (in addition to tests for internal consistency). They can also be derived from quantum theory.

The last two propositions are of counterfactual nature: They state that it is possible to *imagine* the results of unperformed experiments, and moreover, to do that in such a way that these hypothetical results have *correlations* which mimic those of actual experimental results. Although this counterfactual reasoning appears reasonable, it produces inadmissible consequences such as Bell's inequality, which is experimentally violated, or the Kochen-Specker coloring rule for vectors, which is contradictory.

A. Elementary tests

We start with some definitions and propositions which are not controversial.

There are "elementary tests" (yes-no experiments) labelled A, B, C, ... Their outcomes are labelled a, b, c, ... = 1 (yes) or 0 (no).

In quantum theory, these elementary tests are represented by projection operators. It is sufficient here to consider only a subset of quantum theory, where projectors are represented by real matrices of order 2 or 3.

Exercise 7.14 *Show that any 3×3 real projector with unit trace can be written as in Eq. (7.29).*

Exercise 7.15 *Show that any 2×2 real projector with unit trace can be written as*

$$P_\theta = \frac{1}{2} (\mathbf{1} + \sigma_x \sin \theta + \sigma_z \cos \theta). \quad (7.31)$$

A physical realization of P_θ may be a Stern-Gerlach test of spin $\frac{1}{2}$ particles, for which P_θ represents the question "Is the component of spin along the θ direction

positive?" Another possible implementation may involve the linear polarization of photons.

B. State preparation

In general the outcome of a given test cannot be predicted with certainty. Yet, the following exception holds:

For each elementary test, there are ways of preparing physical systems so that the outcome of that test is predictable with certainty.

In quantum theory, a preparation is represented by a density matrix ρ . The result of an elementary test represented by a projector P is predictable if and only if $\text{Tr}(\rho P) = 0$ or 1 . In general, the preparation satisfying this equation is not unique, because P may be degenerate.

C. Compatibility of elementary tests

Some tests are *compatible*. Compatibility is defined as follows:

*If a physical system is prepared in such a way that the result of test A is predictable and repeatable, and if a **compatible** test B is then performed (instead of test A) a subsequent execution of test A shall yield the same result as if test B had not been performed.*

In quantum theory, compatibility occurs when operators A and B commute. We have seen in Sect. 2-2 that not every test is repeatable but, for our present purpose, it is enough to consider repeatable tests, which certainly exist.

A familiar pair of commuting projectors which represent compatible tests is:

$$\left[\frac{1}{2}(\mathbb{1} + \mathbf{m} \cdot \boldsymbol{\sigma}_1), \frac{1}{2}(\mathbb{1} + \mathbf{n} \cdot \boldsymbol{\sigma}_2) \right] = \mathbf{0}, \tag{7.32}$$

where \mathbf{m} and \mathbf{n} are arbitrary unit vectors, and $\boldsymbol{\sigma}_1$ and $\boldsymbol{\sigma}_2$ refer to two distinct spin $\frac{1}{2}$ particles. Another example of commuting projectors is

$$\left[\mathbb{1} - (\mathbf{m} \cdot \mathbf{J})^2, \mathbb{1} - (\mathbf{n} \cdot \mathbf{J})^2 \right] = \mathbf{0}, \tag{7.33}$$

where \mathbf{J} refers to a *single* particle of spin 1, and $\mathbf{m} \cdot \mathbf{n} = 0$.

Remark: If we wished to extend these notions to classical physics, we would find that all tests are compatible.

D. Symmetry and transitivity

Compatibility is a symmetric property, but it is not transitive.

This statement means that if A is compatible with B, then B is compatible with A (this is not obvious, but this follows from quantum theory and this can also be tested experimentally). However, if A is compatible with B and with C, it does not follow that B is compatible with C.

Exercise 7.16 For a spin 1 particle, define

$$A = (\mathbf{m} \cdot \mathbf{J})^2, \quad B = (\mathbf{n} \cdot \mathbf{J})^2, \quad C = (\mathbf{r} \cdot \mathbf{J})^2, \quad (7.34)$$

with $\mathbf{m} \cdot \mathbf{n} = \mathbf{m} \cdot \mathbf{r} = 0 \neq \mathbf{n} \cdot \mathbf{r}$. Show that $[A, B] = [A, C] = 0 \neq [B, C]$.

Exercise 7.17 Show the same for two spin $\frac{1}{2}$ particles, with the definitions

$$A = \mathbf{m} \cdot \boldsymbol{\sigma}_1, \quad B = \mathbf{n} \cdot \boldsymbol{\sigma}_2, \quad C = \mathbf{r} \cdot \boldsymbol{\sigma}_2. \quad (7.35)$$

Remark: It is implicit that compatibility is a reflexive property (this follows from $[A, A] \equiv 0$). If any test is repeated, it will give the same result. As already stated, the present discussion is restricted to repeatable tests.

E. Constraints

When a state preparation is such that compatible tests have predictable results, these results may be constrained.

Example (spin $\frac{1}{2}$): If the test for $P_{\mathbf{m}} := \frac{1}{2}(\mathbb{1} + \mathbf{m} \cdot \boldsymbol{\sigma})$ has a predictable outcome $p_{\mathbf{m}}$, then $p_{\mathbf{m}} + p_{-\mathbf{m}} = 1$.

Example (spin 1): Let $\mathbf{m}, \mathbf{n}, \mathbf{r}$ be three orthogonal unit vectors and let us define $P_{\mathbf{m}} := \mathbb{1} - (\mathbf{m} \cdot \mathbf{J})^2$, corresponding to the question “Is $\mathbf{m} \cdot \mathbf{J} = 0$?”. Likewise define projectors $P_{\mathbf{n}}$ and $P_{\mathbf{r}}$. The three corresponding tests are compatible, as we have seen. Moreover, we have

$$P_{\mathbf{m}} + P_{\mathbf{n}} + P_{\mathbf{r}} = \mathbb{1}. \quad (7.36)$$

Quantum theory predicts, and it can in principle be tested experimentally, that for state preparations such that the outcomes of these three tests are predictable, their outcomes satisfy

$$p_{\mathbf{m}} + p_{\mathbf{n}} + p_{\mathbf{r}} = 1. \quad (7.37)$$

One test is positive and two are negative.

Warning: At this point, we may imagine hypothetical systems subject to constraints that lead to logical contradictions. For example, if we have four distinct tests such that any three are subject to a constraint like (7.37), we obtain

$$a + b + c = 1, \quad a + b + d = 1, \quad a + c + d = 1, \quad b + c + d = 1, \quad (?)$$

whence $3(a + b + c + d) = 4$, which is obviously impossible. Of course, there is no physical system obeying these rules! The important point to notice here is that innocent looking postulates, such as those that we are proposing here, may lead to contradictions. We are always free to propose postulates, but we must carefully check them for internal consistency.

F. Further constraints

The preceding postulate referred to state preparations leading to *predictable* results. It has the following generalization:

*Even if a system is prepared in such a way that the outcomes of constrained tests are **not** predictable, these outcomes will be found to satisfy the proper constraints, if the tests are actually performed.*

In other words, even if the outcomes of individual tests are not predictable, they are not completely random. There appears to be some law and order in nature. This may encourage us to think in terms of a microphysical determinism, and perhaps to attempt to introduce hidden variables. This is not, however, the path followed here. The present discussion is strictly phenomenological (any reference to quantum theory is merely illustrative).

This last proposition can be tested experimentally. It can also be derived from quantum theory, if we wish to use the latter. A complete set of orthogonal projectors satisfies $P_i P_j = P_j P_i = \delta_{ij} P_j$ and $\sum P_i = \mathbb{1}$. We then have, for the corresponding outcomes ($p_i = \pm 1$):

$$\langle (\sum_i p_i)^2 \rangle - \langle (\sum_i p_i) \rangle^2 = \langle (\sum_i P_i)^2 \rangle - \langle (\sum_i P_i) \rangle^2 \equiv 0, \tag{7.38}$$

so that $\sum p_i = 1$ always (this result is dispersion free).

Remark: The derivation of (7.38) assumes that, for orthogonal projectors, the average of a sum is the sum of averages. This rule is amenable to experimental verification. See the discussion that follows Eq. (7.5).

Remark: Postulate *F* has no classical analog (if it had one, there would be an inconsistency of the Kochen-Specker type in *classical* physics, because all classical tests are compatible).

G. Correlations

A weaker form of the preceding postulate is the following statement:

*If an ensemble of systems is prepared in such a way that the outcomes of several compatible tests are neither predictable nor constrained, there may still be **statistical correlations** between these outcomes.*

As an example, consider a pair of spin $\frac{1}{2}$ particles, prepared in a singlet state. Define projectors $P_{1\alpha} = \frac{1}{2}(\mathbb{1} + \alpha \cdot \sigma_1)$ and $P_{2\beta} = \frac{1}{2}(\mathbb{1} + \beta \cdot \sigma_2)$, where α and β are unit vectors. Let $p_{1\alpha}$ and $p_{2\beta}$ be the outcomes (0 or 1) of the measurements of $P_{1\alpha}$ and $P_{2\beta}$, respectively. We then have, on the average,

$$\langle p_{1\alpha} p_{2\beta} \rangle = (1 - \alpha \cdot \beta)/4. \tag{7.39}$$

Exercise 7.18 Show that $\langle p_{1\alpha} \rangle = \frac{1}{2}$, and that (7.39) is just another way of writing the spin correlation in Eq. (6.23).

We already know that this correlation violates Bell's inequality. However, in order to derive that inequality, or to prove the Kochen-Specker theorem, we need two additional postulates, of a radically different nature.

H. Counterfactual realism

In the present discussion, hidden variables are not used explicitly, nor even implicitly by assuming some unspecified kind of determinism. We shall only consider what could have possibly been the results of unperformed experiments, had these experiments been performed.

a) It is possible to imagine hypothetical results for any unperformed test, and to do calculations where these unknown results are treated as if they were definite numbers.

This statement refers to a purely intellectual activity and there can be no doubt that it is experimentally correct. For example, we can very well imagine the possible results of a test P_m . The latter can only be 1 (yes) or 0 (no). We can then perform a set of calculations assuming that the result was 1, and another, different set of calculations, assuming that the result was 0. There is nothing to prevent us from doing the same intellectual exercise for other possible tests, P_n, P_r , etc., even if the latter are mutually incompatible.

b) It is furthermore possible to imagine the results of any set of compatible tests, and to treat them in calculations as if these sets of results had definite values, satisfying the same constraints or correlations that are imposed on the results of real tests.

Again, this refers to a purely intellectual exercise. For example, if we have a pair of spin $\frac{1}{2}$ particles, and we measure $P_{1\alpha}$ on the first one, we can measure either $P_{2\beta}$ or $P_{2\delta}$ on the second particle. These are two different (and mutually incompatible) setups, for which we can imagine $2^3 = 8$ different sets of outcomes. We cannot know which one of these outcomes will turn out to be true, but we certainly can consider all eight possibilities. We can imagine that these experiments are repeated many times, after preparing the particle pairs in a singlet state. The hypothetical results must then be chosen so as to satisfy correlations such as Eq. (7.39) and also

$$\langle p_{1\alpha} p_{2\delta} \rangle = (1 - \alpha \cdot \delta)/4. \quad (7.40)$$

Note that we want both (7.39) and (7.40) to be satisfied, although only one of the two experiments can actually be performed on any given pair of particles.

Likewise, for a spin 1 particle, we can consider two orthonormal triads sharing one unit vector: $\mathbf{m} \cdot \mathbf{n} = \mathbf{m} \cdot \mathbf{r} = \mathbf{n} \cdot \mathbf{r} = 0$ and $\mathbf{m} \cdot \mathbf{s} = \mathbf{m} \cdot \mathbf{t} = \mathbf{s} \cdot \mathbf{t} = 0$. However, $\mathbf{n} \cdot \mathbf{s} \neq 0$. For example, $\mathbf{s} = (\mathbf{n} + \mathbf{r})/\sqrt{2}$. We can now imagine that we measure, together with $P_m := \mathbb{1} - (\mathbf{m} \cdot \mathbf{J})^2$, either P_n and P_r , or P_s and P_t (these projectors are defined in the same way as P_m). The results of these hypothetical measurements must then obey both

$$p_m + p_n + p_r = 1, \tag{7.41}$$

and

$$p_m + p_s + p_t = 1. \tag{7.42}$$

We can for sure write these two equations, although at most one of them can materialize experimentally in a test performed on a given spin 1 particle.

Here however, there is a rather subtle difficulty: Is p_m in (7.41) the same as p_m in (7.42)? This cannot be tested experimentally, because these two setups are mutually incompatible. We therefore propose one more postulate:

1. Counterfactual compatibility

The hypothetical result of an unperformed elementary test does not depend on the choice of compatible tests that may be performed together with it.

This is the crucial “no-contextuality” hypothesis. For example, the result of a measurement of $P_{1\alpha}$ on a spin $\frac{1}{2}$ particle does not depend on whether one elects to measure $P_{2\beta}$ or $P_{2\delta}$ on a second, distant particle. Likewise, the outcome p_m is the same whether one elects to measure P_n and P_r , as in Eq. (7.41), or P_s and P_t , as in Eq. (7.42).

The “psychological reason” suggesting the validity of this last postulate is that, whenever a state preparation guarantees a predictable result for some test, this result is not affected by performing other, compatible tests. One is naturally tempted to generalize this property (just as Postulate *F* generalized Postulate \mathcal{E}) to counterfactual tests whose outcome is *not* predictable.

Summary

Although counterfactual compatibility cannot be tested directly, some of its logical consequences can be shown to conflict with quantum theory—and with experimental results. For example, it can be seen, by direct inspection, that

$$p_{1\gamma} + p_{2\beta} + p_{1\alpha} p_{2\delta} - p_{1\alpha} p_{2\beta} - p_{1\gamma} p_{2\beta} - p_{1\gamma} p_{2\delta} = 0 \text{ or } 1. \tag{7.43}$$

Exercise 7.19 Show that no other value is possible.

Therefore, the average value of the left hand side of (7.43) ought to be in the range [0,1]. This is just another form of Bell’s inequality.¹¹ Nevertheless, by choosing the directions α, β, γ and δ as in Fig. 7.3, the left hand side of (7.43) becomes, on the average, for a pair of spin $\frac{1}{2}$ particles in the singlet state,

$$\frac{1}{2} + \frac{1}{2} + \frac{1}{4} \left(1 + \frac{1}{\sqrt{2}} \right) - \frac{3}{4} \left(1 - \frac{1}{\sqrt{2}} \right) = \frac{1}{2} + \frac{1}{\sqrt{2}} > 1, \tag{7.44}$$

¹¹J. F. Clauser and M. A. Horne, *Phys. Rev. D* 10 (1974) 526.

contrary to the counterfactual prediction in (7.43).

Likewise, Table 7-1 shows that it is possible to choose 33 rays in such a way that Eqs. (7.41) and (7.42) lead to a contradiction, if it is assumed that each one of the outcomes p_m , p_n , etc., has the same numerical value in all the equations where it appears.

Fig. 7.3. The four directions used in Eqs. (7.43) and (7.44) make angles of 45° .

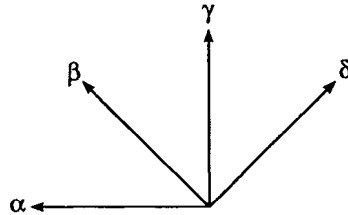

The rationale behind quantum contextuality is the following: An elementary test such as “Is $\alpha \cdot \sigma_1 = 1$?” or “Is $\mathbf{m} \cdot \mathbf{J} = 0$?” has a well defined answer only if the state preparation satisfies $\text{Tr}(\rho P) = 0$ or 1 , so that the required answer is *predictable*. For any other state preparation, these questions, which are represented by degenerate operators, are *ambiguous*. The answer depends on which other (compatible) tests are performed, for example, on whether we shall also measure $\mathbf{n} \cdot \sigma_2$, or $\mathbf{r} \cdot \sigma_2$, together with $\mathbf{m} \cdot \sigma_1$.

This state of affairs can be succinctly summarized: *The same operator may correspond to different observables.* That is, a given Hermitian matrix P_m does not represent a unique “observable.” The symbol P_m has a different meaning if P_m is measured alone, or measured with P_n , or with P_r . The only exception is a nondegenerate variable, such as $K(\mathbf{m}, \mathbf{n})$ in Eq. (7.30), which is equivalent to a complete set of commuting observables, corresponding to compatible tests. One then effectively has a *complete* test, rather than an *elementary* one, and contextuality effects do not appear.

This mismatch of operators and observables was first mentioned by Bell⁵ in his analysis of the implications of Gleason’s theorem:

It was tacitly assumed that measurement of an observable must yield the same value independently of what other [compatible] measurements may be made simultaneously . . . There is no a priori reason to believe that the results should be the same. The result of an observation may reasonably depend not only on the state of the system (including hidden variables) but also on the complete disposition of the apparatus . . .”

The notion of contextuality appears even earlier, in the writings of Bohr¹² who emphasized “the impossibility of any sharp distinction between the behavior of atomic objects and the interaction with the measuring instruments which serve to define the conditions under which the phenomena appear.”

¹²N. Bohr, in *Albert Einstein, Philosopher-Scientist*, ed. by P. A. Schilpp, Library of Living Philosophers, Evanston (1949), p. 210.

7-5. Appendix: Computer test for Kochen-Specker contradiction

The proof of the Kochen-Specker theorem given in Table 7-1 was very simple, because the rays formed a highly symmetrical pattern. It was possible to choose arbitrarily, in some of the triads, the "green" rays to which the value 1 was assigned, because any other choice would have been equivalent to a relabelling of the coordinates.

When there is less symmetry, as in the case of the 31 rays of Plate II (p. 114), different assignments of the value 1 are not equivalent to renaming the axes. Therefore both values, 0 and 1, must be tried. If one of them leads to an inconsistency, one still has the other choice to try. The search for a consistent coloring is similar to the search for a passage through a maze. Whenever the explorer reaches a dead end, he has to retrace his footsteps to the last point where he made an arbitrary choice, and try another choice.

The following FORTRAN code performs this search for any pattern of N rays. The input file is a list of all orthogonal pairs of rays. This list, which describes the geometric structure of the set of rays, must be supplied by the user. The output file returns a string of 0 and 1, if the N rays can be consistently colored, or a message stating that no coloring is possible.

```

C      Kochen-Specker coloring problem for N rays
      PARAMETER (N= )
      INTEGER P(N,N), X(N), Y(N), Z(N), C(N), L(N), OC(N,N)
C      P(I,J)=1 if rays I and J are orthogonal, else P(I,J)=0
C      NTRIAD is number of orthogonal triads
C      X(NT), Y(NT), Z(NT) are the three rays in triad NT
C      C(J) is color of ray J: 0 = red, 1 = green, 4 = unknown
C      LVL = number of rays whose color was arbitrarily chosen
C      L(K) is the ray whose color was assigned in Kth choice
C      OC(LVL,J) was color of ray J after LVL arbitrary choices
      OPEN (8,FILE='INPUT.KS')
      OPEN (9,FILE='OUTPUT.KS')
      DO 10 I=1,N
        C(I)=4
C      Colors are unknown as yet
      DO 10 J=1,N
10     P(I,J)=0
      DO 11 M=1,N*N
C      Read list of pairs of orthogonal rays
      READ (8,'(2I3)',END=12) I, J
        P(I,J)=1
11     P(J,I)=1
12     NTRIAD=0
C      Find triads of orthogonal rays
      DO 13 I=1, N

```



```

DO 13 J=I+1,N
DO 13 K=J+1,N
IF (P(I,J)+P(I,K)+P(J,K).NE.3) GOTO 13
NTRIAD=NTRIAD+1
X(NTRIAD)=I
Y(NTRIAD)=J
Z(NTRIAD)=K
13 CONTINUE
LVL=0
C Choose arbitrarily next green ray, whose number is NG
C All other rays that are already colored are consistent
14 DO 15 NG=1,N
IF (C(NG).EQ.4) THEN
C(NG)=1
GOTO 16
ENDIF
15 CONTINUE
WRITE (9, '(40I2)') C
C A consistent coloring has been found
STOP
16 LVL=LVL+1
LAST=1
C Last arbitrary assignment was to make a ray green
L(LVL)=NG
C This arbitrary assignment was made for ray NG
DO 17 J=1,N
C Record the situation after LVL arbitrary choices
17 OC(LVL,J)=C(J)
18 DO 19 J=1,N
C All the rays orthogonal to a green one must be red
19 IF (P(NG,J).EQ.1) C(J)=0
20 DO 21 NT=1,NTRIAD
C Now check whether there are three orthogonal red rays
IF (C(X(NT))+C(Y(NT))+C(Z(NT)).EQ.0) GOTO 22
21 CONTINUE
GOTO 25
22 IF (LVL+LAST.GT.0) GOTO 23
WRITE (9, '( " No consistent coloring" )')
C All options have been exhausted
STOP
23 DO 24 J=1,N
C Restore status quo at preceding branching
24 C(J)=OC(LVL,J)
C(L(LVL))=0
LAST=0

```

```

C      Last arbitrary assignment was to make a ray red
      LVL=LVL-1
C      Return to preceding branching
      GOTO 20
25     DO 26 NT=1,NTRIAD
C      Is there a triad with two red rays and a colorless ray?
C      If so, the colorless ray must be painted green
      IF (C(X(NT))+C(Y(NT))+C(Z(NT)).EQ.4) GOTO 27
26     CONTINUE
      GOTO 14
27     IF (C(X(NT)).EQ.4) THEN
          C(X(NT))=1
          NG=X(NT)
          GOTO 18
      ENDIF
      IF (C(Y(NT)).EQ.4) THEN
          C(Y(NT))=1
          NG=Y(NT)
          GOTO 18
      ENDIF
      IF (C(Z(NT)).EQ.4) THEN
          C(Z(NT))=1
          NG=Z (NT)
          GOTO 18
      ENDIF
      END

```

Exercise 7.20 Show that the 31 rays in Plate II (p. 114) form 71 orthogonal pairs, which belong to 17 orthogonal triads. ★

Exercise 7.21 Show that removing any one of these 31 rays leaves a set that can be consistently colored. ★★

Exercise 7.22 Write a similar program for the Kochen-Specker problem in four dimensions. ★

7-6. Bibliography

F. J. Belinfante, *A Survey of Hidden-Variable Theories*, Pergamon, Oxford (1973).

M. Redhead, *Incompleteness, Nonlocality, and Realism*, Clarendon Press, Oxford (1987).

These excellent books are unfortunately obsolete, because of the recent developments discussed in this chapter and the preceding one.

N. D. Mermin, "Simple unified form for the major no-hidden-variables theorems," *Phys. Rev. Lett.* 65 (1990) 3373; "Hidden variables and the two theorems of John Bell," *Rev. Mod. Phys.* 65 (1993) 803.

J. Zimba and R. Penrose, "On Bell non-locality without probabilities: more curious geometry," *Studies in History and Philosophy of Science*, 24 (1993) 697.

This paper contains an elegant proof of the Kochen-Specker theorem, involving the geometric properties of the dodecahedron. The proof is based on the following property of spin $\frac{3}{2}$ particles: the eigenvectors ψ and ϕ , satisfying

$$\mathbf{m} \cdot \mathbf{J} \psi = \frac{1}{2} \psi \quad \text{and} \quad \mathbf{n} \cdot \mathbf{J} \phi = \frac{1}{2} \phi, \quad (7.45)$$

are orthogonal if $\mathbf{m} \cdot \mathbf{n} = 1/3$. Recall that $\cos^{-1}(1/3)$ is the angle subtended at the center of a dodecahedron by a pair of next-to-adjacent vertices. Thus, if we consider the results of (mutually incompatible) spin measurements which test whether the spin components along the 20 directions pointing toward the vertices of a dodecahedron are equal to $\frac{1}{2}$, we obtain the following Kochen-Specker coloring rules:

- (a) no two next-to-adjacent vertices can be green,
- (b) the six vertices adjacent to any pair of antipodal vertices cannot all be red.

Rule (a) follows from the orthogonality property mentioned above, and rule (b) can be proved by introducing 20 additional, "implicit" state vectors,⁸ one for each vertex of the dodecahedron, in the following way: Each vertex V_k has three adjacent vertices, which are next-to-adjacent to each other. Therefore the three eigenvectors of type (7.45), corresponding to these three vertices, are mutually orthogonal (in Hilbert space). The fourth orthogonal vector (in Hilbert space) is the "implicit vector" belonging to vertex V_k . It is easily shown that coloring rules (a) and (b) lead to a contradiction.¹³

Higher dimensions

A set of Kochen-Specker vectors for any dimension $n > 3$ is always obtainable from a set of dimension $n-1$ as follows: add to all these vectors a null n -th component, and introduce a new vector $0 \dots 01$. The only consistent coloring is to make the new vector green and all the others red. The latter include $10 \dots 0$. Now introduce more vectors by exchanging the first and n -th components of all the preceding ones. The complete set has no consistent coloring. However, much smaller sets can be obtained in some cases:

M. Kernaghan and A. Peres, "Kochen-Specker theorem for eight-dimensional space," *Phys. Letters A* 198 (1995) 1.

A contradiction is derived for a system of three entangled spin- $\frac{1}{2}$ particles (see page 152). The proof requires 36 vectors. This article also introduces a "state-specific" version of the Kochen-Specker theorem, valid for systems that have been prepared in a known pure state. The projection operators can then be chosen in a way adapted to the known state, and fewer operators are needed (only 13 in the present case).

¹³ Penrose, who first stated that proof in an unpublished article, also showed that the 33 rays of Table 7-1 can be generated by three interpenetrating cubes, as those in Escher's celebrated lithograph *Waterfall*. For further details, see *Scientific American* 268 (Feb. 1993) 12.

Part III

QUANTUM DYNAMICS
AND INFORMATION

Chapter 8

Spacetime Symmetries

8-1. What is a symmetry?

A symmetry is an equivalence of different physical situations. The hallmark of a symmetry is the impossibility of acquiring some physical knowledge.¹ For example, it is impossible to distinguish a photograph depicting a right hand glove from one of a left hand glove, viewed in a mirror.

The laws of nature that you observe in your laboratory are also valid in other laboratories: these laws are invariant under *translations* and *rotations* of the scientific instruments that are used to verify them. Moreover, they are invariant under a *uniform motion* of these instruments. This is a *kinematic symmetry*, first postulated by Galilei for mechanical laws, and later found valid by Michelson and Morley for optical phenomena in vacuum. Einstein proposed that this symmetry applies to electromagnetism in general. This is the principle of relativity, which is today firmly established for all physical phenomena, with the possible exception of gravitation.²

Active and passive transformations

The existence of a symmetry entails the equivalence of two types of transformations, called active and passive. For example, the hand sketched in Fig. 8.1(a) is actively rotated, with no change of shape, into a new position. The new coordinates (of the fingertip, say) are related to the old ones by

$$\begin{aligned} F'_x &= F_x \cos \theta - F_y \sin \theta, \\ F'_y &= F_x \sin \theta + F_y \cos \theta. \end{aligned} \tag{8.1}$$

¹F. E. Low, *Comm. Nucl. Particle Phys.* 1 (1967) 1.

²According to the *general* theory of relativity, the description of gravitational phenomena necessitates the use of a non-Euclidean geometry which does not allow *rigid* motions of extended bodies, such as laboratory instruments. Therefore general relativity, contrary to special relativity, is *not* the theory of a spacetime symmetry. (There are nevertheless exact solutions of the Einstein gravitational field equations with restricted symmetry properties, for example a spherically symmetric black hole.)

In Fig. 8.1(b), the hand is not rotated, but the coordinates are, by the *same* angle. This is a passive transformation, and the components of the fingertip along the new axes are:

$$\begin{aligned} F_{x'} &= F_x \cos \theta + F_y \sin \theta, \\ F_{y'} &= -F_x \sin \theta + F_y \cos \theta. \end{aligned} \quad (8.2)$$

Obviously, the transformation matrix in (8.2) is the inverse of the one in (8.1). Therefore, if both transformations (active and passive) are simultaneously performed, as in Fig. 8.1(c), we obtain:

$$F'_{x'} = F_x \quad \text{and} \quad F'_{y'} = F_y. \quad (8.3)$$

The numerical values of the new components are the same as those of the old components. The mere knowledge of these values does not indicate whether a transformation was performed.

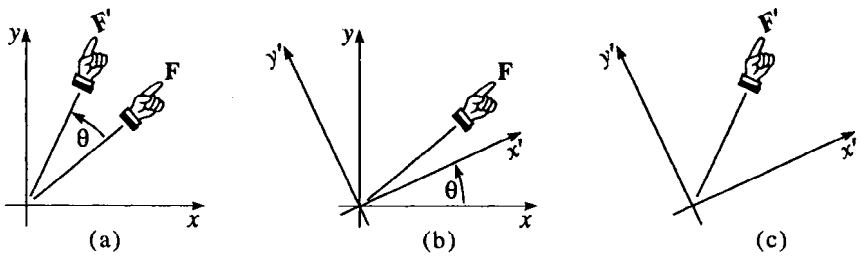

Fig. 8.1. Active and passive transformations.

This indistinguishability is due to a physical property of plane surfaces: it is possible to rigidly rotate any plane figure. On the other hand, an irregular surface does not allow rigid motions. It still allows, of course, passive coordinate transformations, which are nothing more than a relabelling of its points, but there are no corresponding active transformations, which would leave the displaced body unaltered.²

Exercise 8.1 *If we turn a right hand glove inside out, it becomes a left hand glove (assume that the inside and outside textures are indistinguishable—a good approximation for some knitted gloves). This is an example of active transformation. What is the corresponding passive transformation?*

We now turn our attention to *quantum* symmetries. Quantum states are represented by vectors in a Hilbert space and can again be specified by a set of components. The indices which label these components refer to the possible outcomes of a maximal quantum test (see Sect. 3-1). A passive transformation

corresponds to the choice of a different basis—that is, a different maximal test—and it is represented by a unitary operator. On the other hand, an active transformation is an actual change of the state of the quantum system.

As usual, the existence of a symmetry implies a correspondence between active and passive transformations. Thus, if we choose another maximal test to define a new basis for the Hilbert space of states, we may expect that there is an active transformation such that the new physical state, obtained after that transformation, has components with respect to the new basis, which are equal to the components of the original state with respect to the old basis—just as in Eq. (8.3). Actually, the situation is more complicated, because the vector space used in quantum theory is *complex*, and there is no one-to-one correspondence between physical states and sets of vector components. The basis vectors defined by maximal tests may be multiplied by arbitrary phases, inducing a phase arbitrariness in the components of the vector that represents a given physical state.

However, the transition *probabilities* $P_{uv} = |\langle u, v \rangle|^2$, which are experimentally observable, are not affected by this phase arbitrariness. For example, vector u may represent photons in a horizontal beam, with a vertical polarization; and vector v , photons in the same beam, but with a linear polarization at an angle θ from the vertical. Suppose that the apparatus which prepares u photons, and then tests whether they are v photons, is rigidly moved to another location and given a different orientation. With respect to the original basis chosen in Hilbert space, the photons are now prepared with a different polarization u' , and tested for a different polarization v' . Yet, the laws of optics are not affected by rigid displacements of optical instruments. Therefore the probability of passing the test is invariant: $P_{u'v'} = P_{uv} = \cos^2 \theta$.

8-2. Wigner's theorem

This invariance has far-reaching implications, because of an important theorem, due to Wigner.³ Consider a mapping of Hilbert space: $u \rightarrow u'$, $v \rightarrow v'$, and so on. The *only* thing we assume about this mapping is that

$$|\langle u', v' \rangle|^2 = |\langle u, v \rangle|^2, \quad \forall u, v. \quad (8.4)$$

In particular, we do not assume linearity, let alone unitarity. Wigner's theorem states that it is possible to redefine the phases of the new vectors (u', v', \dots) in such a way that, for any complex coefficients α and β , we have either

$$(\alpha u + \beta v)' = \alpha u' + \beta v' \quad \text{and} \quad \langle u', v' \rangle = \langle u, v \rangle, \quad (8.5)$$

or

$$(\alpha u + \beta v)' = \bar{\alpha} u' + \bar{\beta} v' \quad \text{and} \quad \langle u', v' \rangle = \langle v, u \rangle. \quad (8.6)$$

³E. P. Wigner, *Group Theory*, Academic Press, New York (1959) p. 233.

In the first case, the mapping is linear and unitary, in the second case, it is antilinear and antiunitary. The proof of Wigner's theorem follows.

Let \mathbf{e}_j be the vectors of an orthonormal basis, which are mapped into \mathbf{e}'_j . The new vectors \mathbf{e}'_j are also orthonormal, by virtue of Eq. (8.4). Consider now the set of vectors

$$\mathbf{f}_j = \mathbf{e}_1 + \mathbf{e}_j, \quad j = 2, 3, \dots, \quad (8.7)$$

which are mapped into \mathbf{f}'_j . We have, from (8.4),

$$|\langle \mathbf{e}'_1, \mathbf{f}'_j \rangle| = |\langle \mathbf{e}_1, \mathbf{f}_j \rangle| = 1, \quad (8.8)$$

and

$$|\langle \mathbf{e}'_j, \mathbf{f}'_k \rangle| = |\langle \mathbf{e}_j, \mathbf{f}_k \rangle| = \delta_{jk}, \quad (j > 1). \quad (8.9)$$

Therefore, for any $j > 1$, we can write

$$\mathbf{f}'_j = x_j \mathbf{e}'_1 + y_j \mathbf{e}'_j, \quad (8.10)$$

where $|x_j| = |y_j| = 1$. We then redefine the phases of the transformed vectors:

$$\mathbf{f}'_j \rightarrow \mathbf{f}''_j = \mathbf{f}'_j / x_j \quad \text{and} \quad \mathbf{e}'_j \rightarrow \mathbf{e}''_j = y_j \mathbf{e}'_j / x_j, \quad (8.11)$$

(and $\mathbf{e}''_1 = \mathbf{e}'_1$) so as to obtain

$$\mathbf{f}''_j = \mathbf{e}''_1 + \mathbf{e}''_j, \quad (8.12)$$

as in (8.7). We shall henceforth work with the new phases, and write \mathbf{e}'_j instead of \mathbf{e}''_j . We thus have the mapping

$$\mathbf{e}_1 + \mathbf{e}_j \rightarrow (\mathbf{e}_1 + \mathbf{e}_j)' = \mathbf{e}'_1 + \mathbf{e}'_j. \quad (8.13)$$

Consider now the mapping of an arbitrary vector

$$\mathbf{u} = \sum_i a_i \mathbf{e}_i \rightarrow \mathbf{u}' = \sum_i a'_i \mathbf{e}'_i. \quad (8.14)$$

We have

$$|a'_j| = |\langle \mathbf{e}'_j, \mathbf{u}' \rangle| = |\langle \mathbf{e}_j, \mathbf{u} \rangle| = |a_j|. \quad (8.15)$$

Moreover,

$$\langle \mathbf{e}_1 + \mathbf{e}_j, \mathbf{u} \rangle = a_1 + a_j \quad \text{and} \quad \langle \mathbf{e}'_1 + \mathbf{e}'_j, \mathbf{u}' \rangle = a'_1 + a'_j. \quad (8.16)$$

It then follows from Eqs. (8.4) and (8.13) that

$$|a_1 + a_j|^2 = |a'_1 + a'_j|^2. \quad (8.17)$$

Together with (8.15), this gives

$$\overline{a_1} a_j + a_1 \overline{a_j} = \overline{a'_1} a'_j + a'_1 \overline{a'_j}. \quad (8.18)$$

Dividing this equation by

$$(\alpha_1 \overline{a_1} a_j \overline{a_j})^{1/2} = (\alpha'_1 \overline{a'_1} a'_j \overline{a'_j})^{1/2}, \quad (8.19)$$

we obtain

$$(\overline{a_1} a_j / a_1 \overline{a_j})^{1/2} + \text{c.c.} = (\overline{a'_1} a'_j / a'_1 \overline{a'_j})^{1/2} + \text{c.c.}, \quad (8.20)$$

which has the form

$$e^{i\theta} + e^{-i\theta} = e^{i\theta'} + e^{-i\theta'}, \quad (8.21)$$

with two solutions, $\theta' = \pm \theta$. Let us consider them one after another.

Unitary mapping: If $\theta' = \theta$, we have

$$\overline{a'_1} a'_j / a'_1 \overline{a'_j} = \overline{a_1} a_j / a_1 \overline{a_j}. \quad (8.22)$$

Redefine the phase of \mathbf{u}' so that $a'_1 = a_1$. We then have $a'_j / \overline{a'_j} = a_j / \overline{a_j}$ and it follows from (8.15) that $a'_j = a_j$. Therefore

$$\mathbf{u}' = \sum_{\mathbf{i}} a_{\mathbf{i}} \mathbf{e}'_{\mathbf{i}}. \quad (8.23)$$

Given another vector, $\mathbf{v} = \sum b_{\mathbf{i}} \mathbf{e}_{\mathbf{i}}$, we can likewise choose the phase of \mathbf{v}' so as to have $\mathbf{v}' = \sum b_{\mathbf{i}} \mathbf{e}'_{\mathbf{i}}$, whence Eq. (8.5) readily follows.

Antiunitary mapping: If $\theta' = -\theta$, we have

$$\overline{a'_1} a'_j / a'_1 \overline{a'_j} = a_1 \overline{a_j} / \overline{a_1} a_j. \quad (8.24)$$

Redefine the phase of \mathbf{u}' so that $a'_1 = \overline{a_1}$. We then have $a'_j / \overline{a'_j} = \overline{a_j} / a_j$ and it follows from (8.15) that $a'_j = \overline{a_j}$. Therefore

$$\mathbf{u}' = \sum_{\mathbf{i}} \overline{a_{\mathbf{i}}} \mathbf{e}'_{\mathbf{i}}. \quad (8.25)$$

Given another vector, $\mathbf{v} = \sum b_{\mathbf{i}} \mathbf{e}_{\mathbf{i}}$, we can likewise choose the phase of \mathbf{v}' so as to have $\mathbf{v}' = \sum \overline{b_{\mathbf{i}}} \mathbf{e}'_{\mathbf{i}}$, which gives Eq. (8.6).

Whether a specific transformation is unitary or antiunitary depends on its physical nature. Transformations that belong to a continuous group, such as translations and rotations, can only be unitary, because in that case any finite transformation can be generated by a sequence of infinitesimal steps, where the transformed vectors $\mathbf{e}'_{\mathbf{i}}$ are arbitrarily close to $\mathbf{e}_{\mathbf{i}}$; we must then choose $\mathbf{a}'_{\mathbf{i}} = \mathbf{a}_{\mathbf{i}}$

(rather than $\alpha'_i = \overline{\alpha_i}$) if we want u' to be close to u . This rules out antiunitary transformations.

On the other hand, this continuity argument is not applicable to discrete transformations, such as space reflection or time reversal. We shall later see that a space reflection is represented by a unitary transformation, but a time reversal is antiunitary.

Finally, we note that the same results can be derived from premises weaker than Eq. (8.4), by merely assuming that $\langle u, v \rangle = 0$ implies $\langle u', v' \rangle = 0$. In that case, however, the proof is much more difficult.^{4,5}

8-3. Continuous transformations

Consider a set of unitary matrices $U(\alpha_1, \alpha_2, \dots)$, depending on continuous parameters α_j . These matrices are in one-to-one correspondence with the elements of a continuous *group* of transformations, provided that the domain of definition of the parameters α_j is chosen in such a way that:

- 1) One, and only one, of these matrices is the unit matrix $\mathbf{1}$. It is customary to define the parameters α_j in such a way that $U(0, 0, \dots) = \mathbf{1}$.
- 2) Every product of two matrices also is a member of that set of matrices.
- 3) Every matrix of the set has a unique inverse *in that set*, that is, for every choice of the parameters α_j , there also are parameters β_j , in the given domain of definition, such that $U(\alpha_1, \alpha_2, \dots)U(\beta_1, \beta_2, \dots) = \mathbf{1}$.

The fourth characteristic property of a group, which is the associative law, $A(BC) = (AB)C$, is automatically satisfied by matrices.

Exercise 8.2 Give examples of continuous transformations which do **not** satisfy one or more of the above criteria, if the domain of definition of the parameters is not properly chosen.

A unitary matrix which is nearly equal to the unit matrix corresponds to an *infinitesimal transformation* (the unit matrix itself generates the *identity* transformation). The importance of infinitesimal transformations stems from the fact that any finite unitary transformation can be obtained by exponentiation of an infinitesimal one. For example, a finite rotation in the complex plane is represented by a factor $e^{i\theta}$, which is the limit of $(1 + i\theta/N)^N$, for $N \rightarrow \infty$. In this case, $U = e^{i\theta}$ is a trivial unitary matrix of order 1. More generally, for any Hermitian matrix H ,

⁴G. Emch and C. Piron, *J. Math. Phys.* 4 (1963) 469.

⁵N. Gisin, *Am. J. Phys.* 61 (1993) 86.

$$U = e^{-iH} = \lim_{N \rightarrow \infty} (\mathbb{1} - iH/N)^N, \tag{8.26}$$

is a unitary matrix, as can easily be seen by writing this equation in the basis which diagonalizes H (and therefore also diagonalizes U). Actually, it is often more convenient to use the *antihermitian* matrix $A = -iH$, and to write

$$U = e^A = \mathbb{1} + A + \frac{1}{2} A^2 + \dots, \quad (A^\dagger = -A). \tag{8.27}$$

Transformations of operators

If we take a new basis for parametrizing the Hilbert space H , the components of the state vector ψ undergo a unitary mapping, $\psi \rightarrow \psi' = U\psi$, as we have seen in Eq. (3.8). The corresponding transformation law of operators is

$$\Omega \rightarrow \Omega' = U \Omega U^\dagger, \quad (\text{passive transformation}) \tag{8.28}$$

so that the mean values $\langle \psi, \Omega \psi \rangle$ remain invariant. Indeed, these average values, which are experimentally observable, cannot depend on the arbitrary choice of a basis for H (see also page 65). More generally, any matrix element $\langle \phi, \Omega \psi \rangle$ is invariant under a passive transformation.

Exercise 8.3 Show directly from Eq. (8.27) that the transformation law of operators can be written as

$$e^A \Omega e^{-A} = \Omega + [A, \Omega] + \frac{1}{2} [A, [A, \Omega]] + \dots \tag{8.29}$$

What is the next term of this expansion?

Here is an alternative proof of (8.29). Define

$$\Omega(\lambda) = e^{\lambda A} \Omega e^{-\lambda A}, \tag{8.30}$$

where λ is a real parameter. As a result of $d(e^{\pm\lambda A})/d\lambda \equiv \pm A e^{\pm\lambda A}$, we have

$$d\Omega(\lambda)/d\lambda = [A, \Omega(\lambda)]. \tag{8.31}$$

The solution of this operator valued differential equation, subject to the initial condition $\Omega(0) = \Omega$, is

$$\Omega(\lambda) = \Omega + [A, \lambda\Omega + \frac{1}{2} \lambda^2 [A, \Omega] + \dots], \tag{8.32}$$

as you can easily verify by differentiating the right hand side of (8.32) with respect to λ . Setting $\lambda = 1$ in this solution gives Eq. (8.29).

Recall that the above equations refer to the behavior of operators (that is, of finite or infinite matrices) under *passive* transformations (changes of basis in Hilbert space). On the other hand, if the mapping $\psi \rightarrow \psi' = \mathbf{U}\psi$ is due to an *active* transformation—*i.e.*, an actual change of the state of the physical system, while the basis for H remains the same—the matrices that we use for representing physical observables remain unchanged. For example, when we describe the precession of a spin $\frac{1}{2}$ particle in a magnetic field, the components of the spinor ψ evolve in time, but the Pauli σ matrices do not. Then, obviously, the observable mean values $\langle \psi, \sigma \psi \rangle$ evolve in time, as a consequence of the active transformation imposed on the state ψ .

Heisenberg picture

There is another way of describing *active* transformations, which bears the name *Heisenberg picture*.⁶ Instead of transforming the vectors, one transforms the operators,

$$\Omega \rightarrow \Omega_{\mathbf{H}} = \mathbf{U}^\dagger \Omega \mathbf{U}, \quad (\text{active transformation}) \quad (8.33)$$

so that the resulting mean value,

$$\langle \psi, \Omega_{\mathbf{H}} \psi \rangle = \langle \psi, \mathbf{U}^\dagger \Omega \mathbf{U} \psi \rangle = \langle \mathbf{U}\psi, \Omega \mathbf{U}\psi \rangle, \quad (8.34)$$

is the same as when we had $\psi \rightarrow \psi' = \mathbf{U}\psi$ and we kept Ω unchanged. Note that the transformation law (8.33) is the *opposite* of the one for passive transformations, Eq. (8.28). The two laws are always opposite when there is a symmetry, as we have seen for the active and passive transformations (8.1) and (8.2), which are the inverse of each other.

You may perhaps think that the Heisenberg picture, where ψ is fixed and Ω is transformed, is contrived and unnatural. Actually, the Heisenberg picture is closer to the spirit of classical physics, where *dynamical variables* undergo canonical transformations. The point is that a state vector ψ , whose role is to represent a preparation procedure, has no classical analog.⁷ On the other hand, quantum *observables* may have, under appropriate circumstances, properties similar to those of classical canonical variables. The relationship between them is best seen in the Heisenberg picture, where quantum properties can sometimes be conjectured on the basis of analogies with classical models. However, you must be very circumspect if you want to use these semiclassical arguments, because there is no formal correspondence between classical and quantum physics. This issue will be further discussed in Chapter 10.

⁶ The term "Heisenberg picture" is usually given to the unitary transformation generated by the passage of time. Here, I use it in a more general way for arbitrary unitary transformations.

⁷ To be sure, the quantum density matrix, which is $\rho = \psi \psi^\dagger$ for a pure state, bears some analogy to the classical Liouville density in phase space.

Generators of continuous transformations

Consider a transformation which depends on a single parameter α , such as a rotation around a fixed axis, which is defined by a single angle. The parameter α , in $U(\alpha)$, may be the rotation angle itself but, more generally, it could be any function of that angle. Therefore, the result of two consecutive rotations is, in general, $U(\alpha'')U(\alpha') = U(f(\alpha'', \alpha'))$. Obviously, it is advantageous to choose the parameter α proportional to the rotation angle, so as to have simply $U(\alpha'')U(\alpha') = U(\alpha'' + \alpha')$. We can then write

$$U(\alpha) = e^A = e^{-i\alpha G}, \tag{8.35}$$

where G is independent of α . The Hermitian operator G is called the *generator* of the continuous transformation $U(\alpha)$. Generators of transformations that correspond to symmetry properties often have a simple physical meaning, such as energy, momentum, electric charge, and so on (these quantities must be expressed in appropriate units, of course).

When there are several independent parameters, as in a three dimensional rotation which depends on three angles, the choice of a good parametrization is not trivial. Here is an example:

Exercise 8.4 Euler angles, ϕ , θ , and ψ , are commonly used for parametrizing three dimensional rotations. Show that two consecutive rotations by the same angle, around the same axis in space, are **not** equivalent to doubling the values of the Euler angles: $U(2\phi, 2\theta, 2\psi) \neq [U(\phi, \theta, \psi)]^2$. ★

We see from this exercise that $U(\phi, \theta, \psi)$ cannot be written as in (8.35), with an operator A which is a linear combination of ϕ , θ , and ψ . More suitable parameters, for our present purpose, are the components of an axial vector α whose direction is that of the rotation axis, and whose magnitude is that of the rotation angle. Then, by definition, $U(2\alpha) \equiv [U(\alpha)]^2$. More generally, we have, as in Eq. (8.35), $U = e^A$, with $A = -i \sum \alpha_m J_m$. The physical meaning of the generators J_m is that of angular momentum components, in units of \hbar . This matter will be further discussed in Sect. 8-5.

Consecutive transformations

Let us now investigate the result of two consecutive, noncommuting unitary transformations, e^A and e^B . Note that if $[A, B] \neq 0$, then e^A and e^B do not in general commute, but there are exceptions, as in the following exercise:

Exercise 8.5 Show that, if $[x, p] = i\hbar \mathbf{1}$, then $[e^{2\pi i m x/a}, e^{i n a p/\hbar}] = 0$, for any integers m and n . ★

Exercise 8.6 Further show that the set of operators $e^{2\pi i m x/a}$ and $e^{i n a p/\hbar}$, for all integral m and n , is a **complete** set of commuting operators.⁸ ★★

⁸J. Zak, *Phys. Rev. Lett.* 19 (1967) 1385.

Returning to the general case of noncommuting e^A and e^B , let us introduce a continuous parameter λ , as in Eq. (8.30). We have, up to second order in λ ,

$$e^{-\lambda B} e^{-\lambda A} e^{\lambda B} e^{\lambda A} \simeq \mathbb{1} + \lambda^2 [B, A] \simeq e^{\lambda^2 [B, A]}. \quad (8.36)$$

This relationship will be very useful, because it allows one to obtain the value of the commutator $[A, B]$ without having to refer to the *explicit* form of the matrices A and B (see Sect. 8-5).

Exercise 8.7 Show that

$$\begin{aligned} e^{-\lambda B} e^{-\lambda A} \Omega e^{\lambda A} e^{\lambda B} - e^{-\lambda A} e^{-\lambda B} \Omega e^{\lambda B} e^{\lambda A} &\simeq \lambda^2 ([B, [A, \Omega]] - [A, [B, \Omega]]) \\ &= -\lambda^2 [[A, B], \Omega] \simeq e^{-\lambda^2 [A, B]} \Omega e^{\lambda^2 [A, B]} - \Omega. \end{aligned} \quad (8.37)$$

Hint: Use Eq. (8.29) and the identity

$$[[A, B], C] + [[B, C], A] + [[C, A], B] \equiv 0. \quad (8.38)$$

Exercise 8.8 Show that the next term of the power expansion in (8.36) is $\frac{1}{2} \lambda^3 \{ [A, [A, B]] - [B, [B, A]] \}$. ★

Correspondence with Poisson brackets

The identity (8.38) is formally the same as Jacobi's identity for Poisson brackets.⁹ There are other commutator identities which are formally similar to identities for Poisson brackets, in particular

$$[A, BC] \equiv [A, B]C + B[A, C], \quad (8.39)$$

and

$$[AB, C] \equiv A[B, C] + [A, C]B. \quad (8.40)$$

The factor ordering must be carefully respected in the quantum version—it is of course irrelevant for the classical Poisson brackets.

The correspondence rule suggested by these examples is

$$[A, B]_{\text{PB}} \leftrightarrow [A, B]/i\hbar. \quad (8.41)$$

The rule obviously works if A and B are Cartesian coordinates and momenta, or linear or quadratic functions thereof. However, there is in general no strict correspondence between quantum commutators and classical Poisson brackets. For example, the null commutator in Exercise 8.5 has a nonvanishing Poisson bracket counterpart.

⁹H. Goldstein, *Classical Mechanics*, Addison-Wesley, Reading (1980) p. 399.

8-4. The momentum operator

Consider an active translation $x \rightarrow x + a$. The quantum system is transported through a distance a . What happens to its wave function?

To give a meaning to this question, we must first specify the basis used for parametrizing the Hilbert space H . Let us, for instance, represent H by functions of x , with inner product

$$\langle \mathbf{u}, \mathbf{v} \rangle = \int_{-\infty}^{\infty} \overline{u(x)} v(x) dx. \tag{4.53}$$

This is called the x -representation of H . Its physical meaning is illustrated in Fig. 4.3(a), page 100.

Due to translation symmetry, a displacement of the quantum system by a distance a is indistinguishable from a displacement of the origin of coordinates by $-a$. The latter is a passive transformation, a mere substitution of variables, $x = x' - a$. We may therefore be tempted to write the transformation law of state vectors as $\mathbf{v}(x) \rightarrow U\mathbf{v}(x) = \mathbf{v}(x - a)$. For example, a Gaussian function e^{-x^2} becomes $e^{-(x-a)^2}$, so that its peak moves from $x = 0$ to $x = a$, and the system indeed moves through a distance $+a$. (When you deal with symmetry transformations, you must be even more careful than usual with \pm signs!)

Actually, the situation is more complicated. The state vector $\mathbf{v}(x)$ is not a classical scalar field, having at each point of space an objective numerical value, invariant under a transformation of coordinates. Quantum state vectors are defined in a Hilbert space H . When we perform a passive transformation in that space, each one of the new basis vectors may be multiplied by an arbitrary phase (a different phase for each vector). In the x -representation of H that we are presently using, there are, strictly speaking, no basis vectors (because the vector index x takes continuous values), but the above arbitrariness still exists. The most general expression for a shift in the coordinate x thus is:

$$\mathbf{v}(x) \rightarrow \mathbf{v}'(x) = U\mathbf{v}(x) = e^{i\phi(x)} \mathbf{v}(x - a), \tag{8.42}$$

which involves an arbitrary phase function $\phi(x)$.

Exercise 8.9 Show that the transformation (8.42) is unitary, and that the n -th moment of the position operator \mathbf{x} behaves as

$$\langle \mathbf{v}, \mathbf{x}^n \mathbf{v} \rangle \rightarrow \langle \mathbf{v}', \mathbf{x}^n \mathbf{v}' \rangle = \langle \mathbf{v}, (\mathbf{x} + a)^n \mathbf{v} \rangle. \tag{8.43}$$

Exercise 8.10 Show that, with U defined as in (8.42), \mathbf{x} transforms as

$$\mathbf{x} \rightarrow U\mathbf{x}U^\dagger = \mathbf{x} - a. \tag{8.44}$$

Are you puzzled by the minus sign in Eq. (8.44)? It is not a misprint. The system is without any doubt transported through the distance $+a$, as clearly

seen in Eq. (8.43). The point is that the symbol \mathbf{x} in (8.43) and (8.44) is *not* the numerical value of the position of a classical particle. This symbol represents an *operator* (a matrix of infinite order) in Hilbert space. The physical meaning of \mathbf{x} is derived from its matrix representation, or its functional form. In our present basis, labelled by x , the position observable \mathbf{x} is represented by a multiplication by x . The meaning of Eq. (8.44) is that, if we go over to a *new* basis in Hilbert space, by means of the unitary transformation \mathbf{U} , then the *same* position observable is represented by a multiplication by $(x - a)$. And if we perform both the active transformation (8.42) and the passive transformation (8.44), observable mean values remain invariant, as they should.

Exercise 8.11 Show that the active transformation for \mathbf{x} is

$$\mathbf{x} \rightarrow \mathbf{x}_H = \mathbf{U}^\dagger \mathbf{x} \mathbf{U} = \mathbf{x} + a. \quad (8.45)$$

By now, you should be convinced that it is the Heisenberg picture for operator transformations that is closest to the classical formalism.

Returning to Eq. (8.42), it is natural to redefine the phase of the transported state $\mathbf{v}'(x)$ so as to simply have $\mathbf{v}'(x) = \mathbf{v}(x - a)$. If we adopt this convention, and the state function $\mathbf{v}(x)$ can be expanded into a power series, we obtain

$$\mathbf{v}(x - a) = \mathbf{v}(x) - a \frac{d}{dx} \mathbf{v}(x) + \frac{1}{2} \left(-a \frac{d}{dx} \right)^2 \mathbf{v}(x) + \dots \quad (8.46)$$

This can be symbolically written as $e^{-a d/dx} \mathbf{v}(x)$, so that we have, in $\mathbf{U} \equiv e^A$,

$$A = -ia(-i d/dx). \quad (8.47)$$

We thus see that, in the x -representation, the generator of translations is the self-adjoint operator $-id/dx$.

Unitary equivalence

The most general unitary representation of a translation is Eq. (8.42), which involves an arbitrary phase function $\phi(x)$. It can be considered as consisting of two successive transformations: the first one is generated by the operator A in (8.47), and the second one is a multiplication by $e^{i\phi(x)}$, which also is a unitary transformation. This second step is similar to a change of gauge in classical electromagnetic theory.

The most general expression for the translation generator thus is

$$\mathbf{k}_\phi = e^{i\phi(x)} (-i d/dx) e^{-i\phi(x)} = -i d/dx - d\phi(x)/dx. \quad (8.48)$$

Its generalization to three dimensions is

$$e^{i\phi(\mathbf{r})} (-i \nabla) e^{-i\phi(\mathbf{r})} = -i \nabla - \nabla \phi(\mathbf{r}). \quad (8.49)$$

Exercise 8.12 Verify that the x , y , and z components of (8.49) commute.

There can be no doubt that k_ϕ is a *bona fide* translation operator, whatever we choose as the phase function $\phi(x)$. It fulfills the canonical commutation relation $[k_\phi, x] = -i$, or more generally, $[k_\phi, f(x)] = -if'(x)$. Therefore the unitary operator $U = e^{-iak_\phi}$ satisfies $U^\dagger x U = x + a$, exactly as in Eq. (8.45). On the other hand, k_ϕ is *different* from $-id/dx \equiv k_0$, that appears in Eq. (8.47). More generally, for every different choice of the phase function $\phi(x)$, there is a genuinely different operator k_ϕ . In particular, the same state vector $v(x)$, in a given Hilbert space H , will yield different mean values $\langle k_\phi \rangle$.

One may therefore be tempted to ask whether there is a “true” operator $U(a)$, which represents the translation through a given distance a . Natural as this question may seem, it is meaningless. You wouldn’t ask what is the correct form of the three spin matrices J_k : there would be an infinite number of answers, depending on the choice of a basis in spin space. In the present case, where state vectors are represented by wave functions $v(x)$, there is at each point of the x axis a phase ambiguity in the definition of the Hilbert space basis. Therefore the functional form of the translation operator cannot be unique. Indeed, the most general definition of $U(a)$, namely,

$$U^\dagger(a) f(x) U(a) = f(x + a), \quad (8.50)$$

is obviously invariant under the substitution $U(a) \rightarrow U(a) e^{i\phi(x)}$.

It is essential to clearly distinguish two types of unitary equivalence. There is the trivial equivalence due to a change of basis in Hilbert space (a passive transformation). For example, the three J_k matrices in Eq. (7.26), which are antisymmetric and pure imaginary, are equivalent to, and are as legitimate as, the standard form of the J_k matrices found in all elementary textbooks, with J_z diagonal, and J_x real and symmetric.

On the other hand, in a *given* Hilbert space, with a fixed basis, an *active* unitary transformation, such as the one in Eq. (8.42), definitely produces a new physical situation. In that case, the formal unitary equivalence of two operators certainly does *not* imply their equivalence from the point of view of physics.¹⁰ For example, there is a unitary transformation converting J_x into J_y , but, in the given basis, the symbols J_x and J_y have *different* physical meanings. There also is a unitary transformation (or, for that matter, a classical canonical transformation) converting x into p (both defined on the real axis). Yet, these two dynamical variables are of a completely different nature.

We thus see that, while there can be no unique solution to the problem of finding an operator $U(a)$ which satisfies (8.50), this nonuniqueness is essentially irrelevant. The problem is the same as if we were asked to find three J_k matrices with the commutation relations of angular momenta: there is an infinity of different, but unitarily equivalent solutions. It may sometimes be necessary to choose explicitly one of them, in order to perform our calculations, just as it

¹⁰R. Fong and J. Sucher, *J. Math. Phys.* 5 (1964) 456.

is necessary to choose a language in order to write a book on quantum theory. However, the choice of a particular form for J_k , whether the standard one with J_z diagonal, or the one used in Eq. (7.26), or any other one, can only be a matter of taste, or of momentary convenience. This arbitrary choice cannot have any observable consequence, unless there are other physical data which explicitly refer to a particular basis in Hilbert space.

To conclude this discussion: It is simplest and most natural to choose $-id/dx$ as *the* generator of translations along the x axis. That is, we shall choose k_0 among all the unitarily equivalent operators k_ϕ , if we are compelled to make an explicit choice between them. Actually, this necessity rarely happens. In any case, the arbitrariness in this choice has no consequence on physical observations.

Correspondence with classical mechanics

It is customary to multiply the translation operator $-id/dx$ by \hbar and to call the product *momentum*. The reason for this name is that if a quantum system has a classical analog, and if its state $\psi(x)$ is a roughly localized wave packet, the average value of the observable $-i\hbar d/dx$ indeed corresponds to the classical momentum. This may be seen from de Broglie's formula

$$\lambda p = h . \tag{8.51}$$

Planck's constant, $h \equiv 2\pi\hbar$, which appears in de Broglie's formula, is used for linking classical mechanics and quantum mechanics. It never has any other role, and in particular it is never needed for formulating the laws of quantum theory itself. It only is a *conversion factor* that we use if we wish to express the translation operator, $-id/dx$, in units of momentum rather than of inverse length, or for specifying a frequency in units of energy, and so on. The status of \hbar is similar to that of the velocity of light c in relativity theory, where time can be measured in units of length, and mass in units of energy.

In the SI units used in everyday's life, $c \simeq 3 \times 10^8$ m/s is a fairly large number, and $\hbar \simeq 10^{-34}$ Js is exceedingly small.¹¹ Therefore, a typical value of linear momentum for a macroscopic body¹² makes its λ so small that it is practically impossible to observe the wave propagation properties of that body. And conversely, values of λ that are common on the human scale (for electromagnetic waves, say) correspond to momenta so small that recoil effects due to individual photons are hard to detect.

There are nonetheless borderline cases where particles are prepared with a well defined momentum (according to a classical description of the preparation procedure) and then these particles diffract like waves, so that de Broglie's formula $\lambda p = h$ is experimentally verifiable. For example, electrons launched

¹¹ The conversion factor $hc^{-2} \simeq 7 \times 10^{-55}$ kg/Hz is just ridiculous.

¹² A. Zeilinger, *Am. J. Phys.* 58 (1990) 103.

with an energy of 100 eV have a wavelength $\lambda = 1.23 \text{ \AA}$, comparable to crystal lattice spacings. Neutrons with energy around 0.03 eV are copiously produced in nuclear reactors (in thermal units, $0.03 \text{ eV}/k_B = 348 \text{ K}$). The corresponding wavelength is 1.65 \AA . These neutrons are routinely used for solid state studies. Their wavelike diffraction by the crystalline lattice may be elastic, as for X-rays. However, the same waves may also be scattered inelastically, and then the neutrons behave just as ordinary particles, exchanging energy and momentum with the elastic vibration modes of the lattice.

Warning: The so-called principle of correspondence, which relates classical and quantum dynamics, is tricky and elusive. Quantum mechanics is formulated in a separable Hilbert space and it has a fundamentally discrete character. Classical mechanics is intrinsically continuous. Therefore, any correspondence between them is necessarily fuzzy. I shall return to this problem in Chapter 10.

8-5. The Euclidean group

The Euclidean group consists of all possible rigid motions (translations and rotations) in the ordinary Euclidean three dimensional space \mathbf{R}^3 . If we ignore distortions of the spacetime geometry due to gravitational effects, the physical space in which we live has a Euclidean structure. Therefore, the Euclidean group corresponds to a *physical* symmetry, and rigid motions are represented by unitary matrices in the quantum mechanical Hilbert space.

Dynamical variables vs external parameters

We have just created an exquisite fiction: a perfectly empty space which is rigorously symmetric. There is nothing in it to indicate where to put the origin of a Cartesian coordinate system, and how to orient its axes. The laws of physics, Maxwell's equations say, are written in the same way in all these mental coordinate systems. However, when we clutter our pristine space with material objects (buildings, magnets, particle detectors and the like) we destroy that symmetry. It then becomes possible to say that the origin of the xyz axes is located at this particular corner in our laboratory, and that the axes are parallel to specified walls.

Yet the symmetry is not completely lost—it only is more complicated. If we carefully move the entire building, with the magnets and the particle detectors, and the coordinate system which was fastened to the walls of the experimental hall (this Herculean job is a *passive* transformation) and if we likewise move all the particles for which we are writing a Schrödinger equation (this is the *active* transformation) then the new form of the Schrödinger equation is the same as the old form. It is impossible to infer, just by observing the behavior of the quantum particles, that the building and all its equipment have been

transported elsewhere, and the quantum particles too.

We shall therefore distinguish two classes of physical objects. Those whose behavior we are investigating are described by *dynamical variables*; they obey Newton's equations, or the Schrödinger equation, or any other appropriate equations of motion. For these dynamical variables, a symmetry is represented by a canonical transformation in classical physics, or a unitary transformation in quantum theory. And, on the other hand, there are auxiliary objects (magnets, detectors, etc.) whose properties are supposedly known, and whose behavior can be arbitrarily prescribed. These objects are *not* described by dynamical variables and they do *not* obey equations of motion. Their motion, if any, is specified by us.

Depending on the level of accuracy that we demand, the *same* object may be considered either as part of the dynamical system for which we write equations of motion, or as something external to it, specified by nondynamical variables. For example, in the most elementary treatment of the hydrogen atom, there is a point-like proton, located at a given position, \mathbf{R} , and represented by a fixed Coulomb potential, $V = -e^2/|\mathbf{R} - \mathbf{r}|$. Only the components of \mathbf{r} (the position of the electron) are considered as dynamical variables. Those of \mathbf{R} are external parameters. In a more accurate treatment, the components of \mathbf{R} too are dynamical variables, and the proton is a full partner in the hydrogen atom dynamics. In that case, it is obvious that $(\mathbf{R} - \mathbf{r})$ is invariant under a rigid translation of the atom: $\mathbf{R} \rightarrow \mathbf{R} + \mathbf{a}$ and $\mathbf{r} \rightarrow \mathbf{r} + \mathbf{a}$.

However, even in the hybrid description, where only \mathbf{r} is dynamical and \mathbf{R} is an externally controlled parameter, there still is a well defined meaning to translation invariance. Namely, a translation by a vector \mathbf{a} involves two operations: a unitary transformation $\psi(\mathbf{r}) \rightarrow \mathbf{U}(\mathbf{a})\psi(\mathbf{r})$ for the quantum variables, and an ordinary substitution of the classical variables, the parameter \mathbf{R} being replaced by $\mathbf{R} + \mathbf{a}$. The Hamiltonian of the hydrogen atom is invariant under this combined transformation.

Translations

The active transformation shown in Fig. 8.2,

$$\mathbf{r} \xrightarrow{\mathbf{A}} \mathbf{r}' = \mathbf{r} + \mathbf{a}, \quad (8.52)$$

is represented in quantum theory by a unitary operator $\mathbf{U}(\mathbf{a}) \equiv e^{\mathbf{A}}$. Likewise, a rigid translation by a vector \mathbf{b} (not shown in the figure) is represented by $\mathbf{U}(\mathbf{b}) \equiv e^{\mathbf{B}}$. The explicit form of these operators depends on the way we define the Hilbert space of states, and in particular on the number and type of particles in the physical system. However, even without specifying \mathbf{A} and \mathbf{B} explicitly, we can obtain the commutator $[\mathbf{A}, \mathbf{B}]$ from Eq. (8.36), except for an arbitrary additive numerical constant. In the present case, the use of Eq. (8.36) is particularly simple, because translations by \mathbf{a} and \mathbf{b} commute. We have

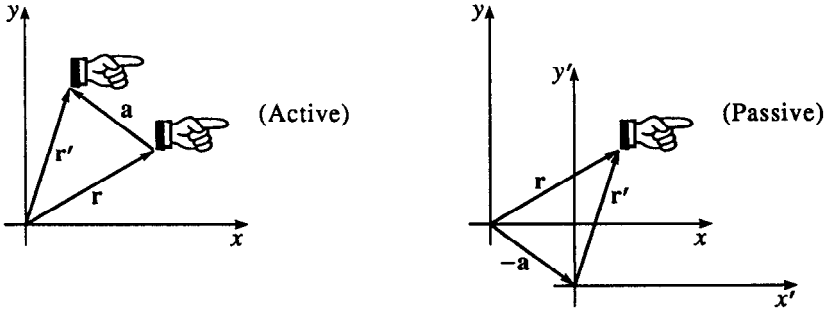

Fig. 8.2. Equivalent active and passive rigid translations of a hand symbol.

$$\mathbf{r} \xrightarrow{\mathbf{A}} \mathbf{r}' = \mathbf{r} + \mathbf{a} \xrightarrow{\mathbf{B}} \mathbf{r}'' = \mathbf{r}' + \mathbf{b} = \mathbf{r} + \mathbf{a} + \mathbf{b} \xrightarrow{-\mathbf{A}} \mathbf{r}''' = \mathbf{r}'' - \mathbf{a} = \mathbf{r} + \mathbf{b} \xrightarrow{-\mathbf{B}} \mathbf{r}'''' = \mathbf{r}''' - \mathbf{b} = \mathbf{r}. \quad (8.53)$$

This brings the point \mathbf{r} (any point) back to its original position. It follows that the left hand side of Eq. (8.36) may be either 1 or, more generally, a phase factor depending on \mathbf{a} and \mathbf{b} . (Recall the discussion in the preceding section: state vectors are defined only up to an arbitrary phase.)

We can therefore write $[\mathbf{A}, \mathbf{B}] = i K(\mathbf{a}, \mathbf{b}) \mathbb{1}$, where $K(\mathbf{a}, \mathbf{b}) = -K(\mathbf{b}, \mathbf{a})$ is a numerical coefficient that we still have to specify. It is obviously simplest to postulate that $K = 0$. For example, if there is a single particle, and if its state is described in the coordinate representation by a wave function $\psi(\mathbf{r})$, it is natural to take $\mathbf{A} = -\mathbf{a} \cdot \nabla$ and $\mathbf{B} = -\mathbf{b} \cdot \nabla$, or more general expressions as in Eq. (8.49), all of which give $K = 0$. This is not, however, the only possibility, as the following exercise shows.

Exercise 8.13 For a single particle in three dimensional space, let

$$\mathbf{A} := -i \sum_m a_m \mathbf{p}_m / \hbar := -i \mathbf{a} \cdot (-i \nabla - \frac{1}{2} \mathbf{V} \times \mathbf{r}), \quad (8.54)$$

where \mathbf{V} is an arbitrary constant vector, having the dimensions of an inverse area. Show that the self-adjoint operators \mathbf{p}_m defined by this equation satisfy $[\mathbf{p}_m, \mathbf{x}_n] = -i \hbar \delta_{mn}$, as any translation operator should. Show moreover that

$$[\mathbf{p}_m, \mathbf{p}_n] = i \hbar^2 \sum_s \epsilon_{mns} V_s \mathbb{1}. \quad (8.55)$$

where ϵ_{mns} is the totally antisymmetric symbol defined by Eq. (8.57) below.

Exercise 8.14 With the above definition of a translation operator, show that if a quantum system is transported along a closed loop, it will return to its original position with its state vector multiplied by a phase factor $e^{i\mathbf{V} \cdot \mathbf{A}}$, where $\mathbf{A} := \frac{1}{2} \oint \mathbf{r} \times d\mathbf{r}$ is the area enclosed by the loop. ★

Note that the translation operators ρ_m defined by Eq. (8.54) and associated with different vectors \mathbf{V} are *not* unitarily equivalent.¹³ This is obvious from the fact that they have different commutators in Eq. (8.55). Therefore, these ρ_m correspond to genuinely different specifications for the transport process of a quantum system: the transport law explicitly involves the vector \mathbf{V} . This obviously breaks rotational symmetry, but not translational symmetry (for example, translation invariance is *not* broken by the presence of a uniform magnetic field throughout space). We shall soon see how the *additional* requirement of rotational symmetry will formally result in $\mathbf{V} = 0$.

Rotations

A rotation is a linear transformation which leaves invariant the scalar product of two vectors, $\mathbf{r} \cdot \mathbf{s} \equiv \sum r_m s_m$. A general infinitesimal linear transformation modifies vector components by $\delta r_m = \sum r_n \Omega_{nm}$ and $\delta s_m = \sum s_n \Omega_{nm}$, where the matrix elements Ω_{nm} are infinitesimal. We thus obtain

$$\delta \sum_m r_m s_m = \sum_{mn} (r_n s_m + r_m s_n) \Omega_{nm}. \quad (8.56)$$

We have a rotation if the above expression vanishes for every \mathbf{r} and \mathbf{s} . This implies that $\Omega_{mn} = -\Omega_{nm}$. In the case of a three dimensional space, it is convenient to introduce a totally antisymmetric symbol ϵ_{mns} whose only non-vanishing elements are

$$\epsilon_{123} = \epsilon_{231} = \epsilon_{312} = 1 \quad \text{and} \quad \epsilon_{321} = \epsilon_{132} = \epsilon_{213} = -1 \quad (8.57)$$

We can then write $\Omega_{nm} = \sum_s \epsilon_{nms} \alpha_s$, where the components of α_s are three independent infinitesimal parameters. Their geometrical meaning is that of Cartesian components of an infinitesimal rotation angle (see next exercise). We have $\delta r_m = \sum r_n \epsilon_{nms} \alpha_s$, or, in the standard vector notation,

$$\mathbf{r} \rightarrow \mathbf{r} + \delta \mathbf{r} = \mathbf{r} + (\boldsymbol{\alpha} \times \mathbf{r}) + O(\alpha^2). \quad (8.58)$$

Exercise 8.15 Show that a rotation by a finite angle is given by

$$\mathbf{r} \rightarrow \mathbf{r}' = \mathbf{r} + \frac{\sin \alpha}{\alpha} (\boldsymbol{\alpha} \times \mathbf{r}) + \frac{1 - \cos \alpha}{\alpha^2} [\boldsymbol{\alpha} \times (\boldsymbol{\alpha} \times \mathbf{r})]. \quad (8.59)$$

The direction of the vector $\boldsymbol{\alpha}$ is that of the rotation axis, and its magnitude α is equal to the rotation angle around that axis. \star

Exercise 8.16 Show that the angular velocity vector $\boldsymbol{\omega}$, which is defined by the relationship $\dot{\mathbf{r}} = \boldsymbol{\omega} \times \mathbf{r}$, is not the time derivative of the rotation vector $\boldsymbol{\alpha}$ defined above, but is given by¹⁴

¹³ They differ in that respect from the one-dimensional translation operators k_ϕ in Eq. (8.48), which were unitarily equivalent.

¹⁴ A. Peres, *Am. J. Phys.* 48 (1980) 70.

$$\boldsymbol{\omega} = \dot{\boldsymbol{\alpha}} + \frac{1 - \cos \alpha}{\alpha^2} (\boldsymbol{\alpha} \times \dot{\boldsymbol{\alpha}}) + \frac{\alpha - \sin \alpha}{\alpha^3} [\boldsymbol{\alpha} \times (\boldsymbol{\alpha} \times \dot{\boldsymbol{\alpha}})]. \quad ** \quad (8.60)$$

To obtain the commutation relations of rotation operators, let us consider four successive rotations, by infinitesimal angles $\alpha, \beta, -\alpha,$ and $-\beta,$ just as we did for consecutive translations. Any point \mathbf{r} moves along the following path:

$$\begin{aligned} \mathbf{r} &\xrightarrow{A} \mathbf{r}' = \mathbf{r} + (\boldsymbol{\alpha} \times \mathbf{r}) \\ &\xrightarrow{B} \mathbf{r}'' = \mathbf{r}' + (\boldsymbol{\beta} \times \mathbf{r}') = \mathbf{r} + (\boldsymbol{\alpha} \times \mathbf{r}) + (\boldsymbol{\beta} \times \mathbf{r}) + \boldsymbol{\beta} \times (\boldsymbol{\alpha} \times \mathbf{r}) \\ &\xrightarrow{-A} \mathbf{r}''' = \mathbf{r}'' - (\boldsymbol{\alpha} \times \mathbf{r}'') = \mathbf{r} + (\boldsymbol{\beta} \times \mathbf{r}) + \boldsymbol{\beta} \times (\boldsymbol{\alpha} \times \mathbf{r}) - \boldsymbol{\alpha} \times (\boldsymbol{\beta} \times \mathbf{r}) \\ &\xrightarrow{-B} \mathbf{r}'''' = \mathbf{r}''' - (\boldsymbol{\beta} \times \mathbf{r}''') = \mathbf{r} + \boldsymbol{\beta} \times (\boldsymbol{\alpha} \times \mathbf{r}) - \boldsymbol{\alpha} \times (\boldsymbol{\beta} \times \mathbf{r}). \end{aligned} \quad (8.61)$$

In this calculation, we have retained terms proportional to $\alpha\beta,$ but ignored those proportional to α^2 and $\beta^2,$ because the latter do not appear in the final result in Eq. (8.36). We now use the vector identity

$$\boldsymbol{\alpha} \times (\boldsymbol{\beta} \times \mathbf{r}) + \boldsymbol{\beta} \times (\mathbf{r} \times \boldsymbol{\alpha}) + \mathbf{r} \times (\boldsymbol{\alpha} \times \boldsymbol{\beta}) \equiv \mathbf{0}, \quad (8.62)$$

and we see that the final result in (8.61) is an infinitesimal rotation

$$\mathbf{r} \rightarrow \mathbf{r} + (\boldsymbol{\beta} \times \boldsymbol{\alpha}) \times \mathbf{r}. \quad (8.63)$$

Recall that, in all the preceding discussion, \mathbf{r} was an ordinary geometrical point, not a quantum operator. In quantum theory, we assume that the unitary transformations e^A and $e^B,$ corresponding to the above rotations, are generated by linear combinations of α_m and $\beta_n:$

$$A = \sum_m \alpha_m J_m / i\hbar \quad \text{and} \quad B = \sum_n \beta_n J_n / i\hbar. \quad (8.64)$$

The operators J_k are Hermitian, and a factor \hbar was introduced to give them the dimensions of angular momentum components (because of their analogy with the generators of classical canonical transformations). We thus obtain, by comparing Eqs. (8.36) and (8.63),

$$\left[\sum_n \beta_n J_n, \sum_m \alpha_m J_m \right] = i\hbar \sum_{nms} \epsilon_{nms} \beta_n \alpha_m J_s. \quad (8.65)$$

Since this relationship has to be valid for every α and $\beta,$ it follows that

$$[J_m, J_n] = i\hbar \sum_s \epsilon_{mns} J_s. \quad (8.66)$$

Here, you could object that the value of $[B, A]$ which can be inferred from the geometrical meaning of the left hand side of Eq. (8.36) is determined only up to an arbitrary additive numerical constant, because of the phase ambiguity inevitably associated with any sequence of active transformations. Therefore the right hand side of Eq. (8.66) should have been written, more generally, as

$i\hbar \sum \epsilon_{mns} (\mathbf{J}_s + w_s \mathbf{1})$, where the w_s are three c -numbers, like V_s in Eq. (8.55). However, in the present case, this ambiguity can easily be removed by adjusting the phase of the rotation operator $e^{-i\alpha \cdot \mathbf{J}/\hbar}$. This is equivalent to redefining $\mathbf{J}_s + w_s \mathbf{1}$ as a new \mathbf{J}_s , which restores the standard commutation relation (8.66).

Rotations and translations

Finally, in order to obtain the commutator $[\mathbf{J}_m, \mathbf{p}_n]$, we consider infinitesimal rotations $\pm\alpha$, alternating with infinitesimal translations $\pm\mathbf{b}$, as sketched in Fig. 8.3. We have (ignoring as before terms of order α^2)

$$\begin{aligned} \mathbf{r} &\xrightarrow{\mathbf{A}} \mathbf{r}' = \mathbf{r} + (\boldsymbol{\alpha} \times \mathbf{r}) \\ &\xrightarrow{\mathbf{B}} \mathbf{r}'' = \mathbf{r}' + \mathbf{b} = \mathbf{r} + (\boldsymbol{\alpha} \times \mathbf{r}) + \mathbf{b} \\ &\xrightarrow{-\mathbf{A}} \mathbf{r}''' = \mathbf{r}'' - (\boldsymbol{\alpha} \times \mathbf{r}'') = \mathbf{r} + \mathbf{b} - (\boldsymbol{\alpha} \times \mathbf{b}) \\ &\xrightarrow{-\mathbf{B}} \mathbf{r}'''' = \mathbf{r}''' - \mathbf{b} = \mathbf{r} - (\boldsymbol{\alpha} \times \mathbf{b}). \end{aligned} \quad (8.67)$$

The result of these four successive transformations is a translation by the infinitesimal vector $-\boldsymbol{\alpha} \times \mathbf{b}$.

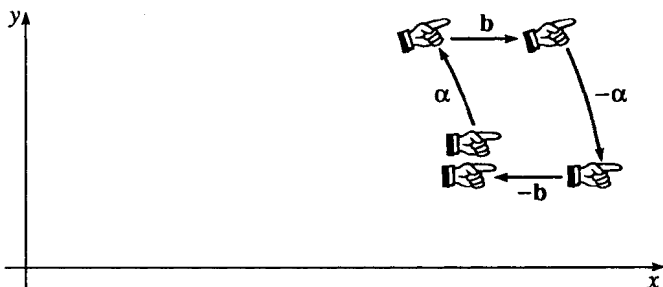

Fig. 8.3. A rotation by a small angle α (around the origin of coordinates) is followed by a translation by a small vector \mathbf{b} , then a rotation by $-\alpha$, and finally a translation by $-\mathbf{b}$. The final result is a translation that is almost equal to $\mathbf{b} \times \boldsymbol{\alpha}$ (it would be exactly equal if $\boldsymbol{\alpha}$ and \mathbf{b} were truly infinitesimal).

In quantum theory, these geometrical operations are represented by unitary operators $e^{\pm\mathbf{A}}$ and $e^{\pm\mathbf{B}}$, with

$$\mathbf{A} = \sum_m \alpha_m \mathbf{J}_m / i\hbar \quad \text{and} \quad \mathbf{B} = \sum_n b_n \mathbf{p}_n / i\hbar. \quad (8.68)$$

Invoking again Eq. (8.36), we obtain

$$\left[\sum_n b_n \mathbf{p}_n, \sum_m \alpha_m \mathbf{J}_m \right] = -i\hbar \sum_{mns} \epsilon_{mns} \alpha_m b_n \mathbf{p}_s. \quad (8.69)$$

Since this is valid for every α_m and b_n , it follows that

$$[\mathbf{J}_m, \mathbf{p}_n] = i\hbar \sum_s \epsilon_{mns} \mathbf{p}_s. \tag{8.70}$$

As in the previous case, we could have added an arbitrary multiple of $\mathbf{1}$ to the right hand side of (8.69), because of the phase arbitrariness accompanying any active transformation. Then, on the right hand side of (8.70), we would have $(\mathbf{p}_s + w_s \mathbf{1})$ instead of \mathbf{p}_s . And, exactly as in the preceding case, we could then adjust the phase of $e^{-ib \cdot \mathbf{p}/\hbar}$, so as to redefine $(\mathbf{p}_s + w_s \mathbf{1})$ as being the new \mathbf{p}_s , thereby regaining the standard commutation relation (8.70).

However, we still have to dispose of the arbitrary vector \mathbf{V} on the right hand side of Eq. (8.55). The latter *cannot* be eliminated by redefining phases. It is intuitively obvious that such a fixed vector is incompatible with rotational invariance. This can also be shown formally, from Jacobi's identity (8.38):

$$[[\mathbf{p}_m, \mathbf{p}_n], \mathbf{J}_k] + [[\mathbf{J}_k, \mathbf{p}_m], \mathbf{p}_n] + [[\mathbf{p}_n, \mathbf{J}_k], \mathbf{p}_m] \equiv \mathbf{0}. \tag{8.71}$$

By virtue of Eqs. (8.55) and (8.70), this identity becomes

$$\mathbf{0} + \sum_s \epsilon_{kms} [\mathbf{p}_s, \mathbf{p}_n] + \sum_s \epsilon_{nks} [\mathbf{p}_s, \mathbf{p}_m] = \mathbf{0}, \tag{8.72}$$

and one more substitution in (8.55) gives

$$\sum_{rs} (\epsilon_{kms} \epsilon_{snr} + \epsilon_{nks} \epsilon_{smr}) \mathbf{V}_r = \mathbf{0}. \tag{8.73}$$

Taking for example $k = m \neq n$, we obtain $V_n = 0$. Therefore finally,

$$[\mathbf{p}_m, \mathbf{p}_n] = \mathbf{0}. \tag{8.74}$$

Remark: It is amusing that this argument would not hold in a two dimensional space where there is no ϵ_{mns} symbol. In a plane, the only generators of the Euclidean group are $\mathbf{p}_x, \mathbf{p}_y$, and $\mathbf{J} \equiv \mathbf{J}_z$, with commutation relations

$$[\mathbf{J}, \mathbf{p}_x] = i\hbar \mathbf{p}_y \quad \text{and} \quad [\mathbf{J}, \mathbf{p}_y] = -i\hbar \mathbf{p}_x. \tag{8.75}$$

No algebraic contradiction results from assuming that $[\mathbf{p}_x, \mathbf{p}_y] = iV\mathbf{1} \neq \mathbf{0}$. There still is a difficulty with the reflection symmetry $x \leftrightarrow y$ which changes the sign of $[\mathbf{p}_x, \mathbf{p}_y]$ but cannot change the sign of $iV\mathbf{1}$, if this reflection is represented by a unitary transformation.¹⁵ This still leaves one possibility: the physical constant V , which commutes with \mathbf{p}_m and with \mathbf{J} , may change sign under a reflection of the Euclidean plane.

¹⁵ Don't speculate on representing it by an antiunitary transformation. While this solution is allowed by Wigner's theorem, it is ruled out by dynamical considerations, as will be shown at the end of this chapter.

Exercise 8.17 Discuss the use of the commutation relations (8.55) and (8.75) for describing the motion of a charged particle in a plane, in the presence of a uniform magnetic field perpendicular to that plane. ★

Vector and tensor operators

We are now employing two completely different types of spaces. One of them is the geometrical space \mathbf{R}^3 in which we live, and which has the Euclidean group symmetry. The other one is an abstract infinite dimensional Hilbert space H that we use to formulate quantum theory. Vectors in H represent quantum states, and Hermitian operators in H correspond to observables. A rotation in \mathbf{R}^3 is represented in H by the unitary transformation (8.33). If that rotation is infinitesimal, namely $U \simeq \mathbb{1} - i \boldsymbol{\alpha} \cdot \mathbf{J} / \hbar$, an observable Ω changes by

$$\delta\Omega := \Omega' - \Omega = i [\boldsymbol{\alpha} \cdot \mathbf{J}, \Omega] / \hbar. \quad (8.76)$$

The result depends on the geometrical nature of Ω . The most common cases are:

Scalar operators, which behave as operators in H , and as scalars in \mathbf{R}^3 . These are the operators which commute with \mathbf{J}_k and therefore are invariant under rotations. For example $\mathbf{p}^2 := \sum \mathbf{p}_m^2$ and $\mathbf{J}^2 := \sum \mathbf{J}_m^2$ are scalars. (The word “operator” is usually omitted in this context, if no confusion is likely to arise.)

Vector operators are triads of observables V_n having commutation relations

$$[\mathbf{J}_m, V_n] = i\hbar \sum_s \epsilon_{mns} V_s. \quad (8.77)$$

Examples of vectors (that is, of vector operators) are $\mathbf{x}_n, \mathbf{p}_n, \mathbf{J}_n$.

Exercise 8.18 Show that if \mathbf{A}_m and \mathbf{B}_m are vectors, then $\sum \mathbf{A}_m \mathbf{B}_m$ is a scalar. Conversely, if \mathbf{A}_m is a vector and $\sum \mathbf{A}_m \mathbf{B}_m$ is a scalar, then \mathbf{B}_m is a vector.

Exercise 8.19 Show that if \mathbf{A}_m and \mathbf{B}_n are vector operators, then

$$\mathbf{C}_s = \sum_{mn} \epsilon_{smn} \mathbf{A}_m \mathbf{B}_n, \quad (8.78)$$

is a vector operator.

Tensor operators behave under rotations as products of vector components. For example, the nine operators $\mathbf{T}_{rs} := \mathbf{A}_r \mathbf{B}_s$ ($r, s = 1, 2, 3$) satisfy

$$[\mathbf{J}_m, \mathbf{T}_{rs}] = i\hbar \sum_n (\epsilon_{mrn} \mathbf{T}_{ns} + \epsilon_{msn} \mathbf{T}_{rn}). \quad (8.79)$$

Higher order tensors, with more than two indices, are occasionally needed.

8-6. Quantum dynamics

A translation in time also is a symmetry: it is impossible to distinguish the description of an experiment performed on a given day from the description of a similar experiment performed on any other day. The laws of nature are invariant in time (though very slow changes, on a cosmological scale, cannot be completely ruled out). An active translation in time amounts to nothing more than *waiting* while the dynamical evolution proceeds. A passive transformation is a resetting of the clock, $t \rightarrow t' = t - \tau$.

Exercise 8.20 Draw figures illustrating active and passive translations in time.

How does a quantum state evolve in time? A reasonable extrapolation from known empirical facts (such as the success of long range interferometry) suggests the following rule:

Quantum determinism. *In a perfectly reproducible environment, a pure state evolves into a pure state.*

This means that if at time t_1 there was a *maximal* test for which the quantum system gave a predictable outcome, then at time $t_2 > t_1$ there will also be a *maximal* test—usually a different one—for which that system will give a predictable outcome. For the other maximal tests that can be performed at time t_2 , only the *probabilities* of the various outcomes are predictable.

In order to verify quantum determinism, the environment must be severely controlled. For instance, consider the precession, in the magnetic field of the Earth, of a silver atom moving between two consecutive Stern-Gerlach apparatuses, as in Fig. 2.2. To obtain a pure spin state at the entrance of the second Stern-Gerlach magnet, the magnetic field between the two apparatuses must be stabilized with enough accuracy to ensure a reproducible precession of the silver atom. An estimation of this accuracy is proposed as an exercise:

Exercise 8.21 Estimate the order of magnitude of the precession angle if the two Stern-Gerlach magnets are 10 cm apart and the magnetic field of the Earth is not shielded. How precisely must that magnetic field be controlled to make the spin precession predictable with an accuracy of 1°?

Exercise 8.22 In the Michelson-Morley historic experiment, how precisely was it necessary to stabilize the ambient temperature, so that the position of the interference fringes would not be affected by the thermal expansion of the interferometer?

In this book, I usually consider ideal experiments, executed in a perfectly controlled and accurately known environment. The consequences of a nonideal environment on quantum dynamics will be examined in Chapter 11. It will be no surprise then to find that a pure state may evolve into a mixture.

Unitary evolution

Quantum dynamics deals with the evolution of quantum states, $\mathbf{v}(t_1) \rightarrow \mathbf{v}(t_2)$. You know for sure that this is a unitary transformation,

$$\mathbf{v}(t_2) = \mathbf{U}(t_2, t_1) \mathbf{v}(t_1), \quad (8.80)$$

and that the unitary operators $\mathbf{U}(t_m, t_n)$ satisfy the group property:

$$\mathbf{U}(t_3, t_1) = \mathbf{U}(t_3, t_2) \mathbf{U}(t_2, t_1). \quad (8.81)$$

You perhaps have read that it *must* be so, because symmetries are represented by unitary transformations. However, this claim is not valid, because time is not a dynamical variable, like position. In the dynamical formalism, whether classical or quantal, t appears as an ordinary number and has vanishing Poisson brackets, or commutators, with every dynamical variable or observable.

The fundamental difference between space translations and time translations can be seen as follows. A passive space translation, $x \rightarrow x - a$, is a mere change of labels, $\psi(x) \rightarrow \psi(x - a)$, similar to a shift $u_m \rightarrow u_{m-n}$ for discrete indices. The scalar product,

$$\int_{-\infty}^{\infty} \overline{\phi(x - a)} \psi(x - a) dx = \int_{-\infty}^{\infty} \overline{\phi(x)} \psi(x) dx, \quad (8.82)$$

is not affected by this relabelling. Therefore this transformation is unitary. It is so because the observable values of \mathbf{x} serve as arguments in the functions $\psi(x)$ used to represent the Hilbert space of states. The sum in Eq. (8.82) runs over these observable values.

None of these properties applies to a shift in time. We do not use functions of time to represent quantum states, and we do not sum over values of time to compute a scalar product. Therefore there is no reason to demand that a translation in time be represented by a unitary transformation.

Canonical formalism

A similar situation exists in classical mechanics. If we start from Newton's second law, $dp/dt = F$, there is no reason to assume that there is a Hamiltonian function, $H(q, p)$, such that $F = -\partial H/\partial q$ and $dq/dt = \partial H/\partial p$. Other laws of motion can as well be written. For example, we have

$$\begin{aligned} q(t) &= e^{-\gamma t} [q(0) \cos \omega t + p(0) \sin \omega t], \\ p(t) &= e^{-\gamma t} [-q(0) \sin \omega t + p(0) \cos \omega t], \end{aligned} \quad (8.83)$$

for a damped harmonic oscillator. If the original dynamical variables $q(0)$ and $p(0)$ are used to define Poisson brackets, we obtain from (8.83)

$$[q(t), p(t)]_{\text{PB}} = e^{-2\gamma t}, \quad (8.84)$$

so that $q(t)$ and $p(t)$ are *not* a pair of canonically conjugate variables.¹⁶

Exercise 8.23 Show from (8.83) that dq/dt and dp/dt can be expressed as functions of q and p , without involving explicitly the time t . It follows that there are differential equations of motion which are **invariant** under a translation in time, and have Eq. (8.83) as their solution.

The dissipative nature of the motion of a damped oscillator is solely due to the incompleteness of the above description, which uses a single degree of freedom. The damping force $-\gamma p$ has no fundamental character. It is only a phenomenological expression, resulting from the time-averaged contributions of an enormous number of inaccessible and “irrelevant” degrees of freedom which belong to the damping medium.

On the other hand, it is commonly assumed that the *fundamental* laws of classical physics are obtainable from a Lagrangian which includes *all* the degrees of freedom. In the Lagrangian formulation, a translation in time is a *canonical* transformation, just as a translation in space, or as a rotation. This canonical approach has important conceptual and computational advantages, and is also systematically used in classical field theory.¹⁶

The Hamiltonian

By analogy with the classical formalism, we shall *assume* that the evolution of a quantum state is given by the unitary transformation (8.80), satisfying the group property (8.81), in the same way that translations and rotations in the physical \mathbf{R}^3 space are represented by unitary operators. Let us define

$$\mathbf{H} := i\hbar \frac{d\mathbf{U}(t, t_0)}{dt} \mathbf{U}^\dagger(t, t_0) = -i\hbar \mathbf{U}(t, t_0) \frac{d\mathbf{U}^\dagger(t, t_0)}{dt}. \quad (8.85)$$

This self-adjoint operator is analogous to the Hamiltonian in classical theory, because it generates the evolution in time, as shown in the following exercises.

Exercise 8.24 Show that $i\hbar \dot{\mathbf{U}} = \mathbf{H}\mathbf{U}$ and $-i\hbar \dot{\mathbf{U}}^\dagger = \mathbf{U}^\dagger \mathbf{H}$. Combining these results with Eq. (8.80), derive the Schrödinger equation

$$i\hbar d\mathbf{v}/dt = \mathbf{H}\mathbf{v}. \quad (8.86)$$

Exercise 8.25 Show from Eq. (8.85) that

$$\mathbf{H}(t) = i\hbar \lim_{\Delta t \rightarrow 0} \frac{\mathbf{U}(t + \Delta t, t) - \mathbf{1}}{\Delta t}. \quad (8.87)$$

¹⁶The reader who is not familiar with the classical canonical formalism should consult the bibliography at the end of Chapter 1.

It follows from Eq. (8.87) that H is independent of t_0 . Moreover, if the physical system is not subject to time dependent external forces, H is also independent of t , and the solution of Schrödinger's equation is¹⁷

$$\mathbf{v}(t) = e^{-iHt/\hbar} \mathbf{v}(0). \quad (8.88)$$

In that case, the unitary time evolution operator is

$$U(t_2, t_1) = e^{-iH(t_2-t_1)/\hbar}, \quad (8.89)$$

which obviously satisfies the group property (8.81).

Consider now the commutator $[H, p_n]$. From the point of view of passive transformations (*i.e.*, the use of new space and time coordinates) it is obvious that $t \rightarrow t - \tau$ commutes with $\mathbf{r} \rightarrow \mathbf{r} - \mathbf{a}$. We are therefore led to write

$$[H, p_n] = 0. \quad (?) \quad (8.90)$$

However, this equation cannot be valid in general. For example, it does not hold for a harmonic oscillator described by

$$H = p^2/2m + kx^2/2. \quad (8.91)$$

Where is the fallacy in the reasoning that led to Eq. (8.90)?

The point is that x is an operator, and we have, in the x -representation, $p = -i\hbar \partial/\partial x$. On the other hand, t is not an operator, and H is not $i\hbar \partial/\partial t$. Although the differential operators $\partial/\partial x$ and $\partial/\partial t$ commute, p need not commute with H . This is true even if we restrict our attention to wave functions $\psi(x, t)$ which satisfy the Schrödinger equation $i\hbar \dot{\psi} = H\psi$. We can then write the identity $\partial^2 \psi / \partial x \partial t \equiv \partial^2 \psi / \partial t \partial x$ as

$$pH\psi = i\hbar \partial(p\psi)/\partial t, \quad (8.92)$$

but the right hand side of (8.92) is *not* equal to $H p\psi$, unless $p\psi$ happens to be a solution of the Schrödinger equation.

Exercise 8.26 Explain why there are opposite signs on the right hand sides of $e^{-i\tau H/\hbar} \psi(x, t) = \psi(x, t + \tau)$ and $e^{-ia p/\hbar} \psi(x, t) = \psi(x - a, t)$. In the first case, the state $\psi(x, t)$ is transformed into a later state of the same system; in the second case, it is translated by a distance a into another position, such that $\langle x^n \rangle \rightarrow \langle (x + a)^n \rangle$. *

¹⁷Note that the unitary transformation (8.88) does not represent the evolution of a physical process, but only the evolution of what we can predict about it. Quantum theory does not give a complete description of what is "really happening." It only is the best description we can give of what we actually see in nature.

Let us return to the harmonic oscillator Hamiltonian (8.91). We may avoid a violation of translational symmetry by introducing nondynamical external parameters, as we have done in Sect. 8-5. Let us write the potential energy as $k(x_1 - x_2)^2/2$, rather than $kx^2/2$. Here, x_1 is an operator which represents the instantaneous position of the oscillator, and x_2 is an ordinary number—the classical equilibrium position. The latter is an *external parameter*. However, we can also use a more fundamental description, in which x_2 is a full-fledged quantum dynamical variable, associated with a particle of very large mass, $m_2 \gg m_1$ (the mass of the oscillator is $m_1 \equiv m$). We then have

$$H = \frac{p_1^2}{2m_1} + \frac{p_2^2}{2m_2} + \frac{k(x_1 - x_2)^2}{2} = \frac{P^2}{2M} + \frac{p^2}{2\mu} + \frac{kx^2}{2}, \tag{8.93}$$

where $M = m_1 + m_2$ is the total mass, $\mu = m_1m_2/(m_1 + m_2) \simeq m_1$ is the reduced mass of the oscillator, and $x = x_1 - x_2$ is its distance from the second particle. The generator of translations, $P = p_1 + p_2$, obviously commutes with x and with the relative momentum

$$p = (m_2 p_1 - m_1 p_2)/(m_1 + m_2). \tag{8.94}$$

In this *complete* description, free from nondynamical external parameters, we have $[H, P] = 0$. In the same manner, it can be shown that a *free* quantum system satisfies $[H, J_n] = 0$.

Nonlinear variants of Schrödinger's equation

The unitary evolution law (8.80) and the Schrödinger equation (8.86) could not be formally derived by using only invariance under time translation. They were *postulated*, by analogy with classical canonical dynamics. It is indeed not difficult to invent nonlinear equations of evolution for the state vector. These nonlinear variants of Schrödinger's equation are mathematically consistent, and they can be ruled out only by introducing additional physical assumptions.

As an elementary example, let $v = \begin{pmatrix} \alpha \\ \beta \end{pmatrix}$ be a two component state vector, which I take here as real, to make things easier. Let $H = \hbar v^\dagger \sigma_z v \sigma_y$, where σ_y and σ_z are the usual Pauli matrices. Schrödinger's equation becomes

$$i \frac{d}{dt} \begin{pmatrix} \alpha \\ \beta \end{pmatrix} = (\alpha^2 - \beta^2) \sigma_y \begin{pmatrix} \alpha \\ \beta \end{pmatrix}. \tag{8.95}$$

There is no explicit time dependence in this equation; it is manifestly invariant under time translations. Explicitly, $\dot{\alpha} = -(\alpha^2 - \beta^2)\beta$ and $\dot{\beta} = (\alpha^2 - \beta^2)\alpha$. These equations are invariant under $\alpha \leftrightarrow \beta$. It is easily seen that $\alpha\dot{\alpha} + \beta\dot{\beta} = 0$, so that $\alpha^2 + \beta^2$ is constant. We also have

$$d(\alpha/\beta)/dt = 1 - (\alpha/\beta)^2, \tag{8.96}$$

whence we obtain two families of solutions:

$$\begin{aligned}\alpha/\beta &= \tanh(t - t_0) & \text{if } |\alpha| < |\beta|, \\ \alpha/\beta &= \coth(t - t_0) & \text{if } |\alpha| > |\beta|.\end{aligned}\tag{8.97}$$

In these solutions, t_0 is an integration constant which depends on the initial conditions: at time $t = t_0$, we have $\alpha = 0$ or $\beta = 0$, respectively.

Exercise 8.27 Write explicitly the state vector $\begin{pmatrix} \alpha \\ \beta \end{pmatrix}$ at time t , and show that its time evolution is not a unitary transformation: the scalar product of two different state vectors is not conserved in time.

There is no mathematical inconsistency in these results. However, they have an unpleasant consequence: All the systems obeying Eq. (8.96), regardless of their initial preparation, converge to the same state, with $\alpha = \beta = 1/\sqrt{2}$. In particular, systems prepared as a random mixture will evolve into that pure state. The dynamical model proposed in Eq. (8.96) therefore violates the law of conservation of ignorance (Postulate C, page 31). In the next chapter, it will be proved quite generally that nonlinear variants of the Schrödinger equation violate the second law of thermodynamics.

8-7. Heisenberg and Dirac pictures

In classical mechanics, the equations of motion are simplest when we use an inertial frame of reference. Nevertheless, it is sometimes more convenient to use a noninertial coordinate system, such as one which rotates with the Earth. (For instance, artillery officers don't consider their guns and targets as being constantly accelerated because of the rotation of the Earth. They rather use an earthbound coordinate system, where guns and targets appear to be at rest. Coriolis and centrifugal forces must then be added to gravity and aerodynamic forces, to compute ballistic trajectories.)

Likewise, it is often convenient to use time dependent bases in quantum mechanics. Two methods are noteworthy and are discussed below. They are known as the Heisenberg picture and the Dirac picture. The approach that was presented in the preceding section is then called the Schrödinger picture.¹⁸ The spirit of Schrödinger's picture is close to that of classical statistical mechanics, where the Liouville density function satisfies a first order partial differential equation. The Heisenberg picture, on the other hand, gives equations of motion that look like Hamilton's equations in classical mechanics, but with commutators instead of Poisson brackets. Dirac's picture has intermediate properties, and is a useful tool in perturbation theory.

¹⁸In the older literature, the term *representation* is used instead of *picture*.

Heisenberg picture

The *Heisenberg picture* is obtained by making each basis vector \mathbf{e}_m move according to the Schrödinger equation (8.86), as if it were a state vector of the quantum system under consideration. Therefore the components $\langle \mathbf{e}_m, \mathbf{v} \rangle$ of the state vector \mathbf{v} are constant. Another way of achieving the same result is to define a “Heisenberg state vector”

$$\mathbf{v}_H := U^\dagger(t, t_0) \mathbf{v}(t) \equiv U(t_0, t) \mathbf{v}(t) \equiv \mathbf{v}(t_0). \quad (8.98)$$

An ordinary state vector \mathbf{v} , without label, is understood to be given in the Schrödinger picture.

One likewise defines Heisenberg observables

$$A_H(t) := U^\dagger(t, t_0) A U(t, t_0), \quad (8.99)$$

as in Eq. (8.33). If A does not depend explicitly on time, this gives

$$\begin{aligned} \frac{dA_H}{dt} &= \dot{U}^\dagger A U + U^\dagger A \dot{U} = \dot{U}^\dagger U A_H + A_H U^\dagger \dot{U}, \\ &= A_H U^\dagger \dot{U} - U^\dagger \dot{U} A_H \equiv [A_H, U^\dagger \dot{U}], \end{aligned} \quad (8.100)$$

where use was made of $U^\dagger U \equiv \mathbb{1}$ and $\dot{U}^\dagger U + U^\dagger \dot{U} \equiv 0$. The expression $U^\dagger \dot{U}$ in the last term is reminiscent of $\dot{U} U^\dagger = \mathbf{H}/i\hbar$ in Eq. (8.85) and is indeed closely related to the Hamiltonian. We have

$$i\hbar U^\dagger \dot{U} = i\hbar U^\dagger \dot{U} U^\dagger U = U^\dagger \mathbf{H} U = H_H. \quad (8.101)$$

This is the Hamiltonian in the Heisenberg picture, defined as in Eq. (8.99). It coincides with H , the Schrödinger picture Hamiltonian, if and only if the latter is time independent. In summary, we have

$$i\hbar \frac{dA_H}{dt} = [A_H, H_H]. \quad (8.102)$$

This is the Heisenberg equation of motion for quantum observables. It is similar to the classical equation of motion, expressed with Poisson brackets.

Note that these results are valid for operators that do not depend *explicitly* on time, when written in the Schrödinger picture. For example, $\mathbf{p} = -i\partial/\partial x$ does not depend explicitly on time. Therefore, in the Heisenberg picture, we have $i\hbar d\mathbf{p}_H/dt = [\mathbf{p}_H, H_H]$.

Constants of the motion

Operators whose matrix elements are independent of time, in the Heisenberg picture, are called *constants of the motion*. Their mean values—and all their higher moments—are constant in time. For instance, if there are no *external*

forces or torques acting on the physical system, the generators of the Euclidean group, \mathbf{p}_n and \mathbf{J}_n , commute with \mathbf{H} and therefore are constants of the motion.

Conversely, any constant of the motion \mathbf{G} generates a symmetry. Indeed, let the mapping $\Omega \rightarrow e^{i\alpha\mathbf{G}}\Omega e^{-i\alpha\mathbf{G}}$ be performed on all the Heisenberg operators in H . This unitary mapping does not affect observable properties, such as the eigenvalues of these operators, or scalar products of their respective eigenvectors, from which we obtain transition probabilities. In particular, the Heisenberg equation of motion (8.102) is not affected, since $d\mathbf{G}/dt = 0$. The transformed situation therefore obeys exactly the same physical laws as the original one—this is the hallmark of a symmetry.

Note that a constant of the motion may depend explicitly on time, when it is written in the Heisenberg picture. Consider for instance $\mathbf{H} = \hbar\omega\sigma_z$. The Schrödinger operators σ_x and σ_y do not depend explicitly on time; therefore the Heisenberg operators σ_{xH} and σ_{yH} obey the equations of motion

$$\begin{aligned} d\sigma_{xH}/dt &= [\sigma_{xH}, \mathbf{H}]/i\hbar = -\omega\sigma_{yH}, \\ d\sigma_{yH}/dt &= [\sigma_{yH}, \mathbf{H}]/i\hbar = \omega\sigma_{xH}. \end{aligned} \quad (8.103)$$

The solution of these equations is

$$\begin{aligned} \sigma_{xH}(t) &= \sigma_x \cos\omega t - \sigma_y \sin\omega t, \\ \sigma_{yH}(t) &= \sigma_x \sin\omega t + \sigma_y \cos\omega t. \end{aligned} \quad (8.104)$$

We can now define new operators, τ_{jH} , which are constants of the motion:

$$\begin{aligned} \tau_{xH} &:= \sigma_{xH} \cos\omega t + \sigma_{yH} \sin\omega t, \\ \tau_{yH} &:= -\sigma_{xH} \sin\omega t + \sigma_{yH} \cos\omega t. \end{aligned} \quad (8.105)$$

Their Heisenberg equations of motion are

$$d\tau_{jH}/dt = \partial\tau_{jH}/\partial t + [\tau_{jH}, \mathbf{H}]/i\hbar = 0, \quad (8.106)$$

where the partial derivative $\partial\tau_{jH}/\partial t$ refers to the *explicit* time dependence in Eq. (8.105). We thus see that τ_{xH} and τ_{yH} are constants of the motion, even though their definition in (8.105) explicitly involves t .

Exercise 8.28 Show that $\tau_{xH} = \sigma_x$ and $\tau_{yH} = \sigma_y$.

Exercise 8.29 Show that the validity of the Heisenberg equation of motion (8.102), without a partial time derivative as in Eq. (8.106), is the necessary and sufficient condition for the absence of an explicit time dependence in the Schrödinger operator $\mathbf{A} = \mathbf{U}(t, t_0)\mathbf{A}_H\mathbf{U}^\dagger(t, t_0)$.

Dirac picture

The Dirac picture, also called *interaction picture*, is useful for treating problems in which the Hamiltonian can be written as $\mathbf{H} = \mathbf{H}_0 + \mathbf{H}_1$, where \mathbf{H}_0 has a simple form and \mathbf{H}_1 is a small perturbation. As in the Heisenberg picture, one defines a unitary matrix \mathbf{U}_0 by

$$i\hbar \frac{d\mathbf{U}_0(t, t_0)}{dt} = \mathbf{H}_0 \mathbf{U}_0(t, t_0), \quad (8.107)$$

with the initial condition $\mathbf{U}_0(t_0, t_0) = \mathbf{1}$. If the form of \mathbf{H}_0 is simple enough, so that its eigenvalues E_λ and eigenvectors \mathbf{u}_λ are known, it is possible to obtain the explicit solution of Eq. (8.107) as a sum over states,

$$\mathbf{U}_0(t, t_0) = \sum_\lambda \mathbf{u}_\lambda \mathbf{u}_\lambda^\dagger \exp[-iE_\lambda(t - t_0)/\hbar]. \quad (8.108)$$

This expression is called the Green's function, or *propagator* of \mathbf{H}_0 .

The Dirac state vector is defined as

$$\mathbf{v}_D(t) := \mathbf{U}_0^\dagger(t, t_0) \mathbf{v}(t). \quad (8.109)$$

It satisfies the equation of motion

$$i\hbar \frac{d\mathbf{v}_D}{dt} = -\mathbf{U}_0^\dagger \mathbf{H}_0 \mathbf{v} + \mathbf{U}_0^\dagger \mathbf{H} \mathbf{v} = \mathbf{U}_0^\dagger \mathbf{H}_1 \mathbf{U}_0 \mathbf{v}_D = \mathbf{H}_{1D} \mathbf{v}_D, \quad (8.110)$$

where $\mathbf{H}_{1D} := \mathbf{U}_0^\dagger \mathbf{H}_1 \mathbf{U}_0$ is the Dirac picture of the perturbation term in the Hamiltonian.

In general, any observable \mathbf{A} becomes

$$\mathbf{A}_D = \mathbf{U}_0^\dagger \mathbf{A} \mathbf{U}_0. \quad (8.111)$$

If \mathbf{A} is not explicitly time dependent, it satisfies the equation of motion

$$i\hbar \frac{d\mathbf{A}_D}{dt} = [\mathbf{A}_D, \mathbf{H}_{0D}]. \quad (8.112)$$

We thus see that \mathbf{H}_{0D} generates the motion of observables, while \mathbf{H}_{1D} generates that of state vectors.

8-8. Galilean invariance

Consider a free particle, in one space dimension, described by the Hamiltonian $\mathbf{H} = \mathbf{p}^2/2m$. Its equations of motion, in the Heisenberg picture, are $\dot{\mathbf{p}} = 0$ and $\dot{\mathbf{x}} = \mathbf{p}/m$. (As from now, the subscript \mathbf{H} which denotes the Heisenberg picture will be omitted, if no confusion is likely to occur.) The dynamical variable

$$\mathbf{G} := \mathbf{p}t - m\mathbf{x}, \quad (8.113)$$

has the property that

$$d\mathbf{G}/dt = \partial\mathbf{G}/\partial t + [\mathbf{G}, \mathbf{H}]/i\hbar = 0, \quad (8.114)$$

just as the matrices τ_j in Eq. (8.106). Therefore \mathbf{G} is a constant of the motion which depends explicitly on time in the Heisenberg picture. If we write \mathbf{G} as a matrix of infinite order, all its elements are constant (they are equal to the matrix elements of $-m\mathbf{x}$ at time $t = 0$).

In spite of its explicit time dependence, \mathbf{G} generates a symmetry, as any other constant of the motion. The physical meaning of the unitary transformation $e^{-i\mathbf{v}\mathbf{G}/\hbar}$ is a *boost* of the physical system by a velocity \mathbf{v} . This is readily seen from the transformation law of the canonical variables:

$$e^{i\mathbf{v}\mathbf{G}/\hbar} \mathbf{x} e^{-i\mathbf{v}\mathbf{G}/\hbar} = \mathbf{x} + [i\mathbf{v}\mathbf{G}/\hbar, \mathbf{x}] + \cdots = \mathbf{x} + \mathbf{v}t, \quad (8.115)$$

where use was made of the expansion (8.29). Note that the last expression in Eq. (8.115) is exact, even for finite \mathbf{v} , because the higher terms in Eq. (8.29) identically vanish in the present case.

Likewise,

$$e^{i\mathbf{v}\mathbf{G}/\hbar} \mathbf{p} e^{-i\mathbf{v}\mathbf{G}/\hbar} = \mathbf{p} + [i\mathbf{v}\mathbf{G}/\hbar, \mathbf{p}] + \cdots = \mathbf{p} + m\mathbf{v}. \quad (8.116)$$

Therefore the new Hamiltonian is

$$e^{i\mathbf{v}\mathbf{G}/\hbar} \frac{\mathbf{p}^2}{2m} e^{-i\mathbf{v}\mathbf{G}/\hbar} = \frac{(\mathbf{p} + m\mathbf{v})^2}{2m} = \frac{\mathbf{p}^2}{2m} + \mathbf{v}\mathbf{p} + \frac{m\mathbf{v}^2}{2}. \quad (8.117)$$

Contrary to translations and rotations which leave \mathbf{H} invariant, boosts do affect the Hamiltonian (that is, they modify the matrix which represents \mathbf{H}) but the functional relationship between \mathbf{H} and \mathbf{p} remains of course unchanged.

Schrödinger's equation in moving coordinates

The motion of a particle of mass m in a one-dimensional potential $V(x)$ is described by the Schrödinger equation:

$$i\hbar \frac{\partial \psi}{\partial t} = -\frac{\hbar^2}{2m} \frac{\partial^2 \psi}{\partial x^2} + V(x) \psi. \quad (8.118)$$

Let us transform this equation to a uniformly moving coordinate system, $x' = x + vt$ (and $t' \equiv t$). This is a passive transformation, which is equivalent to boosting the external potential $V(x)$ by a velocity \mathbf{v} . In quantum mechanics, this transformation involves not only a substitution of coordinates, but also a unitary transformation of ψ . Indeed, if we try to preserve the value of ψ at each spacetime point (that is, to treat ψ as if it were a scalar field), the transformed equation turns out to have a form essentially different from that of Eq. (8.118): it also contains a term $i\hbar v \partial \psi / \partial x'$. To eliminate the latter, one has to change the phase of ψ at each point:

$$\psi \rightarrow \psi' = e^{i(mvx' - mv^2t/2)/\hbar} \psi. \quad (8.119)$$

This gives the desired result,

$$i\hbar \frac{\partial \psi'}{\partial t} = -\frac{\hbar^2}{2m} \frac{\partial^2 \psi'}{\partial x'^2} + V(x' - vt) \psi', \quad (8.120)$$

which has the form of a Schrödinger equation with a moving potential.

Exercise 8.30 Work out explicitly the calculations giving Eq. (8.120). ★

Exercise 8.31 Carry out the same calculation for a uniformly accelerated coordinate system, $x' = x + \frac{1}{2} \gamma t^2$, and show that the transformed wave function,

$$\psi' = e^{i(m\gamma x't - m\gamma^2 t^3/6)/\hbar} \psi, \quad (8.121)$$

satisfies

$$i\hbar \frac{\partial \psi'}{\partial t} = -\frac{\hbar^2}{2m} \frac{\partial^2 \psi'}{\partial x'^2} + V(x' - \frac{1}{2} \gamma t^2) \psi' - m\gamma x' \psi'. \quad (8.122)$$

What is the physical meaning of the last term in this equation? ★

The unitary transformation of ψ in Eq. (8.119) appears to be different from the unitary transformation $e^{-ivG/\hbar}$ that was used in Eqs. (8.115) and (8.116). The reason for this difference is that the operator G in Eq. (8.113) was written in the Heisenberg picture, while Eqs. (8.118) and (8.120) are obviously written in the Schrödinger picture. At time $t = 0$, when these two pictures coincide, both unitary operators are the same, namely $e^{imvx/\hbar}$. Then, for $t \neq 0$, the explicit form of the operator (8.113) results from its being a constant of the motion. On the other hand, the factor $\exp(-imv^2t/2\hbar)$ in Eq. (8.119) is only a trivial phase adjustment which defines the zero on the new energy scale.

The Galilean group

The Galilean group includes translations in space and time, three dimensional rotations, and boosts. If the physical system consists of particles with masses m_A and canonical coordinates x_{Ak} and p_{Ak} , the boosts are generated by the Hermitian operators

$$G_k = \sum_A (t p_{Ak} - m_A x_{Ak}). \quad (8.123)$$

This expression is the obvious generalization of (8.113). It is easily seen that

$$[G_k, G_l] = 0. \quad (8.124)$$

This property is similar to $[p_k, p_l] = 0$ and merely expresses the fact that boosts in different directions commute.

We also have from (8.123)

$$[G_k, J_l] = i\hbar \epsilon_{klm} G_m, \quad (8.125)$$

which states that the generators of boosts are vector operators. Finally,

$$[\mathbf{G}_k, \mathbf{p}_l] = -i\hbar \delta_{kl} \sum_A m_A. \quad (8.126)$$

The last equation displays a novel feature: its right hand side is a c -number (or, if you prefer, it is a multiple of the unit operator). It is instructive to see how this c -number appears in a derivation of the value of $[\mathbf{G}_k, \mathbf{p}_l]$ based on the *geometric* properties of a sequence of translations and boosts, as when we derived the value of $[\mathbf{J}_m, \mathbf{p}_n]$ in Eq. (8.67), by considering alternating rotations and space translations. If we follow the same method, we find that coordinate translations and boosts commute. Therefore, in quantum theory, $[\mathbf{G}_k, \mathbf{p}_l]$ must be a c -number which commutes with everything, like the vector \mathbf{V} in

$$[\mathbf{p}_k, \mathbf{p}_l] = i\hbar^2 \sum_s \epsilon_{kls} V_s \mathbb{1}. \quad (8.55)$$

However, there is an important difference between $[\mathbf{G}_k, \mathbf{p}_l]$ and $[\mathbf{p}_k, \mathbf{p}_l]$. The latter is antisymmetric in the indices kl , while there is no such antisymmetry requirement for $[\mathbf{G}_k, \mathbf{p}_l]$. This gives us more flexibility for constructing an admissible right hand side for Eq. (8.126), because there is an invariant *symmetric* symbol δ_{kl} which can take care of the indices, and there is a physical quantity, *mass*, with the same dimensions as $\mathbf{G}\mathbf{p}/\hbar$. The right hand side of (8.126) thus becomes the geometric definition of the total mass of the system. The *mass* plays an explicit role in *spacetime* transformation properties.

We still have to find the commutator $[\mathbf{G}_k, \mathbf{H}]$. If translations in time, which are generated by \mathbf{H} , are a symmetry (*i.e.*, there is an equivalence between active and passive transformations) this commutator can likewise be obtained from Eq. (8.36) by considering alternating time translations and boosts. These are represented by the unitary transformations $\Omega \rightarrow e^{\mathbf{A}}\Omega e^{-\mathbf{A}}$ and $\Omega \rightarrow e^{\mathbf{B}}\Omega e^{-\mathbf{B}}$, respectively, with

$$\mathbf{A} = i\tau \mathbf{H}/\hbar \quad \text{and} \quad \mathbf{B} = i \sum_k v_k \mathbf{G}_k/\hbar. \quad (8.127)$$

Here, however, we must be careful when we specify the corresponding geometric transformations. While the unitary operator $e^{\mathbf{B}}$ generates the boost $\mathbf{r} \rightarrow \mathbf{r} + \mathbf{v}t$ as in Eq. (8.115), the operator $e^{\mathbf{A}}$ does *not* alter the time t , since the latter is *not* a dynamical variable. What $e^{\mathbf{A}}$ actually does is to modify all the dynamical variables in the following way: each variable is replaced by a new one, whose present value is equal to the value that the old variable will have a time τ later. For example, \mathbf{r} becomes $\mathbf{r} + \tau \dot{\mathbf{r}}$ (recall that higher powers of τ are discarded). We thus have, as in Eq. (8.67),

$$\begin{aligned} \mathbf{r} &\xrightarrow{\mathbf{A}} \mathbf{r}' = \mathbf{r} + \tau \dot{\mathbf{r}} \\ &\xrightarrow{\mathbf{B}} \mathbf{r}'' = \mathbf{r}' + \mathbf{v}t = \mathbf{r} + \tau \dot{\mathbf{r}} + \mathbf{v}t \\ &\xrightarrow{-\mathbf{A}} \mathbf{r}''' = \mathbf{r}'' - \tau \dot{\mathbf{r}}'' = \mathbf{r} + \mathbf{v}t - \mathbf{v}\tau \\ &\xrightarrow{-\mathbf{B}} \mathbf{r}'''' = \mathbf{r}''' - \mathbf{v}t = \mathbf{r} - \mathbf{v}\tau. \end{aligned} \quad (8.128)$$

The result of these four successive transformations is a translation by the infinitesimal vector $-\mathbf{v}\tau$. Invoking again Eq. (8.36), we obtain

$$\left[\sum_k v_k \mathbf{G}_k, \tau \mathbf{H} \right] = -i\hbar \sum_k v_k \tau \mathbf{p}_k. \quad (8.129)$$

Since this is valid for all values of τ and v_k , it follows that

$$[\mathbf{G}_k, \mathbf{H}] = -i\hbar \mathbf{p}_k. \quad (8.130)$$

Exercise 8.32 Show that (8.130) is satisfied by any Hamiltonian of type

$$\mathbf{H} = \sum_A (\mathbf{p}_A^2 / 2m_A) + \sum_{AB} V(\mathbf{r}_{AB}), \quad (8.131)$$

where $\mathbf{r}_{AB} = |\mathbf{r}_A - \mathbf{r}_B|$, so that V depends only on the distances between the various particles—not on their individual positions.

8-9. Relativistic invariance

The laws of physics are not invariant under a Galilean transformation, namely $\mathbf{r} \rightarrow \mathbf{r}' = \mathbf{r} + \mathbf{v}t$ and $t' = t$, even in the limit $v \ll c$. The equation $t' = t$ implies the existence of a universal time, independent of the motion of the clocks that are used to measure it. This is an unphysical assumption: in order to synchronize distant clocks in arbitrary motion, it is necessary to convey information between them, and there is no physical agent capable of doing that instantaneously. The best synchronization method that is available to us is the one that uses optical signals (or equivalent electromagnetic means) because the latter have the same, reproducible velocity in every inertial coordinate system. This implies that the times t and t' , associated with coordinate systems \mathbf{r} and \mathbf{r}' in uniform relative motion, are related by

$$c^2 t^2 - \mathbf{r}^2 = c^2 t'^2 - \mathbf{r}'^2, \quad (8.132)$$

where c is the invariant signal velocity. It follows that, together with the infinitesimal space transformation

$$\mathbf{r} \rightarrow \mathbf{r}' = \mathbf{r} + \mathbf{v}t, \quad (8.133)$$

there must be a time transformation,

$$t \rightarrow t' = t + \mathbf{v} \cdot \mathbf{r} / c^2. \quad (8.134)$$

These two equations define an infinitesimal Lorentz transformation. The latter does not reduce to a Galilean transformation for $v \ll c$, because Eq. (8.134) must hold for arbitrarily large \mathbf{r} . When $v \ll c$, we can neglect terms of order v^2/c^2 , but not those of first order in \mathbf{v} .

Exercise 8.33 Show that the Lorentz transformation for finite \mathbf{v} is given by

$$\mathbf{r}' \cdot \mathbf{v} = \gamma (\mathbf{r} \cdot \mathbf{v} + v^2 t) \quad \text{and} \quad \mathbf{r}' \times \mathbf{v} = \mathbf{r} \times \mathbf{v}, \quad (8.135)$$

and

$$t' = \gamma (t + \mathbf{v} \cdot \mathbf{r}/c^2), \quad (8.136)$$

where $\gamma = (1 - v^2/c^2)^{-1/2}$. **Hint:** Show that Eq. (8.132) is satisfied to all orders in \mathbf{v} , and that the infinitesimal transformations (8.133) and (8.134) are recovered when one neglects v^2/c^2 and higher powers of v/c .

The time transformation law (8.136) involves explicitly the position \mathbf{r} . This leads to amusing counter-intuitive phenomena, such as the “twin paradox.” On the serious side, this creates difficulties in the canonical formalism, if we want the dynamical variables \mathbf{q} to transform like the geometric coordinates \mathbf{r} , so that the physical meaning of \mathbf{q} is that of a position in space. Obviously, we cannot have, in the canonical formalism, $t' = t + \mathbf{v} \cdot \mathbf{q}/c^2$, since t and t' are numerical parameters (c -numbers) while \mathbf{q} is a dynamical variable (or an operator, in quantum theory). This is even more obvious if there are several particles, each one with its own position variable \mathbf{q}_A , while there is (in the canonical, or Schrödinger, formalism) a single time, t or t' , in each one of the two reference frames whose relative velocity is \mathbf{v} .

Relativistic canonical dynamics

It is common to present the theory of relativity as the intimate union of space and time into a single concept—the four-dimensional spacetime of Minkowski. The dynamical laws can be written, concisely and elegantly, in terms of derivatives with respect to a “proper time” $d\tau^2 = dt^2 - d\mathbf{r}^2/c^2$. The relativistic invariance of an equation can be established at once, by mere inspection of its tensorial indices.

Unfortunately, this four-dimensional formalism becomes quite awkward when canonical quantization is contemplated, because algebraic constraints such as $\sum g_{\mu\nu} p^\mu p^\nu = m^2 c^2$ are difficult to handle in a quantized formalism. Moreover, if several particles are involved, there are as many proper times as there are particles, while a *single* wave function has to be used to describe the quantum correlations of a multiparticle system. It is therefore preferable to abandon the elegant four-dimensional formalism and to return to the old fashioned separation of the space and time variables. But then, the relativistic invariance of an equation can no longer be proved simply by inspecting its tensorial indices. More sophisticated methods are needed for deciding whether a theory is, or is not, relativistic. Remember that more than thirty years elapsed between the publication of Maxwell’s equations, and the proof by Lorentz that these equations were invariant under the Lorentz group.

Traditionally, the first step in the quantization of a classical¹⁹ system is to write its equations of motion in canonical form. The conditions for compatibility of these canonical equations of motion with the requirements of special relativity were not clear for many years, until they were finally analyzed by Dirac.²⁰ In essence, Dirac's argument was that if a canonical formulation is possible in one Lorentz frame, it should be possible in every Lorentz frame (by the principle of relativity). Therefore a Lorentz transformation must be a canonical transformation of the dynamical variables—for the same reason that an ordinary spatial rotation is a canonical transformation.

The existence of a relativistic canonical formalism thus demands that the dynamical laws be invariant under the coordinate transformations (8.135) and (8.136), and *moreover* that there be a canonical (or unitary) transformation of the dynamical variables \mathbf{q}_A and \mathbf{p}_A belonging to each particle, such that each \mathbf{q}_A behaves as the geometric coordinate \mathbf{r} in Eq. (8.135). It is not obvious that all these demands can be simultaneously fulfilled (*i.e.*, that the canonical formalism is compatible with relativity theory).

Let us first examine the case of a single free particle, with canonical variables $\mathbf{q}(t)$ and $\mathbf{p}(t)$. The existence of a canonical (or unitary) representation of the Lorentz transformation can be demonstrated as follows. Consider

$$\mathbf{q}(t) \rightarrow \mathbf{q}'(t) \equiv \mathbf{q}(t) + \delta\mathbf{q}(t). \quad (8.137)$$

Note that a single time t appears everywhere in this equation (there is no t'). Indeed, a classical¹⁹ canonical transformation, or a quantum unitary transformation, does not modify the time, which is not a dynamical variable. The effect of a Lorentz transformation is, to first order in \mathbf{v}

$$\begin{aligned} \delta\mathbf{q}(t) &= \mathbf{q}'(t) - \mathbf{q}(t) \\ &= \mathbf{q}'(t' - \mathbf{v} \cdot \mathbf{r}/c^2) - \mathbf{q}(t) \\ &= \mathbf{q}'(t') - (\mathbf{v} \cdot \mathbf{r}/c^2) \dot{\mathbf{q}}'(t') - \mathbf{q}(t), \end{aligned} \quad (8.138)$$

where use was made of the infinitesimal transformation of time (8.134) and the result expanded to first order in \mathbf{v} . We further note that, if the dynamical variable \mathbf{q} transforms as the geometric coordinate \mathbf{r} , we have

$$\mathbf{q}'(t') = \mathbf{q}(t) + \mathbf{v}t, \quad (8.139)$$

by virtue of Eq. (8.133). This means that world-lines are invariant under the canonical transformation which implements a given Lorentz transformation. We can therefore replace \mathbf{r} , in Eq. (8.138), by \mathbf{q} . We can also replace $\dot{\mathbf{q}}'(t')$ by $\dot{\mathbf{q}}(t)$, because the difference is of first order in \mathbf{v} , and is itself multiplied by \mathbf{v} . We thus obtain

¹⁹The word "classical" is used here as the opposite of "quantized" (not as the opposite of "relativistic").

²⁰P. A. M. Dirac, *Rev. Mod. Phys.* 21 (1949) 392.

$$\delta \mathbf{q}(t) = \mathbf{v}t - (\mathbf{v} \cdot \mathbf{q}/c^2) \dot{\mathbf{q}}(t), \quad (8.140)$$

which can be written in terms of Poisson brackets as

$$\delta \mathbf{q}(t) = [\mathbf{q}, \mathbf{v}t \cdot \mathbf{p}]_{\text{PB}} - [\mathbf{q}, (\mathbf{v} \cdot \mathbf{q}/c^2) H]_{\text{PB}}. \quad (8.141)$$

We thus see that the infinitesimal transformation (8.137) is a canonical transformation, generated by $\mathbf{v} \cdot \mathbf{K}$, where

$$\mathbf{K} := t \mathbf{p} - H \mathbf{q}/c^2, \quad (8.142)$$

is the Lorentz boost generator. The corresponding quantum expression is

$$\mathbf{K}_j := t \mathbf{p}_j - (H x_j + x_j H)/2c^2. \quad (8.143)$$

Comparison with the Galilean boost operator (8.123) shows that, instead of the mass m , we now have H/c^2 . This is a nontrivial dynamical variable which, unlike m , does not commute with everything.

Poincaré group algebra

The Poincaré group (also called inhomogeneous Lorentz group) consists of translations in space and time, rotations, and Lorentz boosts. These are generated by \mathbf{p}_n , H , \mathbf{J}_n , and \mathbf{K}_n , respectively.

Let us find the commutation relations between \mathbf{K}_n and the other generators. If the physical system is invariant under spatial translations and rotations, so that H commutes with \mathbf{p}_m and \mathbf{J}_m , we have, from (8.143),

$$[\mathbf{p}_m, \mathbf{K}_n] = i\hbar \delta_{mn} H/c^2, \quad (8.144)$$

and

$$[\mathbf{J}_m, \mathbf{K}_n] = i\hbar \sum_s \epsilon_{mns} \mathbf{K}_s. \quad (8.145)$$

To find $[H, \mathbf{K}_n]$ without the explicit knowledge of H , we proceed as in the derivation of $[H, \mathbf{G}_n]$, by considering alternating time translations and boosts. The new feature here is that boosts are given by Eq. (8.140), rather than simply $\delta \mathbf{r} = \mathbf{v}t$. Nevertheless, the final result is the same as in Eq. (8.128):

$$\begin{aligned} \mathbf{r} &\xrightarrow{\text{A}} \mathbf{r}' = \mathbf{r} + \tau \dot{\mathbf{r}} \\ &\xrightarrow{\text{B}} \mathbf{r}'' = \mathbf{r}' + \mathbf{v}t - (\mathbf{v} \cdot \mathbf{r}'/c^2) \dot{\mathbf{r}}' \\ &\quad = \mathbf{r} + \tau \dot{\mathbf{r}} + \mathbf{v}t - (\mathbf{v} \cdot \mathbf{r}/c^2) \dot{\mathbf{r}} - \tau (\mathbf{v} \cdot \dot{\mathbf{r}}/c^2) \dot{\mathbf{r}} - \tau (\mathbf{v} \cdot \mathbf{r}/c^2) \ddot{\mathbf{r}} \\ \hline &\xrightarrow{\text{A}} \mathbf{r}''' = \mathbf{r}'' - \tau \dot{\mathbf{r}}'' = \mathbf{r} + \mathbf{v}t - \mathbf{v}\tau - (\mathbf{v} \cdot \mathbf{r}/c^2) \dot{\mathbf{r}} \\ &\xrightarrow{\text{B}} \mathbf{r}'''' = \mathbf{r}''' - \mathbf{v}t + (\mathbf{v} \cdot \mathbf{r}'''/c^2) \dot{\mathbf{r}}''' = \mathbf{r} - \mathbf{v}\tau. \end{aligned} \quad (8.146)$$

Recall that throughout this derivation, all terms proportional to τ^2 or v^2 are discarded. We thus obtain, as in Eq. (8.130),

$$[\mathbf{H}, \mathbf{K}_n] = i\hbar \mathbf{p}_n. \tag{8.147}$$

On the other hand, in the special case of a single particle, we have, from the explicit expression for \mathbf{K}_n , given in (8.143),

$$[\mathbf{H}, \mathbf{K}_n] = -(\mathbf{H}[\mathbf{H}, \mathbf{x}_n] + [\mathbf{H}, \mathbf{x}_n]\mathbf{H})/2c^2 = i\hbar (\mathbf{H} \dot{\mathbf{x}}_n + \dot{\mathbf{x}}_n \mathbf{H})/2c^2. \tag{8.148}$$

Comparison with (8.147) gives $\dot{\mathbf{x}}_n = c^2 \mathbf{p}_n / \mathbf{H}$. The same result can be obtained by noting that

$$[\mathbf{H}^2 - \mathbf{p}^2 c^2, \mathbf{K}_n] = \mathbf{0}, \tag{8.149}$$

by virtue of (8.144) and (8.147). Since $(\mathbf{H}^2 - \mathbf{p}^2 c^2)$ also commutes with \mathbf{H} , with \mathbf{p}_n , and with \mathbf{J}_n , it must be a Lorentz scalar (either a c -number, or an operator which depends only on Lorentz invariant internal properties of the physical system). We can therefore define the total *mass* of the system by

$$m^2 c^4 := \mathbf{H}^2 - \mathbf{p}^2 c^2. \tag{8.150}$$

Exercise 8.34 Derive $\dot{\mathbf{x}}_n = c^2 \mathbf{p}_n / \mathbf{H}$ from the preceding relation.

We still have to find the $[\mathbf{K}_m, \mathbf{K}_n]$ commutator. Using the same method as in Eq. (8.146), we consider consecutive boosts with velocities \mathbf{u} and \mathbf{v} :

$$\begin{aligned} \mathbf{r} &\xrightarrow{\mathbf{A}} \mathbf{r}' = \mathbf{r} + \mathbf{u} t - (\mathbf{u} \cdot \mathbf{r} / c^2) \dot{\mathbf{r}} \\ &\xrightarrow{\mathbf{B}} \mathbf{r}'' = \mathbf{r}' + \mathbf{v} t - (\mathbf{v} \cdot \mathbf{r}' / c^2) \dot{\mathbf{r}}' \\ &= \mathbf{r} + \mathbf{u} t + \mathbf{v} t - (\mathbf{u} \cdot \mathbf{r} / c^2) \dot{\mathbf{r}} - (\mathbf{v} \cdot \mathbf{r} / c^2) \dot{\mathbf{r}} - (\mathbf{v} \cdot \mathbf{u} t / c^2) \dot{\mathbf{r}} \\ &\quad + (\mathbf{v} \cdot \dot{\mathbf{r}})(\mathbf{u} \cdot \mathbf{r}) \dot{\mathbf{r}} / c^4 + (\mathbf{v} \cdot \mathbf{r})(\mathbf{u} \cdot \dot{\mathbf{r}}) \dot{\mathbf{r}} / c^4 + (\mathbf{v} \cdot \mathbf{r})(\mathbf{u} \cdot \mathbf{r}) \ddot{\mathbf{r}} / c^4 \\ &\quad - (\mathbf{v} \cdot \mathbf{r} / c^2) \mathbf{u}. \end{aligned} \tag{8.151}$$

After only two steps, this partial result seems frightening. Actually it is quite innocuous, because most of its terms are symmetric under the exchange of \mathbf{u} and \mathbf{v} , and will disappear when we perform the additional boosts, by $-\mathbf{u}$ and $-\mathbf{v}$. This can be seen by using Eq. (8.37) instead of Eq. (8.36). We substitute in that equation $\lambda \mathbf{A} = \mathbf{u} \cdot \mathbf{K} / i\hbar$ and $\lambda \mathbf{B} = \mathbf{v} \cdot \mathbf{K} / i\hbar$, and we obtain, for the Heisenberg operator $\Omega_{\mathbf{H}} = \mathbf{r}$,

$$\begin{aligned} -[[\mathbf{u} \cdot \mathbf{K} / i\hbar, \mathbf{v} \cdot \mathbf{K} / i\hbar], \mathbf{r}] &= (\mathbf{u} \cdot \mathbf{r} / c^2) \mathbf{v} - (\mathbf{v} \cdot \mathbf{r} / c^2) \mathbf{u} \\ &\equiv (\mathbf{u} \times \mathbf{v}) \times \mathbf{r} / c^2. \end{aligned} \tag{8.152}$$

All the other terms that appeared on the right hand side of Eq. (8.151) mutually cancel. The final result in (8.152) is the same as the variation of the Heisenberg operator \mathbf{r} due to a rotation by an infinitesimal angle $(\mathbf{u} \times \mathbf{v}) / c^2$, namely $\delta \mathbf{r} = -[(\mathbf{u} \times \mathbf{v}) \cdot \mathbf{J} / i\hbar c^2, \mathbf{r}]$. We thus have

$$\left[\sum_m u_m \mathbf{K}_m, \sum_n v_n \mathbf{K}_n \right] = -i\hbar \sum_{mns} (\epsilon_{mns} u_m v_n / c^2) \mathbf{J}_s, \tag{8.153}$$

and since this is valid for every \mathbf{u} and \mathbf{v} , it follows that

$$[\mathbf{K}_m, \mathbf{K}_n] = -i\hbar \sum_{m,n,s} \epsilon_{mns} \mathbf{J}_s / c^2. \quad (8.154)$$

You probably wonder why I gave this tedious derivation of (8.154), based on the *nonlinear* transformation (8.140), while it would have been much easier to derive the Lie algebra of the Poincaré group from the *linear* transformations (8.133) and (8.134), and still easier to obtain these results by using a manifestly covariant four dimensional formalism (as is done in most textbooks). The reason for this long derivation is that I wanted to write Lorentz boosts as *canonical* (or unitary) transformations, in order to show the consistency of special relativity with the canonical formalism (or with quantum theory). This is not at all a trivial matter, as will be seen in the next section.

8-10. Forms of relativistic dynamics

If the state vector of a free spinless particle is written as $\psi(\mathbf{q}, t)$, the generators of the Poincaré group are $\mathbf{p} = i\hbar \partial / \partial \mathbf{q}$, $H = (m^2 c^4 + \mathbf{p}^2 c^2)^{1/2}$, $\mathbf{J} = \mathbf{q} \times \mathbf{p}$, and \mathbf{K} given by Eq. (8.143). If we have several noninteracting particles, described by a state vector $\psi(\mathbf{q}_1, \mathbf{q}_2, \dots, t)$, the generators are ordinary sums, namely $\mathbf{p} = \sum \mathbf{p}_A$, $H = \sum H_A$, etc. Note that each particle has three coordinates (and three momenta) but *there is only one time* in the canonical formalism.

Difficulties appear when we want to introduce interactions. If we try to write $H = H_0 + V$, or more generally $H \neq \sum H_A$, either \mathbf{p} or \mathbf{K} (or both) must change and include an interaction term, to ensure the validity of Eq. (8.144): $[\mathbf{p}_m, \mathbf{K}_n] = i\hbar \delta_{mn} H / c^2$. This commutator expresses a *kinematical* relationship between Lorentz boosts and translations in space and time, and it cannot be affected by the presence of Lorentz invariant dynamical interactions.

On the other hand, if we want to interpret the dynamical variables \mathbf{q}_A as *physical positions* in space, we must retain $\mathbf{p} = -i\hbar \sum_A \partial / \partial \mathbf{q}_A$, and also define \mathbf{K} in such a way that the Lorentz transformation law (8.140) is satisfied. When there is more than one particle, this transformation law becomes

$$\delta \mathbf{q}_A(t) = \mathbf{v}t - [(\mathbf{v} \cdot \mathbf{q}_A) \dot{\mathbf{q}}_A + \dot{\mathbf{q}}_A (\mathbf{v} \cdot \mathbf{q}_A)] / 2c^2. \quad (8.155)$$

As already explained, this is the necessary condition for world lines to remain invariant under a canonical Lorentz transformation (a boost by a velocity \mathbf{v}).

Exercise 8.35 *Rephrase the last statement in quantum language, using wave packets and mean values.*

The transformation law (8.155) will hold if we have, as in Eq. (8.143),

$$\mathbf{K} = t \mathbf{p} - (H \mathbf{q}_A + \mathbf{q}_A H) / 2c^2 + \mathbf{Z}_A, \quad (8.156)$$

where \mathbf{Z}_A is any vector operator commuting with \mathbf{q}_A . However, the generator \mathbf{K} belongs to the entire physical system, and its form cannot give a privileged status to the particle labelled A . In the case of *noninteracting* particles, with $\mathbf{H} = \sum \mathbf{H}_A$, this causes no difficulty, because we can take

$$\mathbf{Z}_A = \sum_{B \neq A} [\mathbf{H}_B (\mathbf{q}_B - \mathbf{q}_A) + (\mathbf{q}_B - \mathbf{q}_A) \mathbf{H}_B] / 2c^2, \quad (8.157)$$

so that, in Eq. (8.156), we have $\mathbf{K} = \sum \mathbf{K}_A$. If, on the other hand, \mathbf{H} includes an interaction, it can be shown^{21,22} that this problem has no other solution than pure contact forces (that is, $\mathbf{H} \neq \mathbf{H}_0$ only if $\mathbf{q}_A = \mathbf{q}_B$).

There have been attempts to overcome this "no go theorem" by relaxing the traditional identification of the canonical coordinates \mathbf{q}_A with the physical positions of the particles. At first sight, there seems to be nothing wrong if the physical positions \mathbf{r}_A (which transform as geometrical coordinates under the Poincaré group) are complicated functions of the canonical variables \mathbf{q}_A and \mathbf{p}_A . Possibly, the \mathbf{r}_A may not commute with each other. After all, there are other respectable dynamical variables, such as the components of \mathbf{J} , which do not commute, and therefore cannot be simultaneously ascribed sharp values. This has no harmful consequences, other than the impossibility of writing a classical Lagrangian in terms of these variables and their time derivatives. It thus seems that one can easily forego the requirement that the canonical \mathbf{q}_A transform like geometrical coordinates.

However, it is not so. If no restriction is put on how the canonical coordinates \mathbf{q}_A behave under a Lorentz transformation, the principle of relativity becomes vacuous: Given any \mathbf{H} , \mathbf{P} and \mathbf{J} satisfying the usual commutation relations, it is always possible to construct a vector operator \mathbf{K} which also satisfies all the required commutation relations.²³ Therefore, the existence of dynamical variables satisfying the algebra of the Poincaré group generators is not in itself a guarantee of Lorentz invariance. Other demands, such as cluster decomposition, must be satisfied to obtain a proper physical interpretation.²³

Alternative approaches

Dirac²⁰ attempted to overcome these difficulties by radically modifying the canonical formalism: states would not be defined for a given value of t , but on a Lorentz invariant hypersurface, such as the hyperboloid $c^2 t^2 - \mathbf{r}^2 = \mathbf{a}^2$, or the null plane $ct = z$. This new approach gave to some equations a more symmetric aspect but, contrary to Dirac's hope, it did not allow the introduction of nontrivial interactions.

The only relativistic canonical formalism, including interactions, known at the present time, is *field theory*. A field $\Phi(x, y, z, t)$ is an *infinite* set of dynamical variables. The space coordinates x, y, z are not operators, but numerical

²¹D. G. Currie, T. F. Jordan, and E. C. G. Sudarshan, *Rev. Mod. Phys.* 35 (1963) 350.

²²H. Leutwyler, *Nuovo Cimento* 37 (1965) 556.

²³A. Peres, *Phys. Rev. Lett.* 27 (1971) 1666.

parameters (c -numbers) which serve as *labels* for these variables. Their role is similar to that of the labels A attached to the dynamical variables \mathbf{q}_A and \mathbf{p}_A which describe a finite set of particles. The infinite number of dynamical field variables gives rise to new difficulties: *divergent sums over states*, far worse than those appearing when there is a finite number of continuous variables. These new difficulties, which were briefly discussed at the end of Chapter 4, can be circumvented by a technique called *renormalization* (this topic is far beyond the scope of the present book).

The condition that a field theory must satisfy to be relativistic is the equal-time commutation relation^{24,25}

$$[\mathcal{H}(\mathbf{x}), \mathcal{H}(\mathbf{y})] = -i\hbar \sum_k [\mathcal{P}^k(\mathbf{x}) + \mathcal{P}^k(\mathbf{y})] \frac{\partial}{\partial x^k} \delta(\mathbf{x} - \mathbf{y}), \quad (8.158)$$

where $H(\mathbf{x})$ is the Hamiltonian density and $P^k(\mathbf{x})$ is the momentum density of the field. Examples are given in the following exercises:

Exercise 8.36 Verify the validity of Eq. (8.158) for a real scalar field with Lagrangian density $\mathcal{L} = \frac{1}{2}(c^{-2}\dot{\Phi}^2 - \nabla\Phi \cdot \nabla\Phi - \kappa^2\Phi^2)$.

Exercise 8.37 Verify the validity of Eq. (8.158) for the electromagnetic field, whose Lagrangian density is $\mathcal{L} = \frac{1}{2}(\mathbf{E}^2 - \mathbf{B}^2)$. ★

There is still another formulation of relativistic quantum dynamics, which was first proposed by Heisenberg,²⁶ and was very popular in the 1960's. It is the S -matrix theory, which makes no attempt to describe a continuous time evolution, and only relates asymptotic states, for $t \rightarrow \pm\infty$. The elements of the S -matrix are called *scattering amplitudes*. The fundamental axioms of S -matrix theory are analyticity of the scattering amplitudes (as functions of the kinematical variables of the incoming and outgoing particles), unitarity, and crossing symmetry. The latter is a requirement that amplitudes for given incoming particles be the analytic continuation of amplitudes for the corresponding outgoing antiparticles, and vice versa.^{27,28}

The S -matrix formalism is not restricted to scattering problems. While it is convenient to use plane waves (momentum "eigenstates") to label the elements of the S -matrix, the initial and final states may be arbitrary linear superpositions of these plane waves, such as wave packets prepared and observed at finite times.^{29,30} It can be proved from the analytic properties of the S -matrix, in particular from its *pole structure*, that if the final state (the observation

²⁴P. A. M. Dirac, *Rev. Mod. Phys.* 34 (1962) 592.

²⁵J. Schwinger, *Phys. Rev.* 127 (1962) 324.

²⁶W. Heisenberg, *Z. Phys.* 120 (1943) 513, 673.

²⁷G. F. Chew, *S-Matrix Theory of Strong Interactions*, Benjamin, New York (1962).

²⁸R. J. Eden, P. V. Landshoff, D. I. Olive, and J. C. Polkinghorne, *The Analytic S-Matrix*, Cambridge Univ. Press (1966).

²⁹H. P. Stapp, *Phys. Rev. B* 139 (1965) 257.

³⁰A. Peres, *Ann. Phys. (NY)* 37 (1966) 179.

procedure) is localized outside the future light cone of the initial state (the preparation procedure), the probability for a successful observation becomes vanishingly small. There is no need to impose, as an extraneous condition in the theory, that there be no observations outside the future light cone of the preparations. We only need an unequivocal distinction between preparations (“active” inputs) and observations (“passive” outputs).

The weakness of “pure” S -matrix theory is that it is unable to produce *ab initio* calculations. The general principles of analyticity, unitarity, and crossing symmetry, allow one to derive many useful relationships between observable quantities, but are not strong enough to perform complete calculations. Despite heroic efforts by its proponents, S -matrix theory did not supplant quantum field theory as the leading approach to relativistic quantum theory.

8-11. Space reflection and time reversal

Most physical laws are invariant not only under translations and rotations of the coordinate system, but also under inversions of the space and/or time coordinates. While it is in general impossible to reflect a physical object, it is often possible to prepare an object which is the mirror image of the original one. One cannot then distinguish a picture of the reflected object from one of the original object, viewed in a mirror. This is a *symmetry*, as defined at the beginning of this chapter. Likewise, time cannot be made to run backwards, but many elementary physical phenomena, such as the motion of an ideal pendulum, are invariant under a reversal of time. If we make a movie of the pendulum and then run that movie backward in time, the result will represent a possible motion of the same pendulum.

Quantum theory treats these two symmetries in radically different ways, because the space coordinates of a particle are dynamical variables and are represented by operators, while time is a numerical parameter (a c -number). Moreover, space reflection is defined with respect to some plane, for example $(x, y, z) \rightarrow (x, y, -z)$; and likewise space inversion is defined with respect to a center, as in $(x, y, z) \rightarrow (-x, -y, -z)$. These two operations are related by a 180° rotation around the z -axis. On the other hand, time reversal is not a formal relabelling of t as $-t$. It is the inversion of a *process*, whereby the initial state becomes the final state, and vice versa.

Space reflection

If space reflection is a symmetry of the physical system, it preserves transition probabilities; therefore, by Wigner's theorem, its representation in Hilbert space, $\psi \rightarrow \psi' = R\psi$, is either a unitary or an antiunitary mapping. We shall now see that it can only be unitary.

The simplest way of representing a reflection is $\psi'(x) = \psi(-x)$. This is a unitary transformation, because

$$\int \overline{\phi'(x)} \psi'(x) dx = \int \overline{\phi(-x)} \psi(-x) dx = \int \overline{\phi(x)} \psi(x) dx. \quad (8.159)$$

Exercise 8.38 Show that if $\rho = -i\hbar\partial/\partial x$, then $\langle R^\dagger \rho R \rangle = -\langle \rho \rangle$.

We now easily see that the antiunitary transformation law $\psi'(x) = \overline{\psi(-x)}$ would not be acceptable. It would leave $\langle \rho \rangle$ invariant, while we expect the sign of $\langle \rho \rangle$ to change, as in the preceding exercise. Moreover, an energy eigenstate, $\psi = e^{-iEt/\hbar} f(x)$, would become $e^{+iEt/\hbar} f(-x)$, with the opposite sign of energy. This is impossible if the Hamiltonian has a semi-infinite spectrum, bounded below (that is, if the system has a ground state).

Another unitary transformation, more general than the one in Eq. (8.159), is $R\psi(x) = e^{i\alpha}\psi(-x)$, where α is an arbitrary phase. If we want two consecutive reflections to restore the original state, we must have $e^{i\alpha} = \pm 1$. The \pm sign is a characteristic property of the particle whose state is reflected. This sign is called the *intrinsic parity* of that particle, and its effect becomes manifest in reactions where particles of that type are produced or absorbed.

Exercise 8.39 Show that $J_m = \sum \epsilon_{mns} x_n p_s$ is invariant under inversions.

Time reversal

Time reversal (for which a better name would have been *motion reversal*) is defined as follows. Consider the unitary evolution

$$\mathbf{v}(t_2) = \mathbf{U}(t_2, t_1) \mathbf{v}(t_1). \quad (8.80)$$

If the dynamical properties of the system are symmetric under time reversal, there exists a mapping $\mathbf{v}(t_j) \rightarrow \mathbf{v}^T(t_j)$ such that the *same* unitary operator $\mathbf{U}(t_2, t_1)$, which transforms $\mathbf{v}(t_1)$ into $\mathbf{v}(t_2)$, also transforms $\mathbf{v}^T(t_2)$ into $\mathbf{v}^T(t_1)$:

$$\mathbf{v}^T(t_1) = \mathbf{U}(t_2, t_1) \mathbf{v}^T(t_2). \quad (8.160)$$

We then have, from Eqs. (8.80) and (8.160),

$$\langle \mathbf{v}(t_2), \mathbf{v}^T(t_1) \rangle = \langle \mathbf{v}(t_1), \mathbf{v}^T(t_2) \rangle. \quad (8.161)$$

Since these two inner products are antilinear in $\mathbf{v}(t_1)$ and $\mathbf{v}(t_2)$ it follows that $\mathbf{v}^T(t_j)$ must be an antilinear function of $\mathbf{v}(t_j)$. Therefore time reversal is an *antiunitary* mapping.

This result was first derived by Wigner.³¹ There have been attempts to define time reversal in other ways,^{32,33} but Wigner's definition is the one which is now universally adopted.

³¹ E. P. Wigner, *Göttinger Nachrichten, Math.-Phys.* 31 (1932) 546.

³² G. Racah, *Nuovo Cimento* 14 (1937) 322.

³³ J. Schwinger, *Phys. Rev.* 82 (1951) 914.

Exercise 8.40 Show that $\langle p \rangle$ and $\langle J \rangle$ change sign under time reversal.

Another important symmetry is *charge conjugation* (a better name would have been: particle-antiparticle exchange). A fundamental theorem of quantum field theory states that any Lorentz invariant local field theory must be invariant under the combined operations of space reflection, time reversal, and charge conjugation.^{34,35}

8-12. Bibliography

More details on these topics can be found in specialized books, such as

F. R. Halpern, *Special Relativity and Quantum Mechanics*, Prentice-Hall, Englewood Cliffs (1968).

J. J. Sakurai, *Invariance Principles and Elementary Particles*, Princeton Univ. Press (1964).

P. Ramond, *Field Theory: A Modern Primer*, Addison-Wesley, Redwood City (1989).

J. Wess and J. Bagger, *Supersymmetry and Supergravity*, Princeton Univ. Press (1983).

Supersymmetry is an extension of relativistic spacetime symmetry, which incorporates internal properties of particles. It allows bosons and fermions to appear in the same supermultiplet representation.

Recommended reading

E. Wigner, "On the unitary representations of the inhomogeneous Lorentz group." *Ann. Math.* 40 (1939) 149 [reprinted in *Nucl. Phys. B (Proc. Suppl.)* 6 (1989) 9].

P. A. M. Dirac, "Forms of relativistic dynamics," *Rev. Mod. Phys.* 21 (1949) 392; "The conditions for a quantum field theory to be relativistic," *ibid.* 34 (1962) 592.

L. L. Foldy, "Synthesis of covariant particle equations," *Phys. Rev.* 102 (1956) 568.

R. Peierls, "Spontaneously broken symmetries," *J. Phys. A* 24 (1991) 5273.

S. N. Mosley and J. E. G. Farina, "Quantum mechanics on the light cone: I. the spin zero case; II. the spin $\frac{1}{2}$ case," *J. Phys. A* 25 (1992) 4673, 4687.

³⁴ G. Lüders, *Ann. Phys. (NY)* 2 (1957) 1.

³⁵ R. Jost, *Helv. Phys. Acta* 30 (1957) 409.

Chapter 9

Information and Thermodynamics

9-1. Entropy

Let us perform a quantum test on a physical system that was prepared in a known way. Prior to the test, we can only predict *probabilities* for the possible outcomes. As the test is performed, one of these outcomes materializes, and we have a certainty. A quantitative measure for the average amount of information that we expect to gain in this test can be defined as follows. Let p_1, \dots, p_N be the known probabilities of the various outcomes of the test that we intend to perform. Namely, if we imagine the same test applied to n identically prepared systems, and if n is a large number, we expect about $n_j = n p_j$ outcomes of type j . From our knowledge of the preparation of the physical systems, we can predict the relative frequencies of these outcomes, but not the order in which individual outcomes occur (as for example in Fig. 1.3, page 6). The number of different possibilities to arrange these n outcomes is $n!/(n_1!n_2!\dots)$. If $n \rightarrow \infty$, all the n_j are large and we have, by Stirling's approximation,

$$\log \frac{n!}{n_1!n_2!\dots} \simeq n \log n - n - \sum_j (n_j \log n_j - n_j) = -n \sum_j p_j \log p_j. \quad (9.1)$$

The expression

$$S := - \sum_{j=1}^N p_j \log p_j, \quad (9.2)$$

is called the *entropy* of the probability distribution $\{p_1, \dots, p_N\}$. It is a measure of our ignorance, prior to the test.

It is easy to see that S is maximum when all the p_j are equal to $1/N$. In order to avoid dealing with the constraint $\sum p_j = 1$, let us rewrite (9.2) as

$$S = - \sum_{j=1}^{N-1} p_j \log p_j - p_N \log p_N, \quad (9.3)$$

where p_N is defined by

$$p_N \equiv 1 - \sum_{j=1}^{N-1} p_j, \quad (9.4)$$

and all the other p_j are considered as independent variables. We obtain

$$\partial S / \partial p_k = -\log p_k + \log p_N, \quad (9.5)$$

which vanishes when $p_k = p_N = 1/N$. This is the only extremum of S .

In general, the entropy S depends not only on the preparation process, but also on the choice of the test with respect to which the probabilities p_k are defined. If for *every* test we have maximal ignorance, namely $p_k = 1/N$, the preparation is called a *random mixture* (see Postulate C, page 31), and it is represented by the density matrix

$$\rho_{mn} = \delta_{mn} / N. \quad (9.6)$$

For example, a photon coming from a thermal source is called “unpolarized,” to say that, in *any* unbiased polarization test, both outcomes are equally likely.

The other extreme is a *pure state*, with $\rho^2 = \rho$, as in Eq. (3.80), page 73. This relation implies the existence of a vector v such that

$$\rho_{mn} = v_m \overline{v_n}. \quad (9.7)$$

A pure state as in Eq. (9.7) corresponds to the maximal amount of information which can be supplied on the preparation of a quantum system (Postulate A, page 30). Intermediate cases, as in Eq. (3.78), page 73, correspond to *partial information* on the preparation of a state.

Exercise 9.1 *Photons are prepared by a process that has a 70% probability of producing right handed circular polarization, and a 30% probability of producing left handed circular polarization. What is the entropy of these photons in a test for circular polarization? In a test for linear polarization? Ans.:* 0.61086 and 0.69315, respectively.

Exercise 9.2 *Photons are prepared by a process that has a 70% probability of producing right handed circular polarization, and a 30% probability of producing them linearly polarized in the x direction. What is the entropy of these photons in a test for circular polarization? In a test for linear polarization in the x direction? Ans.:* 0.42271 and 0.64745, respectively.

The notion of entropy originally arose in classical thermodynamics and was later introduced in information theory by Shannon.¹ It will be shown later in this chapter that there is a close relationship between these two definitions

¹ C. E. Shannon, *Bell Syst. Tech. J.* 27 (1948) 379, 623.

of entropy. In particular, the thermodynamic arrow of time which arises in irreversible phenomena is equivalent to the asymmetry between past and future which is intrinsic in the processing of information.

Physicists usually include in the definition of entropy an extra factor equal to Boltzmann's constant. Information theorists use logarithms with base 2. In the latter case, the unit of entropy (or of information) is called a *bit* (from abbreviation of *binary digit*).

Concave functions

An important property of entropy is that $S(p)$ is a *concave function* of its arguments p_1, \dots, p_N . This means that for any two probability distributions $\{p'_j\}$ and $\{p''_j\}$, and for any λ such that $0 \leq \lambda \leq 1$, we have

$$S[\lambda p' + (1 - \lambda)p''] \geq \lambda S(p') + (1 - \lambda) S(p''). \tag{9.8}$$

The physical meaning of this inequality is that mixing different probability distributions can only increase uniformity. The proof of (9.8) follows from

$$\frac{d^2 S[\lambda p' + (1 - \lambda)p'']}{d\lambda^2} \equiv - \sum_j \frac{(p'_j - p''_j)^2}{\lambda p'_j + (1 - \lambda)p''_j} \leq 0, \tag{9.9}$$

which is a sufficient condition for a function to be concave.² Moreover, this second derivative can vanish only if every $p'_j = p''_j$.

Exercise 9.3 *Prove by induction that if $\lambda_\mu > 0$ and $\sum \lambda_\mu = 1$, and also $p_{\mu j} \geq 0$ and $\sum_j p_{\mu j} = 1$, then*

$$S(\sum_\mu \lambda_\mu p_{\mu j}) \geq \sum_\mu \lambda_\mu S(p_{\mu j}). \tag{9.10}$$

Suppose that the properties of a quantum system are specified by giving the probabilities p_m for the outcomes of some maximal test, T , which can be performed on that system. The entropy of this probability distribution is a measure of our ignorance of the actual result of test T . It will now be proved that this entropy can *never decrease* if we elect to perform a *different* maximal test. That other test may be performed either *instead* of test T , or *after* it, if test T is repeatable.

Indeed, if the probabilities for test T are p_m , those for a subsequent test are $p'_\mu = \sum_m P_{\mu m} p_m$, where $P_{\mu m}$ is the doubly stochastic matrix defined in Sect. 2-4. The new entropy thus is³

$$S(p'_\mu) \geq S(p_m). \tag{9.11}$$

² R. Courant, *Differential and Integral Calculus*, Interscience, New York (1936) vol. II, p. 326.
³ This inequality holds not only for entropy, but for any concave function. See G. H. Hardy, J. E. Littlewood, and G. Pólya, *Inequalities*, Cambridge Univ. Press (1952) p. 89.

The above inequality can be proved from⁴

$$\begin{aligned} \sum_m p_m \log p_m - \sum_\mu p'_\mu \log p'_\mu &= \sum_m p_m (\log p_m - \sum_\mu P_{\mu m} \log p'_\mu) \\ &= \sum_{m\mu} p_m P_{\mu m} \log(p_m/p'_\mu), \end{aligned} \quad (9.12)$$

where we used $\sum_\mu P_{\mu m} = 1$. Since $\log x \geq 1 - x^{-1}$ (with equality holding if, and only if, $x = 1$), it follows that

$$S(p'_\mu) - S(p_m) \geq \sum_{m\mu} p_m P_{\mu m} (1 - p'_\mu/p_m) \equiv 0, \quad (9.13)$$

where the equality sign holds if, and only if, $P_{\mu m}$ is a permutation matrix, so that the sets $\{p_m\}$ and $\{p'_\mu\}$ are identical.

You may find it paradoxical that no test whatsoever can decrease our ignorance. To avoid a possible misunderstanding, I emphasize that the probabilities p'_μ are those which are predicted *before* the test (after the test, there are no probabilities—there are definite results). These p'_μ always have a more uniform distribution than the probabilities p_m that were originally given (more precisely, they cannot have a *less* uniform distribution). Further consecutive tests can only further increase the entropy: the more we intend to test, the less we can predict what will be the final outcome. We can of course perform a *selection* after a test, and thereby acquire a perfect knowledge of the new state. This selection, however, amounts to preparing a new state, and erases all knowledge of the original state.

Entropy of a preparation

After a given preparation whose result is represented by a density matrix ρ , different tests correspond to different sets of probabilities p_m , and therefore to different entropies. Let us define the *entropy of a preparation* as the lowest value that can be reached by the expression (9.2) for any complete test performed after that preparation. It will now be shown that the optimal test, which minimizes S in Eq. (9.2), is the one that corresponds to the orthonormal basis v_μ formed by the eigenvectors of the density matrix ρ :

$$\rho v_\mu = w_\mu v_\mu. \quad (9.14)$$

In that basis, ρ is diagonal. The eigenvalues w_μ satisfy

$$0 \leq w_\mu \leq 1 \quad \text{and} \quad \sum_\mu w_\mu = 1. \quad (9.15)$$

Recall now that Postulate K (page 76) asserts that the density matrix ρ *completely specifies* the statistical properties of an ensemble of physical systems

⁴E. T. Jaynes, *Phys. Rev.* 108 (1957) 171.

that were subjected to a given preparation. All the statistical predictions that can be obtained from $\langle A \rangle = \text{Tr}(\rho A)$ are the same as if we had an ordinary (classical) mixture, with a fraction w_μ of the systems being with certainty in state v_μ . Therefore, if the maximal test corresponding to the basis v_μ is designed so as to be repeatable, the probabilities w_μ remain unchanged⁵ and therefore the entropy S remains constant. The choice of any *other* test can only *increase* the entropy, as we have just seen. This proves that the optimal test, which minimizes the entropy, is the one corresponding to the basis v_μ that diagonalizes the density matrix. The entropy of a preparation can therefore be written as

$$S = - \sum_{\mu} w_{\mu} \log w_{\mu} = -\text{Tr}(\rho \log \rho), \quad (9.16)$$

where the logarithm of an operator is defined by Eq. (3.58), page 68.

Exercise 9.4 *What are the eigenvalues and eigenvectors of ρ in Exercise 9.2? What is the physical meaning of these eigenvectors? What is the entropy of the preparation? Ans.:* 0.36535.

Composite systems

The entropic properties of composite systems obey numerous inequalities.⁶ Some of them are proved below, and will be used later in this chapter. First, we need the following lemma:

Let $\{v_m\}$ and $\{e_\mu\}$ be two orthonormal bases for the *same* physical system, and let $\rho = \sum w_m v_m v_m^\dagger$ and $\sigma = \sum \omega_\mu e_\mu e_\mu^\dagger$ be two different density matrices. Their *relative entropy* $S(\sigma|\rho)$ is defined by

$$S(\sigma|\rho) = \text{Tr}[\rho(\log \rho - \log \sigma)]. \quad (9.17)$$

Let us evaluate this expression in the v_m basis, where ρ is diagonal. The diagonal elements of $\log \sigma$ are

$$(\log \sigma)_{mm} = \langle v_m, \sum_{\mu} \log \omega_{\mu} e_{\mu} e_{\mu}^{\dagger} v_m \rangle = \sum_{\mu} \log \omega_{\mu} |\langle e_{\mu}, v_m \rangle|^2. \quad (9.18)$$

The matrix $P_{\mu m} = |\langle e_{\mu}, v_m \rangle|^2$ is doubly stochastic, and we have, as in the proof of Eq. (9.12),

$$\underline{S(\sigma|\rho) = \sum_m w_m (\log w_m - \sum_{\mu} P_{\mu m} \omega_{\mu}) \geq 0}, \quad (9.19)$$

with equality holding if, and only if, $\sigma = \rho$. Note that the above proof holds even though ω_{μ} is not equal to $\sum P_{\mu m} w_m$.

⁵ Here, one would be tempted to say that the state of each system remains unchanged. However, this claim is not experimentally verifiable. Only the probabilities w_μ can be shown to remain constant.

⁶ A. Wehrl, *Rev. Mod. Phys.* 50 (1978) 221.

Consider now a composite system, with density matrix $\rho_{m\mu, n\nu}$ (double indices have the same meaning as in Chapter 5). The reduced density matrices of the two subsystems are

$$(\rho_1)_{mn} = \sum_{\lambda} \rho_{m\lambda, n\lambda} \quad \text{and} \quad (\rho_2)_{\mu\nu} = \sum_j \rho_{j\mu, j\nu}. \tag{9.20}$$

It will now be shown that

$$S(\rho) \leq S(\rho_1) + S(\rho_2). \tag{9.21}$$

This inequality, called *subadditivity*,⁶ means that a pair of correlated systems involves *more information* than the two systems considered separately.

Exercise 9.5 Verify subadditivity for two spin j particles in a singlet state.

Ans.: Eq. (9.21) becomes $0 < \log(2j + 1)$.

In order to prove the inequality (9.21), we first note that

$$S(\rho_1) + S(\rho_2) \equiv S(\rho_1 \otimes \rho_2), \tag{9.22}$$

because

$$\sum_m w_m \log w_m + \sum_{\mu} \omega_{\mu} \log \omega_{\mu} \equiv \sum_{m\mu} W_{m\mu} \log W_{m\mu}, \tag{9.23}$$

where w_m , ω_{μ} , and $W_{m\mu} = w_m \omega_{\mu}$ are the eigenvalues of ρ_1 , ρ_2 , and $\rho_1 \otimes \rho_2$, respectively. Consider now the relative entropy

$$\begin{aligned} S(\rho_1 \otimes \rho_2 | \rho) &= \text{Tr} [\rho (\log \rho - \log \rho_1 \otimes \rho_2)] \\ &= \text{Tr} [\rho (\log \rho - \log \rho_1 - \log \rho_2)]. \end{aligned} \tag{9.24}$$

This is a nonnegative quantity, by virtue of (9.19). On the other hand, we have

$$\text{Tr} (\rho \log \rho_1) \equiv \sum_{m\mu n\nu} \rho_{m\mu, n\nu} (\log \rho_1)_{nm} \delta_{\nu\mu} \equiv \text{Tr} (\rho_1 \log \rho_1), \tag{9.25}$$

and likewise for $\text{Tr} (\rho \log \rho_2)$. The subadditive property (9.21) readily follows.

It can also be shown that⁷

$$S(\rho) \geq |S(\rho_1) - S(\rho_2)|, \tag{9.26}$$

so that $S(\rho)$, $S(\rho_1)$, and $S(\rho_2)$ obey a triangle inequality.

⁷H. Araki and E. H. Lieb *Comm. Math. Phys.* 18 (1970) 160.

Information erasure

We can now see why information processing is associated with an irreversible arrow of time. There is nothing intrinsically irreversible in the logic of the computing process. However, we must initially *load data* into a memory. Assume for simplicity that the memory elements are built in such a way that the binary digits 1 and 0 are represented by orthogonal states, u and v , respectively.⁸ Further assume that the last computation that has been done has left these memory elements in states u and v with equal probabilities. Therefore the state of each memory element is represented by a density matrix, $\rho = \frac{1}{2} \mathbf{1}$, and its entropy is $\log 2$.

We must first reset each memory element to a standard state, such as v , before we can start the computation. Such an erasure or overwriting of one bit of information transfers at least one bit of entropy to the environment,⁹ because no unitary evolution can transform the mixed state $\rho = \frac{1}{2} \mathbf{1}$ into a pure state vv^\dagger . The only way of resetting the memory to zero is to couple it with a reservoir, which initially is in a *known* pure state w , and let the combined system follow a unitary evolution,

$$\left(\frac{1}{2} \mathbf{1}\right) \otimes ww^\dagger \rightarrow vv^\dagger \otimes \left(\frac{1}{2} \mathbf{1}\right). \quad (9.27)$$

This sets the memory element in a standard state, as we wished, but meanwhile one bit of entropy has been dumped into the reservoir which cannot be used again since it now is in a mixed state.

Exercise 9.6 Write explicitly the unitary operator U which produces

$$U(v \otimes w) = v \otimes w \quad \text{and} \quad U(u \otimes w) = v \otimes x, \quad (9.28)$$

where x is orthogonal to w .

9-2. Thermodynamic equilibrium

A Boltzmann distribution (also called *Gibbs state*) is one whose density matrix ρ has eigenvectors which coincide with those of the Hamiltonian, and has eigenvalues w_μ related to the energy levels E_μ by

$$w_\mu = e^{-\beta E_\mu} / Z. \quad (9.29)$$

The sum

$$Z = \sum_\nu e^{-\beta E_\nu} \quad (9.30)$$

⁸A more realistic assumption would be the use of density matrices, rather than pure states. This would bring no change in the conclusions.

⁹R. Landauer, *IBM J. Res. Dev.* 5 (1961) 183.

is called the *partition function* of the system. Preparations satisfying Eq. (9.29) are said to be in *thermodynamic equilibrium* at temperature $T = 1/\beta$. (It is convenient to use energy units for the temperature, so that Boltzmann's constant is unity.) A random mixture satisfying Postulate C, page 31, corresponds to $\beta = 0$, namely thermal equilibrium at infinite temperature.

It readily follows from (9.29) and (9.30) that the mean energy is

$$\langle E \rangle = \sum_{\mu} w_{\mu} E_{\mu} = -\partial(\log Z)/\partial\beta. \tag{9.31}$$

Exercise 9.7 Show that a Gibbs state has the maximal entropy compatible with a given value of $\langle E \rangle$.

Exercise 9.8 Show that $\partial\langle E \rangle/\partial\beta = \langle E \rangle^2 - \langle E^2 \rangle < 0$.

In a process slow enough to preserve thermodynamic equilibrium, we have

$$d\langle E \rangle = \sum_{\mu} (w_{\mu} dE_{\mu} + E_{\mu} dw_{\mu}). \tag{9.32}$$

The term $\sum w_{\mu} dE_{\mu}$ is due to a shift of the energy levels caused by variations of the external parameters. We call it the *work* performed on the system, while

$$\delta Q = \sum_{\mu} E_{\mu} dw_{\mu} = d\langle E \rangle - \sum_{\mu} w_{\mu} dE_{\mu}, \tag{9.33}$$

is the *heat* transferred to the system (the effect of heat transfer is to change the probabilities of occurrence of the various energy levels).

On the other hand, we have from (9.29)

$$dS = - \sum_{\mu} \log w_{\mu} dw_{\mu} = \sum_{\mu} \beta E_{\mu} dw_{\mu}, \tag{9.34}$$

where we have used $\sum dw_{\mu} = 0$. Comparing Eqs. (9.33) and (9.34), we obtain

$$dS = \delta Q/T, \tag{9.35}$$

which is the familiar thermodynamic definition of entropy.¹⁰ It should be kept in mind that this definition applies only to systems in thermal equilibrium, while the more general definition (9.2) is always valid.

We must now explain why it often happens that physical systems tend to thermal equilibrium. An *isolated* system certainly does not. If its density matrix is $\rho = \sum w_{\mu} \mathbf{v}_{\mu} \mathbf{v}_{\mu}^{\dagger}$, each \mathbf{v}_{μ} evolves linearly, as $\mathbf{v}_{\mu}(t) = \mathbf{U} \mathbf{v}_{\mu}(0)$, but the coefficients w_{μ} remain constant. Therefore the entropy given by Eq. (9.16) is constant too. (The same is also true in classical statistical mechanics, where the entropy is defined by the Liouville density in phase space.) The following

¹⁰ F. Reif, *Fundamentals of Statistical and Thermal Physics*, McGraw-Hill, New York (1965) pp. 218–219.

argument ¹¹ shows that thermalization of a quantum system may result from multiple collisions with *other* systems which already are in thermal equilibrium.

Collisions

In a collision of two quantum systems which are initially uncorrelated, the combined density matrix evolves as

$$\rho_a \otimes \rho_b \rightarrow U[\rho_a \otimes \rho_b]U^\dagger = \rho'_{ab}. \quad (9.36)$$

The total entropy, $S(\rho'_{ab}) = S(\rho_a) + S(\rho_b)$, remains constant under this unitary transformation. However if we consider *separately* the final states of the two subsystems after the collision, these are given by the *reduced* density matrices

$$\rho'_a = \text{Tr}_b(\rho'_{ab}) \quad \text{and} \quad \rho'_b = \text{Tr}_a(\rho'_{ab}), \quad (9.37)$$

and we have, by virtue of the subadditivity inequality (9.21),

$$S(\rho'_a) + S(\rho'_b) \geq S(\rho_a) + S(\rho_b). \quad (9.38)$$

This growth of the total entropy is caused by the replacement $\rho'_{ab} \rightarrow \rho'_a \otimes \rho'_b$, whereby we “forget” the correlations that were created in the collision process. This entropy growth is not a dynamical process, and is solely due to the way the problem is formulated. There is no mysterious time-asymmetry here: if we were given the final reduced density matrices (after the collision) and were asked for our best estimate of the initial uncorrelated density matrix, our answer would also involve more entropy than the data supplied to us.

We shall write Eq. (9.38) as

$$\Delta S_a + \Delta S_b \geq 0. \quad (9.39)$$

In general, the symbol Δ will denote the increment of a physical quantity, due to a collision. For example, we have

$$\Delta \langle E_a \rangle + \Delta \langle E_b \rangle = 0, \quad (9.40)$$

by energy conservation.

For a system in a Gibbs state (9.29), we have

$$S - \beta \langle E \rangle = -\text{Tr}(\rho \log \rho + \beta \rho H) = \log Z. \quad (9.41)$$

If that system collides with another one, its final density matrix ρ' will not, in general, be a Gibbs state, but we may still consider the quantity $S(\rho') - \beta \langle E' \rangle$, where β refers to the *initial* state, before the collision. We then have

¹¹M. H. Partovi, *Phys. Letters A* 137 (1989) 440.

$$\begin{aligned}
 -\Delta(S - \beta\langle E \rangle) &= \text{Tr}(\rho' \log \rho' + \beta \rho' H) + \log Z \\
 &= \text{Tr}[\rho' (\log \rho' + \beta H + \log Z)] \\
 &= \text{Tr}[\rho' (\log \rho' - \log \rho)].
 \end{aligned}
 \tag{9.42}$$

This expression is the relative entropy $S(\rho|\rho')$ which was defined by Eq. (9.17) and is nonnegative, as we have seen.

Approach to equilibrium

Consider a collision of system a , initially in any state, with system b , which is initially in a Gibbs state at temperature β^{-1} . We have, from Eq. (9.42),

$$\Delta(S_b - \beta\langle E_b \rangle) \leq 0.
 \tag{9.43}$$

Combining this result with Eqs. (9.39) and (9.40), we obtain

$$\Delta(S_a - \beta\langle E_a \rangle) \geq 0.
 \tag{9.44}$$

Therefore if system a , initially in any state, undergoes multiple collisions with other systems, all initially in Gibbs states at the same temperature β^{-1} , the expression $S_a - \beta\langle E_a \rangle$ never decreases, and it will eventually approach a limiting value. If there are no selection rules (that is, if there are no conservation laws inhibiting transitions between some of the energy levels E_μ of system a) this limiting value is the one which maximizes

$$S_a - \beta\langle E_a \rangle = - \sum_{\mu} w_{\mu} (\log w_{\mu} + \beta E_{\mu}),
 \tag{9.45}$$

subject to the constraint $\sum w_{\mu} = 1$. Using the method of Lagrange multipliers, it is easily found that the solution is the Gibbs state (9.29).

Zeroth law of thermodynamics

Consider now an interaction of two systems, a and b , initially in Gibbs states at different temperatures β_a^{-1} and β_b^{-1} . From Eq. (9.43), we have

$$\Delta(S_b - \beta_b\langle E_b \rangle) \leq 0,
 \tag{9.46}$$

and likewise

$$\Delta(S_a - \beta_a\langle E_a \rangle) \leq 0.
 \tag{9.47}$$

Together with Eqs. (9.39) and (9.40), this gives

$$(\beta_a - \beta_b) \Delta\langle E_a \rangle = \beta_a \Delta\langle E_a \rangle + \beta_b \Delta\langle E_b \rangle \geq \Delta(S_a + S_b) \geq 0,
 \tag{9.48}$$

which means that heat flows from the system having a higher temperature to the system with the lower temperature.

Second law of thermodynamics

Finally, consider multiple interactions of system a with an array of systems b_n , which initially are in Gibbs states at various temperatures β_n^{-1} . At each step, we have, from Eq. (9.44),

$$\Delta_n S_a \geq \beta_n \Delta_n \langle E_a \rangle \equiv -\beta_n \delta Q_n, \quad (9.49)$$

where δQ_n is the energy transferred to the n -th reservoir and converted into heat. In a cyclic process, the initial and final states of system a are identical, so that $\sum_n \Delta_n S_a \equiv 0$, whence $\sum_n \beta_n \delta Q_n \equiv \sum_n \delta Q_n / T_n \geq 0$. The total entropy of the reservoirs must not decrease while system a undergoes a cyclic process.

9-3. Ideal quantum gas

It will now be shown that the quantum entropy (9.16) is genuine entropy, fully equivalent to that of standard thermodynamics. Let us first recall the proof that the entropy of a mixture of dilute, inert, ideal gases is

$$S = -N \sum_j c_j \log c_j, \quad (9.50)$$

where $N = \sum N_j$ is the total number of gas molecules, and $c_j := N_j/N$ is the concentration of the j -th species. The derivation of Eq. (9.50) is given below for the case of two different species. It assumes the existence of semipermeable membranes which are transparent to molecules of type j , and opaque to all others. These membranes are used as pistons in an ideal frictionless engine immersed in an isothermal bath at temperature T , as sketched in Fig. 9-1.

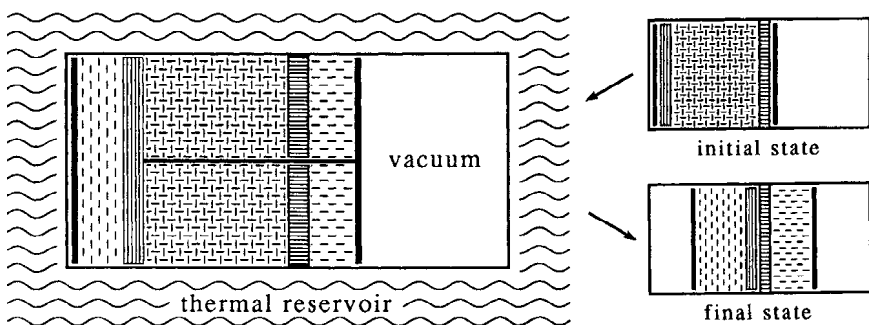

Fig. 9.1. Ideal engine used to separate gases A (to the left) and B (to the right). The vertically and horizontally hatched semipermeable pistons are transparent to gases A and B, respectively. The mechanical work supplied in order to transform the initial state into the final state is released as heat into the thermal bath.

The first step of the separation is a motion toward the right of the pair of pistons that are connected by a rigid rod. Gas *A* exerts no pressure on the left piston (which is transparent to it) and gas *B* exerts the same pressure on *both* pistons. Therefore no work is needed for this reversible separation. Then, each gas is isothermally compressed to reduce its volume by a factor c_j , so that the final total volume is the same as the initial one. The isothermal work needed for compressing the j -th ideal gas is

$$-\int p_j dV = -N_j T \int dV/V = -N_j T \log c_j = -NT c_j \log c_j. \quad (9.51)$$

This work is released into the reservoir where it is converted into heat. Since the entire process is macroscopically reversible, the total entropy is conserved. Therefore the mixing entropy, in the initial state, is given by Eq. (9.50). And vice versa, TS is the maximum amount of heat convertible into mechanical work by isothermal mixing of ideal gases. (Recall that the name *heat* is given to the energy randomly distributed among the many degrees of freedom of the reservoir, for which we gave up the possibility of a detailed description.)

The *quantum* definition of entropy closely parallels the above argument. It also assumes the existence of semipermeable membranes which can be used for performing quantum tests. These membranes separate orthogonal states with perfect efficiency. The fundamental problem here is whether it is legitimate to treat quantum *states* in the same way as varieties of classical ideal gases.

This issue was clarified by Einstein¹² in the early days of the “old” quantum theory, as follows: Consider an ensemble of quantum systems, each one enclosed in a large impenetrable box, so as to prevent any interaction between them. These boxes are enclosed in an even larger container, where they behave *as an ideal gas*, because each box is so massive that classical mechanics is valid for its motion (*i.e.*, there is no need of Bohr-Sommerfeld quantization rules—remember that Einstein’s argument was presented in 1914). The container itself has ideal walls and pistons which may be, according to our needs, perfectly conducting, or perfectly insulating, or with properties equivalent to those of semipermeable membranes. The latter are endowed with automatic devices able to peek inside the boxes and to test the state of the quantum systems enclosed therein. The entire machine can then function like the one in Fig. 9.1.

Similar assumptions were later used by von Neumann¹³ who emphasized that the practical infeasibility of Einstein’s fantastic contraption did not impair its demonstrative power: “In the sense of phenomenological thermodynamics, each conceivable process constitutes valid evidence, provided that it does not conflict with the two fundamental laws of thermodynamics.” von Neumann showed that the mixing entropy (9.50) could be written as $S = -N \text{Tr}(\rho \log \rho)$, where ρ is the density matrix representing the state of each quantum system. The c_j of Eq. (9.50) are analogous to the eigenvalues of ρ .

¹²A. Einstein, *Verh. Deut. Phys. Gesell.* 16 (1914) 820.

¹³J. von Neumann, *Mathematische Grundlagen der Quantenmechanik*, Springer, Berlin (1932) p. 191 [t ransl. by E. T. Beyer: *Mathematical Foundations of Quantum Mechanics*, Princeton Univ. Press (1955) p. 359].

Quantization of Einstein's state selector

This hybrid classical-quantal reasoning is not satisfactory, because there is no consistent dynamical formalism for interacting classical and quantum systems. I shall now outline a genuinely quantal proof of the equivalence of von Neumann's entropy (9.16) to the ordinary entropy of classical thermodynamics.

Let \mathbf{q} denote collectively all the internal degrees of freedom of a quantum system, and let \mathbf{R} denote its center of mass. The components of \mathbf{R} have the same role as the coordinates of Einstein's impenetrable classical boxes, but they are *quantum* variables. The Hamiltonian of the quantum system is

$$H = H_0(\mathbf{q}) + \mathbf{P}^2/2M, \quad (9.52)$$

where H_0 involves only the internal variables, \mathbf{P} is the momentum conjugate to \mathbf{R} , and M is the mass of the system. At this stage, there is no interaction between the internal degrees of freedom \mathbf{q} and the translatory ones, \mathbf{R} and \mathbf{P} .

We now introduce Einstein's large container, which also plays the role of a thermal reservoir. As is customary in thermodynamics, the properties of this container are extremely idealized. Its degrees of freedom fall into two classes: a small number of macrovariables collectively denoted by X (position of the center of mass, spatial orientation, location of the pistons, etc.) and a huge number of microvariables, denoted by x , which describe the atomic structure of the container (the symbols X and x also denote momenta). The idealization here is the absence of "mesovables," such as collective excitations which involve 10^3 or 10^9 atoms, and are neither microscopic nor macroscopic. Such an ideal container can exist only in our imagination. Nevertheless, as long as it does not violate known laws of physics, it is a perfectly legitimate tool for discovering additional laws (see above quote from von Neumann's book).

The characteristic property of the macrovariables is that, if their observable values are initially sharp, namely $\langle X^2 \rangle \simeq \langle X \rangle^2$, they remain sharp during the entire dynamical evolution. This property does not hold for microvariables such as the positions and momenta of individual molecules, whose values quickly acquire a large dispersion, because of multiple collisions. The molecules also collide with the container, but each collision has a very small effect on the latter. Only the *total* effect is noticeable: it is the *pressure* exerted on the walls and pistons, and the fluctuations of that pressure are small if the container is very large and there are many quantum systems enclosed in it.

The Heisenberg equations of motion for x and X have the form

$$dx/dt = f(X, x, \mathbf{q}, \mathbf{R}, \mathbf{P}), \quad (9.53)$$

and

$$dX/dt = F(X, x, \mathbf{q}, \mathbf{R}, \mathbf{P}) + F_{\text{ext}}, \quad (9.54)$$

where F_{ext} (a c -number) is due to external agents under the direct control of the experimenter who is actuating the pistons, opening and closing valves, etc.

Taking average values in the last equation, we obtain

$$d\langle X \rangle / dt = \langle F(X, \mathbf{x}, \mathbf{q}, \mathbf{R}, \mathbf{P}) \rangle + F_{\text{ext}}. \quad (9.55)$$

Thanks to the small dispersion of the X variables, it is possible to replace, on the right hand sides of (9.53) and (9.55), X by $\langle X \rangle$ (or, if you prefer, by $\langle X \rangle + 1$), and to consider $\langle X \rangle$ as a classical variable, that we shall write simply as X . We know that it is in general inconsistent to mix classical and quantum dynamical variables; however, no inconsistency arises if we treat the X variables as mere *numerical parameters*, having a prescribed dependence on time.

We further assume that these X parameters have a very slow motion, so that the microvariables are at every instant in thermal equilibrium. They have a Gibbs distribution at temperature β^{-1} :

$$\rho_c = \exp(-\beta H_c) / \text{Tr} [\exp(-\beta H_c)], \quad (9.56)$$

where H_c is the Hamiltonian of the container, which depends on \mathbf{x} and on the numerical parameters X . It is thanks to this thermal equilibrium that the dispersion of the X variables always remains small.

Finally, we introduce an *interaction* between our quantum system and the container in which it is enclosed. This interaction causes multiple scatterings of the quantum system with the walls and pistons. It is essential that ΔH , the energy spread of the quantum system, far exceeds the average level spacing of the energy spectrum of the macroscopic container, so that the quantum system does not feel the discreteness of the spectrum of the container.

Two cases must now be distinguished, depending on whether the container has semipermeable partitions which interact with the internal variables of the quantum system, or only ordinary walls and pistons. In the latter case, the interaction term in the Hamiltonian involves the macrovariables X (considered as classical parameters), the microvariables \mathbf{x} (quantized), and the position variables \mathbf{R} and \mathbf{P} of the quantum system, but not its internal variables \mathbf{q} . The evolution of the latter thus is completely disjoint from that of the other variables. We can now apply the results of the preceding section. The final value of $S - \beta \langle E \rangle$ for the \mathbf{R} and \mathbf{P} variables corresponds to a Gibbs state at the same temperature β^{-1} as the reservoir. That is, an ensemble of quantum systems described by the Hamiltonian (9.52) has the same statistical properties as a classical ideal gas of free particles of mass M . In particular, it exerts exactly the same pressure on the walls of the container.

Selection of orthogonal states

The situation becomes more interesting if semipermeable partitions are introduced. The latter may be described by an interaction term involving \mathbf{q} , \mathbf{R} , \mathbf{P} , and X . Recall that the classical parameters X , which include the positions of the movable partitions, are *prescribed* functions of time. Their time dependence

must be extremely slow on time scales relevant to the \mathbf{x} , \mathbf{R} , and \mathbf{P} variables, so that the latter always are in thermal equilibrium.

If we add to the right hand side of (9.52) a term $H_{\text{int}}(\mathbf{q}, \mathbf{R}, X)$, its effect will be to generate an entangled state, where the variables \mathbf{q} and \mathbf{R} are correlated. As an extremely simplified model, take a one dimensional container. Particles with spin up can be concentrated on one side of a partition located at position X , and particles with spin down on the other side, by means of an interaction

$$H_{\text{int}} = -V_0 \sigma_z \tanh K(\mathbf{R} - X), \quad (9.57)$$

where V_0 and K are large constants, and the symbol “tanh” stands for any smoothed step function. This interaction produces a force $\sim \sigma_z V_0 K$ acting on the quantum system when its position is in the vicinity of X , the location of the semipermeable partition. The result is like a Stern-Gerlach experiment. Particles with opposite values of σ_z are accelerated in opposite directions. The final wave function (in the coordinate representation) is the sum of two terms. In each one of them, $(\langle \mathbf{R} \rangle - X)$ has the same sign as $\langle \sigma_z \rangle$.

Exercise 9.9 Write an interaction which sorts out different eigenvalues of any operator \mathbf{A} into different regions of a three dimensional container. ★

This simple abstract model demonstrates that it is possible, at least in theory, to dispatch into different regions of the \mathbf{R} -space quantum systems in *orthogonal* states. They behave exactly as if they were a mixture of classical ideal gases of different types. Therefore there should be no doubt that von Neumann’s entropy (9.16) is equivalent to the entropy of classical thermodynamics. (This statement must be understood with the same vague meaning as when we say that the quantum notions of energy, momentum, angular momentum, etc., are equivalent to the classical notions bearing the same names.)

Free energy of a pure state

On the other hand, there also are circumstances under which an ensemble of quantum systems displays thermodynamic properties quite different from those of a mixture of classical ideal gases. This is due to the existence of *non-orthogonal* states, which are essentially nonclassical. These states are partly alike—neither identical, nor completely different from one another. They enable us to convert in a *continuous* way any quantum state into any other quantum state, as shown below (for a concrete example, see Exercise 1.1, page 7).

Exercise 9.10 Let \mathbf{v} and \mathbf{w} be two orthogonal states of a quantum system. Show that $\mathbf{U} = \exp[\lambda(\mathbf{v}\mathbf{w}^\dagger - \mathbf{w}\mathbf{v}^\dagger)]$, with real λ , is a unitary matrix which rotates the subspace spanned by \mathbf{v} and \mathbf{w} :

$$\mathbf{U}\mathbf{v} = \cos \lambda \mathbf{v} - \sin \lambda \mathbf{w}, \quad \mathbf{U}\mathbf{w} = \sin \lambda \mathbf{v} + \cos \lambda \mathbf{w}. \quad (9.58)$$

In the following discussion, it will be assumed that any unitary evolution, such as the one in Eq. (9.58), can in principle be realized in the laboratory. It is an isentropic process, and any energy that has to be supplied can be reversibly recaptured (or, if you prefer, you can put the system in an environment such that v and w become degenerate energy eigenstates).

We shall now see that an ensemble of n quantum systems in any *pure* state can extract energy from a thermal reservoir at temperature T . Indeed, take one half of these systems, and reversibly rotate their pure state into an orthogonal state, as in Eq. (9.58). Then, mix these two subensembles, isothermally and reversibly. This extracts an energy $nT \log 2$ from the thermal reservoir. More generally, if the quantum systems used for this process have N orthogonal states, you can divide an ensemble prepared in a pure state into N identical subensembles, reversibly rotate $N - 1$ of them into mutually orthogonal states, and finally mix them together, thereby extracting an energy $nT \log N$ from the thermal reservoir.

9-4. Some impossible processes

In the preceding section, we examined conceptual processes which would have been exceedingly difficult to realize in practice, but did not violate any fundamental physical principle. I shall now describe truly impossible tasks, and show that there is a close relationship between dynamical evolutions which violate some fundamental principle of quantum theory (such as unitarity) and those which are forbidden by the second law of thermodynamics.

It thus appears that thermodynamics imposes severe constraints on the choice of fundamental axioms for quantum theory. However, this claim heavily relies on the equivalence of von Neumann's entropy to the ordinary entropy of thermodynamics. The proof of this equivalence assumes the validity of Hamiltonian dynamics (in order to derive the existence of thermal equilibrium), and there may be a logical error here, known as *petitio principii*: we invoke Hamiltonian dynamics in order to prove some theorems, and then we claim as a corollary of these theorems that non-Hamiltonian dynamics is inconsistent. Thus, the final conclusion to be drawn from this discussion is that if the integrity of the axiomatic structure of quantum theory is not strictly respected, then *every* aspect of the theory must be reconsidered.

Selection of non-orthogonal states

The interaction in Eq. (9.57) and its multidimensional generalizations allow us to distinguish *different eigenvalues* of Hermitian operators, which correspond to *orthogonal* states of a quantum system. Can there be more general tests? Imagine that a wily inventor claims having produced semipermeable partitions which unambiguously distinguish non-orthogonal states. He can thereby convert

into work an unlimited amount of heat extracted from an isothermal reservoir, as shown below. Will you invest your money in this new technology?

Before we examine how this marvellous invention works, let us first notice that such a process violates the completeness postulate K, which asserts that a density matrix ρ is a *complete* specification of all the physical properties of an ensemble (see page 76). Indeed, let P_1 and P_2 represent two pure states of a quantum system, and let ρ_0 be the initial state of an instrument built for separating them. An interaction with a properly constructed instrument generates the following dynamical evolutions:

$$P_1 \otimes \rho_0 \rightarrow P_1 \otimes \rho_1 \quad \text{and} \quad P_2 \otimes \rho_0 \rightarrow P_2 \otimes \rho_2, \quad (9.59)$$

where the final states ρ_1 and ρ_2 are orthogonal (that is, $\rho_1 \rho_2 = \mathbf{O}$). For example, ρ_1 and ρ_2 may be located in different regions of space.¹⁴ If the initial state of the quantum system is a mixture, $\frac{1}{2}(P_1 + P_2)$, the effect of the separator is

$$\frac{1}{2}(P_1 + P_2) \otimes \rho_0 \rightarrow \frac{1}{2}(P_1 \otimes \rho_1 + P_2 \otimes \rho_2). \quad (9.60)$$

This relation follows from Postulate K, because the representation of a statistical ensemble by the expression $\frac{1}{2}(P_1 + P_2)$ means that this ensemble behaves as if 50% of its elements are in state P_1 and 50% in state P_2 . There is no need here to assume linearity, because there are no interference effects between the two components if the initial state is a mixture.

The dynamical process represented by Eq. (9.60) is a separation of the P_1 and P_2 components of the mixture, such that each one ends up correlated to a different final state of the instrument. Taking the squares of both sides of Eq. (9.60), we obtain, apart from a factor $\frac{1}{4}$:

$$(P_1 + P_2 + P_1 P_2 + P_2 P_1) \otimes \rho_0^2 \rightarrow P_1 \otimes \rho_1^2 + P_2 \otimes \rho_2^2, \quad (9.61)$$

where use was made of $P_j^2 \equiv P_j$, and $\rho_1 \rho_2 = \mathbf{O}$. Subtracting from Eq. (9.61) the *squares* of Eqs. (9.59) then gives $P_1 P_2 + P_2 P_1 = \mathbf{O}$. Therefore Eq. (9.60) is consistent if, and only if, states P_1 and P_2 are orthogonal.

Consider now the cyclic process illustrated in Fig. 9.2, which involves two non-orthogonal photon states. Suppose that there are n photons in the vessel. One half of them are prepared with vertical linear polarization, and the other half with a linear polarization at 45° from the vertical. Initially, in state (a), they occupy two chambers with equal volumes. The first step of the cyclic process is an isothermal expansion, doubling these volumes, as shown in (b). This expansion supplies an amount of work $nT \log 2$, where T is the temperature of the reservoir. At that stage, the impenetrable partitions separating the two photon gases are replaced by semipermeable membranes, as in Fig. 9.1. These

¹⁴ It is always possible to consider ρ_0 as a pure state, which satisfies $\rho_0^2 = \rho_0$, by introducing an auxiliary Hilbert space, as shown in Exercise 5.10. However, that mock Hilbert space does not participate in the dynamical evolution, and one cannot impose that ρ_1 and ρ_2 be pure states too.

membranes, however, have the extraordinary ability of selecting *non-orthogonal* states: One of them is transparent to vertically polarized photons, and reflects those with polarization at 45° from the vertical; the other membrane has the opposite properties. A double frictionless piston, like the one in Fig. 9.1, can thus bring the engine to state (c), without expenditure of work or heat transfer. We have thereby obtained a *mixture* of the two polarization states, with density matrix

$$\rho = \frac{1}{2} \left[\begin{pmatrix} 1 \\ 0 \end{pmatrix} \begin{pmatrix} 1 \\ 0 \end{pmatrix}^\dagger + \frac{1}{2} \begin{pmatrix} 1 \\ 1 \end{pmatrix} \begin{pmatrix} 1 \\ 1 \end{pmatrix}^\dagger \right] = \begin{pmatrix} 0.75 & 0.25 \\ 0.25 & 0.25 \end{pmatrix}. \quad (9.62)$$

The eigenvalues of ρ are 0.854 (corresponding to photons polarized at 22.5° from the vertical) and 0.146 (for the orthogonal polarization).

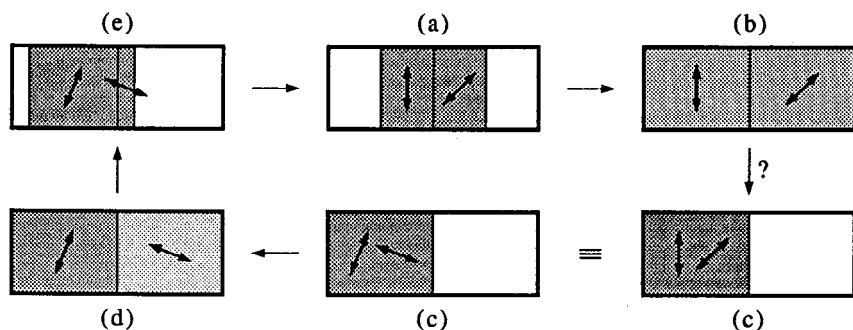

Fig. 9.2. This cyclic process extracts heat from an isothermal reservoir and converts it into work, by using a hypothetical semipermeable partition which separates non-orthogonal photon states. Double arrows indicate the polarizations of the photons.

We now replace the “magic” membranes by ordinary ones, which reversibly separate these two orthogonal polarization states, and yield state (d). The next step is an isothermal compression, leading to state (e) where both chambers have the same pressure and the same total volume as those in state (a). This isothermal compression requires an expenditure of work

$$-nT (0.146 \log 0.146 + 0.854 \log 0.854) = 0.416 nT, \quad (9.63)$$

which is released as heat into the reservoir. This work is less than $nT \log 2$, the amount that was gained in the isothermal expansion from (a) to (b). The net gain is $0.277 nT$. Finally, no work is involved in returning from (e) to (a), by suitable rotations of polarization vectors, as in Eq. (9.58). We have thus demonstrated the existence of a closed cycle whereby an unlimited amount of heat can be extracted from an isothermal reservoir and converted into work, in violation of the second law of thermodynamics.

Nonlinear Schrödinger equation

A similar violation of the second law arises if nonlinear modifications are introduced into Schrödinger's equation, as proposed by many authors with various motivations.^{15,16} A nonlinear Schrödinger equation does *not* violate the superposition principle G (page 50). The latter asserts that the pure states of a physical system can be represented by rays in a complex linear space, but it does not demand that the time evolution of these rays obey a linear equation.

It is not difficult to invent nonlinear variants of Schrödinger's equation with the property that if $u(0)$ evolves into $u(t)$, and $v(0)$ evolves into $v(t)$, the pure state represented by $u(0) + v(0)$ does *not* evolve into $u(t) + v(t)$, but into some other pure state (see for example page 241). I shall now show that such a nonlinear evolution violates the second law of thermodynamics, if *the other postulates of quantum mechanics are kept intact*. In particular, I shall retain the equivalence of von Neumann's entropy to the ordinary thermodynamical entropy, which was demonstrated in the preceding section.

Consider a *mixture* of quantum systems represented by a density matrix

$$\rho = \lambda P_u + (1 - \lambda) P_v, \quad (9.64)$$

where $0 < \lambda < 1$ and where P_u and P_v are projection operators on the pure states u and v , respectively. The nonvanishing eigenvalues of ρ are

$$w_j = \frac{1}{2} \pm \left[\frac{1}{4} - \lambda(1 - \lambda)(1 - x) \right]^{1/2}, \quad (9.65)$$

where $x = |\langle u, v \rangle|^2$. The entropy of this mixture, $S = -k \sum w_j \log w_j$, satisfies $dS/dx < 0$ for any λ . Therefore, if pure quantum states evolve as $u(0) \rightarrow u(t)$ and $v(0) \rightarrow v(t)$, the entropy of the mixture ρ shall not decrease (*i.e.*, that mixture shall not become less homogeneous) provided that $x(t) \leq x(0)$, or

$$|\langle u(t), v(t) \rangle|^2 \leq |\langle u(0), v(0) \rangle|^2. \quad (9.66)$$

In particular, if $\langle u(0), v(0) \rangle = 0$, we also have $\langle u(t), v(t) \rangle = 0$. Orthogonal states remain orthogonal.

Consider now a complete orthogonal set u_k . We have, for every v ,

$$\sum_k |\langle u_k, v \rangle|^2 \equiv 1. \quad (9.67)$$

Therefore, if there is some m for which $|\langle u_m(t), v(t) \rangle|^2 < |\langle u_m(0), v(0) \rangle|^2$, there must also be some n for which $|\langle u_n(t), v(t) \rangle|^2 > |\langle u_n(0), v(0) \rangle|^2$. Then the entropy of a mixture of u_n and v will spontaneously decrease in a closed system, in violation of the second law of thermodynamics.

¹⁵L. de Broglie, *Une Tentative d'Interprétation Causale et Nonlinéaire de la Mécanique Ondulatoire*, Gauthier-Villars, Paris (1956).

¹⁶S. Weinberg, *Nucl. Phys. B (Proc. Suppl.)* 6 (1989) 67; *Ann. Phys. (NY)* 194 (1989) 336.

To retain the second law, we must have $|\langle u(t), v(t) \rangle|^2 = |\langle u(0), v(0) \rangle|^2$ for every u and v . It then follows from Wigner's theorem (Sect. 8-2) that, with an appropriate choice of phases, the mapping $v(0) \rightarrow v(t)$ is unitary (the anti-unitary alternative is ruled out by continuity). Schrödinger's equation must therefore be linear, if we retain the *other* postulates of quantum theory without any change.

No-cloning theorem

It was shown in Sect. 3-5 that, if we know that a *large number* of quantum systems have been prepared identically, it is possible to determine their state unambiguously by suitable quantum tests. On the other hand, we have just seen that it is impossible to distinguish unambiguously non-orthogonal states of a *single* system. Why can't we overcome this difficulty by making many identical replicas of that system, just as we duplicate a letter with a photocopier?

Imagine that there is an *amplifier*, initially in a state Ψ , with the ability of duplicating quantum systems prepared in an arbitrary state. That is,

$$\Psi \otimes v \rightarrow U(\Psi \otimes v) = \Psi' \otimes v \otimes v, \tag{9.68}$$

where Ψ' is the state of the amplifier after performing its duty. Likewise, for a different input state of the quantum system, we would have

$$\Psi \otimes w \rightarrow U(\Psi \otimes w) = \Psi'' \otimes w \otimes w. \tag{9.69}$$

Take the inner product of these two equations. Unitarity implies that

$$\langle \Psi, \Psi \rangle \langle v, w \rangle = \langle \Psi', \Psi'' \rangle \langle v, w \rangle \langle v, w \rangle. \tag{9.70}$$

In this equation, we have $0 < |\langle v, w \rangle| < 1$ for suitable choices of v and w , and also $\langle \Psi, \Psi \rangle \equiv 1$. It follows that $\langle \Psi', \Psi'' \rangle \langle v, w \rangle = 1$, which is impossible, because $|\langle \Psi', \Psi'' \rangle| \leq 1$. Therefore such an amplifier cannot exist.^{17,18}

9-5. Generalized quantum tests

The most efficient way of obtaining information about the state of a quantum system is not always a maximal test (as defined in Chapter 2). It is sometimes preferable to introduce an auxiliary quantum system, prepared in a standard state, and to execute a combined quantum test on both systems together. We shall now examine these indirect quantum tests, which actually are the most common ones. The maximal tests that were considered until now are a convenient conceptual notion, but are seldom realized in practice.

¹⁷ W. K. Wootters and W. H. Zurek, *Nature* 299 (1982) 802.

¹⁸ D. Dieks, *Phys. Letters A* 92 (1982) 271.

Formulation of the problem

The classic treatise on the foundations of quantum theory is von Neumann's book.¹³ Historically, this was the first rigorous presentation of a mathematical formalism for quantum theory, with a consistent physical interpretation. The book had a disproportionate influence on quantum methodology. In particular, most subsequent investigations of the "quantum measurement problem" have revolved around the determination of values of dynamical variables which have classical counterparts: positions, momenta, energies, etc. In von Neumann's approach, these dynamical variables (classically—functions of \mathbf{q} and \mathbf{p}) are represented by self-adjoint operators acting on H , the Hilbert space of quantum states. Their spectrum corresponds to an *orthogonal resolution of the identity*, because the various outcomes of a quantum test are mutually exclusive, and their probabilities sum up to 1.

It was later realized that von Neumann's theory of quantum measurements was too narrow. It did not allow to ask simple questions referring to well defined physical situations. As an example, suppose that a spin $\frac{1}{2}$ particle is prepared in a pure state. Its wave function ψ satisfies $\boldsymbol{\sigma} \cdot \mathbf{n} \psi = \psi$, for some unit vector \mathbf{n} . The state ψ is uniquely defined (up to an irrelevant phase) if \mathbf{n} is given. The question "What is \mathbf{n} ?" has an obvious classical analog ("What is the direction of the angular momentum?"). It is a legitimate way of inquiring about the preparation of the system. That preparation is a *macroscopic* procedure, without any "quantum uncertainties." However, \mathbf{n} is not a quantum dynamical variable (a self-adjoint operator acting on H). The only "quantum observables" of a spin $\frac{1}{2}$ particle are the components of $\boldsymbol{\sigma}$ and linear combinations thereof.

The situation described above may occur in actual experiments. Polarized neutrons are used as probes for measuring magnetic fields in condensed matter. We thus want to know the precession of the neutron's magnetic moment. This is a well defined physical concept (represented in quantum theory by a unitary operator). Yet, there is no possibility of measuring this precession if only one neutron is available. We need numerous, identically prepared neutrons in order to obtain a good estimate of the precession angle. While this is not a serious impediment in experimental solid state physics, where you have an abundance of identical particles, this may become one in other areas of physics, where only a few quanta are available. For example, if we detect a small number of photons from a distant star, how well can we determine their polarization? The most efficient methods are not maximal tests, as we shall soon see.

Shannon's entropy in quantum theory

The novel feature introduced by quantum theory is that preparations which are *macroscopically different* can produce states which are *not orthogonal*, and therefore cannot be distinguished unambiguously from each other. For instance, let the state of a spin $\frac{1}{2}$ particle be prepared by selecting the upper beam in a Stern-Gerlach experiment. We are given the choice of orienting the magnet

along direction \mathbf{n}_1 , or along direction \mathbf{n}_2 . The corresponding quantum states of the resulting beams, ψ_1 and ψ_2 , are then given by $\boldsymbol{\sigma} \cdot \mathbf{n}_j \psi_j = \psi_j$. In general, these states are not orthogonal. Their overlap is

$$|\langle \psi_1, \psi_2 \rangle|^2 = \frac{1}{2} (1 + \mathbf{n}_1 \cdot \mathbf{n}_2). \quad (9.71)$$

This expression is the probability that, following a preparation of state ψ_1 , the question "Was the prepared state ψ_2 ?" will be answered in the affirmative. The answer cannot be predicted with certainty. Once the spin $\frac{1}{2}$ particle has been severed from the macroscopic apparatus which prepared it, it does not carry the full information relative to the preparation procedure. Some questions become ambiguous, and only *probabilities* can be assigned to their answers.

This situation is radically different from the one prevailing in classical physics. Therefore quantum tests cannot be restricted to be mere imitations of classical measurements, where all we want to know is the numerical value of a dynamical variable. More general procedures must be considered, which are adapted to the rules of quantum theory.

Because of the peculiar properties of non-orthogonal states, it is necessary to distinguish Shannon's entropy, $-\sum p_i \log p_i$, from von Neumann's entropy, $-\text{Tr}(\rho \log \rho)$. For instance, our spin $\frac{1}{2}$ particle may have N distinct preparation procedures. If they are equally probable, Shannon's entropy, $\log N$, can be arbitrarily large. On the other hand, von Neumann's entropy never exceeds $\log 2$. Thus, paradoxically, we are *less* ignorant in quantum physics than in classical physics: this is because there are fewer *diferent* (i.e., orthogonal) questions that we are allowed to ask, and therefore there are fewer unknown answers. To clearly distinguish these two kinds of entropies, Shannon's entropy will henceforth be denoted by H (not S) as is customary in information theory. (There is no risk of confusion here with the Hamiltonian.)

Exercise 9.11 Three different preparation procedures of a spin $\frac{1}{2}$ particle are represented by the vectors $\begin{pmatrix} 1 \\ 0 \end{pmatrix}$ and $\frac{1}{2} \begin{pmatrix} -1 \\ \pm\sqrt{3} \end{pmatrix}$. If they are equally likely, the Shannon entropy is $\log 3$, and the von Neumann entropy is $\log 2$. Show that if there are n such particles, all prepared in the **same** way, the von Neumann entropy asymptotically tends to $\log 3$ when $n \rightarrow \infty$. **Hint:** Consider three real unit vectors making equal angles: $\langle \mathbf{u}_i, \mathbf{u}_j \rangle = c$ if $i \neq j$. Show that the eigenvalues of $\sum \mathbf{u}_i \mathbf{u}_i^\dagger$ are $1 - c$, $1 - c$, and $1 + 2c$. ★

Quantum information gain

How well can we distinguish non-orthogonal states? Let us assume that there are N different preparations, represented by known density matrices ρ_i , and let p_i be the known *a priori* probability for preparation i . We further assume that the testing procedure may yield n different outcomes (in general $n \neq N$). If we have enough understanding of the physical processes involved in the test, we can compute the conditional probability $P_{\mu i}$ that preparation i shall yield

result μ . Having found a particular result μ , we can then compute $Q_{i\mu}$, the likelihood (or *a posteriori* probability) for preparation i . It is given by Bayes's theorem (see Appendix to Chapter 2):

$$Q_{i\mu} = P_{\mu i} p_i / q_\mu, \quad (9.72)$$

where

$$q_\mu = \sum_j P_{\mu j} p_j, \quad (9.73)$$

is the *a priori* probability for occurrence of outcome μ .

Before finding the result μ , we only knew the probabilities p_i . Shannon's entropy, which is a measure of our ignorance, was $-\sum p_i \log p_i$. After having found the result μ , we can compute the *a posteriori* probabilities $Q_{i\mu}$, and the new entropy is

$$H_\mu = - \sum_i Q_{i\mu} \log Q_{i\mu}. \quad (9.74)$$

For some outcomes, H_μ may be larger than the initial entropy, so that the result of the test is to increase our uncertainty. Here is an amusing example, due to Uffink: my key has a 90% chance to be in my pocket; if it is not, it may be in a hundred other places, with equal probabilities. The Shannon entropy thus is $-0.9 \log 0.9 - 0.1 \log 0.001 = 0.7856$. If I search in my pocket and I *don't* find the key in it, the Shannon entropy *increases* to $-\log 0.01 = 4.605$. We thus see that Shannon's entropy does not measure an objective ignorance level, but rather our subjective feeling of ignorance.

On the *average*, however, a quantum test reduces the Shannon entropy. The average information gain is

$$I_{av} := H_{\text{initial}} - \langle H_{\text{final}} \rangle = - \sum p_i \log p_i - \sum_\mu q_\mu H_\mu. \quad (9.75)$$

We shall investigate the optimization of this information gain after we have acquired the necessary mathematical tools.

Positive operator valued measures

The information gain (9.75) depends on the conditional probabilities $P_{\mu i}$ for obtaining result μ when the system is prepared in state ρ_i . The value of $P_{\mu i}$ is determined by the testing procedure. Consider the following model for a two-step operation: First, an auxiliary quantum system, called *ancilla*,¹⁹ is prepared in a *known* state ρ_{aux} . The combined, uncorrelated state of the original quantum system and the ancilla is

¹⁹C. W. Helstrom, *Quantum Detection and Estimation Theory*, Academic Press, New York (1976) pp. 74–83.

$$(\rho_i \otimes \rho_{\text{aux}})_{m\Gamma, nS} = (\rho_1)_{m\Gamma} (\rho_{\text{aux}})_{nS}, \tag{9.76}$$

where *italic* and **boldface** indices refer to the original and auxiliary quantum systems, respectively.

A maximal test is then performed in the combined Hilbert space. This is in principle always possible, by virtue of the strong superposition principle \mathbf{G}^* (page 54). That complete test is represented by an orthogonal resolution of the identity. Different outcomes correspond to *orthogonal* projectors which satisfy

$$P_\mu P_\nu = \delta_{\mu\nu} P_\nu \quad \text{and} \quad \sum_\mu P_\mu = \mathbb{1}. \tag{9.77}$$

In such a test, the probability that outcome μ will follow preparation i is

$$P_{\mu i} = \text{Tr} [P_\mu (\rho_i \otimes \rho_{\text{aux}})] \equiv \sum_{m\Gamma, nS} (P_\mu)_{m\Gamma, nS} (\rho_i)_{n\Gamma} (\rho_{\text{aux}})_{mS}. \tag{9.78}$$

This can be written as

$$P_{\mu i} = \text{Tr} (A_\mu \rho_i), \tag{9.79}$$

where

$$(A_\mu)_{m\Gamma} = \sum_{nS} (P_\mu)_{m\Gamma, nS} (\rho_{\text{aux}})_{nS}, \tag{9.80}$$

is an operator acting on the *original* Hilbert space H .

The Hermitian matrices A_μ , which in general do *not* commute, satisfy

$$\sum_\mu A_\mu = \mathbb{1}. \tag{9.81}$$

The set of A_μ is called a *positive operator valued measure*^{20,21} (POVM), because each A_μ is a positive operator (see definition on page 74). The main difference between these POVMs and von Neumann's *projection valued measures* is that the number of available preparations and that of available outcomes may be different from each other, and also different from the dimensionality of Hilbert space. The probability of outcome μ is now given by $q_\mu = \text{Tr} (A_\mu \rho)$, instead of von Neumann's $\text{Tr} (P_\mu \rho)$.

Optimization

We usually want to maximize the average information gain I_{av} for a given set of p_i and ρ_i . Finding the optimal strategy is a difficult problem for which no general solution is known. Some partial results are however available. It can be proved²² that the optimal POVM consists of matrices of rank one:

²⁰ J. M. Jauch and C. Piron, *Helv. Phys. Acta* 40 (1967) 559.

²¹ E. B. Davies and J. T. Lewis, *Comm. Math. Phys.* 17 (1970) 239.

²² E. B. Davies, *IEEE Trans. Inform. Theory* IT-24 (1978) 596.

$$A_\mu = u_\mu u_\mu^\dagger, \quad (9.82)$$

where the vectors u_μ are in general neither normalized nor orthogonal. The required number, n , of different A_μ satisfies the inequality²²

$$d \leq n \leq d^2, \quad (9.83)$$

where d is the dimensionality of the subspace of H spanned by the different preparations ρ_i .

It can also be proved^{23,24} that the average information gain is bounded by

$$I_{av} \leq S\left(\sum_i p_i \rho_i\right) - \sum_i p_i S(\rho_i), \quad (9.84)$$

with equality holding if, and only if, all the ρ_i commute. The recoverable information can never exceed the von Neumann entropy.

Exercise 9.12 (a) Show that the four matrices $(\mathbb{1} \pm \sigma_x)/4$ and $(\mathbb{1} \pm \sigma_z)/4$ are of rank one and form a POVM. (b) Let a spin $\frac{1}{2}$ particle be prepared in one of the eigenstates of σ_x or σ_z , with equal probabilities for these four states. Compute the probability matrices $P_{\mu i}$ and $Q_{i\mu}$. What are the values of the Shannon entropy before and after testing the above POVM? **Ans.:** $\log 4$, and $\log 4 - \frac{1}{2} \log 2$, respectively (the same result for all the outcomes). ★

Exercise 9.13 With the same preparation states as in the preceding exercise, compute the final Shannon entropy for the POVM consisting of the four matrices $[\mathbb{1} \pm (\sigma_x \pm \sigma_z)/\sqrt{2}]/4$, which also are of rank one. **Ans.:** All the elements of $P_{\mu i}$ and $Q_{i\mu}$ are equal to $(1 \pm 1/\sqrt{2})/4$, and the final entropy is $\log 4 - 0.27665$. (The information gain is less than in preceding exercise). ★

In some cases (such as in quantum cryptography, see Sect. 9-8), we are not interested in maximizing the average information gain I_{av} , but in having part of the answers stating with certainty that some definite preparation was used, or was not used. Consider, for instance, two equiprobable preparation states,

$$\mathbf{u} = \begin{pmatrix} \cos \alpha \\ \sin \alpha \end{pmatrix} \quad \text{and} \quad \mathbf{v} = \begin{pmatrix} \sin \alpha \\ \cos \alpha \end{pmatrix}, \quad (9.85)$$

where $0 < \alpha < \pi/4$. We do not want a test giving *a posteriori* probabilities for these two states, but one with definite answers: either \mathbf{u} , or \mathbf{v} , or “I don’t know.” A suitable POVM giving these answers can be constructed as follows. The projectors on states orthogonal to \mathbf{u} and \mathbf{v} are

$$P_{-\mathbf{u}} := \mathbb{1} - \mathbf{u}\mathbf{u}^\dagger \quad \text{and} \quad P_{-\mathbf{v}} := \mathbb{1} - \mathbf{v}\mathbf{v}^\dagger, \quad (9.86)$$

²³ L. B. Levitin, in *Proc. Fourth All-Union Conf. on Information and Coding Theory*, Tashkent (1969) p. 111 [in Russian].

²⁴ A. S. Holevo, *Probl. Inform. Transmission* 9 (1973) 110, 177 [transl. from the Russian].

respectively. Let $S = \langle \mathbf{u}, \mathbf{v} \rangle = \sin 2\alpha$. Then the three positive operators

$$\mathbf{A}_u = P_{-\mathbf{v}}/(1 + S), \quad \mathbf{A}_v = P_{-\mathbf{u}}/(1 + S), \quad \mathbf{A}_? = \mathbf{1} - \mathbf{A}_u - \mathbf{A}_v, \quad (9.87)$$

are the required POVM.

Exercise 9.14 Show that $\mathbf{A}_? \equiv S(1 + S)^{-2}(\mathbf{u} + \mathbf{v})(\mathbf{u} + \mathbf{v})^\dagger$, and that the probability of an inconclusive answer is S .

After an inconclusive answer, Shannon's entropy still has its initial value, $\log 2$. The mean information gain with this method thus is $I_{av} = (1 - S)\log 2$.

A larger gain can be achieved if we are willing to accept probabilities, rather than occasional certainties mixed with totally inconclusive answers. To get this larger I_{av} , we measure the operator $\mathbf{u}\mathbf{u}^\dagger - \mathbf{v}\mathbf{v}^\dagger$, whose eigenvalues are $\pm \cos 2\alpha$. The probabilities of obtaining these eigenvalues, after preparations of \mathbf{u} or \mathbf{v} , are $P_\pm = (1 \pm \cos 2\alpha)/2$, and the average information gain is

$$\begin{aligned} I_{av} &= \log 2 + P_+ \log P_+ + P_- \log P_- \\ &= [(1 + \cos 2\alpha)\log(1 + \cos 2\alpha) + (1 - \cos 2\alpha)\log(1 - \cos 2\alpha)]/2. \end{aligned} \quad (9.88)$$

Exercise 9.15 Plot this result as a function of α , and show that it is always larger than $I_{av} = (1 - \sin 2\alpha)\log 2$, which was obtained with the preceding method. **Hint:** Differentiate both expressions with respect to $\cos 2\alpha$. ★

9-6. Neumark's theorem

It will now be shown that there always exists a physical mechanism (that is, a realizable experimental procedure) generating any desired POVM represented by given matrices \mathbf{A}_μ . This result follows from Neumark's theorem,^{25,26} which asserts that one can extend the Hilbert space of states H , in which the \mathbf{A}_μ are defined, in such a way that there exists, in the extended space K , a set of orthogonal projectors \mathbf{P}_μ satisfying $\sum \mathbf{P}_\mu = \mathbf{1}$, and such that \mathbf{A}_μ is the result of projecting \mathbf{P}_μ from K into H . (The actual realizability of this set of \mathbf{P}_μ follows from the strong superposition principle, see page 54.)

Thanks to Davies's theorem,²² we can restrict our attention to matrices \mathbf{A}_μ that are of rank one, as in Eq. (9.82). The index μ runs from 1 to N , the number of different outcomes (note that $N \geq n$ if all the \mathbf{A}_μ have rank 1, the equality sign holding only if they are orthogonal). Let us add $N - n$ extra dimensions to H by introducing unit vectors \mathbf{v}_s , orthogonal to each other and to all the \mathbf{u}_μ in Eq. (9.82). The index s runs from $n + 1$ to N . Consider

²⁵M. A. Neumark, *Izv. Akad. Nauk SSSR, Ser. Mat.* 4 (1940) 53, 277; *C. R. (Doklady) Acad. Sci. URSS (N.S.)* 41 (1943) 359.

²⁶N. I. Akhiezer and I. M. Glazman, *Theory of Linear Operators in Hilbert Space*, Ungar, New York (1963) Vol. 2, pp. 121-126.

$$\mathbf{w}_\mu := \mathbf{u}_\mu + \sum_{s=n+1}^N c_{\mu s} \mathbf{v}_s, \quad (9.89)$$

where the $c_{\mu s}$ are complex coefficients to be determined. The vectors \mathbf{w}_μ form a complete orthonormal basis in the enlarged space K provided that

$$\langle \mathbf{w}_\lambda, \mathbf{w}_\mu \rangle = \langle \mathbf{u}_\lambda, \mathbf{u}_\mu \rangle + \sum_{s=n+1}^N \overline{c_{\lambda s}} c_{\mu s} = \delta_{\lambda\mu}. \quad (9.90)$$

There are here more equations than unknown coefficients $c_{\mu s}$. However, the \mathbf{u}_μ are not arbitrary: they obey the closure property $\sum \mathbf{u}_\mu \mathbf{u}_\mu^\dagger = \sum \mathbf{A}_\mu = \mathbf{1}$. Explicitly,

$$\sum_{\mu=1}^N \overline{u_{\mu i}} u_{\mu j} = \delta_{ij}, \quad (9.91)$$

where i and j run from 1 to n (the number of dimensions of the original Hilbert space, H). With the same explicit notations, Eq. (9.90) is

$$\sum_{i=1}^n \overline{u_{\lambda i}} u_{\mu i} + \sum_{s=n+1}^N \overline{c_{\lambda s}} c_{\mu s} = \delta_{\lambda\mu}, \quad (\lambda, \mu = 1, \dots, N). \quad (9.92)$$

Consider now the square matrix of order N ,

$$\mathbf{M} = \begin{pmatrix} u_{\alpha 1} & \cdots & u_{\alpha n} & c_{\alpha, n+1} & \cdots & c_{\alpha N} \\ u_{\beta 1} & \cdots & u_{\beta n} & c_{\beta, n+1} & \cdots & c_{\beta N} \\ \vdots & & \vdots & \vdots & & \vdots \\ u_{N1} & \cdots & u_{Nn} & c_{N, n+1} & \cdots & c_{NN} \end{pmatrix}. \quad (9.93)$$

The first n columns are the $u_{\lambda i}$, which are given, and the $(N - n)$ remaining columns are the unknown $c_{\lambda s}$. Equation (9.92) simply states that \mathbf{M} is a unitary matrix. The first n columns, which satisfy the consistency requirement (9.91), can be considered as n orthonormal vectors in a N -dimensional space. There are then infinitely many ways of constructing $N - n$ other orthonormal vectors for the remaining columns. We thereby obtain explicitly the N orthonormal vectors \mathbf{w}_μ defined by Eq. (9.89). Their projections into H are the \mathbf{u}_μ of Eq. (9.82).

Exercise 9.16 Write explicitly the matrix \mathbf{M} for the POVM in (9.87). ★

We now have a formal proof of Neumark's theorem (for a finite dimensional Hilbert space) but we still have the problem of actually constructing the extra dimensions spanned by the vectors \mathbf{v}_s . In some cases, this is easy: it may happen that the set of \mathbf{u}_μ in Eq. (9.82) spans only a subspace of the states available to our quantum system, and that the latter has enough states to accommodate all the \mathbf{v}_s (it is trivially so if we use only a finite number of \mathbf{A}_μ in an infinite dimensional Hilbert space). However, in general, the extension from H to K necessitates the introduction of an ancilla,¹⁹ as shown below.

Case study: three non-orthogonal states

As a simple example, let $\mathbf{n}_1, \mathbf{n}_2$ and \mathbf{n}_3 denote three unit vectors making angles of 120° with each other, so that $\sum \mathbf{n}_\mu = \mathbf{0}$. Consider a spin $\frac{1}{2}$ particle and define three pairs of normalized states by

$$\boldsymbol{\sigma} \cdot \mathbf{n}_\mu \chi_\mu = \chi_\mu \quad \text{and} \quad \boldsymbol{\sigma} \cdot \mathbf{n}_\mu \psi_\mu = -\psi_\mu. \tag{9.94}$$

It is easily verified that the three positive operators

$$\mathbf{A}_\mu = \frac{2}{3} \psi_\mu \psi_\mu^\dagger, \tag{9.95}$$

have sum $\mathbf{1}$ and therefore define a POVM.

Suppose that we are given the following information: The spin $\frac{1}{2}$ particle can be prepared in one of the three quantum states X_μ defined above, and these three preparations have equal *a priori* probabilities. If we are not told which one of the three X_μ is actually implemented, the Shannon entropy is $H = \log 3$. Our problem is to devise a procedure giving us as much information as possible (that is, reducing H as much as possible).

Exercise 9.17 Show that in this case the Levitin-Holevo inequality (9.84) gives $I_{\text{av}} < \log 2$.

We shall now see that the best result which can be achieved is to reduce the value of H to $\log 2$, so that the actual information gain is $\log(3/2)$. This result is obtained by ruling out one of the three allowed states, and leaving equal *a posteriori* probabilities for the two others (see next exercise).

The actual mechanism can be described as follows. The ancilla, which also is a spin $\frac{1}{2}$ particle, is prepared in an initial state ϕ_0 . Let ϕ' be the state orthogonal to ϕ_0 . Let ψ be any arbitrary state of the original particle, and let ψ' be the orthogonal state. Choose phases in such a way that $\langle \psi_\mu, \psi_\nu \rangle = -\frac{1}{2}$ if $\mu \neq \nu$. Then the three states¹⁹

$$\zeta_\mu = \sqrt{2/3} \phi_0 \otimes \psi_\mu + \sqrt{1/3} \phi' \otimes \psi, \tag{9.96}$$

are orthonormal. The fourth orthonormal state is $\phi' \otimes \psi'$. The four projection operators $\mathbf{P}_\mu = \zeta_\mu \zeta_\mu^\dagger$ therefore form an *orthogonal* resolution of the identity, and can in principle be measured in a single maximal test. Moreover, we have $\langle \phi_0, \zeta_\mu \rangle = (2/3)^{1/2} \psi_\mu$ (for $\mu = 1,2,3$) and therefore,²⁷

$$\langle \phi_0, \mathbf{P}_\mu \phi_0 \rangle = \langle \phi_0, \zeta_\mu \rangle \langle \zeta_\mu, \phi_0 \rangle = \mathbf{A}_\mu, \tag{9.97}$$

as in Eq. (9.80). In this particular case, it can be shown²² that the \mathbf{A}_μ in Eq. (9.95) are the optimal set which maximizes I_{av} .

²⁷ Here, $\langle \phi_0, \zeta_\mu \rangle$ denotes the "partial inner product" of the ancilla state ϕ_0 with the combined state ζ_μ . The latter is defined in a larger Hilbert space, namely the tensor product of the ancilla's Hilbert space with the original H . The value of this partial inner product therefore is a vector in H .

Exercise 9.18 Show that $P_{\mu i} = \text{Tr}(A_{\mu} \rho_i) = \frac{1}{2}(1 - \delta_{\mu i})$, and that the final entropy is $H_{\mu} = \log 2$ (the same entropy for all outcomes).

Preparation of the ancilla for arbitrary A_{μ}

This construction will now be generalized to an arbitrary set of A_{μ} . Let ϕ_0 be the initial state of the ancilla, and let $\phi_{n+1}, \dots, \phi_N$, be other states in the ancilla's Hilbert space, forming together with ϕ_0 an orthonormal basis (that is, the ancilla is an $N - n + 1$ state system). Likewise, let e_k denote a complete orthonormal basis in H . Define, as in Eq. (9.89),

$$\zeta_{\mu} := \phi_0 \otimes u_{\mu} + \sum_{s=n+1}^N c_{\mu s} \phi_s \otimes e_1. \quad (9.98)$$

The calculations now proceed just as in the previous case. However, the ζ_{μ} span only a subspace of K , because K has $n(N - n + 1)$ dimensions. The $(N - n)(n - 1)$ remaining orthonormal states can be taken as $\phi_s \otimes e_k$, where $k = 2, \dots, n$. All these states are orthogonal to ϕ_0 and therefore do not affect the validity of Eq. (9.97).

Exercise 9.19 Construct the vector ζ_{μ} for the POVM (9.87).^{28,29} ★

Exercise 9.20 Consider four unit vectors \mathbf{n}_{μ} connecting the center of a tetrahedron to its vertices, so that the angle between any two of these vectors is $\pi - \arccos \frac{1}{3}$. Define X_{μ} , Ψ_{μ} and A_{μ} as in Eqs. (9.94) and (9.95). Construct explicitly the matrix M in Eq. (9.93). Assuming that the four input states Ψ_{μ} are equally probable, show that the information gain is $\log(4/3)$. ★★

In real life, POVMs are not necessarily implemented by the algorithm of Eq. (9.98). There is an infinity of other ways of materializing a given POVM. The importance of Neumark's theorem lies in the proof that any arbitrary POVM with a finite number of elements can in principle, without violating the rules of quantum theory, be converted into a maximal test, by introducing an auxiliary, independently prepared quantum system (the ancilla).

Quantum state resulting from a POVM

After a *repeatable* maximal test, the new state of the quantum system is the pure state which corresponds to the outcome found in that test. What happens after we execute a POVM? The result essentially depends on how that POVM is implemented.³⁰ For example, if we use the method which has just been described and we find the result μ , the state of the *combined* system is given by Eq. (9.98). The reduced density matrix of the original quantum system is obtained by taking a partial trace on the ancilla's variables,²⁷

²⁸D. Dieks, *Phys. Letters A* 126 (1988) 303.

²⁹A. Peres, *Phys. Letters A* 128 (1988) 19.

³⁰S L Braunstein and C. M. Caves, *Found. Phys. Lett.* 1 (1988) 3.

$$\rho'_{(\mu)} = \sum_j \langle \phi_j, \zeta_\mu \zeta_\mu^\dagger \phi_j \rangle = \sum_j |\langle \phi_j, \zeta_\mu \rangle|^2 = \mathbf{u}_\mu \mathbf{u}_\mu^\dagger + \mathbf{e}_1 \mathbf{e}_1^\dagger \sum_{s=n+1}^N |c_{\mu s}|^2. \tag{9.99}$$

The last sum is $1 - \|\mathbf{u}_\mu\|^2 = 1 - \text{Tr} \mathbf{A}_\mu$, as may be seen by setting $\lambda = \mu$ in Eq. (9.90). Therefore the state of the quantum system after we have found the μ -th outcome of the POVM *by the above method* is

$$\rho'_{(\mu)} = \mathbf{A}_\mu + (1 - \text{Tr} \mathbf{A}_\mu) \mathbf{e}_1 \mathbf{e}_1^\dagger. \tag{9.100}$$

If our quantum system was in state ρ , the probability of finding outcome μ is $\text{Tr}(\mathbf{A}_\mu \rho)$. Therefore the expected state after execution of this POVM is

$$\rho' = \sum_\mu \rho'_{(\mu)} \text{Tr}(\mathbf{A}_\mu \rho). \tag{9.101}$$

A special case of this result is von Neumann’s *projection valued measure*, where $\mathbf{A}_\mu = \mathbf{P}_\mu$. We then have $\text{Tr} \mathbf{A}_\mu = 1$, and

$$\rho' = \sum_\mu \mathbf{P}_\mu \text{Tr}(\mathbf{P}_\mu \rho) = \sum_\mu \mathbf{P}_\mu \rho \mathbf{P}_\mu. \tag{9.102}$$

Exercise 9.21 *Derive the last expression in Eq. (9.102).*

Exercise 9.22 *Show that, if we again test the same POVM, the probability of getting result ν is*

$$\mathbf{P}_{\nu\mu} = \text{Tr}(\mathbf{A}_\nu \rho'_{(\mu)}) = \text{Tr}(\mathbf{A}_\mu \mathbf{A}_\nu) + (1 - \text{Tr} \mathbf{A}_\mu) \langle \mathbf{e}_1, \mathbf{A}_\nu \mathbf{e}_1 \rangle. \tag{9.103}$$

9-7. The limits of objectivity

Your supplier of polarized particles (the beam physicist of your accelerator) claims to have produced neutrons with spin up. Can you verify this? If your philosophy is that of the logical positivists, a statement is meaningful only if it is possible to establish *empirically* whether it is true or false. Obviously, you can take one of these neutrons and perform a Stern-Gerlach type experiment. If the answer is “down,” you have caught your beam physicist misleading you; but if the answer is “up,” this does not prove as yet that he told the truth. A neutron polarized at an angle θ from “up” has a probability $\cos^2(\theta/2)$ to yield the “up” result in a Stern-Gerlach experiment. An unpolarized neutron ($\rho = \frac{1}{2} \mathbf{1}$) has a 50% probability to successfully pass the test.

The notions of truth and falsehood acquire new meanings in the logic of quantum phenomena. It is in principle *impossible* to establish by a single test the veracity of a statement about a quantum preparation. You can increase the confidence level by testing more than one neutron, but this, in turn, depends on your willingness to rely on the uniformity of the neutrons preparations. This

issue itself is amenable to a test, but only if other suitable assumptions are made. In general, the residual entropy (*i.e.*, the uncertainty) left after a quantum test depends on the amount and type of information that was available before the test. This is also true in classical information theory (since I_{av} depends on the *a priori* probabilities p_i) but the effect is more striking for quantum information which can be supplied in subtler ways.

State verification

Let us start with an elementary example. You are told that a spin $\frac{1}{2}$ particle was prepared in an eigenstate of σ_z , with equal probabilities for both states. The Shannon entropy is $\log 2$, and this also is the von Neumann entropy, since $\rho = \frac{1}{2} \mathbb{1}$. A Stern-Gerlach test along the z direction can then determine the initial state with certainty. The information gain is $\log 2$.

Now, imagine that there are two observers, who give contradictory reports on the spin preparation procedure. One of them tells you that it is an eigenstate of σ_x (with equal probabilities for both signs) and the other one asserts that it is an eigenstate of σ_y (also with equal probabilities for both signs). If you equally trust (or distrust) your two observers, the Shannon entropy is $\log 4$. You decide to perform a Stern-Gerlach test.

Exercise 9.23 *What is the information gain if that test is performed along the x direction? Along a direction bisecting the angle between the x and y axes?* **Ans.:** $I_{av} = 0.34657$ and 0.27665 , respectively.

The above exercise shows that different testing methods may yield different amounts of information, which is not unexpected. However, no testing whatsoever can determine which one of the two observers told the truth. This is impossible even if you are given an unlimited number of particles to test. This impossibility is fundamental (it follows from Postulate K, page 76). Indeed, if it were not so, instantaneous communication between distant observers would be possible, by using correlated pairs of particles originating from a common source halfway between them, as was shown in Chapter 6.

Continuous variables: a case study

Suppose that the only information prior to a test of σ_z is that the initial state was pure. It satisfied $\boldsymbol{\sigma} \cdot \mathbf{n} \psi = \psi$, with equal probabilities for all directions of the unit vector \mathbf{n} . How well can we determine \mathbf{n} ?

Let us parametrize \mathbf{n} by the polar angle θ and the azimuthal angle ϕ around the z -axis. The outcomes ± 1 of the test for σ_z have probabilities

$$P_{\pm, \theta} = \frac{1}{2} (1 \pm \cos \theta). \quad (9.104)$$

This test therefore gives no information about ϕ (as is obvious, because of the axial symmetry).

With an isotropic distribution of the spin direction \mathbf{n} , the *a priori* probability p_θ for the polar angle θ , irrespective of the value of ϕ , is given by $p_\theta d\theta = \sin \theta d\theta \int d\phi / 4\pi = \sin \theta d\theta / 2$. Let us introduce a new variable, $u = \cos \theta$, and divide the domain of u into a large number N of equal intervals of size $du = 2/N$. The *a priori* probability for any one of these small intervals is

$$p_u = p_\theta d\theta = \frac{1}{2} \sin \theta d\theta = \frac{1}{2} du = N^{-1}, \quad -1 < u < 1. \quad (9.105)$$

The initial Shannon entropy is

$$H_0 = - \sum_u p_u \log p_u = - \int_{-1}^1 \frac{1}{2} du \log \left(\frac{1}{2} du \right) = \log N. \quad (9.106)$$

In the limit $N \rightarrow \infty$, the value of H_0 becomes infinite, but this is harmless, because H_0 is an irrelevant additive constant, as we shall see. (A similar infinity also occurs in the definition of entropy in classical statistical mechanics.³¹)

Exercise 9.24 *What is the density matrix corresponding to a given value of $u = \cos \theta$, in the representation where σ_z is diagonal?*

The *a priori* probabilities for the outcomes ± 1 in a test for σ_z are

$$q_{\pm} = \sum_u P_{\pm,u} p_u = \int_{-1}^1 \frac{1}{2} (1 \pm u) \frac{1}{2} du = \frac{1}{2}. \quad (9.107)$$

The *a posteriori* probability for u therefore is, by Bayes's theorem,

$$Q_{u,\pm} = P_{\pm,u} p_u / q_{\pm} = \frac{1}{2} (1 \pm u) du = (1 \pm u) / N, \quad (9.108)$$

and the final Shannon entropy, after observation of an outcome ± 1 , is

$$\begin{aligned} H_{\pm} &= - \sum_u Q_{u,\pm} \log Q_{u,\pm} = - \int_{-1}^1 \left[\frac{1}{2} (1 \pm u) \right] du \log [(1 \pm u) / N] \\ &= H_0 - \frac{1}{2} \int_{-1}^1 (1 \pm u) \log (1 \pm u) du. \end{aligned} \quad (9.109)$$

The average information gain thus is

$$I_{\text{av}} = H_0 - H_{\pm} = \frac{1}{2} \int_0^2 z \log z dz = \log 2 - \frac{1}{2} = 0.19315. \quad (9.110)$$

As expected, the information gain is smaller than in the previous examples, where there were only a few distinct possibilities for the value of $u = \cos \theta$.

Exercise 9.25 *Generalize the above discussion to the case where the *a priori* probability for the direction of \mathbf{n} is not isotropic. ★*

³¹ F. Reif, *Fundamentals of Statistical and Thermal Physics*, McGraw-Hill, New York (1965) p. 245.

What happens if we know nothing at all about the initial preparation? Strange as it may be, there is no possibility of “knowing nothing” in the present context. The only valid questions are those of the following type: Given the *a priori* probabilities of various preparations, estimate their *a posteriori* probabilities, after the result of the test is known. Within this logical framework, a statement that the initial state is a random mixture, $\rho \sim \mathbb{1}$, leaves no room for *a priori* probabilities. It is a *complete* specification of the preparation: the Shannon entropy is zero and no further information is to be sought. It is only when several distinct alternatives are considered that we have a meaningful statistical problem.

Homogeneous assemblies

Consider a large number n of independent quantum systems of a known type. The supplier asserts that the states of all these systems have been prepared in the same way. If he does not disclose what that state is, it is easy to determine it empirically: the elements of ρ (a density matrix of order N) can be obtained by measuring the mean values of $N^2 - 1$ suitably chosen operators.³² (The example of a 2×2 density matrix was discussed in detail, page 76.) The problem is to verify that these n systems have indeed been prepared in the same way—for example, that the source of particles which produces them is well stabilized.

Recall that quantum theory describes a set of n independently prepared subsystems by a density matrix $\mathcal{R} = \rho_1 \otimes \rho_2 \otimes \cdots \otimes \rho_n$. This is a direct product, where each one of the ρ_j matrices is of order N . The matrix R is of order N^n and treats the assembly as a single composite system. If all the subsystems are prepared in the same way, the ρ_j matrices are identical. They depend on $N^2 - 1$ parameters which can be measured experimentally.³² We shall now see that if $n \gg N^2$, it is possible to verify the uniformity of the preparations.

We divide the n subsystems into v sets, in any suitable *systematic* way—not in a random way—so as to avoid erasing any suspected systematic deviations from homogeneity in the preparation procedure. For example, yesterday’s samples are not mixed with those of the preceding day, if we suspect that the source is not stable. A convenient way of distributing the n samples among v sets is to take $v \sim N\sqrt{n}$, so that $n \gg v \gg N^2$. We then use $N^2 - 1$ of these sets to obtain estimates of the elements of ρ , and we repeat this process many times, to verify that the results of different samples are consistent. If no inconsistency is found beyond the normally expected statistical fluctuations, we are satisfied that the n subsystems have been prepared in the same way, and we have also measured the corresponding one-particle density matrix ρ .

Here, it should be noted that we have asked only a *very small subset of all the possible questions*: while only $N^2 - 1$ different questions are needed for determining ρ , a maximal test could have had N^n different outcomes (this is the dimensionality of R). We shall again see in Chapter 12 that the transition from

³² W. Band and J. L. Park, *Found. Phys.* 1 (1971) 339; *Am. J. Phys.* 47 (1979) 188.

the quantal to the classical description of a physical system requires discarding nearly all the microscopic information pertaining to that system.

9-8. Quantum cryptography and teleportation

Cryptography is the art of transmitting information in such a way that it cannot be understood by an opponent who might intercept it. The original information, called *plaintext*, consists of words or expressions taken from a finite vocabulary and assembled according to definite syntactical rules. Encryption is an invertible deterministic mapping, yielding a *ciphertext* which conforms to none of these rules and appears random and meaningless, so that it can be safely transmitted over a public communication channel.

A demonstrably safe encryption method is the Vernam cipher. The plaintext is written as sequence of bits (0 and 1). Another *random* sequence, called a *key*, is added to it, bit by bit, modulo 2. This addition is equivalent to the Boolean operation XOR (exclusive OR). The resulting ciphertext can then be decrypted by XORing it with the same key. It is essential to use a key as long as the message, and to *never* use it again.³³

The problem we are going to address is how to distribute a cryptographic key (a secret sequence of bits) to several observers who initially share no secret information, by using an insecure communication channel subject to inspection by a hostile eavesdropper. If only classical means are used, this is an impossible task. Quantum phenomena, on the other hand, provide various solutions. The reason for this difference is that information stored in classical form, such as printed text, can be examined objectively without altering it in any detectable way, let alone destroying it, while it is impossible to do that with quantized information encoded in unknown non-orthogonal states, for instance in the polarizations of photons. It is the elusiveness of quantum information which makes it ideal for transmitting secrets.

EPR key distribution

Consider a source of correlated photon pairs, as in the Aspect experiment (see Fig. 6.8, p. 166). Two distant observers receive these photons and test their polarizations along directions α or β , which make a 45° angle with each other. Here, contrary to the original Aspect experiment, the *same* pair of directions is used by both observers. The choice between α and β is randomly made for each photon, by each observer, who keeps a record of the results of all his polarization tests. After they have analyzed a sufficient number of photon pairs,

³³ If two messages are XORed with the same key, the XOR of their ciphertexts is identical to the XOR of the plaintexts. The result is equivalent to the use of one of the messages as a non-random key for encrypting the other message. If only a finite vocabulary is used, it then is an easy cryptographic problem to decipher both messages.

the two observers publicly announce the sequences of directions (α or β) that were chosen by them, but *not* the results of the corresponding tests. In about one half of the cases, it turns out that the same direction was chosen by both observers, and their results must then be the same, because the photons are correlated. This sequence of results, which is known only to the two observers, can be used as the secret key. The results of polarization tests performed along different directions may be discarded,³⁴ or used for eavesdropping control³⁵ (see below).

It is usually necessary to verify that there is no eavesdropper who intercepts some of the photons and substitutes other, uncorrelated photons, to mislead the two observers. Moreover, there is a possibility that two photon pairs are emitted almost simultaneously, and only one photon of each pair is detected by each observer. This may cause a mismatch in the two keys, inducing errors in the encryption-decryption process. In order to ensure that both keys are the same, the observers may publicly disclose the *parity* of the sum of randomly chosen subsets of bits (and then discard the first bit of each subset, so that no information is released to an eavesdropper). Sophisticated methods of verification and “privacy enhancement” have been developed for this purpose,³⁶ making quantum cryptography an absolutely secure method of communication.

Key distribution using two non-orthogonal states

EPR-correlated particles appear to be a very safe agent for distributing a cryptographic key, because they contain no information at all. If these particles can be stored as long as necessary by the distant observers, the key comes to being only when it is needed for transmitting a message. Other methods, however, may be easier to implement. For example, it is possible to use only two non-orthogonal states, u and v , as follows:³⁷ One of the observers emits a sequence of quanta, randomly prepared in the u or v states; the other one executes a POVM of type (9.87) and publicly announces the cases in which the quantum state was positively identified, without saying of course whether it was u or v . The resulting sequence of u and v , which is known only to the two observers, is the cryptographic key.

Double density coding

In the EPR key distribution discussed above, a single bit is transmitted by each EPR pair (if we also count lost EPR pairs for which the observers have used different settings, only half a bit is transmitted, on the average). Remarkably, it is possible to transmit *two* bits with a single EPR pair, by the following

³⁴C. H. Bennett, G. Brassard, and N. D. Mermin, *Phys. Rev. Lett.* 68 (1992) 557.

³⁵A. K. Ekert, *Phys. Rev. Lett.* 67 (1991) 661.

³⁶C. H. Bennett, F. Bessette, G. Brassard, L. Salvail, and J. Smolin, *J. Crypto.* 5 (1992) 3.

³⁷C. H. Bennett, *Phys. Rev. Lett.* 68 (1992) 3121.

procedure:³⁸ Consider an EPR pair distributed to two distant observers. To simplify the discourse, I shall use notations appropriate to spin $\frac{1}{2}$ particles. The pair is in a singlet state, $(\mathbf{u}_1 \mathbf{v}_2 - \mathbf{v}_1 \mathbf{u}_2)/\sqrt{2}$, where $\mathbf{u} = \begin{pmatrix} 1 \\ 0 \end{pmatrix}$ and $\mathbf{v} = \begin{pmatrix} 0 \\ 1 \end{pmatrix}$.

To encode a message, the emitter subjects his particle to a unitary operation,

$$00 \sim \mathbb{1} \qquad 01 \sim \sigma_x \qquad 10 \sim \sigma_y \qquad 11 \sim \sigma_z, \qquad (9.111)$$

and sends it to the other observer. The latter thus possesses a correlated pair, in one of the states (up to an irrelevant phase)

$$(\mathbf{u}_1 \mathbf{v}_2 \pm \mathbf{v}_1 \mathbf{u}_2)/\sqrt{2} \qquad \text{or} \qquad (\mathbf{u}_1 \mathbf{u}_2 \pm \mathbf{v}_1 \mathbf{v}_2)/\sqrt{2}. \qquad (9.112)$$

These four states are orthogonal and a maximal test can distinguish them unambiguously, thereby revealing which unitary operation was performed. On the other hand, an eavesdropper who would intercept the information carrier would find it in a useless random mixture, $\rho = \frac{1}{2} \mathbb{1}$ (that is, if the same procedure, with the same unitary operation, is repeated many times).

Quantum teleportation

The inverse process is even more remarkable. It is the “teleportation” of an *unknown* quantum state by means of an EPR pair and two bits of classical information.³⁹ The first step of this process is the distribution of the EPR pair, in the standard singlet state, to the distant observers, *A* and *B*. Suppose that *A* holds, besides particle 1, another spin $\frac{1}{2}$ particle, labelled 0, in an unknown state ϕ that has to be transmitted to *B* (the particle itself is not sent, only information specifying its *unknown* state). This can be done as follows.

Particles 0 and 1, which are initially *uncorrelated*, are subjected by *A* to a maximal quantum test with eigenstates

$$\Psi_{\pm} = (\mathbf{u}_0 \mathbf{v}_1 \pm \mathbf{v}_0 \mathbf{u}_1)/\sqrt{2} \qquad \text{and} \qquad \Phi_{\pm} = (\mathbf{u}_0 \mathbf{u}_1 \pm \mathbf{v}_0 \mathbf{v}_1)/\sqrt{2}. \qquad (9.113)$$

These are analogous to the states in (9.112). The four outcomes of this test have equal probabilities, regardless of the unknown state ϕ (see exercise below). The result of the test—two apparently random bits of information—is communicated to *B* over a public channel. According to this result, *B* performs on particle 2 a suitable unitary operation from the set (9.111). The state of particle 2 then becomes ϕ , identical to the state of particle 0 before the latter was tested by *A*. That state now is inaccessible to *A*, and is still unknown to *B*.

The *experimental meaning* of the above statements is the following: there is a 25% probability that *A* finds state Ψ_- ; then, if *B* measures any projection operator *P*, the probability of getting the result 1 is $\langle \phi, P\phi \rangle$. Likewise, if *A* finds state Ψ_+ , and *B* measures *P*, the probability of getting the result 1 is $\langle \sigma_z \phi, P\sigma_z \phi \rangle$; and so on. The detailed proof is proposed as the following exercise:

³⁸C. H. Bennett and S. J. Wiesner, *Phys. Rev. Lett.* 69 (1992) 2881.

³⁹C. H. Bennett, G. Brassard, C. Crépeau, R. Jozsa, A. Peres, and W. K. Wootters, *Phys. Rev. Lett.* 70 (1993) 1895.

Exercise 9.26 Show that the combined state of the three particles before A 's test, namely $\psi = \phi_0(\mathbf{u}_1 \mathbf{v}_2 - \mathbf{v}_1 \mathbf{u}_2)/\sqrt{2}$, can also be written as

$$\psi = \frac{1}{2}[-\Psi_- \phi_2 - \Psi_+ (\sigma_x \phi_2) + \Phi_- (\sigma_x \phi_2) - \Phi_+ (i\sigma_y \phi_2)]. \quad (9.114)$$

Hint: Write $\phi_0 = \alpha \mathbf{u}_0 + \beta \mathbf{v}_0$, where α and β are unknown coefficients, and likewise $\phi_2 = \alpha \mathbf{u}_2 + \beta \mathbf{v}_2$. ★

It follows from linearity that teleportation works not only for a pure state ϕ , but also for a mixed one. This includes the possibility that particle 0 is initially correlated to a fourth particle, far away. Then particle 2 will turn out correlated to that fourth, distant particle. This process may look like science fiction, but it is a rigorous consequence of quantum theory.

9-9. Bibliography

Thermodynamics and statistical mechanics

F. Reif, *Fundamentals of Statistical and Thermal Physics*, McGraw-Hill, New York (1965).

M. W. Zemansky, *Heat and Thermodynamics*, McGraw-Hill, New York (1968).

E. T. Jaynes, *Papers on Probability, Statistics and Statistical Physics*, ed. by R. D. Rosenkrantz, Reidel, Dordrecht (1983).

Information and entropy

A. I. Khinchin, *Mathematical Foundations of Information Theory*, Dover, New York (1957).

A. Wehrl, "General properties of entropy," *Rev. Mod. Phys.* 50 (1978) 221.

J. R. Pierce, *An Introduction to Information Theory: Symbols, Signals and Noise*, 2nd ed., Dover, New York (1980).

L. B. Levitin, "Information theory for quantum systems," in *Information Complexity and Control in Quantum Physics*, ed. by A. Blaquièrre, S. Diner, and G. Lochak, Springer, Vienna (1987) p. 15.

C. H. Bennett, "The thermodynamics of computation—a review," *Int. J. Theor. Phys.* 21 (1982) 905.

D. Deutsch, "Uncertainty in quantum measurements," *Phys. Rev. Lett.* 50 (1983) 631.

H. Maassen and J. B. M. Uffink, "Generalized entropic uncertainty relations," *Phys. Rev. Lett.* 60 (1988) 1103.

Maxwell's demon

H. S. Leff and A. F. Rex, eds. *Maxwell's Demon: Entropy, Information, Computing*, Adam Hilger, Bristol (1990).

Maxwell introduced his legendary demon as a challenge to second law of thermodynamics. The problem is whether a microscopic intelligent being can cause a decrease of entropy in a thermodynamic system. The various answers that have been given involve statistical physics, quantum theory, information theory, and computer science. A didactic overview of the problem precedes this collection of reprints which includes, among others, an English translation of Szilard's historic article "On the decrease of entropy in a thermodynamic system by the intervention of intelligent beings," *Z. Phys.* 53 (1929) 840. Important recent contributions are:

C. H. Bennett, "Demons, engines and the second law," *Sci. Am.* 257 (Nov. 1987) 88.

C. M. Caves, "Quantitative limits on the ability of a Maxwell demon to extract work from heat," *Phys. Rev. Lett.* 64 (1990) 2111.

Some comments on the last article, by C. M. Caves, W. G. Unruh, and W. H. Zurek, appear in *Phys. Rev. Lett.* 65 (1990) 1387.

Nonlocal effects

S. L. Braunstein and C. M. Caves, "Information-theoretic Bell inequalities," *Phys. Rev. Lett.* 61 (1988) 662.

B. W. Schumacher, "Information and quantum nonseparability," *Phys. Rev. A* 44 (1991) 7047.

A. Peres and W. K. Wootters, "Optimal detection of quantum information," *Phys. Rev. Lett.* 66 (1991) 1119.

This paper discusses the optimal strategy for determining the common state of two quantum systems, identically prepared in different locations. A single combined test, performed on both systems together, is more efficient than various combinations of POVMs for each system separately. However, the problem of finding the best separate-particle strategy is left unsolved, and it is proposed as a challenge to quantum theorists.

Quantum communication, cryptography, and computation

C. M. Caves and P. D. Drummond, "Quantum limits on bosonic communication rates," *Rev. Mod. Phys.* 66 (1994) 481.

R. Jozsa and B. Schumacher, "A new proof of the quantum noiseless coding theorem," *J. Mod. Optics* 41 (1994) 2343.

A. K. Ekert, B. Huttner, G. M. Palma, and A. Peres, "Eavesdropping on quantum-cryptographical systems," *Phys. Rev. A* 50 (1994) 1047.

A. Barenco, D. Deutsch, A. Ekert, and R. Jozsa, "Conditional quantum dynamics and logic gates," *Phys. Rev. Lett.* 74 (1995) 4083.

Chapter 10

Semiclassical Methods

10-1. The correspondence principle

The historical development of quantum mechanics left it with a heavy legacy of classical concepts. Foremost among them is the *correspondence principle*, which asserts that there are, under suitable conditions, analogies between classical and quantum dynamics. Even today, this principle is often used as an intuitive guide for finding quantum properties similar to known classical laws. These analogies are surprising, because of the radical differences in the mathematical formalisms underlying the two theories: quantum mechanics uses a separable Hilbert space with a *unitary* inner product, while classical mechanics wants a continuous phase space with a *symplectic* structure.¹ Yet, in spite of this fundamental difference, there may be in some situations an approximate correspondence between classical and quantum concepts. The analogy is admittedly vague. Some of its virtues and limitations are pointed out below. In particular, it will be shown how the correspondence principle must ultimately break down in any nontrivial problem.

Classical operators

Formally, we may imagine a sequence of quantum theories having different values of \hbar , and examine under which conditions the limit $\hbar \rightarrow 0$ exists and coincides with classical mechanics. In general, for arbitrary dynamical variables, this limit does *not* exist and quantum theory does *not* reduce to classical mechanics. However, in that sequence of quantum theories, there is a privileged class of operators, which can be expressed in terms of the canonical q and p , without explicit mention of \hbar . These have been called *reasonable* or *classical* operators.^{2,3} For instance, the momentum operator introduced in Sect. 8-4 is reasonable. Likewise $J_z = \mathbf{x} p_y - \mathbf{y} p_x$ is reasonable, but $\cos(J_z/\hbar)$ is not. By

¹H. Goldstein, *Classical Mechanics*, Addison-Wesley, Reading (1980) pp. 391–407.

²L. G. Yaffe, *Rev. Mod. Phys.* 54 (1982) 407.

³K. B. Kay, *J. Chem. Phys.* 79 (1983) 3026.

restricting our attention to these special operators, it becomes possible to find similarities between classical properties and corresponding quantum properties, in an appropriate limit loosely called $\hbar \rightarrow 0$.

Such a limiting process was used in Sect. 6-6, when we lumped together “neighboring” outcomes of quantum tests. In pure quantum theory, this is a meaningless phrase: any two different outcomes of a quantum test correspond to *orthogonal* states, and are as close or distant as any two other different outcomes. However, a meaning can be attributed to “neighboring” outcomes in a *semiclassical* context, where the outcomes that are lumped together are those which correspond to neighboring eigenvalues of *reasonable* operators. The argument presented in Sect. 6-6 was that, if our macroscopic apparatuses are able to measure only operators of that type, it is impossible to observe the strong correlations predicted by quantum mechanics for the results of tests performed at distant locations. The readings of our instruments have only *weaker* classical correlations, which do not violate Bell’s inequality. It is only when our instruments are so keen that they can detect genuine quantum features, such as isolated eigenvalues, that local realism breaks down (together with the correspondence principle itself).

Canonical and unitary transformations

A formal analogy, emphasized by Dirac,⁴ is the one between canonical transformations in classical mechanics and unitary transformations in quantum theory. (The reader who is not familiar with canonical transformations should consult the bibliography at the end of Chapter 1.) Obviously, there cannot be any strict correspondence between these two concepts, because unitary transformations preserve eigenvalues (which are the observable values of quantum dynamical variables) while canonical transformations can relate variables having different domains of definition and even different dimensions. An example of failure of this correspondence for “unreasonable” operators will be given later. First, let us see some cases where it works.

A question which often arises in practice is the following: given a classical physical system, how do we define the analogous quantum mechanical system? This surely is an ill defined question, to which I can only propose the following ill defined answer: *The law of motion of reasonable quantum operators (in the Heisenberg picture) should resemble the classical law of motion.* This criterion is admittedly vague, because any resemblance between these laws is in the eye of the beholder. I shall now illustrate this issue by simple examples, using as dynamical variables the three components of angular momentum.

First, assume that the quantum law of motion is a rotation by an angle β around the y -axis. That rotation is represented by the unitary operator

$$U = e^{-i\beta J_y/\hbar}. \quad (10.1)$$

⁴P. A. M. Dirac, *The Principles of Quantum Mechanics*, Oxford Univ. Press (1947), p. 106.

Obviously, this operator has no limit for $\hbar \rightarrow 0$, if the classical parameter β and the classical operator J_y are kept fixed while \hbar changes. The operator U has an *essential singularity* for $\hbar \rightarrow 0$. We do not obtain classical mechanics as a limiting case of quantum mechanics.

The relationship between U , in Eq. (10.1), and a classical rotation around the y -axis has a formal nature: We note that J_y itself is invariant under the unitary transformation generated by U . For the other components, we have

$$J'_z + i J'_x = e^{i\beta J_y/\hbar} (J_z + i J_x) e^{-i\beta J_y/\hbar}, \quad (10.2)$$

and some algebraic manipulations (best done in the representation where J_y is diagonal) give

$$J'_z + i J'_x = (J_z \cos \beta - J_x \sin \beta) + i (J_z \sin \beta + J_x \cos \beta). \quad (10.3)$$

Written in this form, the quantum law of motion looks *identical* to a classical rotation. In particular, it does not involve \hbar explicitly.

As a second example, consider a linear *twist* around the z -axis, by an angle proportional to J_z/J :

$$\begin{aligned} J'_x &= J_x \cos(\alpha J_z/J) - J_y \sin(\alpha J_z/J), \\ J'_y &= J_x \sin(\alpha J_z/J) + J_y \cos(\alpha J_z/J), \\ J'_z &= J_z. \end{aligned} \quad (10.4)$$

This is a *canonical transformation* of the variables J_x , J_y and J_z , as can be seen from the fact that the J'_n have the same Poisson brackets as the J_n .

In quantum theory, we may still assume that the total angular momentum has a sharp value, $[J(J+1)]^{1/2}\hbar$. For any given J , the twist operator is

$$U = e^{-i\alpha J_z^2/2J\hbar}. \quad (10.5)$$

This unitary operator leaves J_z invariant, and the law of motion of the other components is

$$\underline{J'_x + i J'_y = e^{i\alpha J_z^2/2J\hbar} (J_x + i J_y) e^{-i\alpha J_z^2/2J\hbar}}. \quad (10.6)$$

Note that U has no limit for $\hbar \rightarrow 0$. With some algebraic manipulations (best done in the representation where J_z is diagonal), Eq. (10.6) can be written as

$$J'_x + i J'_y = e^{i\alpha J_z/2J} (J_x + i J_y) e^{i\alpha J_z/2J}, \quad (10.7)$$

where both exponents now have the *same sign*, not opposite signs as in (10.6).

Exercise 10.1 Verify that the transformation (10.4) is canonical.

Exercise 10.2 Verify Eq. (10.7). ★

Again, \hbar seems to have disappeared. It still is here implicitly, of course, because of its presence in the commutation relations of the components of \mathbf{J} . However, if we pretend that the variables in Eq. (10.7) are classical, that equation can be written as

$$J'_x + i J'_y = \left(J_x \cos \frac{\alpha J_z}{J} - J_y \sin \frac{\alpha J_z}{J} \right) + i \left(J_x \sin \frac{\alpha J_z}{J} + J_y \cos \frac{\alpha J_z}{J} \right), \quad (10.8)$$

which looks exactly like the twist transformation in Eq. (10.4).

Unreasonable operators

The correspondence principle completely fails when we consider canonical transformations between classical variables whose quantum analogs have different spectra, and cannot therefore be related by unitary transformations. Even the most fundamental notion of classical mechanics, that of *number of degrees of freedom*, has no quantum counterpart.

Exercise 10.3 *What is the canonical transformation from Cartesian to spherical coordinates? Write explicitly the canonical momenta p_θ and p_ϕ in terms of the Cartesian momenta \mathbf{p} . What is the canonical transformation from the variables $\theta, \phi, p_\theta, p_\phi$, to a new set of variables, among which*

$$J_z = p_\phi \quad \text{and} \quad J^2 = p_\theta^2 + p_\phi^2 / \sin^2 \theta, \quad (10.9)$$

(whose Poisson bracket vanishes) are the two new canonical momenta? What are the canonical coordinates conjugate to J_z and J^2 ? If these dynamical variables are converted into operators, what are their domains of definition? ★

Ans.: The generating function of the second canonical transformation is

$$S = \phi J_z + \int^\theta \sqrt{J^2 - J_z^2 / \sin^2 \xi} d\xi, \quad (10.10)$$

and the corresponding coordinates are

$$Q_1 = \partial S / \partial J_z = \phi + \tan^{-1}(p_\phi \cot \theta / p_\theta), \quad (10.11)$$

and

$$Q_2 = \frac{\partial S}{\partial J^2} = \frac{-1}{2\sqrt{p_\theta^2 + p_\phi^2 / \sin^2 \theta}} \sin^{-1} \left(\frac{p_\theta^2 \sin^2 \theta + p_\phi^2}{p_\theta^2 \tan^2 \theta + p_\phi^2} \right)^{1/2} \quad (10.12)$$

As a sequel to this exercise, let us perform one more canonical transformation, and define new momenta $P_\pm = \hbar^{-2} J^2 \pm \hbar^{-1} J_z$, and their conjugate coordinates Q_\pm . What are the quantum analogs of these variables? These are not reasonable operators, of course, since their definition involves \hbar explicitly. Nonetheless, they have a perfectly well defined domain in Hilbert space. The eigenvalues of P_\pm are all the positive integers, as seen in the following table:

\mathbf{J}^2/\hbar^2	0	2			6				...	
J_z/\hbar	0	-1	0	1	-2	-1	0	1	2	...
P_+	0	1	2	3	4	5	6	7	8	...
P_-	0	3	2	1	8	7	6	5	4	...

The operators P_+ and P_- are *nondegenerate*, and they are functions of each other. Consider the representation where both are diagonal. If there were a correspondence between Poisson brackets and commutators, we would expect P_+ to commute with Q_- , and therefore Q_- would be diagonal too. This would then contradict the requirement that Q_- is conjugate to P_- . Not surprisingly, the correspondence principle fails for these nonclassical operators.

10-2. Motion and distortion of wave packets

Until now, we considered algebraic properties of operators, irrespective of the choice of specific quantum states. There also are analogies of a different type, holding for *localized states* such as wave packets. For simplicity, consider a system with a single degree of freedom, and a Hamiltonian $H = \frac{1}{2} \mathbf{p}^2 + V(\mathbf{q})$. The Heisenberg equations of motion are

$$\dot{\mathbf{q}} = \mathbf{p} \quad \text{and} \quad \dot{\mathbf{p}} = -dV(\mathbf{q})/d\mathbf{q}. \quad (10.13)$$

Let $q = \langle \psi, \mathbf{q} \psi \rangle$ and $p = \langle \psi, \mathbf{p} \psi \rangle$ denote the mean values of the operators \mathbf{q} and \mathbf{p} . We then have, from (10.13),

$$\dot{q} = p \quad \text{and} \quad \dot{p} = -\langle dV(\mathbf{q})/d\mathbf{q} \rangle. \quad (10.14)$$

Therefore, if the potential V changes slowly over the size of a wave packet, so that $\langle dV(\mathbf{q})/d\mathbf{q} \rangle \simeq dV(q)/dq$, the wave packet moves approximately like a classical particle. This is Ehrenfest's theorem.⁵

Let us evaluate deviations from this semiclassical approximation. We have, by a Taylor expansion,

$$V(\mathbf{q}) = V(q) + (\mathbf{q} - q) \frac{dV(q)}{dq} + \frac{1}{2} (\mathbf{q} - q)^2 \frac{d^2V(q)}{dq^2} + \dots, \quad (10.15)$$

whence

$$\frac{dV(\mathbf{q})}{d\mathbf{q}} = \frac{dV(q)}{dq} + (\mathbf{q} - q) \frac{d^2V(q)}{dq^2} + \frac{1}{2} (\mathbf{q} - q)^2 \frac{d^3V(q)}{dq^3} + \dots. \quad (10.16)$$

When we take the expectation value of the last equation, we have $\langle \mathbf{q} - q \rangle \equiv 0$, and $\langle (\mathbf{q} - q)^2 \rangle \equiv (\Delta \mathbf{q})^2$, which is the dispersion of \mathbf{q} (the width of the wave packet). We obtain, neglecting $\langle (\mathbf{q} - q)^3 \rangle$ and higher terms,

⁵P. Ehrenfest, *Z. Phys.* 45 (1927) 455.

$$-\left\langle \frac{dV(\mathbf{q})}{d\mathbf{q}} \right\rangle = -\frac{dV(\mathbf{q})}{d\mathbf{q}} - \frac{1}{2} \frac{d^3V(\mathbf{q})}{dq^3} (\Delta\mathbf{q})^2. \quad (10.17)$$

Because of the last term, the centroid of a wave packet does not move along a classical orbit, and there is a gradual spreading and distortion of the wave packet.⁶ (Note, however, that these are not quantum phenomena: similar effects also occur for classical Liouville densities.)

Poincaré invariants

This difference between the motion of localized wave packets and that of classical point particles has important consequences. In particular, it precludes the existence of quantum analogs for the classical Poincaré invariants.^{7,8} The simplest of these invariants is the volume of a $2N$ -dimensional domain in phase space. As the points which form the boundary of this domain move according to Hamilton's equations, the enclosed volume remains constant—this is Liouville's theorem. Any compact domain, obeying the Liouville equation of motion, is continuously distorted and tends to project increasingly long and thin filaments. As time passes, new, finer filaments emerge, whose volume is less than \hbar^{-N} . The quantum density ρ (or the Wigner function, that will be discussed in Sect. 10-4) cannot reproduce these minute details and smoothes them away.⁹ We therefore expect the quantum dynamical evolution to be qualitatively *milder* than the classical one.

Let us examine the simple case of a single degree of freedom. There is only one Poincaré invariant: the area of a domain in phase space. The evolution of the area of an infinitesimal triangle can be investigated by comparing three slightly different motions of a given particle. In classical mechanics, these would be three neighboring orbits in phase space. In quantum mechanics, we shall have three neighboring wave packets, labelled ψ , ψ' and ψ'' . For the wave packet ψ' , let us define mean values q' , p' and $\Delta'q$, as before. We then have, from Eqs. (10.14) and (10.17),

$$d(q' - q)/dt = (p' - p), \quad (10.18)$$

and

$$\begin{aligned} \frac{d}{dt} (p' - p) &= -\left\langle \psi', \frac{dV(\mathbf{q})}{d\mathbf{q}} \psi' \right\rangle + \left\langle \psi, \frac{dV(\mathbf{q})}{d\mathbf{q}} \psi \right\rangle = \\ &= -\left[\frac{d^2V(q)}{dq^2} + \frac{1}{2} \frac{d^4V(q)}{dq^4} (\Delta q)^2 \right] (q' - q) - \frac{1}{2} \frac{d^3V(q)}{dq^3} [(\Delta'q)^2 - (\Delta q)^2]. \end{aligned} \quad (10.19)$$

⁶M. Andrews, *J. Phys. A* 14 (1981) 1123.

⁷H. Goldstein, *Classical Mechanics*, 1st ed., Addison-Wesley, Reading (1950) pp. 247–250. Unfortunately, this material was deleted from the second edition of this book.

⁸M. Born, *The mechanics of the atom*, Bell, London (1927) [reprinted by Ungar, New York (1960)] p. 36.

⁹H. J. Korsch and M. V. Berry, *Physica D* 3 (1981) 627.

It is the last term in this equation which precludes the existence of a quantum analog of the area preserving theorem.

Indeed, introducing the third neighboring wave packet, ψ'' , with equations of motion similar to (10.18) and (10.19), we obtain the rate of change of the infinitesimal triangle area:¹⁰

$$\begin{aligned} \frac{d}{dt} [(q' - q)(p'' - p) - (q'' - q)(p' - p)]/2 = & \quad (10.20) \\ = \frac{d^3V(q)}{dq^3} \{ (q'' - q)[(\Delta'q)^2 - (\Delta q)^2] - (q' - q)[(\Delta''q)^2 - (\Delta q)^2] \}/4. \end{aligned}$$

This expression does not vanish in general, unless $d^3V/dq^3 = 0$. It can be neglected only if the size of the wave packets is much smaller than the distance between the vertices of the (infinitesimal) triangle. Such an approximation may be valid for planets and other macroscopic bodies, but not for generic quantum systems such as atoms or molecules.

Case study: Rydberg states

If $d^3V/dq^3 \neq 0$, the evolution of a localized quantum wave packet cannot be simulated by that of a classical Liouville density (which represents an ensemble of particles moving on neighboring orbits in phase space) for more than a finite lapse of time, whose duration depends on the type of potential and on the location of the wave packet in phase space.¹⁰ The following example displays some bizarre features of quantum dynamics, with no classical analog.

Consider the motion of a planet around the Sun, with $V = -GMm/r$, or that of an electron in a Coulomb potential, $V = -e^2/r$. For simplicity, take a circular orbit. A classical calculation gives $J = rp$ and $e^2/r^2 = p^2/mr$. We thus have

$$p = me^2/J \quad \text{and} \quad r = J^2/me^2, \quad (10.21)$$

whence

$$E = \frac{p^2}{2m} - \frac{e^2}{r} = -\frac{me^4}{2J^2}. \quad (10.22)$$

In these equations, p is the *tangential* component of the momentum \mathbf{p} . The classical angular velocity along the orbit is

$$\omega = p/mr = me^4/J^3 = (-2E)^{3/2} (me^4)^{-1/2}. \quad (10.23)$$

For neighboring circular orbits, whose energies differ by δE , we have

$$\delta\omega = 3\omega\delta E/2E. \quad (10.24)$$

¹⁰N. Moiseyev and A. Peres, *J. Chem. Phys.* 79 (1983) 5945.

Inner orbits have a higher angular velocity. Consequently, the Liouville density in phase space is sheared, as it moves along concentric orbits. If it initially is a small blob, it will gradually spread over a circular arc, until the head of the pack catches up with its tail. This will occur after a time

$$T_s = 2\pi/\delta\omega = 4\pi E/3\omega\delta E. \quad (10.25)$$

Any remaining analogy between classical motion and quantum motion must then break down, because the quantum wave packet will interfere with itself in a way that the classical Liouville density cannot mimic.

Let us return to quantum mechanics. Instead of (10.22) we have

$$E_n = -me^4/2n^2\hbar^2, \quad (10.26)$$

where $n = J/\hbar$ is an integer. Hydrogen atoms with $n \gg 1$ (for which semi-classical approximations may sometimes be valid) are called *Rydberg atoms*. Consecutive energy levels are separated by $me^4/n^3\hbar^2 = \hbar\omega$, as expected from the correspondence principle: a classical charge in circular motion radiates with the rotational frequency ω . Each emitted photon has an energy $\hbar\omega$, and this has to be the energy difference between the quantized levels.

Let a hydrogen atom be prepared in such a way that the positive-energy part of its spectrum is negligible (that is, ionized atoms are removed by the preparation procedure). The Schrödinger wave function can be expanded into eigenfunctions of H:

$$\psi(\mathbf{r}, t) = \sum_n c_n u_n(\mathbf{r}) e^{-iE_n t/\hbar}, \quad (10.27)$$

where $\int \overline{u_n} u_s d\mathbf{r} = \delta_{ns}$ and $\sum |c_n|^2 = 1$. Since this sum converges, a *finite* number of c_n can make $\sum |c_n|^2$ arbitrarily close to 1, and are therefore sufficient to represent ψ with arbitrary accuracy. As a consequence, any ψ is arbitrarily close to a *periodic* function of time. Indeed, all the exponents in (10.27) have the form $2\pi i t/T_0 n^2$ where $T_0 = 4\pi\hbar^3/me^4 = 3.04 \times 10^{-16}$ s. Let L be the least common multiple of all the n for which we do not neglect c_n . Obviously, ψ has a period $T_0 L^2$. *This recurrence has no classical analog* (the celebrated Poincaré recurrences occur for individual orbits, not for continuous Liouville densities).

Exercise 10.4 Show that if a minimum uncertainty wave packet is placed on a circular orbit, with its central parameters satisfying Eq. (10.21), the number of energy levels appreciably involved is of the order of \sqrt{n} . ★

The required time for an exact recurrence, $T_0 L^2$, is enormous if many levels are appreciably excited. However, *nearly* exact recurrences occur considerably earlier. The probability of finding a recurrence is given by the overlap of $\psi(t)$ with the initial state $\psi(0)$, namely

$$P(t) = |\langle \psi(0), \psi(t) \rangle|^2 = \left| \sum_n w_n e^{-iE_n t/\hbar} \right|^2, \quad (10.28)$$

where $w_n = |c_n|^2$. If the initial wave packet is well localized, its energy dispersion is small ($\Delta E \ll |E|$) and the coefficients w_n are large only in a narrow domain of n . Let N be an integer anywhere in the middle of that domain, and let $\nu = n - N$. We can expand

$$n^{-2} = N^{-2} - 2N^{-3}\nu + 3N^{-4}\nu^2 - 4N^{-5}\nu^3 + 5N^{-6}\nu^4 - \dots \quad (10.29)$$

If we keep only the first two terms of this series, the exponents in Eq. (10.28) are $(2\pi i t/T_0 N^3)(2\nu - N)$. Apart from a common phase $-2\pi i t/T_0 N^2$, all these exponents are integral multiples of $2\pi i$ whenever

$$t = T_{cl} = N^3 T_0/2, \quad (10.30)$$

where $T_{cl} = 2\pi/\omega$ is the classical period of revolution for energy E_N . This is of course the expected result: for short times, the quantum wave packet moves as a classical particle. For longer times, higher terms in (10.29) destroy the phase coherence and the wave packet spreads over the entire orbit.

Yet, it eventually reassembles: the exponent in Eq. (10.28) is, apart from an irrelevant additive constant,

$$\exp[(\pi i t/T_{cl})(2\nu - 3N^{-1}\nu^2 + 4N^{-2}\nu^3 - 5N^{-3}\nu^4 + \dots)]. \quad (10.31)$$

When $t = 2NT_{cl}$, the second term in this series yields an integral multiple of $2\pi i$, and the wave packet reappears at its original position. Actually, this recurrence already occurs after $(N/3 + \frac{1}{2})$ classical periods (where N , which was only loosely defined above, has to be adjusted so as to be a multiple of 3). Indeed, let $t = (N/3 + \frac{1}{2})T_{cl}$. The first two terms in (10.31) give

$$2\pi i \nu \left(\frac{N}{3} + \frac{1}{2} \right) \left(1 - \frac{3\nu}{2N} \right) \simeq 2\pi i \nu \left(\frac{N}{3} - \frac{\nu}{2} + \frac{1}{2} \right) = 2\pi i \left[\frac{\nu N}{3} - \frac{\nu(\nu-1)}{2} \right].$$

We can always adjust N so that $N/3$ is an integer. Also, $\nu(\nu-1)/2$ always is an integer. Therefore, apart from terms of order N^{-1} , the exponent in (10.31) is a multiple of $2\pi i$. The factor $N/3$ (without $\frac{1}{2}$) can also be obtained from semiclassical arguments.¹¹ This recurrence has been experimentally observed.¹²

As time passes, the third term in the series in (10.31) gradually destroys these periodic recurrences, but new ones appear at integral multiples of $N^2 T_{cl}$. The same argument shows that the first such reappearance actually occurs at $t = [(N^2/4) + \frac{1}{2}] T_{cl}$, where N must again be adjusted to make it even, if necessary. These recurrences are then destroyed by the following term in (10.31), and reappear at integral multiples of $[(N^3/5) + \frac{1}{2}] T_{cl}$, and so on. This is illustrated in Fig. 10.1 for the case $N = 1000$, with 21 energy levels having a binomial distribution of weights: $w_n = 2^{-20} 20!/(n-990)!(1010-n)!$. With this value of N , the third recurrence level occurs at $t = 30.4$ s, an exceedingly long time by atomic standards.

¹¹ M. Nauenberg, *Comments Atom. Mol. Phys.* 25 (1990) 151; *J. Phys. B* 23 (1990) L385.

¹² J. A. Yeazell, M. Mallalieu, and C. R. Stroud, Jr., *Phys. Rev. Lett.* 64 (1990) 2007.

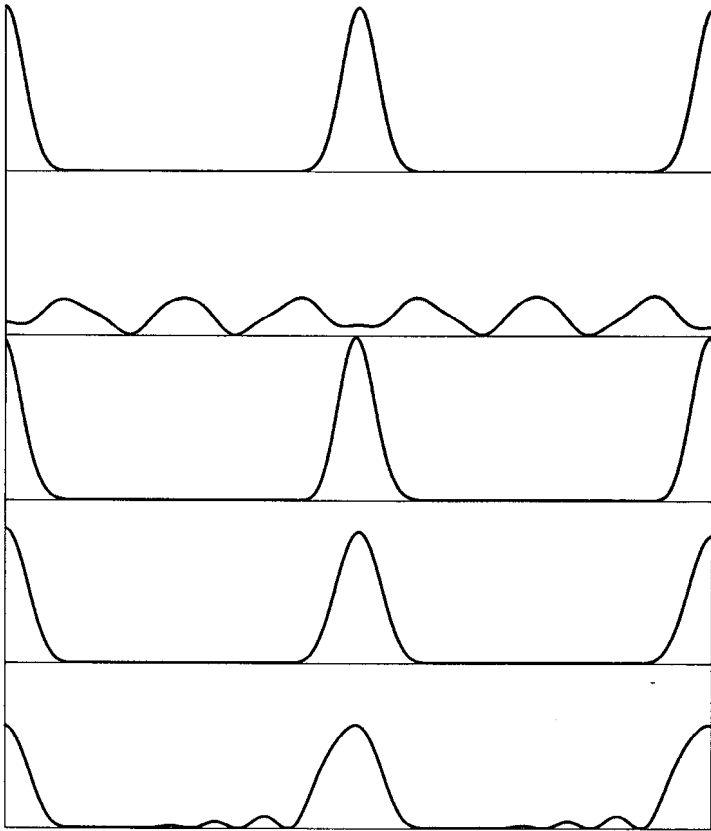

Fig. 10.1. Recurrences of a wave packet consisting of Rydberg states with $n = 990$ to 1010 . The value of $|\langle \psi(0), \psi(t) \rangle|^2$ (vertical axis) is plotted versus time. In each graph, the time (horizontal axis) extends over two classical periods. The central time is, from top to bottom: T_{c1} (one classical period), $100 T_{c1}$ (a random number), $333.5 T_{c1}$ (first order recurrence), $250\,000.5 T_{c1}$ (second order recurrence), and $(2 \times 10^8 + 0.5) T_{c1}$ (third order recurrence).

10-3. Classical action

A short time after the publication of Schrödinger's historic papers, Madelung¹³ proposed a hydrodynamical model for Schrödinger's equation. Let $\psi = R e^{iS/\hbar}$, where R and S are real, and let $\rho = R^2$. [In modern parlance, $\rho(\mathbf{r})$ is the diagonal part of the density matrix $\rho(\mathbf{r}', \mathbf{r}'')$.] Then, the Schrödinger equation for a particle of mass m in a potential $V(\mathbf{r})$ is equivalent to the real equations:

¹³E. Madelung *Z. Phys.* 40 (1926) 322.

$$\frac{\partial \rho}{\partial t} + \nabla \cdot \left(\frac{\rho}{m} \nabla S \right) = 0, \quad (10.32)$$

$$\frac{\partial S}{\partial t} + \frac{1}{2m} (\nabla S)^2 + V - \frac{\hbar^2}{2m} \frac{\nabla^2 R}{R} = 0. \quad (10.33)$$

Exercise 10.5 Verify these equations.

If we ignore the last term in Eq. (10.33), under the pretext that \hbar^2 is very small, the result is identical to the Hamilton-Jacobi equation for particles of mass m and momentum $\mathbf{p} = \nabla S$, in a potential $V(\mathbf{r})$. It is then possible to interpret Eq. (10.32) as a continuity equation for a fluid consisting of these particles, with density $\rho(\mathbf{r})$ and local velocity $\mathbf{v} = \mathbf{p}/m$.

The last term in Eq. (10.33) is called the *quantum potential*. Its order of magnitude is about \hbar^2/lm^2 , where l is a typical length over which the value of $R = |\psi|$ changes by an appreciable fraction of itself. Therefore \hbar/l is the order of magnitude of the “quantum momentum” due to the nonclassical motion of the particle (a kind of Brownian motion, if you wish to visualize this). This semiclassical interpretation should not be taken too seriously. However, even without it, you can see from Eq. (10.33) that if the “quantum momentum” is negligible with respect to the classical momentum ∇S , a semiclassical description of the motion becomes legitimate.

Exercise 10.6 What is the quantum potential for the ground state of a harmonic oscillator? For the ground state of a hydrogen atom?

Van Vleck determinant

The above results show that, in a slowly varying potential, the phase of ψ is analogous to the Hamilton-Jacobi function S . This phase may therefore be approximately obtained by solving the *classical* equations of motion for the given Hamiltonian, with arbitrary initial data. It is then natural to ask what is the classical analog of $\rho = |\psi|^2$. The answer, given by Van Vleck¹⁴ and further elaborated by Schiller,¹⁵ is presented below. The reader who does not feel at ease with the Hamilton-Jacobi equation should skip the next three pages.

Since you seem to feel at ease, let $H(q^k, p_k, t)$ be the Hamiltonian of a classical system with N degrees of freedom. The Hamilton-Jacobi equation is

$$\partial S / \partial t + H(q, \partial S / \partial q, t) = 0, \quad (10.34)$$

where q without indices denotes the set q^1, \dots, q^N . Assume for a moment that (10.34) has, in some domain of the configuration space, a solution which depends on N integration constants P_μ (we shall later return to this point). Denote this solution by $S(q, P, t)$ and define a matrix

¹⁴J. H. Van Vleck, *Proc. Nat. Acad. Sc.* 14 (1928) 178.

¹⁵R. Schiller, *Phys. Rev.* 125 (1962) 1100, 1109, 1116.

$$S_k^\mu := \partial^2 S / \partial q^k \partial P_\mu. \tag{10.35}$$

This matrix too is a function of q and P . The inverse matrix T_μ^i is defined by

$$\sum_\mu T_\mu^i S_k^\mu = \delta_k^i. \tag{10.36}$$

Other functions of q and P are the momentum and the velocity:

$$p_k(q, P, t) = \partial S / \partial q^k, \quad v^k = dq^k / dt = \partial H / \partial p_k. \tag{10.37}$$

Note that $S_k^\mu = \partial p_k / \partial P_\mu$.

It will now be shown that the Van Vleck determinant, $D = \text{Det } S_k^\mu$, satisfies an *equation of continuity* in the N dimensional configuration space. We have

$$\partial D / \partial t \equiv \sum_{k\mu} D T_\mu^k (\partial S_k^\mu / \partial t), \tag{10.38}$$

because $(D T_\mu^k)$ is the coefficient of S_k^μ in an expansion of the determinant D (recall the rule for computing the inverse of a matrix). To obtain $\partial S_k^\mu / \partial t$, we differentiate twice the Hamilton-Jacobi equation (10.34), and obtain

$$\frac{\partial S_k^\mu}{\partial t} + \frac{\partial}{\partial q^k} \sum_i \frac{\partial H}{\partial p_i} \frac{\partial p_i}{\partial P_\mu} \equiv \frac{\partial S_k^\mu}{\partial t} + \frac{\partial}{\partial q^k} \sum_i v^i S_i^\mu = 0. \tag{10.39}$$

Therefore

$$\frac{\partial D}{\partial t} = - \sum_{k\mu} D T_\mu^k \frac{\partial}{\partial q^k} \sum_i v^i S_i^\mu = - \sum_{ik\mu} D T_\mu^k \left(\frac{\partial v^i}{\partial q^k} S_i^\mu + v^i \frac{\partial S_i^\mu}{\partial q^k} \right). \tag{10.40}$$

Using Eq. (10.36) and

$$\partial S_i^\mu / \partial q^k \equiv \partial S_k^\mu / \partial q^i, \tag{10.41}$$

which follows from the definition of S_i^μ , we obtain

$$\begin{aligned} \partial D / \partial t &= - \sum_i \left[D (\partial v^i / \partial q_i) + v^i \sum_{k\mu} D T_\mu^k (\partial S_k^\mu / \partial q_i) \right] \\ &= - \sum_i \left[D (\partial v^i / \partial q_i) + v^i (\partial D / \partial q_i) \right] = - \partial (D v^i) / \partial q_i. \end{aligned} \tag{10.42}$$

This result looks like an equation of continuity for a fluid of density D and velocity v^i , in the N -dimensional configuration space. We are therefore led to interpret the function $D(q, P, t)$ as a *probability density*, which still needs a normalization factor $(\int D d^N q)^{-1}$. To see this more precisely, recall that $S(q, P, t)$ is the generating function of a canonical transformation from q and p , to new dynamical variables, P_μ and $Q^\mu = \partial S / \partial P_\mu$. Each classical orbit corresponds to *fixed* values of P_μ and Q^μ . Let $f(q, p, t) = F(Q, P, t)$ be any dynamical variable. Consider an ensemble of orbits with given values of P_μ and uniformly distributed values of Q^μ (for example, consider an ensemble of harmonic oscillators with the same energy and uniformly distributed phases). The average value of F is

$$\langle F \rangle = \int F(Q, P, t) d^N Q / \int d^N Q. \quad (10.43)$$

To return to the original variables, substitute $Q = Q(q, p, t)$. The Jacobian of this transformation, for fixed P and t , is

$$\text{Det}(\partial Q^\mu / \partial q^k) = \text{Det}(\partial^2 S / \partial q^k \partial P_\mu) = D. \quad (10.44)$$

Therefore, in the original coordinates,

$$\langle f \rangle = \int f(q, p, t) D d^N q / \int D d^N q, \quad (10.45)$$

where $p_k = \partial S / \partial q^k = p_k(q, P, t)$, as in Eq. (10.37). We thus see that D is proportional to the density in configuration space which corresponds to a uniform distribution of Q^μ .

Quantization

We can now define a “classical wave function” $\psi_{\text{cl}} = \sqrt{D} e^{iS/\hbar}$, which satisfies a Schrödinger-like equation, except for a correction term $(\hbar^2/2m)\nabla^2\sqrt{D}/\sqrt{D}$. The latter can be neglected if the variation of D is slow on the scale of \hbar/p . The connection with quantum theory is made by giving to \hbar its usual value (until now, \hbar could be an arbitrary constant). There are however difficulties.

In general, the Hamilton-Jacobi function $S(q, P, t)$ is not globally single-valued in configuration spacetime. This can be seen by following its value along an arbitrary path (not necessarily the true trajectory). We have

$$dS \equiv (\partial S / \partial t) dt + \sum_k (\partial S / \partial q^k) dq^k = -H dt + \sum_k p_k dq^k. \quad (10.46)$$

In particular, if H is time independent, and if we consider a closed loop in configuration spacetime, we get

$$\oint dS = \sum_k \oint p_k dq^k. \quad (10.47)$$

We thus see that S is multiple valued: for each period of the k -th degree of freedom, S increases by the classical action $I_k := \oint p_k dq^k$. To make the wave function $e^{iS/\hbar}$ single valued, we must impose the condition $I_k = 2\pi n_k \hbar$, where n_k is an integer. This is Bohr’s quantization rule for periodic orbits.

Exercise 10.7 Solve the Hamilton-Jacobi equation for a harmonic oscillator. Show that the Bohr quantization rule gives $E = n\hbar\omega$. ★

It is possible to obtain results in closer agreement with quantum mechanics by using the EBK (Einstein-Brillouin-Keller) quantization rule^{16–18}

¹⁶A. Einstein, *Verh. Deut. Phys. Gesell.* 19 (1917) 82.

¹⁷L. Brillouin, *J. Phys. Radium* 7 (1926) 353.

¹⁸J. B. Keller, *Ann. Phys. (NY)* 4 (1958) 180.

$$I_k = \oint p_k dq^k = 2\pi\hbar(n_k + \alpha_k/4), \quad (10.48)$$

where α_k is the *Maslov index* which counts the number of caustics encountered by the classical periodic orbit.¹⁹

However, most orbits of a generic classical system are not periodic, nor even multiply periodic, and the action-angle variables cannot be constructed. *Generic dynamical systems are nonintegrable.* A system with N degrees of freedom has fewer than N constants of the motion P_μ , and the Hamilton-Jacobi equation has no global solution in terms of differentiable functions.²⁰ Integrable systems, for which the Hamilton-Jacobi equation has a global solution with N constants of the motion P_μ , are the exception, not the rule.

Nevertheless, even a nonintegrable classical system has an infinite number of periodic orbits, which may be either stable or unstable with respect to small perturbations of their initial conditions. A domain of phase space where most periodic orbits are stable is called *regular*. If most periodic orbits are unstable, that domain is said to be *irregular* or *chaotic*. In a regular domain, a bundle of neighboring periodic orbits may densely cover a finite volume of phase space. If that volume is much larger than $(2\pi\hbar)^N$, EBK quantization is approximately valid and energy levels can be labelled by integers n_k as in Eq. (10.48).²¹ These are legitimate quantum numbers—just like n, l, m , for the hydrogen atom.

On the other hand, in a chaotic domain, periodic orbits which happen to pass close to each other at some time tend to separate very rapidly, and then to wander over large parts of the energy surface in phase space (in the absence of symmetries, energy may be the only constant of motion). In that case, semiclassical quantization becomes much more intricate. There are however sophisticated methods²² which predict quantum energy levels with reasonable accuracy (but which are beyond the scope of this book).

Feynman path integrals

The most important application of the classical action S to quantum theory is Feynman's sum over paths.²³ This is a radically new approach to quantum dynamics, which is *exactly*—not approximately—equivalent to Schrödinger's equation for Hamiltonians of the type $\sum \mathbf{p}^2/2m + V(\mathbf{q})$. It is not, however, restricted to that class of Hamiltonians.

The time evolution operator $U(t_2, t_1)$ is written, in the q -representation (with Cartesian coordinates),

$$U(q'', t_2; q', t_1) = \int e^{iS[q]/\hbar} \mathcal{D}[q(t)], \quad (10.49)$$

¹⁹M. Tabor, *Chaos and Integrability in Nonlinear Dynamics*, Wiley, New York (1989) p. 238.

²⁰M. Rasetti, *Modern Methods in Equilibrium Statistical Mechanics*, World Scientific, Singapore (1986) p. 31.

²¹A. Peres, *Phys. Rev. Lett.* 53 (1984) 1711.

²²M. C. Gutzwiller, *Chaos in Classical and Quantum Mechanics*, Springer, New York (1991).

²³R. P. Feynman, *Rev. Mod. Phys.* 20 (1948) 367.

where

$$S[q] := \int_{t_1}^{t_2} L(q, \dot{q}, t) dt, \quad (10.50)$$

is the classical action, evaluated along a path $q(t)$ in configuration space. This is the same S as in Eq. (10.46), since the Lagrangian is $L = \sum p_k dq^k - H$.

The symbol $D[q(t)]$ in Eq. (10.49) means that this sum includes *every* continuous path from (q', t_1) to (q'', t_2) , even paths which do not obey the Euler-Lagrange equations of motion. This symbol also tacitly includes an infinite normalization constant, to make $U(q'', t_2; q', t_1) \equiv \delta^N(q'' - q')$. All the paths in the sum (10.49) have equal weights, but only those close to the classical path, where S is stationary, give an appreciable contribution. The other paths interfere destructively because of the rapidly varying phase S/\hbar .

The right hand side of Eq. (10.50) is not a Riemann or Lebesgue integral. It is an integral in a functional space whose functions are continuous, but in general not differentiable (they must however be arbitrarily well approximated by a sequence of *straight* segments). Most paths are like Brownian motion and the value of $S[q]$ in (10.49) depends on the limiting process used for defining this sum. This leads to formidable mathematical difficulties. Not surprisingly, the order of summation in these divergent sums affects the value of the final result. There is therefore no escape from the familiar factor ordering ambiguity that we encounter when we quantize classical expressions in the conventional way, $p \rightarrow -i\hbar\partial/\partial q$.

In spite of these difficulties, path integral methods have found many useful applications, especially in relativistic field theory.²⁴ Some standard sources are listed in the bibliography at the end of this chapter.

10-4. Quantum mechanics in phase space

Let us proceed from configuration space to phase space, that is, from N to $2N$ dimensions. In classical statistical mechanics, the statistical properties of an ensemble of physical systems are represented by a Liouville density $f(\mathbf{q}, \mathbf{p}, t)$, which satisfies the equation of motion²⁵

$$\frac{df}{dt} := \frac{\partial f}{\partial t} + \sum_k \left(\frac{\partial f}{\partial q^k} \frac{dq^k}{dt} + \frac{\partial f}{\partial p_k} \frac{dp_k}{dt} \right) \equiv \frac{\partial f}{\partial t} + [f, H]_{\text{PB}} = 0. \quad (10.51)$$

This is reminiscent of the Schrödinger equation for the density matrix,

$$i\hbar \dot{\rho} = [H, \rho], \quad (10.52)$$

²⁴C. Itzykson and J.-B. Zuber, *Quantum Field Theory*, McGraw-Hill, New York (1980).

²⁵The symbols \mathbf{q} and \mathbf{p} represent the $2N$ Cartesian components q^k and p_k . The dependence of various expressions on time will usually be written explicitly only in dynamical equations.

which follows from its definition, $\rho(\mathbf{q}', \mathbf{q}'', t) = \psi(\mathbf{q}', t) \overline{\psi(\mathbf{q}'', t)}$. Density matrices that are not pure states also obey Eq. (10.52), by linearity.

Let us try to find a quantum analog for the Liouville density in phase space. Since phase space treats on an equal footing position and momentum, we shall define a *momentum representation*, denoted by $\tilde{\psi}(\mathbf{p})$, for the state ψ whose q -representation is the function $\psi(\mathbf{q})$. We want to have identically, for any function of the momentum operator,

$$\langle \psi, f(\mathbf{p}) \psi \rangle = \int \overline{\psi(\mathbf{q})} f(-i\hbar \partial/\partial \mathbf{q}) \psi(\mathbf{q}) d\mathbf{q} = \int |\tilde{\psi}(\mathbf{p})|^2 f(\mathbf{p}) d\mathbf{p}. \quad (10.53)$$

Exercise 10.8 Show that Eq. (10.53) is satisfied by

$$\tilde{\psi}(\mathbf{p}) := (2\pi\hbar)^{-N/2} \int \psi(\mathbf{q}) e^{-i\mathbf{q}\cdot\mathbf{p}/\hbar} d\mathbf{q}. \quad (10.54)$$

There still is a phase ambiguity: $\tilde{\psi}(\mathbf{p})$ can be multiplied by an arbitrary phase factor $e^{i\phi(\mathbf{p})}$ without affecting the validity of Eq. (10.53). This point was already discussed in Sect. 8-4, and I shall not return to it here.

We can likewise define the momentum representation of any operator whose q -representation is given:

$$\tilde{A}(\mathbf{p}', \mathbf{p}'') := (2\pi\hbar)^{-N} \iint A(\mathbf{q}', \mathbf{q}'') e^{i(\mathbf{q}'\cdot\mathbf{p}' - \mathbf{q}''\cdot\mathbf{p}'')/\hbar} d\mathbf{q}' d\mathbf{q}'' . \quad (10.55)$$

In particular we have, for the density matrix corresponding to a pure state, $\tilde{\rho}(\mathbf{p}', \mathbf{p}'') = \tilde{\psi}(\mathbf{p}') \overline{\tilde{\psi}(\mathbf{p}'')}$.

Wigner function

In the course of a study of quantum thermodynamics, Wigner²⁶ proposed, as the quantum analog of a Liouville density, the expression

$$W(\mathbf{q}, \mathbf{p}) := (\pi\hbar)^{-N} \int \rho(\mathbf{q} - \mathbf{r}, \mathbf{q} + \mathbf{r}) e^{2i\mathbf{p}\cdot\mathbf{r}/\hbar} d\mathbf{r}. \quad (10.56)$$

It is easily seen that $W(\mathbf{q}, \mathbf{p})$ is real and gives correct marginal distributions,

$$\int W(\mathbf{q}, \mathbf{p}) d\mathbf{p} = \rho(\mathbf{q}, \mathbf{q}) \quad \text{and} \quad \int W(\mathbf{q}, \mathbf{p}) d\mathbf{q} = \tilde{\rho}(\mathbf{p}, \mathbf{p}). \quad (10.57)$$

It follows that, for any two functions f and g ,

$$\langle f(\mathbf{q}) + g(\mathbf{p}) \rangle = \int [f(\mathbf{q}) + g(\mathbf{p})] W(\mathbf{q}, \mathbf{p}) d\mathbf{q} d\mathbf{p}, \quad (10.58)$$

²⁶E. Wigner, *Phys. Rev.* 40 (1932) 749.

as we would have in classical statistical mechanics. No such formula, however, can hold for more general functions of \mathbf{q} and \mathbf{p} , because of factor ordering ambiguities (a unique ordering can be defined for polynomials,²⁷ but not for arbitrary functions).

Exercise 10.9 Find the Wigner function for the ground state of a one-dimensional harmonic oscillator.

Exercise 10.10 Find the Wigner function for $\psi(x) = \sqrt{2/\pi}/(1+x^2)$. ★

Exercise 10.11 Given a Wigner function $W(\mathbf{q}, \mathbf{p})$, find the density matrix $\rho(\mathbf{q}', \mathbf{q}'')$. What is the condition that $W(\mathbf{q}, \mathbf{p})$ must satisfy so that ρ is a positive operator?

Exercise 10.12 Show that

$$\int W_1(\mathbf{q}, \mathbf{p}) W_2(\mathbf{q}, \mathbf{p}) d\mathbf{q} d\mathbf{p} = \text{Tr}(\rho_1 \rho_2)/(2\pi\hbar)^N, \quad (10.59)$$

and therefore that

$$\int [W(\mathbf{q}, \mathbf{p})]^2 d\mathbf{q} d\mathbf{p} \leq (2\pi\hbar)^{-N}, \quad (10.60)$$

where equality holds only for pure states.

For pure states, $\text{Tr}(\rho_1 \rho_2) = |\langle \psi_1, \psi_2 \rangle|^2$, and it follows from (10.59) that Wigner functions of orthogonal states satisfy $\int W_1(\mathbf{q}, \mathbf{p}) W_2(\mathbf{q}, \mathbf{p}) d\mathbf{q} d\mathbf{p} = 0$. This shows that Wigner functions may occasionally be negative and cannot be interpreted as probability distributions, in spite of their analogy with Liouville densities (the term “quasiprobability” is sometimes used). Moreover, it is seen from Eq. (10.56) that $W(\mathbf{q}, \mathbf{p})$ does not tend to a limit when $\hbar \rightarrow 0$, but rather has increasingly rapid oscillations. Nevertheless, Wigner functions may give a qualitative feeling of the approximate location of a quantum system in phase space. They are often used to visualize the dynamical behavior of quantum systems. Note that they are normalized by $\int W(\mathbf{q}, \mathbf{p}) d\mathbf{q} d\mathbf{p} = 1$, but they cannot be arbitrarily narrow and high, since they must also satisfy Eq. (10.60).

Quantum Liouville equation

We shall now compare the time evolution of a Wigner function with that of a Liouville density which obeys Eq. (10.51). For simplicity, let us take a single degree of freedom, and a Hamiltonian $H = T + V(q)$, where T is the kinetic energy $-(\hbar^2/2m)(\partial^2/\partial q^2)$. For a pure state, we have

$$W(q, p, t) = (\pi\hbar)^{-1} \int \psi(q-r, t) \overline{\psi(q+r, t)} e^{2ipr/\hbar} dr, \quad (10.61)$$

²⁷J. E. Moyal, *Proc. Cambridge Phil. Soc.* 45 (1949) 99.

whence

$$i\hbar \partial W(\mathbf{q}, \mathbf{p}, t) / \partial t = (\pi\hbar)^{-1} \int (H\psi \bar{\psi} - \psi \overline{H\psi}) e^{2i\mathbf{p}\mathbf{r}/\hbar} d\mathbf{r}. \quad (10.62)$$

Let us consider separately T and V . We have

$$\begin{aligned} \int [T\psi(q-r)\overline{\psi(q+r)} - \psi(q-r)\overline{T\psi(q+r)}] e^{2i\mathbf{p}\mathbf{r}/\hbar} d\mathbf{r} = \\ = -\frac{\hbar^2}{2m} \left[\int \frac{\partial^2 \psi(q-r)}{\partial q^2} \overline{\psi(q+r)} e^{2i\mathbf{p}\mathbf{r}/\hbar} d\mathbf{r} - \text{c.c.} \right]. \end{aligned} \quad (10.63)$$

Replacing $\partial^2/\partial q^2$ by $\partial^2/\partial r^2$ and integrating by parts, we obtain

$$\begin{aligned} i\hbar \left. \frac{\partial W}{\partial t} \right|_T = \frac{\hbar^2}{2m} \frac{2i\mathbf{p}}{\hbar} \left[\int \frac{\partial \psi(q-r)}{\partial r} \overline{\psi(q+r)} e^{2i\mathbf{p}\mathbf{r}/\hbar} d\mathbf{r} + \text{c.c.} \right] = \\ = -i\hbar \frac{\mathbf{p}}{m} \frac{\partial}{\partial q} \int \psi(q-r)\overline{\psi(q+r)} e^{2i\mathbf{p}\mathbf{r}/\hbar} d\mathbf{r} = -i\hbar \frac{\mathbf{p}}{m} \frac{\partial W(\mathbf{q}, \mathbf{p}, t)}{\partial \mathbf{q}}. \end{aligned} \quad (10.64)$$

This corresponds to the term $-(d\mathbf{q}/dt)(\partial f/\partial \mathbf{q})$ in Liouville's equation (10.51).

The potential energy term in $(H\psi \bar{\psi} - \psi \overline{H\psi})$ gives

$$\int [V(q-r)\psi(q-r)\overline{\psi(q+r)} - \psi(q-r)V(q+r)\overline{\psi(q+r)}] e^{2i\mathbf{p}\mathbf{r}/\hbar} d\mathbf{r}.$$

If V is a slowly varying function, we can expand

$$\underline{V(q-r) - V(q+r) = -2[rV'(q) + (r^3/3!)V'''(q) + \dots]}. \quad (10.65)$$

We then write $r^n e^{2i\mathbf{p}\mathbf{r}/\hbar} = (\hbar/2i)^n \partial^n(e^{2i\mathbf{p}\mathbf{r}/\hbar})/\partial \mathbf{p}^n$, and obtain

$$i\hbar \left. \frac{\partial W}{\partial t} \right|_V = i\hbar \left[\frac{\partial W}{\partial \mathbf{p}} V'(q) - \frac{\hbar^2}{24} \frac{\partial^3 W}{\partial \mathbf{p}^3} V'''(q) + \dots \right]. \quad (10.66)$$

The first term of this expansion yields a result which is identical to the term $-(\partial f/\partial \mathbf{p})(d\mathbf{p}/dt)$ in Liouville's equation (10.51). The next one involves the third derivative, d^3V/dq^3 , which produces a distortion of the wave packets, as we have seen in Eq. (10.17). In summary, the quantum Liouville equation is

$$\frac{\partial W}{\partial t} = -\frac{\partial W}{\partial \mathbf{q}} \frac{\mathbf{p}}{m} + \frac{\partial W}{\partial \mathbf{p}} \frac{dV}{d\mathbf{q}} - \frac{\hbar^2}{24} \frac{\partial^3 W}{\partial \mathbf{p}^3} \frac{d^3 V}{d\mathbf{q}^3} + \dots \quad (10.67)$$

Exercise 10.13 Show that the quantum Liouville equation can be written in the integro-differential form (valid for N dimensions):

$$\frac{\partial W(\mathbf{q}, \mathbf{p}, t)}{\partial t} = -\frac{\partial W}{\partial \mathbf{q}} \cdot \frac{d\mathbf{q}}{dt} + \int \tilde{V}(\mathbf{q}, \mathbf{p} - \mathbf{p}') W(\mathbf{q}, \mathbf{p}', t) d\mathbf{p}', \quad (10.68)$$

where $d\mathbf{q}/dt = \mathbf{p}/m$, and

$$\tilde{V}(\mathbf{q}, \mathbf{p}) := (i/\pi^N \hbar^{N+1}) \int [V(\mathbf{q} + \mathbf{r}) - V(\mathbf{q} - \mathbf{r})] e^{2i\mathbf{p}\cdot\mathbf{r}/\hbar} d\mathbf{r}. \quad (10.69)$$

Fuzzy Wigner functions

Although Wigner functions are not in general everywhere positive, a small amount of blurring can cause the disappearance of their negative regions. Let $W_0(\mathbf{q}, \mathbf{p})$ be any Wigner function concentrated around $\mathbf{q} = \mathbf{p} = 0$. We know, from Eq. (10.60), that a Wigner function cannot be arbitrarily peaked, but we still assume that $W_0(\mathbf{q}, \mathbf{p})$ is well localized. For example, we may take

$$W_0(\mathbf{q}, \mathbf{p}) = (\pi \hbar)^{-N} e^{-(\mathbf{q}^2/\sigma^2) - (\mathbf{p}^2\sigma^2/\hbar^2)}, \quad (10.70)$$

where σ is any real constant. This $W_0(\mathbf{q}, \mathbf{p})$ has a minimal uncertainty product, with $\Delta q^k = \sigma/\sqrt{2}$ and $\Delta p_k = \hbar/\sigma\sqrt{2}$.

Exercise 10.14 Show that $W_0(\mathbf{q}, \mathbf{p})$ in Eq. (10.70) is the ground state of an isotropic harmonic oscillator:

$$\psi_0(\mathbf{q}) = (\pi\sigma^2)^{-N/4} e^{-\mathbf{q}^2/2\sigma^2}. \quad (10.71)$$

This $W_0(\mathbf{q}, \mathbf{p})$, or any similar one, may then be used to blur other Wigner functions by means of a convolution

$$\begin{aligned} W(\mathbf{q}, \mathbf{p}) &\rightarrow W_\sigma(\mathbf{q}, \mathbf{p}) \\ &= (2\pi\hbar)^{-N} \int W_0(\mathbf{q} - \mathbf{q}', \mathbf{p} - \mathbf{p}') W(\mathbf{q}', \mathbf{p}') d\mathbf{q}' d\mathbf{p}'. \end{aligned} \quad (10.72)$$

If we use the function $W_0(\mathbf{q}, \mathbf{p})$ given by (10.70), this convolution blurs each q^k by an amount of order σ , and each p_k by about \hbar/σ .

Exercise 10.15 Show that if $W(\mathbf{q}, \mathbf{p})$ corresponds to the pure state $\psi(\mathbf{q})$, then $W(\mathbf{q} - \mathbf{q}', \mathbf{p} - \mathbf{p}')$ corresponds to the state $e^{i\mathbf{p}' \cdot \mathbf{q}/\hbar} \psi(\mathbf{q} - \mathbf{q}')$.

The smoothed Wigner function $W_\sigma(\mathbf{q}, \mathbf{p})$ can be interpreted in two ways: It is a linear combination of Wigner functions $W(\mathbf{q}', \mathbf{p}')$, with positive coefficients, and therefore it also is a legitimate Wigner function, which corresponds to a linear combination of noncommuting density matrices. On the other hand, we can consider the right hand side of Eq. (10.72) as a scalar product, like the one in Eq. (10.59), with \mathbf{q}' and \mathbf{p}' being the phase space coordinates and momenta, and \mathbf{q} and \mathbf{p} mere numerical parameters. Such a scalar product is never negative, and it follows that $W_\sigma(\mathbf{q}, \mathbf{p}) \geq 0$, for any value of σ .

If the smoothing function (10.70) is the one used in the convolution (10.72), the result is called a Husimi function.²⁸ The latter has neither correct marginals, as in Eq. (10.57), nor relatively simple equations of motion, like Eq. (10.68). However, Husimi functions have important applications in quantum optics,²⁹ and they can in principle be deconvolved to retrieve the corresponding Wigner functions.

²⁸K. Husimi, *Proc. Phys. Math. Soc. Japan* 22 (1940) 264.

²⁹S. Stenholm, *Ann. Phys. (NY)* 218 (1992) 233.

Rihaczek function

The Wigner function (10.56) is only one of the many quantum analogs of the Liouville density. The most general function which is linear in ρ and has correct marginals, as in Eq. (10.57), was derived by Cohen.³⁰ If linearity in ρ is not required, it is actually possible to construct distributions which are nowhere negative and have correct marginals.³¹

A very simple bilinear function was proposed by Rihaczek:³²

$$R(\mathbf{q}, \mathbf{p}) = (2\pi\hbar)^{-N/2} \psi(\mathbf{q}) \overline{\tilde{\psi}(\mathbf{p})} e^{-i\mathbf{q}\cdot\mathbf{p}/\hbar}, \tag{10.73}$$

where $\tilde{\psi}(\mathbf{p})$ is the momentum representation of ψ , defined by Eq. (10.54). The Rihaczek function for a mixed state can be obtained by diagonalizing $\rho = \sum w_\mu \psi_\mu \psi_\mu^\dagger$, and summing the Rihaczek functions for individual ψ_μ , with relative weights w_μ . Unlike the Wigner function, which is real, the Rihaczek function is complex. On the other hand, its structure is far simpler and it has interesting applications in periodic potentials.³³

Exercise 10.16 What is the relationship between $R(\mathbf{q}, \mathbf{p})$ and $\rho(\mathbf{q}', \mathbf{q}'')$?

Exercise 10.17 Show that, for any two states ψ_1 and ψ_2 ,

$$|\langle \psi_1, \psi_2 \rangle|^2 = (2\pi\hbar)^{-N} \int \overline{R_1(\mathbf{q}, \mathbf{p})} R_2(\mathbf{q}, \mathbf{p}) d\mathbf{q} d\mathbf{p}. \tag{10.74}$$

From Eqs. (10.54) and (10.74) it follows that $\int R(\mathbf{q}, \mathbf{p}) d\mathbf{p} = |\psi(\mathbf{q})|^2$ and $\int R(\mathbf{q}, \mathbf{p}) d\mathbf{q} = |\tilde{\psi}(\mathbf{p})|^2$, and therefore $\langle f(\mathbf{q}) + g(\mathbf{p}) \rangle = \int [f(\mathbf{q}) + g(\mathbf{p})] R(\mathbf{q}, \mathbf{p}) d\mathbf{q} d\mathbf{p}$, just as for Wigner's function.

10-5. Koopman's theorem

Since there are analogies between classical and quantum mechanics, why not try to use quantum methods for solving classical problems? Let us start from the Liouville equation (10.51), which can be written

$$i \partial f / \partial t = L f, \tag{10.75}$$

where L is the Liouville operator, or Liouvillian,

$$L = \left(\frac{\partial H}{\partial \mathbf{p}} \right) \cdot \left(-i \frac{\partial}{\partial \mathbf{q}} \right) - \left(\frac{\partial H}{\partial \mathbf{q}} \right) \cdot \left(-i \frac{\partial}{\partial \mathbf{p}} \right). \tag{10.76}$$

³⁰L. Cohen, *J. Math. Phys.* 7 (1966) 781.

³¹L. Cohen and Y. I. Zaparovanny, *J. Math. Phys.* 21 (1980) 794.

³²A. W. Rihaczek, *IEEE Trans. Inform. Theory* IT-14 (1968) 369.

³³J. Zak, *Phys. Rev. A* 45 (1992) 3540.

Note that $f(\mathbf{q}, \mathbf{p}, t)$ is a function of \mathbf{q} and \mathbf{p} , which are $2N$ independent and commuting variables parametrizing phase space (of course \mathbf{q} does not commute with $-i\partial/\partial\mathbf{q}$, but $-i\partial/\partial\mathbf{q}$ is not at all the same thing as \mathbf{p}). The operator L is "Hermitian." Whether it is truly self-adjoint or only symmetric depends on the explicit properties of H (see p. 87 for precise definitions of these terms).

The normalization condition for a Liouville density is $\int f d\mathbf{q} d\mathbf{p} = 1$, and, in order to mimic quantum mechanics, it is natural to introduce a Liouville wave function Φ , such that $f = |\Phi|^2$. Note that Φ also satisfies the Liouville equation $i\partial\Phi/\partial t = L\Phi$, because L is homogeneous in first partial derivatives. The time evolution of $\Phi(\mathbf{q}, \mathbf{p}, t)$ therefore is a *unitary mapping* in phase space. If there is another Liouville wave function, $\Psi(\mathbf{q}, \mathbf{p}, t)$, which also satisfies Eq. (10.75), their scalar product $\int \overline{\Phi(\mathbf{q}, \mathbf{p}, t)} \Psi(\mathbf{q}, \mathbf{p}, t) d\mathbf{q} d\mathbf{p}$ is invariant in time. This is Koopman's theorem.³⁴

I wrote here $\overline{\Phi(\mathbf{q}, \mathbf{p}, t)}$, rather than simply $\Phi(\mathbf{q}, \mathbf{p}, t)$, because *complex* Liouville wave functions naturally appear in this Hilbert space. For instance, consider a one-dimensional harmonic oscillator, with $H = p^2/2m + kq^2/2$. Its Liouville equation is

$$i \frac{\partial \Phi}{\partial t} = \frac{p}{m} \left(-i \frac{\partial \Phi}{\partial q} \right) - kq \left(-i \frac{\partial \Phi}{\partial p} \right). \quad (10.77)$$

Let us find a stationary solution $\Phi = e^{-i\Omega t} F(\mathbf{q}, \mathbf{p})$. It is convenient to define new variables, $p_{\pm} := p \pm i\omega q$, where $\omega = (k/m)^{1/2}$, as usual. Substituting these expressions in (10.77), we obtain

$$\Omega F = \omega [p_+ (\partial F / \partial p_+) - p_- (\partial F / \partial p_-)]. \quad (10.78)$$

A particular solution is $F = (p_+)^k (p_-)^l$, with $\Omega = (k - l)\omega$. To make F single valued, $(k - l)$ must be an integer. A more general solution is $F = N(H) (p \pm i\omega q)^n$, where n is an integer and $N(H)$ is an arbitrary function of H , which also includes a normalization constant. Therefore the spectrum of this Liouvillian is $\Omega = n\omega$, where n is any positive or negative integer. This spectrum has no lower bound, contrary to that of a quantum Hamiltonian.

Exercise 10.18 *What is the physical meaning of the eigenstates of this Liouvillian?*

Consider now two uncoupled harmonic oscillators, with incommensurable frequencies ω_1 and ω_2 . The spectrum of the quantum Hamiltonian is $E/\hbar = (n_1 + \frac{1}{2})\omega_1 + (n_2 + \frac{1}{2})\omega_2$. It has a *finite* number of points between any two finite energies, E and $E + \delta E$. (For large E , the density of states is $dn/dE = E/\hbar^2 \omega_1 \omega_2$.) On the other hand, the spectrum of the classical Liouvillian is $\Omega = n_1 \omega_1 + n_2 \omega_2$. It has an *infinite* number of points between Ω and $\Omega + \delta\Omega$, because $n_1 n_2$ can be negative. This is a *dense point spectrum*.

³⁴B. O. Koopman, *Proc. Nat. Acad. Sc.* 17 (1931) 315.

In the generic case of nonlinear systems, the spectrum of the Liouvillian is continuous. This gives rise to qualitative differences between the evolution of Liouville densities and that of quantum wave functions for bounded systems. A quantum state can always be represented, with arbitrary accuracy, by a *finite* number of energy eigenstates. The time evolution of a bounded quantum system is multiply periodic, and will sooner or later have recurrences,³⁵ as in Fig. 10.1. On the other hand, the most innocent Liouville density involves a continuous spectrum, equivalent to an infinite number of eigenvalues of L . This infinite basis allows a Liouville density to become more and more distorted with the passage of time, and to form intricate shapes with exceedingly thin and long protuberances, getting close to every point of phase space that can be reached without violating a conservation law. The result is a *mixing* of phase space which, when combined with *coarse graining*, is the rationale for classical irreversibility. These properties have no quantum analog, and there is no similar explanation for irreversibility in quantum phenomena (see Chapter 11).

10-6. Compact spaces

The most elementary quantum systems use a finite dimensional Hilbert space. Their classical analogs have a *compact* phase space. For instance, let q be an angular coordinate, with domain $[0, 2\pi]$, whose points 0 and 2π are identified. The conjugate variable p has the dimension of an action. Assume that p is also bounded in a domain $[-J, J]$, with the points $-J$ and J identified. Define new classical variables

$$\begin{aligned} J_x &= \sqrt{J^2 - p^2} \cos q, \\ J_y &= \sqrt{J^2 - p^2} \sin q, \\ J_z &= p. \end{aligned} \tag{10.79}$$

Their Poisson brackets are $[J_x, J_y]_{\text{PB}} = J_z$, and cyclic permutations, just as for the three components of angular momentum.

If we quantize that system by using the familiar correspondence of Poisson brackets with commutators, we obtain $[J_x, J_y] = i\hbar J_z$, whence it follows that $J^2 = j(j+1)\hbar^2$, where j is an integer (or a half-integer, if two-component wave functions are admitted). For other values of the classical parameter J , canonical quantization is *inconsistent*, if we attempt to do it by means of Eq. (10.79). For large j (that is, in the semiclassical limit) we have $J \simeq (j + \frac{1}{2})\hbar$ and the total area of phase space tends to an integral multiple of Planck's constant,³⁶

$$A = 4\pi J \rightarrow (2j + 1) 2\pi\hbar. \tag{10.80}$$

³⁵I. C. Percival, *J. Math. Phys.* 2 (1961) 235.

³⁶J. H. Hannay and M. V. Berry, *Physica D* 1 (1980) 267.

Case study: a quantum dial

Another way of quantizing this compact phase space is to represent quantum states by *periodic* wave functions $\psi(q)$, and let $p = -i\hbar \partial/\partial q$. The classical constraint, namely $-J \leq p \leq J$, is enforced by restricting the number of Fourier components of ψ :

$$\psi(q) = \sum_{m=-j}^j c_m e^{imq}, \quad (10.81)$$

where $j = J/\hbar$ is an integer or half odd integer, and $\sum |c_m|^2 = (2\pi)^{-1}$. The Hilbert space H has $N = 2j + 1$ dimensions, and the total area of phase space is $4\pi j\hbar = (N - 1)\hbar$.

The eigenstates of the operator p are u_m , and their q -representation is $u_m(q) = e^{imq}/(2\pi)^{1/2}$, where $m = -j, \dots, j$. However, there is no operator corresponding to the classical variable q , because $q\psi(q)$ is not a periodic function, if ψ is defined by Eq. (10.81). Therefore $q\psi(q)$ does not belong to H . It is nevertheless possible to construct states for which q is roughly localized. These will be called *dial states*. They are constructed by making p maximally delocalized, as in

$$v_0(q) = N^{-1/2} \sum_{m=-j}^j u_m(q) = (2\pi N)^{-1/2} \frac{\sin(Nq/2)}{\sin(q/2)}, \quad (10.82)$$

where $N = 2j + 1$, and use was made of the identity

$$\sum_{m=-j}^j x^m \equiv \frac{x^{j+1/2} - x^{-j-1/2}}{x^{1/2} - x^{-1/2}}. \quad (10.83)$$

Since q is an angle, you may imagine a dial, with N equally spaced positions, separated by $2\pi/N$. The problem is to associate N orthogonal quantum states with these N equidistant positions.

If you plot $|v_0(q)|^2$ versus q , there is at $q = 0$ a peak of height $N/2\pi$ and width $\sim 2\pi/N$. However, to give a more precise meaning to this "width" is a delicate matter, and the true width is considerably larger, as you will soon see. The reason is that Δq cannot be defined as $\{(\mathbf{q}^2) - \langle \mathbf{q} \rangle^2\}^{1/2}$, because $qv_0(q)$ does not belong to H (there is no operator q). Even the expression $(\sin q) v_0$ is improper, since $(\sin q) u_{\pm j}(q)$ too is outside H . Let us therefore introduce a truncated sine, denoted by $S(q)$, and defined by

$$\begin{aligned} S(q) u_m &= (u_{m+1} - u_{m-1})/2i, & \forall m \neq \pm j, \\ S(q) u_{\pm j} &= \mp u_{\pm(j-1)}/2i. \end{aligned} \quad (10.84)$$

We may likewise define a truncated cosine $C(q)$:

$$\begin{aligned} C(q) u_m &= (u_{m+1} + u_{m-1})/2, & \forall m \neq \pm j, \\ C(q) u_{\pm j} &= u_{\pm(j-1)}/2. \end{aligned} \quad (10.85)$$

Exercise 10.19 Let $P_{\pm j}$ be the projector on states $u_{\pm j}$. Show that

$$C(q)^2 + S(q)^2 = \mathbb{1} - \frac{1}{2}(P_j + P_{-j}), \tag{10.86}$$

and

$$[C(q), S(q)] = \frac{1}{2}i(P_j - P_{-j}). \tag{10.87}$$

Discuss the properties of the operators $C(q) \pm iS(q)$.

From (10.82) and (10.84) we have $S(q)v_0 = (u_j - u_{-j})/(2iN^{1/2})$, whence

$$\langle S(q)^2 \rangle = \|S(q)v_0\|^2 = 1/2N. \tag{10.88}$$

In the physically interesting case, $N \gg 1$, the so-called uncertainty (that is, the standard deviation) $\Delta S(q) = (2N)^{-1/2}$ is much larger than $2\pi/N$, which is the purported resolution of the quantum dial. This only shows that measuring $S(q)$ or $C(q)$ is not the best way of locating a position on the dial.

A more efficient approach is to construct a set of N orthogonal states v_μ by means of a discrete Fourier transform, as in Eq. (3.28), page 54:

$$v_\mu := N^{-1/2} \sum_{m=-j}^j e^{-2\pi i \mu m/N} u_m \quad (\mu = -j, \dots, j). \tag{10.89}$$

The u_m and v_μ bases are called *complementary*.³⁷ The Fourier transform relationship between them is similar to the one between the continuous q - and p -representations, in Eq. (10.54).

Exercise 10.20 Show that $\langle v_\mu, v_\nu \rangle = \delta_{\mu\nu}$ and that

$$e^{-2\pi i p/N\hbar} v_\mu = v_{\mu+1 \pmod N}. \tag{10.90}$$

Exercise 10.21 Define a “dial operator” $Q = \sum \mu v_\mu v_\mu^\dagger$, which could play the role of a variable conjugate to p (recall that q itself is not a well behaved operator). What are the matrix elements of Q in the u_m basis? What is the commutator $[Q, p]$? **Hint:** The sum $\sum \mu x^\mu$ may be evaluated by applying the operator $x d/dx$ to Eq. (10.83). \star

Group contraction

It is often desirable to approximate continuous variables by discrete ones, in particular for numerical work. As a possible path to discretization, we could attempt to use the relationship (10.79) between a pair of conjugate variables q and p , having the topology of a torus, and three components of angular momentum constrained by $\sum J_k^2 = J^2$. In quantum theory, the latter have

³⁷ J. Schwinger, *Proc. Nat. Acad. Sc.* 46 (1960) 570.

a point spectrum and are intrinsically discrete. Unfortunately, it is difficult to return from the J_k to the original variables, $\mathbf{q} = \tan^{-1}(\mathbf{J}_y/\mathbf{J}_x)$, because this expression becomes awkward in quantum theory. If we are faced with a concrete problem, such as finding the energy levels in a given potential, we must use a different technique, called *group contraction*.³⁸

Consider a $(2j + 1)$ -dimensional representation of \mathbf{J}_k with $j \gg 1$, and define

$$\mathbf{q} := a \mathbf{J}_x / \sqrt{j} \hbar \quad \text{and} \quad \mathbf{p} := \mathbf{J}_y / \sqrt{j} a, \quad (10.91)$$

where a is a constant with the dimensions of length (take any typical length of the system under study, for example the breadth of a potential well). We have

$$[\mathbf{q}, \mathbf{p}] = [\mathbf{J}_x, \mathbf{J}_y] / j \hbar = i \mathbf{J}_z / j. \quad (10.92)$$

If we consider only the subspace of H for which $\langle \mathbf{J}_z \rangle \simeq j \hbar$, this is the canonical commutation relation of \mathbf{q} and \mathbf{p} . The passage to the limit $j \rightarrow \infty$ is called a *contraction* of the rotation algebra with generators \mathbf{J}_k , to the Heisenberg algebra consisting of \mathbf{q} , \mathbf{p} , and $\mathbf{1}$.

In the subspace of H that we are using, the variables \mathbf{q} and \mathbf{p} cover a large range of values, including $|\langle \mathbf{q} \rangle| \gg a$ and $|\langle \mathbf{p} \rangle| \gg \hbar/a$. Indeed, let $\delta \mathbf{J}_z := j \hbar - \langle \mathbf{J}_z \rangle$ (not to be confused with $\Delta \mathbf{J}_z$). We have $\hbar \ll \delta \mathbf{J}_z \ll j \hbar$, so that

$$\langle \mathbf{J}_x^2 + \mathbf{J}_y^2 \rangle \equiv j(j+1)\hbar^2 - \langle \mathbf{J}_z^2 \rangle \simeq j\hbar^2 + 2j\hbar \delta \mathbf{J}_z \gg j\hbar^2. \quad (10.93)$$

Therefore we may have both $|\langle \mathbf{q} \rangle| \gg a$ and $|\langle \mathbf{p} \rangle| \gg \hbar/a$. Their values are only restricted by $|\langle \mathbf{q} \rangle| \ll a\sqrt{j}$ and $|\langle \mathbf{p} \rangle| \ll \sqrt{j}\hbar/a$, because $\langle \mathbf{J}_x^2 + \mathbf{J}_y^2 \rangle \ll j^2\hbar^2$.

Let us write explicitly the \mathbf{q} and \mathbf{p} matrices in the representation where \mathbf{J}_z is diagonal. They can be combined into a pair of dimensionless operators,

$$\mathbf{A}^\pm = [(\mathbf{q}/a) \pm i(\mathbf{p}a/\hbar)]/\sqrt{2} = (\mathbf{J}_x \pm i \mathbf{J}_y)/\sqrt{2j} \hbar. \quad (10.94)$$

Recall that the only nonvanishing matrix elements of $(\mathbf{J}_x \pm i \mathbf{J}_y)$ are

$$(\mathbf{J}_x + i \mathbf{J}_y)_{m+1, m} = (\mathbf{J}_x - i \mathbf{J}_y)_{m, m+1} = [(j-m)(j+m+1)]^{1/2} \hbar. \quad (10.95)$$

Let $m = j - k$, with $k = 1, 2, \dots (\ll \sqrt{j})$. A good approximation to the right hand side of Eq. (10.95) is $(2jk)^{1/2}\hbar$, whence we have, for small enough k ,

$$\mathbf{A}_{j-k+1, j-k}^+ = \mathbf{A}_{j-k, j-k+1}^- \simeq \sqrt{k}. \quad (10.96)$$

These matrix elements are the same as those of the raising and lowering operators in Eq. (5.91), page 140. The *finite* matrices \mathbf{q} and \mathbf{p} that were defined by Eq. (10.91) thus start with elements which are almost equal to those of the *infinite* \mathbf{q} and \mathbf{p} matrices in the energy representation of a harmonic oscillator.

³⁸ R. J. B. Fawcett and A. J. Bracken, *J. Math. Phys.* 29 (1988) 1521.

10-7. Coherent states

A wave function $\psi(x)$ and its Fourier transform $\tilde{\psi}(p)$ cannot both have a narrow localization. This property is commonly known as the quantum mechanical uncertainty relation,

$$\Delta x \Delta p \geq \hbar/2, \quad (4.54)$$

but it is not peculiar to quantum mechanics. A classical acoustic signal with intensity $f(t)$ also cannot have both precise timing and precise pitch. The latter must satisfy

$$\Delta t \Delta \omega \geq \frac{1}{2}, \quad (10.97)$$

where

$$(\Delta t)^2 \equiv \int t^2 f(t) dt - \left(\int t f(t) dt \right)^2, \quad (10.98)$$

and $\Delta \omega$ is likewise defined by the Fourier transform $\tilde{f}(\omega)$. This is a general property of Fourier transforms, quite independent of the underlying physics.³⁹

Yet, *approximate* values for time and frequency are certainly compatible, as every musician knows (see page 214). Likewise, in quantum theory, we can have approximate values for both position and wavelength, $\lambda = h/p$. For example, the wave function

$$\psi(x) = (\pi\sigma^2)^{-1/4} \exp[-(x - x')^2/2\sigma^2 + ip'x/\hbar], \quad (10.99)$$

is a minimum uncertainty wave packet, with $\langle x \rangle = x'$ and $\langle p \rangle = p'$, and

$$\Delta x = \sigma/\sqrt{2} \quad \text{and} \quad \Delta p = \hbar/\sigma\sqrt{2}. \quad (10.100)$$

Exercises 4.14 and 10.15 show that the above $\psi(x)$ is the ground state of a shifted harmonic oscillator, and is the most general wave function for which $\Delta x \Delta p = \hbar/2$ exactly. We shall now see how these Gaussian wave packets can be used as a non-orthogonal and *overcomplete* basis for Hilbert space.

Baker-Campbell-Hausdorff identity

As a preliminary step, let us establish the useful identity

$$e^A e^B \equiv e^{A+B} e^{[A,B]/2}, \quad (10.101)$$

³⁹Do not attempt to quantize Eq. (10.98) into a time-energy uncertainty relation! Time is not an operator in quantum mechanics—nor is it a dynamical variable in classical mechanics. It is a *c*-number, a mere numerical parameter. The measurement of time will be discussed in the last chapter of this book.

which is valid provided that

$$[A, [A, B]] = [B, [A, B]] = 0. \quad (10.102)$$

The proof of Eq. (10.101) is similar to that of Eq. (8.29), page 221. Let

$$F(\lambda) := e^{-\lambda A} e^{\lambda(A+B)} e^{-\lambda B}. \quad (10.103)$$

We shall prove that $F(\lambda) = e^{\lambda^2[B,A]/2}$. Obviously, both expressions are equal to $\mathbf{1}$ when $\lambda = 0$. Moreover, we have

$$\frac{dF(\lambda)}{d\lambda} = e^{-\lambda A} \left(-A e^{\lambda(A+B)} + (A+B) e^{\lambda(A+B)} - e^{\lambda(A+B)} B \right) e^{-\lambda B}. \quad (10.104)$$

We now use Eq. (8.29) in the form

$$[B, e^C] \equiv (B - e^C B e^{-C}) e^C \equiv \left([B, C] - \frac{1}{2} [[B, C], C] + \dots \right) e^C. \quad (10.105)$$

Take $C \equiv \lambda(A+B)$. If $[A, B]$ commutes with both A and B , only the first term on the right hand side of (10.105) does not vanish, and (10.104) becomes

$$\begin{aligned} \frac{dF(\lambda)}{d\lambda} &= e^{-\lambda A} [B, \lambda(A+B)] e^{\lambda(A+B)} e^{-\lambda B} \\ &= \lambda [B, A] e^{\lambda^2[B,A]/2} = \frac{d e^{\lambda^2[B,A]/2}}{d\lambda}. \end{aligned} \quad (10.106)$$

It follows that $F(\lambda) = e^{\lambda^2[B,A]/2}$ for every λ , since both expressions coincide for $\lambda = 0$. This proves the Baker-Campbell-Hausdorff (BCH) identity (10.101).⁴⁰

Fock space formalism for Gaussian wave packets

In Section 5-6, we introduced the Fock space as a technique for representing multiparticle states. We started from a vacuum state, $\Psi_0 \equiv |0\rangle$, and used raising and lowering operators a^\pm for constructing n -particle states:

$$a^+ |n\rangle = \sqrt{n+1} |n+1\rangle \quad \text{and} \quad a^- |n\rangle = \sqrt{n} |n-1\rangle. \quad (10.107)$$

It follows from these definitions that $(a^-)^* = a^+$, and $[a^-, a^+] = \mathbf{1}$. The normalized Fock states are

$$|n\rangle = (n!)^{-1/2} (a^+)^n |0\rangle. \quad (10.108)$$

Another use of this Fock basis is the representation of the energy eigenstates of a harmonic oscillator. The operators

⁴⁰ If $[A, B]$ does not commute with A and B , Eq. (10.101) is the first term of an expansion. For higher terms, see W. Magnus, A. Karrass, and D. Solitar, *Combinatorial Group Theory*, Interscience, New York (1966) p. 368 [reprinted by Dover].

$$x = \sqrt{\hbar/2m\omega} (a^+ + a^-) \quad \text{and} \quad p = i\sqrt{\hbar m\omega/2} (a^+ - a^-) \quad (10.109)$$

satisfy $[x, p] = i\hbar$. The ground state of the Hamiltonian $p^2/2m + kx^2/2$ is

$$\Psi_0 = (m\omega/\pi\hbar)^{1/4} e^{-m\omega x^2/2\hbar}. \quad (10.110)$$

It satisfies $a^- \Psi_0 = 0$. Note that $\sigma = \sqrt{2} \Delta x = (\hbar/m\omega)^{1/2}$. The n -th energy level is $\hbar\omega(n + \frac{1}{2})$. The corresponding eigenstate will be denoted by $|n\rangle$.

We can now write the Gaussian wave packet (10.99) in terms of these Fock states. We shall label this wave packet by its shift parameters, and denote it as $|x', p'\rangle$. Recalling that $e^{-ix'p/\hbar}$ represents a translation by x' , we have

$$|x', p'\rangle = e^{ip'x'/\hbar} e^{-ix'p/\hbar} \Psi_0. \quad (10.111)$$

By virtue of the BCH identity (10.101), this can also be written as

$$|x', p'\rangle = e^{ip'x'/2\hbar} e^{i(p'x - x'p)/\hbar} \Psi_0. \quad (10.112)$$

The first exponential on the right hand side of (10.112) is an irrelevant phase and may be discarded. In the second one, we introduce a *complex* shift parameter α by writing, as in Eq. (10.109),

$$x' = \sqrt{\hbar/2m\omega} (\bar{\alpha} + \alpha) \quad \text{and} \quad p' = i\sqrt{\hbar m\omega/2} (\bar{\alpha} - \alpha). \quad (10.113)$$

We thus have

$$i(p'x - x'p)/\hbar = \alpha a^+ - \bar{\alpha} a^-. \quad (10.114)$$

The expression

$$D(\alpha) := \exp(\alpha a^+ - \bar{\alpha} a^-), \quad (10.115)$$

is called the *displacement operator*. The state (10.112) can now be written as

$$|\alpha\rangle = D(\alpha) |0\rangle. \quad (10.116)$$

It is called a *coherent state*.⁴¹ Note that it has the same dispersion σ^2 as the ground state $|0\rangle$. Different values of σ can be achieved by an operation called *squeezing*, which has important applications in quantum optics.⁴²

Exercise 10.22 Prove the following relationships:

$$D(\alpha) = e^{-|\alpha|^2/2} e^{\alpha a^+} e^{-\bar{\alpha} a^-}, \quad (10.117)$$

$$|\alpha\rangle = e^{-|\alpha|^2/2} e^{\alpha a^+} |0\rangle = e^{-|\alpha|^2/2} \sum_n (n!)^{-1/2} \alpha^n |n\rangle, \quad (10.118)$$

$$D(\alpha) D(\beta) = e^{(\alpha\bar{\beta} - \bar{\alpha}\beta)/2} D(\alpha + \beta), \quad (10.119)$$

⁴¹R. J. Glauber, *Phys. Rev.* 131 (1963) 2766.

⁴²*Nonclassical Effects in Quantum Optics*, ed. by P. Meystre and D. F. Walls, Am. Inst. Phys., New York (1991).

$$D(-\alpha) = [D(\alpha)]^* = [D(\alpha)]^{-1}, \quad (10.120)$$

$$\langle \alpha, \beta \rangle = e^{\bar{\alpha}\beta - (|\alpha|^2 + |\beta|^2)/2}, \quad (10.121)$$

$$|\langle \alpha, \beta \rangle|^2 = e^{-|\alpha - \beta|^2}, \quad (10.122)$$

$$\mathbf{a}^- |\alpha\rangle = \alpha |\alpha\rangle. \quad (10.123)$$

The last equation is often taken as the definition of a coherent state.

Overcomplete basis

The Fock states $|n\rangle$ form a complete orthonormal basis: any state ψ can be written in a unique way as $\psi = \sum_n c_n |n\rangle$, where $\sum_n |c_n|^2 = 1$. It will now be shown that the coherent states $|\alpha\rangle$ can also be used as a basis. That basis is not orthogonal and it is overcomplete, but it is nonetheless possible to obtain, for each ψ , a representation $\psi = \int c(\alpha) |\alpha\rangle d^2\alpha$, where

$$d^2\alpha := d(\operatorname{Re} \alpha) d(\operatorname{Im} \alpha). \quad (10.124)$$

Moreover, this representation is *unique* if we impose suitable restrictions on the admissible functions $c(\alpha)$.

In the proof given below, I follow Glauber's lucid paper⁴¹ and use, as in that paper, Dirac's bra-ket notations (see Table 3-1, page 78). For example, the completeness of a sum of projectors is expressed by $\sum_n |n\rangle\langle n| \equiv \mathbf{1}$. Likewise, with coherent states, we shall see that

$$\pi^{-1} \int |\alpha\rangle\langle\alpha| d^2\alpha \equiv \mathbf{1}, \quad (10.125)$$

so that the set of operators $\pi^{-1} |\alpha\rangle\langle\alpha|$ forms a POVM, as in Eq. (9.81). This identity follows from

$$\int \bar{\alpha}^m \alpha^n e^{-|\alpha|^2} d^2\alpha \equiv \pi \delta_{mn} n!, \quad (10.126)$$

which is easily proved by writing $\alpha = r e^{i\theta}$, and $d^2\alpha = r dr d\theta$. From the definition of a coherent state in Eq. (10.118), we have

$$\int |\alpha\rangle\langle\alpha| d^2\alpha = \sum_{mn} |m\rangle \int \frac{\bar{\alpha}^m \alpha^n}{\sqrt{m!n!}} e^{-|\alpha|^2} d^2\alpha \langle n| = \pi \sum_n |n\rangle\langle n|, \quad (10.127)$$

whence Eq. (10.125) readily follows.

Let us now expand an arbitrary state ψ . In the Fock basis, we have

$$|\psi\rangle = \sum_n |n\rangle\langle n|\psi\rangle \equiv \sum_n c_n |n\rangle, \quad (10.128)$$

which defines the coefficients $c_n = \langle n|\psi\rangle$. Likewise,

$$|\psi\rangle = \frac{1}{\pi} \int |\alpha\rangle \langle \alpha|\psi\rangle d^2\alpha = \frac{1}{\pi} \int |\alpha\rangle \sum_n \frac{\bar{\alpha}^n e^{-|\alpha|^2/2}}{\sqrt{n!}} \langle n|\psi\rangle d^2\alpha, \quad (10.129)$$

where use was made of Eq. (10.118). Let us now introduce a complex variable z and define a function

$$f(z) := \sum_n c_n z^n / \sqrt{n!}, \quad (10.130)$$

where $c_n = \langle n|\psi\rangle$. This function is analytic in every finite region of the z plane (it is called an *entire* function). We thus have

$$|\psi\rangle = \pi^{-1} \int |\alpha\rangle e^{-|\alpha|^2/2} f(\bar{\alpha}) d^2\alpha. \quad (10.131)$$

Conversely, it is possible to obtain for the entire function $f(\bar{\alpha})$ an explicit formula similar to $c_n = \langle n|\psi\rangle$. We have

$$\langle \beta|\psi\rangle = \frac{1}{\pi} \int \langle \beta|\alpha\rangle e^{-|\alpha|^2/2} f(\bar{\alpha}) d^2\alpha = \frac{e^{-|\beta|^2/2}}{\pi} \int e^{\bar{\beta}\alpha - |\alpha|^2} f(\bar{\alpha}) d^2\alpha, \quad (10.132)$$

where use was made of Eq. (10.121). Next, we note that, for any integer n , we have $\int e^{\bar{\beta}\alpha - |\alpha|^2} \bar{\alpha}^n d^2\alpha \equiv \pi \bar{\beta}^n$. This follows from Eq. (10.126) and from the expansion $e^{\beta\alpha} \equiv \sum \bar{\beta}^n \alpha^n / n!$. A more general form of this identity is

$$\int e^{\bar{\beta}\alpha - |\alpha|^2} f(\bar{\alpha}) d^2\alpha \equiv \pi f(\bar{\beta}), \quad (10.133)$$

and Eq. (10.132) gives

$$f(\bar{\beta}) = e^{|\beta|^2/2} \langle \beta|\psi\rangle. \quad (10.134)$$

Exercise 10.23 Show that if $g(\bar{\beta}) = e^{|\beta|^2/2} \langle \beta|\phi\rangle$, then

$$\langle \phi|\psi\rangle = \pi^{-1} \int e^{-|\alpha|^2} \overline{g(\alpha)} f(\alpha) d^2\alpha. \quad (10.135)$$

Note that $\overline{g(\alpha)} = e^{-|\alpha|^2/2} \langle \phi|\bar{\alpha}\rangle$ is in general different from $g(\bar{\alpha})$.

Exercise 10.24 Show that, for all positive integers n ,

$$\int |\alpha\rangle \alpha^n e^{-|\alpha|^2/2} d^2\alpha \equiv 0. \quad (10.136)$$

Hint: Expand $\langle m|\alpha\rangle$ in powers of α and use Eq. (10.126).

In spite of the fact that the coherent states $|\alpha\rangle$ are not linearly independent, the Glauber expansion (10.131) is unique, because the functions $f(\bar{\alpha})$ which appear in the coefficients are required to be smooth, *entire* functions of $\bar{\alpha}$. For example, the trivial identity $|\beta\rangle \equiv \int |\alpha\rangle \delta^2(\alpha - \beta) d^2\alpha$ is *not* a valid Glauber expansion. The correct way of expanding a basis vector is

$$|\beta\rangle \equiv \pi^{-1} \int |\alpha\rangle \langle\alpha|\beta\rangle d^2\alpha \equiv \pi^{-1} \int |\alpha\rangle e^{\bar{\alpha}\beta - |\alpha|^2/2 - |\beta|^2/2} d^2\alpha. \quad (10.137)$$

The coefficient $e^{\bar{\alpha}\beta - |\alpha|^2/2 - |\beta|^2/2}/\pi$ is considerably smoother than $\delta^2(\alpha - \beta)$. Shall we get an even smoother result by iterating this procedure? Let us try:

$$\begin{aligned} |\gamma\rangle &\equiv \pi^{-1} e^{-|\gamma|^2/2} \int |\beta\rangle e^{\bar{\beta}\gamma - |\beta|^2/2} d^2\beta \\ &\equiv \pi^{-2} e^{-|\gamma|^2/2} \int \left[\int |\alpha\rangle e^{\bar{\alpha}\beta - |\alpha|^2/2 - |\beta|^2/2} d^2\alpha \right] e^{\bar{\beta}\gamma - |\beta|^2/2} d^2\beta. \end{aligned} \quad (10.138)$$

Integration over β gives $|\gamma\rangle \equiv \pi^{-1} e^{-|\gamma|^2/2} \int |\alpha\rangle e^{\bar{\alpha}\gamma - |\alpha|^2/2} d^2\alpha$, as in the right hand side of (10.137): there is no further spreading. The expansion is unique.

It is likewise possible to define a coherent representation of *operators*, by using their matrix elements $\langle\beta|\Omega|\alpha\rangle$. More details and various applications to quantum optics can be found in Glauber's article⁴¹ and in the bibliography at the end of this chapter.

Angular momentum coherent states

It is natural to seek generalizations of the minimum uncertainty wave function in Eq. (10.99) to sets of noncommuting operators other than \mathbf{q} and \mathbf{p} . For example, we may want all three components of angular momentum to have small dispersions $(\Delta J_k)^2$. The sum of these dispersions is, for a given total angular momentum,

$$\sum_k (\Delta J_k)^2 = \sum_k \langle J_k^2 \rangle - \sum_k \langle J_k \rangle^2 = J(J + \hbar) - \sum_k \langle J_k \rangle^2. \quad (10.139)$$

To find the minimum value of this expression, let us rotate the coordinate system so that the new z' -axis is parallel to the vector $\langle J_k \rangle$. We then have $\langle J_{x'} \rangle = \langle J_{y'} \rangle = 0$. The maximum value of $\langle J_{z'} \rangle^2$ is J^2 . Therefore, the sum of the dispersions in Eq. (10.139) is minimal for states that fulfill

$$\mathbf{n} \cdot \mathbf{J} \psi = J \psi, \quad (10.140)$$

with the unit vector \mathbf{n} parallel to any given $\langle J_k \rangle$. This equation defines *angular momentum coherent states*,^{43,44} which have the property

$$\sum_k (\Delta J_k)^2 = J \hbar = j \hbar^2. \quad (10.141)$$

In particular, $\Delta J_{\mathbf{n}} = 0$, and $\Delta J_{\perp} = \sqrt{j} \hbar/2$ in any direction perpendicular to \mathbf{n} .

⁴³J. M. Radcliffe, *J. Phys.* A 4 (1971) 313.

⁴⁴P. W. Atkins and J. C. Dobson, *Proc. Roy. Soc. A* 321 (1971) 321.

These coherent states will be denoted by $|\theta, \phi\rangle$, where θ and ϕ are the polar and azimuthal angles of \mathbf{n} . Note that $|\theta, \phi\rangle$ can be obtained from $|0, 0\rangle \equiv |j\rangle$ by rotating that state through Euler angles ϕ around the z -axis, and then θ around the new y -axis. Therefore,⁴⁵

$$|\theta, \phi\rangle = \sum_{m=-j}^j |m\rangle \binom{2j}{j+m}^{1/2} \cos^{j+m}(\theta/2) \sin^{j-m}(\theta/2) e^{-im\phi}. \tag{10.142}$$

Let us evaluate $\int |\theta, \phi\rangle \langle \theta, \phi| \sin \theta d\theta d\phi$. We first perform the integration over ϕ , which gives $\int e^{i(m'-m'')\phi} d\phi = 2\pi \delta_{m',m''}$, and we are left with

$$\begin{aligned} &\int |\theta, \phi\rangle \langle \theta, \phi| \sin \theta d\theta d\phi \\ &= 2\pi \sum_{m=-j}^j |m\rangle \langle m| \binom{2j}{j+m} \int_0^\pi \cos^{2(j+m)}(\theta/2) \sin^{2(j-m)}(\theta/2) \sin \theta d\theta. \end{aligned} \tag{10.143}$$

The integral on the right hand side is recognized as a beta function, which is equal to $2(j+m)!(j-m)!/(2j+1)!$. We thus obtain

$$\int |\theta, \phi\rangle \langle \theta, \phi| \sin \theta d\theta d\phi = \frac{4\pi}{2j+1} \sum_m |m\rangle \langle m| = \frac{4\pi}{2j+1} \mathbf{1}. \tag{10.144}$$

We shall soon see that this is a special case of a more general formula, valid for any group.

Exercise 10.25 Show that

$$\begin{aligned} \langle \theta', \phi' | \theta'', \phi'' \rangle &= \\ &= [\cos(\theta'/2) \cos(\theta''/2) e^{i(\phi' - \phi'')/2} + \sin(\theta'/2) \sin(\theta''/2) e^{i(\phi'' - \phi')/2}]^{2j}, \end{aligned} \tag{10.145}$$

and

$$\begin{aligned} |\langle \theta', \phi' | \theta'', \phi'' \rangle|^2 &= \\ &= 2^{-2j} [1 + \cos \theta' \cos \theta'' + \sin \theta' \sin \theta'' \cos(\phi' - \phi'')]^{2j} \equiv \cos^{4j}(\Theta/2), \end{aligned} \tag{10.146}$$

where Θ is the angle between the directions (θ', ϕ') and (θ'', ϕ'') .

The angular momentum coherent states have many properties similar to those of the harmonic oscillator coherent states,⁴⁶ because they are related to the latter by the *group contraction* that was discussed on page 322.

⁴⁵M. Tinkham, *Group Theory and Quantum Mechanics*, McGraw-Hill, New York (1964) p. 110.

⁴⁶F. T. Arecchi, E. Courtens, R. Gilmore, and H. Thomas, *Phys. Rev. A* 6 (1972) 2211.

Coherent states for any group

The above considerations can be generalized to any group.⁴⁷ Consider a set S of N unitary matrices U_α having the properties of a group: S includes the unit matrix 1 , the inverse U_α^\dagger of any $U_\alpha \in S$, and the product $U_\gamma = U_\beta U_\alpha$ of any two members of S .

For any fixed $|\psi\rangle \in \mathcal{H}$, consider the states $|\psi_\alpha\rangle := U_\alpha |\psi\rangle$. The sum

$$A := \sum_\alpha |\psi_\alpha\rangle\langle\psi_\alpha| = \sum_\alpha U_\alpha |\psi\rangle\langle\psi| U_\alpha^\dagger, \quad (10.147)$$

has the property that, for any U_β ,

$$U_\beta A U_\beta^\dagger = \sum_\alpha U_\beta U_\alpha |\psi\rangle\langle\psi| U_\alpha^\dagger U_\beta^\dagger = \sum_\gamma U_\gamma |\psi\rangle\langle\psi| U_\gamma^\dagger = A, \quad (10.148)$$

because the set of all $U_\gamma = U_\beta U_\alpha$ (for fixed U_β , and for all $U_\alpha \in S$) contains N different matrices, and therefore it runs over all the elements of S .

It follows from (10.148) that $U_\beta A = A U_\beta$ for all the U_β of the group. Therefore, if the matrices U_β are an *irreducible* representation of that group, we have, by virtue of Schur's lemma, $A = c1$. Taking the trace of (10.147), we obtain $cd = \sum_\alpha \langle\psi_\alpha|\psi_\alpha\rangle = N$, where d is the dimensionality of H . It follows that

$$\sum_\alpha |\psi_\alpha\rangle\langle\psi_\alpha| = (N/d) \mathbf{1}. \quad (10.149)$$

The matrices $(d/N)|\psi_\alpha\rangle\langle\psi_\alpha|$ thus are members of a positive operator-valued measure (POVM), as in Eq. (9.81).

These definitions can be extended to continuous groups, once a suitable measure is defined to replace the discrete sum over α . For example, the U_α may be the ordinary rotation matrices of order $d = 2j + 1$. The $|\psi_\alpha\rangle$ then are the coherent states $|\theta, \phi\rangle$ that were discussed earlier. In this case, N becomes $\int \sin \theta d\theta d\phi = 4\pi$, and we obtain again Eq. (10.144).

10-8. Bibliography

D. Park, *Classical Dynamics and its Quantum Analogues*, Springer, Berlin (1990).

W. Dittrich and M. Reuter, *Classical and Quantum Dynamics: from Classical Paths to Path Integrals*, Springer, Berlin (1992).

These textbooks compare many aspects of classical and quantum mechanics that were not discussed in the present chapter. The first one contains numerous exercises, making it ideal for independent study.

⁴⁷A. M. Perelomov, *Comm. Math. Phys.* 26 (1972) 222.

Path integrals

R. P. Feynman and A. R. Hibbs, *Quantum Mechanics and Path Integrals*, McGraw-Hill, New York (1965).

L. S. Schulman, *Techniques and Applications of Path Integration*, Wiley, New York (1981).

M. S. Marinov, "Path integrals in quantum theory: an outlook of basic concepts," *Phys. Rep.* 60 (1980) 1.

Wigner functions

M. Hillery, R. F. O'Connell, M. O. Scully, and E. P. Wigner, "Distribution functions in physics: fundamentals," *Phys. Rep.* 106 (1984) 121.

Coherent states

J. R. Klauder and B.-S. Skagerstam, *Coherent States*, World Scientific, Singapore (1985).

A. Perelomov, *Generalized Coherent States and their Applications*, Springer, Berlin (1986).

Recommended reading

S. A. Hojman and L. C. Shepley, "No Lagrangian? No quantization!" *J. Math. Phys.* 32 (1991) 142.

The authors prove that the canonical commutation relations are compatible with specified equations of motion only if the latter are equivalent to the Euler-Lagrange equations derived from some Lagrangian L (this Lagrangian need not be unique).

I. V. Aleksandrov, "The statistical dynamics of a system consisting of a classical and a quantum subsystem," *Z. Naturf.* 36 a (1981) 902.

This is an interesting attempt to construct a hybrid system, partly classical and partly quantum mechanical. Each element of the quantum density matrix is a Liouville function of the classical dynamical variables. The equation of motion involves both a commutator and a Poisson bracket with the same Hamiltonian. The normalization $\int \text{Tr}(\rho) dqdp = 1$ is invariant. Unfortunately, there is no guarantee that $\int \rho dqdp$ always remains a positive operator, or that $\text{Tr} \rho \geq 0$ for every value of q and p . It thus seems that this hybrid formalism cannot have a consistent physical interpretation.

L. E. Ballentine, *Quantum Mechanics*, Prentice-Hall, Englewood Cliffs (1990) Chapt. 15.

R. G. Littlejohn, "The Van Vleck formula, Maslov theory, and phase space geometry," *J. Stat. Phys.* 68 (1992) 7.

Chapter 11

Chaos and Irreversibility

11-1. Discrete maps

Most dynamical problems have no known analytic solution. In some cases, approximation methods such as perturbation theory give satisfactory answers. However, it often happens that the only available approximation is the use of numerical methods. Thanks to the advent of fast computers, numerical simulations have become a readily available tool, and they may have a high degree of reliability—if correctly used.

In a computer simulation, continuous physical quantities, time in particular, are replaced by discrete surrogates.¹ This naturally suggests to investigate the properties of dynamical models which are *intrinsically* discrete, but still obey some of the ordinary laws of physics. For instance, in quantum mechanics, we may have, instead of the continuous evolution generated by Schrödinger's equation, a discrete sequence of unitary transformations. In classical mechanics, the mapping $\{q(t), p(t)\} \rightarrow \{q(t + \delta t), p(t + \delta t)\}$ will proceed by discrete steps, each one of which is required to be a canonical transformation. These discrete mappings are akin to a sequence of stroboscopic views taken during a continuous evolution, and they share many of the properties of the latter. In the present section, we shall discuss classical (canonical) discrete dynamics, as a preparation to the study of quantum mechanical discrete maps.

Transfer matrices

To simplify notations, let $\mathbf{r} := \{q^1 \dots q^n, p_1 \dots p_n\}$ denote a point in the $2n$ -dimensional phase space. The problem in which we are interested is whether the orbit $\mathbf{r}(t)$ is stable, or unstable, with respect to small perturbations of the initial conditions. This issue can be investigated by considering the behavior of

¹Some authors have proposed that time and space are fundamentally discrete, with units of the order of $\sqrt{G\hbar/c^3} \simeq 1.6 \times 10^{-35}$ m, where G is Newton's gravitational constant. The present discussion has nothing to do with these speculations. At the time of writing, there is no satisfactory quantum theory of gravity.

a small deviation, $\mathbf{r} \rightarrow \mathbf{r} + \epsilon \mathbf{z}$. We shall see that it obeys Eq. (11.6) below.

Let us write Hamilton's equations of motion (for continuous time) as

$$\frac{d\mathbf{r}_i}{dt} = \sum_j \eta_{ij} \frac{\partial H}{\partial \mathbf{r}_j}, \tag{11.1}$$

where

$$\eta_{ij} = -\eta_{ji} = \delta_{i+N,j} = \begin{pmatrix} 0 & \mathbf{1} \\ -\mathbf{1} & 0 \end{pmatrix}, \tag{11.2}$$

is a *symplectic* matrix. Consider a small deviation, $\mathbf{r}_i \rightarrow \mathbf{r}_i + \epsilon \mathbf{z}_i$. To first order in ϵ , we have, from Eq. (11.1),

$$\frac{dz_i}{dt} = \sum_{jk} \eta_{ij} \frac{\partial^2 H}{\partial \mathbf{r}_j \partial \mathbf{r}_k} z_k \equiv \sum_k M_{ik} z_k. \tag{11.3}$$

This is a *linear* equation for the deviation vector z_k . Note that there is a different matrix $M_{ik}(t)$ for each orbit.

Exercise 11.1 Show that the matrix

$$M_{ik}(t) := \sum_j \eta_{ij} \frac{\partial^2 H}{\partial \mathbf{r}_j \partial \mathbf{r}_k} \tag{11.4}$$

satisfies

$$\sum_i M_{ii} \equiv 0 \quad \text{and} \quad \sum_j (\eta_{ij} M_{jk} + M_{ji} \eta_{jk}) \equiv 0. \tag{11.5}$$

The linear equations (11.3) can in principle be integrated, with a result

$$\mathbf{z}(t) = \mathbf{S}(t)\mathbf{z}(0). \tag{11.6}$$

The *transfer matrix* $\mathbf{S}(t)$ satisfies $\dot{\mathbf{S}} = \mathbf{S}\mathbf{M}$ and $\mathbf{S}(0) = 1$. Transfer matrices play in classical mechanics a role similar to that of unitary matrices in quantum mechanics. However, some of their properties are radically different.

Consider two different deviations, \mathbf{y} and \mathbf{z} . The symplectic area which they span in phase space is $\tilde{\mathbf{y}} \cdot \boldsymbol{\eta} \mathbf{z}$ (where $\tilde{\mathbf{y}}$ denotes a row vector which is the transposed of \mathbf{y}). This area is a constant of the motion, because

$$d(\tilde{\mathbf{y}} \boldsymbol{\eta} \mathbf{z})/dt = \tilde{\mathbf{y}} \tilde{\mathbf{M}} \boldsymbol{\eta} \mathbf{z} + \tilde{\mathbf{y}} \boldsymbol{\eta} \mathbf{M} \mathbf{z} = \tilde{\mathbf{y}} (\tilde{\mathbf{M}} \boldsymbol{\eta} + \boldsymbol{\eta} \mathbf{M}) \mathbf{z} = 0, \tag{11.7}$$

where use was made of Eqs. (11.3) and (11.5), and a tilde denotes a transposed matrix. It follows that

$$\tilde{\mathbf{y}}(t) \boldsymbol{\eta} \mathbf{z}(t) = \tilde{\mathbf{y}}(0) \tilde{\mathbf{S}} \boldsymbol{\eta} \mathbf{S} \mathbf{z}(0) = \tilde{\mathbf{y}}(0) \boldsymbol{\eta} \mathbf{z}(0), \tag{11.8}$$

and therefore

$$\tilde{\mathbf{S}} \boldsymbol{\eta} \mathbf{S} = \boldsymbol{\eta}. \tag{11.9}$$

The transfer matrix \mathbf{S} thus belongs to the symplectic group (the group of transformations which leave the symplectic matrix η invariant).

Exercise 11.2 Show that $\text{Det } \mathbf{S} = 1$ and therefore that the volume of a small element of phase space remains invariant under the transformation (11.6).

Exercise 11.3 Show that the area preserving theorem holds for any canonical transformation. ★

An important property of symplectic matrices is that their eigenvalues are paired as λ and λ^{-1} . *Proof:* Let $\mathbf{S}\mathbf{v} = \lambda\mathbf{v}$. We then also have $\mathbf{S}^{-1}\mathbf{v} = \lambda^{-1}\mathbf{v}$, and we obtain from Eq. (11.9), which can also be written as $\tilde{\mathbf{S}}\boldsymbol{\eta}\mathbf{v} = \boldsymbol{\eta}\mathbf{S}\mathbf{v}$,

$$\tilde{\mathbf{S}}\boldsymbol{\eta}\mathbf{v} = \boldsymbol{\eta}\mathbf{S}^{-1}\mathbf{v} = \lambda^{-1}\boldsymbol{\eta}\mathbf{v}. \quad (11.10)$$

Therefore $\boldsymbol{\eta}\mathbf{v}$ is an eigenvector of $\tilde{\mathbf{S}}$, belonging to the eigenvalue λ^{-1} . But \mathbf{S} and $\tilde{\mathbf{S}}$ have the same set of eigenvalues, since they have the same characteristic equation. Therefore all these eigenvalues are paired, as λ and λ^{-1} .

Moreover, since \mathbf{S} is real, its *complex* eigenvalues are also paired as λ and $\bar{\lambda}$. Therefore they come either as conjugate pairs on the unit circle, or as quartets, $\lambda, \lambda^{-1}, \bar{\lambda},$ and $\bar{\lambda}^{-1}$.

Periodic orbits

If a solution of Hamilton's equations (11.1) satisfies $\mathbf{r}(t + T) = \mathbf{r}(t)$, the orbit is said to be periodic, with period T . This notion can be extended to any discrete map. Consider a nonlinear transformation, $\mathbf{r} \rightarrow F(\mathbf{r})$, where F is an invertible continuous function, so that neighboring points are mapped onto neighboring points. We have

$$\mathbf{r}_0 \rightarrow \mathbf{r}_1 = F(\mathbf{r}_0) \rightarrow \mathbf{r}_2 = F(F(\mathbf{r}_0)) \rightarrow \dots \quad (11.11)$$

For some particular \mathbf{r}_0 , this sequence may be periodic, namely $\mathbf{r}_N = \mathbf{r}_0$. We then say that \mathbf{r}_0 is a *fixed point of order N* .

We shall mostly be interested in the case where the map F is a *canonical transformation*. For example, $F(\mathbf{r})$ may be the result of integrating Hamilton's equations (11.1), either for a prescribed time or, more commonly, until the orbit $\mathbf{r}(t)$ reaches a prescribed surface (or higher dimensional manifold). The latter is called a *Poincaré surface of section*. Let \mathbf{r}_0 be a fixed point on that surface of section. Since $F(\mathbf{r}_0)$ is continuous, a neighboring point $\mathbf{r}_0 + \epsilon\mathbf{z}_0$ on the same surface, is mapped onto $\mathbf{r}_0 + \epsilon\mathbf{z}_1$, where $\mathbf{z}_1 = \mathbf{S}\mathbf{z}_0$. Here, the matrix \mathbf{S} refers to a complete period. This matrix is in general a function of \mathbf{r}_0 . It belongs to the symplectic group, because the area preserving theorem is valid for all canonical transformations.

The *stability* of a periodic orbit is determined by the eigenvalues of \mathbf{S} . After k turns (that is, kN steps), the orbit which started at $\mathbf{r}_0 + \epsilon\mathbf{z}_0$ will pass through $\mathbf{r}_0 + \mathbf{S}^k\epsilon\mathbf{z}_0$. Let us write \mathbf{z}_0 as a linear combination of eigenvectors,

$$\mathbf{z}_0 = \sum_{\lambda} c_{\lambda} \mathbf{v}_{\lambda}, \tag{11.12}$$

where \mathbf{v}_{λ} is the eigenvector of \mathbf{S} corresponding to eigenvalue λ . We then have

$$\mathbf{z}_k = \sum_{\lambda} c_{\lambda} \mathbf{S}^k \mathbf{v}_{\lambda} = \sum_{\lambda} c_{\lambda} \lambda^k \mathbf{v}_{\lambda}. \tag{11.13}$$

Let Λ denote the largest eigenvalue of \mathbf{S} . If Λ is real, the asymptotic behavior of \mathbf{z}_k for large k is an exponential growth, $\mathbf{z}_k \rightarrow c_{\Lambda} \Lambda^k \mathbf{v}_{\Lambda}$. We shall call Λ the *Lyapunov factor* of the periodic orbit. (If time is continuous, Λ is usually written as e^{LT} , and L is called the *Lyapunov exponent*.) More generally, the largest eigenvalues of \mathbf{S} may come as conjugate pairs $\Lambda e^{\pm i\theta}$ (where Λ and θ are real). We then have, asymptotically, $\mathbf{z}_k \rightarrow \Lambda^k (c_{\Lambda} \mathbf{v}_{\Lambda} e^{ik\theta} + \text{c.c.})$, so that the exponential growth is modulated by periodic oscillations. In all these cases, the orbit is clearly unstable. It is only when all the eigenvalues of \mathbf{S} lie on the unit circle that a periodic orbit is stable.

KAM manifolds

It will now be shown that, in a $2m$ -dimensional surface of section, all the points $\mathbf{r}_0 + \epsilon \mathbf{z}_k$ lie on m quadratic manifolds

$$\bar{\mathbf{z}} \mathbf{Q}_j \mathbf{z} = 1, \quad j = 1, \dots, m. \tag{11.14}$$

This is illustrated in Fig. 11.1 for the simple case of a fixed point of order 1 on a 2-dimensional surface of section ($m = 1$): the points $\mathbf{z}_0 \dots \mathbf{z}_3$ lie on an ellipse, if the orbit is stable. They would lie on a hyperbola in the case of an unstable fixed point.

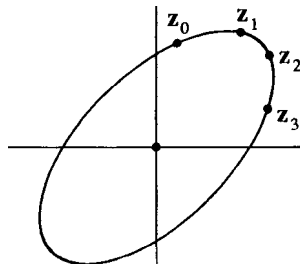

Fig. 11.1. An elliptic fixed point \mathbf{r}_0 is located at the origin of a 2-dimensional surface of section. Consecutive points of a neighboring orbit, $\mathbf{r}_0 + \epsilon \mathbf{z}_k$, lie on an ellipse.

To prove this property, consider Eq. (11.13) for any given value of k . Write the $2m$ values of λ^k as an array, x_{λ} , and the $2m$ components of \mathbf{z}_k as another array, y_{μ} . The result has the form of a linear transformation:

$$y_{\mu} = \sum_{\lambda} A_{\mu\lambda} x_{\lambda}, \tag{11.15}$$

where $A_{\mu\lambda}$ is the μ th component of $c_{\lambda\nu\lambda}$ in the expansion of \mathbf{z}_0 in Eq. (11.12). By inverting (11.15), we obtain $x_\lambda = \sum_{\mu} B_{\lambda\mu} y_\mu$, where B is the inverse matrix of A . Recall now that the $2m$ values of λ are paired, as λ and $\lambda' = \lambda^{-1}$, so that the $2m$ values of $x_\lambda \equiv \lambda^k$ are also paired: $x_\lambda x_{\lambda'} = 1$. It follows that

$$\forall \lambda \quad \sum_{\mu\nu} B_{\lambda\mu} B_{\lambda'\nu} y_\mu y_\nu \equiv \sum_{\mu\nu} (Q_\lambda)_{\mu\nu} y_\mu y_\nu = 1, \quad (11.16)$$

which is just another way of writing Eq. (11.14).

The physical interpretation of this result is a *conservation law*: in the vicinity of the fixed point \mathbf{r}_0 , there is some function of \mathbf{r} (that is, of \mathbf{q} and \mathbf{p}) which is constant, and Eq. (11.14) represents the first terms in a power expansion of this function. However, some care is needed here, and various possibilities must be distinguished.

For a stable (also called *elliptic*) fixed point, the sequence of \mathbf{z}_k may densely cover a closed manifold C . This is an ellipse (or ellipsoid) if the \mathbf{z}_k are infinitesimal, a more complicated manifold if they are finite. In particular, for the simple case of a 2-dimensional surface of section, C is a closed curve which divides the surface of section into two parts. If an initial point \mathbf{r} is inside the domain bounded by C , all the consecutive mappings of \mathbf{r} will also be inside, by continuity. (*Proof*: let a continuous curve R connect the fixed point \mathbf{r}_0 to $\mathbf{r}_0 + \mathbf{z}_0$ and pass through \mathbf{r} . Consecutive mappings of R will connect \mathbf{r}_0 to $\mathbf{r}_0 + \mathbf{z}_k$ without ever leaving the domain bounded by C .)

In the general case of a *finite* deviation \mathbf{z} , the existence of such a manifold is guaranteed, under appropriate conditions, by the KAM theorems.²⁻⁴ Consider an *integrable* Hamiltonian system, namely one with n analytic constants of motion in involution. The orbit of \mathbf{r} then lies on a n -dimensional torus in the $2n$ -dimensional phase space. If that Hamiltonian is perturbed in a way which makes it nonintegrable, there will be fewer than n constants of integration (there may remain only one, the energy). The KAM theorems assert that if the perturbation is analytic, or at least differentiable sufficiently many times, these tori will be distorted *but they will not disappear* as long as the perturbation is small enough. [This property apparently holds under less restrictive conditions, such as for the nonanalytic law of force (11.20) discussed below, but there is no formal proof.] As the perturbation increases, the KAM manifolds gradually break down, and the motion of a point \mathbf{r} in phase space can explore domains of dimensionality higher than n (up to $2n - 1$ dimensions, if energy is the only remaining constant of motion of the perturbed Hamiltonian).

The situation is more complicated in the case of an unstable (or *hyperbolic*) fixed point. In the simplest case of a 2-dimensional surface of section, it may happen that there exists a continuous curve which behaves as a hyperbola in the vicinity of the unstable fixed point, and which is mapped onto itself by

²A. N. Kolmogorov, *Dokl. Akad. Nauk* 98 (1954) 527.

³V. I. Arnol'd, *Usp. Mat. Nauk* 18 (1963) 13 [transl. *Russ. Math. Surveys* 18 (1963) 9].

⁴J. Moser, *Nachr. Akad. Wiss. Göttingen, Math. Phys.* K1 (1962) 1.

the nonlinear transformation $\mathbf{r} \rightarrow F(\mathbf{r})$. However, in the generic case, the sequence of \mathbf{z}_k wanders over all accessible parts of the surface of section that can be reached without crossing a KAM line. Such a motion is called *irregular* or *chaotic*, because it becomes effectively unpredictable for long times: the slightest perturbation of the initial conditions is amplified, step after step, until any computer with finite resources is unable to determine new points in a reliable way. The situation is illustrated by Fig. 11.2, which displays both KAM lines and chaotic areas.

That figure also shows chains of *islands of stability*, namely KAM lines which consist of several disjoint parts. The latter arise whenever a mapping such as the one sketched in Fig. 11.1 does not densely cover a closed curve, but contains only a finite number of points, because it is itself periodic: $\mathbf{z}_s = \mathbf{z}_0$. Each one of these points thus is a fixed point of order s . If this new periodic orbit is stable, the associated KAM line consists of s disjoint parts.

Case study: area preserving map on a torus

Consider a compact 2-dimensional phase space, $-1 \leq q, p \leq 1$. The end points -1 and 1 are identified. The discrete map consists of two steps, namely

$$q \rightarrow q' = q + p \quad (\text{“mod } 2\text{”}), \tag{11.17}$$

followed by

$$p \rightarrow p' = p + f(q) \quad (\text{“mod } 2\text{”}). \tag{11.18}$$

Here, “mod 2” means that if $|q'|$ or $|p'|$ exceeds 1, one must add or subtract an integral multiple of 2 to bring it back to the domain $[-1, 1]$. This map is invertible, by $p = p' - f(q')$, followed by $q = q' - p$.

Exercise 11.4 Show that this transformation is canonical:

$$\frac{\partial q'}{\partial q} \frac{\partial p'}{\partial p} - \frac{\partial q'}{\partial p} \frac{\partial p'}{\partial q} = 1. \tag{11.19}$$

As a simple case, consider the quadratic law of “force”⁵

$$f(q) = -q(1 - |q|). \tag{11.20}$$

We shall give the name *parabolic map* to the resulting law of motion. The point $q = p = 0$ obviously is a first order fixed point of this map. In its vicinity, the map can be linearized as

⁵This is a poor man’s version of the *standard map* with $f = -K \sin(q/\pi)$, about which there is a vast literature. The quadratic law (11.20) is used here for pedagogical reasons, because it allows a detailed investigation with minimal computing tools, as shown in the Appendix.

$$q' = q + p, \quad p' = p - q' = -q. \quad (11.21)$$

The corresponding transfer matrix $\begin{pmatrix} 1 & 1 \\ -1 & 0 \end{pmatrix}$ has eigenvalues $e^{\pm 2\pi i/3}$.

Exercise 11.5 Find the form of the KAM ellipse corresponding to (11.21).

Exercise 11.6 Show that the point $q = \pm 1, p = 0$ is an unstable fixed point, and that the eigenvalues of the transfer matrix are $\lambda = (3 \pm \sqrt{5})/2$.

Some complete orbits of the parabolic map are displayed in Fig. 11.2. As expected, there are concentric elliptic KAM lines in the vicinity of the stable

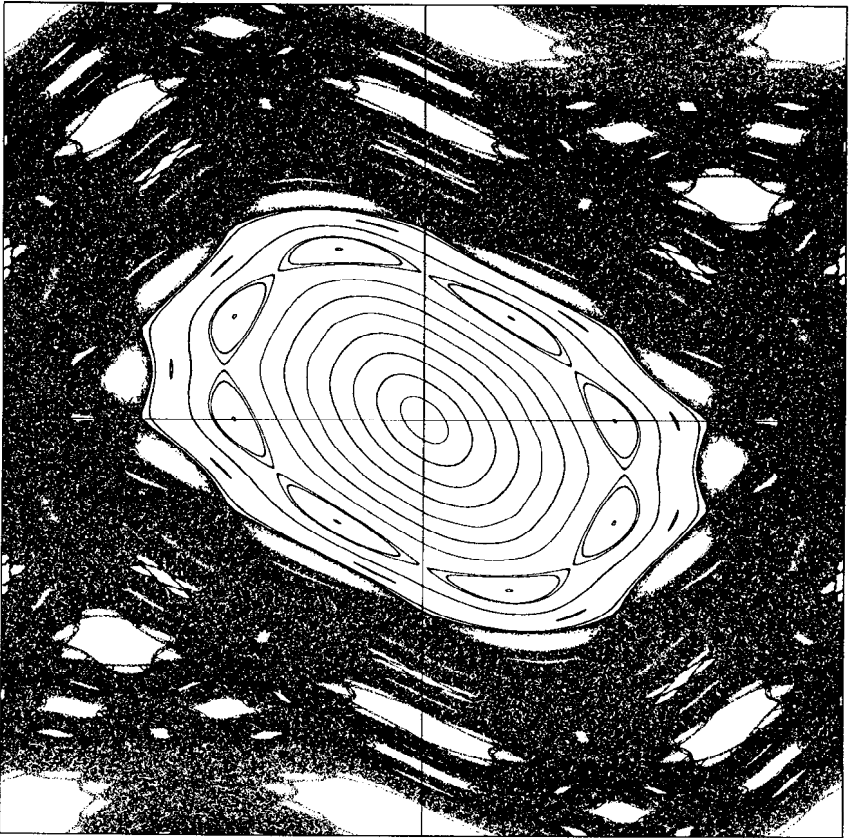

Fig. 11.2. The parabolic map is illustrated here by 13 regular orbits and one chaotic orbit. The vertical axis is $-1 < p < 1$, and the horizontal axis is $-1 < q < 1$. The regular orbits start at $p = 0$ and $q = 0.05, \dots, 0.65$. The chaotic orbit explores most of the phase space (10^6 points were plotted).

fixed point $q = p = 0$. The shape of these closed curves becomes more complicated as their size grows. They occasionally break up into chains of islands of stability, corresponding to higher order fixed points. Further away from the origin, most of phase space is covered by a chaotic region, where blank areas indicate the presence of additional islands of stability.

In the chaotic region, nearly all the periodic orbits have Lyapunov factors $\Lambda > 1$. Therefore an *infinitesimal* region of phase space is stretched, after k steps, by a factor Λ^k (in the limit $k \gg 1$). For a *finite* region, the situation is more complicated, because both Λ and the direction of the eigenvector \mathbf{v}_Λ vary from point to point. This causes the finite region to be distorted in a grotesque way, projecting increasingly long and thin filaments, as illustrated in Figs. 11.3

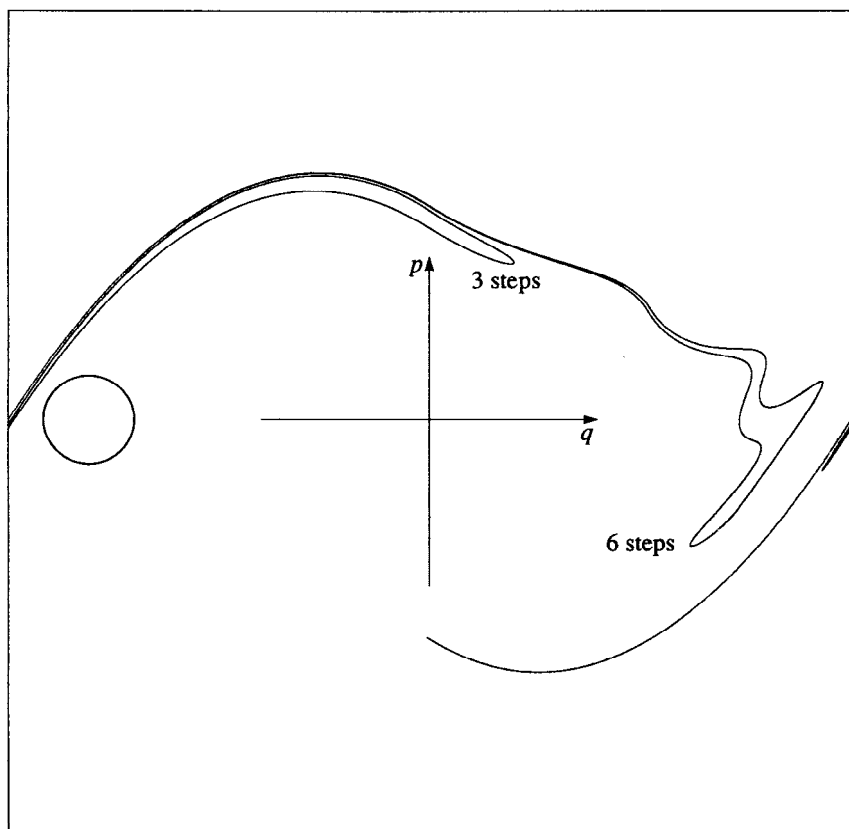

Fig. 11.3. An initially circular domain, entirely within the chaotic region of the parabolic map, is shown after 3 and 6 steps. Note that the area of this domain is conserved, while its shape becomes more and more distorted. The POSTSCRIPT program which draws this figure is given in the Appendix.

and 11.4. As the number of iterations tends to infinity, these filaments will pass arbitrarily close to *any* point which can be reached without crossing a KAM line. This property is called *ergodicity* (the label “ergodic” is sometimes restricted to situations where the entire energy surface can be reached).

Ergodicity and mixing

In the present context, ergodicity is almost tautological because any region which would not be covered by these chaotic filaments would necessarily have a *boundary*, invariant under the dynamical map, and then this boundary itself would be an impenetrable KAM line. There is however a nontrivial and much stronger property, called *mixing*, which has profound consequences.

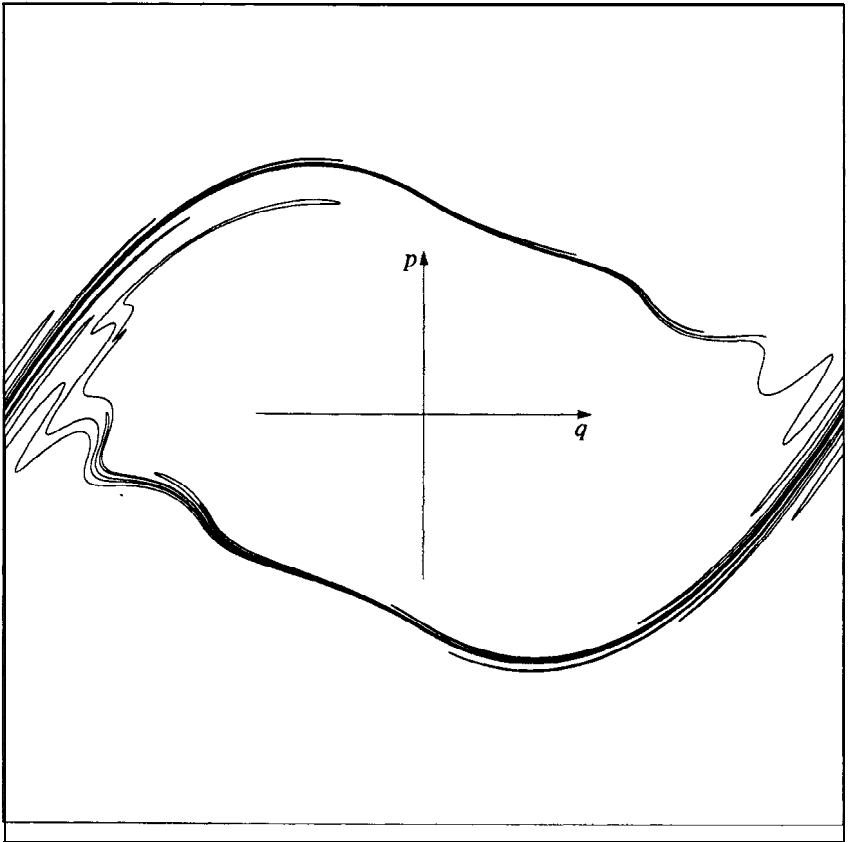

Fig. 11.4. The same circular domain, after 12 steps of the parabolic map. When many additional steps are executed, the increasingly long and thin filaments will pass arbitrarily close to every point of the chaotic region.

Consider a compact region R_0 of phase space, such as the small circle in the preceding figures, and let R_k be its k th iteration by the mapping under consideration. Let μ be the ratio of the volume of R_0 to the total volume of the accessible region which is covered by the successive iterations R_k . Then, as $k \rightarrow \infty$, every accessible *fixed* region of phase space will have the same fraction μ of its volume covered by points belonging to R_k . Seen on a *coarse scale*, the entire accessible region of phase space is *uniformly* covered by R_∞ . The notions of *mixing* and *coarse graining* are essential in the derivation of classical irreversibility.

11-2. Irreversibility in classical physics

The intuitive meaning of “irreversibility” is that there are dynamical evolutions which can easily be prepared, but it is extremely difficult (we say “impossible”) to prepare the time-reversed evolutions. For example, it is easy to get a cup of lukewarm water by placing a cube of ice in a cup of boiling water, and waiting one hour, say. It is impossible to prepare a cup of lukewarm water in such a way that, one hour later, it will turn into an ice cube floating in boiling water.

The *classical* explanation given to irreversibility is based on the concepts of *mixing* and *coarse graining*. Mixing, whose intuitive meaning was illustrated in Fig. 11.4, is a property which can be proved rigorously, in the limit $t \rightarrow \infty$, for some specific physical systems, such as a gas of hard spheres (*i.e.*, impenetrable, nonrotating spheres, which rebound elastically when they collide). Formally, it means the following:⁶ Consider two finite (and *fixed*) regions of phase space, V_1 and V_2 , which are not dynamically separated by an isolating constant of motion (or a closed KAM manifold), and whose measures are fractions μ_1 and μ_2 of the total accessible phase space. Suppose that the Liouville density $f_1(\mathbf{q}, \mathbf{p})$ is uniform in V_1 at time t_1 , with $\int f_1 dV_1 = 1$. The dynamical evolution causes this density to become $f_2(\mathbf{q}, \mathbf{p})$ at time t_2 . Then, for any t_2 sufficiently remote from t_1 (in the future or the past) and for sufficiently large μ_1 and μ_2 , we have $\int f_2 dV_2 \rightarrow \mu_2$, irrespective of where V_1 is. The system appears to have no memory of its origin. Obviously, the smaller μ_1 or μ_2 , the larger the time $|t_1 - t_2|$ needed for mixing. (I consider only finite times, not the unattainable mathematical limit of infinite time.) Notice that the mixing property is *time symmetric*. By itself it cannot explain irreversibility.

In the ice-cube paradigm, V_1 (the region of phase space which corresponds to an ice cube in boiling water) is considerably smaller than V_2 , which corresponds to what we loosely call “lukewarm water” with no further specification of the water properties. This is because, for a given total energy, nearly all the points of phase space are compatible with this vaguely specified state of water, so that $\mu_2 \simeq 1$. Therefore, *almost every* dynamical evolution will lead to lukewarm

⁶ V. I. Arnold and A. Avez, *Ergodic Problems in Classical Mechanics*, Benjamin, New York (1968) pp. 19–22.

water, with extremely small inhomogeneities, since $\mu_2 \simeq 1$ is the probability of finding the final state in V_2 . Nevertheless, we can, conceptually, prepare lukewarm water at time t_2 so that, at a *later* time t_1 it will separate into an ice cube and boiling water. However, this requires a very special preparation: not just any cup of lukewarm water, but one with precise correlations between all the molecules. This preparation is restricted to lie in an *exceedingly* contorted region of phase space, far more complicated than Fig. 11.4, and with structural details so small that mixing, as defined above, will not yet have been accomplished after the given *finite* time $t_1 - t_2$.

Now comes *coarse graining*: we are unable, with our imperfect instruments, to coerce the initial state to reside within a region of phase space which is so small, or with a structure so complicated, that mixing will not yet have occurred after a finite time $t_1 - t_2$. That is, we cannot prepare the system at time t_2 so that, after a finite time $t_1 - t_2$, it will be located with certainty in the desired domain V_1 of phase space. There are evolutions (such as from lukewarm water to an ice cube in boiling water) which cannot be made to proceed.

Deceptive irreversibility

The above argument deserves close scrutiny. The claim that “we are unable to achieve such a preparation” ought to be *proved*. What is the degree of difficulty which is called “impossible”? (How, indeed, do we measure difficulty?) One should never underestimate the skill of experimental physicists. For instance the spin echo^{7,8} phenomenon shows that an apparently irreversible behavior can, under appropriate circumstances, be reversed. In that experiment, a large number of spins, initially aligned, acquire random phases under the influence of random, unknown, but *fixed* internal fields, acting during a *known* time t . A suitable RF pulse can then invert all these phases and, after the *same* time t , all the spins are again aligned. This is possible because all the spin precessions are decoupled from each other. Their equations of motion are integrable. The phases *appear* random to the untrained eye, but actually they are *correlated*. They are similar to a text which has been encrypted by a secret key, appears incomprehensible, but can be decrypted by anyone knowing the key. Information is not destroyed by encryption, it is only made less accessible. Likewise, in the spin echo case, the “key” is the strength of the RF pulse which inverts the phases and realigns the spins.

To give a quantitative measure to these concepts, the notion of *logical depth* was introduced by Bennett.⁹ It is, roughly speaking, the number of elementary logical steps needed to obtain the value of a physical quantity from the minimal program which can compute it. Unfortunately, logical depth itself is not computable: this is due to the most fundamental property of computability theory,

⁷ E. L. Hahn, *Phys. Rev.* 80 (1950) 580.

⁸ J I Rothstein, *Am. J. Phys.* 25 (1957) 510.

⁹ C. H. Bennett, in *Emerging Syntheses in Science*, ed. by D. Pines, Addison-Wesley, Reading (1987) p. 215.

namely the unsolvability of the halting problem.^{10,11} Moreover, the length of a computation can sometimes considerably decrease if the minimal program which generates it is replaced by a longer, but more efficient program. Nevertheless, if we set some arbitrary rate of exchange between run time and program size, the resulting logical depth can be shown to be roughly machine-independent.⁹

Exercise 11.7 *The Kac ring model*^{12,13} consists of n equidistant balls on the circumference of a circle. Each ball can be either black or white. Moreover, m markers are placed on the circumference, in a random way, at fixed positions. All the balls move clockwise with the same velocity and, when a ball passes a marker, its color changes. The initial color distribution is given (for example, all the balls are white). The problem is to find the color distribution after a long time. (Assume $n \gg m \gg 1$.) ★

In the above exercise, we intuitively expect a monotonic approach to an equilibrium state, with equal numbers of white and black balls, except for small fluctuations. This is indeed what happens at the beginning of the motion. Yet, this cannot continue forever. The system is manifestly periodic, because after two complete turns each ball is back to its original color, having passed each marker twice. Here again, the colors of the balls may look random to the untrained eye, but they are strictly correlated: the encryption key is the fixed distribution of markers.

Let us now imagine that an observer starts to watch the n black and white balls only a short time before the end of a complete cycle. Their color distribution, which initially appears random, spontaneously evolves from disorder to order, until all the balls are white; and thereafter, they return to a pseudo-random state. The baffled observer will perhaps try to interpret his findings as a statistical fluctuation, one which would have very low *a priori* probability. (If a cup of lukewarm water turned into an ice cube in boiling water, this would be called a miracle, for sure.)

However, upon closer analysis, our observer would realize that he has been the victim of a conspiracy: the apparently random distribution of white and black balls is logically deep. It has been cleverly contrived by means of a complicated calculation, or a long physical process. To orchestrate this result, the preparer would first have to produce m pseudo-random numbers (the markers positions, between 0 and 2π) and then to count, for each one of the n balls, how many of these pseudo-random numbers fall between $2\pi k/n$ (the initial position of the k th ball) and $2\pi(k+l)/n$ (its position after l steps). Recall that $n \gg m \gg 1$, so that a lot of computation is necessary in order to produce the fake “statistical fluctuation” which mimics a spontaneous decrease of entropy.

¹⁰ A. M. Turing, *Proc. London Math. Soc.* 42 (1936) 230.

¹¹ M. Davis, *Computability and Unsolvability*, Dover, New York (1982).

¹² M. Kac, *Probability and Related Topics in Physical Sciences*, Interscience, New York (1959).

¹³ M. Dresden, in *Studies in Statistical Mechanics*, ed. by J. De Boer and G. E. Uhlenbeck, North Holland, Amsterdam (1962) Vol. I, p. 316.

Computational complexity

Likewise, consider the evolution of a nonintegrable dynamical system. Even though this system is deterministic, its long time behavior is effectively *chaotic* because, as we shall now see, the amount of computation required to predict the motion increases faster than the actual duration of the motion itself. Therefore, for sufficiently long times, no computer with finite resources will be able to predict the final state of the system, except statistically. Chance is supreme. The final state is “random” and the evolution is “chaotic.”

A quantitative measure for the computational work needed to accomplish a given task is its *computational complexity*.¹⁴ This notion is defined in roughly the same way as logical depth, but it refers to a *process* (such as a dynamical evolution) while logical depth is a property of the *end product* of such a process. For instance, let us evaluate the computational complexity of a classical chaotic orbit in a bounded system. That orbit, C , will eventually pass near its initial point. There must therefore be an exactly periodic orbit, O with a starting point very close to that of C (and with a Lyapunov factor $\Lambda > 1$). Let δ be the initial separation of these orbits. After k turns, their separation will be about $\Lambda^k \delta$, provided that this still is small enough to allow the use of the linearized equations of motion (11.3). Conversely, in order to predict the final point of C with a precision ϵ , the initial point must be specified with a precision $\Lambda^{-k} \epsilon$.

The number of digits to be specified in the initial data thus increases *linearly* with the duration of the physical motion that we want to compute.¹⁵ This alone is sufficient to cause the computational complexity to increase, for $t \rightarrow \infty$, faster than $t \log t$, because there surely are some multiplications in the computation, and the best (currently known) algorithm¹⁴ for multiplying two numbers with N bits ($N \gg 1$) requires a number of elementary logical operations which increases faster than $N \log N$. In practice, the computational complexity will increase considerably faster than that, if the computation involves a sequence of iterations, such as in the Runge-Kutta method. The numerical error for a step of duration τ typically behaves as $a\tau^n$ where a depends on the system of equations (not on τ) and n is a small integer. Optimally, the expected numerical error due to the iterative algorithm should be about the same as the admissible round-off error, namely $\Lambda^{-t/T} \epsilon$, where t is the time remaining until the end of the motion, and T is the period of the neighboring orbit O . The required τ thus behaves as $\Lambda^{-t/nT}$, and the total number of steps as $\Lambda^{t/nT}$. The computational complexity of a classical chaotic orbit thus increases *exponentially* with the duration of the motion.

Admittedly, this conclusion was reached by assuming the use of an iterative algorithm of the Runge-Kutta type. For any specific problem, more efficient methods may exist. However, if the computational complexity of the fastest

¹⁴G. Brassard and P. Bratley, *Algorithmics: Theory and Practice*, Prentice-Hall, Englewood Cliffs (1988).

¹⁵Recall that the magnitude of a number is an *exponential* function of the number of digits needed to represent it.

algorithm can be shown to increase more rapidly than the actual duration of the motion, no long range predictions are possible, and the system is chaotic.

Are these difficulties subjective?

We must exert extreme caution before claiming that it is *impossible* to achieve a specific goal, just because it looks difficult. In the case of the spin echo, or the Kac model, what appeared at first sight difficult became easy under closer analysis. Likewise, consider the intricate phase space domain in Fig. 11.4. Since it was obtained by a *canonical* mapping, there must be some canonical variables with which that domain has a simple shape, while the initial circular domain appears utterly distorted and complicated.

These two coordinate systems are canonically equivalent, but they are not equivalent from the point of view of physics. *There are privileged coordinates*, namely those in which the observer and his instruments have a simple shape which can be specified by a short description. Given such a privileged coordinate system, *it is objectively difficult*—but not formally impossible—to prepare an initial state lying within a contorted domain, as in Fig. 11.4, with extremely fine structural details. This is because the extreme precision which is required necessitates the handling of a large amount of *information*, at the very least supplying many digits in the initial data. The process of getting and recording this information dissipates at least an equivalent amount of entropy in the rest of the world (see page 266). However, if the accessible part of the universe is finite, there must be an upper limit to the entropy that we can generate in it: our computing ability may be large, but it is not infinite.

It thus appears that some physical properties are subjective and depend on our intellectual and experimental skills. The spin echo phenomenon, discussed above, is an example: where most people would see only disorder (high entropy), others may recognize a perfectly ordered (but logically deep) state, with zero entropy. This subjectivity should not be a matter of concern, as long as we admit that there is *some* limit to our skill. The precise limit has little importance: our description of physical phenomena is almost indifferent to where this limit is set, because the Lyapunov exponent which rules the dynamical evolution of a macroscopic system is so huge that it will overcome, within an exceedingly brief time, even the most extravagant claims of computability and reversibility.

The role of the environment

Irreversibility results from our accepting that there are things that we cannot do. We should not, however, underestimate our ability. As shown by Hahn's spin-echo⁷ experiment, macroscopic observers are not restricted to coarse-grained variable.¹⁶ If our goal is *motion reversal*, we don't have to measure a velocity in order to reverse it—a mundane elastic bounce will do that job. In a large

¹⁶ J.M.Blatt, *Prog. Theor. Phys.* 22 (1959) 745.

system, a reversal of *all* the velocities does not imply a measurement of *all* the velocities (which would indeed be impossible for a macroscopic observer). Therefore, “proofs” of irreversibility based on a vaguely defined coarse-graining are not really convincing, and further considerations are needed.

Irreversibility would still occur if there were no limit to our resolving power, and if any state specified by a finite algorithm could be prepared experimentally. (We already made such optimistic assumptions when introducing the quantum superposition principle, page 50.) The fundamental limitation to an observer’s ability is of a different nature: he must restrict his observations to a *finite* part of the Universe. Insurmountable difficulties do not arise from having to handle large, complicated systems; rather, they appear with limited and not perfectly isolated systems.¹⁶

It is sometimes claimed that physical systems can be isolated as well as we wish, and that it is only a matter of technological skill to reduce the influence of the external world to an arbitrarily low level. To show the fallacy of this claim, let us for a moment imagine that this external world is completely known to us, and let us examine how it would affect the system under consideration. In the equations of motion, the external world would appear as additional degrees of freedom, weakly coupled to the degrees of freedom of the original system. The coupling being very weak, one could legitimately ignore the *global* energy transfer between the internal and external degrees of freedom (e.g., superconducting currents have been shown to run for an “infinite” time, on a human scale). However, the detailed *microscopic* behavior of a *chaotic* system is appreciably affected by its weak coupling with the external world much more quickly than it is possible for macroscopic variables to approach global equilibrium.¹⁶ Therefore the microscopic motion becomes unpredictable much earlier than irreversibility is apparent on a macroscopic scale.

Note that the “external world” of a macroscopic system includes not only the walls of its container and everything beyond these walls. It also includes all the *internal* degrees of freedom which are not explicitly taken into account in the Hamiltonian description of that system. For example, if we specify the state of a top by the coordinates of its center of mass and three Euler angles for its orientation, all the remaining, unknown, “irrelevant” degrees of freedom, such as the displacements of individual atoms from their equilibrium positions, are part of the external world, or the so-called *environment*. Unless the “relevant” degrees of freedom are *rigorously* decoupled from the irrelevant ones (for example, by virtue of exact conservation laws), they are not truly isolated. Then, if the Hamiltonian equations of motion are not integrable, the system is chaotic and long range predictions are impossible, except statistically.

In order to have chaotic dynamics, the number of degrees of freedom need not be large. In a time independent system, *two* are enough, provided that they are nonlinearly coupled, so that the Hamiltonian equations of motion do not constrain orbits to lie on KAM tori. In an explicitly time dependent system, or in a discrete map, a single degree of freedom is enough to obtain chaotic behavior, as illustrated in the preceding figures.

11-3. Quantum aspects of classical chaos

Can we extend these arguments to quantum systems? We have seen in Sect. 10-1 that the correspondence principle is not a reliable guide, because of fundamental differences between classical and quantum dynamical laws. For example, if two classical chaotic orbits start at neighboring points, their “distance” increases in a roughly exponential manner.¹⁷ On the other hand, if two quantum states are initially almost identical (that is, if their scalar product is very close to 1) they will remain almost identical forever, because the Hamiltonian evolution is a *unitary* mapping which preserves scalar products.

However, a quantum state is *not* the analog of a point in the classical phase space. The classical analog of a quantum state is a *Liouville probability density*. If two Liouville functions are initially concentrated around neighboring points, with some overlap, that overlap remains constant in time, by virtue of Koopman’s theorem (see Sect. 10-5). Each one of the Liouville functions may become distorted beyond description, until all phase space appears thoroughly mixed when seen on a coarse scale. Yet, the overlap of these functions remains constant, as illustrated in Fig. 11.5.

Anyhow, no one is interested in how a Liouville probability density, which was initially given, will later overlap with the tortuous domain covered by the time evolution of another, initially given Liouville density. The experimentally relevant question is how each one of these time dependent domains overlaps with a *fixed* domain of phase space. We know the answer: seen on a coarse scale, the final probability density is homogeneous and roughly independent of the initial conditions. This is the property that was called *mixing*.

Turning now to quantum theory, we may inquire whether Wigner’s function,

$$W(\mathbf{q}, \mathbf{p}) := (\pi\hbar)^{-N} \int \rho(\mathbf{q} - \mathbf{r}, \mathbf{q} + \mathbf{r}) e^{2i\mathbf{p}\cdot\mathbf{r}/\hbar} d\mathbf{r}, \tag{10.56}$$

which is the quantum analog of a Liouville density, is also subject to mixing. The answer is negative: $W(\mathbf{q}, \mathbf{p})$ has a much smoother time evolution than a Liouville function.¹⁸ In particular, it can never develop contorted substructures on scales smaller than \hbar . Therefore, Wigner’s function $W(\mathbf{q}, \mathbf{p})$ does not possess the mixing property, as defined above.

In general, it is found empirically, by numerical simulations, that quantum mechanics tends to suppress the appearance of chaos. Quantum wave packets may remain localized, even when classical orbits are strongly chaotic, because the breakup of KAM surfaces starts in limited regions, and the remnants of these surfaces effectively act as barriers to quantum wave packet motion while

¹⁷The word “distance” was written between quotes because phase space has no metric structure. It has a *symplectic* structure, and the metric distance between two points is not canonically invariant. However, in any arbitrary but *fixed* metric, such as $ds^2 = d\mathbf{q}^2 + d\mathbf{p}^2$, an infinitesimal “distance” between two orbits will end up growing exponentially (as long as it is much smaller than the extent of these orbits) if the system is chaotic.

¹⁸H. J. Korsch and M. V. Berry, *Physica D* 3 (1981) 627.

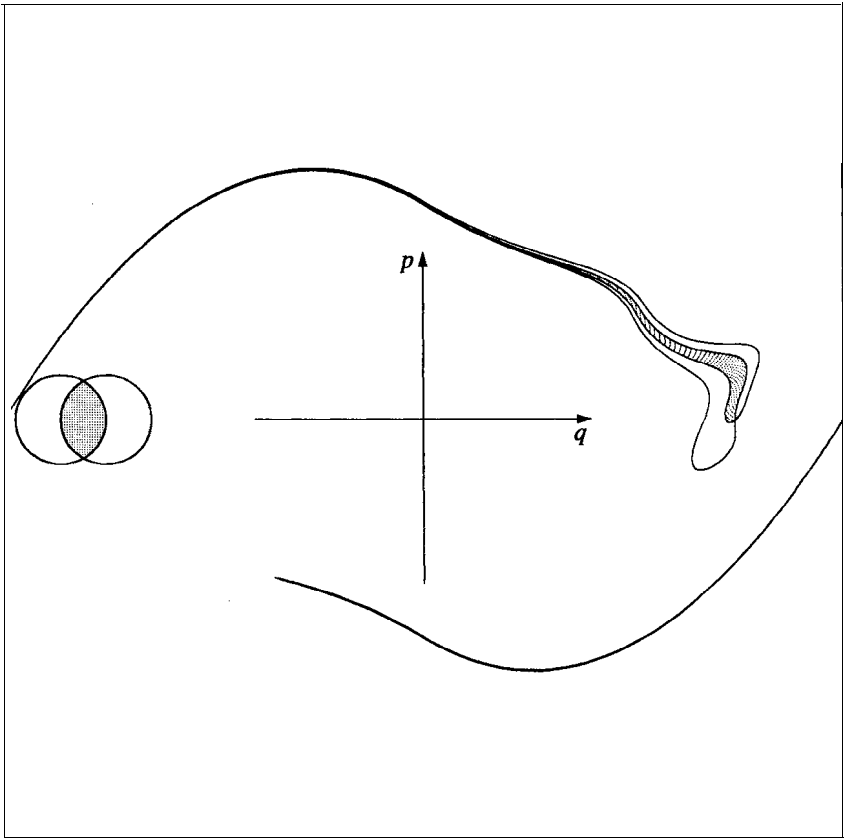

Fig. 11.5. An illustration of Koopman's theorem: two initially circular domains are subjected to five iterations of the parabolic map, Eqs. (11.17–20). The area of their overlap remains constant. Notice how the regular pattern of dots in the common domain is distorted by the area preserving map.

permitting extensive classical flow.¹⁹ A similar phenomenon appears in simple models where the Hamiltonian includes a time-dependent perturbation.²⁰ In these models, which may have a single degree of freedom, the physical system is prepared in a state involving only one, or at most a few energy levels of the unperturbed Hamiltonian. One then finds that the time evolution of the quantum system involves only a few more neighboring energy levels, so that the energy remains “localized” in a narrow domain (even though no vestige remains of the KAM manifolds, the corresponding classical evolution is chaotic, and the

¹⁹ R. C. Brown and R. E. Wyatt, *Phys. Rev. Lett.* 57 (1986) 1.

²⁰ G. Radons and R. E. Prange, *Phys. Rev. Lett.* 61 (1988) 1691.

classical energy increases without bound in a diffusive way).²¹ As a consequence of this energy “localization,” the quantum motion is *almost periodic* and the initial state recurs repeatedly,²² as it would for a time-independent Hamiltonian with a point spectrum. The peculiarity here is not the recurrence itself, which is similar to that in a Poincaré cycle,²³ and is completed only after an inordinately long time, but the fact that the quantum state after an arbitrarily long time can be computed accurately with a finite amount of work. Everything is predictable. Nothing is left to chance.

Quantum simulation of a classically chaotic system

This suggests a curious paradox.²⁴ Rather than computing a classically chaotic orbit by numerical integration of Hamilton’s equations, we could quantize in the standard way the classical Hamiltonian (with an arbitrarily low, but finite value of \hbar) and then integrate the Schrödinger equation in order to follow the motion of a small wave packet. For example, we could integrate the evolution of the solar system for trillions of years, by assuming that the Sun and the planets, and all their moons, and all the asteroids, are point particles with constant and exactly known masses, and by replacing these classical points by Gaussian wave packets of optimum size. Could this be a less complex task (for $t \rightarrow \infty$) than the direct integration of Hamilton’s equations?

Exercise 11.8 *What is the time needed for the quantum diffusion, $\sqrt{\hbar t/m}$, of a mass of one ton, to be equal to one micron?*

The standard method for integrating the time-dependent Schrödinger equation is to compute the eigenvalues and eigenfunctions of H by solving

$$H u_n = E_n u_n. \tag{11.22}$$

Here, it was assumed that the system is bound, so that the Hamiltonian has a discrete spectrum. We then expand the initial state as

$$\psi(0) = \sum_n c_n u_n, \tag{11.23}$$

with $c_n = \langle u_n, \psi(0) \rangle$, and we obtain

$$\psi(t) = \sum_n c_n u_n e^{-iE_n t/\hbar}. \tag{11.24}$$

This result is essentially different from the classical one: a single formula gives the complete answer for any t , without costly step by step numerical integration.

²¹ S. Fishman, D. R. Grempel and R. E. Prange, *Phys. Rev. Lett.* 49 (1982) 509.

²² T. Hogg and B. A. Huberman, *Phys. Rev. A* 28 (1983) 22.

²³ L. S. Schulman, *Phys. Rev. A* 18 (1978) 2379.

²⁴ A. Peres and L. S. Schulman, *J. Phys. A* 21 (1988) 3893.

The computational complexity does *not* increase exponentially with time. It increases somewhat, because, in order to have meaningful phases in Eq. (11.24), the numerical errors in E_n should be much smaller than \hbar/t . The number of significant digits in E_n must therefore increase *logarithmically* with t . This implies more numerical work, but the latter increases very slowly, as $\log t$, rather than exponentially.

Here you may object that the sum in Eq. (11.24) is *infinite*, so that this equation, taken literally, represents an infinite amount of numerical work, even if $t = 0$. Actually, this is already true for Eq. (11.22), unless the latter can be solved analytically, which would happen only for an integrable system. However, it is permissible to *truncate* the sums (11.23) and (11.24), because these are *convergent* sums which can be represented by a finite number of terms with an arbitrarily small error. We thus replace $\psi(0)$ by

$$\psi'(0) = \sum_n' c_n u_n, \quad (11.25)$$

where \sum' denotes the sum of a *finite* number of terms. Likewise we define

$$\psi'(t) = \sum_n' c_n u_n e^{-iE_n t/\hbar}. \quad (11.26)$$

Note that if $\psi'(0)$ is very close to the true initial $\psi(0)$, then $\psi'(t)$ is very close to the true final state $\psi(t)$, by unitarity.

We thus reach the following rather strange conclusion: If we ask what are the initial conditions for a classical orbit so that, after a long time t , it will land in a given small region of phase space, the computational complexity of the answer increases exponentially with t . On the other hand, if we want to specify a *quantum state* such that, a time t later, it will become a wave packet localized in the *same* small region of phase space, then the computational complexity, although formidable, will increase at a rate slower than the time t itself.

Unfortunately, nothing has been gained by this subterfuge, because the initial quantum state from which we obtain the final wave packet is *not* itself a small wave packet, but is likely to be spread throughout all the accessible phase space. If we want a genuine quantum simulation of a classical orbit of total duration t , we must start with a wave packet of size $\Delta q \sim e^{-Lt}(\Delta q)_{\text{final}}$ and $\Delta p \sim e^{-Lt}(\Delta p)_{\text{final}}$, where L is the Lyapunov exponent (of a nearby periodic orbit). Then, for a given value of the *final* uncertainty, the initial $\Delta q \Delta p$ must behave as e^{-2Lt} , and this requires using a fake \hbar which decreases as e^{-2Lt} .

As a consequence, the sum (11.26) will involve an increasing number of states, because the smaller \hbar , the larger the density of energy levels for a given energy. Indeed, for free particles, the number of translational quantum states is simply obtained by dividing the classical phase space into cells of size $(2\pi\hbar)^f$, where f is the number of degrees of freedom.²⁵ For bound, or interacting particles,

²⁵ F. Reif, *Fundamentals of Statistical and Thermal Physics*, McGraw-Hill, New York (1965) p. 358.

with a smooth potential, the same algorithm (counting the number of cells) is asymptotically correct in the limit $\hbar \rightarrow 0$, as all wavelengths become much smaller than the distance over which the potential changes by an appreciable fraction of the total energy. The coarse grained density of states $\rho(E)$ thus behaves, for fixed E , as \hbar^f . A detailed analysis²⁴ then shows that the number of terms needed in (11.26) increases exponentially with t , with at least the same Lyapunov exponent as for the classical problem.

We thus see that if we attach to the word “chaos” the meaning given above (the computational complexity increases faster than the actual duration of the motion), then a *genuine* quantum system, with fixed \hbar and a discrete energy spectrum, is never chaotic. On the other hand, if we want the correspondence principle to hold for a classically chaotic system, all we have to do is to use a fake value of \hbar which decreases as e^{-2Lt} , where t is the total duration of the motion. It is crucial to specify which limit is taken first, $t \rightarrow \infty$ or $\hbar \rightarrow 0$.²⁶ For fixed \hbar , the correspondence principle is expected to break down after a finite time, of the order of $\log(S/\hbar)/L$, where $S \simeq \int p dq$ of the classical orbit.

11-4. Quantum maps

Just as in classical dynamics, numerical simulations are necessary to supplement our intuition when rigorous proofs are not available. A *quantum map* consists of a sequence of unitary transformations, which may correspond to classical canonical transformations if the system has a classical analog. For example, the two steps of the standard map, (11.17) and (11.18), are generated by

$$U_1 = e^{-i p^2 / 2 \hbar} \quad \text{and} \quad U_2 = e^{-i V(q) / \hbar}, \tag{11.27}$$

respectively. The “potential” $V(q)$ which appears in U_2 is defined by $f(q) = -dV/dq$. The complete transformation is $U = U_2 U_1$.

In the simplest cases, the same unitary transformation U will be repeated indefinitely (it may correspond, in particular, to a complete period of a time-periodic Hamiltonian). It is then convenient to diagonalize U ,

$$U \mathbf{v}_m = e^{-i \phi_m} \mathbf{v}_m, \tag{11.28}$$

just as we would diagonalize the Hamiltonian of a time-independent system to obtain its energy levels. The real phases ϕ_m are called *quasienergies* and the eigenvectors \mathbf{v}_m form a complete orthonormal set (see Exercise 3.22). We can thus write $U = \sum e^{-i \phi_m} P_m$, where $P_m = \mathbf{v}_m \mathbf{v}_m^\dagger$ is the projector on the m -th eigenstate of U . After an integral number, t , of iterations, we have

$$\psi \rightarrow U^t \psi = \sum_m e^{-i \phi_m t} P_m \psi = \sum_m e^{-i \phi_m t} \langle \mathbf{v}_m, \psi \rangle \mathbf{v}_m. \tag{11.29}$$

²⁶J. M. Robbins and M. V. Berry, *J. Phys. A* 25 (1992) L961.

Perturbation theory for unitary matrices

It may happen that an explicit solution of Eq. (11.28) is not available, but \mathbf{U} is only slightly different from a finite dimensional unitary matrix \mathbf{U}_0 , with known eigenvalues $e^{-i\phi_{0m}}$ and eigenvectors \mathbf{v}_{0m} . In that case, we may define a Hermitian matrix \mathbf{K} by $e^{i\mathbf{K}} = \mathbf{U}_0^\dagger \mathbf{U}$ and tentatively assume that the effect of the perturbation,

$$\mathbf{U}_0 \rightarrow \mathbf{U} = \mathbf{U}_0 e^{i\lambda \mathbf{K}}, \quad (11.30)$$

can be treated by an expansion in powers of λ :

$$\begin{aligned} e^{i\lambda \mathbf{K}} &= 1 + i\lambda \mathbf{K} + \dots, \\ \phi_m &= \phi_{0m} + \lambda \phi_{1m} + \dots, \\ \mathbf{v}_m &= \mathbf{v}_{0m} + \lambda \mathbf{v}_{1m} + \dots. \end{aligned} \quad (11.31)$$

This gives, to first order in λ ,

$$\mathbf{U}_0 (i\mathbf{K} \mathbf{v}_{0m} + \mathbf{v}_{1m}) = e^{-i\phi_{0m}} (-i\phi_{1m} \mathbf{v}_{0m} + \mathbf{v}_{1m}). \quad (11.32)$$

Multiply on the left by \mathbf{v}_{0n}^\dagger , and recall that $\langle \mathbf{v}_{0n}, \mathbf{v}_{0m} \rangle = \delta_{nm}$ and

$$\mathbf{v}_{0n}^\dagger \mathbf{U}_0 = (\mathbf{U}_0^\dagger \mathbf{v}_{0n})^\dagger = (e^{i\phi_{0n}} \mathbf{v}_{0n})^\dagger = e^{-i\phi_{0n}} \mathbf{v}_{0n}^\dagger. \quad (11.33)$$

We obtain

$$e^{-i\phi_{0n}} (i\mathbf{K}_{nm} + \langle \mathbf{v}_{0n}, \mathbf{v}_{1m} \rangle) = e^{-i\phi_{0m}} (-i\phi_{1m} \delta_{mn} + \langle \mathbf{v}_{0n}, \mathbf{v}_{1m} \rangle), \quad (11.34)$$

where $\mathbf{K}_{nm} = \langle \mathbf{v}_{0n}, \mathbf{K} \mathbf{v}_{0m} \rangle$. Only the nondegenerate case will be discussed. For $n = m$, Eq. (11.34) yields the quasienergy shift

$$\phi_{1m} = -\mathbf{K}_{mm}. \quad (11.35)$$

For $n \neq m$, we have

$$\langle \mathbf{v}_{0n}, \mathbf{v}_{1m} \rangle = i\mathbf{K}_{nm} / [e^{i(\phi_{0n} - \phi_{0m})} - 1]. \quad (11.36)$$

This still leaves $\langle \mathbf{v}_{0m}, \mathbf{v}_{1m} \rangle$ undetermined. Normalization of \mathbf{v}_m implies that the real part of $\langle \mathbf{v}_{0m}, \mathbf{v}_{1m} \rangle$ must vanish, the imaginary part too can always be assumed to vanish, by a suitable choice of the phase of \mathbf{v}_m . Therefore we can always set $\langle \mathbf{v}_{0m}, \mathbf{v}_{1m} \rangle = 0$.

Exercise 11.9 Show that the second order correction to ϕ_m is

$$\phi_{2m} = -\frac{1}{2} \sum_{n \neq m} \frac{|\mathbf{K}_{nm}|^2 \cot[(\phi_{0n} - \phi_{0m})/2]}{e^{i(\phi_{0n} - \phi_{0m})} - 1}, \quad (11.37)$$

and find the value of $\langle \mathbf{v}_{0n}, \mathbf{v}_{2m} \rangle$. \star

11-5. Chaotic quantum motion

Chaos (*i.e.*, unpredictability) arises when the solution of the equations of motion is highly sensitive to tiny changes in the initial data. Chaos may then also result from uncontrollable external perturbations. For a classically chaotic system, there is no essential difference between errors in the initial data and those due to external perturbations. In quantum mechanics, the situation is different. The dynamical law is a *unitary* evolution, $\psi_t = \mathbf{U}\psi_0$, and the scalar product of the perturbed and unperturbed states is constant: $\langle \psi_t, \psi'_t \rangle = \langle \psi_0, \psi'_0 \rangle$. Small imperfections in the preparation of the initial state *do not grow*.

However, in quantum physics too, we may be unable to perfectly isolate the microscopic quantum system from the influence of its macroscopic environment. In other words, the true Hamiltonian \mathbf{H} is not known. The only thing we know is an idealized \mathbf{H}_0 , which differs from \mathbf{H} by a small perturbation, \mathbf{V} , due to the imperfectly controlled environment. In that case, it is *plausible* that \mathbf{V} has little influence on the quantum motion, $\psi_0 \rightarrow \psi_t$, if the analogous classical system is *regular*; on the other hand, if the analogous classical system is *chaotic*, the final state ψ_t is likely to be strongly influenced by a small \mathbf{V} . The state after a long time will therefore be unpredictable if \mathbf{V} is unknown. This plausible scenario is supported by semiquantitative arguments which predict that perturbation theory fails—it does not converge—for quantum systems whose classical analog is chaotic.²⁷

This failure occurs for the following reason: in a perturbation expansion, each successive step involves one more power of \mathbf{V} , and one extra sum over states. For instance, the third order perturbation in an energy level is²⁸

$$E_n^{(3)} = \sum_k' \sum_m' \frac{V_{nm} V_{mk} V_{kn}}{(E_m - E_n)(E_k - E_n)} - V_{nn} \sum_m' \frac{|V_{nm}|^2}{(E_m - E_n)^2}. \tag{11.38}$$

The essential difference between regular and chaotic systems is that the former have *selection rules* (corresponding to the classical isolating constants of motion) so that most matrix elements V_{mn} vanish (that is, they vanish for a reasonable \mathbf{V} , having a classical limit, as discussed in Sect. 10-1.). A chaotic system, on the other hand, has no selection rules and the V_{mn} look like random numbers. A sum over states is therefore like a random walk, and the ratio of consecutive steps in the perturbation series is about $(N\langle |V_{mn}|^2 \rangle)^{1/2}/E$, where N is the number of terms to be summed, and is of the order of the dimensionality of Hilbert space. In this estimate, the symbol $\langle |V_{mn}|^2 \rangle$ stands for the mean square of the various elements V_{mn} , and E is the typical energy scale of the system.

We thus see that, for finite N , convergence of the perturbation series imposes a bound of order E/\sqrt{N} for the “typical” matrix element V_{mn} . In the semi-classical limit ($N \rightarrow \infty$) the perturbation series always diverges for any finite \mathbf{V} . We shall now examine a simple model which has, in its classical version, both

²⁷ M. Feingold and A. Peres, *Phys. Rev. A* 34 (1986) 591.

²⁸ L. D. Landau and E. M. Lifshitz, *Quantum Mechanics*, Pergamon, Oxford (1965) p. 132.

regular and chaotic domains, and which is described, in its quantum version, by a *finite-dimensional* Hilbert space, thereby avoiding the necessity of arbitrary truncations.

Case study: twist and turn dynamics

The dynamical variables of this model are the three components of angular momentum, J_k . Their motion consists of a *twist* around the z -axis, given by Eq. (10.4), followed by a 90° rotation around the y -axis. The total J is constant, and has a given value. The unitary evolution is therefore generated by

$$U = e^{-i\pi J_y/2\hbar} e^{-i\alpha J_z^2/2J\hbar}. \quad (11.39)$$

This system was extensively investigated by Haake, Kuś and Scharf²⁹ who called it a “kicked top.” (It is not really a top, because J_z^2 , in the exponent, generates a *torsion*, not a rigid rotation, of the corresponding classical system).

The classical analog of this unitary transformation is an area preserving map of the unit sphere spanned by the vector \mathbf{J}/J . We shall see that this “twist and turn” map has regular and chaotic domains, belonging to three distinct symmetry classes (detailed numerical calculations will be presented for only one of them). The purpose of this study is to find the effect of a change of the value of the parameter α in Eq. (11.39), from 3.0 to 3.0003. These numerical values were chosen so that the model is near the limit of validity of perturbation theory. As intuitively expected, we shall see that quantum states localized in the regular region of the classical phase space are impervious to this small perturbation. On the other hand, quantum states spread in the classically chaotic domain are strongly affected by the small change in α .

Regular and chaotic domains of the unit sphere

Consider a sequence of mappings of the unit sphere $x^2 + y^2 + z^2 = 1$:

$$\begin{aligned} x' &= z, \\ y' &= x \sin(\alpha z) + y \cos(\alpha z), \\ z' &= -x \cos(\alpha z) + y \sin(\alpha z), \end{aligned} \quad (11.40)$$

The result of these mappings is displayed in the following figures, which were drawn with an area preserving projection of the sphere onto the xz plane. The relationship between radius R (on the paper) and $r^2 := x^2 + z^2 = 1 - y^2$ is $R^2 := 2(1 - |y|)$. Near the poles, $R \simeq r$ (there is almost no distortion) and near the equator, $R \simeq \sqrt{2}r$. Equatorial area elements are stretched by a factor $\sqrt{2}$ in the azimuthal direction (because $ds = r d\phi \rightarrow R d\phi$), and therefore they are compressed by a factor $\sqrt{2}$ in the radial direction.

²⁹ F. Haake, M. Kuś, and R. Scharf, *Z. Phys. B* 65 (1987) 381.

Figure 11.6 shows a *single orbit* (10^5 points) generated by the twist and turn map for $\alpha = 3.0$. Most of the sphere is visited by that chaotic orbit, with the exception of eight “forbidden” areas, which obviously correspond to regular regions of the map. These regular regions are located around fixed points of order 1, 2 and 4, as shown in the following figures. Higher order fixed points also exist, but the regular regions generated by them are barely visible and far too small to be significant.

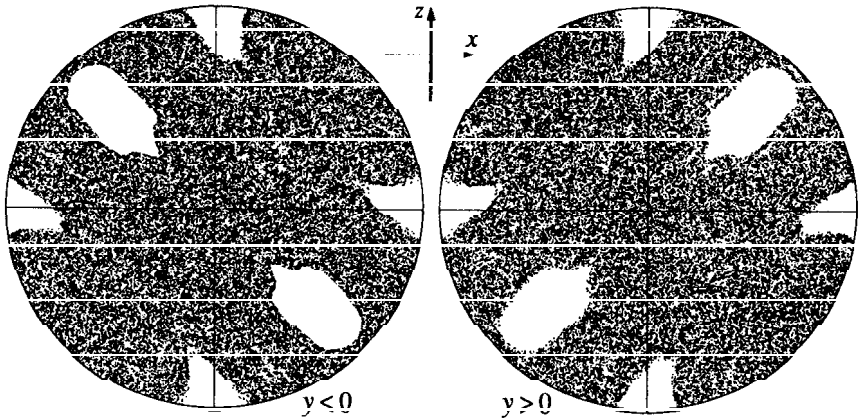

Fig. 11.6. A single orbit (10^5 points) covers most of the unit sphere, with the exception of eight regular regions.

There are two fixed points of order 1 (for $a = 3.0$) obtained by solving the equations $x' = x, y' = y, z' = z$. These are

$$x_1 = z_1 = \pm 0.6294126, \quad y_1 = 0.4557187. \tag{11.41}$$

Orbits starting near these fixed points do not wander chaotically on the entire sphere. They are constrained to stay between invariant KAM lines, as shown in Fig. 11.7. Note that each fixed point can be obtained from the other one by a 180° rotation around the y -axis. This rotation will be denoted by R_y .

There is one fixed point of order 2, obtained by solving $x'' = x, y'' = y, z'' = z$. It is

$$x_2 = -z_2 = \pm x_1, \quad y_2 = -y_1. \tag{11.42}$$

The result is shown in Fig. 11.8, together with nearby KAM lines. Note that a rotation of this fixed point around the x -axis by 180° (henceforth denoted by R_x) yields the *pair* of fixed points of order 1, *together*. This property, which relates two different types of motion, is called a *dynamical symmetry*.²⁹

Finally, Fig. 11.9 shows the fixed point of order 4, at

$$x_4 = \pm 1, 0, \quad z_4 = 0, \pm 1, \quad y_4 = 0. \quad (11.43)$$

The latter is obviously symmetric with respect to R_y and R_x .

Until now, we have considered individual *orbits*, that is, mapping of points into points. A more general approach, giving new and instructive insights, is the mapping of Liouville densities. Let us imagine that an infinitesimal “mass” ρdA (which may be positive or negative) is attached to each area dA . Let us further assume that this mass is *conserved* by the twist and turn mapping, so that its density obeys the *linear law*

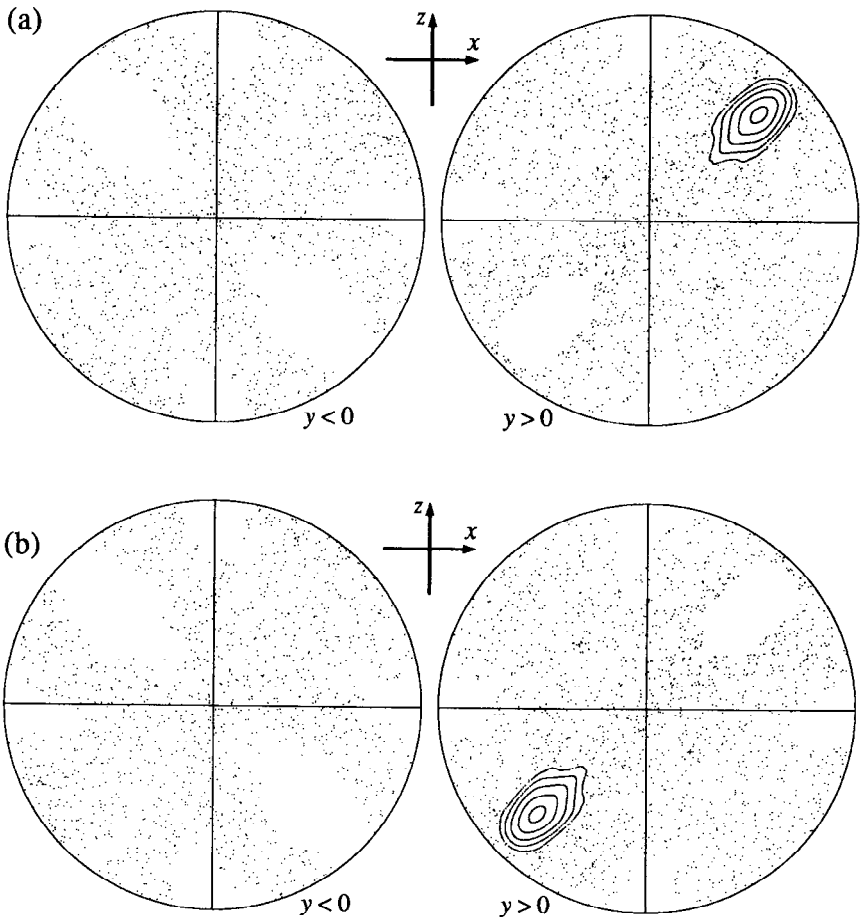

Fig. 11.7. Two fixed points of order 1, surrounded by KAM lines. (a) $x_1 = z_1 > 0$; (b) $x_1 = z_1 < 0$.

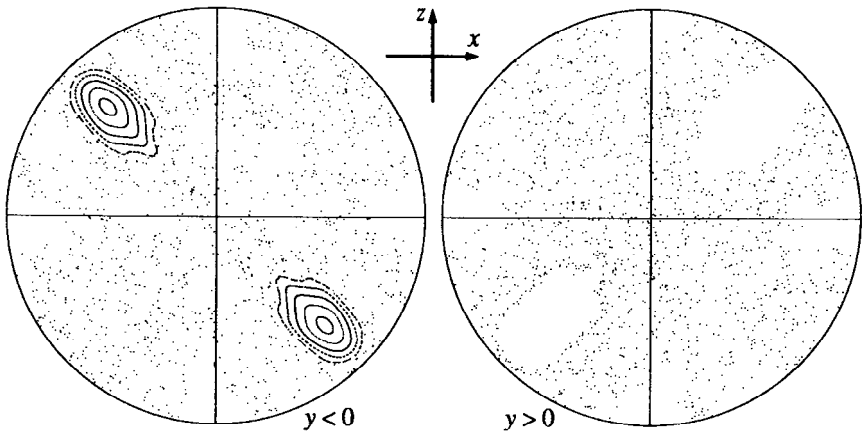

Fig. 11.8. Fixed point of order 2, surrounded by KAM lines.

$$\rho(x',y',z') = \rho(x,y,z), \tag{11.44}$$

because $dA' = dA$. Note that, as the mapping (11.40) is continuous, nearby points are mapped into nearby points, so that a blob is always mapped into a *single* blob (never into several disjoint blobs). In particular, the area found between two nearby KAM lines is mapped onto itself. It follows that a Liouville function for which ρ is constant between two closed KAM lines remains *invariant* under any area conserving map. These invariant Liouville densities generalize the fixed points which were discussed earlier.

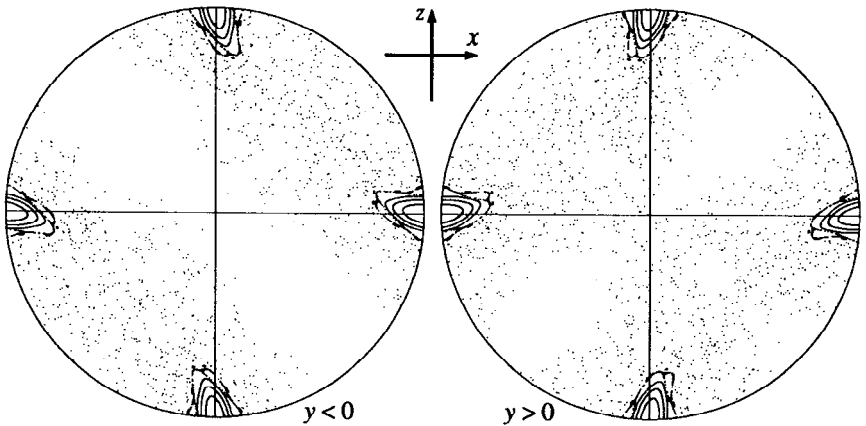

Fig. 11.9. Fixed point of order 4.

In the model considered here, Liouville densities, whether invariant or not, may belong to three invariant *symmetry classes* of the twist and turn map, according to their behavior under R_y and R_x (180° rotations around the y - and x -axes). For example, if $\rho = F(x^2, y^2, z^2, xyz)$ is a single valued function of its four arguments, this ρ is even under R_y and R_x , and is mapped by Eq. (11.40) into another function of the same type. Likewise, any $\rho = yF(x^2, y^2, z^2, xyz)$ is even under R_y , odd under R_x , and is mapped by (11.40) into a function of the same type. For instance, the function $\rho = y$ has this property, because

$$y \rightarrow y' = x \sin(\alpha z) + y \cos(\alpha z) = y \left[\cos(\alpha z) + \frac{xyz \sin(\alpha z)}{y^2 z} \right], \quad (11.45)$$

In summary, any $\rho(x, y, z)$ can be written as the sum of three terms, belonging to one the symmetry classes listed in Table 11-1. It will be no surprise that quantum wave functions too can be classified according to the same symmetries.

Table 11-1. Symmetry classes of Liouville functions.

R_y	R_x	Functional form
even	even	$\rho = F(x^2, y^2, z^2, xyz)$
even	odd	$\rho = yF(x^2, y^2, z^2, xyz)$
odd		$x F_1(x^2, y^2, z^2, xyz) + z F_2(x^2, y^2, z^2, xyz)$

The quantum twist and turn map

Let us introduce dimensionless variables, $\mathbf{j}_k := \mathbf{J}_k/\hbar$, so that

$$U = e^{-i\pi \mathbf{j}_y/2} e^{-i\alpha \mathbf{j}_x^2/2j}. \quad (11.46)$$

Here, j is an integer or half odd integer, and the \mathbf{j}_k are known numerical matrices of order $2j+1$. It is convenient to choose a representation where \mathbf{j}_z is diagonal, with matrix elements $m = j, \dots, -j$, and eigenvectors denoted by $|m\rangle$. Then the twist operator in (11.46) is diagonal too. The 90° rotation operator,

$$Q = e^{-i\pi \mathbf{j}_y/2}, \quad (11.47)$$

is explicitly given by³⁰

$$Q_{mn} = \frac{(-1)^{n-m}}{2^j} \binom{2j}{j-n}^{1/2} \binom{2j}{j+m}^{-1/2} \sum_k (-1)^k \binom{j-n}{k} \binom{j+n}{k+n-m}.$$

³⁰E. P. Wigner, *Group Theory*, Academic Press, New York (1959) p. 167.

The three symmetry classes which were discussed above at the classical level naturally appear again in the quantized version. First, consider $R_y = Q^2$. Its matrix elements, in the j_z representation, are³⁰

$$(R_y)_{mn} = (-1)^{j-m} \delta_{m,-n}. \tag{11.48}$$

It follows that $R_x = R_y R_z$ has matrix elements $(-1)^j \delta_{m,-n}$. We shall henceforth restrict our attention to even j . Suitable bases for the three symmetry classes are given in Table 11-2. The labels *ee*, *oo* and *oe* are reminders that the vectors belonging to the first class contains only even $|m\rangle$, and that they are even under $|m\rangle \rightarrow | -m\rangle$; and likewise for the other classes.

Table 11-2. Orthonormal bases for the three symmetry classes.

Class	R_y	R_x	Basis $(m = 1, \dots, j/2)$	Dimension
<i>ee</i>	even	even	$ 0\rangle$ and $(2m\rangle + -2m\rangle)/\sqrt{2}$	$j/2 + 1$
<i>oo</i>	even	odd	$(2m - 1\rangle - 1 - 2m\rangle)/\sqrt{2}$	$j/2$
<i>oe</i>	odd	$(2m\rangle - -2m\rangle)/\sqrt{2}$ and $(2m - 1\rangle + 1 - 2m\rangle)/\sqrt{2}$		j

When written in this new basis, the U matrix (11.46) breaks down into a block diagonal form, with blocks of size $j/2 + 1$, $j/2$, and j . Each one of its three invariant subspaces is dynamically independent of the others. The numerical calculations reported below were performed for the *oo* basis (R_y even, R_x odd) whose structure is the simplest.³¹ There is no reason to expect that results would be qualitatively different in the other subspaces. These calculations were performed for $j = 120$, 500 , and finally 1600 . Intuitively, one expects quantum mechanics to mimic classical mechanics for large j (at least, it ought to do so for a suitably restricted set of “reasonable” quantum states). Some of the properties that were examined did not change much when j increased beyond 120 , but other ones necessitated the use of $j = 1600$.

Let us define two notions that will be useful for further discourse. The *extent* of a state is

$$\Delta |j_z| := \{ \langle j_z^2 \rangle - \langle |j_z| \rangle^2 \}^{1/2}. \tag{11.49}$$

Note that we must use $|j_z|$, rather than simply j_z , because $\langle j_z \rangle \equiv 0$ for any state belonging one of the symmetry classes. For a state ψ of the *oo* class, represented by

$$\psi = \sum_{m=1}^{j/2} c_m (|2m - 1\rangle - |1 - 2m\rangle)/\sqrt{2}, \tag{11.50}$$

³¹ A. Peres, in *Quantum Chaos*, ed. by H. A. Cerdeira, R. Ramaswamy, M. C. Gutzwiller, and G. Casati (World Scientific, Singapore, 1991) pp. 73–102.

an elementary calculation gives

$$\Delta |j_z| = 2[\langle m^2 \rangle - \langle m \rangle^2]^{1/2}, \quad (11.51)$$

where $\langle m^k \rangle := \sum_m |c_m|^2 m^k$. The extent of ψ is maximal if $|c_1|^2 = |c_{j/2}|^2 = 0.5$, and it is then equal to $(j/2)-1$. One could likewise define $\Delta |j_x|$ and $\Delta |j_y|$, but the latter do not give any additional information on the eigenstates of \mathbf{U} .

Another useful concept is the *entropy* of a state ψ with respect to a complete orthonormal basis \mathbf{e}_μ . This entropy is defined as follows. First, one computes the relative weights of the basis vectors in the given state ψ :

$$p_\mu := |\langle \mathbf{e}_\mu, \psi \rangle|^2. \quad (11.52)$$

The physical meaning of these p_μ is that of probabilities. It is therefore natural to call the expression

$$S := - \sum_\mu p_\mu \log p_\mu, \quad (11.53)$$

an “entropy.” The qualitative meaning of S is that e^S is the number of basis vectors which are “appreciably involved” in the representation of ψ . The word “entropy” is appropriate in this context because S would indeed be the average thermodynamic entropy released to the environment, if we performed maximal quantum tests for the basis $\{\mathbf{e}_\mu\}$ on an ensemble of quantum systems prepared in state ψ .

Perturbed map

Let us examine the response of our dynamical system to small perturbations. Assume that the original (unperturbed) system has twist parameter $\alpha = 3.0$, and is described by a unitary matrix \mathbf{U} satisfying

$$\mathbf{U} \mathbf{v}_n = e^{-i\phi_n} \mathbf{v}_n. \quad (11.54)$$

If we consider only states ψ in the oo symmetry class, the matrix \mathbf{U} that has to be used here actually is the oo block in the original unitary matrix given by Eq. (11.46). I shall however use the same notation, \mathbf{U} , for brevity.

The perturbed system differs from the original one by its twist parameter, $\alpha' = 3.0003$. It is described by a matrix \mathbf{U}' , with

$$\mathbf{U}' \mathbf{w}_\mu = e^{-i\phi_\mu} \mathbf{w}_\mu. \quad (11.55)$$

I have used different alphabets (Latin and Greek) to label the eigenphases ϕ_m and ϕ_μ , and the corresponding eigenvectors \mathbf{v}_m and \mathbf{w}_μ , because there is no reason to expect a one-to-one correspondence between the eigenstates of \mathbf{U} and those of \mathbf{U}' , unless the perturbation is sufficiently small. This is indeed the crux of the problem. Such a one-to-one correspondence is the fundamental

assumption of perturbation theory. In other words, the test for validity of perturbation theory is whether each unperturbed v_n has a *low entropy* with respect to the perturbed basis w_μ .

These entropies,

$$S_m = - \sum_{\mu} | \langle w_{\mu}, v_m \rangle |^2 \log | \langle w_{\mu}, v_m \rangle |^2, \tag{11.56}$$

are plotted in Fig. 11.10 for the case $j = 1600$. It is seen that about 700 eigenstates, out of the 800 in the *oo* subspace, have entropies of the order of 1 (this value has no special significance), and therefore their e^S is not close to 1, so that *perturbation theory is not valid* for these states. They are so sensitive to the tiny change $\alpha \rightarrow \alpha'$ that they bear no resemblance at all to the eigenstates of the perturbed U' . These states are called *fragile*.

On the other hand, we also see in Fig. 11.10 two “strings” of eigenstates of U , having *very low entropies*. This means that each one of these states is nearly identical to one of the eigenstates of U' . States having that property are called *robust*. Upon closer examination, it is found that the string on the left of the figure consists of a sequence of states with *nearly equidistant eigenphases*: this is the Bohr quantization rule—the hallmark of eigenstates localized in a *regular* region of the classical phase space. Indeed, the most localized (*i.e.*, the least extended) of these states have values of $\langle |j_n| \rangle / j$ which are very close to the coordinates of the fixed points of order 1 and 2, shown in Figs. 11.7 and 11.8. On the other hand, the second string of dots, whose extent is close to maximal, represents states localized near the fixed points of order 4.

To conclude this investigation, let us inquire how small the difference between α and α' would have to be, to restore the validity of perturbation theory. The crude estimate given at the beginning of this section sets a limit of order $N^{-1/2}$ for the “typical” matrix element of the perturbing operator. This gives

$$\langle v_m, (\delta\alpha j_z^2 / 2j) v_n \rangle \simeq j^{-1/2}. \tag{11.57}$$

The typical range of values for $\langle v_m, j_z^2 v_n \rangle$ can be inferred from Eq. (11.49) and Fig. 11.10. That range is about the same as $(\Delta |j_z|)^2$, in the present case $\sim 0.1 j^2$. We thus obtain $\delta\alpha \simeq 20 j^{-3/2} \simeq 3 \times 10^{-4}$, which indeed is the $\delta\alpha$ that was used in this numerical example. (The parameters were chosen near the limit of validity of perturbation theory, in order to display both regular and chaotic types of motion, rather than fully developed chaos.) The correctness of these estimates can also be directly seen in Fig. 11.10: even the most fragile states there have only a moderate entropy. On the other hand, a totally chaotic situation would effectively correspond to *randomly* chosen bases. In that case, it can be shown that the expected S would have been much larger, namely³²

$$\langle S \rangle = \log 800 - 1 + \gamma = 6.2618, \tag{11.58}$$

where $\gamma = 0.5772$ is Euler’s constant.

³²W. K. Wootters *Found. Phys.* 20 (1990) 1365.

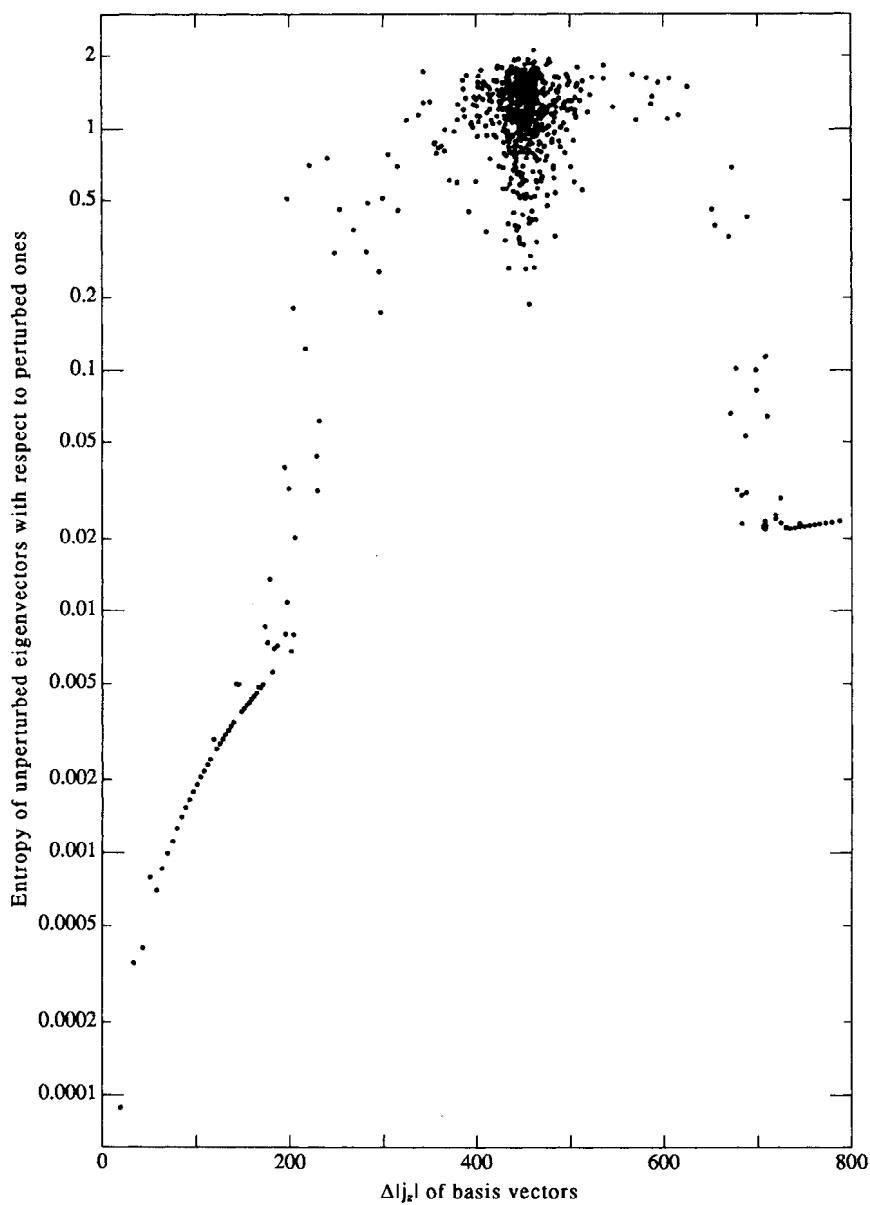

Fig. 11.10. Sensitivity of eigenvectors of U to a perturbation, versus their extent in $|j_z\rangle$ space. The blob at the top contains extended and fragile states. The two strings contain robust states, localized near the classical fixed points.

Robust and fragile states

Until now, we examined dynamical properties of the unitary mappings U and U' , irrespective of the choice of a quantum state. The latter will be introduced next. Initially, it is an angular momentum coherent state (see page 329), satisfying $\mathbf{n} \cdot \mathbf{j}|\theta, \phi\rangle = |\theta, \phi\rangle$, where \mathbf{n} is a unit vector in the direction (θ, ϕ) . For such a coherent state, the uncertainty in j_k is given by Eq. (10.141):

$$[(\mathbf{j}^2) - \langle \mathbf{j} \rangle \cdot \langle \mathbf{j} \rangle]^{1/2} = \sqrt{j}. \tag{11.59}$$

This means that the uncertainty in the direction of \mathbf{j}_k is about $j^{-1/2}$. More precisely, the overlap of two distinct coherent states is given by Eq. (10.146):

$$|\langle \theta', \phi' | \theta'', \phi'' \rangle|^2 = \cos^{4j}(\Theta/2), \tag{11.60}$$

where Θ is the angle between the directions (θ', ϕ') and (θ'', ϕ'') . For large j , this overlap is about $e^{-j\Theta^2/2}$. Two such states are almost orthogonal (in Hilbert space) when $\Theta \gtrsim 2j^{-1/2}$. In our case, with $j = 1600$, the angular resolution of coherent states is about 0.05 radian $\simeq 3^\circ$. This is reasonably small, compared to the size of a regular region on the unit sphere (see Fig. 11.7). This value of j is therefore sufficient to obtain a clean distinction between regular and chaotic quantum motions (smaller values of j would not be adequate).

Two cases will be considered. Their properties are summarized in Table 11-3. A “regular state” ψ_r is obtained if the unit vector \mathbf{n} points toward a fixed point of order 1, as in Eq. (11.41). A “chaotic state” ψ_c results from taking the same n_x and n_z as for ψ_r , but the opposite value of n_y , so that the vector \mathbf{n} will point into the midst of the chaotic region, as may be seen in Fig. 11.6.

Table 11-3. A tale of two states: the preparation and evolution of regular and chaotic vectors.

$n_x = n_z$ of initial coherent state	0.6294126	0.6294126
n_y of initial coherent state	0.4557187	-0.4557187
$p_1 =$ highest weight $ \langle \mathbf{v}_1, \psi \rangle ^2$	0.923359	0.021988
$p_2 =$ second highest weight $ \langle \mathbf{v}_2, \psi \rangle ^2$	0.068007	0.015673
S (Entropy with respect to \mathbf{v}_n basis)	0.306937	5.66864
e^S (Number of eigenvectors effectively involved)	1.35926	289.604
Average fragility of eigenvectors $\sum p_n S_n$	0.000116	1.140183
Average extent $\sqrt{\sum p_n [(\Delta j_z)_n]^2}$	22.1413	460.865
Time average of overlap — see Eq. (11.63)	0.857323	0.003923
Minimum overlap	0.716557	0.0

We now project ψ_r and ψ_c into the three invariant subspaces of U (defined in Table 11-2). Each projection must be considered independently of the others. This separation is essential, because symmetric *regular* regions, separated by *chaotic* ones, behave as a quantum mechanical double well (or multiple well) and the eigenphases belonging to different symmetry classes form *nearly degenerate multiplets*. A state initially localized in one of the regular regions will tunnel into the other ones, and then, after some time, it will reassemble in the initial region, thus displaying a sequence of "collapses and revivals."^{29,33} This phenomenon causes an unnecessary complication of the analysis. It does not appear if each invariant subspace is treated separately.

As before, we consider only the *oo* subspace. The projections of the initial states ψ_r and ψ_c will be normalized to unity, and then simply called ψ_r and ψ_c , like the original states. First, we compute the statistical weights: $p_n = |\langle \mathbf{v}_n, \psi \rangle|^2$ and entropies $S = -\sum p_n \log p_n$. We find radically different results for the two states: ψ_r consists for the most part of a single eigenvector of U , while ψ_c involves about 300 eigenvectors. Moreover, the eigenvectors used to build ψ_r and ψ_c have quite different properties, as may be seen from Fig. 11.11. The chaotic state ψ_c is made of many *fragile* eigenvectors of U . On the other hand, the regular state ψ_r consists of a few *robust* eigenvectors.

The two eigenvectors which contribute most to ψ_r will be called \mathbf{v}_1 and \mathbf{v}_2 . Together, they make more than 99% of the initial state ψ_r . These robust eigenvectors are in fact more stable than the corresponding eigenvalues! They are literally pinned to the classical fixed points. Calling \mathbf{w}_1 and \mathbf{w}_2 the corresponding eigenstates of U' , it is found that $|\langle \mathbf{v}_1, \mathbf{w}_1 \rangle|^2 = 0.99993166$. On the other hand, the corresponding eigenphases ϕ_1 and ϕ'_1 are well separated, by about 0.0950 radian. (For comparison, the *average* separation between neighboring eigenphases of U is only $2\pi/800 = 0.0079$ radian.)

Next, we turn our attention to the time evolution of ψ_r and ψ_c . Initially, when both are coherent states, their extent is given by $\Delta|j_z|_{t=0} = 21.9787$. This can be compared with the extent of the most robust eigenstate, ψ_r , which is 19.11097. Then, as the vectors ψ_r and ψ_c evolve, their extent will fluctuate around a time average which is $\sqrt{\sum p_n [(\Delta|j_z|)_n]^2}$, because interference terms between the various eigenstates \mathbf{v}_n do not contribute to that time average. The results are listed in Table 11-3. It is seen that ψ_r retains its initial compactness, while ψ_c spreads over most of the sphere.

Exercise 11.10 Derive the above expression for the time averaged extent.
Hint: Use Eq. (11.51)

Regular and chaotic quantum motion

Finally, I come to the problem which motivated all this numerical work: the *stability of the motion* of ψ_r and ψ_c with respect to a small change of the twist parameter, from $\alpha = 3.0$ to $\alpha' = 3.0003$. A good indicator of the sensitivity

³³O. Bohigas, S. Tomsovic, and D. Ullmo, *Phys. Rev. Lett.* 64 (1990) 1479.

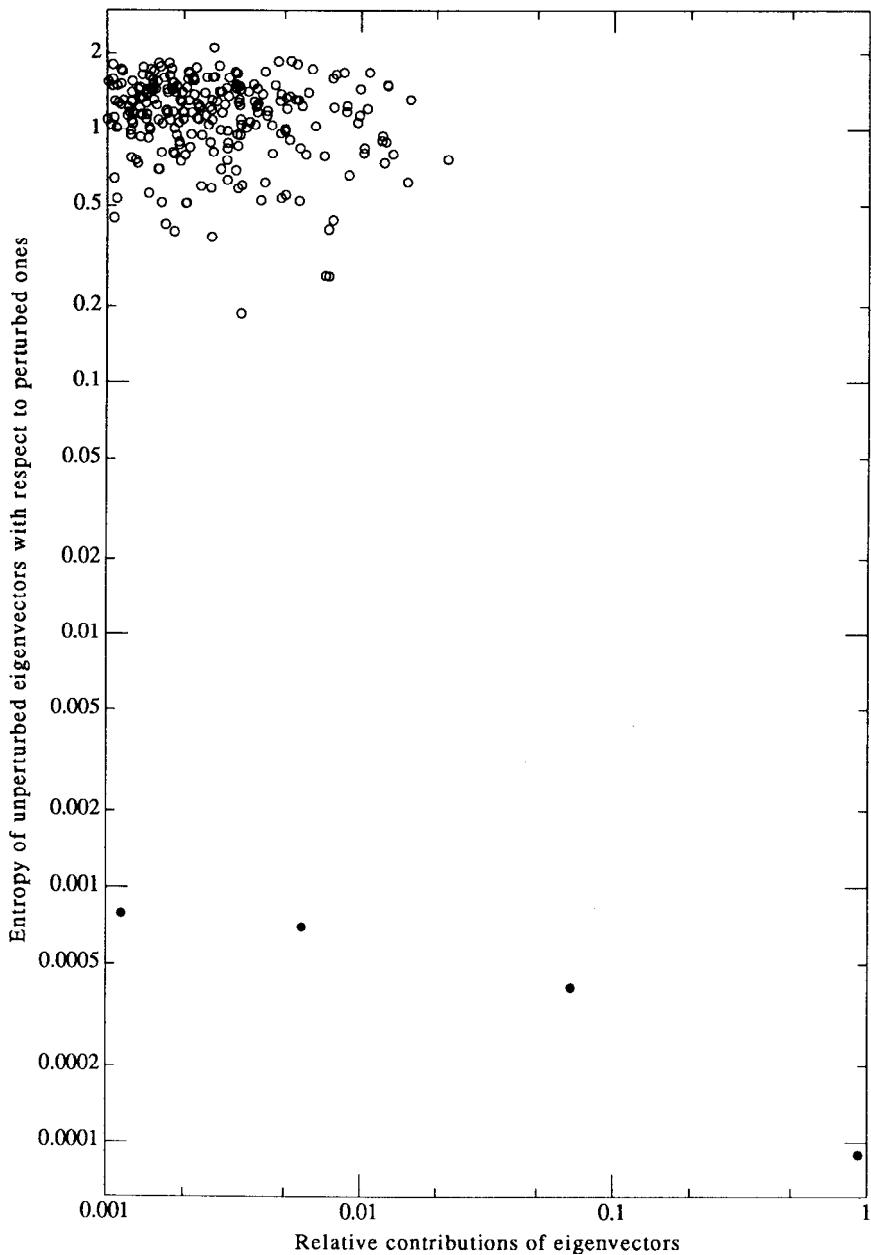

Fig. 11.11. Sensitivity to perturbations vs relative weights p_n of the eigenvectors of U which contribute most to the regular and chaotic states ψ_r and ψ_c (shown by closed and open circles, respectively).

of the dynamical evolution to a small perturbation of α is the overlap of the perturbed and unperturbed state vectors. After t steps, a state which was initially ψ_0 becomes

$$\mathbf{U}^t \psi_0 = \sum_n e^{-it\phi_n} c_n \mathbf{v}_n \quad \text{or} \quad (\mathbf{U}')^t \psi_0 = \sum_\mu e^{-it\phi_\mu} c_\mu \mathbf{w}_\mu, \quad (11.61)$$

where $c_n = \langle \mathbf{v}_n, \psi_0 \rangle$ and $c_\mu = \langle \mathbf{w}_\mu, \psi_0 \rangle$.

The scalar product of these two states is

$$\langle \mathbf{U}^t \psi_0, (\mathbf{U}')^t \psi_0 \rangle = \sum_{n\mu} \bar{c}_n c_\mu \langle \mathbf{v}_n, \mathbf{w}_\mu \rangle e^{it(\phi_n - \phi_\mu)}. \quad (11.62)$$

Their overlap, P_t , is the absolute square of (11.62) and can be written as

$$P_t = \sum_{n\mu} |\bar{c}_n c_\mu \langle \mathbf{v}_n, \mathbf{w}_\mu \rangle|^2 + \text{oscillating terms}. \quad (11.63)$$

The first term on the right hand side of (11.63) is the time average of the overlap. It is listed in Table 11-3, for ψ_r and ψ_c , together with the minimum value of the overlap in the regular case. This minimum is obtained when the phase of the largest contribution to (11.62), namely $\bar{c}_1 c'_1 \langle \mathbf{v}_1, \mathbf{w}_1 \rangle$, is opposite to the phase of all the other contributions. There is no minimum overlap in the chaotic case: the perturbed and unperturbed ψ_c can become orthogonal.

Figures 11.12 and 11.13 show the behavior of P_t over different time scales. The steady oscillations of the overlap of the two regular states are due to the fact that more than 99% of ψ_r is provided by two *robust* vectors, \mathbf{v}_1 and \mathbf{v}_2 , or \mathbf{w}_1 and \mathbf{w}_2 . Their robustness (low entropy) implies that $\langle \mathbf{v}_1, \mathbf{w}_1 \rangle \simeq \langle \mathbf{v}_2, \mathbf{w}_2 \rangle \simeq 1$, while $\langle \mathbf{v}_1, \mathbf{w}_2 \rangle$ and $\langle \mathbf{v}_2, \mathbf{w}_1 \rangle$ are very small. Therefore Eq. [11.62] becomes

$$\langle \mathbf{U}^t \psi_r, (\mathbf{U}')^t \psi_r \rangle \simeq p_1 e^{it(\phi_1 - \phi'_1)} + p_2 e^{it(\phi_2 - \phi'_2)}, \quad (11.64)$$

whence

$$P_t \simeq p_1^2 + 2 p_1 p_2 \cos[t(\phi'_1 - \phi_1 - \phi'_2 + \phi_2)] + O(p_2^2). \quad (11.65)$$

In this case, perturbation theory converges and we have, from Eq. (11.35),

$$\phi'_1 - \phi_1 = -0.0003 \langle \mathbf{v}_1, \mathbf{j}_z^2 \mathbf{v}_1 \rangle / 2j, \quad (11.66)$$

with a similar expression for $\phi'_2 - \phi_2$.

On the other hand, the overlap of the chaotic states $\mathbf{U}^t \psi_c$ and $(\mathbf{U}')^t \psi_c$ is seen to decay very rapidly, and then to randomly fluctuate around an average which is about $1/N$, where $N = e^S$ is the number of eigenstates which appreciably contribute to ψ_c . These fluctuations will effectively last forever, because Eq. (11.63) involves $N^2 \simeq 10^5$ incommensurate frequency differences, and the time needed for a Poincaré recurrence would be considerably larger than the duration of any conceivable numerical experiment.

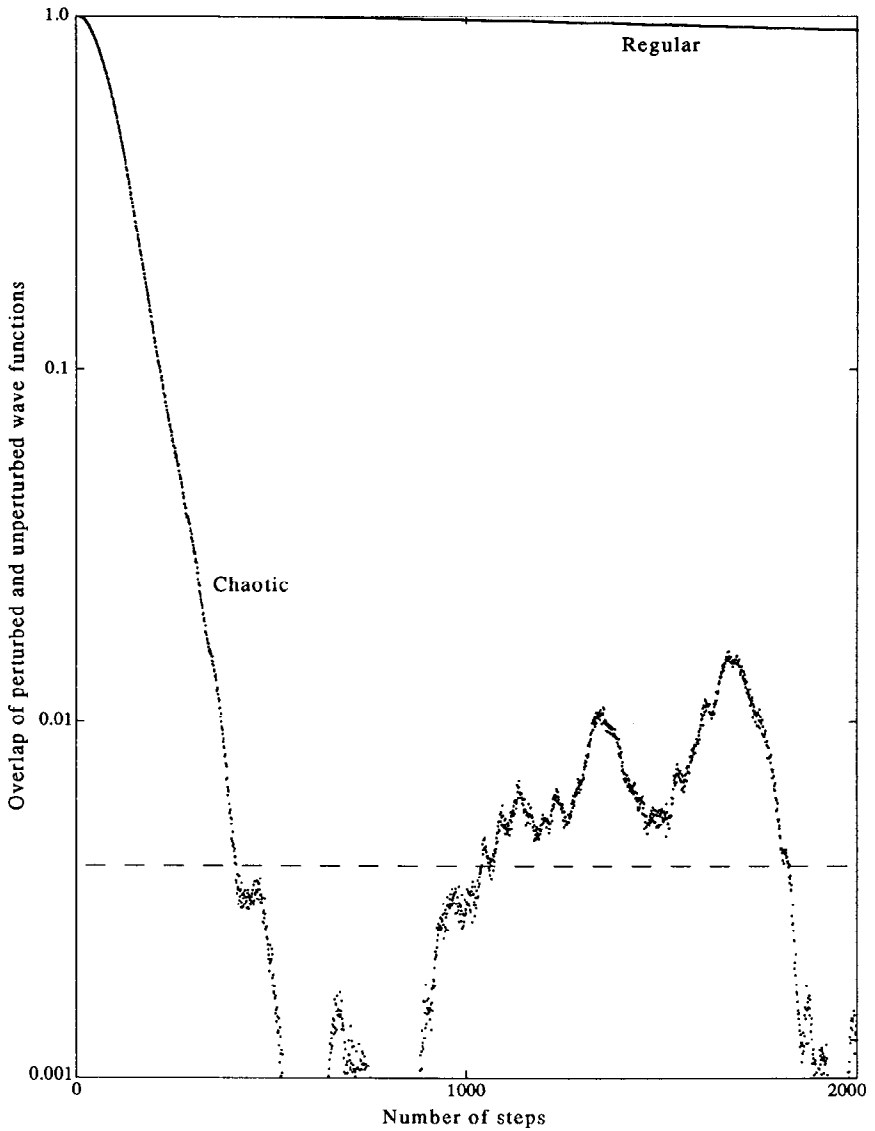

Fig. 11.12. The first 2000 steps. The overlap of the two chaotic states starts to decay quadratically with time, then as an exponential, and finally it fluctuates around its time average 0.003923 (shown by a broken line).

Exercise 11.11 Explain why the initial decay stages are quadratic. ★

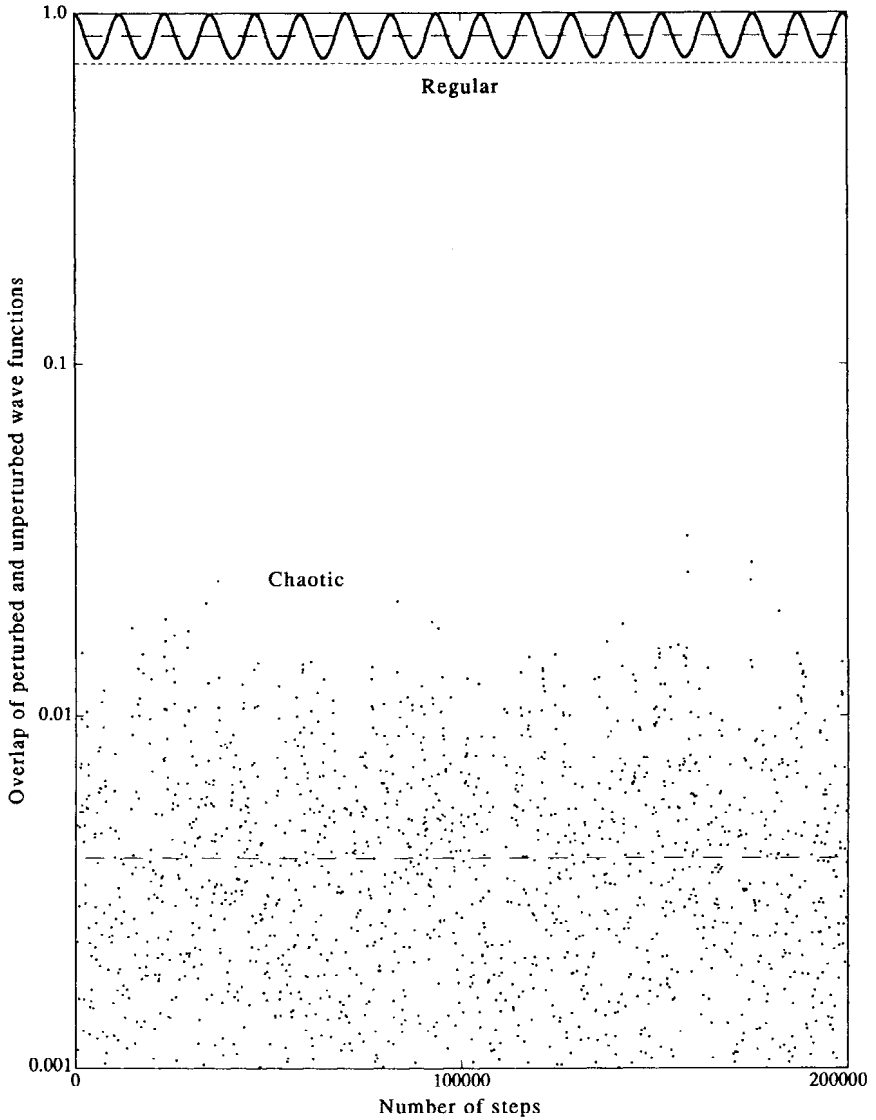

Fig. 11.13. The first 200000 steps. Every hundredth step is shown. The broken lines are the time averages of the overlaps, given by Eq. (11.63). The dotted line is the lowest value attainable by the overlap of the two regular states.

Exercise 11.12 Estimate how often there is a very low overlap of the two chaotic states (10^{-10} , say). ★

11-6. Evolution of pure states into mixtures

The quantum determinism postulate (page 237) asserts that a quantum system prepared in a pure state remains pure when it evolves in a perfectly controlled environment. More generally, the entropy, $S = -\text{Tr}(\rho \log \rho)$, remains invariant under the unitary evolution $\rho \rightarrow \rho' = \mathbf{U}\rho\mathbf{U}^\dagger$. On the other hand, if the environment is not perfectly controlled and is only statistically known, we must replace the evolution operator \mathbf{U} by an ensemble of unitary matrices \mathbf{U}_α , with respective probabilities p_α . The dynamical evolution then is

$$\rho \rightarrow \rho' = \sum_{\alpha} p_{\alpha} \mathbf{U}_{\alpha} \rho \mathbf{U}_{\alpha}^{\dagger}. \quad (11.67)$$

Exercise 11.13 Show that ρ' in Eq. (11.67) satisfies

$$-\text{Tr}(\rho' \log \rho') \geq -\text{Tr}(\rho \log \rho) \quad (11.68)$$

so that the entropy never decreases. ★

Another mechanism which leads to a similar result is the *entanglement* of a quantum system with other systems, found in the environment. In that case, if we use a formalism which *ignores* the systems belonging to the environment, the entropy also increases, by virtue of the subadditivity theorem (9.21).

The role of quantum chaos in irreversibility

In the preceding section, we saw that a small perturbation of the Hamiltonian may cause, over a long time, large deviations from the unperturbed motion: the perturbed and unperturbed quantum states become nearly orthogonal. Therefore, if the perturbation is unknown, the final state is a mixture. All this was shown for a *fixed* perturbation. Obviously, the situation can only be worse for random time-dependent perturbations (which are commonly called *noise*).

It is now possible to reformulate, in the quantum language, the “ice cube in boiling water” paradigm that was proposed in Sect. 11-2. Consider again the twist and turn map (11.46). The question is: can we prepare a quantum state Ψ_0 such that, after 10^5 steps, we obtain, to a good approximation, a *prescribed* coherent state $|\theta, \phi\rangle$? Figure 11.13 indicates that, in the presence of noise, the answer critically depends on the type of state that we intend to reach.

Suppose, for example, that we want to obtain at the end of the evolution the state ψ_r . The latter mostly consists of two robust eigenvectors. Therefore, even if we cannot control the precise value of the twist parameter α , we still know that the motion is stable and that deviations from the planned evolution are bounded: Eqs. (11.65) and (11.66) show that the amplitude of the oscillations is independent of $\delta\alpha$ (it is only their frequency which is proportional to $\delta\alpha$).

On the other hand, if we want to prepare a state that will become, after 10^5 steps, the coherent state ψ_c , we must control the value of α with an accuracy

better than the limit given by Eq. (11.57). If we are unable to achieve such an accuracy, we have every chance of landing far from our target—in a state which will be nearly *orthogonal* to ψ_c . In that case, it is justified to say that the evolution which starts from the state ψ_c is *irreversible*: the reverse evolution cannot be prepared.

11-7. Appendix: PostScript code for a map

The figures in this book, including the various maps in the present chapter, were directly generated by a POST SCRIPT laser printer. POST SCRIPT is a computer language with powerful graphics capabilities.³⁴ Although its primary application is graphics, POST SCRIPT can also be used for ordinary computation, and it may be quite convenient if a graphic output is desired. In particular, a few lines of code can easily generate an iterative map. The computation is entirely done by the microprocessor in the laser printer itself. It could surely be done faster by an ordinary computer, but then the bottleneck would be the transmission of data from the computer to the printer. How much time would your equipment need to transmit 10^6 coordinate pairs for drawing Fig. 11.2? If this is more time than you can afford, use POST SCRIPT. It is an efficient tool for generating iterative maps.

As an example, here is the program which draws Fig. 11.3:

```
% !
% Figure 11.3 (evolution of Liouville domain)
300 400 translate
%
% COORDINATE SYSTEM
/Times-Italic findfont 12 scalefont setfont
-9 73 moveto (p) show 72 -10 moveto (q) show
newpath -80 0 moveto 75 0 lineto
  gsave 80 0 translate
    newpath -10 0 4 -30 30 arc 0 0 lineto closepath fill
  grestore
0 -80 moveto 0 75 lineto
  gsave 0 80 translate
    newpath 0 -10 4 60 120 arc 0 0 lineto closepath fill
  grestore
0.2 setlinewidth stroke
newpath -200 dup moveto 200 -200 lineto 200 dup lineto
  -200 200 lineto closepath stroke
/Times-Roman findfont 12 scalefont setfont
20 65 moveto (3 steps) show 84 -63 moveto (6 steps) show
```

³⁴Adobe Systems Inc., *PostScript Language Reference Manual*, Addison-Wesley, Reading (1985).

```

200 92681 div dup scale
%
/r 10000 def
200 setlinewidth
newpath -75000 0 r 0 360 arc stroke
%
/Helvetica findfont 250 scalefont setfont
/n 0 def
36000 { /n n 1 add def
/a n .01 mul def
/p a sin r mul round cvi def
/q -75000 a cos r mul add round cvi def
2 { 3 { /q q p add
dup 92681 gt { 185362 sub } if
dup -92681 lt { 185362 add } if
def
/p q dup abs 92681 sub mul 92681 idiv p add
dup 92681 gt { 185362 sub } if
dup -92681 lt { 185362 add } if
def
} repeat
q p moveto (.) show
} repeat
} repeat
showpage

```

A CIRCULAR DOMAIN

THE DYNAMICAL MAP

% every 1/100 of degree

In order to accelerate the execution of this iterative map (which may take several minutes, before the POSTSCRIPT printer outputs a page) the code was written with integer arithmetic, which is faster than floating point arithmetic, and more easily transportable to another computer. The variables q and p in this program are not the original variables q and p , but are the integers closest to $92681 q$ and $92681 p$. The prime number 92681 is just less than $2^{16.5} = 92681.9$, so that the expression $|q| (92681 - |q|)$ is always less than 2^{31} , which is the POSTSCRIPT limit for integers.

11-8. Bibliography

M. C. Gutzwiller, *Chaos in Classical and Quantum Mechanics*, Springer, New York (1991).

F. Haake, *Quantum Signatures of Chaos*, Springer, Berlin (1992).

L. E. Reichl, *The Transition to Chaos*, Springer, New York (1992).

M. Tabor, *Chaos and Integrability in Nonlinear Dynamics*, Wiley, New York (1989).

G. M. Zaslavsky, *Chaos in Dynamic Systems*, Harwood, Langhorne, PA (1985).

Some of these books also discuss *dissipative* chaos, which is fundamentally different from the Hamiltonian chaos that was the subject of this chapter.

Recommended reading

An assortment of widely different approaches to quantum chaos can be found in the following articles:

I. C. Percival, "Regular and irregular spectra," *J. Phys. B* 6 (1973) L229.

M. V. Berry, N. L. Balazs, M. Tabor, and A. Voros, "Quantum maps," *Ann. Phys. (NY)* 122 (1979) 26.

M. V. Berry, "Quantizing a classically ergodic system: Sinai's billiard and the KKR method," *Ann. Phys. (NY)* 131 (1981) 163.

P. Pechukas, "Quantum chaos in the irregular spectrum," *Chem. Phys. Lett.* 86 (1982) 553.

M. C. Gutzwiller, "The quantization of a classically ergodic system," *Physica D* 5 (1982) 183; "Stochastic behavior in quantum scattering," *ibid.* 7 (1983) 341.

M. Feingold, N. Moiseyev, and A. Peres, "Classical limit of quantum chaos," *Chem. Phys. Lett.* 117 (1985) 344.

G. Casati, B. V. Chirikov, I. Guarneri, and D. L. Shepelyansky, "Dynamical stability of quantum 'chaotic' motion in a hydrogen atom," *Phys. Rev. Lett.* 56 (1986) 2437.

J. Ford, G. Mantica, and G. H. Ristow, "The Arnol'd cat: Failure of the correspondence principle," *Physica D* 50 (1991) 493.

G. P. Berman, E. N. Bulgakov, and G. M. Zaslavsky, "Quantum chaos of atoms in a resonant cavity," *Chaos* 2 (1992) 257.

R. Schack and C. M. Caves, "Hypersensitivity to perturbations in the quantum baker's map," *Phys. Rev. Lett.* 71 (1993) 525.

Experimental quantum chaos

J. E. Bayfield, G. Casati, I. Guarneri, and D. W. Sokol, "Localization of classically chaotic diffusion for hydrogen atoms in microwave fields," *Phys. Rev. Lett.* 63 (1989) 364.

E. Doron, U. Smilansky, and A. Frenkel, "Experimental demonstration of chaotic scattering of microwaves," *Phys. Rev. Lett.* 65 (1990) 3072.

O. Agam, S. Fishman, and R. E. Prange, "Experimental realizations of quantum chaos in dielectric waveguides," *Phys. Rev. A* 45 (1992) 6773.

Chapter 12

The Measuring Process

12-1. The ambivalent observer

Quantum phenomena do not occur in a Hilbert space. They occur in a laboratory. Their description gives rise to the following dilemma: In order to observe a physical system, we make it interact with an apparatus. The latter must be described by quantum mechanics, because there is no consistent dynamical scheme in which a quantum system interacts with a classical one. On the other hand, the result of the observation is recorded by the apparatus in a classical form—perhaps it will be printed in a scientific journal. Therefore, a *translation* is needed from the Hilbert space formalism into a classical language.

The hallmark of a measuring instrument, which distinguishes it from other physical objects, is this *ambivalence*: it must be treated as a quantum system while it interacts with the measured object, and as a classical system once the measurement is over. How can we “dequantize” the apparatus? Can this “dequantization” be done consistently?

Schrödinger's cat

A vivid example of this ambivalence is Schrödinger's legendary cat,¹ doomed to be killed by an automatic device triggered by the decay of a radioactive atom. Initially, the combined state of the cat and the atom is $L \otimes u$, namely a living cat with an undecayed atom. After one half-life of the atom, this state becomes

$$\psi = 2^{-1/2} (L \otimes u + D \otimes d), \quad (12.1)$$

with obvious notations. Nobody has ever seen a cat in such a strange situation.

Clearly, the “cat paradox” arises because of the naive assumption that the time evolution of the state vector ψ represents a physical process which is actually happening in the real world. In fact, there is no evidence whatsoever

¹E. Schrödinger, *Naturwiss.* 23 (1935) 807 [transl. in *Quantum Theory and Measurement*, ed. by J. A. Wheeler and W. H. Zurek, Princeton Univ. Press (1983) p. 1521.

that every physical system has at every instant a well defined state ψ (or a density matrix ρ) and that the time dependence of $\psi(t)$, or of $\rho(t)$, represents the actual evolution of a physical process. In a strict interpretation of quantum theory, these mathematical symbols represent *statistical information* enabling us to compute the *probabilities* of occurrence of specific events. For example, Eq. (12.1) tells us that if Schrödinger's *gedankenexperiment* is repeated many times, about one half of the cats will be found alive and one half will not. The information specified by $\psi(t)$, or $\rho(t)$, can *evolve* because of known dynamical interactions (such as those causing the decay of the radioactive atom); it can also get *degraded*, and ultimately *obsolete*, with the passage of time if the Hamiltonian is incompletely known (especially if the system is chaotic, as we have seen in the preceding chapter).

Some physicists are not satisfied by the above pragmatic attitude. While they readily accept uncertainty relations, they would like to have at least a definite ontology for quantum theory. There have been many attempts to save the objectivity of the wave function by arguments such as: "Nobody has ever seen a cat in state (12.1), but this is only because the mere *observation* of the cat causes ψ to jump² into either the $L \otimes u$ or the $D \otimes d$ state" (this jump is called a *collapse*³ of the wave function). There is nothing formally inconsistent in this scenario, but it is nevertheless incredible, as it implies a powerful and mysterious interaction between the brain of the observer and the entire body of the cat. A measurement, after all, is not a supernatural event. It is a physical process, involving ordinary matter, and whatever happens ought to be analyzed by means of the ordinary physical laws.

Everett's interpretation and other bizarre theories

Another attempt⁴ to salvage quantum ontology, without invoking a collapse of the wave function, is to assume that an entangled expression like (12.1) *does* represent the actual situation. More precisely, the right hand side of (12.1) is a part of the "wave function of the Universe," in which the cat may be considered as the observer of the atom. However, the two branches of (12.1) correspond to different worlds, between which there can be no communication, once an *irreversible* process has occurred. This approach has several variations⁵ which are called the "relative state interpretation" and the "many worlds interpretation." None is satisfactory because they merely replace the arbitrariness of the collapse postulate by that of the no-communication hypothesis. In particular, there are no objective criteria for the occurrence of the irreversibility which is needed to prevent communication between the various worlds (and there *cannot* be any such criteria, as we have seen in Chapter 11).

²P. A. M. Dirac, *The Principles of Quantum Mechanics*, Oxford Univ. Press (1947), p. 36.

³D. Bohm, *Quantum Theory*, Prentice-Hall, Englewood Cliffs (1951) p. 120.

⁴H. Everett, III, *Rev. Mod. Phys.* 29 (1957) 454.

⁵M. A. B. Whitaker, *J. Phys.* A 18 (1985) 253.

There have also been innumerable attempts to *modify* quantum theory (not only to reinterpret it) so as to avoid the dual nature of the measuring instrument. There is no experimental evidence to support any one of these mutations of quantum theory—there is much evidence *against* them. I shall not further discuss these groundless speculations.

A simple measurement model

To prove that a piece of hardware is a valid measuring instrument, one must produce a dynamical model of its interaction with the physical object being measured. This model should be formulated in quantum mechanical terms, but it must also be understandable in a semiclassical way. A simple example will illustrate how the same physical system may accept two conflicting descriptions, under different circumstances.

Consider again the Stern-Gerlach experiment which was discussed in a classical way in Sect. 1-5, but now use quantum mechanics instead. The dynamical variable which is measured is a component of the magnetic moment of an atom, μ_z say. The “pointer” indicating the observed value of μ_z is the center of mass \mathbf{r} of that atom. Indeed, it is the final value of \mathbf{r} that is irreversibly recorded by a detecting device. The dynamical description of the measuring process involves two stages. When the atom passes through the inhomogeneous field \mathbf{B} of the Stern-Gerlach magnet (see Fig. 1.5), its Hamiltonian,

$$H = \frac{\mathbf{p}^2}{2m} - \boldsymbol{\mu} \cdot \mathbf{B}(\mathbf{r}), \tag{1.4}$$

includes an interaction between the magnetic moment $\boldsymbol{\mu}$, a component of which is the “measured system,” and the center of mass \mathbf{r} which plays the role of the “measuring system.” The atom thus embodies *both* systems. (The symbols \mathbf{r} and \mathbf{p} denote classical variables or operators, according to the context.) The equation of motion for \mathbf{p} , the variable conjugate to \mathbf{r} , is $\dot{\mathbf{p}} = [\mathbf{p}, H]/i\hbar = \nabla(\boldsymbol{\mu} \cdot \mathbf{B})$, just as in Eq. (1.6), but with $[\mathbf{p}, H]_{PB}$ replaced by a commutator since we are now discussing quantum systems.

However, once the atom leaves the magnet, its Hamiltonian $H = \mathbf{p}^2/2m$ no longer couples $\boldsymbol{\mu}$ and \mathbf{r} . The equations of motion have the same solution,

$$\mathbf{r} = \mathbf{r}_0 + \mathbf{p}t/m, \tag{12.2}$$

in classical and in quantum mechanics. If you prefer, the equation of motion for the quantum Wigner function, Eq. (10.67), is identical to that for a classical Liouville density. Nothing irreversible has occurred as yet at this stage, at least in principle.⁶ In particular, the first stage of *amplification*—a necessary step for a quantum measurement—is simply due here to the passage of time, which can make the factor t/m in Eq. (12.2) arbitrarily large.

⁶J. Schwinger, M. O. Scully and B.-G. Englert, *Z. Phys. D* 10 (1988) 135.

The consistency problem

It must now be shown that no inconsistency arises if the measuring instrument, or the “observer” (in the above example, the center of mass position \mathbf{r}), is considered as a genuine quantum object for which no classical description is used, but this quantized instrument is, in turn, observed by some *other* instrument, having both quantum and classical descriptions. For example, it should not matter whether Schrödinger’s cat is considered as the observer, or is an intrinsic part of the atom-cat dynamical system which is observed by someone else. The reason for suspecting a possible inconsistency is the following:

If the observer were not a cat or some other, possibly inanimate but utterly complicated measuring apparatus, the unitary evolution leading to Eq. (12.1) would be reversible. Simple, highly idealized models of measuring apparatuses can easily be concocted, which have that property.⁷ After the measurement is achieved (*i. e.*, the instrument is correlated with the measured system), it still is possible to undo the whole process: A superobserver, capable of fully analyzing the dynamical behavior of the measuring apparatus (e. g., capable of writing explicitly the Hamiltonian of Schrödinger’s cat) could cause the original observer (or apparatus—this makes no difference) to decorrelate itself from the measured system and to “unlearn” the result of the measurement. For example, the cat would be resurrected. And then, the superobserver, by measuring again the same system, could obtain a different result for his measurement.

If such a scenario were indeed possible, the notion of measurement would become meaningless, as no measurement would ever be conclusive. Consistency thus requires the measuring process to be *irreversible*. There are no superobservers in our physical world.

Formally, the logical consistency of the “dequantization” of a measuring apparatus implies the equivalence of two different descriptions of the same process, in which a quantum system S is coupled to an apparatus A , as in Eq. (1.4) above. Let this composite system evolve in time, and then trace out S in its combined density matrix, so as to obtain a reduced ρ_A for the apparatus. This reduced density matrix can be converted by means of Eq. (10.56) into a Wigner function, $W_A(\mathbf{q}, \mathbf{p})$. Some blurring (see page 316) converts the latter into a *fuzzy* Wigner function which is nowhere negative and may be interpreted as a Liouville density $f_A(\mathbf{q}, \mathbf{p})$, if the \hbar^2 terms in the quantum Liouville equation (10.67) are negligible for the macroscopic apparatus. Notice that we obtain a *probability distribution* for the final state of the apparatus. We cannot demand a definite result, since quantum theory makes only statistical predictions.

Consider now a second, bigger apparatus, B , which interacts with apparatus A , in order to measure it. This is a classical measurement. We have a combined Liouville density for A and B . After it evolves according to the Liouville equation, we sum over the variables of A and get a reduced Liouville density $F_B(\mathbf{Q}, \mathbf{P})$ for the big apparatus. All this is quite simple and straightforward.

⁷ A. Peres, *Am. J. Phys.* 42 (1974) 886.

We can however follow an alternative approach, and this possibility gives rise to a consistency problem. Instead of dequantizing ρ_A to obtain $f_A(\mathbf{q}, \mathbf{p})$, we can describe *both* apparatuses by quantum mechanics, let the composite *quantum* system evolve unitarily, and then trace out A to obtain a reduced density matrix ρ_B . The latter is converted into a Wigner function $W_B(\mathbf{Q}, \mathbf{P})$ which, after some blurring, yields a new Liouville function $F_B(\mathbf{Q}, \mathbf{P})$.

The consistency issue is obvious: Is $F_B(\mathbf{Q}, \mathbf{P})$ the same as $F_B(\mathbf{Q}, \mathbf{P})$ which was obtained by the preceding method? This is quite unlikely, in view of the many arbitrary steps in the above calculations. However, since we are only calculating *probabilities*—because quantum theory predicts nothing else—small discrepancies between these two Liouville densities should not be a matter of concern. It is this (approximate) objectivity which characterizes a properly executed measurement (*i.e.*, a quantum test). The result is *definite* and cannot be affected by reconsidering the measuring apparatus as a quantum object, to be observed by still another apparatus. If the latter is *reasonable*, it will give results which *almost always* agree with those of the first apparatus.

The last two clauses must be noted. The restriction to *reasonable* apparatuses (that is, those measuring only reasonable operators, as defined at the beginning of Chapter 10) is equivalent to the former statement that “there are no super-observers.” The proviso *almost always* is essential. It gives a fuzzy aura to the notion of quantum measurement, but there is no escape from this fuzziness. There can be no unambiguous algorithm for converting the quantum language into an utterly different classical language.

A classical description is not an approximation of a quantum description, but is qualitatively different.⁸ A classical pointer has a position which is a real number. A quantum pointer also has a position, but the latter is an operator. There are questions, such as “what is the numerical value of the pointer position,” which make sense in the classical language, but are meaningless in the quantum language. The only vestige of quantum theory which a classical description may retain is the canonical uncertainty relation, namely a minimum spread of order \hbar^n in the $2n$ -dimensional phase space.

Open systems

When is a physical system a good measuring instrument, satisfying the above consistency criteria? An obvious necessary condition is that it is *not isolated* from the environment where the outcome of the test is recorded in a durable structure. Therefore *irreversibility* is a necessary feature of quantum tests. A simple model will illustrate these points.

Let $\psi = \sum c_m u_m$ be the initial state of a quantum system which is submitted to a *maximal* test corresponding to the orthonormal basis u_m . The measuring apparatus has an initial state ϕ (there is no harm in assuming that this is a pure state, see Exercise 5.10). Let $v_{n\alpha}$ set of final states of that apparatus. The

⁸ A. Peres and W. H. Zurek, *Am. J. Phys.* 50 (1982) 807.

index n refers to a macroscopic degree of freedom, such as the position of the center of mass of a pointer which indicates which one of the states u_n has been found in the test. The index α refers to additional, microscopic, “irrelevant” degrees of freedom, such as the internal energy levels of the pointer. Therefore the orthonormal states $v_{m\alpha}$ and $v_{n\beta}$ are macroscopically distinguishable only if $m \neq n$. With these notations, the result of the interaction of the apparatus with the system under study is assumed to be:

$$\psi\phi \rightarrow \sum_{n\alpha} c_{n\alpha} u_n v_{n\alpha}. \quad (12.3)$$

This is a *linear superposition*—it cannot be anything else, if quantum theory is correct. For example, Eq. (12.1) is such a superposition. The process (12.3) is called a “measurement,” because the n th state of the system is *correlated* with the n th set of macroscopically distinguishable final states of the instrument.

Here, it should be pointed out that Eq. (12.3) does not represent the most general type of measurement process. The latter corresponds to a positive operator valued measure (POVM) as explained in Sections 9-5 and 9-6. The present discussion is restricted, for simplicity, to *repeatable tests*, also called “von Neumann measurements,” or “measurements of the first kind.” The fundamental issue of irreversibility is the same for all these processes.

Exercise 12.1 Show that the evolution (12.3) is unitary, provided that

$$|c_n|^2 = \sum_{\alpha} |c_{n\alpha}|^2, \quad (12.4)$$

and construct a Hamiltonian which generates this evolution. ★

If we now want to reverse the arrow in Eq. (12.3), so as to decorrelate the observed system from the observer, we must specify not only a few coefficients g_n corresponding to macroscopically distinguishable states, but every single microscopic $c_{n\alpha}$, with the correct amplitude and phase. Here lies the difficulty. The dynamics of the internal degrees of freedom of any macroscopic apparatus is inherently chaotic. Therefore the values of the $c_{n\alpha}$ are highly sensitive to any interactions with an uncontrollable external environment, weakly coupled to the degrees of freedom of the apparatus.⁹ Reversing the unitary evolution (12.3), for example resurrecting Schrödinger’s cat, is an impossible task.

12-2. Classical measurement theory

Uncertainty relations exist in classical mechanics, just as in quantum mechanics. As there *must* be an interaction between the apparatus and the observed system, measuring one property of the system necessarily causes a disturbance to some

⁹ A.Peres, *Phys. Rev. D* 22 (1980) 879.

of its other properties. In particular, any uncertainty in the preparation of the measuring apparatus affects the subsequent dynamics of the measured system, after completion of the measurement.

To give a concrete example, consider a classical system with Hamiltonian $H_0(\mathbf{q}, \mathbf{p})$ and suppose that we want to measure one of its dynamical variables, $A(\mathbf{q}, \mathbf{p})$, at time t_0 . An ideal measurement is performed as follows. We couple the system to an apparatus which, in the present extreme idealization, simply is a free particle (a “pointer”) of mass M , position Q , and momentum P . The complete Hamiltonian is

$$H = H_0(\mathbf{q}, \mathbf{p}) + (P^2/2M) + g(t - t_0) A(\mathbf{q}, \mathbf{p}) P, \tag{12.5}$$

where $g(t - t_0)$, the strength of the coupling, is controlled by *other* degrees of freedom (not included in H) in such a way that $g(t - t_0)$ is very large when $t_0 < t < t_0 + \epsilon$, and negligible for other t . For example, in a Stern-Gerlach experiment, t_0 is the time of entrance into the magnet, and $t_0 + \epsilon$ is the exit time.⁹ These two parameters are determined by the translational motion of the atom.

We shall now assume that the interaction term in (12.5) dominates all the other terms—which can therefore be neglected—during the brief duration of the measurement. Let us define, for further use,

$$G = \int g(t - t_0) dt. \tag{12.6}$$

The equations of motion of the “pointer” are:

$$\dot{P} = [P, H]_{\mathbf{PB}} = 0, \tag{12.7}$$

and

$$\dot{Q} = [Q, H]_{\mathbf{PB}} = (P/M) + g(t - t_0) A. \tag{12.8}$$

Likewise, for any variable $B(\mathbf{q}, \mathbf{p})$ of the apparatus, we have

$$\dot{B} = [B, H]_{\mathbf{PB}} = [B, H_0]_{\mathbf{PB}} + g(t - t_0) [B, A]_{\mathbf{PB}} P. \tag{12.9}$$

From (12.7) it follows that P is a constant: $P = P_0$. In the special case where $B = A$, Eq. (12.9) gives $\dot{A} = [A, H_0]_{\mathbf{PB}}$ which is a finite quantity. Therefore, the change in A during the very brief interaction is of order ϵ and can be neglected. We thus obtain, from (12.6) and (12.8),

$$Q(t_0 + \epsilon) = Q_0 + G A(t_0) + O(\epsilon), \tag{12.10}$$

which gives us the value of $A(t_0)$, that we wanted to know. Assuming for simplicity that $Q(t_0 + \epsilon)$ is measured with perfect precision, the uncertainty in the recorded value of $A(t_0)$ is

$$\Delta A = \Delta Q_0 / G, \quad (12.11)$$

where ΔQ_0 is the uncertainty in the initial position of the "pointer."

Consider now any other variable B . We have, by integration of (12.9),

$$B(t_0 + \epsilon) = B_0 + G \langle [B, A]_{\text{PB}} \rangle_t P_0 + O(\epsilon), \quad (12.12)$$

which involves the *time average* of the Poisson bracket during the measurement. If the initial value P_0 is known with a precision ΔP_0 , the final value $B(t_0 + \epsilon)$ will be uncertain by

$$\Delta B = G \langle [B, A]_{\text{PB}} \rangle_t \Delta P_0. \quad (12.13)$$

It follows that

$$\Delta B \Delta A = \langle [B, A]_{\text{PB}} \rangle_t \Delta Q_0 \Delta P_0. \quad (12.14)$$

This result looks like the quantum uncertainty relation (4.40). However, the above argument was purely classical. The only role quantum theory could have in this issue is to set an absolute lower bound to the value of $\Delta Q_0 \Delta P_0$, irrespective of the experimenter's skill. We thus see why elementary semiclassical arguments, such as the one commonly presented for Heisenberg's microscope, end up with the same quantum uncertainty as the full quantum treatment. This is simply due to the similarity of Poisson brackets and commutators, which holds for *reasonable* dynamical variables (as defined in Sect. 10-1).

Consecutive measurements

Suppose now that we want to know not only the value of A at a given time t_0 , but the complete time evolution $A(t)$, or at least a sequence of values $A(t_j)$. Obviously, if the value of $A(t_1)$ depends, via the equations of motion, on the value of $B(t_0)$, and if $[B, A]_{\text{PB}} \neq 0$, then $A(t_1)$ will be affected by the disturbance to $B(t_0)$ caused by a prior measurement of $A(t_0)$.

This can also be seen as follows: It is always possible, in principle, to express $A(t_1)$ as a function of $\mathbf{q}(t_0)$ and $\mathbf{p}(t_0)$ with arbitrary accuracy (this can be done analytically, in closed form, if the equations of motion are integrable, but even if they are not, perturbative methods are readily available). We may thus define *unequal time* Poisson brackets $[A(t_0), A(t_1)]_{\text{PB}}$. From the preceding argument, it follows that the measurement of $A(t_0)$ does not perturb $A(t_1)$ if, and only if,

$$[A(t_0), A(t_1)]_{\text{PB}} = 0. \quad (12.15)$$

When this condition is satisfied by a dynamical variable, it is possible to monitor its evolution in a *noninvasive* way, that is, without affecting that evolution. Dynamical variables which satisfy Eq. (12.15) will be called *robust*. (In quantum theory, they are called *QND-variables*—for "quantum nondemolition.")

A simple example of a variable which is *not* robust is the position x of a free particle. Since $x(t) = x_0 + p_0 t/m$, we obtain

$$\Delta x(t') \Delta x(t'') = (\Delta Q \Delta P) |t' - t''|/m. \tag{12.16}$$

A more complicated example is discussed below.

Case study: a forced harmonic oscillator

A situation where classical and quantum physics come in close contact is the detection of gravitational radiation. A gravitational wave is a time-dependent inhomogeneity of the gravitational field, caused by the violent motion of distant masses, and propagating at the speed of light. It acts as a *tidal force* which produces oscillations in the distance between neighboring particles. The latter may be free to move (for example, they may be the mirrors of an interferometric detector) or they may be part of a massive “antenna” in which a dynamic strain is induced.^{10,11}

The problem of detecting gravitational waves may seem completely divorced from quantum theory. Fields are weak, frequencies are low, and the effects of quantized gravity are totally negligible. All we want to measure is a *classical* signal $f(t)$ —a component of the Riemann tensor, averaged over the size of the detector. There should be no quantum uncertainties, and no lower limit to the detectable $f(t)$. The difficulty is solely due to the fact that gravity couples very poorly to the dynamical variables of any detector. This has the following consequence, if we use classical mechanics to perform calculations. The dynamical variables follow an orbit in the classical phase space. The unknown value of the signal, $f(t)$, has to be calculated from the properties of that orbit. However, if the signal is very weak, the orbit may encompass a domain smaller than \hbar . This means, effectively, that classical mechanics is not applicable and the detector must be treated as a quantum system. New problems then arise, which will be discussed in Sect. 12-4.

Let us first consider the properties of a *classical* forced harmonic oscillator. It is assumed that the noise temperature is low enough to allow us to neglect noise and other dissipative effects. With suitable units of mass and time, the Hamiltonian is

$$H_0 = \frac{1}{2}(p^2 + x^2) - x f(t). \tag{12.17}$$

The driving force $f(t)$ is unknown and the problem is to deduce its value from measurements of x and p . The equations of motion are

$$\dot{x} = p \quad \text{and} \quad \dot{p} = -x + f(t). \tag{12.18}$$

These equations can be integrated as follows. Define new variables

$$A := x \cos t - p \sin t \quad \text{and} \quad B := x \sin t + p \cos t. \tag{12.19}$$

¹⁰ J. Weber, *Phys. Rev.* 117 (1960) 306.

¹¹ P. F. Michelson, J. C. Price, and R. C. Taber, *Science* 237 (1987) 150.

We obtain

$$\dot{A} = -\sin t f(t) \quad \text{and} \quad \dot{B} = \cos t f(t), \quad (12.20)$$

whence

$$A(t) = x_0 - \int_0^t \sin t' f(t') dt' \equiv x_0 - S(t), \quad (12.21)$$

and

$$B(t) = p_0 + \int_0^t \cos t' f(t') dt' \equiv p_0 + C(t). \quad (12.22)$$

The last equations define functions $C(t)$ and $S(t)$ which have to be determined experimentally. We have, from (12.19),

$$\begin{aligned} x(t) &= (x_0 - S) \cos t + (p_0 + C) \sin t, \\ p(t) &= -(x_0 - S) \sin t + (p_0 + C) \cos t. \end{aligned} \quad (12.23)$$

It follows that $[x(t), x_0]_{\text{PB}} = -\sin t$ and $[p(t), p_0]_{\text{PB}} = -\sin t$, so that neither x nor p is a robust variable, satisfying (12.15).

Exercise 12.2 Show that the oscillator energy $E = \frac{1}{2}(p^2 + x^2)$ is also not robust, because it satisfies $[E(t), E(0)]_{\text{PB}} = x_0 C + p_0 S \neq 0$.

If we are interested in a continual monitoring of $f(t)$, it would therefore be a bad idea to measure x , or p , or E . On the other hand, the variables $A(t)$ and $B(t)$ are manifestly robust—see Eqs. (12.21) and (12.22)—and *one* of them (but not both!) can be continually monitored. For example, we may choose to measure repeatedly $A(t)$ at the cost of perturbing in an unknown way the value of $B(t)$, or vice versa. By continually monitoring $A(t)$, we obtain the function $S(t)$ from which we can retrieve the value of $f(t)$. This method is called “homodyne” (or “phase-sensitive”) detection.

The next problem is to *materialize* the symbols $\cos t$ and $\sin t$ which appear in Eq. (12.19). Their values are generated by a *clock*. A clock is not an abstract notion. It is a physical system, with dynamical degrees of freedom which must be represented in terms of canonical variables and introduced in the Hamiltonian. Conceptually, the simplest clock is a *rotor* described by an angle θ and its conjugate momentum J , with Poisson brackets $[\theta, J]_{\text{PB}} = 1$. The new Hamiltonian, including that clock, may be taken as

$$H_0 = H_{\text{osc}} + J. \quad (12.24)$$

It gives the same equations as before, together with $\dot{\theta} = 1$ and $\dot{J} = 0$. These additional equations of motion have solutions $\theta = \theta_0 + t$ and $J = \text{const}$. We now define, instead of (12.19),

$$A = x \cos \theta - p \sin \theta \quad \text{and} \quad B = x \sin \theta + p \cos \theta, \tag{12.25}$$

and we obtain

$$\dot{A} = -\sin \theta f(t) \quad \text{and} \quad \dot{B} = \cos \theta f(t), \tag{12.26}$$

with solution

$$\begin{aligned} A(t) &= A_0 - \int_0^t \sin(\theta_0 + t') f(t') dt', \\ B(t) &= B_0 + \int_0^t \cos(\theta_0 + t') f(t') dt'. \end{aligned} \tag{12.27}$$

This gives, with the same notations as before,

$$\begin{aligned} A &= (x_0 - S) \cos \theta_0 - (p_0 + C) \sin \theta_0, \\ B &= (x_0 - S) \sin \theta_0 + (p_0 + C) \cos \theta_0. \end{aligned} \tag{12.28}$$

Note that $A(t)$ and $B(t)$ are robust, because the integrals on the right hand sides of (12.27) have vanishing Poisson brackets with A_0 and B_0 .

The difficulty is that there is no known way of materializing this rotor clock. In quantum theory, it would give a Hamiltonian whose eigenvalues have no lower bound, which is unacceptable. (An approximate construction was proposed by Unruh.¹²) It is also possible to construct, as shown in Sect. 12-7, a rotor clock with a *finite* number of quantum states, but in the finite Hilbert space of the latter neither $\cos \theta$ nor $\sin \theta$ (let alone θ itself) are well defined operators.

A more practical alternative is an *oscillator clock*, with the same frequency as the original oscillator. For example, this clock could be an electric *LC* circuit, coupled to the mechanical oscillator by a suitable transducer.¹³ Let y and p_y be the dynamical variables of the second oscillator. The Hamiltonian becomes

$$H_0 = \frac{1}{2}(p_x^2 + x^2) - f(t)x + \frac{1}{2}(p_y^2 + y^2), \tag{12.29}$$

where p_x now stands for the former p . The equations of motion are the same as before, together with $\dot{y} = p_y$ and $\dot{p}_y = -y$, which are easily solved. Define

$$A := x y + p_x p_y \quad \text{and} \quad B := x p_y - p_x y, \tag{12.30}$$

and also (for later use)

$$D := \frac{1}{2}(p_x^2 + x^2 - p_y^2 - y^2). \tag{12.31}$$

These dynamical variables have Poisson brackets

¹² W. G. Unruh, *Phys. Rev. D* 19 (1979) 2888.

¹³ C. M. Caves, K. S. Thorne, R. W. P. Drever, V. D. Sandberg, and M. Zimmermann, *Rev. Mod. Phys.* 52 (1980) 341.

$$[A, B]_{\text{PB}} = 2D, \quad [B, D]_{\text{PB}} = 2A, \quad [D, A]_{\text{PB}} = 2B, \quad (12.32)$$

like components of angular momentum (multiplied by 2). This property has important consequences when quantization is considered: the observable values of A (or B , or D) are *integers*, and therefore cannot evolve *continuously* as in classical mechanics. Intuitively, the probability of a jump from one eigenvalue to another depends on the lapse of time between consecutive measurements. A detailed calculation, given in Sect. 12-5 below, shows that if measurements are very frequent on the natural time scale of the observed system, that system appears to be paralyzed: the value of A never changes. This is called the *quantum Zeno effect*. To avoid it, one must make *fuzzy* measurements, which do not discriminate between consecutive eigenvalues, and do not prevent the evolution of the system.

Let us return to the classical equations of motion of our driven harmonic oscillator. With the use of an oscillator clock, we have

$$\dot{A} = p_y f(t) \quad \text{and} \quad \dot{B} = -y f(t). \quad (12.33)$$

Therefore $[A, \dot{A}]_{\text{PB}} \neq 0$ and $[B, \dot{B}]_{\text{PB}} \neq 0$. It follows that neither A nor B is robust. We have already seen in Exercise 12.2 that D is not.

We can solve (12.33) explicitly:

$$A(t) = A_0 + \int_0^t p_y(t') f(t') dt', \quad (12.34)$$

whence, with the help of $p_y = -y_0 \sin t + p_{y0} \cos t$,

$$A(t) = (x_0 - S) y_0 + (p_{x0} + C) p_{y0}. \quad (12.35)$$

There are similar expressions for $B(t)$. Comparison with Eq. (12.28) shows the essential difference between rotor and oscillator clocks. The variables $\sin \theta$ and $\cos \theta$ have a vanishing Poisson bracket. On the other hand, the oscillator clock variables satisfy $[y_0, p_{y0}]_{\text{PB}} = 1$, which gives $[A_0, A(t)]_{\text{PB}} = C x_0 + S p_{x0} \neq 0$. Therefore the measurement of A_0 causes an unknown disturbance to the value of $A(t)$. We have

$$\Delta A_0 \Delta A(t) \simeq |C x_0 + S p_{x0}| \Delta Q \Delta P, \quad (12.36)$$

where Q and P are the dynamical variables of the apparatus that measures A . Usually, $\Delta Q \Delta P$ is much larger than its quantum limit $\hbar/2$.

The important result here is that the right hand side of (12.36) is independent of the clock variables y and p_y , while $A(t)$ itself is proportional to the amplitude of the clock oscillations. As the latter can in principle be made as large as we wish, irrespective of the weakness of the signal $f(t)$, the uncertainty in $A(t)$ can be made negligibly small, when compared to $A(t)$ itself. The clock essentially serves to *amplify* the weak signal $f(t)$, and it is theoretically possible to measure $f(t)$ with arbitrary accuracy. The only problem is to realize in the laboratory the couplings that were written in the above equations.

12-3. Estimation of a static parameter

Quantum particles can serve as probes for measuring classical parameters. For instance, in Fig. 1.3 (page 6), we see a beam of photons used for estimating the rotation angle of a polarizer with respect to a calcite crystal. Photons are also often used for measuring the distance between two mirrors in an interferometer. These mirrors are massive, and their quantum diffusion, $(\hbar t/m)^{1/2}$, is totally negligible during the time t needed for measuring their distance. It is therefore justified to consider such mirrors as fixed classical objects.

In the experiment sketched in Fig. 12.1, any variation in the distance between the two mirrors (thick lines), with respect to the distance between the beam splitters, appears as a phase difference at the exit port of the interferometer. This phase difference affects the relative number of counts in the two photodetectors. The final analysis of the results of this experiment is identical to that for the experiment in Fig. 1.3 (see page 46).

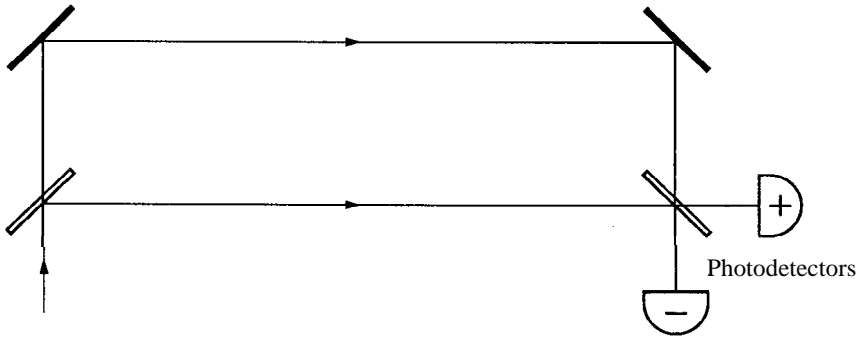

Fig. 12.1. Phase-shift detection by a Mach-Zehnder interferometer.

It is obvious that such a measurement method does not fit into the formal scheme which was proposed by von Neumann in his classic treatise¹⁴ where the emphasis is on the measurement of *dynamical variables* represented by self-adjoint operators. Another type of measurement which is not covered by von Neumann's theory is the determination of an unknown parameter in a wave function which has a known form, for example, the parameter α in a coherent state $|\alpha\rangle$. Since different coherent states are not orthogonal, it is impossible to obtain a definite answer for the value of α . We can at most get a probability distribution. In real life situations, this may lead to intricate problems which necessitate the use of sophisticated statistical methods.¹⁵ Here, I shall only analyze an elementary example.

¹⁴J. von Neumann, *Mathematische Grundlagen der Quantenmechanik*, Springer, Berlin (1932) [transl. by E. T. Beyer: *Mathematical Foundations of Quantum Mechanics*, Princeton Univ. Press (1955)] Chapt. 6.

¹⁵C. W. Helstrom, *Internat. J. Theor. Phys.* 11 (1974) 357.

Determination of polarization parameters

You are given a spin j particle, prepared in an angular momentum coherent state $|\theta, \phi\rangle$, and you are requested to evaluate the angles θ and ϕ . These are *classical* parameters, whose value is determined by the orientation of the macroscopic apparatus which produced the spin j particle.

It is plausible that the best measurement method involves a non-orthogonal POVM, as in Eq. (9.81), because θ and ϕ may take continuous values, while a maximal test (a von Neumann type measurement) has only $(2j + 1)$ different outcomes. In the present case, the natural POVM to use is the one defined in Eq. (10.144): We divide the unit sphere into small areas $\sin \theta d\theta d\phi$, and for each one of them we define a positive operator

$$A_{\theta\phi} = |\theta, \phi\rangle\langle\theta, \phi| \sin \theta d\theta d\phi (2j + 1)/4\pi. \quad (12.37)$$

These operators satisfy $\int A_{\theta\phi} = \mathbf{1}$, so that they indeed form a POVM.

The probability of obtaining a particular $A_{\theta'\phi'}$ as the result of the test is, by virtue of Eq. (9.79), $p_{\theta'\phi'} = \langle\theta, \phi|A_{\theta'\phi'}|\theta, \phi\rangle$. Using Eq. (10.146), we obtain

$$p_{\theta'\phi'} = \cos^{4j}(\Theta/2) \sin \theta' d\theta' d\phi' (2j + 1)/4\pi, \quad (12.38)$$

where Θ is the angle between the directions (θ, ϕ) and (θ', ϕ') .

Once the test has been performed and has indicated a direction (θ', ϕ') , we can derive the *a posteriori* probability distribution for the actual preparation direction (θ, ϕ) . If the *a priori* probability distribution was isotropic, namely $\sin \theta d\theta d\phi/4\pi$, the *a posteriori* probability can be found by Bayesian analysis (Sect. 2-77). The result is $p_{\theta\phi} = \cos^{4j}(\Theta/2) \sin \theta d\theta d\phi (2j + 1)/4\pi$.

Exercise 12.3 Verify that $\int p_{\theta\phi} = 1$.

Exercise 12.4 For the special case $j = \frac{1}{2}$, compare the above result with the one in Eq. (9.11:0), which corresponds to a direct von Neumann measurement, rather than a POVM. **Ans.:** In this particular case, the information gain is the same with both methods. This is no longer true for higher j . ★

Physical constants

Another common type of measurement is that of a physical constant, such as the mass of an elementary particle or the magnitude of its magnetic moment. These unknown constants are *c*-numbers, and are measured in the same way as any other classical parameter. We perform quantum tests on particles which have been prepared in a known way. These tests are described by an interaction Hamiltonian where the unknown physical constants appear as numerical parameters—for example m and μ in the Hamiltonian (1.4). We then attribute to these parameters the values which best fit the experimental results.

12-4. Time-dependent signals

We now turn our attention to a more difficult problem, which is the detection of weak classical signals. This is done by coupling the signal to a detector (a dynamical system of known structure) so that the Hamiltonian H of the detector contains a term depending on the unknown signal. Then, by observing the time dependence of a dynamical variable of the detector, we can reconstruct the entire H , including the unknown signal. An example of signal detection by such a method was discussed in Sect. 12-2, at the *classical* level.

When the signal is extremely weak, the quantum properties of the detector cannot be ignored. There appears then to be a conflict between the continuous nature of a classical signal and the discrete spectrum of a quantum device. Moreover, the final result cannot be recorded by a *quantum* system, which may be in a superposition of eigenstates. The detector has to be “measured” by a suitable apparatus (the “meter”) which then yields another classical signal—namely a sequence of real numbers. We shall now examine the distortion caused by the presence of a quantum interface between these two classical signals. It will be seen that a good meter should have a *moderate* resolution, so as to lump together numerous levels of the quantum detector. Obviously, a poor resolution gives inaccurate results, but a resolution which is too sharp is also undesirable, because it impairs the correspondence between the input and output signals; and a perfect resolution, down to isolated eigenvalues, may completely lock the detection process.

Fuzzy measurements

As a concrete example, let us return to the simplified version of the Stern-Gerlach experiment that was discussed at the beginning of this chapter, both in the classical language and in the Heisenberg picture (formally, these two were the same). I shall now use the Schrödinger picture, which is more appropriate in a situation where the Hamiltonian is not known and has to be determined by observations. Further simplifications help to get a tractable problem. We shall consider a particle of spin $\frac{1}{2}$ whose initial state is described by a spinor $\begin{pmatrix} \alpha \\ \beta \end{pmatrix}$. There are no other degrees of freedom and, at this stage, no forces acting on that particle. The problem is to measure σ_z , a dynamical variable purported to have observable values ± 1 .

The “meter” which performs this measurement is idealized as having a single, dimensionless degree of freedom, q , which indicates the value of the measured variable. The conjugate degree of freedom, p , satisfies $[q, p] = i\hbar$. A stripped down Hamiltonian which describes the measuring process is

$$H = g(t)\sigma_z p, \tag{12.39}$$

where $g(t)$ has a narrow support near $t = 0$, and satisfies $\int g(t) dt = 1$.

Let $\phi(q)$ denote the initial wave function of the meter. The time evolution generated by the Hamiltonian (12.39) is

$$\begin{pmatrix} \alpha \\ \beta \end{pmatrix} \otimes \phi(q) \rightarrow \begin{pmatrix} \alpha \\ 0 \end{pmatrix} \otimes \phi(q-1) + \begin{pmatrix} 0 \\ \beta \end{pmatrix} \otimes \phi(q+1). \quad (12.40)$$

This process is illustrated by Fig. 12.2, where it was assumed that $\phi(q)$ has a sharp maximum at $q = 0$, so that, before the measurement, it is most probable to find the meter near $q = 0$. The meaning of the right hand side of (12.40) is the following: There is a probability amplitude $\alpha\phi(q-1)$ for finding the meter near $q = 1$, and the particle with spin up; and a probability amplitude $\beta\phi(q+1)$ for finding the meter near $q = -1$, and the particle with spin down.

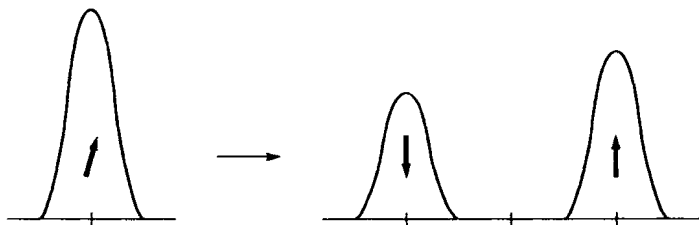

Fig. 12.2. Graphical representation of Eq. (12.40). In this drawing and the following one, $\alpha = 0.8$ and $\beta = 0.6$. The thick arrows indicate the spin orientation.

What we call “the observed value of σ_z ” is the final position of the meter. The state vector (12.40) specifies the probabilities of observing the meter at its possible final positions. Ideally, ϕ should have zero width and the result of the measurement should be ± 1 , *i.e.*, one of the eigenvalues of σ_z . However, the actually observed value of σ_z may differ from the ideal result by a quantity of order Δq , namely the width of the meter wave function. This discrepancy is not a trivial “technical difficulty,” but a matter of principle. We shall actually see that in some cases it may be advantageous to make Δq larger than the separation of consecutive eigenvalues.

The situation when Δq is broad is represented by Fig. 12.3. The probability of observing the meter between q_0 and $q_0 + dq_0$ is

$$P(q_0) dq_0 = [|\alpha|^2 |\phi(q_0-1)|^2 + |\beta|^2 |\phi(q_0+1)|^2] dq_0. \quad (12.41)$$

If the observed value q_0 is such that both terms on the right hand side of (12.41) contribute, the final state of the spin $\frac{1}{2}$ particle is not an eigenstate of σ_z . It is given by the right hand side of Eq. (12.40), evaluated at $q = q_0$, and properly normalized.

For future reference, let us rewrite the preceding equations in terms of density matrices, for the measurement of an arbitrary operator A , with eigenvalues λ_m (in the simple case considered above, A was σ_z and we had $\lambda_m = \pm 1$). Let ρ_{mn}

be the density matrix of the quantum system, in a representation where A is diagonal. Let $\Phi(q', q'') = \phi(q') \overline{\phi(q'')}$ be the initial density matrix of the meter. The combined density matrix is

$$\rho_{mn}(q', q'') = \rho_{mn} \Phi(q', q''). \tag{12.42}$$

The Hamiltonian (12.39) becomes $g(t)A\rho$ and, instead of (12.40), we now have

$$\rho_{mn}(q', q'') \rightarrow \rho_{mn}(q' - \lambda_m, q'' - \lambda_n). \tag{12.43}$$

This expression contains all the information about the correlated state of the quantum system and of the meter which was used for observing that system.

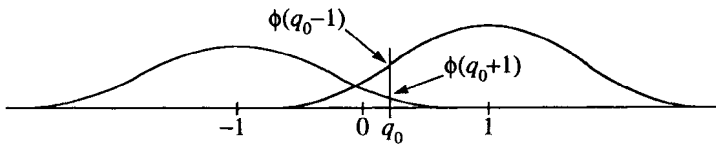

Fig. 12.3. This is the same as the final state in Fig. 12.2, except that the initial location of the meter is uncertain by more than the separation of the eigenvalues ± 1 , so that the measurement is “fuzzy.”

At this point, if we are no longer interested in the quantum system, we may trace out the indices referring to it, and get a reduced density matrix for the meter. Then, the average value of any observable function $f(\mathbf{q})$ —after completion of the interaction between the meter and the quantum system—is

$$\langle f(\mathbf{q}) \rangle = \sum_j w_j \int \Phi(q - \lambda_j, q - \lambda_j) f(q) dq, \tag{12.44}$$

where $w_j = \rho_{jj}$ is the probability of occurrence of the j th eigenstate of A , just before (and also after) the interaction. For example, if the meter is prepared in a symmetric state, $\phi(q) = \phi(-q)$, we have

$$\langle \mathbf{q} \rangle = \sum_j w_j \lambda_j, \tag{12.45}$$

and

$$\langle \mathbf{q}^2 \rangle = \sum_j w_j \left(\int q^2 |\phi(q)|^2 dq + \lambda_j^2 \right). \tag{12.46}$$

It follows that

$$\langle \mathbf{q}^2 \rangle - \langle \mathbf{q} \rangle^2 = (\Delta A)^2 + (\Delta \mathbf{q})^2, \tag{12.47}$$

where

$$(\Delta A)^2 = \sum_j w_j \lambda_j^2 - \left(\sum_j w_j \lambda_j \right)^2, \quad (12.48)$$

and

$$(\Delta q)^2 = \int q^2 |\phi(q)|^2 dq, \quad (12.49)$$

are the variances associated with the states of the quantum system and the meter, respectively.

Conversely, if we are interested in the quantum system (for later use) but not in the meter itself, the reduced density matrix ρ'_{mn} of the quantum system is obtained by tracing out q' and q'' :

$$\rho'_{mn} = \int \rho_{mn}(q - \lambda_m, q - \lambda_n) dq = \rho_{mn} S_{mn}, \quad (12.50)$$

where S_{mn} is the *coherence matrix*:¹⁶

$$S_{mn} := \int \phi(q - \lambda_m) \overline{\phi(q - \lambda_n)} dq. \quad (12.51)$$

Exercise 12.5 Show that $S_{mn} = \langle e^{i\mathbf{p}(\lambda_m - \lambda_n)/\hbar} \rangle$.

E.g., if the meter is prepared in a coherent state, $\phi(q) = (2\pi\sigma^2)^{-1/4} e^{-q^2/4\sigma^2}$, we have $\Delta q = \sigma$ and

$$S_{mn} = \exp[-(\lambda_m - \lambda_n)^2/8\sigma^2]. \quad (12.52)$$

Obviously, $S_{mm} \equiv 1$ (for any ϕ) so that the diagonal matrix elements ρ_{mm} are not affected by the measuring process. On the other hand, the off-diagonal elements of ρ are depressed by a factor S_{mn} , and may even be reduced to zero if the displaced wave packets are mutually orthogonal, as in Fig. 12.2. However, if $\Delta q \gtrsim |\lambda_n - \lambda_{n-1}|$, as in Fig. 12.3, the off-diagonal elements of ρ are not completely suppressed. In particular, if some eigenvalues are degenerate, the submatrix of ρ_{mn} corresponding to these eigenvalues is not affected at all.

Consecutive measurements

The analysis of a time-dependent signal necessitates numerous consecutive measurements¹⁷ so as to get a *sequence of numbers*, corresponding to times t_1, t_2, \dots , and so on. Note that there can be no continuous measurement, if a measurement is defined as a *brief and intense interaction* between the meter and the measured system, as in Eq. (12.39) for example. In particular, the time difference $t_k - t_{k-1}$ must be larger than the duration of $g(t)$, so that consecutive measurements do not overlap.

¹⁶ A. Peres *Phys. Rev. D* 39 (1989) 2943.

¹⁷ C. M. Caves, *Phys. Rev. D* 33 (1986) 1643; 35 (1987) 1815.

On the other hand, we may also consider measurements of finite duration, where the function $g(t)$ is spread over an appreciable time, compared to the natural time scale of the measured system. Such a measurement yields only a *single number* which corresponds, in the best case, to a time-average of the observed variable, as we shall see in Sect. 12-6. One can even consider a passive detector, for example, a Geiger counter waiting for the decay of a nucleus. Such a setup does not correspond at all to the present definition of a measurement. It is best described as a metastable system with several decay channels.¹⁸

Quantum theory does not impose any fundamental limitations to monitoring arbitrarily weak signals within arbitrarily short time intervals. Limitations arise solely because we want to use—or are forced to use—some particular detectors. For example, since gravitational radiation couples very weakly to matter, detectors must be massive antennas¹¹ or gigantic interferometers.¹⁹ It is therefore impractical to have a large number of identical gravitational wave detectors for the purpose of estimating quantum averages. We must extract as much information as possible from *each* measurement. In general, we would like the quantum evolution to mimic the classical one, and the output signal to be an amplified replica of the input. Signal distortion should be minimized. Let us examine how well these aims can be achieved.

Consider a sequence of measurements performed at times t_1, \dots, t_N , by means of meters with coordinates q_1, \dots, q_N , respectively. The initial density matrix of the detector and the meters is a generalization of (12.42):

$$\rho_{mn}(q'_1, q''_1, \dots, q'_N, q''_N) = \rho_{mn} \prod_j \Phi_j(q'_j, q''_j). \tag{12.53}$$

The Hamiltonian of the composite system is

$$H = H_0 + A \sum_j g(t - t_j) p_j, \tag{12.54}$$

with notations similar to those in Eq. (12.39). Here, H_0 involves only the dynamical variables of the detector, not those of the meters. In particular H_0 has a known functional dependence on the unknown signal. As before, there are no terms like $p_j^2/2m_j$ in the Hamiltonian: the masses of the meters are assumed so large that we can ignore the spontaneous spreading of each meter's wave packet.

In the interval between measurements, H_0 generates the unitary evolution $\rho \rightarrow U\rho U^\dagger$. On the other hand, in the immediate vicinity of each $t = t_j$, there is a transformation similar to Eq. (12.43), namely

$$\rho_{mn}(\dots, q'_j, q''_j, \dots) \rightarrow \rho_{mn}(\dots, q'_j - \lambda_m, q''_j - \lambda_n, \dots). \tag{12.55}$$

¹⁸ A. Peres, in *Information Complexity and Control in Quantum Physics*, ed. by A. Blaquièere, S. Diner and G. Lochak, Springer, Vienna (1987) p. 235.

¹⁹ A. Abramovici, W. E. Althouse, R. W. P. Drever, Y. Gürsel, S. Kawamura, F. J. Raab, D. Shoemaker, L. Sievers, R. E. Spero, K. S. Thorne, R. E. Vogt, R. Weiss, S. E. Whitcomb, and M. E. Zucker, *Science* 256 (1992) 325.

Note that the new density matrix entangles in a nontrivial way the discrete indices mn of the detector and the coordinates of the j th meter.

Equation (12.55) contains all the information about the state of the detector and the various meters. We can now ask a variety of questions. For example, if we are interested only in the detector, not in the meters that have already interacted with it, the net result of a measurement is given by Eq. (12.50):

$$\rho_{mn} \rightarrow \rho'_{mn} = \rho_{mn} S_{mn}. \quad (12.56)$$

After that, the following meter, if observed, will give results similar to those in Eqs. (12.45) and (12.46), with

$$w_j = \sum_{mn} U_{jm} \rho'_{mn} \overline{U_{jn}}, \quad (12.57)$$

where U is the unitary matrix representing the free evolution of the detector since the preceding measurement, which left the detector in state ρ'_{mn} .

We may also be interested in comparing the readings of different meters. For example, if there are N consecutive measurements, we may want to predict the expected $\langle (\mathbf{q}_1 - \mathbf{q}_N)^2 \rangle$, regardless of the results obtained at t_2, \dots, t_{N-1} . As before, let ρ_{mn} be the density matrix of the detector just before the first measurement. The latter generates the transformation

$$\rho_{mn} \Phi_1(q'_1, q''_1) \rightarrow \rho_{mn} \Phi_1(q'_1 - \lambda_m, q''_1 - \lambda_n) \equiv \rho_{mn}^{(1)}(q'_1, q''_1). \quad (12.58)$$

The q_j referring to subsequent measurements have been omitted in (12.58), for brevity. Between the first and second measurements, there is again a unitary evolution, $\rho^{(1)} \rightarrow \rho^{(2)} = U^{(1)} \rho^{(1)} U^{(1)\dagger}$, so that, just before t_2 , we have

$$\rho_{rs}^{(2)}(q'_1, q''_1) = \sum_{mn} U_{rm}^{(1)} \overline{U_{sn}^{(1)}} \rho_{mn}^{(1)}(q'_1, q''_1). \quad (12.59)$$

We now perform the second measurement. Since its result is not needed in the calculation of $\langle (\mathbf{q}_1 - \mathbf{q}_N)^2 \rangle$, which is the expression that we want to evaluate, we trace out q'_2 and q''_2 in the density matrix. According to Eq. (12.50), this leads to a reduction of the off-diagonal elements, $\rho_{rs}^{(2)} \rightarrow \rho_{rs}^{(2)} S_{rs}$. Further consecutive measurements can be treated in the same way.

12-5. Quantum Zeno effect

We shall now consider the special case where the measurements are *sharp* (as in Fig. 12.2) so that $S_{rs} = \delta_{rs}$. Returning to Eq. (12.59), we have, immediately after t_2 , a density matrix which contains only the diagonal elements $\rho_{rr}^{(2)}$ given by that equation. Then, between the second and the third measurement, there is another unitary evolution, $\rho^{(2)} \rightarrow \rho^{(3)} = U^{(2)} \rho^{(2)} U^{(2)\dagger}$, with result

$$\rho_{st}^{(3)}(q'_1, q''_1) = \sum_r U_{sr}^{(2)} \overline{U_{tr}^{(2)}} \rho_{rr}^{(2)}(q'_1, q''_1). \tag{12.60}$$

Again, the third measurement is sharp and only the diagonal elements survive. These are

$$\rho_{ss}^{(3)}(q'_1, q''_1) = \sum_r V_{sr}^{(2)} \rho_{rr}^{(2)}(q'_1, q''_1), \tag{12.61}$$

where

$$V_{sr}^{(2)} := |U_{sr}^{(2)}|^2. \tag{12.62}$$

The general rule is obvious. We repeat the same process at t_4, \dots, t_{N-1} , and each time we trace out the intermediate q_j which are not needed for obtaining the value of $\langle (\mathbf{q}_1 - \mathbf{q}_N)^2 \rangle$. After the measurement at t_{N-1} we thus have a diagonal density matrix with elements

$$\rho_{xx}^{(N-1)}(q'_1, q''_1) = \sum_{wv\dots sr} V_{xw}^{(N-2)} V_{wv}^{(N-3)} \dots V_{ts}^{(3)} V_{sr}^{(2)} \rho_{rr}^{(2)}(q'_1, q''_1). \tag{12.63}$$

Then, finally, the N th measurement gives

$$\rho_{zy}^{(N)}(q'_1, q''_1; q'_N, q''_N) = \sum_x U_{zx}^{(N-1)} \overline{U_{yx}^{(N-1)}} \rho_{xx}^{(N-1)}(q'_1, q''_1) \Phi_N(q'_N - \lambda_z, q''_N - \lambda_y).$$

Since we are interested in $\langle (\mathbf{q}_1 - \mathbf{q}_N)^2 \rangle$, we need only the reduced density matrix involving q_1 and q_N , with the detector's indices traced out. This is

$$\rho(q'_1, q''_1; q'_N, q''_N) = \sum_{zr} W_{zr} \rho_{rr}^{(2)}(q'_1, q''_1) \Phi_N(q'_N - \lambda_z, q''_N - \lambda_z), \tag{12.64}$$

where

$$W_{zr} := \sum_{x\dots s} V_{zx}^{(N-1)} V_{xw}^{(N-2)} \dots V_{ts}^{(3)} V_{sr}^{(2)}, \tag{12.65}$$

and

$$\rho_{rr}^{(2)}(q'_1, q''_1) = \sum_{mn} \overline{U_{rn}^{(1)}} U_{rm}^{(1)} \rho_{mn} \Phi_1(q'_1 - \lambda_m, q''_1 - \lambda_n). \tag{12.66}$$

Here, we may be tempted to increase N , the number of steps, so as to make the time intervals very short and have a quasi-continuous monitoring. However, as we shall presently see, this would lead to a complete *loss* of information. Consider in particular the case where the measurements are equally spaced, at intervals $\tau = (t_N - t_1)/(N - 1)$, and let $N \rightarrow \infty$ while $T = t_N - t_1$ is kept fixed. Let

$$\mathbf{h} := \int_{t_n}^{t_n+\tau} \mathbf{H}(t) dt. \tag{12.67}$$

We then have, in the short time interval τ ,

$$U = e^{-i\mathbf{h}} = \mathbb{1} - i\mathbf{h} - \frac{1}{2}\mathbf{h}^2 + \dots, \tag{12.68}$$

whence

$$V_{sr} := |U_{sr}|^2 = \delta_{sr} - \delta_{sr} \sum_j |h_{sj}|^2 + |h_{sr}|^2 + O(\mathbf{h}^4). \tag{12.69}$$

We see that each V_{mn} in Eq. (12.65) differs from the unit matrix by terms of order $(TH/N)^2$. Since there are $N - 2$ such terms in (12.65), it follows that $W_{zr} = \delta_{zr} + O(T^2 H^2/N)$. Thus, in the limit $N \rightarrow \infty$, we can replace all the U_{mn} and V_{mn} by unit matrices, and we obtain

$$\rho(q'_1, q''_1; q'_N, q''_N) = \sum_j w_j \Phi_1(q'_1 - \lambda_j, q''_1 - \lambda_j) \Phi_N(q'_N - \lambda_j, q''_N - \lambda_j), \tag{12.70}$$

where $w_j = \rho_{jj}$, as usual. We then have, by virtue of Eqs. (12.45) and (12.46),

$$\langle (\mathbf{q}_1 - \mathbf{q}_N)^2 \rangle = (\Delta \mathbf{q}_1)^2 + (\Delta \mathbf{q}_N)^2. \tag{12.71}$$

This result depends only on the initial and final $\Delta \mathbf{q}$ of the meter, not on the dynamics of the detector which is subjected to repeated measurements. The evolution of the latter appears paralyzed by its continual interaction with the meters. This is called the *quantum Zeno effect*,^{20,21} or sometimes “quantum Zeno paradox.” It has nothing paradoxical. What happens simply is that the quantum system is overwhelmed by the meters which continually interact with it. The Zeno effect has been experimentally observed with three-level atoms, in which radiative transitions are inhibited by frequent laser pulses aimed at measuring in which level these atoms are.²²

The above derivation essentially depends on the assumption $S_{mn} = \delta_{mn}$ which results from $\Delta \mathbf{q} \ll |\lambda_j - \lambda_{j-1}|$. Meters having a coarser resolution do not completely block the detector’s motion, and τ can even be made as small as we wish,²³ provided that $\Delta \mathbf{q}$ increases as τ^{-1} . Between these two extreme regimes, it is possible to have a “partial Zeno effect,” which is also amenable to an experimental test.²⁴

²⁰ The Greek philosopher Zeno of Elea proposed the following fallacy: “So long as anything is in a space equal to itself, it is at rest. An arrow is in a space equal to itself at every moment of its flight, and therefore also during the whole of its flight. Thus the flying arrow is at rest.” [F. Cajori, *Am. Math. Mon.* 22 (1915) 1, 292].

²¹ Actually, this is only a special case of a process devised long ago by von Neumann (see ref. 14, page 385) for steering a quantum system from any given quantum state to any other given quantum state, by means of a rapid sequence of measurements.

²² W. M. Itano D. J. Heinzen, J. J. Bollinger, and D. J. Wineland, *Phys. Rev. A* 41 (1990) 2295.

²³ C. M. Caves and G. J. Milburn, *Phys. Rev. A* 36 (1987) 5543.

²⁴ A. Peres and A Ron, *Phys. Rev. A* 42 (1990) 5720.

Case study: detection of a time-dependent torque

As an example, assume that a time-dependent torque $\omega(t)$ acts on a rotor with angular momentum \mathbf{J} . We shall see, in an explicit calculation, that frequent sharp measurements block the motion of the rotor. Measurements which are less frequent, or are fuzzy, cause a partial Zeno effect, which disappears in the classical limit.

The Hamiltonian of our rotor is (in classical notations),

$$H = H_0 + \omega(t) J_y. \tag{12.72}$$

If the rotor is spherically symmetric, $H_0 = \mathbf{J}^2 / 2I$ is a constant of the motion, which can be ignored. The equations of motion (in classical or quantum theory) are

$$\dot{J}_x = J_z, \quad \dot{J}_y = 0, \quad \dot{J}_z = -J_x. \tag{12.73}$$

Their solution is

$$\begin{aligned} J_x &= J_{x0} \cos \tau + J_{z0} \sin \tau, \\ J_y &= J_{y0}, \\ J_z &= -J_{x0} \sin \tau + J_{z0} \cos \tau. \end{aligned} \tag{12.74}$$

where

$$\tau = \int_0^t \omega(t) dt. \tag{12.75}$$

Our problem is to determine $\omega(t)$ by observing the motion of \mathbf{J} . In classical physics, the initial values J_{k0} are assumed known, and continual measurements of J_x and J_z give $\tau = \tau(t)$:

$$\tau = \tan^{-1}(J_x/J_z) - \tan^{-1}(J_{x0}/J_{z0}), \tag{12.76}$$

whence we can obtain $\omega(t)$. Unfortunately, this method is not applicable to quantum systems, because J_x and J_z do not commute and Eq. (12.76) becomes meaningless. We shall now see in detail what can be done when the “rotor” is a particle of spin $\frac{1}{2}$. Thereafter, we shall consider a particle of large spin j .

The state of a spin $\frac{1}{2}$ particle can be described by a density matrix

$$\rho = \frac{1}{2} (\mathbf{1} + \mathbf{m} \cdot \boldsymbol{\sigma}), \tag{12.77}$$

where $\mathbf{m} = \langle \boldsymbol{\sigma} \rangle$. Since the equations of motion (12.74) are linear, they are satisfied by \mathbf{m} as well as by \mathbf{J} . For example, if initially $\mathbf{m} = (0,0,1)$, the motion of \mathbf{m} will stay in the xz plane. The coherence matrix S_{mn} has diagonal elements 1, and off-diagonal elements $S_{12} = S_{21} = S < 1$ (assumed real, for simplicity). Thus, in the present notation, the density matrix reduction (12.50) is simply

$$m'_x = S m_x \quad \text{and} \quad m'_z = m_z. \quad (12.78)$$

This can also be written as

$$\begin{pmatrix} m_x \\ m_z \end{pmatrix} \rightarrow \begin{pmatrix} m'_x \\ m'_z \end{pmatrix} = \begin{pmatrix} S \cos \theta & S \sin \theta \\ -\sin \theta & \cos \theta \end{pmatrix} \begin{pmatrix} m_x \\ m_z \end{pmatrix}, \quad (12.79)$$

where $\theta = \int \omega(t) dt$ during the time interval since the preceding measurement. Recall that, for a Gaussian shaped $\phi(q)$, we have $S = \exp[-1/8(\Delta q)^2]$. The extreme cases are $\Delta q \gg 1$, giving $S \simeq 1$ and therefore an unperturbed rotation of the vector \mathbf{m} (but no measurement, of course); and $\Delta q \ll 1$ (whence $S \simeq 0$) which corresponds to a sharp measurement.

Suppose that we repeatedly measure σ_z . Initially, the rotor has been set with $\langle \sigma_z \rangle = 1$. Thereafter, these measurements give us a sequence of +1 and -1, from which we have to reconstruct the function $\tau(t)$. Obviously, a spin $\frac{1}{2}$ particle is not a good torque detector—its Hilbert space is too small. On the other hand, these particles come cheap (that is, for paper-and-pencil experiments) so that we can afford to use a large number, N , of identical detectors. Let us examine the expected average, $m_z = \langle \sigma_z \rangle$, under various scenarios.

The following figures illustrate the behavior of $m_z(t)$ in the simple case where $\omega = 1$ (so that $\tau = t$) from $t = 0$ to $t = 5\pi/2$. The dotted line is $m_z = \cos t$, the undisturbed evolution for $\Delta q \gg 1$ (we would of course need many observations, namely $N \gg (\Delta q)^2$, in order to actually obtain each point of the dotted line as an average over N data). This ideal result is compared, in Fig. 12.4, to the case $S = 0$ (i.e., sharp measurements) for 10, 30, and 90 equally spaced samplings. Obviously, the more frequent the measurements, the less m_z moves (this is the Zeno effect). In every case, m_z decays exponentially—it does not oscillate as the unperturbed m_z . This can be verified by computing the eigenvalues of the matrix in Eq. (12.79). These are given by the secular equation $\lambda^2 - \lambda \cos \theta (1 + S) + S = 0$, whence

$$\lambda_{\pm} = \frac{1}{2} \left[(1 + S) \cos \theta \pm \sqrt{(1 + S)^2 \cos^2 \theta - 4S} \right]. \quad (12.80)$$

If $S = 0$, we obtain: $\lambda_+ = \cos \theta$, with eigenvector $u_+ = \begin{pmatrix} 0 \\ 1 \end{pmatrix}$ and $\lambda_- = 0$, with eigenvector $u_- = \begin{pmatrix} 1 \\ 0 \end{pmatrix}$. As we started from the initial state u_+ , the polarization vector \mathbf{m} is simply shortened by a factor $\cos \theta$ at each measurement.

When $0 < S < 1$, the eigenvalues λ_{\pm} may be real or complex conjugate, according to the sign of $(1 + S)^2 \cos^2 \theta - 4S$. We then have an exponential decay or damped oscillations.²⁵ The transition occurs at $S_{cr} = (1 - \sin \theta)/(1 + \sin \theta)$ Figure 12.5 illustrates the case $\theta = 5\pi/60$, with $S = 0.4$ and 0.9 , corresponding to $\Delta q = 0.37$ and 1.09 , respectively. For the larger Δq , the eigenvalues λ_{\pm} are complex, and m_z has damped oscillations.

The worst case scenario is a pair of consecutive measurements performed at $\tau = \pi/2$ and $\tau = \pi$, respectively, so that $\sin \theta = 1$. The result can easily

²⁵G. J. Milburn, *J. Opt. Soc. Am. B* 5 (1988) 1317.

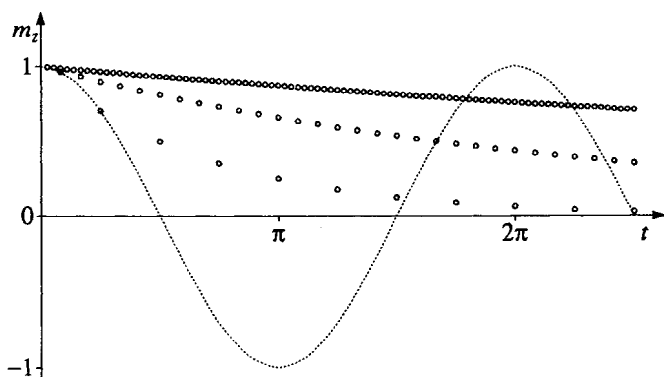

Fig. 12.4. Precession of a spin $\frac{1}{2}$ particle due to a constant torque around the y axis. Initially, $m_z := \langle \sigma_z \rangle = 1$. The dotted line corresponds to the undisturbed evolution (that is, each point represents the value of m_z which would be obtained if there were no measurement before that time). The circles represent consecutive values of m_z that are observed if *sharp* measurements are performed at intervals (from top to bottom) $5\pi/180$, $5\pi/60$, and $5\pi/20$.

be obtained in closed form and will later be compared with the one for a rotor of spin j . Using Eq. (12.79) twice, we see that after two measurements, \mathbf{m} is simply multiplied by $-S$. For very fuzzy measurements ($\Delta q \gg 1$), we have $-S \simeq -1$ and the spin is thus found *flipped* after each half period, as expected. On the other hand, for $S = 0$ (sharp measurements), \mathbf{m} is reduced to zero, and thereafter no further information is obtainable from the rotor motion.

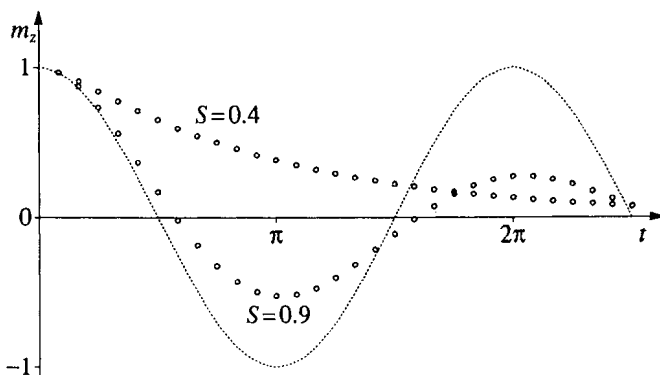

Fig. 12.5. Under the same conditions as in Fig. 12.4, each set of circles represents values of m_z that are observed if *fuzzy* measurements are performed at intervals $5\pi/60$. The coherence factors $S = 0.4$ and 0.9 correspond to $\Delta q = 0.37$ and 1.09 , respectively. The critical value of S for the onset of oscillations of m_z is $S_{cr} = 0.589$.

A rotor with spin j

Obviously, a spin $\frac{1}{2}$ particle cannot mimic the classical rotor described by Eq. (12.72). We therefore turn our attention to spin j . Let $\hbar = 1$, for brevity. We prepare the rotor in an eigenstate of J_z , with $j_z = j$. We shall consider only the “worst case scenario” mentioned above, with $\theta = \pi/2$, so that the first measurement of J_z is performed on an eigenstate of J_x with eigenvalue j .

This rotation through an angle $\theta = \pi/2$ is generated by a unitary matrix U . We have, with Wigner’s notations,²⁶

$$U_{mj} = \mathcal{D}^{(j)}(\{0 \frac{\pi}{2} 0\})_{jm} = \sqrt{(2j)!/[2^j (j+m)!(j-m)!]}. \tag{12.81}$$

The probability of getting $j_z = m$ is the square of this matrix element. This is a binomial distribution with variance $j/2$. The result is shown in Fig. 12.6, for the case $j = 32$ (the standard deviation then is $\Delta J_z = \sqrt{j/2} = 4$).

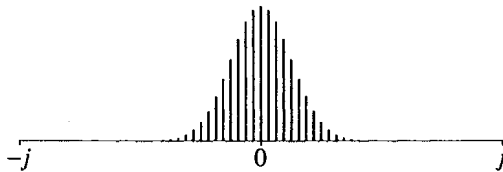

Fig. 12.6. Expected probability distribution for a measurement of J_z , after preparation of a state with $j_z = j$, and its rotation by $\pi/2$. The calculations were done for $j = 32$. The standard deviation is $\Delta J_z = 4$.

The results of further measurements depend on whether the first measurement was sharp or fuzzy. If it was sharp ($S_{mn} = \delta_{mn}$) the histogram of expected results for the second measurement (at $\theta = \pi$) is given by the diagram at the top of Fig. 12.7. The distribution is almost uniform, and very little information can be inferred from it. Better results are obtained if the first measurement was fuzzy. The subsequent diagrams of Fig. 12.7 show the distribution of results of the second measurement, as a function of the Δq of the meter which was used for the first measurement. Obviously, a very broad Δq allows the quantum state to reassemble near $j_z = -j$, which would be its value at time $t = \pi$ if the first measurement had not been performed.

On the other hand, if Δq is too broad, the “measurement” becomes useless. Obviously, the expression which should be optimized is the one in Eq. (12.47). From the example discussed above, it appears that the fuzziness of the meter should be about the same as the natural width of the detector’s wave packet. A poorer resolution gives inaccurate and useless results, but a finer resolution destroys the information in which we are interested.

²⁶ E. P. Wigner, *Group Theory*, Academic Press, New York (1959) p. 167.

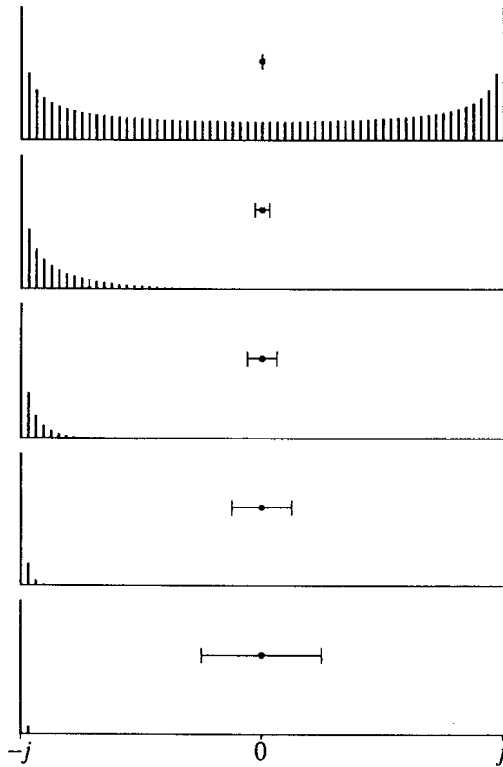

Fig. 12.7. Expected probability distributions for a second measurement of J_z , after one more rotation by $\pi/2$. The results depend on the Δq of the meter which performed the first measurement. From top to bottom, this Δq (shown as a horizontal error bar) is 0, 1, 2, 4, and 8. Different vertical scales are used in the various diagrams, for better visibility. In each diagram, the sum of lengths of the vertical bars is 1, by definition.

Exercise 12.6 Compute the data which are displayed in Fig. 12.7. You will need the rotation matrix $U = e^{-i\pi J_z/2}$. Don't use Wigner's formula²⁶ which becomes unwieldy for large j , because its result is the small difference between large terms with alternating signs. A better way of computing U is by means of the relationship $UJ_z = J_x U$, which gives a recurrence relation between adjacent elements of the matrix U in the basis where J_z is diagonal. ★★

The Zeno effect is a peculiarity of quantum physics. It disappears in the semiclassical limit, when eigenvalues become extremely dense. From the quantum point of view, *classical measurements are always fuzzy*. This is why a watched pot may boil, after all: the observer watching it does not resolve the energy levels of the pot. Any hypothetical device which would resolve these

energy levels would also radically alter the behavior of the pot. Likewise, the mere presence of a Geiger counter does not prevent a radioactive nucleus from decaying.¹⁸ The Geiger counter does not probe the energy levels of the nucleus: it interacts with its decay products whose Hamiltonian, including the kinetic energy, has a continuous spectrum. As we have already learnt when we discussed the implications of Bell's theorem (pp. 183–185), quantum effects violate our classical intuition only when our instruments can resolve individual levels.

QND measurements and QND variables

A quantum nondemolition (QND) measurement is one performed on a system which is known to be in one of the eigenstates of the measured operator. The purpose of such a measurement is to determine that eigenstate. All we have to do is to perform a maximal test, with the basis defined by that operator. If this is a repeatable test, the final state of the system is exactly the same as the initial one, hence the label “nondemolition.”

A QND *variable* (sometimes called QNDD, for “quantum nondemolition detection”¹²) is one which satisfies $[A(t), A(t')] = 0$. It is the quantum analog of a classical *robust* variable, as defined by Eq. (12.15). Such a dynamical variable can in principle be monitored continuously with arbitrary precision without disturbing its evolution. For example, if $v(t)$ is a random classical signal, and if $H = v(t)p$, then q is a QND variable, because $\dot{q} = v(t)$, so that

$$q(t) = q(0) + \int_0^t v(t') dt', \quad (12.82)$$

and $[q(t), q(t')] = 0$. Measuring q will of course disturb p , but this has no effect on the evolution of q itself. Unfortunately, the Hamiltonian $H = v(t)p$ is only a mathematical construct, with no experimental counterpart.

Notice that QND variables have a continuous spectrum. This is intuitively obvious, since they have to follow a continuous evolution, and this can also be formally proved¹⁶ from the property $[A(t), A(t')] = 0$. It is unlikely that a nontrivial QND variable can actually be realized, because of the conflicting requirements that it must satisfy: its time evolution should be sensitive to weak external signals, but on the other hand it should not be affected by the intense interaction needed for the measuring process.

12-6. Measurements of finite duration

Until now, I assumed that the interaction between the measuring instrument and the observed system was almost instantaneous. The motion of the system during that time was ignored, and the measurement was simply represented by a unitary transformation, as in Eq. (12.3). This drastic simplification is

not always justified. Coupling constants occurring in nature are finite, and sometimes very small. It may therefore be necessary to couple the system and the measuring apparatus during a finite, possibly long time. We shall now examine what happens during a measurement of finite duration.

As a first step, let us ignore the free Hamiltonians of the apparatus and of the observed system, and consider only their interaction Hamiltonian, according to the simple model in Eq. (12.39). Let the interaction start at time $t = 0$. Define an evolution parameter $l(t)$ by

$$l(t) := \int_0^t g(t') dt' / \hbar, \tag{12.83}$$

so that $l(t)$ gradually increases from 0 to its final value, 1, which is reached upon completion of the measurement. The unitary transformation (12.40) now becomes a time-dependent relationship, with $[q \pm l(t)]$ instead of $(q \pm 1)$. The wave function on its right hand side is just like the one that was sketched in Fig. 12.3. An unfinished measurement therefore is a special case of a fuzzy measurement, with a time-dependent coherence matrix: the eigenvalues λ_m in Eq. (12.51) are replaced by $\lambda_m l(t)$.

Considering again the simple case of a measurement of σ_z , the situation is described by a density matrix:

$$\rho(q', q''; t) = \begin{pmatrix} |\alpha|^2 \phi(q' - l) \overline{\phi(q'' - l)} & \alpha \bar{\beta} \phi(q' - l) \overline{\phi(q'' + l)} \\ \beta \bar{\alpha} \phi(q' + l) \overline{\phi(q'' - l)} & |\beta|^2 \phi(q' + l) \overline{\phi(q'' + l)} \end{pmatrix}, \tag{12.84}$$

where $l = l(t)$. The physical meaning of this expression is the usual one: We imagine the existence of an *ideal* instrument which can *instantaneously* perform, at time t , correlated tests on the spin $\frac{1}{2}$ particle *and* on the “pointer” which interacts with that particle. The density matrix (12.84) enables us to make statistical predictions on the outcomes of these ideal tests. We have already seen that if we completely ignore the pointer in such a correlated state, and we trace out its coordinate q , the reduced density matrix of the spin $\frac{1}{2}$ particle is given by Eq. (12.50). The only new feature now is that the coherence matrix S_{mn} depends on time while the measurement proceeds.

There is however more to be said.²⁷ For example, we may ask *pairs* of questions, such as: “What is the probability of finding the pointer in a given range, $q_1 < q < q_2$ and, *in that case*, what are the properties of the spin?” To answer these questions, we have to delete from (12.84) all the values of q outside the given range, and then to sum over q in that range:

$$\rho(q', q''; t) \rightarrow R(t) := \int_{q_1}^{q_2} \rho(q, q; t) dq. \tag{12.85}$$

²⁷A. Peres and W. K. Wootters, *Phys. Rev. D* 32 (1985) 1968.

The matrix $R(t)$ is analogous to a density matrix for the spin $\frac{1}{2}$ particle, but it is not normalized to unit trace. Rather, its trace is the probability of finding the pointer in the designated domain. The mean value of any spin variable A when the pointer is found in that domain is

$$\langle A(t) \rangle = \text{Tr}(AR) / \text{Tr} R. \quad (12.86)$$

Exercise 12.7 Show that $R(0)$ is equal to the initial density matrix of the particle, multiplied by the probability of finding the pointer between q_1 and q_2 .

Exercise 12.8 Show that if $l(t)$ has become large enough so that the wave functions $\phi(q + l)$ and $\phi(q - l)$ do not overlap, the find R matrix for $q > 0$ is

$$R = |\alpha|^2 \begin{pmatrix} 1 & 0 \\ 0 & 0 \end{pmatrix}. \quad (12.87)$$

What is the physical meaning of this equation?

Here, there should be no misunderstanding as to the nature of Eq. (12.85). The latter does *not* represent a dynamical process, and it cannot be generated by a Hamiltonian, contrary to Eq. (12.3), for example. Equation (12.85) only formalizes the arbitrary selection of a given range of pointer positions, by an external agent which is not included in the dynamical variables.

Case Study: Stern-Gerlach experiment

As a concrete example, we shall follow the continuous time evolution of a Stern-Gerlach experiment, in which a particle prepared in an eigenstate of σ_x is tested for σ_z and the result is found to be 1, say. Assume for simplicity that $g(t)$ in Eq. (12.39) is a constant, and that the initial state of the pointer is given by

$$\phi(q) = (2a)^{-1/2} \quad \text{if} \quad -a < q < a, \quad (12.88)$$

and $\phi(q) = 0$ elsewhere. The wave packets will separate, and the measurement be complete, when $l(t) = g t / \hbar \geq a$. However, we are interested in the situation at *earlier* times, when $l(t) < a$ and the two wave packets of the pointer still overlap. We ask: "What is the probability, at such a time t , of finding $q > 0$, and *in that case*, what are the properties of the spin?"

Initially, we have, with the same notations as above, $\alpha = \beta = 2^{-1/2}$. From Eqs. (12.84) and (12.85), we obtain

$$R(t) = \frac{1}{4} \begin{pmatrix} 1 + b & 1 - b \\ 1 - b & 1 - b \end{pmatrix}, \quad (12.89)$$

where $b := l(t)/a < 1$. It follows that

$$\langle \sigma_z \rangle / \langle \sigma_x \rangle = b / (1 - b) = l / (a - l). \tag{12.90}$$

Exercise 12.9 Show that the eigenvalues of $R(t)$ are

$$w_j(t) = \frac{1}{4} \left(1 \pm \sqrt{1 - 2b + 2b^2} \right), \tag{12.91}$$

and find the corresponding orthogonal eigenstates.

These results are shown in Fig. 12.8, where pairs of orthogonal eigenstates of R are represented by vectors whose lengths are proportional to the corresponding probabilities w_j . These vectors point in opposite directions, since orthogonal states in Hilbert space correspond to opposite spin polarizations. As expected, we have a continuous evolution between $\langle \sigma_x \rangle = 1$ at the beginning of the measurement, and $\langle \sigma_z \rangle = 1$ at the end of the measurement.

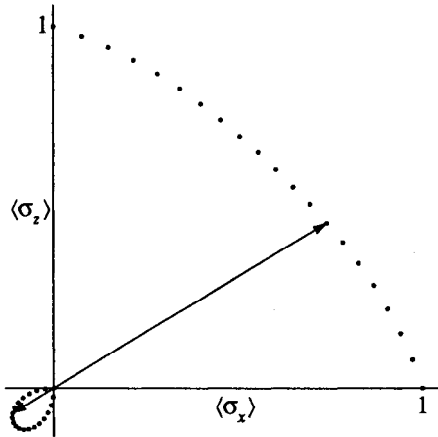

Fig. 12.8. The initial, intermediate, and final states of the spin $\frac{1}{2}$ particle, during its evolution from $\langle \sigma_x \rangle = 1$ to $\langle \sigma_z \rangle = 1$. The dots represent 20 equidistant steps. At intermediate times, we have a mixture of orthogonal spin states, shown by opposite arrows. The length of each arrow is equal to the statistical weight of the corresponding state, given by Eq. (12.91).

The time dependence in Eq. (12.90) or, implicitly, in Eq. (12.89), is not the kind of evolution that can be followed, moment by moment, for a *single* spin $\frac{1}{2}$ particle. Quantum theory is fundamentally statistical. In order to observe the time dependence illustrated by Fig. 12.8, one has to prepare a large number of particles in the given initial state, divide them into 20 subsets (with a large number of particles in each subset), and let each subset evolve for a given amount of time before observing its particles together with the corresponding pointers (there is one pointer for each particle, of course). Then, for each subset,

the *statistical* properties of the particles for which the pointer's position was found positive are correctly described by Eqs. (12.89) and (12.90).

This new way of describing a time evolution is no more or less genuine than Schrödinger's equation. In both cases, one needs to prepare a large number of identical sets in order to observe the time dependence. The only difference is that in the present example one cannot assign an evolution to a subensemble of particles until the observations "right vs left" have been made on the corresponding pointers.

Measurement of time-dependent variables

We shall now examine what happens if we attempt to measure, in a way which is not instantaneous, a dynamical variable which is not a constant of the motion. This problem is not specific to quantum theory. It may arise in everyday life, e.g., when a photographer takes a snapshot of a moving object. However, quantum theory introduces novel features, because a measurement is not only a passive observation, but also the *preparation* of a new state. In particular, we shall see that the result of such a measurement is not, in general, the time average of the observed quantity during the measurement.

In order to disentangle this problem from the preceding one, we shall now consider only measurements which have been brought to completion. As an example, we want again to measure σ_z of a spin $\frac{1}{2}$ particle, but meanwhile, the latter "wants" to precess with angular velocity 2ω around the x -axis, because its free Hamiltonian is $\hbar\omega\sigma_x$. We thus have

$$H = \hbar\omega\sigma_x + g(t)p\sigma_z. \quad (12.92)$$

Assume for simplicity that $g(t) = T^{-1}$ is constant during the interval $0 < t < T$, and vanishes at other times. The question that we address is the same as before: "Given the initial states of the particle and of the pointer, what is the probability of finding $q > 0$ at time $t = T$, and if so, what is the state of the particle?" (For $t > T$, the particle will continue to precess around the x -axis with angular velocity 2ω . This is a trivial evolution which does not concern us.)

It is convenient, for this calculation, to use the momentum representation defined by Eq. (10.54) for the state of the pointer. The operator p then becomes a c -number, p , and the evolution of the composite system, for $0 < t < T$, is given by the unitary operator

$$U(p) = e^{-i \int H dt/\hbar} = e^{-it[\omega\sigma_x + (p\sigma_z/\hbar T)]}. \quad (12.93)$$

For any value of p , this is simply a precession with constant angular velocity $(2\omega, 0, 2p/\hbar T)$. Note, however, that the value of p is not sharp, because $\phi(q)$ ought to be a narrow wave packet, and therefore $\tilde{\phi}(p)$ is broad and different components of the state vector precess with different angular velocities. The narrower the wave packet is in q -space, the larger the values of p which are

involved. In particular, if $\Delta q \ll 1/\omega T$, most of the wave function has $p \gg \hbar\omega T$ so that the precession axis is nearly aligned with the z -axis. In that case, a detailed calculation²⁷ shows that the free precession generated by $\omega\sigma_x$ is nearly stopped, even if T is large so that the coupling constant g is small (this includes the case $\omega T > 2\pi$). If we write the initial wave function as the sum of two components with definite σ_z , these components retain nearly constant amplitudes. This is just another example of the Zeno effect: the free part of the Hamiltonian, $\hbar\omega\sigma_x$, is overwhelmed by the interaction term $gp\sigma_z$.

Exercise 12.10 Write the q -representation of $U(p)$, and obtain the final wave function, for $t = T$, in q -space. ★★

The answer to this exercise is a linear but nonlocal transformation,²⁷ with a kernel $K(q - q')$ which has singularities at $q = q' \pm 1$, and continuous complex values between these two limits. Intuitively, this can be interpreted as follows: The pointer ought to move to the right or left, depending on whether $\sigma_z = 1$ or -1 . But σ_z is not constant. A state with $\sigma_z = \pm 1$ will acquire components with $\sigma_z = \mp 1$, because of the precession $\omega\sigma_x$. This causes the pointer to zigzag, and its final possible positions are not concentrated at $q = \pm 1$, but spread continuously between -1 and 1 .

For a given final position of the pointer, what is the state of the spin? Ideally, we would want to have $\sigma_z = 1$ if $q > 0$, and $\sigma_z = -1$ if $q < 0$. Actually, the spin state is given by the reduced density matrix $R(T)$, as explained above. Since the latter involves a nonlocal kernel, the particle is in a mixture of states with opposite spins. In particular, if we are using this imperfect apparatus to prepare two beams of particles with opposite polarizations, each one of these beams will be contaminated with particles of the wrong polarization.

These results are radically different from what could be expected on purely classical grounds, where an apparatus sensitive to σ_z would simply give the time average of σ_z from $t = 0$ to $t = T$. In the quantum case, such a time average cannot be directly measured with the simple apparatus described above, with constant $g(t)$. More sophisticated methods are however available, if we know in principle the law of motion of the measured system, and our only task is to determine an unknown numerical parameter in that law. It is then possible to tailor a time-dependent interaction Hamiltonian in such a way that, after a prescribed time, the position of a pointer will be correlated with the unknown value of that numerical parameter. Unfortunately, no general recipe is available, and each case must be treated *ad hoc*.

12-7. The measurement of time

The measurement of time is different from that of quantities like position, momentum, energy, etc., because *time is not a dynamical variable*. For example, a classical particle may have a well defined position, an energy, and so on, but

we cannot say that “a particle has a well defined time.” Formally, the Poisson bracket (in classical mechanics) or commutator (in quantum theory) of t with any dynamical variable is always zero.

What we call the measurement of time actually is the observation of some dynamical variable, the law of motion of which is known (and is usually uniform, like the motion of a pointer on a clock dial). For example, if we observe a free particle with classical Hamiltonian $H = p^2/2m$, the expression $T = m q/p$ satisfies $[T, H]_{\text{PB}} = 1$, and can therefore be considered as a “realization of time” (for that particular Hamiltonian).

Exercise 12.11 Show that the operator (in momentum representation)

$$\mathbb{T} = \frac{i\hbar m}{2} \left(\frac{1}{p} \frac{\partial}{\partial p} + \frac{\partial}{\partial p} \frac{1}{p} \right), \quad (12.94)$$

satisfies the commutation relation $[\mathbb{T}, H] = i\hbar$, and that the formal solution of $\mathbb{T}\psi = t\psi$ is $\psi \sim \sqrt{p} e^{-ip^2 t/2m\hbar}$.

No simple physical meaning can be attributed to the results of the above exercise. If you want to try another exercise, take, instead of a free particle, a harmonic oscillator with $H = \frac{1}{2}(p^2 + q^2)$. The result is even worse! In classical mechanics, you can define $T = \tan^{-1}(q/p)$, which is multiple valued, just like the hour on an ordinary watch. But there is no such thing as a “multiple valued operator” in a correctly defined Hilbert space.

Larmor clock

A simple quantum clock²⁸⁻³⁰ can be produced by using the finite-dimensional quantum dial discussed on page 320 as a basis for quantizing the continuous rotor clock that was introduced in Sect. 12-2. The clock’s Hamiltonian is

$$H_c = \omega J = -i\hbar\omega \partial/\partial q. \quad (12.95)$$

Its eigenstates u_m are, in the q -representation, $e^{imq}/\sqrt{2\pi}$, with $m = -j, \dots, j$. The complementary basis is

$$v_\mu := N^{-1/2} \sum_{m=-j}^j e^{-2\pi i\mu m/N} u_m \quad (\mu = -j, \dots, j). \quad (10.89)$$

where $N = 2j + 1$. The vectors v_μ are called *dial states*.

The clock has a time resolution

$$\tau = 2\pi/N\omega, \quad (12.96)$$

²⁸H. Salecker and E. P. Wigner, *Phys. Rev.* 109 (1958) 571.

²⁹M. Büttiker, *Phys. Rev. B* 27 (1983) 6178.

³⁰J. P. Falck and E.H.Hauge, *Phys. Rev. B* 38 (1988) 3287.

as may be seen from

$$e^{-iH_c\tau/\hbar} \mathbf{v}_k = \mathbf{v}_{k+1(\text{mod } N)}. \tag{12.97}$$

If the clock is prepared in the dial state \mathbf{v}_0 , it will successively pass through the orthogonal states $\mathbf{v}_1, \mathbf{v}_2, \dots$, at time intervals τ . It is thus possible to define a *clock-time operator* as in Exercise 10.21 (which you should solve now, if you haven't yet done that):

$$T_c = (2\pi/N\omega) \sum_{\mu} \mu \mathbf{v}_{\mu} \mathbf{v}_{\mu}^{\dagger}. \tag{12.98}$$

Naturally, the finite-dimensional Hamiltonian and clock-time operators cannot satisfy $[T_c, H_c] = i\hbar$.

Let us examine the energetics of our clock. The clock-time eigenstates \mathbf{v}_{μ} have $\langle H_c \rangle = 0$ and

$$\langle H_c^2 \rangle = |H_c \mathbf{v}_{\mu}|^2 = (\hbar^2 \omega^2 / N) \sum \mu^2 = \hbar^2 \omega^2 j(j+1)/3. \tag{12.99}$$

We see that, for large j , the energy spread,

$$\Delta H_c \simeq j\hbar\omega/\sqrt{3} \simeq (\pi/\sqrt{3})(\hbar/\tau), \tag{12.100}$$

is almost as large as the maximum available energy $j\hbar\omega$. Therefore our clock is an essentially nonclassical object. This will be reflected in its interaction with other objects, as we shall soon see.

We already found, when we discussed the properties of the quantum dial, that no *local* function of \mathbf{q} , except $f(\mathbf{q}) = \text{const.}$, was an operator. Conversely, any nontrivial matrix A_{mn} in our N -dimensional Hilbert space becomes a nonlocal function, $A(q', q'')$, in the q -representation. *Nonlocality in time* is an essential feature of finite-dimensional quantum clocks. For example, such a clock is unable to turn an interaction on and off at precise times, as we had assumed possible in our previous measurements models.

Exercise 12.12 Find the q -representation of the matrix $A_{mn} = 1, \forall m, n. \star$

It is possible to construct more classical clocks, with $\Delta H_c \ll \langle H_c \rangle_{\text{max}}$, by using a Hilbert space with many more states than the minimum needed for the required time resolution τ . For example, consider $\psi = A e^{M^2 \cos(q-q_0)}$, where M is a large number and A is a normalization constant. The angular resolution is $\Delta q \simeq M^{-1}$ so that there are about $2\pi M$ distinct "pointer states." But a good representation of this ψ by a Fourier series necessitates about $2M^2$ terms, as can be seen by Fourier-transforming ψ . Not only are we "wasting" most of our Hilbert space, but the energy spread, which is of order $2M^2\hbar\omega \simeq 2M\hbar\omega/\Delta q$, is much higher than the one for a Larmor clock with the same accuracy Δq . Therefore this "classical" clock may cause an even larger disturbance to the quantum system with which it interacts.

Time-of-flight measurement

A quantum clock can be used for measuring the time of passage of a particle between two detectors, by coupling that clock to the translational degree of freedom of the moving particle. In particular, the clock can keep a permanent record of the time of flight, which can be read long after the process has been completed, as we shall now see.

The simplest way of achieving this is to have the movement of the clock activated when the particle passes through the first detector, and stopped when it passes through the second one. Let x_1 and x_2 be the positions of these detectors, and \mathbf{x} be the position operator of the particle (recall that q is the pointer position on the clock dial). Define, in the x -representation, a projector

$$P(x) = \begin{cases} 1 & \text{if } x_1 < x < x_2, \\ 0 & \text{otherwise.} \end{cases} \quad (12.101)$$

A suitable Hamiltonian for the particle (mass m) and the clock is

$$H = (\mathbf{p}^2/2m) + P(\mathbf{x}) \otimes H_c, \quad (12.102)$$

so that the clock runs only when the particle is located between the detectors. Both H and H_c are constants of the motion. The initial state of the clock is the dial state $\mathbf{v}_0 = \sum \mathbf{u}_n/\sqrt{N}$. However, it is easier to solve the equations of motion if the clock is in an eigenstate of H_c , say \mathbf{u}_n , and then to sum the solutions for all n , so as to get the solution corresponding to the initial state \mathbf{v}_0 .

If the state of the clock is \mathbf{u}_n , the operator H_c can be replaced by the numerical constant $n\hbar\omega$, and the Hamiltonian (12.102) simply represents a particle of mass m with a potential barrier of height $V = n\hbar\omega$ and length $L = x_2 - x_1$. Outside the barrier, the wave number is $k = (2mE)^{1/2}/\hbar$, where $E = \mathbf{p}^2/2m$ is the constant value of H . Inside, it is $k' = [2m(E - V)]^{1/2}/\hbar$. Therefore the phase shift caused by the barrier is

$$(k' - k)L \simeq -n\omega L/(2E/m)^{1/2}, \quad (12.103)$$

where the right hand side is an approximation valid for $|V| \ll E$. Note that $v = (2E/m)^{1/2}$ is the classical velocity of the particle, so that L/v is the classical time of flight T . Thus, if the incoming wave function (before the barrier) is

$$e^{ikx} \mathbf{v}_0 = e^{ikx} \sum_n \mathbf{u}_n/\sqrt{N}, \quad (12.104)$$

the outgoing wave function (after the barrier) is

$$e^{ikx} \sum_n e^{-in\omega T} \mathbf{u}_n/\sqrt{N} = e^{ikx} \sum_n e^{in(q-\omega T)/(2\pi N)^{1/2}}. \quad (12.105)$$

The pointer, which was initially directed toward $q \simeq 0$, ends up oriented toward $q \simeq \omega T$. It correctly indicates the time of flight between the detectors.

It is remarkable that this derivation never assumed that the particle was constrained to stay in a wave packet much smaller than L , or in general that it passed through each detector at a definite time. We wanted to measure only the time *interval* between the two detectors. The latter is perfectly well defined by the initial momentum $p = \hbar k$, even though the times of passage through each detector are completely uncertain.

Our only assumption was that $|V| \ll E$, so that the disturbance caused by the measurement is small. Since $|V|$ can be as large as $j\hbar\omega \simeq \pi\hbar/\tau$, it follows that $\tau \gg \hbar/E$. This imposes a lower limit on the time resolution of the clock, which in turn causes a limitation of the accuracy with which the particle velocity can be measured over a distance L :

$$\Delta v \simeq \tau v^2/L \gg \hbar/mL, \tag{12.106}$$

which can also be written as $\Delta p \gg \hbar/L$. This result should not be construed as another Heisenberg uncertainty relation. It rather is an inherent limitation of our time-of-flight method for measuring the velocity of a particle. It is of course quite possible to measure p with arbitrary accuracy by other methods.

When did the atom decay?

When did Schrödinger’s cat die? Instead of the legendary cat, consider a quantum clock which runs as long as the radioactive atom has not decayed. The question becomes: When did the clock stop?

Let us compute the location of its pointer when $t \rightarrow \infty$. As the Hamiltonian, take

$$H = H_a + P_0 H_c, \tag{12.107}$$

where H_a is the Hamiltonian of the radioactive atom, P_0 is the projector on the atom’s initial state ϕ_0 , and $H_c = \hbar\omega J$, as before. We split $H_a = H_0 + V$, where H_0 has both a *discrete* spectrum (and in particular it has an eigenstate ϕ_0 corresponding to the energy E_0) and a *continuous* spectrum in a domain which includes E_0 . For example, ϕ_0 may be an excited state of the atom, while the continuous spectrum corresponds to its ground state accompanied by one or more photons of arbitrary energy. To simplify the discussion, let us assume for a moment that the atom is enclosed in a large box, so that the continuous spectrum becomes discrete and consists of normalizable states ϕ_E , with a coarse grained density ρ_E . All these states are mutually orthogonal.

A further simplification of our model is to assume that the only nonvanishing matrix elements of V are

$$\langle \phi_E, V \phi_0 \rangle = \overline{\langle \phi_0, V \phi_E \rangle}, \tag{12.108}$$

and that these matrix elements have a slow dependence on E . Under these assumptions, it can be shown³¹ that, in the wave function

$$\psi = a_0(t) \phi_0 e^{-iE_0 t/\hbar} + \sum_E a_E(t) \phi_E e^{-iEt/\hbar}, \quad (12.109)$$

the coefficient of the initial state ϕ_0 decays in an *approximately* exponential way: $a_0 \simeq e^{-\gamma t/\hbar}$. Substitution of this result in Schrödinger's equation

$$i\hbar \frac{da_E}{dt} = \langle \phi_E, \mathbf{V} \phi_0 \rangle a_0 e^{i(E-E_0)t/\hbar}, \quad (12.110)$$

gives $a_E(t)$ explicitly. In particular, for $t \rightarrow \infty$, we have

$$a_E \rightarrow \langle \phi_E, \mathbf{V} \phi_0 \rangle / (E - E_0 + i\gamma), \quad (12.111)$$

so that

$$\psi(t) \rightarrow \sum_E \langle \phi_E, \mathbf{V} \phi_0 \rangle \phi_E e^{-iEt/\hbar} / (E - E_0 + i\gamma). \quad (12.112)$$

Conservation of the norm (namely, $\langle \psi, \psi \rangle = 1$) implies that

$$\sum_E |\langle \phi_E, \mathbf{V} \phi_0 \rangle|^2 / [(E - E_0)^2 + \gamma^2] = 1, \quad (12.113)$$

from which we shall now obtain the actual value of γ .

First, we must examine how the above infinite sums behave when the volume of the box, which we shall denote as Ω , increases to infinity. If the normalized eigenfunctions ϕ_E are not localized, their amplitude behaves as $\Omega^{-1/2}$. This also is therefore the behavior of $\langle \phi_E, \mathbf{V} \phi_0 \rangle$, if the initial wave function ϕ_0 is localized. The expression $V(E) := \Omega^{1/2} \langle \phi_E, \mathbf{V} \phi_0 \rangle$ thus tends to a limit (a smooth function of E) as $\Omega \rightarrow \infty$. Likewise, the density of states $\rho(E) := \rho_E / \Omega$ tends to a smooth limit. We can therefore rewrite Eq. (12.113) as

$$\int \frac{|V(E)|^2}{(E - E_0)^2 + \gamma^2} \rho(E) dE = 1. \quad (12.114)$$

Thus, since the functions $\rho(E)$ and $V(E)$ are almost constant over a domain much larger than γ , it follows from (12.114) that

$$\gamma = \pi \rho(E_0) |V(E_0)|^2, \quad (12.115)$$

which is Fermi's golden rule.

Let us now couple our atom to a clock, as in Eq. (12.107). The clock's initial state is $\mathbf{v}_0 = \sum \mathbf{u}_n / \sqrt{N}$, but we shall again solve the problem for a clock in an eigenstate \mathbf{u}_n , so that H_c can be replaced by the numerical constant $n\hbar\omega$. The only change in the Hamiltonian \mathbf{H} is that the energy of the initial state ϕ_0 has been shifted from E_0 to $E_0 + n\hbar\omega$. This may modify the value of γ in (12.115), but the new decay constant will still be very close to the old one, as long as

³¹A. Peres, *Ann. Phys. (NY)* 129 (1980) 33.

$$j \hbar \omega \left| \frac{d\rho(E_0) |V(E_0)|^2}{dE_0} \right| \ll \rho(E_0) |V(E_0)|^2. \quad (12.116)$$

We again obtained a lower limit on the time resolution of the clock:

$$\tau \gg \hbar \left| d[\log \rho(E_0) |V(E_0)|^2] / dE_0 \right|. \quad (12.117)$$

A time resolution which is finer than this expression will alter the decay law (and in the limit $\tau \rightarrow 0$, a Zeno effect will occur, of course).

In what follows, it will be assumed that we have kept the clock energy low enough, and therefore the time resolution poor enough, so that the inequality (12.117) is fulfilled and the decay law is not appreciably affected by the clock. For $t \rightarrow \infty$, the combined state of the atom and the clock is given by Eq. (12.112) with $E_0 \rightarrow E_0 + n\hbar\omega$:

$$\psi = N^{-1/2} \sum_n u_n \sum_E \langle \phi_E, \mathbf{V} \phi_0 \rangle \phi_E e^{-iEt/\hbar} / (E - E_0 - n\hbar\omega + i\gamma). \quad (12.118)$$

We are now going to observe the clock, but not the decay products of the atom. Therefore the state of the clock (more precisely, the statistical properties of an ensemble of clocks which have been subjected to the same experiment) is represented by the reduced density matrix obtained from the state (12.118) by tracing out the degrees of freedom of the atom:

$$\rho_{mn} = \sum_E \langle u_m \otimes \phi_E, \psi \rangle \langle \psi, u_n \otimes \phi_E \rangle. \quad (12.119)$$

In this partial trace, we pass to the continuum limit:

$$\sum_E |\langle \phi_E, \mathbf{V} \phi_0 \rangle|^2 \dots \rightarrow \int |V(E)|^2 \dots \rho(E) dE. \quad (12.120)$$

This gives

$$\rho_{mn} = \frac{1}{N} \int \frac{|V(E)|^2 \rho(E)}{(E - E_0 - m\hbar\omega + i\gamma)(E - E_0 - n\hbar\omega - i\gamma)} dE. \quad (12.121)$$

Both functions in the numerator were assumed very smooth, and their product can therefore be replaced by the constant γ/π , defined in Eq. (12.115). We can then safely extend the integration limits to $\pm\infty$. We obtain

$$\rho_{mn} = N^{-1} \sum [1 + i\alpha(n - m)]^{-1}, \quad (12.122)$$

where $\alpha = \hbar\omega/2\gamma$ is the angle through which the pointer of a classical clock would turn during the average atom lifetime, $\hbar/2\gamma$.

We can now compute the probability for finding a clock stopped at time $t_\mu := \mu\tau = 2\pi\mu/N\omega$. This probability is $p_\mu = \langle \mathbf{v}_\mu, \rho \mathbf{v}_\mu \rangle$, or

$$p_\mu = \frac{1}{N} \sum_{mn} \frac{\langle \mathbf{v}_\mu, \mathbf{u}_n \rangle \langle \mathbf{u}_m, \mathbf{v}_\mu \rangle}{1 + i\alpha(n - m)} = \frac{1}{N^2} \sum_{mn} \frac{e^{2\pi i \mu(n-m)/N}}{1 + i\alpha(n - m)}. \tag{12.123}$$

This double sum can be evaluated explicitly³² and gives, for large N ,

$$p_\mu \rightarrow N^{-1} \sum_{k=-2j}^{2j} e^{2\pi i k \mu/N} / (1 + ik\alpha). \tag{12.124}$$

Exercise 12.13 Let $\theta = 2\pi\mu/N$ be the angle on the dial that corresponds to time t_μ . If $\mu < 0$, redefine $\mu \rightarrow \mu + N$, so that $0 \leq \theta < 2\pi$. Show that the right hand side of Eq. (12.124) is the Fourier series expansion of

$$\frac{2\pi e^{-\theta/\alpha}}{N\alpha(1 - e^{-2\pi/\alpha})} = \frac{2\pi}{N\alpha} [e^{-\theta/\alpha} + e^{-(\theta+2\pi)/\alpha} + e^{-(\theta+4\pi)/\alpha} + \dots]. \tag{12.125}$$

We see from this exercise that the clocks stop (the atoms decay, the cats die) at times distributed according to the familiar exponential decay law, with due account taken of the fact that a clock may run through more than one cycle before stopping. Quantum theory, which makes only statistical predictions, is of course unable to specify when an individual atom will decay, or an individual cat will die.

Switching interactions on and off

A clock can be used not only to measure, but also to control the duration of a physical process. We shall now see how an interaction can be switched on at a preset time t_a , and then switched off at time t_b . For instance, this interaction may involve a magnetic field which causes the precession of a spin $\frac{1}{2}$ particle. The problem is to write a *time-independent* Hamiltonian, such that the precession angle increases linearly between t_a and t_b .

Various models can be devised, which have that effect. If we still want to use a Larmor clock, we may write

$$H = H_c + \frac{1}{2} \hbar \Omega \sigma_z \otimes (\mathbf{v}_a \mathbf{v}_a^\dagger + \mathbf{v}_{a+1} \mathbf{v}_{a+1}^\dagger + \dots + \mathbf{v}_b \mathbf{v}_b^\dagger), \tag{12.126}$$

where Ω denotes the spin precession velocity. As usual, the translational degrees of freedom of the spinning particle have been ignored. Following the same technique as before, we take initial states which are eigenstates of the constant of motion σ_z . We can then replace, in Eq. (12.126), the operator σ_z by ± 1 , and thereby obtain an expression which involves only the clock. On the other hand, H_c is *not* a constant of the motion, because it does not commute with the projectors $\mathbf{v}_\mu \mathbf{v}_\mu^\dagger$. We see that using a clock to control a process perturbs the clock mechanism! Are you surprised?

The equations of motion of the clock can be solved by perturbation theory. The calculations are fairly intricate³² and will not be reproduced here. The end result is that the precession angle is approximately given by the ramp function

³²A. Peres, *Am. J. Phys.* 48 (1980) 552.

$$\begin{array}{ll}
 0 & \text{for } t < t_a, \\
 \Omega(t - t_a) & \text{for } t_a < t < t_b, \\
 \Omega(t_b - t_a) & \text{for } t > t_b.
 \end{array} \tag{12.127}$$

This is the desired result. It was obtained by using the *time-independent* Hamiltonian (12.126). The approximations that are needed for the derivation of this result are $j \gg 1$ (which is necessary for making a good clock) and $\Omega\tau \ll 1$, which means that the clock's time resolution is much finer than the precession period—a physically obvious requirement.³²

Another, more realistic model for switching on and off a magnetic field is to use as our clock the *translational* degree of freedom of the spin $\frac{1}{2}$ particle, which simply enters into a magnet at time t_a , and exits at time t_b . The Hamiltonian describing this model is similar to the one that was used for the time-of-flight measurement:

$$H = (\mathbf{p}^2/2m) + P(\mathbf{x}) \otimes \frac{1}{2} \hbar \Omega \sigma_z. \tag{12.128}$$

Comparing this with Eq. (12.102), we see that the spin and position degrees of freedom have exchanged their roles. The solution of the equations of motion is the same, of course (in the present case, $j = \frac{1}{2}$).

Exercise 12.14 Show that the condition $|V| \ll E$ that was necessary for the time-of-flight measurement becomes now

$$kL \gg \Omega(t_b - t_a), \tag{12.129}$$

where $k = p/\hbar$ and L is the length of the magnet. What is the physical meaning of this condition?

12-8. Time and energy complementarity

It is well known that time and frequency are conjugate variables in a pair of Fourier transforms. As a consequence, the duration of a signal (a musical note, say) and the frequency of that signal (the pitch of the note) are subject to an unsharpness relation, $\Delta t \Delta \omega \geq \frac{1}{2}$. This property, illustrated in Plate III (page 214), is purely classical.

In quantum theory, frequency means energy. You find, in some textbooks and articles, an uncertainty relation $\Delta t \Delta E \geq \hbar/2$, or, even worse, a “relativistic” generalization:

$$\Delta x^\mu \Delta p_\nu \geq \frac{1}{2} \hbar \delta_\nu^\mu. \quad (?) \tag{12.130}$$

What can be the meaning of such a relation? In conventional quantum theory, the statement $\Delta q \Delta p \geq \hbar/2$ means that if we measure q on an ensemble of particles, and p on another identically prepared ensemble, the product of the standard deviations of the results of these measurements is at least $\hbar/2$. If we try to interpret (12.130) in the same way, we are faced with two difficulties: It is in general wrong that $\Delta x \Delta H = 0$, since x is not a constant of the motion; and the expression Δt is undefined, because there is no t operator, and no meaning can be given to "measuring the time of a physical system," in the same way as we measure its position, or momentum, etc.

Another claim which frequently appears in the literature is the following: If δt is the duration of the measurement of an energy, the result is uncertain by $\Delta E \geq \frac{1}{2} \hbar / \delta t$. This claim is absurd. It is analogous to saying that if we measure a momentum with an apparatus of size δx , the momentum uncertainty is $\Delta p \geq \frac{1}{2} \hbar / \delta x$. This is manifestly wrong: a mundane radio receiver whose size is only a few centimeters can determine the wavelength of a radio station with an accuracy $\Delta \lambda / \lambda \ll 1$. In other words, it measures the momentum of the photons emitted by that station with an accuracy

$$\Delta p \ll \hbar / \lambda \ll \hbar / \delta x. \quad (12.131)$$

Still another claim, illustrated in Plate I (page 2), is that the time (registered by a clock) at which an energy is measured with an accuracy ΔE , is uncertain by at least $\hbar / \Delta E$. This already sounds better, because we have defined a clock-time operator T_c , and we can therefore investigate the possible existence of an uncertainty relation between ΔT_c and ΔH . However, there is no reason to expect that there actually is such an uncertainty relation, because the operator T_c refers to the clock, and the operator H to the observed system. These two operators commute, and quantum theory allows us, in principle, to measure both of them simultaneously with arbitrary accuracy. The analogy with a radio receiver can again be used: its position can be accurately determined while it measures the momentum of the photons emitted by the radio station, in such a way that Eq. (12.131) is easily satisfied.

These issues were not understood in the early years of quantum theory. It is only at much later stage that they were thoroughly analyzed by Aharonov and Bohm,³³ who came to the conclusion that "there is no reason inherent in the principles of quantum theory why the energy of a system cannot be measured in as short a time as we please." To support their claim, Aharonov and Bohm constructed a model Hamiltonian, involving two particles (the "system" and the "apparatus"), such that the apparatus could perform a *repeatable* measurement of the energy of the system in an arbitrary short time.

These conclusions were criticized by Fock,³⁴ on the grounds that the Hamiltonian used by Aharonov and Bohm contained an arbitrarily sharp function of time, $g(t)$, for switching on and off the interaction. Fock wrote:

³³Y. Aharonov and D. Bohm, *Phys. Rev.* 122 (1961) 1649.

³⁴V. A. Fock, *J. Exp. Theor. Phys. (U.S.S.R.)* 42 (1962) 1135 [transl.: *Soviet Phys. JETP* 15 (1962) 784].

The introduction of an explicitly time-dependent interaction is equivalent to the introduction of a field which can be described classically (in the correspondence principle sense). However, the classical fields and test bodies used in the equations of quantum mechanics are not free of the limitations imposed by the Heisenberg uncertainty relations. On the contrary, the use of classical fields and test bodies is based on the premise that the uncertainty relations are satisfied for them so strongly [i.e., $\Delta q \Delta p \gg \hbar$] that it is unnecessary to introduce these relations explicitly. If however it is (illegimately) assumed that the classical field or test particle may violate the Heisenberg relations, it should come as no surprise that these relations will also be violated for the quantum mechanical particle serving as object.

To counter Fock's criticism, Aharonov and Bohm³⁵ modified their Hamiltonian by introducing a third particle (a "clock" with linear coordinate z) and replaced the switching function $g(t)$ by a time-independent function, $g(z)$. The resulting time-independent Hamiltonian formally allowed to measure the energy of the system, repeatably and in an arbitrarily short time. Everything in this model was internally consistent.

This still leaves an open question, namely whether there are, in nature, interactions which are arbitrarily intense and localized, like the function $g(z)$. In the present context, however, this is a practical problem, not a fundamental one. It is like asking, when we study Euclidean geometry, whether it is possible to draw arbitrarily thin lines, or to manufacture perfectly rigid rulers and compasses. These technical questions are irrelevant to the study of geometry. Likewise, the practical feasibility of producing in a laboratory the Hamiltonian that we have written (without violating any fundamental law, of course) is irrelevant to the logical structure of quantum theory.

When we analyze these fundamental issues, we should not consider quantum theory as a tool with which we describe existing physical objects. Rather, quantum theory must be seen as a set of abstract rules—just as Euclidean geometry. When we come to the physical interpretation of the theory, its abstract elements are *simulated* by material objects—just as the abstract notions of "line" and "circle" are *simulated* by thin dark bands drawn on white paper with the help of rulers and compasses. How good a simulation we can actually achieve is an important practical problem, but not a fundamental one.

Metastable states

The *survival probability* of a time-dependent quantum state is defined as

$$P(t) := |\langle \psi(0), \psi(t) \rangle|^2 = |\langle \psi(0), e^{-i\mathbf{H}t/\hbar} \psi(0) \rangle|^2. \quad (12.132)$$

(The word "survival," used in the current literature, is somewhat misleading, as it suggests the irreversible death of a member of a living community. No

³⁵ Y. Aharonov and D. Bohm, *Phys. Rev. B* 134 (1964) 1417.

irreversible phenomena are involved in the discussion below, and there is no reason for the “survival probability” $P(t)$ to be a monotonic decreasing function of time. It may also temporarily increase, or oscillate, as in the periodic motion of a coherent state of a harmonic oscillator.)

Exercise 12.15 Let $\psi(0) = \sum c_E u_E$, where u_E denotes energy eigenstates. Show that $\langle \psi(0), \psi(t) \rangle = \sum |c_E|^2 e^{-iEt/\hbar}$.

Exercise 12.16 For systems with a continuous spectrum, the result of the preceding exercise becomes $\langle \psi(0), \psi(t) \rangle = \int w(E) e^{-iEt/\hbar} dE$. Therefore $\langle \psi(0), \psi(t) \rangle$ and $w(E)$ are a pair of Fourier transforms. Show that the exponential decay law, $\langle \psi(0), \psi(t) \rangle = \exp(-\lambda|t|/2 - iE_1 t/\hbar)$, corresponds to

$$w(E) = \frac{\gamma}{\pi[(E - E_1)^2 + \gamma^2]}, \quad (12.133)$$

where E_1 is the mean energy of the metastable state, and $\gamma = \hbar\lambda/2$.

The energy distribution in Eq. (12.133) extends to $\pm\infty$, and in particular has an infinite ΔE . This is obviously unphysical. Therefore, no decay law can be strictly exponential. It can however be shown³¹ that $P(t)$ decays in an *approximately* exponential fashion, provided that

$$\gamma \ll \Delta E \ll E_1 - E_0, \quad (12.134)$$

where E_0 is the ground state of the system. Note in particular that γ , which is the half-width of the resonance curve (12.133) at half its maximum height, is not the same thing as ΔE , the standard deviation of the energy distribution. In perturbation theory, γ is a second order quantity, as shown by Fermi's golden rule (12.115), while $\Delta E = (\langle H^2 \rangle - \langle H \rangle^2)^{1/2}$ is of first order.

Deviations from the exponential decay law are most noticeable for very short times, as may be seen by expanding Eq. (12.132) into powers of t . We have

$$P(t) = 1 - (\langle H^2 \rangle - \langle H \rangle^2) t^2 / \hbar^2 + \dots \quad (12.135)$$

A more accurate formula is³⁶

$$P(t) \geq \cos^2(t\Delta E/\hbar) \quad \forall |t| \leq \pi\hbar/2\Delta E, \quad (12.136)$$

which is easily proved as follows:³⁷ For any operator A we have, by virtue of the uncertainty relation (4.40),

$$\Delta A \Delta H \geq \frac{1}{2} |\langle [A, H] \rangle| = \frac{1}{2} \hbar |\langle dA/dt \rangle| = \frac{1}{2} \hbar |d\langle A \rangle/dt|. \quad (12.137)$$

In particular, let A be the projector on the initial state $\psi(0)$. We then have

³⁶G. N. Fleming, *Nuovo Cimento A* 16 (1973) 232.

³⁷D. Home and M. A. B. Whitaker, *J. Phys. A* 19 (1986) 1847.

$$\langle \mathbf{A} \rangle = \langle \psi(t), \mathbf{A} \psi(t) \rangle = P(t). \tag{12.138}$$

Moreover, $\mathbf{A}^2 = \mathbf{A}$, so that

$$(\Delta \mathbf{A})^2 = \langle \mathbf{A}^2 \rangle - \langle \mathbf{A} \rangle^2 = P - P^2. \tag{12.139}$$

Combining these equations, we obtain

$$|dP/dt| \leq (2\Delta E/\hbar) \sqrt{P(1-P)}, \tag{12.140}$$

and Eq. (12.136) follows, by a trivial integration.

12-9. Incompatible observables

Let us try to measure simultaneously noncommuting operators \mathbf{A} and \mathbf{B} , by generalizing the interaction (12.39) as follows:

$$\mathbf{H} = g(t) (\mathbf{A} p_1 + \mathbf{B} p_2), \tag{12.141}$$

where p_1 and p_2 refer to two *independent* pointers. To simplify the analysis, let $g(t) = 1$ for the duration of the interaction ($0 < t < 1$ with an appropriate choice of the time unit). The result of the interaction (12.141) is most easily seen in the Heisenberg picture or, equivalently, in classical mechanics, with Poisson brackets instead of commutators. The equations of motion are

$$\dot{p}_1 = \dot{p}_2 = 0, \quad \dot{q}_1 = \mathbf{A}, \quad \dot{q}_2 = \mathbf{B}, \tag{12.142}$$

and

$$\begin{aligned} \dot{\mathbf{A}} &= [\mathbf{A}, \mathbf{H}]_{\text{PB}} = p_2 [\mathbf{A}, \mathbf{B}]_{\text{PB}}, \\ \dot{\mathbf{B}} &= [\mathbf{B}, \mathbf{H}]_{\text{PB}} = p_1 [\mathbf{B}, \mathbf{A}]_{\text{PB}}. \end{aligned} \tag{12.143}$$

In classical mechanics, we can always assume that $p_1 = p_2 = 0$, and it then follows from (12.143) that \mathbf{A} and \mathbf{B} are left undisturbed by the measuring process. In quantum theory, the situation is more complicated. We want the pointers to be well localized. Their wave functions $\phi_1(q_1)$ and $\phi_2(q_2)$ must have narrow support, so that the expectation values of the displacements,

$$q_1(1) - q_1(0) = \int_0^1 \mathbf{A}(t) dt \quad \text{and} \quad q_2(1) - q_2(0) = \int_0^1 \mathbf{B}(t) dt, \tag{12.144}$$

are not marred by large dispersions.

However, a narrow support for $\phi(q)$ entails a broad distribution for the corresponding momentum representation, $\tilde{\phi}(p)$. It then follows from (12.143) that A and B do not remain constant during the measuring process. The measurements disturb each other, and the final meter readings, given by Eq. (12.144), do not represent the initial nor the final values of A and B , but rather some mean values, during the interaction.

Positive operator valued measures

A more sensible way of getting information about incompatible observables is to use a non-orthogonal POVM, as in Eq. (9.79). The resulting information will necessarily have some fuzziness, as we shall explicitly see in the example below, but this is the best that can be done in a quantum context.

What is a good POVM? A natural requirement is the following one: if the system was prepared in such a way that A has a sharp value (a fact which could be ascertained by a von Neumann measurement of A), the POVM shall give us a good estimate of that value; and if the system has a sharp value of B , the *same* POVM gives a good estimate of the value of B . This criterion is in general agreement with the classical meaning of the word "measurement," but it also allows for some uncertainty of the results, as demanded by quantum theory.

Conversely, the selection (by a quantum test) of a particular component of the POVM should be equivalent to the preparation of a mixed state for which both A and B have roughly defined values. We have already seen an example of this property on page 386, where a POVM is used for the approximate determination of an angular momentum coherent state.

Exercise 12.17 *Set up, by analogy with Eq. (12.37), a POVM which allows to measure approximately q and p .*

A simple, intuitive method for the simultaneous measurement of q and p was proposed by Arthurs and Kelly.^{38,39} Consider an ancilla, with canonical variables Q and P , prepared in a standard coherent state Ψ_0 , with $\langle Q \rangle = \langle P \rangle = 0$, and $\Delta Q \Delta P = \hbar/2$. The dynamical variables $q - Q$ and $p + P$ commute and can therefore be measured simultaneously.

Before this measurement, the state of the composite system is a direct product, $\psi(q) \otimes \Psi_0$. The expected dispersion of the possible results of the measurement is

$$[\Delta(q - Q)]^2 = \langle (q - Q)^2 \rangle - \langle q - Q \rangle^2 = (\Delta q)^2 + (\Delta Q)^2, \quad (12.145)$$

and likewise for $\Delta(p + P)$. If initially $\Delta q \ll \Delta Q$, we have $\Delta(q - Q) \simeq \Delta Q$, so that the observed value of $q - Q$ typically differs from the sharp value of q by about ΔQ . Conversely, if initially $\Delta p \ll \Delta P$, we have $\Delta(p + P) \simeq \Delta P$, and

³⁸ E. Arthurs and J. L. Kelly, Jr., *Bell System Tech. J.* 44 (1965) 725.

³⁹ S. Stenholm, *Ann. Phys. (NY)* 218 (1992) 233.

the observed value of $p + P$ may differ from the sharp value of p by about ΔP . The criteria for a good POVM are therefore satisfied.

It is instructive to write explicitly the POVM which corresponds to the above procedure. Let $x = q - Q$ and $y = p + P$. These are a complete set of commuting operators, and a pure state of the composite system can be denoted as $\Phi(x, y)$. Let us divide the classical xy plane into small rectangular cells C_μ , centered at (x_μ, y_μ) , and covering the entire plane. The determination of a particular value of the label μ is equivalent to a measurement of x and y , with a resolution equal to the size of the cell C_μ .

Let us define functions

$$f_\mu(x) = \begin{cases} 1 & \text{if } x \in C_\mu, \\ 0 & \text{otherwise,} \end{cases} \tag{12.146}$$

and

$$g_\mu(y) = \begin{cases} 1 & \text{if } y \in C_\mu, \\ 0 & \text{otherwise.} \end{cases} \tag{12.147}$$

Further define $\Pi_\mu(x, y) := f_\mu(x)g_\mu(y)$, which satisfies $\sum_\mu \Pi_\mu(x, y) \equiv 1$ and

$$\Pi_\mu(x, y)\Pi_\nu(x, y) \equiv \delta_{\mu\nu}\Pi_\nu(x, y). \tag{12.148}$$

In quantum theory, the $\Pi_\mu(x, y)$ are a complete set of orthogonal projectors, which correspond to the possible outcomes of a von Neumann measurement. If the initial state of the composite system is Φ , the probability of obtaining outcome μ is

$$\langle \Pi_\mu \rangle = \langle \Phi, f_\mu(x)g_\mu(y)\Phi \rangle = \langle f_\mu(x)\Phi, g_\mu(y)\Phi \rangle. \tag{12.149}$$

Obviously, the most convenient way of expressing $f_\mu(x)\Phi$ is its coordinate representation, namely $f_\mu(q - Q)\psi(q)\Psi_0(Q)$. Likewise, $g_\mu(y)\Phi$ is most easily written by means of the momentum representation, as $g_\mu(p - P)\tilde{\psi}(p)\tilde{\Psi}_0(P)$. The inner product (12.149) is thereby referred to two different bases. This does not cause any difficulty. For example, if $u = \sum a_m u_m$ and $v = \sum b_\mu v_\mu$, we have

$$\langle u, v \rangle = \sum_{m\mu} \overline{a_m} \langle u_m, v_\mu \rangle b_\mu = \sum_{m\mu} \overline{a_m} C_{m\mu} b_\mu, \tag{12.150}$$

where $C_{m\mu}$ is the unitary matrix relating the bases $\{u_m\}$ and $\{v_\mu\}$. Likewise, given the wave functions $\phi(q)$ and $\tilde{\psi}(p)$, we have, from the definition of the momentum representation, Eq. (10.54),

$$\begin{aligned} \langle \phi, \psi \rangle &= \int \overline{\phi(q)} \psi(q) dq = \int \overline{\phi(q)} \left[\int e^{iqp/\hbar} \tilde{\psi}(p) dp / \sqrt{2\pi\hbar} \right] dq, \\ &= \iint \overline{\phi(q)} e^{iqp/\hbar} \tilde{\psi}(p) dq dp / \sqrt{2\pi\hbar}. \end{aligned} \tag{12.151}$$

The value of $\langle \Pi_\mu \rangle$, given by Eq. (12.149), thus becomes

$$\frac{1}{2\pi\hbar} \iiint \overline{f_\mu(q - Q)\Phi(q, Q)} e^{i(qp+QP)/\hbar} g_\mu(p + P)\tilde{\Phi}(p, P) dq dp dQ dP.$$

To evaluate this expression, replace the integration variables q, p, Q , and P , by $q, p, x = q - Q$, and $y = p + P$ (the Jacobian of the transformation is 1). The integrations over x and y are trivial if the cell C_μ is small enough so that the other functions in the integrand can be considered as constant within that cell: we simply replace, everywhere in the integrand, x by x_μ , and y by y_μ . Denoting the cell area by S_μ (which has the dimensions of an action) we obtain

$$\begin{aligned} \langle \Pi_\mu \rangle &= \frac{S_\mu}{2\pi\hbar} \iint \overline{\Phi(q, q - x_\mu)} e^{i(qy_\mu + x_\mu p - x_\mu y_\mu)/\hbar} \check{\Phi}(p, y - p) dq dp, \quad (12.152) \\ &= \frac{S_\mu}{2\pi\hbar} \int \overline{\Phi(q, q - x_\mu)} e^{iqy_\mu/\hbar} dq \int \check{\Phi}(p, y_\mu - p) e^{ix_\mu(p - y_\mu)/\hbar} dp. \end{aligned}$$

This factorization is remarkable! Consider in particular the initial state of the Arthurs-Kelly composite system, namely $\Phi(q, Q) = \psi(q) \Psi_0(Q)$, where

$$\Psi_0(Q) = (\pi\sigma^2)^{-1/4} e^{-Q^2/2\sigma^2}, \quad (12.153)$$

is a coherent state centered at $Q = P = 0$. We have, in (12.152),

$$\int \overline{\Phi(q, q - x_\mu)} e^{iqy_\mu/\hbar} dq = \int \overline{\psi(q)} \Psi_0(q - x_\mu) e^{iqy_\mu/\hbar} dq. \quad (12.154)$$

Now, it is readily seen from Eq. (10.99) that

$$\Psi_0(q - x_\mu) e^{iqy_\mu/\hbar} = (\pi\sigma^2)^{-1/4} e^{-(q - x_\mu)^2/2\sigma^2} e^{iqy_\mu/\hbar} \quad (12.155)$$

is the result of displacing $\Psi_0(q)$, so as to obtain a new coherent state, $\Psi_\mu(q)$, centered at the point (x_μ, y_μ) . Therefore (12.154) becomes

$$\int \overline{\psi(q)} \Psi_0(q - x_\mu) e^{iqy_\mu/\hbar} dq = \langle \psi, \Psi_\mu \rangle. \quad (12.156)$$

Exercise 12.18 Show that the momentum representation of the minimal uncertainty wave packet (12.155) is

$$\tilde{\Psi}_\mu(p) = (\sigma^2/\pi\hbar^2)^{1/4} e^{-(p - y_\mu)^2\sigma^2/2\hbar^2} e^{-ix_\mu(p - y_\mu)/\hbar}, \quad (12.157)$$

and that

$$\int \check{\Phi}(p, y_\mu - p) e^{ix_\mu(p - y_\mu)/\hbar} dp = \langle \Psi_\mu, \psi \rangle. \quad (12.158)$$

Using the results of this exercise, we finally obtain

$$\langle \Pi_\mu \rangle = (S_\mu/2\pi\hbar) \langle \psi, \Psi_\mu \rangle \langle \Psi_\mu, \psi \rangle = \langle \psi, A_\mu \psi \rangle, \quad (12.159)$$

where the POVM element A_μ is proportional to the projector on the coherent state Ψ_μ ,

$$A_\mu := (S_\mu/2\pi\hbar) \Psi_\mu \Psi_\mu^\dagger. \quad (12.160)$$

The WAY theorem

Until now, we considered *pairs* of incompatible observables, represented by non-commuting operators. It was tacitly assumed that any *single* given operator could always be measured, by concocting an interaction Hamiltonian like the one in Eq. (12.39). We shall now examine this assumption more carefully. Quantum theory, by itself, does not preclude the realizability of an arbitrary Hamiltonian. However, additional requirements may restrict the class of admissible interactions. In particular, we may demand that specific conservation laws be respected during the measuring process.

For example, let p be the momentum of the observed system, and P that of the measuring apparatus. If there is no external agent to carry excess momentum, $p + P$ is conserved. This precludes the measurement of any dynamical variable, such as q , that does not commute with $p + P$ (to measure q , there should be a term involving q in the interaction Hamiltonian, and then $p + P$ would not be constant). The reason for this is simple: Conservation of the total momentum implies that we live in a translation invariant world, where the origin of the coordinates is not a physical object. Therefore, the position operator q is experimentally meaningless. Only the *relative position* of the system with respect to the apparatus, $q - Q$, is observable, and indeed $q - Q$ commutes with $p + P$, and can be measured without violating any conservation law.

More generally, the WAY theorem^{40,41} states that it is impossible to measure (in the von Neumann sense) an operator which does not commute with an *additive conserved dynamical variable*. A simple proof⁴² is given below.

Let A and B be two operators belonging to the observed system, and C an operator of the apparatus, having the property that the sum $B+C$ is conserved. In particular, if U is the unitary operator which produces a measurement of A , we have

$$U^\dagger (B + C) U = B + C. \tag{12.161}$$

Recall that such a measurement generates a correlation of the eigenstates of A (which are defined by $Au_m = m u_m$) with various states $v_{m\alpha}$ of the apparatus, as in Eq. (12.3):

$$u_m v_0 \rightarrow U u_m v_0 = u_m \sum_{\alpha} c_{m\alpha} v_{m\alpha} \equiv u_m w_m. \tag{12.162}$$

The last equation defines w_m , which satisfies $\|w_m\| = 1$, by unitarity.

We have to show that A cannot be measured unless $[A, B] = O$. Indeed, in the basis u_m , which diagonalizes A , we have

$$\langle u_m, [A, B] u_n \rangle \equiv \langle u_m, (A B - B A) u_n \rangle \equiv (m - n) B_{mn}. \tag{12.163}$$

⁴⁰E. P. Wigner, *Z. Phys.* 133 (1952) 101.

⁴¹H. Araki and M. M. Yanase, *Phys. Rev.* 120 (1960) 622.

⁴²G. C. Ghirardi, F. Miglietta, A. Rimini, and T. Weber, *Phys. Rev. D* 24 (1981) 347, 353.

Moreover, $[A, C] \equiv O$, because A belongs to the observed system, and C to the apparatus. The matrix elements in (12.163) can therefore be written as

$$\begin{aligned} \langle u_m v_0, [A, B] u_n v_0 \rangle &= \langle u_m v_0, [A, B + C] u_n v_0 \rangle, \\ &= (m - n) \langle u_m v_0, (B + C) u_n v_0 \rangle. \end{aligned} \quad (12.164)$$

Combining these various equations, we obtain, for $m \neq n$,

$$\begin{aligned} B_{mn} &= \langle u_m v_0, U^\dagger (B + C) U u_n v_0 \rangle = \langle u_m w_m, (B + C) u_n w_n \rangle, \\ &= \langle u_m, B u_n \rangle \langle w_m, w_n \rangle + \langle u_m, u_n \rangle \langle w_m, C w_n \rangle = B_{mn} \langle w_m, w_n \rangle, \end{aligned} \quad (12.165)$$

since $\langle u_m, u_n \rangle = 0$. It follows that either $\langle w_m, w_n \rangle = 1$, which effectively means that there is no measurement, or $B_{mn} = 0$, which implies $[A, B] = O$.

Nonetheless, an *approximate* measurement of the operator A is possible,^{41,42} provided that the initial state of the apparatus has a sufficiently large value of ΔC . For instance, if we want to measure q but we can only measure $q - Q$, we shall prepare the apparatus in a state with a very narrow ΔQ . Then the *observed* value of $q - Q$ will typically differ from the *expected* value of q (which we cannot directly observe) by a quantity of order ΔQ . Therefore ΔQ , which is defined as usual as the standard deviation of Q in the initial state, also acquires the meaning of an *uncertainty* in the *inferred* value of q . Obviously, in such a procedure, the initial state of the apparatus has a large ΔP .

Here is another example: the WAY theorem implies that, if the total angular momentum is conserved, we can only measure rotational scalars. Then, how can we measure μ_z in a Stern-Gerlach experiment? This is the z -component of a vector operator, which does not commute with the conserved rotation generators J_x and J_y . Yet, we can *approximately* measure μ_z . The point is that μ_z appears in the Hamiltonian (1.4), which describes the Stern-Gerlach experiment, only in the combination $\boldsymbol{\mu} \cdot \mathbf{B}$. This indeed is a rotational scalar, which can be measured without violating any conservation law. The true problem is to guarantee that \mathbf{B} , the magnetic field at the location of the atomic beam, precisely points toward an externally defined z -direction.

To give the desired orientation to the magnetic field, the magnet has to be prepared in a superposition of many different angular momentum states. We have already encountered this property with a much simpler system, the N -state quantum dial of Sect. 12-7. Each dial state (10.89) has an angular resolution $\alpha = 2\pi/N$ and its angular momentum spread, given by (12.100), is $\Delta J = (\pi/\sqrt{3})(\hbar/\alpha)$. Moreover, for a *macroscopic* body such as a Stern-Gerlach magnet, a given angular resolution α entails a value of ΔJ *considerably larger* than \hbar/α (see Fock's remark on uncertainty relations for classical bodies, quoted on page 415). Thus, if we set an upper bound to ΔJ , the WAY theorem implies that, instead of measuring σ_z , we actually measure some other component, σ_n , along a direction \mathbf{n} which is slightly different from the required direction z .

Exercise 12.19 For given values of J and $\Delta J \gg \sqrt{\hbar J}$, estimate the expected deviation of \mathbf{n} from the z -axis. **

12-10. Approximate reality

Quantum theory is not an objective description of physical reality. It only predicts the probability of occurrence of *stochastic macroscopic events*, following specified preparation procedures, such as, for instance, the triggering of particle detectors following the collision of a specified beam with a given target. These theoretical predictions rely on conceptual models which involve elusive microscopic objects, such as electrons, photons, etc. The latter are usually considered as real things, but they occasionally display extraordinary nonlocal properties, quite at variance with intuitive classical realism, as we have seen in Chapter 6.

The essential difference between these two classes of objects, microscopic and macroscopic, is not a matter of size, but of the completeness of their description: all the degrees of freedom of a quantum system are taken into account in its Hamiltonian. On the other hand, only a very small fraction of the degrees of freedom of a macroscopic system (a few of them, out of 10^{20} or 10^{30}) are explicitly used in its description. We *renounce* keeping track of nearly all the physical properties of macroscopic systems. These are *open systems* the degrees of freedom that are not explicitly taken into account play the same role as an external environment. (There also are intermediate, *mesoscopic* objects, for which a significant fraction, but not all, of the degrees of freedom are explicitly described.)

Since we give only an incomplete description of an open system, it is tempting to postulate that some of its operators are not measurable. For example, let u and v denote two opposite magnetization states of a macroscopic ferromagnet. The operator $M_z = uu^\dagger - vv^\dagger$ is observable (with eigenstates u and v) but, on the other hand, the Hermitian operator $M_x = uv^\dagger + vu^\dagger$ is not. The eigenstates of M_x are $(u \pm v)/\sqrt{2}$, namely coherent superpositions of u and v magnetizations—or, if you prefer, of live and dead Schrödinger's cats. Even if such superpositions could be prepared, we would be unable to maintain their coherence for an appreciable time, as the following exercise shows.

Exercise 12.20 A compass needle containing 10^{20} electrons with aligned spins is placed in a magnetic field which is stabilized with an accuracy of $\pm 10^{-9}$ gauss. How long does it take for the phase difference between the u and v states to become completely uncertain? **Ans.:** $\sim 10^{-17}$ s.

The situation illustrated by this exercise is a special case of the emergence of "pointer states":⁴³ the relevant degrees of freedom of each macroscopic system define a preferred orthogonal basis (such as u and v in the above example, or L and D for Schrödinger's cat). The elements of that basis are called *pointer states* and have the property of being stable, except for an overall phase, with respect to small, uncontrollable fluctuations of the environment. On the other hand, linear combinations of pointer states have essentially non-classical properties

⁴³ W. H. Zurek, *Phys. Rev. D* 24 (1981) 1516; 26 (1982) 1862.

and are experimentally inaccessible. Their interaction with the environment rapidly transforms them into incoherent mixtures.

Admittedly, the above claims of impossibility are no more than heuristic rules. They cannot be formulated, let alone proved, in any rigorous way. There is nothing in formal quantum theory which indicates that linear combinations such as $(u \pm v)/\sqrt{2}$ can be prepared for single particles, or for pairs of particles, but not for 10 , or 10^{10} identical particles. You should never underestimate the skill of experimental physicists!

Assuming that we have set arbitrary rules for distinguishing measurable from nonmeasurable operators, it is then possible to *define* a classical system as a special type of quantum system, for which all measurable operators commute.⁴⁴ All the observable properties of such a classical system are *compatible* and can therefore have sharp values. Note that a “classical” system defined in this way may also have noncommuting operators, but the latter should be considered as abstract mathematical expressions, which are not experimentally observable. With this formal definition, the notion “classical” acquires a meaning with respect to a specified set of dynamical variables. Obviously, by using fine enough observation means, every physical system will display quantum features.⁴⁴ Physics is not an exact science. It is a science of approximations.

Macroscopic objectivity

Real life seldom follows the idealized preparation-observation pattern presented throughout this book. Astronomers, for instance, observe spectral lines (*i.e.*, detect photons) which they interpret as due to the presence of atoms or molecules in interstellar space. Obviously, the atoms were there a long time ago in an excited state; they decayed to their ground state, emitting photons which we can now observe, considerably later. These excited atoms were not prepared by us, nor our research assistants. We can only observe them passively. We also observe bigger objects, such as the Moon moving around the Earth, or various planets, without ever having prepared them.

This would cause no conceptual difficulty with quantum theory if the Moon, the planets, the interstellar atoms, etc., had a well defined state ρ . However, I have insisted throughout this book that ρ is not a property of an individual system, but represents the *procedure* for preparing an ensemble of such systems. How shall we describe situations that have no preparer?

Let us formulate the problem more precisely. Until now, we were interested in questions of the type answered by Eq. (9.79): “Given a preparation ρ , what is the probability for an observation A_μ ?” (the μ -th element of a POVM). Now, there is a different type of question. For example, we may ask what is the probability that if astronomer A successfully detects a POVM element A_μ (e.g., observes a dot on his photographic plate, which he interprets as a star) then another astronomer, B , will likewise detect a definite POVM element B_n .

⁴⁴J. M. Jauch, *Helv. Phys. Acta* 37 (1964) 293.

To make these observations causally independent, let them occur in mutually space-like regions (simultaneously on opposite sides of a star, say). None of the astronomers can then affect the experiments of the other.

In principle, the calculations can be performed as follows. Let p_i denote the *a priori* probability for a configuration ρ_i that can be encountered by our observers (this ρ_i may have been produced naturally, or prepared by other people). If A detects an element A_μ of his POVM, the *a posteriori* probability of configuration ρ_i is, by the rules of Bayesian statistics (see Sect. 2-7),

$$Q_{i\mu} = P_{\mu i} p_i / \sum_j P_{\mu j} p_j, \quad (12.166)$$

where $P_{\mu i} = \text{Tr}(A_\mu \rho_i)$ is the probability of obtaining the result μ , following preparation ρ_i . Then, the conditional probability that observer B will detect an element B_n of her POVM (if A observes element A_μ) is

$$\mathbf{P}\{n|\mu\} = \sum \text{Tr}(B_n \rho_i) Q_{i\mu}, \quad (12.167)$$

where the sum extends over a complete set of configurations ρ_i (all the possible types of stars, say, with all their possible positions). We then intuitively expect that, in a situation involving macroscopic objects for which a classical description ought to be adequate, $\mathbf{P}\{n|\mu\}$ turns out to be vanishingly small unless the observations by A and B are classically compatible. In that case, these observations define an objective (that is, observer independent) classical reality, except for practically negligible quantum uncertainties.

Notice that neither A nor B performs a complete set of measurements. They actually observe *different* subsystems: the photons detected by A do not come from the same atoms as the photons detected by B . Then, why should we expect A and B to agree that there is, objectively, a star somewhere in the sky? The reason is that any macroscopic object, such as a star, involves an enormous number of *identical subsystems with almost identical properties*, in particular identical positions, within the accuracy of our instruments. Thus, a macroscopic object effectively is *assembly*,⁴⁵ which mimics, with a good approximation, a statistical ensemble. Measurements performed on such an assembly have a huge redundancy. In particular, different apparatuses can be used for probing disjoint subassemblies, each one of which is large enough to mimic an infinite ensemble. We can thereby measure, with little dispersion, the expectation values of noncommuting operators.

You must have noted the difference between the present pragmatic approach and the dogmas held in the early chapters of this book. It was then asserted that any operator which can be written by a theorist can also be measured in the laboratory. This fiction was needed in order to establish a formal framework for quantum theory. Now, our goal is different: we want to use a *classical language* for describing, with a good approximation, macroscopic phenomena.

⁴⁵See footnote 9, page 59, and related text.

The transition from the quantum language to the classical one is possible only at the cost of introducing considerable blurring in the physical variables (for example, having $\Delta q \Delta p \gg \hbar$).³⁴ It is this reduction of our resolving power which allows the emergence of an objective reality, even if only a fuzzy one.

Measurable operators form only a small subset of all the operators that can be defined. We can perform only a negligible fraction of all conceivable tests, and we therefore end up with a *partial* knowledge of ρ_i (our lack of knowledge is represented by an appropriately weighted mixture of all admissible possibilities). The accessible data usually are macroscopic variables, such as the position and velocity of the center of mass of an object. For these macroscopic variables, we have $\Delta q \Delta p \gg \hbar$. Compared to these classical uncertainties, disturbances caused by quantum measurements are negligibly small. Moreover, macroscopic masses are large so that corresponding wavelengths are small and diffraction effects can be neglected. Therefore consecutive measurements of position have predictable results. This ensures the applicability of deterministic equations of motion, which enable us to extrapolate our knowledge to the distant past and future, when observers did not, or will not, exist.

Exercise 12.21 A large number of spin- $\frac{1}{2}$ particles have a polarization state $\rho = \frac{1}{2}(\mathbf{1} + \mathbf{m} \cdot \boldsymbol{\sigma})$, with $|\mathbf{m}| \leq 1$. An observer takes three subsets, with 100 particles in each, to measure the three components of $\langle \boldsymbol{\sigma} \rangle$ and thereby determine the polarization parameter \mathbf{m} . A second observer does the same, with three other subsets of 100 particles. By how much are their findings likely to differ? If each observer could examine only one particle for each component of $\boldsymbol{\sigma}_j$, what would be the answer to the same question? ★

In summary, macroscopic objects, containing many identical subsystems with almost identical states, behave, in a good approximation, as if they had objective (*i.e.*, observer independent) properties, provided that the observers restrict their enquiries to a *small subset of all possible questions*. For example, if ρ represents a state of my pen, and ρ' is a state of that pen with one atom removed, these two states are orthogonal. However, they can be distinguished only by measuring an operator A for which $\text{Tr}(\rho A) \neq \text{Tr}(\rho' A)$. If we restrict our attention to the class of operators Ω such that $\text{Tr}(\rho \Omega) \simeq \text{Tr}(\rho' \Omega)$, we cannot find out whether an atom is missing from the pen.

Bell inequalities for consecutive measurements

Once you accept the hypothesis that only pointer states⁴³ of macroscopic bodies can be prepared and observed, you will perhaps be tempted to further assume that a macroscopic body can actually *be* only in one of these states, and never in a linear superposition of different pointer states (e.g., Schrödinger's cat must be either alive or dead, it will never hover between life and death in a quantum mechanical superposition). To be sure, this assumption radically departs from orthodox quantum mechanics, but, since the latter has been tested only for

microscopic systems, it is not illegitimate to speculate that quantum mechanics does *not* apply to macroscopic systems. Perhaps, it is valid only in the limiting case of perfectly isolated microscopic bodies, in the time interval between their preparation and their observation by external agents; but quantum mechanics might fail for open systems with many degrees of freedom.

Let us examine the observable consequences of these assumptions. In view of the macroscopic nature of the pointer states, it is plausible that the latter can be recognized *noninvasively*, that is, without causing transitions to other pointer states. The time evolution of a macroscopic system could then consist of stochastic transitions from one pointer state to another. It would become deterministic in the limit where classical dynamical laws are valid.

Consider now a dichotomic variable, A , with values ± 1 , as in our derivation of Bell's theorem in Chapter 6. According to the above assumptions, A has, at each instant, a definite value, 1 or -1 . Let a_j denote the value of A at time t_j . For three consecutive times, we have, identically

$$(a_1 + a_3)a_2 \leq 1 + a_1 a_3. \quad (12.168)$$

This equation does not assume any specific dynamical law, but only the possibility of performing *noninvasive measurements*:⁴⁶ the value of a_3 on the right hand side (with no measurement of a_2) is the same as that on the left hand side (when there is a measurement of a_2).

If a large number of physical systems are prepared according to the same macroscopic procedure, they may still differ in some microscopic details, and the actual values of a_j for these systems may be different. Let us therefore consider ensemble averages, such as $\langle a_i a_j \rangle$, and define

$$K_{ij} := 1 - \langle a_i a_j \rangle. \quad (12.169)$$

By virtue of Eq. (12.168), the K_{ij} satisfy

$$K_{13} \leq K_{12} + K_{23}. \quad (12.170)$$

This is a slight generalization of Herbert's inequality,⁴⁷ and I shall also call it like that. The only assumption required for its derivation is the noninvasive measurability of the objective pointer states. This is a counterfactual assumption, which might be called *locality in time*: the hypothetical hidden variables which determine the value of a_3 are the same, whether or not we measure a_2 . Recall that Bell's inequality was likewise a consequence of *locality in space*. In both cases, no specific dynamical model is assumed.

The actual values of K_{ij} can be obtained from quantum theory, if the latter is held to be valid, or any other theory which would supersede quantum theory for macroscopic bodies; or they can be measured *experimentally*, irrespective of any theory. Therefore Herbert's inequality (12.170), just as Bell's inequality, is amenable to an experimental test.

⁴⁶ A. J. Leggett and A. Garg, *Phys. Rev. Lett.* 54 (1985) 857; *ibid.* 63 (1989) 2159.

⁴⁷ N. Herbert, *Am. J. Phys.* 43 (1975) 315.

For instance, consider the precession of a spin $\frac{1}{2}$ particle, with $H = \hbar\omega\sigma_x$. If we measure σ_z at equal time intervals t , we obtain $K_{12} = K_{23} = 1 - \cos 2\omega t$ and $K_{13} = 1 - \cos 4\omega t$. Herbert's inequality (12.170) becomes

$$2(1 - \cos 2\omega t) \leq 1 - \cos 4\omega t, \quad (?) \quad (12.171)$$

which is obviously wrong for $|\omega t| < \pi/4$. This is not surprising: a spin $\frac{1}{2}$ particle is a genuine quantum object, without privileged pointer states, and it cannot have the objective properties tentatively attributed to macroscopic bodies.

Exercise 12.22 Consider a uniformly rotating classical particle, for which we measure $a_i = \text{sign}(\cos \theta)$. Show that $K_{ij} = |\theta_i - \theta_j|$, so that Herbert's inequality is satisfied.

Exercise 12.23 Show that, if ΔH is finite, Fleming's unitary limit (12.136) is incompatible with Herbert's inequality (12.170). ★

A more interesting example is a superconducting loop enclosing a quantized magnetic flux. The current in the loop is a collective degree of freedom, well isolated from the environment. The flux eigenstates are separated by a constant amount, $\Phi_0 = h/2e = 2.0678 \times 10^{-15}$ Wb. They can be considered as pointer states. Transitions between these levels were investigated by Leggett and Garg,⁴⁶ who also derived inequalities similar to (12.170) and considered the possibility of their experimental verification.

Experimental results coming close to quantum measurements of macroscopic systems were obtained with ferritin crystals, which are naturally occurring anti-ferromagnetic proteins with about 4500 ordered spins. Quantum transitions between opposite magnetization states were observed.⁴⁸ These experiments were partly inconclusive, because of noisy conditions. It may however be hoped that improved technology will soon enable us to observe coherent superpositions of macroscopically different states, and reversible transitions between them.

12-11. Bibliography

J. von Neumann, *Mathematische Grundlagen der Quantenmechanik*, Springer, Berlin (1932) [transl. by E. T. Beyer: *Mathematical Foundations of Quantum Mechanics*, Princeton Univ. Press, Princeton (1955)].

C. W. Helstrom, *Quantum Detection and Estimation Theory*, Academic Press, New York (1976).

P. Busch, P. J. Lahti, and P. Mittelstaedt, *The Quantum Theory of Measurement*, Springer, Berlin (1991).

⁴⁸D. D. Awschalom, J. F. Smyth, G. Grinstein, D. P. DiVincenzo, and D. Loss, *Phys. Rev. Lett.* 68 (1992) 3092; *ibid.* 70 (1993) 2199.

The first one of these books is a classic, which shaped the early thinking on quantum measurements. It was the first serious attempt to give rigorous foundations to quantum theory, and had a profound influence on its development. Helstrom's book, on the other hand, is written from the pragmatic point of view of a modern communications engineer, with emphasis on the statistical analysis of noisy signals. And the third book will be preferred by readers who enjoy more abstract presentations.

Extensive collections of articles on quantum measurements can be found in the following anthologies, which also include interesting comments by the editors:

Quantum Theory and Measurement, ed. by J. A. Wheeler and W. H. Zurek, Princeton Univ. Press, Princeton (1983).

Foundations of Quantum Mechanics Since the Bell Inequalities, ed. by L. E. Ballentine, Am. Assoc. Phys. Teachers, College Park (1988).

Nonclassical Effects in Quantum Optics, ed. by P. Meystre and D. F. Walls, Am. Inst. Phys., New York (1991).

Finally, if you want to have an idea of the real thing, you should read

C. D. Tesche, "Can a noninvasive measurement of magnetic flux be performed with superconducting circuits?" *Phys. Rev. Lett.* 64 (1990) 2358.

This paper on quantum measurements was written by an *experimental* physicist who analyzed the actual feasibility of the experiment proposed by Leggett and Garg.⁴⁶ The setup involves superconducting quantum interference devices (SQUIDS) with variable threshold switches and magnetometers. These are *open systems*, and an appropriate discussion requires notions such as noise temperature and ohmic resistance, which I found convenient to ignore in the present book.

Author Index

- Abramovici, A., 391
Abrikosov, A. A., 147
Agam, O., 372
Aharonov, Y., 36, 88, 154, 414, 415
Akhiezer, N. I., 285
Albert, D. Z., 154
Aleksandrov, I. V., 331
Alley, C. O., 166
Alon, O. E., 112
Althouse, W. E., 391
Andrews, M., 303
Arago, F., 18
Araki, H., 265, 421
Arecchi, F. T., 329
Arnol'd, V. I., 336, 341
Arthurs, E., 418
Aspect, A., 166
Atkins, P. W., 328
Auberson, G., 43
Au-Yeung, Y. H., 41
Avez, A., 341
Avron, J., 106
Awshalom, D. D., 428
- Balazs, N. L., 372
Ballentine, L. E., 23, 185, 331, 429
Band, W., 292
Barenco, A., 297
Barton, G., 83
Bayes, T., 46
Bayfield, J. E., 372
Belinfante, F. J., 211
Bell, J. S., 21, 158, 160, 171, 185, 196
Bennett, C. H., 294, 295, 296, 297, 342
Bergmann, P. G., 36
Berman, G. P., 372
Berry, M. V., 131, 303, 319, 347, 351, 372
- Bertani, P., 78
Bessette, F., 294
Beyer, E. T., 27, 158, 271, 385
Blaquière, A., 296, 391
Blatt, J. M., 345
Bohigas, O., 364
Bohm, D., 88, 150, 374, 414, 415
Bohr, N., 10, 13, 18, 25, 149, 208
Bollinger, J. J., 394
Born, M., 20, 22, 303
Bracken, A. J., 322
Brassard, G., 294, 295, 344
Bratley, P., 344
Braunstein, S. L., 174, 175, 288, 297
Brillouin, L., 310
Brown, R. C., 348
Bulgakov, E. N., 372
Busch, P., 428
Büttiker, M., 406
- Cajori, F., 394
Casati, G., 359, 372
Caves, C. M., 175, 288, 297, 372, 383, 390, 394
Cerdeira, H. A., 359
Chaitin, G. J., 186
Chew, G. F., 256
Chirikov, B. V., 372
Cirel'son, B. S., 174
Clauser, J. F., 165, 207
Cohen, L., 317
Colodry, R. C., 23
Compton, A. H., 4
Cooper, J. N., 22
Courant, R., 262
Courtens, E., 329
Cox, R. T., 47

- Coxeter, H. M. S., 201
Crépeau, C., 295
Currie, D. G., 255
Cushing, J. T., 185
- Dalibard, J., 166
Davies, E. B., 283
Davis, M., 343
Davisson, C., 4
De Baere, W., 186
De Boer, J., 343
de Broglie, L., 20, 278
d'Espagnat, B., 18
Deutsch, D., 296, 297
Dieks, D., 279, 288
Diner, S., 296, 391
Dirac, P. A. M., 20, 28, 107, 251, 256, 299, 374
Dittrich, W., 330
DiVincenzo, D. P., 428
Dobson, J. C., 328
Doron, E., 372
Dresden, M., 343
Drever, R. W. P., 383, 391
Drummond, P. D., 297
Dzyaloshinskii, I. Ye., 147
- Eden, R. J., 256
Ehrenfest, P., 302
Einstein, A., 3, 19, 20, 148, 150, 271, 310
Ekert, A. K., 294, 297
Emch, G., 220
Englert, B.-G., 375
Erdélyi, A., 82
Everett, H., III, 374
- Falck, J. P., 406
Fano, G., 78
Fawcett, R. J. B., 322
Feingold, M., 353, 372
Feller, W., 38, 90
Fetter, A. L., 147
Feynman, R. P., 311, 331
Finkelstein, D., 23
Fishman, S., 349, 372
Fleming, G. N., 416
Fock, V. A., 414
Fong, R., 227
- Ford, J., 372
Frenkel, A., 372
Fresnel, A., 18
- Galileo, G., 169
Garg, A., 186, 427
Gauss, C. F., 11
Gerlach, W., 14
Germer, L. H., 4
Ghirardi, G. C., 421
Giles, R., 47
Gilmore, R., 329
Gisin, N., 175, 220
Glauber, R. J., 325
Glazman, I. M., 285
Gleason, A. M., 190
Gödel, K., 173
Goldstein, H., 22, 224, 298, 303
Gor'kov, L. P., 147
Gradshteyn, I. S., 109
Green, H. S., 78
Greenberger, D. M., 152, 186
Gempel, D. R., 349
Grinstein, G., 428
Guarneri, I., 372
Gürsel, Y., 391
Gutzwiller, M. C., 311, 359, 371, 372
- Haake, F., 354, 371
Hahn, E. L., 342
Hannay, J. H., 319
Hardy, G. H., 262
Hardy, L., 186
Hartle, J. B., 23, 27
Hauge, E. H., 406
Hawking, S. W., 27
Heinzen, D. J., 394
Heisenberg, W., 4, 20, 256
Helstrom, C. W., 47, 282, 385
Herbert, N., 186, 427
Herbstein, H. J., 78
Hibbs, A. R., 331
Hillery, M., 331
Hofstadter, D. R., 186
Hogg, T., 349
Hojman, S. A., 331
Holevo, A. S., 284
Holt, R. A., 165

- Home, D., 416
 Hooker, C. A., 23
 Horne, M. A., 152, 165, 186, 207
 Huberman, B. A., 349
 Husimi, K., 316
 Huttner, B., 297
- Itano, W. M., 394
 Itzykson, C., 312
 Ivanovic, I. D., 54
- Jammer, M., 160
 Jauch, J. M., 23, 156, 283, 424
 Jaynes, E. T., 263, 296
 Jordan, P., 20
 Jordan, T. F., 78, 112, 255
 Jost, R., 259
 Jozsa, R., 295, 297
- Kac, M., 343
 Kafatos, M., 152, 185
 Karrass, A., 324
 Kawamura, S., 391
 Kay, K. B., 298
 Keller, J. B., 310
 Kelly, J. L., Jr., 418
 Kemble, E. C., 17
 Kennard, E. H., 22
 Kernaghan, M., 201, 212
 Khinchin, A. I., 296
 Kholevo, A. S., *see* Holevo
 Klauder, J. R., 112, 331
 Kochen, S., 21, 196
 Kolmogorov, A. N., 336
 Koopman, B. O., 318
 Korsch, H. J., 303, 347
 Kús, M., 354
- Lahti, P. J., 428
 Lancaster, P., 78
 Lanczos, K., 20
 Landau, L. D., 21, 22, 353
 Landau, L. J., 174
 Landauer, R., 266
 Landshoff, P. V., 256
 Landé, A., 36
 Lebowitz, J. L., 36
 Leff, H. S., 297
- Leggett, A. J., 427
 Leutwyler, H., 255
 Levitin, L., 284, 296
 Lewis, G. N., 4
 Lewis, J. T., 283
 Lieb, E. H., 265
 Lifshitz, E. M., 21, 22, 353
 Lipson, H., 22
 Lipson, S. G., 22
 Littlejohn, R. G., 331
 Littlewood, J. E., 262
 Lochak, G., 296, 391
 Loss, D., 428
 Low, F.E., 215
 Lüders, G., 259
- Maassen, H., 296
 Madelung, E., 307
 Magnus, W., 82, 324
 Mallalieu, M., 306
 Mandel, L., 169
 Mann, A., 174
 Mantica, G., 372
 Marinov, M. S., 331
 McMullin, E., 185
 Mermin, N. D., 152, 177, 181, 185, 186,
 189, 212, 294
 Merzbacher, E., 81
 Meyer, S. L., 47
 Meystre, P., 325, 429
 Michelson, P. F., 381
 Miglietta, F., 421
 Milburn, G. J., 394, 396
 Mittelstaedt, P., 428
 Moiseyev, N., 112, 304, 372
 Moser, J., 336
 Moyal, J. E., 314
 Mozart, W. A., 214
- Nagel, E., 186
 Nařmark, M. A., *see* Neumark
 Nauenberg, M., 306
 Neumark, M. A., 285
 Newman, J. R., 186
- O'Connell, R. F., 331
 Oberhettinger, F., 82
 Olive, D. I., 256

- Palma, G. M., 297
Park, D., 330
Park, J. L., 292
Partovi, M. H., 268
Pechukas, P., 372
Penrose, R., 212
Percival, I. C., 319, 372
Perelomov, A. M., 330, 331
Peres, A., *passim*
Pfleegor, R. L., 169
Pierce, J. R., 181, 296
Piron, C., 220, 283
Pitaevskii, L., 92
Planck, M., 3
Podolsky, B., 148
Poincaré, H., 40
Polkvinghorne, J. C., 256
Pólya, G., 262
Poon, Y. T., 41
Price, J. C., 381
Prange, R. E., 348, 349, 372
- Raab, F. J., 391
Racah, G., 258
Radcliffe, J. M., 328
Radons, G., 348
Ramaswamy, R., 359
Rarity, J. G., 166
Rasetti, M., 311
Reck, M., 78
Redhead, M., 211
Reed, M., 112
Reichl, L. E., 371
Reif, F., 267, 291, 296, 350
Reuter, M., 330
Revzen, M., 174
Rex, A. F., 297
Richtmyer, F. K., 22
Riesz, F., 86, 112
Rihaczek, A. W., 317
Rimini, A., 421
Ristow, G. H., 372
Robbins, J. M., 351
Robertson, H. P., 91
Roger, G., 166
Rohrlich, F., 156
Roman, P., 112
Ron, A., 394
- Roos, M., 43
Rosen, N., 148
Rosenkrantz, R. D., 296
Rothstein, J., 342
Ryzhik, I. M., 109
- Salecker, H., 406
Salvail, L., 294
Sandberg, V. D., 383
Schack, R., 372
Scharf, R., 354
Schiller, R., 308
Schilpp, P. A., 10, 20, 150, 208
Schmidt, E., 147
Schrödinger, E., 20, 373
Schulman, L. S., 331, 349
Schumacher, B. W., 297
Schwartz, L., 107
Schwarz, G. M., 181
Schwinger, J., 54, 256, 258, 321, 375
Scully, M. O., 331, 375
Senitzky, I. R., 56
Shannon, C. E., 261
Shepelyanski, D. L., 372
Shepley, L. C., 331
Shih, Y. H., 166
Shimony, A., 165, 186
Shoemaker, D., 391
Sievers, L., 391
Simon, B., 106, 112
Skagerstam, B.-S., 331
Smilansky, U., 372
Smolin, J., 294
Smyth, J. F., 428
Sokol, D. W., 372
Solitar, D., 324
Sommerfeld, A., 19, 22
Specker, E. P., 21, 196
Spero, R. E., 391
Stapp, H. P., 23, 160, 256
Stenholm, S., 316, 418
Stern, O., 14
Stone, M. H., 102
Stringari, S., 92
Stroud, C. R., Jr., 306
Sucher, J., 227
Sudarshan, E. C. G., 255
Swift, A. R., 191

- Szilard, L., 297
 Sz.-Nagy, B., 86, 112
- Taber, R. C., 381
 Tabor, M., 311, 371
 Tapster, P. R., 166
 Tesche, C. D., 429
 Thomas, H., 329
 't Hooft, G., 45
 Thorne, K. S., 383, 391
 Tinkham, M., 147, 329
 Tismenetsky, M., 78
 Tomsovic, S., 364
 Tricomi, F. G., 82
 Tsirelson, B. S., *see* Cirel'son
 Turing, A. M., 343
- Uffink, J. B. M., 296
 Uhlenbeck, G. E., 343
 Ullmo, D., 364
 Unruh, W. G., 297, 383
- van der Waerden, B. L., 23
 Van Vleck, J. H., 308
 Vogt, R. E., 391
 von Neumann, J., 27, 106, 158, 271, 385, 394
 Voros, A., 372
- Walecka, J. D., 147
 Walls, D. F., 325, 429
 Weber, J., 381
 Weber, T., 421
 Wehrl, A., 264, 296
- Weinberg, S., 278
 Weiss, R., 391
 Weyl, H., 136
 Wheeler, J. A., 373, 429
 Whitaker, M. A. B., 374, 416
 Whitcomb, S. E., 391
 Wiesner, S. J., 295
 Wigner, E. P., 27, 147, 179, 194, 217, 258, 313, 331, 358, 398, 406, 421
 Wilczek, F., 131
 Wilson, W., 19
 Wineland, D. J., 394
 Wolf, E., 22
 Wootters, W. K., 54, 279, 295, 297, 361, 401
 Wright, R., 191
 Wyatt, R. E., 348
- Yaffe, L. G., 298
 Yanase, M. M., 421
 Yeazell, J. A., 306
- Zak, J., 223, 317
 Zaparovanny, Y. I., 317
 Zaslavsky, G. M., 372
 Zeilinger, A., 78, 152, 186, 228
 Zemansky, M. W., 296
 Zhu, C., 112
 Zimba, J., 212
 Zimmermann, M., 383
 Zuber, J.-B., 312
 Zucker, M. E., 391
 Zurek, W. H., 173, 279, 297, 373, 377, 423, 429

Subject Index

- * (adjoint), 86ff
- † (Hermitian conjugate), 64
- ★ (difficult), xi
- ~ (Fourier transform), 321
- ~ (transposed matrix), 333
- $\langle \rangle$ (quantum average), 63
- \langle , \rangle (scalar product), 51ff

- action, classical, **307**, 312
- Aharonov-Bohm effect, 88ff
- algorithms, 344
- amplification, 17, 375, 384
- amplifier, 279
- amplitudes vs. intensities, 39, 61
- analogous classical and quantum systems, 299ff
- ancilla, 282, 286ff, 418
- angular momentum, 29ff, 233
- angular velocity, 233, 304ff
- annihilation operator,
 see lowering operator
- anticommute, 139
 - fields, 146
- anticorrelated, 163
- antilinear, 52
- antiunitary transformation, 219, 235, 258
- anyon, 131
- apparatus, 14
 - quantization of, 26
 - additional, larger, 18, 27, 376ff
- area preserving,
 - map, 337, 354
 - theorem, 304, 334
- arrow of time, 262, 266
- Aspect's experiment, 166, 293
- assembly, 25, 59, 63, 425
 - homogeneous, 292
 - astronomers, 424ff
 - Auger effect, 105
 - autoionization, 105
 - average (notations for), 63

- Baker-Campbell-Hausdorff identity, 323
- basis, 48ff
 - complementary, 59
 - complete, 53
 - orthonormal, 53ff
 - unbiased, 54
- Bayes's
 - postulate, 46
 - rule, 32, **45**
 - theorem, 46, 282
- Bayesian analysis, 386, 425
- Bell inequalities, **160ff**, 187, 206ff, 299
 - chained, 175
 - for consecutive measurements, 426
- Bell's theorem, **148**, 162ff
- Berry phase, 131
- best value, 90
- bi-orthogonal, 123, 176, 179
- bit, 262
 - random, 293, 295
- bizarre ideas, 80, 374
- Bohr quantization, 18ff, 310, 361
- Boltzmann distribution, 266
- Boltzmann, and the energeticists, 171
- bomb, 160ff
- boost,
 - Galilean, 246ff
 - Lorentz, 252, 254
- bosons, 126ff, 140ff
 - composite, 129
- bound state embedded in continuum, 105
- Brownian motion, 38, 308, 312

- canonical formalism, relativistic, 250ff
 canonical quantization, 251
 constraints in, 250
 canonical transformations,
 222, 230, 233, 300, 309, 334
 and unitary transformations, 299, 351
 Carnot engine, 29
 celestial mechanics, 172
 central limit theorem, 90
 chance, 7, 344, 349
 chaos, **332**
 and irreversibility, 369
 dissipative, 372
 experimental, 372
 quantum aspects of classical, **347**
 chaotic,
 domain, 311, 339, 354
 motion, 337, 344
 quantum, **353**, 364
 quantum simulation, 349
 charge conjugation, 259
 Christoffel-Darboux formula, 109
 CHSH inequality, 164ff, 170, 174ff, 179
 ciphertext, 293
 Cirel'son's inequality, 174, 179, 181
 classical measurement theory, 90, **378**, 415
 classical operator, 298
 see also reasonable operator
 classical parameters, 39, 273
 estimation by quantum probes, **385**
 in wave function, 385
 classical system, formal definition, 424
 classical wave function, 310
 clock,
 classical, 407
 free particle, 406
 Larmor, 406, 412
 oscillator, 383ff, 406
 quantum, 408
 disturbance caused by, 410, 412
 resolution, 406, 409ff, 413
 rotor, 382ff, 406
 clock-time operator, 407, 414
 nonlocality in time, 407
 cluster inseparability, 136
 cluster separability, 128, 159, 255
 coarse graining, 341ff, 345ff
 coherence matrix, 390, 395
 time-dependent, 401
 coherent states, **323**, 390, 418, 420
 for angular momentum, 185, 328, 363
 determination of parameters, 386
 overlap, 329, 363
 for any group, 330
 collapse, 154, 374
 collisions, 268, 272
 commutation relations,
 canonical, 11, 227
 fields, 146
 commutator, 71, **89**
 domain of definition, 94
 complementarity principle, 149
 complete set of commuting operators, 188
 completeness of quantum description,
 76, 149, 240, 263, 276
 complexity, 344, 350ff
 composite systems, **115**, 376, 391
 Compton effect, 4
 computability, 342, 344ff, 349
 computation, 266
 concave function, 262
 confidence,
 intervals, 47
 level, 289
 consciousness, 23, 26
 consecutive measurements, 426
 classical, 380
 quantum, 390ff
 conservation laws, 412
 constant of the motion, 243
 generates symmetry, 244
 in involution, 336
 constants, physical, 386
 context of a measurement, 188
 contextuality, **187**, 208
 experimental and logical aspects, **202**
 continual monitoring, 382
 continuous,
 indices, 79, 110
 variables, **79**, 103, 290
 continuous measurement, 390
 passive detector, 391, 400
 convergence, weak and strong, 81
 conversion of units, 228

- Cooper pair, 130
- Copenhagen interpretation, 23
- correlated histories, 171
- correlated questions, 402, 404
- correlated state,
116ff, 294, 376, 378, 389, 421
- correlation, 33, **115**, 187, 205
classical, 183ff
as limit of quantum, 184
quantum, **115**
stronger than classical,
160ff, 167, 299
- correspondence principle,
229, **298**, 347, 415
failure, 103, 222, 302, 351
- correspondence with classical mechanics,
228
- counterfactual, 16, 28, 34, 149, 153, 160,
162, 167, 187ff, 200, 202
compatibility, 207
realism, 206
- coupling constant, 401
- creation operator, *see* raising operator
- cryptodeterminism, **155**, 187, 196
see also hidden variables
- cryptography, 293
quantum, 284, **293ff**
- crystal lattice, 229
- crystal, birefringent, 5ff
- Davies's theorems, 283, 285
- de Broglie wavelength, 20, 228
- decorrelate, 117, 376, 378
- degrees of freedom, number of, 301
- delta function, 85, 96, 106ff
oscillatory behavior, 108ff
square root, 81
- dense set of vectors, 86
- density matrix, 73ff, 263, 388ff
eigenvalues, 74
non-uniqueness of decomposition, 74ff
reduced, 122, 124, 170, 265, 288, 376,
389ff, 401, 411
- density of states, 351, 410
- dequantization, 373
consistency, 376ff
- detector efficiency, 165
- determinism, 5 →
- quantum, 237
statistical, 30
- dial operator, 321, 406
- dial state, 320, 406
- diffusion, quantum, 385
- Dirac picture, **242**, **244**
- Dirac's notation, **77**, 128, 326
table, 78
- direct product, 115, 119, 292
- Dirichlet's theorem, 83
- displacement operator, 325
- distributions, tempered, 107
are not quantum states, 109
operator valued, 111, 146
- dodecahedron, 212
- double density coding, 294
- double refraction, 6
- dynamical variables, 280
vs. external parameters, 229, 241
- dynamics, quantum, **237**
- eavesdropping, 293ff
- EBK quantization, 310ff
- Ehrenfest theorem, 302ff
- eigenphase, 360ff, 364
- eigenvalue, 67ff,
almost, 103ff
degenerate, 70, 187
- eigenvector, 67ff
orthogonality, 69ff
- Einstein locality,
150, 153, 160, 163, 170ff, 187
- electromagnetic theory, classical,
7, 27, 39, 59, 226
- endophysical, 173
- energy equipartition, 3
- ensemble, 25, 45, 55, 183, 271, 425
- entangled state,
148, 155, 175, 274, 374, 392
see also correlated state
- entangled systems, 21, 129
more than two, 177
- entire function, 327
- entropy, 32, **260**, 345, 360
composite systems, 264
depends on test, 261
mixing, 271
never decreases, 262, 264, 278, 369 →

- of preparation, 262
- relative, 264ff, 269
- Shannon, 261, 280ff, 290ff
- spontaneous decrease, 343
- units, 262
- von Neumann, 264, 274, 281, 290
 - equivalence to thermodynamic, 272, 275, 278
 - with respect to perturbed basis, 361
- environment, 172, 178, 266, 353, 378, 423
 - noisy, 181, 345, 369, 428
- EPR (Einstein-Podolsky-Rosen), 148ff, 162, 169, 179, 294
- equilibrium, thermodynamic, 266ff, 274
 - approach to, 269
- ergodicity, 340
- errors,
 - instrumental, 90ff
 - numerical, 344, 350
- Escher's *Waterfall*, 212
- Euclidean geometry, 11ff, 50, 415
- Euclidean group, 229
 - rotations, 232
 - translations, 230
 - translations and rotations, 234
- Euler angles, 223, 329, 346
- event, 38, 45
 - supernatural, 57, 374
- Everett's interpretation, 374
- exophysical, 173
- expectation rule, 54ff
- expectation value, 63, 190
- experimenters, 57, 77, 342, 424, 429
- exponential decay law, 410, 416
 - never strict, 416
- extent of state, 359ff, 364

- Fermi's golden rule, 410, 416
- fermions, 126ff, 138ff
 - composite, 129
- ferritin, 428
- ferromagnet, 178, 423
 - see also* ferritin
- Feynman path integrals, 311, 331
- field, quantized, 83, 110ff, 146ff
- field theory, relativistic, 256, 312
 - local, 127, 138, 255, 259
- filaments (in chaotic maps), 339ff

- five-pointed star, 189
- fixed point, 334ff, 355ff, 361
 - elliptic (stable), 336
 - hyperbolic (unstable), 336
- Fleming unitary limit, 416, 428
- fluctuation, statistical, 343
- flux quantization, 428ff
- Fock space, 137ff
 - for Gaussian wave packets, 324ff
 - in field theory, 147
 - normalized basis, 141
- FORTRAN, 209
- Fourier transform, discrete, 54, 181ff, 321
- fragile states, 361ff, 363ff
- frame function, 193ff
- free energy of pure state, 274
- free will, 13, 149, 166, 169, 171
- freedom of choice, 13, 149, 162ff, 168, 191
 - see also* counterfactual
- frequency, relative, 13, 25, 45
- Freudian typo, 13
- functional consistency, 188

- Galilean group, 247ff
- Galilean invariance, 245
- generator,
 - continuous transformation, 223
 - translation, 226
- genes, 36
- GHZ (Greenberger-Horne-Zeilinger), 152ff
- Gibbs phenomenon, 97
- Gibbs state, 266ff, 273
- Glauber expansion, 327ff
- Gleason's theorem, 56, 190, 208
- gravitation, 215, 229
 - quantum theory of, 332, 381
- gravitational radiation, 381, 391
- group,
 - continuous, 220
 - permutations, 131
 - of 3 objects, 132ff
 - representation, 133
 - equivalent, 133, 226
 - irreducible, 133, 136, 179, 195, 330
 - symmetric, 132ff
- group contraction, 321ff, 329
- gyromagnetic ratio, 15
- Gödel undecidability, 173, 186

- H* (Hilbert space), **79**
 $\hbar \rightarrow 0$, 299ff, 314, 351
 halting problem, 343
 Hamilton- Jacobi equation, 308ff
 solution is not single-valued, 310
 Hamiltonian, 239
 harmonic oscillator,
 damped, 238ff
 forced, 381ff
 ground state, 316
 Liouville equation, 318
 pair of, 383ff
 q and p matrices, 322
 he or she, 12, 153
 heat, 267, 270
 Heisenberg algebra, 322
 Heisenberg microscope, 4, 380
 Heisenberg operator, 253
 Heisenberg picture, 222, **242**, 247, 387, 417
 equations of motion, 243, 272
 observables, 243
 state vector, 243
 helicity, 156
 helium atom, 19ff, 126, 129
 Herbert's inequality, 427ff
 hidden variables, 21, 31, 155, 196, 427
 and relativity theory, 171
 Bell's model, 158, 190
 local, 160, 163
 von Neumann's proof, 158
 see also cryptodeterminism
 Hilbert space, **79**
 completeness, 81
 extension, 285ff
 mock, 276
 pseudo-Hilbert space, 80
 separable, 83
 truncated, **95**, 350
 history, 31ff
 Husimi function, 316
 hybrid classical-quantal theory, 272, 331
 hydrogen atom, 19ff, 24, 105, 115, 130,
 172, 230, 305, 372
 ice cube in boiling water, 341ff, 369
 ideal gas,
 classical, 270ff, 274
 quantum, **270**
 identical particles, 425
 see also indistinguishable
 ignorance, 260, 262, 282
 conservation of, 32, 242
 ignore, we choose to, 122, 369, 423, 429
 see also irrelevant
 imagination, 16, 29, 55, 160, 163, 167, 169,
 206, 272
 "impossible" (very difficult),
 341ff, 345ff, 370, 424
 impossible processes, **275**
 incomplete information, 172
 inconclusive answer, 284ff
 indefinite metric, 80
 indistinguishable particles, **126**, 137
 information, 12, **260**, 345
 classical, 295
 erasure, 266
 gain, 281, 287, 386
 negative, 282
 optimization, 283ff, 297
 obsolete, 374
 recording, 345
 secret, 293
 inner product, *see* scalar product
 partial, 287
 inseparability, quantum, 21
 instantaneous communication,
 170, 192, 290
 interaction picture, *see* Dirac picture
 interference, **36**
 constructive, 37ff
 destructive, 37ff
 polarized light, 18ff, 59
 principle, 38
 interpretation of experiments,
 17, 26ff, 30, 62
 correspondence rules, 30
 intersub jectivity, 18, 58
 inversion, **257**
 irregular, *see* chaotic
 irrelevant degrees of freedom, 122, 239, 346
 chaotic dynamics of, 378
 irreversibility, 13, 36, 58, 266, **332**, **341**
 deceptive, 342
 of quantum test, 377
 island of stability, 337ff

- isolated systems, 346, 377, 427
see also perturbations, external
- isothermal processes, 271, 277
- Jacobi identity, 224, 235
- Kac ring, 343
- KAM (Kolmogorov-Arnol'd-Moser),
 line, 337ff, 355ff
 manifold, 335, 341
 breakup, 347
 theorems, 336
- key,
 cryptographic, 293ff, 342ff
 in my pocket, 282
- kicked top, *see* twist and turn model
- Kochen-Specker theorem, 114, **196ff**, 206
 Bell's proof, 197
 computer proof, **209**
 Conway and Kochen proof, 114, 197
 counting rays used in proof, 199
 Penrose's proof, 212
 physical interpretation, 199
 24 rays, 200ff
 33 rays, 197ff
- Koopman's theorem, **317**, 347ff
- language, classical, 10ff, 26, 58, 387, 425
 transition from quantum,
 293, 373, 377, 426
- Levitin-Holevo inequality, 284, 287
- light cone, 12, 257, 259
- likelihood, 47, 282
- Liouville density, 55ff, 222, 242, 267, 303ff,
 312, 341, 347, 356ff, 375ff
- Liouville equation, 312, 317ff, 376
 quantum, 314ff
 wave function, 318
- Liouville theorem, 303
- Liouvillian, 317ff
 continuous spectrum, 319
- locality in time, 427
- localized states,
 301ff, 320, 347, 354, 361, 417
 in energy, 348ff
- logic, 23, 173
- logical depth, 342ff
- logical positivism, 289
- logical structure of theory, tests for, 44
- Lorentz frame, 154
- Lorentz group, 252
- Lorentz invariance, 255
- Lorentz transformation,
 canonical, 251, 254
 finite, 250
 infinitesimal, 249
- lowering operator, 138, 322, 324
 transformation law, 143
- Lyapunov exponent, 335, 345, 350ff
- Lyapunov factor, 335, 339, 344
- Mach-Zehnder interferometer, 62, 385
- macroscopic degree of freedom, 17
- macroscopic variables, 426
- macroscopic vs. microscopic systems,
 10ff, 345ff, 378, 423
- macroscopically distinguishable, 178, 378
- macrovariables, 272ff
- magnetic moment, 14, 24
- Malus law, 157
- many worlds interpretation, 374
- map,
 discrete, **332**
 parabolic, 337ff
 quantum, **351**
 standard, 337, 351
- marginal distributions, 313, 316ff
- Maslov index, 311
- mass, geometric definition, 248, 253
- matrices,
 antihermitian, 221
 Hermitian, 64
 normal, 72
 orthogonal, 41, 48
 polar decomposition, 72
 transformation law, 64ff
 unitary, 41, 48ff, 64
- matrix mechanics, 20, 23
- Maxwell's demon, 297
- meaningless questions,
 10, 169, 227, 292, 377
- measurable operators, 426
- measurement, **14ff**, **62ff**
 ambiguity, 187ff, 208
 approximate, 422
 disturbance, 14, 93, 148, 378 →

- finite duration, 391, **401ff**
- fuzzy, 29, 384, 387, 397ff, 401
- model, 375
- of first kind, 378
- of time, **405**
- of time-dependent variables, 404ff
- “problem,” 280
- simultaneous, 188
- measurement theory, classical, **378**
 - always fuzzy, 399
- memory, 266
- mental experiments, 25
- mesoscopic, 423
- mesovariables, 272
- message, 153
- metastable states, 415
- “meter,” 387ff
 - width, 388ff, 398ff
- Michelson-Morley experiment, 215, 237
- microvariables, 272ff
- misprint, not a, 225
- mixing, 340, 347
- mixture, **72ff**
- momentum operator, **225**, 313
- momentum representation, 313, 404, 418ff
- Moon, 137, 349, 424
- music, 214, 323

- Neumark’s theorem, **285**
- neutron diffraction, 229
- no-cloning theorem, 279
- noise, 181, 369, 381
- non-orthogonal states, 55, 274, 294
 - selection, 275ff
- nonfactorable, *see* entangled
- nonintegrable systems, 311, 336, 344
- noninvasive, 380, 427
- nonlocal, 169
 - transformation, 405
- nonlocality, 169, 173
 - vs. contextuality, **187**
 - weak and strong, 170, 192
- normal ordering, 145
- number operator, 139

- objective, 4, 14, 16ff, 58, 90, 188, 282, 293, 345, 423, 425, 427ff
- objectivity, 374 →
 - approximate, 377
 - limits of, **289**
 - macroscopic, 424
- observables, **62ff**, 280
 - ambiguity, 208
 - composite systems, 119ff
 - representation by a matrix, 67
- observers, 12, 150, 163, 165, 172, 178, 180, 191ff, 343, 376, 399
 - ambivalent, **373**
 - are physical systems, 168
 - communication between, 154, 170, 293ff
 - macroscopic, 345ff
- ohmic resistance, 429
- one-particle operator, 143
- ontology, 374
- open system, 173, 377, 423, 427
- operators, linear, **84**
 - adjoint, 86ff, 182
 - bounded, 84
 - closed, 87
 - domain of definition, 84, 86
 - extension, 87
 - local, 84
 - norm, 84
 - null, 86
 - quasilocal, 84
 - restriction, 87
 - self-adjoint, 86ff, 102
 - self-adjoint extension, 87ff
 - symmetric, 87
 - transformations of, 221ff
 - unbounded, 85, 95
 - without eigenvalues, 96
- optic axis, 6ff
- orbit,
 - chaotic, 338, 344, 347
 - periodic, 311, 334
 - regular, 338
 - smaller than \hbar , 381
 - stable, unstable, 332, 334ff
- orthogonal states, reversible rotation, 274, 277, 394
- overcomplete basis, 323, 326
 - uniqueness, 326
- overlap of quantum states, 281
 - perturbed and unperturbed, 366ff

- p -representation, 321
see also momentum representation
 paradoxes, 5, 150, 160, 169, 187, 250, 263,
 349, 373, 394
 parafermions, 141
 parastatistics, **131**
 observable consequences, 136
 parity, 156, 258
 partition function, 267
 path, 38ff
 perturbation theory, 332, 416
 failure for chaotic systems, 353
 for unitary matrices, 352
 third order, 353
 perturbations, external, 353
petitio principii, 275
 phase,
 arbitrariness, 54, 123, 217, 225, 227,
 231, 235
 determination, 58ff
 shift, 118, 131, 408
 phase space,
 area = integral multiple of h , 319ff
 classical, 55, 267, 303, 381
 compact, **319**
 distance in, 347
 division into cells, 350
 quantum mechanics in, **312**
 photoelectric effect, 4, 20
 photons, 4
 as probes, 385
 megajoules of, 75
 polarized, 5, 7, 47, 59ff, 116ff, 163ff,
 277, 293ff
 unpolarized, 261
 photon pairs, 155ff, 169
 correlation, 157, 295
 indivisible, 169
 physicists, 3, 4, 12, 13, 50, 58, 59, 172, 374
 plaintext, 293
 Planck's constant, 228
 planets, 304, 349, 424
 Poincaré group, 252
 generators (spinless particles), 254
 Lie algebra, 254
 Poincaré invariants, 303
 Poincaré recurrence, 305, 349, 366
 pointer, 375, 377, 401ff, 409
 free particle, 379
 several, independent, 417
 zigzag motion, 405
 pointer states, 407, 423, 426ff
 Poisson brackets, 15, 238, 300, 382ff
 and commutators,
 225, 242, 319, 380, 417
 for fields, 11
 unequal time, 380
 polarization,
 circular, 8ff
 elliptic, 8ff, 116
 linear, 7ff
 orthogonal, 9, 116
 partial, 76ff
 Polaroid, 5
 position observable, 226, 254
 positive operator, 74, 314
 measure, 282
 see also POVM
 positronium, 156
 POSTSCRIPT, 339, **370ff**
 potential barrier, 408
 POVM, 283ff, 326, 330, 378, 386, 418ff, 424
 choice of, 418
 resulting quantum state, 288, 294, 418
 precession, spin,
 222, 237, 280, 342, 404, 412, 428
 preferred basis, 423
 preparations, 12, 280
 macroscopically different, 280, 428
 "same," 13, 203
 pressure, 271ff
 principle of local causes, 160, 187
 privileged coordinates, 345
 probability, 13, 25
 addition, 38
 conditional, 36, 45, 281, 425
 inverse, 45
 joint, 45ff, 182
 projection operator, 66, 70ff
 orthogonal, 71ff, 190ff
 projection postulate, 442
 projector, 190ff, 202, 351
 orthogonal, 205, 283
 see also projection operator

- propagator, 245
 proper time, 250
 proton recoil, 28
 pure state, 30ff, 48, 56, 117, 261, 314
 evolution into mixture, **369**
q-representation, 313, 321
 see also *x*-representation
 QND (quantum nondemolition), 380, 400
 quantum dial, 320
 quantum number, 311
 hidden, 132
 quantum potential, 308
 quantum state, 24ff
 determination of, **58**
 quantum system, **24**, 60
 quantum theory,
 alterations, 57, 375, 426ff
 “new,” 20
 “old,” 18, 271
 scope, 13, 18, 45, 50, 374, 412, 423
 statistical interpretation, 13, 20ff
 quarks, 130, 132
 quarter wave plate, 8ff
 quasienergy, 351
 quasiprobability, 314
 quaternionic quantum theory, 44

 R matrix, 401ff
 radial momentum, 89
 radiation, thermal, 3, 47
 orthogonal modes, 3
 radio station and receiver, 414
 raising operator, 138, 322, 324
 random mixture,
 31ff, 154, 261, 267, 292, 295
 randomness, **5**, 32
 realism,
 counterfactual, 206
 local, 177, 299, 423
 reality, 10, 14, 16, 45, 153, 173, 425
 approximate, **423**
 elements, 148
 recursive, 151
 fuzzy, 426
 reasonable operator, 298, 377, 380
 reciprocity law, 35ff, 41, 56
 record, 17, 58, 373, 387, 408 →
 irreversible, 375
 reduction of off-diagonal matrix elements,
 390ff, 395
 regular,
 classical system, 353
 domain, 311, 354, 361
 quantum motion, 364
 relative state interpretation, 374
 relativistic dynamics, **254**
 interactions, 254
 no go theorem, 255
 other forms (Dirac), 255, 259
 relativistic invariance, **249**
 proving, 250
 relativistic quantum theory, 171
 relativity, general theory, 215
 remote state, 128ff, 137
 representation, *see also* picture
 reservoir, 266, 270ff
 resolution of the identity, 99, 102, 280, 283
 resolution, instrumental, 387
 resonance, 105, 416
 rest of world, 172ff, 346
 retrodiction, 36
 rigid body, 29, 215
 Rihaczek function, 317
 robust states, 361ff, 363ff
 robust variables, 380, 382ff, 400
 rotating coordinate system, 242
 rotation by finite angle, 232
 rotation operator, 182, 233, 300
 Runge-Kutta method, 344
 Rydberg states, 304ff

S-matrix theory, 256ff
 Sagredo, 168
 Salviati, 168
 scalar operator, 236
 scalar product, 51ff
 Hermitian, 52, 80
 of Wigner functions, 316
 Schmidt decomposition, **123**, 176, 179
 Schrödinger cat,
 178, 373, 376, 378, 423, 426
 when did it die? 409ff
 Schrödinger equation, 239ff, 410
 for density matrix, 312
 hydrodynamical model, 307ff →

- in accelerated coordinates, 246
- in uniformly moving coordinates, 246
- integration, 349
- nonlinear variants, 241ff, 278
- Schrödinger picture, 242, 247, 387
- Schwarz inequality, 52, 80, 91
- science fiction, 171, 296
- second law of thermodynamics, 270, 277ff, 297
- second quantization, 111, **142**, 146
- secular equation, 70
- selection of state, 263, 273ff, 402
- selection rule, 269, 353
- semiclassical, **298ff**, 319
- semipermeable membrane, 270ff, 276ff
- shift parameter, 325
- signals, time-dependent, **387**, 390ff
 - quantum limitations, 391
- similarity transformation, 68
- Simplicio, 168
- singlet, 120, 124, 151, 162, 180
- space reflection, **257**
 - unitarity, 258
- space-like, 166, 168, 425
- spacetime,
 - four-dimensional formalism, 250
 - symmetries, **215**
- spectra, classification, **103**
 - see also* spectrum
- spectral decomposition, 101ff
- spectral family, 101
- spectral theory, **99**
- spectrum,
 - continuous, 96, 103ff
 - discrete, 103
 - mixed, 103, 409
 - point, 349
 - dense, 106, 318
 - power, 181
 - singular continuous, 106
 - white, 181, 183
- speculations, 173, 426ff
- spherical harmonics, 193ff
- spin echo, 342, 345
- spin $\frac{1}{2}$ particles, *passim*
 - pair (in any state), 189, 200
- spin 1, 33, 191ff, 199ff, 203ff
- spin, $\frac{3}{2}$, 18, 132, 212
 - from two spin $\frac{1}{2}$ algebras, 120
- spin 1600, 359ff
- spin j , 179ff, 186, 398
- SPS cascade, 155ff, 163, 166
- squeezing, 325
- SQUID, 429
- stability of quantum motion, 364
- staircase function, 100
- standard deviation, 90ff, 321
- statistical mechanics, classical, 3, 242, 267, 291, 312, 314
- Stern-Gerlach experiment, 29ff, 237, 289ff
 - approximate, 422
 - classical description, 14ff
 - quantum description, 402ff
- Stieltjes integral, 102
- stochastic matrix, 34
 - doubly, 34, 41, 262, 264
 - orthostochastic, 41, 43
- subadditivity, 265, 268
- subjective, 345
- superconducting loop, 428ff
- superobserver, 376ff
- superposition principle,
 - 48**, 115, 117, 127, 278, 378
 - strong, 54, 190ff, 283, 285
- superselection rule, 83
- supersymmetry, 259
- supplier, your
 - of mixed states, 292
 - of polarized particles, 289
 - of pure states, 43, 53
- surface of section, 334, 336
- survival probability, 415ff
- switching on and off, 412, 414
- symmetry, **215ff**, 244, 248
 - axial, 290
 - dynamical, 355
 - kinematic, 215
 - rotational, 155, 180
 - translational, 421
- symplectic matrix, 298, 333ff
 - eigenvalues, 334
- synchronization, 249
- technology, more advanced, 155, 158, 170ff, 276

- teleportation, 295
 temperature, 267ff
 tensor product, *see* direct product
 tensor, 66
 operator, 236
 tests, 12, 24
 biased, 34
 compatible, 190, 203
 constrained results, 204ff
 correlated results, 205
 in classical physics, 203, 425
 complementary, 54
 complete, 29
 consecutive, 27, 33
 see also consecutive measurements
 elementary, 190
 generalized, 279
 idle, 32
 incompatible, 13, 16, 149ff
 see also incompatible observables
 incomplete, 121, 132
 indirect, 279
 maximal, 29, 53, 117, 187, 237, 279,
 283, 292, 295
 repeatable, 27, 203, 378
 unbiased, 31ff
 theorists, 45, 50, 297, 425
 thermal bath, 270
 thermodynamics, 260
 time,
 not a dynamical variable,
 238, 248, 251, 405
 not an operator, 240, 323, 414
 past-future asymmetry, 12ff, 262, 268
 past-future symmetry, 36, 341
 universal, 249
 see also clock-time
 time evolution,
 canonical, 239
 unitary, 238ff, 347
 time ordered products, 44
 time reversal, 257
 antiunitary mapping, 258
 motion reversal, 258, 345
 time-energy complementarity, 413
 time-energy uncertainty, 2, 94, 413ff
 time-of-flight, 408, 413
 time of passage, 409
 tori in phase space, 336
 torque, observation of, 395ff
 trace, 73, 182
 partial, 121, 288, 411
 trace out, 389, 401, 411
 trajectory, quasi-classical, 14, 26, 28
 transfer matrix, 332ff, 338
 transformations,
 consecutive, 223
 continuous, 220, 223
 infinitesimal, 220
 passive vs. active,
 131, 215ff, 222, 225, 229, 231, 237
 transition amplitudes, 39, 48ff
 complex phases, 40ff
 law of composition, 40, 49, 57
 transition probabilities, 40ff, 51, 217
 determine the amplitudes, 42ff, 51
 transitivity, 203
 translation in time, 237
 canonical formalism, 238
 transport law, arbitrariness, 232
 triangle inequality, 53, 265
 truncated sine and cosine, 320ff
 truth and falsehood, 289ff
 tunnelling between regular regions, 364
 twist and turn model, 354ff
 quantum, 358
 perturbed, 360ff
 regular and chaotic vectors, 363ff
 symmetry classes, 358ff
 twist, 300, 354
 two-particle operator, 144
 uncertainty principle, 445
 uncertainty relations,
 59, 89ff, 323, 374, 377, 409
 angle and angular momentum, 93
 classical, 378ff
 stronger than quantum,
 415, 422, 426
 entropic, 296
 time and energy, 2, 94, 414ff
 time and frequency, 214, 323, 413
 unitary equivalence,
 formal, not physical, 227

- universe,
 - expansion, 13
 - finite, 345ff
 - indivisible, 173
 - wave function, 27, 154, 374
- unperformed experiments, 168
- unpredictability, 353
- unreasonable operators, 301
- vacuum, 3
 - state, 138, 324
- Van Vleck determinant, 308ff
- variance, 390, 398
- vector,
 - complex, **48**
 - components, 49ff
 - length, 51
 - norm, 51, 80, 410
 - normalization, 51
 - in a box, 409ff
 - not normalizable, 80
 - null, 49, 138
 - operator, 236
 - orthogonal, 51
 - parallel, 51
 - transformation, 48ff, 65
- verification of a state, 290, 292
- violation of physical principles, 58
- von Neumann measurement,
 - (measurement of the first kind), 378, 385ff, 419, 421
- watched pot, 399
 - see also* Zeno effect
- wave function,
 - discontinuous, 82
 - meaning of, 4, 373ff, 424
 - singular, 81ff
- wave mechanics, 20, 22, 23
 - see also* new quantum theory
- wave packet, 228, 256, 349ff
 - minimum uncertainty, 93, 323, 420
 - motion and distortion, **302**ff, 315
 - overlapping, separating, 402
 - reassembles, 306ff
 - spreading, 18
- WAY (Wigner-Araki-Yanase) theorem, 421 ff
- width, 320
- Wigner function, 313ff, 347, 375
 - fuzzy, 316, 376
- Wigner's theorem, **217**, 235, 279
- work, 267, 270, 276ff
- world line, 251, 254
- wrong equations,
 - 93, 204, 240, 279, 413ff, 426
- x*-representation, 225
- XOR, 293
- Zeno effect, 384, **392**ff, 405, 410
 - partial, 394ff
 - oscillations, 396ff
- zeroth law of thermodynamics, 269

Fundamental Theories of Physics

Series Editor: Alwyn van der Merwe, University of Denver, USA

1. M. Sachs: *General Relativity and Matter. A Spinor Field Theory from Fermis to Light-Years.* With a Foreword by C. Kilmister. 1982 ISBN 90-277-1381-2
2. G.H. Duffey: *A Development of Quantum Mechanics.* Based on Symmetry Considerations. 1985 ISBN 90-277-1587-4
3. S. Diner, D. Fargue, G. Lochak and F. Selleri (eds.): *The Wave-Particle Dualism.* A Tribute to Louis de Broglie on his 90th Birthday. 1984 ISBN 90-277-1664-1
4. E. Prugovečki: *Stochastic Quantum Mechanics and Quantum Spacetime.* A Consistent Unification of Relativity and Quantum Theory based on Stochastic Spaces. 1984; 2nd printing 1986 ISBN 90-277-1617-X
5. D. Hestenes and G. Sobczyk: *Clifford Algebra to Geometric Calculus.* A Unified Language for Mathematics and Physics. 1984 ISBN 90-277-1673-0; Pb (1987) 90-277-2561-6
6. P. Exner: *Open Quantum Systems and Feynman Integrals.* 1985 ISBN 90-277-1678-1
7. L. Mayants: *The Enigma of Probability and Physics.* 1984 ISBN 90-277-1674-9
8. E. Tocaci: *Relativistic Mechanics, Time and Inertia.* Translated from Romanian. Edited and with a Foreword by C.W. Kilmister. 1985 ISBN 90-277-1769-9
9. B. Bertotti, F. de Felice and A. Pascolini (eds.): *General Relativity and Gravitation.* Proceedings of the 10th International Conference (Padova, Italy, 1983). 1984 ISBN 90-277-1819-9
10. G. Tarozzi and A. van der Merwe (eds.): *Open Questions in Quantum Physics.* 1985 ISBN 90-277-1853-9
11. J.V. Narlikar and T. Padmanabhan: *Gravity, Gauge Theories and Quantum Cosmology.* 1986 ISBN 90-277-1948-9
12. G.S. Asanov: *Finsler Geometry, Relativity and Gauge Theories.* 1985 ISBN 90-277-1960-8
13. K. Namsrai: *Nonlocal Quantum Field Theory and Stochastic Quantum Mechanics.* 1986 ISBN 90-277-2001-0
14. C. Ray Smith and W.T. Grandy, Jr. (eds.): *Maximum-Entropy and Bayesian Methods in Inverse Problems.* Proceedings of the 1st and 2nd International Workshop (Laramie, Wyoming, USA). 1985 ISBN 90-277-2074-6
15. D. Hestenes: *New Foundations for Classical Mechanics.* 1986 ISBN 90-277-2090-8; Pb (1987) 90-277-2526-8
16. S.J. Prokhorovnik: *Light in Einstein's Universe.* The Role of Energy in Cosmology and Relativity. 1985 ISBN 90-277-2093-2
17. Y.S. Kim and M.E. Noz: *Theory and Applications of the Poincaré Group.* 1986 ISBN 90-277-2141-6
18. M. Sachs: *Quantum Mechanics from General Relativity.* An Approximation for a Theory of Inertia. 1986 ISBN 90-277-2247-1
19. W.T. Grandy, Jr.: *Foundations of Statistical Mechanics.* Vol. I: *Equilibrium Theory.* 1987 ISBN 90-277-2489-X
20. H.-H von Borzeszkowski and H.-J. Treder: *The Meaning of Quantum Gravity.* 1988 ISBN 90-277-2518-7
21. C. Ray Smith and G.J. Erickson (eds.): *Maximum-Entropy and Bayesian Spectral Analysis and Estimation Problems.* Proceedings of the 3rd International Workshop (Laramie, Wyoming, USA, 1983). 1987 ISBN 90-277-2579-9

Fundamental Theories of Physics

22. A.O. Barut and A. van der Merwe (eds.): *Selected Scientific Papers of Alfred Landé. [1888-1975]*. 1988 ISBN 90-277-2594-2
23. W.T. Grandy, Jr.: *Foundations of Statistical Mechanics. Vol. II: Nonequilibrium Phenomena*. 1988 ISBN 90-277-2649-3
24. E.I. Bitsakis and C.A. Nicolaides (eds.): *The Concept of Probability*. Proceedings of the Delphi Conference (Delphi, Greece, 1987). 1989 ISBN 90-277-2679-5
25. A. van der Merwe, F. Selleri and G. Tarozzi (eds.): *Microphysical Reality and Quantum Formalism, Vol. 1*. Proceedings of the International Conference (Urbino, Italy, 1985). 1988 ISBN 90-277-2683-3
26. A. van der Merwe, F. Selleri and G. Tarozzi (eds.): *Microphysical Reality and Quantum Formalism, Vol. 2*. Proceedings of the International Conference (Urbino, Italy, 1985). 1988 ISBN 90-277-2684-1
27. I.D. Novikov and V.P. Frolov: *Physics of Black Holes*. 1989 ISBN 90-277-2685-X
28. G. Tarozzi and A. van der Merwe (eds.): *The Nature of Quantum Paradoxes*. Italian Studies in the Foundations and Philosophy of Modern Physics. 1988 ISBN 90-277-2703-1
29. B.R. Iyer, N. Mukunda and C.V. Vishveshwara (eds.): *Gravitation, Gauge Theories and the Early Universe*. 1989 ISBN 90-277-2710-4
30. H. Mark and L. Wood (eds.): *Energy in Physics, War and Peace*. A Festschrift celebrating Edward Teller's 80th Birthday. 1988 ISBN 90-277-2775-9
31. G.J. Erickson and C.R. Smith (eds.): *Maximum-Entropy and Bayesian Methods in Science and Engineering. Vol. I: Foundations*. 1988 ISBN 90-277-2793-7
32. G.J. Erickson and C.R. Smith (eds.): *Maximum-Entropy and Bayesian Methods in Science and Engineering. Vol. II: Applications*. 1988 ISBN 90-277-2794-5
33. M.E. Noz and Y.S. Kim (eds.): *Special Relativity and Quantum Theory*. A Collection of Papers on the Poincaré Group. 1988 ISBN 90-277-2799-6
34. I.Yu. Kobzarev and Yu.I. Manin: *Elementary Particles. Mathematics, Physics and Philosophy*. 1989 ISBN 0-7923-0098-X
35. F. Selleri: *Quantum Paradoxes and Physical Reality*. 1990 ISBN 0-7923-0253-2
36. J. Skilling (ed.): *Maximum-Entropy and Bayesian Methods*. Proceedings of the 8th International Workshop (Cambridge, UK, 1988). 1989 ISBN 0-7923-0224-9
37. M. Kafatos (ed.): *Bell's Theorem, Quantum Theory and Conceptions of the Universe*. 1989 ISBN 0-7923-0496-9
38. Yu.A. Izyumov and V.N. Syromyatnikov: *Phase Transitions and Crystal Symmetry*. 1990 ISBN 0-7923-0542-6
39. P.F. Fougère (ed.): *Maximum-Entropy and Bayesian Methods*. Proceedings of the 9th International Workshop (Dartmouth, Massachusetts, USA, 1989). 1990 ISBN 0-7923-0928-6
40. L. de Broglie: *Heisenberg's Uncertainties and the Probabilistic Interpretation of Wave Mechanics*. With Critical Notes of the Author. 1990 ISBN 0-7923-0929-4
41. W.T. Grandy, Jr.: *Relativistic Quantum Mechanics of Leptons and Fields*. 1991 ISBN 0-7923-1049-7
42. Yu.L. Klimontovich: *Turbulent Motion and the Structure of Chaos*. A New Approach to the Statistical Theory of Open Systems. 1991 ISBN 0-7923-1114-0

Fundamental Theories of Physics

43. W.T. Grandy, Jr. and L.H. Schick (eds.): *Maximum-Entropy and Bayesian Methods*. Proceedings of the 10th International Workshop (Laramie, Wyoming, USA, 1990). 1991 ISBN 0-7923-1140-X
44. P.Pták and S. Pulmannová: *Orthomodular Structures as Quantum Logics*. Intrinsic Properties, State Space and Probabilistic Topics. 1991 ISBN 0-7923-1207-4
45. D. Hestenes and A. Weingartshofer (eds.): *The Electron*. New Theory and Experiment. 1991 ISBN 0-7923-1356-9
46. P.P.J.M. Schram: *Kinetic Theory of Gases and Plasmas*. 1991 ISBN 0-7923-1392-5
47. A. Micali, R. Boudet and J. Helmstetter (eds.): *Clifford Algebras and their Applications in Mathematical Physics*. 1992 ISBN 0-7923-1623-1
48. E. Prugovečki: *Quantum Geometry*. A Framework for Quantum General Relativity. 1992 ISBN 0-7923-1640-1
49. M.H. Mac Gregor: *The Enigmatic Electron*. 1992 ISBN 0-7923-1982-6
50. C.R. Smith, G.J. Erickson and P.O. Neudorfer (eds.): *Maximum Entropy and Bayesian Methods*. Proceedings of the 11th International Workshop (Seattle, 1991). 1993 ISBN 0-7923-2031-X
51. D.J. Hoekzema: *The Quantum Labyrinth*. 1993 ISBN 0-7923-2066-2
52. Z. Oziewicz, B. Jancewicz and A. Borowiec (eds.): *Spinors, Twistors, Clifford Algebras and Quantum Deformations*. Proceedings of the Second Max Born Symposium (Wroclaw, Poland, 1992). 1993 ISBN 0-7923-2251-7
53. A. Mohammad-Djafari and G. Demoment (eds.): *Maximum Entropy and Bayesian Methods*. Proceedings of the 12th International Workshop (Paris, France, 1992). 1993 ISBN 0-7923-2280-0
54. M. Riesz: *Clifford Numbers and Spinors* with Riesz' Private Lectures to E. Folke Bolinder and a Historical Review by Pertti Lounesto. E.F. Bolinder and P. Lounesto (eds.). 1993 ISBN 0-7923-2299-1
55. F. Brackx, R. Delanghe and H. Serras (eds.): *Clifford Algebras and Their Applications in Mathematical Physics*. 1993 ISBN 0-7923-2347-5
56. J.R. Fanchi: *Parametrized Relativistic Quantum Theory*. 1993 ISBN 0-7923-2376-9
57. A. Peres: *Quantum Theory: Concepts and Methods*. 1993 ISBN 0-7923-2549-4
58. P.L. Antonelli, R.S. Ingarden and M. Matsumoto: *The Theory of Sprays and Finsler Spaces with Applications in Physics and Biology*. 1993 ISBN 0-7923-2577-X