

DOCUMENT RESUME

ED 059 058

SE 013 182

AUTHOR Corliss, William R.
TITLE Spacecraft Power. America in Space: The First Decade.
INSTITUTION National Aeronautics and Space Administration, Washington, D.C.
REPORT NO NASA-EP-59
PUB DATE 70
NOTE 26p.
AVAILABLE FROM Superintendent of Documents, Government Printing Office, Washington, D.C. 20402 (\$0.35)

EDRS PRICE MF-\$0.65 HC-\$3.29
DESCRIPTORS *Aerospace Education; *Aerospace Technology; Electrical Systems; Electric Batteries; *Electricity; Instructional Materials; *Radioisotopes; Secondary School Science; *Solar Radiation
IDENTIFIERS NASA; *Space Sciences

ABSTRACT

The various electric power sources suitable for use aboard spacecraft are described in this booklet. These power sources include batteries, fuel cells, solar cells, RTGs (radioisotope thermoelectric generator), and nuclear fission power plants. The introductory sections include a discussion of power requirements and the anatomy of a space power plant. Photographs, illustrations and diagrams are used throughout. (PR)

ED 059058

America In Space | The First Decade

SPACECRAFT POWER

U.S. DEPARTMENT OF HEALTH,
EDUCATION & WELFARE
OFFICE OF EDUCATION
THIS DOCUMENT HAS BEEN REPRO-
DUCED EXACTLY AS RECEIVED FROM
THE PERSON OR ORGANIZATION ORIG-
INATING IT. POINTS OF VIEW OR OPIN-
IONS STATED DO NOT NECESSARILY
REPRESENT OFFICIAL OFFICE OF EDU-
CATION POSITION OR POLICY.

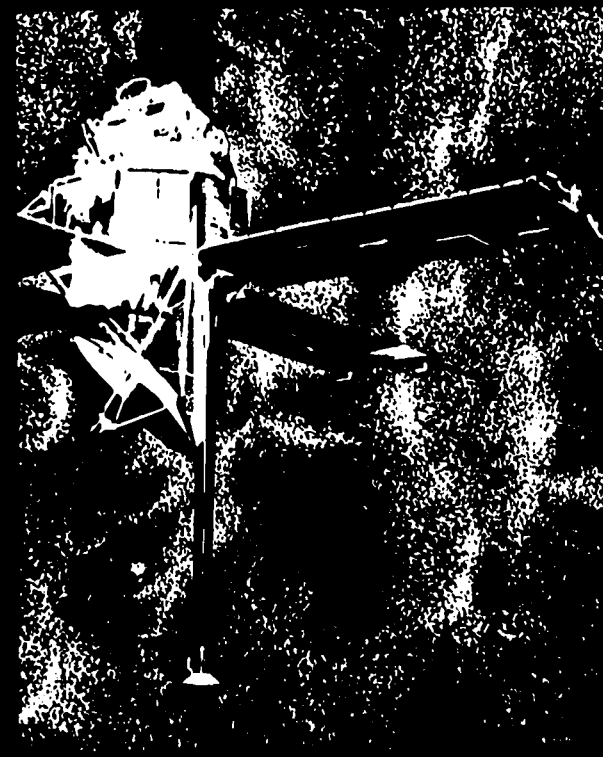
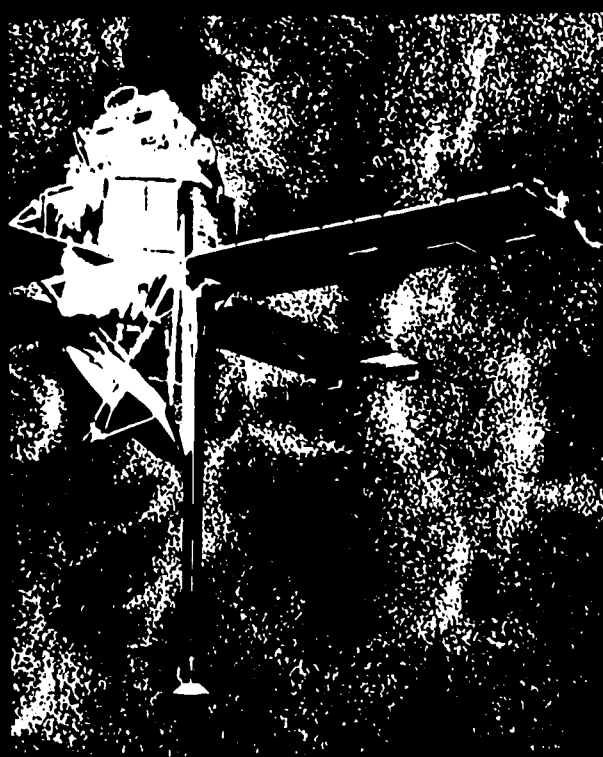
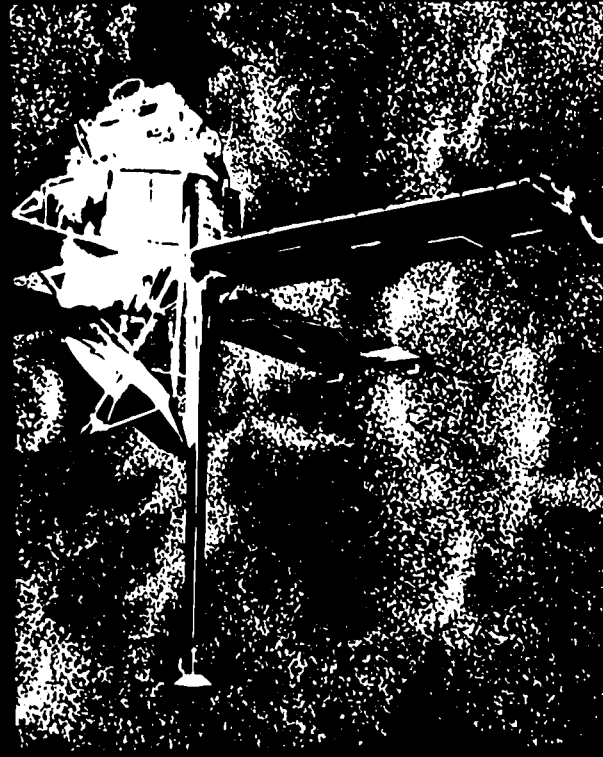
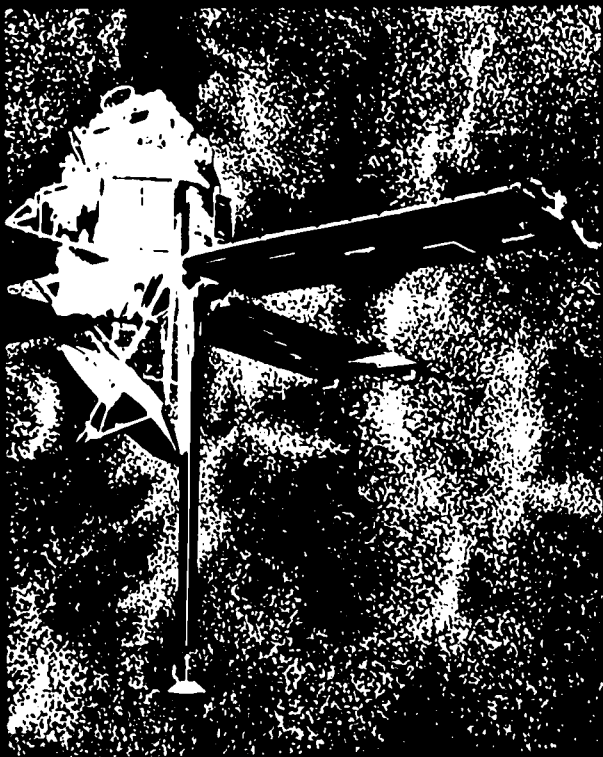

National Aeronautics and Space Administration

6 0110 100x

America
In
Space:
The
First
Decade

SPACECRAFT POWER

by William R. Corliss

National Aeronautics and Space Administration, Washington, D.C. 20546

Introduction

With the exception of a few special-purpose Earth satellites, the lifeblood of every manned and unmanned spacecraft is electrical power.

It is the reliable flow and availability of electrical power that allows man to extend his personal ventures safely beyond the atmosphere and keeps unmanned scientific payloads serving as useful tools for space exploration and applications.

Electric power is essential to space communications, guidance, control, tracking, telemetry, life-support systems, sensors, data handling and storage, and to assure the proper functioning of countless experimental and housekeeping systems and subsystems aboard operating spacecraft.

It remains the task of the National Aeronautics and Space Administration, since NASA's founding in 1958, to fully investigate the chemical, nuclear and solar

sources of energy and to see how best they can be converted to reliable spacecraft power.

The research and technology of power-generating systems illustrates a seldom recognized goal of NASA—to assure this Nation a freedom of choice; the choice, in this case, being that of going where we wish to go in the atmosphere or in space. Technical capability is the key to such freedom.

Oran W. Niels (*acting*)

Associate Administrator for Advanced Research and Technology

Table Of Contents

Who Needs Power?	1
Requirements and Profiles	1
How to Choose the Best Power Plant	2
Anatomy of a Space Power Plant	3
The Vital Parts	3
Interfaces	4
Batteries	4
Fuel Cells	6
Solar Cells	7
RTGs	11
Nuclear Fission Power Plants in Space	14

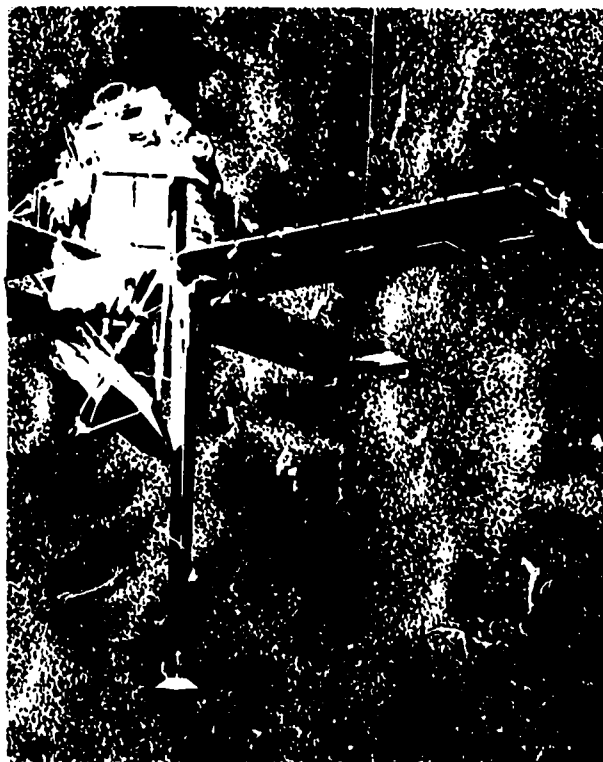

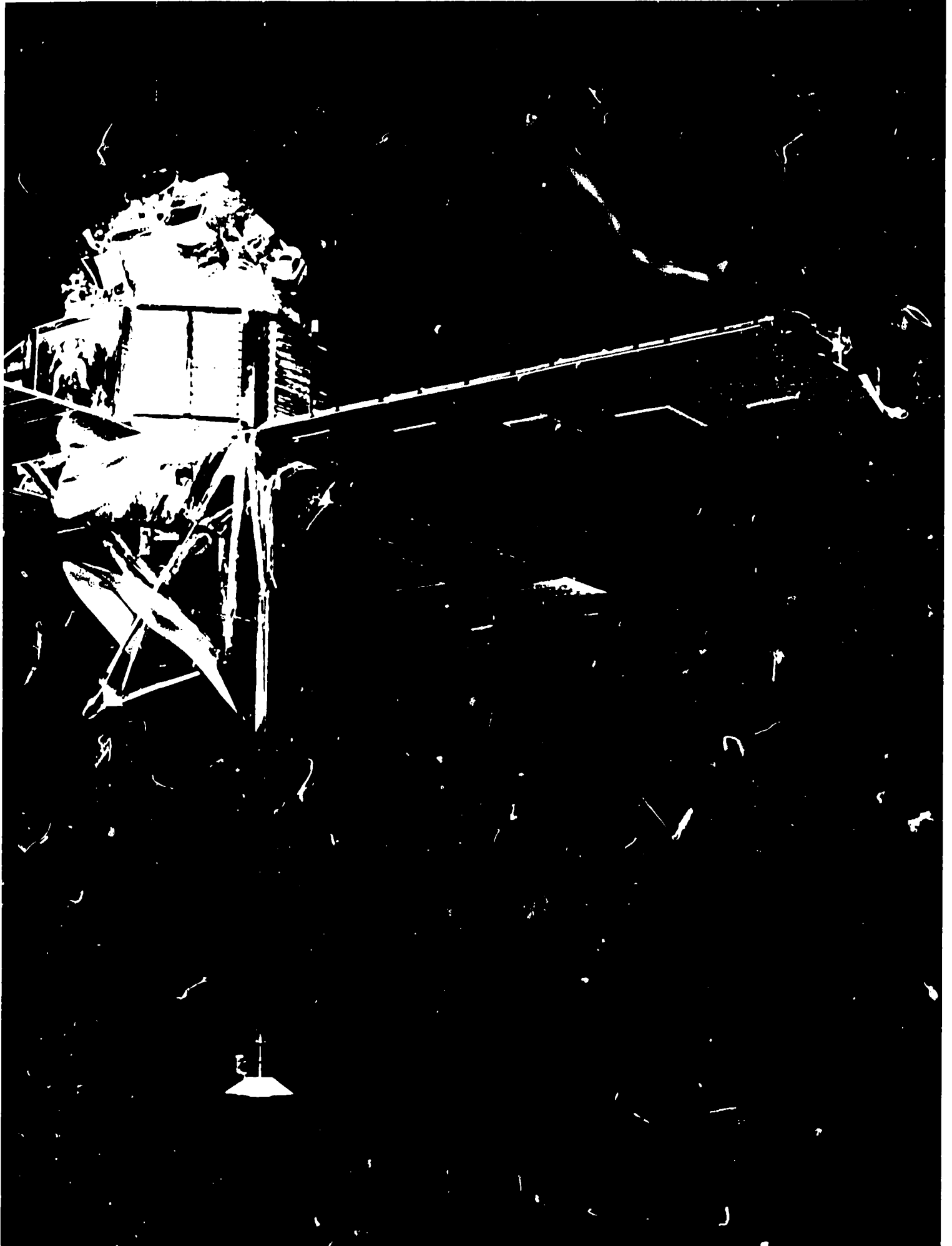

Spacecraft Power

Who Needs Power?

Requirements and Profiles

Modern civilization exists because abundant power nourishes it—especially electrical power. Take away electrical power and the wheels stop, as they did during the Great Northeast Blackout of 1965.

Power is even more critical on a spacecraft. Without electricity, a spacecraft becomes “dark,” which in the language of tracking engineers means that the spacecraft has lost its radio beacon and telemetry transmitter. Without electricity, spacecraft tell us nothing about outer space, or themselves. Spacecraft are electrical machines just as surely as a TV set. A few watts of electrical power will bring pictures of the Martian surface and measurements from the Van Allen belts; a kilowatt will sustain an astronaut.

The quantity of power needed by a spacecraft depends upon the job to be done. The more power required, the bigger and heavier the space power plant. Because weight and space are always coveted by spacecraft engineers for other equipment, the actual power level on any specific spacecraft is a matter of negotiation and compromise. In the spacecraft design process, everyone has to agree upon a weight and space budget as well as a power budget: so much of each commodity for experiments, so much for communications, so much for attitude control, and so on.

The first satellites orbited in late 1957 and 1958 needed no more than a watt or two to radio their sensor readings back to Earth. Today's satellites and probes need more power because they make many more measurements, because they are often much farther away from Earth, because they are bigger and more complex, and because some must sustain astronauts. Despite their higher metabolic rates,

modern satellites and space probes usually consume less than 100 electrical watts of power. In fact, over 90% of the 700-plus spacecraft launched since 1957 have operated successfully on less power than that consumed by an ordinary household light bulb.

The less than 10% of the spacecraft requiring more than 100 watts fall into two classes:

1. The observatory-class satellites, such as the Orbiting Geophysical Observatory and the Nimbus weather satellite, which are large and relatively sophisticated spacecraft. These spacecraft generally draw between 100 and 500 watts—a still modest requirement in terrestrial terms.
2. The manned spacecraft, such as those in the Gemini and Apollo programs, which must support men. From one to four kilowatts suffice for these spacecraft.

NASA has studied more ambitious missions to the outer planets that would consume tens and even hundreds of kilowatts—mostly for electrical propulsion. In general, however, spacecraft are misers with electrical power when compared with the average American household.

Spacecraft do not draw power at a steady rate like a light bulb or radio. Refrigerators and washing machines are better examples because they operate in cycles or sequences of events, each event demanding a different quantity of power. The same is true on spacecraft. A typical cycle for a scientific satellite is illustrated by its record-and-readout operation.

1 *Mariner VI, an instrumented spacecraft designed to pass within 2000 miles of the surface of Mars to investigate the planet's physical characteristics and the possibility of extraterrestrial life.*

Most of the time a scientific satellite's telemetry transmitter is silent while its instruments fill up the spacecraft's tape recorder with data. As the satellite passes over a ground station, it receives a command to readout its tape recorder. The telemetry transmitter switches on and delivers a burst of tape recorder data lasting several minutes. More electrical energy is drawn during readout than during the recording mode. The scientific satellite power profile (power plotted versus time) thus shows peaks and valleys. Other spacecraft functions add to the complexity of the power profile. The power plant designer has to find extra power somewhere for these spurts of activity.

How to Choose the Best Power Plant

Once a spacecraft designer knows approximately how much power he wants and how much weight and space he will be allowed for the power plant, he can begin to look at other factors that influence power plant performance. One of the most influential is power plant lifetime. Obviously, he wants the power plant to provide power reliably during the planned life of the spacecraft—usually six months to a year for unmanned craft. However, the best engineer in the world cannot *guarantee* that a specific power plant will survive for, say, a year in space—or even for a single day, for that matter. What he can state with some assurance is that a given power plant will have a probability of, say, 95% of lasting a year in space. The 95% figure is called the *reliability* of the power plant.

An engineer could build a power plant that would last ten years with a 99% probability; but it would be a monster and would cost a great deal. The three factors of cost, weight, and reliability (lifetime) are mutually dependent; changing one changes the others.

NASA has sponsored considerable research aimed at reducing power plant weight and increasing reliability. Better power plant equipment is always reaching the market. For example, one could hand pick the best solar cells coming off a production line and fabricate a solar cell power supply that would be significantly lighter than one made from run-of-the-mill cells. The best products cost more money, though, just as they do at the grocery store. The construction of a light weight, low cost, reliable space power plant is a continual challenge to the engineer.

2 Typical power profile for a scientific satellite, showing the periodic requirements for high bursts of power.

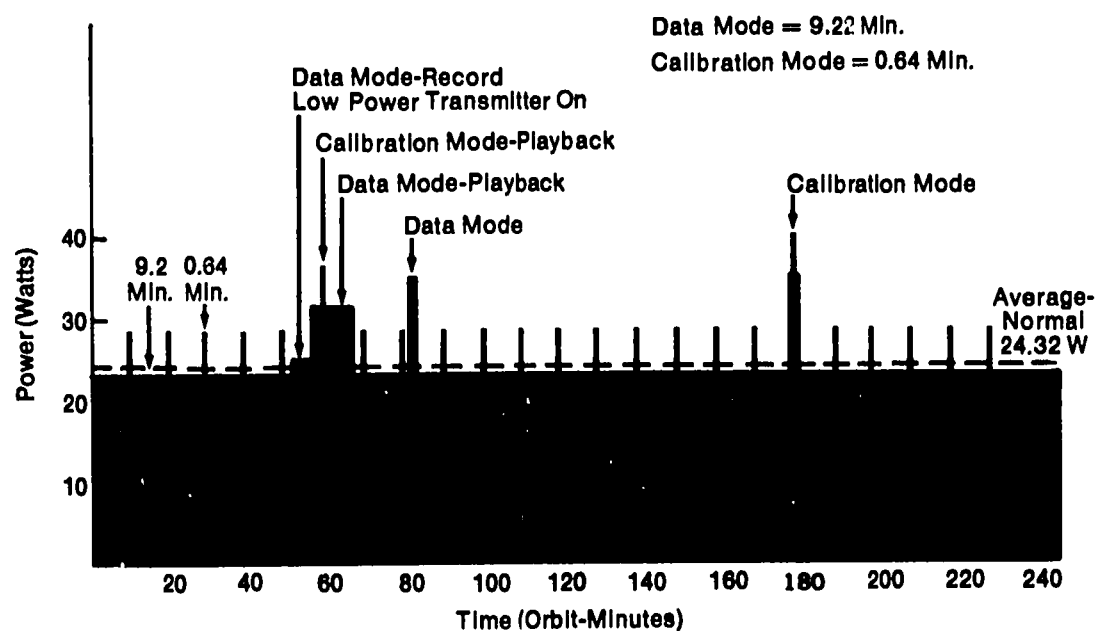

Anatomy of a Space Power Plant

The Vital Parts

Why not put a few dry cells on a satellite and send it off? Unfortunately, satellites are not as simple as Christmas toys. Although spacecraft usually consume only a few watts, they must operate for many months—far longer than dry cells could sustain them. Batteries suffice for a few short-lived satellites and sounding rockets; but better sources of energy are needed for most space missions. This observation introduces the heart of the space power plant: the *energy source*, which is the first of four important sections of the typical space power plant.

In the early days of space technology, engineers looked at all energy sources from clock springs to nuclear reactors. In the decade that has passed, only three energy sources have proven good enough for actual use on spacecraft:

1. Chemical energy sources: both batteries and fuel cells are important in spacecraft power generation. In these energy sources, part of the chemical energy in fuels and oxidizers is converted into electricity through chemical reactions, such as combustion.
2. Solar energy sources: solar cells are the basis for most space power plants. Here, the energy in the Sun's photons is converted directly into electricity. In principle, sunlight could be converted into heat first and then into electricity, but high performance space power plants using solar heat have not been built yet for operational use.
3. Nuclear energy sources: the energy created by the disintegration (decay) of radioisotopes or the fission of uranium can be converted into heat and then to electricity. Nuclear space power plants have seen only limited use in space to date.

Electricity is generated *directly* in batteries, fuel cells, and solar cells without the intervention of the turbines and generators familiar in terrestrial electrical power plants. However, if heat is the basic product of the energy source, as in radioisotope energy sources, the heat must be converted into electricity via thermoelectric elements, a turbogenerator, or some other thermal energy conversion section. This second part of the space power plant is called the *power conversion section*. It is present primarily in the nuclear space power plants.

3 Block diagram of a space power plant, showing typical components. Energy source generates P watts; energy converter has an efficiency of e .

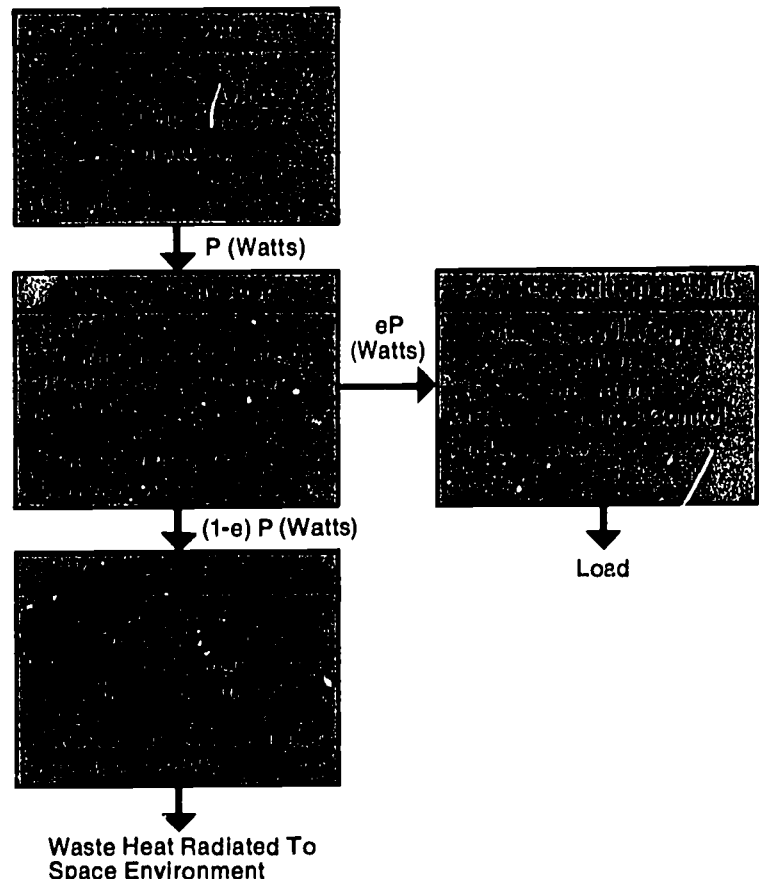

Whenever one form of energy is converted into another, some energy is inevitably wasted. This waste energy usually appears in the form of heat. If the waste heat is not rejected from the power plant, temperatures will quickly rise to catastrophic levels, just as they do in an automobile engine that has lost its water coolant. The third critical part of any space power plant is thus a *heat rejection section*.

The fourth and final cornerstone of the power plant foundation gets little publicity because it is taken for granted. This is the *power conditioning section*. Power conditioning means tailoring the power to meet the needs of the consumer. We require steady, reliable power in our homes; the spacecraft is no different. The power conditioning section must create and maintain a steady voltage on the spacecraft bus bars if all parts of the spacecraft are to work well. Frequently, power conditioning involves changing

low voltage direct current (DC) to high voltage DC, say, 28 volts, a rather common bus bar voltage on NASA spacecraft. The same sort of problem is faced in terrestrial electrical engineering as millions of transformers on utility poles bear witness.

Interfaces

A space power plant has *interfaces* with all the other spacecraft subsystems; that is, it can affect them and vice versa. A sort of Golden Rule on spacecraft states that one component should not infringe upon the rights of another. Radiation from a nuclear power plant should not, by way of illustration, cause Geiger counters to start discharging in an experiment designed to measure Van Allen belt radiation. Nor should waste heat from a power plant be allowed to damage adjacent temperature-sensitive equipment. On the positive side, a power plant can sometimes lend a helping hand across spacecraft interfaces. If the power plant produces considerable waste heat, it can be used to warm cold-sensitive equipment elsewhere on the spacecraft. Spacecraft heating is particularly desirable on missions striking far out into the solar system away from the Sun's warmth or on instrument packages left by astronauts on the cold, dark side of the Moon.

Some other interfaces are important in power plant design. The large wing-like solar-cell panels so typical of modern spacecraft must not interfere with the fields of view of scientific instruments, such as spectroscopes analyzing the Sun's radiation. More obscure is the magnetic interface. Coils of wire in the power plant generate magnetic fields when electricity flows through them. Many scientific spacecraft carry extremely sensitive magnetometers in their payloads to measure the very weak magnetic fields in outer space. The interference is so severe that the magnetometer is often located on the end of a special boom far away from the power plant.

Batteries

Batteries depend upon chemical fuels for energy. There is no need to unfold solar-cell paddles or point the spacecraft toward the Sun. Chemicals keep on releasing their energy whether the spacecraft is in sunlight or in the Moon's shadow. They keep on releasing energy *as long as they last*; and herein lies the rub. Chemicals for all their good points are not concentrated sources of energy. You have to keep

filling up the gas tank, and there are no gasoline stations in outer space; all fuel has to be onboard at the launch pad. Nevertheless, the chemical battery has found numerous applications in space power plants.

One hundred fifty years ago, the battery was the only continuous source of electricity. A battery is also an energy reservoir; that is, some batteries can store energy, release it on demand, store energy again, and release it again. When a battery is utilized as a continuous source of energy and is not rechargeable, it is called a *primary* battery. When it is used as an energy reservoir and is rechargeable, it is termed a *secondary* battery. A few spacecraft and many sounding rockets have employed primary batteries. Most satellites, however, and all space probes require an energy reservoir to help meet their uneven power profile demands and to store energy for use when the spacecraft cannot extract power from sunlight. Secondary batteries are integral parts of most solar-cell power plants because they can store up the extra power generated by the solar cells while they are in sunlight and then release it when the spacecraft swings into the Earth's shadow. Together the solar cell and battery can generate whatever electrical power is required by the power profile for a long period of time—something neither could do separately.

A battery consists of two electrodes of dissimilar materials separated by an electrolyte. When an electrical load is connected across the terminals, ions migrate through the electrolyte, carrying negative charges in one direction and positive charges in the other. Some typical battery chemical reactions are presented in the table below.

When NASA first began using batteries in its spacecraft, it found that the usual commercial products were inadequate. They gave off too much gas during operation; they leaked excessively under zero-g conditions; they could not survive very many charge-discharge cycles. NASA had to invest a great deal of research and development effort before it had lightweight batteries that functioned well in space.

Characteristics of Spacecraft Batteries			
Battery Type	Chemical Reaction *	Practical Storage Capacity (watt-hr/lb)	Remarks
Nickel-cadmium (NiCd)	$2\text{NiOOH} + \text{Cd} + 2\text{H}_2\text{O} \rightarrow 2\text{Ni(OH)}_2 + \text{Cd(OH)}_2$	10-25	High cycling life, negligible gassing, can be overcharged
Silver-cadmium (AgCd)	$\text{Ag}_2\text{O} + \text{Cd} + \text{H}_2\text{O} \rightarrow 2\text{Ag} + \text{Cd(OH)}_2$ also $\text{AgO} + \text{Cd} + \text{H}_2\text{O} \rightarrow \text{Ag} + \text{Cd(OH)}_2$	20-30	Durable, nonmagnetic, lower cycle life
Mercuric oxide-zinc (HgO-Zn)	$\text{HgO} + \text{H}_2\text{O} + \text{Zn} \rightarrow \text{Hg} + \text{Zn(OH)}_2$	30-50†	Good for high temperature operation. Always used as a primary battery.
Silver-zinc (AgZn)	$\text{Ag}_2\text{O} + \text{Zn} + \text{H}_2\text{O} \rightarrow 2\text{Ag} + \text{Zn(OH)}_2$ also $\text{AgO} + \text{Zn} + \text{H}_2\text{O} \rightarrow \text{Ag} + \text{Zn(OH)}_2$	30-40 80-100†	High capacity, reliable, high discharge rate, but temperature-sensitive; gas evolved on standing or charging

* These reactions are rather idealized; cell chemistry is not nearly so clear cut.
† When used as primary batteries.

Explorer I, the first U.S. satellite, carried mercury batteries for its power source. Because of Explorer I's very modest power requirements, the batteries were able to keep the small transmitter functioning for almost four months before they went dead. If Explorer I were designed today, a solar cell-battery combination would probably be used; in 1958 the tried-and-true battery was considered a better risk than the newly developed solar cells. (Historically speaking, sounding rockets had been using batteries for years before Explorer I.) As long as a space

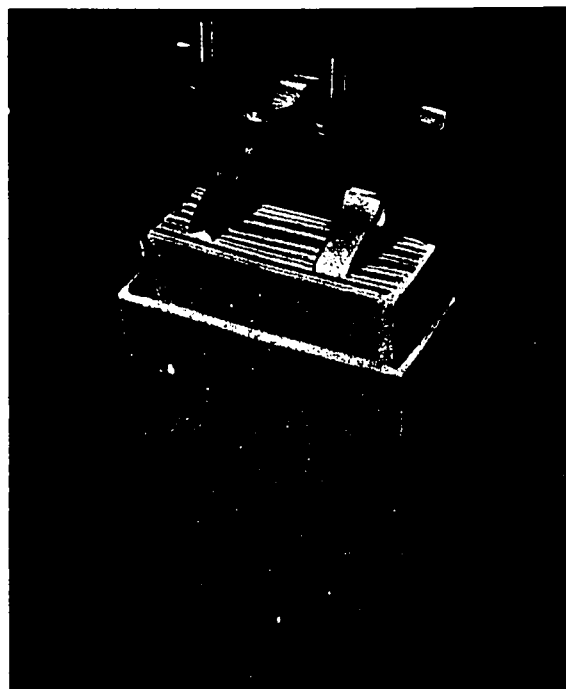

4 A typical silver-zinc battery employed in space power plants. Space batteries must be carefully sealed for operation in a vacuum and under zero-g conditions.

mission lasts less than a month or so and power requirements are modest (under 100 watts), batteries are the best choice from a weight and cost standpoint.

Batteries alone have powered several of NASA's early scientific satellites. For those with short missions, such as Explorer X and Vanguards II and III, batteries were the obvious choice. There are, moreover, a few missions where solar cells interfere with the scientific experiments. In making direct measurements of the upper atmosphere, for example, solar-cell paddles would distort the flow of the thin air around the high-speed satellite. Some satellites in NASA's Atmosphere Explorer series have been built in spherical shape to simplify the calculation of the drag forces due to the tiny bit of air remaining at satellite altitudes. Solar-cell paddles would have complicated the computations immensely. Explorers XIII, XVI, and XXIII, in the NASA Micrometeoroid Explorer series, also employed batteries rather than solar cells. Here, scientists feared that solar cells would have got in the way of the micrometeoroid detectors that covered the external skins of the satellites.

Fuel Cells

The fuel cell is a close relative of the battery. The major difference between the two is that the fuel cell is supplied with fuel and oxidizer from external tanks and rejects the reaction products, while the battery must make do with the chemicals sealed into it during manufacture.

The hydrogen-oxygen cell is typical of most fuel cells. In essence, it combines hydrogen and oxygen to form water, heat, and electricity. The fuel and oxidizer are supplied continuously and the excess water, the combustion product, is drawn off as it is formed, creating a long-lived battery.

In the hydrogen-oxygen fuel cell, the reacting gases are pumped into porous metal electrodes under pressure. At the electrode surfaces they combine to create water. At the *anode*, the hydrogen electrode, electrons are freed and travel through the external electrical load. At the *cathode*, these electrons are returned to the fuel cell. Power will be generated for the load as long as the external fuel/oxidizer supply lasts.

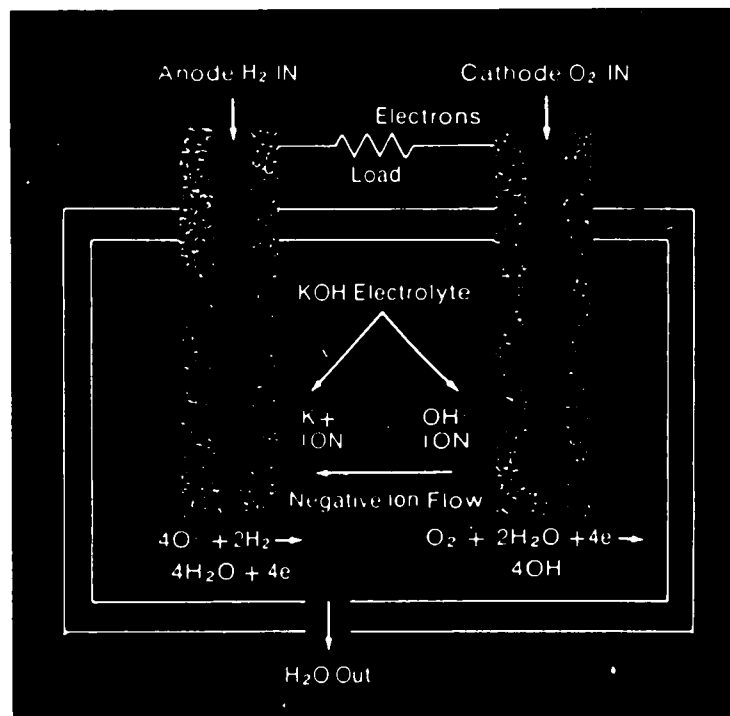

5 Schematic showing the operation of a hydrogen-oxygen fuel cell. The hydrogen and oxygen gases enter through porous electrodes.

The manned orbital missions in NASA's Mercury and Gemini programs lasted between an hour and a half and two weeks. Batteries would seem ideally suited to these short applications; but, in actuality, fuel cells were selected for some of the longer Gemini flights. Why? The main difference between a long Gemini mission and a short scientific satellite mission is not time but power level, or, equivalently, total energy. Ten watts may be sufficient for a small scientific satellite, but the Mercury and Gemini spacecraft needed from a few hundred to over a thousand watts. In terms of total energy required (watt-hours) rather than power (watts), a manned orbital mission is perhaps more than 100 times more demanding than a short-lived unmanned satellite.

Batteries are really energy packages. In a one-pound mercury battery, we have, say, 30 watt-hours of energy; in a two-pound battery, 60 watt-hours, and so on. Much of the weight is actually in the package itself, the heavy electrodes, and the electrolyte. Weight would be saved if dozens of energy packages (batteries) could be replaced by a continuously fueled battery, with only one set of electrodes, one case, etc.; in short, a fuel cell. Whenever the total energy requirements exceed approximately 10,000 watt-hours, fuel cells are usually lighter than batteries. For this reason, NASA has developed fuel cells for use in manned spacecraft (including the Apollo craft) and the 30-day Biosatellite flight.

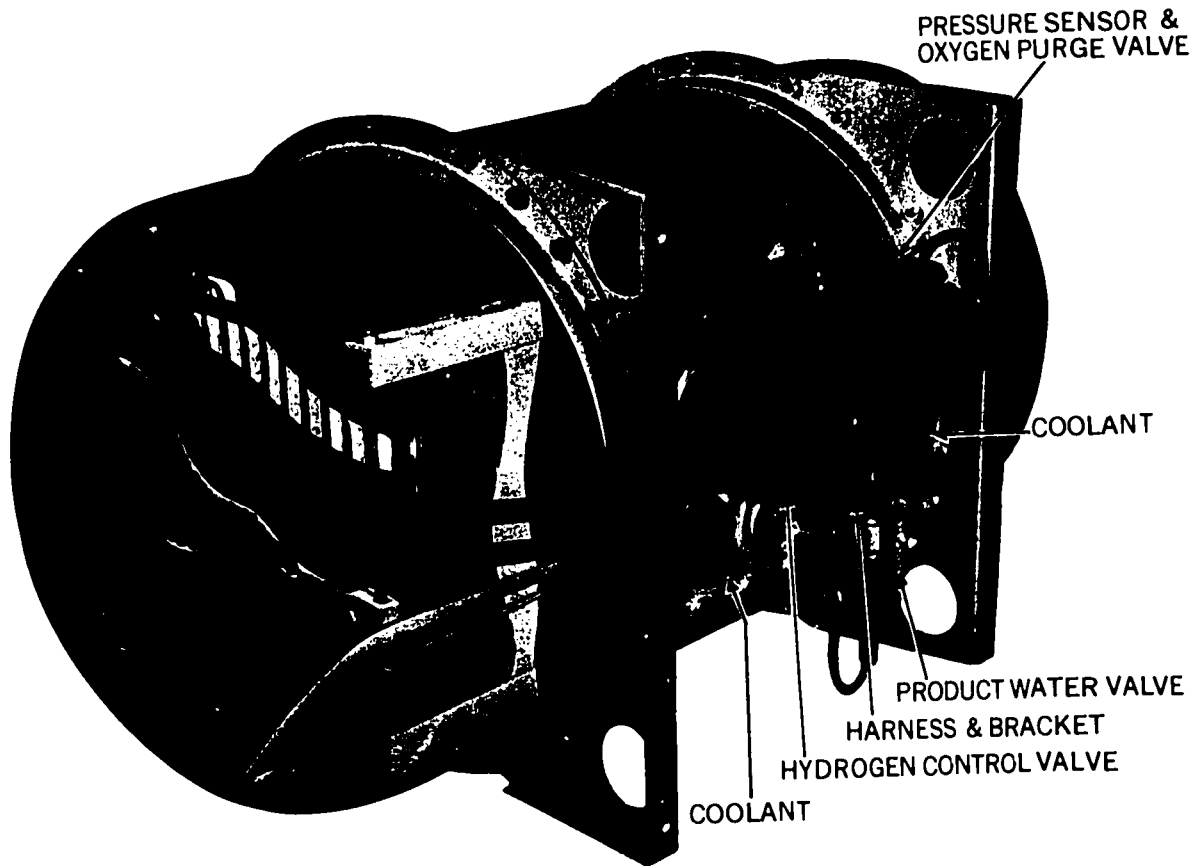

6 The Gemini fuel cell. Hydrogen and oxygen gases were "burned" in this fuel cell to produce electricity. The combustion product was water.

When one looks at practical fuel cells, one finds a lot of valves and plumbing draped around the power plant. In this sense, fuel cells are more complex than the simple battery with its two-terminal case. In the Gemini hydrogen-oxygen fuel cell, for example, the pressures of the two feed gases must be carefully regulated before they enter the fuel cell. Between the gas tanks and the fuel cell are valves, gauges, meters, and, of course, pipes. Fuel cells also generate oxidation combustion products, which must be drawn off and stored. However, the water from hydrogen-oxygen cells is a valuable commodity on manned missions; on Apollo missions it is used for drinking and food preparation. Fuel cells are not as simple as batteries, but the weight they save overcomes this objection.

Solar Cells

The Sun's power flux at the Earth's orbit is a steady 130 watts per square foot. With this power density, why do spacecraft have to spread large, solar-cell-covered wings to capture enough sunlight to generate a few tens of watts? Part of the answer lies in the low power conversion efficiency of solar cells, which is only about 10% in average cells. As a consequence, 90% of the power in sunlight is not used; and solar-cell areas must be at least ten times those expected on the basis of power flux alone.

Another problem with solar energy is its directionality; in other words, objects cast shadows. One shadow caster is the Earth itself. Satellites may spend up to half their time in the Earth's shadow cone. Therefore, they must carry extra solar cells which generate surplus power and store it in batteries for use during the long shadow periods. Shadows cause problems on the Moon, too. Even when spacecraft are in full sunlight, some solar cells may not be pointing directly

at the Sun—a situation that again lowers efficiency. Further, if the spacecraft is spinning, as many do for purpose of stabilization, the solar cells swing in and out of the sunlight and will not be effective all the time. Planetary probes have to cope with the attenuation of sunlight with distance. For example, a solar-cell power plant generating 100 watts as it leaves the vicinity of the Earth will produce only 45 watts when it arrives at Mars.

Despite these difficulties, solar cells are chosen for almost every satellite and space probe. It is often said that solar power plants are dominant on spacecraft because sunlight is free—no need to carry energy sources along. Solar power isn't really free because engineers have to work hard to convert sunlight into electricity efficiently. Because of this development work—much of it NASA-sponsored—solar-cell power plants are cheaper, more reliable, and lighter in weight than chemical and nuclear power plants in most space applications.

Let us look at solar cells in more detail. They are little thin wafers of silicon, black and shiny in appearance, and 1 x 2 or 2 x 2 cm in size (the two standard sizes). Solar cells are sometimes called solar batteries because when sunlight (or almost any kind of light) shines on the silicon surfaces, voltages are developed between the tops and bottoms of the wafers. When a load is connected, electrical power will flow into it as long as the sunlight persists.

Most solar cells are made from silicon, an element much like carbon in its chemical affinities (there are four electrons in the outer shell of each atom). But pure silicon is not used in making solar cells. A few atoms of boron are distributed throughout the crystal structure. The boron atoms act as electron acceptors; they have only three electrons in their outer shells rather than four like the silicon atoms. The boron atoms try to take on extra electrons so that they will have four in their outer shells like the surrounding silicon atoms. The spots where free electrons will be accepted are called *holes* or *vacancies*.

To complete the construction of a solar cell, one side of the silicon wafer is treated with phosphorus to a depth of a micron or two.* Phosphorus in contrast

to boron is an electron donor, having five rather than four outer electrons. Boron and phosphorus are called p-type and n-type materials (for positive and negative), respectively. Together, the two types of silicon make a sandwich. The thin region dividing the two silicon layers containing the different kinds of impurities is called a p-n junction.

The p-n junction is where the action is. The excess electrons on the phosphorus side and the holes on the boron side set up an electrostatic field between them. In fact, the holes act just like positive electric charges. If carriers of electric current—free electrons and mobile holes—are created in the vicinity of the junction, they will flow under the influence of the electrostatic field that has been created by the boron and phosphorus impurity atoms. The absorption of a solar photon in the vicinity of the junction usually creates an electron-hole pair when the photon knocks one of the outer electrons off an atom in the crystal lattice. These pairs attract each other and would quickly recombine if the established electrostatic field did not whisk the electrons away to an external load. Eventually, electrons are returned from the load where they have done useful work as part of the solar-cell electric current; then they recombine with the holes.

The typical solar cell has an area of about a half square inch and converts roughly 10% of the Sun's energy into electricity. Each cell, therefore, generates only a few hundredths of a watt. A space power plant of any consequence employs thousands of the little rectangles. By connecting a string of several dozen together in series, a bus bar voltage of 28 volts can be attained. More strings are connected in parallel to provide the desired current.

Solar cells present a challenge to both the spacecraft designer and the power plant engineer, who must jointly find many square feet of area for the cells. Two methods of mounting solar cells are popular: shingle-mounting and flat-mounting. Shingling is a most accurate description; the cell edges are lapped and the shingled strips attached to a substrate or foundation with an adhesive. Because the substrate does not provide enough mechanical support, the strips of cells are next attached to a lightweight support of plastic or metal. Flat-mounted cells do not overlap and, if a defective cell is discovered, it can be replaced easily. Adjacent flat-mounted cells are usually connected in parallel by metal bus bars running along

* A micron is a millionth of a meter. Other semiconductor materials, such as germanium, are also used to make solar cells.

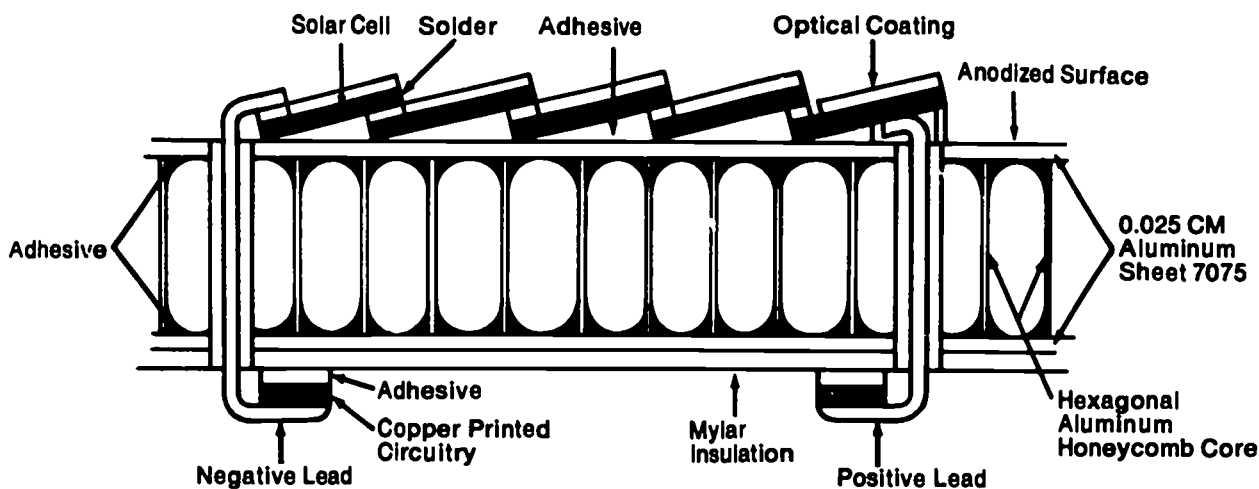

7 Shingled solar cells bonded to an aluminum honeycomb support.

two opposite edges. Dozens, sometimes hundreds, of cells are shingle-mounted or flat-mounted into subassemblies called *modules*.

For attaching solar-cell modules to the spacecraft proper, three approaches are in vogue today: body-mounting, paddle-mounting, and panel-mounting. Body-mounted cells are cemented either directly to the spacecraft skin or to light metallic sheets that are then attached to the spacecraft. Body-mounting is favored for small, spin-stabilized satellites. Patches of solar cells are body-mounted symmetrically on spacecraft facets around the spin axis so that the overall power level will remain relatively constant as the satellite spins. Because some body-mounted cells will always be in the shadow of the spacecraft at any given instant, the overall efficiency of a body-mounted solar-cell power plant may be only 1-2%, even though individual cells can attain 10%.

Medium-sized spacecraft, such as NASA's Interplanetary Monitoring Platform (IMP) series, cannot offer enough body area to meet the spacecraft's power demands. Consequently, NASA engineers have resorted to the familiar wing-like solar-cell paddles. Solar-cell paddles are lightweight structures with cells bonded to both faces. During launch, the paddles are folded up within the launch vehicle shroud. Once in space, the shroud is blown off by a small charge of explosive and the paddles are deployed—often by the centrifugal force created by the spacecraft's spin—and locked into position. The sole function of the

8 Explorer XXXII, an Atmosphere Explorer, showing body-mounted solar cells.



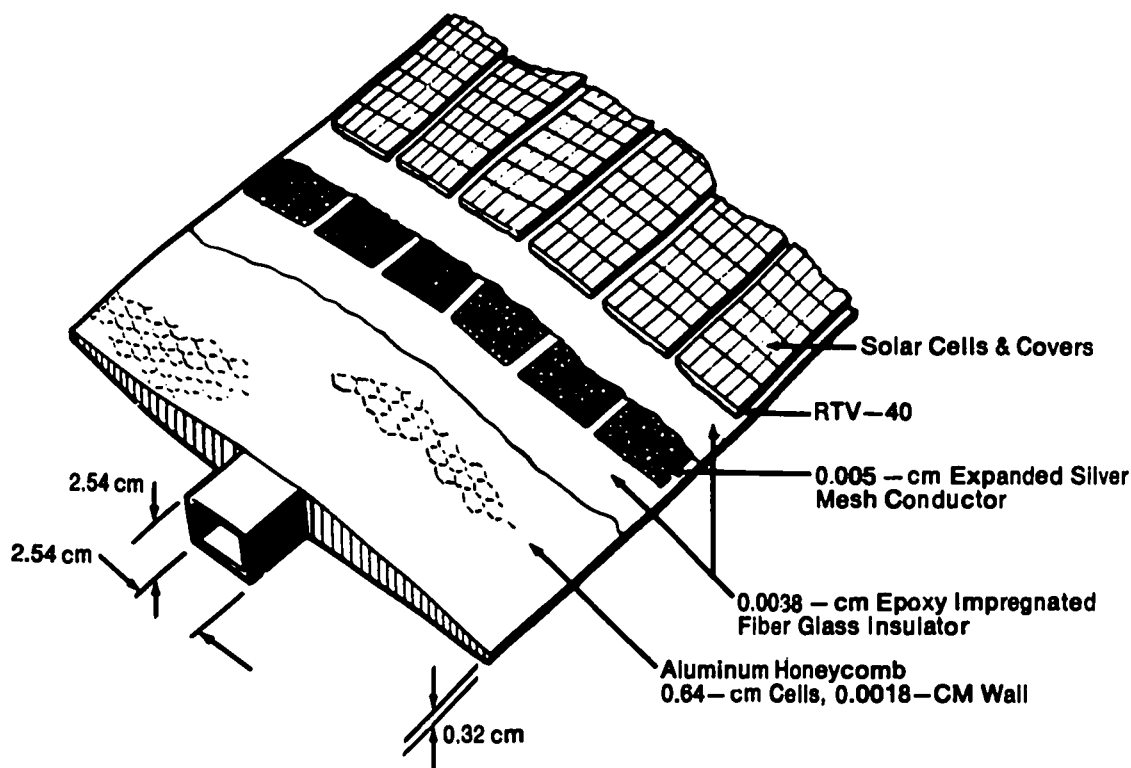

9 Details of construction for the IMP solar paddles.

paddles is to add to the surface area of the spacecraft. With paddles, too, a large fraction of the solar cells will still be in the shade, and the overall efficiency of the power plant will be only 1-2%.

The most efficient kind of solar-cell array developed by NASA is the oriented solar panel, which is used on large spacecraft, such as the Orbiting Geophysical Observatory (OGO), and some space probes. The panels are kept pointed at the Sun by motors that receive pointing information from special Sun sensors. Oriented solar-cell panels can attain overall conversion efficiencies of 6-8%.

A practical problem with solar cells is their susceptibility to space radiation damage in the Van Allen belts. The operation of several early satellites, viz., Telstar I, was severely compromised by the intense electron and proton radiation within the Van Allen belts. To protect solar cells from radiation, very thin glass covers are usually bonded to the top faces of the cells. The glass cuts efficiency a little and increases weight, but solar-cell performance is not impaired as much as it would be by the unattenuated space radiation. Solar cells have been found more resistant to space radiation if the thin side of the sandwich facing the Sun is made from n-type material rather than p-type. Recent NASA spacecraft thus carry n-p cells rather than p-n cells.

10 The scientific satellite Explorer XVIII, showing typical solar cell paddles in deployed position. Body of satellite is 28 inches in diameter. The ball on the end of the boom contains a magnetometer.

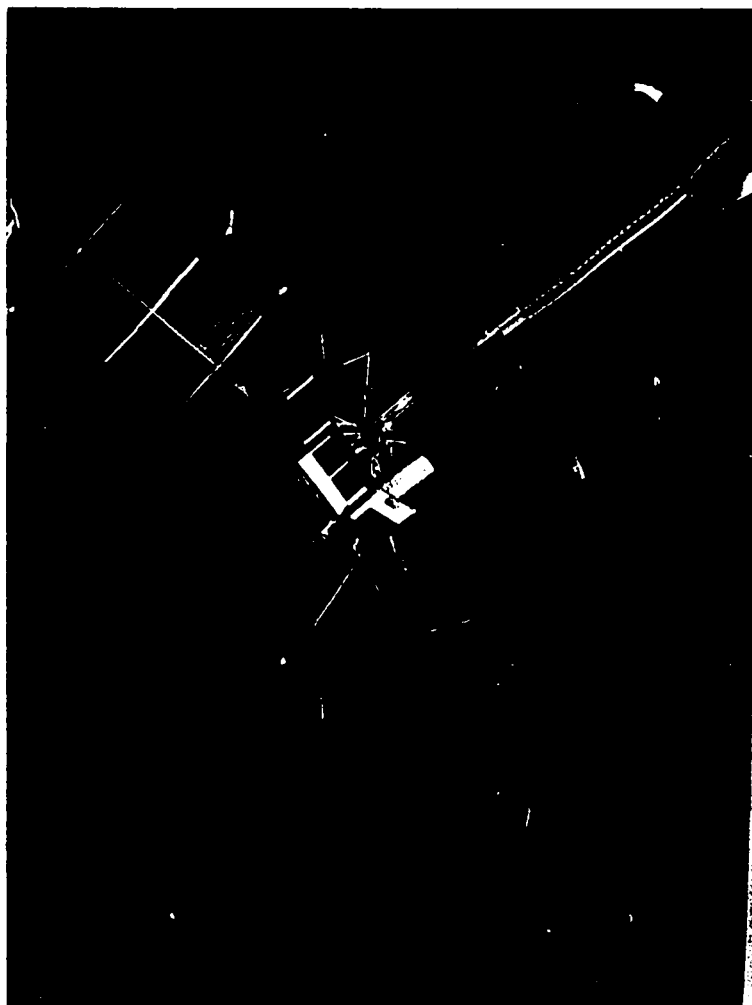

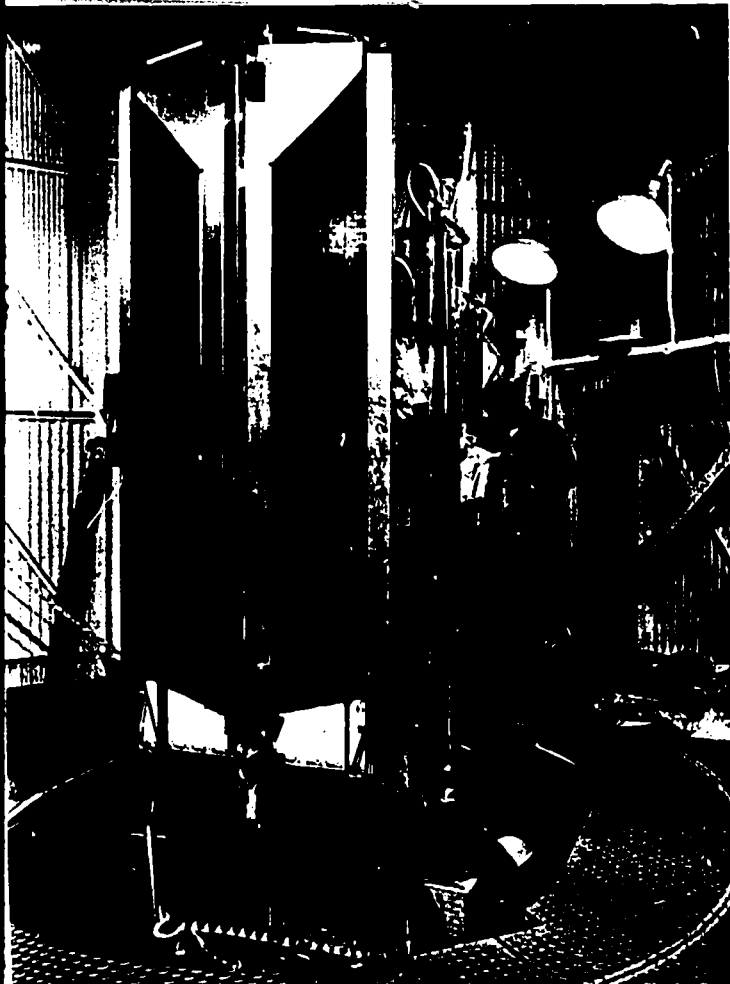

11 The OGO solar panels shown in their folded position.

Solar-cell power plants are tailor-made for each spacecraft; there is no typical model. The OGO-oriented solar panels will be described in some detail to illustrate the engineering behind one particular space power plant. The OGO power requirement was some 500 watts, considerably more than that of most spacecraft. OGO solar cells were the standard 1x 2cm variety, with 0.15-cm glass covers. The cells were assembled in modules of 112 (7 x 16) cells and bonded to beryllium plates. One hundred forty modules were attached to each of two panels. The total number of cells employed was over 31,000. Modules were interconnected to provide a bus bar voltage of 28 volts.

Batteries have almost inevitably accompanied solar cells into space. Secondary batteries act as energy accumulators that help the power plant meet the peaks and valleys in the desired power profile. When the spacecraft moves into the shadow of Earth, Moon, or planet, the batteries become the sole source of electrical power. On OGO, two silver-cadmium batteries were installed. Each contained 24 cells and weighed about 24 pounds. When the solar cells (but not the power-conditioning equipment) were included, the OGO power plant weighed approximately 174 pounds. This figure corresponds to about 3 watts per pound

at the beginning of satellite life. Near the end of OGO's planned life, the solar cells had been degraded by space radiation and the abrasion of micrometeoroids to the point where the power plant produced only about 2 watts per pound.

RTGs

An RTG is a radioisotope thermoelectric generator; the need for the shorter name is obvious. Radioisotopes find application in outer space because, on a weight basis, radioisotope fuel releases roughly 1000 times more energy than the best chemical fuels, and this energy production does not depend upon the Sun.

Radioisotopes generate heat when unstable nuclei disintegrate or decay into more stable nuclei. Plutonium-238—the most often-used nuclear fuel in space—decays into uranium-234 by emitting an alpha particle (a doubly ionized helium atom). The kinetic energies of the alpha particle and recoiling nucleus are quickly converted into thermal energy. Radioisotopes, therefore, are basically heat sources. Although radioisotopes are very concentrated sources of thermal energy, they have the unsettling and uncontrollable property of disappearing exponentially with time. Each species of radioisotope has a *half life*, which is that length of time in which half the nuclei in any given sample will decay and yield up their potential energies. For example, a gram of plutonium-238 will be half gone in 89 years (the half life of plutonium-238) and three-quarters gone in 178 years. With an 89-year half life, this decrease in thermal power level is a minor problem on space missions lasting less than 10 years, which means almost all space missions. But with a radioisotope fuel such as cerium-144, which has a half life of only 290 days, the loss of thermal power during a space mission can be serious.

The half-life problem, however, is not as limiting as the high cost and scarcity of good radioisotope fuel. These factors have restricted the use of radioisotopes in space power plants to a handful of missions. The U.S. Navy has powered several of its Transit navigation satellites with RTGs varying in power level from 2 to 25 watts. NASA has also installed an RTG called SNAP-19* on one of its Nimbus

* SNAP = Systems for Nuclear Auxiliary Power, a joint NASA-AEC Program.

weather satellites. Speaking generally, RTGs are competitive with solar-cell power plants on a weight basis, but they are more costly due to their expensive fuel. For this reason, RTGs find application wherever, for some reason, solar cells cannot do the job well. Potential RTG applications include satellites that must operate in the Van Allen belts, lunar probes that must generate power during the long lunar night, probes to Jupiter and other planets far from the Sun, and probes that go so close to the Sun that solar cells would become overheated and cease to operate efficiently.

In the center of the typical RTG, there is a thick cylindrical fuel capsule, which serves as the heat source. Surrounding the fuel capsule are thermoelectric energy converters that change some of the heat flowing outward from the fuel capsule into electricity. The heat that escapes conversion into electricity (usually some 95% of the radioisotope-generated heat) next flows out to the shell of the RTG, where it is radiated away. To understand the RTG better, we need explanations of the thermoelectric effect and the process of thermal radiation.

The thermoelectric element is a close relative of the thermocouple, the first device used by man to convert heat into electricity directly without moving parts.

12. Idealized RTG, showing heat flowing from fuel capsule through thermoelectric converters to the outer shell, where waste heat is radiated away.

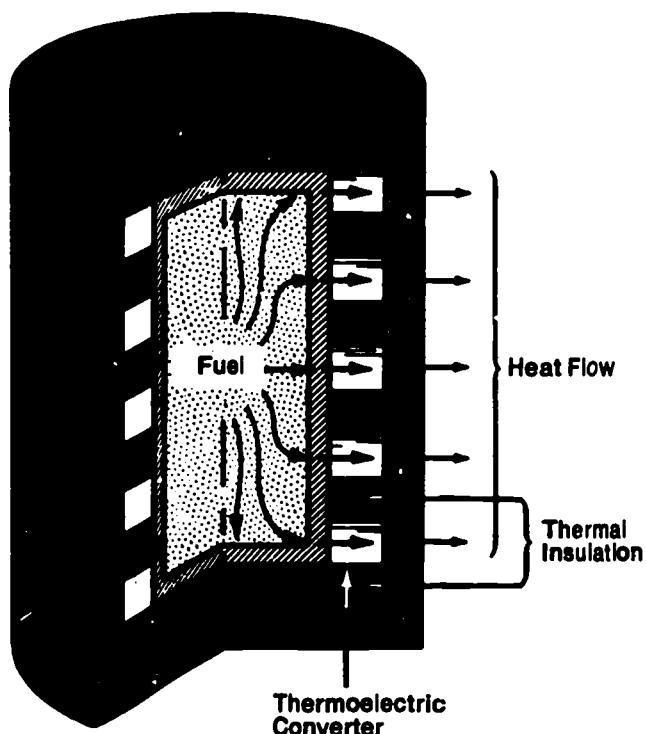

If one takes two dissimilar metal wires, joins them, and heats the junction, one can measure a voltage across the cool ends of the wires. This is the *thermoelectric effect*. In the thermocouple, the magnitude of the voltage measured is a measure of the temperature differential. The key to the practical production of electrical power from the thermoelectric effect is the substitution of semiconductor materials for the metal wires of the thermocouple. For one wire, a p-type semiconductor is used; for the other, an n-type semiconductor, just as in the solar cell, which converts solar radiation instead of heat directly into electricity.

If the semiconductor materials, say, lead telluride, are fashioned into squat cylinders and joined thermally and electrically to a metal plate, a miniature thermoelectric generator is created. If the plate—called the *hot junction*—is heated, the electrons and holes in the semiconductors will both be driven toward the cold ends of the cylinders. An electrical load can be connected across the cold ends and electrical power will be delivered to it as electrons flow through it to combine with the holes in the p-type "leg" of the thermoelectric couple.

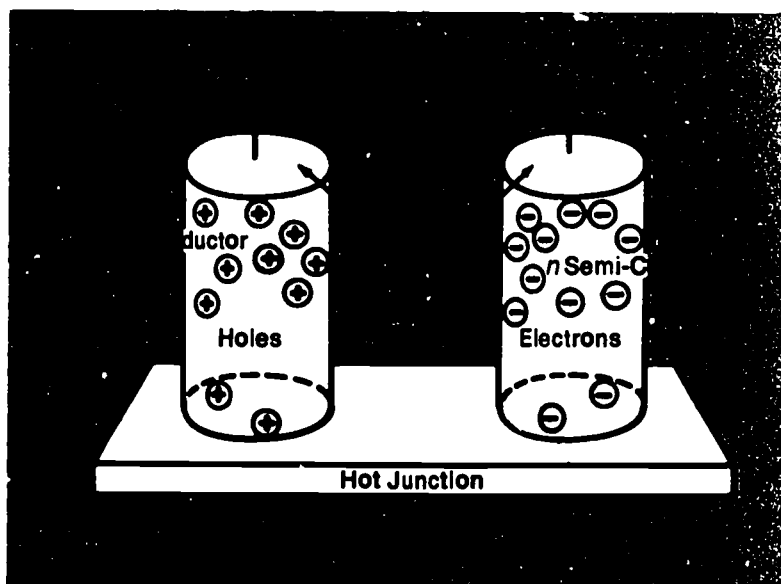

13 When the hot junction of a thermoelectric couple is heated, electrons and holes are driven toward the cold ends of the semiconductor cylinders. Electrons flow through the load and neutralize the positive holes.

In the RTG, the unconverted heat or *waste heat* must be disposed of or the power plant will soon melt. The only practical way to get rid of waste heat in outer space is to radiate it away to cold space. The

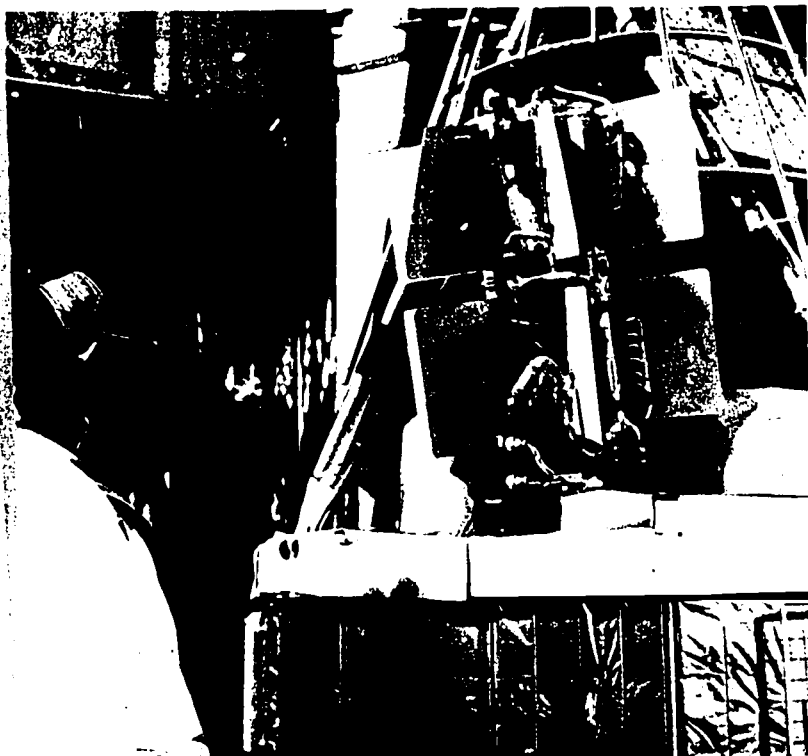

14 Closeup of two SNAP-19's mounted on the Nimbus weather satellite. Note the large fins needed to radiate away waste heat. SNAP-19 generated about 25 watts of electric power and weighed about 30 pounds.

15 Artist's concept of the SNAP-27 radioisotope power plant in use with an Apollo experiment on the Moon's surface. An RTG could operate successfully during the lunar night, powering the helical telemetry antenna just in back of it.

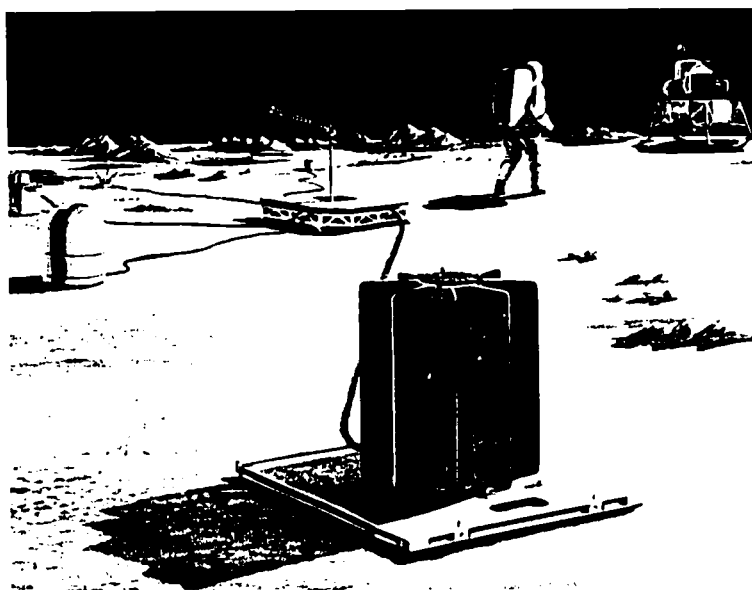

Stefan-Boltzmann law, which describes thermal radiation—whether it be from a hot flatiron or an RTG—states that the rate at which heat will be radiated is proportional to the difference between the fourth powers of the absolute temperatures of the radiating surface and the object absorbing the radiation. In the RTG case, the hot temperature is that of the RTG casing or radiator fins, while the low temperature is that of space itself. The rate at which heat is radiated from the RTG is also proportional to the area of the radiating surface and its emissivity; that is, the surface's ability to emit thermal radiation.

What is the "temperature of space" referred to in the Stefan-Boltzmann law? If the RTG is located far out in interstellar space, the temperature of space would be only a few degrees above absolute zero because only the weak heat fluxes from the distant stars would impinge upon it. But if the RTG is exposed to the hot Sun and warm Earth, as it is in satellite orbit, the temperature of space is close to room temperature. Fortunately, the temperature of the RTG surface needs to be only a few tens of degrees above the temperature of space to radiate waste heat readily, because the difference between the fourth powers of two numbers increases much more rapidly than the difference of first powers.

If an RTG generates more than about 5 electrical watts, there will be enough waste heat to require the addition of radiator fins to the outer surface of the

structure. Because RTGs are generally low-powered devices, the rejection of waste heat is not nearly the problem that it is with the large nuclear space power plants employing nuclear reactors as heat sources.

RTGs are simple, with no moving parts; they generate their electrical power in any environment, since the rate of radioactive decay is not affected by heat, sunlight, Van Allen belt radiation, or any other environmental factor. These advantages have led NASA and the AEC to develop two RTGs, SNAP-19 and SNAP-27, for space use. Two SNAP-19 units were launched on Nimbus B in May 1968, but the satellite failed to attain orbit. Each of the SNAP-19 units was fueled with plutonium-238, weighed 30 pounds, and would have provided 25 watts in space to augment the solar-cell power supply of Nimbus B. Each RTG was 11 inches long and 22 inches in diameter (including fins); they were mounted axially on top of one another. The lifetime expected for SNAP-19 was about 5 years. SNAP-27 is

intended for use during and after manned landings on the Moon. It will power instruments and telemetry transmitters during the cold lunar night. SNAP-27 also employs plutonium-238 fuel, but it generates 65 watts, while weighing only 65 pounds, a significant improvement over SNAP-19. SNAP-27 has a cylindrical envelope 18 inches long and 18 inches in diameter. Its expected lifetime is 5 years

As NASA undertakes the more difficult missions to the outer planets and under the clouds of Venus, RTGs will find more and more missions where sunlight is weak or nonexistent and where they are clearly superior to solar cells.

Nuclear Fission Power Plants In Space

Nuclear fission reactors, like radioisotope fuel capsules, are extremely compact heat sources. When the nucleus of uranium-235 is split by a neutron, the kinetic energies of the fragments quickly appear as heat energy. The amount of energy tied up in one pound of uranium-235 is equivalent to that in 1400 tons of coal. The key to applying the nuclear fission reactor to space power is the controlled release of this immense energy and its partial conversion into electricity.

An important characteristic of the nuclear reactor is its requirement for a certain minimum mass of fissionable fuel before a heat-releasing chain reaction can commence. A nuclear reactor power plant designed for space use may weigh 900 pounds and generate 500 watts, but it would not weigh a great deal less if it produced only 1 watt. Because of this irreducible minimum size, reactor space power plants will be consigned to future missions requiring high power levels—usually over 10 kilowatts.

Compared with the large extant supply of uranium-235, suitable radioisotope fuels for space power plants are rare. Little wonder that space power engineers studied nuclear fission plants early. The NASA-AEC SNAP program has investigated a number of reactor space power plants ranging from 500 watts to 1000 kilowatts. One of these power plants, SNAP-10A, has already flown in an orbital test; another, SNAP-8, is still under development.

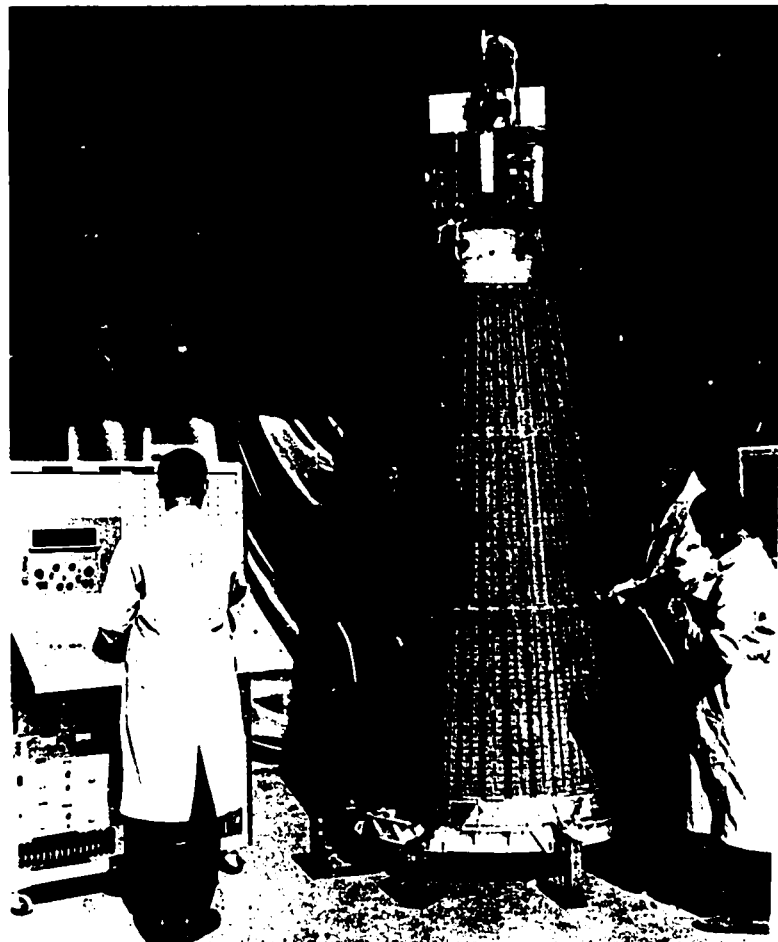

16 SNAP-10A. The reactor is perched on the top of the cone that forms the radiator surface. During launch, the whole power plant was protected by a shroud.

SNAP-10A, like the RTGs, employed thermoelectric elements to convert nuclear heat into electricity. The heart of SNAP-10A was its nuclear reactor, consisting of uranium-zirconium fuel elements surrounded by a neutron reflector of beryllium. When the movable reflector pieces closed in around the reactor fuel core, a heat-producing chain reaction began. The heat was removed by a circulating liquid sodium-potassium alloy called NaK. The NaK conveyed the heat to a conical assembly of tubes that were bonded to the hot junctions of hundreds of thermoelectric elements. The outer surface covering the cold junctions of the thermoelectric elements formed the power plant radiator. The continually flowing stream of NaK was propelled by an electromagnetic pump, which used magnetic force to accelerate the metallic fluid.

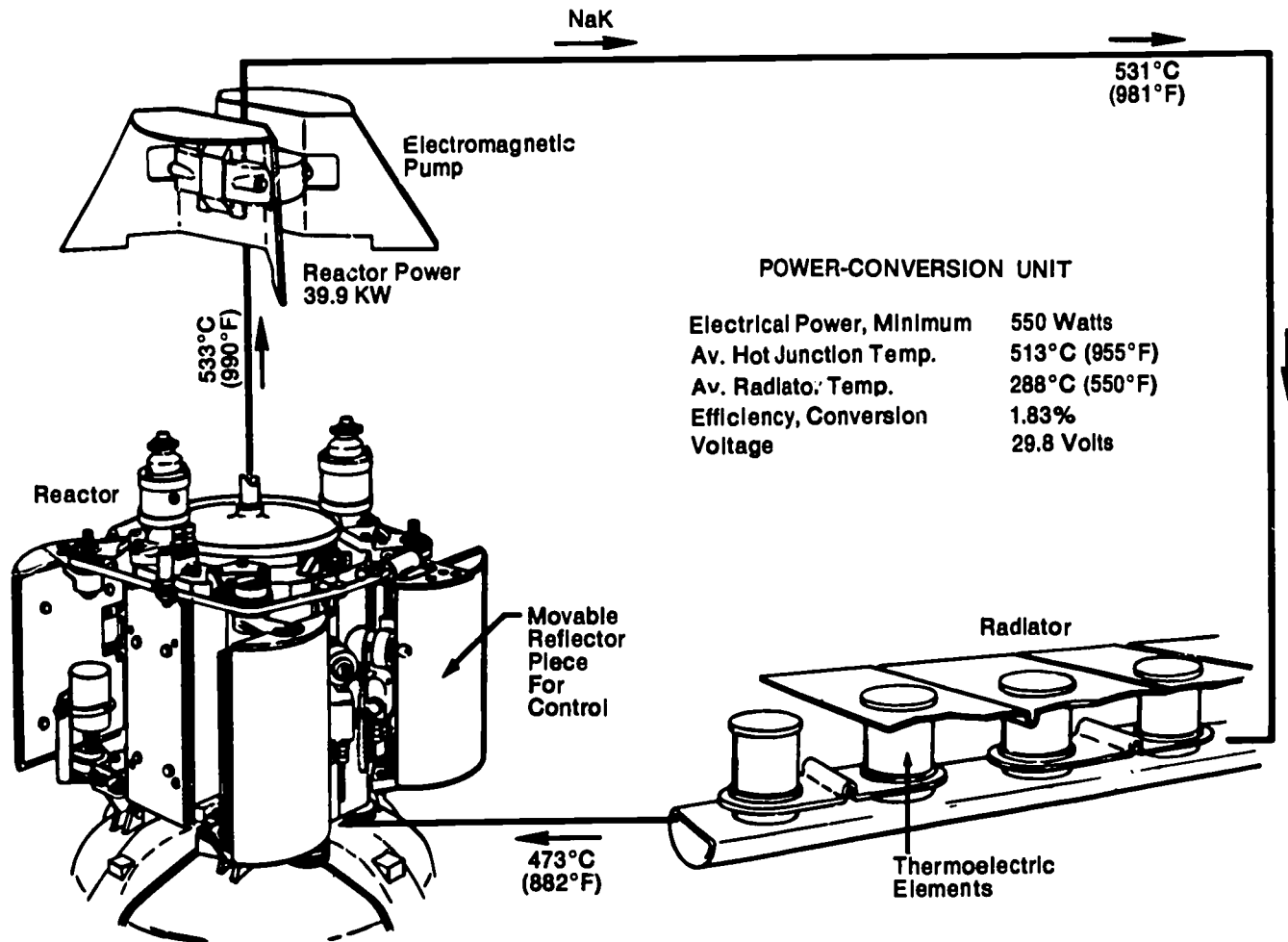

17 Schematic of the SNAP-10A reactor-thermoelectric power plant.

SNAP-10A was launched on an Atlas-Agena rocket from Vandenberg Air Force Base, California, on April 3, 1965, into an 800-mile polar orbit. The power plant generated some 500 watts during the test, which lasted 43 days until telemetry contact was lost with the satellite. SNAP-10A weighed about 960 pounds, yielding about half a watt for each pound. The overall conversion efficiency was less than 2%. It should be emphasized, though, that SNAP-10A was a test power plant, not one intended for operational use. It was in fact the first nuclear reactor ever launched into space.

SNAP-8 is a 35-kilowatt nuclear fission power plant and is in a power range where nuclear fission power is clearly superior to radioisotopes, chemicals, and solar cells on a weight basis. SNAP-8 has not been flown; it is still in the development stage.

SNAP-8 will not employ thermoelectric elements; rather the decision was made to try *dynamic* conversion of heat into electricity. In dynamic conversion, heat is first converted into the motion of a working fluid, say, steam; the high velocity steam then hits a turbine, which is connected to an electrical generator by a shaft. As the turbine turns, electricity is generated. This is the same basic process employed in most commercial coal- and oil-fired electrical power plants.

Mercury will replace water in SNAP-8; mercury vapor will drive the SNAP-8 turbine rather than

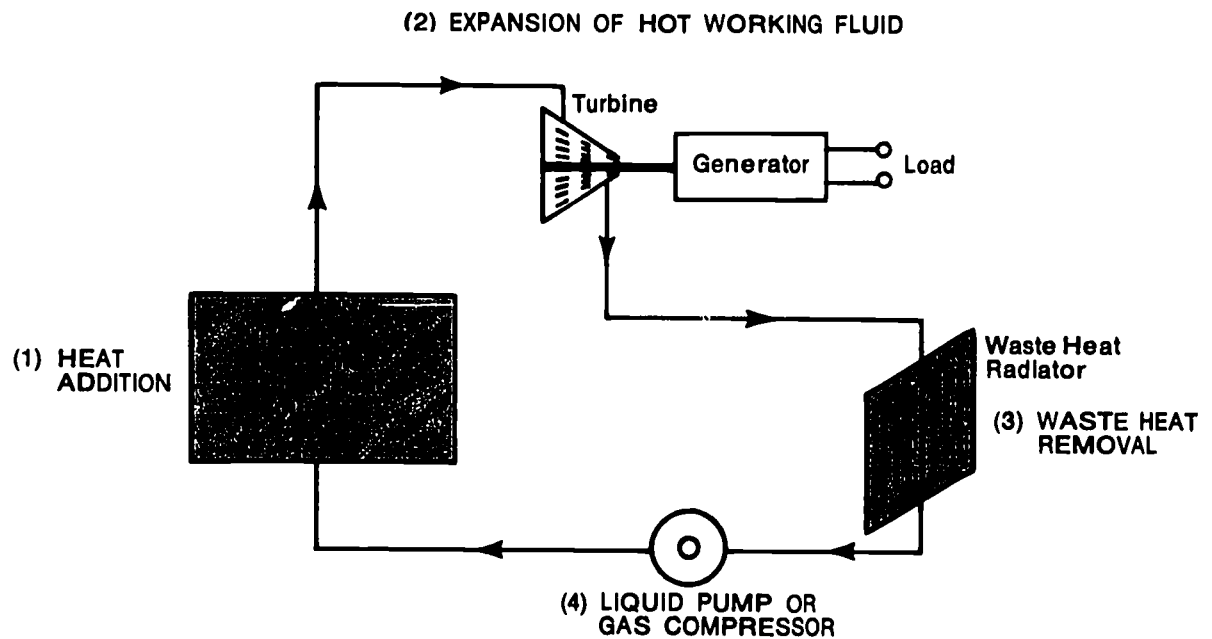

18 A heat engine cycle using a working fluid. In the Rankine cycle, the fluid boils in the heat source and condenses in the radiator

steam. Because the mercury fluid and vapor travel in a continuous circuit from the heat source, to the turbine, to the radiator, the word *cycle* is applied to these types of dynamic conversion systems. In particular, mercury and water cycles are termed Rankine cycles, after William J. M. Rankine, a Scottish engineer. The Rankine cycle can be broken down into four parts: (1) Heat addition at the source (the reactor in SNAP-8); (2) the expansion step, where the vapor created by boiling during heat addition expands through the turbine and turns it; (3) removal of the waste heat at the radiator, which condenses the vapor to a liquid; and (4) repressurization of the fluid by a pump. The liquid then returns to the heat source for reheating. Of course, all four steps are going on all the time but in different portions of the fluid/vapor circuit.

With SNAP-8, the problem of waste heat disposal becomes more critical. The amount of waste heat will be five to ten times the 35 kilowatts of electricity generated. Simple RTG-type finned radiators are grossly inadequate. With an operational SNAP-8 power plant, the spacecraft will require wing-like radiators that make the craft look like some strange airplane. Large solar-cell power plants present the same general appearance, but the objective there is to collect solar radiation rather than to dispose of waste heat derived from an internal fuel supply.

Some other interesting features of SNAP-8 are its three liquid metal circuits and single circuit of organic fluid. The first liquid metal circuit, called the *primary* loop, uses liquid NaK to carry heat from the reactor to a heat exchanger where the heat is transferred to liquid mercury, occupying the *secondary* loop. The liquid mercury boils in the heat exchanger, creating the hot vapor that drives the turbine. Instead of going directly to the radiator for condensation, the mercury vapor is cooled and condensed in

19 Artist's concept of the SNAP-8 flight model. It is planned for development of 30 to 60 kilowatts of electrical power.

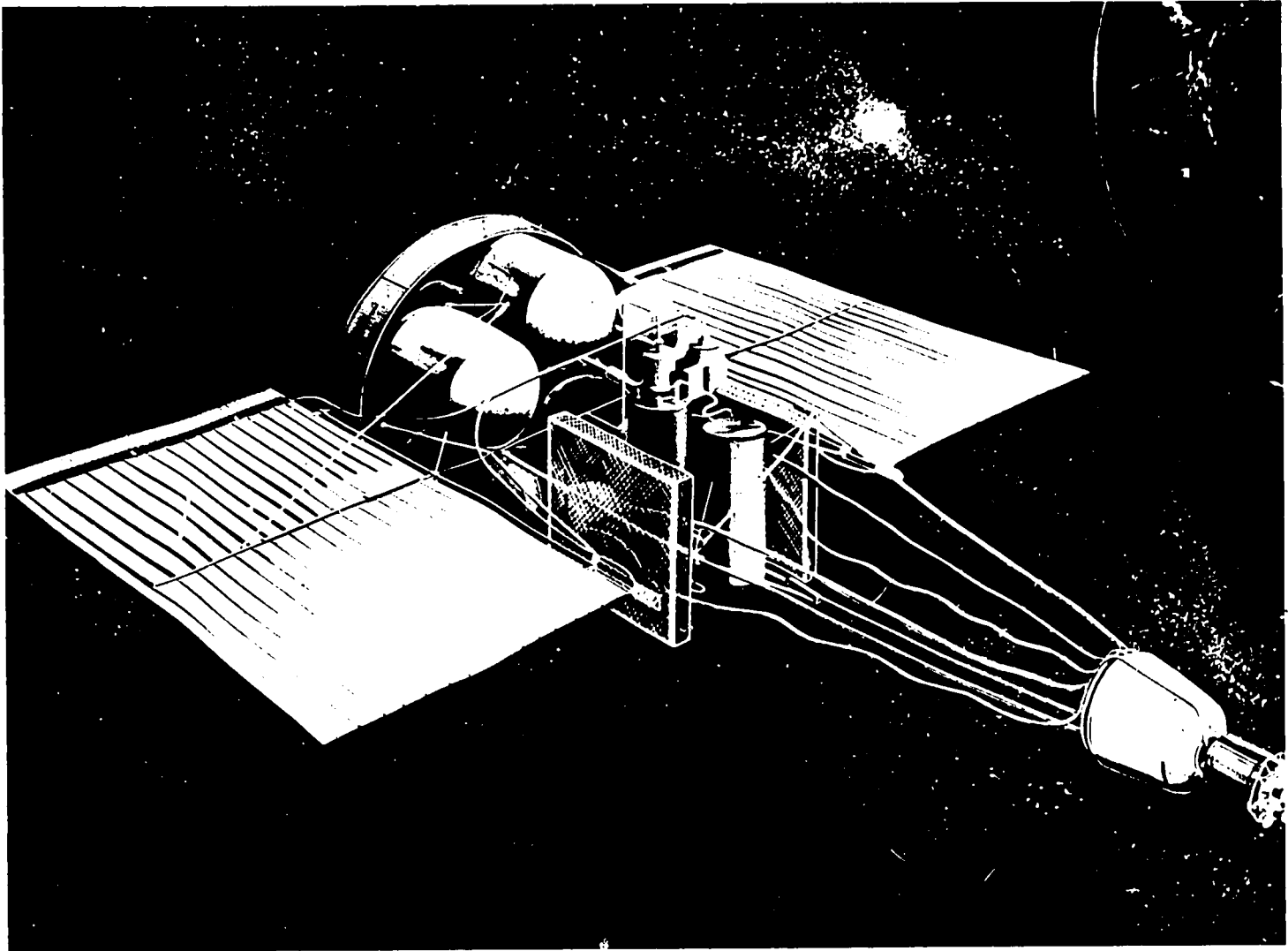

another heat exchanger. The *tertiary* fluid used to cool the mercury vapor is NaK again. The organic coolant loop cools various portions of the power plant where liquid metals would be undesirable. There are several engineering reasons for this complexity; one is that mercury cannot be sent through the reactor directly because its affinity for neutrons would stop the fission chain reaction, NaK is used instead; another reason is that mercury vapor condensation in a huge radiator under zero-g conditions is difficult, instead *fluid* NaK conveys the heat of condensation to the radiator.

When completely developed, SNAP-8 will probably weigh about 10,000 pounds in flight configuration. Because it will generate 35 kilowatts, it will obtain 3 watts for each pound—a much higher figure than those mentioned for other space power plants. Overall thermal efficiency will be about 8%.

What missions would need SNAP-8's 35 kilowatts? NASA's mission planners foresee SNAP-8s being used on large orbital space stations and on lunar bases. NASA has even begun exploratory development work on components for space power plants that will generate hundreds of kilowatts; here, the application would be on advanced missions employing electrical engines, such as ion rockets.

The history of spacecraft design has been one of power-pinching because there has never been enough power for all desired spacecraft components and instruments. If spacecraft engineers had kilowatts rather than watts at their disposal, they would undoubtedly find many things to do with the extra power. They would welcome this kind of affluence.

20 Artist's concept of a Moon city, conforming to actual scientific projections. In upper left is a nuclear power station.



Additional Reading

For titles of books and teaching aids related to the subjects discussed in this booklet, see NASA's educational publication EP-48, Aerospace Bibliography.

Information concerning other educational publications of the National Aeronautics and Space Administration may be obtained from the Educational Programs Division, Code FE, Office of Public Affairs, NASA, Washington, D.C. 20546

**For sale by the Superintendent of Documents
U.S. Government Printing Office, Washington, D.C. 20402
Price 35 cents**

EP59

America

In

Space:

The

First

Decade

Spacecraft Power

National Aeronautics and Space Administration