

PRINCIPLES AND PRACTICE OF

# Clinical Parasitology

EDITED BY  
Stephen Gillespie  
Richard D. Pearson

 WILEY



---

# **Principles and Practice of Clinical Parasitology**

---





# Principles and Practice of Clinical Parasitology

---

*Edited by*

**Stephen H. Gillespie**

*Royal Free Hospital and School of Medicine*

and

**Richard D. Pearson**

*University of Virginia Health Sciences Center,  
Charlottesville, Virginia, USA*

**JOHN WILEY & SONS, LTD**

Chichester • New York • Weinheim • Brisbane • Singapore • Toronto

Copyright © 2001 by John Wiley & Sons Ltd,  
Baffins Lane, Chichester,  
West Sussex PO19 1UD, England

National 01243 779777  
International (+ 44) 1243 779777  
e-mail (for orders and customer service enquiries): cs-books@wiley.co.uk  
Visit our Home Page on: <http://www.wiley.co.uk>  
or <http://www.wiley.com>

All Rights Reserved. No part of this publication may be reproduced, stored in a retrieval system, or transmitted, in any form or by any means, electronic, mechanical, photocopying, recording, scanning or otherwise, except under the terms of the Copyright, Designs and Patents Act 1988 or under the terms of a licence issued by the Copyright Licensing Agency Ltd, 90 Tottenham Court Road, London W1P 0LP, UK, without the permission in writing of the publisher.

Chapter 19b is in the public domain

*Other Wiley Editorial Offices*

John Wiley & Sons, Inc., 605 Third Avenue,  
New York, NY 10158-0012, USA

WILEY-VCH Verlag GmbH, Pappelallee 3,  
D-69469 Weinheim, Germany

John Wiley & Sons Australia Ltd, 33 Park Road, Milton,  
Queensland 4064, Australia

John Wiley & Sons (Asia) Pte, Ltd, 2 Clementi Loop #02-01,  
Jin Xing Distripark, Singapore 129809

John Wiley & Sons (Canada) Ltd, 22 Worcester Road,  
Rexdale, Ontario M9W 1L1, Canada

***Library of Congress Cataloging-in-Publication Data***

Principles and practice of clinical parasitology / edited by Stephen Gillespie, Richard D. Pearson.

p. cm.

Includes bibliographical references and index.

ISBN 0-471-97729-2 (cased)

1. Medical parasitology. I. Gillespie, S. H. II. Pearson, Richard D.

QR251 .P775 2001

616.9'6—dc21

00-047755

***British Library Cataloguing in Publication Data***

A catalogue record for this book is available from the British Library

ISBN 0-471-97729-2

Typeset in 10/12pt Times from authors' disks by Dobbie Typesetting Limited, Tavistock, Devon  
Printed and bound in Great Britain by Antony Rowe Ltd, Chippenham, Wiltshire  
This book is printed on acid-free paper responsibly manufactured from sustainable forestry,  
in which at least two trees are planted for each one used for paper production.

# Contents

<b>List of Contributors</b>	vii	<b>12 Pathogenic and Opportunistic Free-living Amebas: Naegleria fowleri, Acanthamoeba spp. and Balamuthia mandrillaris</b>	269
<b>Preface</b>	ix	<i>Augusto Julio Martínez and Govinda S. Visvesvara</i>	
<b>1 History of Parasitology</b> <i>G. C. Cook</i>	1	<b>13 Leishmaniasis</b>	287
<b>2 Parasite Epidemiology</b> <i>D. A. P. Bundy and E. Michael</i>	21	<i>Richard D. Pearson, Selma M. B. Jeronimo and Anastacio de Q. Sousa</i>	
<b>3 Malaria</b> <i>B.-A. Biggs and G. V. Brown</i>	53	<b>14a African Trypanosomiasis</b>	315
<b>4 Babesiosis</b> <i>Jeffrey A. Gelfand and Debra D. Poutsika</i>	99	<i>I. Balakrishnan and A. Zumla</i>	
<b>5 Toxoplasmosis</b> <i>Joseph D. Schwartzman</i>	113	<b>14b American Trypanosomiasis (Chagas' Disease)</b>	335
<b>6 Cryptosporidiosis and Isosporiasis</b> <i>Cynthia L. Sears and Beth D. Kirkpatrick</i>	139	<i>Louis V. Kirchhoff</i>	
<b>7 Cyclospora</b> <i>Richard L. Guerrant and Theodore S. Steiner</i>	165	<b>15 Blastocystis</b>	355
<b>8 Microsporidia</b> <i>E. U. Canning</i>	171	<i>D. J. Stenzel and R. E. Boreham</i>	
<b>9 Amebas</b> <i>Upinder Singh and William A. Petri Jr</i>	197	<b>16 Schistosomiasis</b>	369
<b>10 Giardia lamblia</b> <i>David R. Hill</i>	219	<i>G. Richard Olds and Srinivasan Dasarathy</i>	
<b>11 Trichomonads</b> <i>J. P. Ackers</i>	243	<b>17 Hepatobiliary and Pulmonary Flukes: Opisthorchis, Clonorchis, Fasciola and Paragonimus Species</b>	407
		<i>Thomas R. Hawn and Elaine C. Jong</i>	
		<b>18a Blood-borne Filarial Infections: Wuchereria bancrofti, Brugia malayi, Brugia timori, Loa loa, Mansonella perstans and Mansonella ozzardi</b>	433
		<i>Thomas B. Nutman</i>	
		<b>18b Onchocerciasis</b>	457
		<i>J. Whitworth</i>	

<b>18c</b>	<b>Strongyloides stercoralis and <i>S. fulleborni</i></b>	<b>479</b>	<b>21</b>	<b>Intestinal Nematodes</b> <i>Stephen H. Gillespie</i>	<b>561</b>
	<i>John F. Lindo and Michael G. Lee</i>				
<b>19a</b>	<b>Toxocariasis</b>	<b>501</b>	<b>22</b>	<b>Echinococcosis</b>	<b>585</b>
	<i>M. R. H. Taylor and Celia V. Holland</i>			<i>R. C. A. Thompson</i>	
<b>19b</b>	<b>Trichinellosis</b>	<b>521</b>	<b>23</b>	<b>Cestodes</b>	<b>613</b>
	<i>Peter M. Schantz and Vance Dietz</i>			<i>Kaethe Willms and Julio Sotelo</i>	
<b>19c</b>	<b>Migrating Worms</b>	<b>535</b>	<b>24</b>	<b>Intestinal Trematodes</b>	<b>635</b>
	<i>Stephen H. Gillespie</i>			<i>Thomas R. Hawn and Elaine C. Jong</i>	
<b>20</b>	<b>Dracunculiasis</b>	<b>553</b>		<b>Index</b>	<b>647</b>
	<i>Ralph Muller</i>				

# Contributors

---

**J. P. Ackers** *Department of Infections and Tropical Diseases, London School of Hygiene and Tropical Medicine, Keppel Street, London WC1E 7HT, UK*

**S. I. Balakrishnan** *Department of Medical Microbiology, Royal Free & University College Medical School, Rowland Hill Street, London NW3 2PF, UK*

**B.-A. Biggs** *Division of Infectious Diseases, Department of Medicine, The Walter and Eliza Hall Institute of Medical Research, Royal Melbourne Hospital, Victoria 3050, Australia*

**R. E. Boreham** *PO Box 1246, Toowong, Queensland 4066, Australia*

**Graham Brown** *Division of Infectious Diseases, Department of Medicine, The Walter and Eliza Hall Institute of Medical Research, Royal Melbourne Hospital, Victoria 3050, Australia*

**D. A. P. Bundy** *The World Bank, 1818 H. Street NW, Washington, DC 20433, USA*

**E. Canning** *Department of Biology, Imperial College of Science, Technology and Medicine, London SW7 2AZ, UK*

**G. C. Cook** *The Wellcome Trust Centre for the History of Medicine at UCL, 183 Euston Road, London NW1 2BE, UK*

**Srinivasan Dasarathy** *MetroHealth Medical Center, Case Western Reserve University, 2500 MetroHealth Drive, Cleveland OH 44109-1998, USA*

**Vance Dietz** *Organización Panamericana de Salud, Marcelo T. de Alvear 684, 4 Piso, 1395 Buenos Aires, Argentina*

**Jeffrey A. Gelfand** *International Medical Affairs Partners, Healthcare System, Massachusetts General Hospital, 50 Stanford Street, Suite 801, Boston, MA 02114-2517, USA*

**Stephen H. Gillespie** *Department of Medical Microbiology, Royal Free and University College Hospital Medical School, Pond Street, London NW3 2QG, UK*

**Richard L. Guerrant** *Division of Geographic and International Medicine, Box 801379, University of Virginia School of Medicine, Charlottesville, VA 22908, USA*

**Thomas R. Hawn** *Division of Allergy and Infectious Diseases, Department of Medicine, University of Washington Medical Center, The Institute for Systems Biology, Suite 200, 4225 Roosevelt Way NE, Seattle, WA 98105, USA*

**David R. Hill** *Division of Infectious Diseases, University of Connecticut Health Center, Farmington, CT 06030-3212, USA*

**Celia V. Holland** *Department of Zoology, Trinity College, Dublin 2, Ireland*

**Selma M. B. Jeronimo** *Department of Biochemistry, Universidade Federal do Rio Grande do Norte, Natal, Brazil*

**Elaine C. Jong** *University of Washington, Hall Health Primary Care Center, Box 354410, Seattle, WA 98195-4410, USA*

**Michael G. Lee** *Department of Medicine, University of the West Indies, Mona, Kingston 7, Jamaica*

**Louis V. Kirchhoff** *University of Iowa, Department of Internal Medicine, 300G EMRB, Iowa City, IA 52242, USA*

**Beth D. Kirkpatrick** *Division of Infectious Diseases, Department of Medicine, University of Vermont School of Medicine, Burlington, VT, USA*

**John F. Lindo** *Department of Microbiology, University of the West Indies, Mona, Kingston 7, Jamaica*

**Augusto Julio Martínez** *University of Pittsburgh School of Medicine, Department of Pathology, Division of Neuropathology, 200 Lothrop Street, Pittsburgh, PA 15213-2582, USA*

**E. Michael** *Department of Infectious Disease Epidemiology, Imperial College School of Medicine, Norfolk Place, London W2 1PG, UK*

**Ralph Muller** *International Institute of Parasitology, 22 Cranbrook Drive, St Albans, Hertfordshire AL4 0SS, UK*

**Thomas B. Nutman** *Helminth Immunology Section and Clinical Parasitology Unit, Laboratory of Parasitic Diseases, National Institute of Allergy and Infectious Diseases, National Institutes of Health, Building 4, Room B1-03, Bethesda, MD 20892-0425, USA*

**G. Richard Olds** *Medical College of Wisconsin, Department of Medicine, 9200 W. Wisconsin Avenue, Suite 4186, Milwaukee, WI 53226, USA*

**Richard D. Pearson** *University of Virginia School of Medicine, Department of Medicine & Pathology, Box 801379, Charlottesville, VA 22908, USA*

**William A. Petri Jr** *University of Virginia Health Sciences Center, 300 Park Place, MR4 Building, Room 2115, Charlottesville, VA 22908, USA*

**Debra D. Poutsika** *New England Medical Center, 750 Washington Street, Boston, MA 02111, USA*

**Peter M. Schantz** *Division of Parasitic Diseases, National Center for Infectious Diseases, Centers for Disease Control and Prevention, 4770 Buford Highway, Atlanta, GA 30341-3724, USA*

**Joseph D. Schwartzman** *Department of Pathology, Dartmouth-Hitchcock Medical Center, 1 Medical Center Drive, Lebanon, NH 03756, USA*

**Cynthia L. Sears** *Department of Medicine, Division of Infectious Diseases and Gastroenterology, Johns Hopkins University School of Medicine, Baltimore, MD 21205, USA*

**Upinder Singh** *University of Virginia School of Medicine, 300 Park Place, Charlottesville, VA 22908, USA*

**Anastacio de Q. Sousa** *Department of Internal Medicine, Universidade Federal do Ceata, Fortaleza, Brazil*

**Julio Sotelo** *Instituto Nacional de Neurología y Neurocirugía, Insurgentes Sur 3877, Mexico City 14269, Mexico*

**Theodore S. Steiner** *Division of Geographic and International Medicine, Box 801379, University of Virginia School of Medicine, Charlottesville, VA 22908, USA*

**D. J. Stenzel** *Analytical Electron Microscopy Facility, Queensland University of Technology, Garden Point Campus, 2 George Street, GPO Box 2434, Brisbane, Queensland 4001, Australia*

**M. R. H. Taylor** *Department of Paediatrics, Trinity College, Dublin 2, and National Children's Hospital, Harcourt Street, Dublin 2, Ireland*

**R. C. A. Thompson** *Department of Veterinary Studies, Murdoch University, Murdoch, WA 6150, Australia*

**J. Whitworth** *Medical Research Council, Uganda Virus Research Institute, PO Box 49, Entebbe, Uganda*

**Kaethe Willms** *Department of Microbiology and Parasitology, Facultad de Medicina, Universidad Nacional Autónoma de México, Mexico City, Mexico*

**Govinda S. Visvesvara** *Division of Parasitic Diseases, National Center for Infectious Diseases, Centers for Disease Control and Prevention, Atlanta, GA 30333, USA*

**A. Zumla** *Centre for Infectious Diseases, University College London, Royal Free and University College Medical School, Rowland Hill Street, London NW3 2PF, UK*

# Preface

---

In the 1970s and 1980s, in an attempt to focus world attention on parasitic diseases, the World Health Organization formed the Tropical Diseases Research Group. Their target was six major infections that damaged the health of individuals in developing countries, and five of these six were parasitic diseases. The Rockefeller Foundation also identified parasitic infections as a major target for health improvement for the world community. They formed a research network to develop new drugs and vaccines by understanding the pathogenesis of diseases. Its title 'The Great Neglected Diseases Network' emphasised that, in the post-colonial world, parasitic diseases were no longer identified by governments and pharmaceutical companies as important subjects for medical research. Despite the success of these two ventures in developing our understanding of the immunology, molecular biology and potential for vaccines and drugs, the position of parasitic diseases in the world is, if anything, worse than it was 30 years ago. The territories in which malaria is endemic have expanded and the number of cases with it. Malaria causes more than a million child deaths in Africa every year. The number of individuals suffering from intestinal helminth infections has more than doubled in the last 50 years and the prevalence of schistosomiasis is rising. Urbanisation in Brazil, where more than 80% of the population live in cities, has resulted in large peri-urban epidemics of Chagas' disease and epidemics of visceral leishmaniasis. This general global deterioration has occurred in a context where, for many countries, endemic parasitic diseases are a thing of the past. In epidemiological terms, parasitic infections are over-dispersed or, in more everyday terms, focused in the poorest sector of the world community.

Globalisation has changed the spectrum of parasitic infection in clinical medical practice. Not only has the incidence of disease worldwide risen, but frequency of travel, migration and population dispersal due to war has resulted in individuals presenting with parasitic infections in locations where these diseases have become rare. Patients with malaria and intestinal protozoan and helminth infections are now an everyday occurrence in family practice throughout the world. The diagnosis of parasitic diseases has also become an everyday component of medical laboratory practice worldwide.

The HIV pandemic has also had a potent influence on the spectrum of parasitic infections. A number of organisms that cause disease rarely have become commonplace. The HIV epidemic itself was identified through an apparent epidemic of *Pneumocystis carinii* infection, at that time considered to be a protozoan and now considered to be a fungus. Intractable cryptosporidiosis and isosporiasis, and the recognition of microsporidium infections and cerebral toxoplasmosis, have all been consequences of severe immunocompromise secondary to HIV infection. Visceral leishmaniasis, too, has been recognised as a major opportunistic disease in HIV-infected individuals in Southern France and Italy.

New technologies have increased our ability to investigate parasitic diseases and to understand the biology of the organisms and the hosts' immune response to them. Developments in immunology and molecular biology have enabled diagnostic laboratories to improve the diagnosis of parasitic infections through enzyme-immunoassays and DNA amplification techniques. Genome sequence programmes are under way for parasites, including malaria, *Leishmania* and

amoebas and these may lead to the identification of new virulence determinants, or targets for chemotherapy or vaccine development. Although new treatments and vaccines have progressed more slowly than in other infection disciplines, effective chemotherapy is now available for almost all parasitic infections.

An international panel of authors have drawn together their experience and understanding of parasitic infections. The chapters contain a clinically orientated overview of all the major

parasitic infections in medical practice. The editors hope that those who read and use this book will develop their clinical diagnostic and therapeutic skills, and that these skills will be used for the benefit of those who most need them—the people who are often the poorest in the world community.

*Stephen H. Gillespie*  
*Richard D. Pearson*



# History of Parasitology

G. C. Cook

*The Wellcome Trust Centre for the History of Medicine at UCL, London, UK*

---

## INTRODUCTION

Many of the larger helminths (e.g. *Ascaris lumbricoides*, *Dracunculus medinensis* and *Taenia* spp.) and ectoparasites must have been visualised in ancient times (Foster, 1965)—in fact, since *Homo sapiens* first became aware of his immediate environment. *D. medinensis* was certainly recognised on the shores of the Red Sea in the pre-Christian era. The first clear documentation of these organisms is to be found in the Papyrus Ebers (c. 1550 BC) and other ancient Egyptian writings (Nunn, 1996); these writers were also aware of *Schistosoma* spp., which remain to this day a major scourge of that country. Aristotle was familiar with helminths involving dogs, fish, and pigs (*Cysticercus cellulosae*) (Foster, 1965); the presence of this latter helminth in the tongues of pigs is alluded to in a comedy (*The Knights*) by Aristophanes. Galen (AD 131–199) recognised three human (macro)parasites: *A. lumbricoides*, *Taenia* spp. and *Enterobius vermicularis*. Aretaeus the Cappodocian (AD 81–138) was apparently familiar with human hydatidosis.

The Arabs seem to have added little (if anything) of importance to existing knowledge of human parasitoses; they, too, were familiar with *D. medinensis*. A twelfth century nun, Hildegardis de Pinguia, recognised the ectoparasite (a mite) causing scabies (Foster, 1965). The first fluke to be well documented was *Fasciola hepatica*; this was accurately described

by Anthony Fitzherbert (1470–1538) in *A Newe Treate or Treatyse most Profytable for All Husbandemen* in 1532.

Helminths were in some cases considered to improve the health of an infected individual (Foster, 1965); the ancient Chinese, for example, believed that a man should harbour at least three worms to remain in good health, and in eighteenth century Europe many regarded the presence of ‘worms’ in children as being beneficial to their health. By contrast, there were reports of fanciful or imaginary worms causing all manner of disease(s); parasites were in fact implicated in the seventeenth century in the aetiology of many diseases, including syphilis and plague.

## The Doctrine of ‘Spontaneous Generation’

From ancient times until the mid-nineteenth century, there was a widespread belief that parasites arose by ‘spontaneous generation’—either on or in the human body (Foster, 1965), that was part of a much broader hypothesis which held that *all* living things arose in this manner. In the seventeenth century, William Harvey (1578–1657) cast doubt on this doctrine and Jan Swammerdam (1637–1680) was firmly of the opinion that it did not occur. Antony van Leeuwenhoek (1632–1723) did *not* consider that weevils spontaneously generate in corn

seed, and Francesco Redi (1626–1697) disproved the widely-held contemporary view that flies arise spontaneously from meat. By carrying out careful dissections of *A. lumbricoides*, Edward Tyson (1650–1708) showed there were two sexes and that in fact they multiplied by sexual reproduction; like most contemporaries, however, he believed that the original parasites arose by ‘spontaneous generation’. Georges Leclerc, Comte de Buton (1717–1788) and Albrecht von Haller (1708–1777) undoubtedly believed in ‘spontaneous generation’ and, as late as 1839, the anatomist Allen Thompson (Foster, 1965) wrote that this form of generation was ‘to be looked upon as no more than an exception to the general law of reproduction . . .’. Two distinguished parasitologists of the later eighteenth century—Marcus Bloch (1723–1799) and Johan Göze (1731–1793) (see below)—both believed that parasites were ‘inborn’ in their hosts. V. L. Brera (1772–1840), professor of medicine at Pavia, wrote in 1798 that he was opposed to the idea of spontaneous generation; although believing that worms develop from eggs ingested with food, he considered that this occurs only in individuals whose constitution is favourable to the worm, i.e. that a ‘host-factor’ has a significant role in the parasite–host equation. The ‘doctrine of spontaneous generation of parasites’ was not finally abandoned until late in the nineteenth century (Foster, 1965).

## ORIGINS OF THE SPECIALITY—PARASITOLOGY

The Italian, Redi (see above) has perhaps the best claim to the title, ‘father of parasitology’: he wrote *Osservazioni intorno agli animali viventi che si trovano negli animali viventi*, and was especially interested in ectoparasites (Foster, 1965), particularly lice, although in his classical text he also described dog and cat tapeworms, and had in 1671 produced an illustration of *Fasciola hepatica*. Another early text was that due to Nicolas André (1658–1742), *De la génération des vers dans le corps de l’homme* (1699); he was the first to illustrate the scolex of a human tape-

worm—*Taenia saginata*. He also associated worms with venereal disease(s) but apparently doubted a cause–effect relationship (Foster, 1965). André considered that predisposing factors (to infection) were bad air and bad food (both of which contained ‘seeds of worms’) and overindulgence in food.

One of the most influential figures in eighteenth century parasitology was Pierre Pallas (1741–1811), whose other major interest was exploration (of the Russian Empire) (Foster, 1965); after graduation at Leyden in 1760, he wrote a thesis, *De infestis viventibus intraviventia*. He also wrote a zoological text, *Miscellanea zoologica*, in which he concentrated on bladder worms—all of which, he considered, belonged to a single species, *Taenia hydatigena*.

Göze (see above), an amateur naturalist, made several important contributions to helminthology; his monumental *Versuch einer Naturgeschichte der Eingeweidewürmer tierischer Körper* was published in 1787. He discovered the scolex of *Echinococcus* spp. in hydatid cysts. Bloch (a doctor of medicine in Berlin) (see above), whose prize-winning essay *Abhandlung von der Erzeugung der Eingeweidewürmer* was published in 1782, was the first to draw attention to the hooklets on the head of the tapeworm.

## The Nineteenth Century

This century saw several important texts on helminthology. Brera (see above) (at Pavia, where he had access to Göze’s fine collection of helminths) poured scorn on the idea that the presence of worms was either necessary for, or contributed to, health. However, like others before him, he confused the two species of human tapeworm—*Taenia solium* and *T. saginata*. Despite Brera’s contributions, Carl Rudolphi (1771–1832), the foremost parasitologist of his day, contributed the most important parasitological work of the early nineteenth century. He utilised the microscope for histological studies, and his scholarly two-volume work *Entozoorum sive vermium intestinalium historia naturalis* (1808), together with *Entozoorum synopsis cui accedunt mantissa duplex et indices locupletissima* (1819), substantially increased the list of known

parasites. Other important texts about this time were due to J. S. Olombel (Foster, 1965) in 1816, and Johann Bremser (1767–1827) in 1819. Another parasitologist of distinction in the early nineteenth century was Félix Dujardin (1801–1860); in 1840 he was appointed to the chair of zoology at Rennes, and was the first worker to appreciate that trematodes and cestodes pass part of their life-cycle in an intermediate host, and that ‘bladder worms’ are part of the life-cycle of tapeworms; these observations were regrettably not published. He also introduced the term ‘proglottis’ (a segment of the tapeworm). His major parasitological text was *Histoire naturelle des helminthes ou vers intestinaux* (1845).

### Early English Texts on Parasitology

At the outset of the nineteenth century there was virtually nothing written on this subject in English, nearly all work emanating from mainland Europe. Matthew Baillie (1761–1823) had included relevant passages in *Morbid Anatomy of Some of the Most Important Parts of the Human Body* (1793); he noted that tapeworm infections were uncommon in Britain (Foster, 1965). In the 1840s several continental works on helminthology were translated into English, most by George Busk FRS (1807–1886) Surgeon to The Seamen’s Hospital Society (Cook, 1997a) and issued by the Ray Society; in 1857, the Sydenham Society published two volumes which contained translations of *Manual of Animal and Vegetable Parasites* (by Gottlieb Küchenmeister, 1821–1890), and *Tape and Cystic Worms* (by Carl von Siebold, 1804–1885). However, the Ray Society had already published *On the Alternation of Generations; or, the Propagation and Development of Animals through Alternate Generations* (1845) (Figure 1.1) by the Danish naturalist Johannes Steenstrup (1813–1897); in Chapter 4 of this seminal text he described cercariae (liberated by fresh-water molluscs) which remained encysted for several months and contained the parasitic fluke *Distoma*. Steenstrup had therefore elucidated, and published, the complete life-cycle of one species of liver

flake—thus illustrating his hypothesis of the ‘alternation of generations’.

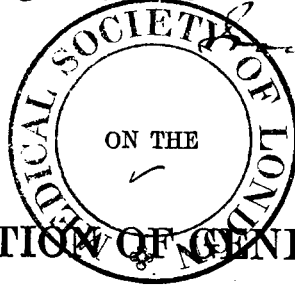
### Emergence of Thomas Spencer Cobbold (1828–1886)

Until the 1860s, parasitology was virtually neglected in Britain; during his lifetime, Cobbold became the major British authority on the subject. The son of a Suffolk clergyman (Anonymous, 1886), he served an apprenticeship with a Norwich surgeon, J. G. Crosse; after a few months of postgraduate study in Paris, he returned to the anatomy department of John Goodsir at Edinburgh, where he studied comparative anatomy, and observed many animal parasites, including *Fasciola gigantica* in the giraffe. In 1857, he obtained the post of Lecturer in Botany at St Mary’s Hospital, London and in 1861 he was appointed to a lectureship at the Middlesex Hospital; in 1864 he was elected FRS, and in 1873 he obtained the post of professor of botany and helminthology at the Royal Veterinary College, London. In 1864, he published *Entozoa, an Introduction to the Study of Helminthology*; this book and its successor (Figure 1.2) contained a detailed account of all the (known) parasites to affect *Homo sapiens*. Following publication of this text (which had many enthusiastic reviews), Cobbold set up as a physician with a specialist interest in parasitic disease. Due to his, by then, worldwide reputation, he presented, on behalf of Patrick Manson (1844–1922; Figure 1.3) the discovery of the development of ‘embryo’ filariae (microfilariae) in the body of the mosquito, to the Linnean Society of London on 7 March 1878. In 1879 he published *Parasites: a Treatise on the Entozoa of Man and Animals including Some Account of the Ectozoa*.

### Other European Contributions in the Nineteenth Century

A French parasitologist (primarily a general practitioner), who is now largely forgotten, was Casimir Davaine (1812–1882); he wrote extensively on anthrax—before Robert Koch (1843–1910) and

*The Medical Society of London*  
*from 50, Cannon Street.*



**ALTERNATION OF GENERATIONS;**

OR,

**THE PROPAGATION AND DEVELOPMENT OF ANIMALS  
 THROUGH ALTERNATE GENERATIONS:**

**A PECULIAR FORM OF FOSTERING THE YOUNG IN THE LOWER CLASSES OF ANIMALS.**

BY

**JOH. JAPETUS SM. STEENSTRUP,**  
 LECTURER IN THE ACADEMY OF SÖRO.

TRANSLATED FROM

THE GERMAN VERSION OF C. H. LORENZEN,

BY

**GEORGE BUSK.**

**LONDON:**

**PRINTED FOR THE RAY SOCIETY.**

**MDCCCXLV.**

**Fig. 1.1** Title page of Steenstrup's text, published in 1845. This, for the first time, linked the adult parasite with its intermediate (cystic) form

# E N T O Z O A

BEING A

## SUPPLEMENT

TO THE

INTRODUCTION TO THE STUDY OF

## HELMINTHOLOGY

BY

T. SPENCER COBBOLD, M.D., F.R.S.,

CORRESPONDENT OF THE ACADEMY OF SCIENCES OF PHILADELPHIA.

LONDON

G R O O M B R I D G E A N D S O N S

5, PATERNOSTER ROW.

M D C C C L X I X .

Fig. 1.2 Title page of Cobbold's text. Published in 1869, this formed a supplement to his major text of 1864



**Fig. 1.3** Patrick Manson (1844–1922), who discovered the man–mosquito component of lymphatic filariasis, and founded (with the Rt. Hon. Joseph Chamberlain) the formal discipline of tropical medicine

Louis Pasteur (1822–1895), as well as on many other aspects of science, including fungus diseases of plants, the development of the oyster, the science of teratology, the movement of leucocytes, and investigations involving: rotifers, nematodes and infusoria. His work, in fact, gives a very full account of the state of parasitology in the mid-nineteenth century. He described *Pentatrichomonas hominis* and *Inermicapsifer madagascariensis*, and first advocated the widespread diagnosis of intestinal helminthiases by examination of faecal samples (1857). He also demonstrated that the eggs of *A. lumbricoides* remain infective for long periods of time in a damp environment. However, his

major contribution to parasitology was *Traité des entozoaires et des maladies vermineuses de l'homme et des animaux domestiques* (1860); although records of the various species are brief, this text contains excellent illustrated descriptions.

## DEVELOPMENT OF HELMINTHOLOGY

### *Dracunculus Medinensis*

The first description of this helminthic infection has been attributed to Moses in the Book of Numbers (Foster, 1965); the Israelites were at

that time living in the Gulf of Akaba. The Papyrus Ebers (Nunn, 1996) also describes probable dracontiasis; there were also several convincing reports during the Middle Ages. However, the first scientific descriptions were by British Army medical officers serving in India during the early years of the nineteenth century (Foster, 1965), suggesting that the infection was acquired from contaminated drinking water, which was at this time aired but not proved! Williams Scott (Foster, 1965), Surgeon to the First Battalion Madras Artillery, confirmed the observation that the female worm emerges when the affected limb is immersed in water. In England, George Busk (see above) documented the anatomy of the parasite on the *Dreadnought* Hospital-ship at Greenwich, but he was not able to enlarge upon its life-cycle. Cobbold (see above) in his *Entozoa* (1864), summarised what was then known of this helminth. The role of *Cyclops* in transmission to man was suggested by Karl Leuckart (1822–1898) and later confirmed by Aleksei Fedschenko (1844–1873) in Turkestan in 1869. These observations were later corroborated by Manson (see above) in 1894, using larvae from a patient with this infection who was under his care at the Albert Dock Hospital, London. Richard Charles (1858–1934), working at Lahore, was probably the first to visualise the *male* worm. Details of the life-cycle were elucidated by Robert Leiper (1881–1969) and Manson in the early twentieth century, but the actual site of copulation and the fate of the male worm apparently remain a mystery to this day (Foster, 1965).

### The Hookworms

An early description of hookworm disease is to be found in the Papyrus Ebers (Foster, 1965); the ancient Chinese were also familiar with this infection. Lucretius (dates unknown) during the first century BC pointed to skin pallor, which was common in miners. The first modern reports which date back approximately 200 years, refer to the disease in Negro slaves to the West Indies; however, confusion with the anaemia associated with *Plasmodium* sp. infection had arisen. The discovery of *Ancylostoma duodenale* was made in

1838 and was recorded by the Milanese physician Angelo Dubini (1813–1902) in 1843. This helminth was next recorded in Egypt by Franz Pruner-Bey (1808–1882) in *Die Krankheiten des Orients vom Standpunkte der vergleichenden Nosologie betrachtet* (1847). Severe anaemia was first attributed to *A. duodenale* infection by Wilhelm Greisinger (1817–1868) and Bilharz (see below) in 1853. This work was confirmed by Otto Wucherer (1820–1873) in 1866; he had attended a Negro slave in Bahia who died, probably as a result of anaemia, and at post mortem his duodenum contained numerous *A. duodenale*. He then carried out similar investigations on a further 20 patients at the General Infirmary, Bahia. His results were corroborated by several helminthologists, including Cobbold (see above). Battista Grassi (1854–1925) demonstrated, in 1878, that infection could be diagnosed by examination of a faecal sample. In 1880, during construction of the St Gotthard tunnel, this infection was often diagnosed by Edoardo Perroncito (1847–1936), Professor of pathology at Turin; this finding was also made at several other mines throughout Europe, including the Cornish tin-mines, as shown by J. S. Haldane (1860–1936) and A. E. Boycott (1877–1938). As a result of a preventive campaign, the infection in German mines diminished from 13% to 0.17% between 1903 and 1914. Arthur Looss (1861–1923) of Leipzig, around the turn of the century, showed that human infection occurred via intact skin (not orally, as had been previously supposed); he accidentally contaminated his hand with a culture of *A. duodenale* larvae and this was followed by excretion of eggs in his own faeces. Following confirmation of the finding, he published a monograph on the subject. In 1902, Charles Bentley (1873–1949), working in an Assam tea plantation, confirmed these results, describing ‘ground itch’ for the first time.

Knowledge of the life history of *A. duodenale* pointed the way to prevention of the disease and initiated the Rockefeller Foundation’s initiative on prevention of infection by this helminth in Puerto Rico: this project subsequently involved all of the southern states of the USA and had international ramifications. The original anthelmintic was of only limited value; thymol was used by Perroncito (see above) and Camillo Bozzolo (1845–1920) about 1880; this agent was

soon followed by oil of chenopodium (1915), carbon tetrachloride, tetrachlorethylene and hexylresorcinol.

There is only limited work, historically, on *Necator americanus*, the other form of human hookworm infection.

### **Trichinosis**

Friedrick Tiedemann (1781–1861) was probably the first investigator in recent times (1822) to record *Trichinella* (nematode) larvae in human muscle. On 2 February 1835, James Paget (1814–1899) (a 21 year-old medical student) noted small ‘specks’ in the muscles of a post-mortem subject; he reported these observations at a meeting of the Abernethian Society on 6 February. On 24 February, Richard Owen (1804–1892) claimed priority for this discovery at the Zoological Society of London; he first used the name *Trichina* (later changed to *Trichinella*) *spiralis*. Disease (‘acute rheumatism’) caused by this parasitic nematode was first recorded by Henry Wood of Bristol in 1835 (Foster, 1965). The next major advance was by Arthur Farre (1811–1887), who showed in the same year that the parasite had a complex internal arrangement, including a digestive tract; these observations were subsequently expanded by Hubert von Luschka (1820–1875) of Tübingen in 1850, and Ernst Herbst of Göttingen (1803–1893) in 1851. That the infection is caused by ingestion of raw or undercooked pork [‘measly’ pork had been identified by Aristotle (384–322 BC)] was documented by Leuckart (see above), Rudolph Virchow (1821–1902) and Friedrich Zenker (1825–1898); this gave rise to the widespread view that other febrile illnesses might be a result of (micro)parasitic infections. Several outbreaks of disease in the European mainland were traced to contaminated pork, but the disease has fortunately remained rare in Britain (Cook, 2001).

### **Lymphatic Filariasis (Including Elephantiasis)**

A seminal discovery by Manson (later to become the ‘father of modern tropical medicine’), which

delineated the man–mosquito component of the life-cycle of *Wuchereria bancrofti* (the major causative agent of lymphatic filariasis), had a profound impact on the development of clinical parasitology and hence tropical medicine (Cook, 1993a). This observation was superimposed upon an expanding interest at the time in natural history, evolution and bacteriology. Also, the resultant disease, elephantiasis, which affects a minority of those affected, is clinically (and in the eyes of the layman) one of the most spectacular of human (tropical) diseases; *W. bancrofti* has a geographical distribution which involves tropical Africa, middle and southern America, the Indian subcontinent, and much of south-east Asia; however, a related species, *Brugia malayi*, is also important in southern India and south-east Asia. Fortunately, these nematode helminths are common in that part of China (Amoy and Formosa) in which Manson served with the Imperial Maritime Customs in the latter half of the nineteenth century (Cook, 1993a).

Demonstration of minute thread-like ‘worms’ or ‘embryos’ (microfilariae) in chylous fluid was initially due to Jean Demarquay (1814–1875) in 1863 (a Frenchman working in Paris, he demonstrated these ‘embryos’ in hydrocele fluid derived from a patient who originally came from Havana, Cuba). In 1866, Wucherer (see above) (of German ancestry but born in Portugal), working at Bahia, Brazil, and totally unaware of this discovery, recorded these worms in a urine sample (Cook, 1993a). Demarquay and Wucherer’s observations were confirmed by, amongst others, Timothy Lewis (1841–1886) in 1870 (Grove, 1990). In 1872, the same investigator (in a more important communication)—who was incidentally to die of pneumonia at the early age of 44—described ‘embryos’ of *Filaria sanguinis hominis* in the peripheral blood of a patient at the Medical College Hospital in Calcutta. Joseph Bancroft (1836–1894), working in Queensland, then proceeded, in 1876, to demonstrate *adult* forms (*Filaria bancrofti*) of this helminth in lymphatic vessels. This observation was communicated to *The Lancet* by Cobbold, by then undoubtedly the foremost British helminthologist of his day (see above), in 1877; the work was later confirmed independently by Lewis (see above), in India (Foster, 1965; Cook, 1993a).



Between 1876 and 1897, Manson made a series of observations, the most important of which was the demonstration of the man–mosquito component of the life-cycle of this helminth (see above). After ascertaining that his gardener, Hin-Lo, was heavily infected with ‘embryos’ of *Filaria sanguinis hominis*, he undertook an experiment (on 10 August 1877) in which he attracted *Culex* mosquitoes by means of candles into a hut in which the gardener was sleeping; when there were many, he closed the door. The following morning, dissection of the mosquitoes revealed plentiful ‘embryos’ of the parasite; this work was published in China, in 1877 (Cook, 1993a). In 1880, Manson demonstrated the diurnal periodicity of the ‘embryos’, i.e. they appeared in the peripheral blood solely at night. By means of a series of painstaking dissections, he demonstrated (in 1884) the development of the ‘embryos’ in *Culex* spp. The fact that they migrate to the lungs during the course of the day was not established until 1897, again by Manson, when resident in London; a post mortem examination on an infected patient who had died suicidally as a result of prussic acid poisoning, showed numerous ‘embryos’ in pulmonary tissue.

Manson, like most others at this time, felt reasonably certain that man contracted lymphatic filariasis by ingesting water that had been contaminated by infected mosquitoes. In this, Manson was probably led astray by a book he had consulted on natural history, which stated that, once their eggs were laid, mosquitoes rapidly die in water; in fact, they live for several weeks after this event! This belief survived for 20 years after Manson’s original discovery implicating the mosquito as the intermediate host. The demonstration of the mosquito–man component of the life-cycle was due to George Carmichael Low (1872–1952) (Cook, 1993b). Manson had sent Low, who had recently joined the staff of the London School of Tropical Medicine (LSTM) to Vienna and Heidelberg to learn a new technique for sectioning mosquitoes in celloidin; previously used methods had been unsatisfactory. When Low returned to London in 1900, Manson had recently received a batch of mosquitoes preserved in glycerine from Thomas Bancroft (1860–1933) (son of Joseph Bancroft) of Brisbane. On sectioning these Low was able to demonstrate

microfilariae in the entire proboscis sheath (pushing forward between the labium and hypopharynx) of the mosquito (Cook, 1993a). Shortly afterwards, this work was confirmed by Sydney Price James (1872–1946), working at Travancore, India. In 1900, Grassi (see above) demonstrated transmission of embryos of *Filaria immitis* (a dog parasite) by anopheline mosquitoes (Foster, 1965). The complete cycle of this helminthic parasite had also been completely elucidated.

Thus, for the first time, the complete life-cycle of a vector-borne parasitosis affecting *Homo sapiens* had been delineated. This series of observations paved the way for the subsequent demonstration of vector transmission of *Plasmodium* spp. and many other ‘tropical’ infections (not all parasitic in nature).

### The Tapeworms (*Cestodes*)

Although the two forms—adult and cystic (larval)—of these common human cestodes, *Taenia solium* and *T. saginata*, had been recognised for many centuries, it was not until the mid-nineteenth century that they were shown to represent different stages of individual life-cycles. Until then, therefore, these two stages had been considered separately.

That tapeworms were in fact animals was accepted by Hippocrates (c. 470–c. 400 BC), Aristotle and Galen. Edward Tyson (see above) was the first to make a detailed study of adult tapeworms (he demonstrated that the head end was more narrow); his observations were published in the *Philosophical Transactions of the Royal Society* for 1683. That there were two distinct species to affect man was not suspected until the late eighteenth century, by Góze (see above). The difference between their scolices had been recognised by Küchenmeister (see above), in 1853. Rudolphi (see above), showed that *T. solium* was the most common in Berlin, while Bremser (see above) maintained that in Vienna, *T. saginata* predominated. Only in the late eighteenth century was it appreciated that the segmented contents contained large ovaries, as stated by Bloch. R. Leuckart, in about 1860, made further advances concerning the adult

worms; he described the generative apparatus in detail in *Parasites of Man* (1862).

The history of the cystic (bladder or larval) forms must be traced separately prior to the mid-nineteenth century. This 'stage' was apparent to the ancients; Aristotle, for example, compared the cysts in pigs to hailstones; Aristophanes, Hippocrates, Galen and Aretaeus were also familiar with these 'bladder' forms. Any cystic swelling was in fact called a 'hydatid cyst' throughout these years, although their nature was totally unknown. Towards the end of the seventeenth century, the animal nature of the cysts was first recorded; this fact was first published by Redi (see above) in 1684 although this did not become widely accepted until the early eighteenth century. The finding, together with those of at least two other investigators, remained generally unknown and was rediscovered by Tyson (see above) in 1691. The Swiss physician, Johann Wepfer (1620–1695) described, also in the seventeenth century, *Cysticercus fasciolaris* of the mouse and cysticerci in the brain of sheep. Pallas (see above), in 1760, considered that all cystic worms from different animals belonged to a single species, '*T. hydatigena*'.

Göze in his *Versuch einer Naturgeschichte der Eingeweidewürmer tierischer Körper* (1782), discovered the relation of the *Echinococcus* cyst to its tapeworm; however, it was not until Steenstrup's publication (see above) that the truth became readily apparent. The German helminthologist von Siebold (see above) held that the cystic worms were 'undeveloped and larvae-form tapeworms'.

But how did man become infected with tapeworms? Küchenmeister (see above) performed in 1854 an experiment on a murderer who was condemned to death; he fed him numerous cysticerci 3 days prior to execution, and at post mortem 10 young tapeworms (4.8 mm in length) were apparent in the lumen of his small intestine. He performed a similar experiment a few years later, but this time the prisoner was executed after 4 months; by this time 19 well-developed adult tapeworms were present at post mortem in the small intestine. Further work by Küchenmeister involved *T. coenuris*. The development of cysticerci from eggs was first observed by Stein (1818–1885) at Prague (Foster, 1965).

Towards the end of 1853, Pierre van Beneden (1809–1894) showed that after oral administration of *T. solium* proglottids to the pig, *Cysticercus cellulosae* developed.

From a public health viewpoint, J. L. W. Thudicum (1829–1901), appointed by the Privy Council in 1864, carried out extensive inspections for 'measly' meat at London's meat markets. Tapeworm infection was a major problem in British troops in nineteenth-century India, up to one-third of whom harboured *T. saginata*.

Recorded deaths from hydatid disease in England and Wales between 1837 and 1880 were always < 60 annually; sheep were, however, commonly affected. In the mid- and late nineteenth century, hydatid disease was common in Iceland and Australia (especially Victoria).

*Diphyllobothrium latum* was originally described by two Swiss physicians, Thadeus Dunos (Foster, 1965) and Felix Plater (1536–1614) of Basle, Switzerland.

### The Liver Fluke (*Fasciola Hepatica*)

This trematode has been known to infect sheep from medieval times; it was in fact mentioned in a fourteenth century French text (Foster, 1965). The first illustration was by Redi (see above) in 1668. Van Leeuwenhoek (see below) was of the opinion that sheep swallowed the flukes in water, and that they then migrated into the biliary tract. Carl Linnaeus (1707–1778) named the parasite *Fasciola hepatica* but regarded it as a fresh-water leech that had been swallowed accidentally; not until 1808 did Rudolphi (see above) separate the flukes from the leeches, thus creating the class of trematodes (flat worms with ventral suckers), classification of which was based on the number of suckers—monostomes, distomes, etc. In the late eighteenth century, cercariae were clearly recognised, and in 1831, Karl Mehlis (Foster, 1965) visualised the hatching of a trematode with liberation of the ciliated miracidium; shortly afterwards (in 1837) Friedrich Creplin (Foster, 1965) visualised the ciliated miracidium of *F. hepatica*. Following Steenstrup's text of 1842 (see above) it seemed probable that a mollusc formed the intermediate host of this fluke; this was shown to be *Limnea truncatula* by David

Weinland (Foster, 1965) in 1874; although correct, this view was not immediately accepted. A. P. Thomas (Foster, 1965) at Oxford finally confirmed this fact, and published his results in the *Journal of the Royal Agricultural Society* for 1881. Simultaneously, Leuckart (see above), also in 1881, published observations that also showed this to be the case; in fact, his publication appeared 10 days before that of Thomas. Thus, the entire life-cycle of *F. hepatica* outside its definitive host had been worked out. In 1892, Adolpho Lutz (1855–1940), a pupil of Leuckart, demonstrated that herbivorous animals become infected by eating encysted worms and, to complete the story, in 1914 the Russian parasitologist Dimtry Sinitzin (1871–1937) demonstrated the path taken by the larval fluke from gut to liver—invading the peritoneal cavity in so doing (Foster, 1965).

### The Schistosomata

In Egypt, disease caused by *Schistosoma* spp. was known from ancient times (see above, Cook, 1993a; Nunn, 1996). Endemic haematuria is mentioned several times in the medical papyri, and calcified eggs have been identified in Egyptian mummies dating from 1200 BC. The first Europeans known to be affected (suffering from haematuria) were soldiers of Napoleon's stranded army in 1799–1801.

Theodore Bilharz (1825–1862), a German parasitologist, discovered the parasite, *Distomum* spp. responsible for Egyptian haematuria on 1 May 1851; some 30–40% of the local population was infected, more commonly men than women. Meanwhile, Cobbold (see above) had described an identical worm (subsequently named *Schistosoma haematobium*) in an ape dying in the gardens of the Zoological Society, London. John Harley (who lacked tropical experience) gave an account of his findings of a supposed new parasite, *Distomum capensis*, in a patient from South Africa, to the Royal Medical and Chirurgical Society, London, in January 1864.

In 1870, Cobbold obtained a supply of *Schistosoma* spp. eggs from a girl in Natal; he observed the hatching of the eggs (by no means the first person to do so), subsequently shown to

be *S. haematobium* (see below), and noted that they preferred fresh, brackish or salt water, and *not* urine, for this transformation. He was, however, unable to determine the intermediate host.

Prospero Sonsini (1835–1901), an Italian graduate of the University of Pisa working in Egypt during 1884–1885, again attempted to elucidate the life-cycle of *S. haematobium*; although he did *not* find a mollusc to support his observations, he claimed to have achieved success in Tunis in 1892; these results (in which he considered that human infection took place orally) were published in 1893. In 1894, G. S. Brock (Foster, 1965), working in the Transvaal and citing circumstantial evidence, suggested that human infection probably occurred not orally, but via intact skin whilst exposed to infected water. Meanwhile, Looss, working in Egypt, concluded that, in the absence of convincing evidence of an intermediate host, transmission must take place from man to man.

Work on other *Schistosoma* species then came to the fore. In April 1904, Fujiro Katsurada (1867–1946) of the Pathological Institute of Okayama recognised eggs of what came to be known as *S. japonicum* in a faecal sample. He also found similar eggs in the portal system of two cats from the province of Yamanashi. Confirmation came from John Catto (1878–1908), of the London School of Tropical Medicine, in a Chinese man who had died at Singapore.

Manson (see above) first drew attention to the fact that the rectal and vesical forms of the disease (previously thought to be caused by a single species) were in fact distinct; he was convinced by observations on an Englishman who came from the West Indies (and had never visited Africa) who passed *only* eggs with lateral spines (*S. mansoni*) in his faeces. That these were two separate species, *S. haematobium* and *S. mansoni*, was taken up by Louis Sambon (1866–1931) in 1907, only to be challenged by an acrimonious correspondence from Looss (who still considered that *S. haematobium* and *S. mansoni* represented the same species and that infection occurred directly from man to man).

The complete life-cycle of *Schistosoma* spp. was elucidated in mice, using *S. japonicum*, by Akira Fujinami (1870–1934) and Hachitaro

Nakamura (Foster, 1965) in 1910. Shortly afterwards, Keinosuke Miyairi (1865–1946) and Masatsugu Suzuki (Foster, 1965) infected fresh water snails with miracidia, whilst Ogata (Foster, 1965) described the cercarial stage of the parasite. This work was both confirmed and extended by Leiper (see above) and Edward Atkinson (1882–1929); the former also elucidated the life-cycle of *S. haematobium* in Egypt in 1915: *Bulinus* (*S. haematobium*) and *Biomphalaria* (*S. mansoni*) were shown to be the intermediate hosts.

## DEVELOPMENT OF PROTOZOOLOGY

The development of this discipline was totally dependent on the introduction of satisfactory microscopes (Cole, 1926). Although Gesner was probably the first to visualise a protozoan parasite in 1565, it was a century later that Robert Hooke (1635–1703) produced a diagram in his *Micrographia*. The birth of protozoology as a science was, however, due to van Leeuwenhoek (Dobell, 1932) (Figure 1.4) who, in 1674, visualised free-living ciliates in fresh water; he later described cysts of *Eimeria stiedae* in rabbit bile. In 1680, the same worker observed motile ‘animalcules’ in the gut of a horse-fly, and in 1681 in his own stool; these were almost certainly *Giardia lamblia*.

Antony van Leeuwenhoek was born in the small Dutch town of Delft. Lacking scientific training, he became a respected local tradesman (he ran a small haberdashery business) but had sufficient leisure time to devote to scientific pursuits. He made his own lenses and microscopes, through which he originally observed ‘animalcules’ in marshy water. Most of his results were communicated to the Royal Society in London, to which he was duly elected. van Leeuwenhoek wrote a great deal, and his last letter was written in 1723, his 91st year. He was without doubt the ‘father of protozoology’.

More than 100 years were to pass before further parasitic protozoa were recorded, although many free-living forms were described during this time. The term ‘Protozoa’ was probably introduced about 1820; shortly after this C. G. Ehrenberg (1795–1876) and Felix Dujardin (1801–1860) published important texts

on the subject. Various protozoa of insects and fish received a great deal of attention at this time. In 1836, Alfred Donne (1801–1878) discovered *Trichomonas vaginalis* and in 1858 a probable case of coccidiosis, accompanied by a post-mortem report, was published. Around the mid-nineteenth century, a number of human intestinal flagellates were documented, and in 1856 Pehr Malmsten (1811–1883) of Stockholm, described what was probably *Balantidium coli*. The first major pathogenic protozoan of *Homo sapiens* to be described was *Entamoeba histolytica*, which was described by Lösch (see below) in 1873.

### *Entamoeba histolytica*

James Annesley (1780–1847) of the East India Company, was aware of two forms of dysentery. In his classic two-volume work, *Researches into the Causes, Nature and Treatment of the More Prevalent Diseases of India...* (1828) he clearly differentiated between what were to become known as amoebic colitis and shigellosis; he associated the former with hepatic problems (including ‘abscess of the liver’). Lösch recorded his observations in *Virchow’s Archiv* for 1875, but did not recognise that some *E. histolytica* were pathogenic whereas others were not (as later suggested by Emile Brumpt [1877–1951]), and furthermore he considered that this organism was not the cause of dysentery but acted as an ‘irritant’, thus preventing the colonic ulcers (caused by another agent) from healing. Following this observation, Robert Koch (1843–1910), who was carrying out his researches in Egypt into cholera in 1883, noted *E. histolytica* in both the colon and liver abscess; he was meanwhile too interested in cholera to pursue this organism, but his observation acted as a catalyst for Staphanos Kartulis (1852–1920), who was working in Alexandria, and in 1887 demonstrated the organism in necrotic tissue of a liver ‘abscess’; in 1904, he published an account of *E. histolytica* in a cerebral ‘abscess’. The results of Kartulis’s studies were published in *Virchow’s Archiv* and attracted the attention of William Osler (1849–1919), at that time working in Baltimore (Cook, 1995). Heinrich Quincke (1842–1922) and Ernst Roos (1866–?) meanwhile described the cystic form of



ANTONIUS A LEEUWENHOEK.

*Regia Societatis Londinensis*

*membrum.*

*J. Verkolje sculp.*

*A. de Blais fecit.*

**Fig. 1.4** Antony van Leeuwenhoek (1632–1723), the founder of protozoology, who probably visualised *Giardia lamblia* in his own faecal sample. Reproduced by courtesy of the Wellcome Institute Library, London

this protozoan parasite, which they showed was infective to cats when given by mouth. At the commencement of the twentieth century, the role of *E. histolytica* in dysentery was far from clear; however, in 1903 Leonard Rogers (1868–1962) published a paper from Calcutta, in which he described how the organism(s) spread from gut to liver via the portal veins. As late as 1909, however, Manson was not totally convinced that *E. histolytica* was the cause of ‘tropical dysentery’.

Ernest Walker (1870–1952) working in Manila, The Philippines, between 1910 and 1913 again suggested that there were two forms of *E. histolytica*, one pathogenic and the other not. During the First World War (1914–1918), C. M. Wenyon (1878–1948), working in Alexandria, emphasised the importance of the ‘carrier state’. Clifford Dobell (1886–1949) published his classic monograph, *The Amoebae Living in Man*, in 1919.

### ***Babesia* spp.**

Elucidation of the life-cycle of *Babesia* spp. the cause of Texas Fever (in cattle) is of interest (Foster, 1965), although this organism is not of great practical importance. Theobald Smith (1859–1934) a pupil of Daniel Salmon (1850–1914) (of *Salmonella* fame) together with Frederick Kilborne (1858–1936), published *Investigations into the Nature, Causation and Prevention of Texas or Southern Cattle Fever* (1893). The disease seemed to be caused by an intra-erythrocytic protozoan parasite, a finding that did not fit into any of the then known classifications. Furthermore, transmission seemed to be associated with a tick (*Ixodes bovis*); details of the development of the parasite (in the tick) were not finally worked out until some 40 years after Smith’s work. In 1888, V. Babes (who in fact gave his name to babesiosis) had previously visualised an intra-erythrocytic protozoan in affected cattle in Romania.

### ***Plasmodium* spp. and ‘the Great Malaria Problem’ (Cook, 1997b)**

In the latter years of the nineteenth century, the cause of malaria (and its treatment) had not

progressed since the introduction of cinchona bark, a specific for the ‘intermittent fevers’. The fact that malaria is transmitted by the bite of mosquitoes had been suspected for many centuries (Cook and Webb, 2000). Mosquito nets were in fact used in ancient Rome to prevent ‘the fever’. Furthermore, there are suggestions in writings over several centuries that the mosquito was indeed involved; for example, in 1717 Giovanni Lancisi (1654–1720), physician to the Pope and a professor at the Sapienza in Rome, suggested this form of transmission, whilst at the same time accepting the miasmatic theory for transmission of disease. In 1716, Lancisi had demonstrated ‘grey-black pigment’ in malaria tissue. In 1882, Dr Albert Freeman Africanus King (1841–1914) read a paper to the Philosophical Society of Washington, suggesting (on epidemiological grounds) that *Plasmodium* was transmitted by the bite of the mosquito. It was not until 1880 that Alphonse Laveran (1845–1922), recipient of the Nobel prize for ‘medicine or physiology’ in 1907 working in Algeria, demonstrated *Plasmodium* in the human erythrocyte (Bruce-Chwatt, 1988; Cook, 1993a); on 6 November of that year he visualised several long flagella being extruded from a hyaline body in a 24 year-old artilleryman. In 1885, Camillo Golgi (1843–1926) was able to show that in malaria, ‘fevers’ correlated with the liberation of merozoites into peripheral blood; he showed furthermore, that tertian and quartan fevers were caused by different parasites. Ettore Marchiafava (1847–1935) and Amico Bignami (1862–1929) were the first to distinguish *P. falciparum* from the ‘benign’ malarias. In 1893, Bignami and Giuseppe Bastianelli (1862–1959) showed, by inoculating volunteers with blood known to contain *Plasmodium* spp., that ‘fever’ was always caused by the ‘young’ parasite, and never the ‘crescent’ (the sexual form, or gametocyte). By 1890 it was widely accepted that Laveran’s parasites were the cause of malaria (Cook, 1995).

In three classical Goulstonian Lectures delivered to the Royal College of Physicians of London in 1896, Manson (in the light of his filaria researches; see above) spelled out his mosquito–malaria hypothesis (which he had first formulated in 1894) in great depth (Cook, 1993a). This, without doubt, formed the stimulus



**Fig. 1.5** Ronald Ross (1857–1932) who established the role of the mosquito in transmission of *Plasmodium* spp. and elucidated the complete life-cycle of avian malaria (*Proteosoma* spp.) in Secunderabad and Calcutta, India, respectively

for the subsequent researches of Ronald Ross (1857–1932) (Bynum and Overy, 1998).

Ross (Figure 1.5) had been born in India. His father, of Scottish descent, was a general in the Indian Army. Ross first became interested in malaria in 1889. After discussions with Manson, who subsequently became his mentor (Bynum and Overy, 1998), he worked on human malaria in India; however, he failed to produce infection

in volunteers by the bites of *Culex* or *Aedes* mosquitoes, but demonstrated malaria pigment in a mosquito at Secunderbad on 20 August 1897 ('mosquito day'). He was then posted to a region where he was not able to study human disease, and therefore turned his attention to avian malaria (*Proteosoma* spp., which is transmitted by the bite of *Culex*). By a series of careful experiments begun in 1897, he demonstrated the

bird–mosquito–bird cycle of this protozoan parasite in 1898; the culmination of this work came on 4 July of that year (Bynum and Overy, 1998). These observations were communicated by Manson to the British Medical Association's meeting, held in Edinburgh on 28 July 1898. Also in 1898 (November–December), Amico Bignami, Giuseppe Bastianelli and Battista Grassi (see above) were able to demonstrate the man–mosquito–man cycle in a series of experiments carried out in Italy; this work was confirmed by Ross in Sierra Leone in 1899. However, because malaria was endemic in both Italy and Sierra Leone, neither study could possibly be definitive, because a *new* infection might easily have been introduced. In 1900, Manson initiated two experiments in order to clinch the man–mosquito–man component of the cycle. A team consisting of Low (see above), Louis Sambon (1865–1931), Signor Terzi (an artist) and a servant slept in a mosquito-proof hut in the Roman Campagna, approximately 8 km from Rome, for a period of 3 months (19 July–19 October 1900); they lived normal outside lives during the course of the day, but did *not* become infected with malaria. In the second experiment, it was arranged (with the collaboration of Bastianelli) to send mosquitoes infected with *P. vivax* from Rome to London in a mosquito box (as late as the 1920s and 1930s *P. vivax* infection was common in the Roman Campagna). On arrival in London, the surviving specimens were allowed to feed on P. T. Manson (1878–1902) (Manson's elder son) and a laboratory technician (George Warren). In both cases, clinical malaria developed; the former subsequently experienced two relapses following quinine chemotherapy. The two experiments were published, like so many early major discoveries in clinical parasitology, in the *British Medical Journal*—for 1900.

Despite his successes, Ross was an extremely difficult individual with whom to work; evidence has been summarised by Eli Chernin (Cook, 1993a). For example, Manson was requested to write a testimonial for a Dr Prout who had applied for Ross's post in Liverpool, which had become vacant in 1912 after his removal to London. He made two comments to which Ross took great exception: 'I sincerely hope that his appointment may be successful, for it would, if I

may use the expression, make good a defect in your system of teaching . . .' and, furthermore, 'A teacher of Tropical Medicine, to be considered efficient, should be not only a scientific man, but one having had extensive experience in tropical practice'. Manson was, either consciously or subconsciously, highlighting the fact that Ross was not a great clinician, even though his scientific work was satisfactory. As a result, Ross sought legal advice, the matter being narrowly resolved without a court case. It seems exceedingly ungrateful of Ross to have pursued this libel action against his mentor who was, in effect, largely responsible for an FRS and Nobel Prize (Cook, 1993a); however, this merely reflects the eccentric nature of Ross, who has variously been described as '. . . capable of magnifying a petty affair out of all proportions', 'chronically maladjusted', or 'a tortured man' (Cook, 1993a).

It was not until the early 1940s that Neil Hamilton Fairley (1891–1966) clearly demonstrated the non-haematogenous phase in the life cycle of *Plasmodium* spp. (Cook, 1993a). He observed that a parasitaemia was present in peripheral blood immediately after infection, but that this disappeared during the incubation period of the disease. In 1948, Henry Shortt (1887–1987) and Percy Garnham (1901–1993) were able to demonstrate the 'hypnozoite' phase of *P. vivax* within the hepatocyte, thus putting a seal on the life-cycles of all human (and monkey) *Plasmodium* spp. infections recognised at that time.

The first attempt(s) at malaria prophylaxis by prevention of anopheles mosquito bites was made by Angelo Celli (1857–1914) in 1899.

Therefore, by the end of 1900, the life-cycles of two vector-borne parasitoses, one helminthic and the other protozoan—lymphatic filariasis and *Plasmodium* spp. infection—had been clearly delineated (see above, Cook, 1993a). In the same year, mosquito transmission of the viral infection yellow fever (see above), was also clearly demonstrated, this time by American workers. The major figures in this breakthrough were Carlos Finlay (1833–1915) and Walter Reed (1851–1902) (Cook, 1993a). However, it seems most unlikely that this discovery could have taken place in the absence of the foregoing British work.



## Trypanosomiasis: Slow Elucidation of the Cause

### *African Trypanosomiasis*

David Livingstone (1813–1873) had been convinced in the mid-nineteenth century that the tsetse fly was responsible for transmission of ‘nagana’, a disease which affected cattle in Central Africa. This is clearly recorded in his classic *Missionary Travels*, first published in 1857; there is, in this work, an accurate drawing of the tsetse fly. It seems probable that he had in fact associated the bite of *Glossina palpalis* with ‘nagana’ as early as 1847. It was not until 1894,

however, that the causative role of *Trypanosoma* (later designated *T. brucei*) was delineated in nagana and this resulted from David Bruce’s (Figure 1.6) brilliant work in Zululand, where he had been posted from military duty in Natal (Cook, 1994). Shortly before this, animal trypanosomes had been visualised, and in 1878 Timothy Lewis (see above) had first indicated that trypanosomes could cause infection in mammals.

A febrile illness associated with cervical lymphadenopathy and lethargy had been clearly recorded in Sierra Leone by T. M. Winterbottom (1765–1859) in 1803. In 1902, Joseph Dutton



**Fig. 1.6** David Bruce (1855–1931), who established the causes of *nagana* (in Zululand) and the ‘negro lethargy’ (in Uganda)

(1874–1905) (Braybrooke and Cook, 1997) and John Todd (1876–1949) demonstrated that *Trypanosoma* spp. were responsible for this condition, then named ‘trypanosome fever’ in West Africa; their observations were made on an Englishman who had been infected in the Gambia. Studies were carried out in both the Gambia and Liverpool. This work was published in 1902 with a full clinical description, accompanied by temperature charts.

Early in the twentieth century an outbreak that was described at the time as ‘negro lethargy’ swept Central Africa; this involved the northern shores of Lake Victoria Nyanza (Cook, 1993b). No-one, it seems equated the disease with ‘trypanosome fever’. In 1902, the Royal Society sent a Sleeping Sickness Expedition, consisting of Low (see above), Aldo Castellani (1877–1971) and Cuthbert Christy (1864–1932) in an attempt to determine the aetiological agent responsible for this disease. Manson was of the opinion that *Filaria perstans* was responsible; he had visualised this parasite in three cases of sleeping sickness investigated in London, at the London and Charing Cross Hospitals. After a great deal of painstaking work, Castellani concluded that the disease was caused by a streptococcus. He reported his finding to the Royal Society’s Malaria Committee, chaired by Joseph Lister (1827–1912), but they were far from enthusiastic. In the meantime, Castellani had visualised *Trypanosoma* spp. in the cerebrospinal fluid of a single case of ‘negro lethargy’; however, he disregarded this organism, and favoured the streptococcal theory. The Royal Society proceeded to send a second team to Uganda in 1903, consisting of Bruce (Figure 1.6) (Cook, 1994) and David Nabarro (1874–1958). They demonstrated *Trypanosoma* spp. in numerous cases of sleeping sickness (in both cerebrospinal fluid and blood) and furthermore, were able to transmit *T. gambiense* to monkeys via the bite of infected *Glossina palpalis* (the local species of tsetse fly); this work clinched the aetiological agent responsible for this disease.

Castellani remained convinced, however, that he should be given credit for discovering the cause of sleeping sickness, now correctly attributed to Bruce and Nabarro. Acrimonious correspondence emerged, some being recorded in *The Times* for 1908 (Cook, 1993b). In retro-

spect, it seems likely that Castellani was unduly influenced by a report from some Portuguese workers which concluded that a diplo-streptococcus was responsible for the disease; Castellani, a trained bacteriologist, was clearly far more impressed with this organism than with *Trypanosoma* spp.!

Several years were to pass before the animal reservoirs of African trypanosomiasis were delineated. Was the causative organism of nagana identical with that which caused African trypanosomiasis? It was not until 1910 that J. W. W. Stephens (1865–1946) and H. B. Fantham (1875–1937) discovered *T. rhodesiense* in Nyasaland (now Malawi) and Northern Rhodesia (now Zambia). In 1911, Allan Kinghorn (?–1955) and Warrington Yorke (1883–1943) demonstrated the transmission of *T. rhodesiense* to man by *Glossina morsitans*.

### **South American Trypanosomiasis**

Human South American trypanosomiasis was first recorded in 1910. Carlos Chagas (1879–1934), working in a remote part of Brazil, became aware that a high proportion of houses were infected with the reduviid bug (the ‘kissing bug’), which bit at night. The bug harboured an organism (which developed in the gut and migrated to the proboscis for subsequent inoculation) which was infective to monkeys and guinea-pigs. Chagas showed, furthermore, that an acute febrile illness in children (characterised by oedema, especially of the eyelids, anaemia and lymphadenopathy) was caused by this organism. In 1917 Torres described the cardiac lesions of Chagas’ disease. Recognition of the ‘mega’ syndromes followed. That faecal material from the bug caused infection had been suggested by Chagas, but demonstrated conclusively by Dias (Foster, 1965) in the early 1930s.

### **Visceral Leishmaniasis (Kala Azar): a Disease with a Potential Influence on the ‘Jewel in the Crown’—India**

The protozoan parasite responsible for kala azar (or ‘dum-dum’ fever) has a patchy distribution

throughout tropical and sub-tropical countries (Cook, 1993a). The causative agent was initially demonstrated by William Leishman (1865–1926) at the Royal Victoria Hospital, Netley (off Southampton Water) in 1900. He did not publish this work until May 1903. In April of that year, Charles Donovan (1863–1951), working at Madras, India, confirmed the observation. The parasite was subsequently named the Leishman–Donovan body (now designated the amastigote of *Leishmania donovani*).

A related agent, *L. tropica*, the causative agent of cutaneous leishmaniasis (Delhi boil), was first demonstrated by J. H. Wright (1870–1928), also in 1903; this organism had incidentally been described 5 years earlier by a Russian worker, P. F. Borovsky (1863–1932). Rogers (see above), a great physician who, amongst many contributions to clinical parasitology and tropical medicine, founded the Calcutta School of Tropical Medicine in 1920, first cultivated ‘Leishman–Donovan bodies’ in Calcutta in 1904. It was not until 1911, however, that Wenyon (see above) was able to demonstrate transmission of (cutaneous) leishmaniasis by *Phlebotomus* spp. (the sandfly).

## THE DISCIPLINE ESTABLISHED

Only in the 1860s i.e. some 20 years before the germ (bacterial) theory of disease, was parasitology as a discipline well established (Foster, 1965); it was then widely appreciated that parasites (both helminths and protozoa) cause major diseases in man and his domestic animals (e.g. hydatid disease and trichinosis). The discipline had developed mainly on the European mainland; prior to the mid-nineteenth century it was a component of zoology. Many of the major advances in this discipline over the next half-century were to come from tropical countries, many being carried out, often under primitive conditions, outside a university environment (e.g. the work of Laveran, Bruce, Ross and Manson, see above). The earliest journal entirely devoted to parasitology was *Archives de Parasitologie* (1898).

In the latter half of the nineteenth century, a great surge in British parasitology got under way

(see above). In 1905, separate departments of protozoology and helminthology were started at the London School of Tropical Medicine, with Wenyon (see above) (a mere 27 years of age) as director of the protozoology department; in 1926 he was to publish the most comprehensive text on protozoology in any language. In 1906, the first (London) university chair of protozoology was established, and E. A. Minchin was elected (he had spent 9 years as assistant to Professor Ray Lancaster at Oxford; Ross applied but was not appointed!)

The founding father of American parasitology was Joseph Leidy (University of California); in 1846, he demonstrated *Trichinella spiralis* in pork, and in 1851 his monograph *The Flora and Fauna within Living Animals* was published; he is perhaps best known however, as a palaeontologist! In 1910 the Helminthology Society of Washington was formed; this became the nucleus for the American Society of Parasitologists, which was founded in 1925, with H. B. Ward as its first president. Influenced by Nuttall’s *Parasitology*, Ward had founded the *Journal of Parasitology* in 1914.

In 1903, the Imperial Health Office in Berlin founded a division of protozoology, with E. Schaudinn in charge.

## CHEMOTHERAPEUTIC AGENTS

### 1901 and 2001 Compared

It might be considered by some that *clinical* parasitology, and hence tropical medicine, have both made slow progress over the last century (Cook, 1993a). However, progress in diagnosis has been steady and dominated by advances in serological techniques. It is worth recalling, too, that in 1901 there were only three recognised chemotherapeutic agents for use in tropical medicine—quinine (in malaria), ipecacuanha (in amoebiasis) and mercury (in the bacterial infections syphilis and yaws). Cinchona had been popularised by Thomas Sydenham (1624–1689) in the seventeenth century after his return from Jamaica. In 2001, a broad armamentarium of chemotherapeutic agents is available. For protozoan infections, for example, the following are in use: synthetic anti-malarials, 5-nitroimidazoles and eflornithine; together with the established

agents, sodium stibogluconate and suramin—they have revolutionised chemotherapy. In helminthic infections, significant advances have also been made: the benzimidazoles, ivermectin and praziquantel have become available, in addition to the older agent, diethylcarbamazine. However, there is still a long way to go. The future is likely to be dominated by vaccines but, as with Jenner's example of smallpox vaccination for a viral infection, many obstacles strew the path ahead. After all, a safe and effective vaccine is not yet available for any human parasitic infection.

## REFERENCES

- Anonymous (1886). T. Spencer Cobbold. *Lancet* vol. i: 616–17.
- Braybrooke J, Cook GC (1997). Joseph Everett Dutton (1874–1905): pioneer in elucidating the aetiology of west African trypanosomiasis. *J Med Biog* 5: 131–6.
- Bruce-Chwatt LJ (1988). History of malaria from prehistory to eradication. In Wernsdorfer WH, McGregor I (eds). *Malaria: Principles and Practice of Malariology*. Churchill Livingstone: London; vol 1: 1–59.
- Bynum WF, Overy C (eds) (1998). *The Beast in the Mosquito: The Correspondence of Ronald Ross and Patrick Manson*. Rodopi: Amsterdam; 528.
- Cook GC (1993a). Some early British contributions to tropical disease. *J Infect* 27: 325–33.
- (1993b). Correspondence from Dr George Carmichael Low to Dr Patrick Manson during the first Ugandan sleeping sickness expedition. *J Med Biog* 1: 215–29.
- (1994). Sir David Bruce's elucidation of the aetiology of *nagana*—exactly one hundred years ago. *Trans R Soc Trop Med Hyg* 88: 257–8.
- (1995). William Osler's fascination with diseases of warm climates. *J Med Biog* 3: 20–9.
- (1997a). George Busk FRS (1807–1886), nineteenth-century polymath: surgeon, parasitologist, zoologist and palaeontologist. *J Med Biog* 5: 88–101.
- (1997b). Ronald Ross (1857–1932): 100 years since the demonstration of mosquito transmission of *Plasmodium* spp.—on 20 August 1897. *Trans R Soc Trop Med Hyg* 91: 487–8.
- (2001). Outbreak of trichinosis (trichiniasis) contracted in London in 1879. *Postgrad Med J* 77: 62–3.
- , Webb AJ (2000). Perceptions of malaria transmission before Ross's discovery in 1897. *Postgrad Med J* 76: 738–40.
- Cole F (1926). *The History of Protozoology*. University of London Press: London; 64.
- Dobell C (1932). *Antony van Leeuwenhoek and His 'Little Animals'*. Staples: London; 435.
- Foster WD (1965). *A History of Parasitology*. E & S Livingstone: Edinburgh, London; 202.
- Grove DI (1990). *A History of Human Helminthology*. CAB International: Wallingford; 848.
- Nunn JF (1996). *Ancient Egyptian Medicine*. British Museum Press: London; 240.

# Parasite Epidemiology

**D. A. P. Bundy and E. Michael\***

*The World Bank, Washington, DC, USA, and \*Department of Infectious Disease Epidemiology, Imperial College School of Medicine, London, UK*

---

## INTRODUCTION

The epidemiology of parasitic infections has emerged over the last two decades as a distinct discipline within medical epidemiology. For many years the direction of parasite epidemiology, as epidemiology in general, was driven by medical statistics, with a focus on association and causation of disease. This approach has served the subject well and led to many important advances in understanding of, for example, the role of mosquito vectors in malaria transmission and snails in schistosomiasis. While this classical approach to epidemiology was dominating research in the area, there was also a parallel stream of investigation that sought to unravel the dynamic processes that created the observed statistical patterns. This second strand of work relied on mathematical language as a way of describing quantitatively the many processes that determined the distributions of infection in communities. Landmark contributions were made by MacDonald and Ross, who started from field observation and moved to the desk to seek interpretation, and by Maurice Bartlett and Norman Bailey, who started from the desk.

These strands of research developed in parallel until the 1970s, when the dynamic approach to understanding parasitic disease transmission was substantially reinforced by the emergence of unifying theories of the ecology of infectious

disease in host populations, largely through the work of Roy Anderson and Robert May (see Anderson and May, 1991, for a resume of the history and literature of the subject). This has led to a remarkable improvement in our understanding of these complex issues, an understanding that derives from the use of mathematical models that are soundly based on epidemiological data, and from the development of a body of ecological theory that captures the dynamic interaction between populations of hosts and pathogens (Anderson and May, 1979; Anderson, 1994).

In this chapter we will touch briefly on the role of classical epidemiology to show how statistical methods have been fundamental to the development of the subject. Readers seeking more information in this area should refer to the many excellent texts available in medical statistics. The main focus of the chapter, however, will be on parasite epidemiology from a population dynamic perspective. We will explore how a dynamic approach can help understanding of the determinants of observed patterns of infection and disease, and examine the practical implications for estimating disease burden and the cost-effectiveness of control. Finally, we will describe how some new technological approaches—remote sensing combined with geographical information systems—has helped add a spatial dimension to our understanding of infection dynamics. Throughout, our aim is to provide

an introduction to the subject which we hope will lead the reader to a more thorough investigation by following up on the original literature.

## POPULATION DYNAMICS AND CONTROL

The complex dynamics of infectious disease can result in counter-intuitive outcomes to attempts at control: inappropriate timing and coverage of a vaccination or community treatment program may make an existing public health problem worse. This unwanted outcome is a result of the complex and inherently non-linear interactions between populations of hosts and the pathogens which infect them (Anderson and May, 1979; Anderson, 1994; Bundy *et al.*, 1995). Such non-linearities lead to intervention outcomes which appear counter-intuitive and are difficult to predict, e.g. partial vaccination coverage may have little effect on infection incidence overall but may make infection more prevalent in different (older) age classes, with potentially disastrous public health consequences if the infection is rubella (Anderson and Grenfell, 1986).

The theory has been explored in detail elsewhere (for an accessible treatment, see May and Anderson, 1990); here we touch briefly on theory before examining how an understanding of population dynamics can influence the design of intervention strategies.

### The Ecology of Infectious Disease

The important point here is that infectious disease population dynamics can be described in the same way as the dynamics of other organisms.  $R_0$ , the basic reproductive number (formerly 'rate'), is a central concept in epidemiology that has come directly from population ecology and which, in its ecological form, is central to the theory of evolution (Anderson and May, 1979, 1992; Ross, 1915).  $R_0$  for infectious diseases may be defined as the average number of secondary cases produced by one primary case in a wholly susceptible population. This definition of the population biology of 'microparasites' is appropriate for many protozoan infections and

**Table 2.1** Estimated basic reproductive number  $R_0$  of some common infections, and the predicted critical proportion of the population to be immunised to achieve herd immunity and, potentially, eradication

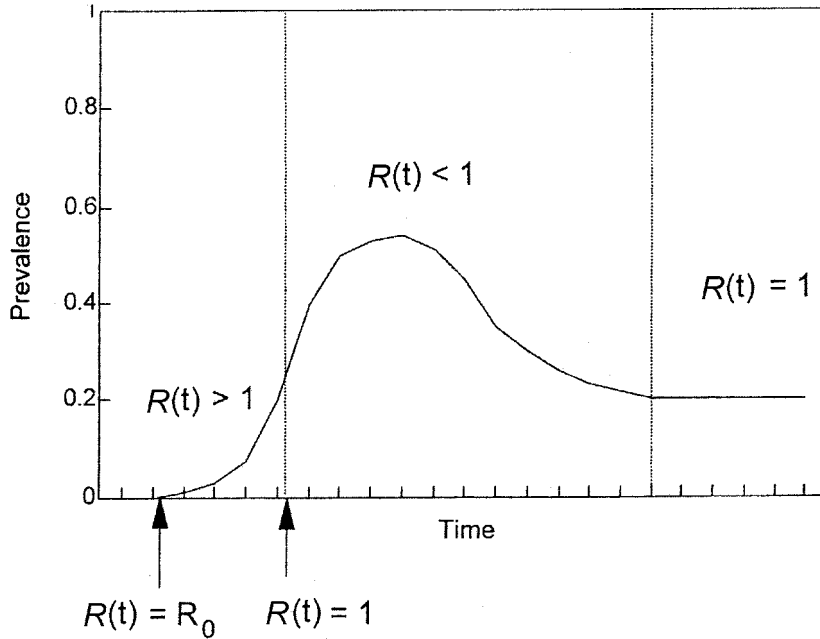
Infection	$R_0$	Critical proportion (%)
Measles	11–17	90–95
Pertussis	16–18	90–96
Mumps	11–14	85–90
Rubella	6–9	82–87
Poliomyelitis	5–6	82–85
Diphtheria	4–5	80–82
Rabies	4	80–82
Smallpox	3–4	70–80

From Anderson and May (1991), with permission.

most bacterial and viral infections. It implies that no infection can maintain itself unless  $R_0$  is greater than unity.

In practice, we observe that the values of  $R_0$  for some common infections are in the range 3–18 (Table 2.1). This implies that a primary case of measles, say, can infect 11–17 other people during the course of the primary infection, and that the 11–17 secondary cases can each do the same. It is this potentially exponential increase in cases that defines the rising phase of the epidemic curve (Figure 2.1). At some point, however, the availability of susceptible people will diminish, and the achievable number of secondary infections will decline accordingly: i.e. the effective reproductive number,  $R$ , will diminish in the presence of constraints on the growth of the population of the infectious agent. This defines the falling phase of the epidemic curve (Figure 2.1).

The availability of susceptible people and the value of  $R_0$  are the crucial determinants of the dynamics of epidemics.  $R_0$  is some function of the biology of the pathogen; a measure of transmissibility and infectiousness. The availability of susceptibles (and the effective reproductive rate), however, is predominantly a function of the host population. Since birth is the primary source of new susceptibles in a stable population, this implies that infectious disease dynamics are determined by some combination of host population size and birth rate, both of which are largely independent of the pathogen itself (except in the case of a prevalent lethal infection, such as HIV).



**Fig 2.1** The course of an epidemic. Infection spreads when the reproductive rate is over unity in value. As the proportion of the population infected or immune grows, the number of contacts with infection that generate new cases falls, thus the effective reproductive rate is reduced. The prevalence of infection will rise for a short time once the effective reproductive rate has fallen below 1 because of the momentum of the epidemic. When a large number of cases are present, then new cases may be generated faster than others recover, even though each case is not on average replacing itself. This carries the effective reproductive rate below unity in value at the peak prevalence, where, as the reduced reproductive rate takes effect, the prevalence of infection starts to fall. It falls until a steady endemic prevalence is reached, when the value of the effective reproductive rate is equal to unity. The endemic proportion of the population not susceptible to infection keeps the effective reproductive rate at unity (modified from Garnett and Ferguson, 1996)

Empirical evidence provides support for the importance of host demography. Studies of island and city communities have shown that a population of some 500 000 or more is required for endemic maintenance of measles (Macdonald, 1957; Bartlett, 1957). Once this population threshold is exceeded, then birth rate is an important determinant of the rate of arrival of new susceptibles, and thus the period between the end of one epidemic and the time at which sufficient susceptibles have accumulated for a new epidemic to begin. For measles, this inter-epidemic period is approximately 2 years in countries of the 'north' (e.g. the USA), with annual population growth rates < 1%, but only 1 year in countries of the 'south', with rates of around 3% (e.g. Kenya) (Anderson and May, 1979; Black *et al.*, 1966; Nokes *et al.*, 1991).

Thus, the dynamic properties of an infection depend not only on the characteristics of the pathogen but also on those of the host populations. This is not the whole explanation, of course, but it does seem to provide a remarkably complete understanding of the dynamic behaviour of some infectious diseases. Interestingly, the rather ragged 2 year cycles for measles in cities have been analysed using current assumptions about 'chaos'. It has been suggested that the apparently random behaviour of these time-series is generated by simple and completely deterministic systems, and that measles epidemics provide one of the best examples of naturally occurring deterministic chaos (Fine *et al.*, 1982). This offers the tantalising prospect of short-term prediction, a prospect which now seems less likely to become a practical reality (Gleick, 1987).

### Estimating the Basic Reproductive Number for Microparasites

For *directly transmitted* (also called 'close contact') microparasitic infections, the basic reproductive number can be defined as:

$$R_0 = \beta Nd$$

where  $\beta$  is the coefficient of transmission,  $N$  is the total population (all assumed susceptible at baseline) and  $d$  is the duration of infectiousness.

The *effective* reproductive number,  $R$  of an infection is unity in a steady, endemic state because each primary case exactly replaces itself. The *basic* reproductive number  $R_0$  is in practice discounted by the proportion,  $x$ , of the population remaining susceptible (as against contacts which have experienced infection and are now immune), where:

$$R \cong R_0 x \cong 1$$

For a stable population, this implies that if people live an average of  $L$  years, become infected at age  $A$ , and are protected by maternal antibodies up to age  $D$ , then the fraction susceptible is given approximately by  $(A - D)/L$ . However, in developing societies, with a growing population, the relevant estimate of  $L$  is the reciprocal of the per capita birth rate,  $B$ , rather than the inverse of the death rate. Hence  $R_0$  can be crudely estimated from  $B/(A - D)$ . For further discussion of this and other issues, see Anderson and May (1992).

For *sexually transmitted* infections this relationship can be modified to give:

$$R_0 = \beta \left( m + \frac{s^2}{m} \right) d$$

where  $m$  is the mean number of sexual partners and  $s^2$  the variance. The number of susceptibles is no longer included in this equation; instead, there is an estimate of the probability of encountering an infectious partner. Note also that the variance has a much greater effect than the mean on  $R_0$ , which implies that the segment of the population with the highest rates of partner change makes a disproportionate contribution to persistence and spread.

For *vector-borne* microparasites (Bolker and Grenfell, 1995) the number is given by:

$$R_0 = R_h \cdot R_v$$

where:

$$R_h = \alpha \cdot \beta_h \cdot \left( \frac{l}{v} \right) \left( \frac{V}{H} \right)$$

and:

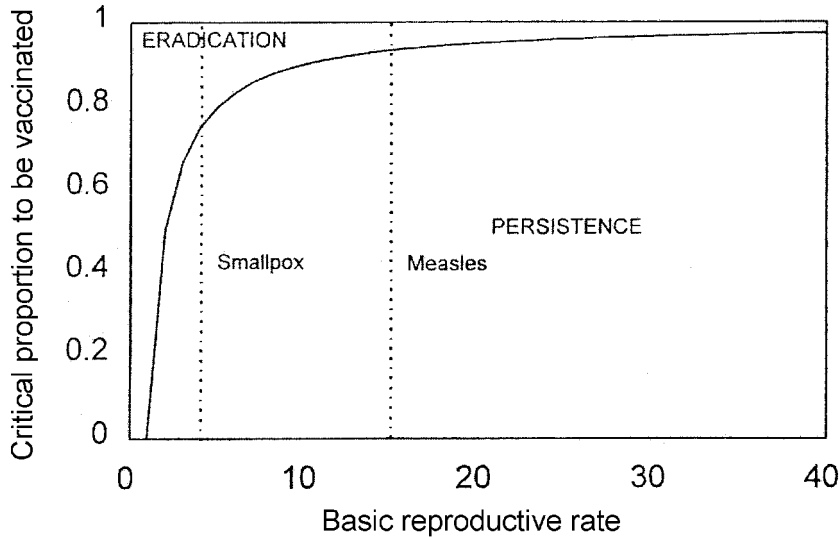
$$R_v = \alpha \cdot \beta_v \cdot P \cdot \left( \frac{1}{\mu} \right)$$

In these equations,  $\alpha$  is the average biting rate per day of the vector species,  $\beta_h$  is the likelihood of transmission to the mosquito when it takes a blood meal from an infectious human and  $\beta_v$  is the likelihood of transmission to the human when it is fed on by an infectious mosquito. The recovery rate of humans from infectiousness,  $v$  is the inverse of the time during which a host is infectious. Likewise,  $\mu_v$ , the mosquito death rate, is the inverse of the mean duration of infectiousness.  $V$  is the number of vectors and  $H$  the number of hosts in the population, so that  $V/H$  is the vector density per host. Finally,  $P$  is the proportion of vectors which when infected become infectious. There is an important asymmetry in the basic model, in that humans can be bitten by a virtually unlimited number of mosquitoes, whereas mosquitoes are limited in the number of blood meals they will take from humans. This asymmetry plays a role in determining the numbers of vectors that are, on average, likely to bite the initial infectious host and so spread the infection. This implies that the density of vectors, relative to the human host, is critical in determining the potential for an epidemic.

### Implications of Infection Dynamic Theory for Public Health Practice

Figure 2.2 shows how the values of  $R_0$  (see Table 2.1) relate to the proportion of the population that must be vaccinated to achieve 'herd immunity' and eradicate an infection (Anderson and May, 1982a). These values are approximate—they also depend on a number of genetic and





**Fig 2.2** The critical proportion of the population that theoretically needs to be vaccinated to eradicate diseases with different reproductive rates. The curve shows the threshold condition between disease eradication and persistence. Typical reproductive rates for measles in developing countries and for fox rabies in Europe are shown by the dashed lines. From Anderson and May (1991), with permission

social factors (see above)—but provide a surprisingly useful guide. They indicate that the higher the value of  $R_0$ , the greater the coverage required to achieve eradication. This helps explain why smallpox, estimated  $R_0$  3–4, was the first disease to be eradicated from the world, and why polio ( $R_0$  5–6) may be the second. It also helps explain why the same coverage with MMR (mumps/measles/rubella) vaccine in the USA has effectively eradicated rubella ( $R_0$  6–9), but not measles ( $R_0$  11–17), as a public health problem.

Vector-borne protozoan parasites, such as those that cause malaria, require that the vector population be taken into account in estimating  $R_0$ , but the dynamics otherwise have behaviours similar to those of directly transmitted micro-parasites. Initial estimates of  $R_0$  for *Plasmodium* suggested that the value was extremely high, of the order of 50–100, with consequent discouraging prospects for control. Such high rates of transmission imply the need for 99% coverage before the age of 3 months with a vaccine that gives life-long protection (Molineaux and Gramiccia, 1980). More recent work, however, which takes into account the antigenic diversity of *Plasmodium*, suggests much lower transmissibility and an  $R_0$  value that is an order of magnitude

less (Gupta *et al.*, 1994). This more encouraging conclusion, for which empirical evidence is being actively sought (Dye and Targett, 1994), suggests that a practical malaria vaccine is a real possibility but argues for a vaccine that is generic rather than strain-specific.

Another perspective on the importance of  $R_0$  is provided by sexually transmitted infections. In this case  $R_0$  is largely dependent on the rate of sexual partner change (see above). The rates of partner change required for HIV to persist and spread are much lower than for most other STDs despite a low transmission probability, largely because of the long duration of infectiousness. It appears that where there is a high probability of transmission (perhaps because of concurrent predisposing STDs) (Laga *et al.*, 1994) or a high rate of partner change, HIV can spread rapidly, while elsewhere the virus may require its full infectious period of some 10 years to spread (Anderson *et al.*, 1991). In the latter case, the epidemic may develop over a period of decades rather than months, which may help explain the marked global variation in the rate of development of the HIV/AIDS pandemic.

STDs also provide a good example of how population-mixing behaviours affect  $R_0$  and the

prospects for control. As with all other types of infections, some (often few) individuals are more likely to acquire and transmit infection, perhaps because of behavioural or genetic characteristics. If these individuals mix randomly in the population, then the effective reproductive number is greater than the simple average. If those with high risk tend to mix with others with high risk (assortative mixing), then the reproductive number is likely to be high within this group and low outside it (Garnett and Anderson, 1993). This may imply that some infections can only persist ( $R < 1$ ) because of the existence of the high risk group, with obvious implications for the targeting of control (Garnett and Anderson, 1995).

### Controlling Disease in Low-income Countries

Population dynamic theory has particular relevance for the design of control programs for developing societies, where populations tend to have high intrinsic rates of increase, low average age and high density. One effect that we have already considered is how the high rate of

population increase may result in short inter-epidemic periods and, therefore, much more frequent epidemics.

Age effects may be even more important, since  $R_0$  is related to the average age at first infection. This is illustrated by Figure 2.3, which shows the age profiles for measles, mumps and rubella seroprevalence in the same Caribbean community. It is apparent that the age at first infection scales in direct proportion to incidence and in inverse proportion to  $R_0$ . This indicates that the opportunity to vaccinate—after the decline of maternal antibody but before the occurrence of natural infection—is shortest for measles and is inversely proportional to  $R_0$ . The greater the value of  $R_0$ , the narrower is the vaccination 'window'. At extreme values of  $R_0$ , which may occur in some developing societies, vaccination at a single age may be insufficient to eradicate infection, even with 100% coverage (McLean and Anderson, 1986).

Population density may also be important in designing an intervention strategy. Populations are typically distributed heterogeneously in space, with some people living in dense urban aggregations (high  $R$ ) and others isolated in villages (low  $R$ ). These rural-urban differences

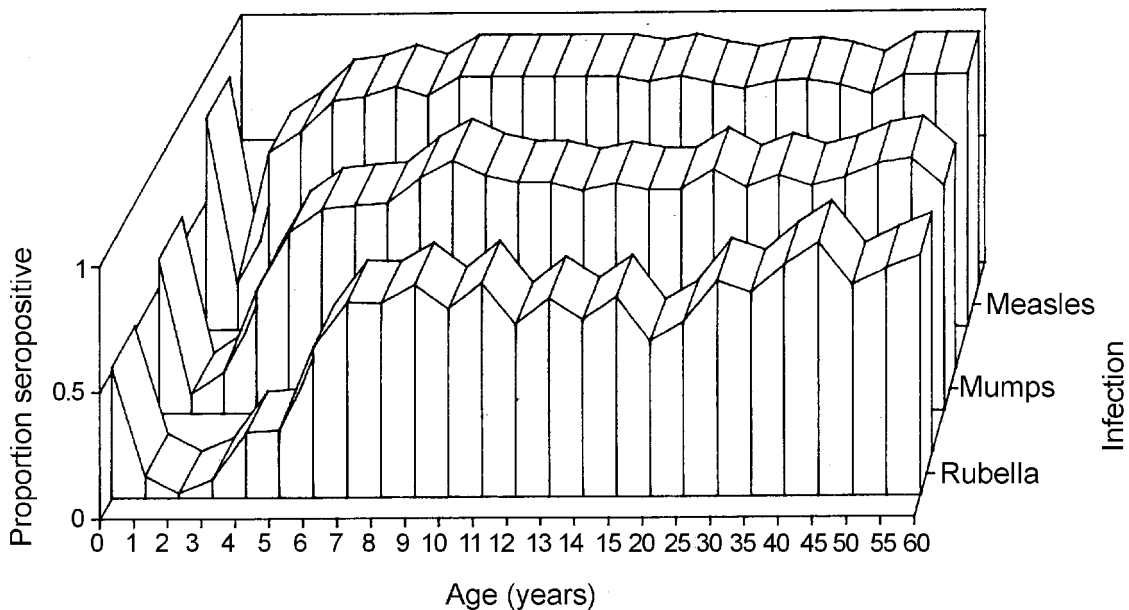


Fig 2.3 Age-specific seroprevalence of mumps, measles and rubella in a St Lucian community (modified from Cox *et al.*, 1989)

tend to be much greater in developing societies, and can result in values of  $R_0$  which are, on average, greater than suggested by estimates based on the assumption of spatial homogeneity. This implies that eradication will be more difficult to achieve in such societies. It may also imply a need to target vaccination coverage in relation to group size, with denser urban populations receiving higher coverage (Anderson and May, 1990).

The high transmission rates found in many developing societies also tend to increase the risks associated with incomplete or partial coverage. Population dynamic theory predicts that, in general, incomplete vaccination coverage will reduce the rate of transmission and increase the age at first infection. In the case of rubella, this age-shift has particularly important consequences, since the primary public health concern is to prevent women contracting rubella once they have reached child-bearing age and so avoid congenital rubella syndrome. The carefully documented experiences of rubella vaccination in the north (Ukkonen and von Bronsdorff, 1988), indicate a remarkable coincidence between theoretical prediction and observation (Anderson, 1994). This could have important implications for developing societies, where  $R_0$  is typically higher, such that first infection with rubella is at 5 years of age rather than the 8–9 years seen in the north. The same robust theory predicts that vaccinating 50% of all 2 year-olds in developing societies could double the incidence of congenital rubella syndrome. This argues strongly against the introduction of MMR vaccination, particularly in developing societies, without first ensuring the protection of women of child-bearing age.

### The Special Case of Helminth Infections

Helminth infections (called ‘macroparasites’ in this context) have fundamentally different population dynamic characteristics from the microparasites, since the dynamics are primarily determined by the number of worms present (the intensity of infection), rather than the number of hosts infected (Anderson and May, 1979; Bundy, 1988). The basic reproductive number for worm

infection is defined in terms of the number of female offspring produced by a female worm in her lifetime, so that the basic unit of transmission is the individual worm, not the individual case infection. Intensity is also believed to be the major determinant of morbidity. Thus, the major aim in controlling helminth infection should be to reduce the overall worm burden in a population, rather than to reduce the number of cases of infection.

Reducing the average intensity of infection may not, however, be enough to achieve significant control. Worm burdens exhibit heterogeneity amongst individuals and so reducing the average burden may still leave some individuals with sufficient burden to cause morbidity and sustain transmission. Furthermore, individuals appear to be predisposed to high (or low) infection intensity (Schad and Anderson, 1985; Bundy *et al.*, 1985; Elkins *et al.*, 1986), such that those with heavy worm burdens tend to reacquire above-average intensity infection, even after successful treatment (Keymer and Pagel, 1990; Hall *et al.*, 1992). Such ‘wormy’ individuals are at greater risk of morbidity and make a disproportionate contribution to the transmission of infection; they would appear, therefore, to be the most important targets for treatment or vaccination. Yet they may be heavily infected precisely because of some failure of immunocompetence, which suggests that a helminth vaccine must be able to convert low responders into high responders if vaccination on a community scale is to be successful (Anderson and May, 1985). Fortunately there is some evidence to suggest that predisposition relates more to exposure than immunological resistance (Chan *et al.*, 1994), but resolution of the causes of predisposition is clearly important to determining the likely success of control measures. Here we will consider how an understanding of population dynamics might help guide the development of putative helminth vaccines, and has helped the evolution of more effective approaches to control by chemotherapy (Chan *et al.*, 1995).

Helminth population dynamics are important in terms of determining the optimal age for delivery of any future helminth vaccine. Immunisation in the pre-school years may be inappropriate for the helminthiases, since for

the schistosomes and some of the major nematode species the peak of intensity, and of potential risk of disease, is attained several years later (Bundy, 1988; Anderson and Medley, 1985). This has potential consequences for the required duration of protection induced by vaccination.

Figure 2.4 shows the results of a preliminary model of the impact of vaccination on helminth dynamics, and compares the effects of vaccine delivery at different ages. The results indicate that if the protection induced has a half-life of some 12 years or less, there is benefit in vaccination at 5 years of age rather than 1 year of age. With increasing duration of protection, however, delivery of a vaccine as part of the EPI package becomes the preferred option. This implies that only a vaccine giving very long-lived protection would qualify for delivery as part of the EPI package. The results also indicate that the benefits of a vaccine giving short-lived protection, with either strategy, are likely to be small (much less than 50% reduction in mean worm burden) and that all strategies tend to shift the peak of intensity and potential morbidity into the older age classes, with unknown consequences.

Similar, although rather more dramatic, consequences are predicted (Crombie and Anderson, 1985; Woolhouse, 1991) if it is assumed that the low parasite infection intensity in adults is a consequence of acquired immunity. In this case, vaccine-induced protection may prevent the natural acquisition of immunity with age, and the acquired immunity model predicts that the eventual loss of protection will result in more rapid acquisition of infection in the older age classes. Furthermore, the peak intensity may exceed that observed in the absence of vaccination unless the protection persists beyond an age (5–15 years) at which infection exposure is negligible.

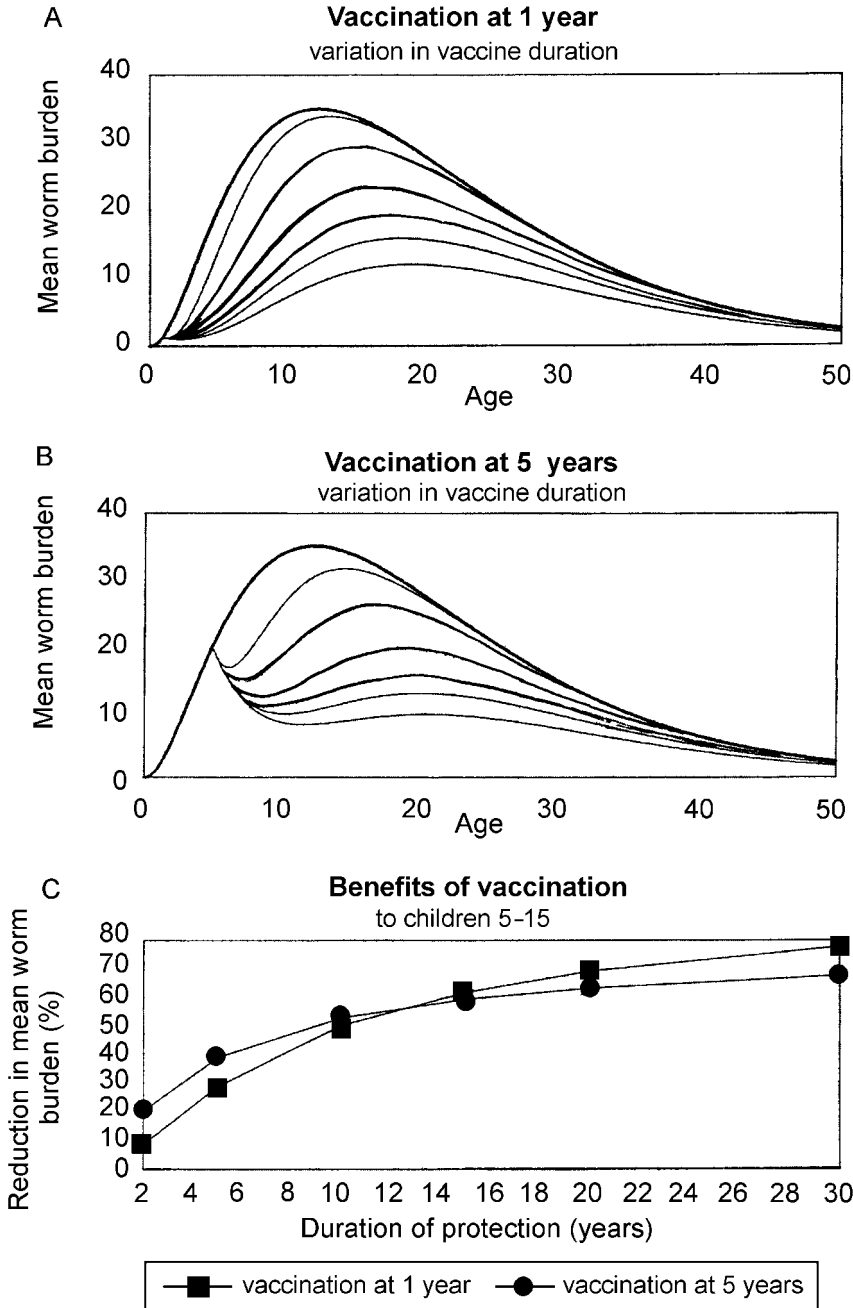
The markedly convex age profiles of infection intensity, with mean worm burdens for schistosomes and more nematodes showing a peak in the 'school-age' population, have consequences for the population dynamics and hence control of helminths (Anderson and May, 1982b). Field studies have shown that these intensely infected age groups may harbour 70–90% of the total worm population (Bundy and Medley, 1992) and theory predicts that these age groups would

therefore make a disproportionate contribution to transmission (and morbidity). Control strategies which specifically target this high-risk group of school-age children have shown that this approach reduces transmission of schistosomes to a rate similar to that achieved when the whole population is treated (Butterworth, 1991) and reduces transmission of nematodes to the untreated adult population (Bundy *et al.*, 1990). Furthermore, models of helminth dynamics accurately predict the outcome of chemotherapy control measures (Chan and Bundy, 1997). Thus, theoretical prediction is again supported by observation, and has led to the practical implementation of school-age targeted control programs (Savioli *et al.*, 1992; Partnership for Child Development, 1997).

## ESTIMATING THE BURDEN OF PARASITIC DISEASE

Parasitic infections are amongst the most ubiquitous of infections of humans. The first estimates of the global extent of infection suggested that more than a quarter of the world's population was infected with one or more important pathogen at any one time (Stoll, 1947) and the latest estimates suggest the same conclusion (Chan *et al.*, 1994a; Michael *et al.*, 1996; Bundy, 1998; WHO, 1997). In Table 2.2 we show the most current estimates of some of the major parasitic infections of humans.

But simply measuring prevalence only tells part of the story. The important variable from a human and public health perspective is not the mere presence of infection, but the burden of death and disability with which it is associated. In order to estimate this, a recent study sponsored by the World Bank has led to the development of a technique that combines information regarding both morbidity and mortality from a specific disease into a single measure (World Bank, 1993). This health indicator is termed the 'disability-adjusted life year' (DALY) and has gained usage not only to provide standardized assessments of the health burden of specific diseases but also to allow comparisons of the impact on public health (both morbidity and mortality) of the various packages of health



**Fig 2.4** Simulated results from a mathematical model of helminth vaccination programs. The upper two figures show predicted age profiles of worm burden generated by assuming that contact with infection is greatest in the early teenage years. Mass vaccination at different ages is modelled. Vaccine protection is assumed to be complete initially but to decay at a rate specified by the inverse of the average vaccine duration. The effect of vaccination is to reduce the rate of infection. The upper figure shows vaccination in 1 year-old children. The top (bold) line shows the age profile in the absence of vaccination and the light lines show vaccination with average vaccine duration of 2, 5, 10, 15, 20 and 30 years, respectively, from top to bottom. The middle figure is identical, except that vaccination occurs at age 5. The lower figure shows the percentage reduction in mean worm burden achieved by the programs as a function of the average vaccine duration with vaccination at age 1 and 5 (modified from Bundy *et al.*, 1995)

**Table 2.2** Estimated global prevalence of the major human helminth infections (in millions)

Helminth	Sub-Saharan Africa	Other Asia and Islands	India	China	Latin America <sup>a</sup>	Middle Eastern crescent	Total
<i>Ascaris lumbricoides</i>	105	303	188	410	171	96	1273
<i>Trichuris trichiura</i>	88	249	134	220	147	64	902
Hookworm <sup>b</sup>	138	242	306	367	130	95	1277
<i>Schistosoma</i> spp. <sup>c</sup>	131	0.5	—*	0.95	6.3	10.7	149.5
<i>Onchocerca volvulus</i>	17.5	—	—	—	0.14	0.03	17.7
<i>Wuchereria bancrofti</i> <sup>d</sup>	50.2	13.15	45.5	5.5	0.4	0.34	115.1
<i>Brugia malayi</i> <sup>d</sup>	—	6.2	2.6	4.2	—	—	12.9

Estimates of prevalence are for both sexes combined.

<sup>a</sup>Includes the Caribbean nations.

<sup>b</sup>Both *Necator americanus* and *Ancylostoma duodenale* combined.

<sup>c</sup>Combined *S. mansoni*, *S. haematobium*, *S. intercalatum*, *S. japonicum* and *S. mekongi* infections.

<sup>d</sup>Denotes both infection and disease cases.

\*Less than 1000 infected.

Reprinted from Michael *et al.* The challenge of controlling common helminthiases of humans today. *Parasitology Today* 13: PTC04. © 1997, with permission from Elsevier Science.

care that may be provided for specific diseases (Jamison, 1993). DALYs translate disabilities into years of healthy life lost, by giving each disease state a disability weight ranging from 0 (healthy) to 1 (death). Additional complexities in the calculation of DALYs include the potential years of life lost as a result of a death at a given age [e.g. the Global Burden of Disease (GBD) study (World Bank, 1993), used a standard expected-life lost based on model life-table West Level 26], age-weighting of the disability experienced, related to the perceived value of life at different ages (weighting function peaking at age 25, used by GBD study), and discounting of the disability experienced in future years (at 3%). A general formula for the number of DALYs lost by one individual is given by:

$$DALY_s = \int_{x=a}^{x=a+L} DW(a)e^{-r(x-a)} dx \quad (1)$$

which is the integral over age  $x$  from the age of onset  $a$  for a duration of  $L$  years of the product of the disability weight  $D$  (or 1 for premature mortality), the age weight,  $W(a)$  and the discounting factor  $e^{-r(x-a)}$ . The DALY measure thus aims to estimate the value of the future years of healthy life lost because of a disability, summed from age  $a$  to age  $a+L$ , where  $L$  would be the life expectancy at age  $a$  in the case of permanent disability or premature mortality, and the duration of the disability in other cases. Note that, by this estimation, the long-term consequences of a

disability caused by a risk factor this year are essentially counted back to the present year. Further details on the calculations of DALYs can be found in Murray and Lopez (1994), but it is clear that reliable estimates of DALYs will require an understanding of the population dynamics of infection and its relationship to morbidity or mortality. This is because, at the very least, data on age/sex-specific infection prevalence, duration of being in various disease or disability states and remissions from these states are required, and ideally data on age and sex-incidence of infection, the proportion of infection incidence leading to a disabling outcome, the average age of disability onset and the distribution of disability by severity are needed for undertaking the DALY calculations (Murray and Lopez, 1994).

Although, as with other summary health burden indicators, DALYs are dependent on the assumptions made regarding the key components listed above (Sayers and Fliedna, 1997; Anand and Hanson, 1995), its utility nonetheless in comparing the health burden of various diseases can be seen from Table 2.3. The Table lists the estimated DALYs and deaths from the major communicable diseases included in the GBD study (World Bank, 1993), and clearly shows how combining morbidity and mortality information from a specific disease into a single health indicator allows the comparison of the relative burdens of disparate diseases, or indeed other health conditions. Thus, while a common disease, such as respiratory infection, by its prevalence will contribute a large

number of DALYs, HIV infection, on the other hand, by virtue of its high fatality rate, contributes a proportionally higher number. In addition, the integration of age-specific incidences (and hence population dynamics), discounting and age weights in calculating DALYs has the result that, while infections of school-age children such as intestinal worm infections, contribute proportionally high DALYs despite inducing low mortality rates, relatively fatal infections of pre-school children (e.g. measles) and adults (e.g. tuberculosis) (Murray and Lopez, 1994) contribute proportionally to lower numbers (Table 2.3). This comparability element to the DALY statistic has highlighted the importance of communicable diseases as a major cause of global disability. For example, the results of the GBD study summarized in Table 2.3 indicate that in 1990 nearly 35% of the total world disease (due to all causes) was contributed by communicable diseases, a statistic which clearly challenges the belief that the war against infectious and parasitic diseases has been won.

### COST-EFFECTIVENESS ANALYSIS

The resources available for investing in health care are finite, which requires that consideration be given not only to the effectiveness of intervention programs, but also to the costs involved. Cost-effectiveness analysis is concerned with identifying the most efficient option for controlling a given disease among a range of alternative strategies. It relates the health outcome, usually lives saved, cases prevented or even DALYs saved (see below), of alternative programs to their costs in order to facilitate the selection of those approaches that provide the maximum effectiveness per level of cost. Thus, once it is accepted that control of a given disease is socially worthwhile, carrying out a cost-effectiveness analysis can facilitate efficient control program design (Prescott, 1993; Guyatt and Evans, 1992).

Although analysis based on detailed empirical estimates of the costs and effectiveness of control can provide important information to the health planner in what can be achieved in practice, because only one study can be managed at one site, evaluating the cost-effectiveness of different strategies in different sites leads to problems of

interpretation, since the control approach is only one amongst many variables. Indeed, differences among studies may be so marked that it could be hard to make any generalizations about them at all (Hammer, 1993). This has led to the adoption of modelling approaches to cost-effectiveness analysis, since such analytical frameworks readily allow predictions to be made in different endemic settings and sensitivity analysis of key variables to be undertaken (Prescott, 1993; Guyatt and Tanner, 1996).

The traditional approach to modelling the cost-effectiveness of parasite control programs has been to use static frameworks (Rosenfield *et*

**Table 2.3** Estimated DALYs and mortality from communicable diseases in the World

Disease	DALYs (hundreds of thousands)	Deaths (thousands)
Tuberculosis	464.5	2016
Syphilis	63.2	186
<i>Chlamydia</i>	15.5	1
Gonorrhoea	4.1	3
Pelvic inflammatory disease	128.0	2
HIV infection	302.1	291
Diarrhoea (acute)	543.8	1553
Diarrhoea (chronic)	290.8	872
Dysentery	156.5	448
Pertussis	119.5	321
Poliomyelitis	48.1	24
Diphtheria	2.3	4
Measles	341.1	1006
Tetanus	164.9	505
Meningitis	80.9	242
Hepatitis	19.3	77
Malaria	257.3	926
Trypanosomiasis	17.8	55
Chagas' disease	27.4	23
Schistosomiasis	45.3	38
Leishmaniasis	20.6	54
Lymphatic filariasis	8.5	0
Onchocerciasis	6.4	30
<i>Ascaris</i>	105.2	13
<i>Trichuris</i>	63.1	9
Hookworm	11.4	6
Leprosy	10.2	3
Trachoma	33.0	0
Respiratory infections (lower)	1147.5	425
Respiratory infections (upper)	29.2	12
<b>Total</b>	<b>4665.5 (34.6)</b>	<b>13 381</b>

DALY, disability-adjusted life year. Figures in bold within brackets denote the proportion of DALYs lost contributed by communicable diseases to the total DALYs lost (1.36 billion) in 1990. Data from World Bank (1993).

*al.*, 1984; Hammer, 1993; Prescott, 1987). Although used gainfully to investigate the optimal chemotherapy strategy for the control of schistosomiasis (Prescott, 1993) and the combined control of intestinal nematodes and schistosomes (Warren *et al.*, 1993), this approach is felt to be limited by the inability to account for dynamic responses in infection (e.g. changes in immunity development, parasite or vector resistance development and human disease in malaria following either drug treatment or vector control, and changes in parasite population and human morbidity as a result of treatment and reinfection in helminth infections) following interventions. As such, the effectiveness measures addressed using static models are usually simple immediate outcomes that reflect coverage (e.g. proportion of infected individuals treated) or both coverage and cure rate (e.g. proportion of infected individuals cured). More recent approaches have therefore sought to develop dynamic models for undertaking cost-effectiveness investigations (Guyatt *et al.*, 1993, 1995). These models have a major advantage in that, since they can monitor changes in the parasite population over time in response to intervention, they not only permit the effectiveness of treatment to be assessed in terms of cases that were prevented because of intervention, but also lend themselves to reliable comparability between strategies varying in the level of coverage, drug efficacy and frequency of mass treatment in areas differing in rate of infection transmission.

This section will address how the use of dynamic models for undertaking cost-effectiveness analysis can provide an understanding of the process, costs and effectiveness of different parasite control strategies. The focus will be on intestinal nematode infections, since most of this new work has been carried out for these infections. Mention will also be made regarding the use of DALYs as an effectiveness measure in carrying out such analyses.

### **Cost-Effectiveness Analysis using a Dynamic Model of Intestinal Nematode Control**

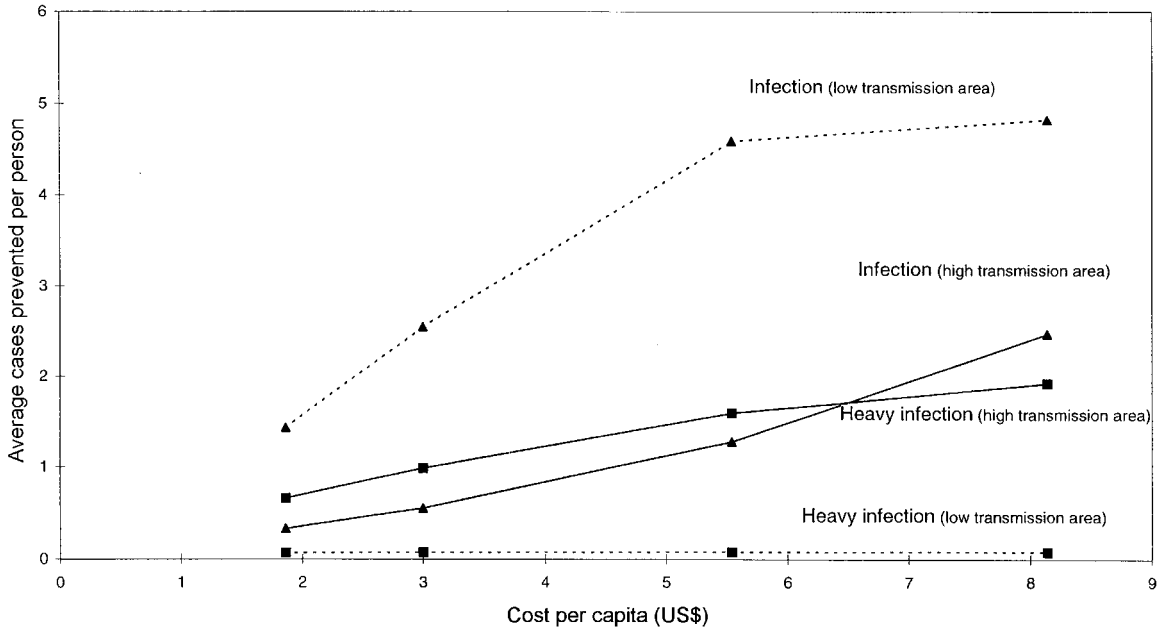
Most cost-effectiveness analyses of intestinal nematode control programs have focused on

strategies for delivering chemotherapy, as this is generally considered to be the most cost-effective approach to controlling infection (Bundy and de Silva, 1998). In the application of mass chemotherapy, an important indecision lies in the frequency of treatment, which depends in part on the intensity, and hence dynamics, of parasite transmission in that endemic locality (Anderson and May, 1985). Guyatt *et al.* (1993) incorporated cost analysis into the dynamic framework for helminth transmission of Medley *et al.* (1993), to assess the cost-effectiveness of alternative mass chemotherapy strategies, which varied in the frequency of treatment of *Ascaris lumbricoides* infection in high- and low-transmission areas. The effectiveness of a 5 year program, with treatment at intervals of 4 months, 6 months, 1 year and 2 years, was assessed over 10 years. Since the control program component is assumed to last for 5 years, it is obvious that the less frequent the treatments, the fewer treatments that are given.

One of the most important qualitative results from this analysis was that measuring effectiveness and cost-effectiveness in terms of the reduction in prevalence of infection gives conclusions that conflict with assessment in terms of reduction in intensity. This is an important observation, given that most control programs are evaluated in terms only of the reduction in prevalence of infection. Figure 2.5 illustrates the relationship between cost and effectiveness for the four treatment options in the high- and low-transmission areas, in terms of reduction in infection and in heavy infection. Reduction in heavy infection was maximized in the high-transmission area and when treating frequently (every 4 months). Maximal reduction in infection prevalence, in contrast, was observed in the low-transmission area. Since, in this model, the costs are independent of endemicity, the cost-effectiveness ratios for heavy infection reduction are consistently lower in the high-transmission area than in the low-transmission area (see Table 2.4), suggesting it is more cost-effective to intervene in the high-transmission area. The cost-effectiveness ratios also indicate that the most cost-effective intervention in terms of heavy infection reduction is to treat every 2 years.

Although treating every 2 years minimizes the cost per heavy infection case prevented per person, treating every year provides an extra





**Fig 2.5** The relationship between effectiveness (average infection and heavy infection cases prevented per person) and costs per capita at increasing frequency of treatment directed at *Ascaris lumbricoides* in a high- and low-transmission area. Modified from Guyatt *et al.* (1993), with permission

**Table 2.4** Cost-effectiveness ratios and incremental cost-effectiveness ratios for delivering anthelmintic treatment directed at *Ascaris lumbricoides* at different frequencies in a high- and low-transmission area

	High-transmission area		Low-transmission area	
	Heavy infection	Infection	Heavy infection	Infection
Cost per case prevented				
2 yearly treatment	2.82	5.65	27.88	1.30
Yearly treatment	3.05	5.44	40.97	1.18
6 monthly treatment	3.48	4.34	72.01	1.21
4 monthly treatment	4.23	3.30	104.72	1.69
Extra cost per case prevented				
1 years instead of 2 years	0.83	5.15	138.62	0.95
6 months vs. 1 year	4.19	3.50	722.38	1.25
4 months vs. 6 months	8.02	2.16	17 000	12.71

Modified from Guyatt *et al.* (1993), with permission.

gain in effectiveness, but at an extra cost. The extra cost required to obtain an extra unit gain in effectiveness, by treating more frequently, is expressed in terms of incremental cost-effectiveness ratios (see Table 2.4). In pictorial terms, these values can be understood by examining the gradient of a line joining any two alternative strategies (see Figure 2.10). The steeper the line, the more efficient the more costly alternative, as any increase in cost returns a high increase in

effectiveness. For instance, treating every year rather than every 2 years requires an extra cost of US\$0.83 per extra gain in heavy infection cases prevented per person in the high-transmission area, and an extra US\$138.62 in the low-transmission area (see Table 2.4). It is evident that treating more frequently requires less cost input to achieve a gain in disease prevalence reduction in a high-transmission area than in a low-transmission area. The incremental cost-

effectiveness ratios for disease reduction also reveal diminishing marginal returns, that is, as the frequency of treatment is increased, a higher cost investment is required per extra gain in effectiveness (for heavy infection reduction) (see Table 2.4). Studies have suggested that the interval between treatments for *A. lumbricoides* infection should be relatively short, of the order of 3–6 months (Cabrera *et al.*, 1976; Arfaa and Ghadirian, 1977), depending on the infection rate of the endemic area (Morishita, 1972). These estimates, however, were based on the rate of rebound in infection prevalence after treatment. Previous studies have shown that prevalence recovers more rapidly than intensity and thus that the frequency of treatment required to maintain low levels of intensity is typically much less than that required to minimize prevalence (Anderson and Medley, 1985). The analyses by Guyatt *et al.* (1993), using the dynamic modelling approach, indicate further that relatively long intervals between treatment offers a cost-effective approach to morbidity reduction, and that measuring effectiveness in terms of infection prevalence reduction can lead to the identification of options that do not optimize morbidity control.

### The Effect of Population Age Structure on the Costs of Control

The cost-effectiveness of age-targeted treatment has also been investigated for different delivery options using an age-structured dynamic model (Chan *et al.*, 1994), which incorporates community demography parameters into parasite population dynamics (Anderson and May, 1991). Indeed, the derivation of such dynamic models offer the only practical method of addressing the issue of age-targeted control. The first delivery option considered was the target group (Guyatt *et al.*, 1995). Although child-targeted treatment can never be more effective than population treatment (see above), it is less costly and may prove to be more cost-effective, since this target group has the highest intensity of infection and is therefore most likely to suffer disease and to be responsible for a larger proportion of the transmission stages (Anderson

and May, 1979). The cost-effectiveness analysis demonstrated that child-targeted treatment was more cost-effective than population treatment in terms of reduction in heavy infection. For example, in the high-transmission area, the cost per heavy infection case prevented was US\$1.78 for child-targeted treatment, compared to US\$2.45 for population treatment. The main reason for this difference was that the intensity of infection was highest in the child age classes and therefore treating children benefits the population as a whole, since the rate of transmission is greatly reduced. In this analysis, the unit cost of treating children was assumed to be identical to that for adults. In practice, the costs are likely to be much smaller for children, since they are more easily accessible through schools (Partnership for Child Development, 1997; World Bank, 1993). Including such a differential cost advantage would further favour child-targeted treatment (Bundy and Guyatt, 1996).

With the exception of drug efficacy, the coverage and frequency of treatment are often the only aspects of a delivery program that can be controlled. Theoretical studies have investigated a control criterion for chemotherapy, which corresponds to the threshold coverage per time period required to eradicate infection or to control infection at a given level (Anderson and May, 1985; Anderson and Medley, 1985). There have been few attempts, however, to dissect the interaction between coverage and frequency of treatment, or to investigate the implications for cost-effectiveness. Again, the use of dynamic models allowed Guyatt *et al.* (1995) to examine three different frequencies of treatment (every 6 months, every year and every 2 years) and three levels of coverage of children (50%, 70% and 90%) over a 5 year treatment period. The analysis demonstrated that of the nine treatment options, the most cost-effective in terms of the reduction in heavy infection was to treat every 2 years at a coverage of 90% (see Table 2.5). This suggests that it is more cost-effective to extend the coverage of an existing cycle than to increase the number of cycles. The main reasons for this are that it is cheaper to treat more people at one visit than to make more visits (due to the relatively lower costs of drugs vs. delivery) and that the *dynamics* are such that the lower the infection levels achieved, the slower the return to equilibrium levels. Medley

**Table 2.5** The cost–effectiveness of different combinations of frequency of treatment and coverage for child-targeted treatment directed at *Ascaris lumbricoides* in a high-transmission area

	Coverage	Frequency of treatment		
		Every 6 months	Every year	Every 2 years
Cost (US\$)	0.5	145	72	44
	0.7	194	97	58
	0.9	243	122	73
Number of heavy infection cases prevented	0.5	52	32	20
	0.7	70	50	33
	0.9	83	68	49
Cost per heavy infection case prevented (US\$)	0.5	280	225	216
	0.7	277	195	178
	0.9	292	178	148

Cost and effectiveness are rounded up to the nearest thousand, but the cost–effectiveness ratios are calculated directly from the original data). Modified from Guyatt *et al.* (1995), with permission.

*et al.* (1993) showed that increasing the coverage of treatment was increasingly beneficial to the untreated portion of the population because of reduced infection rates overall.

The most cost–effective option for child-targeted treatment was shown to be 2 yearly treatment of 90% of children. However, it is possible, in practice, that a 2 yearly treatment program is chosen, but only 70% coverage is achieved. In this situation, one may consider trying to increase coverage to 90%. This may involve extra costs to motivate the community (e.g. through health education) and the staff (e.g. through incentives). In this instance, one would be interested in determining the maximum amount of money that could be spent on achieving a 90% coverage, which would be more cost–effective than leaving the coverage at 70%. This can be calculated by determining how much more the costs of the 90% coverage program can be increased, such that this option still has a lower cost–effectiveness ratio than leaving coverage at 70%. The analyses suggest that, in addition to the extra treatment costs, it would be possible to invest up to US\$14 967 over the 5 year program (approximately 25% of the initial investment) on increasing coverage from 70% to 90%, and this would still be the more cost–effective option.

### Cost–Utility Analysis: the Cost of Gaining a Disability-adjusted Life-year

Nematodes have their main effects on morbidity rather than mortality, so the impact of treatment

cannot be determined in terms of commonly used indicators such as the number of lives saved. As discussed above, the DALY metric, on the other hand, may provide a satisfactory effectiveness measure in this context, not only in calculating the cost–effectiveness of treatment alternatives for a single parasitic infection, but also with regard to comparability with interventions against other diseases. Note that technically, for the current purposes, carrying out the cost–effectiveness analysis of health interventions using utilities, such as DALYs, in the numerator would be called a cost–utility analysis (Drummond, 1987).

The first published attempt at assessing the cost per DALY gained for anthelmintic chemotherapy was undertaken by Warren *et al.* (1993), using a simple static framework. The total cost per child for a 10 year program (albendazole, praziquantel and delivery costs) was assumed to be US\$8–18. The estimated gains in DALYs arose from a reduction in morbidity and mortality in children during the intervention, post-intervention health benefits for the target group, and indirect health benefits for the families of the target group during the intervention. The reduction in morbidity was assessed as functions of the proportion of children with high or mild–moderate infections, and the disability weights for the morbidity associated with high or mild–moderate infections. The mortality prevented was determined from the estimated number of deaths and the life expectancy at death. It was estimated that the program would cost US\$6–12 (moderate-effect estimates) or US\$15–33 (low-effect estimates) per DALY gained.

The model by Warren *et al.* (1993) was essentially static. A more recent cost–utility analysis in terms of cost per DALYs gained for school-based delivery of anthelmintics has been undertaken using a population dynamic model in relation to *A. lumbricoides* infection (Chan *et al.*, 1994a). The model is an extension of the Chan *et al.* (1994b) age-structured model for intestinal nematodes alluded to before, with three rather than two age-groups: pre-school children, school-age children and adults. Morbidity is classified into four types, defined by group affected, duration of disability and the number of worms associated with the condition. A low-threshold worm burden is associated with reversible growth faltering in children and/or reduced physical fitness in children and adults (Type A), and permanent growth retardation in 3% of children (Type B). A high-threshold burden is associated with clinically overt acute illness of short duration (Type C) and acute complications in 70% of those with Type C (Type D). Mortality was assumed to occur in 5% of Type D cases. The low and high-threshold worm burdens were age-dependent, and each morbidity type was associated with assumed disability weights. Chan (1994b) predicted that 70% of the total DALY loss in a community with a high prevalence of infection could be averted by treating 60% of school-aged children every year for 10 years, at a cost per DALY averted of US\$8.

Both these estimates would suggest that helminth control is an exceptionally good ‘buy’ in public health terms (World Bank, 1993). They also show that gaining an understanding of the impact of many of the critical components of cost–effective treatment, such as frequency and duration of treatment, coverage and age-targeting, can only come from incorporating parasite population dynamics and epidemiology into economic evaluation frameworks.

### CLASSICAL PARASITE EPIDEMIOLOGY

No chapter on epidemiology would be complete without some explanation of the application of medical statistical methods to understanding the patterns of disease and their causation and control. Here we give examples of two

approaches—the randomized trial and meta-analysis—that have been fundamental to understanding infectious disease, and indeed much else, in epidemiology. The reader is referred to specific texts (see Hedges and Olkin, 1985) to explore this in more detail.

### A Randomized Trial

Intestinal nematodes infection constrains the physical and intellectual development of school children in low-income countries (Bundy and de Silva, 1998). Few studies have examined the impact of infection on younger children, partly because the burden of worms and, it has been assumed, disease is light at this early age, but perhaps mainly because of the practical difficulty in reaching this pre-school population. In Uttar Pradesh in northern India there are high levels of worm infection and malnutrition in the pre-school group (Gaitonde and Renapurkar, 1979) and a study of supplementary nutrition has shown a benefit of deworming these children (Gupta *et al.*, 1977). Furthermore, the State Integrated Child Development Scheme (ICDS) now provides a health care infrastructure that reaches all children under 5 years of age.

To determine whether there was a growth benefit from the deworming of these pre-school children, we conducted a randomized trial within the ICDS infrastructure of urban Lucknow UP. A health worker in each of the 203 designated urban slum areas provides general care to children under 5, including immunization and 10000 units vitamin A for children 5 years up every 6 months. Fifty of these slum areas were randomly selected for the study. All continued normal care, but 25 were randomly allocated to receive, in addition, 400 mg albendazole (Zentel, SmithKline Beecham) as 10 ml suspension at the same interval as the vitamin A. All resident children aged 1–5 were recruited to the study, and all parents of eligible children provided written consent. A research team measured the height ( $\pm 1$  mm) and weight ( $\pm 100$  g) of each child at baseline, and then at 6 month intervals for 24 months. The health workers and parents were not blind to the intervention, but the measuring team were blind to previous anthropometric data on the subjects.

**Table 2.6** Weight gain over 2 years in children receiving normal care with or without deworming, stratified by nutritional status at baseline

	Normal care Weight gain (kg)	With albendazole (n)
Underweight	3.56 ± 1.13	4.53 ± 1.56
Not underweight	2.57 ± 1.19	3.24 ± 1.41
Stunted	3.01 ± 1.29	4.12 ± 1.39
Not stunted	2.92 ± 1.23	3.69 ± 1.43
Wasted	3.98 ± 1.06	4.88 ± 1.31
Not wasted	2.82 ± 1.22	3.69 ± 1.41

All differences significant at  $p=0.001$ , except for the difference in weight gain between children who were stunted or non-stunted at baseline and received normal care.

A total of 4003 children were enrolled in the study. Relative to WHO reference standards, the point prevalence of underweight was 48.4% ( $\pm 2$  SD, weight for age), stunting 61.3% ( $\pm 2$  SD, height for age), and wasting 17.7% ( $\pm 2$  SD, height for weight). The children were all from families with incomes below the national poverty level, and 51.4% were girls. There were no significant differences at baseline in any of these variables or in age distribution between the two arms of the study. The children were surveyed five times (at 0, 6, 12, 18 and 24 months) and anthropometric data were collected for all surveys from 95% of the children in each arm (1885 children receiving normal care, and 1890 children receiving albendazole in addition). At 24 months, 99% of the surviving children were measured. There were 25 deaths in 2 years, 15 in the normal care group and 10 amongst those receiving albendazole in addition to normal care.

Because treatment and randomization was by area, we compared the area-specific weight and height gains for each of the 25 areas in each treatment arm, although here we report the overall means and standard errors for each arm. At 1 year follow-up there was no significant difference in height gain ( $7.5 \pm 0.3$  cm vs.  $7.6 \pm 0.4$  cm: normal care vs. with deworming), but the albendazole group had gained significantly more weight ( $1.55 \pm 0.06$  kg vs.  $1.93 \pm 0.08$  kg: normal vs. with deworming). At 2 years the albendazole group showed a  $6 \pm 3\%$  greater height gain (13.4 cm vs. 14.1 cm; normal vs. with deworming) but this was still not a significant difference. The albendazole group

continued to show a highly significant difference in weight gain ( $2.8 \pm 0.1$  kg vs.  $3.8 \pm 0.1$  kg: normal care vs. with deworming), with the dewormed children exhibiting a  $35 \pm 5\%$  better weight gain; equivalent to an additional  $1 \pm 0.15$  kg over 2 years.

Table 2.6 shows that for all children, irrespective of treatment group, the weight gain at 2 years was greater for those children who were malnourished initially. For all nutritional categories, the weight gain was significantly greater for those children who received albendazole in addition to normal care, with the greatest gain in weight for wasted children and the least for stunted children. The lack of a significant height gain may reflect an initial increase in tissue mass rather than linear growth for these disadvantaged children, the height gain was greatest for those stunted initially, and least for those wasted (data not shown).

These results suggest that 6 monthly deworming can promote weight gain in malnourished pre-school children in India. The mechanism for this gain is not indicated by the present study. It may reflect a direct effect of deworming on nutrition in general, or an indirect effect leading to greater uptake of vitamin A specifically in these supplemented children. An association between ascariasis and vitamin A malabsorption (Sivakumar and Reddy, 1975) and a recent study in an area of low infection prevalence showed a benefit of vitamin A supplementation that was not further enhanced by deworming (Donnen *et al.*, 1998).

In pre-school children there is a direct correlation between weight and relative risk of death, and in India in particular a high proportion of under 5s mortality is attributed to the potentiating effects of malnutrition on infectious disease (Pelletier *et al.*, 1994). The present results suggest that deworming tablets, costing less than US\$0.10 per annum and delivered through the existing ICDS infrastructure, could contribute to improved child growth and, perhaps, survival.

## A META-ANALYSIS

A meta-analysis, also known as a systematic review, is a statistical procedure in which the

results of previous research are integrated, with the aim of being able to resolve issues that cannot be concluded from a single study alone. It addresses: (a) the formal synthesis of the results of independent studies to yield a quantitative estimate of the overall size of the response parameter, supported by the larger sample sizes afforded by combining individual studies; and (b) the quantification and investigation of sources of heterogeneity among studies. In medical sciences, the intensifying use of meta-analysis has coincided with the increasing focus of medical research on the randomized clinical trial (Peto, 1987), the subject undoubtedly benefiting from the rising level of concern about the interpretation of small and individually inconclusive clinical trials. The use of meta-analysis, however, is not confined to the synthesis of information from experimental studies alone, and a number of studies that involve the meta-analysis of non-experimental data have been published in recent years (Petitti, 1994). More recently, the method has also been applied to the synthesis of ecological and evolutionary data, including data on parasitic infections (Arnqvist and Wooster, 1995; Poulin, 1996; Michael *et al.*, 1994). Here, we will address the use of meta-analysis for gaining a better understanding of the population biology of parasitic infections based on examples from Poulin (1996) and Michael *et al.* (1994). Readers interested in the more traditional use of meta-analysis in summarizing and integrating results from randomized clinical trials in tropical medicine are referred to the excellent systematic reviews addressing the efficacy of different treatments for various parasitic diseases, made available electronically by the Cochrane Parasitic Diseases Group at the Cochrane Collaboration website (Germany <http://www.imbi.uni-freiburg.de>, UK: <http://www.cochrane.co.uk>).

### The Effect of Gender on Helminth Infections

Poulin (1996) employed a fixed effects meta-analysis (Hedges and Olkin, 1985) to investigate whether there was a consistent host sex bias in infection levels (in terms of both prevalence and intensity) with helminth parasites. The analysis was carried out by comparing published data on

parasite burdens between female and male vertebrates. Evidence of a bias in favour of one sex would suggest that higher levels of parasitism may be a relative cost associated with that sex and could have a range of evolutionary implications.

Data for the meta-analysis were obtained from a total of 85 published studies and yielded a total of 295 comparisons of prevalence and 169 comparisons of intensity. Some species were involved in more than one comparison, as certain host species harboured more than one parasite species and certain parasite species infected more than one host species. Host species involved in the comparisons represented several families, although no host taxon was involved in a disproportionate number of comparisons. However, among parasites, digeneans and especially nematodes were well represented in the data set. Comparisons of prevalence and intensity of infection between the sexes were computed for each set of values, essentially to obtain standardized effect size measures that are independent of sample size (Hedges and Olkin, 1985). For prevalence, differences were calculated using the following formula:

$$(P_f - P_m)(J) \quad (2)$$

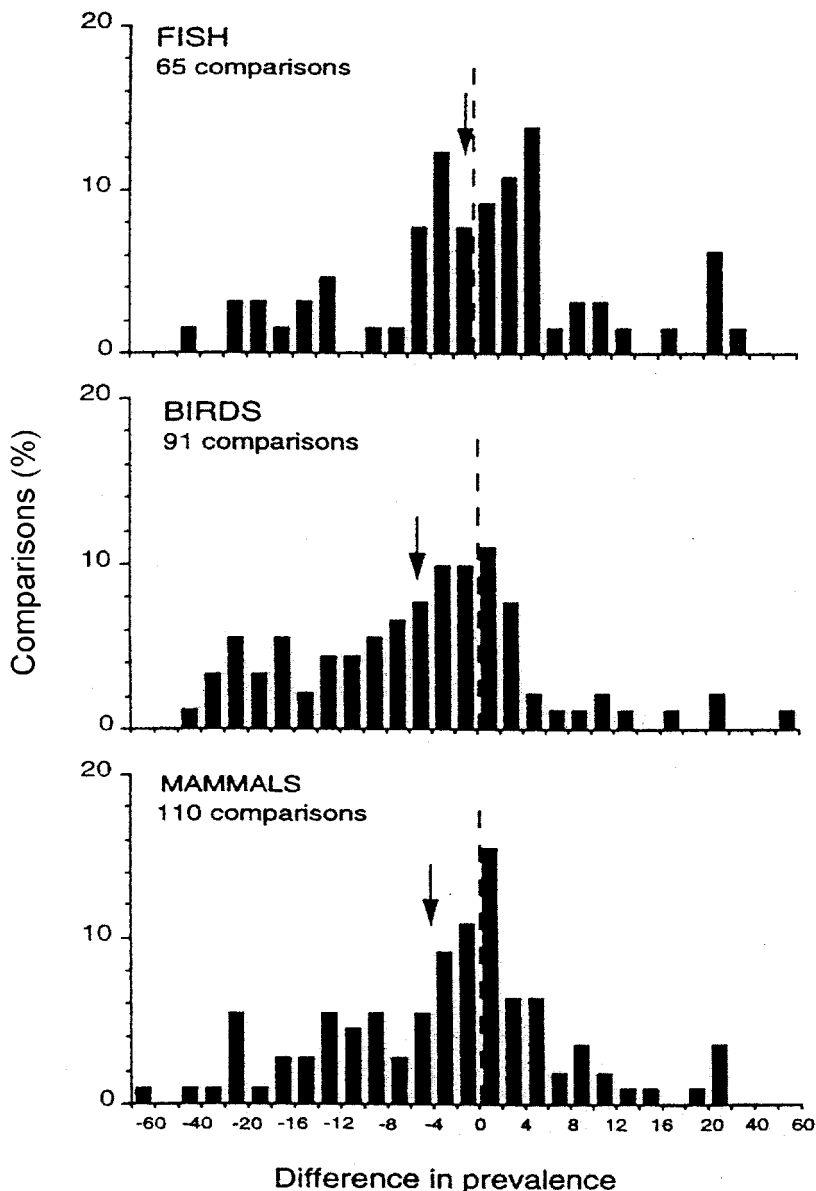
where

$$J = 1 - \frac{3}{4(N_f + N_m - 2) - 1}$$

which is simply the difference between the prevalence in females ( $P_f$ ) and that in males ( $P_m$ ) weighted by  $J$ , which is a correction for small sample sizes or numbers of individuals examined ( $N_f$  and  $N_m$ ). As total sample size increases,  $J$  will approach 1, such that more weight is given to comparisons based on larger sample sizes. The comparison was computed to give positive values when prevalence is greater in females but negative values when greater in males. Similarly, differences in intensities were computed as:

$$\frac{(I_f - I_m)J}{I_f} \quad (3)$$

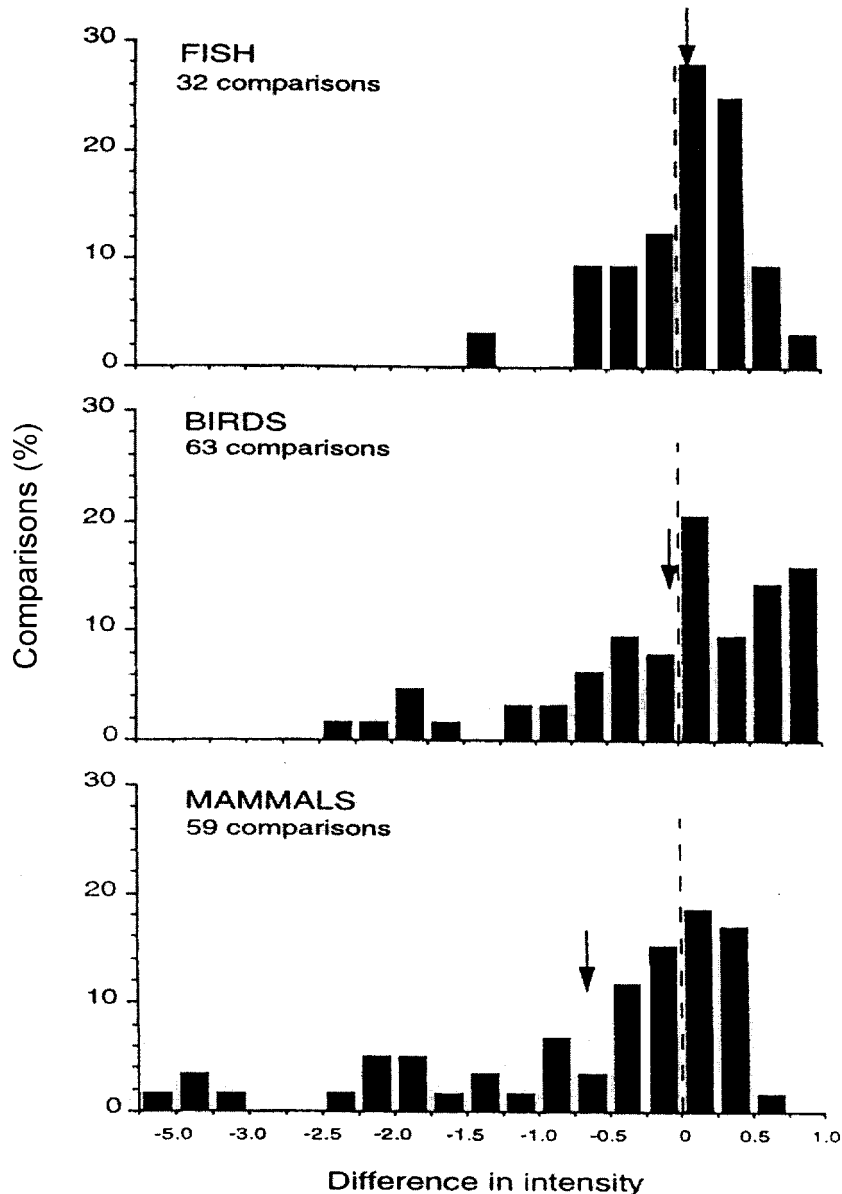
which is again the difference between the mean intensity in females ( $I_f$ ) and that in males ( $I_m$ ) corrected for sample size (here denoting the



**Fig 2.6** Frequency distribution of differences in parasite prevalence from host-parasite systems involving fish, bird and mammal hosts. Arrows indicate the arithmetic mean difference. Values to the left of the broken line denote higher prevalence in males, while values to the right indicate higher prevalence in female hosts. From Poulin (1996), with permission of the University of Chicago Press

numbers of infected individuals). Differences in intensity were expressed as a proportion of the intensity in females to standardize for the variability in the mean intensities recorded, which ranged from a few parasites to several thousand parasites per host. If there is no sex bias

in levels of infection, differences in prevalence and infection are expected to be normally distributed around a mean of zero. Also, the number of positive differences (higher levels of infection in females) should equal the number of negative ones (higher infection in males).



**Fig 2.7** Frequency distribution of differences in infection intensity from host-parasite systems involving fish, bird and mammal hosts. Arrows indicate the arithmetic mean difference. Values to the left of the broken line represent greater intensity in males, while values to the right indicate greater intensity in females. From Poulin (1996), with permission of the University of Chicago Press

The results of the study indicated a tendency for infection prevalence to be higher in males in many types of host-parasite associations, particularly for nematode infections in birds and mammals. The male bias in prevalence was also apparent in birds and mammals when all parasite species comparisons were pooled (birds  $\bar{X} = \square 5.43$ ,

$df=90$ ,  $t$  (two-tailed to compare estimated value against expected mean of zero) = 3.970,  $p < 0.001$ ; mammals,  $\bar{X} = -3.78$ ,  $df=109$ ,  $t=2.993$ ,  $p < 0.005$ ). There were also more negative (male-biased) than positive (female-biased) differences in prevalence among bird and mammal hosts (birds: 63 vs. 25,  $\chi^2=16.41$ ,  $p < 0.001$ ; mammals: 64 vs. 41,  $\chi^2=5.04$ ,



$p < 0.025$ ; see Figure 2.6). By contrast, intensity of infection showed no clear sex bias except for nematodes parasitizing mammals, differences in infection intensity once again being significantly male-biased. When all comparisons were pooled by host type, a male bias was again observed only in mammals  $\bar{X} = -0.69$ ,  $df=58$ ,  $t=4.086$ ,  $p < 0.001$ ). The frequency of male-biased differences were also more common than female-biased ones (37 vs. 21,  $\chi^2=4.41$ ,  $p < 0.05$ ; Figure 2.7).

### The Association between Microfilaraemia and Chronic Disease in Lymphatic Filariasis

A long-held tenet in the epidemiology of lymphatic filariasis, the major mosquito-borne helminth infection of humans, is that patent infection (microfilaraemia) is negatively related to chronic disease. In conjunction with immunological findings (Ottesen, 1992), this perception had led to the conventional explanation that chronic pathology patients (i.e. those with lymphoedema and hydrocele) are negative for patent infection because of re-expression of anti-parasite immunity.

Michael and colleagues (1994) employed meta-analysis techniques to examine the empirical evidence for the relationship between an individual's microfilarial and disease status using published data from field studies carried out in a variety of bancroftian filariasis endemic areas. The aims were two-fold; first, to determine whether there is a negative association between the occurrence of chronic disease (hydrocele, lymphoedema and the two combined) and patent infection, as suggested by the immunological model; second, to determine whether the form of this association varies between studies, and whether this heterogeneity is attributable to variations in the local infection prevalence, as suggested by a dynamic model of disease (Bundy *et al.*, 1991).

The analysis required information on the numbers of individuals in a given community with (a) microfilaraemia (mf) alone, (b) disease alone and (c) both mf and disease signs. An extensive literature survey located a total of 25 studies meeting this data requirement, although only 14 studies provided enough information to

undertake separate analyses for hydrocele and lymphoedema. These surveys encompassed the major filariasis endemic regions (Indian sub-continent, Africa, the South Pacific islands and Brazil) and vector species, as well as a broad range of local infection prevalences. For each community, the association between mf and clinical disease was assessed via the  $2 \times 2$  contingency table using odds ratio analysis (Fleiss, 1993). The odds ratio (OR) is a measure of the degree of association between mf and disease status, and denotes the odds of disease occurring in mf-positives relative to mf-negatives. The  $\chi^2$  test is employed as a test of independence, an OR of 1 indicating an equal chance of disease in mf-positives and mf-negatives. The immunological model of filarial infection and disease implies a significantly *lower odds* of disease in mf-positives (OR less than 1). A fixed effects meta-analysis was undertaken to compare and aggregate results from different studies and to evaluate the global evidence for the observed association between mf and disease. Succinctly, let  $\theta_i$  be the odds of disease occurring in mf-positives relative to mf-negatives, and let  $w_i$  denote the reciprocal of its variance in the  $i$ th study (see standard formulae given in Hedges and Olkin, 1985; Fleiss, 1993). Then a good estimator of the assumed common underlying effect size is:

$$\hat{\theta} = \sum \theta_i w_i / \sum w_i \quad (4)$$

With an approximate 95% confidence interval for the estimate given by:

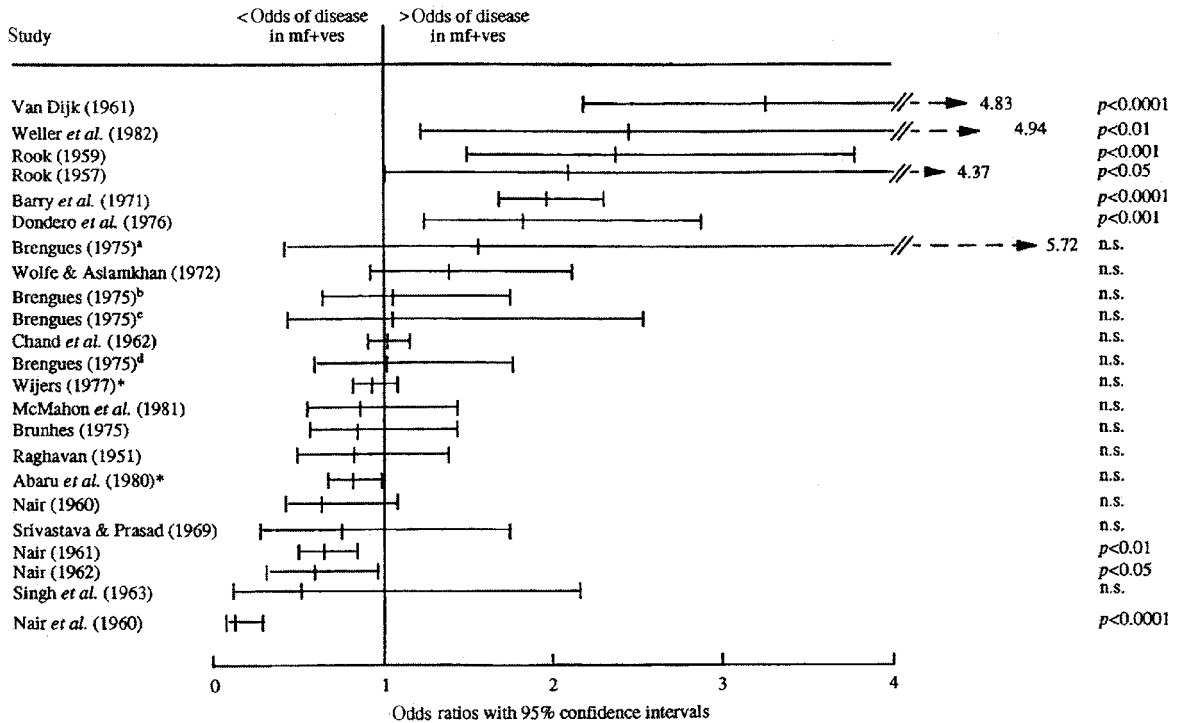
$$\hat{\theta} \pm 1.96 \sqrt{(1 / \sum w_i)} \quad (5)$$

Michael and colleagues (1994) also tested for the existence of significant between-study heterogeneity in the relationship by constructing the statistic:

$$Q = \sum w_i (\theta_i - \hat{\theta})^2 \quad (6)$$

When effect sizes are homogeneous,  $Q$  follows a  $\chi^2$  distribution with  $(k - 1)$  degrees of freedom, where  $k$  denotes the number of studies.

The results of the meta-analyses of the occurrence of combined chronic disease, hydrocele only (for males) and lymphoedema only in mf-positives, are displayed graphically in Figures 2.8–2.10. In each figure, the estimated ORs from



**Fig 2.8** Odds ratios (mf-positives to mf-negatives) and 95% confidence intervals for 23 studies of the relation between the presence of mf and combined chronic disease (hydrocele and lymphoedema) in bancroftian filariasis. Two studies (marked with asterisk) provided data only for males. See text for explanation of the figure and interpretation of the results. <sup>a</sup>Ivory Coast; <sup>b</sup>Koupela; <sup>c</sup>Mali; <sup>d</sup>Tingrela. For references, see source. From Michael *et al.* (1994), with permission

individual studies are plotted in descending order of magnitude, together with their respective 95% confidence intervals. Ratios lying to the right of the unity line (OR > 1) denote a positive association, or a higher observed probability of disease in mf-positives. By contrast, an OR located to the left (OR < 1) represent a negative relationship for that study, with a higher chance of disease in mf-negatives. Studies in which the 95% confidence interval of the estimated OR include 1 signify equal chance of disease in their respective mf-positive and mf-negative populations. The results show that, contrary to the expectation of a negative association between mf and chronic disease, most studies had ORs that did not differ significantly from unity (12/21 for combined chronic disease, 8/14 for hydrocele, and 8/12 for lymphoedema), and thus provide no evidence for a significant association between the presence or absence of patent infection and the occurrence of disease. Indeed, the overall results suggest a bias towards a positive association, with more studies

in each disease category showing significantly higher rather than lower odds of disease in mf-positives (Figures 2.8–2.10). However, for all three meta-analyses, there was significant between-study variability which precluded the computation of a common OR for these studies. Michael and colleagues, however, showed that although there could be regional effects, the observed between-study variability could be explained by the local incidence of infection; in general, there was a trend for the odds of patent infection in diseased individuals to increase positively with increasing prevalence of infection (Figure 2.11). The authors concluded that, on balance, these results supported the prediction of the dynamic model of disease (proportion of individuals with both chronic disease and microfilaraemia increase with increasing prevalence of infection because of higher probabilities of reinfection) rather than the immunological model of infection and disease development in lymphatic filariasis.

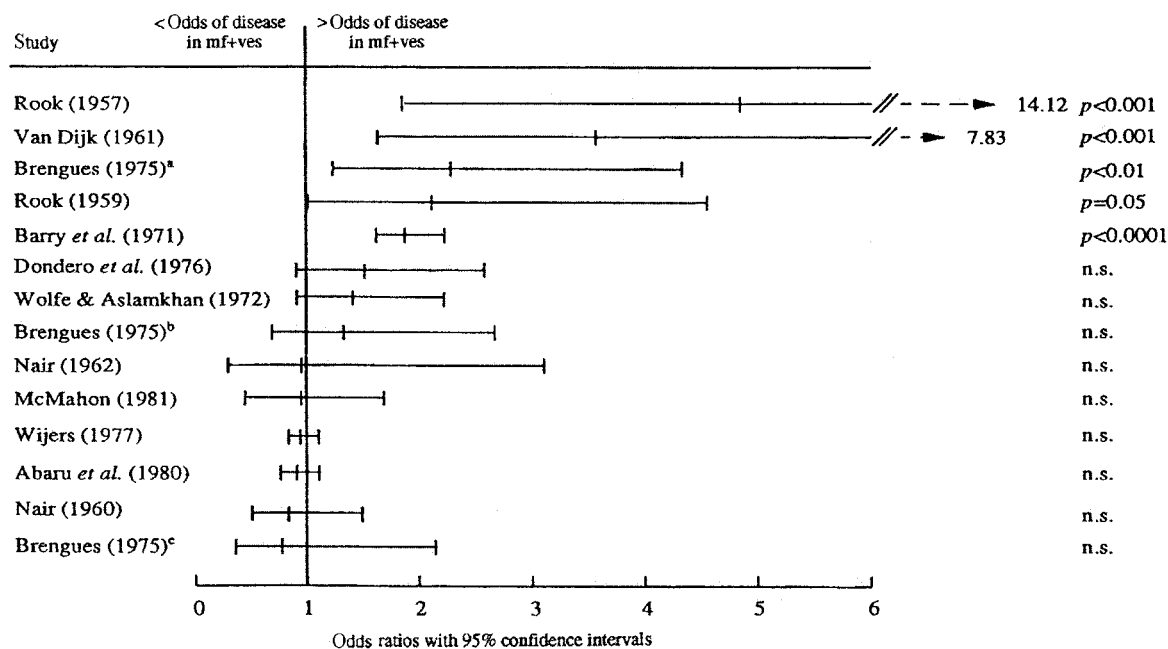


Fig 2.9 Meta-analysis of 14 studies of the relation between the presence of mf and hydroceles in males. The individual study odds ratios (mf-positives to mf-negatives) are plotted together with their 95% confidence intervals. <sup>a</sup>Tingrela; <sup>b</sup>Koupela; <sup>c</sup>Mali. For references, see source. From Michael *et al.* (1994), with permission

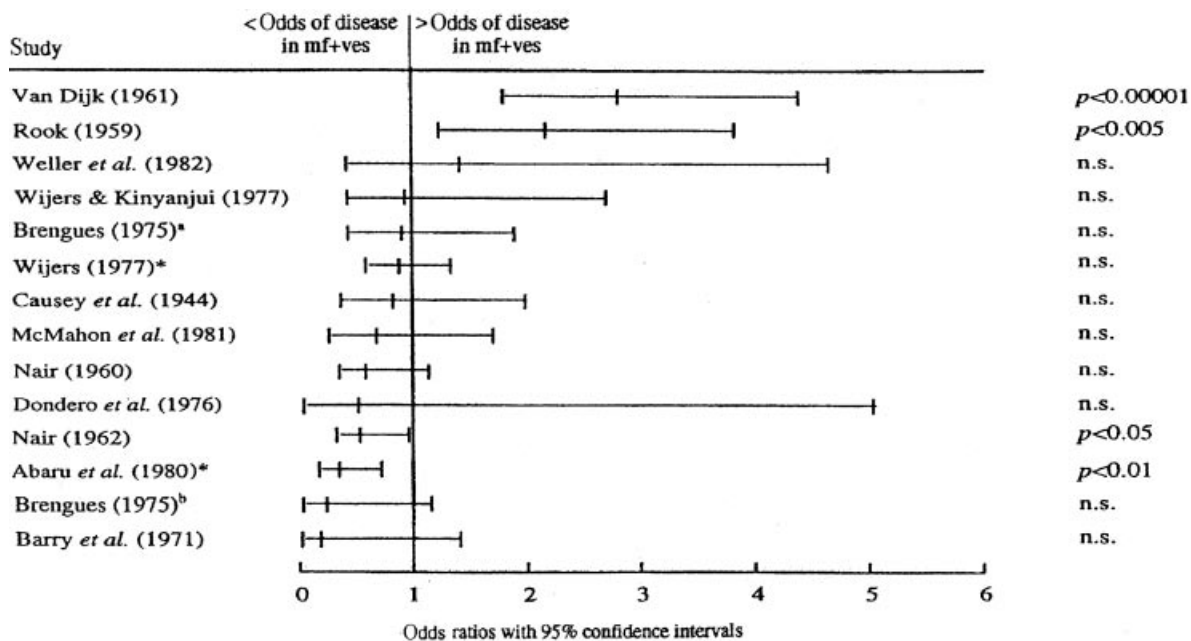
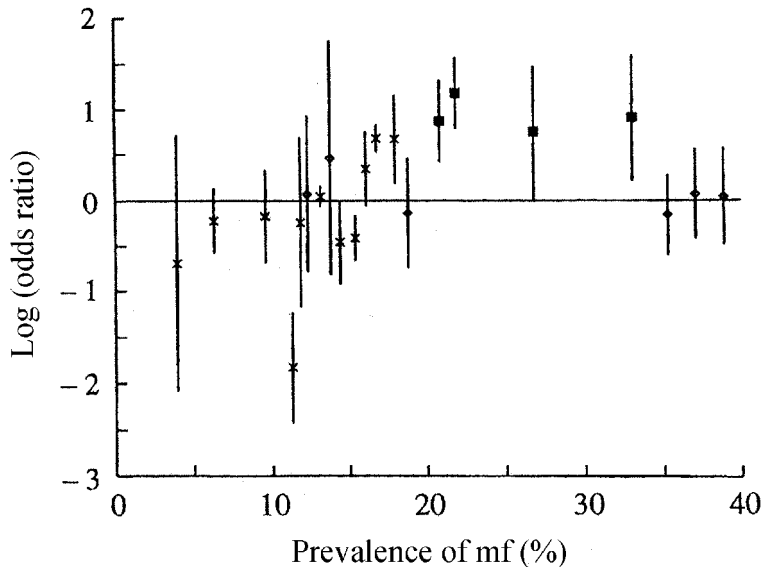


Fig 2.10 Meta-analysis of 14 studies. Two studies provided data for males only (marked with asterisk) of the relation between the presence of mf and lymphoedema. <sup>a</sup>Koupela; <sup>a</sup>Tingrela. For references, see source. From Michael *et al.* (1994), with permission



**Fig 2.11** The relationship between individual study odds ratios (ORs) of disease in mf-positives relative to mf-negatives by region and the prevalence of infection in each study. Note that the natural logarithms of the ORs are plotted—negative ratios indicate more disease in mf-negatives for that study, while positive ratios signify greater probability of disease in the mf-positive subpopulation of the presenting study. Asterisks denote the estimated ORs from studies from the Indian subcontinent, closed squares represent ORs from the South Pacific islands, and diamonds are ORs estimated for studies from Africa. Vertical bars denote the estimated 95% confidence intervals (natural log scale) of each study OR. From Michael *et al.* (1994), with permission

These examples demonstrate that with careful application, meta-analysis can provide a tractable and powerful tool for arriving at general conclusions regarding major epidemiological questions in parasitic infections. Recent developments in incorporating randomization and bootstrap tests into meta-analysis, in order to determine the significance level of a given statistic, have the potential to further enhance the applicability of this technique to non-randomized observational field data (Adams *et al.*, 1997). We predict that meta-analysis will have a substantial impact in uncovering broad patterns in the accumulated body of epidemiological research over the next few years.

#### EMERGING TECHNOLOGIES IN EPIDEMIOLOGY: REMOTE SENSING AND GEOGRAPHICAL INFORMATION SYSTEMS

Disease mapping has a long history (Howe, 1989), and the early studies undertaken in this

area exemplify the power of the method in defining the environmental and social aetiology of a specific disease (Snow, 1854; Palm, 1890). Yet, it is only recently that disease mapping has become integral to the study of infectious disease epidemiology and control (Mott *et al.*, 1995). Two major technological advances underlie this development. The first is the advent of powerful and affordable computer mapping systems in the 1980s (Openshaw, 1996). Known as geographical information systems (GISs), such computer software packages permit the capture, storage, analysis and display of any and all types of geographical reference data. The second technological innovation concerns the increasing availability and ability to integrate data from remote sensors (RS) based on space platforms within GISs, which allow the investigation of disease co-distribution with environmental variables at various spatial scales (Openshaw, 1996). The value of stand-alone GIS and integrated GIS/RS-based approaches, not only to gain understanding of the spatial distribution of infection but also to aid the design and implementation of control programs, has been

demonstrated recently for a range of parasitic diseases, including malaria (Beck *et al.*, 1994; Thomson *et al.*, 1997; Omumbo *et al.*, 1998; Snow *et al.*, 1999). African trypanosomiasis (Rogers and Williams, 1993), onchocerciasis (Richards, 1993) and dracunculiasis (Clarke *et al.*, 1991).

This chapter aims to describe the use of GIS and integrated GIS/RS approaches to understanding infectious disease distribution and control, using examples from work carried out on African trypanosomiasis, and on lymphatic filariasis among helminth parasites. Readers are referred to the review by Mott and colleagues (1995) for descriptions of applications to other tropical parasitic diseases.

### African Trypanosomiasis

The geographic approaches undertaken for this disease illustrate how predicting the distribution of vectors using remotely sensed data on associated environmental co-variables can help to define areas of vector-borne disease transmission. The main utility of these studies has been to demonstrate the potential of remotely sensed satellite data in uncovering vector–environmental relationships relevant to mapping the co-distribution and spread of vectors and the disease they cause (Hay *et al.*, 1997). Thus, Kitron *et al.* (1996) analysed tsetse fly catches from sets of traps set in the Lwambe Valley of Western Kenya during 1988–1990, and found that high resolution Landsat Thematic Mapper (TM) imagery data were able to explain most of the variance in fly catch density. In particular, wavelength band 7 of the Landsat-TM imagery, which is associated with soil-water content, was found to be consistently highly correlated, reflecting the importance of soil moisture in tsetse survival.

By contrast, Rogers and Randolph (1991, 1994) explored the utility of Global Area Coverage (GAC) normalized difference vegetation index (NDVI) data, derived from the National Oceanic and Atmospheric Administration's (NOAA) Advanced Very High Resolution Radiometer (AVHRR), as a proxy for studying tsetse fly ecology and distribution in West Africa, since they considered the NDVI to integrate a

variety of environmental factors of importance to tsetse survival. They found an inverse relationship between monthly NDVI and fly mortality rate in the Yankari game reserve in Nigeria, and significant non-linear relationships between tsetse fly abundance and NDVI in the northern part of Cote d'Ivoire. They focused on a 700 km transect running north–south through Cote d'Ivoire and Burkina Faso. This area is of particular epidemiological interest, since sleeping sickness is found only in the central region of the transect, despite the local vector (*Glossina palpalis*) occurring throughout. The analysis showed that this focalized transmission was a result of differences in overall fly size. During the wet season, the NDVIs across the transect were all high and fly size was uniformly large. In the dry season, however, fly size was strongly correlated with NDVI, with flies in the drier north significantly smaller than those in the wetter south. Since mortality increases with decreasing fly size in tsetse, these data were interpreted as indicating a geographical gradient in the degree of man–fly contact, and thus trypanosome transmission potential. In the south, low mortality rates resulted in high densities of flies, but the flies were not nutritionally stressed (even seasonally) and so did not often resort to biting humans, who are not favoured hosts. Conversely, in the north, fly populations suffered too high a mortality to pose a serious health risk. Only in the central areas was there an intermediate density of sufficiently stressed flies, resulting in a regional and seasonal focus of disease transmission. This study showed that, although at relatively small spatial scales both tsetse distribution and abundance and disease incidence and prevalence could be related to the low-resolution NDVI, the interpretation of the data required a knowledge of local conditions and fly biology from ground studies.

Rogers and Williams (1993) describe the application of NOAA–AVHRR GAC–NDVI data and synoptic meteorological temperature data to the problem of predicting the larger-scale distribution of *Glossina morsitans* in Zimbabwe, Kenya and Tanzania. Temperature data (a critical climatic variable in determining the survival of tsetse) were included in the analysis by interpolating data from meteorological stations to grid squares covering the whole of

Zimbabwe. When these data were combined with NDVI variables in a linear discriminant analysis, the historical distribution of *G. morsitans* in Zimbabwe, as described in Ford and Katondo (1977), was predicted with an accuracy of over 80%, thereby indicating the utility of remotely sensed data in predicting fly distributions at broader spatial scales. However, the statistical difficulties of selecting those climatic and remotely sensed variables of apparent importance in determining the observed distribution pattern were highlighted by Rogers and Randolph (1993). These authors re-assessed the distributions of *G. morsitans* in Zimbabwe, Kenya and Tanzania via predictions from a discriminant analysis of several components of NDVI (monthly mean, minimum, maximum and range), elevation and synoptic temperature data. Although they were able to predict the distribution to an overall accuracy of 82%, the key variables contributing most to the prediction varied between the countries (Figures 2.12–2.14, see Plates I–III). This could suggest that at the very least the environmental–vector abundance relationship varies at regional scales, thereby precluding the building of general global predictive models. Alternatively, the results may indicate difficulties with the analysis of complex multivariate data. Recent work investigating the application of temporal Fourier analysis (Rogers and Williams, 1993) and multivariate techniques based on likelihood principles (Robinson *et al.*, 1997) to climate and remotely sensed vegetation data for predicting fly distributions has attempted to address this issue.

### Lymphatic Filariasis

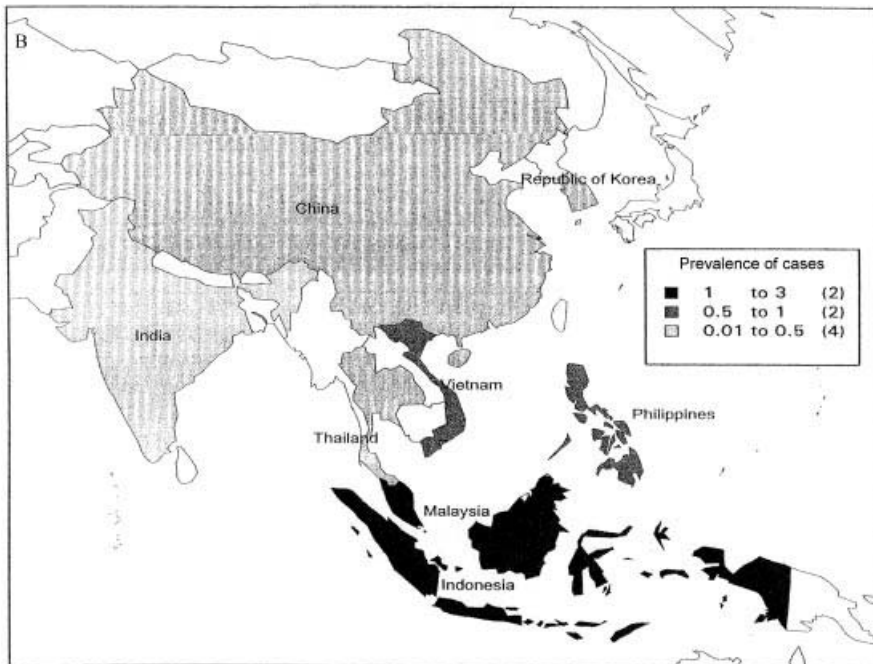
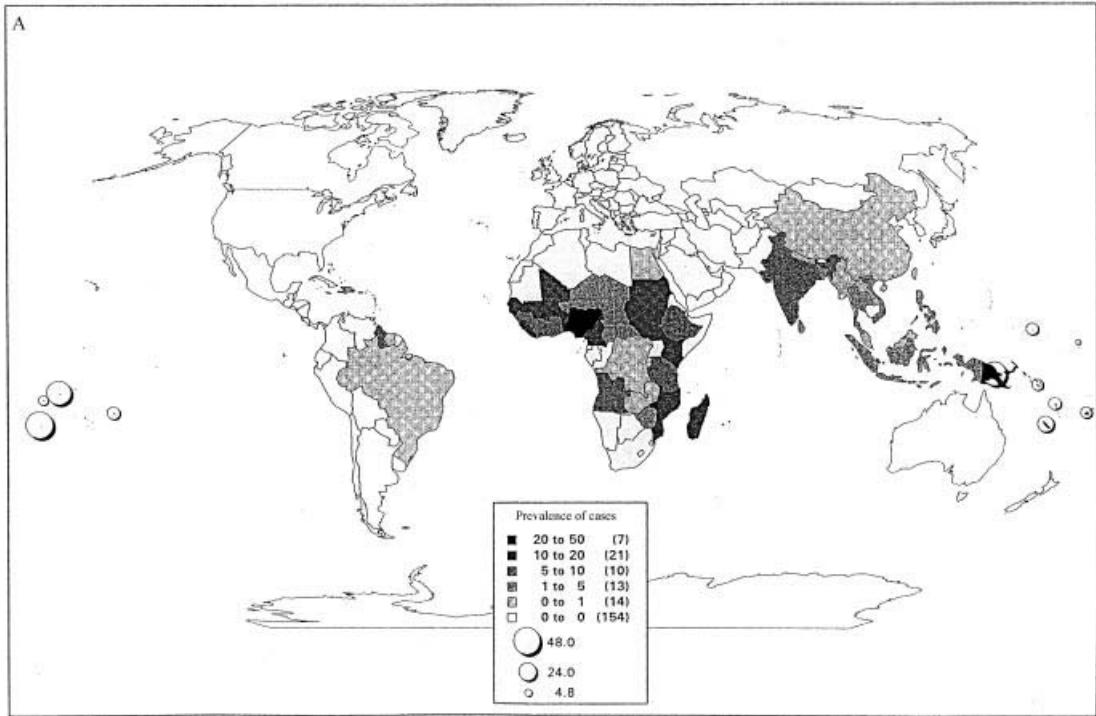
The recent renewed global interest to achieve control of this disease has reinitiated efforts to gain a better understanding of the geographic distribution of lymphatic filariasis at all spatial scales from global, regional to within-endemic country scales (Michael and Bundy, 1997). Recent disease mapping activities have therefore focused on mapping the available information on geographic patterns of infection and disease cases, both for descriptive purposes and for the provision of data for measures of need and

populations at risk, using data at the global and regional scales (Michael and Bundy, 1997). The distribution of cases at a finer spatial scale, however, was undertaken by Thompson *et al.* (1997), who applied an integrated RS–GIS approach to understanding disease distribution among villages within the Southern Nile Delta.

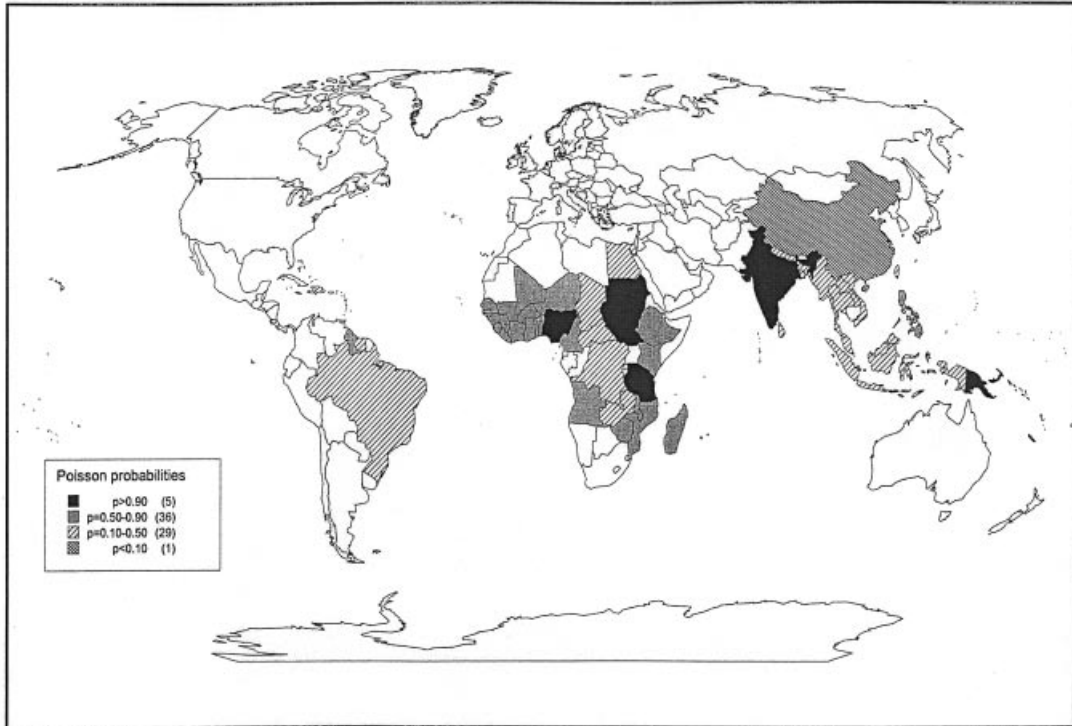
### *Mapping and Analysis of Filariasis Distribution at the Global and Regional Levels*

Michael and Bundy (1997) used a newly assembled database on country-specific estimates of case prevalence (Michael *et al.*, 1996), to construct the first maps of the spatial distribution of lymphatic filariasis case prevalences at both the global and regional levels (Figure 2.15A,B). A striking feature of the resulting maps was the high degree of geographical heterogeneity observed in the estimated country prevalences. In general, countries with bancroftian filariasis (the more important of the two disease forms) in Asia and South America appear to have lower prevalences compared to estimated country prevalences in the sub-Saharan African and Pacific Island regions (Figure 2.15A). The map for brugian filariasis (Figure 2.15B) appears to be relatively more homogeneous, although there is a slightly higher prevalence in the eastern regions of the distribution.

The authors investigated the apparent spatial heterogeneity for bancroftian filariasis distribution using simple statistical models for assessing the significance of area data (Cliff and Hagett, 1988). In particular, the approach of Poisson probability mapping was employed to construct maps of the statistical significance of the difference between disease risk in each study area and the overall risk averaged over the entire map. Such a mapping procedure not only stabilizes the individual prevalence rates for population size variations (which contributes to apparent heterogeneity), but may also provide a tool for highlighting truly anomalous areas (Bailey and Gatrell, 1995). The global probability map for bancroftian filariasis is displayed in Figure 2.16 and, although as expected the transformation of the country prevalences to a



**Fig 2.15** Geographical distributions of bancroftian (A) and brugian (B) filariasis case prevalences based on the crude GBD estimates. Circles denote the corresponding prevalences (%) estimated for various Pacific islands and vary in size proportionately with the prevalence of each island. The figures in brackets indicate the number of countries



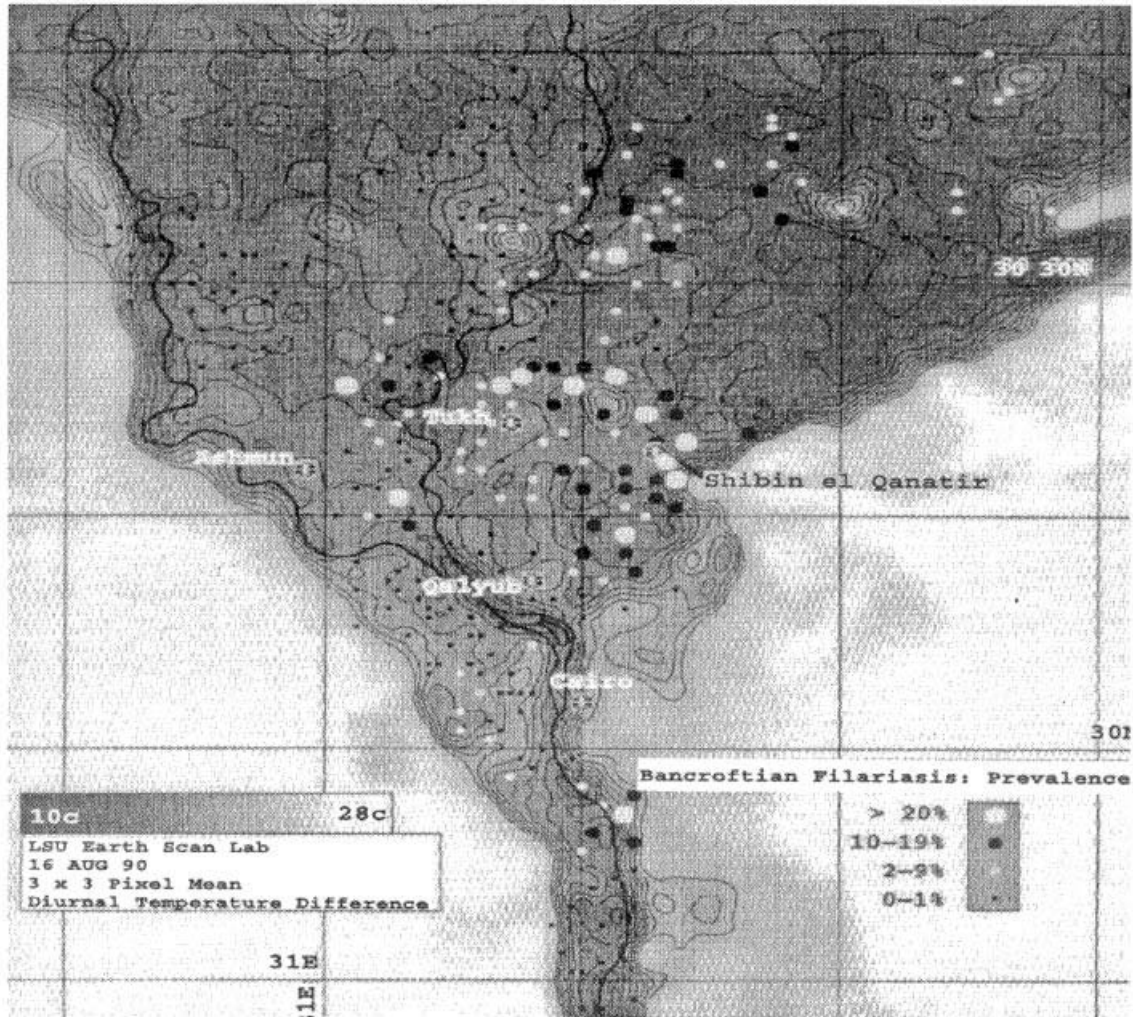
**Fig 2.16** Global Poisson probability map for bancroftian filariasis case prevalences. The map shows  $p_{i > \text{mean}}$  values, and may be interpreted by considering that there is a 'high probability' ( $p > 0.90$ ) that the prevalence estimated in each black area is higher than the mean global value (MGV); there is 'equivocal evidence' that the risk of each dark-shaded area is higher than the MGV ( $p = 0.50-0.90$ ) and that of each light shaded area is lower than the MGV ( $p = 0.10-0.50$ ); and, finally, there is a 'high probability' that the risk of each medium shaded area is lower than the MGV ( $p < 0.10$ ). (Note: caste probabilities for all the other endemic Pacific Island countries lay between 0.50 and 0.90)

probability scale replaces the high spatial variation of the original map with a more homogeneous pattern in the 'between-country' distribution of cases, the results also confirm the impression from Figure 2.15A that the underlying case rate for the disease is not constant across the world. Instead, the case rates exhibit strong regional variations, with more countries in Africa and the Pacific Island region (not shown) with probabilities of infection and disease higher than the global mean rate, compared to countries in Asia or South America (Figure 2.16). This finding of a significant regional influence on spatial variation suggests that separate analytical maps based on regional mean rates will be required to identify anomalous or priority counties within each endemic region. They also argue for a geographically targeted strategy for filariasis control.

### ***The Effect of Diurnal Temperature Differences on Bancroftian Filariasis Distribution***

Thomson *et al.* (1996) used remotely sensed data on diurnal temperature differences (dT) in conjunction with spatial data on case prevalences from 297 villages within the Southern Nile Delta, and showed that this environmental variable may underlie the observed spatial distribution of lymphatic filariasis, at least within their study region. dTs indicate surface and subsurface moisture contained in the soil and plant canopy, and hence may act as a surrogate for the abundance of the mosquito vector, *Culex quinquefasciatus*. Satellite image data from NOAA-AVHRR were analysed to determine dTs for the southern Nile Delta, while the case prevalence and locational data for each of the





**Fig 2.17** Mean diurnal temperature differences of southern Nile delta, 16 August 1990, with study village sites superimposed according to bancroftian filariasis prevalence category

297 villages were inputted into a GIS. Point dT values for each village were obtained by averaging the values for 3 × 3 pixel areas (10 km<sup>2</sup>) centred on the corresponding longitude and latitude of each village. The digitized filariasis prevalence data were superimposed on the dT map and assigned to each of four prevalence categories, 0.5%, 5%, 15% and 25%, respectively (Figure 2.17). The association between village dT value and prevalence category was investigated using stepwise polychotomous logistic regression, which indicated a significant relationship between the two variables. Similar

applications of dT maps or other remotely sensed data to delineate areas of risk with Bancroftian filariasis in other disease-endemic regions await study.

**REFERENCES**

Adams DC, Gurevitch J, Rosenberg MS (1997). Resampling tests for meta-analysis of ecological data. *Ecology* (in press).  
 Anand S, Hanson K (1995). *Disability-adjusted Life Years: A Critical Review*. Working Paper Series, No 95.06. Harvard

- Centre for Population and Development Studies: Cambridge, MA.
- Anderson RM (1994). The Croonian Lecture: populations, infectious diseases and immunity: a very nonlinear world. *Phil Trans R Soc Lond B* **346**: 457.
- Anderson RM, Grenfell BT (1986). Quantitative investigation of different vaccination policies for the control of congenial rubella syndrome (CRS) in the UK. *J Hyg* **96**: 309.
- Anderson RM, May RM (1979). Population biology of infectious disease. *Nature* **280**: 361–7.
- Anderson RM, May RM (1982a). Directly transmitted infectious diseases: control by vaccination. *Science* **215**: 1053.
- Anderson RM, May RM (1982b). Population dynamics of human helminth infections: control by chemotherapy. *Nature* **297**: 557.
- Anderson RM, May RM (1985). Herd immunity to helminth infection and implications for parasite control. *Nature* **315**: 493.
- Anderson RM, May RM (1990). Modern vaccines: immunisation and herd immunity. *Lancet* **335**: 641.
- Anderson RM, May RM (1991). *Infectious Diseases of Humans: Dynamics and Control*. Oxford: Oxford University Press.
- Anderson RM, Medley G (1985). Community control of helminth infections of many by mass and selective chemotherapy. *Parasitology* **90**: 629.
- Anderson RM, May RM, Boily M-C *et al.* (1991). The spread of HIV-1 in Africa: sexual contact patterns and the demographic impact of AIDS. *Nature* **352**: 581.
- Arfaa F, Ghadirian E (1977). Epidemiology and mass treatment of ascariasis in six rural communities in central Iran. *Am J Trop Med Hyg* **26**: 866–71.
- Arnqvist G, Wooster D (1995). Meta-analysis: synthesizing research findings in ecology and evolution. *Trends Ecol Evol* **10**: 236–40.
- Bailey TC, Gatrell AC (1995). *Interactive Spatial Data Analysis*. Longman Scientific & Technical: Harlow, UK.
- Bartlett MS (1957). Measles periodicity and community size. *J R Statist Soc A* **120**: 48.
- Beck LR, Rodriguez MH, Dister SW *et al.* (1994). Remote sensing as a landscape epidemiologic tool to identify villages at high risk for malaria transmission. *Am J Trop Med Hyg* **51**: 271–80.
- Black FL (1966). Measles endemicity in insular populations: critical community size and its implications. *J Theoret Biol* **11**: 297.
- Bolker B, Grenfell B (1995). Space, persistence and dynamics of measles epidemics. *Proc R Soc Lond B* **348**: 308.
- Bundy DAP (1988). Population ecology of intestinal helminth infections in human communities. *Phil Trans R Soc Lond B* **321**: 405.
- Bundy DAP, de Silva NR (1998). Can we deworm this wormy world? *Br Med Bull* **54**: 421–32.
- Bundy DAP, Guyatt HL (1996). Schools for Health: focus on health education and the school-age child. *Parasit Today* **12**: 1–16.
- Bundy DAP, Medley GF (1992). Immunoepidemiology of human geohelminthiasis ecological and immunological determinants of worm burden. *Parasitology* **104**: 105.
- Bundy DAP, Chan MS, Guyatt HL (1995). Practicability and sustainability of vaccination as an approach to parasite control. *Parasitology* **110**: S51.
- Bundy DAP, Grenfell BT, Rajagopalan PK (1991). Immunoepidemiology of lymphatic filariasis between infection and disease. *Immunol Today* **12**: 71–5.
- Bundy DAP, Thompson DE, Cooper ES *et al.* (1985). Population dynamics and chemotherapeutic control of *Trichuris trichiura* infection of children in Jamaica and St Lucia. *Trans R Soc Trop Med Hyg* **79**: 759.
- Bundy DAP, Wong MS, Lewis L *et al.* (1990). Control of geohelminths by delivery of targeted chemotherapy through schools. *Trans R Soc Trop Med Hyg* **84**: 115.
- Butterworth AE, Sturrock RF, Ouma JF *et al.* (1991). Comparison of different chemotherapy strategies against *Schistosoma mansoni* in Machakos District, Kenya: efforts on human infection and morbidity. *Parasitology* **103**: 339–55.
- Cabrera BD, Aramulo PV III, Portillo GP (1975). Ascariasis control and/or eradication in a rural community in the Philippines. *SE Asian J Trop Med Publ Health* **6**: 510–18.
- Chan L, Bundy DAP, Kan SP (1994a). Aggregation and predisposition to *Ascaris lumbricoides* and *Trichuris trichiura* at the familial level. *Trans R Soc Trop Med Hyg* **87**: 46.
- Chan MS, Guyatt HL, Bundy DAP, Medley GF (1994b). The development and validation of an age structured model for the evaluation of disease control strategies for intestinal helminths. *Parasitology* **109**: 389–96.
- Chan MS, Bundy DAP (1997). The effects of community chemotherapy on patterns of morbidity due to *Schistosoma mansoni*. *Trans R Soc Trop Med Hyg* **91**: 216–20.
- Chan MS, Hall BF, Bundy DAP (1995). Workshops on the modelling of potential schistosomiasis vaccination programmes. *Parasitol Today* **12**: 457.
- Clarke KC, Osleeb JR, Sherry JM, Meert JP, Larson RW (1991). The use of remote sensing and geographic information systems in UNICEF's dracunculiasis (Guinea worm) eradication effort. *Prevent Vet Med* **11**: 229–35.
- Cliff AD, Haggett P (1988). *Atlas of Disease Distributions. Analytical Approaches to Epidemiological Data*. Blackwell: Oxford.
- Cox MJ, Anderson RM, Bundy DAP *et al.* (1989). Seroepidemiological study of the transmission of the mumps virus in St Lucia, West Indies. *Epidemiol Infect* **102**: 147–60.
- Crombie JA, Anderson RM (1985). Population dynamics of *Schistosoma mansoni* in mice repeatedly exposed to infection. *Nature* **315**: 491.
- Donnen P, Brasseur D, Dramaix M *et al.* (1998). Vitamin A supplementation but not deworming improves growth of malnourished pre-school children in East Zaire. *J Nutrit* **128** (8): 1320–7.
- Drummond MF (1987). Resource allocation decisions in health care: a role for quality of life assessments? *J Chron Dis* **40**: 605–19.
- Dye C, Targett G (1994). A theory of malaria vaccination. *Nature* **270**: 95.
- Elkins DB, Haswell-Elkins M, Anderson RM (1986). The epidemiology and control of intestinal helminths in the Pulicat lake region of South India: I. Study design and pre-

- and post-treatment observations on *Ascaris lumbricoides* infection. *Trans R Soc Trop Med Hyg* **80**: 774.
- Fine PEM, Clarkson JE (1982). Measles in England and Wales II. The impact of the measles vaccination programme on the distribution of immunity in the population. *Int J Epidemiol* **11**: 15.
- Fleiss JL (1993). The statistical basis of meta-analysis. *Stat Methods Med Res* **2**: 121–45.
- Ford J, Katondo KM (1977). *The Distribution of Tsetse Flies in Africa*. Cook, Hammond & Kell: OAU.
- Gaitonde RB, Renapurkar DM (1979). Helminthiasis in India. Part I: prevalence and geographical distribution. *J Assoc Phys Ind* **27**: 129–35.
- Garnett GP, Anderson RM (1993). Contact tracing and the estimation of sexual mixing patterns: the epidemiology of gonococcal infections. *Sex Transm Dis* **20**: 181.
- Garnett GP, Anderson RM (1995). Strategies for limiting the spread of HIV in developing countries: conclusions based on studies of the transmission dynamics of the virus. *J AIDS* **9**: 500.
- Garnett GP, Ferguson NM (1996). Predicting the effect of varicella vaccine on subsequent cases of zoster and varicella. *Med Virol* **6**: 151.
- Gleick J (1987). *Chaos: Making a New Science*. Viking: New York.
- Gupta E, Trenholme K, Anderson RM *et al.* (1994). Antigenic diversity and the transmission dynamics of *Plasmodium falciparum*. *Science* **263**: 961.
- Gupta MC, Mithal KL, Arora KL, Tandon BN (1977). Effects of periodic deworming on nutritional status of *Ascaris*-infected pre-school children receiving supplementary food. *Lancet* **2**(8029): 108–10.
- Guyatt HL, Evans D (1992). Economic considerations for helminth control. *Parasitol Today* **8**: 397–402.
- Guyatt HL, Bundy DAP, Evans D (1993). A population dynamic approach to the cost-effectiveness analysis of mass anthelmintic treatment: effects of treatment frequency on *Ascaris* infection. *Trans R Soc Trop Med Hyg* **87**: 570–5.
- Guyatt HL, Chan MS, Medley GF, Bundy DAP (1995). Control of *Ascaris* infection by chemotherapy: which is the most cost-effective option? *Trans R Soc Trop Med Hyg* **89**: 16–20.
- Guyatt HL, Tanner M (1996). Different approaches to modelling the cost-effectiveness of schistosomiasis control. *Am J Trop Med Hyg* **55**: 159–64.
- Hall A, Anwar KS, Tomkins AM (1992). Intensity of reinfection with *Ascaris lumbricoides* and its implications for parasite control. *Lancet* **339**: 1253.
- Hammer JS (1993). The economics of malaria control. *World Bank Res Obs* **8**: 1–22.
- Hay SI, Packer MJ, Rogers DJ (1997). The impact of remote sensing on the study and control of invertebrate intermediate hosts and vectors of disease. *Int J Remote Sens* **18**: 2899–930.
- Hedges LV, Olkin I (1985). *Statistical Methods for Meta-analysis*. Academic Press: San Diego, CA.
- Howe FA (1989). Implementation and evaluation of data compression of MR images. *Magn Reson Imaging* **7**: 127–32.
- Jamison DT (1993). Disease control priorities in developing countries: an overview. In Jamison DT, Mosley WH, Measham AR, Bobadilla JL (eds), *Disease Control Priorities in Development Countries*. Oxford University Press: Oxford; 3–34.
- Keymer A, Pagel M (1990). Predisposition to helminth infection. In Schad GA, Warren KS (eds), *Hookworm Infection: Current Status and New Directions*. Taylor & Francis: London.
- Kitron U, Otien LH, Hungerford LL *et al.* (1996). Spatial analysis of the distribution of tsetse flies in the Lambwe Valley, Kenya, using Landsat TM satellite imagery and GIS. *J Animal Ecol* **65**: 371–80.
- Laga M, Diallo MO, Buré A (1994). Inter-relationship of sexually transmitted diseases and HIV: where are we now? *AIDS* **8**: S119.
- Macdonald T (1957). *The Epidemiology and Control of Malaria*. London University Press: London.
- May RM, Anderson RM (1990). Parasite host coevolution. *Parasitology* **100**: S89.
- McClellan A, Anderson RM (1986). The transmission dynamics of the measles virus in developing countries. Part I. *Epidemiol Infect* **100**: 111.
- Medley GF, Guyatt HL, Bundy DAP (1993). A quantitative framework for evaluating the effect of community treatment on the morbidity due to ascariasis. *Parasitology* **106**: 211–21.
- Michael E, Grenfell BT, Bundy DAP (1994). The association between microfilaraemia and disease in lymphatic filariasis. *Proc R Soc Lond B* **256**: 33–40.
- Michael E, Bundy DAP, Grenfell BT (1996). Re-assessing the global prevalence and distribution of lymphatic filariasis. *Parasitology* **112**: 409–28.
- Michael E, Bundy DAP (1997). Global mapping of lymphatic filariasis. *Parasitol Today* **13**: 472–6.
- Molineaux L, Gramiccia C (1980). *The Garki Project*. World Health Organization: Geneva.
- Mott KE, Nutall I, Desjeux P, Cattand P (1995). New geographical approaches to control of some parasitic zoonoses. *Bull WHO* **73**: 274–57.
- Murray CJL, Lopez AD (eds) (1994). *Global Comparative Assessments in the Health Sector, Disease Burden, Expenditures and Intervention Packages*. World Health Organization: Geneva.
- Nokes DJ, Anderson RM, Grabowsky M (1991). Measles immunization strategies for countries with high transmission rates: predictions using a mathematical model. *Int J Epidemiol* **19**: 703.
- Omumbo J, Ouma J, Rapuoda B, Craig MH, le Sueur D, Snow RW (1998). Mapping malaria transmission intensity using geographical information systems (GIS): an example from Kenya. *Ann Trop Med Parasitol* **92**: 7–21.
- Openshaw S (1996). Geographical information systems and tropical diseases. *Trans R Soc Trop Med Hyg* **90**: 337–9.
- Ottesen EA (1992). Infection and disease in lymphatic filariasis: an immunological perspective. *Parasitology* **104**: S71–9.
- Palm TA (1890). The geographical distribution and aetiology of ricketts. *Practitioner* **45**: 270–9.
- Partnership for Child Development (1997). Better health, nutrition and education for the school aged child. *Trans R Soc Trop Med Hyg* **91**: 1–2.

- Pelletier DI, Frongillo EA Jr, Schroeder DG, Habicht JP (1994). A methodology for estimating the contribution of malnutrition to child mortality in developing countries. *J Nutr* **10**: 2106S–22S (meta-analysis of eight prospective studies for association of weight and mortality).
- Petitti DB (1994). *Meta-analysis, Decision Analysis and Cost-Effectiveness Analysis: Methods for Quantitative Synthesis in Medicine*. Oxford University Press: Oxford.
- Peto R (1987). Why do we need systematic overviews of randomized trials? *Stat Med* **6**: 233–40.
- Poulin R (1996). Sexual inequalities in helminth infections: a cost of being male? *Am Natur* **147**: 287–95.
- Prescott NM (1987). The economics of schistosomiasis chemotherapy. *Parasitol Today* **3**: 21–5.
- Prescott NM (1993). Cost-effectiveness analysis of chemotherapy regimes of schistosomiasis control. In Mills A, Lee K (eds), *Health Economics Research in Developing Countries*. Oxford University Press: Oxford, 272–87.
- Richards FO (1993). Use of geographic information systems in control programmes for onchocerciasis in Guatemala. *Bull PAHO* **27**: 52–5.
- Robinson T, Rogers DJ, Williams B (1997). Mapping tsetse habitat in the common fly belt of Southern Africa using multivariate analysis of climate and remotely sensed vegetation data. *Med Vet Entomol* **11**: 235–45.
- Rogers DJ, Randolph SE (1991). Mortality rates and population density of tsetse flies correlated with satellite imagery. *Nature* **351**: 739–41.
- Rogers DJ, Randolph SE (1993). Distribution of tsetse and ticks in Africa, past, present and future. *Parasitol Today* **9**: 266–71.
- Rogers DJ, Randolph SE (1994). Satellite imagery, tsetse flies and sleeping sickness in Africa. *Sistema Terra* **3**: 40–3.
- Rogers DJ, Williams BG (1993). Monitoring trypanosomiasis in space and time. *Parasitology* **106**: 77–92.
- Rosenfield PL, Golladay F, Davidson RK (1984) The economics of parasitic diseases: research priorities. *Soc Sci Med* **19**: 1117–26.
- Ross R (1915). Some *a priori* pathometric equations. *Br Med J* **1**: 546.
- Savioli L, Tomkins AS, Bundy DAP (1992). Intestinal parasitic infections: a soluble public health problem. *Trans R Soc Trop Med Hyg* **86**: 353.
- Sayers B McA, Fliedna TM (1997). The critique of DALYs: a counter reply. *Bull WHO* **75**: 383–4.
- Schad GA, Anderson RM (1985). Predisposition to hookworm infection in humans. *Science* **228**: 1537.
- Sivakumar B, Reddy V (1975). Absorption of vitamin A in children with ascariasis. *J Trop Med Hyg* **78**: 114–15.
- Snow J (1854). *On the Mode of Communication of Cholera*, 2nd edn. Churchill Livingstone: London.
- Snow RW, Craig MH, Deichmann U, le Suer D (1999). A preliminary continental risk map for malaria mortality among African children. *Parasitol Today* **15**: 99–104.
- Stoll NR (1947). This wormy world. *J Parasitol* **33**: 1–18.
- Thomson MC, Malone JB, Harb M *et al.* (1996). Bancroftian filariasis distribution and diurnal temperature differences in the southern Nile delta. *Emerg Infect Dis* **2**: 234–5.
- Thomson MC, Connor SJ, Milligan P, Flasse SP (1997). Mapping malaria risk in Africa: what can satellite data contribute? *Parasitol Today* **13**: 313–18.
- Ukkonen P, von Bronsdorff C (1988). Rubella immunity and morbidity, effects of vaccination in Finland. *Scand J Infect Dis* **20**: 255.
- Warren KS, Bundy DAP, Anderson RM *et al.* (1993). Helminth infections. In Jamison TD, Mosely WH, Measham AR *et al.* (eds), *Disease Control Priorities in Developing Countries*. Oxford University Press: Oxford; 131–60.
- WHO (1997). *The World Health Report 1997: Conquering Suffering, Enriching Humanity*. Geneva: WHO.
- Woolhouse MEJ (1991). On the application of mathematical models of schistosome dynamics. I. Natural transmission. *Acta Tropica* **49**: 241–70.
- World Bank (1993). *World Development Report: Investing in Health*. Oxford University Press: Oxford.

# Malaria

**B.-A. Biggs and G. V. Brown**

*Department of Medicine, University of Melbourne, Royal Melbourne Hospital,  
Victoria, Australia*

Malaria is one of the major causes of disease for people living in tropical and subtropical areas. Despite intensive control efforts during the twentieth century, approximately 40% of the world's population still remain at risk of infection. Globally, it is estimated that there are 300–500 million new *Plasmodium* infections and 1.5–2.7 million deaths annually due to malaria (World Health Organization, 1996). Most morbidity and mortality is caused by *Plasmodium falciparum*, and the greatest disease burden is in African children under 5 years of age. Unfortunately, the impact of malaria infections on health is increasing as financial constraints continue to hamper malaria control programmes. Mosquitoes have become resistant to insecticides and drug-resistant parasites have spread through many endemic areas. Most recently, global warming has the potential to expand the extent of anopheline-susceptible areas and to put even more people at risk.

## HISTORICAL INTRODUCTION

It is likely that malaria first affected monkey and ape populations and then early humans living in the forests of Africa and Asia. The earliest record of probable human malaria infection occurred in a Chinese document prepared around 2700 BC (Bruce-Chwatt, 1988). The disease was well recognised by Hippocrates (460–370 BC) who classified fevers into quotidian, semi-tertian,

tertian and quartan patterns. He also noted the association between splenic enlargement, fever and ill-health and drinking water from marshy places. It had been postulated that 'marsh fevers' were caused by animals that passed through the air and into the body (Marcus Terentius Varro, 116–27 BC). They thus became known as 'mal' 'aria' (spoiled air) (Bruce-Chwatt, 1985). Peruvian bark (quinine-containing bark of the cinchona tree) had been used early in the seventeenth century by Jesuit priests to treat patients with intermittent fevers in South America. The first written account of its use in England occurred in 1652 (Metford, 1652).

Malaria parasites were first discovered in the blood of a soldier suffering from malaria in 1880 by a French Army Surgeon, Charles Laveran (Laveran, 1880a,b). There was considerable initial scepticism about this discovery, as many in the scientific community believed that malaria was caused by a bacterium, '*Bacillus malariae*'. In 1886, *Plasmodium vivax* and *P. malariae* were described as the causes of tertian and quartan malaria, respectively, by Camillo Golgi (1886). Marchiafava and Bignami and colleagues went on to describe *P. falciparum* in 1889 and were able to associate it with the most severe and lethal form of malaria (Marchiafava and Bignami, 1894). *Plasmodium ovale* was eventually observed in the blood of a patient from East Africa in 1922 (Stephens, 1922).

Patrick Manson had shown that mosquitoes were the likely vector for filariasis and in 1894

published the opinion (also held by many others) that mosquitoes were likely to harbour malaria parasites. Influenced and encouraged by Manson, Ronald Ross first observed parasite forms in mosquito stomach cells in India in 1897 (Ross, 1897). Subsequently, the Italian researchers Bignami, Bastianelli and Grassi described the entire sporogonic cycle of human plasmodia in *Anopheles* mosquitoes (Grassi *et al.*, 1899). Some 50 years later the exo-erythrocytic cycle of malaria was defined (Shortt and Garnham, 1948) and the dormant liver stages or hypnozoites responsible for relapses were discovered (Krotowski *et al.*, 1982).

Quinine was identified as the active constituent of Peruvian bark in 1820 and remained the drug of choice for treatment and prevention of malaria for the next century. During World War II, research efforts intensified and mepacrine hydrochloride (Atabrine) was tested, commercialised and then used widely in military personnel. Chloroquine was discovered in Germany and developed in the USA and by 1946 was considered the drug of choice for malaria. During the next few years proguanil and pyrimethamine were developed and used widely, although their effectiveness was noted to be declining during the 1950s. In 1960, *P. falciparum* resistance to chloroquine developed *de novo* in both Colombia and Thailand. Resistance has gradually spread through most malaria-endemic areas and has led to renewed reliance on quinine as the mainstay of malaria therapy, as well as to the development of several new antimalarial drugs.

The successful efforts by many countries to control malaria with insecticide spraying programmes led to the announcement in 1957 of a World Health Organization global campaign for the eradication of malaria. This campaign generated excellent results over the next 15 years in Europe, North America, Asia, Central America and the USSR, but malaria was never really threatened in the more severely affected areas of Africa. Unfortunately, the campaign stalled in many tropical countries due to lack of resources, increasing resistance of mosquitoes to insecticides and increasing resistance of parasites to antimalarial drugs. The resurgence of disease in many countries, together with the discovery by Trager and Jensen (1976) of a method to culture *P. falciparum* *in vitro*, followed by the cloning of

*P. falciparum* genes in 1983, has led to intense efforts to develop a malaria vaccine during the last two decades. Much progress has been made and the first results showing efficacy of a defined antigen malaria vaccine in experimental infections in humans were reported from the USA (Ballou *et al.*, 1987; Herrington *et al.*, 1987). When developed, a vaccine will only be one weapon in the fight against malaria that will need to be integrated with traditional and newer methods of control. In the meantime, current control activities require consolidation and, where appropriate, expansion to meet the complex challenges of this disease.

## DESCRIPTION OF THE ORGANISMS

### Taxonomy

The genus *Plasmodium* can be classified into nine subgenera: three occur in mammals (humans, primates and rodents), four in birds and two in lizards (Garnham, 1966). The species that infect humans are *P. falciparum*, *P. vivax*, *P. ovale* and *P. malariae*.

Molecular phylogenetic analysis using small subunit ribosomal RNA genes from various *Plasmodium* spp. has supported Garnham's original hypothesis, that *P. falciparum* originated from an avian malaria parasite (Waters *et al.*, 1991).

### Life-cycle and Morphology

#### *Pre-erythrocytic Stage*

All human *Plasmodium* spp. are transmitted by the bite of female *Anopheles* mosquitoes (Figure 3.1). At the time of feeding, sporozoites can leave the salivary ducts to enter the bloodstream, where they circulate for a short time before invading hepatocytes. Parasites develop in the liver over the next 7–10 days (pre-erythrocytic stage), with nuclear division to form schizonts. Hepatic infection is asymptomatic and may last from about 6 days to several weeks. When hepatocytes rupture, schizonts release into the bloodstream thousands of merozoites that in turn invade erythrocytes. In *P. vivax* and *P. ovale* malaria, some parasites may become dormant in



**Fig. 3.1** Female *Anopheles* mosquito resting after feeding. Photo courtesy of Dr Robert Gwadz

the liver (hypnozoites) and emerge at a later stage (up to 2 years or more after leaving an endemic area) to cause a relapse of disease. Delayed prepatent *P. vivax* infections also occur, with incubation periods of up to 6–9 months in some returned travellers.

### ***Asexual Stage***

The asexual blood stage begins when parasites leave hepatocytes and invade erythrocytes. The four human species may be differentiated according to their appearance in peripheral blood (Table 3.1; Figures 3.2 and 3.3). During this stage, merozoites mature inside the erythrocyte and develop from ring to mature trophozoites followed by asexual division (schizogony) to form schizonts, each of which may contain 24–32 merozoites (*P. falciparum* and *P. vivax*). Merozoites are released into the bloodstream as schizonts rupture and erythrocytes lyse. Symptoms of malaria typically occur at the time of

schizont rupture, when parasite toxins act on host cells to release cytokines, such as tumour necrosis factor (TNF). The cycle repeats itself at approximately 48 or 72 hour intervals, depending on the species of *Plasmodium*. As infection progresses, there is a tendency for replicative cycles to become synchronous. In some cases the parasitaemia can increase 10-fold every 48 hours.

### ***Sexual Stage***

A subpopulation of parasites differentiates into sexual stages (gametocytes), which can infect feeding mosquitoes to continue transmission. Both female and male gametocytes are produced. In *P. falciparum* infections, immature sexual stages are sequestered in the spleen and bone marrow (Thomson and Robertson, 1935; Smalley *et al.*, 1980). Maturation of gametocytes takes about 10–14 days after patency in *P. falciparum* infections, and 3 days in *P. vivax* infections (Day *et al.*, 1998). *P. falciparum* gametocytes can be

**Table 3.1** Morphology and other features

	<i>P. falciparum</i>	<i>P. vivax</i>	<i>P. malariae</i>	<i>P. ovale</i>
Asexual cycle (hours)	36–48	48	72	48
Erythrocyte preference	Prefers young RBCs but invades all stages	Reticulocytes	Old RBCs	Reticulocytes
Sequestration	Yes—mature asexual stages and gametocytes	No	Probably gametocytes	No
Asexual stages	RBC vary in size; small delicate ring trophozoites on thin smear, often multiple and at the edge of RBC; single or double chromatin dots; Maurer's dots; mature trophozoites and schizonts not seen in peripheral blood; multiple infections and high parasitaemia common	Enlarged RBCs; Schuffner's dots; delicate ring and amoeboid trophozoites; schizonts contain 12–24 merozoites	Normal sized RBCs; thick ring, large nucleus; trophozoites form 'bands'; schizonts have 6–12 merozoites	Enlarged oval RBCs; Schuffner's dots; smaller ring than <i>P. vivax</i> ; non-amoeboid trophozoites; schizonts contain approximately 8 merozoites
Gametocytes	Crescentic (banana)-shaped macro- and microgametocytes	Rounded or oval homogeneous cytoplasm; brown pigment	Similar to <i>P. vivax</i>	Smaller than <i>P. vivax</i>
Appearance of gametocytes (days)	7–10	3	14–21	4–18
Possible duration of untreated infection (years)	At least 2	4	40	4

Adapted from White (1996a).

found for a year or longer in non-immune individuals with untreated, induced infections (Jeffrey and Eyles, 1954, 1955). The morphology of gametocytes is best characterised for *P. falciparum* because of the ability to culture these parasites *in vitro* (Day *et al.*, 1998).

### **Development in the Anopheles Mosquito**

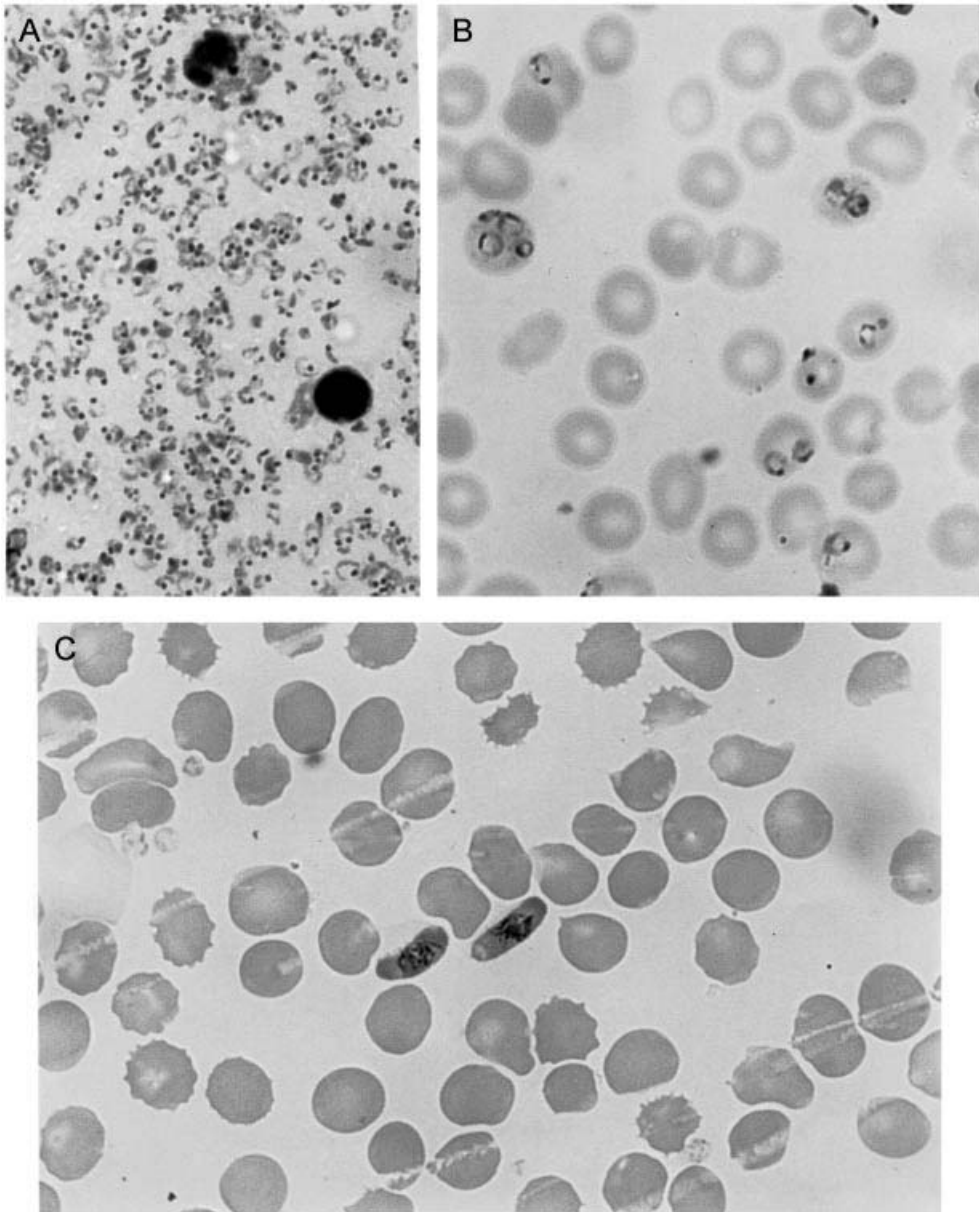
After ingestion by an *Anopheles* mosquito, gametocytes transform into male and female forms (micro- and macrogametes, respectively). Fusion and meiosis then occurs in the mosquito stomach to produce a zygote. The enlarging zygote then penetrates the wall of the mosquito midgut and transforms into an oocyst. Parasite development continues by asexual division until the mature oocyst contains thousands of motile sporozoites. After oocyst rupture, the sporozoites migrate to the salivary glands, where they can enter the human host at the time a blood meal is taken. Inoculation of sporozoites into the vasculature of a new human host during mosquito feeding completes the malaria life cycle. The actual number of sporozoites injected is

uncertain, with estimates ranging from a few (perhaps only those in the salivary duct) to several hundred. The development of the parasite in the mosquito (sporogony) takes 8–35 days.

### **PATHOGENESIS**

The events leading to invasion of erythrocytes following the pre-erythrocytic phase of the life cycle have been studied in great detail. Non-specific attachment to the erythrocyte is followed by apical reorientation of the merozoite prior to invasion. The specificity of the process is exemplified by *P. vivax* parasites, which can only invade erythrocytes of Duffy-positive Fy Fy phenotype (Miller *et al.*, 1976). The paroxysms of fever and chills that characterise acute malaria are related to the rupture of erythrocytes and release of merozoites and parasite products into the circulation. It is likely that the systemic symptoms are mediated by elevated cytokine levels, as anti-TNF antibodies have been shown to reduce fever in acute malaria (Kwiatkowski *et al.*, 1993).





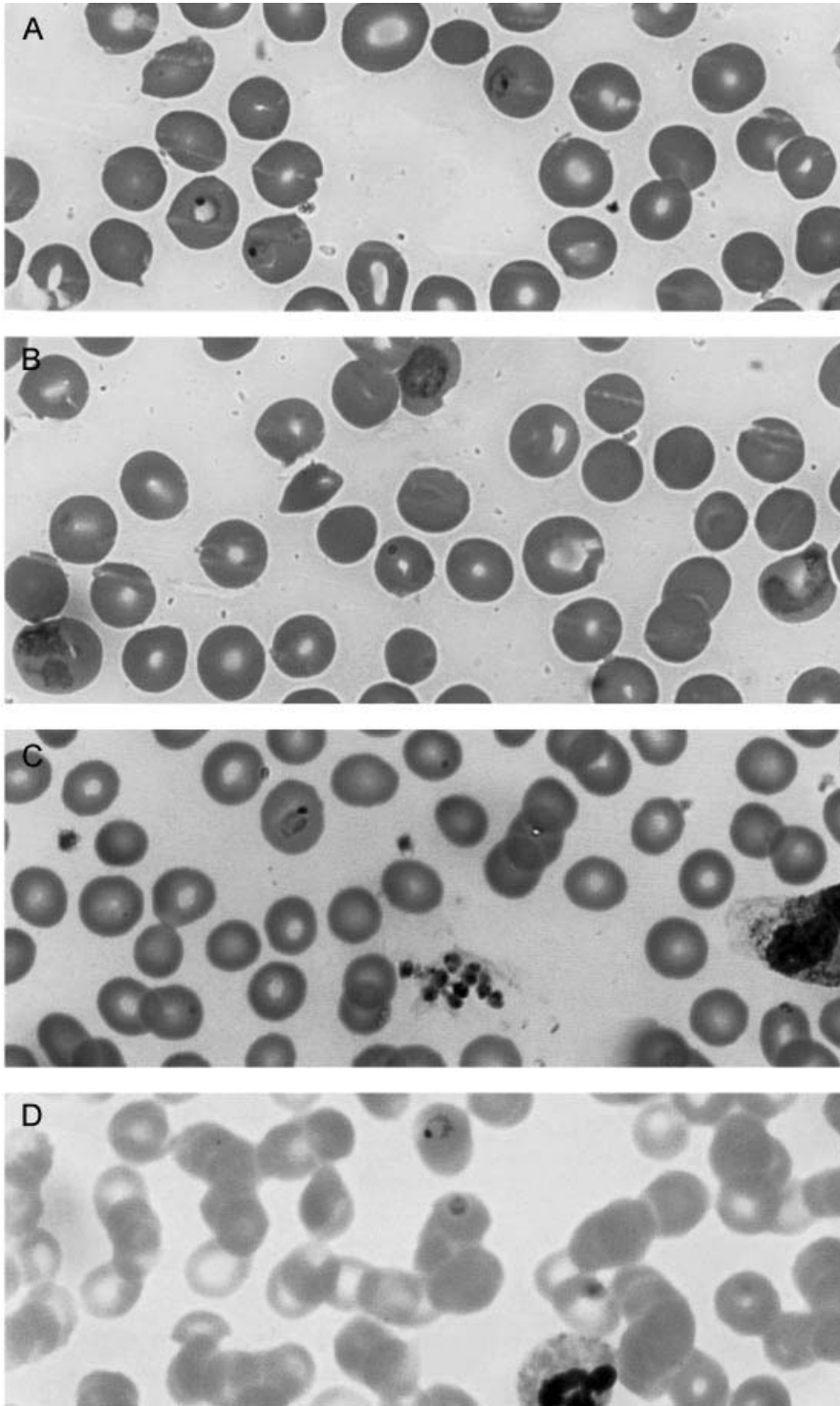
**Fig. 3.2** Morphology of *P. falciparum*. (A,B) Thick and thin films in a patient with high parasitaemia. (C) Gametocytes in peripheral blood after treatment (thin films). Photo courtesy of Mr Joe Manitta

*P. falciparum* has two distinguishing features, which contribute to its increased pathogenicity in comparison to the other species: it has the capacity for amplification to high parasitaemia (sometimes in excess of 30%) because red blood cells of any age can be invaded; and mature forms of the parasite alter the surface of infected

erythrocytes, causing them to sequester in particular vascular beds.

### Sequestration

The hallmark of *P. falciparum* malaria is the sequestration of infected erythrocytes within the



**Fig. 3.3** Morphology of *P. vivax*, *P. ovale* and *P. malariae*. (A) *P. vivax*, ring forms. (B) *P. vivax*, trophozoites. (C) *P. ovale*, ring and free merozoites. (D) *P. malariae*, ring form. Photo courtesy of Mr Joe Manitta

capillaries and postcapillary venules in the brain, lung, heart, bone marrow, kidney, liver, pancreas, intestine and other organs, and in the intervillous spaces of the placenta (Luse and Miller, 1971; White and Ho, 1992). Within 24 hours of erythrocyte invasion by merozoites, mature trophozoite and schizont-infected cells disappear from the peripheral blood and adhere to vascular endothelium (Figure 3.4). The slower blood flow and low oxygen tension provides a favourable environment for further parasite development. Sequestration also allows mature parasites to avoid passage through the spleen and likely clearance. In addition to adhesion to vascular endothelium, infected erythrocytes can adhere to uninfected erythrocytes (Figure 3.5) (see 'Rosetting', below) and clumps or layers of erythrocytes are sometimes observed extending into the vessel lumen in cerebral malaria. Sequestration from the peripheral blood stream may contribute to diagnostic difficulties in patients with highly synchronous infections (i.e. parasites all mature at the same time), as they may be critically ill at a time when parasites are at very low levels or occasionally undetectable in the peripheral circulation. *P. vivax*, *P. ovale* and *P. malariae* do not sequester, do not cause microcirculatory obstruction and are rarely fatal.

### Cytoadherence

Adherence of trophozoite and schizont-infected erythrocytes in target organs appears to be a major feature of the pathophysiology of *P. falciparum* malaria. As parasites mature, the infected erythrocytes become more rigid, less deformable, and changes occur in parasite and host surface proteins. One of the main changes in the host is the aggregation of Band 3, which leads to expression of 'senescence' antigen.

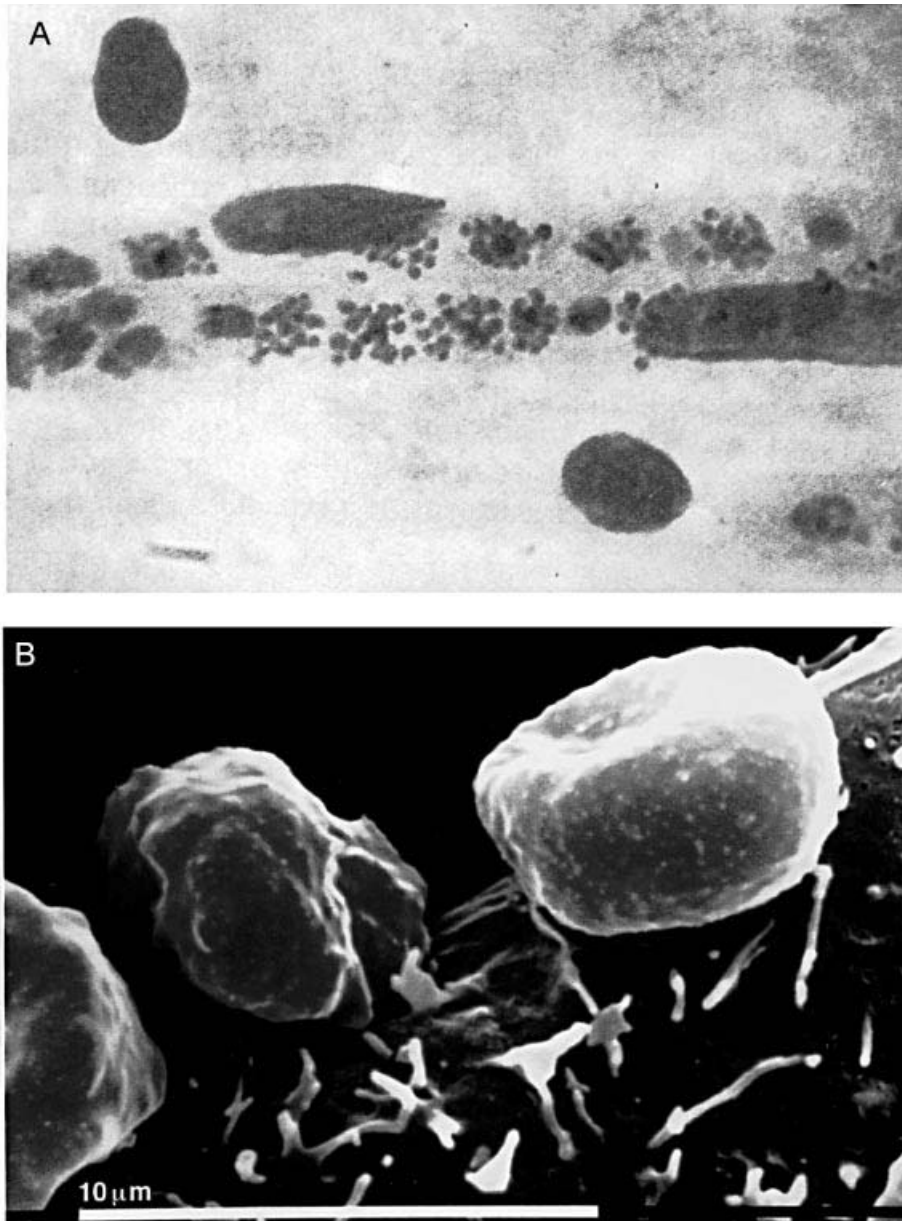
Infected cells usually adhere at the site of parasite-dependent electron-dense protrusions of the red cell membrane (referred to as 'knobs'). In addition, clonally derived populations of *P. falciparum* are able to alter parasite antigens expressed on the red cell surface, a process known as antigenic variation (Biggs *et al.*, 1991). Selection of isolates for a particular cytoadherence

phenotype is associated with antigenic variation, suggesting that the variant antigen is involved in cytoadherence (Biggs *et al.*, 1992). One variant antigen expressed at the surface of malaria-infected cells is known as *P. falciparum* erythrocyte membrane protein 1 (PfEMP1). PfEMP1 can bind to many receptors, including CD36 (Baruch *et al.*, 1995), and is usually expressed in conjunction with knobs. The *var* genes encoding this family of proteins have been identified and sequenced (Baruch *et al.*, 1995; Su *et al.*, 1995) but there may be other families of variant antigens that are also expressed at the surface of infected cells.

Many putative endothelial cytoadherence receptors have been described *in vitro*, and thrombospondin, CD36, ICAM-1, PECAM, VCAM and chondroitin sulphate A all support binding of some, but not all, *P. falciparum* infected erythrocytes *in vitro* (Figure 3.4). Field isolates may bind to any of these receptors, but CD36 binds the highest proportion of isolates. Binding of parasitised cells cultured from peripheral blood does not correlate with particular pathology, but a remarkably high proportion of infected cells harvested from placenta are able to bind to chondroitin sulphate A, suggesting that these may be markers for placental sequestration (Fried and Duffy, 1998; Beeson *et al.*, 1999) or hyaluronic acid (Beeson *et al.*, 2000). Parasite toxins and cytokines increase expression of surface endothelial ligands, thus contributing to a vicious cycle when sequestered cells mature and rupture, causing local cytokine release and upregulation of receptors, thus favouring sequestration of the next brood of parasites.

### Rosetting

Rosetting refers to the adherence of uninfected erythrocytes to erythrocytes containing mature forms of some, but not all, isolates of *P. falciparum*. The phenomenon is observed when suspensions of parasitised cells are viewed under the microscope, and for some isolates depends on the blood group of the cells used for culture (Figure 3.5). The relevance of the *in vitro* findings is debated, as in some (Carlson *et al.*, 1990), but

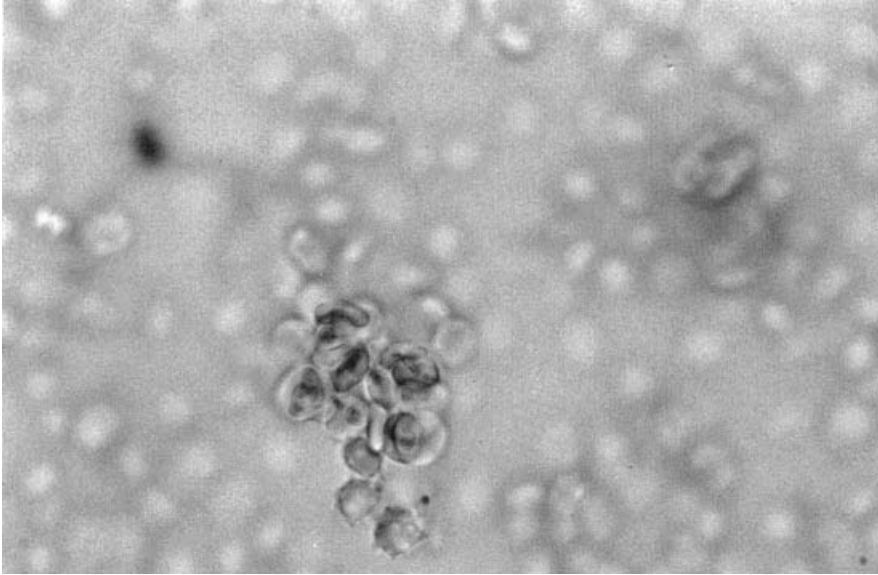


**Fig. 3.4** Adherence of trophozoite- and schizont-infected RBCs to vascular endothelium. (A) Section of brain from a patient with cerebral malaria. (B) *In vitro* cytoadherence of RBCs to Chinese hamster ovary cells. B reprinted from Rogerson and Brown (1997), with permission from Elsevier Science

not all, studies (e.g. al-Yaman *et al.*, 1995), the phenomenon has been associated with cerebral malaria. Other studies show an association with severe malaria with anaemia (Newbold *et al.*, 1997). At least for some parasites, rosetting is mediated by PfEMP1 (Rowe *et al.*, 1995).

### The Role of the Spleen

The spleen plays an important role in protection against malaria, and asplenic individuals may be at serious risk from *P. falciparum* infection. Indeed, experienced surgeons in tropical regions



**Fig. 3.5** Adherence of cultured trophozoite- and schizont-infected RBCs to uninfected RBCs ('rosettes')

take a conservative approach to management of splenic trauma in the knowledge of the increased mortality from malaria in individuals who have undergone splenectomy. The spleen enlarges with acute malaria, presumably as it functions to remove parasitised erythrocytes (recognised either because of their loss of deformability or propensity to form clumps of sequestered cells) from the peripheral circulation, and splenic macrophages remove dead parasites.

Some individuals have an excessively abnormal immune response to malaria and develop massive splenomegaly and hypergammaglobulinaemia [hyper-reactive malarial splenomegaly (HMS), formerly known as tropical splenomegaly syndrome]. These individuals from genetically predisposed populations have apparently normal clinical immunity to malaria but suffer the effects of hypersplenism (anaemia, leukopenia and thrombocytopenia). Characteristic changes are seen in liver histology. Splenectomy is contraindicated and the individuals usually have a gratifying response to long-term administration of antimalarial prophylaxis. The pathophysiology of HMS involves an overproduction of polyclonal IgM in response to repeated infections with *P. falciparum*, *P. malariae* or *P. vivax*. This appears to be due to a depletion of suppressor T cells, leading to a lack of inhibition of B cell

activity and failure of maturation of the immune response to IgG production (Piessens *et al.*, 1985; Bates *et al.*, 1991). HMS and splenic lymphoma with villous lymphocytes are clinically indistinguishable and appear to be aetiologically related (Bates and Bedu-Addo, 1997).

## **PATHOLOGY OF CLINICAL SYNDROMES**

It is likely that many factors influence the severity of malaria. These include the genetic make-up of the host and a complex interaction between immune responses (including circulating cytokines), metabolic disturbances, the vasculature, inducible expression of adhesion ligands on vascular endothelial cells and the variable ability of different parasites to bind to them (Gardner *et al.*, 1996; Rogerson and Brown, 1997).

### **Cerebral Malaria**

The main histopathological feature of cerebral malaria is widespread sequestration of infected erythrocytes in the cerebral microvasculature. Capillaries and postcapillary venules are dilated and congested and appear to be obstructed by

parasitised erythrocytes. Minor endothelial cell damage is apparent and there is evidence of endothelial activation (Turner *et al.*, 1994). Raised intracranial pressure has been reported in some children with cerebral malaria, but the contribution of elevated intracranial pressure to the pathogenesis of cerebral malaria remains unclear (Newton *et al.*, 1991; White and Ho, 1992). Macroscopically, the brain appears oedematous and hyperaemic, with evidence of haemozoin ('malaria pigment') deposition, and petechial or punctate (or 'ring') haemorrhages are well documented at post mortem in non-immune children dying from cerebral malaria (Newton *et al.*, 1998). There is a surprising lack of other findings, such as major haemorrhage, vascular thrombi, ischaemia or inflammatory cell infiltrates.

### Respiratory Distress

Respiratory distress in individuals with severe malaria is well described and has been attributed to pulmonary oedema or to the adult respiratory distress syndrome, especially in adults. It may also be due to coexistent pneumonia, sequestration of malaria parasites in the lungs, or a central drive to respiration in association with cerebral malaria. Recent studies in children have shown that most cases of respiratory distress are secondary to metabolic acidosis, and that this is an indicator of poor prognosis. Acidosis was shown to be associated with lactic acidemia in about 85% of cases in Kenya (Marsh *et al.*, 1996), and has also been reported as a feature in Gambian children with severe malaria (Krishna *et al.*, 1994). Acidosis in conjunction with a normal blood lactate may be due to exogenous acids (such as salicylate) or to reduced clearance of fixed acids in those with renal impairment. Lactic acidosis is likely to be the end result of reduced delivery of oxygen to the tissues and is exacerbated by anaemia and hypovolaemia (White and Ho, 1992; Newton *et al.*, 1998).

### Anaemia

Infection with *P. falciparum* causes changes in the erythrocyte membrane, partly due to alteration of host membrane, such as aggregation of

band 3 to produce 'senescence antigen' and partly due to insertion of parasite proteins. Electron-dense deposits (or 'knobs', that include the knob-associated histidine-rich protein, KAHRP) are associated with alterations in the erythrocyte membrane, which make red cells less deformable and presumably more susceptible to clearance. Exposure of novel immunoreactive antigens may lead to haemolytic anaemia and accelerated splenic clearance but this does not appear to be the major cause of anaemia in chronic malaria. Cytokine-mediated suppression of haematopoiesis is likely to be a cause of dyserythropoiesis and explains why anaemia in malaria is often disproportionately high compared with the level of parasitaemia. This is supported by a recent study, in which levels of IL-10 (a regulator of TNF) were significantly lower in patients with severe anaemia than in other groups (Kurtzhals *et al.*, 1998). Other causes of anaemia, such as deficiency of iron or other haematin and haemoglobinopathies, are also common in malaria-endemic areas and may contribute to malaria-associated anaemia.

### Thrombocytopenia and Coagulation

Moderate thrombocytopenia is a common finding at presentation with all human malaria infections. It is unclear whether thrombocytopenia is caused mainly by decreased platelet survival, enhanced aggregation and sequestration from adherence to activated cells in the spleen and elsewhere, or antibody-mediated clearance (Weatherall and Abdalla, 1982; White and Ho, 1992). It is rarely associated with bleeding but may provide a clue to the diagnosis of malaria. Disseminated intravascular coagulation occurs in about 5% of patients with severe malaria (White, 1998). Microvascular thrombus formation can be seen in severe malaria, but is uncommon (White and Ho, 1992).

### Renal Failure

*P. falciparum* is the only species which causes acute renal failure (although *P. malariae* can cause a chronic nephropathy leading to nephrotic

syndrome and chronic renal failure). Sequestration of parasitised erythrocytes is evident in glomerular and interstitial vessels. There is also evidence of reduced renal blood flow and oxygen delivery in *P. falciparum* malaria (Day *et al.*, 1997). It is unclear whether this is a result of sequestration of parasitised erythrocytes in the kidney or a local or systemic effect of circulating vasoactive compounds. Malaria-associated ARF has features of acute tubular necrosis (ATN), seen in bacterial sepsis. Histologically there are changes in the tubules consistent with ATN, and haemoglobin tubular casts and tubular atrophy have been demonstrated in cases of blackwater fever (Sitprija *et al.*, 1967; Day *et al.*, 1997). Glomerulonephritis is rare.

The descriptive term 'blackwater fever' refers to a clinical setting in which the patient passes very dark urine as a result of excessive intravascular haemolysis, and is not necessarily associated with renal failure. It can occur with severe malaria alone but may be associated with administration of quinine or oxidant drugs in individuals with glucose-6-phosphate dehydrogenase (G-6-PD) deficiency.

### Hypoglycaemia

Hypoglycaemia (blood glucose concentration  $\leq 2.2$  mmol/l or 40 mg/dl) is generally associated with quinine infusion in adults and is most often attributed to quinine-induced hyperinsulinaemia, although other mechanisms, such as the effect of circulating cytokines, are likely to be involved. In children, pretreatment of hypoglycaemia is important. It is present in 10–20% of African children on presentation with cerebral malaria and is associated with a poor prognosis (Newton *et al.*, 1998). High parasitaemias contribute to hypoglycaemia and probably also to lactic acidosis. Parasites consume glucose at a rate of 70 times that of erythrocytes to generate energy from anaerobic glycolysis of glucose to lactic acid. Sick patients are also likely to have high levels of circulating cytokines, which also contribute to the abnormal metabolic state (White *et al.*, 1983; Krishna *et al.*, 1994).

### Pregnancy

In areas of intense malaria transmission, women have clinical immunity to malaria that develops

during childhood. This immunity is challenged when marked proliferation of *P. falciparum* occurs in the placenta during the first pregnancy. In spite of marked sequestration of infected erythrocytes in placental capillaries, pregnant women are often asymptomatic, although infection is linked with maternal anaemia and low birth weight, especially in the first pregnancy (McGregor, 1984; Greenwood *et al.*, 1989). This contrasts to areas of unstable transmission, where symptomatic disease is common and pregnant women are at risk of severe falciparum malaria (White and Ho, 1992). Pregnant women with severe malaria are at higher risk of developing pulmonary oedema and hypoglycaemia (especially quinine-stimulated hyperinsulinaemic hypoglycaemia) and have an increased mortality rate (Looareesuwan *et al.*, 1985). Severe malaria is also associated with premature labour and spontaneous abortion, low birth weight and increased infant mortality (White and Ho, 1992).

### Heart and liver

Sequestration of erythrocytes also occurs in the heart, but myocardial dysfunctions, including arrhythmias, are uncommon in severe falciparum malaria. Jaundice and abnormal liver function tests are often present but hepatic failure is rare. Histologically, hepatocytes appear swollen and contain haemosiderin, there is hyperplasia of Kupffer and mononuclear cells, and sinusoidal dilatation is observed.

## IMMUNOLOGY

The control of acute malaria infection depends on the development of both specific humoral and cell-mediated responses as well as non-specific host defence mechanisms. Immunity is acquired through repeated infections in childhood, although certain genetic determinants are known to confer protection against malaria from birth.

### Specific ('Acquired') Immunity

The complexity of the human immune response to infection with *Plasmodium* reflects the multiple stages of the parasite life cycle and the great

variety of antigens presented to the host. Many of these antigens stimulate immune responses that show some correlation with protection in epidemiological surveys, but the number of antigens and the extent of antigenic diversity has made it difficult to determine the antigens which are the target of protective immunity against blood stages. Immunity to malaria is slow to acquire (following many infections and many years), is incomplete, and wanes rapidly. Sterile immunity rarely occurs and continual or repeated infection is required for maintenance of immunity. Clinical immunity in the presence of ongoing infection (concomitant immunity) is a common feature of chronic parasitism.

Many parasite-specific immune responses correlate with age-dependent acquisition of immunity in an endemic area, but none has been shown to provide a marker for individual immunity and none is of value in clinical management.

The critical role that antibodies may play in protection was shown with the demonstration that immunoglobulin preparations from immune adults could be used to treat parasitaemia in children in West Africa (Cohen and McGregor, 1961). Antibodies directed to antigens on the surface of infected cells provided the best prediction for protection against subsequent clinical episodes in children (Marsh *et al.*, 1996). The important role of antibodies directed against surface antigens as a determinant of clinical immunity gained further support from longitudinal studies of populations in East Africa (Bull *et al.*, 1999).

Many different parasite-specific cellular immune responses have been described in clinically immune individuals in endemic areas but none has been shown to correlate with protection. Various effector immune mechanisms have been described in rodent systems that are of uncertain relevance to *P. falciparum* in its natural human host. Interestingly, the AIDS epidemic does not seem to have led to profound increases in the number of individuals dying from severe malaria.

### Non-specific Immunity and 'Innate' Resistance

Individuals vary in their susceptibility to consequences of malaria infection. A proportion of

individuals in an endemic area die from disease, but the majority develop clinical immunity that protects them throughout life in the presence of continued exposure. Children may survive several episodes of clinical or asymptomatic infection before succumbing to *P. falciparum* malaria. In model systems, 'non-specific' immunity can be induced with immune stimulants such as *Corynebacterium parvum* or BCG, suggesting that macrophage activation may contribute to acquired resistance.

Several factors may contribute to 'innate resistance' to malaria, including red blood cell defects such as polymorphisms of haemoglobin, enzymes or membrane proteins. Children who are carriers of haemoglobin S have 90% protection against severe malaria (Hill *et al.*, 1991). Sequestration of parasitised erythrocytes apparently increases the sickling of parasitised HbAS cells, because cells are trapped in the peripheral microvasculature where the oxygen tension is lower. This leads to inhibition of parasite growth and protection against severe complications, including cerebral malaria. Certain forms of G-6-PD deficiency are associated with approximately 50% reduction in risk of severe malaria (Ruwende *et al.*, 1995). Melanesian ovalocytosis, arising from polymorphism of red cell membrane protein band 3, also provides substantial reduction in risk of cerebral malaria (Genton *et al.*, 1995), and Africans whose erythrocytes lack the Duffy blood group antigen on their erythrocytes are resistant to invasion by *P. vivax*.

Other genetic determinants of the host immune response are also central to the outcome of infection. For example, certain MHC class I and class II alleles were associated with protection against cerebral malaria and anaemia in West Africa (Hill *et al.*, 1991). It is also likely that many other genetic determinants, unrelated to immune responsiveness, provide protection from lethal malaria.

### Clinical Immunity in Individuals Living in Endemic Areas

Infants of immune mothers living in an endemic area have a low incidence of malaria, presumably as a result of passively acquired immunity. Young children have frequent episodes of parasitaemia



(infection) and also develop clinical disease but show marked variation in their ability to tolerate high parasite loads. The development of 'tolerance' to circulating parasites and their products is one of the first signs of clinical immunity. Manifestations of disease in children living in endemic areas are variable, with major morbidity and mortality towards the end of the first year of life in areas of greatest intensity (usually from severe anaemia). This compares with the major impact on slightly older children (2–3 years), especially of cerebral malaria, in areas of less intense transmission. Clinical attacks decrease in frequency until adult life, when disease is uncommon. Immunity is slow to develop and short-lived, so that semi-immune individuals very rapidly lose immunity if they leave an endemic area. Repeated infection appears to be necessary for maintenance of clinical immunity and sterile immunity is rarely, if ever, achieved. Cumulative prevalence of infection in individuals in an endemic area is close to 100%. Elimination of parasitaemia through drugs or lack of exposure leads to rapid reduction in immunity and susceptibility at next exposure. Older children have clinical immunity that lasts throughout adult life (with the exception of pregnancy), so long as there are regular episodes of reinfection. It is important to note, however, that very severe consequences of malaria, including mortality, may occur in individuals who have survived many previous episodes without deleterious consequences. There is no test for immunity to infection and even the most resistant individual must be considered to be only semi-immune.

### **Mechanisms of Immune Evasion—Antigenic Diversity and Antigenic Variation**

Malaria parasites demonstrate extraordinary diversity of many antigens located on the merozoite and infected red cell surface. This has been studied extensively in *P. falciparum* and *P. vivax* but little information exists for the other human malarias.

In addition to the diversity, individual clonal parasite populations of *P. falciparum* are able to alter the antigens expressed on the surface of infected red cells (a process known as antigenic

variation). Each parasite appears to contain 50–150 *var* genes encoding these surface antigens (Smith *et al.*, 1995; Su *et al.*, 1995), thus providing an effective mechanism for evading the host immune response while continuing to live within the host (additionally, as referred to above, variant antigens are able to bind to different vascular endothelial receptors, thereby inducing different pathological consequences).

### **MOLECULAR BIOLOGY**

Plasmodia are haploid organisms whose genome has been studied most extensively in *P. falciparum*. There are 14 chromosomes that vary in size amongst different isolates from 0.6 to 3.4 Mb, with total size approximately 30 Mb (Triglia *et al.*, 1992). Fertilisation in the mosquito gut produces the zygote (a diploid stage), which differentiates into oocysts containing the meiotic products of a single zygote and, finally, haploid sporozoites. Infected individuals frequently carry more than one infection, thus cross-mating, and production of new genotypes is common (Babiker *et al.*, 1994).

Two extra chromosomal elements of 6 kb (linear) and 35 kb (circular) are also present, the latter demonstrating similarity with genes of chloroplasts, suggesting a plant origin.

The genome of *P. falciparum* is the subject of intense scrutiny and the entire sequence is expected to be known by the year 2001. Malaria DNA is AT-rich, with average GC content of 18%, and is noted for its instability during attempts at cloning. Recent advances in obtaining stable transfection (Crabb and Cowman, 1996) have provided impetus to attempts to understand gene regulation and developmental control of gene expression in malaria.

An unusual feature of the genome of *P. falciparum* is the presence of distinctive categories of repeat sequences that account for about 10% of the DNA in *P. falciparum* (Coppel and Black, 1998). Blocks of repeats may provide mechanisms for diverting effective immune responses but they are also apparent in enzymes that are likely to be expressed internally. Multigene families include *var* genes (coding for surface adherence molecules, as described above) and others, such as *stevor* and *rif1*, whose functions are currently

unknown but may also be expressed at the red cell surface.

### Genetic Diversity

Monoclonal antibody typing and, more recently, analysis of PCR products of variant genes have demonstrated tremendous allelic diversity of many different genes encoding parasite antigens, such that essentially every infection is caused by a different parasite (Walliker *et al.*, 1998).

Detection of stage-specific ribosomal RNA in *Plasmodium* allows speciation and assessment of proportions of different subgroups of parasites in a sample (Rogers *et al.*, 1998). The 35 kb extrachromosomal DNA (whose genome is related to the plastid genome of green algae; Kohler *et al.*, 1997) encodes ribosomal RNAs that may provide parasite-specific targets for new antimalarial drugs (Waller *et al.*, 1998).

Much effort has gone into defining the relationship between differing clinical manifestations of *P. falciparum* infection and parasite phenotype (and genotype). The only significant associations identified so far have been with the rosetting phenotype and cerebral malaria (in some but not all studies) and anaemia, and malaria morbidity and levels of TNF (Grau *et al.*, 1989; Kwiatkowski *et al.*, 1990, 1993). It is likely that the latter association is predominantly due to host genetic differences (McGuire *et al.*, 1994, 1999; Burgner *et al.*, 1998). No definite association has been shown between clinical malaria and the cytoadherence phenotype, although the predilection for strains of *P. falciparum* expressing different variants of PfEMP1 for different host cytoadherence receptors and the association between placental malaria and adhesion to chondroitin sulphate A is highly suggestive (Biggs *et al.*, 1992; Rogerson *et al.*, 1995; Rogerson and Brown, 1997; Fried and Duffy, 1998).

## EPIDEMIOLOGY

### Distribution

The prevalence of malaria has increased at an alarming rate during the last decade. There are now an estimated 300–500 million cases

annually, which occur in some 101 countries and territories, of which almost half are situated in Africa south of the Sahara (Figure 3.6, see Plate V) (World Health Organization, 1998b). Recent epidemics have caused a high number of deaths, many in areas previously free of the disease (Nchinda, 1998). It is estimated that 3000 children under the age of 5 years die from malaria every day (World Health Organization, 1998b). Frequent international air travel has also resulted in increasing numbers of imported cases and deaths in returned travellers and visitors to developed countries previously declared free of the disease.

A number of factors appear to have contributed to the resurgence of malaria (Nchinda, 1998). These include breakdown of control programmes, rapid spread of resistance of malaria parasites to chloroquine and other quinolines, and the migration of non-immune populations (for the purposes of agriculture, commerce or trade) from areas that are free from malaria to areas where transmission is high. In addition, armed conflicts have caused displacement of large populations of refugees to areas where living conditions are difficult and the risk of malaria is often high. Changing rainfall patterns and land use, leading to new mosquito breeding sites, and changes in vector behaviour have further compounded the problem. In general, governments have responded slowly to the changing malaria situation because of adverse socioeconomic conditions and limited resources for health.

Malaria occurs most commonly in the tropics as high humidity and ambient temperatures of 20–30°C provide optimal conditions for mosquito vectors and for the development and transmission of malaria parasites. In contrast, malaria transmission does not occur at temperatures below 16°C or at altitudes greater than 2000 m because there is little development of malaria parasites in mosquitoes under these conditions.

Ninety per cent of malaria cases occur in sub-Saharan Africa. *P. falciparum* is the predominant species in Africa and is responsible for the deaths of one in 20 rural African children before they reach the age of 5 (Murphy and Oldfield, 1996). Some 74% of the population in the African region live in areas where malaria transmission is

intense and perennial (World Health Organization, 1996) *P. falciparum* is also the predominant species in Papua New Guinea and Haiti. *P. vivax* predominates in North Africa, the Middle East, and Central and South America. In the Indian subcontinent, some 40% of cases are due to *P. falciparum*. Urban malaria remains a problem in India, occurring in a number of major cities, including Bombay, Delhi, Calcutta and Madras (World Health Organization, 1996). In other areas, the prevalence of the two species is about equal. *P. vivax* is rare in sub-Saharan Africa. *P. ovale* is confined mainly to West Africa, and *P. malariae*, although found in many areas, is most common in Africa.

The transmission and pattern of clinical malaria may vary considerably, even within small geographic areas, depending on the characteristics of the anopheline mosquito vector and the susceptibility and accessibility of human hosts. In most situations, malaria transmission appears to be directly related to vector density (often maximum in the humid rainy season), the number of times the mosquito bites man each day, and the longevity of the mosquito. Different species of anopheline mosquito vary in their ability to transmit malaria, and of the nearly 400 known species only about 60 are considered important vectors. (Bruce-Chwatt 1985; Zheng and Kafatos, 1999) *Anopheles gambiae* complex and *A. funestus* are important vectors in Africa, *A. culicifacies*, *A. dirus*, *A. sinensis*, *A. minimus* in Asia, *A. farauti* and *A. maculatus* in the Pacific and *A. albimanus* in South America.

*Anopheles* mosquitoes can be recognised when feeding as the proboscis, head and abdomen lie in a straight line at an angle of about 45° to the surface on which they rest. Each anopheline species has its own behaviour pattern, which influences its role in transmission. For example,

*A. gambiae* complex are the most successful malaria vectors because they are resilient, long-lived and bite humans frequently. *A. dirus* complex breed in trees near collections of water and are an important cause of 'forest fringe' malaria in South East Asia.

## Types of Malaria Transmission

### Endemic

Malaria is said to be endemic when there is a constant incidence of cases and transmission in an area over a period of successive years (Bruce-Chwatt, 1985). Endemicity may be defined in terms of the spleen and parasite rates in children aged 2–9 years (White, 1996a) (Table 3.2). Hypoendemicity describes a situation where there is little malaria transmission and the impact on the population is minor; mesoendemicity refers to varying intensity of transmission, depending on the local situation; and hyperendemicity refers to intense but seasonal transmission, where immunity is insufficient to protect against disease in all age groups. Holoendemicity refers to year-round intense transmission, resulting in high levels of immunity to malaria in all age groups (especially adults) and maximal morbidity in young children and in pregnancy. Individuals living in holoendemic areas may receive up to two infectious bites per day. Serological evaluation, vector density, longevity and sporozoite infection rates may also be used to assess malaria activity in an endemic area.

### Epidemic

Epidemic malaria indicates periodic increases in the number of malaria cases in an endemic area, or

**Table 3.2** Endemicity of malaria

	Child spleen rate (%) <sup>1</sup>	Adult spleen rate (%) <sup>1</sup>	Parasite prevalence (%) <sup>2</sup>
Hypoendemic	< 10		< 10
Mesoendemic	11–50		11–50
Hyperendemic	51–75	> 25	51–75
Holoendemic	> 75	Low	> 75

<sup>1</sup>The proportion of persons in a given community with enlarged spleens.

<sup>2</sup>The proportion of persons in a given community with malaria parasites in their blood.

Adapted from White (1996a).

a sharp increase in the incidence of malaria among a population in which the disease was unknown. Epidemics are often seasonal and mainly relate to increased breeding activity and survival of the *Anopheles* vector, or to increased susceptibility or accessibility of the human population. Epidemic malaria is associated with a high mortality (Bruce-Chwatt, 1985). Epidemics have occurred in India, Sri Lanka, South East Asia (including Vietnam), Madagascar and Brazil.

### **Imported**

Malaria is classified as imported when the infection was acquired outside a given area. Secondary cases, contracted locally from imported cases, are known as introduced malaria. Imported malaria has increased in recent years as a result of increasing international air travel and worsening antimalarial drug resistance. An imported *Anopheles* mosquito (which has usually been transported from an endemic area to a non-endemic area by aeroplane) sometimes transmits malaria. This is known as airport malaria (Jenkin *et al.*, 1997).

### **Accidental**

Accidental transmission of malaria (usually as a result of a blood transfusion, transplantation, needle-sharing between intravenous drug addicts, or laboratory mishaps; Burne, 1970; Freedman, 1987) may also occur rarely. Congenital infection of the newborn from an infected mother is also well documented (Ahmed *et al.*, 1998) and relatively common in some areas of Africa.

### **Patterns of Clinical Disease**

The prevalence of disease, parasitaemia and splenomegaly decline with age in areas with high malaria endemicity as partial immunity is slowly acquired following repeated infections ('stable' malaria). As intensity of transmission increases, clinical malaria becomes concentrated in the young (< 10 years old) and severe malaria (cerebral malaria or severe anaemia) in the very young (< 5 years old) (Molineaux, 1996). Babies in

endemic areas develop clinical symptoms infrequently, possibly because of the relative inability of parasites to utilise haemoglobin F, and also because of immunity developed *in utero*, including passive transfer of maternal antibody (Pasvol *et al.*, 1977; McGregor, 1984). Infants suffer frequent episodes of malaria before acquiring immunity that provides protection against disease until the onset of the first pregnancy. In the early years of exposure, patterns of clinical disease vary, depending on level of exposure. In the first 2 years of life, severe anaemia is the major killer in areas where transmission is highest. Cerebral malaria predominates at a slightly older age in areas where exposure is slightly less (Snow *et al.*, 1994). Adults almost never develop severe malaria in hyperendemic and holoendemic areas unless they leave the malarious area and return years later when immunity has waned. Indeed, most malaria in adults in these areas is asymptomatic.

Symptomatic infections are more common and may occur at any age in areas where transmission of malaria is low or erratic ('unstable' malaria). Severe malaria, which may manifest as cerebral malaria, pulmonary oedema, jaundice and/or acute renal failure (ARF), is also more common in adults in areas of unstable malaria (Hien *et al.*, 1996). If malaria transmission rates in a hyper- or holoendemic area fall, either as a result of malaria control measures or reduced rainfall, severe malaria is occasionally observed in adults with waning immunity and epidemics may occur.

In non-malarious areas, malaria may be imported in the blood of returning travellers, visitors, immigrants, and military personnel. There are approximately 7000–8000 cases of imported malaria reported each year in Europe (Behrens and Curtis, 1993; Bradley *et al.*, 1994) and 1000 in the USA (Centers for Disease Control and Prevention, 1995). The country of origin of imported malaria depends on the common destinations of the travelling population (e.g. Africa is a common destination for British travellers, South East Asia for Australian travellers) and partly determines whether *P. falciparum* or *P. vivax* is the most likely aetiological agent. The other important factor is the use and type of antimalarial chemoprophylaxis. Those who do take chemoprophylaxis regularly (often less than 50% of travellers), may use a chemoprophylactic regimen which, although protective against

*P. vivax* infection, provides inadequate protection against drug-resistant *P. falciparum* (Svenson *et al.*, 1995). Deaths due to imported malaria are more common in the elderly and are usually the result of delayed diagnosis or misdiagnosis (Greenberg and Lobel, 1990). However, occasionally fulminating disease develops and death occurs despite prompt diagnosis and appropriate treatment (Greenberg and Lobel, 1990).

## Drug Resistance

Wherever antimalarial drugs have been widely used, resistance has eventually followed. Resistance to pyrimethamine and chloroquine are widespread and resistance to sulphadoxine–pyrimethamine described in Thailand and elsewhere is also becoming more frequent in many countries in Africa. Resistance to mefloquine and quinine has been reported in Thailand and Vietnam. The extent of drug-resistant malaria globally is shown in Figure 3.6 on Plate V.

The susceptibility of *P. falciparum* isolates to drugs can be assessed using a standardised WHO *in vitro* test. Parasitised erythrocytes taken directly from patients are cultured in the presence of therapeutic levels of an antimalarial drug. Maturation of ring trophozoites through to schizonts demonstrates resistance of the isolate to the drug. Testing is of value for epidemiological surveys for making policy decisions, but is of little value for individual patients.

The molecular basis of resistance to dihydrofolate reductase inhibitors and sulfa compounds involves mutations in target enzymes in the folate pathway that decrease the affinity of binding of

the drug. Controversy continues on the role of genes involved in resistance to chloroquine, quinine and related compounds. Chloroquine resistance is due to the ability of the parasite to decrease the accumulation of the drug in the cell. The exact mechanism is still under investigation, although at least two proteins, *pfcr* and *pfmdrl*, have been identified that affect the accumulation of this drug (Cowman, 2001).

## CLINICAL FEATURES

Any patient with fever or a history of fever or chills and sweats who has travelled in a malaria area in the last 6 months should be considered to have malaria until proved otherwise.

More than 80% of non-immune patients with malaria present with fever, rigors, malaise and headaches. Afebrile patients almost invariably give a history of chills and sweats. Fever is usually irregular initially, when symptoms may be non-specific and difficult to distinguish from those caused by other infections, such as influenza, dengue and typhoid fever. Vomiting occurs in up to 34% and diarrhoea in approximately 16% of patients (Table 3.3). Classic periodic fever (every second day in *P. falciparum*, *P. vivax* and *P. ovale* and every third day in *P. malariae*) is uncommon initially, although if present is highly suggestive of malaria. Episodes of fever occasionally have well-defined symptoms of cold with shaking, hot, then sweating phases (White, 1996a). Symptoms of malaria may be less specific in semi-immune individuals, with low-grade fever, headache, myalgia or malaise sometimes occurring as isolated symptoms (Murphy and Oldfield, 1996; Stanley, 1997; Kain and Keystone, 1998). It is noteworthy that periodic fever is neither necessary nor sufficient for the diagnosis of malaria.

Like the symptoms, the signs of malaria are non-specific. Splenomegaly and splenic tenderness are the most common physical findings (Table 3.3). Tachycardia, tachypnoea, icterus, pallor, hepatic tenderness, hepatomegaly and hypotension also occur. Rash is not a feature of malaria (Murphy and Oldfield, 1996; Stanley, 1997; Kain and Keystone, 1998).

**Table 3.3** Clinical features of malaria

Symptoms	(%) Signs	(%)
Fever	99	Fever 80
Headache	74	Splenomegaly 34
Myalgia, arthralgia or backache	47	Hepatomegaly 25
Nausea, vomiting	40	Orthostasis or 22
Diarrhoea	19	hypotension
Dyspnoea, chest pain	15	Jaundice 16
		Neurological including 2
		coma

Adapted from Stanley (1997) and Murphy and Oldfield (1996).

***P. falciparum***

Most non-immune individuals present with falciparum malaria within 2 months of departure from a malaria-endemic area, but in semi-immune individuals and those taking malaria prophylaxis, symptomatic malaria may not develop for many months. The minimum time to developing symptoms after entering a malaria-endemic area is 7–8 days. Patients usually present with fever and headache but may have a variety of other symptoms, including cough, myalgia, arthralgia, abdominal pain, nausea, vomiting, diarrhoea, photophobia and altered conscious state. The fever may occur every 48 hours or continuously with intermittent peaks. The clinical presentation can vary substantially, depending on the level of parasitaemia and the immune status of the patient. Atypical presentations, leading to misdiagnosis as gastroenteritis, hepatitis or urinary infection are common. Asymptomatic parasitaemia is a frequent finding in semi-immune adults, hence the detection of parasites in peripheral blood should not abort the search for alternative causes of fever in such an individual.

*P. falciparum* infection may produce severe malaria with serious complications that may be ultimately fatal (Table 3.4). Severe malaria often develops very rapidly with specific complications,

**Table 3.4** Severe malaria

Severe malaria is defined as *P. falciparum* infection with one or more of the following features:

- Repeated generalised convulsions
- Unrousable coma
- Hypoglycaemia:  $\text{glc} < 2.2 \text{ mmol/l}$
- Acute respiratory distress syndrome or pulmonary oedema
- Renal impairment: creatinine  $> 0.265 \mu\text{m/l}$
- Haemoglobinuria
- Anaemia: haemoglobin  $< 50 \text{ g/l}$
- Spontaneous bleeding
- Acidosis:  $\text{pH} < 7.25$

The following features may be indicative of severe malaria in selected patients:

- Jaundice
- Temperature  $> 40^\circ \text{C}$
- Parasitaemia  $> 5\%$  and/or trophozoites/schizonts present in the peripheral blood

From World Health Organization (1990).

including cerebral malaria, severe anaemia, pulmonary oedema, blackwater fever or acute renal failure. Cerebral malaria is usually preceded by a history of fever for several days but the prodromal features may be much shorter. Manifestations include convulsions, hypertonicity, opisthotonos, gaze palsies, delirium, psychosis and coma that sometimes develops rapidly after a fit. These features may also be caused by hypoglycaemia. Patients developing renal failure tend to be oliguric or anuric and often have other organ dysfunction, including coma, jaundice and lactic acidosis (Day *et al.*, 1997). Blackwater fever (massive intravascular haemolysis and haemoglobinuria) is also a cause of acute renal failure. Any parasitaemia over 2% carries an increased risk of death, and parasitaemias over 10% indicate a potentially dangerous infection irrespective of other features (White, 1996a; Stanley, 1997).

The clinical features of severe malaria depend on age and the immune status of the host (White, 1996a). In hyperendemic areas, major manifestations occur in young children (severe anaemia and cerebral malaria) and during pregnancy. Acute renal failure, jaundice and pulmonary oedema are more common in non-immune adults and hypoglycaemia, convulsions, shock and acidosis may occur at any age.

***P. vivax*, *P. ovale* and *P. malariae***

The symptoms and signs are usually indistinguishable from those of *P. falciparum* but patients do not progress to severe disease. The incubation period is usually longer than a month for *P. malariae* infections, and a temperate strain of *P. vivax* may have an incubation period of 9–12 months (White, 1996a; Kain and Keystone, 1998). Fever is more likely to become periodic, occurring every 48 hours with *P. vivax* and *P. ovale* and every 72 hours for *P. malariae*. Serious complications (apart from an increased risk of ruptured spleen) are not usually a feature of malaria caused by these species and sequestration of parasitised erythrocytes does not occur. Relapsing *P. vivax* and *P. ovale* infections due to persisting liver hypnozoites may present 2–5 years after exposure but usually occur in the first

6 months. A relapse is defined as recurrent parasitaemia due to the same species, occurring 1 or more months after the primary infection, in a setting where there is no risk of reinfection. Recurrent *P. malariae* infection may be seen for up to 30–40 years after leaving an endemic area. *P. malariae* has been associated with the nephrotic syndrome (Abdurrahman, 1984; Abdurrahman *et al.*, 1990).

### Malaria in Pregnant Women and Children

*P. falciparum* infection is commonly associated with anaemia and a reduction in birth weight of babies born to primigravidae, even in those who have developed clinical immunity after lifelong exposure to malaria. In non-immune individuals, or in those in whom immunity has waned (including in areas of unstable endemicity), maternal infection may be symptomatic and severe (Looareesuwan *et al.*, 1985). Indeed, severe disease was the rule in *P. falciparum* malaria in a controlled study in India (81% in pregnancy vs. 40% in controls) (Sholapurkar *et al.*, 1988). Severe malaria may lead to fetal loss as well as maternal mortality (McGregor, 1984; Sholapurkar *et al.*, 1988). The clinical manifestations of *P. falciparum* malaria are similar to those in non-pregnant women, except that hypoglycaemia and adult respiratory distress syndrome are more common. The effects of *P. vivax* malaria on pregnancy are poorly defined.

Most children with malaria infections present with fever and malaise and respond rapidly to treatment. Clinical diagnosis may be challenging in areas where the prevalence of malaria is high, and co-infections are common. High parasitaemia usually incriminates malaria as the cause of illness, but some individuals may be completely asymptomatic with similar levels of infection. On the other hand, individuals can be critically ill with cerebral malaria caused by sequestered parasites, when *P. falciparum* is difficult to detect in the peripheral blood. For a non-immune child, detection of parasites in the peripheral blood confirms the diagnosis. Severe malaria is common in young children living in endemic areas (Marsh *et al.*, 1995). Cerebral malaria, hypoglycaemia, lactic acidosis and severe anaemia are particular

problems. Seizures are common, even in uncomplicated malaria, and require prompt treatment. Jaundice and pulmonary oedema are unusual in children and renal failure is rare.

### Malaria in Splenectomised Patients

Patients who are functionally asplenic or have a history of splenectomy may develop fulminant infection and have a poor response to therapy (Looareesuwan *et al.*, 1993), presumably because the spleen is the usual site of removal of sequestered parasites.

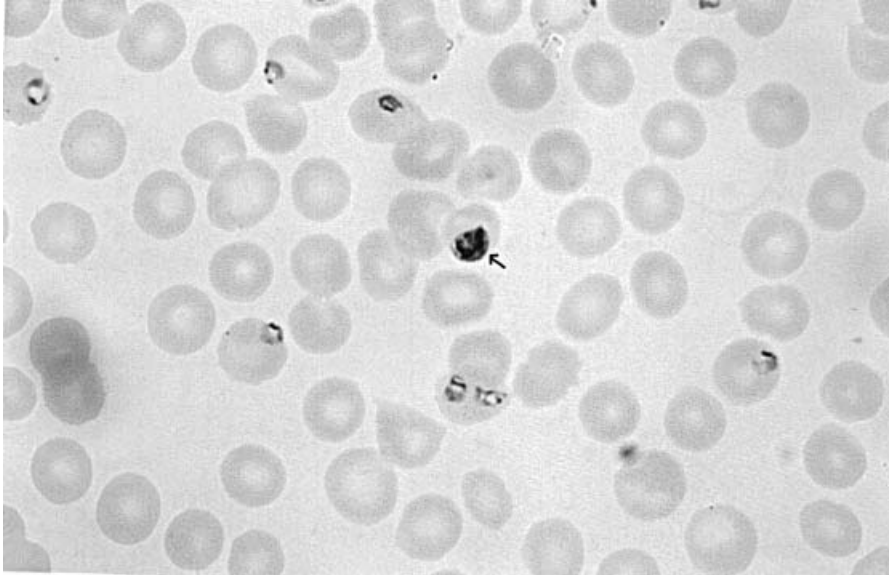
## LABORATORY DIAGNOSIS

The diagnosis of malaria should be suspected in patients presenting with a febrile illness (or history of malaria) in a malaria-endemic area, and elsewhere in febrile individuals who have travelled in an endemic area (particularly during the last 12 months). Laboratory test abnormalities that may heighten the clinical suspicion of malaria include thrombocytopenia associated with a normal white cell count (Svenson *et al.*, 1995), malaria pigment in macrophages and other white blood cells (White and Ho, 1992), abnormal liver function tests and an elevated lactate dehydrogenase, or haemoglobinuria. Anaemia is uncommon in non-immune adults who present early but is a common finding in children living in endemic areas. Importantly, the cerebrospinal fluid is normal in cerebral malaria.

Malaria should be notified to the relevant health authorities and blood slides sent to a reference laboratory for confirmation.

### Microscopy

The diagnosis of malaria is usually made by the examination of Giemsa-stained thick and thin blood smears for intraerythrocytic ring stage parasites using an oil immersion lens (magnification  $\times 1000$ ) (Figure 3.2A,B). Thick films made from a drop of blood dried on a microscope slide, then stained with water-based Giemsa stain allow concentration of parasites (with lysis of the red



**Fig. 3.7** Mature parasite form in a patient with severe *P. falciparum* malaria

cells). They are 20–40 times more sensitive than thin films in samples with low parasitaemia (depending on the expertise of the personnel staining and examining the films). Reasonable sensitivity can be achieved if fields containing 500–1000 leukocytes are examined for parasites or half an hour of examination is completed before deciding that parasites are undetectable. Thin smears are fixed with anhydrous methanol to preserve parasite and erythrocyte morphology, and are used to differentiate parasite species as well as to quantify the percentage of infected erythrocytes (Figure 3.3). The yield from blood films may be highest at or near the peak of fever but blood should be collected when the diagnosis is first considered rather than waiting for the next febrile episode, since patients may be afebrile at presentation. A direct smear from intradermal blood is sensitive in skilled hands but if anticoagulants are used, smears should be prepared within 3 hours, as parasite and red cell morphology may deteriorate with prolonged exposure to the anticoagulant (Ree and Sargeant, 1976).

The method of estimation of parasitaemia is shown in Table 3.5. An accurate assessment of parasitaemia is an important prognostic indicator in *P. falciparum* infections and is required to monitor response to therapy. Immature and

mature asexual stages and sexual stages (gametocytes) are observed in the peripheral blood in *P. vivax*, *P. ovale* and *P. malariae* infections. In *P. falciparum* infections, immature asexual parasites are the usual finding (Figure 3.2). The presence of late trophozoites or schizonts in the peripheral blood is a predictor of mortality, with more than 10 000 mature trophozoites or schizonts/ $\mu$ l having a sensitivity of 90% and a specificity of 72% for mortality (Silamut and White, 1993; Warhurst and Williams, 1996) (Figure 3.7). Occasionally malaria parasites are detected in a bone marrow smear or, at autopsy, in a brain smear.

Identification of malaria parasites in blood smears may be difficult, and depends on the experience of the microscopist and the parasitaemia in the peripheral blood at the time of blood collection. With synchronous replication, there may be very few or even no parasites present, despite severe complications from sequestered parasites. Semi-immunity, chemoprophylaxis with antimalarial drugs, and treatment with some antibiotics (tetracycline, azithromycin, clindamycin, trimethoprim–sulphamethoxazole, erythromycin and fluoroquinolones) may also have an effect on parasitaemia. Therefore, if malaria is suspected, thick and thin smears



**Table 3.5** Estimation of parasitaemia in thick and thin blood films

*Thick films*<sup>1</sup> Count the number of parasites per 200 leucocytes (WBC)<sup>2,3</sup>

$$\text{Parasites}/\mu\text{l blood} = \frac{\text{Parasite count} \times \text{WBC count}^4}{200}$$

$$\text{Approximate \% parasitaemia} = \frac{\text{Parasite count}}{1250}$$

*Thin films*<sup>1</sup> Count the number of parasitised erythrocytes per 1000 erythrocytes (5–10 high-power fields). If parasitaemia is low, it may be necessary to examine more than 10 fields

$$\% \text{ Parasitaemia} = \frac{\text{No. of parasitised erythrocytes}}{\text{Total number of erythrocytes}} \times 100$$

<sup>1</sup>Smears should be stained with freshly prepared 3% Giemsa solution (buffered to pH 7.2) for 30 minutes.

<sup>2</sup>The lower limit of detection by an experienced microscopist is about 10–20 parasites/ml blood.

<sup>3</sup>A negative slide should not be reported until at least 200 fields of a thick film have been examined.

<sup>4</sup>If the WBC count is unknown, a WBC count of 8000/ml of blood is used.

From Bruce-Chwatt (1985) and Warhurst and Williams (1996).

should be repeated every 6–12 hours for 48 hours before the diagnosis can be excluded. In some cases, the clinician may need to commence treatment of malaria on suspicion of the diagnosis (especially in a severely ill or comatose patient), even in the presence of a negative blood slide, while awaiting confirmation of the first and subsequent slides from a reference laboratory.

Malaria is often diagnosed clinically without blood smears in endemic areas where primary health care facilities are limited. In these areas, the predictive value of positive blood smears is limited and has little influence on the decision to treat non-severe disease. It is worth noting that a negative blood smear has a reasonable negative predictive value in highly endemic areas, especially in adults. If patients require empirical treatment for malaria, especially in non-endemic areas, it is important that other serious illnesses are not overlooked.

## Other Tests

Alternative microscopy techniques for the identification of malaria parasites are based on

fluorochromes such as Acridine Orange. Staining with fluorochromes is rapid (< 1 minute) and slides can be rapidly screened at low magnification ( $\times 400$ ), even with low parasitaemia. Acridine dye-stained buffy coat examination (the 'QBC' technique) has been shown to increase the sensitivity of microscopy, but cost and technical concerns have limited its use (Levine *et al.*, 1989; Wongsrichanali *et al.*, 1991; Warhurst and Williams, 1996).

Rapid diagnostic antigen tests using monoclonal antibodies to the *P. falciparum* histidine-rich protein-2 have been shown to be highly sensitive and reliable (Shiff *et al.*, 1993; Beadle *et al.*, 1994; Garcia *et al.*, 1996; Humar *et al.*, 1997). These tests employ an impregnated strip that gives a colour change when blood containing parasites is added. These tests could be used at the primary health care level in malaria-endemic areas, where microscopy is often unavailable, but, as explained above, may have little influence on the decision to treat and are currently too expensive for most health budgets (although a test costing as little as 0.25 US\$ is now available). They could also be invaluable as a screening test in laboratories in non-endemic areas, where low throughput means that personnel often have little experience in the microscopic diagnosis of malaria. They may also assist travellers in the decision to take presumptive self-treatment when in remote areas where medical care is not available. New antigen tests, which differentiate between *P. falciparum* and other species, are currently being field-tested (Figure 3.8).

Gene amplification methods for the detection of malaria parasites have also been developed (McLaughlin *et al.*, 1993). PCR techniques could have application with low parasitaemia, possible mixed infections or uncertain parasite speciation, as well as for reference studies and microepidemiology (Barker *et al.*, 1992; Snounou *et al.*, 1993; Oliveira *et al.*, 1995) or as research tools for detection of low parasitaemia in sophisticated laboratories (Chen *et al.*, 1998).

IFA, IHA and ELISA assays using cultured *P. falciparum*-infected erythrocytes as antigen are well-characterised for antibody detection (Lobel *et al.*, 1973; Spencer *et al.*, 1979; Schapira *et al.*, 1984; Srivastava *et al.*, 1991) but are inappropriate for use in the diagnosis of acute malaria, as they reflect exposure rather than acute infection

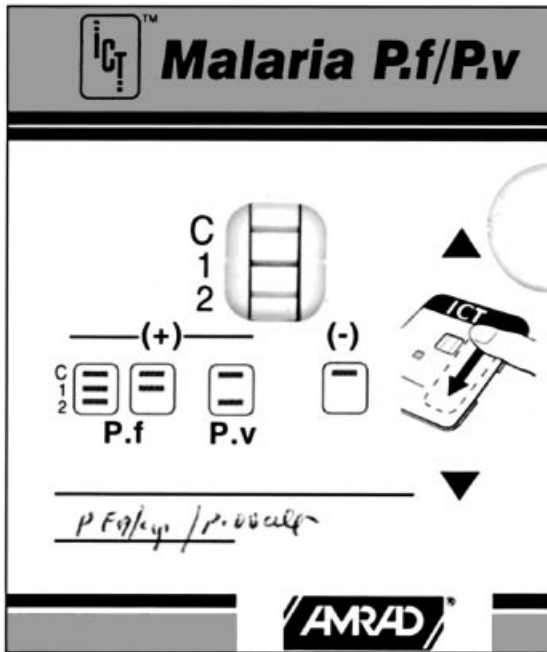


Fig. 3.8 Positive immunochromatographic test for mixed *P. vivax* and *P. falciparum* malaria

or clinical immunity. However, in non-endemic areas, serology may be useful for retrospective diagnosis in patients thought to have had malaria and who received therapy. They are untried for excluding malaria in patients with chronic or recurrent febrile illness, and are too insensitive for transfusion blood screening. In areas where malaria is endemic, serological techniques are useful for epidemiological purposes and for the assessment of infection in mosquitoes.

*In vitro* tests for sensitivity to antimalarial drugs are valuable tools for establishing prevalence and likely degree of clinically relevant drug resistance, but do not help individual patients. Similarly, examination of PCR products for mutations known to be associated with resistance to sulfa drugs or pyrimethamine is of use in research and epidemiological studies.

## CLINICAL MANAGEMENT

The successful management of malaria depends on making an urgent diagnosis, an accurate

clinical assessment, and instituting appropriate antimalarial therapy as soon as possible. Treatment depends not only on the species of malaria but also on the severity of illness, the likely susceptibility to antimalarial drugs, and the age and background immunity of the patient.

The clinical examination should focus on temperature, pulse rate, respiratory rate, blood pressure, hydration, pallor, jaundice, splenomegaly, hepatomegaly, neck stiffness, other CNS signs, urinalysis and weight. A lumbar puncture should be performed to exclude bacterial meningitis in patients with suggestive CNS symptoms or signs. Future studies may resolve the issue of whether possible raised intracranial pressure, which is known to be associated with cerebral malaria in some patients, is a contra-indication to lumbar puncture on presentation (Newton *et al.*, 1991). If this were the case, it is likely that appropriate therapy for both bacterial meningitis and cerebral malaria would need to be instituted and continued until lumbar puncture was considered to be safe and results were available. The CSF should be normal in cerebral malaria.

*P. vivax*, *P. ovale* and *P. malariae* very rarely produce fatal disease (except as a predisposing factor for a ruptured spleen) but *P. falciparum* infection may progress rapidly to multi-organ failure and death.

It is important to weigh children so that accurate mg/kg doses of antimalarial drugs can be administered.

## Uncomplicated Malaria

In patients without evidence of severe malaria (Table 3.4), oral medication is usually sufficient to cure the infection.

### Chemotherapy for Acute Malaria Due to *P. vivax*, *P. ovale* or *P. malariae*

Vivax malaria remains generally sensitive to chloroquine and responds rapidly (Table 3.6). Chloroquine-resistant *P. vivax* infection has been reported in Papua New Guinea, Irian Jaya,

**Table 3.6** Chemotherapy for uncomplicated malaria

<i>P. vivax</i> , <i>P. ovale</i> or <i>P. malariae</i>	
Chloroquine phosphate (tablets each contain 150 mg base)	600 mg base at 0 hours, 300 mg base at 6, 24 and 48 hours. OR 600 mg base at 0 hours, 600 mg base at 24 hours and 300 mg base at 48 hours Children: 10 mg base/kg (max. 600 mg of base) at 0 hours, 5 mg/kg at 6 hours, 24 hours and 48 hours
Followed by primaquine if not returning to endemic area (see Table 3.7)	
<i>P. falciparum</i>	
Oral quinine sulphate	Adults: 600 mg salt (10 mg/kg), every eight hours for 3–7 days Children: 10 mg salt/kg, every eight hours (max. 600 mg) for 5 days
Concurrently with:	
Doxycycline	100 mg b.d. for 7 days
OR	
Fansidar®	Fansidar® (20 mg/kg sulphadoxine and 1 mg/kg pyrimethamine—usually 3 tablets; 1 tablet= 500 mg sulphadoxine and 25 mg pyrimethamine) as a single dose on the last day of quinine treatment
	Tetracycline (4 mg/kg four times daily) or clindamycin (10 mg/kg twice daily for 3–7 days) are alternatives to doxycycline (White, 1996b)
If <i>P. falciparum</i> is likely to be chloroquine-sensitive:	
Chloroquine	Oral chloroquine as for <i>P. vivax</i> malaria (see above)
Alternative regimen in selected patients:	
Mefloquine	Partial immunity to malaria: one dose of 15 mg base/kg (adult dose= 3 tablets. In USA, 1 tablet= 228 mg base; elsewhere 1 tablet= 250 mg base) Non-immune patients or in areas where there is mefloquine resistance: a second dose of 10 mg base/kg (2 tablets) given 8–24 hours later 4 Tablets (250 mg/100 mg) as a single daily dose with food or milk for 3 days
Atovaquone–proguanil (Malarone®)	

As formulations and preparations (e.g. base/salt/compound) of antimalarial drugs vary from centre to centre, it is CRITICAL TO CHECK DOSES with local pharmacists, particularly for drugs used parenterally.

Sumatra, the Solomon Islands, Myanmar, India and Guyana (Rieckmann *et al.*, 1989; Murphy *et al.*, 1993; Phillips *et al.*, 1996; Whitby, 1997) and appears to be spreading. Patients with vivax malaria from these areas may be treated initially with a standard course of chloroquine and then followed up for recrudescences. Chloroquine resistance (i.e. a recurrence of infection within 28 days of treatment) should be treated with Malarone®, oral quinine or mefloquine, as for *P. falciparum* malaria, followed by eradication therapy with primaquine (see below). As rates of resistance increase, chloroquine may eventually be replaced as the first-line therapy. Chloroquine resistance has not been recorded for *P. ovale* or *P. malariae*.

### **Radical Cure for *P. vivax* and *P. ovale* Infections**

*P. vivax* and *P. ovale* infections may not be eradicated by standard therapy because the long-lasting liver forms of the parasite (hypnozoites) are relatively resistant to chloroquine. Relapses or delayed primary attacks of *P. vivax* or *P. ovale* malaria may thus develop from parasites that have been dormant in the liver for several months or years after a person has left a malaria-endemic area. Eradication treatment ('radical cure') eliminates the pre-erythrocytic stages in the liver, thus preventing these attacks. Eradication therapy with primaquine is indicated in individuals who have had acute malaria or have had substantial

**Table 3.7** Malaria chemoprophylaxis—drugs and dosages

Generic name	Adult dose	Paediatric dose
Chloroquine <sup>1</sup>	300 mg base (usually 2 tablets of salt) once a week	5 mg base/kg (up to maximum adult dose) once a week
Doxycycline <sup>2</sup>	100 mg daily	2 mg/kg daily up to adult dose. Not suitable for children younger than 8 years
Mefloquine <sup>1,3</sup>	250 mg (1 tablet) once a week	Children over 5 kg, 5 mg/kg weekly to adult dose. Not suitable for children under 5 kg
Proguanil	200 mg daily (usually combined with weekly chloroquine) <sup>1</sup>	Follow manufacturer's instructions
Primaquine <sup>4</sup> (to prevent relapse)	15 mg base once a day for 14 days; or 45 mg base once a week for 6 weeks For <i>P. vivax</i> acquired in Papua New Guinea and the Pacific, 7.5 mg base three times a day, or 15 mg base twice a day, for 14 days For gametocytocidal effect (to prevent potential transmission of <i>P. falciparum</i> to mosquitoes in a receptive area) 45 mg base as a single dose in hospital	0.25–0.33 mg base/kg/day (up to maximum adult dose) for 14 days; or 0.8 mg base/kg (up to maximum adult dose) once a week for 6 weeks 0.7 mg base/kg given as a single dose
Malarone®	1 adult tablet daily (250 mg atovaquone, 100 mg proguanil). Should be taken with food or milky drink	11 to 20 kg: 1 paediatric tablet (62.5 mg atovaquone, 25 mg proguanil) 21–30 kg: 2 paediatric tablets 31–40 kg: 3 paediatric tablets 40 kg or more: 1 adult tablet

<sup>1</sup>Commence drug(s) at least one week before departure, continue while in and for 4 weeks after leaving the malaria-endemic area. For those living in endemic areas for long periods, consider using no prophylaxis or chloroquine in urban (low prevalence) areas and adding doxycycline for short trips to rural (higher prevalence) areas.

<sup>2</sup>Commence a few days before departure, continue while in and for 4 weeks after leaving the malaria-endemic area.

<sup>3</sup>Significant resistance reported from Thailand, Myanmar and Cambodia.

<sup>4</sup>Treatment with primaquine is primarily to prevent relapses of *P. vivax*. Check for G-6-PD deficiency. Commence at the end of treatment for acute *P. vivax* or *P. ovale* infection, or at the end of post-exposure suppression.

As formulations and preparations (e.g. base/salt/compound) of antimalarial drugs vary from centre to centre, it is CRITICAL TO CHECK DOSES with local pharmacists, particularly for drugs used parenterally.

exposure (workers who have spent months or years in rural areas where malaria transmission is intense), and who are not intending to return to a malarious area in the short term. Primaquine is usually commenced just after a course of suppressive chemotherapy against erythrocytic stages, or after treatment for acute malaria. Primaquine is contraindicated in pregnancy because the G-6-PD status of the foetus is unknown, and pregnant women are advised to take chloroquine chemoprophylaxis until delivery.

A treatment course of primaquine consists of 15 mg base daily or twice daily orally with food for 14 days (Table 3.7). The higher dose is used for *P. vivax* infections after relapse following treatment with 15 mg base, and in infections acquired in the south-west Pacific and in other areas where parasites have been shown to have increased resistance to primaquine. This prevents relapses in the majority of cases. The dose of primaquine in children is 0.25–0.33 mg base/kg/day given once a day orally for 14 days, with the

higher dose being reserved for relapsing *P. vivax* infections and those acquired in the south-west Pacific. A liquid preparation is usually available.

Primaquine may cause oxidant haemolysis in patients with a deficiency of G-6-PD and is contraindicated in those with severe variants of the deficiency. Therefore, screening for G-6-PD deficiency should be performed before treating with primaquine. Primaquine may be given at a higher dose (45 mg base) once per week for 6 weeks (White, 1996b). Relapses are much reduced but may still occur after eradication therapy with primaquine, and the same or a higher dose or longer regimen may need to be repeated.

### ***P. falciparum* Malaria**

Where possible, patients with malaria should be treated according to national guidelines. In disease-endemic countries most patients are treated as outpatients, but in non-endemic

areas, such as the USA, Europe and Australia, it is advisable to admit patients with *P. falciparum* malaria to hospital for treatment and follow-up until parasitaemia has cleared. It is important to consult latest information, as patterns of resistance and drugs of first choice are likely to change in the next few years. Drug sensitivity tests are currently not helpful for individual patients.

Chloroquine-resistant *P. falciparum* malaria (CRPF) is now widespread and, unless malaria was unequivocally acquired in a chloroquine-sensitive area (Figure 3.6), in non-endemic areas it should be treated as resistant. In some endemic areas, chloroquine- or antifolate-sulfa combinations are still used as the drugs of first choice, despite known high prevalence of drug resistance. Quinine is the drug of choice for CRPF and for severe falciparum malaria (see below). Quinidine, although more cardiotoxic, is an alternative. Reports of quinine resistance are increasing, particularly in Thailand, Cambodia and Vietnam. Combination therapies that include artesunate are alternative therapies that should be applied according to national guidelines.

Treatment with oral quinine sulphate should be commenced in the first instance (Table 3.6) in patients in whom parenteral therapy is not indicated (see below). In addition, a course of doxycycline or a single dose of Fansidar® (three tablets in adults) should be commenced at any time in the first 6 days. Fansidar® is used only for malaria acquired in areas where *P. falciparum* is still relatively sensitive to antifolate-sulfa-containing compounds, such as India and some areas of sub-Saharan Africa.

Treatment with oral quinine or quinidine is often poorly tolerated, with patients complaining of a bitter taste as well as nausea, dysphoria, tinnitus and, occasionally, high tone deafness (cinchonism). The addition of doxycycline usually allows quinine to be stopped after 3 days (Watt *et al.*, 1992a). This treatment is still more than 85% effective in most areas and serious side-effects are rare. In areas where there is a decline in the response rate to quinine, such as on the eastern and western borders of Thailand, infection should be treated with 7 days of quinine in addition to doxycycline (White and Pukrittayakamee, 1993). The indications for changing to parenteral therapy are:

- Repeated vomiting of medication.
- Suspected malabsorption.
- Deterioration in clinical condition.
- Increase in parasitaemia after the second day of therapy.

In areas where *P. falciparum* malaria is known to be sensitive to chloroquine, treatment is with oral chloroquine, as for *P. vivax* malaria (Table 3.6). Eradication of gametocytes may also be desirable in areas susceptible to the introduction of malaria (Table 3.7).

### **Alternative Therapies for Uncomplicated *P. falciparum* Malaria**

Mefloquine may be used as an alternative to quinine and has the advantage that only one or two doses are required because of the long half-life (up to 3 weeks) (Palmer *et al.*, 1993). In some parts of Asia (especially along the Thai-Cambodian border) the failure rate of high dose mefloquine exceeds 40% (Looareesuwan *et al.*, 1992). Mefloquine treatment for malaria acquired in South East Asia is therefore best given in combination with another antimalarial agent. Mefloquine treatment should also be avoided after mefloquine prophylaxis because of concerns about toxicity.

Artemisinin and its derivatives have been used widely in China and South East Asia, although they are not registered or available in many other countries. They have been shown to be rapidly acting and effective, particularly if given for 3–5 days in combination with mefloquine (Looareesuwan *et al.*, 1992, 1994) (Table 3.6). When given alone, treatment should be continued for 7 days, as early parasite recrudescences are common (White, 1996b). There is little evidence to suggest that they currently have a role in the treatment of uncomplicated malaria, except in some areas in Thailand, Vietnam, Laos and Myanmar, where multi-drug resistance is common (World Health Organization, 1994).

Although more active and better tolerated than mefloquine (ter Kuile *et al.*, 1993), halofantrine induces a delay in atrioventricular conduction and ventricular repolarization (Nosten *et al.*, 1993) and sudden death has been reported. Its role in malaria treatment is very limited. It is sometimes used in multidrug-resistant *P. falciparum*

malaria in which treatment with quinine has failed. It should be avoided in patients who have received mefloquine in the previous 28 days because of concerns about ventricular arrhythmias (White, 1996b).

Malarone<sup>®</sup>, a fixed combination of atovaquone and proguanil (see Table 3.7) is becoming more widely available as alternative treatment for uncomplicated malaria.

### **Continuing Management of Uncomplicated Malaria**

*P. vivax*, *P. ovale* and *P. malariae* may be managed on an outpatient basis. Patients with *P. falciparum* require hospitalisation and monitoring during treatment, with daily thick and thin blood smears until there are no detectable asexual parasites (gametocytes may persist in the peripheral blood for several weeks and are of no consequence if there is no risk of malaria transmission). Patients should show signs of improvement in 24–36 hours but the parasitaemia may rise in the first 12–24 hours, even after effective treatment has been commenced. This occurs if some malaria parasites have passed the stage in the life cycle at which the drug acts before adequate drug levels have been achieved. If fever persists or recurs during treatment, blood cultures should be taken, as systemic sepsis due to *Salmonella* infections may develop in uncomplicated *P. falciparum* malaria (Mabey *et al.*, 1987) or another cause of fever may coexist. Drug resistance should be suspected and a change in therapy contemplated if repeat smears are still positive after 48 hours (RIII resistance), or recrudescence parasitaemia is detected after Day 7 (RII).

### **Severe Malaria**

#### **General Management**

The patient should be admitted to hospital as an emergency if any of the markers of severe malaria are present (Table 3.4), and admission to the intensive care unit should be considered. Careful monitoring of vital signs, neurological status, EKG/ECG, haematocrit, blood glucose and fluid balance are essential. Arterial pH, blood gases and, if available, lactate levels should also be

monitored. The parasite count should be monitored twice daily in critically ill patients.

#### **Fluid and Electrolyte Balance**

It is important to assess the state of hydration of patients on admission carefully, as dehydration may contribute to hypovolaemia and shock (particularly in children) and result in acute renal failure. In contrast, fluid overload may exacerbate non-cardiogenic pulmonary oedema, particularly in adults. The average adult may require 10–15 ml/kg of crystalloid solution in the first 24 hours to achieve normovolaemia. Recently it has been recognised that there is a strong correlation between acidosis, disease severity and outcome. Underlying acidosis in a dehydrated patient may cause respiratory symptoms that were previously attributed to pulmonary oedema and managed by fluid restriction (English *et al.*, 1997; Crawley *et al.*, 1998). The central venous pressure should therefore be maintained between 0 and 5 cm of water, with a pulmonary capillary pressure that is compatible with adequate cardiac and renal output. If pulmonary oedema does develop, the patient should be treated with diuretics, oxygen and fluid restriction.

#### **Renal Function**

The urinary output should be closely monitored and a urinary catheter inserted if necessary. Acute renal failure (metabolic acidosis, hyperkalaemia, fluid overload or uraemia) should be managed promptly with dialysis or haemofiltration. Pumped veno-venous haemofiltration appears to be more effective than peritoneal or intermittent haemodialysis, particularly in haemodynamically unstable patients. Some patients will require dialysis for more than a week, although in most cases renal function returns after a few days. The doses of quinine and quinidine, but not chloroquine, should be reduced after 2 days in patients with renal failure. The dosage schedules for quinine and quinidine do not need to be adjusted for peritoneal or haemodialysis.

### **Hypoglycaemia**

Hypoglycaemia is present in approximately 8% of adults (White *et al.*, 1983) and 25% of children with severe malaria (White *et al.*, 1987). It is more likely to occur in those given quinine or quinidine and in pregnant or postpartum women and may develop after several days of therapy. The diagnosis may be overlooked, as the clinical features of hypoglycaemia (coma, convulsions, and extensor posture) are frequently attributed to cerebral malaria. Acute hypoglycaemia should be treated with an intravenous injection of 50% dextrose followed by careful monitoring, as it may recur and is associated with a high mortality rate. In general, a maintenance infusion of at least 5% dextrose should be given to all patients after initial rehydration, and the blood glucose level checked every 2–6 hours, or if the conscious state worsens or seizures occur.

### **Cerebral Malaria**

In patients with cerebral symptoms and/or signs, consider the possibility of meningitis and perform a lumbar puncture to exclude this diagnosis. In cerebral malaria, the CSF is normal. Unconscious patients should be nursed on their sides and particular care taken of the airway. Intubation may be necessary, depending on the state of the airway and pulmonary function. Seizures occur in up to 80% of children and 20% of adults. Seizures may be focal and difficult to detect in comatose patients. Acute treatment with intravenous benzodiazepines should be administered and consideration given to the use of prophylaxis with phenytoin or phenobarbitone (White *et al.*, 1988). The use of dexamethasone is contraindicated in cerebral malaria (Warrell *et al.*, 1982).

### **Anaemia**

Anaemia due to haemolysis may develop rapidly, especially in children. Blood transfusion is usually indicated if the haematocrit falls to 20%. Whole blood is preferable to packed cells, particularly if there is evidence of acute blood loss. Although thrombocytopenia is common, clinically significant disseminated intravascular

coagulation with spontaneous bleeding occurs in only 5–10% of adults with severe malaria, and is rare in children. In areas where an uncontaminated blood supply is not guaranteed, it may be necessary to increase the threshold for transfusion. It has been suggested that a haemoglobin of less than 5 g/dl if there is respiratory distress, and less than 3 g/dl if there is not, is a safe threshold in children (Lackritz *et al.*, 1992). Subsequent iron and folate acid supplements may be necessary, especially in pregnancy.

### **Bacterial Infections**

If the condition of a patient with severe malaria deteriorates, it is important to take blood cultures to exclude infection, and to start broad-spectrum antibiotics empirically. Bacterial infections such as pneumonia and urinary tract infections are common in patients requiring intensive care. Spontaneous septicaemia may also occur occasionally and is usually caused by a Gram-negative organism.

### **Circulatory Collapse**

Hypovolaemia, acute blood loss, pulmonary oedema and sepsis should be considered in the shocked patient. Also, hypoglycaemia and cardiac toxicity from therapy with quinine or quinidine should be excluded. Shock, which is refractory to volume repletion, can be treated with inotropes, although adrenaline should be avoided as it causes lactic acidosis in severe malaria (Day *et al.*, 1996).

### **Exchange Transfusion**

Exchange transfusion leads to a rapid reduction in parasite load, corrects anaemia and clotting abnormalities and may remove toxic metabolites. While not fully evaluated in clinical trials, exchange transfusion may be life-saving and should be performed in patients with severe falciparum malaria if the parasitaemia exceeds 15%, providing that adequate facilities exist to ensure that blood products are safe and adequate

medical facilities are available. If there are other signs of poor prognosis it should be considered for parasitaemias in the range 5–15%. Blood should be exchanged between quinine infusions if possible, and transfusions continued until the parasitaemia is below 5%.

### Chemotherapy

Severe *P. falciparum* malaria requires urgent treatment with parenteral antimalarial agents. Quinine is the drug of choice unless the malaria was definitely acquired in a chloroquine-sensitive area. Quinidine may be used as an alternative to quinine if the latter is not available. Drugs with short half-lives (quinine, quinidine, artemesinin) should be given for at least 7 days if given alone. Shorter treatments are required for drugs with longer half-lives (chloroquine, mefloquine, pyrimethamine/sulphadoxine). It is important to distinguish between base and salt when calculating the drug dose. Chloroquine, mefloquine and primaquine prescriptions are usually written as the amount of base, whereas quinine and halofantrine are written as the amount of salt. Always check the doses carefully.

### Recommended Chemotherapeutic Regimens for Treating Severe Malaria

As formulations and preparations (e.g. base/salt/compound) of antimalarial drugs vary from centre to centre, it is CRITICAL TO CHECK DOSES with local pharmacists, particularly for drugs used parenterally.

1. *Parenteral quinine*. A loading dose of parenteral quinine should be given to most patients to ensure rapid attainment of effective drug concentrations. A loading dose should NOT be given if the patient has received quinine, quinidine or mefloquine during the preceding 12–24 hours.

- If intensive care facilities are available, 7 mg quinine dihydrochloride salt/kg diluted in 60 ml 0.9% saline should be infused by motor-driven syringe pump over 30 minutes, followed by an intravenous infusion of 10 mg/

kg quinine dihydrochloride diluted in 10 ml/kg isotonic fluid, given over the next 4 hours (White, 1996b). Maintenance doses should be given 8 hourly, as indicated below.

- Alternatively, a loading dose of 20 mg salt/kg may be infused in 500 ml 5% glucose over 4 hours, followed by a maintenance infusion of 10 mg salt/kg over 2–8 hours, repeated every 8 hours until oral therapy is tolerated. The maintenance dose should be commenced 4 hours after the loading dose is completed (White, 1996b).
- If an intravenous infusion cannot be given, quinine dihydrochloride diluted to between 60 and 100 mg/ml may be administered by deep intramuscular injection into the anterior aspect of the thigh. The initial loading dose can be divided and half injected into each leg. This regimen has been shown to be satisfactory for the treatment of severe malaria in children in Kenya (Pasvol *et al.*, 1991).

*Note:* The bisulphate salt of quinidine has only 70% of the activity of the sulphate salt and appropriate dosage adjustments should be made.

2. *Parenteral quinidine*. Quinidine is more active than quinine but it is also more cardiotoxic. It is mainly used in areas where parenteral quinine is not commonly available (such as in the USA Miller *et al.*, 1989). It has an approximately four-fold greater effect in prolonging the EKG QT interval than quinine and, although arrhythmias have not been reported in association with malaria therapy, EKG monitoring is required. A loading dose of quinidine gluconate (10 mg salt/kg, max 600 mg) should be infused in normal saline over 1–2 hours followed by 0.02 mg/kg/min by infusion pump until the patient can swallow quinine tablets (White, 1996b). The infusion rate should be slowed if the plasma quinidine concentration exceeds 6 mg/ml, or the QT interval exceeds 25% of the baseline value.

Both quinine and quinidine may accumulate during renal failure, so doses should be decreased to one-third to one-half after 48 hours or serum levels should be measured (Murphy and Oldfield, 1996). The therapeutic range for the unbound drug probably lies between 0.8 and 2 mg/l, depending on the sensitivity of the infecting malaria parasites. This corresponds to total



plasma concentrations of 8–20 mg/l for quinine and 4–8 mg/l for quinidine.

- Treatment with quinine or quinidine should be combined with doxycycline (100 mg twice daily for seven days), commenced while the patient is in hospital, or pyrimethamine-sulphadoxine (3 tablets) given on the last day of quinine therapy, provided that these drugs are not contraindicated (in which circumstance a longer course of quinine would be required).
3. *Chloroquine* is as effective as quinine in the treatment of chloroquine-sensitive falciparum malaria.
- The total dose should be 25 mg base/kg/day (not exceeding 15 mg base/kg on the first day) administered as follows. An initial dose of 10 mg base/kg intravenously by constant rate infusion (or, if infusion pump unavailable, in 500 ml isotonic saline or 5% dextrose) given over 8 hours, followed by 15 mg base/kg over 24 hours (White, 1996b). Oral treatment should be substituted as soon as the patient can take tablets.

### **Alternative Chemotherapy for Severe Malaria**

*Artemisinin* and derived compounds should be considered for the treatment of *P. falciparum* malaria that fails standard drug regimens and for severe falciparum malaria acquired in areas where *P. falciparum* is known to be multidrug-resistant:

- Artesunate 2.4 mg/kg by intravenous or intramuscularly injection, followed by 1.2 mg/kg at 12 and 24 hours, then 1.2 mg/kg daily. Parenteral artesunate is unstable in water and must be reconstituted in 5% sodium bicarbonate solution prior to administration (Meshnick *et al.*, 1996; White, 1996b).
- Artemether 3.2 mg/kg by intramuscular injection, followed by 1.6 mg/kg daily, can be used.
- Artesunate suppositories have been shown to clear *P. falciparum* parasitaemia as rapidly as i.v. artesunate and more rapidly than i.v. quinine (Hien *et al.*, 1992).

*Mefloquine* and *halofantrine* have been used as alternatives to quinine/quinidine and artesunate/

artemether therapy, but halofantrine has potential serious cardiotoxicity, referred to previously. Recent studies suggest that the combination of artemisinin derivatives and mefloquine may be more effective than either drug alone and may prevent the late recrudescences typically observed with artesunate alone (Looareesuwan *et al.*, 1992). Artemisinin derivatives appear to have the added advantage of treating sexual forms.

### **Follow-up of Severe Malaria**

Parasitaemia should be followed once or twice a day after therapy begins until thick smears are repeatedly negative (usually 48–96 hours). Parasitaemia may rise during the first 24 hours of therapy if the initial brood of parasites has passed the stage in the life cycle at which the currently available antimalarial drugs are active, and schizonts rupture to release merozoites. If the parasitaemia remains high at 48 hours, high-level drug resistance (R<sub>III</sub>) may be present and consideration should be given to changing the therapeutic regimen (Watt *et al.*, 1992b). Oral medications should replace intravenous therapy as soon as the patient is able to tolerate fluids.

### **Management of Malaria in Pregnancy**

The management of pregnant women with malaria is essentially the same as for other patients, although frequent blood glucose and foetal monitoring is recommended. The choice of chemotherapy will depend on the factors outlined above but will also be influenced by the known safety profile of the drugs in pregnancy. For instance, doxycycline and primaquine are contraindicated and pyrimethamine/sulfa combinations should be used with caution. There is little information about the use of halofantrine or artemisinin and its derivatives. Quinine and chloroquine have been used extensively in pregnancy with no specific adverse findings. Mefloquine appears safe when given in the second or third trimester of pregnancy, although there has been a trend towards increased rates of spontaneous abortion in some studies (Smoak *et al.*, 1997; Phillips-Howard *et al.*, 1998).

## Antimalarial Drugs—A Summary

### Quinoline-containing Drugs (*Cinchona Alkaloids*)

The quinoline-containing antimalarials kill malaria parasites by causing swelling of the food vacuole, increasing granularity and ultimate cell lysis (Foote and Cowman, 1994). This is associated with inhibition of haem polymerisation, but the detailed mechanisms of parasite death have yet to be elucidated. They include quinine, which has been used to treat malaria for centuries, and the relatively recent derivatives, chloroquine, amodiaquine, mefloquine and halofantrine.

#### *Quinine and Quinidine*

Quinine, an alkaloid from the bark of the cinchona tree, is the mainstay of treatment for *P. falciparum* malaria and is occasionally used for self-treatment. Treatment with oral quinine is not well tolerated because of the bitter taste and the frequency of cinchonism (nausea, dysphoria, tinnitus and deafness). Quinine has a narrow therapeutic ratio and, when given parenterally, should be given by intravenous infusion and never by bolus injection. With intravenous use, hyperinsulinaemic hypoglycaemia is the main adverse effect and is usually seen after at least 24 hours of treatment. Cinchonism and hypoglycaemia are not necessarily indications to cease therapy. Cardiac conduction disturbances and hypersensitivity occur occasionally and haemolysis rarely. Quinidine is the dextrorotatory optical isomer of quinine and, although more active, is more likely to cause cardiotoxicity. EKG monitoring is required so that infusion rates can be reduced if prolongation of the QT interval develops. It has the same propensity to cause hypotension and hypoglycaemia.

#### *Chloroquine*

Chloroquine is a 4-amino quinoline compound which is used for treatment and chemoprophylaxis of malaria infections likely to be chloroquine-sensitive. The drug is active against the erythrocytic

stages of chloroquine-sensitive (most) *P. vivax*, *P. ovale*, *P. malariae* and chloroquine-sensitive *P. falciparum* and the gametocytes of *P. vivax*. It is not active against the pre-erythrocytic stages of any of the species, or the gametocytes of *P. falciparum*. It is well tolerated except for its bitter taste, and may be used in pregnant and lactating women and children. Chloroquine is administered as a salt (such as chloroquine phosphate or sulphate) but the dose is calculated according to the amount of chloroquine base that is required. Chloroquine may be given intravenously but should be given by rate-controlled infusion, so that hypotension does not develop (White, 1996b). The drug is also well absorbed intramuscularly and subcutaneously but is best given in small frequent doses to avoid toxic concentrations in blood (White, 1996b). A liquid form is available for children that should preferably contain chloroquine sulphate as the phosphate salt is unstable if kept in liquid suspension for prolonged periods. Hydroxychloroquine sulphate is a 4-aminoquinoline alternative to chloroquine phosphate or chloroquine sulphate.

Side-effects include nausea, headache, pruritis (especially in dark-skinned persons), rash, reversible corneal opacity and partial alopecia. Care is necessary in giving chloroquine to patients with psoriasis, porphyria or impaired liver function. Nail and mucous membrane discoloration, nerve deafness, photophobia, myopathy, blood dyscrasias, psychosis and seizures are rare. Retinopathy is also rare at doses used for malaria prophylaxis, but an ophthalmologic examination is recommended after a cumulative dose of 100–150 g (6–10 years continuous prophylaxis). Concurrent use of chloroquine may interfere with the antibody response to human diploid cell rabies vaccine. Chloroquine has a low toxic:therapeutic ratio and so the drug must be kept away from children.

#### *Mefloquine (Lariam)*

Mefloquine is similar in structure to quinine and is effective against *P. vivax*, *P. ovale* and most *P. falciparum* infections in the prevention and treatment of malaria. There is no parenteral preparation.

Minor side-effects, including nausea, diarrhoea, dizziness, ataxia, vertigo, headache, anxiety, vivid

dreams and insomnia, are reported in 25–40% of those using mefloquine for chemoprophylaxis (Lobel *et al.*, 1993; Steffen *et al.*, 1993). Serious neuropsychiatric reactions (severe depression, seizures and acute psychoses) are reported to occur at a rate of 1:10 000 to 1:13 000 (Steffen *et al.*, 1993) when mefloquine is used for chemoprophylaxis. Minor side-effects are also common (ter Kuile *et al.*, 1996) and severe reactions are 10–60 times more likely when treatment doses (25 mg base/kg) are used (Weinke *et al.*, 1991; Phillips-Howard and ter Kuile, 1995). Minor side-effects with use of prophylactic mefloquine, such as dizziness, appear to be transient and self-limited. The drug is therefore contraindicated in those with a previous history of seizures, psychosis, depression or a past severe reaction to mefloquine. Mefloquine may potentiate cardiac conduction abnormalities and is contraindicated in individuals with this condition and those taking beta-blockers for cardiac arrhythmias. It appears safe in those taking beta-blockers for hypertension if they have no underlying arrhythmia. Mefloquine toxicity is most likely to develop during the first few weeks of use (Phillips-Howard and ter Kuile, 1995). Mefloquine has been used with safety in the second and third trimester of pregnancy and in children  $\geq 15$  kg. The data showing safety in the first trimester of pregnancy and in children  $< 15$  kg is gradually accumulating and may in time be considered the best option in this group (Phillips-Howard and Wood, 1996; Phillips-Howard *et al.*, 1998). Some reports have identified a trend to increased rates of spontaneous abortion in pregnant women taking mefloquine but the significance is not yet clear (Smoak *et al.*, 1997; Phillips-Howard *et al.*, 1998). Halofantrine and quinine should not be given concurrently with mefloquine (Phillips-Howard and ter Kuile, 1995), and halofantrine should be avoided for 28 days after mefloquine use. Concurrent use of mefloquine may interfere with the antibody response to oral Ty21a typhoid vaccine. There is no evidence that long-term use of mefloquine chemoprophylaxis is associated with additional adverse effects (Lobel *et al.*, 1993). However, it should not be reused for treatment within 28 days because of possible potentiation of the CNS side-effects.

As with all medications, physicians should regularly review indications and contraindications

in texts and in the manufacturers' package inserts, when prescribing mefloquine.

### *Primaquine*

Primaquine is an 8-aminoquinoline which is active against *P. vivax* and *P. ovale* pre-erythrocytic stages. It is used primarily to eradicate these parasites from the liver, thereby preventing relapses or delayed primary attacks. The daily administration of primaquine for causal prophylaxis is not often used because of concerns about toxicity. However, it has been used together with doxycycline in military personnel in Papua New Guinea and was shown to be effective against *P. vivax* and *P. falciparum* (Rieckmann *et al.*, 1993). It was also efficacious and well tolerated in a study involving adult men in Irian Jaya who were not deficient for G-6-PD (Fryauff *et al.*, 1995). Primaquine is gametocidal for *P. falciparum* and has been used to eliminate these sexual forms to prevent malaria transmission in areas where susceptible mosquitoes exist.

Gastrointestinal disturbances are common, including nausea, vomiting, anorexia, dizziness and abdominal pain, but ingestion of the medication with food lessens abdominal distress. Primaquine is an oxidant drug that converts haemoglobin to methaemoglobin. Cyanosis becomes clinically detectable when about 1 g methaemoglobin has been produced, which is not uncommon with usual treatment doses. Neutropenia and agranulocytosis occur rarely. The major toxic effect is acute haemolysis with anaemia of varying severity, haemoglobinuria and jaundice in G-6-PD deficient individuals. G-6-PD deficiency is usually a sex-linked recessive trait and so occurs in males, especially of Mediterranean, Asian and African origin. The condition is also common in Papua New Guinea. The trait appears to confer a degree of protection against malaria, consistent with the high carriage rate in peoples of malaria-endemic regions. Haemolysis may be particularly severe in Chinese, Sri Lankans, Papua New Guineans and people of Mediterranean origin. G-6-PD deficiency should be excluded by laboratory testing before primaquine is prescribed. Primaquine has been used in Africans with G-6-PD deficiency,

but at altered dosage and duration. It is contraindicated during pregnancy.

#### *Halofantrine (Halfan)*

Halofantrine was generally reserved for treatment of refractory cases of *P. falciparum* because, apart from occasionally causing cough, pruritus and rash, it can produce cardiac conduction abnormalities, including ventricular arrhythmias and sudden death. The drug is not recommended for prophylaxis because of variable absorption and it no longer has a role in presumptive treatment because of concerns about cardiotoxicity.

Halofantrine should not be given to patients with cardiac conduction defects or to those taking drugs which are known to prolong the QT interval (quinine, quinidine, chloroquine, tricyclic antidepressants, neuroleptic drugs, terfenadine, astemizole). In particular it should not be used in those who have received mefloquine within the previous 28 days, as the cardiac effects are increased. The oral bioavailability of halofantrine is poor but can be increased if the drug is taken with fatty food (White, 1996b). Because of reports of sudden death, the drug now has little place in the treatment of malaria.

#### **Folate Antagonists**

Folate synthesis is essential to malaria parasites as they are unable to scavenge pyrimidines from their host. Blocking synthesis results in depletion of pyrimidines, methionine and serine and leads to cell cycle arrest and finally death of the parasite (Foote and Cowman, 1994). The two classes of antifolates are the dihydrofolate reductase (DHFR) inhibitors (proguanil and pyrimethamine) and sulphonamide antibiotics (sulphadoxine) and sulphones (dapsone).

#### *Pyrimethamine and Sulphadoxine (Fansidar®)*

This fixed combination has been used both for prophylaxis and treatment of falciparum malaria. Fansidar® is no longer used or recommended as

a chemoprophylactic agent because of increasing resistance, as well as serious toxicity. It is used for the treatment of malaria in certain endemic areas of Africa and in some countries has become the recommended drug for first line treatment. Its use in South East Asia is limited because resistance is now widespread, but it will continue to play an important role in sub-Saharan Africa until resistance that is already present becomes a greater problem. It is available in some countries as a fixed combination with mefloquine ('Fansimel') but this is not recommended.

Headache, nausea and folate deficiency are occasional side-effects. Stevens–Johnson syndrome, erythema multiforme, toxic epidermal necrolysis, hepatitis and blood dyscrasias are rare side-effects of sulphadoxine but may be severe. The drug is contraindicated in patients who are allergic to sulphonamide agents and should not be used in combination with drugs containing antifolate agents or other sulphonamides. It should be used with caution in pregnancy, newborn infants and lactating mothers.

#### *Pyrimethamine and Dapsone (Maloprim)*

This combination of a sulphone and a folate antagonist has also been used widely in combination with chloroquine for prevention of chloroquine-resistant malaria. There is now widespread resistance and that, together with a propensity to cause agranulocytosis, has meant that Maloprim is no longer recommended for chemoprophylaxis. It has no place in the treatment of acute malaria.

#### *Proguanil (Paludrine)*

Proguanil is a dihydrofolate reductase inhibitor that is used for chemoprophylaxis. It has few serious side-effects: anorexia, nausea and mouth ulcers occur relatively commonly; haematuria is rare. Resistance is widespread but is not linked to chloroquine resistance, so proguanil should be given in combination with chloroquine for those patients who cannot take mefloquine or doxycycline. The combination has been shown to be more efficacious in sub-Saharan Africa than

chloroquine alone but still only provides about 50–65% protective efficacy (Steffen *et al.*, 1993; Weiss *et al.*, 1995).

### Endoperoxides

Qinghaosu is a traditional Chinese malaria remedy and is derived from cultivated *Artemisia annua*, a plant used by Chinese herbalists since 168 BC (Hien and White, 1993).

#### Artemesinin and Derivatives

Artemesinin is an endoperoxide-containing sesquiterpene lactone and was identified in 1972 as the active component of qinghaosu. Artemesinin (tablet and suppository formulations) and two derivatives, artesunate (tablet, suppository and parenteral formulation) and artemether (tablet and parenteral formulations), are effective in the treatment of multidrug-resistant *P. falciparum* malaria. These agents are converted into free radicals, which react with and damage specific malaria membrane-associated proteins. They are most active against late-stage ring parasites and trophozoites and are gametocytocidal (Meshnick *et al.*, 1996). Artemesinin has been given to millions of patients in China and IndoChina and no serious toxicity has been reported (Hien and White, 1993). Artemesinin given as rectal suppositories appeared to be as effective as parenteral agents in one study (Hien *et al.*, 1992). Artesunate is the most rapidly acting of the available compounds, possibly because it is immediately bioavailable. Two recent studies suggest that artemether is more effective than quinine in reducing fever and clearing parasites from the blood, but the length of time to recovery and case fatality rates appear to be similar (Hien *et al.*, 1996; van Hensbroek *et al.*, 1996). One concern with these agents is the potential for neurological toxicity. Artemether and arteether (a new derivative, which is being assessed in clinical trials) both cause neuropathic lesions in the caudal brain stem when administered to experimental animals in high doses, and in one of the above studies there was an increased incidence of convulsions in the

artemether group (Hoffman, 1996). Water-soluble artesunate is likely to have less risk of neurotoxicity than fat-soluble artemesinin derivatives. Cardiac arrhythmias have been reported rarely (Win *et al.*, 1992). Artemesinin and derivatives have short half-lives and correspondingly high recrudescence parasitaemia rates (up to 50%) when used as monotherapy for  $\leq 5$  days. In the light of recent studies showing higher cure rates, it now seems desirable to use artemesinin and derivatives in combination with mefloquine or tetracycline (Meshnick *et al.*, 1996). The drugs are not suitable for use as chemoprophylactic agents. Many second-generation endoperoxides have been developed, but none appear to have advantages over the first-generation compounds (Meshnick *et al.*, 1996).

### Others

#### Doxycycline

Doxycycline is used both for chemoprophylaxis and as an adjunct to treatment with quinine or quinidine. The requirement for daily dosing may decrease compliance, the major reason for doxycycline failures, as doxycycline is efficacious against mefloquine-sensitive and mefloquine-resistant *P. falciparum* malaria and *P. vivax* malaria. Doxycycline acts partly as a causal prophylactic (by killing liver forms of the parasite) but the effect is incomplete, so prophylaxis must be taken for 4 weeks after leaving a malaria-endemic area to allow killing of erythrocyte stages.

Side-effects include oesophagitis, gastritis, vaginal candidiasis and photosensitivity (which may be severe). Allergic reactions, oesophageal ulceration, hepatic and renal toxicity, and blood dyscrasias are rare. It is contraindicated in pregnant and lactating women and in children younger than 8 years, as it may result in bone deposition and discoloration of the teeth. It should be taken with food or liquid to decrease the likelihood of gastrointestinal disturbances. It is believed that doxycycline can be used for prolonged periods at a dose of 100 mg/day, although safety has yet to be established. It is reassuring that doxycycline has apparently been

used safely for long periods (sometimes years) for the treatment of acne, albeit at a lower dose (Brown, 1993).

#### *Proguanil and Atovaquone (Malarone®)*

Atovaquone-proguanil has been shown to be effective for both the chemoprophylaxis and treatment of *P. falciparum* and *P. vivax* infections. (Radloff *et al.*, 1996; Lell *et al.*, 1998; Shanks *et al.*, 1998). It is administered orally over a 3 day period for treatment (4 tablets, 250 mg/100 mg) as a single dose daily with food or milk for prophylaxis. Nausea and vomiting have been prominent side-effects in some studies (Radloff *et al.*, 1996; Lell *et al.*, 1998). As spontaneous resistance arises rapidly when proguanil or atovaquone are used for monotherapy, there is concern that the combination may not retain long-term efficacy when its use is broadened.

#### **Drug Combinations and New Agents**

There is an urgent need to identify new antimalarial agents and antimalarial drug combinations which are effective against multidrug-resistant *P. falciparum* (Heppner and Ballou, 1998).

The combination of artemether and benflumetol (co-artemether) has been shown to be effective for the treatment of acute uncomplicated malaria in an area of multidrug resistance (van Vugt *et al.*, 1998). Although not as efficacious as artesunate-mefloquine (81% vs. 94%) at the doses used, it was well tolerated, with fewer side-effects. Further studies using higher doses for longer periods will further define the usefulness of this therapy.

Pyronaridine has been used in China for many years to treat *P. falciparum* and *P. vivax* malaria. It has been shown to be superior to chloroquine when used for treatment of *P. falciparum* malaria

in African children but issues of bioavailability and safety have still to be established (Winstanley, 1996).

WR238605 is a long-acting primaquine analogue which has been shown to be effective in preventing relapses of *P. vivax* in adults in Thailand and also in preventing *P. falciparum* infections in adults in Africa when given as a weekly dose (Heppner and Ballou, 1998; Looareesuwan *et al.*, 1998). Further studies are required but it is hoped that this agent will be useful in areas with high rates of primaquine failure.

Chloroproguanil/dapsone (LAPDAP) is a potential new treatment for uncomplicated *P. falciparum* in Africa. It is active against sulphadoxine/pyrimethanine and is currently under evaluation as a possible alternative.

#### **PREVENTION AND CONTROL**

The need for effective malaria control remains great as malaria continues to threaten populations in many parts of the world. Obstacles, such as increasing drug resistance among malaria parasites and increasing insecticide resistance among mosquitoes, have made control more difficult and heightened the need for effective vaccines or improved control measures.

The World Health Organization Global Malaria Control Strategy (Amsterdam, 1992) acknowledges the failure of a single approach to malaria control or eradication and recognises that different approaches are required to tackle the consequences of malaria in areas of different endemicity (Table 3.8). This has resulted in a progressive strengthening of national and local capacities for assessing malaria situations and selecting appropriate measures (some of which are outlined below) to reduce or prevent disease in the community. The 'Roll Back Malaria'

**Table 3.8** WHO malaria control strategy

- 
- Provision of early diagnosis and prompt treatment for the disease
  - Planning and implementation of selective and sustainable preventive measures, including vector control
  - Early detection for the prevention or containment of epidemics
  - Strengthening of local research capacities to promote regular assessment of countries' malaria situations, in particular the ecological, social and economic determinants of the disease
-

campaign was launched as a new initiative on 30 October 1998, bringing together UNDP, UNICEF, WHO and the World Bank in an attempt to provide a higher profile and greater financial resources for malaria control (World Health Organization, 1999).

The prevention of malaria in travellers to endemic areas has also received renewed attention as the number of individuals at risk from malaria because of travel to remote and rural areas in the tropics has increased (Kain and Keystone, 1998).

### Treatment of Acute Cases

The first priority of a malaria control programme is to reduce mortality and morbidity by ensuring that facilities are available for the early diagnosis and treatment of acute malaria. Indeed, easy access to treatment is the main approach to malaria control in many areas. Early treatment of cases also reduces transmission by reducing the opportunities for mosquitoes to become infected. This approach has been quite effective in countries with low malaria endemicity, such as Thailand, but has had less impact in highly endemic areas in Africa (Greenwood, 1997). The therapeutic agents most likely to reduce transmission are those that are gametocytocidal and include artemesinin and its derivatives. Indeed, the introduction of the artemisinin derivatives in routine treatment in a study site on the Western border of Thailand in mid-1994 was associated with a reduction in the subsequent incidence of falciparum malaria of 47(25–69)% (Price *et al.*, 1996). A strategy using artemesinin treatment combined with another antimalarial drug to prevent emergence of resistant and vector control may be effective in the future.

### Chemoprophylaxis in Malaria-endemic Areas

Further reduction in morbidity can be achieved in endemic areas by targeting high risk groups (children, pregnant women and non-immune migrants) with chemoprophylaxis programmes. Although studies suggest that effectiveness in

pregnant women is limited in holoendemic areas (Silver, 1997), in areas of unstable endemicity, chemoprophylaxis has been shown to prevent malaria in the majority of recipients and to increase birth weight in babies of those women who did contract malaria (Greenwood *et al.*, 1989; Nosten *et al.*, 1994). Chloroquine, which has been used in the past, is no longer effective in many areas. Mefloquine (Nosten *et al.*, 1994) and Fansidar® (given as two treatments in the second and third trimester; Schultz *et al.*, 1994) appear to be safe and effective alternatives. In some areas, it may only be necessary to give chemoprophylaxis during first pregnancies, as the risk to mother and baby is much higher in the first than in subsequent pregnancies (Greenwood, 1997).

### Reduction of Transmission of Malaria

#### Vector Control

The control of mosquitoes is a very effective method of protecting a community against malaria infections. Environment modification, including drainage, landfill and other forms of water level management, has been a successful and cost-effective method in some parts of the world. This approach has been combined with widespread larvicide spraying to further prevent mosquito breeding. The use of residual insecticides (such as 2,2-bis-(*p*-chlorophenyl)-1,1,1-trichloroethane, DDT) directed against adult mosquitoes was a major breakthrough. DDT sprayed inside houses is active for many months in killing mosquitoes which rest on interior walls and ceilings after feeding on household inhabitants. Mass spraying campaigns with DDT were very successful in controlling malaria in many countries during the 1950s and 1960s. Unfortunately, *Anopheles* mosquitoes have been able to survive these chemical attacks by developing resistance to the residual insecticides and by changing their feeding and resting habits. There has also been a growing concern about the effect of residual insecticides on the human population and on the environment, leading to an increased focus on individual protection and a renewed interest in larva control, using both biological methods (such as larvivorous fish and bacterial toxins) and chemical agents.

### ***House Screening and Mosquito Repellents***

*Anopheles* mosquitoes tend to bite indoors, so mosquito-proofing measures, such as mesh screens, are important. The use of 'roll-on' insect repellents applied to exposed skin and 'knock-down' sprays are an effective method of protection but may not be available or affordable in many malaria-endemic areas.

### ***Impregnated Bednets and Other Materials***

Insecticide-impregnated bednets and curtains have now been shown to reduce the incidence of clinical attacks of malaria in children in both Africa and Asia. The African trials have shown a reduction in overall child mortality by 20–30% and a reduction of clinical attacks of malaria by approximately 50% (Choi *et al.*, 1995; D'Alessandro *et al.*, 1995a) without rebound mortality following the intervention. Treatment with permethrin (300–500 mg/m<sup>2</sup>) or similar insecticide provides more protection than untreated nets (Choi *et al.*, 1995), although nets require retreatment every 6 months to maintain effectiveness. Sleeping under permethrin-treated nets does not appear to have been hazardous for pregnant women or children, but efficacy in preventing malaria in pregnancy is uncertain. The wide-scale introduction of insecticide-impregnated bednets has been very effective but concerns have been raised about sustainability when costs are shifted to the user (Cham *et al.*, 1997) and also the possibility that morbidity and deaths may not be prevented but delayed until an older age (Greenwood, 1997). In addition, mosquito populations are likely to be able to adapt to interventions by developing resistance to drugs or behavioural change.

### **Prevention of Malaria in Travellers**

The epidemiology of malaria changes constantly, and those advising travellers must have access to the most up-to-date information about the distribution and seasonality of malaria and be conversant with the most recent information on drug sensitivity, availability and side-effects. A

balanced view of the risks and benefits of various approaches to malaria prevention can then be provided.

### ***Assessing Individual Risk***

Assessment of a traveller's risk of acquiring malaria is based on a detailed travel itinerary, including duration of travel and activities in each malaria endemic area. The risk varies according to geographic area. For example, the rate of imported malaria in Australians returning from endemic areas in 1991 varied from 7–9/1000 travellers to Papua New Guinea and the Solomon Islands, to 4/100 000 travellers to Malaysia (Centre for Disease Intelligence, 1991). British travellers to East Africa have attack rates of up to 465/100 000 (Phillips-Howard *et al.*, 1990). Within each geographic area, variations in malaria risk exist because of altitude, climate, season and degree of urbanisation. The types of accommodation (e.g. camping, well-screened, air-conditioned) that will be encountered is also important, given that the mosquito vector feeds mainly between dusk and dawn.

### ***Prevention of Mosquito Bites***

It is important to educate travellers about minimisation of exposure to *Anopheles* mosquito bites, as this will considerably reduce the risk of malaria infection (and other diseases carried by mosquitoes). Female *Anopheles* mosquitoes are evening and night-time feeders, and so wearing light-coloured clothing that reduces the amount of exposed skin during the dusk-to-dawn period, using insect repellent on exposed skin, and sleeping in screened accommodation or under bednets (preferably treated with permethrin, as described above) are all important measures. If bednets are not available, the use of 'knock-down' sprays or coils is useful to clear the room of mosquitoes before going to sleep. Insect repellents containing *N,N*-diethylmetatoluamide (DEET) are most effective for reducing exposure outdoors. Repellents containing high concentrations of DEET (>35%) protect for longer periods of time but have been associated with



seizures and encephalopathy in young children (MMWR, 1989). Therefore, a lower concentration formulation should be applied sparingly on children and this can be washed off before going to sleep under a net.

### **Chemoprophylaxis in Travellers**

Malaria chemoprophylaxis refers to the administration of drugs to prevent the development of symptomatic infection. Most available drugs exert their major effect on the blood stages of the parasite without eliminating the hepatic stages. Therefore, chemoprophylaxis must be continued after exposure for longer than the usual duration of the pre-erythrocytic (hepatic) cycle, so that all parasites entering the blood from the liver will be killed. In the case of *P. vivax* and *P. ovale* infections, the aim is to prevent disease while taking prophylaxis, in the knowledge that a minority of individuals may develop disease months or years later as hypnozoites emerge from the liver.

The need for and type of prophylaxis will depend on the anticipated duration and intensity of exposure to malaria, as well as the pattern of drug resistance in the areas of travel. It is necessary to ascertain whether the traveller will have ready access to competent medical care, whether there will be travel in a drug-resistant *P. falciparum* area (see map) and whether there are any contraindications to the use of a particular antimalarial drug. Any allergies or illnesses that may increase the risk of travel must also be taken into consideration. Individuals who have had splenectomy or who have cardiac, neurological or psychiatric conditions may present special problems. The final decision about the need for and type of chemoprophylaxis should be individualised and should take into account the risk of acquiring infection vs. the potential risks of the drugs.

In general, chemoprophylaxis should be considered for travellers to urban and rural areas of sub-Saharan Africa, Oceania, Haiti, India, Pakistan, Bangladesh and the Terai region of Nepal, and for individuals travelling in rural, non-resort areas of South East Asia, Central and South America, certain parts of Mexico, North Africa

and the Dominican Republic (Kain and Keystone, 1998).

Resistance of *P. falciparum* to chloroquine has been confirmed or is probable in most countries with *P. falciparum* malaria. Some current exceptions include the Dominican Republic, Haiti, Central America north of the Panama Canal Zone, Egypt, and most countries in the Middle East. In addition, resistance to both chloroquine and Fansidar<sup>®</sup> is widespread in Thailand, Myanmar (formerly Burma), Cambodia, and the Amazon basin area of South America, and resistance has also been reported sporadically in sub-Saharan Africa. Resistance to mefloquine has been confirmed in those areas of Thailand with malaria transmission (Centers for Disease Control and Prevention, 2001).

The following regimens are currently recommended (World Health Organization, 1998a; Centers for Disease Control and Prevention, 2001) (Table 3.7):

- Use weekly chloroquine for areas with chloroquine-sensitive malaria—Mexico, the Caribbean, Central America (west of the Panama Canal) and parts of the Middle East as above.
- For areas with chloroquine-resistant malaria use:
  - weekly mefloquine, if not contraindicated. Can be used for long-term prophylaxis but warn travellers of side-effects
  - daily doxycycline, if not contraindicated (not for children < 8 yrs, pregnant or lactating women)
  - daily Malarone<sup>®</sup> (not recommended for children < 11 kg or pregnant women).

All drugs should be commenced 1–2 weeks before entering a malarious areas to allow early detection of side-effects and the establishment of adequate blood levels. Doxycycline and Malarone<sup>®</sup> are exceptions and may be commenced 1–2 days before entering malarious areas. Doxycycline and Malarone<sup>®</sup> are taken daily and chloroquine and mefloquine are taken weekly. Drugs are continued while in and for 4 weeks after leaving the malaria area except for Malarone<sup>®</sup> which is continued for 7 days. It is usually necessary to continue prophylaxis for this 4 week period, as it may take 4 weeks or longer from infection by a

mosquito to the appearance of parasites in the peripheral blood. Occasionally this period may be even longer and primary illness may appear in the few weeks or months after ceasing chemoprophylaxis. Travellers should also be warned that relapses of *P. vivax* and *P. ovale* infections may occur months to years after last leaving a malaria-endemic area.

Not all travellers to countries with chloroquine-resistant malaria require prophylaxis. For example, there is minimal risk in cities and the main seaside resorts of Thailand, despite high level resistance in rural forest border areas (World Health Organization, 1998a), and little risk for travellers visiting the major tourist areas in Bali.

For those living in endemic areas for long periods, consider concentrating on preventing exposure and using safe but less efficacious chloroquine in urban (low prevalence) areas and adding doxycycline for short trips to rural (higher prevalence) areas.

Travellers should be advised that it is still possible to contract malaria, regardless of the protective measures employed and the chemoprophylaxis used, even in situations where a low level of risk was anticipated. They should be cautioned that, although malaria is readily treatable in the early stages, delay in diagnosis or the commencement of appropriate therapy may lead to serious or fatal consequences. Travellers and health care providers must therefore consider the diagnosis of malaria in any febrile illness that occurs during or after travel to a malaria-endemic area. If the diagnosis of malaria is considered, a blood slide should be taken and examined without delay.

### **Pregnancy**

Chloroquine and proguanil are safe for use in pregnant women travelling to areas with chloroquine-sensitive malaria. Non-immune women are advised to postpone travel to areas where there is a significant prevalence of chloroquine-resistant malaria. If this is not possible CDC advises that use of mefloquine "during second and third trimesters of pregnancy is not associated with adverse fetal pregnancy outcomes". Limited data suggest it is safe during first trimester. There is insufficient data about safety

of Malarone<sup>®</sup> in pregnancy and so it is not currently recommended (Centers for Disease Control and Prevention, 2001). However, one limited study suggested a trend towards an increased rate of spontaneous abortion in women receiving mefloquine, compared with controls (Samuel and Barry, 1998). CDC concludes that mefloquine may be considered for prophylaxis in women who are pregnant or likely to become so, when exposure to chloroquine-resistant *P. falciparum* is unavoidable. Doxycycline should not be used. WHO guidelines recommend chloroquine plus proguanil in cases where the risk from malaria is low, especially for those in the first trimester of pregnancy (World Health Organization, 2001). As there is widespread resistance to these drugs, it would also be necessary to carry presumptive therapy, for emergency use if no medical help is immediately available (quinine). Primaquine eradication therapy should not be used in pregnancy because of the rare possibility of severe haemolytic anaemia if the foetus is G-6-PD-deficient (Samuel and Barry, 1998). Instead, weekly prophylaxis can be continued through pregnancy and then primaquine administered to the mother after delivery.

The need for diligence in avoidance of mosquito bites and compliance in taking prophylaxis should be emphasised. The safety of insect repellents containing DEET in pregnancy has not been established and therefore low concentration formulations should be used sparingly and for short periods.

### **Malaria Presumptive Treatment**

Stand-by treatment regimes (Fansidar<sup>®</sup>, Malarone<sup>®</sup>, quinine) may be useful in individuals who will be travelling in remote areas without easy access to medical assistance. It is important to advise patients with a febrile illness to seek out medical care, and self-treatment for malaria should be viewed as a temporary measure only. Standby treatment remains controversial because of concerns about the risk of incorrectly treating another disease, and the potential toxicity of the antimalarial drugs. The recent availability of antigen test kits for falciparum malaria may enable more rational self-treatment and allay some of these concerns (Schlagenhauf *et al.*, 1995).

## Vaccine Development

Vaccination against *P. falciparum* is the intervention that is most likely to reduce malaria-associated severe morbidity and mortality in infants and young children in areas with the most intense transmission and to reduce the risk to non-immune travellers to endemic areas. The rationale for developing a malaria vaccine includes prevention of infection (pre-erythrocytic vaccines), prevention of disease (blood-stage vaccines) and reduction of transmission (transmission blocking vaccines) (Miller and Hoffman, 1998).

### Strategies

The general strategy since the cloning of *P. falciparum* blood-stage antigens in 1983 (Kemp *et al.*, 1983) has been to develop subunit vaccines composed of defined antigens that can be synthesised chemically or by recombinant technology. As malaria immunity is stage-specific, the main focus in the development of a subunit vaccine has been to identify critical target antigens at each stage of the life-cycle (e.g. Coppel *et al.*, 1984). This has involved the characterisation of components of the parasite that are essential for its survival or development, as well as a detailed investigation of the immunological mechanisms that confer partial protection following natural infection (Anders *et al.*, 1985). A range of different vaccine delivery methods has also been developed. These include malaria antigens linked to strong T-helper epitopes, synthetic malaria peptides or recombinant proteins formulated with adjuvant liposomes (Fries *et al.*, 1992) or other particles, malarial protein gene sequences incorporated into live vectors, such as the attenuated vaccinia virus strain, NYVAC (Tine *et al.*, 1996) and DNA vaccines (Hoffman *et al.*, 1995).

### Pre-erythrocytic (Sporozoite) Vaccines

The discovery that human volunteers inoculated with irradiated sporozoites were protected for up to 9 months against infectious challenge (Clyde *et al.*, 1973) has led to much effort to develop a pre-erythrocytic vaccine. It is argued that a vaccine

that prevents sporozoites entering, or developing in, hepatocytes would eliminate infection before the appearance of clinical disease. Even with less effective vaccines, it may be expected that there would be a reduction in the number of parasites entering the blood from the liver and thereby less risk of severe disease.

Pre-erythrocytic vaccine development initially focused on inducing antibodies to the sporozoite surface. Antibodies directed to the circumsporozoite protein (CSP) repeat [asparagine (N), alanine (A), Proline (P), NANP] were shown to neutralize sporozoites *in vitro* but to give inconsistent protection against *P. falciparum* infection *in vivo* (Ballou *et al.*, 1987; Herrington *et al.*, 1987). It is likely that the failure of the early CSP vaccine was due to a failure to induce cell-mediated effector mechanisms, such as cytotoxic T lymphocytes and cytokine-mediated inhibition of parasite development. It is encouraging that a hybrid containing the central repeats and most of the C-terminus of the PfCSP fused to hepatitis B surface antigen in a complex adjuvant mixture (RTS,S-SBAS4) was recently shown to be protective (Stoute *et al.*, 1998) and is now undergoing clinical trial in the Gambia.

### Blood-stage Vaccines

People in endemic areas develop clinical immunity despite frequent blood-stage infections that are usually asymptomatic, demonstrating that it not necessary (and may not be desirable) to prevent infection in order to prevent disease. Based on the principle of mimicking immunity acquired in an endemic area, a blood-stage vaccine could be designed to reduce or interfere with parasite replication, and numerous animal studies have confirmed that immunisation induces protection that may be more effective than chronic repeated infections. A vaccine could also be designed to prevent pathology, rather than infection. An 'anti-adhesion' vaccine could prevent a key step in pathogenesis, for example, to prevent malaria in pregnancy that appeared to be associated with chondroitin sulphate A binding (Rogerson and Brown, 1997; Reeder *et al.*, 1999). An 'anti-disease' vaccine could neutralise key toxins, such as glycosylphosphatidylinositol

(GPI), responsible for pathology (Schofield *et al.*, 1993) or passively transferred antibody could potentially neutralise harmful cytokines.

Many candidate vaccine antigens have been identified and several have been tested in human trials, the furthest developed being SPf66, identified by Patarroyo *et al.* (1987) in Colombia. This vaccine consists of a 66 amino acid peptide polymerised and bound to aluminium hydroxide. The hybrid polymer is a combination of four peptides (three derived from asexual stage antigens and one from the circumsporozoite protein) which had been shown to protect *Aotus* monkeys from *P. falciparum* challenge (Patarroyo *et al.*, 1987). The vaccine was shown to be safe and protective against *P. falciparum* malaria in Columbia (Patarroyo *et al.*, 1987) and had a protective efficacy of 30% for clinical malaria attacks in a randomised double-blind placebo-controlled trial in children aged 1–5 years in Tanzania (Alonso *et al.*, 1994). However, no protective efficacy was observed in infants in the Gambia or in older children in Thailand (D'Alessandro *et al.*, 1995b; Nosten *et al.*, 1996; Bojang *et al.*, 1998). Several other candidate vaccines are progressing to human trials, and efficacy studies are in the planning stage (Rogers and Hoffman, 1999).

Merozoite surface protein (MSP)-1 was identified by monoclonal antibodies and is the major protein on the merozoite surface. It has been shown to induce protection in both mice and monkeys (Holder and Freeman, 1981; Etlinger *et al.*, 1991). Also, antibodies against a specific region of the molecule have been shown to correlate with protection from clinical episodes of malaria (Egan *et al.*, 1996).

Recent work identifying GPI of *P. falciparum* as a toxin capable of inducing massive cytokine release (Schofield *et al.*, 1993; Tachado *et al.*, 1996) provides the basis for a vaccine that could induce immunity to clinical malaria, thus mimicking earliest immunity developed by individuals living in an endemic area.

### **Transmission Blocking (Gametocyte Vaccines)**

Immunisation of the mammalian host with gametocyte antigens generates antibodies that

are carried into the mosquito gut, along with gametocytes. These antibodies then react with sexual stage antigens and interfere with the fertilisation process, thus blocking transmission of malaria (Carter *et al.*, 1984). Experiments in animals suggest that antibodies to a 25 kDa gametocyte antigen block transmission in membrane feeding experiments (Barr *et al.*, 1991) and several other candidates are under consideration. Even though this type of vaccine would confer no direct benefit to the individual, it is hoped that it would reduce the prevalence of malaria in the community and have a significant effect on morbidity and mortality (Kaslow, 1997).

### **DNA Vaccines**

DNA immunisation involves the direct introduction of a plasmid DNA encoding a target antigen, which is then expressed within cells of the host and can stimulate an immune response. This approach will allow a combination of many DNAs, each encoding different antigens, thereby broadening the immune response. Animal studies using genes encoding *P. yoelii* sporozoite proteins have so far been encouraging (Doolan *et al.*, 1998).

### **Acknowledgements**

We acknowledge the help of Heather Saunders and Virginia Champion de Crespigny in preparing the manuscript, Joe Manitta and Stephen Rogerson for slide microscopy and Kevin Kain for reviewing the text.

### **REFERENCES**

- Abdurrahman MB (1984). The role of infectious agents in the aetiology and pathogenesis of childhood nephrotic syndrome in Africa. *J Infect* **8**: 100–9.
- Abdurrahman MB, Aikhionbare HA, Babayo FA *et al.* (1990). Clinicopathological features of childhood nephrotic syndrome in northern Nigeria [see comments]. *Q J Med* **75**: 563–76.
- Ahmed A, Cerilli LA, Sanchez PJ (1998). Congenital malaria in a preterm neonate: case report and review of the literature. *Am J Perinatol* **15**: 19–22.

- al-Yaman F, Genton B, Mokela D *et al.* (1995). Human cerebral malaria: lack of significant association between erythrocyte rosetting and disease severity. *Trans R Soc Trop Med Hyg* **89**: 55–8.
- Alonso PL, Smith T, Armstrong Schellenberg JRM *et al.* (1994). Randomised trial of efficacy of SPf66 vaccine against *Plasmodium falciparum* malaria in children in southern Tanzania. *Lancet* **344**: 1175–81.
- Anders RF, Brown GV, Coppel RL *et al.* (1985). Potential vaccine antigens of the asexual blood-stages of *Plasmodium falciparum*. *Dev Biol Stand* **62**: 81–89.
- Babiker HA, Ranford-Cartwright, LC, Currie D *et al.* (1994). Random mating in a natural population of the malaria parasite *Plasmodium falciparum*. *Parasitology* **109**: 413–21.
- Ballou WR, Sherwood JA, Neva FA *et al.* (1987). Safety and efficacy of a recombinant DNA *Plasmodium falciparum* sporozoite vaccine. *Lancet* **1**: 1277–81.
- Barker RH, Banchongaksora T, Courval JM *et al.* (1992). A simple method to detect *Plasmodium falciparum* directly from blood samples using the polymerase chain reaction. *Am J Trop Med Hyg* **46**: 416–26.
- Barr PJ, Green KM, Gibson HL *et al.* (1991). Recombinant Pfs25 protein of *Plasmodium falciparum* elicits malaria transmission-blocking immunity in experimental animals. *J Exp Med* **174**: 1203–8.
- Baruch DI, Pasloske BL, Singh HB *et al.* (1995). Cloning the *P. falciparum* gene encoding PfEMP1, a malarial variant antigen and adherence receptor on the surface of parasitized human erythrocytes [see comments]. *Cell* **82**: 77–87.
- Bates I, Bedu-Addo G (1997). Chronic malaria and splenic lymphoma: clues to understanding lymphoma evolution. *Leukemia* **11**: 2162–7.
- Bates I, Bedu-Addo G, Bevan DH *et al.* (1991). Use of immunoglobulin gene rearrangements to show clonal proliferation in hyperreactive malarial splenomegaly. *Lancet* **337**: 505–7.
- Beadle C, Long GW, Weiss WR *et al.* (1994). Diagnosis of malaria by detection of *Plasmodium falciparum* HRP-2 antigen with a rapid dipstick antigen-capture assay. *Lancet* **334**: 564–8.
- Beeson JG, Brown GV, Molyneux ME *et al.* (1999). *Plasmodium falciparum* isolates from infected pregnant women and children are each associated with distinct adhesive and antigenic properties. *J Infect Dis* **180**: 464–72.
- Beeson JG, Rogerson SJ, Cooke BM *et al.* (2000). Adhesion of *Plasmodium falciparum*-infected erythrocytes to hyaluronic acid in placental malaria. *Nature Med* **6**: 86–90.
- Behrens RH, Curtis CF (1993). Malaria in travellers: epidemiology and prevention. *Br Med Bull* **49**: 363–81.
- Biggs BA, Anders RF, Dillon H *et al.* (1992). Adherence of infected erythrocytes to venular endothelium selects for antigenic variants of *Plasmodium falciparum*. *J Immunol* **149**: 2047–54.
- Biggs BA, Goozé L, Wycherley K *et al.* (1991). Antigenic variation of *Plasmodium falciparum*. *Proc Natl Acad Sci USA* **88**: 9171–4.
- Bojang KA, Obaro SK, D'Alessandro U *et al.* (1998). An efficacy trial of the malarial vaccine SPf66 in Gambian infants—second year of follow-up. *Vaccine* **16**: 62–7.
- Bradley D, Warhurst D, Blaze M *et al.* (1994). Malaria imported into the United Kingdom in 1992 and 1993. *Commun Dis Rep CDR Rev* **4**: R169–72.
- Brown GV (1993). Chemoprophylaxis of malaria. *Med J Aust* **159**: 187–96.
- Bruce-Chwatt IJ (1988). History of malaria from prehistory in eradication. In Wernsdorfer WH, McGregor IA (eds), *Malaria, Principles and Practice of Malariology*. Churchill Livingstone, Edinburgh; 1–59.
- Bruce-Chwatt LJ (1985). *Essential Malariology*. Heinemann Medical: London; 452.
- Bull PC, Lowe BS, Kortok M *et al.* (1999). Antibody recognition of *Plasmodium falciparum* erythrocyte surface antigens in Kenya: evidence for rare and prevalent variants. *Infect Immun* **67**: 733–9.
- Burgner D, Xu W, Rockett K *et al.* (1998). Inducible nitric oxide synthase polymorphism and fatal cerebral malaria. *Lancet* **352**: 1193–4.
- Burne JC (1970). Malaria by accidental inoculation. *Lancet* **2**: 936.
- Carlson J, Helmby H, Hill AVS *et al.* (1990). Human cerebral malaria: association with erythrocyte rosetting and lack of anti-rosetting antibodies. *Lancet* **336**: 1457–60.
- Carter R, Miller LH, Renner J *et al.* (1984). Target antigens in malaria transmission blocking immunity. *Phil Trans R Soc Lond B* **307**: 201–13.
- Centers for Disease Control and Prevention (1995). Malaria surveillance—United States, 1992. *Morb Mortal Wkly Rep CDC Surveill Summ* **44**: (suppl SS–5).
- Centers for Disease Control and Prevention (2001). *Health Information for International Travel 2001–2002*. Centers for Disease Center and Prevention: Bethesda, MD.
- Centre for Disease Intelligence (1991). Report of the Australian Malaria Register for 1990. *Centre for Disease Intelligence* **15**: 400–8.
- Cham BK, Olayeye B, D'Alessandro U *et al.* (1997). The impact of charging for insecticide on the Gambian National Impregnated Bednet Programme. *Health Policy Planning* (in press).
- Chen Q, Fernandez V, Sundstrom A *et al.* (1998). Developmental selection of *var* gene expression in *Plasmodium falciparum*. *Nature* **394**: 392–5.
- Choi HW, Breman JG, Teutsch SM *et al.* (1995). The effectiveness of insecticide-impregnated bed nets in reducing cases of malaria infection: a meta-analysis of published results. *Am J Trop Med Hyg* **52**: 377–82.
- Clyde DF, Most H, McCarthy, VC *et al.* (1973). Immunization of man against sporozoite-induced falciparum malaria. *Am J Med Sci* **266**: 169–77.
- Cohen S, McGregor IA (1961).  $\alpha$ -Globulin and acquired immunity to human malaria. *Nature* **192**: 733–7.
- Coppel RL, Black CG (1998). Malaria parasite DNA. In Sherman IW (ed.), *Malaria. Parasite Biology, Pathogenesis, and Protection*. ASM Press: Washington, DC; 185–202.
- Coppel RL, Cowman AF, Anders RF *et al.* (1984). Immune sera recognize on erythrocytes *Plasmodium falciparum* antigen composed of repeated amino acid sequences. *Nature* **310**: 789–92.
- Cowman AF (2001). Functional analysis of drug resistance in *Plasmodium falciparum* in the post-genomic era. *Int J Parasitol* **31**: 871–8.

- Crabb BS, Cowman AF (1996). Characterization of promoters and stable transfection by homologous and nonhomologous recombination in *Plasmodium falciparum*. *Proc Natl Acad Sci USA* **93**: 7289–94.
- Crawley J, English M, Waruiru C *et al.* (1998). Abnormal respiratory patterns in childhood cerebral malaria. *Trans R Soc Trop Med Hyg* **92**: 305–8.
- D'Alessandro U, Olaleye B, McGuire W *et al.* (1995a). Mortality and morbidity from malaria in Gambian children after introduction of an impregnated bednet programme. *Lancet* **345**: 479–83.
- D'Alessandro U, Leach A, Drakeley CJ *et al.* (1995b). Efficacy trial of malaria vaccine SPf66 in Gambian infants. *Lancet* **346**: 462–7.
- Day KP, Hayward RE, Dyer M (1998). The biology of *Plasmodium falciparum* transmission stages. *Parasitology* **116**: S95–109.
- Day NP, Nguyen HP, Pham PL (1997). Renal disease. II. Malaria and acute renal failure. *J R College Physicians London* **31**: 146–8.
- Day NPJ, Phu NH, Bethell DB *et al.* (1996). Renal haemodynamics and oxygen transport in severe sepsis and severe malaria. *Trans R Soc Trop Med Hyg* **90**: 465.
- Doolan DL, Hedstrom RC, Gardner MJ *et al.* (1998). DNA vaccination as an approach to malaria control: current status and strategies. *Curr Top Microbiol Immunol* **226**: 37–56.
- Egan AF, Morris J, Barnish G *et al.* (1996). Clinical immunity to *Plasmodium falciparum* malaria is associated with serum antibodies to the 19-kDa C-terminal fragment of the merozoite surface antigen, PfMSP-1. *J Infect Dis* **173**: 765–9.
- English M, Sauerwein R, Waruiru C *et al.* (1997). Acidosis in severe childhood malaria [see comments]. *Q J Med* **90**: 263–70.
- Etlinger HM, Caspers P, Matile H *et al.* (1991). Ability of recombinant or native proteins to protect monkeys against heterologous challenge with *Plasmodium falciparum*. *Infect Immun* **59**: 3498–503.
- Footo SA, Cowman AF (1994). The mode of action and the mechanism of resistance to antimalarial drugs. *Acta Trop* **56**: 157–71.
- Freedman AM (1987). Unusual forms of malaria transmission. A report of 2 cases. *S Afr Med J* **71**: 183–4.
- Fried M, Duffy PE (1998). Maternal malaria and parasite adhesion. *J Mol Med* **76**: 162–71.
- Fries LF, Gordon DM, Richards RL *et al.* (1992). Liposomal malaria vaccine in humans: a safe and potent adjuvant strategy. *Proc Natl Acad Sci USA* **89**: 358–62.
- Fryauff DJ, Baird JK, Basri H *et al.* (1995). Randomised placebo-controlled trial of primaquine for prophylaxis of falciparum and vivax malaria. *Lancet* **346**: 1190–3.
- Garcia M, Kirimoama S, Marlborough D *et al.* (1996). Immunochromatographic test for malaria diagnosis [letter]. *Lancet* **347**: 1549.
- Gardner JP, Pinches RA, Roberts DJ *et al.* (1996). Variant antigens and endothelial receptor adhesion in *Plasmodium falciparum*. *Proc Natl Acad Sci USA* **93**: 3503–8.
- Garnham PCC (1966). *Malaria Parasites and Other Haemosporidia*. Blackwell Scientific: Oxford.
- Genton B, Al-Yaman F, Mgone CS *et al.* (1995). Ovalocytosis and cerebral malaria. *Nature* **378**: 564–5.
- Golgi C (1886) 'Sull' infezione malarica. *Arch Sci Med Torino* **10**: 109–35.
- Grassi B, Bignami A, Bastianelli G (1899). Giclo evolutivo delle semilune nell *Anopheles claviger* ed altri studi sulla malaria dall'ottobre 1898 al maggio 1899. *Ann d'Igiene Speriment* **9**: 258–71.
- Grau GE, Taylor TE, Molyneux ME *et al.* (1989). Tumour necrosis factor and disease severity in children with falciparum malaria. *N Engl J Med* **320**: 1586–91.
- Greenberg AE, Lobel HO (1990). Mortality from *Plasmodium falciparum* malaria in travelers from the United States, 1959–1987. *Ann Intern Med* **113**: 326–7.
- Greenwood BM (1997). What's new in malaria control? *Ann Trop Med Parasitol* **91**: 523–31.
- Greenwood BM, Greenwood AM, Snow RW *et al.* (1989). The effects of malaria chemoprophylaxis given by traditional birth attendants on the course and outcome of pregnancy. *Trans R Soc Trop Med Hyg* **83**: 589–94.
- Heppner DG, Ballou WR (1998). Malaria in 1998: advances in diagnosis, drugs and vaccine development. *Curr Opin Infect Dis* **11**: 519–30.
- Herrington DA, Clyde DF, Losonsky G *et al.* (1987). Safety and immunogenicity in man of a synthetic peptide malaria vaccine against *Plasmodium falciparum* sporozoites. *Nature* **328**: 257–9.
- Hien TT, Arnold K, Vinh H *et al.* (1992). Comparison of artemesinin suppositories with intravenous artesunate and intravenous quinine in the treatment of cerebral malaria. *Trans R Soc Trop Med Hyg* **86**: 582–3.
- Hien TT, Day NPJ, Phu NH *et al.* (1996). A controlled trial of artemether or quinine in Vietnamese adults with severe falciparum malaria. *N Engl J Med* **335**: 76–83.
- Hien TT, White NJ (1993). Qinghaosu. *Lancet* **341**: 1603–8.
- Hill AV, Allsopp CE, Kwiatkowski D *et al.* (1991). Common west African HLA antigens are associated with protection from severe malaria. *Nature* **352**: 595–600.
- Hoffman SL (1996). Artemether in severe malaria—still too many deaths [Editorial; comment]. *N Engl J Med* **335**: 124–6.
- Hoffman SL, Doolan DL, Sedegah M *et al.* (1995). Nucleic acid malaria vaccines. Current status and potential. *Ann NY Acad Sci* **772**: 88–94.
- Holder AA, Freeman RR (1981). Immunization against blood-stage rodent malaria using purified parasite antigens. *Nature* **294**: 361–4.
- Humar A, Ohrt C, Harrington MA *et al.* (1997). Parasight F test compared with polymerase chain reaction and microscopy for the diagnosis of *Plasmodium falciparum* malaria in travelers. *Am J Trop Med Hyg* **56**: 44–8.
- Jeffrey G, Eyles DE (1954). The duration in the human host of infections with a Panama strain of *Plasmodium falciparum*. *Am J Trop Med Hyg* **3**: 219–24.
- Jeffrey G, Eyles DE (1955). Infectivity to mosquitoes of *Plasmodium falciparum* as related to gametocyte density and duration of infection. *Am J Trop Med Hyg* **4**: 781–9.
- Jenkin GA, Ritchie SA, Hanna JN *et al.* (1997). Airport malaria in Cairns. *Med J Aust* **166**: 307–8.

- Kain KC, Keystone JS (1998). Malaria in travellers. Epidemiology, disease, and prevention. *Infect Dis Clin North Am* **12**: 267–84.
- Kaslow DC (1997). Transmission-blocking vaccines: uses and current status of development. *Int J Parasitol* **27**: 183–9.
- Kemp DJ, Coppel RL, Cowman AF *et al.* (1983). Expression of *Plasmodium falciparum* blood-stage antigens in *Escherichia coli*: detection with antibodies from immune humans. *Proc Natl Acad Sci USA* **80**: 3787–91.
- Kohler S, Delwiche CF, Denny PW *et al.* (1997). A plastid of probable green algal origin in Apicomplexan parasites [see comments]. *Science* **275**: 1485–9.
- Krishna S, Waller DW, Ter Kuile F *et al.* (1994). Lactic acidosis and hypoglycaemia in children with severe malaria: pathophysiological and prognostic significance. *Trans R Soc Trop Med Hyg* **88**: 67–73.
- Krotowski WA, Collines WE, Bray RS *et al.* (1982). Demonstration of hypnozoites in sporozite-transmitted *Plasmodium vivax* infection. *Am J Trop Med Hyg* **31**: 1291–3.
- Kurtzals JA, Adabayeri V, Goka BQ *et al.* (1998). Low plasma concentrations of interleukin 10 in severe malarial anaemia compared with cerebral and uncomplicated malaria. *Lancet* **351**: 1768–72.
- Kwiatkowski D, Hill AVS, Sambou I *et al.* (1990). TNF concentrations in fatal cerebral and non-fatal cerebral, and uncomplicated *Plasmodium falciparum* malaria. *Lancet* **336**: 1201–4.
- Kwiatkowski D, Molyneux ME, Stephens S *et al.* (1993). Anti-TNF therapy inhibits fever in cerebral malaria. *Q J Med* **86**: 91–8.
- Lackritz EM, Campbell CC, Ruebuch II TK *et al.* (1992). Effect of blood transfusion on survival among children in a Kenyan hospital. *Lancet* **340**: 524–8.
- Laveran A (1880a). Un nouveau parasite trouvé dans le sang des malades atteints de fièvre palustre origine parasitaire des accidents de l'impaludisme. Communication faite à la Société médicales des hôpitaux dans la séance du 24 décembre 1880. *Bull Mem Soc Méd Hôpit Paris* **17**: 158–64.
- Laveran CLA (1880b). Notre sur un nouveau parasite trouve dans le sang de plusieurs malades atteints de fièvre palustre. *Bull Acad Med* **9**: 1235.
- Lell B, Luckner D, Ndjave M *et al.* (1998). Randomised placebo-controlled study of atovaquone plus proguanil for malaria prophylaxis in children. *Lancet* **351**: 709–13.
- Levine RA, Wardlaw SC, Patton CL (1989). Detection of haemoparasites using quantitative buffy coat analysis tubes. *Parasitol Today* **5**: 132–4.
- Lobel HO, Mathews HM, Kagan IG (1973). Interpretation of IHA titres for the study of malaria epidemiology. *Bull World Health Org* **49**: 485–92.
- Lobel HO, Miani M, Eng T *et al.* (1993). Long-term malaria prophylaxis with weekly mefloquine. *Lancet* **341**: 848–51.
- Looareesuwan S, Phillips RE, White NJ *et al.* (1985). Quinine and severe falciparum malaria in late pregnancy. *Lancet* **ii**: 4–8.
- Looareesuwan S, Suntharasamaj P, Webster HK *et al.* (1993). Malaria in splenectomized patients. Reply. *Clin Infect Dis* **17**: 936–7.
- Looareesuwan S, Vanijanonta S, Viravan C *et al.* (1994). Randomized trial of mefloquine alone and artesunate followed by mefloquine for the treatment of acute uncomplicated falciparum malaria. *Ann Trop Med Parasitol* **88**: 131–6.
- Looareesuwan S, Viravan C, Vanijanonta S *et al.* (1992). Randomised trial of artesunate and mefloquine alone and in sequence for acute uncomplicated falciparum malaria. *Lancet* **339**: 821–4.
- Looareesuwan S, Wilairatana P, Chokejindachai W *et al.* (1998). Research on new antimalarial drugs and the use of drugs in combination at the Bangkok Hospital for Tropical Diseases. *S E Asian J Trop Med Pub Health* **29**: 344–54.
- Luse SA, Miller LH (1971). *Plasmodium falciparum* malaria. Ultrastructure of parasitized erythrocytes in cardiac vessels. *Am J Trop Med Hyg* **20**: 655–60.
- Mabey DCW, Brown A, Greenwood BM (1987). *Plasmodium falciparum* malaria and *Salmonella* infections in Gambian children. *J Infect Dis* **155**: 1319–21.
- Marchiafava E, Bignami A (1894). *Sulle Febbri Estivo-Autunnali*. E. Loescher: Rome (English translation: Thompson JH (1894) *Two Monographs on Malarial Fevers and the Parasites of Malarial Fevers*. New Sydenham Society: London).
- Marsh K, English M, Crawley J *et al.* (1996). The pathogenesis of severe malaria in African children. *Ann Trop Med Parasitol* **90**: 395–402.
- Marsh K, Forster D, Waruiru C *et al.* (1995). Indicators of life-threatening malaria in African children. *N Engl J Med* **332**: 1399–404.
- McGregor IA (1984). Epidemiology, malaria and pregnancy. *Am J Trop Med Hyg* **33**: 517–25.
- McGuire W, Hill AV, Allsopp CE *et al.* (1994). Variation in the TNF- $\alpha$  promoter region associated with susceptibility to cerebral malaria. *Nature* **371**: 508–10.
- McGuire W, Knight JC, Hill AV *et al.* (1999). Severe malarial anemia and cerebral malaria are associated with different tumor necrosis factor promoter alleles. *J Infect Dis* **179**: 287–90.
- McLaughlin GL, Subramanian S, Lepers JP *et al.* (1993). Evaluation of a nonisotopic DNA assay kit for diagnosing *Plasmodium falciparum* malaria in Madagascar. *Am J Trop Med Hyg* **48**: 211–15.
- Meshnick SR, Taylor TE, Kamchonwongpaisan S (1996). Artemisinin and the antimalarial endoperoxides: from herbal remedy to targeted chemotherapy. *Microbiol Rev* **60**: 301–15.
- Metford J (1652). *Observations et curationes Northamptonise absoluta: incipiendo ab anno saluris Christiana 1652*. Manuscript No. 2812. Sloan Collection: London; 134.
- Miller KD, Greenberg AE, Campbell CC (1989). Treatment of severe malaria in the United States with a continuous infusion of quinidine gluconate and exchange transfusion. *N Engl J Med* **321**: 65–70.
- Miller LH, Hoffman SL (1998). Research toward vaccines against malaria. *Nature Med* **4**: 520–4.
- Miller LH, Mason SJ, Clyde DF *et al.* (1976). The resistance factor to *P. vivax* in Blacks: the duffy blood group genotype. *N Engl J Med* **295**: 302–4.
- MMWR (1989). Seizures temporally associated with use of DEET insect repellent—New York and Connecticut. *Morbidity Mortal Wkly Rep* **38**: 678–80.

- Molineaux L (1996). *Plasmodium falciparum* malaria: some epidemiological implications of parasite and host diversity. *Ann Trop Med Parasitol* **90**: 379–93.
- Murphy GS, Basri H, Purnomo *et al.* (1993). Vivax malaria resistant to treatment and prophylaxis with chloroquine. *Lancet* **341**: 96–100.
- Murphy GS, Oldfield EC III (1996). Falciparum malaria. *Infect Dis Clin North Am* **10**: 747–75.
- Nchinda TC (1998). Malaria: a reemerging disease in Africa. *Emerg Infect Dis* **4**: 1–6.
- Newbold C, Warn P, Black G *et al.* (1997). Receptor-specific adhesion and clinical disease in *Plasmodium falciparum* [see comments]. *Am J Trop Med Hyg* **57**: 389–98.
- Newton CR, Kirkham FJ, Winstanley PA *et al.* (1991). Intracranial pressure in African children with cerebral malaria. *Lancet* **337**: 573–6.
- Newton CRJ, Taylor TE, Whitten RO (1998). Pathophysiology of fatal falciparum malaria in African children. *Am J Trop Med Hyg* **58**: 673–83.
- Nosten F, Luxemburger C, Kyle DE *et al.* (1996). Randomised double-blind placebo-controlled trial of Spf66 malaria vaccine in children in north-western Thailand. *Lancet* **348**: 701–7.
- Nosten F, ter Kuile F, Maclankiri L *et al.* (1994). Mefloquine prophylaxis prevents malaria during pregnancy: a double-blind, placebo-controlled study. *J Infect Dis* **169**: 595–603.
- Nosten F, ter Kuile FO, Luxemburger C *et al.* (1993). Cardiac effects of antimalarial treatment with halofantrine. *Lancet* **341**: 1054–6.
- Oliveira DA, Holloway BP, Durigon EL *et al.* (1995). Polymerase chain reaction and a liquid phase nonisotopic hybridization for species and sensitive detection of malaria infection. *Am J Trop Med Hyg* **52**: 139–44.
- Palmer KJ, Holliday SM, Brogden RN (1993). Mefloquine. A review of its antimalarial activity, pharmacokinetic properties and therapeutic efficacy. *Drugs* **45**: 430–75.
- Pasvol G, Newton CRJC, Winstanley PA *et al.* (1991). Quinine treatment of severe falciparum malaria in African children: a randomized comparison of three regimens. *Am J Trop Med Hyg* **45**: 702–13.
- Pasvol G., Weatherall DJ, Wilson RJM (1977). Effects of fetal hemoglobin on susceptibility of red cells to *P. falciparum*. *Nature* **270**: 171–3.
- Patarroyo ME, Romero P, Torres ML *et al.* (1987). Inductive of protective immunity against experimental infection with malaria using synthetic peptides. *Nature* **328**: 629–32.
- Phillips EJ, Keystone JS, Kain KC (1996). Failure of combined chloroquine and high-dose primaquine therapy for *Plasmodium vivax* malaria acquired in Guyana, South America [see comments]. *Clin Infect Dis* **23**: 1171–3.
- Phillips-Howard PA, Radalowicz A, Mitchell J *et al.* (1990). Risk of malaria in British residents returning from malarious areas. *Br Med J* **300**: 499–503.
- Phillips-Howard PA, Steffen R, Kerr L *et al.* (1998). Safety of mefloquine and other antimalarial agents in the first trimester of pregnancy. *J Travel Med* **5**: 121–6.
- Phillips-Howard PA, ter Kuile, FO (1995). CNS adverse events associated with antimalarial agents. Fact or fiction? *Drug Safety* **12**: 370–83.
- Phillips-Howard PA, Wood D (1996). The safety of antimalarial drugs in pregnancy. *Drug Safety* **14**: 131–45.
- Piessens WF, Hoffman SL, Wade AA *et al.* (1985). Antibody-mediated killing of suppressor T lymphocytes as a possible cause of macroglobulinaemia in the tropical splenomegaly syndrome. *J Clin Invest* **75**: 1821–7.
- Price R, Nosten F, Luxemburger C *et al.* (1996). Effects of artemisinin derivatives on malaria transmissibility. *Lancet* **ii**: 701–7.
- Radloff PD, Philipps J, Nkeyi M *et al.* (1996). Atovaquone and proguanil for *Plasmodium falciparum* malaria. *Lancet* **347**: 1511–14.
- Ree GH, Sargeant PG (1976). Laboratory diagnosis of malaria. *Br Med J* **1**: 152.
- Reeder JC, Cowman AF, Davern KM *et al.* (1999). The adhesion of *Plasmodium falciparum*-infected erythrocytes to chondroitin sulfate A is mediated by PfEMP1. *Proc Natl Acad Sci USA* **96**: 5198–202.
- Rieckmann KH, Davis DR, Hutton DC (1989). *Plasmodium vivax* resistance to chloroquine? *Lancet* **2**: 1183–4.
- Rieckmann KH, Yeo AET, Davis DR *et al.* (1993). Recent military experience with malaria chemoprophylaxis. *Med J Aust* **158**: 446–9.
- Rogers MJ, Li J, McCutchan TF (1998). Developmental regulation and drug target. In Sherman IW (ed.), *Malaria. Parasite Biology, Pathogenesis, and Protection*. ASM Press: Washington, DC; 203–18.
- Rogers WO, Hoffman SL (1999). Malaria Vaccines. In: *Malaria. Molecular and Clinical Aspects*. Eds M Wahlgren, P Perlmann. Harwood Academic Publishers, pp. 439–94.
- Rogerson SJ, Brown GV (1997). Chondroitin sulphate A as an adherence receptor for *Plasmodium falciparum* infected erythrocytes. *Parasitol Today* **13**: 70–5.
- Rogerson SJ, Chaiyaroj S, Ng K *et al.* (1995). Chondroitin sulphate A is a cell surface receptor for *Plasmodium falciparum*-infected erythrocytes. *J Exp Med* **182**: 15–20.
- Ross R (1897). On some peculiar pigmented cells found in two mosquitos fed on malarial blood. *Br Med J* **2**: 1786–8.
- Rowe A, Obeiro J, Newbold CI *et al.* (1995). *Plasmodium falciparum* rosetting is associated with malaria severity in Kenya. *Infect Immun* **63**: 2323–6.
- Ruwende C, Khoo SC, Snow RW *et al.* (1995). Natural selection of hemi- and heterozygotes for G6PD deficiency in Africa by resistance to severe malaria. *Nature* **376**: 246–9.
- Samuel BU, Barry M (1998). The pregnant traveller. *Infect Dis Clin North Am* **12**: 325–68.
- Schapiro A, Fogh S, Jepsen S *et al.* (1984). Detection of antibodies to malaria: comparison of results with ELISA, IFAT, and crossed immunoelectrophoresis. *Acta Pathol Microbiol Immunol Scand B* **92**: 299–304.
- Schlagenhauf P, Steffen R, Tschopp A *et al.* (1995). Behavioural aspects of travellers in their use of malarial presumptive treatment. *Bull WHO* **73**: 215–21.
- Schofield L, Vivas L, Hackett F *et al.* (1993). Neutralizing monoclonal antibodies to glycosylphosphatidylinositol, the dominant TNF $\alpha$ -inducing toxin of *Plasmodium falciparum*: prospects for the immunotherapy of severe malaria. *Ann Trop Med Parasitol* **87**: 617–26.
- Schultz LJ, Steketee RW, Macheso A *et al.* (1994). The efficacy of antimalarial regimens containing sulphadoxine-pyrimethamine and/or chloroquine in preventing peripheral and placental falciparum infection among pregnant women in Malawi. *Am J Trop Med Hyg* **51**: 515–22.



- Shanks GD, Gordon DM, Klotz FW *et al.* (1998). Efficacy and safety of atovaquone/proguanil as suppressive prophylaxis for *Plasmodium falciparum* malaria. *Clin Infect Dis* **27**: 494–9.
- Shiff CJ, Minjas J, Premji Z (1993). The rapid manual Parasight-F test. A new diagnostic tool for *Plasmodium falciparum* infection. *Trans R Soc Trop Med Hyg* **87**: 436–43.
- Sholapurkar S, Gupta A, Mahajan R (1988). Clinical course of malaria in pregnancy: A prospective controlled study from India. *Trans R Soc Trop Med Hyg* **82**: 376–9.
- Shortt HE, Garnham PCC (1948). The pre-erythrocytic development of *Plasmodium cynomolgi* and *Plasmodium vivax*. *Trans. R Soc Trop Med Hyg* **41**: 785–95.
- Silamut K, White NJ (1993). Relation of the stage of parasite development in the peripheral blood to prognosis in severe falciparum malaria. *Trans R Soc Trop Med Hyg* **87**: 436.
- Silver HM (1997). Malarial infection during pregnancy. *Infect Dis Clin North Am* **11**: 99–107.
- Sitprijia V, Indraprasit S, Pochangool C *et al.* (1967). Renal failure in malaria. *Lancet* **i**: 186–8.
- Smalley ME, Abdalla S, Brown J (1980). The distribution of *Plasmodium falciparum* in the peripheral blood and bone marrow of Gambian children. *Trans R Soc Trop Med Hyg* **75**: 103–5.
- Smith JD, Chitnis CE, Craig AG *et al.* (1995). Switches in expression of *Plasmodium falciparum* var genes correlate with changes in antigenic and cytoadherent phenotypes of infected erythrocytes. *Cell* **82**: 101–10.
- Smoak BL, Writer JV, Kepp LW *et al.* (1997). The effects of inadvertent exposure of mefloquine chemoprophylaxis on pregnancy outcomes and infants of US Army servicewomen. *J Infect Dis* **176**: 831–3.
- Snounou G, Viriyakosol S, Jarra W *et al.* (1993). Identification of the four human malaria parasite species in field samples by the polymerase chain reaction and detection of a high prevalence of mixed infections. *Mol Biochem Parasitol* **58**: 283–92.
- Snow RW, Bastos de Azevedo I, Lowe BS *et al.* (1994). Severe childhood malaria in two areas of markedly different falciparum transmission in east Africa. *Acta Trop* **57**: 289–300.
- Spencer HC, Collins WE, Skinner JC (1979). The enzyme-linked immunosorbent assay (ELISA) for malaria. II. Comparison with the malaria indirect fluorescent antibody test (IFA). *Am J Trop Med Hyg* **28**: 933–6.
- Srivastava IK, Schmidt M, Grall M *et al.* (1991). Comparative evaluation of an ELISA based on recombinant polypeptides and IFA for serology of malaria. *J Trop Med Hyg* **94**: 189–94.
- Stanley J (1997). Malaria: the global resurgence of disease. *Emerg Med Clin North Am* **15**: 113–55.
- Steffen R, Fuchs E, Schildknecht J *et al.* (1993). Mefloquine compared with other malaria chemoprophylactic regimens in tourists visiting East Africa. *Lancet* **341**: 1299–303.
- Stephens JWW (1922). A new malaria parasite of man. *Ann Trop Med Parasitol* **16**: 383–8.
- Stoute JA, Kester KE, Krzych U *et al.* (1998). Long-term efficacy and immune responses following immunization with the RTS,S malaria vaccine. *J Infect Dis* **178**: 1139–44.
- Su XZ, Heatwole VM, Wertheimer SP *et al.* (1995). The large diverse gene family var encodes proteins involved in cytoadherence and antigenic variation of *Plasmodium falciparum*-infected erythrocytes [see comments]. *Cell* **82**: 89–100.
- Svenson JE, Maclean JD, Gyorkos TW *et al.* (1995). Imported malaria: clinical presentation and examination of symptomatic travelers. *Arch Intern Med* **155**: 861–8.
- Tachado SD, Gerold P, McConville MJ *et al.* (1996). Glycosylphosphatidylinositol toxin of *Plasmodium* induces nitric oxide synthase expression in macrophages and vascular endothelial cells by a protein tyrosine kinase-dependent and protein kinase C-dependent signaling pathway. *J Immunol* **156**: 1897–907.
- ter Kuile FO, Dolan G, Nosten F *et al.* (1993). Halofantrine versus mefloquine in treatment of multidrug-resistant falciparum malaria. *Lancet* **341**: 1044–9.
- ter Kuile FO, Luxemburger C, Nosten F *et al.* (1996). Mefloquine treatment of acute falciparum malaria; a prospective study of non-serious adverse effects in 3673 patients. *Trans R Soc Trop Med Hyg* **73**: 631–42.
- Thomson JG, Robertson A (1935). The structure and development of *Plasmodium falciparum* gametocytes in the internal organs and peripheral circulation. *Trans R Soc Trop Med Hyg* **29**: 31–40.
- Tine JA, Lanar DE, Smith DM *et al.* (1996). NYVAC-Pf7: a poxvirus-vectored, multiantigen, multistage vaccine candidate for *Plasmodium falciparum* malaria. *Infect Immun* **64**: 3833–44.
- Trager W, Jensen JB (1976). Human malaria parasites in continuous culture. *Science* **193**: 673–5.
- Triglia T, Wellems TE, Kemp DJ (1992). Towards a high resolution map of the *Plasmodium falciparum* genome. *Parasitol Today* **8**: 225–9.
- Turner GDH, Morrison H, Jones M *et al.* (1994). An immunohistochemical study of the pathology of fatal malaria. Evidence for widespread endothelial activation and a potential role for intercellular adhesion molecule-1 in cerebral sequestration. *Am J Pathol* **145**: 1057–69.
- van Hensbroek MB, Onyiorah E, Jaffar S *et al.* (1996). A trial of artemether or quinine in children with cerebral malaria. *N Engl J Med* **335**: 69–75.
- van Vugt M, Brockman A, Gemperli B *et al.* (1998). Randomized comparison of artemether–benflumetol and artesunate–mefloquine in treatment of multidrug-resistant falciparum malaria. *Antimicrob Agents Chemother* **42**: 135–9.
- Waller RF, Keeling PJ, Donald RG *et al.* (1998). Nuclear-encoded proteins target to the plastid in *Toxoplasma gondii* and *Plasmodium falciparum*. *Proc Natl Acad Sci USA* **95**: 12352–7.
- Walliker D, Babiker H, Ranford-Cartwright L (1998). The genetic structure of malaria parasite populations. In Sherman IW (ed.) *Malaria. Parasite Biology, Pathogenesis, and Protection*. ASM Press: Washington, DC; 235–52.
- Warhurst DC, Williams JE (1996). Laboratory diagnosis of malaria. ACP Broadsheet No 148, July. *J Clin Pathol* **49**: 533–8.
- Warrell DA, Looareesuwan S, Warrell MJ *et al.* (1982). Dexamethasone proves deleterious in cerebral malaria. A

- double-blind trial in 100 comatose patients. *N Engl J Med* **306**: 313–19.
- Waters AP, Higgins DG, McCutchan TF (1991). *Plasmodium falciparum* appears to have arisen as a result of lateral transfer between avian and human hosts. *Proc Natl Acad Sci USA* **88**: 3140–4.
- Watt G, Loesuttivibool L, Shanks GD *et al.* (1992a). Quinine with tetracycline for the treatment of drug-resistant falciparum malaria in Thailand. *Am J Trop Med Hyg* **47**: 108–11.
- Watt G, Shanks GD, Phintuyothin P (1992b). Prognostic significance of rises in parasitemia during treatment of falciparum malaria. *Trans R Soc Trop Med Hyg* **86**: 359–60.
- Weatherall DJ, Abdalla S (1982). The anaemia of *Plasmodium falciparum* malaria. *Br Med Bull* **38**: 137–51.
- Weinke T, Trautmann M, Held T *et al.* (1991). Neuropsychiatric side effects after the use of mefloquine. *Am J Trop Med Hyg* **45**: 86–91.
- Weiss WR, Oloo AJ, Johnson A *et al.* (1995). Daily primaquine is effective for prophylaxis against falciparum malaria in Kenya: comparison with mefloquine, doxycycline and chloroquine plus proguanil. *J Infect Dis* **171**: 1569–75.
- Whitby M (1997). Drug-resistant *Plasmodium vivax* malaria. *J Antimicrob Chemother* **40**: 749–52.
- White NJ (1996a). Malaria. In Cook GC (ed.), *Manson's Tropical Diseases*. W. B. Saunders: London; 1087–164.
- White NJ (1996b). The treatment of malaria. *N Engl J Med* **335**: 800–6.
- White NJ (1998). Malaria pathophysiology. In Sherman IW (ed.), *Malaria. Parasite Biology, Pathogenesis, and Protection*. ASM Press: Washington, DC; 371–86.
- White NJ, Ho M (1992). The pathophysiology of malaria. *Adv Parasitol* **31**: 134–73.
- White NJ, Looareesuwan S, Phillips RE *et al.* (1988). Single dose phenobarbitone prevents convulsions in cerebral malaria. *Lancet* **2**: 64–6.
- White NJ, Miller KD, Marsh K *et al.* (1987). Hypoglycaemia in African children with severe malaria. *Lancet* **1**: 708–11.
- White NJ, Pukrittayakamee S. (1993). Clinical malaria in the tropics. *Med J Aust* **159**: 197–203.
- White NJ, Warrell DA, Chanthavanich P *et al.* (1983). Severe hypoglycaemia and hyperinsulinaemia in falciparum malaria. *N Engl J Med* **309**: 61–6.
- Win K, Than M, Thwe Y (1992). Comparison of combinations of parenteral artemisinin derivatives plus oral mefloquine with intravenous quinine plus oral tetracycline for treating cerebral malaria. *Bull WHO* **70**: 777–82.
- Winstanley P (1996). Pyronaridine: a promising drug for Africa? [see comments]. *Lancet* **347**: 2–3.
- Wongsrichanali C, Pornsilapatits J, Namsiripongpun V *et al.* (1991). Acridine orange fluorescent microscopy and the detection of malaria in populations with low density parasitaemia. *Am J Trop Med* **44**: 17–20.
- World Health Organization (1990). Severe and complicated malaria. *Trans R Soc Trop Med Hyg* **84** (suppl 2): 1–65.
- World Health Organization (1994). The role of artemisinin and its derivatives in the current treatment of malaria (1994–1995). Report of an Informal Consultation Convened by WHO in Geneva. World Health Organization: Geneva.
- World Health Organization (1996). World malaria situation in 1993. *Wkly Epidemiol Rec* **71**: 17–24.
- World Health Organization (1998a). *International Travel and Health. Vaccination Requirements and Health Advice*. World Health Organization: Geneva.
- World Health Organization (1998b). *Malaria*. WHO Fact Sheet No. 94, Available on the WHO home page: <http://www.who.ch//>, N94.
- World Health Organization (1999). *Roll Back Malaria. Report by the Director General*. Available at <http://www.who.int/gb/eb103/ee6.pdf>. 1–4.
- World Health Organization (2001). *International Travel and Health. Vaccination Requirements and Health Advice*. Available at <http://www.who.int.ith>.
- Zheng L, Kafatos FC (1999). The Anopheles mosquito: genomics and transformation. In: *Malaria. Molecular and Clinical Aspects*. Eds M Wahlgren, P Perlmann. Harwood Academic Publishers, pp. 121–51.

# Babesiosis

Jeffrey A. Gelfand<sup>1</sup> and Debra D. Poutsiaka<sup>2</sup>

<sup>1</sup>*Massachusetts General Hospital, Boston, MA, USA*

<sup>2</sup>*New England Medical Center, Boston, MA, USA*

---

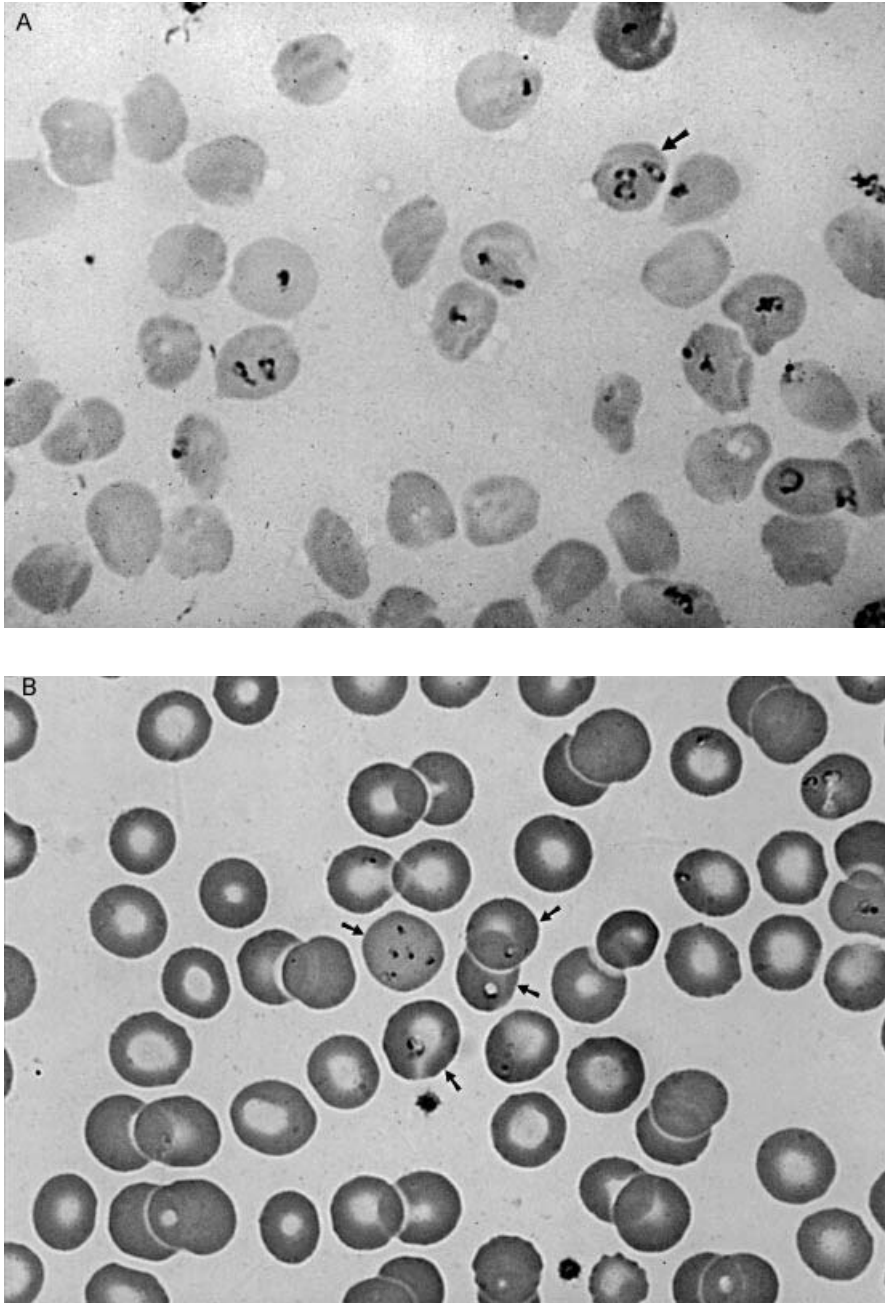
## HISTORICAL INTRODUCTION

Infection by the malaria-like protozoan, *Babesia*, has been recognized for over 100 years. The first written reference to babesiosis was probably made in the Bible (*Exodus* 9:3), in a description of a plague which had befallen the cattle of the Pharaoh Rameses II (Dammin, 1978). Babesiosis, also known as piroplasmosis, was considered a disease of animals, affecting mostly livestock and other domesticated animals. In 1888, V. Babes described an intraerythrocytic pathogen, thought to be a bacterium, in his studies on febrile hemoglobinuria of Romanian cattle (Dammin, 1978). Several years later, in 1893, Smith and Kilbourne provided the first description of an arthropod vector with the demonstration of the transmission of the protozoan causing Texas cattle fever via a bloodsucking tick. The first case of human babesiosis was described by Skrabalo in 1957 (Dammin, 1978). Initial case descriptions were in splenectomized individuals. However, in 1969, human babesiosis in a patient with a functioning spleen was reported from the island of Nantucket off the coast of Massachusetts (Western *et al.*, 1970). Since then, over 100 cases of human babesiosis have been reported. The disease has been described in the eastern, central and western regions of the USA and in Europe and Asia (Garnham, 1980; Quick *et al.*, 1993; Persing *et al.*, 1995; Herwaldt *et al.*, 1996; Shih *et al.*, 1997). The rodent strain *B. microti* has been implicated

in the USA, whereas the cattle strains *B. divergens* and *B. bovis* have been associated with human disease in Europe (Garnham, 1980). Previously unknown *Babesia* strains or *Babesia*-like organisms infecting humans have been described recently (Quick *et al.*, 1993; Persing *et al.*, 1995; Herwaldt *et al.*, 1996; Shih *et al.*, 1997; Thomford *et al.*, 1994).

## DESCRIPTION OF THE ORGANISM

The taxonomy of babesias was recently described in a review by Telford *et al.* (1993) as phylum Apicomplexa, class Aconoidasida, order Piroplasmidora, family Babesidiidae and genus *Babesia*. A listing of the many species and their hosts is included in the review. However, only a few species are known to cause disease in humans. The organisms are intracellular parasites which are piriform, round or oval, depending upon the species. *B. microti*, normally found in rodents, measures  $2.0 \times 1.5 \mu\text{m}$ . Of species found in cattle which infect humans, *B. bovis* measures  $2.4 \times 1.5 \mu\text{m}$  and *B. divergens* measures  $1.5 \times 0.4 \mu\text{m}$ . These organisms are frequently mistaken for *Plasmodium falciparum*, one of the agents that causes malaria, because of their intracellular ring forms and the peripheral location of the parasite in the erythrocyte. However, in contrast to the appearance of the developing intraerythrocytic *Plasmodium*, intraerythrocytic *Babesia* contain no



**Fig. 4.1** (A) Wright-Giemsa stained blood smear of a patient with *B. microti*. Numerous merozoite ring forms are seen (arrow) within erythrocytes. The ring forms resemble *P. falciparum*, but are large, clear and devoid of the brown (hemozoin) pigment seen with *P. falciparum*. The absence of gametocytes and schizonts further distinguishes *B. microti* from *P. falciparum*. Courtesy of Philip R. Daoust MD. (B) Wright-Giemsa stained human blood smear. Ring form merozoites are seen (arrows) but one erythrocyte contains five immature merozoites, characterized by sparse cytoplasm and small nucleus. As these develop, they form rings. The presence of parasites at different stages is consistent with the asynchronous schizogony that characterizes babesial infection. Smear courtesy of Philip R. Daoust MD

hemoglobin-derived pigment. The appearance of the tetrad form of *B. microti*, the result of division by budding rather than schizogony, is diagnostic of babesiosis (Figure 4.1A,B).

## PATHOGENESIS

### The Tick Vector

Babesiosis, a zoonotic disease, requires transmission from an animal reservoir to the human host via a tick vector. The cattle tick *Ixodes ricinus*, in its larval form, is the vector for *B. divergens* (Donnelly and Peirce, 1975). *I. ricinus* is widely distributed across the countryside of the UK. The prevalence of infection of *I. ricinus* by *B. divergens* is thought to be low, with estimates that 1 in 500 or fewer ticks are infective for cattle (Donnelly, 1980). The tick *Boophilus microplus*, which also feeds upon cattle, is the major vector of *B. bovis* (Potgieter *et al.*, 1976; Potgieter and Els, 1976). Spielman (1976) described studies identifying the tick *Ixodes dammini*, the northern deer tick, as the vector of babesiosis on Nantucket Island. *I. dammini* is thought to be the same as *I. scapularis*, which is found in the southern USA, based on genetic, life-cycle and mating studies (Oliver *et al.*, 1993; Wesson *et al.*, 1993), and this name is used here.

Three developmental forms of ticks exist, the larval, nymph and adult forms. Most information on the life-cycle of ticks which harbor *Babesia* pertains to *I. scapularis*. The larval and nymph forms of *I. scapularis* feed mainly on *Peromyscus leucopus*, the white-footed deer mouse (Healy *et al.*, 1976), but have also been found on other hosts, such as rats, other mice, rabbits, deer, dogs and man (Piesman and Spielman, 1979; Spielman *et al.*, 1979). The adult forms feed mainly on deer (Piesman *et al.*, 1979). Interestingly, deer do not become infected with *B. microti*. It is thought that the reintroduction of the deer to Nantucket Island in the 1930s after decimation of herds due to hunting, with the subsequent growth of the deer population, is responsible for the spread of *I. scapularis* (Spielman *et al.*, 1985). The tick requires a blood meal to progress to the next developmental stage. While feeding on the deer, the adult female tick becomes impregnated and produces up to 20 000 eggs.

Almost 80% of white-footed deer mice sampled during a 1976 survey on Nantucket Island were infected with *B. microti*. While feeding on an infected mouse, the tick larvae become infected with *B. microti*. The organism is transmitted from the larval to the nymphal forms via trans-stadial transmission. There is no evidence of transovarian transmission of *B. microti* by *I. scapularis* (Oliveira and Kreier, 1979; Telford *et al.*, 1993). After infection of the nymphal form, the nymph obtains another blood meal and, in the process, infects the host. The host is usually a rodent, although humans also serve as hosts. Infestation of a human by a nymph is difficult to detect, since the nymph is small (1.5–2.5 mm in length) (Telford *et al.*, 1993). The three development forms of *I. scapularis* feed on humans but the nymph is the main vector of babesiosis. The three forms also feed on deer, which do not become infected. Thus, deer are an important link in the life cycle of *B. microti*, since they sustain the adult form of the arthropod vector. A convergence of all three organisms—deer, mouse and tick—is necessary to create the conditions favoring the infection of humans, as incidental hosts, with *B. microti*. For *B. divergens* and *B. bovis*, the convergence of cattle and ticks is necessary to create conditions favoring the infection of humans in Europe (Donnelly, 1980).

### *Babesia* Life-cycle

Most work on the life-cycles of *Babesia* species that are known to infect man has been done on *B. microti*, which is discussed below. Readers are referred to reviews for information on the life cycles of other *Babesia* species, such as *B. equi* and *B. canis* (Mehlhorn and Shein, 1984).

The tick ingests intraerythrocytic forms of *B. microti* when feeding on an infected host. They are first evident in the tick gut after approximately 10 hours of feeding (Telford *et al.*, 1993) (Figure 4.2). A peritrophic membrane forms in the gut of the feeding tick, dividing the gut into ecto- and endoperitrophic spaces. The latter contains the blood meal, including intact erythrocytes containing *B. microti* (Rudzinska *et al.*, 1983). After hours of residence in the endoperitrophic space, organelles appear within

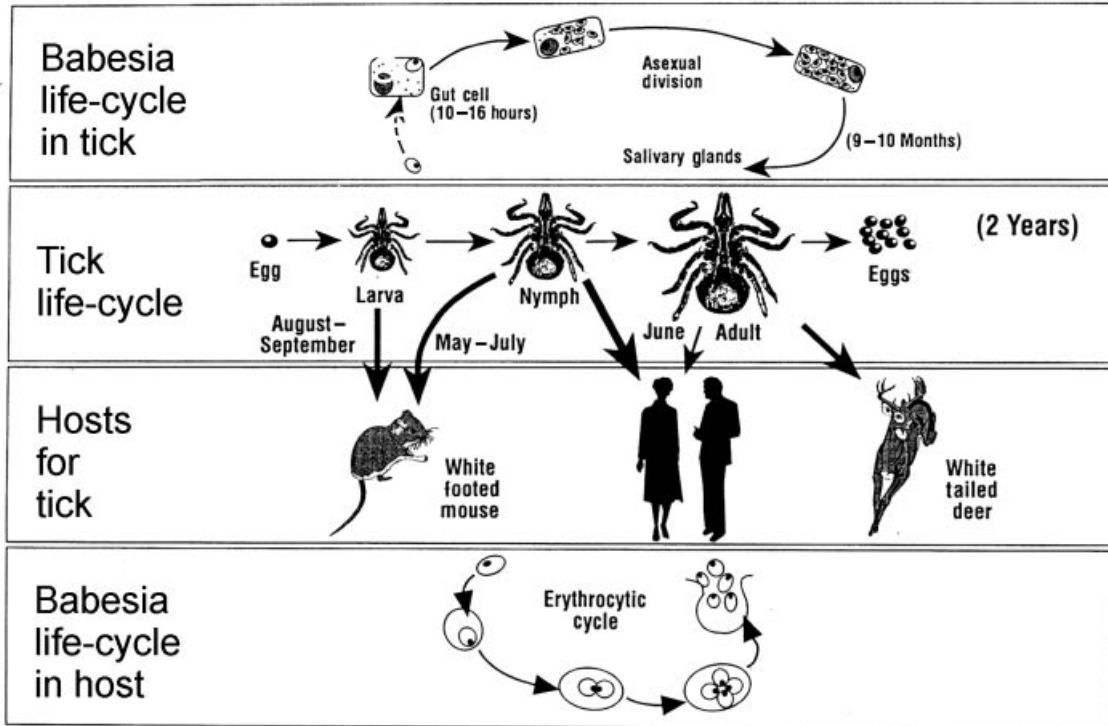


Fig. 4.2 The life-cycle of *Babesia microti*

*B. microti*. These organelles are thought to be gametes, which emerge from the erythrocyte and fuse to form a zygote 14–18 hours after repletion of the feeding tick (Rudzinska *et al.*, 1982). The zygotes possess a unique structure shaped like an arrowhead and possibly containing proteolytic enzymes. The arrowhead structure is required for the passage of *B. microti* through the peritrophic membrane and into the ectoperitrophic space. The arrowhead structure of the invading organism contacts the epithelial cell of the tick gut. At the point of contact, the membrane of the host cell invaginates and eventually encircles the parasite, resulting in its endocytosis. Once within the host cell, *B. microti* is covered by its own plasma membrane as the host cell membrane appears to disintegrate. The arrowhead structure is no longer present (Rudzinska *et al.*, 1983). The zygote is translocated to the basal lamina of the host cell and enters the hemolymph, at which point an ookinete stage is achieved. Ookinetes invade cells of the salivary gland of the tick prior to feeding of the nymphal form and undergo hypertrophy to form sporoblasts (Karakashian

*et al.*, 1983). The sporoblasts are dormant and are thought to remain so throughout the winter. Temperature elevation, through contact of the tick with a mammalian host and feeding of the nymph, stimulates the development of *B. microti* (Karakashian *et al.*, 1983; Telford *et al.*, 1993). Within the host cell, a large meshwork is formed by the sporoblast. Approximately 44–65 hours after attachment of the tick to a mammalian host, sporozoites form from within the meshwork and mature through simultaneous nuclear and cytoplasmic division. The mature sporozoites separate from the sporoblast through a process of budding, forming organisms which are  $2.2 \times 0.8 \mu\text{m}$  in size (Karakashian *et al.*, 1983). During the final hours of attachment of the tick to the host, thousands of sporozoites are deposited into the skin.

The direct invasion of sporozoites into mammalian host erythrocytes has not been demonstrated for *B. microti* and the process by which sporozoites transform into merozoites is not understood (Telford *et al.*, 1993). However,

for *B. equi*, sporozoites directly invade lymphocytes and transform into merozoites, which then leave the lymphocyte and invade the erythrocyte. The existence of lymphocyte invasion by *B. microti* is controversial (Mehlhorn and Shein, 1984; Telford *et al.*, 1993).

The role of complement in the invasion of erythrocytes by *B. microti* is uncertain. However, there is evidence that an intact host alternative complement pathway and an erythrocyte C3b receptor is necessary for the penetration of rat erythrocytes by *B. rodhaini* (Jack and Ward, 1980). In the presence of the parasite, complement is activated and C3b is fixed to the surface of the merozoite. Presumably, the fixed C3b binds to the C3 receptor on the erythrocyte surface. In addition, erythrocytes bearing surface C3 are also infected. These data suggest that complement-mediated changes of the erythrocyte and/or the *B. rodhaini* merozoite facilitate the process of invasion.

The merozoite enters the mammalian erythrocyte through invagination of the host cell membrane. The anterior end of the merozoite, which contains complex apical organelles, attaches to the erythrocyte membrane, which invaginates and then encompasses the merozoite. A parasitophorous vacuole is formed, composed of two membranes, one derived from the host cell and one derived from the merozoite and containing the developing trophozoite. The host cell membrane disintegrates, leaving *B. microti* free within the host cell cytoplasm. This is an important difference from the life cycle of *Plasmodium* species (Telford *et al.*, 1993).

Within the erythrocytes, maturing trophozoites develop organelles, such as polar rings and double membrane segments. Some of these segments represent bud precursors. Via asynchronous budding, two to four merozoites are formed. The rare but diagnostic tetramere seen with light microscopy of erythrocytes parasitized by *B. microti* is a representation of four merozoites within the parental *Babesia* (Figure 4.1). Thus, schizogony does not occur (Telford *et al.*, 1993). The erythrocyte membrane is damaged, with perforations, protrusions and inclusions, as the merozoites leave the cell, ultimately resulting in hemolysis (Sun *et al.*, 1983). Because there is no synchronous schizogony, as with *Plasmodium* species, massive hemolysis does not occur.

## Mechanisms of Injury

There are three identified mechanisms by which infection with *Babesia* species causes injury to the host: hemolysis and resultant anemia; increased cytoadherence of erythrocytes within the vasculature; and the release of harmful mediators. In studies of hamsters infected with *B. microti*, intravascular and extravascular hemolysis ensues, often resulting in profound anemia (Lykins *et al.*, 1975; Cullen and Levine, 1987; Dao and Eberhard, 1996; Wozniak *et al.*, 1996). In a morphological study of erythrocytes from an asplenic human infected with *B. microti*, extensive damage to erythrocyte membranes was observed (Sun *et al.*, 1983). Such damage could theoretically result in intravascular hemolysis, as well as retention in the spleen of the deformed and potentially more rigid erythrocytes, resulting in clearance of infected erythrocytes, as is thought to occur in malaria (Looareesuwan *et al.*, 1987). It has been suggested that anti-erythrocyte membrane antibodies are produced during *Babesia* infection and that the resultant anemia might be due to a humoral mechanism (Adachi *et al.*, 1992, 1994).

Vascular lesions characterized by the accumulation of erythrocytes within blood vessels as a result of *Babesia* infection have been described by some but not all investigators. The brains of *B. bovis*-infected cattle were found to contain capillaries packed with erythrocytes. The erythrocytes contained knob-like projections which formed the point of attachment to endothelial cells, in a manner reminiscent of the attachment of erythrocytes to endothelial cells in cerebral malaria (Aikawa *et al.*, 1992). Earlier studies had demonstrated the isolation and characterization of a cryofibrinogen complex in the plasma of *B. bovis*-infected cattle. It was postulated that the complex facilitated the sludging of erythrocytes within visceral blood vessels (Goodger *et al.*, 1978). A newly identified strain of *Babesia*, strain WA-1, recently isolated from a patient in Washington State, was noted to cause profound intravascular stasis within several organs in infected hamsters (Dao and Eberhard, 1996). Aggregates of inflammatory cells occluded blood vessels. Thrombosis and coagulation necrosis were described. In contrast, no vascular lesions were detected in hamsters in the same and other

studies infected with *B. microti* (Cullen and Levine, 1987; Wozniak *et al.*, 1996). In summary, it appears that host injury in *Babesia* infection might be mediated through vascular occlusion, perhaps via mechanisms similar to those observed in malaria.

Host soluble mediators have been implicated in the injury resulting from *Babesia* infection. Clark postulated that endotoxin was involved in injury and death during babesiosis and acute malaria (Clark, 1978). He noted that babesiosis has effects similar to 'endotoxin shock'. Since these studies have been performed, it has become clear that much of endotoxin shock is mediated by the release of cytokines (Dinarello *et al.*, 1993). It is possible that *Babesia* also elicits the production of cytokines by host cells and that cytokines might be responsible for some of the observed injury, in much the same manner as postulated for malaria (Harpaz *et al.*, 1992; Urquhart, 1994). Other potential mediators of injury in *Babesia* infection have been postulated, including oxygen-derived free radicals (Clark *et al.*, 1986).

## IMMUNOLOGY

The encounter between *Babesia* organisms and the host results in several immune responses. The finding of potentially protective immune responses against *Babesia* has led to a search for a suitable vaccine, particularly against *B. bovis*.

Immunoglobulin production is induced during *Babesia* infection. There is a non-specific B cell response after infection, resulting in a marked polyclonal hypergammaglobulinemia, in humans acutely infected with *B. microti* (Benach *et al.*, 1982). Additionally, specific antibody production directed against *Babesia* antigens has been well documented. An early indication of antibody production was the demonstration of passive protection of mice from *B. rodhaini* infection with immune serum (Abdalla *et al.*, 1978; Meeusen *et al.*, 1984). After experimental infection of calves with *B. bigemina*, specific IgG and IgM appeared at 7 days. Whereas IgM titers declined by 4 weeks after infection, IgG titers remained elevated after 7 weeks (O'Donoghue

*et al.*, 1985). In studies of hamsters infected with *B. microti*, specific antibody was detected 2 weeks after infection. The peak antibody response was correlated temporally with a fall in parasitema (Hu *et al.*, 1996).

## Humoral Immunity

Antibody production appears to be protective during infection with *Babesia*. A study of *B. bovis*-infected cattle demonstrated that those animals which did not produce a serologic response to the parasite died after primary or secondary challenge. All cattle that mounted a serological response survived primary and secondary challenges with *B. bovis* (Goff *et al.*, 1982). IgG titers produced during an amnestic response to *B. microti* in a mouse model correlated well with protection against infection (Meeusen *et al.*, 1985).

In contrast, in a study of adoptive transfer of immunity to *B. rodhaini* in mice, protection from challenge by the parasite was maintained despite irradiation of the adoptively transferred cells at a radiation dose which would be expected to suppress antibody production. This led the investigators to suggest that antibody production is of minor if any importance in protecting against *B. rodhaini* infection (Zivkovic *et al.*, 1984).

Studies with monoclonal antibodies have identified *Babesia* antigens that are important for successful infection. Winger *et al.* (1987) developed a monoclonal antibody to a 50–60 kDa protein from *B. divergens* merozoites; the presence of the antibody in cultures prevented the invasion of bovine erythrocytes by *B. divergens*. Immunization of gerbils with the antigen provided partial immunity when the animals were later challenged with parasitized erythrocytes. Those animals which survived were found to have a strong serological response to the 50–60 kDa antigen (Winger *et al.*, 1989). In similar studies, monoclonal antibodies to a 17 kDa antigen isolated from *B. divergens* inhibited parasite growth *in vitro* (Precigout *et al.*, 1993). The same group later demonstrated that a 37 kDa glycoprotein present on the membrane of *B. divergens* merozoites induced a



strong antibody response, which was felt to be protective (Carcy *et al.*, 1995). These and other antigens from *Babesia* that might be important in successful infection of erythrocytes have not been identified, nor has their function been elucidated. Antigenic variation of *Babesia*-derived components has been observed, which can only complicate the study of important structures on the surface of *Babesia* and infected erythrocytes (Allred *et al.*, 1994).

### Phagocytosis

Phagocytosis of *Babesia* as a means of immune protection has been studied. Phagocytosis of *B. bovis*-infected erythrocytes and of cell-free parasites occurred in the presence of antibody raised against a particular fraction of the parasite. However, in the presence of immune serum, phagocytosis did not occur (Jacobson *et al.*, 1993). In another study, phagocytosis of *B. rodhaini*-infected erythrocytes or cell-free forms occurred in the presence of hyperimmune serum. Phagocytosis was not enhanced and perhaps was reduced in the presence of complement (Parrodi *et al.*, 1991). Both studies suggest that phagocytosis of opsonized erythrocytes and parasites might be an important means of immune protection during *Babesia* infection.

### Cell-mediated Immunity

T lymphocyte responses also appear to be important in the development of immunity to *Babesia* infection, although the topic has not been thoroughly examined. Mice depleted of T lymphocytes and infected with *B. microti* displayed higher parasitemias than control mice. The natural degree of resistance could be restored by reconstitution of the T lymphocyte-depleted mice by transfer of B lymphocyte-depleted spleen cells (Ruebush and Hanson, 1980). In a murine model, depletion of T lymphocytes with a cytotoxic/suppressor phenotype resulted in increased resistance to *B. microti* infection, whereas depletion of CD4<sup>+</sup> T lymphocytes resulted in increased susceptibility to infection. The converse was true for *B. rodhaini* infection (Shimada *et al.*, 1996),

suggesting that cellular immunity to *Babesia* infections is complex. The results of other studies suggest that antibody-independent, T lymphocyte-mediated mechanisms are important in the resolution of acute infection of mice with *B. microti* (Cavacini *et al.*, 1990).

Further studies of the T lymphocyte response to *Babesia* antigens have been conducted recently. A 77kDa protein, isolated from *B. bovis* produced during natural infection in cattle and thought to be an apical complex-associated protein, was cloned. The recombinant protein elicited the proliferation of CD4<sup>+</sup> and CD8<sup>+</sup> T lymphocyte cell lines (Tetzlaff *et al.*, 1992). Two epitopes capable of stimulating CD4<sup>+</sup> T lymphocyte clones were identified. The epitopes from the *B. bovis*-derived protein appeared to preferentially stimulate the Th1 subset of CD4<sup>+</sup> T lymphocytes (Brown *et al.*, 1993). Studies on  $\gamma/\delta$  T lymphocyte lines suggested that these cells might be important in modulating the CD4<sup>+</sup> T lymphocyte response to *Babesia* antigens (Brown *et al.*, 1994). Subsequent studies have identified five different antigenic groups of *B. bovis* merozoite proteins which stimulate proliferation of Th clones. The authors suggest that these antigens are potentially useful for the construction of a vaccine (Brown *et al.*, 1995).

### EPIDEMIOLOGY

Human infections with *Babesia*, particularly *B. microti*, are no longer a novelty. Well over 100 cases of human babesiosis have been reported, with new reports arising frequently (Dammin *et al.*, 1981; Herwaldt *et al.*, 1995; Falagas and Klempner, 1996; Herwaldt *et al.*, 1997). Human infections with *Babesia* species have been documented from several continents. In Europe, reports of infection, usually with *B. divergens*, have come from the former Yugoslavia, France, Russia, Ireland, Scotland, Sweden and the Canary Islands (Dammin *et al.*, 1981; Uhnnoo *et al.*, 1992; Olmeda *et al.*, 1997). Most European cases have occurred in splenectomized individuals. Additionally, several cases of babesiosis in Asia, Central America and South Africa have been reported (Dammin *et al.*, 1981; Li and Meng, 1984; Bush *et al.*, 1990; Shih *et al.*, 1997).

Most human cases of babesiosis have been reported from the USA, particularly from the north eastern part of the country (Dammin *et al.*, 1981). *B. microti* is responsible for almost all of the American cases. However, recent reports document infection by newly identified species of *Babesia* in California, Missouri and Washington State (Quick *et al.*, 1993; Persing *et al.*, 1995; Herwaldt *et al.*, 1996). The emergence of human babesiosis in the USA, where most epidemiologic studies have been conducted, appears to be related to the increase in the deer population (Spielman, 1994).

Several serological surveys have demonstrated that infection with *Babesia* is more widespread than case reports would indicate, suggesting that most human babesiosis caused by this organism is subclinical. Over half of 173 men from a north-western region of Nigeria were infected by *Babesia* species. Similar results were obtained in a study of persons residing in Mozambique. This has led some to suggest that so-called drug-resistant malaria might actually represent misdiagnosed babesiosis (Telford *et al.*, 1993).

Similar results have been obtained in the USA. In a survey of persons at high risk for infection in New York State, 4.4% were seropositive in June, whereas 6.9% were seropositive in October, resulting in a seroconversion rate of 5.9% (Filstein *et al.*, 1980). None were symptomatic. In a survey of sera from 779 blood donations on Cape Cod, 3.7% of persons had positive *B. microti* antibodies (Popovskiy *et al.*, 1988). Children are as likely as adults to be infected with *Babesia* without a formal diagnosis of babesiosis being made (Krause *et al.*, 1992).

A group with an increased likelihood of seropositivity for *B. microti* consists of persons with a history of infection by *Borrelia burgdorferi*, the causative agent of Lyme disease. Positive *B. microti* serologies have been found in 9.5–66% of persons with positive serologies for *Borrelia burgdorferi* (Benach *et al.*, 1985; Krause *et al.*, 1991, 1992, 1996c). Similar findings occur in children (Krause *et al.*, 1992). The explanation for this is the transmission of both agents by the same vector, *I. scapularis*. Co-infection with *Ehrlichia*, which is also transmitted by *I. scapularis*, has been documented in persons infected with *Babesia* and/or *Borrelia* (Magnarelli *et al.*, 1995; Mitchell *et al.*, 1996). The phenomenon of

co-infection might be more than a mere curiosity, since there is evidence that persons co-infected with *Borrelia burgdorferi* and *Babesia microti* exhibit more severe and prolonged symptoms (Krause *et al.*, 1996c).

Although transmission of human babesiosis occurs in most cases through a tick bite, there are other modes of transmission. Infectious parasites have been retrieved from *B. microti*-infected blood stored at 4°C for up to 21 days, under conditions which are replicated during blood banking (Eberhard *et al.*, 1995). Not surprisingly, acquisition of babesiosis through blood transfusion has been well documented. Almost all reports have concerned the transmission of *B. microti* (Wittner *et al.*, 1982; Marcus *et al.*, 1982; Gordon *et al.*, 1984; Rosner *et al.*, 1984; Mintz *et al.*, 1991; Anderson *et al.*, 1991). However, there is a recent case report of transmission of the WA1-type parasite by transfusion in Washington State in the USA (Herwaldt *et al.*, 1997). A comparison between *B. microti*-seronegative and -seropositive blood donors in Massachusetts identified no differences that would enable the identification of high-risk donors (Popovskiy *et al.*, 1988). Despite this, the risk of acquiring babesiosis from a blood transfusion obtained from a donor residing in an endemic area is very low (Gerber *et al.*, 1994).

Another, less well-documented mode of transmission of babesiosis is vertical transmission. This has been documented in humans and cattle (Esernio-Jenssen *et al.*, 1987; New *et al.*, 1997; De Vos *et al.*, 1976). There is no data on the efficiency of transmission. However, there is a report of a woman who became infected with *Babesia* during the fifth month of pregnancy. Her illness resolved without chemotherapy and the fetus had no evidence of infection (Raucher *et al.*, 1984).

A final mode of transmission, which has been documented only experimentally, is the oral route in a mouse model (Malagon and Tapia, 1994).

## CLINICAL FEATURES

European and North American cases of human babesiosis differ markedly in clinical manifestations. Most cases (84%) in Europe have occurred

in splenectomized individuals, where the infecting organism is usually bovine *Babesia* species, particularly *B. bovis* and *B. divergens* (Telford *et al.*, 1993). Of the 19 cases reviewed by Telford, over half died. Mortality among splenectomized individuals was over 70% (Rosner *et al.*, 1984). The infection is fulminant, with sudden onset accompanied by hemoglobinuria, jaundice and fever. Renal failure is a common complication. This is usually due to intravascular hemolysis, which can be severe. The susceptibility of splenectomized individuals to *Babesia* species has been observed in experimentally splenectomized chimpanzees, which developed severe infection after inoculation. In comparison, non-splenectomized chimpanzees were resistant to infection (Garnham and Bray, 1959).

Human babesiosis in North America is usually caused by the rodent strain, *B. microti* (Dammin *et al.*, 1981). The infection is frequently sub-clinical (Ruebush *et al.*, 1977b; Filstein *et al.*, 1980; Popovsky *et al.*, 1988; Krause *et al.*, 1992) and symptomatic disease is usually less severe than the European form (Ruebush *et al.*, 1977b; Ruebush, 1980), including in splenectomized individuals (Teutsch *et al.*, 1980). The incubation period is usually 1–3 weeks, although periods as long as 6 weeks have been observed (Ruebush *et al.*, 1981). Most patients do not recall a tick bite, most likely because of the small size (2 mm) of the engorged nymph (Benach and Habicht, 1981). Approximately 70% of patients infected with *B. microti* have intact spleens. Almost all of the over 120 patients with babesiosis due to *B. microti* have survived (Dammin *et al.*, 1981). Those individuals with intact spleens who have developed clinical illness usually have been 50 years of age or older, suggesting that age is a risk factor for more severe disease (Benach and Habicht, 1981). Patients with splenectomies who have contracted babesiosis tend to be younger than previously healthy persons who develop the infection (48 years and over 60 years of age, respectively; Benach and Habicht, 1981).

Clinical manifestations of *B. microti* infection are non-specific and of gradual onset. Fever is frequent, may reach levels of 40°C, and may be sustained or intermittent (Gombert *et al.*, 1982). Common are malaise, fatigue, anorexia, rigors, headache, myalgias, arthralgias, nausea, vomiting, abdominal pain and dark urine (Anderson

*et al.*, 1974; Parry *et al.*, 1977; Scharfman and Taft, 1977; Ruebush *et al.*, 1977a; Sun *et al.*, 1983; Golightly *et al.*, 1989; Anonymous, 1993). Other symptoms include photophobia, conjunctival injection, sore throat, depression, emotional lability and cough.

Physical findings in addition to fever are few, if any. Splenomegaly is probably the most common finding (Ruebush *et al.*, 1977a). Hepatomegaly also occurs (Iacopino and Earnhart, 1990). Skin changes have been noted and include splinter hemorrhages, petechiae, ecchymoses, purpura and palor (Scharfman and Taft, 1977; Gombert *et al.*, 1982; Sun *et al.*, 1983). In addition, a rash resembling erythema chronicum migrans (ECM) has been observed, but this most likely represents patients with intercurrent Lyme disease. Other findings include icteric sclerae and jaundice (Parry *et al.*, 1977; Iacopino and Earnhart, 1990). Lymphadenopathy has not been noted.

Occasional patients may become critically ill when infected with *B. microti* (Iacopino and Earnhart, 1990; Herwaldt *et al.*, 1995; Boustani *et al.*, 1994). In one series, hospital stay for 17 patients averaged 19 days, with the duration of convalescence lasting up to 18 months (Benach and Habicht, 1981). Adult respiratory distress syndrome (ARDS) is a complication of babesiosis (Horowitz *et al.*, 1994). At our institution, three patients with babesiosis and shock, and two with ARDS, were cared for in a 14 month time period (Boustani *et al.*, 1994). Fatalities, although unusual, have occurred.

Hemolytic anemia, occasionally severe, is common, as are associated findings of decreased haptoglobin and increased reticulocyte count (Scharfman and Taft, 1977). The leukocyte count may be normal or somewhat decreased (Ruebush *et al.*, 1977a). Thrombocytopenia is common, observed in two-thirds of patients in one series (Gombert *et al.*, 1982). The erythrocyte sedimentation rate can be elevated and the direct Coombs test can react positively. Renal function can be disturbed, as manifested by hemoglobinuria, proteinuria, and elevated blood urea nitrogen and creatinine (Ruebush *et al.*, 1977a; Teutsch *et al.*, 1980; Iacopino and Earnhart, 1990). Elevations of bilirubin, alkaline phosphatase, serum aspartate aminotransferase, serum alanine aminotransferase and lactic dehydrogenase have been observed (Ruebush *et al.*, 1977a;

Iacopino and Earnhart, 1990). In a few cases where bone marrow examination has been performed, hemophagocytosis has been noted (Auerbach *et al.*, 1986; Gupta *et al.*, 1995), although it is not invariably present (Ruebush *et al.*, 1977a; Scharfman and Taft, 1977).

Severe infections with newly identified *Babesia* organisms have occurred in the USA. In Washington State, the WA1 strain of *Babesia* was identified from a man with an intact spleen who suffered moderately severe disease (Quick *et al.*, 1993). Subsequently, four asplenic patients from Northern California were infected with a similar, if not identical, organism and suffered severe disease, with two fatalities (Persing *et al.*, 1995). The infecting organism was more closely related to the canine strain, *B. gibsoni*, than to *B. microti*. Finally, a fatal infection with an organism closely related to *B. divergens* occurred in a 73 year-old asplenic man in the state of Missouri (Herwaldt *et al.*, 1996).

Certain groups of patients might be at more risk for severe disease. There is some evidence that those with concurrent Lyme disease and babesiosis have more severe and prolonged symptomatology (Krause *et al.*, 1996c). Thus, intercurrent Lyme disease should be investigated in any patient with known or suspected babesiosis. Advanced age might be a risk factor for more severe disease (Benach and Habicht, 1981). Underlying medical illness, including splenectomy, might predispose to severe disease (Benach and Habicht, 1981). One underlying illness, HIV infection, is associated with severe *B. microti* infections, which can be prolonged and chronic (Benezra *et al.*, 1987; Ong *et al.*, 1990; Falagas and Klempner, 1996).

## LABORATORY DIAGNOSIS

The usual method in diagnosing babesiosis is by microscopic examination of Giemsa- or Wright-stained thick and thin smears of the blood. Most studies have been in reports of humans infected with *B. microti*. However, differentiation between species on morphologic grounds is unreliable (Hoare, 1980). Usually 1–10% of erythrocytes are parasitized in patients with clinical disease. However, the range is from less than 1–85%

(Gombert *et al.*, 1982). More than one ring form can be present in an individual erythrocyte (Telford *et al.*, 1993). The ring forms of *Plasmodium falciparum* are very similar to the predominant forms of *Babesia* seen within the erythrocyte, making differentiation difficult. The babesial forms can have one or more chromatin masses or dots. In heavy infestation, trophozoites can be seen outside erythrocytes. There are several morphological features that enable distinction between *Babesia* and *P. falciparum*: (a) older stages of *P. falciparum* contain hemozoin, which is brownish pigment deposits not found in babesial forms (Dammin, 1978); (b) *Babesia* forms lack the synchronous stages, schizonts and gametocytes, found with *Plasmodium* species; (c) a rare but pathognomonic feature of *Babesia* infection is the presence of tetrads of merozoites (Figure 4.1), which are not present in malaria (Dammin, 1978; Healy and Ruebush, 1980); (d) in *Babesia* infection, larger ring forms can contain a central white vacuole, which is not present in malaria (Garnham, 1980).

Serologic testing for *B. divergens* is not useful for the diagnosis of acute infection. This is due to the detection of antibody approximately 1 week after the onset of illness. However, testing may be useful for identification of *B. divergens* as the infecting species (Telford *et al.*, 1993). Serological testing for *B. microti* utilizing an indirect immunofluorescence test (Chisholm *et al.*, 1986; Krause *et al.*, 1994) is available through the Centers for Disease Control and Prevention. Cross-reaction among species of *Babesia*, as well as among species of *Plasmodium*, occur (Chisholm *et al.*, 1986). Usually, persons with active infection have titers of 1:1024 or greater, which fall over time to 1:256 or less. A titer of 1:256 is diagnostic of *B. microti* infection. Titers of 1:32 or greater are indicative of past infection. Some consider a titer as low as 1:16 as positive (Krause *et al.*, 1991). An immunoglobulin M indirect immunofluorescent antibody test was found useful for the rapid diagnosis of acute babesiosis in a research setting (Krause *et al.*, 1996a).

Diagnosis by polymerase chain reaction holds promise as a sensitive and specific method for the diagnosis of *B. microti* (Persing *et al.*, 1992; Krause *et al.*, 1996b).

Confirmation of infection can be made by inoculation of the suspect blood into surrogate

hosts. For *B. divergens*, oxen or, more conveniently, gerbils, can be used. After inoculation of gerbils, rapidly progressive infection and death ensues within 3–6 days (Telford *et al.*, 1993). Suspected *B. microti* infection can be confirmed by the intraperitoneal inoculation of 1.0 ml EDTA–whole blood into golden hamsters.

## CLINICAL MANAGEMENT

European babesiosis, particularly disease caused by *B. divergens*, is a potentially explosive disease, especially in splenectomized individuals. Thus, supportive measures and specific antiparasitic treatment should be instituted rapidly. Most sources recommend treatment with quinine (650 mg administered orally three times/day) and clindamycin (600 mg intravenously administered three to four times/day) for 7–10 days, often with erythrocyte exchange transfusion as adjunctive therapy (Rosner *et al.*, 1984; Uhnou *et al.*, 1992; Telford *et al.*, 1993). Pentamidine and cotrimoxazole were used to successfully treat one patient with babesiosis due to *B. divergens* (Raoult *et al.*, 1987). Ineffective therapies of European babesiosis have included chloroquine alone (Telford *et al.*, 1993), pentamidine (Clarke *et al.*, 1989), quinine followed by chloroquine and Daraprim, with exchange transfusion (Williams, 1980), and Beneril (diminazene aceturate) (Dammin, 1978).

Atovaquone, a hydroxynaphthoquinone most frequently used in the treatment of *Toxoplasma* encephalitis in AIDS patients, is a promising agent for the treatment of babesiosis. In *in vitro* and *in vivo* studies of *B. divergens*, atovaquone was more effective than imidocarb, which is routinely used for the treatment of bovine babesiosis and occasionally used for the treatment of European babesiosis (Pudney and Gray, 1997). In this study, severe infection of gerbils was adequately treated with as little as 1 mg/kg body weight of atovaquone. Atovaquone (750 mg every 12 hours) and azithromycin (500 mg on day one, then 250 mg daily thereafter) together may be as effective and less toxic (Krause *et al.*, 1997).

Novel approaches to the treatment of European babesiosis currently under study include the

use of the 3-hydroxy-3-methylglutaryl coenzyme A reductase inhibitors, lovastatin and simvastatin, which inhibit the intraerythrocytic development of *B. divergens* (Grellier *et al.*, 1994) and the use of the lipophilic folate analogues, piritrexam and trimetrexate, which inhibited the growth of *B. bovis in vitro* (Nott and Bagnara, 1993).

Most patients infected with *B. microti* develop mild or subclinical illness and recover without specific therapy. In severely ill patients, clindamycin (300–600 mg intravenously every 6 hours) and oral quinine (25 mg/kg/day in children, 650 mg every 6–8 hours) for 7–10 days appear effective (Wittner *et al.*, 1982; Centers for Disease Control, 1983). Failure of this regimen has occurred (Smith *et al.*, 1986). Other promising agents include atovaquone or azithromycin, either alone or in combination, including with quinine, which were successful in treating *B. microti* infection in hamsters (Weiss *et al.*, 1993; Hughes and Oz, 1995; Krause *et al.*, 1997).

Chloroquine is ineffective in the treatment of *B. microti* infection (Miller *et al.*, 1978). Pentamidine therapy of three patients with intact spleens resulted in clinical improvement but was not curative (Francioli *et al.*, 1981). Other agents that have been of no or questionable value in the treatment of human *B. microti* infection include quinacrine, primaquine, pyrimethamine, pyrimethamine–sulfadoxine, sulfadiazine and tetracycline. Diminazene aceturate was effective in one patient, who later developed the Guillain–Barré syndrome (Centers for Disease Control, 1983).

Erythrocyte exchange transfusions are useful in severely ill patients with high levels of parasitemia and hemolysis (Jacoby *et al.*, 1980; Cahill *et al.*, 1981; Machtiger *et al.*, 1993). When used in conjunction with chemotherapy, the level of parasitemia is reduced. In addition, toxic factors produced by the parasites or of host origin might be removed.

Persons infected with *B. microti* should receive therapy for early infection with *Borrelia burgdorferi* because of the well-documented co-transmission of these two pathogens by *I. scapularis* (Benach *et al.*, 1985; Krause *et al.*, 1996c). Effective regimens include doxycycline, 100 mg b.i.d.; amoxicillin, 500 mg q.i.d. (50 mg/kg/day in children); or cefuroxime axetil, 500 mg

b.i.d. Unless there is evidence of disseminated Lyme disease, a 10 day course should be sufficient (Steere, 1995).

## PREVENTION AND CONTROL

Prevention of human babesiosis relies upon avoidance of exposure to the tick vectors. For *I. scapularis*, the months of May–September represent the times of greatest activity. In endemic areas, avoidance of grassy areas and brush is advisable. Splenectomized individuals and those who are immunocompromised in other ways should avoid areas of endemicity during times of high tick activity. Clothing should cover the body, especially the lower portion, through wearing long-sleeved shirts and long pants with socks. Tucking pant legs into socks is effective in preventing ticks from crawling up the legs. Ticks are more obvious if light-colored clothing is worn. Insect repellents such as diethyltoluamide (DEET) applied to the skin or clothing, or permethrin applied to clothing only, might be effective. Children and pets should be carefully inspected for ticks. If a tick is found, it should be removed expediently. The tick is grasped below the mouth at the site of attachment to the skin with forceps or tweezers and pulled off steadily. Vaccines against human babesiosis are not available.

Although transfusion-associated babesiosis is rare, this form of transmission can potentially be reduced by discouraging blood donors from endemic areas during times of the year characterized by increased tick activity. Donors with fever within 2 months prior to donation should be avoided. One promising approach to preventing transfusion-associated babesiosis is photosensitization, using lipophilic pheophorbide and red light illumination. This strategy eliminated *B. divergens*-infected erythrocytes from whole blood (Grellier *et al.*, 1997). Screening of blood for babesiosis is unlikely to be adopted, so the possibility of transfusion-associated babesiosis will remain.

## REFERENCES

- Abdalla HS, Hussein HS, Kreier JP (1978). *Tropenmed Parasitol* **29**: 295–306.
- Adachi K, Tateishi M, Horii Y, Nagatomo H, Shimizu T, Makimura S (1994). *J Vet Med Sci* **56**: 757–9.
- Adachi K, Yoshimoto A, Hasegawa T, Shimizu T, Goto Y, Makimura S (1992). *J Vet Med Sci* **54**: 1081–4.
- Aikawa M, Pongponratn E, Tegoshi T, Nakamura K, Nagatake T, Cochrane A, Ozaki LS (1992). *Mem Inst Oswaldo Cruz* **87**: 297–301.
- Allred DR, Cinque RM, Lane TJ, Ahrens KP (1994). *Infect Immun* **62**: 91–8.
- Anderson AE, Cassaday PB, Healy GR (1974). *Am J Clin Pathol* **62**: 612–18.
- Anderson JF, Mintz ED, Gadbaw JJ, Magnarelli LA (1991). *J Clin Microbiol* **29**: 2779–83.
- Anonymous (1993). *N Engl J Med* **329**: 194–9.
- Auerbach M, Haubenstock A, Soloman G (1986). *Am J Med* **80**: 301–3.
- Benach J, Habicht G (1981). *J Infect Dis* **144**: 481.
- Benach JL, Coleman JL, Habicht GS, MacDonald A, Grunwaldt E, Giron JA (1985). *J Infect Dis* **152**: 473–7.
- Benach JL, Habicht GS, Hamburger MI (1982). *J Infect Dis* **146**: 369–80.
- Benezra D, Brown A, Polsky B, Gold J, Armstrong D (1987). *Ann Intern Med* **107**: 944.
- Boustani M, Lepore T, Gelfand J, Lazarus D (1994). *Am J Resp Crit Care Med* **149**: 1689–91.
- Brown WC, Davis WC, Choi SH, Dobbelaere DA, Splitter GA (1994). *Cell Immunol* **153**: 9–27.
- Brown WC, Logan KS, Zhao S, Bergman DK, Rice-Ficht AC (1995). *Infect Immun* **63**: 3106–16.
- Brown WC, Zhao S, Woods VM *et al.* (1993). *Infect Immun* **61**: 236–44.
- Bush J, Isaacson M, Mohamed A, Potgieter F, Dewaal D (1990). *S Afr Med J* **78**: 699.
- Cahill KM, Benach JL, Reich LM *et al.* (1981). *Transfusion* **21**: 193–8.
- Carcy B, Precigout E, Valentin A, Gorenflot A, Schrevel J (1995). *Infect Immun* **63**: 811–17.
- Cavacini LA, Parke LA, Weidanz WP (1990). *Infect Immun* **58**: 2946–50.
- Centers for Disease Control (1983). *Morbid Mortal Wkly Rep* **32**: 65–71.
- Chisholm ES, Sulzer AJ, Ruebush TKD (1986). *Am J Trop Med Hyg* **35**: 921–5.
- Clark I, Hunt N, Cowden W (1986). *Adv Parasitol* **25**: 1–44.
- Clark IA (1978). *Lancet* **2**: 75–7.
- Clarke C, Rogers E, Egan E (1989). *Postgrad Med J* **65**: 591–3.
- Cullen JM, Levine JF (1987). *Lab Anim Sci* **37**: 640–3.
- Dammin G (1978). In Weinstein L, Fields B (eds), *Seminars in Infectious Disease*. Stratton: New York; 169–99.
- Dammin GJ, Spielman A, Benach JL, Piesman J (1981). *Human Pathology* **12**: 398–400.
- Dao AH, Eberhard ML (1996). *Lab Invest* **74**: 853–9.
- De Vos AJ, Imes GD, Cullen JS (1976). *Onderstepoort J Vet Res* **43**: 75–8.
- Dinarello C, Gelfand J, Wolff S (1993). *J Am Med Assoc* **269**: 1829–35.
- Donnelly J (1980). *Trans R Soc Trop Med Hyg* **74**: 158.
- Donnelly J, Peirce MA (1975). *Int J Parasitol* **5**: 363–7.
- Eberhard ML, Walker EM, Steurer FJ (1995). *J Parasitol* **81**: 790–2.

- Esernio-Jenssen D, Scimeca P, Benach J, Tenenbaum M (1987). *J Pediat* **110**: 570–2.
- Falagas ME, Klempner MS (1996). *Clin Infect Dis* **22**: 809–12.
- Filstein MR, Benach JL, White DJ *et al.* (1980). *J Infect Dis* **141**: 518–21.
- Francioli PB, Keithly JS, Jones TC, Branstetter RD, Wolf DJ (1981). *Ann Intern Med* **94**: 326–30.
- Garnham P (1980). *Trans R Soc Trop Med Hyg* **74**: 153–5.
- Garnham P, Bray R (1959). *J Protozool* **6**: 355–9.
- Gerber MA, Shapiro ED, Krause PJ, Cable RG, Badon SJ, Ryan RW (1994). *J Infect Dis* **170**: 231–4.
- Goff WL, Wagner GG, Craig TM, Long RF (1982). *Vet Parasitol* **11**: 109–20.
- Golightly LM, Hirschhorn LR, Weller PF (1989). *Rev Infect Dis* **11**: 629–37.
- Gombert ME, Goldstein EJ, Benach JL *et al.* (1982). *J Am Med Assoc* **248**: 3005–7.
- Goodger BV, Wright IG, Mahoney DF, McKenna RV (1978). *Zeitschr Parasitenkunde* **58**: 3–13.
- Gordon S, Cordon RA, Mazdzer EJ, Valigorsky JM, Blagg NA, Barnes SJ (1984). *Chest* **86**: 633–4.
- Grellier P, Santus R, Mouray E *et al.* (1997). *Vox Sang* **72**: 211–20.
- Grellier P, Valentin A, Millerioux V, Schrevel J, Rigomier D (1994). *Antimicrob Agents Chemother* **38**: 1144–8.
- Gupta P, Hurley R, Helseth P, Goodman J, Hammerschmidt D (1995). *Am J Hematol* **50**: 60–2.
- Harpaz R, Edelman R, Wasserman S, Levine M, Davis J, Sztejn M (1992). *J Clin Invest* **90**: 515–23.
- Healy GR, Ruebush TKD (1980). *Am J Clin Pathol* **73**: 107–9.
- Healy GR, Spielman A, Gleason N (1976). *Science* **192**: 479–80.
- Herwaldt B, Persing DH, Precigout EA *et al.* (1996). *Ann Intern Med* **124**: 643–50.
- Herwaldt B, Springs F, Roberts P *et al.* (1995). *Am J Trop Med Hyg* **53**: 146–51.
- Herwaldt BL, Kjemtrup AM, Conrad PA *et al.* (1997). *J Infect Dis* **175**: 1259–62.
- Hoare CA (1980). *Trans R Soc Trop Med Hyg* **74**: 143–8.
- Horowitz M, Coletta F, Fein A (1994). *Chest* **106**: 1299–301.
- Hu R, Yeh MT, Hyland KE, Mather TN (1996). *J Parasitol* **82**: 728–32.
- Hughes W, Oz H (1995). Successful prevention and treatment of babesiosis with atovaquone. *J Infect Dis* **172**: 1042–6.
- Iacopino V, Earnhart T (1990). *Arch Intern Med* **150**: 1527–8.
- Jack RM, Ward PA (1980). *J Immunol* **124**: 1566–73.
- Jacobson RH, Parrodi F, Wright IG, Fitzgerald CJ, Dobson C (1993). *Parasitol Res* **79**: 221–6.
- Jacoby GA, Hunt JV, Kosinski KS (1980). *N Engl J Med* **303**: 1098–1100.
- Karakashian SJ, Rudzinska MA, Spielman A, Lewengrub S, Piesman J, Shoukrey N (1983). *Cell Tissue Res* **231**: 275–87.
- Krause P, Ryan R, Telford SR III, Persing D, Spielman A (1996a). *J Clin Microbiol* **34**: 2014–16.
- Krause P, Telford SR III, Spielman A *et al.* (1996b). *J Clin Microbiol* **34**: 2791–4.
- Krause P, Telford S, Spielman A (1997). In *Program and Abstracts of the 46th Annual Meeting of the American Society of Tropical Medicine and Hygiene*. Lake Buena Vista, FL (abstract).
- Krause PJ, Telford SR III, Ryan R *et al.* (1994). *J Infect Dis* **169**: 923–6.
- Krause PJ, Telford SR III, Spielman A *et al.* (1996c). *J Am Med Assoc* **275**: 1657–60.
- Krause PJ, Telford SR III, Pollack RJ *et al.* (1992). *Pediatrics* **89**: 1045–8.
- Krause PJ, Telford SR III, Ryan R *et al.* (1991). *J Clin Microbiol* **29**: 1–4.
- Li J, Meng D (1984). *Chin J Vet Med* **10**: 19–20.
- Looareesuwan S, Ho M, Wattanagoon Y *et al.* (1987). *N Engl J Med* **317**: 675–9.
- Lykins JD, Ristic M, Weisiger RM (1975). *Exp Parasitol* **37**: 388–97.
- Machtlinger L, Telford S, Inducil C, Klapper E, Pepkowitz S, Goldfinger D (1993). *J Clin Apheresis* **8**: 78–81.
- Magnarelli LA, Dumler JS, Anderson JF, Johnson RC, Fikrig E (1995). *J Clin Microbiol* **33**: 3054–7.
- Malagon F, Tapia JL (1994). *Parasitol Res* **80**: 645–8.
- Marcus LC, Valigorsky JM, Fanning WL, Joseph T, Glick B (1982). *J Am Med Assoc* **248**: 465–7.
- Meeusen E, Lloyd S, Soulsby EJ (1984). *Austr J Exp Biol Med Sci* **62**: 551–66.
- Meeusen E, Lloyd S, Soulsby EJ (1985). *Austr J Exp Biol Med Sci* **63**: 261–72.
- Mehlhorn H, Shein E (1984). *Adv Parasitol* **23**: 37–103.
- Miller LH, Neva FA, Gill F (1978). *Ann Intern Med* **88**: 200–2.
- Mintz ED, Anderson JF, Cable RG, Hadler JL (1991). *Transfusion* **31**: 365–8.
- Mitchell PD, Reed KD, Hofkes JM (1996). *J Clin Microbiol* **34**: 724–7.
- New D, Quinn B, Qureshi M, Sigler S (1997). *J Pediat* **131**: 163–4.
- Nott SE, Bagnara AS (1993). *Int J Parasitol* **23**: 399–402.
- O'Donoghue P, Friedhoff K, Vizcaino O, Weyreter H (1985). *Vet Parasitol* **18**: 1–12.
- Oliveira MR, Kreier JP (1979). *J Parasitol* **65**: 816–17.
- Oliver J, Owsley M, Hutcheson H *et al.* (1993). *J Med Entomol* **30**: 54–63.
- Olmeda AS, Armstrong PM, Rosenthal BM *et al.* (1997). *Acta Trop* **67**: 229–34.
- Ong KR, Stavropoulos C, Inada Y (1990). *Lancet* **336**: 112.
- Parrodi F, Jacobson RH, Wright IG, Fitzgerald CJ, Dobson C (1991). *Parasite Immunol* **13**: 457–71.
- Parry MF, Fox M, Burka SA, Richar WJ (1977). *J Am Med Assoc* **238**: 1282–3.
- Persing DH, Herwaldt BL, Glaser C *et al.* (1995). *N Engl J Med* **332**: 298–303.
- Persing DH, Mathiesen D, Marshall WF *et al.* (1992). *J Clin Microbiol* **30**: 2097–103.
- Piesman J, Spielman A (1979). *Ann Entomol Soc Am* **72**: 829–32.
- Piesman J, Spielman A, Etkind P, Ruebush TK, Juranek DD (1979). *J Med Entomol* **15**: 537–40.
- Popovskiy MA, Lindberg LE, Syrek AL, Page PL (1988). *Transfusion* **28**: 59–61.
- Potgieter FT, Els HJ (1976). *Onderstepoort J Vet Res* **43**: 123–8.
- Potgieter FT, Els HJ, Vuuren AS (1976). *Onderstepoort J Vet Res* **43**: 1–9.
- Precigout E, Valentin A, Carcy B *et al.* (1993). *Exp Parasitol* **77**: 425–34.
- Pudney M, Gray JS (1997). *J Parasitol* **83**: 307–10.

- Quick RE, Herwaldt BL, Thomford JW *et al.* (1993). *Ann Intern Med* **119**: 284–90.
- Raoult D, Soulayrol L, Toga B, Dumon H, Casanova P (1987). *Ann Intern Med* **107**: 944.
- Raucher HS, Jaffin H, Glass JL (1984). *Obstet Gynecol* **63**: 7–9S.
- Rosner F, Zarrabi MH, Benach JL, Habicht GS (1984). *Am J Med* **76**: 696–701.
- Rudzinska MA, Lewengrub S, Spielman A, Piesman J (1983). *J Protozool* **30**: 338–46.
- Rudzinska MA, Spielman A, Lewengrub S, Piesman J, Karakashian S (1982). *Cell Tissue Res* **221**: 471–81.
- Ruebush MJ, Hanson WL (1980). *Am J Trop Med Hyg* **29**: 507–15.
- Ruebush T (1980). *Trans R Soc Trop Med Hyg* **74**: 149–52.
- Ruebush TK, Cassaday PB, Marsh HJ *et al.* (1977a). *Ann Intern Med* **86**: 6–9.
- Ruebush TK, Juranek DD, Chisholm ES, Snow PC, Healy GR, Sulzer AJ (1977b). *N Engl J Med* **297**: 825–7.
- Ruebush TKD, Juranek DD, Spielman A, Piesman J, Healy GR (1981). *Am J Trop Med Hyg* **30**: 937–41.
- Scharfman WB, Taft EG (1977). *J Am Med Assoc* **238**: 1281–2.
- Shih CM, Liu LP, Chung WC, Ong SJ, Wang CC (1997). *Clin Microbiol* **35**: 450–4.
- Shimada T, Shikano S, Hashiguchi R, Matsuki N, Ono K (1996). *J Vet Med Sci* **58**: 343–7.
- Smith P, Evans A, Popovsky M, Mills L, Spielman A (1986). *J Am Med Assoc* **256**: 2726–7.
- Spielman A (1976). *Am J Trop Med Hyg* **25**: 784–7.
- Spielman A (1994). *Ann NY Acad Sci* **740**: 146–56.
- Spielman A, Clifford C, Piesman J, Corwin M (1979). *J Med Entomol* **15**: 218–34.
- Spielman A, Wilson ML, Levine JF, Piesman J (1985). *Ann Rev Entomol* **30**: 439–60.
- Steere A (1995). In Mandell G, Bennett J, Dolin R (eds), *Principles and Practice of Infectious Diseases*. Churchill Livingstone: New York; 2143–55.
- Sun T, Tenenbaum MJ, Greenspan J (1983). *J Infect Dis* **148**: 239–48.
- Telford S, Gorenflot A, Brasseur P, Spielman A (1993). In Kreier J (ed.), *Parasitic Protozoa*, vol 5. Academic Press: New York; 1–47.
- Tetzlaff CL, Rice-Ficht AC, Woods VM, Brown WC (1992). *Infect Immun* **60**: 644–52.
- Teutsch SM, Etkind P, Burwell EL *et al.* (1980). *Am J Trop Med Hyg* **29**: 738–41.
- Thomford JW, Conrad PA, Telford SR III *et al.* (1994). *J Infect Dis* **169**: 1050–6.
- Uhnou I, Cars O, Christensson D, Nystrom-Rosander C (1992). *Scand J Infect Dis* **24**: 541–7.
- Urquhart A (1994). Putative pathophysiological interactions of cytokines and phagocytic cells in severe falciparum malaria. *Clin Infect Dis* **19**: 117–31.
- Weiss LM, Wittner M, Wasserman S, Oz HS, Retsema J, Tanowitz HB (1993). *J Infect Dis* **168**: 1289–92.
- Wesson D, McLain D, Oliver J, Piesman J, Collins F (1993). *Proc Natl Acad Sci* **90**: 10221–5.
- Western K, Benson G, Gleason N, Healy G, Schultz M (1970). *N Engl J Med* **283**: 854–6.
- Williams H (1980). *Trans R Soc Trop Med Hyg* **74**: 157–8.
- Winger CM, Canning EU, Culverhouse JD (1987). *Parasitology* **94**: 17–27.
- Winger CM, Canning EU, Culverhouse JD (1989). *Parasitology* **99**, 341–8.
- Wittner M, Rowin KS, Tanowitz HB (1982). *Ann Intern Med* **96**: 601–4.
- Wozniak EJ, Lowenstine LJ, Hemmer R, Robinson T, Conrad PA (1996). *Lab Anim Sci* **46**: 507–15.
- Zivkovic D, Seinen W, Kuil H, Albers-van Bommel CM, Speksnijder JE (1984). *Vet Immunol Immunopathol* **5**: 343–57.



# Toxoplasmosis

**Joseph D. Schwartzman**

*Dartmouth–Hitchcock Medical Center, Lebanon, NH, USA*

---

## INTRODUCTION

*Toxoplasma gondii* is a complex eukaryotic parasite that appears to have all the cellular machinery required for independent life but that has adopted an obligate intracellular existence. It can infect and grow within many cell types of a wide range of animal species. *T. gondii* causes a broad spectrum of disease in the various species it infects, including humans; however, most infections are asymptomatic. The parasite actively penetrates host cells, sets up a privileged compartment in which it replicates and finally kills the cell. A coordinated host cell-mediated immune response is required to control the acute infection and maintain suppression of the long-lived cysts, which may persist for the life of the host. The ability of *T. gondii* to infect many animal species and its worldwide distribution set it apart from other members of the phylum Apicomplexa, which typically are strictly host-specific and geographically constrained. *T. gondii* is found on all continents, with only a few isolated islands apparently free of this successful parasite. The ability to infect birds, domestic animals and people by several possible routes, and the wide distribution of the parasite, are the likely causes of a high prevalence of infection in humans. Up to one-third of the world's population has evidence of exposure to and chronic infection with *T. gondii*. Symptomatic disease is unusual except in those with severe immunocompromise and in infants with congenital infection.

In the agricultural sector, toxoplasmosis causes an economically important incidence of fetal loss among domesticated animals such as goats, sheep and pigs.

## HISTORY

Investigators on two continents first described *T. gondii* in 1908. Nicolle and Manceaux, at the Institut Pasteur in Tunis, identified and named the parasite in a cricetine rodent, the North African gundi (*Ctenodactylus gundi*), native to the mountains of southern Tunisia, and maintained in their laboratory (Nicolle and Manceaux, 1908, 1909). Splendore, in Brazil, noted identical forms in a laboratory rabbit (Splendore, 1908, 1909). Appreciation of the spectrum of disease that the parasite can cause came slowly. Wolf and Cowen (1937) at Columbia University identified the parasite in central nervous system lesions in infants that had been diagnosed with meningoencephalitis. Understanding of the role of chronic infection came with the identification by Wilder (1952) of *Toxoplasma* in necrotic lesions of the retina of eyes previously thought to have been involved with tuberculosis or syphilis. The high prevalence of the infection in various populations was first shown by the serological test developed by Sabin and Feldman (1948), which relied on the ability of human serum to induce leakage of

extracellular dye into live tachyzoites in the presence of complement. The recognition of congenital toxoplasmosis in infants came before either generalized disease in adults or the lymphadenitis of primary *Toxoplasma* infections in adults was appreciated (Wolf and Cowen, 1937). The role of reactivation of latent infections in the production of disease in immunosuppressed adults was recognized at the outset of solid organ transplantation (Ruskin and Remington, 1976). In the early 1980s, central nervous system reactivation with multifocal encephalitis became a major presentation of disease in patients with AIDS (Luft *et al.*, 1983a).

## DESCRIPTION OF THE ORGANISM

### Classification

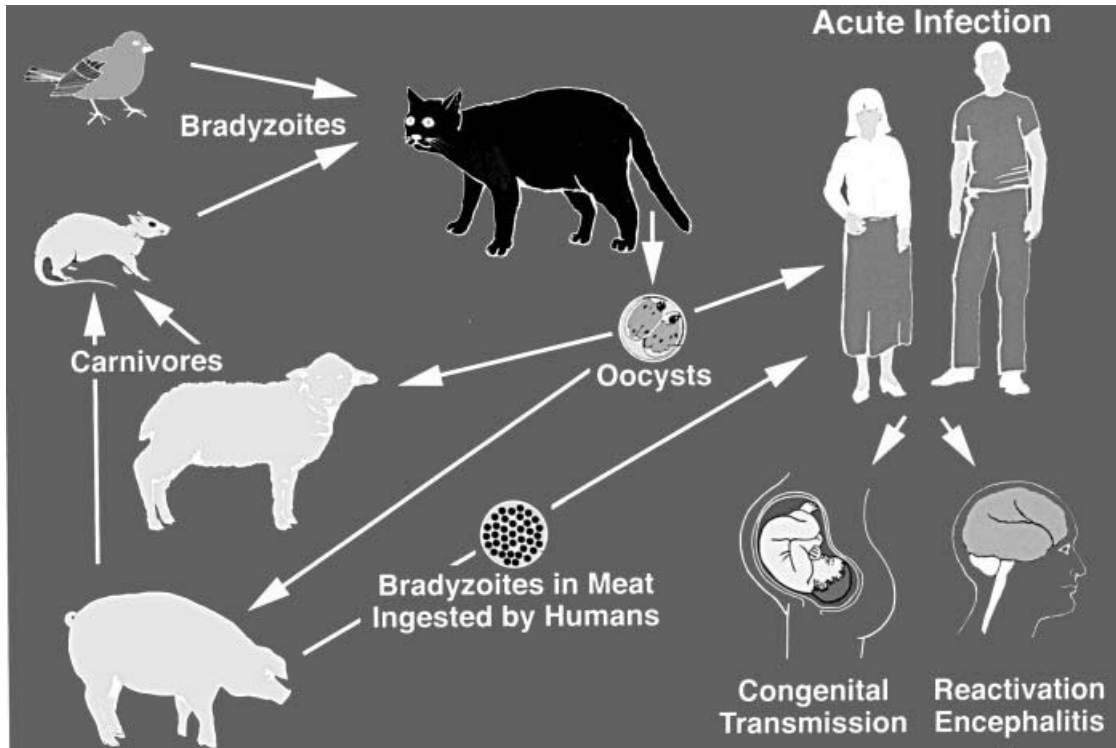
The parasite is a member of the phylum Apicomplexa, class Sporozoa, subclass Coccidia, order Eucoccidia and suborder Eimeria (Levine *et al.*, 1980). It is therefore related to malaria and a large number of coccidians that generally infect birds and mammals. The parasite was recognized as a coccidian only in 1969, when four laboratories independently established the sexual cycle (Frenkel, 1970; Frenkel *et al.*, 1970). Traditional classification schemes have relied on morphological comparisons of the various life stages, most importantly the sexual stages. By these criteria, *T. gondii* closely resembles *Isospora* spp. and *Sarcocystis* spp. and, although it has been argued that the organism name should be changed, it continues to be validly named as *T. gondii*. More recently, molecular genetic techniques have shown that *T. gondii* is a single species related to *Isospora*, *Sarcocystis*, *Frenkelia* and *Hammondia* but most closely related to *Neospora caninum* (Guo and Johnson, 1995).

Molecular analysis of genes of *T. gondii* indicates that some genetic elements of the parasite may derive from a member of the green algae (Fichera and Roos, 1997; Stokkermans *et al.*, 1996). This situation may have arisen by an incorporation of algal DNA by endosymbiosis, and may be of importance in development of novel drug targets that take advantage of differences between 'plant-like' and mammalian gene characteristics. A membrane-bound, plastid-

like structure, the apicoplast, contains a 35 kb circular genome and can be specifically inhibited by ciprofloxacin, clindamycin and macrolide antibiotics, which block parasite replication in a peculiar delayed fashion. The target of these drugs is likely protein synthesis in the apicoplast. Plastid replication is immediately affected, but overall parasite growth is maintained until the second or third parasite replication cycle (Fichera and Roos, 1997). Many of the plastid genes have been transferred to the nucleus and may explain the plant-like character of *T. gondii* structural proteins such as tubulin (Stokkermans *et al.*, 1996). Other evidence that *T. gondii* has plant-like characteristics conveyed by the apicoplast is that the parasite expresses enzymes of the shikimate pathway, which is essential for the synthesis of folate, ubiquinone and aromatic amino acids in algae and plants (Roberts *et al.*, 1998). A well-characterized inhibitor of the shikimate pathway, the herbicide glyphosate, also inhibits *T. gondii*. Four enzymes of the shikimate pathway have been detected in *T. gondii*, and the pathway is also present in the apicomplexan parasites *Plasmodium falciparum* and *Cryptosporidium parvum*.

### Life-cycle

The asexual stages of *T. gondii* can cause disease in humans and most animals (Figure 5.1). There are two asexual forms. The first form, called the tachyzoite, can invade all types of cells and divides rapidly, leading to cell death (Figure 5.2). The second form, called the bradyzoite, divides slowly and forms cysts, most prominently in muscle and brain (Figure 5.3). Tachyzoite replication causes acute disease, while encysted bradyzoites are long-lived, with slow turnover, and are responsible for maintaining the latent infection. Cysts in tissue elicit no inflammation, and presumably have little effect on surrounding cellular function until they break down and release the bradyzoites, which can convert to tachyzoites and cause necrosis and inflammation. Reactivation of bradyzoites from cysts is responsible for most disease in immunosuppressed hosts. The infection is maintained in nature in numerous animals, both wild and domesticated.



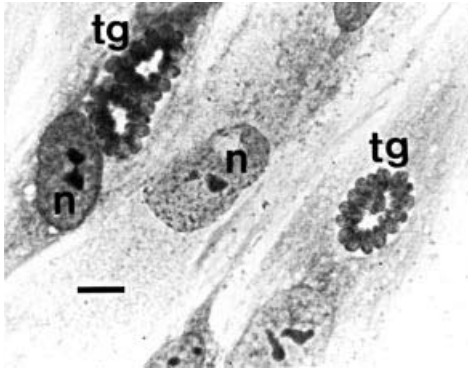
**Fig. 5.1** Life-cycle of *T. gondii*. The cat is the definitive host, in which the sexual cycle is completed. Oocysts shed in cat feces can infect birds, rodents and grazing animals or humans. The cysts found in the muscle of food animals may infect humans eating insufficiently cooked meat. Human disease takes many forms, but congenital infection and encephalitis from reactivation of latent infection in the brains of immunosuppressed persons are the most important manifestations of disease

Rodents and birds ingested by cats keep the sexual cycle going in the wild. Human food animals, especially sheep, pigs and goats, may harbor cysts in muscle, which are infectious for people and other carnivores when ingested in raw or undercooked meat (Dubey, 1990, 1992; Dubey *et al.*, 1995). The sexual cycle takes place in the superficial epithelium of the small intestine of both wild and domestic members of the cat family (Figure 5.4). Oocysts, which are shed in feces of recently infected cats, are resistant to desiccation and heat (Dubey, 1995; Jacobs *et al.*, 1960). Oocysts are less dense than water and remain in the upper soil horizon, where they may contaminate skin and may be ingested, either directly by hand-to-mouth transmission or on raw vegetables (Frenkel *et al.*, 1970). Oocysts require exposure to air, after cat feces are deposited in soil, for at least 12 hours but up to several days in order to complete sporulation,

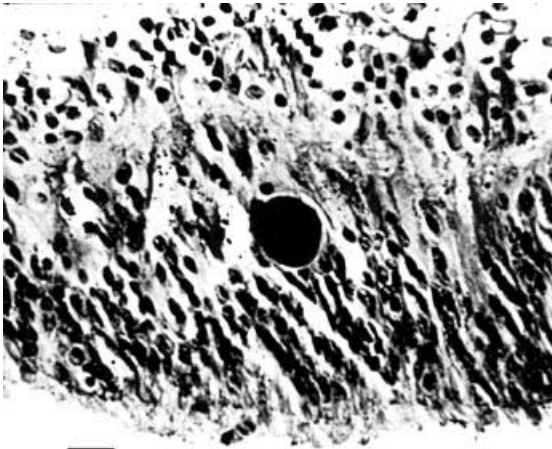
after which they are infectious by mouth (Frenkel *et al.*, 1975). This information is useful in the management of cat litter boxes, which have a lower chance of harboring infectious oocysts if the feces are removed daily.

### Population Genetics

Strains of *T. gondii* from all continents have been compared genetically and shown to be a homogeneous single species with less than 5% sequence variation between isolates from any area of the world (Boothroyd, 1993). The species sorts genetically into three major clonal lineages (designated as I, II and III), with little evidence of recombination (Howe and Sibley, 1995). Demonstration of the sexual cycle in the cat intestine indicates that sexual recombination is possible, and it can be shown to occur in

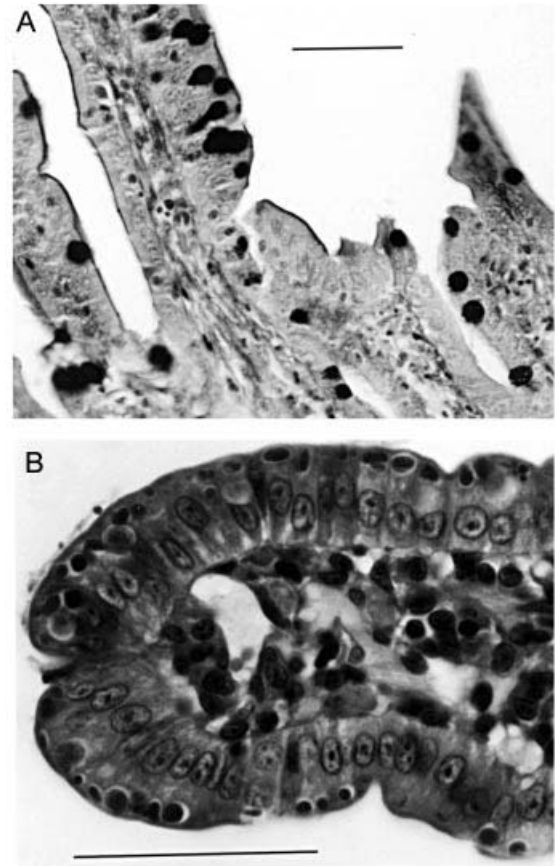


**Fig. 5.2** *T. gondii* infection of cultured human fibroblasts, demonstrating 'rosettes' of tachyzoites (tg) within parasitophorous vacuoles in the cytoplasm of the host cells. The parasites are orientated with their posterior poles to the inside of the ring, n, host nucleus. Bar=10µm



**Fig. 5.3** Bradyzoite cyst in the retina, stained with PAS. No inflammation is evident adjacent to the intact cyst. Individual bradyzoites cannot be distinguished. Bar= 50µm

experimental infections (Pfefferkorn *et al.*, 1977; Pfefferkorn and Pfefferkorn, 1980). This must be relatively infrequent in nature, however, probably because it would require a cat to ingest two separate strains of *T. gondii* in close temporal proximity, so that the initial intestinal infection produced gametes that could cross-fertilize. Virulence differences between three defined genotypes can be demonstrated in experimental infections of inbred mouse strains. There is evidence, from analysis of a collection of 109 isolates from around the world, that the type II genotype, as defined by Sibley, is over-



**Fig. 5.4** Sexual stages of *T. gondii* in epithelial cells of cat small intestine. (A) Early sexual stages (types B and C), 40 hours after infection, stained by PAS. (B) Later stages (types D, E and gamonts) in the periphery of intestinal epithelial cells after 8 days, stained with haematoxylin and eosin. Bars=75µm. Histological preparations courtesy of Dr Jack Frenkel, University of Kansas Medical Center

represented in human disease, and that type III is more frequent in animals (Howe and Sibley, 1995; Sibley and Howe, 1996). Type I, which is most virulent in the mouse model, may be more frequent in human congenital disease (Sibley and Howe, 1996). Genetic tools, including genetic crosses (Pfefferkorn and Pfefferkorn, 1980), transfection and homologous recombination to produce knockout phenotypes (Roos *et al.*, 1994) a preliminary genetic map (Sibley and Boothroyd, 1992; Sibley *et al.*, 1992) and an expressed-sequence-tag library (Ajioka *et al.*, 1998), have been developed to aid the genetic analysis of the parasite.

## EPIDEMIOLOGY AND ECOLOGY

Humans may be infected either by eating cysts in meat or by ingestion of sporulated oocysts from contaminated soil. The relative risk of infection in the USA, Canada and Europe is considered to be higher from the ingestion of undercooked meat, but in societies with little meat in the diet, oocysts are more important (Frenkel *et al.*, 1995). Studies of vegetarians show a lower incidence of toxoplasmosis in this population in industrialized countries (Roghmann *et al.*, 1999) and the tropics (Rawal, 1959). Birds and rodents are important in picking up oocysts from soil and scavenging bradyzoite cysts from infected animals (Frenkel, 1973, 1997). Grazing food animals, e.g. sheep, are probably infected by soil oocysts, but swine are omnivores and may also ingest infected rodents (Dubey, 1998; Dubey and Beattie, 1998). The incidence of *Toxoplasma* in swine is quite variable. Bovine and fowl *Toxoplasma* levels are low (Dubey, 1992).

The distribution of *T. gondii* is worldwide; all genotypes are found on all continents except Antarctica. Islands without *T. gondii* have been found in the Pacific, and along the coast of Central America (Etheredge and Frenkel, 1995; Wallace, 1969). Hot, dry climates have a lower incidence of toxoplasmosis than temperate, moist climates, and rates decrease with increase in altitude (Etheredge and Frenkel, 1995; Walton *et al.*, 1966). The role of the cat in the transmission of toxoplasmosis is established, but the epidemiology of transmission also includes the possible role of dogs as carriers of infectious oocysts. Dogs are associated in epidemiological surveys with increased rates of toxoplasmosis. Their habit of rolling in cat feces or eating cat feces suggests a possible mechanism for transfer of infectious oocysts (Frenkel, 1997). Fresh water contaminated with oocysts was implicated as the source of an outbreak in troops training in a jungle in Panama (Benenson *et al.*, 1982). *Toxoplasma* infection is also acquired by transplacental transmission (Desmonts and Couvreur, 1974a) and, less commonly, through organ transplantation (Ruskin and Remington, 1976) and laboratory accidents (Jacobs, 1974). Although *Toxoplasma* DNA can be detected by PCR in blood from chronically infected individuals (Dupon *et al.*, 1995), transmission of

toxoplasmosis by transfusion of banked blood has not been established as a public health problem (Kimball *et al.*, 1965). Man is a dead-end host for *T. gondii*, which is of importance in the understanding of the epidemiology of drug resistance. Strains can become resistant to particular chemotherapeutic agents, but cannot be passed from person to person.

Serological surveys demonstrate wide variation in prevalence of infection in various geographic locations (Zuber and Jacquier, 1995). In Paris, France, where rates of infection reach 90% by the fifth decade (Desmonts and Couvreur, 1974b; Remington *et al.*, 1995; Thulliez, 1992) transmission appears to be related to preferences of ingesting poorly cooked or raw meat, especially lamb. In contrast, antibody positivity in the UK and Finland is approximately 20% in the total population (Joynson, 1992; Koskiniemi *et al.*, 1992). In moist tropical areas of Latin America and sub-Saharan Africa, where cats are abundant and the climate favors survival of oocysts, the prevalence may approach 90% (Etheredge and Frenkel, 1995; Frenkel *et al.*, 1995; Onadeko *et al.*, 1992; Sousa *et al.*, 1988). In comparison, rates in hot, dry regions, such as North Africa, usually do not exceed 20% (Hamadto *et al.*, 1997). Rates in the USA also vary, with a recent survey in military recruits showing rates from 3% in the mountain states to 13% in the mid-Atlantic and east-south-central states (Smith *et al.*, 1996). These results are about one-third lower than earlier surveys, and may indicate a decrease in the load of infectious organisms in the meat supply, since the number of cats has increased in recent years.

Recent statistics on the incidence of toxoplasmosis presenting as an opportunistic infection of the brain in AIDS have been published by the Centers for Disease Control and Prevention in Atlanta, GA (Prevention, 1999). Between 1992 and 1997, the incidence of toxoplasmic encephalitis declined from 20.7/1000 to 7.0/1000 person-years in HIV-infected persons. The percentage of males dying of AIDS in this period who had toxoplasmic encephalitis at any time in the course of their illness was 7.1% overall, but 13.0% in those who acquired HIV through heterosexual contact. These figures are lower than those quoted at the outset of the AIDS epidemic.

## CELL BIOLOGY

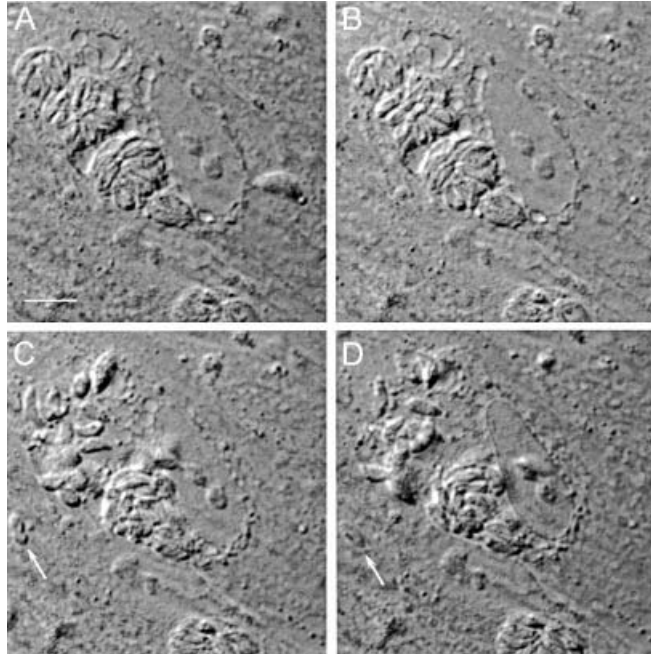
*T. gondii* must invade host cells in order to replicate (Morisaki *et al.*, 1995) and is able to penetrate virtually any cell type (Figure 5.5). Active forward movement of the parasite is an absolute requirement for host cell penetration (Zaman and Colley, 1972). The ability of *T. gondii* to actively invade host cells is key to its wide host cell range (Dubremetz, 1998). *T. gondii* also actively exits the host cell to continue the infection (Schwartzman and Saffer, 1992). Active egress from host cells is likely to be important, both in acute disease and in reactivation of dormant bradyzoites.

The basic behavior of *T. gondii* in its interaction with cells in culture can be observed by light microscopy (Figure 5.2). Saltatory gliding motility of tachyzoites over a solid substrate is followed by rapid penetration of cultured cells of almost any type (Håkansson *et al.*, 1999). The movement of the parasite is in a forward clockwise helical rotation without obvious deformation of the parasite body, although torsion of the parasite external membrane has been noted by scanning electron microscopy (Bonhomme *et al.*, 1992). Anterior-posterior flexing of non-gliding parasites and forward protrusion of the anterior tip of the organism can also be seen (Nichols and O'Connor, 1981).

Rather than depending on a particular cell type to take the parasite up by host-dependent mechanisms, or on specific cellular receptors that would limit its ability to invade, *T. gondii* is able to penetrate a very wide variety of cell types in a broad range of host species. Invasion has been shown to depend on gliding movement (Dobrowolski and Sibley, 1997; Håkansson *et al.*, 1999). The motor for gliding is likely to be actin/myosin (Dobrowolski *et al.*, 1997; Morisaki *et al.*, 1995). Recent work has focused on defining the motor proteins that power active invasion. An unusual family of small myosins has been described in *T. gondii* that may be implicated in gliding, although the mechanism has yet to be established (Heintzelman and Schwartzman, 1997). Phylogenetic analysis reveals that the three myosins represent a novel, highly divergent class in the myosin superfamily. *T. gondii* myosin-A (TgM-A) is an unusually small (approximately 93 kDa) myosin that shows a striking departure from

typical myosin heavy chain structure, in that it lacks a neck domain between the head and tail, and in the absence of recognizable regulatory sites. The tail domain of TgM-A encompasses only 57 amino acid residues and has a highly basic charge. Two other *Toxoplasma* myosins, TgM-B and TgM-C, are proteins of 114 kDa and 125 kDa, respectively. These two myosins differ only in their distal tail structure. The tails, like that of TgM-A, share no homology to any other myosin tails apart from a highly basic charge. Both TgM-A and TgM-C are membrane-associated and bind actin in the absence, but not in the presence, of ATP (Heintzelman and Schwartzman, 1999). The localization of TgM-A is to the anterior pole of the parasite, with subtle redistribution to apical patches along the cell membrane in extracellular gliding parasites. Two additional *T. gondii* genes (TgM-D and TgM-E), which strongly resemble TgM-A in size and sequence, have been cloned (Hettmann *et al.*, 2000). In addition to the work done on *T. gondii*, a small unconventional myosin highly homologous to TgM-A has also been found in *Plasmodium falciparum* (PfM-A) (Pinder *et al.*, 1998). This myosin is expressed in motile merozoites and sporozoites, but disappears in the intracellular trophozoite stage. This myosin is localized to the parasite cortex, with some concentration at the apical pole, not unlike the distribution of TgM-A. As PfM-A appears to be the dominant or perhaps the only myosin expressed at this stage, it is the best candidate for the molecular motor driving the invasive process in *Plasmodium*.

At least 17 different classes of unconventional myosins have been identified in Protozoa, plants and animals across the phylogenetic spectrum (Mermall *et al.*, 1998). Phylogenetic analysis reveals that the five myosins so far described in *T. gondii*, together with the three myosins from *Plasmodium*, represent at least one, and more likely two, novel, highly divergent classes in the myosin superfamily. As such, they may perform functions not yet documented for the existing myosins, such as powering gliding motility. Although the functions of the parasite myosins have not yet been determined, the distribution of these molecules does strongly support the hypothetical role of these myosins in parasite motility.



**Fig. 5.5** Active egress of *T. gondii* from host fibroblasts following stimulation of motility by calcium. (A–D) Intracellular rosettes of parasites are demonstrated by differential-interference-contrast microscopy. Following calcium stimulation of parasite movement, the individual tachyzoites penetrate the wall of the parasitophorous vacuole and traverse the host cell cytoplasm on their own power, to exit the cell. A single tachyzoite is seen in panels C and D, showing constriction of the parasite body as it pushes through the host plasma membrane (arrow). Interval between panels, 10 seconds. Bar = 10  $\mu$ m. Courtesy of Dr Elijah Stommel, Dartmouth Medical School

*T. gondii* motility is actin-dependent, but fibrillar actin has been very difficult to demonstrate in the parasite (Dobrowolski and Sibley, 1997). By the use of an agent that polymerizes and stabilizes actin filaments, specific actin processes can be demonstrated at the anterior pole of the parasite and beneath the parasite plasma membrane (Shaw and Tilney, 1999). This localization is consistent with roles for actin in both the probing movement of the anterior tip of the parasite seen during cell penetration and in gliding motility. Gliding motility is seen in bacteria, fungi, algae and many other protists, but the mechanisms responsible for producing movement over a substratum without deformation of the moving organism are as yet unexplained. Understanding the mechanism of gliding locomotion in *T. gondii* is complicated by the unusual arrangement of membranes of *T. gondii* zoites. An apparently ordinary plasma membrane surrounds the organism. Two additional unit membranes, positioned immediately

subjacent to the plasma membrane, are arranged as side-by-side envelopes, appearing like 'pavement blocks' (Figure 5.6), with cross-sections showing two unit membranes closely apposed (Schwartzman and Saffer, 1992). The cisternae of the inner membrane complex (IMC) are not continuous beneath the entire parasite cell membrane, being absent at the poles of the organism. Beneath the IMC is an array of 22 longitudinal microtubules (Nichols and Chiappino, 1987). The function of the inner membrane complex is unknown.

Penetration and establishment of a parasitophorous vacuole requires constitutive and regulated secretion of parasitic factors (Karsten *et al.*, 1998). The parasite has three secretory organelles, the rhoptries and micronemes that secrete their contents at the anterior pole, and dense granules that secrete along the lateral surface and posterior pole of the parasite (Dubremetz *et al.*, 1993). The combined function of these secretory products appears to be modification of the host



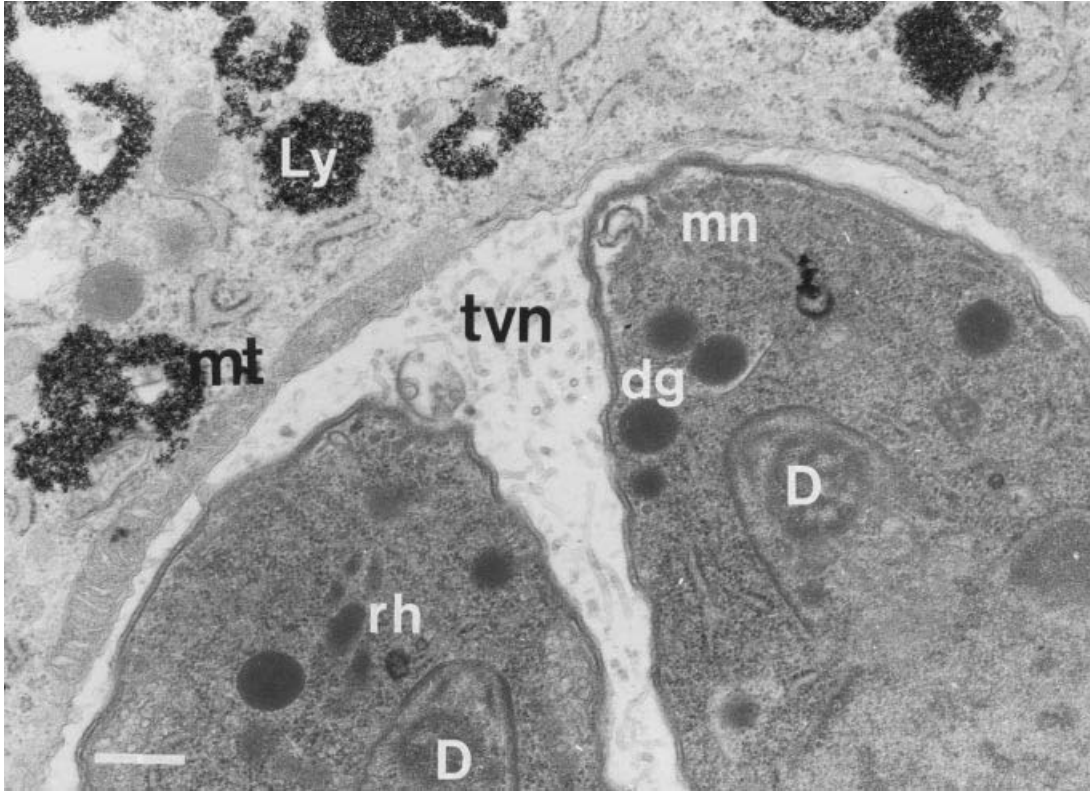
**Fig. 5.6** Montage of micrographs of a freeze-fractured *T. gondii* tachyzoite, shadowed by evaporated platinum to show the exterior surface of the organism. The plasma membrane has been largely lost, and the surface is made up of the several layers of the inner membrane complex, which covers the parasite in large 'pavement blocks'. The longitudinal ridges represent the membranes supported from the interior by the microtubule cytoskeleton

membrane to provide a vacuole that does not fuse with host compartments (Sibley and Krahenbuhl, 1988) and that allows the parasite to salvage small molecular weight molecules for its metabolic and synthetic functions (Schwab *et al.*, 1994) (Figure 5.7).

## IMMUNOLOGY

Antibody and cell-mediated immunity are both elicited by *T. gondii* infection. The role of antibody in the control of the infection is secondary to the effects of the cell-mediated immune response. A balance between innate and adaptive mechanisms leads to proinflammatory and regulatory responses in the immunopathology of toxoplasmosis (Alexander and Hunter, 1998). Cell-mediated production of Th1 responses that limit *Toxoplasma* growth must be controlled to limit host damage. Several cell types are responsible for controlling intracellular growth of *T. gondii* (Suzuki, 1999). T lymphocytes of CD8<sup>+</sup>, CD4<sup>+</sup> and  $\gamma\delta$  specificity, as well as macrophages, dendritic cells and neutrophils, are important in creating and maintaining the Th1 response (Denkers and Gazzinelli, 1998). The immune reaction to *T. gondii* infection also involves depression of parts of the immune machinery (Channon and Kasper, 1996). Microneme and surface antigens of *T. gondii* trigger monocytes to downregulate mitogen-induced lymphoproliferation (Channon *et al.*, 1999). Experimental animal studies involving the natural oral route of infection have revealed the importance of gut immunity in the acute stages of toxoplasmosis. Intraepithelial CD8<sup>+</sup> lymphocytes isolated from infected mice can be shown to provide long-term protection against infective challenge (Lepage *et al.*, 1998). The lymphokines that are known to be important in host protection include interferon (IFN) gamma (IFN $\gamma$ ), tumor necrosis factor alpha (TNF $\alpha$ ) and nitric oxide, which have been shown to be key components in anti-*Toxoplasma* responses. While these are unquestionably necessary, they may not explain all aspects of parasite control. IFN and TNF $\alpha$  stimulation of non-immune effector cells to kill *T. gondii* may not be completely dependent on nitric oxide production





**Fig. 5.7** Electron micrograph of two intracellular *T. gondii* that are each beginning the second round of division by endodyogeny, as shown by the formation of daughter apical complexes (D) within each parent. Several apical organelles, including dense granules (dg), micronemes (mn) and rhoptries (rh), are seen within the parents. The parasitophorous vacuole space is filled with the tubulovesicular network (tvn), which is thought to function in parasite salvage of host metabolites. A host mitochondrion (mt) is seen at the edge of the parasitophorous vacuole. The host lysosomal compartments (ly) are labeled by granular thorium dioxide, showing that none of these bodies fuse with the parasitophorous vacuole. Magnification  $\times 10\,000$

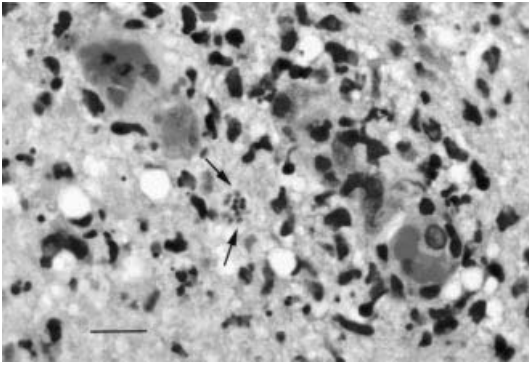
(Yap and Sher, 1999a,b), neither does the long-term immunity induced by vaccination rely on nitric oxide, although it is IFN-dependent (Khan, Matsuura and Kasper, 1998). Dendritic cells may be important in the immune response to re-exposure to *T. gondii*. Lymphocytes from donors with evidence of previous toxoplasmosis induced rapid and strong production of interleukin 12 (IL-12) from human dendritic cells, which would be expected to produce a rapid burst of IFN $\gamma$  (Seguin and Kasper, 1999).

The effective and balanced immune response of immunocompetent individuals controls the infection, in most cases causing little organ damage, but does not eradicate the infection. The bradyzoite cysts elicit little immune reaction and may persist for the life of the host. Changes

in the host's immune functions may allow reactivation of actively replicating tachyzoites which must be controlled by further cell-mediated mechanisms. If the host is incapable of mounting or regulating this response, the outcome is extensive organ damage.

## PATHOGENESIS

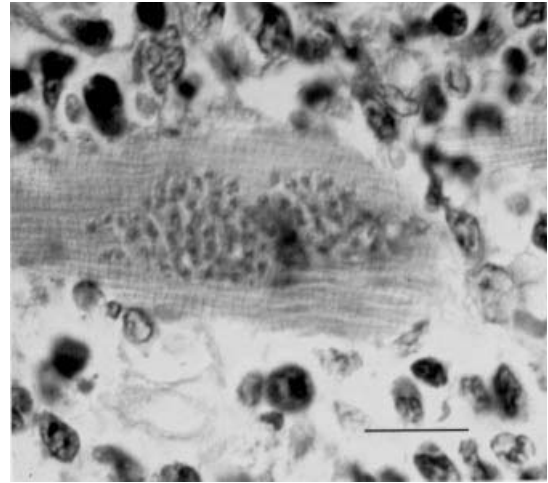
The primary route of infection is oral, with progression of the infection through the gastrointestinal tract to local lymphatics and spread to other organs documented in the mouse, but all of these steps have not been shown in humans (Channon and Kasper, 1996; Fadul *et al.*, 1995;



**Fig. 5.8** Toxoplasmic encephalitis. An area of necrosis with perivascular inflammatory infiltrate and clusters of intracellular tachyzoites (arrow). Extracellular tachyzoites are more difficult to distinguish from fragments of necrotic cells. Haematoxylin and eosin stain. Bar= 50  $\mu$ m

Frenkel, 1973, 1988). In mice fed bradyzoites, the first step appears to be local invasion of the small intestinal epithelium. The bradyzoite and tachyzoite are both capable of active invasion of many cell types, and replicate within a parasite-modified vacuole (Dubremetz, 1998; Lingelbach and Joiner, 1998; Schwab *et al.*, 1994). Bradyzoites rapidly convert to tachyzoites *in vivo*. *In vitro* the formation of bradyzoite cysts can be stimulated by various maneuvers that stress the infected cells, including change of pH or temperature or various mitochondrial poisons (Dubey *et al.*, 1998; Dubremetz, 1998; Soete *et al.*, 1994). The key step in spreading the infection from the localized initial site is likely infection of circulating monocytes in the lamina propria; this cell subset has been shown to be permissive for *T. gondii* replication in both mice and humans, and may therefore be responsible for transport of the parasite widely throughout tissues (Fadul *et al.*, 1995).

Tachyzoites are found in all organs in acute infection, most prominently in muscle, including heart, and in liver, spleen, lymph nodes and the central nervous system (Bertoli *et al.*, 1995; Figures 5.8, 5.9). The initial pathological lesion is necrosis caused by death of parasitized cells, with a vigorous acute inflammatory reaction. As the disease progresses, more lymphocytic infiltration develops but true granulomas are not formed. If the host controls the replication of tachyzoites effectively, tissues are restored to



**Fig. 5.9** Toxoplasmic myocarditis. Intracellular tachyzoites are within a myocardial muscle cell, which is surrounded by extensive edema and inflammatory infiltrate. Geimsa stain. Bar= 50  $\mu$ m

anatomic integrity without scarring, and cysts containing the long-lived bradyzoites remain without sign of host reaction. The humoral immune response is rapid and may be capable of killing extracellular tachyzoites (and is of use diagnostically), but it is not protective in the mouse model (Frenkel, 1973). Control of the disease appears to depend on the elaboration of appropriate cytokines including IL-12 and IFN $\gamma$  (Suzuki *et al.*, 1988a; Yap and Sher, 1999a), followed by a specific cell-mediated immunity, with CD8<sup>+</sup> helper T cells apparently the most important subgroup (Suzuki, 1999; Yap and Sher, 1999a). In some experimental infections there is intense acute inflammation with few identifiable parasites and early death, which may be caused by an overly vigorous cytokine response to the infection (Khan *et al.*, 1997).

## CLINICAL SYNDROMES

### Acute Disease in Adults

Most individuals positive for *T. gondii* antibodies have no history of a clinical syndrome that was diagnosed as toxoplasmosis, leading to the supposition that most primary infections are asymptomatic or unrecognized. The most

common recognized finding is cervical lymphadenopathy, usually painless and sometimes accompanied by low-grade fever (McCabe *et al.*, 1987a). Single or multiple enlarged nodes may persist at one site or there may be involvement of many scattered nodes. Toxoplasmic lymphadenopathy may be evident for weeks, and may need to be distinguished from lymphoma (McCabe *et al.*, 1987b). The other common presentation is a mononucleosis-like syndrome, which is characterized by fever, headache, malaise, lymphadenopathy, hepatosplenomegaly, myalgia and atypical lymphocytosis, and which develops within 1–3 weeks after exposure to infectious material (Krick and Remington, 1978; Remington, 1974; Remington *et al.*, 1995). The symptomatic illness may persist for up to several months. The most severe manifestations of toxoplasmosis in persons with normal immune function are rare and include pneumonitis, myocarditis, meningoencephalitis, polymyositis and systemic disease leading to death (Evans and Schwartzman, 1991; Feldman, 1968a,b; Frenkel, 1985; Greenlee *et al.*, 1975; Krick and Remington, 1978; Mawhorter *et al.*, 1992; Wilder, 1952).

### Congenital Disease

*Toxoplasma* may infect the maternal side of the placenta in the course of acute primary disease, and if the parasite penetrates to the fetal side, the fetus may become infected. The ability of the parasite to cross the placenta depends on the anatomic characteristics of the placenta, which change with the stage of gestation. Total maternal–fetal transmission is about 30% throughout all of gestation, but varies from 6% at 13 weeks to 72% at 36 weeks (Dunn *et al.*, 1999). However, fetuses infected in early pregnancy are at a higher risk of manifesting clinical signs of infection. The two trends combine to give women who seroconvert at 24–30 weeks of gestation the highest risk (10%) of having a congenitally infected child with early clinical signs of infection, a child that is therefore at risk of long-term sequelae.

Congenital infection has been reported only rarely when the mother has antibody to *T. gondii* or symptoms of primary infection acquired

before gestation (Vogel *et al.*, 1996). Evidence of infection within months prior to pregnancy should be considered to carry a small risk of congenital infection. Immunosuppression of women (as with corticosteroid therapy) who have prior *T. gondii* infections may also lead, rarely, to transplacental transmission of infection. Acute infection is clinically apparent in the minority of infected pregnant women, but both symptomatic and asymptomatic infections can lead to transplacental transmission. The rate of transplacental transmission and the severity of disease varies with time of gestation. A large study of congenital toxoplasmosis in Norway (Jenum *et al.*, 1998) showed that, in 35 940 pregnant women, 10.9% had evidence of infection preceding pregnancy and 0.17% showed evidence of primary infection during pregnancy. Congenital infection was detected in 11 infants and 13% occurred in the first, 29% in the second and 50% in the third trimester. After 1 year of follow-up, only one infant, born without gestational treatment, was clinically affected, with unilateral chorioretinitis. Between 0.6% and 1.3% of women were falsely positive by a commercial IgM assay when tested from the beginning to the end of pregnancy. Of the women infected prior to pregnancy, 6.8% had persisting specific IgM. A positive specific-IgM result had a low predictive value for identifying primary *T. gondii* infection. Another large screening study found that 50% of positive cord-blood IgM assays were false positives, but of the true positives, 40% of infants had identifiable signs, but not symptoms, of infection (Guerina *et al.*, 1994). These conclusions are in accordance with poor performance of other commercial IgM assays in detection of congenital disease (Wilson *et al.*, 1997). Improvements in IgM assays are under development (Tuuminen *et al.*, 1999), but the low-affinity IgM seen in infants makes serological diagnosis of congenital disease difficult.

The great majority (> 75%) of infants born with toxoplasmosis are asymptomatic or have disease that is not detected by routine neonatal examination (Desmonts and Couvreur, 1974a,b; Guerina *et al.*, 1994). Careful ophthalmological examination may reveal evidence of chorioretinitis in otherwise asymptomatic infants (McAuley *et al.*, 1994). The majority of congenitally

infected infants will subsequently develop clinically apparent evidence of infection within months to years (Koppe *et al.*, 1986; Koppe and Meenken, 1999; Wilson *et al.*, 1980). Reactivation of congenital infection may be correlated with Th2-type cytokine responses, which have been noted, in experimental infection, to be associated with progressive disease (Kahi *et al.*, 1999).

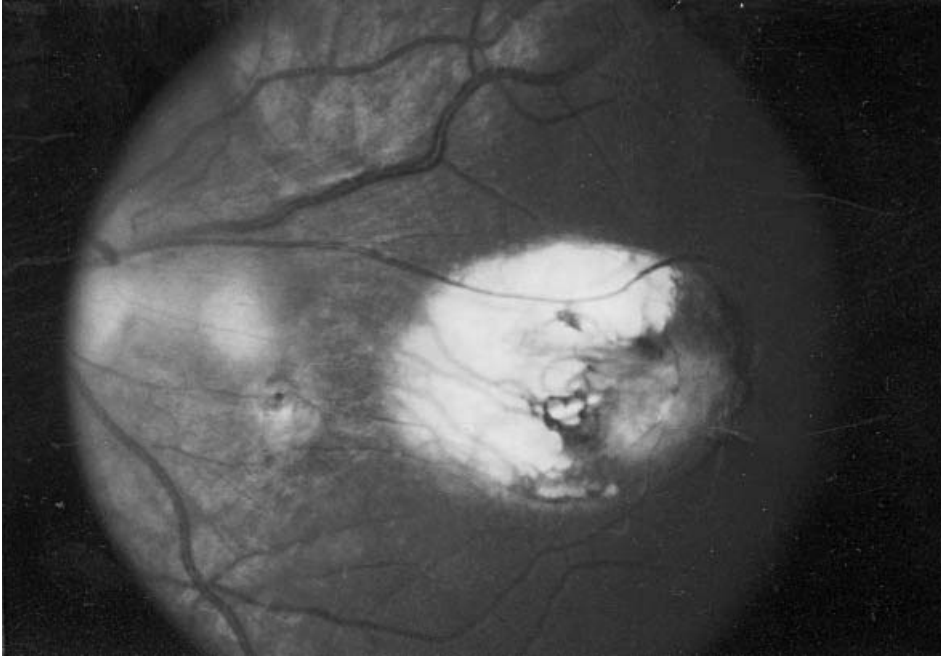
Infections in the first trimester and early second trimester may lead to spontaneous abortion, stillbirth or severe neonatal disease (Frenkel, 1974; Remington *et al.*, 1995). The most severely affected organ is the brain, where focal necrosis and perivascular mononuclear inflammation is seen, with intracellular and extracellular tachyzoites and early cysts. Resolving lesions may show microglial nodules and calcification. Large lesions may be associated with thrombosis of small and medium-sized vessels of the white and gray matter. Lesions are frequently periventricular and, when they involve the aqueduct of Sylvius, subsequent fibrosis may lead to hydrocephalus. Neurological sequelae include seizures, developmental delay, deafness, hydrocephalus, microcephalus and prominent intracerebral calcifications. Approximately 75% of clinically apparent congenital toxoplasmosis manifests as visual impairment caused by bilateral retinochoroiditis (Mets *et al.*, 1997). Peripheral retinal lesions may be difficult to detect in infants without an examination under anesthesia. In infants severely affected with congenital toxoplasmosis, systemic manifestations, such as fever, hypothermia, jaundice, hepatosplenomegaly, diarrhea, vomiting, lymphadenopathy, pneumonitis, myocarditis and petechial or purpuric rash, may be evident (McAuley *et al.*, 1994). Laboratory findings may include anemia, thrombocytopenia, elevated CSF protein and CSF pleocytosis (McAuley *et al.*, 1994). The presence of symptoms and signs of systemic and CNS involvement may not guarantee a bad prognosis, however, in infants who are diagnosed and treated appropriately (McAuley *et al.*, 1994). Factors correlating with poor outcomes include episodes of hypothermia, bradycardia and apnea or hypoxemia. Cerebral atrophy persisting after therapy for hydrocephalus, and CSF protein levels greater than 1 g/dl, have also been noted in infants who have had the worst outcomes in a longitudinal study (McAuley *et al.*, 1994).

## Ocular Disease

Involvement of the eye is commonly seen in congenital disease, but recent outbreaks in Canada and Brazil have demonstrated that retinochoroiditis is a more common result of acute primary infection in adults than has been previously appreciated (Bowie *et al.*, 1997; Glasner *et al.*, 1992). In these studies, the high incidence of ocular involvement was associated with infection contracted from food or water. Retinochoroiditis in children and teenagers is most frequently ascribed to congenital infection that was silent or undetected at birth (Mets *et al.*, 1997; Pavesio and Lightman, 1996). Therapy for toxoplasmosis in gestation or in the first year of life may decrease the incidence and/or severity of retinochoroiditis (Peyron *et al.*, 1996). Symptoms of acute retinochoroiditis include blurred vision, scotoma, photophobia and pain, without fever or other systemic manifestations. Funduscopic examination shows evidence of vitritis, with elevated pale, cotton-like patches in the retina, resembling a 'headlight in fog' (Montoya and Remington, 2000). The pathology of the lesions involves coagulative necrosis of the retina with inflammatory infiltrates and loose granulomas in the choroid (Roberts and McLeod, 1999). Healed scars are pale with distinct margins and prominent black pigment of choroidal epithelium (Roberts and McLeod, 1999) (Figure 5.10). Recurrent retinochoroiditis involving the macula may lead to blindness. Vascularization of scars from the choroid may predispose to retinal detachment, especially in those with myopia (Bosch-Driessen *et al.*, 2000; Lafaut *et al.*, 1999). Micro-ophthalmia, strabismus, cataracts, glaucoma and optic atrophy are long-term complications of severe retinochoroiditis.

## Disease in Persons with Human Immunodeficiency Virus (HIV) and Other Causes of Immunodeficiency

Cell-mediated immunity is required for the continued control of *T. gondii* infection, and any disease process or therapeutic regimen that depresses cellular immunity may allow for reactivation of disease, leading to overwhelming



**Fig. 5.10** Toxoplasmic retinochoroiditis in a patient with congenital infection. Courtesy of Dr Rima McLeod, University of Chicago

infection. The most frequent condition predisposing to systemic toxoplasmosis is advanced HIV disease. Persons with persistently less than 100 CD4<sup>+</sup> T cells/ $\mu$ l are at risk for reactivation of previous infection (Israelski *et al.*, 1993; Ruskin and Remington, 1976). There is some evidence that CD8<sup>+</sup> T cells are key effectors in long-term immunity to *T. gondii* (Parker *et al.*, 1991) and the CD8<sup>+</sup> cell count falls late in HIV disease. In populations that have a high incidence of inadequately treated opportunistic infections, such as in developing countries, toxoplasmosis may be less prevalent, since patients may die before the disease is manifested. Other immunosuppressed persons at high risk are those treated for solid organ transplantation, especially those without *T. gondii* antibody who have been given organs from *T. gondii*-positive donors (Luft *et al.*, 1983b). Hodgkin's disease and other lymphomas have also been found to predispose to serious *Toxoplasma* infections. Toxoplasmosis in AIDS is most frequently the result of reactivation of latent infection (Mariuz *et al.*, 1994). The underlying incidence of *T. gondii* exposure of a population therefore affects the risk of reactivation,

and patients from groups with high incidence of anti-*Toxoplasma* antibody are at higher risk. AIDS patients who lack evidence of *T. gondii* antibody may have symptomatic toxoplasmosis, but disease in the absence of an antibody response is rare, even in advanced immunosuppression. In one series of patients with toxoplasmic encephalitis, 16% of cases had no evidence of IgG antibody (Porter and Sande, 1992). Without chemoprophylaxis, the incidence of reactivation of latent *T. gondii* infection in AIDS is up to 30% (Mariuz *et al.*, 1994) but the practice of *Pneumocystis carinii* prophylaxis, which suppresses *T. gondii* as well, has reduced this dramatically (Richards *et al.*, 1995). There is preliminary evidence that persons who respond to HIV treatment with sustained immune reconstitution above 200 CD4<sup>+</sup> T cells/ $\mu$ l of blood are at low risk for toxoplasmic encephalitis, and may be removed from anti-*Toxoplasma* prophylaxis (Furrer *et al.*, 2000).

Although toxoplasmosis in immunosuppressed individuals can affect all organ systems, there is a remarkable predominance of toxoplasmic encephalitis seen in AIDS patients, which is not fully

explained but is thought to be caused by the reactivation of latent cysts in the central nervous system. This disease is usually manifested by multiple necrotizing lesions in the cerebral corticomedullary regions or the basal ganglia, which may be detected by various imaging techniques (see below). Symptoms most frequently include a subacute presentation of fever, headache, altered mental state and/or a wide range of neuropsychiatric manifestations, focal neurological findings (including cranial nerve deficits, cerebellar deficits and movement disorders, weakness and sensory changes) and indications of generalized CNS dysfunction, such as seizures. Signs of meningeal irritation are not usually seen. Laboratory tests of CSF are frequently only minimally abnormal, with CSF protein being the most commonly elevated indicator. The course of disease can also be acute and rapidly fatal.

Other organs involved most frequently in immunosuppressed patients include the heart and lungs (Tschirhart and Klatt, 1988). Toxoplasmic myocarditis is infrequently symptomatic but may cause arrhythmia and heart failure (Montoya and Remington, 2000). When symptomatic, it may be the predominant feature of disseminated disease (Figure 5.9). Dermal and skeletal myositis has also been described as a symptomatic feature of toxoplasmosis. Pulmonary toxoplasmosis is most frequently seen late in the course of AIDS, and clinically resembles pneumonitis caused by *Pneumocystis carinii*, but is more rapidly progressive, with pulmonary infiltrates and respiratory decompensation. Virtually all other organ systems have been found to harbor tachyzoites in disseminated disease, but clinical symptoms attributable to individual organs other than the brain, heart, muscle and lung are unusual.

## DIAGNOSIS

### Imaging Studies

Lesions in organs other than brain are non-specific and cannot be distinguished from other infectious processes by imaging studies. In the central nervous system, computed tomography (CT) scans in typical cases of toxoplasmic

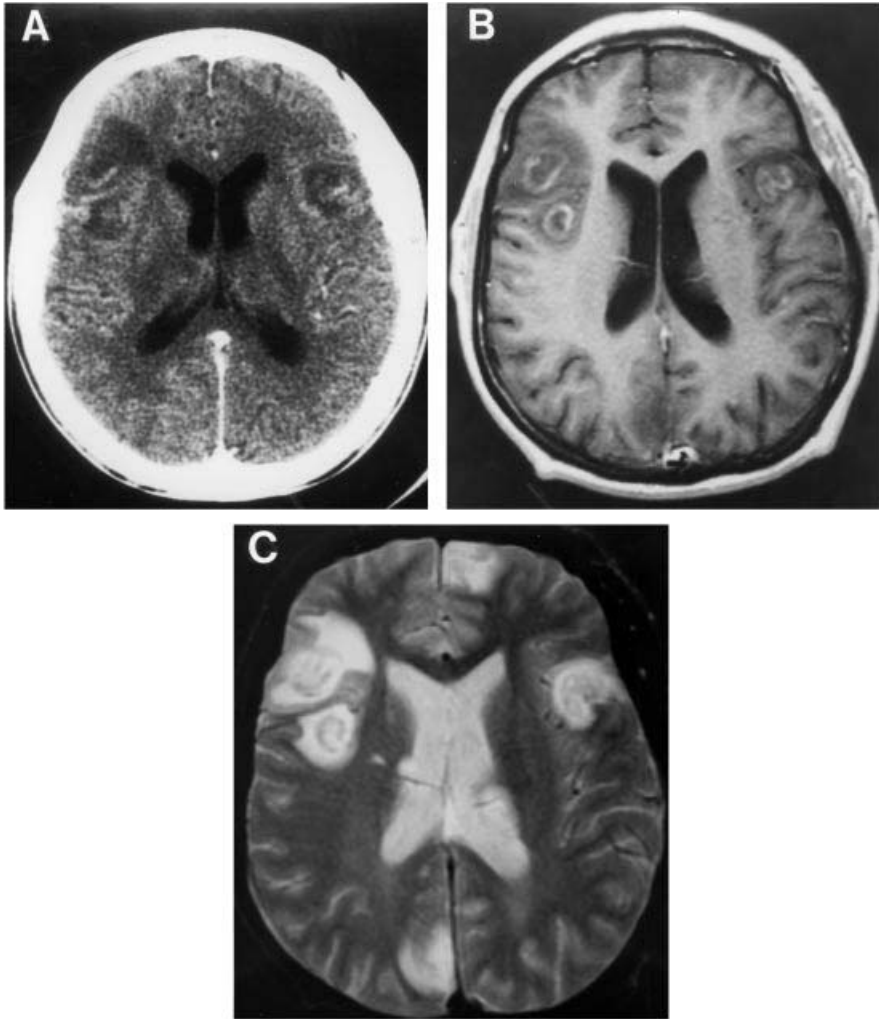
encephalitis show multiple isodense or hypodense lesions, at the corticomedullary junction or in the basal ganglia, that are enhanced following the administration of intravenous contrast material (Figure 5.11A–C). Lesions may also be single, or the encephalitis may be poorly demarcated, involving the cerebrum diffusely and not producing typical CT or magnetic resonance (MR) images. MR findings typical of toxoplasmic encephalitis are ring enhancement around the lesions on T1-weighted images with gadolinium contrast material, and high signal lesions on T2-weighted images (Figures 5.11B,C). ‘Bullseye’ lesions may be seen, representing successive expansion and contraction of the necrotic focus with interruption of therapy. CT scans are less sensitive for detecting lesions, even with intravenous contrast (Figure 5.11A) (Knobel *et al.*, 1995; Maschke *et al.*, 1999). Response to therapy, as observed by imaging studies, is slower than the clinical response, taking up to 3 weeks to be evident. Complete resolution of lesions may take up to 6 months, and small residua may persist from large lesions. It is not possible to differentiate completely between the radiographic findings of toxoplasmic encephalitis and CNS lymphoma. Various newer imaging techniques, including positron emission tomography (PET), radionuclide uptake scans and MR proton spectroscopy, have been investigated to help in this differentiation, but none is established as a definitive diagnostic modality.

In cases of congenital infection, calcifications may be detected by plain X-ray or by CT and are suggestive of toxoplasmosis, especially when they are seen outlining a unilaterally or bilaterally enlarged ventricle (Figure 5.12A) (McAuley *et al.*, 1994). Calcifications are more easily detected on CT images (Figure 5.12B).

## Laboratory Diagnosis

### *Direct Detection and Isolation of Parasites*

The list of conditions that must be distinguished from toxoplasmosis is large and varies with the clinical circumstances (Table 5.1). The diagnosis of toxoplasmosis may be established by several modalities, the most specific being the identification of tachyzoites within tissue. In most clinical

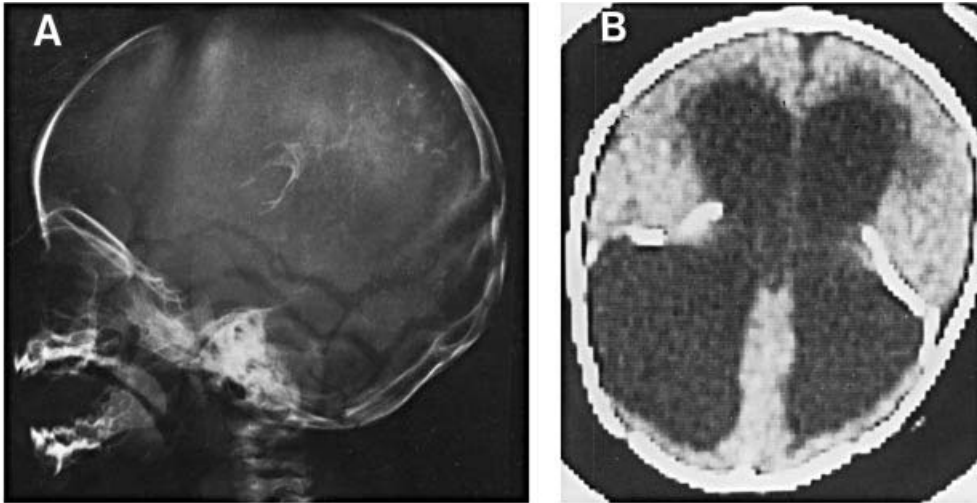


**Fig. 5.11** Toxoplasmic encephalitis in a 31 year-old man with AIDS. The multiple lesions demonstrated by CT scan are better defined by MR scanning. (A) CT scan with intravenous contrast. (B) MR image, T<sub>1</sub> weighted with gadolinium contrast. (C) MR scan, T<sub>2</sub> weighted. Courtesy of Dr Laurence D. Cromwell, Dartmouth-Hitchcock Medical Center

circumstances this is not necessary, and serological tests may be used to establish the diagnosis and rule out other conditions.

Tissue biopsies may demonstrate tachyzoites or cysts, which stain with hematoxylin and eosin in routine histopathological preparations. The Romanovsky stains, such as Geimsa and Wright's, also demonstrate *T. gondii* forms well (Figure 5.13). The parasite is most easily seen as clusters of slightly elongate to oblate  $5.7 \times 2.3 \mu\text{m}$  nucleated bodies, within a vacuole inside infected cells. The parasite can be found in various cell types, including endothelial cells, fibroblasts,

hepatocytes, myocytes, macrophages and various cells of the central nervous system. This characteristic differentiates *T. gondii* from other intracellular parasites, which infect only a single cell type. Yeast such as *Histoplasma capsulatum*, which may be found in macrophages, may have a similar appearance but are usually smaller and more abundant than *T. gondii* and may demonstrate budding division. The hemoflagellates, such as *Leishmania* and *Trypanosoma cruzi*, demonstrate both nuclei and deeply staining kinetoplasts within individual organisms. Extracellular *T. gondii* tachyzoites are easily seen by



**Fig. 5.12** Congenital toxoplasmosis. Periventricular calcifications are demonstrated in the brain of a 7 month-old boy by plain films and CT scan. (A) Plain film (B) CT scan without contrast. The calcifications are prominent white areas surrounding the dilated ventricles. Courtesy of Dr Laurence D Cromwell, Dartmouth–Hitchcock Medical Center

standard stains, but may be obscured in necrotic areas that have abundant cell debris and inflammatory infiltrate. Specific immunological staining may demonstrate *T. gondii* antigen in such necrotic lesions. Cytocentrifuge preparations of cerebrospinal fluid, amniotic fluid or bronchoalveolar lavage fluid may also demonstrate tachyzoites. None of these morphological techniques is sensitive, and many lesions attributable to *T. gondii* infection have no identifiable parasites. Toxoplasmic lymphadenitis is characterized by reactive follicular hyperplasia, irregular infiltrates of large histiocytes ('epithelioid cells') at the germinal center margin and scattered islands of monocytic and apoptotic cells in distended sinuses. Cysts may be stained by the periodic acid–Schiff (PAS) protocol, which stains both the cyst wall of the mature cyst and the intracellular amylopectin of individual bradyzoites, or by argyrophilic stains, which stain cyst walls. Finding cysts does not establish the diagnosis of acute disease in the absence of necrosis and inflammation, since they may be stable for years.

Alternatives to morphological identification of tachyzoites are tissue culture, animal inoculation and detection of specific *T. gondii* DNA by amplification techniques. Culture of live parasites definitively establishes the etiology of infection in

tissues, but it is relatively insensitive and slow, taking up to several weeks. Many tissue culture lines may be used, but human fibroblasts are the most easily observed for evidence of parasite growth. Peritoneal inoculation of mice is a more sensitive technique, especially for strains of genetic type I, which may kill mice with a single infective parasite. Some strains of *T. gondii* may not elicit clinical disease in mice, however, and the infection may have to be detected by serology of mouse blood, or by examination of brains for cysts after 4–6 weeks (Dubey and Beattie, 1998). No culture approaches are readily available in clinical laboratories, but may be available from the *Toxoplasma* Reference Laboratories. PCR amplification of parasite DNA from tissue, CSF, amniotic fluid or blood is a sensitive method for detection of infection, and several potential amplification targets have been described. The B1 gene, which is present in all *T. gondii* strains in 35 copies, has been the most frequently used target (Grover *et al.*, 1990) but SAG1, the major surface antigen gene, and ribosomal gene targets have also been described (Contini *et al.*, 1999). PCR is available from several reference laboratories and is the preferred test for establishment of infection during gestation, by assay of amniotic fluid (Foulon *et al.*, 1999a; Grover *et al.*, 1990).



**Table 5.1** Differential diagnoses for toxoplasmosis in various circumstances

Clinical setting	Possible alternative etiological agents	Distinguishing points
Tissue biopsy or aspirate with intracellular organisms seen morphologically	<i>Histoplasma capsulatum</i>	Only in macrophages, may see budding
	<i>Leishmania</i> spp.	Only in macrophages, amastigote has kinetoplast
	<i>Trypanosoma cruzi</i>	Amastigotes only in myocytes, kinetoplasts seen
	Other intracellular yeast	Only in macrophages, morphology characteristic
Mononucleosis syndrome	EBC	Distinguish by serologic tests
	CMV	Distinguish by serologic tests
	Acute HIV	Distinguish by serologic tests
	African trypanosomiasis	Trypomastigotes seen in blood film
Lymphadenitis	South American trypanosomiasis	Distinguish by serologic tests
	Cat scratch disease	Distinguish by serologic tests
	Lymphoma	Biopsy of tissue
	Tuberculosis	Biopsy of tissue and culture
	Sarcoidosis	Biopsy of tissue
	Leprosy	Biopsy of tissue
	Tularemia	Distinguish by culture
Congenital infection	Trypanosomiasis	Distinguish by serologic tests
	CMV	Distinguish by culture of virus
	HSV	Distinguish by culture of virus
	Rubella	Distinguish by culture and serologic tests
	Syphilis	Distinguish by serologic tests
	<i>Listeria</i>	Distinguish by culture
	<i>T. cruzi</i>	Distinguish by serologic tests
Retinochoroiditis in immunocompetent individuals	Erythroblastosis fetalis	Distinguish by hematological tests
	Tuberculosis	Distinguish by culture
	Syphilis	Distinguish by serologic tests
	Leprosy	Distinguish by biopsy
Retinochoroiditis in AIDS	Histoplasmosis	Distinguish by serologic and antigen tests
	CMV	Distinguish by culture or PCR of virus
	Syphilis	Distinguish by serologic tests
	HSV	Distinguish by culture or PCR
	VZV	Distinguish by culture or PCR
CNS lesions in AIDS	Fungal infection	Distinguish by culture
	Lymphoma or metastatic tumor	Distinguish by tissue biopsy
	Brain abscess	Distinguish by culture
	Progressive multifocal leukoencephalopathy	Distinguish by PCR
	Fungal or mycobacterial disease	Distinguish by biopsy and culture

### Interpretation of Serological Tests

The humoral immune response to *T. gondii* is rapid and intense, and forms the basis of useful diagnostic tests for the various forms of the disease. Antibodies may be produced to a number of *T. gondii* antigens, but the immunodominant antigen is the 30 kDa major surface antigen, SAG-1. IgG antibodies are a reliable and sensitive indicator of exposure to *T. gondii*, but do not establish the chronicity of the infection. Several methods are available for the determination of anti-*Toxoplasma* IgG, and all are sensitive and specific. The historical gold standard assay is the Sabin–Feldman dye test,

which relies on the ability of complement-fixing IgG or IgM antibody in the patient serum to produce changes in permeability of live *T. gondii* and allow dye to enter the parasite. This test is no longer widely available, but is still useful clinically because it has a very high specificity and can be used for comparison with other IgG assays. Indirect immunofluorescence assays and various forms of ELISA and microparticle immunoassays all correlate well with the Sabin–Feldman dye test. All of these tests are reliable to establish past infection with *T. gondii*. If IgG tests are negative and there is no evidence of IgM antibody, the diagnosis of toxoplasmosis can be considered very unlikely. If the IgG assay is



**Fig. 5.13** Intracellular and extracellular tachyzoites (arrows) in a smear of peritoneal exudate cells of an infected mouse. Wright's stain. Bar = 10  $\mu$ m

equivocal, another specimen should be tested after 2–3 weeks to establish whether a real seroconversion has taken place. Once present, IgG antibody usually persists for the life of the host, even at high levels for years. Clinical settings in which it would be useful to perform IgG serology include before conception or very early in gestation, before therapeutic immunosuppression, and early after the primary diagnosis of HIV.

Determination of the time of infection is more difficult. Tests for IgM do not have ideal performance characteristics to allow straightforward interpretation of the time of primary infection. Commercially available IgM solid-phase assays may produce both false negative and false positive results in some situations (Anonymous, 1997). Most available assays of IgM antibody lack sensitivity to detect the low avidity IgM antibodies synthesized by neonates and young infants. If specific IgG antibody is present and an IgM assay is equivocal or positive, further investigation is necessary to establish with confidence that the individual has been recently infected. This is best done at a large public health laboratory or reference laboratory with experience and availability of alternative assays that can be performed to support the diagnosis. If an IgG assay is positive and IgM is

truly negative, the infection has most likely been established for more than 1 year. Specific anti-*Toxoplasma* IgM may be detected for 18 months or more with sensitive assays (Wilson and McAuley, 1999). IgM ELISA assays in the 'capture' format, which trap serum IgM on the solid phase in the first step, are useful to indicate the relative subset of IgM that recognizes *Toxoplasma* antigen. This method is less likely to be interfered with by excess non-specific IgM or rheumatoid factor (Naot and Remington, 1980; Siegal and Remington, 1983).

Tests useful as adjuncts to confirm an equivocal or positive IgM titer include the IgA and IgE ELISA assays. The IgA ELISA is useful to confirm IgM determinations and can be elevated in acute disease and, although it is not a sensitive test in congenital disease, it may be useful in confirmation of IgM in that setting (Foudrinier *et al.*, 1995; Stepick-Biek *et al.*, 1990). IgE antibodies may be present in the acute phase of disease and disappear rapidly (Wong *et al.*, 1993). The IgE ELISA is therefore useful in dating infection and confirming congenital infection. There is some evidence that IgE antibodies also appear in reactivation episodes associated with toxoplasmic encephalitis and retinochoroiditis (Wong *et al.*, 1993). A differential agglutination test has been developed to

distinguish the pattern of antibodies seen in recent acute infection from those seen in more distant infections (Dannemann *et al.*, 1990). Tachyzoites fixed with acetone or methanol (AC antigen) display antigens that are recognized by antibodies made early in primary infection, and can be agglutinated by serum diluted at alkaline pH (Suzuki *et al.*, 1988b). Tachyzoites fixed in formalin (HS antigen) are agglutinated by antibodies produced later in primary infection. The AC:HS agglutination titer ratio can be used to assign acute and non-acute patterns to sera. Among persons known to be infected for more than 2 years, only 13% showed an acute pattern with the AC:HS test (Dannemann *et al.*, 1990). The IgM immunosorbent agglutination assay (ISAGA) has better sensitivity than IgM ELISA assays, and is useful in detection of IgM in congenitally infected infants (Desmonts *et al.*, 1981). The avidity of IgG antibodies produced early in infection is low (Hedman *et al.*, 1989). Avidity can be used to help differentiate between recent and long-standing infection in pregnancy (Cozon *et al.*, 1998; Jenum *et al.*, 1997; Lappalainen *et al.*, 1993).

## THERAPY AND MANAGEMENT OF TOXOPLASMOSIS

### Drugs for Treatment of Toxoplasmosis

The major drugs used for the therapy of toxoplasmosis are targeted at the folate pathway of the parasite. The best-established regimen is a combination of pyrimethamine and sulfadiazine. Both of these agents inhibit parasite folate metabolism. Pyrimethamine in adults should be started with a loading dose of 100–200 mg over 1 day in divided doses, followed by a daily dose of 25–100 mg/day for 3–4 weeks. The drug is available only in 25 mg tablets, is well absorbed from the gastrointestinal tract, and has a 4–5 day half-life. The pediatric dosage is 2 mg/kg/day for 3 days (followed by a maximum dose of 25 mg/day for 4 weeks) (Anonymous, 2000). Sulfadiazine is the preferred sulfonamide, and should be given at 4–6 g/day in four divided doses for adults and 100–200 mg/kg/day in children, for the same duration as the pyrimethamine. Leukovorin (folinic acid) 10–25 mg should be administered

simultaneously with each dose of pyrimethamine to ameliorate bone marrow suppression. Marrow toxicity should be monitored by complete blood count in each week of pyrimethamine therapy.

Alternatives to the standard regimen include the use of spiramycin, a macrolide, which has been used for treatment of infection in pregnant women. The drug has been extensively used in Europe, but there are no published randomized comparisons and the published studies are insufficient to establish unambiguously that the drug can prevent congenital infection (Wallon *et al.*, 1999). There is evidence that it has inhibitory activity for *T. gondii* (Chang and Pechere, 1988), although other macrolides, notably azithromycin, have higher activity (Araujo *et al.*, 1991). Spiramycin use in pregnancy has not been shown to be teratogenic, and it appears to decrease the severity of disease (Foulon *et al.*, 1999b; Hohlfeld *et al.*, 1989). Clindamycin, a lincomycin, inhibits *T. gondii* by an unknown mechanism that involves the parasite organelle called the apicoplast (Fichera and Roos, 1997). The kinetics of killing are unusual, in that multiple rounds of parasite replication proceed normally after exposure to the drug before death occurs (Fichera *et al.*, 1995). Clindamycin has been used in combination with sulfadiazine for therapy of toxoplasmic retinochoroiditis and encephalitis.

Other drugs that have activity against *T. gondii* include dapsone, azithromycin, clarithromycin, roxithromycin, atovaquone, minocycline and rifabutin (Montoya and Remington, 2000).

### Treatment of Immunocompetent Hosts

Toxoplasmosis in those with normal immune mechanisms is usually a self-limited disease and does not require drug therapy. No drugs currently available are capable of eliminating the bradyzoite cyst stage, and therefore do not eradicate infection. Indications for treating immunocompetent adults are thus limited to control of clinically severe or persistent disease, and to the prevention of future pathology in infected infants and pregnant women. Treatment during pregnancy is aimed at prevention of fetal infection, or minimizing fetal damage if infection

broaches the placenta. Treatment of the infected infant is required to prevent unchecked damage that will result in symptomatic disease. Management of gestational and neonatal toxoplasmosis is covered below. Clinical situations requiring treatment of immunocompetent adults include severe or protracted lymphadenitis and retinochoroiditis. Indications for treating lymphadenitis include symptomatic disease that persists for a month or more, especially if fever or fatigue is manifest. Treatment with the standard regimen of pyrimethamine and sulfadiazine for 2–4 weeks is usually recommended. Retinochoroiditis involving the macula or causing significant vitreous inflammation should be treated for 1 month with both anti-*Toxoplasma* drugs and corticosteroids to reduce inflammation (Tabbara, 1995). Immunosuppressed patients require continued therapy to control progressive disease, which must be extended for the period of cell-mediated immunosuppression in order to prevent relapse.

### Management of Toxoplasmosis in Pregnant Women and Treatment of Congenital Disease

Screening for *Toxoplasma* seroconversion in pregnancy is established practice in western Europe, where rates of maternal infection are high and the system for sampling and uniform analysis of specimens has been centralized in public health facilities. In the USA, rates of acute maternal infection are thought by many to be below the threshold of cost-effectiveness, and neither uniform recommendations for prenatal screening have been accepted, nor are the laboratory resources available for uniform serology or amniotic fluid analysis. As an alternative approach, screening of newborns for IgM antibodies to *T. gondii* is practiced by several state public health laboratories in the USA to identify subclinical as well as symptomatic congenital infections. Neither approach is financially feasible in developing countries, even where rates of maternal infection are high.

Spiramycin (3–4 g/day in divided doses) is recommended for treatment of pregnant women with evidence of recent *T. gondii* infection until it can be determined whether the fetus is infected

by assay of amniotic fluid. If the fetus is determined to be infected *in utero* after the first trimester, when pyrimethamine is contraindicated because of teratogenic potential, therapy with pyrimethamine, sulfadiazine and leukovorin are given until delivery. If direct evidence of fetal infection is not produced, the pregnancy should be monitored by periodic fetal ultrasonography and spiramycin continued. Repeat amniocentesis is indicated if signs of fetal infection are found. The newborn should be tested for infection at the time of delivery and treated for congenital disease if evidence of infection is found. Several treatment regimens have been employed for congenital toxoplasmosis, differing in dosage and drug combinations, but it is clear that treatment must be continued for at least 1 year. A practical dosage regimen of pyrimethamine and sulfonamides has been described by a collaborative congenital toxoplasmosis treatment trial, based at the University of Chicago (Dr Rima McLeod, 773-834-4125) (McAuley *et al.*, 1994). This is a continuous regimen of pyrimethamine, sulfadiazine and leukovorin in specific formulations that are practical to administer to infants. Prednisone is recommended when active retinochoroiditis is present or if CSF protein levels exceed 1000 mg/dl. This approach has been found to decrease the long-term sequelae of developmental delay, hearing and visual problems and seizure disorder in most treated infants.

### Treatment of Acute Disease in Immunocompromised Persons, Maintenance Therapy and Prophylaxis

Active toxoplasmosis in immunosuppressed patients is a potentially lethal disease and requires therapy until symptoms resolve and for 4–6 weeks thereafter. Following acute therapy, a prophylactic regimen should be continued for the duration of functional immunosuppression. The standard combination of pyrimethamine, sulfadiazine and leukovorin is the mainstay of therapy, but reactions to one or more of these drugs may require alternative regimens, especially in patients with AIDS. Clindamycin 600 mg orally or intravenously four times/day in

combination with pyrimethamine at standard dosage has been used for treatment of adult AIDS patients with toxoplasmic encephalitis who have had serious reactions to sulfonamides. This combination also has a high incidence of serious side-effects. Alternative regimens include pyrimethamine and leukovorin, with the addition of atovaquone (Anonymous, 2000), or clarithromycin, azithromycin or dapsone (Montoya and Remington, 2000).

Secondary prophylaxis or maintenance therapy should be continued for the duration of immunosuppression (Kovacs and Masur, 2000). The most effective regimen is the combination of sulfadiazine 500–1000 mg four times/day and pyrimethamine 25–75 mg/day with leukovorin 10 mg/day. An alternative is clindamycin 300 mg orally four times/day, or 450 mg orally three times/day with oral pyrimethamine 25–75 mg/day and oral leukovorin 10–25 mg/day. Primary prophylaxis to prevent reactivation of toxoplasmosis should be given to all HIV-infected persons who have a positive serological test for antibodies to *T. gondii* and CD4<sup>+</sup> T lymphocyte counts less than 100/ml of blood. Trimethoprim-sulfamethoxazole, one double-strength tablet orally per day, is the first choice for this indication, but all regimens used for *Pneumocystis carinii* are effective for primary prophylaxis, except aerosolized pentamidine (Kovacs and Masur, 2000). Trimethoprim-sulfamethoxazole, one single strength tablet/day or the combination of dapsone 50 mg/day plus pyrimethamine 50 mg/week (with leukovorin 25 mg/week) or atovaquone (750 mg suspension twice daily) are alternatives (Kovacs and Masur, 2000).

### PUBLIC HEALTH STRATEGIES FOR CONTROL OF TOXOPLASMOSIS

Educational programs to raise awareness of the routes of acquisition of *Toxoplasma* in pregnancy have shown some success (Carter *et al.*, 1989; Henderson *et al.*, 1984). Pregnant women without pre-existing specific antibody to *Toxoplasma* should avoid exposure to infective oocysts in cat litter boxes or in soil that has been contaminated with cat feces. Cats that have been raised entirely on commercial feed and have not hunted birds or

rodents have low incidence of toxoplasmosis, and pose little risk of transmission. Hand washing is the most practical and important preventative measure to be recommended, to decrease the ingestion of both oocysts and tissue-born bradyzoite cysts from raw meat. Incidental transmission of oocysts may be facilitated by insects such as cockroaches (Chinchilla *et al.*, 1994) and dogs that roll in cat feces may carry infectious oocysts on their fur (Frenkel, 1995; Frenkel *et al.*, 1995).

A live vaccine, based on a strain of *T. gondii* that does not persist in the tissues of vaccinated animals, is available in New Zealand, the UK and Europe, that prevents *T. gondii* abortion in sheep (Buxton and Innes, 1995). This may decrease the incidence of *T. gondii* infection among herds and eventually decrease the burden of infectious cysts in meat. Careful husbandry practices in swine, including cooking feed and excluding cats from farms, may decrease *Toxoplasma* levels in herds. A live vaccine using a mutant strain of *T. gondii* (T-263) is under development in the USA to reduce oocyst shedding by cats (Choromanski *et al.*, 1995). It will not change the epidemiology of disease, but could be recommended to cat owners who are willing to pay to decrease the risk of transmission of toxoplasmosis from their pets. The possibility of a human vaccine is still remote. No drugs are available that can eradicate tissue cysts in animal tissues. Freezing to  $-12^{\circ}\text{C}$ , cooking to an internal temperature of  $67^{\circ}\text{C}$ , or  $\gamma$ -irradiation (0.5 kGy) will kill tissue cysts in meat. Drying meat does not reliably kill cysts.

### REFERENCES

- Ajioka JW, Boothroyd JC, Brunk BP *et al.* (1998). Gene discovery by EST sequencing in *Toxoplasma gondii* reveals sequences restricted to the Apicomplexa. *Genome Res* **8**: 18–28.
- Alexander J, Hunter CA (1998). Immunoregulation during toxoplasmosis. *Chem Immunol* **70**: 81–102.
- Anonymous (1997). *FDA Public Health Advisory: Limitations of Toxoplasma IgM Commercial Test Kits*. Rockville, MD: Department of Health and Human Services, Food and Drug Administration.
- Anonymous (2000). Drugs for parasitic infections. *Medical Letter* website, March. <http://www.medletter.com>
- Araujo FG, Shepard RM, Remington JS (1991). *In vivo* activity of the macrolide antibiotics azithromycin,

- roxithromycin and spiramycin against *Toxoplasma gondii*. *Eur J Clin Microbiol Infect Dis* **10**: 519–24.
- Benenson MW, Takafuji ET, Lemon SM (1982). Oocyst-transmitted toxoplasmosis associated with ingestion of contaminated water. *N Engl J Med* **307**: 666–9.
- Bertoli F, Espino M, Arosemena JR, Fishback JL, Frenkel JK (1995). A spectrum in the pathology of toxoplasmosis in patients with acquired immunodeficiency syndrome. *Arch Pathol Lab Med* **119**: 214–24.
- Bonhomme A, Pingret L, Pinon JM (1992). Review: *Toxoplasma gondii* cellular invasion. *Parasitologia* **34**: 31–43.
- Boothroyd JC (1993). Population biology of *Toxoplasma*: clonality, virulence, and speciation (or not). *Infect Agents Dis* **2**: 100–2.
- Bosch-Driessen LH, Karimi S, Stilma JS, Rothova A (2000). Retinal detachment in ocular toxoplasmosis. *Ophthalmology* **107**: 36–40.
- Bowie WR, King AS, Werker DH *et al.* (1997). Outbreak of toxoplasmosis associated with municipal drinking water. *Lancet* **350**: 173–7.
- Buxton D, Innes EA (1995). A commercial vaccine for ovine toxoplasmosis. *Parasitology* **110**: S11–16.
- Carter AO, Gelmon SB, Wellsl GA, Toepell AP (1989). The effectiveness of a prenatal education programme for the prevention of congenital toxoplasmosis. *Epidemiol Infect* **103**: 539–45.
- Center for Disease Control and Prevention (1999). Surveillance for AIDS-defining opportunistic illnesses, 1992–1997. *CDC Surveillance Summaries MMWR* **48**: 12.
- Chang HR, Pechere JC (1988). Activity of spiramycin against *Toxoplasma gondii* *in vitro*, in experimental infections and in human infection. *J Antimicrob Chemother* **22**: 87–92.
- Channon JY, Kasper LH (1996). *Toxoplasma gondii*-induced immune suppression by human peripheral blood monocytes: role of gamma interferon. *Infect Immun* **64**: 1181–9.
- Channon JY, Suh EI, Seguin RM, Kasper LH (1999). Attachment ligands of viable *Toxoplasma gondii* induce soluble immunosuppressive factors in human monocytes. *Infect Immun* **67**: 2547–51.
- Chinchilla M, Guerrero OM, Castro A, Sabah J (1994). Cockroaches as transport hosts of the protozoan *Toxoplasma gondii*. *Rev Biol Trop* **42**: 329–31.
- Choromanski L, Freyre A, Popiel R, Brown K, Grieve R, Shibley G (1995). Safety and efficacy of modified live feline *Toxoplasma gondii* vaccine. *Dev Biol Stand* **84**: 269–81.
- Contini C, Seraceni S, Cultrera R (1999). Different PCR systems to detect *Toxoplasma gondii* tachyzoites or bradyzoites in clinical specimens from patients with and without overt disease. *J Eukaryot Microbiol* **46**: 77–8S.
- Cozon GJ, Ferrandiz J, Nebhi H, Wallon M, Peyron F (1998). Estimation of the avidity of immunoglobulin G for routine diagnosis of chronic *Toxoplasma gondii* infection in pregnant women. *Eur J Clin Microbiol Infect Dis* **17**: 32–6.
- Dannemann BR, Vaughan WC, Thulliez P, Remington JS (1990). Differential agglutination test for diagnosis of recently acquired infection with *Toxoplasma gondii*. *J Clin Microbiol* **28**: 1928–33.
- Denkers EY, Gazzinelli RT (1998). Regulation and function of T-cell-mediated immunity during *Toxoplasma gondii* infection. *Clin Microbiol Rev* **11**: 569–88.
- Desmonts G, Couvreur J (1974a). Congenital toxoplasmosis: a prospective study of 378 pregnancies. *N Engl J Med* **290**: 1110–16.
- Desmonts G, Couvreur J (1974b). Toxoplasmosis in pregnancy and its transmission to the fetus. *Bull NY Acad Med* **50**: 146.
- Desmonts G, Naot Y, Remington JS (1981). Immunoglobulin M immunosorbent agglutination assay for diagnosis of acute congenital and acquired toxoplasma infections. *J Clin Microbiol* **14**: 486–91.
- Dobrowolski J, Sibley LD (1997). The role of the cytoskeleton in host cell invasion by *Toxoplasma gondii*. *Behring Inst Mitt* **99**: 90–6.
- Dobrowolski JM, Carruthers VB, Sibley LD (1997). Participation of myosin in gliding motility and host cell invasion by *Toxoplasma gondii*. *Mol Microbiol* **26**: 163–73.
- Dubey JP (1990). Status of toxoplasmosis in sheep and goats in the United States. *J Am Vet Med Assoc* **196**: 259.
- Dubey JP (1992). Status of toxoplasmosis in cattle and the United States. *J Am Vet Med Assoc* **196**: 257.
- Dubey JP (1995). Duration of immunity to shedding of *Toxoplasma gondii* oocysts by cats. *J Parasitol* **81**: 410–15.
- Dubey JP (1998). Advances in the life cycle of *Toxoplasma gondii*. *Int J Parasitol* **28**: 1019–24.
- Dubey JP, Beattie CP (1998). *Toxoplasmosis in Animals and Man*. CRC Press: Boca Raton, FL.
- Dubey JP, Lindsay DS, Speer CA (1998). Structures of *Toxoplasma gondii* tachyzoites, bradyzoites, and sporozoites and biology and development of tissue cysts. *Clin Microbiol Rev* **11**: 267–99.
- Dubey JP, Weigel RM, Siegel AM *et al.* (1995). Sources and reservoirs of *Toxoplasma gondii* infection on 47 swine farms in Illinois. *J Parasitol* **81**: 723–9.
- Dubremetz JF (1998). Host cell invasion by *Toxoplasma gondii*. *Trends Microbiol* **6**: 27–30.
- Dubremetz JF, Achbarou A, Bermudes D, Joiner KA (1993). Kinetics and pattern of organelle exocytosis during *Toxoplasma gondii* host–cell interaction. *Parasitol Res* **79**: 402–8.
- Dunn D, Wallon M, Peyron F, Petersen E, Peckham C, Gilbert R (1999). Mother-to-child transmission of toxoplasmosis: risk estimates for clinical counselling. *Lancet* **353**: 1829–33.
- Dupon M, Cazenave J, Pellegrin JL *et al.* (1995). Detection of *Toxoplasma gondii* by PCR and tissue culture in cerebrospinal fluid and blood of human immunodeficiency virus-seropositive patients. *J Clin Microbiol* **33**: 2421–6.
- Etheredge GD, Frenkel JK (1995). Human *Toxoplasma* infection in Kuna and Embera children in the Bayano and San Blas, eastern Panama. *Am J Trop Med Hyg* **53**: 448–57.
- Evans TG, Schwartzman JD (1991). Pulmonary toxoplasmosis. *Semin Resp Inf* **6**: 51–7.
- Fadul CE, Channon JY, Kasper LH (1995). Survival of immunoglobulin G-opsonized *Toxoplasma gondii* in non-adherent human monocytes. *Infect Immun* **63**: 4290–4.

- Feldman HA (1968a). Toxoplasmosis. *N Engl J Med* **279**: 1431–7.
- Feldman HA (1968b). Toxoplasmosis. *N Engl J Med* **279**: 1370–5.
- Fichera ME, Bhopale MK, Roos DS (1995). *In vitro* assays elucidate peculiar kinetics of clindamycin action against *Toxoplasma gondii*. *Antimicrob Agents Chemother* **39**: 1530–7.
- Fichera ME, Roos DS (1997). A plastid organelle as a drug target in apicomplexan parasites. *Nature* **390**: 407–9.
- Foudrinier F, Marx-Chemla C, Aubert D, Bonhomme A, Pinon JM (1995). Value of specific immunoglobulin A detection by two immunocapture assays in the diagnosis of toxoplasmosis. *Eur J Clin Microbiol Infect Dis* **14**: 585–90.
- Foulon W, Pinon JM, Stray-Pedersen B *et al.* (1999a). Prenatal diagnosis of congenital toxoplasmosis: a multicenter evaluation of different diagnostic parameters. *Am J Obstet Gynecol* **181**: 843–7.
- Foulon W, Villena I, Stray-Pedersen B *et al.* (1999b). Treatment of toxoplasmosis during pregnancy: a multicenter study of impact on fetal transmission and children's sequelae at age 1 year. *Am J Obstet Gynecol* **180**: 410–15.
- Frenkel JK (1970). Pursuing *Toxoplasma*. *J Infect Dis* **122**: 553–7.
- Frenkel JK (1973). Toxoplasmosis: parasite life cycle, pathology, and immunology. In Hammond DM, Long PL (eds), *The Coccidia: Eimeria, Isospora, Toxoplasma, and Related Genera*. University Park Press: Baltimore, MD: 344–410.
- Frenkel JK (1974). Pathology and pathogenesis of congenital toxoplasmosis. *Bull NY Acad Med* **50**: 182–91.
- Frenkel JK (1985). Toxoplasmosis. *Pediatr Clin N Am* **32**: 917–32.
- Frenkel JK (1988). Pathophysiology of toxoplasmosis. *Parasitol Today* **4**: 273–8.
- Frenkel JK (1995). Prevention of *Toxoplasma* infection in pregnant women and their fetuses. *Clin Infect Dis* **20**: 727–9.
- Frenkel JK (1997). Toxoplasmosis. In Connor DH, Chandler FW, Schwartz DA (eds), *Pathology of Infectious Diseases*. Appleton & Lange: Stamford, CT: 1261–75.
- Frenkel JK, Dubey JP, Miller NL (1970). *Toxoplasma gondii* in cats: faecal stages identified as coccidian oocysts. *Science* **167**: 893.
- Frenkel JK, Hassanein KM, Hassanein RS, Brown E, Thulliez P, Quintero-Nunez R (1995). Transmission of *Toxoplasma gondii* in Panama City, Panama: a five-year prospective cohort study of children, cats, rodents, birds, and soil. *Am J Trop Med Hyg* **53**: 458–68.
- Frenkel JK, Ruiz A, Chinchilla M (1975). Soil survival of *Toxoplasma* oocysts in Kansas and Costa Rica. *Am J Trop Med Hyg* **24**: 439.
- Furrer H, Opravil M, Bernasconi E, Telenti A, Egger M (2000). Stopping primary prophylaxis in HIV-1-infected patients at high risk of toxoplasma encephalitis. *Lancet* **355**: 2217–18.
- Glasner PD, Silveira C, Kruszon-Morananda D *et al.* (1992). An unusually high prevalence of ocular toxoplasmosis in southern Brazil. *Am J Ophthalmol* **114**: 132.
- Greenlee JE, Johnson WDJ, Campaanda JF *et al.* (1975). Adult toxoplasmosis presenting as polymyositis and cerebellar ataxia. *Ann Intern Med* **83**: 367.
- Grover CM, Thulliez P, Remington JS, Boothroyd JC (1990). Rapid prenatal diagnosis of congenital *Toxoplasma* infection by using polymerase chain reaction and amniotic fluid. *J Clin Microbiol* **28**: 2297–301.
- Guerina NG, Hsu HW, Meissner HC *et al.* (1994). Neonatal serologic screening and early treatment for congenital *Toxoplasma gondii* infection. The New England Regional *Toxoplasma* Working Group [see comments]. *N Engl J Med* **330**: 1858–63.
- Guo ZG, Johnson AM (1995). Genetic characterization of *Toxoplasma gondii* strains by random amplified polymorphic DNA polymerase chain reaction. *Parasitology* **111**: 127–32.
- Håkansson S, Morisaki H, Heuser J, Sibley LD (1999). Time-lapse video microscopy of gliding motility in *Toxoplasma gondii* reveals a novel, biphasic mechanism of cell locomotion. *Mol Biol Cell* **10**: 3539–47.
- Hamadto HA, Rashid SM, el-Fakahany AF, Lashin AF (1997). Seroepidemiological studies for toxoplasmosis among out- and inpatients in Benha University Hospitals, Qalyobia Governate. *J Egypt Soc Parasitol* **27**: 223.
- Hedman K, Lappalainen M, Seppä I, Makela O (1989). Recent primary toxoplasma infection indicated by a low avidity of specific IgG. *J Infect Dis* **159**: 736–40.
- Heintzelman MB, Schwartzman JD (1997). A novel class of unconventional myosins from *Toxoplasma gondii*. *J Mol Biol* **271**: 139–46.
- Heintzelman MB, Schwartzman JD (1999). Characterization of myosin-A and myosin-C: two class XIV unconventional myosins from *Toxoplasma gondii*. *Cell Motil Cytoskel* **44**: 58–67.
- Henderson JB, Beattie CP, Hale EG, Wright T (1984). The evaluation of new services: possibilities for preventing congenital toxoplasmosis. *Int J Epidemiol* **13**: 65–72.
- Hettmann C, Herm A, Geiter A, Frank B, Schwarz E, Soldati T, Soldati D (2000). A dibasic motif in the tail of a class XIV Apicomplexan is an essential determinant of plasma membrane localization. *Mol Biol Cell* **11**: 1385–1400.
- Hohlfeld P, Daffos F, Thulliez P *et al.* (1989). Fetal toxoplasmosis: outcome of pregnancy and infant follow-up after in utero treatment [see comments]. *J Pediatr* **115**: 765–9.
- Howe DK, Sibley LD (1995). *Toxoplasma gondii* comprises three clonal lineages: correlation of parasite genotype with human disease. *J Infect Dis* **172**: 1561–6.
- Israelski DM, Chmiel JS, Poggensee L, Phair JP, Remington JS (1993). Prevalence of *Toxoplasma* infection in a cohort of homosexual men at risk of AIDS and toxoplasmic encephalitis [see comments]. *J Acq Immune Defic Syndr* **6**: 414–18.
- Jacobs L (1974). *Toxoplasma gondii*: parasitology and transmission. *Bull NY Acad Med* **50**: 128–45.
- Jacobs L, Remington JS, Melton ML (1960). The resistance of the encysted form of *Toxoplasma gondii*. *J Parasitol* **46**: 11–21.
- Jenum PA, Stray-Pedersen B, Gundersen AG (1997). Improved diagnosis of primary *Toxoplasma gondii* infection in early pregnancy by determination of

- antitoxoplasma immunoglobulin G avidity. *J Clin Microbiol* **35**: 1972–7.
- Jenum PA, Stray-Pedersen B, Melby KK, Kapperud G, Whitelaw A, Eskild A, Eng J (1998). Incidence of *Toxoplasma gondii* infection in 35940 pregnant women in Norway and pregnancy outcome for infected women. *J Clin Microbiol* **36**: 2900–6.
- Joynson DHM (1992). Epidemiology of toxoplasmosis in the U.K. *Scand J Infect Dis* **84** (suppl): 65.
- Kahi S, Cozon GJ, Pinon JM *et al.* (1999). A switch towards Th2 during serological rebound in children with congenital toxoplasmosis. *Clin Exp Immunol* **117**: 524–8.
- Karsten V, Qi H, Beckers CJM *et al.* (1998). The protozoan parasite *Toxoplasma gondii* targets proteins to dense granules and the vacuolar space using both conserved and unusual mechanisms. *J Cell Biol* **141**: 1323–33.
- Khan IA, Matsuura T, Kasper LH (1998). Inducible nitric oxide synthase is not required for long-term vaccine-based immunity against *Toxoplasma gondii*. *J Immunol* **161**: 2994–3000.
- Khan IA, Schwartzman JD, Matsuura T, Kasper LH (1997). A dichotomous role for nitric oxide during acute *Toxoplasma gondii* infection in mice. *Proc Natl Acad Sci USA* **94**: 13955–60.
- Kimball AC, Kean BH, Kellner A (1965). The risk of transmitting toxoplasmosis by blood transfusion. *Transfusion* **5**: 447.
- Knobel H, Guelar A, Graus F, Miro JM, Padro S, Mercader JM (1995). Toxoplasmic encephalitis with normal CT scan and pathologic MRI. *Am J Med* **99**: 220–1.
- Koppe JG, Loewer-Sieger DH, de Roeber-Bonnet H (1986). Results of 20-year follow-up of congenital toxoplasmosis. *Lancet* **1**: 254.
- Koppe JG, Meenken C (1999). Congenital toxoplasmosis, later relapses and treatment. *Acta Paediat* **88**: 586–8.
- Koskiniemi M, Lappala M, Kostelaanda P *et al.* (1992). The programme for antenatal screening of toxoplasmosis in Finland: a prospective cohort study. *Scand J Infect Dis* **84** (suppl): 70.
- Kovacs JA, Masur H (2000). Prophylaxis against opportunistic infections in patients with human immunodeficiency virus infection. *N Engl J Med* **342**: 1416–29.
- Krick JA, Remington JS (1978). Toxoplasmosis in the adults—an overview. *N Engl J Med* **298**: 550–3.
- Lafaut BA, Meire FM, Leys AM, Dralands G, De Laey JJ (1999). Vasoproliferative retinal tumors associated with peripheral chorioretinal scars in presumed congenital toxoplasmosis. *Graefes Arch Clin Exp Ophthalmol* **237**: 1033–8.
- Lappalainen M, Koskela P, Koskiniemi M *et al.* (1993). Toxoplasmosis acquired during pregnancy: improved serodiagnosis based on avidity of IgG. *J Infect Dis* **167**: 691–7.
- Lepage AC, Buzoni-Gatel D, Bout D, Kasper LH (1998). Gut derived intraepithelial lymphocytes induce long term immunity against *Toxoplasma gondii*. *J Immunol* **161**: 4902–8.
- Levine ND, Corliss JO, Cox FEG *et al.* (1980). A newly revised classification of the protozoa. *J Protozool* **27**: 37–58.
- Lingelbach K, Joiner KA (1998). The parasitophorous vacuole membrane surrounding *Plasmodium* and *Toxoplasma*: an unusual compartment in infected cells. *J Cell Sci* **111**: 1467–75.
- Luft BJ, Conley F, Remington JS (1983a). Outbreak of central-nervous-system toxoplasmosis in Western Europe and North America. *Lancet* **1**: 781–3.
- Luft BJ, Naot Y, Araujo FG, Stinson EB, Remington JS (1983b). Primary and reactivated *Toxoplasma* infection in patients with cardiac transplants. Clinical spectrum and problems in diagnosis in a defined population. *Ann Intern Med* **99**: 27–31.
- Mariuz P, Bosler EM, Luft BJ (1994). Toxoplasmosis in individuals with AIDS. *Infect Dis Clin N Am* **81**: 365.
- Maschke M, Dietrich U, Prumbaum M *et al.* (1999). Opportunistic CNS infection after bone marrow transplantation. *Bone Marrow Transpl* **23**: 1167–76.
- Mawhorter SD, Effron D, Blinkhorn R, Spagnuolo PJ (1992). Cutaneous manifestations of toxoplasmosis. *Clin Infect Dis* **14**: 1084–8.
- McAuley J, Boyer KM, Patel D *et al.* (1994). Early and longitudinal evaluations of treated infants and children and untreated historical patients with congenital toxoplasmosis: the Chicago Collaborative Treatment Trial [published erratum appears in *Clin Infect Dis* 1994; **19**(4): 820]. *Clin Infect Dis* **18**: 38–72.
- McCabe RE, Brooks RG, Dorfman RF *et al.* (1987a). Clinical spectrum in 107 cases of toxoplasmic lymphadenopathy. *Rev Infect Dis* **9**.
- McCabe RE, Brooks RG, Dorfman RF, Remington JS (1987b). Clinical spectrum in 107 cases of toxoplasmic lymphadenopathy. *Rev Infect Dis* **9**: 754–74.
- Mermall V, Post PL, Mooseker MS (1998). Unconventional myosins in cell movement, membrane traffic, and signal transduction. *Science* **279**: 527–33.
- Mets MB, Holfels E, Boyer KM *et al.* (1997). Eye manifestations of congenital toxoplasmosis. *Am J Ophthalmol* **123**: 1.
- Montoya JG, Remington JS (2000). *Toxoplasma gondii*. In Mandell GL, Bennett JE, Dolin R (eds), *Principles and Practice of Infectious Disease*, 5th edn. Churchill Livingstone: Philadelphia, PA; 2858–88.
- Morisaki JH, Heuser JE, Sibley LD (1995). Invasion of *Toxoplasma gondii* occurs by active penetration of the host cell. *J Cell Sci* **108**: 2457–64.
- Naot Y, Remington JS (1980). An enzyme-linked immunosorbent assay for detection of IgM antibodies to *Toxoplasma gondii*: use for diagnosis of acute acquired toxoplasmosis. *J Infect Dis* **142**: 757–66.
- Nichols BA, Chiappino ML (1987). Cytoskeleton of *Toxoplasma gondii*. *J Protozool* **34**: 217–26.
- Nichols BA, O'Connor GR (1981). Penetration of mouse peritoneal macrophages by the protozoan *Toxoplasma gondii*. *Lab Invest* **44**: 324–35.
- Nicolle MMC, Manceaux L (1908). Sur une infection à corps de Leishman (ou organisme voisins) du gondi. *Compte Rend Acad Sci* **147**: 763–6.
- Nicolle MMC, Manceaux L (1909). Sur un protozoaire nouveau du gondi (*Toxoplasma* n.g.). *Arch Inst Pasteur Tunis* **2**: 97–103.



- Onadoko MO, Joynson DHM, Payne RA (1992). The prevalence of *Toxoplasma* infection among pregnant women in Ibadan, Nigeria. *J Trop Med Hyg* **95**: 143.
- Parker SJ, Roberts CW, Alexander J (1991). CD8<sup>+</sup> T cells are the major lymphocyte subpopulation involved in the protective immune response to *Toxoplasma gondii* in mice. *Clin Exp Immunol* **84**: 207–12.
- Pavesio CE, Lightman S (1996). *Toxoplasma gondii* and ocular toxoplasmosis: pathogenesis. *Br J Ophthalmol* **180**: 1099.
- Peyron F, Walton M, Bernardoux C (1996). Long-term follow-up of patients with congenital ocular toxoplasmosis. *N Engl J Med* **334**: 993–4.
- Pfefferkorn ER, Pfefferkorn LC, Colby ED (1977). Development of gametes and oocysts in cats fed cysts derived from cloned trophozoites of *Toxoplasma gondii*. *J Parasitol* **63**: 158–9.
- Pfefferkorn LC, Pfefferkorn ER (1980). *Toxoplasma gondii*: genetic recombination between drug-resistant mutants. *Exp Parasitol* **50**: 305–16.
- Pinder JC, Fowler RE, Dluzewski AR *et al.* (1998). Actomyosin motor in the merozoite of the malaria parasite, *Plasmodium falciparum*: implications for red cell invasion. *J Cell Sci* **111**: 1831–9.
- Porter SB, Sande MA (1992). Toxoplasmosis of the central nervous system in the acquired immunodeficiency syndrome. *N Engl J Med* **327**: 1643–8.
- Rawal BD (1959). Toxoplasmosis: a dye-test survey on sera from vegetarians and meat eaters in Bombay. *Trans R Soc Trop Med Hyg* **53**: 61.
- Remington JS (1974). Toxoplasmosis in the adult. *Bull NY Acad Med* **50**: 211–17.
- Remington JS, McLeod R, Desmonts G (1995). Toxoplasmosis. In Remington JS, Klein JO (eds), *Infectious Diseases of the Fetus and Newborn Infant*, 4th edn. W.B. Saunders: Philadelphia, PA; 140.
- Richards FO Jr, Kovacs JA, Luft BJ (1995). Preventing toxoplasmic encephalitis in persons infected with human immunodeficiency virus. *Clin Infect Dis* **21**: S49–56.
- Roberts F, McLeod R (1999). Pathogenesis of toxoplasmic retinochoroiditis. *Parasitol Today* **15**: 51–7.
- Roberts F, Roberts CW, Johnson J *et al.* (1998). Evidence for the shikimate pathway in apicomplexan parasites. *Nature* **393**: 801–5.
- Roghmann MC, Faulkner CT, Lefkowitz A, Patton S, Zimmerman J, Morris JG Jr (1999). Decreased seroprevalence for *Toxoplasma gondii* in Seventh Day Adventists in Maryland. *Am J Trop Med Hyg* **60**: 790–2.
- Roos DS, Donald RG, Morrisette NS, Moulton AL (1994). Molecular tools for genetic dissection of the protozoan parasite *Toxoplasma gondii*. *Methods Cell Biol* **45**: 27–63.
- Ruskin J, Remington JS (1976). Toxoplasmosis in the compromised host. *Ann Intern Med* **84**: 193.
- Sabin AB, Feldman HA (1948). Dyes as microchemical indicators of a new immunity phenomenon affecting a protozoan parasite (*Toxoplasma*). *Science* **108**: 660.
- Schwab JC, Beckers CJ, Joiner KA (1994). The parasitophorous vacuole membrane surrounding intracellular *Toxoplasma gondii* functions as a molecular sieve. *Proc Natl Acad Sci USA* **91**: 509–13.
- Schwartzman JD, Saffer LD (1992). How *Toxoplasma gondii* gets in and out of cells. In Harris JR (ed.), *Intracellular Parasites*. Plenum: New York; 333–64.
- Seguin R, Kasper LH (1999). Sensitized lymphocytes and CD40 ligation augment interleukin-12 production by human dendritic cells in response to *Toxoplasma gondii*. *J Infect Dis* **179**: 467–74.
- Shaw MK, Tilney LG (1999). Induction of an acrosomal process in *Toxoplasma gondii*: visualization of actin filaments in a protozoan parasite. *Proc Natl Acad Sci USA* **96**: 9095–9.
- Sibley LD, Boothroyd JC (1992). Construction of a molecular karyotype for *Toxoplasma gondii*. *Mol Biochem Parasitol* **51**: 291–300.
- Sibley LD, Howe DK (1996). Genetic basis of pathogenicity in toxoplasmosis. *Curr Top Microbiol Immunol* **219**: 3–15.
- Sibley LD, Krahenbuhl JL (1988). Modification of host cell phagosomes by *Toxoplasma gondii* involves redistribution of surface proteins and secretion of a 32kDa protein. *Eur J Cell Biol* **47**: 81–7.
- Sibley LD, Le BA, Pfefferkorn ER, Boothroyd JC (1992). Generation of a restriction fragment length polymorphism linkage map for *Toxoplasma gondii*. *Genetics* **132**: 1003–15.
- Siegal JP, Remington JS (1983). Comparison of methods for quantitating antigen-specific immunoglobulin M antibody with reverse enzyme-linked immunosorbent assay. *J Clin Microbiol* **18**: 63–70.
- Smith KL, Wilson M, Hightower AW *et al.* (1996). Prevalence of *Toxoplasma gondii* antibodies in US military recruits in 1989: comparison with data published in 1965. *Clin Infect Dis* **23**: 1182–3.
- Soete M, Camus D, Dubremetz JF (1994). Experimental induction of bradyzoite-specific antigen expression and cyst formation by the RH strain of *Toxoplasma gondii* *in vitro*. *Exp Parasitol* **78**: 361–70.
- Sousa OE, Saenz RE, Frenkel JK (1988). Toxoplasmosis in Panama: a 10-year study. *Am J Trop Med Hyg* **38**: 315–22.
- Splendore A (1908). Un nuovo protozoa parassite dei congl. Incontrato nelle lesioni anatomiche d'una malattia che ricorda in molti punti il Kala-azar dell' unomo. *Rev Soc Sci (Sao Paulo)* **3**: 109.
- Splendore A (1909). Sur un nouveau protozoaire de lapin. *Bull Soc Path Exot* **2**: 462–5.
- Stepick-Biek P, Thulliez P, Araujo F, Remington JS (1990). IgA antibodies for diagnosis of acute congenital and acquired toxoplasmosis. *J Infect Dis* **162**: 270–3.
- Stokkermans TJW, Schwartzman JD, Keenan K, Morrisette NS, Tilney LG, Roos DS (1996). Inhibition of *Toxoplasma gondii* replication by dinitroaniline herbicides. *Exp Parasitol* **84**: 355–70.
- Suzuki Y (1999). Genes, cells and cytokines in resistance against development of toxoplasmic encephalitis. *Immunobiology* **201**: 255–71.
- Suzuki Y, Orellana MA, Schreiber RD, Remington JS (1988a). Interferon-gamma: the major mediator of resistance against *Toxoplasma gondii*. *Science* **240**: 516–18.
- Suzuki Y, Thulliez P, Desmonts G, Remington JS (1988b). Antigen(s) responsible for immunoglobulin G responses specific for the acute stage of toxoplasma infection in humans. *J Clin Microbiol* **26**: 901–5.

- Tabbara KF (1995). Ocular toxoplasmosis: toxoplasmic retinochoroiditis. *Int Ophthalmol Clin* **35**: 15–29.
- Thulliez P (1992). Screening programme for congenital toxoplasmosis in France. *Scand J Infect Dis* **84** (suppl): 43.
- Tschirhart D, Klatt EC (1988). Disseminated toxoplasmosis in the acquired immunodeficiency syndrome. *Arch Pathol Lab Med* **112**: 1237–41.
- Tuuminen T, Seppanen H., Pitkanen EM, Palomaki P, Kapyaho K (1999). Improvement of immunoglobulin M capture immunoassay specificity: toxoplasma antibody detection method as a model. *J Clin Microbiol* **37**: 270–3.
- Vogel N, Kiristis M, Michael E *et al.* (1996). Congenital toxoplasmosis transmitted from an immunologically competent mother infected before conception. *Clin Infect Dis* **23**: 1055–60.
- Wallace GD (1969). Serologic and epidemiologic observations on toxoplasmosis on three Pacific atolls. *Am J Epidemiol* **90**: 103.
- Wallon M, Liou C, Garner P, Peyron F (1999). Congenital toxoplasmosis: systematic review of evidence of efficacy of treatment in pregnancy. *Br Med J* **318**: 1511–14.
- Walton BC, Arjona I, Benchoff BM (1966). Relationship of *Toxoplasma* antibodies to altitude. *Am J Trop Med Hyg* **15**: 492.
- Wilder HC (1952). *Toxoplasma* chorioretinitis in adults. *Am Med Assoc Arch Ophthalmol* **48**: 127.
- Wilson CB, Remington JS, Stagno S, Reynolds DW (1980). Development of adverse sequelae in children born with subclinical congenital *Toxoplasma* infection. *Pediatrics* **66**: 767.
- Wilson M, McAuley JB (1999). *Toxoplasma*. In Murray PJ (ed.), *Manual of Clinical Microbiology*, 7th edn. ASM Press: Washington, DC.
- Wilson M, Remington JS, Clavet C, Varney G, Press C, Ware D (1997). Evaluation of six commercial kits for detection of human immunoglobulin M antibodies to *Toxoplasma gondii*. The FDA Toxoplasmosis Ad Hoc Working Group. *J Clin Microbiol* **35**: 3112–15.
- Wolf A, Cowen D (1937). Granulomatous encephalomyelitis due to an encephalitozoon (encephalitozoic encephalomyelitis), a new protozoan disease of man. *Bull Neurol Inst NY* **6**: 306–71.
- Wong S, Hadju M, Ramirez R, Thulliez P, McLeod R, Remington JS (1993). Role of specific immunoglobulin E in diagnosis of acute *Toxoplasma* infection and toxoplasmosis. *J Clin Microbiol* **31**: 2952–9.
- Yap GS, Sher A (1999a). Cell-mediated immunity to *Toxoplasma gondii*: initiation, regulation and effector function. *Immunobiology* **201**: 240–7.
- Yap GS, Sher A (1999b). Effector cells of both nonhemopoietic and hemopoietic origin are required for interferon gamma- and tumor necrosis factor alpha-dependent host resistant to the intracellular pathogen. *Toxoplasma gondii*. *J Exp Med* **189**: 1083–91.
- Zaman V, Colley FC (1972). Ultrastructural study of penetration of macrophages by *Toxoplasma gondii*. *Trans R Soc Trop Med Hyg* **66**: 781–2.
- Zuber P, Jacquier P (1995). Epidemiology of toxoplasmosis: worldwide status. *Schweiz Med Wochenschr* **65** (suppl): 19–22S.

# Cryptosporidiosis and Isosporiasis

Cynthia L. Sears<sup>1</sup> and Beth D. Kirkpatrick<sup>2</sup>

<sup>1</sup>Johns Hopkins University School of Medicine, Baltimore, MD 21205, and

<sup>2</sup>University of Vermont School of Medicine, Burlington, VT, USA

## CRYPTOSPORIDIOSIS

### INTRODUCTION

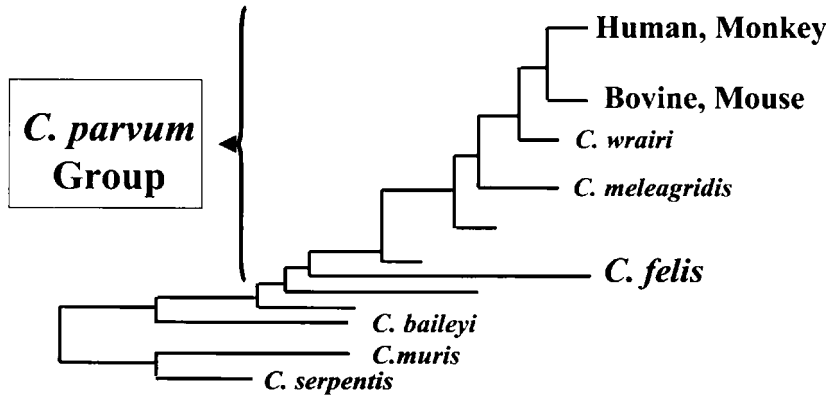
*Cryptosporidium* spp. were first identified in the gastric epithelium of mice in 1907 by Tyzzer, who coined the name '*Cryptosporidium*' (Greek, meaning 'hidden spore') (reviewed by Fayer *et al.*, 2000). This term reflects the unusual morphologic observation that *Cryptosporidium* oocysts contain naked sporozoites not surrounded by a sporocyst. This initial species, which causes infection localized to the mouse stomach, was designated as *C. muris* and, in 1912, Tyzzer identified a similar small intestinal parasite, which he termed *C. parvum*. Over the ensuing years, *Cryptosporidium* spp. were recognized in increasing numbers of avian, animal and reptilian hosts, were assigned host-specific names and were primarily of interest to veterinarians as causes of avian and bovine diarrhea. However, reports by Nime *et al.* (1976) and Meisel *et al.* (1976) indicated that *Cryptosporidium* was a likely cause of human diarrheal disease. In fact, these case reports, on a 3 year-old farm child with chronic diarrhea and a woman receiving chemotherapy with profuse watery diarrhea, provided a snapshot of what would be learned over time about the clinical disease in humans. The report by Current *et al.* (1983) further highlighted the fact that normal and immunocompromised patients were susceptible to diarrheal disease caused by

*Cryptosporidium*. The advent of the AIDS epidemic and the recognition of water-borne outbreaks of cryptosporidiosis (particularly the 1993 Milwaukee epidemic affecting more than 400 000 individuals) led to the inclusion of *Cryptosporidium* as an emerging infectious pathogen. Today the focus of both clinicians and researchers is on the species *C. parvum* which designates isolates or strains of *Cryptosporidium* that infect humans and which is the subject of the first part of this chapter.

### DESCRIPTION OF THE ORGANISM

#### Classification

*Cryptosporidium* spp. are protozoan parasites of the phylum Apicomplexa, class Sporozoasida, subclass Coccidia, order Eucoccidiorida, family Cryptosporidiidae (four sporozoites within oocyst) (Tzipori and Griffiths, 1998). Like other related coccidial parasites, such as *Eimeria*, *Cyclospora* and *Isospora*, *Cryptosporidium* develops in the gastrointestinal tract of vertebrates. Unlike *Sarcocystis* and *Toxoplasma*, *Cryptosporidium* does not require extraintestinal development and is not included in the classification of cyst-forming coccidia. *Cryptosporidium* spp. also differ from other coccidians by their predominant



**Fig. 6.1** Proposed phylogeny of *C. parvum* species. Recently, neighbor-joining analysis of small subunit rRNA sequences of *C. parvum* and other proposed *Cryptosporidium* species suggests that closely related strains from humans, monkeys, calves, mice, guinea pigs (*C. wrairi*), geese (*C. meleagridis*) and cats (*C. felis*) be considered a *C. parvum* group. It should be noted that *C. felis* has recently been identified in AIDS patients. Adapted by permission from Xiao *et al.* (1999b); reproduced by permission from Sears (2000)

lack of host specificity, antibiotic resistance, use of the parasitophorous vacuole and ability to auto-infect the host.

*Cryptosporidium* spp. were traditionally named after the host species in which they were originally found. After further study, however, most original species names have been discarded. Up to eight current species of *Cryptosporidium* are recognized, four mammalian (*C. parvum*, *C. muris*, *C. felis* and *C. wrairi*), two avian (*C. baileyi* and *C. meleagridis*), one reptilian (*C. serpentis*) and one fish (*C. nesorum*). Synonyms for the human pathogen *C. parvum* include *C. agni*, *C. bovis*, *C. cuniculus*, *C. garnhami* and *C. rhesi* (Tzipori and Griffiths, 1998; Xiao *et al.*, 1999a).

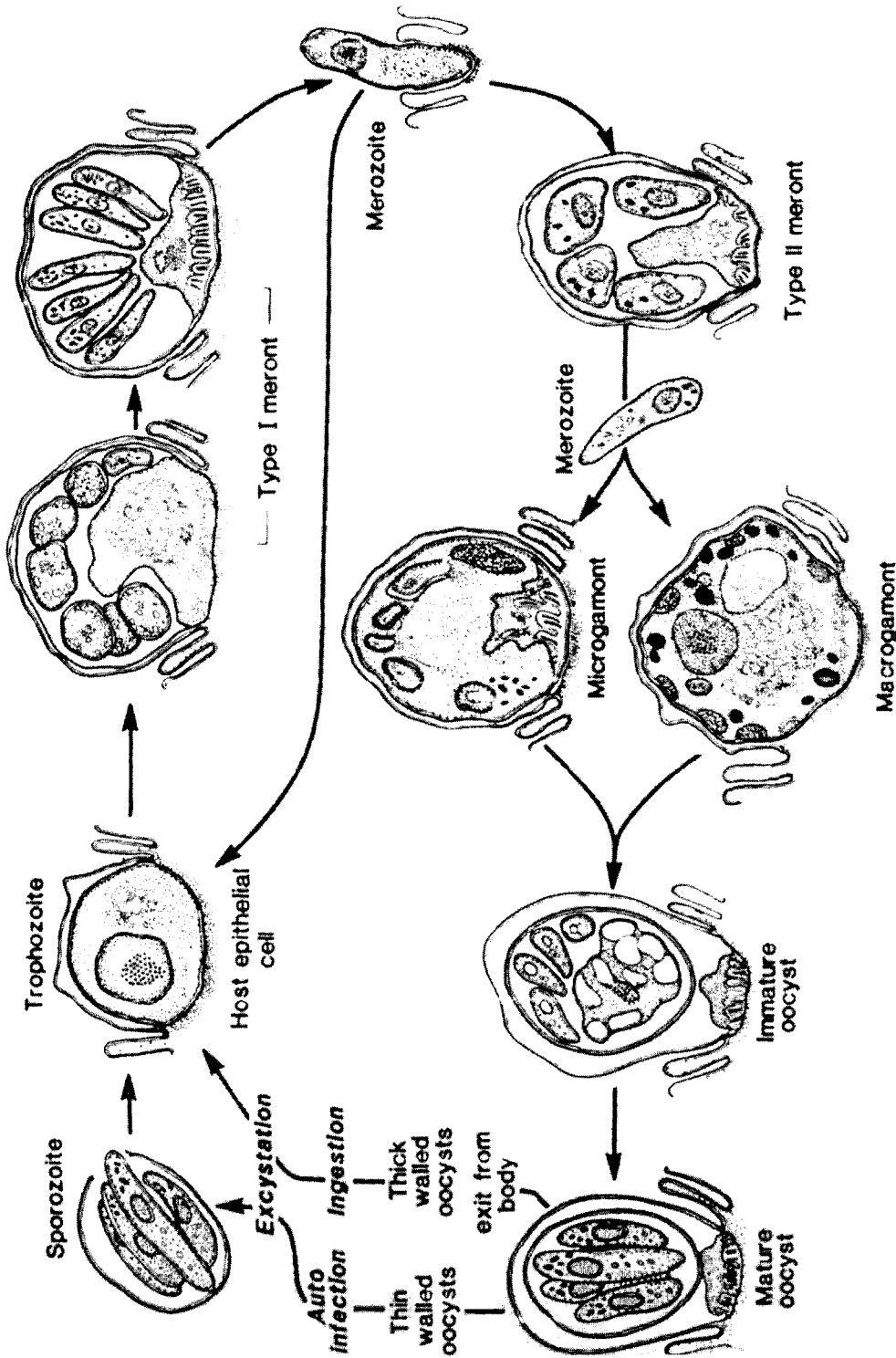
Taxonomic classification of *Cryptosporidium* into species remains controversial, given conflicting morphologic, genotypic and cross-transmission data. Recent evaluations of the genetic variability of *Cryptosporidium* by sequence analysis of the parasite small subunit (SSU) rRNA suggest that isolates from humans, monkeys, calves and mice were highly related and somewhat more distantly related to *C. felis*, isolated from cats (Xiao *et al.*, 1999b) (Figure 6.1). It is of interest that genetic studies of the SSU rRNA have identified infection with *C. felis* and with an isolate from a dog in AIDS patients, suggesting greater variability in the *C. parvum* strains infecting at least AIDS patients than previously appreciated (Pieniazek *et al.*, 1999).

Numerous studies now indicate that *C. parvum* isolates exhibit considerable molecular heterogeneity. Molecular diversity of *C. parvum* has been demonstrated by identification of parasite antigens, isoenzyme-typing studies and by studies evaluating genetic polymorphisms of *C. parvum* genes or DNA fragments. An important advance in the understanding of *C. parvum* is the genetic distinction between 'human' (genotype 1) and 'bovine or animal' (genotype 2) isolates (Table 6.1). This distinction has been made by evaluations of polymorphisms in *C. parvum* DNA by numerous techniques, including random amplified polymorphic DNA analysis (RAPD) (Morgan *et al.*, 1995), evaluation of restriction enzyme sites in repetitive DNA sequences (Bonnin *et al.*, 1996; Carraway *et al.*, 1997), by comparison of the nucleotide sequences of the 18S rRNA gene and the internal transcribed spacer 1 (ITS1) from the ribosomal repeat unit (Carraway *et al.*, 1996; Morgan *et al.*, 1997) and in mutations in the gene encoding

**Table 6.1** *C. parvum*: two distinct genotypes

	Hosts	Infects calves or mice
Genotype 1 (human)	Humans	No*
Genotype 2 (bovine)	Humans/animals	Yes*

\*Neonatal pigs and one macaque have been reported infected with a genotype 1 strain. Genotype 1 and 2 strains will both infect INFγ knockout mice.



**Fig. 6.2** Life-cycle of *C. parvum*. Mature, fully infective oocysts are released from the intestinal epithelial cells to exit in stool or initiate host autoinfection. Ingestion of mature excreted oocysts results in excystation (under the influence of gastric acid and proteases in the small bowel) and release of four sporozoites, which invade the apical microvillous membrane of small intestinal epithelial cells to form trophozoites. Trophozoites undergo two rounds of merogony, with production of either Type I or Type II meronts. Type II meronts are thought to initiate sexual reproduction, with formation of microgametes (males) and macrogametes (females). Fertilization yields immature oocysts, which sporulate *in situ* rapidly yielding mature oocysts. Reproduced by permission from Fayer *et al.* (2000)

thrombospondin-related anonymous protein 2 (Peng *et al.*, 1997). In general, animal/bovine isolates are infectious to both humans and animals, whereas human isolates are only infectious for humans. This latter fact has hampered in-depth studies of human isolates because of the inability to propagate large numbers of these oocysts experimentally. A recent review analyzing 12 studies, in which human *C. parvum* stool isolates ( $n=173$ ; ~60% from AIDS patients) were genotyped revealed that 78% of all endemic and epidemic human isolates examined were the human genotype (Clark, 1999). Improved understanding of the genetic variability of *Cryptosporidium* is essential for evaluation of potentially distinct species, to pinpoint outbreak sources, to delineate virulence factors and ultimately to identify drug and vaccine targets.

### Life-cycle

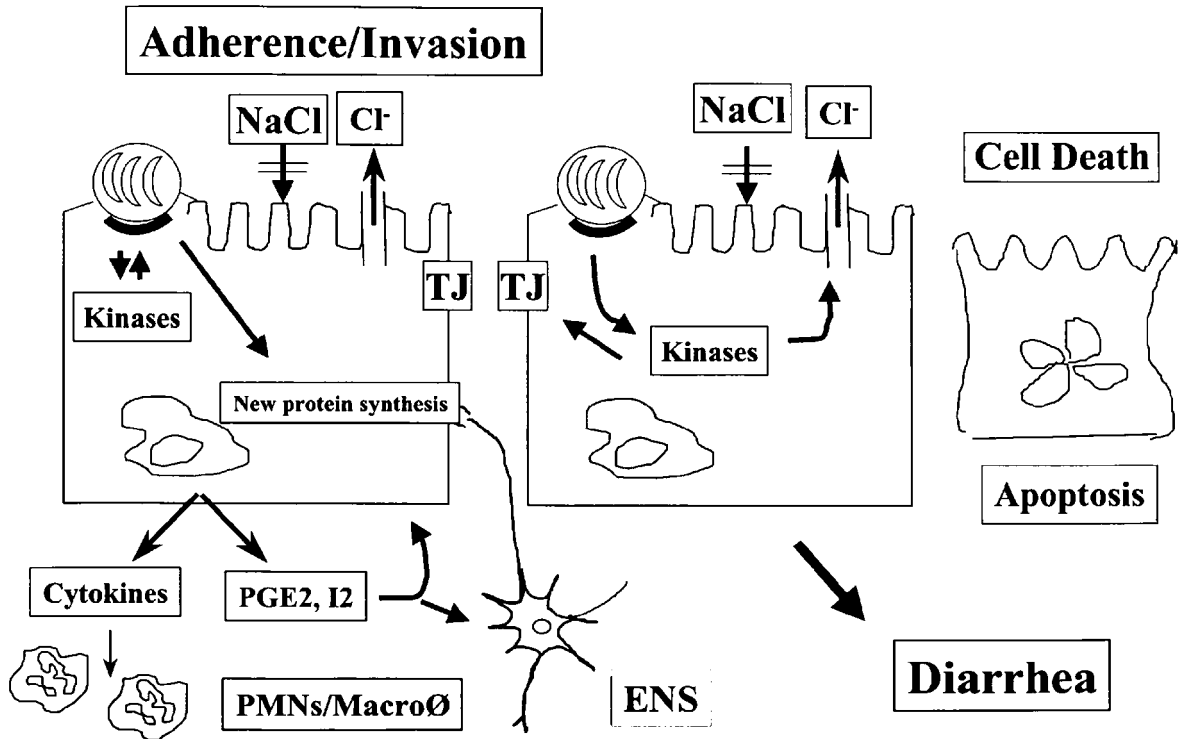
The life-cycle of *Cryptosporidium* is monoxenous, completed within the gastrointestinal tract of a single host (Figure 6.2) (Current and Haynes, 1984; Current *et al.*, 1986; Fayer *et al.*, 2000). The oocyst is the only exogenous stage and is approximately 4–6  $\mu\text{m}$  in diameter, with distinct inner and outer layers and four fully developed and infectious sporozoites. Ingestion of oocysts initiates infection. After exposure to gastric acid, bile salts and/or proteolytic enzymes in the upper gastrointestinal tract, excystation of the sporozoites occurs through a small suture in the end of the oocyst wall. Released motile sporozoites probe and attach with their apical membrane selectively to the apical membrane (luminal surface) of enterocytes. Infection (and hence presumably excystation) has also been reported in other sites (often contiguous with the intestinal tract), such as the biliary tract, pancreatic ducts, sinuses and respiratory tract, which are also lined with epithelial cells. Release of presumably membrane-lysing molecules by the apical complex of sporozoites cause the host cell membrane and microvilli to indent and fold around the sporozoite, which ultimately places it in an intracellular but extracytoplasmic compartment below the cell's outer membrane, termed the

'parasitophorous vacuole'. A 'feeder organelle' (located at the base of the parasitophorous vacuole) forms between the developing intracellular parasite and the host cell. This distinctive electron-dense structure is presumed to permit exchange of molecules with the host cell (see also Pathogenesis: Intestinal Disease).

After invasion, sporozoites differentiate into rounded trophozoites, which, after asexual reproduction (merogony or schizogony), become type I meronts (or schizonts) with six to eight merozoites. Similar to sporozoites, merozoites are curved parasites with a double inner membrane and an apical complex of rings and micronemes. The rupture of type I meronts releases mature merozoites, which can further invade adjacent epithelial cells and become either type I or II meronts. The cycling of type I meronts is thought to partially explain the ability of *C. parvum* to persist in the human host. Type II meronts have four merozoites that invade host cells to undergo sexual reproduction (gametogony) and become male or female gamonts, which can be seen as early as 36 hours post-infection. Mature micro- (male) and macro- (female) gamonts attach and fuse and form the zygote, which develops into either a thick-walled or thin-walled oocyst, each with four fully infectious sporozoites. Thin-walled oocysts are associated with autoinfection of the intestine, providing a second mechanism by which *C. parvum* can auto-infect the host, resulting in persistent infection. In contrast, thick-walled oocysts are capable of surviving for long periods of time in the environment. The prepatent period, or time from oocyst ingestion to the excretion of infectious oocysts, is approximately 4–22 days for humans.

### PATHOGENESIS: INTESTINAL DISEASE

The mechanisms by which *C. parvum* cause diarrhea are not well understood, although available data suggest that *C. parvum* alters intestinal epithelial cell function as well as the enteric immune and nervous systems. The outcome of *C. parvum* infection, asymptomatic colonization vs. diarrheal disease, can be expected to be dependent on both parasite virulence



**Fig. 6.3** Intestinal disease pathogenesis. Adhesion/invasion of *C. parvum* sporozoites/merozoites to the apical membrane of intestinal epithelial cells with trophozoite formation appears to stimulate the activity of several cellular kinases that participate in the cytoskeletal rearrangement associated with *C. parvum* invasion of the cell. Cellular invasion also stimulates the intestinal epithelial cells to produce prostaglandin synthase, IL-8 and  $\text{TNF}\alpha$ . Recruitment of polymorphonuclear leukocytes (by IL-8), activation of macrophages (by  $\text{TNF}\alpha$ ), production of prostaglandins (by prostaglandin synthase) and alteration in the function of ion transporters (by cellular kinases) would be predicted to stimulate intestinal secretion in response to cellular infection with *C. parvum*. Cellular invasion also results in flattened and fused small intestinal villi, possibly secondary to cell infection and/or in response to the submucosal immunologic response. This morphologic picture is associated with malabsorption, which contributes to *C. parvum* diarrheal disease. Additionally, a subset of cells infected by *C. parvum*, which undergo apoptotic cell death, and the enteric nervous system are also probably contributing to the pathophysiology of disease. Reproduced by permission from Sears (2000)

factors and the intestinal response to the infection. However, despite the appreciation that *C. parvum* isolates are genetically diverse, there is as yet no delineation of specific virulence factors of *C. parvum*, nor genetic means to create defined mutants for pathogenetic analysis. Thus, insight into the pathogenesis of this infection currently arises from evaluation of the intestinal pathology of human and animal infections and from studies of *in vitro* and *in vivo* disease models (reviewed in Clark and Sears, 1996; Sears, 2000; Sears and Guerrant, 1994). Based on these data, Figure 6.3 proposes a model by which *C. parvum* infection may result in diarrheal disease.

Attachment of *C. parvum* sporozoites to intestinal epithelial and/or biliary cells appears to be a specific host-parasite interaction requiring both Gal/GalNAc epitopes on intestinal epithelial cell glycoproteins and on the sporozoite surface (Chen and LaRusso, 2000; Joe *et al.*, 1994, 1998). Subsequent intestinal epithelial cell invasion by *C. parvum* sporozoites and merozoites has been shown to be dependent on remodeling of host cell actin (Chen and LaRusso, 2000; Elliot and Clark, 2000; Forney *et al.*, 1999) but not tubulin, resulting in a plaque-like actin structure at the host-parasite interface. It is of interest that, in addition to actin and the

actin binding protein  $\alpha$ -actinin (Elliott and Clark, 2000), a putative *C. parvum* transport protein termed CpABC localizes to the host cell-parasite boundary, where it is postulated to play a role in exporting molecules from the parasite to the cell or vice versa (Perkins *et al.*, 1999). The exact mechanisms by which *C. parvum* cellular invasion results in actin rearrangement are unknown but current data suggest involvement of host cell kinase signaling pathways (Forney *et al.*, 1999). *C. parvum* cellular invasion also appears to trigger new protein synthesis, including prostaglandin H synthase 2, proinflammatory cytokines/chemokines [tumor necrosis factor  $\alpha$  (TNF $\alpha$ ), interleukin-8 (IL-8), GRO- $\alpha$  and possibly interleukin-1 $\beta$  (IL-1 $\beta$ )] and the mucosal antibiotic peptide,  $\beta$ -defensin, all potentially contributors to *C. parvum* disease pathogenesis, as outlined below (Laurent *et al.*, 1997, 1998; Seydel *et al.*, 1998; Tarver *et al.*, 1998).

The histopathology resulting from invasion of the intestinal epithelium by *C. parvum* varies. Information on human intestinal pathology is primarily available from biopsies in AIDS patients with cryptosporidiosis and chronic diarrhea (Genta *et al.*, 1993; Goodgame *et al.*, 1993, 1995; Lumadue *et al.*, 1998). In general, higher-intensity infections, as assessed by histopathology and number of stool oocysts, are accompanied by more severe gut injury, including villous atrophy and fusion, crypt hyperplasia and cellular submucosal infiltration (including both mononuclear cells and polymorphonuclear leukocytes), and are associated with evidence of carbohydrate, protein and vitamin (e.g. B<sub>12</sub>) malabsorption. Reduced activity of brush border enzymes (e.g. lactase, sucrase) occurs and is likely of clinical importance. However, no association between stool volume in AIDS patients and the intensity of infection by biopsy has been identified to date (Genta *et al.*, 1993; Goodgame *et al.*, 1995; Lumadue *et al.*, 1998; Manabe *et al.*, 1998). Furthermore, severe diarrhea is reported in some patients with low-intensity infections and normal duodenal histology. This latter observation could be due, for example, to severe infection in an unbiopsied site, unrecognized co-pathogens and/or variations in the virulence of *C. parvum* strains.

In addition to malabsorption, several other potential mechanisms are postulated to contri-

bute to the development of intestinal symptoms (particularly diarrhea) in individuals with *C. parvum* infection. First, physiologic studies of *C. parvum*-infected intestinal tissue of mice and piglets and of human intestinal epithelial cell monolayers suggest that *C. parvum* infection may alter intestinal ion transport and/or increase gut permeability (Adams *et al.*, 1994; Argenzio *et al.*, 1990, 1993, 1994; Griffiths *et al.*, 1994; Kapel *et al.*, 1997; Moore *et al.*, 1995). In the animal models, impaired absorption of sodium coupled to glucose occurs whether or not symptomatic disease results (Argenzio *et al.*, 1990; Kapel *et al.*, 1997; Moore *et al.*, 1995). In contrast, glutamine-stimulated sodium absorption appears to remain largely intact, suggesting that glutamine-based oral rehydration solutions may be superior to glucose-based oral rehydration solutions in the treatment of *C. parvum*-induced diarrhea (Argenzio *et al.*, 1990; Kapel *et al.*, 1997; Levine *et al.*, 1994). In more severe disease with diarrhea in piglets, prostanoid-dependent secretion may occur and it can be postulated that the kinases activated by cellular invasion by *C. parvum* may also act to stimulate intestinal secretion (Argenzio *et al.*, 1990; Forney *et al.*, 1999). Of note, consistent with the available *in vitro* results, studies of AIDS patients with *C. parvum* have also provided evidence of reduced intestinal barrier function (Goodgame *et al.*, 1995; Lima *et al.*, 1997). Second, elevated levels of the neuroactive prostaglandin, PGI<sub>2</sub>, are present in *C. parvum*-infected piglet intestinal tissue and inhibitor analyses suggest that the enteric nervous system contributes to secretion in *C. parvum* disease (Argenzio *et al.*, 1996, 1997). Third, pro-inflammatory cytokines (e.g. TNF $\alpha$ , IL-8) are expected to stimulate mucosal recruitment of leukocytes, with production of inflammatory mediators such as prostaglandins (Kandil *et al.*, 1994; Laurent *et al.*, 1997, 1998; Seydel *et al.*, 1998). These inflammatory mediators generated in response to *C. parvum* infection are known to stimulate intestinal secretion. Consistent with the potential importance of inflammation in the pathogenesis of diarrhea in *C. parvum* infection, up to 75% of symptomatic, but not asymptomatic, Brazilian children with *C. parvum* infection had evidence of fecal leukocytes in their stools (Newman *et al.*, 1999). Fourth, cellular injury and apoptosis have been



**Table 6.2** *C. parvum*: a very infectious parasite

Strain	ID <sub>50</sub> (oocysts)	Attack rate (%)	Duration of diarrhea (hours)
TAMU	9	86	94
Iowa	87	52	64
UCP	1042	59	82

Adapted from Okhuysen *et al.* (1999).

observed in response to *C. parvum* infection *in vitro* and in human intestinal tissue, which may contribute to disease pathogenesis (Chen *et al.*, 1998; Griffiths *et al.*, 1994; Lumadue *et al.*, 1998). Fifth, *C. parvum* has been suggested to produce an enterotoxin capable of stimulating intestinal secretion (Guarino *et al.*, 1994, 1995). However, this is controversial and has not been demonstrated to be a parasite-specific product (Clark and Sears, 1996; Sears and Guerrant, 1994). Together these mechanisms may serve to account for diarrheal illnesses caused by *C. parvum* infection.

Exciting contributions to our understanding of the pathogenesis of *C. parvum* disease have accrued from recent studies of human volunteers infected with *C. parvum*. In particular, a human volunteer study by Okhuysen *et al.* (1999) indicates that *C. parvum* isolates of the bovine genotype exhibit variable virulence and emphasizes the low number of oocysts required to cause disease, even in healthy adults (Table 6.2). This study, in which healthy volunteers (serologically negative for anti-*C. parvum* antibodies) were infected with one of three bovine genotype isolates of *C. parvum*, revealed a ~10–100-fold difference in the number of oocysts required to infect 50% (ID<sub>50</sub>) of each volunteer group. The attack rate for and duration of diarrhea were greatest for the most virulent isolate (TAMU strain), which had an ID<sub>50</sub> of only nine oocysts. Volunteer studies further suggest that single exposures to *C. parvum* isolates are not protective against the occurrence of diarrhea on re-exposure to the same isolate, although the severity of illness may be less (Okhuysen *et al.*, 1998). In contrast, exposure to a large number of oocysts (of a presumably heterologous isolate) in antibody-positive individuals is associated with an increased severity of illness, suggesting that immune responses, at least in some individuals,

may contribute to the pathogenesis of diarrheal disease symptoms (Chappell *et al.*, 1999). Alternatively, protective immunity to high inocula of *C. parvum* oocysts may simply be incomplete.

## IMMUNOLOGY

### Host Response to *C. parvum*

The human immune response to *C. parvum* infection is poorly understood. As evidenced by the severity and persistence of disease in patients with congenital immunodeficiencies, AIDS and immune deficiency induced by drug therapy (Colford *et al.*, 1996; Hashmey *et al.*, 1997; reviewed in Clark, 1999), activation of the immune system is necessary for the prevention and control of cryptosporidial infection. Our current understanding of this area is hampered by the inability to culture the organism readily and the lack of an animal model that mimics the complexity of human *C. parvum* disease (e.g. acute, persistent or chronic diarrhea). Most data to date have been gathered through the use of susceptible neonatal or genetically altered immunocompromised mouse models.

Most immunocompetent animals are susceptible to *C. parvum* only when very young (i.e. neonatal) and then rapidly develop innate resistance. Immaturity of the acquired intestinal microflora (Harp *et al.*, 1992) and antigen-specific and non-specific immunologic effector systems (including IL-12 and IFN $\gamma$  pathways, discussed below) are thought to account for the susceptibility to *C. parvum* infection found in very young animals (reviewed in Theodos, 1998). In contrast, in humans, age-related susceptibility to *C. parvum* is not clear-cut and persons of any age may acquire infection. This again illustrates the difficulty of using currently available animal models to understand the pathogenesis of human *C. parvum* infection and/or disease.

### Cell-mediated Immunity (CMI)

CMI is thought to be the cornerstone of the immune response to *C. parvum* infection and appears to be vital in both protection against and recovery from infection. The overall importance

of T cells, particularly CD4<sup>+</sup> T cells, in the immune response to *C. parvum* infection is suggested by the persistent infections, chronic diarrhea and death from *C. parvum* observed in AIDS patients, as well as in severe combined immunodeficiency (SCID) and nude (athymic) mice (Heine *et al.*, 1984; Mead *et al.*, 1991). In experimental data using mouse models, CD4<sup>+</sup> T cells, INF $\gamma$  and IL-12 appear important in defining the duration of infection/disease and/or recovery from infection. CD4-deficient mouse models exhibit increased susceptibility to infection and persistent symptomatic infection, which is cured upon transfer of splenic lymphocytes from immune mice (Aguirre *et al.*, 1994; Ungar *et al.*, 1990a, 1991). These data mimic the human clinical experience in which an adequate absolute peripheral CD4 count ( $\geq 150$  cells/mm<sup>3</sup>) correlates with the ability of HIV-infected patients to resolve *C. parvum* infection (Blanshard *et al.*, 1992; Flanigan *et al.*, 1992; Manabe *et al.*, 1998; McGowan *et al.*, 1993). The role of CD4<sup>+</sup> cells in the intestinal immune system (GALT, or gut-associated lymphoid tissue, which includes Peyer's patches, lamina propria and intraepithelial lymphocytes) and the intestinal epithelium's role in controlling disease, such as through activation of innate immune responses (e.g. induction of  $\beta$ -defensin (Tarver *et al.*, 1998)) are beginning to be explored as the first line of defense for control of infection. Intraepithelial lymphocytes (IEL) and mesenteric lymph node (MLN) cells can be primed to *C. parvum* infection, producing a large number of specific CD4<sup>+</sup> cells, which confer recovery from *C. parvum* infection if adoptively transferred to an infected SCID mouse by 'homing' to the gut. Depletion of CD4<sup>+</sup> (but not CD8<sup>+</sup>) cells in the immune IEL or MLN abrogates their ability to cure infection (McDonald *et al.*, 1996). Although natural killer cells have not been implicated in the control of *C. parvum* infection, data on the role of CD8 cells varies (Aguirre *et al.*, 1994, 1998). The systemic loss of CD8<sup>+</sup> T cells does not seem to alter susceptibility to infection or shedding of oocysts, whereas intraepithelial CD8 cells may contribute to disease resolution (Aguirre *et al.*, 1998; Rohlman *et al.*, 1993; Wyatt *et al.*, 1997).

Production of INF $\gamma$ , a Th1 lymphocyte response, appears to be important to control of experimental and human (see below) *C. parvum*

infection. Depletion of INF $\gamma$  in mice (e.g. via antibodies) enhances oocyst shedding but alone does not lead to persistent infection (Aguirre *et al.*, 1998; Mino *et al.*, 1999; Theodos *et al.*, 1997; Ungar *et al.*, 1991). In contrast, mice with disruption of the INF $\gamma$  gene (GKO mice) develop overwhelming *C. parvum* infection and succumb to death within 2–3 weeks (Theodos *et al.*, 1997). Pretreatment of immunodeficient mice with IL-12 prevents or reduces the severity of infection, an effect attributable to stimulation of INF $\gamma$  production by IL-12 (Urban *et al.*, 1996). Despite the importance of the Th1 cytokine INF $\gamma$  in the control of *C. parvum* infection, additional data suggest that production of Th2 cytokines, such as IL-4, also contributes to disease control, indicating that the CMI response to *C. parvum* infection defies precise Th1 vs. Th2 categorization as presently understood. Lastly, activation of the CD<sub>40</sub> ligand [a tumor necrosis factor (TNF)-like molecule expressed on activated T cells] may contribute to the control of *C. parvum* infection. The CD<sub>40</sub> ligand has been shown to participate in control of other intracellular pathogens via effects on T cell activation, signaling to B cells and interactions with production of INF $\gamma$  and IL-12 (Cosyns *et al.*, 1998).

Human clinical studies of the cellular immune responses to *C. parvum* are very limited. Gomez Morales *et al.* (1995, 1999) demonstrated an antigen-specific proliferation of human peripheral blood mononuclear cells (PBMC) in three immunocompetent patients with a history of *C. parvum* after stimulation with a crude oocyst extract (CCE) and the 190 kDa *C. parvum* oocyst wall protein (COWP). In HIV-positive patients, PBMC were not found to proliferate in response to CCE, although they did respond to mitogenic stimulation. In previously infected healthy patients, the cytokines IL-2, IL-10 and INF $\gamma$  were elevated in the supernatants of PBMC stimulated with CCE. Examination of INF $\gamma$  expression in jejunal biopsies of experimentally infected volunteers has suggested that INF $\gamma$  expression correlates with prior exposure to *C. parvum* (i.e. identified in 90% vs. 25% of *C. parvum* antibody-positive and -negative volunteers, respectively;  $p < 0.01$ ) and the absence of oocyst shedding. These results suggest that INF $\gamma$  production may contribute to resistance to infection but that mechanisms required to

control primary infection are more complex (White *et al.*, 2000).

### Humoral Immune Response

Serum antibodies (IgM, IgG, IgA) to *C. parvum* are found in most immunocompetent and immunocompromised patients infected with *C. parvum* (including persistently infected HIV patients), but their role in protection and clearance of cryptosporidiosis has not been conclusively demonstrated (Heyworth, 1992; Kassa *et al.*, 1991). Volunteer studies have looked at the impact of antibodies on clinical symptoms and have used immunoblot techniques to monitor antibody changes in patients with experimental *C. parvum* infection. IgG reactivity to 15, 17 and 27 kDa *Cryptosporidium* antigens following experimental human infection was more common in symptomatic than in asymptomatic individuals. Volunteers with immunoblot evidence of IgM antibodies to the 17 and 27 kDa antigen group before experimental infection with *C. parvum* (consistent with a prior undiagnosed infection) were found to be protected from disease (symptomatic infection) but not from infection itself (Moss *et al.*, 1998). Additional volunteer data suggest that the antibody response to *C. parvum* infection is either not protective or only partially protective (Chappell *et al.*, 1999; Okhuysen *et al.*, 1998). However, the number of oocysts necessary to cause infection and illness is increased in antibody-positive volunteers, suggesting that pre-existing anticryptosporidial antibodies may be protective against low oocyst challenges, such as may occur commonly through water ingestion.

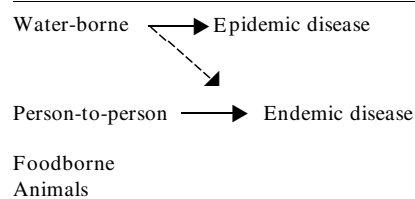
Exogenously-administered and/or endogenously-produced intestinal antibodies to *C. parvum* have also been studied and conflicting data support their role in disease protection. *C. parvum* life-cycle stages that exist outside the cell (sporozoites and merozoites) have been studied experimentally as targets for specific antibodies. In mice, anti-sporozoite and anti-merozoite antibodies have reduced the ability of *C. parvum* oocysts to infect mice (Bjorneby *et al.*, 1990; Riggs and Perryman, 1987). Human monoclonal IgG<sub>1</sub> antibodies (Mab) have been

shown to bind to *C. parvum* sporozoites and oocysts by immunofluorescence and to inhibit infection in a human enterocyte cell line *in vitro* (Elliot *et al.*, 1997). Numerous oocyst and sporozoite antigens are recognized by anti-*C. parvum* bovine colostrum. Feeding of purified anti-*C. parvum* antibodies and bovine colostrum containing *C. parvum* antibodies leads to partial protection of calves and mice against infection (Fayer *et al.*, 1989, 2000; Heyworth, 1992). Case reports and small series suggest clearance or improvement of infection in at least some immunocompromised individuals treated with anti-cryptosporidial hyperimmune bovine colostrum (Nord *et al.*, 1990; Plettenberg *et al.*, 1993; Rump *et al.*, 1992; Shield *et al.*, 1993; Ungar *et al.*, 1990b). However, failure to change parasite burdens in humans has also been shown (Saxon and Weinstein, 1987). In addition, patients with AIDS fail to clear the infection despite elevation of both total and *C. parvum*-specific fecal IgA and IgM, suggesting that humoral immune responses alone are insufficient to control *C. parvum* intestinal infection (Benhamou *et al.*, 1995).

### EPIDEMIOLOGY

Cryptosporidiosis is a worldwide disease. Four major modes of transmission to humans occur: person-to-person, water-borne, animal-to-human and foodborne (Table 6.3). Although the proportion of infections resulting from each route of transmission is unknown, person-to-person and water-borne transmission most likely account for endemic and epidemic *C. parvum* disease, respectively. However, increasing recognition that low-level contamination of water with *C. parvum* oocysts may occur commonly raises the concern that water-borne transmission is also

**Table 6.3** Transmission of *Cryptosporidium*



a significant mode of transmission for endemic *C. parvum* infections. Populations at particular risk of infection include children (particularly in developing countries and in daycare), the elderly, travelers, persons with animal contacts, caregivers of patients with *Cryptosporidium* (including nosocomial exposures) and immunocompromised patients, including those with AIDS.

Several features of *C. parvum* enhance its infection and outbreak potential. First, environmental contamination may be ubiquitous, with oocysts found in >80% of surface waters and 87% of raw water samples in the USA (LeChevallier *et al.*, 1991). Second, both animal and human hosts excrete large numbers of oocysts ( $10^7$ – $10^{11}$  oocysts/g feces) (Chappell *et al.*, 1996; Geata *et al.*, 1993; Goodame *et al.*, 1993). Third, *C. parvum* oocysts are small (4–6  $\mu$ m) and thick-walled. Thus, they are difficult to physically remove from the water supply and resistant to many disinfectants and standard water treatments. For example, a proportion of oocysts remain viable after 24 hours of exposure to full-strength household bleach (Korich *et al.*, 1990). Lastly, the 50% infectious dose (ID<sub>50</sub>) for human volunteers is very low ranging upwards from nine oocysts depending on the *C. parvum* strain used for inoculation (Table 6.2) (DuPont *et al.*, 1995; Okhuysen *et al.*, 1999). The extremely low infectious dose of certain *C. parvum* strains facilitates person-to-person (even from asymptomatic individuals) as well as water-borne transmission.

Prevalence rates of *C. parvum* vary globally with, as expected, reported stool positivity rates for *C. parvum* oocysts generally lower than the reported seroprevalence rates. In developed countries, infection rates, as determined by stool examination for oocysts, are in the range 0.6–4.3% of persons of all ages (Fayer and Ungar, 1986). Reported prevalence rates of stool oocysts (with or without diarrheal disease) are broader in developing nations. In children 0–5 years of age, rates range from a reported 7.9% of Liberian children to 32% of Mexican and Bolivian children (Chacin-Bonilla *et al.*, 1997; Deng and Cliver, 2000; Esteban *et al.*, 1998; Griffiths, 1998; Nchito *et al.*, 1998; Soave *et al.*, 1989). It is noteworthy that the reported Bolivian children were all asymptomatic.

Seroprevalence rates also vary widely between the developed and developing world. Rates in industrialized countries are approximately 17–32% in adults, demonstrating largely unrecognized exposures. For example, prior to service, Peace Corps volunteers had seropositive rates of 32%, which increased to 58% after 2 years in Africa (Ungar *et al.*, 1989). In developing countries, such as Brazil, almost all children (91%) are seropositive by 2 years of age (Newman *et al.*, 1994). In China, 55% of children less than 16 years old are seropositive, as compared to 50% of Chinese adults and 16.9% of children <16 years of age from Virginia (Zu *et al.*, 1994). In contrast, 86% of randomly chosen blood donors in Australia are positive (Tzipori and Campbell, 1981), and 64% of adults and children in a shantytown of Peru (Ungar *et al.*, 1988). Variations in seroprevalence data may be artifactual, however, as different testing methods and population sampling techniques have been used.

Overall, the peak age of symptomatic infection appears to be 1–5 years. In developing nations, the highest rates of infection in children correlate with increasing mobility and their expanding diets, or approximately 6–24 months of age (Molbak *et al.*, 1993; Newman *et al.*, 1994, 1999). Additional risk factors for *C. parvum* infection in developing countries include exposures to untreated water or contaminated food, poor sanitary conditions, zoonotic contacts, and defects in immunity, such as those due to malnutrition. Conflicting evidence supports the role of breastfeeding in preventing infection (Griffiths, 1998). The prevalence of infection clearly diminishes after the early childhood years.

In patients with AIDS, the prevalence of *Cryptosporidium* infection is reportedly 10–15% in the USA and 30–50% in the developing world (Guerrant, 1997; Petersen, 1992). However, since the mid-1990s, the advent of highly active antiretroviral therapy (HAART) in industrialized nations has led to the dramatic decline of cryptosporidiosis in individuals with access to this therapy in developed countries (Manabe *et al.*, 1998).

The ability of *C. parvum* to spread through drinking or recreational water, even despite adequate treatment, has been well documented.

During 1991–1994, 64 drinking water-associated disease outbreaks, affecting 422 800 individuals, were documented in the USA. Twenty-two per cent of the outbreaks with a known etiology were due to *C. parvum*, affecting 406 822 people (Steiner *et al.*, 1997). In addition, in the same time period, eight recreational water outbreaks, affecting 1219 individuals, involved *C. parvum* (Steiner *et al.*, 1997). The latter outbreaks occurred in well-chlorinated public swimming facilities. However, outbreaks from recreational lake water have also been described (Kramer *et al.*, 1998). The largest documented water-borne disease outbreak due to *C. parvum* occurred in Milwaukee, Wisconsin in 1993. Over 403 000 people had watery diarrhea, i.e. over half the population receiving water from the a icted water treatment plant (MacKenzie *et al.*, 1995). In Clark County, Nevada, in 1993–1994, another water-borne outbreak occurred despite a state-of-the-art water-testing facility. The majority of confirmed cases were in HIV-infected individuals, who had a mean length of diarrhea of 60 days and a high death rate, at least partly, attributable to *C. parvum*. This outbreak was only recognized because *C. parvum* infection is a reportable disease in Nevada (Goldstein *et al.*, 1996).

Although the risk of *C. parvum* infection from food is estimated at 8–62 million cases a year (ISSI Consulting Group, 1999), well-documented cases or outbreaks have only infrequently been reported (Quiroz *et al.*, 2000). Food-borne *C. parvum* is thought to occur most often from fresh fruits and vegetables, which are contaminated by the food handler, rather than at the farm. The first clearcut food-borne outbreak of cryptosporidiosis was reported in 1994, from apple cider contaminated by cow manure (Millard *et al.*, 1994). Other implicated food vehicles have included fresh sausages, raw milk and potato salad.

In general, person-to-person transmission is likely to be common, due to the low infective dose of *C. parvum* (Okhuysen *et al.*, 1999) and the large numbers of oocysts shed from the stools of infected patients (Chappell *et al.*, 1996; Genta *et al.*, 1993; Goodgame *et al.*, 1993). Secondary transmission within families is frequent particularly when the source case is a child and, for example, was found in 19% of family contacts in

Northern Brazil (Newman *et al.*, 1994). In contrast, lower rates of family transmission were found when adults were primarily infected in the Milwaukee outbreak (MacKenzie *et al.*, 1995). Hospital personnel and caregivers of infected patients (Griffiths, 1998) and sexual practices involving oral–anal contact also increase exposure risk. Transmission in daycare settings is both sporadic and epidemic, occurring especially in diapered children. Adult contacts of children in daycare are also at increased risk of infection, due to secondary transmission (Griffiths, 1998).

Direct animal-to-person transmission is less frequently reported. *C. parvum* has been shown to infect a wide range of animals, including farm animals (cows, pigs, goats, horses and sheep), wild ruminants and domestic pets (cats, rodents and dogs) (reviewed in Fayer and Ungar, 1986). However, companion animals are only infrequently implicated in human disease. Newborn and young animals < 6 months of age have the highest likelihood of infection. Groups at high risk include veterinary students and animal caretakers, such as cow farmers (Current *et al.*, 1983).

## CLINICAL FEATURES

Since the initial appreciation of human cryptosporidiosis, the symptomatic clinical presentation of *C. parvum* infection has manifested as two major syndromes. First, in healthy, immunocompetent individuals, *C. parvum* infection is most often manifested by acute watery self-limited diarrhea, which may be accompanied by other symptoms of gastrointestinal distress, including nausea, vomiting, fecal urgency and abdominal cramps and discomfort. Fever is most often low-grade or absent but high fevers (e.g. 39°C) are reported. Diarrhea in the immunocompetent host is usually self-limited, but not trivial, as illustrated by the Milwaukee water-borne outbreak (Cicirello *et al.*, 1997; MacKenzie *et al.*, 1994, 1995). Data from this outbreak (depending on how the analysis was done) indicated median durations of illness of 4–12 days, with 8–19 total stools per day and a median weight loss of 4.5 kg in normal hosts. A subset of individuals developed predominantly upper-tract gastrointestinal symptoms marked by vomiting

thought to be due to gastric *C. parvum* infection (MacKenzie *et al.*, 1994).

Second, one of the notable features of *C. parvum* is its ability to establish persistent infections in hosts with diverse deficiencies in immunity, including IgG deficiency, HIV infection and deficits in cell-mediated immunity secondary to, for example, steroids or cytotoxic chemotherapy. Data on the clinical presentation of *C. parvum* in immunocompromised hosts largely comes from case reports or small collections of cases, except in HIV infection, where sizeable series of patients have been reported (Blanshard *et al.*, 1992; Colford *et al.*, 1996; Hashmey *et al.*, 1997; Manabe *et al.*, 1998; McGowan *et al.*, 1993; Navin *et al.*, 1999; Pozio *et al.*, 1997; Wuhib *et al.*, 1994). Immunocompromised hosts experience protracted, sometimes life-threatening, diarrheal illnesses (also potentially accompanied by other symptoms of gastrointestinal disease) which may not resolve without reversal of the underlying immunodeficiency. Despite the persistent and, on occasion, dramatic nature of the diarrheal illnesses (e.g. up to 20 liters of stool output) in AIDS patients, it is now apparent that, even in AIDS patients with CD4 counts less than 100/mm<sup>3</sup>, *C. parvum* disease may have a variable clinical presentation (Blanshard *et al.*, 1992; Manabe *et al.*, 1998). Approximately 50% of AIDS patients with low CD4 counts will have persistent or relapsing diarrhea; approximately one-third will experience dehydrating diarrhea requiring intravenous rehydration (i.e. 'cholera-like'); and 15% will experience limited or self-resolving diarrhea (Manabe *et al.*, 1998). The reasons for this clinical variability are unknown but include individual differences in the response to infection and/or differing virulence of the infecting *C. parvum* strains. Several analyses have indicated that acquisition of *C. parvum* infection by patients with AIDS increases mortality, and this remains true even when AIDS patients with cryptosporidiosis are compared to AIDS patients with similar CD4 counts and/or similar numbers of other opportunistic infections (Blanshard *et al.*, 1992; Colford *et al.*, 1996; Manabe *et al.*, 1998). Additional data suggest that *C. parvum* infection marked by prominent vomiting in AIDS patients identifies a subgroup for whom *C. parvum* infection is likely to be lethal (Pozio

*et al.*, 1997; Vakil *et al.*, 1996). Whether these symptoms are ascribable to gastric and/or biliary tract involvement is unclear.

Biliary tract infection in patients with AIDS and intestinal *C. parvum* infection appears to occur with clinical symptoms in up to one-third of patients. A CD4 count less than 50 mm<sup>3</sup> is a risk factor for the development of biliary symptoms (Blanshard *et al.*, 1992; Hashmey *et al.*, 1997; McGowan *et al.*, 1993; Vakil *et al.*, 1996). However, asymptomatic biliary tract infection in patients with intestinal disease also occurs. Symptomatic cryptosporidial infection of the biliary tree in AIDS is marked by recalcitrant right upper quadrant pain and modest changes in serum transaminases, but with often striking changes in serum alkaline phosphatase levels and with an abnormal radiographic evaluation. Acalculous cholecystitis, papillary stenosis and sclerosing cholangitis have been described in association with *C. parvum* biliary tract infection.

Data from the developing world, volunteers infected with *C. parvum* and outbreak settings, such as Milwaukee, indicate that both relapsing diarrhea (following an initial diarrheal illness) and repeated infections (occurring at some time distant from the initial infection) are likely with *C. parvum* infection (Chappell *et al.*, 1999; MacKenzie *et al.*, 1994, 1995; Newman *et al.*, 1999; Okhuysen, 1998). Relapsing diarrhea due to *C. parvum* infection, defined as breaks in diarrhea of 2 or more days, has been reported in up to 40% of infected individuals or even more frequently if the break in diarrhea is defined as only 1 day of normal stool (Chappell *et al.*, 1999; Newman *et al.*, 1999; Okhuysen, 1998). Repeated infections upon re-exposure to *C. parvum* are also highly likely suggesting that a single infection with *C. parvum* will not result in protective immunity (Chappell *et al.*, 1999; Newman *et al.*, 1999; Okhuysen, 1998). In Brazilian children, for example, symptomatic infections were not necessarily followed by less severe illnesses (again consistent with lack of induction of protective immunity) (Newman *et al.*, 1999). In contrast, in healthy volunteers, 70% experienced diarrhea with the initial *C. parvum* infection and, on reinfection with the same isolate 1 year later, 70% again experienced diarrhea, although these repeat infections were less severe and fewer

oocysts were detected in the volunteers' stools (DuPount *et al.*, 1995; Okhuysen, 1998).

Evaluation of clinical cryptosporidiosis in young children in the developing world has established *C. parvum* as an important cause of persistent diarrhea in young children (Mølbak *et al.*, 1994; Newman *et al.*, 1999). Persistent diarrhea is further associated with increased diarrheal disease burdens and nutritional shortfalls (Lima *et al.*, 1992, 2000). Even more critical may be the impact of *C. parvum* on the subsequent health of children (Table 6.4). Growth faltering in weight and height has been demonstrated post-infection, with failure of catch-up growth in children infected in infancy (Checkley *et al.*, 1997, 1998; Mølbak *et al.*, 1997). It is of note that, impaired growth occurred whether or not the infections were symptomatic and the impact on linear (height) growth was persistent, lasting at least 1 year. Additional data indicate that cryptosporidiosis depresses nutritional status and growth (Janoff *et al.*, 1990; Sallon *et al.*, 1988, 1991). After cryptosporidial diarrhea, healthy Brazilian children  $\leq 1$  year of age experienced both a decline in growth and an increase in further diarrheal disease morbidity from other enteric pathogens (Agnew *et al.*, 1998). In addition, acquisition of early *C. parvum* infection (i.e. between birth and 2 years of age) has been associated with impaired physical fitness and cognitive function subsequently at 6–9 years of age (Guerrant *et al.*, 1999). Increased acute and delayed mortality persisting into the second year of life has been reported after *C. parvum* infection and could not be explained by malnutrition, socioeconomic factors, hygiene or breast feeding (Mølbak *et al.*, 1993).

## DIAGNOSIS

### Differential Diagnosis

Acute diarrhea with *C. parvum* has no distinguishing features. Its differential diagnosis encompasses all potential causes of non-bloody, watery diarrhea and the frequency of detection of specific pathogens will be dictated by the patient population and epidemiologic setting. Thus, other protozoan infections (*Giardia*, *Isospora* and *Cyclospora*), non-invasive bacterial infec-

**Table 6.4** Adverse outcomes of cryptosporidiosis in young children in developing countries

Reference	Outcome
Mølbak <i>et al.</i> (1993)	↑Acute and delayed mortality*
Mølbak <i>et al.</i> (1997)	↓Height and weight for $\geq 6$ months post-infection
Checkley <i>et al.</i> (1997, 1998)	↓Height $\geq 1$ year post-infection
Agnew <i>et al.</i> (1998)	↑Diarrheal disease morbidity*

\*For 2 years, post-infection.

tions (e.g. enterotoxigenic *Escherichia coli*) and viral infections (e.g. Norwalk and rotavirus) have clinical findings similar to cryptosporidiosis, although Norwalk-like viral illnesses are usually marked by more prominent vomiting. Cryptosporidiosis should always be included in the differential diagnosis of persistent or chronic diarrhea, especially in children of developing countries, travelers and immunocompromised hosts, including individuals with defects in either cell-mediated immunity (e.g. AIDS, steroid use, transplant patients) or humoral immunodeficiency. Evaluation of epidemics of diarrheal disease must consider *C. parvum* as a potential etiology.

### Laboratory Diagnosis

Clinical laboratory diagnosis of *C. parvum* is primarily by stool examination and oocyst visualization. Oocyst excretion is intermittent and multiple samples (either fresh or fixed in 10% formalin) may be necessary for diagnosis. Several techniques may be used to concentrate and stain oocysts for visualization. Stool concentration to detect oocysts is particularly necessary for epidemiological studies (e.g. of asymptomatic individuals) where the number of oocysts excreted is small, and also improves the sensitivity of testing in the evaluation of diarrhea. Concentration techniques involve either flotation or sedimentation. Flotation techniques include Sheather's sugar solution, zinc sulfate or saturated sodium chloride. Sedimentation (originally designed for diagnosis of helminths and protozoans larger than *C. parvum*) is performed with either formalin-ether or formalin-ethyl acetate, with a lengthy centrifugation step. Opinions vary

on the sensitivity of these different techniques (Current, 1990).

### Stains

The modified Ziehl–Neelsen or Kinyoun acid-fast stains of stool are the most convenient and widely used diagnostic methods to detect stool oocysts, which stain bright pink and are 4–6 µm in size. *C. parvum* oocysts must be differentiated from yeasts and the larger oocysts of *Cyclospora* (8–10 µm) by use of an ocular micrometer. Thus, accurate diagnosis requires experience to distinguish the morphologic characteristics of the small *C. parvum* oocysts. It should be noted that, stains for diagnosing other parasites, such as polyvinyl alcohol, trichrome and iron hematoxylin, are not acceptable for the identification of *C. parvum* oocysts. Alternatively, newer tests, such as direct immunofluorescence (DFA) with monoclonal antibodies to the oocyst wall (Merifluor, Meridian Biosciences) and a specific *C. parvum* enzyme-linked immunosorbent assay (ELISA) (Prospect, Alexon) are more sensitive than acid-fast stool examination. One inexpensive approach is to use non-specific fluorescent stains such as auramine–rhodamine or auramine–carbolfuchsin, to screen stools at lower power (e.g. × 40 objective) to identify appropriately sized structures suspected of being *C. parvum* oocysts. Subsequent more detailed analysis of suspicious stools using acid-fast stains and an oil objective is often sufficient to secure the diagnosis. This cost-effective approach is utilized in certain microbiology laboratories of large hospitals (e.g. Johns Hopkins Hospital, Baltimore, MD).

Fecal blood is found infrequently in cryptosporidial diarrhea. In contrast, a recent study in Brazilian children identified fecal leukocytes or the fecal leukocyte marker, lactoferrin, in up to 75% of children with acute or persistent diarrhea associated with *C. parvum* infection, but in no asymptomatic children (Newman *et al.*, 1999). In this study, detection of fecal leukocytes or lactoferrin was not correlated with the presence of enteric co-pathogens. This unexpected finding may be explained by the observation that *C. parvum* infection of intestinal epithelial cells

stimulates production of the proinflammatory cytokine, IL-8, which is expected to lead to mucosal recruitment of leukocytes (Laurent *et al.*, 1997). However, detailed studies of an intestinal inflammatory response to *C. parvum* in other populations are not yet available.

### Polymerase Chain Reaction (PCR)

Assays for the direct PCR detection of *C. parvum* in stool have been developed (Balatbat *et al.*, 1996; Morgan *et al.*, 1998; Wagner-Wiening and Kimmig, 1995; Zhu *et al.*, 1998) but are not yet commonly used in the diagnosis of clinical disease. This modality may show the greatest promise, has both superior sensitivity and specificity as compared with microscopy and permits multiple specimens to be batched. PCR techniques have detected < 20 oocysts/g stool, whereas 10 000–500 000 oocysts/g stool are necessary for detection by microscopy (Zhu *et al.*, 1998). The differentiation between animal and human-adapted strains, most important in outbreaks, can be done by PCR (Morgan *et al.*, 1995, 1997, 1998b). However, PCR is time-consuming, expensive and takes experienced personnel. PCR may also be ‘inhibited’ by many products in stool, including complex polysaccharides, bile salts and bilirubin, and additional lengthy steps are often needed to remove stool inhibitors (Zhu *et al.*, 1998).

Very rarely, intestinal biopsy is necessary for diagnosis. For example, in a prospective study of 22 AIDS patients with diarrhea, two cases of *C. parvum* infection were not detected by three stool examinations but were detected by small bowel biopsy (Greenson *et al.*, 1991). Histologic samples are stained by hematoxylin and eosin and reveal intracellular life stages of *C. parvum* in the brush border of the intestinal epithelium. Aspiration of duodenal fluid (for acid-fast staining) or small intestinal brushings can also be performed, but may be less sensitive. In biliary disease, alkaline phosphatase,  $\gamma$ -glutamyl transferase (GGT) and bilirubin levels are often elevated, but transaminases are usually normal (Heshmey *et al.*, 1997; Vakil *et al.*, 1996). Ultrasound and CT scanning may show irregular dilatation of the biliary ducts (Vakil *et al.*,



1996). Endoscopic retrograde cholangiopancreatography (ERCP) to obtain bile or tissue is the most sensitive method to detect *C. parvum* oocysts and diagnose biliary disease.

### Serology

Serologic testing has little role in clinical diagnosis, but is used in outbreak situations and for epidemiological study. Most commonly, an ELISA method is used to detect IgM and IgG antibodies. Elevated levels of IgM are found within 2 weeks of exposure and may persist for over a year in some individuals (Newman *et al.*, 1994). Thus, detection of anti-cryptosporidial IgM is only clearly diagnostic of acute infection if detected when anti-cryptosporidial IgG antibodies are absent or only weakly positive.

Evaluating water for infectious *C. parvum* oocysts involves water sample collection and concentration, separation of oocysts from debris, detection of oocysts and determination of oocyst viability (Fricker and Crabb, 1998). In general, large volumes of water (100–1000L) are passed through filters or membranes for concentration of oocysts. Classic density centrifugation techniques are inefficient in separating oocysts from fecal debris and newer methods, such as immunomagnetic separation (in which magnetic particles attached to specific antibodies bind oocysts, separating them from debris) are under development. For detection of oocysts in water samples, the sensitivity and specificity of PCR surpasses microscopic techniques; PCR can detect single oocysts in water. Difficulties in applying PCR to the diagnosis of *C. parvum* oocysts in water include inhibitors of PCR found in many water types and the inability to quantitate viable oocysts, since *C. parvum* oocysts must be ruptured to perform PCR. Oocyst viability may be examined through vital dye methods, nucleic acid stains, *in vitro* excystation, animal infectivity, cell culture techniques and/or genetic analysis using RT-PCR to detect mRNA (Fricker and Crabb, 1998). Recent work utilizing immunomagnetic separation of oocysts combined with *in vitro* cell culturing and PCR detected infectious *C. parvum* oocysts in 5% of raw water samples and 7.4% of filter backwash

water samples examined (Di Giovanni *et al.*, 1999).

### CLINICAL MANAGEMENT AND TREATMENT

As for all diarrheal illnesses, the most critical aspect of management is the maintenance of adequate hydration. Studies examining rehydration of patients with cryptosporidiosis have not been reported. However, clinical experience indicates that for most patients (including immunocompromised hosts) cryptosporidiosis can be successfully managed with oral rehydration solutions, such as the standard World Health Organization formulation or cereal-based oral rehydration salts (e.g. Ceralyte, marketed in the USA). Although not specifically studied in cryptosporidiosis, the advantage of cereal-based rehydration solutions is their potential to diminish the volume of diarrheal stools and to promote more rapid rehydration through the release of additional glucose molecules from complex carbohydrates, promoting enhanced sodium–glucose co-transport in the small bowel (Avery and Snyder, 1990). Although *C. parvum* infection disrupts the architecture of the small bowel, resulting in flattened and fused villi potentially impacting on small intestinal absorptive mechanisms, oral rehydration therapy is predicted to be successful based on prior observations in rotaviral diarrhea, in which a similar intestinal pathology is observed.

No effective antimicrobial agents against *C. parvum* have been clearly identified to date and no studies of therapeutic agents have been conducted in immunologically normal hosts with clinical cryptosporidiosis. All available data on therapy of symptomatic cryptosporidiosis are derived either from reported anecdotes or from small studies of patients with AIDS and chronic infection. Only effective HAART therapy has been clearly shown to result in the resolution of *C. parvum* disease in AIDS patients, presumably due to improved host immune function (Carr *et al.*, 1998; Le *et al.*, 1998). The aminoglycoside analog paromomycin (Humatin; also used therapeutically in amebiasis) appears to have modest activity against *C. parvum*, based on

experimental data (Griffiths *et al.*, 1998a,b) and clinical experience. Up to two-thirds of patients with HIV infection/AIDS are reported to experience some clinical benefit with paromomycin therapy, although clinical experience suggests that any benefit usually occurs early in infection and wanes with time in AIDS patients not taking HAART (Hashmey *et al.*, 1997). The mechanism of action of paromomycin, a poorly absorbed antibiotic that does not enter the host cell cytoplasm, is unclear. However, available data suggest that paromomycin enters the parasitophorous vacuole through the apical membranes overlying the parasite, which demonstrate enhanced permeability (Griffiths *et al.*, 1994, 1998a). The massive dilution of the drug in the intestinal lumen, below concentrations effective against *C. parvum*, may account for its limited therapeutic effectiveness. The antiparasitic nitazoxanide has been reported to be helpful in small studies and anecdotal reports (Blagburn *et al.*, 1998; Rossignol *et al.*, 1998; Theodos *et al.*, 1998) but review of the data by the FDA in 1999 did not support therapeutic effectiveness of this drug. A recent uncontrolled therapy trial by Smith *et al.* (1998) involving 11 AIDS patients suggested that a month of combined paromomycin (1g twice daily) and azithromycin (600mg once daily) therapy, followed by 2 months of paromomycin, may be helpful. Of five patients surviving more than 12 months after treatment, three had mild diarrhea controllable with non-specific therapies (e.g. antiperistaltic agents) and two were asymptomatic. Although a report of AIDS patients receiving clarithromycin and/or rifabutin for prophylaxis or treatment of *Mycobacterium avium* infections suggested that these individuals had decreased rates of acquiring *C. parvum* infection (Holmberg *et al.*, 1998), there is no hint that these drugs are useful in treating active cryptosporidiosis. Lastly, despite supportive experimental data and the theoretical attractiveness of intraluminal specific immunotherapy for *C. parvum* infection, studies evaluating the prophylactic or therapeutic effectiveness of hyperimmune bovine colostrum (i.e. colostrum derived from cows immunized with whole oocyst antigens) have been disappointing (Okhuysen *et al.*, 1998; and reviewed in Crabb, 1998).

Although asymptomatic infection of both immunologically normal and immunocompromised hosts is not uncommon, no regimens for elimination of stool carriage of *C. parvum* are known. This is of relevance to the potential for food-borne transmission of infection, given the low infectious inoculum required for some strains of *C. parvum* (Okhuysen *et al.*, 1999). Note, however, that recognized food-borne outbreaks of cryptosporidiosis reported to date have been linked to ill food handlers (Quiroz *et al.*, 2000).

## PREVENTION AND CONTROL

Prevention and control of *C. parvum* infections are difficult, due to the small size, durability and ubiquitous nature of the oocysts, as well as the small infectious dose. Avoidance of contact with human and animal feces in water and food and via sexual practices is the cornerstone of prevention for all hosts, particularly immunocompromised patients (USPHS/IDSA Prevention of Opportunistic Infections Working Group, 2000). Specific guidelines to prevent exposure to *C. parvum* for immunocompromised patients (particularly HIV-infected patients) have been outlined (USPHS/IDSA Prevention of Opportunistic Infections Working Group, 2000). High-risk contacts include diapered children attending daycare, sexual practices involving fecal contact, and caring for any infected person, particularly in hospital settings (Koch *et al.*, 1985). Vigilant handwashing and use of gloves are necessary to prevent person-to-person transmission. The risk from pet ownership is unknown but appears highest with domestic animals < 6 months of age. Patients should be advised about the risk of contracting *C. parvum* from young pets, calves, lambs and all animals with diarrhea. Ingestion of surface water from lakes or rivers should be avoided, and patients should be aware of the risk of swimming in public pools shared by diapered children. Patients who are infected should avoid recreational swimming to prevent inadvertent contamination of pools. No good data exist to recommend that immunocompromised patients avoid tap water or use bottled or filtered water.

The thick wall of the *C. parvum* oocysts permits survival for many months in the environment. Most disinfectants at usual dilutions do not kill oocysts. Chlorination at normal dilutions (usually kept at 1 ppm by water utilities) is insufficient, particularly when there is fecal contamination (Carpenter *et al.*, 1999). A chlorine concentration of 80 ppm for 2 hours is necessary for oocyst death (Korich *et al.*, 1990). Oocysts can be killed by 50% ammonia, 10% formalin, exposure to temperatures over 60°C (or by boiling water for 1 minute, regardless of the altitude) or less than -20°C for over 30 minutes. They can be successfully filtered through an 'absolute'  $\leq 1 \mu\text{m}$  filter or smaller. Filters must meet National Science Foundation (NSF) standard No. 53 for cyst removal. 'Nominal' 1  $\mu\text{m}$  filters will not remove all oocysts (USPHS/IDSA Prevention of Opportunistic Infections Working Group, 2000). It should be noted that 'point-of-use' submission personal filters substantially reduced the risk of diarrhea in the 1993 Milwaukee outbreak and should be advised in any outbreak setting (Addiss *et al.*, 1996).

The difficulty of eliminating *C. parvum* from public drinking water is an important public health problem. Standard tests of water purity have focused on the bacterial coliform count, which does not assess protozoal contamination. Data demonstrate that *C. parvum* oocysts are present in the majority of surface waters in the USA (LeChevallier *et al.*, 1991b). Protected deep water sources, such as wells, are generally thought to be free from exposure to oocysts. Municipal water supply treatment typically involves three steps; coagulation of raw water with chemicals such as alum and ferric chloride, sedimentation and filtration. Used together, these modalities have the potential to remove up to 99% of oocysts, but backwash of the filter system may allow reflux of oocysts and was thought to play a role in the Milwaukee outbreak of cryptosporidiosis in 1993 (MacKenzie *et al.*, 1994). It is important to note that, although chlorination is routine, filtration of public water supplies is not mandated in the USA (e.g. New York City water is not filtered). In fully disinfected and filtered water, *C. parvum* oocysts have been shown to breach filters in up to 54% of communities although the actual percentage contaminated with infectious oocysts may be considerably less

(Di Giovanni *et al.*, 1999; LeChevallier *et al.*, 1991a). To begin to resolve the issues regarding the contribution of various types of water supplies to public health, a double-blind study funded by the Centers for Disease Control and Prevention is under way to assess the impact of ultraviolet light and filters on endemic diarrheal disease rates.

Bottled water should not be assumed to be free of oocysts. Few regulations exist to assure the quality or treatment of bottled water. Brands obtained from deep wells or springs are likely to be safest. Vendors should be individually questioned regarding the treatment of their product. This is particularly true for bottled products obtained in developing countries. If the water is treated by reverse osmosis or distillation, or filtered using an absolute  $\leq 1 \mu\text{m}$  filter, elimination of *C. parvum* oocysts is expected.

## FUTURE CHALLENGES

Many aspects of cryptosporidiosis remain poorly defined. Critical areas for future investigation include: (a) the need to define specific virulence traits of *C. parvum*; (b) the development of techniques permitting studies of the human genotype of *C. parvum*; (c) studies to better understand the impact of this parasite on the immediate and long-term health of children, particularly in the developing world; (d) investigations to understand the mechanisms by which *C. parvum* infects and alters the biology and physiology of the intestinal epithelium; and (e) research to identify unique parasite or host targets for the development of specific effective therapies for this potentially devastating infection. Current *in vitro* and *in vivo* models of disease, including experimental infections of healthy human volunteers, have yielded important data illustrating the complexity of this infection. However, future prospective studies in critically affected populations, particularly HIV-infected and -uninfected populations in developing countries, where infection rates may approach 100% early in life, will be essential to unraveling the pathogenesis of this disease and to the development of effective therapies.

## ISOSPORIASIS

### HISTORY

Attention was first clearly drawn to human infection with *Isospora belli* in 1915, during evaluations of diarrheal illnesses in military personnel participating in hostilities in the Near East including Gallipoli (Ledingham *et al.*, 1915; Wenyon, 1915). These authors noted that the excreted stool form of the parasite was immature and developed over the subsequent 3–4 days into a mature oocyst containing two sporocysts, each containing four sporozoites. These observations were accurate and consistent with our understanding of this parasite today.

### DESCRIPTION OF THE ORGANISM

*Isospora* spp. are host-specific coccidian protozoan parasites of the phylum Apicomplexa and are related to *Cryptosporidium* spp. The clinically important human *Isospora* sp. is *Isospora belli*. Similar to *Cryptosporidium* spp., *I. belli* undergoes both asexual and sexual development in the intestinal epithelial cell, with excretion by the host of oocysts 1–2 weeks after initial ingestion of the parasite. Unlike *Cryptosporidium* spp., *I. belli* invades the host cell cytoplasm (i.e. is not restricted to the apical surface of the cells, as in *Cryptosporidium* spp.) and the excreted oocysts are typically not fully sporulated and, thus, not immediately infective for man (Brandborg *et al.*, 1970; Henderson *et al.*, 1963; Ledingham *et al.*, 1915; Trier *et al.*, 1974; Wenyon, 1915). The speed of sporulation of the excreted oocysts appears to be dependent on environmental conditions. Given the need in most cases for maturation of the oocysts outside the human host, amplification of the infection in man (i.e. 'autoinfection', as occurs in *C. parvum* infections) is not thought to occur. Occasionally, just prior to termination of infection or in protracted infections, fully sporulated oocysts have been observed in both duodenal fluid and stool (Brandborg *et al.*, 1970; Henderson *et al.*, 1963).

### PATHOGENESIS AND IMMUNOLOGY

Neither the pathogenesis nor the immunology of human isosporiasis has received any experimental

attention, although studies of individual patients have afforded some insight into the impact of this infection on the intestinal epithelium (Brandborg *et al.*, 1970; Soave and Johnson, 1988; Trier *et al.*, 1974). Intestinal biopsies, often performed in protracted or refractory infections, have revealed a flattened mucosa with shortened villi and hypertrophic crypts. The parasite developmental stages are found predominantly within the epithelial cells and rarely in the lamina propria or submucosa. The reported inflammatory response in the lamina propria may be mixed, consisting of mononuclear cells (lymphocytes, plasma cells), polymorphonuclear leukocytes and often eosinophils. Consistent with these observations, malabsorption of fat, protein, sugar and vitamin B<sub>12</sub> have been reported.

### EPIDEMIOLOGY

Humans are the only recognized source of *I. belli* infection and, thus, unlike cryptosporidiosis, isosporiasis is not a zoonotic infection (Kirkpatrick, 1988). Given the usual need for sporulation of the oocysts of *I. belli* outside the human host, *I. belli* is believed to be transmitted primarily by contaminated food or water. Person-to-person spread through oral–anal contact in individuals with AIDS has been suggested (DeHovitz *et al.*, 1986; Forthal and Guest, 1984; Ma and Soave, 1983).

*I. belli* is reported more commonly from tropical and subtropical areas of the world, but its true prevalence is unknown (Faust *et al.*, 1961; Hunter *et al.*, 1992; Soave and Johnson, 1988). In recent years, more attention has been drawn to this parasitic infection because of the recognition that it was a relatively common and treatable cause of persistent or chronic diarrhea in patients with AIDS living outside the USA (DeHovitz *et al.*, 1986; Pape *et al.*, 1989). In the USA, < 0.2% of patients with AIDS have been recognized to have *I. belli* infection, whereas this infection is identified in approximately 15–20% of patients with chronic diarrhea and AIDS from, for example, Haiti, Zambia, Uganda and the Democratic Republic of Congo (formerly Zaire [1971–1997]) (Colebunders *et al.*, 1988; Conlon

*et al.*, 1990; Henry *et al.*, 1986; Hunter *et al.*, 1992; Sewankambo *et al.*, 1987; Soave and Johnson, 1988). *I. belli* infection is recognized as a cause of acute, persistent (> 14–30 days) or chronic (> 30 days) diarrhea in travelers (Godwala and Yaeger, 1987; Shaffer and Moore, 1989). Occasional institution-based epidemics of *I. belli* infection have been reported suggesting that nosocomial spread or spread within daycare centers is feasible (Henderson *et al.*, 1963).

## CLINICAL FEATURES

In both immunocompetent and immunocompromised hosts, a non-specific watery diarrheal illness accompanied by abdominal cramps, nausea, malaise, anorexia and weight loss is the most common presentation of *I. belli* infection. Most infections in immunocompetent individuals are expected to be short-lived, whereas individuals with defects in cell-mediated immunity, such as AIDS, are predominantly reported to experience chronic diarrheal illnesses (DeHovitz *et al.*, 1986; Forthal and Guest, 1984; Whiteside *et al.*, 1984). However, the illness may be severe, resulting in dehydration. Up to 6 liters of stool output has been reported in an apparent immunocompetent host (Brandborg *et al.*, 1970). This general pattern of illness makes this infection clinically indistinguishable from *C. parvum* infection. One of the notable features of *I. belli* infection is the ability of the parasite to cause strikingly protracted illnesses in immunocompetent hosts (Brandborg *et al.*, 1970; Shaffer and Moore, 1989; Trier *et al.*, 1974). Intermittent diarrheal illnesses of several months to possibly years in duration have been reported in immunocompetent individuals, including travelers. Dysentery or high fevers are not features of *I. belli* infection but, as indicated above, malabsorption is likely. Extraintestinal dissemination of infection has been reported in an AIDS patient (Restrepo *et al.*, 1987).

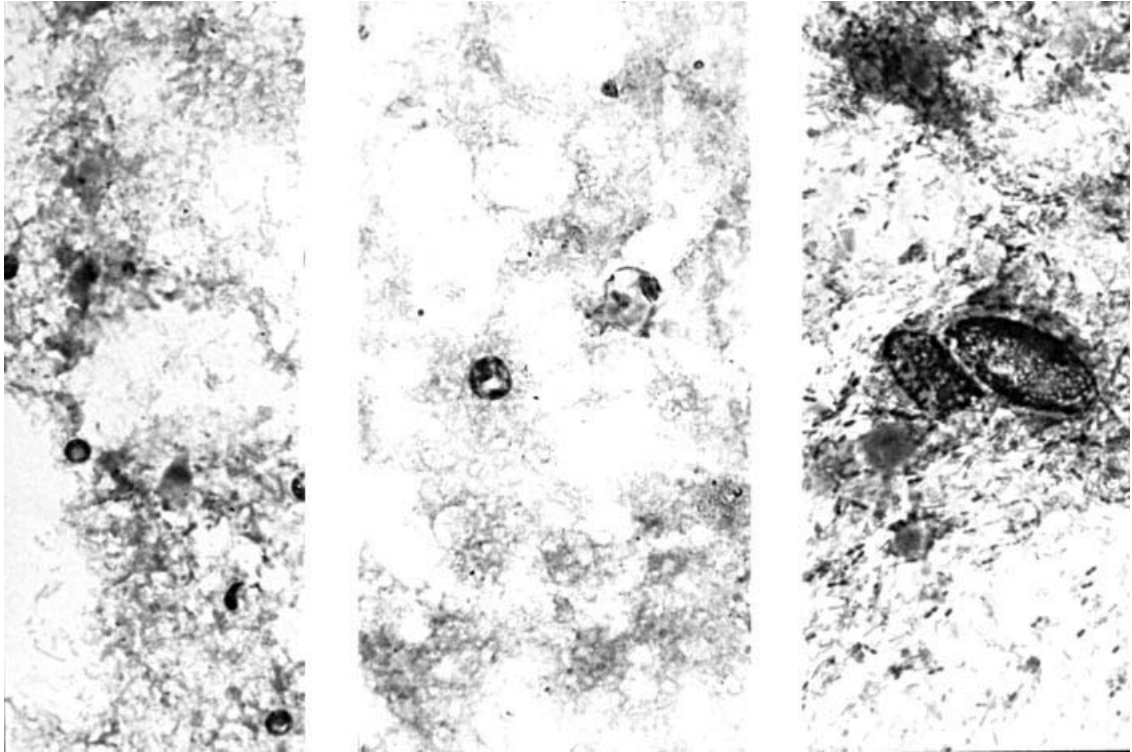
## LABORATORY DIAGNOSIS

Diagnosis of *I. belli* infection is dependent upon stool examination to identify the oocysts of this parasite. Since oocyst excretion may be

intermittent, stool concentration and examination of multiple stools are advised to improve diagnostic sensitivity. The optimum number of stools necessary to establish a diagnosis is unknown, but examination of two unconcentrated stools had a diagnostic sensitivity of approximately 80% in AIDS patients (Pape *et al.*, 1989). Similar to *C. parvum*, *I. belli* oocysts are acid-fast and will be detected using the rhodamine–auramine stain (Ma and Soave, 1983; Ng *et al.*, 1984). The distinct morphology of *I. belli* oocysts permits them to be readily distinguished from either *C. parvum* or *Cyclospora cayetanensis* oocysts (Figure 6.4). Typically, the excreted unsporulated *I. belli* oocysts contain two sporoblasts. *I. belli* oocysts do not stain with hematoxylin, trichrome or iodine. In the absence of effective antibiotic treatment, oocyst excretion post-infection can be very protracted, often lasting 1–2 months with as long as 4 months reported (Henderson *et al.*, 1963). The developmental stages of the parasite can be demonstrated in the epithelium of small bowel biopsies but this should only rarely be necessary for diagnosis (Brandborg *et al.*, 1970; Trier *et al.*, 1974). Neither fecal leukocytes nor blood are clearly reported in stools of patients infected with *I. belli*, although sensitive (but non-specific) assays for intestinal inflammation, such as the fecal lactoferrin test, have not been evaluated (DeHovitz *et al.*, 1986; Matsubayashi and Nozawa, 1948; Soave and Johnson, 1988). A notable feature of *I. belli* infection is its propensity to stimulate an eosinophilic response in the lamina propria, with concomitant Charcot–Leyden crystals detectable in stool samples. In addition, mild to moderate systemic eosinophilia in the absence of leukocytosis is commonly reported, although not always clearly attributable to *I. belli* infection (Brandborg *et al.*, 1970; Matsubayashi and Nozawa, 1948; Trier *et al.*, 1974).

## CLINICAL MANAGEMENT

Similar to *C. parvum* infection, the cornerstone of management is maintaining adequate hydration orally or, if clinically indicated, parenterally in *I. belli* infection. However, unlike *C. parvum*



**Fig. 6.4** Acid-fast stain of stool containing *Cryptosporidium parvum*, *Cyclospora cayetanensis* and *Isospora belli*. This figure illustrates the morphology and size differences between the oocysts of *C. parvum* (~ 5  $\mu$ m, left panel), *C. cayetanensis* (~ 8–10  $\mu$ m, middle panel) and *I. belli* (~ 10–19  $\times$  20–30  $\mu$ m, right panel). Magnification,  $\times$  400

infection, *I. belli* infection is rapidly responsive to appropriate antimicrobial therapy, as was first reported by Trier *et al.* (1974). The drug of choice is trimethoprim–sulfamethoxazole. Treatment with trimethoprim–sulfamethoxazole leads to resolution of diarrhea on average in 2 days, with a range of 1–6 days even in immunocompromised hosts (including AIDS patients), and is associated with the disappearance of fecal oocysts (DeHovitz *et al.*, 1986; Pape *et al.*, 1989; Verdier *et al.*, 2000; Westerman and Christensen, 1979). Although more intensive regimens were originally studied (DeHovitz *et al.*, 1986; Pape *et al.*, 1989), the infection appears to respond promptly in AIDS patients to trimethoprim–sulfamethoxazole 160 mg/800 mg twice daily for 7 days (Verdier *et al.*, 2000). Since approximately 50% of AIDS patients have been reported to relapse after a mean of 8 weeks (range 2–20 weeks) once therapy is discontinued (DeHovitz *et al.*, 1986), subsequent suppressive therapy with

trimethoprim–sulfamethoxazole 160 mg/800 mg three times a week is suggested for AIDS patients and possibly other persistently immunocompromised hosts (Verdier *et al.*, 2000). Of note, however, relapses respond promptly to reinstitution of treatment. A recent study suggests that ciprofloxacin (500 mg twice daily for 7 days) may be an acceptable alternative in patients who do not tolerate trimethoprim–sulfamethoxazole (Verdier *et al.*, 2000). Anecdotal reports suggest that *I. belli* may respond to treatment with pyrimethamine and sulfadiazine, sulfadoxine–pyrimethamine (Fansidar<sup>®</sup>) or macrolides such as roxithromycin (Musey *et al.*, 1988; Trier *et al.*, 1974; Weiss *et al.*, 1988).

## PREVENTION AND CONTROL

Similar to *C. parvum*, the oocysts of *I. belli* are hardy and resistant to many disinfectants, with a

propensity to survive for months in the environment under moist, cool conditions. Studies to demonstrate methods to kill *I. belli* oocysts are not reported. However, it seems reasonable to utilize the approaches tested for inactivation of *C. parvum* oocysts.

## REFERENCES

- Adams RB, Guerrant RL, Zu S, Fang G, Roche JK (1994). *Cryptosporidium parvum* infection of intestinal epithelium: morphologic and functional studies in an *in vitro* model. *J Infect Dis* **169**: 170–77.
- Addiss DG, Pond RS, Remshak M *et al.* (1996). Reduction of risk of watery diarrhea with point-of-use water filters during a massive outbreak of waterborne *Cryptosporidium* infection in Milwaukee, Wisconsin, 1993. *Am J Trop Med Hyg* **54**: 549–53.
- Agnew DG, Lima AA, Newman RD *et al.* (1998). Cryptosporidiosis in northeastern Brazilian children: association with increased diarrhea morbidity. *J Infect Dis* **177**: 754–60.
- Aguirre SA, Mason PH, Perryman LE (1994). Susceptibility of major histocompatibility complex (MHC) class II. *Infect Immun* **62**: 697–9.
- Aguirre SA, Perryman LE, Davis WC, McGuire TC (1998). IL-4 protects adult C57BL/6 mice from prolonged *Cryptosporidium parvum* infection: analysis of CD4<sup>+</sup>  $\alpha\beta$ <sup>+</sup> IFN- $\gamma$ <sup>+</sup> and CD4<sup>+</sup>  $\alpha\beta$ <sup>+</sup> IL-4<sup>+</sup> lymphocytes in gut-associated lymphoid tissue during resolution of infection. *J Immunol* **161**: 1891–1900.
- Argenzio RA, Armstrong M, Blikslager A, Rhoads JM (1997). Peptide YY inhibits intestinal Cl<sup>-</sup> secretion in experimental porcine cryptosporidiosis through a prostaglandin-activated neural pathway. *J Pharmacol Exp Ther* **283**: 692–7.
- Argenzio RA, Armstrong M, Rhoads JM (1996). Role of the enteric nervous system in piglet cryptosporidiosis. *J Pharmacol Exp Ther* **279**: 1109–15.
- Argenzio RA, Lecce J, Powell DW (1993). Prostanoids inhibit intestinal NaCl absorption in experimental porcine cryptosporidiosis. *Gastroenterology* **104**: 440–47.
- Argenzio RA, Liacos JA, Levy ML *et al.* (1990). Villous atrophy, crypt hyperplasia, cellular infiltration, and impaired glucose–Na absorption in enteric cryptosporidiosis of pigs. *Gastroenterology* **98**: 1129–40.
- Argenzio RA, Rhoads JM, Armstrong M, Gomez G (1994). Glutamine stimulates prostaglandin-sensitive Na<sup>+</sup>–H<sup>+</sup> exchange in experimental porcine cryptosporidiosis. *Gastroenterology* **106**: 1418–28.
- Avery ME, Snyder JD (1990). Oral therapy for acute diarrhea. The underused simple solution. *N Engl J Med* **323**: 891–4.
- Balatbat AB, Jordan GW, Tang YJ, Silva J Jr (1996). Detection of *Cryptosporidium parvum* DNA in human feces by nested PCR. *J Clin Microbiol* **34**: 1769–72.
- Benhamou Y, Kapel N, Hoang C *et al.* (1995). Inefficacy of intestinal secretory immune response to *Cryptosporidium* in acquired immunodeficiency syndrome. *Gastroenterology* **108**: 627–35.
- Bjorneby JM, Riggs MW, Perryman LE (1990). *Cryptosporidium parvum* merozoites share neutralization-sensitive epitopes with sporozoites. *J Immunol* **145**: 298–304.
- Blagburn BL, Drain KL, Land TM (1998). Comparative efficacy evaluation of dicationic carbazole compounds, nitazoxanide, and paromomycin against *Cryptosporidium parvum* infections in a neonatal mouse model. *Antimicrob Agents Chemother* **42**: 2877–82.
- Blanshard C, Jackson AM, Shanson DC, Francis N, Gazzard BG (1992). Cryptosporidiosis in HIV-seropositive patients. *Q J Med* **85**: 813–23.
- Bonnin A, Fourmaux MN, Dubremetz JF *et al.* (1996). Genotyping human and bovine isolates of *Cryptosporidium parvum* by polymerase chain reaction–restriction fragment length polymorphism analysis of a repetitive DNA sequence. *FEMS Microbiol Lett* **137**: 207–11.
- Brandborg LL, Goldberg SB, Breidenbach WC (1970). Human coccidiosis—a possible cause of malabsorption. *N Engl J Med* **283**: 1306–13.
- Carpenter C, Fayer R, Trout J, Beach MJ (1999). Chlorine disinfection of recreational water for *Cryptosporidium parvum*. *Emerg Infect Dis* **5**: 579–84.
- Carr A, Marriott D, Field A, Vasak E, Cooper DA (1998). Treatment of HIV-1-associated microsporidiosis and cryptosporidiosis with combination antiretroviral therapy. *Lancet* **351**: 256–61.
- Carraway M, Tzipori S, Widmer G (1996). Identification of genetic heterogeneity in the *Cryptosporidium parvum* ribosomal repeat. *Appl Environ Microbiol* **62**: 712–16.
- Carraway M, Tzipori S, Widmer G (1997). A new restriction fragment length polymorphism from *Cryptosporidium parvum* identifies genetically heterogeneous parasite populations and genotypic changes following transmission from bovine to human hosts. *Infect Immun* **65**: 3958–60.
- Chacin-Bonilla L, Bonilla MC, Soto-Torres L *et al.* (1997). *Cryptosporidium parvum* in children with diarrhea in Zulia State, Venezuela. *Am J Trop Med Hyg* **56**: 365–9.
- Chappell CL, Okhuysen PC, Sterling CR, DuPont HL (1996). *Cryptosporidium parvum*: intensity of infection and oocyst excretion patterns in healthy volunteers. *J Infect Dis* **173**: 232–6.
- Chappell CL, Okhuysen PC, Sterling CR *et al.* (1999). Infectivity of *Cryptosporidium parvum* in healthy adults with pre-existing anti-*C. parvum* serum immunoglobulin G. *Am J Trop Med Hyg* **60**: 157–64.
- Checkley W, Epstein LD, Gilman RH *et al.* (1998). Effects of *Cryptosporidium parvum* infection in Peruvian children: growth faltering and subsequent catch-up growth. *Am J Epidemiol* **148**: 497–506.
- Checkley W, Gilman RH, Epstein LD *et al.* (1997). Asymptomatic and symptomatic cryptosporidiosis: their acute effect on weight gain in Peruvian children. *Am J Epidemiol* **145**: 156–63.
- Chen XM, LaRusso NF (2000). Mechanisms of attachment and internalization of *Cryptosporidium parvum* to biliary and intestinal epithelial cells. *Gastroenterology* **118**: 368–79.
- Chen XM, Levine SA, Tietz P *et al.* (1998). *Cryptosporidium parvum* is cytopathic for cultured human biliary epithelia

- via an apoptotic mechanism [see comments]. *Hepatology* **28**: 906–13.
- Cicirello HG, Kehl KS, Addiss DG *et al.* (1997). Cryptosporidiosis in children during a massive waterborne outbreak in Milwaukee, Wisconsin: clinical, laboratory and epidemiologic findings. *Epidemiol Infect* **119**: 53–60.
- Clark DP (1999). New insights into human cryptosporidiosis. *Clin Microbiol Rev* **12**: 554–63.
- Clark DP, Sears CL (1996). The pathogenesis of cryptosporidiosis. *Parasitol Today* **12**: 221–5.
- Colebunders R, Lusakumuni K, Nelson AM *et al.* (1988). Persistent diarrhoea in Zairian AIDS patients: an endoscopic and histological study. *Gut* **29**: 1687–91.
- Colford JM Jr, Tager IB, Hirozawa AM *et al.* (1996). Cryptosporidiosis among patients infected with human immunodeficiency virus. Factors related to symptomatic infection and survival [see comments]. *Am J Epidemiol* **144**: 807–16.
- Conlon CP, Pinching AJ, Perera CU *et al.* (1990). HIV-related enteropathy in Zambia: a clinical, microbiological, and histological study. *Am J Trop Med Hyg* **42**: 83–8.
- Cosyns M, Tsirkin S, Jones M *et al.* (1998). Requirement of CD40–CD40 ligand interaction for elimination of *Cryptosporidium parvum* from mice. *Infect Immun* **66**: 603–7.
- Crabb JH (1998). Antibody-based immunotherapy of cryptosporidiosis. *Adv Parasitol* **40**: 122–51.
- Current WL (1990). Techniques and laboratory maintenance of *Cryptosporidium*. In Dubey JP, Speer CA, Fayer R (eds), *Cryptosporidiosis of Man and Animals*. CRC Press: Boca Raton, FL; 31–50.
- Current WL, Haynes TB (1984). Complete development of *Cryptosporidium* in cell culture. *Science* **224**: 603–5.
- Current WL, Reese NC, Ernst JV *et al.* (1983). Human cryptosporidiosis in immunocompetent and immunodeficient persons. Studies of an outbreak and experimental transmission. *N Engl J Med* **308**: 1252–7.
- Current WL, Upton SJ, Haynes TB (1986). The life cycle of *Cryptosporidium baileyi* n. sp. (Apicomplexa, Cryptosporidiidae) infecting chickens. *J Protozool* **33**: 289–96.
- DeHovitz JA, Pape JW, Boney M, Johnson WD Jr (1986). Clinical manifestations and therapy of *Isospora belli* infection in patients with the acquired immunodeficiency syndrome. *N Engl J Med* **315**: 87–90.
- Deng MQ, Cliver DO (2000). Comparative detection of *Cryptosporidium parvum* oocysts from apple juice [in process citation]. *Int J Food Microbiol* **54**: 155–62.
- Di Giovanni GD, Hashemi FH, Shaw NJ *et al.* (1999). Detection of infectious *Cryptosporidium parvum* oocysts in surface and filter backwash water samples by immunomagnetic separation and integrated cell culture-PCR. *Appl Environ Microbiol* **65**: 3427–32.
- DuPont HL, Chappell CL, Sterling CR *et al.* (1995). The infectivity of *Cryptosporidium parvum* in healthy volunteers. *N Engl J Med* **332**: 855–9.
- Elliot BC, Wisniewski AV, Johnson J *et al.* (1997). *In vitro* inhibition of *Cryptosporidium parvum* infection by human monoclonal antibodies. *Infect Immun* **65**: 3933–5.
- Elliott DA, Clark DP (2000). *Cryptosporidium parvum* induces host cell actin accumulation at the host–parasite interface. *Infect Immun* **68**: 2315–22.
- Esteban JG, Aguirre C, Flores A *et al.* (1998). High *Cryptosporidium* prevalences in healthy Aymara children from the northern Bolivian Altiplano. *Am J Trop Med Hyg* **58**: 50–55.
- Faust EC, Giraldo LE, Caicedo G, Bonfante R (1961). Human isosporiasis in the western hemisphere. *Am J Trop Med Hyg* **10**: 343–9.
- Fayer R, Andrews C, Ungar BL, Blagburn B (1989). Efficacy of hyperimmune bovine colostrum for prophylaxis of cryptosporidiosis in neonatal calves. *J Parasitol* **75**: 393–7.
- Fayer R, Perryman LE, Riggs MW (1989). Hyperimmune bovine colostrum neutralizes *Cryptosporidium* sporozoites and protects mice against oocyst challenge. *J Parasitol* **75**: 151–3.
- Fayer R, Speer CA, Dubey JP (2000). General biology of *Cryptosporidium*. In Dubey JP, Speer CA, Fayer R (eds), *Cryptosporidiosis of Man and Animals*. CRC Press: Boca Raton, FL; 1–29.
- Fayer R, Ungar BL (1986). *Cryptosporidium* spp. and cryptosporidiosis. *Microbiol Rev* **50**: 458–83.
- Flanigan T, Whalen C, Turner J *et al.* (1992). *Cryptosporidium* infection and CD4 counts. *Ann Intern Med* **116**: 840–42.
- Forney JR, DeWald DB, Yang S, Speer CA, Healey MC (1999). A role for host phosphoinositide 3-kinase and cytoskeletal remodeling during *Cryptosporidium parvum* infection. *Infect Immun* **67**: 844–52.
- Forthal DN, Guest SS (1984). *Isospora belli* enteritis in three homosexual men. *Am J Trop Med Hyg* **33**: 1060–64.
- Fricker CR, Crabb JH (1998). Water-borne cryptosporidiosis: detection methods and treatment options. *Adv Parasitol* **40**: 242–78.
- Genta RM, Chappell CL, White AC Jr, Kimball KT, Goodgame RW (1993). Duodenal morphology and intensity of infection in AIDS-related intestinal cryptosporidiosis. *Gastroenterology* **105**: 1769–75.
- Godiwala T, Yaeger R (1987). *Isospora* and traveler's diarrhea [letter]. *Ann Intern Med* **106**: 908–9.
- Goldstein ST, Juranek DD, Ravenholt O *et al.* (1996). Cryptosporidiosis: an outbreak associated with drinking water despite state-of-the-art water treatment [published erratum appears in *Ann Intern Med* 1996, Jul 15; **125**(2): 158]. *Ann Intern Med* **124**: 459–68.
- Gomez Morales MA, Ausiello CM, Urbani F, Pozio E (1995). Crude extract and recombinant protein of *Cryptosporidium parvum* oocysts induce proliferation of human peripheral blood mononuclear cells *in vitro*. *J Infect Dis* **172**: 211–16.
- Gomez Morales MA, La Rosa G, Ludovisi A, Onori AM, Pozio E (1999). Cytokine profile induced by *Cryptosporidium* antigen in peripheral blood mononuclear cells from immunocompetent and immunosuppressed persons with cryptosporidiosis. *J Infect Dis* **179**: 967–73.
- Goodgame RW, Genta RM, White AC, Chappell CL (1993). Intensity of infection in AIDS-associated cryptosporidiosis. *J Infect Dis* **167**: 704–9.
- Goodgame RW, Kimball K, Ou CN *et al.* (1995). Intestinal dysfunction and injury in acquired immunodeficiency syndrome-related cryptosporidiosis. *Gastroenterology* **108**: 1075–82.



- Greenon JK, Belitsos PC, Yardley JH, Bartlett JG (1991). AIDS enteropathy: occult enteric infections and duodenal mucosal alterations in chronic diarrhea [see comments]. *Ann Intern Med* **114**: 366–72.
- Griffiths JK (1998). Human cryptosporidiosis: epidemiology, transmission, clinical disease, treatment and diagnosis. *Adv Parasitol* **40**: 38–87.
- Griffiths JK, Balakrishnan R, Widmer G, Tzipori S (1998a). Paromomycin and geneticin inhibit intracellular *Cryptosporidium parvum* without trafficking through the host cell cytoplasm: implications for drug delivery. *Infect Immun* **66**: 3874–83.
- Griffiths JK, Moore R, Dooley S, Keusch GT, Tzipori S (1994). *Cryptosporidium parvum* infection of Caco-2 cell monolayers induces an apical monolayer defect, selectively increases transmonolayer permeability, and causes epithelial cell death. *Infect Immun* **62**: 4506–14.
- Griffiths JK, Theodos C, Paris M, Tzipori S (1998b). The gamma interferon gene knockout mouse: a highly sensitive model for evaluation of therapeutic agents against *Cryptosporidium parvum*. *J Clin Microbiol* **36**: 2503–8.
- Guarino A, Canani RB, Casola A *et al.* (1995). Human intestinal cryptosporidiosis: secretory diarrhea and enterotoxic activity in Caco-2 cells. *J Infect Dis* **171**: 976–83.
- Guarino A, Canani RB, Pozio E, Terracciano L, Albano F, Mazzeo M (1994). Enterotoxic effect of stool supernatant of *Cryptosporidium*-infected calves on human jejunum [see comments]. *Gastroenterology* **106**: 28–34.
- Guerrant DI, Moore SR, Lima AA *et al.* (1999). Association of early childhood diarrhea and cryptosporidiosis with impaired physical fitness and cognitive function 4–7 years later in a poor urban community in north-east Brazil. *Am J Trop Med Hyg* **61**: 707–13.
- Guerrant RL (1997). Cryptosporidiosis: an emerging, highly infectious threat. *Emerg Infect Dis* **3**: 51–7.
- Harp JA, Chen W, Harmsen AG (1992). Resistance of severe combined immunodeficient mice to infection with *Cryptosporidium parvum*: the importance of intestinal microflora. *Infect Immun* **60**: 3509–12.
- Hashmey R, Smith NH, Cron S *et al.* (1997). Cryptosporidiosis in Houston, Texas. A report of 95 cases. *Medicine (Baltimore)* **76**: 118–39.
- Heine J, Moon HW, Woodmansee DB (1984). Persistent *Cryptosporidium* infection in congenitally athymic (nude) mice. *Infect Immun* **43**: 856–9.
- Henderson HE, Gillespie GW, Kaplan P, Steber M (1963). The human *Isospora*. *Am J Hygiene* **78**: 302–9.
- Henry MC, De Clercq D, Lokombe B *et al.* (1986). Parasitological observations of chronic diarrhoea in suspected AIDS adult patients in Kinshasa (Zaire). *Trans R Soc Trop Med Hyg* **80**: 309–10.
- Heyworth MF (1992). Immunology of *Giardia* and *Cryptosporidium* infections. *J Infect Dis* **166**: 465–72.
- Holmberg SD, Moorman AC, Von Bargen JC *et al.* (1998). Possible effectiveness of clarithromycin and rifabutin for cryptosporidiosis chemoprophylaxis in HIV disease. HIV Outpatient Study (HOPS) Investigators. *J Am Med Assoc* **279**: 384–6.
- Hunter G, Bagshawe AF, Baboo KS, Luke R, Procriv P (1992). Intestinal parasites in Zambian patients with AIDS. *Trans R Soc Trop Med Hyg* **86**: 543–5.
- ISSI Consulting Group (1999). *Cryptosporidium spp. Systematics and Waterborne Challenges in Public Health*. Summary Report, EPA Office of Water, April 29–30.
- Janoff EN, Mead PS, Mead JR *et al.* (1990). Endemic *Cryptosporidium* and *Giardia lamblia* infections in a Thai orphanage. *Am J Trop Med Hyg* **43**: 248–56.
- Joe A, Hamer DH, Kelley MA *et al.* (1994). Role of a Gal/GalNAc-specific sporozoite surface lectin in *Cryptosporidium parvum*-host cell interaction. *J Eukaryot Microbiol* **41**: 44S.
- Joe A, Verdon R, Tzipori S, Keusch GT, Ward HD (1998). Attachment of *Cryptosporidium parvum* sporozoites to human intestinal epithelial cells. *Infect Immun* **66**: 3429–32.
- Kandil HM, Berschneider HM, Argenzio RA (1994). Tumour necrosis factor alpha changes porcine intestinal ion transport through a paracrine mechanism involving prostaglandins. *Gut* **35**: 934–40.
- Kapel N, Huneau JF, Magne D, Tome D, Gobert JG (1997). Cryptosporidiosis-induced impairment of ion transport and Na<sup>+</sup>-glucose absorption in adult immunocompromised mice. *J Infect Dis* **176**: 834–7.
- Kassa M, Comby E, Lemeteil D, Brasseur P, Ballet JJ (1991). Characterization of anti-*Cryptosporidium* IgA antibodies in sera from immunocompetent individuals and HIV-infected patients. *J Protozool* **38**: 179S–80S.
- Kirkpatrick CE (1988). Animal reservoirs of *Cryptosporidium* spp. and *Isospora belli* [letter]. *J Infect Dis* **158**: 909–10.
- Koch KL, Phillips DJ, Aber RC, Current WL (1985). Cryptosporidiosis in hospital personnel. Evidence for person-to-person transmission. *Ann Intern Med* **102**: 593–6.
- Korich DG, Mead JR, Madore MS, Sinclair NA, Sterling CR (1990). Effects of ozone, chlorine dioxide, chlorine, and monochloramine on *Cryptosporidium parvum* oocyst viability. *Appl Environ Microbiol* **56**: 1423–8.
- Kramer MH, Sorhage FE, Goldstein ST *et al.* (1998). First reported outbreak in the United States of cryptosporidiosis associated with a recreational lake. *Clin Infect Dis* **26**: 27–33.
- Laurent F, Eckmann L, Savidge TC *et al.* (1997). *Cryptosporidium parvum* infection of human intestinal epithelial cells induces the polarized secretion of C-X-C chemokines. *Infect Immun* **65**: 5067–73.
- Laurent F, Kagnoff MF, Savidge TC, Naciri M, Eckmann L (1998). Human intestinal epithelial cells respond to *Cryptosporidium parvum* infection with increased prostaglandin H synthase 2 expression and prostaglandin E2 and F2a production. *Infect Immun* **66**: 1787–90.
- Le M, Bissuel VF, Costagliola D *et al.* (1998). Decreased prevalence of intestinal cryptosporidiosis in HIV-infected patients concomitant to the widespread use of protease inhibitors [letter]. *AIDS* **12**: 1395–7.
- LeChevallier MW, Norton WD, Lee RG (1991a). *Giardia* and *Cryptosporidium* spp. in filtered drinking water supplies. *Appl Environ Microbiol* **57**: 2617–21.
- LeChevallier MW, Norton WD, Lee RG (1991b). Occurrence of *Giardia* and *Cryptosporidium* spp. in surface water supplies [published erratum appears in *Appl Environ Microbiol* 1992, Feb; **58**(2): 780]. *Appl Environ Microbiol* **57**: 2610–16.
- Ledingham JCG, Penfold WJ, Woodcock HM (1915). Recent bacteriological experiences with typhoidal disease and dysentery. *Br Med J* **2**: 704–11.

- Levine SA, Nath SK, Tse CM, Yun C, Donowitz M (1994). L-Glutamine in intestinal sodium absorption: lessons for physiology, pathobiology, and therapy for diarrhea. *Gastroenterology* **106**: 1698–1702.
- Lima AA, Fang G, Schorling JB *et al.* (1992). Persistent diarrhea in northeast Brazil: etiologies and interactions with malnutrition. *Acta Paediatr (Suppl)* **381**: 39–44.
- Lima AA, Moore SR, Barboza MS *et al.* (2000). Persistent diarrhea signals a critical period of increased diarrhea burdens and nutritional shortfalls: a prospective cohort study among children in north-eastern Brazil. *J Infect Dis* **181**: 1643–51.
- Lima AA, Silva TM, Gifoni AM *et al.* (1997). Mucosal injury and disruption of intestinal barrier function in HIV-infected individuals with and without diarrhea and cryptosporidiosis in north-east Brazil. *Am J Gastroenterol* **92**: 1861–6.
- Lumadue JA, Manabe YC, Moore RD *et al.* (1998). A clinicopathologic analysis of AIDS-related cryptosporidiosis. *AIDS* **12**: 2459–66.
- Ma P, Soave R (1983). Three-step stool examination for cryptosporidiosis in 10 homosexual men with protracted watery diarrhea. *J Infect Dis* **147**: 824–8.
- MacKenzie WR, Hoxie NJ, Proctor ME *et al.* (1994). A massive outbreak in Milwaukee of *Cryptosporidium* infection transmitted through the public water supply [published erratum appears in *N Engl J Med* 1994, Oct 13; **331**(15): 1035] [see comments]. *N Engl J Med* **331**: 161–7.
- MacKenzie WR, Schell WL, Blair KA *et al.* (1995). Massive outbreak of waterborne *Cryptosporidium* infection in Milwaukee, Wisconsin: recurrence of illness and risk of secondary transmission [see comments]. *Clin Infect Dis* **21**: 57–62.
- Manabe YC, Clark DP, Moore RD *et al.* (1998). Cryptosporidiosis in patients with AIDS: correlates of disease and survival. *Clin Infect Dis* **27**: 536–42.
- Matsubayashi H, Nozawa T (1948). Experimental infection of *Isospora hominis* in man. *Am J Trop Med* **28**: 633–7.
- McDonald V, Robinson HA, Kelly JP, Bancroft GJ (1996). Immunity to *Cryptosporidium muris* infection in mice is expressed through gut CD4<sup>+</sup> intraepithelial lymphocytes. *Infect Immun* **64**: 2556–62.
- McGowan I, Hawkins AS, Weller IV (1993). The natural history of cryptosporidial diarrhoea in HIV-infected patients. *AIDS* **7**: 349–54.
- Mead JR, Arrowood MJ, Healey MC, Sidwell RW (1991). Cryptosporidial infections in SCID mice reconstituted with human or murine lymphocytes. *J Protozool* **38**: 59S–61S.
- Meisel JL, Perera DR, Meligio C, Rubin CE (1976). Overwhelming watery diarrhea associated with a *Cryptosporidium* in an immunosuppressed patient. *Gastroenterology* **70**: 1156–60.
- Miao YM, Awad-El-Kariem FM, Gibbons CL, Gazzard BG (1999). Cryptosporidiosis: eradication or suppression with combination antiretroviral therapy? [letter]. *AIDS* **13**: 734–5.
- Millard PS, Gensheimer KF, Addiss DG *et al.* (1994). An outbreak of cryptosporidiosis from fresh-pressed apple cider [published erratum appears in *J Am Med Assoc* 1995, Mar 8; **273**(10): 776]. *J Am Med Assoc* **272**: 1592–6.
- Molbak K, Andersen M, Aaby P *et al.* (1997). *Cryptosporidium* infection in infancy as a cause of malnutrition: a community study from Guinea-Bissau, west Africa. *Am J Clin Nutr* **65**: 149–52.
- Molbak K, Hojlyng N, Gottschau A *et al.* (1993). Cryptosporidiosis in infancy and childhood mortality in Guinea Bissau, west Africa. *Br Med J* **307**: 417–20.
- Molbak K, Wested N, Hojlyng N *et al.* (1994). The etiology of early childhood diarrhea: a community study from Guinea-Bissau. *J Infect Dis* **169**: 581–7.
- Moore R, Tzipori S, Griffiths JK *et al.* (1995). Temporal changes in permeability and structure of piglet ileum after site-specific infection by *Cryptosporidium parvum*. *Gastroenterology* **108**: 1030–39.
- Morgan UM, Constantine CC, Forbes DA, Thompson RC (1997). Differentiation between human and animal isolates of *Cryptosporidium parvum* using rDNA sequencing and direct PCR analysis. *J Parasitol* **83**: 825–30.
- Morgan UM, Constantine CC, O'Donoghue P *et al.* (1995). Molecular characterization of *Cryptosporidium* isolates from humans and other animals using random amplified polymorphic DNA analysis. *Am J Trop Med Hyg* **52**: 559–64.
- Morgan UM, Pallant L, Dwyer BW *et al.* (1998a). Comparison of PCR and microscopy for detection of *Cryptosporidium parvum* in human fecal specimens: clinical trial. *J Clin Microbiol* **36**: 995–8.
- Morgan UM, Sargent KD, Deplazes P *et al.* (1998b). Molecular characterization of *Cryptosporidium* from various hosts. *Parasitology* **117** (1): 31–7.
- Moss DM, Chappell CL, Okhuysen PC *et al.* (1998). The antibody response to 27-, 17-, and 15-kDa *Cryptosporidium* antigens following experimental infection in humans. *J Infect Dis* **178**: 827–33.
- Musey KL, Chidiac C, Beaucaire G, Houriez S, Fourrier A (1988). Effectiveness of roxithromycin for treating *Isospora belli* infection [letter]. *J Infect Dis* **158**: 646.
- Navin TR, Weber R, Vugia DJ *et al.* (1999). Declining CD4<sup>+</sup> T-lymphocyte counts are associated with increased risk of enteric parasitosis and chronic diarrhea: results of a 3-year longitudinal study. *J Acquir Immune Defic Syndr Hum Retrovirol* **20**: 154–9.
- Nchito M, Kelly P, Sianongo S *et al.* (1998). Cryptosporidiosis in urban Zambian children: an analysis of risk factors. *Am J Trop Med Hyg* **59**: 435–7.
- Newman RD, Sears CL, Moore SR *et al.* (1999). Longitudinal study of *Cryptosporidium* infection in children in north-eastern Brazil. *J Infect Dis* **180**: 167–75.
- Newman RD, Zu SX, Wuhib T *et al.* (1994). Household epidemiology of *Cryptosporidium parvum* infection in an urban community in north-east Brazil [see comments]. *Ann Intern Med* **120**: 500–505.
- Ng E, Markell EK, Fleming RL, Fried M (1984). Demonstration of *Isospora belli* by acid-fast stain in a patient with acquired immune deficiency syndrome. *J Clin Microbiol* **20**: 384–6.
- Nime FA, Burek JD, Page DL, Holscher MA, Yardley JH (1976). Acute enterocolitis in a human being infected with the protozoan *Cryptosporidium*. *Gastroenterology* **70**: 592–8.

- Nord J, Ma P, DiJohn D, Tzipori S, Tacket CO (1990). Treatment with bovine hyperimmune colostrum of cryptosporidial diarrhea in AIDS patients. *AIDS* **4**: 581–4.
- Okhuysen PC, Chappell CL, Crabb J *et al.* (1998). Prophylactic effect of bovine anti-*Cryptosporidium* hyperimmune colostrum immunoglobulin in healthy volunteers challenged with *Cryptosporidium parvum*. *Clin Infect Dis* **26**: 1324–9.
- Okhuysen PC, Chappell CL, Crabb JH, Sterling CR, DuPont HL (1999). Virulence of three distinct *Cryptosporidium parvum* isolates for healthy adults. *J Infect Dis* **180**: 1275–81.
- Okhuysen PC, Chappell CL, Sterling CR, Jakubowski W, DuPont HL (1998). Susceptibility and serologic response of healthy adults to reinfection with *Cryptosporidium parvum*. *Infect Immun* **66**: 441–3.
- Pape JW, Verdier RI, Johnson WD Jr (1989). Treatment and prophylaxis of *Isospora belli* infection in patients with the acquired immunodeficiency syndrome [see comments]. *N Engl J Med* **320**: 1044–7.
- Peng MM, Xiao L, Freeman AR *et al.* (1997). Genetic polymorphism among *Cryptosporidium parvum* isolates: evidence of two distinct human transmission cycles. *Emerg Infect Dis* **3**: 567–73.
- Perkins ME, Riojas YA, Wu TW, Le Blancq SM (1999). CpABC, a *Cryptosporidium parvum* ATP-binding cassette protein at the host-parasite boundary in intracellular stages. *Proc Natl Acad Sci USA* **96**: 5734–9.
- Petersen C (1992). Cryptosporidiosis in patients infected with the human immunodeficiency virus [see comments]. *Clin Infect Dis* **15**: 903–9.
- Pieniazek NJ, Bornay-Llinares FJ, Slemenda SB *et al.* (1999). New *Cryptosporidium* genotypes in HIV-infected persons. *Emerg Infect Dis* **5**: 444–9.
- Plettenberg A, Stoehr A, Stellbrink HJ, Albrecht H, Meigel W (1993). A preparation from bovine colostrum in the treatment of HIV-positive patients with chronic diarrhea. *Clin Invest* **71**: 42–5.
- Pozio E, Rezza G, Boschini A *et al.* (1997). Clinical cryptosporidiosis and human immunodeficiency virus (HIV)-induced immunosuppression: findings from a longitudinal study of HIV-positive and HIV-negative former injection drug users. *J Infect Dis* **176**: 969–75.
- Quiroz ES, Bern C, MacArthur JR *et al.* (2000). An outbreak of cryptosporidiosis linked to a foodhandler. *J Infect Dis* **181**: 695–700.
- Restrepo C, Macher AM, Radany EH (1987). Disseminated extraintestinal isporiasis in a patient with acquired immune deficiency syndrome. *Am J Clin Pathol* **87**: 536–42.
- Riggs MW, Perryman LE (1987). Infectivity and neutralization of *Cryptosporidium parvum* sporozoites [published erratum appears in *Infect Immun* 1988, Feb; **56**(2): 537]. *Infect Immun* **55**: 2081–7.
- Rohlman VC, Kuhls TL, Mosier DA, Crawford DL, Greenfield RA (1993). *Cryptosporidium parvum* infection after abrogation of natural killer cell activity in normal and severe combined immunodeficiency mice. *J Parasitol* **79**: 295–7.
- Rossignol JF, Hidalgo H, Feregrino M *et al.* (1998). A double-blind placebo-controlled study of nitazoxanide in the treatment of cryptosporidial diarrhoea in AIDS patients in Mexico. *Trans R Soc Trop Med Hyg* **92**: 663–6.
- Rump JA, Arndt R, Arnold A *et al.* (1992). Treatment of diarrhoea in human immunodeficiency virus-infected patients with immunoglobulins from bovine colostrum. *Clin Invest* **70**: 588–94.
- Sallon S, Deckelbaum RJ, Schmid II *et al.* (1988). *Cryptosporidium*, malnutrition, and chronic diarrhea in children. *Am J Dis Child* **142**: 312–15.
- Sallon S, el Showwa R, el Masri M *et al.* (1991). Cryptosporidiosis in children in Gaza. *Ann Trop Paediatr* **11**: 277–81.
- Saxon A, Weinstein W (1987). Oral administration of bovine colostrum anti-cryptosporidia antibody fails to alter the course of human cryptosporidiosis. *J Parasitol* **73**: 413–15.
- Sears CL (2000). *Cryptosporidium parvum*: minuscule but mighty. In Scheld WM, Craig WA, Hughes JM (eds), *Emerging Infections*, 4th edn. ASM Press: Washington, DC; 149–64.
- Sears CL, Guerrant RL (1994). Cryptosporidiosis: the complexity of intestinal pathophysiology [editorial; comment]. *Gastroenterology* **106**: 252–4.
- Sewankambo N, Mugerwa RD, Goodgame R *et al.* (1987). Enteropathic AIDS in Uganda. An endoscopic, histological and microbiological study. *AIDS* **1**: 9–13.
- Seydel KB, Zhang T, Champion GA *et al.* (1998). *Cryptosporidium parvum* infection of human intestinal xenografts in SCID mice induces production of human tumor necrosis factor alpha and interleukin-8. *Infect Immun* **66**: 2379–82.
- Shaffer N, Moore L (1989). Chronic travelers' diarrhea in a normal host due to *Isospora belli* [letter]. *J Infect Dis* **159**: 596–7.
- Shield J, Melville C, Novelli V *et al.* (1993). Bovine colostrum immunoglobulin concentrate for cryptosporidiosis in AIDS [see comments]. *Arch Dis Child* **69**: 451–3.
- Smith NH, Cron S, Valdez LM *et al.* (1998). Combination drug therapy for cryptosporidiosis in AIDS [see comments]. *J Infect Dis* **178**: 900–903.
- Soave R, Johnson WD Jr (1988). *Cryptosporidium* and *Isospora belli* infections. *J Infect Dis* **157**: 225–9.
- Soave R, Ruiz J, Garcia-Saucedo V, Garrocho C, Kean BH (1989). Cryptosporidiosis in a rural community in central Mexico [letter]. *J Infect Dis* **159**: 1160–2.
- Steiner TS, Thielman NM, Guerrant RL (1997). Protozoal agents: what are the dangers for the public water supply? *Ann Rev Med* **48**: 329–40.
- Tarver AP, Clark DP, Diamond G *et al.* (1998). Enteric beta-defensin: molecular cloning and characterization of a gene with inducible intestinal epithelial cell expression associated with *Cryptosporidium parvum* infection [published erratum appears in *Infect Immun* 1998, May; **66**(5): 2399]. *Infect Immun* **66**: 1045–56.
- Theodos CM (1998). Innate and cell-mediated immune responses to *Cryptosporidium parvum*. *Adv Parasitol* **40**: 88–121.
- Theodos CM, Griffiths JK, D'Onfro J, Fairfield A, Tzipori S (1998). Efficacy of nitazoxanide against *Cryptosporidium parvum* in cell culture and in animal models. *Antimicrob Agents Chemother* **42**: 1959–65.
- Theodos CM, Sullivan KL, Griffiths JK, Tzipori S (1997). Profiles of healing and non-healing *Cryptosporidium*

- parvum* infection in C57BL/6 mice with functional B and T lymphocytes: the extent of gamma interferon modulation determines the outcome of infection. *Infect Immun* **65**: 4761–9.
- Trier JS, Moxey PC, Schimmel EM, Robles E (1974). Chronic intestinal coccidiosis in man: intestinal morphology and response to treatment. *Gastroenterology* **66**: 923–35.
- Tzipori S, Campbell I (1981). Prevalence of *Cryptosporidium* antibodies in 10 animal species. *J Clin Microbiol* **14**: 455–6.
- Tzipori S, Griffiths JK (1998). Natural history and biology of *Cryptosporidium parvum*. *Adv Parasitol* **40**: 5–36.
- Ungar BL, Burris JA, Quinn CA, Finkelman FD (1990a). New mouse models for chronic *Cryptosporidium* infection in immunodeficient hosts. *Infect Immun* **58**: 961–9.
- Ungar BL, Gilman RH, Lanata CF, Perez-Schael I (1988). Seroepidemiology of *Cryptosporidium* infection in two Latin American populations. *J Infect Dis* **157**: 551–6.
- Ungar BL, Kao TC, Burris JA, Finkelman FD (1991). *Cryptosporidium* infection in an adult mouse model. Independent roles for IFN-gamma and CD4+ T lymphocytes in protective immunity. *J Immunol* **147**: 1014–22.
- Ungar BL, Mulligan M, Nutman TB (1989). Serologic evidence of *Cryptosporidium* infection in US volunteers before and during Peace Corps service in Africa. *Arch Intern Med* **149**: 894–7.
- Ungar BL, Ward DJ, Fayer R, Quinn CA (1990b). Cessation of *Cryptosporidium*-associated diarrhea in an acquired immunodeficiency syndrome patient after treatment with hyperimmune bovine colostrum. *Gastroenterology* **98**: 486–9.
- Urban JF Jr, Fayer R, Chen SJ *et al.* (1996). IL-12 protects immunocompetent and immunodeficient neonatal mice against infection with *Cryptosporidium parvum*. *J Immunol* **156**: 263–8.
- USPHS/IDSA Prevention of Opportunistic Infections Working Group (2000). 1999 USPHS/IDSA guidelines for the prevention of opportunistic infections in persons infected with human immunodeficiency virus. *Clin Infect Dis* **30**: S29–S65.
- Vakil NB, Schwartz SM, Buggy BP *et al.* (1996). Biliary cryptosporidiosis in HIV-infected people after the water-borne outbreak of cryptosporidiosis in Milwaukee. *N Engl J Med* **334**: 19–23.
- Verdier RI, Fitzgerald DW, Johnson WD Jr, Pape JW (2000). Trimethoprim-sulfamethoxazole compared with ciprofloxacin for treatment and prophylaxis of *Isospora belli* and *Cyclospora cayetanensis* infection in HIV-infected patients. A randomized, controlled trial. *Ann Intern Med* **132**: 885–8.
- Wagner-Wiening C, Kimmig P (1995). Detection of viable *Cryptosporidium parvum* oocysts by PCR. *Appl Environ Microbiol* **61**: 4514–16.
- Weiss LM, Perlman DC, Sherman J, Tanowitz H, Wittner M (1988). *Isospora belli* infection: treatment with pyrimethamine. *Ann Intern Med* **109**: 474–5.
- Wenyon CM (1915). The common intestinal protozoa of man: their diagnosis and pathogenicity. *Lancet* **2**: 1178–83.
- Westerman EL, Christensen RP (1979). Chronic *Isospora belli* infection treated with co-trimoxazole. *Ann Intern Med* **91**: 413–14.
- White AC, Robinson P, Okhuysen PC *et al.* (2000). Interferon-gamma expression in jejunal biopsies in experimental human cryptosporidiosis correlates with prior sensitization and control of oocyst excretion. *J Infect Dis* **181**: 701–9.
- Whiteside ME, Barkin JS, May RG *et al.* (1984). Enteric coccidiosis among patients with the acquired immunodeficiency syndrome. *Am J Trop Med Hyg* **33**: 1065–72.
- Wuhib T, Silva TM, Newman RD *et al.* (1994). Cryptosporidial and microsporidial infections in human immunodeficiency virus-infected patients in north-eastern Brazil. *J Infect Dis* **170**: 494–7.
- Wyatt CR, Brackett EJ, Perryman LE *et al.* (1997). Activation of intestinal intraepithelial T lymphocytes in calves infected with *Cryptosporidium parvum*. *Infect Immun* **65**: 185–90.
- Xiao L, Escalante L, Yang C *et al.* (1999a). Phylogenetic analysis of *Cryptosporidium* parasites based on the small-subunit rRNA gene locus. *Appl Environ Microbiol* **65**: 1578–83.
- Xiao L, Morgan UM, Limor J *et al.* (1999b). Genetic diversity within *Cryptosporidium parvum* and related *Cryptosporidium* species. *Appl Environ Microbiol* **65**: 3386–91.
- Zhu G, Marchewka MJ, Ennis JG, Keithly JS (1998). Direct isolation of DNA from patient stools for polymerase chain reaction detection of *Cryptosporidium parvum*. *J Infect Dis* **177**: 1443–6.
- Zu SX, Li JF, Barrett LJ *et al.* (1994). Seroepidemiologic study of *Cryptosporidium* infection in children from rural communities of Anhui, China and Fortaleza, Brazil. *Am J Trop Med Hyg* **51**: 1–10.

# Cyclospora

Richard L. Guerrant and Theodore S. Steiner

University of Virginia School of Medicine, Charlottesville, VA, USA

## HISTORICAL INTRODUCTION

*Cyclospora carolytica* has been recognized since its description by Schaudin (1901) as a cause of enteritis in moles. It was first implicated in human disease by R. W. Ashford (1979), who described the sporulation of the coccidian parasite in specimens from three patients in Papua New Guinea. Soave *et al.* (1986) reported an acid-fast, autofluorescent 'large *Cryptosporidium*-like' parasite in the stools of a patient with HIV infection and of a medical student with diarrhea. Thereafter, Long and others considered this organism to be a 'cyanobacterium-like body' (CLB) associated with diarrhea in immunocompetent and immunocompromised patients in the Caribbean, in expatriates in Nepal and in an apparent water-borne outbreak among house staff at a hospital in Chicago (Long *et al.*, 1990; Hoge *et al.*, 1991, 1993, 1996; Rabold *et al.*, 1994; Shlim *et al.*, 1991; Huang *et al.*, 1995). The organism was then clearly shown to sporulate and was named *Cyclospora cayetanensis* by Ortega *et al.* (1992, 1993).

Since that time, impressive annual outbreaks in the USA and Canada in the late spring in each of four consecutive years (1995–1998) in association with imported raspberries have brought *Cyclospora* to increasing attention as a potential cause of significant diarrheal illnesses with prominent fatigue (Koumans *et al.*, 1998; Herwaldt and Ackers, 1997; Herwaldt and Beach, 1999).

## DESCRIPTION OF THE ORGANISM AND TAXONOMY

With the conclusive documentation of the sporulation of *Cyclospora* (Ashford, 1979; Ortega *et al.*, 1993), its classification as an eimerian member of the order Eucoccidiida and phylum Apicomplexa as a distant relative of *Plasmodium* sp. became clear (Guerrant and Thielman, 1998). Key to its potential modes of spread is the obligatory requirement for the excreted oocysts to mature outside the host before it is infectious (see Figure 7.1). Recent phylogenetic analyses of ribosomal DNA demonstrate that human *Cyclospora* spp. are closely related to species of *Eimeria*

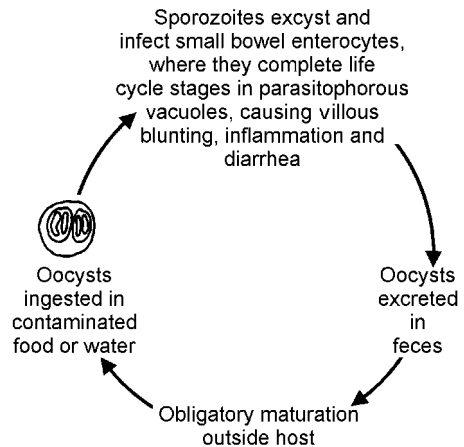


Fig. 7.1 Life-cycle of *Cyclospora cayetanensis*

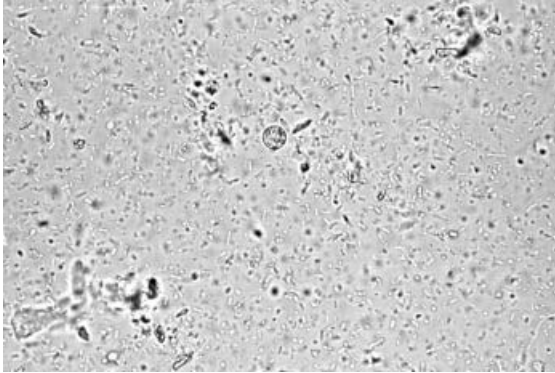


Fig. 7.2 *Cyclospora* oocysts in stool ×640

that commonly infect birds (Relman *et al.*, 1996; Pieniasek and Herwaldt, 1997). *Cyclospora*-like organisms have been reported in chickens, ducks, dogs, chimpanzees and baboons, but their relationship to human *Cyclospora* infections remains unclear (Ashford *et al.*, 1993; Smith *et al.*, 1996; Zepa *et al.*, 1995; Garcia-Lopez *et al.*, 1996; Yai *et al.*, 1997).

## PATHOGENESIS

After ingestion of apparently relatively small infectious doses, *Cyclospora* oocysts excyst in the small bowel and the sporozoites invade enterocytes, but, unlike *Cryptosporidium*, enter cells and develop into type I and II meronts within parasitophorous vacuoles, with 8–12 and four fully differentiated merozoites, respectively, in the luminal ends of epithelial cells (Ortega *et al.*, 1997).

The histopathologic changes seen with *Cyclospora* infection are similar to those seen with *Cryptosporidium* and microsporidial infections, namely villous blunting (with widening and shortening of the small intestinal villi due to diffuse edema), crypt hyperplasia, inflammatory infiltration in the lamina propria with reactive hyperemia, vascular dilatation and capillary congestion (Ortega *et al.*, 1998; Wurtz, 1994; Connor *et al.*, 1993).

## IMMUNOLOGY

Although little is known about the specifics of effective immunity to *Cyclospora* infections, its

severity and protracted course in patients with AIDS suggests that, like *Cryptosporidium*, cellular immunity likely plays an important role in containing the infection (Long *et al.*, 1990; Pape *et al.*, 1994). In addition, the predominance of infections in children and its relative rarity in adults living in endemic areas like Peru and Haiti further suggests that protective immunity develops relatively early in life (Ortega *et al.*, 1997; Eberhard *et al.*, 1999).

## MOLECULAR BIOLOGY

The small subunit rRNA coding region from cyclosporin oocysts has been purified from a human fecal specimen, amplified and sequenced by Relman *et al.* (1996) and work is under way to use this information to develop a PCR-based diagnostic assay. It is also this work that has led to the re-evaluation of the molecular taxonomy of *Cyclospora* and its eimerian relatives from chickens, cattle and rats (Pieniasek and Herwaldt, 1997).

## EPIDEMIOLOGY

While the reservoir(s) of *Cyclospora* remain unclear, the seasonal occurrence of infections among expatriates in Nepal (Hoge *et al.*, 1993, 1996), its association with drinking contaminated water (Rabold *et al.*, 1994; Huang *et al.*, 1995) and with foods such as imported raspberries, mesclun lettuce and basil, all suggest that *Cyclospora* is a hardy, chlorine-resistant cyst, much like that of *Cryptosporidium*. However, an important difference from *Cryptosporidium* is that *Cyclospora* oocysts require an obligatory phase of maturation in the environment after they are excreted in the feces, and thus are unlikely to be transmitted directly from person to person like *Cryptosporidium* is in institutions such as hospitals, daycare centers or households.

Like *Cryptosporidium*, *Cyclospora* infections often have a striking summer, rainy-season seasonality, although a study in Haiti suggests an association with cooler, dry seasons there (Eberhard *et al.*, 1999). In addition, *Cyclospora*

infections have been associated with drinking contaminated water despite apparently adequate chlorination (Bern C, unpublished data; Long *et al.*, 1990; Hoge *et al.*, 1993; Ortega *et al.*, 1993; Guerrant and Thielman, 1998). In an outbreak among house staff at a Chicago hospital in 1990, at least 11 persons with documented infection experienced self-limited, watery diarrhea, cramps, anorexia and low-grade fever following the consumption of tap water in a physician's dormitory that may have been contaminated with stagnant water from a storage tank due to pump failure (Huang *et al.*, 1995). A small outbreak also occurred among 12 of 14 British troops in Pokhara, Nepal, in June 1994 that was associated with water that was fully chlorinated to 0.3–0.8 ppm (Rabold *et al.*, 1994). One report notes recovery of waterborne oocysts of *Cyclospora cayetanensis* by Asian freshwater clams (Graczyk *et al.*, 1998) and another notes detection of oocysts in wastewater (Sturbaum *et al.*, 1998).

*Cyclospora* has been associated with ingestion of imported raspberries from Guatemala in the springs of 4 consecutive years 1995–1998. A retrospective matched case–control study of two clusters of laboratory-confirmed cases of cyclosporiasis in Florida in May 1995 documented associations with consumption of imported raspberries from Guatemala and with bare-handed contact with soil (Koumans, *et al.*, 1998). It was the association of cyclosporiasis with 1465 cases of illness (978 were laboratory-confirmed) throughout 20 states in the USA and in Washington DC, Quebec and Ontario, traced to consumption of Guatemalan raspberries in May–June 1996, that brought *Cyclospora* to attention as an emerging threat to the food supply (Herwaldt and Ackers, 1997). These cases were associated with many different social events, often at country clubs, and involved 22 cases being hospitalized but no deaths. Herwaldt *et al.* (1999) again reported another series of outbreaks with over 1000 cases (762 documented) in 41 clusters in 13 states in the USA, Washington DC and one province of Canada in April–May 1997, again incriminating raspberries from a small number of farms in Guatemala (Anonymous, 1998). In the spring of 1998, although Guatemalan raspberries were not imported to the USA, they were again associated with prolonged diarrhea and fatigue, with an 8

day incubation period following a dinner in a Toronto hotel (Anonymous, 1998). The recurrence of spring, but not fall, outbreaks of cyclosporiasis (despite considerable fall shipments of raspberries from Guatemala) has led to the suggestion that they may be associated with seasonal migrations of birds infected with this eimerian parasite (Osterholm, 1997), although evidence to prove this is lacking. This has also led to further consideration of irradiation of food to assure safety of fresh produce (Osterholm, 1999).

Finally, several recent outbreaks have also incriminated mesclun (baby leaves) lettuce in two outbreaks associated with separate events in two different cities in Florida in March and April (Anonymous, 1997a) and, in northern Virginia, Washington DC and Maryland, with basil in a pesto pasta salad served cold by a gourmet caterer with some 185 cases (60 laboratory-confirmed) in 25 confirmed clusters (Anonymous, 1997b). In one case, the only contact was using the spoon from the basil salad to serve another dish, suggesting a very low infectious dose as mentioned above under pathogenesis. Furthermore, in a study of market vegetables collected from small vendors in an endemic peri-urban slum in Pampas de San Juan, south of Lima, Peru, 1.8% of vegetables sampled had *Cyclospora* oocysts (14.5% had *Cryptosporidium parvum* oocysts) that were not completely removed by washing (Ortega *et al.*, 1997).

## CLINICAL FEATURES

Although many, if not most *Cyclospora* infections in endemic areas, such as Peru or Haiti, are asymptomatic (Ortega *et al.*, 1993; Eberhard *et al.*, 1999), those seen in expatriates in Nepal (admittedly at a diarrhea clinic) and in the outbreaks in the USA and Canada have been associated with substantial symptoms of diarrhea, anorexia, striking fatigue, weight loss and abdominal cramps, as noted in Table 7.1 (Hoge *et al.*, 1996; Shlim *et al.*, 1991; Huang *et al.*, 1995; Herwaldt and Ackers, 1997). A raspberry-associated outbreak 7 days following a wedding reception in Boston involved over half of the attendees with an impressive diarrheal

**Table 7.1** Symptoms of cyclosporiasis (760 confirmed cases in the USA and Canada in 1996)

Diarrhea	99%
Anorexia	93%
Fatigue	92%
Weight loss (med = 8 pounds)	91%
Abdominal pain, gas	75–84%
Nausea/vomiting	27–71%
Fever (med = 38.3°C)	54%

From Herwaldt and Ackers (1997), with permission.

illness with weight loss (93%), fatigue (91%) and anorexia (90%), which lasted longer than 3 weeks in 61% and recurred in 89% of cases (Fleming *et al.*, 1998). There is one report of Guillain-Barré syndrome occurring after *Cyclospora* infection (Richardson *et al.*, 1998).

In the setting of HIV infection, *Cyclospora* infection is often associated with persistent diarrhea and weight loss, lasting for many weeks and often relapsing after therapy. In Haiti, *Cyclospora* accounted for fully 11% of diarrhea lasting 3 weeks or longer in HIV-positive patients (Pape *et al.*, 1994).

## LABORATORY DIAGNOSIS

Although new, improved diagnostic methods are badly needed and are being developed, the diagnosis of cyclosporiasis is best made using direct acid-fast stain (or microwave-heated safranin staining) of fecal specimens (Long *et al.*, 1990, 1991; Visvesvara *et al.*, 1997). A major limitation is the difficulty detecting infectious oocysts in contaminated food or water in the concentration that are actually infectious for humans. Indeed, the most sensitive test at present may well be consumption by humans who, if not apparently immune, are susceptible to disease from subdetectable numbers of parasites. With the development of immunologic and gene probe reagents, we can expect the diagnosis of *Cyclospora* infections and contamination to improve considerably. PCR, with RFLP of amplification products, is able to identify as few as 10–25 oocysts of *Eimeria tenella* and *Cyclospora cayentanensis* directly from raspberries (Jinneman *et al.*, 1998).

**Table 7.2** Trimethoprim–sulfamethoxazole (TXS) for *Cyclospora*

43 HIV+ve patients in Haiti; 11% of 450 with diarrhea (vs. 30% with <i>Cryptosporidium</i> ; 12% with <i>Isospora belli</i> ; 3% <i>Giardia lamblia</i> ; 1% <i>Entamoeba histolytica</i> ) TXS q.i.d. × 10 days 100% responded (diarrhea and stool positivity) by 2.5 days 43% relapsed in 1 month (all responded again) suppressed with TXS 3/week in 11/12 (× 7 months) (Pape <i>et al.</i> , 1994)
21 Kathmandu expatriates with TXS b.i.d. × 7 days eradicated <i>Cyclospora</i> in 29% at 3 days, 94% at 7 days v.s. 19 double-blind placebo controls (0 at 3 days; 12% at 7 days) $p < 0.02$ and 0.0001; no relapses 7 days after (Hoge <i>et al.</i> , 1995)

## CLINICAL MANAGEMENT

Unlike its relative, *Cryptosporidium*, which is difficult if not impossible to treat effectively, *Cyclospora* infections are readily treated, even in patients with AIDS, with trimethoprim–sulfamethoxazole (TXS) (Pape *et al.*, 1984; Hoge *et al.*, 1995). As described in Table 7.2, 29% of Kathmandu expatriates with diarrhea had their *Cyclospora* eradicated after 3 days and 94% after 7 days of one DS TXS b.i.d, both highly significantly different from placebo-treated controls. None of 21 patients treated for 7 days relapsed. In contrast, although all 43 HIV-positive patients with *Cyclospora* diarrhea in Haiti improved within 3 days, 43% relapsed, but responded again to TXS treatment or to chronic thrice-weekly suppression (Pape *et al.*, 1994). Shlim *et al.* (1997) have also reported that, while tinidazole, diloxanide, quinacrine and azithromycin are apparently ineffective for *Cyclospora* infections, trimethoprim alone (tested in an open trial) holds promise for treating the patient who is allergic to sulfamethoxazole. More recently, Pape *et al.* (2000) reported that ciprofloxacin can also be used as an alternative.

## PREVENTION AND CONTROL

Critical to the prevention and control of *Cyclospora* infections is detection of infections in patients and of viable oocysts in food and



water supplies. At present, a high index of clinical suspicion is key to deciding to obtain appropriate stool studies for case (or outbreak) detection. However, as the reservoir(s) are poorly defined, the concern about human and possibly avian or mammalian fecal contamination of fresh fruits and vegetables that are eaten raw remains paramount in preventing transmission of this hardy parasite. The apparent resistance of *Cyclospora* oocysts to chlorine or known chemical food or water disinfection, and the apparent very low infectious dose required, again raise the potential value of irradiation as one of the few available means to disinfect foods that are consumed fresh. Improved detection methods will doubtless improve our standing and control of this challenging threat to the global food supply.

## REFERENCES

- Anonymous (1997a). Update: outbreaks of cyclosporiasis—United States and Canada, 1997. *Morbid Mortal Week Rep* **46**: 521–3.
- Anonymous (1997b). Outbreaks of cyclosporiasis—northern Virginia–Washington, DC–Baltimore, Maryland, metropolitan area, 1997. *Morbid Mortal Week Rep* **46**: 689–91.
- Anonymous (1998). Outbreak of cyclosporiasis—Ontario, Canada, May 1998. *Morbid Mortal Week Rep* **47**: 806–9.
- Ashford RW (1979). Occurrence of an undescribed coccidian in man in Papua New Guinea. *Ann Trop Med Parasitol* **73**: 497–500.
- Ashford RW, Warhurst DC, Reid GD (1993). Human infection with cyanobacterium-like bodies [letter]. *Lancet* **341**: 1034.
- Connor BA, Shlim DR, Scholes JV, Rayburn JL, Reidy J, Rajah R (1993). Pathologic changes in the small bowel in nine patients with diarrhea associated with a coccidia-like body. *Ann Intern Med* **119**: 377–82.
- Eberhard ML, Nace EK, Freeman AR, Streit RG, DeSilva AJ, Lammie PJ (1999). *Cyclospora cayetanensis* infections in Haiti: a common occurrence in the absence of watery diarrhea. *Am J Trop Med Hyg* **60**: 584–6.
- Fleming CA, Caron D, Gunn JE, Barry MA (1998). A foodborne outbreak of *Cyclospora cayetanensis* at a wedding: clinical features and risk factors for illness. *Arch Intern Med* **158**: 1121–5.
- Garcia-Lopez HL, Rodriguez-Tovar LE, Medina-De la Carza CE (1996). Identification of *Cyclospora* in poultry [letter]. *Emerg Infect Dis* **2**: 356–7.
- Graczyk TK, Ortega YR, Conn DB (1998). Recovery of waterborne oocysts of *Cyclospora cayetanensis* by Asian freshwater clams (*Corbicula fluminea*). *Am J Trop Med Hyg* **59**: 928–32.
- Guerrant RL, Thielman NM (1998). Emerging enteric protozoa: *Cryptosporidium*, *Cyclospora* and *Microsporidia*. In Scheld WM, Armstrong D, Hughes JM (eds), *Emerging Infections*. ASM Press: Washington, DC; 233–45.
- Herwaldt BL, Ackers ML (1997). An outbreak in 1996 of cyclosporiasis associated with imported raspberries. The *Cyclospora* Working Group [see comments]. *N Engl J Med* **336**: 1548–56.
- Herwaldt BL, Beach MJ (1999). The return of *Cyclospora* in 1997: another outbreak of cyclosporiasis in North America associated with imported raspberries. *Cyclospora* Working Group [see comments]. *Ann Intern Med* **130**: 210–20.
- Hoge CW, Shlim DR, Echeverria P, Rajah R, Hermann JE, Cross JH (1996). Epidemiology of diarrhea among expatriate residents living in a highly endemic environment. *J Am Med Assoc* **275**: 533–8.
- Hoge CW, Shlim DR, Ghimire M *et al.* (1995). Placebo-controlled trial of co-trimoxazole for *Cyclospora* infections among travellers and foreign residents in Nepal [see comments] [published erratum appears in *Lancet* 1995, Apr 22; **345** (8956): 1060]. *Lancet* **345**: 691–3.
- Hoge CW, Shlim DR, Rajah R *et al.* (1993). Epidemiology of diarrhoea illness associated with coccidian-like organism among travellers and foreign residents in Nepal. *Lancet* **341**: 1175–9.
- Huang P, Weber JT, Sosin DM *et al.* (1995). The first reported outbreak of diarrheal illness associated with *Cyclospora* in the United States. *Ann Intern Med* **123**: 409–14.
- Jinneman KC, Wetherington JH, Hill WE *et al.* (1998). Template preparation for PCR and RFLP of amplification products for the detection and identification of *Cyclospora* sp. and *Eimeria* spp. oocysts directly from raspberries. *J Food Protect* **61**: 1497–1503.
- Koumans EH, Katz DJ, Malecki JM *et al.* (1998). An outbreak of cyclosporiasis in Florida in 1995: a harbinger of multistate outbreaks in 1996 and 1997. *Am J Trop Med Hyg* **59**: 235–42.
- Long EG, Ebrahimzadeh A, White EH, Swisher B, Callaway C (1990). Alga associated with diarrhea in patients with acquired immunodeficiency syndrome and in travellers. *J Clin Microbiol* **28** (6): 1101–4.
- Long EG, White EH, Carmichael WW *et al.* (1991). Morphologic and staining characteristics of a cyanobacterium-like organism associated with diarrhea. *J Infect Dis* **164**: 199–202.
- Ortega YR, Nagle R, Gilman RH *et al.* (1997). Pathologic and clinical findings in patients with cyclosporiasis and a description of intracellular parasite life-cycle stages. *J Infect Dis* **176**: 1584–9.
- Ortega YR, Roxas CR, Gilman RH *et al.* (1997). Isolation of *Cryptosporidium parvum* and *Cyclospora cayetanensis* from vegetables collected in markets of an endemic region in Peru. *Am J Trop Med Hyg* **57**: 683–6.
- Ortega YR, Sterling CR, Gilman RH, Cama VA, Diaz F (1992). *Cyclospora cayetanensis*: a new protozoan pathogen of humans. *Am J Trop Med Hyg* **47**: 210 (Abstract No. 289).
- Ortega YR, Sterling CR, Gilman RH, Cama VA, Diaz F (1993). *Cyclospora* sp.—a new protozoan pathogen of humans. *N Engl J med* **328**: 1308–12.

- Osterholm MT (1997). Cyclosporiasis and raspberries—lessons for the future. *N Engl J Med* **336**: 1597–8.
- Osterholm MT (1999). Lessons learned again: cyclosporiasis and raspberries [Editorial; comment]. *Ann Intern Med* **130**: 233–4.
- Pape JW, Verdier RI, Boney M, Boney J, Johnson WD Jr (1994). *Cyclospora* infection in adults infected with HIV. Clinical manifestations, treatment, and prophylaxis. *Ann Intern Med* **121**: 654–7.
- Pieniazek NJ, Herwaldt BL (1997). Reevaluating the molecular taxonomy: is human-associated *Cyclospora* a mammalian *Eimeria* species? *Emerg Infect Dis* **3**: 381–3.
- Rabold JG, Hoge CW, Shlim DR, Kefford C, Rajah R, Echeverria P (1994). *Cyclospora* outbreak associated with chlorinated drinking water [letter]. *Lancet* **344**: 1360–61.
- Relman DA, Schmidt TM, Gajadhar A *et al.* (1996). Molecular phylogenetic analysis of *Cyclospora*, the human intestinal pathogen, suggests that it is closely related to *Eimeria* species. *J Infect Dis* **173**: 440–45.
- Richardson RF, Remler BF, Katirji B, Murad MH (1998). Guillain-Barré syndrome after *Cyclospora* infection. *Muscle Nerve* **21**: 669–71.
- Schaudinn F (1901). Studien über krankheitsserregende Protozoen I. *Cyclospora carolytica* Schaud., de Erreger der perniciosen Enteritis des Maulwurfs. *Arbeit Kaiserl Gesundheits* **18** (378): 416.
- Shlim DR, Cohen MT, Eaton M, Rajah R, Long EG, Ungar BL (1991). An alga-like organism associated with an outbreak of prolonged diarrhea among foreigners in Nepal. *Am J Trop Med Hyg* **45**: 383–9.
- Shlim DR, Pandey P, Rabold JG, Walch A, Rajah R (1997). An open trial of trimethoprim alone against *Cyclospora* infections. *J Trav Med* **4**: 44–5.
- Smith HV, Paton CA, Girdwood RW, Mtambo MM (1996). *Cyclospora* in non-human primates in Gombe, Tanzania [letter]. *Vet Rec* **138**: 528.
- Soave R, Dubey JP, Ramos LJ, Tummings M (1986). A new intestinal pathogen? *Clin Res* **34**: 533A.
- Sturbaum GD, Ortega YR, Gilman RH, Sterling CR, Cabrera L, Klein DA (1998). Detection of *Cyclospora cayetanensis* in wastewater. *Appl Environ Microbiol* **64**: 2284–6.
- Verdier RI, Fitzgerald DW, Johnson WD Jr, Pape JW (2000). Trimethoprim–sulfamethoxazole compared with ciprofloxacin for treatment and prophylaxis of *Isospora belli* and *Cyclospora cayetanensis* infection in HIV-infected patients. A randomized, controlled trial. *Ann Intern Med* **132**: 885–8.
- Visvesvara GS, Moura H, Kovacsnae E, Wallace S, Eberhard ML (1997). Uniform staining of *Cyclospora* oocysts in fecal smears by a modified safranin technique with microwave heating. *J Clin Microbiol* **35**: 730–33.
- Wurtz R (1994). *Cyclospora*: a newly identified intestinal pathogen of humans [review]. *Clin Infect Dis* **18**: 620–23.
- Yai LE, Bauab AR, Hirschfeld MP, de Oliveira ML, Damaceno JT (1997). The first two cases of *Cyclospora* in dogs, São Paulo, Brazil. *Revista Instit Med Trop Sao Paulo* **39**: 177–9.
- Zerpa R, Uchima N, Huicho L (1995). *Cyclospora cayetanensis* associated with watery diarrhoea in Peruvian patients. *J Trop Med Hyg* **98**: 325–9.

# Microsporidia

E. U. Canning

Imperial College of Science, Technology and Medicine, London SW7 2AZ, UK

Previously considered as oddities and chance infections of great rarity, the AIDS epidemic has revealed that a considerable number of microsporidian species are involved in human disease and that some of these species are quite common. To date, 14 species have been recognised in human infections. They have been detected in AIDS patients because of the fulminating nature of the infections but there may also be high prevalences in immunocompetent people which have passed unnoticed because of transient or low levels of infection. Information is slowly accumulating on microsporidiosis in otherwise healthy people and this chapter aims to call attention to the importance of microsporidia in human medicine. An important new volume deals with the biology of microsporidia and their host–parasite relationships (Wittner and Weiss, 1999).

## HISTORICAL INTRODUCTION

Of three cases of microsporidiosis reported in the first half of this century, only one (Torres, 1927) remains as a possibly correct identification (see Canning and Lom, 1986, for historical summary). Torres (1927) described *Encephalitozoon chagasi* as the cause of meningocephalomyelitis with myositis and myocarditis in a baby girl who died 2 days after birth. Unfortunately the material has been lost and confirmation of its

microsporidial nature cannot be obtained. The first certain case was that of an 11 year-old boy in Japan who suffered a severe convulsive illness, the cause of which was *Encephalitozoon* sp. (Matsubayashi *et al.*, 1959). After a gap of 25 years a similar illness in a 2 year-old Colombian child resident in Sweden was found to be of microsporidian origin (*Encephalitozoon cuniculi*) (Bergquist *et al.*, 1984). Unidentified microsporidia in two cases of corneal microsporidiosis (Ashton and Wirasinha, 1973; Pinnolis *et al.*, 1981), and *Nosema connori* (Sprague, 1974) (now *Brachiola connori*; Cali *et al.*, 1998) causing a generalised infection in an athymic infant (Margileth *et al.*, 1973) complete the list of microsporidia found before the AIDS epidemic. The history of human microsporidiosis might have remained at the level of occasional severe cases had it not been for AIDS.

The first microsporidium found in an AIDS patient was *Enterocytozoon bieneusi*, an entirely new genus and species causing chronic diarrhoea (Desportes *et al.*, 1988) and to this have been added another three new genera and eight new species in HIV-positive or HIV-negative patients, bringing the known total to 14 species. The new species are: *Encephalitozoon hellem* (Didier *et al.*, 1991); *Vittaforma corneae* (*Nosema corneae*) (Shaddock *et al.*, 1990; Silveira and Canning, 1995); *Encephalitozoon intestinalis* (*Septata intestinalis*) (Cali *et al.*, 1993; Hartskeerl *et al.*, 1995); *Pleistophora* sp. (Ledford *et al.*, 1985); *Nosema ocularum* (Cali *et al.*, 1991);

*Trachipleistophora hominis* (Hollister *et al.*, 1996b); *Trachipleistophora anthropophthera* (Vávra *et al.*, 1998b); *Brachiola vesicularum* (Cali *et al.*, 1998) and *Brachiola algerae* (*Nosema algerae*) (Visvesvara *et al.*, 1999; Lowman *et al.*, 2000). It is highly likely that these do not represent the full range of microsporidia capable of infecting man and that with increasing awareness of these organisms, new species will be added to this list.

## DESCRIPTION OF THE ORGANISMS

### Reproduction

Microsporidia are unicellular organisms which produce very small spores, characterised by an extrusible polar tube which is used to convey the infective agent (sporoplasm) out of the spore directly into host cell cytoplasm (Figures 8.2G, p.175, and 8.5A, Plate IV). They were first recognised as a distinct group of organisms (microsporidies) in 1882 and are now accommodated within their own phylum Microsporidia Balbiani, 1882. They have no functional mitochondria and their ribosomes are unusual, being of a size typical of prokaryotes (70S with 16S and 23S ribosomal RNAs, the 5.8S rRNA gene being incorporated in the 23S rRNA), but in other respects they are true eukaryotes with membrane-bound nuclear material and nuclear division by intranuclear mitosis. Some genera have isolated nuclei (monokaryotic), others have paired (diplo-karyotic) nuclei which divide synchronously.

All microsporidia are obligate parasites with a life-cycle involving repeated proliferation by merogony, followed by sporogony, in which sporonts divide into two or more sporoblasts that mature into spores. Meronts usually have a simple plasma membrane while sporonts have an electron-dense surface coat which later becomes the outer (exospore) layer of the spore wall. However, meronts of *Pleistophora*, *Trachipleistophora* and *Brachiola* have a well developed surface coat and the sporont of *Enterocytozoon* does not lay down the surface coat until it is actually undergoing division into sporoblasts. The repeated merogonic divisions by binary or multiple fission are responsible for massive infections, resulting in complete destruction of cells and whole tissues.

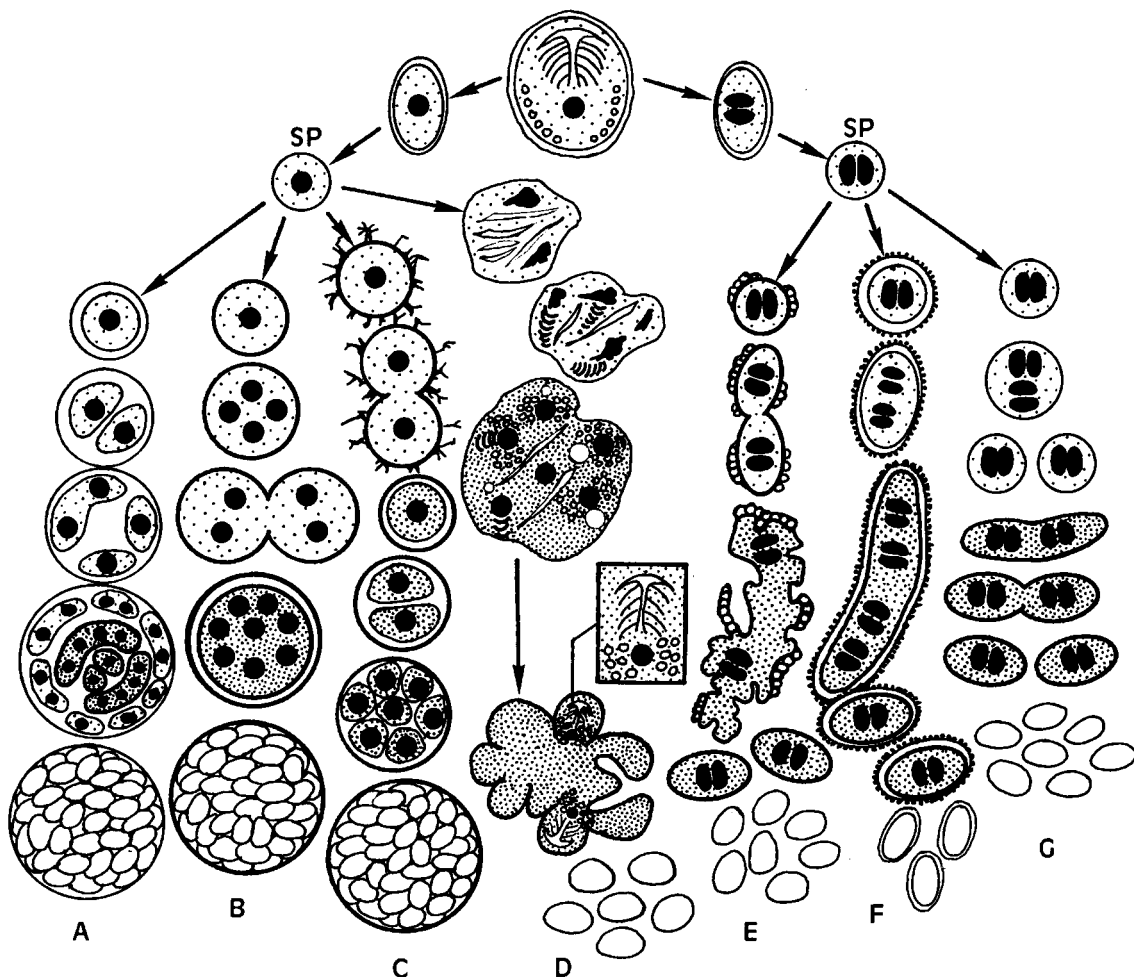
In some genera, sporonts produce sporoblasts (the precursors of spores) by binary or multiple fission in direct contact with host cell cytoplasm, so that the resultant spores are freely dispersed in the host cell. In other genera, an envelope separates from the sporont surface and division, again by binary or multiple fission, occurs within this envelope (sporophorous vesicle), resulting in packets of spores rather than free spores. In one medically important genus, all stages of development take place in a host membrane-bound vacuole (=parasitophorous vacuole).

### Spores

Microsporidian spores are unique. Within the spore wall, consisting of an electron-dense exospore and a lucent endospore, together having proteinaceous and chitinous components, lie the cytoplasmic structures limited by a plasma membrane (see Figure 8.3G). At the anterior end, lying within a polar sac, shaped like the cap of a mushroom, is an anchoring disc into which the base of the polar tube is inserted. The tube runs a straight course posteriad for about half the length of the spore, then forms a coil in the peripheral cytoplasm. The coiled part of the tube may be of uniform diameter (isofilar) or show a sharp change to a narrower diameter for the posterior coils (anisofilar). Surrounding the straight section is the polaroplast, an organelle composed of tightly packed or loose membranes, and vesicles. The nucleus (or nuclei), together with undifferentiated cytoplasm, occupy the central and most of the posterior regions of the spore. A membrane-bound posterior vacuole, visible even in fresh spores, is a prominent feature of some species. During germination in a new host or spontaneously in the tissues, the polar tube is evaginated and the sporoplasm (cytoplasm and nucleus) pass through it to be injected into the cytoplasm of a host cell, which the tip of the tube may have penetrated by chance during eversion (Figure 8.2G). No other organisms are known to have this type of infection mechanism.

### Phylogeny

On the basis of sequences of rRNA and elongation factor EF1 $\alpha$  genes in comparison



**Fig. 8.1** Diagrammatic representation of the life-cycles of the seven genera of microsporidia parasitising man. (A–D) monokaryotic; (E–G) diplokaryotic. SP, sporoplasms after emergence from spores. Light stippling, merogonic stages; heavy stippling, sporogonic stages. (A) *Encephalitozoon*: merogonic and sporogonic stages in a host-derived parasitophorous vacuole; spores retained in vacuole until disintegration of host cell. (B) *Pleistophora*: plurinucleate meronts surrounded by amorphous coat divide into smaller segments; amorphous coat separates from the surface of multinucleate sporont to form a sporophorous vesicle and the sporont divides within it, to give numerous uninucleate spores in a persistent vesicle. (C) *Trachipleistophora*: meronts, bearing an amorphous coat with branched extensions, divide by binary fission; coat separates from the surface of a uninucleate sporont to form a sporophorous vesicle; sporont divides repeatedly by binary fission to give numerous spores in a persistent vesicle. (D) *Enterocytozoon*: meronts with irregular nuclei and electron-lucent slits merge into sporonts without a surface coat, by formation of electron-dense discs and change of nuclei to a rounded shape; after merging of the discs into polar tubes, sporoblast formation occurs by invagination of the membrane, simultaneously with deposition of the amorphous surface coat, to isolate each complex of nucleus, polaroplast and polar tube, and form free spores. (E) *Brachiola*: all stages are diplokaryotic and surrounded by an electron-dense coat; division by binary fission in merogony and sporogony; merogonic stages, often of bizarre shape, bear tubular structures embedded in amorphous surface coat. Spores free. (F) *Vittaforma*: all stages surrounded by a complete cisterna of host endoplasmic reticulum, the outer membrane of which is ribosome-bearing; merogony by binary fission of stages without surface coat; sporonts with up to eight diplokarya and a surface coat divide into diplokaryotic sporoblasts. Spores free. (G) *Nosema*: diplokaryotic meronts without a surface coat divide by binary fission; sporonts acquire a surface coat and divide by binary fission to give two diplokaryotic sporoblasts. Spores free. (Figure drawn by Dr L. A. Winchester)

with other protists (Vossbrinck *et al.*, 1987; Kamaishi *et al.*, 1996), microsporidia were thought to be primitively amitochondrial and to have separated from the main evolutionary line of the eukaryotes before the mitochondrial symbiosis event had occurred. However, recent analyses of  $\alpha$ - and  $\beta$ -tubulin (Edlind *et al.*, 1996; Li *et al.*, 1996) and of the largest subunit of RNA polymerase II (Hirt *et al.*, 1999) have suggested that microsporidia are probably related to fungi and that the absence of typical fungal features, such as hyphae and cell walls, is a result of degeneracy due to parasitism. The detection of genes for mitochondrial-derived heat shock protein (HSP70) in microsporidia (Germot *et al.*, 1997; Hirt *et al.*, 1997) strengthens the view that these organisms once had mitochondria. The very close association of host cell mitochondria with the surface of multiplying microsporidia is indicative of microsporidian reliance on the host for chemical energy but does not preclude the possibility that relic mitochondria are retained in some species. The probable affinity of microsporidia with fungi has important implications for chemotherapy.

***Enterocytozoon bienewsi* (Figures 8.5D,E,I on Plate IV; 8.1D; 8.2J,L)**

*E. bienewsi* is the most strikingly different microsporidian species among those infecting humans. All developmental stages are multinucleate plasmodia with unpaired nuclei and development is in direct contact with the host cell

cytoplasm (Figure 8.2J). *Merogony*: early stages have a small number of irregularly-shaped nuclei and electron lucent clefts with dense borders. *Sporogony*: characterised by polar tube precursors in the form of electron dense discs which become stacked; nuclei compact, rounded, each associated with an anchoring disc, polar tube (formed by coalescence of the precursor discs), and a stack of membranes representing the future polaroplast. Sporoblasts formed by invagination of plasma membrane around each set of spore organelles with simultaneous secretion of surface coat. Spore maturation requires only the secretion of a thin endospore layer. *Spores*:  $1.5 \times < 1.0 \mu\text{m}$  (fresh), broadly ellipsoid with five or six isofilar coils of polar tube in two rows (Figure 8.2L). (For details, see Desportes *et al.*, 1985; Cali and Owen, 1990.)

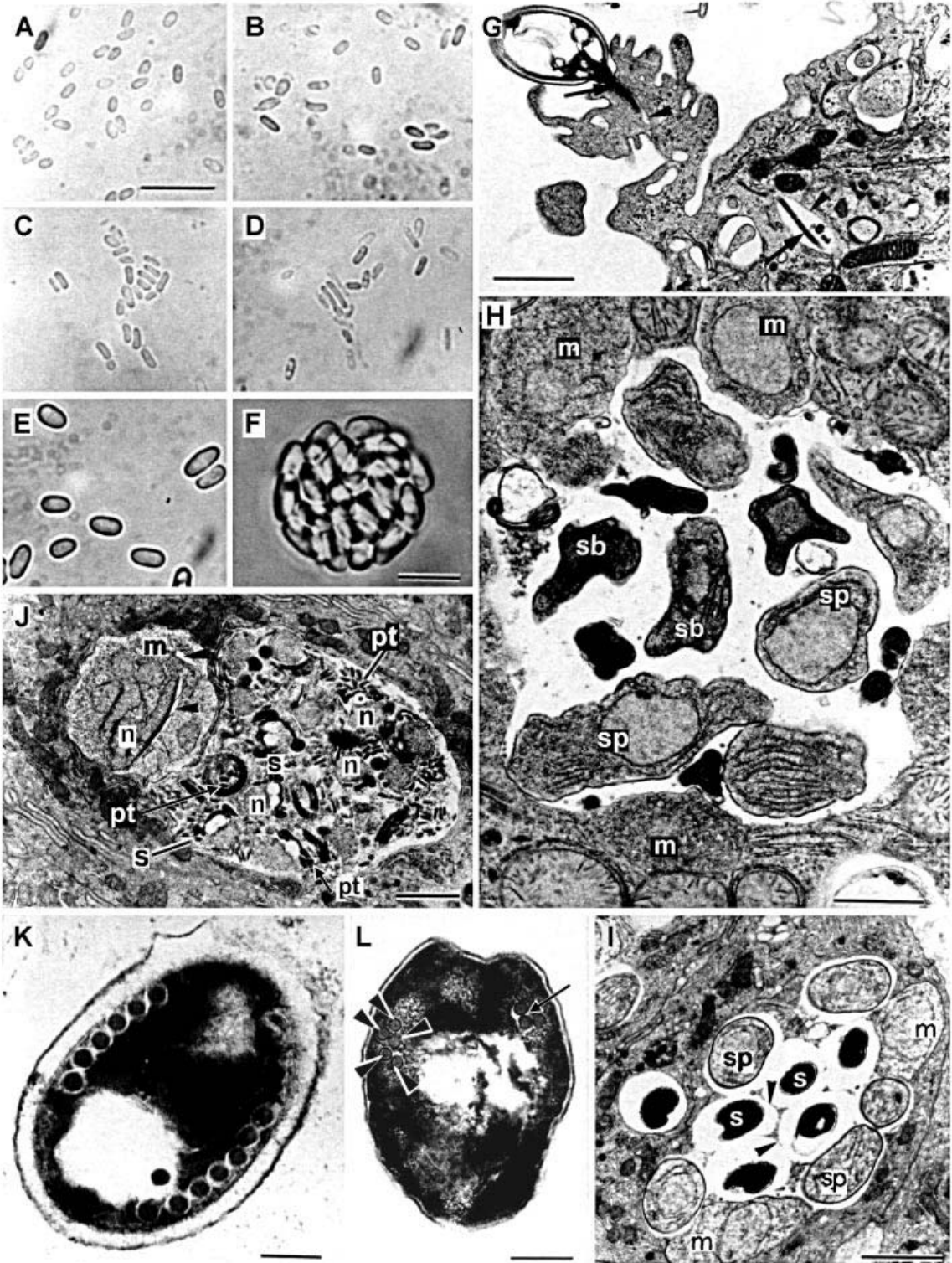
***The Encephalitozoon Group* (Figures 8.5C,F on Plate IV; 8.1A; 8.2A–C,H,I,K)**

The feature that distinguishes the *Encephalitozoon* spp. from almost all other microsporidia is that the entire life-cycle evolves within a host cell vacuole (Figure 8.2H,I). Nuclei are unpaired (monokaryotic).

In *Encephalitozoon cuniculi*, *E. hellem* and *E. intestinalis* (formerly *Septata intestinalis*) after inoculation of sporoplasm into a host cell, a membrane encloses the multiplying stages in a vacuole. *Merogony*: binary fission of bi- or tetranucleate meronts attached to vacuolar membrane. *Sporogony*: sporonts detach from vacuolar

---

**Fig. 8.2 (opposite)** (A–F) Fresh spores from culture of some of the microsporidia that infect man, for comparison of size and shape. The *Encephalitozoon* spp. are similar but not identical. Bar on (A) =  $10 \mu\text{m}$  and refers also to (B–E). (A) *Encephalitozoon cuniculi*. (B) *Encephalitozoon hellem*. (C) *Encephalitozoon intestinalis*. (D) *Vittaforma corneae*—note narrow spores of variable length. (E) Free spores of *Trachipleistophora hominis*. (F) Sporophorous vesicle of *Trachipleistophora hominis*. Bar =  $5 \mu\text{m}$ . (G) Germination of a spore of *E. intestinalis* showing everted polar tube in two places in the host cell (arrows) and invagination of the host cell plasma membrane (arrowheads) alongside the polar tube. This membrane is probably the origin of the parasitophorous vacuole. Bar =  $1.0 \mu\text{m}$ . From Magaud *et al.* (1997), by permission of the *Journal of Eukaryotic Microbiology*. (H) Parasitophorous vacuole of *E. cuniculi* in culture showing meronts (m) in contact with vacuolar membrane and free sporonts (sp) and sporoblasts (sb). Note sparse matrix between parasites and no septa. Bar =  $1.0 \mu\text{m}$ . Original photograph of Professor J. Vávra. (I) Parasitophorous vacuole of *E. intestinalis* in enterocyte showing meronts (m) in contact with vacuolar membrane and free sporonts (sp) and spores (s) separated by septa (arrowheads) formed by compression of the vacuolar matrix. Bar =  $2.0 \mu\text{m}$ . From Canning *et al.* (1994), by permission of the *European Journal of Protistology*. (J) *Enterocytozoon bienewsi*. Meront (m) and adjacent sporont (s) in enterocyte showing electron-lucent slits (arrowheads) nuclei (n) and electron dense precursors of the polar tube (pt). Bar =  $1.0 \mu\text{m}$ . Original photograph of Dr A. Curry. (K) Spore of *E. intestinalis* showing six and a half coils of the polar tube in one rank. Bar =  $0.25 \mu\text{m}$ . From Van Gool *et al.* (1994), by permission of Cambridge University Press. (L) Spore of *Encephalitozoon bienewsi* showing five coils of the polar tube in two ranks (arrowheads) and poorly developed endospore. Bar =  $0.25 \mu\text{m}$ . Original photograph of Dr A. Curry



membrane as the surface coat is secreted; disporoblastic or tetrasporoblastic division in centre of vacuole. *Spores*:  $2.5 \times 1.5 \mu\text{m}$  (fresh) (Figure 8.2A,B,C), ellipsoid, five to eight isofilar polar tube coils in a single row (Figure 8.2K); spores retained in the vacuole in an enlarging host cell until cell destroyed. *Differentiation of species*: spore morphology similar but species show slightly different sizes and shapes (Figure 8.2A,B,C). Parasitophorous vacuoles of *E. intestinalis* have conspicuous septa formed by compression of vacuolar matrix (Figure 8.2I). Otherwise, species are differentiated by protein profiles (SDS-PAGE), Western blotting, PCR amplification of ribosomal DNA with species-specific primers, restriction analysis and double-stranded heteroduplex mobility shift analysis. (For details, see Canning and Lom, 1986; Didier *et al.*, 1991; Cali *et al.*, 1993; Hartskeerl *et al.*, 1995.)

### The Anisofilar Polar Tube Group

The polar tube of several of the monokaryotic species infecting man shows a sharp change of diameter from wide anterior coils to narrow posterior coils (anisofilar). It is not clear whether the spores of *Pleistophora* sp. of Ledford *et al.*

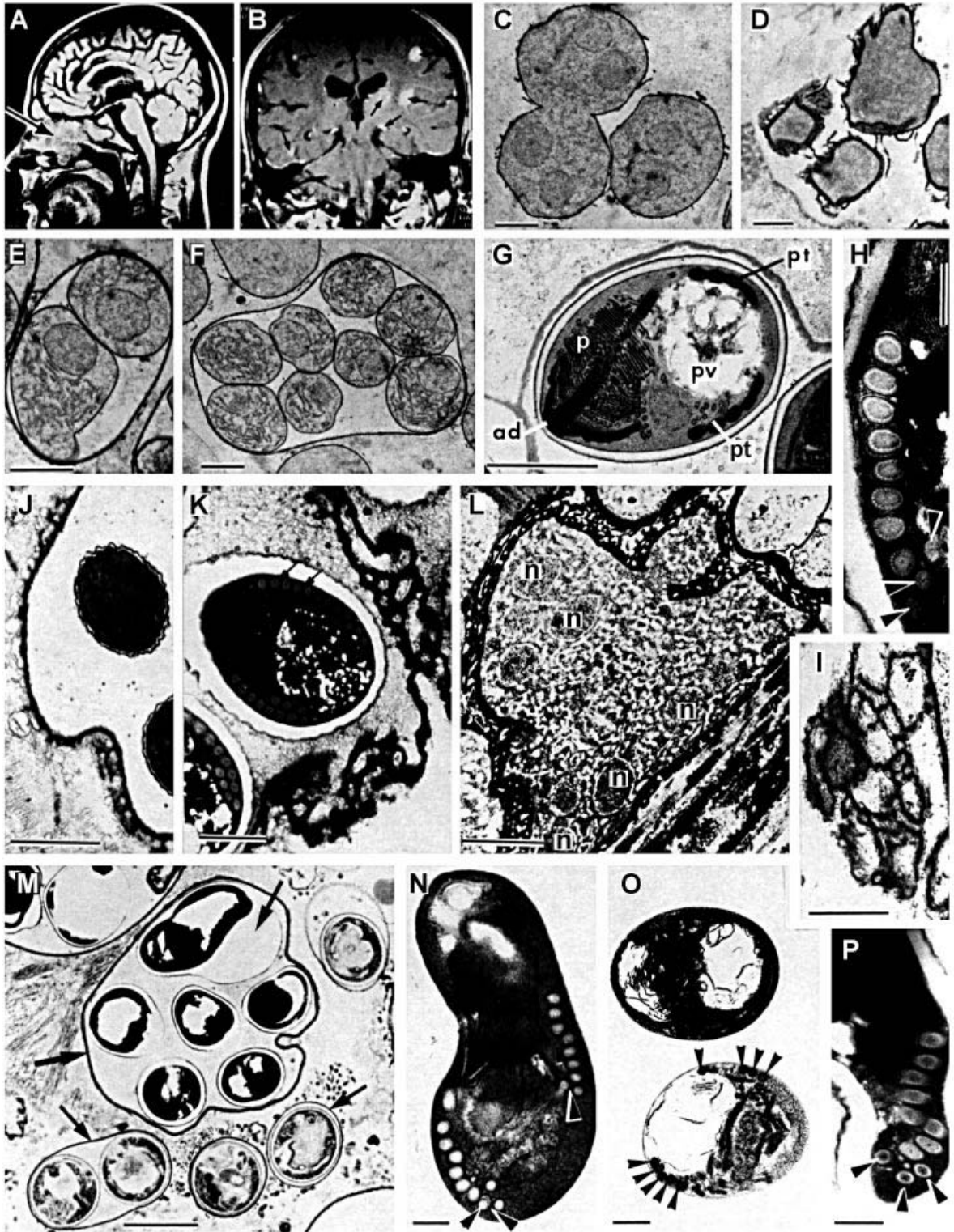
(1985) are anisofilar but this species is included in this grouping because it produces spores in sporophorous vesicles like *Trachipleistophora*. The two species of indeterminate genus, placed in *Microsporidium* are also anisofilar.

In *Trachipleistophora hominis* (Figures 8.5J on Plate IV; 8.1C; 8.2E,F; 8.3C–J), all stages are surrounded by a thick surface coat which becomes the sporophorous vesicle envelope. *Merogony*: binary fission of bi- or tetra-nucleate stages. Surface coat, 25–50 nm thick, extends out as complex branches (Figure 8.3D,I) which make contact with 35–40 nm tubules in lysed host cell cytoplasm. *Sporogony*: surface coat on uninucleate products of merogony detaches to form the envelope of a sporophorous vesicle simultaneously losing the surface coat branches. Division occurs within the enlarging vesicle, by one to several binary fissions, giving two to many sporoblasts (Figure 8.3E,F) in a sparse fibrillar matrix with granules. Envelope persists round mature spores (Figure 8.2F). *Spores*: elongate pear-shaped  $4.0 \times 2.4 \mu\text{m}$  (fresh) (Figure 8.2E,F); prominent posterior vacuole; polar tube with 8–11 wide coils and 2–3 narrow coils (Figure 8.3G,H). (For details, see Hollister *et al.*, 1996b; Field *et al.*, 1996.)

*Pleistophora* sp. of Chupp *et al.* (1993) resembles *Trachipleistophora hominis*. Spores of this '*Pleistophora*' sp. are  $4.0 \times 2.0 \mu\text{m}$  (fixed),

**Fig. 8.3 (opposite)** (A) Magnetic resonance image showing *Encephalitozoon hellem*-induced hypertrophic epithelium (arrow) blocking the nasal airway. From Lacey *et al.* (1992), by permission of BMJ Publishing Group. (B) Magnetic resonance image showing multiple ring-enhancing lesions (arrows) in cerebral cortex, representing sites of *Trachipleistophora anthropophthera*. Unpublished micrograph provided by Dr A. T. Yachnis. (C–J) *Trachipleistophora hominis*: all stages with isolated nuclei, in skeletal muscle of experimentally-infected mouse (C–F,H,J) or AIDS patient (G,I). (C,D) Meronts with well-developed surface coat extensions into host tissue. Bars= $2.0 \mu\text{m}$  (C) and  $1.0 \mu\text{m}$  (D). (E,F) Sporogonic division within sporophorous vesicles derived from surface coat, now almost devoid of branched extensions. Bars= $2.0 \mu\text{m}$ . (C,E,F) From Hollister *et al.* (1996b) by permission of Cambridge University Press. (G) Spore showing anchoring disc (ad) polaroplast (p) posterior vacuole (pv) and some polar tube coils (pt). Bar= $1.0 \mu\text{m}$ . From Field *et al.* (1996), by permission of American Society for Microbiology. (H) Detail of polar tube coil with eight wide coils and three narrow coils (arrowheads). Bar= $0.25 \mu\text{m}$ . Unpublished micrograph of Dr E. Weidner. (I) Detail of surface coat branches on meront. Bar= $0.5 \mu\text{m}$ . From Field *et al.* (1996), by permission of American Society for Microbiology. (J) Part of a sporophorous vesicle with immature spores showing pale fibrillar matrix with granules. Bar= $2.0 \mu\text{m}$ . Original micrograph of Dr E. Weidner. (K) Part of a sporophorous vesicle of *Pleistophora* sp. of Chupp *et al.* (1993), showing labyrinthine surface coat and spore lying in a dense matrix with tubules. Arrows point to polar tube coils. Bar= $0.5 \mu\text{m}$ . Original micrograph of Dr J. Alroy. (L) *Pleistophora* sp. of Ledford *et al.* (1985). Multinucleate (n) plasmodium in skeletal muscle, showing dense labyrinthine surface coat making contact with adjacent sporophorous vesicle. Bar= $1.0 \mu\text{m}$ . From Cali and Owen (1988), with permission. (M–O) *Trachipleistophora anthropophthera* in brain of AIDS patient. (M) Polysporous (large arrow) and disporous (small arrows) sporophorous vesicles. Bar= $2.0 \mu\text{m}$ . (N) Large spore from polysporous sporophorous vesicle showing wide coils and narrow coils (arrowheads) of the anisofilar polar tube. Bar= $0.5 \mu\text{m}$ . (O) Small spores from disporous sporophorous vesicle showing four or five coils of the isofilar polar tube (arrowheads) and rows of polyribosomes. Bar= $1.0 \mu\text{m}$ . Original micrograph of Dr J. Vávra. (M,N) From Vávra *et al.* (1998b), by permission of the *Journal of Eukaryotic Microbiology*. (P) *Microsporidium ceylonensis*: anisofilar polar tube with three narrow coils (arrowheads). Bar= $0.23 \mu\text{m}$ . From Canning *et al.* (1998), by permission of Princeps Editions, Paris





with 10 wide and three narrow coils of polar tube. The fibrillar matrix with tubules in the sporophorous vesicles (Figure 8.3K) is denser than the matrix of *T. hominis* (Figure 8.3J). *Pleistophora* sp. of Grau *et al.* (1996) is probably also a *Trachipleistophora* sp. Few details can be discerned from the original publication but one unpublished micrograph provided by D. S. Ellis shows an anisofilar polar tube (Figure 8.4M).

In *Trachipleistophora anthropophthera* (Figures 8.5G,H,K,L on Plate IV; 8.3B,M,N,O), merogony is as in *T. hominis*. Sporogony: dimorphic, one sporogonic sequence resembling *T. hominis*, forming eight or more large spores. A second sequence produces only two spores in small sporophorous vesicles (Figure 8.3M). Spores: (a)  $3.7 \times 2.0 \mu\text{m}$  (fixed) with six to eight wide and one to three narrow diameter polar tube coils (Figure 8.3N); (b)  $2.2\text{--}2.5 \times 1.8\text{--}2.0 \mu\text{m}$  (fixed) with four or five isofilar coils (Figure 8.3O). (For details, see Yachnis *et al.*, 1996; Berg *et al.*, 1996; Vávra *et al.*, 1998a,b.)

In *Microsporidium ceylonensis* (Figure 8.3P), merogony and sporogony are unknown except for synchronous development of several sporoblasts in a vacuole. Spores:  $3.5 \times 1.5 \mu\text{m}$  (fixed) in groups of eight or more in vacuoles in macrophages. Polar tube anisofilar, with six to ten wide coils and two to three narrow coils (Figure 8.3P). In the case history given by Ashton and Wirasinha (1973), genus is indeterminate, so the species was placed in the collective genus *Microsporidium* and named by Canning and Lom (1986); ultrastructural data are given by Canning *et al.* (1998).

In *Microsporidium africanum*, merogony and sporogony are unknown. Spores:  $4.5\text{--}5.0 \times 2.5\text{--}$

$3.0 \mu\text{m}$  (fixed) in groups in macrophages. The single published electron micrograph shows at least eight wide coils and three narrow coils of the polar tube (Pinnolis *et al.*, 1981).

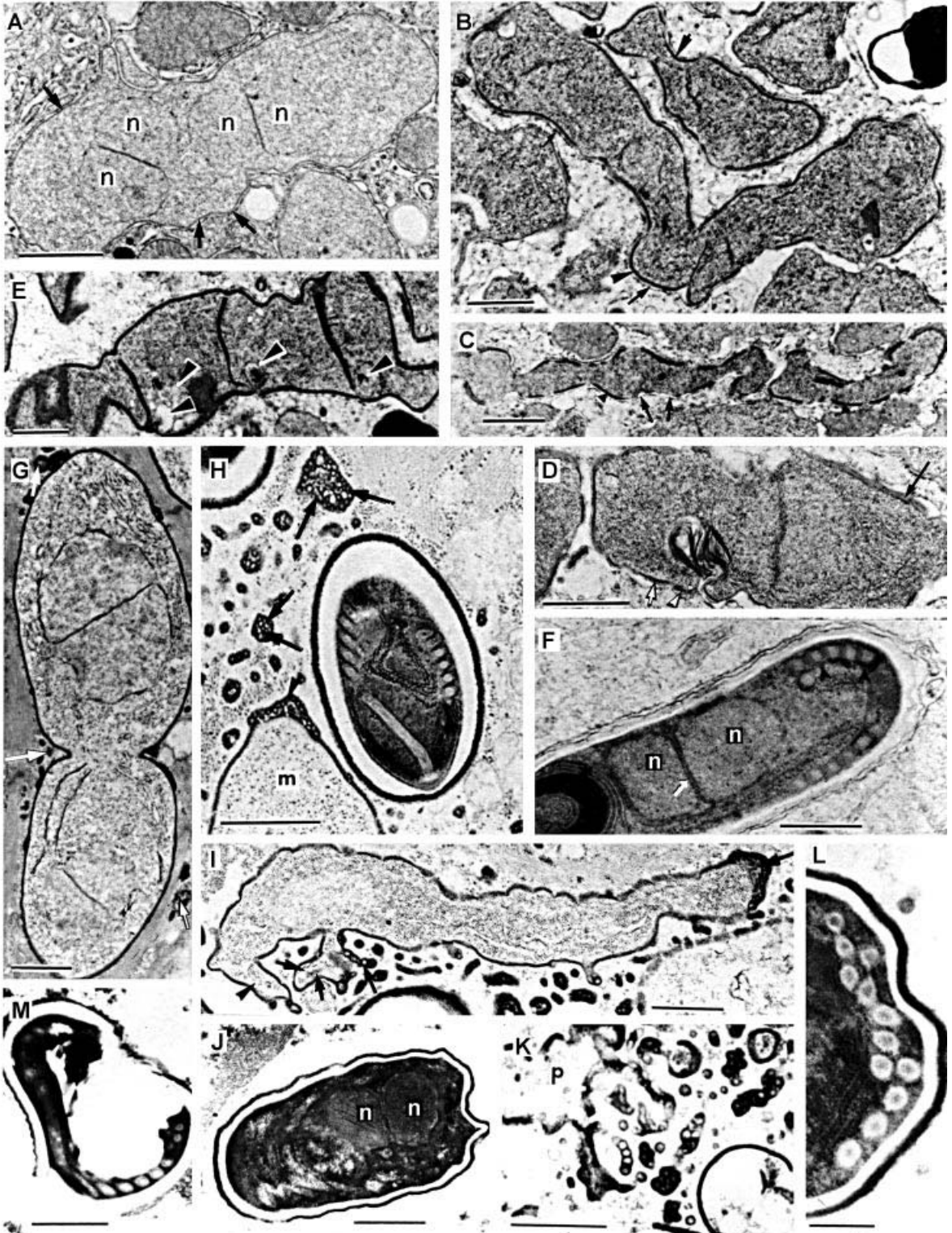
Spores of all species in this anisofilar group, measured fresh (*T. hominis*) or fixed (*T. anthropophthera*, *M. ceylonensis*, *M. africanum*) are generally larger ( $\geq 4.0 \mu\text{m}$  long) than those of other microsporidia infecting man. The only species in man with larger spores ( $5.0 \times 3.0 \mu\text{m}$ ) is *Nosema ocularum* (see below). It also appears to have an anisofilar polar tube and, on the published evidence, there is no certainty that the nuclear complement is diplokaryotic. It may also be one of the anisofilar group.

*Pleistophora* sp. (Figures 8.1B, 8.3L). Merogony and sporogony: multinucleate plasmodia surrounded by a thick surface coat with branched extensions forming links between adjacent parasites. The surface coat becomes a sporophorous vesicle, within which groups of 12 or more sporoblasts are formed from the plasmodium. Spores:  $3.2\text{--}3.4 \times 2.8 \mu\text{m}$  (fixed), with 11 coils of the polar tube. The published micrograph suggests that the polar tube may be anisofilar. However, the multinucleate plasmodia resemble the genus *Pleistophora* rather than *Trachipleistophora*. (For details, see Ledford *et al.*, 1985; Cali and Owen, 1988.)

### The Diplokaryotic Group

All stages diplokaryotic, lying in direct contact with host cell cytoplasm, no sporophorous vesicles.

**Fig. 8.4 (opposite)** (A–F) *Vittaforma corneae*: characteristic ribosome-studded encircling cisternae of endoplasmic reticulum (er), indicated by arrows. (A) Meront with two diplokarya (n). Bar=1.0  $\mu\text{m}$ . (B) Sporonts with electron dense surface coat (arrowheads). Bar=0.5  $\mu\text{m}$ . (C) Elongate sporont, progenitor of about eight sporoblasts. Bar=1.0  $\mu\text{m}$ . (D) Early sporont showing membrane-filled invagination of sporont surface membrane and the encircling er cisterna. Bar=1.0  $\mu\text{m}$ . (E) Almost complete division of sporont with new cross walls in vicinity of membrane-filled invaginations (arrowheads). Bar=0.5  $\mu\text{m}$ . (A–E) from Silveira and Canning (1995), by permission of the *Journal of Eukaryotic Microbiology*. (F) Region of spore showing \*polaroplast, close apposition (arrow) of the two nuclei (n) and polar tube coils (arrowheads). Bar=0.5  $\mu\text{m}$ . From Shadduck *et al.* (1990), by permission of the University of Chicago Press. (G–I) *Brachiola vesicularum*: characteristic vesiculotubular structures are indicated by arrows. All stages have an electron-dense surface coat. (G) Diplokaryotic proliferative stage. Bar=1.0  $\mu\text{m}$ . (H) Region of spore showing only the anterior (wide) polar tube coils. Spore is free of tubules but an adjacent meront (m) has a polar group of tubules (arrowhead). Other bundles of tubules (arrows) lie in lysed host cell cytoplasm. Bar=1.0  $\mu\text{m}$ . (I) Elongate proliferative stage bearing cytoplasmic extensions (arrowheads) with attached tubules and a cap of tubules at one end (arrow). Bar=1.0  $\mu\text{m}$ . From Cali *et al.* (1998), by permission of the *Journal of Eukaryotic Microbiology*. (J–L) *Brachiola connori*. (J) Spore showing diplokaryon (n). Bar=1  $\mu\text{m}$ . (K) Vesiculotubular structures free and attached to cytoplasmic extensions of proliferative stage (p). Bar=1.0  $\mu\text{m}$ . (L) Part of spore showing seven wide coils and five narrow coils. Bar=0.25  $\mu\text{m}$ . Original micrographs of Dr J. A. Shadduck. (M) *Pleistophora* sp. of Grau *et al.* (1996). Region of spore showing anisofilar polar tube. Bar=1.0  $\mu\text{m}$ . Original micrograph of Dr D. S. Ellis



*Vittaforma corneae* (= *Nosema corneum*) (Figures 8.1F; 8.2D; 8.4A–F). All stages surrounded by a complete cisterna of host cell endoplasmic reticulum (ER), which divides with the parasite. *Merogony*: stages with two diplokarya divide by binary fission (Figure 8.4A). *Sporogony*: sporonts with surface coat and up to eight diplokarya (Figure 8.4B–E). Separation of sporoblasts occurs by invagination of the ER cisternae, together with the parasite plasma membrane and surface coat, into ‘pockets’ situated at intervals along the length of the sporont (Figure 8.4D). Invaginations of the same elements from the other side meet and fuse with the ‘pockets’ to complete the formation of sporoblasts in chains, each still surrounded by ER (Figure 8.4E). *Spores*:  $3.7 \times 1.0 \mu\text{m}$  (fresh) (Figure 8.2D), elongate, individually encased in ER; five to seven isofilar coils of the polar tube (Figure 8.4F). This species was described by Shadduck *et al.*, 1990. The species was transferred from *Nosema* to *Vittaforma* by Silveira and Canning (1995).

*Brachiola vesicularum* (Figures 8.1E; 8.4G–I). Surface coat is present on all stages, including meronts. *Merogony* and *sporogony*: shapes range from simple ovoid (Figure 8.4G) to bizarre elongate shapes with branching cytoplasmic extensions (Figure 8.4I). There are never more than two diplokarya. Associated with the surface coat are aggregates of 50–100 nm diameter vesiculotubular structures, either embedded in the surface coat or arranged like strings of beads, especially at the ends of elongate stages. During sporogony many of these aggregates are lost. Division is by binary fission. *Spores*: ovoid,  $2.5\text{--}2.9 \times 1.9\text{--}2.0 \mu\text{m}$  (fixed) (Figure 8.4H); polar tube anisofilar, with six or seven wide coils and two or three narrow coils arranged in one to three rows. (For details, see Cali *et al.*, 1998.)

*Brachiola connori* (= *Nosema connori*) (Figure 8.4J–L). Only spores are described with the case history (Margileth *et al.*, 1973). Further material examined by J. A. Shadduck (personal communication) shows that all stages have a surface coat. Aggregates of tubules embedded in the surface coat material are associated with the branched ends of meronts (Figure 8.4K). On the basis of diplokaryotic stages and vesiculotubular structures enveloped by the surface coat, Cali *et al.* (1998) transferred the species to *Brachiola*. *Spores*:  $4.0 \times 2.0 \mu\text{m}$  (fixed) diplokaryotic, anisofilar with

seven or eight wide and three to five narrow coils (Figure 8.4J,L). This species was named *Nosema connori* by Sprague (1974); diplokaryotic spores were clearly demonstrated by Shadduck *et al.* (1979); the presence of vesiculotubular structures was used as basis for transfer to genus *Brachiola* (Cali *et al.*, 1998).

*Brachiola algerae* (= *Nosema algerae*). Surface coat present on all stages, including meronts. *Merogony* and *sporogony*: stages with vesiculotubular projections as described in *B. vesicularum*. Division by binary fission. Sporogony disporous. *Spores*: ovoid,  $3.5 \times 2.0 \mu\text{m}$  (in sections). Polar tube anisofilar with up to 12 coils of which two or three are narrow, arranged as a single row (or as two or three rows in culture at 38°C). As these features are identical to those of *B. vesicularum*, it has been suggested that the two species are identical. (For details, see Visvesvara *et al.*, 1999; Trammer *et al.*, 1999; Lowman *et al.*, 2000.)

*Nosema ocularium* (Figure 8.1G). Few details are available. *Spores*:  $5.0 \times 3.0 \mu\text{m}$  (fixed), diplokaryotic (though this is not clear from the published micrograph). Polar tube has nine to twelve coils, of which the last three appear to be narrower. Without further study, no conclusions can be drawn about its true generic position (see above under the anisofilar group).

## PATHOGENESIS AND CLINICAL SIGNIFICANCE

Almost all of the organs of the human body can be infected by one or more of the spectrum of 14 microsporidian species described in the previous section. Many tissues and cell types are involved (Table 8.1). According to site of infection, clinical manifestations may be diarrhoea, weight loss, cholecystitis, cholangitis, bronchitis, bronchiolitis, pneumonitis, sinusitis, rhinitis, hepatitis, peritonitis, nephritis, ureteritis, cystitis, urethritis, prostatitis, keratoconjunctivitis, corneal ulcer, myositis or encephalitis. The pathology has been reviewed by Weber *et al.* (1994) and Schwartz *et al.* (1996). Cardiac disease and probable pancreatic, parathyroid and thyroid dysfunction have been reported for *T. anthropophthera* (Yachnis *et al.*, 1996). Without treatment, the outcome is likely to be fatal for severely immunocompromised hosts infected with the disseminating species.

**Table 8.1** Sites of infection of microsporidia in immunocompromised and/or immunocompetent human patients

<i>E. bienewisi</i>	Epithelia of intestine, bile duct, gall bladder, pancreatic duct, trachea, bronchi, nasal sinuses and nose; non-parenchymal liver cells
<i>E. intestinalis</i>	Epithelia of intestine, bile duct, gall bladder and bronchi; macrophages, fibroblasts and endothelial cells of lamina propria; kidney tubule cells; non-parenchymal liver cells; nasal epithelium; corneal epithelium
<i>E. hellem</i>	Epithelia of respiratory tract (trachea to bronchioles), nasal sinuses, nose, cornea and conjunctiva; kidney tubule cells and renal blood vessel endothelium; bladder; prostate; liver. Not intestine
<i>E. cuculluli</i>	Epithelium (tubule cells) and endothelium of kidneys, adrenal glands, trachea; myocytes of heart; macrophages of brain, heart, urinary bladder, spleen and lymph nodes (suggestive of phagocytosis after release from other cells) (Mertens <i>et al.</i> , 1997); epithelium of duodenum (transiently) and conjunctiva and detected in sputum, urine and stool (Franzen <i>et al.</i> , 1995); liver; peritoneum
<i>V. corneae</i>	Corneal stroma (Shaddock <i>et al.</i> , 1990); urinary system (Deplazes <i>et al.</i> , 1998). In experimentally infected athymic mice, liver, spleen, kidney, intestine, heart, lung, brain and retina (Silveira <i>et al.</i> , 1993)
<i>M. ceylonensis</i>	Corneal stroma in macrophages and free between lamellae
<i>M. africanum</i>	Corneal stroma in histiocytes and free between lamellae
<i>N. oculorum</i>	Corneal stroma (Bryan <i>et al.</i> , 1990)
<i>Pleistophora</i> sp.	Skeletal muscle myocytes (Ledford <i>et al.</i> , 1985)
<i>T. hominis</i>	Skeletal muscle myocytes, nasal sinus (detected in nasal secretions) and conjunctival epithelium (Field <i>et al.</i> , 1996). Systemic infection (not including brain) in athymic mice (Hollister <i>et al.</i> , 1996b)
<i>T. anthropophthera</i>	Brain astrocytes, endothelium, macrophages; heart myocytes, macrophages; kidney tubular and glomerular epithelium, endothelium, macrophages; pancreas endocrine and exocrine cells, Schwann cells; vascular smooth muscle; thyroid follicular epithelium; parathyroid epithelium, adipocytes; liver hepatocytes; unknown cells in bone marrow, lymph node and spleen (Yachnis <i>et al.</i> , 1996)
<i>B. vesicularum</i>	Skeletal muscle myocytes (Cali <i>et al.</i> , 1998)
<i>B. connori</i>	Disseminated, especially involving myocytes (myocardium, <i>muscularis</i> of gastrointestinal tract, walls of arteries in urinary bladder, kidney, liver, adrenals, heart and diaphragm) but also present in adrenal cortical epithelium, kidney tubules and foci of hepatocytes (Margileth <i>et al.</i> , 1973)
<i>B. algerae</i>	Cornea (Visvesvara <i>et al.</i> , 1999)

Typical reactions to microsporidial infections in immunologically intact hosts are hypertrophy of infected cells and tissues, without inflammation as long as the infected cells remain intact, but with an inflammatory response once the spores are liberated. The response is in the form of a diffuse cellular infiltration, leading to granuloma formation, involving lymphocytes, plasma cells and macrophages. In immunocompromised patients the cellular response may be similar but is sometimes minimal.

### Intestinal Infection

Although alterations to the intestinal architecture are not universal in patients infected with *E. bienewisi* or *E. intestinalis*, there may be villus stunting, atrophy and other histological changes. *E. intestinalis* spreads throughout the epithelium and into the lamina propria (Figure 8.5B on Plate IV), while *E. bienewisi* is restricted to the enterocytes between the brush border and the nucleus. Immunocompetent patients may suffer an acute,

self-limited diarrhoea, while AIDS patients usually have chronic, intractable diarrhoea. Contact spread from the intestinal epithelium to the bile duct, gall bladder, pancreatic duct and respiratory surfaces, causing epithelial hyperplasia and associated clinical signs, has occurred with both species. *E. hellem* does not infect the gastrointestinal tract. *E. cuculluli* has only been found in the intestinal epithelium in a patient with disseminated infection but suffering no intestinal disorder, suggesting that infection of the intestine represents merely the route to the deeper viscera.

### Renal Infection

The kidney is a site of predilection for all three *Encephalitozoon* spp. (Figure 8.5F on Plate IV) and was involved in disseminated cases of *V. corneae*, *B. connori* and *T. anthropophthera*. Infection is principally in the tubules but glomeruli may be involved. Breakdown of tubule epithelial cells stimulates an interstitial nephritis and debris

accumulates in the tubule lumina. Kidney tissue destruction may be massive and there may be spread to the ureters and bladder. The spores can be detected in urine.

### Muscular including Myocardial Infection

Infection in myocytes of the heart has been reported for *B. connori*, *E. cuniculi* and *T. anthropophthera* (Figure 8.5K on Plate IV). In all cases, each focus contained myriads of spores. Reactive cells were absent, except for macrophage activity after release of the spores, but areas with multiple lesions were associated with necrosis and fibrosis of adjacent tissue. Myocytes of skeletal muscle were the sites of infection with *T. hominis* (Figure 8.5J on Plate IV) and *Pleistophora* sp., while *B. connori* showed a predilection for the walls of blood vessels in most organs, occurring also in the kidney tubules and adrenal cortex, with no inflammatory response. However, a marked inflammatory infiltration was present in the severely infected *muscularis* of the diaphragm of the *B. connori*-infected immunocompromised infant.

### Cerebral Infection

The brain has been reported only once in a human patient as a site of infection for *E. cuniculi* (Mertens *et al.*, 1997). Spores were found free in parenchyma and perivascular spaces and others were in macrophages. Experience with animals has shown that the largest aggregates of spores occur in grey and white matter at all levels of the brain and that microgranulomata are formed after spore release. It is likely that brain infection also occurs regularly in human *E. cuniculi* infections but, in most of the few cases that have been diagnosed, parasites have been isolated from urine or bronchoalveolar lavage, the patients have responded to treatment and autopsies have not been performed. The most extensive catalogue of brain injuries due to microsporidia is that by Yachnis *et al.* (1996), who reported two cases of infection with the parasite now known as *T. anthropophthera*. Parasites were present in astrocytes (Figure 8.5G on Plate IV) and endothelial

cells in numerous lesions each measuring up to 2.5 cm (Figure 8.5L on Plate IV; Figure 8.3B). These lesions were characterised by a central necrosis with spores engulfed by macrophages, surrounded by infected astrocytes (Figure 8.5G on Plate IV).

### Ocular Infection

There are two types of ocular microsporidiosis. Infections caused by *E. hellem*, *E. cuniculi*, *E. intestinalis* and *T. hominis* have been restricted to the corneal and conjunctival epithelia, and caused distressing bilateral punctate keratopathy with redness, irritation and decreased visual acuity. *M. ceylonensis*, *M. africanum*, *V. corneae*, *B. algerae* and *N. ocularum* have infected cells of the corneal stroma. The cases of *M. ceylonensis* and *B. algerae* led to severe ulceration and necessitated keratoplasty, while that of *M. africanum* required surgical removal of the eye.

### Respiratory Infection

Respiratory disease is a common manifestation of *E. hellem* and less frequent involvement has been reported for *E. intestinalis*, *E. cuniculi* and *E. bieneusi*. *E. bieneusi* has been found in nasal and nasal sinus epithelia (Eeftinck Schattenkerk *et al.*, 1993) and bronchial epithelium (Weber *et al.*, 1992b), *E. cuniculi* in the tracheal epithelium (intense infection) (Mertens *et al.*, 1997) and *E. intestinalis* in bronchial and nasal sinus epithelia (Molina *et al.*, 1995). The extent of infection of *E. hellem* in the respiratory system and its absence from the intestine led Schwartz *et al.* (1992) to suggest that the respiratory epithelium was the port of entry. In one focus, parasites were found in subepithelial granulation tissue adjacent to capillaries, suggesting a route from the respiratory surface to the kidney. Manifestations of respiratory infection may be chronic cough and shortness of breath and finally even respiratory failure. Infection of the nasal and nasal sinus epithelia leads to formation of polypoid tissue and consequent nasal obstruction and discharge (Figure 8.3A).

## Liver Infection

*E. cuniculi* has been reported once as a cause of hepatitis (Terada *et al.*, 1987) and once as a cause of peritonitis (Zender *et al.*, 1989) but both reports were made before *E. hellem* and *E. intestinalis* were described and the diagnosis remains unconfirmed. Surprisingly, liver parenchyma is rarely involved in human microsporidiosis.

## Pathogenic Mechanisms

The mechanisms of pathogenesis are little understood. In *E. cuniculi*, the formation of immune complexes undoubtedly contributes to disease in carnivores (Mohn and Nordstoga, 1975) and recently Sharpstone *et al.* (1997) proposed that elevated TNF $\alpha$  levels in the intestine of *E. bienewisi*-infected AIDS patients contributed to the diarrhoea, which could be alleviated by thalidomide, a TNF $\alpha$  inhibitor.

## IMMUNOLOGY

### Cell-mediated Immunity

Current knowledge of immune responses to microsporidial infection have been summarised by Didier, Snowden and Shadduck (1998). It is not surprising that microsporidiosis have emerged as important opportunistic infections in AIDS patients, as evidence derived from experimental infections of mice with *E. cuniculi* shows that cell-mediated immune responses are paramount in controlling infection. Thus, transfer of sensitised syngeneic T cell-enriched spleen cells to athymic mice just prior to infection with *E. cuniculi* gave protection from lethal disease (Schmidt and Shadduck, 1984). SCID mice were similarly protected if the T cell transfer occurred before infection but they were only partially protected if the T cell transfer was effected after infection (Hermanek *et al.*, 1993). Macrophage activation by cytokine release from lymphocytes, to stimulate phagocytosis and degradation of spores by nitrogen intermediates, has been demonstrated as one mechanism of protection, and interferon gamma (IFN $\gamma$ ) has been implicated as the

mediator (Didier *et al.*, 1994; Didier, 1995). Achbarou *et al.* (1996) confirmed the importance of IFN $\gamma$  in their mouse model for chronic infection with *E. intestinalis*, using IFN $\gamma$ R<sup>0/0</sup> mice, a strain with a deletion in the gene coding for the IFN $\gamma$  receptor. In their studies, spores of *E. intestinalis* were shed in increasing numbers by the IFN $\gamma$ R<sup>0/0</sup> mice during the experimental period, whereas there was a decrease in spore output in wild-type mice over the same period.

### Humoral Immunity

The role of antibodies in the control of microsporidial infection appears to be of secondary importance to the cell-mediated response. Nothing is known of the role, if any, of IgA in preventing infection via the intestine. Both IgM and IgG antibodies are produced in response to infection but are only likely to have an opsonising effect on spores for uptake by macrophages (Niederhorn and Shadduck, 1980). In immunocompetent animals the persistence of high antibody levels after clinical recovery may indicate the presence of latent infections and this has been shown by reactivation of latent infections in mice by administration of hydrocortisone (Bismanis, 1970). However, it has yet to be determined whether the severe infections in AIDS patients are newly acquired or are reactivations of latent infections. Examination of serum taken from an AIDS patient before detection of *E. hellem* and at intervals after diagnosis showed a decline to almost non-detectable levels of specific antibody as the CD4<sup>+</sup> T-cell count dropped, although the parasite burden remained high (Hollister *et al.*, 1993b). Antibodies to *Encephalitozoon* spp. have been detected in several serological surveys using blood from healthy donors and patients suffering a variety of diseases (Hollister *et al.*, 1991; Van Gool *et al.*, 1997).

Two of the species first discovered in AIDS patients, *E. bienewisi* and *E. intestinalis*, have since been found in immunocompetent people as transient infections. This possibility was first signalled by Bretagne *et al.* (1993), who detected *E. bienewisi* spores in the stool of 8/990 children in Niger who were unlikely to have been HIV



positive. Spores of *E. bienersi* have also been detected in a child in Tunisia who was experiencing severe diarrhoea (Aoun *et al.*, 1997) and in a child in Zambia (Hautvast *et al.*, 1997). *E. bienersi* has also been found as a cause of traveller's diarrhoea in an otherwise healthy child (Sobottka *et al.*, 1995) and an adult (Sandfort *et al.*, 1994). Wanke *et al.* (1996) and Gainzairain *et al.* (1998) reported other adult cases and reviewed previous cases. *E. intestinalis* has been detected in several immunocompetent adults (Raynaud *et al.*, 1998). Surprisingly, only two cases of microsporidiosis have been reported to date in people who were immunosuppressed after organ transplantation (Rabodonirina *et al.*, 1996; Sax *et al.*, 1995).

## MOLECULAR BIOLOGY

### Gene Sequencing

The presence of 16S ribosomes in microsporidia has facilitated amplification of microsporidian ribosomal genes even without purification from host tissue. PCR amplification and sequencing of several microsporidian genes have now been achieved and the results have been used to examine the phylogenetic position of microsporidia (see above), contribute to an understanding of systematic relationships of genera, to epidemiology and above all to diagnosis (see below). Complete or partial sequences have been obtained for several genes, including the complete sequence of the rDNA unit of *E. cucurbiti* comprised of the 16S gene, ITS1 region, 5.8S gene and 23S gene plus flanking regions (Biderre *et al.*, 1997c). Sequences are also available for the small subunit rDNA (many species), isoleucyl-tRNA synthetase in *Nosema locustae* (Brown and Doolittle, 1995),  $\beta$ - and  $\alpha$ -tubulin in *E. hellem*, *E. cucurbiti*, *E. intestinalis* and *Nosema locustae* (Edlind *et al.*, 1996; Li *et al.*, 1996), a U2 RNA homologue in *Vairimorpha necatrix* (De Maria *et al.*, 1996), elongation factor 1 $\alpha$  in *Glugea plecoglossi* (Kamaishi *et al.*, 1996), mitochondrial-type heat-shock protein genes HSP70 in *N. locustae* (Germot *et al.*, 1997) and *V. necatrix* (Hirt *et al.*, 1997), and the largest subunit of RNA polymerase II (Hirt *et al.*, 1999). Sequences of these genes have been used variously to deduce

that microsporidia are primitive eukaryotes or highly derived fungi, with the balance of evidence in favour of fungal affinities (summarised in Canning, 1998; Weiss *et al.*, 1999).

### Molecular Karyotypes

Using another approach to species identification and, indeed, to investigation of microsporidian genomic organisation, molecular karyotypes have been obtained by pulsed field gel electrophoresis. Haploid genomes of only 2.9 Mb with 11 chromosomal bands in *E. cucurbiti* (smaller than that of *Escherichia coli* at 4.7 Mb) (Biderre *et al.*, 1995) up to 19.5 Mb with 16 bands for *Glugea atherinae* have been demonstrated (Biderre *et al.*, 1997b). In hybridisation experiments, ribosomal DNA probes hybridised to all 11 chromosomes of *E. cucurbiti*, while  $\beta$ -tubulin and aminopeptidase genes were each found on two chromosomes, and five other protein-encoding genes were found on only one chromosome (Biderre *et al.*, 1997a).

The symbiont-like HSP70 genes identified in microsporidia would be expected to function in mitochondria, which are reportedly absent. These genes are unusual in having a peroxisomal targeting signal (Hirt *et al.*, 1997), unlike all previously described HSP70 genes, and these organelles have also not been described. This is yet another highly unusual character of microsporidia and determination of the function of these genes is clearly a requirement for our understanding of microsporidian biology.

## EPIDEMIOLOGY

### Transmission

Most microsporidia are transmitted directly between hosts by ingestion of spores, which are released into the environment via faeces or urine or by death and degeneration of the hosts e.g. of fish and invertebrates. There is evidence of transplacental transmission of *E. cucurbiti* in rodents, rabbits and carnivores (see Canning and Lom, 1986) but not in man. Strong circumstantial evidence was provided that *E. hellem* may enter via the respiratory system (Schwartz *et al.*, 1992).



Spores released from patients or from animal sources could easily enter the water supplies, as the spores are small enough for all species reported in man to pass through the filters used in water purification. Indeed, evidence for the presence of microsporidian spores in river water and sewage effluent, including several species which infect man, has been obtained by combining water concentration, filtration through various pore sizes and PCR amplification of the residues (Sparfel *et al.*, 1997; Dowd *et al.*, 1998).

In considering the epidemiology of microsporidiosis, there are many questions for which answers are still needed. How many of the 14 species already known to infect man are natural parasites which occur subclinically at low prevalence and are transmitted human-to-human through the general population? If directly human to human, what is the likely mode of transmission? How many species are examples of single, unfortunate encounters between parasite and host, when the host is unusually susceptible (immunocompromised)? In how many cases are alternative hosts involved? How many of the fulminant infections seen in AIDS patients are reactivations of latent infection and how many are newly acquired? To what extent can microsporidia of invertebrate hosts adapt to mammalian body temperature and pose a threat to immunocompromised people? If only a small fraction of the possible range of microsporidia capable of infecting man is known, what are the limiting factors and where should we look for potential sources of infection?

### *Enterocytozoon bieneusi*

*E. bieneusi* is the most commonly occurring species in man with prevalences of 10–44% recorded in AIDS patients whose CD4<sup>+</sup> cell counts have fallen below 100/ml<sup>3</sup> and who suffer chronic diarrhoea. Similar spores detected in the stool of domestic pigs have been confirmed as *E. bieneusi* by 16S rRNA sequence data (Deplazes *et al.*, 1996b) but contact between man and pigs is too limited to account for the recorded prevalences and none of the four genotypes found in pigs match those found in humans. However, rabbits and dogs have also been identified as

hosts (del Aguila *et al.*, 1999). Mansfield *et al.* (1997) reported the spontaneous occurrence of a microsporidium very close, if not identical, to *E. bieneusi*, in 35.2% (18/51) of several species of macaque monkeys with simian AIDS (SIV infection), which had shown signs of hepatobiliary and intestinal disease at a primate centre. Again, monkeys cannot be considered as a source for human infection but an argument can be made that *E. bieneusi* is a species that naturally infects primates. Mansfield *et al.* (1997) stated that there was preliminary evidence that an *E. bieneusi*-like organism was present at subclinical levels in the colony of normal rhesus monkeys (*Macaca mulatta*) at the primate centre and proposed that the disease in macaques was due to reactivation after SIV infection. It is possible that, after a short, acute episode, *E. bieneusi* remains latent in man unless the immune constraints are removed. The demonstration of genetic diversity in *E. bieneusi*, with four types based on restriction (RFLP) analysis of PCR products (Liguory *et al.*, 1998), further complicates the elucidation of *E. bieneusi* epidemiology.

### *Encephalitozoon spp.*

Unlike *E. bieneusi*, which still cannot be maintained *in vitro*, culture of *Encephalitozoon spp.* has made it possible to conduct serological surveys to detect latent infections. Hollister *et al.* (1991), using whole spores of *E. cuniculi* as antigen in ELISA identified infections in numerous patients suffering tropical disease and confirmed their results by Western blotting of spore protein profiles with the patients' sera. They found that only 2/1002 healthy blood donors were positive. In contrast, Van Gool *et al.* (1997), using sonicated spore preparations of *E. intestinalis* as antigen in ELISAs and counter-immunoelectrophoresis, and germinated spores in immunofluorescence tests, found that 8% (24/300) of blood donors and 5% (13/276) of pregnant women had high antibody titres. The tests used by Van Gool *et al.* (1997) were genus-specific and indicated that one or more of the *Encephalitozoon spp.* occur as latent or past infections at significant levels in human population groups, thus providing a possible pool from

which reactivations can occur in AIDS. Franzen *et al.* (1996c), using PCR amplification and Southern hybridisation with species-specific primers and probes, detected five cases of *E. bieneusi*, five cases of *E. intestinalis* and five double infections among 46 AIDS patients (33%). These results indicate a much higher prevalence of *E. intestinalis* (22%) than had previously been determined by parasitological examinations and echo those of Van Gool *et al.* (1994), who isolated *E. intestinalis in vitro* several times from the stool of AIDS patients, in whom the parasite had not been detected by direct faecal examination. *E. cuculi* has been reported from two apparently immunocompetent children who suffered transitory neurological disorders (see Historical Introduction). Although these parasitological detections occurred before the other *Encephalitozoon* spp. had been recognised, it is likely that the diagnoses were correct because *E. intestinalis* infections are not associated with neurological damage, even in AIDS patients. *E. intestinalis* has recently been found in several immunocompetent people suffering diarrhoea (Raynaud *et al.*, 1998) but *E. hellem* has only been found in people with AIDS.

Recently, a microsporidium contributing to morbidity and mortality in budgerigars (*Melopsittacus undulatus*) in a commercial aviary, has been identified by PCR and Southern blot analysis as *E. hellem* (Black *et al.*, 1997). The infections were unusual in that the intestinal epithelium was heavily infected, a site not associated with *E. hellem* in man. Black *et al.* (1997) recorded that some of the AIDS patients with *E. hellem* infection had owned or been exposed to caged birds. Although yet to be confirmed as a source of infection, pet birds might be involved in the epidemiology of *E. hellem* infections. Recently, infections of *E. intestinalis* have been found in dog, donkey, pig, cow and goat faeces, suggesting that human infections may have a zoonotic origin (Bornay-Llinares *et al.*, 1998).

The most complete evidence for zoonotic sources of human microsporidial diseases lies with *E. cuculi*. This species has a wide host range among mammals. Canning and Lom (1986) recorded 25 hosts from several orders of mammals and these are probably just a few of the total of susceptible animals. Sequencing of the

intergenic spacer region (ITS) of the ribosomal genes has revealed that isolates fall into three categories, based on the number of tetranucleotide repeats (5'-GTTT-3') in the ITS. The rabbit type has three repeats, mouse type has two and dog type has three (Didier *et al.*, 1995b). Deplazes *et al.* (1996a) examined six isolates of *E. cuculi* from AIDS patients in Switzerland and found that all were of the rabbit subtype, and concluded that *E. cuculi* microsporidiosis in this situation was a zoonotic disease derived from rabbits. In contrast, other isolates of *E. cuculi* from AIDS patients have been identified as dog subtypes (Hollister *et al.*, 1993a, 1996a; Didier *et al.*, 1996b). Dogs are, thus, a likely source of infection, as had been previously suggested by seroconversion of a child who had had close contact with dogs with overt encephalitozoonosis (McInnes and Stewart, 1991).

### Other Species

No firm data are available on the possible sources of infection of the remaining human microsporidia. The *Pleistophora* sp. of Ledford *et al.* (1985), *T. hominis* and *T. anthropophthera* have some morphological features in common with the numerous *Pleistophora* spp. which are found in fish or crustaceans, mostly parasitising skeletal muscle (Canning and Lom, 1986). The finding of unidentified microsporidia, still enveloped by undigested muscle, in the stool of an AIDS patient with diarrhoea (McDougall *et al.*, 1993) supports the concept of a dietary source for some of these species. Toczylowski *et al.* (1997) found unidentified organisms, thought to be microsporidia, in an extracellular position close to the caecal epithelium in puffin chicks (*Fratercula corniculata*), which had been captured and fed on silversides and krill. If their identification was correct it further shows that microsporidia can survive the digestive process in abnormal hosts.

Another possible route of infection to skeletal muscle is by direct inoculation by a blood-sucking invertebrate. Microsporidia are very common in mosquitoes, with many genera and species involved. When the sequences of the 16S rDNA of several genera of polysporous microsporidia derived from fish, crustacea and

haematophagous insects were compared, the sequence closest to that of *T. hominis* was that of *Vavraia culicis*, a parasite of many species of culicine and anopheline mosquitoes (Cheney *et al.*, 2000). Furthermore, *T. hominis* readily infects anopheline and culicine mosquitoes when spores are fed to larvae, and spores harvested from these larvae are infective to athymic mice (Weidner *et al.*, 1999). Although *T. hominis* is morphologically distinct from *V. culicis*, it is possible that the human *T. hominis* was derived from a species closely related to *V. culicis* infecting another biting fly. Recently a well known parasite of mosquitoes, *Brachiola algerae* (= *Nosema algerae*), has been isolated from human cornea (Visvesvara *et al.*, 1999) and ultrastructural data (Trammer *et al.*, 1999) suggested that *Brachiola vesicularum*, which was described as a new species from a skeletal muscle biopsy taken from an AIDS patient, might actually be *N. algerae*. However, although *N. algerae* was transferred to the genus *Brachiola*, it was considered to differ from *B. vesicularum* (Lowman *et al.*, 2000). The possibility that *T. hominis* has an insect origin raises issues of public health importance, and indicates that microsporidia of invertebrate origin should be investigated for their ability to adapt to human body temperature.

It was originally proposed that the corneal infection of *V. corneae* might have been acquired directly by swimming in a lake. However, subsequent investigation has shown that *V. corneae* gives rise to a systemic infection in athymic mice (Silveira and Canning, 1993) and in an AIDS patient (Deplazes *et al.*, 1998), so that it is more likely that the corneal infection was secondary. However, an invertebrate origin for this species cannot be ruled out. Nothing is known about the generic status or likely sources of the other ocular infections due to *M. ceylonensis*, *M. africanum* or *N. ocularum*.

## LABORATORY DIAGNOSIS

### Light Microscopy

Several staining techniques have proved particularly useful for detection of microsporidian spores in urine, faeces or tissue specimens. The original chromotrope-based stain (Weber *et al.*,

1992a) and modifications thereof (Ryan *et al.*, 1993; Kokoskin *et al.*, 1994) stain spores pinkish-red and can be used with light background counterstains to advantage on faecal and urine smears (Figures 8.5C,D on Plate IV) and tissue sections. An acid-fast chromotrope method has been developed that will stain both microsporidian spores and *Cryptosporidium* oocysts, both of which may be present in stool (Ignatius *et al.*, 1997). Warthin–Starry stains spores brownish-black and is best used on tissue sections, in which even single spores are easily detected (Figure 8.5B on Plate IV) (Field *et al.*, 1993). Other useful stains are Gram's, which stain spores blackish-purple, and Ziehl–Neelsen, which stains them red (Figure 8.5F on Plate IV). Spores are more difficult to detect in Giemsa-stained smears but advantages of this method are that developmental stages are revealed and that the nuclei are visible (Figure 8.5I on Plate IV) to aid generic diagnosis. Haematoxylin and eosin used in routine histological processing is a poor method for microsporidia (Figure 8.5K on Plate IV) but the spores are clear when viewed with polarised light (Figure 8.5H on Plate IV). Toluidene blue gives excellent results on resin-embedded sections (Figure 8.5G,J on Plate IV).

The fluorescence brighteners (fluorochromes) Uvitex 2B (Van Gool *et al.*, 1993) and Calcofluor M2R (Vávra *et al.*, 1993) are without doubt the most sensitive for quick detection of spores in smears and sections. Both give brilliant blue-white fluorescence when examined with a fluorescence microscope at wavelengths of 390–415 nm (Figure 8.5E on Plate IV). However, as the fluorescence depends on the presence of chitin in the spore wall, fungal spores will also fluoresce and may give false positives in inexperienced hands. Chromotrope and fluorochromes have proved equally valuable in comparative tests (Didier *et al.*, 1995a; Ignatius *et al.*, 1997) and an excellent routine would be to scan specimens stained with Uvitex or Calcofluor and, if spores are suspected, to re-stain new preparations with Chromotrope.

### Antibody Detection of Microsporidian Spores

Polyclonal and monoclonal antibodies raised against microsporidian species have been used

as aids to detection and identification. It is likely that similar epitopes are present on the spore coat proteins of many microsporidia, so that polyclonal sera raised against spores will be cross-reactive. This was found when polyclonal sera raised against *E. hellem* or *E. cuniculi* bound strongly in immunofluorescence tests (IFAT) in homologous and heterologous reactions using fresh or formalin-fixed *E. hellem*, *E. cuniculi*, *E. intestinalis* and *E. bienersi* (Aldras *et al.*, 1994). Surprisingly, a polyclonal serum raised against spores of *E. cuniculi* was highly specific and was used to identify this species in nasal discharge from an AIDS patient, there being no reaction of the spores with polyclonal sera raised against *E. hellem* or *E. intestinalis* (Franzen *et al.*, 1995). Species-specific polyclonal antisera have also been used to identify *E. intestinalis* in animals that may be a reservoir for human infection (Bornay-Llinares *et al.*, 1998). Aldras *et al.* (1994) found that even monoclonal antibodies (Mabs) raised against *E. hellem* were cross-reactive with the other *Encephalitozoon* spp. and with *E. bienersi* but not with *N. corneum* (= *V. corneae*). A similar level of specificity was found by Enriquez *et al.* (1997) for a Mab that reacted with all *Encephalitozoon* spp. in IFAT but, in this case, not with *E. bienersi* or *V. corneae*. In contrast, one Mab raised against *E. hellem* by Croppo *et al.* (1998) was not cross-reactive, in IFAT or Western blots, with any other of the microsporidia tested and thus might be useful in identification of *E. hellem* in fixed tissues. Although IFAT is less convenient than chromotrope or fluorochromes for detection, it may become a valuable technique in species identification, when Mabs for all species are available.

### Detection of Antibodies in Patient's Sera

Several serological tests have been designed to detect antibodies in human sera and thus determine the extent to which microsporidian infections occur in immunocompetent healthy people, as well as in those suffering AIDS or other diseases. Some results of serological surveys for *E. cuniculi* are presented in the section on Epidemiology (see above). In the absence of a

satisfactory culture method for *E. bienersi*, it has not been possible to develop serological tests for this species, based on *E. bienersi* antigens. Ombrouck *et al.* (1995) reported binding of sera from *E. bienersi*-infected, HIV-positive patients in Western blots of SDS-PAGE separated proteins of *Glugea atherinae*, a microsporidium derived from fish. Unfortunately, the binding patterns were highly variable and two of the most frequently recognised proteins were also recognised by sera from two of six patients uninfected with microsporidia and infected with *Cryptosporidium*. Clearly the development of serological tests for *E. bienersi* awaits improvement in culture techniques.

### Polymerase Chain Reaction (PCR)

PCR offers considerable promise both for detection of microsporidia in clinical samples and identification of species. Sequences are known for the 16S rRNA genes of the *Encephalitozoon* spp., *E. bienersi*, *V. corneae* and *T. hominis* and, from these, it is possible to design primers which will amplify all species (based on highly conserved regions), or are genus- or species-specific. When genus-specific primers are used, species identification can still be achieved by using species-specific oligonucleotide probes on Southern blots or by restriction digests. Vossbrinck *et al.* (1993) used primers for a region of the rDNA spanning part of the small subunit, the ITS region and part of the large subunit to amplify *E. hellem*, *E. cuniculi* and *V. corneae* from culture and differentiated these with restriction digests using *Sau3a*, *EcoR1*, *Dra1* and *Hinf1*.

The first attempt to amplify microsporidian DNA from stool involved a lengthy (4 day) and complicated procedure involving mechanical and chemical disruption of spores (Fedorko *et al.*, 1995). Later methods have shortened and simplified the procedure. Fresh, fixed or frozen tissue samples can be used for DNA extraction, with or without prior disruption by grinding. Stool samples can be processed after formalin fixation and dilution. Specimens are usually incubated in lysis buffer containing SDS and proteinase K. Ombrouck *et al.* (1997) recommended simple boiling of formalin-fixed faeces at 100°C and

found that as few as 10 spores in a specimen could be detected.

PCR has been compared with standard staining techniques in several surveys. David *et al.* (1996) detected microsporidia (*E. bienewsi* or *E. intestinalis*) in 26/28 (93%) of intestinal biopsies from patients with proven microsporidiosis. Coyle *et al.* (1996) used PCR amplification with species-specific primers on intestinal biopsies for detection of *E. bienewsi* or *E. intestinalis*. They found that 25/68 patients with diarrhoea and 1/43 patients without diarrhoea were positive for *E. bienewsi*. Only 24 of these were positive by electron microscopy. Also *E. intestinalis* was detected in five out of the 68 patients with diarrhoea and none of the patients without diarrhoea, in accord with the TEM studies. Confirmation of the positive results was obtained by specific oligonucleotide probes on Southern blots. Franzen *et al.* (1996c), using PCR and Southern blots with *E. bienewsi*- and *E. intestinalis*-specific probes, detected five *E. bienewsi*, five *E. intestinalis* and five dual infections in 15 patients. The same technique was used to demonstrate the presence of *E. intestinalis* in stool samples, duodenal and bile juice, duodenal biopsies, urine, sputum, bronchiolar lavage and blood of one patient (Franzen *et al.*, 1996b) and has also provided evidence for latent infection of *E. intestinalis* (Franzen *et al.*, 1996a). The presence of *E. intestinalis* in blood is of special interest because it suggests that blood cells are used to transport the infection from the intestinal wall to the deeper viscera.

Amplification by PCR with non-specific primers, followed by restriction digests, have given good results with species identification. Raynaud *et al.* (1998) used HinfI for identification of *E. intestinalis* and were the first to identify this species in immunocompetent patients with diarrhoea. This restriction enzyme was also useful in differentiating the three *Encephalitozoon* spp. and *E. bienewsi* (Delbac and Vivarès, 1997). Didier *et al.* (1996a) used FokI to identify *E. hellem* from a patient with conjunctival and renal infections. Other examples of progress in the use of PCR for microsporidian infections are: (a) specific amplification of part of the ITS region of *E. bienewsi* (Velásquez *et al.*, 1996); (b) use of selected primers which amplified all *Encephalitozoon* spp., *E. bienewsi* and *V. corneae* but which gave

amplification products of different sizes according to species (Kock *et al.*, 1997); (c) combination of PCR and RFLP to differentiate *E. bienewsi*, *E. hellem*, *E. intestinalis* and *E. cuniculi* from cultures (Katzwinkel-Wladarsch *et al.*, 1997); (d) use of species-specific primers for the same range of species (del Aguila *et al.*, 1997); and (e) use of *E. intestinalis*-specific primers to confirm identification of *E. intestinalis* infections in animals that may be a source of infection to man (Bornay-Llinares *et al.*, 1998).

## CLINICAL MANAGEMENT AND PREVENTION

In immunocompetent people microsporidian infections are likely to be self-limiting and require no treatment but chemotherapy can be given if necessary. In immunocompromised people, *E. bienewsi* causes chronic disorders (diarrhoea, cholecystitis, etc.) and, in the absence of any really effective drug, only palliative measures, such as non-specific antidiarrhoeal medication are useful. Microsporidiosis due to the *Encephalitozoon* spp. are progressive, with potentially fatal outcome if untreated.

### Fumagillin

The first anti-microsporidian drug, fumagillin, was used for the control of *Nosema* disease (*Nosema apis*) of honey bees (Bailey, 1953) and was later found to inhibit proliferation of *E. cuniculi* *in vitro* without killing the spores (Shaddock, 1980). It is an antibiotic produced by *Aspergillus fumigatus* but, both as the water-insoluble native product and as its water-soluble bicyclohexyl amino salt, Fumidil B, it is highly toxic if given systemically. Nevertheless, it has shown potent activity when applied topically in cases of keratoconjunctivitis caused by *E. hellem* and *E. intestinalis* (reviewed by Didier, 1997). A solution containing 3 mg/ml Fumidil B ( $\equiv 70 \mu\text{g/ml}$  fumagillin), applied hourly as drops, brought about relief of symptoms and reduction of epithelial damage in two patients with *E. hellem* ocular lesions but did not eliminate the spores, which were able to initiate proliferation on

discontinuation of treatment (Diesenhouse *et al.*, 1993). Didier *et al.* (1996a) used drops of 0.03% solution of fumagillin coupled with oral albendazole (300 mg) twice daily and achieved complete resolution of conjunctival infection of *E. hellem* in another patient. Purified fumagillin given orally to AIDS patients with *E. bienewsi* diarrhoea appeared to eradicate the microsporidia but induced toxic side effects in all cases (Molina *et al.*, 1997).

### TNP-470

A new analogue of fumagillin TNP-470 has been shown to inhibit tumour growth by preventing neovascularisation. As TNP-470 is significantly less toxic than fumagillin, it has been tested against the three *Encephalitozoon* spp. *in vitro* and *in vivo* in athymic mice (Coyle *et al.*, 1998) and against *E. intestinalis* and *V. corneae* *in vitro*, in comparison with fumagillin and albendazole (Didier, 1997). Significant inhibition of proliferation in the presence of TNP-470 was observed with all species tested at concentrations of 10 ng/ml, above which Didier (1997) found that there was host cell toxicity. Coyle *et al.* (1998) found that *E. intestinalis* was inhibited *in vitro* at this concentration and that athymic mice infected with *E. cuniculi* tolerated a dose of 50 mg/kg three times a week, which conferred prolonged survival and prevented development of ascites. As an *in vitro* system for *E. bienewsi* is not available, the action of TNP-470 against this species has not been tested, but a related species, *Nucleospora salmonis*, has been eradicated from fish by incorporation of TNP-470 into the diet (unpublished data quoted in Coyle *et al.*, 1998). Thus, TNP-470 shows promise as a drug for amelioration of microsporidiosis due to *E. bienewsi*.

### Albendazole

Albendazole is a drug which inhibits microtubule polymerisation by preventing new tubulin dimers being added. Its antimicrosporidial activity was first demonstrated by Blanshard *et al.* (1992), who found that the drug, given as 400 mg twice

daily for 4 weeks, gave complete or partial resolution of *E. bienewsi*-associated diarrhoea in most of the patients in the study. This was without elimination of parasites, although in a later study many parasites were shown to be abnormal (Blanshard *et al.*, 1993). Subsequent work has shown that the response of *E. bienewsi*-infected patients to albendazole is highly variable. However, in numerous studies in AIDS patients using albendazole against *Encephalitozoon* spp., there has been a dramatic response, with complete elimination of parasites or apparent elimination followed by treatable relapses. When tested in tissue culture against *E. cuniculi* (Colbourn *et al.*, 1994) and against *E. intestinalis* and *V. corneae* (Didier, 1997), there was inhibition of development without elimination, even at doses toxic to the host cells. A possible explanation of the difference between *in vitro* and *in vivo* results is that, although the drug does not penetrate spores in both cases, spores will germinate on withdrawal of drug *in vitro*, whereas spores are removed by phagocytosis *in vivo* and recrudescences are unlikely to occur. Albendazole was almost certainly the active drug in the combination that cleared the muscle infection with *T. hominis* (Field *et al.*, 1996). Topical fumagillin (or TNP-470) and oral albendazole remain the most efficacious drugs at present.

### Other Drugs

Other drugs that have been reported to have antimicrosporidial activity are: itraconazole and toltrazuril, which were found ineffective *in vitro* by Sichtova *et al.* (1993); metronidazole (Eeftink Schattenkerk *et al.*, 1991), which may help resolve diarrhoea due to *E. bienewsi* but does not reduce parasite numbers; azithromycin, also only palliative for *E. bienewsi* diarrhoea (Hing *et al.*, 1993); octreotide, which gave variable results in treating *E. bienewsi* diarrhoea (Simon *et al.*, 1991); and propamidine isethionate, which was inhibitory in cases of *E. hellem* keratoconjunctivitis (Metcalf *et al.*, 1992). Most recently, furadolizone (Dionisio *et al.*, 1997) and thalidomide (Sharpstone *et al.*, 1997) have been shown to confer clinical benefit on intestinal

microsporidiosis and, in the former case, also partial clearance of *E. bienersi*.

Finally, in tests of patients with *E. bienersi*, in the late stages of AIDS (CD4<sup>+</sup> lymphocyte counts  $\leq 50 \times 10^6/l$ ), potent antiretroviral therapy (indinavir or zidovudine plus nucleoside analogue reverse transcriptase inhibitors) brought about improvement in stool frequency and consistency, increase in body weight and, usually, remission of the intestinal microsporidiosis, demonstrating that reversal of CD4<sup>+</sup> cell decline can itself enable the body to inhibit or eliminate microsporidia (Goguel *et al.*, 1997; Foudraïne *et al.*, 1998).

Sensible precautions to be taken by severely immunocompromised patients would be to avoid contact with the known reservoir hosts and to boil water, which in any case is recommended to avoid cryptosporidiosis.

## REFERENCES

- Achbarou A, Ombrouck C, Gneragbe T *et al.* (1996). Experimental model for human intestinal microsporidiosis in interferon gamma receptor knockout mice infected by *Encephalitozoon intestinalis*. *Parasite Immunol* **18**: 387–92.
- Aldras AM, Orenstein JM, Kotler DP, Shaddock JA, Didier ES (1994). Detection of microsporidia by indirect immunofluorescence antibody test using polyclonal and monoclonal antibodies. *J Clin Microbiol* **32**: 608–12.
- Aoun K, Bouratbine A, Detry A, Biligui S, Ben Ismail R (1997). Présence de microsporidies intestinales en Tunisie: à propos d'un cas. *Bull Soc Pathol Exot* **90**: 176.
- Ashton N, Wirasinha PA (1973). Encephalitozoonosis of the cornea. *Br J Ophthalmol* **57**: 669–74.
- Bailey L (1953). Effect of fumagillin on *Nosema apis* (Zander). *Nature* **171**: 212.
- Balbani G (1882). Sur les microsporidies ou psorospermies des articules. *Compte Rend Acad Sci Paris* **95**: 1168–71.
- Berg J, Diaz LE, Bender BS (1996). Microsporidia in humans. *Ann Intern Med* **125**: 522–3.
- Bergquist NR, Stintzing G, Smedman L, Waller T, Andersson T (1984). Diagnosis of encephalitozoonosis in man by serological tests. *Br Med J* **288**: 902.
- Bidre C, Pagès M, Méténier G, Canning EU, Vivarès C (1995). Evidence for the smallest nuclear genome (2.9 Mb) in the microsporidium *Encephalitozoon cuniculi*. *Mol Biochem Parasitol* **74**: 229–31.
- Bidre C, Duffieux F, Pyretailade E *et al.* (1997a). Mapping of repetitive and non-repetitive DNA probes to chromosomes of the microsporidia *Encephalitozoon cuniculi*. *Gene* **191**: 39–45.
- Bidre C, Pagès M, Méténier G *et al.* (1997b). On small genomes in eukaryotic organisms: molecular karyotypes of two microsporidian species (Protozoa) parasites of vertebrates. *Compte Rend Acad Sci Paris* **317**: 399–404.
- Bidre C, Peyretailade E, Duffieux F, Peyret P, Méténier G, Vivarès C (1997c). The rDNA unit of *Encephalitozoon cuniculi* (Microsporidia): complete 23S sequence and copy number. *J Eukaryot Microbiol* **44**: 76S.
- Bismanis JE (1970). Detection of latent murine nosematosis and growth of *Nosema cuniculi* in cells cultures. *Can J Microbiol* **16**: 237–42.
- Black SS, Steinhart LA, Bertucci DC, Rogers LB, Didier ES (1997). *Encephalitozoon hellem* in budgerigars *Melopsittacus undulatus*. *Vet Pathol* **34**: 189–98.
- Blanshard C, Ellis DS, Tovey DG, Dowell S, Gazzard BG (1992). Treatment of intestinal microsporidiosis with albendazole in patients with AIDS. *AIDS* **6**: 311–13.
- Blanshard C, Ellis DS, Dowell S, Tovey DG, Gazzard BG (1993). Electron microscopic changes in *Enterocytozoon bienersi* following treatment with albendazole. *J Clin Pathol* **46**: 898–902.
- Bornay-Llinares FJ, da Silva AJ, Moura H *et al.* (1998). Immunologic, microscopic, and molecular evidence of *Encephalitozoon intestinalis* (*Septata intestinalis*) infection in mammals other than humans. *J Infect Dis* **178**: 820–6.
- Bretagne S, Foulet F, Alkassoum W, Fleury-Feith J, Develoux M (1993). Prevalence of microsporidian spores in stools from children in Niamey, Niger. *AIDS* **7**: S34–5.
- Brown JR, Doolittle WG (1995). Root of the universal tree of life based on ancient aminoacyl-tRNA synthetase gene duplication. *Proc Natl Acad Sci USA* **92**: 2441–5.
- Bryan RT, Cali A, Owen RL, Spencer HC (1990). Microsporidia: opportunistic pathogens in patients with AIDS. In Sun T (ed.), *Progress in Clinical Parasitology*. New York: Field and Wood Medical; pp. 1–26.
- Cali A (1991). General microsporidian features and recent findings on AIDS isolates. *J Protozool* **38**: 625–9.
- Cali A, Owen RL (1988). Microsporidiosis. In Balows A, Hausler W Jr, Lennette EH (eds), *The Laboratory Diagnosis of Infectious Diseases: Principles & Practice*. New York: Springer Verlag; pp. 928–49.
- Cali A, Owen RL (1990). Intracellular development of *Enterocytozoon*, a unique microsporidian found in the intestine of AIDS patients. *J Protozool* **37**: 145–55.
- Cali A, Meisler DM, Lowder CY *et al.* (1991). Corneal microsporidiosis: characterization and identification. *J Protozool* **38**: S215–17.
- Cali A, Kotler DP, Orenstein JM (1993). *Septata intestinalis* n.g., n.sp., an intestinal microsporidian associated with chronic diarrhea and dissemination in AIDS patients. *J Protozool* **40**: 101–12.
- Cali A, Takvorian PM, Lewin S *et al.* (1998). *Brachiola vesicularum* n.g., n.sp., a new microsporidium associated with AIDS and myositis. *J Eukaryot Microbiol* **45**: 240–51.
- Canning EU (1998). Evolutionary relationships of microsporidia. In Coombs GH, Vickerman K, Sleigh MA, Warren A (eds), *Evolutionary Relationships among Protozoa*. London: Chapman & Hall; pp. 77–90.
- Canning EU, Lom J (1986). *The Microsporidia of Vertebrates*, p. 289. London: Academic Press.
- Canning EU, Field AS, Hing MC, Marriott DJ (1994). Further observations on the ultrastructure of *Septata*

- intestinalis*. Cali, Kotler and Orenstein 1993. *Eur J Protistol* **30**: 414–22.
- Canning EU, Curry A, Vávra J, Bonshek RE (1998). Some ultrastructural data on *Microsporidium ceylonensis*, a cause of corneal microsporidiosis. *Parasite* **5**: 247–54.
- Cheney SA, Lafranchi-Tristem NJ, Canning EU (2000). Phylogenetic relationships of *Pleistophora*-like microsporidia based on small subunit ribosomal DNA sequences and implications for the source of *Trachipleistophora hominis* infections. *J Eukaryot Microbiol* **47**: 280–7.
- Chupp GL, Alroy J, Adelman LS, Breen JC, Skolnik PR (1993). Myositis due to *Pleistophora* (Microsporidia) in a patient with AIDS. *Clin Infect Dis* **16**: 15–21.
- Colbourn NI, Hollister WS, Curry A, Canning EU (1994). Activity of albendazole against *Encephalitozoon cuniculi* *in vitro*. *Eur J Protistol* **30**: 211–20.
- Coyle CM, Wittner M, Kotler DP *et al.* (1996). Prevalence of microsporidiosis due to *Enterocytozoon bieneusi* and *Encephalitozoon (Septata) intestinalis* among patients with AIDS-related diarrhea: determination by polymerase chain reaction to the microsporidian small-subunit rRNA gene. *Clin Infect Dis* **23**: 1002–6.
- Coyle CM, Kent M, Tanowitz HB, Wittner M, Weiss LM (1998). TNP-470 is an effective antimicrosporidial agent. *J Infect Dis* **117**: 515–18.
- Cropo CP, Visvesvara GS, Leitch GJ, Wallace S, Schwartz DA (1998). Identification of the microsporidian *Encephalitozoon hellem* using immunoglobulin G monoclonal antibodies. *Arch Pathol Lab Med* **122**: 182–6.
- David F, Schuitema ARJ, Sarfati C *et al.* (1996). Detection and species identification of intestinal microsporidia by polymerase chain reaction in duodenal biopsies from human immunodeficiency virus-infected patients. *J Infect Dis* **174**: 874–7.
- del Aguila C, Lopez-Velez R, Fenoy S *et al.* (1997). Identification of *Enterocytozoon bieneusi* spores in respiratory samples from an AIDS patient with a 2-year history of intestinal microsporidiosis. *J Clin Microbiol* **35**: 1862–6.
- del Aguila C, Izquierdo F, Navajas R *et al.* (1999). *Enterocytozoon bieneusi* in animals: rabbits and dogs as new hosts. *J Eukaryot Microbiol* **46**: S8–9.
- Delbac F, Vivarès C (1997). A PCR technique for detecting and differentiating known microsporidia in AIDS patients. *J Eukaryot Microbiol* **44**: S75.
- De Maria P, Palic B, Debrunner-Vossbrinck BA, Lapp J, Vossbrinck CR (1996). Characterization of the highly divergent U2 RNA homolog in the microsporidian *Vairimorpha necatrix*. *Nucleic Acids Res* **24**: 515–22.
- Deplazes P, Mathis A, Baumgartner R, Tanner I, Weber R (1996a). Immunologic and molecular characteristics of *Encephalitozoon*-like microsporidia isolated from humans and rabbits indicate that *Encephalitozoon cuniculi* is a zoonotic parasite. *Clin Infect Dis* **22**: 557–9.
- Deplazes P, Mathis A, Müller C, Weber R (1996b). Molecular epidemiology of *Encephalitozoon cuniculi* and first detection of *Enterocytozoon bieneusi* in faecal samples of pigs. *J Eukaryot Microbiol* **43**: S93.
- Deplazes P, Mathis A, Van Saanen M *et al.* (1998). Dual microsporidian infection due to *Vittaforma corneae* and *Encephalitozoon hellem* in an AIDS patient. *J Infect Dis* **27**: 1521–4.
- Desportes I, Le Charpentier Y, Galian A *et al.* (1985). Occurrence of a new microsporidian: *Enterocytozoon bieneusi* n.g., n.sp. in the enterocytes of a human patient with AIDS. *J Protozool* **32**: 250–4.
- Didier ES (1995). Reactive nitrogen intermediates implicated in the inhibition of *Encephalitozoon cuniculi* (Phylum Microsporida) replication in murine peritoneal macrophages. *Parasite Immunol* **17**: 405–12.
- Didier ES (1997). Effects of albendazole, fumagillin, and TNP-470 on microsporidian replication *in vitro*. *Antimicrob Agents Chemother* **41**: 1541–6.
- Didier ES, Didier PJ, Friedberg DN *et al.* (1991). Isolation and characterization of a new human microsporidian *Encephalitozoon hellem* (n.sp.) from three AIDS patients with kerato-conjunctivitis. *J Infect Dis* **163**: 617–21.
- Didier ES, Varner PW, Didier PJ *et al.* (1994). Experimental microsporidiosis in immunocompetent and immunodeficient mice and monkeys. *Folia Parasitol* **41**: 1–11.
- Didier ES, Orenstein JM, Aldras A, Bertucci D, Rogers LB, Janney FA (1995a). Comparison of three staining methods for detecting microsporidia in fluids. *J Clin Microbiol* **33**: 3138–45.
- Didier ES, Vossbrinck CR, Baker MD, Rogers LB, Bertucci DC, Shaddock JA (1995b). Identification and characterization of three *Encephalitozoon cuniculi* strains. *Parasitology* **111**: 411–21.
- Didier ES, Rogers LB, Brush AD, Wong S, Tnaina-Dorge V, Bertucci D (1996a). Diagnosis of disseminated microsporidian *Encephalitozoon hellem* infection by PCR–Southern analysis and successful treatment with albendazole and fumagillin. *J Clin Microbiol* **34**: 947–52.
- Didier ES, Visvesvara GS, Baker MD *et al.* (1996b). A microsporidian isolated from an AIDS patient corresponds to *Encephalitozoon cuniculi* III, originally isolated from domestic dogs. *J Clin Microbiol* **34**: 2835–7.
- Didier ES, Snowden KF, Shaddock JA (1998). Biology of microsporidian species infecting mammals. *Adv Parasitol* **40**: 279–316.
- Diesenhause MC, Wilson LA, Corrent GF, Visvesvara GS, Grossniklaus HE, Bryan RT (1993). Treatment of microsporidian keratoconjunctivitis with topical fumagillin. *Am J Ophthalmol* **115**: 293–8.
- Dionisio D, Ibba Manneschi L, Di Lollo S *et al.* (1997). *Enterocytozoon bieneusi* in AIDS: symptomatic relief and parasite changes after furazolidone. *J Clin Pathol* **50**: 472–6.
- Dowd SE, Gerba CP, Pepper IL (1998). Confirmation of the human pathogenic microsporidia *Enterocytozoon bieneusi*, *Encephalitozoon intestinalis* and *Vittaforma corneae* in water. *Appl Environm Microbiol* **64**: 3332–5.
- Edlind TD, Li J, Visvesvara GS, Vodkin MH, McLaughlin GL, Katyar SK (1996). Phylogenetic analysis of  $\beta$ -tubulin sequences from amitochondrial protozoa. *Mol Phylogenet Evol* **5**: 359–67.
- Eeftinck Schattenkerk JKM, Van Gool T, Van Ketel RJ *et al.* (1991). Clinical significance of small-intestinal microsporidiosis in HIV-1-infected individuals. *Lancet* **337**: 895–8.



- Eeftinck Schattenkerk JKM, Van Gool T, Van den Bergh Weerman MA, Schot LJ, Dankert J (1993). Chronic rhinosinusitis in HIV-infected patients. *AIDS* **7**: S36–7.
- Enriquez FJ, Ditrich O, Palting JD, Smith K (1997). Simple diagnosis of *Encephalitozoon* sp. microsporidial infections by using a panspecific antiexospore monoclonal antibody. *J Clin Microbiol* **35**: 724–9.
- Fedorako DP, Nelson NA, Cartwright CP (1995). Identification of microsporidia in stool specimens by using PCR and restriction endonucleases. *J Clin Microbiol* **33**: 1739–41.
- Field AS, Hing MC, Milliken ST, Marriott DJ (1993). Microsporidia in the small intestine of HIV infected patients. A new diagnostic technique and a new species. *Med J Austral* **158**: 390–4.
- Field AS, Marriott DJ, Milliken ST *et al.* (1996). Myositis associated with a newly described microsporidian *Trachipleistophora hominis*, in a patient with AIDS. *J Clin Microbiol* **34**: 2803–11.
- Foudraine NA, Weverling GJ, Van Gool T *et al.* (1998). Improvement of chronic diarrhoea in patients with advanced HIV-1 infection during potent antiretroviral therapy. *AIDS* **12**: 35–41.
- Franzen C, Schwartz DA, Visvesvara GS *et al.* (1995). Immunologically confirmed disseminated, asymptomatic *Encephalitozoon cuniculi* infection of the gastrointestinal tract of a patient with AIDS. *Clin Infect Dis* **21**: 1480–4.
- Franzen C, Kuppers R, Müller A *et al.* (1996a). Genetic evidence for latent *Septata intestinalis* infection in human immunodeficiency virus-infected patients with intestinal microsporidiosis. *J Infect Dis* **173**: 1038–40.
- Franzen C, Müller A, Hartmann P, Kochanek M, Diehl V, Fätkenheuer G (1996b). Disseminated *Encephalitozoon (Septata) intestinalis* infection in a patient with AIDS. *N Engl J Med* **335**: 1610–11.
- Franzen C, Müller A, Hegener P *et al.* (1996c). Polymerase chain reaction for microsporidian DNA in gastrointestinal biopsy specimens of HIV-infected patients. *AIDS* **10**: F23–7.
- Gainzarain JC, Canut A, Lozano M *et al.* (1998). Detection of *Enterocytozoon bieneusi* in two human immunodeficiency virus-negative patients with chronic diarrhea by polymerase chain reaction in duodenal biopsy specimens and review. *Clin Infect Dis* **27**: 394–8.
- Germot A, Philippe H, le Guyader H (1997). Evidence for loss of mitochondria in microsporidia from a mitochondrial type Hsp70 in *Nosema locustae*. *Mol Biochem Parasitol* **87**: 159–68.
- Goguel J, Katlama C, Sarfati C, Maslo C, Lepout C, Molina J-M (1997). Remission of AIDS-associated intestinal microsporidiosis with highly active retroviral therapy. *AIDS* **11**: 1658–9.
- Grau A, Valls ME, Williams JE *et al.* (1996). Miositis por *Pleistophora* en un paciente con sida. *Med Clin* **107**: 779–81.
- Hartskeerl RA, Van Gool T, Schuitema ARJ, Didier ES, Terpstra WJ (1995). Genetic and immunological characterization of the microsporidian *Septata intestinalis* Cali, Kotler and Orenstein, 1993: reclassification to *Encephalitozoon intestinalis*. *Parasitology* **110**: 277–85.
- Hautvast JLA, Tolboom JJM, Derks TJMM, Beckers P, Sauerwein RW (1997). Asymptomatic intestinal microsporidiosis in a human immunodeficiency virus—seronegative immunocompetent Zambian child. *Pediatr Infect Dis* **16**: 415–16.
- Hermanek J, Koudela B, Kučerová Z, Ditrich O, Trávníček J (1993). Prophylactic and therapeutic immune reconstitution of SCID mice infected with *Encephalitozoon cuniculi*. *Folia Parasitol* **40**: 287–91.
- Hing MC, Marriott DJ, Verre J, Field AS (1993). Enteric microsporidiosis: response to azithromycin therapy. *AIDS* **7**: S45–6.
- Hirt RP, Healy B, Vossbrinck CR, Canning EU, Embley TM (1997). A mitochondrial Hsp70 orthologue in *Vairimorpha necatrix*: molecular evidence that microsporidia once contained mitochondria. *Curr Biol* **7**: 995–8.
- Hirt RP, Logsdon JM Jr, Healy B, Dorey MW, Doolittle WF, Embley TM (1999). Microsporidia are related to fungi: evidence from the largest subunit of RNA polymerase II and other proteins. *Proc Natl Acad Sci USA* **96**: 580–5.
- Hollister WS, Canning EU, Willcox A (1991). Evidence for widespread occurrence of antibodies to *Encephalitozoon cuniculi* (Microspora) in man provided by ELISA and other serological tests. *Parasitology* **102**: 33–43.
- Hollister WS, Canning EU, Colbourn NI (1993a). A species of *Encephalitozoon* isolated from an AIDS patient: criteria for species differentiation. *Folia Parasitol* **40**: 293–5.
- Hollister WS, Canning EU, Colbourn NI, Curry A, Lacey CJM (1993b). Characterization of *Encephalitozoon hellem* (Microspora) isolated from the nasal mucosa of a patient with AIDS. *Parasitology* **107**: 351–8.
- Hollister WS, Canning EU, Anderson CL (1996a). Identification of microsporidia causing human disease. *J Eukaryot Microbiol* **43**: S104–5.
- Hollister WS, Canning EU, Weidner E, Field AS, Kench J, Marriott DJ (1996b). Development and ultrastructure of *Trachipleistophora hominis* n.g., n.sp. after *in vitro* isolation from an AIDS patient and inoculation into athymic mice. *Parasitology* **112**: 143–54.
- Ignatius R, Henschel S, Liesenfeld O *et al.* (1997). Comparative evaluation of modified trichrome and Uvitex 2B stains for detection of low numbers of microsporidial spores in stool specimens. *J Clin Microbiol* **35**: 2266–9.
- Iwano H, Ishihara R (1989). Intracellular germination of spores of a *Nosema* sp. immediately after their formation in cultured cell. *J Invert Pathol* **54**: 125–7.
- Kamaishi T, Hashimoto T, Nakamura Y *et al.* (1996). Protein phylogeny of translation elongation factor EF-1 $\alpha$  suggests microsporidians are extremely ancient eukaryotes. *J Mol Evol* **42**: 257–63.
- Katzwinkel-Wladarsch S, Deplazes P, Weber R, Löscher T, Rinder H (1997). Comparison of polymerase chain reaction with light microscopy for detection of microsporidia in clinical specimens. *Eur J Clin Microbiol Infect Dis* **16**: 7–10.
- Kock NP, Petersen H, Fenner T *et al.* (1997). Species-specific identification of microsporidia in stool and intestinal biopsy specimens by the polymerase chain reaction. *Eur J Microbiol Infect Dis* **16**: 369–76.
- Kokoskin E, Gyorkos T, Camus A, Celidotte L, Puntill T, Ward B (1994). Modified technique for efficient detection of microsporidia. *J Clin Microbiol* **32**: 1074–5.
- Lacey CJN, Clarke AMT, Fraser P, Metcalfe T, Bonsor C, Curry A (1992). Chronic microsporidian infection of the

- nasal mucosae, sinuses and conjunctivae in HIV disease. *Genitourin Med* **68**: 179–81.
- Ledford DK, Overman MD, Gonzalo A, Cali A, Mester W, Lockey RF (1985). Microsporidiosis myositis in a patient with acquired immunodeficiency syndrome. *Ann Intern Med* **102**: 628–30.
- Li J, Katyar SK, Hamelin A, Visvesvara GS, Edlind TD (1996). Tubulin genes from AIDS associated microsporidia and implications for phylogeny and benzimidazole sensitivity. *Mol Biochem Parasitol* **78**: 289–95.
- Liguory O, David F, Sarfati C, Derouin F, Molina J-M (1998). Determination of types of *Enterocytozoon bieneusi* strains isolated from patients with intestinal microsporidiosis. *J Clin Microbiol* **36**: 1882–5.
- Lowman PM, Takverian PM, Cali A (2000). The effects of elevated temperatures and various time-temperature combinations on the development of *Brachiola (Nosema) algerae* n. comb. in mammalian cell culture. *J Eukaryot Microbiol* **47**: 221–34.
- Magaud P, Achbarou A, Deportes-Livage I (1997). Cell invasion by the microsporidium *Encephalitozoon intestinalis*. *J Eukaryot Microbiol* **44**: S81.
- Mansfield KG, Carville A, Schvetz D, MacKey J, Tzipori S, Lackner AA (1997). Identification of an *Enterocytozoon bieneusi*-like microsporidian parasite in simian-immunodeficiency-virus inoculated macaques with hepatobiliary disease. *Am J Pathol* **150**: 1395–405.
- Margileth AM, Strano AJ, Chandro R, Neafie R, Blum M, McCully RM (1973). Disseminated nosematosis in an immunologically compromised infant. *Arch Pathol* **95**: 145–50.
- Matsubayashi H, Koike T, Mikata I, Takei H, Hagiwara S (1959). A case of *Encephalitozoon*-like body infection in man. *Arch Pathol* **67**: 181–7.
- McDougall RJ, Tandy MW, Boreham RE, Stenzel DJ, O'Donoghue PJ (1993). Incidental finding of a microsporidian parasite from an AIDS patient. *J Clin Microbiol* **31**: 436–9.
- McInnes EF, Stewart CG (1991). The pathology of subclinical infections of *Encephalitozoon cuniculi* in canine dams producing pups with overt encephalitozoonosis. *J S Afr Vet Assoc* **62**: 51–4.
- Mertens RB, Didier ES, Fishbein MC, Bertucci DC, Rogers LB, Orenstein JM (1997). *Encephalitozoon cuniculi* microsporidiosis: infection of the brain, heart, kidneys, trachea, adrenal glands, and urinary bladder in a patient with AIDS. *Mod Pathol* **10**: 68–77.
- Metcalf TW, Doran RML, Rowland P, Curry A, Lacey CJN (1992). Microsporidian keratoconjunctivitis in a patient with AIDS. *Br J Ophthalmol* **76**: 177–8.
- Mohn SF, Nordstoga K (1975). Electrophoretic patterns of serum proteins in blue foxes with special reference to changes associated with nosematosis. *Acta Vet Scand* **16**: 297–306.
- Molina J-M, Oksenhendler E, Beauvais B *et al.* (1995). Disseminated microsporidiosis due to *Septata intestinalis* in patients with AIDS: clinical features and response to albendazole therapy. *J Infect Dis* **171**: 245–9.
- Molina J-M, Goguel J, Sarfati C *et al.* (1997). Potential efficacy of fumagillin in intestinal microsporidiosis due to *Enterocytozoon bieneusi* in patients with HIV infection: results of a drug screening study. *AIDS* **11**: 1603–10.
- Niederborn JY, Shadduck JA (1980). Role of antibody and complement in the control of *Encephalitozoon cuniculi* infection by rabbit macrophages. *Infect Immun* **17**: 995–1002.
- Ombrouck C, Romestand B, Correia da Cost J-M *et al.* (1995). Use of cross reactive antigens of the microsporidian *Glugea atherinae* for the possible detection of *Enterocytozoon bieneusi* by Western blot. *Am J Trop Med Hyg* **52**: 89–93.
- Ombrouck C, Ciceron L, Biligui S *et al.* (1997). Specific PCR assay for direct detection of intestinal microsporidia *Enterocytozoon bieneusi* and *Encephalitozoon intestinalis* in specimens from human immunodeficiency virus-infected patients. *J Clin Microbiol* **35**: 652–5.
- Pinnolis M, Egbert PR, Font RL, Winter FC (1981). Nosematosis of the cornea. Case report, including electron microscopic studies. *Arch Ophthalmol* **99**: 1044–7.
- Rabodonirina M, Bertocchi M, Deportes-Livage I *et al.* (1996). *Enterocytozoon bieneusi* as a cause of chronic diarrhoea in a heart–lung transplant recipient who was seronegative for human immunodeficiency virus. *Clin Infect Dis* **23**: 114–17.
- Raynaud L, Delbac F, Brousolle V *et al.* (1998). Identification of *Encephalitozoon intestinalis* in travellers with chronic diarrhea by specific PCR amplification. *J Clin Microbiol* **36**: 37–40.
- Ryan NJ, Sutherland G, Coughlan K *et al.* (1993). A new trichrome blue stain for detection of microsporidian species in urine, stool and nasopharyngeal specimens. *J Clin Microbiol* **31**: 3264–9.
- Sandfort J, Hannemann A, Gelderblom H, Stark K, Owen RL, Ruf B (1994). *Enterocytozoon bieneusi* infection in an immunocompetent patient who had acute diarrhea and who was not infected with the human immunodeficiency virus. *Clin Infect Dis* **19**: 514–16.
- Sax PE, Rich JD, Pieciak WS, Trnka YM (1995). Intestinal microsporidiosis occurring in a liver transplant recipient. *Transplantation* **60**: 617–18.
- Schmidt EC, Shadduck JA (1984). Mechanisms of resistance to the intracellular protozoan *Encephalitozoon cuniculi* in mice. *J Immunol* **133**: 2712–19.
- Schwartz DA, Bryan RT, Hewan-Lowe KO *et al.* (1992). Disseminated microsporidiosis (*Encephalitozoon hellem*) and acquired immunodeficiency syndrome. Autopsy evidence for respiratory acquisition. *Arch Pathol Lab Med* **116**: 660–7.
- Schwartz DA, Sobottka I, Leitch GJ, Cali A, Visvesvara GS (1996). Pathology of microsporidiosis. Emerging parasitic infections in patients with acquired immunodeficiency syndrome. *Arch Pathol Lab Med* **120**: 173–87.
- Shadduck JA (1980). Effect of fumagillin on *in vitro* multiplication of *Encephalitozoon cuniculi*. *J Protozool* **27**: 202–8.
- Shadduck JA, Kelsoe G, Helmke J (1979). A microsporidian contaminant of a non-human primate cell culture: ultrastructural comparison with *Nosema connori*. *J Parasitol* **65**: 185–8.

- Shadduck JA, Meccoli RA, Davis R, Font RL (1990). Isolation of a microsporidian from a human patient. *J Infect Dis* **162**: 773–6.
- Sharpstone D, Rowbottom A, Francis N *et al.* (1997). Thalidomide, a novel therapy for microsporidiosis. *Gastroenterology* **112**: 1823–9.
- Šichtová M, Haque MA, Vávra J, Canning EU, Robert-Gero M (1993). Evaluation of the antibiotic sinefungin as an antimicrosporidial drug. *Folia Parasitol* **40**: 85–91.
- Silveira H, Canning EU (1995). *Vittaforma corneae* N. Comb. for the human microsporidium *Nosema corneum* Shadduck, Meccoli, Davis & Font, 1991, based on its ultrastructure in the liver of experimentally infected athymic mice. *J Eukaryot Microbiol* **42**: 158–65.
- Silveira H, Canning EU, Shadduck JA (1993). Experimental infection of athymic mice with the human microsporidium *Nosema corneum*. *Parasitology* **107**: 489–96.
- Simon D, Weiss LM, Tanowitz HB, Cali A, Jones J, Wittner M (1991). Light microscopic diagnosis of human microsporidiosis and variable response to octreotide. *Gastroenterology* **100**: 271–3.
- Sobottka A, Albrecht H, Schottelius J *et al.* (1995). Self-limited traveller's diarrhea due to a dual infection with *Enterocytozoon bieneusi* and *Cryptosporidium parvum* in an immunocompetent HIV-negative child. *Eur J Clin Microbiol Infect Dis* **14**: 919–20.
- Sparfel JM, Sarfati C, Liguory O *et al.* (1997). Detection of microsporidia and identification of *Enterocytozoon bieneusi* in surface water by filtration followed by specific PCR. *J Eukaryot Microbiol* **44**: 78S.
- Sprague V (1974). *Nosema connori* n.sp., microsporidian parasite of man. *Trans Am Microsc Soc* **93**: 400–3.
- Terada S, Reddy KR, Jeffers LJ, Cali A, Schiff ER (1987). Microsporidian hepatitis in the acquired immunodeficiency syndrome. *Ann Intern Med* **107**: 61–2.
- Tocidlowski ME, Cornish TE, Loomis MR, Stoskopf MK (1997). Mortality in captive wild-caught horned puffin chicks (*Fratercula corniculata*). *J Zoo Wildlife Med* **28**: 298–306.
- Torres CM (1927). Morphologie d'un nouveau parasite de l'homme, *Encephalitozoon chagasi* n.sp. observé dans un cas de méningoencéphalomyélite avec myosite et myocardite. *Seances Soc Brésilienne Biol* **97**: 1787–90.
- Trammer T, Chioralia G, Maier WA, Seitz HM (1999). *In vitro* replication of *Nosema algerae* (Microsporidia), a parasite of anopheline mosquitoes that infects in human cells above 36°C. *J Eukaryot Microbiol* **46**: 464–8.
- Van Gool T, Snijders R, Reiss P *et al.* (1993). Diagnosis of intestinal and disseminated microsporidial infections in patients with HIV by a new rapid fluorescence technique. *J Clin Pathol* **46**: 694–9.
- Van Gool T, Canning EU, Gilis H *et al.* (1994). *Septata intestinalis* frequently isolated from stool of AIDS patients with a new cultivation method. *Parasitology* **109**: 281–9.
- Van Gool T, Vetter JCM, Weinmayr B, Van Dam A, Derouin F, Dankert J (1997). High seroprevalence of *Encephalitozoon* species in immunocompetent subjects. *J Infect Dis* **175**: 1020–4.
- Vávra J, Dahbiová R, Hollister WS, Canning EU (1993). Staining of microsporidian spores by optical brighteners with remarks on the use of brighteners for the diagnosis of AIDS associated human microsporidiosis. *Folia Parasitol* **40**: 267–72.
- Vávra J, Yachnis AT, Canning EU, Curry A, Shadduck JA, Orenstein JM (1998a). A *Trachipleistophora*-like microsporidium of man: its dimorphic nature and relationship with *Thelohania apodemi*. *Folia Parasitol* **45**: 157–62.
- Vávra J, Yachnis AT, Shadduck JA, Orenstein JM (1998b). Microsporidia of the genus *Trachipleistophora*—causative agents of human microsporidiosis: description of *Trachipleistophora anthropophthera* n.sp. (Protozoa: Microsporidia). *J Eukaryot Microbiol* **45**: 273–83.
- Velásquez JN, Carnevale S, Guarnera EA *et al.* (1996). Detection of the microsporidian parasite *Enterocytozoon bieneusi* in specimens from patients with AIDS by PCR. *J Clin Microbiol* **34**: 3230–2.
- Visvesvara GS, Belloso M, Moura H *et al.* (1999). Isolation of *Nosema algerae* from the cornea of an immunocompetent patient. *J Eukaryot Microbiol* **46**: 10S.
- Vossbrinck CR, Maddox JV, Friedman S, Debrunner-Vossbrinck BA, Woese CR (1987). Ribosomal RNA sequence suggests microsporidia are extremely ancient eukaryotes. *Nature* **326**: 411–14.
- Vossbrinck CR, Baker MD, Didier ES, Debrunner-Vossbrinck BA, Shadduck JA (1993). Ribosomal DNA sequences of *Encephalitozoon hellem* and *Encephalitozoon cuniculi*: species identification and phylogenetic construction. *J Eukaryot Microbiol* **40**: 354–62.
- Wanke CA, DeGirolami P, Federman M (1996). *Enterocytozoon bieneusi* infection and diarrheal disease in patients who were not infected with human immunodeficiency virus: case report and review. *Clin Infect Dis* **23**: 816–18.
- Weber R, Bryan RT, Owen RL *et al.* (1992a). Improved light microscopic detection of microsporidia spores in stool and duodenal aspirates. *N Engl J Med* **326**: 161–5.
- Weber R, Kuster H, Keller R *et al.* (1992b). Pulmonary and intestinal microsporidiosis in a patient with the acquired immunodeficiency syndrome. *Am Rev Resp Dis* **146**: 1603–5.
- Weber R, Bryan RT, Schwartz DA, Owen RL (1994). Human microsporidial infections. *Clin Microbiol Rev* **7**: 426–61.
- Weidner E, Canning EU, Rutledge CR, Meek CL (1999). Mosquito (Diptera: Culicidae) host compatibility and vector competency for the human myositic parasite *Trachipleistophora hominis* (Phylum Microsporida). *J Med Entomol* **36**: 522–5.
- Weiss LM, Edlind TD, Vossbrinck CR, Hashimoto T (1999). Microsporidian molecular phylogeny: the fungal connection. *J Eukaryot Microbiol* **46**: S17–18.
- Wittner M, Weiss LM (eds) (1999). *The Microsporidia and Microsporidiosis*, p. 553. Washington, DC: ASM Press.
- Yachnis AT, Berg J, Martinez-Salazar A *et al.* (1996). Disseminated microsporidiosis especially infecting the brain, heart and kidneys. Report of a newly recognised pansporoblastic species in two symptomatic AIDS patients. *Am J Clin Pathol* **106**: 535–43.
- Zender HO, Arrigoni E, Eckert J, Kapanci Y (1989). A case of *Encephalitozoon cuniculi* peritonitis in a patient with AIDS. *Am J Clin Pathol* **92**: 352–6.



# Amebas

**Upinder Singh and William A. Petri Jr**

*University of Virginia Health Sciences Center, Charlottesville, VA, USA*

---

## INTRODUCTION

This chapter will discuss the parasites *Entamoeba histolytica*, *E. dispar*, *E. coli*, *E. polecki* and *E. nana* and their clinical importance, disease

presentations and contribution to human illness. Of these amoeba species, *E. histolytica* is the most medically relevant parasite and causes the greatest human disease, and therefore will receive the greatest emphasis.

## ENTAMOEBIA HISTOLYTICA

### HISTORY

*E. histolytica* has recently been separated from *E. dispar* on the basis of genetic differences. Both protozoa are morphologically identical but have genetic, and functional differences; *E. histolytica* is invasive and causes disease such as colitis and liver abscess, and *E. dispar* causes a asymptomatic colonization which does not need to be medically treated (WHO/PAHO/UNESCO, 1997). In 1828, James Annesley wrote in *Prevalent Diseases of India*, '... hepatic disease seems to be induced by the disorder of the bowels, more particularly when this disorder is of a subacute or chronic kind', recognizing for the first time a link between dysentery and liver abscess. Approximately 30 years later, in 1855, LambI described amebae in the stool of a child who had diarrhea (Stillwell, 1955). Fedor Losch described amebae in the stool of a young farmer with dysentery from his first evaluation in November 1873 until his death in April 1874. The amebae causing the ultimate demise of the

farmer were described as 'round, pear-shaped or irregular form and which are in a state of almost continuous motion', and autopsy studies ultimately revealed colonic ulcerations. Koch's postulates were fulfilled when the patient's stool inoculated orally and rectally into a dog caused dysentery, with amebic ulcers (Stillwell, 1955; Kean, 1988). The first North American case of amebiasis was reported in 1890 by Sir William Osler, when he described a young physician in Baltimore with dysentery. Osler wrote: 'Dr B, aged 29, resident in Panama for nearly 6 years, where he had had several attacks of dysentery, or more correctly speaking a chronic dysentery, came north in May, 1889 . . .'. Subsequently, in 1890, the patient developed tender hepatosplenomegaly and amebae were observed in the stool and abscess fluid: 'The general character of the amoebae (found in the stool) correspond in every particular with those found in the liver' (Osler, 1890). A year later, Osler's colleagues Councilman and Laffleur (1891) proceeded through a classic investigation of 14 cases of amebic dysentery to

clearly distinguish amebiasis from bacterial dysentery, and coined the terms 'amebic dysentery' and 'amebic liver abscess'.

Historically, ipecac bark was used in the treatment of dysentery. Piso introduced ipecac bark, which had been used for centuries in Peru for the treatment of dysentery, to Europe in 1658. Helvetius used ipecac to successfully treat the dysentery of King Louis XIV, and subsequently sold it as a secret remedy to the French government. Not until 1858 was the use of large doses of ipecac for the treatment of dysentery promoted by Surgeon E. S. Docker in Mauritius, who demonstrated that ipecac (60 grains, two or three times daily) decreased mortality from 10–18% to only 2%. However, large doses of ipecac by mouth was complicated by severe nausea and vomiting and necessitated the co-administration of opium, chloral hydrate or tannic acid. An alternative therapy was discovered by Leonard Rogers, Professor of Pathology in Calcutta, India, who found that emetine, the principal alkaloid in ipecac, killed amebae in the mucus of stools from patients with dysentery at dilutions as high as 1/100 000. In 1912 he reported successfully treating three patients in Calcutta, who had been unable to tolerate oral ipecac, by injection of emetine (Rogers, 1912).

The cyst form of *E. histolytica* was implicated as the infective form of the parasite by Walker and Sellards (1913) in the Philippines, and the parasite's life-cycle was outlined by Dobell (1925). Axenic culture of *E. histolytica* (free of any associated microorganisms) was accomplished by Diamond (1961) at the NIH in 1961. This milestone in the history of amebiasis has enabled study of the cell biology and biochemistry of the parasite, upon which our current understanding of amebiasis is based.

## DESCRIPTION OF THE ORGANISM

### Taxonomy

*E. histolytica*, a pseudopod-forming non-flagellated protozoan parasite, is the most invasive of the *Entamoeba* group (which includes *E. dispar*, *E. hartmanni*, *E. polecki*, *E. coli* and *E. gingivalis*). It is the *Entamoeba* that most often

causes clinical disease in humans, such as amebic colitis and liver abscess. Trophozoites of this parasite contain a single nucleus, and nuclear division occurs without the formation of condensed metaphase chromosomes. No sexual forms of the parasite have been identified.

The taxonomy of *E. histolytica* has changed significantly in the last decade and it has recently been reclassified into two species which are morphologically identical but genetically distinct: *E. histolytica* (Schaudinn, 1903), an invasive disease-causing parasite, and *E. dispar* (Brumpt, 1925), a non-invasive parasite. This separation was initially proposed in 1925 by Brumpt, who found that only one of the species caused disease in kittens or human volunteers, and named the non-pathogenic species *E. dispar* (Thompson and Glasser, 1986). However, in the absence of a means to distinguish the two morphologically identical parasites, this distinction was not generally accepted. In 1978, Sargeant and colleagues demonstrated that isoenzyme typing could be used to distinguish the pathogenic from the non-pathogenic species of *Entamoeba* and the issue was re-examined. The two species can be differentiated by isoenzyme analysis, typing by monoclonal antibodies to surface antigens, and restriction fragment length polymorphisms and PCR (Table 9.1) (Sargeant *et al.*, 1978; Tannich *et al.*, 1989; Tannich and Burchard, 1991; Diamond and Clark, 1993; Garfinkel *et al.*, 1989; Clark and Diamond, 1993). Earlier reports that *E. histolytica* and *E. dispar* could convert in culture (Andrews *et al.*, 1990; Mirelman *et al.*, 1986) were recently shown to be artifactual with the apparent conversion due to contamination of laboratory strains (Clark and Diamond, 1993).

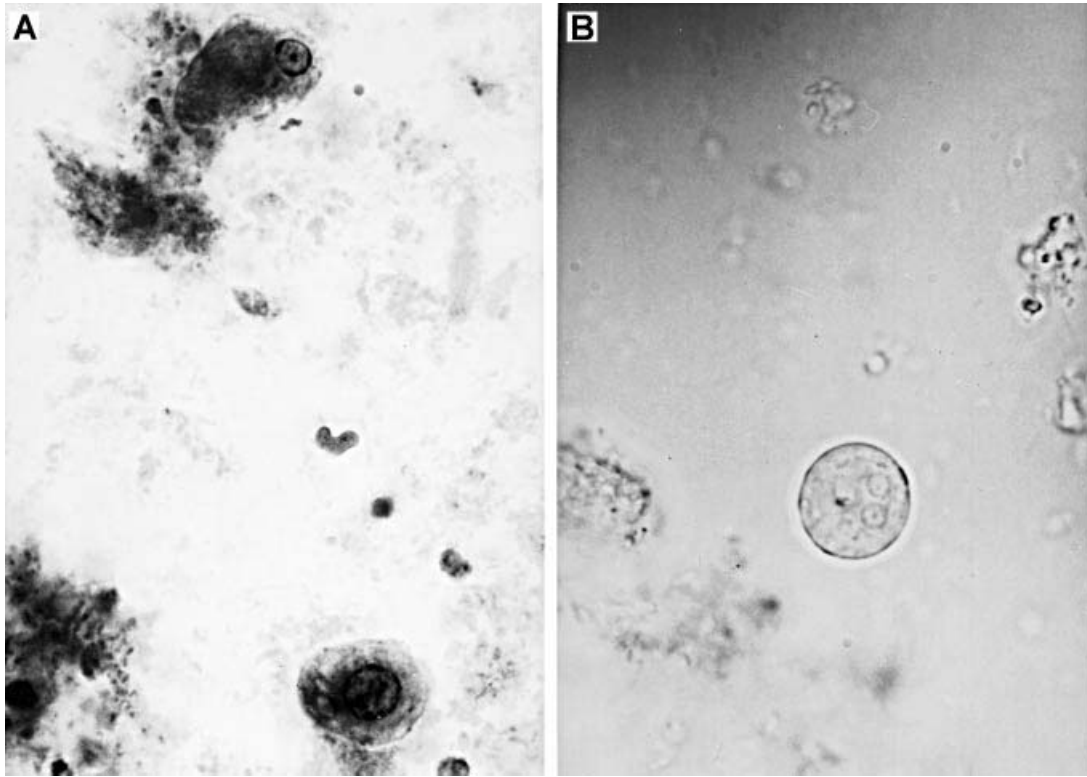
**Table 9.1** Differentiation of *E. histolytica* and *E. dispar*

---

Biochemical characters	Discrimination by isoenzyme migration
Immunological characters	Monoclonal antibodies
Genetic characters	Restriction fragment pattern comparisons
	Repetitive DNA sequences
	Riboprinting
Clinical characters	<i>E. dispar</i> has not been associated with tissue invasion

---

From Petri (1996), with permission.



**Fig. 9.1** *E. histolytica* trophozoite and cyst. (A) The motile and invasive trophozoite forms each contain a single nucleus and are 10 and 60  $\mu\text{m}$  in diameter, respectively. (B) The infectious cyst form is 10–15  $\mu\text{m}$  in diameter and contains four nuclei. Note that it is not possible to distinguish *E. histolytica* from *E. dispar* morphologically (photograph courtesy of Centers for Disease Control)

Since *E. dispar* infection need not be treated, an important clinical advance has been the development of antigen detection tests that differentiate infection by the two amebae (see Diagnosis).

### Life-cycle

The *E. histolytica* life-cycle is relatively simple and consists of an infective cyst and an invasive trophozoite form. The trophozoite stage is 10–60  $\mu\text{m}$  in diameter, containing a single nucleus with a central karyosome (Figure 9.1A). The cyst is 10–15  $\mu\text{m}$  in diameter and contains four or fewer nuclei (Figure 9.1B). The quadrinucleate cyst is the infectious form of the parasite, is resistant to chlorination, gastric acidity and desiccation, and can survive in a moist

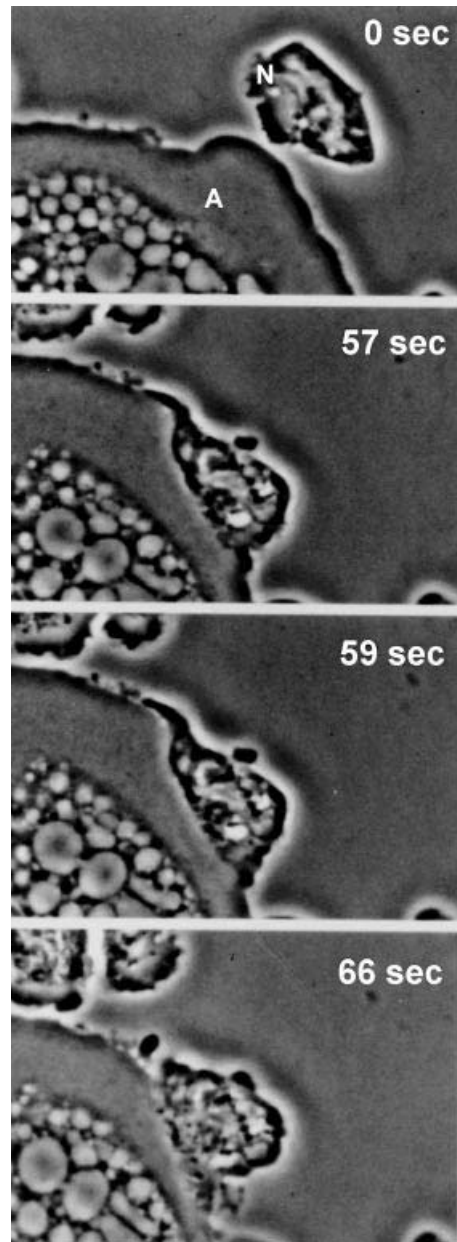
environment for several weeks. Infection with *E. histolytica* occurs due to fecal–oral spread with fecally contaminated food or water. Excystation of the cyst occurs in the intestine where the cyst undergoes nuclear and cytoplasmic division to form eight trophozoites. The trophozoites can then colonize and/or invade the large bowel. Cysts are never found within invaded tissues. Invasion of the colonic intestinal epithelium by trophozoites leads to the formation of the classically described flask-shaped ulcers. Hepatic abscesses are thought to occur due to migration of the parasite via the portal vein. All infections with *E. histolytica* are not alike, and whether infection results in colonization or invasion may be influenced by the *E. histolytica* strain and its interaction with bacterial flora, host genetic susceptibility and factors such as malnutrition, sex, age and immunocompetence.

## PATHOGENESIS

Carbohydrate–protein interactions play a key role in human infection by *E. histolytica*. Killing of host cells by *E. histolytica* trophozoites *in vitro* occurs only upon direct contact (Figure 9.2), which is mediated by an amebic adhesin that recognizes *N*- and *O*-linked oligosaccharides (Ravdin and Guerrant, 1981; Petri and Ravdin, 1987; Petri, 1996). This amebic Gal/GalNAc lectin is a heterodimer of heavy and light subunits, which are encoded by multigene families designated *hgl* and *lgl*, respectively (Petri, 1996). Apposition of amebic and target cell plasma membranes will not lead to cytolysis if the amebic lectin is inhibited with Gal/GalNAc, which indicates that the lectin mediates adherence and also participates in the cytolytic event. Anti-lectin monoclonal antibodies (mAb), directed against epitope 1 of the lectin heavy subunit, block cytotoxicity but not adherence, implicating the lectin in the cytotoxic as well as adherence events. Anti-lectin antibodies, which block cytotoxicity, also cause a conformational change in the lectin, which increases carbohydrate-binding capacity.

The human colonic mucin layer of the large intestine may be the first receptor encountered by the lectin (Tse and Chadee, 1992). Binding of the lectin to colonic mucins is Gal/GalNAc-inhibitable and of very high affinity (dissociation constant of  $8.2 \times 10^{-11} \text{ M}^{-1}$ ). Interaction between the trophozoites and colonic mucins appears to be a dynamic process, with trophozoites both inducing the secretion of colonic mucins and degrading them (Tse and Chadee, 1991). The mucin layer may have a paradoxical role of both protecting the host from contact-dependent cytotoxicity of the parasite by binding to and neutralizing the lectin, while at the same time serving as a site of attachment for the parasite to colonize and invade the large bowel.

During its invasion of the colon and hematogenous spread to the liver, the trophozoite has continuous exposure to the human complement system. Virulent *E. histolytica* isolated from patients with invasive amebiasis activate the alternative complement pathway but are resistant to C5b-9 complexes deposited on the membrane surface (Reed and Gigli, 1990). This complement resistance is due to the presence of a C5b-9



**Fig. 9.2** Killing of a human polymorphonuclear neutrophil (N) by an ameba (A). Upon establishing contact with the ameba the neutrophil undergoes membrane blebbing, and loss of granules and cytoplasmic integrity. Magnification  $\times 2000$ . From Petri (1996), with permission

inhibitory molecule on the amebic surface, which has been identified as the Gal/GalNAc lectin (Braga *et al.*, 1992). The sequence of the 170 kDa subunit of the surface lectin showed limited



identity with CD59, a human inhibitor of C5b-9 assembly, and the purified lectin was recognized by anti-CD59 antibodies. The lectin bound to purified human C8 and C9 and blocked assembly in the amebic membrane of the complement membrane attack complex at the steps of C8 and C9 insertion. Reconstitution of the lectin from serum-resistant into serum-sensitive amebae conferred resistance to the membrane attack complex, a direct demonstration of its C5b-9 inhibitory activity. The lectin therefore appears to be multifactorially involved in the pathogenesis of the amebae by having a central role in adherence and host cell killing, and by allowing the amebae to evade the complement system of the host (Braga *et al.*, 1992).

Contact-dependent killing by *E. histolytica* has been intensively investigated. Intracellular calcium in target cells rises approximately 20-fold within seconds of direct contact by an amebic trophozoite and is associated with membrane blebbing (Ravdin *et al.*, 1988) and cell death occurs 5–15 minutes afterwards. Murine myeloid cells killed by *E. histolytica* undergo a process of death that morphologically resembles apoptosis, the programmed cell death seen with growth factor deprivation, which is associated with a nucleosomal pattern of DNA fragmentation. This apoptotic pattern of host cell death induced by the amebae was blocked with Gal/GalNAc. However, overexpression of Bcl-2, a protein that confers resistance to apoptotic death from some stimuli, did not block killing (Ragland *et al.*, 1994).

Amebic pore-forming proteins, similar in function to pore-forming proteins of the immune system, have been reported (Leippe *et al.*, 1994) and a purified 5 kDa amebapore has recently been shown to have cytolytic activity for nucleated cells at high concentrations (10–100  $\mu\text{M}$ ) (Leippe *et al.*, 1994). Interaction with the extracellular matrix may be mediated by fibronectin, laminin and collagen receptors (Talamas-Rohana and Meza, 1989; Munoz *et al.*, 1991). Proteolytic activities, such as the collagenase contained within electron-dense granules in the amebic cytoplasm, are also believed to be involved in damage of cells and the extracellular matrix of the host. Secreted amebic cysteine proteases cause a cytopathic effect manifest by cells being released from

monolayers *in vitro* without cell death (McKerrow *et al.*, 1993). The availability of DNA transfection and inducible promoter systems for *E. histolytica* (Nickel and Tannish, 1994; Purdy *et al.*, 1994; Vines *et al.*, 1995; Hamann *et al.*, 1995; Ramakrishnan *et al.*, 1997) should enable the *in vivo* validation of virulence factors such as the lectin, cysteine proteinases and amebapore in the near future.

## IMMUNOLOGY

The immune response and immunity from infection with this parasite are poorly understood. Limited evidence exists in humans for acquired immunity to invasive infection with *E. histolytica*. De Leon (1970), working in Mexico, followed 1021 patients recovered from amebic liver abscess for the 5 year period 1963–1968 and found that only three individuals relapsed with a second episode of liver abscess; unfortunately this study lacked case-controls. It is also unclear whether immunity is acquired against colonization, since *E. dispar* and *E. histolytica* can colonize individuals who have serum anti-amebic antibodies, albeit at a lower frequency than seronegative individuals (Gathiram and Jackson, 1987; Choudhuri *et al.*, 1991). In Colombia, it was demonstrated that individuals with serum anti-amebic antibodies were less frequently colonized: 3.5% of individuals who were not infected with *E. histolytica*–*E. dispar* had an indirect hemagglutination inhibition titer of anti-amebic antibodies of  $\geq 1/320$ , compared to 2.0% of colonized individuals. Titers of anti-amebic antibodies  $< 1/320$  were not associated with a lower incidence of colonization, suggesting that the quantity of anti-amebic antibodies was a predictor of protection (Krupp, 1970).

Spontaneous resolution of asymptotically colonized individuals over a period of weeks to months also suggests that the immune system is able to protect against colonization (Gathiram and Jackson, 1987). However, immunity to colonization, if it exists, is not complete, as individuals can remain colonized with *E. histolytica* for months, despite the presence of serum anti-amebic antibodies (Choudhuri *et al.*, 1991). Evidence against immunity to colonization exists,

such as the observation that the incidence of *E. histolytica*-*E. dispar* infection increased with age in the Gambia, West Africa, from 1.9% of children <1 year of age to 35% of individuals aged >40 (Bray and Harris, 1977). In contrast, surveys of patients with diarrhea in Natal, South Africa, and amebic colitis in Dhaka, South Africa (Wanke *et al.*, 1988) have demonstrated a decline in the incidence of *E. histolytica*-*E. dispar* infection after age 14, with a second peak of infection in adults aged >40. In Dhaka, Bangladesh, *E. histolytica*-*E. dispar* is less frequently observed in the stools of individuals aged >14 with diarrhea, which could be interpreted as supporting the existence of immunity to intestinal colonization or invasion. Additional studies are needed to determine whether protective immunity is acquired after infection with *E. histolytica*, and whether immunity, if it exists, protects against both colonization and invasion. The current literature can be summarized as supporting the existence of acquired, albeit incomplete, immunity against colonization.

Evidence for both humoral and cell-mediated immunity has been detected in patients recovering from invasive disease. The relative contributions of different anti-*E. histolytica* immune responses to protective immunity observed have not been conclusively established. Support for a role for protective antibodies has been demonstrated, using a severe combined immunodeficient (SCID) mouse model. SCID mice lack functional B and T cells and, unlike immunocompetent mice, are susceptible to amebic liver abscess. Passive transfer of rabbit anti-amebic sera to SCID mice resulted in complete protection against amebic liver abscess in 58% of the mice (Cieslak *et al.*, 1992).

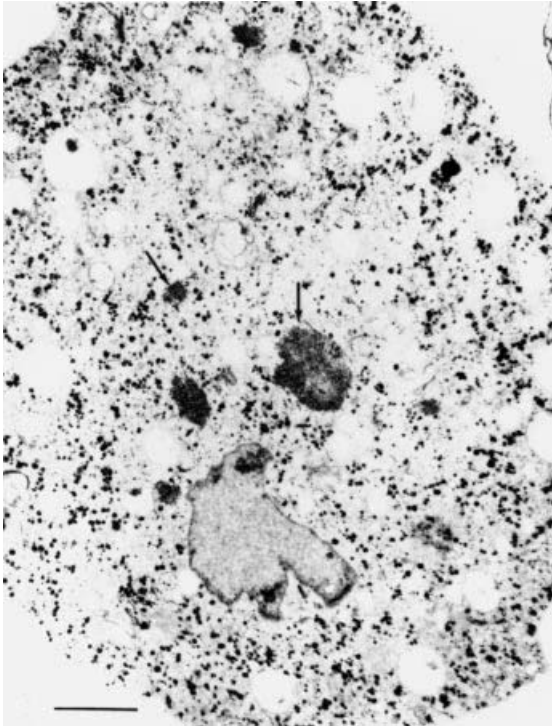
A secretory immune response has also been observed, with anti-amebic and anti-adherence lectin IgA antibodies detected in the stool, saliva and colostrum of patients with clinical amebiasis (Aceti *et al.*, 1991; Agarwal *et al.*, 1992; Kelsall *et al.*, 1994). Anti-adherence lectin antibodies directed against epitopes 1 and 2 have been shown to increase the adherence of amebae to human colonic mucins by directly activating the lectin's carbohydrate binding activity (Petri *et al.*, 1991).

Cell-mediated immunity has an important role in protection against *E. histolytica* infection via

cytokine activation of macrophages and neutrophils. In animal models, decreased cellular immunity, such as neonatal thymectomy, splenectomy, steroid treatment, radiation, silica therapy and anti-macrophage or anti-lymphocyte globulin enhanced the formation of amebic liver abscesses. Lymphocytes from patients recovered from invasive amebic disease demonstrated cell-mediated immune responses, such as T cell proliferation, amebicidal activity and interleukin-2 (IL-2) and interferon gamma (IFN $\gamma$ ) production (Salata *et al.*, 1985, 1986) *in vitro* against total *E. histolytica* extracts. IFN $\gamma$ - and TNF $\alpha$ -stimulated human macrophages and neutrophils are capable of killing *E. histolytica* trophozoites, while in the absence of IFN $\gamma$  these effector cells were killed by the amebae (Denis and Chadee, 1989; Salata *et al.*, 1985, 1986; Lin and Chadee, 1992). In murine macrophages, TNF $\alpha$  was shown to play a central role in activating macrophages for nitric oxide-dependent cytotoxicity against *E. histolytica* (Denis and Chadee, 1989; Lin and Chadee, 1992; Lin *et al.*, 1994).

## MOLECULAR BIOLOGY

*E. histolytica* is a eukaryotic organism with unusual cellular characteristics. It lacks organelles that morphologically resemble rough endoplasmic reticulum, Golgi or mitochondria (Figure 9.3; Table 9.2) (Rosenbaum and Wittner, 1970; McLaughlin and Aley, 1985; Hasegawa and Hashimoto, 1993; Clark and Roger, 1995; Mann *et al.*, 1991); however, the presence of nuclear-encoded mitochondrial genes, such as pyridine nucleotide transhydrogenase and hsp60, is consistent with *E. histolytica* having contained mitochondria at one time. Cell surface and secreted proteins contain signal sequences, and tunicamycin inhibits protein glycosylation, implicating functional rough endoplasmic reticulum or Golgi apparatus (Mann *et al.*, 1991). Ribosomes form aggregated crystalline arrays in the cytoplasm of the trophozoite (Rosenbaum and Wittner, 1970). Unique biochemical pathways from metazoans include the lack of glutathione and enzymes required for glutathione metabolism, the use of pyrophosphate instead of



**Fig. 9.3** Electron micrograph of an *E. histolytica* trophozoite. Note the nucleus with peripheral and central chromatin, the lack of structures resembling mitochondria or rough endoplasmic reticulum, and the prominent intracytoplasmic vacuoles

**Table 9.2** Some unusual features of the cell biology and biochemistry of *E. histolytica*

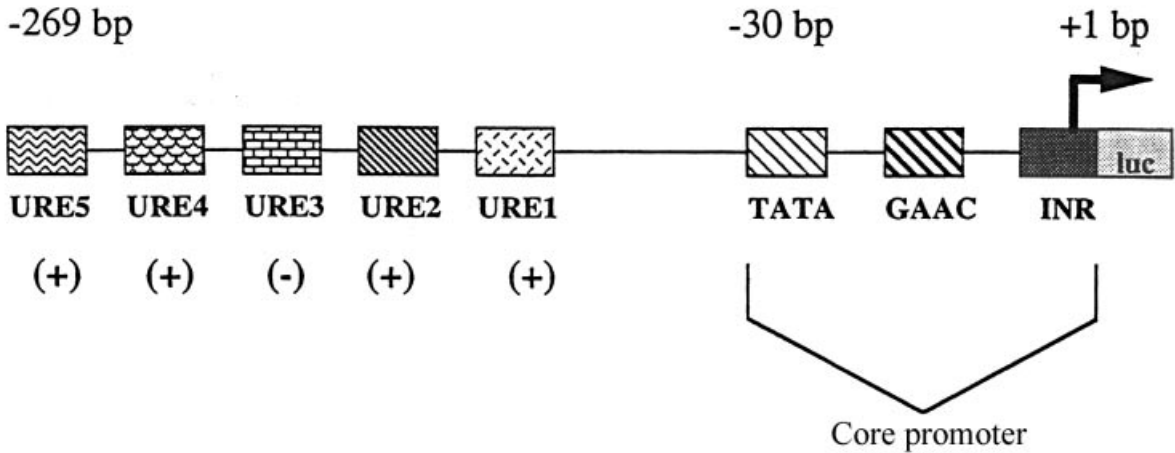
- Lack of mitochondria, rough endoplasmic reticulum or Golgi
- Presence of crystalline arrays of aggregated ribosomes
- Ribosomal RNA genes on multicopy circular DNA molecules
- Lack of glutathione and enzymes of glutathione metabolism
- Use of pyrophosphate instead of ATP at several steps in glycolysis
- Inability to synthesize purine nucleotides *de novo*

From Petri (1996), with permission.

ATP at several steps in glycolysis, and the inability to synthesize purine nucleotides *de novo*. Glucose is actively transported into the cytoplasm, where the end-products of carbohydrate metabolism are ethanol, CO<sub>2</sub> and, under aerobic conditions, acetate (McLaughlin and

Aley, 1985). *E. histolytica* genomic organization and transcriptional control appear to be distinct from both metazoan and better-characterized protozoan organisms. The genome is relatively small for a eukaryote ( $3.2 \times 10^7$  bp; Gelderman *et al.*, 1971) and extremely AT-rich (67% within coding regions and 78% overall; Gelderman *et al.*, 1971; Tannich and Horstmann, 1992). Transcription of protein-encoding genes is by an RNA polymerase that is resistant to 1 mg/ml  $\alpha$ -amanitin (Lioutas and Tannich, 1995). Introns are rarely identified (Lohia and Samuelson, 1993; Plaimauer *et al.*, 1994), suggesting that *cis*-splicing is a rare event, and there is no evidence of *trans*-splicing or polycistronic transcription (Bruchhaus *et al.*, 1993). However, recent work suggests that coding regions are tightly packed, with all four intergenic regions characterized to date smaller than 1.35 kb (Bruchhaus *et al.*, 1993). The structure of the mRNA is remarkable as well, with the 5' -untranslated region having an average length of 11 bases compared to a metazoan average of 60–80 bases (Kozak, 1984). The 3'-untranslated region is also short, with an average size of only 33 bases (Bruchhaus *et al.*, 1993). Ribosomal RNA is not contained within the genome but is encoded on a circular, 24 kb DNA episome (Bhattacharya *et al.*, 1989).

Both transient and stable DNA-mediated transfection of *E. histolytica* with heterologous gene expression have been recently accomplished (Buss *et al.*, 1995; Nickel and Tannich, 1994; Purdy *et al.*, 1994; Vines *et al.*, 1995; Hamann *et al.*, 1995). Gene expression in *E. histolytica* appears to involve species-specific transcription factors. An inducible promoter based on the tetracycline repressor system has also been developed (Hamann *et al.*, 1997; Ramakrishnan *et al.*, 1997). Analysis of the *hgl5* gene has revealed four positive upstream regulatory elements and one negative upstream regulatory element in the 200 bases upstream of the start of transcription (Figure 9.4). The architecture of the core promoter is unique and differs even from more closely related protozoa, consisting of three conserved elements: a TATA box, an initiator and a third conserved region, the GAAC element, which are all able to direct the site of transcription initiation (Singh *et al.*, 1997; Singh and Rogers, 1998). Recent work has implicated inside-out signaling from the cytoplasmic tail of



**Fig. 9.4** Structure of the promoter of the *hgl5* gene of *E. histolytica*. Four positive and one negative upstream regulatory regions have been identified by linker scanner mutagenesis and transient transfection system using the reporter gene luciferase. Three regions have also been identified in the core promoter, which appears to control gene expression

the surface lectin, involved in adherence and cytotoxicity of the ameba (Vines *et al.*, 1998). The carbohydrate recognition domain of the lectin has been identified and interestingly has sequence conservation with hepatocyte growth factor, implicating a possible molecular mechanism of tropism of the ameba for the liver (Dodson *et al.*, 1999).

## EPIDEMIOLOGY

The largest burden of disease caused by *E. histolytica* infection is in Central and South America, Africa and the Indian subcontinent. The current epidemiology of amebiasis is somewhat confusing because of the recently appreciated distinction between *E. histolytica* and *E. dispar*. Surveys that determine prevalence of infection by examining stool for parasites measure predominantly *E. dispar*, as this species is the more common, while serologic surveys reflect the incidence of *E. histolytica* infection, as *E. dispar* infection does not result in a positive serologic test (Jackson *et al.*, 1985; Ravdin *et al.*, 1990; Walsh, 1986). Further epidemiologic studies looking specifically at *E. histolytica* infection are needed to determine the true prevalence of the disease.

In 1987–1988 a Mexican national survey of a 67 668 sera demonstrated a 8.4% seropositivity

for *E. histolytica*, as measured with the indirect hemagglutination assay (Caballero-Salcedo *et al.*, 1994). Peak seropositivity was in the 5–9 age group, in which 11% were seropositive. A correlation with lower socioeconomic strata was not obvious, since rates of seropositivity were only marginally higher in rural, poorly educated and lower socioeconomic class individuals. The rate of seropositivity was higher in females than males (9% vs. 7%). During 1987–1988 in Mexico there were an estimated 1 million cases of amebiasis and 1216 deaths due to *E. histolytica* infection (Petri *et al.*, 1996b). Not surprisingly, *E. histolytica* infection was highest in the children of farmworkers exposed to human wastewater used to irrigate crops (Cifuentes *et al.*, 1994). The preponderance of disease in the developing world due to fecal–oral spread of infection is the result of complex socioeconomic problems, for which there are no immediate solutions.

In order to differentiate infection by the two parasites *E. histolytica* and *E. dispar*, the prevalence of intestinal infection by the two organisms has been revisited, using *E. histolytica*-specific antigen detection tests in 2000 children in Bangladesh. The antigen detection test selectively identifies an *E. histolytica* surface antigen and does not cross-react with *E. dispar*. Antigen detection identified more cases of *E. histolytica*–*E. dispar* infection than did culture or microscopy. Microscopic identification of

*E. histolytica*–*E. dispar* complex infection in stool did not equate with the diagnosis of amebic dysentery, because most amebic infections in this population were due to *E. dispar*: urban children with diarrhea had a 4.2% prevalence of *E. histolytica* infection and a 6.5% prevalence of *E. dispar* infection. Children aged 6–14 with diarrhea had the highest incidence (8%) of *E. histolytica* infection. Rural asymptomatic children had a 1.0% prevalence of *E. histolytica* infection and a 7.0% prevalence of *E. dispar* infection. *Shigella dysenteriae* and *S. flexneri* infection were more frequent in children with diarrhea who also had *Entamoeba* infection, a potentially important consideration for the empiric treatment of dysentery in this population (Haque *et al.*, 1997). Whether the amebae serve as a transport mechanism for the bacteria is unclear, although laboratory studies have shown the growth of *Shigella* intracellularly in *E. histolytica* (Mirelman, 1987).

In developed nations individuals that are at higher risk of amebiasis include immigrants from or travelers to countries where amebiasis is endemic (Weinke *et al.*, 1990; Abuhara *et al.*, 1982; Pehrson, 1983), sexually active male homosexuals (who are predominantly infected with *E. dispar* (Quinn *et al.*, 1983; Smith *et al.*, 1988; Krogstad *et al.*, 1978) and residents of institutions for the mentally retarded (Nagakura *et al.*, 1989; Krogstad *et al.*, 1978). In 1993, 2970 cases of amebiasis in the USA were reported to the Centers for Disease Control; 33% of the patients were Hispanic and 17% Asian or Pacific Islanders (1993).

Metastatic foci of infection such as amebic liver abscess are 7–12 times more common in men, with equal sex distribution in children (Gathiram and Jackson, 1987; Tony and Martin, 1992). More severe disease is seen in the very young and old, the malnourished and pregnant women (Walsh, 1986; Armon, 1978; Wanke *et al.*, 1988). *E. histolytica* infection in HIV-infected children was clustered in the most severely malnourished children with chronic diarrhea in a study from Tanzania (Cegielski *et al.*, 1993). Human genetic susceptibility to infection has not been described to date.

Amebic liver abscess is 7–12% -fold more common in men than in women. Although amebic abscess rarely occurs in children, when

it presents there is no apparent sex predilection. In the USA, the classic patient with amebic liver abscess is a Hispanic male between the ages of 20–40. In immigrants, infection with *E. histolytica* generally presents clinically within a year of immigration to the USA, although cases of amebic disease occurring 12 years after immigration have been reported. Travelers to the tropics are at low but definite risk for acquiring amebic infection (Weinke *et al.*, 1990; de Lalla *et al.*, 1992) and one study of 2700 German travelers returning from tropical areas demonstrated a 4% incidence of *E. histolytica*–*E. dispar* infection.

## CLINICAL FEATURES

Disease presentation can range clinically from asymptomatic colonization, to colitis and/or liver abscess.

### Asymptomatic

Asymptomatic colonization is a common presentation of *E. histolytica* infection (Table 9.3) and patients may have some ill-defined gastrointestinal complaints, but for the most part tolerate the infection well. The patients that are found to be colonized with *E. histolytica* are at risk for the future development of invasive disease months to even years later and should

**Table 9.3** Clinical manifestations of *Entamoeba* infection

Asymptomatic colonization
<i>E. histolytica</i>
<i>E. dispar</i>
Intestinal amebiasis and its complications ( <i>E. histolytica</i> only)
Amebic colitis
Ameboma
Toxic megacolon
Peritonitis
Cutaneous amebiasis
Extraintestinal amebiasis ( <i>E. histolytica</i> only)
Amebic liver abscess
Splenic abscess
Brain abscess
Empyema
Pericarditis

From Petri (1996), with permission.

be treated (Irusen *et al.*, 1992). Colonization with *E. histolytica* has been described in the male gay population of Japan, in which 13–20% of homosexual men are seropositive for *E. histolytica* infection. Invasive disease has been reported in homosexual and HIV-infected males (Takeuchi *et al.*, 1987, 1989; Ohnishi *et al.*, 1994) and indicates the need for a more aggressive approach to the management of intestinal amebic infection in homosexual males in Japan.

### Dysentery

Dysentery/colitis are the major complications of infection with this parasite. In a patient with dysentery (diarrhea that contains visible or microscopic blood), it is vital to differentiate amongst infectious causes (including amebiasis, *Shigella*, *Salmonella*, *Campylobacter* and enteroinvasive and enterohemorrhagic *E. coli*) and non-infectious causes (including inflammatory bowel disease, ischemic colitis and gastrointestinal bleeding secondary to AV malformations or diverticulosis). At times it is difficult to make the diagnosis of amebic colitis, as the presentation of the illness may be atypical, with non-bloody diarrhea and lack of systemic symptoms, such as fever. In such patients laboratory diagnosis is problematic, since a single stool exam for parasites is insensitive, histopathologic confirmation of infection on biopsy specimens may be difficult, and serologic tests for anti-amebic antibodies are not always positive in the acute setting (Table 9.4).

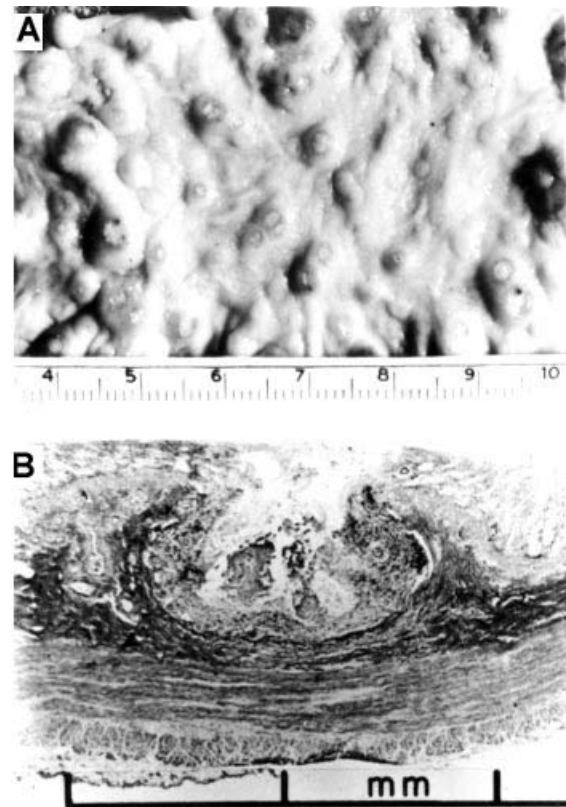
A thorough travel and exposure history is critical, since in developed countries most patients with amebiasis will be immigrants or travelers from areas with endemic amebiasis. Symptoms of amebic colitis are typically a several-week history of gradual onset of abdominal pain and tenderness, diarrhea and bloody stools. The relative subtlety of presentation is demonstrated by one series in which patients with amebic colitis had an average duration of prehospital illness of 21 days, compared to 4 days for patients with shigellosis (Speelman *et al.*, 1987). Weight loss is common although fever is present in only the minority (8–38%) of patients with amebic colitis (Speelman

**Table 9.4** Symptoms and signs of amebic colitis

Gradual onset	Most
Symptoms > 1 week	
Diarrhea	94–100%
Dysentery	94–100%
Abdominal pain	12–80%
Weight loss	44%
Fever >38° C	10%
Heme (+) stools	100%
Male:female	1:1
Resident, immigrant or traveler exposed in endemic area	Most

From Petri (1996), with permission.

*et al.*, 1987; Adams and MacLeod, 1977a; Jammal *et al.*, 1985). Colonic lesions can vary from only mucosal thickening to flask shaped ulcerations to necrosis of intestinal wall (Figure 9.5).



**Fig. 9.5** Amebic colitis. (A) Multiple mucosal ulcers are visible in the resected section of colon (smallest division of scale is mm). (B) Mucosal ulceration of amebic colitis, with extension of the ulcer into the submucosa (hematoxylin and eosin). From the collection of the late Harrison Juniper

Atypical manifestations of amebic colitis do occur and include acute necrotizing colitis, ameboma (granulation tissue in colonic lumen mimicking colonic cancer in appearance), cutaneous amebiasis and recto-vaginal fistulas. Acute fulminant or necrotizing colitis is the most feared complication, occurs in about 0.5% of cases, usually requires surgical intervention and has a mortality > 40% (Ellyson *et al.*, 1986; Aristizabal *et al.*, 1991). Abdominal pain, distension and rebound tenderness are present in most patients with fulminant colitis, although frank guarding is uncommon. Indications for surgery in fulminant disease include free extraperitoneal perforation, failure of a perforation with a localized abscess to respond to anti-amebic drugs, and persistence of abdominal distension and tenderness while on anti-amebic therapy. With localized colonic disease, partial colectomy with exteriorization of the ends is recommended over primary anastomosis, as anastomoses may fail due to the friable condition of the bowel wall. Better surgical results for extensive disease have been achieved with total colectomy with exteriorization of the proximal and distal ends (Ellyson *et al.*, 1986; Aristizabal *et al.*, 1991).

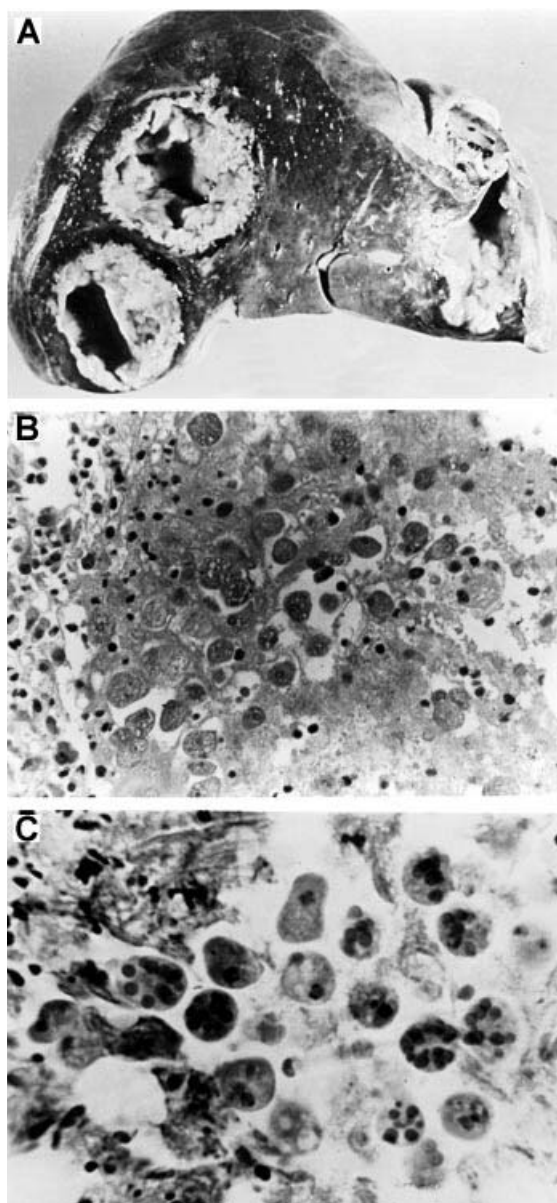
### Liver Abscess

Typically, signs of amebic liver abscess include right upper quadrant pain, fever of 38.5–39.5°C, leukocytosis, abnormal serum transaminases and alkaline phosphatase, an elevated right hemidiaphragm and a defect on hepatic imaging study (Table 9.5; Figures 9.6 and 9.8) (Adams and MacLeod, 1976; Maltz and Knauer, 1991;

**Table 9.5** Symptoms and signs of amebic liver abscess

Length of symptoms	>4 weeks	21–51%
Fever		85–90%
Abdominal tenderness		84–90%
Hepatomegaly		30–50%
Jaundice		6–10%
Diarrhea		20–33%
Weight loss		33–50%
Cough		10–30%
Male:female		9:1
Resident, immigrant or traveler exposed in endemic area		Most

From Petri (1996), with permission.



**Fig. 9.6** Amebic liver abscess. Gross (A) and microscopic (B,C) pathology of amebic liver abscess. *E. histolytica* trophozoites are surrounded by amorphous eosinophilic debris (B, hematoxylin and eosin). Host inflammatory cells are present only at the periphery of the lesion, most likely a reflection of the parasite's ability to lyse macrophages. (C) Microscopic example of erythrophagocytosis by *E. histolytica*. (A) and (C) from the collection of the late Harrison Juniper; (B) courtesy of Dr Sharon Reed

Thompson and Glasser, 1986). A more chronic presentation of 2–12 weeks of weight loss, fever and abdominal pain has been reported in a subset of patients with single abscesses (Katzenstein *et al.*, 1982). The majority (90%) of adult patients with liver abscess are made with equal sex distribution in children (Nazir and Moazam, 1993; Johnson *et al.*, 1994). Amebic liver abscess is usually single and in the right lobe of the liver 80% of the time. The location is not helpful in distinguishing the etiology of an abscess, since the most common location for a pyogenic abscess is also in the right lobe (Mehta *et al.*, 1986; Hai *et al.*, 1991). Patients with pyogenic, as opposed to amebic, liver abscesses are more likely to be older (> 50 years), have a palpable mass and present with jaundice, pruritis, sepsis or shock (Conter *et al.*, 1986).

Although a history of dysentery within the last year can sometimes be obtained, most patients with liver abscess do not have concurrent colitis. Atypical presentations of liver abscess include an acute illness with fever, right upper abdominal tenderness and pain, or subacutely with prominent weight loss, fever and abdominal pain. Laboratory abnormalities include leukocytosis and an elevated alkaline phosphatase level. Elevation of the right hemidiaphragm in radiographic studies is evident in most patients (Chuah *et al.*, 1992; Greaney *et al.*, 1985; Ravdin and Guerrant, 1981). Early evaluation of the hepatobiliary system with ultrasound, CT or MRI is essential to demonstrate the abscess in the liver.

The differential diagnosis of a hepatic lesion includes pyogenic abscess (less likely if the gall bladder and intrahepatic ducts appear normal), hepatoma and echinococcal cyst (patients are usually asymptomatic and are unlikely to present acutely with fever and abdominal pain).

Severe amebic liver abscesses occur and were defined in one study as abscesses that rupture despite at least 3 days of anti-amebic treatment, or abscesses complicated by secondary bacterial infection. These are associated with dyspnea, elevated right hemidiaphragm and pleural effusion, jaundice, anemia and diabetes mellitus (Chuah *et al.*, 1992; Greaney *et al.*, 1985). Patients with findings listed above that are associated with more severe disease might benefit from early drainage. Intrathoracic and intra-

peritoneal rupture of an amebic liver abscess can be adequately treated with anti-amebic therapy without surgery if secondary bacterial infection is absent (Greaney *et al.*, 1985). Unusual extra-intestinal manifestations of amebiasis include direct extension of the liver abscess to pleura or pericardium, brain abscess and genitourinary amebiasis.

### Cutaneous Amebiasis

This is a rare, albeit reported, complication of amebic infection. Cases of amebiasis involving the abdominal wall, face, vulva and vagina, and penis have been reported (Rimsza and Berg, 1983; Baez Mendoza and Ramirez Barba, 1986; Citronberg and Semel, 1995; Loschiavo *et al.*, 1997). These conditions are thought to occur from fistulous tracts that arise from underlying enteric disease or hepatic abscesses. Significant tissue necrosis can occur in these cases and often requires significant surgical debridement in addition to antibiotic treatment.

### DIAGNOSIS

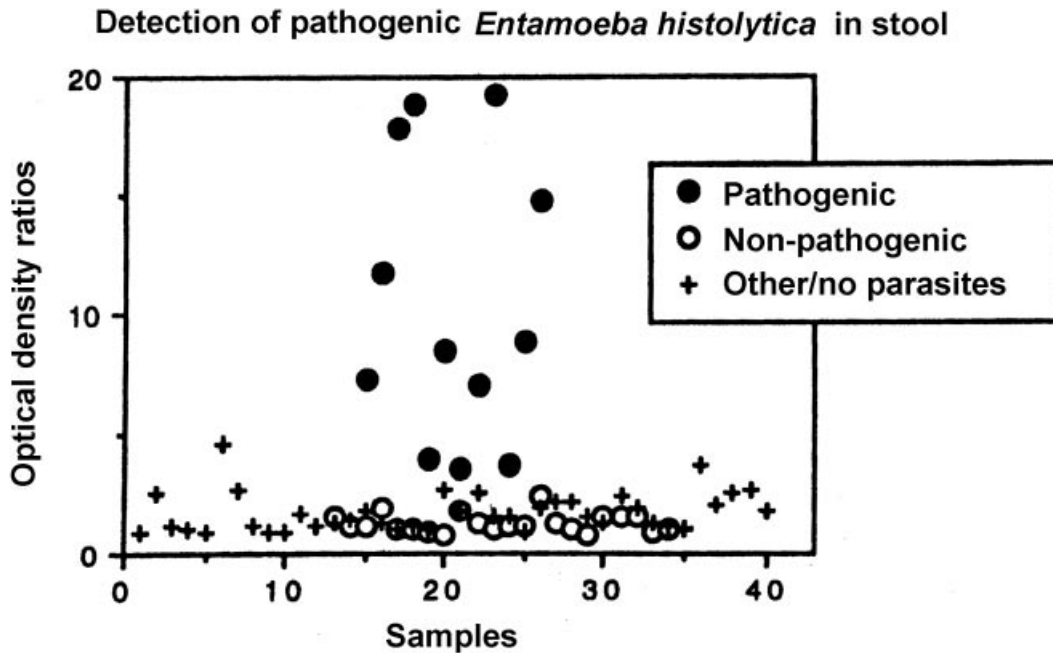
Diagnosis can be accomplished using a variety of techniques outlined below.

#### Microscopy

Examination of stools reveals occult blood; however, microscopic examination of stool for *E. histolytica* cysts and trophozoites is very insensitive. A single examination is positive in only one-third to one-half of cases, with three or more examinations required in most cases to identify the organism. Antigen detection is more sensitive than microscopy and is specific for *E. histolytica* infection.

Amebae are identified microscopically in the stool in 18% of cases at the time of diagnosis of liver abscess, although they can be identified in the stool by culture in the majority of patients. Microscopic examination of a single stool specimen for amebic cysts and trophozoites in a patient with amebic colitis is only 33–50%





**Fig. 9.7** Antigen detection test for *E. histolytica* in stool. Stool specimens with culture-confirmed *E. dispar* (open circles) or *E. histolytica* (closed circles) infection, or stools without detectable *Entamoeba* detected by microscopy (crosses), were assayed using an ELISA containing mAb specific for *E. histolytica*

sensitive, and is unable to distinguish pathogenic *E. histolytica* from the morphologically identical non-pathogenic *E. dispar* (Haque *et al.*, 1995, 1997; Petri and Mann, 1993). Erythrophagocytic amebae are more likely to be *E. histolytica* than *E. dispar* (Gonzalez-Ruis *et al.*, 1994), but *E. dispar* trophozoites have also been found to contain ingested red blood cells (Haque *et al.*, 1995).

In patients with amebic liver abscess, microscopic examination of the stool is even less efficacious, as repeated stool examinations in patients with amebic liver abscess were only able to detect the parasite in 8–44% of cases (Katzenstein *et al.*, 1982; Petri *et al.*, 1990). Aspiration of the abscess is occasionally required to diagnose amebiasis, and although amebae are visualized in the pus in only the minority of cases, antigen detection on the abscess fluid appears to be very sensitive. In pyogenic abscesses, bacteria will be seen and/or cultured from the aspirated fluid. Antibodies to *E. histolytica* are present in the serum of 92–97% of patients upon acute presentation with amebic liver abscess, and therefore are very useful diagnostically. Because

a significant proportion of the population in developing countries is seropositive, however, antibody tests are less specific in residents or immigrants from the developed world. Identification of the parasite in aspirated pus from liver abscesses, even in the most experienced hands, is only 20% sensitive (Haque *et al.*, 1995; Katzenstein *et al.*, 1982).

### Antigen Detection

Antigen detection is a recently developed tool which exploits the molecular differences between *E. histolytica* and *E. dispar*. A stool antigen detection test that is specific for *E. histolytica* is now commercially available for clinical use from TechLab Inc. (Blacksburg, VA, USA) (Figure 9.7) (Haque *et al.*, 1993, 1995, 1997). The *E. histolytica* antigen test is rapid, has improved sensitivity compared to microscopy, and is only slightly less sensitive than the 'gold standard' of culture/isoenzyme analysis. The TechLab *E. histolytica* test is based on detection of

the Gal/GalNAc lectin in stool; another *E. histolytica* specimen antigen test is also available (Gonzalez-Ruiz *et al.*, 1994). A test to detect the Gal/GalNAc lectin in serum appears promising for the diagnosis of amebic liver abscess (a situation where it is more difficult than amebic colitis to demonstrate the parasite in stool), with a reported sensitivity in initial tests of 67%. Detection of Gal/GalNAc lectin in liver abscess aspirates has demonstrated to be a sensitive test in a small number of patients (R. Haque and W. Petri, unpublished).

### Polymerase Chain Reaction

Polymerase chain reaction (PCR) can now be used to diagnose *E. histolytica* in stool samples with sensitivity comparable to antigen detection (Haque *et al.*, 1998). Preliminary results for PCR detection of *E. histolytica* DNA in liver abscess pus appear encouraging. Use of PCR can be used also to distinguish amongst isolates of *E. histolytica*, which should prove useful for epidemiologic purposes, as well as determining the virulence characteristics of different isolates (Garfinkel *et al.*, 1989; Tachibana *et al.*, 1991; Tannich *et al.*, 1991; Acuna-Solo *et al.*, 1993).

### Serology

Serology using an indirect hemagglutination (IHA) test for anti-amebic antibody is eventually reportedly 99% sensitive for amebic liver abscess and 88% sensitive for amebic colitis (Kagan, 1970). However, early in the course of amebic liver abscess the indirect hemagglutination test may be negative. The major problem limiting clinical use of the current serologic tests is that they remain positive for years after an episode of amebiasis. As a result, a substantial number (10–35%) of residents of developing countries have anti-amebic antibodies detected by current serologic tests (Caballero-Salcedo *et al.*, 1994; Choudhuri *et al.*, 1991). This has resulted in a situation where it is impossible to distinguish current from past infection in individuals from countries with high prevalence of infection (Ximenez *et al.*, 1993). In five recent series of

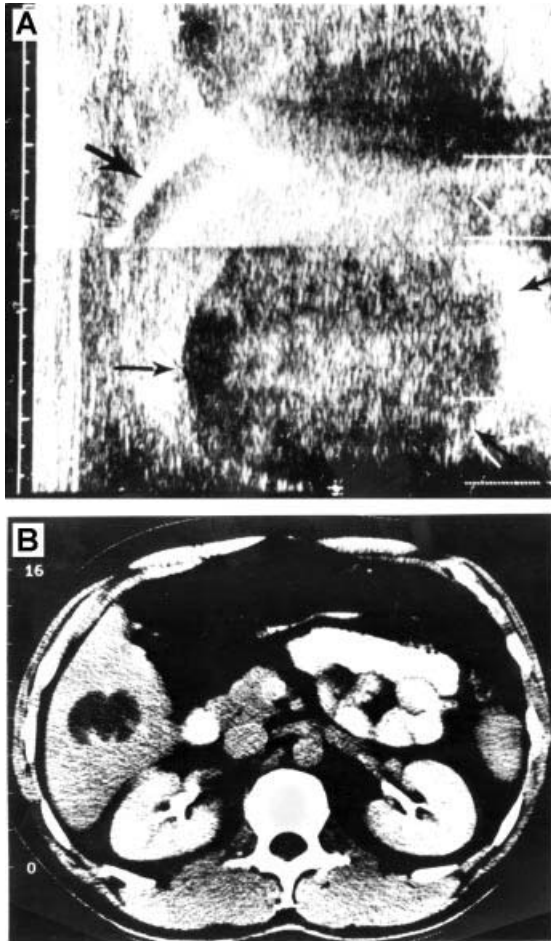
patients in the USA with amebic liver abscess, 80–96% of patients were immigrants (Aceti *et al.*, 1991; Agarwal *et al.*, 1992; Iruzen *et al.*, 1992; Kelsall *et al.*, 1994). Therefore, current serologic tests may be inadequate for the differentiation of acute from past amebiasis, even in developed nations, and one should not make the diagnosis of amebiasis in a native of a country with endemic amebiasis on the basis of a serologic test alone.

### Colonoscopy

Colonoscopy is preferable to sigmoidoscopy in the diagnosis of amebic colitis because disease may be localized to the cecum or ascending colon. Cathartics or enemas interfere with the identification of the parasite and should not be used. Wet preparations of material aspirated or scraped from the base of ulcers should be examined for motile trophozoites and tested for *E. histolytica* antigen. The appearance of amebic colitis may resemble that of inflammatory bowel disease, with granular, friable and diffusely ulcerated mucosa, and large geographic ulcers and pseudomembranes may also be present (Chun *et al.*, 1994). Biopsy specimens should be taken from the edge of the ulcers. The detection rate of trophozoites upon histopathologic examination of colonic biopsy specimens from patients with amebic colitis is quite variable (Yoon *et al.*, 1991). Periodic acid–Schiff stains the parasites a magenta color (Figure 9.6), increasing the ease of detection in biopsies. *E. histolytica* has been shown to invade into carcinomas, causing diagnostic confusion (Mhlanga *et al.*, 1992).

### Imaging

Imaging procedures such as ultrasound, computer tomography and magnetic resonance imaging studies of the liver are equally sensitive at detecting amebic abscesses (Figure 9.8). However, no technique can differentiate an amebic from a pyogenic abscess (Sheen *et al.*, 1989; Ravdin *et al.*, 1988; Ahmed *et al.*, 1990; Elizondo *et al.*, 1987). Radiographic resolution of amebic liver abscesses is prolonged and at 6 months'



**Fig. 9.8** Imaging of hepatic amebic abscess from different patients by (A) ultrasound, (B) computed tomography. (A) From Ahmed (1990) and (B) from Radin (1988), both with permission

follow-up only one-third to two-thirds of amebic liver abscesses had disappeared upon repeat ultrasonography (Sheen *et al.*, 1989; Ahmed *et al.*, 1990; Agarwal *et al.*, 1992).

## MANAGEMENT

Treatment of colonization with *E. histolytica* should be treated with a luminal agent alone (Table 9.6). Drugs effective against luminal infection include diloxanide furoate, 500 mg t.i.d. for 10 days (not commercially available in the USA), paromomycin 25–35 mg/kg in three

**Table 9.6** Treatment of amebiasis

Asymptomatic colonization
<i>E. histolytica</i> —a luminal agent or metronidazole
<i>E. dispar</i> —no treatment required
Amebic colitis—metronidazole and/or a luminal agent (paromomycin, diloxanide furoate or diiodohydroxyquin)
Amebic liver abscess—metronidazole and a luminal agent

From Petri (1996), with permission.

doses for 7 days, and iodoquinol (650 mg t.i.d. for 20 days). All these agents are relatively well tolerated (McAuley *et al.*, 1992; McAuley and Juranek, 1992). Invasive amebiasis, such as colitis and liver abscess, should be treated with metronidazole, 500–750 mg t.i.d. for 10 days, plus a luminal agent. The majority of patients with amebic liver abscess defervesce after 3–4 days' treatment with metronidazole, resistance to which has not yet been reported. Chloroquine, dehydroemetine and percutaneous drainage of the liver abscess have all been successfully added to metronidazole treatment for the rare patient not responding to metronidazole alone (Bassily *et al.*, 1987; Simjee *et al.*, 1985; van Allen *et al.*, 1992). In most cases of liver abscess, percutaneous drainage is not required and does not speed recovery (van Allen *et al.*, 1992). Metronidazole does not eliminate intestinal colonization in up to 50% of patients with invasive amebiasis unless therapy is prolonged for a minimum of 10 days. With shorter courses of metronidazole therapy, patients may suffer a relapse of invasive infection months later (Bassily *et al.*, 1987; Simjee *et al.*, 1985). For this reason the addition of a luminal agent is recommended.

## PREVENTION AND CONTROL

Prevention and control of amebiasis requires interruption of the fecal–oral spread of the infectious cyst stage of the parasite by improved hygiene, sanitation and water treatment. The development of a vaccine to prevent disease in residents and travelers to the developing world is still in the future. Both the serine-rich antigen and the adherence lectin have proven effective in the prevention of liver abscess in the gerbil model of the disease (Zhang and Stanley, 1994; Petri and

Ravdin, 1991). Current efforts include experiments directed at understanding the mechanisms of immune protection in animal models and humans, and testing whether it is possible to prevent

colonization via immunization with the adherence lectin. As humans are the only significant reservoir of infection, a vaccine that blocked colonization could lead to elimination of the parasite.

### ENTAMOEBA DISPAR

*Entamoeba dispar*, a non-invasive protozoan, has recently been separated from *E. histolytica*. The two parasites are morphologically identical species but genetically distinct species. *Entamoeba dispar* is the predominant cause of colonization in many asymptomatic 'cyst-passers' in developing countries, as well as in sexually active male homosexuals in developed countries.

#### DESCRIPTION OF THE ORGANISM

Brumpt (1925) suggested that there were two species of *Entamoeba*. Only one of these caused disease in kittens or human volunteers, and he named the other, non-pathogenic, species *Entamoeba dispar*. However, the inability to differentiate between these two species by morphological or biochemical means until recently led to significant debate on this topic. Sargeant *et al.* (1978) demonstrated that isoenzyme typing could be used to distinguish the pathogenic from the non-pathogenic species of *Entamoeba*, and the issue was re-examined. Today the two species are classified as *E. histolytica* (Schaudinn, 1903) and *Entamoeba dispar* (Brumpt, 1925) and can be separated on the basis of isoenzyme analysis, typing by monoclonal antibodies to surface antigens and restriction fragment length polymorphisms (Table 9.1) (Sargeant and Williams, 1979; Sargeant *et al.*, 1978; Strachan *et al.*, 1988; Tannich and Burchard, 1991; Tannich *et al.*, 1989, 1991; Diamond and Clark, 1993; Garfinkel *et al.*, 1988; Edman *et al.*, 1990; Clark and Diamond, 1991).

#### PATHOGENESIS

*E. dispar* has never been documented to cause colitis or liver abscess. Because *E. dispar* colonization is more common than *E. histolytica*

infection and need not be treated, an important clinical advance has been the development of antigen detection tests that differentiate between them (see Diagnosis). In 1997, a consensus statement from the World Health Organization was released, stating that *E. dispar* infection/colonization does not need to be treated, even in countries with high rates of prevalence (WHO/PAHO/UNESCO, 1997).

It is not completely clear at a pathophysiological level why *E. dispar* is incapable of causing disease. Morphologically, ultrastructurally, biochemically and at a molecular level the two parasites are very similar. *E. dispar* has been found to have many of the same enzymes and surface proteins (including the Gal/GalNAc adhesin lectin) that have been implicated in the pathogenesis of *E. histolytica* (Mann *et al.*, 1997). These enzymes are similar, although not identical, in the two parasites. *In vitro*, *E. dispar* is capable of killing target cells such as neutrophils, albeit at a quantitatively reduced level compared to the virulent *E. histolytica*. Further study into the pathogenesis of *E. histolytica* may one day provide insight into the dichotomy of these two related but functionally separate parasites.

#### IMMUNOLOGY

Immunity to both *E. histolytica* and *E. dispar* is poorly understood, as outlined above.

#### MOLECULAR BIOLOGY

At a molecular level, *E. dispar* is very similar to its pathogenic counterpart, *E. histolytica*. *E. dispar* has been found to have a surface lectin, amebapore and cysteine proteases, all of which are very similar to their counterparts in

*E. histolytica*. The functional differences between the two organisms is thus not clear from a purely molecular level.

## EPIDEMIOLOGY

In contrast to the distribution of *E. histolytica* (concentrated in Central and South America, Africa and the Indian subcontinent) *E. dispar* is found worldwide. *E. dispar* is the predominant cause of colonization in many asymptomatic 'cyst-passers' in developing countries, as well as in sexually active male homosexuals from developed countries. Almost all *E. histolytica*-*E. dispar* isolates from colonized homosexual males in Europe and the USA are *E. dispar* (Weinke *et al.*, 1990; Goldmeier *et al.*, 1986; Allason-Jones *et al.*, 1986); this explains the general lack of invasive amebiasis in this population at risk for HIV infection.

Currently, the epidemiology of amebiasis is somewhat uncertain because of the recently appreciated distinction between *E. histolytica* and *E. dispar*. Previous studies that examined the prevalence of infection by examining stool for parasites measured predominantly *E. dispar*, as this species is much more common. However, serologic surveys reflected the incidence of *E. histolytica* infection, as *E. dispar* colonization does not result in a positive serologic test (Jackson *et al.*, 1985; Ravdin *et al.*, 1990; Walsh, 1986). The prevalence of intestinal infection by the invasive parasite *E. histolytica* and the non-invasive parasite *E. dispar* has been revisited, using *E. histolytica*-specific antigen detection tests in 2000 children in Bangladesh. Microscopic identification of *E. histolytica*-*E. dispar* complex infection in stool did not equate with the

diagnosis of amebic dysentery because most amebic infections in this population were due to *E. dispar*: urban children with diarrhea had a 4.2% prevalence of *E. histolytica* infection and a 6.5% prevalence of *E. dispar* infection. Rural asymptomatic children had a 1.0% prevalence of *E. histolytica* infection and a 7.0% prevalence of *E. dispar* infection. Further epidemiologic studies using the recently available specific diagnostic tests are needed to clarify the true incidence of *E. dispar* colonization in other geographic locations.

## CLINICAL FEATURES, MANAGEMENT, PREVENTION AND CONTROL

Although colonization with *E. dispar* is known to occur, the organism has never been known to cause disease. In patients with HIV infection no correlation has been established between the presence of *E. dispar* and gastrointestinal symptoms, and apparently anti-amebic treatment is not warranted.

## LABORATORY DIAGNOSIS

Morphologically, *E. dispar* cannot be differentiated from *E. histolytica*. The two parasites must therefore be separated on the basis of specific tests. A stool antigen detection test that is specific for *E. histolytica* is now commercially available for clinical use from TechLab Inc. (Blacksburg, VA, USA) (Figure 9.7) (Haque *et al.*, 1993, 1995, 1997). This test utilizes the molecular differences between the Gal/GalNAc lectin of *E. histolytica* and *E. dispar*.

## ENTAMOEBIA COLI

*Entamoeba coli* is a non-pathogenic protozoan that has a wide human distribution. The presence of this organism in a patient's stool is a useful indication of fecal-oral exposure. The life-cycle of *E. coli* is identical to that of *E. histolytica*, and the two organisms are found concurrently in 10–30% of patients in an endemic area. However, *E. coli* is non-pathogenic and requires no specific

treatment. The cysts and trophozoites of *E. coli* can be distinguished from those of the pathogenic *E. histolytica* on the basis of nuclear morphology and cyst size. Whereas *E. histolytica* cysts usually have fewer than five nuclei and are 10–15 µm in diameter, the cysts of *E. coli* are greater than 15 µm and have more than five to eight nuclei (Ravdin and Guerrant, 1986).

**ENTAMOEBA POLECKI**

*Entamoeba polecki*, an intestinal protozoan, can be found in monkeys and pigs. In rare cases it has been reported to cause human infections, although the true pathogenic potential is currently unclear. Studies have reported that up to 19% of children in Papua New Guinea are colonized. Most infected individuals are asymptomatic; however, heavy burdens with this parasite can produce non-specific gastrointestinal

symptoms, such as diarrhea, cramps, anorexia and malaise. Therapy with metronidazole and diloxanide furoate is recommended for symptomatic individuals. The trophozoite form of *E. polecki* resembles that of *E. histolytica* and *E. coli*, and differentiation from these and other protozoa rely on identification of the cyst stage of the organism, which is characteristically uninucleate with a large karyosome (Ravdin, 1986; Leber 1999).

**ENDOLIMAX NANA**

*Endolimax nana* is a non-pathogenic commensal parasite with a worldwide distribution which commonly infects humans. It has the same life cycle as *E. histolytica* and is transmitted through fecal-oral spread and poor sanitary conditions. In the tropics it may be identified in the stool in 10–33% of individuals but requires no specific

treatment. It can be distinguished from *E. histolytica* on the basis of its small size (cyst 6–10 µm and trophozoite 8–12 µm), vesicular nucleus and large irregular karyosome. The cysts are often quadrinucleate (Ravdin and Guerrant, 1986; Garcia and Bruckner, 1993, 1995).

**REFERENCES**

- Abuabara SF, Barrett JA *et al.* (1982). Amebic liver abscess. *Arch Surg* **117** (2): 239–44.
- Aceti A, Pennica A *et al.* (1991). Salivary IgA antibody detection in invasive amebiasis and in asymptomatic infection [letter; comment]. *J Infect Dis* **164** (3): 613–15.
- Acuna-Solo R, Samuelson J *et al.* (1993). Application of the polymerase chain reaction to the epidemiology of pathogenic and non-pathogenic *Entamoeba histolytica*. *Am J Trop Med Hyg* **48** (1): 58–70.
- Adams EB, MacLeod IN (1977a). Invasive amebiasis. I. Amebic dysentery and its complications. *Med (Baltimore)* **56** (4): 315–23.
- Adams EB, MacLeod IN (1977b). Invasive amebiasis. II. Amebic liver abscess and its complications. *Med (Baltimore)* **56** (4): 325–34.
- Agarwal SK, Somani A *et al.* (1992). Colonic immunity in patients and amoebic liver abscess. *J Commun Dis* **24** (1): 49–54.
- Agrawal A, Pandey VC *et al.* (1992). Partial purification of acid phosphomonoesterase in axenically grown *Entamoeba histolytica* NIH-200. *J Commun Dis* **24** (1): 42–5.
- Ahmed L, Rooby A *et al.* (1990). Ultrasonography in the diagnosis and management of 52 patients with amebic liver abscess in Cairo. *Rev Infect Dis* **12** (2): 330–7.
- Allason-Jones E, Mindel A *et al.* (1986). *Entamoeba histolytica* as a commensal intestinal parasite in homosexual men. *N Engl J Med* **315** (6): 353–6.
- Andrews BJ, Mentzoni L *et al.* (1990). Zymodeme conversion of isolates of *Entamoeba histolytica*. *Trans R Soc Trop Med Hyg* **84** (1): 63–5.
- Anonymous (1997). WHO/PAHO/UNESCO report. A consultation with experts on amoebiasis. Mexico City, Mexico, 28–29 January 1997. *Epidemiol Bull* **18** (1): 13–14.
- Aristizabal H, Acevedo J *et al.* (1991). Fulminant amebic colitis. *World J Surg* **15** (2): 216–21.
- Armon PJ (1978). Amoebiasis in pregnancy and the puerperium. *Br J Obstet Gynaecol* **85** (4): 264–9.
- Baez Mendoza J, Ramirez Barba EJ (1986). Cutaneous amebiasis of the face: a case report. *Am J Trop Med Hyg* **35** (1): 69–71.
- Bassily S, Farid Z *et al.* (1987). Treatment of intestinal *E. histolytica* and *G. lamblia* with metronidazole, tinidazole and ornidazole: a comparative study. *J Trop Med Hyg* **90** (1): 9–12.
- Bhattacharya S, Bhattacharya A *et al.* (1989). Circular DNA of *Entamoeba histolytica* encodes ribosomal RNA. *J Protozool* **36** (5): 455–8.
- Braga LL, Ninomiya H *et al.* (1992). Inhibition of the complement membrane attack complex by the galactose-specific adhesion of *Entamoeba histolytica*. *J Clin Invest* **90** (3): 1131–7.
- Bray RS, Harris WG (1977). The epidemiology of infection with *Entamoeba histolytica* in the Gambia, West Africa. *Trans R Soc Trop Med Hyg* **71** (5): 401–7.
- Bruchhaus I, Leippe M *et al.* (1993). Unusual gene organization in the protozoan parasite *Entamoeba histolytica*. *DNA Cell Biol* **12** (10): 925–33.
- Buss H, Lioutas C *et al.* (1995). Analysis of the 170-kDa lectin gene promoter of *Entamoeba histolytica*. *Mol Biochem Parasitol* **72** (1–2): 1–10.

- Caballero-Salcedo A, Viveros-Rogel M *et al.* (1994). Seroepidemiology of amebiasis in Mexico. *Am J Trop Med Hyg* **50** (4): 412–19.
- Cegielski JP, Msengi AE *et al.* (1993). Intestinal parasites and HIV infection in Tanzanian children with chronic diarrhea. *AIDS* **7** (2): 213–21.
- Choudhuri G, Prakash V *et al.* (1991). Protective immunity to *Entamoeba histolytica* infection in subjects with antiamebic antibodies residing in a hyperendemic zone. *Scand J Infect Dis* **23** (6): 771–6.
- Chuah SK, Chang-Chien CS *et al.* (1992). The prognostic factors of severe amebic liver abscess: a retrospective study of 125 cases. *Am J Trop Med Hyg* **46** (4): 398–402.
- Chun D, Chandrasoma P *et al.* (1994). Fulminant amebic colitis. A morphologic study of four cases. *Dis Colon Rectum* **37** (6): 535–9.
- Cieslak PR, Virgin HWT *et al.* (1992). A severe combined immunodeficient (SCID) mouse model for infection with *Entamoeba histolytica*. *J Exp Med* **176** (6): 1605–9.
- Cifuentes E, Blumenthal U *et al.* (1994). Epidemiologic setting of the agricultural use of sewage: Valle del Mezquital, Mexico. *Salud Publica Mex* **36** (1): 3–9.
- Citronberg RJ, Semel JD (1995). Severe vaginal infection with *Entamoeba histolytica* in a woman who recently returned from Mexico: case report and review. *Clin Infect Dis* **20** (3): 700–2.
- Clark CG, Diamond LS (1993). *Entamoeba histolytica*: an explanation for the reported conversion of 'non-pathogenic' amebae to the 'pathogenic' form. *Exp Parasitol* **77** (4): 456–60.
- Clark CG, Roger AJ (1995). Direct evidence for secondary loss of mitochondria in *Entamoeba histolytica*. *Proc Natl Acad Sci USA* **92** (14): 6518–21.
- Conter RL, Pitt HA *et al.* (1986). Differentiation of pyogenic from amebic hepatic abscesses. *Surg Gynecol Obstet* **162** (2): 114–20.
- Councilman W, Lafleur H (1891). *Johns Hopkins Hos Rep* **2**: 395.
- de Lalla F, Rinaldi E *et al.* (1992). Outbreak of *Entamoeba histolytica* and *Giardia lamblia* infections in travellers returning from the tropics. *Infection* **20** (2): 78–82.
- DeLeon A (1970). *Arch Invest Med (Mex)* **Suppl 1**: S205.
- Denis M, Chadee K (1989). Human neutrophils activated by interferon-gamma and tumour necrosis factor-alpha kill *Entamoeba histolytica* trophozoites *in vitro*. *J Leukoc Biol* **46** (3): 270–4.
- Diamond L (1961). *Science* **134**: 336.
- Diamond LS, Clark CG (1993). A redistribution of *Entamoeba histolytica* Shaudinn, 1903 (amended Walker, 1911) separating it from *Entamoeba dispar* Brumpt, 1925. *J Eukaryot Microbiol* **40** (3): 340–4.
- Diamond LS, Cunnick CC (1991). A serum-free, partly defined medium, PDM-805, for axenic cultivation of *Entamoeba histolytica* Schaudinn, 1903, and other *Entamoeba*. *J Protozool* **38** (3): 211–16.
- Dodson JM, Lenkowski PW KR *et al.* (1999). Infection and immunity mediated by the carbohydrate recognition domain of the *Entamoeba histolytica* Gal/GalNAc lectin. *J Infect Dis* **179** (2): 460–6.
- Elizondo GR, Weissleder R *et al.* (1987). Amebic liver abscess: diagnosis and treatment evaluation with MR imaging. *Radiology* **165** (3): 795–800.
- Ellyson JH, Bezmalinovic Z *et al.* (1986). Necrotizing amebic colitis: a frequently fatal complication. *Am J Surg* **152** (1): 21–6.
- Garcia LS, Shimizu RY *et al.* (1993). Evaluation of intestinal protozoan morphology in polyvinyl alcohol preservative: comparison of zinc sulfate- and mercuric chloride-based compounds for use in Schaudinn's fixative. *J Clin Microbiol* **31** (2): 307–10.
- Garfinkel LI, Giladi M *et al.* (1989). DNA probes specific for *Entamoeba histolytica* possessing pathogenic and non-pathogenic zymodemes. *Infect Immun* **57** (3): 926–31.
- Gathiram V, Jackson TF (1987). A longitudinal study of asymptomatic carriers of pathogenic zymodemes of *Entamoeba histolytica*. *S Afr Med* **72** (10): 669–72.
- Gelderman AH, Keister DB *et al.* (1971). Characterization of the deoxyribonucleic acid of representative strains of *Entamoeba histolytica*, *E. histolytica*-like amebae, and *E. moshkovskii*. *J Parasitol* **57** (4): 906–11.
- Goldmeier D, Sargeant PG *et al.* (1986). Is *Entamoeba histolytica* in homosexual men a pathogen? *Lancet* **1** (8482): 641–4.
- Gonzalez-Ruiz A, Haque R *et al.* (1994). Value of microscopy in the diagnosis of dysentery associated with invasive *Entamoeba histolytica*. *J Clin Pathol* **47** (3): 236–9.
- Greaney GC, Reynolds TB *et al.* (1985). Ruptured amebic liver abscess. *Arch Surg* **120** (5): 555–61.
- Hai AA, Singh A *et al.* (1991). Amebic liver abscess. Review of 220 cases. *Int Surg* **76** (2): 81–3.
- Hamann L, Buss H *et al.* (1997). Tetracycline-controlled gene expression in *Entamoeba histolytica*. *Mol Biochem Parasitol* **84** (1): 83–91.
- Hamann L, Nickel R (1995). Transfection and continuous expression of heterologous genes in the protozoan parasite *Entamoeba histolytica*. *Proc Natl Acad Sci USA* **92** (19): 8975–9.
- Haque R, Ali IK *et al.* (1998). Comparison of PCR, isoenzyme analysis, and antigen detection for diagnosis of *Entamoeba histolytica* infection. *J Clin Microbiol* **36** (2): 449–52.
- Haque R, Faruque AS *et al.* (1997). *Entamoeba histolytica* and *Entamoeba dispar* infection in children in Bangladesh. *J Infect Dis* **173** (3): 734–6.
- Haque R, Kreiss K *et al.* (1993). Diagnosis of pathogenic *Entamoeba histolytica* infection using a stool ELISA based on monoclonal antibodies to the galactose-specific adhesin [see comments]. *J Infect Dis* **167** (1): 247–9.
- Haque R, Neville LM *et al.* (1995). Rapid diagnosis of *Entamoeba* infection by using *Entamoeba* and *Entamoeba histolytica* stool antigen detection kits. *J Clin Microbiol* **33** (10): 2558–61.
- Hasegawa M, Hashimoto T *et al.* (1993). Early branchings in the evolution of eukaryotes: ancient divergence of *Entamoeba* that lacks mitochondria revealed by protein sequence data. *J Mol Evol* **36** (4): 380–8.
- Irusen EM, Jackson TF *et al.* (1992). Asymptomatic intestinal colonization by pathogenic *Entamoeba histolytica* in amebic liver abscess: prevalence, response to therapy, and pathogenic *Entamoeba histolytica* in amebic liver abscess:

- prevalence, response to therapy, and pathogenic potential [see comments]. *Clin Infect Dis* **14** (4): 889–93.
- Jackson TF, Gathiram V *et al.* (1985). Seroepidemiological study of antibody responses to the zymodemes of *Entamoeba histolytica*. *Lancet* **1** (8431): 716–19.
- Jammal MA, Cox K *et al.* (1985). Amebiasis presenting as rectal bleeding without diarrhea in childhood. *J Pediatr Gastroenterol Nutr* **4** (2): 294–6.
- Johnson JL, Baird JS *et al.* (1994). Amebic liver abscess in infancy: case report and review. *Clin Infect Dis* **19** (4): 765–7.
- Kagan IG (1970). Serologic diagnosis of parasitic diseases. *N Engl J Med* **282** (12): 685–6.
- Katzenstein D, Rickerson V *et al.* (1982). New concepts of amebic liver abscess derived from hepatic imaging, serodiagnosis, and hepatic enzymes in 67 consecutive cases in San Diego. *Med (Baltimore)* **61** (4): 237–46.
- Kean B (1988). *A History of Amebiasis*. Wiley: New York.
- Kelsall BL, Jackson TG *et al.* (1994). Secretory immunoglobulin A antibodies to the galactose-inhibitable adherence protein in the saliva of patients with amebic liver disease. *Am J Trop Med Hyg* **51** (4): 454–9.
- Kelsall BL, Ravdin JI (1994). Amebiasis: human infection with *Entamoeba histolytica*. *Prog Clin Parasitol* **4**: 27–54.
- Kozak M (1984). Compilation and analysis of sequences upstream from the translational start site in eukaryotic mRNAs. *Nucleic Acids Res* **12** (2): 857–72.
- Krogstad DJ, Spencer HC Jr *et al.* (1978). Amebiasis: epidemiologic studies in the United States, 1971–1974. *Ann Intern Med* **88** (1): 89–97.
- Krupp IM (1970). Antibody response in intestinal and extraintestinal amebiasis. *Am J Trop Med Hyg* **19** (1): 57–62.
- Leber AL (1999). Intestinal amebae. *Clin Lab Med* **19** (3): 601–19, vii.
- Leippe M, Andra J *et al.* (1994). Amoebapores, a family of membranolytic peptides from cytoplasmic granules of *Entamoeba histolytica*: isolation, primary structure, and pore formation in bacterial cytoplasmic membranes. *Mol Microbiol* **14** (5): 895–904.
- Lin JY, Chadee K (1992). Macrophage cytotoxicity against *Entamoeba histolytica* trophozoites is mediated by nitric oxide from L-arginine. *J Immunol* **148** (12): 3999–4005.
- Lin JY, Seguin R *et al.* (1994). Tumor necrosis factor alpha augments nitric oxide-dependent macrophage cytotoxicity against *Entamoeba histolytica* by enhanced expression of the nitric oxide synthase gene. *Infect Immun* **62** (5): 1534–41.
- Lioutas C, Tannich E (1995). Transcription of protein-coding genes in *Entamoeba histolytica* is insensitive to high concentrations of alpha-amanitin. *Mol Biochem Parasitol* **73** (1–2): 259–61.
- Lohia A, Samuelson J (1993). Cloning of the *Eh cdc2* gene from *Entamoeba histolytica* encoding a protein kinase p34cdc2 homologue. *Gene* **127** (2): 203–7.
- Loschiavo F, Guarneri B *et al.* (1997). Cutaneous amebiasis in an Iranian immunodeficient alcoholic: immunochemical and histological study [letter]. *Dermatology* **194** (4): 370–1.
- Maltz G, Knauer CM (1991). Amebic liver abscess: a 15-year experience. *Am J Gastroenterol* **86** (6): 704–10.
- Mann BJ, Dodson JM *et al.* (1997). Structure and function of the galactose/N-acetyl-D-galactosamine inhibitable adhesin of *Entamoeba dispar*. *Arch Med Res* **28** (Special Issue): 168–9.
- Mann BJ, Torian BE *et al.* (1991). Sequence of a cysteine-rich galactose-specific lectin of *Entamoeba histolytica*. *Proc Natl Acad Sci USA* **88** (8): 3248–52.
- McAuley JB, Herwaldt BL *et al.* (1992). Diloxanide furoate for treating asymptomatic *Entamoeba histolytica* cyst passers: 14 years' experience in the United States [see comments]. *Clin Infect Dis* **15** (3): 464–8.
- McAuley JB, Juranek DD (1992). Paromomycin in the treatment of mild-to-moderate intestinal amebiasis [letter]. *Clin Infect Dis* **15** (3): 551–2.
- McKerrow JH, Sun E *et al.* (1993). The proteases and pathogenicity of parasitic protozoa. *Ann Rev Microbiol* **47**: 821–53.
- McLaughlin J, Aley S (1985). The biochemistry and functional morphology of the *Entamoeba*. *J Protozool* **32** (2): 221–40.
- Mehta RB, Parija SC *et al.* (1986). Management of 240 cases of liver abscess. *Int Surg* **71** (2): 91–4.
- Mhlanga BR, Lanoie LO *et al.* (1992). Amebiasis complicating carcinomas: a diagnostic dilemma. *Am J Trop Med Hyg* **46** (6): 759–64.
- Mirelman D (1987). Ameba–bacterium relationship in amebiasis. *Microbiol Rev* **51** (2): 272–84.
- Mirelman D, Bracha R *et al.* (1986). Changes in isoenzyme patterns of a cloned culture of non-pathogenic *Entamoeba histolytica* during axenization. *Infect Immun* **54** (3): 827–32.
- Munoz MDL, Moreno MA *et al.* (1991). Possible role of calmodulin in the secretion of *Entamoeba histolytica* electron-dense granules containing collagenase. *Mol Microbiol* **5** (7): 1707–14.
- Nagakura K, Tachibana H *et al.* (1989). An outbreak of amebiasis in an institution for the mentally retarded in Japan. *Jpn J Med Sci Biol* **42** (2): 63–76.
- Nazir Z, Moazam F (1993). Amebic liver abscess in children. *Pediatr Infect Dis J* **12** (11): 929–32.
- Nickel R, Tannich E (1994). Transfection and transient expression of chloramphenicol acetyltransferase gene in the protozoan parasite *Entamoeba histolytica*. *Proc Natl Acad Sci USA* **91** (15): 7095–8.
- Ohnishi K, Murata M *et al.* (1994). Symptomatic amebic colitis in a Japanese homosexual AIDS patient. *Intern Med* **33** (2): 120–32.
- Osler W (1890). *Bull Johns Hopkins Hosp* **1**: 53.
- Pehrson PO (1983). Amoebiasis in a non-endemic country. Epidemiology, presenting symptoms and diagnostic methods. *Scand J Infect Dis* **15** (2): 207–14.
- Petri WA (1996a). Amebiasis and the *Entamoeba histolytica* Gal/Galnac lectin—from lab bench to bedside. *J Invest Med* **44** (2): 24–35.
- Petri WA Jr (1996b). Recent advances in amebiasis. *Crit Rev Clin Lab Sci* **33**, 1–37.
- Petri WA Jr, Mann BJ (1993). Molecular mechanisms of invasion by *Entamoeba histolytica*. *Semin Cell Biol* **4** (5): 305–13.
- Petri WA Jr, Ravdin JI (1987). Cytopathogenicity of *Entamoeba histolytica*: the role of amebic adherence and



- contact-dependent cytolysis in pathogenesis. *Eur J Epidemiol* **3** (2): 123–36.
- Petri WA Jr, Ravdin JI (1991). Protection of gerbils from amebic liver abscess by immunization with the galactose-specific adherence lectin of *Entamoeba histolytica*. *Infect Immun* **59** (1): 97–101.
- Petri WA Jr, Jackson TF *et al.* (1990a). Pathogenic and non-pathogenic strains of *Entamoeba histolytica* can be differentiated by monoclonal antibodies to the galactose-specific adherence lectin. *Infect Immun* **58** (6): 1802–6.
- Petri WA Jr, Snodgrass TL *et al.* (1990b). Monoclonal antibodies directed against the galactose-binding lectin of *Entamoeba histolytica* enhance adherence. *J Immunol* **144** (12): 4803–9.
- Plaimauer B, Ortner S *et al.* (1994). An intron-containing gene coding for a novel 39-kilodalton antigen of *Entamoeba histolytica*. *Mol Biochem Parasitol* **66** (1): 181–5.
- Purdy JE, Mann BJ *et al.* (1994). Transient transfection of the enteric parasite *Entamoeba histolytica* and expression of firefly luciferase. *Proc Natl Acad Sci USA* **91** (15): 7099–103.
- Quinn TC, Stamm WE *et al.* (1983). The polymicrobial origin of intestinal infections in homosexual men. *N Engl J Med* **309** (10): 576–82.
- Radhakrishnan S, Nakib B *et al.* (1986). The value of colonoscopy in schistosomal, tuberculous, and amebic colitis. Two-year experience. *Dis Colon Rectum* **29** (12): 891–5.
- Radin DR, Ralls PW *et al.* (1988). CT of amebic liver abscess. *Am J Roentgenol* **150** (6): 1297–301.
- Ragland BD, Ashley LS *et al.* (1994). *Entamoeba histolytica*: target cells killed by trophozoites undergo DNA fragmentation which is not blocked by Bcl-2. *Exp Parasitol* **79** (3): 460–7.
- Ramakrishnan G, Ragland BD *et al.* (1996). Physical mapping and expression of gene families encoding the N-acetyl D-galactosamine adherence lectin of *Entamoeba histolytica*. *Mol Microbiol* **19** (1): 91–100.
- Ramakrishnan G, Vines RR *et al.* (1997). A tetracycline-inducible gene expression system in *Entamoeba histolytica*. *Mol Biochem Parasitol* **84** (1): 93–100.
- Ravdin J, Guerrant R (1986). *Current Problems in Diagnosis and Treatment of Amebic Infections*.
- Ravdin JI, Guerrant RL (1981). Role of adherence in cytopathogenic mechanisms of *Entamoeba histolytica*. Study with mammalian tissue culture cells and human erythrocytes. *J Clin Invest* **68** (5): 1305–13.
- Ravdin JI, Jackson TF *et al.* (1990). Association of serum antibodies to adherence lectin with invasive amebiasis and asymptomatic infection with pathogenic *Entamoeba histolytica*. *J Infect Dis* **162** (3): 768–72.
- Ravdin JI, Moreau F *et al.* (1988). Relationship of free intracellular calcium to the cytolytic activity of *Entamoeba histolytica*. *Infect Immun* **56** (6): 1505–12.
- Reed SL, Gigli I (1990). Lysis of complement-sensitive *Entamoeba histolytica* by activated terminal complement components. Initiation of complement activation by an extracellular neutral cysteine proteinase. *J Clin Invest* **86** (6): 1815–22.
- Rimsza ME, Berg RA (1983). Cutaneous amebiasis. *Pediatrics* **71** (4): 595–8.
- Rogers L (1912). *Br Med J* **1**: 1424.
- Rosenbaum RM, Wittner M (1970). Ultrastructure of bacterized and axenic trophozoites of *Entamoeba histolytica* with particular reference to helical bodies. *J Cell Biol* **45** (2): 367–82.
- Salata RA, Martinez-Palomo A *et al.* (1986). Patients treated for amebic liver abscess develop cell-mediated immune responses effective *in vitro* against *Entamoeba histolytica*. *J Immunol* **136** (7): 2633–9.
- Salata RA, Pearson RD *et al.* (1985). Interaction of human leukocytes and *Entamoeba histolytica*. Killing of virulent amebae by the activated macrophage. *J Clin Invest* **76** (2): 491–9.
- Sargeant PG, Williams JE *et al.* (1978). The differentiation of invasive and non-invasive *Entamoeba histolytica* isoenzyme electrophoresis. *Trans R Soc Trop Med Hyg* **72** (5): 519–21.
- Sheen IS, Chien CS *et al.* (1989). Resolution of liver abscesses: comparison of pyogenic and amebic liver abscesses. *Am J Trop Med Hyg* **40** (4): 384–9.
- Simjee AE, Patel A *et al.* (1985). Serial ultrasound in amoebic liver abscess. *Clin Radiol* **36** (1): 61–8.
- Singh U, Rogers JB (1998). The novel core promoter element Gaac in the Hg15 gene of *Entamoeba histolytica* is able to direct a transcription start site independent of TATA or initiator regions. *J Biol Chem* **273** (34): 21663–8.
- Singh U, Rogers JB *et al.* (1997). Transcription initiation is controlled by three core promoter elements in the hg15 gene of the protozoan parasite, *Entamoeba histolytica*. *Proc Natl Acad Sci USA* **94** (16): 8812–17.
- Smith PD, Lane HC *et al.* (1988). Intestinal infections in patients with the acquired immunodeficiency syndrome (AIDS). Etiology and response to therapy. *Ann Intern Med* **108** (3): 328–33.
- Speelman P, McGlaughlin R *et al.* (1987). Differential clinical features and stool findings in shigellosis and amoebic dysentery. *Trans R Soc Trop Med Hyg* **81** (4): 549–51.
- Tachibana H, Kobayashi S *et al.* (1991). Distinguishing pathogenic isolates of *Entamoeba histolytica* by polymerase chain reaction [letter]. *J Infect Dis* **164** (4): 825–6.
- Takeuchi T, Kobayashi S *et al.* (1987). Correlation of positive syphilis serology with invasive amebiasis in Japan. *Am J Trop Med Hyg* **36** (2): 321–4.
- Takeuchi T, Okuzawa E *et al.* (1989). High seropositivity of Japanese homosexual men for amebic infection [letter]. *J Infect Dis* **159** (4): 808.
- Talamas-Rohana P, Meza I (1989). Interaction between pathogenic amebas and fibronectin: substrate degradation and changes in cytoskeleton organization. *J Cell Biol* **106** (5): 1787–94.
- Tannich E, Bruchhaus I *et al.* (1991). Pathogenic and non-pathogenic *Entamoeba histolytica*: identification and molecular cloning of an iron-containing superoxide dismutase. *Mol Biochem Parasitol* **49** (1): 61–71.
- Tannich E, Horstmann RD (1992). Codon usage in pathogenic *Entamoeba histolytica* [letter]. *J Mol Evol* **34** (3): 272–3.
- Tannich E, Horstmann RD *et al.* (1989). Genomic DNA differences between pathogenic and non-pathogenic *Entamoeba histolytica*. *Proc Natl Acad Sci USA* **86** (13): 5118–22.

- Thompson JE Jr, Glasser AJ (1986). Amebic abscess of the liver. Diagnostic features. *J Clin Gastroenterol* **8** (5): 550–4.
- Tony JC, Martin TK (1992). *Arch Med Res (Mex)* **23**: 249–50.
- Tse SK, Chadee K (1992). Biochemical characterization of rat colonic mucins secreted in response to *Entamoeba histolytica*. *Infect Immun* **60** (4): 1603–12.
- Van Allan RJ, Katz MD *et al.* (1992). Uncomplicated amebic liver abscess: prospective evaluation of percutaneous therapeutic aspiration. *Radiology* **183** (3): 827–30.
- Vines RR, Purdy JE *et al.* (1995). Stable episomal transfection of *Entamoeba histolytica*. *Mol Biochem Parasitol* **71** (2): 265–7.
- Vines RR, Ramakrishnan G *et al.* (1998). Regulation of adherence and virulence by the *Entamoeba histolytica* lectin cytoplasmic domain, which contains a beta-2 integrin motif. *Mol Biol Cell* **9** (8): 2069–79.
- Walker E, Sellavels A (1913). *Phillipine J Sci B Trop Med* **8**: 253.
- Walsh JA (1986). Problems in recognition and diagnosis of amebiasis: estimation of the global magnitude of morbidity and mortality. *Rev Infect Dis* **8** (2): 228–38.
- Wanke C, Butler T *et al.* (1988). Epidemiologic and clinical features of invasive amebiasis in Bangladesh: a case–control comparison with other diarrheal diseases and postmortem findings. *Am J Trop Med Hyg* **38** (2): 335–41.
- Weinke T, Friedrich-Janicke B *et al.* (1990). Prevalence and clinical importance of *Entamoeba histolytica* in two high-risk groups: travelers returning from the tropics and male homosexuals. *J Infect Dis* **161** (5): 1029–31.
- WHO/PAHO/UNESCO (1997). Report of a consultation of experts on amoebiasis. *Week Epidemiol Repo WHO* **72**: 97–99.
- Ximenez C, Leyva O *et al.* (1993). *Entamoeba histolytica*: antibody response to recent and past invasive events. *Ann Trop Med Parasitol* **87** (1): 31–9.
- Yoon JH, Ryu JG *et al.* (1991). Atypical clinical manifestations of amebic colitis. *J Korean Med Sci* **6** (3): 260–6.
- Zhang T, Cieslak PR *et al.* (1994). Protection of gerbils from amebic liver abscess by immunization with a recombinant *Entamoeba histolytica* antigen. *Infect Immun* **62** (4): 1166–70.
- Zhang T, Stanley SL Jr (1994). Protection of gerbils from amebic liver abscess by immunization with a recombinant protein derived from the 170-kilodalton surface adhesin of *Entamoeba histolytica*. *Infect Immun* **62** (6): 2605–8.

# *Giardia lamblia*

David R. Hill

*University of Connecticut School of Medicine, Farmington, CT, USA*

## HISTORICAL INTRODUCTION

*Giardia lamblia*, also known as *G. duodenalis* and *G. intestinalis*, is one of the most common intestinal protozoans throughout the world. In North America it is the most frequently isolated enteric parasite and in developing regions there is almost universal infection by the end of childhood. Humans infected with *Giardia* may have asymptomatic infections, acute diarrhea or chronic diarrhea with malabsorption, weight loss and failure to thrive.

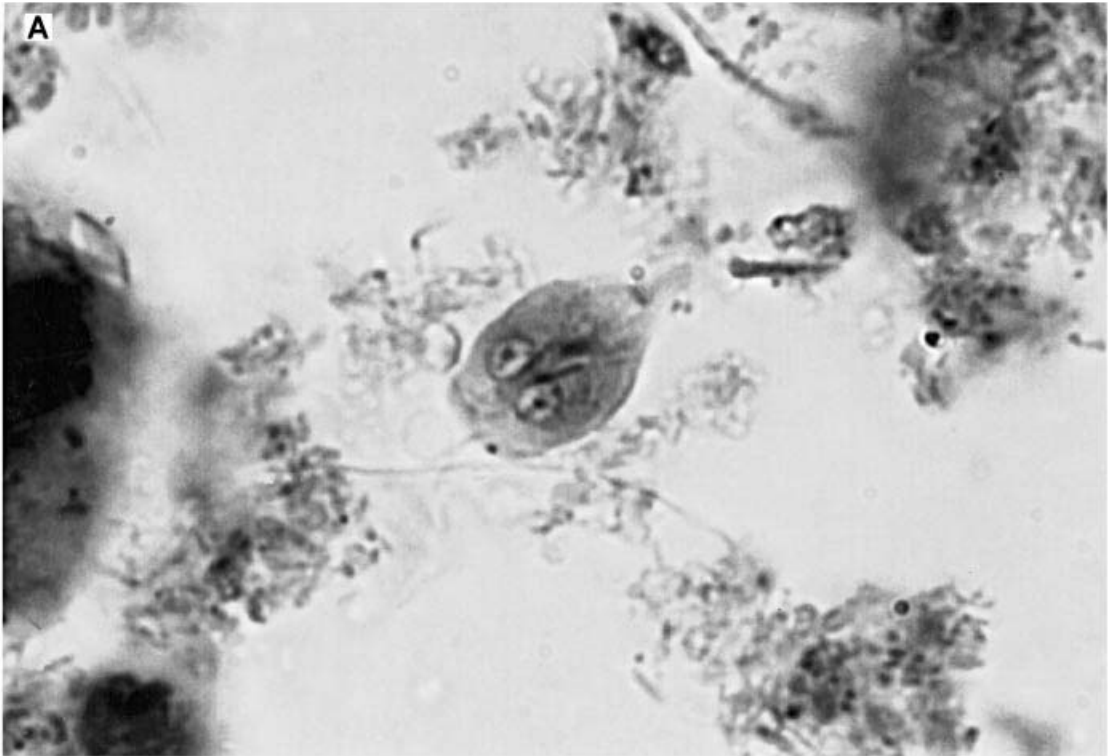
*Giardia* was first described in 1681 by Antony van Leeuwenhoek, who wrote: 'My excrement being so thin, I was . . . persuaded to examine it . . . wherein I have sometimes also seen animalcules a-moving very prettily; some of 'em bigger, others a bit less, than a blood-globule . . .; their bodies were somewhat longer than broad and their belly, which was flatlike, furnished with sundry little paws, wherewith they made such a stir in the clear medium . . .' (Dobell, 1920). It was reported in more detail in 1859 by Lambl, after whom the human species was named (Lambl, 1859). However, it has only been in the last 30–40 years that its real role in diarrheal syndromes has been described. A large water-borne outbreak of giardiasis, which occurred during the winter season of 1965/1966 in Vail, Colorado, brought *Giardia* wide recognition (Moore *et al.*, 1969) and the first major reviews of *Giardia* were published

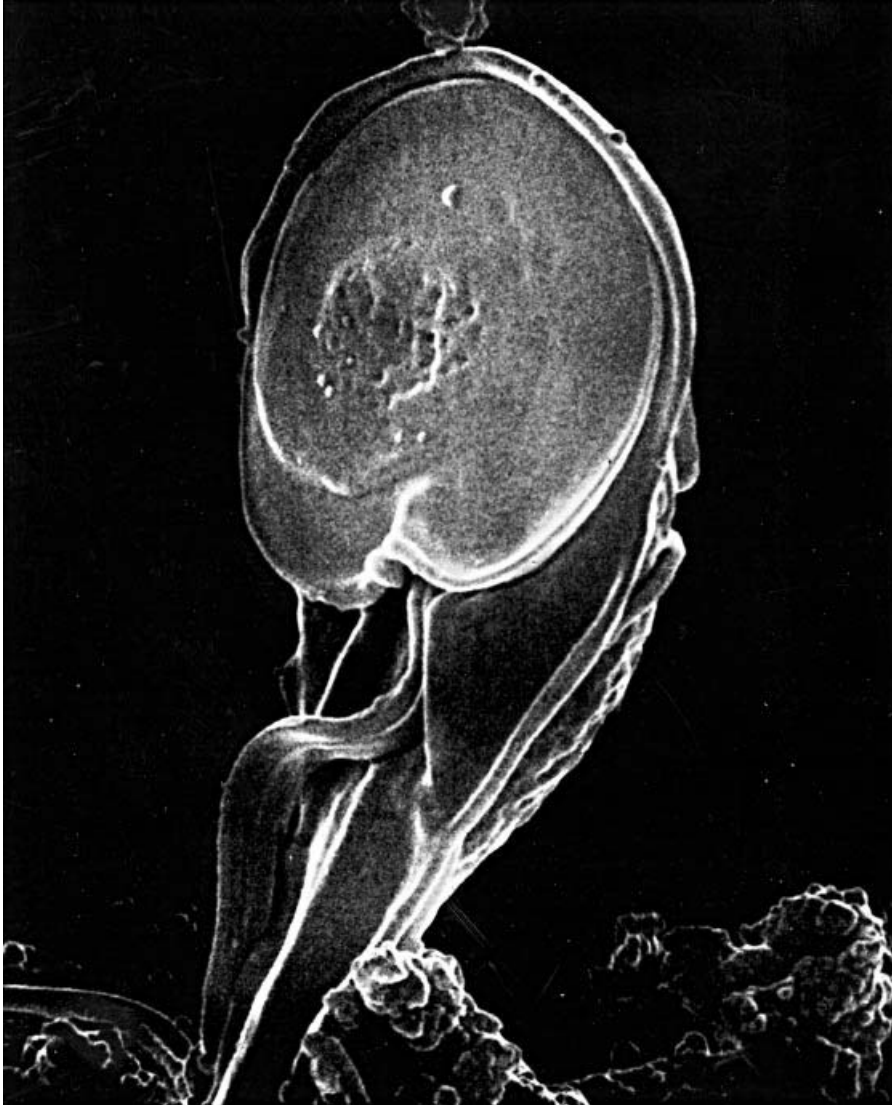
in the 1970s (Petersen, 1972; Burke, 1975; Wolfe, 1975; Meyer and Radulescu, 1979). Since that time there has been extensive research describing the epidemiology and biology of *Giardia*. While much is known about this parasite, there is still much to learn, particularly about how *Giardia* causes diarrhea.

## DESCRIPTION OF THE ORGANISM

*Giardia* is a flagellated, teardrop-shaped parasite which has only two life forms, the trophozoite and the cyst (Figures 10.1A,B). It belongs to the class Zoomastigophorea, the order Diplomonadida and the family Hexamitidae (Meyer, 1990). It is one of the oldest eukaryotic organisms, based on the sequence analysis of its small 16S ribosomal RNA (Sogin *et al.*, 1989). It also lacks many of the organelles typical of higher eukaryotes, such as mitochondria, peroxisomes and a typical Golgi apparatus (Adam, 1991; Gillin *et al.*, 1996; Roger *et al.*, 1998). Because of its early evolutionary status, the study of *Giardia* can yield valuable insight into eukaryotic development.

The trophozoite, which measures 9–21 µm in length × 5–15 µm in width (Figure 10.1A), contains four sets of posteriorly directed flagella, which aid in the parasite's movement. The most prominent feature of the trophozoite is the ventral disk, which may help *Giardia* to attach





**Fig. 10.2** Scanning electron micrograph of the ventral surface of a *Giardia lamblia* trophozoite. The ventral adhesion disk and one pair of flagella are seen. Courtesy of S. L. Erlandsen, Department of Cell Biology and Neuroanatomy, University of Minnesota School of Medicine, Minneapolis, MN

to intestinal epithelial cells (Figure 10.2). This disk is composed of a tight, clockwise spiral of microtubules, bound together by microribbons (Feely *et al.*, 1990; Adam, 1991; Thompson *et al.*, 1993; Gillin *et al.*, 1996; Upcroft and Upcroft,

1998). In the disk are the prominent antigens of tubulin within microtubules and giardins within the microribbons (Peattie, 1990; Marshall and Holberton, 1993). The microtubules are critical to the functioning of the disk, as well as to the

---

**Fig. 10.1 (opposite)** (A) A trophozoite and (B) a cyst are pictured in a trichrome stain of a stool sample. The teardrop shape and two nuclei of the trophozoite with central karyosomes are readily apparent. The median body lies centrally. Trophozoites measure 5–15  $\mu\text{m}$  wide and 9–21  $\mu\text{m}$  long. In the cyst, the cytoplasm has separated from the smooth cyst wall. Centrally located axonemes, a transversely placed, claw-like median body, and two eccentrically located nuclei can be detected. Cysts measure 6–10  $\mu\text{m}$  wide and 8–12  $\mu\text{m}$  long

movement of the flagella. There are two apparently equal nuclei which, on stained preparations, create the characteristic face-like image (Kabnick and Peattie, 1990).

There have traditionally been only a few species designated for *Giardia*, based on host restriction and microscopic morphology; *G. lamblia* in humans and *G. muris* in rodents have been studied most thoroughly. *G. agilis*, an amphibian species, is also recognized. Morphologically, *G. lamblia* differs from *G. muris* by its shape and the pattern of the median bodies—centrally located tight collections of microtubules. The median bodies of *G. lamblia* lie transversely in a claw-like shape compared with the round median bodies in *G. muris*. The trophozoites of *G. muris* are also more rounded.

### Trophozoite Analysis

Only *G. lamblia* has been cultured *in vitro* (Keister, 1983). The ability to culture *G. lamblia* has allowed a detailed characterization of parasites. Although the *Giardia* that infect humans appear morphologically identical, they are quite heterogeneous when carefully analyzed. Studies on parasites have included analysis of surface antigens and isoenzymes (Meloni *et al.*, 1988; Homan *et al.*, 1992; Thompson *et al.*, 1993), restriction fragment length polymorphism (Nash *et al.*, 1985), sequence differences in the 16S subunit rRNA (Weiss *et al.*, 1992; van Keulen *et al.*, 1995), ability to express surface proteins (Nash and Mowatt, 1992) and the nature of these proteins (Ey *et al.*, 1996), gene products (Monis *et al.*, 1996) and sequence differences in the triose phosphate isomerase genes (Baruch *et al.*, 1996). Based on these analyses, investigators are beginning to classify *Giardia* spp. into groups or assemblages (Nash and Mowatt, 1992; Weiss *et al.*, 1992; Ey *et al.*, 1996; Monis *et al.*, 1996; Lu *et al.*, 1998). It is possible that differences between groups may translate into a phenotypic difference in the ability of a given strain to cause diarrhea (Nash *et al.*, 1987; Paintlia *et al.*, 1998). These analyses have also led to the determination that *Giardia* which infect other non-human mammalian species may be similar, and at times identical, to those that infect humans

(Strandén *et al.*, 1990; Thompson *et al.*, 1993; Baruch *et al.*, 1996; Ey *et al.*, 1996). *Giardia* has at least five sets of chromosomes per nucleus, with a total genomic size of approximately  $1.2 \times 10^7$  base pairs (Adam *et al.*, 1988; Upcroft and Upcroft, 1998).

### Growth Requirements

Requirements for *in vitro* growth of *G. lamblia* are an anaerobic or microaerophilic environment and exogenous cysteine (Gillin *et al.*, 1996). Growth is enhanced by biliary lipids and intestinal mucous. Given the location of *Giardia* in the host and the absence of mitochondria, it is not surprising that it relies upon anaerobic metabolic pathways for energy production (Brown *et al.*, 1998). Alanine is the predominant end-product of carbohydrate metabolism under these anaerobic growth conditions (Adam, 1991; Thompson *et al.*, 1993). *Giardia* uses glucose as a major energy source to produce ethanol and acetate and CO<sub>2</sub> (Adam, 1991). It may also generate ATP via the arginine dihydrolase pathway (Edwards *et al.*, 1992). It can reduce O<sub>2</sub> to water by the action of an NADH oxidase (Upcroft and Upcroft, 1998). Because of an inability to synthesize cellular lipids and nucleic acid precursors, it must scavenge phospholipids, fatty acids, purines and pyrimidines from intestinal contents (Adam, 1991; Thompson *et al.*, 1993; Stevens *et al.*, 1997). It divides by binary fission and has a doubling time in culture of 9–12 hours.

### Antigenic Variation

One of the most interesting biologic properties of *Giardia* is the ability to vary its surface proteins, both in culture and during infection (Nash, 1997). *Giardia* is covered by one of a family of variant specific surface proteins (VSPs), which are rich in cysteine and may also contain zinc and iron. These change spontaneously *in vitro* and *in vivo* in both human and animal infection (Aggarwal and Nash, 1988; Gottstein *et al.*, 1990; Nash *et al.*, 1990; Byrd *et al.*, 1994). A potential role of the VSPs could be to help

*Giardia* to survive *in vivo* by protecting it against the action of intestinal proteases (Gillin *et al.*, 1990; Nash *et al.*, 1991). Changes in VSPs could also help *Giardia* to evade immune recognition, although there is only limited experimental data to support this (Nash, 1997; Stager and Muller, 1997).

### Encystation and Excystation

As *Giardia* pass through the small bowel to the colon they encyst, forming a rigid, filamentous shell that allows them to survive outside the host (Campbell and Faubert, 1994). *In vitro*, encystation was first accomplished in 1987 (Gillin *et al.*, 1987) and since then the process has been well defined. It can be induced by culturing trophozoites in a milieu of reduced bile acid and decreased cholesterol concentration, followed by the presence of excess bile salts in an alkaline environment (Gillin *et al.*, 1996; Lujan *et al.*, 1997). After induction of encystation, cyst wall proteins (CWPs) are transcribed and secreted into newly formed encystment-specific vesicles (ESVs), which develop just under the dorsal surface of the trophozoite (Mowatt *et al.*, 1995). During this differentiation into cysts, there is the induction of Golgi-like enzyme activities (Lujan *et al.*, 1995; Gillin *et al.*, 1996). The proteins then become incorporated into the cyst wall in a fibrous, filamentous layer. One of these CWPs may be detected in a stool ELISA assay (Rosoff and Stibbs, 1986; Rosoff *et al.*, 1989; Boone *et al.*, 1999). A prominent sugar associated with CWPs is N-acetylgalactosamine (Das and Gillin, 1996). *In vitro*, the process from intracellular production of the CWPs to their assembly into the cyst wall takes 14–16 hours (Erlandsen *et al.*, 1996). As the cyst matures, there is a single trophozoite division.

After ingestion by a host, excystation occurs when the cysts are exposed to gastric acid, pancreatic enzymes and the induction of a parasite-derived cysteine protease (Gillin *et al.*, 1996; Hetsko *et al.*, 1998). The process of excystation is a highly coordinated sequence of structural, physiological and molecular events, initiated when the parasite detects the

appropriate environmental stimuli (Hetsko *et al.*, 1998).

### PATHOGENESIS AND IMMUNOLOGY

Clinical illness with *Giardia* results from the interaction of an individual *Giardia* isolate with the human host and the host's subsequent response to the parasite. The precise pathogenic mechanisms are not known but appear to be multifactorial.

### Contribution of the Parasite to Disease

Following oral ingestion of as few as 10–25 *Giardia* cysts (Rendtorff, 1954), there is excystation, multiplication of trophozoites and colonization of the small bowel. In murine models of *Giardia muris* infection, the highest numbers of trophozoites are found in the jejunum (Olveda *et al.*, 1982).

Information from both human and animal experimental infection indicates that different isolates have different capacities to cause infection and disease (Aggarwal and Nash, 1987; Nash *et al.*, 1987; Visvesvara *et al.*, 1988; Cevallos *et al.*, 1995). The ability to stably transfect trophozoites will help to define the role of the parasite in producing disease (Singer *et al.*, 1998; Sun *et al.*, 1998). As examples of differences between isolates, only one isolate of a group categorized by genetic and antigenic analysis was capable of infecting mice (Byrd *et al.*, 1994) and other isolates differed in the duration of infection and the intensity of cyst excretion (Aggarwal and Nash, 1988). In experimental human infection, only one of two isolates was capable of causing infection, even though both were originally obtained from patients with giardiasis (Nash *et al.*, 1987, 1990).

In a study that compared *Giardia* obtained from patients with asymptomatic infection vs. symptomatic infection, a preponderance of the isolates causing symptomatic infection came from a single grouping (Paintlia *et al.*, 1998). Therefore, efforts are now being made to determine whether there are non-pathogenic vs. pathogenic strains. However, these types of

analyses have not translated into clinical usefulness, since the methodology is complex and not available outside research settings. The mechanism by which individual isolates of *Giardia* differ in their ability to cause disease is not known.

*Giardia* trophozoites are closely associated with intestinal mucosa but do not invade. It appears that adherence is necessary for *Giardia* to establish infection and cause disease. Gerbils fed a high-fiber diet had lower rates of experimental infection, presumably because the fiber trapped trophozoites in the mucous layer, preventing them from adhering (Leitch *et al.*, 1989). This close association of parasite with mucosa may directly affect the brush border and its enzyme system, by disrupting it during attachment by the disk. Although most findings have been documented in murine models, electron microscopy of mucosa has demonstrated the blanketing of villi with parasites, disruption of microvilli and imprinting of the disk on the microvillus layer (Balazs and Szaltocky, 1978; Chávez *et al.*, 1995). Parasites probably adhere via the ventral disk. There is likely to be a combination of a clasping mechanism as well as a suction-like effect produced by the beating of the ventral set of flagella, which emerge posteriorly from the disk (Farthing, 1997). Other receptor–ligand adherence mechanisms have not been excluded (Ward *et al.*, 1990).

The close adherence of *Giardia*, without invasion, in addition to affecting the brush border, may stimulate an inflammatory cytokine response which, similar to other organisms that adhere rather than invade, can result in secretion of fluid and electrolytes or damage to enterocytes (Underdown *et al.*, 1988; Goyal *et al.*, 1993; Chávez *et al.*, 1995; Goodgame, 1996; Nataro and Kaper, 1998). Indeed, intact trophozoites are not necessary to stimulate this inflammatory reaction, with parasite antigen alone able to do this (Mohammed and Faubert, 1995). Neither a cytotoxin nor a classic enterotoxin has been described.

Another mechanism for diarrhea in giardiasis, such as the deconjugation of bile salts by overgrowth of bacteria leading to malabsorption (Tomkins *et al.*, 1978), seems associative rather than causal, since the degree of colonization in experimental human infection did not correlate with diarrhea (Nash *et al.*, 1987).

### Immune Response

The presence of *Giardia* in the gut leads to antigen processing and a host immune response. This response can result in clearance of the parasite with the development of partial immunity, as well as to production of disease in some cases. Much of the understanding of the host response comes from rodent models (mouse and gerbil). Early studies of experimental infection in mice demonstrated clearance of infection over a 3–4 week period (Roberts-Thomson *et al.*, 1976b). Parasites reached peak levels in 7–14 days and then gradually declined over the next 1–2 weeks. When mice were rechallenged, they did not become infected and appeared immune (Roberts-Thomson *et al.*, 1976a). Some parasites persisted below the level of detection; when female mice became pregnant, they excreted parasites again (Stevens and Frank, 1978). Additional important findings from these studies were the changes noted on histology of the small bowel. There was a mononuclear inflammatory infiltrate in the intestinal mucosa, crypt hypertrophy and villous blunting. Thus, the immune response contributed to clearance of trophozoites, immunity to reinfection and disease production.

There has been extrapolation of these murine findings to human infection. First, most humans experimentally infected with *Giardia* self-cured an average of 18 days following infection (Rendtorff, 1954). Second, evidence for incomplete immunity following infection has been inferred from epidemiologic studies. Persons living in areas highly endemic for *Giardia*, such as mountainous regions of North America, have had lower rates of infection than newly arrived visitors (Istre *et al.*, 1984; Isaac-Renton *et al.*, 1994). In the developing world, the highest rates of infection often occur in younger children, compared with adults (Gilman *et al.*, 1985; Miotti *et al.*, 1986; Mahmud *et al.*, 1995). Although improvements in fecal–oral hygiene could account for this discrepancy, in one study there was increasing prevalence in older persons of another enteric pathogen, *Entamoeba*, while the prevalence of *Giardia* decreased (Oyerinde *et al.*, 1977). Third, the changes seen in animal histology have also been seen in some cases of human giardiasis—mononuclear inflammation in



the mucosa with crypt hypertrophy and villous blunting (Ridley and Ridley, 1976; Duncombe *et al.*, 1978; Hjelt *et al.*, 1992). These changes are rarely as severe as those seen in tropical sprue, which typically has a completely flat mucosa. Some have reported a positive correlation of mucosal pathology with clinical symptoms (Ridley and Ridley, 1976; Duncombe *et al.*, 1978), whereas others have not (Oberhuber *et al.*, 1997). Also, as the bowel regenerates, crypt cells that move to the tips of villi are more likely to be secretory, further contributing to diarrhea (Buret *et al.*, 1990; Farthing, 1997).

Both cellular and humoral mechanisms contribute to the immune response. The initial processing of *Giardia* antigen probably occurs in the Peyer's patches, or lymphoid follicles, of the small bowel. In electron microscopy sections of Peyer's patches, *Giardia* has been demonstrated within macrophages (Owen *et al.*, 1981); *in vitro*, macrophages can ingest opsonized trophozoites (Hill and Pohl, 1990). Specific proliferative responses in Peyer's patches occur just prior to clearance of *Giardia* (Gottstein *et al.*, 1990; Hill, 1990). Lymphocytes, particularly those of the helper T cell (CD4<sup>+</sup>) class, are critical to clearance (Heyworth, 1992). In mice deficient of this class, there is failure to clear parasites; however, following immune reconstitution, parasites are eliminated (Roberts-Thomson and Mitchell, 1978; den Hollander *et al.*, 1988). It is also following this reconstitution that the histopathological changes occur.

The CD4<sup>+</sup> lymphocyte is also critical in the development of the IgA class of antibody (Heyworth, 1989). In animal models, IgA is the predominant antibody detected in gut secretions, correlates temporally with clearance of parasites, and its absence is associated with failure to resolve infection (Snider *et al.*, 1985; Underdown *et al.*, 1988; Heyworth, 1989, 1992; Stager and Muller, 1997). Although the failure to develop IgA antibody in human infection is postulated to correlate with chronic giardiasis (Char *et al.*, 1993), this has never been definitively shown, and persons with selective IgA deficiency do not seem to be at a higher risk of infection (Jones and Brown, 1974). IgA could work by preventing binding of *Giardia* to intestinal mucosa.

Protection against *Giardia* can be conferred by breast milk. Breast feeding in mice is protective, and in epidemiologic studies in humans, breast feeding also appears protective (Nayak *et al.*, 1987; Morrow *et al.*, 1992). The mechanism may be from direct cytotoxic activity of breast milk on parasites when free fatty acids are released from milk triglycerides by bile salt-stimulated lipases (Reiner *et al.*, 1986), the provision of antibody, or other unknown factors.

### Predisposition to Giardiasis

Defects in some immune functions predispose to infection. Patients with common variable hypogammaglobulinemia are at increased risk for giardiasis. They have an illness characterized by prolonged diarrhea, malabsorption and severe, histologic changes in the intestine, which can include nodular lymphoid hyperplasia (Hartong *et al.*, 1979). These patients cannot spontaneously clear infection and frequently relapse after treatment. Children with X-linked agammaglobulinemia are also predisposed (Rosen *et al.*, 1995). HIV and AIDS patients do not appear to have an increased frequency of giardiasis but may have an impaired systemic immune response (Janoff *et al.*, 1988). Additionally, it is the experience of many clinicians that it is more difficult to eradicate infection in some AIDS patients, and they may require prolonged or combination therapy (Nash *et al.*, 2001).

There is no association with blood group type (Jokipii and Jokipii, 1980). Previous gastric surgery and reduced gastric acidity can increase susceptibility.

### EPIDEMIOLOGY

In developed regions of the world, *Giardia* is usually transmitted via contaminated water (Table 10.1). However, its ubiquitous distribution makes person-to-person transmission frequent in settings of poor fecal-oral hygiene, and food transmission is increasingly recognized. In the USA, *Giardia* can be found in 4–7% of submitted stool specimens (Kappus *et al.*, 1994), and it may cause as many as 2.5 million infections per year (Furness *et al.*, 2000).

**Table 10.1** Transmission of *Giardia lamblia*


---

Water
Person-to-person in settings of poor fecal–oral hygiene
Children in day care or developing world settings
Sexually active gay males
Custodial institutions
Food

---

### Water-borne Transmission

*Giardia* is one of the most common agents identified in water-borne outbreaks of diarrhea (Marshall *et al.*, 1997). In the USA during 1985–1994 it accounted for 44% of outbreaks from known causes, and infected several thousand individuals (Kramer *et al.*, 1996). Several factors contribute to the frequency of water-transmitted disease. First, *Giardia* is widely distributed in both humans and other mammalian species, allowing for frequent contamination of surface water supplies (LeChevallier *et al.*, 1991). Second, the cyst form of *Giardia* can survive for weeks in cold fresh water (deRegnier *et al.*, 1989). These two factors, the use of surface water for drinking and survival in cold temperatures, may predispose mountainous regions of the USA and Canada to outbreaks (Wright *et al.*, 1977; Dykes *et al.*, 1980; López *et al.*, 1980; Isaac-Renton and Pillion, 1992; Dennis *et al.*, 1993). Some of the first outbreaks of giardiasis were described in persons camping in these regions (Barbour *et al.*, 1976). Third, *Giardia* cysts are relatively resistant to chlorination alone (Centers for Disease Control, 1980; Jarroll *et al.*, 1981; Backer, 1995). Therefore, when water supplies are only treated by chlorination, there is the possibility that *Giardia* will escape inactivation. And fourth, only a few parasites are necessary to establish infection (Rendtorff, 1954).

Although most of these community outbreaks have occurred with the use of inadequately treated surface water, others have occurred when raw sewage became mixed with water intended for drinking (Moore *et al.*, 1969; Shaw *et al.*, 1977; Ljungström and Castor, 1992). Finally, there have been many outbreaks associated with recreational exposure to water in lakes and swimming pools (Porter *et al.*, 1988; Dennis *et al.*, 1993; Gray *et al.*, 1995; Kramer *et al.*, 1996).

### Person-to-person Transmission

Person-to-person transmission occurs in situations of poor fecal–oral hygiene, such as in developing regions of the world, day-care centers, some custodial institutions (Brannan *et al.*, 1996) and in the sexual practice of oral–anal stimulation (Keystone *et al.*, 1980; Markell *et al.*, 1984). In developing regions, over 60% of children may become infected at some point during childhood, with prevalence rates at any one time of 15–30% in children less than 10 years of age (Gilman *et al.*, 1985, 1988; Kaminsky, 1991; Meloni *et al.*, 1993; Fraser *et al.*, 1997; Gamboa *et al.*, 1998). In day care, 20–50% of children may be infected, often without symptoms, making it difficult to control giardiasis in these settings (Ish-Horowicz *et al.*, 1989; Rauch *et al.*, 1990; Addiss *et al.*, 1991c, 1992; Thompson, 1994). Although many of these children are asymptomatic, they can introduce *Giardia* to family members and contribute to high endemic rates in the community (Sealy and Schuman, 1983; Polis *et al.*, 1986; Overturf, 1994).

### Transmission by Food and During Travel

Transmission of *Giardia* by food has occurred in multiple settings, including corporate offices, commercial food establishments and within small gatherings (Osterholm *et al.*, 1981; Petersen *et al.*, 1988; White *et al.*, 1989; Quick *et al.*, 1992; Mintz *et al.*, 1993; Bean *et al.*, 1996). These outbreaks have typically been associated with an infected food handler, rather than environmental contamination of the food item. With survival of cysts outside the human host, it is surprising that more clusters of food-borne infection are not recognized.

*Giardia* has been acquired during overseas travel, particularly to areas of poor fecal–oral hygiene (Brodsky *et al.*, 1974; Isaac-Renton and Pillion, 1992; Gray *et al.*, 1995; DuPont and Capsuto, 1996; Hoge *et al.*, 1996; Hadjichristodoulou *et al.*, 1998). A traveler may present a few weeks following his/her return; therefore, a travel history is important in evaluating all patients with suspected giardiasis.

There has been a seasonal distribution of infection described in the mid-west of the USA and in the UK (Wright *et al.*, 1977; Addiss *et al.*, 1992; Flanagan, 1992). In both areas there was a late summer peak. This could be explained by recreational water exposure or international travel during the summer months (Gray *et al.*, 1995).

### Cross-species Transmission

Evidence for animal-to-human transmission is limited, despite the wide distribution of *Giardia* organisms in non-human mammalian hosts. Mice, gerbils, beavers, sheep, dogs, cattle, cats and birds have been experimentally infected, or found to be infected, with organisms similar to, if not identical to, human isolates (Hill *et al.*, 1983; Woo, 1984; Nash *et al.*, 1985; Erlandsen *et al.*, 1988; Faubert, 1988; Capon *et al.*, 1989; Strandén *et al.*, 1990; Buret *et al.*, 1991; Byrd *et al.*, 1994; Upcroft *et al.*, 1996b; Monis *et al.*, 1998). For instance, many domestic dogs and cats are documented to have *Giardia* organisms, but there is no evidence of human infections from this reservoir (Castor and Lindqvist, 1990; Hopkins *et al.*, 1997). On the other hand, a well-studied outbreak in Canada documented transmission from beaver to human; human isolates in the outbreak were identical to those isolated from the beavers living in the watershed area (Isaac-Renton *et al.*, 1993; Baruch *et al.*, 1996).

### CLINICAL FEATURES

Infection with *Giardia lamblia* ranges from asymptomatic passage of cysts, to acute diarrhea, to a syndrome of chronic diarrhea and malabsorption. It can be estimated that 5–15% of infected persons will become asymptomatic cyst passers, 25–50% will have a diarrheal syndrome, and 35–70% will have no trace of infection (Hill, 1993).

The incubation period for acute giardiasis is 1–2 weeks. Symptoms may develop prior to the excretion of cysts, therefore a stool examination done at the onset of symptoms may be negative. In reality, most patients will have had diarrhea

**Table 10.2** Symptoms of giardiasis

	% (Range)
Diarrhea	90 (64–100)
Malaise	86 (72–97)
Flatulence	75 (35–97)
Foul-smelling, greasy stools	75 (57–87)
Abdominal cramps	71 (44–85)
Bloating	71 (42–97)
Nausea	69 (59–79)
Anorexia	66 (41–82)
Weight loss (average 4 kg)	66 (56–76)
Vomiting	23 (11–36)
Fever	15 (0–24)
Constipation	13 (0–26)
Urticaria	10 (5–14)

Data from Moore *et al.*, 1969; Brodsky *et al.*, 1974; Barbour *et al.*, 1976; Shaw *et al.*, 1977; Dykes *et al.*, 1980; López *et al.*, 1980; Osterholm *et al.*, 1981; Petersen *et al.*, 1988; Mintz *et al.*, 1993.

for several days before presenting to their physician, and stools should be positive.

The onset of illness is generally abrupt, with diarrhea, abdominal cramping, bloating and flatulence the most common symptoms (Table 10.2). In addition, patients frequently complain of malaise, nausea and anorexia, and may experience sulfuric belching. It is unusual to have vomiting or fever. The presence of anorexia and nausea probably contribute to the important finding of weight loss, which occurs in over 50% of patients by the time they present to a physician (Moore *et al.*, 1969; Brodsky *et al.*, 1974; Wright *et al.*, 1977). On average, persons suffering from *Giardia* have lost 4 kg.

Stools will range from profuse and watery to greasy and foul-smelling. They should not contain gross or microscopic blood, or polymorphonuclear cells, since *Giardia* is not an invasive pathogen.

Another hallmark of giardiasis is the duration of symptoms by the time a patient presents. Most persons will have been sick for 7–10 days. This feature, combined with weight loss, help distinguish giardiasis from most viral and bacterial etiologies of diarrhea, which usually have shorter durations of illness. Viral diarrhea may also be more commonly associated with vomiting and, if there is an invasive bacterial etiology, inflammatory stool changes should be seen. Protozoal causes of diarrhea, such as *Cyclospora cayotensis* and *Cryptosporidium parvum*, have clinical features that are similar to giardiasis (Adel *et al.*,

1995; Goodgame, 1996; Soave, 1996). Although *Cryptosporidium* can be more severe, it would be difficult to distinguish it without specific stool studies.

Extraintestinal manifestations of *Giardia* have been described. These include urticaria in about 5% of infected persons and, rarely, a reactive arthritis (Shaw and Stevens, 1987; Clyne and Eliopoulos, 1989; Layton *et al.*, 1998). It is possible that allergic manifestations occur because of passage across an injured gut of food or other allergens (Di Prisco *et al.*, 1998). *Giardia* may infect the biliary tract and the stomach; however, the latter occurs only when there is achlorhydria. There is frequent coinfection with *Helicobacter pylori* in gastric giardiasis (Doglioni *et al.*, 1992).

Most persons with symptomatic giardiasis have an illness which is uncomfortable and requires treatment but is usually not severe or life-threatening. It is now recognized, however, that some persons do have severe diarrhea with significant volume depletion, which necessitates hospitalization (Lengerich *et al.*, 1994; Robertson, 1996). In some of these severe cases, a hypokalemic myopathy has been described (Cervelló *et al.*, 1993). In a US study, rates of hospitalization for *Giardia* were similar to those for *Shigella* (approximately two cases per 100 000 persons and about 4600 annual admissions) and highest for children under the age of 5 and for women of child-bearing age (Lengerich *et al.*, 1994).

### Chronic Giardiasis and Nutritional Abnormalities

Chronic giardiasis is characterized by malaise, fatigue, diffuse abdominal cramping and stools which are usually greasy and foul-smelling. Weight loss is nearly always present in these cases. Over time there may be periods of constipation with clinical improvement, but it is typical for the diarrhea to return.

In chronic disease there may be evidence for malabsorption of fat, vitamins A and B<sub>12</sub>, protein, D-xylose, iron and lactose (Solomons, 1982; Jové *et al.*, 1983; Welsh *et al.*, 1984; Gillon, 1985; Sutton and Kamath, 1985). Of the disaccharidases, deficiency of lactase is most common, and may persist for several weeks

after therapy. All patients should be instructed to avoid lactose-containing products during this recovery period, so that any recurrent diarrhea will not be confused with relapse of infection.

Failure to thrive in children is associated with *Giardia* (Burke, 1975; Hjelt *et al.*, 1992; Lengerich *et al.*, 1994). It is not known, however, how many infected children will develop this syndrome, neither it is known which parasite or host factors influence the outcome, since the pediatric age group is also the most likely to have asymptomatic excretion of parasites. Also, while failure to thrive has been attributed to giardiasis in children in the developed world, the role that *Giardia* plays in chronic diarrhea and malnutrition in developing regions is less defined. In settings of poor hygiene, infection with *Giardia* during childhood is nearly universal (Islam *et al.*, 1983; Gilman *et al.*, 1985; Mahmud *et al.*, 1995) but it is often one of many pathogens to infect children (Kaminsky, 1991; Lanata *et al.*, 1992; Meloni *et al.*, 1993). Therefore, it is difficult to attribute diarrheal symptoms to *Giardia* alone. Nevertheless, for some children *Giardia* appears to be the most important cause of diarrhea and malnutrition (Mata, 1978; Islam *et al.*, 1983; Farthing *et al.*, 1986; Kaminsky, 1991; Sullivan *et al.*, 1991a).

In summary, *Giardia* can produce chronic diarrhea, failure to thrive, and severe illness requiring hospitalization. It also may cause asymptomatic infection or be one of many infecting pathogens, when it could act synergistically to cause diarrhea and malabsorption. The variety in outcome is likely related to the infecting strain of *Giardia*, the underlying nutritional status of the host, and the host's previous experience with the parasite. Until isolates of *Giardia* from these various settings can be analyzed for their pathogenic potential, the resolution of this debate is not likely.

### LABORATORY DIAGNOSIS

The initial consideration of giardiasis is based on clinical findings—a patient with diarrhea that is prolonged and associated with weight loss, but who usually does not have fever, significant vomiting, tenesmus or blood in the stool.

Frequently there are important epidemiologic factors of travel, camping or exposure to conditions of poor fecal–oral hygiene. However, the ubiquitous nature of the parasite should place it in the differential of most cases of non-inflammatory diarrhea. As an example of the importance of accounting for epidemiologic risks when evaluating a clinical syndrome, one can consider the case of a young woman who presents with diarrhea. She should always be asked if she has small children and if they are in day-care. The children can be the source for introduction of *Giardia* into the home, even though they may be asymptotically infected.

### Ova and Parasite Examination

Throughout the years, the standard diagnostic method for *Giardia* has been the stool examination for ova and parasites (O&P) (Burke, 1977; Thornton *et al.*, 1983; Wolfe, 1992). This examination remains necessary and valuable when other parasitic causes of intestinal infection are being considered, or when the technology to perform antigen detection is not available. In an O&P exam the stool is usually examined fresh, and after fixation with polyvinyl alcohol or 10% buffered formalin. It may also be concentrated by formalin–ethyl acetate or zinc sulphate flotation to try to increase the yield.

A saline wet mount of a fresh, liquid stool may yield motile trophozoites as well as cysts; stools which are semi-formed will usually contain only cysts. Cysts may be more easily detected by mixing the sample with iodine, which will stain the cysts brown and highlight the intracystic structures. Fixed specimens can be stained with trichrome or iron hematoxylin and then examined (Figure 10.1A,B). Yields from an O&P exam are 50–70% for one stool and as high as to 90% after three stools (Hiatt *et al.*, 1995).

### Antigen Detection Assays

In settings where the technology is available, stool antigen detection tests have frequently replaced the O&P exam for *Giardia*. Antigen tests may use ELISA techniques or anti-*Giardia* fluorescein-labeled monoclonal antibodies in a

direct fluorescence assay (DFA). These assays have been extensively evaluated against both stool O&P and each other (Alles *et al.*, 1995; Garcia and Shimizu, 1997; Mank *et al.*, 1997; Aldeen *et al.*, 1998). Compared to the O&P exam, they are more sensitive; ELISA assays carry a 89–99% sensitivity, and the DFAs are nearly 100% sensitive (Garcia and Shimizu, 1997; Aldeen *et al.*, 1998). Both techniques are extremely specific, approaching 100%. The benefit of these assays is their automation, reproducibility and speed. A study that evaluated nine ELISA kits indicated that they could be performed within 1–2 minutes (Aldeen *et al.*, 1998). They also no longer require an expert technician trained in parasite recognition and differentiation. Although a single sample will usually be positive, in some cases two or three may be necessary (Addiss *et al.*, 1991b).

The assays detect one or more of several *Giardia* antigens. One of the earliest antigens to be described was a cyst antigen, now used in an ELISA kit (Rosoff and Stibbs, 1986; Rosoff *et al.*, 1989). This antigen appears to be a cyst wall protein (Boone *et al.*, 1999). Other assays use fluorescein-tagged monoclonal antibodies to the cyst wall, and combine the detection of *Giardia* with that of *Cryptosporidium* (Grigoriev *et al.*, 1994; Alles *et al.*, 1995; Garcia and Shimizu, 1997). The antigen tests, however, should not be used exclusively, since they will not detect other intestinal parasites. Their most appropriate applications are in outbreak situations, in testing family members when one member has giardiasis, and in following patients to document cure. They are also helpful in testing when *Giardia* is the sole diagnosis, and in defining the epidemiology of *Giardia* in a particular population.

Detection of *Giardia* nucleic acid has been primarily limited to screening water samples for contamination with the parasite (Weiss, 1995; Kaucner and Stinear, 1998; Mahbubani *et al.*, 1998).

### Duodenal Sampling

In some patients, the diagnosis of giardiasis can be difficult. However, with antigen detection assays this situation should occur infrequently. In difficult-to-diagnose patients, sampling duodenal secretions may be necessary (Beal *et al.*,

1970; Rosenthal and Liebman, 1980; Goka *et al.*, 1990). This can be accomplished by using the string test, or more commonly by endoscopy. In the string test, a weighted gelatin capsule containing a nylon string is swallowed (Beal *et al.*, 1970). The gelatin dissolves, and the string passes into the duodenum. After fasting for 4–6 hours or overnight, the string is removed, the bile-stained mucous contents placed on a slide and the material examined for trophozoites.

An advantage of endoscopy is direct visualization of the bowel and the ability to obtain biopsies. In HIV/AIDS patients, in whom the differential includes multiple pathogens, such as microsporidia, *Cyclospora* and *Cryptosporidium*, biopsy with both light and electron microscopy performed on the specimen can be helpful. Examination of bowel histology is also helpful in patients with common variable immunodeficiency or in whom sprue is suspected.

### Serology and Radiography

Serology is neither routinely available nor is it particularly helpful in diagnosing this luminal parasite. Although systemic and secretory anti-*Giardia* antibodies do develop in infected patients (Ridley and Ridley, 1976; Visvesvara *et al.*, 1980; Reiner and Gillin, 1992; Rosales-Borjas *et al.*, 1998; Soliman *et al.*, 1998), it is difficult to distinguish acute vs. chronic or resolved infection by serology. Some have indicated that the presence of anti-*Giardia* IgM antibody correlates with newly acquired infection (Sullivan *et al.*, 1991b). The most productive use for serologic testing has been in epidemiologic studies (Gilman *et al.*, 1985; Miotti *et al.*, 1985; Miotti *et al.*, 1986).

Radiographic studies are usually not helpful in diagnosis. They are non-specific and demonstrate increased bowel transit time and irregular thickening of small bowel folds (Reeder, 1997). The total white blood cell count should be normal, without eosinophilia. Stools should not contain inflammatory cells or blood.

### Culture and Sensitivity Testing

Culture of *G. lamblia* has only been performed in research settings. In order to obtain trophozoites, cysts which have been purified from stool

specimens can be excysted *in vitro* and then cultured (Boucher and Gillin, 1990) or passed into rodents (mice or gerbils), with the animals' duodenal and jejunal contents then removed, purified and cultured (Isaac-Renton *et al.*, 1992; Mayrhofer *et al.*, 1992). Trophozoites can also be cultured directly from duodenal contents obtained by the string test, aspiration or endoscopy (Gordts *et al.*, 1985a; Korman *et al.*, 1990). However, the yield from these methods is limited, so that only a minority of patients would be able to have their isolate recovered in culture.

With the ability to culture *Giardia*, sensitivity testing can be performed on trophozoites. However, the methods are not standardized and there are wide variations in results. There is also heterogeneity within a *Giardia* isolate when individual clones are tested (Boreham *et al.*, 1987; Majewska *et al.*, 1991). Finally, there has not been a consistent correlation between *in vitro* sensitivity or resistance and the clinical sensitivity or resistance (Smith *et al.*, 1982; McIntyre *et al.*, 1986; Upcroft *et al.*, 1990; Majewska *et al.*, 1991).

Testing methods have included macrodilution (Gordts *et al.*, 1985b), incorporation of tritiated thymidine (Boreham *et al.*, 1985; McIntyre *et al.*, 1986; Boreham *et al.*, 1987; Inge and Farthing, 1987), growth inhibition (Smith *et al.*, 1982; Inge and Farthing, 1987; Crouch *et al.*, 1990; Edlind *et al.*, 1990; Majewska *et al.*, 1991), enzyme activity (Kang *et al.*, 1998), adherence (Crouch *et al.*, 1990; Meloni *et al.*, 1990; Farbey *et al.*, 1995), motility (Andrews *et al.*, 1994) and morphologic changes (Meloni *et al.*, 1990; Andrews *et al.*, 1994).

*In vitro* studies have usually demonstrated that drugs of the nitroimidazole class are most active. Although the benzimidazoles, albendazole and mebendazole, are more active than the nitroimidazoles in some assays (Edlind *et al.*, 1990; Meloni *et al.*, 1990), in patients the nitroimidazoles remain the most effective agents, demonstrating again the discordance in *in vitro* testing. Azithromycin has shown *in vitro* activity but was not able to clear parasites in an animal model (Boreham and Upcroft, 1991).

Efforts are being made to establish structure–function activity by correlating binding sites with drug affinity and, therefore, effectiveness (Edlind *et al.*, 1990). Resistance can be induced *in vitro*, but the clinical correlates of this have not been

established (Upcroft *et al.*, 1990, 1996a; Upcroft and Upcroft, 1998). Drug resistance to the nitroimidazoles appears to be caused by decreased activity of the parasite pyruvate-ferredoxin oxidoreductase, with decreased reduction and activation of the drug (Townson *et al.*, 1996).

## MANAGEMENT

Treatment of the infected individual is the main focus in management of giardiasis (Table 10.3). Most information on therapy derives from clinical experience. Therapeutic agents come primarily from the nitroimidazole family of drugs and, while other effective classes exist, development of new drugs for treatment has been relatively limited. Thus, one chooses an agent based on past experience and drug availability (Lerman and Walker, 1982; Davidson, 1984; Wolfe, 1992; Hill, 1993; Farthing, 1996; Zaat *et al.*, 1997; Medical Letter, 1998; Gardner and Hill, 2001).

### Nitroimidazoles

In the USA the manufacture of quinacrine was discontinued in 1992, leaving metronidazole, a nitroimidazole, as the standard of therapy. Agents of the nitroimidazole class have extensive experience throughout the world as safe and effective therapy for giardiasis in all age groups (Jokipii and Jokipii, 1978; Speelman, 1985; Kuzmicki and Jeske, 1994; Bulut *et al.*, 1996).

It is likely that these agents work by serving as terminal electron acceptors from *Giardia* ferredoxin, after which they become activated and then inhibit parasite DNA synthesis (Townson *et al.*, 1994). Although metronidazole is the only nitroimidazole available in the USA, tinidazole and ornidazole are available in other countries. This class has success rates of 85–100% depending upon the drug, the duration of therapy and the follow-up interval.

Metronidazole is most commonly given in a 5–7 day course, whereas tinidazole is effective when given in a single dose (2 g for adults) (Speelman, 1985). Shorter course and high-dose regimens have been employed for metronidazole, but these may be less well tolerated (Jokipii and Jokipii, 1978). The most common side effects are nausea, headache and dizziness, and the drugs may leave a metallic taste in the mouth. They are rarely associated with a reversible neutropenia. Nitroimidazoles should not be taken with alcohol because they can precipitate a disulfiram-like reaction by interfering with the hepatic degradation of acetaldehyde, a breakdown product of ethanol (Table 10.4) (Goldman, 1980).

### Other Agents

Quinacrine, although no longer produced in the USA, may be obtained through alternative sources (see Table 10.3). It may be helpful to use in difficult to treat cases as either an alternative agent or in combination with metronidazole. The drug has an excellent efficacy of

**Table 10.3** Treatment of giardiasis

Drug	Dosage	
	Adult	Child
Metronidazole*	250 mg t.i.d. × 5–7 days	5 mg/kg t.i.d. × 5–7 days
Tinidazole <sup>†</sup>	2 g × 1 dose	50 mg/kg × 1 dose (max. 2 g)
Quinacrine <sup>‡</sup>	100 mg t.i.d. × 5–7 days	2 mg/kg t.i.d. × 7 days
Furazolidone <sup>Δ</sup>	100 mg q.i.d. × 7–10 days	2 mg/kg q.i.d. × 10 days
Paromomycin*	25–30 mg/kg/day in 3 doses × 5–10 days	
Albendazole*	400 mg q.d. × 5 days	

\*Not a US Food and Drug Administration-approved indication.

<sup>†</sup>Not available in the USA.

<sup>‡</sup>No longer produced in the USA. May be obtained from Panorama Pharmacy, Panorama City, CA 1-800 515-7776.

<sup>Δ</sup>Available in a liquid formulation.

**Table 10.4** Treatment of giardiasis

Drug	Efficacy	Side-effects
Metronidazole	80–95%	GI, metallic taste, headache, disulfiram-like reaction with alcohol, rash. Rare: leukopenia, neuropathy, seizures. ?Mutagenic/carcinogenic
Tinidazole	90–98%	GI, metallic taste, headache, disulfiram-like reaction with alcohol
Quinacrine	90–95%	GI, headache, yellow discoloration. Rare: toxic psychosis. Should not be given to patients with psoriasis
Furazolidone	80%	GI, allergic reaction, headache, rash. Rare: mild hemolysis in G6PD-deficiency. ?Carcinogenic
Paromomycin	60–70%	GI, accumulation may occur in patients with impaired renal function.
Albendazole	≈ 90% *	GI, dizziness. Reversible transaminase elevation with prolonged use. Rare: leukopenia, renal, rash. Teratogenic in animals

\*Only limited clinical trials.

Abbreviations: GI, gastrointestinal; G6PD, glucose-6-phosphate dehydrogenase.

over 90%, but may be poorly tolerated, particularly in children, with side effects of nausea, vomiting and abdominal cramping (Wolfe, 1975; Craft *et al.*, 1981). As an atabrine derivative, many patients will have yellow/orange discoloration of the sclerae, skin and urine. An exfoliative dermatitis and psychosis can be rare side effects.

The nitrofurans furazolidone has a limited efficacy of about 80%, but has been used frequently in children because it comes in a liquid formulation (Bassily *et al.*, 1970; Craft *et al.*, 1981; Murphy and Nelson, 1983). It needs to be taken for 10 days and is generally well tolerated, but may have gastrointestinal side-effects and can turn the urine brown and cause mild hemolysis in G-6-PD-deficient persons.

The benzimidazoles have generated a great deal of interest for the therapy of parasitic infections. Albendazole is now widely used for many helminths, including larval cestodes, filariae and intestinal nematodes (Venkatesan, 1998). In the treatment of *Giardia*, it has had mixed success (Reynoldson *et al.*, 1992; Hall and Nahar, 1993; Kollaritsch *et al.*, 1993; Dutta *et al.*, 1994). From limited data, it appears that 400 mg in adults for 5 days will be the most effective dose. Mebendazole is not as effective (di Martino *et al.*, 1991; Bulut *et al.*, 1996).

The non-absorbable agent bacitracin zinc, given in a dose of 120 000 units twice daily for 10 days, was effective in a trial in children and adults in Tanzania (Andrews *et al.*, 1995). This formulation of bacitracin, however, is not readily available and the regimen suffers from the need to give it for 10 days.

Adjunctive measures in therapy include attention to hydration and maintenance of nutritional status. Since many hospitalizations for giardiasis occur in children under the age of 5 years who suffer from dehydration, it is particularly important to focus on this group. If a child suffers from failure to thrive, replenishment of nutrients will be needed, and it may take some time for the gut to recover from its injury. In all age groups, lactase is the most common of the disaccharidase deficiencies, so patients should be counseled to avoid lactose-containing products for several weeks following diagnosis and treatment.

### Asymptomatic Infection

Treatment of asymptomatic cases is controversial (Pickering *et al.*, 1984; Ish-Horowicz *et al.*, 1989; Addiss *et al.*, 1991a). Consideration of the setting, the likelihood of reinfection, the potential for the patient to pass *Giardia* to others (e.g. family members, day-care attendees) and the possibility for long-term sequelae, need to be considered when making the decision (Hill, 1993). If the parasite has been detected and the patient will not be exposed again, then treatment is reasonable. There should also be treatment if there is any question that the infection may be contributing to nutritional abnormalities.

Treatment of children in settings of poor food and liquid sanitation results in clearance of the parasite, but has been followed by rapid reinfection (Gilman *et al.*, 1988). Although some have



argued that this *Giardia*-free period will result in improved nutritional status and catch-up growth (Mata, 1978; Gupta and Urrutia, 1982; Solomons, 1982; Farthing *et al.*, 1986), others have stated that rapid reinfection negates the potential benefit of repeated treatment campaigns (Gilman *et al.*, 1988; Sullivan *et al.*, 1988). It is also unclear, in these settings where there are multiple pathogens, exactly what role *Giardia* is playing. Therefore, any intervention should be undertaken within the context of an entire plan for management of diarrheal illness, which should include proper sewage disposal and access to potable water.

### Resistance and Relapse

Some infections may appear clinically resistant because of the return of diarrhea after improvement, or failure to resolve initially. In these patients, persistent *Giardia* should be documented first, since some may only be exhibiting lactose intolerance. If *Giardia* is found, a repeat course of the same agent, or treatment with a drug of a different class may be effective. Combination therapy with metronidazole and quinacrine has also been successful in particularly difficult cases (Lerman and Walker, 1982; Taylor *et al.*, 1987; Nash *et al.*, 2001).

### Pregnancy

Pregnant women with *Giardia* pose a challenge, since the physician wants to assure that treatment is effective but also safe. Ideally, no agents should be given during pregnancy. However, if the woman cannot maintain hydration and nutritional status because of constant nausea or emesis, dehydration or failure to gain weight, then therapy will be necessary. One agent that has been used in these settings is a poorly absorbed aminoglycoside called paromomycin (Kreutner *et al.*, 1981; Rotblatt, 1983). While it is only effective in 60–70% of cases (Kreutner *et al.*, 1981; Rotblatt, 1983), it may allow the patient to improve, if only for a limited period, and move her into the second trimester, when there is increased comfort in using metronidazole.

Safety concerns have been raised about the use of metronidazole in pregnancy (Rotblatt, 1983; Beard *et al.*, 1988; Briggs *et al.*, 1990; Burtin *et al.*, 1995). While it has been demonstrated to be mutagenic in bacteria and carcinogenic in large doses in animals (Goldman, 1980; Beard *et al.*, 1988), these have not translated into human risks (Burtin *et al.*, 1995) and it has an extensive record of safety when used for the therapy of trichomoniasis during pregnancy (Rosa *et al.*, 1987). It has also been used in young children for the therapy of anaerobic infections, with no record of long-term adverse effects. Therefore, it can probably be given safely throughout pregnancy, although it may still be prudent to avoid its use in the first trimester.

### PREVENTION AND CONTROL

The prevention of giardiasis requires the proper disposal of human waste, the provision of potable water in community settings, and fecal-oral hygiene for individuals. Because of the relative resistance of *Giardia* to halogenation, chlorination alone may not be sufficient to render water safe for drinking. Therefore, when communities use water from streams, rivers, lakes or reservoirs, the water should be processed by flocculation, then sedimentation, filtration and finally chlorination (Navin *et al.*, 1985; Centers for Disease Control and Prevention, 1995). Standard chlorination levels are approximately 0.4 mg/l (Centers for Disease Control, 1980), but this may not be sufficient in some situations, particularly when chlorination is being relied upon alone. In community outbreaks, water treatment plants have had to resort to hyperchlorination (levels of 5–9 mg/l) to end the outbreak (Centers for Disease Control, 1980; López *et al.*, 1980). This attention to water treatment is particularly important to prevent cryptosporidiosis, which, because of its smaller size and resistance to chlorination, has caused outbreaks even when all treatment procedures were in place (MacKenzie *et al.*, 1994; Goldstein *et al.*, 1996).

The detection of protozoan pathogens in water supplies has received intense focus as an increasing number of water-borne parasites are

recognized (Wallis *et al.*, 1996; Marshall *et al.*, 1997; Steiner *et al.*, 1997). *Giardia* has usually been detected by filtering a large volume of water and then examining for parasites eluted from the filters. This is now being done using immunofluorescence or PCR techniques to improve the yield over original visual detection methods (LeChevallier *et al.*, 1995; Nieminski *et al.*, 1995; Kaucner and Stinear, 1998; Mahbubani *et al.*, 1998). Determination of parasite viability is also important, since not all identified cysts may be viable and infectious (Wallis *et al.*, 1996; Dowd and Pillai, 1997). Levels of *Giardia* in drinking water which exceed 3–5 cysts/100 l have been associated with community-wide outbreaks of giardiasis (Wallis *et al.*, 1996). Most methods being employed combine detection for *Giardia* with that of *Cryptosporidium*.

Water for personal use may be boiled, halogenated or filtered. Bringing water to a boil is sufficient to kill *Giardia* cysts (Backer, 1995). At altitudes above 2000 m, boiling should be continued for 2–3 minutes. Routine halogenation will kill bacteria and viruses; however, halogenation alone is often insufficient to kill cysts and the pH, temperature, turbidity and organic content of the water may further affect efficacy. For halogenation, iodine or chlorine-based preparations are used (Jarroll *et al.*, 1980; Ongerth *et al.*, 1989; Backer, 1995). Potable Aqua™ (1 tablet/l/30 minutes) is the most common iodine-based product, and Halazone™ (5 tablets/l/30 minutes) the most common chlorine-based product. Cold or turbid water requires an increased halogen dose (usually twice the dose) and contact time. Warming the water will also improve efficacy. Pregnant women and those with unstable thyroid functions should probably not use iodine preparations.

If small-volume filters are used, they should have a filter size of 'absolute'  $\leq 1 \mu\text{m}$  (not 'nominal'), as designated by the American National Standards Institute (Centers for Disease Control and Prevention, 1995). This size will be sufficient to filter both *Giardia* and *Cryptosporidium*. Since some bacteria and all viruses will not be trapped by a filter of this size, one can combine filtration with an iodine resin to inactivate any organisms that escape filtration. Using a simple pre-filter to remove particulate debris will increase the efficacy of these personal

water filtration devices. Water can also be clarified by the use of alum (10–30 mg/l), allowed to settle, decanted and then filtered (Backer, 1995). Filters that only employ activated carbon or charcoal will not disinfect the water, although they may improve its taste.

## Day Care

Control of *Giardia* in day-care settings is difficult. Day-care centers should have strict rules for hygiene. Diaper-changing areas should be separated from play and eating areas. All day-care center personnel should employ careful hand-washing, or use disposable gloves that are properly discarded after changing diapers. Changing areas should be cleaned after use (Cody *et al.*, 1994). Any child who has diarrhea caused by *Giardia* should be excluded from attendance and treated. In many cases it may be helpful to screen family members as an attempt to control the infection within the family.

Many experts do not advocate screening an entire day-care center population in the situation of only a few symptomatic cases (Ish-Horowitz *et al.*, 1989; Rauch *et al.*, 1990; Bartlett *et al.*, 1991). The potential difficulty and cost in both screening and then exclusion and treatment of all infected children may not be practical. If, however, there are ongoing cases of diarrhea, then a strict approach such as this may be necessary (Stekete *et al.*, 1989).

At this stage, there are no immunoprophylactic measures for the prevention of *Giardia*.

## REFERENCES

- Adam RD (1991). The biology of *Giardia* spp. *Microbiol Rev* **55**: 706–32.
- Adam RD, Nash TE, Wellems TE (1988). The *Giardia lamblia* trophozoite contains sets of closely related chromosomes. *Nucleic Acids Res* **16**: 4555–67.
- Addiss DG, Davis JP, Roberts JM, Mast EE (1992). Epidemiology of giardiasis in Wisconsin: increasing incidence of reported cases and unexplained seasonal trend. *Am J Trop Med Hyg* **47**: 13–19.
- Addiss DG, Juranek DD, Spencer HC (1991a). Treatment of children with asymptomatic and non-diarrheal *Giardia* infection. *Pediatr Infect Dis J* **10**: 843–6.
- Addiss DG, Mathews HM, Stewart JM *et al.* (1991b). Evaluation of a commercially available enzyme-linked

- immunosorbent assay for *Giardia lamblia* antigen in stool. *J Clin Microbiol* **29**: 137–42.
- Addiss DG, Stewart JM, Finton RJ *et al.* (1991c). *Giardia lamblia* and *Cryptosporidium* infections in child day-care centers in Fulton County, Georgia. *Pediatr Infect Dis J* **10**: 907–11.
- Adel K, Sterling CR, Guerrant RL (1995). *Cryptosporidium* and related species. In Blaser MJ, Smith PD, Ravdin JI *et al.* (eds), *Infections of the Gastrointestinal Tract*. Raven: New York; 1107–28.
- Aggarwal A, Nash TE (1987). Comparison of two antigenically distinct *Giardia lamblia* isolates in gerbils. *Am J Trop Med Hyg* **36**: 325–32.
- Aggarwal A, Nash TE (1988). Antigenic variation of *Giardia lamblia* in vivo. *Infect Immun* **56**: 1420–3.
- Aldeen WE, Carroll K, Robison A *et al.* (1998). Comparison of nine commercially available enzyme-linked immunosorbent assays for the detection of *Giardia lamblia* in fecal specimens. *J Clin Microbiol* **36**: 1338–40.
- Alles AJ, Waldron MA, Sierra LS, Mattia AR (1995). Prospective comparison of direct immunofluorescence and conventional staining methods for detection of *Giardia* and *Cryptosporidium* spp. in human fecal specimens. *J Clin Microbiol* **33**: 1632–4.
- Andrews BJ, Mylvaganam H, Yule A (1994). *In vitro* sensitivity of *Trichomonas vaginalis*, *Tritrichomonas foetus* and *Giardia intestinalis* to bacitracin and its zinc salt. *Trans R Soc Trop Med Hyg* **88**: 704–6.
- Andrews BJ, Panitescu D, Jipa GH *et al.* (1995). Chemotherapy for giardiasis: randomized clinical trial of bacitracin, bacitracin zinc, and a combination of bacitracin zinc with neomycin. *Am J Trop Med Hyg* **52**: 318–21.
- Backer HD (1995). Field water disinfection. In Auerbach P (ed.), *Wilderness Medicine. Management of Wilderness and Environmental Emergencies*. C. V. Mosby: St. Louis, MO; 1060–1110.
- Balazs M, Szalocky E (1978). Electron microscopic examination of the mucosa of the small intestine in infection due to *Giardia lamblia*. *Pathol Res Pract* **163**: 251–60.
- Barbour AG, Nichols CR, Fukushima T (1976). An outbreak of giardiasis in a group of campers. *Am J Trop Med Hyg* **25**: 384–9.
- Bartlett AV, Englander SJ, Jarvis BA *et al.* (1991). Controlled trial of *Giardia lamblia*: control strategies in day care centers. *Am J Publ Health* **81**: 1001–6.
- Baruch AC, Isaac-Renton J, Adam RD (1996). The molecular epidemiology of *Giardia lamblia*: a sequence-based approach. *J Infect Dis* **174**: 233–6.
- Bassily S, Farid Z, Mikhail JW *et al.* (1970). The treatment of *Giardia lamblia* infection with mepacrine, metronidazole and furazolidone. *J Trop Med Hyg* **73**: 15–18.
- Beal GB, Viens P, Grant RGL, Highes JM (1970). A new technique for sampling duodenal contents: demonstration of upper small bowel pathogens. *Am J Trop Med Hyg* **19**: 349–52.
- Bean NH, Goulding JS, Lao C, Angulo FJ (1996). Surveillance for foodborne-disease outbreaks—United States, 1988–1992. In CDC Surveillance Summaries, October 25, 1996. *Morbid Mortal Wkly Rep* **45**: (No. SS-5), 1–66.
- Beard CM, Noller KL, O'Fallon WM (1988). Cancer after exposure to metronidazole. *Mayo Clin Proc* **63**: 147–53.
- Boone JH, Wilkins TD, Nash TE *et al.* (1999). TechLab and Alexon *Giardia* enzyme-linked immunosorbent assay kits detect cyst wall protein 1. *J Clin Microbiol* **37**: 611–14.
- Boreham PFL, Phillips RE, Shepherd RW (1985). A comparison of the *in-vitro* activity of some 5-nitroimidazoles and other compounds against *Giardia intestinalis*. *J Antimicrob Chemother* **16**: 589–95.
- Boreham PFL, Phillips RE, Shepherd RW (1987). Heterogeneity in the responses of clones to *Giardia intestinalis* to anti-giardial drugs. *Trans R Soc Trop Med Hyg* **81**: 406–7.
- Boreham PFL, Upcroft JA (1991). The activity of azithromycin against stocks of *Giardia intestinalis* in vitro and in vivo. *Trans R Soc Trop Med Hyg* **85**: 620–1.
- Boucher SEM, Gillin FD (1990). Excystation of *in vitro*-derived *Giardia lamblia* cysts. *Infect Immun* **58**: 3516–22.
- Brannan DK, Greenfield RA, Owen WL *et al.* (1996). Protozoal colonization of the intestinal tract in institutionalized Romanian children. *Clin Infect Dis* **22**: 456–61.
- Briggs GG, Freeman RK, Yaffe SJ (1990). Metronidazole. In Briggs GG, Freeman RK, Yaffe SJ (eds), *Drugs in Pregnancy and Lactation*. Williams & Wilkins: Baltimore, MD; 430–3.
- Brodsky RE, Spencer HC, Schultz MG (1974). Giardiasis in American travelers to the Soviet Union. *J Infect Dis* **130**: 319–23.
- Brown DM, Upcroft JA, Edwards MR, Upcroft P (1998). Anaerobic bacterial metabolism in the ancient eukaryote *Giardia duodenalis*. *Int J Parasitol* **28**: 149–64.
- Bulut BU, Gulnar SB, Aysev D (1996). Alternative treatment protocols in giardiasis: a pilot study. *Scand J Infect Dis* **28**: 493–5.
- Buret A, den Hollander N, Wallis PM *et al.* (1991). Zoonotic potential of giardiasis in domestic ruminants. *J Infect Dis* **162**: 231–7.
- Buret A, Gall DG, Nation PN, Olson ME (1990). Intestinal protozoa and epithelial kinetics, structure and function. *Parasitol Today* **12**: 375–80.
- Burke JA (1975). Giardiasis in childhood. *Am J Dis Child* **129**: 1304–10.
- Burke JA (1977). The clinical and laboratory diagnosis of giardiasis. *CRC Crit Rev Clin Lab Sci* **7**: 372–91.
- Burtin P, Taddio A, Ariburnu O *et al.* (1995). Safety of metronidazole in pregnancy: a meta-analysis. *Am J Obstet Gynecol* **172**: 525–9.
- Byrd LG, Conrad JT, Nash TE (1994). *Giardia lamblia* infections in adult mice. *Infect Immun* **62**: 3583–5.
- Campbell JD, Faubert GM (1994). Comparative studies on *Giardia lamblia* encystation *in vitro* and *in vivo*. *J Parasitol* **80**: 36–44.
- Capon AG, Upcroft JA, Boreham PFL *et al.* (1989). Similarities of *Giardia* antigens derived from human and animal sources. *Int J Parasitol* **19**: 91–8.
- Castor SB, Lindqvist KB (1990). Canine giardiasis in Sweden: no evidence of infectivity to man. *Trans R Soc Trop Med Hyg* **84**: 249–50.

- Centers for Disease Control (1980). Waterborne giardiasis—California, Colorado, Oregon, Pennsylvania. *Morbid Mortal Wkly Rep* **29**: 121–3.
- Centers for Disease Control and Prevention (1995). Assessing the public health threat associated with waterborne cryptosporidiosis: report of a workshop. *Morbid Mortal Wkly Rep* **44** (RR-6): 1–19.
- Cervelló A, Alfaro A, Chumillas MJ (1993). Hypokalemic myopathy induced by *Giardia lamblia* (letter). *N Eng J Med* **329**: 210–11.
- Cevallos A, Carnaby S, James M, Farthing MJG (1995). Small intestinal injury in a neonatal rat model of giardiasis is strain dependent. *Gastroenterology* **109**: 766–73.
- Char S, Cevallos AM, Yamson P *et al.* (1993). Impaired IgA response to *Giardia* heat shock antigen in children with persistent diarrhoea and giardiasis. *Gut* **34**: 38–40.
- Chávez B, González-Mariscal L, Cedillo-Rivera R, Martínez-Palomo A (1995). *Giardia lamblia*: *in vitro* cytopathic effect of human isolates. *Exp Parasitol* **80**: 133–8.
- Clyne CA, Eliopoulos GM (1989). Fever and urticaria in acute giardiasis. *Arch Intern Med* **149**: 939–40.
- Cody MM, Sottnek HM, O'Leary VS (1994). Recovery of *Giardia lamblia* cysts from chairs and tables in child day-care centers. *Pediatric Infect Dis J* **94** (suppl): 1006–8.
- Craft JC, Murphy T, Nelson JD (1981). Furazolidone and quinacrine. Comparative study of therapy for giardiasis in children. *Am J Dis Child* **135**: 164–6.
- Crouch AA, Seow WK, Whitman LM, Thong YH (1990). Sensitivity *in vitro* of *Giardia intestinalis* to dyadic combinations of azithromycin, doxycycline, mefloquine, tinidazole and furazolidone. *Trans R Soc Trop Med Hyg* **84**: 246–8.
- Das S, Gillin FD (1996). *Giardia lamblia*: increased UDP-N-acetyl-D-glucosamine and N-acetyl-D-galactosamine transferase activities during encystation. *Exp Parasitol* **83**: 12–29.
- Davidson RA (1984). Issues in clinical parasitology: the treatment of giardiasis. *Am J Gastroenterol* **79**: 256–61.
- den Hollander N, Riley D, Befus D (1988). Immunology of giardiasis. *Parasitol Today* **4**: 124–31.
- Dennis DT, Smith RP, Welch JJ *et al.* (1993). Endemic giardiasis in New Hampshire: a case-control study of environmental risks. *J Infect Dis* **167**: 1391–5.
- deRegnier DP, Cole L, Schupp DG, Erlandsen SL (1989). Viability of *Giardia* cysts suspended in lake, river, and tap water. *Appl Environ Microbiol* **55**: 1223–9.
- di Martino L, Nocerino A, Pettoello Mantovani M (1991). Mebendazole in giardial infections: confirmation of the failure of this treatment (letter). *Trans R Soc Trop Med Hyg* **85**: 557–8.
- Di Prisco MC, Hagel I, Lynch NR *et al.* (1998). Association between giardiasis and allergy. *Ann Allergy, Asthma Immunol* **81**: 261–5.
- Dobell C (1920). The discovery of the intestinal protozoa of man. *Proc R Soc Med* **13**: 1–15.
- Dogliani C, De Boni M, Cielo R *et al.* (1992). Gastric giardiasis. *J Clin Pathol* **45**: 964–7.
- Dowd SE, Pillai SD (1997). A rapid viability assay for *Cryptosporidium* oocysts and *Giardia* cysts for use in conjunction with indirect fluorescent antibody detection. *Can J Microbiol* **43**: 658–62.
- Duncombe VM, Bolin TD, Davis AE, Crouch RL (1978). Histopathology in giardiasis: a correlation with diarrhea. *Austr N Z J Med* **8**: 392–6.
- DuPont HL, Capsuto EG (1996). Persistent diarrhea in travelers. *Clin Infect Dis* **22**: 124–8.
- Dutta AK, Phadke MA, Bagade AC *et al.* (1994). A randomised multicentre study to compare the safety and efficacy of albendazole and metronidazole in the treatment of giardiasis in children. *Ind J Pediatr* **61**: 689–93.
- Dykes AC, Juranek DD, Lorenz RA *et al.* (1980). Municipal waterborne giardiasis: an epidemiologic investigation. Beavers implicated as a possible reservoir. *Ann Intern Med* **92** (pt 1): 165–70.
- Edlind TD, Hang TL, Chakraborty PR (1990). Activity of the anthelmintic benzimidazoles against *Giardia intestinalis* *in vitro*. *J Infect Dis* **162**: 1408–11.
- Edwards MR, Schofield PJ, O'Sullivan WJ, Costello M (1992). Arginine metabolism during culture of *Giardia intestinalis*. *Mol Biochem Parasitol* **53**: 97–103.
- Erlandsen S, Sherlock LA, Januschka M *et al.* (1988). Cross-species transmission of *Giardia* spp.: inoculation of beavers and muskrats with cysts of human, beaver, mouse, and muskrat origin. *Appl Environ Microbiol* **54**: 2777–85.
- Erlandsen SL, Macechko PT, van Keulen H, Jarroll EL (1996). Formation of the *Giardia* cyst wall: studies on extracellular assembly using immunogold labeling and high resolution field emission SEM. *J Eukaryot Microbiol* **43**: 416–29.
- Ey PL, Bruderer T, Wehrli C, Kohler P (1996). Comparison of genetic groups determined by molecular and immunological analyses of *Giardia* isolated from animals and humans in Switzerland and Australia. *Parasitol Res* **82**: 52–60.
- Farbey MD, Reynoldson JA, Thompson RC (1995). *In vitro* drug susceptibility of 29 isolates of *Giardia intestinalis* from humans as assessed by an adhesion assay. *Int J Parasitol* **25**: 593–9.
- Farthing MJG (1996). Giardiasis. *Gastroenterol Clin N Am* **25**: 493–515.
- Farthing MJG (1997). The molecular pathogenesis of giardiasis. *J Pediatr Gastroenterol Nutr* **24**: 79–88.
- Farthing MJG, Mata L, Urrutia JJ, Kronmal RA (1986). Natural history of *Giardia* infection of infants and children in rural Guatemala and its impact on physical growth. *Am J Clin Nutr* **43**: 395–405.
- Faubert GM (1988). Evidence that giardiasis is a zoonosis. *Parasitol Today* **4**: 66–8.
- Feely DE, Holberton DV, Erlandsen SL (1990). The biology of *Giardia*. In Meyer EA (ed.), *Giardiasis*. Elsevier Science: The Netherlands; 11–49.
- Flanagan PA (1992) *Giardia*—diagnosis, clinical course and epidemiology. A review. *Epidemiol Infect* **109**: 1–22.
- Fraser D, Dagan R, Naggan L *et al.* (1997). Natural history of *Giardia lamblia* and *Cryptosporidium* infections in a cohort of Israeli Bedouin infants: a study of a population in transition. *Am J Trop Med Hyg* **57**: 544–9.
- Furness BW, Beach MJ, Roberts JM (2000). Giardiasis surveillance—United States, 1992–1997. *Morbid Mortal Wkly Rep* **49** (No. SS-7): 1–13.
- Gamboa MI, Basualdo JA, Kozubsky L *et al.* (1998). Prevalence of intestinal parasitosis within three

- population groups in La Plata, Argentina. *Eur J Epidemiol* **14**: 55–61.
- Garcia LS, Shimizu RY (1997). Evaluation of nine immunoassay kits (enzyme immunoassay and direct fluorescence) for detection of *Giardia lamblia* and *Cryptosporidium parvum* in human fecal specimens. *J Clin Microbiol* **35**: 1526–9.
- Gardner TB, Hill DR (2001). Treatment of giardiasis. *Clin Microbiol Rev* **14**: 114–28.
- Gillin FD, Hagblom P, Harwood J *et al.* (1990). Isolation and expression of the gene for a major surface protein of *Giardia lamblia*. *Proc Natl Acad Sci USA* **87**: 4463–7.
- Gillin FD, Reiner DS, Gault MJ *et al.* (1987). Encystation and expression of cyst antigens by *Giardia lamblia* *in vitro*. *Science* **235**: 1040–3.
- Gillin FD, Reiner DS, McCaffery JM (1996). Cell biology of the primitive eukaryote *Giardia lamblia*. *Ann Rev Microbiol* **50**: 679–705.
- Gillon J (1985). Clinical studies in adults presenting with giardiasis to a gastrointestinal unit. *Scott Med J* **30**: 89–95.
- Gilman RH, Brown KH, Visvesvara GS *et al.* (1985). Epidemiology and serology of *Giardia lamblia* in a developing country: Bangladesh. *Trans R Soc Trop Med Hyg* **79**: 469–73.
- Gilman RH, Miranda E, Marquis GS *et al.* (1988). Rapid reinfection by *Giardia lamblia* after treatment in a hyperendemic Third World community. *Lancet* **1**: 343–5.
- Goka AKJ, Rolston DDK, Mathan VI, Farthing MJG (1990). The relative merits of faecal and duodenal juice microscopy in the diagnosis of giardiasis. *Trans R Soc Trop Med Hyg* **84**: 66–7.
- Goldman P (1980). Metronidazole. *N Engl J Med* **303**: 1212–18.
- Goldstein ST, Juranek DD, Ravenholt O *et al.* (1996). Cryptosporidiosis: an outbreak associated with drinking water despite state-of-the-art water treatment. *Ann Intern Med* **124**: 459–68.
- Goodgame RW (1996). Understanding intestinal spore-forming protozoa: cryptosporidia, microsporidia, isospora, and cyclospora. *Ann Intern Med* **124**: 429–41.
- Gordts B, Hemelhof W, Asselman C, Butzler JP (1985a). Evaluation of a new method for routine *in vitro* cultivation of *Giardia lamblia* from human duodenal fluid. *J Clin Microbiol* **22**: 702–4.
- Gordts B, Hemelhof W, Asselman C, Butzler JP (1985b). *In vitro* susceptibilities of 25 *Giardia lamblia* isolates of human origin to six commonly used antiprotozoal agents. *Antimicrob Agents Chemotherapeut* **28**: 378–80.
- Gottstein B, Harriman GR, Conrad JT, Nash TE (1990). Antigenic variation in *Giardia lamblia*: cellular and humoral immune response in a mouse. *Parasit Immunol* **12**: 659–73.
- Goyal R, Mahajan RC, Ganguly NK *et al.* (1993). Macrophage-mediated enterocyte damage in BALB/c mice infected with different strains of *Giardia lamblia*. *Scand J Gastroenterol* **28**: 845–8.
- Gray SF, Gunnell DJ, Peters TJ (1995). Risk factors for giardiasis: a case-control study in Avon and Somerset. *Epidemiol Infect* **113**: 95–102.
- Grigoriev GA, Walmsley S, Law L *et al.* (1994). Evaluation of the Merifluor immunofluorescent assay for the detection of *Cryptosporidium* and *Giardia* in sodium acetate formalin-fixed stools. *Diagn Microbiol Infect Dis* **19**: 89–91.
- Gupta MC, Urrutia JJ (1982). Effect of periodic antiascaris and anti-giardia treatment on nutritional status of preschool children. *Am J Clin Nutr* **36**: 79–86.
- Hadjichristodoulou C, Achileas G, Yianis P, Yianis T (1998). Outbreak of giardiasis among English tourists in Crete. *Lancet* **351**: 65–6.
- Hall A, Nahar Q (1993). Albendazole as a treatment for infections with *Giardia duodenalis* in children in Bangladesh. *Trans R Soc Trop Med Hyg* **87**: 84–6.
- Hartong WA, Gourley WK, Arvanitakis C (1979). Giardiasis: clinical spectrum and functional-structural abnormalities of the small intestinal mucosa. *Gastroenterology* **77**: 61–9.
- Hetsko ML, McCaffery JM, Svard SG *et al.* (1998). Cellular and transcriptional changes during excystation of *Giardia lamblia* *in vitro*. *Exp Parasitol* **88**: 172–83.
- Heyworth MF (1989). Intestinal IgA responses to *Giardia muris* in mice depleted of helper T lymphocytes and in immunocompetent mice. *J Parasitol* **75**: 246–51.
- Heyworth MF (1992). Immunology of *Giardia* and *Cryptosporidium* infections. *J Infect Dis* **166**: 465–72.
- Hiatt RA, Markell EK, Ng E (1995). How many stool examinations are necessary to detect pathogenic intestinal protozoa? *Am J Trop Med Hyg* **53**: 36–9.
- Hill DR (1990). Lymphocyte proliferation in Peyer's patches of *Giardia muris* infected mice. *Infect Immun* **58**: 2683–5.
- Hill DR (1993). Giardiasis: issues in management and treatment. *Infect Dis Clin N Am* **7**: 503–25.
- Hill DR, Guerrant RL, Pearson RD, Hewlett EL (1983). *Giardia lamblia* infection of suckling mice. *J Infect Dis* **147**: 217–21.
- Hill DR, Pohl R (1990). Ingestion of *Giardia lamblia* trophozoites by murine Peyer's patch macrophages. *Infect Immun* **58**: 3202–7.
- Hjelt K, Pørrregaard A, Krasilnikoff PA (1992). Giardiasis causing chronic diarrhoea in suburban Copenhagen: incidence, physical growth, clinical symptoms and small intestinal abnormality. *Acta Paediat* **81**: 881–6.
- Hoge CW, Shlim DR, Echeverria P *et al.* (1996). Epidemiology of diarrhea among expatriate residents living in a highly endemic environment. *J Am Med Assoc* **275**: 533–8.
- Homan WL, van Enckevort FHJ, Limper L *et al.* (1992). Comparison of *Giardia* isolates from different laboratories by isoenzyme analysis and recombinant DNA probes. *Parasitol Res* **78**: 316–23.
- Hopkins RM, Meloni BP, Groth DM *et al.* (1997). Ribosomal RNA sequencing reveals differences between the genotypes of *Giardia* isolates recovered from humans and dogs. *J Parasitol* **83**: 44–51.
- Inge PMG, Farthing MJG (1987). A radiometric assay for anti-giardial drugs. *Trans R Soc Trop Med Hyg* **81**: 345–7.
- Isaac-Renton JL, Cordeiro C, Sarafis K, Shahriari H (1993). Characterization of *Giardia duodenalis* isolates from a waterborne outbreak. *J Infect Dis* **167**: 431–40.
- Isaac-Renton JL, Lewis LF, Ong CS, Nulsen MF (1994). A second community outbreak of waterborne giardiasis in Canada and serological investigation of patients. *Trans R Soc Trop Med Hyg* **88**: 395–9.

- Isaac-Renton JL, Philion JJ (1992). Factors associated with acquiring giardiasis in British Columbia residents. *Can J Publ Health* **83**: 155–8.
- Isaac-Renton JL, Shahriari H, Bowie WR (1992). Comparison of an in vitro method and an in vivo method of *Giardia* excystation. *Appl Environ Microbiol* **58**: 1530–3.
- Ish-Horowitz M, Korman SH, Shapiro M *et al.* (1989). Asymptomatic giardiasis in children. *Pediat Infect Dis J* **8**, 773–9.
- Islam A, Stoll BJ, Ljungström I *et al.* (1983). *Giardia lamblia* infections in a cohort of Bangladeshi mothers and infants followed for one year. *J Pediat* **103**: 996–1000.
- Istre GR, Dunlop TS, Gaspard B, Hopkins RS (1984). Waterborne giardiasis at a mountain resort: evidence for acquired immunity. *Am J Publ Health* **74**: 602–4.
- Janoff EN, Smith PD, Blaser MJ (1988). Acute antibody responses to *Giardia lamblia* are depressed in patients with AIDS. *J Infect Dis* **157**: 798–804.
- Jarroll EL, Bingham AK, Meyer EA (1980). *Giardia* cyst destruction: effectiveness of six small-quantity water disinfection methods. *Am J Trop Med Hyg* **29**: 8–11.
- Jarroll EL, Bingham AK, Meyer EA (1981). Effect of chlorine on *Giardia lamblia* cyst viability. *Appl Environ Microbiol* **41**: 483–7.
- Jokipii L, Jokipii AMM (1978). Comparison of four dosage schedules in the treatment of giardiasis with metronidazole. *Infection* **6**: 92–4.
- Jokipii L, Jokipii AMM (1980). Is predisposition to giardiasis associated with the ABO blood groups? *Am J Trop Med Hyg* **29**: 5–7.
- Jones EG, Brown WR (1974). Serum and intestinal fluid immunoglobulins in patients with giardiasis. *Dig Dis* **19**: 791–6.
- Jové S, Fagundes-Neto U, Wehba J *et al.* (1983). Giardiasis in childhood and its effects on the small intestine. *J Pediat Gastroenterol Nutrit* **2**: 472–7.
- Kabnick KS, Peattie DA (1990). *In situ* analyses reveal that two nuclei of *Giardia lamblia* are equivalent. *J Cell Sci* **95**: 353–60.
- Kaminsky RG (1991). Parasitism and diarrhoea in children from two rural communities and marginal barrio in Honduras. *Trans R Soc Trop Med Hyg* **85**: 70–3.
- Kang EW, Clinch K, Furneaux RH *et al.* (1998). A novel and simple colorimetric method for screening *Giardia intestinalis* and anti-giardial activity *in vitro*. *Parasitology* **117** (pt 3): 229–34.
- Kappus KD, Lundgren RGJ, Juranek DD *et al.* (1994). Intestinal parasitism in the United States: update on a continuing problem. *Am J Trop Med Hyg* **50**: 705–13.
- Kaucner C, Stinear T (1998). Sensitive and rapid detection of viable *Giardia* cysts and *Cryptosporidium parvum* oocysts in large-volume water samples with wound fiberglass cartridge filters and reverse transcription-PCR. *Appl Environ Microbiol* **64**: 1743–9.
- Keister DB (1983). Axenic culture of *Giardia lamblia* in TYI-S-33 medium supplemented with bile. *Trans Assoc Am Physicians* **77**: 487–8.
- Keystone JS, Keystone DL, Proctor EM (1980). Intestinal parasitic infections in homosexual men: prevalence, symptoms and factors in transmission. *Can Med Assoc J* **123**: 512–14.
- Kollaritsch H, Jeschko E, Wiederman G (1993). Albendazole is highly effective against cutaneous larva migrans but not against *Giardia* infection: results of an open pilot trial in travellers returning from the tropics. *Trans R Soc Trop Med Hyg* **87**: 689.
- Korman SH, Hais E, Spira DT (1990). Routine *in vitro* cultivation of *Giardia lamblia* by using the string test. *J Clin Microbiol* **28**: 368–9.
- Kramer MH, Herwaldt BL, Craun GF *et al.* (1996). Surveillance for waterborne-disease outbreaks—United States, 1993–1994. In CDC Surveillance Summaries, April 12, 1996. *Morbidity Mortal Wkly Rep* **45** (SS-1): 1–30.
- Kreutner AK, Del Bene VE, Amstey MS (1981). Giardiasis in pregnancy. *Am J Obstet Gynecol* **140**: 895–901.
- Kuzmicki R, Jeske J (1994). Observations of the efficacy of ornidazole (Tiberal La Roche) in treatment of giardiasis. *Wiadomosci Parazytologiczne* **40**: 65–8.
- Lamb W (1859). Mikroskopische untersuchungen der darmexcrete. Beitrag zur diagnostik am krankenbette. *Vierteljahrsschr Prakt Heilkunde (Prague)* **61**: 1–58.
- Lanata CF, Black RE, Maurtua D *et al.* (1992). Etiologic agents in acute vs. persistent diarrhea in children under three years of age in peri-urban Lima, Peru. *Acta Paediat* **381** (suppl): 32–8.
- Layton MA, Dziedzic K, Dawes PT (1998). Sacroiliitis in an HLA B27-negative patient following giardiasis (letter). *Br J Rheumatol* **37**: 581–3.
- LeChevallier MW, Norton WD, Lee RG (1991). Occurrence of *Giardia* and *Cryptosporidium* spp. in surface water supplies. *Appl Environ Microbiol* **57**: 2610–16.
- LeChevallier MW, Norton WD, Siegle JE, Abbaszadegan M (1995). Evaluation of the immunofluorescence procedure for detection of *Giardia* cysts and *Cryptosporidium* oocysts in water. *Appl Environ Microbiol* **61**: 690–7.
- Leitch GJ, Visvesvara GS, Wahlquist SP, Harmon CT (1989). Dietary fiber and giardiasis: dietary fiber reduces rate of intestinal infection by *Giardia lamblia* in the gerbil. *Am J Trop Med Hyg* **41**: 512–20.
- Lengerich EJ, Addiss DG, Juranek DD (1994). Severe giardiasis in the United States. *Clin Infect Dis* **18**: 760–3.
- Lerman SJ, Walker RA (1982). Treatment of giardiasis. Literature review and recommendations. *Clin Pediat* **21**: 409–14.
- Ljungström I, Castor B (1992). Immune response to *Giardia lamblia* in a water-borne outbreak of giardiasis in Sweden. *J Med Microbiol* **36**: 347–52.
- López CE, Dykes AC, Juranek DD *et al.* (1980). Waterborne giardiasis: a communitywide outbreak of disease and a high rate of asymptomatic infection. *Am J Epidemiol* **112**: 495–507.
- Lu SQ, Baruch AC, Adam RD (1998). Molecular comparison of *Giardia lamblia* isolates. *Int J Parasitol* **28**: 1341–5.
- Lujan HD, Marotta A, Mowatt MR *et al.* (1995). Developmental induction of golgi structure and function in the primitive eukaryote *Giardia lamblia*. *J Biol Chem* **270**: 4612–18.
- Lujan HD, Mowatt MR, Nash TE (1997). Mechanisms of *Giardia lamblia* differentiation into cysts. *Microbiol Mol Biol Rev* **61**: 294–304.
- MacKenzie WR, Hoxie NJ, Proctor ME *et al.* (1994). A massive outbreak in Milwaukee of cryptosporidium

- infection transmitted through the public water supply. *N Engl J Med* **331**: 161–7.
- Mahubani MH, Schaefer FWI, Jones DD, Bej AK (1998). Detection of *Giardia* in environmental waters by immunopCR amplification methods. *Curr Microbiol* **36**: 107–13.
- Mahmud MA, Chappell C, Hossain MM *et al.* (1995). Risk factors for development of first symptomatic *Giardia* infection among infants of a birth cohort in rural Egypt. *Am J Trop Med Hyg* **53**: 84–8.
- Majewska AC, Kasprzak W, De Jonckheere JF, Kaczmarek E (1991). Heterogeneity in the sensitivity of stocks and clones of *Giardia* to metronidazole and ornidazole. *Trans R Soc Trop Med Hyg* **85**: 67–9.
- Mank TG, Zaat JO, Deelder AM *et al.* (1997). Sensitivity of microscopy versus enzyme immunoassay in the laboratory diagnosis of giardiasis. *Eur J Clin Microbiol Infect Dis* **16**: 615–19.
- Markell EK, Havens RF, Kuritsubo RA, Wingerd J (1984). Intestinal protozoa in homosexual men of the San Francisco Bay area: prevalence and correlates of infection. *Am J Trop Med Hyg* **33**: 239–45.
- Marshall J, Holberton DV (1993). Sequence and structure of a new coiled protein from a microtubule bundle in *Giardia*. *J Mol Biol* **231**: 521–30.
- Marshall MM, Naumovitz D, Ortega Y, Sterling CR (1997). Waterborne protozoan pathogens. *Clin Microbiol Rev* **10**: 67–85.
- Mata LJ (1978). *The Children of Santa Mariá Cauque: A Prospective Field Study of Health and Growth*. MIT Press: Cambridge, MA.
- Mayrhofer G, Andrews RH, Ey PL *et al.* (1992). The use of suckling mice to isolate and grow *Giardia* from mammalian faecal specimens for genetic analysis. *Parasitology* **105**: 255–63.
- McIntyre P, Boreham PFL, Phillips RE, Shepard RW (1986). Chemotherapy in giardiasis: clinical responses and *in vitro* drug sensitivity of human isolates in axenic culture. *J Pediatr* **108**: 1005–10.
- Medical Letter (1998). Drugs for parasitic infections. *Med Lett Drugs Therapeut* **40**: 1–12.
- Meloni BP, Lymbery AJ, Thompson RCA (1988). Isoenzyme electrophoresis of 30 isolates of *Giardia* from human and felines. *Am J Trop Med Hyg* **38**: 65–73.
- Meloni BP, Thompson RC, Hopkins RM *et al.* (1993). The prevalence of *Giardia* and other intestinal parasites in children, dogs and cats from aboriginal communities in the Kimberly. *Med J Austr* **158**: 157–9.
- Meloni BP, Thompson RCA, Reynoldson JA, Seville P (1990). Albendazole: a more effective anti-giardial agent *in vitro* than metronidazole or tinidazole. *Trans R Soc Trop Med Hyg* **84**: 375–9.
- Meyer EA (1990). Taxonomy and nomenclature. In Meyer EA (ed.), *Giardiasis*. Elsevier Science: The Netherlands; 51–60.
- Meyer EA, Radulescu S (1979). *Giardia* and giardiasis. *Adv Parasitol* **17**: 1–47.
- Mintz ED, Hudson-Wragg M, Mshar P *et al.* (1993). Foodborne giardiasis in a corporate office setting. *J Infect Dis* **167**: 250–3.
- Miotti PG, Gilman RH, Pickering LK *et al.* (1985). Prevalence of serum and milk antibodies to *Giardia lamblia* in different populations of lactating women. *J Infect Dis* **152**: 1025–31.
- Miotti PG, Gilman RH, Santosham M *et al.* (1986). Age-related rate of seropositivity of antibody to *Giardia lamblia* in four diverse populations. *J Clin Microbiol* **24**: 972–5.
- Mohammed SR, Faubert GM (1995). Disaccharidase deficiencies in Mongolian gerbils (*Meriones unguiculatus*) protected against *Giardia lamblia*. *Parasitol Res* **81**: 582–90.
- Monis PT, Andrews RH, Mayrhofer G *et al.* (1998). Novel lineages of *Giardia intestinalis* identified by genetic analysis of organisms isolated from dogs in Australia. *Parasitology* **116**: 7–19.
- Monis PT, Mayrhofer G, Andrews RH *et al.* (1996). Molecular genetic analysis of *Giardia intestinalis* isolates at the glutamate dehydrogenase locus. *Parasitology* **112**: 1–12.
- Moore GT, Cross WM, McGuire D *et al.* (1969). Epidemic giardiasis at a ski resort. *N Engl J Med* **281**: 402–7.
- Morrow AL, Reves RR, West MS *et al.* (1992). Protection against infection with *Giardia lamblia* by breast feeding in a cohort of Mexican infants. *J Pediatr* **121**: 363–70.
- Mowatt MR, Lujan HD, Cotten DB *et al.* (1995). Developmentally regulated expression of a *Giardia lamblia* cyst wall protein gene. *Mol Microbiol* **15**: 955–63.
- Murphy TV, Nelson JD (1983). Five vs. ten days' therapy with furazolidone for giardiasis. *Am J Dis Child* **137**: 267–70.
- Nash TE (1997). Antigenic variation in *Giardia lamblia* and the host's immune response. *Phil Trans R Soc Lond Ser B Biol Sci* **352**: 1369–75.
- Nash TE, Herrington DA, Levine MM *et al.* (1990). Antigenic variation of *Giardia lamblia* in experimental human infections. *J Immunol* **144**: 4362–9.
- Nash TE, Herrington DA, Losonsky GA, Levine MM (1987). Experimental human infections with *Giardia lamblia*. *J Infect Dis* **156**: 974–84.
- Nash TE, McCutchan T, Keister D *et al.* (1985). Restriction-endonuclease analysis of DNA from 15 *Giardia* isolates obtained from humans and animals. *J Infect Dis* **152**: 64–73.
- Nash TE, Merritt JW, Conrad JT (1991). Isolate and epitope variability in susceptibility of *Giardia lamblia* to intestinal proteases. *Infect Immun* **59**: 1334–40.
- Nash TE, Mowatt MR (1992). Identification and characterization of a *Giardia lamblia* group-specific gene. *Exp Parasitol* **75**: 369–78.
- Nash TE, Ohl CA, Thomas E *et al.* (2001). Treatment of patients with refractory giardiasis. *Clin Infect Dis* **33**: 22–8.
- Nataro JP, Kaper JB (1998). Diarrheagenic *Escherichia coli*. *Clin Microbiol Rev* **11**: 142–201.
- Navin TR, Juranek DD, Ford M *et al.* (1985). Case-control study of waterborne giardiasis in Reno, Nevada. *Am J Epidemiol* **122**: 269–75.
- Nayak N, Ganguly NK, Walia BNS *et al.* (1987). Specific secretory IgA in the milk of *Giardia lamblia*-infected and uninfected women. *J Infect Dis* **155**: 724–7.
- Nieminski EC, Schaefer FWI, Ongerth JE (1995). Comparison of two methods for detection of *Giardia* cysts and *Cryptosporidium* oocysts in water. *Appl Environ Microbiol* **61**: 1714–19.

- Oberhuber G, Kastner N, Stolte M (1997). Giardiasis: a histologic analysis of 567 cases. *Scand J Infect Dis* **32**: 48–51.
- Olveda RK, Andrews JS, Hewlett EL (1982). Murine giardiasis: localization of trophozoites and small bowel histopathology during the course of infection. *Am J Trop Med Hyg* **31**: 60–6.
- Ongerth JE, Johnson RL, MacDonald SC *et al.* (1989). Backcountry water treatment to prevent giardiasis. *Am J Publ Health* **79**: 1633–7.
- Osterholm MT, Forfang JC, Ristinen TL *et al.* (1981). An outbreak of foodborne giardiasis. *N Engl J Med* **304**: 24–8.
- Overturf GD (1994). Endemic giardiasis in the United States—role of the daycare center (editorial). *Clin Infect Dis* **18**: 764–5.
- Owen RL, Allen CL, Stevens DP (1981). Phagocytosis of *Giardia muris* by macrophages in Peyer's patch epithelium in mice. *Infect Immun* **33**: 591–601.
- Oyerinde PO, Ogunbi O, Alonge AA (1977). Age and sex distribution of infections with *Entamoeba histolytica* and *Giardia intestinalis* in the Lagos population. *Int J Epidemiol* **6**: 231–4.
- Paintlia AS, Descoteaux S, Spencer B *et al.* (1998). *Giardia lamblia* groups A and B among young adults in India. *Clin Infect Dis* **26**: 190–1.
- Peattie DA (1990). The giardins of *Giardia lamblia*: genes and proteins with promise. *Parasitol Today* **6**: 52–6.
- Petersen H (1972). Giardiasis (lambliasis). *Scand J Gastroenterol* **7** (Suppl. 14): 1–44.
- Petersen LR, Cartter MC, Hadler JL (1988). A food-borne outbreak of *Giardia lamblia*. *J Infect Dis* **157**: 846–8.
- Pickering LK, Woodward WE, DuPont HL, Sullivan P (1984). Occurrence of *Giardia lamblia* in children in day care centers. *J Pediat* **104**: 522–6.
- Polis MA, Tuazon CU, Alling DW, Talamis E (1986). Transmission of *Giardia lamblia* from a day care center to the community. *Am J Publ Health* **76**: 1142–4.
- Porter JD, Ragassoni HP, Buchanon JD *et al.* (1988). *Giardia* transmission in a swimming pool. *Am J Publ Health* **78**: 659–62.
- Quick R, Paugh K, Addiss D *et al.* (1992). Restaurant-associated outbreak of giardiasis. *J Infect Dis* **166**: 673–6.
- Rauch AM, Rory VMT, Bartlett AV, Pickering LK (1990). Longitudinal study of *Giardia lamblia* infection in a day care center population. *Pediat Infect Dis J* **9**: 186–9.
- Reeder MM (1997). Radiological diagnosis of giardiasis. *Semin Roentgenol* **32**: 291–300.
- Reiner DS, Gillin FD (1992). Human secretory and serum antibodies recognize environmentally induced antigens of *Giardia lamblia*. *Infect Immun* **60**: 637–43.
- Reiner DS, Wang CS, Gillin FD (1986). Human milk kills *Giardia lamblia* by generating toxic lipolytic products. *J Infect Dis* **154**: 825–32.
- Rendtorff RC (1954). The experimental transmission of human intestinal protozoan parasites: II. *Giardia lamblia* cysts given in capsules. *Am J Hyg* **59**: 209–20.
- Reynoldson JA, Thompson RCA, Horton RJ (1992). Albendazole as a future anti-giardial agent. *Parasitol Today* **8**: 412–14.
- Ridley MJ, Ridley DS (1976). Serum antibodies and jejunal histology in giardiasis. *J Clin Pathol* **29**: 30–4.
- Roberts-Thomson IC, Mitchell GF (1978). Giardiasis in mice: I. Prolonged infections in certain mouse strains and hypothyroid (nude) mice. *Gastroenterology* **75**: 42–6.
- Roberts-Thomson IC, Stevens DP, Mahmoud AAF, Warren KS (1976a). Acquired resistance to infection in an animal model of giardiasis. *J Immunol* **117**: 2036–7.
- Roberts-Thomson IC, Stevens DP, Mahmoud AAF, Warren KS (1976b). Giardiasis in the mouse: an animal model. *Gastroenterology* **71**: 57–61.
- Robertson LJ (1996). Severe giardiasis and cryptosporidiosis in Scotland, UK. *Epidemiol Infect* **117**: 551–61.
- Roger AJ, Svard SG, Tovar J *et al.* (1998). A mitochondrial-like chaperonin 60 gene in *Giardia lamblia*: evidence that diplomonads once harbored an endosymbiont related to the progenitor of mitochondria. *Proc Natl Acad Sci USA* **95**: 229–34.
- Rosa FW, Baum C, Shaw M (1987). Pregnancy outcomes after first-trimester vaginitis drug therapy. *Obstet Gynecol* **69**: 751–5.
- Rosales-Borjas DM, Diaz-Rivadeneira J, Dona-Leyva A *et al.* (1998). Secretory immune response to membrane antigens during *Giardia lamblia* infection in humans. *Infect Immun* **66**: 756–9.
- Rosen FS, Cooper MD, Wedgwood RJP (1995). The primary immunodeficiencies. *N Engl J Med* **333**: 431–40.
- Rosenthal P, Liebman WM (1980). Comparative study of stool examinations, duodenal aspiration, and pediatric Entero-Test for giardiasis in children. *J Pediat* **96**: 278–9.
- Rosoff JD, Sanders CA, Sonnad SS *et al.* (1989). Stool diagnosis of giardiasis using a commercially available enzyme immunoassay to detect *Giardia*-specific antigen 65 (GSA 65). *J Clin Microbiol* **27**: 1997–2002.
- Rosoff JD, Stibbs HH (1986). Physical and chemical characterization of a *Giardia lamblia*-specific antigen useful in the coprodiagnosis of giardiasis. *J Clin Microbiol* **24**: 1079–83.
- Rotblatt MD (1983). Giardiasis and amebiasis in pregnancy. *Drug Intell Clin Pharmacol* **17**: 187–8.
- Sealy DP, Schuman SH (1983). Endemic giardiasis and day care. *Pediatrics* **72**: 154–8.
- Shaw PK, Brodsky RE, Lyman DO *et al.* (1977). A communitywide outbreak of giardiasis with evidence of transmission by a municipal water supply. *Ann Intern Med* **87**: 426–32.
- Shaw RA, Stevens MB (1987). The reactive arthritis of giardiasis. *J Am Med Assoc* **258**: 2734–5.
- Singer SM, Yee S, Nash TE (1998). Episomal and integrated maintenance of foreign DNA in *Giardia lamblia*. *Mol Biochem Parasitol* **92**: 59–69.
- Smith PD, Gillin FD, Spira WM *et al.* (1982). Chronic giardiasis: studies on drug sensitivity, toxin production, and host immune response. *Gastroenterology* **83**: 797–803.
- Snider DP, Gordon J, McDermott MR, Underdown BJ (1985). Chronic *Giardia muris* infection in anti-IgM-treated mice. *J Immunol* **134**: 4153–62.
- Soave R (1996). *Cyclospora*: an overview. *Clin Infect Dis* **23**: 429–35.
- Sogin ML, Gunderson JG, Elwood HJ *et al.* (1989). Phylogenetic meaning of the kingdom concept: an unusual ribosomal RNA from *Giardia lamblia*. *Science* **243**: 75–7.



- Soliman MM, Taghi-Kilani R, Abou-Shady AF *et al.* (1998). Comparison of serum antibody response to *Giardia lamblia* of symptomatic and asymptomatic patients. *Am J Trop Med Hyg* **58**: 232–9.
- Solomons NW (1982). Giardiasis: nutritional implications. *Rev Infect Dis* **4**: 859–69.
- Speelman P (1985). Single-dose tinidazole for the treatment of giardiasis. *Antimicrob Agents Chemotherapeut* **27**: 227–9.
- Stager S, Muller N (1997). *Giardia lamblia* infections in B-cell-deficient transgenic mice. *Infect Immun* **65**: 3944–6.
- Steiner TS, Thielman NM, Guerrant RL (1997). Protozoal agents: what are the dangers for the public water supply? *Ann Rev Med* **48**: 329–40.
- Stekete RW, Reid S, Cheng T *et al.* (1989). Recurrent outbreaks of giardiasis in a child care center, Wisconsin. *Am J Publ Health* **79**: 485–90.
- Stevens DP, Frank DM (1978). Local immunity in murine giardiasis: is milk protective at the expense of maternal gut? *Trans Assoc Am Physicians* **91**: 268–72.
- Stevens TL, Gibson GR, Adam R *et al.* (1997). Uptake and cellular localization of exogenous lipids by *Giardia lamblia*, a primitive eukaryote. *Exp Parasitol* **86**: 133–43.
- Strandén AM, Eckeret J, Köhler P (1990). Electrophoretic characterization of *Giardia* isolated from humans, cattle, sheep, and a dog in Switzerland. *J Parasitol* **76**: 660–8.
- Sullivan PB, Marsh MN, Phillips MB *et al.* (1991a). Prevalence and treatment of giardiasis in chronic diarrhoea and malnutrition. *Arch Dis Child* **66**: 304–6.
- Sullivan PB, Neale G, Cevallos AM, Farthing MJG (1991b). Evaluation of specific serum anti-*Giardia* IgM antibody response in diagnosis in children. *Trans R Soc Trop Med Hyg* **85**: 748–9.
- Sullivan PS, DuPont HL, Arafat RR *et al.* (1988). Illness and reservoirs associated with *Giardia lamblia* infection in rural Egypt: the case against treatment in developing world environments of high endemicity. *Am J Epidemiol* **127**: 1272–81.
- Sun CH, Chou CF, Tai JH (1998). Stable DNA transfection of the primitive protozoan pathogen *Giardia lamblia*. *Mol Biochem Parasitol* **92**: 123–32.
- Sutton DL, Kamath KR (1985). Giardiasis with protein-losing enteropathy. *J Pediat Gastroenterol Nutr* **4**: 56–9.
- Taylor GD, Wenman WM, Tyrrell DLJ (1987). Combined metronidazole and quinacrine hydrochloride therapy for chronic giardiasis. *Can Med Assoc J* **136**: 1179–80.
- Thompson RCA, Reynoldson JA, Mendis AH (1993). *Giardia* and giardiasis. *Adv Parasitol* **32**: 71–160.
- Thompson SC (1994). *Giardia lamblia* in children and the child care setting: a review of the literature. *J Paediat Child Health* **30**: 202–9.
- Thornton SA, West AH, DuPont HL, Pickering LK (1983). Comparison of methods for identification of *Giardia lamblia*. *Am J Clin Pathol* **80**: 858–60.
- Tomkins AM, Wright SG, Drasar BS, James WPT (1978). Bacterial colonization of jejunal mucosa in giardiasis. *Trans R Soc Trop Med Hyg* **72**: 33–6.
- Townson SM, Hanson GR, Upcroft JA, Upcroft P (1994). A purified ferredoxin from *Giardia duodenalis*. *Eur J Biochem* **220**: 439–46.
- Townson SM, Upcroft JA, Upcroft P (1996). Characterization and purification of pyruvate:ferredoxin oxidoreductase from *Giardia duodenalis*. *Mol Biochem Parasitol* **79**: 183–93.
- Underdown BJ, Skea DL, Loney GM, Snider DP (1988). Murine giardiasis and mucosal immunity: a model for the study of immunity to intestinal protozoan parasites. *Monogr Allergy* **24**: 287–96.
- Upcroft J, Mitchell R, Chen N, Upcroft P (1996a). Albendazole resistance in *Giardia* is correlated with cytoskeletal changes but not with a mutation at amino acid 200 in beta-tubulin. *Microb Drug Resist* **2**: 303–8.
- Upcroft J, Upcroft P (1998). My favorite cell: *Giardia*. *Bioessays* **20**: 256–63.
- Upcroft JA, Chen N, Upcroft P (1996b). Mapping variation in chromosome homologues of different *Giardia* strains. *Mol Biochem Parasitol* **76**: 135–43.
- Upcroft JA, Upcroft P, Boreham PFL (1990). Drug resistance in *Giardia intestinalis*. *Int J Parasitol* **20**: 489–96.
- van Keulen H, Homan WL, Erlandsen SL, Jarroll EL (1995). A three nucleotide signature sequence in small subunit rRNA divides human *Giardia* in two different genotypes. *J Eukaryot Microbiol* **42**: 392–4.
- Venkatesan P (1998). Albendazole. *J Antimicrob Chemother* **41**: 145–7.
- Visvesvara GS, Dickerson JW, Healy GR (1988). Variable infectivity of human-derived *Giardia lamblia* cysts for Mongolian gerbils (*Meriones unguiculatus*). *J Clin Microbiol* **26**: 837–41.
- Visvesvara GS, Smith PD, Healy GR, Brown WR (1980). An immunofluorescence test to detect serum antibodies to *Giardia lamblia*. *Ann Int Med* **93**: 802–5.
- Wallis PM, Erlandsen SL, Isaac-Renton JL *et al.* (1996). Prevalence of *Giardia* cysts and *Cryptosporidium* oocysts and characterization of *Giardia* spp. isolated from drinking water in Canada. *Appl Environ Microbiol* **62**: 2789–97.
- Ward HD, Keusch GT, Pereira MEA (1990). Induction of a phosphomannosyl binding lectin activity in *Giardia*. *Bioessays* **12**: 211–15.
- Weiss JB (1995). DNA probes and PCR diagnosis of parasitic infection. *Clin Microbiol Rev* **8**: 113–30.
- Weiss JB, van Keulen H, Nash TE (1992). Classification of subgroups of *Giardia lamblia* based upon ribosomal RNA gene sequence using the polymerase chain reaction. *Mol Biochem Parasitol* **54**: 73–86.
- Welsh JD, Poley JR, Hensley J, Bhatia M (1984). Intestinal disaccharidase and alkaline phosphatase activity in giardiasis. *J Pediat Gastroenterol Nutr* **3**: 37–40.
- White KE, Hedberg CW, Edmonson LM *et al.* (1989). An outbreak of giardiasis in a nursing home with evidence for multiple modes of transmission. *J Infect Dis* **160**: 298–304.
- Wolfe MS (1975). Giardiasis. *J Am Med Assoc* **233**: 1362–5.
- Wolfe MS (1992). Giardiasis. *Clin Microbiol Rev* **5**: 93–100.
- Woo PK (1984). Evidence for animal reservoirs and transmission of *Giardia* infection between animal species. In Erlandsen SL, Meyer EA (eds), *Giardia and giardiasis*. Plenum: New York; 341–64.
- Wright RA, Spencer HC, Brodsky RE, Vernon TM (1977). Giardiasis in Colorado: an epidemiologic study. *Am J Epidemiol* **105**: 330–6.
- Zaat JO, Mank TG, Assendelft WJ (1997). A systematic review on the treatment of giardiasis. *Trop Med Int Health* **2**: 63–82.



# Trichomonads

J. P. Ackers

London School of Hygiene and Tropical Medicine, UK

'Trichomonads' is the term usually applied to members of the Order Trichomonadida, which comprises a number of parasitic protozoans, typically having four to six flagella. True cysts are known in very few, if any, species and none are formed by any of the trichomonads of importance in human medicine. These latter comprise four species—*Trichomonas vaginalis*, *Trichomonas tenax*, *Pentatrichomonas hominis* and *Dientamoeba*

*fragilis*, of which *T. vaginalis* is the most important. In human medicine, the term 'trichomoniasis' is invariably used to mean 'infection with *T. vaginalis*' (with or without symptoms). In this short chapter, extensive references are generally given only for statements of clinical importance, otherwise only selected publications are mentioned. A good general starting point for further enquiries is the monumental volume edited by Honigberg (1989).

## TRICHOMONAS VAGINALIS (DONNÉ)

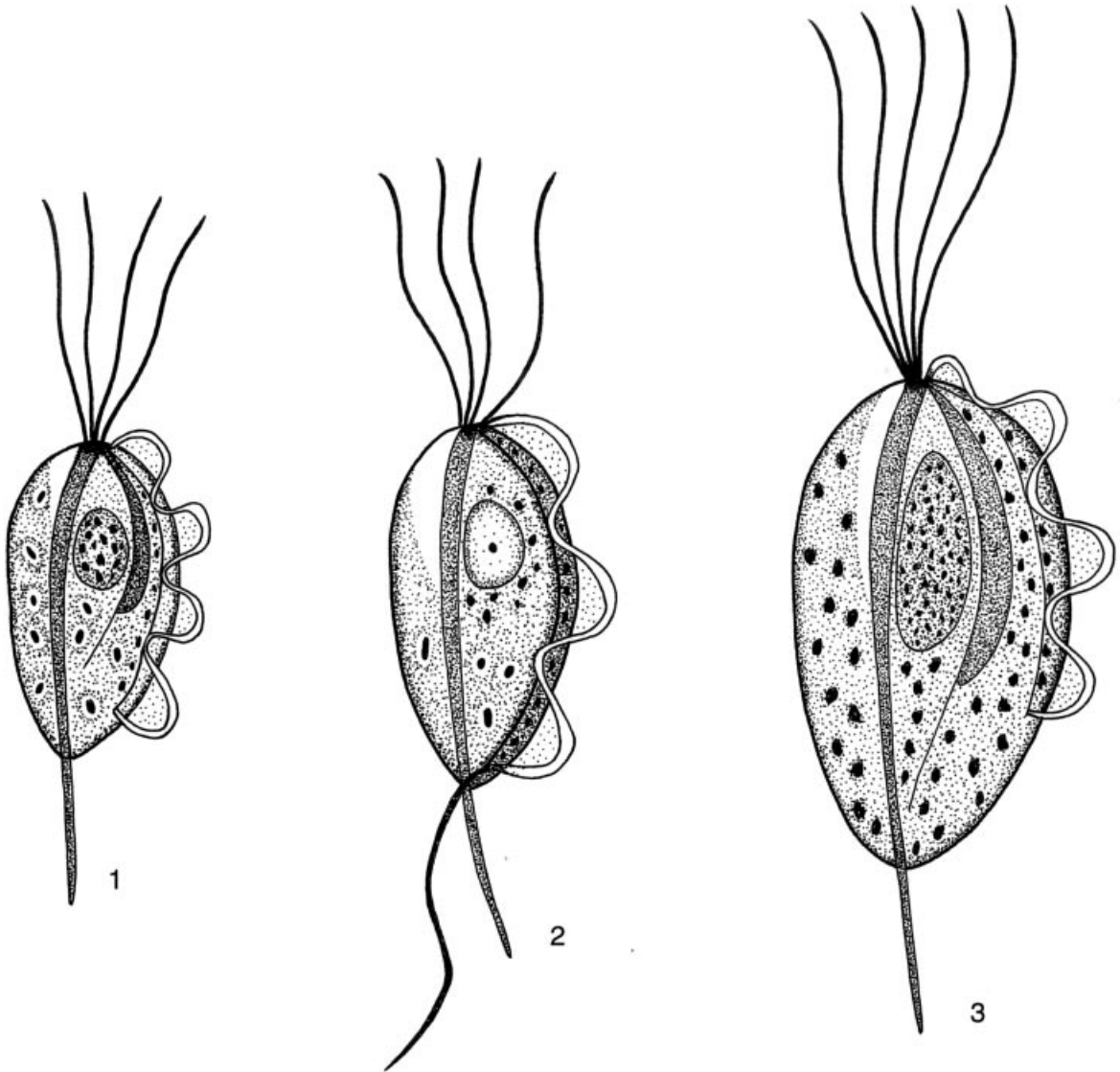
### HISTORICAL INTRODUCTION

The organism which we now know as *Trichomonas vaginalis* was first described in 1836 by the French scientist Alfred Donné; he had observed it in the abnormal discharge from a woman suffering from vaginitis. Initially he was inclined to believe that the presence of these organisms was related to the existence of vaginitis but he later changed his mind after finding them in asymptomatic women. For the next 80 years the organisms were generally regarded as harmless commensals and it was not until 1916 that Höhne asserted that *T. vaginalis* was the aetiological agent in some cases of vaginitis. That concept took many years to become universally accepted (Honigberg, 1978) but no-one now doubts that *T. vaginalis* is a genuine pathogen. The organism naturally forms the subject matter of the greater part of Honigberg's monograph (1989) and three

relatively recent reviews (Wolner Hannsen *et al.*, 1989; Krieger, 1995; Petrin *et al.*, 1998) will also be found useful.

### DESCRIPTION OF THE ORGANISM

Light microscopy (Figures 11.1, 11.2) shows *T. vaginalis* to be pear-shaped, approximately 10–13 × 8–10 μm (when living; fixed and stained organisms are about 25% smaller), with four anterior flagella and a fold of cytoplasm; the undulating membrane, running along one side of the body for about two-thirds of its length. The latter is supported by a third rod called the costa; its wave-like motion is produced by a fifth (recurrent) flagellum attached to it. In *T. vaginalis* and *T. tenax* this does not extend beyond the end of the undulating membrane to form a free

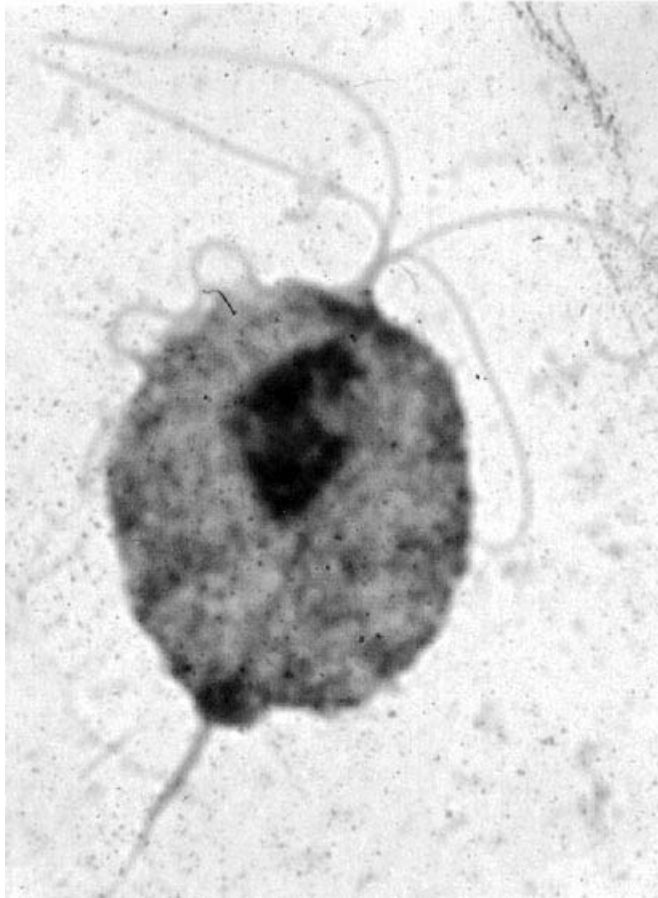


**Fig. 11.1** Line drawing of the three trichomonads that parasitize human beings. 1, *Trichomonas vaginalis*; 2, *Trichomonas tenax*; 3, *Pentatrichomonas hominis*.  $\times 2500$

flagellum, while in *P. hominis* it does (Figure 11.1). A rigid microtubular rod, the axostyle, runs through the body of the organism and appears to project from its posterior end; the prominent nucleus is enfolded by the anterior end of the axostyle. Electron microscopy (Honigberg and Brugerolle, 1989) reveals the deeply staining parabasal body to consist of an elaborate Golgi complex supported by filaments; anterior to this the basal bodies (one orthogonal to the other

four), from which the flagella arise, comprise the kinetosomal complex. An intricate system of microtubular organelles presumably maintains the shape of the organism. A considerable number of electron-dense granules are also present, arranged alongside the costa and the axostyle; these are now identified as hydrogenosomes (see below).

The description given here refers to *T. vaginalis* in clinical specimens or free in culture; it has long



**Fig. 11.2** *Trichomonas vaginalis* from axenic culture. Giemsa,  $\times 6000$

been known, however, that it will adhere to certain cultured cells and some non-living surfaces, becoming much more amoeboid in the process (Arroyo *et al.*, 1993). In contact with vaginal epithelial cells *in vitro*, the organism became extremely flattened and adherent and it seems likely that this is their normal morphological form in infected females.

### Classification

Classically, *T. vaginalis* is placed in a well-characterized Order Trichomonadida within the Superorder Parabasalidea; as a non-photosynthetic flagellate, the higher classification is Class Zoomastigophorea, Subphylum Mastigophora, Phylum Sarcomastigophora. Although

the first two taxa are almost certainly valid, the larger scheme probably relies too much on features (such as modes of locomotion) much subject to convergent evolution to give an accurate phylogenetic tree. Molecular taxonomy suggests that trichomonads branched very early from the main eukaryotic line of descent, although the suggestion that this occurred before the acquisition of the pre-mitochondrial symbiont appear to have been disproved (Roger *et al.*, 1996).

Hydrogenosomes (the electron-dense granules) are membrane-bound organelles, functionally equivalent to but metabolically very different from mitochondria. Within them pyruvate is oxidised and further ATP is produced; under strictly anaerobic conditions, protons act as terminal electron acceptors and molecular

hydrogen is evolved. Whether hydrogenosomes are highly evolved mitochondria, arose following a separate endosymbiotic event or have some different origin is not clear, although evidence supporting the first suggestion is increasing.

## **PATHOGENESIS**

In women trichomoniasis may present as anything from an asymptomatic infection to an acute inflammatory disease, with a copious and malodorous discharge. The severity of the discharge may wax and wane over time and untreated, the infection may be spontaneously lost or may persist for many months or years. *T. vaginalis* may be found in the vagina and the exterior cervix in over 95% of infections, but is only recovered from the endocervix in 13%. The urethra and Skene's glands are also very commonly infected. In men the urethra is the most common site of infection, but the organism has also been recovered from epididymal aspirates. Prostatic involvement has been reported, but its frequency and significance are not clear. Asymptomatic infections are more common than in women, although not nearly as characteristic as is frequently believed (Krieger *et al.*, 1993). In both sexes, dissemination beyond the lower urogenital tract is extremely rare and is not regularly found even in severely immunocompromised patients.

In women, signs of erythema and capillary fragility are often present. Cervical and vaginal biopsies reveal areas of surface necrosis, erosion of the epithelium and infiltration by polymorphs and macrophages. Increased epithelial and subepithelial vascularity and small subepithelial haemorrhages are also observed in such specimens (Gupta and Frost, 1989). Intracellular organisms have also been observed and tissue invasion has also been seen in human prostatic tissues (Gardner *et al.*, 1986). *T. vaginalis* is chemotactic for neutrophils; in this case a low molecular weight product has been implicated but in the case of the related cattle parasite, *Tritrichomonas foetus*, the molecule concerned appears to be the enzyme superoxide dismutase. Neutrophils, attracted this way and also, possibly, as the result of alternative pathway complement activation, make up the

bulk of the discharge observed in female cases of trichomoniasis.

## **Hormonal Influence**

In women the nature of the vaginal epithelium and the resident bacterial flora are both profoundly affected by hormonal status. After puberty the vaginal stratified squamous epithelial cells are rich in glycogen and the microbial flora is dominated by lactobacilli; the pH is low (about 4.5, partly but not exclusively because of bacterial lactic acid production) and the redox potential is relatively high. These conditions discourage colonization by anaerobic bacteria. They are also far from ideal for *T. vaginalis* which, *in vitro* at least, grows best at pH 6 and under low oxygen tension. Nevertheless, it is in this milieu that the organism grows most luxuriantly under natural conditions. Interestingly, in infected women lactobacilli tend to disappear, the pH rises and anaerobic bacteria join the vaginal flora; if, and if so how, *T. vaginalis* brings about this change is not known.

Glycogen-rich stratified epithelial cells (but not lactobacilli) are also transiently present in new born girls who are influenced by their mother's oestrogen and it is these conditions which are believed to allow colonization in neonatal trichomoniasis. As soon as the effect of exogenous oestrogen fades, glycogen disappears and the pH rises, these conditions persisting until puberty. Similar changes occur later after the menopause that, if not ideal for colonization by *T. vaginalis* they are clearly not impossible, since both prepubertal and post-menopausal trichomoniasis in females are well described. The hormonal influences, if any, on colonization of males are, however, very little known. Unusually for a sexually transmitted infection (STI), trichomoniasis in women appears to be less prevalent in oral contraceptive users than in those using barrier methods.

## **Virulence Factors**

A number of putative virulence factors have been tentatively identified but the relationship between

them and the observed signs and symptoms is far from clear.

It seems likely that the severity of the illness in women is due to both host- and parasite-related factors; the importance of the former is suggested by the fact that about one-third of untreated asymptomatic women become symptomatic over the following 6 months and that several women who have been in sexual contact with the same infected man can show widely different clinical pictures (Rein, 1989). On the other hand, isolates of *T. vaginalis* have been shown to differ in serotype, growth rate and zymodeme (isozyme pattern). Both small size and slow growth rate of isolates in culture have been linked to more severe clinical illness but no consistent correlation of zymodeme with virulence has been detected. Although long-lasting vaginal infections in mice are not easy to establish, *T. vaginalis* is highly virulent in this species when injected either intraperitoneally or subcutaneously. The severity of the pathology or the size of the resulting abscess has been correlated with the severity of signs and symptoms in the women from whom the isolates were obtained (Kulda, 1989). Test procedures must be rigorously standardized to obtain reproducible results, but the real value of these experiments is in showing that some part of the variable severity of human trichomoniasis is probably due to parasite rather than host factors.

The experimentally determined activities of the parasite that have been suggested as virulence factors include those involved in adhesion, proteolysis, haemolysis, detachment of cultured mammalian cells from their substrate (cell-detaching factor, CDF) and cytotoxicity.

Adherence to host cells is a common feature of infections with many pathogenic microorganisms, permitting both colonization and persistence. There is no doubt that *T. vaginalis* can adhere strongly to epithelial cells, undergoing a profound morphological change as it does so (Arroyo *et al.*, 1993); at least four adhesins (AP65, AP51, AP33 and AP23) are involved in this process (Alderete *et al.*, 1995a). Expression of all four proteins is decreased when organisms are grown in low-iron medium; in women, parasite numbers decrease during menstruation (Demes *et al.*, 1988a) and it has been suggested that the upregulation of adhesin levels produced by the availability of additional iron may help the

organism to persist through what is clearly an unfavourable environmental change. Otherwise, there is no strong evidence for the involvement of adhesins in pathogenicity. Adhesins alone are not sufficient to ensure adherence—surface proteases are also necessary.

Of the other *in vitro* activities, levels of extracellular proteases did not correlate with virulence but those of CDF and haemolysin apparently did. CDF is a heat- and acid-stable glycoprotein that has been purified from culture filtrates which, when applied to monolayer cultures, causes the cells to detach but not to die. Controversy surrounds the haemolytic activity of *T. vaginalis*; first described in detail by Dailey *et al.* (1990), the molecule has never been fully characterized, although a pore-forming protein may be involved (Fiori *et al.*, 1996).

When cultures of *T. vaginalis* are applied to monolayers of cultured mammalian cells, rapid destruction occurs. The process is usually termed 'contact-mediated cytotoxicity' and has been extensively studied by both light and electron microscopy (González-Robles *et al.*, 1995) but, again, doubts have been raised about how specific it is (Pindak *et al.*, 1993). Lysis of target cells are slower and less complete when a less virulent strain of *T. vaginalis* was employed (González-Robles *et al.*, 1995).

### Unpleasant but Essentially Harmless?

No-one could possibly doubt the unpleasantness of symptomatic trichomoniasis to the sufferer and this is vividly illustrated by the distress of those, fortunately rare, patients from whom the organism cannot be eliminated. However, the possibility of more significant and long-term harm has only been taken seriously quite recently.

The fact that many patients are simultaneously infected with more than one STI is usually attributed to a common mode of transmission of the latter, but there were suggestions that both viruses and bacteria (specifically *Neisseria gonorrhoeae*) might be carried far up the genitourinary tract by the motile and phagocytic *T. vaginalis*; it was also speculated that such bacteria would be protected from contact with

antibiotics. Although some evidence for short-term survival of viruses was obtained, ingested bacteria were rapidly killed and interest in this area has waned.

It has long been known that the presence of ulcerating STIs increases the probability of the transmission of HIV during heterosexual intercourse, but more recently the role of non-ulcerating infections, such as trichomoniasis, has received attention. In 1993, Laga *et al.* found that the odds ratio for seroconversion to HIV positivity was 1.9 for female prostitutes in the Democratic Republic of Congo (formerly Zaire, 1971–1997) infected with *T. vaginalis*; an earlier study (ter Meulen *et al.*, 1992) had found an even higher relative risk (2.96) amongst gynaecological inpatients in Tanzania. Because all the factors that lead to a higher incidence of trichomoniasis in a population also increase the risk of infection with HIV, it is very difficult to control this type of study adequately and to be sure that trichomoniasis is an independent risk factor; it is also fair to say that other studies have not found a significantly increased risk or have suggested that bacterial vaginosis is more important. Nevertheless, the effect is biologically plausible and could be brought about in at least two ways—the fragile and oedematous vaginal wall bleeds easily when touched and this could make virus entry or exit much more likely, and neutrophils (for which *T. vaginalis* is powerfully chemotactic) induce HIV replication in infected mononuclear cells (Ho *et al.*, 1995). Even asymptomatic males infected with *T. vaginalis* may frequently have urethral inflammation (Jackson *et al.*, 1997) and urethritis in males leads to an increase in the concentration of HIV-1 in semen (Cohen *et al.*, 1997). Similarly, in HIV-1 seropositive pregnant women, abnormal cervical and vaginal discharge was associated with increased genital virus shedding and thus, potentially, with an increased risk of vertical transmission of HIV. Overall, even if the relative risk of HIV transmission associated with *T. vaginalis* infection is lower than that due to other STIs, the fact that trichomoniasis is so common means that the total effect could be highly significant.

Both older (Hardy *et al.*, 1984) and more recent (Cotch *et al.*, 1997) studies have detected an association between trichomoniasis in pregnancy and an increased risk of adverse outcome—pre-

term delivery or low birth weight, although, again other workers have found non-significant results or an association with other pathogens. Although *T. vaginalis* infection *per se* has never been convincingly linked to pelvic inflammatory disease as a co-factor in women infected with *Chlamydia trachomatis*, it recently has (Paisarntantiwong *et al.*, 1995).

Finally, what of carcinoma of the cervix? It is well known that the non-specific inflammatory responses that occur in infected women cause changes in epithelial cell morphology which make interpretation of Papanicolaou-stained smears difficult (Gupta and Frost, 1989); the usual advice is to treat the patient and repeat the examination after 3 months. Suggestions of a causal link between trichomoniasis and cervical carcinoma were generally rejected as merely the consequences of similar risk factors. However, in recent years Zhang and colleagues have re-analysed 24 previous studies (1994) and conducted a prospective study in China (1995), as a result of which they believe that *T. vaginalis* may be true cause of 4–5% of cervical cancers in that country. A genuine role of *T. vaginalis* as a predictor of cervical neoplasia was also found by Viikki *et al.* (2000). For a recent review see Boyle and Smith (1999).

## IMMUNOLOGY

A very large literature, much in eastern European languages, exists on this subject; it has been expertly summarized by Honigberg (1970). A later review (Ackers, 1989) discusses more recent work and should be consulted for more details than can be accommodated here.

Clinical experience shows that repeated infections with *T. vaginalis* can occur and that in most cases the parasite is not rapidly cleared without treatment. A long-lasting sterile immunity clearly does not result, although the majority of women will develop modest levels of serum antibody. This response has been extensively studied in the hopes of developing a serodiagnostic test, but a combination of generally modest titres, background natural antibodies in uninfected persons and considerable antigenic diversity has meant that no such tests have been found to be useful in



practice; the immune response in males is, in general, even more feeble. Local IgA responses occur in some women but were not detected in a small study of male patients and did not seem to protect against reinfections in a primate model.

Cell-mediated immune responses in human trichomoniasis are even less well-defined, although delayed-type hypersensitivity may be detected by skin testing in a proportion of patients. The contribution, if any, of these responses to host defence is not known, although unactivated human macrophages appear to be able to kill *T. vaginalis*. The predominant cell type in the discharge seen in many patients is, however, the neutrophil, which the parasite appears to attract both by releasing chemotactic factors (see above) and by activating complement via the alternative pathway; these cells may then be activated by a parasite-derived factor similar to leukotriene B<sub>4</sub>. Anti-trichomonal IgG augments this response. This behaviour by the parasite seems most unwise, since neutrophils can kill *T. vaginalis*, apparently via bound C3b.

The ability of human complement to kill trichomonads, either directly or with the help of neutrophils, may well be one of the factors that prevent systemic dissemination by *T. vaginalis*—a fortunate circumstance, given the highly pathogenic nature of the organisms when artificially introduced into the skin or peritoneal cavity of mice. Freshly isolated strains differ greatly in their susceptibility to complement-mediated killing, although all seem to become uniformly sensitive after prolonged *in vitro* cultivation (Demes *et al.*, 1988b). Cervical mucus contains very little complement and menstrual blood significantly lower levels than those found in serum. The presence of complement in the vagina during menstruation may account for the lower number of parasites found at that time (Demes *et al.*, 1988a); the fact that iron increases the complement resistance of *T. vaginalis* (Alderete *et al.*, 1995b) may represent a response by the parasite to a temporarily hostile environment.

Other factors that may limit the dissemination or multiplication of *T. vaginalis* include its predilection for squamous epithelium and, in males, the high levels of zinc present in prostatic fluid (Krieger and Rein, 1982); the modest role of specific immune responses in controlling trichomoniasis is emphasized by the general absence of

reports of more severe disease in patients with HIV/AIDS.

A particular problem in studying the immunology of trichomoniasis is that most available animal models either do not result in long-lasting, symptomatic infections or are quite unphysiological. Intravaginal infections in small laboratory animals are usually transitory and asymptomatic, although altering the vaginal milieu can improve matters (McGrory and Garber, 1992). A primate model (in *Saimiri sciurius*) develops realistic histopathology (Gardner *et al.*, 1987), and infection with the bovine parasite *Tritrichomonas foetus* has been proposed as a guide to understanding trichomoniasis in women.

## MOLECULAR BIOLOGY

The molecular biology of *T. vaginalis* is not well studied or understood—this is nicely illustrated by considering the organism's chromosome number. As with many protozoans, mitosis occurs without dissolution of the nuclear membrane and clearly visible condensed chromosomes are not seen. Thus, neither the karyotype nor the ploidy are known for certain. Very recently, two groups have published answers to this problem; unfortunately they do not wholly agree, for while both describe six different chromosomes, one finds the organism to be diploid but the other haploid.

A complex relationship exists between expression of a highly immunogenic glycoprotein (referred to as P270) on the surface of *T. vaginalis* and other biological properties. All strains seem to contain the gene for P270 and to synthesize the P270 protein, but in some isolates (Type I strains) P270 is exclusively cytoplasmic, while in others (Type II strains) it is also expressed on the cell surface—not continuously, however, for Type II strains alternately express P270 and the four adhesins (AP65, AP51, AP33 and AP23) described above (Alderete, 1988). The phenotype is described by the expression of P270—those cells expressing it are positive, those expressing adhesins instead are of negative phenotype. Because only negative Type II cells express adhesins, only they can bind to and kill target cells *in vitro*. Further complexity is provided by the observation that only negative phenotype

cells are found to harbour the double-stranded RNA virus present in some isolates, suggesting that the presence of this virus somehow controls the surface expression of P270. Undoubtedly those observations represent but a small part of the complex responses that all pathogens make to the changing host environment (Petrin *et al.*, 1998), but at present we do not know enough to understand fully what is going on.

## EPIDEMIOLOGY

### Prevalence

Trichomoniasis is probably the most prevalent non-viral STI in the world, with at least 170 million new infections acquired per annum (WHO, 1995); is certainly much more common than the classical STIs (Table 11.1).

Few if any studies have been made of genuinely unselected populations, and the majority of surveys have examined either pregnant women or those attending STI clinics. There are wide national variations, but most report 10–25% infected, although the full range is 0–63% (Lossick, 1989). The highest incidence coincides with the years of maximum sexual activity. In most clinical surveys, female cases outnumber male by 5 or 10 to 1, partly because the number of parasites in males is usually much lower than in females and because the proportion of male partners of infected women who are diagnosed positive declines quite rapidly with time after exposure. In the last 20 years the

incidence in developed countries has declined sharply (Evans *et al.*, 1995; Kent, 1991); the reasons for this are not known but behavioural changes seem the most likely explanation. In contrast, in less developed countries and amongst some disadvantaged groups in developed ones, the infection appears still to be extremely widespread. Human trichomoniasis is becoming a disease of the underprivileged.

### Transmission

Forty years ago a review of the epidemiological evidence concluded that the vast majority of cases of trichomoniasis were acquired through sexual contact (Whittington, 1957) and nothing discovered since has seriously challenged that conclusion. Four lines of evidence support the classification of trichomoniasis as an almost exclusively sexually-acquired infection: (a) in most surveys, the prevalence is highest in the age groups corresponding to the period of maximum sexual activity and is much lower before puberty or after the menopause; (b) the prevalence is much higher in populations (such as STI clinic attenders) with a high prevalence of other STIs than in the general population (to the extent that such data are available); (c) although symptomatic trichomoniasis in males is uncommon, *T. vaginalis* can be recovered from the urethra and/or the prostate of a highly significant proportion of the male contacts of women with trichomoniasis; and (d) the parasite dies rapidly when dried or exposed to high or low temperatures (no resistant cyst is formed by *T. vaginalis*). Use of both male and female condoms reduces the risk of transmission. Mechanical transfer between sexual partners on fingers, vibrators or sex toys is possible and has been recorded. The number of cases of gonorrhoea and trichomoniasis in women in England and Wales has declined in parallel over a 15 year period (Figure 11.3), suggesting that whatever has caused this drop is acting on similar epidemiological situations.

Most epidemiological studies conducted in the USA have shown a higher prevalence of trichomoniasis in Black patients than in members of other racial groups (Cotch *et al.*, 1991); this

**Table 11.1** Two recent estimates of the number of new cases (millions) of certain sexually transmitted infections acquired each year, world-wide

Infection	1992 Estimate*	1995 Estimate**
Trichomoniasis	120	170
Chlamydia	50	89
Genital warts	30	ND
Gonorrhoea	35	62
Genital herpes	20	ND
Syphilis	3.5	12
Hepatitis B	2.5	ND
Chancroid	2	7 approx.

\*Data from Quinn (1994).

\*\*Data from WHO (1995).

ND, no data included.

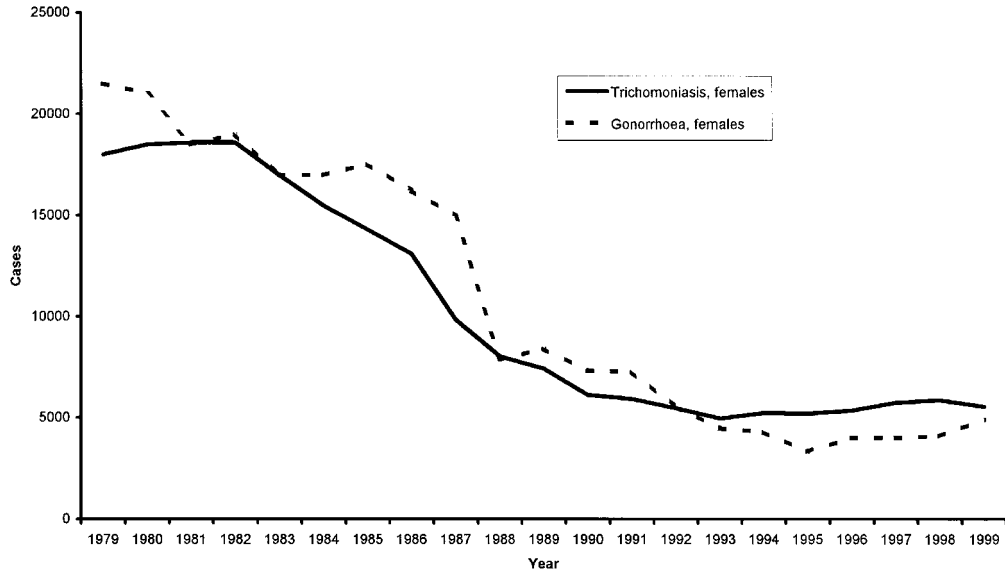


Fig. 11.3 Number of cases of trichomoniasis and gonorrhoea in women, reported in England and Wales, 1979–1999

difference is usually attributed to socioeconomic and behavioural factors but an enhanced susceptibility due to a generally higher vaginal pH has also been suggested (Stevens Simon *et al.*, 1994). For unknown reasons, the prevalence of trichomoniasis in women seems to decline more slowly with age than other STIs, such as gonorrhoea; it is possible that this phenomenon is caused by long-lasting asymptomatic infections that subsequently recrudescence. If such cases are common, they could have major epidemiological implications as reservoirs of infection.

### Transmission of *T. vaginalis* without Deliberate Sexual Contact

Despite the undoubted overwhelming importance of sexual contact in the epidemiology of trichomoniasis, because *T. vaginalis* can survive for a surprisingly long time outside the body if kept moist (Table 11.2), the possibility of transmission via toilet seats, shared sponges or towels, communal bathing or living under poor and overcrowded conditions has been raised. Furthermore, Whittington (1957) showed that on four of 38 occasions *T. vaginalis* could be

cultivated from toilet seats after use by women with trichomoniasis. Nevertheless, while admitting the theoretical possibility, she and most other authors regard transmission without sexual contact as very unlikely in practice.

Because trichomonads are found in both the mouth (*T. tenax*) and in the large bowel (*P. hominis*), it is natural to wonder if either organism could survive in the genitourinary tract if introduced there. There is very good evidence, however (summarized by Wenrich 1947), that each species is strictly site-specific.

Rosedale (1977), impressed by a number of infected women who were members of apparently strictly monogamous couples, felt that the label 'sexually transmitted' was unwarranted and caused unnecessary distress to his patients; in addition, he did not treat their male sexual partners and still obtained cure rates as good as other clinics which did. The author did not speculate as to how his female patients *did* become infected, but it has been postulated that chronic and asymptomatic infections could exist from birth (see below) and be provoked into clinical disease by the psychological and hormonal changes accompanying the start of regular sexual intercourse. Apart from any other objections, this interesting idea would seem to founder

**Table 11.2** Survival of *T. vaginalis* outside the human body under various conditions

Material	Temperature (°C)	Variable <i>T. vaginalis</i> organisms still present after:	Reference
Vaginal exudate	10 approx.	Up to 48 hours (1/11 samples)	Whittington, 1951
Urine + vaginal secretion	20	9–20 hours	Jirovec and Petru, 1968
Isotonic saline	30	All dead after 150 minutes	Kostara <i>et al.</i> , 1998
Semen	Not stated	6 hours	Keutel, quoted by Gallai and Sylvestre, 1966
Moist washcloths*	Room temperature	3 hours, 1/15 at 23 hours	Burch <i>et al.</i> , 1959
Dry vaginal exudate†	Room temperature	1–2 hours, rarely up to 6 hours	Jirovec and Petru, 1968; Kessel and Thompson, 1950
Vaginal material on hard plastic or polished wood toilet seat	11–15	45 minutes	Whittington, 1957
Vaginal material on absorbent wood toilet seat	11	30 minutes	Whittington, 1957
Warm mineral bath water	Not stated	30 minutes–3 hours	Krieger and Kimmig, 1995
Chlorinated swimming pool water	Not stated	A few seconds	Nett and Schar, 1986

The organism cannot survive freezing (in the absence of a cryoprotectant), exposure to temperatures above 44°C, drying or direct sunlight (Jirovec and Petru, 1968), but viability is preserved for several days in transport or culture media (Whittington, 1957).

\*External genitalia of 38 women were wiped with moist cloths; about 15 cloths became culture-positive for *T. vaginalis*.

†On wood, brass, paper, towelling and sponge.

on the apparent rarity of cases of neonatal trichomoniasis. Nevertheless, Rosedales's experience is certainly shared by other practising physicians.

### Trichomoniasis in Children

Trichomonal vaginitis has been described many times in pre-pubertal children; Neinstein *et al.* (1984) listed 10 publications which reported 48 cases amongst 1740 children examined, and Kurnatowska and Komorowska (1989) devote an entire chapter to the subject. In almost all of the earlier literature, the possibility of infection through sexual abuse does not seem to have been considered and the existence of alternative routes of infection was taken for granted, as it still is by a number of authors (Adu Sarkodie, 1995). Although some apparently very convincing cases have been reported (Charles, 1991; Adu Sarkodie, 1995), they are probably rare and trichomoniasis in children should always raise the suspicion of sexual abuse (Neinstein *et al.*, 1984; Jones *et al.*, 1985). Clearly, though, even the theoretical possibility of alternative sources for the infection has medico-legal implications (Ross *et al.*, 1993).

### Neonatal Trichomoniasis

A special case of prepubertal infection is that of neonatal trichomoniasis in girls. Women with trichomoniasis may occasionally infect their female babies while giving birth (Crowther, 1962; Al Salihi *et al.*, 1974; Danesh *et al.*, 1995); however, transmission to the baby does not necessarily occur, even from mothers infected at the time of delivery. In one study, 14 female babies delivered to such mothers were repeatedly examined, but none were found to harbour the parasite (Bramley 1976). The organism is believed to be able to establish itself because the baby's vaginal epithelium is under the influence of maternal oestrogen; as the hormone levels drop it is commonly found that the infection is spontaneously lost, but it also responds to treatment with metronidazole.

## CLINICAL FEATURES

### Trichomoniasis in Women

In most published studies 10–50% of women infected with *T. vaginalis* are found to be asymptomatic at the time of examination, although one-third may be expected to become

**Table 11.3** Symptoms and signs that were significantly associated with infection with *T. vaginalis* in a group of 118 women attending an STI clinic

Symptom or sign	Present in (%)
Yellow discharge	42
Abnormal vaginal odour	50
Vulvar itching	60
Colpitis macularis	44
Purulent discharge	59
Homogeneous discharge	66
Frothy discharge	8
Vulvar erythema	37
Vaginal erythema	20

Adapted from Wolner Hanssen *et al.* (1989).

symptomatic within 6 months (Rein, 1989). Both vaginal pH and bacterial flora may be quite normal.

Women who do have symptoms usually complain of vaginal discharge and vulvovaginal soreness and irritation; dysuria and dyspareunia are also frequently mentioned. However, multiple infections are common in patients with trichomoniasis and it has proved difficult to extract the symptoms specifically due to *T. vaginalis*. A recent study (Wolner Hanssen *et al.*, 1989) found nine symptoms or signs to be significantly associated with trichomoniasis (Table 11.3); however, after eliminating confounding variables, only symptoms of yellow vaginal discharge and vulvar itching and signs of colpitis macularis (strawberry cervix), purulent vaginal discharge and vulval and vaginal erythema remained significantly associated with the infection. Colpitis macularis (defined as diffuse or patchy maculoerythematous lesions of the ectocervical epithelium) was seen frequently if colposcopy was undertaken, but hardly ever found by naked-eye examination. Vaginal pH is generally raised above the normal value of 4.5. Signs and symptoms vary in intensity and are usually worst at the time of menstruation. Clinical experience and a small number of volunteer studies suggest an incubation period of 5–28 days in women.

### Trichomoniasis in Men

In various studies, *T. vaginalis* has been isolated from 14–60% of the male partners of infected

women (Krieger, 1995). However, many men with trichomoniasis are asymptomatic; nevertheless, the parasite is clearly responsible for a small but significant proportion (5–15%) of cases of non-gonococcal urethritis. The discharge is usually only present in very small amounts, but the condition is not clinically distinguishable from other types of non-gonococcal urethritis. The incubation period has been reported as 3–8 days in clinical studies and was 6–9 days in a very small group of volunteers infected with cultured organisms (Lancely and McEntegart, 1953). A recent review (Krieger, 1995) discusses this often-neglected disease.

### LABORATORY DIAGNOSIS

The symptoms and signs described above are too non-specific to establish the diagnosis, which must be made by detecting the parasite or its products.

#### Wet-film Examination

Diagnosis of trichomoniasis is still most frequent (and certainly most rapidly and cheaply) carried out by wet-film microscopic examination of vaginal secretions, urethral scrapings mixed with a drop of saline, centrifuged urine sediment or prostate fluid. The specimen should be examined as soon as possible, as the size and jerky motility of a living organism are all but diagnostic. Identification as a trichomonad is confirmed by observing the flagella (in healthy organisms they will be moving too quickly to be counted) and the undulating membrane. Phase-contrast, dark-field or bright-field illumination should be used, with the substage condenser almost closed. Wet-film microscopy will detect about half to three-quarters of infected women, but only 1–20% of infected men.

Although the morphology of the three human trichomonads is not identical (Figure 11.1) in reality they cannot be distinguished in wet preparations by light microscopy and reliance must be placed on the site-specificity of each species. In very unusual cases (see below), trichomonads have been recovered from sites

other than the urogenital tract, the oral cavity or the large intestine and faeces; in these cases it is often impossible to make an absolutely certain identification of the species involved. Finally, it is important to be aware of the existence of detached ciliary tufts; these are anucleate fragments of ciliated columnar epithelial cells which may be found in many body fluids, probably without clinicopathological significance. Surprisingly, the cilia continue to beat vigorously for up to 48 hours and these cell fragments have in the past been mistaken for pathogenic protozoa (Ashfaq Drewett *et al.*, 1990).

### Other Microscopical Methods

Preparing fixed and stained specimens, although it has been widely investigated, does not on balance seem to increase sensitivity, and immediacy is lost. Mixing the fluorescent dye acridine Orange with the specimen has been claimed to make the method more sensitive than culture by some workers, but not by others; the method suffers from the disadvantage that an expensive fluorescence microscope is needed. Papanicolaou staining is an attractive idea; not only is it widely available, but the ability to diagnose infection with *T. vaginalis* from routine cervical smears would clearly be valuable. However, results have been mixed; some investigators have found the method useful but others have found it very difficult to make a positive identification using this technique and suspect that it yields many false-positive results (Perl, 1972).

Staining films with specific, usually monoclonal, antibodies reacting only with *T. vaginalis* organisms is a technique with many theoretical advantages. Initial trials were very promising (Krieger *et al.*, 1988) and the materials were made available in kit form by a number of manufacturers; however, it is not clear how widely used the method is in routine clinical practice.

At present, culture techniques are still regarded as the most sensitive and specific; they provide the 'gold standard' against which other methods are judged. Media vary in efficiency but Diamond's TYM medium (Diamond, 1957) (sometimes with minor modifications) is amongst

the best (Schmid *et al.*, 1989; Gelbart *et al.*, 1990). Most tubes will be positive within 48-hours but should be kept for 7–10 days before being finally discarded. A very convenient, but expensive, way of culturing specimens is the InPouch® system, which appears to be at least as sensitive as conventional tubed media (Borchardt *et al.*, 1997; Borchardt and Smith, 1991).

### Other Diagnostic Procedures and New Developments

A number of antigen diagnostic systems have been marketed; although still not in routine use and relatively expensive, they can combine the speed of the wet film with the sensitivity of culture methods (Carney *et al.*, 1988). Immunological methods of diagnosis have been discussed in a recent review (Ackers and Yule, 1988).

Both DNA probe- and PCR-based tests have been developed; the former technique has not found widespread acceptance, but the sensitivity PCR-based methods offer exciting new possibilities for making an accurate diagnosis on specimens obtained in less invasive ways (Witkin *et al.*, 1996; Heine *et al.*, 1997), including self-administered tampons (Paterson *et al.*, 1998).

## CLINICAL MANAGEMENT

The 5-nitroimidazole drugs were introduced in 1960 and provided the first, and so far the only, group of effective chemotherapeutic agents. Metronidazole is the prototype and by far the most widely used member of this class of drugs, all of which have similar potencies and success rates but differ somewhat in their pharmacokinetics. Doses given here are for metronidazole and should be adjusted to give the equivalent amount of other compounds. Two regimens are commonly used:

1. A 7 day course comprising either 250 mg three times a day or 500 mg twice a day.
2. A single 1.6 or 2 g dose.

The advantages of the single-dose regimen include better compliance and less interference with the normal flora, but side-effects (nausea,

**Table 11.4** Some possible alternative therapies for metronidazole-resistant *T. vaginalis*

Compound or preparation	Proportion cured	Reference
Systemic:		
<i>Lactobacillus</i> immunotherapy	0/2	Van der Weiden <i>et al.</i> , 1990
Mebendazole	0/2	Pattman <i>et al.</i> , 1989
Tinidazole	1/1, 1/1	Hamed and Studemeister, 1992; Lewis <i>et al.</i> , 1997
Local applications:		
AVC pessaries*	8/45 <sup>‡</sup>	du Bouchet <i>et al.</i> , 1997
Acetarsol	1/1, 1/1, 0/1, 3/3	Lewis <i>et al.</i> , 1997; Watson and Pattman, 1996; Walker <i>et al.</i> , 1997; Chen <i>et al.</i> , 1999
Clotrimazole	5/45 <sup>‡</sup> , 0/2	Lewis <i>et al.</i> , 1997; du Bouchet <i>et al.</i> , 1997
Gynalgin <sup>†</sup>	7/7	Sikorski <i>et al.</i> , 1992
Nonoxynol-9	1/1, 3/17	Livengood and Lossick, 1991; Antonelli <i>et al.</i> , 2000
Paromomycin <sup>‡</sup>	0/1, 7/9, 1/1	Lewis <i>et al.</i> , 1997; Nyirjesy <i>et al.</i> , 1998; Poppe, 2001
Povidone-iodine	1/1, 3/3	Wong <i>et al.</i> , 1990; Yu and Tak Yin, 1993
Active <i>in vitro</i> :		
Butoconazole		Bouree and Isoire, 1992
Benzoizothiazolinon derivatives		Ziomko and Kuczynska, 1994
Furazolidone		Narcisi and Secor, 1996
Geneticin (G418)		Riley and Krieger, 1996
Benzimidazoles		Katiyar <i>et al.</i> , 1994
Niridazole		Yarlett <i>et al.</i> , 1987; Hof <i>et al.</i> , 1987
Disulfiram and ditiocarb		Bouma <i>et al.</i> , 1998

\*AVC pessaries contain sulphanilamide, aminacrine HCl and allantoin.

<sup>†</sup>A single oral dose of 2 g metronidazole cured 36/45 cases.

<sup>‡</sup>Gynalgin contains metronidazole, chloroquine and citric acid.

<sup>‡</sup>High incidence of local side effects.

metallic taste, disulfiram-like reaction to alcohol) may be more noticeable. Cure rates in women are similar (about 95%) with both regimens if male sexual partners are also treated, but appear to be lower with the single-dose regimen if they are not. Only the 7 day regimen has been extensively evaluated in males, where it is just as effective as in women.

The acute toxicity of metronidazole is low, but it is a mutagen and long-term, high-dose administration to mice can produce lung tumours. Follow-up of treated women has failed to show any malignancies and any risk from short-term treatment appears to be very small. Similarly, there is no evidence that the drug is teratogenic, but it does cross the placenta and it seems only prudent to avoid its use during the first trimester if at all possible. Local treatments or simple douching have very disappointing long-term cure rates but may be of value in controlling symptoms during pregnancy until metronidazole can be used.

Treatment failures with any of the 5-nitroimidazole drugs are uncommon and are usually due to non-compliance. Failure to absorb the drug and inactivation by vaginal flora are other, rare causes, but a small but slowly growing proportion

of treatment failure is due to genuinely resistant isolates. Careful measurement of sensitivity *in vitro*, using specified media and controlled oxygen tension, is necessary to obtain consistent results (Ackers, 1995) but a high level of resistance can be shown in some isolates. The mechanism of this resistance is, to some extent, understood (Edwards, 1993). Most such cases can be managed by increased and repeated doses but if that fails, no really effective alternative drugs are available, although occasional successes with a variety of preparations have been reported (Table 11.4) and discussed in a recent article (Lewis *et al.*, 1997).

## PREVENTION AND CONTROL

As with all the sexually transmitted infections, prevention requires changes in the way that people behave. Since the onset of the AIDS epidemic some 15 years ago, a growing barrage of advice and exhortation to practise 'safe sex' has filled the world's media, and it seems more than a coincidence that the incidence of trichomoniasis, which had barely changed during the

1970s, has, since then, declined precipitately in many countries and populations.

Control of trichomoniasis requires accessible, affordable and high-quality health care, as well as health promotion; this is by no means easy or cheap to provide. Whilst most new resources in this field are, naturally, targeted at controlling the spread of HIV, there is now ample evidence that controlling other STIs is one of the most

cost-effective ways of doing this (Grosskurth *et al.*, 1995). The availability of accurate and affordable diagnostic methods for trichomoniasis, whose symptoms are not specific enough to make syndromic management very useful, would be a major advance, since treatment is reasonably cheap and highly effective. Widespread implementation could have a very significant effect in slowing the spread of HIV.

## OTHER HUMAN TRICHOMONADS

Both *Trichomonas tenax* and *Pentatrichomonas hominis* normally receive only brief mention in medical texts—they are of doubtful pathogenicity and therefore little studied, so there is not much to say. *Dientamoeba fragilis* is rather better known, as many people regard it as a genuine, if far from invariable, pathogen—but again, it attracts far less interest than, say, *Entamoeba histolytica*.

The same pattern will also be found true of this review. However, for the late Professor Honigberg, any trichomonad was of absorbing interest and any reader wanting to know much, much more about one of these three organisms can be confidently referred to the relevant chapters of the monograph which he edited (Honigberg, 1989; Ockert, 1989).

## TRICHOMONAS TENAX (O. F. MÜLLER)

### HISTORICAL INTRODUCTION

Dobell has stated that *T. tenax* was first seen in 1773 by Müller, who named it *Cercomonas tenax*. The name *Trichomonas tenax* is now universally employed, although the same organism has in the past been referred to as *T. buccalis* or *T. elongata*.

### DESCRIPTION OF THE ORGANISM

*T. tenax* differs from *T. vaginalis* and *P. hominis* in being smaller—4–13 µm (mean 7.1 µm) long × 2–9 µm (mean 4.7 µm) wide—and from *P. hominis* in having only four anterior flagella and a recurrent flagellum that does not extend beyond the end of the undulating membrane (Figure 11.1). The axostyle is slender and appears to extend beyond the body. In humans it is found in the oral cavity, particularly in the periodontal crevices; it has also been recovered from the submaxillary glands, sinus cavities, the ear and the throat. Accounts of trichomonads, normally assumed to be *T. tenax*, causing respiratory tract pathology are controversial (see Ectopic Infections, below).

*T. tenax* may be cultivated in bacteria-containing media without undue difficulty, and such cultures are useful diagnostically, but axenization is more difficult than with the other human trichomonads. Originally, a chick embryo extract was regarded as essential but it was subsequently found that Diamond's TPS-1 medium was suitable if modified to contain 0.01% agar. Ultrastructural studies show typical trichomonad features, including hydrogenosomes and ingested bacteria.

### PATHOGENESIS

*T. tenax* is normally regarded as a non-pathogen that merely flourishes in the presence of already diseased tissue, but a number of workers in Eastern Europe and the Former Soviet Union regard it as causally linked to periodontal disease. Despite the detection of collagen-degrading secreted proteinases, neither adherence nor perceptible damage occurred when mammalian cell monolayers were exposed to the parasite *in vitro*.



## IMMUNOLOGY

One group of patients with gingivitis and *T. tenax* infection has been shown to produce specific serum antibodies, which faded away after successful treatment; this result clearly shows that parasite antigens can reach the immune system through damaged oral tissue but does not bear on the question of pathogenicity. Other immunological studies have concentrated on antigenic differences between isolates, including those recovered from the lung; the results have been admirably summarized by Honigberg (1978, 1989).

## MOLECULAR BIOLOGY

A number of genes, including those for small subunit ribosomal RNA and two elongation factors, have been partially sequenced (mainly for taxonomic analyses) but no detailed studies of the molecular biology of this organism have been carried out.

## EPIDEMIOLOGY

### Prevalence

According to many published surveys, *T. tenax* is surprisingly common; Honigberg (1978) gave some examples that showed a prevalence in Europe and the USA which varied from 4% to 54%. In a later review, Honigberg (1989) examined the factors affecting prevalence and concluded that a major one is age, the organism being very rare in young children. Whether the subsequent increase in positivity is solely due to the passage of time is, however, unlikely and it is more probable that the deterioration in the condition of teeth and gums provides an increasingly favourable environment for the parasite. In agreement with this, the organism is uncommon in edentulous elderly persons. Other factors, such as sex or socioeconomic status, appear to be either irrelevant or surrogate markers for the healthiness of the gums. Having said that, the incidence was not increased in children with drug-induced gingivitis and it is not actually clear what aspect of 'poor oral condition' is causally linked to enhanced risk of infection.

## Transmission

In the absence of any resistant cyst, the only plausible route of acquisition is by direct oral contact although, hypothetically, very close range droplet transmission and spread by shared toothbrushes, saliva-contaminated food, etc. is possible. One report has described *T. tenax* surviving for up to 48 hours in saliva. Exactly the same factors are involved in the dissemination of *Entamoeba gingivalis*; not surprisingly, the two parasites are common in the same population groups and are not uncommonly recovered from the same patient.

## CLINICAL FEATURES

Although *T. tenax* may be isolated from diseased gums in a significant number of cases, this is widely supposed to be a consequence, not a cause, of periodontal disease and no specific clinical entity due to the organism is recognized.

## LABORATORY DIAGNOSIS

Virtually all accounts of infection with *T. tenax* have depended either on the examination of wet film prepared for gingival scrapings or on culture of the same specimens to make the diagnosis. A PCR-based diagnostic test has been developed (Kikuta *et al.*, 1997) but is not yet in widespread use.

## CLINICAL MANAGEMENT

No treatment of this infection is normally considered necessary, although metronidazole has been shown to be active *in vitro* and would probably be effective *in vivo*.

## PREVENTION AND CONTROL

No significant effort has been devoted to trying to reduce the incidence of infection with *T. tenax* and the obvious approach—improved oral hygiene—might or might not be effective.

**PENTATRICHOMONAS HOMINIS (DAVAINE)****HISTORICAL INTRODUCTION**

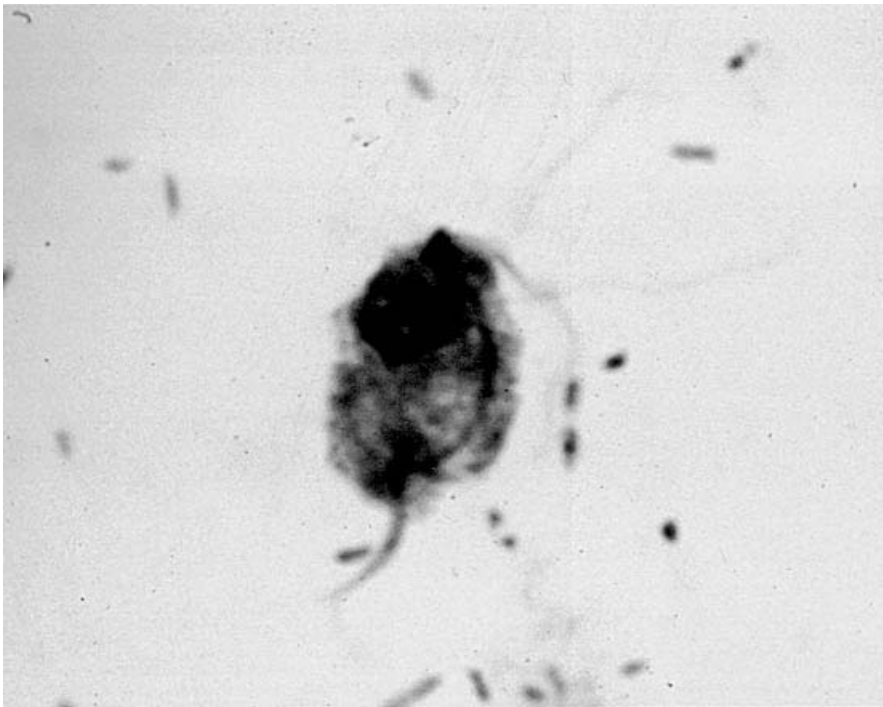
A long-standing controversy has existed concerning the correct nomenclature of the human faecal trichomonad, largely due to the fact that not all organisms in culture possess the full complement of five anterior flagella. Thus, while most authorities consider that *Pentatrichomonas hominis* is the correct name, a minority still refer to the same organism as *Trichomonas hominis* and this name is widely found in the older literature.

**DESCRIPTION OF THE ORGANISM**

Trophozoites of *P. hominis* (Figures 11.1, 11.4) are pear- or teardrop-shaped and, in fixed and stained preparations, 6–14  $\mu\text{m}$  long  $\times$  4–6.5  $\mu\text{m}$  wide. They possess five anterior flagella and an undulating membrane whose recurrent flagellum extends well beyond the length of the body. A moderately thick axostyle extends through the

body from the region of the nucleus and appears to project some way beyond the posterior end. In fresh preparations or in culture, the flagella and undulating membrane beat rapidly (and are thus impossible to observe), propelling the organism with a characteristic jerky motion.

The ultrastructure of *P. hominis* has been described (Honigberg *et al.*, 1968) and is basically similar to that of other trichomonads; interestingly, the basal body of the fifth anterior flagellum is perpendicular to the other four. Also surprisingly, the number of anterior flagella is not invariable, at least in culture, a minority of organisms having a lesser number (Flick, 1954). Microbodies (presumably hydrogenosomes) are visible and many enzyme activities have been detected during studies on isoenzyme characterization, including superoxide dismutase, but few detailed biochemical studies appear to have been undertaken, although the purine salvage pathway is known and some cysteine proteases have been detected. Axenic culture is possible (Linstead, 1989).



**Fig. 11.4** *Pentatrichomonas hominis* from culture. Giemsa,  $\times$  3500

## PATHOGENESIS

*Pentatrichomonas hominis* is normally regarded as non-pathogenic, but Honigberg, in a recent review (1989), was prepared to admit that in occasional cases it might cause diarrhoea, and Chung *et al.* (1988) have described 45 heavily infected patients with chronic gastrointestinal symptoms which were abolished by chemotherapy. Diarrhoea in children has also been attributed to this infection but if the organism does cause disease, the mechanism is not known. Unlike *T. vaginalis*, *P. hominis* is apparently not cytopathic for mammalian cells in culture.

## IMMUNOLOGY

Nothing is known of any human host response to *P. hominis*, but the organism is killed by normal serum and this would presumably control any tendency to disseminate outside the intestinal lumen. An immense amount of work, using hyperimmune sera and cross-absorption, was carried out in Estonia and Russia to define antigenic types of *P. hominis*; interested readers should first consult the summary provided by Honigberg (1989).

## MOLECULAR BIOLOGY

The 5.8S rRNA gene of *P. hominis* has been sequenced for the purposes of molecular taxonomy but otherwise almost nothing is known of the molecular biology of this organism.

## EPIDEMIOLOGY

### Prevalence

The results of no fewer than 62 published surveys have been summarized by Honigberg (1989) but, as he points out, differences in patient population and diagnostic techniques make any averaging of the results meaningless. It seems that in developed countries the incidence in the general population is very low indeed and even in those with diarrhoea is likely to be under 1%; in less developed countries 1–2% of samples may be positive, with a few

surveys producing much higher figures. More recent results do not contradict this conclusion and *P. hominis* must be regarded as one of the less common human parasites—always remembering that, as with *D. fragilis*, the lack of a robust cyst makes routine diagnosis considerably less likely to be successful. Xenic cultivation in several media is possible and will aid diagnosis.

## Transmission

Because of the lack of a true cyst, new infections with *P. hominis* must arise from the ingestion of material contaminated with trophozoites; it has been demonstrated that these forms can survive in faeces outside the body for up to a week if kept cool and moist (Hegner, 1928) and in artificial gastric juice for 30 minutes (Shinohara, quoted by Honigberg, 1989). Experimentally, cultured trophozoites can initiate a human infection (Dobell, 1934). Both Dobell and, later, Foresi have described rounded-up, immotile forms *in vitro* which are similar to the pseudocysts described in *Trichomitus batrachorum* and *Tritrichomonas muris*; it would be logical to attribute transmission to them, except that they have never been observed in faeces.

## CLINICAL FEATURES

The pathogenicity of *P. hominis* is not widely accepted, although Honigberg (1989) has discussed at length the reasons why he believed that in certain cases it might be the cause of gastrointestinal upset. He did, however, concede that the vast majority of infections were certainly asymptomatic. There are so many possible causes of diarrhoea (both infectious and non-infectious), multiple infections are so frequent and many aetiological agents are still so poorly known or hard to identify, that attempting to pin down the few cases in which *P. hominis* is the actual cause of symptoms is extremely difficult.

## LABORATORY DIAGNOSIS

This is invariably made by microscopic examination of faeces. It might be expected that the

methods involving rapid fixation and staining, which work so well for *D. fragilis* (see below) would be equally effective with *P. hominis*, but there are no published accounts of their use. Culture has been used to identify the infection in dogs.

### CLINICAL MANAGEMENT

In those few cases where treatment has been considered necessary, metronidazole or tinidazole (in doses similar to those employed for infections with *E. histolytica/E. dispar*) has proved effective.

### *DIENTAMOEBIA FRAGILIS* (JEPPS & DOBELL)

*Dientamoeba fragilis* looks like an amoeba, but it is not one. Ultrastructural examination shows clearly that it is an aberrant trichomonad with basal bodies but no flagella; since no trichomonads are known to produce true cysts, the fact that *D. fragilis* does not do so is not surprising. The trophozoite is, as its name applies, very sensitive to environmental conditions and becomes unrecognizable in faeces soon after it is passed. Unless rapidly fixed, stained preparations are examined or a technique like immunofluorescence is employed, *D. fragilis* is likely to be drastically underdiagnosed.

### HISTORICAL INTRODUCTION

In their original description of *D. fragilis* Jepps and Dobell described it as an amoeba and stated that there was no reason to think that it was a human pathogen. By 1940, however, Dobell noted the possible relationship to the pathogenic flagellate of poultry, *Histomonas meleagridis*, and subsequently antigenic comparisons, ultrastructural studies and ribosomal RNA sequencing (Silberman *et al.*, 1996) have confirmed the trichomonad nature of this organism. Its pathogenicity, however, remains controversial (see below). The most detailed recent review of *D. fragilis* (Ockert, 1989) was

Furazolidone was successfully employed in an infant with persistent diarrhoea which was attributed to *P. hominis* (Mancilla Ramirez and Gonzalez Yunes, 1989).

### PREVENTION AND CONTROL

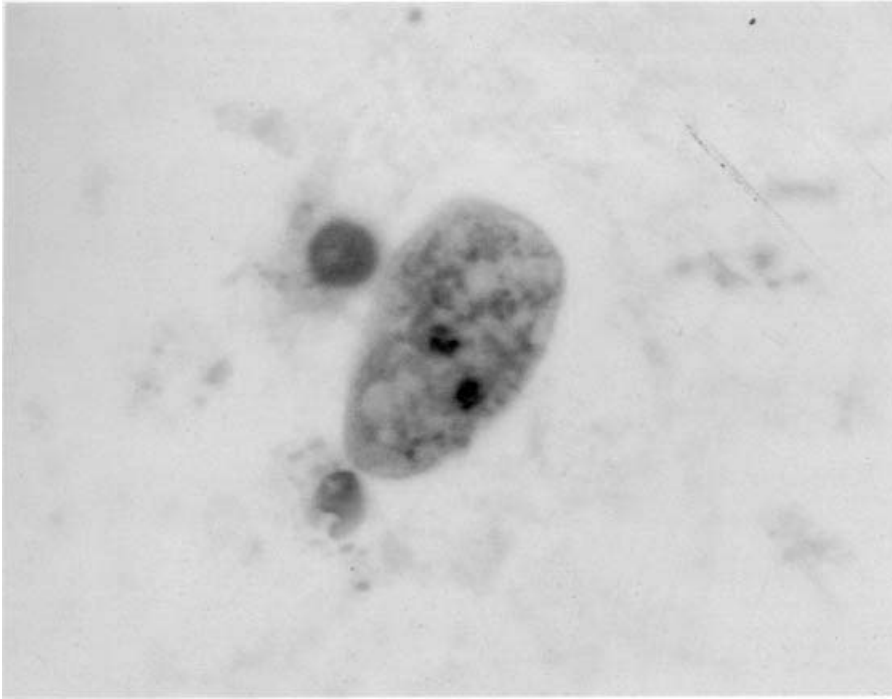
As with any organism transmitted by the faecal-oral route, ample supplies of clean water, effective disposal of faeces and high standards of personal hygiene will effectively eliminate this infection.

written by one who definitely believes in its ability to cause disease.

### DESCRIPTION OF THE ORGANISM

Trophozoites (Figure 11.5) are reported to be in the range 3–22 µm in diameter, but a more usual size range is 9–13 µm; the majority of organisms have two nuclei, usually joined by a spindle or filament (desmose), but up to 40% may be uninucleate. The nuclear endosome is composed of four to eight small, deeply-staining granules and peripheral chromatin is absent. The cytoplasm contains ingested bacteria and other food material.

*D. fragilis* can be grown in xenic culture, the medium of Dobell and Laidlaw (1962) apparently being particularly suitable, although growth also occurs in other media, such as that of Robinson (1968). Attempts to adapt the organism to axenic culture have not yet succeeded. Such cultures enabled isoenzyme patterns to be obtained from three isolates but otherwise few biochemical studies have been carried out. Camp *et al.* (1974) described microbodies which are presumed now to be hydrogenosomes; in agreement with their presence, the organism is moderately sensitive to metronidazole (Chan *et al.*, 1994). Nothing is known of the transcriptional activity of the two nuclei and, despite its unusual appearance, the organism divides by simple binary fission.



**Fig. 11.5** *Dientamoeba fragilis* from culture. Iron-haematoxylin,  $\times 3000$

## PATHOGENESIS

As with *Blastocystis hominis* (see Chapter 15) the pathogenic potential of *D. fragilis* is not universally accepted, although there are fewer sceptics than in the case of that parasite. The evidence consists of a large number of accounts of patients with gastrointestinal symptoms (usually fairly mild but chronic; Yang and Scholten, 1977) in whom no other pathogen could be detected and whose symptoms resolved when the infection was treated or lost. All authors agree that some infected patients may be asymptomatic, but the difficulties in definitely attributing a pathogenic role to *D. fragilis* are exemplified by the work of Oxner *et al.* (1987). These authors report on the outcome of treating three infected, symptomatic patients—in the first case the symptoms resolved prior to eradication, in the second the organism was eliminated without clinical improvement, and in the third both symptoms and parasites disappeared together.

There is no evidence for mucosal invasion by *D. fragilis* and if it is a pathogen, then its pathogenic mechanisms are unknown. A small but detailed study of surgically removed appendixes found a significant number to be infected with this organism (and *Enterobius vermicularis*); a common pathological finding was fibrosis of the appendiceal wall (Swerdlow and Burrows, 1955); *D. fragilis* in this organ has also been reported in another, larger, series (Cerva *et al.*, 1991).

## IMMUNOLOGY

Little is currently known in this area. Until recently, no reports of local or systemic immune responses had been published; however, Chan *et al.* (1996) have recently described antibody against a 39kDa antigen in the serum of three infected, symptomatic young people. Remarkably, 91% of a group of nearly 200 healthy children had positive immunofluorescence titres

(1:10 or higher) against *D. fragilis*. While at least some infections appear to be lost spontaneously, no role for the immune system in this process has yet been defined, neither is it known if there is any immunity to reinfection.

## MOLECULAR BIOLOGY

Studies in this area are almost non-existent but Silberman *et al.* (1996) have confirmed the trichomonad affinity of *D. fragilis* by analysis of its ribosomal RNA gene sequence.

## EPIDEMIOLOGY

### Prevalence

Two issues have dominated the limited number of epidemiological studies of *D. fragilis*—how common is the infection, and how is so frail an organism transmitted in the absence of a resistant cyst? It is safe to say that the answer to neither of these questions is definitely known.

Simple wet film examination will reveal few examples of *D. fragilis* infection but adoption of careful fixing and staining procedures will significantly increase isolation rates—to 4.2% of submitted specimens in one large survey (Yang and Scholten, 1977; Grendon *et al.*, 1991). The organism has been reported from all parts of the world and is probably more common in developing countries (Muller *et al.*, 1987); very high incidence figures have also been reported in children (Spencer *et al.*, 1983; Keystone *et al.*, 1984) and in members of a semicomunal group (Millet *et al.*, 1983) but the incidence in AIDS patients is not dramatically increased.

### Transmission

Although *P. hominis* may be successfully orally transmitted despite the absence of a true cyst (see above), it has always seemed unlikely that *D. fragilis* could survive such a journey. It has been suggested (Burrows and Swerdlow, 1956) that the organism might well be transmitted inside the eggs of the pinworm *E. vermicularis*,

the evidence supporting this being that the two infections occur simultaneously more often than could be expected, that bodies which could be *D. fragilis* organisms are visible inside pinworm eggs, and that the related avian parasite *Histomonas meleagridis* is transmitted in the egg of the poultry roundworm *Heterakis gallinae* (Graybill and Smith, 1920). Although it has not proved possible to culture *D. fragilis* from *E. vermicularis* eggs, the theory is by no means implausible; the review by Ockert (1989) should be consulted for further details.

## CLINICAL FEATURES

Two reasonably large series and a compilation of other published studies (Yang and Scholten, 1977; Grendon *et al.*, 1995) agree in finding that abdominal pain, abdominal cramping and diarrhoea are the most common findings in symptomatic patients infected with *D. fragilis*. Other common findings are bloating and flatulence, nausea, and pruritus and, in one group, fatigue. A wide variety of other symptoms have been reported by some patients. In comparison with a *D. fragilis*-free group, a significantly higher proportion of those infected had eosinophilia; eosinophilia was also found in 7/11 paediatric patients in a more recent study (Cuffari *et al.*, 1998).

## LABORATORY DIAGNOSIS

### Wet-film Examination

Unless the specimen is extremely fresh, simple wet film examination of a faecal sample is unlikely to reveal many cases of infection, and concentration methods will certainly destroy the trophozoites. A much more satisfactory procedure is to provide the patient with a container of fixative into which a portion of the faeces is placed as soon as it has been passed and well mixed. Such samples are then stable for many weeks. Trophozoites are visualized by staining, usually with either trichrome or iron haematoxylin. Various fixatives may be used; SAF (sodium acetate formaldehyde) is good and has

the advantage that it does not contain toxic mercury compounds. A disadvantage is that trichrome staining of SAF-fixed specimens is not very satisfactory. A discussion of the alternatives and full practical details are given in the handbook by Garcia and Bruckner (1997).

### Other Microscopical Methods

A promising indirect immunofluorescence method for the detection of trophozoites in fixed faecal specimens has been described (Chan *et al.*, 1993) but it is not clear how widespread its use is.

### Other Diagnostic Procedures and New Developments

Culture can result in a spectacular increase in the number of positive specimens detected, although the inoculation must be made within a few hours, at most, of the specimen being passed (Ockert, 1989). In another study, cultures were successfully established from faeces stored at room temperature for 24 hours, but only after 10 hours, storage at 4°C (Sawangjaroen *et al.*, 1993). A very high proportion of healthy children are apparently seropositive (defined as IFA-positive at dilutions of 1:10 or higher; Chan *et al.*, 1996), making serology of little use for identifying infected patients.

## CLINICAL MANAGEMENT

Because of its greater safety, metronidazole has been the preferred treatment in most recent series (Butler, 1996; Cuffari *et al.*, 1998). It is by no means always effective, however, and diiodo-hydroxyquin (650 mg three times daily for 20 days) or tetracycline (500 mg four times daily for 10 days) have both been used successfully in adults (Oxner *et al.*, 1987). These three compounds, and paromomycin, have demonstrated activity *in vitro* (Chan *et al.*, 1994). Paromomycin (25–30 mg/kg/day in three doses for 7 days; Garcia and Bruckner, 1997) has also proved

effective in clinical practice (J. E. Williams, personal communication).

## PREVENTION AND CONTROL

As with *P. hominis*, preventing the contamination of food and water with human faeces should reduce the incidence of infection. In addition, since transmission via *Enterobius* eggs is a distinct possibility, control of pinworm infections, particularly in children, would be a highly rational strategy.

### Ectopic Infections

Although the normal site-specificity of the three human trichomonads (and presumably *D. fragilis* also) is well established, there are occasional reports of these organisms being recovered from sites other than their normal habitats. Although these organisms are often identified as specific species, it should be remembered that this precision is almost impossible unless fixed and stained material is examined; the existence of detached ciliary tufts (see above) should also not be forgotten. It is likely that in the future newer diagnostic methods (such as PCR) will remove much of the ambiguity from these reports.

Ectopic trichomonads are often recovered from sites also infected with other pathogens, such as anaerobic bacteria, or from seriously or terminally ill patients, and so it is difficult to be sure to what extent they cause or contribute to the observed pathology. A detailed (and fairly sceptical) review of this subject is included in a book chapter by Honigberg (1989) and only a brief account will be given here.

The most frequent reports of this type are trichomonads, normally assumed to be *T. tenax*, causing respiratory tract pathology (reviewed by Hersh, 1985); the same organism has been apparently found in the submaxillary gland and in children with chronic tonsillitis. Hiemstra *et al.* (1984) wondered whether *T. vaginalis* might cause pneumonia in newborn babies and unidentified species of trichomonad have been implicated in bronchitis and found in pleural fluid. In an interesting case of oesophageal

intramural pseudodiverticulosis, trichomonads were discovered in some of the pseudodiverticula. Electron microscopy showed them to possess only four anterior flagella, thus identifying them as either *T. tenax* or *T. vaginalis* (Guccion and Ortega, 1996).

When injected intraperitoneally or subcutaneously in mice, at least some strains of *T. vaginalis* are highly pathogenic, producing large abscesses. Such lesions in humans are fortunately very rare but a perinephric abscess attributed to *T. vaginalis* and a trichomonal abscess of the median raphe of the penis have been described, as has the presence of trichomonads (and bacteria) in a subhepatic abscess.

## REFERENCES

- Ackers JP (1989). Immunologic aspects of human trichomoniasis. In Honigberg BM (ed.), *Trichomonads Parasitic in Humans*. Springer-Verlag: New York; 36–52.
- Ackers JP (1995). Trichomonads. In Gillespie SH, Hawkey PM (eds), *Medical Parasitology: A Practical Approach*. IRL Press: Oxford; 137–50.
- Ackers JP, Yule A (1988). Immunological diagnosis of trichomoniasis. In Young H, McMillan A (eds), *Immunological Diagnosis of Sexually Transmitted Diseases*. Marcel Dekker: New York; 275–302.
- Adu Sarkodie Y (1995). *Trichomonas vaginalis* transmission in a family. *Genitourin Med* **71**: 199–200.
- Al Salihi FL, Curran JP, Wang J (1974). Neonatal *Trichomonas vaginalis*: report of three cases and review of the literature. *Pediatrics* **53**: 196–200.
- Alderete JF (1988). Alternating phenotypic expression of two classes of *Trichomonas vaginalis* surface markers. *Rev Inf Dis* **10** (Suppl 2): S408–12.
- Alderete JF, Lehker MW, Arroyo R (1995a). The mechanisms and molecules involved in cytoadherence and pathogenesis of *Trichomonas vaginalis*. *Parasitol Today* **11**: 70–74.
- Alderete JF, Provenzano D, Lehker MW (1995b). Iron mediates *Trichomonas vaginalis* resistance to complement lysis. *Microb Pathog* **19**: 93–103.
- Antonelli NM, Diehl SJ, Wright JW (2000). A randomized trial of intravaginal nonoxynol 9 versus oral metronidazole in the treatment of vaginal trichomoniasis. *Am J Obstet Gynecol* **182**: 1008–10.
- Arroyo R, González-Robles A, Martínez-Palomo A, Alderete JF (1993). Signalling of *Trichomonas vaginalis* for amoeboid transformation and adhesion synthesis follows cytoadherence. *Mol Microbiol* **7**: 299–309.
- Ashfaq Drewett R, Allen C, Harrison RL (1990). Detached ciliary tufts. Comparison with intestinal protozoa and a review of the literature. *Am J Clin Pathol* **93**: 541–5.
- Borchardt KA, Zhang MZ, Shing H, Flink K (1997). A comparison of the sensitivity of the InPouch TV, Diamond's, and Trichosel media for detection of *Trichomonas vaginalis*. *Genitourin Med* **73**: 297–8.
- Borchardt KA, Smith RF (1991). An evaluation of an InPouch TV culture method for diagnosing *Trichomonas vaginalis* infection. *Genitourin Med* **67**: 149–52.
- Bouma MJ, Snowdon D, Fairlamb AH, Ackers JP (1998). Activity of disulfiram, (bis(diethylthiocarbamoyl)disulphide), and ditiocarb (diethylthiocarbamate) against metronidazole-sensitive and -resistant *Trichomonas vaginalis* and *Trichomonas foetus*. *J Antimicrob Chemother* **42**: 817–20.
- Bouree P, Isoire C (1992). Evaluation *in vitro* de l'activité du butoconazole sur *Trichomonas vaginalis* [In vitro evaluation of the activity of butoconazole against *Trichomonas vaginalis*]. *Pathol Biol Paris* **40**: 492–4.
- Boyle DCM, Smith JR (1999). Infection and cervical intraepithelial neoplasia. *Int J Gynecol Cancer* **9**: 177–86.
- Bramley M (1976). Study of female babies of women entering confinement with vaginal trichomoniasis. *Br J Vener Dis* **52**: 58–62.
- Burch TA, Rees CW, Reardon LV (1959). Epidemiological studies on human trichomoniasis. *Am J Trop Med Hyg* **8**: 312–18.
- Burrows RB, Swerdlow MA (1956). *Enterobius vermicularis* as a probable vector of *Dientamoeba fragilis*. *Am J Trop Med Hyg* **5**: 258–65.
- Butler WP (1996). *Dientamoeba fragilis*. An unusual intestinal pathogen. *Dig Dis Sci* **41**: 1811–13.
- Camp RR, Mattern CF, Honigberg BM (1974). Study of *Dientamoeba fragilis* Jepps & Dobell. I. Electronmicroscopic observations of the binucleate stages. II. Taxonomic position and revision of the genus. *J Protozool* **21**: 69–82.
- Carney JA, Unadkat P, Yule A, Rajakumar R, Lacey CJ, Ackers JP (1988). New rapid latex agglutination test for diagnosing *Trichomonas vaginalis* infection. *J Clin Pathol* **41**: 806–8.
- Cerva L, Schrottenbaum M, Kliment V (1991). Intestinal parasites: a study of human appendices. *Folia Parasitol Praha* **38**: 5–9.
- Chan F, Stewart N, Guan M *et al.* (1996). Prevalence of *Dientamoeba fragilis* antibodies in children and recognition of a 39kDa immunodominant protein antigen of the organism. *Eur J Clin Microbiol Infect Dis* **15**: 950–54.
- Chan FT, Guan MX, Mackenzie AM (1993). Application of indirect immunofluorescence to detection of *Dientamoeba fragilis* trophozoites in fecal specimens. *J Clin Microbiol* **31**: 1710–14.
- Chan FTH, Ming Xu Guan, Mackenzie AMR, DiazMitoma F (1994). Susceptibility testing of *Dientamoeba fragilis* ATCC 30948 with iodoquinol, paromomycin, tetracycline, and metronidazole. *Antimicrob Agents Chemother* **38**: 1157–60.
- Charles SX (1991). Epidemiology of *Trichomonas vaginalis* (TV) in rural adolescent and juvenile children. *J Trop Pediatr* **37**: 90.
- Chen MHY, Smith NA, Fox EF, Bingham JS, Barlow D (1999). Acetarsol pessaries in the treatment of metronidazole resistant *Trichomonas vaginalis*. *Int J STD AIDS* **10**: 277–80.



- Chunge CN, Estambale BB, Pamba HO, Chitayi PM, Munanga P, Kangethe S (1988). Pathogenicity of *Trichomonas hominis* in Kenya. *East Afr Med J* **65**: 532–4.
- Cohen MS, Hoffman IF, Royce RA *et al.* (1997). Reduction of concentration of HIV-1 in semen after treatment of urethritis: implications for prevention of sexual transmission of HIV-1. AIDSCAP Malawi Research Group. *Lancet* **349**: 1868–73.
- Cotch MF, Pastorek JG, Nugent RP, Yerg DE, Martin DH, Eschenbach DA (1991). Demographic and behavioral predictors of *Trichomonas vaginalis* infection among pregnant women. The Vaginal Infections and Prematurity Study Group. *Obstet Gynecol* **78**: 1087–92.
- Cotch MF, Pastorek II JG, Nugent RP *et al.* (1997). *Trichomonas vaginalis* associated with low birth weight and preterm delivery. *Sex Transm Dis* **24**: 353–60.
- Crowther IA (1962). *Trichomonas* vaginitis in infancy. *Lancet* **1**: 1074.
- Cuffari C, Oligny L, Seidman EG (1998). *Dientamoeba fragilis* masquerading as allergic colitis. *J Pediatr Gastroenterol Nutr* **26**: 16–20.
- Dailey DC, Chang TH, Alderete JF (1990). Characterization of *Trichomonas vaginalis* haemolysis. *Parasitology* **101** (2), 171–7.
- Danesh IS, Stephen JM, Gorbach J (1995). Neonatal *Trichomonas vaginalis* infection. *J Emerg Med* **13**: 51–4.
- Demes P, Gombosova A, Valent M, Fabusova H, Janoska A (1988a). Fewer *Trichomonas vaginalis* organisms in vaginas of infected women during menstruation. *Genitourin Med* **64**: 22–4.
- Demes P, Gombosova A, Valent M, Janoska A, Fabusova H, Petrenko M (1988b). Differential susceptibility of fresh *Trichomonas vaginalis* isolates to complement in menstrual blood and cervical mucus. *Genitourin Med* **64**: 176–9.
- Diamond LS (1957). The establishment of various trichomonads of animals and man in axenic cultures. *J Parasitol* **43**: 488–90.
- Dobell C (1934). Researches on the intestinal protozoa of monkeys and man VI. Experiments with the trichomonads of man and macaques. *Parasitology* **26**: 531–77.
- Dobell C, Laidlaw PP (1926). On the cultivation of *Entamoeba histolytica* and some other entozoic amoebae. *Parasitology* **18**: 283–318.
- duBouchet L, Spence MR, Rein MF, Danzig MR, McCormack WM (1997). Multicenter comparison of clotrimazole vaginal tablets, oral metronidazole, and vaginal suppositories containing sulfanilamide, aminacrine hydrochloride, and allantoin in the treatment of symptomatic trichomoniasis. *Sex Transm Dis* **24**: 156–60.
- Edwards DI (1993). Nitroimidazole drugs—action and resistance mechanisms. II. Mechanisms of resistance. *J Antimicrob Chemother* **31**: 201–10.
- Evans BA, McCormack SM, Kell PD, Parry JV, Bond RA, MacRae KD (1995). Trends in female sexual behaviour and sexually transmitted diseases in London, 1981–1992. *Genitourin Med* **71**: 286–90.
- Fiori PL, Rappelli P, Addis MF, Sechi A, Cappuccinelli P (1996). *Trichomonas vaginalis* haemolysis: pH regulates a contact-independent mechanism based on pore-forming proteins. *Microb Pathog* **20**: 109–18.
- Flick EW (1954). Experimental analysis of some factors influencing the flagella number of *Trichomonas hominis* from man and other primates and their relationship to nomenclature. *Exp Parasitol* **3**: 105–21.
- Gallai Z, Sylvestre L (1966). The present status of urogenital trichomoniasis. A general review of the literature. *Appl Ther* **8**: 773–8.
- Garcia LS, Bruckner DA (1997). *Diagnostic Medical Parasitology*, 3rd edn. ASM Press: Washington DC.
- Gardner WA, Culberson DE, Scimeca JM, Brady AG, Pindak FE, Abee CR (1987). Experimental genital trichomoniasis in the squirrel monkey (*Saimiri sciureus*). *Genitourin Med* **63**: 188–91.
- Gardner WAJ, Culberson DE, Bennett BD (1986). *Trichomonas vaginalis* in the prostate gland. *Arch Pathol Lab Med* **110**: 430–32.
- Gelbart SM, Thomason JL, Osypowski PJ, Kellett AV, James JA, Broekhuizen FF (1990). Growth of *Trichomonas vaginalis* in commercial culture media. *J Clin Microbiol* **28**: 962–4.
- Gonzalez-Robles A, Lazaro-Haller A, Espinosa-Cantellano M, Anaya-Velázquez F, Martínez-Palomo A (1995). *Trichomonas vaginalis*—ultrastructural bases of the cytopathic effect. *J Eukaryot Microbiol* **42**: 641–51.
- Graybill HW, Smith T (1920). Production of fatal blackhead in turkeys by feeding embryonated eggs of *Heterakis papillosa*. *J Exp Med* **31**: 647–55.
- Grendon JH, Digiacoimo RF, Frost FJ (1991). *Dientamoeba fragilis* detection methods and prevalence: a survey of state public health laboratories. *Public Health Rep* **106**: 322–5.
- Grendon JH, Digiacoimo RF, Forst FJ (1995). Descriptive features of *Dientamoeba fragilis* infections. *J Trop Med Hyg* **98**: 309–15.
- Grosskurth H, Mosha F, Todd J *et al.* (1995). Impact of improved treatment of sexually transmitted diseases on HIV infection in rural Tanzania: randomised controlled trial. *Lancet* **346**: 530–36.
- Guccion JG, Ortega LG (1996). Trichomoniasis complicating esophageal intramural pseudodiverticulosis: diagnosis by transmission electron microscopy. *Ultrastruct Pathol* **20**: 101–7.
- Gupta PK, Frost JK (1989). Cytopathology and histopathology of female genital tract in *Trichomonas vaginalis* infection. In Honigberg BM (ed.), *Trichomonads Parasitic in Humans*. Springer-Verlag: New York; 274–90.
- Hamed KA, Studemeister AE (1992). Successful response of metronidazole-resistant trichomonal vaginitis to tinidazole. A case report. *Sex Transm Dis* **19**: 339–40.
- Hardy PH, Hardy JB, Nell EE, Graham DA, Spence MR, Rosenbaum RC (1984). Prevalence of six sexually transmitted disease agents among pregnant inner-city adolescents and pregnancy outcome. *Lancet* **2**: 333–7.
- Hegner R (1928). Experimental studies on the viability and transmission of *Trichomonas hominis*. *Am J Hyg* **8**: 16–34.
- Heine RP, Wiesenfeld HC, Sweet RL, Witkin SS (1997). Polymerase chain reaction analysis of distal vaginal specimens: a less invasive strategy for detection of *Trichomonas vaginalis*. *Clin Infect Dis* **24**: 985–7.
- Hersh SM (1985). Pulmonary trichomoniasis in *Trichomonas tenax*. *J Med Microbiol* **20**: 1–10.

- Hiemstra I, Van Bel F, Berger HM (1984) Can *Trichomonas vaginalis* cause pneumonia in newborn babies? *Br Med J* **289**: 355–6.
- Ho JL, He S, Hu A *et al.* (1995). Neutrophils from human immunodeficiency virus (HIV)-seronegative donors induce HIV replication from HIV-infected patients' mononuclear cells and cell lines: an *in vitro* model of HIV transmission facilitated by *Chlamydia trachomatis*. *J Exp Med* **181**: 1493–505.
- Hof H, Muller KM, Schrank w, Schweizer EH, Zak O (1987). Therapeutic activities of nitrothiazoles against trichomonads. *Arzneimittelforschung* **37**: 306–9.
- Honigberg BM, Mattern CF, Daniel WA (1968). Structure of *Pentatrachomonas hominis* (Davaine) as revealed by electron microscopy. *J Protozool* **15**: 419–30.
- Honigberg BM (1970). Trichomonads. In Jackson GJ, Herman R, Singer L (eds), *Immunity to Parasitic Animals*. Appleton Century Crofts: New York; 469–550.
- Honigberg BM (1978). Trichomonads of importance in human medicine. In Kreier JP (ed.), *Parasitic Protozoa*. Academic Press: New York; 275–454.
- Honigberg BM (1989). Trichomonads found outside the urogenital tract of humans. In Honigberg BM (ed.), *Trichomonads Parasitic in Humans*. Springer-Verlag: New York; 342–93.
- Honigberg BM (ed.) (1989). *Trichomonads Parasitic in Humans*. Springer-Verlag: New York.
- Honigberg BM, Brugerolle G (1989). Structure. In Honigberg BM (ed.), *Trichomonads Parasitic in Humans*. Springer-Verlag: New York; 5–35.
- Jackson DJ, Rakwar JP, Bwayo JJ, Kreiss JK, Moses S (1997). Urethral *Trichomonas vaginalis* infection and HIV-1 transmission. *Lancet* **350**: 1076.
- Jirovec O, Petru M (1968). *Trichomonas vaginalis* and trichomoniasis. *Adv Parasitol* **6**: 117–88.
- Jones JG, Yamauchi T, Lambert B (1985). *Trichomonas vaginalis* infestation in sexually abused girls. *Am J Dis Child* **139**: 846–7.
- Katiyar SK, Gordon VR, McLaughlin GL, Edlind TD (1994). Antiprotozoal activities of benzimidazoles and correlations with beta-tubulin sequence. *Antimicrob Agents Chemother* **38**: 2086–90.
- Kent HL (1991). Epidemiology of vaginitis. *Am J Obstet Gynecol* **165**: 1168–76.
- Kessel JF, Thompson CF (1950). Survival of *Trichomonas vaginalis* in vaginal discharge. *Proc Soc Exp Biol Med* **74**: 755–8.
- Keystone JS, Yang J, Gridale D, Harrington M, Pillon L, Andreychuk R (1984). Intestinal parasites in metropolitan Toronto day-care centres. *Can Med Assoc J* **131**: 733–5.
- Kikuta N, Yamamoto A, Fukura K, Goto N (1997). Specific and sensitive detection of *Trichomonas tenax* by the polymerase chain reaction. *Lett Appl Microbiol* **24**: 193–7.
- Kostara I, Carageorgiou H, Varonos D, Tzannetis S (1998). Growth and survival of *Trichomonas vaginalis*. *J Med Microbiol* **47**: 555–60.
- Krieger H, Kimmig P (1995). Untersuchungen zur Überlebensfähigkeit von *Trichomonas vaginalis* in Mineralbädern [Survival ability of *Trichomonas vaginalis* in mineral baths]. *Gesundh Wes* **57**: 812–19.
- Krieger JN, Tam MR, Stevens CE *et al.* (1988). Diagnosis of trichomoniasis. Comparison of conventional wet-mount examination with cytologic studies, cultures and monoclonal antibody staining of direct specimens. *J Am Med Assoc* **259**: 1223–7.
- Krieger JN, Jenny C, Verdon M *et al.* (1993). Clinical manifestations of trichomoniasis in men. *Ann Intern Med* **118**: 844–9.
- Krieger JN (1995). Trichomoniasis in men: old issues and new data. *Sex Transm Dis* **22**: 83–96.
- Krieger JN, Rein MF (1982). Zinc sensitivity of *Trichomonas vaginalis*: *in vitro* studies and clinical implications. *J Infect Dis* **146**: 341–5.
- Kulda J (1989). Employment of experimental animals in studies of *Trichomonas vaginalis* infection. In Honigberg BM (ed.), *Trichomonads Parasitic in Humans*. Springer-Verlag: New York; 112–54.
- Kurnatowska A, Komorowska A. (1989). Urogenital trichomoniasis in children. In Honigberg BM (ed.), *Trichomonads Parasitic in Humans*. Springer-Verlag: New York; 246–73.
- Laga M, Manoka A, Kivuvu M *et al.* (1993). Non-ulcerative sexually transmitted diseases as risk factors for HIV-1 transmission in women: results from a cohort study. *AIDS* **7**: 95–102.
- Lancely F, McEntegart MG (1953). *Trichomonas vaginalis* in the male: the experimental infections of a few volunteers. *Lancet* **1**: 668–71.
- Lewis DA, Habgood L, White R, Barker KF, Murphy SM (1997). Managing vaginal trichomoniasis resistant to high-dose metronidazole therapy. *Int J Sex Transm Dis AIDS* **8**: 780–84.
- Linstead D (1989). Cultivation of trichomonads parasitic in humans. In Honigberg BM (ed.), *Trichomonads Parasitic in Humans*. Springer-Verlag: New York; 91–111.
- Livengood CH, Lossick JG (1991). Resolution of resistant vaginal trichomoniasis associated with the use of intravaginal nonoxynol-9. *Obstet Gynecol* **78**: 954–6.
- Lossick JG (1989). Epidemiology of urogenital trichomoniasis. In Honigberg BM (ed.), *Trichomonads Parasitic in Humans*. Springer-Verlag: New York; 311–23.
- Mancilla Ramirez J, Gonzalez Yunes R (1989). Diarrhea associated with *Trichomonas vaginalis* in a newborn infant. *Bol Med Hosp Infant Mex* **46**: 623–5.
- McGrory T, Garber GE (1992). Mouse intravaginal infection with *Trichomonas vaginalis* and role of *Lactobacillus acidophilus* in sustaining infection. *Infect Immun* **60**: 2375–9.
- Millet VE, Spencer MJ, Chapin MR, Garcia LS, Yatabe JH, Stewart ME (1983). Intestinal protozoan infection in a semicommunal group. *Am J Trop Med Hyg* **32**: 54–60.
- Muller R, Lillywhite J, Bending JJ, Catford JC (1987). Human cysticercosis and intestinal parasitism amongst the Ekari people of Irian Jaya. *J Trop Med Hyg* **90**: 291–6.
- Narcisi EM, Secor WE (1996). *In vitro* effect of tinidazole and furazolidone on metronidazole-resistant *Trichomonas vaginalis*. *Antimicrob Agents Chemother* **40**: 1121–5.
- Neinstein LS, Goldenring J, Carpenter S (1984). Nonsexual transmission of sexually transmitted diseases: an infrequent occurrence. *Pediatrics* **74**: 67–76.

- Nett G, Schar M (1986). Übertragung von *Trichomonas vaginalis* in Hallenbädern? [Transmission of *Trichomonas vaginalis* in swimming pools?] *Soz Präventivmed* **31**: 247–8.
- Nyirjesy P, Sobel JD, Weitz MV, Leaman DJ, Gelone SP (1998). Difficult-to-treat trichomoniasis: results with paromomycin cream. *Clin Infect Dis* **26**: 986–8.
- Ockert G (1989). Symptomology, pathology, epidemiology and diagnosis of *Dientamoeba fragilis*. In Honigberg BM (ed.), *Trichomonads Parasitic in Humans*. Springer-Verlag: New York; 394–410.
- Oxner RB, Paltridge GP, Chapman BA, Cook HB, Sheppard PF (1987). *Dientamoeba fragilis*: a bowel pathogen? *NZ Med J* **100**: 64–5.
- Paisarntantiwong R, Brockmann S, Clarke L, Landesman S, Feldman J, Minkoff H (1995). The relationship of vaginal trichomoniasis and pelvic inflammatory disease among women colonized with *Chlamydia trachomatis*. *Sex Transm Dis* **22**: 344–7.
- Paterson BA, Tabrizi SN, Garland SM, Fairley CK, Bowden FJ (1998). The tampon test for trichomoniasis: a comparison between conventional methods and a polymerase chain reaction for *Trichomonas vaginalis* in women. *Sex Transm Inf* **74**: 136–9.
- Pattman RS, Sprott MS, Kearns AM, Earnshaw M (1989). Failure of mebendazole to cure trichomonal vaginitis resistant to metronidazole: case reports. *Genitourin Med* **65**: 274–5.
- Perl G (1972). Errors in the diagnosis of *Trichomonas vaginalis* infections as observed among 1199 patients. *Obstet Gynecol* **39**: 7–9.
- Petrin D, Delgaty K, Bhatt R, Garber G (1998). Clinical and microbiological aspects of *Trichomonas vaginalis*. *Clin Microbiol Rev* **11**: 300–317.
- Pindak FF, Mora de Pindak M, Gardner WAJ (1993). Contact-independent cytotoxicity of *Trichomonas vaginalis*. *Genitourin Med* **69**: 35–40.
- Poppe WA (2001). Nitroimidazole-resistant vaginal trichomoniasis treated with paromomycin. *Eur J Obstet Gynecol Reprod Biol* **96**: 119–20.
- Quinn TC (1994). Recent advances in diagnosis of sexually transmitted diseases. *Sex Transm Dis* **21**: S19–27.
- Rein MF (1989). Clinical manifestations of urogenital trichomoniasis in women. In Honigberg BM (ed.), *Trichomonads Parasitic in Humans*. Springer-Verlag: New York; 225–34.
- Riley DE, Krieger JN (1996). Kinetics of killing or growth of *Trichomonas vaginalis* in the presence of aminoglycosides, neomycin and geneticin (G418). *Int J Antimicrob Agents* **7**: 257–9.
- Robinson GL (1968). Laboratory cultivation of some human parasitic amoebae. *J Gen Microbiol* **53**: 69–79.
- Roger AJ, Clark CG, Doolittle WF (1996). A possible mitochondrial gene in the early-branching amitochondriate protist *Trichomonas vaginalis*. *Proc Natl Acad Sci USA* **93**: 14618–22.
- Rosedale N (1977). Trichomonal vaginitis is not a sexually transmitted disease. *World Med* **13** July, 33.
- Ross JDC, Scott GR, Busuttill A (1993). *Trichomonas vaginalis* infection in pre-pubertal girls. *Med Sci Law* **33**: 82–5.
- Sawangjaroen N, Luke R, Prociw P (1993). Diagnosis by faecal culture of *Dientamoeba fragilis* infections in Australian patients with diarrhoea. *Trans R Soc Trop Hyg* **87**: 163–5.
- Schmid GP, Matheny LC, Zaidi AA, Kraus SJ (1989). Evaluation of six media for the growth of *Trichomonas vaginalis* from vaginal secretions. *J Clin Microbiol* **27**: 1230–33.
- Sikorski R, Hencner Z, Glinski Z *et al.* (1992). Ocena mikrobiologiczna skuteczności Gynalginu w zapaleniach pochwy u kobiet [Microbiological evaluation of the effectiveness of gynalgin in the treatment of vaginitis]. *Wiad Lek* **45**: 263–9.
- Silberman JD, Clark CG, Sogin ML (1996). *Dientamoeba fragilis* shares a recent common evolutionary history with the trichomonads. *Mol Biochem Parasitol* **76**: 311–14.
- Spencer MJ, Millet VE, Garcia LS, Rhee L, Masterson L (1983). Parasitic infections in a pediatric population. *Pediatr Infect Dis* **2**: 110–13.
- Stevens Simon C, Jamison J, McGregor JA, Douglas JM (1994). Racial variation in vaginal pH among healthy sexually active adolescents. *Sex Transm Dis* **21**: 168–72.
- Swerdlow MA, Burrows RB (1955). *Dientamoeba fragilis*, an intestinal pathogen. *J Am Med Assoc* **158**: 176–8.
- ter Meulen J, Mgaya HN, Chang Claude J *et al.* (1992). Risk factors for HIV infection in gynaecological inpatients in Dar es Salaam, Tanzania, 1988–1990. *East Afr Med J* **69**: 688–92.
- van der Weiden RM, van der Meijden WI, Bogchelmann DH, Polderman AM (1990). Treatment failure in trichomoniasis and persistence of the parasite after *Lactobacillus* immunotherapy: two case reports. *Eur J Obstet Gynecol Reprod Biol* **34**: 171–8.
- Viikki M, Pukkala E, Nieminen P, Hakama M (2000). Gynaecological infections as risk determinants of subsequent cervical neoplasia. *Acta Oncol* **39**: 71–5.
- Walker PP, Hall RE, Wilson JD (1997). Arsenical pessaries in the treatment of metronidazole-resistant *Trichomonas vaginalis*. *Int J Sex Transm Dis AIDS* **8**: 473.
- Watson PG, Pattman RS (1996). Arsenical pessaries in the successful elimination of metronidazole-resistant *Trichomonas vaginalis*. *Int J Sex Transm Dis AIDS* **8**: 296–7.
- Wenrich DH (1947). The species of *Trichomonas* in man. *J Parasitol* **33**: 177–8.
- Whittington MJ (1951). The survival of *Trichomonas vaginalis* at temperatures below +37°C. *J Hyg (Camb)* **49**: 400–409.
- Whittington MJ (1957). Epidemiology of infections with *Trichomonas vaginalis* in the light of improved diagnostic methods. *Br J Vener Dis* **33**: 80–91.
- WHO (1995). *An Overview of Selected Curable Sexually Transmitted Diseases*. WHO/GPA/STD/95.1. World Health Organization: Geneva; 1–13.
- Witkin SS, Inglis SR, Polaneczky M (1996). Detection of *Chlamydia trachomatis* and *Trichomonas vaginalis* by polymerase chain reaction in introital specimens from pregnant women. *Am J Obstet Gynecol* **175**: 165–7.
- Wolner Hanssen P, Krieger JN, Stevens CE *et al.* (1989). Clinical manifestations of vaginal trichomoniasis. *J Am Med Assoc* **261**: 571–6.

- Wong CA, Wilson PD, Chew TA (1990). Povidone-iodine in the treatment of metronidazole-resistant *Trichomonas vaginalis*. *Aust NZ J Obstet Gynaecol* **30**: 169–71.
- Yang J, Scholten T (1977). *Dientamoeba fragilis*: a review with notes on its epidemiology, pathogenicity, mode of transmission, and diagnosis. *Am J Trop Med Hyg* **26**: 16–22.
- Yarlett N, Hof H, Yarlett NC (1987). Activities of metronidazole and niridazole against *Trichomonas vaginalis* clinical isolates. *J Antimicrob Chemother* **19**: 767–70.
- Yu H, Tak Yin M (1993). The efficacy of povidone-iodine pessaries in a short, low-dose treatment regime on candidal, trichomonal and non-specific vaginitis. *Postgrad Med J* **69** (suppl 3): S58–61.
- Zhang ZF, Graham S, Yu SZ *et al.* (1995). *Trichomonas vaginalis* and cervical cancer: a prospective study in China. *Ann Epidemiol* **5**: 325–32.
- Zhang ZF, Begg CB (1994). *Trichomonas vaginalis* a cause of cervical neoplasia? Results from a combined analysis of 24 studies. *Int J Epidemiol* **23**: 682–90.
- Ziomko I, Kuczynska E (1994). Aktywnosc rzesistkobjcza nowo zsyntetyzowanych pochodnych benzoizotiazolinou (BIT) *in vitro* [Trichomonacidal activity of newly synthesized derivatives of benzoizothiazolinon (BIT) *in vitro*]. *Wiad Parazytol* **40**: 59–64.

# Pathogenic and Opportunistic Free-living Amebas: *Naegleria fowleri*, *Acanthamoeba* spp. and *Balamuthia* *mandrillaris*

Augusto Julio Martínez<sup>1</sup> and Govinda S. Visvesvara<sup>2</sup>

<sup>1</sup>University of Pittsburgh School of Medicine, Pittsburgh, PA, and <sup>2</sup>Centers for Disease Control and Prevention, Atlanta, GA, USA

## HISTORICAL INTRODUCTION

Pathogenic and opportunistic free-living amebas of the genera *Naegleria*, *Acanthamoeba* and *Balamuthia* are eukaryotic protists that are capable of producing serious diseases in humans and animals. *N. fowleri* infects immunocompetent hosts with a history of warm water-related activities and produces a necrotizing and hemorrhagic meningoencephalitis called primary amebic meningoencephalitis (PAM). *Acanthamoeba*, and more recently *Balamuthia*, have also been shown to cause infections in humans and animals including an insidious and chronic granulomatous disease known as granulomatous amebic encephalitis (GAE) in humans (both immunocompetent and immunosuppressed) and animals (Anzil *et al.*, 1991; John, 1993; Kinde *et al.*, 1998; Lozano-Alarcón *et al.*, 1997; Ma *et al.*, 1990; Martínez and Visvesvara, 1997; Rideout *et al.*, 1997; Visvesvara and Stehr-Green, 1990).

Historically, Puschkarew (1913) has been credited with the discovery of *Acanthamoeba*, as he was the first to isolate cyst-forming

amebas from dust in 1913 and identified them as *Amoeba polyphagus*. Page (1967) redescribed this ameba as *Acanthamoeba polyphaga*. Sir Aldo Castellani (1930) also isolated an ameba which was found as a contaminant in his yeast culture, and this ameba was later named as *Acanthamoeba castellanii*. The pathogenic potential of *Acanthamoeba* was demonstrated by Culbertson *et al.* (1958), when they isolated an ameba that occurred as a contaminant in monkey kidney cell cultures during the production of the poliomyelitis vaccine. This isolate is now named as *Acanthamoeba culbertsoni*. However, it was Fowler and Carter (1965) from Adelaide, Australia, who demonstrated for the first time that these small free-living amebas can cause human disease leading to death. The ameba isolated by them from human brain is now designated *Naegleria fowleri*. *Balamuthia mandrillaris*, the third ameba known to cause human disease (Visvesvara *et al.*, 1993), was first isolated in 1986 from the brain of a mandrill baboon and was initially identified as a leptomyxid ameba (Visvesvara *et al.*, 1990).

## DESCRIPTION OF THE ORGANISMS

*Naegleria*, *Acanthamoeba* and *Balamuthia*, along with a heterogeneous group of amoebas that include both free-living forms (e.g. *Hartmannella*, *Vahlkampfia*, *Vannella*) and parasitic amoebas (e.g. *Entamoeba histolytica*), are classified under the class Lobosea, superclass Rhizopodea, subphylum Sarcodina, phylum Sarcomastigophora. The sarcodinidan rhizopods locomote by producing hemispherical bulges, the lobopodia, from the surface of the body. *Naegleria*, *Acanthamoeba* and *Balamuthia* are aerobic and mitochondria-bearing amoebas that cause diseases mainly of the central nervous system of humans and animals, leading almost always to death. Since these amoebas have the ability to exist as free-living organisms in nature and occasionally to invade the host and live as parasites within host tissue, they have also been called amphizoic amoebas. In contrast, *E. histolytica* is an anaerobic amoeba that lacks mitochondria and causes mainly gastrointestinal disease (see Chapter 9).

Historically, the taxonomic classification of the small free-living amoebas has been based on the

type of locomotion of the trophozoites, the morphology of cysts and the type of nuclear division. Recently, however, these criteria have been questioned and biochemical parameters have been used, such as the isoenzyme profiles of the organisms or their genetic make-up, especially with reference to their sequence homology of the small subunit ribosomal DNA. It is also argued that classification of these amoebas should not be based on just one technique (Visvesvara, 1991). Taxonomic classification of these and other amoebas as currently accepted by the Society of Protozoologists (see Lee *et al.*, 1985), is shown in Figure 12.1.

The genus *Naegleria* comprises several species. However, only one species, *N. fowleri* (*N. aerobia* and *N. invadens* are non-valid synonyms) is known to cause the disease, primary amoebic meningoencephalitis (PAM) in humans. The genus *Acanthamoeba*, on the other hand, has more than 20 species. Several of these (e.g. *A. castellanii*, *A. culbertsoni*, *A. rhyodes*, *A. polyphaga* and *A. healyi*) have been identified as agents of the granulomatous amoebic encephalitis (GAE) in humans and other animals.

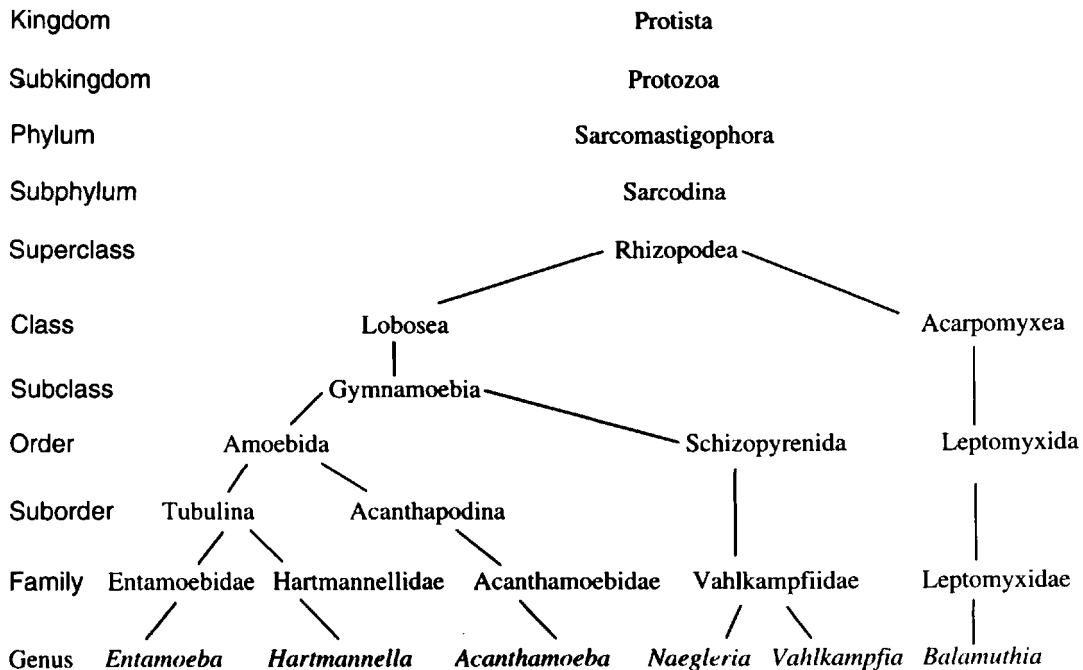


Fig. 12.1 Taxonomic classification of the small free-living amoebas, according to the Society of Protozoologists

Additionally, several species of *Acanthamoeba* are also known to cause infections of the cornea (*Acanthamoeba keratitis*, AK) as well as skin, nasal sinuses and pulmonary infections. The only known species of *Balamuthia*, *B. mandrillaris*, is known to cause GAE and skin infections in humans and other animals (John, 1982, 1993, 1998; Martínez and Visvesvara, 1997; Visvesvara and Stehr-Green, 1990).

### *Naegleria fowleri*

*N. fowleri*, as well as other species of *Naegleria*, has three stages in its life-cycle: a feeding stage, the trophozoite; a transient, non-feeding stage, the flagellate; and a resistant stage, the cyst (Figure 12.2). Because of the presence of a flagellate stage, *N. fowleri* is also called an ameboflagellate. The trophozoite, from culture, measures around 8–20  $\mu\text{m}$ , is uninucleate, feeds

normally on bacteria and multiplies by binary fission (Figure 12.3A). The trophozoite, however, under certain conditions, e.g. a sudden change in the ionic concentration in the immediate environment, may differentiate into a pear-shaped biflagellate stage (Figure 12.3B). The flagellate stage is transitory and usually reverts to the trophic stage. When conditions become unfavorable, the trophozoite differentiates into the cyst stage (Figure 12.3C). The trophic nucleus is spherical and contains a large, centrally placed, dense nucleolus. The trophozoite also possesses numerous dumbbell-shaped mitochondria, vacuoles, lysosomes and ribosomes (Figure 12.3D). The cyst is usually round, measuring 7–14  $\mu\text{m}$ , is uninucleate and is surrounded by a dense cyst wall, which is plugged with one or more flat pores (John, 1982; Ma *et al.*, 1990; Marciano-Cabral, 1988; Martínez and Visvesvara, 1997; Visvesvara and Stehr-Green, 1990).

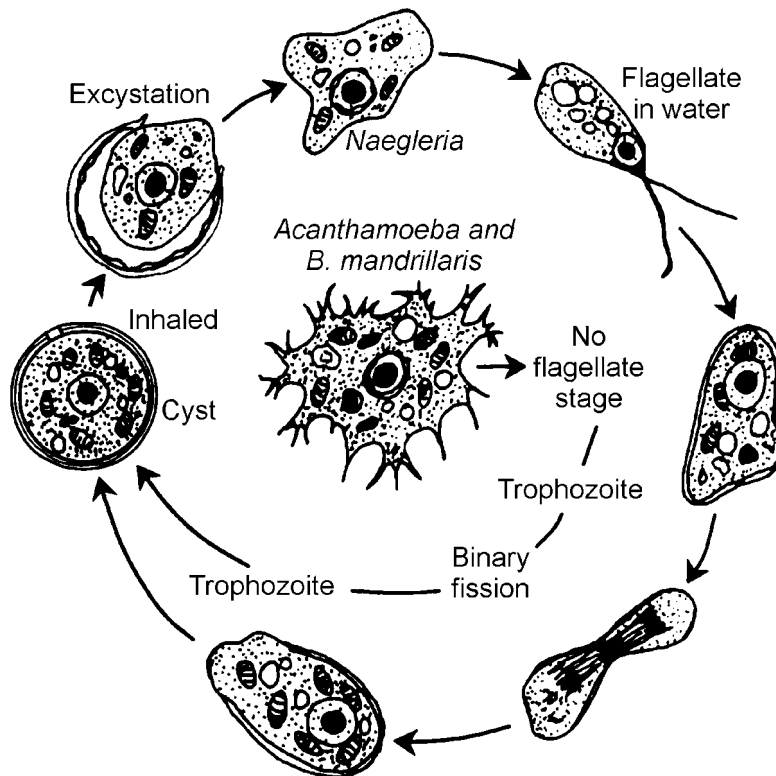
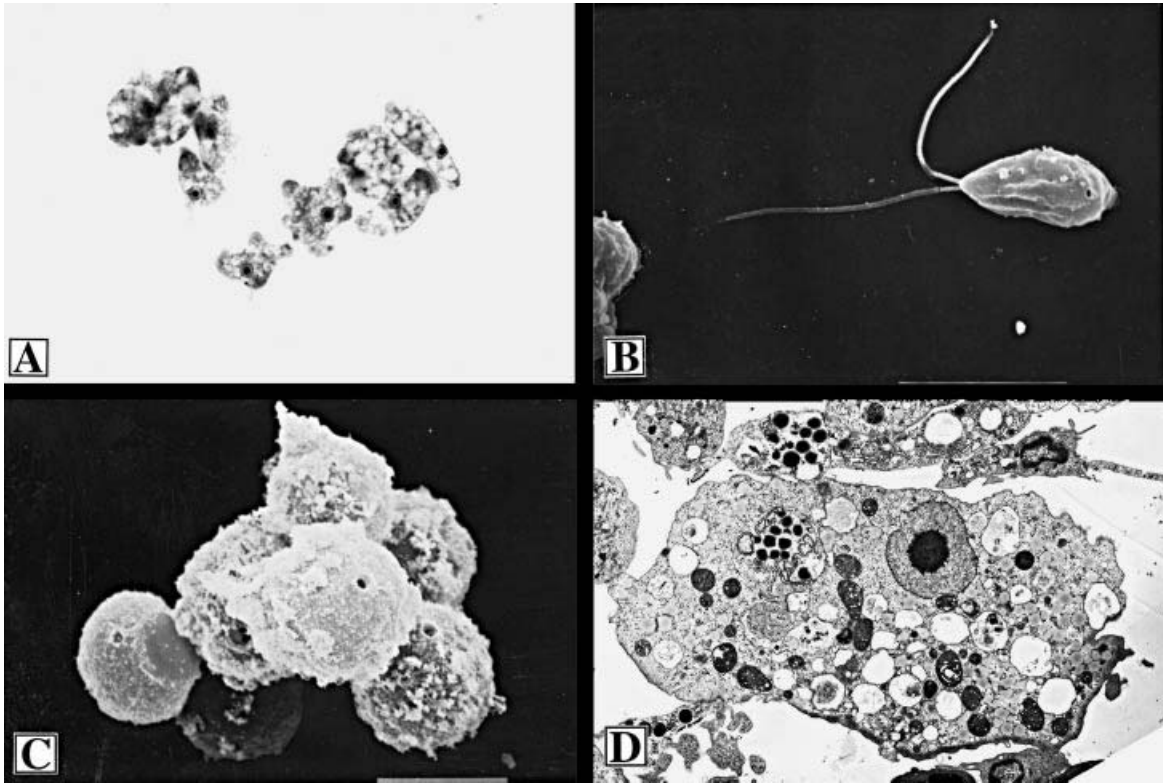


Fig. 12.2 Life-cycle of *Naegleria fowleri*, *Acanthamoeba* spp. and *Balamuthia mandrillaris*



**Fig. 12.3** (A) Trophozoites of *Naegleria fowleri*. Plastic embedded, toluidine blue,  $\times 500$ . (B) Flagellate form of *N. fowleri*. Scanning electron microscopy. Courtesy of Dr D. T. John (John, 1993). (C) Typical cysts of *N. fowleri*. Scanning electron microscopy. Courtesy of Dr D. T. John (John, 1993). (D) Ultrastructural features of *N. fowleri* trophozoite, Electron microscopy,  $\times 5000$

### *Acanthamoeba* spp.

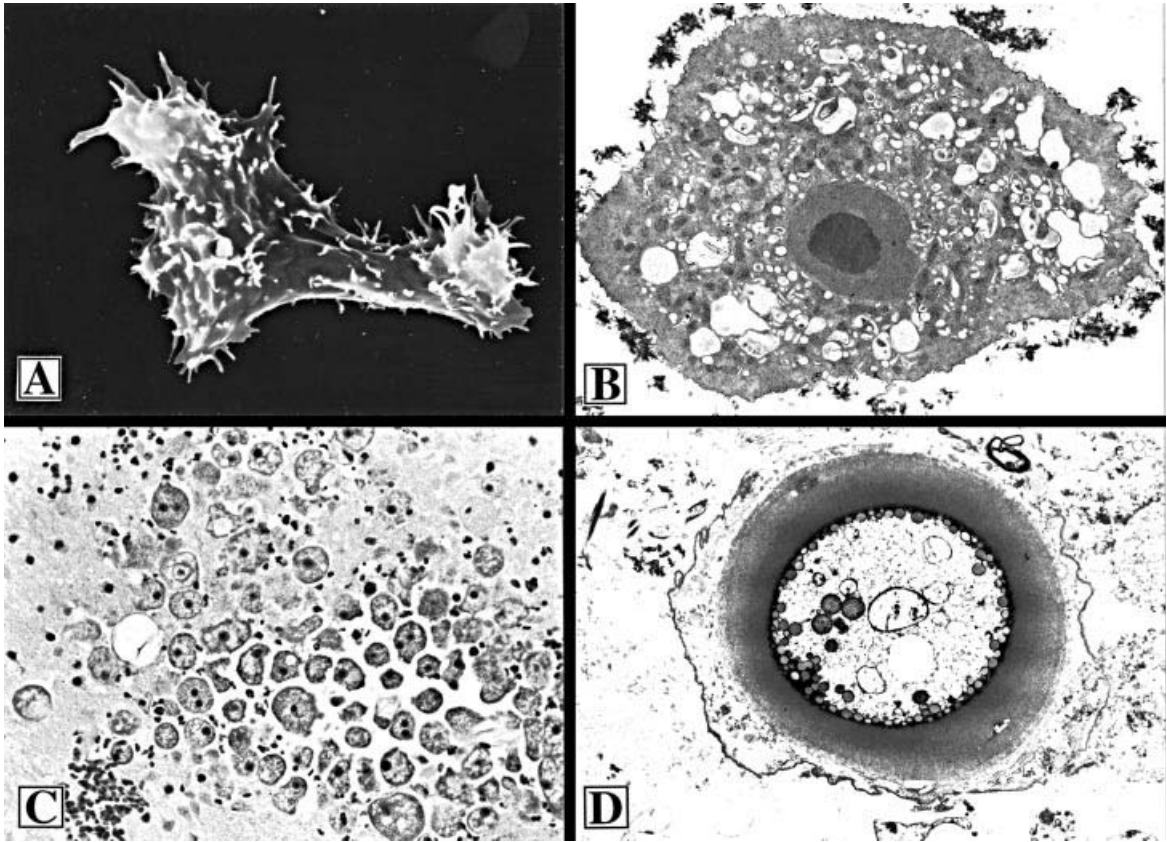
*Acanthamoeba* has two stages in its life-cycle, a feeding and reproducing trophozoite stage and a resistant cyst stage (Figure 12.2). The trophozoites feed on bacteria and detritus present in the environment and multiply by binary fission. One of the most characteristic features of *Acanthamoeba* is the presence of fine, tapering, thorn-like pseudopodia, the acanthopodia, which emanate from the surface of the body (Figure 12.4A). The trophozoites, from culture, measure 15–45  $\mu\text{m}$ . They are uninucleate and the nucleus has a centrally placed, large, densely-staining nucleolus. The cytoplasm is finely granular and contains numerous mitochondria, ribosomes, vacuoles and lysosomes (Figure 12.4B). Cysts are double-walled and measure from 10–25  $\mu\text{m}$ . The outer cyst wall,

the ectocyst, is wrinkled or mamillated and contains protein. The inner cyst wall, the endocyst, is usually stellate, polygonal, oval or spherical and contains cellulose. Pores or osteoles are present at the junction of the ectocyst and the endocyst. The pores are covered by opercula, which pop open at the time of encystation. The cysts are uninucleate and possess a centrally placed dense nucleolus (John, 1993; Ma *et al.*, 1990; Martínez and Visvesvara, 1997; Page, 1967; Visvesvara and Stehr-Green, 1990).

### *Balamuthia mandrillaris*

*B. mandrillaris*, like *Acanthamoeba*, has two stages in its life-cycle (Figure 12.2). The trophozoite is pleomorphic and measures 12–60  $\mu\text{m}$ ,





**Fig. 12.4** (A) Trophozoite of *Acanthamoeba* spp. showing the fine, thorn-like acanthopodia. Scanning electron microscopy. Courtesy of Dr D. T. John (John, 1993). (B) Ultrastructural features of *Balamuthia mandrillaris* trophozoite containing numerous mitochondria. Electron microscopy,  $\times 6000$ . (C) Trophozoites of *B. mandrillaris* within infected CNS tissue of a congenitally immunosuppressed mouse. Hematoxylin and eosin,  $\times 300$ . (D) Cyst of *B. mandrillaris* from a case of GAE showing a spherical thick wall with endocyst and delicate ectocyst. Electron microscopy,  $\times 5000$

with a mean of about  $30\mu\text{m}$ . It is usually uninucleate but binucleate forms are occasionally seen. The nucleus possesses a large, centrally placed, dense nucleolus. Occasionally, however, trophozoites with two or three nucleolar bodies have been seen, especially in infected tissues (Figure 12.4C). The cysts are also uninucleate, more or less spherical and measure  $12\text{--}30\mu\text{m}$ , with a mean of  $15\mu\text{m}$ . The cysts, when examined with a light microscope, appear to be double-walled, the outer wall being wavy and the inner wall round. Ultrastructurally, however, the cysts possess three walls—an outer thin and irregular ectocyst, an inner thick endocyst, and a middle amorphous fibrillar mesocyst (Figure 12.4D)

(Martínez and Visvesvara, 1997; Visvesvara *et al.*, 1990, 1993; Visvesvara and Stehr-Green, 1990).

### Culture

*Acanthamoeba* spp. and *N. fowleri*, but not *B. mandrillaris*, can be easily cultivated on non-nutrient agar plates coated with a suitable Gram-negative bacterium, such as *Escherichia coli* or *Enterobacter aerogenes*. The amebas will feed on the bacteria, multiply and completely cover the surface of the plates within a few days. When

almost all of the bacteria are gone, the amebas differentiate into cysts. They can be maintained in the laboratory indefinitely by periodically cutting out a small piece of agar containing trophozoites and/or cysts and transplanting it onto a fresh agar plate, coated with bacteria as before. Additionally, both *Naegleria fowleri* and *Acanthamoeba* spp. can also be cultured on mammalian cell cultures. Unlike *Acanthamoeba* and *Naegleria*, *Balamuthia* cannot be cultured on agar plates coated with bacteria. *B. mandrillaris* has not been isolated from the environment so far and the food source of these organisms is not yet known. However, it is well known that when it infects humans and other animals, it feeds on host tissue cells and destroys their normal architecture. Therefore, it is usually isolated by inoculating infected host tissue on to mammalian cell cultures. *Balamuthia* feeds on the cell culture and multiplies (John, 1993; Martínez and Visvesvara, 1997; Visvesvara *et al.*, 1990, 1993; Visvesvara and Stehr-Green, 1990).

*N. fowleri*, *Acanthamoeba* spp. and *B. mandrillaris* can be cultivated without bacteria in complex chemical media. Although several different formulations are available, Centers for Disease Control and Prevention (CDC) laboratories use a modified version of Nelson's medium that contains a 0.5% solution of liver digest, 0.1% glucose and a low-osmolarity buffered salt solution supplemented with 3–5% fetal bovine serum. *Acanthamoeba* spp. can also be easily grown in a medium composed of 2% proteose peptone, 0.5% yeast extract and 0.1% glucose, made up in a low osmotic buffered salt solution with or without serum (John, 1993). *B. mandrillaris* can also be grown in a highly complex medium (Schuster and Visvesvara, 1996). Serum-free, chemically defined media have also been devised to grow *N. fowleri* and several species of *Acanthamoeba*.

## PATHOGENESIS

### Primary Amebic Meningitis (PAM)

The olfactory neuroepithelium in the upper portion of the nasal mucosa is the portal of entry into the CNS and the anatomic site of the

primary lesion in PAM. Sustentacular cells of the olfactory neuroepithelium are capable of actively phagocytosing the amebas. The route of invasion into the brain is through the fila olfactoria of the olfactory nerves. The amebic trophozoites pierce the cribriform plate of the sphenoid bone and penetrate into the subarachnoid space, then continue to reproduce in the brain parenchyma. During their invasion and migration into the CNS, *N. fowleri* use the mesaxonal spaces of the unmyelinated olfactory nerves as a pathway. The olfactory nerves terminate in the olfactory bulb within the subarachnoid space, which is surrounded by the CSF. This space is richly vascularized and constitutes the ideal medium for amebas to grow and disseminate to other areas of the brain (Martínez and Visvesvara, 1997).

The incubation period of PAM varies from 2 to 15 days, depending on the size of the inoculum and the virulence of the amebas. The less virulent the strain, the longer the incubation period. In experimental infections by a mildly virulent *N. fowleri*, the incubation period has been as long as 3–4 weeks (John, 1982; Martínez and Visvesvara, 1997).

*N. fowleri* trophozoites secrete a proteolytic enzyme that contributes to the dissolution and necrosis of the CNS tissue. Also, the presence of polymorphonuclear leukocytes, macrophages and lymphocytes, and the cytokines they contain may play an important role in the structural changes within brain tissue (Marciano-Cabral, 1988; Martínez and Visvesvara, 1997).

### Granulomatous Amebic Encephalitis (GAE)

By contrast, *Acanthamoeba* spp. and *Balamuthia mandrillaris* are apparently more frequent opportunistic free-living amebas, causing a relentless subacute or chronic, usually GAE, affecting mainly chronically ill, debilitated individuals and immunocompromised hosts. GAE has an element of opportunism, promoted mainly by loss of metabolic, physiological or immunological integrity of the host (Martínez, 1980). Among the commonly recognized causes of susceptibility are diseases such as diabetes mellitus, hematologic malignancies, cancer,

acquired immunodeficiency syndrome (AIDS) and pregnancy. Treatment with broad-spectrum antibiotics and cytotoxic agents and immunomodulating drugs in patients undergoing cytoreductive iatrogenic or immunosuppressive therapy after organ transplants to avoid organ rejection in liver, kidney, heart, lung or bone marrow transplantation (such as corticosteroids, cyclosporine, tacrolimus (FK-506)) are also predisposing risk factors for the development of GAE (Anderlini *et al.*, 1994; Martínez, 1980, 1982).

GAE is also seen in some patients apparently in good health and with no evidence of immunosuppression. The incubation period is unknown and several weeks or months may elapse before the disease becomes apparent. The portal of entry is thought to be the lower respiratory tract or the skin. The etiologic agents may enter the respiratory tract through aerosol or inhalation of airborne dust containing the trophic or cyst stage. The trophozoites, or most likely the cysts, are inhaled and go to the lung parenchyma, where they may temporarily be contained by the body's immune system. However, if the immune system is impaired and weakened by age, disease or stress, then the cyst excysts and provokes the disease. The route of invasion to the brain must be through the blood stream, since there are no lymphatic channels within the brain (Martínez and Visvesvara, 1997).

The portal of entry into the CNS is postulated to be the lower respiratory tract or an ulceration of the skin, with subsequent hematogenous dissemination. The skin lesions may be the presenting infection, suggesting either a portal of entry or a terminal 'metastatic' dissemination of the parasites. The amebic trophozoites and cysts may reach the brain by hematogenous spread. More than 20 cases of skin ulcers/abscesses due to *Acanthamoeba* spp. have been reported (e.g. Chandrasekar *et al.*, 1977; Helton *et al.*, 1993; Khalife *et al.*, 1994; May *et al.*, 1992; Park *et al.*, 1994; Selby *et al.*, 1998; Sison *et al.*, 1995; Tan *et al.*, 1993; and others listed in References). At least one patient with skin abscesses has been treated successfully with topical chlorhexidine gluconate, parenteral pentamidine and oral itraconazole (Slater *et al.*, 1994).

## IMMUNOLOGY: IMMUNITY TO FREE-LIVING AMEBAS

Immunodeficiency states may be divided in two types, primary and secondary (acquired). In both cases free-living amebic infection may be found. There are predisposing risk factors for the opportunistic amebas to produce disease.

### Predisposing Factors

Primary immunodeficiency is due to genetic abnormalities, usually single mutations. They may be inherited (hemophilia, cystic fibrosis, DiGeorge syndrome, ataxia-telangiectasia syndrome, Wiskott-Aldrich syndrome and severe combined immunodeficiency syndrome). The immune system is damaged later in life. The most frequent causes are malnutrition, tumors, trauma, medical treatment, protein loss or infection (HIV). The most common acquired immunodeficiencies are those caused by HIV and those caused by immunosuppressive therapies for prevention of allograft rejection.

There is very little information on the antibody response to *N. fowleri* infections, probably because most of the patients die too soon to produce detectable levels. However, in one patient who survived, a specific antibody titer of 4096 to *N. fowleri* was demonstrated by an immunofluorescence test in serum samples obtained at 7, 10 and 42 days of hospitalization (Seidel *et al.*, 1982). Serum antibodies to *N. fowleri* persisted after 4 years (Visvesvara and Stehr-Green, 1990). Antibodies to *Naegleria* species and *N. fowleri* have also been reported in apparently healthy persons (John, 1982; Marciano-Cabral, 1988; Martinez and Visvesvara, 1997). Free-living amebas, especially *Acanthamoeba*, have been isolated from human throats, suggesting that the amebas may exist transiently and cause no harm to healthy persons. Antibodies to *Acanthamoeba* have also been detected in patients suffering from upper respiratory tract illnesses in the UK; 20% of 128 patients hospitalized for respiratory problems had complement-fixing (CF) antibody to *Acanthamoeba* spp. (Martínez, 1980; Visvesvara and Stehr-Green, 1990), indicating that many unrecognized infections caused by *Acanthamoeba* may exist in nature. It is interesting to note that Kenney (John, 1993;

Martínez and Visvesvara, 1997; Visvesvara and Stehr-Green, 1990) also demonstrated CF antibody to *A. culbertsoni* in two of 1000 serum samples collected randomly. Notably, one of the serum samples was from a patient with an old brain infarct. The initial serum sample had a CF titer of 8 and rose to 16 and 64 in subsequent samples taken after 1 and 2 months, respectively. The patient subsequently died of cerebral hemorrhage and amebas were demonstrated in the brain sections, but unfortunately the species of the ameba was not identified. In another study, Cleland *et al.* (cited in Martínez and Visvesvara, 1997; Visvesvara and Stehr-Green, 1990) detected an increase in titer from 256 to 1024 against *A. rhysodes* in serum samples collected 16 months apart from a Nigerian patient from whose CSF *A. rhysodes* was repeatedly isolated. Immunofluorescent and precipitin antibody to *Acanthamoeba* has also been demonstrated in patients with *Acanthamoeba* keratitis. Antibodies to *Acanthamoeba* species have also been detected in apparently healthy persons (John, 1993; Martínez and Visvesvara, 1997; Visvesvara and Stehr-Green, 1990).

The significance of antibodies to *Naegleria* and *Acanthamoeba* in apparently healthy people is not clear. One reason for this is probably the ubiquity and the universal distribution of these amebas in nature, resulting in the exposure of most humans to the various amebic antigens, resulting in the development of antibodies.

Ferrante (1991) has suggested that human serum containing IgG and IgM antibodies is the first-line of defense against *Acanthamoeba* infection in humans. Immunoglobulins and complement promote recognition of the amebas by neutrophils, macrophages and probably lymphocytes. These cells destroy amebas in the normal immunocompetent host. However, in the immunosuppressed individual, due to the lack of T lymphocytes and impairment of cell-mediated immunity, free-living amebas continue to proliferate and produce structural damage to the CNS and other tissues (Martínez, 1982).

## MOLECULAR BIOLOGY

During the last few years there have been significant advances regarding molecular biology

techniques for the diagnosis of infectious diseases. Southern blots, isoenzyme profiles and chromatographic analysis have been used to type and differentiate strains of free-living amebas. Mitochondrial DNA fingerprinting by restriction fragment length polymorphism of *Acanthamoeba* spp. has been used to compare and classify clinical and environmental isolates. Genus- and subgenus-specific oligonucleotide probes for *Acanthamoeba* spp. have also been developed. Immunoperoxidase and immunofluorescence methods using monoclonal antibodies directed against specific strains of free-living amebas have the advantage of specificity for a single antigen and therefore can be used for precise identification and differentiation of isolates.

## EPIDEMIOLOGY

*Naegleria fowleri* is widely distributed throughout the world and has been isolated from freshwater, thermal discharges of power plants, heated swimming pools, hydrotherapy and remedial pools, aquaria, sewage, and even from the nasal passages and throats of healthy individuals. The typical cases of PAM occur in the hot summer months, when large numbers of people engage in aquatic activities in freshwater bodies, such as lakes, ponds and swimming pools that may harbor these amebas (John, 1982; Marciano-Cabral, 1988; Martínez and Visvesvara, 1997; Visvesvara and Stehr-Green, 1990).

*Acanthamoeba* spp. have been isolated from soil, bottled mineral water, the cooling towers of electric and nuclear power plants, physiotherapy pools, jacuzzis, heating, ventilating and air-conditioning units, dialysis machines, dust in the air, bacterial, fungal and mammalian cell cultures, contact lens materials, the nose and throat of patients with respiratory complaints, and healthy individuals. *Acanthamoeba* spp. have been known to harbor *Legionella* sp. and *Mycobacteria* (John, 1993; Martínez and Visvesvara, 1997; Visvesvara and Stehr-Green, 1990).

*B. mandrillaris*, however, has only been isolated so far from biopsy and autopsy specimens of humans and other animals. It has not been as yet isolated from the environment. Cases of GAE may occur at anytime of the year and therefore have no relation to climatological changes.

Several species of *Acanthamoeba*, such as *A. castellanii*, *A. culbertsoni*, *A. astronyxis*, *A. hatchetti*, *A. lenticulata*, *A. palestinensis*, *A. polyphaga*, *A. rhysodes* and other free-living leptomyxid amebas, such as *B. mandrillaris*, were considered originally as harmless, innocuous soil microorganisms, incapable of infecting mammals. But it is now known that these amebas can produce encephalitis, keratitis and skin ulcers, primarily in people with defective cellular immune systems without a history of water exposure (John, 1993; Martinez and Visvesvara, 1997; Visvesvara and Stehr-Green, 1990).

Until recently it was thought that *N. fowleri* infected only humans. However, Lozano-Alarcón *et al.* (1997) described the first case of *N. fowleri* infection in an animal (South American tapir) other than a human. Recently, a number of cows died of *N. fowleri* meningoencephalitis (Kinde, personal communication). *Acanthamoeba* and *Balamuthia* are also known to infect animals other than humans and cause GAE (Kinde *et al.*, 1998; Martínez and Visvesvara, 1997; Rideout *et al.*, 1997; Visvesvara *et al.*, 1990; Visvesvara and Stehr-Green, 1990).

## CLINICAL FEATURES

### Primary Amebic Meningoencephalitis due to *Naegleria fowleri*

#### *Clinical Signs and Symptoms*

PAM is an acute, rapidly progressing illness. It is characterized by bifrontal or bitemporal headaches, fever, nausea, vomiting and stiff neck. The symptoms progress rapidly, leading to lethargy, confusion, coma and, in most cases, to death in a few hours. Seizures, and sometimes abnormalities in taste or smell and ataxia, may be seen. Nuchal rigidity with positive Kernig's and Brudzinski's signs may be present. Photophobia may be present late in the clinical course. Palsies involving the third, fourth and sixth cranial nerves may also be present in some patients and indicate brain edema and herniations. Raised intracranial pressure has been reported in the majority of patients. Cardiac rhythm abnormalities detected by ECG have been found in some cases. The peripheral white blood cell count is

generally elevated, with a marked increase in polymorphonuclear leukocytes and with some lymphocytosis. The majority of cases end fatally within 1 week from the beginning of the symptoms; however, a few cases have been reported to have survived without neurological sequelae. The cause of death is usually increased intracranial pressure with brain herniation leading to cardiorespiratory arrest (Butt, 1996; Fowler and Carter, 1965; Seidel *et al.*, 1982).

#### *Pathological Findings*

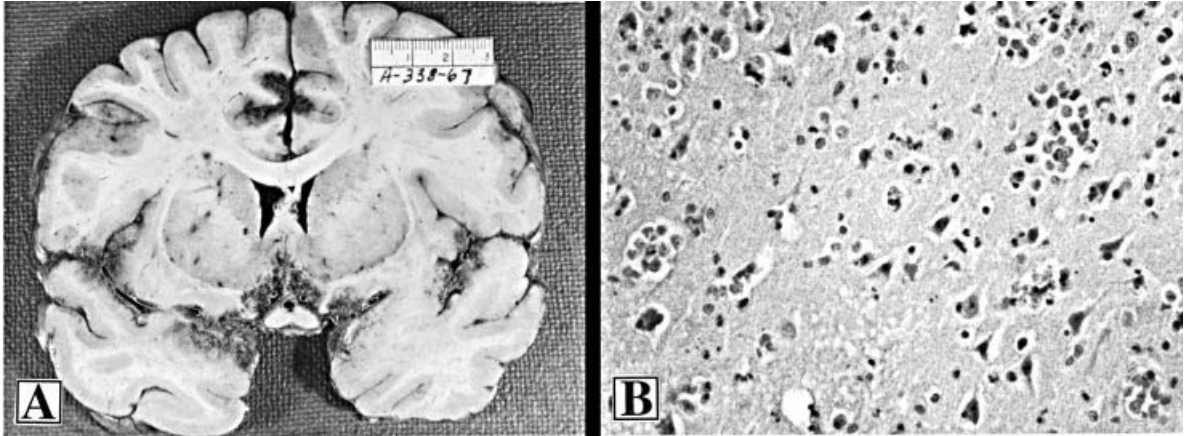
*Gross CNS findings.* The cerebral hemispheres are usually swollen and edematous. Hemorrhagic necrosis of the cerebral cortex is characteristic (Figure 12.5A). Uncal and cerebellar tonsillar herniations may be seen. The leptomeninges are congested, with scant purulent exudate that may be seen along the sulci and around blood vessels. The olfactory bulbs and the orbitofrontal cortices are usually necrotic and hemorrhagic.

*Microscopic findings.* Histopathologically, PAM is characterized by modest amounts of purulent exudate, necrosis and edema, with diffuse hemorrhages of the cortical areas and CNS parenchyma (Figure 12.5B). Amebic trophozoites are present within the perivascular spaces, with minimal or no inflammatory reaction (Figure 12.5B). Cysts are not present within the CNS lesions. Necrotizing angitis is occasionally seen. The leptomeninges show a fibrinopurulent exudate composed of polymorphonuclear leukocytes and eosinophils with fewer macrophages and lymphocytes. These changes are usually found at the base of the cerebral hemispheres, the brainstem, the cerebellum and the upper portions of the spinal cord. Amebic trophozoites can be seen within the purulent exudate (Butt, 1996; Fowler and Carter, 1965; Martínez and Visvesvara, 1997; Visvesvara and Stehr-Green, 1990).

### Granulomatous Amebic Encephalitis (GAE) produced by *Acanthamoeba* spp. and *B. mandrillaris*

#### *Clinical Signs and Symptoms*

Granulomatous amebic encephalitis (GAE) is characterized by a protracted, insidious clinical



**Fig. 12.5** (A) Primary amebic meningoencephalitis. Coronal section at the level of the optic chiasm showing focal necrosis with hemorrhage on the orbitofrontal cortices and cingulate gyri. From the Medical College of Virginia, A338-67, with permission. (B) The cerebral cortex contains multiple clusters of *N. fowleri* trophozoites with negligible acute inflammatory reaction. Hematoxylin and eosin,  $\times 250$ . From the Medical College of Virginia, A338-67, with permission

course (Anzil *et al.*, 1991; Martínez and Visvesvara, 1997). GAE has a clinical picture that mimics a single or multiple space-occupying lesion. Localizing neurologic signs and symptoms, such as hemiparesis and seizures, appear early in the clinical course. Mental status abnormalities, headache and stiff neck may be present. Palsies involving the third and the sixth cranial nerves may be seen. Nausea, vomiting, low-grade fever, lethargy, cerebellar ataxia and diplopia are also part of the clinical features. Chest X-rays of the lungs may demonstrate focal consolidated areas and pneumonitis. The direct cause of death in GAE is usually acute bronchopneumonia, liver or renal failure septicemia (Carter *et al.*, 1981; Martínez and Visvesvara, 1997; Visvesvara and Stehr-Green, 1990).

### **Pathological Features**

The route of invasion and penetration into the brain in cases of GAE is hematogenous, probably from a primary focus in either the lower respiratory tract or the skin. Amebic trophozoites and cysts may be found within the pulmonary parenchyma or skin lesions. The CNS is the target of clinical illness, but other organs including lungs, kidneys, uterus, prostate and testes may be

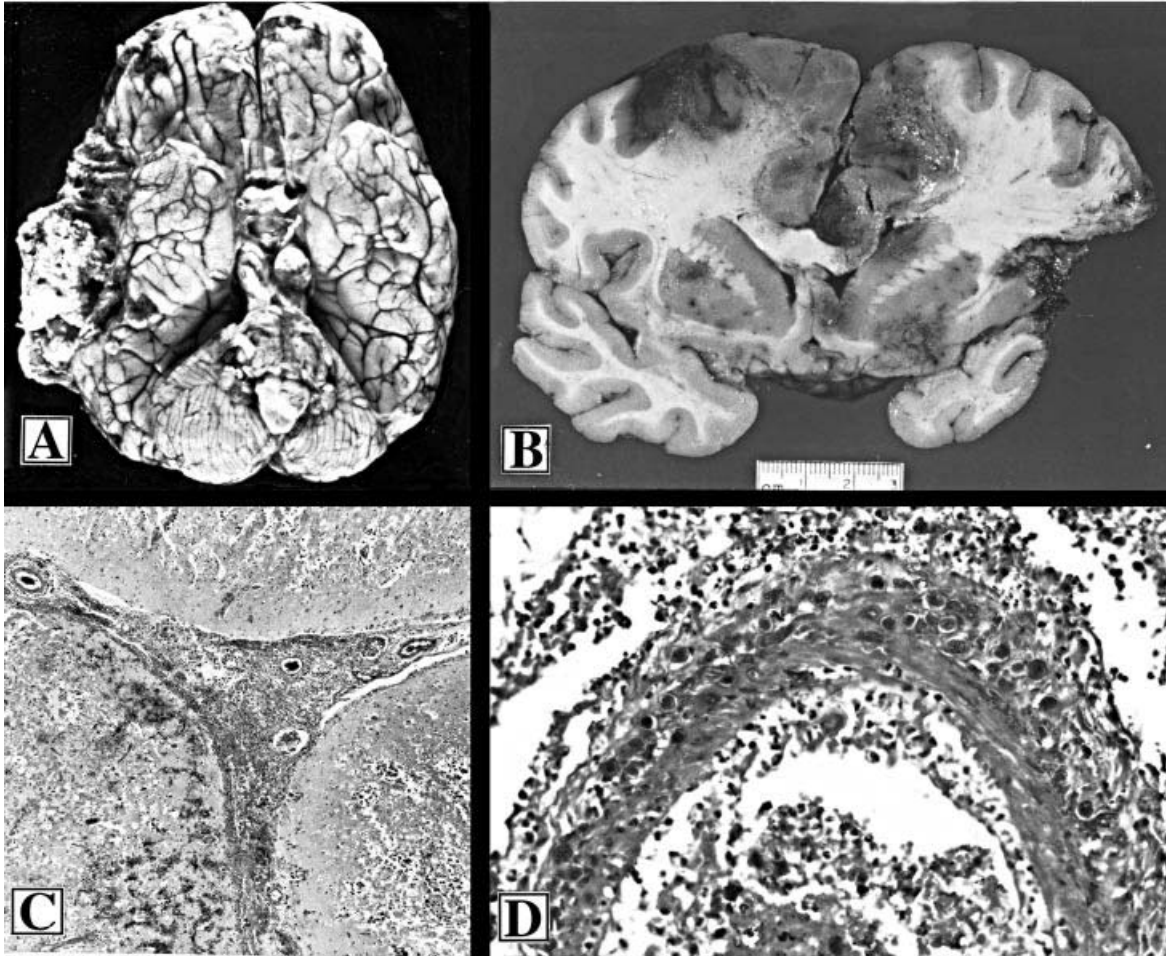
involved, secondary to terminal hematogenous spread (Martínez and Visvesvara, 1997).

### **Gross CNS, Dermatologic and Other Findings**

In the cerebral hemispheres there are multifocal areas of cortical and basal ganglia softening, with necrosis of CNS tissue and hemorrhages (Figure 12.6A). The brainstem, cerebral hemispheres and cerebellum may show areas of 'hemorrhagic infarcts' (Figure 12.6B). Ulcerations of the skin may be seen mainly in patients with AIDS, with acute and chronic inflammation (see numerous references in endlist). A skin biopsy may demonstrate amebic trophozoites and cysts. Ulcerated skin lesions may serve as the portal of entry for amebas or they may represent 'terminal' dissemination of the infection. Several cases of skin involvement without dissemination to the CNS have also been reported.

### **Neuropathological Findings of GAE**

The histopathologic changes consist of multifocal, subacute or chronic necrotizing granulomatous encephalitis with multinucleated giant cells in the



**Fig. 12.6** (A) Granulomatous amebic encephalitis due to *B. mandrillaris*, showing areas of disruption of cerebral cortex and encephalomalacias. Courtesy of E. Yunis MD, Children's Hospital of Pittsburgh, CA-76-79. (B) Coronal section of the cerebral hemisphere, showing multifocal areas of encephalomalacia involving cerebral cortex and subcortical white matter. Courtesy of E. Yunis MD, Children's Hospital of Pittsburgh, CA-76-79. (C) Microscopic appearance of cerebral cortex and subarachnoid space with profuse inflammatory reaction. Courtesy of Presbyterian University Hospital, PA-80-28. (D) Arteriole showing amebic trophozoites and cysts of *Acanthamoeba castellanii* within the vascular walls. Hematoxylin and eosin,  $\times 350$ . Courtesy of Presbyterian University Hospital, PA-80-28

cerebral hemispheres, midbrain, basal ganglia and cerebellum (Figure 12.6C). Trophozoites and cysts are found within the CNS lesions, particularly around and within blood vessel walls (Figure 12.6D). CNS tissues show inflammatory changes that vary depending on the immunologic status of the host. Focal chronic leptomeningitis may be seen. In patients with AIDS, the lesions may be mostly necrotic, with minimal or negligible inflammation. This probably is due to an

impairment of cell-mediated immunity or a defect in histiocytic response, with failure to produce multinucleated giant cells (Anzil *et al.*, 1991; DiGregorio *et al.*, 1992; Denney *et al.*, 1997; Jaramillo-Rodriguez *et al.*, 1989; Lowichik *et al.*, 1995; Martínez and Visvesvara, 1997). Arteritis with the presence of trophozoites and cysts may also be seen (Jaramillo-Rodriguez *et al.*, 1989; May *et al.*, 1992; Murakaura *et al.*, 1995).

## LABORATORY DIAGNOSIS

### Primary Amebic Meningitis

There are no distinctive clinical features to differentiate PAM from acute pyogenic or bacterial meningoencephalitis. Serologic tests usually are of no value in the diagnosis of *N. fowleri* infections, since most patients die too early (within 5–7 days) in the disease to mount a detectable immune response.

### CSF Examination

The cerebrospinal fluid in PAM is characterized by pleocytosis, with a predominance of polymorphonuclear leukocytes and no bacteria. The CSF pressure is elevated (300–600 mmH<sub>2</sub>O). Glucose concentration may be slightly reduced or normal, but the protein content is elevated (100–1000 mg/100 ml) (John, 1982; Ma *et al.*, 1990; Martínez and Visvesvara, 1999).

Amebic trophozoites may be detected by their movement in a drop of CSF when examined under a microscope or may be identified in CSF smears stained with Wright or Giemsa stains. Gram stain is not useful.

### Brain Biopsy

Brain biopsy could potentially be used to detect amebic trophozoites and the characteristic histopathological features, but to date no case of PAM has yet been diagnosed by brain biopsy (John, 1982; Martínez and Visvesvara, 1997).

### Neuroimaging Findings

CT scans or MRI show obliteration of the cisterns around the midbrain and the subarachnoid space over the cerebral hemispheres. Marked diffuse enhancement in these regions may be seen after administration of intravenous contrast medium (Lowichik *et al.*, 1995).

## Granulomatous Amebic Encephalitis

### CSF Examination

Results of CSF examination are non-specific in GAE and consist of lymphocytic pleocytosis with mild elevation of proteins and normal glucose. Unlike *N. fowleri*, *Acanthamoeba* spp. and *B. mandrillaris* are rarely found in the CSF. *Acanthamoeba* spp. have been isolated from the CSF in only two cases; however, they have been identified in brain biopsies from several patients (Martínez, 1982; Martínez and Visvesvara, 1997).

### Brain and Skin Biopsies

Brain or skin biopsies may be diagnostic; amebic trophozoites and cysts, if present, are easily identified by light microscopic examination of tissue sections. However, in the majority of cases the diagnosis of GAE has been made at autopsy. In general, *Acanthamoeba* spp. and *B. mandrillaris* are difficult to differentiate in tissue sections by light microscopy because of their similar morphology (Martínez and Visvesvara, 1997). They can be differentiated by immunofluorescence analysis of tissue sections using rabbit anti-*Acanthamoeba* or anti-*B. mandrillaris* sera. Alternatively, biopsy or autopsy tissues fixed in formalin can be deparaffinized, rehydrated, post-fixed in Karnovsky's, dehydrated and embedded in plastic (EPON) for electron microscopic studies. The morphology of the cysts is particularly useful in the identification of *B. mandrillaris*. To identify the species of *Acanthamoeba*, one of following can be performed: immunoperoxidase or immunofluorescence tests, the modified indirect *Staphylococcus* protein A co-agglutination test, or culture. *Acanthamoeba* spp. can be easily grown on non-nutrient agar plates seeded with bacteria. Specimens for culture should be processed as soon as possible (Gordon *et al.*, 1992). *Balamuthia* in contrast does not grow on bacteria-coated agar plates. Hence, biopsy specimens should also be inoculated on mono-layers of mammalian cells, e.g. human lung fibroblasts (HLF) or monkey kidney cells (EG).



### Neuroimaging Findings

CT and MRI of the head are important radiologic tests. Single or multiple heterogenous, hypodense, non-enhancing 'space-occupying lesions' involving the basal ganglia, cerebral cortex, subcortical white matter, cerebellum or pons may be encountered. These features may mimic a brain abscess, tumor or intracerebral hematoma (Lowichik *et al.*, 1995; Schumacher *et al.*, 1995).

### *Acanthamoeba* Keratitis (AK)

#### Clinical

*Acanthamoeba* keratitis (AK) is a subacute or chronic inflammatory reaction of the cornea, usually arising from an area of trauma to the corneal epithelium and resulting in ulceration and a 360° stromal ring infiltrate. AK usually produces severe ocular pain and congestion of the conjunctiva. In general, AK affects healthy individuals who wear contact lenses or who have a history of a small traumatic injury or abrasion to the cornea and exposure to contaminated water or other products.

#### Histopathology

Histopathologically, AK is characterized by chronic inflammation, with the presence of amebic trophozoites and cysts. Recurrent ulceration with a waxing and waning course that is refractory to medications used for bacterial, viral, or fungal infections is characteristic.

In the early stages of AK, the anterior cornea is destroyed by the invading *Acanthamoeba* trophozoites. Amebic trophozoites and cysts are seen infiltrated between the lamellae of the cornea. Infiltration, primarily of polymorphonuclear leukocytes, is commonly seen into the superficial and middle layers of the corneal stroma. During later stages of the disease, AK is characterized by ulceration, descemetocoele formation and perforation of the cornea.

### Isolation

*Acanthamoeba* trophozoites and especially cysts can be recovered from corneal scrapings or biopsy. Attempts should be made to isolate the organism by culture so that the species can be identified by isoenzyme electrophoresis and *in vitro* sensitivity testing performed with various chemotherapeutic agents (Berger *et al.*, 1990; Illingworth *et al.*, 1995; Larkin *et al.*, 1992; Rabinovitch *et al.*, 1990; Stehr-Green *et al.*, 1989).

## CLINICAL MANAGEMENT

### Primary Amebic Meningoencephalitis

Only a few patients have survived this disease. Amphotericin B, miconazole and rifampin may be effective. Amphotericin B and miconazole have been administered intrathecally or intravenously, alone or in combination, with rifampin given orally (Rowen *et al.*, 1995).

### Granulomatous Amebic Encephalitis

To date no effective treatment for GAE due to *Acanthamoeba* species has been identified although a few patients have survived (Martinez and Visvesvara, 1997; Seijo Martinez *et al.*, 2000). The prognosis is uniformly poor, probably because of the inadequacy of the host's immune system (Schuster and Visvesvara, 1996). *In vitro* experiments suggest that diamidine derivatives, such as pentamidine, propamidine, or dibromopropamidine; paramomycin; neomycin; ketoconazole and miconazole; 5-fluorocytosine; and magainins may have activity against *Acanthamoeba* species (John, 1993; Martínez and Visvesvara, 1997; Schuster and Jacob, 1992). The prognosis of patients with disseminated skin infections without CNS involvement is, however, good (Hunt *et al.*, 1995; Schuster and Visvesvara, 1996). Recent studies indicate that *Balamuthia mandrillaris* is sensitive to pentamidine isethionate *in vitro* and treatment with this drug may be beneficial to patients with *Balamuthia* GAE (Schuster and Visvesvara, 1996).

### ***Acanthamoeba* Keratitis**

Polyhexamethylene biguanide (PHMB) has been used topically to treat AK, with excellent prognosis for visual recovery. Propamidine isothionate and dibromopropamidine (Brolene) have also been used with some success. When medical treatment has failed, penetrating keratoplasty, corneal grafting or debridement have been performed with good results in some cases. Recurrence of AK has been reported following corneal transplantation. Therefore, eradication of amebic infection should be achieved before transplant (Berger *et al.*, 1990; Illingworth *et al.*, 1995; Larkin *et al.*, 1992; Ma *et al.*, 1990; Martínez and Visvesvara, 1997; Rabinowitz *et al.*, 1990).

## **PREVENTION AND CONTROL**

### **Primary Amebic Meningoencephalitis**

Warm temperatures (above 30°C) and pollution of the water with organic material are ideal for the proliferation of *N. fowleri*. Since *N. fowleri* is susceptible to chlorine at one part per million, it is necessary that swimming pools be adequately chlorinated. Since it is not possible to chlorinate natural bodies of water such as lakes and ponds, appropriate warnings should be posted, particularly during the hot summer months (John, 1982; Ma *et al.*, 1990; Martínez and Visvesvara, 1997).

### **Granulomatous Amebic Encephalitis**

GAE produced by *A. castellanii* spp. and by *B. mandrillaris* occurs in hosts with compromised immunity. The poor prognosis in patients infected with these free-living, opportunistic amebas requires the development of new approaches to treatment and prevention (John, 1993; Martínez and Visvesvara, 1997).

### ***Acanthamoeba* Keratitis**

Education of patients regarding the proper care of contact lenses and contact lens solutions is

important in the prevention of AK. Contact lenses should not be used during swimming or while performing water-sport activities (Ma *et al.*, 1990; Martínez and Visvesvara, 1997; Stehr-Green *et al.*, 1989).

## **PERSPECTIVES, CONCLUSIONS AND OUTLOOK**

Ubiquitous environmental free-living amebas have emerged as important opportunistic pathogens, causing disease in immunocompetent individuals and in those with defective immunity (John, 1993; Martínez and Visvesvara, 1997). Subclinical infection with free-living amebas is probably common in healthy individuals, with the parasites residing as part of the 'normal flora' in the oral mucosa, throat and nasal cavities. It is likely that antibodies and cell-mediated immunity protect the host in ordinary circumstances against invasive infection. But in debilitated, chronically ill individuals and others with depressed cell-mediated immunity, amebas may proliferate and produce a fulminant 'opportunistic' infection (Martínez, 1982). More insight is needed into the pathogenic factors and mechanisms of virulence that determine host injury in free-living amebic infections. Transgenic mice may provide a good experimental animal model for future studies.

Emerging and re-emerging infectious diseases are now important public health problems worldwide. There are several reasons for the rise in these infections: (a) increased numbers of immunocompromised patients due to neoplasms, transplants or infection with the human immunodeficiency virus (HIV); (b) greater longevity for persons with chronic and debilitating illnesses; (c) pollution of the environment with chemicals, fertilizers and toxic substances; (d) awareness of physicians and public health authorities of the pathogenic potential of microorganisms that were formerly considered non-pathogenic and an increase in incidence of pathogens that previously declined or have developed antimicrobial resistance; (e) social changes, international travel, overcrowding and poverty; and (f) lack of sanitation and climate changes associated

with natural disasters, such as hurricanes or typhoons and volcanic eruptions.

Clinical diagnosis of GAE is difficult. The majority of the cases have been diagnosed at post mortem examination. Obviously the practice of autopsies in suspected cases should be encouraged, particularly in patients with AIDS.

Free-living amebic infections should be a driving force in searching for new ideas and avenues, looking for answers regarding the ecology, epidemiology, natural history, pathogenesis and therapies. The results of these investigations would have widespread applications to other pathologies in the human CNS, allowing prevention and cure for these devastating diseases.

## ACKNOWLEDGEMENTS

This work was supported in part by the Pathology Education and Research Foundation (PERF) of the Pathology Department of the University of Pittsburgh School of Medicine, Pittsburgh, PA, USA.

## REFERENCES

- Anderson MP, Oosterhuis JE, Kennedy S, Benirschke K (1986). Pneumonia and meningoencephalitis due to amoeba in a lowland gorilla. *J Zool Anim Med* **17**: 87–91.
- Anzil AP, Rao C, Wrzolek MA, Visvesvara GS, Sher JH, Kozlowski PB (1991). Amebic meningoencephalitis in a patient with AIDS caused by a newly recognized opportunistic pathogen leptomyxid Ameba. *Arch Pathol Lab Med* **115**: 21–5.
- Anderlini P, Przepiorka D, Luna M *et al.* (1994). *Acanthamoeba* meningoencephalitis after bone marrow transplantation. *Bone Marrow Transpl* **14**: 459–61.
- Berger ST, Mondino BJ, Hoft RH *et al.* (1990). Successful medical management of *Acanthamoeba* keratitis. *Am J Ophthalmol* **10**: 395–403.
- Butt CG (1996). Primary amebic meningoencephalitis. *N Engl J Med* **274**: 1473–6.
- Carter RF, Cullity GJ, Ojeda VJ, Silberstein P, Willaert E (1981). A fatal case of meningoencephalitis due to a free-living amoeba of uncertain identity: probably *Acanthamoeba* sp. *Pathology* **13**: 51–68.
- Castellani A (1930). An amoeba found in culture of a yeast: preliminary note. *J Trop Med Hyg* June 2; 160; second note, July 1; 188; third note, August 1; 221.
- Chandrasekar PH, Nandi PS, Fairfax MR, Crane LR (1977). Cutaneous infections due to *Acanthamoeba* in patients with acquired immunodeficiency syndrome. *Arch Intern Med* **157**: 569–72.
- Chimelli L, Hahn MD, Scaravilli F, Visvesvara GS (1992). Granulomatous amebic encephalitis due to leptomyxid ameba. Report of the first Brazilian case. *Trans R Soc Trop Med* **86**: 635.
- Culbertson CG, Smith JW, Minner JR (1958). *Acanthamoeba*: observation on animal pathogenicity. *Science* **127**: 1506.
- DiGregorio C, Rivasi F, Mongiardo M, DeRienzo B, Wallace S, Visvesvara GS (1992). *Acanthamoeba* meningoencephalitis in a patient with acquired immunodeficiency syndrome. *Arch Pathol Lab Med* **116**: 1363–5.
- Denney CF, Iragui LD, Uber-Zak LD *et al.* (1997). Amebic meningoencephalitis caused by *Balamuthia mandrillaris*: case report and review. *Clin Infect Dis* **25**: 1354–8.
- Ferrante A (1991). Immunity to *Acanthamoeba*. *Rev Infect Dis* **13** (5): S403–9.
- Friedland LR, Raphael SA, Deutsch ES *et al.* (1992). Disseminated *Acanthamoeba* infection in a child with symptomatic human immunodeficiency virus infection. *Pediatr Infect Dis J* **11**: 404–7.
- Fowler M, Carter RF (1965). Acute pyogenic meningitis probably due to *Acanthamoeba* sp. A preliminary report. *Br Med J* **2**: 740–3.
- Gardner HAR, Martínez AJ, Visvesvara GS, Sotrel A (1991). Granulomatous amebic encephalitis in an AIDS patient. *Neurology* **41**: 1993–5.
- Gordon SM, Steinberg JP, DuPuis MH, Kozarsky PE, Nickerson JF, Visvesvara GS (1992). Culture isolation of *Acanthamoeba* species and leptomyxid amebas from patients with amebic meningoencephalitis, including two patients with AIDS. *Clin Infect Dis* **15**: 1024–30.
- González-Alfonso JE, Martínez AJ, García-Tamayo J, Céspedes G (1999). Granulomatous encephalitis due to a leptomyxid amoeba. *Trans R Soc Trop Med Hyg* **85**: 480.
- Griesemer DA, Barton LL, Reese ChM *et al.* (1994). Amebic meningoencephalitis caused by *Balamuthia mandrillaris*. *Pediatr Neurol* **10**: 249–54.
- Helton J, Loveless M, White CR Jr (1993). Cutaneous *Acanthamoeba* infection associated with leukocytoclastic vasculitis in an AIDS patient. *Am J Dermatopathol* **15**: 146–9.
- Hunt SJ, Reed SI, Mathews WC, Torian B (1995). Cutaneous *Acanthamoeba* infection in the acquired immunodeficiency syndrome; response to multidrug therapy. *Cutis* **56**: 285–7.
- Hawley HB, Czachor JS, Malhotra V, Funkhauser JW, Visvesvara GS (1997). *Acanthamoeba* encephalitis in patients with AIDS. *The AIDS Reader*, 137–42.
- Illingworth CD, Cook SD, Karabatsos CH, Easty DL (1995). *Acanthamoeba* keratitis: risk factors and outcome. *Br J Ophthalmol* **72**: 1078–82.
- Jaramillo-Rodríguez Y, Chavez-Macías LG, Olvera-Rabiela JE, Martínez AJ (1989). Encefalitis por una nueva ameba de vida libre, probablemente Leptomyxid. *Patología (Mexico)* **27**: 127–41.
- John DT (1982). Primary amebic meningoencephalitis and the biology of *Naegleria fowleri*. *Ann Rev Microbiol* **36**: 101–23.
- John DT (1993). Opportunistically pathogenic free-living amoebae. In Kreier JP, Baker JR (eds), *Parasitic Protozoa*, 2nd edn. San Diego: Academic Press; 143–246.

- John DT (1998). Opportunistic Amoebae. In Cox FEC, Kreier JP, Wakelin D (eds), *Microbiology and Microbial Infection Parentology*, 4th edn. London: Edward Arnold; 179–92.
- Khalife GE, Pambuccian SE, Visvesvara GS, Horten B (1994). Disseminated *Acanthamoeba* infection masquerading as bacillary angiomatosis in a patient with AIDS. *Int J Surg Pathol* **2** (1): 11–16.
- Kinde H, Visvesvara GS, Barr BC, Nordhausen RW, Chiu HW (1998). Amebic meningoencephalitis caused by *Balamuthia mandrillaris* (leptomyxid amoeba) in a horse. *J Vet Diagn Invest* **10**: 378–81.
- Larkin DFP, Kilvington S, Dart JKG (1992). Treatment of *Acanthamoeba* keratitis with polyhexan methylene biguanide. *Ophthalmology* **99**: 185–91.
- Lee JJ, Hutner SH, Bovee EC (eds) (1985). *An Illustrated Guide to the Protozoa*. The Society of Protozoologists: Lawrence, KS; 158–211.
- Lowichik A, Rollins N, Delgado R, Visvesvara GS, Burns DK (1995). Leptomyxid amebic meningoencephalitis mimicking brain stem glioma. *Am J Neuroradiol* **16** (4): 926–9.
- Lozano-Alarcón F, Bradley GA, Houser BS, Visvesvara GS (1997). Primary amebic meningoencephalitis due to *Naegleria fowleri* in a South American tapir. *Vet Pathol* **34**: 239–43.
- Ma P, Visvesvara GS, Martínez AJ, Theodore FH, Daggett PM, Sawyer TK ((1990). *Naegleria* and *Acanthamoeba* infections: review. *Rev Infect Dis* **12**: 490–513.
- May LP, Sidhu GS, Buchness MR (1992). Diagnosis of *Acanthamoeba* infection by cutaneous manifestations in a man seropositive to HIV. *J Am Acad Dermatol* **26**: 352–5.
- Marciano-Cabral F (1988). Biology of *Naegleria* spp. *Microbiol Rev* **52** (1): 114–33.
- Martínez AJ (1980). Is *Acanthamoeba* encephalitis an opportunistic infection? *Neurology* **30**: 567–74.
- Martínez AJ (1982). Acanthamoebiasis and immunosuppression. Case report. *J Neuropathol Exp Neurol* **41**: 548–57.
- Martínez AJ, Visvesvara GS (1997). Free-living amphizoic and opportunistic amoebas. *Brain Pathol* **7**: 583–98.
- May LP, Sidhu GS, Bachness MR (1992). Diagnosis of *Acanthamoeba* infection by cutaneous manifestations in a man seropositive to HIV. *J Am Acad Dermatol* **26**: 352–5.
- Murakawa GJ, McCalmont T, Altman J *et al.* (1995). Disseminated acanthamoebiasis in patients with AIDS. *Arch Dermatol* **131**: 1291–6.
- Page FC (1967). Re-definition of the genus *Acanthamoeba* with descriptions of three species. *J Protozool* **14**: 709–24.
- Park CH, Lyengan V, Hefter L, Pestaner JP, Vandel NM (1994). Cutaneous *Acanthamoeba* infection associated with acquired immunodeficiency syndrome. *Lab Med* **25** (6): 386–8.
- Popek EJ, Neafie RC (1992). Granulomatous meningoencephalitis due to leptomyxid amoeba. *Pediatr Pathol* **12**: 871–81.
- Rabinovitch J, Fook TC, Hunter WS, Ghosh M (1990). *Acanthamoeba* keratitis in a soft contact lens wearer. *Can J Ophthalmol* **25**: 25–8.
- Rideout BA, Gardiner CH, Stalis IH, Zuba JR, Hadfield T, Visvesvara GS (1997). Fatal infections with *Balamuthia mandrillaris* (a free-living amoeba) in gorillas and other old world primates. *Vet Pathol* **34**: 15–22.
- Rowen JL, Doerr CA, Vogel H, Baker CJ (1995). *Balamuthia mandrillaris*: a newly recognized agent for amebic meningoencephalitis. *Pediatr Infect Dis J* **14**: 705–10.
- Rutherford GS (1986). Amebic meningoencephalitis due to free-living amoeba. *S Afr Med J* **69**: 52–5.
- Schuster FL, Jacob LS (1992). Effects of Magainins on amoeba and cyst stages of *Acanthamoeba polyphaga*. *Antimicrob Agents Chemother* **36**: 1263–71.
- Schuster DL, Visvesvara GS (1996). Axenic growth and drug sensitivity studies on *Balamuthia mandrillaris*, an agent of amebic meningoencephalitis in humans and other animals. *J Clin Microbiol* **34**: 385–8.
- Schumacher DJ, Tien RD, Lane K (1995). Neuroimaging findings in rare amebic infection of the central nervous system. *Am J Neuroradiol* **16**: 930–5.
- Seidel JS, Harmatz P, Visvesvara GS, Cohen A, Edwards J, Turner J (1982). Successful treatment of primary amebic meningoencephalitis. *N Engl J Med* **306**: 346–8.
- Seijo Martínez M, Gonzalez-Mediero G, Santiago P, Rodriguez de Lope A, Diz J, Conde C, Visvesvara GS (2000). Granulomatous amebic encephalitis in a patient with AIDS: Isolation of *Acanthamoeba* Sp. Group II from brain tissue and successful treatment with sulfadiazine and fluconazole. *J Clin Microbiol* **38**: 3892–5.
- Selby DM, Chandra RS, Rakusan TA, Loechelt B, Markle BM, Visvesvara GS (1998). Amebic osteomyelitis in a child with Acquired Immunodeficiency Syndrome: a case report. *Ped Pathol Lab Med* **18**: 89–95.
- Sison JP, Kemper CA, Loveless M, McShane D, Visvesvara GS, Deresinski SC (1995). Disseminated *Acanthamoeba* infection in patients with AIDS: case reports and review. *Clin Infect Dis* **20**: 1207–16.
- Slater CA, Sichel JZ, Visvesvara GS, Pabico RC, Gaspari AA (1994). Brief report: successful treatment of disseminated *Acanthamoeba* infection in an immunocompromised patient. *N Engl J Med* **331**: 85–7.
- Stehr-Green JK, Bailey TM, Visvesvara GS (1989). The epidemiology of *Acanthamoeba* keratitis in the United States. *Am J Ophthalmol* **107**: 331–6.
- Symmers WStC (1969). Primary amoebic meningoencephalitis in Britain. *Br Med J* **4**: 449–54.
- Taratuto AL, Monges J, Acefe JC, Meli F, Paredes A, Martínez AJ (1991). Leptomyxid amoeba encephalitis: report of the first case in Argentina. *Trans R Soc Trop Med Hyg* **85**: 77.
- Tan B, Weldon-Linne CM, Rhone DP, Penning CL, Visvesvara GS (1993). *Acanthamoeba* infection presenting as skin lesions in patients with acquired immunodeficiency syndrome. *Arch Pathol Lab Med* **117**: 1043–6.
- Visvesvara GS (1991). Classification of *Acanthamoeba*. *Rev Infect Dis* **13** (5): 5369–72.
- Visvesvara GS, Martínez AJ, Schuster FL *et al.* (1990). Leptomyxid amoeba, a new agent of amebic meningoencephalitis in humans and animals. *J Clin Microbiol* **28**: 2750–6.
- Visvesvara GS, Stehr-Green JK (1990). Epidemiology of free-living amoeba infection. *J Protozool* **37**: 25–33S.
- Visvesvara GS, Schuster FL, Martínez AJ (1993). *Balamuthia mandrillaris*, N.G., N. Sp., Agent of amebic

- meningoencephalitis in humans and other animals. *J Eukaryot Microbiol* **40**: 504–14.
- Wiley CA, Safrin RE, Davis CE *et al.* (1987). *Acanthamoeba* meningoencephalitis in a patient with AIDS. *J Infect Dis* **155**: 130–3.
- Zagardo MT, Castellani RJ, Zoarski GH, Bauserman SC (1997). Granulomatous amebic encephalitis caused by leptomycid amebae in an HIV-infected patient. *Am J Neuroradiol* **18**: 903–8.



# Leishmaniasis

**Richard D. Pearson,<sup>1</sup> Selma M. B. Jeronimo<sup>2</sup> and Anastacio de Q. Sousa<sup>3</sup>**

<sup>1</sup>*University of Virginia School of Medicine, Charlottesville, VA, USA*

<sup>2</sup>*Universidade Federal do Rio Grande do Norte, Natal, Brazil, and*

<sup>3</sup>*Universidade Federal do Ceara, Fortaleza, Brazil*

## INTRODUCTION

Leishmaniasis refers to the spectrum of clinical disease produced by *Leishmania* spp., which belong to the order Kinetoplastida, family Trypanosomatidae (Lainson and Shaw, 1987). *Leishmania* spp. reside solely within mononuclear phagocytes as intracellular amastigotes in humans and other mammals and as flagellated, extracellular promastigotes in the gut of their sand fly vectors. The clinical manifestations of disease depend on complex interactions between virulence factors of the infecting *Leishmania* spp. and the genetically determined, cell-mediated immune responses of its mammalian host (Pearson and Sousa, 1996). The spectrum of disease has traditionally been divided into three major syndromes: cutaneous, mucosal and visceral leishmaniasis. Each of these encompasses an array of findings and there is overlap among them.

Descriptions of cutaneous leishmaniasis in Central Asia have been traced to the first century AD, and pottery demonstrating facial disfigurement suggestive of mucosal leishmaniasis in Peru and Ecuador has been dated to 400–900 AD (Lainson and Shaw, 1987). The parasite was identified late in the nineteenth century. In 1885 Cunningham observed amastigotes in biopsies of skin lesions from patients with ‘Delhi boil’ in

India (Cunningham, 1885). He mistakenly thought that they were fungi. Borovsky, a Russian army physician, also observed amastigotes in biopsies of cutaneous lesions and correctly identified them as protozoa in his studies of ‘Sart sores’ in Turkmenistan (Borovsky, 1898).

*Leishmania* were identified as the cause of visceral leishmaniasis several years later. Major W. B. Leishman, Professor of Pathology at the Royal Army Medical College, London, UK, reported the case of a young English army private who had been stationed in Dum-Dum, India, 7 miles from Calcutta (Leishman, 1903). The patient was similar to others whom Leishman had observed. He presented with an ‘...irregularly remittent type of fever, grave anemia, progressive muscular atrophy, and great enlargement of the spleen...’. The disease progressed over 7 months and the patient died. At autopsy Leishman confirmed massive splenomegaly. On examining smears of the spleen, he was struck by the appearance of small, round or oval bodies, which had a round nucleus and the characteristic rod-shaped kinetoplast of *Leishmania* amastigotes.

Three months later, Captain C. Donovan at the Government Hospital in Madras, India, reported similar organisms in smears taken post mortem from the enlarged spleens of Indian

patients who were initially thought to have died of chronic malaria (Donovan, 1903). Laveran and Mesnil (1903) mistakenly thought that the organism was a piroplasm and named it '*Piroplasma*' *donovani*. Ross (1903) later amended the name to *Leishmania donovani*. Rogers (1904) and Nicolle and Comte (1908) subsequently cultured *Leishmania* from infected tissues and described the promastigote form.

There are an estimated 1 million new cases of cutaneous leishmaniasis and 150 000 of visceral leishmaniasis in the world each year (Division of Communicable Disease Prevention and Control, 1994). In many locations leishmaniasis is a zoonosis, with rodents and canines serving as reservoirs. Humans become infected when they enter an endemic region. In some settings humans are the reservoir. Cutaneous leishmaniasis most often occurs among residents, laborers and military personnel living or working in rural, endemic areas of Latin America, the Middle East, Asia and the Indian subcontinent. It is periodically diagnosed in tourists who have been exposed in endemic regions. Mucosal leishmaniasis, also known as 'espundia', follows cutaneous leishmaniasis in a small percentage of those infected with *L. (Viannia) braziliensis* and related *Leishmania* spp. in Latin America. Visceral leishmaniasis usually occurs sporadically or in small outbreaks in endemic areas, but epidemics have been reported from the Indian subcontinent (Addy and Nandy, 1992), among refugees in the Sudan (Zijlstra *et al.*, 1994) and in the suburbs of cities in north-east Brazil (Jeronimo *et al.*, 1994). In recent years visceral leishmaniasis has emerged as an important opportunistic disease in patients with AIDS in southern Europe (Montalban *et al.*, 1990; Alvar *et al.*, 1997), as well as in transplant recipients and others with suppressed cell-mediated immunity (Moulin *et al.*, 1992).

### LEISHMANIA SPP. AND THEIR VECTORS

*Leishmania* spp. that cause human disease, their geographic distribution and the clinical syndromes that they produce are summarized in Table 13.1. Although there are minor ultra-structural differences in the size and shape of

promastigotes and amastigotes, *Leishmania* spp. can not be differentiated on morphologic grounds. Speciation has historically been based on geographic location, the developmental characteristics of the parasite in the gut of its sand fly vector, the mammalian reservoir(s) of infection, and the clinical characteristics of human disease.

### CLASSIFICATION

Lainson and Shaw (1987) have divided *Leishmania* spp. into two subgenera, *Viannia* and *Leishmania*, based on the site of their development in the gut of the sand fly. The *Viannia* subgenus includes *L. (Viannia) braziliensis* and related species that develop in the hindgut before migrating to the midgut and foregut (peritrypanosomes). Species in the subgenus *Leishmania*, such as *L. (Leishmania) donovani*, occupy only the midgut and foregut (supratrypanosomes).

The classification has been further refined based on isoenzyme analysis, species-specific monoclonal antibodies and genetic analysis. Speciation of clinical isolates at WHO reference laboratories is usually based on isoenzyme analysis. Polymerase chain reaction (PCR)-based assays are under development for both diagnosis and speciation, but they are available only in research laboratories.

### Morphological Types

*Leishmania* exists in two morphological forms, amastigotes and promastigotes (Figures 13.1–13.3). A sexual stage has not been identified. Amastigotes are oval or round in shape and 2–3 µm in diameter. They reside and multiply within phagolysosomes in mammalian mononuclear phagocytes. Amastigotes have a relatively large, eccentrically located nucleus, a bar-shaped kinetoplast at the base of the flagellar pocket, and a flagellum that lies within the confines of the flagellar pocket and does not extend beyond the surface of the parasite. The kinetoplast contains a substantial amount of extranuclear DNA that is arrayed as a catenated



**Table 13.1** Clinical syndromes and geographic distribution of *Leishmania* spp.

Clinical syndromes	<i>Leishmania</i> subsp.	Location
Visceral leishmaniasis		
Kala-azar: generalized involvement of the reticulo-endothelial system (spleen, bone marrow, liver, etc.)	<i>L. (L.) donovani</i> <i>L. (L.) infantum</i>  <i>L. (L.) subsp.</i> <i>L. (L.) chagasi</i> <i>L. (L.) amazonensis</i> <i>L. (L.) tropica</i> (rare)	Indian subcontinent, north and east China, Pakistan, Nepal, east Africa Middle East, Mediterranean littoral, Balkans, central and south-west Asia, north and north-west china, north and sub-Saharan Africa Kenya, Ethiopia, Somalia Latin America Brazil (Bahia State) Mediterranean littoral, Middle East, north Africa, Pakistan, India, south-west Asia
Post-kala-azar dermal leishmaniasis	<i>L. (L.) donovani</i> <i>L. (L.) subsp.</i>	Indian subcontinent, east Africa Kenya, Ethiopia, Somalia
Old World cutaneous leishmaniasis		
Single or limited number of skin lesions	<i>L. (L.) major</i>  <i>L. (L.) tropica</i>  <i>L. (L.) aethiopica</i> <i>L. (L.) infantum</i> (rare) <i>L. (L.) donovani</i> (rare) <i>L. (L.) subsp.</i> <i>L. (L.) aethiopica</i>	Middle East, north-west China, north-west India, Pakistan, Africa, south-west Asia Mediterranean littoral, Middle East, north Africa, Pakistan, India, south-west Asia Ethiopian highlands, Kenya, Yemen Mediterranean basin Sudan, east Africa Kenya, Ethiopia, Somalia Ethiopian highlands, Kenya, Yemen
Diffuse cutaneous leishmaniasis	<i>L. (L.) aethiopica</i>	Ethiopian highlands, Kenya, Yemen
New World cutaneous leishmaniasis		
Single or limited number of skin lesions	<i>L. (L.) mexicana</i> (chicle ulcer) <i>L. (L.) amazonensis</i>  <i>L. (Viannia) braziliensis</i> <i>L. (V.) guyanensis</i> (forest yaws) <i>L. (V.) peruviana</i> (uta) <i>L. (V.) panamensis</i> <i>L. (V.) pifanoi</i> <i>L. (V.) garnhami</i> <i>L. (V.) venezuelensis</i> <i>L. (V.) colombienseis</i> <i>L. (L.) chagasi</i> <i>L. (L.) amazonensis</i>	Central and South America, Texas Amazon basin, neighboring areas, Bahia and other states in Brazil Multiple areas of Central and South America Guyana, Surinam, northern Amazon basin Peru (western Andes), Argentinean highlands Panama, Costa Rica, Colombia Venezuela Venezuela Venezuela Colombia and Panama Central and South America Amazon basin, neighboring areas, Bahia and other states in Brazil Venezuela Mexico, Central America Dominican Republic Central and South America
Diffuse cutaneous leishmaniasis	<i>L. (V.) pifanoi</i> <i>L. (L.) mexicana</i> <i>L. (L.) subsp.</i> <i>L. (V.) braziliensis</i>	Venezuela Mexico, Central America Dominican Republic Central and South America
Mucosal leishmaniasis (espundia)	<i>L. (V.) braziliensis</i>	Central and South America

Adapted from Lainson and Shaw (1987); Grimaldi *et al.* (1989); Desjeux (1991); and Pearson and Sousa (1996).

network of several thousand mini-circles and 25–50 maxi-circles. The surface membrane overlies a series of closely arrayed microtubules, much like the fabric of an umbrella over its struts.

## Vectors

Blood-sucking, female sand flies (Diptera: Psychodidae) (Lewis and Ward, 1987) are the vectors. *Lutzomyia* spp. are responsible for

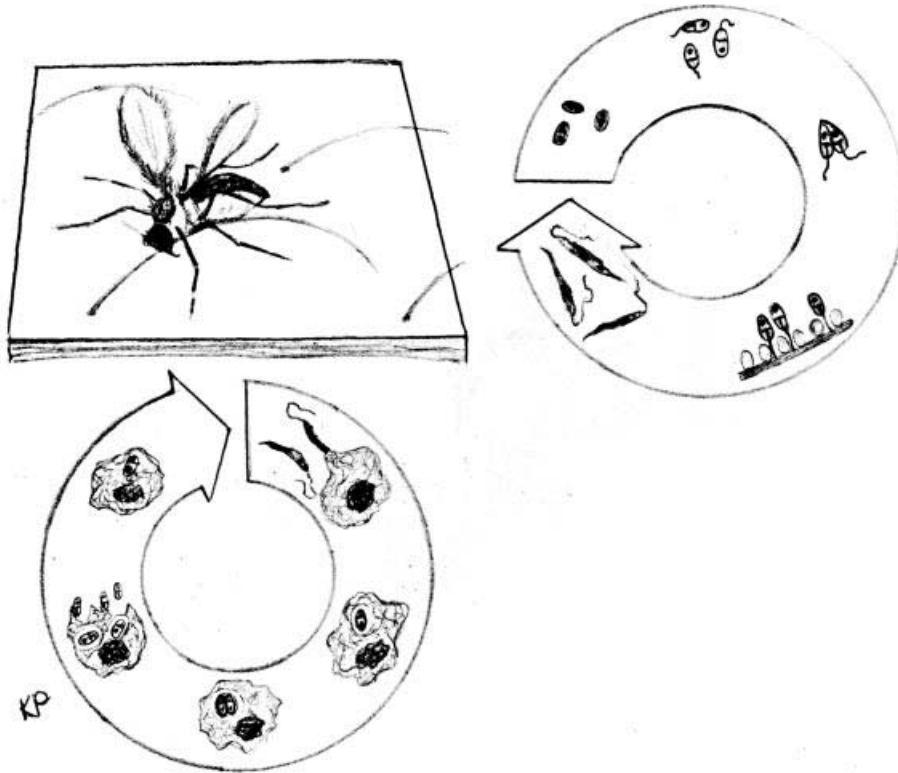


Fig. 13.1 Life-cycle of *Leishmania* sp.

transmitting *Leishmania* in the Americas and *Phlebotomus* spp. elsewhere in the world. Sand flies are relatively weak fliers. They reside in vegetation in forested areas, in rodent burrows in arid regions, and in debris around houses in sites where peridomestic transmission is observed.

### Life-cycle

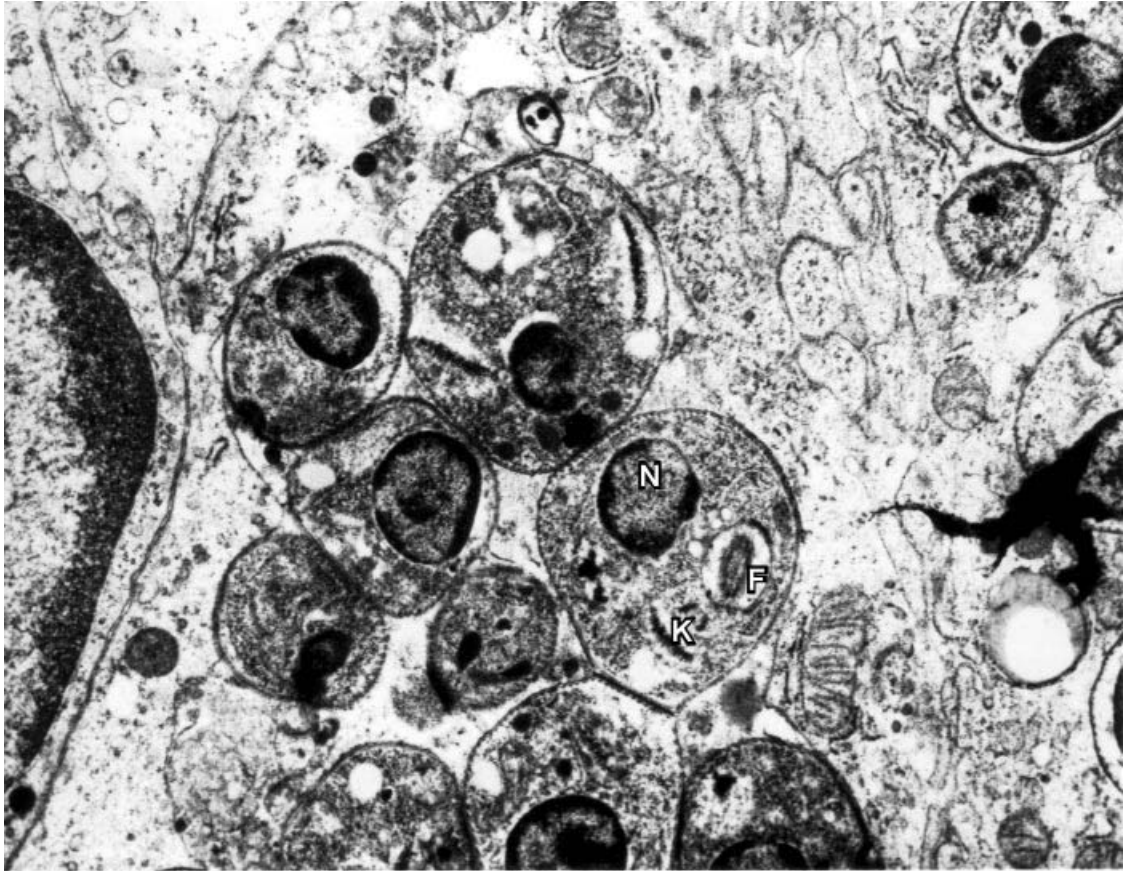
The female sand fly probes with its proboscis, lacerating capillaries to form a small pool of blood, from which it feeds. It becomes infected when it consumes blood containing amastigote-infected macrophages. Amastigotes convert to promastigotes in the gut of the sand fly at ambient temperatures. Promastigotes multiply and differentiate through a series of intermediate stages, including procyclic, nectomonad and haptomonad forms, before emerging as infectious metacyclic promastigotes, which measure approximately 10–20  $\mu\text{m}$  in length and 1.5–3.0  $\mu\text{m}$

in diameter. A single flagellum, which is often longer than the body, extends from the flagellar pocket at the anterior pole and pulls the parasite forward. Development from amastigotes to metacyclic promastigotes takes 1–2 weeks, depending on the *Leishmania* sp.

When mature, metacyclic promastigotes migrate to the proboscis of the sand fly. They interfere with its ability to take the next blood meal. Although not thoroughly quantified, it is likely that only a small number of promastigotes are deposited in the skin. The saliva of sand flies contains factor(s) that enhance their infectivity for macrophages by inhibiting the L-arginine-dependent nitric oxide killing mechanism of macrophages (Theodos *et al.*, 1991; Hall and Titus, 1995).

### Cultivation

Promastigotes can be grown *in vitro* in a number of media including NNN (Novy, McNeal,



**Fig. 13.2** Transmission electron micrograph of *L. (L.) donovani* amastigotes within a human monocyte-derived macrophage infected *in vitro*. The nucleus (N), kinetoplast (K) and flagellum within the flagellar pocket (F) are easily seen. Subpellicular microtubules lie under the outer membrane. Dividing amastigotes are present. From Pearson *et al.* (1983), by permission of the University of Chicago Press

Nicolle) media, Schneider's insect media and others, to which fetal calf serum is added, at 22–26°C. Cultured promastigotes vary in size and shape; some are stumpy, while others are thin and elongated. As the culture enters stationary phase, the number of infectious, metacyclic promastigotes increases. They have distinct lectin-binding characteristics (Sacks *et al.*, 1985; Sacks and Perkins, 1984). Rosettes or clumps of promastigotes are observed in older cultures as well as in the gut of sand flies. Their significance is uncertain.

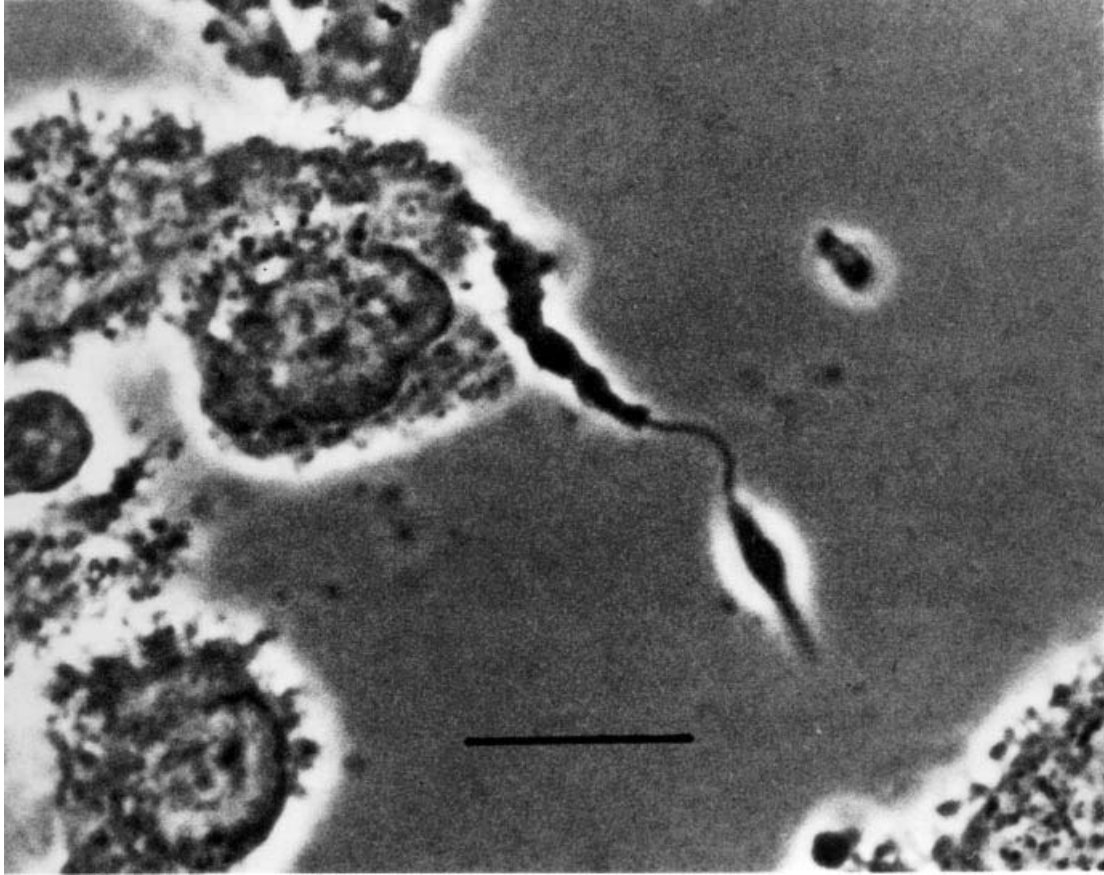
## PATHOGENESIS

The manifestations of cutaneous leishmaniasis typically occur at the site where promastigotes

are inoculated into the skin (Ridley, 1979; Ridley and Ridley, 1984). Although the precise sequence of events that follows in humans has not been defined, histopathological studies in hamsters inoculated subcutaneously with cultured *L. (L.) donovani* promastigotes suggest that some are killed by neutrophils, while others are phagocytized by mononuclear phagocytes, convert to amastigotes within them, and then multiply (Wilson *et al.*, 1987). Additional monocytes are subsequently recruited to the site and become infected.

## Cutaneous Disease

Early in cutaneous infection, amastigote-filled macrophages are the dominant finding (Ridley,



**Fig. 13.3** Phase contrast photomicrograph of an *L. (L.) donovani* promastigote attached to a human monocyte-derived macrophage *in vitro*. Bar = 10  $\mu$ m

1979; Ridley and Ridley, 1984). A necrotizing granulomatous response subsequently develops. There is focal necrosis and ulceration of the overlying skin. The mechanism of tissue necrosis has not been defined, but it is thought to be immune-mediated. Over time the number of amastigote-infected mononuclear cells decreases and the number of lymphocytes increases. After a period of months, the typical lesion heals, leaving a flat, atrophic scar as evidence of disease.

Data from experimentally infected animals and observations in humans suggest that amastigotes reach draining lymph nodes early in infection. This is particularly evident in a subset of patients infected with *L. (V.) braziliensis*, who present with tender regional adenopathy, fever and other constitutional symptoms before a skin lesion appears (Barral *et al.*, 1992; Sousa *et al.*, 1995).

Blood cultures have been positive in a few cases. As the skin lesions enlarge and then ulcerate, lymphadenopathy and constitutional symptoms resolve. Months to years later, a small percentage of those infected with *L. (V.) braziliensis* or related *Leishmania (V.)* spp. develop mucosal leishmaniasis involving the nose, oral pharynx or other mucosal structures.

Two variants of cutaneous leishmaniasis, diffuse cutaneous leishmaniasis and leishmaniasis recidiva, lie at the extremes of the spectrum of human disease. Diffuse cutaneous leishmaniasis, an anergic variant, is characterized by a predominance of amastigote-filled macrophages and relatively few lymphocytes. The lesions do not ulcerate and those affected fail to mount cell-mediated immune responses. Lesions can persist for decades. Leishmaniasis recidiva is a chronic,

ulcerative condition characterized by a granulomatous response, with a predominance of lymphocytes and few amastigotes seen in macrophages. Those infected mount delayed-type hypersensitivity responses to leishmanial antigens, but the lesions can persist for years.

The spectrum of cutaneous leishmaniasis has been compared to that of leprosy. Persons with diffuse cutaneous leishmaniasis are similar to those with lepromatous leprosy, in whom large numbers of mycobacteria are observed within macrophages, while those with leishmaniasis recidiva are similar to those with tuberculoid leprosy, in whom there is a tissue-damaging granulomatous response but few parasites. However, as Ridley and Ridley (1984) have pointed out, in leprosy the histopathological findings are predictive of the clinical syndrome, while in simple cutaneous leishmaniasis the histopathology evolves from a predominance of amastigote-filled macrophages early in infection to a granulomatous response with lymphocyte predominance as the lesions age.

### Visceral Disease

The majority of those infected with *L. (L.) donovani* and related species that are associated with visceral disease have asymptomatic, self-resolving infections and do not come to clinical attention. In humans who progress to typical visceral leishmaniasis and in the Syrian hamster model (Wilson *et al.*, 1987), amastigotes disseminate to mononuclear phagocytes in the liver, spleen, bone marrow and other organs. A skin lesion is seldom apparent at the site of inoculation. Massive splenomegaly and hepatomegaly develop as monocytes are recruited to those organs and become infected. In persons who are immunocompromised by HIV, amastigote-infected macrophages are frequently observed in the gastrointestinal tract, lung and other organs (Figure 13.4).

### IMMUNOLOGY

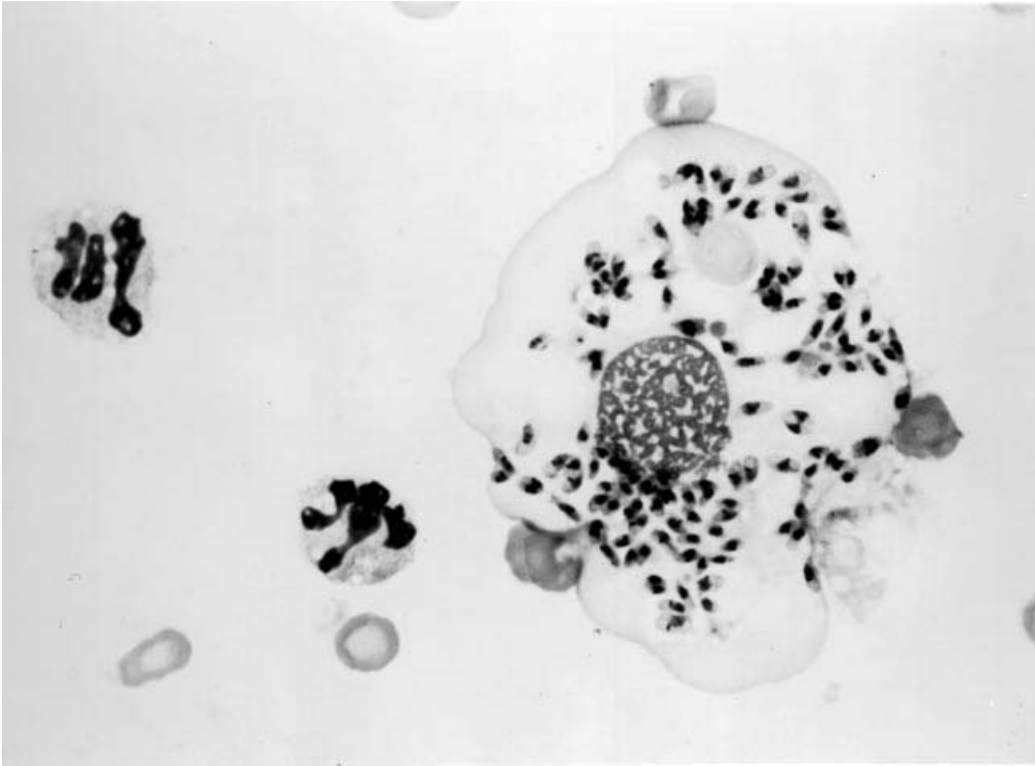
Great strides have been made toward understanding the immunology of leishmanial infections during the past two decades (Locksley

and Louis, 1992; Reiner and Locksley, 1993; Scharton-Kersten and Scott, 1995). The life cycle has been reproduced entirely *in vitro*, genetically susceptible and resistant inbred strains of mice have been used to explore the immunogenetics of murine infection, and the immunology of human disease has been studied in a number of endemic areas. The findings indicate that spontaneous resolution of leishmanial infection and protection against reinfection are controlled by cell-mediated immune responses.

### Leishmania in Macrophages

The interactions of promastigotes with mononuclear phagocytes have been characterized *in vitro* using axenically cultured promastigotes and murine peritoneal or human monocyte-derived macrophages (Wilson *et al.*, 1992) (Figure 13.3). Promastigotes can attach to several macrophage receptors, including the mannose–fucose receptor, the complement receptor for C3bi (CR3) (Blackwell *et al.*, 1985; Wozencraft *et al.*, 1986; Wilson *et al.*, 1992) and the receptor for advanced glycosylation end-products (Russel and Wilhelm, 1986). Two parasite surface molecules are known to be involved in attachment; a 63 kDa neutral protease (GP63) and a lipophosphoglycan (LPG). The glycosylation of these molecules is dependent on the *Leishmania* sp. and the stage of promastigote development. In the presence of serum, complement is activated by either the alternative or the classical pathway, depending on the *Leishmania* sp., and promastigotes are opsonized for binding to CR1 or CR3. With metacyclic promastigotes, complement activation occurs at a distance from the cell membrane, the membrane attack complex (C5b–C9) is not inserted and the parasites are not lysed (Puentes *et al.*, 1990). Phagocytosis by macrophages follows attachment. Once inside a parasitophorous vacuole, promastigotes convert to amastigotes and lysosomes fuse with the vacuole. Amastigotes are adapted to survival under acidic conditions.

In landmark studies Murray *et al.* (1983) demonstrated that interferon- $\gamma$  (IFN $\gamma$ ) could activate human monocyte-derived macrophages to kill intracellular *Leishmania*. Oxidative



**Fig. 13.4** *Leishmania* sp. amastigotes (stained with Wright–Giemsa) are seen in a pulmonary macrophage in a cytocentrifuge preparation of pleural fluid from a patient with AIDS, fever and a pleural effusion. The patient had traveled extensively in the Mediterranean littoral (Chenoweth *et al.*, 1993). Photograph by courtesy of David M. Markovitz MD

microbicidal mechanisms were initially thought to be responsible, but subsequent studies with murine macrophages have pointed to the importance of the L-arginine-dependent nitric oxide microbicidal system. This results from tumor necrosis factor- $\alpha$  (TNF $\alpha$ )-dependent sustained induction of nitric oxide synthase (iNOS) by IFN $\gamma$ , resulting in the production of large amounts of nitric oxide and associated metabolites that are lethal for amastigotes (Green *et al.*, 1990; Liew *et al.*, 1991). Anti-leishmanial microbicidal mechanisms can also be activated in an antigen-specific manner by direct contact with CD4<sup>+</sup> cells bearing surface-bound TNF $\alpha$  (Sypek and Wyler, 1991).

#### Cell-mediated Immune Responses in the Murine Model

The activation of macrophages to kill intracellular amastigotes is dependent on complex and only partially understood cell-mediated immune

responses. Early studies in rodents revealed that ablation of T helper cells by radiation or chemotherapy resulted in progressive disease in animals that were otherwise capable of mounting protective immune responses against *Leishmania*. Immunity was restored by the transfer of syngeneic lymphocytes from immune animals. Anti-leishmanial antibodies were not protective.

Bradley, Blackwell and colleagues observed that inbred strains of mice differ in their susceptibility to *Leishmania* spp. (Plant *et al.*, 1982; Blackwell *et al.*, 1994). They found that the murine *Nramp* (natural-resistance-associated macrophage protein) locus on chromosome 1, previously known as *Lsh/Ity/Bcg*, governed susceptibility to *L. (L.) donovani*. Mice that were homozygous for the sensitive allele developed large parasite burdens, while those that were heterozygous or homozygous for the resistant allele spontaneously cleared infection. Among susceptible mice, alleles at H-2 loci

determined whether the strain was able to reduce the parasite burden later in infection. The *Nramp* locus has pleiotropic effects. It controls priming and activation of macrophages for antimicrobial activity and the differential expression of the early response gene *KC*. Low levels of nitric oxide synthase are involved in the signal transduction that controls *Nramp* expression. The murine model of *L. (L.) donovani* infection is limited in that susceptible mice do not develop signs of visceral disease. In addition, there does not appear to be an association between *Nramp 1* and the development of human visceral leishmaniasis (Blackwell *et al.*, 1997).

*Leishmania (L.) major* has emerged as the major model for visceralizing *Leishmania* infection. It disseminates to lymph nodes, liver and spleen in BALB/c and other susceptible strains of mice, which have been extensively studied (Moll and Mitchell, 1988; Locksley and Louis, 1992; Reiner and Locksley, 1993; Scharton-Kersten and Scott, 1995; Noben-Trauth *et al.*, 1996; Scott and Farrel, 1998). In the case of *L. (L.) major*, multiple loci other than *Nramp* govern susceptibility to infection.

The outcome of *L. (L.) major* infection in mice is dependent on complex interactions between potentially protective and disease-enhancing cell-mediated immune responses. The identification of morphologically similar, but functionally distinct CD4<sup>+</sup> T helper cell populations in mice led to rapid advances. *Leishmania*-specific Th1 cells were found to dominate in mice with self-resolving infection and correlated with resistance to re-infection. Th2 cells were dominant in mice with progressive disease. Th1 cells from immune mice secreted IFN $\gamma$  and interleukin-2 (IL-2) in response to leishmanial antigens, whereas Th2 cells from mice with progressive infection produced IL-4, IL-5 and IL-10. As previously discussed, IFN $\gamma$  can activate macrophages to kill amastigotes. It can also inhibit expansion of Th2 cells. In contrast, IL-4 and IL-10 can inhibit proliferation of Th1 cells and activation of macrophages by IFN $\gamma$ .

A key question, which has not been fully resolved, is why Th1 responses become dominant in strains of mice with self-resolving infection and Th2 responses in those with progressive disease. mRNAs for Th1 and Th2 cytokines are present early in infection in both susceptible and

resistant animals. Analysis of the T-cell receptor repertoires in mice infected with *L. (L.) major* suggests that the same parasite epitopes can drive Th1 responses in immune animals and Th2 responses in animals with progressive disease (Reiner *et al.*, 1993). IL-4 was initially hypothesized to be responsible for inhibiting the development of protective Th1 cells in mice with progressive infection (Reiner and Locksley, 1993), but subsequent studies in which the IL-4 gene was knocked out demonstrated that infection progressed even in the absence of IL-4 (Noben-Trauth *et al.*, 1996).

It now appears that macrophages may play a critical role in the development of Th1 or Th2 responses. In immune animals, secretion of IL-12 precedes and supports the expansion of *Leishmania*-specific Th1 cells and the production of IFN $\gamma$  (Heinzel *et al.*, 1993, 1995). IL-12 stimulates natural killer (NK) cells, and they in turn produce IFN $\gamma$ , which can activate macrophage microbicidal mechanisms and prime macrophages to produce IL-1 and THF $\alpha$  when they encounter the parasite. The CD40-CD40 ligand signaling process appears to mediate IL-12 secretion (Campbell *et al.*, 1996). In the murine model, CD8<sup>+</sup> cytotoxic/suppressor cells may also contribute to protection by secreting IFN $\gamma$  (Murray *et al.*, 1992).

In contrast, transforming growth factor- $\beta$  (TGF $\beta$ ) stimulates Th2 expansion and inhibits the development of Th1 cells (Barral-Netto, 1992). It has been postulated to play an important role in the progression of disease in susceptible mice. In addition, intracellular amastigotes have been shown to inhibit the secretion of IL-1 and TNF $\alpha$  by infected macrophages and to decrease the expression of HLA Class I and Class II antigens (Reiner *et al.*, 1987). Finally, *Leishmania*-infected macrophages produce prostaglandins and leukotrienes that may suppress development of protective cell-mediated immune responses (Reiner and Malemud, 1985).

It is likely that the manner in which leishmanial antigens are presented by macrophages, dendritic cells or other antigen-presenting cells and the presence of accessory molecules is important. Data from the murine model suggest that different T-cell subsets are activated when leishmanial antigens are presented by B

lymphocytes rather than macrophages (Rossi-Bergmann B *et al.*, 1993). The balance of protective and disease-enhancing immune responses and the outcome of infection are affected by other factors. For example, a small promastigote inoculum was shown to result in the development of protective immune responses in genetically susceptible mice that developed progressive disease when infected with a larger inoculum (Bretscher *et al.*, 1992).

### Immune Responses in Humans

The majority of humans infected with *L. (L.) donovani* or *L. (L.) chagasi* have asymptomatic or mild, self-resolving infections and manifest *Leishmania*-specific Th1 responses. Their peripheral blood lymphocytes proliferate and secrete IFN $\gamma$  and IL-2 in response to leishmanial antigens *in vitro*, and most develop delayed-type cutaneous hypersensitivity responses to leishmanial antigens *in vivo*, as demonstrated by a positive leishmanin (Montenegro) skin test. Antibodies are not protective. In general the antibody titer is inversely correlated with the parasite burden.

Persons with progressive visceral leishmaniasis do not manifest *Leishmania*-specific Th1 responses. Their peripheral blood mononuclear cells neither proliferate nor secrete IFN $\gamma$  in response to leishmanial antigens *in vitro*, and the leishmanin skin test is non-reactive. mRNA for IL-10 has been demonstrated in the bone marrow of persons with visceral leishmaniasis, and elevated levels have been found in their serum (Karp *et al.*, 1993; Holaday *et al.*, 1993). IL-10 probably plays a role in inhibiting the development of protective T cell responses. The importance of Th1 responses in defense against *L. (L.) donovani* and related species is further supported by the emergence of visceral leishmaniasis as an opportunistic infection among persons with concurrent HIV infection or other forms of T cell suppression.

Persons with chronic cutaneous or mucosal leishmanial lesions show evidence of Th1 responses systemically. They have positive leishmanin skin tests, and their peripheral blood mononuclear cells proliferate and produce IFN $\gamma$

in response to leishmanial antigens *in vitro*. While the systemic immune response is Th1 in character, there seems to be a mixture of potentially protective and disease-enhancing cellular elements and cytokines at the site of infection. Biopsies of lesions demonstrate mRNA for both Th1 cytokines, including IFN $\gamma$  and IL-2, and Th2 cytokines such as IL-4, IL-5 or IL-10 (Caceres-Dittmar *et al.*, 1993; Pirmez *et al.*, 1993; Melby *et al.*, 1994). The result is a delay in eradication of amastigotes and the persistence of the lesions. Eventually, cutaneous lesions heal, and persons are left with high-level immunity against the infecting *Leishmania* sp.

Individuals with diffuse cutaneous leishmaniasis, like those with visceral leishmaniasis, have negative leishmanin skin tests and their lymphocytes fail to respond to leishmanial antigens *in vitro*. Recent attention has focused on the potential role of chemokines, the mediators that attract phagocytes and lymphocytes to lesions, in the human immune response. Monocyte chemoattractant protein-1 is secreted by persons with localized cutaneous leishmaniasis, while macrophage inflammatory protein-1a is secreted by those with diffuse cutaneous leishmaniasis (Ritter *et al.*, 1996). The importance of these chemokines in immunopathogenesis remains to be defined.

In human leishmaniasis, antibodies and T cell responses are directed against an array of leishmanial antigens, and persons who are infected differ in the antigens that they recognize (Evans *et al.*, 1989; Jeronimo *et al.*, 1995). Several *L. (L.) chagasi* proteins that elicit T cell responses have been characterized. One is an abundant 70 kDa heat shock protein (HSP70) (Jeronimo *et al.*, 1995). T cells from patients with mucosal leishmaniasis due to *L. (V.) braziliensis* recognize HSP83 as well as HSP70 (Skeiky *et al.*, 1995). It is notable that the cytokine profile of peripheral blood mononuclear cells in response to them represented both Th1 and Th2 responses.

These observations and data from murine models illustrate the complexity of immune responses in leishmaniasis and the difficulty in generalizing from one *Leishmania* sp. to another or from animals to humans. Nonetheless, a great deal has been learned about the cell-mediated immune responses that determine the outcome of leishmanial infection, and it is likely that unifying explanations will emerge in time and become the



basis for the design of effective approaches to immunoprophylaxis.

## BIOCHEMISTRY AND MOLECULAR BIOLOGY

*Leishmania* spp. are eukaryotic organisms with 36 chromosomes ranging in size from 0.35 to 3 Mb. The chromosomes are conserved across *Leishmania* spp. although there is substantial size polymorphism (Wincker *et al.*, 1996). A first-generation map of the *L. (L.) major* genome has recently been assembled and should provide a suitable framework for DNA sequencing and functional studies (Ivens *et al.*, 1998).

A substantial amount of leishmanial DNA is extranuclear and is located in the kinetoplast, a specialized mitochondrial structure that consists of a catenated network of several thousand DNA mini-circles (0.8–1.2 kb) and 25–50 maxi-circles (20 kb). Species-specific probes that complement kinetoplast DNA (kDNA) have been used for speciation and diagnosis. Topoisomerase II is integral to the decatenation, replication and catenation of the circles during cell division (Werbovitz *et al.*, 1994).

Unlike their mammalian hosts, *Leishmania* spp. cannot synthesize purine nucleosides and depend on a salvage pathway to obtain them (Marr, 1991). They convert adenosine and inosine to a common intermediate, hypoxanthine, then synthesize purines. There is preferential synthesis of guanine nucleotides, as indicated by the high guanosine:adenosine ratio. Another important difference between *Leishmania* and mammals is that leishmanial hypoxanthine–guanine phosphoribosyl transferase can use xanthine analogues, such as allopurinol, as substrates. In contrast to purines, *Leishmania* spp. possess pathways for the *de novo* synthesis of pyrimidines.

*Leishmania* amastigotes are adapted for survival inside acidic phagolysosomes in macrophages, while promastigotes grow extracellularly at neutral pH in the gut of the sand fly (Jeronimo and Pearson, 1992). A proton-translocating ATPase in the membrane is responsible for maintaining cytoplasmic pH. The uptake of amino acids and glucose is coupled to the proton pump. Glucose was once thought to be the

principal substrate for metabolism, but *Leishmania* spp. can grow without glucose, provided that amino acids such as proline and glutamine are present. Amino acids are deaminated and their carbon skeletons utilized in the tricarboxylic acid pathway. Fatty acids are also important substrates. Like the trypanosomes, *Leishmania* spp. have a glycosome that contains enzymes involved in the glycolytic pathway, glycerol metabolism, carbon dioxide fixation,  $\beta$ -oxidation of fatty acids and the synthesis of ether lipids.

Two abundant molecules have been identified on the surface of *Leishmania* spp. The first, a 63 kDa glycoprotein known as GP63, is a zinc metalloproteinase. It has a glycosylphosphatidylinositol anchor and is found on the surface of promastigotes. Expression of GP63 protects promastigotes from complement-mediated lysis but does not appear to affect intracellular survival (Joshi *et al.*, 1998). The second major surface molecule is lipophosphoglycan (LPG). The carbohydrate fragment of *L. (L.) donovani* LPG contains approximately 16 phosphorylated disaccharides coupled by  $\alpha$ -glycosidic linkage. The hydrophobic moiety is a lysoalkylphosphatidylinositol membrane anchor. LPG has been shown to perturb cytokine gene expression in mammals, nitric oxide synthesis and macrophage function (Hatzigeorgiou *et al.*, 1996; Liew *et al.*, 1997). *Leishmania* spp. also have a surface acid phosphatase that can inhibit the oxidative burst of mammalian phagocytes (Shakarjian *et al.*, 1997).

## EPIDEMIOLOGY

*Leishmania* spp. are found on every continent except Australia and Antarctica (Lainson and Shaw, 1987; Grimaldi *et al.*, 1989; Desjeux, 1991; Division of Communicable Disease Prevention and Control, 1994). They have been reported from 21 countries in the western hemisphere and 62 countries in the rest of the world. It is estimated that 350 million people are at risk worldwide. The incidence of cutaneous disease is 1.0–1.5 million cases per year and that of visceral leishmaniasis is estimated to be 150 000 cases per year. The epidemiology varies among species and geographic locations. In the majority of endemic

areas leishmaniasis is a zoonosis, with rodents, canines or other mammals serving as reservoirs, but in some sites, such as *L. (L.) donovani* in India, humans are the only reservoir.

Female sand flies serve as vectors. *Lutzomyia* spp. are responsible for transmission in the western hemisphere and *Phlebotomus* spp. elsewhere in the world. On rare occasions *L. (L.) donovani* or other visceralizing *Leishmania* spp. infect neonates *in utero*, causing congenital leishmaniasis (Nyakundi *et al.*, 1988; Yadav *et al.*, 1989; Eltoun *et al.*, 1992). Amastigotes can also be transmitted through contaminated blood (Grogil *et al.*, 1993; Shulman, 1994; Cummins *et al.*, 1995) and rarely through person-to-person contact (Symmers, 1960). Laboratory infections following accidental needle stick injuries are well documented (Evans and Pearson, 1988; Herwaldt and Juranek, 1993).

### ***Leishmania* spp. in the Americas**

*L. (L.) mexicana*, *L. (L.) amazonensis*, *L. (V.) braziliensis*, *L. (V.) panamensis*, *L. (V.) peruviana*, *L. (L.) guyanensis*, *L. (V.) pifanoi*, *L. (V.) venezuelensis* and *L. (V.) chagasi* are responsible for cutaneous, mucosal or visceral leishmaniasis in the western hemisphere (Lainson and Shaw, 1987; Grimaldi *et al.*, 1989; Desjeux, 1991) (see Table 13.1).

#### ***Leishmania (L.) mexicana***

*L. (L.) mexicana* causes cutaneous leishmaniasis in scattered regions, extending from Texas (Shaw *et al.*, 1976; Gustafson *et al.*, 1985) to northern Argentina. It is an occupational disease among gum (chicle) collectors, as well as others who live, work or visit in endemic rural areas. Ulcerative skin lesions typically develop on exposed areas of the face, extremities or ears where sand flies bite. They are known locally as 'chicle' ulcers. A number of sylvatic rodents serve as reservoirs.

#### ***Leishmania (L.) amazonensis***

*L. (L.) amazonensis* is endemic in South America. It produces a spectrum of disease that includes simple cutaneous and diffuse cutaneous

leishmaniasis. It has also been isolated from persons with mucosal leishmaniasis or visceral leishmaniasis in north-eastern Brazil (Barral *et al.*, 1991).

#### ***Leishmania (V.) braziliensis***

*L. (V.) braziliensis* is endemic in focal areas of Central and South America. It is an important cause of cutaneous leishmaniasis. Cases of infection are frequent and sporadic, but epidemics occur. Settlers, workers and military personnel working or living in rural, forested areas are at greatest risk. A number of sylvatic mammals serve as reservoirs. A small percentage of those infected develop mucosal leishmaniasis, known locally as 'espundia', months to years after their skin lesions heal.

#### ***L. (V.) peruviana* and *L. (V.) guyanensis***

#### ***Leishmania (V.) panamensis***

*L. (V.) panamensis* is endemic in Panama and adjacent countries. It has been an important problem for US military personnel training in jungle areas. *L. (V.) peruviana* is the cause of 'uta' in Peru. It typically causes dry cutaneous lesions. *L. (V.) guyanensis* is responsible for 'pian bois' or 'bush yaws' in the Amazon basin. Those affected develop ulcerative skin lesions that are frequently accompanied by regional lymphadenopathy. All three of these species are endemic in rural areas; various mammals serve as reservoirs. *Leishmania (V.) pifanoi* and *L. (V.) venezuelensis* cause cutaneous leishmaniasis in focal areas of Latin America.

#### ***Leishmania (L.) chagasi***

*L. (L.) chagasi*, which is closely related to *L. (L.) infantum*, is the principal cause of visceral leishmaniasis in Brazil and other Latin-American countries (Badaro *et al.*, 1986c, Evans *et al.*, 1995). The majority of cases occur in children under age 10. *Lutzomyia longipalpis* is the major vector. Cases tend to be sporadic, but epidemics occur. Relatively large suburban outbreaks have

been reported from north-east Brazil as cities have expanded into endemic regions (Jeronimo *et al.*, 1994). *L. (L.) chagasi* infection is well documented in domestic dogs and foxes. Domestic dogs have historically been considered the major reservoir for human infection, but the prevalence of infection in dogs does not correlate closely with human disease. The clustering of cases of visceral leishmaniasis within households has raised the possibility that humans might also serve as reservoirs. *L. (L.) chagasi* has been identified as a common cause of cutaneous leishmaniasis in Honduras and Costa Rica. It has also been isolated from a limited number of cases of cutaneous leishmaniasis in Brazil (Noyes *et al.*, 1997; Oliveira *et al.*, 1986).

### ***Leishmania* spp. of the Old World**

*L. (L.) major*, *L. (L.) tropica*, *L. (L.) aethiopica*, *L. (L.) donovani* or *L. (L.) infantum* are responsible for leishmaniasis in the Mediterranean littoral, the Middle East, Africa, Asia and India. In various locations cutaneous leishmaniasis is known as 'oriental sore', 'Delhi boil', 'Biskra button', 'bouton de Crête', 'bouton d'Alep', 'Aleppo evil' and 'caneotica' (Manson-Bahr and Apted, 1982). Visceral leishmaniasis is known as 'kala-azar' in India and elsewhere.

### ***Leishmania (L.) major***

*L. (L.) major* is endemic in rural, arid or desert regions of the Mediterranean littoral, Middle East, North Africa, Central Asia and India. Although variable, human lesions tend to be relatively large and 'wet', with an overlying exudate. Desert rodents are the reservoirs. *Phlebotomus papatasi* and other *Phlebotomus* spp. serve as vectors. *L. (L.) major* has been a major problem for rural settlers in Israel as well as military personnel operating in the Sinai Desert, Israel, Iraq and Iran.

### ***Leishmania (L.) tropica***

*L. (L.) tropica* is endemic in urban areas of the Middle East, the Mediterranean littoral, India, Pakistan and Central Asia. The reservoirs are

dogs and humans; the vectors include *Phlebotomus papatasi*, *P. sergenti* and *P. chadaudi*. The lesions tend to be smaller and crusted, or 'dry', in contrast to those of *L. (L.) major*. In Iran and elsewhere in the Middle East, *L. (L.) tropica* produces leishmaniasis recidiva, a condition characterized by chronic lesions on the face or other exposed areas that can persist for years. *Leishmania (L.) tropica* is occasionally isolated from persons presenting with classical visceral leishmaniasis. It was also responsible for the viscerotropic syndrome that developed in a small group of American military personnel who were infected in the Persian Gulf War (Magill *et al.*, 1993).

### ***Leishmania (L.) aethiopica***

*L. (L.) aethiopica* causes simple cutaneous and diffuse cutaneous leishmaniasis in Africa, Ethiopia, Kenya and bordering countries. *Phlebotomus longipes* and *P. pedifer* are vectors. Hyraxes are reservoirs.

### ***Leishmania (L.) donovani* and *L. (L.) infantum***

*L. (L.) donovani* and *L. (L.) infantum* are the principal causes of visceral leishmaniasis in the Mediterranean littoral, Middle East, Indian subcontinent and eastern Africa. Sporadic cases among young children or immunocompromised adults are the rule in the Mediterranean littoral and the Middle East. Dogs, wild canines and rodents serve as reservoirs. Visceral leishmaniasis has emerged as an important opportunistic pathogen among persons with AIDS in Spain, southern France and Italy (Montalban *et al.*, 1990; Alvar *et al.*, 1997). Multiple zymodemes of *L. (L.) infantum* and *L. (L.) donovani* have been identified from them, including some that were previously associated only with cutaneous leishmaniasis and others that had not been previously isolated from humans (Pratlong *et al.*, 1995a).

Large numbers of cases of visceral leishmaniasis due to *L. (L.) donovani* occur in India, particularly in the states of Assam and Bihar, and in Bangladesh (Addy and Nandy,

1992). Humans are the only reservoir there; anthropophilic *P. argentipes* is the major vector. Historically, children and young adults were the most frequently affected, but the mean age has risen to 20 years, possibly due to a fall in herd immunity (Basu and Mallik, 1995). Endemic foci of *L. (L.) donovani* are found in Kenya. Infection has been associated with termite hills, which serve as breeding sites for *P. martini* and other *Phlebotomus* species. The reservoir is uncertain. A major epidemic of visceral leishmaniasis has been reported among refugees in the Sudan (Zijlstra *et al.*, 1994). *Phlebotomus orientalis* is a vector. The reservoirs include rats, gerbils, small carnivores and possibly humans. Visceral leishmaniasis is also endemic in southern China, but the number of cases is now small (Guan, 1991). *L. (L.) donovani* or *L. (L.) infantum* are occasionally isolated from persons with simple cutaneous leishmaniasis (Mebrahtu *et al.*, 1993; Jimenez *et al.*, 1995).

## CLINICAL MANIFESTATIONS

Leishmaniasis is a spectral disease (Pearson and Sousa, 1996). The clinical manifestations depend on complex interactions between the virulence characteristics of the infecting *Leishmania* spp. and the genetically determined cell-mediated immune responses of its human host. There are three major clinical syndromes: cutaneous, mucosal or visceral leishmaniasis. Variations occur in each of these, and many *Leishmania* spp. can cause more than one syndrome.

### Cutaneous Leishmaniasis

#### Simple Cutaneous Leishmaniasis

In simple cutaneous leishmaniasis, lesions develop where promastigotes are inoculated by sand flies feeding on exposed areas of skin. They may be single or multiple. The incubation period varies from 2 weeks to several months. In rare cases it has been as long as 3 years. The morphology of the lesions varies, even among persons infected with the same *Leishmania* sp. They typically begin as papules that progressively enlarge and, in the majority of cases, ulcerate. In



**Fig. 13.5** Cutaneous leishmaniasis due to *L. (V.) braziliensis* in north-eastern Brazil. The lesion has a 'pizza-like' morphology: it is round with a raised border, red granulating base and overlying yellowish exudate

some cases lesions are papular, acneiform or nodular, with minimal or no ulceration.

Many lesions develop a 'pizza-like' appearance (Figure 13.5), with a circular, raised outer border, beefy, red, granulating base and overlying yellow exudate. These are sometimes referred to as 'wet' lesions. 'Dry' lesions tend to be smaller, with less pronounced ulceration and an overlying crust. In a few cases a hard excrescence forms at the center of the lesion, which may take the form of a cutaneous horn. Satellite lesions may be seen, and secondary staphylococcal or streptococcal cellulitis of adjacent skin can develop. Regional lymphadenopathy may accompany skin lesions, particularly in persons infected with *L. (V.) guyanensis*. In some persons with *L. (V.) braziliensis*, regional lymphadenopathy, fever and constitutional symptoms precede the development of skin lesions and resolve as the lesion develops.

After a variable period of time, cutaneous lesions heal, leaving flat, atrophic, burn-like scars as evidence of disease. In general, lesions of *L. (L.) mexicana* and *L. (L.) major* tend to heal within several months, while those of *L. (V.) braziliensis* and *L. (L.) tropica* persist longer. After lesions resolve, persons are usually immune to the infecting *Leishmania* spp.

On rare occasions, persons infected with *L. (V.) braziliensis* develop a large number of skin lesions, suggesting hematogenous dissemination. Disseminated cutaneous disease has also been

reported in persons with concurrent HIV infection, but the number is small in comparison to HIV-associated visceral leishmaniasis.

### ***Diffuse Cutaneous Leishmaniasis***

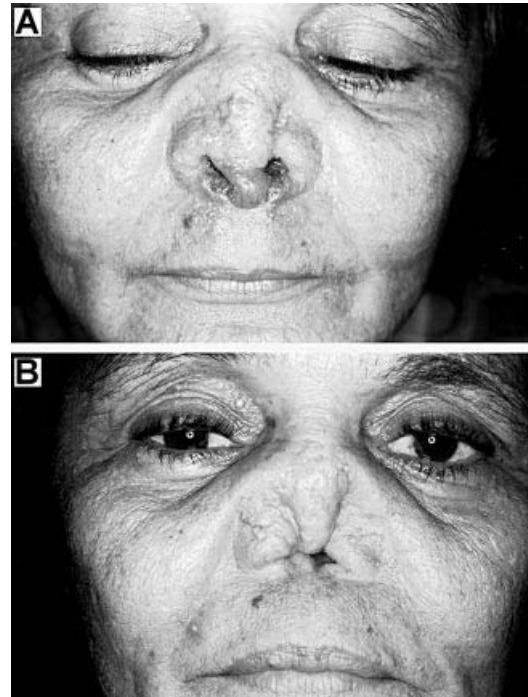
In diffuse cutaneous leishmaniasis, plaque-like or nodular lesions develop on the face or other exposed areas and slowly spread. They do not ulcerate. Large numbers of amastigote-filled macrophages are found at biopsy, the leishmanin skin test is negative, and peripheral blood mononuclear cells neither proliferate nor produce  $\text{IFN}\gamma$  or IL-2 in response to leishmanial antigens. The disease persists over a period of many years and responds poorly to chemotherapy. Diffuse cutaneous leishmaniasis is most frequently associated with *L. (L.) aethiopica* in Africa and *L. (L.) amazonensis* in Latin America.

### ***Leishmaniasis recidiva***

Leishmaniasis recidiva is a chronic, localized process associated with *L. (L.) tropica* in the Middle East. Lesions expand slowly and frequently persist for years, healing at the center as the margins expand. They are typically found on the face or other exposed areas. Biopsies reveal a chronic granulomatous response with few parasites.

### **Mucosal Leishmaniasis (Espundia)**

Healing of cutaneous lesions due to *L. (V.) braziliensis* and occasionally other *Leishmania (V.)* spp. is followed in a small percentage of cases by the development of destructive mucosal lesions months to years later. The nose is frequently involved (Figure 13.6). Presenting symptoms include nasal stuffiness, discharge or discomfort. Over time the septum may be destroyed, resulting in nasal collapse and the development of a 'tapir' nose. Destructive lesions of the lips, oral pharynx or larynx can also develop. If untreated, mucosal leishmaniasis can progress to substantial disfigurement



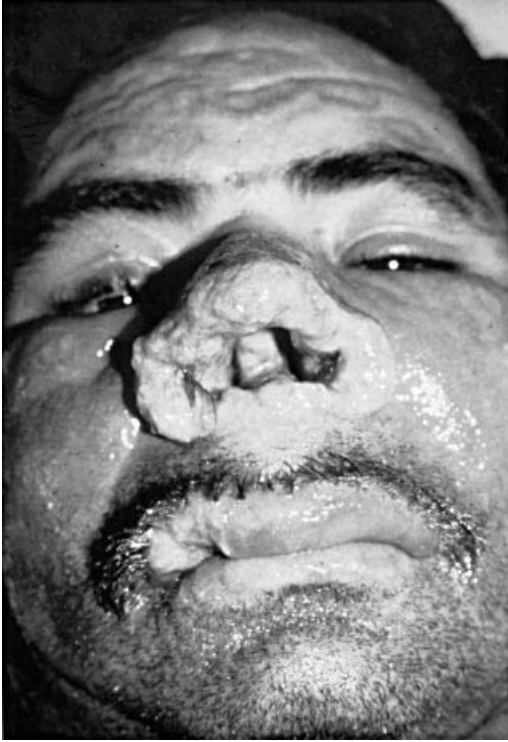
**Fig. 13.6** Mucosal leishmaniasis due to *L. (V.) braziliensis*. (A) Mucosal leishmaniasis develops months to years after the primary cutaneous lesion(s) heal. This patient had involvement of the nasal mucosa and septum, which has collapsed, resulting in the development of a 'tapir' nose. (B) Further collapse of nasal structures occurred after successful chemotherapy with meglumine antimonate

(Figure 13.7). In rare instances, death has resulted from chronic aspiration pneumonia.

Mucosal involvement is occasionally seen with other *Leishmania* spp. as a result of contiguous spread of cutaneous leishmaniasis of the face and in some persons with HIV-associated visceral leishmaniasis. The pathophysiology and natural history in those instances are similar to those of cutaneous leishmaniasis and visceral leishmaniasis, respectively, rather than that of mucosal disease due to *L. (V.) braziliensis*.

### **Visceral Leishmaniasis (Kala-azar)**

*Leishmania (L.) donovani*, *L. (L.) chagasi* and *L. (L.) infantum* are responsible for the majority of cases of visceral leishmaniasis, although occasionally other *Leishmania* spp., such as *L. (L.) amazonensis* or *L. (L.) tropica*, are isolated.



**Fig. 13.7** Mucosal leishmaniasis due to *L. (V.) braziliensis* involving the lips and face

The clinical spectrum is similar throughout the world.

In early epidemiological studies in East Africa and Italy, many persons living in endemic areas were found to have positive leishmanin skin tests, even though they had never been diagnosed or treated for visceral leishmaniasis. This suggested that the majority of *L. (L.) donovani* and *L. (L.) infantum* infections might be subclinical and self-resolving. The full spectrum of *L. (L.) chagasi* infection was subsequently defined in prospective studies in north-eastern Brazil (Badaro *et al.*, 1986b, 1986c; Evans *et al.*, 1992). The ratio of symptomatic visceral leishmaniasis to self-resolving infections ranged from 1:4.5 to 1:18, depending on the subject's age and the geographic location. Young children living in highly endemic areas were the most likely to develop disease. In one study, a subset of those infected were observed to have a subclinical course before either progressing to typical visceral leishmaniasis or spontaneously clearing infection (Badaro *et al.*, 1996b).

The time from inoculation of promastigotes by sand flies to the development of clinically apparent visceral leishmaniasis is variable. It is typically several months, but it has been reported to be as short as 10 days or as long as 34 months in immunocompetent persons. In a few instances, persons who have moved from endemic areas have developed visceral leishmaniasis years later after becoming immunosuppressed (Badaro *et al.*, 1986a).

Persons with visceral leishmaniasis typically experience the subacute onset of fever, weakness, fatigue, weight loss, splenomegaly and hepatomegaly (Evans *et al.*, 1985) (Figure 13.8). In some cases, the onset is more acute and suggestive of malaria. Fever may be intermittent, remittent with twice daily temperature spikes, or continuous. Patients tolerate the fever relatively well.

The liver and spleen progressively enlarge; they are firm in texture, not hard. In some cases the spleen becomes massively enlarged and may extend into the left lower quadrant. In a few cases it is not palpable. Hyperpigmentation is observed in Indian patients. It is the basis for the Hindi term 'kala-azar', which means black fever. It is not a feature of visceral leishmaniasis in other geographic areas. Peripheral lymphadenopathy is associated with visceral leishmaniasis in patients in the Sudan and China, but it is not common elsewhere. Wasting occurs as an apparent consequence of cytokines such as TNF- $\alpha$  and IL-1 (Pearson *et al.*, 1992), and severe cachexia may be observed late in infection.

The laboratory findings of visceral leishmaniasis include anemia, leukopenia and hypergammaglobulinemia (Evans *et al.*, 1985). Anemia may be pronounced, particularly in areas where malaria and hookworm infections are also endemic. The total white count may be as low as 1000/mm<sup>3</sup>. The platelet count is frequently decreased as well. Eosinophilia, which is prevalent in the tropics because of concurrent infection with helminths, is absent in patients with visceral leishmaniasis.

Hypergammaglobulinemia, which has been attributed to polyclonal B cell activation, can be pronounced. Globulin levels as high as 9 g/dl have been reported, and there is reversal of the albumin:globulin ratio. Elevated liver enzymes



**Fig. 13.8** Visceral leishmaniasis due to *L. (L.) chagasi* in north-eastern Brazil. The child is wasted and has massive hepatosplenomegaly

and bilirubin are observed in some patients. Petechiae, ecchymoses and bleeding may develop late in the disease as a consequence of coagulopathy and thrombocytopenia.

Although the natural history of untreated visceral leishmaniasis has not been fully characterized, it progresses to death in the vast majority of cases. Secondary bacterial and viral infections are common (Andrade *et al.*, 1990). Pneumonia, septicemia or measles are often the immediate cause of death. Even with chemotherapy, the mortality rate approaches 10% in the Sudan and Brazil (Evans *et al.*, 1985; Jeronimo *et al.*, 1994).

#### **Visceral Leishmaniasis in Patients with HIV Infection**

Visceral leishmaniasis is a well-recognized opportunistic disease in persons with AIDS. They can present in the classical manner with fever, constitutional symptoms, splenomegaly and hepatomegaly, but atypical presentations

are common (Datry *et al.*, 1990; Montalban *et al.*, 1990; Sendino *et al.*, 1990; Abbas *et al.*, 1992; Matheron *et al.*, 1992; Chenoweth *et al.*, 1993; Rosenthal *et al.*, 1995; Alvar *et al.*, 1997). Splenomegaly may be absent. Amastigote-infected macrophages may be encountered in the lungs, pleura, oral mucosa, esophagus, stomach or small intestine. Some persons present with aplastic anemia due to bone marrow involvement (Grau *et al.*, 1989). Asymptomatic leishmanial infection has also been reported in persons with AIDS (Condom *et al.*, 1989). Visceral leishmaniasis usually develops late in the course of HIV infection. The prognosis has been poor even with antileishmanial chemotherapy, but most of the reported experience antedates the introduction of highly active anti-retroviral therapy.

#### **Viscerotropic Leishmaniasis**

A small group of American troops who served in the Persian Gulf War developed low-grade fever,

malaise, fatigue and lassitude as a consequence of visceralizing *L. (L.) tropica* infection (Magill *et al.*, 1993). Although splenomegaly was observed in some, it was not massive. None of them progressed to classical visceral leishmaniasis. The diagnosis was confirmed by culturing *L. (L.) tropica* from bone marrow aspirates.

### **Post-kala-azar Dermal Leishmaniasis**

Post-kala-azar dermal leishmaniasis develops after therapy in a subset of persons with visceral leishmaniasis in Africa and India. It is characterized by macular, papular or nodular lesions on the face, trunk or extremities that may be mistaken for leprosy. Amastigotes are present in macrophages in the lesions. In African post-kala-azar, dermal leishmaniasis lesions usually appear at the end of therapy or within a few months and persist for several months. In India they can appear up to 2 years after treatment and persist for many years. Persons with post-kala-azar dermal leishmaniasis may serve as reservoirs of infection in those areas.

## **DIAGNOSIS**

### **Parasite Identification or Culture**

The diagnosis of leishmaniasis is suggested by the clinical syndrome and a history of exposure in an endemic area. It is confirmed by identifying amastigotes in tissue specimens or by isolating promastigotes in culture (Pearson *et al.*, 1990). When biopsies, aspirates or touch preparations are stained with a Wright–Giemsa preparation (e.g. Diff-Quik), the cytoplasm of amastigotes appears light blue, the nucleus is eccentrically located and red, and the kinetoplast appears as an intensely stained, small, red rod (Figure 13.4). Amastigotes must be differentiated from *Histoplasma capsulatum*, which are of similar size but lack a kinetoplast.

*Leishmania* spp. can also be isolated in culture. Biopsies from persons with cutaneous leishmaniasis, splenic or bone marrow aspirates from those with visceral leishmaniasis, or other specimens can be cultured in Novy, Nicolle and MacNeal's (NNN) medium, Schneider's insect

medium or one of several alternatives to which fetal calf serum is added. Cultures are incubated at 22–26°C. Motile promastigotes are easily visualized in a hemocytometer at ×400 magnification, but it may take several weeks for the concentration to reach detectable levels. Speciation of cultured promastigotes by isoenzyme analysis is available at a number of World Health Organization reference laboratories (Kreutzer *et al.*, 1983). Species-specific monoclonal antibodies are also available (Grimaldi and McMahon-Pratt, 1996). PCR assays using genus- or species-specific probes are under development, but they are currently available only in research laboratories (Rodriguez *et al.*, 1994; Nuzum *et al.*, 1995).

The diagnosis of cutaneous leishmaniasis can be confirmed by identifying amastigotes in touch preparations or tissue, or by isolating promastigotes in culture. The sensitivity of these assays decreases in older or healing lesions. Parasite isolation and speciation is particularly helpful in persons acquiring cutaneous leishmaniasis in Latin America, since infection with *L. (V.) braziliensis* and some other *Leishmania (V.)* spp. associated with mucosal disease require systemic treatment, whereas infection with *L. (L.) mexicana* or other species that do not disseminate to the mucosa can be followed expectantly if the lesion is small, cosmetically unimportant or healing.

The skin should be cleaned thoroughly with soap and water followed by alcohol. A small wedge or punch biopsy is taken from the margin of the lesion at a site that has not ulcerated. A portion of the specimen is used for culture, a portion for histopathology and a portion blotted onto clean glass slides to make touch preparations. In addition, a small amount of saline that does not contain a microbicidal preservative is injected at the margin of the lesion and aspirated for culture. Staining with monoclonal antibodies has been used to increase the sensitivity of parasite identification in persons with American cutaneous leishmaniasis, but trained observers are needed to differentiate parasites from tissue debris.

The most sensitive approach to the diagnosis of visceral leishmaniasis is splenic aspiration with a fine-gauge needle (Chulay and Bryceson, 1983). Touch preparations are made of the aspirate and cultures seeded. The procedure is usually well



tolerated provided that the patient is compliant, there is no evidence of coagulopathy and the operator is experienced. Splenic hemorrhage has been reported in a few cases. Patients should be monitored closely for evidence of bleeding after the procedure.

Some physicians prefer bone marrow aspiration from the iliac crest as the first diagnostic test. The sensitivity is less, in the range of 60–80%, but the risk of hemorrhage is avoided. Splenic aspiration is performed if the bone marrow aspirate is non-diagnostic. Liver biopsy is estimated to detect leishmania in approximately 50% of cases, but it carries with it the risk of hemorrhage.

The diagnosis of visceral leishmaniasis is occasionally made by lymph node aspiration or biopsy in persons with lymphadenopathy. On occasion, amastigote-infected macrophages are identified in biopsies of the gastrointestinal tract, lung, pleural, bone marrow or other tissues in persons with concurrent HIV infection. Blood cultures are usually negative in immunocompetent patients but may be positive in those with HIV.

### Anti-leishmanial Antibodies

A number of tests have been developed to detect anti-leishmanial antibodies. They include the immunofluorescent antibody assay (IFA), ELISA and direct agglutination assay (DAT) (Kar, 1995). The sensitivity and specificity depend on the antigen employed as well as the test. In general, the most sensitive assays employ antigens from the infecting *Leishmania* sp.

Anti-leishmanial antibodies are present in high titer in most immunocompetent persons with visceral leishmaniasis. A positive test in a person with the appropriate exposure history and clinical manifestations supports the diagnosis of visceral leishmaniasis, but both false negative and false positive results can occur. Antibodies may be absent or present at low titer in persons with concurrent HIV infection. Cross-reacting antibodies may be present in persons with Chagas' disease in Latin America, *Trypanosoma brucei gambiense* or *T. brucei rhodesiense* infection in Africa, schistosomiasis, malaria, tuberculosis or toxoplasmosis. Defined, recombinant antigens

appear to provide greater specificity than whole or crude promastigote preparations. An ELISA using a recombinant kinesin-related antigen, kR39, from *L. (L.) chagasi* appears to be highly sensitive and specific in the diagnosis of visceral leishmaniasis (Burns *et al.*, 1993).

Serological assays play little or no role in the diagnosis of cutaneous leishmaniasis. Anti-leishmanial antibodies are detectable in approximately two-thirds of persons, but the titers are low. Cross-reacting 'natural' antibodies are present in low titer in persons who have never been exposed to *Leishmania* spp. making it difficult to differentiate true from false positives.

### Leishmanin (Montenegro) Skin Test

The leishmanin intradermal skin test detects delayed-type hypersensitivity responses to leishmanial antigens. Reagents for the test have not been approved for use in the USA, but they are available in Brazil and other endemic regions. The sensitivity of the leishmanin test is greatest when the antigen is derived from the infecting *Leishmania* sp. (Akuffo *et al.*, 1995). The leishmanin test is usually positive in persons with cutaneous and mucosal leishmaniasis. It may be helpful in the diagnosis of persons with chronic mucosal lesions, in whom smears and cultures may be negative. Patients with diffuse cutaneous leishmaniasis are anergic and do not respond to intradermal antigens.

The leishmanin skin test is also negative in persons with progressive visceral leishmaniasis. It becomes positive in the majority of those with asymptomatic, self-resolving *L. (L.) donovani*, *L. (L.) infantum* or *L. (L.) chagasi* infections and in persons with visceral leishmaniasis who have been successfully treated.

## THERAPY

### Drugs with Anti-leishmanial Activity

The optimal treatment of leishmaniasis depends on the infecting *Leishmania* sp. and the clinical syndrome (Pearson and Sousa, 1996; Berman, 1997). Pentavalent antimony (Sb<sup>v</sup>)-containing drugs, sodium stibogluconate (Pentostam) and

meglumine antimonate (Glucantime) have been the mainstay of therapy for decades, but untoward effects are common and therapeutic failures have been increasingly recognized (Grogl *et al.*, 1992; Herwaldt and Berman, 1992). Amphotericin B deoxycholate is effective but relatively toxic (Thakur *et al.*, 1994). The most important recent advance in chemotherapy has been the use of liposome-encapsulated and lipid-associated amphotericin B for the treatment of visceral leishmaniasis. It is effective and less toxic than amphotericin B deoxycholate. Liposomal amphotericin B recently became the first drug approved by the US Food and Drug Administration (FDA) for the treatment of visceral leishmaniasis.

### Sodium Stibogluconate and Meglumine Antimonate

Sodium stibogluconate and meglumine antimonate are considered equivalent when dosed on the basis of their  $\text{Sb}^{\text{V}}$  content, although bio-availability may vary among lots. They are administered intravenously or intramuscularly at a dose of 20 mg  $\text{Sb}^{\text{V}}$  body weight daily.  $\text{Sb}^{\text{V}}$  does not accumulate in persons with normal renal function. Side effects such as myalgias, arthralgias, fatigue, nausea, malaise and headache are common. Amylase and lipase elevations occur in the majority of recipients. Clinically apparent pancreatitis develops in some; it is particularly common among persons with chronic renal insufficiency.  $\text{Sb}^{\text{V}}$  can adversely affect the heart. It produces non-specific ST-T wave changes and  $\text{QT}_c$  prolongation. Shock and sudden death have been reported in persons who were receiving more than the recommended daily dose of 20 mg  $\text{Sb}^{\text{V}}$  body weight. Lower doses of  $\text{Sb}^{\text{V}}$  are sometimes used in older recipients, particularly those with underlying cardiac problems. Infrequent side-effects include rash, liver enzyme elevation, transient renal insufficiency, hemolytic anemia, leukopenia and thrombocytopenia.

### Amphotericin B

Amphotericin B targets ergosterol-like sterols in the outer membrane of *Leishmania* as well as

fungi. Amphotericin B deoxycholate is effective against all *Leishmania* spp., but toxicity has limited its use. It is frequently associated with fever, malaise, other constitutional symptoms, progressive renal impairment and electrolyte disturbances. Liposome-encapsulated amphotericin B is equally effective, but side-effects are less frequent and less severe (Torre-Cisneros *et al.*, 1993; Gokhale *et al.*, 1994; Davidson *et al.*, 1994; di Martino *et al.*, 1993; Seaman *et al.*, 1995). Other lipid-associated amphotericin B preparations are likely to be effective, but they have been less extensively studied (Sundar *et al.*, 1997). Lipid-associated drugs are attractive because they are targeted to macrophages, the site of infection. Major liabilities are their expense and limited availability.

### Pentamidine Isethionate

Pentamidine is another alternative that has been widely used. It is effective but quite toxic (Thakur *et al.*, 1991). It can result in hypotension if infused too rapidly. It is also associated with bone marrow suppression, nausea, vomiting, reversible azotemia and damage to pancreatic B cells, resulting in the release of insulin and life-threatening hypoglycemia. Those affected may later develop insulin-dependent diabetes mellitus, a potential fatal complication for someone living in an area without electricity, refrigeration or access to insulin. Less frequent side-effects are acute pancreatitis, rash and allergic reactions, including anaphylaxis.

### Others

The introduction of recombinant  $\text{IFN}\gamma$ , which activates macrophages to kill amastigotes, was accompanied by initial enthusiasm, but unfortunately, it has been variably effective in the treatment of leishmaniasis when administered alone. The concurrent administration of  $\text{IFN}\gamma$  with a pentavalent antimony-containing drug has been used successfully to treat persons with visceral leishmaniasis who have failed pentavalent antimony therapy, and in those with diffuse cutaneous leishmaniasis or mucosal

leishmaniasis, two syndromes in which a pentavalent antimony-containing drug alone often fails (Badaro and Johnson, 1993; Berman, 1996). IFN $\gamma$  can induce a flu-like reaction with fever, chills, fatigue, myalgia, headache and, rarely, neutropenia. It is currently available only in research settings. A number of other approaches to therapy have been studied or are under development, as discussed below.

### Treatment of Visceral Leishmaniasis

Sodium stibogluconate or meglumine antimonate 20 mg Sb<sup>v</sup>/kg body weight daily for 20–28 days remains the treatment of choice in many areas. The rate of primary failure varies with the infecting *Leishmania* sp. and location. Primary failures have been increasingly common with *L. (L.) donovani* in India. Persons who fail pentavalent antimony therapy can be treated with a second course of the drug or an alternative. Longer treatment courses are routinely used in some locations. The treatment course may also be continued if the initial response is slow or repeated if the patient relapses.

Liposome-encapsulated amphotericin B (AmBisome) is the only drug licensed for the treatment of visceral leishmaniasis in the USA. It is available in other industrialized countries. It is better tolerated than amphotericin B deoxycholate, but more expensive. For immunocompetent patients the manufacturer's recommended dose is 3.0 mg/kg/day on days 1–5, 14 and 21. The course of therapy may be repeated in those who do not achieve parasite clearance. For immunocompromised patients the recommended dose is 4.0 mg/kg/day on days 1–5, 10, 17, 24, 31 and 38. Relapses are common in persons with AIDS. Other lipid-associated amphotericin B preparations appear to be effective, but experience is less than with liposome-encapsulated amphotericin B, and they have not yet been approved by the USA FDA.

Alternative therapeutic approaches include conventional amphotericin B deoxycholate, 0.5–1.0 mg/kg body weight daily, or every other day for 20 doses (Thakur *et al.*, 1994), or pentamidine isetionate 4 mg/kg body weight every other day for 15 doses (Thakur *et al.*,

1991). As noted above, IFN $\gamma$  administered concurrently with a pentavalent antimony-containing drug has been used successfully to treat patients who fail to respond to pentavalent antimony alone (Sundar *et al.*, 1995; Berman, 1996). Parenterally administered aminosidine (paromomycin) alone or with a pentavalent antimony-containing drug has been used in a limited number of persons with visceral leishmaniasis. It is effective in some but not all cases. Like other aminoglycosides, aminosidine is associated with renal and auditory toxicity. Recently published data suggest that miltefosine, a phosphocholine analog that affects cell-signaling pathways and membrane synthesis, is a highly effective and acceptably tolerated oral therapy for visceral leishmaniasis (Jha *et al.*, 1999). Studies now ongoing or planned will determine whether it will emerge as the treatment of choice for visceral leishmaniasis and other leishmanial syndromes, or whether it will join the list of once-promising drugs that have fallen by the wayside (Herwaldt, 1999).

Patients with visceral leishmaniasis usually become afebrile and show symptomatic improvement within a few days of the start of successful chemotherapy, but laboratory abnormalities and hepatosplenomegaly resolve more slowly. Patients should be followed for 6 months following the completion of therapy; most relapses occur within the first few months. Relapses are common in patients with AIDS who have been treated with either Sb<sup>v</sup> or liposome-encapsulated amphotericin B. It is advisable to administer chronic, suppressive anti-leishmanial therapy to them, but the optimal drug and regimen have not been defined.

### Treatment of Cutaneous Leishmaniasis

Persons with functionally or cosmetically significant skin lesions and those infected with *L. (V.) braziliensis* or other *Leishmania* spp. known to cause mucosal disease should be treated. Sodium stibogluconate or meglumine antimonate, 20 mg Sb<sup>v</sup>/kg body weight daily for 20 days, is currently recommended. Lower doses or a shorter duration are used in some locations, but they may contribute to the development of

antimony resistance. Persons with small, cosmetically unimportant or healing lesions who are infected with *Leishmania* spp. that are not associated with mucosal spread can be followed expectantly. In general, cutaneous lesions due to *L. (L.) mexicana* or *L. (L.) major* heal more rapidly than those due to *L. (V.) braziliensis* or *L. (L.) tropica*.

Cutaneous leishmaniasis responds slowly to treatment. Healing is often incomplete at the end of pentavalent antimony therapy. Relapses occur in some persons, usually within the first 6 months. Failures with pentavalent antimony are common in persons infected with *L. (L.) aethiopica* and those with diffuse cutaneous leishmaniasis and leishmaniasis recidiva.

A number of alternative approaches exist for the treatment of cutaneous leishmaniasis. When systemic therapy is desired, amphotericin B deoxycholate at the doses described for visceral leishmaniasis can be used. The efficacy of liposome-encapsulated or lipid-associated amphotericin B has not been assessed in patients with cutaneous leishmaniasis. Another alternative is pentamidine isetionate, 2 mg/kg body weight every other day for seven doses, or 3 mg/kg body weight daily for four doses, but the risk of toxicity is significant. The combination of IFN $\gamma$  and pentavalent antimony has been used successfully to treat patients with diffuse cutaneous leishmaniasis in Latin America (Badaro and Johnson, 1993).

Imidazoles, which inhibit ergosterol biosynthesis, have activity against some *Leishmania* spp. Ketoconazole (Berman, 1996) is effective in some persons with *L. (L.) mexicana* infection, but failures are common with *L. (V.) braziliensis*. Although allopurinol and related compounds initially appeared promising (Martinez and Marr, 1992), failures have been reported and they are not recommended (Herwaldt *et al.*, 1992).

Local therapy is another option, provided that the infecting *Leishmania* sp. is not associated with the potential for mucosal leishmaniasis. Intralesional injections of stibogluconate sodium have been reported to be effective in approximately three-quarters of persons with localized *L. (L.) tropica* infection, but each lesion must be injected intermittently over a period of approximately 1 month. Topical administration of 15%

paromomycin and 12% methylbenzethonium chloride in soft white paraffin twice daily for 10 days has been used successfully in the treatment of *L. (L.) major* (el-On *et al.*, 1992). It is associated with local burning, pruritis and vesicle formation in some persons. The local application of heat to the lesions of American cutaneous leishmaniasis can result in cure, but treatment is prolonged and technically difficult (Navin *et al.*, 1990). Immunotherapy with a crude promastigote antigen and BCG has also been reported to be effective (Convit *et al.*, 1987), but the response is slow.

### Treatment of Mucosal Leishmaniasis

Mucosal leishmaniasis due to *L. (V.) braziliensis* is usually treated with a pentavalent antimony-containing drug, but primary failures and relapses are relatively common. Alternatives include amphotericin B deoxycholate and pentamidine isetionate. Liposome-encapsulated and lipid-associated amphotericin B have not been studied. Preliminary data suggest that the combination of pentavalent antimony and IFN $\gamma$  is more effective, but IFN $\gamma$  is available only in research settings. When necessary, plastic surgery should be delayed for 6–12 months after apparent cure of mucosal disease because relapses are common and associated with a poor cosmetic outcome.

### PREVENTION

The development of leishmaniasis depends on a competent sand fly vector, an appropriate mammalian reservoir(s) and a susceptible human host. A dramatic reduction in the incidence of visceral leishmaniasis occurred in India and other areas following the introduction of residual DDT spraying for malaria control after World War II. Unfortunately, epidemics of visceral leishmaniasis occurred when spraying was discontinued. Although residual insecticides are still useful on a limited scale where peridomestic transmission occurs, their application is impractical in rural areas where leishmaniasis is a zoonosis. It is further limited by cost, the development of

resistance among arthropods and environmental concerns. Permethrin-impregnated clothing and DEET-containing insect repellents applied to exposed skin provide partial protection for short-term visitors and military personnel visiting or working in endemic areas (Schreck *et al.*, 1982; Soto *et al.*, 1995).

Reservoir control programs have been implemented in several areas. In north-eastern Brazil, large numbers of farm dogs in endemic areas have been tested for anti-leishmanial antibodies and killed if positive. The effectiveness of the program is controversial. In north-eastern Brazil the killing of infected dogs has correlated with a decrease in the incidence of human disease in some areas, but outbreaks of visceral leishmaniasis are sporadic there and resolve spontaneously, even in the absence of control programs. Reservoir control programs are obviously impossible in many rural regions where leishmaniasis is a zoonosis involving wild animals.

Given the natural history of leishmanial infections, there is every reason to anticipate that an effective form of immunoprophylaxis will be developed. The resolution of human infection, whether spontaneous or after anti-leishmanial chemotherapy, is typically associated with protection against reinfection with the offending *Leishmania* sp. For centuries, mothers in the Middle East exposed the bottoms of their infants to sand flies to facilitate the development of cutaneous leishmaniasis at a site that was not of cosmetic importance. The children were protected against later infection on the face or extremities. Immunity has also been achieved by injecting viable, cultured *L. (L.) major* promastigotes into the buttocks of military personnel in Israel and Russia (Greenblatt, 1980). Although this resulted in protection, the practice was discontinued in Israel because some of the lesions were large and slow to heal, and there was concern that viable amastigotes could persist even after the lesions healed.

A vaccine composed of killed promastigotes from several *Leishmania* spp. was administered to Brazilian troops (Antunes *et al.*, 1986). It elicited T cell-mediated immune responses, but its efficacy in protecting against cutaneous leishmaniasis was not documented. An attractive alternative is the development of a defined

vaccine, using recombinant leishmanial antigens administered with the proper cytokine or adjuvant to elicit protective Th1 responses. Another alternative is the development of a live, genetically engineered, avirulent leishmanial vaccine. Experience with humans and in animal models suggests that it is only a matter of time until an effective vaccine(s) of some form becomes available.

## REFERENCES

- Abbas K, el Toum IA, Hassan AM (1992). Oral leishmaniasis associated with kala-azar. A case report. *Oral Surg Oral Med Oral Pathol* **73**: 583–4.
- Addy M, Nandy A (1992). Ten years of kala-azar in west Bengal, Part I. Did post-kala-azar dermal leishmaniasis initiate the outbreak in 24-Parganas? *Bull World Health Org* **70**: 341–6.
- Akuffo H, Darce M, Maasho K, Berhan TY (1995). *In vivo* evaluation of immune responses in leishmaniasis: the use of cross-species leishmanin preparations for skin testing. *Am J Trop Med Hyg* **53**: 16–22.
- Alvar J, Canavate C, Gutierrez-Solar B *et al.* (1997). Leishmania and human immunodeficiency virus coinfection: the first 10 years. *Clin Microbiol Rev* **10**: 298–319.
- Andrade TM, Carvalho EM, Rocha H (1990). Bacterial infections in patients with leishmaniasis visceral. *J Infect Dis* **162**: 1354–9.
- Antunes CM, Mayrink W, Magalhaes PA *et al.* (1986). Controlled field trials of a vaccine against New World cutaneous leishmaniasis. *Int J Epidemiol* **15**: 572–80.
- Badaro R, Carvalho EM, Rocha H, Queiroz AC, Jones TC (1986a). *Leishmania donovani*: an opportunistic microbe associated with progressive disease in three immunocompromised patients. *Lancet* **1**: 647–9.
- Badaro R, Johnson WD Jr (1993). The role of IFN $\gamma$  in the treatment of visceral and diffuse cutaneous leishmaniasis. *J Infect Dis* **167** (suppl 1): S13–17.
- Badaro R, Jones TC, Carvalho EM *et al.* (1986b). New perspectives on a subclinical form of visceral leishmaniasis. *J Infect Dis* **154**: 1003–1011.
- Badaro R, Jones TC, Lorenco R *et al.* (1986c). A prospective study of visceral leishmaniasis in an endemic area of Brazil. *J Infect Dis* **154**: 639–49.
- Barral A, Barral-Netto M, Almeida R *et al.* (1992). Lymphadenopathy associated with *Leishmania braziliensis* cutaneous infection. *Am J Trop Med Hyg* **47**: 587–92.
- Barral A, Pedral-Sampaio D, Grimaldi G Jr *et al.* (1991). Leishmaniasis in Bahia, Brazil: evidence that *Leishmania amazonensis* produces a wide spectrum of disease. *Am J Trop Med Hyg* **44**: 536–46.
- Barral-Netto M, Barral A, Brownell CE *et al.* (1992). Transforming growth factor-beta in leishmanial infection: a parasite escape mechanism. *Science* **257**: 545–8.

- Basu D, Mallik KK (1995). Changes in age incidence of kala-azar in India. *Ind J Publ Health* **39**: 26.
- Berman JD (1996). Treatment of New World cutaneous and mucosal leishmaniasis. *Clin Dermatol* **14**: 519–22.
- Berman JD (1997). Human leishmaniasis: clinical, diagnostic, and chemotherapeutic developments in the last 10 years. *Clin Infect Dis* **24**: 684–703.
- Blackwell JM, Barton CH, White JK *et al.* (1994). Genetic regulation of leishmanial and mycobacterial infections: the *Lsh/Ity/Bcg* gene story continues. *Immunol Lett* **43**: 99–107.
- Blackwell JM, Black GF, Peacock CS *et al.* (1997). Immunogenetics of leishmanial and mycobacterial infections: the Belem Family Study. *Phil Trans R Soc London Ser B* **352**: 1331–45.
- Blackwell JM, Ezekowitz RA, Roberts MB *et al.* (1985). Macrophage complement and lectin-like receptors bind *Leishmania* in the absence of serum. *J Exp Med* **162**: 324–31.
- Bretscher PA, Wei G, Menon JN, Bielefeldt-Ohmann H (1992). Establishment of stable, cell-mediated immunity that make 'susceptible' mice resistant to *Leishmania major*. *Science* **257**: 539–42.
- Borovsky PF (1988). [On Sart Sore] *Voenna-Medicinskiy (Military Medical Journal)* **195**: 925–41 (as cited in Lainson R, Shaw JJ, 1987).
- Burns JM Jr, Shreer WG, Benson DR, Ghalib HW, Badaro R, Reed SG (1993). Molecular characterization of a kinasin-related antigen of *Leishmania chagasi* that detects specific antibody in African and American visceral leishmaniasis. *Proc Natl Acad Sci USA* **90**: 775–9.
- Caceres-Dittmar G, Tapia FJ, Sanchez MA *et al.* (1993). Determination of the cytokine profile in American cutaneous leishmaniasis using the polymerase chain reaction. *Clin Exp Immunol* **91**: 500–505.
- Campbell KA, Owendale PJ, Kennedy MK, Fanslow WC, Reed SG, Maliszewski CR (1996). CD40 ligand is required for protective cell-mediated immunity to *Leishmania major*. *Immunity* **4**: 283–9.
- Chenoweth CE, Singal S, Pearson RD, Betts RF, Markovitz DM (1993). Acquired immunodeficiency syndrome-related visceral leishmaniasis presenting in a pleural effusion. *Chest* **103**: 648–9.
- Chulay JD, Bryceson AD (1983). Quantitation of amastigotes of *Leishmania donovani* in smears of splenic aspirates from patients with visceral leishmaniasis. *Am J Trop Med Hyg* **32**: 475–9.
- Condom MJ, Clotet B, Sirera G, Milla F, Foz M (1989). Asymptomatic leishmaniasis in the acquired immunodeficiency syndrome (AIDS). *Ann Intern Med* **111**: 767–8.
- Convit J, Castellanos PL, Rondon A *et al.* (1987). Immunotherapy versus chemotherapy in localised cutaneous leishmaniasis. *Lancet* **1**: 401–405.
- Cummins D, Amin S, Halil O, Chiodini PL, Hewitt PE, Radley-Smith R (1995). Visceral leishmaniasis after cardiac surgery. *Arch Dis Child* **72**: 235–6.
- Cunningham DD (1885). On the presence of peculiar parasitic organisms in the tissue culture of a specimen of Delhi boil. *Sci Mem Med Off Army India* **1**: 21–31 [as cited by Lainson R, Shaw JJ, 1987].
- Datry A, Similowski T, Jais P *et al.* (1990). AIDS-associated leishmaniasis: an unusual gastroduodenal presentation. *Trans R Soc Trop Med Hyg* **84**: 239–40.
- Davidson RN, di Martino L, Gradoni L *et al.* (1994). Liposomal amphotericin B (AmBisome) in Mediterranean visceral leishmaniasis: a multi-centre trial. *Q J Med* **87**: 75–81.
- Desjeux P (1991). *Information on the Epidemiology and Control of Leishmaniasis by Country and Territory (WHO/Leish/91.30)*. World Health Organization: Geneva.
- di Martino L, Raimondi F, Scotti S, Davidson RN, Gradoni L, Giacchino R (1993). Efficacy and tolerability of liposomal amphotericin B in Italian infants with visceral leishmaniasis. *Trans R Soc Trop Med Hyg* **87**: 477.
- Division of Communicable Disease Prevention and Control, Communicable Disease Program, HPC/HCT, PAHO (1994). Leishmaniasis in the Americas. *Epidemiol Bull* **15**: 8–13.
- Donovan C (1903). On the possibility of the occurrence of trypanosomiasis in India. *Br Med J* **2**: 79.
- el-On J, Halevy S, Grunwald MH, Weinrauch L (1992). Topical treatment of Old World cutaneous leishmaniasis caused by *Leishmania major*: a double-blind control study. *J Am Acad Dermatol* **27**: 227–31.
- Eltoum IA, Zijlstra EE, Ali MS *et al.* (1992). Congenital kala-azar and leishmaniasis in the placenta. *Am J Trop Med Hyg* **46**: 57–62.
- Evans TG, Krug EC, Wilson ME, Vasconcelos AW, Alencar JE, Pearson RD (1989). Evaluation of antibody responses in American visceral leishmaniasis by ELISA and immunoblot. *Mem Inst Oswaldo Cruz* **84**: 157–66.
- Evans TG, Pearson RD (1988). Clinical and immunological responses following accidental inoculation of *Leishmania donovani*. *Trans R Soc Trop Med Hyg* **82**: 854–6.
- Evans T, Reis M de F, de Alencar JE *et al.* (1985). American visceral leishmaniasis (kala-azar). *West J Med* **142**: 777–81.
- Evans TG, Teixeira MJ, McAuliffe IT *et al.* (1992). Epidemiology of visceral leishmaniasis in north-east Brazil. *J Infect Dis* **166**: 1124–32.
- Evans TG, Teixeira MJ, Sousa A de Q, Pearson RD (1995). Extended follow-up of the natural history of persons infected with *Leishmania chagasi*. *Am J Trop Med Hyg* **53**: 360–61.
- Gokhale PC, Kshirsagar NA, Khan MU *et al.* (1994). Successful treatment of resistant visceral leishmaniasis with liposomal amphotericin B. *Trans R Soc Trop Med Hyg* **88**: 228.
- Grau JM, Bosch X, Salgado AC, Urbano-Marquez A (1989). Human immunodeficiency virus (HIV) and aplastic anemia. *Ann Intern Med* **110**: 576–7.
- Green SJ, Meltzer MS, Hibbs JB Jr, Nacy CA (1990). Activated macrophages destroy intracellular *Leishmania major* amastigotes by an L-arginine-dependent killing mechanism. *J Immunol* **144**: 278–83.
- Greenblatt CL (1980). The present and future of vaccination for cutaneous leishmaniasis. In Mizrahi A, Hertman I, Klingberg MA *et al.* (eds), *Progress in Clinical and Biological Research, Vol. 47, New Developments with Human and Veterinary Vaccines*. Alan R. Liss: New York; 259–85.

- Grimaldi G, McMahon-Pratt D (1996). Monoclonal antibodies for the identification of New World *Leishmania* species. *Mem Inst Oswaldo Cruz* **91**: 37–42.
- Grimaldi G Jr, Tesh RB, McMahon-Pratt D (1989). A review of the geographic distribution and epidemiology of leishmaniasis in the new world. *Am J Trop Med Hyg* **41**: 687–725.
- Grogl M, Daugirda JL, Hoover DL, Magill AJ, Berman JD (1993). Survivability and infectivity of viscerotropic *Leishmania tropica* from Operation Desert Storm participants in human blood products maintained under blood bank conditions. *Am J Trop Med Hyg* **49**: 308–15.
- Grogl M, Thomason TN, Franke ED (1992). Drug resistance in leishmaniasis: its implication in systemic chemotherapy of cutaneous and mucocutaneous disease. *Am J Trop Med Hyg* **47**: 117–26.
- Guan LR (1991). Current status of kala-azar and vector control in China. *Bull World Health Org* **69**: 595–601.
- Gustafson TL, Reed CM, McGreevy PB, Pappas MG, Fox JC, Lawyer PG (1985). Human cutaneous leishmaniasis acquired in Texas. *Am J Trop Med Hyg* **34**: 58–63.
- Hall LR, Titus RG (1995). Sand fly vector saliva selectively modulates macrophage functions that inhibit killing of *Leishmania major* and nitric oxide production. *J Immunol* **155**: 3501–6.
- Hatzigeorgiou DE, Geng J, Zhu B *et al.* (1996). Lipophosphoglycan from *Leishmania* suppresses agonist-induced interleukin-1 $\beta$  gene expression in human monocytes via a unique promoter sequence. *Proc Natl Acad Sci USA* **93**: 14708–13.
- Heinzel FP, Ahmed F, Hujer AM, Rerko RM (1995). Immunoregulation of murine leishmaniasis by interleukin-12. *Res Immunol* **146**: 575–81.
- Heinzel FP, Schoenhaut DS, Rerko RM, Rosser LE, Gately MK (1993). Recombinant interleukin-12 cures mice infected with *Leishmania major*. *J Exp Med* **177**: 1505–9.
- Herwaldt BL (1999). Miltefosine—the long-awaited therapy for visceral leishmaniasis. *N Engl J Med* **341**: 1840–42.
- Herwaldt BL, Berman JD (1992). Recommendations for treating leishmaniasis with sodium stibogluconate (Pentostam) and review of pertinent clinical studies. *Am J Trop Med Hyg* **46**: 296–306.
- Herwaldt BL, Juranek DD (1993). Laboratory-acquired malaria, leishmaniasis, trypanosomiasis and toxoplasmosis. *Am J Trop Med Hyg* **48**: 313–23.
- Herwaldt BL, Neva FA, Berman JD (1992). Allopurinol in the treatment of American cutaneous leishmaniasis. *N Engl J Med* **327**: 498–9.
- Ivens AC, Lewis SM, Bagherzadeh A, Zhang L, Chan HM, Smith DF (1998). A physical map of the *Leishmania major* Friedlin genome. *Genome Res* **8**: 135–45.
- Jeronimo SM, Higgs E, Vedvick T *et al.* (1995). Identification of *Leishmania chagasi* antigens recognized by human lymphocytes. *J Infect Dis* **172**: 1055–60.
- Jeronimo SM, Oliveira RM, Mackay S *et al.* (1994). An urban outbreak of visceral leishmaniasis in Natal, Brazil. *Trans R Soc Trop Med Hyg* **88**: 386–8.
- Jeronimo SM, Pearson RD (1992). The *Leishmania*: protozoans adapted for extracellular and intracellular survival. *Subcell Biochem* **18**: 1–37.
- Jha TK, Sundar S, Thakur CP *et al.* (1999). Miltefosine, an oral agent, for the treatment of Indian visceral leishmaniasis. *N Engl J Med* **341**: 1795–1800.
- Jimenez M, Ferrer-Dufol M, Canavate C *et al.* (1995). Variability of *Leishmania (Leishmania) infantum* among stocks from immunocompromised patients and dogs in Spain. *FEMS Microbiol Lett* **131**: 197–204.
- Joshi PB, Sacks DL, Modi G, McMaster WR (1998). Targeted gene deletion of *Leishmania major* genes encoding developmental stage-specific leishmanolysin (GP63). *Mol Microbiol* **27**: 519–30.
- Kar K (1995). Serodiagnosis of leishmaniasis. *Crit Rev Microbiol* **21**: 123–52.
- Karp CL, el-Safi SH, Wynn TA *et al.* (1993). *In vivo* cytokine profiles in patients with kala-azar. Marked elevation of both interleukin-10 and interferon-gamma. *J Clin Invest* **91**: 1644–8.
- Kreutzer RD, Semko ME, Hendricks LD, Wright N (1983). Identification of *Leishmania* spp. by multiple isozyme analysis. *Am J Trop Med Hyg* **32**: 703–15.
- Lainson R, Shaw JJ (1987). Evolution, classification and geographic distribution. In Peters W, Killick-Kendrick R (eds), *The Leishmaniases in Biology and Medicine*, vol. 1. Academic Press: London; 1–120.
- Laveran A, Mesnil F (1903). Sur un protozoaire nouveau (*Piroplasma donovani* Lav. et Mesu.). Parasite d'une fièvre de l'Inde. *Compt Rend Hebd Seanc Acad Sci* **137**: 957–61.
- Leishman WB (1903). On the possibility of the occurrence of trypanosomiasis in India. *Br Med J* **1**: 1252–4.
- Lewis DJ, Ward RD (1987). Transmission and vectors. In Peters W, Killick-Kendrick R (eds), *The Leishmaniases in Biology and Medicine*, vol. 1. Academic Press: London; 235–42.
- Liew FY, Li Y, Moss D, Parkinson C, Rogers MV, Moncada S (1991). Resistance to *Leishmania major* infection correlates with the induction of nitric oxide synthase in murine macrophages. *Eur J Immunol* **21**: 3009–14.
- Liew FY, Wei XQ, Proudfoot L (1997). Cytokines and nitric oxide as effector molecules against parasitic infections. *Phil Trans R Soc Lond Ser B* **352**: 1311–15.
- Locksley RM, Louis JA (1992). Immunology of leishmaniasis. *Curr Opin Immunol* **4**: 413–18.
- Magill AJ, Grogl M, Gasser RA Jr, Sun W, Oster CN (1993). Visceral infection caused by *Leishmania tropica* in veterans of Operation Desert Storm. *N Engl J Med* **328**: 1383–7.
- Manson-Bahr PEC, Apter FIC (1982). *Manson's Tropical Diseases*, 18th edn. Baillière-Tindall: London; 93–115.
- Matheron S, Cabie A, Parquine F *et al.* (1992). Visceral leishmaniasis and HIV infection: unusual presentation with pleuropulmonary involvement, and effect of secondary prophylaxis. *AIDS* **6**: 238–40.
- Marr JJ (1991). Purine analogs as chemotherapeutic agents in leishmaniasis and American trypanosomiasis. *J Lab Clin Med* **118**: 111–19.
- Martinez S, Marr JJ (1992). Allopurinol in the treatment of American cutaneous leishmaniasis. *N Engl J Med* **326**: 741–4.
- Mebrantu YB, Van Eys G, Guizani I *et al.* (1993). Human cutaneous leishmaniasis caused by *Leishmania donovani* s.l. in Kenya. *Trans R Soc Trop Med Hyg* **87**: 598–601.

- Melby PC, Andrade-Narvaez FJ, Darnell BJ, Valencia-Pacheco G, Tryon VV, Palomo-Cetina A (1994). Increased expression of proinflammatory cytokines in chronic lesions of human cutaneous leishmaniasis. *Infect Immun* **62**: 837–42.
- Moll H, Mitchell GF (1988). Analysis of variables associated with promotion of resistance and its abrogation in T cell-reconstituted nude mice infected with *Leishmania major*. *J Parasitol* **74**: 993–8.
- Montalban C, Calleja JL, Erice A *et al.* (1990). Visceral leishmaniasis in patients infected with human immunodeficiency virus. Co-operative Group for the Study of Leishmaniasis in AIDS. *J Infect* **21**: 261–70.
- Moulin B, Ollier J, Bouchouareb D, Purgus R, Olmer M (1992). Leishmaniasis: a rare cause of unexplained fever in a renal graft recipient. *Nephron* **60**: 360–62.
- Murray HW, Rubin BY, Rothermel CD (1983). Killing of intracellular *Leishmania donovani* by lymphokine-stimulated human mononuclear phagocytes. Evidence that interferon-gamma is the activating lymphokine. *J Clin Invest* **72**: 1506–10.
- Murray HW, Squires KE, Miralles CD *et al.* (1992). Acquired resistance and granuloma formation in experimental visceral leishmaniasis. Differential T cell and lymphokine roles in initial versus established immunity. *J Immunol* **148**: 1858–63.
- Navin TR, Arana BA, Arana FE *et al.* (1990). Placebo-controlled clinical trial of meglumine antimonate (glucantime) vs. localized controlled heat in the treatment of cutaneous leishmaniasis in Guatemala. *Am J Trop Med Hyg* **42**: 43–50.
- Nicolle C, Comte C (1908). Origine canine du kala-azar. *Bull Soc Pathol Exot Fil* **1**: 299–301 (as cited by Lainson R, Shaw JJ, 1987).
- Noben-Trauth N, Kropf P, Muller I (1996). Susceptibility to *Leishmania major* infection in interleukin-4-deficient mice. *Science* **271**: 987–90.
- Noyes H, Chance M, Ponce C, Ponce E, Maingon R (1997). *Leishmania chagasi*: genotypically similar parasites from Honduras cause both visceral and cutaneous leishmaniasis in humans. *Exp Parasitol* **85**: 264–73.
- Nuzum E, White F III, Thakur C *et al.* (1995). Diagnosis of symptomatic visceral leishmaniasis by the use of the polymerase chain reaction on patient blood. *J Infect Dis* **171**: 751–4.
- Nyakundi PM, Muigai R, Were JB, Oster CN, Gachihi GS, Kirigi G (1988). Congenital visceral leishmaniasis: case report. *Trans R Soc Trop Med Hyg* **82**: 564.
- Oliveira Neto MP, Grimaldi G Jr, Momen H *et al.* (1986). Active cutaneous leishmaniasis in Brazil, induced by *Leishmania donovani chagasi*. *Mem Inst Oswaldo Cruz* **81**: 303–9.
- Pearson RD, Cox G, Jeronimo SM *et al.* (1992). Visceral leishmaniasis: a model for infection-induced cachexia. *Am J Trop Med Hyg* **47** (1, Pt. 2): 8–11.
- Pearson RD, Wheeler DA, Harrison LH, Kay HD (1983). The immunobiology of leishmaniasis. *Rev Infect Dis* **5**: 907–27.
- Pearson RD, Navin TR, Sousa AO, Evans TG (1990). Leishmaniasis. In Kass EH, Platt R (eds), *Current Therapy in Infectious Diseases*, vol. 3. BC Decker: Toronto; 384–9.
- Pearson RD, Sousa AQ (1996). Clinical spectrum of leishmaniasis. *Clin Infect Dis* **22**: 1–13.
- Pirmez C, Yamamura M, Uyemura K *et al.* (1993). Cytokine patterns in the pathogenesis of human leishmaniasis. *J Clin Invest* **91**: 1390–95.
- Plant JE, Blackwell JM, O'Brien AD, Bradley DJ, Glynn AA (1982). Are the *Lsh* and *Ity* disease resistance genes at one locus on mouse chromosome 1? *Nature* **297**: 510–11.
- Pratlong F, Dedet JP, Marty P *et al.* (1995b). *Leishmania*—human immunodeficiency virus co-infection in the Mediterranean basin: isoenzymatic characterization of 100 isolates of the *Leishmania infantum* complex. *J Infect Dis* **172**: 323–6.
- Puentes SM, da Silva RP, Sacks DL, Hammer CH, Joiner KA (1990). Serum resistance of metacyclic stage *Leishmania major* promastigotes is due to release of C5b-9. *J Immunol* **145**: 4311–16.
- Reiner NE, Malemud CJ (1985). Arachidonic acid metabolism by murine peritoneal macrophages infected with *Leishmania donovani*: *in vitro* evidence for parasite-induced alternations in cyclooxygenase and lipoxygenase pathways. *J Immunol* **134**: 556–63.
- Reiner NE, Ng W, McMaster WR (1987). Parasite-accessory cell interactions in murine leishmaniasis II. *Leishmania donovani* suppresses macrophage expression of Class I and Class II major histocompatibility complex gene products. *J Immunol* **138**: 1926–32.
- Reiner SL, Locksley RM (1993). Cytokines in the differentiation of Th1/Th2 CD4<sup>+</sup> subsets in leishmaniasis. *J Cell Biochem* **53**: 323–8.
- Reiner SL, Wang ZE, Hatam F, Scott P, Locksley RM (1993). TH1 and TH2 cell antigen receptors in experimental leishmaniasis. *Science* **259**: 1457–60.
- Ridley DS (1979). The pathogenesis of cutaneous leishmaniasis. *Trans R Soc Trop Med Hyg* **73**: 150–60.
- Ridley MJ, Ridley DS (1984). Cutaneous leishmaniasis: immune complex formation and necrosis in the acute phase. *Br J Exp Pathol* **65**: 327–36.
- Ritter U, Moll H, Laskay T *et al.* (1996). Differential expression of chemokines in patients with localized and diffuse cutaneous American leishmaniasis. *J Infect Dis* **173**: 699–709.
- Rodriguez N, Guzman B, Rodas A, Takiff H, Bloom BR, Convit J (1994). Diagnosis of cutaneous leishmaniasis and species discrimination of parasites by PCR and hybridization. *J Clin Microbiol* **32**: 2246–52.
- Rogers L (1904). Preliminary note on the development of *Trypanosoma* in cultures of the Cunningham–Leishman–Donovan bodies of cachexial fever and kala-azar. *Lancet* **2**: 215–16.
- Rosenthal E, Marty P, Poizot-Martin I *et al.* (1995). Visceral leishmaniasis and HIV-1 co-infection in southern France. *Trans R Soc Trop Med Hyg* **89**: 159–62.
- Ross R (1903). (1) Note on the bodies recently described by Leishman and Donovan and (2) further notes on Leishman's bodies. *Br Med J* **2**: 1261, 1401.
- Rossi-Bergmann B, Muller I, Godinho EB (1993). TH1 and TH2 T-cell subsets are differentially activated by macrophages and B cells in murine leishmaniasis. *Infect Immun* **61**: 2266–9.



- Russell DG, Wilhelm H (1986). The involvement of the major surface glycoprotein (gp63) of *Leishmania* promastigotes in attachment to macrophages. *J Immunol* **136**: 2613–20.
- Sacks DL, Hieny S, Sher A (1985). Identification of cell surface carbohydrates and antigenic changes between non-infective and infective developmental stages of *Leishmania major* promastigotes. *J Immunol* **135**: 564–9.
- Sacks DL, Perkins PV (1984) Identification of an infective stage of *Leishmania* promastigotes. *Science* **223**: 1417–19.
- Scharton-Kersten T, Scott P (1995). The role of the innate immune response in Th1 cell development following *Leishmania major* infection. *J Leukocyte Biol* **57**: 515–22.
- Schreck CE, Kline DL, Chaniotis BN *et al.* (1982). Evaluation of personal protection methods against phlebotomine sand flies including vectors of leishmaniasis in Panama. *Am J Trop Med Hyg* **31**: 1046–53.
- Scott P, Farrell JP (1998). Experimental cutaneous leishmaniasis: induction and regulation of T cells following infection of mice with *Leishmania major*. *Chem Immunol* **70**: 60–80.
- Seaman J, Boer C, Wilkerson R *et al.* (1995). Liposomal amphotericin B (AmBisome) in the treatment of complicated kala-azar under field conditions. *Clin Infect Dis* **21**: 188–93.
- Sendino A, Barbado FJ, Mostaza JM *et al.* (1990). Visceral leishmaniasis with malabsorption syndrome in a patient with acquired immunodeficiency syndrome. *Am J Med* **89**: 673–5.
- Shakarjian AM, Ellis SL, Mallinson DJ, Olafson RW, Dwyer DM (1997). Two tandemly arrayed genes encode the (histidine) secretory acid phosphatases of *Leishmania donovani*. *Gene* **196**: 127–37.
- Shaw PK, Quigg LT, Allain DS, Juranek DD, Healy GR (1976). Autochthonous dermal leishmaniasis in Texas. *Am J Trop Med Hyg* **25**: 788–96.
- Shulman IA (1994). Parasitic infections and their impact on blood donor selection and testing. *Arch Pathol Lab Med* **118**: 366–70.
- Skeiky YA, Benson DR, Guderian JA *et al.* (1995). Immune responses of leishmaniasis patients to heat shock proteins of *Leishmania* species and humans. *Infect Immun* **63**: 4105–14.
- Soto J, Medina F, Dember N, Berman J (1995). Efficacy of permethrin-impregnated uniforms in the prevention of malaria and leishmaniasis in Colombian soldiers. *Clin Infect Dis* **21**: 599–602.
- Sousa A de Q, Parise ME, Pompeu MM *et al.* (1995). Bubonic leishmaniasis: a common manifestation of *Leishmania (Viannia) braziliensis* infection in Ceara, Brazil. *Am J Trop Med Hyg* **53**: 380–85.
- Sundar S, Agrawal NK, Sinha PR, Horwith GS, Murray HW (1997). Short-course, low-dose amphotericin B lipid complex therapy for visceral leishmaniasis unresponsive to antimony. *Ann Intern Med* **127**: 133–7.
- Sundar S, Rosenkaimer F, Lesser ML, Murray HW (1995). Immunochemotherapy for a systematic intracellular infection: accelerated response using interferon-gamma in visceral leishmaniasis. *J Infect Dis* **171**: 992–6.
- Symmers W St C (1960). Leishmaniasis acquired by a contagion. A case of marital infection in Britain. *Lancet* **1**: 127–32.
- Sypek JP, Wyler DJ (1991). Antileishmanial defense in macrophages triggered by tumor necrosis factor expressed on CD4<sup>+</sup> T lymphocyte plasma membrane. *J Exp Med* **174**: 755–9.
- Thakur CP, Kumar M, Pandey AK (1991). Comparison of regimes of treatment of antimony-resistant kala-azar patients: a randomized study. *Am J Trop Med Hyg* **45**: 435–41.
- Thakur CP, Sinha GP, Pandey AK, Barat D, Singh RK (1994). Daily versus alternate-day regimen of amphotericin B in the treatment of kala-azar: a randomized comparison. *Bull World Health Org* **72**: 931–6.
- Theodos CM, Ribeiro JM, Titus RG (1991). Analysis of enhancing effect of sand fly saliva on *Leishmania* infection in mice. *Infect Immun* **59**: 1592–8.
- Torre-Cisneros J, Villanueva JL, Kindelan JM, Jurado R, Sanchez-Guijo P (1993). Successful treatment of antimony-resistant visceral leishmaniasis with liposomal amphotericin B in patients infected with human immunodeficiency virus. *Clin Infect Dis* **17**: 625–7.
- Werbovetz KA, Spoor PG, Pearson RD, Macdonald TL (1994). Cleavable complex formation in *Leishmania chagasi* treated with anilinoacridines. *Mol Biochem Parasitol* **65**: 1–10.
- Wilson ME, Donnelson JE, Pearson RD, Ramamoorthy R (1992). Macrophage receptors and leishmania. In Korkonen TK, Hovi T, Makela PH (eds), *Molecular Recognition in Host-Parasite Interactions*. Plenum: New York; 17–30.
- Wilson ME, Innes DJ, Sousa AQ, Pearson RD (1987). Early histopathology of experimental infection with *Leishmania donovani* in hamsters. *J Parasitol* **73**: 55–63.
- Wincker P, Ravel C, Blaineau C *et al.* (1996). The *Leishmania* genome comprises 36 chromosomes conserved across widely divergent human pathogenic species. *Nucleic Acids Res* **24**: 1688–94.
- Wozencraft AO, Sayers G, Blackwell JM (1986). Macrophage type 3 complement receptors mediate serum-independent binding of *Leishmania donovani*. Detection of macrophage-derived complement on the parasite surface by immunoelectron microscopy. *J Exp Med* **164**: 1332–7.
- Yadav TP, Gupta H, Sattaya U, Kumar R, Mittal V (1989). Congenital kala-azar. *Ann Trop Med Parasitol* **83**: 535–7.
- Zijlstra EE, el-Hassan AM, Ismael A, Ghalib HW (1994). Endemic kala-azar in eastern Sudan: a longitudinal study on the incidence of clinical and subclinical infection and post-kala-azar dermal leishmaniasis. *Am J Trop Med Hyg* **51**: 826–36.



# African Trypanosomiasis

I. Balakrishnan and A. Zumla

*Royal Free and University College Medical School, London, UK*

## HISTORICAL INTRODUCTION

The disease now known to be African trypanosomiasis has been recognised since the fifteenth century. However, active research into the disease did not begin until the commencement of European colonial expansion, and the link between the causative parasite, *Trypanosoma brucei*, and its vector, the tsetse fly, was not established until the late nineteenth century (Bruce, 1895). Trypanosomiasis remains as much a major public health hazard today as it did when studies first began more than 100 years ago (Hide, 1999). The effects of the disease on community life and productivity are best assessed in terms of disability-adjusted life years (DALYs) lost. Human sleeping sickness is responsible for 1.78 million DALYs (Molyneux, 1997).

Since 1962, several WHO expert committees have made recommendations to achieve better control and management of trypanosomiasis. These include suggestions that trypanosomiasis be given higher priority in national development strategies, that WHO be involved in assisting countries with endemic trypanosomiasis to run disease control programmes, that the importance of data collection should be stressed and that vector control should be improved where needed (Anonymous, 1998). Following a recommendation made by a Joint Food and Agriculture Organisation (FAO)/WHO Expert Committee on African Trypanosomiasis, maps and computer programs are now available that facilitate the

storage and analysis of data regarding endemicity, tsetse fly distribution and any other relevant information.

Trypanosomiasis remains an intractable problem for a variety of reasons. The financial and political constraints in Africa make it extremely difficult to implement effective control measures, and the administrative infrastructure necessary to adopt new developments is lacking. Furthermore, the trypanosome itself is capable of sophisticated genetic variation and has adapted to develop in a wide variety of hosts and vectors with a range of ecological niches. All these issues will need to be addressed before any significant impact can be made on the morbidity and mortality exacted by this versatile pathogen.

## DESCRIPTION OF THE ORGANISMS

### Classification

Human African trypanosomiasis is caused by two kinetoplastid flagellates, *Trypanosoma brucei* var. *rhodesiense* and *Trypanosoma brucei* var. *gambiense*, which are subspecies of *T. brucei*. The third subspecies, *T. brucei* var. *brucei*, is generally considered to be solely an animal pathogen. The *T. brucei* complex belongs to the order Kinetoplastida, family Trypanosomatidae, genus *Trypanosoma*, section *salivaria* and subgenus *Trypanozoon*. The three members of the *T. brucei* complex are phenotypically very similar, being

morphologically identical and sharing major biochemical features. However, electrophoretic analysis of isoenzymes (zymodeme typing) and restriction fragment length polymorphism (RFLP) analysis has revealed considerable variation, not only within species but also within subspecies (Enyaru *et al.*, 1993).

### Phylogeny

Phylogenetic analysis of 18S rRNA sequences indicates that *T. brucei* and *T. cruzi* have very different origins and divergent evolutionary patterns (Stevens *et al.*, 1999a). The period during which this divergence occurred remains uncertain; palaeogeographical evidence dates the divergence to around 100 million years ago, when Africa became isolated from other continents, but estimates based on host–parasite associations place it at 260–500 million years ago (Haag *et al.*, 1998). It is possible that *T. brucei*, in a background of continuous tsetse fly contact, co-evolved with primates in Africa for about 15 million years, with eventual emergence of the genus *Homo* about 3 million years ago. *T. cruzi*, on the other hand, could not have developed an evolutionary relationship with humans until human migration to the Americas, which is presumed to have occurred around 30 000–40 000 years ago (Stevens *et al.*, 1999b).

### Structure

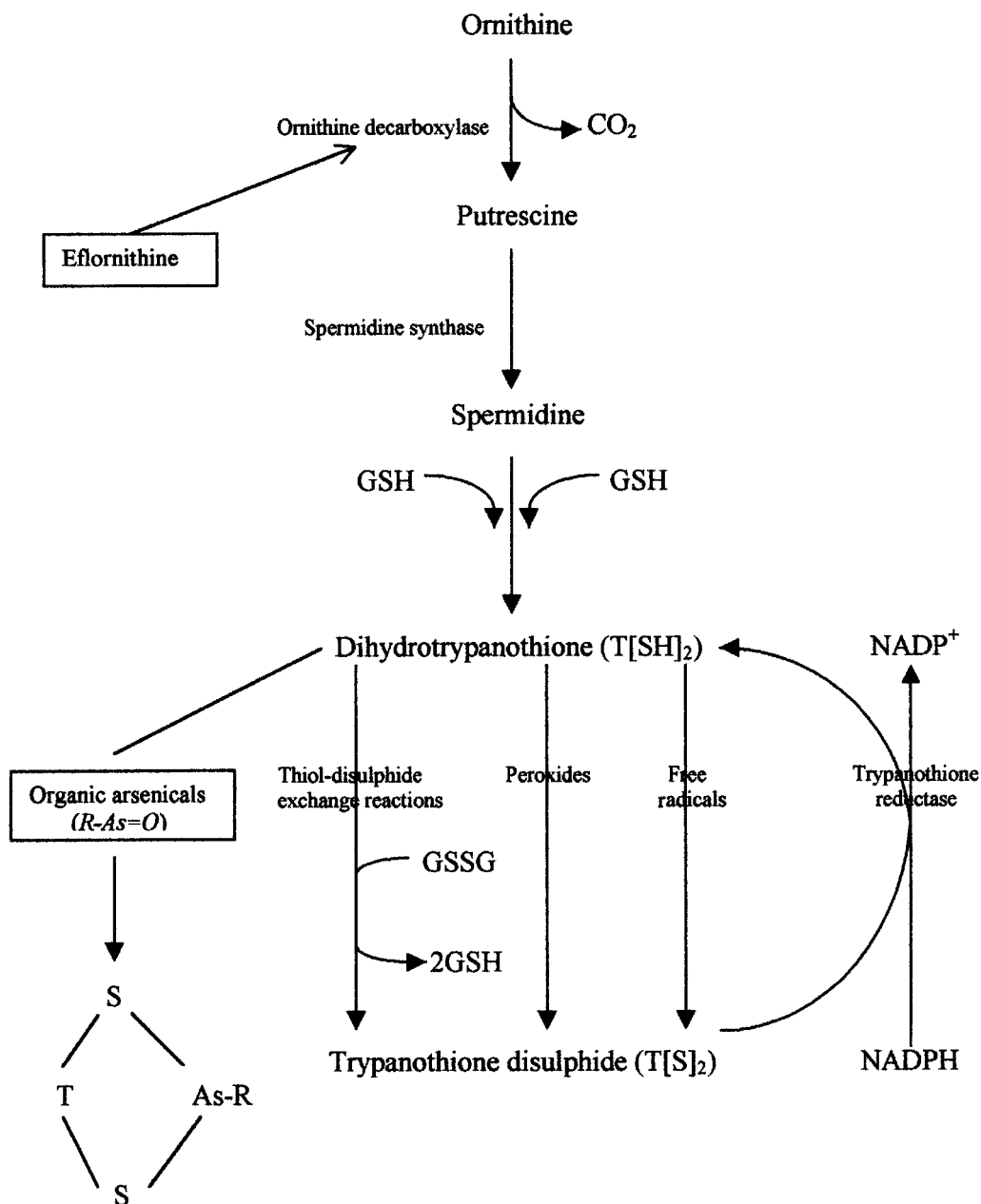
These single-celled flagellated protozoa are characterised by the possession of an organelle unique to the Kinetoplastida, called a ‘kinetoplast’. This DNA-containing organelle is located in the organism’s single, complex mitochondrion, and resembles a nucleus on Giemsa staining. The kinetoplast–mitochondrion complex differs both morphologically and functionally among the different forms of the trypanosome that exist at the different stages of the life cycle. Studies by transmission electron microscopy have identified several other organelles within the trypanosome, including a Golgi apparatus, a nucleus with nucleolus and peripheral chromatin, an endoplasmic reticulum, glycosomes and a basal body

and flagellar pocket, from which extends a single flagellum. The trypanosomes also possess a cell membrane, attached to the inside of which is a complex network of microfilaments and microtubules. Surrounding the outside of the cell membrane is a surface coat, which contains the variant surface glycoprotein (VSG), the subject of antigenic variation. The flagellar pocket is devoid of both cytoskeletal attachments and VSG—this area has numerous receptors and provides a site for receptor-mediated endocytosis. In the procyclic forms of the trypanosome, VSG is replaced by procyclin.

### Biochemistry

In bloodstream trypanosomes, glucose catabolism is carried out by the Embden–Meyerhof pathway in a specialised organelle called a glycosome. ATP is generated by the substrate phosphorylation stages in this catabolic pathway. These stages lack lactate dehydrogenase and pyruvate decarboxylase, and pyruvate is hence excreted directly or transaminated into alanine. NADH generated during glycolysis is reoxidised by a dihydroxyacetone phosphate-glycerol-3-phosphate oxidase, which uses molecular oxygen as a terminal electron acceptor, does not require a respiratory chain and does not generate ATP (Fairlamb, 1989). In contrast, the procyclic forms possess the Krebs cycle and respiratory chain enzymes, and generate ATP primarily by oxidative phosphorylation.

Trypanosomes appear to have little capacity for the synthesis of amino acids, most of which are acquired directly from the host. Alanine, aspartate and glutamate are also acquired by transamination of pyruvate, oxaloacetate and  $\alpha$ -ketoglutarate, respectively (Gutteridge *et al.*, 1977). Trypanosomes do, however, synthesise polyamines (e.g. putrescine and spermidine), compounds which are essential for proliferation and differentiation of the bloodstream stages. A key step in polyamine biosynthesis is the decarboxylation of ornithine to putrescine via ornithine decarboxylase. In contrast to nearly all other eukaryotes, which have a thiol metabolism based on the glutathione/glutathione reductase system, trypanosomatids lack glutathione



**Fig. 14a.1** Biosynthesis, metabolism and functions of trypanothione in trypanosomatids. GSH, reduced glutathione; GSSG, glutathione disulphide. Inhibitors are shown in boxes: R-As = O, melarsoprol (after Smith *et al.*, 1991)

reductase (Fairlamb and Cerami, 1985). The main thiol compound is a conjugate between spermidine and glutathione called bis(glutathionyl)spermidine (trypanothione). Trypanothione metabolism plays several key roles in trypanosomal survival (see Figure 14a.1).

- Trypanothione and trypanothione reductase contribute significantly to the maintenance of the correct intracellular thiol redox potential. Trypanothione reductase is an FAD-cystine-oxidoreductase unique to trypanosomes; it utilises NADPH to maintain trypanothione

disulphide (T[S]<sub>2</sub>) as the dithiol, dihydrotrypanothione (T[SH]<sub>2</sub>) (Smith *et al.*, 1991).

- Trypanothione and trypanothione peroxidase play an important role in defence against oxidant and radical damage.
- Thiol metabolism, particularly trypanothione, is crucial in defence against heavy metal toxicity.

Whereas trypanosomes synthesise pyrimidines by a pathway similar to that in mammals, there is no evidence of *de novo* purine biosynthesis. Salvage pathways are employed for this purpose (Hammond *et al.*, 1984).

### LIFE-CYCLE

Human African trypanosomes are transmitted by several species of tsetse flies of the genus *Glossina*; although these distinctions are not absolute, it is generally accepted that *T. brucei* var. *rhodesiense* is transmitted by dry flies (*G. morsitans* group) and *T. brucei* var. *gambiense* by wet flies (*G. palpalis* group). A wide variety of vertebrate hosts may be infected and, particularly for *T. brucei* var. *rhodesiense*, serve as important zoonotic reservoirs.

The life-cycle of *T. brucei* is depicted in Figure 14a.2. Development in the tsetse commences when an uninfected fly bites an infected vertebrate, ingesting trypomastigote forms of *T. brucei*. The trypanosomes in the vertebrate's blood migrate into the vector's midgut, where the short stumpy (SS) forms complete the development of their mitochondrion and change their surface coat to differentiate into the long, slender procyclic stages. As the procyclic stages have a fully developed mitochondrion and polysomes highly loaded with mRNA, they exhibit significantly higher levels of metabolic activity and protein synthesis than do the bloodstream stages (Brecht *et al.*, 1998). These stages have Krebs cycle enzymes and actively respire using an electron transport system. This mitochondrial development also brings about a change in the positional relationship between the nucleus and the kinetoplast-mitochondrial complex, as well as in flagellar motion and hence trypanosomal motility. The procyclic forms develop further, undergoing more morphological changes and,

after numerous cycles of multiplication, migrate into the vector's salivary glands and differentiate into epimastigotes (Figure 14a.3a), which attach to the cells of the gland and continue multiplying. Eventually, some epimastigotes undergo a final transformation stage into non-dividing metacyclic trypomastigotes (Figure 14a.3b), which are short, stumpy and highly motile. They lack free flagella, and have a terminally located kinetoplast. Mature metacyclic trypomastigotes detach from the salivary gland cells, synthesise a surface coat and are then able to infect a vertebrate bitten by the vector. This completion of development of the vector stages in the salivary glands (anterior station), and subsequent inoculative transmission to the mammalian host, are characteristic of the section *salivaria* of the genus *Trypanosoma*.

After metacyclic trypomastigotes have been transmitted from the tsetse fly to the vertebrate host, they transform into long slender (LS) forms (20–40 × 0.1 μm). The LS forms lack cytochromes and several Krebs cycle enzymes, and generate ATP solely by glycolysis. These forms multiply by binary fission until a threshold population is reached, whereupon a switch occurs, resulting in LS forms transforming first into intermediate forms and then into SS forms (15–25 × 3.5 μm). This transition involves cell cycle arrest and a decrease in protein synthesis, mediated by a reduction in ribosome loading (Brecht *et al.*, 1998). The SS forms are morphologically and functionally very different. They do not divide and have no free flagellum. Considerable changes are also seen in their kinetoplast-mitochondrion complex—the kinetoplast is posteriorly located, and the first stages of functional mitochondrial development are seen. It is likely that the SS form is the form infective for the tsetse, and the switch from a predominance of LS forms to SS forms is therefore essential for the cycle to continue (Seed, 1998).

### PATHOLOGY

Early involvement of the cardiovascular and lymphatic systems results in perivascular cellular infiltration, haemorrhage and oedema

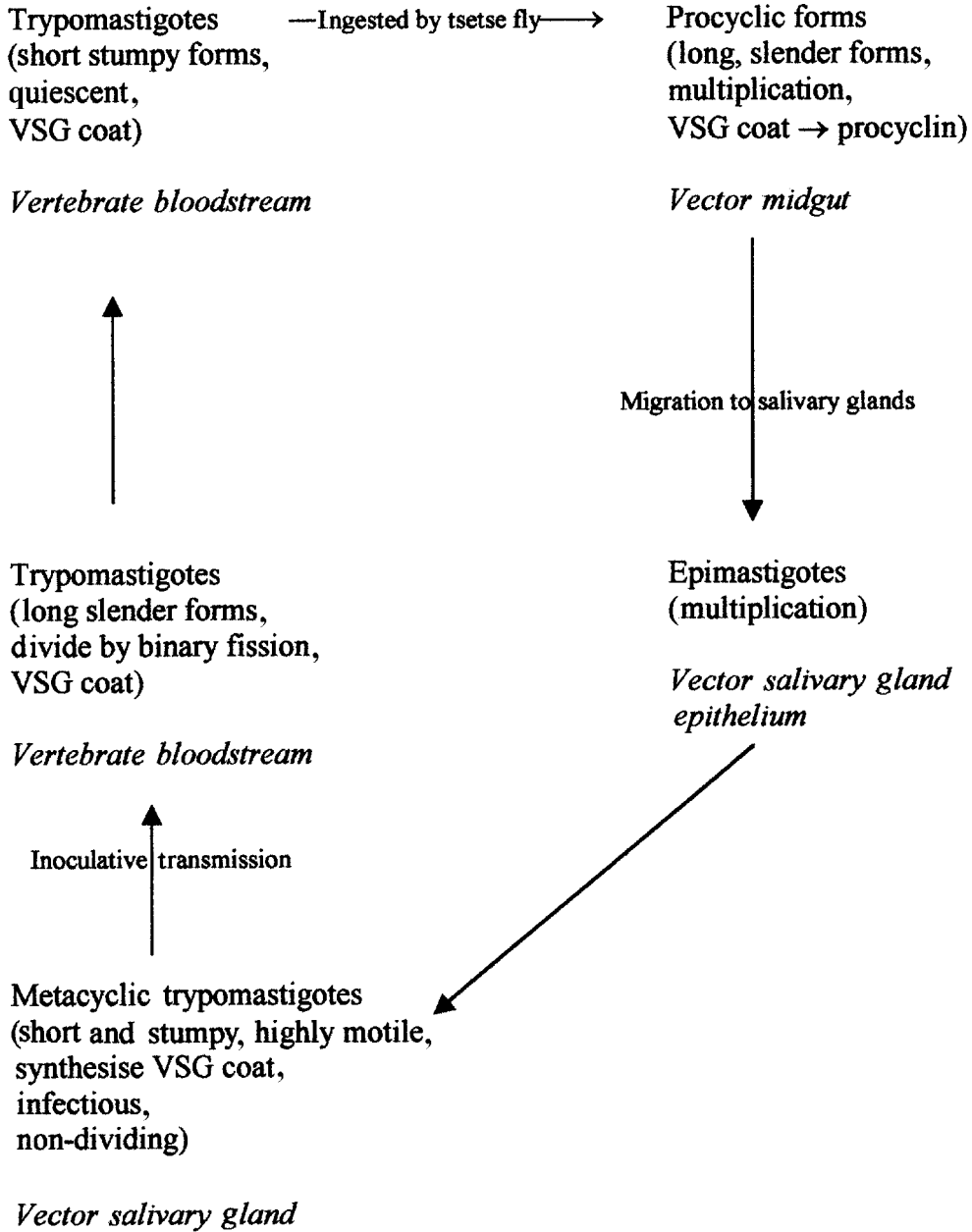
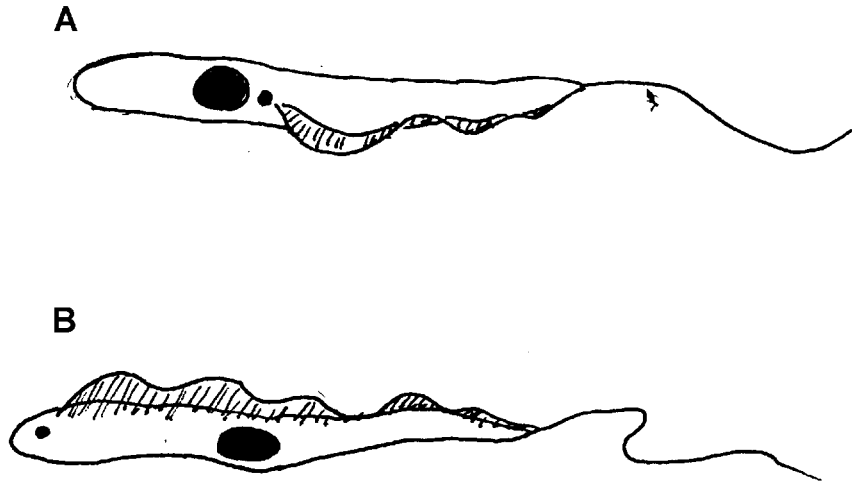


Fig. 14a.2 Life-cycle of *T. brucei*

(Pentreath, 1995). Widespread meningeal inflammation with injury to the choroid plexus soon follows, resulting in choroid plexus breakdown, allowing parasites to enter into the cerebrospinal fluid (CSF) and infiltrate periventricular areas

and a relatively thin blood-brain barrier. Although parasite entry into the CSF is achieved at this early state, trypanosomes usually remain undetectable in the CSF until considerably later (weeks in the case of *T. brucei* var. *rhodesiense*



**Fig. 14a.3** Diagram showing main morphological differences between (A) epimastigote and (B) trypomastigote

and months in *T. brucei* var. *gambiense* infection). This is probably because the CSF is a relatively hostile environment for trypanosomal survival. However, permeation into the CSF allows trypanosomes access to the perivascular extensions of the subarachnoid space, which penetrate deep into cerebral tissue. This generates an intense inflammatory reaction, resulting in generalised perivascular cuffing with T helper and B lymphocytes and morular cells (plasma cells producing IgM), particularly in the cerebellum and brainstem, and marks the transition from meningitis to encephalitis. There is also evidence of astrocyte and microglial hyperplasia and microglial activation (Chianella *et al.*, 1999). The cellular infiltrates described suggest that the immune response against trypanosomal invasion of the central nervous system is primarily a T-dependent B cell response.

As disease progresses, vasogenic oedema is seen, with characteristic changes in brain tissue density and electrolyte levels. The blood-brain barrier is progressively more damaged. Trypanosomes infiltrate areas of cerebral parenchyma with relatively little blood-brain barrier (e.g. pineal gland, median eminence) and spinal sensory ganglia. Except in terminal disease, trypanosomal invasion of brain tissue is rare.

Expression of major histocompatibility complex (MHC) Class I molecules is upregulated in

parasite-infiltrated parenchyma; this is accompanied by a cellular influx of CD8<sup>+</sup> T lymphocytes and macrophages, and may be mediated largely by interferon-gamma (IFN $\gamma$ ).

The biochemical disturbances produced by trypanosomal invasion of the CNS also extend to chemicals not directly related to the immune response. Several monoamine neurotransmitters have been shown to have increased turnover (Stibbs and Curtis, 1987), and there is substantial overproduction of lipid mediators, such as prostaglandins D<sub>2</sub> and F<sub>2 $\alpha$</sub> , the release of which is the result of synergistic activity between endotoxin and various trypanosomal products (Pentreath *et al.*, 1990). Endotoxaemia is a common occurrence in both the blood and CSF of patients with late-stage trypanosomiasis (Alafiatayo *et al.*, 1983). The source of the endotoxin is unclear, but non-specific endotoxin-like substances may be released by trypanosomes, and intestinal and hepatic damage could contribute by producing increased bacterial translocation and reduced clearance, respectively.

## IMMUNOLOGY

The immune response to African trypanosome infection is complex and remains poorly elucidated. The immune response is challenged by a



series of rapidly changing VSGs, together with thousands of invariant antigens, as if the host were being invaded by a series of organisms that were closely related but not identical. The inaccessibility of the invariant antigens in the living trypanosome prevents effective clearing of the parasite. The response is characterised by two major phenomena:

- Massive polyclonal activation of B cells, resulting in the release of large amounts of IgM (Donelson *et al.*, 1998). This response is stimulated partly by the changing VSG epitopes, but the antibodies produced are heterospecific and bind other trypanosomal antigens as well as host proteins and nucleic acids. The elevated levels of IgM result in the formation of large numbers of immune complexes, which lead to reticuloendothelial hyperplasia. Although the precise stimuli are unknown, it is likely that a trypanosomal antigen acts as the mitogen driving this hyper-responsiveness.
- Generalised suppression of both T and B cell function, resulting in a failure of humoral and cellular responses. This leaves the host with increased susceptibility to opportunistic infection, and also prevents maturation of the initial IgM response to trypanosomal infection. Hence, the usual secondary response manifested by the appearance of IgG and other immunoglobulin classes is absent.

Immune suppression is produced in two ways. Early on, there is a rapid but transient suppression resulting from the production of large amounts of nitric oxide in the spleen. The protracted immune suppression of chronic infection is the result of the parasite's ability to induce production of very high titres of IFN $\gamma$  by CD8<sup>+</sup> cells, by secreting a protein called T lymphocyte triggering factor (TLTF) (Olsson *et al.*, 1992). IFN $\gamma$  stimulates macrophages to produce large quantities of tumour necrosis factor (TNF) and to adopt an immunosuppressive phenotype, ultimately leading to downregulation of the production of IL-2 and its receptor. Despite the immune suppression mediated by IFN $\gamma$ , there is evidence that host resistance is associated with an intense Th1 response (Hertz *et al.*, 1998), the mainstay of host defence against *T. brucei* being

opsonic phagocytosis by liver macrophages (Dempsey *et al.*, 1983).

### Immunopathology

The immune response generated in response to trypanosomal invasion of the CNS contributes significantly to the neurological damage inflicted by a number of mechanisms (Hunter and Kennedy, 1992).

Autoantibody production is a feature of trypanosomiasis, autoantibodies being produced against antigens both outside and within the CNS. Autoantibodies have been demonstrated against muscle, single-stranded deoxyribonucleic acid (DNA), erythrocytes, brain myelin proteins and galactocerebrosides. Good correlation has been shown between the levels of antibody to myelin basic protein, galactocerebrosides and gangliosides and damage sustained by the CNS (Hunter *et al.*, 1992). However, it should be borne in mind that correlation does not prove causality—the autoantibodies produced could be the result of extensive tissue damage resulting in the release of autoantigens, and could therefore be the result of neuropathology, rather than its cause.

The neuroglial cells contribute significantly to the course and outcome of African trypanosomiasis. Astrocytes respond to trypanosomal invasion by reactive gliosis, a response marked by increases in several enzyme activities and increased production of numerous cytokines (Eddleston and Mucke, 1993). Astrocyte activation has been shown to precede the development of significant brain lesions, and is marked by upregulation of MHC Class I and Class II, IL-1 $\alpha$ , IL-6, IFN $\gamma$ , TNF and prostaglandins D<sub>2</sub> and E<sub>2</sub> (Hunter *et al.*, 1991, 1992). Hence, the microglia could act as accessory immune cells, playing a role in both cytokine production and antigen presentation, to modulate the cytokine network and mediate intracerebral inflammatory processes.

Trypanosomes directly modulate the production of some cytokines—*T. brucei* var. *brucei* stimulates IFN $\gamma$  production by CD8<sup>+</sup> T lymphocytes by releasing a triggering factor (trypanosome lymphocyte triggering factor).

IFN $\gamma$ , in addition to its immunomodulatory effects, stimulates trypanosomal growth. Trypanosomes also stimulate TNF $\alpha$  production by macrophages. Both IFN $\gamma$  and TNF $\alpha$  could act as pro-inflammatory mediators within the CNS. Studies using knockout mice have demonstrated that TNF $\alpha$  is a key mediator involved in both control of parasitaemia and infection-associated pathology (Magez *et al.*, 1999).

## MOLECULAR BIOLOGY

The interphase nucleus of *T. brucei* is about 3  $\mu\text{m}$  in diameter. The total nuclear DNA content has been estimated at  $3.5 \times 10^7$  base pairs (bp) per haploid genome, with up to 25% variation between isolates (cf. *T. cruzi*:  $4.3\text{--}5 \times 10^7$  bp; *Plasmodium falciparum*:  $2.7\text{--}3.0 \times 10^7$  bp) (Ersfeld *et al.*, 1999). The karyotype of *T. brucei* comprises about 100 minichromosomes of 50–100 kilobase pairs (kbp), one to five intermediate chromosomes of 200–900 kbp (the number and size vary between strains) and at least 11 pairs of large or megabase chromosomes of 1–6 mbp. About 10% of the trypanosomal DNA is contained within a network in the kinetoplast (Stuart, 1983). This DNA is organised in two forms. About 5% of kinetoplast DNA is organised into 25–50 large 20 kb circular strands called maxicircles, which encode mitochondrial proteins. The remaining 95% forms thousands of interlaced minicircles of about 1000 bp, which encode small guide RNA molecules that play a vital role in editing mRNA from the maxicircles. This is done by the addition or deletion of uridine molecules not encoded by the maxicircle genes, and serves to correct the raw transcripts, producing functional mRNA. The maxicircles are not free in the matrix, but are in fact entwined within the minicircle network.

Trypanosomes are notoriously successful at evading the host immune response by periodically changing the variant surface glycoprotein (VSG) in their surface coat by the phenomenon of antigenic variation. However, the trypanosomal surface coat also functions as the interface between the trypanosomal *milieu int rieur* and the extracellular spaces of its host, and hence must contain essential molecules (e.g. receptors

and translocators) that will need to be relatively invariant. The composition of the surface coat is stage-specific. The coat of the bloodstream forms of the parasite is composed of variant surface glycoprotein, acquired as the metacyclic trypanosomes progress through the final stage of maturation in the salivary glands of the tsetse fly. VSG is replaced by another glycoprotein, procyclin (also termed procyclic acidic repetitive protein, or PARP), when the parasite is ingested by the tsetse fly and differentiates into procyclic forms.

Each VSG molecule consists of a 350–400 amino acid N-terminal, which exhibits considerable variability, and a relatively conserved 50–100 amino acid C-terminal, which is anchored to the plasma membrane by a glycosphosphatidylinositol (GPI) anchor, containing two myristic acid residues. Despite the variability in primary structure of the N-terminal domain, its tertiary structure appears quite similar between different VSG molecules. The N-terminal domain folds into two long antiparallel  $\alpha$ -helices separated by a turn, resulting in the molecules existing as dimers, adopting an extended configuration perpendicular to the trypanosomal surface (Blum *et al.*, 1993). The trypanosomal coat contains about  $10^7$  molecules of a single VSG. This tight packing serves to conceal both the invariant proteins as well as the conserved C-terminal domains of the VSG molecules (Ziegelbauer *et al.*, 1993). Each trypanosome is able to sequentially express well in excess of 100 VSGs; this variation occurs spontaneously as a function of time and independently of any external stimulus (such as antibody), at a rate of about  $10^7$  switches per cell and per generation (Turner *et al.*, 1989). A given trypanosome strain will always express the same VSGs at a given stage during the infection, hence preventing rapid exhaustion of the entire VSG repertoire in the early stages.

There are more than 1000 *vsg* genes per trypanosome, occupying more than 2% of the parasite's genome (Van der Ploeg *et al.*, 1982). The majority of these genes are non-telomeric and located in chromosome-internal positions. A library of telomeric *vsgs* is located at the ends of about 100 mini-chromosomes, which contain a *vsg* at one if not at both ends, and about 25 larger chromosomes (Van der Ploeg *et al.*, 1984; Weiden

*et al.*, 1991). These telomeric genes are usually flanked by arrays of imperfect 70bp repeats upstream and telomeric repeats downstream (Aline *et al.*, 1989). Most, if not all, telomeric *vsgs* of the large chromosomes can be transcribed *in situ*—these telomeric loci are termed expression sites (ESs). Particularly in bloodstream forms, these ESs are polycistronic, containing about 10 different genes, termed ‘expression site-associated genes’ (*esags*), which encode a variety of membrane proteins, including adenyl cyclase and a transferrin receptor. Telomeric *vsgs* in the mini-chromosomes and the non-telomeric *vsgs* are not preceded by transcription promoters and are never transcribed *in situ*. About 20 ESs can be active in bloodstream trypomastigotes, but only one ES is transcribed at any one time, producing a single VSG (Navarro *et al.*, 1996).

Antigenic variation may be produced by one of two different genetic mechanisms—the alternative use of different *vsg* ESs (*in situ* activation) and changing the *vsg* present in a single active ES by a DNA recombination event (Figure 14a.4). *In situ* activation involves the activation of a new ES, coupled with simultaneous inactivation of the former ES. Two types of DNA recombination event are employed—gene conversion and reciprocal recombination. Gene conversion involves the replacement of a DNA sequence by the copy of another. As most *vsgs* are located in chromosome-internal positions, gene conversion is the most frequently employed mechanism for switching from one *vsg* to another (Robinson *et al.*, 1999). During this process, novel *vsg* hybrids are often synthesised by intragenic recombination of the copied sequences of the new *vsg* with residual fragments from the old. Hence, gene conversion produces new chimeric *vsgs* by sequence reassortment, increasing the trypanosome’s capacity for antigenic variation (Barber *et al.*, 1993). Reciprocal recombination occurs less frequently than gene conversion. It entails the exchange of telomeric *vsgs* with the gene present in the active *vsg* ES. Different strains of *T. brucei* hardly ever have common VSGs—the existence of two gene-switching mechanisms allows the *vsg* repertoire to be rapidly altered by continuous creation, storage and deletion of different *vsgs*.

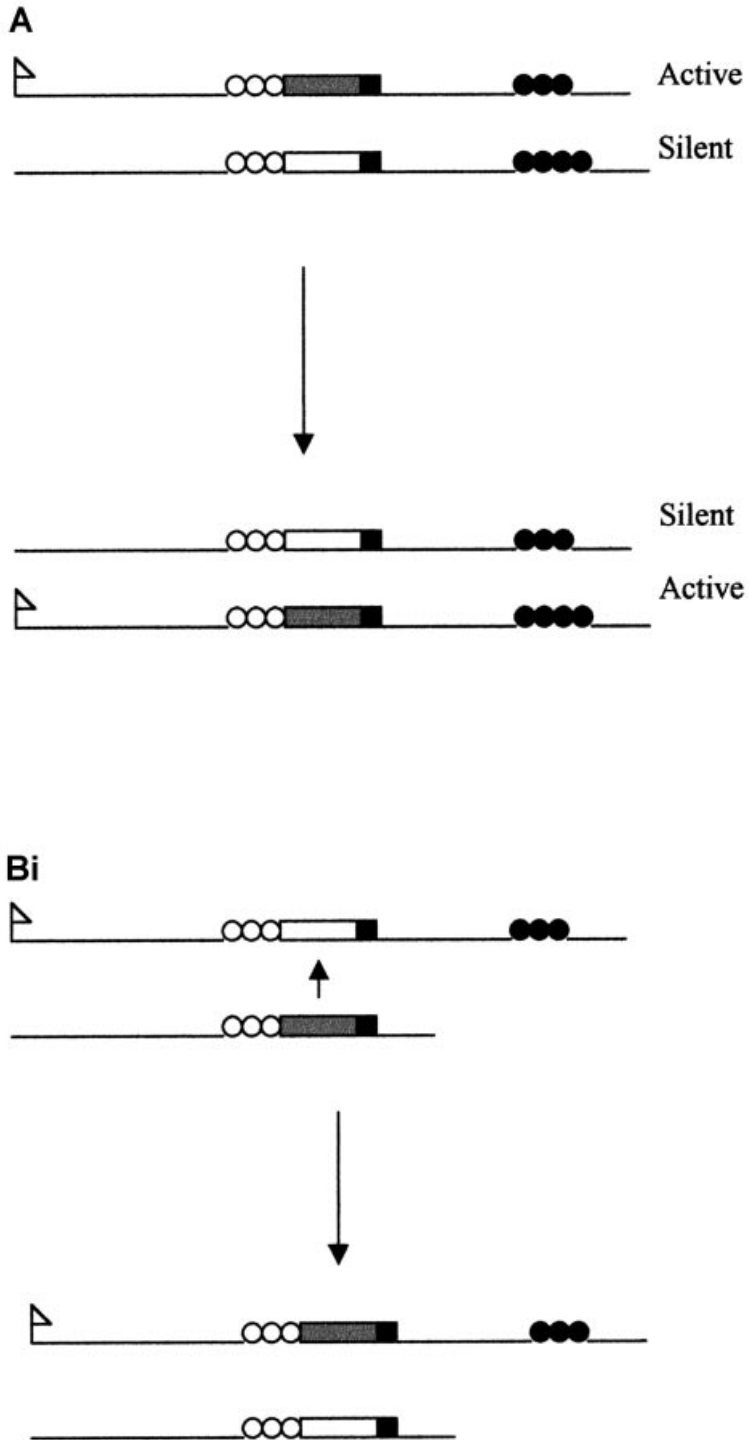
The procyclin coat of the procyclic forms (also known as procyclic acidic repetitive protein or

PARP) consists of four classes of related proteins, one of which contains repeats of the pentapeptide GPEET and the other three of which contain an extensive array of Glu–Pro repeats of different lengths and extents of N-glycosylation. A GPI anchor binds procyclin to the plasma membrane (Ferguson *et al.*, 1993). The likeliest role of procyclin is to protect the trypanosome from proteases in the midgut of the tsetse fly. This protein is developmentally regulated, changing from being the major surface protein in the procyclic stages to being undetectable in the blood stream forms. The control of procyclin expression is complex, expression in the bloodstream stages being downregulated at several levels:

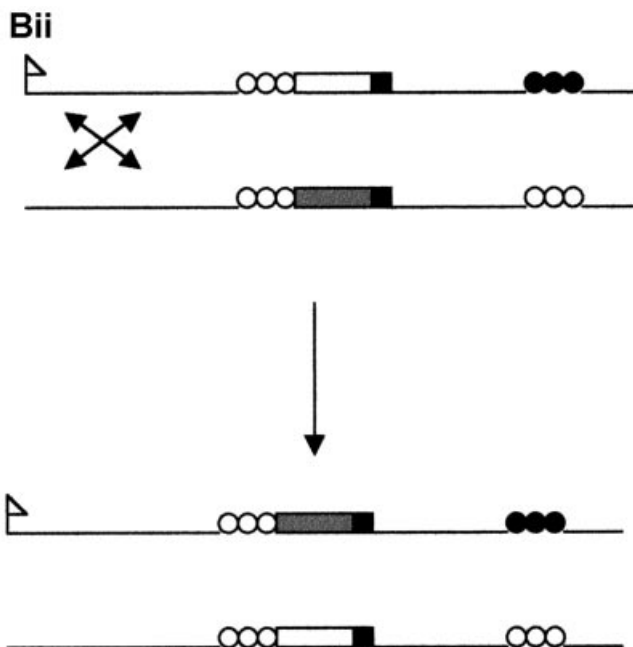
- Transcription is downregulated 5–10-fold (Biebinger *et al.*, 1996).
- Post-transcriptional regulation—sequences in the 3′-untranslated region (3′-UTR) induce rapid degradation of mRNA, reducing mRNA levels by 11-fold (Hotz *et al.*, 1998; Wilson *et al.*, 1999).
- Translation is downregulated by the same 3′-UTR sequences.

## EPIDEMIOLOGY

There are 31 known species of tsetse fly under the genus *Glossina*; speciation of flies has been facilitated by a recently produced computer program called ‘Glossina expert’. These species can be grouped into three main groups, which have different ecological preferences. The *Glossina morsitans* group preferentially occupy savanna woodland but have recently adapted to vegetation in the face of extensive deforestation. The *Glossina palpalis* group inhabit areas of secondary forest and vegetation associated with surface water (e.g. mangrove forest and riverine forest). The *Glossina fusca* group is not thought to transmit human African trypanosomiasis; it inhabits primary forest. Changes in the distribution of some species can occur with alterations in the environment. Detailed information regarding the distribution of the tsetse fly may be obtained from maps produced under the auspices of the Inter-African Bureau for Animal Resources of the Organisation of African Unity (OAU/IBAR).



**Fig. 14a.4** (A) and (B)



**Fig. 14a.4** Genetic mechanisms for antigenic variation. (A) *In situ* activation. (B) DNA recombination by (i) gene conversion and (ii) reciprocal recombination. White and grey boxes represent transcribed and silent genes, respectively. White and black circles represent 70 bp repeats and telomeric repeats, respectively. Redrawn after Pays *et al.*, 1998

*Glossina* spp. have an ability to spread rapidly, being able to fly about 6 km/day. They can also be dispersed passively by animals, floating vegetation and vehicles. Not all tsetse flies have the same vectorial capacity (i.e. capacity to transmit trypanosomes). The factors affecting vectorial capacity remain unclear, but a large number of environmental factors are implicated.

Human trypanosomiasis is characterised by periods of long-term endemicity in specific foci, interspersed with short-term epidemics.

In endemic foci, transmission of African trypanosomiasis to humans is influenced by several factors related to tsetse flies and the animal and human reservoir. The factors relevant to *Glossina* species are vectorial capacity, degree of anthropophily, longevity and dispersal. The density of the fly population is also of relevance in East African trypanosomiasis. The factors pertaining to the human reservoir that affect transmission include place of residence and behaviour, particularly agricultural and water-related activities, and the nature of the animal reservoir. Data from studies based on molecular

and biological strain characterisation suggest that each focus may be associated with a particular trypanosome strain that is responsible for the long-term stability of that area as a disease focus (Hide, 1999). There is also evidence from population studies using minisatellite markers that frequent genetic exchange occurs in the field, and that a significant proportion of tsetse flies and mammalian hosts are infected with a mixture of trypanosome genotypes (Macleod *et al.*, 1999).

Factors influencing transmission at epidemic level include sudden environmental alterations (e.g. deforestation), variations in human behaviour (produced by ethnic diversity) and massive population movements. Studies based on restriction fragment length polymorphism (RFLP) analysis of trypanosomal repetitive DNA sequences have shown that the strains that are harboured during periods of endemicity are similar to those that circulate during an epidemic peak (Hide *et al.*, 1998).

Trypanosomiasis is found exclusively in sub-Saharan Africa between latitudes 14°N and 29°S.



East African trypanosomiasis



West African trypanosomiasis

Fig. 14a.5 Distribution of East and West African trypanosomiasis. Redrawn after Kirchhoff, 1990

The geographical distributions of east and west African trypanosomiasis are shown in Figure 14a.5. The at-risk population is about 60 million, and it is estimated that about 300 000 new cases occur annually. Regrettably, less than 10% of this number reach medical attention.

### West African Trypanosomiasis

Although the tsetse fly is adapted to feeding on a wide variety of mammals, the slow rate of progression of this disease makes the human reservoir of prime importance. The main vectors are *G. palpalis palpalis*, *G. palpalis gambiensis*, *G. fuscipes fuscipes* and *G. tachinoides*. These

vectors inhabit forests and wooded areas along rivers, where favourable conditions of temperature, moisture and darkness are combined with the availability of mammalian blood. This distribution of the vectors restricts the occurrence of human infection to the tropical rain forests of Central and West Africa. Transmission is related to the site, intensity and frequency of contact between humans and the tsetse fly and occurs mainly in the following situations:

- Savannah and forest galleries—places that humans visit during their daily domestic schedule (e.g. for washing, fetching water), work (e.g. fishing) or while walking by or across rivers.
- Forest habitats—areas of human activity attract tsetse flies.
- Mangrove swamps—transmission mainly occurs in areas of human activity (e.g. encampments).

Other transmission sites include mango plantations and patches of forest around villages. Peridomestic transmission is relatively rare, occurring mainly when there are few zoonotic hosts or when the ecological environment around human habitations is unfavourable for the tsetse fly. Epidemic peaks can result from minor alterations in the environment, such as changes in temperature, humidity and vegetation, that alter the ecological balance.

### East African Trypanosomiasis

The epidemiology of endemic disease is zoonotic in nature, human infection being acquired from species of tsetse fly that inhabit the savanna and usually feed on a wide variety of domestic and wild animals. The bushbuck is probably the most important animal reservoir, it can live close to human habitation; important domestic reservoirs include cattle, dogs, sheep and goats. Human infection usually follows entry into woodland areas infested by the tsetse fly, the principal species involved being *G. morsitans morsitans*, *G. morsitans centralis*, *G. swynnertoni*, *G. pallidipes* and *G. fuscipes fuscipes*. Hence, the infection tends to have a patchy distribution, affecting predominantly adult men.

Epidemic disease is associated with changes in the distribution of *G. morsitans* populations, resulting in increased feeding on humans by tsetse flies, possibly caused by an alteration in the distribution of wild animals. It has a different transmission cycle, the human and domestic animal reservoirs predominating. In consequence, men, women and children are equally affected.

## CLINICAL FEATURES

The signs and symptoms of East and West African trypanosomiasis are very similar. However, the former is a more acute illness, with overt clinical manifestations appearing within days to weeks of infection, and death supervening in weeks to months. West African trypanosomiasis runs a more indolent course, with an incubation period of months to years. Studies based on isoenzyme characterisation suggest that particular zymodemes may be associated with certain clinical features (Smith *et al.*, 1997).

The haemolymphatic stage of trypanosomiasis is characterised by a chancre, which develops 2–3 days after the bite of an infecting tsetse fly as a tender, erythematous swelling. It is more common in *T. brucei* var. *rhodesiense* infection, and subsides within 3 weeks. Posterior cervical lymphadenopathy (Winterbottom's sign) often occurs with West African trypanosomiasis, lymphadenopathy being more generalised in East African disease. Fever, arthralgia, headache and myalgia are the commonest symptoms—unfortunately these symptoms occur in numerous febrile illnesses and are of little diagnostic value. The fever takes the form of recurrent febrile episodes coinciding with each wave of parasitaemia, each bout lasting 1–3 days. The haemolymphatic stage of trypanosomiasis is also marked by anaemia, hepatosplenomegaly and characteristic cutaneous ring-like patches, with polycyclic contours called trypanids. Other manifestations that can develop in the haemolymphatic stage and progress in the meningoencephalitic stage include oedema, ascites, albuminuria, endocrine and cardiac dysfunction (including pericardial effusion) and intercurrent infection.

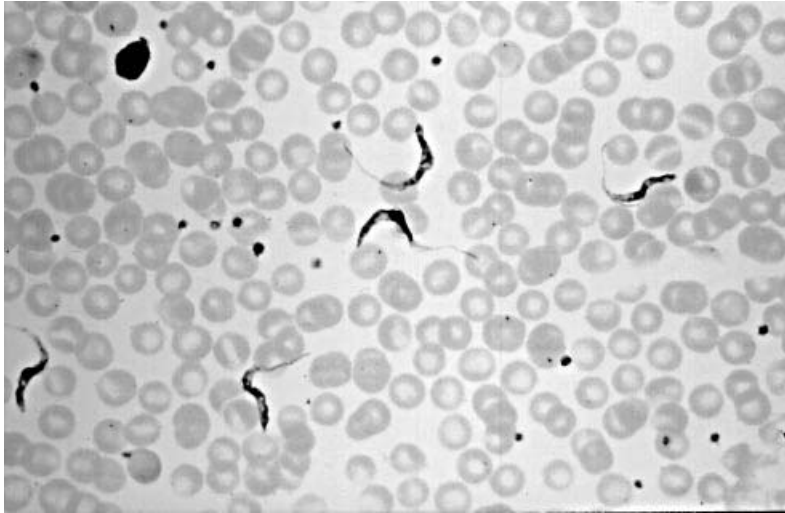
Although the clinical features of the haemolymphatic stage may persist, the meningoencephalitic stage is characterised by the onset of neurological phenomena. These can manifest in a myriad of ways, the loss of the circadian sleep–wake rhythm being commonest. Daytime somnolence develops, sometimes alternating with nighttime insomnia. The progressive severity of the somnolence has resulted in the use of the term 'sleeping sickness'. Other manifestations include hyper-reflexia, presence of primitive reflexes, coordination disorders, sensory disorders, tremor and choreoathetosis, hyper- or hypotonia, convulsions, impairment of conscious level and alteration of the mental state, including confusion, disorientation, alteration of mood (e.g. depression or euphoria) and behavioural changes marked by progressive indifference.

## LABORATORY DIAGNOSIS

### Parasite Detection

Diagnosis is most accurately made by demonstration of the parasite in body fluids. In early *T. brucei* var. *rhodesiense* infection, trypanosomes can be detected in serous fluid aspirates from the trypanosomal chancre, when present. In acute illness, trypanosomes can be detected in blood films. Wet blood films can be used for the visualisation of motile trypanosomes and have a detection limit of 25 parasites/ml of sample; thin (Figure 14a.6) and thick blood smears fixed in methanol and stained with Field's or Giemsa stain should also be made and have detection limits of 33 and 17 parasites/ml, respectively. The number of parasites in the blood is often very low, and multiple sampling and a variety of concentration techniques may be employed to facilitate detection:

- *Capillary tube centrifugation (microhaematocrit centrifugation) technique*—microscopic examination of the buffy coat of blood spun in microhaematocrit tubes. Detection limit is about 16 parasites/ml (Anonymous, 1998).
- *Quantitative buff coat technique*—a glass haematocrit tube precoated with acridine orange and anticoagulant is centrifuged, with a float forcing the sedimentation of



**Fig. 14a.6** Photomicrograph of a Giemsa-stained peripheral blood smear demonstrating African trypanosomes

erythrocytes. Motile fluorescent trypanosomes are concentrated in the buffy coat around the float. Detection limit is about 16 parasites/ml.

- *Miniature anion-exchange centrifugation technique*—the difference in electrical charge on the surface of trypanosomes from that in blood is used to effect a separation on an anion exchange (diethylaminoethyl cellulose) chromatography column. Trypanosomes are detected in the eluate after the passage of infected blood through the column, followed by centrifugation. This is the most sensitive of the blood concentration techniques, with a detection limit of 3–4 parasites/ml (Anonymous, 1998).
- *Density gradients and differential haemolytic agents* can be employed to enable separation of trypanosomes from erythrocytes by centrifugation.

In early illness, lymph node aspiration is easily performed and microscopic examination of a wet preparation of aspirates often enables visualisation of trypanosomes. Examination of cerebrospinal fluid (CSF) is of particular use in demonstrating cerebral involvement. The double centrifugation technique substantially enhances sensitivity to a detection limit of 1 parasite/ml. In the absence of trypanosomes in CSF, a raised CSF leucocyte count ( $> 5/\text{mm}^3$ ), the presence of

morula cells and raised protein are all indicators of possible cerebral trypanosomiasis. In late disease, elevated IgM titres are also of diagnostic value, and can now be determined through a latex agglutination test (latex/IgM) which is sensitive, simple and stable (Lejon *et al.*, 1998).

*In vivo* and *in vitro* culture systems may be used for the isolation of trypanosomes, but neither technique is currently practical for routine diagnosis. The *in vivo* technique is more sensitive for *T. brucei* var. *rhodesiense* (utilising mice and rats) than for *T. brucei* var. *gambiense* (utilising *Mastomys natalensis*, guinea-pigs and suckling rats) and achieves detection limits of 3–5 parasites/ml. A kit for *in vitro* isolation of trypanosomes (KIVI) from infected patients has been developed, but its diagnostic value is limited because detectable numbers of trypanosomes are produced only after several days (Aerts *et al.*, 1992).

### Indirect Diagnosis

As the density of trypanosomes in body fluids is often beyond the limits of even the most sensitive detection systems, indirect diagnostic techniques employing detection of antibodies, antigens or nucleic acids often need to be employed.



### Antibody Tests

Various antibody detection tests have been developed, including ELISA, immunofluorescence, immune trypanolysis, direct agglutination, indirect haemagglutination, latex agglutination, Western blot and dot-blot. The card agglutination test for trypanosomiasis (CATT) uses a reagent made of fixed, stained intact trypanosomes of variable antigen type LiTat 1.3 (Büscher *et al.*, 1999). This test has the advantages of high sensitivity and specificity, low costs, simplicity and speed, results being obtained within 5 minutes in the field. However, the LiTat 1.3 gene is not present in a small proportion of isolates, and non-expression of this gene could also produce a false-negative result. CATT is not equally effective in all geographical areas and is only currently available for *T. brucei* var. *gambiense* infection. Preliminary studies show that the Trypanosomiasis Agglutination Card Test (TACT) could be a promising development in the serological diagnosis of *T. brucei* var. *rhodesiense* infection (Akol *et al.*, 1999).

### Antigen Tests

Several direct, indirect and sandwich ELISA antigen-detection systems are being developed. The card indirect agglutination test for trypanosomiasis (*TrypTect* CIATT) uses specific antibodies coupled to latex beads to detect circulating trypanosomal antigens in patients' blood (Asonganyi *et al.*, 1998). The antigens are invariant antigens expressed on the surface of procyclic forms of *T. brucei*, and are common to all *T. brucei* var. *gambiense* and *T. brucei* var. *rhodesiense* stocks. *TrypTect* CIATT has been shown to have high sensitivity and specificity (both > 99%) and is simple and quick to perform. It is applicable for both *T. brucei* var. *gambiense* and *T. brucei* var. *rhodesiense* infection.

PCR techniques have been developed for trypanosome detection in both CSF and blood, and sensitivity thresholds of 1 parasite/ml have been reported. However, further evaluation is required before they are used for routine diagnosis.

### CLINICAL MANAGEMENT

The clinical course of trypanosomiasis divides into two fairly distinct stages, an earlier haemolymphatic stage and a later meningoencephalitic stage. Management of the two stages is different, and determination of the stage by examination of CSF must therefore always be performed once parasites have been detected in other body fluids. The criteria for diagnosing the meningoencephalitic stage are an elevated CSF leucocyte count (> 5/mm<sup>3</sup>) or protein concentration (> 37 mg/100 ml). Detection of trypanosomes in the CSF is not essential.

#### Haemolymphatic Stage

Suramin, a polysulphonated naphthylamine derivative of trypan red, is usually successful in treating patients with trypanosomiasis not involving the central nervous system. It is effective against both *T. brucei* var. *gambiense* and *T. brucei* var. *rhodesiense*, but cannot be used in the meningoencephalitic stage, as it does not cross the blood-brain barrier. The exact mode of action of suramin remains unclear, but, being a polyanion, it forms firm complexes with proteins, and several trypanosomal enzymes, including those involved with glycolysis and mitochondrial glycerol phosphate oxidase, are inhibited by the drug (Fairlamb and Bowman, 1977). Suramin is a relatively toxic drug. Immediate side effects include nausea, vomiting, shock, loss of consciousness, fever, urticaria and occasionally death. Later side effects that may occur include optic atrophy, nephrotoxicity, adrenal insufficiency, chronic diarrhoea and prostration. Agranulocytosis and haemolytic anaemia occur rarely. Pre-existing renal or hepatic disease are relative contraindications to suramin administration. Suramin is a white microcrystalline powder that dissolves readily in water. It is suitable only for intravenous administration. All doses are given by slow intravenous infusion of a 10% aqueous infusion; a test dose of 5 mg/kg is given on the first day, followed by doses of 20 mg/kg (maximum dose 1 g) on days 3, 10, 17, 24 and 31. Suramin is highly plasma protein-bound and may remain detectable in serum for up to 3 months after a dose.

Pentamidine isethionate was identified as a trypanocidal agent in the 1930s. Like suramin, it is highly protein-bound and therefore does not cross the blood–brain barrier and is not effective in meningoencephalitic disease. Pentamidine has a lower cure rate than suramin in *T. brucei* var. *gambiense* infection, and some cases of *T. brucei* var. *rhodesiense* infection do not respond to this agent. The precise mode of action of pentamidine is unclear. However, the strongly basic dicationic molecule is known to bind many cell components. Pentamidine binds trypanosomal kinetoplast DNA, resulting in swelling and distortion of the kinetoplast (Croft and Brazil, 1982). It also interferes with RNA synthesis and ribosomal function, and disrupts synthesis of proteins, phospholipids, polyamines and nucleic acids (Wallis, 1966). Pentamidine is a toxic drug when administered by intramuscular injection or intravenous infusion, common adverse effects being nausea, vomiting, tachycardia, hypotension, vertigo, facial flushing, dyspnoea and a metallic taste (Hill and Hutner, 1968). Approximately 25% of patients develop reversible mild to moderate renal failure (Western *et al.*, 1970). Hypoglycaemia can also occur—this may be life-threatening and has been attributed to a direct toxic effect of pentamidine on the  $\beta$  cells of the pancreatic islets of Langerhans (Osei *et al.*, 1984). Insulin-dependent diabetes mellitus may develop up to several months after therapy. Less common side effects of pentamidine include leucopenia, thrombocytopenia, abnormal liver function tests, acute pancreatitis, fever, hypocalcaemia, cardiac arrhythmias (particularly *torsades de pointes*), confusion and hallucinations. Intramuscular injection is often complicated by pain, swelling and sterile abscesses at the injection site; hence, the commonest route of administration is by slow intravenous infusion over a period of 1–2 hours. If the intramuscular route is used, patients should remain supine and under observation for at least 1 hour because of the risk of hypotension and syncope. The recommended dosage regimen is 4 mg/kg daily or on alternate days to a total of 7–10 injections; however, recent pharmacokinetic data and *in vitro* experiments suggest that cure may be achieved with lower dosages and shorter durations of therapy. The cure rate achieved with the current treatment regimen is 98%; relapse rates of 7–16% have been reported.

### Meningoencephalitic Stage

Eflornithine (DL- $\alpha$ -difluoromethylornithine) is now the treatment of choice for *T. brucei* var. *gambiense* meningoencephalitis. *T. brucei* var. *rhodesiense* is not susceptible to the drug (Bacchi *et al.*, 1990). It acts by irreversibly inhibiting the enzyme ornithine decarboxylase, which is involved in trypanosomal polyamine synthesis (Figure 14a.1) (Haegle *et al.*, 1981). Eflornithine does not bind plasma proteins and readily crosses the blood–brain barrier. The drug has a half-life of about 3 hours and approximately 80% is excreted unchanged in the urine within 24 hours. Adverse effects include myelosuppression, diarrhoea, convulsions, vomiting and fever. The current recommended dosage regimen is 400 mg/kg intravenously in four divided doses for 14 days; however, comparative studies with a view to reducing the duration of treatment are underway. Treatment regimens based on oral administration of the drug have resulted in a failure rate, and are hence not recommended. Eflornithine is a much less toxic drug than suramin, pentamidine or melarsoprol and is likely to eventually replace them as the treatment of choice for *T. brucei* var. *gambiense* infection. It is not currently used as a first-line agent in West Africa for economic and logistic reasons (Pécoul and Gastellu, 1999).

### Melarsoprol

Melarsoprol used to be the most effective drug for trypanosomal meningoencephalitis before the introduction of eflornithine, and remains so for *T. brucei* var. *rhodesiense* meningoencephalitis. This drug is an arsenical compound which reacts avidly with sulphhydryl groups, interacting with several proteins and inactivating a number of enzymes. It also forms a stable 1:1 adduct with dihydrotrypanothione and the resulting complex is a potent inhibitor of trypanosomal trypanothione reductase (Figure 14a.1) (Fairlamb *et al.*, 1989). The drug enters parasites using an adenosine transporter, which has been found to be absent in melarsoprol-resistant isolates. Melarsoprol is a highly toxic drug, its most serious complication being a reactive encephalopathy

which affects 5–10% of patients in the first 4 days of therapy and carries a 6% mortality (Arroz, 1987). Other adverse effects include a Guillain-Barré-like syndrome, hepatotoxicity, agranulocytosis, exfoliative dermatitis, myocardial damage, gastrointestinal disturbances, polyneuropathy and allergic reactions. Patients with glucose-6-phosphate dehydrogenase deficiency can develop severe haemolysis on treatment with melarsoprol. The drug has a plasma half-life of 35 hours, the primary route of excretion being in the bile. Various treatment regimens are used in different areas. In general, three series of three or four daily injections are given for 3–4 days, separated by a week's rest period; the dosage is increased from 1.2 to 3.6 mg/kg within each series to a total dose of 26–27 mg/kg. However, a recent trial suggests that a shorter treatment schedule, comprising 10 daily injections of 2.2 mg/kg, is equally efficacious (Burri *et al.*, 2000). Melarsoprol treatment is usually preceded by one or two injections of either pentamidine or suramin to eliminate parasites from the blood and lymph.

There is evidence that the incidence and severity of adverse reactions to melarsoprol may be reduced by simultaneous administration of corticosteroids. The recommended regimen is prednisolone 1 mg/kg/day up to a maximum 40 mg/day. Corticosteroid treatment should be commenced 1 day before the first dose of melarsoprol and continued throughout therapy.

Patients should be followed up at 3 monthly intervals for the first 6 months and at 6 month intervals for the next 18 months. At each session, blood and CSF examination should be carried out in addition to clinical assessment. CSF cell counts and protein levels usually take several months to return to normal; preliminary work shows that PCR may be a useful technique for staging African trypanosomiasis.

## PREVENTION AND CONTROL

Strategies for the prevention and control of trypanosomiasis are based on reducing infection by vector control and suppression of disease in infected people by early treatment.

## Vector Control

The goal of programmes aimed at controlling the tsetse fly population is to reduce their numbers to a level where transmission is greatly diminished or interrupted. Total eradication is no longer regarded as achievable. Numerous techniques have been developed and tried with varying degrees of success. Techniques that cause significant environmental damage, such as eradication of animal reservoirs and bush clearance, are no longer permitted. Biological control techniques have been found to be ineffective and the mainstay of tsetse fly control is now based on the use of insecticides and traps and screens. Older insecticides, such as diphenyltrichloroethane (DDT), dieldrin and endosulfan, are effective but difficult to use in large-scale programmes, owing to cost, environmental pollution and the time required. Fortunately, the recently developed synthetic pyrethroid compounds (e.g. cypermethrin and deltamethrin) overcome these problems to a large extent. The development of ultra-low-volume aerial spraying techniques has also contributed significantly by reducing both the time and quantity of insecticide required; however, the feasibility of aerial spraying is limited by the terrain, and is not possible in forests. The main advantage of using traps and screens to reduce the tsetse fly population is that these techniques are virtually harmless to the environment. Traps are enclosures which may be hung from posts, into which tsetse flies enter and then die, either by contact with insecticide or sun exposure. Screens are flat pieces of blue and black cloth suspended by wooden posts. They are impregnated with insecticide and trap flies in flight.

## Disease Suppression

Suppression of disease in infected individuals requires an efficient system of case detection to be in place. This is hampered by a failure of patients to present in the early stages of illness and the inability of medical staff to correctly diagnose trypanosomiasis, owing to the non-specificity of signs and symptoms in the early stages and the relative insensitivity of parasitological

techniques. The development of simple, cheap serodiagnostic techniques has greatly facilitated case detection, and the approach that has been adopted is that of initial serological screening and subsequent parasitological confirmation of positive cases. The main problems with serological screening are that the sensitivity of these techniques varies between areas and a significant proportion of cases are seropositive but parasite-negative; this proportion also exhibits considerable inter-regional variation. Whereas these cases could represent serological false-positives, it is possible that some of them are infected patients with parasitaemias too low to be detected; hence, these patients require 3–6 monthly follow-up for 1–2 years unless they become seronegative. Treatment is not usually commenced unless trypanosomiasis is confirmed parasitologically.

Case detection can be conducted either actively, where entire populations in at-risk areas are screened, or passively, where patients presenting to health centres with symptoms suggestive of trypanosomiasis are subjected to appropriate diagnostic techniques. The former, whilst being very costly, can be highly effective if conducted efficiently. In practice, a combination of these techniques is applied.

A major factor compromising the establishment of effective trypanosomiasis control is the heavy economic burden this places on impoverished African countries. The necessary resources are scarce in many areas and are often further depleted by civil unrest, which also serves to interrupt the flow of foreign aid into control programmes.

## Vaccination

Trypanosomes have thwarted all attempts at vaccine production so far, mainly as a result of the phenomena of antigenic variation and immune suppression. Their tremendous capacity for antigenic variation of VSG precludes the use of this immunodominant antigen for vaccination, and the intense immune suppression that is produced prevents the generation of an adequate response to protective antigens. The most promising vaccine candidates are the invariant surface receptors. These proteins are mostly

concealed in the flagellar pocket or else buried beneath the tight VSG coat. However, some of these proteins, such as the transferrin receptor, are encoded by variant *esags*, and hence are difficult to exploit for vaccination. Other receptors in the flagellar pocket are in fact VSG molecules. Nevertheless, some success has been achieved by vaccinating cattle and mice with a vaccine based on flagellar pocket extracts (Olenick, 1988; Mkunza, 1995).

## REFERENCES

- Aerts D, Truc P *et al.* (1992). A kit for *in vitro* isolation of trypanosomes in the field: first trial with sleeping sickness patients in the Congo Republic. *Trans R Soc Trop Med Hyg* **86**: 394–5.
- Akol MN, Olaho-Mukani W, Odiit M *et al.* (1999). Trypanosomiasis agglutination card test for *Trypanosoma brucei rhodesiense* sleeping sickness. *E Afr Med J* **76**: 38–41.
- Alafiatayo RA, Crawley B, Oppenheim BA, Pentreath VW (1993). Endotoxins and the pathogenesis of *Trypanosoma brucei brucei* infection in mice. *Parasitology* **107**: 49–53.
- Aline RFJ, Stuart KD (1989). *Trypanosoma brucei*: conserved sequence organisation 3' to telomeric variant surface glycoprotein genes. *Exp Parasitol* **68**: 57–66.
- Anonymous (1998). Control and surveillance of African trypanosomiasis. Report of a WHO Expert Committee. *WHO Tech Rep Ser* **881** (I–VI), 1–114.
- Arroz JO (1987). Melarsoprol and reactive encephalopathy in *Trypanosoma brucei rhodesiense*. *Trans R Soc Trop Med Hyg* **81**: 192.
- Asonganyi T, Doua F, Kibona SN, Nyasulu YMZ, Masake R, Kuzoe F (1998). A multi-centre evaluation of the card indirect agglutination test for trypanosomiasis (*Tryp*Tect CIATT). *Ann Trop Med Parasitol* **92**: 837–44.
- Bacchi CJ, Nathan HC, Livingston T (1990). Differential susceptibility to DL- $\alpha$ -difluoromethylornithine in clinical isolates of *Trypanosoma brucei rhodesiense*. *Antimicrob Agents Chemother* **34**: 1183–8.
- Barber AF, Kamper SM (1993). The importance of mosaic genes to trypanosome survival. *Parasitol Today* **9**: 63–6.
- Biebinger S, Rettenmaier S, Flaspohler J *et al.* (1996). The PARP promoter of *Trypanosoma brucei* is developmentally regulated in a chromosomal context. *Nucleic Acids Res* **24**: 1202–11.
- Blum ML, Down JA, Gurnett AM, Carrington M, Turner MJ, Wiley D (1993). A structural motif in the variant surface glycoproteins of *Trypanosoma brucei*. *Nature* **362**: 603–9.
- Brecht M, Parsons M (1998). Changes in polysome profiles accompany trypanosome development. *Mol Biochem Parasitol* **97**: 189–98.
- Bruce D (1895). *Preliminary Report on the Tsetse Fly Disease or Nagana in Zululand*. Bennett and David: Durban, South Africa.

- Burri C, Nkunku S, Merolle A, Smith T, Blum J, Brun R (2000). Efficacy of new, concise schedule for melarsoprol in treatment of sleeping sickness caused by *Trypanosoma brucei gambiense*: a randomised trial. *Lancet* **355**: 1419–25.
- Büscher P, Lejon V, Magnus E, Van Meirvenne N (1999). Improved latex agglutination test for detection of antibodies in serum and cerebrospinal fluid of *Trypanosoma brucei gambiense* infected patients. *Acta Tropica* **73**: 11–20.
- Chianella S, Semprevivo M, Peng ZC *et al.* (1999). Microglia activation in a model of sleep disorder: an immunohistochemical study in the rat brain during *Trypanosoma brucei* infection. *Brain Res* **832**: 54–62.
- Croft SL, Brazil RP (1982). Effect of pentamidine isethionate on the ultrastructure and morphology of *Leishmania mexicana amazonensis* in vitro. *Ann Trop Med Parasitol* **76**: 37–43.
- Dempsey WA, Mansfield JM (1983). Lymphocyte function in experimental African trypanosomiasis. V. Role of antibody and the mononuclear phagocyte system in variant-specific immunity. *J Immunol* **130**: 405–11.
- Donelson JE, Hill KL, El-Sayed NMA (1998). Multiple mechanisms of immune evasion by African trypanosomes. *Mol Biochem Parasitol* **91**: 51–66.
- Eddleston E, Mucke L (1993). Molecular profile of reactive astrocytes—implications for their role in neurologic disease. *Neuroscience* **54**: 15–36.
- Enyaru JCK, Allingham R *et al.* (1993). The isolation and genetic heterogeneity of *Trypanosoma brucei gambiense* from the North-West Uganda. *Acta Trop* **54**: 31–9.
- Ersfeld K, Melville SE, Gull K (1999). Nuclear and genome organization of *Trypanosoma brucei*. *Parasitol Today* **15**: 58–63.
- Fairlamb AH, Henderson GB, Cerami A (1989). Trypanothione is the primary target for arsenical drugs against African trypanosomes. *Proc Natl Acad Sci USA* **86**: 2607–11.
- Fairlamb AH (1989). Novel biochemical pathways in parasite protozoa. *Parasitology* **99**: S93–112.
- Fairlamb AH, Bowman IB (1977). *Trypanosoma brucei*: suramin and other trypanocidal compounds' effects on sn-glycerol-3-phosphate oxidase. *Exp Parasitol* **43**: 353–61.
- Fairlamb AH, Cerami A (1985). Identification of a novel, thiol-containing co-factor essential for glutathione reductase enzyme activity in trypanosomatids. *Mol Biochem Parasitol* **14**: 187–98.
- Ferguson MAJ, Murray P, Rutherford H, McConville MJ (1993). A simple purification of procyclic acid repetitive proteins and demonstration of a sialated glycosyl-phosphatidylinositol membrane anchor. *Biochem J* **290**: 51–5.
- Gutteridge WE, Coombs GH (1977). *Biochemistry of Parasitic Protozoa*. University Park Press: Baltimore MD; 89–107.
- Haag J, O'Huigin C, Overath P (1998). The molecular phylogeny of the trypanosomes: evidence of an early divergence of the Salivaria. *Mol Biochem Parasitol* **91**: 37–49.
- Haegele KD, Alken RG, Grove J, Schechter PJ, Koch-Weser J (1981). Kinetics of  $\alpha$ -difluoromethylornithine: an irreversible inhibitor of ornithine decarboxylase. *Clin Pharmacol Therapeut* **30**: 210–17.
- Hammond DJ, Gutteridge WE (1984). Purine and pyrimidine metabolism in the trypanosomatidae. *Mol Biochem Parasitol* **13**: 242–61.
- Hertz CJ, Filutowicz H, Mansfield JM (1998). Resistance to the African trypanosomes is IFN- $\gamma$  dependent. *J Immunol* **161**: 6775–883.
- Hide G, Angus SD, Holmes PH, Maudlin I, Welburn SC (1998). *Trypanosoma brucei*: comparison of circulating strains in an endemic and epidemic area of a sleeping sickness focus. *Exp Parasitol* **89**: 21–9.
- Hide G (1999). History of sleeping sickness in East Africa. *Clin Microbiol Rev* **12**: 112–25.
- Hotz H-R, Biebinger S, Flaspohler J, Clayton C (1998). PARP gene expression: control at many levels. *Mol Biochem Parasitol* **91**: 131–43.
- Hunter CA, Jennings FW, Kennedy PGE, Murray M (1992). Astrocyte activation correlates with cytokine production in central nervous system of *Trypanosoma brucei brucei* infected mice. *Lab Invest* **67**: 635–42.
- Hunter CA, Gow JW, Kennedy PGE, Jennings FW, Murray M (1991). Immunopathology of experimental African sleeping sickness: detection of cytokine mRNA in the brains of *Trypanosoma brucei brucei* infected mice. *Infect Immun* **59**: 4636–46.
- Hunter CA, Kennedy PGE (1992). Immunopathology in central nervous system human African trypanosomiasis. *J Neuroimmunol* **36**: 91–5.
- Kirchhoff LV (1990). *Trypanosoma* species (American Trypanosomiasis, Chagas' Disease): biology of trypanosomes. In Mandell GL, Douglas RG, Bennett JE, *Principles and Practice of Infectious Diseases* 4th edn. Churchill Livingstone: New York; 2077–84.
- Lejon V, Büscher P, Sema NH, Magnus E, Van Meirvenne N (1998). Human African trypanosomiasis: a latex agglutination field test for quantifying IgM in cerebrospinal fluid. *Bull WHO* **76**: 553–8.
- Magez S, Radwanska M, Beschin A, Sekikawa K, De Baetselier P (1999). Tumour necrosis factor alpha is a key mediator in the regulation of experimental *Trypanosoma brucei* infections. *Infect Immun* **67**: 3128–32.
- Macleod A, Turner MR, Tait A (1999). A high level of mixed *Trypanosoma brucei* infections in tsetse flies detected by three hypervariable minisatellites. *Mol Biochem Parasitol* **102**: 237–48.
- Mkunza F, Olaho WM, Powell CN (1995). Partial protection against natural trypanosomiasis after vaccination with a flagellar pocket antigen from *Trypanosoma brucei rhodesiense*. *Vaccine* **13**: 151–4.
- Molyneux DH (1997). Current public health status of the trypanosomiasis and leishmaniasis. In Hide G, Mottram JC, Coombs GH, Holmes PH (eds), *Trypanosomiasis and Leishmaniasis: Biology and Control*. CAB International: Wallingford, UK; 39–50.
- Navarro M, Cross GAM (1996). DNA rearrangements associated with multiple consecutive directed antigenic switches in *Trypanosoma brucei*. *Mol Cell Biol* **16**: 3615–25.
- Olenick JG, Wolff R, Nauman RK, McLaughlin J (1988). A flagellar membrane pocket fraction from *Trypanosoma brucei rhodesiense*: immunogold localization and non-variant immunoprotection. *Infect Immun* **56**: 92–8.

- Olsson T, Bakhiet M, Kristensson K (1992). Interactions between *Trypanosoma brucei* and CD8<sup>+</sup> T-cells. *Parasitol Today* **8**: 237–9.
- Osei K, Falko JM, Nelson KP, Stephens R (1984). Diabetogenic effect of pentamidine. *In vitro* and *in vivo* studies in a patient with malignant insulinoma. *Am J Med* **77**: 41–6.
- Pays E, Nolan DP (1998). Expression and function of surface proteins in *Trypanosoma brucei*. *Mol Biochem Parasitol* **91**: 3–36.
- Pécoul B, Gastellu M (1999). Production of sleeping-sickness treatment. *Lancet* **354**: 955–6.
- Pentreath VW (1995). Trypanosomiasis and the nervous system. *Trans R Soc Trop Med Hyg* **89**: 9–15.
- Pentreath VW, Rees K, Owolabi OA, Philip KA, Doua F (1990). The somnogenic T lymphocyte suppressor prostaglandin D<sub>2</sub> is selectively elevated in cerebrospinal fluid of advanced sleeping sickness patients. *Trans R Soc Trop Med Hyg* **84**: 795–9.
- Robinson NP, Burman N, Melville SE, Barry JD (1999). Predominance of duplicative VSG conversion in antigenic variation in African trypanosomes. *Mol Cell Biol* **19**: 5839–46.
- Seed JR (1998). African trypanosomiasis. In Cox F, Kreier, Wakelin D (eds), *Topley and Wilson's Microbiology and Microbial Infection. Vol 5 Parasitology*, 9th edn. Arnold: London; 267–82.
- Smith DH, Bailey JW (1997). Human African trypanosomiasis in south-eastern Uganda: clinical diversity and isoenzyme profiles. *Ann Trop Med Parasitol* **91**: 851–6.
- Smith K, Mills A, Thornton JM, Fairlamb AH (1991). Trypanothione metabolism as a target for drug design: molecular modelling of trypanothione reductase. In Coombs G, North M (eds), *Biochemical Protozoology*. Taylor and Francis: London; 482–92.
- Stevens JR, Noyes HA, Dover GA, Gibson WC (1999a). The ancient and divergent origins of the human pathogenic trypanosomes, *Trypanosoma brucei* and *Trypanosoma cruzi*. *Parasitology* **118** (Pt 1): 1076.
- Stevens JR, Gibson WC (1999b). The molecular evolution of trypanosomes. *Parasitol Today* **15**: 427–68.
- Stibbs HH, Curtis DA (1987). Neurochemical changes in experimental African trypanosomiasis in voles and mice. *Ann Trop Med Parasitol* **81**: 673–9.
- Stuart K (1983). Kinetoplast DNA, mitochondrial DNA with a difference. *Mole Biochem Parasitol* **9**: 93–104.
- Turner CMR, Barry JD (1989). High frequency of antigenic variation in *Trypanosoma brucei rhodesiense* infections. *Parasitology* **99**: 67–75.
- Van der Ploeg LHT, Valerio D, De Lange T, Bernards A, Borst P, Grosveld FG (1982). An analysis of cosmid clones of nuclear DNA from *Trypanosoma brucei* shows that the genes for variant surface glycoproteins are clustered in the genome. *Nucleic Acids Res* **10**: 5905–23.
- Van der Ploeg LHT, Schwartz DC, Cantor CR, Borst P (1984). Antigenic variation in *Trypanosoma brucei* analysed by electrophoretic separation of chromosome-sized DNA molecules. *Cell* **37**: 77–84.
- Wallis OC (1966). The effect of pentamidine on ribosomes of the parasitic flagellate *Crithidia (Strigomonas) oncopelti*. *J Protozool* **13**: 234–9.
- Weiden M, Osheim YN, Beyer AL, Van der Ploeg LHT (1991). Chromosome structure: DNA nucleotide sequence elements of a subset of the mini-chromosomes of the protozoan *Trypanosoma brucei*. *Mole Cell Biol* **11**: 3823–4.
- Western KA, Perera DR, Schultz MG (1970). Pentamidine isethionate in the treatment of *Pneumocystis carinii* pneumonia. *Ann Intern Med* **73**: 695–702.
- Wilson K, Uyetake L, Boothroyd J (1999). *Trypanosoma brucei*: cis-acting sequences involved in the developmental regulation of PARP expression. *Exp Parasitol* **91**: 222–30.
- Ziegelbauer K, Overath P (1993). Organisation of two invariant surface glycoproteins in the surface coat of *Trypanosoma brucei*. *Infect Immun* **61**: 4540–45.

# American Trypanosomiasis (Chagas' Disease)

**Louis V. Kirchhoff**

*University of Iowa, Iowa City, IA, USA*

---

## HISTORICAL INTRODUCTION

Trypanosomes are single-celled protozoan parasites that have an amazingly wide distribution in nature. They are found in both cold- and warm-blooded vertebrates, and also in many invertebrate species that often act as vectors. Broadly stated, if an animal has blood, it is likely to be a host for these creatures. Trypanosomes were first observed in 1841 by Gabriel Valentin who saw the motile organisms while examining the blood of a trout under a microscope. Similar organisms were seen in the blood of a toad 2 years later by David Gruby, who provided an elegant description of their undulating membranes. Trypanosomes were first noted in mammals in 1878 by Timothy Lewis, who saw them while examining blood from rats. Shortly thereafter, Griffith Evans, a veterinarian working in the Punjab, observed trypanosomes in the blood of horses, mules and camels that were affected with an often fatal febrile illness called 'surra'. Evans demonstrated the relationship between the trypanosomes and surra by passing the infection from a sick animal to a previously healthy dog and horse and observing the development of the disease (Paredes-Espinoza and Paredes-Casillas, 1996).

Towards the end of the nineteenth century, major observations relating to trypanosomes

were made in Africa. In 1894, David Bruce concluded that the trypanosomes he saw in the blood of animals affected with a disease called 'nagana' were the cause of that illness. Nagana had been a major killer of cattle and horses since early colonial times, and the parasite he observed was later designated *Trypanosoma brucei*. Bruce also established that the 'tsetse disease' that had been a persistent problem in domestic animals during the colonial period was caused by the same organism. It fell to Robert Koch (1906) to propose that *T. brucei* was cycling through tsetse flies and in this way was transmitted from one mammalian host to another (Duggan, 1970).

The first human trypanosome infection noted was in an English boat captain who was travelling up the Gambia River shortly after the turn of the century. An alert physician searching the patient's blood for *Plasmodium* encountered trypanosomes, which were later designated *Trypanosoma gambiense* by J. Everett Dutton, who reported the case after the patient's death. A second case was reported by Patrick Manson shortly thereafter, and within a few years it was suggested by Maxwell Adams and confirmed by cerebrospinal fluid studies by Aldo Castellani that sleeping sickness, which had killed hundreds of thousands of people in epidemics in many areas of Africa, was also caused by trypanosomes.

The history of the discovery of *Trypanosoma cruzi* and its role as the cause of Chagas' disease was quite different in that one person, the Brazilian physician Carlos Chagas, discovered the organism, vector, domestic and sylvatic reservoirs, and described the clinical manifestations of the disease in humans. In 1908 Chagas was sent as a public health official to the interior of the Brazilian state of Minas Gerais to control malaria among railroad construction workers. At that time he already was familiar with trypanosomes, having previously discovered, in a monkey, an organism he called *Trypanosoma minasense*. Local residents of the area in which Chagas was working pointed out some blood-sucking bugs that Chagas thought were the species *Conorhinus megistus*. When he examined their intestinal contents in his makeshift laboratory, he encountered flagellated organisms. He then sent infected insects to Oswaldo Cruz, his mentor and employer in Rio de Janeiro, who succeeded in passing the infection from the insects to monkeys. The trypanosomes observed in the blood of the infected monkeys had a morphology distinct from *T. minasense*. Shortly thereafter, Chagas established that this new trypanosome, which he called *Trypanosoma cruzi* in honor of his mentor, could be passed experimentally to dogs, cats and rabbits, and also that it could be grown on blood agar. With this knowledge of the infectivity of *T. cruzi* in hand, Chagas soon set out to find the parasite in mammals in the community in which he was working. He soon found trypanosomes in a cat, and shortly thereafter found similar organisms in the blood of a 2 year-old febrile child. In 1910, at the age of 29, in recognition of his discovery of the new disease, he was made an 'Extraordinary Tenured Member of the Brazilian National Academy of Medicine'. In subsequent work, spanning many years, Chagas described other natural mammalian reservoirs, most notably the armadillo, *Dasypus novemcinctus*, and other species of triatomine vectors. He also described in detail the clinical syndromes of acute and chronic Chagas' disease, and published his findings in prestigious medical journals in Portuguese, English, French and German (Prata, 1981; Chagas, 1909, 1916).

## DESCRIPTION OF THE ORGANISM

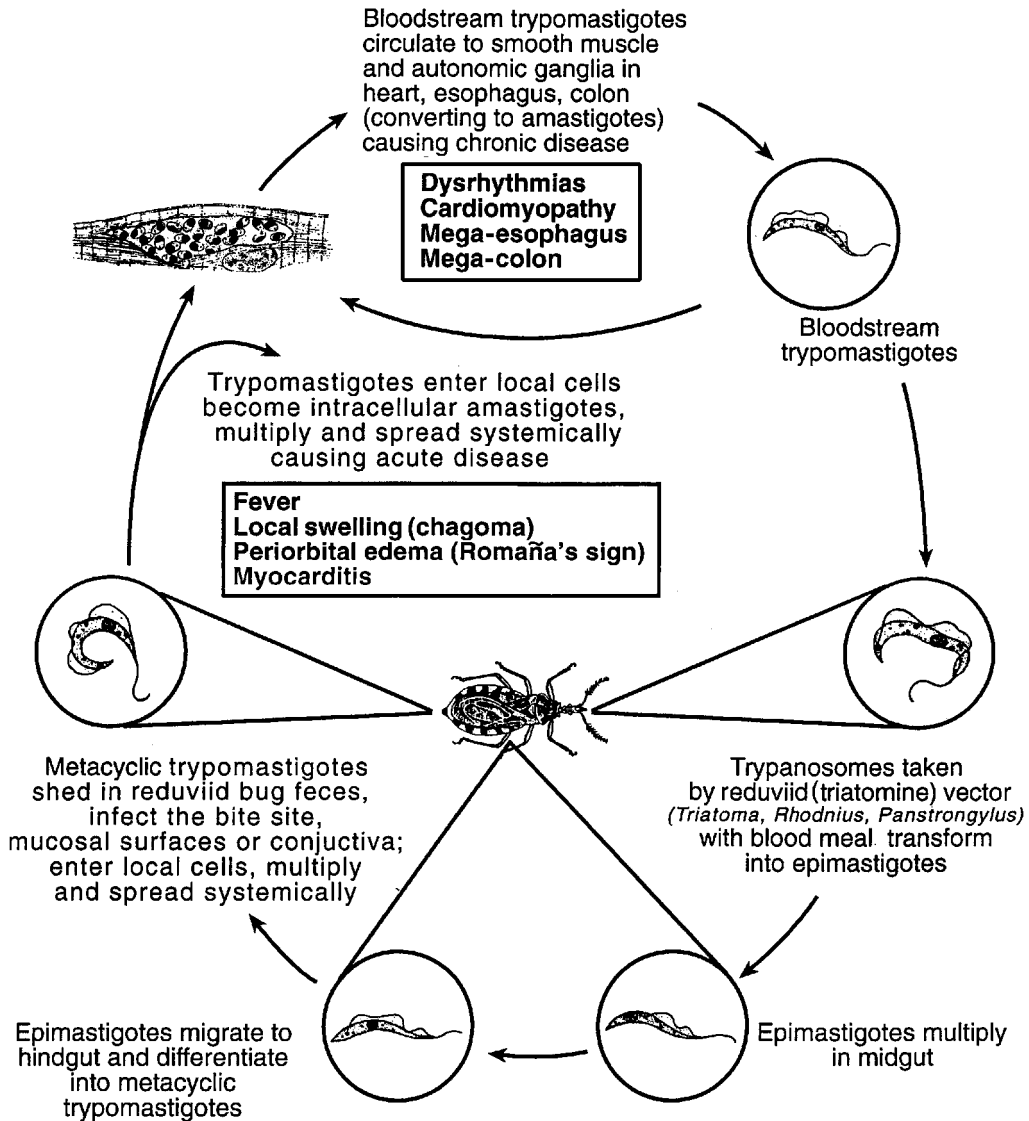
### Taxonomy

*Trypanosoma cruzi* belongs to the genus *Trypanosoma*, which consists of approximately 20 species of protozoans. Only *T. cruzi* and two African trypanosome subspecies, *T. brucei gambiense* and *T. brucei rhodesiense*, cause disease in humans (Levine *et al.*, 1980). Broadly defined, the organisms in this genus are protozoan flagellates that belong to the family Trypanosomatidae, order Kinetoplastida, that pass through different morphologic stages (trypomastigote, amastigote and epimastigote) in their invertebrate and vertebrate hosts. The order Kinetoplastida is characterized by an organelle called the kinetoplast that is located in each cell's single, large mitochondrion. The kinetoplast contains many thousands of circular DNAs called minicircles and maxicircles, which play roles in the synthesis of mitochondrial proteins (see p. 346).

### Life-cycle

*T. cruzi* has a complex life-cycle involving insect vectors as well as mammalian hosts (Figure 14b.1). The vectors, often called triatomines or kissing bugs (Figure 14b.2), become infected when they ingest blood from mammals that have circulating trypomastigotes, which are non-dividing but infective forms of the parasite (Figure 14b.3). Once inside the midgut of a triatomine host, the parasites differentiate into epimastigotes, which are flagellates having a distinct morphology, and these organisms then multiply extracellularly. After migration to the hindgut, epimastigotes become non-dividing metacyclic trypomastigotes which are then discharged with the feces around the time of a subsequent blood meal. Transmission to a second mammalian host occurs when mucous membranes, breaks in the skin, or conjunctivas are contaminated with insect feces containing infective metacyclic forms. Once inside the new host, these parasites enter a variety of host cell types and, after differentiating into amastigotes, multiply intracellularly. When proliferating amastigotes fill the host cell, they differentiate into





**Fig. 14b.1** Life-cycle of *T. cruzi* (Chagas' disease). Reservoir hosts include armadillos, opossums, dogs, cats, rats and many other mammals

trypomastigotes, which are released as the cell ruptures. The parasites released invade adjacent tissues and spread via the bloodstream and lymphatics to distant sites where they initiate further cycles of intracellular multiplication. By cycling asynchronously in this manner they maintain a parasitemia infective for vectors. *T. cruzi* can also be transmitted by transfusion of blood donated by infected persons (Schmunis, 1991), in laboratory accidents (Herwaldt, 2000)

and from mother to fetus (Bettencourt, 1976; Freilij and Altech, 1995).

**PATHOGENESIS**

An inflammatory lesion called a chagoma often develops at the site where *T. cruzi* gains entry into a new host (Santos-Buch, 1979; Andrade

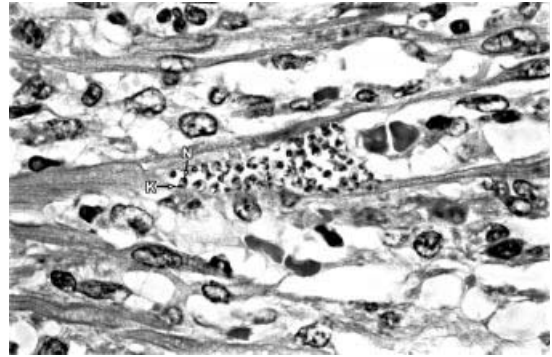


**Fig. 14b.2** Adult, second instar nymph, and eggs of *Rhodnius prolixus*, a triatomine vector of *T. cruzi*



**Fig. 14b.3** *T. cruzi* trypomastigote in human blood (Giemsa stain,  $\times 625$ ). Courtesy of Dr Maria Shikanai Yasuda, São Paulo, Brazil

and Andrade, 1979). Local histologic changes include lymphocytic infiltration, intracellular parasitism of muscle and other subcutaneous tissues, interstitial edema, and reactive hyperplasia of the lymph nodes that drain the area of the lesion. Trypomastigotes released when host cells rupture frequently can be seen by microscopic examination of fresh blood. After the organisms spread systemically, muscles, including the myocardium, are the most heavily parasitized tissues. Myocarditis may involve



**Fig. 14b.4** *T. cruzi* in heart muscle of a Texan child who died of acute Chagas' disease. The several dozen amastigotes shown are inside a cardiomyocyte. Arrowheads point to the nucleus (N) and kinetoplast (K) of one amastigote. The kinetoplast is the organelle that characterizes the order Kinetoplastida

patchy areas of infected cells, infiltration of mononuclear cells and necrosis (Ochs *et al.*, 1996; Parada *et al.*, 1997). The pseudocysts often seen in sections of infected tissues in patients with acute *T. cruzi* infection are intracellular aggregates of amastigotes (Figure 14b.4). A lymphocytosis accompanies the high parasitemias of the acute disease, and mild elevation of transaminases may be present. In some acutely infected patients, organisms may be found in the cerebrospinal fluid (Hoff *et al.*, 1978).

In chronic Chagas' disease the heart is the organ most commonly affected. Gross examination of the hearts of chronic chagasic patients who died of congestive heart failure often shows marked bilateral ventricular enlargement, typically involving the right side of the heart more than the left. The ventricular walls are often thin, and mural thrombi and apical aneurysms may be present. Widespread lymphocytic infiltration can be present, accompanied by diffuse interstitial fibrosis and atrophy of myocardial cells. Parasites are rarely seen in stained sections of such myocardial tissue, but recent studies using polymerase chain reaction (PCR) assays have demonstrated an association between the presence of parasite DNA and focal inflammation (Jones *et al.*, 1993).

Pathologic changes are frequently found in the conduction systems of chronic chagasic hearts and often correlate with pre-mortem rhythm

disturbances (Andrade *et al.*, 1978). Dense fibrosis and chronic inflammatory lesions often involve the left anterior branch and right branch of the bundle of His, but similar lesions are found in other parts of the conduction system as well.

The striking feature apparent on gross examination of the colon or esophagus of a patient with chronic Chagas' disease of the digestive tract (megadisease) is the enormous dilatation of the affected organs (Tanowitz *et al.*, 1992). Focal inflammatory lesions with lymphocytic infiltration may be seen on microscopic examination. The number of neurons in the myenteric plexus is markedly reduced, and peri- and intraganglion fibrosis in the presence of Schwann cell proliferation and lymphocytosis is found. Quantitative evaluations of this process have shown that in severely affected persons as many as 85% of the neurons in the esophagus and 50% of those in the colon may be lost (Koberle, 1968). In most patients the clinical effects of this parasympathetic denervation is confined to the colon and/or the esophagus, but similar lesions have been observed in the stomach, ureters, biliary tree and other hollow viscera. Decreased acid secretion, hypotonia, hypoperistalsis and delayed emptying of the stomach have been described in patients with megaesophagus, but dilatation of the stomach is not found frequently (Troncon *et al.*, 1993). The factors that underlie the variable rate and pattern of neuronal destruction are unknown.

The pathogenesis of the cardiac and gastrointestinal lesions of chronic Chagas' disease is poorly understood and has been debated for many years. Some investigators argue that tissue injury occurring during the acute phase of *T. cruzi* infection constitutes the fundamental pathogenic insult, which results, many years later, in lesions of the chronic phase (Koberle, 1968). Others hold the view that autoimmune mechanisms cause the chronic pathology (Cossio *et al.*, 1974; Teixeira and Santos-Buch, 1975). Considerable laboratory work has been done in attempts to resolve the issue. Several studies have shown that mammalian nerve and cardiac cells have epitopes that cross-react with *T. cruzi* epitopes (Cunha-Neto *et al.*, 1995; Van Voorhis *et al.*, 1991; Wood *et al.*, 1982), suggesting that autoimmunity plays the major role in the pathogenesis of chronic Chagas' disease. On the

other hand, a small number of studies have provided evidence supporting the concept that a low-level presence of parasites in chronically affected cardiac tissue, detectable with recently developed PCR assays, stimulates a chronic inflammatory response that, over time, is the basis of the pathogenesis (Buckner *et al.*, 1997; Jones *et al.*, 1993). The issue remains unresolved, and it is certainly possible that both mechanisms play a role in the development of the lesions associated with chronic *T. cruzi* infection.

## IMMUNOLOGY

For decades *T. cruzi* has been the focus of study by immunologists, who are fascinated by the parasite's subversion of the mammalian immune system to maintain long-term infection but generally without killing its hosts (reviewed by Reed, 1998). Immune regulation is the area most intensively studied in recent years. Rodents, and particularly mice, have been used widely to study the interactions of *T. cruzi* with the immune system. Studies done on immune regulation of *T. cruzi* infections in humans have been limited by the fact that Chagas' disease occurs mostly among poor people in developing nations.

Studies carried out in mice have demonstrated a key role for T cells in controlling *T. cruzi* infections. Recombinant interferon- $\gamma$  (IFN $\gamma$ ), produced by CD4<sup>+</sup> and CD8<sup>+</sup> cells, plays a crucial role in mediating resistance to *T. cruzi* infection. The importance of this cytokine in providing early protection has been demonstrated in several studies, including experiments in which mice were protected from otherwise fatal *T. cruzi* infections by exogenous IFN $\gamma$  (Reed, 1988).

*T. cruzi* causes immune suppression, particularly in the acute phase of the infection, and it is thought that much of this effect may be mediated by suppression of IL-2 production. This view is supported by the observation that immune function abnormalities associated with the acute infection in mice are largely corrected by the administration of exogenous IL-2. Other experimental evidence suggests a role for TGF $\beta$  in increasing susceptibility to *T. cruzi* infection as a negative response mediator through direct

suppressive effects on the production of IFN $\gamma$  and on T cell effector functions. In experiments in a *T. cruzi*-resistant mouse strain, morbidity and mortality were significantly increased by the administration of TGF $\beta$ . The results of more recent studies suggest that *T. cruzi* produces an enzyme capable of activating TGF $\beta$ , thereby frustrating host immune responses that could lead to its destruction. A similar role as a negative mediator has been proposed for IL-10, as it has been shown that the administration of an anti-IL-10 monoclonal antibody prevents the development of acute *T. cruzi* infection in susceptible mice. A shadow was cast on the significance of this observation, however, when it was subsequently shown that IL-10 knockout mice infected with *T. cruzi* die in greater numbers than wild-type control mice. These and other studies suggest complex roles for IL-10 that will be elucidated only by additional studies. Despite the extensive knowledge relating to the immunology of experimental *T. cruzi* infections that has accumulated in recent years, it is unlikely that in the foreseeable future the application of this information will change the way Chagas' disease is diagnosed and treated.

## EPIDEMIOLOGY

### Epizootiology of *T. cruzi*

Infection with *T. cruzi* is a zoonosis, and the cycle of transmission continues in nature without the involvement of humans. *T. cruzi* is found only in the Americas, where it primarily infects wild and domestic mammals and insects. Triatomine vectors capable of transmitting *T. cruzi* are patchily distributed from the southern half of the USA to central Argentina (Beard *et al.*, 1988; Lent and Wygodzinsky, 1979). Palm trees, burrows, hollow trees and other animal shelters are places where transmission of the parasite occurs among infected vectors and non-human mammalian reservoirs. Piles of wood, household rubble and roof tiles near houses have also been found to harbor large numbers of insects (Starr *et al.*, 1991). Vector-borne transmission to humans takes place only where triatomine species that defecate during or immediately after blood meals are found. This restriction does not apply to transmission to non-

human mammalian hosts, however, because the latter can acquire *T. cruzi* by eating infected insects (Ryckman and Olsen, 1965).

*T. cruzi* has been isolated from more than 100 species of wild and domestic mammals in the geographic range mentioned above (Barr *et al.*, 1995; Goble, 1970; Karsten *et al.*, 1992; Wisnivesky-Colli *et al.*, 1985, 1992; Yaeger, 1988). Opossums, armadillos, racoons, wood rats, dogs and cats are typical hosts but, in contrast to African trypanosomes, *T. cruzi* is not a problem in livestock. This lack of host-specificity, in conjunction with the fact that infected mammals have life-long parasitemias, results in an enormous sylvatic and domestic reservoir in enzootic areas.

### Epidemiology of Chagas' Disease in Latin America

Historically, humans have become part of the cycle of *T. cruzi* transmission as land is opened up in enzootic regions. When this process occurs, vectors such as *Rhodnius prolixus*, *Triatoma infestans* and *Panstrongylus megistus* invade the nooks and crannies of the primitive mud-walled, wood- and stone houses that are typical of rural Latin America. In this manner the insects become domiciliary and establish a cycle of transmission involving humans and domestic mammals that is independent of the sylvatic cycle (Gurtler *et al.*, 1993; Starr *et al.*, 1991). For the most part, Chagas' disease has been a problem of poor people in rural areas. In recent decades, however, large numbers of *T. cruzi*-infected people have migrated to cities seeking jobs, thus urbanizing the disease and resulting in frequent transmission by transfusion of contaminated blood (Carrasco *et al.*, 1990; Grijalva *et al.*, 1995; Schmunis, 1991).

Few age-specific and geographic data regarding the incidence of acute Chagas' disease have been available historically because most cases go undetected due to its mild nature and a lack of access to medical care among those at highest risk. Early reports indicated that most cases of acute Chagas' disease that came to medical attention occurred in children (Laranja *et al.*, 1956). The Pan-American Health Organization (PAHO) recently estimated that 16–18 million people are infected with *T. cruzi* and that

approximately 43 000 deaths each year are attributable to the disease (Anonymous, 1997). In recent years, however, the epidemiology of *T. cruzi* infection has been improving in several endemic countries, as blood bank and vector control programs have been implemented and prevalence rates in younger age groups have decreased in many areas (Acquatella *et al.*, 1987; de Andrade *et al.*, 1992; Goldsmith *et al.*, 1992; Mota *et al.*, 1990). A major international control program in the 'Southern Cone' countries of South America (Bolivia, Chile, Argentina, Uruguay, Paraguay and Brazil) has provided the context for much of this progress. If current trends continue, by 2003 transmission will be for the most part eliminated in much of the endemic range (Anonymous, 1997, 2000). The obstacles hindering the elimination of *T. cruzi* transmission to humans are political and economic, and no technological advances, such as the development of a vaccine, are necessary for its completion.

The epidemiology of symptomatic chronic Chagas' disease merits mention. As many as 70–90% of persons who harbor *T. cruzi* chronically never develop the associated gastrointestinal or cardiac symptoms. This reflects near-perfect parasitism, in that the mammalian hosts of *T. cruzi* remain infective for life but rarely die of the infection. Among persons who do develop either type of symptoms, the mean age of onset is 35–45 years, although the range is quite broad. In the past, the relatively high frequency of sudden death among young adults in some areas has been attributed to dysrhythmias of chronic Chagas' disease. Among Brazilian patients with chronic *T. cruzi* infection, the prevalence of megadisease ranges from 2.6% to 17.3% (Barbosa, Pittella and Tafuri, 1970; Chapadeiro *et al.*, 1964). There is considerable geographic variation in the relative prevalence of cardiac and megadisease in patients with chronic *T. cruzi* infections. It is not known whether parasite strain differences or host factors cause these different patterns of clinical manifestations.

### Epidemiology of Chagas' Disease in the USA

Although the sylvatic cycle of *T. cruzi* is present in many parts of the southern and western USA,

only five cases of autochthonous transmission there have been described (Herwaldt *et al.*, 2000; Ochs *et al.*, 1996; Schier *et al.*, 1984). The low overall vector density and relatively high housing standards are responsible for the rarity of transmission of *T. cruzi* to humans in the USA. In the last 26 years, nine imported infections and seven laboratory-acquired cases of acute *T. cruzi* infection have been reported to the Centers for Disease Control and Prevention (CDC), but none of the imported cases occurred in returning tourists (Navin TA, personal communication). Although the number of autochthonous and imported cases of acute Chagas' disease may be many times the number reported, the fact remains that the illness is rare in the USA.

In contrast, the number of people in the USA with chronic *T. cruzi* infections has grown markedly in recent years. Since 1972, more than 5.5 million persons have emigrated to the USA legally from countries in which Chagas' disease is endemic (Bureau of Census, 1996) and several million more may have entered illegally. A large percentage of these immigrants have come from Central America, a region in which *T. cruzi* prevalence is high (Cedillos, 1975; Schmunis, 1991). A study among Nicaraguans and Salvadorans in Washington DC, found a 5% prevalence rate of *T. cruzi* infection (Kirchoff *et al.*, 1987). Studies done in a Los Angeles hospital where 50% of donors are Hispanic have shown that 1:1000–1:500 donors are infected with *T. cruzi* (Appleman *et al.*, 1993; Kerndt *et al.*, 1991; Shulman *et al.*, 1997). In another study, performed in seven blood banks in three southwestern states, roughly 1 in 600 donors with Hispanic last names were found to be infected (Winkler *et al.*, 1995). In a much larger investigation carried out in Los Angeles and Miami, the prevalence rate of *T. cruzi* infection was found to be 1:8800 in the general donor population and 1:710 among donors who had spent a month or more in an endemic area (Leiby *et al.*, 1997). It can be estimated from these findings and census data that at least 50 000–100 000 *T. cruzi*-infected persons now live in the USA. These immigrants create a risk for transfusion-associated transmission of the parasite in the USA and in other areas to which Latin Americans have emigrated (Frank *et al.*, 1997; Kirchoff, 1989). To date, seven such cases have been reported in the USA, Canada

and Europe (Cimo, Luper and Scouros, 1993; Geiseler *et al.*, 1987; Grant *et al.*, 1989; Leiby *et al.*, 1999; Nickerson *et al.*, 1989; Villalba *et al.*, 1992). These cases all occurred in immunosuppressed patients in whom the diagnosis of *T. cruzi* infection was made because of the fulminant course of the illness. Given that most transfusions are given to immunocompetent patients in whom acute Chagas' disease would cause only mild symptoms, it is reasonable to infer that many other cases of transfusion-associated transmission of *T. cruzi* are unrecognized. In the last few years, however, the risk may have been reduced by screening prospective blood donors with questions relating to residence in endemic countries (Appleman *et al.*, 1993).

## CLINICAL FEATURES

### Acute and Indeterminate Phases of Chagas' Disease

The first sign of acute *T. cruzi* infection can be a chagoma, which is an indurated and erythematous inflammatory lesion at the site where the parasite entered a week or two earlier (Rassi, 1979). If the parasite enters through a conjunctiva, the patient may develop unilateral and painless periorbital edema, which is called the Romana sign (Figure 14b.5). Spread of the parasites from the site of initial multiplication may be accompanied by fever and malaise, as well as edema of the face and lower extremities, hepatosplenomegaly and generalized lymphadenopathy. Occasionally patients develop morbilliform rashes called schizotrypanides (Figure 14b.6). Heavy parasitization of skeletal and cardiac muscles can develop, and symptomatic myocarditis occurs in a small proportion of patients, occasionally leading to fatal congestive heart failure (Laranja *et al.*, 1956; Ochs *et al.*, 1996). Non-specific electrocardiogram (ECG) abnormalities can result, but the life-threatening rhythm disturbances that are frequent in patients with chronic cardiac Chagas' disease usually are not present. *T. cruzi* also can invade the central nervous system (Hoff *et al.*, 1978), but in general neurologic findings are not common in patients with acute *T. cruzi* infections. Meningoencephalitis occurs rarely and is associated with a poor



**Fig. 14b.5** Unilateral periorbital edema (Romana sign) in an Argentinian patient with acute Chagas' disease. Courtesy of Dr Mário Shiroma, São Paulo, Brazil



**Fig. 14b.6** Skin rash (schizotrypanides) associated with acute Chagas' disease in a Mexican patient. Courtesy of Dr Patricia Paredes, Guadalajara, Jalisco, Mexico

prognosis (Villanueva, 1993). Acute Chagas' disease resolves spontaneously in 4–8 weeks in the vast majority of patients, who then enter the *indeterminate phase* of the infection, which is characterized by a lack of symptoms, easily

detectable antibodies to *T. cruzi* antigens, and life-long subpatient parasitemias.

### Chronic Chagas' Heart Disease

Most patients with chronic *T. cruzi* infections remain in the indeterminate phase for life, but approximately 10–30% develop symptomatic chronic Chagas' disease. Symptoms typically appear years or even decades after the infection was acquired. Cardiac problems are the most frequent consequence of chronic *T. cruzi* infection and result from mononuclear cell infiltration and diffuse fibrosis, affecting the conduction system as well as the cardiac muscle (Andrade *et al.*, 1978; Andrade and Andrade, 1979). The inflammatory process results in a variety of dysrhythmias, including atrial bradyarrhythmias and fibrillation; premature ventricular contractions; bundle branch blocks, typically of the right bundle; and third degree atrioventricular block. The symptoms associated with chronic cardiac

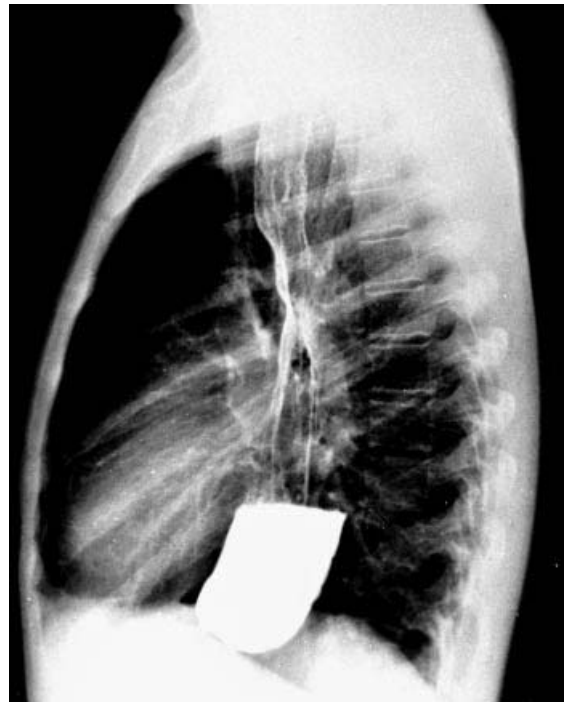
Chagas' disease reflect the congestive failure, rhythm disturbances and thromboembolism that result from the fibrosing cardiopathy (Figure 14b.7) (Kirchhoff and Neva, 1985). The dysrhythmias can cause dizziness and syncope, and sudden death is common (Amorim, 1979; Prata, Lopes and Chapadeiro, 1985). Symptoms of right-sided heart failure are frequently present, as the cardiomyopathy often affects the right heart more than the left.

### Chronic Gastrointestinal Chagas' Disease (Megadisease)

Dysfunction of the gastrointestinal tract is the second most common consequence of chronic *T. cruzi* infection (Kirchhoff, 1996). Symptoms resulting from mega-esophagus (Figure 14b.8) are the most typical clinical manifestations of megadisease, but symptoms related to megacolon



**Fig. 14b.7** Chest radiograph of a Bolivian patient with Chagas' cardiopathy. The patient had congestive heart failure consistent with his markedly enlarged heart. Syncope led to a diagnosis of complete heart block and pacemaker placement (wires visible in lower right corner)



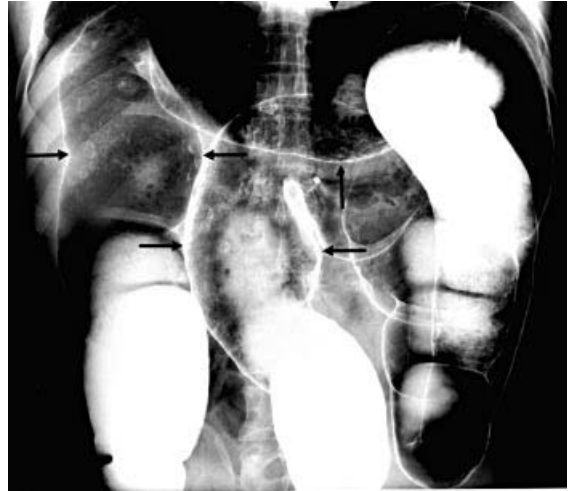
**Fig. 14b.8** Barium esophagogram of a Brazilian patient with dolichomega-esophagus caused by chronic Chagas' disease. Barium is pooled in the distal esophagus, which is markedly enlarged. Courtesy of Franklin A. Neva, MD. From Neva and Brown (1994), with permission

are also common (Figure 14b.9). Patients with mega-esophagus have complaints similar to those of idiopathic achalasia, such as odynophagia, dysphagia, cough, chest pain and regurgitation (Kirchhoff, 1996; de Oliveira *et al.*, 1998). Hypersalivation and parotid gland hypertrophy also have been observed. Aspiration can occur, and repeated episodes of aspiration pneumonitis are common in patients with severe esophageal dysfunction. Weight loss and even cachexia can combine with pulmonary infection to result in death in patients with mega-esophagus. An increased incidence of cancer of the esophagus has been reported in patients with chagasic esophageal disease, as is the case in idiopathic achalasia (Camara-Lopes, 1961).

Patients with megacolon associated with chronic *T. cruzi* infection are plagued by chronic constipation and abdominal pain. Patients with advanced megacolon can go for weeks between bowel movements, and acute obstruction, occasionally with volvulus, can lead to perforation, septicemia and death (Kirchhoff and Neva, 1985; Kobayasi *et al.*, 1992).

### Immunosuppression and *T. cruzi* Infection

Immunosuppression of patients chronically harboring *T. cruzi* can lead to reactivation of the infection, frequently with an intensity that is atypical of acute Chagas' disease in immunocompetent patients. The incidence of reactivation of *T. cruzi* in chronically infected patients who are immunosuppressed is unknown, and both its occurrence (Kohl *et al.*, 1982; Rivero *et al.*, 1974; Salgado *et al.*, 1996) and absence (Barousse *et al.*, 1980) have been described. A handful of reports of reactivations of chronic *T. cruzi* infections after renal transplantation have appeared, and in two of these cases the central nervous system was involved (Leiguarda *et al.*, 1990; Mocelin *et al.*, 1977; Pizzi *et al.*, 1982). Although chronic Chagas' disease should not be considered a contraindication for renal transplantation, the possibility of reactivation should be kept in mind during follow-up care. Persons co-infected with *T. cruzi* and human immunodeficiency virus (HIV) are also at risk for reactivation of the former. Several dozen cases of this type have



**Fig. 14b.9** Barium enema examination of a Bolivian patient with megacolon caused by Chagas' disease. Markedly increased diameter of the ascending, transverse and sigmoid segments of the large bowel are marked with opposing arrows

been described (Rocha *et al.*, 1994; Sartori *et al.*, 1998) and the fact that a large proportion of these patients developed *T. cruzi* brain abscesses, which do not occur in immunocompetent persons with Chagas' disease, is noteworthy. Calculations based on the epidemiologies of *T. cruzi* and HIV in Latin America suggest that the incidence of *T. cruzi* brain abscesses in co-infected persons is extremely low. The diagnosis of *T. cruzi* brain abscesses in HIV-infected persons is complicated by the difficulty in distinguishing these lesions from those of cerebral toxoplasmosis in imaging studies.

## LABORATORY DIAGNOSIS

### Acute Chagas' Disease

A history of possible exposure to the parasite is the first item to look for when considering the diagnosis of acute *T. cruzi* infection. This could result from residence in an environment in which vector-borne transmission occurs, a recent blood transfusion in an endemic area, birth to a mother chronically infected with *T. cruzi*, or a laboratory accident involving the parasite. In the USA it is important to keep in mind that no imported cases in tourists returning from endemic countries have



been reported and that autochthonous transmission of *T. cruzi* is extremely rare.

The diagnosis of acute Chagas' disease is made by detecting parasites, and serologic tests play a limited role. Bloodstream organisms are highly motile and in many cases can be seen in wet preparations of anticoagulated blood or buffy coat. Often the parasites can also be seen in Giemsa-stained smears of these specimens. In immunocompetent patients suspected of acute *T. cruzi* infection, examination of blood preparations is the primary diagnostic approach. In immunocompromised patients, however, microscopic examination of other specimens, such as pericardial fluid, lymph node and bone marrow aspirates and cerebrospinal fluid, may give positive results. When these approaches fail to detect *T. cruzi* in a patient whose clinical and epidemiologic histories suggest the presence of *T. cruzi*, as is often the case (Shikanai-Yasuda *et al.*, 1990), attempts to grow the parasite can be carried out. This can be done by culturing blood or other specimens in liquid media (Chiari *et al.*, 1989), or by xenodiagnosis (Marsden *et al.*, 1979), which involves letting laboratory-reared triatomines feed on blood from a patient suspected of having acute Chagas' disease. The fact that these two methods take at least a month to complete is a major drawback, as this is beyond the time at which decisions regarding treatment need to be made. Moreover, although hemoculture and xenodiagnosis are 100% specific, their sensitivities may be no greater than 50–80%. Thus, it is clear that improved methods for diagnosing acute Chagas' disease are needed, and PCR-based assays may fulfill this role (see below).

### Chronic Chagas' Disease

Chronic *T. cruzi* infection is usually diagnosed by detecting IgG antibodies that react specifically with parasite antigens, and detecting the parasite is not necessary. Several sensitive serologic tests are used in Latin America, such as indirect immunofluorescence assay (IIF), indirect hemagglutination assay, and enzyme-linked immunosorbent assay (ELISA) (Carvalho *et al.*, 1993; Pan *et al.*, 1992). A persistent shortcoming

of these assays has been the occurrence of false positive results. This typically occurs with specimens from persons having illnesses such as leishmaniasis, malaria, toxoplasmosis, syphilis and other parasite and non-parasitic diseases. Because of this problem, most Latin American authorities recommend that specimens be tested in two or three serologic tests. This latter approach carries with it a large logistical and economic burden, both in blood banks and clinical settings. For example, in the largest blood donor center in São Paulo, Brazil, 3.4% of donated units are discarded due to reactivity in one or more of the three assays used. As many as two-thirds of these may actually come from donors not infected with *T. cruzi*, but have to be discarded because of inconsistent test results (Carvalho *et al.*, 1993). In this context, then, improved tests for chronic *T. cruzi* infection are needed as well.

A variety of assay kits for detecting antibodies to *T. cruzi* are available for purchase in Latin America. These kits are used in many endemic countries for clinical testing and for screening donated blood, but in some endemic regions screening of the blood supply is limited by a lack of appreciation of the risk of transfusion-associated transmission of *T. cruzi* and financial limitations (Carrasco *et al.*, 1990). Several options for serologic testing for *T. cruzi* infection are available in the USA. Abbott Laboratories has received Food and Drug Administration (FDA) clearance for marketing an assay for clinical testing but not blood bank screening (Chagas EIA; Abbott Laboratories, Abbott Park, IL) (Pan *et al.*, 1992). Clearance for clinical use also has been obtained for tests manufactured by Hemagen Diagnostics (Chagas' Kit, EIA method; Waltham, MA) and Meridian Diagnostics (Chagas' IgG ELISA; Meridian Diagnostics, Cincinnati, OH). Limited comparative studies of the Meridian and Abbott assays suggest that the latter may have a slight advantage in terms of sensitivity and specificity (Barrett *et al.*, 1997; Carvalho *et al.*, 1993; Leiby *et al.*, 2000). A confirmatory radioimmune precipitation assay is available that has been shown to be highly sensitive and specific when used to test geographically diverse groups of positive and negative samples (Kirchhoff *et al.*, 1987; Leiby *et al.*, 2000).

### Recombinant Assays

In response to the need for better assays, several laboratories have assessed the usefulness of synthetic peptides and recombinant *T. cruzi* proteins as target antigens. Most of these efforts are focused on detecting antibodies to *T. cruzi* in chronically infected patients (Burns *et al.*, 1992; Carvalho *et al.*, 1993; Frascch and Reyes, 1990; Houghton *et al.*, 1999; Luquetti, 1990; Oelemann *et al.*, 1999; Umezawa *et al.*, 1999). The results of these studies suggest that recombinant tests will be developed that have higher specificities than the conventional assays based on native antigens, while still maintaining high levels of sensitivity. The tests developed to date have not been evaluated in large field trials, however, and none is available commercially.

### PCR

The possibility of using PCR tests for detecting *T. cruzi* infection has also been studied (Kirchhoff, 1993a; Kirchhoff and Donelson, 1993). Although the parasitemias of patients with chronic *T. cruzi* infection are very low, PCR assays have the potential for detecting such low numbers because the organisms have highly repetitive nuclear and kinetoplast DNA (kDNA) sequences that can be amplified by PCR. Moser *et al.* (1989) described a PCR test in which a 188 base pair repetitive nuclear DNA sequence, of which each parasite has ca. 100 000 copies, is amplified. In *in vitro* experiments as little as 1/200th of the DNA of a single parasite gave a positive result. Subsequent studies in mice showed clearly that this PCR assay is much more sensitive than microscopic examination of blood throughout the course of *T. cruzi* infection (Kirchhoff *et al.*, 1996). Russomando *et al.* (1992) confirmed this sensitivity in a study of acutely and chronically infected patients, and other investigators have achieved similarly encouraging results.

In another PCR-based assay, described initially by Sturm *et al.* (1989), a 330 base pair segment of *T. cruzi* kinetoplast minicircles is amplified. Each parasite has ca. 120 000 copies of this sequence, and in contrived experiments the

authors were able to detect 1/1000<sup>th</sup> of a parasite genome. Results obtained in later studies in humans suggest that this test may be useful for the definitive diagnosis of *T. cruzi* infection (Avila *et al.*, 1993; Britto *et al.*, 1995; Gomes *et al.*, 1998, 1999). False positive results can occur when *Trypanosoma rangeli* DNA is present in samples, however, but this problem does not occur with the assay in which the nuclear repetitive sequence is amplified (Ochs *et al.*, 1996). In view of the results obtained to date, it appears that there may be a useful role for PCR assays for diagnosing *T. cruzi* infection. The occurrence of false positive results due to contamination of reaction mixtures, as well as the complexity of a technology that may not be appropriate for the developing countries in which Chagas' disease is endemic, may limit their widespread use. At the present time, no PCR assay for detecting *T. cruzi* is available commercially.

## CLINICAL MANAGEMENT

### Antiparasitic Drugs

Two drugs are available currently for treating persons infected with *T. cruzi* (Coura, 1996; Levi *et al.*, 1996; Marr and Docampo, 1986; Urbina, 1999). The first, the nitrofurán derivative nifurtimox (Lampit, Bayer 2502), has been used widely for more than 30 years. Nifurtimox markedly reduces the duration and severity of acute Chagas' disease and decreases mortality as well. Unfortunately, however, it is less than an optimal drug in that it has a parasitologic cure rate of only about 70% in patients with acute *T. cruzi* infections and 20% in persons with long-standing infections. Moreover, it can cause bothersome side-effects, and must be taken for an extended period (Ferreira, 1988; Rassi and Ferreira, 1971). Gastrointestinal side effects include nausea, vomiting, anorexia, abdominal pain and weight loss. Possible neurologic symptoms include insomnia, restlessness, paresthesias, twitching and seizures. Symptoms usually disappear when the dosage is reduced or therapy is discontinued.

Nifurtimox is supplied in 30 and 120 mg tablets. The recommended oral dosage for adults is 8–10 mg/kg/day; for adolescents 12.5–15 mg/

kg/day; and for children aged 1–10 years, 15–20 mg/kg/day. Nifurtimox should be given daily in four divided doses for 90–120 days.

Benznidazole (Rochagan, Roche 7-1051), a nitroimidazole derivative, is the agent most commonly used to treat patients with Chagas' disease. Its efficacy is similar to that of nifurtimox (Ferreira, 1988), but its side-effect profile is different and commonly includes rash, peripheral neuropathy and granulocytopenia. Benznidazole should be given in a dose of 5 mg/kg/day by mouth for 60 days. It is viewed as the drug of choice for Chagas' disease by most Latin American experts.

The question of whether patients in the indeterminate or chronic symptomatic phases of *T. cruzi* infection should be given antiparasitic therapy has been debated for decades. Recent studies of *T. cruzi*-infected laboratory animals and humans indicate that the presence of parasites in cardiac muscle is specifically associated with inflammation, thereby implicating the organisms in the chronic pathogenesis (Andrade *et al.*, 1991; Bellotti *et al.*, 1996; Jones *et al.*, 1993). Furthermore, in several long-term follow-up studies, the appearance of and/or progression of heart lesions in drug-treated patients was significantly less than in untreated controls (Andrade *et al.*, 1996; Fragata Filho *et al.*, 1995; Viotti *et al.*, 1994). After reviewing these findings, an international panel of experts convened by the World Health Organization recently concluded that all infected persons with *T. cruzi* should be treated with either benznidazole or nifurtimox, regardless of their clinical status or the time elapsed since acquiring the infection (Anonymous, 1999).

The treatment of acute *T. cruzi* infection with two drugs developed for other purposes merits discussion. Reed (1988) reported that injection of recombinant IFN $\gamma$  reduced mortality in mice acutely infected with *T. cruzi*. To my knowledge, only two patients with acute Chagas' disease have been given recombinant IFN $\gamma$ . The first was an immunosuppressed patient who received a blood transfusion from an asymptomatic chronically infected donor (Grant *et al.*, 1989) and the other became infected through laboratory work with the parasite (H. B. Tanowitz, personal communication). Both patients received IFN $\gamma$  in addition to nifurtimox and recovered. Sero-

logic and PCR studies done on the second patient 8 years after treatment suggest that the therapy was curative, and this issue has not been addressed in the other person. Further studies need to be carried out before a recommendation regarding the use of IFN $\gamma$  in patients with acute *T. cruzi* infection can be made.

The usefulness of itraconazole, fluconazole and allopurinol has been studied extensively in laboratory animals and to a lesser extent in people with *T. cruzi* infections. The results obtained with these drugs do not justify their use in *T. cruzi*-infected patients.

### Treatment of Clinical Chagas' Disease

Most patients with acute *T. cruzi* infections do not require therapy other than benznidazole or nifurtimox, since this phase of the illness generally resolves spontaneously, even in the absence of anti-parasitic treatment. Management of the occasional severely ill patient with acute chagasic myocarditis or meningoencephalitis is for the most part supportive. The therapy of patients with symptomatic chronic Chagas' heart disease is also supportive. All patients with chronic *T. cruzi* infections should have ECGs performed every 6 months or so, because pacemakers have been shown to be useful in controlling the rhythm disturbances of chronic Chagas' disease (Chuster, 1985). Congestive heart failure caused by Chagas' cardiomyopathy is generally treated with measures used in patients with cardiomyopathies resulting from other processes (Hagar and Rahimtoola, 1991, 1995).

Mega-esophagus in Chagas' disease patients should be treated in the same way as idiopathic achalasia. Balloon dilatation of the lower esophageal sphincter provides symptomatic relief for most patients (Salis *et al.*, 1991). Patients not responding to repeated dilatations should be treated surgically (Pinotti *et al.*, 1991, 1993). The procedure most frequently used in esophagocardiomyectomy of the anterior gastroesophageal junction, combined with valvuloplasty for control of reflux. In industrialized nations, the use of laparoscopic myotomy for treating idiopathic achalasia is becoming common. This relatively simple approach may become the treatment of

choice for idiopathic achalasia and severe Chagas' mega-esophagus if the encouraging results achieved to date continue.

Patients with Chagas' disease and early colonic dysfunction can be managed with high-fiber diets and occasional laxatives and enemas. Fecal impaction necessitating manual disimpaction can occur, as can toxic megacolon, which requires surgical treatment (Kobayasi *et al.*, 1992). Volvulus is another complication of megacolon that requires surgical intervention. Initially, endoscopic emptying can be done in patients without clinical, radiographic, or endoscopic signs of ischemia in the affected portion of the colon. More complicated cases require surgical decompression. In either event, surgery is eventually required because recurrence of the volvulus is highly likely. Several surgical procedures have been used to treat severe chagasic megacolon, all of which include removal of part of the rectum and resection of the sigmoid colon.

### Cardiac Transplantation in Patients with Chagas' Disease

Heart transplantation is an option for patients with end-stage heart disease associated with chronic Chagas' disease. A dozen or so *T. cruzi*-infected persons have undergone cardiac transplantation in the USA and several dozen have had the procedure in Brazil (Bocchi *et al.*, 1993; Kirchhoff, 1993b; Libow *et al.*, 1991). Reactivated acute Chagas' disease developed in many of the transplanted Brazilian patients due to post-operative immunosuppression, and this may have contributed to the deaths of several who died despite benznidazole treatment. Three of the US patients were given nifurtimox post-transplant and did not develop reactivated acute *T. cruzi* infection. Two of three US patients not treated prophylactically developed skin lesions caused by *T. cruzi* that resolved with nifurtimox treatment. The high frequency of reactivation in the Brazilian patients, which was often indicated in part by the presence of parasites in cardiac tissue obtained by biopsy, may have been the result of the relatively high doses of immunosuppressive drugs used. Less aggressive immunosuppressive protocols combined with

prophylactic antiparasitic treatment may reduce the incidence of reactivation, and recent experience in Brazil has been supportive of this approach (Bocchi *et al.*, 1996; de Carvalho *et al.*, 1996). It merits mention, however, that the efficacy and side-effects of long-term nifurtimox or benznidazole therapy have not been examined. These uncertainties, when considered in light of the fact that the number of candidates for cardiac transplantation far exceeds the number of hearts available, suggest that heart transplantation in patients with Chagas' disease needs to be approached with caution.

### PREVENTION AND CONTROL

There are no vaccines or drugs for preventing transmission of *T. cruzi*, and thus reducing the number of new cases in endemic areas has to depend on reducing contact with insect vectors and on serologic identification of infected blood donors. Eliminating domiciliary vectors is best done by improving housing conditions, spraying of residual insecticides, and educating populations at risk. As noted above, implementation of these measures has resulted in considerable progress in reducing transmission in several endemic countries (Anonymous, 1997, 2000; Schofield and Dias, 1999). Elimination of the sylvatic reservoirs of the parasite is not a reasonable goal. In view of the successes of low-technology control measures, it appears unlikely that recent advances in understanding the molecular biology of the parasite and the pathogenesis of Chagas' disease will play substantive roles in controlling this public health problem.

Tourists who travel in areas where vector-borne *T. cruzi* transmission occurs should avoid sleeping in dilapidated dwellings and should use insect repellent and bednets to reduce contact with vectors. It is important to keep in mind, nonetheless, that the risk of becoming infected with *T. cruzi* during short-term residence in an endemic country is extremely low. Only two such instances have been reported: a French woman developed acute chagasic myocarditis and heart failure after participating in a several-week archeology dig in Colombia, and an Italian tour guide developed acute Chagas' disease

after returning from a stay in Brazil (Brisseau *et al.*, 1988; Crovato and Reborá, 1997).

In the USA and other industrialized countries, prospective blood donors from areas in which Chagas' disease is endemic should be tested for *T. cruzi* and deferred if found to be infected. Laboratory personnel who work with living parasites in any context should wear gloves and eye protection.

## REFERENCES

- Acquatella H, Cataliotti F, Gomez-Mancebo JR, Davalos V, Villalobos L (1987). Long-term control of Chagas' disease in Venezuela: effects on serologic findings, electrocardiographic abnormalities, and clinical outcome. *Circulation* **76**: 556–62.
- Amorim DS (1979). Chagas' disease. *Prog Cardiol* **8**: 235–79.
- Andrade ALSS, Zicker F, Oliveira RM *et al.* (1996). Randomised trial of efficacy of benznidazole in treatment of early *Trypanosoma cruzi* infection. *Lancet* **348** (1407): 1413.
- Andrade SG, Stocker-Guerret S, Pimentel AS, Grimaud JA (1991). Reversibility of cardiac fibrosis in mice chronically infected with *Trypanosoma cruzi*, under specific chemotherapy. *Mem Inst Oswaldo Cruz* **86** 187: 200.
- Andrade ZA, Andrade SG (1979). Patologia. In Brener Z, Andrade ZA (eds), *Trypanosoma cruzi e Doença de Chagas*. Guanabara Koogan: Rio de Janeiro; 199–248.
- Andrade ZA, Andrade SG, Oliveira GB, Alonso DR (1978). Histopathology of the conducting tissue of the heart in Chagas' myocarditis. *Am Heart J* **95**: 316–24.
- Anonymous (1997). Chagas disease—interruption of transmission, Brazil. *Weekly Epidemiol Rec* **72** (32): 1–8.
- Anonymous (1999). *Tratamiento Etiológico de la Enfermedad de Chagas. Conclusiones de una Consulta Técnica*. OPS/HCP/HCT/140/99. Pan American Health Organization: Geneva.
- Anonymous (2000). Chagas disease, Chile. Certification of interruption of transmission. *Weekly Epidemiol Rec* **2**: 10–12.
- Appleman MD, Shulman IA, Saxena S, Kirchoff LV (1993). Use of a questionnaire to identify potential donors at risk for infection with *Trypanosoma cruzi*. *Transfusion* **33**: 61–4.
- Avila HA, Pereira JB, Thiemann O *et al.* (1993). Detection of *Trypanosoma cruzi* in blood specimens of chronic Chagasic patients by polymerase chain reaction amplification of kinetoplast minicircle DNA: comparison with serology and xenodiagnosis. *J Clin Microbiol* **31**: 2421–6.
- Barbosa AJA, Pittella JEH, Tafuri WL (1970). Incidência de cardiopatia chagásica em 15,000 necrópsias consecutivas e sua associação com os 'megás'. *Rev Soc Brasil Med Trop* **4**: 219–23.
- Barousse AP, Costa JA, Esposto M, Laplume H, Segura EL (1980). Enfermedad de Chagas e inmunosupresión. *Med (Buenos Aires)* **40** (suppl): 17–26.
- Barr SC, Van Beek O, Carlisle-Nowak MS *et al.* (1995). *Trypanosoma cruzi* infection in Walker hounds in Virginia. *Am J Vet Res* **56**: 1937–44.
- Barrett VJ, Leiby DA, Odom JL *et al.* (1997). Negligible prevalence of antibodies against *Trypanosoma cruzi* among blood donors in the south-eastern United States. *Am J Clin Pathol* **108** (5): 499–503.
- Beard CB, Young DG, Butler JF, Evans DA (1988). First isolation of *Trypanosoma cruzi* from a wild-caught *Triatoma sanguisuga* (LeConte) (Hemiptera: Triatominae) in Florida, USA. *J Parasitol* **74**: 343–4.
- Bellotti G, Bocchi EA, de Moraes AV *et al.* (1996). *In vivo* detection of *Trypanosoma cruzi* antigens in hearts of patients with chronic Chagas' heart disease. *Am Heart J* **131** (2): 307–7.
- Bettencourt AL (1976). Congenital Chagas' disease. *Am J Dis Child* **130**: 97–103.
- Bocchi EA, Bellotti G, Mocelin AO *et al.* (1996). Heart transplantation for chronic Chagas' heart disease. *Ann Thorac Surg* **61** (6): 1727–33.
- Bocchi EA, Bellotti G, Uip D *et al.* (1993). Long-term follow-up after heart transplantation in Chagas' disease. *Transplant Proc* **25**: 1329–30.
- Brisseau JM, Cebren JP, Petit T *et al.* (1998). Chagas' myocarditis imported into France. *Lancet* **7**: 1046.
- Britto C, Cardoso MA, Monteiro Vanni CM *et al.* (1995). Polymerase chain reaction detection of *Trypanosoma cruzi* in human blood samples as a tool for diagnosis and treatment evaluation. *Parasitology* **110**: 241–7.
- Buckner FS, Wilson AJ, Van Voorhis WC (1997). Tissues of mice chronically infected with *Trypanosoma cruzi* have demonstrable parasites in inflammatory infiltrates. *J Invest Med* **45** (1): 123A.
- Bureau of Census (1996). *Statistical Abstract of the United States. The National Data Book*, 116th edn. United States Department of Commerce: Washington, DC.
- Burns Jr JM, Shreer WG, Rosman DE, Sleath PR, March CJ, Reed SG (1992). Identification and synthesis of a major conserved antigenic epitope of *Trypanosoma cruzi*. *Proc Natl Acad Sci USA* **89**: 1239–43.
- Camara-Lopes LH (1961). Carcinoma of the esophagus as a complication of megaesophagus. An analysis of seven cases. *Am J Dig Dis* **6**: 742–56.
- Carrasco R, Miguez H, Camacho C *et al.* (1990). Prevalence of *Trypanosoma cruzi* infection in blood banks of seven departments of Bolivia. *Mem Inst Oswaldo Cruz* **85**: 69–73.
- Carvalho MR, Krieger MA, Almeida E *et al.* (1993). Chagas' disease diagnosis: evaluation of several tests in blood bank screening. *Transfusion* **33**: 830–4.
- Cedillos RA (1975). Chagas' disease in El Salvador. *PAHO Bull* **9**: 135–41.
- Chagas C (1909). Nova tripanozomíase humana. Estudos sobre a morfologia e o ciclo evolutivo do *Schizotrypanum cruzi* n. gen., n. sp., agente etiológico de nova entidade mórbida do homem. *Mem Inst Oswaldo Cruz* **1**: 159–218.
- Chagas C (1916). Tripanosomíase americana: forma aguda da molestia. *Mem Inst Oswaldo Cruz* **8**: 37–65.
- Chapadeiro E., Lopes ER, Mesquita PM, Pereira FEL (1964). Incidência de 'megás' associados à cardiopatia chagásica. *Rev Inst Med Trop São Paulo* **6**: 287–91.

- Chiari E, Dias JCP, Lana M, Chiari CA (1989). Hemocultures for the parasitological diagnosis of human chronic Chagas disease. *Rev Soc Brasil Med Trop* **22**: 19–23.
- Chuster M (1985). Implante de marcapasso nas bradiarritmias chagásicas. In Cançado JR, Chuster M (eds), *Cadiopatía Chagásica*. Fundação Carlos Chagas: Belo Horizonte, Brazil; 289–97.
- Cimo PL, Luper WE, Scouros MA (1993). Transfusion-associated Chagas' disease in Texas: report of a case. *Texas Med* **89** (12): 48–50.
- Cossio PM, Diez C, Szarfman A (1974). Chagasic cardiopathy—demonstration of a serum  $\gamma$ -globulin factor which reacts with endocardium and vascular structures. *Circulation* **49**: 13–21.
- Coura JR (1996). Current prospects of specific treatment of Chagas' disease [Spanish]. *Bol Chil Parasitol* **51** (3–4), 69–75.
- Crovato F, Rebora A (1997). Chagas' disease: a potential problem for Europe? *Dermatology* **195**: 184–5.
- Cunha-Neto E, Duranti M, Gruber A *et al.* (1995). Autoimmunity in Chagas disease cardiopathy: biological relevance of a cardiac myosin-specific epitope cross-reactive to an immunodominant *Trypanosoma cruzi* antigen. *Proc Natl Acad Sci USA* **92**: 3541–5.
- de Andrade ALSS, Zicker F, Luquetti AO *et al.* (1992). Surveillance of *Trypanosoma cruzi* transmission by serological screening of schoolchildren. *Bull WHO* **70**: 625–9.
- de Carvalho VB, Sousa EF, Vila JH *et al.* (1996). Heart transplantation in Chagas' disease. 10 years after the initial experience. *Circulation* **94** (8): 1815–17.
- de Oliveira RB, Troncon LE, Dantas RO, Menghelli UG (1998). Gastrointestinal manifestations of Chagas' disease. *Am J Gastroenterol* **93**: 884–9.
- Duggan AJ (1970). An historical perspective. In Mulligan HW (ed.), *The African Trypanosomiasis*. Allen and Unwin: London; 41–88.
- Ferreira HO (1988). Tratamento específico na fase aguda da doença de Chagas. *Jornal de Pediatria* **64**: 1–3.
- Fragata Filho AA, Boianain E, Silva MAD *et al.* (1995). Validade do tratamento etiológico da fase crônica da doença de Chagas com benznidazol. *Arq Bras Cardiol* **65** (suppl 1): 71.
- Frank M, Hegenscheid B, Janitschke K, Weinke T (1997). Prevalence and epidemiologic significance of *Trypanosoma cruzi* infection among Latin American immigrants in Berlin, Germany. *Infection* **25** (5): 1–4.
- Frasch ACC, Reyes MB (1990). Diagnosis of Chagas' disease using recombinant DNA technology. *Parasitol Today* **6**: 137–9.
- Freilij H, Altchek J (1995). Congenital Chagas' disease: diagnostic and clinical aspects. *Clin Infect Dis* **21** (3): 551–5.
- Geiseler PJ, Ito JI, Tegtmeier BR, Kerndt PR, Krance R (1987). Fulminant Chagas' disease (CD) in bone marrow transplantation (BMT). *Abstracts of the 1987 Interscience Conference on Antimicrobial Agents and Chemotherapy* p. 169.
- Goble FC (1970). South American trypanosomes. In Jackson GJ, Herman R, Singer I (eds), *Immunity to Parasitic Diseases in Animals*. Appleton-Century-Crofts: New York; 597–689.
- Goldsmith RS, Zarate RJ, Zarate LG *et al.* (1992). Clinical and epidemiologic studies of Chagas' disease in rural communities of Oaxaca, Mexico, and an eight-year follow-up: II. Chila. *Bull Pan Am Health Org* **26**: 47–59.
- Gomes ML, Galvao LMC, Macedo AM, Pena SDJ, Chiari E (1999). Chagas' disease diagnosis: comparative analysis of parasitologic, molecular, and serologic methods. *Am J Trop Med Hyg* **60** (2): 205–10.
- Gomes ML, Macedo AM, Vago AR, Pena SD, Galvao LM, Chiari E (1998). *Trypanosoma cruzi*: optimization of polymerase chain reaction for detection in human blood. *Exp Parasitol* **88** (1): 28–33.
- Grant IH, Gold JWM, Wittner M *et al.* (1989). Transfusion-associated acute Chagas disease acquired in the United States. *Ann Intern Med* **111**: 849–51.
- Grijalva MJ, Rowland EC, Powell MR, McCormick TS, Escalante L (1995). Blood donors in a vector-free zone of Ecuador potentially infected with *Trypanosoma cruzi*. *Am J Trop Med Hyg* **52** (4): 360–3.
- Gurtler RE, Cecere MC, Petersen RM, Rubel DN, Schweigmann NJ (1993). Chagas disease in north-west Argentina: association between *Trypanosoma cruzi* parasitaemia in dogs and cats and infection rates in domestic *Triatoma infestans*. *Trans R Soc Trop Med Hyg* **87**: 12–15.
- Hagar JM, Rahimtoola SH (1991). Chagas' heart disease in the United States. *N Engl J Med* **325**: 763–8.
- Hagar JM, Rahimtoola SH (1995). Chagas' heart disease. *Curr Probl Cardiol* **20** (12): 825–924.
- Herwaldt BL (2000). Laboratory-acquired parasitic diseases. *Clin Microbiol Rev* (in press).
- Herwaldt BL, Grijalva MJ, Newsome AL *et al.* (2000). Use of polymerase chain reaction to diagnose the fifth reported US case of autochthonous transmission of *Trypanosoma cruzi*, in Tennessee, 1998. *J Am Soc Trop Med Hyg* **1** (395): 399.
- Hoff R, Teixeira RS, Carvalho JS, Mott KE (1978). *Trypanosoma cruzi* in the cerebrospinal fluid during the acute stage of Chagas' disease. *N Engl J Med* **298**: 604–6.
- Houghton RL, Benson DR, Reynolds LD *et al.* (1999). A multi-epitope synthetic peptide and recombinant protein for the detection of antibodies to *Trypanosoma cruzi* in radioimmunoprecipitation-confirmed and consensus-positive sera. *J Infect Dis* **179**: 1226–34.
- Jones EM, Colley DG, Tostes S, Lopes ER, Vnencak-Jones CL, McCurley TL (1993). Amplification of a *Trypanosoma cruzi* DNA sequence from inflammatory lesions in human Chagasic cardiomyopathy. *Am J Trop Med Hyg* **48**: 348–57.
- Karsten V, Davis C, Kuhn R (1992). *Trypanosoma cruzi* in wild raccoons and opossums in North Carolina. *J Parasitol* **78**: 547–9.
- Kerndt PR, Waskin HA, Kirchoff LV *et al.* (1991). Prevalence of antibody to *Trypanosoma cruzi* among blood donors in Los Angeles, California. *Transfusion* **31**: 814–18.
- Kirchoff LV (1989). Is *Trypanosoma cruzi* a new threat to our blood supply? *Ann Intern Med* **111**: 773–5.
- Kirchoff LV (1993a). Chagas disease. American trypanosomiasis. *Infect Dis Clin N Am* **7**: 487–502.

- Kirchhoff LV (1993b). American trypanosomiasis (Chagas' disease)—a tropical disease now in the United States. *N Engl J Med* **329**: 639–44.
- Kirchhoff LV (1996). American trypanosomiasis (Chagas disease). *Gastroenterol Clin N Am* **25** (3): 517–33.
- Kirchhoff LV, Donelson JE (1993). PCR detection of *Trypanosoma cruzi*, African trypanosomes, and *Leishmania* species. In Persing DH *et al.* (eds), *Diagnostic Molecular Microbiology—Principles and Applications*. American Society for Microbiology: Washington, DC: 443–55.
- Kirchhoff LV, Gam AA, Gilliam FC (1987). American trypanosomiasis (Chagas' disease) in Central American immigrants. *Am J Med* **82**: 915–20.
- Kirchhoff LV, Gam AA, Gusmao RD, Goldsmith RS, Rezende JM, Rassi A (1987). Increased specificity of serodiagnosis of Chagas' disease by detection of antibody to the 73- and 90-kilodalton glycoproteins of *Trypanosoma cruzi*. *J Infect Dis* **155**: 561–4.
- Kirchhoff LV, Neva FA (1985). Chagas' disease in Latin American immigrants. *J Am Med Assoc* **254**: 3058–60.
- Kirchhoff LV, Votava JR, Ochs DE, Moser DR (1996). Comparison of PCR and microscopic methods for detecting *Trypanosoma cruzi*. *J Clin Microbiol* **34** (5): 1171–5.
- Kobayasi S, Mendes EF, Rodrigues MAM, Franco MF (1992). Toxic dilatation of the colon in Chagas' disease. *Br J Surg* **79**: 1202–3.
- Koberle F. (1968). Chagas' disease and Chagas' syndromes: the pathology of American trypanosomiasis. *Adv Parasitol* **6**: 63–116.
- Kohl S, Pickering LK, Frankel LS, Yaeger RG (1982). Reactivation of Chagas' disease during therapy of acute lymphocyte leukemia. *Cancer* **50**: 827–8.
- Laranja FS, Dias E, Nobrega G, Miranda A (1956). Chagas' disease: A clinical, epidemiologic, and pathologic study. *Circulation* **14**: 1035–60.
- Leiby DA, Lenes BA, Tibbals MA, Tames-Olmedo MT (1999). Prospective evaluation of a patient with *Trypanosoma cruzi* infection transmitted by transfusion [letter]. *N Engl J Med* **341** (16): 1237–9.
- Leiby DA, Read EJ, Lenes BA *et al.* (1997). Seroepidemiology of *Trypanosoma cruzi*, etiologic agent of Chagas' disease, in US blood donors. *J Infect Dis* **176**: 1047–52.
- Leiby DA, Wendel S, Takaoka DT *et al.* (2000). Serologic testing for *Trypanosoma cruzi*: comparison of radioimmunoprecipitation assay with commercially available indirect immunofluorescence assay, indirect hemagglutination assay, and enzyme-linked immunosorbent assay kits. *J Clin Microbiol* **38** (2): 639–42.
- Leiguarda R, Roncoroni A, Taratuto AL *et al.* (1990). Acute CNS infection by *Trypanosoma cruzi* (Chagas' disease) in immunosuppressed patients. *Neurology* **40**: 850–1.
- Lent H, Wygodzinsky P (1979). Revision of the Triatominae (Hemiptera, Reduviidae), and their significance as vectors of Chagas' disease. *Bull Am Mus Nat Hist* **163**: 123–520.
- Levi GC, Lobo IM, Kallas EG, Amato Neto V (1996). Etiological drug treatment of human infection by *Trypanosoma cruzi*. *Rev Inst Med Trop São Paulo* **38** (1): 35–8.
- Levine ND, Corliss JO, Cox FEG *et al.* (1980). A newly revised classification of the protozoa. *J Protozool* **27**: 37–58.
- Libow LF, Beltrani VP, Silvers DN, Grossman ME (1991). Post-cardiac transplant reactivation of Chagas' disease diagnosed by skin biopsy. *Cutis* **48**: 37–40.
- Luquetti AO (1990). Use of *Trypanosoma cruzi* defined proteins for diagnosis—multicentre trial serological and technical aspects. *Mem Inst Oswaldo Cruz* **85**: 497–505.
- Marr JJ, Docampo R (1986). Chemotherapy for Chagas' disease: a perspective on current therapy and considerations for future research. *Rev Infect Dis* **8**: 884–903.
- Marsden PD, Barreto AC, Cuba CC, Gama MB, Ackers J (1979). Improvements in routine xenodiagnosis with first instar *Dipetalogaster maximus* (Uhler 1894) (Triatominae). *Am J Trop Med Hyg* **28**: 649–52.
- Mocelin AJ, Brandina L, Gordon PA, Baldy JLS, Chieffi PP (1977). Immunosuppression and circulating *Trypanosoma cruzi* in a kidney transplant recipient. *Transplantation* **23**: 163.
- Moser DR, Kirchhoff LV, Donelson JE (1989). Detection of *Trypanosoma cruzi* by polymerase chain reaction gene amplification. *J Clin Microbiol* **27**: 1744–9.
- Mota EA, Guimaraes AC, Santana OO, Sherlock I, Hoff R, Weller TH (1990). A nine year prospective study of Chagas' disease in a defined rural population in Northeast Brazil. *Am J Trop Med Hyg* **42**: 429–40.
- Neva FA, Brown HW (1994). *Basic Clinical Parasitology*, 6th edn. Appleton & Lange: Norwalk, CT.
- Nickerson P, Orr P, Schroeder M-L, Sekla L, Johnston JB (1989). Transfusion-associated *Trypanosoma cruzi* infection in a non-endemic area. *Ann Intern Med* **111**: 851–3.
- Ochs DE, Hnilica V, Moser DR, Smith JH, Kirchhoff LV (1996). Postmortem diagnosis of autochthonous acute chagastic myocarditis by polymerase chain reaction amplification of a species-specific DNA sequence of *Trypanosoma cruzi*. *Am J Trop Med Hyg* **34**: 526–9.
- Oelemann W, Vanderborgh BO, Verissimo Da Costa GC *et al.* (1999). A recombinant peptide antigen line immunoassay optimized for the confirmation of Chagas' disease. *Transfusion* **39** (7): 711–17.
- Pan AA, Rosenberg GB, Hurley MK *et al.* (1992). Clinical evaluation of an EIA for the sensitive and specific detection of serum antibody to *Trypanosoma cruzi* (Chagas' disease). *J Infect Dis* **165**: 585–8.
- Parada H, Carrasco HA, Anez N, Fuenmayor C, Inglessis I (1997). Cardiac involvement is a constant finding in acute Chagas' disease: a clinical, parasitological and histopathological study. *Int J Cardiol* **60** (1): 49–54.
- Paredes-Espinoza M, Paredes-Casillas P (1996). Historia de las tripanosomiasis humanas. *Med Intern Mexico* **12**: 38–41.
- Pinotti HW, Felix VN, Zilberstein B, Ceconello I (1991). Surgical complications of Chagas' disease: megaesophagus, achalasia of the pylorus, and cholelithiasis. *World J Surg* **15**: 198–204.
- Pinotti HW, Habr-Gama A, Ceconello I, Felix VN, Zilberstein B (1993). The surgical treatment of megaesophagus and megacolon. *Dig Dis* **11**: 206–15.
- Pizzi TP, De Crioizret VA, Smok G, Diaz M (1982). Enfermedad de Chagas en un paciente con transplante

- renal y tratamiento inmunosupresor. *Rev Med Chile* **110**: 1207–11.
- Prata A (1981). *Carlos Chagas: Coletânea de Trabalhos Científicos*. Editora Universidade de Brasília: Brasília.
- Prata A, Lopes ER, Chapdeiro E (1985). Morte súbita. In Cançado JR, Chuster M (eds), *Cardiopatía Chagásica*. Fundação Carlos Chagas: Belo Horizonte; 114–20.
- Rassi A (1979). Clínica: fase aguda. In Brener Z, Andrade ZA (eds), *Trypanosoma cruzi e Doença de Chagas*. Guanabara Koogan: Rio de Janeiro; 249–64.
- Rassi A, Ferreira HO (1971). Tentativas de tratamento específico de fase aguda da doença de Chagas com nitrofuranos em esquemas de duração prolongada. *Rev Soc Brasil Med Trop* **5**: 235–62.
- Reed SG (1988). *In vivo* administration of recombinant IFN $\gamma$  induces macrophage activation, and prevents acute disease, immune suppression, and death in experimental *Trypanosoma cruzi* infections. *J Immunol* **140**: 4342–7.
- Reed SG (1998). Immunology of *Trypanosoma cruzi* infections. *Chem Immunol* **70**: 124–43.
- Rivero I, Moravenik M, Morales J, Gomez M, De Rosas JM (1974). Chagas' disease—another hazard in acute leukemia. *N Engl J Med* **290**: 285.
- Rocha A, Oliveira de Meneses AC, da Silva AM *et al.* (1994). Pathology of patients with Chagas' disease and acquired immunodeficiency syndrome. *Am J Trop Med Hyg* **50**: 261–8.
- Russomando G, Figueredo A, Almiron M, Sakamoto M, Morita K (1992). Polymerase chain reaction-based detection of *Trypanosoma cruzi* DNA in serum. *J Clin Microbiol* **30**: 2864–8.
- Ryckman RE, Olsen LE (1965). Epizootiology of *Trypanosoma cruzi* in Southwestern North America. Part VI. Insectivorous hosts of Triatominae—the perizootiological relationship to *Trypanosoma cruzi*. *J Med Entomol* **2**: 99–106.
- Salgado PR, Gorski AG, Aleixo AR, de Barros EOM (1996). Tumor-like lesion due to Chagas' disease in a patient with lymphocytic leukemia. *Rev Inst Med Trop São Paulo* **38** (4): 285–8.
- Salis GB, Chiocca JC, Perisse E, Acosta E, Mazure PA (1991). Acalasia del esófago: Veinte años de experiencia en el tratamiento no quirúrgico. *Acta Gastroent Latinoamer* **21**: 249–54.
- Santos-Buch CA (1979). American trypanosomiasis: Chagas' disease. *Int Rev Exp Pathol* **19**: 63–100.
- Sartori AM, Shikanai-Yasuda MA, Amato Neto V, Lopes MH (1998). Follow-up of 18 patients with human immunodeficiency virus infection and chronic Chagas' disease, with reactivation of Chagas' disease causing cardiac disease in three patients. *Clin Infect Dis* **26** (1): 177–9.
- Schi er RJ, Mansur GP, Navin TR, Limpakarnjanarat K (1984). Indigenous Chagas' disease (American trypanosomiasis) in California. *J Am Med Asso* **25**: 2983–4.
- Schmunis GA (1991). *Trypanosoma cruzi*, the etiologic agent of Chagas' disease: status in the blood supply in endemic and non-endemic countries. *Transfusion* **31**: 547–57.
- Schofield CJ, Dias JC (1999). The Southern Cone initiative against Chagas disease. *Adv Parasitol* **42**: 1–27.
- Shikanai-Yasuda MA, Lopes MH, Tolezano JE *et al.* (1990). Doença de Chagas aguda: vias de transmissão, aspectos clínicos e resposta à terapêutica específica em casos diagnosticados em um centro urbano. *Rev Inst Med Trop São Paulo* **32**: 16–27.
- Shulman IA, Appleman MD, Saxena S, Hiti AL, Kirchoff LV (1997). Specific antibodies to *Trypanosoma cruzi* among blood donors in Los Angeles, California. *Transfusion* **37**: 727–31.
- Starr MD, Rojas JC, Zeledon R, Hird DW, Carpenter TE (1991). Chagas' disease: risk factors for house infestation by *Triatoma dimidiata*, the major vector of *Trypanosoma cruzi* in Costa Rica. *Am J Epidemiol* **133**: 740–7.
- Sturm NR, Degraeve W, Morel C, Simpson L (1989). Sensitive detection and schizodeme classification of *Trypanosoma cruzi* cells by amplification of kinetoplast minicircle DNA sequences: use in diagnosis of Chagas' disease. *Mol Biochem Parasitol* **33**: 205–14.
- Tanowitz HB, Kirchoff LV, Simon D, Morriss SA, Weiss LM, Wittner M (1992). Chagas' disease. *Clin Microbiol Rev* **5**: 400–419.
- Teixeira ARL, Santos-Buch CA (1975). The immunology of experimental Chagas' disease. *Immunology* **28**: 401–10.
- Troncon LEA, Oliveira RB, Romanello LMF, Rosa-E-Silva L, Pinto MCC, Iazigi N (1993). Abnormal progression of a liquid meal through the stomach and small intestine in patients with Chagas' disease. *Dig Dis Sci* **38** (8): 1511–17.
- Umezawa ES, Bastos SF, Camargo ME *et al.* (1999). Evaluation of recombinant antigens for serodiagnosis of Chagas' disease in South and Central America. *J Clin Microbiol* **37** (5): 1554–60.
- Urbina JA (1999). Chemotherapy of Chagas' disease: the how and the why. *J Mol Med* **77**: 332–8.
- Van Voorhis WC, Schlekewy L, Trong HL (1991). Molecular mimicry by *Trypanosoma cruzi*: the F1-160 epitope that mimics mammalian nerve can be mapped to a 12-amino acid peptide. *Proc Natl Acad Sci USA* **88**: 5993–7.
- Villalba R, Fornes G, Alvarez MA *et al.* (1992). Acute Chagas' disease in a recipient of a bone marrow transplant in Spain: case report. *Clin Infect Dis* **14**: 594–5.
- Villanueva MS (1993). Trypanosomiasis of the central nervous system. *Semin Neurol* **13**: 209–18.
- Viotti R, Vigliano C., Armenti H, Segura E (1994). Treatment of chronic Chagas' disease with benznidazole: clinical and serologic evolution of patients with long-term follow-up. *Am Heart J* **127** (1): 151–62.
- Winkler MA, Brashear RJ, Hall HJ, Schur JD, Pan AA (1995). Detection of antibodies to *Trypanosoma cruzi* among blood donors in the south-western and western United States. II. Evaluation of a supplemental enzyme immunoassay and radioimmuno-precipitation assay for confirmation of seroreactivity. *Transfusion* **35**: 219–25.
- Wisnivesky-Colli C, Gurtler RE, Solarz ND, Lauricella MA, Segura EL (1985). Epidemiological role of humans, dogs, and cats in the transmission of *Trypanosoma cruzi* in a central area of Argentina. *Rev Inst Med Trop São Paulo* **27**, 346–52.
- Wisnivesky-Colli C., Schweigmann NJ, Alberti A *et al.* (1992). Sylvatic American trypanosomiasis in Argentina. *Trypanosoma cruzi* infection in mammals from the Chaco forest in Santiago del Estero. *Trans R Soc Trop Med Hyg* **86**: 38–41.



Wood JN, Hudson L, Jessell TM, Yamamoto M (1982) A monoclonal antibody defining antigenic determinants on subpopulations of mammalian neurones and *Trypanosoma cruzi* parasites. *Nature* **296**: 34–8.

Yaeger RG (1988). The prevalence of *Trypanosoma cruzi* infection in armadillos collected at a site near New Orleans, Louisiana. *Am J Trop Med Hyg* **38**: 323–6.



# *Blastocystis*

D. J. Stenzel<sup>1</sup> and R. E. Boreham<sup>2</sup>

<sup>1</sup>Queensland University of Technology, Brisbane, and <sup>2</sup>Consultant Parasitologist, Toowong, Queensland, Australia

## HISTORICAL INTRODUCTION

*Blastocystis* was first definitively described as a distinct organism by Alexeieff in 1911, although there is some suggestion that it may have been recognised prior to this time (Zierdt, 1991). Alexeieff (1911) proposed the name *Blastocystis enterocola*, and considered that only one species of *Blastocystis* was present in the various animal hosts he examined. An extensive morphological description of the organism was given and a plausible life-cycle proposed.

Brumpt (1912), believing that different species of *Blastocystis* were present in different hosts, proposed the name *B. hominis* for the organism from humans. This is the name now recognised in the literature. *B. hominis* is often considered to be the only species of the organism, although recent morphological and molecular studies have presented some evidence that several species of *Blastocystis* exist (Boreham and Stenzel, 1998; Kukoschke and Müller, 1991; Boreham *et al.*, 1992; Müller, 1994; Mansour *et al.*, 1995).

A small number of reports of *B. hominis* infections from humans were published in the years subsequent to its description, and it was frequently listed in parasitological surveys, particularly from tropical countries (Zierdt, 1991). However, it was not until the study of Zierdt *et al.* (1967) that the scientific community regained interest in the organism. Since then a considerable number of reports have been

published, covering both clinical and experimental aspects. However, our knowledge of the organism, including its fundamental biology and its pathogenic potential, remains limited.

Many of the dogmas perpetuated in the modern literature are collated from early work which has not been substantiated, and much of the current data are contradictory. Considerable research will need to be performed before we can make a conclusive statement about the epidemiology, pathogenic mechanisms and need for treatment of *B. hominis* infections.

## DESCRIPTION OF THE ORGANISM

### Taxonomy

The classification of *Blastocystis* remains controversial, it has been described as a yeast, a fungus, an alga, the cyst of other organisms (including *Trichomonas* spp.) and as a morphological form of *Dietamoeba fragilis* (for reviews, see Zierdt, 1991; Stenzel and Boreham, 1996).

Ultrastructural and physiological studies, first performed by Zierdt *et al.* (1967), have demonstrated that *Blastocystis* has protozoan characteristics. Such studies have not, however, allowed definitive taxonomic placement of the organism.

The first molecular study (Johnson *et al.*, 1989), utilising small subunit rRNA sequencing

techniques, indicated that *Blastocystis* is not closely related to the yeasts, fungi, amoebae, sarcodines or sporozoans, as had been suggested in earlier reports (Stenzel and Boreham, 1996). *Blastocystis* also did not appear to be closely related to the ciliates, dinoflagellates or amoebae examined in the study. A more recent study (Silberman *et al.*, 1996), using similar molecular techniques and citing previously reported ultrastructural data, has placed *Blastocystis* with the stramenopiles (a grouping including brown algae and diatoms). However, this proposed taxonomic position needs confirmation, as some ultrastructural characteristics and, particularly, the reproductive modes cited in this work (Silberman *et al.*, 1996) are not in accordance with accepted data (Stenzel and Boreham, 1996).

At the present time, it is considered that only one species of *Blastocystis*, viz. *B. hominis*, is present in humans. However, immunological assays, polypeptide patterns obtained by sodium dodecyl sulphate–polyacrylamide gel electrophoresis, and DNA hybridisation with random probes, indicate that two or more distinctly different groups or ‘demes’ of *B. hominis* can be identified (Kukoschke and Müller, 1991; Boreham *et al.*, 1992; Müller, 1994). Similarly, at least two zymodemes of *B. hominis* have been distinguished by isoenzyme patterns (Mansour *et al.*, 1995; Gericke *et al.*, 1997). These results warrant further study in order to clarify the speciation of *Blastocystis* in human hosts and to assess any relevance to pathogenicity.

A number of species of *Blastocystis* have been proposed for non-human hosts (Boreham and Stenzel, 1993, 1998), although these must be regarded cautiously until further confirmatory evidence is obtained. It also must be recognised that differing phenotypic characteristics do not necessarily indicate genotypic differences and, thus, may not be suitable for differentiating species.

Morphological criteria (predominantly size of the organism) have been used in several reports to differentiate the proposed species *B. galli* from chickens, *B. anatis* from domestic ducks and *B. anseri* from domestic geese (Boreham and Stenzel, 1993). The dimensions given for these proposed species overlap to a considerable degree and also overlap with the reported size range for *B. hominis*. Hence, size cannot be considered a

valid criterion to delineate these species. Differences in nuclear ultrastructure, as compared to *B. hominis*, appear to be a possible means of distinguishing *B. galli*, the proposed species from chickens (Boreham and Stenzel, 1993). However, this needs further clarification by more extensive morphological studies and needs to be supported by molecular data. *B. lapemi*, from a sea-snake, has been differentiated from *B. hominis* by electrophoretic karyotyping and by different culture requirements, although morphological differences were not found (Boreham and Stenzel, 1993).

### Morphology

A number of morphological forms of *Blastocystis* have been reported from culture and from faecal material. Considerable morphological variability occurs, and it is not known if this relates to speciation and/or pathogenicity. The forms most commonly reported in faeces include the vacuolar, granular, multivacuolar and cyst forms (Figure 15.1, see Plate VI, and Figures 15.2–15.5). An amoeboid form has been reported only rarely, and there are a number of conflicting reports on its morphology. An avacuolar form is thought to be present in the intestine of humans. In culture, the vacuolar or granular forms predominate, and by changing culture conditions it is possible to alter which form is seen.

By transmission electron microscopy, all forms of *B. hominis* show a characteristic nuclear morphology—a crescentic band of electron-opaque material at one pole (see Figures 15.2–15.5). This morphology does not appear to depend on cell cycle stage or physiological conditions. Mitochondria-like organelles are present, varying in number and morphology. They usually contain low numbers of sacculate or tubular cristae. Other eukaryotic cell structures, such as Golgi complex, coated pits, endocytic vesicles, rough endoplasmic reticulum and polyribosomes are also seen (Zierdt, 1991; Boreham and Stenzel, 1993; Stenzel and Boreham, 1996).

#### *Vacuolar Form*

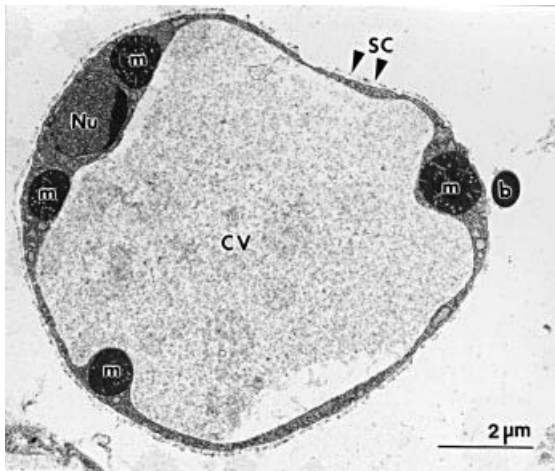
The vacuolar form (synonyms: vacuolated form, central body form) has been considered to be the

typical *Blastocystis* form and it is the form generally sought in routine diagnosis by light microscopy. It predominates in most cultures of *B. hominis*.

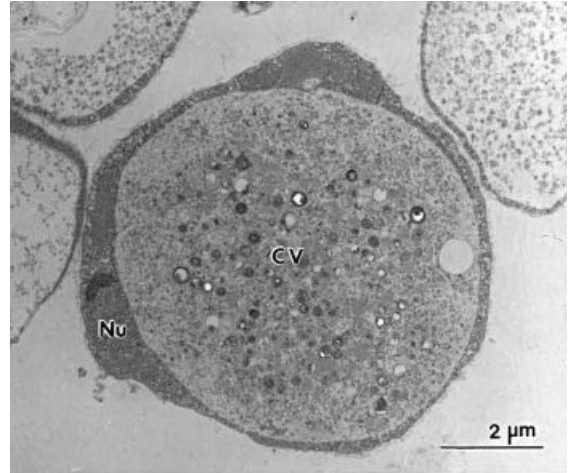
The vacuolar form appears as a spherical or slightly irregularly shaped cell of varying diameter (2–200 µm; Zierdt, 1991; Stenzel and Boreham, 1996). The average size range of vacuolar forms found in human faecal material is approximately 4–15 µm. Larger cells may be found in culture.

By light microscopy (Figure 15.1E), the nuclei and mitochondria are indistinguishable but are seen in the peripheral rim of the cell, surrounding the central vacuole (synonym: central body). By transmission electron microscopy, the cell is seen to consist of a thin band of peripheral cytoplasm, containing organelles, which surrounds a large central vacuole (Figure 15.2). Multiple nuclei (commonly up to four) are present in many vacuolar cells (Zierdt, 1973; Matsumoto *et al.*, 1987; Dunn *et al.*, 1989).

There is considerable variability in the morphology of the vacuolar forms, particularly in the contents and, therefore, staining reactions, within the central vacuole (MacPherson and MacQueen, 1994; Garcia and Bruckner, 1997). The complete



**Fig. 15.2** Transmission electron micrograph of the vacuolar form of *B. hominis*. A thin rim of cytoplasm, containing a nucleus (Nu), mitochondria-like organelles (m) and other organelles, surrounds a large central vacuole (CV). The cell is surrounded by a thin surface coat (SC), with an adherent bacterium (b)



**Fig. 15.3** Transmission electron micrograph of the granular form of *B. hominis*. Granules of various morphologies are present in the central vacuole (CV). Nu, nucleus

function of the central vacuole has not been defined, although it appears to have a function in metabolism and storage (Dunn *et al.*, 1989; Yoshikawa *et al.*, 1996). A role in reproduction has been suggested (Zierdt, 1988, 1991; Singh *et al.*, 1995) but is not supported by ultrastructural data.

A surface coat, also called 'slime layer' or 'capsule' in some reports (Stenzel and Boreham, 1996), of variable thickness and morphology may surround vacuolar forms. It is altered by laboratory culture, becoming thinner or absent after longer periods in culture (Stenzel *et al.*, 1991).

### **Granular Form**

The granular form (Figure 15.3) is morphologically identical to the vacuolar form, apart from the contents of the central vacuole. This form shows numerous small granules within the central vacuole. Cytochemical and ultrastructural studies have indicated that many of the granules are composed of lipid (Zierdt, 1973; Dunn *et al.*, 1989). Granular forms are not commonly seen in faecal material, but are induced by a number of culture conditions (Stenzel and Boreham, 1996).

### Multivacuolar Form

Recent ultrastructural studies (Stenzel *et al.*, 1991; Stenzel and Boreham, 1996) have determined that the form of *B. hominis* present in fresh human faecal material may be multivacuolar, rather than vacuolar, as has previously been assumed. These multivacuolar forms are usually smaller (approximately 5–8 µm in diameter) than the ‘typical’ vacuolar forms. Rather than a large single vacuole, numerous smaller vacuoles are seen (Figure 15.1C, 15.4). These vacuoles may be distinct entities or may comprise an interconnected network: sufficient study has not yet been performed to ascertain this. Often, the vacuoles are too small to be resolved by light microscopy, and the multivacuolar form appears as a small, often irregularly shaped, vacuolar form in stained faecal smears (Figure 15.1A,B). The surface coat surrounding all multivacuolar forms found in human faecal material (Figure 15.4) is thicker than that seen on the cultured forms (compare to Figures 15.2, 15.3). After short-term laboratory culture, the multivacuolar form gives rise to the vacuolar or granular forms, with vacuolar forms being the only form present after longer periods in culture (Stenzel *et al.*, 1991).

### Avacuolar Form

The avacuolar form has been reported only twice in the literature: once from a patient producing

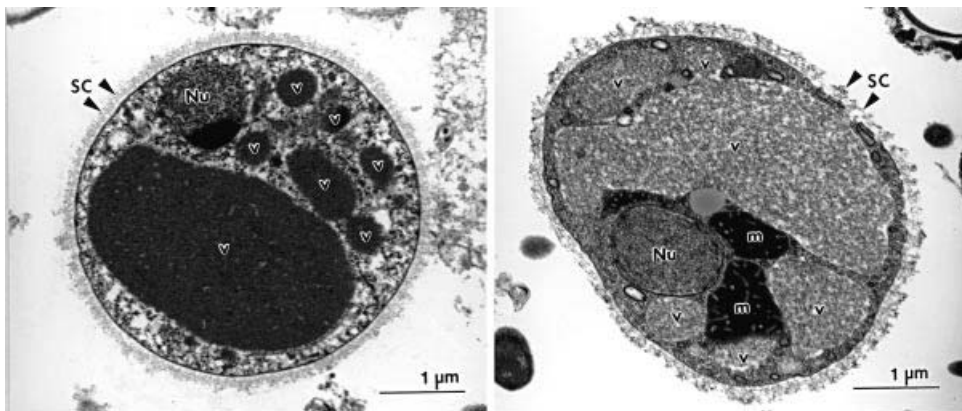
copious quantities of diarrhoeal fluid (Zierdt and Tan, 1976) and once from a sample taken at colonoscopy (Stenzel *et al.*, 1991). These organisms were approximately 5 µm in diameter and lacked a central vacuole and a surface coat.

The avacuolar form has not been found in culture. Zierdt and Tan (1976) suggested that this form gave rise to the vacuolar form after laboratory culture. Further work is needed to determine whether the avacuolar form is the form of *B. hominis* present within the human intestine, as has been assumed (Stenzel and Boreham, 1996).

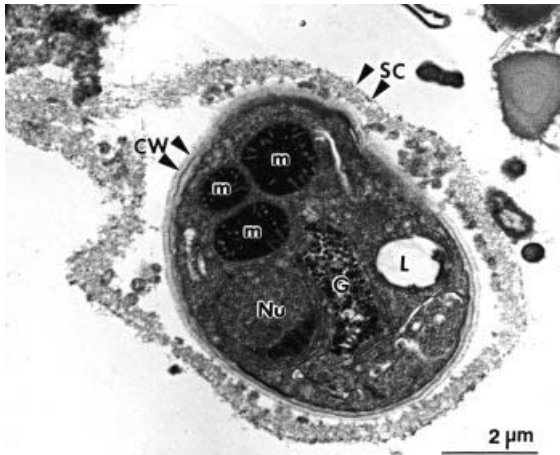
### Cyst Form

The presence of a cyst form (synonyms: cystic form, cyst-like form, resistant form), although first reported by Alexeieff in 1911, was confirmed only recently by ultrastructural studies (Mehlhorn, 1988; Stenzel and Boreham, 1991; Figure 15.5). The cyst form ranges in diameter (approximately 3–10 µm). It is commonly less than 5 µm in diameter and, hence, may be very difficult to identify by light microscopy.

The condensed cytoplasm of the cyst contains many vacuoles and often large reserves of glycogen or lipid, which give the cell a very refractile appearance in wet mounts. These materials do not stain with trichrome and may be extracted by some microscopy preparation



**Fig. 15.4** Transmission electron micrographs of multivacuolar forms of *B. hominis*. Numerous small vacuoles (v) are noted. The cells are surrounded by a thick surface coat (SC). Nu, nucleus; m, mitochondrion-like organelle



**Fig. 15.5** Transmission electron micrograph of the cyst form of *B. hominis*, showing a multilayered cyst wall (CW) surrounding the cell. A surface coat (SC) is noted exterior to, and separating from, the cyst wall. Lipid (L) and glycogen (G) are seen within the cyst cytoplasm. Nu, nucleus; m, mitochondrion-like organelle

methods, particularly those used for transmission electron microscopy, giving the appearance of a large vacuole within the cyst (see Figures 15.1d, 15.5).

A thick, multilayered cyst wall is present (Figure 15.5). This wall appears to form beneath the surface coat, and cysts are often seen with the surface coat and cellular debris present external to the cyst wall (Figure 15.5).

### **Amoeboid Form**

The amoeboid forms (synonyms: amoeba form, amoeba-like form, amoebiform) is uncommon but has been described from culture and faeces. A number of conflicting definitions have been presented in the literature (Stenzel and Boreham, 1996). Several studies suggest that this form extends pseudopodia and feeds on bacteria (Zierdt, 1973; Dunn *et al.*, 1989; Suresh *et al.*, 1994; Singh *et al.*, 1995). A central vacuole was not noted, and the cells varied in diameter (approximately 3–8  $\mu\text{m}$ ).

### **Other Forms**

The existence of other forms of *B. hominis*, as suggested by Zierdt (1991), remains unverified.

Recent studies have indicated that culture conditions affect the morphology of the organism (Stenzel and Boreham, 1996), although these have not been fully defined. Hence, it is important for future studies to clearly discriminate between morphological differences induced by the microenvironment or physiology of the cell and distinct life-cycle stages.

### **LIFE-CYCLE**

A number of life-cycles have been proposed for *Blastocystis*, but none have been verified *in vitro* or *in vivo*. The elucidation of several new forms of *Blastocystis* (particularly the cyst form) has invalidated most of the earlier life-cycles. This includes the life-cycle proposed by Zierdt (1973), which is presented in most recent texts.

Binary fission is the only mode of reproduction that has been well demonstrated by light microscopy and electron microscopy. Thus, recently proposed life-cycles incorporating other reproductive modes need to be regarded circumspectly until such modes are conclusively demonstrated.

Very little information is available on the amoeboid form and the avacuolar form, and their role in a proposed life-cycle is uncertain. Similarly, little conclusive information is available on the origin of the multivacuolar form, although it is assumed to arise from the avacuolar form in the host intestine (Stenzel and Boreham, 1996). It is known that the vacuolar form can be derived from the multivacuolar form, at least *in vitro*, presumably by the coalescence and enlargement of the smaller multiple vacuoles (Stenzel *et al.*, 1991). The factors involved in this differentiation have not been identified. The granular form may be induced from the vacuolar form by altering culture conditions (Stenzel and Boreham, 1996) and appears to revert to the vacuolar form after adjusting to culture.

It is assumed that the cyst form is the infective form of *Blastocystis*, and that excystation occurs within the host intestine after ingestion of the cyst (Stenzel and Boreham, 1996). Factors involved in inducing excystation and encystation have not been defined. It is not conclusively known which form results from excystation,

although it has been assumed to be the avacuolar form (Stenzel and Boreham, 1996).

Further studies are required to elucidate the life-cycle of *Blastocystis*: the existence of additional forms of the organism and reproductive modes other than binary fission cannot yet be totally refuted.

## MOLECULAR BIOLOGY

Very little is known of the molecular biology of *Blastocystis*. Very few studies have been performed, and the published data differ considerably.

Sequencing of small subunit rRNA has been used for taxonomic purposes (Johnson *et al.*, 1989; Silberman *et al.*, 1996). The latter study completely sequenced the 16S-like rRNA genes for a human isolate and a guinea-pig isolate of *Blastocystis*, and found the genes from the two isolates differed by 6.4%. This is the greatest degree of intraspecific variation detected in any of the eukaryotic organisms studied to date (Clarke, 1997).

Karyotypic analyses have been controversial, demonstrating either genetic heterogeneity (Upcroft *et al.*, 1989; Carbajal *et al.*, 1997) or homology (Ho *et al.*, 1994) between isolates of *B. hominis*. All of these studies have found differing numbers of chromosomes in isolates from humans: 10–12 chromosomes, ranging in size from 200 kilobase pairs (kb) to 1.3 megabase pairs (Mb) in three isolates (Upcroft *et al.*, 1989); 14–16 chromosomes, ranging in size from 590 kb to 1.91 Mb in five isolates (Ho *et al.*, 1994); and 9–13 chromosomes, ranging in size from 260 kb to 2.2 Mb in 15 isolates (Carbajal *et al.*, 1997).

Despite the heterogeneity noted in karyotypic profiles, the isolates in the most extensive study (Carbajal *et al.*, 1997) could be grouped into three karyotypes. This supports immunological and biochemical data (Kukoschke and Müller, 1991; Boreham *et al.*, 1992; Müller, 1994; Mansour *et al.*, 1996; Gericke *et al.*, 1997) suggesting that different demes (or possibly even different species) of *Blastocystis* are found in human hosts. Such differences may have significance for pathogenicity. Similarly, the existence of distinct groups within *Blastocystis*

isolates may explain the conflicting published data across a range of applied techniques.

## Biochemistry

The few biochemical studies that have been performed have necessarily employed *Blastocystis* grown in culture, as there is no currently known method of separating viable *Blastocystis* directly from faecal material. In light of the morphological differences noted in cultured organisms and the presence of a limited number of life-cycle stages in cultures, as compared to faecal samples (Stenzel and Boreham, 1996), these studies must not be over-interpreted.

To date, there is little confirmed information on the metabolic capabilities of *Blastocystis*. *B. hominis* appears to be a strict anaerobe when grown in culture (Zierdt, 1988, 1991; Boreham and Stenzel, 1993; Stenzel and Boreham, 1996), although it contains numerous organelles that morphologically resemble mitochondria. Conflicting reports have been published on investigations of mitochondrial marker enzymes (Zierdt, 1986, 1988; Zierdt *et al.*, 1988; Hollebeke and Mayberry, 1993), lipid metabolism (Keenan *et al.*, 1992; Keenan and Zierdt, 1994) and other cellular enzymes (Sargeant and Williams, 1979; Zierdt *et al.*, 1988; Mansour *et al.*, 1995).

## PATHOGENESIS

It has not yet been conclusively shown that *Blastocystis* causes disease in either humans or animals. The current controversies are reviewed in Stenzel and Boreham (1996). Evidence supporting a causal role in gastrointestinal disease is based on the presence of *Blastocystis* as the sole putative agent of disease, although there is considerable difficulty in eliminating all other infectious and non-infectious causes of symptoms, particularly when the pathogenicity of concomitant organisms is also uncertain (Doyle *et al.*, 1990; Markell and Udkow, 1986, 1990; Markell, 1995). Similarly, the decrease or elimination of symptoms and the organism after antiprotozoal therapy, while supporting the possibility of *Blastocystis* being the causative



agent, is also confounded by the fact that the drugs used, primarily 5-nitroimidazoles, are not specific for *Blastocystis*, and will act on a range of other organisms, including Gram-negative and Gram-positive bacteria.

To date, case-control studies have not been performed, primarily due to the difficulties involved in case selection and in interpreting the results. A number of studies have not considered non-infectious causes of symptoms in patients (Miller and Mineshew, 1988) and most studies have not assessed the impact of all known pathogenic bacteria, viruses and protozoa.

## IMMUNOLOGY

Some authors suggest that the self-limiting nature of *B. hominis* infection in some patients is due to protective immunity (Sun *et al.*, 1989; Nimri, 1993). In several comprehensive studies it has been noted that lower infection rates and fewer symptoms are seen in older children and adults than in younger children, and this may reflect immunity induced by previous infections (Nimri, 1993; Nimri and Batchoun, 1994). However, a considerable number of studies have found higher infection rates in adults than in children (Hussain Qadri *et al.*, 1989; Doyle *et al.*, 1990; Ashford and Atkinson, 1992), so this remains controversial. There is no evidence of the acquisition of protective immunity to *B. hominis* at the community level (Ashford and Atkinson, 1992).

Conflicting data exist on serum immunoglobulin G antibody responses to *B. hominis* in symptomatic patients. One report found no antibody response (Chen *et al.*, 1987), while antibodies of the IgG2 subclass were found to be elevated in two other studies (Zierdt *et al.*, 1995; Hussain *et al.*, 1997). This issue needs to be resolved, particularly if immunologically based tests are to be developed for clinical diagnosis of *B. hominis* infections.

## EPIDEMIOLOGY

*Blastocystis* of undetermined speciation has been identified from a wide range of animal hosts,

including mammals, birds, reptiles and arthropods (Zierdt, 1991; Boreham and Stenzel, 1993, 1998). It has been found in almost all species of animals examined, albeit in low numbers in some. *Blastocystis* has not been clearly associated with gastrointestinal symptoms in animals, although some infected individuals have presented with diarrhoea. It is not known whether *Blastocystis* from animals is capable of infecting humans.

The true prevalence of *B. hominis* infections in humans is not known. Studies have been hampered by confusion regarding the significance of the organism and by lack of information on, and recognition of, the forms present in faecal specimens (Stenzel and Boreham, 1996). In the larger surveys that have been performed in recent years, *B. hominis* is often the most prevalent protozoan organism found in patients with gastrointestinal symptoms (Pikula, 1987; Figueroa *et al.*, 1990; Waghorn and Hancock, 1991; Biolley and Oberg, 1993) and in healthy individuals (Ashford and Atkinson, 1992; Fujita *et al.*, 1993; Hazen, 1993; Kobayashi *et al.*, 1995).

Distribution of *B. hominis* infections is worldwide (Zierdt, 1991; Stenzel and Boreham, 1996). Developing countries or communities with poor sanitary conditions are reported to have higher prevalences (up to approximately 50%; Lai, 1992; Fujita *et al.*, 1993; Mangali *et al.*, 1993; Kobayashi *et al.*, 1995) than developed countries and regions with good community hygiene (usually less than approximately 10%; Mai Nguyen and Krech, 1989; Mendis *et al.*, 1995; Horiki *et al.*, 1997). Similarly, within communities, groups with lower standards of personal hygiene may show higher prevalences than the remainder of the community (Libanore *et al.*, 1991; Fujita *et al.*, 1993; Nimri and Batchoun, 1994). However, infections have been reported in all socioeconomic groups and in all communities examined to date.

Travel, particularly to tropical countries, has been suggested as a risk factor in the acquisition of *B. hominis* infections (Hahn and Fleischer, 1985; Debat Zoguereh *et al.*, 1995). This may reflect hygiene standards rather than climatic conditions. There does not appear to be a seasonal variation in the prevalence of infections, although further data needs to be collected on this.

## CLINICAL FEATURES

### Gastrointestinal Presentation

Symptoms attributed to gastrointestinal *B. hominis* infection are generally non-specific and include diarrhoea, abdominal pain and cramps or discomfort, nausea, flatulence and fever (Zierdt, 1988, 1991; Stenzel and Boreham, 1996). Illness may be acute or chronic with symptoms persisting for several years. Profuse watery diarrhoea has been reported in some acute cases, and has been fatal in one case reported (Zierdt and Tan, 1976).

Other signs and symptoms occasionally reported to be associated with *B. hominis* infection of the gastrointestinal tract include rectal bleeding, faecal leukocytes, eosinophilia, hepatomegaly and splenomegaly, cutaneous rashes and itching (Zierdt, 1988, 1991; Stenzel and Boreham, 1996).

Several reports suggest that ulcerative colitis may result from *B. hominis* infection (Jeddy and Farrington, 1991; Galantowicz *et al.*, 1993; Al-Tawil *et al.*, 1994). A possible connection between *B. hominis* infection and irritable bowel syndrome (IBS) has been suggested by one study (Hussain *et al.*, 1997). Infection has also been correlated with diabetes, leukaemia and tropical pulmonary eosinophilia, but in these cases it appears unlikely that *B. hominis* is related to the cause of the underlying disease or its symptoms.

### Extraintestinal Infections

Several case reports suggest that *B. hominis* can infect extraintestinal sites, although few of these present irrefutable data. Infection of the synovial fluid has been noted to result in joint pains and swelling (Lee *et al.*, 1990) and arthritis (Lakhanpal *et al.*, 1991; Kruger *et al.*, 1994).

### Symptomless Infections

Although extensive epidemiological surveys have not been performed, symptomless infections with *B. hominis* appear to be common (Stenzel and Boreham, 1996). Indeed, large numbers of *B. hominis* may be present in faecal specimens

from individuals without symptoms of infection (Sun *et al.*, 1989; Kukoschke and Müller, 1992; Udkow and Markell, 1993). Given that many studies diagnose *B. hominis* infections solely on the presence of the vacuolar form, without recognising other forms of the organism, it appears likely that the prevalence of symptomless infections has been considerably underestimated.

## LABORATORY DIAGNOSIS

### Microscopy

Light microscopic examination of faecal specimens is the most common method of diagnosis of *B. hominis* infections. Wet mounts, either unstained or stained with iodine, are often used because of their simplicity. However, stained permanent smears are recommended as the procedure of choice (Garcia and Bruckner, 1997), as some forms of *B. hominis* are difficult to identify in wet mounts. Trichrome staining is recommended, although a variety of other stains, including iron haematoxylin, Giemsa, Gram and Wright's, have been used successfully (Stenzel and Boreham, 1996).

By light microscopy, the forms of *B. hominis* present in faecal specimens vary in diameter (approximately 3–20 µm) and in shape. In wet mounts, all appear as refractile organisms with or without a single vacuole, and with four to six 'dots' clustered around the rim or within the body of the organism. A thick wall may or may not be seen surrounding the cell.

In trichrome-stained smears, the morphology is more clearly defined (Figure 15.1). This is particularly relevant for the small forms, which can be easily missed in wet preparations. The small, red-stained dots seen within the cells correspond to the nuclei and mitochondria-like organelles seen in *B. hominis* examined by transmission electron microscopy. The vacuole may stain red or green. The cyst form shows a thick surrounding wall, which stains green (Figure 15.1B,D).

Variability in staining, particularly of the central vacuole, is reported with all stains, including trichrome (MacPherson and MacQueen, 1994; Garcia and Bruckner, 1997). Similarly, variability in morphology is noted and, with a

reported size range of approximately 6–40 µm for the vacuolar form in faecal material (Garcia and Bruckner, 1997), *B. hominis* may present challenges in diagnosis. Recent studies have elucidated the morphology of several forms of the organism (notably the multivacuolar and cyst forms) that are not reported in most diagnostic texts. In some infections, these small (approximately 3–5 µm in diameter) forms may be the predominant or only forms present in faecal samples (Boreham *et al.*, 1996).

### Culture

Concentration methods, as used for other protozoa and faecal parasites, generally appear unsuitable for concentrating *B. hominis*, as they are reported to disrupt the vacuolar, granular and multivacuolar forms (Miller and Minshew, 1988; Guimarães and Sogayar, 1993). However, some laboratories report the successful use of concentration methods (LeBar *et al.*, 1985; Hussain Qadri *et al.*, 1989; Aldeen and Hale, 1992). Hence, their use should be further evaluated before specific recommendations are made.

Transmission electron microscopy may assist in confirming diagnosis of atypical morphological forms of *B. hominis* but is not generally used for routine diagnostic purposes.

Culture of *B. hominis* from faecal material, prior to light microscopic examination (Kukoschke *et al.*, 1990; Zaman and Khan, 1994), appears to have no significant advantages over direct microscopy of faecal smears. Any perceived advantage is likely to be due to the presence of the large vacuolar forms in culture, thus enabling easy recognition, particularly by inexperienced laboratory personnel. It has been reported that culture may be successful only if large numbers of *B. hominis* are present in the faecal material (Zierdt, 1983, 1991), so cases with low numbers of organisms (which are difficult to diagnose by direct microscopic examination) also may not be detected by culturing. The success of culture from cases where solely cyst forms appear present in the faeces has not been assessed.

*B. hominis* may be cultured anaerobically in media which has been pre-reduced prior to

inoculation with the organism. Incubation at 37°C gives optimal growth for the organism isolated from humans (Zierdt and Williams, 1974). *Blastocystis* spp. from other hosts may have different optimal growth temperatures and may require different culture conditions (Boreham and Stenzel, 1998). Boeck and Drbohlav's inspissated egg medium is commonly used, but successful culturing of *Blastocystis* has been reported on Iscove's modified Dulbecco's medium supplemented with 10% horse serum, minimal essential medium containing 10% horse serum, Diamond's Trypticase Panmede serum (TP-S-1) monophasic medium, Loefer medium covered with Ringer solution containing 20% human serum, and Dobell and Laidlaw medium covered with Ringer solution and supplemented with 20% human serum (Zierdt, 1988, 1991; Stenzel and Boreham, 1996).

### Immunological Diagnosis

Appropriate antibodies or immunological tests for *B. hominis* are not currently available for clinical diagnostic applications.

In a research environment, an immunofluorescence assay (IFA) and an enzyme-linked immunosorbent assay (ELISA) were able to detect serum antibodies to *B. hominis* in four patients (Garavelli *et al.*, 1992). Similarly, an ELISA has been used to detect IgG antibodies in sera from 28 patients (Zierdt *et al.*, 1995), although this required threshold dilutions of approximately 1 in 50.

The availability of antibodies specific for *B. hominis* would greatly assist the diagnosis of the organism in faecal material, especially if low numbers or atypical forms are present. To date, there has been limited success. Zierdt (1991) presented previously unpublished data on the use of rabbit antisera to whole-cell *B. hominis* antigens, which specifically detected the vacuolar, granular and amoeboid forms in an IFA.

### Other Diagnostic Procedures

Invasive procedures such as endoscopy and colonoscopy have detected *B. hominis* in the intestine in several case reports (Matsumoto

*et al.*, 1987; Dellers *et al.*, 1992; Debongnie *et al.*, 1994). These methods are not recommended for routine diagnosis of the organism.

## CLINICAL MANAGEMENT

The treatment of *B. hominis* infections remains controversial, particularly in light of its uncertain pathogenicity. Strong opinions have been expressed regarding the use of potentially dangerous chemotherapeutic agents to treat *B. hominis*, particularly without a thorough investigation of other possible causes of symptoms (Markell and Udkow, 1990; Markell, 1995). Additionally, there is some evidence that infection may be self-limiting in some cases, and intervention may not be required (Sun *et al.*, 1989; Doyle *et al.*, 1990; Albrecht *et al.*, 1995). However, in the presence of chronic or acute debilitating symptoms for which no other cause is obvious, treatment by some means is warranted (LeBar *et al.*, 1985; Vanatta *et al.*, 1985; Lambert *et al.*, 1992).

### Chemotherapy

Conventional chemotherapeutic treatments tend to be largely empirical, using general anti-protozoal drugs, particularly 5-nitroimidazoles (Stenzel and Boreham, 1996). Variable success in treatment, either for reduction of symptoms or removal of organisms from the faeces, has been reported (Stenzel and Boreham, 1996). Antibacterial compounds, such as ampicillin, penicillin, streptomycin, gentamicin, colistin, ceftizoxime and vancomycin, and the antifungal compound amphotericin B do not appear to be effective against *B. hominis* and do not inhibit growth of the organism *in vitro* (Zierdt and Williams, 1974; Dunn and Boreham, 1991; Zierdt, 1991).

Efficacy of drugs used clinically to treat *B. hominis* has not been experimentally verified, with only two studies testing *in vitro* responses of *B. hominis* to various drugs. Zierdt *et al.* (1983) investigated the effects of 10 antiprotozoal drugs on the growth of four isolates, and Dunn and Boreham (1991) used one isolate to compare the

efficacy of 42 drugs. Variability in response to drugs was noted among isolates and between the two studies. The drugs most commonly used to treat *B. hominis* infections in the clinical situation (metronidazole and iodoquinol) showed *in vitro* activity against the isolates used in these two studies. However, iodoquinol is no longer available in many parts of the world, due to its toxicity.

Recommended doses for metronidazole in the treatment of *B. hominis* infections in adults are in the range 200–750 mg three times per day, over a 5–10 day period (Stenzel and Boreham, 1996). Treatment failures have been reported at all dosage levels. Co-trimoxazole has been suggested as an alternative (Schwartz and Houston, 1992), particularly if symptoms persist after treatment with metronidazole (Zaki *et al.*, 1991). Furazolidone has also been suggested to be effective and has been used as a treatment for *B. hominis* infections in AIDS patients (Narkewicz *et al.*, 1989).

Traditional Chinese medicinal herbs have been examined in one *in vitro* study (Yang *et al.*, 1996). From 20 crude extracts, two extracts (*Brucea javanica* and *Coptis chinensis*) were considered highly inhibitory to the growth of three isolates of *B. hominis*, although inhibition was not as great as with similar concentrations of metronidazole used for comparison in this study. However, the herbs were used as crude extracts and the active components may be far more efficacious if identified and purified prior to use.

Further *in vitro* testing of a wider range of *B. hominis* isolates is necessary to determine the variability in response to drugs and whether drug resistance occurs. Additional chemotherapeutic reagents, particularly those with minimal potential toxicity to the patient, need to be assessed. However, it must be recognised that *in vitro* testing cannot completely mimic the *in vivo* situation, and *in vitro* responses cannot necessarily be extrapolated to drug efficacies in humans or other hosts.

### Other Management Strategies

Dietary management has been suggested to reduce symptoms or numbers of *B. hominis* found in patients' faeces (Swellengrebel, 1917;

Kain *et al.*, 1987). In the most recent study (Kain *et al.*, 1987), dietary management, including the introduction of a high fibre and/or lactose-free diet, resulted in a higher proportion of patients showing clinical improvement than those treated with metronidazole. However, dietary management of *B. hominis* infections has not been well assessed, and it is possible that *B. hominis* was not the primary cause of symptoms in the six patients responding to dietary change in this study.

It has been suggested that physiological changes in the intestine, such as changes in nutrient availability, redox potential or bacterial flora, may influence the growth of *B. hominis* (Miller and Minshew, 1988). Thus, dietary changes which influence such factors may be of potential benefit to patients. However, intestinal factors that are detrimental to *B. hominis* have not so far been identified, so efficacious dietary recommendations cannot yet be made.

## PREVENTION AND CONTROL

Based on available data, it is assumed that *Blastocystis* is transmitted by the faecal-oral route (Stenzel and Boreham, 1996; Garcia and Bruckner, 1997). Thus, prevention and control measures include education to maintain personal and community hygiene standards, and improvement in community sanitary engineering to prevent faecal contamination of the environment and ingestion of faecally contaminated material.

*Blastocystis* is known to be prevalent in a range of companion animals and economically important livestock (Boreham and Stenzel, 1993, 1998). However, there is insufficient evidence at present to either support or refute the suggestion that humans are at risk from zoonotic infection. As a general hygiene practice, it is prudent to minimise human exposure to animal faeces, regardless of the zoonotic potential of *Blastocystis*.

The survival capabilities of *Blastocystis* in the environment have not been conclusively determined. It has been reported from laboratory studies that the granular and vacuolar forms are sensitive to air and desiccation (Zierdt *et al.*, 1967; Zierdt, 1973, 1988, 1991), so these forms are not expected to pose significant contamina-

tion risks in the environment. However, the cyst form appears resistant to some environmental conditions. One experimental study (Moe *et al.*, 1996) found that cysts from the faeces of a symptomatic patient were able to maintain viability, as assessed by subsequent culture techniques, for up to 19 days in water at room temperature, and up to 14 days in water at 4°C. *Blastocystis* has been isolated from sewage, using culture techniques (Zaman *et al.*, 1994).

The cyst form appears capable of survival in water treated with chlorine in the concentration ranges used to treat public drinking water supplies (Zaki *et al.*, 1996). However, cysts were reported to rapidly lose viability when frozen, when heated to 40–50°C, when desiccated, and when exposed to common detergents (Moe *et al.*, 1996).

## CONCLUSIONS

The study of *Blastocystis* as a cause of human disease would benefit from a more holistic approach. It is becoming apparent that diseases have multifactorial causes (Rothman and Greenland, 1997). Even for infectious organisms, disease outcomes are significantly influenced by characteristics of the individual host, interactions with other organisms present and physical factors within the microenvironment (Salminen *et al.*, 1995; Garavelli, 1998). To date, *Blastocystis* has been assessed for its involvement as the sole cause of symptoms in infected individuals: this appears to be a very restrictive approach, considering the lack of knowledge of possible pathogenic mechanisms. Whether the existence of multiple demes or species of *Blastocystis* implies that there are differing pathogenic events in humans has not been resolved. The lack of recognition of different morphological forms of the organism in diagnostic and research applications has hindered understanding, interpretation and diagnosis. Many of the epidemiological and immunological studies to date are incomplete. Hence, comprehensive studies of symptomatic and asymptomatic individuals, across the entire spectrum of community groups and geographical areas, are needed.

Knowledge of all aspects of *Blastocystis* remains rudimentary and considerable further work is required to elucidate the nature and significance of this ubiquitous organism.

## REFERENCES

- Aldeen WE, Hale D (1992). Use of Hemo-De to eliminate toxic agents used for concentration and trichrome staining of intestinal parasites. *J Clin Microbiol* **30**: 1893–5.
- Albrecht H, Stellbrink HJ, Koperski K, Greten H (1995). *Blastocystis hominis* infection in human immunodeficiency virus-related diarrhea. *Scand J Gastroenterol* **30**: 909–14.
- Al-Tawil YS, Gilger MA, Gopalakrishna GS, Langston C, Bommer KE (1994). Invasive *Blastocystis hominis* infection in a child. *Arch Pediatr Adolesc Med* **148**: 882–5.
- Alexieff A (1911). Sur la nature des formations dites 'kystes de *Trichomonas intestinalis*'. *Compt Rend Soc Biol* **71**: 296–8.
- Ashford RW, Atkinson EA (1992). Epidemiology of *Blastocystis hominis* infection in Papua New Guinea: age-prevalence and associations with other parasites. *Ann Trop Med Parasitol* **86**: 129–36.
- Biolley MA, Oberg C (1993). Blastocystosis en pacientes sintomáticos del Hospital Regional de Temuco, Chile. *Bol Chil Parasitol* **48**: 25–7.
- Boreham RE, Benson S, Stenzel DJ, Boreham PFL (1996). *Blastocystis hominis* infection. *Lancet* **348**: 272–3.
- Boreham PFL, Stenzel DJ (1993). *Blastocystis* in humans and animals: morphology, biology, and epizootiology. *Adv Parasitol* **32**: 1–70.
- Boreham PFL, Stenzel DJ (1998). Blastocystosis. In Palmer SR, Soulsby L, Simpson DIH (eds), *Zoonoses*. Oxford Medical Publications: Oxford, UK; 625–34.
- Boreham PFL, Upcroft JA, Dunn LA (1992). Protein and DNA evidence for two demes of *Blastocystis hominis* from humans. *Int J Parasitol* **22**: 49–53.
- Brumpt E (1912). CÔlite à *Tetramitus Mesnili* (Wenyon 1910) et cÔlite à *Trichomonas intestinalis* Leuchart 1879. *Blastocystis hominis* n. sp. et formes voisines. *Bull Soc Pathol Exot* **5**: 725–30.
- Carbajal JA, Del Castillo L, Lanusa MD, Villar J, Borrás R (1997). Karyotypic diversity among *Blastocystis hominis* isolates. *Int J Parasitol* **27**: 941–5.
- Cegielski JP, Msengi EA, Dukes CS *et al.* (1993). Intestinal parasites and HIV infection in Tanzanian children with chronic diarrhea. *AIDS* **7**: 213–21.
- Chen M (1997). Gay bowel syndrome in HIV positive homosexual men. *Venereology* **10**: 223–5.
- Chen J, Vaudry WL, Kowalewska K, Wenman WM (1987). Lack of serum immune response to *Blastocystis hominis*. *Lancet* **1**: 1021.
- Church DL, Sutherland LR, Gill M *et al.* (1992). Absence of an association between enteric parasites in the manifestations and pathogenesis of HIV enteropathy in gay men. *Scand J Infect Dis* **24**: 567–75.
- Clarke CG (1997). Riboprinting: a tool for the study of genetic diversity in microorganisms. *J Eukaryot Microbiol* **44**: 277–83.
- Cotte L, Rabodonirina M, Piens MA, Perreard M, Mojon M, Trepo C (1993). Prevalence of intestinal protozoans in French patients infected with HIV. *J Acq Immun Defic Syndr* **6**: 1024–9.
- Debat Zoguerh D, Delmont J, Faugere B, Bourgeade A (1995). *Blastocystis hominis*, parasite potentiellement pathogène fréquemment identifié après un voyage tropical. *Presse Méd* **24**: 1578.
- Debonnie JC, Mairesse J, Donnay M, Dekoninck X (1994). Touch cytology. A quick, simple, sensitive screening test in the diagnosis of infections of the gastrointestinal mucosa. *Arch Pathol Lab Med* **118**: 1115–18.
- Dellers EA, Dunn JC, DeSantis P, Aronchick CA (1992). Identification of *Blastocystis hominis* by colonic brush cytology. A case report. *Acta Cytol* **36**: 757–8.
- Doyle PW, Helgason MM, Mathias RG, Proctor EM (1990). Epidemiology and pathogenicity of *Blastocystis hominis*. *J Clin Microbiol* **28**: 116–21.
- Dunn LA, Boreham PFL (1991). The *in vitro* activity of drugs against *Blastocystis hominis*. *J Antimicrob Chemother* **27**: 507–16.
- Dunn LA, Boreham PFL, Stenzel DJ (1989). Ultrastructural variation of *Blastocystis hominis* stocks in culture. *Int J Parasitol* **19**: 43–56.
- Escobedo A, Núñez FA (1997). *Blastocystis hominis* infection in Cuban AIDS patients. *Mem Inst Oswaldo Cruz* **92**: 321–2.
- Figueroa L, Moraleta L, Garcia N (1990). Enteroparasitosis en niños con síndrome diarreico agudo de la ciudad de Valdivia, X region, Chile con especial referencia a *Cryptosporidium* sp. *Parasitol al Dia* **14**: 78–82.
- Fujita O, Ohnishi M, Diaz V, Martinez L, Kamiya M (1993). Epidemiological investigation for intestinal parasitic infection in children in rural communities in Paraguay. *Japan J Parasitol* **42**: 409–14.
- Galantowicz BB, Illueca MD, Levy J, Rayburn JL, Weinstock DJ (1993). Neonatal *Blastocystis hominis* diarrhea. *Pediatr Infect Dis J* **12**: 345–7.
- Garavelli PL (1998). The pathogenicity of the protozoa. *ASM News* **64**: 124–5.
- Garavelli PL, Scaglione L, Fleisher T, Zierdt CH (1992). Serology of *Blastocystis hominis*: preliminary data. Abstract, Sixth European Multicollloquium of Parasitology, The Hague, The Netherlands.
- Garcia LS, Bruckner DA (1997). *Diagnostic Medical Parasitol*, 3rd edn. ASM Press: Washington, DC; 28–35.
- Gericke AS, Burchard GD, Knoblock J, Walderich B (1997). Isoenzyme patterns of *Blastocystis hominis* patient isolates derived from symptomatic and healthy carriers. *Trop Med Int Health* **2**: 245–54.
- Guimarães S, Sogayar MIL (1993). *Blastocystis hominis*: occurrence in children and staffmembers of municipal day-care centres from Botucatu, São Paulo State, Brazil. *Mem Inst Oswaldo Cruz* **88**: 427–9.
- Hahn P, Fleischer NFK (1985). *Blastocystis hominis*—is it of clinical importance? *Trop Med Parasitol* **36**: 7–8.
- Hazen KC (1993). Controversial fungal and protozoan gastrointestinal infections. *Curr Opin Infect Dis* **6**: 77–82.

- Ho LC, Singh M, Suresh K, Ng GC, Yap EH (1994). A study of the karyotypic patterns of *Blastocystis hominis* by pulsed-field gradient electrophoresis. *Parasitol Res* **80**: 620–2.
- Hollebeke NL, Mayberry LF (1993). Cytochrome oxidase activity and cyanide-insensitivity in *Blastocystis hominis* mitochondria. *Am J Trop Med Hyg* **49**: 197–8.
- Horiki N, Maruyama M, Fujita Y, Yonekura T, Minato S, Kaneda Y (1997). Epidemiologic survey of *Blastocystis hominis* infection in Japan. *Am J Trop Med Hyg* **56**: 370–4.
- Hussain R, Jaferi W, Zuberi S *et al.* (1997). Significantly increased IgG2 subclass antibody levels to *Blastocystis hominis* in patients with irritable bowel syndrome. *Am J Trop Med Hyg* **56**: 301–6.
- Hussain Qadri SM, Al-Okaili GA, Al-Dayel F (1989). Clinical significance of *Blastocystis hominis*. *J Clin Microbiol* **27**: 2407–9.
- Jeddy TA, Farrington GH (1991). *Blastocystis hominis* complicating ulcerative colitis. *J R Soc Med* **84**: 623.
- Johnson AM, Thanou A, Boreham PFL, Baverstock PR (1989). *Blastocystis hominis*: phylogenetic affinities determined by rRNA sequence comparison. *Exp Parasitol* **68**: 283–8.
- Kain KC, Noble MA, Freeman HJ, Barteluk RL (1987). Epidemiology and clinical features associated with *Blastocystis hominis* infection. *Diagn Microbiol Infect Dis* **8**: 235–44.
- Keenan TW, Huang CM, Zierdt CH (1992). Comparative analysis of lipid composition in axenic strains of *Blastocystis hominis*. *Comp Biochem Physiol* **102B**: 611–15.
- Keenan TW, Zierdt CH (1994). Lipid biosynthesis by axenic strains of *Blastocystis hominis*. *Comp Biochem Physiol* **107B**: 525–31.
- Kobayashi J, Hasegawa H, Forli AA *et al.* (1995). Prevalence of intestinal parasitic infection in five farms in Holambra, São Paulo, Brazil. *Rev Inst Med Trop São Paulo* **37**: 13–18.
- Kruger K, Kamilli I, Schattenkirchner M (1994). *Blastocystis hominis* infection—a rare cause of arthritis. *Z Rheumatol* **53**: 82–5.
- Kukoschke K-G, Müller HE (1991). SDS-PAGE and immunological analysis of different axenic *Blastocystis hominis* strains. *J Med Microbiol* **35**: 35–9.
- Kukoschke K-G, Müller HE (1992). Varying incidence of *Blastocystis hominis* in cultures from faeces of patients with diarrhoea and from healthy persons. *Z Bakteriologie* **277**: 112–18.
- Kukoschke K-G, Necker A, Müller HE (1990). Detection of *Blastocystis hominis* by direct microscopy and culture. *Eur J Clin Microbiol Infect Dis* **9**: 305–7.
- Lai KPF (1992). Intestinal protozoan infections in Malaysia. *SE Asian J Trop Med Publ Health* **23**: 578–86.
- Lakhanpal S, Cohen SB, Fleischmann RM (1991). Reactive arthritis from *Blastocystis hominis*. *Arthritis Rheum* **34**: 251–3.
- Lambert M, Gigi J, Bughin C (1992). Persistent diarrhoea and *Blastocystis hominis*. *Acta Clin Belg* **47**: 129–30.
- LeBar WD, Larsen EC, Patel K (1985). Afebrile diarrhea and *Blastocystis hominis*. *Ann Intern Med* **103**: 306.
- Lee MG, Rawlins SC, Didier M, DeCeulaer K (1990). Infective arthritis due to *Blastocystis hominis*. *Ann Rheum Dis* **49**: 192–3.
- Libanore M, Rossi MR, Scaglione L, Garavelli PL (1991). Outbreak of blastocystosis in institution for the mentally retarded. *Lancet* **337**: 609–10.
- MacPherson DW, MacQueen WM (1994). Morphological diversity of *Blastocystis hominis* in sodium acetate–acetic acid–formalin preserved stool samples stained with iron hematoxylin. *J Clin Microbiol* **32**: 267–8.
- Mai Nguyen X, Krech T (1989). *Blastocystis hominis*, ein parasitärer Durchfallerreger. *Schweiz Med Wochenschr* **119**: 457–60.
- Mangali A, Sasabone P, Syafruddin AK *et al.* (1993). Intestinal parasitic infections in Campalagian District, South Sulawesi, Indonesia. *SE Asian J Trop Med Publ Health* **24**: 313–20.
- Mansour NS, Mikhail EM, El Masry NA, Sabry AG, Mohareb EW (1995). Biochemical characterisation of human isolates of *Blastocystis hominis*. *J Med Microbiol* **42**: 304–7.
- Markell EK (1995). Editorial: Is there any reason to continue treating *Blastocystis* infections? *Clin Infect Dis* **21**: 104–5.
- Markell EK, Udkow MP (1986). *Blastocystis hominis*: pathogen or fellow traveler? *Am J Trop Med Hyg* **35**: 1023–6.
- Markell EK, Udkow MP (1990). Association of *Blastocystis hominis* with human disease? *J Clin Microbiol* **28**: 1085.
- Matsumoto Y., Yamada M, Yoshida Y (1987). Light-microscopical appearance and ultrastructure of *Blastocystis hominis*, an intestinal parasite of man. *Zentralbl Bakteriologie Microbiol Hyg A* **264**: 379–85.
- Mehlhorn H (1988). *Blastocystis hominis*, Brumpt 1912: are there different stages or species? *Parasitol Res* **74**: 393–5.
- Mendis L, Kumarasinghe G, Chow C *et al.* (1995). Bacteria, viruses, yeasts and protozoans associated with diarrheal disease in Singapore. *Pathology* **27**: 48–52.
- Miller RA, Minshew BH (1988). *Blastocystis hominis*: an organism in search of a disease. *Rev Infect Dis* **10**: 930–8.
- Moe KT, Singh M, Howe J *et al.* (1996). Observations on the ultrastructure and viability of the cystic stage of *Blastocystis hominis* from human feces. *Parasitol Res* **82**: 439–44.
- Morgan D, Whitworth J, Eotu H, Omoding N, Moore M (1996). Gastrointestinal parasite infections. *Lancet* **348**: 965–7.
- Müller H (1994). Four serologically different groups within the species *Blastocystis hominis*. *Z Bakteriologie* **280**: 403–8.
- Narkewicz MR, Janoff EN, Sokol RJ, Levin MH (1989). *Blastocystis hominis* gastroenteritis in a hemophiliac with acquired immune deficiency syndrome. *J Pediatr Gastroenterol Nutr* **8**: 125–8.
- Nimri LF (1993). Evidence of an epidemic of *Blastocystis hominis* infections in preschool children in northern Jordan. *J Clin Microbiol* **31**: 2706–8.
- Nimri L, Batchoun R (1994). Intestinal colonization of symptomatic and asymptomatic schoolchildren with *Blastocystis hominis*. *J Clin Microbiol* **32**: 2865–6.
- Pikula ZP (1987). *Blastocystis hominis* and human disease. *J Clin Microbiol* **25**: 1581.
- Ok ÜZ., Cirit M, Üner A *et al.* (1996). Cryptosporidiosis and blastocystosis in renal transplant recipients. *Nephron* **75**: 171–4.

- Rothman KJ, Greenland S (1997). Causation and Causal Inference. In Rothman KJ (ed.), *Modern Epidemiology*, 2nd edn. Lippincott-Raven: Philadelphia, PA; 7–28.
- Sanad MM, Darwish RM, Yousef SM, Nassef NE (1991). *Blastocystis hominis*: laboratory identification and clinical relevance. *J Trop Med* **1**: 61–70.
- Salminen S, Isolauri E, Onnela T (1995). Gut flora in normal and disordered states. *Chemotherapy* **41** (1): 5–15.
- Sargeant PG, Williams JE (1979). Electrophoretic isoenzyme patterns of the pathogenic and non-pathogenic intestinal amoebae of man. *Trans R Soc Trop Med Hyg* **73**: 225–7.
- Schwartz E, Houston R (1992). Effect of co-trimoxazole on stool recovery of *Blastocystis hominis*. *Lancet* **339**: 428–9.
- Sheehan JP, Ulchaker MM (1990). *Blastocystis hominis* treatable cause of diabetic diarrhea. *Diabet Care* **13**: 906–7.
- Silberman JD, Sogin ML, Leipe DD, Clark CG (1996). Human parasite finds taxonomic home. *Nature* **380**: 398.
- Singh M, Suresh K, Ho LC, Ng GC, Yap EH (1995). Elucidation of the life cycle of the intestinal protozoan *Blastocystis hominis*. *Parasitol Res* **81**: 446–50.
- Stenzel DJ, Boreham PFL (1991). A cyst-like stage of *Blastocystis hominis*. *Int J Parasitol* **21**: 613–15.
- Stenzel DJ, Boreham PFL (1996). *Blastocystis hominis* revisited. *Clin Microbiol Rev* **9**: 563–84.
- Stenzel DJ, Boreham PFL, McDougall R (1991). Ultrastructure of *Blastocystis hominis* in human stool samples. *Int J Parasitol* **21**: 807–12.
- Sun T, Katz S, Tanenbaum B, Schenone C (1989). Questionable clinical significance of *Blastocystis hominis* infection. *Am J Gastroenterol* **84**: 1543–7.
- Suresh K, Howe J, Chong SY *et al.* (1994). Ultrastructural changes during *in vitro* encystment of *Blastocystis hominis*. *Parasitol Res* **80**: 327–35.
- Swellengrebel NH (1917). Observations on *Blastocystis hominis*. *Parasitology* **9**: 451–9.
- Udkow MP, Markell EK (1993). *Blastocystis hominis*: prevalence in asymptomatic versus symptomatic hosts. *J Infect Dis* **168**: 242–4.
- Upcroft JA, Dunn LA, Dommett LS, Healey A, Upcroft P, Boreham PFL (1989). Chromosomes of *Blastocystis hominis*. *Int J Parasitol* **19**: 879–83.
- Vannatta JB, Adamson D, Mullican K (1985). *Blastocystis hominis* infection presenting as recurrent diarrhea. *Ann Intern Med* **102**: 495–6.
- Waghorn DJ, Hancock P (1991). Clinical significance of *Blastocystis hominis*. *Lancet* **337**: 609.
- Yang LQ, Singh M, Yap EH, Ng GC, Xu HX, Sim KY (1996). *In vitro* response of *Blastocystis hominis* against traditional Chinese medicine. *J Ethnopharmacol* **55**: 35–42.
- Yoshikawa H, Satoh J, Enose Y (1995). Light and electron microscopic localization of lipids in *Blastocystis hominis*. *J Electron Microsc* **44**: 100–3.
- Zaki M, Daoud AS, Pugh RNH, Al-Ali F, Al-Mutairi G, Al-Saleh Q (1991). Clinical report of *Blastocystis hominis* infection in children. *J Trop Med Hyg* **94**: 118–22.
- Zaki M, Zaman V, Ali Sheikh N (1996). Resistance of *Blastocystis hominis* cysts to chlorine. *J Pak Med Assoc* **46**: 178–9.
- Zaman V, Khan KZ (1994). A comparison of direct microscopy with culture for the diagnosis of *Blastocystis hominis*. *SE Asian J Trop Med Publ Health* **25**: 792–3.
- Zaman V, Khan KZ, Khan MA, Khan MA (1994). Isolation of *Blastocystis hominis* from sewage. *SE Asian J Trop Med Publ Health* **25**: 211.
- Zierdt CH (1973). Studies of *Blastocystis hominis*. *J Protozool* **20**: 114–21.
- Zierdt CH (1983). *Blastocystis hominis*, a protozoan parasite and intestinal pathogen of human beings. *Clin Microbiol Newsl* **5**: 57–9.
- Zierdt CH (1986). Cytochrome-free mitochondria of an anaerobic protozoan—*Blastocystis hominis*. *J Protozool* **33**: 67–9.
- Zierdt CH (1988). *Blastocystis hominis*, a long-misunderstood intestinal parasite. *Parasitol Today* **4**: 15–17.
- Zierdt CH (1991). *Blastocystis hominis*—past and future. *Clin Microbiol Rev* **4**: 61–79.
- Zierdt CH, Donnelly CT, Muller J, Constantopoulos G (1988). Biochemical and ultrastructural study of *Blastocystis hominis*. *J Clin Microbiol* **26**: 965–70.
- Zierdt CH, Rude WS, Bull BS (1967). Protozoan characteristics of *Blastocystis hominis*. *Am J Clin Pathol* **48**: 495–501.
- Zierdt CH, Swan JC, Hosseini J (1983). *In vitro* response of *Blastocystis hominis* to antiprotozoal drugs. *J Protozool* **30**: 332–4.
- Zierdt CH, Tan HK (1976). Ultrastructure and light microscope appearance of *Blastocystis hominis* in a patient with enteric disease. *Z Parasitenkd* **50**: 277–83.
- Zierdt CH, Williams RL (1974). *Blastocystis hominis*: axenic cultivation. *Exp Parasitol* **36**: 233–43.
- Zierdt CH, Zierdt WS, Nagy B (1995). Enzyme-linked immunosorbent assay for detection of serum antibody to *Blastocystis hominis* in symptomatic infections. *J Parasitol* **81**: 127–9.



# Schistosomiasis

G. Richard Olds<sup>1</sup> and Srinivasan Dasarathy<sup>2</sup>

<sup>1</sup>*Medical College of Wisconsin, Milwaukee, WI, and* <sup>2</sup>*Case Western Reserve University, Cleveland, OH, USA*

## HISTORY

The earliest descriptions of schistosomiasis are found in the *Papyrus Ebers* of ancient Egypt (Girges, 1934). The ancient Assyro-Babylonian literature alludes to a worm disease associated with urinary bleeding. It was not, however, until the nineteenth century that a systematic attempt was made to understand the basic life-cycle and pathogenesis of disease.

The German pathologist Theodor Bilharz is credited with the first description of the adult worm, which he found in the portal vein of a young man at autopsy (Bilharz, 1853a). In retrospect, it is unclear whether Bilharz was describing *S. mansoni* or *S. haematobium*, since he described eggs with a terminal spine. His communication in 1851 to von Freholdtz, his professor, was presented in a meeting at Breslau in 1853. He also described the characteristic pathologic changes and clinical features of schistosomiasis (Bilharz, 1853b, 1856). Bilharz named the worm *Distomium haematobium*. Wienland and Cobbald suggested the name *Schistosoma* in 1858 because of the observation that only one of the two suckers of the *Distomium* led into the oral cavity (Cobbald, 1859; Warren, 1973a). 'Schisto' was used to describe the cleft in the female and 'soma' for the body of the enveloped male worm. Although the term 'bilharzia' has been used throughout Europe and the Middle East, the official scientific

nomenclature has been 'schistosomiasis' since 1864.

## INTRODUCTION

Schistosomiasis is among the oldest known infections of man. Evidence for human infection with these parasites can be found in mummified remains from ancient Egypt and China (Girges, 1934). The macroscopic size of the adult worms allowed full descriptions of both the life cycle and the end-organ pathology of the disease by the early 1900s. Schistosomiasis historically has been a disease confined to the tropical rural poor. Its geographic distribution has been determined primarily by the distribution of the snail intermediate hosts. Human infection was characteristically chronic and resulted in significant end-organ damage (liver fibrosis and kidney failure) in a small subset of the infected population.

During the twentieth century, significant changes have taken place in the geographic distribution of infection. Through improvements in health and sanitation, schistosomiasis has been largely eliminated as a public health problem from Japan, Taiwan, and several Caribbean islands, while massive snail control programs eliminated transmission in the lower Yangtze River Valley of China. The development of effective chemotherapy and its implementation

through national control programs has changed the prevalence as well as the natural history of schistosomiasis in Egypt, Morocco, China, Brazil, The Philippines and several smaller countries in the Middle East. Schistosomiasis today in these countries is characterized by recurrent acute infections followed by parasitologic cure.

In contrast to this significant progress, dam and irrigation projects have increased the natural habitat of the snail intermediate host and today schistosomiasis is widely endemic in many new locations in Africa, such as Senegal and Ghana, as well as in central China. Where economic resources do not allow organized national control efforts, severe end-organ disease remains common. Finally, evidence suggests the development of drug resistance to the single most effective drug available, praziquantel, raising concerns about the sustainability of current efforts.

In industrialized countries, schistosomiasis remains a rare disease, occasionally encountered in immigrants from and travelers in endemic areas of the world. In this setting, it is critical to consider schistosomiasis in the differential diagnosis of individuals with hepatosplenic enlargement, bleeding esophageal varices or unusual bladder pathology. This is particularly relevant today, since curative treatment is available and much of the parasite-induced pathology is reversible.

Finally, as we look forward, it appears that schistosomiasis will remain an important global health problem for the foreseeable future. Drug treatment alone appears to be insufficient to eliminate all schistosome-induced morbidity or to dramatically affect transmission. Hopefully, through major new initiatives, a safe and effective vaccine can be developed during the early twenty-first century to continue progress toward eradication.

A report by Harley (1864) in South Africa referred to two *Bilharzia* species causing hematuria. It is interesting to note that Harley believed that one of his patients had acquired his disease in Nagasaki, Japan (Harley, 1864). In 1902, Manson described a West Indian form of intestinal schistosomiasis (*S. mansoni*). In 1907, two species of schistosomiasis were identified based on egg morphology, one with a terminal

spine (*S. haematobium*) and another (*S. mansoni*) with a lateral spine (Sambon, 1909). Although Bilharz is generally credited with the discovery of schistosomiasis, Fujii, in the district of Katayama, Japan, described Katayama fever, an acute form of schistosomiasis, even earlier (Fujii and Matsubayashi, 1847). This acute febrile illness was followed by portal hypertension and death. Fujii did not, however, describe the adult worm or the eggs of the parasite.

In 1904, Katsurada discovered the adult worms of *S. japonicum* in a cat and then in man. Miyairi and Suzuki (1913, 1914) discovered the snail intermediate host of the Far Eastern species and the life-cycle in molluscs. British naval physicians, Leiper and Atkinson, stationed in Shanghai prior to World War I, described in 1915 the complete life-cycle of *S. japonicum* in mammalian hosts (Leiper and Atkinson, 1915; Leiper, 1915a, b, c). By 1918, it was clear that the three schistosome species had different mollusc intermediate hosts and their unique individual life-cycles had been fully described.

Although both Fujii and Bilharz had described some clinical and pathologic aspects of schistosomiasis, it was not until the turn of the century that the complete spectrum of human disease caused by this parasite was understood. In 1904, Symmers described clay pipe stem fibrosis, which he related to the deposition of schistosome eggs in the liver. It is interesting to note that Symmers, like Bilharz before him, was describing the eggs of *S. haematobium*, not the far more common *S. mansoni* ova which more characteristically cause 'Symmers' fibrosis. In 1924, Day definitively demonstrated the schistosomal etiology for this peculiar form of hepatic fibrosis. In 1911, Ferguson suggested the now well-established association of schistosomiasis with cancer of the urinary bladder.

In 1919, Cort described the unique morphology of cercariae. Pulmonary schistosomiasis was described by Shaw and Ghareeb in 1938 in Egypt while referring to an earlier description by Day. In 1928, Cort coined the term 'schistosome dermatitis' to describe the early stage of cercarial skin penetration. Katayama fever was again described by American and British physicians living in China during this same period (Warren, 1973a). They embellished the original description by Fujii. Cerebral schistosomiasis was described

initially in 1889 by Yamagiwa. In 1948, based on experience among World War II veterans in the USA, 27 new cases were described (Kane and Most, 1948).

Progress on the prevention of disease was begun before the entire life-cycle had been described. In 1913, Fujinami and Natabyashi from Japan suggested three prerequisites for control/prophylaxis: (a) prevent entry of the organism through the skin; (b) eradicate the source of the organism by eliminating infected animals; and (c) eliminate or control the snail. These remained the basic tenets of control until the 1960s. By reproducible and repeated experiments, Fujinami and Natabyashi (1913) showed that lime mixed with infected water killed cercariae and protected experimental animals from disease. After the identification of the mollusc intermediate host by Niyain and Suzuki, molluscicides became the major means of disease control in both Africa and Asia (Warren, 1973a). Initial use of copper sulphate was followed by sodium pentachlorophosphate and finally Bayluscide (Warren, 1973a; Goennert and Schraufstaetter, 1959). Biological means of control were tried in several countries, using competitive snails, without significant success (Michelson, 1957). Finally, advances in sanitation and public health awareness, as well as altered farming practices, were used successfully in countries such as Japan and Taiwan. Unfortunately, this same approach was largely unsuccessful in Egypt and The Philippines.

No treatment was available for any form of schistosomiasis until after World War II. Christopherson (1918) described the first successful use of antimony-containing tartar emetic as an intravenous injection. In 1948, miracil, which was less toxic and could be administered intramuscularly, was used in the treatment of schistosomiasis (Kikuth and Goennert, 1948). In 1954, stibophen and antimony dimercaptosuccinate were reported to be successful when given intramuscularly (Mansour and Bueding, 1954). The toxicity for all these drugs was high and reinfection universal. It was not until the 1960s that new, safer, oral drugs were developed. These included metrifonate for *S. haematobium* (1960), niridazole (1964), hycanthone (1965), oxamniquin (1969) and finally praziquantel in 1977 (Shekhar, 1991).

The classic study on schistosomiasis control took place in St Lucia in the 1960s (Goodfield, 1985). *Schistosoma mansoni* had been brought to the New World with the slave trade of the fifteenth century. Brazil and several Caribbean islands became highly endemic. In 1965, the Rockefeller Foundation sponsored an island-wide experiment in St Lucia in which snail control, chemotherapy of infected humans and control of the fresh water supply were tried in three distinct valleys of the island. Following almost a decade of work, it was concluded that neither snail control nor improvements in the fresh water supply could control the disease alone. The development of safe and effective treatment, toward the end of this experiment, appeared the best hope for control. Following this work, chemotherapy became the mainstay for national control programs, augmented by snail control, improvements in health and sanitation facilities and health education of the populus.

## DESCRIPTION OF THE ORGANISM

Human schistosomiasis is caused by five species (Table 16.1), each with its own unique epidemiology and geographic range (Elliott, 1996b). The adult schistosomes live as worm pairs (male and female) and are approximately 1–2 cm long. They are elongated and cylindrical, perhaps as an adaptation to living in vascular channels. They have oral and ventral suckers (Webbe, 1982b). The most important sources of energy for the parasites are carbohydrates and incompletely degraded organic acids, such as lactic, acetic and propionic acids. Adult schistosomes also digest red blood cells, which they break down using a unique hemoglobinase. The adult worm pairs live within the human vasculature, where they have evolved elaborate mechanisms to avoid host immune destruction.

The female of the genus has longitudinal outfoldings that form a gynecophoral canal in which the filiform male is clasped (Figure 16.1). Adults and the eggs of various species differ morphologically (Mahmoud *et al.*, 1990). Speciation (i.e. identifying the species) is generally performed by reference to the characteristic morphology of the ova recovered from body fluids/tissues. The eggs of the major schistosome species are shown in Figure 16.1.

**Table 16.1** Characteristics of different human schistosomes

Characteristic	<i>S. japonicum</i>	<i>S. mansoni</i>	<i>S. haematobium</i>	<i>S. intercalatum</i>	<i>S. mekongi</i>
Adult worm location	Superior and inferior mesenteric veins	Inferior mesenteric veins	Vesical plexus	Inferior mesenteric veins	Superior mesenteric veins
Length of male worm (mm)	10–20	6–13	10–15	11–14	12–15
Tubercles	Absent	Absent	Coarse	Fine	Fine
Female length (mm)	20–30	10–20	15–25	10–15	10–12
Egg shape	Round	Ovoid	Ovoid	Ovoid	Round
Spine	Lateral	Lateral	Terminal	Terminal	Lateral
Size of eggs ( $\mu\text{m} \times \text{mm}$ )	$60 \times 600$	$60 \times 140$	$60 \times 150$	$60 \times 175$	$57 \times 66$
Excreted	Stool	Stool	Urine	Stool and urine	Stool
Eggs/day ( <i>n</i> )	3500	250	100	250	Unknown
Intermediate snail host	<i>Oncomelania</i>	<i>Biomphalaria</i>	<i>Bulinus</i>	<i>Bulinus</i>	<i>Tricula</i>
Site of major pathology	Liver, CNS	Liver	Urinary bladder	Liver	Liver

## Life-cycle

### Eggs and Miracidia

The life-cycle of human schistosomiasis is shown in Figure 16.2. Humans are the principal definitive host for two of the species (*S. mansoni* and *S. haematobium*), while two (*S. japonicum* and *S. intercalatum*) infect a wider range of mammals (Webbe, 1982a). It is currently not known whether non-humans are important hosts for *S. mekongi* (Voge *et al.*, 1978). Adult worms reproduce sexually in the definitive host (man) and pass characteristically shaped eggs into the environment with urine and stool (World Health Organization, 1985). In fresh water, the eggs hatch to release ciliated, motile, short-lived, free-swimming, sexually distinct (male and female) miracidia. The miracidia in turn drill through the epithelium of the appropriate snail's foot process, infecting the intermediate host (Jourdane and Théron, 1987). The parasite–snail interaction is highly specific, and only a few species of fresh-water snails will support the life-cycle of each specific schistosome species (Sobhon and Suchart, 1990). Infection with schistosomes does not normally affect the lifespan of the snail.

### Snails

The geographic distribution of schistosomiasis is highly dependent on the distribution of the intermediate hosts and an adequate opportunity

to complete the life-cycle by urine and fecal contamination of fresh water (World Health Organization, 1993). Once inside the snails, the miracidium sheds its ciliated glycocalyx and reforms into a primary sporocyst (Webbe, 1982a; Jourdane and Théron, 1987). The primary sporocyst migrates into the snail's digestive gland or matures in its foot process. Germinal cells of the sporocyst replicate (asexual multiplication, increasing parasite numbers by several logs). These replicating cells mature and bud off as secondary sporocysts, then migrate to the snail's liver and mature. This process is repeated multiple times until the snail contains many maturing sporocysts. The germinal cells mature into motile, forked-tailed, infective 0.4–0.6 mm larval forms called cercariae.

### Cercariae

Cercariae are infective to the definitive host (man). Infected snails continue to shed cercariae for many weeks. The cercariae leave the snail from the edge of the snail's mantle and enter the surrounding water. The cercariae have a discrete head and a bifurcated tail that allows locomotion. The head carries small oral and ventral suckers, flame cells and a non-functional gut. Unicellular glands near the ventral suckers secrete mucilage, which assists the parasite in attachment, while other glands (penetration glands) secrete digestive enzymes, which aid in skin penetration. The parasite is able to migrate

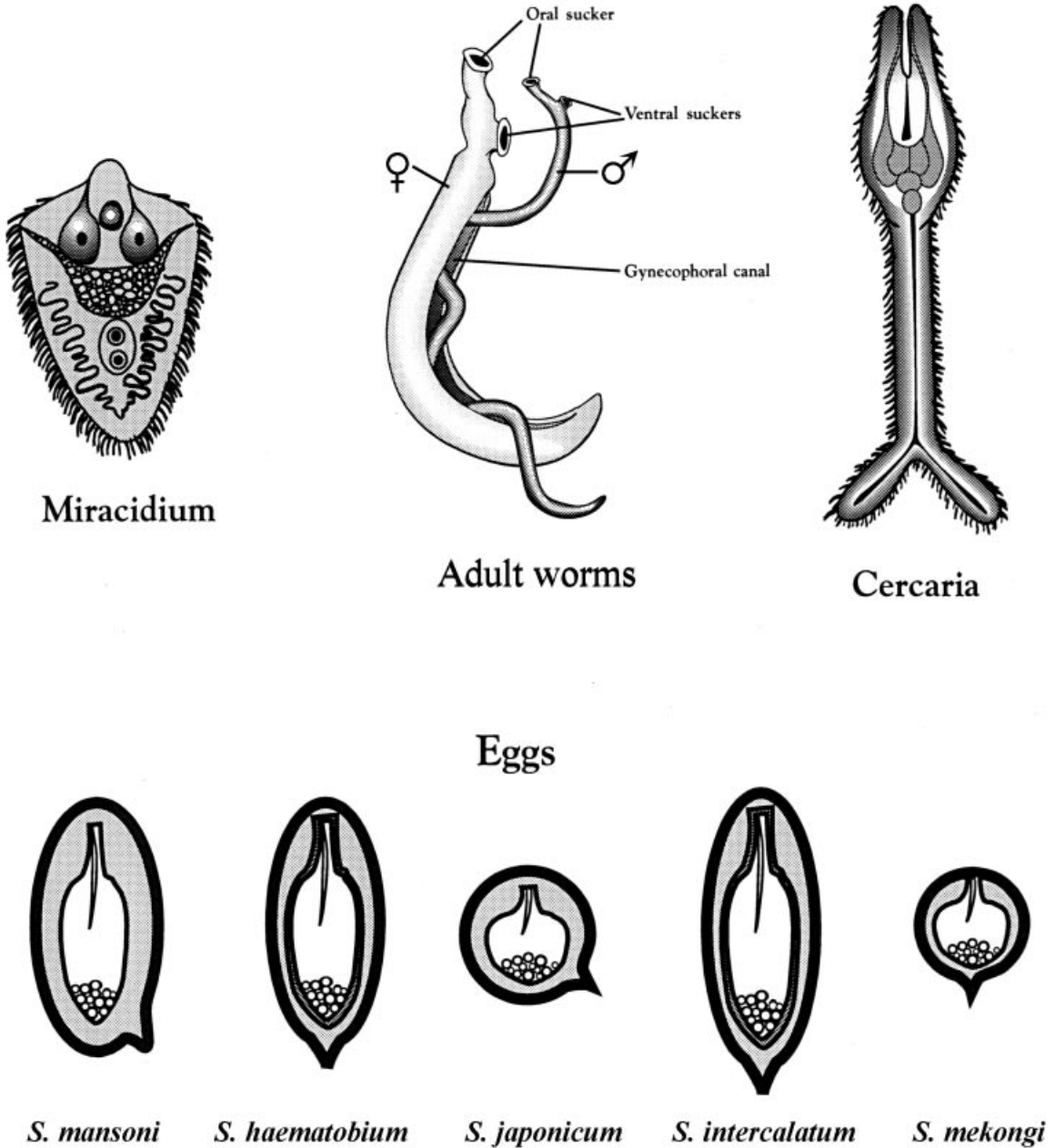


Fig. 16.1 The various stages of schistosomes

through human epidermis in 5–10 minutes. The total lifespan of a shed cercarium in fresh water is about 48 hours, but infectivity decreases dramatically after about 4 hours. Death occurs due to exhaustion of the glycogen stores (Wilson, 1987).

#### **Skin Penetration**

During penetration, the cercaria leaves its tail on the dermis, and the cercarial head penetrates into deeper structures (Figure 16.2). The parasite glycocalyx is transformed into a heptalaminate

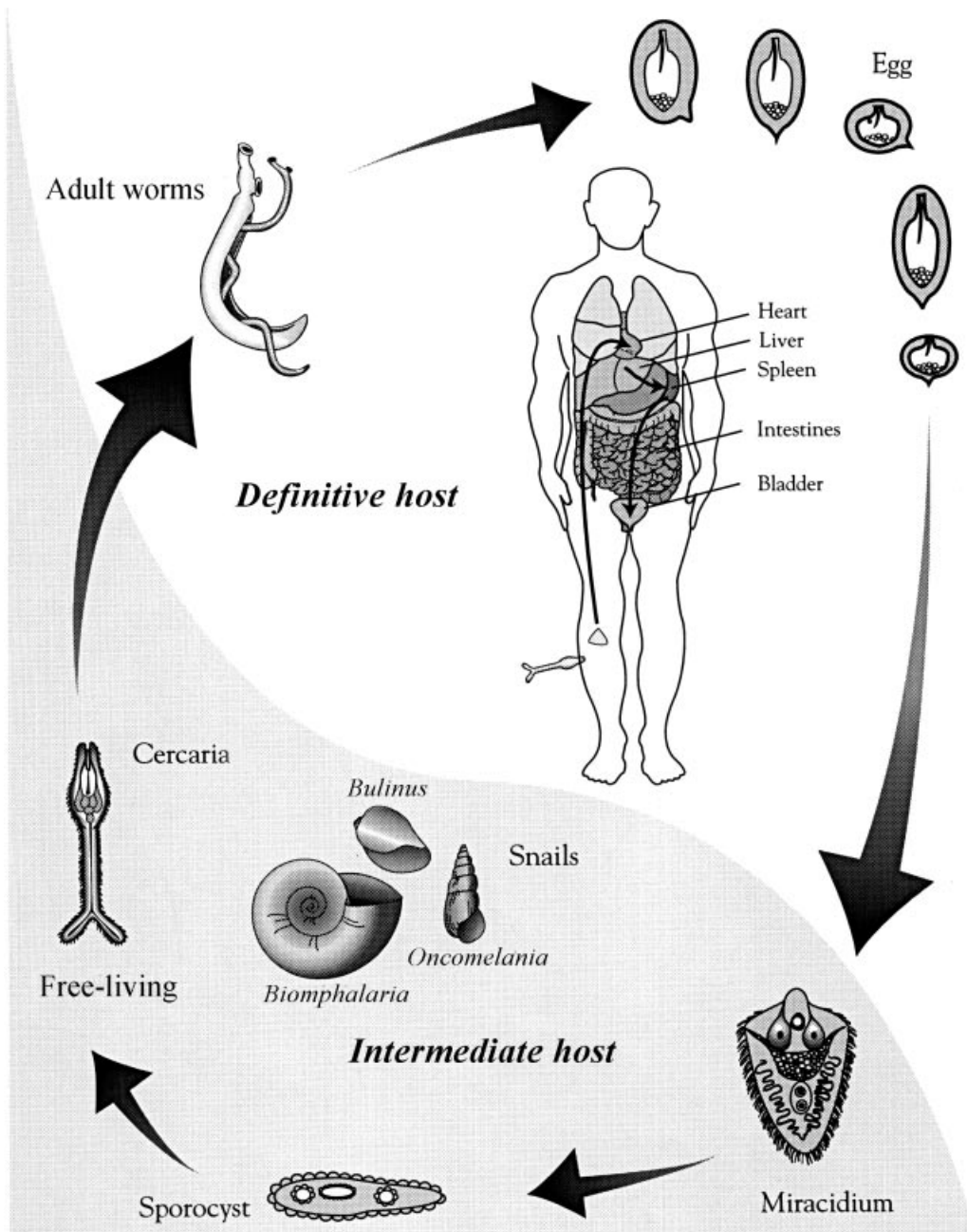


Fig. 16.2 Life-cycle of schistosomes

double lipid bilayer as part of its rapid adaptation to the definitive host (Wiest *et al.*, 1988). This transformed cercaria is then called a schistosomula. Schistosomulae take up host antigens and attach them to their surface membranes, thus preventing host immune attack.

Other mechanisms of immune evasion are described in greater detail in the section on Immunology (see below). In the first 48 hours, the schistosomula penetrates into subcutaneous tissues and migrates through the dermis to gain access into the veins and/or lymphatics (Wilson,



**Fig. 16.3** A typical village in The Philippines endemic for schistosomiasis

1987). The host range for any specific schistosomula species is often very narrow. Cercariae can penetrate a wide range of animals and even plants but rapidly die in the dermis of the wrong host. During the next 5–7 days, successful schistosomulae are transported via the heart to the lungs (Miller and Wilson, 1980).

### **Somatic Migration**

The schistosomulae migrate via the pulmonary capillaries to enter the left side of the heart and systemic circulation (Wilson, 1987; Miller and Wilson, 1980). Schistosomulae are carried with the arterial blood flow to the mesenteric arteries, splanchnic arteries and portal veins and eventually reach the appropriate venous plexus and mature. Repeated cycles through the systemic circulation may be required. This process takes

10–20 days. Each schistosomula is either male or female. After migration to the appropriate peripheral venous plexus, maturation takes place. Adult worms pair with the opposite sex and live out their lifespan together. Migration in the veins is aided by the worm's ventral and oral suckers, which are used to attach to the endothelial wall. The worm pair migrates against the mesenteric or vesical blood flow to lay their eggs. Different species tend to prefer different anatomical locations for optimal growth and survival. Thus, *S. haematobium* prefers the vesical veins, while adult *S. mansoni*, *S. japonicum*, *S. mekongi* and *S. intercalatum* worms prefer the portal circulation (Elliott, 1996b). Throughout infection, the adult worm pair migrates up and down these veins, laying eggs. *S. mansoni* prefers the colonic vasculature, while *S. japonicum* can deposit eggs throughout the length of the small and large intestine. Overlap of sites of preference for adult worms occurs, so that *S. haematobium* eggs can occasionally be found in the stool, while *S. intercalatum* and *S. mansoni* eggs have been described in the urine (Elliott, 1996b; Zwingenberger, 1990).

During migration, when the diameter of the venule becomes small enough to restrict further movement, the female often leaves the male and continues to migrate to the farthest point permitted by the worm's diameter. This minimizes backflow of ova. Adult worms induce little direct damage to the host unless they die and embolize to the liver or lungs (*S. haematobium*). The eggs, however, are capable of boring through tissue planes and generally cause microperforations in the colon and urinary bladder (von Lichtenberg, 1987).

### **Lifespan**

The lifespan of the schistosome adult worms averages 3–10 years, but survival for more than 30 years has been reported (Arnon, 1990; Christopherson, 1924). Pathology results primarily from the eggs, either through microperforation of tissue or from an exuberant host immune response to the ova (Doenhoff and Bain, 1978; Elliott, 1996b). The maximum number of eggs that can be laid daily by each worm pair depends

on the schistosome species (500 for *S. mansoni* to 5000 for *S. japonicum*). Eggs of *S. mansoni* and *S. haematobium* are released singly, while the smaller eggs of *S. japonicum* are released as aggregates of 8–10 (World Health Organization, 1985).

### Egg Release

The eggs release histolytic enzymes and a variety of antigenic macromolecules (mostly glycoproteins). Nearly half the eggs fail to reach the lumen of the bladder (with *S. haematobium*) or intestine (with all other species) and instead get trapped permanently in host tissues. All eggs in tissues induce a T lymphocyte-dependent granulomatous response (Cheever and Powers, 1971). Subsequent tissue damage occurs as an indirect result of this inflammatory reaction. The pathologic sequelae of this process are discussed in later sections. The eggshell is composed of glycine-rich protein that is highly cross-linked by tyrosine residues (Cordingley, 1987). This structure makes the eggs resistant to host protease activity and can therefore allow the maturing egg to survive aggressive host inflammatory responses for several weeks. Granuloma formation is, in fact, required for successful migration of the ova across tissue planes and into the environment with the urine or stool (Doenhoff and Bain, 1978; Doenhoff *et al.*, 1986). Animals unable to form egg granulomas around schistosome eggs (T cell-deficient animals) do not successfully secrete eggs in their stool and the ova collect in tissues, inducing only a foreign-body reaction from the host. Thus, some host inflammatory response appears to be a necessity for successful completion of the life-cycle.

Eggs gain access to the environment by urination, defecation, laundering of soiled clothing or bathing after recent defecation. The hypotonic environment of fresh water allows the eggs to hatch. When this occurs in proximity to the intermediate host (snails), the life-cycle is completed.

As a result of this complex life-cycle, schistosomiasis is not acquired by person-to-person contact. Adult schistosome worms do not multiply in the human host, which has important epi-

miologic implications. It also implies that less than 100% curative drugs or vaccines should still be highly useful in the control of the infection.

### Intermediate Hosts

Human schistosomiasis infects a very narrow range of snail hosts (Wright, 1973). *S. haematobium* and *S. intercalatum* infect snails of the *Bulinus* spp. while *S. mansoni* infects *Biomphalaria* spp. Both snails are aquatic and therefore direct water contact is required for transmission (Brown, 1980). Only a few species are capable of prolonged survival without immersion in water. Thus, most transmission occurs in areas of persistent moisture, such as rivers and lakes.

*Bulinus* and *Biomphalaria* snails do not breed well outside the tropical environment and thus limit the potential geographic range of *S. mansoni* and *S. haematobium*. In the New World, a narrow spectrum of the genus *Biomphalaria* can successfully transmit infection, and these are restricted to specific Caribbean Islands, Venezuela, Surinam, French Guyana and Brazil (Malek, 1988). This, to a large extent, explains the current endemic foci in the New World.

*S. japonicum* is transmitted by *Oncomelania* snails (Webbe, 1982b). These are amphibious snails and can survive out of water. Thus, transmission can also occur through contact with moist vegetation such as grass and reeds and on muddy surfaces. Some *Oncomelania* snails can survive harsh climatic changes, enduring prolonged dry spells and freezing winters. As a result, schistosomiasis can be found in a wide variety of habitats in China. In The Philippines, the endemic genus *Oncomelania* requires continuous moisture and thus infection is restricted to the eastern islands, where continuous rainfall occurs (Figure 16.3). The intermediate hosts of *S. mekongi* are fully aquatic and have a range restricted to the Mekong River Basin in south-east Asia.

Cercarial production also varies between the schistosome species and specific snail hosts (Meulemann, 1972). Large South American *Biophilia* snails can shed 2000–4000 cercariae/day, while many *Oncomelania*, infected with *S. japonicum*, shed less than 20 cercariae/day.



Light is the major stimulus for cercarial shedding for all species. Most species maximally shed cercariae in mid- to late morning, which results in optimal human transmission (Pesigan *et al.*, 1958). Some *S. japonicum* species shed cercariae maximally late in the afternoon and occasionally at night, perhaps as an adaptation to maintenance in rodent definitive hosts (Webbe, 1982a; Rollinson *et al.*, 1986).

### Alternative Hosts

*S. mansoni* and *S. haematobium* are restricted in nature to humans. Some epidemiological evidence suggests that baboons can transmit *S. haematobium* infection in the wild (Fenwick, 1969). Rats, mice and a variety of other mammals can be infected experimentally, but under natural conditions appear not to be an important reservoir in transmission to humans (Cheng, 1971; Rollinson *et al.*, 1986). Infection of young dogs may play a minor role in the transmission of *S. mansoni* in Africa (Bruce *et al.*, 1980). In Brazil, the *Nectomys* species of rodent appears to maintain infection in some areas (Rollinson and Southgate, 1987).

*S. japonicum* has a broad host range. Wild rodents appear to maintain infection in some endemic areas. A variety of domestic animals are also important to transmission, including dogs, pigs and, most importantly, cattle and cariboo (Pesigan *et al.*, 1958). In The Philippines and China, the latter two animals are critical reservoirs of infection, particularly in rice-growing areas, where cariboo are involved extensively in agriculture (Cheng, 1971).

## EPIDEMIOLOGY

### Geographical Distribution

Schistosomiasis is one of the world's major health problems. In 1993, the World Health Organization estimated that at least 200 million people in 74 countries were infected, and at least 600 million more are at risk (World Health Organization, 1994, 1996). *S. mansoni* is endemic throughout Africa and the Middle East. It was brought in the fifteenth and sixteenth centuries to

South America and the Caribbean by the slave trade. *S. haematobium* is confined to Africa and the Middle East, while *S. japonicum* and *S. mekongi* are found only in Asia (Doumenge *et al.*, 1987). A map of the geographic distribution of schistosomiasis is shown in Figure 16.4 and Table 16.2 lists specific endemic countries (World Health Organization, 1987, 1993).

### Transmission

Transmission of schistosomiasis depends on human contact with fresh water, the presence of a specific snail species capable of completing the schistome life-cycle, and contamination of fresh water with human waste. In endemic areas, the highest prevalence and intensity of infection occurs in adolescents, 10–16 years of age (Davis, 1985). Males generally have a much higher prevalence and intensity than females, presumably through higher water contact. It is common to have marked variations in prevalence rates, even in nearby communities. It is not uncommon, for example, to have a village with a community prevalence of 30–40% located within a few miles of another village with little or no infection. In communities with a population of more than 1000, it is not uncommon to have one or two 'hot spots' where prevalence may be high only for a cluster of a few families. This is due to the microtransmission dynamics created by the overlap of contributing factors (snails, contamination and human contact with water). High-prevalence areas have a greater frequency of patients with heavy infections. In *S. mansoni* and *S. haematobium* endemic communities, there is often a sharp drop-off in the prevalence and intensity in adults over 25 years of age (Jordan and Webbe, 1993). This is partially explained by decreased water contact. Many investigators believe that this epidemiologic pattern also results from the slow development of acquired resistance to reinfection over time (Macdonald, 1965; Butterworth, 1998). This age distribution (peak in adolescence) is not seen, for example, in some populations who relocate to schistosomiasis endemic areas (Stelma *et al.*, 1993; Butterworth, 1998).

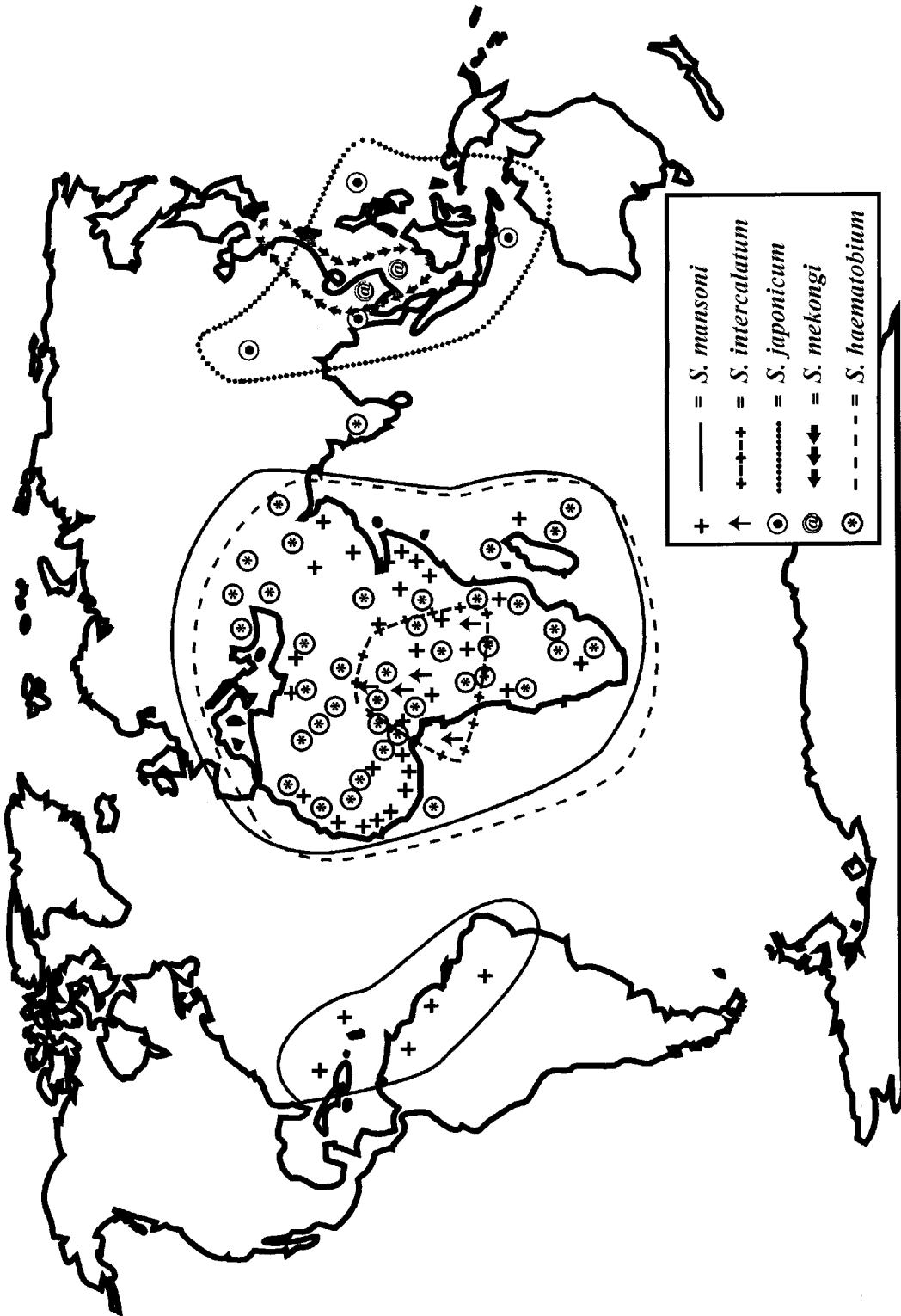


Fig. 16.4 A world map with the current distribution of various schistosomes

**Table 16.2** Geographic location of different *Schistosoma* species\*

	<i>S. japonicum</i>	<i>S. mansoni</i>	<i>S. haematobium</i>	<i>S. intercalatum</i>	<i>S. mekongi</i>
Asia, Orient	China, Indonesia, The Philippines, Thailand	Not reported	India	Not reported	Cambodia, Laos
Europe, Middle-East	Not reported	Egypt, Libya, Morocco, Oman, Saudi Arabia, Somalia, Sudan, Yemen	Egypt, Iran, Iraq, Jordan, Lebanon, Libya, Morocco, Saudi Arabia, Somalia, Syria, Turkey	Not reported	Not reported
Americas	Not reported	Brazil, Dominican Republic, Puerto Rico, Suriname, Venezuela	Not reported	Not reported	Not reported
Africa	Not reported	Angola, Botswana, Burundi, Cameroon, Central Africa, Chad, Congo, Ethiopia, Gambia, Ghana, Guinea, Ivory Coast, Kenya, Liberia, Madagascar, Malawi, Mozambique, Niger, Nigeria, Rwanda, Senegal, Sierra Leone, South Africa, Uganda, Democratic Republic of Congo (formerly Zaire), Zambia, Zanzibar, Zimbabwe	Algeria, Angola, Botswana, Cameroon, Central Africa, Chad, Congo, Ethiopia, Gambia, Ghana, Guinea, Ivory Coast, Kenya, Liberia, Madagascar, Malawi, Mali, Mauritius, Mozambique, Namibia, Niger, Nigeria, Rwanda, Senegal, Sierra Leone, South Africa, Uganda, Democratic Republic of Congo (formerly Zaire), Zambia, Zanzibar, Zimbabwe	Cameroon, Central Africa, Chad, Congo, Gabon, Nigeria, Democratic Republic of Congo (formerly Zaire)	Not reported

Data from World Health Organization, 1993.

In *S. japonicum*, water contact is often continuous, due to the important linkage between rice farming and exposure. In these populations, a high prevalence of infection can be seen in all age groups above age 6 years (World Health Organization, 1985). The intensity of infection, however, often reaches its peak in the same 12–16 year age range and then declines. This has similar implications for the probable development of at least partial immunity to reinfection. In one large longitudinal study from The Philippines, individuals previously infected and cured of a schistosome infection appeared to acquire a second infection slower than age- and sex-matched controls living in the same village (Olveda *et al.*, 1996). These observations again

suggest that prior immunologic experience with the parasite induces some degree of resistance to newly invading cercariae (Butterworth, 1998).

### Occupational Risk

Some specific occupations are strongly associated with schistosome infections in endemic regions. These include farming, fishing (fresh water) and working in irrigation canals. Performing laundry or other domestic activities in open bodies of water are also considered high-risk. The presence of piped water significantly reduces the risk of

infection, as does the availability of pit latrines (Hairston, 1973; Wilkins, 1987b).

In addition to the marked micro-ecologic characteristics of the infection, the degree of morbidity induced by infection is also highly variable. Communities in which the prevalence, intensity and duration of exposure appear similar often have marked differences in morbidity. In one study from Kenya, for example, the village prevalence of hepatosplenic enlargement differed dramatically between villages despite similar exposure to the parasite (Fulford *et al.*, 1991). Regional variation in morbidity has also been reported in China with *S. japonicum* (Warren *et al.*, 1983; Wiest *et al.*, 1992; World Health Organization, 1994). Whether this is due primarily to other co-morbid conditions or genetic variability in either the parasite or the host is currently unknown. Some experimental evidence exists for all three hypotheses.

The implementation of large national control programs has also changed the epidemiology of schistosomiasis. The most successful control programs have occurred in the Americas, the Middle East and Asia, so that today over 80% of cases of schistosomiasis are now found in sub-Saharan Africa. In these countries, the historic

epidemiology of infection and disease is found. In countries with active control programs, access to health care, compliance and participation in primary schools now greatly influence the persistence of infection within a population. In these countries, schistosomiasis is increasingly characterized by recurrent acute infections.

## PATHOLOGY

The various lesions due to schistosomes are primarily related to egg granuloma formation and the locations of these granulomas (Table 16.3).

### Egg Granuloma

The major pathologic lesion in schistosomiasis is the granulomatous response observed around eggs trapped in tissues (von Lichtenberg, 1987). Each egg contains a growing miracidium, which secretes large quantities of enzymatically active and immunologically stimulating antigens as they mature. These antigens, often referred to as

**Table 16.3** Major pathology and sites of disease in schistosomiasis

	<i>S. japonicum</i>	<i>S. mansoni</i>	<i>S. haematobium</i>	<i>S. intercalatum</i>	<i>S. mekongi</i>
Urinary bladder	–	–	Sandy patches, granuloma, vesical ulcers, bladder polypoid lesions, calcified bladder	Rare: usually due to hybridization with <i>S. haematobium</i>	?
Ureter	–	–	Less frequent than bladder. Lesions similar to bladder lesions	–	?
Liver	Hepatosplenomegaly. Presinusoidal portal hypertension (variceal bleeding)	Hepatic involvement in heavy infection	Hepatic involvement occasionally in heavy infection	Similar to <i>S. mansoni</i> but less severe	? related to co-infection with other parasites
Gastrointestinal tract	Involvement of both small and large intestines with polypoidal lesions	Primarily restricted to colonic polyposes	Occasional involvement with heavy infection	Restricted to colonic ulceration and infiltration of mucosa	Similar to <i>S. japonicum</i>
Ectopic lesions	Central nervous system lesions	Spinal cord involvement		Unknown	Unknown
Pulmonary	Second most frequent site of egg location. Cor pulmonale rare	Pulmonary hypertension and cor pulmonale	Rarely pulmonary arteritis, cor pulmonale	Unknown	Unknown

soluble egg antigens (SEA), induce both humoral and cellular immune responses in the host (Warren, 1973b). Within the egg granulomas, focal areas of necrosis are found, with deposition of eosinophilic hyaline material known as the 'Hoepli phenomenon' (Smith and von Lichtenberg, 1967). Central necrosis and perivascular eosinophilic material decrease over time, with epithelioid cells replacing the leukocytes. Finally, a pseudotubercle is formed with foreign body giant cells surrounding the dead egg (Cheever and Powers, 1971; Elliott, 1996b). Dead eggs may calcify (particularly in *S. japonicum*) or disappear completely.

The outcome of this granulomatous process ranges from complete healing without residua, to scarring of intestinal or vesical walls progressing to dense deposits of collagen in the liver and bladder (von Lichtenberg, 1987). Exuberant granulomatous inflammation and adjacent tissue damage is particularly common during acute infections or reinfections. During chronic infection, most infected hosts appear to downregulate and refine granulomatous inflammation, a process termed 'immune modulation' (Boros *et al.*, 1975; Olds and Stavitsky, 1986). This results in less adjacent tissue injury but continued efficient egg destruction. This beneficial immunologic adjustment has been studied extensively in the mouse model and is immunologically mediated. Mimicking this process artificially forms the basis of several 'anti-disease' experimental vaccines (Bergquist and Colley, 1998). Despite these modulating forces, dense deposits of collagen and glycosaminoglycans can be found in many older adults chronically exposed to this parasite. This accumulation of extracellular matrix causes the major pathologic lesions observed in chronic schistosomiasis: obstruction to portal blood flow, bleeding esophageal varices and urinary obstruction.

### Intestinal Pathology

The adult worms of *Schistosoma mansoni*, *S. japonicum* and *S. mekongi* live in the mesenteric veins, and therefore eggs of these species primarily affect the gut and liver. Less than half of the eggs produced escape in the feces to

continue the life-cycle. As the ova transit the intestinal wall, they elicit a strong granulomatous reaction, ultimately leading to fibrotic, irregular thickening of the bowel wall (Prata, 1978). Eggs in the mucosa and submucosa of the colon and small intestine may produce confluent intestinal mucosal ulceration (Cheever *et al.*, 1978). Inflammatory pseudopolyps of the colon may occur with *S. mansoni* infection and probably represent a particularly exuberant immunologic response to the parasite eggs (El-Masry *et al.*, 1986). These polyps are non-adenomatous with ulcerated surface mucosa and dense eosinophilic and mononuclear infiltrate of the lamina propria. Schistosomal eggs may produce fibrosis, masses or pseudotumors along the intestinal tract. They may also be associated with abscess formation or papillomatous growth, progressing to strictures, adhesions or fistulae (Cheever, 1968).

In *S. japonicum*, intestinal inflammation can be found not only in the colon but throughout the small intestine (Strickland, 1994). Chronic infection and inflammation of the intestinal mucosa in *S. mansoni*, *S. japonicum* and *S. mekongi* may lead to increased risk of colon cancer. This has been suggested by several small epidemiologic studies but is still an area of controversy (Cheng and Mott, 1988; Elsebai, 1977; Lucas, 1982; Brand, 1979; Cheever *et al.*, 1978; Dimmette *et al.*, 1956).

### Hepatosplenic Pathology

In *S. mansoni*, *S. intercalatum*, *S. japonicum* and *S. mekongi*, more than half the ova produced are swept downstream in the portal circulation, where they induce hepatic and splenic pathology. The intrahepatic portal venules narrow in the liver as part of a second capillary bed designed to extract nutrients from the gastrointestinal tract. Eggs become lodged in these vascular channels and elicit an intense granulomatous response, as described above. This occurs primarily in the portal triad. Hepatic granulomas caused by these ova may completely occlude the intrahepatic radicals of the portal venules. An acute endophlebitis also occurs and occludes other vessels by organized thrombus formation (Chen and Mott, 1988). The recanalized, newly formed

blood vessels communicate with other vessels. There is also an increase in the straight arterial branches without obstruction. This increase in arterial branches may be responsible for the large periportal vascular network that maintains normal blood flow to hepatic cells but also contributes to portal hypertension (Andrade and Cheever, 1971c). This largely inflammatory reaction is observed early in schistosomiasis and results primarily in liver enlargement and collateral blood flow. At this stage, pathology is entirely reversible with parasitologic cure, but hepatic enlargement may take several months to resolve (Doehring-Schwerdtfeger *et al.*, 1992; Weist *et al.*, 1994).

A fibrotic scar develops over time as a consequence of recurrent egg granulomas and pseudotubercle formation. The portal vein and its tributaries gradually become fibrosed, producing severe portal hypertension. The extensive periportal and perilobular fibrosis observed in schistosomiasis is distinct from all other forms of fibrotic or cirrhotic pathology and is termed 'Symmers's clay pipe stem fibrosis' (Symmers, 1904). At autopsy, when the whole liver is cut, the liver appears to be filled with criss-crossing tubes of dense collagen, resembling clay pipe stems inserted into an otherwise normal-appearing organ. These deposits are easily visible on abdominal ultrasound as well as CT and NMR scans (Hatz et al., 1992). The thickness of these dense portal bands of collagen are used to grade hepatic fibrosis non-invasively (Abdel-Wahab *et al.*, 1992).

Portal hypertension in schistosomiasis is intra-hepatic and presinusoidal, very much like idiopathic portal fibrosis and non-cirrhotic portal fibrosis. The pathology is primarily related to portal venular injury (Warren, 1984). Hepatic parenchymal damage is unusual until very late in the disease. Furthermore, preservation of the hepatic arterial blood flow protects the hepatocytes from classical cirrhosis (micronodular lesions). True cirrhosis (micronodular lesions) can be observed only when there is co-infection with another agent such as hepatitis B or C or associated alcohol abuse (Lyra *et al.*, 1976; Koshy *et al.*, 1993). The fibrotic deposits observed in chronic schistosomiasis were thought in the past to be an irreversible sequela of infection. Population studies using ultrasound, however, show that many dense deposits can

slowly resolve if the individual can be kept free of recurrent infections (Doehring-Schwerdtfeger *et al.*, 1992; Ohmae *et al.*, 1992). In studies from China and Sudan, this process appears to take several years to occur (Weist *et al.*, 1994; Homeida *et al.*, 1988). Some older individuals and those with mixed schistosomiasis and hepatitis B, C or alcohol abuse appear to have irreversible liver pathology.

Early hyperplasia of the splenic reticular tissue is followed by marked splenomegaly secondary to both portal hypertension and lymphocytic hyperplasia. Splenomegaly due to the cellular proliferation and reticular hyperplasia is seen early in the natural history of infection and is induced by the extensive granulomatous inflammation occurring throughout the host. It is predominantly seen in the red pulp and germinal centers of the lymphoid follicles. This proliferation is followed by a basophilic proliferation that coincides with the raised immunoglobulin levels observed in the serum. Portal hypertension and venous congestion are seen later in hepatic schistosomiasis, when distended venous sinuses contribute to splenomegaly (von Lichtenberg, 1987).

Chronic hepatic inflammation due to schistosomiasis may place individuals at increased risk for the development of hepatocellular carcinoma. This has been difficult to document in *S. mansoni*, since careful epidemiologic studies are complicated by the high-prevalence coexistence of hepatitis B and C. The best epidemiologic evidence for the association of hepatocellular carcinoma with schistosomiasis comes from China, where the prevalence of hepatitis B is uniform, but the population risk for hepatocellular carcinoma is statistically higher in areas endemic for schistosomiasis (Nakashima *et al.*, 1975; Li *et al.*, 1993, 1993; World Health Organization, 1994). A recent study from China has questioned this and has suggested that hepatitis B virus prevalence rates are not higher in patients with *S. japonicum* (Ye *et al.*, 1998).

### Pulmonary Fibrosis

In hepatosplenic schistosomiasis, after portal hypertension is well-established, collateral pathways shunt parasite eggs to the lungs (Chen and

Mott, 1989). In this way, eggs may pass through the rectal, esophageal and gastric portocaval shunts into the caval system, bypassing the hepatic filter to reach the pulmonary capillary bed through the right side of the heart. The resultant granulomatous response results in arteritis and vascular obliteration. Recurrent pulmonary embolization leads to progressive pulmonary arterial hypertension, with plexiform arterIALIZATION and dilatation of pulmonary arterioles and arteries (Rivero *et al.*, 1993). Pulmonary hypertension is usually moderate, but can result in cor pulmonale and right heart failure (Sadigursky and Andrade, 1982). In *S. haematobium* infection, ova can migrate directly to the lungs and induce pulmonary inflammation. Prior to the use of population-based chemotherapy, right heart failure was one of the leading causes of death in Egypt associated with schistosomiasis.

### Neuroschistosomiasis

Neuroschistosomiasis is caused by aberrant migration of adult worm pairs and the resultant entry of eggs into the vertebral or cerebral venous plexuses. Cerebral migration is more common in *S. japonicum*, while vertebral migration is more commonly observed in *S. mansoni* and *S. haematobium* (Scrimgeour and Gajdusek, 1985). Embolized eggs to the spinal cord or brain induce locally destructive egg granulomas. This may lead to transient increases in intracranial pressure or transverse myelitis. Cerebral inflammation commonly leads to focal motor or generalized seizures (Pittella, 1997). Schistosomiasis is second only to cysticercosis as a cause of seizures in several endemic countries in Asia (Hinz, 1985). Unfortunately, permanent injury is common and complications include hemiplegia or hydrocephalus. Some patients may be left with a permanent epileptogenic focus in the brain, even after the inflammation has resolved.

### Urinary Pathology

*S. haematobium* affects primarily the lower urinary tract and secondarily the lungs. Adult

worms of this species live in the vesical vasculature. The eggs are laid in the mucosa and submucosa of the urinary bladder and the lower parts of the ureters. The granulomatous reaction is initially highly cellular and results in large polypoid lesions (Smith *et al.*, 1974). These may cause acute obstructive uropathy. Later, the lesions become relatively acellular and fibrotic. At this stage, lesions are called 'sandy patches'. The rectum, seminal vesicles, urethra and ureters may also be involved. Without the hepatic filter present in hepatic schistosomiasis, eggs may migrate to the lungs (see Pulmonary Fibrosis, above). Ova perforating the urinary tract lead to both microscopic and macroscopic hematuria and proteinuria (Wilkins and Gilles, 1987a).

The bladder lesions may calcify or deform. Sloughing and ulceration of the bladder mucosa may occur in the early phase of the disease and chronic ulceration may occur during chronic infection. Both acute inflammation and chronic scar formation can lead to unilateral or bilateral obstruction of the ureters. Chronic stasis in the urinary tract also predisposes to renal calculi and recurrent urinary infections, particularly with *Salmonella* (Young *et al.*, 1973).

Immune complex-mediated glomerulosclerosis has also been reported with all forms of schistosomiasis. Andrade has described the glomerular disease associated with *S. mansoni* in Brazil (Andrade and Roeha, 1979). Involvement of the mesangium with electron-dense deposits is characteristic. This complication is thought to represent deposits of immune complexes stimulated by the chronic inflammation (Sobh *et al.*, 1987). In hospitalized patients from Brazil, chronic glomerulonephritis is seen in up to 15% of patients. Occasionally, focal sclerosis has also been found on biopsy. These renal lesions are generally seen in individuals with hepatosplenic disease (Andrade *et al.*, 1971b). Amyloid deposits have been reported in children from the Sudan but have not been found in large series of kidney biopsies in other studies (Barsoum *et al.*, 1979).

Chronic inflammation in the urinary bladder is strongly associated with malignant transformation (Chen and Mott, 1989). Squamous cell carcinoma of the bladder has been clearly associated with urinary schistosomiasis for many decades (Elsebai, 1977; Smith and Christie, 1986).

### Subtle Morbidity

Population-based chemotherapy has decreased the prevalence of severe end-organ disease caused by schistosomiasis. During the last 10 years, investigators have concentrated on more subtle morbidity caused by schistosomes, with particular interest in vulnerable groups such as growing children and pregnant women (McGarvey *et al.*, 1996; Stephenson and Holland, 1987).

Schistosomes have long been suspected to stunt the growth of growing children. Classic studies performed by Stephenson (1993) reported an effect on skin-fold thickness following infection with *S. haematobium* and *S. mansoni*. Historically, *S. japonicum* had been associated with a condition in China described as 'schistosomal dwarfism' (McGarvey *et al.*, 1993). In addition, military recruits during World War II in Japan, from the two prefectures endemic for *Schistosoma japonicum*, were known to be significantly shorter than those from non-endemic areas. Population-based studies have now clearly demonstrated an effect of schistosome infection on child growth (McGarvey *et al.*, 1993, 1996; Stephenson, 1993). The effect appears maximal during the adolescent growth spurt and is seen predominantly in populations with marginal nutritional status. Catch-up growth is observed, but can be retarded by reinfections (Olveda *et al.*, 1996; Olds *et al.*, 1996).

Anemia is often multifactorial, particularly in populations with poor dietary iron. Schistosomiasis exacerbates anemia by a variety of mechanisms, including direct ingestion of red cells by adult worms, decreased red cell survival due to hypersplenism, loss of blood in the stool or urine, and through anemia of chronic infection (Mahmoud and Woodrugg, 1972). Many consider prevention of anemia as the most compelling reason to aggressively 'de-worm' children in schistosome-endemic areas (Olds *et al.*, 1999). This is particularly true for adolescent females growing up in areas of high infectivity. In two recent double-blind controlled studies, hemoglobin increased over 6 months in all school-aged children living in a schistosomiasis-endemic community following praziquantel treatment (McGarvey *et al.*, 1996; Olds *et al.*, 1999). This effect on hemoglobin was seen in one study even in those below the detection rate of a

single stool examination (Olds *et al.*, 1999). In both cases, an increase in hemoglobin was seen without iron supplementation.

Schistosomiasis has also been shown to adversely affect cognition, particularly in young children, and decrease functional work capacity (Nokes *et al.*, 1999). All these effects, taken together, have made school-aged children prime targets for population-based mass treatment. They have also prompted the World Health Organization to consider linking schistosomiasis with control measures for other intestinal worms that induce similar morbidity. These studies also suggest that 'deworming' and micronutrient supplementation would improve the growth and nutrition of the worm-infested children (Berkley and Jamison, 1991).

### IMMUNOLOGY

The role of host immunity in the life-cycle, clinical disease and epidemiology of schistosomiasis has been suggested in several earlier sections. There are at least three separate and distinct aspects of the complex immunologic interaction that takes place between man and this multicellular helminth. The first is immune evasion, which allows developing parasites and adult worms to survive within the human vasculature for many years (Maizels *et al.*, 1993). The second is the complex immunologic host reaction to parasite eggs, which is important for egg transport, induces most of the clinical pathology, and is the target of host modulating responses that attempt to destroy trapped ova and yet minimize secondary tissue damage (Doenhoff *et al.*, 1986; Hernandez *et al.*, 1997a). Finally, humans chronically infected with schistosomes appear to develop partial acquired resistance to new invasions by schistosomulae (Butterworth, 1998; Capron, 1992). As a result, most older humans, chronically exposed to schistosomes, appear relatively resistant to new infections (Colley *et al.*, 1986; Butterworth, 1998). This observation serves as the scientific basis for several current attempts at vaccine development.

#### Immune Evasion

Adult schistosomes hide from the human immune system by a variety of mechanisms.



The tegument of the worm undergoes rapid restructuring as the parasite develops and is the major interface between the worm and the host (Pearce and Sher, 1987). The tegument is a metabolically active, complex, double-membrane structure that protects the parasite from host immune-mediated reactions. It is also highly resistant *in vitro* to enzymatic attack and a variety of toxins. The best-studied of the schistosome immune evasion tactics is a process by which the adult worm acquires host antigens onto its surface. They include host HLA and blood group glycolipids, host immunoglobulins, serum protein inhibitors (serpins) and low-density lipoproteins (Simpson *et al.*, 1984). The parasite, in effect, is immunologically masquerading as the host's own tissue. Both humoral and cell-mediated immune responses are thus modified by this approach.

The tegument proteins also have the ability to recognize the F<sub>c</sub> receptors of host antibody. In this way, immunoglobulins are pointed in the wrong direction, forming a shield against a variety of host effector mechanisms as well as blocking complement fixation. Surface proteolytic activity can also destroy tegument-bound antibody. Recently, a schistosomal complement-inhibiting protein (SCIP-1) has been found on the worm's tegument and appears to inhibit complement-mediated lysis (Parizade *et al.*, 1994). Cellular immunity is inhibited by the release of phosphatidylcholine, which lyses adherent macrophages (Golan *et al.*, 1986). Immunosuppressive neuropeptides, which impair T cell activity, have also been identified emanating from the schistosome worms (Duvoux-Miret *et al.*, 1992). Interference with this active process (immune evasion) has been suggested as a major mechanism by which the drug praziquantel kills adult worms (Shekhar, 1991).

In addition to this antigenic masking, worms also shed their tegument actively. This shed material is highly antigenic and distracts the immune system from the adult schistosomes. It has also been speculated that these shed antigens are responsible for stimulating host immune responses which destroy new invading larvae and contribute to resistance to new infections (Pearce *et al.*, 1986). Through such a mechanism, most humans would become chronically infected with a small number of schistosomes, and the life

span of the host would not be dramatically altered, which may be of advantage to the parasite.

### Egg Granuloma

The immunology of an egg granuloma has been studied most extensively in the mouse, which can be infected with both *S. mansoni* and *S. japonicum* in the laboratory (Boros, 1986; Elliott, 1996a). The culmination of this work has been the study of egg granulomas in 'knock-out mice', genetically altered to lack specific components of the immune system (Kaplan *et al.*, 1998; Wynn *et al.*, 1997; Yap *et al.*, 1997). This has shed a great deal of light on this critical reaction. Granulomatous hypersensitivity can be transferred by lymphoid cells but not serum and can be inhibited by anti-lymphocyte globulin, pointing out that T cells are central to the induction of egg granulomas (Butterworth, 1998; Cheever and Yap, 1997). The key eliciting antigens are largely glycoproteins, known collectively as soluble egg antigens (SEA) (Capron, 1992; Pillay, 1996). SEA-coated bentonite particles can induce granuloma formation, and eggs depleted of SEA do not induce granulomas. It appears that these soluble components of the egg are actively secreted into the surrounding environment and induce the host cellular immune system (Butterworth and Hagan, 1987). The egg granuloma itself may have several benefits to the host, including allowing ova to pass out of the body in the stool as well as limiting the diffusion of toxic egg antigens into adjacent tissues.

Unfortunately, these exuberant egg granulomas also cause tissue damage and can obstruct blood flow when present in portal venules in large numbers. Thus, the egg granuloma is clearly a two-edged sword from the standpoint of the host (Doenhoff *et al.*, 1986). For example, in T cell-deficient mice, which cannot form egg granulomas, trapped ova induce rapid hepatocyte damage and liver failure (Buchanan *et al.*, 1973; Jankovic *et al.*, 1998; Fidel and Boros, 1990). On the other hand, exuberant granulomatous hypersensitivity seen in normally immune animals damages adjacent tissues and stimulates the deposition of extracellular matrix, leading

ultimately to periportal fibrosis (Olds *et al.*, 1989a, 1989b).

Most experimental animals and humans eventually resolve this immunologic dilemma through a process called immune modulation (Boros and Warren, 1974; Warren, 1973b; Boros *et al.*, 1975; Boros, 1986; Olds and Stavitsky, 1986). During chronic infection, smaller egg granulomas are formed, which are efficient at limiting the diffusion of toxic egg proteins, allow transition of ova across tissue planes, yet rapidly destroy ova trapped permanently in tissues while limiting secondary tissue damage and fibrogenesis. All these changes clearly benefit the host and serve as the only reasonable response to a parasite that cannot be eliminated. The best evidence for the existence of immune modulation in humans comes from studies by Rocklin *et al.*, who examined the granulomatous reaction around *S. mansoni* eggs in rectal strips of children in Egypt (Rocklin *et al.*, 1977, 1980; Mahmoud, 1983). Granuloma size was smaller in children with presumed chronic infections. Indirect evidence can also be found in the examination of populations chronically exposed to schistosomiasis prior to the widespread use of praziquantel. In these populations, young children aged 6–10 years had the highest prevalence of hepatic enlargement (primary granulomatous inflammation) with infection, while older children (presumably more chronically infected) appear to have less hepatic enlargement with the same intensity of infection (Olds *et al.*, 1996).

Significant debate has occurred over the years as to whether the egg granuloma is predominantly a Th1- or a Th2-driven response (Boros, 1994). Th1 responses are associated with stimulation of IFN $\gamma$  and IL-2, while TH2 responses are characterized by increased IL-4, IL-5, IL-6, IL-9, IL-10 and IL-13 following stimulation of host lymphocytes with SEA (Wynn *et al.*, 1997; Hernandez *et al.*, 1997a, 1997b; Kaplan *et al.*, 1998; Butterworth, 1998). In experimental animals, both TH1 and TH2 responses appear to play a role, with the most successful immunologic adaptation being a balance between these two extremes. The most conclusive work so far has been done with 'knock-out mice' which genetically lack the ability to produce a TH1 or alternative TH2 response (Jankovic *et al.*, 1998; Cheever and Yap, 1997; Asseman *et al.*, 1996;

Yap *et al.*, 1997). IL-4/IL-10 knock-out mice, which produce a polar TH1 response, have small egg granulomas but have a high early mortality. In contrast, IL-12/IL-10 knock-out animals have predominant TH2 responses but end up with extensive hepatic fibrosis. Thus, the compensated animal immunologically creates a balance between these extremes, with a modulated response nearer the TH2 than the TH1 pole. This state can be created experimentally by immunizing mice with egg antigens and IL-12, which creates an animal which develops small egg granulomas but can limit fibrosis on subsequent infection challenge (Wynn *et al.*, 1997; Hernandez *et al.*, 1997a; Asseman *et al.*, 1996; Mountford *et al.*, 1998). This is close to the immunologic state observed in chronically infected mice that successfully undergo immune modulation *in vivo*.

Most humans infected with schistosomes have a predominant TH2 response in that they have eosinophilia, high IgE titers and suppression of schistosome antigen-induced TH1 responses *in vitro* (James, 1992; Musmann *et al.*, 1986). Nonetheless, a similar balance between TH1 and TH2 responses is thought to take place in most individuals, with increased pathology developing in patients who immunologically drift toward either extreme (TH1 or TH2). In studies from Kenya, individuals with chronic infections and hepatosplenic disease appear to have predominantly TH1-type responses to schistosome antigens and more severe pathology (Butterworth, 1998). Specifically, they have high schistosome antigen-driven TNF, IFN $\gamma$  and IL-2 responses *in vitro*. Similarly, with *S. haematobium*, decreased morbidity was associated with high IgE anti-SEA (TH2 response) responses (Mwatha *et al.*, 1998).

The predominantly TH2 immune responses observed during chronic schistosome infection convert to TH1 dominant responses following parasitologic cure (Allen and Maizels, 1997; Cheever and Yap, 1997). The blastogenic responses, IL-2 or IFN $\gamma$  response to schistosome antigens frequently increase 1–2 months following successful chemotherapy. If TH1 responses are more pathogenic, this could suggest that recurrent acute schistosome infections could cumulatively induce significant morbidity over time. This would be particularly true in areas where reinfection is

very rapid and a second round of treatment is delayed. This concept has been termed *rebound morbidity*, since the elimination of modulating immune responses (induced by infection) could result in heightened immunologically-mediated morbidity on reinfection (Olds *et al.*, 1996). Rapid development of hepatic involvement has been documented in The Philippines with *S. japonicum* and is seen in the setting of high transmission (incidence >25%) and in areas where follow-up treatment is delayed by more than 1 year (Olveda *et al.*, 1996; Olds *et al.*, 1996). A similar phenomenon has also been suggested in *S. haematobium* in areas of very high transmission, where patients appeared to rapidly progress pathologic lesions in the kidneys and bladder (by ultrasound) on reinfection.

Another interesting immunologic aspect of the schistosome egg granuloma comes from the study of HIV-positive patients co-infected with schistosomiasis. In a study from Kisumu, Kenya, HIV-infected individuals were observed to have a decreased egg excretion as compared to HIV-negative individuals when controlled for adult worm infestation, estimated by circulating adult worm antigens (Karanja *et al.*, 1997). This observation supports the concept that an intact T cell response is necessary for successful egg transport across the intestines.

The predominance of a TH2 immune response observed during chronic schistosome infection may be beneficial in limiting pathology, but does have implications for several co-morbid diseases. In endemic areas for schistosomiasis, hepatitis B and C are frequently found and co-infection is common. Although there is no definitive evidence directly linking schistosomiasis to enhanced morbidity from hepatitis B and C, it is theoretically possible that the TH2 responses induced by schistosomiasis *in vivo* could interfere with the development or maintenance of TH1 responses that limit replication of hepatitis B or C. This could lead to more extreme pathology in co-infected individuals. In studies from both Egypt and The Philippines, 25–50% of patients thought to have schistosome-induced hepatic fibrosis have evidence on biopsy of concomitant hepatitis B or C (Helal *et al.*, 1998; Farghaly and Barakat, 1993; Koshy *et al.*, 1993).

Schistosomiasis may also have an influence on the administration of vaccines that require a

functioning TH1 response (Bassily *et al.*, 1987, 1992; Akhiani *et al.*, 1993; el-Ghorab *et al.*, 1992). Active schistosomiasis infection has been found to interfere with the immune response to hepatitis B vaccine (TH1-driven response) and, as a result, current recommendations are to treat active schistosomiasis prior to any primary immunization series.

### Resistance to Infection

Protective immunity to schistosomiasis has been studied extensively in animal models. Adult worms seem to provide the stimulus (presumably through shed antigens) for immunity to invasion by new parasites in rhesus monkeys, rats and mice (Bergquist and Colley, 1998). The protection is directed against newly migrating schistosomulae. Chronically infected mice, challenged with new cercariae, develop far fewer adult worms from this second challenge than naive animals. Schistosomulae themselves are also capable of stimulating protective immunity. The best working model for this is the use of irradiated cercariae (Coulson, 1997; Dean *et al.*, 1996; Yole *et al.*, 1996). These fatally irradiated cercariae are capable of penetrating the skin but die shortly thereafter in the skin and lungs of the host. This early cercarial attrition sets up an immunologic response in the host that results in a significant reduction in a new challenge with fully viable parasites. Irradiated cercarial vaccines work in a wide variety of susceptible hosts, including rats, mice, rabbits, cattle and primates. Cross-immunization against different schistosome species is not observed, despite significant antigenic cross-reactivity (Moloney *et al.*, 1986; Kresina *et al.*, 1991). The exact mechanism of either form of resistance observed in animals is unknown, but probably involves both T and B cells. Work with highly purified schistosomal antigens suggests that protective immune responses may in fact be specific to individual molecules. For example, the worm protein paramyocin appears to work in *S. mansoni* by stimulating a TH1- and cell-mediated immune response in host animals (James *et al.*, 1987; James and Pearce, 1988; Pearce *et al.*, 1988). Alternatively, several other protective antigens

appear to work through the induction of anti-schistosome antibodies, including anti-parasite IgG2a, IgA and IgE (Yang and Gobert, 1997; Dunne *et al.*, 1995; Dean, 1983; Noya *et al.*, 1995).

Human correlate studies have been used to gain insights into potential protective mechanisms relevant to humans. In classic studies performed in Kenya, IgE antibody in general and specific IgEs directed toward schistosomulae antigens appear to correlate with resistance to reinfection in children when corrected for water contact (Dunne *et al.*, 1992a, 1992b).

Interestingly, in these same studies, IgG antibodies directed toward the parasite appear to have a negative correlation with resistance. The authors suggest that these isotypes interfere with the development of acquired immunity early in infection by blocking more effective IgE and IgA responses (Butterworth *et al.*, 1992; Dunne *et al.*, 1992a; Butterworth, 1993; Noya *et al.*, 1995). Several other putative vaccine molecules have been studied in this manner in humans, and a variety of specific immune responses to these highly purified molecules have been found to correlate with resistance to reinfection over time. These include IgE, IgA and several subclasses of IgG as well as specific cell-mediated responses, including IL-2 and IFN $\gamma$  responses *in vitro* (Butterworth, 1998; Dunne *et al.*, 1992a; Rihet *et al.*, 1991; Correa-Oliveira *et al.*, 1998; Capron, 1998).

Less work has been done on *S. japonicum*. In one longitudinal study, acquired immunity appears to develop to this species in humans around age 14 or after approximately 8–10 years of exposure (Olds *et al.*, 1996). Immunity appears to last only about 3–5 years after parasitologic cure. Ultimately, the testing of candidate vaccine molecules in humans will be needed to resolve these issues.

## CLINICAL DISEASE

Schistosomes are well adapted to the human host and generally establish a balanced host–parasite relationship. As a result, the majority of infected people are asymptomatic or have only mild non-specific symptoms. Severe symptoms and major

clinical sequelae occur in approximately 10–15% of the infected populations without treatment. The life expectancy of patients with mild schistosomiasis is probably not substantially shorter than that of uninfected individuals living in the same geographic area. Prior to the development of effective treatment, approximately 1% of the infected population died each year, generally as a result of bleeding esophageal varices, renal failure or an associated malignancy (Hinz, 1985). The clinical importance of schistosomiasis, however, has probably been greatly underestimated in the past. Morbid sequelae are common, and growing children, pregnant women and the most malnourished segments of a population probably suffer disproportionately from infection (Stephenson and Holland, 1987; Olds *et al.*, 1996).

## Acute Schistosomiasis

Most people become infected with schistosomes asymptotically. In a small percentage of patients, an immediate itching and urticaria is seen at the site of cercarial penetration. Often referred to as ‘schistosome dermatitis’, it may progress into papular lesions that can persist for 5–7 days (Amer, 1994). This condition is far more common when non-human schistosome cercariae penetrate the skin (e.g. avian schistosomal cercariae) and is called swimmer’s itch.

Migration of schistosomulae in the venous system, arterial bed and specific venous beds may be associated with mechanical and inflammatory changes in the lung and liver but generally is also asymptomatic. As worms mature in the liver, migrate to the small venules and begin to lay eggs, a second form of acute schistosomiasis may be observed, termed Katayama fever (Warren, 1973a). Symptoms generally have an acute onset, 3–6 weeks after a heavy exposure to cercariae. Spiking fever with chills, myalgia, headache, diarrhea, fatigue and weight loss are observed. Nausea, vomiting and cough are common. Occasionally, hepatosplenic enlargement is seen. Large patches of urticaria may also be seen on various parts of the body.

Katayama fever is thought to represent a form of serum sickness in which a rising antibody titer

occurs in the setting of significant antigen production from freshly deposited ova (Hiatt *et al.*, 1980). Patients can be quite ill and occasional fatalities have been reported. Katayama fever appears to be more common in Asia, but has been reported for all species. It may also be more common in heavy infections of a naive host or on massive reinfection after a significant time interval. Fever subsides 2–10 weeks after the onset even without treatment (Lawley *et al.*, 1979). Aggressive treatment with antiparasitic agents and immunosuppression probably alter the course of illness.

### Intestinal Schistosomiasis (*S. mansoni*, *S. japonicum*, *S. mekongi*)

Non-specific symptoms, such as abdominal pain and malaise, are common. Intermittent diarrhea is the most common symptom of intestinal involvement and may alternate with constipation. The stool may occasionally contain blood and mucus. Frank schistosomal dysentery is uncommon (Cheever, 1978). A severe form of intestinal involvement is colonic polyposis (El Masry *et al.*, 1986). This condition generally affects young males and, in addition to bloody diarrhea, protein-losing enteropathy, hypokalemia and severe dehydration are often found. On sigmoidoscopy and biopsy, intense granulomatous inflammation with parasite ova is found. Occasionally, inflammatory masses are observed along the colon and need to be differentiated from malignant lesions (Mohamed *et al.*, 1990). Intestinal schistosomiasis is most commonly confused clinically with ulcerative colitis or Crohn's disease and occasional abdominal tuberculosis. The condition responds well to effective antiparasitic treatment.

### Hepatosplenic Disease (*S. haematobium*, *S. japonicum*, *S. mekongi*)

The clinical manifestations of chronic hepatosplenic schistosomiasis are shown in Table 16.3, the most common being enlargement of the liver (Noonan *et al.*, 1974). Hepatic enlargement is diffuse and non-tender. A firm liver edge is

palpable below the mid-clavicular and mid-sternal lines. Hepatic enlargement commonly develops 6 months to 2 years after initial infection (or re-infection) and is primarily a result of granulomatous inflammation (Warren, 1984; Dunn and Kamel, 1981). During this stage, 50–90% of individuals may have palpable hepatomegaly, particularly children. Two such children are shown in Figure 16.5. The classic fibrotic lesions have been reported on liver biopsy as early as 80 days after exposure, but the clinical manifestations generally take months to years to develop. Multiple exposures are probably required to acquire a sufficient number of eggs and the associated granulomas to produce symptomatic disease. Prothrombin time is only mildly prolonged and transaminases are normal or mildly elevated in pure schistosomiasis-induced liver disease (Dunn and Kamel, 1981). Serum alkaline phosphatase and bilirubin are also

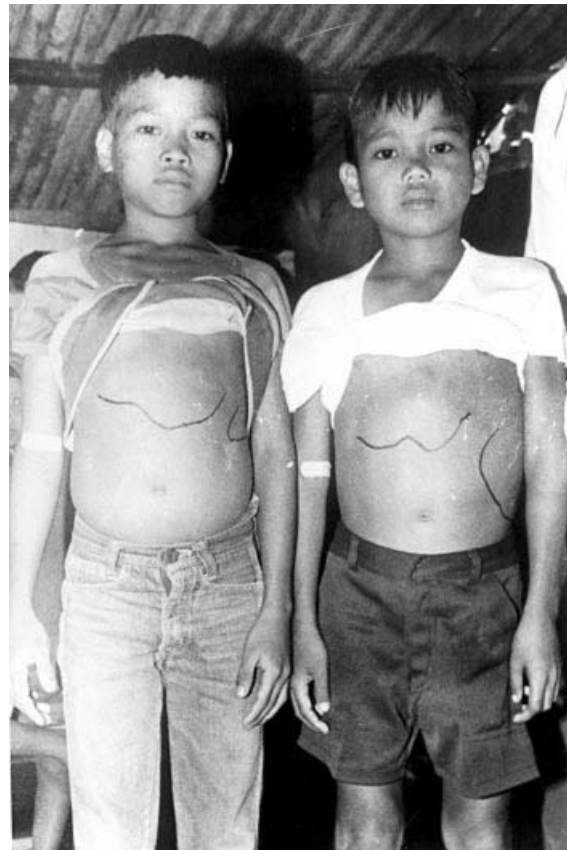


Fig. 16.5 Two boys with schistosomiasis and hepatosplenomegaly

normal or mildly elevated. Jaundice, ascites and encephalopathy are manifestations of hepatocellular decompensation and are unusual in pure schistosomiasis (Elliott, 1996b). Because patients with portal hypertension secondary to schistosomiasis tolerate episodes of variceal bleeding much better than those with cirrhosis, repeated non-fatal episodes of bleeding are common (Raia *et al.*, 1984).

Enlargement of the spleen is quite common when sensitive tests such as ultrasound are used. Palpable splenomegaly occurs less commonly. Massive splenomegaly, often as much as 8–12 cm below the left costal margin, is found in less than 5% of untreated cases. Hypersplenism with thrombocytopenia occurs rarely. Hypoalbuminemia and hypergammaglobulinemia are seen in less than 25% of patients. Anemia is very common and is multifactorial, including acute or chronic blood loss, hypersplenism and anemia of chronic disease, as well as the fact that adult worms ingest red blood cells. Hepatosplenic enlargement generally responds well to curative chemotherapy (Ohmae *et al.*, 1992).

Ascites is seen in late hepatosplenic disease and results from both portal hypertension and hypoalbuminemia. Low albumin can result from intestinal loss, associated nephrotic syndrome, and from co-morbid conditions such as hepatitis B or C. The 'swollen bellies' of schistosomiasis have been used to identify schistosomiasis-endemic communities historically. The condition is most commonly seen in males 16–25 years of age. At this stage, end-organ damage may not be reversible with drugs.

Prior to the development of effective chemotherapy, most patients did not develop severe hepatosplenic schistosomiasis despite years of chronic infection. The degree of fibrosis also does not correlate well with either the size of the liver or the presence of splenic enlargement. In humans, the pathologic progression is therefore highly variable and could develop within a few months in heavily infected patients but more commonly develops over many years and in only a small subset. Most evidence suggests the hepatosplenic schistosomiasis in humans is a result of the inflammatory injury accumulated over years of moderately intense schistosomal infection (Dunn and Kamel, 1981). Some individuals may be particularly genetically susceptible

to the pathologic sequelae of schistosomiasis (Abdul-Salem *et al.*, 1986). In addition, individuals who fail to 'modulate' their infection immunologically may progress more rapidly and suffer greater pathology (Olds *et al.*, 1996).

### Genitourinary Involvement (*S. haematobium*)

Urinary frequency and dysuria are early symptoms of *S. haematobium* infection, but hematuria is the classic presenting feature (Smith and Christie, 1986). *S. haematobium* is so common in endemic areas of upper Egypt that it is culturally considered the equivalent of the male menarche. Intermittent terminal hematuria, dysuria and urinary frequency are characteristic of vesical involvement. Suprapubic or perineal pain may occur intermittently, with bladder distention (Smith *et al.*, 1977). Hydronephrosis from granulomas in the bladder wall, ureters and urethra is the most common clinical sequela. Hydronephrosis, pyelonephritis and recurrent urinary tract infection may be due to progressive ureteral obstruction (Lehman *et al.*, 1973). Late sequelae include clinical presentation of acute or chronic renal failure or squamous cell carcinoma of the bladder (Thomas *et al.*, 1990). This diagnosis should be entertained in an individual presenting with hematuria from an endemic country or in those suspected of having a malignancy of the bladder or kidney. Urinary tract ultrasound, urine cytologies and even biopsy material have been misdiagnosed as malignant by physicians unfamiliar with this disease. Most early pathology responds well to treatment.

Vaginal schistosomiasis was reported in Egypt around the turn of the 19th–20th century. Recently, genital disease has been described, not necessarily involving the bladder and ureters (Wright *et al.*, 1982). The maximal age of involvement is older than classically described for *S. haematobium* and may be found in women with very few eggs in their urine. In one community-based study from Africa, 30–75% of women infected with *S. haematobium* had egg-associated lesions in their lower reproductive tract (Poggensa *et al.*, 1998). In Madagascar,

43% of boys and men aged 15–49 had *S. haematobium* eggs in their semen and genital schistosomiasis (Leutscher *et al.*, 1998). These findings have now increased in importance, since they may increase the risk of acquiring HIV infection and could predispose to cervical cancer (Helling-Giese *et al.*, 1996). Patients generally respond well to chemotherapy.

Nephrotic syndrome is occasionally seen in association with hepatosplenic schistosomiasis (Farid *et al.*, 1972; Andrade and Rocha, 1979). It responds well to treatment if this is initiated early in the course of disease.

### Association with Other Infections

#### *Salmonella*

Persistent *Salmonella* bacteremia has been well described with *S. mansoni* and occasionally seen in *S. japonicum* (Rocha *et al.*, 1971). The organism is not always *S. typhi* and often has a delayed clinical presentation. Patients often do not appear acutely ill, but generally have a low-grade fever. Most patients with dual infections (schistosomiasis and salmonellosis) have hepatosplenic enlargement. Patients respond promptly to antibiotics but frequently relapse (Neves *et al.*, 1969). *Salmonella* has been isolated from the tegument and intestinal tract of adult *S. mansoni* worms and the adult worms are thought to serve as a protected intravascular reservoir for bacteriologic relapse (Ottens and Dickerson, 1972). Treatment of schistosomiasis alone cures 90% of patients. Dual treatment is recommended. *Salmonella* urinary tract infections are also described with *S. haematobium*, but bacteremia is less common (Farid *et al.*, 1970). Dual treatment is recommended, but occasionally infected calculi complicate management.

#### *Hepatitis*

Co-infections with hepatitis B and C have been reported to be more common in patients with schistosomiasis than in the general population (El-Rooby, 1985; Koshy *et al.*, 1993; Gang, 1993). This could be due to the administration of injectable drugs or blood transfusions used to

treat schistosomiasis prior to the 1980s (Madwar *et al.*, 1989). In addition, it has been suggested that immunologic responses to chronic schistosomiasis may interfere with the development of a curative immune response to hepatitis, contributing to more severe hepatic sequelae of co-infection.

#### *Cancer*

Chronic schistosomiasis may increase the risk of several types of cancer. *S. haematobium* infection results in squamous metaplasia of the urinary bladder and urethral mucosa (Cheever, 1978; Chen and Mott, 1989). A clear association of *S. haematobium* infection with squamous cell cancer of the lower urinary tract has been established (Elsebai, 1977; Thomas *et al.*, 1990; Obafunwa, 1991). The risk of malignant transformation may persist even after parasitologic cure.

*S. mansoni* infections may be associated with the development of inflammatory pseudopolyps of the colon (Mohamed *et al.*, 1990; Strickland, 1994). These polyps, however, do not contain dysplastic epithelium and therefore are not thought to have a malignant potential. Anecdotal reports of an association between *S. mansoni* infection and lymphoma, hepatocellular carcinoma, or colorectal cancer have not, however, been supported by epidemiologic or prospective cohort studies (Johnstone, 1990; Chen and Mott, 1988; Cheever, 1981). Giant follicular lymphoma may develop in the spleen of patients with chronic severe hepatosplenic schistosomiasis (Andrade, 1971a). An association between hepatocellular and colonic cancer has been suggested with *S. japonicum* but epidemiologic studies from China and Japan do not support this association (Gang, 1993; Nakashima *et al.*, 1975; Li *et al.*, 1991, 1993).

## DIAGNOSIS

### Current Approach

Since most people infected with schistosomiasis are asymptomatic, a high index of suspicion is required to clinically identify infection, especially in geographic areas where infection is uncommon. The diagnosis should be considered in any

patient with a possible exposure history who presents with fever, eosinophilia, hepatosplenomegaly, anemia, hematuria, obstructive uropathy, recurrent urinary tract infection (especially with *Salmonella*), glomerulonephritis, seizures, transverse myelitis, pulmonary hypertension or cor pulmonale.

In addition, asymptomatic infection, e.g. travelers, should be actively screened for. Suspicion should be particularly high in an individual with esophageal varices, hepatic enlargement and normal liver function tests (El Rooby, 1985; Raia *et al.*, 1984). Most other etiologies for bleeding varices result in small cirrhotic livers, elevation in transaminases and low serum albumin. Travel history, history of contact with fresh water, skin rash or acute febrile episodes should be specifically elicited. A definitive diagnosis is made by identification of the characteristic schistosome eggs in feces, urine or a biopsy specimen (Feldmeier, 1993). The excretion of eggs may be scanty or absent in the early phase of illness and repetitive examinations are recommended, using the appropriate stool or urine concentration techniques (World Health Organization, 1983; Peters and Kazura, 1987). Parasite eggs may also be absent or in low numbers in patients who present with chronic fibrotic complications of schistosomiasis.

Hematuria is often used as a marker for infection in endemic areas and empiric treatment initiated without parasitologic confirmation (Taylor *et al.*, 1990). In order to increase the diagnostic utility of the reagent strip test of hematuria, additional measurement of proteinuria and leukocyturia have been suggested (Kaiser *et al.*, 1992).

### **Stool Diagnosis**

*S. mansoni*, *S. japonicum*, *S. intercalatum* and *S. mekongi* are diagnosed using stool samples. Various concentration methods can be used, including a formol-ether, merthiolate-iodine-formol method, Bell filtration method using ninhydrin as the stain, or the Kato method using glycolmalachite green (Bailenger, 1979; Bell, 1963; Feldmeier, 1993; Martin and Bearer, 1968; Katz *et al.*, 1970). The most common

method for the detection of eggs in stool is the Kato-Katz thick smear technique. This technique is inexpensive, quick to perform and has been adapted for use in the field. It also allows quantification of the intensity of infection. Standard wet mounts do not contain a large enough sample to reliably find schistosome eggs, and the standard zinc sulfate sedimentation method does not recover schistosome eggs (Elliott, 1996b). Flotation methods of concentration should not be used if schistosomiasis is suspected, because schistosome eggs do not float on the usual solvents because of their weight. It is therefore imperative that the laboratory be notified about the possible diagnosis of schistosomiasis.

The Kato-Katz thick smear preparation is based on the principle of using glycerol to clarify the stool sample. That enables the eggs to be easily visualized microscopically (Katz *et al.*, 1970). This increases the accuracy of diagnosis under field conditions and is now used in all national control programs (Katz *et al.*, 1970; Teesdale and Amin, 1976). It is an inexpensive, non-invasive, highly specific test with an acceptable sensitivity. Low-level infection may not be diagnosed by the standard triplicate Kato-Katz thick smear using a single stool specimen. Sensitivity is improved if multiple stool samples are examined (Sleigh *et al.*, 1982; Katz *et al.*, 1970). This is particularly true in *S. japonicum*, where significant stool/stool variations in egg counts have been documented. One limitation of the standard Kato-Katz technique is the requirement for at least 8–12 hours to clear the slide. This time requirement is suboptimal for walk-in clinics, where it is preferable to treat people before they leave. A quick Kato technique has been developed for this purpose that can be read in 2 hours (Engels *et al.*, 1996).

### **Urine Diagnosis**

The eggs of *S. haematobium* are passed in the urine with diurnal periodicity, with peak excretion between mid-morning and mid-afternoon (Doehring *et al.*, 1985). Urine collected during this period may be concentrated by simple sedimentation or passing the urine through a



cellulose filter to concentrate the parasite eggs. The latter allows quantification of infection. Filtration techniques that give quantitative assessment of egg excretion are replacing the simple sedimentation or centrifugation techniques (Dazo and Biles, 1974).

### **Viability**

Viable ova can be hatched from specimens and the diagnosis made by examining for miracidia (Braun-Munzinger and Southgate, 1993). Mixing the ova (in stool or urine) in water and exposing them to light results in miracidia in the supernatant in a few hours. All species of schistosomiasis can be diagnosed using a variety of these egg-hatching techniques (Weber, 1973). These techniques are quite labor-intensive and non-quantifiable, but they can be more sensitive than a single stool examination (Braun-Munzinger and Southgate, 1993).

### **Biopsy**

Eggs can be found in biopsy specimens in all schistosome species. Rectal biopsy has been considered to be the most sensitive method to diagnose schistosomiasis when repeated stools are negative (Abdel-Hafez and Bolbol, 1992). Biopsy specimens may show mucosal inflammation with eosinophilic infiltration. A granulomatous response surrounding a viable egg is diagnostic of schistosomiasis. Crushing the biopsy specimen between slides and surveying the entire sample microscopically increases the diagnostic sensitivity (Feldmeier, 1993). Six biopsy specimens examined after crushing are more sensitive than duplicate Kato-Katz stool smears (Abdel-Wahab *et al.*, 1992). A single rectal biopsy specimen, however, is less sensitive than multiple Kato-Katz smears.

### **Ultrasound**

One of the most important advances in the diagnosis of chronic schistosomiasis is the use of ultrasound (Hatz *et al.*, 1992). This technique can

not only diagnose schistosome-induced liver disease but determines the grade of hepatic fibrosis (Abdel-Wahab *et al.*, 1992). Comparison of ultrasound with open liver biopsies has confirmed the accuracy of this approach (Cerri *et al.*, 1984; Homeida *et al.*, 1988). The World Health Organization (1991) has developed a standardized scale for comparative evaluation. Several double-blind studies have demonstrated that the ultrasonographic appearance of multiple echogenic areas with central lucency in the liver is highly suggestive of hepatic schistosomiasis (Hussain *et al.*, 1984). This is particularly true for World Health Organization Grades II and III fibrosis. Unfortunately, many other diseases can be confused with Grade I or minimal periportal fibrosis, including acute hepatitis, tuberculosis and salmonellosis. Grade I fibrosis can even occasionally be confused with a normal liver. As a result, ultrasound is only diagnostic when schistosomal damage is extensive. Many patients with early schistosomiasis have normal or non-specific changes on ultrasound (Hussain *et al.*, 1984; Olds *et al.*, 1996; Abdel-Wahab *et al.*, 1992). It is particularly common for children to have an enlarged liver on echo without evidence of periportal fibrosis. Ultrasonography is also superior to physical examination in the documentation of hepatomegaly and splenomegaly, particularly for large population-based studies (Hussain *et al.*, 1984; Olveda *et al.*, 1996; Wiest *et al.*, 1992). Ultrasonography has also been shown to be useful in follow-up of the hepatic fibrosis and hepatosplenic enlargement, especially in patients treated with schistosomicidal drugs (Doehring-Schwerdtfeger *et al.*, 1992; Ali *et al.*, 1991; Wiest *et al.*, 1992). Ultrasound is also useful in the diagnosis of urinary schistosomiasis but other pathologies can appear similar, including urinary tuberculosis and several malignant lesions (Jenkins and Hatz, 1992). Cystoscopy with biopsy is recommended if ova cannot be recovered and urine cytologies are negative (Feldmeier *et al.*, 1981).

### **Liver Biopsy**

The diagnosis of schistosomal-induced liver disease has classically required an open wedge

biopsy. Sampling error and the limited tissue obtained make percutaneous liver biopsy an insensitive method for the detection of schistosome eggs (Maharaj *et al.*, 1986). With the advent of non-invasive tools such as abdominal ultrasound, liver biopsy is no longer used to specifically diagnose schistosomiasis. Liver biopsy is helpful to establish or rule out other co-morbid conditions, such as hepatitis B or C-related disease or alcoholic cirrhosis.

### Serodiagnosis

The labor-intensive nature of stool and urine examinations and the logistical difficulty of obtaining specimens have directed attention to serodiagnostic tests. Antibodies against schistosomes remain elevated even after the resolution of infection (Maddison, 1987). Detection of antischistosome antibodies in endemic areas, therefore, has limited utility (Bergquist, 1992). Serodiagnosis based on antibodies does, however, have a role in confirming exposure to mature schistosomes in travelers visiting endemic areas (Feldmeier, 1993).

Serodiagnosis is helpful in the diagnosis of acute schistosomiasis (since the clinical manifestations can occur prior to eggs appearing in the stool or urine). An antibody assay system that utilizes the cross-reactivity between keyhole limpet (*Megathura crenulata*; KHL) and schistosome carbohydrate antigens has been used to diagnose acute schistosomiasis (Grzych *et al.*, 1987). In acute schistosomiasis, antibodies to KHL develop rapidly and then wane during chronic infection (Alves-Brito *et al.*, 1992). Thus, KHL reactivity carries the same implications as IgM antibody titers in most other infectious diseases.

Detection of circulating schistosomal antigens in blood or urine can identify patients with active infection. Circulating antigen disappears after parasitologic cure, making this an attractive option for use in endemic countries. Based on the electrophoretic affinity, two antigens have been identified and extensively tested for this purpose: circulating anodic (CAA) and cathodic (CCA) adult worm antigens (Deelder *et al.*, 1994). These are proteoglycan gut-associated

antigens that are a part of the heterogeneous group of antigens derived from the gut of the parasites. These are released by the regurgitation of digested blood and indicate an active infection with viable worms (Nash and Deelder, 1985). The serum levels of these circulating antigens can be detected by the use of monoclonal antibodies, which are very specific (Gundersen *et al.*, 1992). These antigens (and their enzymatic breakdown products) appear in the urine, and thus a urine-based antigen detection system is feasible and would be a very attractive diagnostic test for field applications. A prototype is currently under development in Europe. Serum and urine antigen titers correlate with the intensity of infection, as determined by egg counts (DeJonge *et al.*, 1988; Van Wout *et al.*, 1992). The antigen assay systems are not yet commercially available and are not currently more sensitive than multiple stool or urine exams for ova. The concentrations of CAA or CCA do not vary significantly over short periods of time (van Leishout *et al.*, 1991). It has been shown that parasitologic cure or drug failure can be detected as early as 10 days after treatment (Barsoum *et al.*, 1991; Van Wout *et al.*, 1992). The antigen assays also avoid the day-to-day, or circadian, variations observed with egg excretion and aid in the assessment of response to chemotherapy. The major limitations of antigen assays include: the cost of highly purified monoclonal antibodies needed; expensive biochemical reagents with a short half-life; and the need for trained technicians. These make antigen assay systems of limited utility, even in developed countries. As a result, multiple stool examinations remain the most sensitive and cost-effective way to diagnose schistosomiasis today. When negative, given the low toxicity of praziquantel, empiric treatment is generally considered preferable to multiple rectal biopsies in suspected cases (Deelder *et al.*, 1994).

### TREATMENT

The major advance in the treatment of schistosomiasis has been the development of praziquantel (Cioli *et al.*, 1995). Until the 1960s, the only effective schistosomicidal agents available were the intravenous antimonials. The

toxicity of antimonials was a major limitation, especially for mass therapy. Most of these earlier drugs should not be considered as a treatment option (Shekhar, 1991).

### Praziquantel

Praziquantel is currently the drug of choice for all human schistosomes. The dosage is adjusted for different species. Praziquantel is a mixture of stereoisomers of pyrazionisoquinoline ring structures with broad-spectrum antihelminth properties against trematodes and cestodes. It is lipophilic and rapidly taken up and concentrated by the worm. It is the safest schistosomicide in current use. Praziquantel undergoes extensive first-pass metabolism and the drug metabolites are inactive and are excreted in urine (Mandour *et al.*, 1990). Absorption is enhanced by a high fat content in the lumen of the bowel and inhibited by corticosteroids. A total dose of 60 mg/kg yields cure rates for all schistosome species, with reported cure rates of 60–98%. Unfortunately, this dose is poorly tolerated as a single ingestion. A single dose of 40 mg/kg body weight is less efficient in achieving cure rates than a 20 mg/kg body weight dose given three times over 4–6 hours (van Leishout *et al.*, 1994). Single-dose treatment, however, is often used in population-based programs for logistical reasons. Almost all individuals treated with an appropriate dose of praziquantel have a significant reduction in egg excretion, even if infection persists. Re-treatment generally results in cure.

The exact mechanism of action for praziquantel is unclear. Its schistosomicidal action appears related in part to inducing violent contractions in the worm. These contractions result in paralysis of the parasite. A calcium-mediated severe destruction and rapid vacuolization of the tegument has also been demonstrated with praziquantel and probability also contributes to the parasite's destruction. It is hypothesized that the drug increases the permeability of the worm muscle cells to calcium ions. These calcium-dependent effects of praziquantel do not appear to be mediated by specific membrane G channel proteins. Praziquantel appears to destabilize the worm's surface and renders it susceptible to the

host humoral immune attack (Fallon *et al.*, 1992). This has been shown in studies on mice unable to mount a B cell (antibody) response that cannot be cured by praziquantel (Sabah *et al.*, 1985; Brindley and Sher, 1989). Serum antibodies from normal mice infected with schistosomiasis re-establish the curative properties of the drug in these animals. Praziquantel appears, therefore, to disrupt active immune evasion at the level of the tegument and exposes antigens that were previously masked (Doenhoff *et al.*, 1988). The worms are then killed by host immunoglobulin-mediated mechanisms. This also helps to explain the observation that cure rates are often lower during acute schistosomiasis. In this setting, the infected host may not yet have developed an appropriate B cell response to the worm.

Although no evidence of mutagenesis or teratogenesis exists, praziquantel has not been tested in pregnant or lactating women. Side effects of the drug are usually mild and self-limited (Olds *et al.*, 1999). In patients heavily infested with *S. mansoni* or *S. japonicum*, passage of blood in the stool shortly after therapy has been reported. Recovery is rapid and without clinical sequelae (Watt *et al.*, 1986). In placebo-controlled trials, only headache and abdominal pain are significantly associated with treatment and these symptoms may be due more to the host response to dead and dying worms than to a direct toxic effect of the drug (Olds *et al.*, 1999). It has been suggested that mass treatment could be administered by schoolteachers and other non-medical personnel because of the safety of this drug.

Recently, concern has developed over the potential development of praziquantel-resistant parasites. In Senegal, the drug appeared to be ineffective during a major outbreak of infection (Stelma *et al.*, 1995). A careful review of this situation has suggested that very high transmission rates and the presence of many new acute infections in naive hosts may have contributed to this observation. Careful studies in Egypt, where praziquantel has been used extensively for over a decade, have suggested that some parasites are developing resistance to this drug (Bennett *et al.*, 1997). Fortunately, resistance does not appear to increase on repeated exposure to the drug experimentally, and as yet does not appear to be a public health concern. As a result,

praziquantel remains the drug of choice, but all patients should be followed up to assure parasitologic cure.

### Oxamniquine

Oxamniquine is a tetrahydroquinoline, active against *S. mansoni* in a single dose of 15 mg/kg body weight (Bassily *et al.*, 1978). Its mechanism of action is not completely understood. It is probably metabolized by the parasite into an ester and subsequently alkylates macromolecules. Oxamniquine also disrupts the tegument of the male schistosome and could work in synergism with the immune system in a way analogous to praziquantel (Lambertucci *et al.*, 1989). Female worms may survive, but cannot lay eggs.

Reports of parasite tolerance to oxamniquine have appeared in Brazil, and concern now exists that this drug may not be as effective in the future. Some strains of *S. mansoni* exist that are able to survive 1000-fold standard doses of the drug. Dissecting this high-level resistance has helped us understand the mechanism of action of the drug. Oxamniquine appears to be a pro-drug and requires a sulfa-transferase to be active (Cioli *et al.*, 1995). This enzyme is absent in humans, giving it a very high toxic:therapeutic ratio. Unfortunately, *S. japonicum* parasites lack this enzyme, explaining their lack of response. Resistant *S. mansoni* organisms have mutated enzymes. Fortunately, resistance is recessive and results in less environmental fitness. From a public health standpoint, resistance does not spread.

Oxamniquine has been used extensively in Brazil, where it has been locally manufactured for a decade. Oxamniquine is not active against *S. japonicum* or *S. haematobium*. Some African strains of *S. mansoni* are less sensitive to this drug (Katz *et al.*, 1991). Total doses of up to 60 mg/kg body weight administered over 2 days may be required to obtain satisfactory results (15 mg b.i.d. × 2 days). This drug has been recently used in African patients who were praziquantel treatment failures (Stelma *et al.*, 1997).

Unfortunately, the drug manufacturer may discontinue this medication due to a lack of

profitability. This would be a severe setback to control programs that are counting on oxamniquine if praziquantel resistance becomes a public health issue in the future.

Oxamniquine is a well-tolerated drug. Adverse effects include drowsiness, dizziness and, rarely, lowering of the seizure threshold. In addition, a benign self-limited orange-red discoloration of the urine has been reported.

### Metrifonate

Metrifonate is still used occasionally and only for *S. haematobium* infections. It is an organophosphate compound and its metabolites cause the schistosomes to detach from the vessel wall, forcing the worms to travel downstream with the blood flow (Doehring *et al.*, 1986). Intestinal schistosomes that are detached in this way can migrate back to the portal vein after the effect of the drug has passed, but in *S. haematobium* the adult worms pass from the vesical plexus through the right side of the heart into the pulmonary vasculature, where they are trapped and die. Clinical tolerance to this drug is good. There are no contraindications to retreatment. It remains an acceptable alternative to praziquantel for urinary schistosomiasis but, unfortunately, its commercial production was discontinued due to a lack of profitability.

## PREVENTION AND CONTROL

### Schistosomal Vaccines

Vaccination against schistosomiasis has been under active investigation for over three decades. Most vaccines have been targeted toward prevention of infection. More recently, investigators have worked toward developing a vaccine that would minimize end-organ damage by inducing a modification in the immune response to eggs. This would be an antidisease vaccine (Bergquist and Colley, 1998). Finally, Dr Capron in France is currently pursuing a vaccine whose primary effort is directed at making ova incapable of completing the life-cycle after they pass from humans into the environment. This anti-fecundity approach would need to be used on a population

basis (Capron, 1998). This would be an anti-transmission vaccine. Thus, like the malaria vaccine story, three vaccine approaches are being actively pursued, one against infection, one against disease and one against transmission.

A vaccine that prevents schistosome infection by destroying the invading schistosomula has been under intense investigation for two decades. This approach is helped by the fact that schistosomes do not multiply within the host. Hence, even a partially effective vaccine could have a substantial impact on transmission and morbidity.

As of the mid-1990s, over 20 molecules had been developed that either protected experimental animals from schistosome challenge or were found in human correlate studies to be associated with decreased re-infection rates in human field populations (Waine and McManus, 1997). In 1996, the World Health Organization organized an expert panel to examine the current state of these vaccine efforts and make recommendations. They concluded that six molecules had reached the state of development where they could be considered for human testing. This group commissioned a blinded, human correlate study using highly purified or recombinant molecules in Egypt during 1997–1998. This study and related information suggested that all six antigens had potential, but that the type of immune response stimulated would be critical (el-Sherbini, personal communication). For example, in some cases, a TH1 response to the putative vaccine molecule strongly correlated with resistance to a schistosome infection over time, while a TH2 response to the same antigen showed a negative correlation. The reverse findings were observed with other antigens. Thus, some antigens may be incompatible with each other (TH1 vs. TH2), and the exact nature of the human immune response appears critical for protection (Caulada-Benedetti *et al.*, 1991).

One of the antigens, glutathione S transferase Sm-28, developed by Dr Capron in France, is already moving toward human field trials (Capron, 1998). Another antigen, fatty acid binding protein Sm-14, developed by Brazilian investigators, is moving toward human field trials in Brazil (Tendler *et al.*, 1996). Two antigens, paramyocin and the multiple antigenic peptide MAP-4 (developed by Dr Harn at Harvard),

were recommended to be tested in humans as purified recombinant molecules (Ferru *et al.*, 1997). Two others, IrV<sub>5</sub> (developed by the late Dr Metta Strand; Soisson *et al.*, 1993) and a second carbohydrate antigen, MAP-3 (developed by Dr Donald Harn), were felt to be better suited for formulation as a naked DNA vaccine. Paramyocin and MAP-4 are currently in the process of Phase I development through a joint program funded by US/AID and the Egyptian Ministry of Health.

### Prospects for Control

Whether or not an effective vaccine can be developed in the present millennium, schistosomiasis could be better controlled in the world given existing drugs and control strategies. When the cost of praziquantel was \$2.50–3.50 per curative dose, control programs centered around case findings and treatment. Given the decreasing cost of praziquantel (now \$0.22–0.50 per curative dose) and its proven safety record, targeted mass treatment is now a very attractive option. Although concern exists over the potential of praziquantel resistance, an objective review of the current information does not suggest a major public health problem for the near future.

One of the obstacles to further progress in schistosomiasis is past success, which has been incorrectly translated as having eradicated the problem, with no further need for investment in continued control and preventive measures. In addition, as a result of success in the Middle East, the Americas and Asia, most of the major endemic areas for schistosomiasis are now in sub-Saharan Africa, where over 88% of the active cases and most of the morbidity are found. This is also the area of the world in which schistosomiasis is actually on the increase. With competing diseases such as HIV, malaria and tuberculosis, it is unclear whether schistosomiasis will attract enough attention to allow the development of at least some type of national control strategy.

The first step is to make praziquantel readily available throughout Africa at all primary care facilities in endemic communities. The World Health Organization is currently trying to

develop such a program. Combining schistosomiasis control with comprehensive health initiative aimed at school children is also an attractive option. Mass deworming for both schistosomiasis and intestinal helminths, combined with micronutrient enrichment, could have a significant impact on the health of this target population and is as cost-effective as many expanded programs of immunization (Berkley *et al.*, 1991).

Despite these efforts, schistosomiasis will remain an important worldwide health problem for the foreseeable future, and a familiarity with its signs and symptoms remain a requirement of every physician's training.

## REFERENCES

- Abdel-Wahab MF, Esmat G, Farrag A, el-Boraey YA, Strickland GT (1992). Grading of hepatic schistosomiasis by the use of ultrasonography. *Am J Trop Med Hyg* **46**: 403–8.
- Abdel-Hafez MA, Bolbol AH (1992). Fibre-optic sigmoidoscopy compared with the Kato technique in diagnosis and evaluation of the intensity of *Schistosoma mansoni* infection. *Trans R Soc Trop Med Hyg* **86**: 641–3.
- Abdel-Salam E, Abdel-Khalik A, Abdel-Meguid A *et al.* (1986). Association of HLA class I antigens (A1, B5, B8 and CW2) with disease manifestations and infection in human schistosomiasis mansoni in Egypt. *Tissue Antigens* **27**: 142–6.
- Akhiani AA, Nilsson LA, Ouchterlony O (1993). Effect of cholera toxin on vaccine-induced immunity and infection in murine schistosomiasis mansoni. *Infect Immun* **61**: 4919–24.
- Ali QM, Doehring-Schwerdtfeger E, Abdel-Rahim IM *et al.* (1991). Ultrasonographical investigation of periportal fibrosis in children with *Schistosoma mansoni* infection: reversibility of morbidity seven months after treatment with praziquantel. *Am J Trop Med Hyg* **44**: 444–51.
- Allen JE, Maizels RM (1997). Th1-Th2: reliable paradigm or dangerous dogma? *Immunol Today* **18**: 387–92.
- Alves-Brito CF, Simpson AJ, Bahia-Oliveira LM *et al.* (1992). Analysis of anti-keyhole limpet hemocyanin antibody in Brazilians supports its use for the diagnosis of acute *Schistosoma mansoni*. *Trans R Soc Trop Med Hyg* **86**: 53–6.
- Amer M (1994). Cutaneous schistosomiasis. *Dermatol Clin* **12**: 713–17.
- Andrade ZA, Abreu WN (1971a). Follicular lymphoma of the spleen in patients with hepatosplenic schistosomiasis mansoni. *Am J Trop Med Hyg* **20**: 237–43.
- Andrade ZA, Andrade SG, Sadigursky M (1971b). Renal changes in patients with hepatosplenic schistosomiasis. *Am J Trop Med Hyg* **20**: 77–83.
- Andrade ZA, Cheever AW (1971c). Alterations of intrahepatic vasculature in hepatosplenic schistosomiasis mansoni. *Am J Trop Med Hyg* **20**: 425–32.
- Andrade ZA, Rocha H (1979). Schistosomal glomerulopathy. *Kidney Int* **16**: 23–9.
- Arnon R (1990). Life span of parasite in schistosomiasis patients (editor's comment). *Isr J Med Sci* **20**: 404–5.
- Asseman C, Pancore V, Quatennens B, Aurialt C (1996). *Schistosoma mansoni* infected mice show augmented hepatic fibrosis and selective inhibition of liver cytokine production after treatment with anti-NK 1-1 antibodies. *Immunol Lett* **54**: 11–20.
- Bailenger J (1979). Mechanisms of parasitological concentration in coprology and their practical consequences. *J Am Med Techn* **41**: 65–71.
- Barsoum IS, Kamal KA, Bassily S *et al.* (1991). Diagnosis of human schistosomiasis by detection of circulating cathodic antigen with a monoclonal antibody. *J Infect Dis* **164**: 1010–13.
- Barsoum RS, Bassily S, Solimann MM *et al.* Renal amyloidosis and schistosomiasis. *Trans R Soc Trop Med Hyg* **73**: 367–74.
- Bassily S, Farid Z, Higashi GI, Watten RH (1978). Treatment of complicated schistosomiasis mansoni with oxamniquine. *Am J Trop Med Hyg* **27**: 1284–6.
- Bassily S, Hyans KC, el-Ghorab NM *et al.* (1987). Immunogenicity of hepatitis B vaccine in patients infected with *Schistosoma mansoni*. *Am J Trop Med Hyg* **36**: 549–53.
- Bassily S, Strickland GD, Abdel-Wahab MF *et al.* (1992). Efficacy of hepatitis B vaccination in primary school children from a village endemic for *Schistosoma mansoni*. *J Infect Dis* **166**: 265–8.
- Bell DR (1968). A new method for counting *Schistosoma mansoni* eggs in feces with special reference to therapeutic trials. *Bull WHO* **29**: 525–30.
- Bennett JL *et al.* (1997). The development of resistance to antihelminths: a perspective with an emphasis on the anti-schistosomal drug praziquantel. *Exp Parasitol* **87**: 260–7.
- Bergquist R (1992). In Bergquist R (ed.), *Immunodiagnostic Approaches in Schistosomiasis*. Chichester: Wiley; 1–8.
- Bergquist RN, Colley DG (1998). Schistosomiasis vaccines: research to development. *Parasitol Today* **14**: 99–104.
- Berkley S, Jamison D (1991). A conference on the health of school-aged children, summary report. In *Division of Health Science of the Rockefeller Foundation and the Division of Global and Inter-regional Programmes of the United Nations Development Programme*, Bellagio, Italy.
- Bilharz T (1853a). A study on human helminthography. Derived from information by letter from Dr. Bilharz in Cairo, along with remarks by Prof. Th. V. Siebold in Breslau. *Z Wiss Zool* **4**: 53–71.
- Bilharz T (1853b). Further observations concerning *Distomum haematobium* in the portal vein of man and its relationship to certain pathological formations. With brief notes by Prof. V. Siebold on 29 March 1852. *Z Wiss Zool* **4**: 72–6.
- Bilharz T (1856). *Distomum haematobium* and its relation to certain pathological changes of the human urinary organs. *Wich Med Wochenschr* **6**: 49–52, 65–8.
- Boros DL (1986). Immunoregulation of granuloma formation in murine schistosomiasis mansoni. *Ann NY Acad Sci* **465**: 313–23.
- Boros DL (1994). The role of cytokines in the formation of schistosome egg granuloma. *Immunology* **191**: 441–50.

- Boros DL, Pelley RP, Warren KS (1975). Spontaneous modulation of granulomatous hypersensitivity in schistosomiasis mansoni. *J Immunol* **116**: 1437–41.
- Boros DL, Warren KS (1974). Models of granulomatous inflammation. *Ann NY Acad Sci* **221**: 331–4.
- Brand KG (1979). Schistosomiasis-cancer: etiological considerations. *Acta Trop* **36**: 203–14.
- Braun-Munzinger RA, Southgate BA (1993). Egg viability in urinary schistosomiasis. III. Repeatability and reproducibility of new methods. *J Trop Med Hyg* **96**: 179–85.
- Brindley PJ, Sher A (1989). The chemotherapeutic effect of praziquantel against *Schistosoma mansoni*: identification of target antigens. *Mol Biochem Parasitol* **34**: 99–108.
- Brown DS (1980). *Freshwater Snails of Africa and their Medical Importance*. London: Taylor.
- Bruce JI, Sornmani S, Asch HL, Crawford KA (eds) (1980). The Mekong Schistosome. *Malacol Rev* **2** (suppl): 282.
- Buchanan RD, Fine DP, Colley DG (1973). *Schistosoma mansoni* infection in mice depleted of thymus-dependent lymphocytes. II. Pathology and altered pathogenesis. *Am J Pathol* **71**: 207–18.
- Butterworth AG (1993). Immunology of schistosomiasis. In Jordan P, Webbe G, Sturrock RF (eds), *Human Schistosomiasis*. Wallingford: CAB International; 331–66.
- Butterworth AG (1998). Immunological aspects of schistosomiasis. *Br Med Bull* **54**: 357–68.
- Butterworth AG, Dunne DW, Fulford AJ, Thorne AJ *et al.* (1992). Human immunity to *Schistosoma mansoni*: observations on mechanisms and implications for control. *Immunol Invest* **21**: 391–407.
- Butterworth AG, Hagan P (1987). Immunity in human schistosomiasis. *Parasitol Today* **3**: 11–16.
- Capron A (1992). Immunity to schistosomes. *Curr Opin Immunol* **4**: 419–26.
- Capron A (1998). Schistosomiasis: forty years' war on the worm. *Parasitol Today* **14**: 379–84.
- Capron M, Capron A (1994). Immunoglobulin E and effector cells in schistosomiasis. *Science* **264**: 1876–7.
- Caulada-Benedetti Z *et al.* (1991). Comparison of Th1- and Th2-associated immune reactivities stimulated by single versus multiple vaccination of mice with associated *Schistosoma mansoni* cercariae. *J Immunol* **146**: 1655–60.
- Cerri GA, Alves VAF, Magalhães A (1984). Hepatosplenic schistosomiasis mansoni: ultrasound manifestations. *Radio-logy* **153**: 777–80.
- Cheever AW (1968). A quantitative post-mortem study of schistosomiasis mansoni in man. *Am J Trop Med Hyg* **17**: 38–64.
- Cheever AW (1978). Schistosomiasis and neoplasia. *J Natl Cancer Inst* **61**: 13–18.
- Cheever AW (1981). Schistosomiasis and colon cancer. *Lancet* **1**: 1369–70.
- Cheever AW, Kamel IA, Elwi AM *et al.* (1978). *Schistosoma mansoni* and *S. haematobium* infections in Egypt. III. Extrahepatic pathology. *Am J Trop Med Hyg* **27**: 55–75.
- Cheever AW, Powers KG (1971). Rate of destruction of *Schistosoma mansoni* eggs and adult worms in the tissues of rhesus monkeys. *Am J Trop Med Hyg* **20**: 69–76.
- Cheever AW, Yap AS (1997). Immunological basis of disease and disease regulation in schistosomiasis. *Chem Immunol* **66**: 159–76.
- Chen MG, Mott KE (1988). Progress in assessment of morbidity due to *Schistosoma mansoni* infection. Progress in Assessment of Morbidity Due to Schistosomiasis. Reviews of recent literature. *Trop Dis Bull* **85**: R1–56.
- Chen MG, Mott KE (1989). Progress in the assessment of morbidity due to *Schistosoma haematobium*. A review of recent literature. In Progress in Assessment of Morbidity Due to Schistosomiasis. *Trop Dis Bull* **86**: R1–36.
- Cheng MG, Mott KE (1988). Progress in assessment of morbidity due to *Schistosoma japonicum*. A review of recent literature. In Progress in Assessment of Morbidity due to Schistosomiasis. *Trop Dis Bull* **85**: R1–45.
- Cheng TH (1971). Schistosomiasis in mainland China. A review of research and control programs since 1949. *Am J Trop Med Hyg* **20**: 26–53.
- Christopherson JB (1918). The successful use of antimony in bilharziasis administered as intravenous injections of antimonium tartarum emetic. *Lancet* **21**: 325–7.
- Christopherson JB (1924). Longevity of parasitic worms. The term of living existence of *Schistosoma haematobium* in the human body. *Lancet* **1**: 742–3.
- Cioli D, Pica-Mattocchia L, Archer S (1995). Antischistosomal drugs: past, present and future? *Pharmacol Ther* **68**: 35–85.
- Cobbold TS (1859). On some new forms of entozoa. *Trans Linn Soc Lond* **22**: 363–6.
- Colley DA, Barsoum IS, Dahawi HSS *et al.* (1986). Immune responses and immunoregulation in relation to schistosomiasis in Egypt. III Immunity and longitudinal studies of *in vitro* responsiveness after treatment. *Trans R Soc Trop Med Hyg* **80**: 952–7.
- Cordingley JS (1987). Trematode egg shells: novel protein biopolymers. *Parasitol Today* **3**: 341–66.
- Correa-Oliveira R, Malaquias LC, Falcao PL *et al.* (1998). Cytokines as determinants of resistance and pathology in human *Schistosoma mansoni* infection. *Braz J Med Biol Res* **31**: 171–7.
- Cort WW (1919). *The Cercariae of the Japanese Blood Fluke, Schistosoma japonicum*.
- Cort WW (1928). Schistosome dermatitis in the United States (Michigan). *J Am Med Assoc* **90**: 1027–9.
- Coulson PS (1997). The radiation-attenuated vaccine against schistosomes in animal models: paradigm for a human vaccine? *Adv Parasitol* **39**: 271–336.
- Davis A (1985). Schistosomiasis. In Robinson D (ed.), *Epidemiology and the Community Control of Disease in Warm Climate Countries*, 2nd edn. Edinburgh: Churchill Livingstone; 389–412.
- Day HB (1924). The etiology of Egyptian splenomegaly and hepatic cirrhosis. *Trans R Soc Trop Med Hyg* **18**: 121–30.
- Dazo BC, Biles JE (1974). Two new field techniques for detection and counting of *Schistosoma haematobium* eggs in urine samples. *Bull WHO* **51**: 399–408.
- Dean DA (1983). A review: *Schistosoma* and related genera: acquired resistance in mice. *Exp Parasitol* **58**: 1–104.
- Dean DA, Mangold BL, Harrison RA, Ricciardone MD (1996). Homologous and heterologous protective immunity to Egyptian strains of *Schistosoma mansoni* and

- S. haematobium* induced by ultraviolet irradiated cercariae. *Parasitol Immunol* **18**: 403–10.
- Deelder AM, Qian ZL, Kremsner PG *et al.* (1994). Quantitative diagnosis of schistosoma infection by measurement of circulating antigens in serum and urine. *Trop Geogr Med* **46** (4 Spec No.): 233–8.
- DeJonge N, Gryseels B, Hilberoth AW *et al.* (1988). Detection of circulating anodic antigen by ELISA for seroepidemiology of schistosomiasis mansoni. *Trans R Soc Trop Med Hyg* **82**: 591–4.
- Dimmette RM, Elwi AM, Sproat HF (1956). Relationship of schistosomiasis to polyposis and adenocarcinoma of the large intestine. *Am J Clin Pathol* **26**: 266.
- Doehring E, Rester U, Ehrlich JHH *et al.* (1985). Circadian variation of ova excretion, proteinuria, haematuria and leucocyturia in urinary schistosomiasis. *Kidney Int* **27**: 667–71.
- Doehring G, Poggensee U, Feldmeier H (1986). The effect of metrifonate on mixed *Schistosoma haematobium* and *Schistosoma mansoni* in humans. *Am J Trop Med Hyg* **35**: 323–9.
- Doehring-Schwerdtfeger E, Abdel-Rahim IM, Kardoff R *et al.* (1992). Ultrasonographical investigation of periportal fibrosis in children with *Schistosoma mansoni* infection: reversibility of morbidity twenty-three months after treatment with praziquantel. *Am J Trop Med Hyg* **46**: 409–15.
- Doenhoff MJ, Hassounah O, Murare H *et al.* (1986). The schistosome egg granuloma: immunopathology in the cause of host protection or parasite survival? *Trans R Soc Trop Med Hyg* **80**: 503–14.
- Doenhoff MJ, Modha J, Lambertucci JR (1988). Antischistosome chemotherapy enhanced by antibodies specific for a parasite esterase. *Immunology* **465**: 507–10.
- Doenhoff MJ, Bain J (1978). The immune dependence of schistosomicidal chemotherapy: relative lack of efficacy of an antimonial in *Schistosoma mansoni*-infected mice deprived of their T cells and the demonstration of drug synergy. *Clin Exp Immunol* **33**: 232–8.
- Doumenge JP, Mott KE, Cheung C *et al.* (1987). *Atlas de la Répartition Mondiale des Schistosomiasis* [Atlas of the global distribution of schistosomiasis]. Talence: CEGET-CRNS, Geneva, WHO; Talence: PUB:400.
- Dunn MA, Kamel R (1981). Hepatic schistosomiasis. *Hepatology* **1**: 653–61.
- Dunne DW, Butterworth AG, Fulford AJ *et al.* (1992a). Human IgE responses to *Schistosoma mansoni* and resistance to reinfection. *Mem Inst Oswaldo Cruz* **87** (suppl 4): 99–103.
- Dunne DW, Butterworth AG, Fulford AJC *et al.* (1992b). Immunity after treatment of human schistosomiasis: association between IgE antibodies to adult worm antigens and resistance to reinfection. *Eur J Immunol* **22**: 1483–94.
- Dunne DW, Hagan P, Abath FGC (1995). Prospects for immunological control of schistosomiasis. *Lancet* **345**: 1488–91.
- Duvaux-Miret O, Stefano GB, Smith EM *et al.* (1992). Immunosuppression in the definitive and intermediate hosts of the human parasite *Schistosoma mansoni* by release of immunoactive neuropeptides. *Proc Natl Acad Sci USA* **8**: 778–81.
- El-Ghorab NM, Bassily S, Fouad S *et al.* (1992). Immunological response to diptheria/tetanus vaccine in schistosomiasis mansoni patients. *J Egypt Soc Parasitol* **22**: 747–65.
- Elliott DE (1996a). Methods used to study immunoregulation of schistosome egg granulomas. *Methods* **2**: 255–67.
- Elliott DE (1996b). Schistosomiasis. Pathophysiology, diagnosis and treatment. *Gastroenterol Clin N Am* **25**: 599–625.
- El-Masry NA, Farid Z, Bassily S *et al.* (1986). Schistosomal colonic polyposis: clinical, radiological and parasitological study. *J Trop Med Hyg* **89**: 13–17.
- El-Rooby A (1985). Management of hepatic schistosomiasis. *Semin Liver Dis* **5**: 263–76.
- Elsebai I (1977). Parasites in the etiology of cancer—bilharziasis and bladder cancer. *CA Cancer J Clin* **27**: 100–6.
- Engels D, Nahimana S, Gryseels B (1996). Comparison of the direct fecal smear and two thick smear techniques for the diagnosis of intestinal parasitic infection. *Trop Med Hyg* **90**: 523–5.
- Fallon PG, Cooper RO, Probert AJ *et al.* (1992). Immune-dependent chemotherapy of schistosomiasis. *Parasitology* **105**: 541–8.
- Farghaly AG, Barakat RM (1993). Prevalence, impact and risk factors of hepatitis C infection. *J Egypt Pub Health Assoc* **68**: 63–79.
- Farid Z, Bassily S, Kent DC *et al.* (1970). Chronic urinary salmonella carriers with intermittent bacteraemia. *Am J Trop Med Hyg* **73**: 153–6.
- Farid Z, Higashi GI, Bassily S, Young SW, Sparks HA (1972). Chronic salmonellosis, urinary schistosomiasis and massive proteinuria. *Am J Trop Med Hyg* **21**: 578–81.
- Feldmeier H (1993). Diagnosis. In Jordan PG, Sturrock RF (eds), *Human Schistosomiasis*. Wallingford: CAB International; 271–303.
- Feldmeier H, Dietrich M, Mannweiler F (1981). Correlation of clinical, parasitological and immunological data of patients with *Schistosoma haematobium* infection. *Trans R Soc Trop Med Hyg* **75**: 183–4.
- Fenwick A (1969). Baboons as reservoir hosts of *Schistosoma mansoni*. *Trans R Soc Trop Med Hyg* **63**: 557–67.
- Ferguson AR (1911). Associated bilharziasis and primary malignant disease of the urinary bladder. With observations on a series of 40 cases. *J Pathol Bact* **16**: 76–96.
- Ferru I, Georges B, Bossus M *et al.* (1997). Analysis of the immune responses elicited by a multiple antigen peptide (MAI) composed of two distinct protective antigens derived from the parasite *Schistosoma mansoni*. *Parasite Immunol* **19**: 1–11.
- Fidel PL Jr, Boros DL (1990). Regulation of granulomatous inflammation in murine schistosomiasis IV. Antigen-induced suppressor T cells downregulate proliferation and IL-2 production. *J Immunol* **145**: 1257–64.
- Fujii Y, Matsubayashi H (1847). Katayama disease. *Chugai Iji Shimpo N* **691**: 55–6.
- Fujinami K, Narabayashi H (1913). Prevention of schistosomiasis, especially by mixing lime in infective water. *Chugai Iji Shimpo* **34**: 649–57.



- Fulford AJ, Mbugua AA, Oumo JH *et al.* (1991). Differences in the rate of hepatosplenomegaly due to *Schistosoma mansoni* infection between two areas in Machakos District of Kenya. *Trans R Soc Trop Med Hyg* **85**: 481–8.
- Gang CM (1993). *Schistosoma japonicum* and *S. japonicum*-like infections: epidemiology, clinical and pathological aspects. In Jordan P, Webbe G, Sturrock RF (eds), *Human Schistosomiasis*. Wallingford: CAB International; 237–70.
- Girges K (1934). *Schistosomiasis (Bilharziasis)*. London: John Bale, Sons & Danielson, Ltd.
- Goennert R, Schraufstaetter G (1959). A new molluscicide: molluscicide Bayer 73. *Proc 6 Int Congr Trop Med Malor Lisbon* **2**: 197–202.
- Golan DG, Brown CS, Cianci CM *et al.* (1986). Schistosomula of *Schistosoma mansoni* use lysophosphatidyl choline to lyse adherent human red blood cells and immobilize red cell membrane components. *J Cell Biol* **103**: 819–28.
- Goodfield J (1985). The three valleys of St. Lucia. In Goodfield J (ed.), *Quest for the Killers*. New York: Hill and Wang; 99–146.
- Grzych JM, Dissous C, Capron M *et al.* (1987). *Schistosoma mansoni* shares a protective carbohydrate epitope with keyhole limpet hemocyanin. *J Exp Med* **165**: 865–78.
- Gunderson SA, Haagensen I, Jonassen TO *et al.* (1992). Quantitative detection of schistosomal circulating anodic antigen by magnetic bead capture enzyme-linked immunosorbent assay (MBAC-ELISA) before and after mass chemotherapy. *Trans R Soc Trop Med Hyg* **86**: 175–8.
- Hairston NG (1973). The dynamics of transmission. In Ansari N (ed.), *Epidemiology and Control of Schistosomiasis (Bilharziasis)*. Basel: Karger; 250–336.
- Harley J (1864). On the endemic hematuria of the Cape of Good Hope. *Med Chir Trans* **47**: 55–73.
- Hatz C, Jenkins JM, Tanner M (1992). Ultrasound in schistosomiasis. *Acta Tropica* **51**: 1–97.
- Helal TE, Danial MF, Ahmed HF (1998). The relationship between hepatitis C virus and schistosomiasis: histopathologic evaluation of liver biopsy specimens. *Human Pathol* **29**: 743–9.
- Helling-Giese A, Kjetland EF, Gundersen GG *et al.* (1996). Schistosomiasis in women: manifestations in the upper reproductive tract. *Acta Tropica* **62**: 225–38.
- Hernandez HJ, Wang Y, Tzellas N, Stadecker MJ (1997a). Expression of class II but not class I major histocompatibility complex molecules is required for granuloma formation in infection with *Schistosoma mansoni*. *Eur J Immunol* **27**: 1170–6.
- Hernandez HJ, Wang Y, Stadecker MH (1997b). In infection with *Schistosoma mansoni*, B cells are required for T helper type 2 cell responses but not for granuloma formation. *J Immunol* **158**: 4832–7.
- Hiatt RA, Ottesen EA, Sotomayor ZR *et al.* (1980). Serial observations of circulating immune complexes in patients with acute schistosomiasis. *J Infect Dis* **142**: 665–70.
- Hinz E (1985). *Waterborne Helminthiasis: Schistosomiasis (Bilharziasis)*. *Human Helminthiasis in the Philippines: the Epidemiological and Geomedical Situation*. Berlin: Springer-Verlag, 80–145.
- Homeida M, Abdel-Gadir AF, Cheever AW *et al.* (1988). Diagnosis of pathologically confirmed Symmer's periportal fibrosis by ultrasonography: a prospective blinded study. *Am J Trop Med Hyg* **38**: 86–91.
- Homeida MA, Fenwick A, DeFalla AA *et al.* (1988). Effect of antischistosomal chemotherapy on prevalence of Symmer's fibrosis in Sudanese villages. *Lancet* **11**: 437–40.
- Hussain S, Hawass ND, Zaidi AJ (1984). Ultrasonographic diagnosis of schistosomal periportal fibrosis. *J Ultrasound Med* **3**: 449–52.
- James SL (1992). Experimental models of immunization against schistosomes: lessons for vaccine development. *Immunol Invest* **21**: 477–93.
- James SL, Pearce EJ (1988). The influence of adjuvant on induction of protective immunity by a non-living vaccine against schistosomiasis. *J Immunol* **140**: 2753–9.
- James SL, Pearce EJ, Sher A (1987). Prospects for a non-living vaccine against schistosomiasis based on cell-mediated immune resistance mechanisms. *Mem Inst Oswaldo Cruz* **82**: 121–3.
- Jankovic D, Cheever AW, Kullberg MC *et al.* (1998). CD4 and T cell-mediated granulomatous pathology in schistosomiasis is downregulated by a B cell-dependent mechanism requiring F<sub>c</sub> receptor signalling. *J Exp Med* **187**: 619–29.
- Jenkins JM, Hatz C (eds) (1992). The Cairo Working Group: the use of ultrasound in schistosomiasis—attempts at standardization of methodology. *Acta Tropica* **51**: 45–63.
- Johnstone PAS (1990). Parasitic association with malignant neoplasms. *Trop Geog Med* **42**: 301–11.
- Jordan P, Webbe G (1993). Epidemiology. In Jordan P, Webbe G, Stussock RF (eds), *Human Schistosomiasis*. Wallingford: CAB International; 87–158.
- Jourdane JG, Théron A (1987). Larval development: eggs to cercariae. In Rollinson D, Simpson AJG (eds), *The Biology of Schistosomes from Genes to Latrines*. London: Academic Press; 83–113.
- Kaiser C, Bergel F, Doehring-Schwerdtfeger F *et al.* (1992). Urine test strips: reliability of semiquantitative findings under tropical conditions. *Pediatr Nephrol* **8**: 145–8.
- Kane CA, Most H (1948). Schistosomiasis of the central nervous system: experiences in World War II and a review of the literature. *Arch Neurol Psychiat* **59**: 161–83.
- Kaplan MH, Whitfield JR, Boros DL, Grusby MJ (1998). Th<sub>2</sub> cells granulomatous response. *J Immunol* **160**: 1850–6.
- Karanja DM, Colley DC, Nahlen BL, Ouma JH, Secor WE (1997). Studies on schistosomiasis in western Kenya: I. Evidence for immune-facilitated excretion of schistosome eggs from patients with *Schistosoma mansoni* and human immunodeficiency virus coinfections. *Am J Trop Med Hyg* **56**: 515–21.
- Katsurada F (1904). *Schistosoma japonicum*, a new parasite of man by which an endemic disease is caused in various areas of Japan. *Annot Zool Japan* **8**: 146–60.
- Katz N, Coelho PM, Pellegrino J (1970). Evaluation of Kato's quantitative method through the recovery of *Schistosoma mansoni* eggs added to human feces. *J Parasitol* **56**: 1032–3.
- Katz N, Rocha RS, DeSouza CP *et al.* (1991). Efficacy of alternating therapy with oxamniquine and praziquantel to

- treat *Schistosoma mansoni* in children following failure of first treatment. *Am J Trop Med Hyg* **44**: 509–12.
- Kikuth W, Goennert R (1948). Experimental studies on the therapy of schistosomiasis. *Ann Trop Med Parasitol* **42**: 256–67.
- Koshy A, Al-Nakib B, Al-Mufti S *et al.* (1993). Anti-HCV positive cirrhosis associated with schistosomiasis. *Am J Gastroenterol* **88**: 1428–37.
- Kresina TF, Guan XH, Posner M, Ramirez B, Olds GR (1991). Comparison of immune repertoires of Chinese and Philippine patients infected with *Schistosoma japonicum*. *Infect Immun* **59**: 4698–700.
- Lambertucci JR, Modha J, Doenhoff M (1989). *Schistosoma mansoni*: the therapeutic efficacy of oxamniquine is enhanced by immune serum. *Trans R Soc Trop Med Hyg* **83**: 362–3.
- Lawley TJ, Ottensen EA, Hiatt RA *et al.* (1979). Circulating immune complexes in acute schistosomiasis. *Clin Exp Immunol* **37**: 221–2.
- Lehman JS Jr, Farid Z, Smith JH *et al.* (1973). Urinary schistosomiasis in Egypt: clinical, radiological, bacteriological and parasitological correlations. *Trans R Soc Trop Med Hyg* **67**: 384–99.
- Leiper RT, Atkinson EL (1915). Observations on the spread of Asiatic schistosomiasis with a note on Katayama nosophora by AC Robson. *Br Med J* **1**: 201–3.
- Leiper RT (1915a). Report on the results of the bilharzia mission in Egypt 1915, Part I. Transmission. *J Royal Army Med Corps* **25**: 1–55.
- Leiper RT (1915b). Report on the results of the bilharzia mission in Egypt 1915. Part II. Prevention and eradication. *J Royal Army Med Corps* **26**: 147–92.
- Leiper RT (1915c). Report on the results of the bilharzia mission in Egypt 1915. Part III. Development. *J Royal Army Med Corps* **26**: 253–67.
- Leutscher P, Ravaoalimalala VG, Raharisolo C *et al.* (1998). Clinical findings in female genital schistosomiasis in Madagascar. *Trop Med Int Health* **3**: 327–32.
- Li Y, Yu D, Yuan L, Xiang Y, Zhao Z, Xia M (1993). A study and analysis of the deaths due to advanced *Schistosoma japonicum* infection in the Dongting Lake area of China. *J Trop Med Hyg* **96**: 128–30.
- Li ZJ, Luo DD, Zheng LL *et al.* (1991). Immunohistochemical detection of HbsAg and HbcAg in the liver of patients with *Schistosomiasis japonica* complicated by hepatocellular carcinoma. *J Tongyi Med Univ* **11**: 141–6.
- Lucas SB (1982). Squamous cell carcinoma of the bladder and schistosomiasis. *East Afr Med J* **59**: 345–51.
- Lyra LG, Reboucas G, Andrade ZA (1976). Hepatitis B surface antigen carrier state in hepatosplenic schistosomiasis. *Gastroenterology* **71**: 641–5.
- Macdonald G (1965). The dynamics of helminthic infections with special reference to schistosomes. *Trans R Soc Trop Med Hyg* **59**: 489–506.
- Maddison SE (1987). The present status of serodiagnosis and seroepidemiology of schistosomiasis. *Diag Microb Infect Dis* **7**: 93–105.
- Madwar MA, El Tahawy M, Strickland GT (1989). The relationship between uncomplicated schistosomiasis and hepatitis B infection. *Trans R Soc Trop Med Hyg* **83**: 233–6.
- Maharaj B, Maharaj RJ, Leary WP *et al.* (1986). Sampling variability and its influence on the diagnostic yield of percutaneous needle biopsy of the liver. *Lancet* **1**: 523–5.
- Mahmoud AAF (1983). Regulation of immunopathology in parasitic infections. In Ogra PO, Jacobs DM (eds), *Proceedings of the 8th International Convocation on Immunology*. Basel: Karger; 267.
- Mahmoud AAF, Abdel Wabab MF (1990). Schistosomiasis. In Warren KS, Mahmoud AAF (eds), *Tropical and Geographical Medicine*, 2nd edn. New York: McGraw Hill; 458–73.
- Mahmoud AAF, Woodrugg AW (1972). Mechanisms involved in the anaemia of schistosomiasis. *Trans R Soc Trop Med* **66**: 75–84.
- Maizels RM *et al.* (1993). Immunological modulation and evasion by helminth parasites in human populations. *Nature* **365**: 797–805.
- Malek EA (1988). *Snail Hosts of Schistosomiasis and Other Snail-transmitted Diseases in Tropical America: A Manual*. Scientific Publication No. 478, Pan American Health Organization, World Health Organization. Geneva: WHO; 1–316.
- Mandour ME, el-Turabi H, Homeida MM *et al.* (1990). Pharmacokinetics of praziquantel in healthy volunteers and patients with schistosomiasis. *Trans R Soc Trop Med Hyg* **84**: 389–93.
- Manson P (1902). Report of a case of bilharzia from the West Indies. *J Trop Med Hyg* **5**: 384–5.
- Mansour TE, Bueding G (1954). The actions of antimonials on glycolytic enzymes of *Schistosoma mansoni*. *Br J Pharmacol* **9**: 459–62.
- Martin LK, Bearer PC (1968). Evaluation of Kato thick-smear technique for quantitative diagnosis of helminth infections. *Am J Trop Med Hyg* **17**: 382–91.
- McGarvey ST, Aligui A, Graham K *et al.* (1996). Schistosomiasis japonica and childhood nutritional status in north-eastern Leyte, The Philippines: a randomized trial of praziquantel versus placebo. *Am J Trop Med Hyg* **54**: 498–502.
- McGarvey ST, Wu A, Zhang S *et al.* (1993). Child growth, nutritional status and schistosomiasis japonicum in Jiangxi, People's Republic of China. *Am J Trop Med Hyg* **48**: 547–53.
- Meulemann EA (1972). Host–parasite interrelationships between the freshwater pulmonate *Biomphalaria pfeifferi* and the trematode *Schistosoma mansoni*. *Neth J Zool* **22**: 355–427.
- Michelson GH (1957). Studies on the biological control of schistosome-bearing snails: predators and parasites of fresh water molluscs, a review of the literature. *Parasitology* **47**: 413–28.
- Miller P, Wilson RA (1980). Migration of the schistosomula of *Schistosoma mansoni* from the lungs to the hepatic portal system. *Parasitology* **80**: 267–88.
- Miyairi K, Suzuki M (1913). On the development of *Schistosoma japonicum*. *Tokyo Iji Shinshi Gokyo Med J* **1836**: 1–5.
- Miyairi K, Suzuki M (1914). The intermediate host of *Schistosoma japonicum katsurada*. *Med Fak Kais Univ Kyushu, Fukuoka* **1**: 187–98.

- Mohamed ARS, Mohamed AAK, Yasawy MI (1990). Schistosomal colonic disease. *Gut* **31**: 439–42.
- Moloney NA, Garcia EG, Webbe G (1985). The strain specificity of vaccinations with ultraviolet attenuated cercariae of the Chinese strain of *Schistosoma japonicum*. *Trans R Soc Trop Med Hyg* **79**: 245–7.
- Mountford AP, Shires VL, Anderson S (1998). Interleukin 12 and protective immunity to schistosomes. *Braz J Med Biol Res* **31**: 163–9.
- Musmann TR, Cherwinsky H, Bond MW, Gierdlin MA, Coffman RL (1986). Two types of murine helper T cell clones. I. Definition according to profiles of lymphokine activities and secreted proteins. *J Immunol* **136**: 2348–57.
- Mwatha JK *et al.* (1998). High levels of TNF, soluble TNF2 receptors, sICAM-1 and IFN- $\gamma$ , but low levels of IL-5, are associated with hepatosplenic disease in human schistosomiasis mansoni. *J Immunol* **160**: 1992–9.
- Nakashima T, Okuda K, Kojiro M, Sakamoto K, Kubo Y (1975). Primary liver cancer coincident with schistosomiasis japonica. A study of 24 necropsies. *Cancer* **36**: 1483–9.
- Nash TG, Deelder AM (1985). Comparison of four schistosome excretory–secretory antigens: phenol sulfuric acid active peak, cathodic circulating antigen, gut-associated proteoglycan and circulating anodic antigen. *Am J Trop Med Hyg* **34**: 236–41.
- Neves J, Marinho RP, Martins NR *et al.* (1969). Prolonged septicaemic salmonellosis: treatment of intercurrent schistosomiasis with niridazole. *Trans R Soc Trop Med Hyg* **63**: 79–84.
- Nokes K, McGarvey ST, Shiue L *et al.* (1999). Evidence for an improvement in cognitive function following treatment of *Schistosoma japonicum* infection in Chinese primary school children. *Am J Trop Med Hyg* (in press).
- Nooman ZM, Nafeh MA, El-Kateb H, Atta SM, Ezzat ES (1974). Hepatosplenic disease caused by *Bilharzia haematobium* in Upper Egypt. *J Trop Med Hyg* **77**: 42–8.
- Noya O, Fermin Z, Alarconde Noya B, Lusada S *et al.* (1995). Humoral immune response of children with chronic schistosomiasis. Isotype recognition of adult worm antigens. *Parasite Immunol* **17**: 319–28.
- Obafunwa JO (1991). Histopathological study of vesical carcinoma in plateau states, Nigeria. *Eur J Surg Oncol* **17**: 489–91.
- Ohmae H, Tanaka M, Hayashi M *et al.* (1992). Improvement of ultrasonographic and serologic changes in *Schistosoma japonicum*-infected patients after treatment with praziquantel. *Am J Trop Med Hyg* **48**: 99–104.
- Olds GR, El-Meneza S, Mahmoud AAF, Kresina TF (1989a). Differential immunoregulation of granulomatous inflammation, portal hypertension and hepatic fibrosis in murine schistosomiasis mansoni. *J Immunol* **142**: 3605–11.
- Olds GR, Kresina TE (1989b). Immunoregulation of hepatic fibrosis in murine schistosomiasis japonica. *J Infect Dis* **159**: 798–801.
- Olds GR, Olveda R, Wu G *et al.* (1996). Immunity and morbidity in schistosomiasis japonicum infection. *Am J Trop Med Hyg* **55** (suppl 5): 121–6.
- Olds GR, Stavitsky AB (1986). Mechanisms of *in vivo* modulation of granulomatous inflammation in murine schistosomiasis japonica. *Infect Immun* **52**: 513–18.
- Olds GR, King C, Hewlett J *et al.* (1999). Double-blind placebo-controlled study of concurrent administration of albendazole and praziquantel in schoolchildren with schistosomiasis and geohelminths. *J Infect Dis* (in press).
- Olveda RM, Daniel BL, Ramirez BD *et al.* (1996). Schistosomiasis japonica in the Philippines: The long-term impact of population-based chemotherapy on infection, transmission and morbidity. *J Infect Dis* **174**: 163–72.
- Ottens H, Dickerson A (1972). Studies on the effects of bacteria on experimental schistosome infections in animals. *Trans R Soc Trop Med Hyg* **66**: 85–107.
- Parizade M, Arnon R, Lachmann PJ *et al.* (1994). Functional and antigenic similarities between a 94 kDa protein of *Schistosoma mansoni* (SCIRI) and human CD 59. *J Exp Med* **17**: 1625–36.
- Pearce GJ, Basch PF, Sher A (1986). Evidence that the reduced surface antigenicity of developing *Schistosoma mansoni* schistosomula is due to antigen shedding rather than host molecule acquisition. *Parasite Immunol* **8**: 79–94.
- Pearce GJ, James SL, Hieny S, Lamar DE, Sher A (1988). Induction of protective immunity against *Schistosoma mansoni* by vaccination with schistosome paromyosin (Sm97), a non-surface parasite antigen. *Proc Natl Acad Sci USA* **85**: 5678–82.
- Pearce GJ, Sher A (1987). Mechanisms of immune evasion in schistosomiasis. *Contrib Microbiol Immunol* **8**: 219–32.
- Pesigan TP, Farooq M, Hairston NG *et al.* (1958). Studies on *Schistosoma japonicum* infection in the Philippines. 1. General considerations and epidemiology. *Bull WHO* **18**: 345–455.
- Peters PAS, Kazura JW (1987). Update on diagnostic methods for schistosomiasis. In Mahma AAF (ed.), *Clinical Tropical Medicine and Communicable Diseases*. London: Baillière-Tindall; 419–34.
- Pillay D (1996). Electrophoretic differentiation of soluble egg antigens from *Schistosoma mansoni* isolate using SDS-PAGE. *J Helminthol* **70**: 91–3.
- Pittella JE (1997). Neuroschistosomiasis. *Brain Pathol* **7**: 649–62.
- Poggensa A, Kiwelu I, Saria M, Richter JD, Karntz I, Feldmeier A (1998). Schistosomiasis of the lower reproductive tract. *Am J Trop Med Hyg* **59**: 782–3.
- Prata A (1978). Schistosomiasis mansoni. *Clin Gastroenterol* **7**: 49–75.
- Raia S, Mies S, Macedo AL (1984). Surgical treatment of portal hypertension in schistosomiasis. *World J Surg* **8**: 738–52.
- Rabello AL, Garcia MM, daSilva RA *et al.* (1995). Humoral immune responses in acute schistosomiasis mansoni and relation to morbidity. *Clin Infect Dis* **21**: 608–15.
- Rihet P, Demeuse GC, Bourgeois A *et al.* (1991). Evidence for an association between human resistance to *Schistosoma mansoni* and high antilarval IgE levels. *Eur J Immunol* **21**: 2679–86.
- Rivero MJ, Marcial MA, Reyes A (1993). Pathology of pulmonary hypertension and schistosomiasis mansoni. *Puerto Rico Health Sci J* **12**: 43–5.
- Rocha H, Kirk JW, Hearey CF Jr (1971). Prolonged *Salmonella* bacteremia in patients with *Schistosoma mansoni* infection. *Arch Intern Med* **128**: 265–57.

- Rocklin RE, Brown AP, Warren KS *et al.* (1980). Factors that modify the cellular immune response in patients infected by *Schistosoma mansoni*. *J Immunol* **125**: 1916–23.
- Rocklin RE, Brown A, Warren KS, Pelley N, Houba V *et al.* (1977). Immunologic modulations in children with schistosomiasis. *Clin Res* **25**: 486A.
- Rollinson D, Southgate VR (1987). The genus *Schistosoma*: a taxonomic appraisal. In Rollinson D, Simpson AJG (eds), *The Biology of Schistosomes: From Genes to Latrines*. London: Academic Press; 1–4.
- Rollinson D, Imbert-Establet D, Ross GC (1986). *Schistosoma mansoni* from naturally infected *Rattus rattus* in Guadeloupe identification, prevalence and enzyme polymorphism. *Parasitology* **93**: 39–53.
- Sabah AA, Fletcher C, Webbe G *et al.* (1985). *Schistosoma mansoni*: reduced efficacy of chemotherapy in infected T cell deprived mice. *Exp Parasitol* **60**: 348–54.
- Sadigursky M, Andrade AZ (1982). Pulmonary changes in schistosomes cor pulmonale. *Am J Trop Med Hyg* **31**: 779–84.
- Sambon LW (1909). What's *Schistosoma mansoni* Sambon, 1907? *J Trop Med Hyg* **12**: 1–11.
- Scrimgeour EM, Gajdusek DC (1985). Involvement of the central nervous system in *Schistosoma mansoni* and *S. haematobium* infection: a review. *Brain* **108**: 1023–38.
- Shaw AFB, Ghareeb AA (1938). The pathogenesis of pulmonary schistosomiasis in Egypt with special reference to Ayerza's disease. *J Pathol Bact* **46**: 401–26.
- Shekhar KC (1991). Schistosomiasis drug therapy and treatment considerations. *Drugs* **42**: 379–405.
- Simpson AJ, Payares A, Walker P *et al.* (1984). The modulation of expression of polypeptide surface antigens on developing schistosomulae of *Schistosoma mansoni*. *J Immunol* **133**: 2725–30.
- Sleigh A, Hoff R, Mott KE *et al.* (1982). Comparison of filtration staining (Bell) and thick-smear (Kato) for the detection and quantification of *Schistosoma mansoni* eggs in feces. *Trans R Soc Trop Med Hyg* **76**: 403–6.
- Smith JH, Christie JD (1986). The pathobiology of *Schistosoma haematobium* in humans. *Hum Pathol* **17**: 333–45.
- Smith JH, Kamel IA, Elwi A, von Lichtenberg F (1974). A quantitative post mortem analysis of urinary schistosomiasis in Egypt. I. Pathology and pathogenesis. *Am J Trop Med Hyg* **23**: 1054–71.
- Smith JH, Kelada AS, Khalil A *et al.* (1977). Surgical pathology of schistosomal obstructive uropathy: a clinicopathologic correlation. *Am J Trop Med Hyg* **26**: 96–103.
- Smith JH, von Lichtenberg FH (1967). The Hoeppli phenomenon in Schistosomiasis. II. Histochemistry. *Am J Pathol* **50**: 993–1007.
- Sobh MA, Moustafa FE, El-Housseni F *et al.* (1987). Schistosomal specific nephropathy leading to end-stage renal failure. *Kidney Int* **31**: 1006–11.
- Sobhon P, Suchart UE (1990). *Snail Hosts, Life Cycle and Tegmental Structure of Oriental Schistosomes*. UNDP/World Bank/WHO Special Programme for Research and Training in Tropical Diseases. Geneva: WHO; 1–31.
- Soisson LB, Reid GDF, Farah IO *et al.* (1993). Protective immunity in baboons vaccinated with a recombinant antigen or radiation-attenuated cercariae of *Schistosoma mansoni* is antibody-dependent. *J Immunol* **151**: 4781–9.
- Stelma FF, Sall S, Daff B, Sow S *et al.* (1997). Oxamniquine cures *Schistosoma mansoni* infection in a focus in which cure rates with praziquantel are usually low. *J Infect Dis* **176**: 304–7.
- Stelma FF, Talla I, Polman K *et al.* (1993). Epidemiology of *Schistosoma mansoni* infection in a recently exposed community in northern Senegal. *Am J Trop Med Hyg* **49**: 701–6.
- Stelma FF, Talla J, Sow S *et al.* (1995). Efficacy and side effects of praziquantel in an epidemic focus of *Schistosoma mansoni*. *Am J Trop Med Hyg* **53**: 167–70.
- Stephenson L (1993). The impact of schistosomiasis on human nutrition. *Parasitology* **107**: 5107–23.
- Stephenson LS, Holland C (1987). Schistosomiasis. In Stephenson LS, Holland C (eds), *The Impact of Helminth Infections on Human Nutrition. Schistosomiasis and Soil-Transmitted Helminths*. Philadelphia, PA: Taylor and Francis; 47–88.
- Strickland GT (1994). Gastrointestinal manifestations of schistosomiasis. *Gut* **35**: 1334–7.
- Symmers WStC (1904). Note on a new form of liver cirrhosis due to the presence of the ova of *Bilharzia haematobia*. *J Pathol Bact* **9**: 237–9.
- Taylor P, Chandiwana SK, Matanhire D (1990). Evaluation of reagent strip test for hematuria in the control of *Schistosoma haematobium* infection in school children. *Acta Tropica* **47**: 91–1001.
- Teesdale CH, Amin MA (1976). Comparison of the Bell technique and a modified Kato thick-smear technique and a digestion method for the field diagnosis of schistosomiasis mansoni. *J Helminthol* **50**: 17–20.
- Tendler M, Brito CA, Vilar MM *et al.* (1996). A *Schistosoma mansoni* fatty acid-binding protein, Sm14, is the potential basis of a dual-purpose antihelminth vaccine. *Proc Natl Acad Sci USA* **93**: 269–73.
- Thomas JG, Bassett MT, Sigola LB *et al.* (1990). Relationship between bladder cancer incidence, *Schistosoma haematobium* infection, and geographical region of Zimbabwe. *Trans R Soc Trop Med Hyg* **84**: 551–3.
- Van Wout AB, DeJonge N, Tiu WY *et al.* (1992). Schistosome circulating anodic antigen in serum of individuals infected with *Schistosoma japonicum* from the Philippines before and after chemotherapy with praziquantel. *Trans R Soc Trop Med Hyg* **86**: 410–13.
- Van Lieshout L, DeJonge N, Bassily S *et al.* (1991). Assessment of cure in schistosomiasis patients after chemotherapy with praziquantel by quantification of circulating anodic antigen (CAA) in urine. *Am J Trop Med Hyg* **44**: 323–8.
- Van Lieshout L, DeJonge N, el-Masry N *et al.* (1994). Monitoring the efficacy of different doses of praziquantel by quantification of circulating antigens in serum and urine of schistosomiasis patients. *Parasitology* **108**: 519–26.
- Voge M, Bruckner DG, Bruce JI (1978). *Schistosoma mekongi* sp. n. from man and animals compared with four geographic strains of *Schistosoma japonicum*. *J Parasitol* **64**: 577–84.
- Von Lichtenberg F (1987). Consequences of infections with schistosomes. In Rollinson D, Simpson AJG (eds), *The*

- Biology of Schistosomes: From Genes to Latrines*. London: Academic Press; 185–232.
- Waive EJ, McManus DP (1997). Schistosomiasis vaccine development. The current picture. *Bio Essays* **19**: 435–43.
- Warren KS (1973a). History of schistosomiasis. In Warren KS (ed.), *Schistosomiasis. The Evolution of a Medical Literature*. Selected Abstracts and Citations, 1852–1972. MIT Press: Cambridge, MA.
- Warren KS (1973b). The pathology of schistosome infections. *Helminthol Abstr* **42**: 592–633.
- Warren KS (1984). The kinetics of hepatosplenic schistosomiasis. *Semin Liver Dis* **4**: 293–300.
- Warren KS, Su DL, Xu ZY *et al.* (1983). Morbidity in *Schistosoma japonica* in relation to intensity of infection. A study of two rural brigades in Anhui province, China. *N Engl J Med* **309**: 1533–9.
- Watt A, Baldovino PC, Castro JT *et al.* (1986). Bloody diarrhea after praziquantel therapy. *Trans R Soc Trop Med Hyg* **84**: 394–400.
- Webbe G (1982a). The intermediate hosts and host–parasite relationships. In Jordan P, Webbe G (eds), *Schistosomiasis, Epidemiology, Treatment and Control*. London: Heinemann; 16–49.
- Webbe G (1982b). The life cycle of the parasites. In Jordan P, Webbe G (eds), *Schistosomiasis, Epidemiology, Treatment and Control*. London: Heinemann; 50–78.
- Weber MC (1973). Miracidial hatching in the diagnosis of bilharziasis. *Central Afr J Med* **19**: 11–17.
- Wiest PM, Tartakoff AM, Aikawa M *et al.* (1988). Inhibition of surface membrane maturation in schistosomula of *Schistosoma mansoni*. *Proc Natl Acad Sci USA* **85**: 3825–29.
- Wiest PM, Wu G, Zhong S *et al.* (1992). Morbidity due to schistosomiasis japonicum in the People's Republic of China. *Am J Trop Med Hyg* **86**: 47–50.
- Wiest PM, Wu G, Zhong S *et al.* (1994). Impact of annual screening and chemotherapy with praziquantel on schistosomiasis japonica on Jishan Island, People's Republic of China. *Am J Trop Med Hyg* **51**: 162–9.
- Wilkins A, Gilles H (1987a). Schistosomiasis hematobia. In Mahmoud AAF (ed.), *Clinical Tropical Medicine and Communicable Diseases*. London: Baillière-Tindall; 333–48.
- Wilkins HA (1987b). Epidemiology of schistosome infections in man. In Rollinson D, Simpson AJG (eds), *The Biology of Schistosomes. From Genes to Latrines*. London: Academic Press; 379–97.
- Wilson RA (1987). Cercariae to liver worms: development and migration in the mammalian host. In Rollinson D, Simpson AJG (eds), *The Biology of Schistosomes. From Genes to Latrines*. London: Academic Press; 115–46.
- World Health Organization (1985). The control of schistosomiasis. *WHO Tech Rep Ser* **728**: 1–49.
- World Health Organization (1987). *Atlas of the Global Distribution of Schistosomiasis*. Parasitic Diseases Programme. Geneva: WHO.
- World Health Organization (1991). Proposals for a practical guide to the standardized use of ultrasound in the assessment of pathological changes. Meeting on ultrasonography in schistosomiasis, 1–4 October 1990, Cairo, Egypt TDR/SCH/Ultrason 191.3.
- World Health Organization (1983). *Diagnostic Techniques in Schistosomiasis Control*. WHO, Schisto, 83.69. Geneva: WHO; 1–36.
- World Health Organization (May 1996). *WHO Fact Sheet*. Geneva: WHO; 115.
- World Health Organization (1993). The control of schistosomiasis: second report of the WHO Expert Committee. WHO Tech Rep Ser 830. Geneva: WHO; 1–86.
- World Health Organization (1994). Infection with schistosomes (*Schistosoma hematobium*, *Schistosoma mansoni* and *Schistosoma japonicum*). IARC Monographs on the Evaluation of Carcinogenic Risks to Humans, 61: 45–119.
- Wright ED, Chiphangi J, Hutt MSR (1982). Schistosomiasis of the female genital tract. A histopathological study of 176 cases from Malawi. *Trans R Soc Trop Med Hyg* **76**: 822–9.
- Wright WH (1973). Geographical distribution of schistosomes and their intermediate hosts. In Ansari N (ed.), *Epidemiology and Control of Schistosomiasis (Bilharziasis)*. Basel: Karger; 32–249.
- Wynn TA, Morawetz R, Schartor-Kersten T *et al.* (1997). Analysis of granuloma formation in double cytokine deficient mice reveals a central role for IL-10 in polarizing both T helper cell 1 and T helper cell 2-type cytokine responses *in vivo*. *J Immunol* **159**: 5014–23.
- Yang W, Gobert AN (1997). Oral vaccination of mice with recombinant *Schistosoma japonicum* proteins induces specific antiparasite antibodies and damage to adult worms after a challenge infection. *Int J Parasitol* **27**: 843–53.
- Yap G, Cheever AW, Caspar P, Jankovic D, Sher A (1997). Unimpaired down-modulation of the hepatic granulomatous response in CD8 T-cell and r-interferon-deficient mice chronically infected with *Schistosoma mansoni*. *Infect Immunol* **65**: 2583–6.
- Ye XP, Fu YL, Anderson RM, Nokes DJ (1998). Absence of relationship between *Schistosoma japonicum* and hepatitis B virus infection in the Dongting Lake region, China. *Epidemiol Infect* **121**: 193–5.
- Yole DS, Reid AD, Wilson RA (1996). Protection against *Schistosoma mansoni* and associated immune responses induced in the ferret monkey *Cerpithecus aethiops* by the irradiated cercariae vaccine. *Am J Trop Med Hyg* **54**: 265–70.
- Young SW, Higashi A, Kamel R *et al.* (1973). Interaction of salmonellae and schistosomes in host–parasite relations. *Trans R Soc Trop Med Hyg* **67**: 797.
- Zwingenberger K, Feldmeier H, Bienzte U (1990). Mixed *S. haematobium/S. intercalatum* infection. *Ann Trop Med Parasitol* **84**: 85–7.



# Hepatobiliary and Pulmonary Flukes: *Opisthorchis*, *Clonorchis*, *Fasciola* and *Paragonimus* spp.

Thomas R. Hawn and Elaine C. Jong

University of Washington Medical Center, Seattle, WA, USA

## GENERAL CONSIDERATIONS

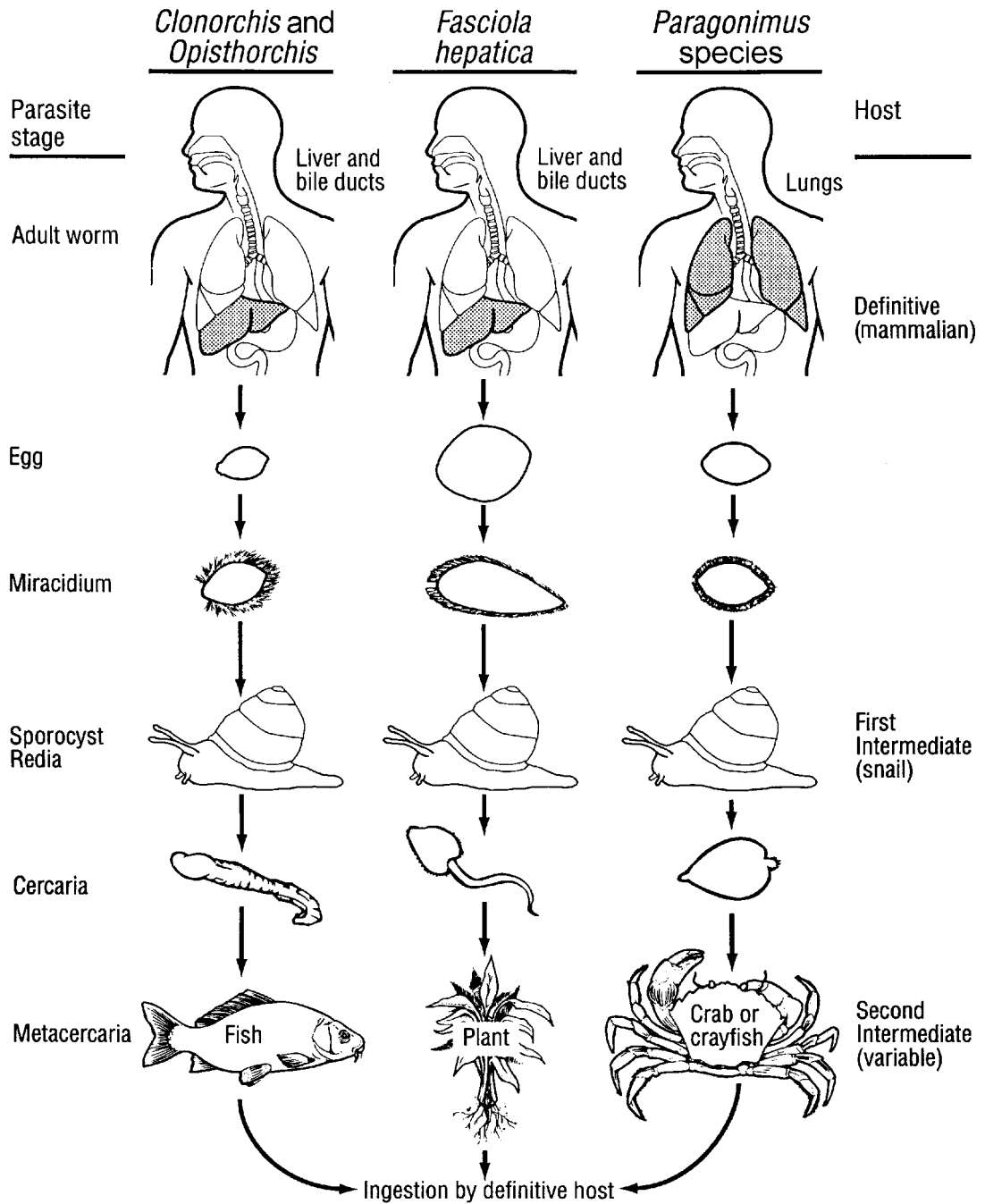
Hepatobiliary and pulmonary trematodes are found worldwide, with a predominance in Asia, Africa and South America (Table 17.1). Although not as common as blood flukes, these helminths infect over 53 million people and also cause morbidity and mortality in animals (Hopkins, 1992). The life-cycles of these helminths share a number of features, beginning with the ingestion of metacercariae by the definitive host (Figure 17.1). After excystment in the duodenum, the metacercariae mature into

adult worms, which secrete eggs that hatch into miracidia and then infect snails. The miracidia develop into cercariae, which are secreted in water and encyst as metacercariae in a second intermediate host (fish for *Opisthorchis* or *Clonorchis* spp., crustaceans for *Paragonimus*) or attach to freshwater plants (*Fasciola*). The metacercariae are ingested from uncooked food by the mammalian host to complete the life-cycle. This chapter will describe some of the medically important hepatobiliary and pulmonary trematodes that infect humans (Table 17.1) (Harinasuta and Bunnag, 1987a).

## OPISTHORCHIS AND CLONORCHIS SPP.

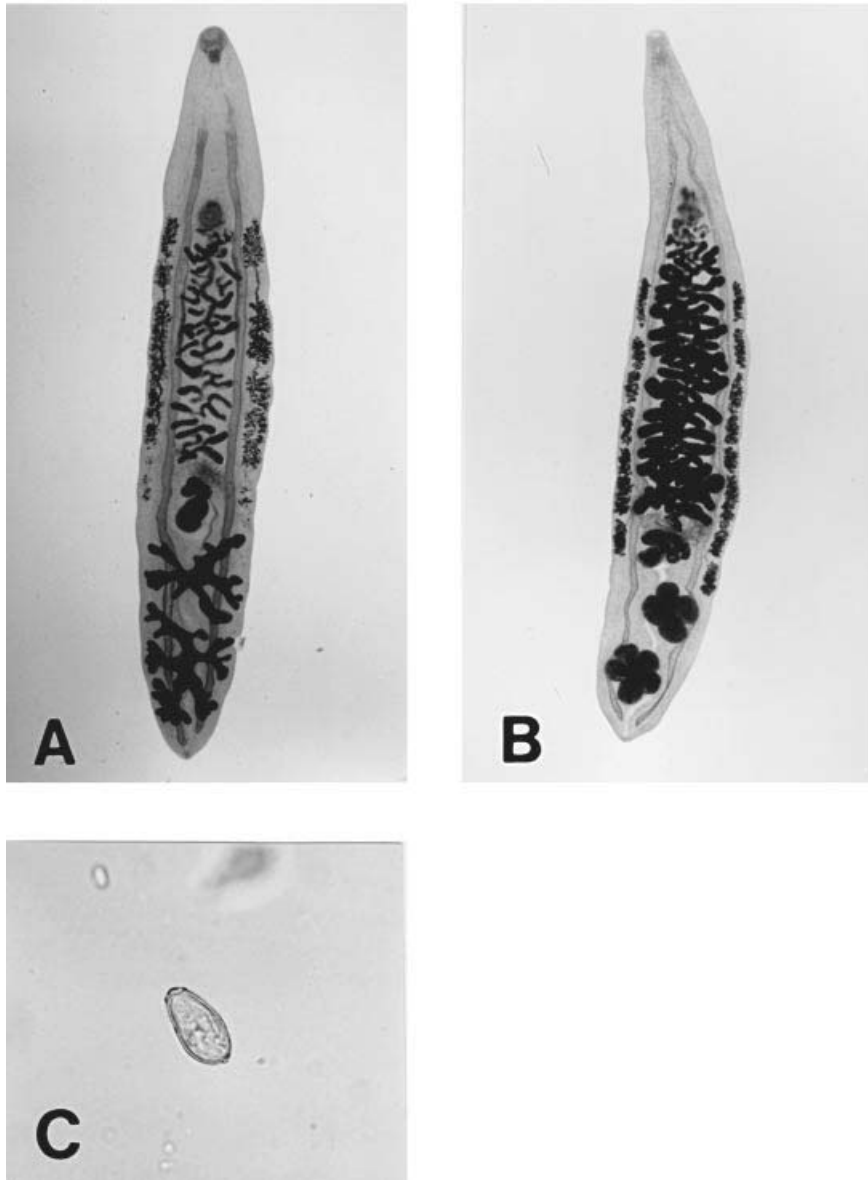
Opisthorchiasis and clonorchiasis are caused by biliary flukes and are estimated to infect over 30 million people worldwide (Hopkins, 1992). Acquired by the ingestion of metacercariae from raw fish, these organisms are endemic in China and South-east Asia. *Clonorchis sinensis* was discovered in Calcutta in 1875 by McConnel and was originally named *Distomum spathulatum* (Komiya, 1966). In 1895, Blanchard named the genus *Opisthorchis*

and placed *Distomum sinense* in it. Looss later created the genus *Clonorchis* in 1907 and distinguished it from *Opisthorchis* by the presence of branched instead of lobed testes. Although considered a member of the genus *Opisthorchis*, the name *C. sinensis* persists due to its long tradition of use. The life-cycle and clinical features of *C. sinensis*, *O. viverrini* and *O. felinus* are similar and will be described together.



**Fig. 17.1** Life-cycles of *Opisthorchis*, *Clonorchis*, *Fasciola hepatica* and *Paragonimus* spp. Life-cycle stages not drawn to scale. Illustrated by David W. Ehlert, MAMS





**Fig. 17.2** (A) *Clonorchis sinensis* adult ( $\approx 10 \times 3$  mm). (B) *Opisthorchis viverrini*, adult ( $\approx 10 \times 3$  mm). (C) *O. viverrini* egg ( $\approx 26 \times 15 \mu\text{m}$ ). *C. sinensis* adult distinguished from *O. viverrini* by branched vs. lobed testes. While *C. sinensis* eggs are similar to *O. viverrini* eggs, the former also have a terminal knob and a shoulder around the operculum. Eggs photographed at same magnification in Figures 17.2–17.4. Reproduced by courtesy of Professor Prayong Radomyos, Faculty of Allied Health Sciences, Thammasat University, Thailand

### DESCRIPTION OF THE ORGANISMS

Both *Opisthorchis* and *Clonorchis* are digenetic, hermaphroditic trematodes with life-cycles that include two intermediate hosts (snail and fish)

and a definitive mammalian host (Figure 17.1). The adult worms measure  $10 \times 3$  mm, are colorless and can live up to 30 years in humans (Figure 17.2). They contain an oral and ventral sucker, cuticle, alimentary system, ovaries and testes

(Komiya, 1966). The testes of *C. sinensis* are more branched than *O. viverrini* but are otherwise difficult to distinguish. *O. viverrini* and *O. felineus* can only be distinguished by the flame cell patterns of the cercariae or metacercariae (Wykoff *et al.*, 1965). The adult worm resides in the intrahepatic bile ducts and occasionally in the gall bladder, common bile duct and pancreatic duct. *C. sinensis* eggs are ovoid, yellowish-brown, measure approximately  $28 \times 16 \mu\text{m}$  and are distinguished by an opercular shoulder and a terminal knob. *Opisthorchis* eggs are similar to *C. sinensis*, except that they lack the shoulder around the operculum and do not have the terminal knob. As a group, these eggs are among the smallest of common human parasites. *O. viverrini* eggs measure  $26 \times 15 \mu\text{m}$ , while *O. felineus* are  $30 \times 11 \mu\text{m}$  (Sun, 1982). The eggs are secreted in the feces, ingested by a snail and then hatch into miracidia, which are released in the alimentary canal of the snail and subsequently develop into sporocysts, rediae and finally cercariae ( $230 \times 70 \mu\text{m}$ ). The latter are secreted into fresh water and within 24 hours encyst in piscine muscle or subcutaneous tissue. After ingestion of inadequately prepared fish, a mammalian host may become infected, as the metacercariae are released in the duodenum and then migrate to the bile ducts within 15–48 hours of consumption. After approximately 1 month of maturation, the adult worm secretes eggs.

### PATHOGENESIS AND IMMUNOLOGY

The major pathologic findings are in the bile ducts, where the epithelium undergoes adenomatous proliferation and goblet cell metaplasia, with increased mucin secretion (Hou, 1955). The adenomatous cells are gradually replaced by fibrous tissue, which can lead to thickening of the bile ducts, often with a predilection for the left hepatic lobe. The worms often reside in the intrahepatic bile ducts, which become dilated to a size of 3–6 mm. In one series of patients with opisthorchiasis, pathological examination revealed inflammatory infiltration of the ductal walls in 76%, proliferation of ducts in 75% and periductal fibrosis in 52% of patients (Koompirochana *et al.*, 1978). Cholangio-

carcinoma is strongly associated with chronic infections of both Clonorchis and Opisthorchis. The pathology is characterized by prominent mucin secretion and extensive fibrosis often near the hilum of the liver (Sun, 1984).

The immunologic response to *C. sinensis* infection includes a humoral immune response that appears to be non-protective, as infected patients do not appear to acquire long-term immunity (Sun, 1984). The evidence for acquired resistance is not strong, although some preliminary studies suggest it. In one, egg-negative residents had higher IgG, IgA and IgM antibody levels to adult worm homogenate than egg-positive residents, suggesting that these individuals may be immunologically resistant to infection (Akai *et al.*, 1994). Acquired resistance can be induced in hamsters with a primary infection of five metacercariae followed by a challenge infection with 50 metacercariae. In this model, there was a 25% reduction in the number of worms that survived in the group previously infected, compared to uninfected controls (Flavell, 1982).

### EPIDEMIOLOGY

*C. sinensis* is endemic to South-east Asia, including China, Japan, Korea, Vietnam and Taiwan. *O. viverrini* is endemic in Thailand and Laos, while *O. felineus* is present in Eastern Europe and Russia (Table 17.1). Prevalence rates for *C. sinensis* vary dramatically according to geography and local customs. For example, Taiwan had an overall estimated prevalence rate of 0.012–1.5% in 1984, compared to a rate of 52–57% in areas where raw freshwater fish was ingested (Lin *et al.*, 1987). In South Korea the overall rate was 2.6% in 1981, while the rate in riverside areas was 21.5% (Rim, 1997). Non-human reservoirs for *C. sinensis* can be substantial (Komiya, 1966). In Korea, for example, the infection rate was 23.6% for dogs and 15.1% for pigs (Lin *et al.*, 1987). The major risk factors for acquisition are ingestion of raw or smoked fish that contain metacercariae, and living in a region with poor sanitation that allows transmission of the life-cycle. The latter occurs when

**Table 17.1** Biliary, hepatic and pulmonary trematodes: location, source of infection, clinical features, and treatment\*

Species	Location	Source of infection	Clinical features	Treatment
<b>Hepatobiliary flukes</b>				
Family Opisthorchidae				
<i>Opisthorchis viverrini</i>	Thailand, Laos	Freshwater fish	Asymptomatic or abdominal pain with eosinophilia	Praziquantel
<i>O. felineus</i>	Eastern Europe, Vietnam	Freshwater fish		Praziquantel
<i>Clonorchis sinensis</i>	Far East	Freshwater fish		Praziquantel
<i>Metorchis conjunctus</i>	North America	Fish	Rarely infects humans	Praziquantel <sup>†</sup>
Family Fasciolidae				
<i>Fasciola hepatica</i>	Worldwide-sheep and cattle-raising areas	Raw vegetables, especially watercress	Abdominal pain, hepatomegaly, fever, and eosinophilia	Bithionol and experimental drugs
<i>F. gigantica</i>				
Family Dicrocoeliidae				
<i>Dicrocoelium dendriticum</i>	Europe, North and South America, Africa, and Saudi Arabia	Ants	Rarely infects humans	Praziquantel <sup>†</sup>
<i>D. hospes</i>	Africa			
<i>Eurytrema pancreaticum</i>	Japan, South-east Asia	Grasshopper and crickets	Rarely infects humans, usually in pancreatic duct in animals	
<b>Lung flukes</b>				
Family Paragonimidae				
<i>Paragonimus westermani</i>	Worldwide	Freshwater crustaceans, such as crabs or crayfish	Hemoptysis, cough, ±central nervous system involvement with eosinophilia	Praziquantel <sup>†</sup>
<i>P. heterotremus</i>	Thailand, Laos, China			
<i>P. philippinensis</i>	The Philippines			
<i>P. uterobilateralis</i>	Cameroons, Liberia, Nigeria			
<i>P. africanus</i>	Cameroons			
<i>P. mexicanus</i>	Central America			
<i>P. peruvianus</i>	Peru			
<i>P. caliensis</i>	South America			
<i>P. rudis</i>	Brazil, Guatemala			
<i>P. kellicotti</i>	South America			
<i>P. miyazakii</i>	Japan			
<i>P. ohirai</i>	Japan			
<i>P. compactus</i>	India			
<i>P. skrjabini</i> ( <i>P. szechuanensis</i> )	China	Freshwater crustaceans, such as crabs or crayfish	Same but also with cutaneous nodules	

\*Adapted from Harinasuta and Bunnag (1987a). <sup>†</sup>Considered an investigational drug for this indication.

egg-infested feces contaminate public water sources, often from a lack of available latrines.

## CLINICAL FEATURES

### Acute

Minimal information is available on the acute stage of infection. Symptoms in one outbreak of acute *C. sinensis* infection included malaise and fever,

followed by mild scleral icterus with an enlarged and tender liver. Peripheral eosinophilia was often present and stool studies were usually negative until 3–4 weeks after the infection. The symptoms were usually self-limited (Koenigstein, 1949).

### Chronic

While chronic infections have a range of clinical manifestations, the majority of patients are

**Table 17.2** Clinical and laboratory features of clonorchiasis and opisthorchiasis

Study	Percentage affected (%)					
	Strauss (1962)	Strauss (1962)	Upatham <i>et al.</i> (1982)	Wykoff <i>et al.</i> (1966)	Wykoff <i>et al.</i> (1966)	Pungpak <i>et al.</i> (1985)
Country	USA	USA	Thailand	Thailand	Thailand	Thailand
<i>n</i>	105	105	211	921	921	88
	Controls C*	Infected C	O*	Controls O	Infected O	Severe O
Sign, symptom, or laboratory test						
Right upper quadrant abdominal pain	4	4	25			
Diarrhea	21	9	23			
Constipation	2	7				
Nausea, vomiting	5	9	18	51	49	
Epigastric pain	11	15		59	66	
Jaundice	0	0		19	28	45
Hepatomegaly	16	13	13	14	1	50
Ascites	0	1				
Blood tests:						
Eosinophilia (> 6%)				16	55	
Leukocytosis				47	47	
Anemia				41	48	
Elevated bilirubin				3	3	47
Occult blood	25	16				

\*C= clonorchiasis, O= opisthorchiasis.

asymptomatic. Strauss studied the clinical manifestations of clonorchiasis in a controlled study and found no difference from controls in the incidence of abdominal pain, diarrhea, nausea, vomiting, jaundice, hepatomegaly or ascites (Table 17.2) (Strauss, 1962). Similar to clonorchiasis, opisthorchiasis is most often asymptomatic, although patients with heavier infections may have symptoms that are correlated with the level of egg burden (Table 17.2) (Upatham *et al.*, 1982). Right upper quadrant abdominal pain and weakness were associated with heavy worm burdens, while anorexia, nausea and vomiting had no correlation. In another controlled study, the only symptom found more commonly in heavily infected patients was jaundice (28 vs. 19%) (Wykoff *et al.*, 1966). In addition to eosinophilia, elevated IgE levels have been detected more often in infected patients (Woolf *et al.*, 1984).

### Obstructive Biliary Disease

Severe infections can lead to cholangitis secondary to biliary duct obstruction by the adult

worms. In one study of severely infected patients, jaundice was found in 47% of patients and cholangitis in 30% (Pungpak *et al.*, 1985). The radiographic appearance on cholangiograms includes filling defects and changes in the intra- and extrahepatic biliary ducts (Choi *et al.*, 1984). If a patient does not need acute surgical or endoscopic decompression, definitive treatment can be accomplished with praziquantel (see below). There has been some debate as to whether *C. sinensis* infections are associated with an increased incidence of gallstone disease. In a survey of 947 patients with clonorchiasis, Hou *et al.* (1989) found no statistically significant difference in the prevalence of cholelithiasis compared to controls.

### Recurrent Pyogenic Cholangitis

Recurrent pyogenic cholangitis (RPC: previously called oriental cholangiohepatitis) is a syndrome with intermittent episodes of intra and extrahepatic gallstone disease. Patients present with abdominal pain, fever, jaundice and hepatomegaly (Sun, 1984). Bile ducts show branching,

with dilatation and strictures mainly involving the left hepatic lobe. Pathologic studies reveal periductal fibrosis. While it is one of the most common causes of obstructive biliary disease in some Asian countries, the theories of its etiology continue to be debated. Whether *C. sinensis* is an innocent bystander or a causative agent of RPC remains unknown. Fung (1961) found that 91% of patients with RPC had *C. sinensis*, compared to 46% of the general population. In a study of the gallstones of 42 patients with RPC, eight contained *C. sinensis*, while 16 had *Ascaris lumbricoides* (Teoh, 1963). The preference of both RPC and *C. sinensis* for the left hepatic lobe and the absence of RPC in countries without *C. sinensis* all argue for the parasites being more than innocent bystanders (Bonar *et al.*, 1989). Surgical treatment is different than that for cholangitis secondary to gallstones. Instead of a cholecystectomy, patients often receive a choledochostomy or hepatic lobectomy (Bonar *et al.*, 1989).

### Cholangiocarcinoma

A high association has been observed between cholangiocarcinoma and both clonorchiasis and opisthorchiasis (Schwartz, 1980). Hou (1986) estimated that 15% of primary liver cancers in Hong Kong were associated with *C. sinensis* and were cholangiocarcinomas. The neoplasias are often multifocal adenocarcinomas, with extensive mucin secretion and a tendency to undergo squamous metaplasia. Surgery is the only treatment option and is often only of a palliative nature, with a 1 year survival rate of 15% (Bhudhisawasdi, 1997). The vast majority of patients with these infections do not develop cholangiocarcinoma, which raises the question of whether there is another carcinogen that acts synergistically with the parasite. Nitrosamines and aflatoxins have been implicated as potential culprits (Flavell, 1981). The genetic alterations associated with cholangiocarcinoma differ between patients from endemic and non-endemic areas for clonorchis and opisthorchis. Mutations in the *ras* oncogene and *p53* tumor suppressor gene are found less frequently in Thai patients compared to English and Japanese patients (Petmir, 1997). Hepatocellular carcinoma has

not been found to be associated with *C. sinensis* or *O. viverrini*.

## LABORATORY DIAGNOSIS

### Stool Studies and Serology

Stool studies remain the most widely used technique for diagnosing both clonorchiasis and opisthorchiasis. Sithithaworn *et al.* (1991) examined the sensitivity of stool studies in 181 victims of fatal accidents by comparing stool studies with worm burdens. The sensitivity of stool egg studies ranged from 28% for light infections to 100% for heavier infections. In addition, there was a correlation of egg counts with worm burden. This study underlines the fact that community studies are likely to underreport the prevalence of this disease. ELISA studies are also available for research purposes. For opisthorchiasis, the sensitivity and specificity of the ELISA test in one study were 93% and 54%, respectively (Srivatanakul *et al.*, 1985). The Centers for Disease Control and Prevention (CDC) does not currently offer serologic tests for diagnosis.

### Radiology

Other diagnostic options include ultrasonography. In one study of 1807 infected patients, 36% had an abnormal gall bladder size, which correlated with egg counts (Elkins *et al.*, 1996). Other abnormalities included gall bladder sludge in 25%, abnormal wall thickness in 23% and cholelithiasis in 5%. This last finding was not clearly correlated with infection when compared to controls.

### Molecular Techniques

DNA-based techniques have not had a role in the clinical diagnosis of clonorchiasis or opisthorchiasis.

## CLINICAL MANAGEMENT

Praziquantel is the drug of choice for treating both clonorchiasis and opisthorchiasis (Bunnag

**Table 17.3** Treatment of clonorchiasis and opisthorchiasis

Drug	Total daily dose (mg/kg) and duration	n	Efficacy (%)	Study and parasite*	Side effects
Praziquantel	75, 1 day	29	97	Jong <i>et al.</i> (1985) C+ O	Frequent: malaise, headache, dizziness. Occasional: sedation, abdominal discomfort, fever, nausea, eosinophilia. Rare: pruritis, rash
	75, 1 day	35	86	Rim <i>et al.</i> (1981) C	
	40, 1 day	28	25	Rim <i>et al.</i> (1981) C	
	75, 1 day	67	100	Yangco (1987) C	
	75, 1 day	107	84	Chen <i>et al.</i> (1983) C 4m	
	40, 1 day	122	96	Pungpak <i>et al.</i> (1983) O	
	75, 1 day	23	100	Bunnag and Harinasuta (1980) O	
	75, 2 days	26	100	Bunnag and Harinasuta (1980) O	
Mebendazole	20–30, 3–4 weeks	37	70–94	Jaroonvesama <i>et al.</i> (1981) O	Experimental
Albendazole	400 mg b.i.d. 3 days	25	12	Pungpak <i>et al.</i> (1984) O	Experimental
	7 days	27	33		

\*C= clonorchiasis, O= opisthorchiasis.

and Harinasuta, 1980; Chen *et al.*, 1983; Jong *et al.*, 1985; Pungpak *et al.*, 1983; Rim *et al.*, 1981; Yangco *et al.*, 1987) (Table 17.3). Efficacy rates are excellent, ranging from 86% to 100% with 75 mg/kg/day divided into three doses for 1 day. By comparison, only 8% of *C. sinensis* infections resolved in a placebo group at 60 days (Jong *et al.*, 1985). For *C. sinensis*, doses of less than 75 mg/kg/day decrease the efficacy (cure rate of 25% at 40 mg/kg/day), while for *O. viverrini* lower doses appear to be adequate (cure rate of 96% at 40 mg/kg/day). Side effects of praziquantel include frequent malaise, headache and dizziness, as well as occasional sedation, abdominal discomfort, fever, nausea and eosinophilia. The mechanism of action of praziquantel remains unknown but is thought to involve spastic paralysis of the musculature and vacuolization of the outer membrane. In animal models, its mechanism is dependent on an intact immune system (King and Mahmoud, 1989). Experimental treatments for *O. viverrini* include mebendazole and albendazole, with moderate

efficacy of the former and limited success with the latter (Table 17.3) (Jaroonvesama *et al.*, 1981; Pungpak *et al.*, 1984).

## PREVENTION AND CONTROL

No vaccine is currently available for either clonorchiasis or opisthorchiasis. Control can be achieved through interruption of transmission by avoiding uncooked fish (including smoked, dried and salted), providing improved sanitation, and treating with praziquantel. An intervention study in Thailand demonstrated that the prevalence of opisthorchis can be reduced from 64% to 4% over 3 years (Saowakontha *et al.*, 1993). The intervention consisted of treatment with praziquantel every 6 or 12 months as well as health education and sanitation improvement every 6 months. There was no difference in reduction between those treated every 6 vs. 12 months with praziquantel.

## FASCIOLA SPP.

### INTRODUCTION

The hepatobiliary fluke *Fasciola hepatica* is estimated to infect over 17 million people worldwide and cause significant morbidity and

mortality in livestock (Hopkins, 1992). Also known as liver rot, infection occurs by ingestion of metacercariae from contaminated freshwater vegetables, such as watercress and water chestnuts. First described in animals by Jean de Brie in

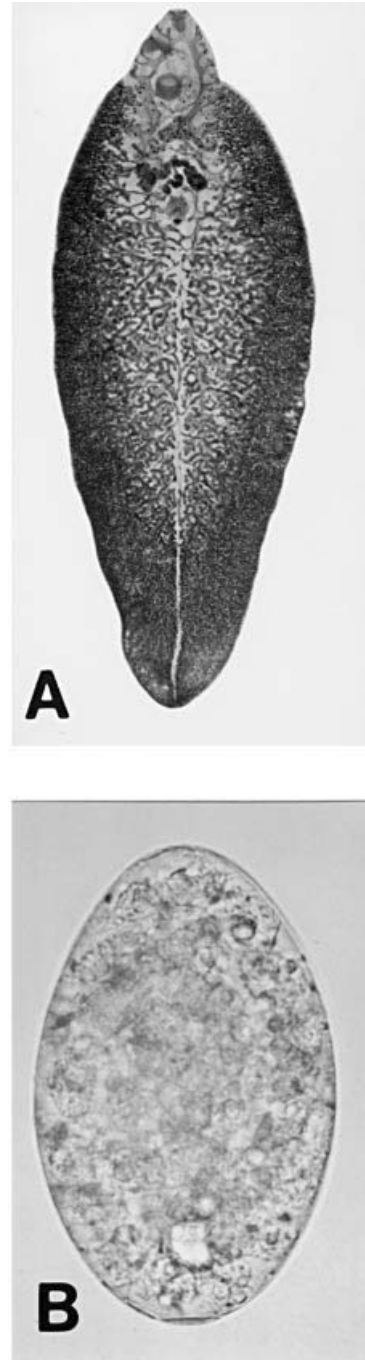
1379, *F. hepatica* was later discovered in humans in 1600. The life-cycle was elucidated in the 1880s by Leuckart and Thomas (Naquira-Vildoso and Marcial-Rojas, 1971).

### DESCRIPTION OF THE ORGANISM

*F. hepatica* is a digenetic, hermaphroditic trematode with a life-cycle that includes an intermediate (snail) and definitive (mammalian) host (Figure 17.1). The adult worm is leaf-shaped, measures up to  $30 \times 13$  mm and has an average lifespan in humans of up to 10 years (Figure 17.3) (Chen and Mott, 1990). It contains a ventral oral sucker, uterus, testes, intestinal system and surface spines and resides in the biliary ducts, where it secretes an average of 9000–25 000 eggs/day. The operculated ova are yellowish-brown and measure  $140 \times 75$   $\mu$ m. The eggs are significantly larger than those of *Opisthorchis* and *Paragonimus* and are characterized by the presence of yolk cells and an indistinct operculum (Sun, 1982). After passage from the bile ducts into the small intestine, the eggs are excreted in the feces, where they hatch into miracidia after a maturation phase of 10–15 days in water. They subsequently infect snails of the genus *Lymnaea*, which are often found in marshes and swamps. After infecting snails, the miracidia are transformed in 6–7 weeks into sporocysts, rediae and then cercariae, which are secreted from snails. They attach to aquatic plants and encyst to form metacercariae, which are infective for mammals within 24 hours. Ingestion of this stage by herbivores leads to excystment in the duodenum (Boray, 1969; Chen and Mott, 1990; Dawes and Hughes, 1964; Naquira-Vildoso and Marcial-Rojas, 1971).

### PATHOGENESIS

After excystment, the metacercariae penetrate the intestine and enter the peritoneal cavity as immature flukes. They migrate to the liver after several days and penetrate Glisson's capsule during the acute hepatic phase of infection. After migration through the liver for 5–6 weeks, the worms enter the bile ducts to begin



**Fig. 17.3** *Fasciola hepatica* adult (A) ( $\approx 30 \times 13$  mm) and egg (B) ( $\approx 140 \times 75$   $\mu$ m). Reproduced by courtesy of Professor Prayong Radomyos, Faculty of Allied Health Services, Thammasat University, Thailand

the chronic biliary phase. The flukes mature after 3–4 months and begin to secrete eggs. Other routes of migration have been proposed including a hematogenous and biliary route (directly from the intestine). These theories seem less probable since worms have not been found in the circulation and do not reach the biliary tree until late in the disease course (Naquira-Vildoso and Marcial-Rojas, 1971).

The pathologic findings of the acute stage include focal hemorrhage and inflammation in the duodenum. When the flukes enter the liver, they digest hepatic tissue and cause inflammation, hemorrhage, dilated intrahepatic bile ducts, subcapsular cavities and surface liver nodules of 5–15 mm in diameter. Migration tracks from some of these nodules extend 1–2 cm into the parenchyma. These tracks contain cellular debris, Charcot–Leyden crystals, eosinophilic inflammation and sometimes flukes. The gall bladder also contains nodules as well as adhesions (Acosta-Ferreira *et al.*, 1979). Inflammation is often present, which can result in fibrosis, thickening and dilatation of the extrahepatic bile ducts and gall bladder.

## IMMUNOLOGY

The host immune response to the parasite has been studied in various animal models with minimal human data. Some animals (e.g. dogs and cats) have natural resistance to infection, while others (e.g. rats and cattle) acquire resistance after the primary infection. In some animals, this resistance depends on both humoral and cellular components of the immune response, while in others it may be due to non-immunologic mechanisms, such as a damaged and fibrotic liver, which may prevent worm migration and maturation (Hughes, 1985). Vaccine trials have been performed in animals with several proteins, including proteases from the excretory/secretory products. These proteins partially induce protection in cattle against a challenge infection (Dalton *et al.*, 1996). In addition, the viability of eggs from vaccinated cattle is reduced, suggesting that an anti-fecundity effect of the vaccine may help to prevent transmission of disease. Other proteins that are being tested in

vaccines in animals include hemoglobin and a fatty-acid binding protein. Vaccination studies in mice with a schistosome antigen related to this fatty acid-binding protein protected against *F. hepatica* and schistosome challenge infection and raised the possibility of a dual helminth vaccine (Tendler *et al.*, 1996).

*F. hepatica* has a number of immune evasion mechanisms that allow for chronic infections. Among the proposed mechanisms are rapid turnover of the glycocalyx and cleavage of surface-bound immunoglobulins by secreted proteases in order to prevent antibody-dependent cellular cytotoxicity (Carmona *et al.*, 1993; Hanna, 1980; Hughes, 1985). These proteases have also been shown to be directly toxic to host cells and to be capable of degrading extracellular matrix components, which may assist in tissue migration (Berasain *et al.*, 1997; Goose, 1978). Finally, these proteases may have host cytokine mimicry, which enables the fluke to control the immune response. A 28 kDa protein has been isolated with interleukin-5-like activity, which stimulates production of a T helper cell type 2 response that may favor tolerance of the infection (Rifkin *et al.*, 1996).

## EPIDEMIOLOGY

Fascioliasis is endemic in many parts of the world and often associated with sheep and cattle raising. Human infections have been reported in over 40 countries in Europe, North Africa, Asia, South America and the Western Pacific (Chen and Mott, 1990). While it was previously thought to be a rare cause of human infection, recent prevalence surveys suggest that it is relatively common, with rates of 3% in Portugal (Chen and Mott, 1990), 9% in Peru (Knobloch *et al.*, 1985) and 7% in Egypt (Farag *et al.*, 1979). The highest rate was found in Bolivia, where the prevalence was 28% in one community (Esteban *et al.*, 1997). Endemicity relies on a warm and humid climate for the snail intermediate host, animal reservoirs (usually sheep and cattle) and ingestion by humans of metacercariae from raw watercress or other freshwater vegetables. Infections are often present in the fall or winter,



**Table 17.4** Clinical and laboratory features of fascioliasis

Study	Percentage affected (%)						
	Arjona <i>et al.</i> (1995)	Arjona <i>et al.</i> (1995) (Review)	Hardman <i>et al.</i> (1970)	El-shabrawi <i>et al.</i> (1997)	Bacq <i>et al.</i> (1991)	Pulpeiro (1991)	Knobloch <i>et al.</i> (1985)
Country	Spain		England	Egypt	France	Spain	Peru
<i>n</i>	20	75	28	16	10	15	34
Sign of symptom							
Abdominal pain	65	77	68		50	53	74
Fever	60	64	46		30		21
Constitutional symptoms	35	63					
Weight loss			54				
Urticaria/pruritis			25				
No symptoms	10	12	14		0		
Hepatomegaly				88	40	33	
Ascites				38			
Blood tests:							
Eosinophilia (> 500 eos/ml)	95	96		100	100	93	62
Leukocytosis	65	64					
Anemia				100			
Elevated AST/ALT	~50			0	50	67	
Elevated bilirubin	0			0	0		
Elevated alkaline phosphatase				100	60		
Ova in stool	0	47	71	44	0		100

AST/ALT, aspartate aminotransferase/alanine aminotransferase.

sometimes with familial clusters and often in a rural setting (Chen and Mott, 1990).

## CLINICAL FEATURES

Infections with *F. hepatica* have a diverse range of clinical manifestations, from an asymptomatic state to prominent gastrointestinal complaints. The illness can be divided into two phases with a minority of patients presenting with extra-intestinal manifestations.

### Acute Hepatic Phase

The acute phase of infection occurs after the excysted metacercaria penetrates the duodenal wall, enters the peritoneal cavity, and migrates through the liver over 2–4 months. The classic triad of symptoms and signs is abdominal pain, fever and hepatomegaly (Facey and Marsden, 1960). These features are not uniformly present, with abdominal pain in 50–77%, fever in 21–64% and hepatomegaly in 33–48% of patients (Table

17.4) (Arjona *et al.*, 1995; Bacq *et al.*, 1991; Chen and Mott, 1990; El-Shabrawi *et al.*, 1997; Facey and Marsden, 1960; Hardman *et al.*, 1970; Knobloch *et al.*, 1985; Pulpeiro *et al.*, 1991). A minority of patients (0–14%) present with no symptoms. The abdominal pain is often in the right upper quadrant, although it can be vague and non-localized and its intensity ranges from mild to excruciating. The incubation period before the first appearance of symptoms is approximately 6 weeks. One peculiar presenting feature is urticaria and/or pruritis, which occurs in 20–25% in some series and is classically described as occurring with dermatographia. The physical exam may reveal splenomegaly or ascites in addition to the hepatomegaly.

### Chronic Obstructive Biliary Phase

After the worm reaches the biliary tree, the chronic phase of the disease begins. There may be an asymptomatic latent phase, which can last for several months to years. Prominent features of the chronic phase are related to the inflammatory

**Table 17.5** Diagnostic value of tests for fascioliasis

Study	Percentage affected (%)						
	Arjona <i>et al.</i> (1995)	El-Shabrawi <i>et al.</i> (1997)	Bacq <i>et al.</i> (1991)	Pulpeiro <i>et al.</i> (1991)	Han <i>et al.</i> (1993)	Stork <i>et al.</i> (1973)	Hillyer <i>et al.</i> (1992)
Country	Spain	Egypt	France	Spain	Korea	Peru	Bolivia
<i>n</i>	20	16	10	15	6	135	20
Test abnormalities							
Ultrasonography			0				
Liver	0	93		36	100		
Gall bladder	0	73					
CT scan	80			82			
Serology*							
IHA <sup>†</sup>	90	100	90				
EITB <sup>†</sup>							100
ELISA <sup>†</sup>							95
IE <sup>†</sup>			100			51	
Intradermal						81	

\*Sensitivity. <sup>†</sup>IHA= indirect hemagglutination, EITB= electro-immunotransfer blot, ELISA= enzyme linked immunosorbent assay, IE= immunoelectrophoresis.

changes in the bile ducts and the mechanical effects of the worm, which can lead to biliary obstruction. Patients can develop cholangitis and cholecystitis, although it is not known what percentage of patients will progress to these complications. In contrast to *O. viverrini* or *C. sinensis* infections, there is no known association of chronic fascioliasis with cholangiocarcinoma (Chen and Mott, 1990).

### Ectopic Manifestations

Occasionally, worms migrate to locations outside of the hepatobiliary system and cause symptoms from their migratory tracks. These areas include the skin, stomach, pancreas, cecum and lungs. A condition known as 'halzoun' was previously thought to be due to pharyngeal fascioliasis from ingestion of raw liver contaminated with adult worms. More recently, this has been thought to be due to nymphs of *Linguatula serrata* (Drabick, 1987).

### Laboratory Findings

The most striking laboratory abnormality is eosinophilia, which is present in 62–100% of patients (Table 17.4). Anemia is often present

and is proposed to be caused by hemorrhage from tissue destruction and ingestion of red blood cells by the worms (Chen and Mott, 1990). While a substantial number of patients may have abnormal transaminases and alkaline phosphatase (0–67%), the bilirubin is often normal.

## LABORATORY DIAGNOSIS

### Stool Studies and Serology

Useful laboratory tests in the evaluation of fascioliasis include stool, serologic, and radiologic studies. Stool analysis for ova has 0–100% sensitivity, which depends on the technique employed, the intensity of infection and the phase of infection, since there is no egg secretion during the hepatic phase (Table 17.4) (Chen and Mott, 1990; Knobloch *et al.*, 1985). In addition to the low sensitivity, there can be false positives from human consumption of raw liver from infected livestock. Two or more positive stool samples are recommended to decrease the chance that the detected eggs are from ingestion of contaminated liver. A number of serologic tests with high sensitivity are available for research purposes (Table 17.5) (Chen and Mott, 1990). These include enzyme-linked immunosorbent assay (ELISA), indirect hemagglutination

(IHA), immunoelectrophoresis (IE) and electro-immunotransfer blot (EITB) (Arjona *et al.*, 1995; Bacq *et al.*, 1991; El-Shabrawi *et al.*, 1997; Hillyer *et al.*, 1992; Stork *et al.*, 1973). While these tests generally have high sensitivities, the specificities are not always optimal and are often compromised by cross-reactivity with other helminths. This problem may be overcome by genus-specific antigens. The advantages of serologic studies include their ability to diagnose disease during the hepatic migration stage as well as their high sensitivity. An intradermal test has been used previously but is not widely available. Duodenal aspirates for ova are also occasionally used but there has not been adequate evaluation of their utility in diagnosis. In one study with stool analysis as the gold standard, duodenal sampling with a blind string passage method had a sensitivity of 38% (Knobloch *et al.*, 1985). This method relied on adherence of duodenal mucus to the string and probably has a lower sensitivity than aspiration with esophagogastroduodenoscopy (EGD). The latter method has not been examined in a systematic fashion.

### Radiology

None of the radiologic findings are pathognomonic for fascioliasis, although they can be suggestive of the diagnosis as well as determine the extent of organ involvement. Ultrasound abnormalities are present in anywhere between 0–93% of patients (Table 17.5). Three distinctive features noted during the hepatic phase are tract-like microabscesses, a subcapsular location and slow evolution of these findings on follow-up (Han *et al.*, 1993). During the biliary phase, filling defects in the common bile duct have been observed and are thought to represent flukes. In addition, radiologic findings consistent with cholelithiasis or cholecystitis may be present. In some studies, no ultrasound abnormalities were noted, which necessitated a CT scan. Two main lesions on CT scan have been described; small nodules (< 1 cm) and tortuous linear tracks, both present in peripheral locations and often in the right lobe (Pulpeiro *et al.*, 1991). Radioisotope scans have also been utilized and often reveal 'cold' areas of limited tracer uptake. Most of the

hepatic lesions resolve after treatment. If all tests are non-diagnostic, then a liver biopsy may be necessary. In one series, 12 out of 13 biopsies were abnormal, with the majority showing eosinophilic abscesses and some with worms (El-Shabrawi *et al.*, 1997).

### Molecular Techniques

DNA-based techniques have not had a role in the clinical diagnosis of fascioliasis. In Japan, analysis of parasite DNA assisted in the identification of Japanese *Fasciola* species as *F. gigantica* rather than *F. hepatica* (Blair, 1993).

### CLINICAL MANAGEMENT

The first line agent for fascioliasis is bithionol, which is used at a dose of 30–50 mg/kg on alternate days for 10–15 doses and has an efficacy ranging from 58% to 100% (Table 17.6) (Arjona *et al.*, 1995; Bacq *et al.*, 1991; Bassiouny *et al.*, 1991; Farag *et al.*, 1988; Farid *et al.*, 1990). Frequent side effects include photosensitivity, vomiting, diarrhea, abdominal pain and urticaria. Rarely, leukopenia or hepatitis may occur. Unfortunately, bithionol is no longer manufactured and its availability is limited. In the USA, the CDC provides bithionol for domestic use only, while in many countries, such as the UK, it is unavailable. While praziquantel is efficacious for most trematode infections, it has had limited success with treating fascioliasis. The results have been disappointing, with cure rates of 0–71% (Arjona *et al.*, 1995; Farid *et al.*, 1986, 1989; Knobloch *et al.*, 1985). Praziquantel is not currently recommended for treatment. Previous to bithionol, the drug of choice was emetine or dehydroemetine, which had a 93% cure rate in one series (Chen and Mott, 1990; Hardman *et al.*, 1970). The major drawback to this drug is its toxicity, including cardiac side effects with hypotension and prolongation of the QT interval on ECG. Other drugs being tested experimentally include nicofolan, metronidazole and albendazole, with case reports of successful use (Eckhardt and Heckers, 1981; Nik-Akhtar and Tabibi, 1977).

**Table 17.6** Treatment of fascioliasis

Drug	Total daily dose (mg/kg) and duration	<i>n</i>	Efficacy (%)	Study	Side effects, comments
Bithionol	25, 10 days	8	62.5	Bacq <i>et al.</i> (1991)	Frequent: photosensitivity, vomiting, diarrhea, abdominal pain, urticaria. Rare: leukopenia, hepatitis
	30, q.o.d.* 10 days	14	100	Bassiouny <i>et al.</i> (1991)	
		6	100	Farag <i>et al.</i> (1988)	
	40, q.o.d.* 30 days	11	91	Arjona <i>et al.</i> (1995)	
	40, q.o.d.* 28 days	12	58	Farid <i>et al.</i> (1990)	
Praziquantel	75–125, 3–5 days	34	21	Knobloch <i>et al.</i> (1985)	See Table 17.3
	30–75, 1–5 days	5	0	Farid <i>et al.</i> (1986)	
	75, 1–3 days	7	71	Arjona <i>et al.</i> (1995)	
	75, 7 days	6	0	Farid <i>et al.</i> (1989)	
Emetine	30 mg/day, 18 days	44	93	Hardman <i>et al.</i> (1970)	Frequent: cardiac arrhythmias, chest pain. Occasional: diarrhea, vomiting, neuropathy, heart failure
Triclabendazole	10, one dose	24	79	Apt <i>et al.</i> (1995)	Experimental

\*q.o.d.= every 48 hours.

Another experimental drug, triclabendazole, had a cure rate of 79% in a study with 19 patients (Apt *et al.*, 1995). In this study, ELISA tests correlated with cure rates: 91% of egg-negative patients had negative ELISA tests 12 months after treatment.

## PREVENTION AND CONTROL

Fascioliasis can be prevented by avoiding ingestion of watercress or other raw vegetables. Due to the high morbidity and mortality associated

with veterinary populations, vaccine development in animals is under way.

## FASCIOLA GIGANTICA

*F. gigantica* is similar to *F. hepatica* in many respects, including its life-cycle, clinical features and treatment (Figure 17.3). The adult worm is larger, with a length up to 7.5 cm, has larger eggs (170 × 80 μm) and has a more limited geographic distribution in Africa, Hawaii and the Western Pacific (Harinasuta and Bunnag, 1987a). Few published reports are available for information.

## LESS COMMON HEPATOBILIARY FLUKES

*Metorchis conjunctus* is in the same family as *Opisthorchis* and *Clonorchis* species but is only found in North America, where it normally infects wild carnivores and has been noted as a cause of death of sled dogs (Table 17.1). Human infection occurs rarely. Recently, an outbreak of acute illness caused by *M. conjunctus* was described in 19 people who ate raw fish near Montreal, Canada (MacLean *et al.*, 1996). Many of the individuals had abdominal pain, fever, headache, weight loss and fatigue after an incubation period of 1–15 days. In addition, eosinophilia and elevated liver enzyme concen-

trations were noted in the majority of those infected. The symptoms lasted for 3 days to 4 weeks, with rapid resolution after treatment with praziquantel. Besides this description of acute illness, there is little information on infection attributed to *M. conjunctus*. While the eggs have been detected in asymptomatic individuals, there is no known association of this parasite with chronic clinical features such as cholangitis or cholangiocarcinoma associated with other hepatobiliary flukes.

*Dicrocoelium* species have also rarely been associated with human infection. *Dicrocoelium*

*dendriticum* is found in Europe, North and South America, Africa and Saudi Arabia, while *D. hospes* is present in Africa. Infections are acquired by ingesting metacercariae from ants, which serve as the second intermediate host (Mohamed and Mummery, 1990). Humans can also acquire a pseudoinfection by ingesting adult worms in raw or undercooked liver from infected mammals. In a series of 208 individuals from Saudi Arabia, 81%

had symptoms, which most often included abdominal pain. In addition, liver enzyme concentration elevations, eosinophilia and gall bladder abnormalities on ultrasound were noted in many of the patients. There were no control groups for comparison to evaluate the specificity of the clinical features of the illness or the radiographic abnormalities. Praziquantel was successful in alleviating symptoms in four of nine individuals.

## PARAGONIMUS SPP.

### INTRODUCTION

Lung fluke infections caused by *Paragonimus* are estimated to affect over 6 million people worldwide (Hopkins, 1992). Also known as endemic hemoptysis, paragonimiasis is transmitted to humans via ingestion of raw crustaceans. The first description of lung flukes was in 1850 by Diesing. In 1878, Kerbert discovered and later named *Paragonimus westermani* during the autopsy of a tiger in a zoo in Amsterdam (Yokogawa *et al.*, 1960). The first descriptions of human infection were by Baelz in Japan and Manson in China in 1880, while the intricate life-cycle was established by many investigators during 1915–1934 (Yokogawa *et al.*, 1960). Of the more than 10 species known to infect humans, *P. westermani* is the most common (Table 17.1).

### DESCRIPTION OF THE ORGANISM

*Paragonimus* is a digenetic, hermaphroditic trematode with a life-cycle that includes two intermediate hosts (snails and crustaceans) as well as the definitive (mammalian) host (Figure 17.1). The adult worm is reddish-brown, mobile and has a flattened ventral surface, with an average size of 10 × 5 mm and a thickness of 5 mm (Figure 17.4). The adult contains an oral and ventral sucker, reproductive organs, including ovaries and testes, an intestinal system and spines on its surface which are useful for species identification (Yokogawa *et al.*, 1960). The mature adult resides in the mammalian lungs, where it can produce up to 40 000 eggs/day. The

eggs are yellow-brown, contain yolk cells and a flat operculum, and measure approximately 80 × 50 μm. After developing for approximately 3 weeks, the eggs are passed into the environment from the lungs via the sputum or are swallowed and excreted in the feces. The eggs hatch into miracidia, which then infect fresh water snails, the first intermediate host. Several snails can serve this function, including the families Thiariidae, Pleuroceridae and Hydrobiidae (Malek, 1980). *Semisulcospira libertina* is one of the more common vectors for *P. westermani*. Within the snail, the miracidia develop into sporocysts, rediae and then cercariae (100 × 270 μm), which are either secreted into the water or ingested by freshwater crabs or crayfish that are often found in streams. At least 21 species can serve as this second intermediate host including the genus *Potamon* (Nana and Bovornkitti, 1991). The encysted metacercariae (0.4 × 0.4 mm) mature in the gills and muscles over 42–106 days (Yokogawa *et al.*, 1960). The metacercariae are then ingested by the definitive host when raw crabs or crayfish are consumed. Definitive hosts include dogs, cats, pigs, wild carnivores and humans.

### PATHOGENESIS

The metacercariae pass to the small intestine of the definitive host, where they encyst into larval forms, which burrow through the small intestine into the peritoneal cavity. The excystment process is enhanced at pH 8–9, with a temperature of 40°C and bile salts. Cysteine proteases may



**Fig. 17.4** *Paragonimus westermani* adult (A) ( $\approx 10 \times 5$  mm) and egg (B) ( $\approx 80 \times 50 \mu\text{m}$ ). Reproduced by courtesy of Professor Prayong Radomyos, Faculty of Allied Health Sciences, Thammasat University, Thailand)

modulate the process by degrading the cyst wall (Chung *et al.*, 1995). After several days to weeks, the larval worms migrate through the diaphragm into the thoracic cavity. After penetrating through the visceral pleura, the worms then reside in the lung parenchyma. Cysts form

around the flukes over 8–10 weeks as they develop into adult worms, which then secrete eggs. The liver is involved in a large number of infections, although it is not clear whether this is an obligatory step in the life-cycle. The peritoneal stage of migration appears to be essential for proper development, since immature worms directly transplanted into the lungs of animals fail to reach maturity (Yokogawa *et al.*, 1960). A number of tissues and organs can be involved less commonly, including the pericardium, eyes, subcutaneous tissue and central nervous system (Chung *et al.*, 1981). Although the tissue migration life-cycle theory is the most widely accepted, there are some proponents of a circulatory route of migration to explain the ability of the organism to gain access to many different areas of the body.

Pathologic changes during the acute stage include transient areas of hemorrhage and leukocyte infiltration, as well as torn muscle fibers in the diaphragm with 0.5–1 mm residual holes (Yokogawa *et al.*, 1960). In chronic infections, fibrous tissue surrounds areas of active inflammation where the worms reside and eventually forms cysts which contain the worm, eggs, Charcot–Leyden crystals and fluid with inflammatory cells. In the lungs, these cysts become walled off except for a passage into the bronchi, through which the eggs can be secreted (Chung, 1971; Yokogawa *et al.*, 1960). In the liver, pathologic changes include cysts and eosinophilic abscesses (Hu *et al.*, 1982). In the brain, both worms and eggs have been found within granulomatous and cystoid lesions (Higashi *et al.*, 1971). The majority of changes are found in the temporal region near the cranial foramina, with 40% of the specimens containing worms in one series (Shih *et al.*, 1958). The organisms may migrate through the soft tissue of the neck and then through the jugular foramen and into the brain.

## IMMUNOLOGY

Minimal information is available on the cell biology, molecular biology or immunology of *Paragonimus* infections. With a lifespan of up to 10 years in the definitive host, immune evasion mechanisms are essential for survival. A neutral

thiol protease (NTP) has been isolated from metacercariae and has been shown to cause various types of immunosuppression of some B and T lymphocyte functions. The worm may secrete this protein to induce tolerance to its antigens (Hamajima *et al.*, 1994). There is some evidence in animals that repeated infections induce acquired immunity but no studies have been performed in humans that corroborate this (Yokogawa *et al.*, 1960).

## EPIDEMIOLOGY

*Paragonimus* infections in humans are found in many areas of the world, including Asia, Africa and South America. Infection of immigrants from endemic countries has broadened the geography of its presentation (Johnson *et al.*, 1985). Of the 43 known species, at least 10 have been found to infect humans (Table 17.1) (Harinasuta and Bunnag, 1987b). Areas of endemicity are often scattered around streams, where the intermediate hosts are found. Prevalence studies in Korea in 1960 revealed positive skin tests in 13.9% and 46.8%, respectively, of those tested in two separate regions (Sadun and Buck, 1960). Current prevalence rates are estimated at less than 2% (Cho *et al.*, 1997). Other studies showed prevalence rates of 15–45% in China (Chung *et al.*, 1981), 12.5% in The Philippines (Carbrera and Fevidal, 1974) and 5% in Cameroon (Kum and Nchinda, 1982).

Transmission to humans occurs from the ingestion of raw crustaceans. Cultural practices contributing to successful transmission have included the use of crayfish juice as a remedy for measles (Nana and Bovornkitti, 1991), ingestion of 'drunken crabs' soaked in wine (Sharma, 1989), use of raw crab juice in soup or beverages (Kagawa, 1997) and the belief that eating raw crab aids in fertility (Kum and Nchinda, 1982).

## CLINICAL FEATURES

Due to the wide variety of tissues that *Paragonimus* invades, its clinical features are protean (Table 17.7). The clinical presentation centers around

the pulmonary manifestations, which are usually detected in the chronic stage. Around 30% of patients present with extrapulmonary clinical features. In one series from Korea, 22% of patients had cerebral, 6% abdominal and 5% subcutaneous involvement (Shim *et al.*, 1991). Even though there are many species that infect humans, few differences in clinical presentation among them are known. One clear difference appears to be the high propensity of *P. skrjabini* (also known as *P. szechuanensis*) to present with subcutaneous nodules and fewer pulmonary symptoms (Chung and Ts'ao, 1962).

## Acute Paragonimiasis

While the vast majority of cases of paragonimiasis are detected in the chronic stage, a symptomatic acute stage exists and was observed in an outbreak of *P. westermani* (Chung *et al.*, 1981). The average incubation period was 2–15 days for 23 patients who ate a meal that included raw crayfish. Approximately 2–4 days after ingestion, patients developed diarrhea and abdominal pain, which may have correlated with excystment and intestinal penetration. At 6–15 days, fever, chest, pain and cough developed, with the addition of dyspnea from 11–20 days.

## Pulmonary Paragonimiasis

The majority of cases of paragonimiasis are detected during the pulmonary stage (Benjapong *et al.*, 1984; Chang *et al.*, 1958; Im *et al.*, 1992; Johnson and Johnson, 1983; Sadun and Buck, 1960; Shim *et al.*, 1991; Singh *et al.*, 1986). The average onset of pulmonary symptoms is 6 months after infection but can occur up to several years later. Cough and/or hemoptysis are present in 61–100% of those infected (Table 17.7). Hemoptysis is often intermittent and is thought to result from cyst rupture. A smaller percentage of people have dyspnea or chest pain. In addition to the pulmonary symptoms, a number of systemic features may be present, such as fever and weight loss in 8–67% of cases. One study compared the presentation of hospitalized patients with those detected in a

**Table 17.7** Clinical features of paragonimiasis

Study	Percentage of patients affected (%)									
	Shim <i>et al.</i> (1991)	Singh <i>et al.</i> (1986)	Benjapong <i>et al.</i> (1984)	Johnson and Johnson (1983)	Sadun and Buck Sadun and Buck (surv.*) (1960)	Chung and Ts'ao (1958)	Chang <i>et al.</i> Shih <i>et al.</i> (1958)	Higashi <i>et al.</i> (1971)		
Country	Korea	India	Thailand	USA	Korea	China	China	China	Japan	
<i>n</i>	76	39	100	25	63	81 <sup>†</sup>	200	76 <sup>‡</sup>	10 <sup>‡</sup>	
Sign or symptom										
Cough	66	62		92	95	79	100		10	
Hemoptysis	61	95	94	64	65	10	74		10	
Chest pain	41	62	5		37	46	94			
Dyspnea	42	5			19		53			
Fever	11	23	8		33		67			
Weight loss			23		11		36			
Headache			1		24		23		50-90	
Seizure			1		5		18		40-69	
Visual symptoms			1				14		55	
Motor symptoms			1				16		10-47	
Skin nodules			2				19			
None	8			8		37-61	0			

\*Hosp = hospitalized patients, surv = community survey.

<sup>†</sup> Exclusively *P. skrjabini* (= *P. szechuanensis*).<sup>‡</sup> Patients selected for neurologic involvement.



community survey and found a higher percentage of cough, chest pain and headache in the former but a similar degree of hemoptysis (Sadun and Buck, 1960). The chronic and non-specific nature of some of the symptoms can make the diagnosis difficult. Patients are often initially being evaluated for tuberculosis or chronic bronchitis when *Paragonimus* is detected. The physical examination is not helpful in distinguishing *Paragonimus* from other pulmonary infections and, in fact, was normal in 77% of patients in one study (Benjapong *et al.*, 1984).

### Extrapulmonary Paragonimiasis

Due to the wide range of tissue tropism of the adult worm, a number of organs besides the lungs can be affected, including the skin, brain, heart, liver, eyes and scrotum. Liver involvement often presents with abdominal pain and hepatomegaly and occasionally with an abscess. Incarcerated hernias have been noted, with scrotal lesions and exophthalmos with ocular disease.

The most serious sequela is neural paragonimiasis, which often presents with headache and seizure and can also include motor and visual disturbances (Table 17.7). The average onset of symptoms is around 16 months, approximately 10 months after pulmonary symptoms. Prevalence estimates are difficult to make and range from 1% to 51%, depending on the population studied (Higashi *et al.*, 1971). Among several studies, the incidence of headaches was 1–24%, while seizures occurred in 1–18% of patients. In case studies selected for CNS involvement, seizures, visual disturbances and motor deficits occur in the majority of patients (Higashi *et al.*, 1971; Shih *et al.*, 1958). Concurrent presentation of pulmonary and nervous system complaints ranged from 10% to 100% in different studies. In the absence of pulmonary symptoms, the index of suspicion for neural paragonimiasis may initially be quite low.

Subcutaneous nodules are a distinct feature of *P. skrjabini* infections and can be found in as many as 61% of cases (Chung *et al.*, 1981). The nodules range in size from a few mm to 10 cm, are most often found on the abdomen and

chest and can be migratory, which has given rise to the name 'trematode larva migrans'. While *P. skrjabini* infections are more likely than *P. westermani* to have subcutaneous nodules, leukocytosis and eosinophilia, they are less likely to have cough, sputum, hemoptysis, nervous system involvement and detectable ova.

### LABORATORY DIAGNOSIS

The chest roentgenogram is central to the diagnosis, with abnormalities present in 79–95% of patients (Table 17.8) (Benjapong *et al.*, 1984; Chang *et al.*, 1958; Im *et al.*, 1992; Johnson and Johnson, 1983; Miller and Walker, 1955; Ogakwu and Nwokolo, 1973; Shim *et al.*, 1991; Singh *et al.*, 1986; Suwanik and Harinasuta, 1959; Yang *et al.*, 1955). Abnormalities include parenchymal changes such as infiltrates, nodules and cavities, as well as pleural changes, including effusions and thickening. One X-ray finding that is suggestive of paragonimiasis is the ring cyst, which is a cavity of varying size (0.5–4 cm) with a crescent-shaped opacity along one wall (Figure 17.5). The incidence varies (3–63%). The difference between a ring and an ordinary cyst or cavity is often not distinguished in case studies and probably also not in practice. Hematologic abnormalities include leukocytosis in 28–58% of patients and eosinophilia in 50–66%. If pleural fluid is analyzed, a small study showed that it characteristically has low glucose lactate dehydrogenase (LDH) of 1000–4200 IU/l, protein >6 mg/dl and eosinophilia (Romeo and Pollock, 1986). In contrast, tuberculous effusions often have glucose >50 mg/dl, LDH less than 1000 IU/l, protein below 6 mg/dl and lymphocytosis. For neural paragonimiasis, plain skull films show intracranial calcifications in 39–70% of cases. Cerebrospinal fluid analysis is only moderately helpful, with an elevated opening pressure and protein in some patients (Higashi *et al.*, 1971).

A variety of tests are available to diagnose paragonimiasis and are essential, since the clinical presentation is often non-specific and includes a broad differential diagnosis.

**Table 17.8** Radiologic and hematologic findings in patients with paragonimiasis

Study	Percentage of patients affected (%)									
	Im <i>et al.</i> (1992)	Shim <i>et al.</i> (1997)	Singh <i>et al.</i> (1986)	Benjapong <i>et al.</i> (1984)	Johnson (1983)	Ogakwu and Nwokolo (1973)	Su and Harinasuta (1959)	Chang <i>et al.</i> (1958)	Yang <i>et al.</i> (1955)	Miller and Walker (1955)
Country	Korea	Korea	India	Thailand	USA	Niger	Thailand	China	China	Korea
<i>n</i>	71	76	39	100	25	100	38	200	100	227
Sign or symptom										
Radiology										
Parenchymal										
Infiltration	52	59	62	53	44	>50	48	29	29	5
Cyst/cavity	46	32	13	85	20	12	82	0	0	
Ring cyst	23		3		8			2	2	63
Linear density	41	26	3			21	21			
Nodule	25	22	8		20			59		
Pleural										
Effusion	37	39	10	5	48		0			3
Thickening	7	18	28	83		4	21	30	30	14
None		5	13	7		21	5	12	12	15
Heme										
WBC > 10K*	30		33					28	58	
Eos > 500/ml*	66		62					> 50		
> 4%										

\*WBC = white blood cells, Eos = eosinophils.



**Fig. 17.5** Chest roentgenogram of patient infected with *Paragonimus* with a ring cyst at the left heart border. Reproduced by courtesy of Dr Richard Johnson, University of Washington Medical Center, Seattle, USA

### Intradermal Test

An intradermal test with an extract of *Paragonimus* antigens measures an immediate wheal reaction after 15 minutes (Sadun and Buck, 1960). The sensitivity range is in the 82–100%, with a specificity of 97% in one series (Table 17.9) (Chang *et al.*, 1988; Sadun and Buck, 1960; Shim *et al.*, 1991). Although this test has good performance characteristics, it is not widely available, is not standardized, has some cross-reactivity with *Clonorchis* antigens and does not differentiate between current and past infections. It is predominantly used for epidemiologic studies.

### Sputum and Stool Analysis

With the secretion of eggs by the adult worms in the lungs, analysis of the sputa for ova provides the most direct method for detecting infection. Sensitivity for submission of one sample is limited, with a range of 37–57% (Table 17.9). Submission of

serial samples improves the sensitivity to as high as 89% with greater than six samples. The specificity of these tests is presumed to be high, although it has not been reported. Less specific tests include analysis for Charcot–Leyden crystals and eosinophils, which are both present in the majority of cases. The absence of these findings is helpful in ruling out *Paragonimus*.

Since the eggs are often swallowed after expulsion from the lungs, some cases can be diagnosed by detecting ova in the stool (Table 17.9). Even though the sensitivity is low, occasional patients will have no ova in their sputum and be diagnosed through stool studies.

### Serologic

Excellent serologic tests are available to complement sputum and stool studies. The most widely used test in the past has been complement fixation, which has a sensitivity of around 96% (Table 17.9). More recently, ELISA tests have become available, which are more practical for widespread use (Johnson and Johnson, 1983; Pariyanonda *et al.*, 1990). The CDC currently utilizes the immunoblot, which has a sensitivity and specificity of 96% and 99%, respectively (Slemenda *et al.*, 1988). An antigen detection test is also available, with a sensitivity of 100% and a specificity of >99%, but is not currently in widespread use (Zhang *et al.*, 1993).

### Molecular Techniques

DNA-based techniques have not yet had a role in the clinical diagnosis of paragonimiasis.

Overall, diagnosis of paragonimiasis is usually accomplished by detection of eggs in sputum or stool, with or without the assistance of serologic studies.

## CLINICAL MANAGEMENT

Praziquantel is the drug of choice for paragonimiasis, although the US Food and Drug Administration has not approved its use for this indication (Table 17.10). Historically,

**Table 17.9** Diagnostic value of tests for paragonimiasis

Study	Sensitivity (sn) and specificity (sp) of tests (%)								
	Shim <i>et al.</i> (1991)	Kim* <i>et al.</i> (1970)	Singh <i>et al.</i> (1986)	Johnson and Johnson (1983)	Chang <i>et al.</i> (1958)	Sadun and Buck (1960)	Benjapong <i>et al.</i> (1984)	Pariyonanda <i>et al.</i> (1990)	Siemenda <i>et al.</i> (1988)
Country	(Korea)	(?Korea)	(India)	(USA)	(China)	(Korea)	(Thailand)		
<i>n</i>	67	3518	39	25	200	477	100	32	45
Test									
Intradermal	sn 82				99	100			
	sp					97			
Ova in sputum	sn1 39	37		48		57			
	2	49							
	3	54							
	>		85		89	79			
	6								
Charcot-Leyden	sn		92		75				
Eosinophils	sn				90		100		
Stool	sn		26		15		10		
Serologic									
Complement fixation	sn			96					
ELISA-IgG	sn	92					100		
	sp						97		
Immunoblot	sn								96
	sp								99

\*Discussed by Shim *et al.* (1991).

**Table 17.10** Treatment of paragonimiasis

Drug	Total daily dose (mg/kg) and duration <sup>†</sup>	n	Efficacy (%)	Study	Side effects, comments
Praziquantel	1 day				
	50–60	9–12	33–57	Johnson <i>et al.</i> * (1985)	See Table 3
	75	12–21	71–75	Benjapong (1984)	
					Not FDA-approved for this indication
	2–3 days				
	45–50	7–31	81–90	Johnson <i>et al.</i> (1985)	
	75	6–19	88–100	Benjapong (1984)	
Bithionol	30–50, 10–15 doses, q.o.d.	1355	91	Shim <i>et al.</i> (1991)*	See Table 6
		39	97	Singh <i>et al.</i> (1986)	
		3971	97	Chung <i>et al.</i> (1981)	
Triclabendazole	10, one dose	10	79	Ripert <i>et al.</i> (1992)	Experimental
Niclofolan			95	Shim <i>et al.</i> (1991)*	Neurotoxicity, hepatotoxicity

\*Includes summary of other trials. <sup>†</sup>d= days.

chloroquine was used without much success, with a cure rate of only 13% (Sadun and Buck, 1960). The first widespread use of a successful drug was bithionol, which was instituted around 1960. While it has an efficacy of 65–97%, it has several side effects that limit its usefulness, including photosensitivity, vomiting and diarrhea (Yokogawa *et al.*, 1963). The dose is 30–50 mg/kg for 10–15 doses every other day. The introduction of praziquantel in the 1980s provided an equally efficacious drug with a more favorable side-effect profile. Small clinical studies of praziquantel have demonstrated that 2 days of treatment is more effective than 1 day (Johnson *et al.*, 1985). The total daily dose should be 75 mg/kg, divided into three doses. Response to treatment is usually rapid for hemoptysis and more gradual for complete resolution of all symptoms. Serologic tests can be used to follow the response of chemotherapy, although it can take several months for titers to decline (Kagawa, 1997). Other drugs which have been used include niclofolan and triclabendazole. Neither drug is recommended for use, since more effective treatment is available (Ripert *et al.*, 1992; Shim *et al.*, 1991). Niclofolan has a narrow therapeutic window, with potential side effects including hepatotoxicity and neurotoxicity.

Treatment for cerebral paragonimiasis involves both medical and surgical management. One study indicated that early central nervous system symptoms with ophthalmologic and meningeal involvement responded to bithionol, while chronic, stabilized disease did not (Oh, 1967). Surgical

treatment is sometimes indicated for cases with localized pathology or symptoms unresponsive to medical treatment (Shih *et al.*, 1958).

## PREVENTION AND CONTROL

Prevention of paragonimiasis can be achieved by avoiding ingestion of uncooked crabmeat and crayfish. Mass control efforts to interrupt the life-cycle at various stages have been successful. For example, education efforts in China coupled with mass treatment with bithionol resulted in a decrease in the prevalence rate from 21% to 0.6% (Chung *et al.*, 1981). There are no available vaccines and no immediate prospects for such a control measure.

## REFERENCES

- Acosta-Ferreira W, Vercelli-Retta J, Falconi LM (1979). *Fasciola hepatica* human infection. Histopathological study of 16 cases. *Virchows Arch Pathol Anat Histol* **383**: 319–27.
- Akai PS, Pungpak S, Kitikoon V *et al.* (1994). Possible protective immunity in human opisthorchiasis. *Parasite Immunol* **16**: 279–88.
- Apt W, Aguilera X, Vega F *et al.* (1995). Treatment of human chronic fascioliasis with triclabendazole: drug efficacy and serologic response. *Am J Trop Med Hyg* **52**: 532–5.
- Arjona R, Riancho JA, Aguado JM *et al.* (1995). Fascioliasis in developed countries: a review of classic and aberrant forms of the disease. *Medicine* **74**: 13–23.
- Bacq Y, Besnier J, Duong T *et al.* (1991). Successful treatment of acute fascioliasis with bithionol. *Hepatology* **14**: 1066–9.

- Bassiouny HK, Soliman NK, El-Daly SM *et al.* (1991). Human fascioliasis in Egypt: effect of infection and efficacy of bithionol treatment. *J Trop Med Hyg* **94**: 333–7.
- Benjapong W, Naeypatimanond S, Benjapong K *et al.* (1984). Studies on paragonimiasis: treatment with mebendazole, emetine with mebendazole and praziquantel. *SE Asian J Trop Med Publ Health* **15**: 354–9.
- Berasain P, Goni F, McGonigle S *et al.* (1997). Proteinases secreted by *Fasciola hepatica* degrade extracellular matrix and basement membrane components. *J Parasitol* **83**: 1–5.
- Bhudhisawasdi V (1997). Place of surgery in opisthorchiasis associated cholangiocarcinoma. *SE Asian J Trop Med Publ Health* **28**: 85–90.
- Blair D (1993). Molecular variation in fasciolids with *Paragonimus*. *Acta Trop* **53**: 277–89.
- Bonar S, Burrell M, West B *et al.* (1989). Recurrent cholangitis secondary to oriental cholangiohepatitis. *J. Clin Gastroenterol* **11**: 464–8.
- Boray JC (1969). Experimental fascioliasis in Australia. *Adv Parasitol* **7**: 95–210.
- Bunnag D, Harinasuta T (1980). Studies on the chemotherapy of human opisthorchiasis in Thailand: I. Clinical trial of praziquantel. *SE Asian J Trop Med Publ Health* **11**: 528–31.
- Carbrera BD, Fevidal PM (1974). Studies on *Paragonimus* and paragonimiasis in The Philippines. *SE Asian J Trop Med Publ Health* **5**: 39–45.
- Carmona C, Dowd AJ, Smith A *et al.* (1993). Cathepsin L proteinase secreted by *Fasciola hepatica* *in vitro* prevents antibody-mediated eosinophil attachment to newly excysted juveniles. *Mol Biochem Parasitol* **62**: 9–18.
- Chang H, Wang C, Yu C *et al.* (1958). Paragonimiasis: a clinical study of 200 adult cases. *Chin Med J* **77**: 3–9.
- Chen M, Hua X, Wan Z *et al.* (1983). Praziquantel in 237 cases of *Clonorchis sinensis*. *Chin Med J* **96**: 935–40.
- Chen MG, Mott KE (1990). Progress in assessment of morbidity due to *Fasciola hepatica* infection: a review of the recent literature. *Trop Dis Bull* **87**: R1–38.
- Cho S, Kong Y, Kang S (1997). Epidemiology of paragonimiasis in Korea. *SE Asian J Trop Med Hyg* **28**: 32–6.
- Choi TK, Wong KP, Wong J (1984). Cholangiographic appearance in clonorchiasis. *Br J Radiol* **57**: 681–4.
- Chung CH (1971). Human paragonimiasis (pulmonary distomiasis, endemic hemoptysis). In Marcial-Rojas (ed.), *Pathology of Protozoal and Helminthic Diseases*. Baltimore, MO: Williams and Wilkins; 504–35.
- Chung HL, Ho LY, Hsu CP *et al.* (1981). Recent progress in studies of paragonimus and paragonimiasis control in China. *Chin Med J* **94**: 483–94.
- Chung HL, Ts'ao WC (1962). *Paragonimus westermani* (Szechuan variety) and a new species of lung fluke—*Paragonimus szechuanensis*. *Chin Med J* **81**: 419–34.
- Chung Y, Kong Y, Joo I *et al.* (1995). Excystment of *Paragonimus westermani* metacercariae by endogenous cysteine protease. *J Parasitol* **81**: 137–42.
- Dalton JP, McGonigle S, Rolph TP *et al.* (1996). Induction of protective immunity in cattle against infection with *Fasciola hepatica* by vaccination with cathepsin L proteinases and with hemoglobin. *Infect Immun* **64**: 5066–74.
- Dawes B, Hughes DL (1964). Fascioliasis: the invasive stages of *Fasciola hepatica* in mammalian hosts. *Adv Parasitol* **2**: 97–168.
- Drabick JJ (1987). Pentastomiasis. *Rev Infect Dis* **9**: 1087–94.
- Eckhardt T, Heckers H (1981). Treatment of human fascioliasis with niclofolan. *Gastroenterology* **81**: 795–8.
- El-Shabrawi M, El-Karaksy H., Okasha S *et al.* (1997). Human fascioliasis: clinical features and diagnostic difficulties in Egyptian children. *J Trop Pediatr* **43**: 162–6.
- Elkins DB, Mairiang E, Sithithaworn P *et al.* (1996). Cross-sectional patterns of hepatobiliary abnormalities and possible precursor conditions of cholangiocarcinoma associated with infection in humans. *Am J Trop Med Hyg* **55**: 295–301.
- Esteban J, Flores A, Aguirre C *et al.* (1997). Presence of very high prevalence and intensity of infection with *Fasciola hepatica* among Aymara children from the Northern Bolivian Altiplano. *Acta Trop* **66**: 1–14.
- Facey RV, Marsden PD (1960). Fascioliasis in man: an outbreak in Hampshire. *Br Med J* **2**: 619–25.
- Farag HF, Barakat RMR, Ragab M *et al.* (1979). A focus of human fascioliasis in the Nile delta, Egypt. *J Trop Med Hyg* **82**: 188–90.
- Farag HF, Salem A, El-Hifni SA *et al.* (1988). Bithionol (Bitin) treatment in established fascioliasis in Egyptians. *J Trop Med Hyg* **91**: 240–44.
- Farid Z, Kamal M, Mansour N (1989). Praziquantel and *Fasciola hepatica* infection. *Trans R Soc Trop Med Hyg* **83**: 813.
- Farid Z, Mansour N, Kamal M *et al.* (1990). The treatment of acute *Fasciola hepatica* infection in children. *Trop Geogr Med* **42**: 95–6.
- Farid Z, Trabolsi B, Boctor F *et al.* (1986). Unsuccessful use of praziquantel to treat acute fascioliasis in children. *J Infect Dis* **154**: 920–1.
- Flavell DJ (1981). Liver-fluke infection as an aetiological factor in bile-duct carcinoma of man. *Trans R Soc Trop Med Hyg* **75**: 814–24.
- Flavell DJ (1982). Acquired resistance to *Opisthorchis viverrini* in the hamster. *Trans R Soc Trop Med Hyg* **76**: 800–2.
- Fung J (1961). Liver fluke infestation and cholangio-hepatitis. *Br J Surg* **48**: 404–15.
- Goose J (1978). Possible role of excretory/secretory products in evasion of host defences by *Fasciola hepatica*. *Nature* **275**: 216–17.
- Hamajima F, Yamamoto M, Tsuru S *et al.* (1994). Immunosuppression by a neutral thiol protease from parasitic helminth larvae in mice. *Parasite Immunol* **16**: 261–73.
- Han JK, Choi BI, Cho JM *et al.* (1993). Radiological findings of human fascioliasis. *Abdom Imag* **18**: 261–4.
- Hanna REB (1980) *Fasciola hepatica*: glycoalyx replacement in the juvenile as a possible mechanism for protection against host immunity. *Exp Parasitol* **50**: 103–14.
- Hardman EW, Jones RLH, Davies AH (1970). Fascioliasis—a large outbreak. *Br Med J* **3**: 502–5.
- Harinasuta T, Bunnag D (1987a). Liver fluke diseases of humans. In Weatherall DJ, Ledingham JGG, Warrell DA (eds), *Oxford Textbook of Medicine*. New York: Oxford University Press.

- Harinasuta T, Bunnag D (1987b). Lung flukes (paragonimiasis). In Weatherall DJ, Ledingham JGG, Warrell DA (eds), *Oxford Textbook of Medicine*. New York: Oxford University Press.
- Higashi K, Aoki H, Tatebayashi K *et al.* (1971). Cerebral paragonimiasis. *J Neurosurg* **34**: 515–27.
- Hillyer GV, Soler de Galanes M, Rodriguez-Perez J *et al.* (1992). Use of the Falcon™ assay screening test-enzyme-linked immunosorbent assay (FAST-ELISA) and the enzyme-linked immunoelectrotransfer blot (EITB) to determine the prevalence of human fascioliasis in the Bolivian Altiplano. *Am J Trop Med Hyg* **46**: 603–9.
- Hopkins DR (1992). Homing in on helminths. *Am J Trop Med Hyg* **46**: 626–34.
- Hou M, Ker C, Sheen P *et al.* (1989). The ultrasound survey of gallstone disease of patients infected with *Clonorchis sinensis* in Southern Taiwan. *J Trop Med Hyg* **92**: 108–11.
- Hou PC (1955). The pathology of *Clonorchis sinensis* infestation of the liver. *J Pathol Bacteriol* **70**: 53–64.
- Hou PC (1956). The relationship between primary carcinoma of the liver and infestation with *Clonorchis sinensis*. *J Pathol Bacteriol* **72**: 239–46.
- Hu X, Feng R, Zheng Z *et al.* (1982). Hepatic damage in experimental and clinical paragonimiasis. *Am J Trop Med Hyg* **31**: 1148–55.
- Hughes DL (1985). Trematodes, excluding schistosomes, with special emphasis on *Fasciola*. *Curr Top Microbiol Immunol* **120**: 241–60.
- Im J, Whang HY, Kim WS *et al.* (1992). Pleuropulmonary paragonimiasis: radiologic findings in 71 patients. *Am J Roentgenogr* **159**: 39–43.
- Jaroonvesama N, Charoenlarp K, Cross JH (1981). Treatment of *Opisthorchis viverrini* with mebendazole. *SE Asian J Trop Med Publ Health* **12**: 595–7.
- Johnson RJ, Johnson JR (1983). Paragonimiasis in Indochinese refugees. *Am Rev Resp Dis* **128**: 534–8.
- Johnson RJ, Jong EC, Dunning SB *et al.* (1985). Paragonimiasis: diagnosis and the use of praziquantel in treatment. *Rev Infect Dis* **7**: 200–6.
- Jong EC, Wasserheit JN, Johnson RJ *et al.* (1985). Praziquantel for the treatment of *Clonorchis/Opisthorchis* infections: report of a double-blind, placebo-controlled trial. *J Infect Dis* **152**: 637–40.
- Kagawa FT (1997). Pulmonary paragonimiasis. *Semin Resp Infect* **12**: 149–58.
- King CH, Mahmoud AAF (1989). Drugs five years later: praziquantel. *Ann Intern Med* **110**: 290–6.
- Knobloch J, Delgado E, Alvarez AA *et al.* (1985). Human fascioliasis in Cajamarca/Peru. I. Diagnostic methods and treatment with praziquantel. *Trop Med Parasitol* **36**: 88–90.
- Koenigstein RP (1949). Observations on the epidemiology of infections with *Clonorchis sinensis*. *Trans R Soc Trop Med Hyg* **42**: 503–6.
- Komiya Y (1966). *Clonorchis* and clonorchiasis. *Adv Parasitol* **4**: 53–106.
- Koompirochana C, Sonakul D, Chinda K *et al.* (1978). Opisthorchiasis: a clinicopathologic study of 154 autopsy cases. *SE Asian J Trop Med Publ Health* **9**: 60–4.
- Kum PN, Nchinda TC (1982). Pulmonary paragonimiasis in Cameroon. *Trans R Soc Trop Med Hyg* **76**: 768–72.
- Lin AC Chapman SW, Turner HR *et al.* (1987). Clonorchiasis: an update. *South Med J* **80**: 919–22.
- MacLean J, Arthur J, Ward B *et al.* (1996). Common-source outbreak of acute infection due to the North American liver fluke *Metorchis conjunctus*. *Lancet* **347**: 154–8.
- Malek EA (1980). In *Snail-transmitted Parasitic Diseases*. Boca Raton, FL: CRC Press.
- Miller FL, Walker R (1955). The Roentgen characteristics of pulmonary paragonimiasis. *Radiology* **65**: 231–5.
- Mohamed A, Mummery V (1990). Human microcoeliasis. Report on 208 cases from Saudi Arabia. *Trop Geogr Med* **42**: 1–7.
- Nana A, Bovornkitti S (1991). Pleuropulmonary paragonimiasis. *Semin Resp Med* **12**: 46–54.
- Naqira-Vildoso F, Marcial-Rojas RA (1971). Fascioliasis. In Marcial-Rojas RA (ed.), *Pathology of Protocol and Helminthic Diseases*. Baltimore: The Williams and Wilkins Company.
- Nik-Akhtar B, Tabibi V (1977). Metronidazole in fascioliasis report of four cases. *J Trop Med Hyg* **80**: 179–80.
- Ogakwu M, Nwokolo C (1973). Radiological findings in pulmonary paragonimiasis as seen in Nigeria: a review based on one hundred cases. *Br J Radiol* **46**: 699–705.
- Oh SJ (1967). Bithionol treatment in cerebral paragonimiasis. *Am J Trop Med Hyg* **16**: 585–90.
- Pariyanonda S, Maleewong W, Pipitgool V *et al.* (1990). Serodiagnosis of human paragonimiasis caused by *Paragonimus heterotremus*. *SE Asian J Trop Med Publ Health* **21**: 103–7.
- Petmir S (1997). Cancer genes and cholangiocarcinoma. *SE Asian J Trop Med Publ Health* **28**: 80–4.
- Pulpeiro JR, Armesto V, Varela J *et al.* (1991). Fascioliasis: findings in 15 patients. *Br J Radiol* **64**: 798–801.
- Pungpak S, Bunnag D, Harinasuta T (1983). Clinical and laboratory evaluation of praziquantel in opisthorchiasis. *SE Asian J Med Publ Health* **14**: 363–6.
- Pungpak S, Bunnag D, Harinasuta T (1984). Albendazole in the treatment of opisthorchiasis and concomitant intestinal helminthic infections. *SE Asian J Trop Med Publ Health* **15**: 44–50.
- Pungpak S, Riganti M, Bunnag D *et al.* (1985). Clinical features in severe *Opisthorchiasis viverrini*. *SE Asian J Trop Med Publ Health* **16**: 405–9.
- Rifkin M, Seow H, Jackson D *et al.* (1996). Defence against the immune barrage: helminth survival strategies. *Immunol Cell Biol* **74**: 564–74.
- Rim H (1997). Epidemiology and control of clonorchiasis in Korea. *SE Asian J Trop Med Publ Health* **28**: 47–50.
- Rim H, Lyu K, Lee J *et al.* (1981). Clinical evaluation of the therapeutic efficacy of praziquantel (Embay 8440) against *Clonorchis sinensis* infection in man. *Ann Trop Med Parasitol* **75**: 27–33.
- Ripert C, Couprie B, Moyou R *et al.* (1992). Therapeutic effect of triclabendazole in patients with paragonimiasis in Cameroon: a pilot study. *Trans R Soc Trop Med Hyg* **86**: 417.
- Romeo DP, Pollock JJ (1986). Pulmonary paragonimiasis: diagnostic value of pleural fluid analysis. *South Med J* **79**: 241–3.
- Sadun EH, Buck AA (1960). Paragonimiasis in South Korea—immunodiagnostic, epidemiologic, clinical, roentgenologic

- and therapeutic studies. *Am J Trop Med Hyg* **9**: 562–99.
- Saowakontha S, Pipitgool V, Pariyanonda S *et al.* (1993). Field trials in the control of *Opisthorchis viverrini* with an integrated programme in endemic areas of northeast Thailand. *Parasitology* **106**: 283–8.
- Schwartz DA (1980). Helminths in the induction of cancer: *Opisthorchis viverrini*, *Clonorchis sinensis* and cholangiocarcinoma. *Trop Geog Med* **32**: 95–100.
- Sharma OP (1989). The man who loved drunken crabs. A case of pulmonary paragonimiasis. *Chest* **95**: 670–2.
- Shih Y, Ch'en Y, Chang Y (1958). Paragonimiasis of central nervous system: observations on 76 cases. *Chin Med J* **77**: 10–19.
- Shim Y, Cho S, Han Y (1991). Pulmonary paragonimiasis: a Korean perspective. *Semin Resp Med* **12**: 35–45.
- Singh TS, Mutum SS, Razaque MA (1986). Pulmonary paragonimiasis: clinical features, diagnosis, and treatment of 39 cases in Manipur. *Trans R Soc Trop Med Hyg* **80**: 967–71.
- Sithithaworn P, Tesana S, Pipitgool V *et al.* (1991). Relationship between faecal egg count and worm burden of *Opisthorchis viverrini* in human autopsy cases. *Parasitology* **102**: 277–81.
- Slemenda SB, Maddison SE, Jong EC *et al.* (1988). Diagnosis of paragonimiasis by immunoblot. *Am J Trop Med Hyg* **39**: 469–71.
- Srivatanakul P, Viyanant V, Kurathong S *et al.* (1985). Enzyme-linked immunosorbent assay for detection of *Opisthorchis viverrini* infection. *SE Asian Trop Med Publ Health* **16**: 234–9.
- Stork MG, Venables GS, Jennings SM *et al.* (1973). An investigation of endemic fascioliasis in Peruvian village children. *J Trop Med Hyg* **76**: 231–5.
- Strauss WG (1962). Clinical manifestations of clonorchiasis: a controlled study of 105 cases. *Am J Trop Med Hyg* **11**: 625–30.
- Sun T (1982). *Pathology and Clinical Features of Parasitic Diseases*. New York: Masson.
- Sun T (1984). Pathology and immunology of *Clonorchis sinensis* infection of the liver. *Ann Clin Lab Sci* **14**: 208–15.
- Suwanik R, Harinasuta C (1959). Pulmonary paragonimiasis: an evaluation of Roentgen findings in 38 positive sputum patients in an endemic area in Thailand. *Am J Roentgenogr* **81**: 236–44.
- Tendler M, Brito CA, Vilar MM *et al.* (1996). A *Schistosoma mansoni* fatty acid-binding protein, Sm14, is the potential basis of a dual-purpose anti-helminth vaccine. *Proc Natl Acad Sci USA* **93**: 269–73.
- Teoh TB (1963). A study of gallstones and included worms in recurrent pyogenic cholangitis. *J Pathol Bacteriol* **86**: 123–9.
- Upatham ES, Viyanant V, Kurathong S *et al.* (1982). Morbidity in relation to intensity of infection in opisthorchiasis viverrini: study of a community in Khon Kaen, Thailand. *Am J Trop Med Hyg* **31**: 1156–63.
- Woolf A, Green J, Levine JA *et al.* (1984). A clinical study of Laotian refugees infected with *Clonorchis sinensis* or *Opisthorchis viverrini*. *Am J Trop Med Hyg* **33**: 1279–80.
- Wykoff DE, Chittayasothorn K, Winn MM (1966). Clinical manifestations of *Opisthorchis viverrini* infections in Thailand. *Am J Trop Med Hyg* **15**: 914–18.
- Wykoff DE, Harinasuta C, Juttijudata P *et al.* (1965). *Opisthorchis viverrini* in Thailand—the life cycle and comparison with *O. felineus*. *J Parasitol* **52**: 207–14.
- Yang S, Cheng CS, Ghen KM (1955). Chest X-ray findings and some clinical aspects in pulmonary paragonimiasis. *Dis Chest* **27**: 88–95.
- Yangco BG, De Lerma C, Lyman GH *et al.* (1987). Clinical study evaluating efficacy of praziquantel in clonorchiasis. *Antimicrob Agents Chemother* **31**: 135–8.
- Yokogawa S, Cort WW, Yokogawa M (1960). *Paragonimus* and paragonimiasis. *Exp Parasitol* **10**: 81–137.
- Yokogawa M, Iwasaki M, Shigeyasu M *et al.* (1963). Chemotherapy of paragonimiasis with bithionol. V. Studies on the minimum effective dose and changes in abnormal X-ray shadows in the chest after treatment. *Am J Trop Med Hyg* **12**: 859–69.
- Zhang Z, Zhang Y, Shi Z *et al.* (1993). Diagnosis of active *Paragonimus westermani* infections with a monoclonal antibody-based antigen detection system. *Am J Trop Med Hyg* **49**: 329–34.



# Blood-borne Filarial Infections: *Wuchereria bancrofti*, *Brugia malayi*, *Brugia timori*, *Loa loa*, *Mansonella* *perstans* and *Mansonella ozzardi*

Thomas B. Nutman

National Institutes of Health, Bethesda, MD, USA

## INTRODUCTION

Filarial worms are nematodes or roundworms that dwell in the subcutaneous tissues and the lymphatics. Although eight filarial species commonly infect humans, six are typically considered blood-borne, in that the parasite stages infectious for the vector reside in the blood (Table 18a.1). These are the causative agents of lymphatic filariasis: *Brugia malayi*, *B. timori*, *Wuchereria bancrofti*, *Loa loa*, and two *Mansonella* species, *M. ozzardi* and *M. perstans*. Taken together, these human filarial parasites infect an estimated 200 million persons worldwide. Each of the parasites is transmitted by living insects. Each goes through a complex life cycle that includes an infective larval stage carried by the insects and an adult worm stage that can be found either in the lymph nodes, the adjacent lymphatics or the subcutaneous tissue. The offspring of the adults, the microfilariae

(160–300 µm long and 5–7 µm wide) circulate in the blood. These microfilariae then can be ingested by the appropriate biting arthropod and develop over a 1–2 week period into infective larvae, which are in turn capable of initiating the life-cycle.

Adult worms are long-lived, whereas microfilarial lifespans range from 3 months to 3 years. Infection is generally not established unless exposure to infective larvae is intense and prolonged. Furthermore, the clinical manifestations of these diseases develop relatively slowly and should be considered chronic infections with long-term associated debilitation.

There are significant differences in the clinical manifestations of filariasis, or at least in the time course over which these infections are acquired, in patients native to the endemic areas and those who are travellers to, or recent arrivals in, these same areas.

## THE LYMPHATIC FILARIASES

Lymphatic filariasis constitutes the principal mosquito-borne nematode infection of humans

today, with up to 129 million people currently thought to be infected with either *Wuchereria*

**Table 18a.1** Blood-borne filarial parasites

	<i>Wuchereria bancrofti</i>	<i>Brugia malayi</i> / <i>B. timori</i>	<i>Loa loa</i>	<i>Mansonella perstans</i>	<i>Mansonella ozzardi</i>
Geographic distribution	Throughout the tropics	Asia and Indian subcontinent	West and Central Africa	Africa, Central and South America	Central and South America, Caribbean
Periodicity of microfilaremia	Nocturnal periodic, diurnal subperiodic, nocturnal subperiodic	Nocturnal periodic, nocturnal subperiodic	Diurnal periodic	None	None
Length in stained blood film	244–296 µm	177–230 µm	231–250 µm	190–200 µm	163–203 µm
Width in stained blood film	7.5–10 µm	5–6 µm	5–7 µm	4–5 µm	3–5 µm
Sheath (in Giemsa stain)	Present, stains poorly	Present, stains pink	Present, does not stain	Absent	Absent
Nuclei in body	Well defined and spaced, easily counted	Intermingled, not readily counted	Not applicable	Not applicable	Not applicable
Tail	Tapers to a point	Tapered	Tapered	Tapers, blunt and rounded	Long and slender
Tail nuclei	Absent	Two in terminal thread, separated by a space from the tapered portion of tail	Extend to tip of tail	Extend to tip of tail	Do not extend to tip of tail

*bancrofti*, *Brugia malayi* or *B. timori*, the three lymph-dwelling filariae of humans (Michael, 2000). Bancroftian filariasis is the most prevalent of the three, occurring throughout the tropics and subtropics. In contrast, brugian filariasis is restricted to south and south-east Asia, including southern China.

## DESCRIPTION OF THE ORGANISMS

The lymphatic filariae have similar life cycles in which larval development takes place in the mosquito (intermediate) host and larval and adult development takes place in the human (definitive) host. Infection is initiated by the deposition of the third-stage larvae ( $L_3$ ) on the skin of the human host following a bite by an infective mosquito. The larvae enter the body through the skin and undergo an additional molt to the fourth larval stage ( $L_4$ ) as they mature into lymphatic-dwelling, thread-like adult male and female worms. The lymphatic-dwelling filariae mate, resulting in the release of fully-formed, sheathed, first-stage larvae ( $L_1$  or microfilariae) from the female. The microfilariae enter the peripheral circulation of the human host, where they are available to be ingested by the vector during a blood meal. In the vector, the parasite

penetrates the gut wall, migrates to the flight muscles, and molts to the second larval stage ( $L_2$ ). After several days, the parasite undergoes an additional molt to the  $L_3$  parasite.  $L_3$ s migrate to the mouthparts of the vector, where they are positioned to be passed on to the vertebrate host during a subsequent blood meal.

## EPIDEMIOLOGY

### *Brugia malayi* and *B. timori*

The distribution of brugian filariasis is limited primarily to China, India, Indonesia, Korea, Japan, Malaysia and The Philippines. In both brugian species, two forms of the species can be distinguished by the periodicity of their microfilariae. Nocturnally periodic forms have microfilariae present in the peripheral blood primarily at night, whereas the subperiodic forms have microfilariae present in the blood at all times, but with the maximum levels in the afternoon. The nocturnally periodic form of brugian filariasis is more common and is transmitted in the areas of coastal rice fields (by mansonian and anopheline mosquitoes), while the subperiodic form is found in the forests (mansonian vector). Although humans are the common host, *B. malayi* can be a natural

infection of cats. *B. timori* has been described only on two islands in Indonesia.

### ***Wuchereria bancrofti***

*W. bancrofti* is the most widely distributed parasite among humans, with distribution throughout the tropics and subtropics, including Asia and the Pacific Islands, Africa, areas of South America and the Caribbean basin. The total number of individuals infected with *W. bancrofti* is estimated to be 115 million. Again, humans are the only definitive host for the parasite and are therefore the natural reservoir for infection. Like brugian filariasis, there is both a periodic and subperiodic form of the parasite. Generally, the subperiodic form is found only in the Pacific Islands; elsewhere, *W. bancrofti* is nocturnally periodic. The natural vectors are *Culex* mosquitoes in urban settings and anopheline or aedean mosquitoes in rural areas.

## **PATHOLOGY**

The principal pathological changes in lymphatic filariasis result from inflammatory damage to the lymphatics. Adult worms live in the afferent lymphatics or sinuses of the lymph nodes and induce local changes that result in dilatation of the lymphatics and thickening of the vessel walls. Histologically, there is infiltration with plasma cells, eosinophils and macrophages in and around the infected vessels. There is endothelial and connective tissue proliferation with tortuosity of the lymphatics and damaged or incompetent lymph valves. The overlying skin shows lymphedema and chronic stasis changes with hard or brawny edema.

It is believed that some of the pathological consequences of filariasis relate to the nature of the host immune response to the parasite. In the lymphatics, local immune responses directed toward the adult parasite are believed to cause the granulomatous and proliferative processes that precede total lymphatic obstruction. It is said that as long as the worm remains viable, the vessel remains patent. Death of the worm, however, leads to local necrosis of a granulo-

matous reaction around the parasite. Fibrosis occurs and lymphatic obstruction develops; although some collateralization of the lymphatics takes place, lymphatic function remains compromised.

Recent evidence, from both clinical observations and immunohistologic and bacteriologic studies of tissue from lymphedematous limbs of affected patients, has suggested that bacterial or fungal superinfections of limbs with compromised lymphatic function play a significant role in triggering some episodes of adenolymphangitis (ADL) (Olszewski *et al.*, 1998; Dreyer and Noroes, 1997; Montestruc *et al.*, 1960; Suarez, 1936) which, themselves, actually cause or exacerbate the chronic obstructive changes in the lymphatics of affected patients. These studies have shown that the acute process usually starts in the skin and then spreads along the lymphatics to the lymph nodes. Based on these observations, some have proposed that the syndrome be renamed 'dermatolymphangiadenitis' (DLA) (Addiss and Dreyer, 2000).

## **CLINICAL MANIFESTATIONS**

The clinical manifestations of lymphatic filariasis vary from one endemic area to another and also differ, to some extent, according to the species of the parasite that is involved (Partono, 1987). In parts of Africa such as Tanzania, the most common clinical form of the disease is hydrocele, while lymphedema and elephantiasis are much less common (Sasa, 1976). In other areas of the world such as India, both hydrocele and lymphedema are seen with almost equivalent frequency (Pani *et al.*, 1991). Some forms of the disease, such as tropical pulmonary eosinophilia (TPE) and chyluria, are restricted in their distribution to certain parts of the world. For example, TPE has been reported most commonly from the Indian subcontinent, Brazil and Malaysia. Several studies have shown that there is a slight preponderance of females with chronic disease (when hydroceles are excluded) (Brabin, 1990). Other reports, especially from Ghana, indicate a male preponderance of the disease (Gyapong *et al.*, 1994).

Differences in clinical presentation between bancroftian and brugian filariasis have also been reported (Partono, 1987; Sasa, 1976). It is recognized that inguinal lymphadenitis is more common in brugian filariasis than in bancroftian filariasis. Lymphangitis also occurs more frequently in brugian filariasis and in some individuals the inflamed lymphatics may stand out as cords. These are painful and prevent movement of the limbs. In the upper limbs, they can easily be palpated ('string sign'). Genital disease (hydrocele and filarial scrotum) is not seen in brugian filariasis.

### The Microfilaremic Stage

In areas where *W. bancrofti* or *B. malayi* are endemic, the overwhelming majority of infected individuals have few overt clinical manifestations of filariasis, despite the presence of large numbers of circulating microfilariae in the peripheral blood. The prevalence of microfilaremia increases with age during childhood and usually reaches a plateau between 20 and 30 years of age. During the childbearing years, the prevalence tends to be higher among men than among women (Brabin, 1990).

A growing body of evidence indicates that, although they may be clinically asymptomatic, virtually all persons with *W. bancrofti* or *B. malayi* microfilaremia have some degree of subclinical disease. First, it was recognized that many (ca. 40%) of these microfilaremic individuals have hematuria and/or proteinuria that reflect low-grade renal damage. The hematuria may be macroscopic, but is most often microscopic and may be accidentally discovered during routine urine examination (Dreyer *et al.*, 1992). These renal abnormalities appear to be associated with the presence of microfilariae rather than adult worms, because clearing microfilariae from the blood results in complete reversal of these renal abnormalities (Dreyer *et al.*, 1992). Second, and even more dramatic, were the observations on microfilaremic individuals using lymphoscintigraphy to visualize the functional anatomy of lymphatic vessels. Although clinically asymptomatic, they had markedly abnormal, dilated and tortuous lymphatics and markedly

abnormal patterns of lymphatic flow (Suresh *et al.*, 1997; Dissanyake *et al.*, 1995; Freedman *et al.*, 1994). In parallel studies from Brazil using ultrasound examination of scrotal lymphatics, microfilaria-positive asymptomatic men demonstrated lymphangiectasia (Noroes *et al.*, 1996a).

Although reversibility with treatment has not yet been demonstrated, it is clear that the 'asymptomatic microfilaremic state' is not as benign as initially believed, although the majority of individuals appear to remain asymptomatic for years, with relatively few progressing to the acute and chronic stages.

### Acute Manifestations of Lymphatic Filariasis

The acute clinical manifestations of filariasis are characterized by recurrent attacks of fever associated with inflammation of the lymph nodes (adenitis) and/or lymph vessels (lymphangitis), termed adenolymphangitis (ADL).

In bancroftian filariasis, recurrent attacks of fever associated with lymphadenitis are less frequently seen than in brugian filariasis (Partono, 1987). In addition to the lymph nodes in the inguinal, axillary and epitrochlear regions, the lymphatic system of the male genitalia is frequently affected, leading to funiculitis, epididymitis or orchitis, or to a combination of these (Pani *et al.*, 1995). In brugian filariasis, the affected lymph nodes are mostly situated in the inguinal and axillary regions, with inflammation along the course of the distal lymphatic vessels (Partono, 1987; Pani *et al.*, 1990).

The acute clinical course of filariasis may last for several days or up to 4–6 weeks with a fulminant episode. The diagnostic criteria for the identification of acute filarial attacks have been codified (World Health Organization, 1992) and require pain, tenderness and local warmth, with either lymphadenitis/lymphangitis/cellulitis (Shenoy *et al.*, 1995) (for lungs and breasts) or epididymo-orchitis (for the scrotum). The presence of scars at typical locations, e.g. over the inguinal and epitrochlear lymph nodes, supports the diagnosis of filariasis (Figure 18a.1). In patients with filarial disease, acute attacks of ADL may involve the limb, breast or male external genitalia.



**Fig. 18a.1** Scar following rupture of subcutaneous abscess in *Brugia malayi* adenolymphangitis. Courtesy of Dr Stephen Hoffman

These acute episodes are characterized by local pain, tenderness, warmth and lymphadenitis and/or lymphangitis. Other commonly associated findings include fever, edema, constitutional complaints and localized or ulcerated abscesses, especially in areas where *Brugia* is endemic.

In endemic areas, there are two distinct types of acute ADL episodes: ADL secondary to bacterial or fungal infection, and ADL caused directly by the parasite infection itself.

### Filarial Acute Attacks

The most common presentation is that of a cord-like structure associated with retrograde lymphangitis in the lower or upper limbs. In the scrotal area or the breast, it may present as a painful palpable nodule. Funiculo-epididymo-orchitis is the usual presenting feature of acute attacks of ADL involving the male genitalia. Acute hydrocele may also be present. The systemic reactions are mild, and distal edema is rare. Recurrence of these attacks at the same site is common (Addiss and Dreyer, 2000; Pani *et al.*, 1990).

### Acute Attack Secondary Bacterial or Fungal Infection: Reticular Lymphangitis

This is the most common form of ADL. It is usually recognized as a syndrome with a clinical

picture that can include high fever, chills, myalgia and headache. Edematous inflammatory plaques clearly demarcated from normal skin are seen. Occasionally, vesicles, ulcers and hyperpigmentation may also be noted (Dreyer and Piessesns, 1999). There is often a history of trauma, burns, radiation, insect bites, punctiform lesions or chemical injury. Entry lesions, especially in the interdigital area, are common (Dreyer and Piessesns, 2000).

It is now generally agreed that it is possible to distinguish the two forms of acute attacks. The first type, the so-called 'filarial' fever, is characterized by lymphadenitis and retrograde lymphangitis in the absence of any injury or entry site for bacterial infections. The second form is usually diagnosed as cellulitis and is almost always associated with a visible site of entry for bacteria, edematous infiltration of the surrounding subcutaneous tissues, or even formation of abscesses, which may in turn ulcerate and lead to scarring. In contrast to bacterial infections, the ulcer in filariasis is relatively clean and produces a serosanguinous fluid. Lymphedema is quite often present in these fulminant episodes. Usually, the edema subsides after each episodic attack, but with repeated attacks the edema persists, leading to chronic lymphedema. Typically, each attack of fever and lymphadenitis lasts for several days and usually subsides spontaneously following bed rest.

Repeated episodes of ADL have been shown to be important in the progression of the disease, and data exist showing a direct relationship between the number of acute attacks and the grade of lymphedema (Pani *et al.*, 1990). The frequency of acute attacks is generally higher in bancroftian as compared with brugian filariasis (Pani *et al.*, 1990; Dreyer and Piessesns, 2000).

### Chronic Manifestations of Lymphatic Filariasis

The chronic signs of filariasis rarely develop before the age of 15 years, and only a small proportion of the filaria-infected population is affected; however, immigrants from areas where filariasis is not endemic tend to develop elephantiasis more often and much sooner (sometimes



**Fig. 18a.2** Hydrocele secondary to *Wuchereria bancrofti* infection



**Fig. 18a.3** Elephantiasis of lower extremities in *Wuchereria bancrofti* infection

within 1–2 years) than do the indigenous populations of endemic areas (Partono, 1987).

In bancroftian filariasis, the occurrence of the major signs of chronic disease—hydrocele (Figure 18a.2), chyluria, lymphedema and elephantiasis (Figure 18a.3)—may differ from one area to another. The most common are hydrocele and swelling of the testis, followed by elephantiasis of the entire lower limb, the scrotum, the entire arm, the vulva and the breast, in descending order of frequency (Shenoy *et al.*, 1995).

### ***Lymphedema of the Limbs***

Swelling of the limbs is most common. In bancroftian filariasis the entire limb may be affected, but in brugian filariasis the leg below the knee

and sometimes the arm below the elbow are characteristically involved. Lymphedema can be graded as follows (World Health Organization, 1992): grade 1, pitting edema of the limb that is reversible on elevating the limb; grade 2, pitting/non-pitting edema that is not reversible on elevating the limb, and skin is normal; grade 3, non-pitting edema of the limb that is not reversible on elevation, and the skin is thickened; grade 4, non-pitting edema with fibrotic and verrucous skin changes (elephantiasis).

In brugian filariasis, the leg below the knee is characteristically affected, and sometimes the arm below the elbow. Genital involvement has not been reported, except in areas where brugian filariasis occurs together with *W. bancrofti* (Pani *et al.*, 1990). Lymphoscintigraphic studies have shown that lymphedema is not always the result of occlusion of lymphatic channels but can also occur when there is extensive collateralization.

Secondary skin changes, such as skin-fold thickening, hyperkeratosis, hypo- or hypertrichosis, pachydermia, pigmentary changes, chronic ulceration, epidermal and subepidermal nodules and clinical intertrigo may also be seen in chronic filarial infections (Burri *et al.*, 1996).

### ***Male Genital Disease (Seen only in Bancroftian Filariasis)***

Hydroceles result as a consequence of the accumulation of fluid in the tunica vaginalis. The fluid that accumulates is usually clear and the presence of microfilariae in the hydrocele fluid can occasionally be demonstrated. Transillumination is characteristic and quite often very helpful to identify fluid. Hydroceles should be differentiated from inguinal–scrotal swellings and hernias.

Hydroceles are seen only in areas where there is bancroftian filariasis. This is the most common clinical manifestation in many endemic communities, with 40–50% of the males affected. The prevalence of hydrocele in endemic communities is generally underestimated, and it is not uncommon for small hydroceles to be missed. Repeated episodes of ADL involving the testicular lymphatics (epididymo-orchitis) may precede the development of hydrocele; however, hydroceles can also develop silently, and recent ultrasound

studies have shown that lymphangiectasia of the scrotal lymphatics is common in patients with hydroceles (Noroës *et al.*, 1996b).

### ***Lymphedema of the Genitalia***

This is characterized by swelling of the scrotum with or without thickened scrotal or penile skin, which may have a characteristic 'peau d'orange' appearance. In long-standing cases, verrucous lesions and lymphorrhea are common. The genitals may be grossly deformed; terms such as 'ramshorn penis' have been used to describe the gross distortion of the penis seen in this condition.

### ***Lymphorrhea***

In this condition, lymph oozes out to the exterior directly from dilated ruptured lymphatic vessels. The dermis may be normal. This frequently occurs in the scrotal wall.

### ***Chyluria***

The patient with chyluria often complains of passing milky urine. Chyluria is more frequently observed after a hyperlipidemic meal and may, in many cases, be associated with blood in the urine (hematochyluria). Patients may have a spontaneous regression of their symptoms. The diagnosis of chyluria is confirmed by the presence of lymphocytes in the urine. The level of communication between the lymphatics and the genitourinary system can occur anywhere along the genitourinary tract (from the kidney to the urethra) but is usually at the level of the renal pelvis. Chyluria should be differentiated from pyuria and phosphaturia. In these conditions, white blood cells are absent and a sediment rather than an emulsion seen.

### **Tropical Pulmonary Eosinophilia (TPE)**

The usual presenting features of TPE are cough, dyspnea and wheezing similar to bronchial asthma

(Udwadia, 1975; Spry and Kumaraswami, 1982). Chest radiographs may show diffuse mottling. In some areas, it is associated with paroxysmal nocturnal cough, breathlessness and wheezing, occasionally accompanied by a radiologic picture of diffuse patchy infiltration of the lungs. In other areas, it is associated with lymphadenopathy and sometimes hepatosplenomegaly (so-called 'occult filariasis'; Beaver, 1990). Microfilariae are almost never present in the blood, but remnants of microfilariae surrounded by aggregates of eosinophils are sometimes found in the spleen, liver, lymph nodes or lungs (Udwadia, 1975). The total eosinophil count is greater than 3000/ $\mu$ l. Increased levels of IgE and antifilarial antibodies are commonly found (Ottesen and Nutman, 1992).

TPE is characterized by immunologic hyper-responsiveness of the human hosts to the parasite, especially the microfilariae (Ottesen *et al.*, 1979). Although microfilariae are not found in the circulation, lung biopsies have shown the presence of dead or dying microfilariae in the lung tissue (Webb *et al.*, 1960). Bronchoalveolar lavage studies have shown increased numbers of eosinophils in the lavage fluid (Pinkston *et al.*, 1987). The eosinophils are 'activated' and have been shown to release oxygen radicals and other proinflammatory molecules (Rom *et al.*, 1990). Treatment with diethylcarbamazine citrate (DEC) leads to a rapid regression of the clinical symptoms and also to a decrease in the number of eosinophils. Similar syndromes may occur in the presence of intestinal worm infections, with a clinical picture that is difficult to distinguish from that of TPE apart from its inability to be cured by DEC, but which responds to anthelmintics such as albendazole and ivermectin (Vijayan, 1991; Rocha *et al.*, 1995).

### **Filarial Granulomata**

Painless lumps in the breasts, testicles or subcutaneous tissues and a 'coin' lesion in the lung can reflect granulomatous reactions around adult or developing adult worms of human or animal filarial parasites. They should be regarded as filarial infections in an unusual location or in an abnormal host.

### Adenopathy

Chronic adenopathy is a common but non-specific feature of filarial disease (Englehorn and Wellman, 1945), occurring in infected persons of all ages. It is more commonly seen in *B. malayi* infections. Enlargement of the lymph node is usually painless and may be the only clinical sign in individuals who are asymptomatic and microfilaria-positive. The lymph nodes most commonly involved are in the inguinal, epitrochlear, axillary and, rarely, other areas such as the submandibular (Figueroa-Silva *et al.*, 1994).

### Clinical Manifestations in Expatriates and Transmigrants

The clinical manifestations in individuals who move from filarial-non-endemic areas to filarial-endemic areas are characterized by the rapid appearance of signs and symptoms that are not commonly seen in endemic populations. They rapidly develop inflammatory pathology, including lymphadenitis, hepatomegaly and splenomegaly. Such manifestations were initially seen in soldiers who were posted in filarial-endemic areas in south-east Asia (Wartmann, 1947; King, 1944; Huntington *et al.*, 1944; Hodge *et al.*, 1945; Galliard, 1957) and in humans experimentally infected with filarial parasites (reviewed in Nutman, 1991). Similar manifestations were reported among transmigrants in Indonesia, where populations were relocated from non-endemic areas to areas endemic for filariasis (Partono, 1987). In travelers, acute lymphedema accompanied by massive eosinophilia can be seen (Moore *et al.*, 1996), as can mass lesions that, on biopsy, show filarial parasites (McCarthy *et al.*, 1996). All of these conditions tend to respond rapidly to specific treatment and, more importantly, can be reversed when the individuals return to their non-endemic environment. This is probably because these syndromes are associated with the stages of the parasites (L<sub>3</sub>s, L<sub>4</sub>s, early adults) that are very sensitive to DEC (Ottesen, 1985).

### Differential Diagnosis

Lymphedema and elephantiasis of filariasis are often difficult to differentiate clinically from

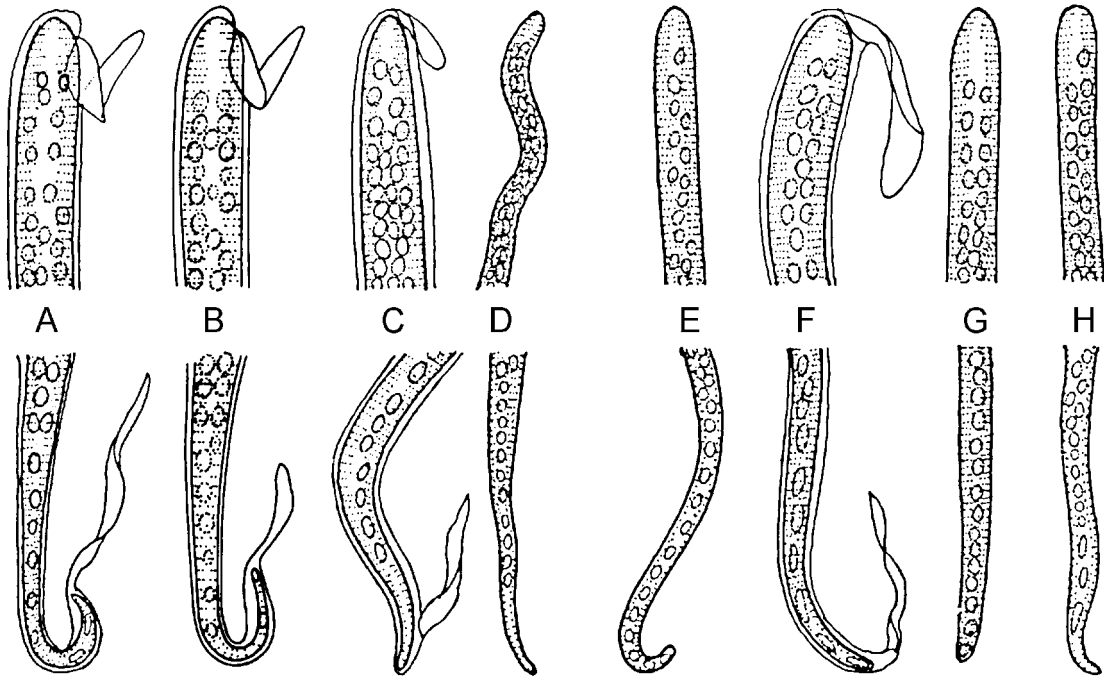
other conditions that may evoke similar changes secondary to damaged lymphatics. Elephantiasis is characterized by hyperplasia and fibrosis of the subcutaneous tissue and thickening of the skin; however, in barefoot farming communities, skin thickening is quite common. Other conditions that cause compression of the lymphatic vessels may reduce lymph flow and produce subsequent lymphedema or even elephantiasis of the affected part of the body, distal to the compression. These include tumors and fibrotic tissue formation as a result of burns, irradiation or surgical lymphadenectomy. Onchocerciasis may also cause elephantiasis. In Africa, elephantiasis with a physicochemical etiology (absorption of silicate particles through the skin, known as podocniosis) has been reported in certain areas where filariasis is not endemic (Price and Bailey, 1984).

### DIAGNOSIS

The diagnosis of filarial diseases can be problematic, because these infections require parasitologic techniques to demonstrate the offending organisms (Figure 18a.4). In addition, satisfactory methods for the definitive diagnosis in amicrofilaric states can be difficult. The definitive diagnosis of filariasis can only be made by the demonstration of the offending parasites. Microfilariae can be found in the blood, hydrocele fluid or, occasionally, in another body fluid. These fluids can be examined microscopically, either directly or, for greater sensitivity, after concentration of the parasites by the passage of fluid through a polycarbonate cylindrical filter (pore size, 3 µm) or by the centrifugation of fluid fixed in 2% formalin (Knott's concentration technique) or 2% formalin/10% Teepol (Dickerson *et al.*, 1990). The blood sample can be stored in this condition for several months at room temperature prior to filtration in the standard fashion. The use of formalin inactivates any blood-borne infectious agents. Speciation of the parasite can be undertaken by morphologic examination (Figure 18a.4).

Occasionally, diagnostic aspiration for cytologic examination (e.g. hydrocele or breast lump) results in the identification of microfilariae in the aspirate (Bapat and Pandit, 1992; Varghese *et al.*, 1996; Kapila and Verma, 1996).





**Fig. 18a.4** Differential characterizations of microfilariae. (A) *Brugia malayi*. (B) *Brugia timori*. (C) *Wuchereria bancrofti*. (D) *Onchocerca volvulus*. (E) *Mansonella streptocerca*. (F) *Loa loa*. (G) *Mansonella perstans*. (H) *Mansonella ozzardi*. Redrawn after Craig and Faust (1964). *Clinical Parasitology*, 7th edn, Lea and Febiger: Philadelphia, PA; with permission

### Parasitologic Diagnosis by Identification of the Adult Parasite

Surgical removal of a nodule or mass for diagnostic purposes may lead to the discovery of a nematode within lymphatic tissue. Speciation of the parasite can be undertaken by morphologic examination (Ash and Orihel, 1987) or by PCR (see below).

### Detection of Circulating Parasite Antigen

Assays for circulating antigens of *W. bancrofti* permit the diagnosis of microfilaremic and cryptic (amicrofilaremic) infection (More and Copeman, 1990; Lammie *et al.*, 1994; Chanteau *et al.*, 1994; Rocha *et al.*, 1996; Weil *et al.*, 1997). There are currently two commercially available tests, one in an ELISA format (Trop-Ag *W. bancrofti*, manufactured by JCU Tropical Biotechnology Pty. Ltd, Townsville, Queensland, Australia) and the other a rapid-format card

test (marketed by Binax, Portland, ME, USA). Both assays have reported sensitivities in the range 96–100% and specificities that approach 100% (More and Copeman, 1990; Lammie *et al.*, 1994; Chanteau *et al.*, 1994; Rocha *et al.*, 1996; Weil *et al.*, 1997). There are currently no tests for circulating antigens in brugian filariasis.

### Serodiagnosis Using Parasite Extract

The development of serodiagnostic assays of sufficient sensitivity and specificity for routine use has proved problematic (Ambroise-Thomas, 1974; Voller and deSavigny, 1981; Speiser, 1980), primarily because of their poor specificity. Extensive cross-reactivity is found in the sera of individuals infected with closely related helminth parasites and even certain protozoal parasites (Maizels *et al.*, 1985; Lal and Ottesen, 1988). Further, as is the case for serodiagnosis of most infectious diseases, it is difficult to differentiate previous infection or exposure to the parasite

(aborted infection) from current active infection. Indeed, most residents of filariasis-endemic regions are antibody-positive (Ottesen *et al.*, 1982). Nevertheless, such serologic assays have a definite place in diagnosis, as a negative assay result effectively excludes past or present infection.

The prominent role of antifilarial antibodies of the IgG<sub>4</sub> subclass in active filarial infection (Ottesen *et al.*, 1985) has led to the development of serodiagnostic assays based on antibodies of this subclass. Antifilarial IgG<sub>4</sub> antibodies have improved specificity, but positive assays may still be seen in uninfected individuals living in endemic areas (Chanteau *et al.*, 1994) and in those infected with other filarial species (e.g. onchocerciasis, loiasis, mansonelliasis).

### Molecular Diagnostics

PCR-based assays for DNA of *W. bancrofti* and *B. malayi* in blood have also been developed. In a number of studies evaluating PCR-based diagnosis, the method is of equivalent or greater sensitivity compared with parasitologic methods, detecting patent infection in almost all infected subjects. In addition, the technique is able to detect cryptic infection (amicrofilaremic, circulating antigen-positive infection) in some subjects (Abbasi *et al.*, 1996; Lizotte *et al.*, 1994; Williams *et al.*, 1996), and parasite DNA can be detected in the saliva of microfilaremic individuals (Abbasi *et al.*, 1996). The technique is, in addition, useful for the speciation of parasite material removed at surgery, especially when morphologic diagnosis is not possible.

### Imaging Studies

In cases of suspected lymphatic filariasis, examination of the scrotum (Amaral *et al.*, 1994) or female breast using high-frequency ultrasound in conjunction with Doppler techniques may result in the identification of motile adult worms within dilated lymphatics. Worms may be visualized in the lymphatics of the spermatic cord in up to 80% of infected men (Noroës *et al.*, 1996b; Dreyer *et al.*, 1995a). Live adult worms have a distinctive pattern of movement within the

lymphatic vessels (termed the 'filaria dance sign') (Amaral *et al.*, 1994). Worms appear to remain in a constant location, in so-called 'nests' (Noroës *et al.*, 1996b) within lymphatic vessels. This technique may be useful to monitor the success of antifilarial chemotherapy, by observing for the disappearance of the dance sign (Dreyer *et al.*, 1995a,b; Noroës *et al.*, 1997).

Evaluation of lymphatic function by lymphoscintigraphy can provide useful information in lymphatic filariasis. This technique involves injection of <sup>99</sup>Tc-radiolabeled albumin or dextran into the dermis, followed by sequential imaging with a gamma camera (Suresh *et al.*, 1997; Dissanyake *et al.*, 1995; Freedman *et al.*, 1994). Radionuclide lymphoscintigraphic imaging of the limbs reliably demonstrates widespread lymphatic abnormalities in both asymptomatic and microfilaremic persons, as well as in those with clinical manifestations of lymphatic pathology (Dreyer and Noroës, 1997). While of potential utility in the delineation of anatomical changes associated with infection, lymphoscintigraphy is unlikely to assume first place in the diagnostic evaluation of individuals with suspected infection.

### TREATMENT

With newer definitions of clinical syndromes in lymphatic filariasis and new tools to assess clinical status (e.g. ultrasound, lymphoscintigraphy, circulating filarial antigen assays), approaches to treatment based on infection status and pathogenesis have been proposed (Addiss and Dreyer, 1999). These changing perspectives of lymphatic filariasis have important implications for treatment.

### Microfilaria-positive Individuals

In areas where lymphatic filariasis is endemic, most infected persons are clinically asymptomatic despite the presence of circulating microfilariae. A growing body of evidence indicates that although they may be asymptomatic, virtually all persons with *W. bancrofti* or *B. malayi* microfilaremia have some degree of subclinical

disease (hematuria, proteinuria, abnormalities on lymphoscintigraphy). Thus, early treatment of asymptomatic persons is recommended to prevent further lymphatic damage. DEC, which has both macrofilaricidal and microfilaricidal properties, is the drug of choice (Ottesen, 1985). The macrofilaricidal action of DEC is not intended to reverse existing lymphatic damage but rather to prevent further adult worm-associated lymphatic damage and dysfunction. The microfilaricidal activity of DEC clears the blood of microfilariae, reduces the opportunity for mosquito-borne transmission of the parasite, and reverses filaria-associated hematuria and proteinuria.

Regimens that emphasize single-dose diethylcarbamazine, ivermectin or combinations of single doses of albendazole and diethylcarbamazine, or albendazole and ivermectin, have each been demonstrated to have a sustained microfilaricidal effect.

### **Microfilaria-negative Antigen-positive Individuals**

Because lymphatic disease is associated with the adult worm, treatment with DEC is recommended for microfilaria-negative adult worm carriers, i.e. persons who are microfilaria-negative but filaria antigen- or ultrasound-positive.

### **Acute Manifestations of Lymphatic Filariasis: Filarial Adenolymphangitis (FADL)**

Supportive treatment is recommended, including rest, postural drainage (particularly if the lower limb is affected), cold compresses at the site of inflammation, and antipyretics and analgesics for symptomatic relief. During the acute episode, treatment with antifilarial drugs is not recommended, because it may provoke additional adult worm death and exacerbate the inflammatory response. After the acute attack has resolved, if the patient remains microfilaria- or antigen-positive, DEC can be given to kill the remaining adult worms.

### **Acute Dermatolymphangioadenitis (ADLA)**

Dilatation of the lymphatic vessels induced by the presence of the adult worm eventually leads to lymphatic dysfunction and accumulation of protein-rich fluid in the tissues. The lower limbs, in particular, become predisposed to recurrent bacterial infections. Trauma, interdigital fungal infections, and onychomycosis provide entry sites for these bacteria, which multiply rapidly and cause a reticular lymphangitis of the small collecting vessels (ADLA) (Dreyer and Noroes, 1997; Dreyer and Piessesns, 1999). Treatment with DEC appears to have no effect on the outcome of ADLA (Shenoy *et al.*, 1995). Instead, cold compresses, antipyretics and analgesics are recommended. The patient should remain at rest with the affected limb elevated. Antibiotic therapy must be initiated while awaiting results of cultures of blood or tissue aspirates. The bacteria isolated during these attacks are sensitive to most systemic antibiotics, including penicillin.

### **Chronic Manifestations of Lymphatic Filariasis**

Chronic manifestations of lymphatic filariasis include lymphedema, urogenital disease and adenopathy. Although antifilarial drug therapy is rarely, if ever, the 'definitive' treatment for these conditions, such treatment is indicated if the patient has evidence of active infection, e.g. detection of microfilaria or filarial antigen in the blood, or of the 'filaria dance sign' on ultrasound examination. Not infrequently, the inflammatory response secondary to treatment-induced death of the adult worm exacerbates manifestations of chronic disease.

### **Lymphedema**

Data indicate that filarial elephantiasis and lymphedema of the leg may be partially reversible with a treatment regimen that emphasizes hygiene, prevention of secondary bacterial infections and physiotherapy. This regimen is similar to that now recommended for treatment of

lymphedema in Europe, Australia, and the USA (Foldi *et al.*, 1989; Kobayashi and Miller, 1987; Mortimer, 1990; Campisi, 1991; Casley-Smith and Casley-Smith, 1992; Pappas and O'Donnell, 1992; Boris *et al.*, 1994), where it is known by a variety of names, including 'complex decongestive physiotherapy' and 'complex lymphedema therapy'.

A variety of surgical procedures for lymphedema have been attempted since early in the century (Matas, 1913), but results have generally been unsatisfactory (Watson, 1953; Miller, 1977; Jamal, 1981). These procedures include lymphangioplasty, lympho-venous anastomosis, and excision ('de-bulking') of fibrotic subcutaneous tissue (Kobayashi and Miller, 1987; Mortimer, 1990; Jamal, 1981).

### Urogenital Manifestations of Lymphatic Filariasis

The chronic urogenital manifestations of lymphatic filariasis include lymphedema and elephantiasis, lymph scrotum, hydrocele, chylocele and chyluria. The principles of treatment of scrotal and penile lymphedema are similar to those described above for lymphedema of the leg, although the prognosis is more guarded. Attention to hygiene and skin care are essential to prevent secondary bacterial infections. Additional treatment for fungi, especially candidiasis, is particularly important. The results of surgical intervention are less than ideal.

Treatment of elephantiasis of the penis is particularly difficult. Surgical procedures have been recommended, but only after secondary bacterial infections have been adequately treated (Bejanga and Husain, 1984).

### Hydrocele

Hydrocele is the most frequent chronic manifestation of bancroftian filariasis. The prevalence of hydrocele in men increases with age and tends to parallel that of microfilaremia in the general population. The definitive treatment for hydrocele is surgical; a variety of techniques have been recommended (Lord, 1964; Rodriguez *et al.*,

1981; Wannas, 1983; Dandapat *et al.*, 1984; Albrecht *et al.*, 1991).

### Chyluria

Treatment for chyluria includes rest and a diet rich in protein but low in fat (Yu, 1984). Improvement has been reported when medium-chain triglyceride was the only source of dietary fat (Hashim, 1964). Adequate hydration is recommended to increase the frequency of micturition and decrease the risk of clot formation within the bladder. Surgical treatment for chyluria is controversial, but it is sometimes recommended for severe or intractable cases (Kanetkar *et al.*, 1966; Wickham, 1976). Lymphangiography-directed surgical 'lymphatic disconnection' for intractable cases has been reported to have good results (Karanjavala, 1979).

### Tropical Pulmonary Eosinophilia (TPE)

DEC is the drug of choice for treatment of TPE. Characteristically, respiratory symptoms rapidly resolve following treatment with DEC. Because DEC does not appear to kill all the adult worms in most infected persons, the short-term resolution of TPE symptoms following treatment is most likely the result of rapid killing of the microfilariae. A 12 or 21 day course of DEC results in more rapid clearance of microfilaremia than a single 6 mg/kg dose. Therefore, the longer course of treatment is recommended in order to kill microfilariae as rapidly as possible. Despite dramatic initial improvement following conventional treatment with DEC, symptoms recur in approximately 20% of patients 12–24 months after treatment (Udwadia, 1975), and a majority of patients continue to have subtle clinical, radiographic and functional abnormalities 5–40 months after treatment (Dreyer and Noroes, 1997). If the adult worms are visible by ultrasound, ultrasonographic monitoring may be used to assess efficacy of treatment against the adult worm (Dreyer *et al.*, 1996). Repeat treatment may be necessary.

## Dosage

In summary, the currently recommended 12 day, 72 mg/kg course of DEC treatment, or variations thereof (Anonymous, 1998), have remained the standard for many years; however, recent data indicate that single-dose treatment with 6 mg/kg DEC has comparable macrofilaricidal and long-term microfilaricidal efficacy. The 12 day course provides more rapid short-term microfilarial suppression but when other factors are considered, including cost, convenience and patient compliance, it now seems reasonable to recommend single-dose treatment for individual patients with *W. bancrofti* or *B. malayi* infection. Single-dose treatment can be repeated every 6–12 months for persons who remain infected. Because it reduces microfilarial density more rapidly, the 12 day course of treatment is recommended for patients with TPE or hematuria, both of which are associated with microfilariae rather than the adult worm (Addiss and Dreyer, 2000).

## PREVENTION AND CONTROL

Avoidance of mosquito bites is usually not feasible for residents of endemic areas, but visitors should make use of insect repellent and mosquito nets. DEC has the ability of killing

developing forms of filarial parasites and has been shown to be useful as a prophylactic agent in humans.

Implementation of community-based intervention is currently the approach being taken toward the elimination of lymphatic filariasis as a public health problem (Ottesen *et al.*, 1997). The underlying tenet of this approach is that mass annual distribution of antimicrofilarial chemotherapy will suppress microfilaremia profoundly. If the suppression is sustained, then transmission can be interrupted.

Because single-dose ivermectin or DEC or combinations of several antifilarial drugs (ivermectin/albendazole, ivermectin/DEC) have already been shown to be capable of suppressing microfilaremia for up to 2 years, these regimens are being readied for use in community-based mass treatment programs. An alternative approach to control of lymphatic filariasis is the use of salt fortified with DEC (Hawking and Marques, 1967; Gelband, 1994). Community use of DEC-fortified salt has been shown to dramatically reduce microfilarial density with no apparent adverse reactions.

Community education and clinical care for persons already suffering from the chronic sequelae of lymphatic filariasis should be seen as important components of filariasis control and elimination programs.

## LOIASIS

Loiasis, infection with the filarial nematode *Loa loa*, is limited to and highly endemic in western and central Africa. Characteristic clinical features include Calabar swellings (transient localized angioedema) and subconjunctival migration of the adult parasite ('eyeworm'). Severe manifestations of infection, including cardiomyopathy, nephropathy and fatal encephalitis, are rare but do occur.

larvae develop into white, thread-like adult worms that migrate through the subcutaneous tissues. In bisexual infections, microfilariae are produced and released into the bloodstream, from which they can be ingested by the vector in a bloodmeal to complete the cycle.

## EPIDEMIOLOGY

*L. loa* is estimated to cause chronic infection in 3–13 million residents of endemic areas in western and central Africa (Sasa, 1976). Most infected individuals have a history of prolonged exposure (>4 month residence in an endemic area) (Nutman *et al.*, 1986), although individuals

## DESCRIPTION OF THE ORGANISM

Infective larvae are transmitted to the host by the bite of an infected female fly of the genus *Chrysops*. Over the course of 6–12 months, these

have been shown to be infected after repeated short stays (Rakita *et al.*, 1993). Although non-human primates can be experimentally infected with *L. loa*, natural infection appears to be restricted to humans (Duke, 1957; Rodhain, 1980).

## CLINICAL MANIFESTATIONS

Whereas the majority of infected individuals from endemic areas are asymptomatic despite high levels of microfilariae detectable in the peripheral blood, visitors to endemic areas tend to be symptomatic, with a predominance of 'allergic symptoms' including pruritus, urticaria and transient, migratory angioedema or Calabar swellings (Nutman *et al.*, 1986; Klion *et al.*, 1991; Noireau *et al.*, 1990). Clinical complications, with the exception of renal abnormalities, are also more common in non-endemic patients. Circulating microfilariae in these patients are rarely detectable. Characteristic laboratory abnormalities in loiasis include eosinophilia (often in excess of 3000/ $\mu$ l) and elevated serum IgE, both of which are more pronounced in symptomatic patients without detectable microfilariae in the blood.

### Calabar Swellings

Calabar swellings (Figure 18a.5) may occur anywhere on the body but are most common on the face and extremities and may be brought

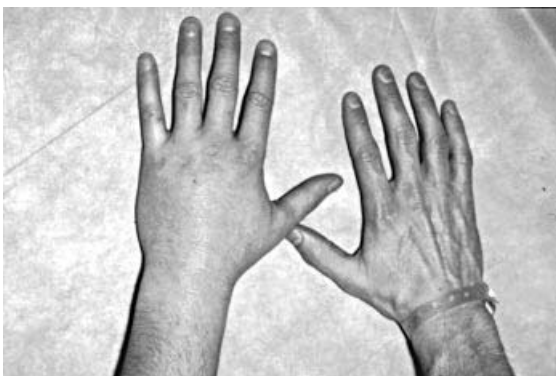


Fig. 18a.5 Calabar swelling on the left hand

on following local trauma. These are evanescent and migratory angioedematous swellings. The edema is often preceded by local pain or itching lasting 1–2 hours, after which a 10–20 cm non-erythematous, non-pitting swelling develops. The swelling generally resolves in 2–4 days but may last as long as several weeks. Recurrences are common in the same site but may develop anywhere on the body. The precise etiology of Calabar swellings remains unproven, although they are thought to represent hypersensitivity responses to antigens or microfilariae released by the adult parasite as it migrates.

### Eyeworm

Migration of the adult worm across the conjunctiva, 'eyeworm', occurs with equal frequency in natives of and visitors to endemic areas (Klion *et al.*, 1991). Although this migration is often associated with a transient intense edematous conjunctivitis, most episodes resolve without sequelae.

### Complications

Renal involvement, as defined by hematuria and/or proteinuria, occurs in up to 30% of infected individuals and may be transiently exacerbated by treatment (Nutman *et al.*, 1986; Zuidema, 1971; Pillay *et al.*, 1973). Proposed mechanisms for these findings include immune complex glomerulonephritis and/or mechanical trauma due to the filtration of large numbers of blood-borne microfilariae (Zuidema, 1971; Pillay *et al.*, 1973; Katner *et al.*, 1984; Chippaux *et al.*, 1996), although microfilariae are occasionally seen (Katner *et al.*, 1984; Fritel *et al.*, 1970). Azotemia or progression to renal failure is uncommon.

Encephalitis is certainly the most serious complication of *L. loa* infection (van Bogaert *et al.*, 1955). It most commonly occurs following treatment in individuals with high levels of microfilaremia (> 5000 microfilariae/ml blood) and can be associated with the presence of microfilariae in the cerebrospinal fluid (Carme *et al.*, 1991; Kivits, 1952). Symptoms may range

from headache, irritability and insomnia to coma and death. In fatal cases, autopsies have demonstrated generalized acute cerebral edema and/or encephalitis, with necrotizing granulomas around degenerating microfilariae (van Bogaert *et al.*, 1955). More recently, mass distribution of ivermectin in areas where *L. loa* and *Onchocerca volvulus* are co-endemic has revealed similar post-treatment CNS effects (Chippaux *et al.*, 1996).

Other less common complications of loiasis include entrapment neuropathy (Schofield, 1955; Bourgeade *et al.*, 1989), psychiatric disturbances (Kenney and Hewitt, 1950), arthritis (Bouvet *et al.*, 1977; Ismail and Nagaratman, 1973), lymphadenitis (Paleologo *et al.*, 1984), hydrocele (Negesse *et al.*, 1985), pleural effusion (Klion *et al.*, 1992; Madell and Springarn, 1953), retinal artery occlusion (Corrigan and Hill, 1968), posterior uveitis (Choyce, 1976; Garin *et al.*, 1975), macular retinopathy (Toussaint and Danis, 1965), blindness (Osuntokun and Olurin, 1975) and endomyocardial fibrosis (EMF) (Nutman *et al.*, 1986; Brockington *et al.*, 1967; Andy *et al.*, 1981; Ive *et al.*, 1967).

### Other Manifestations

Microfilariae and adult worms have been detected in pathologic and cytology specimens from various unusual anatomic locations (Whitaker *et al.*, 1980; Callihan *et al.*, 1977) and calcified adult worms may be detected by routine radiography in some infected individuals (Novak, 1989; Wilms *et al.*, 1983).

### Differential Diagnosis

The differential diagnosis of Calabar swellings includes angioedema associated with C1 inhibitor deficiency, infection with other filariae (particularly *Mansonella perstans* and *Onchocerca volvulus*), nematode and trematode infection (e.g. trichinosis, gnathostomiasis) and the idiopathic hypereosinophilic syndrome. Although eyeworm in the setting of a compatible exposure history is extremely suggestive of loiasis, subconjunctival migration of other nematodes—including *Dirofilaria repens*, a filarial parasite of dogs and cats, and *Thelazia californiensis*, deer eyeworm—has been reported (Beaver, 1989;

Kirschner *et al.*, 1990). Finally, the symptoms of *L. loa* infection may sometimes be difficult to distinguish from those of onchocerciasis or bancroftian filariasis, infections that may be co-endemic with loiasis.

### DIAGNOSIS

Definitive diagnosis is by extraction of an adult worm from the subcutaneous (or subconjunctival) space or the identification of *L. loa* microfilariae in peripheral blood. Adult male worms are approximately 3.5 cm × 0.5 mm and female worms 5–7 cm × 0.3 mm. *L. loa* microfilariae are approximately 290 μm × 7.5 μm in size and are distinguished from the microfilariae of other species (most notably *W. bancrofti*, *B. malayi*, and *Mansonella perstans*) by their diurnal periodicity, sheath, and the presence of three or more terminal nuclei (Eberhard and Lammie, 1991).

### Serology

Serology may be useful in confirming the diagnosis of filariasis in visitors to endemic areas who have suggestive clinical symptoms or unexplained eosinophilia; however, currently available methods using crude antigen extracts from *Brugia* or *Dirofilaria* species do not differentiate between *L. loa* and other filarial pathogens (Ambroise-Thomas, 1974; Goussard *et al.*, 1984). The utility of such testing in endemic populations is limited by the presence of anti-filarial antibodies in up to 95% of individuals in some regions (Eberhard and Lammie, 1991).

### DNA-based Diagnostics

The identification of *Loa*-specific DNA sequences that are present in the parasite genome, often in multiple copies (Klion *et al.*, 1991; Egwang *et al.*, 1990, 1992), has enabled the development of PCR-based strategies for both speciation of *L. loa* from pathologic specimens difficult to identify on morphologic grounds and for sensitive diagnostic strategies (Nutman *et al.*, 1994).

## TREATMENT

DEC is effective against both microfilariae and adult worms and, at a dose of 8–10 mg/kg/day for 21 days, remains the drug of choice for the treatment of *L. loa* infection in amicrofilaremic patients, including most long-term visitors to endemic areas (Anonymous, 1998; Klion *et al.*, 1994). Although it is curative in 45–50% after a single course in such patients, multiple courses are often necessary, and recrudescence may occur up to 8 years post-treatment (Klion *et al.*, 1994). Mild side effects of treatment are common and include Calabar swellings, pruritus, arthralgias, fever, nausea, diarrhea, right upper quadrant discomfort and a sensation of creeping under the skin (Nutman *et al.*, 1986; Ten Berg, 1952). Antihistamines or steroids reduce the incidence and severity of these symptoms. Occasionally, mobile adult worms are seen under the skin following DEC treatment and may be removed with forceps through a small skin incision (Ten Berg, 1952) or by excisional biopsy (vanDellen *et al.*, 1985).

More serious complications of the treatment of loiasis, including renal failure, shock, coma and fatal encephalitis, are related to the microfilarial burden and may be provoked or exacerbated by the massive microfilarial lysis that occurs with DEC treatment (Coudert *et al.*, 1971; Gentilini and Carme, 1981). Historically, a gradual increase in the dose of DEC and pretreatment with antihistamines and steroids have been advocated to prevent these complications; however, numerous reports have demonstrated that these interventions do not prevent encephalitis (Carme *et al.*, 1991a). Alternatives for individuals with high levels of circulating microfilariae include no treatment, removal of circulating microfilariae by cytopheresis prior to DEC treatment (Muylle *et al.*, 1983; Abel *et al.*, 1986), and

newer drugs, including ivermectin (Carme *et al.*, 1991b; Martin-Prevel *et al.*, 1993) and albendazole (Klion *et al.*, 1993).

Ivermectin, the microfilaricidal drug of choice in onchocerciasis, has been shown to decrease microfilarial levels in patients with *L. loa* infection, but it is ineffective against the adult worms (Carme *et al.*, 1991b; Ducorps *et al.*, 1995). In addition, side effects secondary to microfilarial lysis occur in 30–70% of patients with high levels of circulating microfilariae and, in rare cases, may be life-threatening (Carme *et al.*, 1991b; Ducorps *et al.*, 1995).

Albendazole has been shown in a double-blind, placebo-controlled study to decrease microfilarial levels in *Loa*-infected patients (Klion *et al.*, 1993). Adverse effects were not observed, even in individuals with > 50 000 microfilariae/ml of blood. The gradual decrease in blood microfilarial levels over the course of several months suggests that albendazole may have a preferential effect on the adult parasite, explaining the lack of adverse effects associated with massive microfilarial antigen release during albendazole treatment. Sequential therapy with albendazole and a microfilaricidal agent (DEC or ivermectin) may provide an alternative to pretreatment cytopheresis in patients with high microfilarial levels.

## PREVENTION AND CONTROL

Weekly chemoprophylaxis with DEC (300 mg) is effective for prevention of loiasis in long-term travelers to endemic areas (Nutman, 1988). In an uncontrolled study, monthly administration of DEC (100 mg/day for 3 successive days each month) has also been suggested as a regimen that would provide effective prophylaxis.

## PERSTANS FILARIASIS

Perstans filariasis, infection caused by *Mansonella perstans*, is distributed across the center of Africa, parts of North Africa, the Caribbean basin and in north-eastern South America (Sasa, 1976). Although generally associated with little morbidity, clinical manifestations

may include transient angioedema and pruritus of the arms, face or other parts of the body (analogous to the Calabar swellings of loiasis), fever, headache, arthralgias and right upper quadrant pain. Pericarditis and hepatitis occasionally occur.



## DESCRIPTION OF THE ORGANISM

Infective larvae are transmitted to the host by the bite of a number of different species of infected midges (*Culicoides* spp.). Over the course of 9–12 months, these larvae develop into creamy white, thread-like adult worms (males, 35–45 mm × 50–70 µm; females, 60–80 mm × 100–150 µm) that live in serous cavities—pericardial, pleural and peritoneal—as well as in the mesentery and in the perirenal and retroperitoneal tissues. In bisexual infections, microfilariae (sheathless, 3.5–4.5 × 100–200 µm) are produced and are found in the blood without any periodicity.

## EPIDEMIOLOGY

At least 30 million residents of endemic areas are infected with *M. perstans* (Sasa, 1976). Distributed mainly in Africa (generally south of the Sahara, extending from Senegal east to Uganda and south to Zimbabwe), South America (along the northern coast of the entire continent, Brazil and Argentina), and in New Guinea. Minor foci have been identified in Tunisia and Algeria. In highly endemic areas, close to 100% of people may have circulating microfilariae. Although humans are the major reservoir of infection, non-human primates can also be definitive hosts for the parasite.

## CLINICAL MANIFESTATIONS

The clinical and pathologic features of this infection are poorly defined. Although most patients appear to be asymptomatic (Adolph *et al.*, 1962; Woodman, 1955; Holmes *et al.*, 1969; Clarke *et al.*, 1971), a wide range of clinical manifestations have been ascribed to *M. perstans* (Baker *et al.*, 1967; Strohschneider, 1956; Stott, 1962; Sondergaard, 1972; Foster, 1956; Bourguignon, 1937; Gelfand and Wessels, 1964; Dukes *et al.*, 1968; Baird *et al.*, 1988; Basset *et al.*, 1991; Rubin *et al.*, 1987), including transient angioedema and pruritus of the arms, face, or other parts of the body (analogous to the Calabar swellings of loiasis) and recurrent urticaria. Less commonly, fever, headache,

arthralgias and right upper quadrant pain can occur. Pericarditis, hepatitis, meningoencephalitis and neuropsychiatric disturbances have also been reported. Rarely, conjunctival granulomata have been seen in *M. perstans* infection.

The pathogenesis of symptomatic *M. perstans* infection is poorly understood. Whereas hyper-eosinophilia and IgE elevations are common (Baker *et al.*, 1967; Rubin *et al.*, 1987), inflammatory reactions in this infection have been difficult to document (Rubin *et al.*, 1987). There is some evidence that when inflammation occurs it is granulomatous (Baird *et al.*, 1988; Basset *et al.*, 1991). Live adults induce little host response and pathologic findings are rare (Baird *et al.*, 1987). Occasionally, cerebrospinal fluid and urine contain microfilariae.

## DIAGNOSIS

The diagnosis is made by finding microfilariae in blood or serosal effusions. Concentration techniques may be necessary in light infections. Rarely, adult worms may be recovered, generally as an incidental finding. Perstans filariasis is often associated with peripheral blood eosinophilia and antifilarial antibody elevations (Rubin *et al.*, 1987; Almaviva *et al.*, 1984; Roberts and Usayi, 1971).

## TREATMENT

Although DEC (8–10 mg/kg/day for 21 days) remains the treatment of choice, there is little evidence that it is efficacious (Goldsmid and Rogers, 1979). Multiple courses of therapy are often necessary to achieve resolution of symptoms and eosinophilia. Mebendazole (100 mg/day for 30 days) alone or in combination with levamisole has also been reported to be effective (Wahlgren and Frolov, 1983; Wahlgren, 1982; Maertens and Wery, 1975). Neither ivermectin nor albendazole (up to 400 mg/day for 10 days) has been shown to be effective in perstans filariasis (Richard-Lenoble *et al.*, 1989; van den Enden *et al.*, 1993; Schulz-Key *et al.*, 1993; van den Enden *et al.*, 1992).

**MANSONELLA OZZARDI**

Infection with the filarial nematode *M. ozzardi* is restricted to Central and South America and certain Caribbean islands. Although infected individuals are usually asymptomatic, a constellation of non-specific symptoms have been ascribed to this infection (Nathan *et al.*, 1978).

**ORGANISM**

Infective larvae are transmitted to the host by the bite of an infected midge (*Culicoides* spp.) or blackfly (*Simulium amazonicum*). Over the course of months to years, these larvae develop into slender, threadlike adult worms (males, 24–28 mm × 150 μm; females, 32–51 mm × 130–160 μm), which probably inhabit the thoracic and peritoneal cavities. Adult worms have also been found in the lymphatics. In bisexual infections, microfilariae (sheathless, 3–5 mm × 170–240 μm) are produced and are found in the skin and blood, generally without periodicity (Rachou and Lacerda, 1954).

**EPIDEMIOLOGY**

The number of individuals infected with *M. ozzardi* is unknown (Sasa, 1976). The distribution of *M. ozzardi* is restricted to Central America, South America (Colombia, Venezuela, Guyana, Surinam, Brazil, Argentina, Bolivia), and certain Caribbean islands (Puerto Rico, Antigua, Guadeloupe, Nevis, Dominican Republic, Haiti, Martinique, St. Kitts, St. Lucia, St. Vincent, and Trinidad) (Sasa, 1976). In highly endemic areas, 65–70% of people may have circulating microfilariae. Although non-human primates, other mammals and certain birds and amphibians can be infected with *M. ozzardi*, humans are the only significant reservoir of infection.

**CLINICAL MANIFESTATIONS**

Although *M. ozzardi* is generally thought to cause little or no disease in humans, several reports have clearly associated this infection with urticaria,

lymphadenopathy, articular pains, pruritic skin eruptions, headache and pulmonary symptoms (Rachou and Lacerda, 1954; Marinkelle and German, 1970; Restrepo *et al.*, 1962; Baumgartner, 1953; Botero *et al.*, 1965; Batista *et al.*, 1960; Oliveira, 1961; McNeeley *et al.*, 1989; Undiano, 1966; Weller *et al.*, 1978). Eosinophilia is common.

**DIAGNOSIS**

Definitive diagnosis of *M. ozzardi* infection can only be made by identification of the parasite in blood or skin biopsies.

**TREATMENT**

Treatment of *M. ozzardi* infection has been problematic, because DEC and benzimidazoles are ineffective against this parasite (Hawking, 1981; Bartholomew *et al.*, 1978; Chadee *et al.*, 1995; Raccurt *et al.*, 1983; Mazzotti, 1948). Ivermectin has been shown to be effective in reducing symptoms and circulating microfilariae (Nutman *et al.*, 1987).

**REFERENCES**

- Abbasi I, Hamburger J, Githure J *et al.* (1996). Detection of *Wuchereria bancrofti* DNA in patients' sputum by the polymerase chain reaction. *Trans R Soc Trop Med Hyg* **90**: 531–2.
- Abel L, Ioly V, Jeni P, Carbon C, Bussel A (1986). Apheresis in the management of loiasis with high microfilariaemia and renal disease. *Br Med J Clin Res Ed* **292**: 24.
- Addiss DG, Dreyer G (2000). Treatment of lymphatic filariasis. In Nutman TB (ed.), *Lymphatic Filariasis*. Imperial College Press: London, pp. 151–200.
- Adolph PE, Kagan IG, McQuay RM (1962). Diagnosis and treatment of *Acanthocheilonema perstans* filariasis. *Am J Trop Med Hyg* **11**: 76–88.
- Albrecht W, Holtl W, Aharinejad S (1991). Lord's procedure—the best operation for hydrocele? *Br J Urol* **68**: 187–9.
- Almaviva M, Galli M, Rizzi M, Simonelli E, Negri C, Vigevani GM (1984). Immune response in a symptomatic case of *Tetrapetalonema perstans* infection. *Trans R Soc Trop Med Hyg* **78**: 489–91.

- Amaral F, Dreyer G, Figueredo-Silva J *et al.* (1994). Live adult worms detected by ultrasonography in human bancroftian filariasis. *Am J Trop Med Hyg* **50**: 753–7.
- Ambroise-Thomas P (1974). Immunological diagnosis of human filariasis: present possibilities, difficulties and limitations. *Acta Trop* **31**: 108–28.
- Andy JJ, Bishara FF, Soyinka OO, Odesanmi WO (1981). Loasis as a possible trigger of African endomyocardial fibrosis: a case report from Nigeria. *Acta Trop* **38**: 179–86.
- Anonymous (1998). Drugs for parasitic infections. *Med Lett Drug Ther* **40**: 1–11.
- Ash LR, Orihel TC (1987). *Parasites. A Guide to Laboratory Procedures and Identification*. ASCP Press: Chicago.
- Baird JK, Neafie RC, Lanoie L, Connor DH (1987). Adult *Mansonella perstans* in the abdominal cavity in nine Africans. *Am J Trop Med Hyg* **37**: 578–84.
- Baird JK, Neafie RC, Connor DH (1988). Nodules in the conjunctiva, bung-eye, and bulge-eye in Africa caused by *Mansonella perstans*. *Am J Trop Med Hyg* **38**: 553–7.
- Baker NM, Baldachin BJ, Rachman I, Thomas JE (1967). A study of eosinophilia and *A. perstans* infestation in African patients. *Cent Afr J Med* **13**: 23–31.
- Bapat KC, Pandit AA (1992). Filarial infection of the breast. Report of a case with diagnosis by fine needle aspiration cytology. *Acta Cytol* **36**: 505–6.
- Bartholomew CF, Nathan MB, Tikasingh ES (1978). The failure of diethylcarbamazine in the treatment of *Mansonella ozzardi* infections. *Trans R Soc Trop Med Hyg* **72**: 423–4.
- Basset D, D'Hermies F, Pouliquen Y, Lagrange PH (1991). Allergic granulomatous nodule of the conjunctiva disclosing onchocerciasis. *J Fr Ophthalmol* **14**: 113–17.
- Batista D, Oliveira WR, Rabello VD (1960). Study of the pathogenicity of *Mansonella ozzardi* and the pathology of mansonelliasis. *Rev Inst Med Trop Sao Paulo* **2**: 281–9.
- Baumgartner J (1953). Noticia acerca de la microfilaria por *Manzonella ozzardi* en el territorio federal amazonas, Venezuela. *Bol Indigenista Venez* **1**: 353.
- Beaver PC (1989). Intraocular filariasis: a brief review. *Am J Trop Med Hyg* **40**: 40–5.
- Beaver PC (1990). Filariasis without microfilaremia. *Am J Trop Med Hyg* **10**: 181.
- Bejanga BI, Husain I (1984). Genital lesions in the tropics. In Husain I (ed.), *Tropical Urology and Renal Disease*. Edinburgh: Churchill Livingstone; 243–360.
- Boris M, Weindorf S, Lasinski B, Boris G (1994). Lymphedema reduction by noninvasive complex lymphedema therapy. *Oncology* **8**: 95–106.
- Botero D, Restrepo A, Velez H (1965). Human filariasis in Colombia: review of the literature (Colombian) and report of one case caused by *Wuchereria* or *Brugia*. *Antioquia Med* **15**: 623–30.
- Bourgeade A, Nosny Y, Olivier-Paufique M, Faugere B (1989). 32 Cases of recurrent localized edema on return from the tropics. *Bull Soc Pathol Exot Filiales* **82**: 21–8.
- Bourguignon GC (1937). Fatal acute hepatitis with massive localisation of microfilaria perstans in liver: case. *Ann Soc Belg* **17**: 1–5.
- Bouvet JP, Therizol M, Auquier L (1977). Microfilarial polyarthritis in a massive *Loa loa* infestation. A case report. *Acta Trop* **34**: 281–4.
- Brabin L (1990). Sex differential in susceptibility to lymphatic filariasis and implications for maternal child immunity. *Epidemiol Infect* **105**: 335–53.
- Brockington IF, Olsen EGJ, Goodwin JF (1967). Endomyocardial fibrosis in Europeans resident in tropical Africa. *Lancet* **1**: 583–8.
- Burri H, Loutan L, Kumaraswami V, Vijayasekaran V (1996). Skin changes in chronic lymphatic filariasis. *Trans R Soc Trop Med Hyg* **90**: 671–4.
- Callihan TR, Oertel YC, Mendoza M (1977). *Loa loa* in a gynecologic smear. *Am J Trop Med Hyg* **26**: 572–3.
- Campisi C (1991). A rational approach to the management of lymphedema. *Lymphology* **24**: 48–53.
- Carme B, Boulesteix J, Boutes H, Puruehnce MF (1991). Five cases of encephalitis during treatment of loiasis with diethylcarbamazine. *Am J Trop Med Hyg* **44**: 684–90.
- Carme B, Boulesteix J, Boutes H, Puruehnce MF (1991a). Five cases of encephalitis during treatment of loiasis with diethylcarbamazine. *Am J Trop Med Hyg* **44**: 684–90.
- Carme B, Ebikili B, Mbisi A, Copin N (1991b). Therapeutic trial with ivermectin in loiasis with medium and high microfilaremia. *Ann Soc Belge Med Trop* **71**: 47–50.
- Casley-Smith JR, Casley-Smith JR (1992). Modern treatment of lymphoedema. I. Complex physical therapy: the first 200 Australian limbs. *Australas J Dermatol* **33**: 61–8.
- Chadee DD, Tilluckdharry CC, Rawlins SC, Doon R, Nathan MB (1995). Mass chemotherapy with diethylcarbamazine for the control of Bancroftian filariasis: a twelve-year follow-up in northern Trinidad, including observations on *Mansonella ozzardi*. *Am J Trop Med Hyg* **52**: 174–6.
- Chanteau S, Glaziou P, Moulia-Pelat JP, Plichart C, Luquiaud P, Cartel JL (1994). Low positive predictive value of anti-*Brugia malayi* IgG and IgG4 serology for the diagnosis of *Wuchereria bancrofti*. *Trans R Soc Trop Med Hyg* **88**: 661–2.
- Chanteau S, Moulia-Pelat JP, Glaziou P *et al.* (1994). Og4C3 circulating antigen: a marker of infection and adult worm burden in *Wuchereria bancrofti* filariasis. *J Infect Dis* **170**: 247–50.
- Chippaux J-P, Boussinesq M, Gardon J, Gardon-Wendel N, Ernoult J-C (1996). Severe adverse reaction risks during mass treatment with ivermectin in loiasis-endemic areas. *Parasitol Today* **12**: 448–50.
- Choyce DP (1976). Uveitis in tropical ophthalmology. *Trans Ophthalmol Soc UK* **96**: 145–7.
- Clarke VdV, Harwin RM, MacDonald DF, Green CA, Rittey DA (1971). Filariasis: *Dipetalonema perstans* infections in Rhodesia. *Cent Afr J Med* **17c**: 1–11.
- Corrigan MJ, Hill DW (1968). Retinal artery occlusion in loiasis. *Br J Ophthalmol* **52**: 477–80.
- Coudert J, Latifi AW, Forestier JM, Lu Huynh T, Bertrand MH, Sacdpraseuth S (1971). Considerations on the diagnosis and treatment of *Loa loa* filariasis. *Bull Soc Pathol Exot Filiales* **64**: 473–8.
- Craig CF, Faust EC (1964). *Clinical Parasitology*, 7th edn. Lea and Febiger: Philadelphia, PA.
- Dandapat MC, Mohapatro SK, Patro SK (1984). Surgery for large hydrocele. *Am J Surg* **147**: 387–9.
- Dickerson JW, Eberhard ML, Lammie PJ (1990). A technique for microfilarial detection in preserved blood using nuclepore filters. *J Parasitol* **76**: 829–33.

- Dissanayake S, Watawana L, Piessens WF (1995). Lymphatic pathology in *Wuchereria bancrofti* microfilaremic infections. *Trans R Soc Trop Med Hyg* **89**: 517–21.
- Dreyer G, Amaral F, Noroes J, Medeiros Z, Addiss D (1995a). A new tool to assess the adulticidal efficacy *in vivo* of antifilarial drugs for Bancroftian filariasis. *Trans R Soc Trop Med Hyg* **89**: 225–6.
- Dreyer G, Noroes J, Amaral F *et al.* (1995b). Direct assessment of the adulticidal efficacy of a single dose of ivermectin in Bancroftian filariasis. *Trans R Soc Trop Med Hyg* **89**: 441–3.
- Dreyer G, Noroes J (1997). Filariose bancroftiana. In Militao F, deAndrade Lima TM, Silva TF, deLucena VG (eds), *Conduas em Clinica Medica*. Editora Universitaria: Recife, Brazil; 399–421.
- Dreyer G, Noroes J, Rocha A, Addiss D (1996). Detection of living adult *Wuchereria bancrofti* in a patient with tropical pulmonary eosinophilia. *Braz J Med Biol Res* **29**: 1005–8.
- Dreyer G, Ottesen EA, Galdionio E *et al.* (1992). Renal abnormalities in microfilaremic patients with bancroftian filariasis. *Am J Trop Med Hyg* **46**: 745–51.
- Dreyer G, Piessens W (2000). Worms and microorganisms can cause lymphatic disease in residents of filariasis-endemic areas. In Nutman TB (ed.), *Lymphatic Filariasis*. Imperial College Press: London, pp. 245–64.
- Ducorps M, Gardon-Wendel N, Ranque S *et al.* (1995). Secondary effects of the treatment of hypermicrofilaremic loiasis using ivermectin. *Bull Soc Pathol Exot* **88**: 105–12.
- Duke BOL (1957). Experimental transmission of *Loa* from man to monkey. *Nature* **179**: 1357–8.
- Dukes DC, Gelfand M, Gadd KG, Clarke VD, Goldsmid JM (1968). Cerebral filariasis caused by *Acanthocheilonema perstans*. *Cent Afr J Med* **14**: 21–7.
- Eberhard ML, Lammie PJ (1991). Laboratory diagnosis of filariasis. *Clin Lab Med* **11**: 977–1010.
- Egwang TG, Ajuh PM, Akue JP (1992). Cloning and characterization of a *Loa loa*-specific repetitive DNA. *Mol Biochem Parasitol* **56**: 189–96.
- Egwang T, Pinder M, Akue JP (1990). *Loa loa*: identification of genomic DNA clones expressing recombinant antigens. *Exp Parasitol* **70c**: 490–3.
- Englehorn TD, Wellman WE (1945). Filariasis in soldiers on an island in the South Pacific. *Am J Med Sci* **209**: 141–52.
- Figuerdo-Silva J, Dreyer G, Guimaraes K, Brandt C, Medeiros Z (1994). Bancroftian lymphadenopathy: absence of eosinophils in tissues despite peripheral blood hypereosinophilia. *Am J Trop Med Hyg* **97**: 55–9.
- Foldi E, Foldi M, Clodius L (1989). The lymphedema chaos: a lancet. *Ann Plast Surg* **22**: 505–15.
- Foster DG (1956). Filariasis: a rare cause of pericarditis. *J Trop Med Hyg* **59**: 212–14.
- Freedman DO, deAlmeida Filho PJ, Besh S *et al.* (1994). Lymphoscintigraphic analysis of lymphatic abnormalities in symptomatic and asymptomatic human filariasis. *J Infect Dis* **170**: 927–33.
- Fritel D, Bariety J, Gentilini M (1970). Loase et la nephropathie. Etude anatomoclinique de trois cas. *Med Afr Noire* **1**: 13–18.
- Galliard H (1957). Outbreak of filariasis (*Wuchereria malayi*), among French and North African servicemen in North Vietnam. *Bull WHO* **16**: 601–8.
- Garin JP, Rougier J, Mojon M (1975). Loiasis and posterior uveitis. A propos of a case. *Acta Trop* **32**: 384–8.
- Gelband H (1994). Diethylcarbamazine salt in the control of lymphatic filariasis. *Am J Trop Med Hyg* **50**: 655–62.
- Gelfand M, Wessels P (1964). *Acanthocheilonema perstans* in a European female. A discussion of its possible pathogenicity and a suggested new syndrome. *Trans R Soc Trop Med Hyg* **58**: 552–6.
- Gentilini M, Carme B (1981). Treatment of filariases in a hospital setting. Complications and results. *Ann Soc Belge Med Trop* **61**: 319–26.
- Goldsmid JM, Rogers S (1976). Studies on the diagnosis and treatment of human filariasis in Rhodesia. *S Afr Med J* **50c**: 1129–32.
- Goldsmid JM, Rogers S (1979). A preliminary study on the treatment of filariasis due to *Dipetalonema perstans*. *Cent Afr J Med* **25**: 51–2.
- Goussard B, Ivanoff B, Frost E, Garin Y, Bourderiou C (1984). Age of appearance of IgG, IgM, and IgE antibodies specific for *Loa loa* in Gabonese children. *Microbiol Immunol* **28**: 787–92.
- Gyapong J, Magnussen P, Binka FN (1994). Parasitological and clinical aspects of Bancroftian filariasis in Kassena-Nankana District, upper east region, Ghana. *Trans R Soc Trop Med Hyg* **88**: 555–7.
- Hashim SA (1964). Treatment of chyluria and chylothorax with medium chain triglycerides. *N Engl J Med* **270**: 756–61.
- Hawking F (1981). Chemotherapy of filariasis. *Antibiot Chemother* **30**: 135–62.
- Hawking F, Marques RJ (1967). Control of bancroftian filariasis by cooking salt medicated with diethylcarbamazine. *Bull WHO* **37**: 405–14.
- Hodge IG, Denhoff E, van der Veer JB (1945). Early filariasis (*bancrofti*), in American soldiers. *Am J Med Sci* **210**: 207–23.
- Holmes GK, Gelfand M, Boyt W, Mackenzie P (1969). A study to investigate the pathogenicity of a parasite resembling *Acanthocheilonema perstans*. *Trans R Soc Trop Med Hyg* **63**: 479–84.
- Huntington RW Jr, Fogel RH, Eichold S, Dickson JG (1944). Filariasis among troops in a South Pacific island group. *Yale J Biol Med* **16**: 529–37.
- Ismail MM, Nagaratman N (1973). Arthritis possibly due to filariasis. *Trans R Soc Trop Med Hyg* **67**: 405–9.
- Ive FA, Willis JP, Ikeme AC, Brockington IF (1967). Endomyocardial fibrosis and filariasis. *Q J Med* **34**: 495–516.
- Jamal S (1981). Lymphovenous anastomosis in filarial lymphedema. *Lymphology* **14**: 64–8.
- Kanetkar AV, Karanjawalla DK, Deshmukh SM, Sen PK (1966). Initial experiences in the management of chyluria. *Ind J Surg* **28**: 381–9.
- Kapila K, Verma K (1996). Diagnosis of parasites in fine needle breast aspirates. *Acta Cytol* **40**: 653–6.
- Karanjaval DK (1979). Technique of clearance (or disconnection) of dilated lymphatics in the renal hilum and lower ureter and bladder in cases of intractable chyluria or haemochyluria. *Br J Urol* **51**: 440–2.
- Katner H, Beyt BE Jr, Krotoski WA (1984). Loiasis and renal failure. *South Med J* **77**: 907–8.

- Kenney M, Hewitt R (1950). Psychoneurotic disturbances in filariasis and their relief by removal of adult worms or treatment with hetrazan. *Ann J Trop Hyg* **30**: 895–9.
- King BG (1944). Early filariasis diagnosis and clinical findings: a report of 268 cases in American troops. *Am J Trop Med* **24**: 285–98.
- Kirschner BI, Dunn JP, Ostler HB (1990). Conjunctivitis caused by *Thelazia californiensis*. *Am J Ophthalmol* **110**: 573–4.
- Kivits M (1952). Quatre cas d'encéphalite mortelle avec invasion du liquide céphalo-rachidien par microfilaria loa. *Ann Soc Belge Med Trop* **32**: 235–42.
- Klion AD, Eisenstein EM, Smirniotopoulos TT, Neumann MP, Nutman TB (1992). Pulmonary involvement in loiasis. *Am Rev Respir Dis* **145**: 961–3.
- Klion AD, Massougbdji A, Horton J *et al.* (1993). Albendazole in human loiasis: results of a double-blind, placebo-controlled trial. *J Infect Dis* **168**: 202–6.
- Klion AD, Massougbdji A, Sadeler B-C, Ottesen EA, Nutman TB (1991). Loiasis in endemic and non-endemic populations: immunologically mediated differences in clinical presentation. *J Infect Dis* **163**: 1318–25.
- Klion AD, Ottesen EA, Nutman TB (1994). Effectiveness of diethylcarbamazine in treating loiasis acquired by expatriate visitors to endemic regions: long-term follow-up. *J Infect Dis* **169**: 604–10.
- Klion AD, Raghavan N, Brindley PJ, Nutman TB (1991). Cloning and characterization of a species-specific repetitive DNA sequence from *Loa loa*. *Biochem Parasitol* **45**: 297–306.
- Kobayashi MR, Miller TA (1987). Lymphedema. *Clin Plastic Surg* **14**: 303–13.
- Lal RB, Ottesen EA (1988). Enhanced diagnostic specificity in human filariasis by IgG4 antibody assessment. *J Infect Dis* **158**: 1034–7.
- Lammie PJ, Hightower AW, Eberhard ML (1994). Age-specific prevalence of antigenemia in a *Wuchereria bancrofti*-exposed population. *Am J Trop Med Hyg* **51**: 348–55.
- Lizotte MR, Supali T, Partono F, Williams SA (1994). A polymerase chain reaction assay for the detection of *Brugia malayi* in blood. *Am J Trop Med Hyg* **51**: 314–21.
- Lord PH (1964). A bloodless operation for the radical cure of idiopathic hydrocele. *Br J Surg* **51**: 914–16.
- McCarthy JS, Zhong M, Gopinath R, Ottesen EA, Williams SA, Nutman TB (1996). Evaluation of a polymerase chain reaction-based assay for diagnosis of *Wuchereria bancrofti* infection. *J Infect Dis* **173**: 1510–14.
- McNeeley DF, Raccourt CP, Boney J, Lowrie RC Jr (1989). Clinical evaluation of *Mansonella ozzardi* in Haiti. *Trop Med Parasitol* **40**: 107–10.
- Madell SH, Springarn CC (1953). Unusual thoracic manifestations in filariasis due to *Loa loa*. Results of treatment with hetrazan and naphuride sodium. *Am J Med* **15**: 272–80.
- Maertens K, Wery M (1975). Effect of mebendazole and levamisole on *Onchocerca volvulus* and *Dipetalonema perstans*. *Trans R Soc Trop Med Hyg* **69**: 359–60.
- Maizels RM, Sutanto I, Gomez-Priego A, Lillywhite J, Denham DA (1985). Specificity of surface molecules of adult *Brugia* parasites: cross-reactivity with antibody from *Wuchereria*, *Onchocerca* and other human filarial infections. *Trop Med Parasitol* **36**: 233–7.
- Marinkelle CJ, German E (1970). Mansonelliasis in the Comisaria del Vaupes of Colombia. *Trop Geogr Med* **22**: 101–11.
- Martin-Prevel Y, Cosnefroy JY, Ngari P, Pinder M (1993a). Reduction of microfilaraemia with single high-dose of ivermectin in loiasis. *Lancet* **342**: 442.
- Martin-Prevel Y, Cosnefroy JY, Tshipamba P, Ngari P, Chodakewitz JA, Pinder M (1993b). Tolerance and efficacy of single high-dose ivermectin for the treatment of loiasis. *Am J Trop Med Hyg* **48**: 186–92.
- Matas R (1913). The surgical treatment of elephantiasis and elephantoid states dependent on chronic obstruction of the lymphatic and venous channels. *Am J Trop Dis* **1**: 60–85.
- Mazzotti L (1948). Negative results with hetrazan in two patients infected with *Mansonella ozzardi*. *Med Rev Mex* **28**: 317–18.
- Michael E (2000). The population dynamics and epidemiology of lymphatic filariasis. In Nutman TB (ed.), *Lymphatic Filariasis*. Imperial College Press: London, pp. 41–82.
- Miller TA (1977). A surgical approach to lymphedema. *Am J Surg* **134**: 191–5.
- Montestruc E, Courmes E, Fontan R (1960). Endemic lymphangitis in French Guiana and its relation to *W. bancrofti* filariasis. *Ind J Malariol* **14**: 637–50.
- Moore TA, Reynolds JC, Kenney RT, Johnston W, Nutman TB (1996). Diethylcarbamazine-induced reversal of early lymphatic dysfunction in a patient with bancroftian filariasis: assessment with use of lymphoscintigraphy. *Clin Infect Dis* **23**: 1007–11.
- More SJ, Copeman DB (1990). A highly specific and sensitive monoclonal antibody-based ELISA for the detection of circulating antigen in bancroftian filariasis. *Trop Med Parasitol* **41**: 403–6.
- Mortimer PS (1990). Investigation and management of lymphoedema. *Vasc Med Rev* **1**: 1–20.
- Muylle L, Taelman H, Moldenhauer R, van Brabant R, Peetermans ME (1983). Usefulness of apheresis to extract microfilarias in management of loiasis. *Br Med J Clin Res Ed* **287**: 519–20.
- Nathan MB, Bartholomew CF, Tikasingh ES (1978). The detection of *Mansonella ozzardi* microfilariae in the skin and blood with a note on the absence of periodicity. *Trans R Soc Trop Med Hyg* **72**: 420–2.
- Negesse Y, Lanoie LO, Neafie RC, Connor DH (1985). Loiasis: 'Calabar' swellings and involvement of deep organs. *Am J Trop Med Hyg* **34**: 537–46.
- Noireau F, Apembet JD, Nzoulani A, Carme B (1990). Clinical manifestations of loiasis in an endemic area in the Congo. *Trop Med Parasitol* **41**: 37–9.
- Noroës J, Addiss D, Amaral F, Coutinho A, Medeiros Z, Dreyer G (1996a). Occurrence of adult *Wuchereria bancrofti* in the scrotal area of men with microfilaremia. *Trans R Soc Trop Med Hyg* **90**: 55–6.
- Noroës J, Addiss D, Santos A, Medeiros Z, Coutinho A, Dreyer G (1996b). Ultrasonographic evidence of abnormal lymphatic vessels in young men with *Wuchereria bancrofti* infection in the scrotal area. *J Urol* **156**: 409–12.

- Noroës J, Dreyer G, Santos A, Mendes VG, Medeiros Z, Addiss D (1997). Assessment of the efficacy of diethylcarbamazine on adult *Wuchereria bancrofti* in vivo. *Trans R Soc Trop Med Hyg* **91**: 78–81.
- Novak R (1989). Calcifications in the breast in *Filaria loa* infection. *Acta Radiol* **30**: 507–8.
- Nutman TB (1991). Experimental human infections with filariae. *Rev Infect Dis* **13**: 1018–22.
- Nutman TB, Miller KD, Mulligan M, Ottesen EA (1986). *Loa loa* infection in temporary residents of endemic regions: recognition of a hyperresponsive syndrome with characteristic clinical manifestations. *J Infect Dis* **154**: 10–18.
- Nutman TB, Miller KD, Reinhardt GN, Currie BJ, Steel C, Ottesen EA (1988). Diethylcarbamazine prophylaxis for human loiasis: results of a double-blinded study. *N Engl J Med* **319**: 752–6.
- Nutman TB, Nash TE, Ottesen EA (1987). Ivermectin in the successful treatment of a patient with *Mansonella ozzardi* infection. *J Infect Dis* **156**: 662–5.
- Nutman TB, Zimmerman PA, Kubofcik J, Kostyu DD (1994). ELISA-based detection of PCR products: a universally applicable approach to the diagnosis of filarial and other infections. *Parasitol Today* **10**: 239–43.
- Oliveira WR (1961). Mansonelliasis and its symptomatology. *Hospital Rio* **59**: 539–43.
- Olszewski WL *et al.* (1993). Skin changes in filarial and non-filarial lymphoedema of the lower extremities. *Trop Med Parasitol* **44**: 40–4.
- Osuntokun O, Olurin O (1975). Filarial worm (*Loa loa*) in the anterior chamber. Report of two cases. *Br J Ophthalmol* **59**: 166–7.
- Ottesen EA (1985). Efficacy of diethylcarbamazine in eradicating infection with lymphatic-dwelling filariae in humans. *Rev Infect Dis* **7**: 341–56.
- Ottesen EA, Duke BO, Karam M, Behbehani K (1997). Strategies, tools for the control/elimination of lymphatic filariasis. *Bull WHO* **75**: 491–503.
- Ottesen EA, Neva FA, Paranjape RS, Tripathy SP, Thiruvengadam KV, Beaven MA (1979). Specific allergic sensitization to filarial antigens in tropical eosinophilia syndrome. *Lancet* **1**: 1158–61.
- Ottesen EA, Nutman TB (1992). Tropical pulmonary eosinophilia. *Ann Rev Med* **43**: 417–24.
- Ottesen EA, Skvaris F, Tripathy SP, Poindexter RW, Hussain R (1985). Prominence of IgG4 in the IgG antibody response to human filariasis. *J Immunol* **134**: 2707–12.
- Ottesen EA, Weller PF, Lunde MN, Hussain R (1982). Endemic filariasis on a Pacific Island. II. Immunologic aspects: immunoglobulin, complement, and specific antifilarial IgG, IgM, and IgE antibodies. *Am J Trop Med Hyg* **31**: 953–61.
- Paleologo FP, Neafie RC, Connor DH (1984). Lymphadenitis caused by *Loa loa*. *Am J Trop Med Hyg* **33**: 395–402.
- Pani SP, Balakrishnan N, Srividya A, Bundy DAP, Grenfell BT (1991). Clinical epidemiology of Bancroftian filariasis: effect of age and gender. *Trans R Soc Trop Med Hyg* **85**: 260–4.
- Pani SP, Krishnamoorthy K, Rao AS, Prathiba J (1990). Clinical manifestations in malayan filariasis with special reference to lymphedema grading. *Indian J Med Res* **81**: 200–7.
- Pani SP, Yuvaraj J, Vanamail P *et al.* (1995). Episodic adenolymphangitis and lymphedema in patients with bancroftian filariasis. *Trans R Soc Trop Med Hyg* **89**: 72–4.
- Pappas CJ, O'Donnell TF (1992). Long-term results of compression treatment for lymphedema. *J Vasc Surg* **16**: 555–64.
- Partono F (1987). The spectrum of disease in lymphatic filariasis. In *Filariasis*. CIBA Symposium. Wiley: Chichester; 15–31.
- Pillay VK, Kirch E, Kurtzman NA (1973). Glomerulopathy associated with filarial loiasis. *J Am Med Assoc* **225**: 179.
- Pinkston P, Vijayan VK, Nutman TB *et al.* (1987). Acute tropical pulmonary eosinophilia. Characterization of the lower respiratory tract inflammation and its response to therapy. *J Clin Invest* **80**: 216–25.
- Price EW, Bailey D (1984). Environmental factors in the etiology of endemic elephantiasis of the lower legs in tropical Africa. *Trop Geogr Med* **36**: 1–5.
- Raccurt C, Boncy J, McNeeley DF (1983). Absence of response of *Mansonella ozzardi* microfilaria in the diethylcarbamazine provocation test. *Bull Soc Pathol Exot Filiales* **76**: 178–82.
- Rachou RG, Lacerda NB (1954). Hourly variation of microfilaraemia of *Mansonella ozzardi*. *Rev Bras Malariol Doenc Trop* **6**: 343–8.
- Rakita RM, White AC Jr, Kielhofner MA (1993). *Loa loa* infection as a cause of migratory angioedema: report of three cases from the Texas Medical Center. *Clin Infect Dis* **17**: 691–4.
- Restrepo M, Latorre R, Botero D (1962). Presentation of a case of *Mansonella*. *Antioquia Med* **12**: 233–41.
- Richard-Lenoble D, Kombila M, Chandenier J, Gaxotte P (1989). The efficacy and tolerance of ivermectin (Mectizan) prescribed for the patient with multiple filarial infections (*Loa loa/Onchocerca* and/or *M. perstans*). *Bull Soc Pathol Exot Filiales* **82**: 65–71.
- Richard-Lenoble D, Kombila M, Rupp EA *et al.* (1988). Ivermectin in loiasis, concomitant *O. volvulus* and *M. perstans* infections. *Am J Trop Med Hyg* **39**: 480–3.
- Roberts CJ, Usayi E (1971). Further observations on *Dipetalonema perstans*. *Cent Afr J Med* **17**: 144–6.
- Rocha A, Addiss D, Ribeiro ME *et al.* (1996). Evaluation of the Og3C3 ELISA in *Wuchereria bancrofti* infection: infected persons with undetectable or ultra-low microfilarial densities. *Trop Med Int Health* **1**: 859–64.
- Rocha A, Dreyer G, Poindexter RW, Ottesen EA (1995). Syndrome resembling tropical pulmonary eosinophilia but of non-filarial aetiology: serological findings with filarial antigens. *Trans R Soc Trop Med Hyg* **89**: 573–5.
- Rodhain F (1980). Hypotheses on the dynamic ecology of *Loa* infections. *Bull Soc Pathol Exot Filiales* **73**: 182–91.
- Rodriguez WC, Rodriguez DD, Fortuno RF (1981). The operative treatment of hydrocele: a comparison of four basic techniques. *J Urol* **125**: 804–5.
- Rom WN, Vijayan VK, Cornelius MJ *et al.* (1990). Persistent lower respiratory tract inflammation associated with interstitial lung disease in patients with tropical pulmonary eosinophilia following conventional treatment with diethylcarbamazine. *Am Rev Resp Dis* **142**: 1088–92.
- Rubin RH, Austen KF, Goetzl EJ (1987). Studies of immediate hypersensitivity in a patient with *Acanthocheilonema perstans* filarial infection. *J Infect Dis* **151**: S98–S103.

- Sasa M (1976). *Human Filariasis. A Global Survey of Epidemiology and Control*. University Park Press: London.
- Schofield FD (1955). Two cases of loiasis with peripheral nerve involvement. *Trans R Soc Trop Med Hyg* **49**: 588–9.
- Schulz-Key H, Albrecht W, Heuschkel C, Soboslay PT, Banla M, Gorgen H (1993). Efficacy of ivermectin in the treatment of concomitant *Mansonella perstans* infections in onchocerciasis patients. *Trans R Soc Trop Med Hyg* **87**: 227–9.
- Shenoy RK, Sandhya K, Suma TK, Kumaraswami V (1995). A preliminary study of filariasis related acute adenolymphangitis with special reference to precipitating factors and treatment modalities. *SE Asian J Trop Med Pub Health* **26**: 301–5.
- Sondergaard J (1972). Filariasis caused by *Acanthocheilonema perstans*. *Arch Dermatol* **106**: 547–8.
- Speiser F (1980). Application of the enzyme-linked immunosorbent assay (ELISA) for the diagnosis of filariasis and echinococcosis. *Tropenmed Parasitol* **31**: 459–66.
- Spry CJF, Kumaraswami V (1982). Tropical pulmonary eosinophilia. *Semin Haematol* **19**: 101–15.
- Stott G (1962). Pathogenicity of *Acanthocheilonema perstans*. *J Trop Med Hyg* **65**: 230–2.
- Strohschneider H (1956). Oral and intraperitoneal treatment of *Acanthocheilonema (Dipetalonema) perstans* with diethylcarbazine. *Am J Trop Med Hyg* **5**: 158–62.
- Suarez J (1936). Clinical findings in 139 cases of recurrent tropical lymphangitis. *PR J Pub Health Trop Med* **12**: 81–99.
- Suresh S, Kumaraswami V, Suresh I *et al.* (1997). Ultrasonographic diagnosis of subclinical filariasis. *J Ultrasound Med* **16**: 45–9.
- Ten Berg JAG (1952). Filariasis loa: treatment with hetrazan. *Doc Med Geogr Trop* **4**: 209–18.
- Toussaint D, Danis P (1965). Retinopathy in generalized *Loa loa* filariasis. A clinicopathological study. *Arch Ophthalmol* **74**: 470–6.
- Udwadia FE (1975). Tropical eosinophilia. In *Pulmonary Eosinophilia: Progress in Respiration Research*, vol 17. Karger: Basel; 35–155.
- Undiano C (1966). Importance, status of the new concept of the pathogenicity of mansonelliasis. *Rev Fac Cienc Med Cordoba* **24**: 183–9.
- van Bogaert L, Dubois A, Janssens PG, Radermecker J, Tverdy G, Wanson M (1955). Encephalitis in *Loa loa* filariasis. *J Neurol Neurosurg Psychiat* **18**: 103–19.
- vanDellen RG, Ottesen EA, Gocke TM, Neafie RC (1985). *Loa loa*. An unusual case of chronic urticaria and angioedema in the United States. *J Am Med Assoc* **253**: 1924–5.
- van den Enden E, van Gompel A, van der Stuyft P, Vervoort T, van den Ende J (1993). Treatment failure of a single high dose of ivermectin for *Mansonella perstans* filariasis. *Trans R Soc Trop Med Hyg* **87**: 90.
- van den Enden E, van Gompel A, Vervoort T, van der Stuyft P, van den Ende J (1992). *Mansonella perstans* filariasis: failure of albendazole treatment. *Ann Soc Belg Med Trop* **72**: 215–18.
- Varghese R, Raghuvver CV, Pai MR, Bansal R (1996). Microfilariae in cytologic smears: a report of six cases. *Acta Cytol* **40**: 299–301.
- Vijayan VK (1991). Allergic bronchopulmonary helminthiasis (APBH). *Lung India* **9**: 145–8.
- Voller A, deSavigny D (1981). Diagnostic serology of tropical parasitic diseases. *J Immunol Meth* **46**: 1–29.
- Wahlgren M (1982). The successful treatment of *Dipetalonema perstans* filariasis with mebendazole. *Ann Trop Med Parasitol* **76**: 557–9.
- Wahlgren M, Frolov I (1983). Treatment of *Dipetalonema perstans* infections with mebendazole. *Trans R Soc Trop Med Hyg* **77**: 422–3.
- Wannas HR (1983). An outpatient operation for the cure of primary hydrocele. *Br J Surg* **7**: 212.
- Wartmann WB (1947). Filariasis in American armed forces in World War II. *Medicine (Baltimore)* **26**: 333–94.
- Watson J (1953). Chronic lymphoedema of the extremities and its management. *Br J Surg* **41**: 31–7.
- Webb JKG, Job CK, Gault EW (1960). Tropical eosinophilia: demonstration of microfilariae in lung, liver and lymph nodes. *Lancet* **1**: 835–42.
- Weil GJ, Lammie PJ, Weiss N (1997). The ICT filariasis test: a rapid-format antigen test for diagnosis of bancroftian filariasis. *Parasitol Today* **13**: 401–4.
- Weller PF, Simon HB, Parkhurst BH, Medrek TF (1978). Tourism-acquired *Mansonella ozzardi* microfilaraemia in a regular blood donor. *J Am Med Assoc* **240**: 858–9.
- Whitaker D, Reed WD, Shilkin KB (1980). A case of filariasis diagnosed on gastric cytology. *Pathology* **12**: 483–6.
- Wickham JEA (1976). Diseases of the renal artery, veins, and lymphatics. In Blandy J (ed.), *Urology*. Blackwell: Oxford; 369–74.
- Williams SA, Nicolas L, Lizotte-Waniewski M *et al.* (1996). A polymerase chain reaction assay for the detection of *Wuchereria bancrofti* in blood samples from French Polynesia. *Trans R Soc Trop Med Hyg* **90**: 384–7.
- Wilms G, Tschibwabwa-Ntumba E, Nijssens M, Baert AL (1983). Calcified *Loa loa* infestations. *J Belg Radiol* **66**: 133–6.
- Wiseman RA (1967). *Acanthocheilonema perstans*, a cause of significant eosinophilia in the tropics: comments on its pathogenicity. *Trans R Soc Trop Med Hyg* **61**: 667–73.
- Woodman H (1955). African filariasis. *Centr Afr J Med* **1**: 289–94.
- World Health Organization (1992). Informal consultation on evaluation of morbidity in lymphatic filariasis. Madras. Mimeographed document WHO/TDR/FIL/92.3 1.
- Yu HYY (1984). Chyluria. In Husain I (ed.), *Tropical Urology and Renal Disease*. Edinburgh: Churchill Livingstone; 296–304.
- Zuidema PJ (1971). Renal changes in loiasis. *Folia Med Neerl* **14**: 168–72.





# Onchocerciasis

J. Whitworth

*Uganda Virus Research Institute, Entebbe, Uganda*

---

## INTRODUCTION

Onchocerciasis (river blindness) is a chronic parasitic infection of humans caused by the nematode *Onchocerca volvulus* and transmitted by blackflies of the genus *Simulium*. For infected individuals, the major features of the disease are ocular and dermatological pathology, of which itching is the commonest and blindness the most serious. If many people are infected in a community, onchocerciasis may lead to socioeconomic depression. The disease is endemic in 37 countries in West, East and Central Africa, the Arabian Peninsula and parts of South and Central America (Figure 18b.1). About 126 million people are at risk of infection in endemic areas, of whom about 18 million are estimated to be infected. The great majority of those infected live in Africa (WHO, 1995). These figures are generally accepted to underestimate the true situation.

## HISTORY

The first description of the microfilariae of *Onchocerca volvulus* was probably made by O'Neill (1875) from samples taken from the skin of six West African natives with papular skin rashes. He described the microfilaria as:

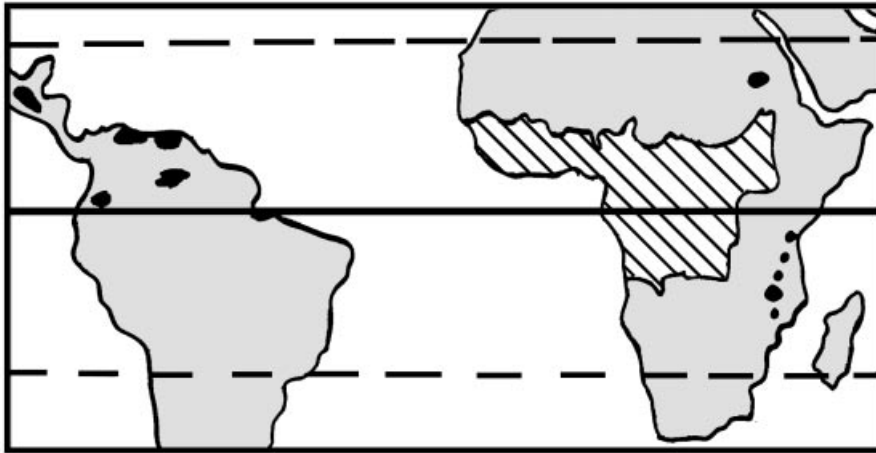
. . . easily detectable . . . by its violent contortions. Thread-like in form, at one

time undulating, and now twisted as if into an inexplicable knot, then, having rapidly untwined itself, it curls and coils into many loops.

This evocative description is readily recognised by those who have examined microfilariae emerging from skin fragments under a microscope. O'Neill also described the pointed tail and reported the microfilariae to be about  $250\ \mu\text{m} \times 12\ \text{mm}$  in size. There can be little doubt that O'Neill was describing *O. volvulus* microfilariae.

Leuckart (1893) described and named worms from specimens sent by missionaries from the Gold Coast. Prout (1901) later described worms from a subcutaneous nodule removed from a Sierra Leone frontier policeman with vague rheumatic pains. He described the adult male and female worms and microfilariae (unsheathed, with a sharp tail, central granular appearance and a size of  $250\ \mu\text{m} \times 5\ \mu\text{m}$ ), which he tentatively called *Filaria volvulus* after Leuckart. Parsons (1908) also gave a description of nodules and commented that he suspected that the disease was more common than generally recognised and probably spread by a blood-sucking insect.

Robles (1917) working in Guatemala, demonstrated an association between nodules and clinical features of onchocerciasis—the skin lesions and anterior ocular disease—and suggested that blackflies could transmit the infection. However, it was



**Fig. 18b.1** The global distribution of onchocerciasis. Cross-hatched area—main endemic area; black-shaded areas—isolated endemic foci

Blacklock (1926a, b), working in Sierra Leone, who provided definite evidence of transmission of onchocerciasis by *Simulium damnosum*. He showed that onchocercal larvae developed in the gut, then thorax, of simuliids and subsequently that the head of the blackfly is invaded by developing worms, which can escape from the proboscis through the membranous labrum.

The use of skin snips to make the diagnosis was first recorded by Macfie and Corson (1922), who used a needle and scissors to remove a 0.25 cc piece of skin from the lower back. The recognition of ocular onchocerciasis in Africa occurred in the 1930s with the work of Hissette (1932) in the Congo, who described punctate keratitis, sclerosing keratitis, iritis, retrobulbar neuritis and retinal lesions, while Bryant (1935) noted diffuse retino-choroiditis associated with optic atrophy in the Sudan. The definitive description of ocular onchocerciasis by Ridley (1945), working in Ghana, was published as a monograph.

## DESCRIPTION OF THE ORGANISM

### Taxonomy

The species *Onchocerca volvulus* (Phylum Nematoda, Superfamily Filarioidea, Family Dipetalonematidae) is a vector-borne filarial nematode transmitted by blackflies of the genus

*Simulium*. All filarial genera of medical importance belong to the Dipetalonematidae. The adult female *Onchocerca volvulus* is exceptionally long for a member of the Filarioidea, as adult filariae usually measure only 2–10 cm in length. Adult *O. volvulus* are normally found in characteristic fibrous nodules, which allows them to be distinguished from *Dracunculus medinensis* (Superfamily Dracunculoidea), another long (about 100 cm) filarial human parasite found in subcutaneous tissues.

### Life-cycle

A diagram of the life-cycle is shown in Figure 18b.2. Infective third stage ( $L_3$ ) larvae are introduced into the human host by biting female *Simulium damnosum* or other blackfly vectors. There is no significant zoonotic cycle. Larvae undergo two moults before developing into adult worms. The first moult occurs close to the point of entry after 3–10 days (Strote, 1987; Bianco *et al.*, 1989; Duke, 1991) and the second moult about 1–2 months later (Lok *et al.*, 1984; Duke, 1991).

### Adult Worms

Adult worms are long and thin, tapering at both ends, with a rounded anterior end. They are

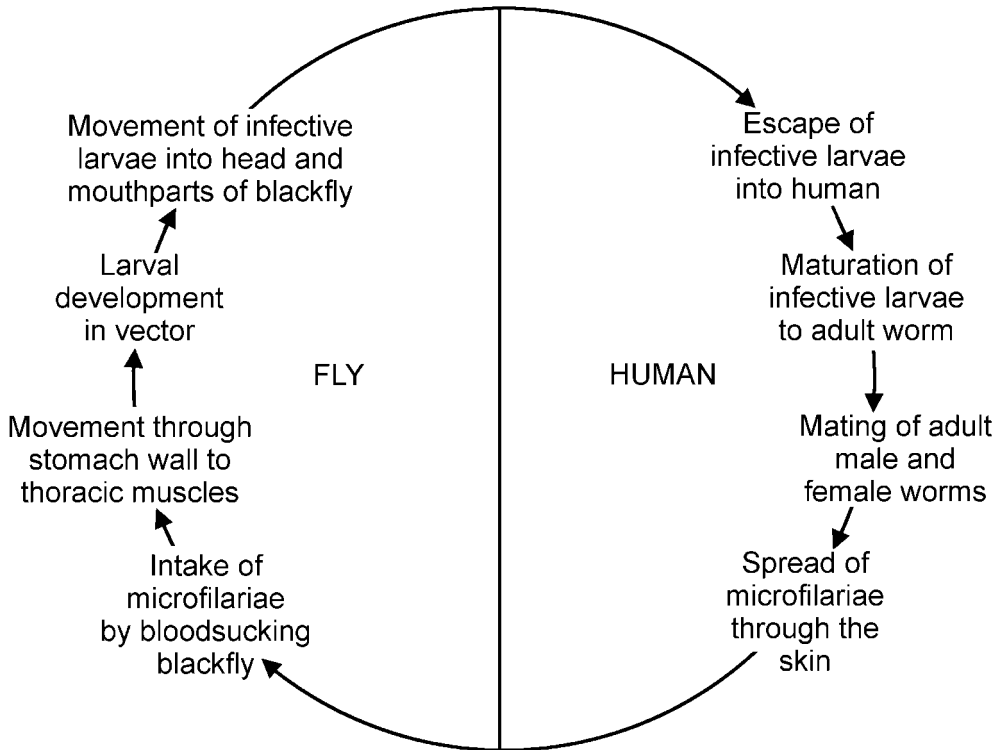


Fig. 18b.2 The life-cycle of *Onchocerca volvulus*

typically found in subcutaneous nodules and in lymph spaces in the tissues of humans. Both sexes exhibit sluggish movement. Microscopically, the cuticle is seen to be raised in prominent transverse ridges and annular and oblique thickenings, which are more distinct posteriorly. The annulations on males are more closely spaced and inconspicuous compared with those on females. The presence of two striae in the inner layer of the cuticle is a helpful diagnostic feature of *Onchocerca* in tissue sections. Adult worms are long-lived; the average lifespan of female worms is estimated to be about 8 years but can be as long as 15 years (Roberts *et al.*, 1967). The prominence of the cuticular ridges and the cuticular coat diminish with age. As worms become older they become discoloured, changing from transparent white to yellowish to brown. They also exhibit more inclusions and patches of calcification as they age.

Subcutaneous nodules (onchocercomata) are usually less than 2 cm in diameter, firm, mobile

and well-defined, and neither tender nor painful. Adult worms in nodules are generally no more than a minor cosmetic problem, as they do not directly cause the pathological features of onchocerciasis. In an average nodule, one or two male and one or two female worms are found coiled in a mass within a rim composed of vascularised and hyalinised scar tissue derived from the host. Interspersed in the worm bundle are evidence of chronic inflammation: macrophages, fibrin, plasma cells, neutrophilic and eosinophilic granulocytes, lymphocytes, giant cells and Russell bodies. These nodules may rarely contain 10 or more adult worms and are usually found in association with bony prominences lying subcutaneously, sometimes attached to the skin, or occasionally more deeply. Some nodules contain liquefied or calcified necrotic worms. It is recognised that not all nodules are palpable and that not all adult worms are found within such nodules (Albiez, 1983).

Adult male worms lengthen throughout life but are usually found to measure 2–4 cm in length  $\times$  about 0.15–0.20 cm in breadth. In nodules, males are usually found on the outside of the worm bundle, coiled around the anterior end of a female. The nerve ring is 140  $\mu$ m from the anterior end. The alimentary canal is straight, ending close to the tip of the tail. The tail ends in a spiral and has a bulbous tip. There are two pairs of preanal and two postanal papillae, an intermediate large papilla and two unequal copulatory spicules, which can protrude from the cloaca. The reproductive tract consists of a testis, a vas deferens and an ejaculatory duct leading to the cloaca.

Adult female worms measure 35–70 cm in length  $\times$  about 400  $\mu$ m in breadth. The nerve ring is 170  $\mu$ m from the anterior end, and the anus is about 210  $\mu$ m from the posterior end of the worm. The female reproductive tract runs from the posterior to anterior end of the worm and consists of paired ovaries, oviducts, seminal receptacles and uteri, and a single vagina and vulva found close to the anterior extremity. *O. volvulus* are ovoviviparous and the eggs (30–50  $\mu$ m in diameter) have a striated shell with a pointed process at each end.

The sessile female worms have a cyclical reproductive pattern, requiring fertilization by males for each successive brood of larvae (Schulz-Key and Karam, 1986). From the evidence that nodules normally contain more female worms than males (ratio 1:1.1 or 1.2) and that some nodules contain fertilized females but no male worms, it is thought that the much shorter male worms are migratory, moving from nodule to nodule (Schulz-Key and Albiez, 1977). Primary oocytes mature as they pass down the length of the ovary and are released as individual cells into the oviduct and seminal receptacles, where they are fertilised and begin dividing. Multicellular stages develop along the length of the uteri until, finally, they escape from the vulva as stretched microfilariae. Unfertilised oocytes degenerate within the uterus and are not released. The prepatent period, from infection with infective larvae to production of detectable microfilariae, is usually 12–15 months, with a range of 7–34 months (Prost, 1980).

The unsheathed, non-periodic microfilariae occur mainly in the skin (90%) and are also

found in nodules. They are occasionally found in blood specimens, probably by dislodgement from the skin. They are also found in the tissues and chambers of the eye in heavy infections and have been reported in urine, sputum, cerebrospinal fluid and ascitic fluid, particularly after treatment with diethylcarbamazine.

### *Microfilariae*

Microfilariae are produced in large numbers from female worms, possibly up to 10 000 per female daily (Eberhard and Orihel, 1986) and migrate to the skin and eyes of infected subjects. Microfilariae are usually 200–360  $\mu$ m long and 5–9  $\mu$ m broad. They have a cephalic space 7–13  $\mu$ m long. The anterior nuclei are found in rows. The caudal space is 9–15  $\mu$ m long and the terminal nuclei are elongated. The tail is tapered to a fine point. These features distinguish microfilariae of *O. volvulus* from those of *Mansonella perstans* (under 200  $\mu$ m long and no caudal space), *Mansonella streptocerca* (180–240  $\mu$ m long, a curved tail and no caudal space) and *Mansonella ozzardi* (200–230  $\mu$ m long and a fine attenuated tail), which are all unsheathed microfilariae that are possible sources of misdiagnosis of onchocerciasis in endemic zones (Figure 18b.3). Skin microfilariae are characteristically found in the upper dermis, usually without any surrounding host reaction. It has been suggested that normally they reside in the lymph vessels of dermal papillae, at which site they cause no host reaction, and that it is only extralymphatic microfilariae, particularly those that are dead or dying, which excite the host inflammatory response (Vuong *et al.*, 1988). Normally, microfilariae live 1–2 years before dying (Eberhard, 1986) unless taken up by the vector.

If microfilariae are taken up with the blood meal by biting female Simuliids, some of them migrate from the gut of the blackfly into the thoracic muscles. There they undergo three moults and develop into infective larvae over a period of 6–8 days. Infective larvae migrate to the head of the blackfly, where they may be transmitted to humans in the process of the blackfly taking a blood meal by emerging through the membranous labrum of the mouthparts and

*Onchocerca volvulus*

Africa, Central and South America.  
Found in skin

*Mansonella perstans*

Africa and South America.  
Found in blood

*Mansonella streptocerca*

West Africa.  
Found in skin

*Mansonella ozzardi*

West Indies and South America.  
Found in skin

**Fig. 18b.3** Schematic representation of the tails of microfilariae of *O. volvulus* and other unsheathed human microfilariae

into the wound created by the vector. Infective larvae are 440–700  $\mu\text{m}$  in length  $\times$  19–28  $\mu\text{m}$  broad. The caudal extremity narrows behind the anus and ends in a rounded tip.

### PATHOGENESIS

The majority of lesions of onchocerciasis are caused by the host's inflammatory response to dead and dying microfilariae. These dying microfilariae cause local inflammation, leading to damage to surrounding tissues, which accumulates and produces the pathological features of the disease. Early skin changes include perivascular inflammatory infiltrates of eosinophils, plasma cells, histiocytes and lymphocytes; hyperkeratosis; acanthosis, with increased melanin in

the upper dermis and dilated tortuous lymph and blood capillaries. This progresses to loss of elastic fibres, fibrosis and eventual atrophy of the epidermis associated with binding of eosinophil-derived protein (MBP, major basic protein) to elastic fibres. Skin lesions may, consequently, show a wide range of histopathological appearances, including acute exudative, granulomatous and fibrotic changes.

Ocular lesions are also thought to be directly or indirectly related to invasion and local death of microfilariae. The snowflake opacities of punctate keratitis are focal collections of lymphocytes and eosinophils, with some transient interstitial oedema around dead or dying microfilariae. Sclerosing keratitis, by contrast consists of an inflammatory exudate, mainly of lymphocytes and eosinophils, scarring and a fibrovascular pannus formation. Uveitis and chorioretinitis are

usually low-grade, chronic non-granulomatous inflammatory processes involving lymphocyte and macrophage infiltration.

## IMMUNOLOGY

The immunology of onchocerciasis is complex and has not been fully elucidated. Current understanding has been reviewed by Ottesen (1995). Infected subjects may have more than 100 million microfilariae in their skin, of which half a million die each day. While the anti-parasitic components of the immune response are proinflammatory, the main thrust of the host immune response is to suppress these damaging inflammatory responses to dying microfilariae. When this is effective, there is minimal tissue damage, but if immune mechanisms are poorly developed or overwhelmed (such as by treatment with diethylcarbamazine), acute inflammation occurs. The degree of pathology depends upon the balance between the intensity of the pro-inflammatory response and the effectiveness of specific suppressive mechanisms.

In infected subjects there is typically a prominent antibody response but very little cellular immune response (Ottesen, 1995). Increased titres of specific and non-specific antibodies, particularly IgG, IgM and IgE, are found directed against microfilariae, infective larvae and adult worms in symptomatic subjects (Mackenzie, 1980; Greene *et al.*, 1981, 1985a; Ottesen, 1985). Skin microfilarial levels correlate with specific IgG<sub>4</sub> antibodies, and inversely with IgG<sub>1</sub>, IgG<sub>2</sub>, IgG<sub>3</sub> and IgM (Dafa'Alla *et al.*, 1992; Kawabata *et al.*, 1983). There are also increased levels of circulating immune complexes of unknown significance. Non-specific and specific autoantibodies, including immunoglobulinins (Ngu and Blackett, 1976), anticytoplasmic antibodies (Meilof *et al.*, 1993) and antibodies to retinal pigment epithelial cells (McKechnie *et al.*, 1993), have been reported. Cell-mediated immune responses are generally suppressed, at least in adults (Greene *et al.*, 1983; Gallin *et al.*, 1988). In patients with localised hyper-responsive skin disease ('Sowda'), specific IgG and IgG subclass levels are reported to be very high (Brattig *et al.*, 1994). Sowda patients

also have greater CD4/CD8 ratios in peripheral blood than patients with generalised disease (Brattig *et al.*, 1987).

It seems that the immune responsiveness of individuals changes with time of exposure to infection (Karam and Weiss, 1985), with the balance of Th1/Th2 cytokine responses being central to these changes. These affect IgG and IgE levels, which are important determinants of microfilarial levels and clinical disease and, linked to the suppression of cell-mediated immunity, alter between the ages of 10 and 19 years. The intriguing features of immunoregulation in onchocerciasis are the marked increases in polyclonal IgE and eosinophils, yet the persistence of skin microfilariae with minimal host responsiveness (immune tolerance). The major effect of the immune system is to reduce inflammation around the thousands of dying microfilariae through blocking antibodies and downregulating cytokines (IL-4, IL-5 and IL-10). Whether this is initiated by parasites producing substances which inhibit the inflammatory response, or whether the death of parasites exposes previously hidden antigens, is not known. There is some evidence of active and specific immune suppression by parasite antigens; indeed, most people in endemic areas are asymptomatic yet microfilaridermic, and have reduced specific antibody levels and B and T cell responses *in vitro* (King and Nutman, 1991). These authors suggest that, at low antigen concentrations, a subset of parasite-specific Th2 cells produce IL-4, IL-5 and IL-10, while at higher antigen levels less specific CD4 cells produce IFN $\gamma$ . It is the relative activity of these cells that controls the balance of IgE and IgG<sub>4</sub>.

Following treatment with diethylcarbamazine or ivermectin, there is initial eosinopenia, reflecting degranulation of eosinophils around microfilariae, monocyte and macrophage activation, and production of IL-6 and TNF $\alpha$ . After 24 hours there is a rise in IL-5, and after 2 weeks rises in IgG antibodies and eosinophils. These changes return to normal within 4 weeks of treatment. If microfilariae are cleared from the skin by repeated treatment cellular proliferative responses, IL-2, IL-4 and IFN $\gamma$  responses all improve, while IgG and IgE levels fall.

Prenatal or early post-natal exposure to parasite antigens can alter immune responsiveness to

infection. This is characterised by higher levels of skin microfilariae and a Th2 response to parasite antigens. These suggest that exposed neonates are more susceptible to infection (Elson *et al.*, 1996) and this may be the cause of the immune tolerance observed in many subjects in endemic areas.

There is no good evidence of immunity to reinfection with onchocerciasis. However, some subjects in endemic areas appear to be immune from initial infection. These putatively immune subjects have different immune responses from those who are demonstrably infected and they tend to produce an antigen-specific Th1 type response characterised by raised IFN $\gamma$  and less IL-5 and IL-10 (Elson *et al.*, 1995).

## EPIDEMIOLOGY

Onchocerciasis is one of the four major causes of blindness in the world, affecting some 270 000 people, with an additional 500 000 with severe visual impairment. It is generally a cumulative

infection, the severity of clinical features depending mainly on the length of exposure to blackfly bites and the density of microfilariae in the skin. Because of this, it tends to affect predominately the rural poor in endemic areas. Onchocerciasis is a nasty disease, lasting many years and causing ever-increasing disability to those affected. It has serious socioeconomic consequences for the most heavily affected communities. In such communities, perhaps 70% of the population will be infected with microfilariae but only half of these will have any symptoms. About 15% will have serious skin or eye disease, and up to 5% will be blind.

## Infective Density

The most important determinant of the burden of infection in a community is the infective density of the vector. A measure of the biting density of blackflies can be made by regular dawn-to-dusk catches, using human bait at selected sites (Figure 18b.4). This allows the



**Fig. 18b.4** Catching blackflies using human bait

calculation of the monthly biting rate (MBR), a theoretical estimate of the total number of bites an individual could receive if maximally exposed at that site:

$$\text{MBR} = \text{Number of blackflies caught} \\ \times \text{Number of days in month} / \text{Number} \\ \text{of catching days in month}$$

The annual biting rate (ABR) is the sum of 12 consecutive MBRs.

The estimation by dissection of the parous rate and the number of third stage infective ( $L_3$ ) larvae permits the calculation of the monthly transmission potential (MTP), a theoretical estimate of the number of infective larvae that could be transmitted to a maximally exposed individual (Duke, 1968b; Walsh *et al.*, 1978):

$$\text{MTP} = \text{MBR} \times \text{Number of } \textit{Onchocerca} \\ \textit{volvulus} \text{ } L_3 \text{ larvae detected} / \text{Number} \\ \text{of flies dissected}$$

The annual transmission potential (ATP) is the sum of 12 consecutive MTPs.

In practice, these indices give only a rough guide to the level of transmission. For example, not all third-stage larvae are truly infective, only about 80% of  $L_3$  larvae are transmitted during a blood meal, no one individual is likely to be maximally exposed to bites, and the infective larvae of other worms may be hard to distinguish from *O. volvulus*. However, it has been shown that, in the forest zone of West Africa, the prevalence and intensity of infection and clinical features in humans are related to the numbers of biting flies and measured transmission potentials (Duke *et al.*, 1972a, b).

### Geographical Variation in Disease

The pattern of clinical features of the disease shows geographical variation throughout its range. For example, the majority of nodules in African patients occur on the pelvic girdle (Albiez *et al.*, 1988). In young children in Africa, relatively more nodules are found on the upper part of the body, especially the head. In Guatemala and Mexico, nodules are more

frequent on the head in all age groups, while in South America nodules are not common, but are mostly found on the lower half of the body. This variation is thought to be related to parasite strain differences and vector-parasite relationships. This has been studied most closely in West Africa, where the main differentiation is into three strains: a forest strain with low ocular pathogenicity, associated with high nodule numbers and severe skin disease; a dry savanna strain, with high ocular pathogenesis and an associated high rate of blindness; and a humid savanna strain, with an intermediate pattern (Anderson *et al.*, 1974b). This pattern of lower prevalences of ocular lesions for a given ocular microfilarial load in the forest, compared to savanna areas, has been confirmed by other workers (Dadzie *et al.*, 1989), but McMahon *et al.* (1988) have argued that this could be explained by higher ultraviolet radiation in savanna regions, causing more microfilarial deaths in the eye and hence more anterior segment eye disease, rather than different invasiveness or pathogenicity of putative parasite strains, as suggested by Duke and Anderson (1972b). Microfilariae are generally morphologically indistinguishable throughout their range, but in West Africa at least four different patterns of acid phosphatase staining are found, supporting the hypothesis that a number of biological strains exist. Use of DNA probes has been reported which can distinguish *O. volvulus* parasites from forest and savanna areas of West Africa (Erttmann *et al.*, 1987; Zimmerman *et al.*, 1992). It is postulated that local populations of microfilariae have become adapted to the specific sibling-species of vector in their area. This could lead to incompatibility between parasite strains and vectors from different areas (WHO, 1981; Duke *et al.*, 1966). However, recent work shows that the relationship between savanna vectors and the blinding strain of the parasite is not clear-cut (Toe *et al.*, 1997).

Research is under way into developing improved molecular tools to identify vector and parasite populations (Tang *et al.*, 1995). These include the heteroduplex technique, which allows identification based on hybridization with mitochondrial DNA fragments, and microsatellite DNA analysis, which provides polymorphic markers for populations or even individuals.



## Entomology

Adult blackflies are small (under 4 mm long) dipterans, found in all parts of the world except for a few islands. They are squat, heavy-bodied flies with a pronounced humped thorax. They are usually black and may have black, white or silvery hairs on the body. The wings are short and broad, with well-developed anterior veins but otherwise membranous. Males can be distinguished from females by the compound eyes. In males the eyes occupy almost all the head and meet anteriorly and superiorly (holoptic), whereas the eyes are separated on top in females (dichoptic). The rasp-like mouthparts are short and broad and do not penetrate deeply into the host's skin.

The main vector of onchocerciasis, while always a blackfly, varies in different parts of the world. In most of Africa and Arabia blackflies of the *Simulium damnosum* species complex are the main vectors, while in East Africa the *Simulium neavei* complex are the principal vectors, and in

Central America *Simulium ochraceum* is the main vector. *S. exiguum*, *S. metallicum*, *S. guianense*, *S. oyapockense* are the primary vectors in South America. In West Africa, different sibling species of *Simulium damnosum* have been identified in different geographical areas (Crosskey, 1987). For example, in dry savanna areas the dominant vectors are *Simulium damnosum sensu stricto* and *Simulium sirbanum*, while in forest areas the main vectors are *S. sanctipauli*, *S. soubrense*, *S. squamosum* and *S. yahense*.

*S. damnosum* blackflies lay their eggs on trailing vegetation in fast-flowing, well-oxygenated water, while *S. neavei* lay their eggs on amphibious *Potamonautes* crabs. Each egg batch may contain 100–900 eggs, which are laid with a secretion of mucus that is immediately wetted and cements the eggs to the substrate. The eggs hatch after 1–2 days, the emerging larvae remaining attached to their substrate and filtering the water for food. It is their feeding and oxygen requirements that restrict blackfly breeding to rapidly flowing, well-oxygenated water (Figure 18b.5). The larvae



**Fig. 18b.5** A fast-flowing river in west Africa: a typical breeding site for blackflies

develop into pupae after 5–10 days, and adult flies emerge to the surface in a gas bubble 2 days later. Swarming and mating usually occur soon after emergence. Female blackflies need mate only once during their life.

All blackflies feed on plant juices and sugar solutions. Only the female feeds on blood and this process has to be repeated for each ovarial cycle. For *Simulium damnosum*, feeding occurs in daylight, with peak biting activity soon after sunrise and a lesser peak in the late afternoon (Garms, 1973). Location of a blood host is probably related to odour, CO<sub>2</sub> output, movement, colour or outline (Wenk, 1981). In West Africa, most blackfly bites on humans are on the ankles and calves, with few bites more than 50 cm above the ground (Renz and Wenk, 1983). If these areas are not exposed, then the blackfly will probably seek an alternative host, and the relative efficiency of a species of blackfly as a vector for *O. volvulus* therefore depends partly on the degree of anthropophily and the persistence with which a blackfly will seek a human, rather than an animal, blood meal. *Simulium damnosum* normally takes 5 minutes to feed to full engorgement on humans (Crosskey, 1962). The labrum stretches the skin, which is then penetrated by the maxillae and the rapid scissor-like action of the paired mandibles to a depth of about 400 µm. These tear a ragged hole in the host's skin, blood pools in the wound from capillaries and is then sucked up by the blackfly. The bite is notoriously painful and often continues to bleed for some time.

Only a few ingested microfilariae will penetrate the mid-gut wall and reach the flight muscles of the blackfly, so that the average number of infective larvae per infected fly is only two in the savanna and five in the forest. However, once larvae have started to develop, their mortality is fairly low. The survival rate of the blackfly is not adversely affected unless parasitised with more than 20 microfilariae (Duke, 1962). The gonotrophic cycle is usually about 3–6 days, but the extrinsic cycle of *O. volvulus* is 6–8 days. The parasitic cycle therefore cannot be completed between two successive blood meals; thus, a female infected at her first blood meal cannot transmit larvae until her third meal. The longevity of blackflies in the wild was estimated at about 15 days (Duke, 1968a), with a theoretical

maximum of four infective bites, but more recent reports estimate the maximum life span at 4 weeks (WHO, 1987), and studies of the movement of waves of migrating flies suggest that survival is possible for as long as 7–10 weeks (Baker *et al.*, 1990).

There are normally major differences in blackfly populations in the dry and wet seasons, related to the height of rivers and availability of sites for larvae. This can vary at individual sites. Some rivers will dry up completely in the dry season and only support breeding during the rainy season. Other rivers may have potential breeding sites that are completely submerged when water levels are high and are only uncovered during the dry season. Bimodal variation may occur when rapid changes in water levels disrupt breeding sites by submerging or drying out.

Dispersal of blackflies is normally linear in savanna areas along the course of rivers, although nulliparous females usually display more radial dispersal than parous flies, which characteristically remain close to the river banks. Consequently, the risk of infection is higher close to the river, which explains the lay term for onchocerciasis—'river blindness'. In forested areas, more radial dispersal is observed, with higher proportions of infective blackflies found away from the breeding river (Duke, 1975), particularly during the rainy season (Garms, 1973). Under field conditions the natural infectiveness of blackfly populations is low. Near emergence sites in the savanna, it averages 3–5% of the total population and 6–10% of the parous population. Exceptionally, the theoretical maximum of 25% infective parous flies is reached (Philippon, 1977). Migration, as distinct from dispersal, of blackflies is probably mainly a wind-borne phenomenon. In West Africa this may be of long distances, up to 500 km (Baker *et al.*, 1990), and may be crucial for the survival of *S. damnosum* populations during the dry season.

## CLINICAL FEATURES

The pattern and frequency of the clinical features of onchocerciasis vary according to duration and frequency of exposure, geographic location and

individual variation (Manson-Bahr and Bell, 1987). The most frequent symptom is itching. This may be of any degree of severity and is sometimes incapacitating. It is usually generalised and often associated with excoriations. Other acute reactive dermal lesions include papular eruptions anywhere on the body, representing intraepithelial abscesses, transient localised intradermal oedema, and lymphadenopathy, particularly of the inguinal and femoral glands. These are typically firm and non-tender and show histological evidence of atrophy, chronic inflammation and fibrosis (Gibson and Connor, 1978). Later, skin lesions give the appearance of premature ageing, with lichenoid change, hyperkeratosis and exaggerated wrinkling of the skin; atrophy of the epidermis, with loose, redundant, thin and shiny skin (Anderson *et al.*, 1974a); discoloration, often initially hyperpigmented macules, but more typically a spotty depigmentation of the shins, which represents islands of repigmentation around hair follicles in areas of depigmentation. This is often termed 'leopard skin' (Buck, 1974). Chronic enlargement of the lymph nodes and the surrounding fluid may become dependent, leading to 'hanging groin' (Nelson, 1958), and predispose to hernia formation, lymphatic obstruction and mild elephantiasis. Sowda is a localised form of onchocerciasis common in Yemen, but occasionally found in Africa. The infection is usually localised to one limb, which becomes swollen, the skin darkens and there is an itchy papular rash and lymphadenopathy. Patients with sowda usually have a strong immune response to infection and skin microfilariae are rarely found. Clinical photographs of some of these features are shown in Figures 18b.6A–C. The subcutaneous nodules containing adult worms are often visible and palpable but rarely cause any symptoms (Figure 18b.7). Occasionally they may spontaneously rupture through the skin, causing local pressure symptoms, or the contents may necrose, leading to abscess formation.

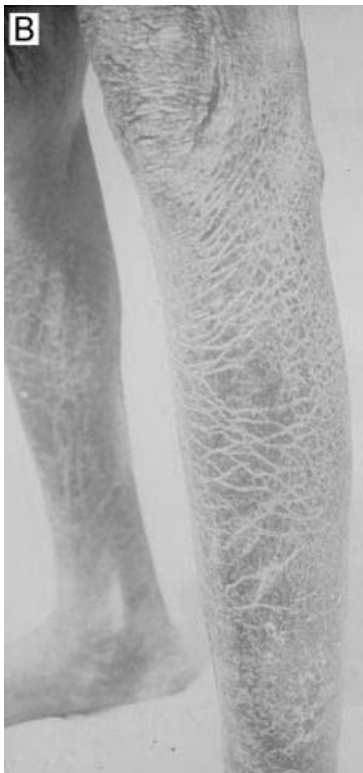
Visual damage is the most serious clinical feature of onchocerciasis, which may affect all tissues of the eye. Ocular lesions are usually seen only in those with moderate or heavy microfilarial loads. Conjunctivitis with photophobia is a common early feature that does not have

sequelae. Two types of lesion affect the cornea: punctate keratitis and sclerosing keratitis (Anderson *et al.*, 1974a). Punctate keratitis is caused by an acute inflammatory exudate surrounding dead and dying microfilariae in the cornea. These give rise to 'snowflake opacities' and resolve without sequelae. Sclerosing keratitis is a progressive exudative process with fibrovascular pannus formation, which starts at the inferior or medial and lateral margins of the cornea and slowly becomes confluent. This may lead to irreversible visual damage and blindness if it encroaches on the visual axis. Anterior uveitis and iridocyclitis are usually mild, chronic conditions, but may cause anterior and posterior synechiae, leading to seclusio or oclusio pupillae and serious complications, such as secondary cataract and glaucoma. Characteristic chorioretinal lesions are atrophy or hyperplasia of the retinal pigment epithelium, chronic non-granulomatous chorioretinitis and chorioretinal atrophy. These are typically widespread, unlike in toxoplasmosis, and usually are first seen temporal to the macula. Postneuritic optic atrophy with constriction of visual fields is common in advanced disease, often associated with dense sheathing of retinal vessels.

Other clinical features, such as weight loss, musculoskeletal pains and dizziness, have been associated with onchocerciasis (Pearson *et al.*, 1985; Lamp, 1967; Burnham, 1991), but the main clinical burden is due to the skin and eye lesions. In West Africa the prevalence of infection, as measured by the presence of skin microfilariae, increases with age up to 25 years, being generally higher in males (Kirkwood *et al.*, 1983a). The degree of visual damage is associated with the microfilarial density and the prevalence of visual loss increases with age. Males are 1.5 times more likely to be blind than females of the same age and microfilarial density (Kirkwood *et al.*, 1983b). Visual damage is also significantly associated with blindness ( $\times 3$ ), poor nutritional status and increased risk of premature death ( $\times 1.5$ ) (Kirkwood *et al.*, 1983b; Prost and Vaugelade, 1981). Other studies from villages in the West African savanna suggest that blindness from onchocerciasis reduces life expectancy by at least 13 years, and that if the prevalence of blindness in a community is 5%, almost half of adult males and one-third of females will become



**Fig. 18b.6** (A) Depigmentation ('leopard skin') on the shins (courtesy of Dr D. Morgan). (B) Skin atrophy (presbydermia) on the leg of a young man (courtesy of Dr D. Morgan). (C) Asymmetrical papular eruption (onchodermatitis) on the thighs of an adolescent girl (courtesy of Dr D. Morgan)



blind before they die (WHO, 1987). Blindness strikes mainly at economically active adults in the prime of life. The development of onchocercal eye disease in an individual is therefore a catastrophe for himself and a burden for his family. If many people are affected in a village, this can have serious socioeconomic consequences for the community. If, in addition, the village is in an area of high transmission, so that heavy infections are acquired relatively early in life, there may be a considerable proportion of young, productive men with visual loss, multiplying the socioeconomic impact of the disease. It is in situations such as these that villages in fertile river valleys were abandoned in Burkina Faso and northern Ghana prior to the start of the WHO Onchocerciasis Control Programme.

## LABORATORY DIAGNOSIS

### Skin Snips

The mainstay of diagnosis is the demonstration of characteristic microfilariae in skin snips. Bloodless skin snips (typically two to six) should be taken from both iliac crests and/or the calves in African or Yemeni cases and shoulders in



**Fig. 18b.7** A nodule (onchocercoma) on the forehead of a young man (courtesy of Dr D. Morgan)



**Fig. 18b.8** Skin snips being taken with a corneoscleral punch

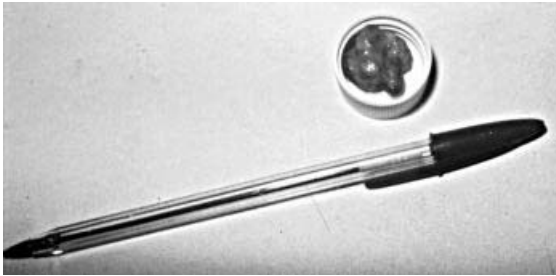
American cases. The skin should be cleaned with spirit and allowed to dry before a piece of skin 2–3 mm in diameter and 0.5–1 mm deep is taken. The skin can be raised with a needle and the tip sliced off with a razor blade, or a corneoscleral punch (an obsolete ophthalmological surgical instrument) can be used (Figure 18b.8). These



**Fig. 18b.9** Skin snips being incubated in saline on microscope slides (note the timer)

punches enable snips to be taken easily and rapidly, but are expensive and need regular setting and sharpening. They should be sterilized in cold glutaraldehyde between patients. The piece of skin should be placed in normal saline or distilled water on a slide or in the well of a microtitre plate for a fixed period (anything from 30 minutes to 24 hours) (Figure 18b.9). About 60% of microfilariae will emerge after 30 minutes incubation in normal saline, rising to over 75% after 24 hours. Live microfilariae can be seen vigorously moving in the medium by direct microscopy. They can be distinguished from other species of microfilariae after staining with Giemsa or Mayer's haemalum.

In detailed community-based surveys in endemic areas, the number of microfilariae will be counted and the skin snip may be weighed. The community microfilarial load (CMFL) can then be derived as the geometric mean microfilarial count (per skin snip or mg of skin) for a cohort of



**Fig. 18b.10** An excised nodule

adults aged 20 years or older. This gives an accurate measure of the endemicity of onchocerciasis in a community (Remme *et al.*, 1986).

### Slit Lamp Examination

Rarely, onchocerciasis can be diagnosed clinically during slit lamp examination by visualising live microfilariae in the anterior chamber of the eye. It can also be diagnosed by finding adult microfilariae in surgically removed nodules (Figure 18b.10).

### Mazzotti Test

A provocative diagnostic test, the Mazzotti test, is also possible. This is based on the reaction that is seen, to some degree, in virtually all patients treated with diethylcarbamazine (DEC) (Mazzotti, 1948). A single small oral dose of DEC (50 mg) is given and a positive response is the development of pruritus and rash within 24 hours. Because of the dangers of Mazzotti reactions, this test should only be used for patients suspected of having onchocerciasis but with negative skin snips. This is because occasionally, particularly in heavily infected patients, more severe side-effects may occur, such as headache, musculoskeletal pains, polyarthritis, large joint effusions, tender swollen lymph nodes, fever, tachycardia, hypotension and vertigo. Ocular reactions, including conjunctival irritation, photophobia, punctate keratitis, acute uveitis, retinal pigment epithelial defects and optic neuritis, have also been reported. The mechanism of these reactions is thought to be

associated with monocyte and macrophage activation and IL-6 and TNF $\alpha$  release in response to eosinophil degranulation related to microfilarial killing. Recently a safer variation of the Mazzotti reaction, based on the dermal application of DEC, has been developed and evaluated (WHO, 1997).

### Other Techniques

In non-endemic areas the combination of typical clinical features and eosinophilia is suggestive of onchocerciasis. Various ELISA tests have been described, but there is normally considerable cross-reactivity with other helminths, limiting their usefulness except as a screening test in non-endemic areas. Recently, more specific ELISA tests and a diagnostic test based on the polymerase chain reaction (PCR) to detect microfilarial antigen in skin samples have been described, but these are not yet in general use.

## CLINICAL MANAGEMENT

### Historical

Until the introduction of ivermectin in the 1980s, chemotherapy for onchocerciasis had been unsatisfactory. Suramin was the first drug to be used successfully for the treatment of onchocerciasis, and remains the only true macrofilaricide. A dose of 6 g is sufficient to kill all adult worms, but significant side-effects are reported in 10–30% of patients. This drug must be given in a course of intravenous injections over several weeks and so is restricted to hospital inpatients. It is too toxic for general use, occasionally resulting in death. Its use followed the report of van Hoof *et al.*, (1947), who found that patients treated with suramin for sleeping sickness were cured of concomitant onchocerciasis. Suramin inhibits metabolic enzymes that are of importance to the filariae and the host. It binds avidly to plasma and tissue proteins, particularly in the kidney, which leads to the slow and progressive macrofilaricidal effect and partly explains its toxicity. Side-effects include anaphylactic shock, nephropathy with albuminuria, skin and mucous membrane

exfoliation, jaundice, diarrhoea, asthenia and pain and tenderness of the palms and soles. A Mazzotti skin reaction and anterior uveitis may also occur; these are thought to be due to the microfilaricidal effects of the drug. This is clearly not a drug that can be used on a wide scale in endemic zones.

Hewitt *et al.* (1947) first reported on the filaricidal action of DEC. There was much hope that the drug would be useful for onchocerciasis but, while DEC is an effective microfilaricidal drug, it does not kill adult *O. volvulus* and produces serious side-effects. Treatment was therefore suppressive rather than providing radical cure, and needed repeating as long as the adult female worms were fertile. Severe systemic reactions were more common in heavily infected patients and DEC could aggravate ocular lesions or precipitate new ones. Treatment was oral, and usually a 5–7 day course of increasing doses was given to a total dose of 3.5 g, often in combination with corticosteroids, aspirin or antihistamines to control the side effects. These have included blindness and even death (Bird *et al.*, 1979; Oomen, 1969).

### Ivermectin

Ivermectin is now established as the drug of choice for treating onchocerciasis and has rendered other forms of chemotherapy obsolete (reviewed by Goa *et al.*, 1991). Treatment is given orally as a single dose of 150–200 µg/kg body weight at 3–24 month intervals. The drug is formulated in 6 mg tablets, and most adults require 9 mg or 12 mg. In non-endemic areas, where infections are usually light and patients are not exposed to further infection, ivermectin may be given at 3–6 monthly intervals as necessary, depending on the reappearance of skin microfilariae or recurrence of symptoms. About two-thirds of patients can be expected to relapse within 6 months of each dose of treatment (Churchill *et al.*, 1994).

Ivermectin is a semi-synthetic product, being an 80:20 mixture of avermectin B<sub>1a</sub> and avermectin B<sub>1b</sub>. These are macrocyclic lactones that are synthesised by an actinomycete, *Streptomyces avermectilis*, first found in a soil sample from a

Japanese golf course. The manufacturer's exclusion criteria are: children under 5 years of age or 15 kg body weight, pregnant women, breast-feeding mothers within 1 week of delivery, and individuals with neurological disorders or severe intercurrent disease. The drug reaches a peak plasma concentration about 4 h after administration, is highly bound to albumin, and has a wide tissue distribution. The drug acts on parasite neurotransmitters by potentiation or direct opening of glutamate-gated chloride channels, which paralyse the microfilariae (Arena *et al.*, 1995).

Ivermectin was initially developed as a wide spectrum anthelmintic veterinary product, and has been very successful in that market for more than 15 years. Ivermectin was first studied in man in Senegal by Aziz *et al.* (1982) and subsequent studies found that ivermectin was as effective as DEC in reducing microfilarial counts, and with significantly fewer side-effects (Greene *et al.*, 1985b; Lariviere *et al.*, 1985; Diallo *et al.*, 1986). The suppression of microfilarial levels lasts longer after ivermectin than DEC. Whereas microfilarial levels start to rise 6 months after DEC, they remain low for at least 12 months after ivermectin (Awadzi *et al.*, 1986; Taylor *et al.*, 1986). This is explained by parasitological examinations, which show that ivermectin does not kill adult worms but inhibits microfilarial release from female worms, with a consequent intrauterine accumulation of degenerate microfilariae (Schulz-Key *et al.*, 1985, 1986). Since ivermectin is only a microfilaricidal agent, treatment is suppressive rather than curative. Therefore, it may need to be taken for at least the lifespan of adult worms (up to 15 years) (Whitworth, 1992).

Community trials have shown that the drug is safe and well accepted and has important effects on the clinical morbidity of the disease, particularly on the ocular lesions (Whitworth *et al.*, 1991b; Abiose *et al.*, 1993). Ivermectin also has some impact on the skin lesions of onchocerciasis and itching (Whitworth *et al.*, 1996; UNDP, 1995). Ivermectin has some useful activity against other nematode parasites including *Wuchereria bancrofti*, *Ascaris lumbricoides*, *Strongyloides stercoralis* (Whitworth *et al.*, 1991a), ectoparasites including head lice (Dunne *et al.*, 1991) and scabies mites (Meinking *et al.*, 1995). Caution should be applied in the 12 African countries



**Fig. 18b.11** Periorbital oedema following treatment with ivermectin

where *Loa loa* and *O. volvulus* coexist, as ivermectin may rarely cause serious side-effects, such as encephalopathy, in heavy infections of loiasis. In these areas, appropriate follow-up and provision of care facilities should be provided if mass treatment with ivermectin is given (Gardon *et al.*, 1997).

The risk of adverse reactions is related to the severity of infection, and these occur in approximately 20% of individuals in hyperendemic areas. The vast majority of adverse reactions are mild and self-limiting. About 5% have more severe reactions, which affect the ability to work for a day or more. Commonly seen adverse reactions include: increased skin rash and itching, non-tender soft tissue swelling, musculoskeletal pains, fever, lymph gland pain and swelling (Figure 18b.11). Serious reactions have been reported, but are rare. These include severe postural hypotension, bronchospasm in asthmatics, abscesses and bullous eruptions. All of these respond to symptomatic treatment. Adverse reactions are much less common after subsequent doses of treatment, presumably because the microfilarial load has been reduced (Whitworth *et al.*, 1991c).

### Other Drugs

Studies in Central and Southern America in the early 1990s suggested that amocarzine was effective at killing adult worms and microfilariae,

and that the level of side-effects was acceptable (Guderian *et al.*, 1991; Zea-Flores *et al.*, 1991). More recent studies in Ghana found that amocarzine provoked Mazzotti-type allergic reactions and was a less potent macrofilaricide than ivermectin (Awadzi *et al.*, 1997). The researchers concluded that amocarzine has no role in the treatment of onchocerciasis in Africa.

Research on other drugs which could kill or sterilize adult worms is continuing. Work on moxidectin is promising (WHO, 2000) and studies in Ghana show that doxycycline in doses of 100 mg daily for 6 weeks can sterilize adult female worms for at least 18 months. The drug acts by depletion of symbiotic wolbachia endobacteria (order Rickettsiales) normally present in the hypodermis, where they are essential for worm homeostasis. Histological sections show uteri are empty or contain only degenerate early embryos several months after treatment, which raises the possibility that the sterility is irreversible (Hoerauf *et al.*, 2001). If this work is confirmed, doxycycline might be a useful adjunct to ivermectin for the interruption of transmission in endemic areas, although the current dosage regimen is a serious practical barrier to mass treatment.

## PREVENTION AND CONTROL

The control of onchocerciasis can be approached in two main interrelated ways: identifying cases and reducing their morbidity, or reducing transmission of infection and thereby preventing new cases. The two main current methods of control are: reducing morbidity with the drug ivermectin, and interrupting transmission by the use of vector control.

### Vector Control

Once the life cycle of *O. volvulus* and the role of blackflies in transmitting infection had been established, it became clear that control of the disease might be feasible by attacking the vector. The history of vector control has been comprehensively reviewed by Davies (1994). The first report of successful vector control was made by



Buckley (1951), who achieved control of *S. naevei* in a small focus in Kenya by removing all the shade trees along the rivers. However, most subsequent attempts to control the vector have been directed against the larvae, which are confined to a highly restricted and easily identified habitat. Garnham and McMahon (1947) successfully eradicated *S. naevei* and eventually onchocerciasis from four isolated foci in Kenya by using large doses of DDT at 10–14 daily intervals. The insecticide was carried downstream, killing simuliid larvae over long stretches of river. Heartened by this success, several attempts to control *S. damnosum* were made in West Africa during the 1950s and 1960s (Taub, 1955; Davies *et al.*, 1962; Le Berre, 1968). All gave some degree of success so long as the control activities were maintained. They also demonstrated the problem of regular invasion by adult blackflies from untreated surrounding areas. For example, in the Abuja control scheme (Davies *et al.*, 1962), where there was a focus of hyperendemic onchocerciasis, DDT was applied weekly for 12 weeks at the onset of the rainy season for 5 years at 10 selected sites on four rivers. Larvae were eradicated, biting rates and transmission were significantly reduced, but blackflies reinvaded the area as soon as the control measures were stopped.

However, it was felt that the disease could be controlled in the West Africa savanna by the use of larvicides if carried out on a large enough scale. This led to the inception of the Onchocerciasis Control Programme (OCP) in 1974, a programme with an original expected duration of 20 years and with two objectives: to combat a disease that is widespread and severe in West Africa, and to remove a major obstacle to economic development (Walsh *et al.*, 1981). The original area chosen for the OCP was the Volta river basin, tributaries of the Niger river and some smaller river valleys to the west. This area of 654 000 km<sup>2</sup> and 40 000 km of rivers was to be controlled by the regular application of 20% temephos, a organophosphate insecticide, from fixed-wing aircraft and helicopters. Since larval development is rapid in West African conditions, it was necessary to plan a weekly treatment cycle, with dosages of 0.03–0.10 ppm discharged over 10 minutes. The calculation of dose requires consideration of the flow rate and depth of water

in the rivers, and this may vary considerably at different times of year. Vector collection teams visit treated breeding sites weekly and record the presence of nulliparous females, pupae and late instar larvae. On the basis of the entomological and hydrological data, plans for larviciding are drawn up each week. The operations have been very successful, with *S. damnosum* virtually eliminated from large areas, with ABRs and ATPs generally being reduced to very low levels, almost always to less than 10% of pre-control figures. Since 1990, larviciding operations have ceased in many areas. However, the programme has faced problems. First, the development of widespread resistance to temephos has necessitated the introduction of other, more expensive and more toxic insecticides; and second, the invasion of the control area by infective blackflies from neighbouring areas has led to the need to extend the original control areas. OCP now covers some 1.3 million km<sup>2</sup> in 11 countries (Niger, Burkina Faso, Mali, Senegal, Guinea Bissau, Guinea, Sierra Leone, Ivory Coast, Ghana, Togo and Benin). The programme is estimated to have prevented 125 000–200 000 cases of blindness since 1974 and currently protects some 30 million people at a cost of less than 1 \$US/person/year. Six insecticide compounds (BT-14, temephos, phoxim, pyraclofos, permethrin and carbosulfan) are now used routinely, sometimes in rotation, in an attempt to limit the development of resistance. A seventh insecticide, a pseudopyrethroid called etofenprox, has recently been introduced for use in particularly high river discharges. The success of the programme is largely based on the high-quality evaluation of the spraying operations and the potential for rapid response to evidence of treatment failure.

The OCP is now entering its final phase, combining repeated mass ivermectin treatment with vector control. This combination allows for the reduction of morbidity more quickly and stops transmission, thus preventing new infections. Computer modelling suggests that larviciding alone will take 14 years to achieve control, while with larviciding combined with ivermectin this can be reduced to 12 years (Habbema *et al.*, 1992). The OCP will continue operations until 2002, when residual activities will be transferred to the participating countries.

### Mass Treatment with Ivermectin

Ivermectin is provided free by the manufacturers, Merck & Co., who are committed to provide the drug free for as long as necessary to control the public health problem of onchocerciasis. This unprecedented humanitarian gesture has allowed the development of regular community-based mass treatment campaigns to reduce disease morbidity and the transmission of infection. It is calculated that at least 65% of the exposed population needs to be treated for the success of mass distribution for the elimination of onchocerciasis as a public health problem (Remme, 1995).

Mass distribution of ivermectin using sustainable community systems underpins new control programmes established in Africa (APOC: African Programme for Onchocerciasis Control) and the Americas (OEPA: Programme for the Elimination of Onchocerciasis in the Americas). APOC is based in the 19 endemic countries in Africa outside the OCP, and annual ivermectin treatment is targeted at hyperendemic and mesoendemic communities. A rapid assessment technique, based on the prevalence of palpable nodules, has been developed to simplify the identification of at-risk communities in areas where *Simulium damnosum* is the main vector (WHO, 1992; Ngoumou and Walsh, 1993). The philosophy behind APOC is to ensure that there is adequate community involvement to sustain drug delivery for 15 years after an initial 5 years with donor support. Studies suggest that community-directed treatment is feasible and effective in a range of diverse settings. The cost of population-based distribution in endemic countries ranges from less than \$0.20 to more than \$2 per person, depending on the precise system that is used (WHO, 1991). In a few areas where *Simulium* populations are isolated, non-migratory and susceptible to temephos, vector elimination has been included by APOC.

In the Americas, vector control is generally not feasible. Twice-yearly distribution of ivermectin is under way in Mexico and Guatemala in an effort to control transmission as well as to reduce morbidity. Elsewhere, treatment is given on an annual basis free of charge. In the Yemen, an

ivermectin control programme has recently been commenced.

In all, during 1996 over 19 million treatments were given under population-based distribution schemes, which are likely to be necessary for at least 10 years (Mectizan Programme Notes, 1997). In the first 11 years of such schemes over 100 million treatments have been given (Dull and Meredith, 1998).

### Nodulectomy

Systematic nodulectomy campaigns in Latin America were stimulated by the work of Robles in Guatemala and Mexico. In Guatemala, nodulectomy campaigns have been carried out since 1935, with over 250 000 nodules being removed. During this time the nodule carrier rate has been noted to fall from 24% to 9%. It is not clear whether all this reduction has been due to the campaign or to other factors. However, in one area with hyperendemic onchocerciasis the prevalence of blindness fell from 7% in 1934 to 0.5% in 1979 (WHO, 1987). Nodulectomy has been less popular in Africa, with no systematic campaigns. This is probably because nodules tend to be distributed around the pelvis rather than the head and neck in Africa, and consequently a smaller proportion of them are palpable, compared to Latin America (Albiez, 1983). A study in Liberia and Burkina Faso found that if all detectable nodules were removed, 2 years later one-third of patients had no new nodules and operated patients had significantly lower microfilaria counts than controls (Albiez, 1985). However, removal of just one or two nodules, as is more common in the African setting, does not reduce microfilarial density significantly (Kale, 1982). Given the widespread distribution of onchocerciasis, the relatively poor state of African rural health services, and the lack of major impact of nodulectomy on the disease, mass nodulectomy campaigns are generally thought to be inappropriate for West Africa. However, since head nodules are associated with ocular complications (Anderson *et al.*, 1975; Fuglsang and Anderson, 1977), it may be reasonable to remove head nodules, particularly from children.

## Vaccine Development

The Edna McConnell Clark Foundation has sponsored the development of a vaccine against onchocerciasis since 1984. This programme is scheduled to finish in 1999. Over this period a considerable amount of progress has been made. Many candidate recombinant antigens have been screened for the development of protective immunity in two small animal models based on *Acanthocheilonema viteae* in jirds and *Onchocerca volvulus* third-stage larvae implanted in micro-pore chambers in mice. A number of defined antigens have been identified that give partial protection of about 50% against invading larvae. A natural model based on *Onchocerca ochengi* infection in cattle has also been established to test candidate antigens in cross-protection experiments. A high level of protection induced by irradiated larvae has recently been demonstrated in cattle, serving as a standard for immunizations with defined preparations.

## REFERENCES

- Abiose A, Jones BR, Cousens SN *et al.* (1993). A randomized, controlled trial of ivermectin for onchocerciasis: evidence for a reduction in the incidence of optic nerve disease. *Lancet* **41**: 130–34.
- Albiez EJ (1983). Studies on nodules and adult *Onchocerca volvulus* during a nodulectomy trial in hyperendemic villages in Liberia and Upper Volta. I. Palpable and impalpable onchocercosmata. *Tropenmed Parasitol* **34**: 54–60.
- Albiez EJ (1985). Effects of a single complete nodulectomy on nodule burden and microfilarial density two years later. *Trop Med Parasitol* **36**: 17–20.
- Albiez EJ, Büttner DW, Duke BOL (1988). Diagnosis and extirpation of nodules in human onchocerciasis. *Trop Med Parasitol* **39**: 331–46.
- Anderson J, Fuglsang H, Hamilton PJS, Marshall TFdeC (1974a). Studies on onchocerciasis in the United Cameroon Republic. I. Comparison of populations with and without *Onchocerca volvulus*. *Trans R Soc Trop Med Hyg* **68**: 190–208.
- Anderson J, Fuglsang H, Hamilton PJS, Marshall TFdeC (1974b). Studies on onchocerciasis in the United Cameroon Republic. II. Comparison of onchocerciasis in the rain-forest and sudan-savanna. *Trans R Soc Trop Med Hyg* **68**: 209–22.
- Anderson J, Fuglsang H, Hamilton PJS, Marshall TFdeC (1975). The prognostic value of head nodules and microfilariae in the skin in relation to ocular onchocerciasis. *Tropenmed Parasitol* **26**: 191–5.
- Arena JP, Liu KK, Paress PS, Frazier EG, Cully DF, Mrozik H, Schaeffer JM (1995). The mechanism of action of avermectins in *Caenorhabditis elegans*: correlation between activation of glutamate-sensitive chloride current, membrane binding, and biological activity. *J Parasitol* **81**: 286–94.
- Awadzi K, Dadzie KY, Schulz-Key H, Haddock DRW, Gilles HM, Aziz MA (1986). The chemotherapy of onchocerciasis. XI. A double-blind comparative study of ivermectin, diethylcarbamazine and placebo in human onchocerciasis in Northern Ghana. *Ann Trop Med Parasitol* **80**: 433–42.
- Awadzi K, Opoku NO, Attah SK *et al.* (1997). The safety and efficacy of amocarzine in African onchocerciasis and the influence of ivermectin on the clinical and parasitological response to treatment. *Ann Trop Med Parasitol* **91**: 281–96.
- Aziz MA, Diallo S, Diop IM, Lariviere M, Porta M (1982). Efficacy and tolerance of ivermectin in human onchocerciasis. *Lancet* **ii**: 171–3.
- Baker RHA, Guillet P, Seketeli A *et al.* (1990). Progress in controlling the reinvasion of windborne vectors into the western area of the Onchocerciasis Control Programme in West Africa. *Phil Trans R Soc Lond* **328**: 731–50.
- Bianco AE, Mustapha MB, Ham PJ (1989). Fate of developing larvae of *Onchocerca lienalis* and *O. volvulus* in micropore chambers implanted into laboratory hosts. *J Helminthol* **63**: 218–26.
- Bird AC, El-Sheikh H, Anderson J, Fuglsang H (1979). Visual loss during oral diethylcarbamazine treatment for onchocerciasis. *Lancet* **ii**: 46.
- Blacklock DB (1926a). The development of *Onchocerca volvulus* in *Simulium damnosum*. *Ann Trop Med Parasitol* **20**: 1–48.
- Blacklock DB (1926b). The further development of *Onchocerca volvulus* Leuckart in *Simulium damnosum* Theobald. *Ann Trop Med Parasitol* **20**: 203–18.
- Brattig NW, Tischendorf FW, Albiez EJ, Buttner DW, Berger J (1987). Distribution pattern of peripheral lymphocyte subsets on localised and generalised forms of onchocerciasis. *Clin Immunol Immunopathol* **44**: 149–59.
- Brattig W, Krawietz I, Abakar AZ, Erttman KD, Kruppa TK, Massougbdji A (1994). Strong immunoglobulin G isotypic antibody response in Sowdah type onchocerciasis. *J Infect Dis* **170**: 155–61.
- Bryant J (1935). Endemic retino-choroiditis in the Anglo-Egyptian Sudan and its possible relationship to *Onchocerca volvulus*. *Trans R Soc Trop Med Hyg* **28**: 523–32.
- Buck AA (1974). *Onchocerciasis. Symptomatology, Pathology, Diagnosis*. WHO: Geneva; 80 pp.
- Buckley JJC (1951). Studies on human onchocerciasis and *Simulium* in Nyanza province, Kenya. II. The disappearance of *Simulium naevei* from a bush-cleared focus. *J Helminthol* **25**: 213–22.
- Burnham GM (1991). Onchocerciasis in Malawi. 2. Subjective complaints and decreased weight in persons infected with *Onchocerca volvulus* in the Thyolo highlands. *Trans R Soc Trop Med Hyg* **85**: 497–500.
- Churchill DR, Godfrey-Faussett P, Birley HD, Malin A, Davidson RN, Bryceon AD (1994). A trial of a three-dose regimen of ivermectin for the treatment of patients with

- onchocerciasis in the UK. *Trans R Soc Trop Med Hyg* **88**: 242.
- Crosskey RW (1962). Observations on the uptake of human blood by *Simulium damnosum*: the engorgement time and size of the blood meal. *Ann Trop Med Parasitol* **56**: 141–8.
- Crosskey RW (1987). A taxa summary of the *Simulium damnosum* complex, with special reference to distribution outside the control areas of West Africa. *Ann Trop Med Parasitol* **81**: 181–92.
- Dadzie KY, Remme J, Rolland A, Thylefors B (1989). Ocular onchocerciasis and intensity of infection in the community. II. West African rainforest foci of the vector *Simulium yahense*. *Trop Med Parasitol* **40**: 348–54.
- Dafa'Alla TH, Ghalib HW, Abdelmageed A, Williams JF (1992). The profile of IgG and IgG subclasses of onchocerciasis patients. *Clin Exp Immunol* **88**: 258–63.
- Davies JB (1994). Sixty years of onchocerciasis vector control: a chronological summary with comments on eradication, reinvasion and insecticide resistance. *Ann Rev Entomol* **39**: 23–45.
- Davies JB, Crosskey RW, Johnston MRL (1962). The control of *Simulium damnosum* at Abuja, Northern Nigeria. *Bull WHO* **27**: 491–510.
- Diallo S, Aziz MA, Lariviere M *et al.* (1986). A double-blind comparison of the efficacy and safety of ivermectin and diethylcarbamazine in a placebo-controlled study of Senegalese patients with onchocerciasis. *Trans R Soc Trop Med Hyg* **80**: 927–34.
- Duke BOL (1962). Studies on factors influencing the transmission of onchocerciasis. II. The intake of *Onchocerca volvulus* microfilariae by *Simulium damnosum* and the survival of the parasites in the fly under laboratory conditions. *Ann Trop Med Parasitol* **56**: 255–63.
- Duke BOL, Lewis DJ, Moore PJ (1966). *Onchocerca-Simulium* complexes. I. Transmission of forest and sudan-savanna strains of *Onchocerca volvulus*, from Cameroon, by *Simulium damnosum* from various West African bioclimatic zones. *Ann Trop Med Parasitol* **60**: 317–36.
- Duke BOL (1968a). Studies on factors influencing the transmission of onchocerciasis. V. The stages of *Onchocerca volvulus* in wild 'forest' *Simulium damnosum*, the fate of the parasite in the fly and the age distribution of the biting population. *Ann Trop Med Parasitol* **62**: 107–16.
- Duke BOL (1968b). Studies on factors influencing the transmission of onchocerciasis. VI. The infective biting potential of *Simulium damnosum* in different bioclimatic zones and its influence on the transmission potential. *Ann Trop Med Parasitol* **62**: 164–70.
- Duke BOL, Moore PJ, Anderson J (1972a). Studies on factors influencing the transmission of onchocerciasis. VII. A comparison of the *Onchocerca volvulus* transmission potentials of *Simulium damnosum* populations in four Cameroon rain-forest villages and the pattern of onchocerciasis associated therewith. *Ann Trop Med Parasitol* **66**: 219–34.
- Duke BOL, Anderson J (1972b). A comparison of the lesions produced in the cornea of the rabbit eye by microfilariae of the forest and sudan-savanna strains of *Onchocerca volvulus* from Cameroon. I. The Clinical Picture. *Tropenmed Parasitol* **23**: 354–68.
- Duke BOL (1975). The differential dispersal of nulliparous and parous *Simulium damnosum*. *Tropenmed Parasitol* **26**: 88–97.
- Duke BOL (1991). Observations and reflections on the immature stages of *Onchocerca volvulus* in the human host. *Ann Trop Med Parasitol* **85**: 103–10.
- Dull HB, Meredith SEP (1998). The Mectizan Donation Program—a 10-year report. *Ann Trop Med Parasitol* **92**: S69–71.
- Dunne CL, Malone CJ, Whitworth JAG (1991). A field study of the effects of ivermectin on ectoparasites in man. *Trans R Soc Trop Med Hyg* **85**: 550–51.
- Eberhard ML, Orihel TC (1986). *Loa loa*: output of microfilariae in a single pair infection. *Trop Med Parasitol* **37**: 369–74.
- Eberhard ML (1986). Longevity of microfilariae following removal of the adult worms. *Trop Med Parasitol* **37**: 361–3.
- Elson LH, Calvopina MH, Paredes WY *et al.* (1995). Immunity to onchocerciasis: putative immune persons produce a Th1-like response to *Onchocerca volvulus*. *J Infect Dis* **171**: 652–8.
- Elson LH, Days A, Calvopina MH *et al.* (1996). *In utero* exposure to *Onchocerca volvulus*: relationship to subsequent infection intensity and cellular immune responsiveness. *Infect Immun* **64**: 5061–5.
- Erttmann KD, Unnasch TR, Greene BM *et al.* (1987). A DNA sequence specific for forest form *Onchocerca volvulus*. *Nature* **327**: 415–17.
- Fuglsang H, Anderson J (1977). The concentration of microfilariae in the skin near the eye as a simple measure of the severity of onchocerciasis in a community and as an indicator of danger to the eye. *Tropenmed Parasitol* **28**: 63–7.
- Gallin M, Edmonds K, Ellner JJ *et al.* (1988). Cell-mediated immune responses in human infection with *Onchocerca volvulus*. *J Immunol* **140**: 1999–2007.
- Gardon J, Gardon-Wendell N, Demanga N, Kamgno J, Chippaux JP, Boussinesq M (1997). Serious reactions after mass treatment of onchocerciasis with ivermectin in an area endemic for *Loa loa* infection. *Lancet* **350**: 18–20.
- Garms R (1973). Quantitative studies of the transmission of *Onchocerca volvulus* by *Simulium damnosum* in the Bong Range, Liberia. *Tropenmed Parasitol* **24**: 358–72.
- Garnham PCC, McMahon JP (1947). The eradication of *Simulium damnosum* Roubaud from an onchocerciasis area in Kenya colony. *Bull Ent Res* **37**: 619–28.
- Gibson DW, Connor DH (1978). Onchocercal lymphadenitis: clinicopathologic study of 34 patients. *Trans R Soc Trop Med Hyg* **72**: 137–54.
- Goa KL, McTavish D, Clissold SP (1991). Ivermectin: a review of its antifilarial activity, pharmacokinetic properties and clinical efficacy in onchocerciasis. *Drugs* **42**: 640–58.
- Greene BM, Taylor HR, Aikawa M (1981). Cellular killing of microfilariae of *Onchocerca volvulus*: eosinophil and neutrophil-mediated immune serum-dependent destruction. *J Immunol* **127**: 1611–18.
- Greene BM, Fanning MM, Ellner JJ (1983). Non-specific suppression of antigen-induced lymphocyte blastogenesis

- in *Onchocerca volvulus* infection in man. *Clin Exp Immunol* **52**: 259–65.
- Greene BM, Gbakima AA, Albiez EJ, Taylor HR (1985a). Humoral and cellular immune responses to *Onchocerca volvulus* infection in humans. *Rev Infect Dis* **7**: 789–95.
- Greene BM, Taylor HR, Cupp EW *et al.* (1985b). Comparison of ivermectin and DEC in the treatment of onchocerciasis. *N Engl J Med* **313**: 133–8.
- Guderian RH, Anselmi M, Proano R *et al.* (1991). Onchocercicidal effects of three drug regimens of amocazine in 148 patients of two races and both sexes in Esmeraldas, Ecuador. *Trop Med Parasitol* **42**: 263–85.
- Habbema JDF, Alley ES, Plaisier AP, Van Oortmarssen GJ, Remme JHF (1992). Epidemiological modelling for onchocerciasis control. *Parasitol Today* **8**: 99–103.
- Hewitt RI, Kushner S, Steward HI *et al.* (1947). Experimental chemotherapy of filariasis. III. Effect of 1-diethylcarbamy-1,4-methylpiperazine hydrochloride against naturally acquired infections in cotton rats and dogs. *J Lab Clin Med* **32**: 1314–29.
- Hissette J (1932). Mémoire sur l'*Onchocerca volvulus* 'Leuckart' et ses manifestations oculaires au Congo belge. *Ann Soc Belge Méd Trop* **12**: 433–529.
- Hoerauf A, Mand S, Adjei O, Fleisher B, Buttner DW (2001). Depletion of wolbachia endobacteria in *Onchocerca volvulus* by doxycycline and microfilaridermia after ivermectin treatment. *Lancet* **357**: 1415–16.
- Kale OO (1982). Controlled studies on the effect of nodulectomy on the concentration of microfilariae in the skin of patients exposed to continuing transmission of *Onchocerca volvulus* in the rain forest zone of Western Nigeria. *Tropenmed Parasitol* **33**: 40–42.
- Karam M, Weiss N (1985). Seroepidemiological investigations of onchocerciasis in a hyperendemic area of West Africa. *Am J Trop Med Hyg* **34**: 907–17.
- Kawabata M, Izui S, Anan S *et al.* (1983). Circulating immune complexes and their possible relevance to other immunological parameters in Guatemalan onchocerciasis. *Int Arch Allergy Appl Immunol* **72**: 128–33.
- King CL, Nutman TB (1991). Regulation of the immune response in lymphatic filariasis and onchocerciasis. *Parasitol Today* **7**: A54–8.
- Kirkwood B, Smith P, Marshall T, Prost A (1983a). Variations in the prevalence and intensity of microfilarial infections by age, sex, place and time in the area of the Onchocerciasis Control Programme. *Trans R Soc Trop Med Hyg* **77**: 857–61.
- Kirkwood B, Smith P, Marshall T, Prost A (1983b). Relationships between mortality, visual acuity and microfilarial load in the area of the Onchocerciasis Control Programme. *Trans R Soc Trop Med Hyg* **77**: 862–8.
- Lamp HC (1967). Musculoskeletal pain in onchocerciasis. *W Afr Med J* **16**: 60–2.
- Larivière M, Aziz M, Weimann D *et al.* (1985). Double-blind study of ivermectin and diethylcarbazine in African onchocerciasis patients with ocular involvement. *Lancet* **ii**: 174–7.
- Le Berre R (1968). Bilan sommaire pour 1967 de lutte contre le vecteur de l'onchocercose. *Med Afr Noire* **15**: 71–2.
- Leuckart R (1893). *Filaria volvulus*. Skin diseases of tropical countries by Manson P. In Young J (ed.), *Andrew Hope Davidson's Hygiene and Diseases of Warm Climates*. Pentland: Edinburgh; 963.
- Lok JB, Pollack RJ, Cupp EW, Barnardo MJ, Donnelly JJ, Albiez EJ (1984). Development of *Onchocerca lienalis* and *O. volvulus* from the third to fourth larval stage *in vitro*. *Tropenmed Parasitol* **35**: 209–11.
- Macfie JWS, Corson JF (1922). Observations on *Onchocerca volvulus*. *Ann Trop Med Parasitol* **16**: 459–64.
- Mackenzie CD (1980). Eosinophil leucocytes in filarial infections. *Trans R Soc Trop Med Hyg* **74** (suppl): 51–8.
- Manson-Bahr PEC, Bell DR (eds) (1987). *Manson's Tropical Diseases*, 19th edn. Ballière-Tindall: London; 373–87.
- Mazzotti L (1948). Possibilidad de utilizar como medio diagnostico en la onchocercosis, las reacciones alergicas consecutivas a la administracion de 'Hetrazan'. *Rev Inst Salubr Enferm Trop (Mex)* **9**: 235–7.
- McKechnie NM, Braun G, Connor V *et al.* (1993). Immunologic cross-reactivity in the pathogenesis of ocular onchocerciasis. *Invest Ophthalmol Vis Sci* **34**: 2888–902.
- McMahon JE, Sowa SI, Maude GH, Hudson CM, Kirkwood BR (1988). Epidemiological studies of onchocerciasis in savanna villages of Sierra Leone. *Trop Med Parasitol* **39**: 260–68.
- Mectizan Programme Notes (1997). Mectizan Donation Program: Atlanta, GA; 17.3.
- Meilof JF, Van der Lelij A, Rokeach LA, Hoch SO, Smeenk RJT (1993). Autoimmunity and filariasis: autoantibodies against cytoplasmic cellular proteins in sera of patients with onchocerciasis. *J Immunol* **151**: 5800–9.
- Meinking TL, Taplin D, Hermida JL, Pardo R, Kerdel FA (1995). The treatment of scabies with ivermectin. *N Engl J Med* **333**: 26–30.
- Nelson GS (1958). 'Hanging groin' and hernia complications of onchocerciasis. *Trans R Soc Trop Med Hyg* **52**: 272–5.
- Ngoumou B, Walsh JF (1993). *A Manual for Rapid Epidemiological Mapping of Onchocerciasis*. World Health Organization: Geneva; TDR/TDE/ONCHO/93.4.
- Ngu JL, Blackett K (1976). Immunological studies of onchocerciasis in Cameroon. *Trop Geogr Med* **28**: 111–20.
- O'Neill J (1875). On the presence of a filaria in craw-craw. *Lancet* **i**: 265–6.
- Oomen AP (1969). Fatalities after treatment of onchocerciasis with diethylcarbazine. *Trans R Soc Trop Med Hyg* **63**: 548.
- Ottesen EA (1985). Immediate hypersensitivity responses in the immunopathogenesis of human onchocerciasis. *Rev Infect Dis* **7**: 796–801.
- Ottesen EA (1995). Immune responsiveness and the pathogenesis of human onchocerciasis. *J Infect Dis* **171**: 659–71.
- Parsons AC (1908). *Filaria volvulus* Leuckart, its distribution, structure and pathological effects. *Parasitology* **1**: 359–68.
- Pearson CA, Brieger WR, Ramakrishna J, Kale OO, Adeniyi JD (1985). Improving recognition of onchocerciasis in primary care—I: non-classical symptoms. *Trop Doct* **15**: 160–63.
- Phillipon B (1977). A study of the transmission of *Onchocerca volvulus* by *Simulium damnosum* in tropical Africa. *Trav Doc ORSTOM* **63**: 308.
- Prost A (1980). Latence parasitaire dans l'onchocercose. *Bull WHO* **58**: 923–5.
- Prost A, Vaugelade J (1981). La surmortalité des aveugles en zone de savane ouest-africaine. *Bull WHO* **59**: 773–6.

- Prout WT (1901). A filaria found in Sierra Leone. *Filaria volvulus* (Leuckart). *Br Med J* **i**: 209–11.
- Remme J, Ba O, Dadzie KY, Karam M (1986). A force of infection model for onchocerciasis and its applications in the epidemiological evaluation of the Onchocerciasis Control Programme in the Volta River basin area. *Bull WHO* **64**: 667–81.
- Remme JHF (1995). The African Programme for Onchocerciasis Control: preparing to launch. *Parasitol Today* **11**: 403–6.
- Renz A, Wenk P (1983). The distribution of the microfilariae of *Onchocerca volvulus* in the different body regions in relation to the attacking behaviour of *Simulium damnosum* s.l. in the Sudan savanna of northern Cameroon. *Trans R Soc Trop Med Hyg* **77**: 748–52.
- Ridley H (1945). Ocular onchocerciasis, including an investigation in the Gold Coast. *Br J Ophthalmol* **10** (suppl): 58.
- Roberts JMD, Neumann E, Goeckel CW, Highton RB (1967). Onchocerciasis in Kenya 9, 11 and 18 years after elimination of the vector. *Bull WHO* **37**: 195–212.
- Robles R (1917). Enfermedad nueva en Guatemala. *La Juventud Medica (Guatemala)* **17**: 97–115.
- Schulz-Key H, Albiez EJ (1977). Worm burden of *Onchocerca volvulus* in a hyperendemic village of the rain forest in West Africa. *Tropenmed Parasitol* **28**: 431–8.
- Schulz-Key H, Kläger S, Awadzi K *et al.* (1985). Treatment of human onchocerciasis: the efficacy of ivermectin on the parasite. *Trop Med Parasitol* **36** (suppl II): 20.
- Schulz-Key H, Greene BM, Awadzi K *et al.* (1986). Efficacy of ivermectin on the reproductivity of female *Onchocerca volvulus*. *Trop Med Parasitol* **37**: 89.
- Schulz-Key H, Karam M (1986). Periodic reproduction of *Onchocerca volvulus*. *Parasitol Today* **2**: 284–6.
- Strote G (1987). Morphology of third- and fourth-stage larvae of *Onchocerca volvulus*. *Trop Med Parasitol* **38**: 73–4.
- Tang J, Toe L, Back C, Zimmerman PA, Pruess K, Unnasch TR (1995). The *Simulium damnosum* species complex: phylogenetic analysis and molecular identification based on mitochondrially encoded gene sequences. *Insect Mol Biol* **4**: 79–88.
- Taubert R (1955). Une campagne de lutte contre *Simulium damnosum* au Mayo Kebbi. *Bull Soc Pathol Exot* **48**: 564–76.
- Taylor HR, Murphy RP, Newland HS *et al.* (1986). Treatment of onchocerciasis. The ocular effects of ivermectin and diethylcarbamazine. *Arch Ophthalmol* **104**: 863–70.
- Toe L, Tang J, Back C, Katholi CR, Unnasch TR (1997). Vector-parasite transmission complexes for onchocerciasis in West Africa. *Lancet* **349**: 163–6.
- United Nations Development Programme (UNDP)/World Bank/World Health Organization (1995). *The Importance of Onchocercal Skin Disease. Report of a Multi-country Study*. TDR/ARF/RP/95.1. World Health Organization: Geneva.
- van Hoof L, Henrard C, Peel E, Wanson M (1947). Sur la chimiothérapie de l'onchocercose. *Ann Soc Belge Méd Trop* **27**: 173–7.
- Vuong PN, Bain O, Cabaret J *et al.* (1988). Forest and savanna onchocerciasis: comparative morphometric histopathology of skin lesions. *Trop Med Parasitol* **39**: 105–10.
- Walsh JF, Davies JB, Le Berre R, Garms R (1978). Standardization of criteria for assessing the effect of *Simulium* control in onchocerciasis control programmes. *Trans R Soc Trop Med Hyg* **72**: 675–6.
- Walsh JF, Davies JB, Cliff B (1981). World Health Organization Onchocerciasis Control Programme in the Volta River Basin. In Laird M (ed.), *Blackflies: The Future for Biological Methods in Integrated Control*. Academic Press: London; 85–103.
- Wenk P (1981). Bionomics of adult blackflies. In Laird M (ed.), *Blackflies: The Future for Biological Methods in Integrated Control*. Academic Press: London; 259–79.
- Whitworth JAG, Morgan D, Maude GH, McNicholas AM, Taylor DW (1991a). A field study of the effect of ivermectin on intestinal helminths in man. *Trans R Soc Trop Med Hyg* **85**: 232–4.
- Whitworth JAG, Gilbert CE, Mabey DM, Maude GH, Morgan D, Taylor DW (1991b). The effects of repeated doses of ivermectin on ocular onchocerciasis—results from a community based trial in Sierra Leone. *Lancet* **338**: 1100–3.
- Whitworth JAG, Morgan D, Maude GH, Downham MD, Taylor DW (1991c). A community trial of ivermectin for onchocerciasis in Sierra Leone: adverse reactions after the first five treatment rounds. *Trans R Soc Trop Med Hyg* **85**: 501–5.
- Whitworth J (1992). Drug of the month: ivermectin. *Trop Doct* **22**: 163–4.
- Whitworth JAG, Maude GH, Downham MD (1996). Clinical and parasitological responses after up to 6.5 years of ivermectin treatment for onchocerciasis. *Trop Med Int Health* **1**: 786–93.
- World Health Organization (1981). *Report of the WHO Independent Commission on the Long-term Prospects of the Onchocerciasis Control Programme*. World Health Organization: Geneva; 77 pp.
- World Health Organization (1987). *WHO Expert Committee on Onchocerciasis. Third Report*. Technical Report Series 752. World Health Organization: Geneva; 167 pp.
- World Health Organization (1991). *Strategies for Ivermectin Distribution through Primary Health Care Systems*. WHO/PBL/91.24. World Health Organization: Geneva.
- World Health Organization (1992). *Methods for Community Diagnosis of Onchocerciasis to Guide Ivermectin-based Control in Africa*. TDR/TDE/ONCHO/92.2. World Health Organization: Geneva.
- World Health Organization (1995). *Onchocerciasis and Its Control*. Technical Report Series 852. World Health Organization: Geneva; 167 pp.
- World Health Organization (1997). *OCP in West Africa. Expert Advisory Committee Report*. OCP/EAC/18.2. World Health Organization: Geneva.
- World Health Organization (2000). A suitable macrofilaricide? *TDR News* **62**: 11.
- Zea-Flores G, Beltranena F, Poltera AA *et al.* (1991). Amocarcizine investigated as total onchocercicidal drug in 272 adult male patients from Guatemala. Results from three dose regimens spread over three days. *Trop Med Parasitol* **42**: 240–62.
- Zimmerman PA, Dadzie KY, De Sole G *et al.* (1992). *Onchocerca volvulus* DNA probe classification correlates with epidemiological pattern of blindness. *J Infect Dis* **165**: 964–8.

# *Strongyloides stercoralis* and *S. fulleborni*

John F. Lindo and Michael G. Lee

*The University of the West Indies, Mona, Kingston, Jamaica*

## STRONGYLOIDES STERCORALIS

### HISTORICAL BACKGROUND

*Strongyloides stercoralis* might be described as 'the military worm'. It was first described by a military physician in soldiers returning from war and in recent times much work on diagnosis, immunology and epidemiology has been conducted on veterans of World War II and Vietnam. Louis Normand (1876) first described *Strongyloides stercoralis* in French soldiers returning from Cochin China (now Vietnam), who were suffering intractable diarrhoea. This was an important breakthrough, since at last a plausible causative agent of the disease known as 'diarrhoea of Cochin China' was found. Very soon after his discovery, Normand realised that the stages which were initially isolated could also be found in several organs throughout the body at autopsy. Bavay (1878), who was a professor of pharmacy in the Navy, named the parasite *Anguillula stercoralis* and provided detailed descriptions of the worm. It is interesting to note that in this short time Bavay was also able to describe free-living adult parasites, which he found would develop *in vitro* if the stool was kept at favourable conditions (Grove, 1989a).

Normand continued his quest to describe the possible causative agent of 'diarrhoea of Cochin China' and at an autopsy in 1876 he removed a worm from the intestine that was about 2 mm long and that appeared different from those seen

in stool or previous autopsies. He sent this specimen to Bavay, who concluded that it was a separate species, which he named *Anguillula intestinalis* (Bavay, 1877a). In addition, he and Normand, for the first time, saw larval stages in faecal culture that were longer than those previously seen, had a notched tail and an oesophagus that extended to about half the length of the body (Bavay, 1877b). This description of the infective filariform larvae of *S. stercoralis* was interpreted as a larval stage of *A. intestinalis* (Grove, 1989a).

From these military beginnings, several workers took an interest in the parasite. Notable among these was Laveran (1877), who confirmed the findings of Bavay (1877a,b) and Normand (1876). He also concluded that there were two separate species, '*A. stercoralis*', which produced larvae in the stool and adults in the external environment, and '*A. intestinalis*', which lived in the gut and produced larvae with notched tails *in vitro*. However, these findings were overturned when Grassi and Parona (1879), working in Italy, found that the parasitic form (*A. intestinalis*) laid eggs in the intestinal lumen that hatched to release larvae identical to those of '*A. stercoralis*'. Furthermore, these larvae did not develop into free-living adults, as described by earlier workers, but into notched-tailed larvae. Grassi (1879) suggested a new genus, *Strongylus*, for the parasite and later *Strongyloides intestinalis*,

which was readily accepted, since the genus *Anguillula* already existed for eels (Grove, 1989a).

A confusing observation was made by Perroncito (1881), who cultured free-living adults from larvae that were identical to those described by Normand (1876). He observed that they laid eggs that hatched to release rhabditiform larvae, which moulted into notched-tailed larvae identical to those of '*A. intestinalis*' (Grove, 1989b). Therefore, these notched-tailed larvae were now known to develop in two ways; first, directly from larvae collected from patients with '*A. intestinalis*' and second, from faecal culture of free-living adults of '*A. stercoralis*'. It was Leuckart (1883) who suggested that this was the same parasite with two separate modes of development and who suggested the name '*Rhabdonema strongyloides*'.

One of Leuckart's students, Loos, observed that some of the newly passed rhabditiform larvae could develop into free-living adults, which in turn produced eggs and more rhabditiform larvae that developed into filariform larvae, whilst others developed directly into filariform larvae in the same faecal cultures (Grove, 1989b). Golgi and Monti (1884) brought this to the attention of the academic community with arguments on whether or not environmental conditions could influence the mode of development.

Among the observations made by Bavay (1877b) was the absence of parasitic males in the intestines of humans. This raised the question of whether or not these disappeared soon after fertilisation or whether the females were hermaphroditic. Grassi (1882) suggested that the females were parthenogenetic. However, Kreis (1932) reported finding parasitic male worms in the faeces of dogs and humans. Faust (1933) also reported that male worms were found in the respiratory tree and that mating may have taken place there before the parasite become embedded in the gut mucosa.

After several name changes to the causative agent of 'diarrhoea of Cochin China', Stiles and Hassal (1902) suggested that the correct name for the organism should be *Strongyloides stercoralis*, to give precedent to the first species name. The International Commission on Zoological Nomenclature (1915) accepted this.

## DESCRIPTION OF THE ORGANISM

Morphological description of *Strongyloides stercoralis* is based on the work of Little (1966) and Speare (1986). These works have been thoroughly reviewed by Speare (1989), Schad (1989) and Grove (1996).

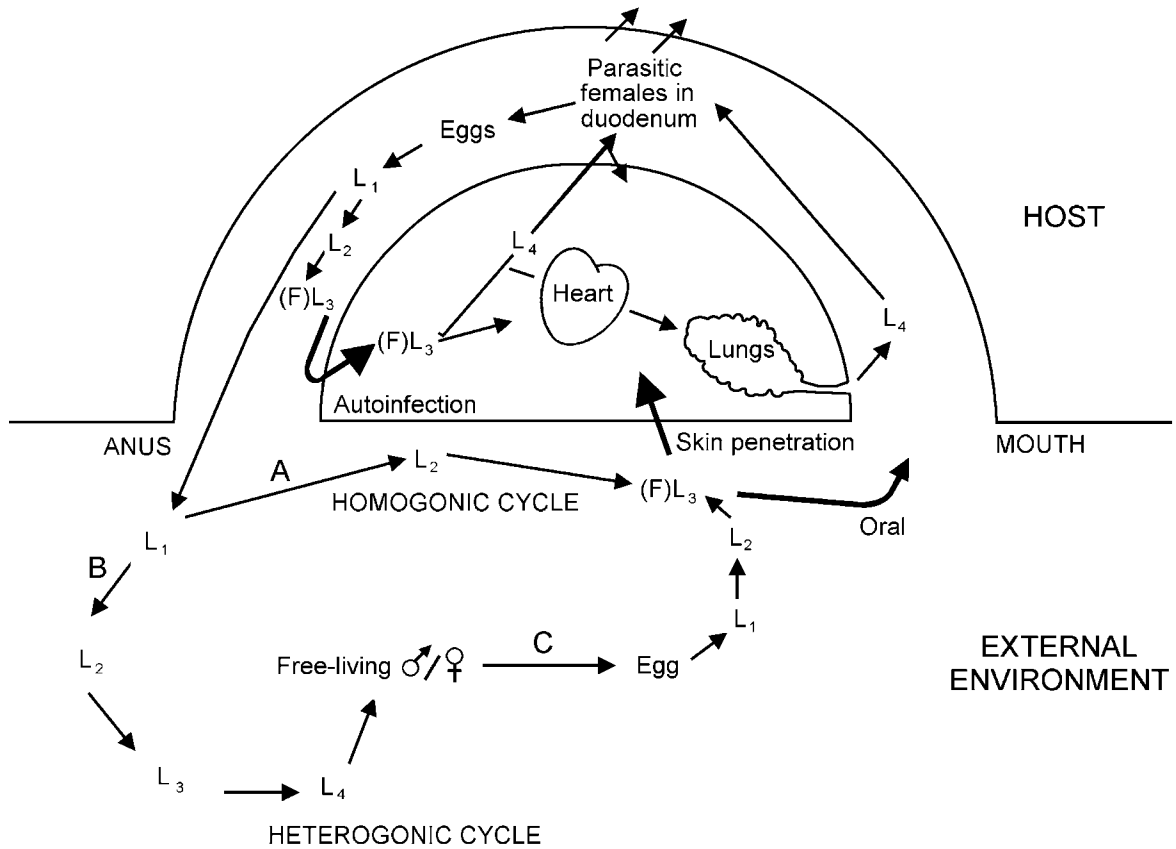
### Parasitic Female

Clinical parasitologists may never encounter a parasitic female (Figure 18c.1) of *S. stercoralis* throughout their careers, since this stage is very seldom seen in the stool and was to be removed from the intestine using special techniques. They may, however, be found in patients with very severe infections (Scowden *et al.*, 1978). Parasitic females are 2.0–2.8 mm long and have an average diameter of 37  $\mu$ m. They are very slender and threadlike, giving rise to the common name, 'threadworm'. Their almost transparent nature makes them difficult to visualise with the naked eye, even when they are separated from faecal material. Anteriorly the worm is tapered and this portion contains the pharynx or 'oesophagus', which extends for about one-quarter of the body length. Food is drawn into the pharynx through the mouth (which is hexagonal in shape and contains six papillae), by the creation of negative pressure caused by its expansion. Sequential contractions and expansions pass the food backwards and force it into the intestine. The intestine is a single cell layer thick and passes almost to the posterior tip of the body, where it ends in a cuticular rectum, which opens to the outside through the anus on the mid-ventral line close to the tail.

A nerve ring surrounds the oesophagus and roughly divides it into a muscular anterior 25% and a posterior, mainly glandular 75%, with a small constriction in between. The pharynx is divided into two subventral pharyngeal glands which empty their secretions into the pharyngeal lumen and a dorsal gland which opens near the mouth (Little, 1966). Based on the site at which they empty their contents, the glands are thought to differ in function (Schad, 1989).

The excretory system consists of two longitudinal canals running the length of the worm, and these are joined just behind the nerve cord





**Fig. 18c.1** Life-cycle of *Strongyloides stercoralis* in humans. Courtesy of Dr Ralph Robinson, University of the West Indies, Jamaica

by a transverse duct to give an H-shaped reproductive system. The duct is connected to a single excretory cell and together their contents are emptied to the exterior via a short excretory canal and excretory pore on the mid-ventral line.

The female reproductive system is quite prominent in *S. stercoralis*. The vulva is located in the posterior third of the body in the mid-ventral line. From a short vagina, uteri in which eggs can be readily seen extend anteriorly and posteriorly. The oviducts also extend anteriorly and posteriorly; the former branches up to the pharynx and then folds back on itself, whilst the latter extends almost to the tip of the tail before folding. Eggs in the uteri are aligned in single file and occupy most of the body of the worm where they occur.

### Free-living Adult Female

Free-living adult females are easily seen in culture using a dissecting microscope. The most striking feature is the number of eggs they contain. With some patience, egg laying can be observed using the microscope. They are 1.0–1.5 mm long  $\times$  ca. 85  $\mu$ m in diameter and taper at both ends. The oesophagus (pharynx) is typical of free-living rhabditiform worms. It is attached to the terminal mouth by a small vestibule and is demarcated into three distinct regions; the procorpus, isthmus and bulb. The procorpus is the most anterior and is cylindrical in shape; behind this lies the narrow isthmus and the bulb, which leads into the intestine. The bulb of the pharynx is the so-called 'rhabditiform oesophagus' and is typical of microbivorous nematodes.

The reproductive system of the free-living female is very similar to that of parasitic females, except that numerous eggs are present in the uteri. The point where each uterus enters its oviduct is sperm-filled and acts as a seminal receptacle (Schad, 1989).

### Free-living Male

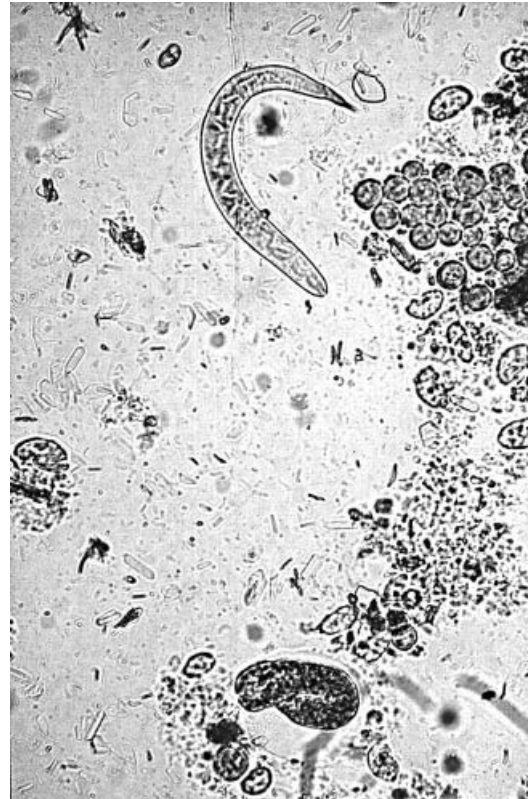
The free-living males of *S. stercoralis* are <math>1.0\text{--}1.2\text{ mm}</math> long  $\times 55\ \mu\text{m}</math> in diameter. This stage is rhabditiform in nature and has a similar mouth, oesophagus and intestine to the free-living female. Male worms are typically J-shaped, which is caused by the bending of the conical tail anteriorly during fixing. The reproductive system consists of a blindly ending testis at the anterior end and this is attached to a poorly demarcated vas deferens and seminal vesicle. Within the reproductive system, spermatogonia, spermatocytes and spermatozoa may be seen (Grove, 1996). Copulatory spicules, which are inserted into the female during mating, surround the cloaca. In addition to the spicules there are six pairs of caudal papillae and a single mid-ventral precloacal papilla (Grove, 1996).$

### Eggs

Eggs of free-living females and parasitic are morphologically similar. They are thin-shelled, ellipsoidal and measure about  $40 \times 70\ \mu\text{m}</math> (Little, 1966). The eggs may be fully embryonated when laid or may have undergone several cell divisions. Eggs of the parasitic female hatch in the crypts of Lieberkühn and are rarely seen in stool (Grove, 1996).$

### First-stage Larvae

First-stage larvae voided in faeces or recovered from intestinal fluids and those that develop from the heterogonic cycle are morphologically similar (Little, 1966). They measure ca.  $250\ \mu\text{m}</math> long  $\times 17\ \mu\text{m}</math> in diameter when passed in stool, but are  $180\text{--}240\ \mu\text{m}</math> long  $\times 14\text{--}16\ \mu\text{m}</math> wide when newly hatched. The pharynx of first stage larvae is similar morphologically to that described for$$$$



**Fig. 18c.2** Smear showing partially embryonated egg and first-stage larva of *S. stercoralis* obtained following whole gut irrigation. Photograph courtesy of Dr Ralph Robinson, University of the West Indies, Jamaica

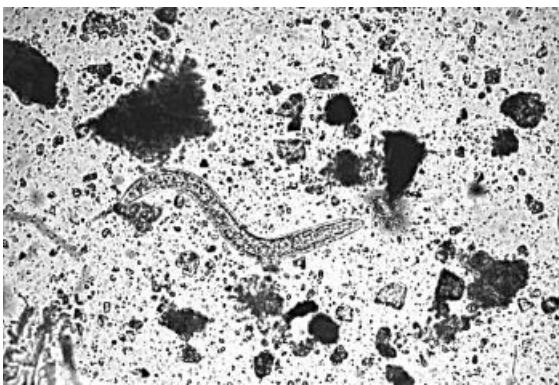
free-living adults. It extends throughout the anterior third of the body and is  $89\text{--}94\ \mu\text{m}</math> long (Little, 1966). Of importance is the short buccal cavity, which is central in the differentiation of *S. stercoralis* from hookworms. Whilst the buccal cavity of the *S. stercoralis* is shorter than the body is wide at the base of the buccal cavity ( $4\text{--}8\ \mu\text{m}</math>), that of hookworms is about as long as the body in this region ( $6\text{--}19\ \mu\text{m}</math>) (Speare, 1989). Also, the genital primordium is larger (about  $4\ \mu\text{m}</math>) in *S. stercoralis* than in hookworms and is refractile instead of cellular (Speare, 1989) (Figures 18c.2, 18c.3 and 18c.4).$$$$

### Second-stage Rhabditiform Larvae

This stage is larger than the first stage and the major change is reorganisation of the head, with



**Fig. 18c.3** Stool smear showing first-stage larva of *S. stercoralis*. Note the genital primordium and short buccal cavity

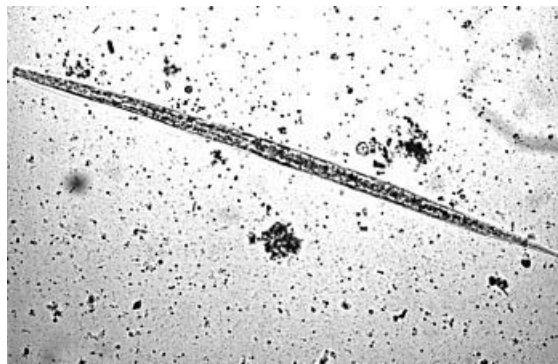


**Fig. 18c.4** Stool smear showing first-stage larva of hookworm. The genital primordium is inconspicuous and the buccal cavity is longer than in *S. stercoralis*. Photograph courtesy of Dr Ralph Robinson, University of the West Indies, Jamaica

the shifting of the cephalic lobe from a dorso-ventral to a lateral position (Grove, 1989b). Larvae that are destined to become infective and filariform will undergo major changes, including lengthening of the oesophagus, with the end posteriorad to the nerve ring becoming more glandular and less muscular. The nuclei of the three oesophageal glands become more apparent. Little (1966) reported that these cephalic changes also occur in rhabditiform larvae.

### Third-stage Rhabditiform Larvae

Third-stage rhabditiform larvae are merely larger versions of second stage larvae.



**Fig. 18c.5** Filariform (infective larva of *S. stercoralis*). Note the filariform oesophagus, which extends almost half the length of the worm and the characteristic notched tail. Photograph courtesy of Dr Ralph Robinson, University of the West Indies, Jamaica



**Fig. 18c.6** Third-stage larva of *Strongyloides stercoralis*

### Third-stage Filariform Larvae

This stage (Figures 18c.5, 18c.6) is long and slender and, unlike other stages, seems to be suited for rapid directional movement and percutaneous penetration. The worm measures 400–700  $\mu\text{m}$  long  $\times$  12–20  $\mu\text{m}$  in diameter. The cuticle is striated and is divided into two adjacent flanges called alae. The alae extend along the entire length of the worm and are thought to be important in stability during movement. They extend slightly beyond the tip of the larva and give the appearance of a notch under light microscopy (Little, 1966). Diagnostically, this feature is important in distinguishing *Strongyloides* from hookworm species, where the notch is absent. Examination at high magnification shows

that the alae are paired and that the tail is in fact tetrafurcate (Little, 1966). Scanning electron microscopy of the tail of *S. ratti* has shown that there is a circular aperture surrounded by eight apertures (Zaman *et al.*, 1980). However, it is not known whether this is the case with *S. stercoralis*.

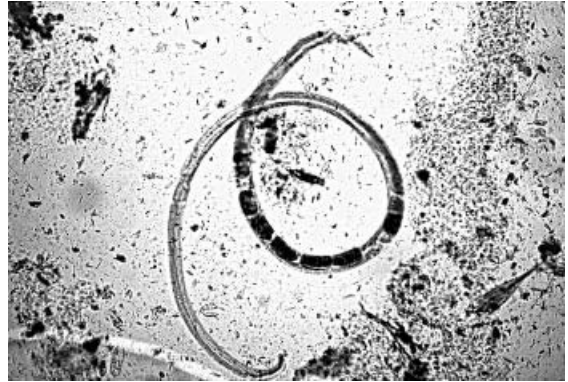
The mouth of the filariform larva is a small shallow pore, thought to be closed to particulate materials and liquids. There is no marked buccal cavity and the pharynx (oesophagus) begins almost immediately behind the mouth and extends for about 40% of the body length. The oesophagus is a thin cylindrical tube, without the bulb seen in rhabditiform stages (Schad, 1989). A nerve ring encompasses the oesophagus at about 25% of its length from the anterior end. Shortly behind this, the excretory pore opens to the exterior.

The sensory system consists of two pairs of minute sensilla that lie between the lateral alae and another pair at the level of the excretory pore. The latter pair are putative mechanoreceptors, which may signal the worm when it enters a space too small to permit it to pass. A pair of putative chemoreceptors lies between the alae at a point half-way between the anus and the tail; these lateral sensilla are the phasmids in *Strongyloides* (Schad, 1989).

## LIFE-CYCLE

Infection with *S. stercoralis* (see Figure 18c.1) are initiated from skin penetration by infective ( $L_3$  or filariform) larvae, although they may be established following ingestion of these larvae (Grove, 1996). Larvae enter the circulation and lymphatics and are carried to the lungs. They break out of the alveoli, ascend the bronchial tree and are eventually swallowed, enter the wall of the proximal duodenum and moult to become adult worms (Figure 18c.5).

Recent evidence using radiolabelled  $L_3$  larvae to track the route of migration in an animal model shows that not all larvae reach the intestinal tract via the lungs. A significant number were seen to be able to do so by other routes (Aikens and Schad, 1989; Mansfield *et al.*, 1995; Schad *et al.*, 1989). Clinically, this is important because absence of larvae from the lungs may not necessarily rule out disseminated disease.



**Fig. 18c.7** Adult female *S. stercoralis* recovered following whole gut irrigation. Note the filariform oesophagus, conical tail and the presence of several eggs in the uterus. Photograph courtesy of Dr Ralph Robinson, University of the West Indies, Jamaica

Parasitic females (Figure 18c.7) produce eggs by parthenogenesis and these hatch in the crypts of Lieberkühn soon after they are deposited to release first-stage ( $L_1$ ) rhabditiform larvae. This accounts for the presence of  $L_1$  larvae rather than eggs in the stool.  $L_1$  larvae are well suited for a microbivorous life and thrive on organisms in faeces-enriched soil.

It appears that a proportion of these larvae are destined to undergo two moults, giving rise to infective larvae ( $L_2$  rhabditiform, and then  $L_2$  filariform). This is the homogonic route of development; the resulting infective larvae will live for about 1–2 weeks, as judged by their survival in laboratory cultures (Grove, 1989b, 1996). This is a rapid mode of development and may result in infective larvae in about 24 hours.

Those  $L_1$  larvae that do not undergo homogonic development will moult to rhabditiform  $L_2$ , then to rhabditiform  $L_3$  larvae, then to free-living male and female adults, retaining their rhabditiform morphology. Free-living females contain 5–45 eggs and will mate with the smaller males (Hammond and Robinson, 1994). Pseudofertilisation is believed to take place and this results in egg production. All  $L_1$  larvae hatched from the eggs of free-living females are destined to become infective  $L_3$  (filariform) larvae, since heterogonic development occurs over a single generation only (Yamada *et al.*, 1991; Schad, 1989).

Factors determining the mode of development of *S. stercoralis* in the free-living phase are not well understood. A simplified view is that a hostile host environment and/or a favourable external environment drives the heterogonic development of larvae. Conversely, a favourable host and/or an unfavourable external environment results in homogonic development (Moncol and Triantaphyllou, 1978). In the related species *S. ratti*, the direction of external development can be determined by factors such as ambient temperature, and generally tropical strains are more likely to undergo heterogonic development than temperate strains in coproculture (Viney, 1996). Furthermore, strains of *S. ratti* have been selected to develop homogonically or heterogonically (Wertheim and Lengy, 1965). Manipulation of the host immune status may also result in clonal larvae, which are more likely to develop heterogonically in response to specific immunity (Gemmill *et al.*, 1997).

### Autoinfection

*S. stercoralis* infections are notoriously chronic: infections lasting for more than four decades are not uncommon (Gill and Bell, 1979; Pelletier, 1984). These long-lasting infections are due to autoinfection, and this parasite is almost unique among intestinal nematodes because of its ability to replicate and multiply within the host in the absence of external sources of infection.

Autoinfection in strongyloidiasis results from the moulting of more L<sub>1</sub> larvae into infective L<sub>3</sub> larvae while they are in the intestine or on the perineum. These larvae will penetrate the wall of the intestine or perineum and establish as adults in the gut. The factors that regulate autoinfection are not well understood but host immunologic factors appear to play an important role in its regulation. However, by this method infections can be sustained for very long periods and have the potential to increase the parasite burden in the absence of external sources of re-infection.

### PATHOGENESIS

Infective filariform larvae can penetrate intact skin or mucous membranes. Infection can also develop if the larvae are ingested. Filariform

larvae penetrate the skin or mucous membrane in contact with faecally contaminated soil or other surfaces. They then travel in the venous circulation to the lungs, where they break into the alveolar spaces, ascend the tracheo-bronchial tree, are swallowed and thereby reach the proximal small intestine (Liu and Weller, 1998). A minority of filariform larvae may also reach the small intestine by migration via other viscera or through the connective tissues (Grove, 1994, 1996). In the small intestine the infective filariform larvae moult twice to become female adult worms.

A small number of rhabditiform larvae in the bowel lumen develop into infective filariform larvae, which penetrate the bowel mucosa or perianal skin, enter the venous circulation and undergo a migratory cycle to return to the small bowel. Thus, the infection can be perpetuated without leaving the host, resulting in continuing infection for many years.

*S. stercoralis* differs from other human worm infection in that there is a complex dual life-cycle, including one in which reproduction occurs by parthenogenesis in the host and another free-living cycle in which full development occurs in the environment (Grove, 1996). Therefore, *Strongyloides stercoralis* has the unique ability to perpetuate itself both in the soil and in its host (Celedon *et al.*, 1994).

### Hyperinfection

The severity of disease in helminth infections is directly related to worm burden. Therefore, since most cases of strongyloidiasis are asymptomatic, the rate of autoinfection is regulated so that there is no significant increase in adult worm burden. However, immunosuppression may increase the rate of autoinfection, leading to large numbers of filariform larvae penetrating the wall of the bowel and the establishment of many adult worms in the intestinal mucosa. This phenomenon is referred to as hyperinfection and may be drug-induced or associated with concurrent immunosuppressive conditions, such as solid tumours, corticosteroid use, HTLV-I infection or Hodgkin's lymphoma (Igra-Sieman *et al.*, 1981; Scowden *et al.*, 1978). The simple

explanation of impaired cell-mediated immunity is inadequate to account for hyperinfection, especially since it is not widely seen in AIDS or other cellular immune deficiencies. It has been postulated that hyperinfection may result from an increase in the moulting rate of L<sub>1</sub> larvae in the gut under the direct endocrine influence of corticosteroids on the worms, and not from host immunosuppression (Genta, 1992).

Uncontrolled hyperinfection may result in dissemination of infection to extraintestinal organs. Disseminated autoinfective larvae will carry faecal material from the gut, which may result in septicaemia and secondary bacterial infections, often associated with high mortality rates (Igra-Sieman *et al.*, 1981). Larvae have been retrieved from almost all sites in the human body as a result of disseminated disease. *S. stercoralis* infection remains a serious infection of man because of intestinal symptoms, hyperinfection and disseminated disease. Grove (1989b) suggested the terms 'chronic uncomplicated strongyloidiasis' and 'severe complicated strongyloidiasis' to describe the spectrum of disease encountered by infected individuals. Patients in the former group are either asymptomatic or have mainly cutaneous and intestinal symptoms, while those with severe complicated strongyloidiasis have hyperinfection and disseminated disease and are more difficult to manage clinically.

## IMMUNOLOGY

*Strongyloides* infections are notorious for their longevity. They may be maintained for periods of up to six decades and in most cases cause no harm to the infected individual. These infections are remarkable; patients have been identified with clinical and serological manifestations of infection but with no coprological confirmation of the parasite. Anecdotal evidence suggests that some individuals who are exposed to the parasite may in fact be resistant to infection (Grove, 1996). Clinicians are all too familiar with the devastating effects of hyperinfection and disseminated strongyloidiasis in patients who are immunosuppressed by chemotherapy or underlying disease. Taken together, these scenarios suggest a range of host immunological responses

to the parasite that will manifest themselves in a range of states of health or illnesses.

Of central interest is the maintenance and reactivation of chronic occult infection into patent overwhelming strongyloidiasis. Occult infection in dogs can be made patent by administering prednisone (Schad *et al.*, 1984). Adult female worms have also been shown to become barren under the influence of the immune response. In these infections female worms can be made to become fecund by immunological manipulation, which suggests that it is the reduced anti-fecundity effect of the host that results in the resumption of egg-laying in barren females (Schad *et al.*, 1997). These anti-fecundity responses in humans are not well-defined, but examination of individual humoral and T cell responses may shed some light on the important factors.

## Humoral Responses

Antibodies produced against the infective larvae of *S. stercoralis* are predominantly IgG1, IgG4, IgE, IgA and IgM (Conway *et al.*, 1994).

## IgG

Immunoglobulin G is the most abundant circulating antibody produced against *S. stercoralis*. In the early days of serological diagnosis, when whole larvae were used in the assays, up to 95% of patients were seen to have an IgG response against surface antigens (Dafalla, 1972; Grove and Blair, 1981). For this reason, measurement of IgG has become central in serological diagnosis. ELISAs, which now utilise crude extracts of the worm instead of whole worms, are largely based on IgG detection.

Despite being almost ubiquitous in strongyloidiasis, levels of IgG have not been shown to correlate with parasitological parameters, such as larval shedding in human or animal models (Sato *et al.*, 1985; Genta *et al.*, 1984, 1986). Carvalho *et al.* (1983) reported IgG levels to be significantly higher in patients who were asymptomatic compared to those with severe disease. This finding was not confirmed by follow-up studies, which

showed that there was no relationship between IgG levels and the clinical severity of strongyloidiasis (Badaro *et al.*, 1987). IgG was demonstrated in nine immunocompromised patients, four of whom had disseminated infections (Genta *et al.*, 1986). However, there was selective suppression of IgG (and IgE) in a single patient co-infected with HTLV-I who had severe strongyloidiasis.

A study of the subclasses of IgG in strongyloidiasis has shown that IgG1 and IgG4 are the major components of this immunoglobulin response (Conway *et al.*, 1994). IgG4 was the prominent subclass seen in a study of 20 patients and, with IgG2, was significantly more elevated in immunocompetent than immunocompromised patients (Genta and Lillibridge, 1989). Furthermore, IgG1 was seen to be upregulated early in infection but declined as infection became chronic, while IgG4 responses were also upregulated and sustained throughout the duration of infection (Atkins *et al.*, 1997).

### IgA

Like IgG, a large majority of persons infected with *S. stercoralis* have IgA responses against the parasite, demonstrable by ELISA (Genta *et al.*, 1987). The role of IgA in the immune control of strongyloidiasis is at best controversial. IgA-deficient dogs were similar to normal dogs with respect to the course and severity of infection and it was concluded that this isotype does not play a central role in protection from the parasite (Mansfield and Schad, 1992). However, in a study of chronically infected persons, those with occult infections (i.e. no detectable larvae in the stool) had significantly elevated IgA when compared to persons who had detectable larvae in stool. This finding suggests a role for IgA in determining the intensity of infection, similar to that postulated in *Trichuris trichiura* infections (Needham *et al.*, 1994).

### IgE

This isotype has been considered central in the control of strongyloidiasis and has been found in up to 90% of patients (McRury *et al.*, 1986).

However, in chronic strongyloidiasis total IgE response is often not elevated and there appears to be immunotolerance, with resulting reduction in gut-related morbidity (Gill and Bell, 1979; Sato *et al.*, 1986). Similarly, parasite-specific IgE decreases with duration of infection (Atkins *et al.*, 1997). Interestingly, both parasite-specific and total IgE production is depressed in patients with concurrent HTLV-I infection, which suggests that this isotype is central to the immune control of strongyloidiasis (Atkins *et al.*, 1998; Hayashi *et al.*, 1997; Robinson *et al.*, 1994; Newton *et al.*, 1992).

### IgM

Direct measurement of IgM in the sera of *S. stercoralis*-infected patients has not been very rewarding, since this is technically difficult and does not lead to clear results. However, in a series of experiments using larvae within diffusion chambers in the mouse, IgM has been shown to be central to immunity against invasive L<sub>3</sub> larvae in sensitised mice (Brigandi *et al.*, 1996). The mechanism of killing is dependent upon eosinophils and is thought to be via IgM-mediated classical pathway fixation of C3 (Brigandi *et al.*, 1996; Rotman *et al.*, 1996). About 90% of invasive L<sub>3</sub> and host-adapted L<sub>3</sub> larvae are killed in challenge infections (Brigandi *et al.*, 1997). In contrast, there is no killing of L<sub>3</sub>s involved in the autoinfective cycle, despite the presence of eosinophils and IgM bound to the surface of these larvae. Differences in antigenic composition are thought to be the main reasons for the resistance of autoinfective L<sub>3</sub> larvae to invasive L<sub>3</sub> killing mechanisms (Brigandi *et al.*, 1997). Although IgG1 was seen to be elevated in this model and in fact recognised more antigens than IgM, it did not play a role in protective immunity to invasive L<sub>3</sub> larvae.

### Cytokines

The T cell response against *S. stercoralis* is predominantly Th-2-immune, as seen in the antibody isotype response. Further, protective immunity against L<sub>3</sub> larvae can be ablated in

CD4<sup>+</sup>-depleted mice but is unaffected by CD8<sup>+</sup> depletion (Rotman *et al.*, 1997). Switching from a Th-2 to a Th-1 response by administering IL-12 also results in an ablation of protective immunity.

## EPIDEMIOLOGY

*Strongyloides stercoralis* is thought to infect 80–100 million persons worldwide (Genta, 1989c). This may be an underestimate, since most studies are based on examination of a single stool sample and the use of assays that are not sensitive.

Generally, the parasite is found throughout the tropics and sub-tropics, however, transmission of infections has been reported from many temperate countries, including Poland, the UK, southern USA, Romania, Belgium and Bulgaria (Stuerchler, 1981). The northern limits of transmission for the parasite appear to be a little above 56° (Prokhorov, 1983; Pawloski, 1989).

In tropical regions, where the parasite is endemic, it has been observed that the prevalence of infection is usually low, often less than 20%. This is thought to result from low fecundity of the parasitic female, which results in only a few infective larvae in the environment at any time. Filariform larvae are very susceptible to desiccation and require optimal conditions for survival; at best they can be expected to live for a few weeks. In addition, the free-living life cycle occurs for a single generation only and does not significantly prolong the presence of infective larvae in the environment (Yamada *et al.*, 1991). Low transmission, coupled with the chronic nature of strongyloidiasis (due to autoinfection), results in the low force of infection and low prevalence.

Among the places where *S. stercoralis* infection commonly occurs are mental institutions, where sanitation may be inadequate (Jeffrey, 1960; Proctor *et al.*, 1987; Braun *et al.*, 1988). In such instances the transmission of the parasite is likely to be by the homogonic route and close contact between the patients. Initial spread from and around a single case was documented in one study, although more widespread transmission was seen as prevalence increased. Rates of up to 42% have been recorded in a mental institution in

Chile (Cronjero *et al.*, 1985). Interestingly, such a pattern of close-contact transmission was not seen in a group of wives of infected exPOWs (Grove, 1982a). In contrast, possible close contact spread of infection was seen under conditions of acceptable hygiene and this may be more common than expected in endemic areas (Lindo *et al.*, 1995).

In addition to mental institutions, *S. stercoralis* infections are found in refugees or immigrants from developing countries (Sampson and Grove, 1987; Gyorkos *et al.*, 1990; Marnell *et al.*, 1992) and ex-prisoners of war (Gill *et al.*, 1979; Grove, 1980; Proctor *et al.*, 1985). Prevalence of 0.5–37% has been reported amongst Allied ex-prisoners of war who were detained in South-east Asia during World War II and were found to be infected (Genta, 1989c). Most surveys of refugees and recent immigrants to industrialised countries show very low prevalence (> 4%) which may reflect the situation in their countries of origin. Whilst control programmes for strongyloidiasis must be aimed at persons living in endemic areas in the tropics and subtropics, these well-established groups should be the focus of screening for the parasite before the initiation of immunosuppressive therapy.

The age-prevalence profile of *S. stercoralis* in endemic areas may follow two patterns. In areas of low endemicity (e.g. Jamaica and Okinawa, Japan) there is a slow rate of acquisition of infection with age (Lindo *et al.*, 1995; Arakaki *et al.*, 1992c). More typically, a rapid increase in prevalence is seen in the youngest age classes, with a peak at around 10 years of age. After this, infection levels may reach an asymptote or show a decline in the older age classes (Illardi *et al.*, 1987; Sornami *et al.*, 1974; Faust and Giraldo, 1960; Ashford *et al.*, 1992). Despite major differences in their life-cycles, these profiles are quite similar to those the common intestinal nematodes *Trichuris trichiura* and *Ascaris lumbricoides*.

It is not known what role acquired immunity to infection/reinfection with time (age) and/or differential exposure to infective stages plays in the observed age-prevalence patterns. However, more severe forms of strongyloidiasis are associated with increased rates of larval shedding, and typically disease occurs in persons of middle age (Rawlins *et al.*, 1983). These findings are



consistent with an increase in intensity of infection with age and may be related to changes in host or parasite factors, which results in a shift in the host–parasite balance.

An interesting epidemiological observation is the clustering of *S. stercoralis* infections within households. This pattern has been reported from Poland, Bangladesh, Jamaica and the USA, suggesting that it is more likely to result from characteristics of the parasite and the shared genetics within the family and less on those of the endemic area (Soroczan, 1976; Walzer *et al.*, 1982; Hall *et al.*, 1994; Lindo *et al.*, 1995). Household clusters present ideal targets for control programmes. Common infections within households may result from close-contact spread of infection, which may be enhanced by certain social and behavioural characteristics of the residents.

## CLINICAL FEATURES

In uncomplicated strongyloidiasis, most patients have a low worm burden and are asymptomatic or have only mild cutaneous and/or abdominal symptoms. When symptoms occur in these patients, they may do so irregularly and with asymptomatic periods (Liu and Weller, 1993).

### Skin Manifestations

The migrating filariform larvae may elicit a typical serpiginous eruption, larva currens, which is a pruritic, raised erythematous lesion that advances along the course of larval migration. The eruption tends to affect the buttocks, groins and trunk and occasionally the neck and thighs. The rash may migrate several centimetres per hour for up to 1–2 days (Gill and Bell, 1979; Grove, 1996). While currens are pathognomonic for *S. stercoralis* infection in some endemic areas, they have not been reported from others, such as the Caribbean (Terry, 1987).

There may be a non-specific urticarial rash in which wheals appear, especially around the wrist, lower abdomen and on the buttocks (Gann *et al.*, 1994). Petechial haemorrhages, pruritis ani and

papular rashes are other skin manifestations that may occur.

### Gastrointestinal Symptoms

Adult parasites burrow into the duodenojejunal mucosa and may cause abdominal pain, usually epigastric and usually worsened by food ingestion; this may mimic peptic ulcer disease. Nausea, vomiting, bloating and abdominal distention may be additional features. Abdominal tenderness, especially epigastric, is the most common abnormality on physical examination (Milder *et al.*, 1981). Cramping lower abdominal pain may be associated with intermittent or persistent diarrhoea. Malabsorption can be a complication in severe infection (Liu and Weller, 1993). Necrotising jejunitis, arteriomesenteric occlusion and small bowel infarct are unusual complications (Lee and Terry, 1989). Upper and lower gastrointestinal bleeding are rare complications (Bhatt *et al.*, 1990).

### Pulmonary Features

Pulmonary symptoms are unusual in uncomplicated strongyloidiasis. Filariform larvae passing through the lungs may produce a pneumonitis with patchy infiltrates. In complicated strongyloidiasis an irritative, non-productive cough may be present. Dyspnoea with wheezing may also occur. Respiratory failure is a rare development (Grove, 1996).

### Other Features

Anaemia, hypoalbuminaemia and eosinophilia are common with severe strongyloidiasis. Mild leucocytosis may occur. Stools may contain occult blood, mucus and Charcot–Leyden crystals.

### Disseminated Strongyloidiasis

Decreased host immunity may lead to hyperinfection, with the generation of a large number

of filariform larvae that may disseminate throughout the body. This is associated with a high morbidity and mortality. In disseminated strongyloidiasis larvae may invade the gastrointestinal tract, lungs, central nervous system, peritoneum, liver and kidney (Wurtz *et al.*, 1994; Liu and Weller, 1998). Bacteraemia and meningitis may develop due to enteric flora entering through disrupted mucosal barriers. Disseminated strongyloidiasis occurs most commonly in patients with organ transplants, leukaemia or lymphoma and those on corticosteroids (Torres *et al.*, 1993).

## LABORATORY DIAGNOSIS

### Stool Examination

Examination of fresh stool samples for rhabditiform larvae or cultured stool for filariform larvae are the main methods used for diagnosis of *S. stercoralis* because they are non-invasive. This is despite low sensitivity of stool examination; a single sample will yield a positive result in about 30% of cases (Milder *et al.*, 1981). At least two and up to seven samples should be examined to increase the sensitivity of the methods used (Grove, 1980; Dreyer *et al.*, 1996).

Clinical laboratories (especially those serving outpatient populations) frequently do not receive multiple stool samples from the same patient and the most sensitive technique for a single sample should be used. Information on the patient's travel history and non-specific indicators, such as eosinophilia and intestinal symptoms, will help in directing the laboratory towards examining the stool for *S. stercoralis*. The chance of finding the parasite will also increase with the size of the stool sample, and rectal swabs are unacceptable.

Examination of stool after a direct smear examination is unlikely to reveal larvae on a single sample and this method is not recommended for *S. stercoralis* (Kobayashi *et al.*, 1994). On the other hand, the formalin-ether technique, which is employed routinely by most clinical laboratories, will diagnose about half of infected cases on a single stool sample and is

preferred to direct smear examination (Ritchie, 1948; Allen and Ridley, 1970; Sato *et al.*, 1995b).

First-stage larvae can be extracted from fresh stool samples using the Baermann method. Stool is placed on cloth supported by a mesh in a funnel filled with water. The larvae will crawl through the cloth and into the water, from which they can be collected via a tap. The mass of stool may vary between 5 and 25 g and larger masses enhance the sensitivity of the method (de Kaminsky, 1993; Dreyer *et al.*, 1996; Lima and Delgado, 1961). Baermann extraction is labour-intensive and therefore does not lend itself to routine use in clinical laboratories. However, it is an excellent method for collecting large numbers of larvae for experimental studies.

Culture of the parasite on filter paper (Harada Mori method) or nutrient agar are preferred methods for improving the sensitivity of diagnosis of *S. stercoralis*. The former method is designed to harness the heterogonic component of the parasite's life cycle. Appearance of filariform larvae in the faecal culture will require at least 5 days (Harada and Mori, 1955). Faeces from the patient are smeared onto filter paper, which is placed into a test tube containing about 1 ml water. Care is taken that the smear is kept above the level of the water and the stool will be kept moist by the capillary movement of water up the filter paper. The cultures are kept at 22–25°C and after 5 days filariform larvae can be recovered and identified.

Agar plate culture is the most sensitive stool examination technique used for the diagnosis of *S. stercoralis* (Koga *et al.*, 1990, 1991, 1992). At least 3 g stool are placed on a nutrient agar plate, which is then incubated at 26–33°C for 2 days, and after this time tracks can be seen on the plate. These are colonies of bacteria that have grown in the paths of rhabditiform and homogonic filariform larvae (Figure 18c.3). Agar plate culture may detect > 90% of patients with known infection and is therefore the stool examination method of choice for diagnosing strongyloidiasis. In spite of the sensitivity of agar plate culture, multiple stool samples must always be examined to confirm a negative result. This is especially important, since a significant proportion of patients with chronic infections may be misdiagnosed, even after multiple stool examinations (Sato *et al.*, 1995b).

## Serological Diagnosis

Serological diagnosis of *S. stercoralis* infections is undertaken to rule out chronic infections in which larvae are not likely to be seen in the stool, to follow treatment and for mass screening of persons in endemic areas. These assays act as adjuncts to stool examination but are necessary because of the low sensitivity of the latter even when agar plate culture is used (Sato *et al.*, 1995a,b).

Serodiagnosis was first undertaken for human strongyloidiasis when Fulleborn (1926) developed a skin test. The assay has since been used by several workers as recently as the 1980s (Brannon and Faust, 1949; Tribouley-Duret *et al.*, 1976; Sato *et al.*, 1986). Generally, the assays were able to distinguish between infected and uninfected persons. However, these assays have generally given way to the enzyme-linked immunosorbent assay (ELISA).

Currently, the ELISA is the test most often used for serological diagnosis of strongyloidiasis. It has been reported to have sensitivities of 80–95% (Bailey, 1989; Conway *et al.*, 1993; Lindo *et al.*, 1994; Neva *et al.*, 1981). The ELISA for strongyloidiasis is limited by low specificity, due to cross-reactivity with hookworms and filarial worms (Conway *et al.*, 1993). However, specificity can be increased by pre-absorbing the test sera with antigens of *Onchocerca gutturosa* and *Dirofilaria immitis* adult worms (Conway *et al.*, 1993; Lindo *et al.*, 1994). The ELISA for strongyloidiasis may have limited use in immunocompromised patients, although the sensitivity can be increased by using anti-human biotinylated IgG avidin–peroxidase conjugates (Abdul-Fattah *et al.*, 1995).

Antigens used in ELISA are obtained from faecal cultures from infected patients or from animals kept for this purpose. The assays most often detect parasite-specific IgG and although they cannot distinguish between past and present infection, their use is invaluable in the diagnosis of occult infections. This is especially important for patients with clinical signs of disease but in whom worms cannot be demonstrated using stool examination (Gill and Bailey, 1989). Further, ELISA may rule out potentially fatal strongyloidiasis in patients who are candidates for immunosuppression.

A gelatin particle agglutination test (GPAT) for the diagnosis of *S. stercoralis* was developed and field-tested in Japan (Sato and Ryumon, 1990; Sato *et al.*, 1991). The method is based on the principle of indirect haemagglutination, but uses inert gelatin particles instead of sheep red blood cells as the antigen carrier. Unlike ELISA, this is a one-step assay which can be carried out in the field. Since gelatin beads are inert and there is no need for absorption of sera before the test, the test has increased adaptability for both clinical laboratories and mass screening in the field. GPAT was comparable to ELISA in diagnosing *S. stercoralis*, although there were a higher number of false positive results compared to ELISA. The method is easily adapted to field conditions and has the advantage that specialised equipment is not required.

## Use of Serology in Treatment Follow-up

High treatment failure rates necessitate follow-up of patients treated for strongyloidiasis. Often-times these persons will have reduced numbers of larvae in the stool as a result of chemotherapy and this leads to even lower sensitivity of stool examination. Serological diagnosis can be used to follow the efficacy of drug treatment since there is a fall in both parasite specific IgG and in the serum antibody isotypes IgG1, IgG4, IgA and IgE (Genta and Weil, 1982; Grove, 1982b; Lindo *et al.*, 1996b; Kobayashi *et al.*, 1994). The most applicable serological method for treatment follow-up is ELISA for parasite-specific IgG (Lindo *et al.*, 1996b; Kobayashi *et al.*, 1994). Patients in whom a significant fall in titre is not seen 1 year after treatment must be subsequently followed using stool examination (ideally agar plate culture).

Another important application of serological diagnosis of *S. stercoralis* has been to determine the efficacy of drug intervention. Several studies have shown a decrease in parasite-specific serum antibody titres following treatment for *S. stercoralis*. This decline provides presumptive evidence of drug efficacy, but it must be borne in mind that titres did not fall below pre-treatment levels in 32% of patients in one study (Kobayashi *et al.*, 1994) and the choice of controls is

important in determining the serological outcome (Lindo *et al.*, 1996b).

Future development in serological diagnosis of strongyloidiasis using coproantigen detection is promising. Work on *S. ratti* (Nageswaran Craig and Devaney, 1994) has shown that, using polyclonal antibodies, somatic antigens of the parasite could be detected at concentrations as low as 8 ng/ml and of E/S antigens could be detected at 8 ng/ml. The assay is limited by non-specific binding to faecal components but shows excellent specificity against several nematode antigens.

The use of antigens produced using recombinant DNA technology has also led to advances in the diagnosis of *S. stercoralis* (Ramachandran *et al.*, 1998). The use of these antigens obviates the need for infected animals. Work in this regard has produced a series of antigens which are equally or more reactive than the somatic antigens produced from filariform extracts. This work represents a first step towards the making of commercial assays.

### Detection of the Parasite in Material other than Stool

Larvae of *S. stercoralis* are often recovered from specimens other than stool, especially in patients with disseminated disease. Larvae are most often found in sputum samples and, although the respiratory tract is part of the normal path of larval migration, routine examination of sputum is unlikely to reveal larvae in the absence of disseminated disease. Examination of the sputum of patients with disseminated disease in wet mounts, Gram stain or Papanicolaou-stained smears may reveal larvae of the parasite (Harris *et al.*, 1980; Venizelos *et al.*, 1980; Kapila and Verma, 1982; Pillai *et al.*, 1993; Coulter *et al.*, 1992). Furthermore, parasites may also be found in gastric cytological sections (Sarangarajan, Belmonte and Tchertkoff, 1997). Whilst most authorities report finding filariform larvae, ova and rhabditiform larvae have been reported from sputum (Smith *et al.*, 1985; Chu *et al.*, 1990). These are probably the progeny of ectopic females.

Parasites may also be recovered from samples of duodenal fluid and the 'string test' (Beal *et al.*,

1970; Bezjak, 1972; Grove, 1980). This method appears less sensitive than stool examination and is not widely used (Grove, 1980). Whilst *S. stercoralis* may be demonstrated following duodenoscopy (either in duodenal fluid or biopsies; Grove, 1980; Milder *et al.*, 1981; Berk *et al.*, 1996), these methods are not considered sufficiently sensitive to be undertaken for the sole purpose of diagnosing *S. stercoralis* infections.

### MANAGEMENT

*Strongyloides stercoralis* infection presents a therapeutic challenge but should always be treated even in asymptomatic individuals when detected, because of the potential for hyperinfection, which may be fatal. For uncomplicated strongyloidiasis, thiabendazole, 25 mg/kg twice daily for 3 days is the traditional treatment. Thiabendazole is widely available and is rapidly absorbed, but is probably the least satisfactory of the available agents (Grove, 1996). In disseminated strongyloidiasis therapy should be continued for at least 7–10 days. Side-effects include nausea, vomiting, diarrhoea, dizziness, drowsiness, headache and neuropsychiatric disturbances. These include disorientation and delirium.

Albendazole is an alternative and cure rates are in the range 50–85%. In uncomplicated strongyloidiasis, albendazole is given in a dose of 400 mg twice daily for 3 days. Using this regimen, the primary cure rate is 75% (Archibald *et al.*, 1993). The side-effects, nausea and diarrhoea, are mild and transient. Mebendazole, 100 mg twice daily for 3 days, has a cure rate of 50% or less. It may be more effective when given daily for 3 weeks.

Ivermectin is now the drug of choice for strongyloidiasis. It is more effective and better tolerated than thiabendazole (Gann, 1994). Cure rates reported vary (67–100%; Naquira *et al.*, 1989; Liu and Weller, 1993). In uncomplicated strongyloidiasis, ivermectin is given in a single dose of 200 µg (0.2 mg)/kg. Ivermectin eradicates adult worms and larvae from the intestine but is not reliable in removing infective larvae from other organs.

In patients with uncomplicated strongyloidiasis who fail the initial regimen and for patients with disseminated strongyloidiasis, the following regimens may be considered: (a) thiabendazole 25 mg/kg for 7–14 days or until the parasites are eradicated; (b) albendazole 400 mg daily for 3 weeks; (c) ivermectin 200 µg/kg weekly for 4 weeks; (d) mebendazole 100 mg daily for 3 weeks.

## PREVENTION AND CONTROL

*S. stercoralis* transmission requires poor sanitation, thus infection will decline with increasing socioeconomic status. This is evident in Japan, where transmission is not likely to have occurred in the last 20 years and where infection is rare in individuals less than 40 years old (Arakaki *et al.*, 1992b). Improvement in sanitation may be the best approach to the control of *S. stercoralis* and other soil-transmitted nematodes.

High-risk groups, such as former prisoners-of-war, recent immigrants from endemic areas, institutionalised patients such as the mentally handicapped and prisoners should be targeted for chemotherapy. This is especially important before these persons are given immunosuppressive therapy.

In endemic areas, particular risk factors for transmission must be identified before the implementation of control programmes. For example, in Bangladesh poor sanitation, young age, use of community latrines as opposed to private facilities and Bihari ethnicity were important risk factors for transmission (Conway *et al.*, 1994). Similarly, in the southern USA poor sanitation and lack of indoor plumbing were the most important factors (Walzer *et al.*, 1982). There appears to be no general predilection to gender, despite a finding of higher prevalence in males in some studies (Hall *et al.*, 1994). The occurrence of household outbreaks may provide an ideal target for chemotherapeutic intervention. Identification of a single case can lead to the finding of foci of infection and this method has been used in research to track infected individuals in communities of low prevalence (Lindo *et al.*, 1995; Atkins *et al.*, 1997). Targeted chemotherapy is most suited for areas of low prevalence where population-based treatment would not be a cost-

effective option. Therefore, as a general rule it appears that sanitary disposal of faeces and maintenance of good basic personal hygiene are the best approaches to prevention of strongyloidiasis. To this end, the use of 'night soil' as fertiliser and the use of recycled sewage for irrigation should be discouraged.

The best prospects for chemotherapeutic control of strongyloidiasis are in using improved techniques of diagnosis (ELISA, GPAT and agar plate culture) and the safest and most efficacious drug (ivermectin). In fact, with the availability of ivermectin, which is well-tolerated and efficacious, there is now a real prospect of community treatment for strongyloidiasis. The best approach may be screening of individuals using serology, followed by stool examination in persons who are seropositive, and treatment of those found infected.

Mass chemotherapy using thiabendazole was used in Brazil and Costa Rica, with a significant decline in prevalence. However, such an approach is unlikely to be cost-effective in areas of low endemicity and, although ivermectin is better tolerated than thiabendazole, its widespread use cannot be encouraged in the face of the potential of target and non-target pathogens developing resistance.

In endemic areas, where the force of infection is high, the age-prevalence profile is similar to that seen for other common worm infections, such as *Trichuris trichiura* or *Ascaris lumbricoides*. There may be some merit in incorporating control of *S. stercoralis* infection in school-based control programmes for helminths, e.g. the Partnership for Child Development. In this case the drug of choice would be albendazole, which is effective against more worm species than ivermectin (Marti *et al.*, 1996). Evidence from mass treatment of *S. stercoralis* infection and what we know of the biology of the parasite (general low force of infection) suggests that the rates of reinfection among school children would be low. Therefore, it is expected that there would be a community-wide benefit from the treatment of school children.

Clearly, it may be necessary to have more than one approach to targeted chemotherapy to effect a reduction in prevalence of infection over all age classes within a short time. This depends on the dynamics of transmission in the endemic area under consideration.

## HUMAN INFECTIONS WITH *STRONGYLOIDES FULLEBORNI*

### INTRODUCTION AND CLASSIFICATION

Human infections with egg-producing *Strongyloides* have been reported in a very discontinuous distribution across much of Africa (Ashford and Barnish, 1989; Pampiglione and Riccardi, 1971, 1972). Such infections have been recorded from the horn of Africa to southern Namibia and South Africa and to West and Central Africa and have been attributed to *S. fulleborni*, a parasite commonly found in non-human primates (Ashford and Barnish, 1989; Muriuki *et al.*, 1998; Munene *et al.*, 1998).

Outside of Africa, human infection with an egg-producing *Strongyloides* was reported from isolated areas of Papua New Guinea (Kelly *et al.*, 1976). The absence of naturally occurring non-human primates on Papua New Guinea raised the question of the phylogeny of this species and for a long time it was described as *Strongyloides* cf. *fulleborni*, which speaks both to its taxonomic closeness to the African species and the uncertainty of its true lineage. However, based on analysis of isoenzyme data, the position of its phasmid pore and appearance of the cuticle in the peri-vulval region, the New Guinea *Strongyloides* was designated a subspecies of *S. fulleborni* and is now *S. fulleborni* var *kellyi*.

### EPIDEMIOLOGY

Both the African and Papua New Guinea species were generally found in isolated villages associated with forest dwellings. However, the parasite is not a strict zoonosis with non-primate reservoir hosts, since this would not account for infections in Papua New Guinea or in urban and peri-urban areas in some areas of Africa (Hira and Patel, 1980). In at least some areas, *S. fulleborni* should be considered a well-adapted species in man.

The parasite has been isolated from very young children and adults in both locations (Brown and Girardeau, 1977; Ashford *et al.*, 1978). In Africa, infections have been reported from children as young as 50 days old, while in Papua New Guinea infections have been reported in children

as young as two months old. The isolation of three larvae from the milk of a woman in the Republic of Congo (formerly Zaire) suggests that transmammmary transmission of the organism may occur (Brown and Girardeau, 1977). However, several efforts at establishing this as the main mode of transmission have failed. Prenatal infections are unlikely to occur based on the pre-patent period of parasite (Ashford *et al.*, 1992).

While the mode of initial infection remains unclear, the high intensities of infection seen in very young children in Papua New Guinea have been attributed to the cultural habit of carrying infants in string bags carriers (bilium) for the entire first year of life. These bags are lined with dried banana leaves and can become very soiled with faeces. Eggs and larvae have been recovered from the bags and this suggests that they serve as a good source of infective larvae. In an isolated New Guinea village, intensity peaked at 20 months and declined thereafter and by age one, 60% of children were infected. Since eggs and not larvae are recovered in the stool, it is unlikely that internal or indeed external autoinfection takes place (Hira and Patel, 1980).

### CLINICAL FEATURES

The clinical presentation of *Strongyloides fulleborni kellyi* has been described (Vince *et al.*, 1979; Ashford *et al.*, 1992). There is no apparent relationship between intensity of infection and clinical presentation since some heavily infected children are apparently asymptomatic. The most severe disease presentation is referred to as 'swollen belly syndrome' or 'swollen belly disease'. Typically, this affects children around 2 months old and has been reported from only two areas of Papua New Guinea. The disease presents as a protein-losing enteropathy caused by the effects of the worms on the gut (Ashford *et al.*, 1992; Barnish and Harari, 1989; Vince *et al.*, 1979). Classically, the patient will present with abdominal distention and respiratory distress and there is no gender predilection. While there may be mild diarrhoea, fever and vomiting, but these are not consistent findings. Pitting oedema

and greatly reduced serum protein levels are more typically found. Interestingly, babies are said to have a high-pitched cry and the syndrome is often fatal.

## LABORATORY DIAGNOSIS

Diagnosis of *S. fülleborni* is based on the detection of eggs in the stool of the patient. The eggs, which contain developing larvae, measure 50 × 30 µm and must be distinguished from those of hookworms, which are longer and narrower (60 × 40 µm). Examination of the stool soon after it is voided is advantageous, since it is typically held together in clumps and will contain developing larvae. The shape of the eggs may become distorted as the larvae and range of sizes and shapes may be seen in a single stool sample.

## TREATMENT

Infections with both *S. fülleborni* and *S. fülleborni kellyi* have been successfully treated with thiabendazole at a dosage of 25 mg/kg twice daily for 3 days. However, it is not known whether some of the safer anthelmintics, such as albendazole and ivermectin, are effective against the parasites.

## REFERENCES

- Abdul-Fattah MM, Nasr ME, Yousef SM *et al.* (1995). Efficacy of ELISA in diagnosis of strongyloidiasis among the immune-compromised patients. *J Egypt Soc Parasitol* **25**: 491–8.
- Abraham D, Rotman HL, Haberstroh HF *et al.* (1995). *Strongyloides stercoralis*: protective immunity to third-stage larvae in BALB/cByJ mice. *Exp Parasitol* **80** (2): 297–307.
- Aikens LM, Schad GA (1989). Radiolabelling of infective third-stage larvae of *Strongyloides stercoralis* [<sup>35</sup>Se] selenomethionine-labelled *Escherichia coli* to first and second stage larvae. *J Parasitol* **75**: 735–9.
- al-Bahrani ZR, al-Saleem T, al-Gailani MA (1995). Sub-acute intestinal obstruction by *Strongyloides stercoralis*. *J Infect* **30** (1): 47–50.
- Allen AHV, Ridley DS (1970). Further observations on the formal-ether concentration technique for faecal parasites. *J Clin Pathol* **23**: 545–6.
- Arakaki T, Iwanaga M, Kinjo F *et al.* (1990). Efficacy of agar-plate culture in detection of *Strongyloides stercoralis* infection. *J Parasitol* **76**: 425–8.
- Arakaki T, Asato R, Ikeshiro T, Sakiyama K, Iwanaga M (1992a). Is the prevalence of HTLV-1 infection higher in *Strongyloides* carriers than in non-carriers? *Trop Med Parasitol* **43**: 199–200.
- Arakaki T, Kohakura M, Asato R *et al.* (1992b). Epidemiological aspects of *Strongyloides stercoralis* infection in Okinawa, Japan. *J Trop Med Hyg* **95**: 210–13.
- Arakaki T, Iwanaga M, Asato R, Ikeshiro T (1992c). Age-related prevalence of *Strongyloides stercoralis* infection in Okinawa, Japan. *Trop Geogr Med* **44**: 299–303.
- Archibald LK, Beeching NJ, Gill GV, Bailey JW, Bell DR (1993). Albendazole is effective treatment for chronic strongyloidiasis. *Q J Med* **86**: 191–5.
- Arguedas GJA, Villarejos VM, Swartwelder JC *et al.* (1975). Community control of *Strongyloides stercoralis* by thiabendazole. *Texas Rep Biol Med* **33**: 265–8.
- Ashford RW, Barnish G (1989). *Strongyloides fülleborni* infections in humans. In Grove DI (ed.), *Strongyloidiasis: A Major Helminth Infection of Man*. London: Taylor and Francis.
- Ashford RW, Barnish G, Viney ME (1992). *Strongyloides fülleborni kellyi*: infection and disease in Papua New Guinea. *Parasitol Today* **8**: 314–18.
- Ashford RW, Craig PS, Oppenheimer SJ (1992). Polyparasitism on the Kenyan Coast 1. Prevalence and associations between parasitic infections. *Ann Trop Med Parasitol* **86**: 67–679.
- Ashford RW, Vince JD, Gratten MJ, Mile WE (1978). *Strongyloides* infection associated with acute infantile disease in Papua New Guinea. *Trans R Soc Trop Med Hyg* **72**: 554.
- Ashraf M, Gue CL, Baddour LM (1996). Case report: strongyloidiasis refractory to treatment with ivermectin. *Am J Med Sci* **311**: 178–9.
- Atkins NS, Lindo JF, Lee MG *et al.* (1997). Humoral responses in human strongyloidiasis: correlations with infection chronicity. *Trans R Soc Trop Med Hyg* **91**: 609–13.
- Atkins NS, Lindo JF, Lee MG *et al.* (1998). Immunomodulatory effects of concurrent HTLV-1 infection in strongyloidiasis. *J Acq Imm Defic Syndr Hum Retrovirol* **18**: 188–90.
- Badaro F, Carvalho EM, Santos RB, Gam AA, Genta RM (1987). Parasite-specific immune responses in different clinical forms of strongyloidiasis. *Trans R Soc Trop Med Hyg* **81**: 149–50.
- Bailey JW (1989). A serological test for the diagnosis of *Strongyloides* antibodies in ex-Far East Prisoners of War. *Ann Trop Med Parasitol* **83**: 241–7.
- Barnish G, Harari M (1989). Possible effects of *Strongyloides fülleborni*-like infections on children in the Karimui area of Simbu Province. *Papua New Guinea Med J* **32**: 51–4.
- Bavay (1876). Sur l'anguillule stercorale (presentee par MP Gervais). *Compt Rend Hebd Seanc Acad Sci* **83**: 694–6.
- Bavay A (1877a). Sur l'anguillule intestinale (*Anguillula intestinalis*) nouveau ver nematoide, trouve par le Dr Normand chez les malades atteints de diarrhee de Cochinchine (presentee par M. P. Gervais). *Compt Rend Hebd Seanc Acad Sci* **84**: 266–8.
- Bavay A (1877b). Note sur l'anguillule intestinale (*Anguillula intestinalis*), nouveau ver nematoide, trouve par Dr

- Normand chez les malades atteints de diarrhee de Cochinchine. *Arch Med Navale* **28**: 64–7.
- Beal CB, Viens P, Grant RG (1970). A new technique for sampling duodenal contents: demonstration of upper small bowel pathogens. *Am J Trop Med Hyg* **19**: 349–52.
- Berk SL, Verghese A, Alvarez S, Hall K, Smith B (1996). Clinical and epidemiologic features of strongyloidiasis in rural Tennessee. *Arch Intern Med* **147**: 1257–61.
- Bezjak BA (1972). Evaluation of a new technique for sampling duodenal contents in parasitologic diagnosis. *Am J Dig Dis* **17**: 848–50.
- Bezjak B (1975). Immunoglobulin studies in strongyloidiasis with special reference to raised serum IgE levels. Preliminary communication. *Am J Trop Med Hyg* **24**: 945–8.
- Bhatt BD, Cappell MS, Smilow PC, Das KM (1990). Recurrent massive upper gastrointestinal hemorrhage due to *Strongyloides stercoralis* infection. *Am J Gastroenterol* **85**: 1034–6.
- Boken DJ, Leoni PA, Preheim LC (1993). Treatment of *Strongyloides stercoralis* hyperinfection syndrome with thiabendazole administered per rectum. *Clin Infect Dis* **16** (1): 123–6.
- Brannon MJ, Faust EC (1949). Preparation and testing of a specific antigen for diagnosis of human strongyloidiasis. *Am J Trop Med Hyg* **29**: 229–39.
- Braun TI, Fekete T, Lynch A (1988). Strongyloidiasis in an institution for mentally retarded persons. *Arch Int Med* **148**: 634–6.
- Brigandi RA, Rotman HL, Yutanawiboonchai W *et al.* (1996). *Strongyloides stercoralis*: role of antibody and complement in immunity to the third stage of larvae in BALB/cByJ mice. *Exp Parasitol* **82** (3): 279–89.
- Brigandi RA, Rotman HL, Nolan TJ, Schad GA, Abraham D (1997). Chronicity in *Strongyloides stercoralis* infections: dichotomy of the protective immune response to infective larvae in a mouse model. *Am J Hyg* **56**: 640–6.
- Brocq O, Breuil V, Agopian V *et al.* (1996). Reactive arthritis induced by *Strongyloides stercoralis*. *Rev Rheumat* **63** (3): 217–19.
- Brown RC, Girardeau HF (1977). Transmammary passage of *Strongyloides* sp. larvae in the human host. *Am J Trop Med Hyg* **26**: 215–19.
- Carvalho EM, Andrade TM, Andrade JA, Rocha H (1983). Immunological features in different clinical forms of strongyloidiasis. *Trans R Soc Trop Med Hyg* **77**: 346–9.
- Celedon JC, Mathur-Wagh U, Fox J *et al.* (1994). Systemic strongyloidiasis in patients infected with the human immunodeficiency virus. A report of three cases and review of the literature. *Medicine* **73**: 256–63.
- Chu E, Whitlock WL, Dietrich RA (1990). Pulmonary hyperinfection syndrome with *Strongyloides stercoralis*. *Chest* **97**: 1475–7.
- Conway DJ, Lindo JF, Robinson RD, Bundy DAP, Bianco AE (1994). *Strongyloides stercoralis*: characterization of immunodiagnostic larval antigens. *Exp Parasitol* **79**: 99–105.
- Conway DJ, Atkins NS, Lillywhite JE *et al.* (1993). Immunodiagnosis of *Strongyloides stercoralis* infection: a method for increasing the specificity of the indirect ELISA. *Trans R Soc Trop Med Hyg* **87** (2): 173–6.
- Conway DJ, Hall A, Anwar KS, Rahman ML, Bundy DAP (1995). Household aggregation of *Strongyloides stercoralis* in Bangladesh. *Trans R Soc Trop Med Hyg* **89**: 258–61.
- Coulter C, Walker DG, Gunsberg M *et al.* (1992). Successful treatment of disseminated strongyloidiasis. *Med J Aust* **157**: 331–2.
- Cremades Romero MJ, Martinez Garcia MA, Menendez Villanueva R, Cremades Romero ML, Peman Garcia JP (1996). [*Strongyloides stercoralis* infection in a cortico-dependent patient with chronic airflow obstruction.] *Arch Bronconeumol* **32** (8): 430–1 (in Spanish).
- Cronjero J, Arias B, Subiabre V, Quijada M, Schenone H (1985). Estudio epidemiológico de protozosis y helmintiasis intestinales en 490 pacientes crónicos del hospital Psiquiátrico de Putaendo V. Region Chile. *Bol Chileno Parasitol* **40**: 91–3.
- Crouch PR, Shield JM (1982). *Strongyloides fulleborni*-like infections in Anga children. *Papua New Guinea Med J* **25**: 164–5.
- Dafalla AA (1972). The indirect fluorescent antibody test for the serodiagnosis of strongyloidiasis. *J Trop Med Hyg* **75**: 109–11.
- Datry A, Hilmarsdottir I, Mayorga-Sagastume R *et al.* (1994). Treatment of *Strongyloides stercoralis* infection with ivermectin compared with albendazole: results of an open study of 60. *Trans R Soc Trop Med Hyg* **88** (3): 344–5.
- do Goede E, Martens M, Van Rooy S, VanMoerkerke I (1995). A case of systemic strongyloidiasis in an ex-coal miner with idiopathic colitis. *Eur J Gastroenterol Hepatol* **7** (8): 807–9.
- de Kaminsky RG (1993). Evaluation of three methods for laboratory diagnosis of *Strongyloides stercoralis* infection. *J Parasitol* **79** (2): 277–80.
- Dreyer G, Fernandes-Silva E, Alves S *et al.* (1996). Patterns of detection of *Strongyloides stercoralis* in stool specimens: implications for diagnosis and clinical trials. *J Clin Microbiol* **34** (10): 2569–71.
- Dwarakanath AD, Welton M, Ellis CJ, Allan RN (1994). Interrelation of strongyloidiasis and tuberculosis. *Gut* **35** (7): 1001–3.
- Faust EC (1933). Experimental studies on human and primate species of *Strongyloides* in the experimental host. *Am J Trop Med Hyg* **18**: 144–32.
- Faust FC, Giraldo LE (1960). Parasitological survey in Cali Del Valle, Colombia. *Trans R Soc Trop Med Hyg* **54**: 556–63.
- Gann PH, Neva FA, Gam AA (1994). A randomized trial of single and two-dose ivermectin versus thiabendazole for treatment of strongyloidiasis. *J Infect Dis* **169**: 1076–9.
- Gelber M, Rodrig J (1996). [*Strongyloides stercoralis* hyperinfection.] *Harefuah* **130** (2): 90–2, 143 (in Hebrew).
- Gemmill AW, Viney ME, Read AF (1997). Host immune status determines sexuality in a parasitic nematode. *Evolution* **51**: 393–401.
- Genta RM (1989a). *Strongyloides stercoralis*: loss of ability to disseminate after repeated passage in laboratory beagles. *Trans R Soc Trop Med Hyg* **83**: 539–41.
- Genta RM (1989b). Immunology. In Grove DI (ed.), *Strongyloidiasis: A Major Roundworm Infection of Man*. London: Taylor and Francis.



- Genta RM (1989c). Global prevalence of strongyloidiasis: critical review with epidemiologic insight into prevention of disseminated disease. *Rev Infect Dis* **11**: 755–67.
- Genta RM (1992). Dysregulation in strongyloidiasis: new hypothesis. *Clin Micro Rev* **5**: 345–55.
- Genta RM, Lillibridge JP (1989). Prominence of IgG4 antibodies in the human responses to *Strongyloides stercoralis* infection. *J Infect Dis* **160**: 692–9.
- Genta RM, Weil GJ (1982). Antibodies to *Strongyloides stercoralis* larval surface antigens in chronic strongyloidiasis. *Lab Invest* **47**: 87–90.
- Genta RM, Harper JS, Gam AA, London WJ, Neva FA (1984). Experimental disseminated strongyloidiasis in *Erythrocebus patas*. Part II. Immunology. *Am J Trop Med Hyg* **33**: 444–50.
- Genta RM, Schad GA, Hellman ME (1986). *Strongyloides stercoralis*: parasitologic immunological and pathological observations in immunosuppressed dogs. *Trans R Soc Trop Med Hyg* **80**: 34–41.
- Genta RM, Frei DF, Linke MJ (1987). Demonstration and partial characterization of parasite-specific immunoglobulin A responses in human strongyloidiasis. *J Clin Microbiol* **25**: 1505–10.
- Gill GV, Bailey JW (1989). Eosinophilia as a marker for chronic strongyloidiasis—use of a serum ELISA test to detect asymptomatic cases. *Ann Trop Med Parasitol* **83**: 249–52.
- Gill GV, Bell DR (1979). *Strongyloides stercoralis* infection in former Far East prisoners of war. *Br Med J* **2**: 572–4.
- Gill GV, Bell DR, Fifield ● (1979). Lack of immunoglobulin E response in longstanding strongyloidiasis. *Clin Exp Immunol* **37**: 292–4.
- Golgi C, Monti A (1884). Intorno ad una questione elmintologica. *Rendi Reale Ist Lombardo Sci Lett Milan Ser II* **17**: 285–8.
- Gordon SM, Gal AA, Solomon AR, Bryan JA (1994). Disseminated strongyloidiasis with cutaneous manifestations in an immunocompromised host. *J Am Acad Dermatol* **31** (2, pt 1): 255–9.
- Goulart EG, Jourdan MC, Brazil RP *et al.* (1977). Ecological control of hookworm and strongyloidiasis. *J Helminthol* **51**: 131–2.
- Graeff-Teixeira C, Medeiros E, Zanini GM *et al.* (1938). Studies on *Strongyloides*. II. Homogonic and heterogonic progeny of the single homogonically derived parasite. *Am J Trop Med Hyg* **24**: 71–87.
- Graeff-Teixeira C, Medeiros E, Zanini GM *et al.* (1997). Inexpensive alternative material for the isolation of larvae with the Baermann method. *Mem Inst Oswaldo Cruz* **92**: 399–400.
- Grassi GB (1876). Sovra l'Anquillula intestinale. *Rendi Reale Ist Lombardo Sci Lett Milan Ser II* **12**: 228–33.
- Grassi GB (1879). Parasitologia umna Rivista. Sovra l'Anquillula intestinale. *Med Contemp Milan* **3**: 495–7.
- Grassi GB (1882). Anchylostomi e anquillule. *Gazz ospedali Clin Milan* **3**: 325.
- Grassi GB, Parona ● (1879). Sovra l'Anquillula intestinale (dell'uomo) e sopra embrioni probabilmente d'Anquillula intestinale. *Arch Sci Med Torino* **3**: 1–15.
- Grove DI (1980). Strongyloidiasis in Allied ex-prisoners of war in south-east Asia. *Br Med J* **3**: 598–601.
- Grove DI (1982a). Strongyloidiasis: is it transmitted from husband to wife? *Br J Ven Dis* **58**: 271–2.
- Grove DI (1982b). Treatment of strongyloidiasis with thiabendazole: an analysis of toxicity and effectiveness. *Trans R Soc Trop Med Hyg* **76**: 114–18.
- Grove DI (1989a). Historical introduction. In Grove DI (ed.), *Strongyloidiasis: A Major Roundworm Infection of Man*. London: Taylor & Francis.
- Grove DI (1989b). Diagnosis. In Grove DI (ed.), *Strongyloidiasis: A Major Roundworm Infection of Man*. London: Taylor & Francis.
- Grove DI (1994). Strongyloidiasis: a conundrum for gastroenterologists. *Gut* **35**: 437–40.
- Grove DI (1996). Human strongyloidiasis. *Adv Parasitol* **38**: 251–309.
- Grove DI, Blair AJ (1981). Diagnosis of human strongyloidiasis by immunofluorescence, using *Strongyloides ratti* and *S. stercoralis* larvae. *Am J Trop Med Hyg* **30**: 344–9.
- Gyorkos TW, Genta RM, Viens P (1990). Seroepidemiology of *Strongyloides stercoralis* in the south-east Asian refugee population in Canada. *Am J Trop Med Hyg* **132**: 257–64.
- Hall A, Conway DJ, Anwar KS, Rahman ML (1994). *Strongyloides stercoralis* in an urban slum community in Bangladesh: factors independently associated with infection. *Trans R Soc Trop Med Hyg* **88**: 527–30.
- Hall A, Conway DJ, Anwar KS, Rahman ML (1994). *Strongyloides stercoralis* in an urban slum community in Bangladesh: factors independently associated with infection. *Trans R Soc Trop Med Hyg* **8**: 527–30.
- Hammond MP, Robinson RD (1994). Chromosome complement, gametogenesis and development of *Strongyloides stercoralis*. *J Parasitol* **80**: 689–95.
- Harada Y, Mori O (1955). A new method for culturing hookworms. *Yonago Acta Med* **1**: 177–9.
- Harris RA, Musher DM, Fainstein V, Young EJ, Clarridge J (1980). Disseminated strongyloidiasis: diagnosis made by sputum examination. *J Am Med Assoc* **244**: 65–6.
- Hayashi J, Kishihara Y, Yoshimura E *et al.* (1997). Correlation between human T cell lymphotropic virus type-1 and *Strongyloides stercoralis* infections and serum immunoglobulin E responses in residents of Okinawa, Japan. *Am J Trop Med Hyg* **56**: 71–5.
- Hira PR, Patel BG (1977). *Strongyloides fülleborni* infections in man in Zambia. *Am J Trop Med Hyg* **26**: 640–3.
- Hira PR, Patel BG (1980). Human strongyloidiasis due to the primate species *Strongyloides fülleborni*. *Trop Geogr Med* **32**: 23–9.
- Huang MS, Hwang KP, Chiang PC, Hwang JJ (1996). Pulmonary hyperinfection with *Strongyloides stercoralis*. *J Formosan Med Assoc* **95** (7): 551–4.
- Igra-Siegman U, Kapila R, Sen P, Kaminski ZC, Louria DB (1981). Syndrome of hyperinfection with *Strongyloides stercoralis*. *Rev Infect Dis* **3**: 397–407.
- Illardi I, Shiddo SC, Mohamed HH, Mussa C, Hussein AS (1987). The prevalence and intensity of intestinal parasites in two Somali communities. *Trans R Soc Trop Med Hyg* **81**: 336–8.
- International Commission on Zoological Nomenclature (1915). Nematode and Gordiacea names placed in the

- official list of generic names (Opinion 66). Publication 2359. Smithsonian Institution: Washington, DC; 171–6.
- Jeffrey GM (1960). A three year epidemiologic study of intestinal parasites in a selected group of mental patients. *Am J Trop Med Hyg* **71**: 1–8.
- Jozefzoon LM, Oostburg BF (1994). Detection of hookworm and hookworm-like larvae in human feco-cultures in Surinam. *Am J Trop Med Hyg* **51** (4): 501–5.
- Kapila K, Verma K (1982). Cytologic detection of parasitic disorders. *Acta Cytol* **26**: 359–62.
- Kelly A, Little MD, Vogue M (1976). *Strongyloides fulleborni*-like infections in man in Papua New Guinea. *Am J Trop Med Hyg* **25**: 694–9.
- Kobayashi J, Sato Y, Toma H, Takara M, Shiroma Y (1994). Application of enzyme immunoassay for postchemotherapy evaluation of human strongyloidiasis. *Diagn Microbiol Infect Dis* **18** (1): 19–23.
- Koga K, Kasuya S, Ohtomo H (1992). How effective is the agar plate method for *Strongyloides stercoralis*? *J Parasitol* **78**: 155–6.
- Koga K, Kasuya S, Khamboonruang C *et al.* (1990). An evaluation of the agar plate method for the detection of *Strongyloides stercoralis* in northern Thailand. *J Trop Med Hyg* **93**: 183–8.
- Koga K, Kasuya S, Khamboonruang C *et al.* (1991). A modified agar plate method for detection of *Strongyloides stercoralis*. *Am J Trop Med Hyg* **45**: 518–21.
- Kreis HA (1932). Studies on the genus *Strongyloides*. *Am J Trop Med Hyg* **16**: 450–91.
- Laveran A (1877). Note relative de nematoide de ladsenterie de Cochinchine. *Gaz Hebd Med Chir* **14**: 42–3.
- Lee MG, Terry SI (1989). Arterioesenteric duodenal occlusion associated with strongyloidiasis. *J Trop Med Hyg* **92**: 41–5.
- Leeman BJ, Cabrera MR (1995). No association found between *Strongyloides* infestation and asthma. *J Asthma* **32** (1): 57–62.
- Lessnau KD, Can S, Talavera W (1993). Disseminated *Strongyloides stercoralis* in human immunodeficiency virus-infected patients. Treatment failure and a review of the literature. *Chest* **104** (1): 119–22.
- Leuckart R (1883). Über die Lebensgeschichte der sogenannten *Anguillula stercoralis* und deren Beziehungen zu sogenannten *Anguillula intestinalis*. Bericht über die Verhandlungen der königlich sächsischen. *Gesellsch Wissensch Leipzig Math Phys Class* **34**: 85–107.
- Lima JP, Delgado PG (1961). Diagnosis of strongyloidiasis: importance of Baermann's method. *Am J Dig Dis* **6**: 899.
- Lindo JF, Robinson RD, Terry SI *et al.* (1995). Age-prevalence and household clustering of cases of *Strongyloides stercoralis* infection in Jamaica. *Parasitology* **110**: 97–102.
- Lindo JF, Dubon JM, Ager AL *et al.* (1998). Intestinal parasitic infections in human immunodeficiency virus (HIV)-positive and HIV-negative individuals in San Pedro Sula, Honduras. *Am J Trop Med Hyg* **58** (4): 431–5.
- Lindo JF, Conway DJ, Atkins NS *et al.* (1994). Prospective evaluation of enzyme-linked immunosorbent assay and immunoblot methods for the diagnosis of endemic *Strongyloides stercoralis* infection. *Am J Trop Med Hyg* **51** (2): 175–9.
- Lindo JF, Atkins NS, Lee MG, Robinson RD, Bundy DA (1996a). Short report: long-term serum antibody isotype responses to *Strongyloides stercoralis* filariform antigens in eight patients treated with ivermectin. *Am J Trop Med Hyg* **55**: 474–6.
- Lindo JF, Atkins NS, Lee MG, Robinson RD, Bundy DA (1996b). Parasite-specific serum IgG following successful treatment of endemic strongyloidiasis using ivermectin. *Trans R Soc Trop Med Hyg* **90** (6): 702–3.
- Little MD (1966). Comparative morphology of six species of *Strongyloides* (Nematoda) and redefinition of the genus. *J Parasitol* **52**: 69–84.
- Liu LX, Weller PF (1998). Intestinal nematodes. In Fauci AS, Braunwald E, Isselbacher KJ *et al.* (eds), *Principles of Internal Medicine*, 14th edn. McGraw-Hill: New York.
- Liu LX, Weller PF (1993). Strongyloidiasis and other intestinal nematode infections. *Infect Dis Clin N Am* **3**: 655–82.
- Mansfield LS, Schad GA (1992). *Strongyloides stercoralis* infection in IgA-deficient dogs. *Am J Trop Med Hyg* **47**: 830–6.
- Mansfield LS, Alavi A, Wortman JA, Schad GA (1995). Gamma camera scintigraphy for direct visualization of larval migration in *Strongyloides stercoralis*-infected dogs. *Am J Trop Med Hyg* **52** (3): 236–40.
- Marnell F, Guillet A, Holland C (1992). A survey of intestinal helminths of refugees in Juba Sudan. *Ann Trop Med Parasitol* **86**: 387–93.
- Marti H, Haji HJ, Savioli L *et al.* (1996). A comparative trial of a single-dose ivermectin versus three days of albendazole for treatment of *Strongyloides stercoralis* and other soil-transmitted helminth infections in children. *Am J Trop Med Hyg* **55** (5): 477–81.
- McRury J, deMessias IT, Walzer PD, Huitger T, Genta RM (1986). Specific IgE responses in human strongyloidiasis. *Clin Exp* **65**: 594–601.
- Milder JE, Walzer PD, Kilgore G (1981). Clinical features of *Strongyloides stercoralis* infection in an endemic area of the United States. *Gastroenterology* **80**: 1481–8.
- Mojon M, Nielsen PB (1987). Treatment of *Strongyloides stercoralis* with albendazole. A cure rate of 86%. *Zentralbl Bakteriol Mikrobiol Hyg* **263**: 619–24.
- Moncol DJ, Triantaphyllou AC (1978). *Strongyloides ransomi*: factors influencing the *in vitro* development of the free-living generation. *J Parasitol* **64**: 220–5.
- Munene E, Otsyula M, Mbaabu DA *et al.* (1998). Helminth and protozoan gastrointestinal tract parasites in captive and wild-trapped African non-human primates. *Vet Parasitol* **78**: 195–201.
- Muriuki SM, Murugu RK, Munene E, Karere GM, Chai DC (1998). Some gastrointestinal parasites of zoonotic (public health) importance commonly observed in old world non-human primates in Kenya. *Acta Trop* **71**: 73–82.
- Nageswaran C, Craig PS, Devaney E (1994). Coproantigen detection in rats experimentally infected with *Strongyloides ratti*. *Parasitology* **108** (3): 335–42.
- Naquira C, Jimenez G, Guerra JG *et al.* (1989). Ivermectin for human strongyloidiasis and other intestinal helminths. *Am J Trop Med Hyg* **40**: 304–9.

- Needham CS, Lillywhite JE, Didier JM, Bundy DAP (1994). Serum isotype responses after treatment of human trichuriasis. *Trans R Soc Trop Med Hyg* **88**: 3541–55.
- Neva FA, Gam AA, Burke J (1981). Comparison of larval antigens in an enzyme-linked immunosorbent assay for strongyloidiasis. *J Infect Dis* **144**: 427–32.
- Newton RC, Limpaungthip P, Greenberg S, Gam A, Neva FA (1992). *Strongyloides stercoralis* hyperinfection in a carrier of HTLV-1 virus with evidence of selective immunosuppression. *Am J Med* **91**: 109–13.
- Nomura J, Rekrut K (1996). *Strongyloides stercoralis* hyperinfection syndrome in a patient with AIDS: diagnosis by fluorescent microscopy. *Clin Infect Dis* **22** (4): 736.
- Normand L (1876). Sur la maladie dite diarrhee de Cochinchine. (Extrait d'une lettre adressee à M. le President par M. le vice-amiral Jurien de la Graviere.) *Compt Rend Hebd Seanc Acad Sci* **83**: 316–18.
- Owen RL (1993). Parasitic Diseases. In Slesinger MH, Fordtran JS (eds), *Gastrointestinal Disease*, 5th edn. WB Saunders: Philadelphia, PA; 1190–224.
- Palau LA, Pankey GA (1997). *Strongyloides* hyperinfection in a renal transplant recipient receiving cyclosporine: possible *Strongyloides stercoralis* transmission by kidney transplant. *Am J Trop Med Hyg* **57**: 413–15.
- Pampiglione S, Ricciardi ML (1971). The presence of *Strongyloides fülleborni* von Linstow, 1905, in man in Central and East Africa. *Parasitologia* **13**: 257–69.
- Pampiglione S, Ricciardi ML (1972). [Presence of *Strongyloides fülleborni* in man in tropical Africa. Further epidemiological studies. Human experimental infection.] *Bull Soc Pathol Exot Filiales* **65**: 112–19 (in French).
- Pawloski ZS (1980). Epidemiology, prevention and control. In Grove DI (ed.), *Strongyloidiasis: A Major Roundworm Infection of Man*. Taylor & Francis: London.
- Pelletier LL (1984). Chronic strongyloidiasis in World War II Far East ex-prisoners of war. *Am J Trop Med Hyg* **33**: 55–61.
- Perroncito E (1881). Observations sur le developpement de l'*Anguillula stercoralis* (Bavay) *Pseudorhabditis stercoralis* hors de l'organisme humain. *J Anat Physiol* **17**: 499–519.
- Phelps KR (1993). *Strongyloides* hyperinfection in patients co-infected with HTLV-I and *S. stercoralis*. *Am J Med* **94**: 447–9.
- Pillai KR, Nair GR, Amma NS, Nair MK (1993). Diagnosis of pulmonary strongyloidiasis by sputum cytology: a case report. *Ind J Pathol Microbiol* **36** (4): 489–91.
- Plumelle Y, Edouard A (1996). *Strongyloides stercoralis* in T-cell leukemia/lymphoma in adults and acquired immunodeficiency syndrome. *Rev Med Intern* **17** (2): 125–9.
- Plumelle Y, Gonin C, Edouard A *et al.* (1997). Effect of *Strongyloides stercoralis* infection and eosinophilia on age at onset and prognosis of adult T-cell leukemia. *Am J Clin Pathol* **107**: 81–7.
- Plumelle Y, Pascaline N, Nguyen D *et al.* (1993). Adult T-cell leukemia-lymphoma: a clinico-pathologic study of twenty-six patients from Martinique. *Hematol Pathol* **7**: 251–62.
- Polderman AM, Verweij JJ, Vetter JC, Verburg GP, de Geus A (1994). *Strongyloides* infections in former prisoners of war in South-East Asia in the Second World War: additional information from serological diagnosis. *Ned Tijdschr Geneesk* **138** (23): 1174–7.
- Prociw P, Luke R (1993). Observations on strongyloidiasis in Queensland aboriginal communities. *Med J Aust* **158**: 160–3.
- Proctor EM, Isaac-Renton JL, Robertson WB (1985). Strongyloidiasis in Canadian Far East war veterans. *J Can Med Assoc* **133**: 876–8.
- Proctor EM, Muth HAV, Proudfoot DL *et al.* (1987). Endemic institutional strongyloidiasis in British Columbia. *J Can Med Assoc* **136**: 1173–6.
- Prokhorov AF (1983). Prediction of the northern border of strongyloidiasis distribution in a moderate climatic zone. *Med Parazitol Parazitarnye Bolezni* **61**: 71–8.
- Ramachandran S, Thompson RW, Gam AA, Neva FA (1998). Recombinant cDNA clones for immunodiagnosis of strongyloidiasis. *J Infect Dis* **177**: 196–203.
- Rawlins SC, Terry SI, Chen WN (1983). Some laboratory, epidemiological and clinical features of *Strongyloides stercoralis* infection in a focus of low endemicity. *West Ind Med J* **32**: 212–18.
- Ritchie IM (1948). Formalin-ether sedimentation for stool examination. *Bull US Army Med Dep* **8**: 326.
- Robinson RD, Lindo JF, Neva FA *et al.* (1994). Immunoepidemiologic studies of *Strongyloides stercoralis* and human T cell lymphotropic virus type I infections in Jamaica. *J Infect Dis* **169** (3): 692–6.
- Rotman HL, Yutanawiboonchai W, Brigandi RA *et al.* (1996). *Strongyloides stercoralis*: eosinophil-dependent immune-mediated killing of third stage larvae in BALB/cByJ mice. *Exp Parasitol* **82** (3): 267–78.
- Rotman HL, Schnydercandrian S, Scott P *et al.* (1997). IL-12 eliminates the TH-2-dependent protective immune response of mice to *Strongyloides stercoralis*. *Parasite Immunol* **19**: 29–39.
- Sampson IA, Grove DI (1987). Strongyloidiasis is endemic in another Australian population group: Indochinese immigrants. *Aus J Med* **146**: 580–2.
- Sarangarajan R, Belmonte AH, Tchertkof f V (1997). *Strongyloides stercoralis* hyperinfection diagnosed by gastric cytology in an AIDS patient. *AIDS* **11**: 394–6.
- Sato Y, Kobayashi J, Shiroma Y (1995a). Serodiagnosis of strongyloidiasis. The application and significance. *Rev Inst Med Trop Sao Paulo* **37** (1): 35–41.
- Sato Y, Ryumon I (1990). Gelatin particle indirect agglutination test for serodiagnosis of human strongyloidiasis. *Jap J Parasitol* **39**: 213–19.
- Sato Y, Otsuru M, Takara M, Shiroma Y (1986). Intradermal reactions in strongyloidiasis. *Int J Parasitol* **16**: 87–91.
- Sato Y, Kobayashi J, Toma H, Shiroma Y (1995b). Efficacy of stool examination for detection of *Strongyloides* infection. *Am J Trop Med Hyg* **53** (3): 248–50.
- Sato Y, Shiroma Y, Kiyuna S, Toma H, Kobayashi J (1994). Reduced efficacy of chemotherapy might accumulate concurrent HTLV-1 infection among strongyloidiasis patients in Okinawa, Japan. *Trans R Soc Trop Med Hyg* **88** (1): 59.
- Sato Y, Toma H, Kiyuna S, Shiroma Y (1991). Gelatin particle indirect agglutination test mass examination for human strongyloidiasis. *Trans R Soc Trop Med Hyg* **85**: 515–18.

- Sato Y, Takara M, Otsuru M (1985). Detection of antibodies in strongyloidiasis by enzyme-linked immunosorbant assay (ELISA). *Trans R Soc Trop Med Hyg* **79**: 51–5.
- Schad GA (1989). Morphology and life history of *Strongyloides stercoralis*. In Grove DI (ed.), *Strongyloidiasis: A Major Roundworm Infection of Man*. Taylor & Francis: London.
- Schad GA, Aikens LM, Smith G (1989). *Strongyloides stercoralis*: is there a canonical migratory route through the host? *J Parasitol* **75**: 740–9.
- Schad GA, Thompson F, Talham G *et al.* (1997). Barren female *Strongyloides stercoralis* from occult chronic infections are rejuvenated by transfer to parasite-naive recipient hosts and give rise to an autoinfective burst. *J Parasitol* **83**: 785–91.
- Schad GA, Hellman ME, Muncey DW (1984). *Strongyloides stercoralis*: hyperinfection in immunosuppressed dogs. *Exp Parasitol* **57**: 287–96.
- Scowden EB, Schaffner W, Stone WJ (1978). Overwhelming strongyloidiasis. An unappreciated opportunistic infection. *Medicine* **57**: 527–44.
- Sen P, Gil C, Estrellas B, Middleton JR (1995). Corticosteroid-induced asthma: a manifestation of limited hyperinfection syndrome due to *Strongyloides stercoralis*. *South Med J* **88** (9): 923–7.
- Shikiya K, Zaha O, Niimura S *et al.* (1994). [Clinical study on ivermectin against 125 strongyloidiasis patients.] *Kansenshogaku Zasshi—J Jap Assoc Infect Dis* **68** (1): 13–20 (in Japanese).
- Smith B, Verghese A, Guitierrez C, Dralle W, Berk SL (1985). Pulmonary strongyloidiasis: diagnosis by sputum Gram stain. *Am J Med* **79**: 633–6.
- Sornami S, Pathammavong O, Bunnang T *et al.* (1974). An epidemiological survey of human intestinal parasites in Vientiane, Laos. *SE Asia J Trop Med Publ Health* **5**: 541–6.
- Soroczan W (1976). *Strongyloides stercoralis* in eastern and south-eastern Poland. *Wiadomosci Parazytologiczne* **22**: 515–16.
- Speare R (1986). Studies on the Taxonomy of *Strongyloides* (Nematoda: Strongyloidea). PhD Thesis, James Cook University of North Queensland, 290 pp.
- Speare R (1989). Identification of species of *Strongyloides*. In Grove DI (ed.), *Strongyloidiasis: A Major Roundworm Infection of Man*. Taylor & Francis: London.
- Stiles CW, Hassal A (1902). *Strongyloides stercoralis*, the correct name of the parasite of Cochin China diarrhoea. *Am Med* **4**: 343.
- Stuerchler D (1981). *Endemiegebiete tropischer Infektionskrankheiten*. Hans Huber: Bern; 204–5.
- Terry SI (1987). *Strongyloides stercoralis*—a dangerous helminthic infection. *Postgrad Doctor* **10**: 152–62.
- Terry SI, Blattner WA, Neva FA *et al.* (1989). Coincidental HTLV-1 influences outcome of treatment of strongyloidiasis. *W Ind Med J* **38** (suppl): 36.
- Torres JR, Isturiz R, Murillo J, Guzman M, Contreras R (1993). Efficacy of ivermectin in the treatment of strongyloidiasis complicating AIDS. *Clin Infect Dis* **17** (5): 900–2.
- Tribouley-Duret J, Tribouley J, Pautrizel R (1976). Interet des tests d'allergie cutanee por le diagnostic de la strongyloidose. *Bull Soc Pathol Exot* **69**: 360–7.
- Venzelos PC, Lopata M, Bardawil WA, Sharp JT (1980). Respiratory failure due to *Strongyloides stercoralis* in a patient with a renal transplant. *Chest* **78**: 104–6.
- Vince JD, Ashford RW, Gratten MJ, Bana-Koiri J (1979). *Strongyloides* species infestation in young infants of Papua, New Guinea: association with generalised oedema. *Papua New Guinea Med J* **22**: 120–7.
- Viney ME (1996). Developmental switching in the parasitic nematode *Strongyloides ratti*. *Proc R Soc Lond Ser B: Biol Sci* **263** (1367): 201–8.
- Walzer PD, Milder JE, Barnwell JG *et al.* (1982). Epidemiologic features of *Strongyloides stercoralis* infection in an endemic area of the United States. *Am J Trop Med Hyg* **31**: 313–19.
- Wehner JH, Kirsch CM, Kagawa FT *et al.* (1994). The prevalence and response to therapy of *Strongyloides stercoralis* in patients with asthma from endemic areas. *Chest* **106** (3): 762–6.
- Wertheim G, Lengy J (1965). Growth and development of *Strongyloides ratti* Sandground, 1925, in the albion rat. *J Parasitol* **51**: 636–9.
- Wurtz R, Mirot M, Fronda G, Peters C, Kocka F (1994). Gastric infection by *Strongyloides stercoralis*. *Am J Trop Med Hyg* **513**: 339–40.
- Yamada M, Matsuda S, Nakazawa M, Arizono N (1991). Species-specific differences in heterogonic development of serially transferred free-living generation of *Strongyloides planiceps* and *Strongyloides stercoralis*. *J Parasitol* **51**: 339–40.
- Yoeli M, Most H, Hammond J, Scheinsson GP (1972). Parasitic infections in a closed community. *Trans R Soc Trop Med Hyg* **66**: 764–76.
- Zaman V, Dawkins HJS, Grove DI (1980). Scanning electron microscopy of the penetration of newborn mouse skin by *Strongyloides ratti* and *Ancylostoma caninum* larvae. *SE Asian J Trop Med Publ Health* **112**: 212–19.

# Toxocariasis

**M. R. H. Taylor and Celia V. Holland**

*Trinity College, Dublin, Ireland*

## HISTORICAL INTRODUCTION

The nematode worms *Toxocara canis* and *Toxocara cati* were first described by Werner (1798) and Schrank (1788), respectively. Ransom and Foster (1920) recognised that *T. canis* infected hosts other than the dog. These authors found the larvae of *T. canis* in the lungs of rats following the ingestion of embryonated eggs. Sprent (1952) noted the presence of larvae in the intestine, liver, lungs, kidneys, skeletal muscles and nervous tissue of mice following infection. Levine (1980) showed that many mammals and birds could be infected. Basic features of the life-cycles of *T. canis* and *T. cati* were first described by Sprent (1957, 1958).

Three clinical syndromes have now been associated with human infection with *Toxocara*: visceral larva migrans, ocular larva migrans and covert toxocariasis. Historically speaking these syndromes were described as follows.

### Visceral Larva Migrans (VLM)

In the early 1920s and 1930s a number of authors recognised that larval *Toxocara* spp. were potentially infective to humans (Fulleborn, 1921; Chandler, 1925; Schwartz, 1932) but it was not until 20 years later that a clinical syndrome in children, characterised by persistent eosinophilia, was attributed to infection with ascarid larvae. Four reports described chronic extreme

eosinophilia accompanied by eosinophilic granulomatous lesions in an enlarged liver, together with some degree of pulmonary infiltration, fever, cough and hyperglobulinaemia (Zuelzer and Apt, 1949; Perlingiero and Gyorgy, 1947; Mercer *et al.*, 1950; Behrer, 1951). Parasites were not described by Zuelzer and Apt, but the other three reports suggested that the infective agent was *Ascaris lumbricoides* (this was disputed by Beaver and colleagues in their subsequent paper and *Toxocara* was put forward as a more credible aetiological agent). Then Beaver *et al.* (1952) described three further human cases and identified *T. canis* larvae in a liver biopsy specimen. This led to the designation of the term 'visceral larva migrans' to describe the migration of larvae through the tissues and the consequent clinical symptoms and pathogenesis associated with the larval presence. The essentials for diagnosis of visceral larva migrans have been regarded as eosinophilia of over 30% in children with a history of eating dirt and with no other cause of eosinophilia (Snyder, 1961).

### Ocular Larva Migrans (OLM)

The second major clinical syndrome associated with toxocariasis is ocular larva migrans and this was first recognised by Wilder (1950), who observed microscopic evidence of nematode infection in eyes which had been enucleated because retinoblastoma was suspected. In 24 of

the 46 eyes, either the larva or a residual hyaline capsule was seen. These larvae were later identified as *Toxocara* spp. by Nichols (1956). Prior to this, Calhoun (1937) had recorded invasion of the anterior chamber of a child's eye by a nematode larva, which he identified as an *Ascaris* larva.

### Covert Toxocariasis (CT)

The third, much more recently described syndrome associated with human toxocariasis is covert toxocariasis. This term was put forward by Taylor *et al.* (1987) to describe a series of comparatively non-specific but recognisable symptoms and signs associated with raised *Toxocara* titres but not falling into either of the categories of ocular larva migrans or classical visceral larva migrans. That such an entity might exist had been suggested by Bass *et al.* (1983). Taylor *et al.* (1987) recorded symptoms and signs, including abdominal pain, anorexia, nausea, vomiting, hepatomegaly, splenomegaly, lethargy and weakness, limb pains, cough, wheeze, asthma, cervical adenitis and pharyngitis.

Recent reviews of toxocaral disease, mainly from the viewpoint of human disease, have been published both as papers (Gillespie, 1993; Magnaval *et al.*, 1994) and in book form (Lewis and Maizels, 1993).

## DESCRIPTION OF THE ORGANISM

### Taxonomic Classification

*Toxocara* spp. belong to the Phylum Nematoda, Subclass II Secernentea, Order 2 Ascaridida, Superfamily Ascaridoidea (Smyth, 1994). The order Ascaridida is described as a group of large intestinal worms with a three-lipped mouth, pharynx bulbed or cylindrical, vagina elongate, male usually with ventrally curled tail and two spicules, alae may be present.

### Morphology

#### Adult Worms

The two species *Toxocara canis* (Werner, 1782) Johnstone, 1916, and *Toxocara cati* (Shrank,

1788; Brumpt, 1927), are ascaridid nematodes which live as adult worms in the proximal intestine of dogs and cats, respectively (Coombs and Crompton, 1991). Adult female *T. canis* worms measure 6–18 cm and males 4–10 cm; female *T. cati* measure 4–12 cm and males 3–6 cm (Glickman and Schantz, 1981).

### Eggs

The eggs of the two species are indistinguishable at the light microscopic level, both being described as nearly or almost spherical, sometimes oval, with a thick, rough pitted shell and dark brown to black granular contents. The eggs of *T. canis* are sometimes larger, measuring 75 × 90 µm, in contrast to *T. cati* at 65 × 75 µm (Thienpoint *et al.*, 1979).

### Larvae

The infective larvae of *T. canis* and *T. cati* are about 400 µm long and 15–21 µm in diameter. The two species are almost identical morphologically, differing only in their maximum diameter (*T. canis* 18–21 µm, *T. cati* 15–17 µm).

### Life-cycle

The life-cycle of *T. canis* in the dog, *T. cati* in the cat and *Toxocara* infection in the paratenic host, including humans, will be described separately. It should be stated that there is a perception, albeit based upon circumstantial evidence, that *T. cati* is less significant as an aetiological agent in human infections, but at this stage it is not routinely possible to distinguish between the two species serologically.

However, Petithory *et al.* (1993) reported, out of a total of nine human cases of ocular larva migrans, the presence of antibody to *T. cati* in the vitreous humour of six subjects. In all cases but one, antibody to *T. canis* was also present. On the basis of these observations, the authors put forward the suggestion that *T. cati* may play a more important role in ocular larva migrans than previously thought.

One significant factor in reducing the likelihood of human *T. cati* infection may be the

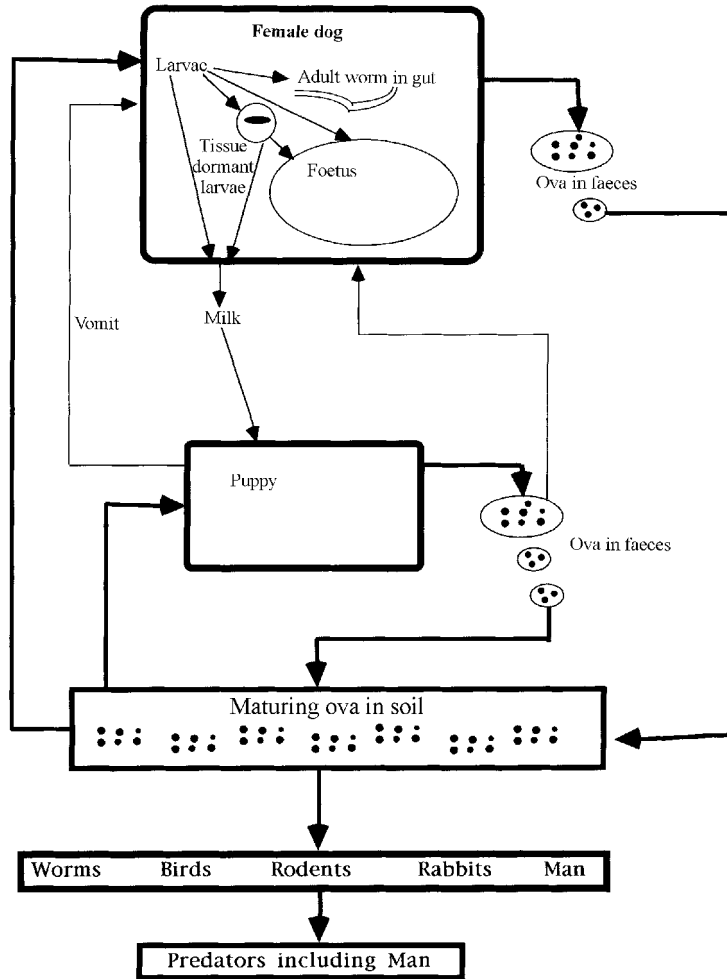


Fig. 19a.1 Life-cycle of *Toxocara canis*

more fastidious defaecation habits of cats compared with dogs, and hence the lower number of *T. cati* eggs compared to *T. canis* eggs detected in soil samples (O’Lorcain, 1994). Under experimental conditions, O’Lorcain (1995) recorded that embryonated *T. cati* ova exhibited greater resistance to freezing than those of *T. canis*, a factor that might influence the relative survival of the ova under certain climatic conditions.

**Life-cycle in the Dog**

Lloyd (1993) has suggested that the life-cycle in the dog (Figure 19a.1) is best understood if

divided into two parts: (a) adult *T. canis* infections in the intestines of puppies and the lactating bitch; and (b) adult *T. canis* infections in mature dogs.

Adult *T. canis* infections in the intestines of puppies and the lactating bitch arise from three sources—somatic migration of larvae, maternal transmission of larvae to the puppies and infection of immature worms from puppies to the mother. Embryonated and hence infective eggs in the environment are ingested by the bitch (and other mature dogs), hatch in the intestine, and then the larvae undergo a somatic migration to the tissues. Larvae are first found in the liver, then the lungs and finally the skeletal muscles;

they can also be found in other sites, including the brain. Maternal transmission of larvae from mother to offspring usually occurs transplacentally and arises from somatic larvae accumulated prior to or in early pregnancy (Burke and Roberson, 1985). Transplacental migration occurs after the 42nd day of pregnancy and has been attributed to hormonal changes in the pregnant bitch. Larvae can also be transmitted via the mammary glands and the milk. Once the puppies are born, larvae from their tissues complete their migration via the lungs and end up as adult worms in the small intestine. Lactating bitches can become infected with *Toxocara* eggs by cleaning up after their puppies and ingesting faeces or vomitus containing eggs.

Mature dogs, like bitches, can become infected by ingesting infective *T. canis* eggs from the environment. These hatch and the larvae undergo a tracheal migration and end up as mature adult worms in the intestine. This tracheal migration involves the penetration of larvae into the pulmonary blood vessels, followed by entrance into the alveoli, migration up the bronchi and trachea and eventual swallowing of larvae and their emergence into the small intestine. Some larvae may also become arrested in the tissues and become dormant. In addition, adult dogs may become infected as a consequence of ingesting the tissues of a variety of infected paratenic hosts (see below). Infection with *T. canis* occurs in a range of other carnivores, particularly the red fox (*Vulpes vulpes*) (Richards and Lewis, 1993).

### ***Life-cycle in the Cat***

The life-cycle of *T. cati* is essentially similar to that of *T. canis*. The major difference lies in the fact that transplacental infection from mother to offspring does not occur but transmammary infection is common (Oldham, 1965; Soulsby, 1982). Infection derived from paratenic hosts is likely to be important in cats, due to their predatory nature and the fact that sources of infective eggs will be less common due to their fastidious defaecatory behaviour.

### ***Toxocara canis* Infection in the Paratenic Host, Including Humans**

*Toxocara* infective eggs can be ingested by a variety of non-canid paratenic or transport hosts. These include earthworms, rats, mice, pigeons, chickens, lambs, pigs and, most significantly, humans. The eggs hatch to produce second stage larvae that undergo a somatic migration but fail to mature into adult worms in the intestine. It should be noted that there is some debate as to the number of moults the larvae undergo at this stage. Following maturation in the soil, the embryonic eggs undergo one moult within the egg and then infective larvae hatch in the host intestine to produce the invasive L<sub>2</sub> stage. The larvae remain arrested in a variety of tissues and organs and only upon ingestion by an appropriate definitive host will they develop to maturity in the host intestine. There is also evidence from experimentally infected rodents that these *Toxocara* larvae are capable of accumulation in the brain (Dunsmore *et al.*, 1983). Human infection has classically been associated with geophagia (earth eating). Infection may also occur from ingestion of eggs from soil-contaminated hands or from soil-contaminated vegetables, eaten raw, or from undercooked or raw animal products (Salem and Schantz, 1992; Nagakura *et al.*, 1989).

### **PATHOGENESIS**

The pathogenesis of disease differs in different hosts. In a definitive host such as the dog, infection of the adult intestine with *Toxocara* worms normally causes little disturbance or intestinal pathology. Infected puppies can exhibit intestinal pathology accompanied by poor growth, vomiting and diarrhoea, and death can occur when infections are very heavy (Lloyd, 1993).

Other species, such as mice and humans, can act as paratenic hosts in which the life-cycle halts at the larval stage and no adult worms develop to maturity within the host intestine. In this situation, the presence of migrating larvae within the tissues contributes to pathology that is dependent upon the intensity of infection and the location of the larvae. Two organs of particular concern that



are known to be invaded by *Toxocara* larvae are the eye and the brain. Various aspects of ocular toxocariasis are discussed further in the sections on Epidemiology, Clinical Signs, Diagnosis and Treatment. Most of the pathology associated with this infection results from tissue damage caused by inflammatory responses induced by the presence of larvae and the activity of certain toxic products produced by the larvae themselves.

Larval invasion of the brain is common in mice and there is evidence that larvae accumulate in that organ (Dunsmore *et al.*, 1983). The relationship between observed behavioural changes in infected murine hosts and the potential significance for humans is discussed in the Epidemiology section. A number of cases of infection of the human brain have been recorded in the literature (Hill *et al.*, 1985). One particular case was reported from a child aged 2.5 years, killed by non-accidental injury (Hill *et al.*, 1985). The child was said to have cried incessantly. Nematode larvae were found in the pons, right frontal lobe and white matter of the cerebellum and surrounded by a giant cell reaction.

Transplacental infection has not been recorded in humans. Kincekova *et al.* (1995) reported the detection of anti-*Toxocara* IgM antibody in seven out of 24 neonates born to IgG-seropositive mothers suggesting that transplacental infection may have occurred. Taylor *et al.* (1996) studied maternal and cord blood sera. The cord blood sera were found to reflect maternal levels of total anti-*Toxocara* antibody. All positive cord blood samples were examined for IgM anti-*Toxocara* antibody but none was found, suggesting that reactivation of dormant larvae with subsequent transplacental infection of the foetus did not occur in this human study group. It was noted that there was a higher miscarriage rate in the *Toxocara*-positive mothers.

In contrast, evidence for transplacental infection in mice has been recorded by a number of authors (Lee *et al.*, 1976; Hassan and El-Manawaty, 1994). Reduction in litter size has also been reported in *Toxocara canis*-infected mice (Akao *et al.*, 1990).

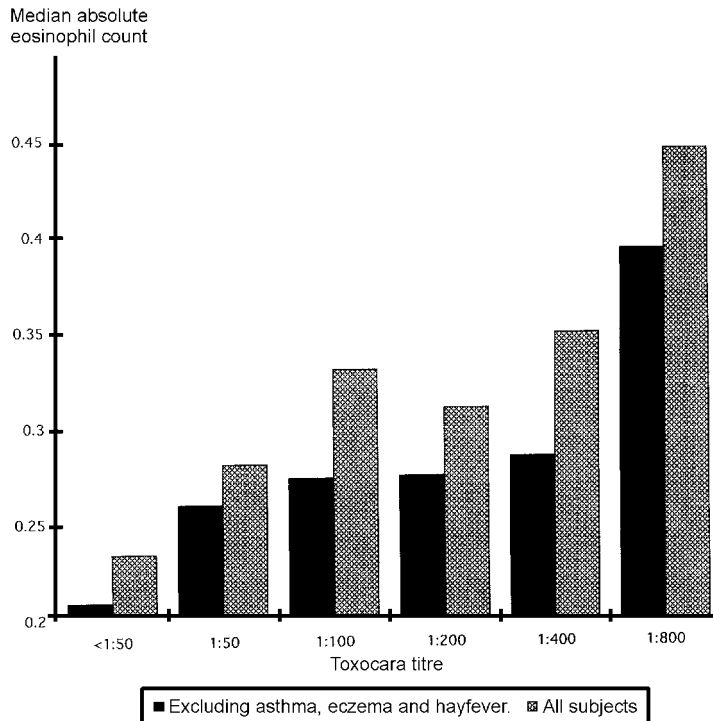
### Excretory–Secretory Antigens

Larvae of *T. canis* are known to survive for long periods of time in culture and to produce large

amounts of excretory–secretory (ES) antigen (de Savigny, 1975). These properties have provided the opportunity for this system to be used to study the functional aspects of the ES antigen, and as a model for other tissue-invasive helminths that are less easily maintained under laboratory conditions (Maizels and Robertson, 1991).

Five major TES (*Toxocara canis* excreted–secreted antigens) macromolecules have been defined and are described as TES-32, TES-55, TES-70, TES-120 and TES-400 kDa (Maizels *et al.*, 1984; Meighiji and Maizels, 1986; Maizels and Robertson, 1991). All the major TES products are glycosylated and there is evidence for *O*-linked sugars and proteoglycan-like polymers (Maizels *et al.*, 1993). These glycoconjugates are rapidly recognised by the immune system and provoke strong antibody responses. There is no indication that these responses have a protective function and it has been suggested by Maizels and Robertson (1991) that one advantage of producing large quantities of ES antigen is to divert the immune system into the synthesis of ineffective antibody.

*Toxocara* larvae have been shown to be resistant to direct killing by eosinophils from guinea pigs (Badley *et al.*, 1987) and humans (Fattah *et al.*, 1986). Eosinophils adhere, activate and degranulate but the larvae show little sign of damage and indeed are able to slough off the cells, together with extracuticular material (Maizels and Robertson, 1991). The release of surface antigens may be additional to the normal turnover of surface antigens from the larval cuticle (Maizels *et al.*, 1984; Smith *et al.*, 1981). Evidence now suggests that the surface coat, containing some TES antigen, is formed to serve as a labile structure to be shed on attack by antibody or effector cells (Page *et al.*, 1992). This ties in with the earlier suggestion by Smith *et al.* (1981) of a dynamic larval surface which, when bound by antibody, is sloughed off unless metabolically arrested. The extracuticular layer has been described as an electron-dense, fuzzy envelope 10 nm in thickness and detached from the epicuticle (Maizels and Selkirk, 1988; Maizels and Page, 1990). It has been termed the electron-dense layer of granular material (DGM), with similarities to a glycocalyx (Page *et al.*, 1992). More recently, Maizels and colleagues have



**Fig. 19a.2** Median absolute eosinophil counts in relation to *Toxocara* titre for (a) all subjects and (b) after exclusion of those with asthma, eczema or hay fever

extended this investigation of ES antigens to characterise two different presumptive ES/surface molecules, one an abundantly expressed mucin-like protein (Gems and Maizels, 1996) and the other a phosphatidyl ethanolamine-binding protein (Gems *et al.*, 1995).

*T. canis* larvae produce an elastase-like protease that is capable of degrading extracellular matrix proteins (Robertson *et al.*, 1989). It has been suggested that these secreted proteases are used by the larvae during tissue migration. In addition to these protective and other functions, the ES antigens on the surface of *Toxocara* larvae also contribute to pathogenesis. Antigen has been identified in circulating immune complexes (Bowman *et al.*, 1987) and in the tissues of infected animals (Parsons *et al.*, 1986). In chronic infections antigen was localised within granulomas as well as in 'verminous tracks' in the absence of larvae, a finding which suggests antigen shedding.

## IMMUNOLOGY

Infective larvae elicit a characteristically strong and persistent immune response in humans, involving leucocytosis, eosinophilia and hypergammaglobulinaemia in the form of an increase in IgG, IgM and IgE antibodies to TES (Smith, 1993). Children who are *Toxocara*-seropositive have higher eosinophil counts than those who are seronegative (Taylor *et al.*, 1997) (see Figure 19a.2). In some situations, the larvae may be surrounded by a granulomatous response, which may immobilise and destroy the larva, although this is not always the case.

### Antibody Responses

The antibody response to toxocaral infection may not be uniform in all human subjects. For example, Smith and colleagues have demonstrated

a range of titres to TES in patients with covert toxocariasis (Taylor *et al.*, 1987; Smith *et al.*, 1988; Page and Smith, 1988). In a comparison of patients who met the criteria of VLM, OLM and CT, the IgE responses of the VLM/OLM group were much higher than the CT group (Smith, 1993). Furthermore, the ability of antibodies from the CT group to bind the surfaces of metabolically arrested larvae were less than those of the VLM/OLM group (Smith, 1993).

## Liver

The liver is now well recognised as an important site for controlling the migration of larval *T. canis*. Several authors have shown that, unlike the migration in immunologically naive mice, where larvae pass from the liver to the lungs and then progress to other sites such as the brain, in sensitised mice a large proportion of larvae remain in the liver and do not migrate to other organs (see Parsons and Grieve, 1990a,b). This so-called 'liver-trapping phenomenon' (Grieve *et al.*, 1993) has been shown to be influenced by sensitising egg dose and duration of infection (Parsons and Grieve, 1990a,b). Liver trapping has also been shown to be under immunological control and athymic mice, for example, do not exhibit this phenomenon (Sugane and Oshima, 1983). Various potential effector mechanisms for liver trapping have been investigated, including the involvement of eosinophils and parasite-specific IgE, but neither of these effectors appeared to be important (Grieve *et al.*, 1993).

## EPIDEMIOLOGY OF TOXOCARIASIS

This section will deal primarily with humans and other animal hosts will only be mentioned in the context of their relevance to human infection.

### Seroprevalence

Due to the fact that in humans *Toxocara* parasites do not mature to adulthood in the intestine but remain arrested as larvae in the tissues, exposure to toxocariasis in the human

population can only be assessed indirectly by means of serology. Population-based studies on the prevalence of infection in humans are still comparatively rare and the interpretation of the significance of seropositivity still remains difficult. Seroprevalence values based upon sera from hospitalised patients, blood donors or high-risk groups are likely to introduce bias and will not provide accurate population assessments of the extent of infection (Holland *et al.*, 1995).

Taylor (1993) highlighted some of the difficulties inherent in comparing seroprevalence studies and the need for standardisation. Factors such as (a) the lack of agreed cut-off titres for delineating positivity and the fact that some reports do not record a cut-off titre; (b) the potential differences in enzyme-linked immunosorbent assay (ELISA) methodologies (see Diagnosis), including antigen preparation and assay procedures; (c) the variation in the populations surveyed, including age, range, hospital vs. healthy populations, rural vs. urban, and so on. All these factors can introduce confounding variables into a seroprevalence study. Holland (1997), in comparing the Irish studies undertaken on toxocariasis in humans, illustrated how different cut-off titres and methodologies were employed to assess serology and different populations selected for investigation (Table 19a.1).

Perhaps the most crucial issue in understanding seroprevalence studies in humans is the difficulty in interpreting the relationship between titre and symptomatology. This compounds the problem in assessing the public health significance of this disease (see below). Seroprevalence values for toxocariasis in children measured by ELISA from a variety of geographical locations are shown in Table 19a.2. Values fluctuate significantly and are particularly high from the wet tropics, St Lucia, in comparison to the arid tropics, Jordan and within Europe, e.g. Ireland vs. Spain.

### Host Factors and Seroprevalence

A number of epidemiological studies have endeavoured to assess the relationship between host factors and risk factors and exposure to toxocariasis.

**Table 19a.1** Comparison of studies investigating seroprevalence of toxocariasis in Ireland

Source	Population	Age (years)	Titre cut-off	<i>n</i>	Seropositive (%)
Kenny and Alwright (1987)	Urban (hospital)	2–5	≥ 1:8 <sup>1</sup>	302	19
			≥ 1:32	302	8.6
Taylor <i>et al.</i> (1988)	Mostly urban family asthma	0–15	≥ 0.3 <sup>2</sup>	76	8
			≥ 1:50 <sup>3</sup>	78	53.2
Holland <i>et al.</i> (1991)	Urban family asthma	Adults and children	≥ 1:50 <sup>3</sup>	140	52
			≥ 1:800	140	7.8
Holland <i>et al.</i> (1995)	Urban and rural	4–19	≥ 1:50 <sup>3,4</sup>	2129	31
			≥ 1:800	2129	3.1

<sup>1</sup>Measured by ELISA at the Communicable Diseases Center, Atlanta, GA, USA.

<sup>2</sup>Measured in optical density units at the *Toxocara* Reference Laboratory, London.

<sup>3</sup>Measured by ELISA at the *Toxocara* Reference Laboratories, London and Glasgow.

<sup>4</sup>Measured by ELISA at the Department of Zoology Trinity College, Dublin, and validated by the *Toxocara* Reference Laboratory, Glasgow. Reproduced by permission from Holland (1997).

**Table 19a.2** Seroprevalence of toxocariasis in children from a range of countries measured by ELISA

Reference and locality	<i>n</i>	Age (years)	Titre cut-off	Seropositive (%)
van Gemund <i>et al.</i> (1989). The Hague, The Netherlands	234	3–6	≥ 1:32	11.0
Joseph <i>et al.</i> (1981). London, UK	133	3–9	n.a.	14.3
Conde, Muro and Simon (1989). Salamanca, Spain	90	10	≥ 1:120	7.0
Worley <i>et al.</i> (1984). North Carolina, USA	333	5–7	≥ 1:32	23.1
Matsumura and Endo (1983). Yamaguchi, Japan	83	< 1–15	≥ 1:20	3.6
Abo-Shehada <i>et al.</i> (1992). Irbid, Jordan	699	5–24	n.a.	10.9
Thompson <i>et al.</i> (1986). Anse la Rouge, St Lucia	82	0.5–6	≥ 1:32	86
Holland <i>et al.</i> (1995). Dublin, Ireland	2129	4–19	≥ 1:50	31.0

Reproduced by permission from Holland (1997).

### Age and Sex

In general, seroprevalence is higher in children compared to adults (Ree *et al.*, 1984; Conde *et al.*, 1989), although a Japanese survey of children and adult women showed a peak prevalence of positives in women over 70 years old (Matsumura and Endo, 1983). Within a range of child age groups (4–19 years), Holland *et al.* (1995) observed a peak within the 6–9 year-olds, with more raised titres (≥ 1:800) also being observed in this age range. A similar trend was observed from a survey of over 8000 serum samples collected as part of a survey in the USA (Glickman and Schantz, 1981). Holland *et al.* (1995) also observed a rise in median titre with increasing age (coupled with a decrease in titres ≥ 1:800 after 9 years of age), which was attributed to a gradual acquisition of low-level infection by previously seronegative individuals over 9 years old, resulting in progressive elevation of the median titre.

Some studies have shown that boys have higher seroprevalence values than girls (Embil *et al.*, 1988; Abo-Shehada *et al.*, 1992; Holland *et al.*, 1995) and explanations put forward to explain this observation have included differences in forms of play, although Holland *et al.* (1995) found no differences in geophagia between the sexes. Abo-Shehada *et al.* (1992) studied a group of children and young adults from Jordan and found significant differences in seroprevalence between the sexes, but only within certain age groups. The authors suggested that differences in social behaviour and the fact that outdoor activities are restricted in girls in Jordan aged over 14, might explain some of the observed sex and age-related differences in seroprevalence.

### Location

Some studies have used schools as units of epidemiological investigation. Three studies

from Ireland, The Netherlands and the USA recorded significant variations in seropositivity between schools (Worley *et al.*, 1984; van Gemund *et al.*, 1989; Holland *et al.*, 1995). Seroprevalence amongst Irish schools showed pronounced differences at cut-off titres of 1:50 (16.4–46.7%) and 1:800 (0–7.5%).

Rural primary schools had significantly higher proportions of seropositive children and, in general, rural schools had significantly higher seropositive rates than urban schools. In The Netherlands the schools studied were all located in The Hague and seropositivity was in the range 4.5–24.2% (at a cut-off of 1:32). Differences did not appear to relate to socioeconomic status or dog ownership but one difference between a pair of adjacent schools might be explained by a boycott of the school sandpit. In contrast, in the USA Worley *et al.* (1984) did explain differences in seropositivity between elementary schools by differences in socioeconomic status. The Irish study concluded that schoolchildren from rural locations had significantly higher seropositivity rates than those from urban ones. Results from other studies have been somewhat contradictory, with inhabitants from Nova Scotia and Sweden showing a trend to higher seroprevalence in rural populations, but the opposite was the case for individuals from western Japan and western Spain (Matsumura and Endo, 1983; Embil *et al.*, 1988; Ljungstrom and van Knappen, 1989; Conde *et al.*, 1989). Differences in the pattern of risk factors may be one of the explanations for rural/urban differences (Holland *et al.*, 1995).

### **Risk Factors**

Good, Holland and Taylor (unpublished observations), in a study of over 120 000 schoolchildren, found that 67% had a dog at home and 56% a cat. These pets provide a huge potential for zoonotic infection. It has been estimated that the dog population in the UK is 7.8 million, in France 9 million and in the USA more than 55 million (Glickman, 1993; Magnaval *et al.*, 1994).

Dog ownership is highly significantly associated with seropositivity (Holland *et al.*, 1995). Dog ownership was also found to be significantly

higher in rural areas (70.3%) compared to urban locations (54.4%) (Holland *et al.*, 1995). In St Lucia, dog ownership was also very high (77%) and the authors concluded that the presence of a largely untreated and unconstrained dog population contributed significantly to the high seropositivity rate for toxocariasis in humans (Thompson *et al.*, 1986). In Nova Scotia, dog ownership was also found to be a significant risk factor for infection in rural children, whereas a household dog appeared to present no risk to urban children (Embil *et al.*, 1988). Geophagia was also found to be significantly associated with seropositivity and more titres ( $\geq 1:800$ ) were observed in children with a history of geophagia (Holland *et al.*, 1995).

Logistic regression analysis was performed by Holland *et al.* (1995) in order to identify factors that might contribute to an increased risk of exposure to infection with *Toxocara*. The factors included in the model were divided into four groups: (a) host characteristics, such as age, sex and school location; (b) risk factors, such as dog ownership and geophagia; (c) symptoms and specific illnesses (see below); (d) haematological values, including eosinophilia. At a cut-off titre of 1:50, geophagia, pet ownership, school location and host age and sex were all significant factors in the model. The inclusion of both dog ownership and school location indicates that the contribution of location to enhanced exposure cannot be explained only in terms of differences in dog ownership between rural and urban areas. This would suggest that there are other, as yet unidentified, factors operating in rural areas that enhance exposure to toxocariasis (Holland, 1997).

### ***Toxocara Ova in the Environment***

Data on the presence, concentration and embryonation status of potentially infective *Toxocara* spp. ova in the environment can provide a useful assessment of the level and significance of contamination in a given location (Holland, 1997). Potentially infective *T. canis* ova were recovered from soil samples collected from domestic gardens and public parks in Dublin, Ireland (Holland *et al.*, 1991; O'Lorcain, 1994).

The proportion of positive samples was higher from gardens than parks and the average number of eggs per sample was significantly higher per gram of soil in the gardens. This observation was also made in Baton Rouge, USA by Smith *et al.* (1984), who recorded higher proportions of positive samples in backyards compared to public spaces, although the levels were lower than in the Irish gardens.

### Epidemiology of Ocular Toxocariasis

Ocular toxocariasis is generally regarded as being uncommon but there are a lack of population-based estimates of the incidence of the condition worldwide. Maetz *et al.* (1987) recorded an estimated prevalence of 1/1000 in Alabama on the basis of reports from ophthalmologists and optometrists. Holland *et al.* (1995) found no cases in a study of over 2000 schoolchildren (although the sister of one child had ocular toxocariasis), despite a seroprevalence of 31% in the children studied. In a more recent, larger study in Ireland, the same group have found a much lower prevalence of ocular disease than Maetz and colleagues. This may partly relate to the fact that this study employed a population-based case-control study design (Good, Holland and Taylor, unpublished observations). Few case-control studies of toxocaral eye disease have been published, although Schantz *et al.* (1980) reported risk factors for eye disease in Atlanta, Georgia. The results of this study confirmed the importance of household dogs as a risk factor for human toxocariasis. The literature mainly consists of case reports of small numbers of ocular toxocariasis patients and highlights the diagnostic difficulties associated with this syndrome (Dinning *et al.*, 1988; Gillespie *et al.*, 1993a).

It has been suggested that the infective dose may influence the development of sequelae, with those developing OLM having ingested lower numbers of infective ova. Glickman and Schantz (1981) have postulated that at low doses the antigenic mass is insufficient to stimulate a marked rise in eosinophil and antibody levels. As a result, larvae migrate unimpeded through the liver and lungs and incite minimal tissue response or clinical signs. These few larvae then

enter the circulation and migrate randomly, with the consequence that occasionally the eye will be invaded.

### Toxocariasis in the Rodent Paratenic Host and Its Significance for Human Infection

Arrested *Toxocara* larvae can remain in the tissues and organs of wild and experimentally-infected small mammals, which act as paratenic hosts for the parasite. There is evidence to show that these larvae are capable of accumulation in the brain of experimentally infected rodents (Dunsmore *et al.*, 1983) and the level of accumulation varies significantly between individual animals (Skerrett and Holland, 1997). Dubinsky *et al.* (1995) recorded the presence of *Toxocara* larvae in the brains of a variety of small wild mammals in Slovakia. It was observed that more larvae were recorded from urban rodents compared to rural rodents. If such infected mammals are consumed by dog or cat definitive hosts, the larvae can then develop to maturity in the host intestine.

The concept of parasite-altered host behaviour has become of increasing interest (Moore and Gotelli, 1990), particularly with regard to the hypothesis that certain parasites may have evolved a strategy to increase their transmission success to a final host. *Toxocara* infection in the mouse is a useful host-parasite model for two reasons (Holland, 1997). First, it can act as a model for human infection, and observed changes in murine behaviour may be relevant to humans with toxocariasis. Second, and less importantly here, it can be used to test the hypothesis that parasite-altered host behaviour may contribute to increased predation of the infected paratenic host and hence enhanced transmission to the final host. In a study of the effects of *Toxocara* infection on social behaviour and response to novelty, observed changes in murine behaviour were related to the level of larval infection in the brain (Cox and Holland, 1998). Furthermore, for non-specific tests, such as level of activity, higher levels of infection in the brain induced a greater alteration in behaviour, whereas for specific tests, such as learning and anxiety, the behaviour of mice with low

infections produced a greater alteration in behaviour. This latter observation, that low-level larval infections in the brain have a larger effect on specific cognitive functions, may be relevant to infection in young children (Cox, 1997; Holland, 1997; Cox and Holland, 1998).

## CLINICAL FEATURES

Clinical toxocaral infection in humans occurs in three forms, visceral larva migrans (VLM), ocular larva migrans (OLM) and covert toxocariasis (CT).

### Visceral Larva Migrans

Visceral larva migrans (VLM) is predominantly a disease of children. The essentials for clinical diagnosis in the past have been regarded as an eosinophilia of over 30% in children with a history of eating dirt and with no other cause for eosinophilia (Snyder, 1961). Beaver (1956) reported that an eosinophilia of over 50% was common, but regarded other evidence of infection as variable. Initially the diagnosis was made by biopsy (usually of the liver) and histological examination to confirm the presence of *Toxocara* larvae, usually in granulomata (Beaver, 1956; Snyder, 1961). The two reported studies of experimental toxocariasis in humans have both noted an eosinophilia, although the features of true visceral larva migrans were not documented. An adult was infected with 100 embryonated eggs. On the 13th day after ingestion he developed a blood eosinophilia of 2704/mm<sup>3</sup>, which rose to 13 516 by the 30th day and fell to 6144 by 4.5 months. He subsequently developed a chronic cough (Chaudri and Saha, 1959). Two mentally retarded children were given 200 *T. canis* eggs. They developed a blood eosinophilia that was still present 13 months after ingestion (Smith and Beaver, 1953).

The other characteristics of visceral larva migrans are geophagia, anaemia, cough, wheeze, pulmonary infiltrates on X-ray, hepatosplenomegaly, fever and anorexia. Suspicion of the diagnosis is normally aroused by the raised eosinophilia. Histological confirmation of the

diagnosis is now not commonly undertaken, and a finding of a raised *Toxocara* titre in conjunction with the characteristic features and history is normally taken as diagnostic. Ideally a changing titre should be sought.

### Clinical Diagnosis

The diagnosis of visceral larva migrans in an appropriately aged child is relatively straightforward. The extreme eosinophilia usually draws attention to the possibility of a diagnosis of toxocaral infection and the other features of anaemia, fever, hepatosplenomegaly, pulmonary infiltrates and wheeze usually result in a more detailed history being taken to enquire about dog ownership and geophagia.

A *Toxocara*-specific ELISA titre will normally confirm the diagnosis. Ideally, a rising or falling titre will provide firmer grounds for diagnosis than a single estimate. The titre is likely to rise rapidly in the early stages of the disease but falls slowly and may take as long as a year to return to a negative value (Taylor, 1993; Taylor *et al.*, 1988). The gold standard for diagnosis is histological examination and confirmation of the presence of a *T. canis* larva. *T. canis* larvae have been identified in enucleated eyes and also in liver granulomata. While in the past liver biopsies have been carried out to make the diagnosis, reliance is now placed on antibody titres rather than histology.

### Toxocaral Eye Disease

Toxocaral eye disease is usually referred to as ocular larva migrans (OLM) because the larva migrates to the eye and, at its most acute, infection may result in blindness (Sheilds, 1984). Reaction to its presence and to its shed antigens may cause local or widespread damage to the retina and to other intra-ocular structures. Intra-ocular infection usually occurs unilaterally in children, but occasionally both eyes are affected and adults develop the condition (Sheilds, 1984).

Pollard *et al.* (1979) reported the following presenting complaints in 41 cases: decreased vision, 83%; strabismus, 10%; leukokoria, 7%.

The ocular lesions in these patients were: posterior pole mass; peripheral mass (unilateral pars planitis); posterior pole and peripheral mass; peripheral mass with retinal detachment; diffuse endophthalmitis. Gillespie *et al.* (1993a) recorded the following causes of severe visual loss in ocular toxocariasis: fibrous traction band; endophthalmitis; macular lesion; retinal detachment; pars planitis; papillitis.

### Covert Toxocariasis

Taylor *et al.* (1988) suggested that the term 'covert toxocariasis' might be used for toxocariasis which did not fall into the categories of visceral larva migrans or ocular larva migrans. They reported 18 clinical features in an investigation of 221 subjects and added a further four clinical features detected on clinical examination of 167 subjects. The features most commonly associated with a raised *Toxocara* titre were abdominal pain, hepatomegaly, anorexia, nausea, vomiting, sleep and behaviour disturbance, pneumonia, cough, wheeze, pharyngitis, cervical adenitis and limb pains. These studies were carried out on children attending hospital and on their families. Glickman *et al.* (1987) had reported 15 signs and symptoms in 37 French adults with visceral larva migrans. Ten of the features they described were the same as those reported by Taylor *et al.* (1988) but with different frequency, which may be due to differences of age, race, atopic background, duration of infection or parasite differences between the two countries.

### Other Associated Illnesses

#### **Social, Learning and Behavioural Abnormalities**

Behavioural and learning abnormalities have been demonstrated in mice infected with *Toxocara canis* (Cox, 1997; Cox and Holland, 1998). Infected mice perform less exploration, respond less to novelty and exhibit impaired learning ability. Aggression is reduced in infected animals, which may lead to a reduction in dominance. In humans the situation is less clear. Lower academic performance was recorded in infected

children, but this effect was not significant when social class was taken into account (Worley *et al.*, 1984). Marmor *et al.* (1987) reported small deficits in neuropsychological testing of *Toxocara*-positive children. Taylor *et al.* (1988) reported higher rates of behaviour disturbance in children with raised *Toxocara* titres. Nelson *et al.* (1996) assessed the risk factors for toxocariasis in a prospective study of disadvantaged pre-school children in addition to testing the hypothesis that *T. canis* exposure is associated with lower intelligence. Their findings suggested that for disadvantaged children, lower initial intelligence and less advantageous child rearing are risk factors for *Toxocara* exposure, but they failed to show a significant association between lower intelligence and infection.

### Epilepsy

There have been conflicting reports regarding an association or lack of association between epilepsy and *Toxocara* titres (Woodruff *et al.*, 1966; Arpino and Curatolo, 1988; Glickman *et al.*, 1979). Glickman *et al.* (1979) noted that, while raised *Toxocara* titres were more common in those with epilepsy, pica was reported in 64% of this group compared to 19% of controls. Geophagia (earth-eating) is associated with a raised *Toxocara* titre (Holland *et al.*, 1995), which may well explain why Glickman and colleagues found more raised *Toxocara* titres in their epilepsy group than in controls. Arpino *et al.* (1990) reported a significant association between seropositivity and epilepsy, but noted that that pica was more common in children with seizures. Logistic regression for risk factors was not reported in this study.

Good, Holland and Taylor (unpublished observations) have found no association between convulsions and a raised *Toxocara* titre in a community study of over 100 000 schoolchildren but have found an association between convulsions and toxocaral eye disease in a case-control study. In a case-control investigation of human *Toxocara* infection of the central nervous system, Magnaval *et al.* (1997) failed to find an association between case status and clinical signs but did record a significant association between case



**Table 19a.3** Comparison studies investigating a relationship between asthma and *Toxocara* seropositivity

	Toxocara cut-off	Seropositivity (%)	
		Non-asthmatic	Asthmatic
Desowitz <i>et al.</i> (1981)	Not recorded	6.40	28%
		With asthma/recurrent bronchitis (%)	
		Sero-negative	Sero-positive
Buijs (1994)	1:20	10	19
			$p = 0.045$

status and an elevated cerebrospinal fluid cell count. In addition, rural residence, ownership of dogs and dementia were shown to be risk factors for toxocaral infection of the central nervous system.

### ***Asthma and Toxocariasis***

*Toxocara* seroprevalence is increased in asthmatics (Desowitz *et al.*, 1981) (Table 19a.3). Buijs (1994) reported an increased prevalence of 'recurrent bronchitis' (a diagnosis which includes a very high proportion of children with asthma) in schoolchildren with positive *Toxocara* titres (Table 19a.3). Taylor (1993) reported a lack of association between wheeze and *Toxocara* titre in a different study population and this lack of relationship has been confirmed by a more recent study (Taylor, Holland, Good and Cox, unpublished observations). This may suggest that the relationship with asthma is indirect and may occur because *Toxocara* titre and asthma are each related to a third factor, rather than to each other.

### ***Transient Myositis***

Transient myositis has been reported in children, with isolated swelling of the calf or lower part of the leg (Taylor *et al.*, 1988; Walsh *et al.*, 1988). In two cases the symptoms resolved within 72 hours, while in the third resolution was much slower.

### **LABORATORY DIAGNOSIS IN HUMANS**

Due to the fact that *Toxocara* larvae remain arrested in the tissues and do not develop to adulthood in the intestine, neither parasites nor their products are detected in the faeces. Diagnosis usually depends upon indirect measures, including the detection of *Toxocara*-specific antibodies in serum. A variety of parasite antigens are used, which may vary in their specificity. Additional information may include the presence of certain clinical symptoms and signs and knowledge of risk factors. Larvae can be detected in biopsy materials and have been found at post-mortem examination, but in general, biopsy is regarded as unrewarding (due to the small numbers of larvae present and the difficulty in finding them). Also an appropriate specimen is rarely available (Glickman *et al.*, 1986). Symptoms and signs can also be non-specific, which is why an accompanying serological test is recommended. Such an immunodiagnostic test is required to be highly sensitive and specific, capable of distinguishing *T. canis* infection from other parasites (Glickman *et al.*, 1986).

### **Serological Tests**

There are many serological tests available for diagnosing toxocariasis. These have been summarised in the review by Glickman *et al.* (1986) and include skin tests, complement fixation, bentonite flocculation, larval precipitation tests, gel diffusion, capillary tube precipitation tests,

indirect haemagglutination, direct or indirect immunofluorescence, ELISA and radioimmunoassay. Antigens used in the tests have included both somatic extracts of adult and larval parasites. Tests using antigens derived from adult worms have been shown to lack specificity (Glickman *et al.*, 1978), whereas antigens derived from eggs require sera to be pre-absorbed with *Ascaris* antigens to retain specificity (Glickman *et al.*, 1985). At present, the test that is now widely recommended is the ELISA, utilising *Toxocara* larval ES antigens (TES) (de Savigny *et al.*, 1979). These so-called ES antigens are excretory–secretory antigens derived from *in vitro* culture of infective *Toxocara* larvae (de Savigny, 1975).

### New Approaches

More recently, a variety of new approaches to diagnosis of toxocariasis in humans have been reported, including the use of IgE-specific methods and antigen capture ELISA. Magnaval *et al.* (1992a) developed an immunoenzymatic assay with ES antigen of *Toxocara* to detect specific immunoglobulin E (sIgE ELISA). The value of this assay for post treatment follow-up and its specificity and sensitivity characteristics were evaluated. The authors concluded that, due to only moderate specificity and sensitivity, the test could not be used alone but could act as a complementary method for the detection of specific IgG. Furthermore, it was the only assay to detect positivity in sera from hypereosinophilic patients and it revealed reductions in sIgE post-treatment, and so had some value as a follow-up assessment after treatment.

An antigen capture ELISA that can detect a carbohydrate epitope on the excretory–secretory (ES) antigens of *Toxocara* was evaluated by Gillespie *et al.* (1993b). The sera from patients with acute visceral larva migrans, ocular disease and inactive toxocariasis were assessed, along with healthy controls and patients with other helminth infections. Over half the patients with acute toxocariasis tested positive, in contrast to low numbers from the inactive disease or ocular complications. False positives were, however, detected in 25% of the patients with schistosomiasis and filariasis. For this reason, the

authors concluded that this assay was useful for case confirmation only.

PCR-based methods were used to detect ascarid larvae from animal tissues including cats, dogs and foxes, and species differentiation between *T. canis*, *T. cati* and *Toxascaris leonina* was possible (Jacobs *et al.*, 1997). These methods may prove to be good candidates for further development for the detection and/or identification of ascarid larvae in human tissues.

### Ocular Disease

A definitive diagnosis of ocular larva migrans can be obtained by histological detection of a larva, but suitable specimens are rarely available. Whilst the concentration of *Toxocara* antibody in serum is usually raised in ocular disease, the concentrations are generally lower than in visceral disease (Glickman and Schantz, 1981). There are therefore difficulties in diagnosis associated with low levels of IgG antibodies. Some other workers have advocated the use of IgE for the serological diagnosis of ocular disease, since it is thought that ocular disease is caused by a lower number of infective larvae compared to visceral larva migrans, and that the smaller amounts of circulating antigen may stimulate the production of IgE rather than IgG (Genchi *et al.*, 1986).

Immunological reactions in aqueous and vitreous humour may be a more reliable indicator of toxocaral eye disease but such measurements are made only infrequently. Petithory *et al.* (1993) reported a comparison of sera and vitreous humour antibody studies in 10 subjects. In eight patients sera were negative for *T. canis* antibody, while vitreous humour antibody was found in nine subjects. Furthermore, for six (out of a total of nine) patients, antibody to *T. cati* was detected in the vitreous humour. Petithory *et al.* (1987) have suggested the following criteria for the diagnosis of ocular larva migrans: (a) positive immunologic tests for nematode antigens in aqueous or vitreous humour; (b) eosinophilia of aqueous or vitreous humour (c) ocular lesions. However, few ophthalmologists have aqueous or vitreous humour material available to them, and in most cases the diagnosis is based on the

appearance of the ocular lesions, a supportive history and exclusion of other likely causes.

## TREATMENT

Abo-Shedhada and Herbert (1984) found that the killing of *T. canis* larvae in mice with levamisole, ivermectin, albendazole and fenbendazole was maximal 2–7 days after infection. Treatment 8–13 days after infection had no effect on the larvae, suggesting that larvae that have invaded brain or muscle are not susceptible to these antihelminthics. As most human infections are likely to be diagnosed much later than 7 days after infection, the outlook for therapy is not good; even in dogs it seems that the main action of treatment is likely to be the prevention of adult worm formation in the gut, rather than the elimination of larvae in the tissues.

### Dogs

The vast majority of puppies are born already infected unless the mother has been treated during pregnancy. It is possible, by treating the bitch, to produce almost infection-free puppies. Current veterinary recommendations are as follows:

1. Adult dogs and non-breeding bitches should be wormed every 1–3 months.
2. Breeding and nursing bitches should be wormed before mating, and at 2, 4, 6, 8, 10 and 12 weeks after whelping and every 1–3 months at other times.
3. Puppies should be wormed at 2 weeks of age and then every 2 weeks until 12 weeks of age. After 12 weeks they may be wormed at 16 weeks and 20 weeks and then as for adult dogs.

A wide range of antihelminthics with proven efficacy against *Toxocara* are available (Lloyd, 1993).

### Humans

Treatment of human toxocariasis is unsatisfactory. In general, treatment is unlikely to be provided unless the patient exhibits very severe symptoms. A number of preparations, including

fenbendazole, mebendazole and diethyl carbamazine, have been used for treatment in humans but good evidence for their efficacy based upon well-designed, double-blind clinical trials is generally lacking.

### Visceral Larva Migrants

Sturchler *et al.* (1989) randomly assigned 34 patients diagnosed with either VLM or OLM to a 5-day course of treatment with thiabendazole or albendazole. Drug tolerability was assessed on the fifth day of treatment and efficacy at approximately 30 weeks. Median eosinophilia was the same after treatment with thiabendazole and 27% of patients were judged to be clinically cured, whereas for the albendazole-treated patients median eosinophilia fell from 10% to 3.5% after treatment and clinical cure was determined for 32% of the patients. Despite the fact that the efficacy of the two drugs was similar, the authors recommended albendazole for the treatment of human toxocariasis because fewer adverse events were associated with administration of this drug.

Magnaval *et al.* (1992b) reported the results of a double-blind, placebo-controlled, randomised study on the efficacy of mebendazole for the treatment of human toxocariasis. Patients were selected on the basis of seropositivity and clinical and biological symptoms, including total and *Toxocara*-specific IgE. On the basis of the results, the authors concluded that mebendazole was only moderately effective against human toxocariasis. Magnaval (1995) went on to assess the relative efficacy of diethylcarbamazine and mebendazole, using an open random study design. The two drugs showed similar reductive effects on clinical signs and eosinophil counts, but mebendazole showed more pronounced effects on *Toxocara*-specific IgE kinetics. Patients receiving diethylcarbamazine reported significantly more adverse effects and, for this reason, Magnaval advocated the use of mebendazole over diethylcarbamazine for the treatment of human toxocariasis.

### Ocular Disease

Ocular toxocariasis presents a difficult problem. Evidence from an experimental mouse model of ocular toxocariasis developed by Ghafoor *et al.*

(1984) revealed that the inflammatory response, which is the main cause of visual loss, is directed against the excretory–secretory antigens, rather than the larvae themselves. Thus, steroids are the mainstay of treatment. There is some evidence that antihelminthics may be helpful in acute cases, but strong evidence is lacking. Ocular surgery and laser coagulation may be necessary, as retinal traction bands may cause retinal detachment (Dinning *et al.*, 1988; Gillespie *et al.*, 1993a).

Dinning *et al.* (1988) reported on the course of treatment for three children with ocular toxocariasis. One case received thiabendazole and oral prednisolone and vitrectomy and epiretinal dissection in order to clear the vitreous and relieve retinal traction. A second case was treated with topical steroids and mydriatics but, after subsequent increased inflammation, thiabendazole was given along with subtenons depomedrone injection. A third case received oral prednisolone followed by thiabendazole. All three cases were improved following treatment but it was difficult to assess the relative contribution of steroids and specific chemotherapy. These authors recommended the following management for patients with ocular toxocariasis:

1. Eye disease alone.  
Local and periocular or systemic steroids: surgery where appropriate.
2. Eye disease alone which does not respond to (1): add specific antihelminthic (thiabendazole) and continue systemic steroids.
3. Eye disease with VLM or high antibody levels.  
Local steroids and mydriatics and thiabendazole and systemic steroids, as in (2).

## PREVENTION

Control of *Toxocara* in the dog and cat can be facilitated by regular and appropriate deworming and requires the encouragement and cooperation of the veterinary community. Attention also needs to be paid to the exposure of young children to potentially infective faecal material, particularly within the context of recreational areas such as parks. Draconian measures such as total ban on dogs, implemented by Iceland

in response to their hydatid disease problem, are unlikely to be taken up by other countries (Gillespie, 1988). More realistically, in some countries dogs have been precluded from children's public play areas and owners provided with containers for faecal disposal when walking their dogs in public. Public health education measures are also important in order to raise awareness of the disease implications for humans. In the UK, for example, an organization known as Community Hygiene Concern has posted advertisements about the dangers of toxocariasis to humans in national newspapers.

## REFERENCES

- Abo-Shehada MN, Herbert IV (1984). Anthelmintic effects of levamisole, ivermectin, albendazole and fenbendazole on larval *Toxocara canis* infection in mice. *Res Vet Sci* **36**: 87–91.
- Abo-Shehada MN, Sharif L, El-Sukhon SN, Abuharfeil N, Atmeh RF (1992). Seroprevalence of *Toxocara canis* antibodies in humans in Northern Jordan. *J Helminthol* **66**: 75–8.
- Akao N, Desowitz RS, Kondo K (1990). Decrease in litter size of female mice with *Toxocara canis*. *Trans R Soc Trop Med Hyg* **84**: 724.
- Arpino C, Curatolo P (1988). Toxocariasis in children. *Lancet* **2**: 1172.
- Arpino C, Gattinara GC, Piergili D, Curatolo P (1990). *Toxocara* infection and epilepsy in children: a case control study. *Epilepsia* **31**: 33–6.
- Badley JE, Grieve RB, Bowman DD, Glickman LT (1987). Immune-mediated adherence of eosinophils to *Toxocara canis* infective larvae: the role of excretory–secretory antigens. *Parasite Immunol* **9**: 133–43.
- Bass JL, Mehta KA, Glickman LA, Eppes BM (1983). Clinically inapparent *Toxocara* infection in children. *N Engl J Med* **308**: 723–4.
- Beaver PC, Synder CH, Carrera GM, Dent JH, Lafferty JW (1952). Chronic eosinophilia due to visceral larva migrans. *Paediatrics* **9**: 7–19.
- Beaver PC (1956). Parasitological reviews: larva migrans. *Exp Parasitol* **5**: 587–621.
- Behrer MR (1951). Hypereosinophilia with eosinophilic granuloma of liver associated with ascaris infestation. *J Paediatr* **38**: 635.
- Bowman DD, Mika-Grieve M, Grieve RB (1987). Circulating excretory–secretory antigen levels and specific antibody responses in mice infected with *Toxocara canis*. *Am J Trop Med Hyg* **36**: 75–82.
- Buijs J (1994). *Toxocara* seroprevalence in 5-year-old elementary schoolchildren: relation with allergic asthma. *Am J Epidemiol* **140**: 839–47.

- Burke TM, Roberson EL (1985). Prenatal and lactational transmission of *Toxocara canis* and *Ancylostomum caninum*: experimental infection of the bitch before pregnancy. *Int J Parasitol* **15**: 71–5.
- Calhoun FP (1937). Intraocular invasion by the larva of *Ascaris*. *Arch Ophthalmol* **18**: 963–70.
- Chandler AC (1925). The helminthic parasites of cats in Calcutta and the relation of cats to human helminthic infections. *Ind J Med Res* **13**: 213–28.
- Chaudri RN, Saha TK (1959). Tropical eosinophilia. Experiments with *T. canis*. *Lancet* **2**: 493–4.
- Conde GL, Muro AA, Simon MF (1989). Epidemiological studies on toxocariasis and visceral larva migrans in a zone of Western Spain. *Ann Trop Med Parasitol* **83** (6): 615–20.
- Coombs I, Crompton DWT (1991). *A Guide to Human Helminths*. London: Taylor and Francis.
- Cox D (1997). The effect of *Toxocara canis* infection on the paratenic host behaviour of two strains of mice. PhD Thesis, Trinity College, Dublin.
- Cox D, Holland CV (1998). The relationship between numbers of larvae recorded from the brain of *Toxocara canis*-infected mice and social behaviour and anxiety in the host. *Parasitology* **116**: 579–94.
- de Savigny DH (1975). *In vitro* maintenance of *Toxocara canis* larvae and a simple method for the production of *Toxocara* ES antigen for use in serodiagnostic tests for visceral larva migrans. *J Parasitol* **61**: 781–2.
- de Savigny DH, Voller A, Woodruff AW (1979). Toxocariasis: serological diagnosis by enzyme immunoassay. *J Clin Pathol* **32**: 284–8.
- Desowitz RS, Rudoy R, Barnwell JW (1981). Antibodies to canine helminth parasites in asthmatic and non-asthmatic children. *Int Arch Allergy Appl Immunol* **65**: 361–6.
- Dinning WJ, Gillespie SH, Cooling RJ, Maizels RM (1988). Toxocariasis: a practical approach to management. *Eye* **2**: 580–2.
- Dubinsky P, Havasiova-Reiterova K, Petko B, Hovorka I, Tomasovicova O (1995). Role of small mammals in epidemiology of toxocariasis. *Parasitology* **13**: 517–21.
- Dunsmore JD, Thompson RCA, Bates IA (1983). The accumulation of *Toxocara canis* larvae in the brains of mice. *Int J Parasitol* **83** (5): 517–21.
- Embil JA, Tanner CE, Periera LH *et al.* (1988). Seroepidemiological survey of *Toxocara canis* infection in urban and rural children. *Public Health* **102**: 129–33.
- Fattah DI, Maizels RM, McClaren DJ, Spry CJF (1986). *Toxocara canis*: interaction of human eosinophils with infective larvae. *Exp Parasitol* **61**: 421–31.
- Fulleborn F (1921). Askarisin fektion durch verzehren eingekapselter larven und uber gelungene intrauterine askarisin fektion. *Arch Schiffs-u Tropen-hyg* **25**: 367–75.
- Gems D, Ferguson CJ, Robertson BD *et al.* (1995). An abundant *trans*-spliced mRNA from *Toxocara canis* infective larvae encodes a 26-kDa protein with homology to phosphatidylethanolamine-binding proteins. *J Biol Chem* **270** (31): 18517–22.
- Gems D, Maizels RM (1996). An abundantly expressed mucin-like protein from *Toxocara canis* infective larvae: the precursor of the larval surface coat glycoproteins. *Proc Natl Acad Sci USA* **93** (4): 1665–70.
- Genchi C, Tinelli M, Brunello F, Falagiani P (1986). Serodiagnosis of ocular toxocariasis: a comparison of specific IgE and IgG. *Trans R Soc Trop Med Hyg* **80**: 993–4.
- Ghafoor SYA, Smith HV, Lee WR, Quinn R, Girdwood RWA (1984). Experimental ocular toxocariasis: a mouse model. *Br J Ophthalmol* **68**: 89–96.
- Gillespie SH (1988). The epidemiology of *Toxocara canis*. *Parasitol Today* **4** (6): 180–2.
- Gillespie SH (1993). Human toxocariasis. *Commun Dis Rep* **3**: R140–3.
- Gillespie SH, Dinning WJ, Voller A, Crowcroft NS (1993a). The spectrum of ocular toxocariasis. *Eye* **7**: 415–18.
- Gillespie SH, Bidwell D, Voller A, Robertson BD, Maizels RM (1993b). Diagnosis of human toxocariasis by antigen capture enzyme linked immunosorbent assay. *J Clin Pathol* **46**: 551–4.
- Glickman LT, Schantz PM, Dombroske R, Cypess R (1978). Evaluation of serodiagnostic tests for visceral larva migrans. *Am J Trop Med Hyg* **27**: 492–8.
- Glickman LT, Cypess R, Crumrine L, Gitlin D (1979). *Toxocara* infection and epilepsy in children. *J Paediatr* **94**: 75–8.
- Glickman LT, Schantz PM (1981). Epidemiology of zoonotic toxocariasis. *Epidemiol Rev* **3**: 230–50.
- Glickman LT, Grieve RB, Lauria SS, Jones DL (1985). Serodiagnosis of ocular toxocariasis: a comparison of two antigens. *J Clin Pathol* **38**: 103–7.
- Glickman LT, Schantz PM, Grieve RB (1986). Toxocariasis. In Walls KW, Schantz PM (eds), *Immunodiagnosis of Parasitic Diseases*, vol 1, *Helminthic Diseases*. New York: Academic Press; 201–3.
- Glickman LT, Magnaval JF, Domanski LM, *et al.* (1987). Visceral larva migrans in French adults. A new disease? *Am J Epidemiol* **125**: 1019–33.
- Glickman LT (1993). The epidemiology of human toxocariasis. In Lewis JW, Maizels RM (eds), *Toxocara and Toxocariasis*. London: Institute of Biology and British Society for Parasitology; 3–10.
- Grieve RB, Stewart VA, Parsons JC (1993). Immunobiology of larval toxocariasis. In Lewis JW, Maizels RM (eds), *Toxocara and Toxocariasis*. London: Institute of Biology and British Society for Parasitology.
- Hassan AT, El-Manawaty NHA (1994). Experimental murine toxocariasis histopathological study of chronic renal infection, transplacental transmission and ultrastructural study of egg shell. *J Egypt Soc Parasitol* **24** (2): 333–9.
- Hill IR, Denham DA, Scholtz CL (1985). *Toxocara canis* larvae in the brain of a British child. *Trans R Soc Trop Med Hyg* **79**: 351–4.
- Holland CV, O'Connor P, Taylor MRH *et al.* (1991). Families, parks, gardens and toxocariasis. *Scand J Infect Dis* **23**: 225–31.
- Holland CV, O'Lorcain P, Taylor MRH, Kelly A (1995). Sero-epidemiology of toxocariasis in school children. *Parasitology* **110**: 535–45.
- Holland CV (1997). Epidemiology of toxocariasis in Ireland: human, animal and experimental aspects. In Holland CV (ed.), *Modern Perspectives on Zoonoses*. Dublin: Royal Irish Academy.

- Jacobs DE, Zhu XQ, Gasser RB, Chilton NB (1997). PCR-based methods for identification of potentially zoonotic ascaridoid parasites of the dog, fox and cat. *Acta Tropica* **68** (2): 191–200.
- Josephs DS, Bhinder P, Thompson AB (1981). The prevalence of *Toxocara* infection in a child population. *Public Health* **95**: 273–5.
- Kenny V, Allwright SPA (1987). Seroprevalence of toxocar-iasis in a hospital based sample in Ireland. *Irish J Med Sci* **156**: 361–3.
- Kincekova J, Dubinsky P, Pirochova O (1995). Transmission of anti-*Toxocara* antibodies from mothers to neonates. *Helminthologica* **32**: 175–9.
- Lee KT, Min HK, Soh CT (1976). Transplacental migration of *Toxocara canis* larvae in experimentally infected mice. *J Parasitol* **62**: 460–5.
- Levine ND (1980). *Nematode Parasites of Domestic Animals and Man*, 2nd edn. Minneapolis, MI: Burgess.
- Lewis JW, Maizels RM (eds) (1993). *Toxocara and Toxocar-iasis*. London: Institute of Biology and the British society for Parasitology.
- Lloyd S (1993). *Toxocara canis*: the dog. In Lewis JW, Maizels RM (eds), *Toxocara and Toxocar-iasis*. London: Institute of Biology and British Society for Parasitology; 11–24.
- Ljungstrom I, van Knapen F (1989). An epidemiological and serological study of toxocara infection in Sweden. *Scand J Infect Dis* **21**: 87–93.
- Maetz MH, Kleinstein RN, Federico D, Wayne J (1987). Estimated prevalence of ocular toxoplasmosis and toxocar-iasis in Alabama. *J Infect Dis* **156**: 414.
- Maizels RM, de Savigny D, Ogilvie BM (1984). Character-ization of the surface and excretory–secretory antigens of *Toxocara canis* infective larvae. *Parasite Immunol* **6**: 23–37.
- Maizels RM, Selkirk ME (1988). Immunobiology of nema-tode antigens. In Kennedy MW (ed.), *The Biology of Parasitism*. New York: Alan R. Liss; 285–308.
- Maizels RM, Page AP (1990). Surface associated glycopro-teins from *Toxocara canis* L<sub>2</sub> parasites. *Acta Tropica* **47**: 355–64.
- Maizels RM, Robertson BD (1991). *Toxocara canis*: Secreted glycoconjugate antigens in immunobiology and immuno-diagnosis. In Englund PT, Sher A (eds), *Parasitic Nema-todes—Antigens, Membranes and Genes*. London: Taylor and Francis; 95–115.
- Maizels RM, Gems DH, Page AP (1993). Synthesis and secretion of TES antigens from *Toxocara canis* infective larvae. In Lewis JW, Maizels RM (eds), *Toxocara and Toxocar-iasis*. London: Institute of Biology and British Society for Parasitology; 141–50.
- Magnaval J-F, Fabre R, Maurieres P, Charlet JP, de Larrard B (1992a). Evaluation of an immunoenzymatic assay detecting specific anti-*Toxocara* immunoglobulin E for diagnosis and posttreatment follow-up of human toxocar-iasis. *J Clin Microbiol* **September**: 2269–74.
- Magnaval J-F, Charlet JP, de Larrard B (1992b). A double-blind study of the efficacy of mebendazole in the minor forms of human toxocar-iasis. *Thérapie* **47** (2): 145–8.
- Magnaval J-F, Glickman LT, Dorchie PH (1994). La toxocarose, une zoonose helminthique majeure. *Revue Méd Vet* **145**: 611–27.
- Magnaval J-F (1995). Comparative efficacy of diethylcarba-mizine and mebendazole for the treatment of human toxocar-iasis. *Parasitology* **110**: 529–33.
- Magnaval J-F, Galindo V, Glickman LT, Clanet M (1997). Human *Toxocara* infection of the central nervous system and neurological disorders: case–control study. *Parasitol-ogy* **115**: 537–43.
- Marmor M, Glickman L, Shofer F *et al.* (1987). *Toxocara canis* infection of children: epidemiologic and neuropsy-chologic findings. *Am J Publ Health* **77**: 554–9.
- Matsumura K, Endo R (1983). Seroepidemiological study on *Toxocara* infection in man by enzyme-linked immunoab-sorbant assay. *J Hygiene* **90**: 61–5.
- Meghji M, Maizels RM (1986). Biochemical properties of larval excretory–secretory (ES) glycoproteins of the parasitic nematode *Toxocara canis*. *Mol Biochem Parasitol* **18**: 155–70.
- Mercer RD, Lund HZ, Bloomfield RA, Caldwell FE (1950). Larval ascariasis as cause of chronic eosinophilia with visceral manifestations. *Am J Dis Childhood* **80**: 46.
- Moore J, Gotelli NJ (1990). A phylogenetic perspective on the evolution of altered host behaviours: a critical look at the manipulation hypothesis. In Barnard CJ, Behnke JM (eds), *Parasitism and Host Behaviour*. London: Taylor and Francis; 193–339.
- Nagakura K, Tachibana H, Kaneda Y, Kato Y (1989). Toxocar-iasis possibly caused by ingesting raw chicken. *J Infect Dis* **160**: 735–6.
- Nelson S, Greene T, Ernhart CB (1996). *Toxocara canis* infection in preschool age children: risk factors and the cognitive development of preschool children. *Neurotoxicol Teratol* **18** (2): 167–74.
- Nicholas WL, Stewart AC, Mitchell GF (1984). Antibody response to *Toxocara canis* using sera from parasite infec-ted mice, and protection from toxocar-iasis by immunisation with ES antigens. *Austr J Biol Med Sci* **62**: 619–26.
- Nichols RI (1956). The etiology of visceral larva migrans. *J Parasitol* **42**: 363–78.
- O’Lorcain P (1994). Prevalence of *Toxocara canis* ova in public playgrounds in the Dublin area of Ireland. *J Helminthol* **68**: 237–41.
- O’Lorcain P (1995). The effects of freezing on the viability of *Toxocara canis* and *T. cati* embryonated eggs. *J Helminthol* **69**: 169–71.
- Oldham JN (1965). Observations on the incidence of *Toxocara* and *Toxascaris* in dogs and cats from the London area. *J Helminthol* **39**: 252–6.
- Page AP, Smith HV (1988). Antibody reactivity of patients with covert toxocar-iasis. *Trans R Soc Trop Med Hyg* **82**: 942.
- Page AP, Rudin W, Fluri E, Blaxter ML, Maizels RM (1992). *Toxocara canis*. A labile antigenic surface coat overlying the cuticle of infective larvae. *Exp Parasitol* **75**: 72–86.
- Parsons JC, Bowman DD, Grieve RB (1986). Tissue localization of excretory–secretory antigens of larval *Toxocara canis* in acute and chronic murine toxocar-iasis. *Am J Trop Med Hyg* **35**: 974–81.

- Parsons JC, Grieve RB (1990a). Effect of egg dosage and host genotype on liver trapping in murine larval toxocariasis. *J Parasitol* **76**: 53–8.
- Parsons JC, Grieve RB (1990b). Kinetics of liver trapping of infective larvae in murine toxocariasis. *J Parasitol* **76**: 529–36.
- Petithory JC, Chaumeil C, Liotet S *et al.* (1993). Immunological studies on ocular larva migrans. In Lewis JW, Maizels RM (eds), *Toxocara and Toxocariasis*. London: Institute of Biology and the British Society for Parasitology; 81–9.
- Petithory JC, Derouin F, Rosseau M, Luffau M, Quedoc M (1987). Serological arguments for multiple etiology of visceral larva migrans. In Geerts S, Kumar V, Brandt J (eds), *Helminth Zoonoses*. Current Topics in veterinary and Medical Animal Sciences. Boston USA: Martinus Nijhoff; 183–7.
- Perlingiero JG, Gyorgy P (1947). Chronic eosinophilia: report of case with necrosis of liver, pulmonary infiltrations, anemia and ascariis infection. *Am J Dis Childhood* **73**: 34.
- Pollard ZA, Jarrett WH, Hagler WS (1979). ELISA for diagnosis of ocular toxocariasis. *Ophthalmology* **86**: 743–9.
- Ransom BH, Foster WD (1920). Observations on the life history of *Ascaris lumbricoides*. Bulletin 817. Washington: US Department of Agriculture; 12 May.
- Ree GH, Voller A, Rowland HA (1984). Toxocariasis in the British Isles. *Br Med J* **288**: 628–9.
- Richards DT, Lewis JW (1993). Epidemiology of *Toxocara canis* in the fox. In Lewis JW, Maizels RM (eds), *Toxocara and Toxocariasis*. London: Institute of Biology and the British Society for Parasitology; 25–37.
- Robertson BD, Bianco AE, McKerrow JH, Maizels RM (1989). Proteolytic enzymes secreted by the larvae of the nematode *Toxocara canis*. *Exp Parasitol* **69**: 30–6.
- Salem G, Schantz P (1992). Toxocaral visceral larva migrans after ingestion of raw lamb liver. *Clin Infect Dis* **15**: 743–4.
- Schantz PM, Weis PE, Pollard ZF, White MC (1980). Risk factors for ocular toxocariasis: a case control study. *Am J Publ Health* **70**: 1269–72.
- Schwartz B (1932). Some parasites of dogs and cats transmissible to human beings and domesticated animals. *Vet Alum Q June*.
- Sheilds JA (1984). Ocular toxocariasis. A review. *Surv Ophthalmol* **28** (5): 361–81.
- Skerrett H, Holland CV (1997). Variation in the larval recovery of *Toxocara canis* from the murine brain: implications for behavioural studies. *J Helminthol* **71**: 253–5.
- Smith RE, Hagstead HV, Beard GB (1984). Visceral larva migrans: a risk assessment in Baton Rouge, Louisiana. *Int J Zoonoses* **11**: 189–94.
- Smith HV (1993). Antibody reactivity in human toxocariasis. In Lewis JW, Maizels RM (eds), *Toxocara and Toxocariasis*. London: Institute of Biology and British Society for Parasitology; 91–109.
- Smith HV, Quinn R, Kusel JR, Girdwood RWA (1981). The effect of temperature and antimetabolites on antibody binding to the outer surface of second stage *Toxocara canis* larvae. *Mol Biochem Parasitol* **4**: 183–93.
- Smith HV, Hinson A, Girdwood RA, Taylor MRH (1988). Variation in antibody isotype responses in clinically covert toxocariasis. *Lancet* **2**: 167.
- Smith MHD, Beaver PC (1953). Persistence and distribution of *Toxocara* larvae in tissues of children and mice. *Paediatrics* **12**: 491.
- Smyth JD (1994). *Introduction to Animal Parasitology* 3rd edn. Cambridge: Cambridge University Press.
- Snyder CH (1961). Visceral larva migrans. *Paediatrics* **28**: 85–91.
- Sprent JFA (1952). On migratory behaviour of larvae of various *Ascaris* species in white mice. *J Infect Dis* **90**: 163–76.
- Sprent JFA (1957). The life history and development of *Toxocara cati* Schrank (1788) in the domestic cat. *Parasitology* **46**: 54–77.
- Sprent JFA (1958). Observations on the development of *Toxocara canis* (Werner 1782) in the dog. *Parasitology* **48**: 184–209.
- Soulsby E JL (1982). In *Helminths, Arthropods and Protozoa of Domesticated Animals*, 7th edn. London: Baillière Tindall.
- Sturchler D, Schubarth P, Gualzata M, Gottstein B, Oetli A (1989). Thiabendazole vs. albendazole in treatment of toxocariasis: a clinical trial. *Ann Trop Med Parasitol* **83**: 473–8.
- Sugane K, Oshima T (1983). Trapping of large numbers of larvae in the livers of *Toxocara*-reinfected mice. *J Helminthol* **57**: 95–9.
- Taylor MRH, Keane CT, O'Connor P, Girdwood RWA, Smith H (1987). Clinical features of covert toxocariasis. *Scand J Infect Dis* **19**: 693–6.
- Taylor MRH, Keane CT, O'Connor P, Mulvihill E, Holland CV (1988). The expanded spectrum of toxocaral disease. *Lancet* **i**: 692–4.
- Taylor MRH (1993). Toxocariasis in Ireland. In Lewis JW, Maizels RM (eds), *Toxocara and Toxocariasis*. London: Institute of Biology and the British Society for Parasitology; 71–80.
- Taylor MRH, O'Connor P, Hinson AR, Smith HV (1996). *Toxocara* titres in maternal and cord blood. *J Infect* **32**: 231–3.
- Taylor MRH, Holland CV, Spencer R *et al.* (1997). Haematological reference ranges for schoolchildren. *Clin Lab Haematol* **19**: 1–15.
- Thienpoint D, Rochette F, Vanparijs O (1979). *Diagnosing Helminthiasis through Coprological Examination*. Janssen Research Foundation: Beerse, Belgium.
- Thompson DE, Bundy DAP, Cooper ES, Schantz PM (1986). Epidemiological characteristics of *Toxocara canis* zoonotic infection of children in a Caribbean community. *Bull WHO* **64**: 283–90.
- van Gemund JJ, Buijs J, Van Dongen PAM, van den Burgh JPAM (1989). Seroprevalence of *Toxocara* in young children in the city of the Hague. *Trop Geogr Med* **4**: 294–6.
- Walsh SS, Robson WJ, Hart CA (1988). Acute transient myositis due to *Toxocara*. *Arch Dis Childhood* **63**: 1087–8.
- Wilder HC (1950). Nematode endophthalmitis. *Trans Am Acad Ophthalmol Otolaryngol* **55**: 99–108.

Woodruff AW, Bisseru B, Bowe JC (1966). Infection with animal helminths as a factor in causing poliomyelitis and epilepsy. *Br Med J* **1**: 1576–9.

Worley G, Green JA, Frothingham TE *et al.* (1984). *Toxocara canis* infections: clinical and epidemiological associations

with seropositivity in kindergarten children. *J Infect Dis* **149**: 591–7.

Zuelzer W, Apt L (1949). Disseminated visceral lesions associated with extreme eosinophilia. *Am J Dis Childhood* **78**: 153.



# Trichinellosis

Peter M. Schantz<sup>1</sup> and Vance Dietz<sup>2</sup>

<sup>1</sup>*National Center for Infectious Diseases, Atlanta, GA, USA, and* <sup>2</sup>*Organización Panamericana de Salud, Buenos Aires, Argentina*

## HISTORICAL INTRODUCTION

Although the first report of *Trichinella* was made after the organism was observed microscopically in 1835, knowledge of the existence of the disease may date back to antiquity; the early Israelites were specifically interdicted by Mosaic law from consuming the flesh of swine. These and other historical milestones are documented by Kean *et al.* (1978). *Trichinella* cysts were first recognized in 1835 when, in the midst of an anatomic dissection, a British medical student, James Paget in London, noted distinct white flecks distributed throughout a muscle specimen. Microscopic examination of this material revealed what was to become recognized as the typical 'trichina' cyst, containing a single dormant larva. In 1846, Joseph Leidy, a physician in Philadelphia, USA, recorded the similarity of 'specks' he observed in pork with the trichina cysts he had seen in human cadavers. However, the association between the encysted organism in humans and the ingestion of contaminated meat products was not realized until 1850, when Ernst Herbst in Germany demonstrated that the carcass of a badger fed trichinous meat could transfer cysts to the musculature of dogs that ate meat from the carcass. The first recognized fatality associated with this organism was documented by Zenker in 1860, when post-mortem examination of a young woman dying of presumed typhoid fever revealed a heavy infection with *Trichinella* larvae.

Epidemics of trichinellosis began to be documented about this time. Outbreaks occurring in 1849, 1862 and 1865 in Germany were associated with mortality rates of 19%, 17% and 30%, respectively. Clinical trichinellosis was first recognized in the USA by Krombein in 1864. By the 1880s this disease was recognized worldwide. Current knowledge of the nematodes and the diseases they cause has been reviewed (Murrel and Bruschi, 1994; Capo and Despommier, 1996).

## DESCRIPTION OF THE ORGANISMS

Trichinellosis, a nematode infection with worldwide distribution, is caused by tissue-dwelling nematodes of the species *Trichinella*. The infection is acquired by eating raw or inadequately cooked meat products containing encysted larvae (Figure 19b.1). Formerly, the etiologic agent was considered a monotypic nematode species, *Trichinella spiralis*. However, accumulating evidence of variation in transmission cycles, infectivity to experimental hosts and biochemical and genetic characteristics has led to taxonomic revision. Currently, seven genetically distinct species exist that vary according to major reservoir hosts and geographic distribution; three other forms exist whose classifications remain to be determined (Table 19b.1). Each species has been characterized by a combination

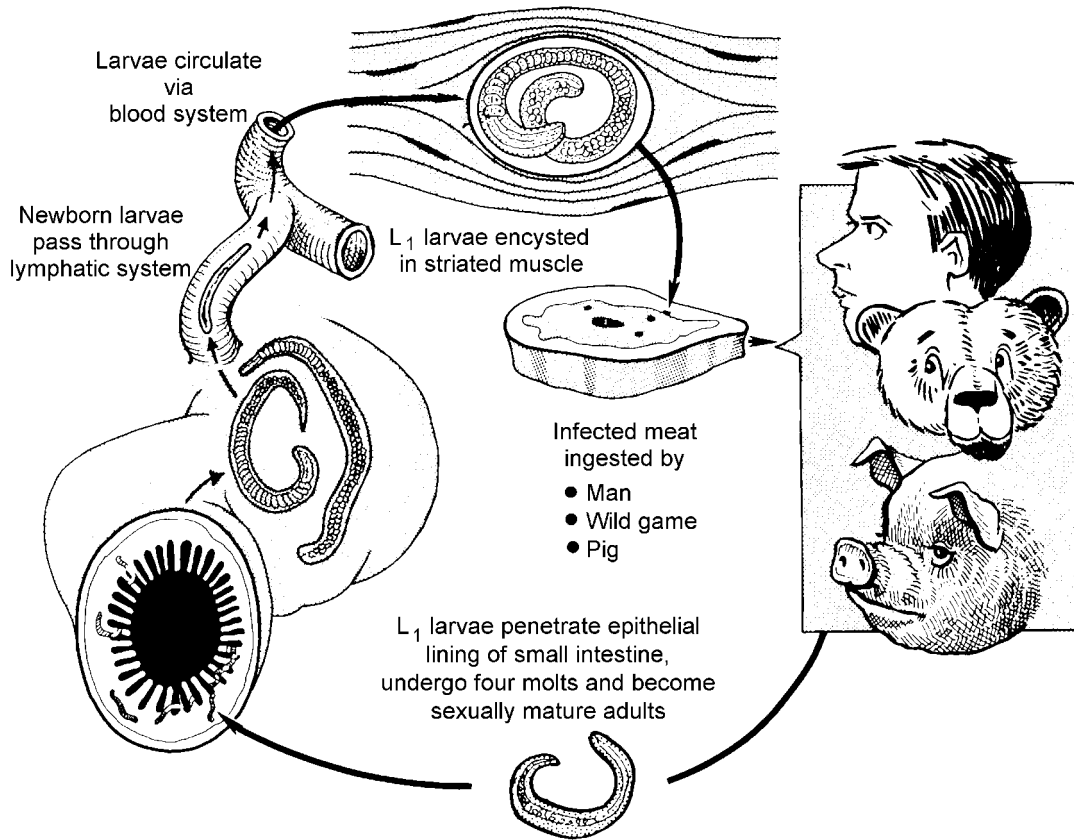


Fig. 19b.1 Life-cycle of *Trichinella spiralis*. US Department of Agriculture, by courtesy of Dr H. Ray Gamble

Table 19b.1 Known hosts and geographic distribution of *Trichinella* spp.

Species	Hosts	Geographic distribution
<i>Trichinella spiralis</i>	Domestic swine, rats and other scavenging carnivores	Cosmopolitan
<i>T. nativa</i>	Wild carnivorous mammals including polar, grizzly and black bears, foxes, and dogs	Arctic and subarctic areas throughout Holarctic regions
<i>T. britovi</i>	Wild carnivorous mammals including red fox, racoon dog, wild boar and other	Palaearctic region south of 7 6°C (Europe, North Africa, Asia Minor, India)
<i>T. nelsoni</i>	Wild carnivorous mammals	Sub-Saharan Africa
<i>T. murrelli</i>	Wild carnivorous mammals	Temperate North America
<i>T. pseudospiralis</i>	Raptorial birds, marsupials, rodents and wild canids	Caucasia, Central Asia, North America and Tasmania
<i>T. papuae</i>	Domestic and sylvatic swine	Papua New guinea
T6	Wild carnivorous mammals	Rocky Mountains, North America
T8	Wild carnivorous animals	Southern Africa
T9	Wild carnivorous mammals	Japan

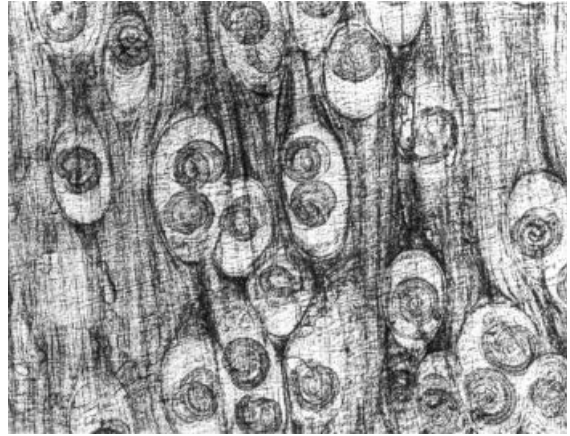
of DNA typing and isozyme patterns (Bandi *et al.*, 1995; Pozio and La Rosa, 1998; Appleyard *et al.*, 1999); a single polymerase chain reaction (PCR) performed in a single muscle larva distinguishes all currently recognized genotypes

(Zarlenga *et al.*, 1999; Pozio and La Rosa, 2000). All recognized variants are adapted to survival in life-cycles involving various species of carnivorous hosts. *T. spiralis* is adapted to the common domestic pig and is historically responsible for

most of the infections in the USA and Europe and, most likely, in other regions as well. *T. nelsoni*, transmitted to humans through wild pigs, is found in Africa and southern Europe. *T. nativa* is maintained in Arctic and sub-Arctic scavenging wildlife (e.g. polar and grizzly bears, arctic and red foxes). *T. britovi* occurs in a variety of carnivores in northern Europe, Asia Minor and India. *T. pseudospiralis*, a distinct non-encapsulating species, has a sylvatic life-cycle, primarily involving small mammalian and marsupial predators and raptorial birds but also infects swine and has become increasingly recognized as a cause of human disease (Ancelle *et al.*, 1985, 1998; Andrews *et al.*, 1994; Jongwutiwes, 1998; Ranque *et al.*, 2000). A second non-encapsulating species, *T. papuae*, was recently described in domestic and sylvatic swine in Papua New Guinea (Pozio *et al.*, 1999). The taxonomic status of other variants (*Trichinella* T6, T8 and T9), also adapted to scavenging wild carnivores, is currently under review. The sylvatic animal *Trichinella* species and variants show distinct characteristics of adaptive advantage for survival in nature, such as variable degrees of resistance to temperature extremes. Most if not all of these known variants are capable of infecting humans when ingested. Evidence suggests that the frequency, duration and severity of clinical signs may be related in part to the infecting species (Murrell and Bruschi, 1994; Pozio and La Rosa, 2000).

## PATHOGENESIS

*T. spiralis* is an obligate intracellular parasite in both its larval (striated skeletal muscle cell) and adult (cytoplasm of a row of enterocytes in the small intestine) niches. In both settings, it induces a series of changes through its secreted proteins, which alter the host, allowing the infection to proceed (Capo and Despommier, 1996). Encysted *Trichinella* larvae ingested in raw or inadequately cooked meat products are released after gastric digestion of the cyst wall. The larvae then invade the columnar epithelium in the mucosa of the small bowel. Within 48 hours, female worms molt four times to the adult stage and are fertilized. Larval deposition begins within 5–6 days. Each female worm is capable



**Fig. 19b.2** Press preparation of striated muscle demonstrating numerous encysted larvae of *Trichinella spiralis*

of producing up to 1500 larvae during its lifetime. Larviposition generally continues for approximately 5 weeks before a combination of immune responses forces the expulsion of the adults from the small intestine (Despommier, 1986). New-born larvae penetrate the mucosa to enter the capillaries and lymphatics of the small intestine, from which they are distributed systemically. Immature larvae that reach striated muscle will enter and induce the myocyte to differentiate into a 'nurse-cell' unit, which subsequently contributes to and supports the process of encystation or encapsulation (Figure 19b.2). These cystic structures may begin to calcify as early as 6 months following the initial infection. However, larvae may remain viable within cysts for several years. If infection occurs in wild game or animals destined for slaughter, the cycle may be reinitiated when a human eats the infected meat. Larvae that reach non-striated muscles or other tissues do not encyst. These larvae continue to migrate within the tissues, which results in marked inflammation and local tissue necrosis. Although this process is usually self-limited, severe multi-organ disease and chronic sequelae may develop.

## IMMUNOLOGY

Murine models of trichinellosis have provided an important model for the study of mechanisms of

host immune response to helminth parasites; aspects of these studies have been summarized by Wakelin (1996), Takahashi (1997) and Bell (1998). Infection with *T. spiralis* in the immune host elicits a strong response that causes rapid expulsion of parasites, a reduction in reproductive capacity of the remaining parasites, a reduction in the number of larvae recovered from host muscles, and impairment of the mobility of worms in the intestine. Worm loss is associated with profound inflammatory changes, the most obvious of which are infiltration of the mucosa by mast cells, villous atrophy and crypt hyperplasia, secretion and accumulation of fluid in the gut lumen and increased peristalsis. These are accompanied by a number of more subtle structural, functional and biochemical changes in the epithelial and lamina propria cells of the mucosa. The result of all of these changes is to make the intestine inhospitable for the worm, changing its environment to such a degree that it is no longer able to maintain its preferred position in the small intestine (Wakelin, 1996).

### Cellular Immune Responses

The inflammatory changes that result in expulsion of *Trichinella* are immune-induced and dependent upon the local activity of a population of CD4<sup>+</sup> T cells (primarily Th2 cells) that develop in the lamina propria and drain mesenteric lymph nodes. These cells cannot bring about worm expulsion by themselves, but interact with bone marrow-derived myeloid cell populations to do so. This interaction is dependent upon release of cytokines that operate both locally and centrally (at the level of the bone marrow) to generate the differentiated cell populations (mast cells, eosinophils) that infiltrate the intestinal wall. Many data support the idea that mast cells are functionally involved in worm loss; mastocytosis depends upon release of a number of cytokines, primarily IL-3, IL-4 and IL-9, released from Th2 cells. Th2 cells also release the cytokine IL-5, which is necessary for development of eosinophils, which are characteristic in the response; eosinophil-derived enzymes and mediators may also be involved in worm expulsion.

### Humoral Immune Responses

Locally produced antibody, particularly Th2-dependent IgE and perhaps IgA, are also prominent in the immune response to *Trichinella* spp. IgA antibodies are believed to contribute to worm expulsion by blocking penetration of epithelial cells by adult worms and interfering with worm growth and reproduction (Bell, 1998). Worms are ejected from their niche in the mucosa because they can no longer maintain themselves there, having suffered non-permanent structural and biochemical damage prior to rejection. Damage is evident in stunting, reduced fecundity, movement within the intestine and ultrastructural lesions in the worm.

*Trichinella* infections in most species of hosts are characterized by strong protective immune responses against the worms of a primary infection and by high levels of resistance to reinfection. The mechanisms that regulate the response to a primary infection in human hosts are not clear; however, it is observed that severity and manifestations of clinical disease in humans is modified by prior experience with the parasite (Maclean *et al.*, 1989).

### EPIDEMIOLOGY

Cases of trichinellosis in humans have been reported from most regions of the world. Although most documented cases have been associated with ingestion of pork products, the number of potential alternative meat sources is great and recognition of cases caused by other sources of infection continues to increase.

The USA is one example of a country in which trichinellosis has long been recognized as an endemic public health problem. Historically, the infection has been mainly associated with ingestion of pork from domestic pigs; however, this meat source has declined in importance and, in recent years, cases caused by ingestion of meat from a variety of wild animals roughly equal the number of those associated with pork. The presence of the parasite in the USA was first described by Leidy in 1846 and, subsequently, numerous outbreaks involving hundreds of cases were reported in the literature. A National

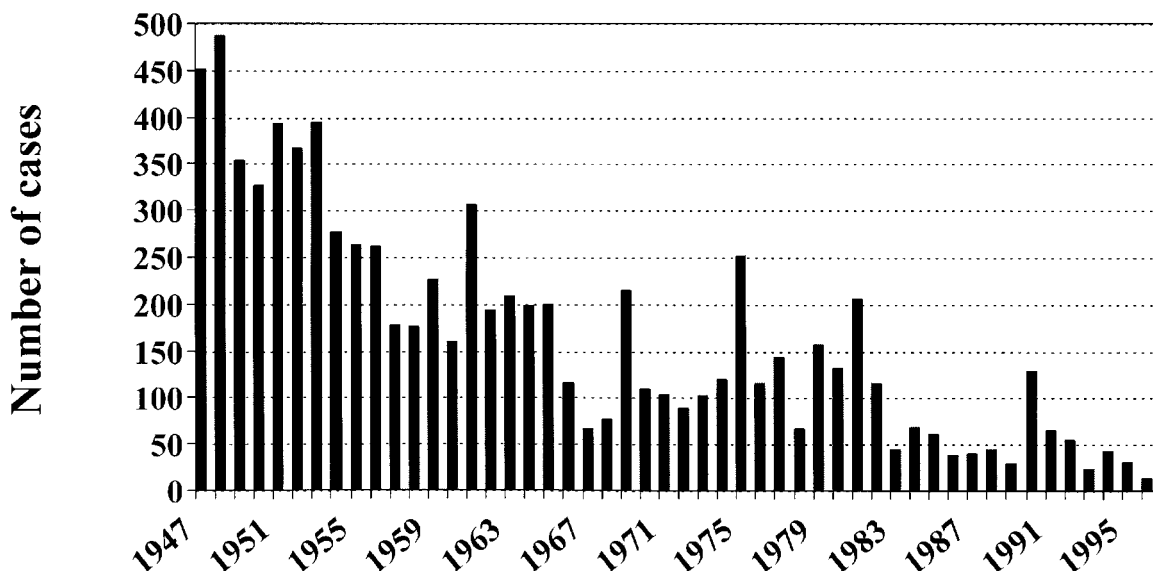


Fig. 19b.4 Annual incidence of reported cases of trichinellosis, USA 1940–1996

Institutes of Health report published in 1943 and based on data collected at autopsies found that one of every six people (16.7%) in the USA were infected (Wright *et al.*, 1943). National reporting of trichinosis did not begin until 1947, at which time an average of 400–500 cases and 15–20 deaths were reported each year (Schantz, 1983) (Figure 19b.3, courtesy of Dr D. Despommier, see Plate VII). The incidence of the disease declined subsequently as a result of legislation prohibiting the feeding of raw garbage to swine (Federal Swine Health Protection Act, 1980), widespread commercial and home freezing of pork, and increased public awareness of the dangers of eating inadequately cooked pork products. In 1982–1986, an annual average of only 57 cases was reported, with three associated fatalities (Bailey and Schantz, 1990) and during 1991–1996, the most recent period for which summarized data are available (Figure 19b.4), an average of 38 cases per year were reported, with three deaths (Moorhead *et al.*, 1999). Pork was implicated in 60% of the cases, bear meat in 23%, walrus meat in 10% and cougar meat in 7%. The proportion of cases attributable to consumption of commercial pork in the USA continues to decline due to a combination of factors, including the continued reduction in the prevalence of *Trichinella spiralis* in domestic

swine through improved production systems (Gamble *et al.*, 1999), widespread use of home freezers and the common practice of thoroughly cooking pork.

In most years the majority of cases reported in the USA occur in multiple-case outbreaks associated with a common meat source. Outbreaks have often occurred in persons belonging to ethnic groups that prefer pork raw, partially cooked or lightly processed. The usual higher incidence of human trichinellosis in the northeastern USA probably resulted, in part, from the greater concentration of ethnic groups (e.g. German, Italian, Eastern European) that have a fondness for lightly cooked sausage dishes (Schantz *et al.*, 1977). Immigrants from southeast Asia have been identified as the most recently identified group at risk because of their preference for raw spiced pork (Stehr-Green and Schantz, 1986). Persons at high risk for bear and other wild animal meat-associated cases have included native Alaskans, who traditionally eat the meat of bears, walrus and other species that may harbor *T. nativa*; however, cases also occur sporadically in hunters of such game throughout the country.

In parts of Europe, *T. spiralis* is enzootic in domestic pigs and *T. britovi* occurs widely in foxes and other sylvatic carnivores (Pozio, 1997).

In most Western European countries, rigorous standards of meat inspection involving examination of a piece of muscle from the carcass of each slaughtered pig has effectively prevented swine-associated trichinellosis. However, occasional outbreaks, sometimes involving hundreds of cases, have been reported as a result of evasion of established swine inspection procedures. Since 1975, horse meat has become the most important cause of trichinellosis in humans in Western Europe. Cases associated with ingestion of horse meat have emerged as an important problem in France and Italy, where this meat source is popular and usually ingested raw or lightly cooked. Although no horsemeat-associated cases were reported before 1975, since then at least 13 horsemeat-associated outbreaks involving more than 3000 cases have been reported (Dupouy-Camet, 2000). Although horses are generally considered to be herbivores and would not seem vulnerable to meat-borne infections, it is believed that horses may occasionally be fed ground meat for 'fattening' before slaughter, or accidentally ingest rodents or other small mammals that are inadvertently ground up in horse rations.

Trichinellosis has re-emerged in Russia, a number of the former Soviet Socialist Republics (Latvia, Lithuania, Ukraine) and Eastern European countries (Bulgaria, Croatia, Romania), in apparent association with lapses in governmental services, including careful meat inspection. Hundreds and even thousands of cases are now reported every year from these countries (International Commission on Trichinellosis, 1999).

In populations in which pork ingestion is proscribed for religious or other reasons, trichinellosis associated with pork ingestion has been rare or non-existent. Nevertheless, outbreaks have been described, in which such populations unknowingly ingested pork. Examples are outbreaks involving hundreds of cases in southern Lebanon, associated with ingestion of ground meat dishes traditionally prepared with lamb but for which pork was substituted (Haim *et al.*, 1997).

## CLINICAL FEATURES

The clinical manifestations of trichinellosis are protean, ranging from asymptomatic or mildly

symptomatic to severe life-threatening disease with neurologic and cardiac manifestations. The development of specific clinical symptoms parallels the different stages of development of the parasite and they are often grouped into three phases: enteric, systemic or parenteral (muscular), and a convalescent phase. In addition, clinical entities of chronic trichinellosis and neuro-trichinellosis have been reported. The number of living larvae ingested and the species of *Trichinella* affect the clinical spectrum, as well as its severity (Murrell and Bruschi, 1994). Severity also depends on such host factors as age, gender, general health status of the infected individual and previous exposure to the parasite.

*T. spiralis* is responsible for most human infections and also for the classic description of the clinical illness; therefore, it may be used as a prototype. The incubation period of trichinellosis is generally 5–51 days and is inversely related to severity, i.e. the shorter the incubation period, the more severe the disease, e.g. 7 days for severe cases.

### Enteric Phase

After ingestion of infected meat, gastrointestinal symptoms appear and are related to the inflammation associated with the larval penetration of the intestinal mucosa. Anorexia, nausea, vomiting, diarrhea or constipation, upper abdominal pain and malaise have been reported. Patients are generally afebrile or have a mild fever. Vomiting can be sudden, sometimes starting within hours of ingestion of contaminated meat and, in some cases, can persist up to 4 weeks. Diarrhea can also be variable, ranging from mild to severe cholera-like, and has been reported to last as long as 3 months. However, the severity of the enteric phase can be so mild as to be overlooked, with patients seeking medical care only after the onset of the parenteral or systemic phase. The enteric phase generally lasts 1–2 weeks. Death during this phase is rare but when it occurs it is generally related to dehydration from severe diarrhea.

### Parenteral or Severe Phase

The parenteral or systemic phase begins 1–6 weeks after ingestion of larvae in meat, with

symptoms associated with the migratory behavior of the larvae (Capo and Despommier, 1996). A classic 'trichinellotic' syndrome is described, consisting of fever, facial edema, myalgias, muscle swelling and weakness. However, any organ can be involved, producing a myriad of signs and symptoms, all due in some part to the penetration of striated musculature and other organs by the larvae. Other signs and symptoms observed during the parenteral phase include hot flushes, folliculitis, furunculosis, urticaria, dermatographia, difficulty in speaking, hepatomegaly, splenomegaly, diarrhea and vomiting.

### ***Ocular Manifestations***

These are common and are particularly useful in establishing a diagnosis. These include periorbital edema, chemosis, conjunctivitis, and conjunctival hemorrhages and eye pain (Murrell and Bruschi, 1994). Periorbital edema, although not always observed, is believed to be highly suggestive of trichinellosis; when present, particularly when associated with peripheral eosinophilia, it should raise suspicion of the disease. The edema can begin 7–21 days after infection and usually lasts a week.

### ***Pulmonary Manifestations***

Pulmonary symptoms have been reported and include dyspnea, bronchitis, pleuritis and cough. Pulmonary symptoms are believed to be related to the parasite in thoracic muscles. Pneumonitis occurs in < 5% of hospitalized cases and may be immunologically related (Gould, 1970; Pawlowski, 1983; Janiszkiewicz, 1967). Chest radiographs may exhibit infiltrates or lesions characteristic of pulmonary vasculitis or disseminated emboli (Janiszkiewicz, 1967).

### ***Neurologic Manifestations***

Neurologic manifestations can occur in 10–24% of infections and include headache, vertigo, tinnitus, deafness, convulsions, loss of reflexes, hemiplegia, encephalitis, focal motor deficits,

insomnia and incontinence (Murrell and Bruschi, 1994; Capo and Despommier, 1996; Bia and Barry, 1986). In addition, mental changes have been reported, including psychosis and depression (Simon *et al.*, 1986). Neurologic manifestations are associated with brain tissue damage due to arterial occlusion or to granulomatous formation. An evaluation of nine patients with neurotrichinellosis showed, via CT scan, that the principal manifestation was encephalitis, associated with small hypodensities in the cortex and white matter (Fourestie *et al.*, 1993). The authors also reported hypereosinophilia of  $\geq 4000 \text{ mm}^3$  and cardiovascular damage, including infarction, in eight of the nine patients. They postulated that this represented a cardioneurologic syndrome of trichinellosis and that all patients who exhibit neurologic manifestations should be evaluated for silent myocardial injury as well.

### ***Cardiovascular Manifestations***

Cardiovascular involvement has been reported in 20% of hospitalized patients and manifests as myocarditis or myocardial injury. Symptoms include chest pain, shortness of breath and palpitations and heart failure. ECG changes include premature contractures, prolonged PR interval, small QRS complexes and flattening or inversion of T waves (Bruschi and Murrell, 1994).

### ***Other Manifestations***

These include chills, diaphoresis, peripheral edema, pruritis, headache, a maculo-papular skin rash resembling that of measles or rubella, dysphagia, hemorrhages in the nail bed, retinal hemorrhages, insomnia, nerve sensations and paresthesiae, lymphadenopathy and hoarseness (Murrell and Bruschi, 1994; Capo and Despommier, 1996).

### ***Muscles***

Myalgias are common; in about half of cases the muscular pain is characterized by pain on

contraction, while others have continuous pain (Ferraccioli *et al.*, 1989). The pain can be severe and can be accompanied by weakness, limiting function and giving the appearance of paralysis. An evaluation of 150 patients showed that 67% had tenderness of the musculature of the scapular girdle, 41% of the biceps/triceps, 34% of the extensors/flexors of the forearm, 31% of leg muscles, and 13% of the sacrospinal area (Ferraccioli *et al.*, 1988).

### Laboratory Parameters

Leukocytosis is common, with a predominance of eosinophils. Eosinophilia is present in all cases and reaches its highest levels by 3–4 weeks after infection. The magnitude of eosinophilia is related to the number of infecting parasites. Circulating muscle enzymes, i.e. creatinine phosphokinase (CPK), lactate dehydrogenase and others, are often elevated and are useful in making a diagnosis. Hypoalbuminemia has also been reported.

### Convalescent Phase

The convalescent phase is heralded by lysis of fever and improvement in muscular symptoms, usually around 5–6 weeks after infection. However, some symptoms, such as dyspnea, edema and bronchitis, when present, can persist for several more weeks. Recovery is generally complete, although some patients demonstrate fatigue, weakness and diarrhea for months after infection. Controversy exists over whether 'chronic trichinellosis' is a real entity. Follow-up evaluation of 17 patients years after infection revealed 15 with persistent myalgias, eight with burning of the eyes and seven with headaches (Froscher *et al.*, 1988). In six of the 15 patients who had a muscle biopsy, focal myositis was observed and five patients had living parasites. While some clinicians support the concept of 'chronic trichinellosis' (Froscher *et al.*, 1988), others dispute that it represents a distinct entity (Cox *et al.*, 1969; Kassur and Januszkiewicz, 1970).

### Trichinellosis in Pregnancy

Trichinellosis during pregnancy may result in spontaneous abortion, fetal death, placental parasitism and passage to the fetus (Pawlowski, 1983). In addition, infection can manifest in unusual locations or as a mass that is incidentally diagnosed as trichinellosis after surgical exploration (Schantz and Michelson, 1998). These lesions are often associated with old or calcified muscle cysts and do not necessarily require drug therapy after surgical excision.

### Severity and Prognosis

Death due to trichinellosis is usually related to congestive heart failure due to myocarditis, encephalitis or pneumonitis (Gould, 1970; Pawlowski, 1983). Mortality is a function of the intensity of the infections, which is related to the larval dose; as discussed below the course of infection by *T. spiralis* is more severe and more likely to result in death than that caused by other species. Mortality rates are usually low and decreasing due to improved therapy, e.g. in the USA during 1982–1986, of 287 cases reported only three (0.1%) resulted in death (Bailey and Schantz, 1990).

As mentioned previously, different species of *Trichinella* may produce differing clinical pictures. For example, comparison of symptomatology in different outbreaks in Europe involving horsemeat showed that 44% of persons infected with *T. nativa* had a rash vs. 11% with *T. spiralis* and 4% with *T. britovi* (Murrell and Bruschi, 1994). While 90% of those with *T. nativa* reported fever, 85% of those with *T. spiralis* infections and 70% with *T. britovi* reported fever. Infection with *T. nativa* has been associated with prolonged diarrhea, i.e. average duration of 44 days, without fever and a brief period of myalgia, i.e. average duration of 13 days, or, in some cases, no parenteral phase (Maclean *et al.*, 1989). *T. britovi* infections are of moderate pathogenicity, have a long incubation period and infected persons exhibit few gastrointestinal symptoms (Pozio *et al.*, 1993). *T. nelsoni* infections, originally reported from Africa, are associated with low pathogenicity,



although very high larva burdens have been documented (Murrell and Bruschi, 1994). In one case series of *T. nelsoni* infections, all were clinically mild with muscular symptoms predominating and without evidence of neurologic or cardiac involvement (Ferracioli *et al.*, 1989). Infections caused by *T. murrelli*, resulting from infection of horsemeat, showed a general similarity to those caused by *T. spiralis*; however, there were differences in the frequency of facial edema and cutaneous rash (Pozio and La Rosa, 2000). The first described case of *T. pseudospiralis* infection was characterized by a muscular or parenteral phase and an asymptomatic gastrointestinal phase; treatment with steroids caused a worsening of the patient's condition that may have been related to the fact that *T. pseudospiralis* does not induce a host muscle capsule around the larva (Andrews *et al.*, 1994). Recently described outbreaks of *T. pseudospiralis* infections in Thailand and France suggest clinical course and responses to antiparasitic chemotherapy similar to those caused by *T. spiralis* infection.

It has been speculated that one or more previous *Trichinella* infections may alter the clinical presentation of the illness (Maclean *et al.*, 1989). Likewise, low numbers of infecting organisms may alter the clinical manifestations, i.e. a generally mild illness or absence of gastrointestinal symptoms. Partial processing of infected meat may injure the larvae and affect their invasiveness and this has been postulated to be responsible for foci of trichinellosis characterized by a mild clinical course (Kociecka *et al.*, 1994).

## LABORATORY DIAGNOSIS

### Clinical

The diagnosis of trichinellosis depends on identifying and correlating the numerous clinical signs, symptoms and laboratory findings (Capo and Despommier, 1996). Figure 19b.4 summarizes the clinical presentation of infection with *T. spiralis*. It illustrates that certain symptoms are correlated with the phase of infection and this is associated with the presence of the different

stages of the parasite in the intestine or peripheral tissues.

When the classic symptoms are present, i.e. myalgias, periorbital edema, fever and eosinophilia, the diagnosis is highly suggestive of trichinellosis. However, many patients do not present with these classic manifestations. During the enteric phase, symptoms may be confused with food poisoning. The disease may mimic a viral syndrome, e.g. with gastrointestinal symptoms, muscle aches and pain (Morse and Ridenour, 1994). Thus, physicians need to include questions about food consumption and travel in their history taking. The differential diagnosis for the parenteral phase includes serum sickness, dermatomyositis, periarteritis nodosa, angioneurotic edema, periorbital edema, cavernous sinus thrombosis, typhoid fever, rheumatic fever, influenza, trypanosomiasis, hypothyroidism and heart failure. Myositis with eosinophilia may occur in visceral larva migrans and, rarely, cysticercosis. Neurologic involvement may mimic meningitis, encephalitis, cerebral infarct or polyneuritis. Cardiac and pulmonary symptoms may be suggestive of myocarditis, endocarditis, ischemic cardiomyopathy and pneumonia.

### Parasite Diagnosis

The diagnosis of trichinellosis can be made by muscle biopsy by identifying the characteristic larval spiral, although a negative biopsy does not rule out the disorder. Preferred sampling sites include the deltoid and gastrocnemius muscles. In addition to its value for diagnosis, the results of biopsy can be used to measure the severity of the infection, as reflected by the number of larvae per gram of tissue. Biopsy material can also be used to determine the species of *Trichinella* by PCR; however, the technology for these procedures may currently be available only at certain reference laboratories (Bandi *et al.*, 1995; Zarlenga *et al.*, 1999). Ova and parasite examination of stool specimens rarely yields a positive diagnosis. Adult worms, which rarely are found in feces, do not produce eggs and newborn larvae are rapidly disseminated systemically from their submucosal location.

### Serologic Diagnosis

Serologic tests useful for the diagnosis of trichinellosis detect antibodies to antigens secreted by L1 (muscle stage) larvae (Gamble, 1994). A large number of serologic procedures have been used and their operating characteristics (sensitivity and specificity) have improved over time with the refinement of techniques and improved definition and purification of the important diagnostic antigens. For most tests, seroconversion occurs by the third to fourth week after infection; however, antibodies can persist from months to years, making interpretation difficult. Thus, serologic testing is most useful in conjunction with a thorough clinical evaluation. By day 14 after infection, most clinically ill persons will have sought medical care and may be positive by enzyme-linked immunosorbent assay (ELISA) for IgG. The sensitivity of the ELISA (IgG) reaches 100% 50 days after infection (Capo and Despommier, 1996). Recent comparative evaluations of tests in outbreak situations have shown that most techniques, including ELISA (IgG), indirect hemagglutination (IHA) and immunofluorescence (IF-IgG) were highly sensitive for detecting cases of confirmed trichinellosis; however, the ELISA (IgG) proved to be the most reliable test for detecting specific immunoglobulins in late (> 1 year) infections (Bruschi *et al.*, 1990). A commonly used test in the USA is the bentonite flocculation test. A colloidal suspension of aluminum silicate particles (bentonite), to which *Trichinella* antigen is bound, is incubated with serial dilutions of serum from a suspected case. Agglutination of these particles at a dilution of 1:5 or greater represents the presence of specific antibody and denotes a positive test (Kagan, 1979). Although widely used, false negatives and positives are reported (Murrell and Bruschi, 1994). Data suggest that the antibodies involved in the test are IgM. The disadvantage of this test is that it cannot detect antibodies in early or light infections.

### TREATMENT

Therapy of trichinellosis has several goals, including alleviation of the symptoms and

elimination of the adult and larval stage nematodes.

Specific anthelmintic drugs are used to eliminate intestinal stage adults and tissue-migrating and encysted larvae. Experimental studies and clinical experience suggest that benzimidazole drugs are most effective against larval stage *Trichinella* prior to encapsulation within the muscle cell; it appears that the nurse-cell acts as a barrier to penetration of benzimidazole drugs, thus reducing the efficacy of anthelmintic treatment administered post-encapsulation, even when given at high doses [Pozio *et al.*, 2001 (in press)]. Unfortunately, the complexity of the clinical picture of trichinellosis frequently results in delayed diagnosis and initiation of treatment. Clinical experiences (Fourestie *et al.*, 1993; Cabie *et al.*, 1996; Watt *et al.*, 2000), indicate that, when promptly administered, benzimidazole therapy resolves muscle pain and other symptoms and reduces muscle larval burdens more effectively than placebo.

Infected patients may harbor adults that shed larvae for weeks. Specific treatment of the intestinal-stage parasite involves the use of a benzimidazole, i.e. mebendazole (200 mg/day for 5 days) or albendazole [400 mg/day for 3 days for adults (except pregnant women) and 5 mg/kg/day for 4 days for children] or pyrantel pamoate (10 mg/kg/day for 5 days) (Murrell and Bruschi, 1994). The use of these medications within several days of eating contaminated food may effectively prevent evolution of the disease (Ozeretskovskaya *et al.*, 1978).

During the parenteral phase of the disease, treatment is aimed at reducing muscle damage and eliminating encysted muscle larva. Thus, a benzimidazole in conjunction with a steroid preparation may be indicated, especially in patients with severe symptoms. Mebendazole in doses of 5 mg/kg PO b.i.d. for 10–13 days or albendazole (probably the more effective drug) in a dose of 15 mg/kg PO for 10–15 days until fever and allergic signs recede is indicated. Thiabendazole has also been used but adverse events are common and can be life-threatening. In two clinical trials that assessed the therapeutic effectiveness between thiabendazole and albendazole or mebendazole the latter benzimidazoles were better tolerated (Cabie *et al.*, 1996; Watt *et al.*, 2000), while in another there was no difference

between the two (Fourestie *et al.*, 1993). Albendazole was shown to be more effective when outcome was assessed by serologic status and muscle biopsy months after the onset (Fourestie *et al.*, 1993).

Concurrent administration of corticosteroids (e.g. prednisone 40–60 mg PO q.d.) is indicated in symptomatic disease with incapacitating symptoms such as prolonged fever or intense hypersensitivity symptoms during the illness or associated with anthelmintic therapy. It has been argued that the clinical picture observed in most patients is primarily due to inflammatory and allergic reactions; thus the resolution of symptoms is more dependent on timely administration of corticosteroids rather than anthelmintic drugs (Pozio *et al.*, 2001).

## PREVENTION AND CONTROL

To prevent infection, it is necessary to cook pork products to an internal temperature of 160°F (71°C), which is well above the death point for *T. spiralis* larvae (131–135°F) and is usually achieved if the meat is cooked until it is no longer pink inside (Code of Federal Regulations USA, 1994). US regulations for commercial preparation of pork for consumption state that pork must be heated to at least 137°F (58.3°C). In addition, pork cuts less than 6 inches thick can be rendered safe if frozen to 5°F (7 17°C) for 20 days, 7 10°F (7 23.3°C) for 10 days or 7 20°F (7 28.9°C) for 6 days. Larger pieces, of course, require longer exposures or lower temperatures. As mentioned above, the larvae of *T. nativa* and some other sylvatic variants are more resistant to freezing temperatures and may not be completely inactivated. Microwave cooking may not be sufficient to inactivate *Trichinella* larvae (because of uneven heating) unless a microwave cooking bag is used as well (Murrell *et al.*, 1991).

Curing (salting), drying and smoking, except under rigidly defined conditions, may not be consistently effective in killing infective larvae. Low levels of ionizing radiation (0.15 kGy) applied to infected pork prevents further development of the parasites (Loaharanu and Murrell, 1994). Although this process is now approved by the US Food and Drug Administration and

official authorities in many other countries, its application for control of trichinellosis requires acceptance by consumers and the meat production industry.

Many countries inspect every pig carcass for the presence of *Trichinella*. The most commonly used method of inspection is the pooled sample digestion method, which is described in the Directives of the European Union (EEC Commission Directive 77/96/EEC, 1977; EEC Commission Directive 84/319/EEC, 1984). Enzyme immunoassays are sensitive and specific for detection of *Trichinella*-infected swine before or during the slaughtering process and are a useful adjunct to traditional swine inspection procedures (Gamble, 1996). Serologic tests are not as reliable for detection of infected horses, however, because experimentally infected horses become seronegative within 6 months of infection, even while still harboring infective larvae in their muscle (Soule *et al.*, 1989, 1993).

The declining incidence of cases of human trichinosis in the USA is associated temporally with a continuing decline in the prevalence of the infection in market hogs. At the turn of the 20th century it was estimated that 1.0–2.5% of market hogs were infected. In 1970, the prevalence in pigs was determined to be 0.12% and has declined substantially since then. A serologic survey of pigs performed as part of the National Swine Survey in 1995 gave an infection rate of only 0.013%; thus, trichinellosis infection rates in pigs are now extremely low. Current efforts by the US Department of Agriculture are aimed at monitoring hog farms for trichinellosis risk practices and promoting the elimination of such practices, with the goal of eventual certification of trichinae-free farms; when implemented, this program is expected to reduce the rate in swine further (Gamble, 1998).

## REFERENCES

- Ancelle T, Dupouy-Camet J, Bougnoux M-E *et al.* (1988). Two outbreaks of trichinosis caused by horsemeat in France in 1985. *Am J Epidemiol* **127**: 1302–11.
- Ancelle T, Dupouy-Camet J, Desenclos JC *et al.* (1998). A multifocal outbreak of trichinellosis linked to horse meat imported from North America to France in 1993. *Am J Trop Med Hyg* **59**: 615–19.

- Andrews JR, Ainsworth R, Abernethy D (1984). *Trichinella pseudospiralis* in humans: description of a case and its treatment. *Trans R Soc Trop Med Hyg* **88**: 200–3.
- Appleyard GD, Zarlenga D, Pozio E, Gajadhar AA (1999). Differentiation of *Trichinella* genotypes by polymerase chain reaction using sequence-specific primers. *J Parasitol* **85**: 556–9.
- Bailey TM, Schantz PM (1990). Trends in the incidence and transmission patterns of human trichinosis in the United States: comparisons of the periods 1975–1981 and 1982–1986. *Rev Infect Dis* **12**: 5–10.
- Bandi C, La Rosa G, Bardin MG *et al.* (1995). Random amplified polymorphic DNA fingerprints of the eight taxa of *Trichinella* and their comparison with allozyme analysis. *Parasitology* **110**: 401–7.
- Bell RG (1998). The generation and expression of immunity to *Trichinella spiralis* in laboratory rodents. *Adv Parasitol* **41**: 150–217.
- Bia FJ, Barry J (1986). Parasitic infections of the central nervous system. *Neurol Clin* **4** (1): 171–207.
- Cabie A, Bouchaud O, Houze S *et al.* (1996). Albendazole versus thiabendazole as therapy for trichinosis: a retrospective study. *Clin Infect Dis* **22**: 1033–5.
- Capo V, Despommier DD (1996). Clinical aspects of infection with *Trichinella* spp. *Clin Microbiol Rev* **9**: 47–54.
- Code of Federal Regulations (1994). *Animals and Animal Products*, Chapter 9. Washington: Office of the Federal Register, Government Printing Office; 212–20.
- Cox PM, Schultz MG, Kagan IG, Preizler J (1969). Trichinosis: five-year serologic and clinical follow-up. *Am J Epidemiol* **89**: 651–4.
- Despommier DD (1986). Trichinellosis. In Walls KW, Schantz PM (eds), *Immunodiagnosis of Parasitic Diseases, vol 1, Helminthic Diseases*. Orlando, FL: Academic Press; 163–81.
- Despommier DD (1990). *Trichinella spiralis*: the worm that would be virus. *Parasitol Today* **6**: 193–6.
- Dupouy-Camet J (2000). Trichinellosis: a worldwide zoonosis. *Vet Parasitol* **93**: 191–200.
- European Economic Community (1977). Commission Directive 77/96/EEC. *Offic J Eur Commun* **26**: 67–77.
- European Economic Community (1984). Commission Directive 84/319/EEC. *J Eur Commun* **167**: 34–43.
- Ferraccioli GF, Mercadanti M, Salaffi F *et al.* (1989). Aspetti clinico-biologici della miosite da *Trichinella* T3 con particolare riguardo ad uno studio reumatologico. *Ann Inst Super Sanità* **25**: 641–8.
- Ferraccioli GF, Mercadanti M, Salaffi *et al.* (1988). Prospective rheumatological study of muscle and joint symptoms during *Trichinella nelsoni* infection. *Q J Med* (New Series) **69** (260): 973–84.
- Fourestie V, Bounoux ME, Ancelle T *et al.* (1988). Randomized trial of albendazole versus thiabendazole plus flubendazole during an outbreak of human trichinellosis. *Parasitol Res* **75**: 36–41.
- Fourestie V, Douceron H, Brugieres P, Ancelle T, Lejone JL, Gherardi RK (1993). Neurotrichinosis. *Brain* **116**: 603–16.
- Froscher W, Gullotta F, Saathoff M, Tackmann W (1988). Chronic trichinosis: clinical biologic, serological and electromyographic observations. *Eur Neurol* **28**: 221–6.
- Gamble HR (1994). Larval (L1) antigens for the serodiagnosis of trichinellosis in swine and other species. In *Trichinellosis*, Proc Eth International Conference on Trichinellosis, Orvieto, Italy. Rome. 1st Sup San Press; 323–5.
- Gamble HR (1996). Detection of trichinellosis in pigs by artificial digestion and enzyme immunoassay. *J Food Protect* **59**: 295–8.
- Gamble HR (1998). Getting rid of the trichinae stigma. *Nat Hog Farmer* **Jan15** 30–2.
- Gamble HR, Brady RC, Bulaga LL *et al.* (1999). Prevalence and risk factors for *Trichinella* infection in domestic pigs in the north-eastern United States. *Vet Parasitol* **82**: 59–69.
- Gould SE (1970). *Trichinosis in Man and Animals*. Springfield, IL: Charles C Thomas; 289.
- Haim M, Efrat M, Wilson M, Schantz PM, Cohen D, Shemer J (1997). An outbreak of *Trichinella spiralis* infection in southern Lebanon. *Epidemiol Infect* **119**: 357–62.
- International Commission on Trichinellosis. Recent trichinellosis outbreaks. Available on <http://www.krenet.it/ict/statusrp.html>. Accessed 15 January 1999.
- Januszkiewicz J (1967). Participation of the respiratory system in trichinosis. *Epidemiol Rev* **21**: 169.
- Kagan IG (1979). Diagnostic, epidemiologic, and experimental parasitology: immunologic aspects. *Am J Trop Med Hyg* **28**: 429.
- Kassur B, Januszkiewicz J (1970). On the inappropriateness of the idea of chronic trichinellosis. *Epidemiol Rev* **24**: 68.
- Kean BH, Mott KE, Russel AJ (eds) (1978). Trichinosis. In *Tropical Medicine and Parasitology. Classical Investigations*, Vol II. Ithaca: Cornell University Press; 458–72.
- Kociecka W, van Knappen F, Kortbeek T (1994). Focus on trichinellosis and factors determining its mild clinical course. *Wiad Parazytol* **40**: 375–80.
- MacLean JD, Viallet J, Law C, Staudt M (1989). Trichinosis in the Canadian Arctic: report of five outbreaks and a new clinical syndrome. *J Infect Dis* **160**: 513–20.
- Moorehead A, Grunenwald PE, Dietz VJ, Schantz PM (1999). Trichinellosis in the United States 1991–1996: declining but not yet gone. *Am J Trop Med Hyg* **60**: 66–9.
- Morse J, Ridenour R (1994). Unterseher P. Trichinosis: infrequent diagnosis or frequent misdiagnosis? *Ann Emerg Med* **24**: 969–71.
- Murrell KD, Bruschi F (1994). Clinical trichinellosis. *Progr Clin Parasitol* **4**: 117–50.
- Murrell KD, Woods GT, Biehl LG (1991). Trichinellosis. In *Pork Industry Handbook*. PIH-103, Purdue University Cooperative Extension Service; 1–4.
- Murrell KD, Lichtenfels RJ, Zarlenga DS, Pozio E (2000). The systematics of *Trichinella* with a key to species. *Vet Parasitol* **93**: 293–307.
- Ozeretskovskaya N, Peverzeva E, Tumolskaya N *et al.* (1978). Benzimidazoles in the treatment and prophylaxis of synanthropic and sylvatic trichinellosis. In Kim CW, Pawloski ZS (eds), *Trichinellosis*. Hanover, NH: University Press of New England; 381–93.
- Pawloski ZS (1983). Clinical aspects in Man. In Campbell WC (ed.), *Trichinella and Trichinosis*. New York: Plenum; 367–401.

- Pozio E (1997). Trichinellosis in the European Union: epidemiology, ecology and economic impact. *Parasitol Today* **14**: 35–8.
- Pozio E, Varese PK, Gomez Morales MA, Croppo GP, Pelliccia D, Bruschi F (1993). Comparison of human trichinellosis caused by *Trichinella spiralis* and by *Trichinella britovi*. *Am J Trop Med Hyg* **48**: 568–75.
- Pozio E, La Rosa G (1998). Biology aspects of speciation in the Genus *Trichinella*. *Proceedings of the Ninth International Conference on Trichinellosis*. Mexico City, 1997; Ortega-Pierres G, Gamble R, Van Knapen F, Wakelin D (eds). Centr Invest Estud Avanz Inst Pol Nac Mex, Mexico; 19–22.
- Pozio E, Owen IL, La Rosa G, Sacchi L, Rossi P, Corona S (1999). *Trichinella papuae* n.sp. (Nematoda), a new non-encapsulating species from domestic and sylvatic swine of Papua New Guinea. *Int J Parasitol* **29**: 1825–39.
- Pozio E, La rosa G (2000). *Trichinella murrelli* n.sp.: etiological agent of sylvatic trichinellosis in temperate areas of North America. *J Parasitol* **86**: 134–9.
- Pozio E, Sacchini D, Sacchi L, Tamburrini A, Alberici F (2001). Failure of mebendazole in treating *Trichinella spiralis* infection at the stage of encapsulating larvae. *Clin Infect Dis* (in press).
- Schantz PM (1983). Trichinosis in the United States, 1947–1981. *Food Technol March*: 83.
- Schantz PM, Juranek DD, Schultz MG (1977). Trichinosis in the United States, 1975: increase in cases attributed to numerous common-source outbreaks. *J Infect Dis* **136**: 712–15.
- Schantz PM, Michelson MK (1998). Trichinosis. In Gorbach SL, Bartlett JG, Blacklow NR (eds), *Infectious Diseases*, 2nd edn. Philadelphia: W. B. Saunders; 1616–20.
- Simon JW, Riddell N, Wong AW, Au A, Ko R, Templer M (1986). Further observations on the first documented outbreak of trichinosis in Hong Kong. *Trans R Soc Trop Med Hyg* **80**: 394–7.
- Soule C *et al.* (1989). Experimental trichinellosis in horses: biological and parasitological evaluation. *Vet Parasitol* **31**: 19–36.
- Soule C *et al.* (1993). Biological and parasitic variations in horses infested and reinfested by *Trichinella spiralis*. *Vet Res* **24**: 21–31.
- Stehr-Green JK, Schantz PM (1986). Trichinosis in south-east Asian refugees in the United States. *Am J Public Health* **76**: 1238–9.
- Takahashi Y (1997). Antigens of *Trichinella spiralis*. *Parasitol Today* **13**: 104–6.
- Wakelin D (1996). Immunity to *Trichinella*. In Wakelin D, *Immunity to Parasites. How parasitic infections are controlled*, 2nd edn. Cambridge University Press, Cambridge: 134–9.
- Watt G, Saisorn S, Johnsakul K, Sakolvaree Y, Chaicumpa W (2000). Blinded, placebo-controlled trial of antiparasitic drugs for trichinosis myositis. *J Infect Dis* **182**: 371–4.
- Wright WH, Kerr KB, Jacobs L (1943). Studies on trichinosis. XV. Summary of the findings of *Trichinella spiralis* in a random sampling and other samplings of the populations of the United States. *Public Health Rep* **58**: 1293.
- Zarlenga DS, Chute MB, Martin A, Kapel CMO (1999). A multiplex PCR for unequivocal differentiation of all encapsulated and non-encapsulated genotypes of *Trichinella*. *Int J Parasitol* **29**: 1859–63.



# Migrating Worms

Stephen H. Gillespie

*Royal Free and University College Hospital Medical School, London, UK*

Migration of helminth larvae is a normal part of the life cycle of many parasites. This includes the migration and development of cercariae of *Schistosoma* or the multi-stage development of ascarids such as *Ascaris lumbricoides* and hookworms such as *Ancylostoma duodenale* or *Necator americanus*. A detailed description of these parasites can be found in Chapter 21. For some parasites the migration of larval stages may be responsible for the main clinical syndrome, as in the case of *Strongyloides stercoralis* infection, and this is described in detail in Chapter 18c. The main purpose of this chapter is to discuss those helminths which migrate through the human body but in whom this is an abnormal phenomenon, since humans are not a natural host of the parasite, which is thus unable to complete its life-

cycle. This is to distinguish our subject from several zoonotic infections, such as hydatid disease, where humans are accidental intermediate hosts but behave in a similar way to the natural hosts. For many of the migrating worms that form the subject of this chapter, the migratory stage may be prolonged. Among such organisms must be included *Toxocara canis*, which is the commonest cause of visceral larva migrans, but because of its prevalence and importance in human medicine toxocariasis is discussed separately in its own chapter (see Chapter 5). The organisms that will be discussed here are: *Angiostrongylus cantonensis*, *Angiostrongylus costaricensis*, *Gnathostoma spinigerum*, *Ancylostoma braziliense*, *Ancylostoma caninum*, *Spirometra* and *Dirofilaria* spp. (see Table 19c.1).

## ANCYLOSTOMA CANINUM AND ANCYLOSTOMA BRAZILIENSE

### INTRODUCTION

Infections with dog hookworms have traditionally been associated with creeping eruption or cutaneous larva migrans. This condition is found worldwide and was thought to be due to the fact that these larvae could not complete their life-cycle in non-canine hosts (Jelinek *et al.*, 1994). Recent studies, however, indicate that *Ancylostoma caninum* can achieve a wider migration and is implicated in the condition of eosinophilic enteritis (Croese *et al.*, 1994).

### DESCRIPTION OF THE ORGANISMS

The *Ancylostoma caninum* adult male worm has an average length of 10 mm and a diameter of 0.4 mm. The female is longer at 14 mm and 0.6 mm in diameter. They have a wide buccal capsule bearing three pairs of ventral teeth and this feature is diagnostic (Figure 19c.1). The eggs of the species are similar to those of *A. duodenale* but are slightly larger (64 × 40 µm) (Figure 19c.2). *A. braziliense* males are approximately 8 mm in length × 0.3 mm in diameter and the females are

**Table 19c.1** Summary of non-human migrating helminths

Species	Natural host	Principal syndrome	Diagnostic method	Therapy
<i>Ancylostoma caninum</i>	Dog	Cutaneous larva migrans Eosinophilic enteritis	Clinical features Antibody capture EIA Tissue biopsy	10% thiabendazole paste with occlusive dressing 200 mg mebendazole
<i>Ancylostoma braziliense</i>	Dog	Cutaneous larva migrans	Clinical features	10% thiabendazole paste with occlusive dressing
<i>Gnathostoma spinigerum</i>	Dog, cat, mink, racoon, others	Migrating space-occupying inflammatory lesions Visceral disease: pulmonary, myelitis–encephalitis, ocular	Clinical features, biopsy, antibody capture EIA	Surgical removal if accessible
<i>Angiostrongylus cantonensis</i>	Rodents	Eosinophilic meningitis	CSF eosinophilic antibody capture EIA	Naturally self-limiting
<i>Angiostrongylus costaricensis</i>	Rodents	Acute abdominal mass	Antibody capture EIA	See text
<i>Sparganum mansoni</i>	Dogs, cats, other carnivores	Subcutaneous mass	Clinical features, CT scan, excision biopsy Antibody capture EIA	Excision, praziquantel
<i>Dirofilaria immitis</i>	Dog	Granulomatous lung lesions	Chest X-ray, eosinophilia and antibody capture EIA	Conservative, alternatively DEC
<i>Baylisascaris procyonis</i>	Racoons	Visceral larva migrans	History of exposure, clinical features and eosinophilia	Insufficient experience Benzimidazoles may be beneficial
<i>A. laria</i> spp.	Small game, frogs	Ocular lesions, respiratory symptoms, rare fatal infections	History of exposure, eosinophilia, biopsy	Insufficient experience Praziquantel may be beneficial

DEC, diethylcarbamazine; EIA, enzyme immunoassay.



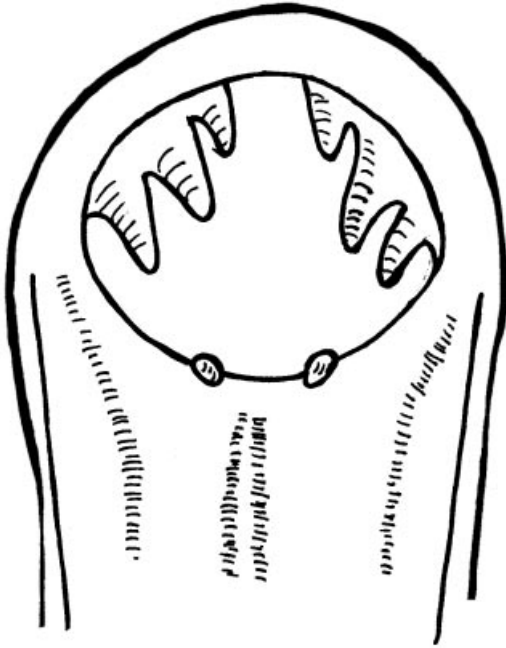


Fig. 19c.1 Mouth parts of *Ancylostoma caninum*

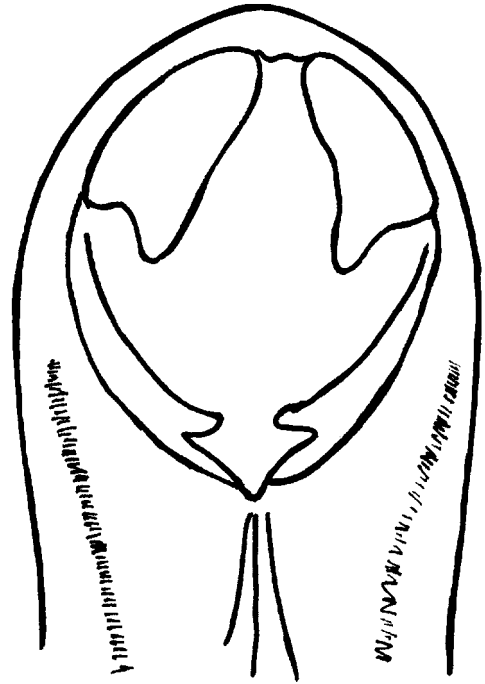


Fig. 19c.3 Mouth parts of *Ancylostoma braziliense*



Fig. 19c.2 Characteristic hookworm egg

longer at  $10\text{ mm} \times 0.3\text{ mm}$ . The buccal capsule possesses a pair of small inconspicuous median teeth and a pair of larger outer teeth (Beaver *et al.*, 1984) (Figure 19c.3). The eggs are not readily distinguishable from those of *A. duodenale*.

### Life-cycle

Hookworm eggs are passed in dog faeces and L<sub>1</sub> larvae hatch within 24–48 hours at optimal

temperatures and humidity, rapidly developing through the L<sub>2</sub> to the filariform stage (L<sub>3</sub>) from day 5. Survival in the L<sub>3</sub> form is for probably less than 1 week in the environment. The larvae stand up on their tails and undulate in response to vibrations, warmth and carbon dioxide and adhere to the host on contact (Granzer and Haas, 1991). Invasion occurs via hair follicles, which provides the necessary traction for penetration in dogs. Additionally, L<sub>3</sub> larvae, when swallowed, can cause infection in dogs. L<sub>3</sub> larvae undergo somatic migration, puncturing the alveolae to reach the gut via the tracheal or oesophageal migration route. For *A. caninum* a similar path may be followed in humans. In the intestine L<sub>4</sub> larvae attach to the mucosa by the buccal capsule and moult again to become an adult within a week. In their definitive hosts, hookworms survive for approximately 6 months and adult females can produce up to 28 000 eggs/day at their peak, usually within the first to second month (Anderson, 1991). In humans both adult females and males have been found, although they have never been fertile and probably do not survive long.

L<sub>3</sub> larvae may undergo larval arrest in the canine host and there is some evidence that this may also occur in humans. Larval arrest allows the larvae to reactivate at a later date and complete their development to adults. There have been many theories about the environmental cues which control this process by changes in humidity, host factors or a parasite 'clock' (Schad and Page, 1982; Gibbs 1986). Larval arrest may explain the seasonality of eosinophilic enteritis and relapse of infections after cure.

## **PATHOGENESIS**

### **Cutaneous Larva Migrans**

Cutaneous larva migrans does not occur after the first exposure to *A. caninum* and *A. braziliense* L<sub>3</sub> but follows re-infection only after several weeks, and this suggests that the disease is due to hypersensitivity to larval secretions (Provic and Croese, 1996b). The larva produces a number of enzymes which may assist in dermal invasion. These include a metalloprotease of 68 kDa and a minor protease of 38 kDa (Hotez *et al.*, 1990). Both organisms produce a hyaluronidase of 87 kDa (Hotez, Hawdon and Capello, 1995).

### **Eosinophilic Enteritis**

Adult hookworms secrete a wide range of molecules that are essential for the attachment to the intestine and all of these may result in allergy. The organisms produce potent anti-coagulant activity, expressing a 37 kDa elastinolytic metalloprotease that demonstrates fibrinolytic anticoagulant properties (Capello *et al.*, 1995). *A. caninum* also expresses a peptide inhibitor of the clotting factor 1Xa (Capello *et al.*, 1995). *A. caninum* expresses two proteases, a 41 kDa cysteine protease (Dowd *et al.*, 1994) and another 68 kDa protease with uncertain function. Hyaluronidases have been associated with tissue invasion for a number of hookworms and *A. caninum* produces one such (Hotez *et al.*, 1994). It also expresses a 41 kDa glycoprotein which is a potent inhibitor of neutrophil function (Moyle *et al.*, 1994).

### **Immunopathology**

Intense inflammation is found in the small bowel and occasionally in the colon, caecum and appendix area. It is inflamed and oedematous and heavily infiltrated with eosinophils (Croese *et al.*, 1996). Worms can be seen surrounded by an eosinophilic infiltration. In some patients the disease may be much more mild, limited to asymptomatic aphthous ulceration of the gut. The immunological mechanisms in eosinophilic enteritis are unknown but probably reflect common mechanisms of helminth inflammation, described elsewhere (see p. 563).

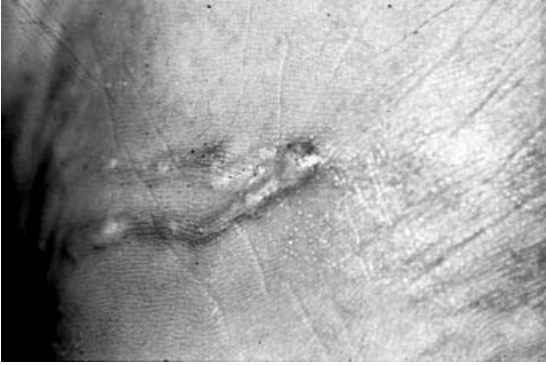
## **EPIDEMIOLOGY**

*A. braziliense* and *A. caninum* are ubiquitous hookworms found in dogs, cats and other mammals. Creeping eruption is described worldwide but is much more common in the tropics, where human behaviour such as walking without shoes or sleeping on the beach may result in contact with soil containing infective L<sub>3</sub> larvae (Jelinek *et al.*, 1994). Consequently, clinical surveys of cutaneous larva migrans reflect this, with the majority of patients acquiring their disease in the tropics. Eosinophilic enteritis is a newly recognised syndrome first described as a common condition in north-east Australia, in an area centred on Townsville (Croese *et al.*, 1994). Occasional cases have now been described in the USA.

## **CLINICAL FEATURES**

### **Cutaneous Larva Migrans**

The lower extremities are more often affected with eruptions on the feet, making up almost two-thirds of all cases. Lesions may be found on the upper legs, urogenital region and on the arms and trunk. Lesions on the head are extremely rare but have been described (Jelinek *et al.*, 1994). The lesions are intensely itchy, red and oedematous and show a worm-like migratory pathway under the skin. Frequently, patients describe a history of ineffective medication where



**Fig. 19c.4** Typical skin lesion of cutaneous larva migrans

the correct diagnosis has not been made (see Figure 19c.4).

Eosinophilic enteritis is characterised by abdominal pain that is often colicky, moving to the periumbilical region or right of the iliac fossa. It usually lasts up to 1 month. It is associated with anorexia, nausea and diarrhoea and some patients can be sufficiently ill to present with an acute abdominal condition that may mimic acute appendicitis or intestinal obstruction (Croese *et al.*, 1996). Patients very rarely have a history of exposure and previous symptoms of creeping eruption.

## DIAGNOSIS

The diagnosis of cutaneous larva migrans is made on the basis of the characteristic clinical features. The laboratory has no role to play in diagnosis. Eosinophilia is only a feature of a minority of cases, the total serum IgE is usually normal and other serological tests for helminth infections are unhelpful.

In eosinophilic enteritis the patient has significant eosinophilia and a high total IgE level, but

these laboratory features may be absent in some patients (Provic and Croese, 1996). The diagnosis is made histologically using tissue biopsies obtained during colonoscopy (Croese *et al.*, 1994); aphthous ulcers can be seen in the caecum and terminal ileum. Laparotomy, when performed for a suspected diagnosis of appendicitis, often reveals an inflamed ileum with intense serositis and enlarged mesenteric lymph nodes. An unequivocal diagnosis is often impossible, as it is very rare to find worms *in situ*. Antibodies to the excretory–secretory antigens of adult *A. caninum* patients can be found in more than 85% of patients with eosinophilic enteritis by antibody capture enzyme immunoassay (EIA) or immunoblotting (Loukas *et al.*, 1992, 1994).

## TREATMENT

Cutaneous larva migrans is readily treated by application of 10% thiabendazole paste and an occlusive dressing for 24 hours. In severe cases, systemic treatment with albendazole or ivermectin may also be used (Caumes *et al.*, 1993). Biopsy, surgical excision or liquid nitrogen is contraindicated.

Eosinophilic enteritis is readily treated with 200 mg mebendazole and patients will respond rapidly to this. Failure to respond within 24 hours would suggest an alternative diagnosis. Relapse is common and this may reflect reinfection or may be a result of failure to respond to the initial treatment, and this may also be caused by L<sub>3</sub> larvae that have undergone migration arrests (see above). Alternative therapies that may be beneficial include albendazole and ivermectin.

## GNATHOSTOMA SPINIGERUM

### DESCRIPTION OF THE ORGANISM

There are 12 recognised species of *Gnathostoma*. Human gnathosomiasis is principally caused by *Gnathostoma spinigerum*, but disease has been associated with *G. hispidum*, *G. nipponicum* and *G. doloresi*, although these are much less frequent

(Nawa, 1991; Sato *et al.*, 1992). The adult worm is rust-coloured, 2–3 cm long. It has a bulbous head with 4–8 rows of hooklets. The L<sub>3</sub> form generally has four rows of hooklets, while the adult has eight (see Figure 19c.5). The anterior part of the worm is covered with rows of cuticular spines. There are four fluid-filled muscular

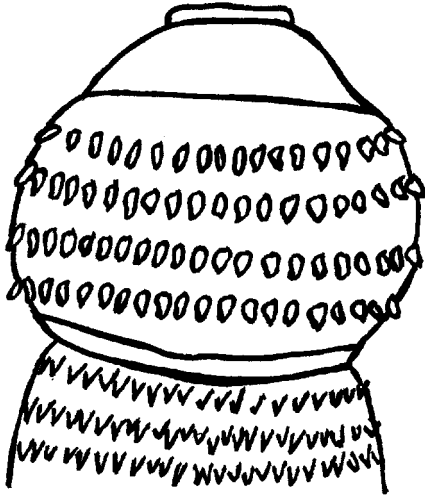


Fig. 19c.5 Head of L<sub>3</sub> larva of *Gnathostoma spinigerum*

sacs opening into the cephalic bulb and these are thought to contract and expand the bulb, enabling the worm to migrate through the tissues. Within the definitive host adult worms reach a length of 2–3 cm but migrating worms found in humans and other hosts tend to be smaller and less mature. The eggs are oval, with a mucoid plug, and measure 40–70 µm. The eggs are found in the definitive host faeces but not usually in the stools of humans.

#### Life-cycle

Dogs, cats, feral canids and felids, mink, racoons and otters are among the organisms which are definitive hosts for *G. spinigerum* (Nawa, 1991) (Figure 19c.6). In these hosts the adult worms live

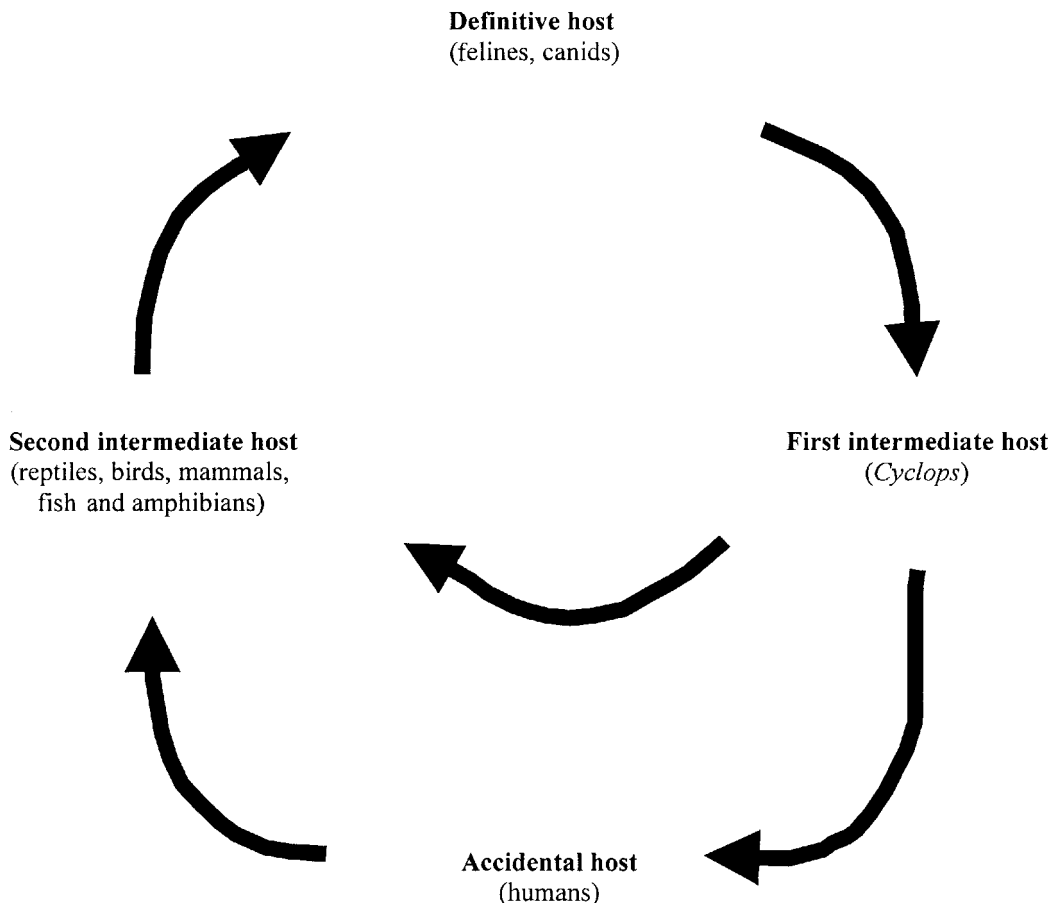


Fig. 19c.6 Life-cycle of *Gnathostoma* spp.

in a tumour-like structure within the gastric wall, discharging eggs into the stomach. In the environment, L<sub>1</sub> larvae hatch within 7 days and these are ingested by the first intermediate host, a crustacean of the genus *Cyclops*, in which they undergo L<sub>2</sub> and L<sub>3</sub> development. *Cyclops* is ingested by the second intermediate host, which includes fish, frogs, snakes, domestic chickens and domestic pigs. The larvae penetrate the gastric wall of this host and migrate to the muscles, where they mature into advanced L<sub>3</sub> larvae and then encyst. When the definitive host eats this second intermediate host, the larvae excyst in the stomach, penetrate the gastric wall and migrate to the liver and subsequently through the connective tissues and muscles. After 4 weeks the larval forms migrate back to the gastric wall, where they enter externally to produce the tumour-like structure that connects with the gastric lumen. Up to 8 months is required for maturation into adults. When the adults mate and pass eggs through the aperture into the gastric lumen, egg excretion continues for up to a year after ingestion of the third stage larvae.

## EPIDEMIOLOGY

Gnathosomiasis is acquired through the ingestion of third stage larval forms or, more rarely, by penetration of the skin. The usual vehicle is ingestion of raw or inadequately cooked fish, poultry or pork or, rarely, by the ingestion of snakes or frogs. Prenatal transmission of this organism has been described.

Gnathosomiasis is endemic in South East Asia and is found most commonly in Thailand, Japan and Korea (Nawa, 1991). However, the disease must be suspected in any patient with a characteristic presentation and an appropriate travel history (Rusnak 1993). Infection is associated with ingestion of raw fish and dishes that are implicated in this disease include Hu-sae, a Thai dish (Migasena *et al.*, 1991). Until recently it was assumed that *G. spinigerum* was the only species of this genus to infect man, but the genus contains at least 12 distinct species and among these, six are found in wild animals in Asia. In the 1980s cases of *G. hispidum* were identified in Japan, caused by eating raw loaches imported from Taiwan, Korea

or mainland China. More recently, infections with *G. nipponicum* have been caused by eating locally obtained raw loaches in Mie prefecture (Sato *et al.*, 1992). Freshwater raw fish was associated with infection with *G. doloresi* in 14 individuals in the Miasaki prefecture (Nawa, 1991). Human cases of *G. nipponica* have been detected in northern Japan following ingestion of raw freshwater fish, kokanee (*Salmo nerka nerka*), carp, cruseum carp or common ice fish.

## CLINICAL FEATURES

Human gnathosomiasis is characterised by space-occupying inflammatory lesions and haemorrhage as a result of the migration of, very often, a single larva of *G. spinigerum*. It produces intermittent cutaneous migratory swellings that continue for many years (Rusnak and Lucey, 1993). The worm is able to migrate into deeper tissues, so other organ systems may become involved.

Patients may present with nausea, vomiting, abdominal cramps and diarrhoea as little as 24 hours after ingestion of infected meat (Rusnak and Lucey, 1993). This may later be associated with weakness, pruritis and migratory swellings and myalgia. The swellings are found in cutaneous tissues, and this is the most common and characteristic manifestation. The oedema is typically intense and non-pitting and is associated with pain, pruritis and redness. Infection is usually due to a single gnathostome but multiple infections have been reported. Over time the episodes of migration occur less frequently, the intensity diminishes and recurrent migratory swellings have been known for up to 12 years, but re-infection cannot be excluded (Rusnak and Lucey, 1993). On some occasions, cutaneous gnathosomiasis presents as a skin abscess, skin nodule or creeping eruption that is in a position that allows surgical resection. At present this is the only possible means of cure.

## Visceral Gnathosomiasis

Gnathosomiasis can involve the lung, when infection presents as cough, pleuritic chest pain,

dyspnoea, haemoptysis, lobar consolidation, pleural effusions, pneumothorax and hydro-pneumothorax. Some patients may expectorate the worm and if this occurs it is followed by resolution of the symptoms. Visceral gnathosomiasis is associated with peripheral blood eosinophilia. Gastrointestinal involvement is rare, presenting as a right lower quadrant mass or acute abdominal pain mimicking appendicitis or intestinal obstruction. Diagnosis is often made by pathological examination of the material after resection. The genitourinary system is rarely involved. As in the case of other migratory worms, the eye may become involved and infection with gnathosomiasis is associated with uveitis, iritis, intra-ocular haemorrhage, retinal scarring, detachment and blindness. The immediate symptoms can be relieved by topical steroids but the definitive treatment is removal of the worm (Punyagupta *et al.*, 1990).

### Cerebral Gnathosomiasis

Cerebral involvement by gnathosomiasis is probably quite common and is thought to be the most important parasitic disease of the central nervous system in Thailand. Patients present with myelitis, signs of encephalitis or hemiplegia. The case fatality rate is high, up to 12%. Cerebral gnathosomiasis can be differentiated from eosinophilic meningitis caused by *Angiostrongylus cantonensis*, as gnathosomiasis is suggested by focal neurological findings, often beginning with severe neuritic pain followed by paralysis, or multiple cranial nerves can be involved, whereas in *Angiostrongylus*, infection is characterised by low-grade fever, headache, meningitis and lowered cerebral function associated with cerebrospinal fluid (CSF) eosinophilia. Cranial nerve involvement is less common and, when it occurs, usually involves cranial nerves VII or VIII.

### DIAGNOSIS

The diagnosis of gnathosomiasis is usually made clinically and confirmed by serology. The diagnosis is suggested by the characteristic clinical presentation of localised intermittent migratory

swellings of the skin and subcutaneous tissue associated with localised pain, pruritis and erythema. This is generally found in a patient coming from the endemic area or a person who has travelled there (Rusnak and Lucey, 1993). Patients often have an associated eosinophilia. The diagnosis can be made histologically on skin biopsy samples, where the characteristic morphology of the third-stage larva can be seen. There is evidence that albendazole, given at a dosage of 400 mg twice daily for 2 weeks, stimulates migration of the larvae to the skin making excisional biopsy possible (Suntharasamai *et al.*, 1992).

A 24 kDa antigen derived from the third-stage larvae appears to provide a specific diagnostic test in an antibody capture EIA, and several different preparation methods have been described. One uses the excretory-secretory antigen, with molecular weight below 29 kDa (Tuntipopipat *et al.*, 1995); alternatively, water extract of the 24 kDa or whole larval antigen has been used (Nopparantana *et al.*, 1992). This diagnostic component is anatomically located in the body fluid, oesophagus and intestine of the larvae (Morakote *et al.*, 1991). This assay is reported to have a sensitivity and specificity approaching 100%. A circulating antigen can be detected in a mouse model of infection, and this approach may have application in human cases early in the natural history (Maleewong *et al.*, 1992).

### MANAGEMENT

There is no effective therapy for gnathostomiasis (Rusnak and Lucey, 1993). Experimental studies in animals have identified agents with activity, but toxicity or lack of human data limits their use (Daengsvang, 1980; Katiyar *et al.*, 1982). Thiabendazole and DEC are ineffective. Steroids and quinine may reduce the inflammation (Jaroonsama and Hiramatsu, 1973). Surgical resection is the only effective mod of therapy when the position of worm is in an accessible site, such as the eye, skin or subcutaneous tissues. Resection may occur when gnathostomiasis is the unexpected diagnosis of an abdominal mass (Teekhasaence *et al.*, 1986; Adko *et al.*, 1988; Hira *et al.*, 1989).

## PREVENTION AND CONTROL

Gnathostomiasis may be prevented by avoiding the ingestion of undercooked fish or raw animal flesh, and by wearing gloves when handling tissues that may contain larval forms. Foods

that are a risk include Thai fermented freshwater fish, *sum-fak*, or *seviche* when freshwater fish are used in its preparation. Raw saltwater fish are not a risk for this infection. Freezing of meat or fish to 7 20°C for more than 5 days is likely to kill infective larvae (Rusnak and Lucey, 1993).

## ANGIOSTRONGYLUS

The genus *Angiostrongylus* was established by Kamenskii in 1905 for a dog lungworm, *Strongylus basorum*. Twenty species of *Angiostrongylus* are described, of which two are pathogens of man. *A. cantonensis* and *A. costaricensis*. *A. cantonensis* was first described by Chen in 1935 in the pulmonary arteries of the right side of the heart of rodents (Chen, 1935). *A. costaricensis* was described by Morera and Cespedes (1971) in the mesenteric arteries of the cotton rat, *Sigmodon hispidus*, in Costa Rica and other American countries. Some other species, e.g. *A. mackerrasae* and *A. malaysiensis*, are similar to *A. cantonensis*. *A. siamensis* is similar to *A. costaricensis* and therefore may cause human disease. It should be noted that alternative names are *Morerastrongylus costaricensis* and *Parastrongylus costaricensis*. In rodents the adult worms live in the mesenteric arteries of the terminal ileum and the caecum.

## DESCRIPTION OF THE ORGANISM

*A. cantonensis* normally lives in the pulmonary arteries and right ventricles of rodents. Males are 12–27 mm long and 0.2–0.4 mm wide and have two equal spicules and a gubernaculum. Females are characterised by white uteri, winding around the blood-filled intestine to give a 'barber's pole' appearance. Females are 15–24 mm long and 0.24–0.5 mm wide. They have a long thin-walled vagina and the vulva is near the posterior end.

### *Angiostrongylus cantonensis*

Copulation occurs in the pulmonary artery and females produce eggs which develop into first-stage larvae. They penetrate the alveoli, migrate through the respiratory tract into the alimentary

tract and pass out of the definitive host in the faeces. They then infect a molluscan intermediate host, usually terrestrial snails such as *Achatina fulica* or aquatic snails such as *Pila* spp. Third-stage larvae emerge a little over 2 weeks later and infect the rodent definitive host, usually when it eats an infected mollusc (Mackerras and Sanders, 1955) (Figure 19c.7). At least 24 species of rodent can act as definitive hosts for *A. cantonensis*, including *Rattus norvegicus* and *Rattus rattus*. A wide range of animals may act as paratenic hosts (Ash, 1968).

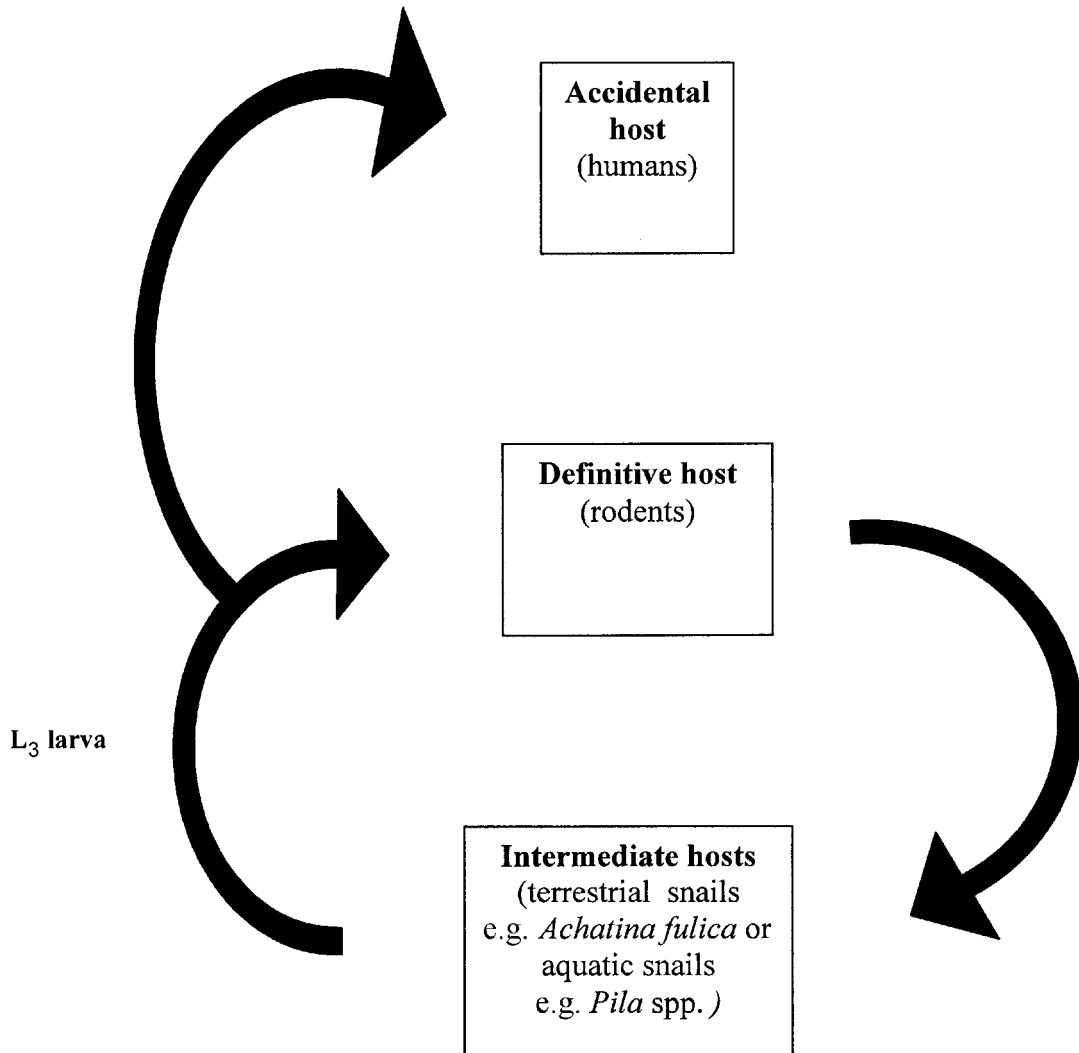
### *Angiostrongylus costaricensis*

*A. costaricensis* has the cotton rat and the black rat as the main definitive hosts and the common slug *Paginulus plebeius* as the intermediate host. The adult males are 22 mm × 0.14 mm and the female 42 mm × 0.35 mm (see Figure 19c.7). In the male, the oesophagus has a maximum length of 225 µm and the testes is found just posterior to the oesophagus. The spicules are striated and relatively short (330 µm or less). In the female the tail is conical and sharply flexed ventrally with a minute projection at the tip. The vulva is slightly protruding and is less than 300 µm from the tip of the tail.

The first-stage larvae are excreted in the faeces and ingested by slugs. Rodents become infected by ingesting molluscs containing infected third-stage larvae (Rambo *et al.*, 1997).

## EPIDEMIOLOGY

*A. cantonensis* is found in south-east Asia, the Pacific and Australia, including Polynesia, Indonesia and Papua New Guinea (Hung and



**Fig. 19c.7** Life-cycle of *Angiostrongylus* spp.

Chen, 1988). Because of its lack of host specificity and the mobility of rats, *A. cantonensis* has become established throughout much of the tropical and sub-tropical parts of the world. Infection is transmitted to humans and is acquired by eating raw molluscs or raw food that has been contaminated by them.

*A. costaricensis* is found throughout Central and South America and is enzootic in Texas, although no human diseases have been detected (Hulbert *et al.*, 1992). A case-control study showed that the risk of abdominal angiostrongyliasis was related to ingestion of raw food items

such as mint, shrimp and ceviche that contain mint (Kramer *et al.*, 1998). The slug that is the intermediate host of this pathogen is not considered to be good to eat, and this suggests that contaminated food is the main vehicle of infection (Bonetti and Graeff-Teixeira, 1998).

#### **PATHOGENESIS**

*A. cantonensis* produces an acute eosinophilic meningo-encephalitis (Nishimura and Hung,



1997). Worms of both sexes can be found in the vascular and perivascular tissues of the cerebrum and cerebellum and the blood vessels of the meninges. There may be areas of necrosis and granulomatous reaction. Large numbers of Charcot-Leyden crystals can be found in the granulomatous lesions. Pulmonary lesions have also been described and these have proved fatal, with adult *Angiostrongylus* in the larger branches of the pulmonary artery associated with granulomas that were indistinguishable from those of Wegener's granulomatosis (Pirisi *et al.*, 1995). The granulomas contain lymphocytes, eosinophils mixed with lymphocytes and giant cells.

In abdominal angiostrongyliasis, nematodes are found within the mesenteric blood vessels and there is an acute eosinophilic granulomatous reaction with areas of necrosis (Hulbert *et al.*, 1992; Kramer *et al.*, 1998).

## CLINICAL FEATURES

*A. cantonensis* infection is characterised by acute meningitis with a severe headache which may persist for as long as 6 weeks, associated with stiffness of the neck and intermittent fever (Yii and Chen, 1968; Shih *et al.*, 1992). Additionally, burning sensations and exaggerated sensitivity to touch, pain and numbness can also be found. VI and VII cranial nerve palsies may occur, but in general focal neurological signs are absent and their presence would point to a diagnosis of gnathosomiasis.

In *A. costaricensis* infection, the patient generally presents with the features that resemble acute appendicitis. There is a pain in the right iliac fossa in most patients and a painful mass is often palpated on rectal examination. *A. costaricensis* infection may also mimic torsion of the testes. The diagnosis of infection may be made only after abdominal laparotomy and resection has occurred (Hulbert *et al.*, 1992). The disease is naturally self-limiting and many cases are mild and unrecognised. In others the ileitis may be severe and result in intestinal perforation (Wu *et al.*, 1997).

## LABORATORY DIAGNOSIS

The diagnosis of eosinophilic meningitis is confirmed by examination of CSF obtained at lumbar puncture. Characteristically there is eosinophilia of  $0.2\text{--}5.0 \times 10^7$  /l and larvae may be seen in the CSF. The peripheral blood eosinophil count may be as high as 70% of white cell count. Antibodies to *Angiostrongylus* can be detected. A serological test is available by EIA or by latex agglutination using crude antigens.

Diagnosis of *A. costaricensis* infection is made on the characteristic clinical features in the presence of a peripheral blood eosinophilia. Definitive diagnosis is only made on histopathological examination of resected material (Kramer *et al.*, 1998). A serological diagnosis using crude *A. cantonensis* antigens cross-reacts and may provide serological support for such a diagnosis. Cross-reactivity with *Toxocara*, *Strongyloides* and *Paragonimus* is known to occur. An EIA based on a surface antigen from female worms, and absorbed with the pig ascarid *Ascaris suum*, had a 86% and 83% sensitivity and specificity (Graeff-Teixeira *et al.*, 1997).

More specific diagnosis can be provided by use of a 31 kDa surface antigen, although cross-reactions with trichinellosis, trichiuriasis and opisthorchiasis sera could be a problem (Nuamantong, 1996). A two-site antigen detection EIA for a 204 kDa antigen may prove valuable in diagnosis when applied to CSF and serum (Chye *et al.*, 1997).

## TREATMENT

*A. cantonensis* infection is naturally self-limiting (Punyagupta *et al.*, 1975) and a fatal outcome is rare. Anthelmintics may not be beneficial and may exacerbate symptoms, due to the release of parasite antigens. Management is directed towards analgesia and the use of corticosteroids to reduce inflammation.

In *A. costaricensis* infection, treatment is controversial and in most patients the diagnosis is made post-operatively, but where it has been made in advance of surgery some authors suggest that chemotherapy should be withheld, expecting the illness to be self-limiting. Others recommend

chemotherapy with thiabendazole in combination with diethylcarbamazine. Alternatives such

as mebendazole and albendazole may also be useful.

### *SPARGANUM MANSONI*

The genus *Sparganum* was originally described by Diesning (1854). The first human case was described by Manson (1882) in China. Another species, *Spirometrum mansonioides*, was described by Muller (1935).

#### LIFE-CYCLE

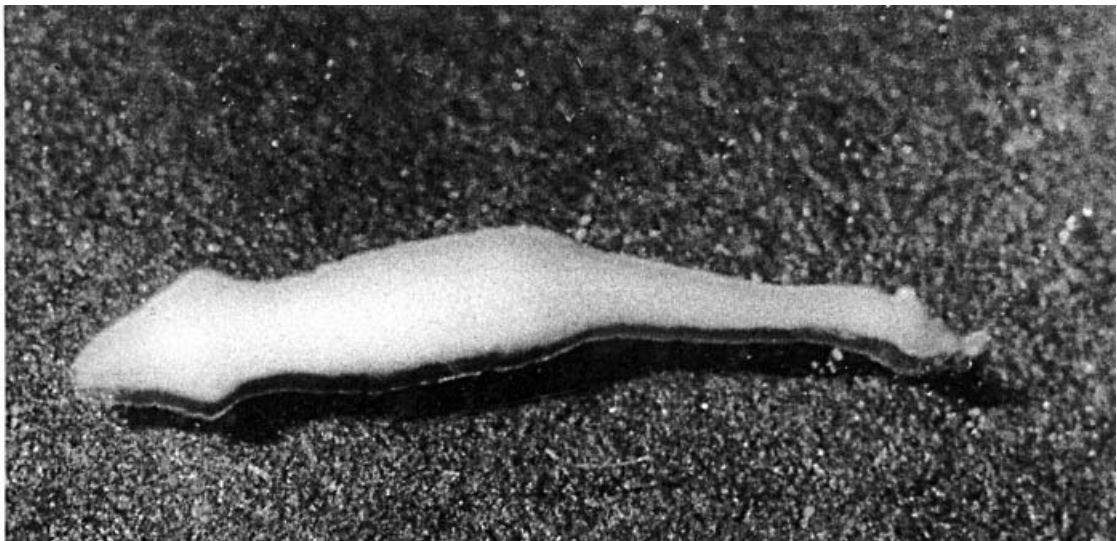
The adult tapeworm affects dogs, cats and other carnivores and the eggs are passed in the faeces of these hosts into freshwater, where they are ingested by the first intermediate host, planktonic copepods. They mature into proceroid larvae, which are ingested by mice, frogs, snakes and birds, the second intermediate host, and develop into plerocercoid larvae. When the flesh of these animals is eaten by the primary host, the life cycle is completed. Humans act as accidental second intermediate hosts for this organism (Holodniy *et al.*, 1991).

#### EPIDEMIOLOGY

Human infection usually follows ingestion of water contaminated with copepods, ingestion of inadequately cooked flesh of the vertebrate intermediate host, e.g. snakes or frogs, or the application of flesh of these animals to open wounds and mucus membranes in the form of alternative medicine poultices.

#### PATHOGENESIS

After ingestion, larvae migrate through the intestinal wall to distant sites, mostly the skin and skeletal muscle, where they are unable to undergo further development (Kron *et al.*, 1991). Thus, the disease presents as a slowly growing subcutaneous mass, commonly diagnosed after excisional biopsy. Other sites involved include the periorbital tissue, genitourinary system and



**Fig. 19c.8** Plerocercoid larva of *Sparganum mansoni* excised from an adult patient with migratory swelling

abdominal viscera. Central nervous system infection is very uncommon but the consequences are much more severe than other forms of the disease. Seizures are the most common clinical symptoms, associated with motor weakness and altered mental status in a minority of cases. The condition is chronic, with presentation occurring between 2 weeks and 24 years after infection. A satisfactory history of exposure to intermediate hosts can usually be obtained.

## DIAGNOSIS

The diagnosis of cutaneous sparganosis is made on the basis of the characteristic clinical features

and history of relevant exposure (Yamashitz *et al.*, 1990). Definitive diagnosis is made by examination of the excised worm (see Figure 19c.8). Sparganosis may be diagnosed by CT scanning, showing a low-density lesion in the white matter with adjacent ventricular dilatation, and the lesion may enhance with contrast.

A serological diagnosis can be made by EIA for the presence of *Sparganum*-specific antibody in the majority of cases (Kong *et al.*, 1994). In the case of cerebral sparganosis, CSF EIA test is almost invariably positive. The treatment of cerebral sparganosis depends on removal of the viable worm and, where this is not possible, the patient should be treated with praziquantel, although evidence of its clinical efficacy is not available.

## DIROFILARIA SPP.

*Dirofilaria* spp. are zoonotic filaria that are natural parasites of a wide variety of animals. The earliest case was identified by Addario (1885), when a *Dirofilaria* worm was removed from the eyelid of a woman in Milan. A wide range of *Dirofilaria* species infect humans, including *D. conjunctivae*, *D. tenuis*, *D. ursi*, *D. striata*, *D. repens* and *D. immitis* (Orihel and Eberhard, 1998).

## LIFE-CYCLE

Dirofilariae have mosquitoes as the intermediate hosts and the development in the mosquito takes about 2 weeks. In the definitive host the parasites require approximately 6 months to achieve sexual maturity.

The cuticle is multi-layered, 5–8 µm thick, with longitudinal, smoothly rounded ridges about 10 µm apart. On the inner surface of the cuticle there is a cuticular ridge that protrudes into the inner surface of the lateral chords. The mouth is without lips, there are inconspicuous cephalic papillae, the chordal papillae are large and numerous and the vulva is posterior to the oesophagus. The tail is short and rounded in both sexes. Microfilaria are unsheathed and circulate in the blood (Orihel, 1961; Boreham, 1988).

## CLINICAL FEATURES

*Dirofilaria immitis* is a common parasite of dogs. The adult worms live in the right side of the heart, where they produce microfilaria that circulate in the peripheral blood. In human infection, *D. immitis* worms have been found in the heart and the major vessels at post mortem examination, but it is much more usual to find immature worms located in, and partially occluding, small pulmonary arteries, where an infarct is produced (Pampiglione *et al.*, 1995; Orihel and Eberhard, 1998). Later, a well-circumscribed granulomatous lesion containing the worm develops. This can be visualised in a chest X-ray. The differential diagnosis includes lung carcinoma, tuberculosis, fungal infections and benign developmental tumours. The lesions are usually asymptomatic, but some patients complain of cough, chest pains and, rarely, haemoptysis and fever. Nodules are usually single but multiple nodular lesions have been reported (Beaver *et al.*, 1965; Ciferri, 1982).

## DIAGNOSIS

The diagnosis is made on X-ray associated with a peripheral eosinophilia. The definitive diagnosis is made by examination of the intact worm, when

the characteristic features will enable a species identification to be made (Orihel and Eberhard, 1998). The nodules usually contain a single worm but rarely, two or three worms are found in the same nodule. Serological investigations directed against a 22 kDa molecule of *D. immitis* has been found to be useful in the diagnosis of pulmonary disease (Perera *et al.*, 1998). A mixture of secretory–excretory products from *D. immitis* adults have been evaluated in the diagnosis of human *Dirofilaria* by EIA and Western blot. The data are intriguing because they show that healthy individuals from an endemic area can be seropositive without symptoms, and that a specific band of 22–28 kDa is recognised in patients with pulmonary dirofilariasis (Santamaria *et al.*, 1995).

### Skin and Subcutaneous Tissues

The majority of dirofilarial infections other than by *D. immitis* cause lesions in the subcutaneous tissues. Patients complain of transitory inflam-

matory swellings or nodules. If living worms enter the conjunctiva, acute conjunctivitis occurs. Subcutaneous nodules occur more frequently in the upper half of the body, with a large number localised around the eyes, in the eyelids or under the conjunctiva. Worms have been found in deeper tissues in the peritoneal cavity and, rarely, in the lungs and pulmonary blood vessels.

The diagnosis is made clinically and a definitive identification can be made by histological examination of worms removed in biopsies.

### TREATMENT

The infections are usually self-limiting so no further treatment is necessary. In subcutaneous disease diagnostic biopsy is often curative. Some authors suggest that subcutaneous dirofilariasis should be treated with diethylcarbamazine 2 mg/kg over a period of 4 weeks, allied to surgical treatment. Reports of the use of ivermectin have been made.

### BAYLISASCARIS PROCYONIS

*Baylisascaris procyonis* is the ascarid of racoons that is capable of causing severe disease in other hosts. The prevalence of infection in racoons can be high, with more than 90% of animals infected in some areas of the USA (Kazacos and Boyce, 1989), and infection is more common in juveniles. Infected racoons shed 20 000–250 000 eggs per gram of faeces (Cunningham *et al.*, 1994) and the eggs remain viable for long periods in the soil, providing a source for human and animal infection for many years. The organism does not cause severe disease in its natural host, but the migration of larvae in paratenic hosts can result in severe acute inflammatory responses, although mild or asymptomatic infection is probably the most common outcome of infection, even in humans (Cunningham *et al.*, 1994). The results of animal experiments indicate that the severity of symptoms is related to the size of the infective dose (Kazacos and Boyce, 1989). Approximately 5% of larvae migrate to the brain, where eosinophilic granulomas develop. Similarly, larvae can be found in the eye where

they cause an acute inflammatory response characterised by sub-retinal necrosis, vasculitis and eosinophil perivascular sheathing, or sub-choroidal granulomas (Kazacos *et al.*, 1984).

Despite the intensity of infection in the natural host, human infection has only rarely been reported. Visceral larva migrans characterised by a severe meningo-encephalitis is the most serious and frequently reported presentation. In two of these cases the outcome was fatal, and in a third the child was left with severe neurological deficit (Huff *et al.*, 1984; Fox *et al.*, 1985; Cunningham *et al.*, 1994). In one case, a 10 year-old boy died suddenly and at post mortem examination he was found to have a polypoid mass in the left ventricle that protruded into the ventricular lumen. The morphometry of the larval remnants strongly supported the diagnosis of *Baylisascaris* (Boschetti and Kasznica, 1995).

Diagnosis of *Baylisascaris* infection is difficult because an effective serological test is not available. The morphology of the larvae in histological sections can be differentiated from

other migrating larvae based on the length of the body, shape of the anterior end, and the shape of the tail. Also, there are characteristic differences in the internal structures (Bowman, 1987).

There are no guidelines for treatment as it is not certain that killing migrating larvae might not result in an increase in the inflammatory response to dying worms. There is experimental evidence that the organism is susceptible to

ivermectin (Papini *et al.*, 1996), and pyrantel (Lindquist, 1978). Benzimidazoles, ivermectin and levamisole have also been used in treatment of human and animal infections, with no clear evidence of clinical benefit (Kazacos and Boyce, 1989; Fox *et al.*, 1985; Cunningham *et al.*, 1994). Infection can be prevented by suitable hygienic practices in areas where contact with racoon faeces is possible.

### INFECTION WITH *ALARIA AMERICANA*

The life-cycle of *Alaria* involves three hosts: a snail, the first intermediate; a tadpole or frog, the second intermediate; and a carnivore definitive host. Humans become infected when they enter the life-cycle as the carnivore definitive host, and cases have been reported in patients who have eaten under-cooked intermediate hosts (Kramer *et al.*, 1996; Freeman *et al.*, 1976). There are few reports of human infections, but those that exist report respiratory symptoms and subcutaneous granulomata. A fatal infection has been reported in a patient who had several thousand meso-

cercariae present in the peritoneal cavity, bronchial aspirate, brain, heart, kidneys, liver, lung, lymph nodes, pancreas, retroperitoneal tissue, spinal cord, spleen and stomach (Freeman *et al.*, 1976). The patient died due to extensive pulmonary haemorrhage, possibly related to immunemediated mechanisms. It was believed that the patient became infected through eating inadequately cooked frogs' legs while hiking. There is no experience of the use of anthelmintic treatment for these patients, but praziquantel may be beneficial.

### REFERENCES

- Addario C (1885). Su un nematode dell'occhio umano. *Ann Ottalmolog* **13**: 135–47.
- Adko K, Tanaka H, Taniguchi Y, Shimizu M, Koudo K (1988). Two human cases of *Gnathostoma nipponicum* in Japan. *J Parasitol* **74**: 623–7.
- Anderson RC (1991). The superfamily Ancylostomatidae. In *Nematode Parasites of Vertebrates*. CAB International: Wallingford; 40–61.
- Ash LP (1968). The occurrence of *Angiostrongylus cantonensis* in frogs of New Caledonia with observations on paratenic hosts of metastrongyles. *J Parasitol* **54**: 432–6.
- Beaver PC, Orihel TC, Johnson MH (1965). Human infection with filaria of animals in the United States. *Am J Trop Med Hyg* **14**: 1010–29.
- Beaver PC, Young RC, Cupp EW (1984). *Clinical Parasitology*, 9th Edition. Lea & Febiger: Philadelphia.
- Biswas J, Gopal L, Sharma T, Badrinath SS (1994). Intraocular *Gnathostoma spinigerum*. Clinicopathologic study of two cases with review of literature. *Retina* **14**: 438–44.
- Bonetti VC, Graeff-Teixeira C (1998). *Angiostrongylus costaricensis* and the intermediate hosts: observation on elimination of L<sub>3</sub> in the mucus and inoculation of L<sub>1</sub> through the tegument of molluscs. *Rev Soc Brasil Med Trop* **31**: 289–94.
- Boreham PFL (1988). *Dirofilariasis* in man. In Boreham PFL, Atwell RB (eds), *Dirofilariasis*. CRC Press: Boca Raton FL; 217–26.
- Boschetti A, Kasznica J (1995). Visceral larva migrans induced eosinophilic cardiac pseudotumor: a cause of sudden death in a child. *J Forens Sci* **40**: 1097–9.
- Bowman DD (1987). Diagnosis morphology of four larval ascaridoid nematodes that may cause visceral larva migrans: *Toxascaris leonina*, *Baylisascaris procyonis*, *Lagochilascaris sprenti*, and *Hexameta leidy*. *J Parasitol* **73**: 1198–215.
- Capello M, Vlasuk GP, Bergum PW, Huang S, Hotez PJ (1995). *Ancylostoma caninum* anticoagulant peptide: a hookworm-derived inhibitor of human coagulation factor Xa. *Proc Natl Acad Science USA* **93**: 6152–6.
- Caumes E, Carriere J, Daltry A, Gaxotte P, Danis M, Gentilini M (1993). A randomized trial of ivermectin versus albendazole for the treatment of cutaneous larva migrans. *Am J Trop Med Hyg* **49**: 641–4.
- Chen HT (1935). Un nouveau nematode pulmonaire, *Pulmonema cantonensis* n.g., n.sp. des rats de Canton. *Ann Parasitol* **13**: 312–17.
- Chye SM, Yen CM, Chen ER (1997). Detection of circulating antigen by monoclonal antibodies for immunodiagnosis of angiostrongyliasis. *Am J Trop Med Hyg* **56**: 408–12.
- Ciferri F (1982). Human pulmonary dirofilariasis in the United States: a critical review. *Am J Trop Med Hyg* **31**: 302–8.

- Croese J, Loukas A, Opdebezcck J, Fairley S, Prociw P (1994). Human enteric infection with canine hookworms. *Ann Intern Med* **20**: 369–74.
- Croese J, Fairley S, Loukas A, Hack J, Stronach P (1996). A distinctive aphthous ileitis linked to *Ancylostoma caninum*. *J Gastroenterol Hepatol* **11**: 524–31.
- Cunningham CK, Kazaco KR, McMillan JA, Lucas JA, McAulet JB, Wozniak EJ, Weiner LB (1994). Diagnosis and management of *Baylisascaris procyonis* infection in an infant with nonfatal meningoencephalitis. *Clin Infect Dis* **18**: 868–72.
- Daengsvang S (1980). Chemotherapy of feline *Gnathostoma spinigerum* migrating stage with multiple subcutaneous doses of ivermectin. *S E Asian J Trop Med Public Health* **11**: 359–62.
- Dowd AJ, Dalton JP, Loukas AC, Prociw P, Brindey PJ (1994). Secretion of cysteine proteinase by the human pathogen *Ancylostoma caninum*. *Am J Trop Med Hyg* **51**: 341–7.
- Fox AS, Kazacos KR, Gould NS, Heyderman PT, Thomas C, Boyer KM (1985). Fatal eosinophilic meningoencephalitis and visceral larva migrans caused by the racoon ascarid *Baylisascaris procyonis*. *N Eng J Med* **312**: 1619–23.
- Freeman RS, Stuart PF, Cullen JB *et al.* (1976). Fatal human infection with mesocercariae of the trematode *Alaria americana*. *Am J Trop Med Hyg* **25**: 803–7.
- Gibbs HC (1986). Hypobiosis in parasitic nematodes—an update. *Adv Parasitol* **25**: 129–74.
- Graeff-Teixeira C, Agostini AA, Camillo-Coura L, Ferreira da Cruz MF (1997). Seroepidemiology of abdominal angiostrongyliasis: the standardization of an immunoenzymatic assay and prevalence of antibodies in two locations in southern Brazil. *Trop Med Int Health* **2**: 254.
- Granzer M, Haas W (1991). Host-finding and host recognition of infection in *Ancylostoma caninum* larvae. *Int J Parasitol* **21**: 429–40.
- Hira PR, Neafie R, Prakesh B, Tammin L, Behbehani K (1989). Human gnathostomiasis: infection with an immature male *Gnathostoma spirigerum*. *Am J Trop Med Hyg* **41**: 91–4.
- Holodniy M, Almenoff J, Loutit J, Steinberg GK (1991). Cerebral spargenosis: a case report and review. *Rev Infect Dis* **13**: 155–9.
- Hotez P, Haggerty J, Hawdon J *et al.* (1990). Metalloproteases of infective *Ancylostoma* hookworm larvae and their possible function in tissue invasion and ecdysis. *Infect Immun* **58**: 3883–92.
- Hotez P, Cappello M, Hawdon J, Beckers C, Sakanari I (1994). Hyaluronidases of the gastrointestinal invasive nematodes *Ancylostoma caninum* and *Anisakis simplex*: possible functions in the pathogenesis of human zoonoses. *J Infect Dis* **170**: 918–26.
- Hotez P, Hawdon J, Capello M (1995). Molecular mechanisms of invasion by *Ancylostoma* hookworms. In Boothroyd JC, Komunieki R (eds), *Molecular Approaches to Parasitology*. Wiley-Liss: New York; 21–9.
- Huff DS, Neafie RC, Binder MJ, De Leon GA, Brown LW, Kazacos KR (1984). The first fatal case of *Baylisascaris procyonis* infection in humans: an infant with eosinophilic meningoencephalitis. *Pediatr Pathol* **2**: 345–52.
- Hulbert TV, Larson RA, Chandrasoma PT (1992). Abdominal angiostrongyliasis mimicking acute appendicitis and Meckel's diverticulum: report of a case in the United States and review. *Clin Infect Dis* **14**: 836–40.
- Hung T-P, Chen ER (1988). Angiostrongyliasis (*Angiostrongylus cantonensis*). In Vinken PJ, Bruyn GW, Klawans HL, Harris AA (eds), *Handbook of Clinical Neurology*, vol 52. Elsevier Science: Amsterdam: 545–64.
- Jaroonvesama N, Harinasatu T (1973). Comparison of quinine with prednisolone in treatment of gnathostomiasis. *J Med Assoc Thai* **56**: 312–13.
- Jelinek T, Maiwald H, Northdurft HD, Loscher T (1994). Cutaneous larva migrans in travellers: synopsis of histories, symptoms and treatment of 98 patients. *Clin Infect Dis* **19**: 1062–6.
- Katiyar JC, Visen PKS, Gupata S, Sen AB, Dubey SK, Sharma S (1982). 3,5-Dibromo-2'-chloro-4'-isothiocyanatosalicylanilide, a potent antihelminthic. *Experientia* **38**: 457–60.
- Kazacos KR, Boyce WM (1989). *Baylisascaris* larva migrans. *J Am Vet Med Assoc* **195**: 894–903.
- Kazacos KR, Vestre WA, Kazacos EA (1984). Racoon ascarid larvae (*Baylisascaris procyonis*). *Invest Ophthalmol Vis Sci* **25**: 1177–83.
- Kong Y, Cho SY, Kang WS (1994). Sparganum infections in normal adult population and epileptic patients in Korea: a seroepidemiologic observation. *Ki Saengchunghak Chapchi* **32**: 85–92.
- Kramer MH, Eberhard ML, Blankenberg TA (1996). Respiratory symptoms and subcutaneous granuloma caused by mesocercariae: a case report. *Am J Trop Med Hyg* **55**: 447–8.
- Kramer MH, Greer GJ, Quinonez JF *et al.* (1998). First reported outbreak of abdominal angiostrongyliasis. *Clin Infect Dis* **26**: 365–72.
- Kron MA, Guderian R, Guevara A, Hidalgo A (1991). Abdominal sparganosis in Ecuador. *Am J Trop Med Hyg* **44**: 146–50.
- Lindquist WD (1978). *Baylisascaris procyonis* for testing anthelmintics against migratory ascarids. *Am J Vet Res* **39**: 1868–9.
- Loukas A, Croese J, Opdebezcck J, Prociw P (1992). Detection of antibodies to secretions of *Ancylostoma caninum* in human eosinophilic enteritis. *Trans R Soc Trop Med Hyg* **86**: 650–53.
- Loukas A, Opdebezcck J, Croese J, Prociw P (1994). Immunologic incrimination of *Ancylostoma caninum* as a human enteric pathogen. *Am J Trop Med Hyg* **50**: 69–77.
- Mackerras MJ, Sanders DF (1955). The life history of the rat lung worm, *Angiostrongylus cantonensis* (Chen) (Nematode: Metastrongylidae). *Aust J Zool* **7**: 1–21.
- Maleewong W, Wongkham C, Intapan P *et al.* (1992). Detection of circulating parasite antigens in murine gnathostomiasis by a two-site enzyme-linked immunosorbent assay. *Am J Trop Med Hyg* **46**: 80–84.
- Migasena S, Pitisuttithum P, Desakorn V (1991). *Gnathostoma* larva migrans among guests of a New Year party. *S E Asia J Trop Med Publ Health* **22** (suppl): 225–7.
- Morakote N, Nateewatana N, Navacharoen W, Jitpimolmard S, Chotmongkol W, Maleewong W (1991). Specificity of antibodies in cerebrospinal fluid of human cerebral

- gnathostomiasis. *S E Asia J Trop Med Publ Health* **22** (suppl): 228–32.
- Morera P, Cespedes R (1971). *Angiostrongylus costaricensis* n.sp. (Nematoda: Metastrongyloidea) a new lung worm occurring in man in Costa Rica. *Rev Biol Trop* **18**: 175–85.
- Moyle M, Foster DF, McGrath DE *et al.* (1994). A hookworm glycoprotein that inhibits neutrophil function is a ligand of the integrin CD116/CD18. *J Biol Chem* **269**: 10008–10015.
- Nawa Y (1991). Historical review and current status of gnathostomiasis in Asia. *S E Asian J Trop Med Public Health* **22** (suppl): 217–19.
- Nishimura K, Hung T-P (1997). Current views of geographic distribution and modes of infection of neurohelminthic diseases. *J Neurol Sci* **145**: 5–14.
- Nopparantana C, Chaicumpa W, Tapchaisri P, Setasuban P, Ruangkuarn Y (1992). Towards a suitable antigen for diagnosis of *Gnathostoma spinigerum*. *Int J Parasitol* **22**: 1151–6.
- Nuamantong S (1996). The evaluation of the 29 and 31 kDa antigens in female *Angiostrongylus cantonensis* for serodiagnosis of human angiostrongyliasis. *S E Asian J Trop Med Public Health* **27**: 291–6.
- Orihel TC (1961). Morphology of the larval stages of *Dirofilaria immitis* in the dog. *J Parasitol* **47**: 251–62.
- Orihel TC, Eberhard ML (1998). Zoonotic filariasis. *Clin Microbiol Rev* **11**: 366–81.
- Pampiglione S, Canestri Trotti G, Rivasi F (1995). Human dirofilariasis due to *Dirofilaria (Nochtiella) repens*: a review of world literature. *Parasitologia* **37**: 149–93.
- Papini R, Lo Piccolo MS, Casarosa L (1996). Effect of ivermectin on the migration of *Baylisascaris transfuga* larvae into the brain of mice. *Folia Parasitol (Praha)* **43**: 157–8.
- Perera L, Perez-Arellano JL, Cordero M, Sunón F, Muro A (1998). Utility of antibodies against a 22 kDa molecule of *Dirofilaria immitis* in the diagnosis of human pulmonary dirofilariasis. *Trop Med Health* **3**: 151–5.
- Pirisi M, Gutierrez Y, Minini C *et al.* (1995). Fatal human pulmonary infection caused by an *Angiostrongylus*-like nematode. *Clin Infect Dis* **20**: 59–65.
- Provic P, Croese J (1996). Human enteric infection with *Ancylostoma caninum*: hookworms reappraised in the light of a 'new' zoonosis. *Acta Tropica* **62**: 25–44.
- Punyagupta S, Juttijudata P, Bunnag T (1975). Eosinophilic meningitis in Thailand: clinical studies of 484 typical cases probably caused by *Angiostrongylus cantonensis*. *Am J Trop Med Hyg* **24**: 921–31.
- Punyagupta S, Bunnag T, Juttijudata P (1990). Eosinophilic meningitis in Thailand: clinical and epidemiological characteristics of 162 patients with myeloencephalitis probably caused by *Gnathostoma spinigerum*. *J Neurol Sci* **96**: 241–56.
- Rambo PR, Agostini AA, Graeff-Teixeira C (1997). Abdominal angiostrongylosis in Southern Brazil—prevalence and parasitic burden in mollusc intermediate hosts from eighteen endemic foci. *Mem Inst Oswaldo Cruz* **92**: 9–14.
- Rusnak JM, Lucey DR (1993). Clinical gnathostomiasis: case report and review of the English language literature. *Clin Infect Dis* **16**: 33–50.
- Santamaría B, Cordero M, Muro A, Simón F (1995). Evaluation of *Dirofilaria immitis* excretory/secretory products for sero-epidemiological studies on human dirofilariasis. *Parasite* **2**: 269–73.
- Sato H, Kamiya H, Hanada K (1992). Five confirmed human cases of *Gnathostoma nipponica* recently found in northern Japan. *J Parasitol* **78**: 1006–10.
- Schad GA, Page MR (1982). *Ancylostoma caninum*: adult worm removal, corticosteroid treatment, and resumed development of arrested larvae in dogs. *Exp Parasitol* **54**: 303–9.
- Shih SL, Hsu CH, Huang FY, Shen EY, Lin JCT (1992). *Angiostrongylus cantonensis* infection in infants and young children. *Paediatr Infect Dis J* **11**: 1064–6.
- Suntharasamai P, Riganti M, Chittamas S, Desakorn V (1992). Albendazole stimulates outward migration of *Gnathostoma spinigerum* to the dermis in man. *S E Asian J Trop Med Public Health* **23**: 716–22.
- Teekhasaence C, Ritch R, Kanchanaranya C (1986). Ocular parasitic infections in Thailand. *Rev Infect Dis* **8**: 350–56.
- Tuntipopipat S, Chawengkirttikul R, Sirisinha S (1993). A simplified method for the fractionations of *Gnathostoma*—specific antigens for sero diagnosis. *J Helminthol* **67**: 297–304.
- Wu SS, French Sw, Turner JA (1997). Eosinophilic ileitis with perforation caused by *Angiostrongylus (Parastrostrongylus) costaricensis*. A case study and review. *Arch Pathol Lab Med* **121**: 989–91.
- Yamashita K, Akimura T, Kawano K, Walcuta Y, Aoki H, Gondon T (1990). Cerebral *Sparganosis mansoni*. A report of two cases. *Surg Neurol* **33**: 28–34.
- Yii CH, Chen CY (1968). Human angiostrongyliasis involving the lungs. *Chin J Microbiol* **1**: 148–50.





# Dracunculiasis

Ralph Muller

*International Institute of Parasitology, St Albans, UK*

---

## HISTORICAL INTRODUCTION

Dracunculiasis is a long-established human parasitic disease. Adult worms have been found in Egyptian mummies and the disease has been reported from ancient writings. Probably the oldest are the description of the 'winding worm' in the Hindu *Rig Veda* (ca. 1350 BC) and in the 'Turin' Papyrus but it was also mentioned in the writings of Plutarch, Pliny the Elder, Galen and Avicenna (Ibn Sina). More controversially, the worms have been identified with the fiery serpents that afflicted the Israelites in the wilderness (*Holy Bible*, Numbers, XXI, 6). If the prepatent period had not been so long, it is likely that the life-cycle would have been elucidated in antiquity. Infection was carried to the New World by the slave trade but died out spontaneously, as it did from areas of North Africa and the Middle East.

## DESCRIPTION OF THE ORGANISM

The causative organism, *Dracunculus medinensis* (Linnaeus, 1758) Gallandant 1773, is a nematode worm belonging to the Order Spirurida, Superfamily Dracunculoidea (allied to but separate from the filariae belonging to the Superfamily Filarioidea). A mature adult female measures 50–80 cm long × 2.0 mm in diameter. It has a mouth surrounded by a cuticular plate but does

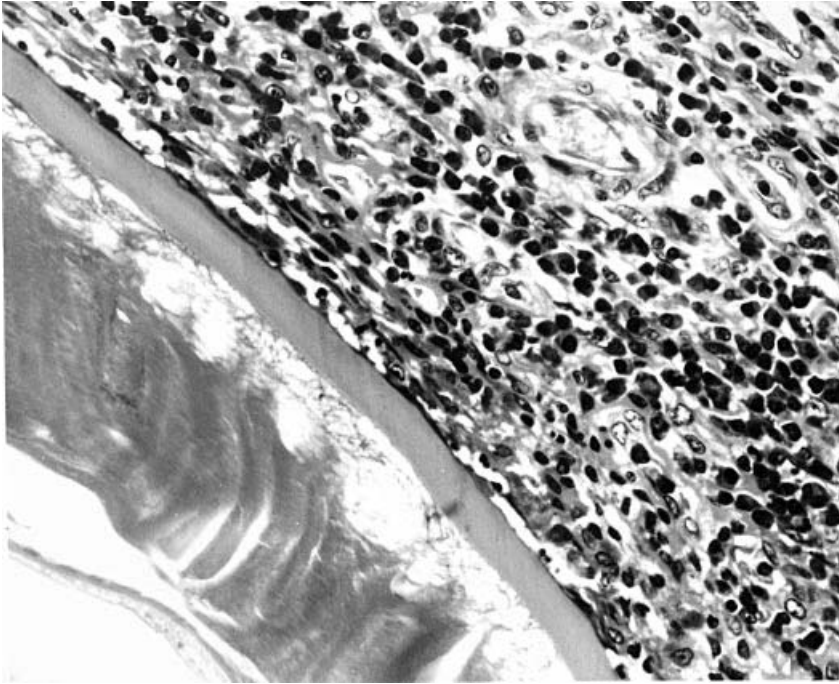
not feed, as the intestine is flattened because the whole of the body cavity is taken up by the uterus, containing up to 3 million larvae. The mature female worms live between the muscle planes of the subcutaneous tissues, usually of the feet and lower legs. The adult male has only doubtfully been recovered from humans but in experimental animals it measures 1.5–4.0 cm long × 0.4 mm in diameter. The first-stage larva expelled from the body of the female measures 640 × 23 μm and has a long pointed tail and fully functional gut.

## PATHOGENESIS

There is little host reaction to the prepatent worms but once the mature female has initiated a blister (probably caused by extrusion of larvae at the anterior end) there is a marked inflammatory response against the cuticle of the entire worm, preventing its rapid removal (Figures 20.1 and 20.2). The fluid in the blister which forms at the site of emergence of the female worm is bacteriologically sterile and contains numerous larvae with white cells adhering to them. At first the cells are principally polymorphonuclear neutrophils but after a few days there are also macrophages, lymphocytes and eosinophils (there is often a high eosinophilia at this stage). The chronic response over the next few weeks, with necrosis and some vasculitis along the track of



**Fig. 20.1** (A) Foot of girl with three female guinea worms emerging and being wound out on sticks in the traditional manner. Courtesy of Dr A. Tayeh. (B) Foot of child with loop of adult female guinea worm emerging from a large blister. (C) Knee of girl with female guinea worm emerging; local remedy of palm oil has been placed on the lesion and the knee has become secondarily infected. (D) Foot of child with three female guinea worms emerging. Courtesy of Dr A. Tayeh



**Fig. 20.2** Microscopical section showing acute host reaction and adherence to cuticle of emerging adult female worm

the worm, resolves quickly once the worm is completely expelled.

Sometimes mature female worms burst in the tissues, releasing many thousands of larvae, and this results in a very large pus-filled abscess and severe cellulitis. Males and infertile females elicit a slight inflammatory reaction, followed by absorption or calcification evident on X-rays.

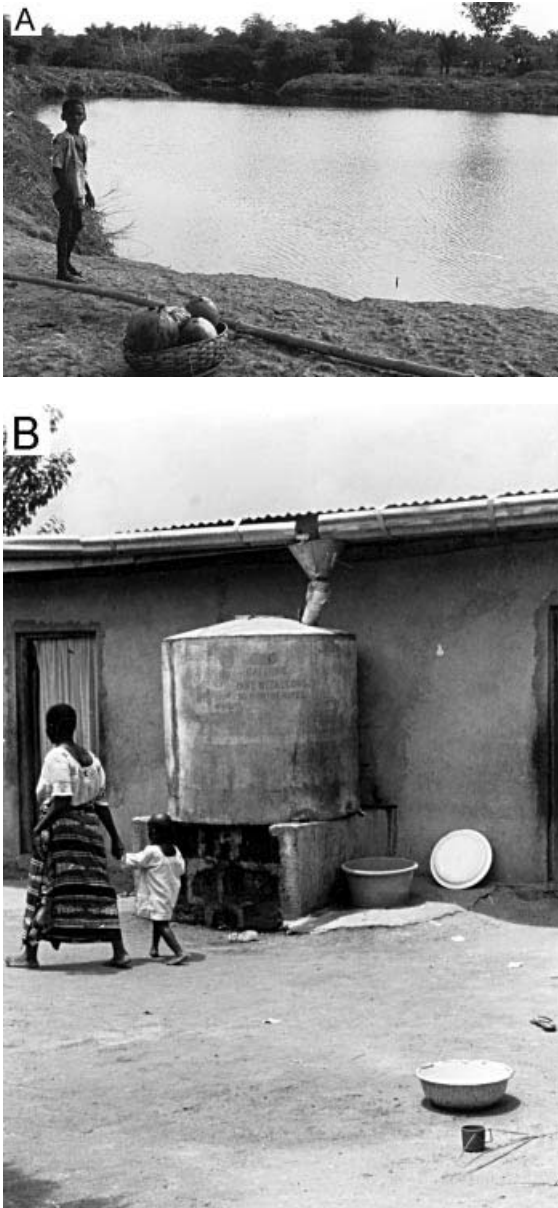
### IMMUNOLOGY

Guinea worm infection is unusual in that the same individual can be repeatedly reinfected and there is little evidence of acquired immunity. The response to the extrusion of larvae is indicative of an Arthus reaction, followed by a delayed hypersensitivity response.

### EPIDEMIOLOGY

The life-cycle of *Dracunculus* is seemingly rather bizarre but is actually well adapted for trans-

mission of a parasite that utilises an aquatic intermediate host but occurs in arid or semi-arid areas. When an infected individual with a blister or ulcer places the affected portion of the body into a pond, or until recently the large open step wells found in India, thousands of first-stage larvae are released into the water from the uterus of the female worm. Not all of the 3 million larvae contained in the uterus are released at once and the now flaccid end of the worm usually dries up and more larvae are released on subsequent re-immersion. In water the larvae thrash actively and can live for a few days. If they are ingested by suitable species of predatory microcrustacean, commonly known as cyclops (previously regarded as all belonging to the one genus, *Cyclops*, but recently split into numerous genera, of which species of *Tropocyclops*, *Mesocyclops* and *Metacyclops* are important as intermediate hosts), the larvae penetrate from the stomach into the body cavity (haemocoel) and develop into the infective third stage in 14 days at a temperature above 21°C. Human infection occurs when drinking water is obtained from ponds (Figure 20.3) and large open step



**Fig. 20.3** (A) Large man-made pond in Eastern Nigeria, source of infection for dracunculiasis, schistosomiasis and malaria. (B) Domestic rain-water storage cistern

wells. After ingestion of infected cyclops, larvae are released in the stomach, penetrate through the abdominal wall, and about 3 months later males and females, measuring 3–4 cm long, mate in the subcutaneous tissues of the thorax region. The males remain in the tissues and die, while the females continue to grow and slowly move

through the muscle planes to the final site of emergence (in about 80% of cases this is the lower limbs) which occurs around 1 year after infection. In most cases only one worm emerges, but there can be many. Twenty years ago, infection was widespread in rural communities in India, Pakistan, Yemen and most countries of sub-Saharan Africa, from Senegal to Ethiopia. It was estimated then that about 10 million people were infected world-wide each year.

Everywhere it occurs, dracunculiasis is seasonal: transmission is principally in the wet season in the semidesert (Sahel) areas of Africa, such as Burkina Faso, Mali, Niger and northern Ghana, Nigeria and Sudan; in humid (Guinea) areas of West Africa with rainfall exceeding 150 cm/year, such as Benin, Cameroon, Ivory Coast, Togo and southern Ghana, Nigeria and Sudan, there is less transmission during the rainy season, as many ponds turn into streams and there are few infected cyclops in the abundant, turbid water. In these areas, maximum transmission (and thus infection) occurs in the latter part of the dry season extending to the first rains, the main planting period. A high percentage of the inhabitants of a village may be infected each year (particularly in the 14–40 year-old working population). However, there is no carry-over of infection from one transmission season to the next.

Infection was eliminated from the Bokhara area in the 1930s and from southern Iran in the 1970s.

*Dracunculus* can infect various mammals, particularly dogs, but there is no evidence that they act as reservoir hosts of human disease.

### CLINICAL FEATURES

In the majority of cases (60%) the blister is the first clinical sign and this is bacteriologically sterile containing numerous white cells and larvae. In some cases the blister is preceded by urticaria, possibly accompanied by fever and gastrointestinal upsets. The blister grows in size to above 3 cm and bursts in about 4 days, the worm emerging a few centimetres a day; the body becomes flaccid as larvae are extruded (a process aided by immersion of the affected area in cold

water). Provided that the track of the worm does not become secondarily infected, infection with a single worm will usually resolve in about 6 weeks. Unfortunately however, secondary bacterial infection is very common: in one study in Nigeria, 58% of patients suffered severe disability, lasting on average almost 13 weeks (Smith *et al.*, 1989) and in another survey 28% of cases were still seriously disabled 12–18 months later, with 0.5% suffering permanent impairment from ankylosis and arthritis (Hours and Cairncross, 1994). Tetanus is another serious complication. However, guinea worm is rarely a fatal disease and in the majority of cases will spontaneously resolve, even in the absence of treatment, but it does have a profound socio-economic effect on the poor rural communities where it occurs.

### LABORATORY DIAGNOSIS

Most patients living in an endemic area are familiar with infection, either personally or within their family, and have no doubt of the diagnosis when, or just before, the first signs appear. These are a burning pain at the site of a small blister, usually accompanied by intense itching and possibly urticaria. If cold water is placed on the ulcer following the bursting of the blister and examined under a lower power microscope, actively moving larvae can be seen.

Recently, immunodiagnostic methods have been evaluated and can possibly detect infection for a few months before patency (Saroj-Bapha and Renapurkar, 1996) but are not useful in practice. The FAST-ELISA and EITB techniques, using a 16000 MW adult protein (DM16) as antigen, was positive just before patency and became negative 2 months after expulsion of worms (Fagbemi and Hillyer, 1990).

### CLINICAL MANAGEMENT

Numerous chemotherapeutic agents have been suggested (principally benzimidazoles and ivermectin) but none are used in clinical management (some do appear to have an anti-inflammatory effect and could aid more rapid expulsion of

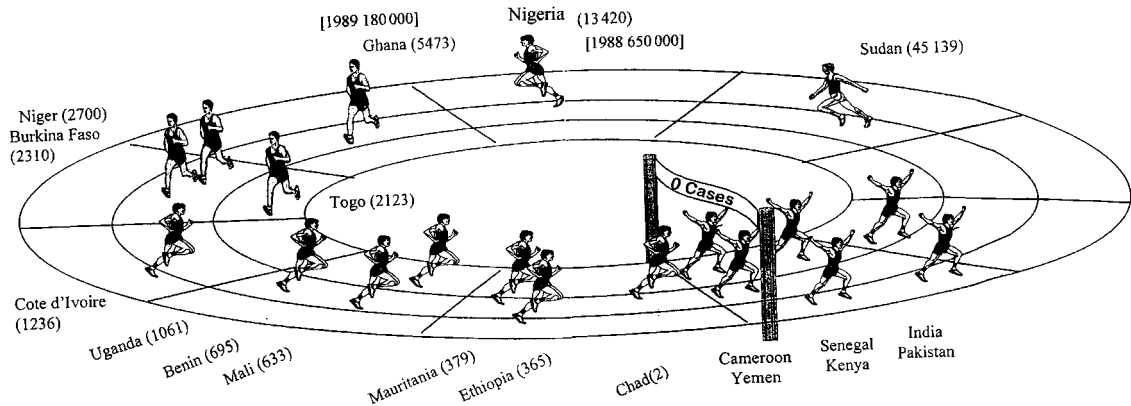
patent worms). The best management is to wind the worm out a few centimetres per day in the time-honoured manner, after soaking in clean, cold water, and then keeping the lesion banded. Surgical removal of pre-emergent worms (if seen) has been traditionally practised in India and recently introduced to Africa.

### PREVENTION AND CONTROL

Individual prevention is easy, and consists of always drinking clean, boiled or filtered water. There is at present a world eradication campaign, adopted as a sub-goal of the Clean Drinking Water and Sanitation Decade by the United Nations World Health Assembly in 1986 and 1989 (Cairncross *et al.*, 2001). The first priority in any eradication campaign is to have accurate figures on the distribution and annual incidence of infection and this has required active surveillance, as the disease is rarely reported to health clinics: passive surveillance has been estimated as identifying only about 2.5% of infections. Annual national case searches have now been replaced by community-based surveillance, followed by case-containment strategies.

There are various possible interventions:

1. *Provide a safe drinking-water supply (mains, tube wells or safe draw wells).* Where piped water is supplied, the disease usually vanishes rapidly and it no longer exists anywhere in towns but this provision is too expensive for endemic rural areas. The most important control measure of the current effort is the provision of bore holes and hand-operated pumps, the funds being provided by governments, charities and international agencies. These have many other health benefits and are part of a general campaign, by UNICEF in particular, to provide safe drinking water to all developing countries during the next decade. Where bore holes are not feasible, traditional brick-lined draw wells with a parapet can be built by local communities, particularly if the initial hole is made by a mechanical digger. Large cisterns for storing rainwater are a useful adjunct for schools in some areas.



**Fig. 20.4** The progress in the eradication campaign at the end of 1998 shown as a race (modified from the website *Guinea Worm Wrap Up*, April 1999)

2. *Boil or filter all drinking water.* Boiling water for drinking is effective but not usually feasible, as firewood is in very short supply in most endemic regions. Water can be filtered and this is a short-term measure which is playing a large part in the current campaign. A monofilament nylon net with a standard pore size of 0.15 mm filters out cyclops, is not easily clogged and is long-lasting. Enough material to supply all endemic villages has been donated by the manufacturers.
3. *Persuade or prevent all persons with an emerging female worm from entering drinking water ponds or step wells.* The cooperation of the local population, particularly school children, in preventing contamination of the water sources is playing an important role in control campaigns, and trained village health teams have been set up in all endemic countries. Bandaging of the lesion at the beginning of patency helps to stop the patient from entering water, as well as preventing secondary infection.
4. *Treat water sources with chemicals to kill cyclops.* Chemical treatment of ponds is most useful towards the end of a campaign, when there are only a few cases left or where the provision of wells has not stopped transmission. The organophosphate temephos (Abate) can be safely added to potable water sources and will kill cyclops for up to 6 weeks at 1 ppm. Enough to treat ponds in endemic areas of Africa has been donated by the manufacturers.

Since the beginning of the eradication campaign, the disease has been certified as having been eliminated from Pakistan in 1994 and there have been no cases in India since 1996. In Africa, there has been a great fall in the number of cases in Ghana and Nigeria in the last 10 years (Figure 20.4) and active campaigns are also under way in Benin, Burkina Faso, Chad, Ethiopia, Ivory Coast, Mali, Mauritania, Niger, Kenya, Senegal, Sudan, Togo, Uganda and Yemen. In all these countries except Sudan, there are only a few limited foci left. The situation in Sudan, where 56 000 cases were reported in 1999, remains the most problematical. Thirty-seven countries where the disease has occurred in historical times have applied for certification of its absence.

It is to be hoped that by the next edition of this book, this chapter will be superfluous.

## REFERENCES

- Anon. (Quarterly). Guinea Worm Wrap Up. Centers for Disease Control: Atlanta, GA (Website = [www.cdc.gov/ncidod/dpd/list\\_drc.htm](http://www.cdc.gov/ncidod/dpd/list_drc.htm)).
- Cairncross S, Muller R, Zagaria N (2001). Dracunculiasis (guinea worm disease) and its eradication. *Clin Microbiol Rev* (in press).
- Chippaux JP (1994). *Le Ver de Guinée en Afrique: Méthodes de Lutte pour l'Eradication*. ORSTOM: Paris, 202 p.
- Eberhard ML, Brandt FH *et al.* (1990). Chemoprophylactic drug trials for treatment of dracunculiasis using the *Dracunculus insignis*-ferret model. *J Helminthol* **64**: 79–86.
- Fagbemi BO, Hillyer GV (1990). Immunodiagnosis of dracunculiasis by falcon assay screening test–enzyme-linked immunosorbent assay (FAST–ELISA) and by

- enzyme-linked immunoelectrotransfer blot (EITB) technique. *Am J Trop Med Hyg* **43**: 665–8.
- Hopkins DR, Ruiz-Tiben E (1991). Strategies of dracunculiasis eradication. *Bull WHO* **69**: 533–40.
- Hours M, Cairncross S (1994). Long-term disability due to guinea worm disease. *Trans R Soc Trop Med Hyg* **88**: 559–60.
- Magnussen P, Yakuba A, Bloch P (1994). The effect of antibiotic and hydrocortisone-containing ointments in preventing secondary infections in Guinea worm disease. *Am J Trop Med Hyg* **51**: 797–9.
- Muller R (1971). *Dracunculus* and dracunculiasis. *Adv Parasitol* **9**: 73–151.
- Muller R (1999). Slaying the little dragon. *Biologist* **46**: 57–60.
- Periès H, Cairncross S (1997). Global eradication of guinea worm. *Parasitol Today* **13**: 431–7.
- Saroj-Bapna, Renapurkar DM (1996). Immunodiagnosis of early dracunculiasis. *J Comm Dis* **28**: 33–7.





# Intestinal Nematodes

Stephen H. Gillespie

*Royal Free and University College Medical School, London, UK*

---

## INTRODUCTION

Some of the roundworms that parasitise the human intestinal tract, and that on occasion may be present in the faeces, are large enough to be seen with the naked eye, even by observers who are not particularly inquisitive. Adult pinworms (*Enterobius vermicularis*) measure about 1 cm in length and *Ascaris lumbricoides* may attain lengths of 30 cm or more. Consequently, humans have most likely been aware of their acquaintance with intestinal nematodes since antiquity. Some of the earliest written records known, including the Ebers Papyrus (ca. 1500 BC), contain descriptions of what is almost certainly *A. lumbricoides*. Hippocrates and Aristotle both referred to roundworms and threadworms in their writings (ca. 350–400 BC), and Avicenna described a treatment of pinworms (ca. 1000 AD). Tyson, in 1683, described detailed anatomical studies of *A. lumbricoides*. However, until the nineteenth century worms were generally considered to appear spontaneously in the body as a result of disease, putrefaction and changes in the body's humours. Werner, in 1780, is credited with the first assault on this view—an assault which was largely ignored at the time. The paradigm shift that accompanied the recognition of worms as infectious agents heralded a new era in the study of these organisms, and from the mid-nineteenth century onwards much work

was carried out on the transmission and life-cycles of the parasitic nematodes of humans. The progress of this work was greatly assisted by parallel progress in the development of laboratory technology. This trend continues today as developments in fields such as molecular biology, immunology and biochemistry open up new areas of research in the study of the parasitic nematodes of humans. The understanding of the health impact of these parasites evolved over a period of time, and indeed continues to evolve for some of the more common worms, as new research and interpretation or definitions of morbidity and ill-health shape current opinion.

More than 100 species of nematode have been found in association with human tissues. This species list includes representatives of 18 superfamilies, 26 families and 63 genera within the Phylum Nematoda, and thus must be considered a grouping of diverse organisms. The list contains a considerable number of instances (48.6%) in which a nematode species has been found in association with human tissue but the nature of the relationship between nematode and human is as yet unresolved. These include cases in which it is now known for certain in what capacity the human serves as a host for a particular parasite (e.g. as a definitive host or an intermediate host), as well as those in which it is uncertain whether the relation is a parasitic one at all. In

still other cases, reports were inconclusive in terms of the descriptions provided and await confirmation. In other cases the validity of the species is considered doubtful.

More than 71 of the species (51.4%) have been reported in association with the tissues of the alimentary tract, defined as the buccal cavity to the anus, including the biliary system and pancreatic duct. This small list is very diverse, containing members of 12 superfamilies, 17 families and 37 genera. Undoubtedly, some members of this list will eventually come to be considered as having been spurious parasites, i.e. free-living organisms, or parasites of non-human hosts, which transiently occupied the human intestine through being accidentally ingested, e.g. in contaminated food or drink (see Table 21.1). Several of the intestinal nematodes are described in other chapters because of their individual importance or because of their pathological characteristics in specific disease, e.g. *Strongyloides stercoralis* (see Chapter 18c) in eosinophilic enteritis, visceral larva migrans and cutaneous larva migrans (see Chapters 19c and 5). Only intestinal nematodes that are regular human pathogens will be described in detail.

## PATHOGENESIS

### Intestinal Nematodes and Cognitive Function

Intestinal nematodes have been identified as a major source of chronic ill-health, compromising the growth potential and intellectual achievements of children throughout the world. This association was first suggested by a study early in the twentieth century that demonstrated a correlation between helminth infection and the educational achievements of school children (Stiles, 1902). Children with hookworm infection and, to a lesser extent, *Ascaris*, developed more slowly at school and had a significant deficit in the grades achieved. In the subsequent 85 years, many other studies have attempted to relate failures in educational achievement with helminthic infections. The literature is complicated by different measures of school achievement and different methods of assessing cognitive function. Recent studies in 9–12 year-old children in

Jamaica found a negative correlation between geo-helminth infection and academic achievement (Nokes *et al.*, 1991). Also the level of school absenteeism was related to intensity of infection in these children, with the proportion of the children absent from school increasing with increasing intensity of *Trichuris* infection (Nokes and Bundy, 1993). However, infection status is associated with poor socio-economic status and school absence may be related to social factors, e.g. the need to work with parents to provide an income.

The mechanisms whereby cognitive impairment may occur have been suggested to be nutritional deficiency. Iron deficiency has a strong association with impaired school performance and is common in children with high-intensity hookworm infections. Lower height for age (stunting) has also been associated with detriments in cognitive function, mental development, behaviour and educational achievement, and these are complications of heavy intestinal nematode infection (see above). This suggests that the nutritional consequences of intestinal helminth infection impair the ability of children to perform well at school. Another possible mechanism is that the subclinical symptoms of heavy intestinal infection reduce attention at school. Further support for the idea that intestinal nematodes impair cognitive function has been provided by intervention studies, where various measures of cognitive function have been measured before and after intestinal nematode treatment. Various tests have been applied in this context, including measuring accuracy, speed and productivity. In children with *Trichuris* dysentery syndrome, a case-controlled study demonstrated that after 1 year of regular treatment, children had significant improvements in measure of locomotor development and nutritional status. In a study of children with moderate to heavy infections of *Trichuris*, significant improvements in treated children were found within 9 weeks in comparison to untreated children, as measured by auditory short-term memory, scanning and retrieval of long-term memory (Callender *et al.*, 1992, 1998). Treated and uninfected controls no longer differed significantly in their performance of these tests. This suggests that moderate to heavy infections with *Trichuris* have a detrimental and reversible impact on a child's working memory.

**Table 21.1** Nematode species associated with human intestines

<b>ANCYLOSTOMATOIDEA</b>	<b>RHABDITOIDEA</b>
Ancylostomatidae	Strongyloidea
<i>Ancylostoma carinum</i>	<i>Strongyloides fuelleborni</i>
<i>Ancylostoma ceylonicum</i>	<i>Strongyloides cf fuelleborni</i>
<i>Ancylostoma duodenale</i>	<i>Strongyloides procyonis</i>
<i>Ancylostoma japonica</i>	<i>Strongyloides ransomi</i>
<i>Ancylostoma malayanum</i>	<i>Strongyloides stercoralis</i>
<i>Cyclodontostomum purvisea</i>	
<i>Necator americanus</i>	<b>SPIRUROIDEA</b>
<i>Necator argentinus</i>	Gongylonematidae
<i>Necator suillis</i>	<i>Gongylonema pulchrum</i>
	Spirocercidae
<b>ASCAROIDEA</b>	<i>Spirocerca lupi</i>
Anisakidae	<b>STRONGYLOIDEA</b>
<i>Anisakis simplex</i>	Chabertiidae
<i>Contracaecum osculatum</i>	<i>Oesophagostomum apiostomum</i>
<i>Pseudoterranova decipiens</i>	<i>Oesophagostomum bifurcum</i>
Ascaridae	<i>Oesophagostomum stephanostomum</i>
<i>Ascaris lumbricoides</i>	<i>Ternidens deminutus</i>
<i>Ascaris suum</i>	
<i>Baylisascaris procyonis</i>	<b>TRICHINELLOIDEA</b>
<i>Toxascaris leonina</i>	Trichinellidae
<i>Toxocara canis</i>	<i>Trichinella nativa</i>
<i>Toxocara cati</i>	<i>Trichinella nelsoni</i>
	<i>Trichinella spiralis</i>
<b>DIOCTOPHYMATOIDEA</b>	Trichuridae
Dioctophymatidae	<i>Anchotheca phippinensis</i>
<i>Eustrongyides</i> sp.	<i>Calodium hepaticum</i>
	<i>Trichuris suis</i>
<b>MERMITHOIDEA</b>	<i>Trichuris trichiura</i>
Mermithidae	<b>TRICHOSTRONGYLOIDEA</b>
<i>Aganomermis hominis oris</i>	Trichostrongylidae
<i>Mermis nigrescens</i>	<i>Haemonchus contortus</i>
<b>METASTRONGYLOIDEA</b>	<i>Marchallagia marchallii</i>
Angiostrongylidae	<i>Mecistocirrus digitatus</i>
<i>Parastrongylus costaricensis</i>	<i>Nematodirus abnormalis</i>
Metastrongylidae	<i>Ostertagia circumcincta</i>
<i>Metastrongylus elongatus</i>	<i>Ostertagia ostertagi</i>
<b>OXYUROIDEA</b>	<i>Trichostrongylus affinis</i>
Oxyuridae	<i>Trichostrongylus axei</i>
<i>Enterobius gregorii</i>	<i>Trichostrongylus brevis</i>
<i>Enterobius vermicularis</i>	<i>Trichostrongylus calcaratus</i>
<i>Syphacia obvelata</i>	<i>Trichostrongylus capricola</i>
	<i>Trichostrongylus colubriformis</i>
<b>PHYSALOPTEROIDEA</b>	<i>Trichostrongylus lerouxi</i>
Physalopteridae	<i>Trichostrongylus orientalis</i>
<i>Physaloptera caucasica</i>	<i>Trichostrongylus probolurus</i>
<i>Physaloptera transfuga</i>	<i>Trichostrongylus skrjabini</i>
	<i>Trichostrongylus vitrinis</i>
	<i>Capillaria</i> spp.

## Morbidity

The relationship between infection and morbidity is non-linear in intestinal nematode infections. Infection does not inevitably lead to disease and

severe symptoms are generally only associated with higher worm burdens. At higher intensities of infection with hookworm, there is severe anaemia and chronic colitis in *Trichuris* dysentery syndrome. For example, in hookworm infection

there is a disproportionate reduction in haemoglobin concentration after a threshold worm burden is exceeded. This threshold probably differs depending on the host's iron status. This is a surprising finding, since hookworm feeding is a constant per capita and thus might be expected to produce a linear relationship between burden and anaemia. A similar relationship between protein-losing enteropathy and trichuriasis is found.

## EPIDEMIOLOGY

### The Global Burden

It is often difficult to establish the significance of infection with intestinal nematodes. Infection is rarely life-threatening and usually well tolerated. The severity of disease is usually related to the density of infection, with light infections being well tolerated even in patients with compromised nutrition. It is, perhaps, in the scale of the problem that intestinal nematode infection acquires its significance, and more recently the more subtle consequences of infection have come to be recognised.

The global burden of helminth infections was first estimated more than 50 years ago (Stoll, 1947). Calculations then suggested that 644 million people were infected with *Ascaris lumbricoides*, 355 million with *Trichuris* and 457 million with hookworm. Since then the number has grown to more than 1.2 billion *Ascaris* infection, 902 million *Trichuris* infection and more than 1.2 billion hookworm infections (Chan *et al.*, 1994c; de Silva *et al.*, 1997). These estimates are based on extrapolations from prevalence studies and thus must be treated with caution but, even allowing for large error margins, the global burden of infection is vast and a very significant source of human ill-health. The global burden is more serious than these figures suggest. Since Stoll made his estimates there have been very significant changes in the prevalence of infection in some countries. In the first half of the twentieth century (Schwartzwelder, 1924), intestinal infections were reported in Europe and North America, but in these countries they have now all but disappeared. Many countries in Asia have also been successful

in controlling intestinal nematode infections (Seo, 1990). This picture is contrasted with that in developing countries, with urbanisation and population growth combining to increase the total burden of disease. Within this global estimate, there have been variable falls in the prevalence of *Ascaris* infection and a more sharp increase in the rise in hookworm prevalence. This may be in part due to the relative ineffectiveness of current anthelmintic agents used in parasite control programmes against hookworm (Venkatesan, 1998). Additionally, the burden of disease is not evenly spread within developing countries. The majority of worms are found in the poorest sections of the community, compounding poverty and social deprivation (see below).

Mortality with intestinal nematode infections does occur, but is relatively uncommon in comparison with more acute infectious challenges in developing countries, but this importance of intestinal nematode infections is emphasised by measuring disability-adjusted life years (DALYs). This assesses the disease burden by estimating disability weights for each condition and then weighing the years lived with the disability to calculate the years lost due to the disability, introduced in the *World Development Report* (World Bank, 1993). The total for intestinal nematode infections has been estimated as 39.0 million, and this compares with malaria (35.7), measles (34.1) and tuberculosis (46.5). Irrespective of the method of calculation, intestinal nematode infections are a major health challenge, affecting the poorest members of human society.

### Helminth Reproduction

Almost all helminth infections differ from those organisms previously described as micro-parasites, e.g. bacteria and protozoa, by their reproductive behaviour. Most helminth species reproduce within the definitive host, producing stages that are only infective to other hosts. Thus, the size of the infectious burden does not increase other than by ingestion of more eggs or invasion by larvae. The concept of the worm burden or the intensity of the infection is very important in

understanding helminth transition dynamics and also the morbidity of intestinal nematode infections. The exceptions to this rule include *Strongyloides* (see Chapter 18c) and *Capillaria*, which is described in detail in this chapter. This fundamental difference between macro- and microparasites is most strikingly obvious in disease expression. In microparasitic infections there is a close relationship between infection and disease, whereas in intestinal nematode infections the relationship is less clear but is related to the size of the worm burden (Stephenson, 1987).

### Infection Intensity

The infection intensity is not uniformly or randomly distributed among individuals. It is highly over-dispersed. In other words, most individuals have a few or no worms, while a few hosts harbour a disproportionate number of worms. This has been described for all of the major intestinal nematode species: *Ascaris lumbricoides* (Holland *et al.*, 1989), hookworm (Schad and Anderson, 1985), *Trichuris trichiura* (Bundy and Cooper, 1989; Chan *et al.*, 1994c) and *Enterobius vermicularis* (Haswell-Elkins *et al.*, 1987a,b). The heavily infected individuals are often described as ‘wormy individuals’ and these people are both at risk of the more severe complications of infection and act as an important source of transmission. The reasons for over-dispersion are both genetic and environmental, although it is often difficult to tease these different components apart, as families not only share their genes but their environment. It is clear that the risk of re-infection is related to the pre-treatment infection density, and that is also true within families. The risks of infection depend on behavioural factors that are notoriously difficult to study (Keymer and Pagel, 1989). Studies in a West Indian population exposed to *Ascaris* and *Trichuris* indicate that the HLA type A20C7DR18 haplotype was significantly more frequent in individuals with intense infection with either parasite. The significance of this finding is unclear, as this haplotype has not previously been associated with any specific immunological defect and occurred in less than 5% of heavily infected individuals in the community. That

genetics has an important role has been shown in a study of *Trichuris* and *Ascaris* re-infection in Malaysia (Chan *et al.*, 1994a,b). This showed that the co-variants between initial and re-infection worm burdens was significantly stronger if the data were analysed by family unit rather than by randomly assigned groups of individuals. Over-dispersion of infection also occurs with respect to age group. In hookworm infection, adults have the highest rate of disease, whereas in *Ascaris* and *Trichuris* infection, the age prevalences peak in childhood and fall with increasing age (usually before the age of 5 years).

There is no simple relationship between prevalence and intensity. For most helminth species, the initial rise in intensity with age closely mirrors that of prevalence. Maximum intensity occurs at a host age which is parasite- and species-specific and depends on the basic biology of the parasite and parasite longevity and is independent of local transmission rates. For *Ascaris* and *Trichuris*, maximum worm burdens occur at 5–10 years of age, whereas for hookworms this occurs at 20–25 years of age (Chan *et al.*, 1994a,b; Haswell-Elkins *et al.*, 1987b, 1988; Needham *et al.*, 1992). With *Enterobius vermicularis* there is a biphasic age intensity pattern, typically a peak in childhood and a secondary peak among adults, that has generally been associated with familial transmission. Thus, there can be a reduction in intensity in patients who have large worm burdens without there being a detectable reduction in prevalence, although this will result in a reduction in morbidity and mortality.

The risk of re-acquisition of infection after treatment is age-dependent, with children re-acquiring worm burdens at a higher rate than adults. This reflects the balance between exposure and resistance to infection. This implies that the behaviour of children predisposes them to the soil-borne nematodes, *Ascaris* and *Trichuris*. This contrasts with hookworm, where the peak in the adult age groups tends to imply an occupational exposure.

### Intensity and Transmission

With increasing intensities of infection there is a greater risk of transmission of infective stages, but this relationship is non-linear because the

per capita fecundity of female worms is density-dependent. Thus, at large worm burdens the total egg output is lower than would be expected. Despite this, individuals with large worm burdens probably play the most significant role in transmission. This contention has been supported experimentally by treatment studies focused on the most intensely infected age groups in environmentally isolated populations. By targeting school-age children, it brought about a significant decline in *Ascaris* and *Trichuris* infection in the untreated adult population (Bundy and de Silva, 1998; Holland *et al.*, 1996a).

### Life-cycles of Intestinal Nematodes

Intestinal nematodes share similar life-cycles that have evolved in response to new ecological niches. The core nematode life-cycle involves development from an egg through five stages of growth. The first four stages are known as larval stages and are referred to as L<sub>1</sub>, L<sub>2</sub>, L<sub>3</sub> and L<sub>4</sub>. The fifth and final stage of development is a sexually mature adult worm. At each stage the cuticle of the parasite moults. In all of the nematodes parasitic in man, the sexes are morphologically distinct. The life-cycles of free-living nematodes are simple and very similar to the cycle described above. However, nematodes adapted to human infection have developed a number of complexities arising from their parasitic lifestyle. These complexities arise from their need to infect, develop and reproduce within the

different organ systems of the host species, and also their need to disperse progeny to parasitise new hosts.

### Entry to the Host

There are usually only two sites of entry for intestinal nematodes infecting humans: the mouth and the skin. The ingestion of eggs or, in some cases, L<sub>3</sub> larvae, results in infections. Eggs may be ingested, for example, on inadequately washed, uncooked vegetables and L<sub>3</sub> larvae may be ingested in contaminated water. For several parasites, pica is important mode of transmission, as is faecal-oral transmission on unwashed fingers. The L<sub>3</sub> larvae of hookworms, notably *Ancylostoma duodenale* and *Necator americanus*, have the capacity of penetrating intact skin. After skin penetration they pass through the blood vessels and are carried in the circulation via the liver to the lungs. From there they follow a path similar to that set out below for other intestinal nematodes, finally developing into adults in the small intestine.

Eggs hatch in the intestine, liberating a single L<sub>1</sub> larvae. They may invade through the intestinal tract and are then carried in the portal circulation to the liver and from there to the lungs, after which they are carried up the bronchi and trachea and swallowed, to return to the intestinal tract. During this period they develop through the L<sub>2</sub>, L<sub>3</sub> and L<sub>4</sub> larval stages and finally into mature adult worms.

## ASCARIS LUMBRICOIDES

### HISTORICAL INTRODUCTION

Infections with *Ascaris* have been recognised since antiquity the Greeks coined the word ασκαρις meaning worm, although the ancients often confused the human infection with earthworms. The first description of the parasite in the modern age was probably made by Tyson (1683), who distinguished it from the common earthworm. Linnaeus gave the organism its current name in 1758 and the pig

worm, *Ascaris suum*, was described by Goeze (1782).

### DESCRIPTION OF THE ORGANISM

#### Classification

*Ascaris lumbricoides* is a member of the super-family Ascaridoidea. The Ascaridoidea possess a mouth that has three conspicuous lips. Males

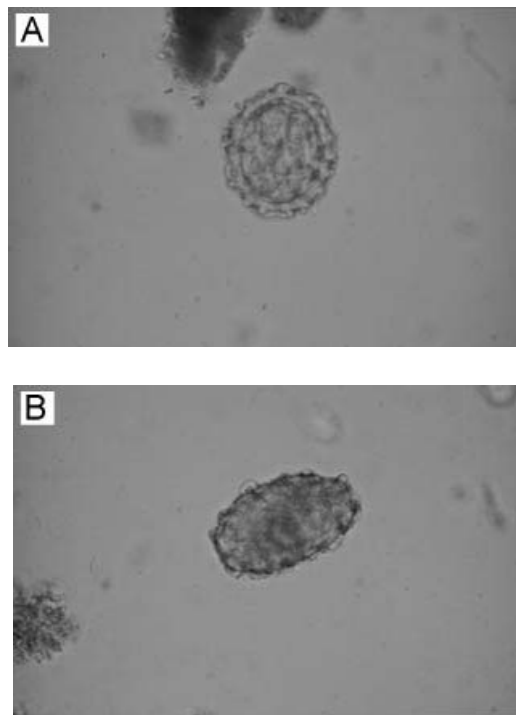
have one or two copulatory spicules but no bursa copulatrix and usually no caudal alae. This family includes a number of human parasites that are pathogenic in their adult stage, e.g. *Ascaris lumbricoides*, or in their larval stages, e.g. *Toxocara canis* and *Anisakis*. *Ascaris suum* is the most closely related member of the genus and is a roundworm endemic to pigs. Although humans and pigs often share the same environment, it seems that these closely related organisms have separate transmission cycles, and a different karyotype with distinct differences in the structure of the chromosomes in metaphase (He *et al.*, 1986). Some investigators have used restriction mapping of mitochondrial DNA and have shown evidence that cross-infection between pigs and humans does occur (Anderson *et al.*, 1993, 1995) (see below). Experimental human infections with *A. suum* suggest that the parasite is unable to pass the L<sub>4</sub> stage and thus does not cause an infection in man.

### Adult

The adult *Ascaris lumbricoides* is a long whitish-pink cylindrical worm, tapering at both ends, curving ventrally in the male. Females reach 49 cm with a diameter of 3–6 mm. Males are much smaller, slightly more than half of the size of females.

### Eggs

*Ascaris* eggs vary widely in size and appear in two forms, fertilised and unfertilised (Figure 21.A,B). The fertilised egg is golden brown, ovoid, mammilated and 30–40 µm wide × 50–60 µm long, with a dense outer irregular shell and a more translucent regular inner shell. The thick external mammilated layer is often lost, giving a decorticate appearance. Evidence of segmentation or embryonation is often seen. The unfertilised egg is larger, more elongated and 40–50 µm wide × 88–95 µm long. The internal structure of the egg is poorly differentiated. Female worms produce up to 240 000 eggs/day, which corresponds to just under 3000 eggs/gram of faeces (Mello, 1974). The egg shell is made up



**Fig. 21.1** (A) Fertilised egg of *Ascaris lumbricoides*. (B) Unfertilised egg of *Ascaris lumbricoides*

of four layers: an outer mucopolysaccharide layer (Foor, 1967), a vitelline layer, a protein and chitin layer, and an inner selectively permeable layer consisting of an unsaponifiable lipid ascaroside (Perry and Clarke, 1982).

## EPIDEMIOLOGY

### Life-cycle

*Ascaris lumbricoides* is a geo-helminthic parasite (see above) and transmission is favoured by conditions that improve the survival of the eggs in the soil, in particular warm moist shady conditions. It is most common in crowded rural areas with poor sanitation. It is transmitted to humans by ingestion of embryonated eggs. Eggs passed in the faeces into the soil develop over 10–15 days, ideally in moist soil conditions with oxygen and shaded from ultra-violet light. Desiccation and very high environmental temperatures will significantly reduce the viability of the eggs. In endemic areas environmental contamination can

be severe, and in dry windy conditions the eggs can become airborne and be ingested. The eggs hatch in the small intestine and follow the pathway described above (see page 566).

### Genetic Predisposition

An epidemiological study of the contribution of genetic and shared environmental factors in Tibet indicated that genetic factors accounted for 30–50% of the variation in worm burden in a re-infection study and shared environment for 3–13% (Williams-Blangero *et al.*, 1999).

In a study in Venezuela, children with a strong atopic background demonstrated immunoglobulin responses concordant with enhanced protective responses to helminthic parasites, and had significantly lower intestine infection than their non-atopic counterparts. This suggests that the atopic status confirmed a selective evolutionary advantage that could compensate for its involvement in allergic diseases (Lynch *et al.*, 1998).

### CLINICAL FEATURES

*Ascaris* infection is often considered to be an unimportant infection and, although acute mortality is rare, the high prevalence of infection means that there are probably 10 000 deaths directly from this infection (de Silva *et al.*, 1997). High-intensity infections are associated, along with other intestinal nematodes, with stunting of linear growth and this is described in more detail above (see page 565). Pulmonary migration of larvae may result in a self-limiting pneumonia lasting up to 2 weeks, developing about 2 weeks after ingestion. Seasonal attacks occur in countries where transmission only occurs during rainy seasons (Gelpi and Mustafa, 1967). Those

sensitised with recurrent exposure may suffer more severe reactions. Pulmonary migration is associated with fever, dyspnoea and asthma, associated with eosinophilia (Spillman, 1975). Larvae are found in the terminal air-spaces and bronchioles, provoking an intense eosinophilic inflammatory reaction and consolidation. This complication is occasionally fatal (Beaver and Danaraj, 1958).

Intestinal ascariasis is usually well tolerated, although there is an association with vague abdominal pains. There is an increased risk of intestinal obstruction with increasing worm burdens and this results in 3–5% of cases in endemic countries. This complication is associated with a 17% mortality (Akgun, 1996). An international systematic review indicated that intestinal obstruction was the single most common complication and accounted for 38–87.5% of all complications. The case fatality rates were in the range 0–8.6% (de Silva *et al.*, 1997a). Treatment of this complication is by early operative intervention, allowing the worms to be milked towards the colon and, if this is not successful, to ‘deliver’ them through an enterotomy. With early surgical intervention the prognosis is good (de Silva *et al.*, 1997b). Adult *Ascaris* can enter the hepatobiliary and pancreatic system, causing obstruction, and this problem has often been underestimated in endemic countries. The diagnosis can be made by ultrasonography, endoscopic retrograde cholangio-pancreogram (ERCP) or CT scanning, where there are characteristic appearances (Khuroo *et al.*, 1990; Ng *et al.*, 1999). Intestinal ascariasis presents with symptoms and signs of biliary colic, cholecystitis, acute cholangitis, acute pancreatitis or a hepatic abscess (Khuroo *et al.*, 1990). Conservative management is usually successful but endoscopic removal of some worms may be required (Khuroo *et al.*, 1993).

## HOO KWORMS

### HISTORICAL INTRODUCTION

Human hookworm infections have been known from antiquity and are referred to in the Ebers Papyrus and by the Persian physician Avicenna. The first comprehensive description was made by

Dubini (1843). Its importance was brought to the attention of scientists by an epidemic of miner’s anaemia in workers constructing the Saint Gotthard railway in the Swiss Alps. Looss (1898) described the percutaneous transmission of hookworm and elucidated the entire life-cycle



of *Ancylostoma duodenale*. A few years later, Stiles (1902) described a second major hookworm species, later re-named *Necator americanus*. This disease was widespread in the southern USA.

**CLASSIFICATION**

Hookworms belong to the Ancylostomatidae, a part of the superfamily Strongyloidea (see page 563). The genera that affect man include *Necator americanus*, *Ancylostoma duodenale*, *A. caninum*, *A. braziliense*, and *A. ceylanicum*. The latter three are discussed in Chapter 19c. *A. duodenale* is transmitted by skin penetration and oral ingestion, whereas *N. americanus* can only complete its life-cycle after skin penetration.

The adult worms are cylindrical, slightly constricted anteriorly and have a cervical curvature. The males are 8–11 mm in length and have a maximum diameter of 0.5 mm, whereas the females are on average 10–13 mm in length and 0.6 mm in diameter. On the dorsal aspect of the mouth there is a dental plate with a buccal cleft. The morphology of the head is useful in speciating the worms. Hookworm eggs have a characteristic appearance and are approximately 40 × 60 μm (Figure 21.2).

**LIFE-CYCLE**

Hookworm eggs are discharged into the environment but may also develop in the human intestine. Development occurs at 10–40 °C, with an optimal

developmental temperature at 20–30 °C. *A. duodenale* eggs hatch sooner than *N. americanus* and the embryos die rapidly in direct sunlight and when the moisture of the soil falls below 9% (Smith, 1990; Smith and Schad, 1989).

A first-stage larva, L<sub>1</sub>, emerges from the egg and is approximately 250–300 μm in length, with a characteristic flask-shaped muscular oesophagus. This is also known as the rhabditiform larva. It feeds on organic debris and bacteria and after 3 days of growth undergoes a moult, with the emergence of the second-stage, L<sub>2</sub>, larva. In the L<sub>2</sub> stage the open mouth closes after 5–8 days, and mouth closure is concurrent with the transformation into the non-feeding third-stage filariform larva (L<sub>3</sub>). The L<sub>3</sub> stage is infective from man; it migrates along moisture and travels in the soil. It is naturally highly susceptible to desiccation and is able to invade through intact skin, where it migrates to the lungs, then breaks out into alveolar capillaries, up the trachea and into the pharynx, is swallowed into the small intestine, where it develops into an adult and mates (Smith, 1990).

**Skin Invasion**

Hookworm invasion of the skin is mediated by production of proteolytic enzymes, including hyaluronidase (Hotez *et al.*, 1992) and two *Ancylostoma*-secreted proteins, 1 and 2 (Hawdon *et al.*, 1996, 1999). The L<sub>3</sub> larvae respond to thermal gradients and burrow through the skin; they enter the vasculature and are passively carried to the pulmonary capillaries, where they become trapped (Croll *et al.*, 1975; Croll and Smith, 1972; Matthews, 1982). *A. braziliense* does not penetrate beyond the basement membrane but migrates to the deeper tissues of the epidermis, forming the characteristic serpiginous lesions. After the cutaneous stage, the larvae migrate into the lungs, move up the respiratory tract and pass down the digestive tract, where they become sexually mature adult worms in the small intestine.

The infective larvae of *Necator americanus* secrete a range of proteolytic enzymes, with two overall pH optima of 6.5 and 8.5. Larval secretions attack collagen types I, III, IV and

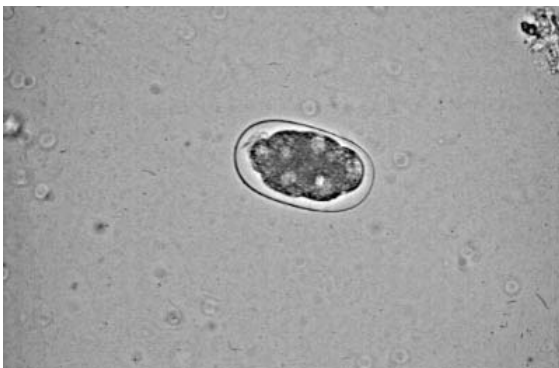


Fig. 21.2 Characteristic hookworm egg

V, fibronectin, laminin, and elastin. All the skin macromolecules tested were hydrolysed by aspartyl proteinase activity, which was inhibitable by pepstatin A. Collagen and elastin was also hydrolysed by metalloproteinase activity, while the serine proteinase activity hydrolysed only elastin. Larval penetration in an experimental model was inhibited only by pepstatin A, confirming the importance of aspartyl proteinase activity during the skin penetration process (Brown *et al.*, 1999).

### HOOKWORM PATHOGENESIS

Hookworms cause disease by their attachment to the human intestine and consequent blood loss and protein-losing enteropathy. The pathogenesis of hookworms has been extensively studied, both in the human parasites, *A. duodenale* and *N. americanus*, and also the animal pathogens, *A. braziliense* and *A. caninum* (Hotez *et al.*, 1995). Hookworms secrete a complex series of proteins, the excretory–secretory antigens. The complexity of the protein antigens is seen in the recent review of expressed genes (Daub *et al.*, 2000).

*Ancylostoma* spp. produce a family of peptides that block the activity factor of Xa and factor VIIa/TF. These peptides, *A. caninum* anti-coagulant protein (AcAP) inhibit coagulation by a unique mechanism (Stassens *et al.*, 1996). The blood loss results in a hyperchromic microcytic anaemia, the severity of which is highly dependent on daily iron intake and the iron reserves of the host (Gilles, 1985). Iron loss also has an effect on enzyme systems with an iron prosthetic group, especially neurotransmitters, and this may be a mechanism whereby hookworms contribute to the intellectual deficits associated with intestinal nematode infection (Lozoff, 1989). An alternative mechanism whereby this may occur is the loss of plasma proteins in the gut.

### IMMUNOLOGY

In many hookworm endemic areas, the intensity of infection increases during the first decade of

life and remains relatively constant through adulthood. This suggests a contribution of host immunity to age resistance. Resistance to animal hookworm can be achieved by administering live or X-ray-attenuated L<sub>3</sub> larvae (Emery, 1996) and there are individuals who acquire a disproportionately heavy infection and others who appear to have much lighter infections than would be anticipated. Experimental work in *N. americanus* infections in inbred mice provides evidence that there are genetically determined differences in the cellular immune response to primary hookworm infections (Timothy and Behnke, 1997). Recent studies in Papua New Guinea show that there is a significant negative correlation between total IgE levels and the parasite weight and fecundity, once the effects of host age hookworm burden were controlled (Pritchard *et al.*, 1995; Shakib *et al.*, 1993). There is also a similar negative correlation between the number of eosinophils and the hookworm weight and fecundity at diagnosis. These data indicate that TH2-mediated eosinophil responses are critical in specific immunity to hookworm infections (Pritchard *et al.*, 1995).

A neutrophil inhibitory factor is found in the canine hookworm, *A. caninum*, but is not present in *N. americanus*. The 61 kDa glycoprotein that inhibits CD11B/CD18 MAC-1 depend on neutrophil activation and adherence to the vascular endothelium (Moyle *et al.*, 1994). Hookworms also produce an acetylcholinesterase. This molecule has growth-promoting properties and may be involved in increasing the regenerative ability of intestinal tissues. It also acts as an anti-inflammatory molecule, stimulating human lymphocytes to secrete inflammatory cytokines by acting on muscarinic receptors on the lymphocyte surface (Pritchard *et al.*, 1994).

The immune response to hookworm is dominated by TH2, which produce cytokine profile interleukins 4, 5, 6, 9 and 10, favouring eosinophilia and antibody production and antibody-dependent cellular cytotoxicity. The activated immune cells have the potential to damage parasites via the secretion of toxic granules and the release of reactive oxygen intermediates and nitric oxide. This may, to some extent, be neutralised by the secretion of glutathione-S-transferase and superoxide dismutase. Parasite glutathione-S-transferases have a high affinity for

lipid peroxidation derived cytotoxic carboniles and the reactive oxygen intermediates can be mopped up by the activity of superoxide dismutase (Brophy *et al.*, 1995).

Hookworms achieve inhibition of platelets by blockade of the integrins GP2b/3a  $\alpha$ 2b  $\beta$ 3, and GP1a/2a  $\alpha$ 2  $\beta$ 1. The protein is named hookworm platelet inhibitor and has an estimated molecular mass of 15 kDa. It prevents the adhesion of resting platelets to immobilised fibrinogen and collagen. The activity is present in the excretory–secretory products of adult worms (Chadderdon and Cappello, 1999).

Experiments in hamsters initially exposed to primary infection with *A. ceylonicum* were infected with L<sub>3</sub> larvae, which were also to establish, but not continue, their development. This developmental arrest is associated with accelerated mucosal mastocytosis and increased systemic antibody, implying effective acquired immunity to the L<sub>3</sub> and L<sub>4</sub> stages (Behnke *et al.*, 1997). Immunity could be correlated with antibodies to the somatic and excretory–secretory (ES) antigens. Both somatic and ES antigens showed moderate to significant protection but ES antigens were more immunogenic and provided the highest level of protection (Khan *et al.*, 1996).

Immune evasion may occur by secretion of an IgA protease that has the potential to produce Fab fragments, blocking complement or phagocytic ingestion mediated by IgG or IgM.

Secretory IgA is also important in producing eosinophil de-granulation, and thus an IgA protease would be an important mechanism of preventing this destructive mechanism.

## CLINICAL FEATURES

Non-specific symptoms, such as abdominal pain, nausea and anorexia, are associated with the appearance of hookworms in the gut and these symptoms may be relieved by pica. In some patients, abdominal pain may be found in the prepatent period (Maxwell *et al.*, 1987). The principal mechanism of disease formation is the development of anaemia, due to the hookworms taking up blood meals. This feeding is associated with a blood loss in the order of 0.05–0.04 ml per adult worm. In *A. duodenale* the blood loss is 0.05–0.3 ml per adult and for *Necator* 0.01–0.4 ml (Roche and Layrisse, 1966). The impact of anaemia is clearly dependent on the nutrition of the host and therefore must take account of dietary factors, host iron reserves and the presence of other conditions, such as menorrhagia. Like other intestinal nematode infections, hookworm infection is associated with intellectual impairment, and improvement in cognitive function has been associated with effective treatment with albendazole.

## TRICHURIS TRICHIURA

### INTRODUCTION

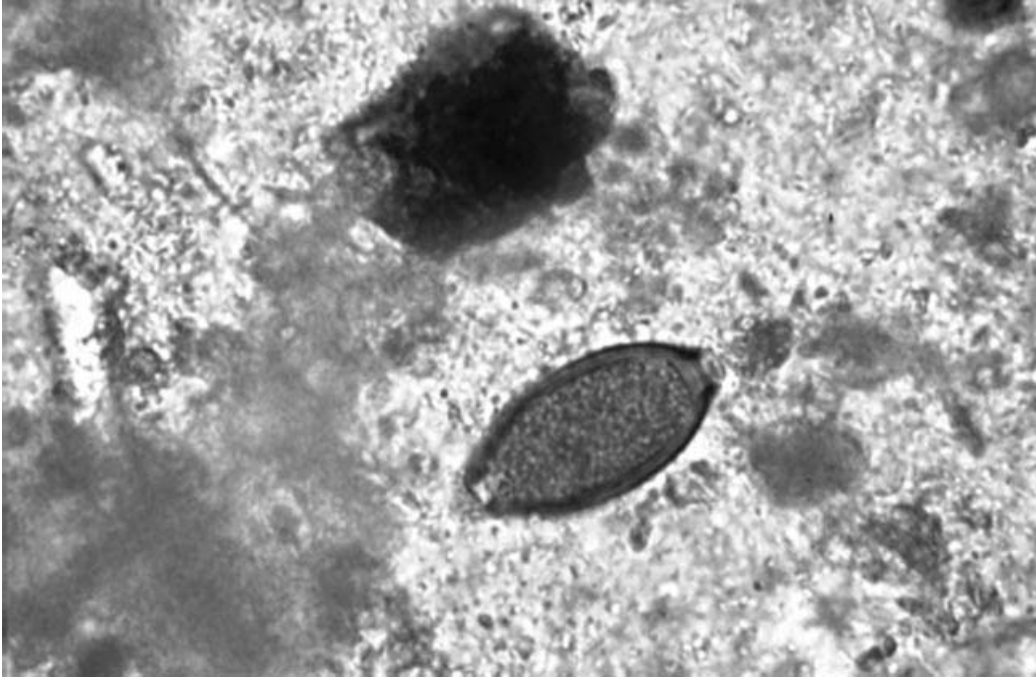
*Trichuris* has a cosmopolitan distribution. Although it is more common in warm, moist parts of the world, it is found worldwide and was once a serious health problem in the southern USA. *Trichuris* eggs have been recovered from mummified bodies, many thousands of years old, in Chile, China and Europe. It was first described by Karl Linnaeus in 1771 and the life-cycle was first studied by Grassi (1887), Fullborn (1923) and Hasagawa (1934). Its importance in human medicine was not fully recognised until the work of Jung and Beaver (1951), who described more than 300 children in Louisiana with severe colonic inflammation and diarrhoea which they

associated with heavy *Trichuris* infection. Following the work of Gilman *et al.* (1983) demonstrating the nutritional cost of high intensity *Trichuris* infection, the importance of this parasite has been recognised and its control has been given a high public health priority (Chan *et al.*, 1994c).

### DESCRIPTION OF THE ORGANISM

#### Classification

*Trichuris trichiura* is a member of the superfamily, Trichuroidea, and is thus closely related to *Trichinella spiralis* (see Chapter 19b). The



**Fig. 21.3** Barrel-shaped egg of *Trichuris trichiura*

adult has a thin elongated anterior portion and a thickened posterior, giving it a whip-like appearance, and its common name is the whipworm. The worm is approximately 4 cm long and the male has a curled posterior end. The female genitalia, consisting of a singular sacculate ovary, is found in the extreme posterior part of the body. The eggs are characteristically barrel-shaped, 50–54  $\mu\text{m}$   $\times$  22–23  $\mu\text{m}$  (see Figure 21.3).

### LIFE-CYCLE

Eggs passed in human faeces are not infectious and require a period of embryonation lasting 2–4 weeks, a process that occurs in the soil. The embryonated egg contains an L<sub>1</sub> larva and, following ingestion, this larva is released from the egg, passes into the large intestine and penetrates the epithelium in the mucosal crypts, most commonly in the caecum. In this site it develops fully by moulting and the adult develops from the L<sub>4</sub> stage. The anterior part of the adult lies between the crypts, and the

posterior part is free in the lumen. The sex ratio of adults is approximately equal and when copulation occurs, adult worms are unlikely to be able to migrate. Adult females produce 20 000 eggs/day and the life expectancy of adults is approximately 3 years (Bundy and Cooper, 1989).

The major ES protein of *Trichuris trichiura*, the human whipworm, is highly immunogenic and consists of a complex mixture of antigens. A 47 kDa protein, it has a pore-forming activity that is thought to be essential for the attachment of the worm to host mucosal epithelium (Lillywhite *et al.*, 1995).

### CLINICAL FEATURES

As in the case of other intestinal nematode infections, the severity of symptoms is directly related to the intensity of infection. Patients who are well-nourished will be able to tolerate a small number of adult worms. Heavy infections are associated with the *Trichuris* dysentery syndrome, characterised by chronic

diarrhoea, anaemia and growth retardation. Mucus is characteristically found in the stools and in most cases there is frank blood (Bundy and Cooper, 1989; Ramsay 1962). The stools, although frequent, are usually of small volume. The severity of symptoms is directly proportional to the intensity of infection, as can be seen in the proportion of individuals with finger clubbing (Bundy and Cooper, 1989). Rectal prolapse is a well-known symptom and occurs in approximately one-third of all patients (Bundy and Cooper, 1989). Growth retardation is perhaps the most important symptom and may occur with an intensity of around 100 worms. In children with *Trichuris* infection, a mean reduction in height for age of 71% has been recorded in a systematic review of studies

(Bundy and Cooper, 1989). Studies have clearly shown that patients with heavy *Trichuris* infections have a protein-losing enteropathy, as demonstrated by the leakage of  $\alpha$ -1-antitrypsin into the stool (Cooper *et al.*, 1992). Similarly, loss of mucosal integrity results in abnormally high permeability to disaccharide molecules, as shown by the lactulose-ramose differential sugar absorption test (Cooper *et al.*, 1992). Also, children with severe *Trichuris* infection have low serum albumin concentrations that return to normal after treatment. The evidence of growth retardation, although indirect, with an increase in growth velocity on treatment, makes *Trichuris* an important public health problem for children in developing countries.

### ENTEROBIUS VERMICULARIS

#### INTRODUCTION

*Enterobius vermicularis* is perhaps one of the most common helminthic infections worldwide but, because it lacks serious clinical complications, there is little research describing its pathogenesis.

#### DESCRIPTION OF THE ORGANISM

The organism was first identified in 1758 by Karl Linnaeus, who named it *Oxyuris vermicularis*. There are two species recognised currently: *E. vermicularis* and a more recently identified

*E. gregorii* (Ashford *et al.*, 1988; Chittenden and Ashford, 1987), although some authors have cast doubt on the validity of this species (Hasegawa *et al.*, 1998). The male measures 2–5 mm in length  $\times$  0.1–0.2 mm in diameter and has a single conspicuous copulatory spicule. The female measures 8–15 mm in length  $\times$  0.3–0.5 mm in diameter. The tail is sharply pointed and the vulva opens mid-ventrally just in front of the middle third of the body. In gravid females the uteri are distended and the entire body is packed with eggs. The eggs are ovoid, 50–54  $\mu$ m  $\times$  20–27  $\mu$ m in size, and almost colourless. The shell is thick with an outer albuminous layer that assists in adherence to skin and other objects (see Figure 21.4).



Fig. 21.4 Typical D-shaped egg of *Enterobius vermicularis*

#### Life-cycle

Adult worms inhabit the caecum, appendix and adjacent portions of the ascending colon. The female migrates down the colon when her uterus is distended with eggs and crawls onto the perianal and perineal skin, where she deposits all her eggs and then dies. It takes 15–43 days for full development to take place. The females deposit up to 17 000 eggs, with a mean of 11 000. The eggs become infective within 6 hours and remain viable for up to 5 days. Infection may be acquired by direct faecal or auto-infection, exposure to

viable eggs on soil, bed linen and other environmental objects. Children who suck their fingers are more likely to be infected. It has been suggested that retro-infection may occur after hatching on the anal mucosa; larvae may migrate into the sigmoid colon and from thence to the caecum.

## PATHOGENESIS

For the most part, *Enterobius* infections are asymptomatic or associated with mild peri-anal itching and excoriation. Serious complications with *Enterobius* are exceedingly rare and related to the appearance of eggs or worms in an ectopic location. There has been a suggestion of an association between *Enterobius* infection and acute appendicitis but this interaction is complex and difficult to dissect (Dahlstrom and Macarthur, 1994; Wiebe, 1991). *Enterobius* may cause symptoms in children that mimic appendicitis, with the effect that *Enterobius* is more frequently identified in appendiceal biopsies than would be anticipated. Additionally, the presence of *Enterobius* in the vermiform appendix may result in inflammation that causes true appendicitis (Bredesen *et al.*, 1988). Intriguingly, more female *Enterobius* are found in the appendix than male (Williams and Dixon, 1988). It is clear that, at least on some occasions, *E. vermicularis* has a causal role in appendicular pain and may on occasions contribute to acute appendicitis.

Atopic worms may result in a granulomatous response and these have previously been reported in the perianal area, causing vaginitis and post-menopausal bleeding. Although usually asymptomatic, there are reports of eosinophilic colitis associated with the larvae of *Enterobius* that resolved on treatment of this infection (Liu *et al.*, 1995). It has often been implicated in the causation of urinary tract infection in young girls (Ok *et al.*, 1995). Other sites of *Enterobius* granulomata include the ovary (Donofrio *et al.*, 1994), epididymis and, rarely, ileal perforation (Patterson *et al.*, 1993) has been associated with infection. *Enterobius* has been reported to form granulomas in the peritoneum (Pearson *et al.*, 1981; Sun *et al.*, 1991).

## CLINICAL FEATURES

Most infections are asymptomatic but patients often present with pruritis ani and perineal pruritis. Symptoms are typically worse at night and may produce insomnia and restlessness. Heavily infected children may develop blood loss, poor concentration and emotional disturbance and enuresis. Local eczematous reactions and dermatitis artefacta may be seen. Chronic abdominal pain is probably more common than is currently recognised (see above). In girls, vulval vaginitis, acute urinary infections, enuresis and incontinence are associated with infection. In addition to this, many parents become anxious about the appearance or stigmata of worm infection.

The diagnosis of *E. vermicularis* depends on acquiring samples from the perianal skin (Ashford *et al.*, 1988). This can be achieved by the application of a strip of adhesive tape to the anus and then sticking it to a microscope slide. Optimal yields are obtained with at least three samples taken at night. Commercial systems to facilitate specimen collection are available. Faecal samples may occasionally be positive but their yield is significantly lower than perianal samples and are not recommended for diagnosis.

## MANAGEMENT

The management of *Enterobius* infection is more complex than the simple prescription of an effective anthelmintic agent. Benzimidazoles, such as mebendazole and albendazole, are active and piperazine and pyrantel can also be used (see below). It is usually necessary to treat the whole family to prevent re-infection, and a second dose 1 month after the first is often used for this. In practice, the management of pinworm infection can be very difficult, with patients re-attending with re-infection on several occasions. Pharmacological treatment should be given only when it is associated with suitable advice on adequate hygiene and handwashing, ensuring that children and adults keep fingernails clipped short. It may be helpful to encourage children to wear gloves at night to assist in breaking the infection cycle.

**CAPILLARIA PHILIPPINENSIS****INTRODUCTION**

*Capillaria* spp. are members of the superfamily Trichinelloidea and are thus closely related to *Trichuris* and *Trichinella* (see page 563). The first description of human *Capillaria* infection was made by Chitwood *et al.* (1968), who reported a single case from the Philippines. At this time an outbreak of diarrhoeal disease, resulting in more than 1000 deaths, was reported and the causative organism identified as *Capillaria philippinensis*.

**DESCRIPTION OF THE ORGANISM**

More than 250 species of *Capillaria* have been described in mammals, birds, reptiles and amphibians (Cross, 1992), although only four species have been associated with human infection: *C. hepatica*, *C. aerophila*, *C. plica* and *C. philippinensis*. Of these, only *C. philippinensis* is a regular human pathogen, and has been associated with large-scale epidemics. The adult males are 1.5–3.9 mm long and the females longer, 2.3–5.3 mm. The male has a long spicule (230–300 µm), with the spicular sheath extending up to 440 µm. The eggs exhibit a characteristic peanut shape with small bipolar plugs (Cross, 1992).

**Life-cycle**

The life-cycle of *C. philippinensis* has been deduced after a series of experimental animal studies and epidemiological investigations in The Philippines (Cross and Basaca-Sevilla, 1983a,b). Eggs have been found to hatch experimentally in the intestine of freshwater fish in The Philippines and Thailand (Bhaibulaya and Indra-Ngarm, 1979; Cross *et al.*, 1972), and in the fish *Hypseleotris bipartita* in the wild. Larvae isolated from fish are capable of infecting experimental monkeys, and thousands of worms were recovered from infections following an infective dose of 50 larvae. Adult female worms were found to be larviparous, suggesting that an auto-infective cycle is important. Experimental studies suggest that fish-eating birds can be infected by

*C. hepatica*, and these may be the natural definitive host (Bhaibulaya and Indra-Ngarm, 1979). Humans become infected as accidental hosts when they eat, raw, the small fish larvae normally the prey of fish-eating birds.

**PATHOGENESIS**

In human infection, worms at all stages of development are found in the small intestine, predominantly in the jejunum. Worms are rarely found outside the intestine (Fresh *et al.*, 1972). The lamina propria is heavily infiltrated with lymphocytes, neutrophils and macrophages, the villi are flat and mucosal glands dilated, causing malabsorption.

The evidence from longitudinal studies suggests that human infection with *Capillaria philippinensis* always becomes symptomatic through the auto-infection cycle (Detels *et al.*, 1969), amplifying the worm burden. In this respect, capillariasis resembles strongyloidiasis, in that the organism is able to multiply within the host, but unlike in that multiplication is uncontrolled. The consequence of this is that very large numbers of adult worms are found, with increasingly severe symptoms. This difference supports the idea that humans are not the natural host for *Capillaria*.

**EPIDEMIOLOGY**

Most reported infections with *C. philippinensis* have occurred in the central Philippines (Cross, 1992), but cases have now been reported in Thailand, where it is widespread, Taiwan and the Middle East (Cross, 1992; Mansour *et al.*, 1990; Pradatsundarasar *et al.*, 1973). Critical to this distribution is the dietary habits of the population. Transmission usually occurs in regions where raw food is eaten, including fish, crabs, clams and shrimps (Cross, 1992).

**CLINICAL FEATURES**

Patients present with a slow onset of abdominal pain, borborygmi and diarrhoea. Up to 10

high-volume stools may be passed daily and the patient develops significant weight loss through intestinal malabsorption. If early treatment is not instituted, severe protein-losing enteropathy develops and the patient suffers cardiac failure. Death, when it occurs, is due to the cardiac effects of electrolyte deficiency or septicaemia (Fresh *et al.*, 1972; Whalen *et al.*, 1969).

### LABORATORY DIAGNOSIS

The diagnosis of capillariasis is suggested by the clinical presentation, taken together with origin or travel history of the patients and previous ingestion of suspect foods. Evidence of protein-losing enteropathy can be detected, including low sodium, calcium, total protein and potassium. Malabsorption of fat and sugar is present. Serum IgE levels are increased. A definitive diagnosis is made by identifying the characteristic ova in the patient's faeces.

### TRICHOSTRONGYLUS

*Trichostrongylus* spp. are pathogens of mammals and occasionally cause infections in humans. Infection is most common in the Middle East, notably Iran (Ghadirian and Arfaa, 1975), and in Egypt and the Far East, including Japan and Australia (Boreham *et al.*, 1995). *Trichostrongylus* has been reported in Europe (Dancescu, 1979). The species associated with human infection are *T. orientalis*, *T. colubriformis*, *T. vitrinus*, *T. axei* and *T. capriolola* (Ghadirian and Arfaa, 1975).

The worms live in the mucosa of the small intestine, and adult females release eggs that are in the morula phase and develop within 24 hours

### TREATMENT

*Capillaria* are susceptible to benzimidazoles and these drugs provide definitive treatment. Thiabendazole, 25 mg/kg/day or 1 g/day for 30 days, or mebendazole, 200 mg twice daily for 20 days, or albendazole 400 mg for 10 days should be given. The latter agent is now the treatment of choice (Cross, 1992). Prolonged treatment is required because only the adult parasites are susceptible, thus treatment must be maintained until all the larvae are sufficiently mature to be killed by the drug.

### PREVENTION AND CONTROL

Control depends on public education to avoid eating raw fish that carry the intermediate stages of the parasite. Early recognition of the condition, coupled with diagnosis and treatment with benzimidazoles, reduces the mortality.

in favourable conditions. Larval development through three free-living stages is followed by invasion through the skin. The larvae come to sexual maturity within 3 weeks. Infection is usually acquired through eating green vegetables contaminated by animal faeces (Boreham *et al.*, 1995).

Infection is often associated with few symptoms, but when they occur are due to large numbers of maturing adult worms causing local damage in the small intestine. Diagnosis is by identifying the characteristic eggs in the faeces. One report suggests that the infection can be treated with pyrantel (Boreham *et al.*, 1995).

### LABORATORY DIAGNOSIS OF INTESTINAL NEMATODE INFECTION

#### Specimens

Faecal specimens should be collected in a clean dry container and transported to the laboratory with the minimum of delay. Ideally, these specimens should be examined immediately on arrival, although helminth eggs are usually robust and survive for extended periods. When necessary,

specimens should be preserved at 4°C. Detailed protocols exist for long-term preservation of positive faecal smears (Miller and Holmes, 1995).

#### Simple Faecal Smears

The simplest technique for the identification of intestinal nematode eggs is a direct faecal smear.



As nematode eggs are not uniformly distributed in the faecal mass, the sample should be mixed thoroughly before it is examined to distribute the eggs throughout the sample.

A small portion of faeces is mixed with a small amount of saline on a glass slide and examined under a low-power objective. This method utilises approximately 2 mg faeces and is relatively insensitive in detecting species that produce relatively few eggs. However, it is inexpensive and rapid and identifies the heaviest infections, which are those most appropriate for therapeutic intervention in endemic areas.

To increase the sensitivity of faecal examination, various concentration techniques have been developed. Some of these require minimal equipment and reagents, whereas others require a properly equipped laboratory with centrifuges, etc. Perhaps the simplest concentration technique uses a tea strainer to remove faecal debris and a household detergent and overnight sedimentation to concentrate the pathogenic organisms (Ramsay *et al.*, 1991).

### Kato–Katz Technique

The Kato and Miura thick smear technique was originally developed for use in schistosomiasis control programmes in Japan. Since then it has been applied generally to the diagnosis of intestinal helminth infections (Katz *et al.*, 1972). The advantage of this method is that it increases the amount of faecal material that can be examined and it also provides an accurate measure of the number of eggs present. It is of particular value in clinical trials and epidemiological surveys, where accurate quantitation is important. A 50 mg sample of faeces is placed on a glass slide by using a template with a central hole. The specimen is covered with a glycerine-soaked cellophane rectangle and inverted onto absorbent paper. Pressure is applied to spread the sample almost to the edge of the cover slip and then turned over, so that the specimen can now be examined when it has been cleared by the glycerine. A skilled operator is then able to examine the contents of the whole slide. The egg count can be calculated by multiplying by 20 the number of eggs identified.

### Formol–Ether Concentration

The technique most widely used for routine faecal diagnosis is formol–ether concentration, originally described by Allen and Ridley (1970). It increases the yield of all types of faecal parasites, including helminth eggs and protozoan cysts. A 1 g sample is placed in a tube containing formalin and mixed after an initial filtration step to remove food vegetable material. Diethyl ether or ethyl acetate is mixed in and the tube is centrifuged. This produces an ether layer, under which there is a plug of fatty debris and, at the bottom of the centrifuge tube, the deposit contains the ova and cysts. The faecal preparation is cleared of most of the faecal debris and is easy to examine; moreover, the whole of the deposit can then be examined and this increases the sensitivity of the technique significantly.

### Flotation Techniques

The specific gravity of helminth ova and larvae and many protozoan cysts is in the range 1.05–1.14 and thus, if a liquid medium that is denser than the parasites is utilized, they will rise to the surface. They can then be skimmed from the surface using a microscope cover slip and examined. Several flotation media have been described, including concentrated aqueous sodium chloride solution (specific gravity 1.12–1.2), sucrose solutions (specific gravity 1.180) and 33% zinc sulphate. In general, these techniques are rather difficult to perform and if the eggs are left in the hypertonic solutions for a prolonged period, the morphology may be significantly altered, making identification difficult (Denham and Suswillo, 1995).

### Identification of Eggs

In general the identification of intestinal nematode eggs is relatively straightforward. The different species have characteristic shapes and colours. However, the most important diagnostic feature of helminth eggs is their size. Thus, when examining faecal samples unknown eggs should be carefully measured using a calibrated

microscope stage micrometer. Some of the eggs, e.g. *Trichuris trichiura*, are instantly recognisable, and are unlikely to be mis-identified (see Figure 21.4). Other eggs have a viable morphology, e.g. those of *Ascaris lumbricoides* may be fertilised or unfertilised (see Figures 21.1 and 21.2). The eggs of *Ancylostoma duodenale* and *Necator americanus* are indistinguishable (Denham and Suswillo, 1995). To identify these nematodes to species level it is necessary to culture the infective larvae to produce L<sub>3</sub> stages. The differences between the larvae are sufficient to allow species identification. This technique is described below.

### Examination of Larvae

When faecal specimens arrive in the laboratory after a considerable delay, it is possible that hookworm eggs may be already hatched into L<sub>1</sub> larvae or developed onto the L<sub>2</sub> stage. *Strongyloides stercoralis* larvae also develop rapidly in faeces and these may be confused with those of the hookworm species. Furthermore, to differentiate the main intestinal hookworm species, it is necessary to cultivate the faeces to produce the L<sub>3</sub> larval stage. This technique, originally described by Haradi and Mori, allows the development of the larvae to proceed. The infective larvae of hookworms and *S. stercoralis* can then be identified. Hookworms are distinguished from *S. stercoralis* on the appearance of the buccal chamber. In hookworms this is deep and lined with refractile material that makes it easy to see, whereas the buccal cavity of *Strongyloides* is much shorter and difficult to visualise. The L<sub>3</sub> larvae of hookworms can be differentiated by examining the tip of the tail. The tail of *Ancylostoma* is blunt whereas that of *Necator* is sharply pointed. There is also a gap between the oesophagus and the intestine indicate and the body length is different (*Ancylostoma duodenale* = 160 µm; *Necator americanus* = 119 µm). *Trichostrongylus* spp. L<sub>3</sub> larvae are rarely found in faecal cultures. These are much longer than the hookworms and the tail has a knob at its extremity (Denham and Suswillo, 1995).

## MANAGEMENT OF INTESTINAL NEMATODE INFECTIONS

### Benzimidazoles

The benzimidazole structure consists of a benzene fused to the 4- and 5-position of a heterocycle. A wide range of chemical variations on the benzimidazole nucleus have been synthesised and several have been found to be valuable as anthelmintic drugs (Townsend and Wise, 1990).

The benzimidazole agent first introduced into human medicine was thiabendazole and since then three others have been introduced for use: flubendazole, mebendazole and albendazole, of which the latter is the most active and has found a place in the treatment of tissue helminth infections (Horton, 1997) (Table 21.2). The benzimidazoles most commonly used for intestinal nematode infections are mebendazole and albendazole. The use of thiabendazole is limited because of its side-effect profile but both mebendazole and albendazole are well tolerated. In most clinical trials each of the drugs is effective against *Ascaris* infections and albendazole has also shown to produce a higher cure rate than mebendazole in hookworm infections. *Trichuris trichiura* and *Enterobius vermicularis* also respond to benzimidazoles but cure rates for these parasites are lower. Albendazole has established an important place in mass single dose treatment in control programmes (see below). The non-absorbable benzimidazole, oxibendazole, with a previous record of activity in intestinal infection in animals, has also been shown to be beneficial in human intestinal nematodes infections (Gillespie *et al.*, 2000).

Benzimidazoles act by interfering with the organisation of the β-tubulin worms that are resistant to benzimidazoles and have alterations in the β-tubulin gene. There is extensive polymorphism in the β-tubulin genes between

**Table 21.2** The activity of benzimidazole agents against intestinal nematodes

Helminth	Mebendazole	Albendazole
<i>Ascaris lumbricoides</i>	++	++
Hookworm	++	++
<i>Trichuris trichiura</i>	+	+

individual worms and susceptible populations, but within resistant population patterns are similar, indicating the rapid selection of the resistant variants (Bennett *et al.*, 1999; Ross, 1990).

### Pyrantel

Pyrantel is a pyrimidine with a wide spectrum of anthelmintic activity. It acts in a similar way to levamisole. It is poorly absorbed from the gastrointestinal tract, with more than half of the dose found unchanged in the faeces (Kimura and Kume, 1971). It is active against *Enterobius vermicularis*, hookworm and *Ascaris lumbricoides* and is indicated for the treatment of these infections. Cure rates of 80–100% can be achieved with a single dose of 10 mg/kg, although results with *Necator americanus* are nearer 80%, but only with a dose of 20 mg/kg for 3 days (Sinniah and Sinniah, 1981; Chege *et al.*, 1974). The drug is well tolerated and most side-effects are transient and mild: mainly abdominal pain, nausea, diarrhoea, headache and vomiting. A transient elevation of liver transaminases may be detected. Curiously, pyrantel antagonises the effects of piperazine *in vitro* and potentiates the effect of levamisole in pigs, but the mechanism of this interaction is unknown.

### Levamisole

Levamisole was first introduced as an anthelmintic agent in animal health. It is active against ascarids and hookworm (Miller, 1980). The mechanism of action is thought to be through stimulation of the autonomic ganglia of the immature and adult worms, resulting in spastic contractions and tonic paralysis (van Wauwe and Janssen, 1991). The degree of absorption is not known, although the drug has a high volume of distribution; it is extensively metabolised, mainly to glucuronide conjugates (Luckyx *et al.*, 1982; Adams, 1978).

Cure rates in the region of 90% can be achieved in *Ascaris* infection and single-dose therapy using 2.5–5 mg/kg to a maximum of 150 mg was proved to be as effective as repeated

dosage regimens (Moens *et al.*, 1978). High cure rates are also achieved in ancylostomiasis but variable results are obtained in *Necator* infection (Lucas and Oduntan, 1972). The side-effect profile is favourable, with most adverse events noted being mild: typically nausea, vomiting, abdominal pain and headache (Lionel *et al.*, 1969), although with prolonged treatment, using the drug as an immunomodulator for blood disorders, renal failure, vasculitis and photosensitivity have been reported (Amery and Butterworth, 1983). Its relatively narrow spectrum of activity means that its use is mainly limited to monoinfections with *Ascaris*.

### Piperazine

Piperazine is a heterocyclic organic base originally developed for the treatment of gout. It has been used in the treatment of *Ascaris* and *Enterobius* infections for more than 50 years (Fayard, 1949; Mouriquand *et al.*, 1951). It acts by causing hyperpolarisation of *Ascaris* muscle so that it is no longer responsive to acetylcholine. This leads to flaccid paralysis of the worms, which lose their attachment to the intestinal wall and are removed from the gut by the action of normal peristalsis (del Castillo *et al.*, 1964). There is little pharmacokinetic data but the drug is rapidly absorbed orally, although there is considerable person-to-person variability (Rogers, 1958; Fletcher *et al.*, 1982).

Cure rates of over 90% can be achieved for *Enterobius vermicularis* when the drug is given for 1 week, followed by a gap of 1 week and then a further 1 week of therapy (Brown and Chan, 1955; Rachelson and Ferguson, 1955). Similar cure rates against *Ascaris* can be obtained using two doses (Brown and Stenman, 1954). Self-limiting nausea, vomiting and abdominal cramps are common side-effects. Serious adverse events are rare but include allergic skin reactions, bronchospasm and neuropsychiatric disorders, such as dizziness and ataxia, depersonalisation, headache, visual disturbances and petit mal attacks (McCullagh, 1968; Bomb and Bedi, 1976; Nickey, 1966). There have been reports of congenital malformations in children whose mothers took piperazine, and although a causal

relationship could not be determined it is best avoided during pregnancy (Leach, 1990).

## PREVENTION AND CONTROL

Prevention of many of the intestinal nematode infections depends on the provision of adequate sanitary facilities to allow the safe disposal of human faeces. In addition, control of hookworm requires individuals to wear appropriate footwear, especially when working in the fields, as occupational exposure is thought to be an important risk factor for infection (Haswell-Elkins *et al.*, 1987a). Control programmes also utilise mass treatment as an important component. There is now an international programme targeting school-age children for treatment with albendazole. This approach has been shown to be cost-effective (Bundy and de Silva, 1998; Holland *et al.*, 1996a,b) in field studies and mathematical models of intestinal nematode infection. This approach may, in the end, prove disappointing, as the children most likely not to attend school come from the poorest members of society who are most likely to have helminth infections.

## REFERENCES

- Adams LG (1978). Pharmacokinetics of levamisole. *J Rheumatol* **5**: 137–42.
- Akgun Y (1996). Intestinal obstruction caused by *Ascaris lumbricoides*. *Dis Colon Rect* **39**: 1159–63.
- Allen AV, Ridley DS (1970). Further observations on the formal-ether concentration technique for faecal parasites. *J Clin Pathol* **23**: 545–6.
- Amery WK, Butterworth BS (1983). The dosage regimen in cancer: is it related to efficacy and safety? *Int J Immunopharmacol* **5**: 1–9.
- Anderson TJ, Romero-Abal ME, Jaenike J (1993). Genetic structure and epidemiology of *Ascaris* populations: patterns of host affiliation in Guatemala. *Parasitology* **107** (3): 319–34.
- Anderson TJ, Romero-Abal ME, Jaenike J (1995). Mitochondrial DNA and *Ascaris* microepidemiology: the composition of parasite populations from individual hosts, families and villages. *Parasitology* **110** (2): 221–9.
- Ashford RW, Hart CA, Williams RG (1988). *Enterobius vermicularis* infection in a children's ward. *J Hosp Infect* **12**: 221–4.
- Beaver PC, Danaraj TJ (1958). Pulmonary ascariasis resembling eosinophilic lung. Autopsy report with description of larvae in the bronchioles. *Am J Trop Med Hyg* **7**: 100–111.
- Behnke IM, Guest J, Rose R (1997). Expression of acquired immunity to the hookworm *Ancylostoma ceylanicum* in hamsters. *Parasite Immunol* **19**: 309–18.
- Bennett AB, Barker GC, Bundy DA (1999). A  $\beta$ -tubulin gene from *Trichuris trichiura*. *Mol Biochem Parasitol* **103**: 111–16.
- Bhaibulaya M, Indra-Ngarm S (1979). *Amauromnis phoenicurus* and *Ardeola bacchus* as experimental definitive hosts for *Capillaria philippinensis* in Thailand. *Int J Parasitol* **9**: 321–2.
- Bomb RS, Bedi HK (1976). Neurotoxic side effect of piperazine. *Trans R Soc Trop Med Hyg* **70**: 358.
- Boreham RE, McCowan MJ, Ryan AE, Allworth AM, Robson JM (1995). Human trichostrongyliasis in Queensland. *Pathology* **27**: 182–5.
- Bredesen J, Falensteen LA, Kristiansen VB, Sorensen C, Kjersgaard P (1988). Appendicitis and enterobiasis in children. *Acta Chir Scand* **154**: 585–7.
- Brophy PM, Patterson LH, Brown A, Pritchard DI (1995). Glutathione S-transferase (GST) expression in the human hookworm *Necator americanus*: potential roles for excretory–secretory forms of GST. *Acta Trop* **59**: 259–63.
- Brown A, Girod N, Billett EE, Pritchard DI (1999). *Necator americanus* (human hookworm) aspartyl proteinases and digestion of skin macromolecules during skin penetration. *Am J Trop Med Hyg* **60**: 840–47.
- Brown HW, Chan KF (1955). The treatment of *Enterobius vermicularis* infections with piperazine. *Am J Trop Med* **4**: 321–5.
- Brown HW, Stenman MM (1954). Treatment of *Ascaris* infection with piperazine. *Am J Trop Med Hyg* **3**: 750–54.
- Bundy DA, Cooper ES (1989). *Trichuris* and trichuriasis in humans. *Adv Parasitol* **28**: 107–73.
- Bundy DA, de Silva NR (1998). Can we deworm this wormy world? *Br Med Bull* **54**: 421–32.
- Callender JE, Grantham-McGregor S, Walker S, Cooper ES (1992). *Trichuris* infection and mental development in children. *Lancet* **339**: 181.
- Callender JE, Walker SP, Grantham-McGregor SM, Cooper ES (1998). Growth and development four years after treatment for the *Trichuris* dysentery syndrome. *Acta Paediatr* **87**: 1247–9.
- Chadderdon RC, Cappello M (1999). The hookworm platelet inhibitor: functional blockade of integrins GPIIb/IIIa (alphaIIb beta3) and GPIa/IIa (alpha2 beta1) inhibits platelet aggregation and adhesion *in vitro*. *J Infect Dis* **179**: 1235–41.
- Chan L, Bundy DA, Kan SP (1994a). Aggregation and predisposition to *Ascaris lumbricoides* and *Trichuris trichiura* at the familial level. *Trans R Soc Trop Med Hyg* **88**: 46–8.
- Chan LD, Bundy DA, Kan SP (1994b). Genetic relatedness as a determinant of predisposition to *Ascaris lumbricoides* and *Trichuris trichiura* infection. *Parasitology* **108**: 77–80.
- Chan MS, Medley GF, Jamison D, Bundy DA (1994c). The evaluation of potential global morbidity attributable to intestinal nematode infections. *Parasitology* **109**: 373–87.
- Chege SW, Gitoho F, Wanene GSN, Mwega VJ, Rees PH, Kinyanjui H (1974). Single dose treatment of hookworm in Murang's District. *E Afr Med J* **11**: 60–2.

- Chittenden AM, Ashford RW (1987). *Enterobius gregorii* Hugot 1983; first report in the UK. *Ann Trop Med Parasitol* **81**: 195–8.
- Chitwood MB, Valesquez C, Salazar NG (1968). *Capillaria philippinensis* sp. n. (Nematoda: Trichinellida), from the intestine of man in The Philippines. *J Parasitol* **54**: 368–71.
- Cooper ES, Whyte-Alleng CA, Finzi-Smith JS, MacDonald TT (1992). Intestinal nematode infections in children: the pathophysiological price paid. *Parasitology* **104** (suppl): S91–103.
- Croll NA, Matthews BE, Smith JM (1975). Hookworm behaviour: larval movement patterns after entering hosts. *Int J Parasitol* **5**: 551–6.
- Croll NA, Smith JM (1972). Mechanism of thermopositive behavior in larval hookworms. *J Parasitol* **58**: 891–6.
- Cross JH (1992). Intestinal capillariasis. *Clin Microbiol Rev* **5**: 120–29.
- Cross JH, Banzon T, Clarke MD, Basaca-Servilla V, Watten RH, Dizon JJ (1972). Studies on the experimental transmission of *Capillaria philippinensis* in monkeys. *Trans R Soc Trop Med Hyg* **66**: 819–27.
- Cross JH, Basaca-Servilla V (1983a). Experimental infections of *Capillaria philippinensis* in multimammate rats (*Mastomys natalensis*). *SE Asian J Trop Med Publ Health* **14**: 264.
- Cross JH, Basaca-Servilla V (1983b). Experimental transmission of *Capillaria philippinensis* to birds. *Trans R Soc Trop Med Hyg* **77**: 511–14.
- Dahlstrom JE, Macarthur EB (1994). *Enterobius vermicularis*: a possible cause of symptoms resembling appendicitis. *Aust NZ J Surg* **64**: 692–4.
- Dancescu P (1979). Incidence of the parasite *Trichostrongylus* among the population of the higher altitude areas of Romania. *Rev Ig Bacteriol Virusol Parazitol Epidemiol Pneumofiziol Bacteriol* **24**: 223–6.
- Daub J, Loukas A, Pritchard DI, Blaxter M (2000). A survey of genes expressed in adults of the human hookworm, *Necator americanus*. *Parasitology* **120**: 171–84.
- del Castillo J, de Mello WC, Morales T (1964). Mechanism of the paralysing action of piperazine on *Ascaris* muscle. *Br J Pharmacol* **22**: 463–77.
- de Silva NR, Chan MS, Bundy DA (1997). Morbidity and mortality due to ascariasis: re-estimation and sensitivity analysis of global numbers at risk. *Trop Med Int Health* **2**: 519–28.
- de Silva NR, Guyatt HL, Bundy DA (1997a). Morbidity and mortality due to *Ascaris*-induced intestinal obstruction. *Trans R Soc Trop Med Hyg* **91**: 31–6.
- de Silva NR, Guyatt HL, Bundy DA (1997b). Worm burden in intestinal obstruction caused by *Ascaris lumbricoides*. *Trop Med Int Health* **2**: 189–90.
- Denham DA, Suswillo RR (1995). Diagnosis of intestinal helminth infections. In Gillespie SH, Hawkey PM (eds), *Medical Parasitology: A Practical Approach*. IRL/Oxford University Press: Oxford; 253–65.
- Detels R, Gutman L, Jaramillo J et al. (1969). An epidemic of human intestinal capillariasis: a study in a barrio in North Luzon. *Am J Trop Med Hyg* **21**: 676–92.
- Donofrio V, Insabato L, Mossetti G, Boscaio A, de Rosa G (1994). *Enterobius vermicularis* granuloma of the ovary: report of a case with diagnosis by intraoperative cytology. *Diagn Cytopathol* **11**: 205–6.
- Dubini A (1843). Nuovo verme intestinale umano (*Anchylostoma duodenale*), costituente un sesto genere dei nematodei proprii dell'uomo. *Ann Univ di Med Milano* **106**: 5–13.
- Emery DL (1996). Vaccination against worm parasites of animals. *Vet Parasitol* **64**: 31–45.
- Fayard C (1949). *Ascariidose et piperazine* Thesis, Faculty of Medicine, Paris.
- Fletcher KA, Evans DAP, Kelly JA (1982). Urinary piperazine excretion in healthy Caucasians. *Ann Trop Med Parasitol* **76**: 77–82.
- Foor WE (1967). Ultrastructural aspects of oocyte development and shell formation in *Ascaris lumbricoides*. *J Parasitol* **53**: 1245–61.
- Fresh JW, Cross JH, Reyes V, Whalen GE, Uylangco CV, Dizon JJ (1972). Necropsy findings in intestinal capillariasis. *Am J Trop Med Hyg* **21**: 169–73.
- Furmidge BA, Horn LA, Pritchard DI (1996). The anti-haemostatic strategies of the human hookworm *Necator americanus*. *Parasitology* **112**: 81–7.
- Gelpi AP, Mustafa A (1967). Seasonal pneumonitis with eosinophilia. A study of larval ascariasis in Saudi Arabs. *Am J Trop Med Hyg* **16**: 646–57.
- Ghadirian E, Arfaa F (1975). Present status of trichostrongyliasis in Iran. *Am J Trop Med Hyg* **24**: 935–41.
- Gilles HM (1985). Selective primary health care: strategies for control of disease in the developing world. XVII. Hookworm infection and anemia. *Rev Infect Dis* **7**: 111–18.
- Gillespie SH, Ramsay ARC, Msaki EP, Mwerinde H, Horton RJ, Sam M (2001). The efficacy and safety of oxibendazole in the treatment of intestinal nematode infections in Tanzania: an open label clinical trial. (submitted).
- Gilman RH, Chong YH, Davis C, Greenberg B, Virik HK, Dixon HB (1983). The adverse consequences of heavy *Trichuris* infection. *Trans R Soc Trop Med Hyg* **77**: 432–8.
- Hasegawa H, Takao Y, Nakao M, Fukuma T, Tsuruta O, Ide K (1998). Is *Enterobius gregorii* Hugot, 1983 (Nematoda: Oxyuridae) a distinct species? *J Parasitol* **84**: 131–4.
- Haswell-Elkins MR, Elkins DB, Anderson RM (1987a). Evidence for predisposition in humans to infection with *Ascaris*, hookworm, *Enterobius* and *Trichuris* in a South Indian fishing community. *Parasitology* **95**: 323–37.
- Haswell-Elkins MR, Elkins DB, Manjula K, Michael E, Anderson RM (1988). An investigation of hookworm infection and reinfection following mass anthelmintic treatment in the south Indian fishing community of Vairavankuppam. *Parasitology* **96**: 565–77.
- Hawdon JM, Jones BF, Hoffman DR, Hotez P (1996). Cloning and characterization of *Ancylostoma*-secreted protein. A novel protein associated with the transition to parasitism by infective hookworm larvae. *J Biol Chem* **271**: 6672–8.
- Hawdon JM, Narasimhan S, Hotez PJ (1999). *Ancylostoma* secreted protein 2: cloning and characterization of a second member of a family of nematode secreted proteins from *Ancylostoma caninum*. *Mol Biochem Parasitol* **99**: 149–65.
- He L, Min XT, Liu GZ, Xu PB, Li WS (1986). Preliminary karyotype studies on *Ascaris lumbricoides* and *Ascaris suum* from Guangzhou. *Chi Sheng Chung Hsueh Yu Chi Sheng Chung Ping Tsa Chih* **4**: 206–8.

- Holland CV, Asaolu SO, Crompton DW, Stoddart RC, Macdonald R, Torimiro SE (1989). The epidemiology of *Ascaris lumbricoides* and other soil-transmitted helminths in primary school children from Ile-Ife, Nigeria. *Parasitology* **99**: 275–85.
- Holland CV, Asaolu SO, Crompton DW, Whitehead RR, Coombs I (1996a). Targeted anthelmintic treatment of school children: effect of frequency of application on the intensity of *Ascaris lumbricoides* infection in children from rural Nigerian villages. *Parasitology* **113**: 87–95.
- Holland CV, O'Shea E, Asaolu SO, Turley O, Crompton DW (1996b). A cost-effectiveness analysis of anthelmintic intervention for community control of soil-transmitted helminth infection: levamisole and *Ascaris lumbricoides*. *J Parasitol* **82**: 527–30.
- Horton RJ (1997). Albendazole in treatment of human cystic echinococcosis: 12 years of experience. *Acta Trop* **64**: 79–93.
- Hotez PJ, Hawdon JM, Cappello M, Jones BF, Pritchard DI (1995). Molecular pathobiology of hookworm infection. *Infect Agents Dis* **4**: 71–5.
- Hotez PJ, Narasimhan S, Haggerty *et al.* (1992). Hyaluronidase from infective *Ancylostoma* hookworm larvae and its possible function as a virulence factor in tissue invasion and in cutaneous larva migrans. *Infect Immun* **60**: 1018–23.
- Jung RC, Beaver PC (1951). Clinical observation on *Trichocaphus trichiuris*. *Pediatrics* **8**: 548–57.
- Katz N, Chaves A, Pellegrino J (1972). A simple device for quantitative stool thick-smear technique in *Schistosomiasis mansoni*. *Rev Inst Med Trop São Paulo* **14**: 397–400.
- Keymer A, Pagel M (1989). Predisposition to hookworm infection. In Schad GA, Warren KS (eds), *Hookworm Infections: Current Status and New Directions*. Taylor and Francis: London.
- Khan AM, Gupta S, Katiyar JC, Srivastava VK (1996). Correlation between degree of protection and humoral antibody response in hamsters immunized with somatic and excretory–secretory antigens of *Ancylostoma ceylanicum*. *Ind J Exp Biol* **34**: 1015–18.
- Khuroo MS, Zargar SA, Mahajan R (1990). Hepatobiliary and pancreatic ascariasis in India. *Lancet* **335**: 1503–6.
- Khuroo MS, Zargar SA, Yattoo GN *et al.* (1993). Worm extraction and biliary drainage in hepatobiliary and pancreatic ascariasis. *Gastrointest Endosc* **39**: 680–85.
- Kimura Y, Kume M (1971). Absorption, distribution, excretion and metabolism of pyrantel pamoate. *Pharmacometrics* **5**: 347–58.
- Leach FN (1990). Management of threadworm infections during pregnancy. *Arch Dis Child* **65**: 399–400.
- Lillywhite JE, Cooper ES, Needham CS, Venugopal S, Bundy DA, Bianco AE (1995). Identification and characterization of excreted/secreted products of *Trichuris trichiura*. *Parasite Immunol* **17**: 47–54.
- Lionel ND, Miranda EH, Nanayakkara JC, Soysa PE (1969). Levamisole in the treatment of ascariasis in children. *Br Med J* **4**: 340–41.
- Liu LX, Chi J, Upton MP, Ash LR (1995). Eosinophilic colitis associated with larvae of the pinworm *Enterobius vermicularis*. *Lancet* **346**: 410–12.
- Looss A (1898). Zur Lebensgeschichte des *Ancylostoma duodenale*. *Cbl Bakt* **24**: 441–9.
- Lozoff B (1989). Iron and learning potential in children. *Bull N Y Acad Med* **65**: 1050–66.
- Lucas AO, Oduntan SO (1972). Treatment of hookworm infection and other parasites with L-tetramisole. *Ann Trop Med Parasitol* **66**: 391–8.
- Lucy M, Pousseu F, Cazin M *et al.* (1982). Pharmacokinetics of levamisole in healthy subjects and cancer patients. *Eur J Drug Metab Pharmacokinet* **7**: 237–54.
- Lynch NR, Hagel IA, Palenque ME *et al.* (1998). Relationship between helminth infection and IgE response in atopic and nonatopic children in a tropical environment. *J Allergy Clin Immunol* **101**: 217–21.
- Mansour NS, Anis MH, Mikhail EM (1990). Human intestinal capillariasis in Egypt. *Trans R Soc Trop Med Hyg* **84**: 114.
- Matthews BE (1982). Skin penetration by *Necator americanus* larvae. *Z Parasitenkd* **68**: 81–6.
- Maxwell C, Hussain R, Nutman TB *et al.* (1987). The clinical and immunologic responses of normal human volunteers to low dose hookworm (*Necator americanus*) infection. *Am J Trop Med Hyg* **37**: 126–34.
- Mello DA (1974). A note on egg production of *Ascaris lumbricoides*. *J Parasitol* **60**: 380–81.
- McCullagh SF (1968). Allergenicity of piperazine: a study in environmental aetiology. *Br J Ind Med* **25**: 319–25.
- Miller JM, Holmes HT (1995). Specimen collection, transport and storage. In Murray PJ, Baron EJ, Tenover FC, Tenover RH (eds), *Manual of Clinical Microbiology*, 6th edn. American Society of Microbiology: Washington, DC: 19–32.
- Miller MJ (1980). Use of levamisole in parasitic infections. *Drugs* **19**: 122–30.
- Mouriquand G, Roman E, Coisnard J (1951). Essai de traitement de l'oxyurose par la piperazine. *J Méd Lyon* **32**: 189–95.
- Moens M, Dom J, Burke WE, Schlossberg S, Scheurmans V (1978). Levamisole in ascariasis. A multicentre controlled evaluation. *Am J Trop Med Hyg* **27**: 897–904.
- Moyle M, Foster DL, McGrath DE *et al.* (1994). A hookworm glycoprotein that inhibits neutrophil function is a ligand of the integrin CD11b/CD18. *J Biol Chem* **269**: 10008–10015.
- Needham CS, Bundy DA, Lillywhite JE *et al.* (1992). The relationship between *Trichuris trichiura* transmission intensity and the age-profiles of parasite-specific antibody isotypes in two endemic communities. *Parasitology* **105**: 273–83.
- Ng KK, Wong HF, Kong MS *et al.* (1999). Biliary ascariasis: CT, MR cholangiopancreatography, and navigator endoscopic appearance—report of a case of acute biliary obstruction. *Abdom Imaging* **24**: 470–72.
- Nickey LN (1966). Possible precipitation of petit mal seizures with piperazine citrate. *J Am Med Assoc* **195**: 193–4.
- Nokes C, Bundy DA (1993). Compliance and absenteeism in school children: implications for helminth control. *Trans R Soc Trop Med Hyg* **87**: 148–52.
- Nokes C, Cooper ES, Robinson BA, Bundy DA (1991). Geohelminth infection and academic assessment in Jamaican children. *Trans R Soc Trop Med Hyg* **85**: 272–3.

- Ok UZ, Ertan P, Limoncu E, Ece A, Ozbakkaloglu B (1999). Relationship between pinworm and urinary tract infections in young girls. *APMIS* **107**: 474–6.
- Patterson LA, Abedi ST, Kottmeier PK, Thelmo W (1993). Perforation of the ileum secondary to *Enterobius vermicularis* report of a rare case. *Mod Pathol* **6**: 781–3.
- Pearson DR, Irons RP Sr, Irons RP Jr (1981). Chronic pelvic peritonitis due to the pinworm *Enterobius vermicularis*. *J Am Med Assoc* **245**: 1340–41.
- Perry RN, Clarke AJ (1982). Hatching mechanisms of nematodes. *Parasitology* **83**: 435–9.
- Pradatsundarasar A, Pecharanond K, Chintanawongs C, Ungthavorn P (1973). The first case of intestinal capillaritis in Thailand. *S E Asian J Trop Med Publ Health* **4**: 131–4.
- Pritchard DI, Brown A, Toutant JP (1994). The molecular forms of acetylcholinesterase from *Necator americanus* (Nematoda), a hookworm parasite of the human intestine. *Eur J Biochem* **219**: 317–23.
- Pritchard DI, Quinnell RJ, Walsh EA (1995). Immunity in humans to *Necator americanus*: IgE, parasite weight and fecundity. *Parasite Immunol* **17**: 71–5.
- Rachelson MH, Ferguson WR (1955). Piperazine in the treatment of enterobiasis. *Am J Dis Child* **89**: 346–9.
- Ramsay A, Gillespie SH, Mnzava TD, Ngowi FI, Fox R (1991). A field evaluation of the formol-detergent method for concentrating faecal parasites. *J Trop Med Hyg* **94**: 210–13.
- Ramsay FC (1962). *Trichuris* dysentery syndrome. *West Ind Med J* **11**: 235.
- Roche M, Layrissé M (1966). The nature and causes of 'hookworm anemia'. *Am J Trop Med Hyg* **15**: 1029–102.
- Rogers EW (1958). Excretion of piperazine salts in the urine. *Br Med J* **i**: 136–7.
- Roos MH (1990). The molecular nature of benzimidazole resistance in helminths. *Parasitol Today* **6**: 125–7.
- Schad GA, Anderson RM (1985). Predisposition to hookworm infection in humans. *Science* **228**: 1537–40.
- Schwartzwelder J (1924). Clinical ascariasis: an analysis of 202 cases in New Orleans. *Am J Dis Child* **72**: 172–80.
- Seo BS (1990). Epidemiology and control of ascariasis in Korea. *Kisaengchunghak Chapchi* **28** (suppl): 49–61.
- Shakib F, Pritchard DI, Walsh EA *et al.* (1993). The detection of autoantibodies to IgE in plasma of individuals infected with hookworm (*Necator americanus*) and the demonstration of predominant IgG1 anti-IgE autoantibody response. *Parasite Immunol* **15**: 47–53.
- Sinniah B, Sinniah D (1981). The antihelminthic effects of pyrantel pamoate, oxtantel pyrantel pamoate, levamisole and mebendazole in the treatment of intestinal nematodes. *Ann Trop Med Parasitol* **75**: 315–21.
- Smith G (1990). The ecology of the free-living stages: a reappraisal. In Schad GA, Warren KS (eds), *Hookworm Disease: Current Status and Future Directions*. Taylor and Francis: London; 89–104.
- Smith G, Schad GA (1989). *Ancylostoma duodenale* and *Necator americanus*: effect of temperature on egg development and mortality. *Parasitology* **99**: 127–32.
- Spillman RK (1975). Pulmonary ascariasis in tropical communities. *Am J Trop Med Hyg* **24**: 791.
- Stassens P, Bergum PW, Gansemans Y *et al.* (1996). Anticoagulant repertoire of the hookworm *Ancylostoma caninum*. *Proc Natl Acad Sci USA* **93**: 2149–54.
- Stephenson LS (1987). *The Impact of Helminth Infections on Human Nutrition*. Taylor and Francis: London.
- Stiles CW (1902). A new species of hookworm (*Uncinaria americana*) parasitic in man. *Am Med* **3**: 777–8.
- Stoll NR (1947). This wormy world. *J Parasitol* **33**: 1–18.
- Sun T, Schwartz NS, Sewell C, Lieberman P, Gross S (1991). *Enterobius* egg granuloma of the vulva and peritoneum: review of the literature. *Am J Trop Med Hyg* **45**: 249–53.
- Timothy LM, Behnke JM (1997). *Necator americanus* in inbred mice: evidence in support of genetically determined differences in the cellular immune response to a primary infection. *Parasitology* **114**: 53–63.
- Townsend LB, Wise DS (1990). The synthesis and chemistry of certain anthelmintic benzimidazoles. *Parasitol Today* **6**: 107–12.
- Tyson E (1683). *Lumbricus teres*, or some anatomical observations on the roundworm bred in human bodies. *Phil Trans R Soc Lond* **13**: 152–61.
- van Wauwe J, Janssen PAJ (1991). On the biochemical mode of action of levamisole: an update. *Int J Immunopharmacol* **13**: 3–9.
- Venkatesan P (1998). Albendazole. *J Antimicrob Chemother* **41**: 145–7.
- Whalen GE, Rosenberg EB, Strickland GT *et al.* (1969). Intestinal capillaritis. A new disease in man. *Lancet* **1**: 13–16.
- Wiebe BM (1991). Appendicitis and *Enterobius vermicularis*. *Scand J Gastroenterol* **26**: 336–8.
- Williams-Blangero S, Subedi J, Upadhayay RP *et al.* (1999). Genetic analysis of susceptibility to infection with *Ascaris lumbricoides*. *Am J Trop Med Hyg* **60**: 921–6.
- Williams DJ, Dixon MF (1988). Sex, *Enterobius vermicularis* and the appendix. *Br J Surg* **75**: 1225–6.
- World Bank (1993). *World Development Report 1993: Investing in Health*. World Bank: Oxford.





# Echinococcosis

R. C. A. Thompson

*Murdoch University, Murdoch, Western Australia*

---

## INTRODUCTION

### Hydatid Disease

Infection with *Echinococcus* may be naturally transmitted between humans and other animals and therefore claims membership of the most significant group of communicable diseases, the zoonoses.

The clinical and economic significance of the parasite are almost completely confined to infection with the larval stage, or metacestode, of *Echinococcus*, known as a hydatid cyst. 'Hydatid disease' and 'hydatidosis' are terms that should be restricted to infection with the metacestode, and 'echinococcosis' to infection with the adult stage. This is the convention with *Taenia* infections, in which the terms 'cysticercosis' and 'taeniasis' apply to infection with the metacestode (cysticercus) and adult, respectively. However, in view of a recent trend to use the three terms interchangeably, no attempt will be made to restrict their usage here.

### History

The cystic nature of larval infection with *Echinococcus* was recognised in ancient times in humans and other animals. Fascinating accounts of the early history are given by Hosemann (1928), Schwabe (1986) and Grove (1990). Hippocrates (460–379 BC) referred to water-filled

bladders in the lungs and liver of livestock and humans and, although similar observations were made in succeeding centuries, it was not until late in the seventeenth century that the parasitic origin of these cysts was proposed through the work of Redi, Hartmann and Tyson (Grove, 1990). Approximately a century later, Goeze described the scoleces from within hydatid cysts and demonstrated their similarity to the anterior end of tapeworms. He named the parasite as *Taenia visceralis socialis granulosa* but a few years later Batsch (1786) renamed it as *Hydatigera granulosa*. It was Rudolphi (1801) who erected the genus *Echinococcus*, in which the hydatid parasite was known as *Echinococcus granulosa*. Although Rudolphi (1808) examined the adult stages in a naturally infected dog, they were identified as *Taenia cateniformis*. It was not until 1852, when von Siebold experimentally infected a dog with hydatid cysts, that the life-cycle and association between larval and adult stages was proven. This was followed by the work of Haubner in 1855 (Kuchenmeister, 1857), who demonstrated the developing hydatid cysts in a pig experimentally infected with the eggs of *E. granulosa*.

From an historical perspective, the next major event was the discovery that the condition known as 'alveolar colloid' (Zeller, 1854) was related to the hydatid parasite. Virchow (1856) recognised it as such and Leuckart differentiated the multicystic nature of these hydatid cysts from the unilocular variety caused by *E. granulosa*, and

designated a new species, *E. multilocularis* Leuckart 1863 (Leuckart, 1886). However, the taxonomic status of *E. multilocularis* remained in doubt for nearly 100 years (Kumaratilake and Thompson, 1982), until Vogel (1957) completed the life-cycle in the laboratory and described distinct morphological characteristics of the adult tapeworm, and emphasised the multi-vesicular nature of the larval stage and its occurrence in rodents.

## DESCRIPTION OF THE ORGANISM

### Taxonomy

Since these early times, the taxonomic designation of the causative agents of echinococcosis has remained controversial, with numerous revisions (Rausch, 1967; Krotov, 1979; Kumaratilake and Thompson, 1982; Thompson and Lymbery, 1988; Thompson *et al.*, 1994, 1995). *Echinococcus* belongs to the order Cyclophyllidea, which characteristically includes tapeworms that have four muscular suckers and hooks on their scolex for attachment to the mucosa of the definitive (final) host (Figure 22.1). *Echinococcus* is a member of the family Taeniidae, whose members all have indirect life-cycles, with two mammalian hosts and larval (metacestode) stages of the fluid-filled, 'bladder-worm' type. However, the hydatid metacestode of *Echinococcus* contains numerous scoleces as a result of asexual multiplication within the cyst. The degree of definitive host specificity is much greater than with the intermediate host, and is restricted to canids, vulpines and felids. In contrast, intermediate hosts include numerous species of herbivorous or omnivorous animals. Although a total of 16 species and 13 subspecies were originally described in the genus *Echinococcus*, subsequent taxonomic revisions recognised only four valid species, *Echinococcus granulosus*, *E. multilocularis*, *E. oligarthrus* and *E. vogeli*. Their characteristics are summarised in Table 22.1.

Taxonomic uncertainty has been largely due to the limitations of morphological descriptions and lack of evidence for geographical or ecological segregation (reviewed in Kumaratilake and Thompson, 1982; Thompson and Lymbery,

1988; Thompson and Allsopp, 1988; Eckert and Thompson, 1988; Thompson *et al.*, 1995).

The situation has been exacerbated by a lack of appreciation of the extent and significance of variability in *Echinococcus*. As a result, certain features that characterized a particular population were overlooked because of uncertainty regarding its taxonomic status. It is now clear that many of the populations previously given taxonomic status do exhibit strongly defined and distinct characteristics. Because of the epidemiological significance of the variation exhibited between populations of *Echinococcus*, particularly *E. granulosus*, such variant populations were designated informally as being different strains (Table 22.2) and there are clear morphological, behavioural and genetic characteristics by which most of them can be distinguished (Thompson *et al.*, 1995). The situation with *E. multilocularis* is not as clear-cut and, although there is increasing evidence of variability in a range of behavioural and other phenotypic characteristics between geographically separated populations, compared to *E. granulosus*, there is little evidence of genetic distinctness between populations of *E. multilocularis* (Thompson and Lymbery, 1988; Thompson *et al.*, 1994; Haag *et al.*, 1997). However, both mitochondrial and rDNA sequencing of isolates of *E. multilocularis* from Europe, North America and Japan have confirmed the genetic distinctness of Eurasian and North American 'strains' of *E. multilocularis* (Bowles *et al.*, 1992; Rinder *et al.*, 1997).

Recent, comprehensive molecular genetic and phylogenetic analyses of *Echinococcus* populations based on sequence data from the mitochondrial cytochrome *c* oxidase subunit I (COI) and NADH dehydrogenase 1 (ND1) genes, and the nuclear rDNA internal transcribed spacer 1 (ITS1) (Bowles *et al.*, 1992, 1995; Bowles and McManus, 1993a,b; Lymbery, 1995; Thompson *et al.*, 1995; Lymbery and Thompson, 1996) has revealed that many of these strains most likely represent distinct species, and the reinstatement of their formal taxonomic status has been proposed (Thompson *et al.*, 1995; Lymbery and Thompson, 1996). As for any infectious disease, an evolutionarily sound species-level classification for the genus *Echinococcus* is essential for the control of hydatid disease. Molecular genetic studies have therefore laid the foundation for a

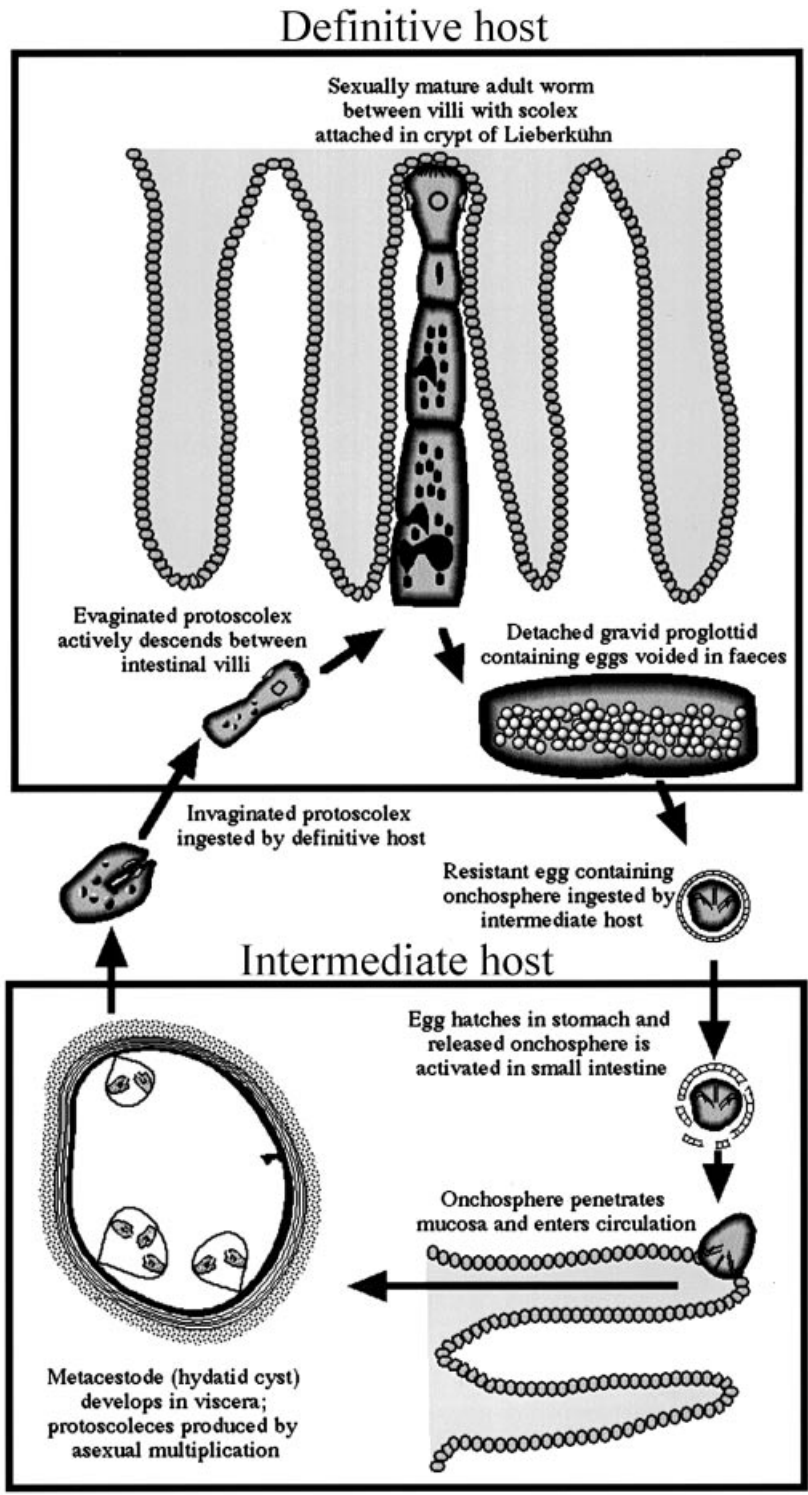


Fig. 22.1 Life-cycle and development of *Echinococcus*. Redrawn and designed by Russ Hobbs after Thompson, 1995

**Table 22.1** Characteristics of the four species currently recognised within the genus *Echinococcus*

	<i>E. granulosus</i>	<i>E. multilocularis</i>	<i>E. oligarthrus</i>	<i>E. vogeli</i>
Geographical distribution	Cosmopolitan	Central and northern Eurasia, northern North America	Central and South America	Central and south America
Host range				
Definitive hosts	Primarily canids	Primarily foxes; also domestic dogs and cats	Wild felids	Bush dog
Intermediate hosts	Primarily ungulates, also marsupials and primates, including humans	Primarily arvicolid rodents, also other small mammals and humans	Rodents; agoutis, paca, spiny rats and humans	Primarily agoutis, also other rodents and humans
Metacystode				
Nature of cyst	Unilocular, endogenous proliferation, no infiltration or metastasis	Multivesicular, endogenous proliferation, infiltration and metastasis	Polycystic, endogenous and exogenous proliferation, no infiltration or metastasis	Polycystic, endogenous and exogenous proliferation, no infiltration or metastasis
Location of cysts	Visceral, primarily liver and lungs	Visceral, primarily liver with subsequent metastatic spread particularly in humans	Peripheral, primarily muscles	Visceral, primarily liver
Adult				
Mean number of segments (range)	3 (2–7)	5 (2–6)	3	3
Total length of strobila (mm)	2.0–11.0	1.2–4.5	2.2–2.9	3.9–5.5

**Table 22.2** Revised species and strains in the genus *Echinococcus*

Suggested taxonomic <sup>1</sup> designation	Known definitive hosts	Known intermediate hosts	Probable <sup>2</sup> geographic distribution	Synonyms	Strains
<i>E. intermedius</i>	Dog	Pigs, humans (?), camels (?)	Europe, Russia, South America	<i>E. granulosus</i> pig strain	Pig strain?, camel strain?
<i>E. ortleppi</i>	Dog	Cattle, buffalo, humans	Europe, Africa, India, Sri Lanka, Russia	<i>E. granulosus ortleppi</i> , <i>E. granulosus</i> cattle strain	
<i>E. equinus</i>	Dog	Horses, and other equines	Europe, Middle East, South Africa, (New Zealand, USA?)	<i>E. granulosus equinus</i> , <i>E. granulosus</i> horse strain	
<i>E. multilocularis</i>	Fox, dog, cat	Rodents, pigs, horses, humans	Europe, North America, Canada, Japan, China	<i>E. sibiricensis</i>	European strain, North American strain, Alaskan strain, Hokkaido strain
<i>E. vogeli</i>	Bush dog	Rodents, humans	South America		
<i>E. oligarthrus</i>	Felines	Rodents, humans	South America		
<i>E. granulosus</i>	Dog, fox, dingo, jackal, hyena	Sheep, cattle, pigs, goats, buffalo, camels, macropods, humans	Australia, Europe, USA, New Zealand, Africa, China, Middle East, Asia, South America, Russia	<i>E. pampeanus</i> , <i>E. cruzi</i> <i>E. patagonicus</i> , <i>E. cepanazo</i> , <i>E. granulosus</i> , <i>E. newzealandensis</i>	Common sheep strain, Tasmanian sheep strain, buffalo strain

<sup>1</sup>For further details, see Thompson *et al.* (1995).<sup>2</sup>The geographic range of some species still needs to be fully defined.

taxonomic revision of the genus *Echinococcus*. However, before this can be finally achieved, there is a need to collect and characterise, using both traditional and molecular genetic techniques, additional isolates from several of the proposed new taxa, as well as isolates of *E. vogeli* and *E. oligarthrus*. In particular, some forms, such as those utilising cervids, camels and pigs as intermediate hosts, require further study, as only a relatively small number of isolates have so far been examined using molecular criteria, and further geographic variation may be present. For example, molecular characterisation of isolates of *Echinococcus* from humans and pigs in Poland has recently identified a new genotype which does not fall into either the expected pig or common sheep strains (Scott *et al.*, 1997).

In addition to the well-recognised species (Tables 22.1, 22.2), the concept of a series of host-adapted species for the forms of *Echinococcus* affecting livestock fits in perfectly with observations on host range, life-cycle and transmission patterns in areas where hydatid disease is endemic. The maintenance of what were previously considered to be host-adapted strains of *E. granulosus*, in areas where definitive hosts could potentially harbour mixed infections, is indicative of the existence of different species. For example, in the UK, the Middle East and parts of Europe and Africa, *Echinococcus* may be perpetuated in the same geographical area in more than one cycle involving horses, sheep, cattle or pigs, with the possibility that a definitive host could acquire infections from more than one species of intermediate host (Thompson and Lymbery, 1988; Thompson *et al.*, 1995). Furthermore, available data indicates that the metacestodes of the different strains all produce fertile cysts in their respective intermediate hosts. This is significant, as Rausch (1997) considers that a uniform, typical larval structure, with long survival without degenerative changes and high protoscolex production, are characteristic of metacestodes of recognised species in their natural intermediate hosts.

The notion of a series of host-adapted species in the genus *Echinococcus* is not new. It is a situation that was recognised by many of the early descriptive parasitologists, whose published observations provide a logical nomenclature for the 'new' species that have

been proposed on the basis of molecular phylogeny. Consequently, a revised nomenclature for species within the genus *Echinococcus* should not be a contentious issue, since we can find taxonomic designations for all the putative species in the literature, supported by appropriate ecological information.

Although the species name *E. granulosus* derives from Batsch's (1786) early descriptions of hydatid cysts in sheep, the classical description of *E. granulosus* was given by Vogel (1957) from a type locality in Germany. Unfortunately, however, Vogel's description was based on adult worms of German pig/dog origin. Such a description can not be considered to be representative of *E. granulosus*, since the morphological characteristics of Vogel's material closely correspond to the pig strain (Kumaratilake and Thompson, 1982; Eckert *et al.*, 1993), which occurs in Europe and is almost certainly a distinct species. Consequently, the description given by Williams and Sweatman (1963) for the subspecies, *E.g. granulosus*, which is based on material of New Zealand sheep/dog origin, is the most appropriate for the species *E. granulosus*.

Similarly, the most suitable species name for the former horse strain would appear to be *E. equinus*. This was originally designated as the subspecies name by Williams and Sweatman (1963), who provided a detailed and accurate description of the parasite of horse/dog origin from the type locality in Britain.

According to morphological and genetic analyses, the cattle strain occurs throughout Europe as well as parts of Africa and Asia. The South African bovine form was initially described as the species *E. ortleppi* by Lopez-Neyra and Soler Planas (1943), based on adult worms originally described by Ortlepp (1934) from the type locality in South Africa, and which Verster (1965), Kumaratilake (1982) and Thompson *et al.* (1984) considered to be of cattle origin. Thus *E. ortleppi* may be the most appropriate species name for the cattle strain.

Similarly, *E. intermedius* may be the most appropriate species name for the pig strain and the closely related form adapted to camels. Lopez-Neyra and Soler Planas (1943) gave this name to specimens of *Echinococcus* they found in a naturally infected dog in the south of Spain, where the pig strain predominates.

## DEVELOPMENT

*Echinococcus* is a small endoparasitic cestode (phylum Platyhelminthes) which, in its adult stage, is rarely more than 8mm in length. The life-cycle of *Echinococcus* is illustrated in Figure 22.1.

### Development in the Definitive Host

The definitive or final host becomes infected by ingesting protoscoleces, which are produced by asexual multiplication of the metacestode. Protoscoleces may be ingested while still within the hydatid cyst or after cyst rupture, as free brood capsules and/or protoscoleces contaminating meat or other intermediate host tissues. Activation (evagination) of the protoscoleces occurs after exposure to enzymes and other environmental factors in the small intestine, after which they quickly attach within the crypts of Lieberkuhn in order to avoid being passed out of the intestine (Thompson, 1995). Attachment of the developing worms is principally achieved by grasping substantial plugs of tissue with their suckers. The hooks only superficially penetrate the mucosal epithelium but act as anchors to assist in preventing the worms from being dislodged.

The sequence of development in the definitive host is essentially the same for all species of *Echinococcus* but the rate of development varies, particularly in relation to growth and the commencement of egg production. A genital rudiment usually appears at around 11 days after infection and by 14 days the first proglottid is clearly evident. Subsequent stages of maturation follow the general cestode pattern (Thompson, 1995). However, the development of *Echinococcus* exhibits considerable variability in the definitive host. This is seen between different species of definitive host, between individuals of the same species of host and, in addition, between different regions of the small intestine. The factors involved, particularly the influence of the host on the establishment and development of *Echinococcus*, are complex and have yet to be fully determined (Constantine *et al.*, 1998).

*Echinococcus* is hermaphroditic and capable of both self- and cross-insemination, although it is predominantly self-fertilising (Lymbery *et al.*, 1997). The initial onset of egg production varies between species and even between strains of *Echinococcus*. In *E. granulosus* it ranges from 34 to 58 days, whereas *E. multilocularis* has a far more rapid rate of maturation, with egg production commencing 28–35 days after infection (see Thompson, 1995).

Although development up to the initial onset of egg production has been extensively studied, little is known of subsequent development. The number of eggs produced may be as high as 1500 per proglottid for *E. granulosus* but less for *E. multilocularis* (see Thompson, 1995). It is unclear exactly how often species of *Echinococcus* produce gravid proglottids, although in *E. granulosus* it has been shown to continue for at least 80 days, with cycles of production at variable intervals during this period, sometimes as close as 14 days apart (Gemmell, 1962; Yamashita *et al.*, 1956; Heath and Lawrence, 1991; Thompson, 1995). In *E. multilocularis*, Ishige *et al.* (1990) showed that, in experimentally infected dogs, egg production continued for 14–111 days after infection, with proglottid shedding occurring every 7–13 days.

### Development in the Intermediate Host

When released from the definitive host, the egg of *Echinococcus* is presumed to be fully embryonated and infective to a suitable intermediate host. The outer keratinised embryophore gives physical protection to the inner embryo, or oncosphere. *Echinococcus* eggs are extremely resistant, enabling them to withstand a wide range of environmental temperatures (Gemmell and Lawson, 1986). Following ingestion by a suitable intermediate host, the eggs hatch, releasing the oncosphere (Figure 22.1), which becomes activated in the stomach and small intestine under the action of proteolytic enzymes, including pepsin, pancreatin and bile salts. Animal experiments have shown that the oncospheres of *E. granulosus* penetrate the tips of the villi in the jejunal and upper ileal regions of the small intestine (Heath, 1971). Penetration appears to

involve both hook and body movements, the actions of which are probably enhanced by oncospherical secretions, which cause lysis of host tissue (see Thompson, 1995).

The factors that determine the final localisation of the metacestode of *Echinococcus* are not clear, but probably include anatomical and physiological characteristics of the host, as well as the species and strain of parasite. Heath (1971) provided strong circumstantial evidence that oncospheres of *E. granulosus* are capable of completing a lymphatic or venous migration. He further postulated that, since the lymphatic lacteals of the villus differed in size between different hosts, the size of the oncosphere in relation to the venules and lacteals in various animals may determine the distribution of cysts between the liver and lungs.

Once the oncosphere attains a site of predilection (Table 22.1), post-oncospherical development proceeds, leading to the formation of the metacestode (Figures 22.1, 22.2). The oncosphere rapidly undergoes a series of re-organisational events during the first 2 weeks, which involve cellular proliferation, degeneration of oncospherical hooks, muscular atrophy, vesicularisation and central cavity formation, and development of both germinal and laminated layers (see Thompson, 1995).

### *Echinococcus granulosus*

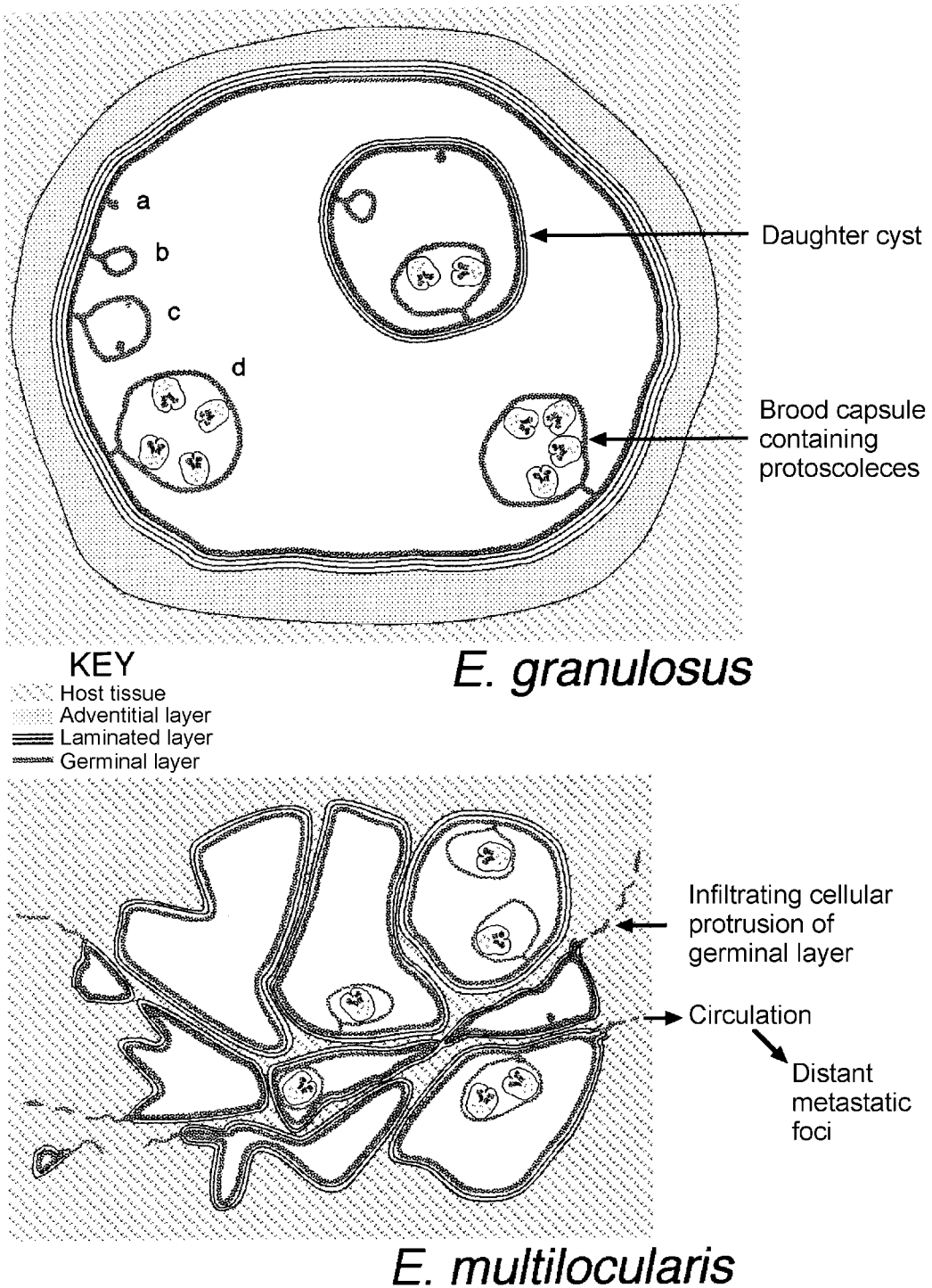
In *Echinococcus granulosus*, the fully developed metacestode is typically unilocular, subspherical in shape, fluid-filled and has the least complex structure of the four species (Figure 22.2). The rate of cyst development is slow and variable and dependent on a number of factors, including the strain of parasite, the species and strain of host and the intensity of infection. Cysts increase in diameter by 1–5 cm/year (Heath, 1973), whereas brood capsule formation may vary from a few months to years, and in humans and other 'abnormal' hosts it may not occur at all. The production of brood capsules and protoscoleces is not a factor of cyst size and appears to be dependent upon the nature of the host–parasite relationship. A cyst in which brood capsules and protoscoleces have developed is referred to as

being 'fertile', whereas in a 'sterile' cyst they are absent. The life-span of hydatid cysts of *E. granulosus* can be as long as 16 years in horses (Roneus *et al.*, 1982) and 53 years in humans (Spruance, 1974).

Histologically, a unilocular hydatid cyst of *E. granulosus* consists of an inner germinal or nucleated layer, supported externally by a tough, elastic, acellular laminated layer of variable thickness, surrounded by a host-produced fibrous or adventitial layer (Figures 22.2, 22.3). Typically, cyst growth is expansive by concentric enlargement, and asexual proliferation of the germinal layer from which brood capsule formation takes place entirely endogenously. Pouching of the cyst walls may give rise to secondary chambers, communicating with the central cavity (Vanek, 1980), and sometimes the central cavity may be partly separated from the secondary chambers by incomplete septa. Occasionally, cysts may abut and coalesce, forming groups or clusters of small cysts of variable size. In some hosts, particularly humans, where abnormally large cysts often develop, daughter cysts may form within the primary cyst (Figure 22.2).

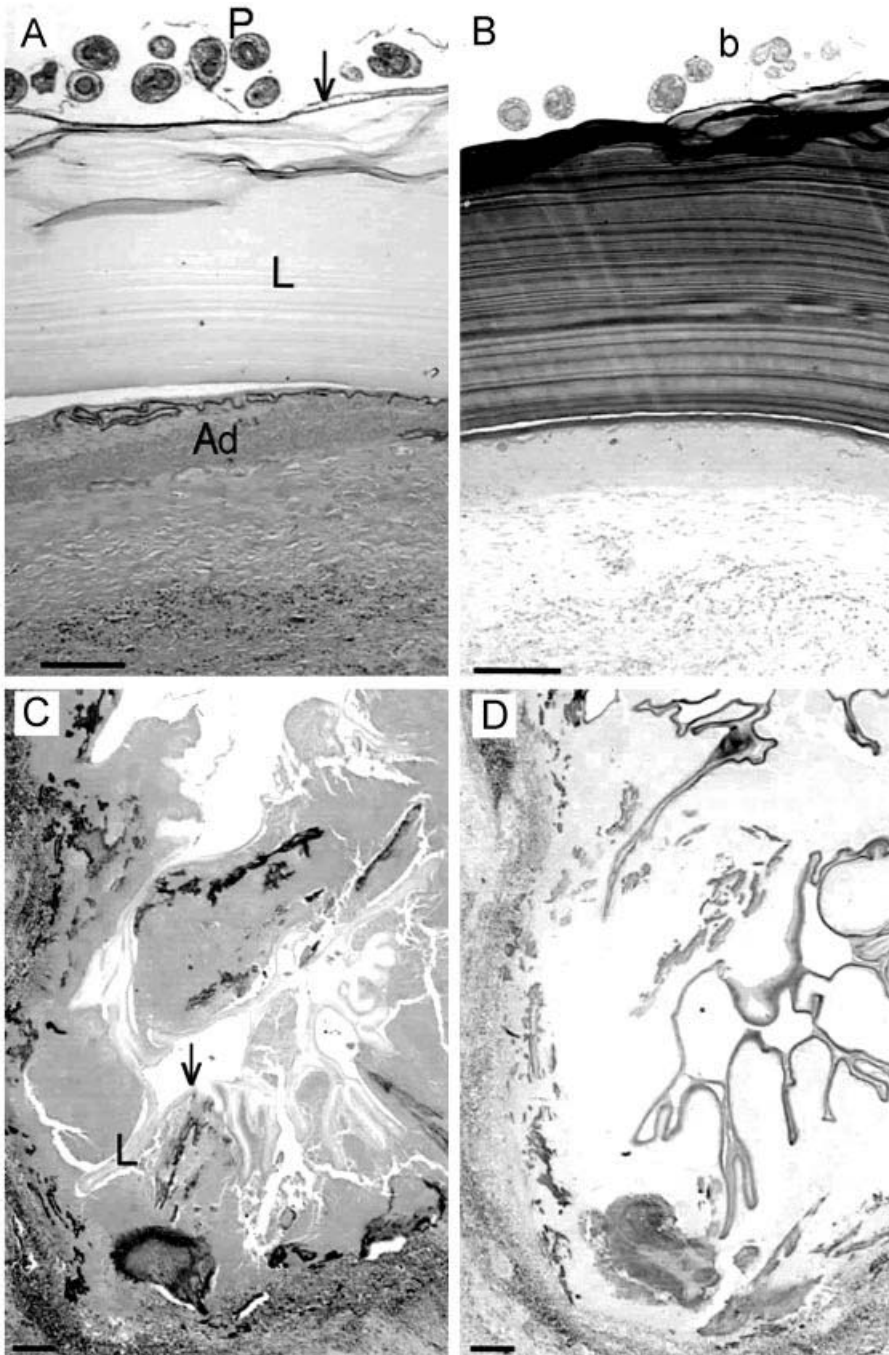
The germinal layer is similar in structure to the metabolically active cellular covering (the tegument) of the adult worm. Undifferentiated cells in the germinal layer proliferate and form brood capsules, which originate as small buds that proliferate towards the cystic cavity (Figure 22.2). Brood capsules enlarge, vacuolate and become stalked. Within their lumen, a repetition of the asexual budding process takes place, leading to the production of numerous protoscoleces. The formation of protoscoleces is asynchronous and a number of different developmental stages are usually present in a brood capsule at the same time. Fully developed protoscoleces are characterised by the possession of hooks on the invaginated rostellum.

The thin germinal layer is supported externally by the laminated layer. All species of *Echinococcus* are characterised by the possession of a laminated layer which, because it is periodic acid–Schiff (PAS)-positive (Figure 22.3; Kilejian *et al.*, 1961), provides a useful diagnostic marker. It is a polysaccharide protein complex secreted by the germinal layer. The laminated layer assists in supporting the cyst and allows an often considerable intracystic tension to develop (Cameron



**Fig. 22.2** Schematic diagram of the metacystodes of *Echinococcus granulosus* and *E. multilocularis*; a, b, c and d are stages in the development of the brood capsule in *E. granulosus*. Redrawn and designed by Russ Hobbs after Thompson, 1995





**Fig. 22.3** Sections through cysts in human liver stained with haematoxylin and eosin (A) and periodic acid–Schiff (PAS; B, D). Sections (A) and (B) are both *Echinococcus granulosus*, and C and D both *E. multilocularis*. Note the preferential staining of the laminated layer, L, by PAS in (B) and (C), which makes it much easier to detect scattered exogenous vesicles of *E. multilocularis* (C). The germinal layer (arrow) gives rise to brood capsules, b, containing protoscolices, P, in *E. granulosus*, and overlies the germinal layer, which in turn overlies the laminated layer, L. In *E. granulosus*, there is a characteristic fibrous adventitial layer, Ad separating the laminated layer from host tissue, whereas with *E. multilocularis* the proliferating parasite lesions are scattered within a dense mass of connective tissue. Figure produced by Russ Hobbs

and Webster, 1969; Slais, 1973). It may also protect the cyst from immunological attack by offering an immunologically inert barrier that can deny access to host defence cells (Coltorti and Varela-Diaz, 1974; Rogan and Richards, 1989; Leducq and Gabrion, 1992). Immunoglobulin, however, can pass through the laminated layer and the capacity to regulate penetration of macromolecules into the cyst appears to be a function of the germinal rather than the laminated layer (Coltorti and Varela-Diaz, 1974).

The host fibrous capsule (adventitial layer), which typically surrounds fully developed, viable cysts of *E. granulosus*, is the product of a three-layered host cellular inflammatory reaction initiated in the early stages of post-oncospherical development (Figures 22.2, 22.3; Cameron and Webster, 1969; Smyth and Heath, 1970; Slais and Vanek, 1980). The initial intensity of this reaction varies between hosts and governs the fate of the developing metacestode. If too intense, it will cause the degeneration and eventual death of the parasite, whereas in suitable intermediate hosts the initial reaction resolves, leaving a fibrous capsule (Thompson and Lymbery, 1990). The latter situation is common where a stable host-parasite relationship has evolved, as appears to be the case, for example, with strains (species) adapted to sheep, cattle and horses.

### *E. multilocularis*

The metacestode of *E. multilocularis* is the most complex and develops quite differently to that of *E. granulosus*. It is a multivesicular, infiltrating structure with no limiting fibrous host-tissue barrier (adventitial layer), consisting of numerous small vesicles embedded in a dense framework of connective tissue (Figure 22.2). The larval mass usually contains a semisolid matrix, rather than fluid. Proliferation of the undifferentiated cells of the germinal layer occurs both endogenously and exogenously, giving rise to an infiltrating network of filamentous, solid cellular protrusions, which develop into tube-like and cystic structures (Figures 22.2, 22.3; Vogel, 1978; Eckert *et al.*, 1983; Mehlhorn *et al.*, 1983). The detachment of germinal cells from infiltrating cellular protrusions and their subsequent distribution via the

lymph or blood is responsible for the distant metastatic foci that characterise the disease in humans (Ali-Khan *et al.*, 1983; Eckert *et al.*, 1983; Mehlhorn *et al.*, 1983).

*E. multilocularis* develops rapidly in its natural intermediate rodent host, producing protoscoleces in a few months, after which there is little if any further increase in size (Rausch, 1975; Rausch and Wilson, 1973). In humans, growth is very different and proliferation continues indefinitely, although there may be few if any protoscoleces produced (Rausch and Wilson, 1973). The larval mass proliferates peripherally and at the same time regressive changes occur centrally. Thus, a progressively enlarging mass of necrotic tissue with a relatively thin zone of viable proliferating parasite is produced. The term 'alveolar hydatid' is used to describe this form of growth, which is not a feature of the development in natural intermediate host species.

The metacestode of *E. multilocularis* has been found on a number of occasions in extra-intestinal sites in dogs and cats (Geisel *et al.*, 1990; Deplazes *et al.*, 1997a; Losson and Coignoul, 1997). It is not known whether such infections resulted directly from the ingestion of eggs or indirectly by autoinfection as a result of a previously acquired worm burden, but they illustrate the unusual developmental potential of *E. multilocularis*.

### *E. vogeli* and *E. oligarthrus*

The metacestodes of *E. vogeli* and *E. oligarthrus* exhibit developmental and structural characteristics intermediate to those of *E. granulosus* and *E. multilocularis* (Rausch *et al.*, 1981). The metacestodes of both species are termed 'polycystic', since they are characterised by the internal division of fluid-filled cysts to form multichambered structures. *E. vogeli* produces cysts varying greatly in size (2–80 mm), which may occur singly, in small groups or occasionally in dense aggregations. In *E. vogeli*, endogenous proliferation and convolution of both germinal and laminated layers leads to the formation of secondary subdivisions of the primary vesicle, with the production of brood capsules and protoscoleces in the resultant chambers, which

are often interconnected. In *E. oligarthrus*, there is less subdivision into secondary chambers and the laminated layer is much thinner than that of *E. vogeli* (Sousa and Thatcher, 1969; Rausch *et al.*, 1981). Exogenous proliferation has been reported in both species but, at least in *E. vogeli*, it appears to be abnormal and does not occur in the natural intermediate host.

## **PATHOGENESIS**

### **Adult**

Like most adult tapeworms, *Echinococcus* is seldom associated with a morphologically apparent host response. Occasionally, in heavy infections, there may be an excessive production of mucus. The host tissue that is grasped by the suckers is usually necrotic, but the hooks cause little damage (Thompson *et al.*, 1979). Observations at the ultrastructural level have shown that hook damage is restricted to columnar cells, with an associated loss of some host microvilli (Thompson *et al.*, 1979). *Echinococcus* has a very mobile and extensible apical rostellar region, which it extends into the crypts of Lieberkuhn. Secretions released from this region of the worm may have a nutritional function for the worm by digesting proteins at the host-parasite interface (see Thompson, 1995). Invasion of the crypts of Lieberkuhn by the mature worm may therefore be of particular physiological significance to *Echinococcus*. The epithelium of parasitised crypts is commonly flattened and there may be occasional rupture of a crypt wall, with release of host cells into the crypt (Smyth *et al.*, 1969). Adult worms have been observed to invade the lamina propria, but this appears to be a rare event. There is little evidence of a host cellular reaction (Thompson *et al.*, 1979; Thompson and Eckert, 1983), although the presence of the adult parasite does not go unnoticed by the host and a specific humoral response, with the production of circulating IgG antibodies, does occur (Jenkins and Rickard, 1986). Recent studies have also demonstrated local humoral and cellular reactions in the intestine of dogs experimentally infected with *E. granulosus* (Deplazes *et al.*, 1994). These experiments highlight the importance of Peyer's patches in localised

immunological responses to infection with *E. granulosus*. Interestingly, no significant correlation was found between the localised responses and the number or development of worms (Deplazes *et al.*, 1994) and further research is required to determine the role of localised immune responses in adult infections with *Echinococcus*.

### **Larval Parasite (Metacestode)**

The pathogenesis of infection with the larval parasite differs considerably between *E. multilocularis*, the causative agent of multivesicular/alveolar echinococcosis (MAE), and other species and strains in the genus which are the causative agents of cystic (CE) or polycystic (PE) echinococcosis. Consequently, they will be treated separately.

### ***Cystic Echinococcosis***

Most information is available for *E. granulosus* which, in humans, gives rise to a slow-growing, space-occupying lesion. The cyst(s) are usually well-tolerated unless they interfere mechanically with adjacent organ systems and compromise their functional integrity. Growing cysts may also damage surrounding tissues and blood vessels. Any associated clinical problems will be dependent upon the number of cysts, their size, location and rate of growth. This is characteristically highly variable, which can prove problematic in the clinical management of CE, particularly in inoperable cases (see below). The organs most frequently affected are the liver and lungs, in approximately 65% and 25% of cases, respectively (Schwabe, 1986). In remaining cases, virtually any other location in the body may be affected, including kidney, spleen, brain, heart, skeletal system and musculature. Pawlowski (1997) has made a useful distinction between active and inactive echinococcosis, which may account for an equal proportion (50%) of human cases. The former condition is characterised by fast-growing cysts, which exert pressure on the surrounding tissues and are frequently symptomatic. The lesions are highly immunogenic and

clinical complications may occur (Pawlowski, 1997). In contrast, inactive echinococcosis is usually asymptomatic, with slow-growing or dormant cysts that may be caseated, non-viable, degenerating and partially or totally calcified.

A serious complication of CE may result from a cyst bursting and releasing fluid, causing anaphylaxis. This is most likely to occur in active echinococcosis, where fast-growing cysts with relatively thin cyst walls may burst as a result of mechanical pressure.

### ***Polycystic Echinococcosis***

Human infection with the larval stages of *E. vogeli* and *E. oligarthrus* is characterised by the formation of clusters of small cysts or multichambered cystic masses (Schwabe, 1986; Gottstein and Hemphill, 1997). These are fluid-filled and usually confined to the liver, where they form deep-seated lesions. However, the cystic lesion is capable of limited exogenous proliferation, a little like *E. multilocularis*. However, lesion spread appears to be restricted compared to *E. multilocularis* (Gottstein and Hemphill, 1997). Little information is available on the natural history of human infection with *E. oligarthrus* because of the few human cases reported. However, cystic development appears to be similar to *E. vogeli*, although organ localisation includes the eye (Lopera *et al.*, 1989).

### ***Multivesicular/Alveolar Echinococcosis***

The pathogenesis of infection with the larval stage of *E. multilocularis* in the human host is clinically far more serious than any of the other species of *Echinococcus*. This is because of the rapid, progressive nature of its development and the proliferative, invasive behaviour of the parasite lesion, which gives rise to small exogenous vesicles. These vesicles can be disseminated in the circulatory system, resulting in distant metastatic foci. The parasite is thus very similar in its clinical progression to a malignant neoplasm. Therefore, although primary development of the parasite usually takes place in the liver, second-

ary lesions may subsequently develop in the lungs, brain and other organs (Schwabe, 1986). Consequently, although some patients may present with pain and possibly hepatomegaly associated with the parasite's initial organ location, it is common for patients to initially seek medical advice because of the consequences of pulmonary or central nervous system involvement.

Lesions, particularly those in the liver, are characterised by a diffuse mass of scattered germinal layer and fibrous tissue with numerous cavities of variable size, ranging from less than 1 mm to several cm in diameter (Figure 22.3; Ammann and Eckert, 1996). The central core of primary lesions usually degenerates, becoming necrotic and liquefied, but viable proliferative activity continues at the periphery of the lesion (Schwabe, 1986; Ammann and Eckert, 1996). Small, root-like, cellular protrusions of the germinal layer and exogenous budding are responsible for the infiltrating proliferation to adjacent tissues and probably for invasion of blood and lymph vessels, resulting in the spread of metacestodes to distant organs (Eckert *et al.*, 1983; Mehlhorn *et al.*, 1983).

### **Strain/Species Differences**

Variation in the pathogenicity of strains/species of *Echinococcus* will influence the prognosis in patients with hydatid disease, particularly with the alveolar form, for which early diagnosis is critical (see Thompson *et al.*, 1995). Epidemiological evidence suggests that the sylvatic strain of *E. granulosus* in northern North America is infective to humans, causing a benign infection of low pathogenicity, with predominant localisation of cysts in the lungs (Wilson *et al.*, 1968; Rausch 1986; Eckert and Thompson, 1988). Epidemiological observations in China suggest that strains of *E. granulosus* in certain regions may have lower pathogenicity for humans (Schantz *et al.*, 1995). In contrast, in parts of Kenya and Libya, it has been suggested that there are local virulent strains of *E. granulosus* (French *et al.*, 1982; Gebreel *et al.*, 1983).

There is also increasing epidemiological evidence that certain strains of *E. granulosus* may

not be infective to humans, such as the form adapted to horses (Thompson and Lymbery, 1988, 1991). In contrast, recent isoenzyme and molecular studies have confirmed what has long been presumed on the basis of epidemiological data, that the sheep strain is infective to humans (Bowles and McManus, 1993a,b). Indeed, until recently, most *E. granulosus* material obtained from human patients by surgery conformed to the sheep strain (Bowles and McManus, 1993a), except one case from The Netherlands, in which the cattle strain was typed by PCR-based molecular characterisation procedures (Bowles *et al.*, 1992).

It is thought that the pig strain may have a low infectivity for humans. Recent investigations of endemic foci in the Ukraine and Poland demonstrated the common occurrence of *E. granulosus* infections in dogs and pigs but little evidence of the disease in humans (Shabovskaya *et al.*, 1989; Pawlowski *et al.*, 1993). Although camels are commonly infected in the Middle East and Africa (Ibraheim and Craig, 1998), opinions differ regarding the infectivity of *E. granulosus* of camel origin to humans (Eckert *et al.*, 1989; Wachira *et al.*, 1993). DNA characterisation of 42 *E. granulosus* isolates of human origin from different parts of the Turkana district in Kenya did not provide evidence that humans are susceptible for the local camel strain (Wachira *et al.*, 1993). Therefore, it has been assumed that this strain might have low or no infectivity to humans (Wachira *et al.*, 1993). However, a recent extensive molecular epidemiological study of *E. granulosus* infections in Iran found that of 38 human CE cases, 8% were caused by infection with the camel strain and the remainder with the sheep strain of *E. granulosus* (Fasihi Harandi *et al.*, submitted for publication).

## IMMUNOLOGY

### Intermediate Host

The intermediate host of species of *Echinococcus* develops specific humoral and cellular responses to the parasite that may confer a significant level of resistance against reinfection (reviewed in Heath, 1986; Dixon 1997; Gottstein and Hemphill, 1997). This is also well-illustrated by

the successful attempts to vaccinate sheep against subsequent infection with *Echinococcus granulosus* (Heath, 1995; Heath and Lightowlers, 1997; Lightowlers *et al.*, 1996; Heath and Holcman, 1997). Unfortunately, little information is available on the details of immune responses directed against the invading and establishing oncosphere, as well as the developing and fully developed metacestode. It would appear that the invading oncosphere is vulnerable to the immune effector mechanisms of the host and hence the success of recent immunoprophylactic strategies. In this respect, antibody-mediated, complement-dependent destruction of *E. multilocularis* oncospheres, either in the gut or during migration, is thought to be the most effective mechanism of host defence in rodent models (Gottstein, 1992). However, once established, the developing and fully developed metacestode appears able to escape anti-oncospherical immunity (Gottstein and Hemphill, 1997). It has been proposed that *Echinococcus* metacestodes may hide, disguise or vary their antigens (Gottstein and Hemphill, 1997), thus acting as a mechanism for avoiding host immunity. However, any balance achieved in the parasite–host relationship is subject to mutual regulatory factors and includes the possibility of spontaneous rejection of the parasite, which may occur as a result of drug treatment, which impairs cyst integrity and exposes immunogenic cyst contents of the parasite to immune effector mechanisms. Two immunoregulatory, cytokine-like factors have been detected in the metacestodes of *Echinococcus*, one of which appears to influence T suppressor cells and the other macrophage activity (Dixon, 1997). As long as cyst integrity is maintained, the host–parasite relationship appears to be sustained in a dynamic equilibrium between parasite growth and acquired immunity (Dixon, 1997). As discussed earlier, it would appear that an intact laminated layer is the most important factor in protecting the parasite from immunological attack.

The nature of the host–parasite relationship in the face of apparently hostile immunity is interesting and provides a challenge for future research. Some clues can be obtained from the situation in animals. In areas where sheep are the principal intermediate host for the perpetuation of the life-cycle of *E. granulosus*, hydatid cysts are

usually fertile and in good condition, even in older animals examined at slaughter. In contrast, cysts in cattle are usually sterile and the cysts often degenerate and caseating. Histological examination of cysts from these animals typically reveals a well-formed, uniform laminated layer and a distinct fibrous (adventitial) layer, with little evidence of active host cellular proliferation (Thompson and Lymbery, 1990). In contrast, cysts in cattle reveal laminated layers of variable thickness, with little evidence of a fibrous layer, but ongoing active cellular proliferation is usually apparent. It would appear that in sheep, some measure of a balanced host–parasite relationship has developed and the initial cellular response against the parasite has resolved, resulting in the formation of an inactive fibrous layer that affords some degree of protection to the parasite and allows uniform development of the regulatory laminated layer, which in turn provides the developing parasite with the correct conditions to sustain development. Although susceptible to infection with the sheep strain of *E. granulosus*, cattle are clearly accidental hosts (Thompson, 1992), and there is no evidence of a balanced host–parasite relationship, since the host’s fibrous response shows no evidence of resolving (Thompson and Lymbery, 1990). The lack of a protective fibrous layer impairs normal development of the metacestode, often resulting in degeneration of the metacestode. This contrasting picture in sheep and cattle infected with the common sheep strain of *E. granulosus* illustrates the influence host responses can have on the development of the larval parasite, and that metacestode integrity is essential for survival of the metacestode. However, the mechanisms involved are not understood, particularly the factors that appear to regulate the intensity of host cellular responses.

Although humans are clearly not normal hosts for *Echinococcus*, cystic development in humans is highly variable. In some cases, large fertile cysts, with typical adventitial and laminated layers, may develop, whereas in other cases cysts may remain sterile and/or degenerate and calcify. The reasons for this are not clear but may reflect the fact that humans are susceptible to infection with a number of species/strains of *Echinococcus*, as well as differences related to age of the host.

### Definitive Host

Compared to the metacestode, very little attention has been given to the nature of immunological responses directed against the adult parasite by the definitive host. This is disappointing in view of the potential for controlling echinococcosis with immunoprophylactic strategies directed against infection in dogs. Specific antibodies have been detected in dogs as early as 5 days after infection (Jenkins and Rickard, 1986). In addition, systemic and localised cellular and humoral immune responses have been demonstrated in experimentally infected dogs (Deplazes *et al.*, 1994). In particular, these studies demonstrated the importance of Peyer’s patches in the immunological responses to infection with *Echinococcus* in dogs.

### EPIDEMIOLOGY

Understanding the causation of any parasitic disease necessitates the accurate characterisation of the aetiological agent(s) and a clear understanding of how that agent or agents are transmitted. In the case of echinococcosis, criteria have now been developed for identifying the aetiological agents but there are numerous endemic areas where transmission patterns and sources of infection have still to be determined. The situation is exacerbated by the inadequacies of current surveillance and the fact that the causative agents, particularly *E. multilocularis*, are extending their range. Although more comprehensive survey data, particularly in regions like China, may account for new information on the range of *Echinococcus*, there is also evidence of parasite occurrence in areas previously known to be free of infection.

### Geographic Distribution

Table 22.1 summarises the broad geographical distribution of the four currently recognised species of *Echinococcus*. However, the information in this table hides the fact that, within the species *E. granulosus*, there are a number of host-adapted strains/species (Table 22.2) and the

geographical distribution of these may not be as broad as that indicated in Table 22.1. For example, the pig strain of *E. granulosus* has been described from parts of Europe and South America and the horse strain appears to be largely restricted to Europe. Details of the geographical distribution of these different forms can be found in Schantz *et al.* (1995). However, as indicated earlier, there are many endemic areas where further studies are required to determine the geographical distribution of species and strains of *Echinococcus*. This applies particularly to the Middle East, Africa and China. Indeed, China is now recognised as the country with most major foci of both *E. granulosus* and *E. multilocularis* (Jenkins, 1998). One or both species of *Echinococcus* can be found in more than 87% of China, mainly in the northern, western and central provinces (Craig *et al.*, 1991; Chai, 1995; Schantz *et al.*, 1995).

The global distribution of *Echinococcus* and its perpetuation in domestic life-cycle patterns has resulted from human activity; either by translocation of livestock and non-native fauna during periods of colonisation or the establishment of 'man-made' cycles of transmission. We see examples of both situations in Australia, where the sheep strain of *E. granulosus* was introduced during European colonisation. As a result, a typical sheep-dog cycle was established and perpetuated by poor husbandry practices in many parts of the country, which has also resulted in 'spill-over' situations with the interaction of wild animal cycles, which serve as reservoirs of infection for both cattle and sheep (Lymbery *et al.*, 1995; Grainger and Jenkins, 1996). More recently, urban foci of transmission have been detected in Australia and are a consequence of interaction between wild animals and domestic dogs, as a result of increased hunting activity on the outskirts of urban areas (Thompson *et al.*, 1988, 1993, 1996; Thompson, 1992; Jenkins, 1998). The situation is also exacerbated by the increasing migration of foxes (an introduced animal) into urban environments in Australia (Jenkins and Craig, 1989). Similarly, in North America, the translocation of foxes for recreational hunting purposes has extended the range of *E. multilocularis* (Davidson *et al.*, 1992; Lee *et al.*, 1993; Storandt and

Kazacos, 1993; Schantz *et al.*, 1995; Wilson *et al.*, 1995).

The expanding distribution of *E. multilocularis*, as demonstrated in Europe, North America and Japan, is of particular concern because of the severity of the disease it causes in humans and the difficulties of controlling a parasite which is principally perpetuated in wild animal cycles of transmission. Newly identified endemic foci in Europe include Poland, the Czech Republic, parts of Germany and Switzerland (Malczewski *et al.*, 1995; Pavlasek *et al.*, 1997; Schmitt *et al.*, 1997; Tackmann *et al.*, 1998). Interestingly, the situation in central Europe has been exacerbated by the rabies control programme, which has resulted in a population expansion of the definitive host, the fox (Lucius and Bilger, 1995).

As discussed later in this chapter, effective control of echinococcosis depends upon a detailed knowledge of life cycle patterns, particularly human involvement in both perpetuating transmission cycles and being at risk of infection.

### Life-cycle Patterns

In endemic regions where a number of species of livestock are infected with cystic echinococcosis, it is important to determine which species are responsible for maintaining the life-cycle. This provides the basis not only for implementing targeted control efforts but, more fundamentally, for a reliable surveillance system, which is essential for successful control interventions (Gemmell and Roberts, 1995). This applies to parts of Europe, central Asia, China, Australia, Africa and the Middle East. For example, in Australia, where sheep, cattle, pigs and goats are susceptible to infection with the strain/species of *Echinococcus* present (Figure 22.4), husbandry factors suggest that sheep are the most important domestic intermediate host (Thompson, 1992). Cysts in sheep are usually fertile and dogs are likely to have access to sheep cysts as a result of direct feeding or scavenging. By contrast, sheep, cattle, buffalo and goats (Figure 22.5) all play a role in maintaining the life cycle of *Echinococcus* in many Middle Eastern countries, and where comparative studies have been undertaken, such

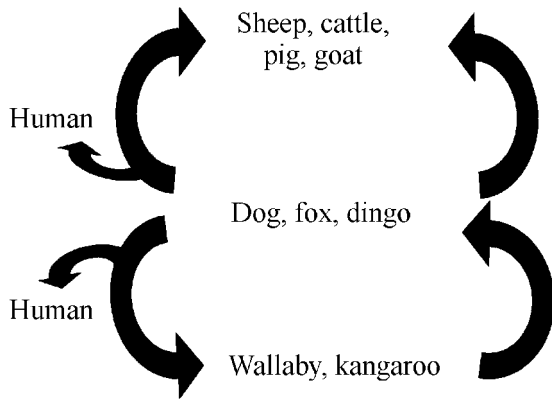


Fig. 22.4 Life-cycle and transmission patterns of *Echinococcus granulosus* in Australia

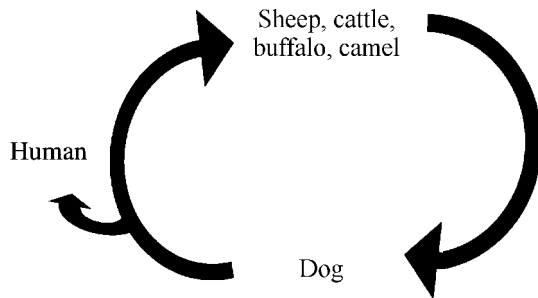


Fig. 22.5 Life-cycle of *Echinococcus granulosus* in the Middle East

as in Iran, data suggest that it is the same strain that infects these hosts (Hosseini, 1995; Fasihi Harandi *et al.*, submitted for publication). In the Xinjiang Uygur autonomous region of China, approximately 50–80% of sheep, cattle, horses and camels are infected with hydatid disease, and dogs may become infected by ingesting cysts from any one of these animals, or they may have mixed infections of adult worms at any given time (Rausch, 1993). In Spain and Jordan, a range of domestic intermediate hosts are also commonly infected, but it has been shown that three distinct strains (probably different species) of *E. granulosus* are perpetuated in different life-cycle patterns (Figure 22.6), of which the sheep strain appears to be the most important to public health (Kamhawi and Hijjawi, 1992; Siles Lucas *et al.*, 1994).

The problem of elucidating transmission patterns and putting strategies in place to interrupt the cycles is compounded in regions where wildlife are infected with *Echinococcus* and where there is the possibility of interaction with domestic hosts. Under such circumstances it is essential to determine whether species of wildlife act as reservoirs of the strain/species of *Echinococcus* to which livestock and humans are susceptible. In Australia, for example, wildlife are susceptible to the form of *Echinococcus* affecting sheep and other livestock. Interaction

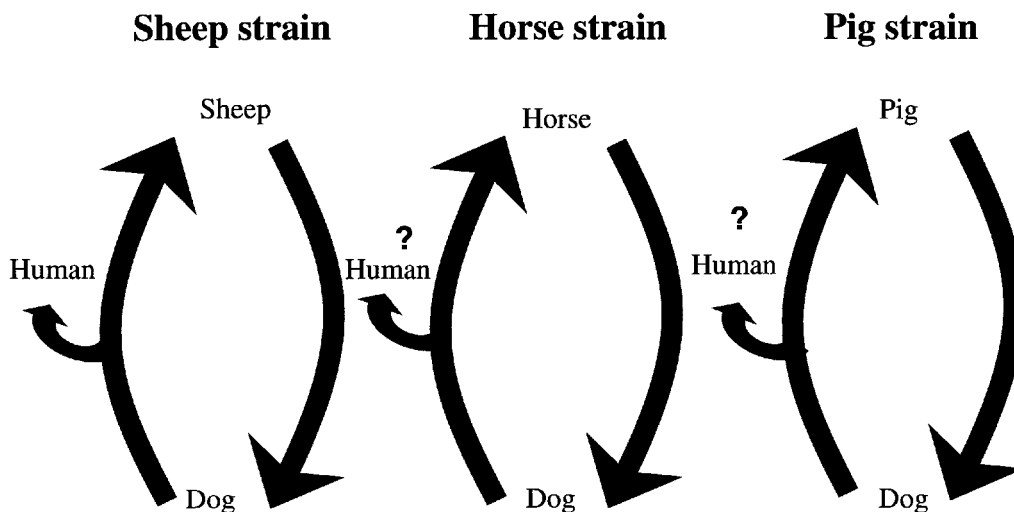


Fig. 22.6 Life-cycles and transmission patterns of *Echinococcus granulosus* in Spain and Jordan



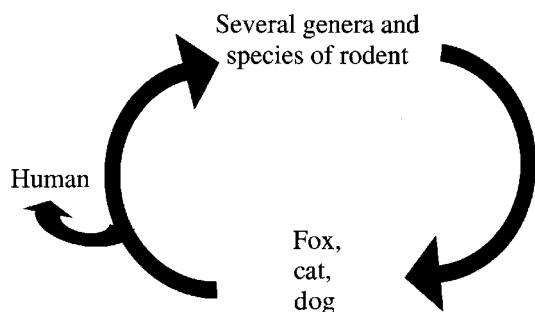


Fig. 22.7 Life-cycle of *Echinococcus multilocularis* in France and China

between wild and domestic cycles has been shown to occur on the Australian mainland (see below), and wild and feral animals appear to be important as sources of infection for cattle (Thompson, 1992; Lymbery *et al.*, 1995; Schantz *et al.*, 1995; Figure 22.4).

*E. multilocularis* also has a wide range of potential intermediate hosts (Rausch, 1995) and there is increasing concern over the interaction between the wild cycles of transmission and domestic definitive hosts. This is the case in France and China, where at least six genera of rodent intermediate hosts are involved in the transmission of *E. multilocularis* (Schantz *et al.*, 1995; Figure 22.7) and where it is important to determine which are the most important for transmission in both wild and domestic environments.

Determination of the role of different hosts in the transmission of *Echinococcus* requires accurate characterisation of the species and/or strain infecting a particular host. Although morphological techniques have been, and will continue to be, of value in this respect, the application of DNA techniques, particularly those utilising PCR procedures, are proving to be very useful (Thompson *et al.*, 2001). The adult stages recovered from definitive hosts may often be in too poor condition for morphological examination, and reliance on hook morphology is problematic for a number of reasons. There may not be sufficient discriminatory characters for differentiation based on hook morphology, and host-induced morphological variation may make specific identification difficult. It is for these reasons that molecular epidemiological techniques

are providing valuable data for characterising the aetiological agents of echinococcosis and elucidating transmission patterns.

### Molecular Epidemiology

In areas where there are several intermediate host species, it is important to know whether each harbours a different strain and whether there is the possibility of interaction between cycles. For example, in Britain, extensive studies have shown that *E. granulosus* is perpetuated in two distinct cycles of transmission, sheep–dog and horse–dog, and interaction is unlikely, since each cycle is associated with the perpetuation of a distinct strain/species exhibiting different intermediate host specificity characteristics (Thompson and Smyth, 1975; Thompson, 1991). Molecular characterisation of isolates of the parasite from horses and sheep has shown them to be genetically distinct, thus supporting the epidemiological observations (reviewed in Thompson *et al.*, 1995).

In contrast, on the mainland of Australia (Figure 22.4), although *E. granulosus* is maintained in contrasting cycles of transmission involving either domestic or wild host assemblages, there is no evidence of genetic distinctness between the parasites maintained in domestic or wild host populations (Lymbery *et al.*, 1990; Thompson and Lymbery, 1990, 1991; Hope *et al.*, 1991). However, interaction between wild and domestic cycles of transmission has been demonstrated, in areas where they overlap, by the use of a novel ‘transmission typing’ procedure, which takes advantage of host-induced morphological variation. Host-induced morphological variation may be a complicating factor in identifying strains, but in this case alterations to hook shape have proved to be very useful in epidemiological studies (Thompson and Lymbery, 1991), since they are induced during development in a particular species of intermediate host and are recognisable in the definitive host. These differences have been shown to be of great practical value in determining predator–prey relationships in areas of Australia where sylvatic and domestic cycles overlap (Constantine *et al.*, 1993).

Molecular genetic techniques provide tools for characterising species and strains of *Echinococcus* in different endemic areas and, in addition, can be used to obtain information about population structure. Estimates of gene flow between populations of *Echinococcus* in different hosts or geographic areas can have valuable epidemiological applications. For example, it has been shown that gene flow is restricted between populations of *E. granulosus* on the mainland of Australia and in the island state of Tasmania, and these populations are now recognised as different strains (Lymbery and Thompson, 1988; Thompson and Lymbery, 1988). Despite the genetic differences between mainland and Tasmanian populations, however, migration between the populations was calculated to be of sufficient magnitude to be responsible for occasional breakdowns in the largely successful Tasmanian hydatid control campaign (Lymbery, 1995; Lymbery *et al.*, 1997). In addition, Constantine *et al.* (1991) argued that the genetic distinctness of a population of *E. granulosus* on King Island, located between mainland Australia and Tasmania, made it unlikely to have originated from a recent introduction from either area.

## CLINICAL FEATURES

### Cystic Echinococcosis

The course of infection and clinical features of CE are characteristically very variable and are dependent upon:

- Strain of parasite.
- Rate of cyst growth and size.
- Organ and specific site of cystic involvement (e.g. involvement with ducts, airways or vascular system).
- Cyst integrity/rupture.
- Secondary infections.

The initial phase of infection in the human host is usually asymptomatic and infection may proceed for some time without any overt signs (Spruance, 1974). Recent studies indicate that over half of cases may be asymptomatic (Caremani *et al.*, 1991). It has also been estimated that, if cysts remain less than 5 cm, then they may not induce symptoms for many years (Grossi *et al.*, 1991). However, if the cyst continues to grow, the

infection may eventually become symptomatic if the cyst exerts pressure on tissue, interferes with organ function, becomes secondarily infected with bacteria or bursts. The latter complication may be life-threatening if it gives rise to acute immunological reactions such as anaphylactic shock or asthma (Ammann and Eckert, 1996).

Recurrence of the disease may occur after operation on primary cysts, often many years later (Ammann and Eckert, 1995). Spontaneous cure of CE has been reported, particularly as a result of cyst calcification or collapse, or if a cyst ruptures with subsequent discharge of cyst contents from the body via the airways or bile ducts (Ammann and Eckert, 1995).

### Multivesicular/Alveolar Echinococcosis

The clinical consequences in humans of MAE are much more serious than CE and there is a high lethality rate in untreated patients (Ammann and Eckert, 1995). As with CE, the initial phase of infection is asymptomatic and the incubation period may vary from 5 to 15 years (reviewed in Ammann and Eckert, 1995). The disease typically exhibits a chronic progressive clinical course lasting for weeks, months or years (Drolshammer *et al.*, 1973) but which may lead to death in more than 90% of untreated patients within 10 years after the onset of symptoms (Ammann and Eckert, 1995). The liver is the principal site of parasite development and, initially, the patient may present with epigastric pain, jaundice, hepatomegaly and/or weight loss. However, subsequent metastatic spread to other organs, such as the brain, lungs or bone, may result in a variety of clinical symptoms. Spontaneous cure due to the death of the metacestode has been reported (Rausch *et al.*, 1987; Gottstein, 1991), although the frequency of such cases is not known, nor whether the lesion degenerated before metastatic spread, although this would seem likely.

## LABORATORY DIAGNOSIS

### Non-human Hosts

The diagnosis of *Echinococcus* infection in animals is usually for public health reasons, particularly surveillance.

Unfortunately, there has been little success in developing immunological procedures for the diagnosis of hydatid infection in mammalian intermediate hosts apart from humans (Lightowers and Gottstein, 1995). The detection of hydatid cysts in livestock and other intermediate hosts is usually achieved at post mortem (Thompson and Allsopp, 1988; Craig *et al.*, 1996). The collection of data on the prevalence or incidence of hydatid infection in livestock by meat inspectors in abattoirs is an important aspect in monitoring the success of control programmes. Cysts can be detected visually in affected organs but palpation and, if necessary, incision of the organ is undertaken in food animals slaughtered for human consumption. It is important to differentiate hydatid lesions from those of other parasites, such as *Taenia hydatigena* cysticerci, and from other pathological lesions and developmental abnormalities, such as cystic bile ducts, which give rise to cysts often indistinguishable from hydatid cysts macroscopically. In such cases, histological confirmation may be necessary, which can be enhanced with special staining such as periodic acid–Schiff (PAS), which can be used to preferentially stain the laminated layer in cysts devoid of protoscoleces (Figure 22.3). Small nodular, calcified or granulomatous lesions, which may represent degenerating foci of hydatid infection, are difficult to identify specifically if a laminated layer is absent, and in these cases it may not be possible to determine the aetiology of the lesions.

As with animal intermediate hosts, the most reliable method of detecting an infection with the adult stages of *Echinococcus* in the definitive host is at post mortem, when the small intestine can be carefully examined for the presence of worms (Craig *et al.*, 1996). Such procedures are often used in surveys of wild or feral animals but require adequate laboratory facilities to limit the chances of human infection. Faecal diagnosis is less reliable, since *Echinococcus* eggs cannot be differentiated from those of *Taenia* species morphologically. The presence of proglottids in the faeces confirms diagnosis and a common method of diagnosis in dogs has been to use a purgative, usually arecoline, to cause evacuation of the intestinal contents. The faecal sample can then be washed, sieved and examined for the presence of proglottids or whole worms. How-

ever, arecoline purging has many limitations as a diagnostic tool for dogs. The response to the drug is variable and some dogs do not respond (WHO, 1981; Craig *et al.*, 1996). In addition, worms are sometimes not expelled from infected dogs which do respond to arecoline. Recent research has therefore concentrated on the development of immunodiagnostic and molecular techniques to detect infection in the definitive host. Of these, the detection of *Echinococcus* antigens in the faeces (copro-antigens) has proved to be a very successful diagnostic tool (Allan *et al.*, 1992; Deplazes *et al.*, 1992, 1997b, 1999; Craig *et al.*, 1996). Screening the sera from dogs for antibodies to the parasite has proved problematic but, with further research, may become a useful adjunct to copro-antigen detection, particularly in epidemiological surveys (Craig *et al.*, 1995, 1996; Malgor *et al.*, 1997). A more sensitive approach than copro-antigen assays may be possible using DNA procedures based on the polymerase chain reaction (PCR). As well as offering greater sensitivity, PCR-based techniques permit greater specificity and are likely to be useful tools in field surveys (Monnier *et al.*, 1996).

## Humans

The history of patients presenting with conditions suggestive of echinococcosis should be considered in supporting such a diagnosis, particularly with patients from endemic regions. For example, with CE, a history of exposure to sheep dogs in rural areas, or with MAE, fox trappers are clearly at risk.

Differential diagnosis for CE includes benign cystic lesions, cavitory tuberculosis, mycoses, abscesses and benign or malignant neoplasms; in the case of MAE, it is important to eliminate hepatic carcinoma and cirrhosis, which have similar clinical presentations (Schantz, 1997).

With CE, diagnosis is usually based on a combination of imaging techniques and immunodiagnostic tests. Imaging techniques include radiography, computed tomography (CT) ultrasound imaging and, occasionally, magnetic resonance imaging (MRI). Radiography is most useful for the detection of pulmonary cysts, since in other sites some calcification of the cysts is

necessary for visualisation (Schantz, 1997). CT, ultrasound and MRI are of value for detecting lesions in the liver and most other organs, especially with deep-seated lesions. Ultrasound imaging is proving to be a useful surveillance and epidemiological screening technique amongst some at-risk populations, particularly in Africa and China (Craig *et al.*, 1996). Ultrasound is relatively easy to perform, and portable units can be employed for the examination of patients in remote areas and for mass screening of populations (Ammann and Eckert, 1995).

Serology offers a useful adjunct to imaging and may provide confirmatory diagnostic information. It may also be an important element to control, particularly where surveillance for the disease in humans may add to early diagnosis and treatment. Enzyme immunoassays and the indirect haemagglutination test are highly sensitive procedures for initial screening, but specific confirmation of reactivity can be obtained by demonstrating specific *Echinococcus* antigens by arc 5 immunodiffusion or immunoblot assays (Schantz, 1997). However, overall the results of serology have been disappointing because of a lack of species specificity and poor diagnostic sensitivity (Lightowers and Gottstein, 1995). This may be improved with the availability of purified, species-specific antigens that enable serological discrimination between patients infected with *E. multilocularis* and *E. granulosus*. However, some infected individuals with CE do not develop a detectable immune response (Gottstein, 1992), and in those that do there is variability in serological sensitivity, due to differences in the host-parasite relationship and strain variation of the parasite (Lightowers and Gottstein, 1995). Thus, antigenic differences between strains/species, such as those demonstrated between isolates of *E. multilocularis* (Gottstein, 1991), could affect the reliability of immunological screening strategies. To have diagnostic value, immunological studies need to be undertaken separately for different strains/species that have been identified, because significant antigen homology would only be expected within such strains or species.

Craig (1993) raised the possibility of strain-specific antibody responses to *E. granulosus* several years ago, with reference to a human patient with CE in The Netherlands who was

found to be seronegative against routine sheep and horse hydatid cyst fluid antigens, but seropositive when tested against local bovine hydatid cyst fluid (Van Knapen, personal communication to Craig, 1993). DNA analysis of surgical samples from the Dutch patient identified the parasite as the cattle strain (Bowles *et al.*, 1992), and it was difficult to interpret this observation as anything other than strain/isolate-specific immunoreactivity (Craig, 1993).

In suspected CE patients who are serologically negative, diagnostic confirmation can be made by the recovery of laminated membrane and/or protoscoleces from biopsy material aspirated percutaneously from accessible and viable cysts, whereas with MAE, needle biopsy of the liver is required (Schantz, 1997). This procedure can nowadays be reliably effected with ultrasound guidance of the needle aspiration, and anticipatory precautions set in place in case of internal leakage of cyst contents.

## CLINICAL MANAGEMENT

### Cystic Echinococcosis

Surgery remains the most commonly employed approach for the clinical management of CE. Removal of intact cysts remains the treatment of choice, offering the fewest complications and the best prognosis (Schantz, 1997). The main surgical options are pericystectomy, partial organ resection and cystectomy (Morris and Richards, 1992). Recently, the percutaneous puncture of cysts, aspiration of cyst fluid, introduction of protoscolicide and re-aspiration (PAIR) technique has provided a useful alternative to surgery alone (Ammann and Eckert, 1995). This technique is enhanced with the use of ultrasound guidance of the percutaneous puncture, and hypertonic saline or ethanol have been most commonly used as protoscolicidal agents (Ammann and Eckert, 1995).

Over the last 15 years, chemotherapy has provided a useful adjunct to traditional surgical intervention for the treatment of CE and is often used in conjunction with the PAIR procedure. Benzimidazole (BZ) drugs are most often used, particularly albendazole, which is often given for 1–2 weeks before surgery and for several weeks

afterwards. The aim of using albendazole in this way is to provide sufficient anthelmintic 'cover' in the body to prevent recurrence of cystic development from any parasite material that may 'spill' or be left behind following surgical intervention. This is particularly likely if viable protoscolexes or germinal layer material are not removed at surgery.

In some cases, surgery may not be possible because of the patient's clinical condition, location of the cyst(s), or when there are multiple cystic foci. Treatment with BZs may be indicated in such circumstances or to prevent secondary echinococcosis following spontaneous or traumatic rupture of cysts (WHO, 1992; Schantz, 1997). Mebendazole was the first BZ to be used against CE, but more recently albendazole has been introduced and is now more often used, not only for treatment but also before surgery to reduce the risk of recurrence. Comparative studies have shown that albendazole is slightly more effective than mebendazole (10–15%) and may be more effective in producing 'cure' (Horton, 1996). Albendazole is more efficacious because of its superior pharmacokinetic profile, which favours intestinal absorption and penetration into the cyst(s) (Schantz, 1997). Albendazole is more consistently absorbed than mebendazole and is subsequently metabolised into an effective sulphoxide metabolite. Furthermore, in terms of dosing convenience and duration of therapy, albendazole has a clear advantage. The 'standard' 800 mg/day regimen requires only four tablets to be taken, compared to doses of at least 2 g/day with mebendazole (Horton, 1996). A positive response is also achieved with a shorter duration of therapy. To date, more than 1000 well-documented cases of CE have been treated with albendazole or mebendazole, with approximately one-third being cured; between 30–50% have shown signs of cyst degeneration or regression of cyst size; and in 20–40%, cysts remained morphologically unchanged (Horton, 1996; Ammann and Eckert, 1996). Small (less than 7 mm diameter) isolated cysts, surrounded by a minimal adventitial layer, respond best to chemotherapy, whereas complicated cysts with multiple compartments or daughter cysts, or with thick or calcified surrounding adventitial reactions, are relatively refractory to treatment (Schantz, 1997).

### Multivesicular/Alveolar Echinococcosis

Because of the more aggressive nature and metastatic potential of the disease caused by *E. multilocularis* in humans, radical surgical resection of the affected liver lobes or parts of other organs is the only therapeutic option for MAE. As such, excision of the parasite lesions must follow the rules of radical tumour surgery (Uchino and Sato, 1993). Ammann and Eckert (1996) have summarised the main factors that determine the resectability of MAE:

- Localisation and extension of the liver lesions; absence of involvement of major blood vessels; absence of distant metastases.
- Age, general condition of the patient, and the condition of the unaffected liver (e.g. cirrhosis).
- Competence of the surgical team in performing large liver resections.

Because it is difficult or impossible to predict whether or not all metacestode tissue has been removed by radical surgery, it is now common practice, and recommended by WHO, that patients receive postoperative chemotherapy for 2 years after radical surgery and remain under supervision for at least 10 years (Ammann and Eckert, 1996; WHO, 1996).

Because MAE is often not diagnosed until the disease is advanced, the lesion is often inoperable (Schantz, 1997). However, liver transplantation has been carried out successfully on a few otherwise inoperable terminal patients (Bresson-Hadni *et al.*, 1991). Unfortunately, subsequent recurrence in some of the patients and concern over the adverse effects of post-operative immunosuppressive treatment suggests that this procedure may only have a limited indication for a selected, small group of patients (Ammann, 1995; Ammann and Eckert, 1996).

Long-term chemotherapy with BZs inhibits growth of the metacestode lesion, reduces metastasis and enhances both the quality and length of survival (Schantz, 1997). The evidence suggests that limited duration of drug treatment is unlikely to be of benefit, and that it needs to be continued for months or even years (Horton, 1996). Using albendazole, it has been shown that regression and possible cure of MAE can be obtained with doses of albendazole of 20 mg/kg/day

continuously for at least 20 months (Yue Han *et al.*, 1993). This is very encouraging in a disease which formerly had a 5 year survival rate of about 20% (Horton, 1996).

## PREVENTION AND CONTROL

The efforts of localised control programmes, such as those targeting the causative agent of CE, *E. granulosus*, in Tasmania and Cyprus, have clearly shown the benefits of preventative strategies in reducing the incidence of disease in humans and domestic animals. Such results have been reinforced by recent mathematical modelling of the life-cycles of species of *Echinococcus*, which has indicated that the transmission dynamics of the parasite should make it vulnerable to control intervention (Gemmell and Roberts, 1995). However, before any control programme is initiated, adequate base-line data of the prevalence in dogs and livestock are essential, as is knowledge of local epidemiology. Without such data, it is impossible to monitor the success of any control campaign.

The aim of control programmes is to break the life-cycle of the parasite, and the most important factors in the prevention and control of echinococcosis are surveillance and education. Appropriate, targeted health education is the key to success, particularly in campaigns which elicit community participation, and it is arguable whether more effective control would be possible, even if anti-metacestocidal vaccines or drugs were used.

### *E. granulosus*

A number of successful, localised CE control programmes have all relied upon efficient educational programmes to prevent infection of dogs, and have all achieved significant reductions in prevalence (Schantz *et al.*, 1995). Concurrent with the educational campaigns are effective monitoring of the level of infection in dogs, livestock and humans, legislative measures, including fines and quarantine of affected livestock, control of stray dogs, and control of

livestock slaughtering in abattoirs and on farms (Schantz *et al.*, 1995). However, as indicated earlier in this chapter, the effectiveness of such control programmes requires an understanding of local patterns of transmission (Thompson, 1992; Schantz *et al.*, 1995). Essentially, the disease is entirely preventable, particularly in domestic cycles of transmission, where human involvement in perpetuating the life-cycle has long been recognised (Ross, 1926), and is a key focal point in successful control programmes. However, in most endemic areas, effective control has not been achieved or even attempted (Schantz *et al.*, 1995) and there is evidence from many parts of the world that the causative agents of both CE and MAE are extending their range (Storandt and Kazacos, 1993; Lucius and Bilger, 1995; Malczewski *et al.*, 1995; Schantz *et al.*, 1995).

An important and controversial aspect of control programmes is whether to strive for complete eradication. The reproductive potential of the parasite would suggest that it might 'bounce back' if the pressure of an intensive control campaign was lessened, but there is insufficient information to enable an accurate prediction from mathematical models (Gemmell and Roberts, 1995; Roberts and Aubert, 1995). However, warnings of the dangers of complacency if control measures are relaxed or not sustained due to either budgetary or political reasons, have been made with respect to Tasmania, Wales and Cyprus (Goldsmid and Pickmere, 1987; Palmer *et al.*, 1996; Economides, 1997). Tasmania offers a useful example. Although occasional human cases are still recorded (Anon, 1998), they are not considered to represent recently acquired infections of CE, and this Australian island state was declared 'provisionally free' of hydatid disease in February 1996. This was following disposal of the last known infected sheep flocks, and the rationale for this declaration was based on the following (M. Middleton, Department of Primary Industry and Fisheries, Tasmania, personal communication):

- There were no more sheep flocks known to be infected.
- *E. granulosus* is not known to infect Tasmanian wildlife.
- The last infected dog was detected 8 years previously.

- Epidemiological evidence strongly suggests that transmission to the human population in Tasmania ceased in the early 1970s.
- A robust surveillance programme is in place, involving the slaughter inspection of about 400 000 adult sheep and 60 000 cattle each year.
- Meat inspection staff have a demonstrated ability to detect extremely low levels of infection and very small cysts.
- A proven traceback system is in place.
- Tasmania maintains a 'contain and stamp out' policy for infected sheep flocks, regardless of the level of infection detected.
- Animals from infected flocks can only be sold direct for slaughter.
- In July 1997, Tasmania introduced pre-entry treatment for dogs entering the State, greatly reducing the risk of introduction of *Echinococcus* from the mainland.

Since this provisional freedom declaration, two large Tasmanian sheep flocks have been placed in quarantine following detection of very low levels of hydatid infection at slaughter (M. Middleton, personal communication). Large numbers of sheep from each flock have subsequently been slaughtered and inspected, with negative results. One cattle herd was also placed in quarantine following detection of viable cysts in young cattle. The source was an imported working dog from the Australian mainland, which entered the State before the pre-entry treatment programme commenced.

### *E. multilocularis*

Effective control of echinococcosis is often complicated by a wide intermediate host range, and exacerbated further where there is the possibility of interaction with susceptible species of wildlife. This is particularly so for *E. multilocularis* because of the importance of wild animal cycles in perpetuating the parasite in all endemic regions. In most cases, control through elimination of sylvatic hosts would be impractical, but where human exposure to the risk of infection is likely to be related to cycles involving domestic hosts, protection might be achieved by regular

cestocidal treatment of dogs (Schantz *et al.*, 1995).

Prevention of human infection with MAE in regions where *E. multilocularis* is perpetuated in wild animal cycles is dependent on personal preventive measures, particularly avoiding foxes and other potentially infected definitive hosts. It is also important to try to prevent infection from sylvatic cycles becoming established in domestic pets, and thus domestic dogs and cats must be well controlled in such endemic areas. A more recent approach to controlling the transmission of *E. multilocularis* in wild animal cycles is to deliver cestocidal drugs, such as praziquantel, in baits (Schantz *et al.*, 1995). Recent trials in southern Germany using bait pellets each containing 50 mg praziquantel have shown a reduction in prevalence in foxes from 32% to 4% after six baiting campaigns over a period of 14 months (Schelling *et al.*, 1997). However, the long-term efficacy of this control strategy has still to be determined.

### Strain Variation

Developmental differences between species and strains of *Echinococcus*, and in particular variation in the onset of egg production, is likely to be a limiting factor in control programmes that employ regular, adult cestocidal treatment of definitive hosts for breaking the cycle of transmission. This has been demonstrated in several strains of *E. granulosus* (Kumaratilake *et al.*, 1983; Thompson *et al.*, 1984; Eckert *et al.*, 1989). For example, with the cattle strain, the adult parasite exhibits a precocious development in the definitive host, with a short prepatent period of only 33–35 days, nearly a week earlier than that of the common sheep strain (Thompson *et al.*, 1984).

### The Future—Vaccination?

With CE, some authorities consider that vaccination of livestock, particularly sheep, may be a useful approach where reinfection of livestock is likely to occur from outside the control area (Heath and Lightowlers, 1997). The recent

development of an effective recombinant vaccine against ovine echinococcosis (Lightowlers *et al.*, 1996) may thus provide a useful adjunct in control programmes. The vaccine is currently being trialled in a number of geographical areas where CE is endemic, in order to compare efficacy and also to determine whether the vaccine is effective against more than one strain of *E. granulosus* (Heath and Lightowlers, 1997). The future potential of any immunoprophylactic strategy for echinococcosis may be jeopardised by demonstrated antigenic differences between isolates of *Echinococcus* (Thompson, 1995). Results to date have demonstrated up to 98% resistance to a challenge infection in sheep (Heath and Holcman, 1997). For the practical benefits of this vaccine to be realised in the context of control, depends upon the support of Governments and farmers. This is highlighted by the lack of commercial success with the *Taenia ovis* recombinant vaccine (Rickard *et al.*, 1995). In this respect, recent developments with novel expression vectors and routes of administration (Carol *et al.*, 1997; Chabalgoity *et al.*, 1997) may enhance the future potential of vaccines as a practical tool in the control of echinococcosis. However, perhaps a different approach should be investigated, in which the definitive host is targeted for the development of novel immunoprophylactic strategies against *Echinococcus*. Although this presents new challenges in terms of the research required and the need for global collaborative interactions, if successful, it is likely to be both a practical and commercial success.

## REFERENCES

- Ali-Khan Z, Siboo R, Gomersall M *et al.* (1983). Cystolytic events and the possible role of germinal cells in metastasis in chronic alveolar hydatidosis. *Ann Trop Med Parasitol* **77**: 497–512.
- Allan JC, Craig PS, Gracie Noval J *et al.* (1992). Coproantigen detection for immunodiagnosis of echinococcosis and taeniasis in dogs and humans. *Parasitology* **104**: 347–55.
- Ammann RW (1995). Alveolar echinococcosis and liver transplantation. *Hepatology* **20**: 1007.
- Ammann RW, Eckert J (1995). Clinical diagnosis and treatment of echinococcosis in humans. In Thompson RCA, Lymbery AJ (eds), *Echinococcus and Hydatid Disease*. CAB International: Wallingford; 411–63.
- Ammann RW, Eckert J (1996). Cestodes: *Echinococcus*. *Gastroenterol Clin N Am* **25**: 655–89.
- Anon. (1998). Communicable Diseases Surveillance. *Comm Dis Intell* **22**: 81–91.
- Batsch AJGC (1786). *Naturgeschichte der Bandwurmgattung überhaupt und ihrer Arten insbesondere, nach den neuen Beobachtungen in einem systematischen Auszuge*. Halle.
- Bowles J, McManus DP (1993a). Rapid discrimination of *Echinococcus* species and strains using a polymerase chain reaction-based RFLP method. *Mol Biochem Parasitol* **57**: 231–9.
- Bowles J, McManus DP (1993b). Molecular variation in *Echinococcus*. *Acta Trop* **53**: 291–305.
- Bowles J, van Knapen F, McManus D (1992). Cattle strain of *Echinococcus granulosus* and human infection. *Lancet* **339**: 1358.
- Bowles J, Blair D, McManus DP (1995). A molecular phylogeny of the genus *Echinococcus*. *Parasitology* **110**: 317–28.
- Bresson-Hadni S, Franza A, Miguet JP *et al.* (1991). Orthotopic liver transplantation for incurable alveolar echinococcosis of the liver. *Hepatology* **13**: 1061–70.
- Cameron TWM, Webster GA (1969). The histogenesis of the hydatid cyst (*Echinococcus* spp.). Part 1. Liver cysts in large mammals. *Can J Zool* **47**: 1405–10.
- Caremani M, Vincenti A, Filice C *et al.* (1991). Detection of hydatid cysts with echography: survey on 249 299 patients. *Arch Hidatidosis* **30**: 277–307.
- Carol H, Nieto A, Villacres-Eriksson M *et al.* (1997). Intranasal immunization of mice with *Echinococcus granulosus* surface antigens iscoms evokes a strong immune response, biased towards glucidic epitopes. *Parasite Immunol* **19**: 197–205.
- Chabalgoity JA, Harrison JA, Esteves A (1997). Expression and immunogenicity of an *Echinococcus granulosus* fatty acid-binding protein in live attenuated *Salmonella* vaccine strains. *Infect Immun* **65**: 2402–12.
- Chai JJ (1995). Epidemiological studies on cystic *Echinococcus* in China: a review. *Biomed Environm Sci* **8**: 122–36.
- Coltorti EA, Varela-Diaz VM (1974). *Echinococcus granulosus*: penetration of macromolecules and their localization on the parasite membranes of cysts. *Exp Parasitol* **35**: 225–31.
- Constantine CC, Lymbery AJ, Thompson RCA *et al.* (1991). The origin of a new focus of infection with *Echinococcus granulosus* in Tasmania. *Int J Parasitol* **21**: 959–62.
- Constantine CC, Thompson RCA, Jenkins DJ *et al.* (1993). Morphological characterization of adult *Echinococcus granulosus* as a means of determining transmission patterns. *J Parasitol* **79**: 57–61.
- Constantine CC, Bennet-Jenkins EM, Lymbery AJ *et al.* (1998). Factors influencing the development and carbohydrate metabolism of *Echinococcus granulosus* in dogs. *J Parasitol* **84**: 873–81.
- Craig PS (1993). Immunodiagnosis of *Echinococcus granulosus*. In Anderson FL, Chai J, Liu F (eds), *Compendium on Cystic Echinococcosis with Special Reference to the Xinjiang Uygur Autonomous Region, The People's Republic of China*. Brigham Young University: Provo, UT; 85–118.
- Craig PS, Deshan L, Zhaoxun D (1991). Hydatid disease in China. *Parasitol Today* **7**: 46–50.
- Craig PS, Gasser RB, Parada L *et al.* (1995). Diagnosis of canine echinococcosis: comparison of coproantigen and



- serum antibody tests with arecoline purgation in Uruguay. *Vet Parasitol* **56**: 293–301.
- Craig PS, Rogan MT, Allan JC (1996). Detection, screening and community epidemiology of Taeniid cestode zoonoses: cystic echinococcosis, alveolar echinococcosis and neurocysticercosis. *Adv Parasitol* **38**: 169–250.
- Davidson WR, Appel MJ, Doster GL *et al.* (1992). Diseases and parasites of red foxes, gray foxes, and coyotes from commercial sources selling to fox-chasing enclosures. *J Wildlife Dis* **28**: 581–9.
- Deplazes P, Gottstein N, Eckert J *et al.* (1992). Detection of *Echinococcus* coproantigens by enzyme-linked immunosorbent assay in dogs, dingoes and foxes. *Parasitol Res* **78**: 303–8.
- Deplazes P, Thompson RCA, Constantine CC *et al.* (1994). Primary infection of dogs with *Echinococcus granulosus*: systemic and local (Peyer's patches) immune responses. *Vet Immunol Immunopathol* **40**: 171–84.
- Deplazes P, Arnold P, Kaser-Hotz B *et al.* (1997a). Concurrent infections of the liver and intestine with *Echinococcus multilocularis* in dogs. *Arch Int Hidatidosis* **32**: 201–2.
- Deplazes P, Mathis A, Eckert J (1997b). Diagnosis of *Echinococcus* infections in final hosts by coproantigen and DNA detection. *Arch Int Hidatidosis* **32**: 198–201.
- Deplazes P, Alther P, Tanner I, Thompson RCA, Eckert J (1999). *Echinococcus multilocularis* coproantigen detection by enzyme-linked immunosorbent assay in fox, dog and cat populations. *J Parasitol* **85**: 115–21.
- Dixon JB (1997). Echinococcosis. *Comp Immunol Microbiol Infect Dis* **20**: 87–94.
- Drolshammer I, Wiesmann E, Eckert J (1973). Echinokokkose beim Menschen in der Schweiz, 1956–1969. *Schweiz Med Wochenschr* **103**: 1337–41; 1386–92.
- Eckert J, Thompson RCA (1988). *Echinococcus* strains in Europe: a review. *Tropenmed Parasitol* **39**: 1–8.
- Eckert J, Thompson RCA, Mehlhorn H (1983). Proliferation and metastases formation of larval *Echinococcus multilocularis*. I. Animal model, macroscopical and histological findings. *Zeitschr Parasit* **69**: 737–48.
- Eckert J, Thompson RCA, Michael SA *et al.* (1989). *Echinococcus granulosus* of camel origin: development in dogs and parasite morphology. *Parasitol Res* **75**: 536–44.
- Eckert J, Thompson RCA, Lymbery AJ *et al.* (1993). Further evidence for the occurrence of a distinct strain of *Echinococcus granulosus* in European pigs. *Parasitol Res* **79**: 42–8.
- Economides P (1997). Experience gained and evaluation of the echinococcosis/hydatidosis eradication campaign in Cyprus, 12 years after its completion. *Arch Int Hidatidosis* **32**: 91–6.
- French CM, Nelson GS, Wood M (1982). Hydatid disease in the Turkana district of Kenya. I. The back-ground to the problem with hypotheses to account for the remarkably high prevalence of the disease in man. *Ann Trop Med Parasitol* **76**: 425–37.
- Gebreel AO, Gilles HM, Prescott JE (1983). Studies on the seroepidemiology of endemic diseases in Libya. *Ann Trop Med Parasitol* **77**: 391–7.
- Geisel O, Barutzki D, Minkus G *et al.* (1990). Hunde als Finnertrager (Intermediarwirt) von *Echinococcus multilocularis* (Leuckart, 1863), Vogel 1957. *Kleintierpraxis* **35**: 275–80.
- Gemmell MA (1962). Natural and acquired immunity factors interfering with development during the rapid growth phase of *Echinococcus granulosus* in dogs. *Immunology* **5**: 496–503.
- Gemmell MA, Lawson JR (1986). Epidemiology and control of hydatid disease. In Thompson RCA (ed.), *The Biology of Echinococcus and Hydatid Disease*. George Allen and Unwin: London; 189–216.
- Gemmell MA, Roberts MG (1995). Modelling *Echinococcus* life cycles. In Thompson RCA, Lymbery AJ (eds), *Biology of Echinococcus and Hydatid Disease*. CAB International: Wallingford; 333–54.
- Goldsmid JM, Pickmere J (1987). Hydatid eradication in Tasmania. Point of no return? *Aust Fam Physic* **16**: 1672–4.
- Gottstein B (1991). *Echinococcus multilocularis*: antigenic variance between different parasite isolates. *Parasitol Res* **77**: 359–61.
- Gottstein B (1992). *Echinococcus multilocularis*: immunology and immunodiagnosis. *Adv Parasitol* **31**: 321–80.
- Gottstein B, Hemphill A (1997). Immunopathology of Echinococcosis. *Chem Immunol* **66**: 177–208.
- Grainger HJ, Jenkins DJ (1996). Transmission of hydatid disease to sheep from wild dogs in Victoria, Australia. *Int J Parasitol* **26**: 1263–70.
- Grossi G, Lastilla MG, Teggi A *et al.* (1991). 420 patients with hydatid cysts: observations on the clinical picture. *Arch Int Hidatidosis* **30**: 1021.
- Grove DI (1990). *A History of Human Helminthology*. CAB International: Wallingford.
- Haag KL, Zaha A, Araujo AM, Gottstein B (1997). Reduced genetic variability within coding and non-coding regions of the *Echinococcus multilocularis* genome. *Parasitology* **115**: 521–9.
- Heath DD (1971). The migration of oncospheres of *Taenia pisiformis*, *T. serialis* and *Echinococcus granulosus* within the intermediate host. *Int J Parasitol* **1**: 145–52.
- Heath DD (1973). The life cycle of *Echinococcus granulosus*. In Brown RW, Salisbury JR, White WE (eds), *Recent Advances in Hydatid Disease*. Hamilton Medical and Veterinary Association: Victoria, Australia; 7–18.
- Heath DD (1986). Immunobiology of *Echinococcus* infections. In Thompson RCA (ed.), *The Biology of Echinococcus and Hydatid Disease*. Allen and Unwin: London; 164–88.
- Heath DD (1995). Immunology of *Echinococcus* infections. In Thompson RCA, Lymbery AJ (eds), *Echinococcus and Hydatid Disease*. CAB International: Wallingford; 183–99.
- Heath DD, Lawrence SB (1991). Daily egg production of dogs infected with *Echinococcus granulosus*. *Arch Int Hidatidosis* **30**: 321–8.
- Heath DD, Holcman B (1997). Vaccination against *Echinococcus* in perspective. *Acta Trop* **67**: 37–41.
- Heath DD, Lightowlers MW (1997). Vaccination on hydatidology—state of the art. *Arch Int Hidatidosis* **32**: 209–14.
- Hope M, Bowles J, McManus DP (1991). A reconsideration of the *Echinococcus granulosus* strain situation in Australia following RFLP analysis of cystic material. *Int J Parasitol* **21**: 471–5.

- Horton J (1996). Albendazole: a review of the pharmacology, pharmacokinetics, clinical efficacy and safety in hydatid disease. In Uchino J, Sato N (eds), *Alveolar Echinococcus: Strategy for Eradication of Alveolar Echinococcosis of the Liver*. Fuji Shoin: Japan; 261–82.
- Hosemann G (1928). Morphologie und Biologie des *Echinococcus cysticus*. In Hosemann G, Schwarz E, Lehmann JC, Posselt A (eds), *Die Echinokokkenkrankheit*. Ferdinand Enke: Stuttgart; 1–66.
- Hosseini SH (1995). Morphological characterisation of *Echinococcus granulosus* in Iran. Master's Thesis, University of Tehran.
- Ibrahim MM, Craig PS (1998). Prevalence of cystic echinococcosis in camels (*Camelus dromedarius*) in Libya. *J Helminthol* **72**: 27–31.
- Ishige M, Yagi K, Itoh T (1990). Egg production and life span of *Echinococcus multilocularis* in dogs, Hokkaido, Japan. In *Proceedings of an International Workshop in Alveolar Hydatid Disease*, Anchorage, Alaska, pp 14–15.
- Jenkins DJ (1998). Hydatidosis—a zoonosis of unrecognised increasing importance? *J Med Microbiol* **47**: 1–3.
- Jenkins DJ, Craig NAT (1989). The role of foxes (*Vulpes vulpes*) in the epidemiology of *Echinococcus granulosus* in urban environments. *Med J Aust* **157**: 754–6.
- Jenkins DJ, Rickard MD (1986). Specific antibody responses in dogs experimentally infected with *Echinococcus granulosus*. *Am J Trop Med Hyg* **35**: 345–9.
- Kamhawi S, Hijawi N (1992). Current studies on the epidemiology of unilocular hydatidosis in Jordan and its social implications. *Report on Parasitic Diseases of the Middle East*. National Institutes of Health: Bethesda, MD: 8.
- Kilejian A, Schinazi LA, Schwabe CW (1961). Host–parasite relationships in echinococcosis. V. Histochemical observations on *Echinococcus granulosus*. *J Parasitol* **47**: 181–8.
- Krotov AI (1979). The question of the subspecies of *Echinococcus Rudolphi*, 1801. *Meditinskaya Bolezni* **48**: 22–6.
- Küchenmeister F (1857). On animal and vegetable parasites of the human body. *Soc Sydenham Lond* **1**: 192–43.
- Kumaratilake LM (1982). Aspects of the Speciation of *Echinococcus granulosus* in Australia. PhD Thesis, Murdoch University.
- Kumaratilake LM, Thompson RCA (1982). A review of the taxonomy and speciation of the genus *Echinococcus*. *Zeitschr Parasit* **68**: 121–46.
- Kumaratilake LM, Thompson RCA, Dunsmore JD (1983). Comparative strobilar development of *Echinococcus granulosus* of sheep origin from different geographical areas of Australia *in vivo* and *in vitro*. *Int J Parasitol* **13**: 151–6.
- Leducq R, Gabrion C (1992). Developmental changes of *Echinococcus multilocularis* metacystodes revealed by tegumental ultrastructure and lectin-binding sites. *Parasitology* **104**: 129–41.
- Lee GW, Lee KA, Davidson WR (1993). Evaluation of fox-chasing enclosures as sites of potential introduction and establishment of *Echinococcus multilocularis*. *J Wildlife Dis* **29**: 498–501.
- Leuckart R (1886). *Die Parasiten des Menschen und die von ihnen herrührenden Krankheiten*, 2nd edn, vol 1. GF Winter: Leipzig, Heidelberg; 578–92.
- Lightowers MW, Gottstein B (1995). Echinococcosis/hydatidosis: antigens, immunological and molecular diagnosis. In Thompson RCA, Lymbery AJ (eds), *Echinococcus and Hydatid Disease*. CAB International: Wallingford; 355–410.
- Lightowers MW, Lawrence SB, Gauci CG *et al.* (1996). Vaccination against hydatidosis using a defined recombinant antigen. *Parasite Immunol* **18**: 457–62.
- Lopera RD, Melendez RD, Fernandez I *et al.* (1989). Orbital hydatid cyst of *Echinococcus oligarthrus* in a human in Venezuela. *J Parasitol* **75**: 467–70.
- Lopez-Neyra CR, Soler Planas MA (1943). Revision del genero *Echinococcus* Rud y description de una especie nueva Parasita intestinal del porro en Almeria. *Rev Ibér Parasitol* **3**: 169–94.
- Losson BJ, Coignoul F (1997). Larval *Echinococcus multilocularis* infection in a dog. *Vet Rec* **141**: 49–50.
- Lucius R, Bilger B (1995). *Echinococcus multilocularis* in Germany: increased awareness or spreading of a parasite? *Parasitol Today* **11**: 430–4.
- Lymbery AJ (1995). Genetic diversity, genetic differentiation and speciation. In Thompson RCA, Lymbery AJ (eds), *Echinococcus and Hydatid Disease*. CAB International: Wallingford; 51–87.
- Lymbery AJ, Thompson RCA (1988). Electrophoretic analysis of genetic variation in *Echinococcus granulosus* from domestic hosts in Australia. *Int J Parasitol* **18**: 803–11.
- Lymbery AJ, Thompson RCA (1996) Species in the genus *Echinococcus*: pattern and process. *Parasitol Today* **12**: 486–91.
- Lymbery AJ, Thompson RCA, Hobbs RP (1990). Genetic diversity and genetic differentiation in *Echinococcus granulosus* (Batsch, 1786) from domestic and sylvatic hosts on the mainland of Australia. *Parasitology* **101**: 283–9.
- Lymbery AJ, Thompson RCA, Constantine CC *et al.* (1995). The geographic distribution of hydatid infection in cattle in Western Australia. *Aust Vet J* **72**: 430–1.
- Lymbery AJ, Constantine CC, Thompson RCA (1997). Self-fertilization without genomic or population structuring in a parasite tapeworm. *Evolution* **51**: 289–94.
- Malczewski A, Rocki B, Ramisz A *et al.* (1995). *Echinococcus multilocularis* (Cestoda), the causative agent of alveolar echinococcosis in humans: first record in Poland. *J Parasitol* **81**: 318–21.
- Malgor R, Nonaka N, Basmadjian I *et al.* (1997). Coproantigen detection in dogs experimentally and naturally infected with *Echinococcus granulosus* by a monoclonal antibody-based enzyme-linked immunosorbent assay. *Int J Parasitol* **27**: 1605–12.
- Mehlhorn H, Eckert J, Thompson RCA (1983). Proliferation and metastases formation of larval *Echinococcus multilocularis*. II. Ultrastructural investigations. *Zeitschr Parasit* **69**: 749–63.
- Monnier P, Cliquet F, Aubert M *et al.* (1996). Improvement of a polymerase chain reaction assay for the detection of *Echinococcus multilocularis* DNA in faecal samples of foxes. *Vet Parasitol* **67**: 185–95.
- Morris DL, Richards KS (1992). *Hydatid Disease. Current Medical and Surgical Management*. Butterworth-Heinemann: Oxford.

- Ortlepp RJ (1934). *Echinococcus* in dogs from Pretoria and vicinity. *Onderstepoort J Vet Sci* **3**: 97–108.
- Palmer SR, Biffin AH, Craig PS *et al.* (1996). Control of hydatid disease in Wales. *Br Med J* **312**: 674–5.
- Pavlašek I, Chalupsky J, Kolarova L *et al.* (1997). Occurrence of *Echinococcus multilocularis* Leuckart, 1863, in foxes (*Vulpes vulpes*) in the Czech Republic. *Epidemiol Mikrobiol Immun.*
- Pawlowski ZS (1997). Critical points in the clinical management of cystic *Echinococcus*: a revised review. In Andersen FL, Ouhelli H, Kachani M (eds), *Compendium on Cystic Echinococcosis*. Brigham Young University: Provo, UT; 119–35.
- Pawlowski Z, Mrozewicz B, Stefaniak J *et al.* (1993). *Echinococcus granulosus* pig strain from Poland has low infectivity to humans. *Am J Trop Med Hyg* **49**: 342–3.
- Rausch RL (1967). A consideration of intraspecific categories in the genus *Echinococcus* Rudolphi, 1801 (Cestoda: Taeniidae). *J Parasitol* **53**: 484–91.
- Rausch RL (1975). Taeniidae. In Hubbert WT, McCulloch WF, Schurrenberger PE (eds), *Diseases Transmitted from Animals to Man*. Thomas: Springfield, IL; 678–707.
- Rausch RL (1986). Life-cycle patterns and geographic distribution of *Echinococcus* species. In Thompson RCA (ed.) *The Biology of Echinococcus and Hydatid Disease*. Allen and Unwin: London; 44–80.
- Rausch RL (1993). The biology of *Echinococcus granulosus*. In Anderson FL, Chai J, Liu F (eds), *Compendium on Cystic Echinococcosis with Special Reference to the Xinjiang Uygur Autonomous Region, The People's Republic of China*. Brigham Young University: Provo, UT; 27–56.
- Rausch RL (1995). Life cycle patterns and geographic distribution of *Echinococcus* species. In Thompson RCA, Lymbery AJ (eds), *Echinococcus and Hydatid Disease*. CAB International: Wallingford; 89–134.
- Rausch RL (1997). *Echinococcus granulosus*: biology and ecology. In Anderson FL, Ouhelli H, Kachani M (eds), *Compendium of Cystic Echinococcosis in Africa and in Middle Eastern Countries with Special Reference to Morocco*. Brigham Young University: Provo, UT; 18–53.
- Rausch RL, Wilson JF (1973). Rearing of the adult *Echinococcus multilocularis* Leuckart, 1863, from sterile larvae from man. *Am J Trop Med Hyg* **22**: 357–60.
- Rausch RL, D'Alessandro A, Rausch VR (1981). Characteristics of the larval *Echinococcus vogeli* Rausch and Bernstein, 1972, in the natural intermediate host, the paca, *Cuniculus paca* L. (Rodentia: Dasyproctidae). *Am J Trop Med Hyg* **30**: 1043–52.
- Rausch RL, Wilson JF, Schantz JF *et al.* (1987). Spontaneous death of *Echinococcus multilocularis*: cases diagnosed serologically (by Em2-ELISA) and clinical significance. *Am J Trop Med Hyg* **36**: 576–85.
- Rickard MD, Harrison GB, Heath DD *et al.* (1995). *Taenia ovis* recombinant vaccine—'quo vadit'? *Parasitology* **110**: S5–9.
- Rinder H, Rausch RL, Takahashi K *et al.* (1997). Limited range of genetic variation in *Echinococcus multilocularis*. *J Parasitol* **83**: 1045–50.
- Roberts MG, Aubert MF (1995). A model for the control of *Echinococcus multilocularis* in France. *Vet Parasitol* **56**: 67–74.
- Rogan MT, Richards KS (1989). Development of the tegument of *Echinococcus granulosus* (Cestoda) protoscolices during cystic differentiation *in vivo*. *Parasitol Res* **75**: 299–306.
- Roneus O, Christensson D, Nilsson NG (1982). The longevity of hydatid cysts in horses. *Vet Parasitol* **11**: 149–54.
- Ross IC (1926). A survey of the incidence of *Echinococcus granulosus* (Batsch) or hydatid disease in New South Wales. *J Aust Vet Assoc* **11**: 56–67.
- Rudolphi CA (1801). Beobachtungen über die Eingeweidewürmer. *Arch Zool Zoot* **2**: 1–65.
- Rudolphi CA (1808). *Entozoorum sive vermium intestinalium historia naturalis*, 2 vols. Treuttel et Wurtz: Paris; 1370.
- Schantz P (1997). *Echinococcus granulosus*, *E. multilocularis* and *E. vogeli* (agents of cystic, alveolar, and polycystic echinococcosis). In Long SS, Pickering LK, Prober CG (eds), *Pediatric Infectious Diseases*. Churchill-Livingstone: New York; 1488–92.
- Schantz PM, Chai J, Craig PS *et al.* (1995). Epidemiology and control of hydatid disease. In Thompson RCA, Lymbery AJ (eds), *Echinococcus and Hydatid Disease*. CAB International: Wallingford; 233–331.
- Schelling U, Frank W, Will R *et al.* (1997). Chemotherapy with praziquantel has the potential to reduce the prevalence of *Echinococcus multilocularis* in wild foxes (*Vulpes vulpes*). *Ann Trop Med Parasitol* **91**: 179–86.
- Schmitt M, Saucy F, Wyborn S *et al.* (1997). Infestation of water voles (*Arvicola terrestris*) with metacystodes of *Echinococcus multilocularis* in the Canton Freiburg. *Schweiz Arch Tierheilk* **139**: 84–93.
- Schwabe CW (1986). Current status of hydatid disease: a zoonosis of increasing importance. In Thompson RCA (ed.), *The Biology of Echinococcus and Hydatid Disease*. Allen and Unwin: London; 81–113.
- Scott JC, Stefaniak J, Pawlowski ZS *et al.* (1997). Molecular genetic analysis of human cystic hydatid cases from Poland: identification of a new genotypic group (G9) of *Echinococcus granulosus*. *Parasitology* **114**: 37–43.
- Shabovskaya EA, Bulgakov VW, Ponomareva VE *et al.* (1989). Hydatidosis in the Ukrainian SSR. *Meditinskaya Parazitologiya i Parazitarnye Bolezni* **6**: 49–51.
- Siles Lucas M, Felleisen R, Cuesta-Bandera C *et al.* (1994). Comparative genetic analysis of Swiss and Spanish isolates of *Echinococcus granulosus* by Southern hybridization and Random Amplified Polymorphic DNA technique. *Appl Parasitol* **35**: 107–17.
- Slais J (1973). Functional morphology of cestode larvae. *Adv Parasitol* **11**: 395–480.
- Slais J, Vanek M (1980). Tissue reactions to spherical and lobular hydatid cysts of *Echinococcus granulosus* (Batsch, 1786). *Folia Parasitol* **27**: 135–43.
- Smyth JD, Heath DD (1970). Pathogenesis of larval cestodes in mammals. *Helminthol Abstr Ser A* **39**: 1–23.
- Smyth JD, Gemmel M, Smyth MM (1969). Establishment of *Echinococcus granulosus* in the intestine of normal and vaccinated dogs. *Ind J Helminthol*, Srivastava Commemorative Volume: 167–78.
- Sousa OE, Thatcher VE (1969). Observations on the life cycle of *Echinococcus oligarthrus* (Diesing, 1863) in the Republic of Panama. *Ann Trop Med Parasitol* **63**: 165–75.
- Spruance SL (1974). Latent period of 53 years in a case of hydatid cyst disease. *Arch Int Med* **134**: 741–2.

- Storandt ST, Kazacos KR (1993). *Echinococcus multilocularis* identified in Indiana, Ohio, and east-central Illinois. *J Parasitol* **79**: 301–5.
- Tackmann K, Lossner U, Mix H *et al.* (1998). Spatial distribution patterns of *Echinococcus multilocularis* (Leuckart, 1863) (Cestoda: Cyclophyllidae: Taeniidae) among red foxes in an endemic focus in Brandenburg, Germany. *Epidemiol Infect* **120**: 101–9.
- Thompson RCA (1991). *Echinococcus* and *Giardia*: variation on a theme. *Int J Parasitol* **21**: 291–7.
- Thompson RCA (1992). Echinococcosis/hydatidosis in Australia. In *Zoonoses*, Proceedings 194. Post-graduate Committee in Veterinary Science, University of Sydney: Sydney; 77–87.
- Thompson RCA (1995). Biology and systematics of *Echinococcus*. In Thompson RCA, Lymbery AJ (eds), *Echinococcus and Hydatid Disease*. CAB International: Wallingford; 1–50.
- Thompson RCA, Smyth JD (1975). Equine hydatidosis: a review of the current status in Great Britain and the results of an epidemiological survey. *Vet Parasitol* **1**: 107–27.
- Thompson RCA, Eckert J (1983). Observations on *Echinococcus multilocularis* in the definitive host. *Zeitschr Parasit* **69**: 335–45.
- Thompson RCA, Allsopp CE (1988). *Hydatidosis: Veterinary Perspectives and Annotated Bibliography*. Commonwealth Agricultural Bureau: Wallingford.
- Thompson RCA, Lymbery AJ (1988). The nature, extent and significance of variation within the genus *Echinococcus*. *Adv Parasitol* **27**: 209–58.
- Thompson RCA, Lymbery AJ (1990). *Echinococcus*: biology and strain variation. *Int J Parasitol* **20**: 457–70.
- Thompson RCA, Lymbery AJ (1991). The epidemiological significance of biological variation in *Echinococcus*. *Arch Hidatidol* **30**: 195–200.
- Thompson RCA, McManus DP (2001). Aetiology: parasites and life-cycles. In Eckert J, Gemmell MA, Meslin FX, Pawlowski ZS (eds). *WHO/OIE Manual on Echinococcosis in Humans and Animals: a Zoonosis of Global Concern*. World Organization for Animal Health (OIE): Paris, 1–19.
- Thompson RCA, Dunsmore JD, Hayton AR (1979). *Echinococcus granulosus*: secretory activity of the rostellum of the adult cestode *in situ* in the dog. *Exp Parasitol* **48**: 144–63.
- Thompson RCA, Kumaratilake LM, Eckert J (1984). Observations on *Echinococcus granulosus* of cattle origin in Switzerland. *Int J Parasitol* **14**: 283–91.
- Thompson RCA, Lymbery AJ, Hobbs RP *et al.* (1988). Hydatid disease in urban areas of Western Australia: an unusual cycle involving western grey kangaroos (*Macropus fuliginosus*), feral pigs and domestic dogs. *Aust Vet J* **65**: 188–9.
- Thompson RCA, Lymbery AJ, Meloni BP *et al.* (1994). Molecular epidemiology of parasite infections. In Ehrlich R, Nieto A (eds), *Biology of Parasitism*. Edicio Trilce: Montevideo, Uruguay; 167–85.
- Thompson RCA, Robertson ID, Gasser RB *et al.* (1993). Hydatid disease in Western Australia: a novel approach to education and surveillance. *Parasitol Today* **9**: 431–3.
- Thompson RCA, Lymbery AJ, Constantine CC (1995). Variation in *Echinococcus*: towards a taxonomic revision of the genus. *Adv Parasitol* **35**: 145–76.
- Thompson RCA, Robertson ID, Barrett SL (1996). Hydatid disease in urban areas. *National Hydatid Disease Symposium*, Centre for Infectious Diseases and Microbiology, University of Sydney; 20–7.
- Uchino J, Sato N (eds) (1993). *Alveolar Echinococcosis of the Liver*. Sapporo: Hokkaido University School of Medicine.
- Vanek M (1980). A morphological study of hydatids of *Echinococcus granulosus* (Batsch, 1786) from pigs. *Folia Parasitol* **27**: 37–46.
- Verster AJM (1965). Review of *Echinococcus* species in South Africa. *Onderstepoort J Vet Res* **32**: 7–118.
- Virchow R (1856). Die multiloculäre, ulcerirende Echinokokkengeschwulst der Leber Verhandlungen. *Sitzungsber Phys Med Gesellsch Würzburg* **6**: 84–95 (Sitzungen 10 March–12 May 1855).
- Vogel H (1957). Über den *Echinococcus multilocularis* Süddeutschland. I. Das Bandwurmstadium von Stämmen menschlicher und tierischer Herkunft. *Zeitschr Tropenmed Parasitol* **8**: 404–504.
- Vogel H (1978). Wie wächst der Alveolarechinokokkus? *Zeitschr Tropenmed Parasitol* **29**: 1–11.
- von Siebold T (1852). Über die Verwandlung der *Echinococcus*-Brut in Taenien. *Zeitschr Wissensch Zool* **4**: 409–22.
- Wachira TM, Bowles J, Zeyhle E *et al.* (1993). Molecular examination of the sympatry and distribution of sheep and camel strains of *Echinococcus granulosus* in Kenya. *Am J Trop Med Hyg* **48**: 473–9.
- WHO (1981). *FAO/UNEP/WHO Guidelines for Surveillance, Prevention and Control of Echinococcosis/Hydatidosis*. World Health Organization: Geneva.
- WHO (1992). *Report of the WHO Working Group Meeting on Clinical Medicine and Chemotherapy of Alveolar and Cystic Echinococcosis* (WHO/CDS/VPH.93.118). World Health Organization: Geneva.
- WHO (1996). Guidelines for treatment of cystic and alveolar echinococcosis in humans. *Bull WHO* **74**: 231.
- Williams RJ, Sweatman GK (1963). On the transmission, biology and morphology of *Echinococcus granulosus equinus*, a new subspecies of hydatid tapeworm in horses in Great Britain. *Parasitology* **53**: 391–407.
- Wilson JF, Diddams AC, Rausch RL (1968). Cystic hydatid disease in Alaska. A review of 101 autochthonous cases of *Echinococcus granulosus* infection. *Am Rev Resp Dis* **98**: 1–15.
- Wilson JF, Rausch RL, Wilson FR (1995). Alveolar hydatid disease. Review of the surgical experience in 42 cases of active disease among Alaskan Eskimos. *Ann Surg* **221**: 315–23.
- Yamashita J, Ohbayashi M, Konno S (1956). Studies on echinococcosis. III. On experimental infection in dogs, especially on the development of *Echinococcus granulosus* (Batsch, 1786). *Jap J Vet Res* **4**: 113–22.
- Yue-Han L, Xiao-Gen W, Ya-Tang C *et al.* (1993). Computer tomography of liver in alveolar echinococcosis treated with albendazole. *Trans R Soc Trop Med Hyg* **87**: 319–21.
- Zeller E (1854). Alveolarcolloid der Leber. Inaugural dissertation, Tübingen University.

# Cestodes

Kaethe Willms<sup>1</sup> and Julio Sotelo<sup>2</sup>

<sup>1</sup>Universidad Nacional Autónoma de México and <sup>2</sup>Instituto Nacional de Neurología  
Neurocirugía Mexico City, Mexico

## INTRODUCTION

The true tapeworms, Class Cestoda, belong to the Phylum Platyhelminthes and those of medical importance are placed in two orders: the Pseudophyllidea and the Cyclophyllidea. Platyhelminthes are among the oldest invertebrates in the animal kingdom, with bilateral symmetry and specialized tissues that support complex male and female reproductive organs that generate millions of infective embryos, called oncospheres, capable of developing into new tapeworms. Tapeworms are hemaphrodites, with one of the highest reproductive capabilities in biology (Bruce-Conn, 1993): a single tapeworm in the human intestine can grow several meters long and produce 20–30 million eggs a year. With the exception of *Hymenolepis nana*, cestode oncospheres are enclosed in a keratin shell (embryophore) that protects them from environmental variations. The persistence of these tapeworms in endemic areas is supported

by their enormous reproductive capacity and the built-in protection from environmental factors.

The cestodes are segmented, ribbon-like flatworms that normally reside in the intestines of their definitive mammalian hosts. Their life-cycle includes at least one intermediary host, in which the tapeworm develops from the embryo to the larval stage. In this chapter, only tapeworms that cause significant disease in humans are discussed: *Taenia solium*, *Taenia saginata*, Asian *Taenia* and *Hymenolepis nana* belonging to the Order Cyclophyllidea and *Diphyllobothrium latum*, belonging to the Order Pseudophyllidea. *Echinococcus granulosus*, which is also a cyclophyllidean cestode, will be described in a separate chapter. *T. solium*, *T. saginata*, Asian *Taenia* and *H. nana* still cause widespread disease in developing countries of Asia, Africa and Latin-America (Bao, *et al.*, 1995; Dada *et al.*, 1993; Díaz *et al.*, 1992; Díaz-Camacho *et al.*, 1991; Sarti *et al.*, 1994; Sánchez *et al.*, 1997). The taeniid tapeworms are responsible for zoonoses almost always associated with ignorance and poverty.

## TAENIA

### DESCRIPTION OF THE ORGANISM

#### Adult Tapeworm Morphology

Adult tapeworms are attached to the upper third of the duodenum of the human intestine.

Humans are the only known natural definitive hosts for taeniids. The adult tapeworm has a **scolex** at the anterior end bearing **bothria** (in pseudophyllideans, such as *Diphyllobothrium latum*) or **suckers** (in cyclophyllideans, such as Taeniidae and Hymenolepidae), followed by a

neck region of undifferentiated tissue, which gives rise to a chain of **proglottids** (segments). Each proglottid can be considered an independent reproductive unit, as it contains both male and female organs (Schmidt, 1986).

As proglottids progress distally along the chain (also known as the **strobila**), they mature and produce a large number of eggs in the uterus, which are fertilized by sperm released from the testes. The resulting embryos, known as **oncospheres**, are then encapsulated in a protective keratin shell and eventually released with the gravid proglottid, each of which contains thousands of infective oncospheres (encapsulated embryos).

Tapeworms can be identified by differences in the morphology of the scolex, proglottids, length of the strobila and number of worms per infection: *T. solium*, *T. saginata* (1.5–12 m) and *D. latum* (up to 10 m, or 30 feet) being very long and usually found as single worms, with *H. nana* measuring 2–3 cm and generally found as a multiple infection.

The external surface of adult tapeworms consists of a tegument, a continuous protoplasmic band joined to cell bodies (tegumentary cytons) by cytoplasmic processes and separated from the rest of the parasite wall by a basement membrane. All cestode tegumentary surfaces have a brush border covered by microvilli or microtriches, structures that are in contact with the host tissue. Beneath the basement membrane are found various cell types: flame cells, myocytes, calcareous corpuscle cells and glycogen storage cells within a loose matrix of connective tissue fibers. The parenchyma of proglottids is divided into cortical and medullary tissues by a system of longitudinal and transverse muscle fibers. Reproductive structures are located within the medullary portion. Interspersed throughout the cortical area are calcareous corpuscles, structures unique to cestodes, oval-shaped with a whorled appearance and a complex chemical composition that includes calcium carbonate.

### Larval (Metacestode) Morphology

Since *T. solium* metacestodes (larval stage) are the best studied larvae, both by light and electron

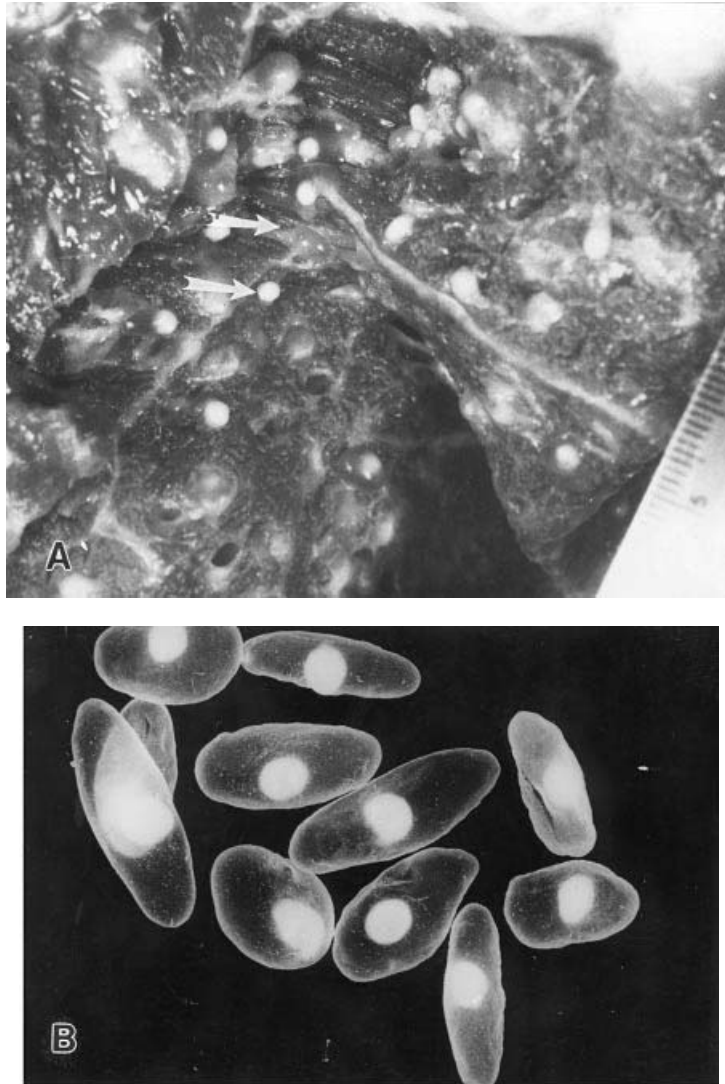
microscopy, we will use them to illustrate the main structures (Lumsden *et al.*, 1982).

The larvae are extracellular parasites, visible to the naked eye, seen as bladders 0.5–1.5 cm in diameter, with an invaginated scolex, observed as a white opaque sphere suspended within the vesicle. In pig muscle infections they are readily apparent (Figure 23.1A, B). Under the light microscope, the external surface is a tegumentary tissue, similar to that found in the adult worm, with microvilli or microtriches projecting from it and in direct contact with the host tissue (Figure 23.2). The bladder wall contains various cell types surrounded by loose connective tissue and calcareous corpuscles that blend into the vesicular fluid, which makes up about 90% of the larval contents. In human infections, these larvae can survive for a number of years. An immune response eventually elicits an inflammatory reaction of the granulomatous type, with a large number of eosinophils degranulating on the surface of the parasite. Dead parasite tissue is reabsorbed slowly, leaving a calcified concretion in both muscle and brain tissue.

### Oncosphere, Egg Morphology

Mature eggs from *T. solium* and *T. saginata* are indistinguishable. As shown in Figure 23.3, they can be seen under the light microscope as 50  $\mu$ m diameter spheres, with a striated border corresponding to the keratin envelope and frequently a triple set of hooks within. Their presence in stool is diagnostic of *Taenia* sp. Electron micrographs of sections through these eggs illustrate the oncospheres with a number of cells; the hooks and several cell types have been identified (Figure 23.4). In addition, the embryo is surrounded by several membranes. The protective envelope (embryophore) is made up of keratin blocks, which are cemented together and become unglued when the egg comes into contact with hydrochloric acid, digestive enzymes and bile in the small intestine, thus liberating the oncosphere, which can penetrate the intestinal wall and reach the blood or lymphatic vessels of the mesentery, from where it is passively transported to the host tissues.

Once the oncosphere has reached an extracellular site (the mechanisms by which the



**Fig. 23.1** (A) Light micrograph of infected pork meat, showing a large number of cysticerci (arrows). Bar=1 cm. (B) *Taenia solium* larval metacestodes dissected from infected pork

oncosphere traverses the intestinal and vessel walls are not understood), it develops to the larval stage, a process that takes about 8 weeks.

#### LIFE-CYCLE

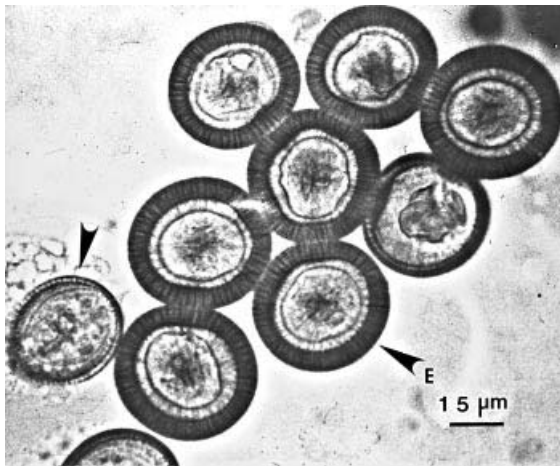
##### ***Taenia saginata* (*Taeniarhynchus saginatus*) (Beef Tapeworm) (Figure 23.5)**

The adult tapeworm lives only in the small intestine of humans and so far has never been found naturally in any other definitive host.

Experimental infections have been established in immunosuppressed golden hamsters, but without obtaining gravid proglottids (Verster, 1971). The tapeworm is acquired by ingesting raw or undercooked beef infected with larvae. The larvae evaginate in the small intestine of the host. After digestive juices and bile promote the evagination of the scolex through the bladder wall, this structure attaches to the intestinal wall, probably by burrowing through the intestinal villi with the unarmed rostellum, penetrating a crypt of Lieberkühn while simultaneously anchoring to

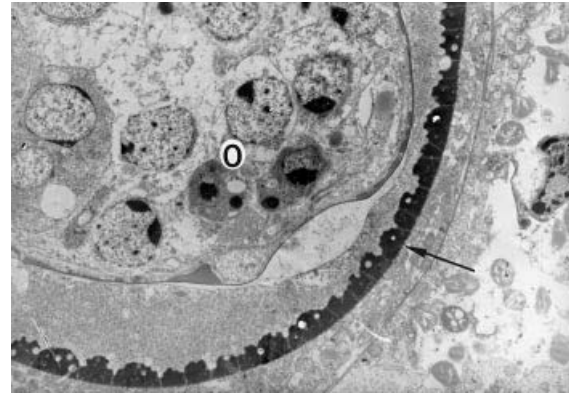


**Fig. 23.2** Electron micrograph of *Taenia solium* metacystode surface, illustrating microvilli (arrow)



**Fig. 23.3** *Taenia* sp. eggs. Light micrograph showing typical embryophore outer shell (arrow, E). Reproduced by permission from Flisser *et al.* (1982)

neighboring villi by all four suckers, similar to the mechanism that has been identified for *Echinococcus granulosus* in experimental dogs and in experimental *T. solium* infections in hamsters.



**Fig. 23.4** Transmission electron micrograph through *Taenia solium* egg. Arrow, embryophore. O, oncosphere

Growth of the adult tapeworm then proceeds continuously from the neck region by an ever-lengthening chain of proglottids; 4–6 months after infection, the tapeworm begins to eliminate gravid proglottids containing 50 000–80 000 infective eggs, which are shed in the stool.

When infective eggs are ingested by cattle in contaminated fodder or water, the oncospheres penetrate the intestinal wall and are carried to various tissues, mostly the heart and masseter muscles but also throughout the musculature, where they develop into larvae or cysticerci. Ingestion of viable larvae in raw or undercooked beef by humans can then produce a new adult tapeworm.

### ***Taenia solium* (Pork Tapeworm)** (Figure 23.6)

*Taenia solium* is the most important human tapeworm, because it is the only intestinal parasite responsible for human cysticercosis as well as pig cysticercosis. *T. solium* continues to be an endemic parasitic disease in many countries of Central and South America, South Africa and Asia. Humans are the only natural definitive host. Tapeworms attach to the epithelial wall of the small bowel and grow in segments (proglottids) which contain male and female sex organs. Its importance resides in the capacity of the embryos to traverse the intestinal wall and lodge in muscle masses or in the brain, where they develop into the larval (metacystode) stage of the



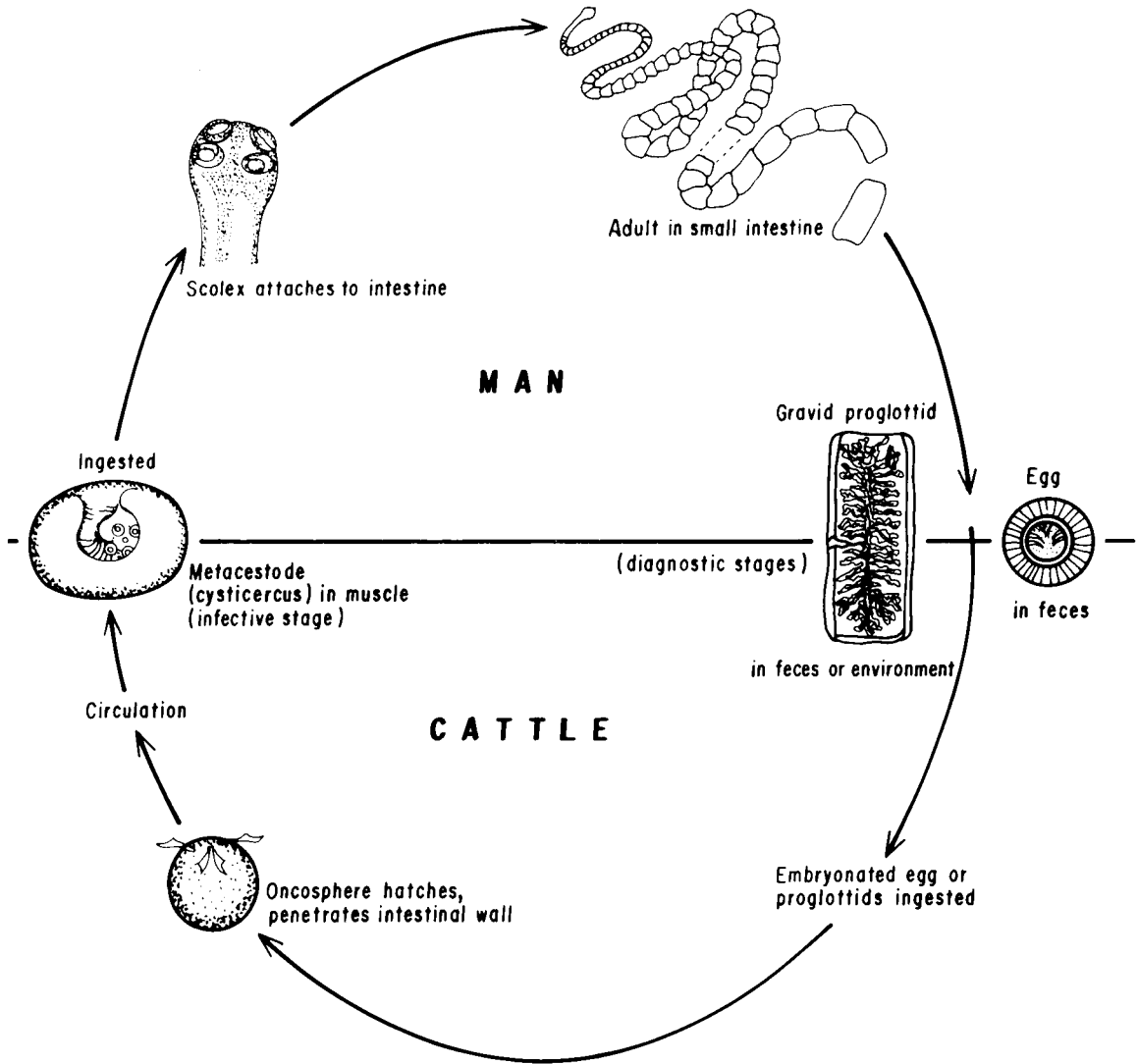


Fig. 23.5 Life-cycle of *Taenia saginata*

parasite. In humans, neurocysticercosis (NC) is by far the most important disease caused by this parasite. Pigs are the intermediate host for the larval stage, which they acquire by ingesting feces containing adult tapeworm proglottids. The life-cycle thrives in rural areas with poor sanitation, without water or drainage and where pigs are left to roam and scavenge on human excrement and garbage. It has been recognized for many years that the larval stage can survive for long periods in the host before being destroyed or attacked by the immune response. The classic

work of Dixon and Lipscomb (1961), showed that British soldiers returning in 1948 from India, a country with a high prevalence of *Taenia solium*, took an average of 2–5 years to develop symptoms of NC, suggesting that the parasite, lodged in the nervous tissue, either does not release antigens or has evasion mechanisms that allow survival for long periods.

The adult worm has an armed scolex (Figure 23.7) which consists of a rostellum bearing two rows of hooks (22–32). Recent experimental evidence, obtained by infection of golden

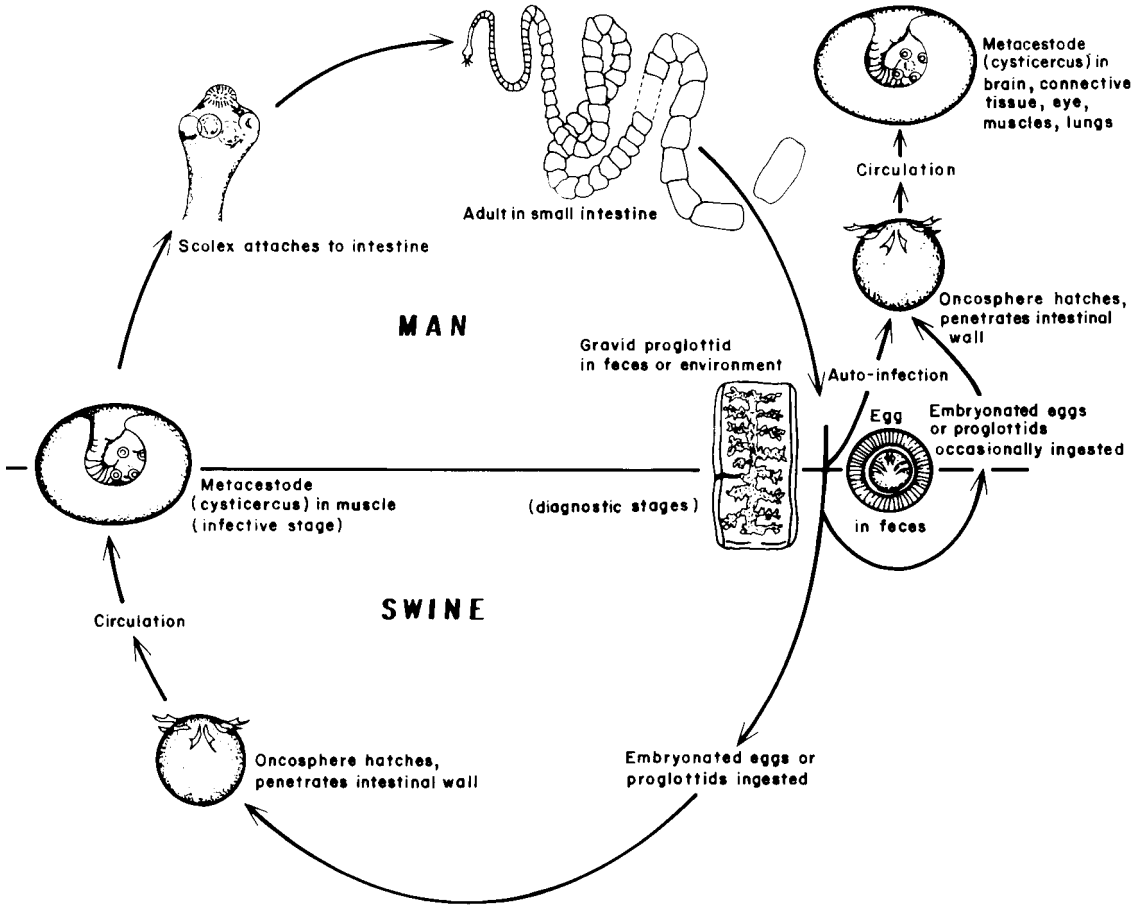


Fig. 23.6 Life-cycle of *Taenia solium*

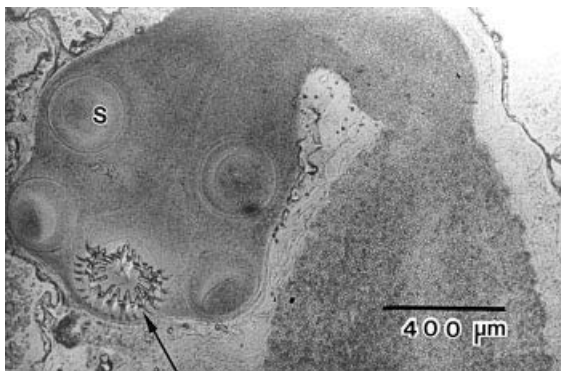


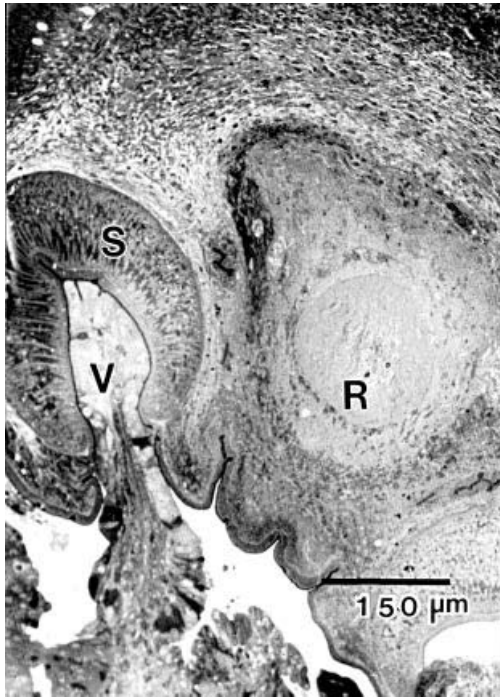
Fig. 23.7 Light micrograph of *Taenia solium* whole worm preparation, to show scolex with four suckers (s) and rostellum with double row of hooks (arrow)

hamsters, has shown that the scolex implants in the upper third of the duodenum (Merchant *et al.*, 1998), by engulfing intestinal villi in the four suckers (Figure 23.8) and burrowing the rostellar pad into the crypts of Lieberkuhn of the sub-mucosa, similar to what has been described for the dog tapeworm, *Echinococcus granulosus* (Figure 23.9).

**EPIDEMIOLOGY**

*Taenia saginata*

*Taenia saginata* continues to be a frequent helminthic disease in developing countries



**Fig. 23.8** Light micrograph of section through hamster duodenum, showing implanted *Taenia solium* and sucker engulfing intestinal villus. S, sucker; V, villus; R, worm rostellum

(Pawlowski, 1982). This is due to several difficulties in diagnosing tapeworm infections, particularly in isolated rural areas (where human excrement is disposed of on open ground), the absence of symptoms in otherwise healthy carriers, poor personal hygiene and lack of adequate meat inspection in many countries (Mobius, 1993).

### Taeniasis/Cysticercosis

The life-cycle of *T. solium* has been understood since Küchenmeister (1855) proved that the ingestion of cysts obtained from infected pork and mixed with food gave rise to adult tapeworms in the intestine in prisoners (Figure 23.7). Two years earlier, in 1853, Van Beneden had shown that the ingestion of *T. solium* proglottids caused cysticercosis in pigs. Rigorous meat inspection practices, the development of an increasing number of farms in which pigs are



**Fig. 23.9** Light micrograph of section through hamster intestine, showing implantation site of *Taenia solium*. Iv, intestinal villi; W, worm

reared under highly controlled conditions, and significant improvement in hygiene standards and sanitary installations in Europe and North America have contributed to the eradication of taeniasis and human cysticercosis in the majority of developed countries (Gemmel *et al.*, 1983). Population mobility has, however, contributed to the appearance of an increasing number of cases of NC in the USA among Latin-American immigrants. In 1992, cases of autochthonous NC were reported in the Bronx, NY, which were probably transmitted by a Mexican domestic worker who was diagnosed with intestinal *T. solium* (Schantz *et al.*, 1992). During the past 15 years a number of epidemiological studies have been carried out in Mexico, Guatemala, Honduras and Peru (Díaz-Camacho *et al.*, 1991; Sarti *et al.*, 1992; Allan *et al.*, 1996; Sánchez *et al.* 1997; García *et al.*, 1995) in order to obtain more precise information on the frequency and geographic distribution of *Taenia* NC parasitosis.

Seroepidemiological surveys carried out in Mexico have indicated a high percentage of individuals with antibodies against *T. solium* antigens in areas of porciculture, an observation which has been interpreted as frequent contact with cestode antigens (Larralde *et al.*, 1992). Detailed studies in small rural communities have found up to 10% of individuals infected with adult tapeworms, high seropositivity rates, the presence of infected pigs reared domestically, as well as the practice of human defecation on open ground. Studies of small rural communities in Mexico indicate a significant association between the number of *T. solium* carriers and the practice of defecating on open ground (Sarti *et al.*, 1992). The studies of Diaz-Camacho *et al.* (1991) in small rural communities revealed that sharing living quarters with a tapeworm carrier increased the number of individuals with antibodies to cestode antigens five-fold over inhabitants who had no contact with such carriers. Daily domestic contact with a tapeworm carrier also increases the risk of acquiring NC, as has been shown by the studies of Sarti *et al.* (1992). These results emphasize the importance of treating tapeworm carriers opportunely with anthelmintics. The elimination of *T. solium* tapeworms in endemic areas should become a public health priority, since it has been shown that persons living with a tapeworm carrier have a significantly higher risk of acquiring NC.

### Asian *Taenia*

This cestode was originally described in Taiwanese aborigines (Eom and Rim, 1993) and has since been found in Korea, Indonesia, Thailand and The Philippines. Genetic characterization of this cestode, as well as the macroscopic morphology of an unarmed scolex, a large number of uterine branches and a posterior protuberance, has pointed to a close genetic relationship with *T. saginata* (Bowles and McManus, 1994). The larval stages are viscerotropic and infect the liver of pigs and cattle. Humans acquire the adult tapeworm after ingesting raw viscera (Fan *et al.*, 1992). The prevalence of this taeniasis appears to be high in Asia and the South Pacific basin and is therefore

an important public health problem. However, due to its close relationship with *T. saginata*, it is unlikely to be a causal agent of human cysticercosis.

## CLINICAL FEATURES AND PATHOLOGY

### *Taenia saginata*

Symptomatology in *Taenia* carriers is vague and may include abdominal pain, nausea, dizziness, headache, weight loss, increased appetite, pruritus ani and excitation. Presence of the tapeworm can often be detected by the carrier after observing proglottids in the stool or active migration of segments through the anus. It should be stressed that many infections may go undetected. *T. saginata* should be suspected in a patient who ingests raw beef and who describes elimination of tapeworm segments in the stool and/or has recovered segments migrating through the anus.

### *Taenia solium*

The intestinal symptoms of *T. solium* infection are similar to infection with *T. saginata*. The most important complication of clinical syndrome is cysticercosis. It is the larval stage (metacestode) of *Taenia solium* that produces cysticercosis. Three sites are preferred targets for cysticerci: the nervous system, the muscle and the eye (Willms, 1998). Exceptionally, cysticercosis has been described in other organs, such as the placenta, liver, heart, peritoneum, etc. By far the most frequent and most important form of human cysticercosis is neurocysticercosis (NC). Cysticercosis is endemic in most countries of Latin America, Asia, Africa and some European countries. With the exception of populations in which the life-cycle of *T. solium* cannot prosper because pork meat is not consumed, the disease is endemic in the developing world. In recent years, the disease has spread as a consequence of immigration from endemic areas to developed countries, where the disease had previously been controlled by strict meat inspection practices, as well as sanitary and hygiene measures. Thus, cysticercosis is increasingly seen in countries of

North America and Europe where, despite sanitary measures that impede the perpetuation of the parasite life-cycle, immigrants infected in an endemic country transport the disease that may manifest clinically months or years after the infection was acquired.

The feces of human carriers with the intestinal cestode *T. solium* contain mature proglottids, each with several thousand viable eggs that contaminate the environment of places without sanitation and vegetables irrigated with sewage contaminated with human feces. Both humans and pigs can become infected by ingesting water and raw fruit or vegetables contaminated with *Taenia* eggs. The eggs lose their keratin coat when they come in contact with the digestive enzymes, and free oncospheres traverse the intestinal wall and enter the blood stream, which will carry them to the nervous system. In most endemic areas the popular belief is that cysticercosis is acquired after eating infected pork, and the link between human carriers of the adult intestinal worm and pig cysticercosis is not understood (Nieto, 1982). Ignorance of basic facts of the life-cycle of taeniasis/cysticercosis prevents the instrumentation of simple hygiene measures, such as washing vegetables and drinking boiled water to prevent the ingestion of taeniid eggs.

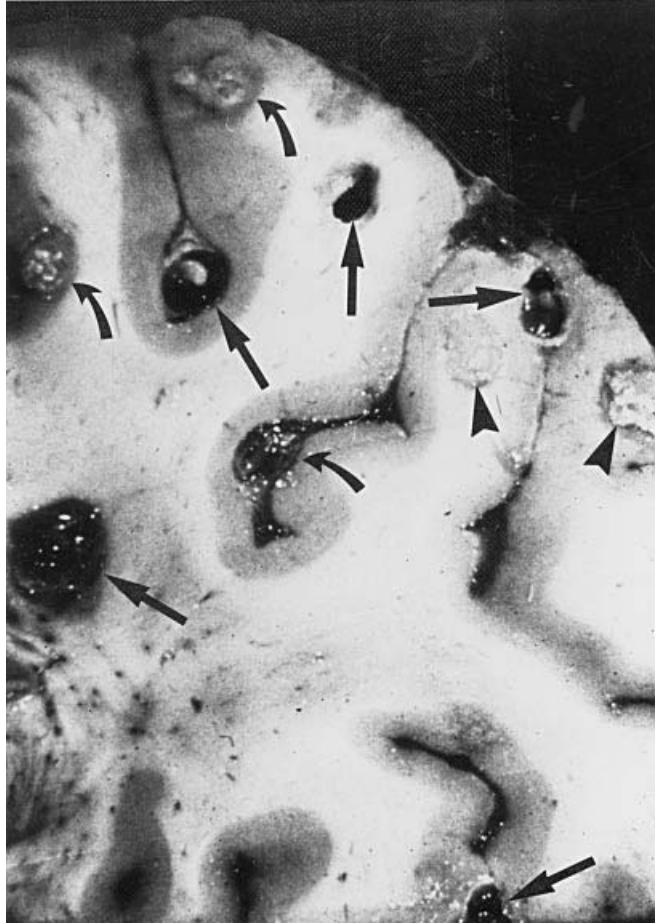
### Pathology

The complex host–parasite relationship in cysticercosis is still poorly understood. Some patients present a remarkable tolerance to the parasite, which can live in the brain for long periods without inducing a noticeable immune reaction (Pitella, 1997); in others, the immune response is unable to destroy the parasite, but is an important cause of damage to the surrounding tissue; in still other patients, the immune response is intense, leading to rapid destruction of the larva. The reasons for this variable response between individuals are not yet understood. Some HLA antigens have been weakly associated either to increased resistance (HLA DQw2) or susceptibility (HLA A28) to infection. It has also been shown that the parenchymal inflammatory response is more intense in females

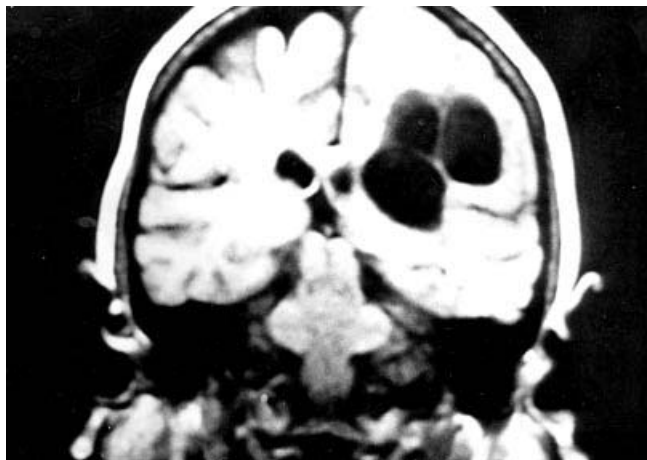
than in males; however, the reasons for these differences have not been explained (Monteiro *et al.*, 1993; Rangel *et al.*, 1987; Del Brutto *et al.*, 1988).

The sequence of events corresponding to the stage of the parasite in the brain begins when the hexacanth embryo (oncosphere) is passively carried by the systemic circulation to the brain parenchyma, where it differentiates into a larva 1–1.5 cm in diameter within 2 months. Different events will follow, depending on the immune response of the host to the newly established parasite (Figure 23.10) (Pitella, 1997):

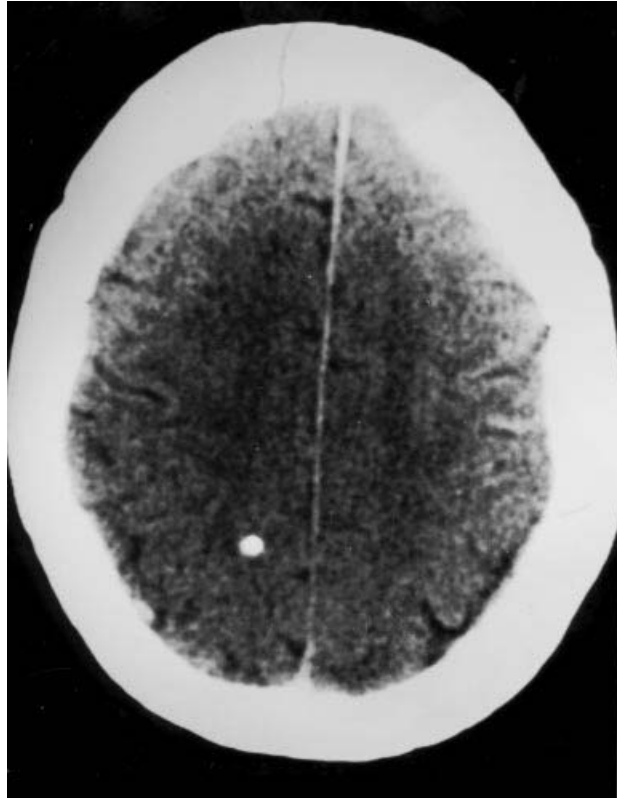
1. If immune tolerance develops, the cyst can remain in the tissue for several years (up to 12 years have been documented by neuro-imaging studies). In most of these cases, the cysts will continue to grow undisturbed; some may develop into cysts 10–15 cm in diameter years after infection (Figure 23.11). In many other cases, although the cysts grew undisturbed for long periods, the sudden appearance of a host immune reaction will induce an intense inflammation around the cyst, an event which seems to trigger death of the cysticercus. When the size of the cyst exceeds 2 cm in diameter, most of them lose the scolex due to a degenerative process that nevertheless allows the tegumentary membranes of the cysticercus to continue proliferating. The membranes can produce a giant cyst containing up to 50 ml fluid without an identifiable scolex in its interior.
2. Within 2 months of implantation, the cysticercus will acquire its typical morphological features of a 1 cm diameter cyst filled with a clear fluid and containing the scolex and neck, with the characteristic features of the cestode, a worm-like body with a head composed by four suckers and a double crown of hooks. If the immune response is strong enough to induce death of the parasite, it will undergo hyaline degeneration of the cystic fluid, followed, a few weeks later, by macrophage infiltration and the formation of a granulomatous lesion, which in turn will either disappear without evident damage to the surrounding tissue or remain as a permanent granuloma, composed mostly of fibrotic scar tissue. Over 2–7 years this granuloma will



**Fig. 23.10** Brain slice from a patient with neurocysticercosis, showing multiple lesions in different stages; live cysts with the characteristic metacestode inside (straight arrows), granulomas (curved arrows) and calcifications (arrowheads)



**Fig. 23.11** Magnetic resonance imaging, showing a clump of three large cysts producing a space-occupying lesion



**Fig. 23.12** Computed tomography, showing a parenchymal brain calcification, the most conspicuous sequel of neurocysticercosis and a frequent cause of epilepsy in endemic areas

gradually calcify, becoming a permanent calcification which is easily observed in a simple X-ray study of the skull (Figure 23.12).

3. The two patterns described above in the natural history of brain parenchyma cysticercosis represent opposite pictures that depend on either immune tolerance or a hyper-immune response of the host (Estañol *et al.*, 1986). However, in many patients the immune response is mild and chronic, not enough to destroy the parasite but sufficient to induce damage in neighboring tissues, such as vasculitis, fibrosis and astrogliosis. The parasites may remain for long periods in this stage. Thus, by imaging studies, many patients are found to have degenerating cysts that remain unchanged and surrounded by a thick capsule of fibrous tissue secondary to chronic perilesional inflammation. An intriguing feature

of NC is the frequent finding of various parenchymal lesions in different stages, i.e. live cysticerci without signs of surrounding inflammation, hyaline cysts, granulomas and calcifications. This combination of lesions indicates either that the intensity of the local immune response varies from one site to another in the same host or that the cysticerci were the result of different infections (see Figure 23.10). Both possibilities appear feasible.

When cysticerci are lodged in cavities, such as the ventricular system or the vitreous cavity of the eye, the cysticercus may remain viable, floating within the fluid for long periods. In the case of ventricular cysticercosis, the parasite may lodge in the third or fourth ventricle and occlude

the cerebrospinal fluid (CSF) circulation causing subacute hydrocephalus. Meningeal cysticercosis is the most severe form of the disease (Lobato *et al.*, 1981; Estañol *et al.*, 1983). When cysticerci infect the arachnoid membrane, the inflammatory response is intense, and may last for several years and be a persistent source of tissue damage, which, in contrast with parenchymal cysticercosis, is not restricted to the infection site. The CSF circulation disseminates the inflammatory cells and cytokines throughout the central nervous system, causing cerebritis, vasculitis (Del Brutto, 1992), fibrous entrapment of cranial nerves and fibrotic obstruction of CSF absorption at the arachnoid villi, which in turn will induce chronic hydrocephalus in most patients (Sotelo and Marín, 1987). The intense inflammation of the meninges and its dissemination by the CSF circulation are the source of severe neurological damage, evidenced as brain infarctions, amaurosis, diplopia, other cranial nerve dysfunctions, intracranial hypertension and dementia. In meningeal cysticercosis, the inflammatory response of the host is the source of most of the pathological features.

### **Clinical Manifestations**

The clinical manifestations of cysticercosis depend to a great extent on the location of the parasites (Earnest *et al.*, 1987; Salgado *et al.*, 1997). Parenchymal cysticercosis induces epilepsy in most cases (López-Hernández and Garaizar, 1982; Grisolia and Wiederholt, 1982; Chandy *et al.*, 1989; Monteiro *et al.*, 1991). When the number of parasites is large, mental disturbances or focal neurological symptoms may be present. Giant cysticerci may induce a tumor-like picture. The severity of neurological disturbances depends on the intensity of perilesional inflammation, where cerebritis and vasculitis magnify the parenchymal lesions.

In endemic areas, the diagnosis of NC (either active or inactive) in the form of residual granulomas accounts for more than 50% of late-onset epilepsy (Figure 23.12) (Rajshekhar, 1991; Del Brutto *et al.*, 1992a). Therefore, in patients or immigrants from endemic areas who present a first seizure after the age of 20, a neuroimaging study is mandatory to investigate a possible case

of cysticercosis (Monteiro *et al.*, 1995; Medina *et al.*, 1990).

Ventricular cysticercosis in most cases induces a subacute picture of hydrocephalus, due to the valvular occlusion of the CSF fluid circulation; usually a single cyst is visually located in the fourth ventricle, in some cases ependymitis is associated with signs of brainstem dysfunction.

Meningeal cysticercosis is the most severe form of the disease. When cysticerci are located at the base of the brain, widespread vasculitis ensues, with vascular headache and, in severe cases, small and large brain infarctions may appear in distant sites. Clinical manifestations are either mental deterioration or acute motor abnormalities. Chronic inflammation of the arachnoid membranes, disseminated by the CSF circulation, leads to fibrosis and dysfunction of the mechanisms of CSF absorption, with the progressive development of hydrocephalus and intracranial hypertension, gait disturbances and mental deterioration (Sotelo and Marín, 1987). The same mechanisms induce fibrotic entrapment of the cranial nerves, the most frequent clinical manifestation being diplopia, due to dysfunction of the oculomotor nerves.

Muscle cysticercosis is usually asymptomatic, with the finding on clinical examination of subcutaneous nodules. In severe cases muscle pseudohypertrophy develops, due to massive infection of the muscle by countless cysticerci (Wadia *et al.*, 1988). In contrast to the other host for cysticercosis, pigs, which usually present muscle cysticercosis, in humans this is a rare location.

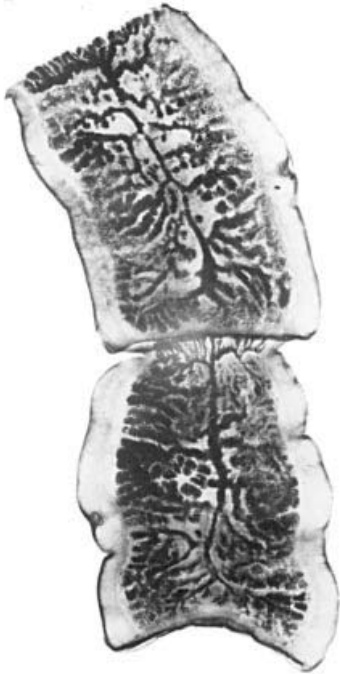
Ocular cysticercosis is also rare. The parasite lodges in either the vitreous cavity or the sub-retinal space. In both cases, visual abnormalities develop. The diagnosis is made by fundoscope examination (Keane, 1982; Kruger-Leite *et al.*, 1985; Corona *et al.*, 1986). Cysticerci located in other organs are rare; in most cases they are an autopsy finding associated with severe cases of disseminated cysticercosis.

## **DIAGNOSIS**

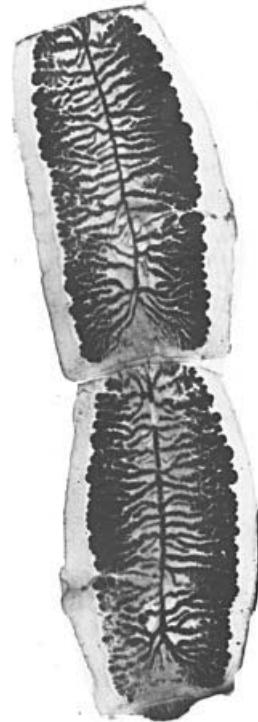
### **Intestinal Taeniasis**

Taeniasis can be diagnosed on the basis of the following findings: (a) a history of ingesting raw



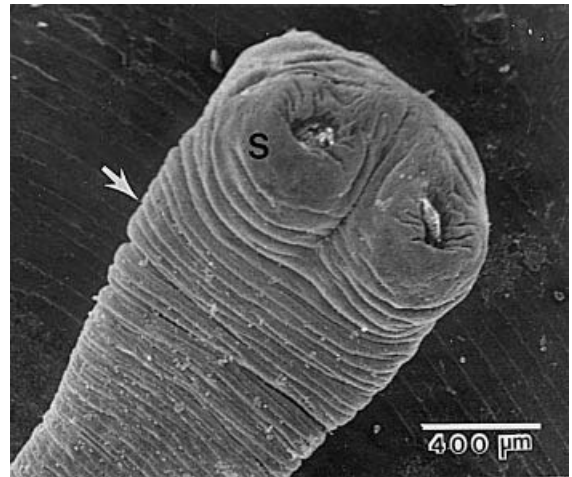


**Fig. 23.13** Proglottids of *Taenia solium*. Reproduced from Willms (1998) by permission of WB Saunders Company



**Fig. 23.14** Proglottids of *Taenia saginata*. Reproduced from Willms (1998) by permission of WB Saunders Company

or undercooked pork (homemade sausages) or beef; (b) discharging of proglottids or worm segments in the stool or the presence of loose proglottids in underclothing or bedding, which has been reported in *T. saginata* infections; (c) coprological analysis—three consecutive stool examinations using the methods of Faust *et al.* (1938), Ritchie (1948) or Kato are recommended. The perianal swab method of Graham (1941) may also be used. If proglottids are available, an effort should be made to identify the number of uterine branches under a microscope, by fixing the segments in formalin and dehydrating in glycerol. Less than 12 uterine branches is indicative of *T. solium* and the patient should be given anthelmintic treatment as soon as possible, as he/she is a potential risk to other humans (Figures 23.13 and 23.14). The patient should be asked to recover the tapeworm and bring it to the laboratory for definitive diagnosis. Care should be taken to identify the scolex to ascertain whether it has an armed or unarmed rostellum (Figure 23.15). If the scolex is not present, the



**Fig. 23.15** Scanning electron micrograph of *Taenia saginata* scolex. S, sucker. Arrow, neck

proglottids should be prepared for microscopic observation. Patients should be re-examined 4–6 months after treatment, particularly if the scolex was not found or the proglottids were too

macerated to be identified. It should be emphasized that the eggs of *T. solium* and *T. saginata* are identical under the light microscope. The morphological identification of proglottids and scolices requires laboratory facilities and trained personnel, which are frequently not available in rural areas of developing countries. Recently, several groups have worked out an antigen capture method based on an ELISA technique (Allan *et al.*, 1993) as well as the preparation of specific DNA probes for the detection of *Taenia* eggs in stool samples, methods which promise rapid and efficacious results and that should be helpful in epidemiological surveys (Chapman *et al.*, 1995).

### Cysticercosis

Neuroimaging studies, magnetic resonance imaging (MRI) and computed tomography (CT), are irreplaceable studies for proper diagnosis and characterization of active and inactive neurocysticercosis (NC) (Martínez *et al.*, 1989). Cysts, granulomas, infarctions and hydrocephalus are clearly identified by these studies. Also, the degree of inflammation can be determined; a conspicuous lesion of cysticercosis can be determined in brain parenchyma through the aid of neuroimaging studies. Immuno-diagnostic tests in serum are useful as a screening procedure for epidemiological studies (Simac *et al.*, 1995; Ramos-Kuri *et al.*, 1992) but not as a diagnostic tool for individual cases, as patients with single lesions or with sequelae such as granulomas and calcifications are frequently seronegative (Chang *et al.*, 1988). Analyses of CSF, including immuno-diagnostic tests, are very useful for NC cases as they give reliable information on the degree of inflammation in the subarachnoid space (Ramos-Kuri *et al.*, 1992; Miller *et al.*, 1985), which are of paramount importance for anti-inflammatory steroid therapy.

## TREATMENT

### Intestinal Taeniasis

Two anthelmintics have been used successfully for the treatment of intestinal taeniasis: praziquantel and albendazole. Both have shown a high cure ratio and have also been used for the treatment of

human NC (see below) (Pawlowski, 1989; Groll, 1980). The recommended dose of praziquantel in adults is 2.5–10 mg/kg, given in a single dose. For albendazole, the recommended dose in adults is 6.6 mg/kg or two doses, each of 200 mg/day on 3 consecutive days. This drug should not be used in children under 2 years old or during pregnancy, owing to embryotoxic and teratogenic effects observed in experimental animals.

Several publications have emphasized the positive results of population or individual case treatment for the elimination of tapeworms in endemic areas (Anderson and May, 1982). Treatment is innocuous and inexpensive. A note of caution should be introduced: although large-scale anthelmintic treatment has been effective in temporarily reducing the number of tapeworm carriers in a community, the increasing number of reports on drug resistance to praziquantel and other antiparasitic drugs in wide use support the policy that anthelmintics should be administered only in individually diagnosed cases.

### Cysticercosis

After more than a decade since the first descriptions of cysticidal drugs, great advances have been made on the optimal schedules for the treatment against both the parasites and inflammation (Robles, 1982; Colli *et al.*, 1986; Sotelo *et al.*, 1990; Corral *et al.*, 1996; Sotelo and Flisser, 1997). Two drugs, albendazole (Takayanagui and Jardim, 1992; Botero *et al.*, 1993; Rajshekhar, 1993) and praziquantel (Wadia *et al.*, 1988; Robles *et al.*, 1987; Bittencourt *et al.*, 1990) are very effective cysticidal drugs. They are indicated in all cases of parenchymal or arachnoid cysticercosis (Martínez *et al.*, 1995; Vázquez and Sotelo, 1992), so that nowadays surgical extirpation of cysts is reserved only for cases of therapeutic failure with cysticidal drugs (Del Brutto, 1993; Del Brutto and Sotelo, 1990).

A novel schedule for praziquantel therapy has reduced the treatment to a single day, with results similar to those obtained with the 2 week treatment schedule (Corona *et al.*, 1996; Sotelo, 1997). In the 'single-day' schedule, praziquantel therapy is administered in a total dose of 75 mg/kg, divided into three administrations of 25 mg/kg

each at 2 hour intervals (e.g. at 7, 9 and 11 a.m.). Five hours later (e.g. at 4 p.m.) 20mg of dexamethasone i.m. are administered; the same dose of dexamethasone is repeated the next 2 days in the morning. With this schedule, a plateau of about 6 hours of high plasma concentrations of praziquantel is obtained, exposing the parasites to a longer and continuous period of cysticidal concentration of the drug (Jung *et al.*, 1997; Sotelo and Jung, 1998). In contrast with earlier schedules, in which the drug is administered every 8 hours, achieving very brief periods of high praziquantel concentrations, whose half-life in plasma is less than 3 hours, the 'single-day' schedule of praziquantel produces the same cysticidal effects (destruction of about 70% of parenchymal cysticerci) with the advantage of administering less than 10% the total dose, significantly diminishing the time of treatment and the cost of the drug. Dexamethasone is administered 5 hours later, at the time when most of the praziquantel has been cleared from the blood and its cysticidal action has already taken place. In this way, the treatment against the parasite and the inflammation that follows its destruction are given sequentially, without pharmacological interference between the two drugs.

Albendazole is also given in a brief course, in this case during 8 days, in doses of 15 mg/kg/day divided into two doses, every 12 hours (Sotelo and Jung, 1998; Cruz *et al.*, 1995). With this schedule, around 80% of parenchymal and subarachnoid cysts are destroyed. Albendazole is also effective in ocular and ventricular cysticercosis (Santos *et al.*, 1984; Lozano-Elizondo and Barbosa-Horta, 1990; Del Brutto *et al.*, 1992b). As no pharmacological interference between albendazole and dexamethasone exists (Takayanagui *et al.*, 1997), during the first 4 days of therapy 10–20 mg of i.m. dexamethasone are given to prevent reactions secondary to acute inflammation triggered by the sudden destruction of parasites (Sotelo and Jung, 1998).

In cases of meningeal cysticercosis with intense inflammation, diagnosed by CSF analysis, chronic administration of steroids must be contemplated. A useful schedule is 50 mg prednisone in the morning, three times a week (e.g. Monday, Wednesday and Friday) for long periods (up to years). The continuation of therapy must be decided on the basis of sequential analysis of CSF (Suastegui-Roman *et al.*, 1996).

## PREVENTION

Several measures can be taken to interfere with the life-cycle of taeniasis/cysticercosis. The most important and affordable is public education on the life-cycle of the parasite to implement simple measures aimed at preventing infection, such as proper disposal of human feces whenever feasible, the routine freezing of pork, proper cooking of pork at > 70°C, identification and treatment of taenia carriers, confinement of pigs, and preventing irrigation of vegetables with water contaminated with human feces. Porcine vaccination with recombinant *Taenia* antigens seems a technological possibility in the near future (Sciutto *et al.*, 1990), a measure designed to reduce cysticercosis in pigs in endemic areas and interruption of the life-cycle.

Tapeworm infections can be prevented by eating only well-cooked pork or beef, and avoiding the ingestion of uncooked sausages. Education of residents in small communities in which domestic animals are slaughtered by the owners without the benefit of meat inspection should be attempted, by explaining the necessity of cooking meat properly in order to kill viable larvae, which are the source of tapeworms. Domestic animals, in this case pigs and cows, should be kept away from human excrement, particularly pigs. Systematic treatment of tapeworm carriers should be encouraged, especially since treatment is inexpensive and innocuous.

## *HYMENOLEPIS NANA*

### LIFE-CYCLE (FIGURE 23.16)

*H. nana* belongs to the Family Hymenolepididae, originally described in rodents and discovered in

humans by Theodor Bilharz in 1851, in an autopsy carried out on a child in Egypt. It is the only human tapeworm capable of completing the parasite cycle in one host. The scolex has four

suckers and an armed rostellum with 8–30 hooks. The adult worm is 2–3 cm, its length being proportional to the number of individual worms present in the small intestine. The scolices attach to the upper third of the duodenum and the gravid proglottids rupture into the lumen, releasing the embryonated eggs (40–50  $\mu\text{m}$  in diameter), which hatch in the intestinal lumen and lodge between the intestinal villi, where they develop into cysticeroids. The cysticeroids mature to adult worms in 15–20 days, when they began to release infective eggs.

## EPIDEMIOLOGY

Hymenolepiosis is also a disease of populations living under conditions of poor hygiene and poverty. It is prevalent in school children in tropical and subtropical climates. The disease is acquired by ingestion of water and food contaminated with mouse feces, and can also be transmitted from one child to another by passing infective eggs on dirty hands.

*H. nana* infections induce humoral and cellular immunity, which probably accounts for the

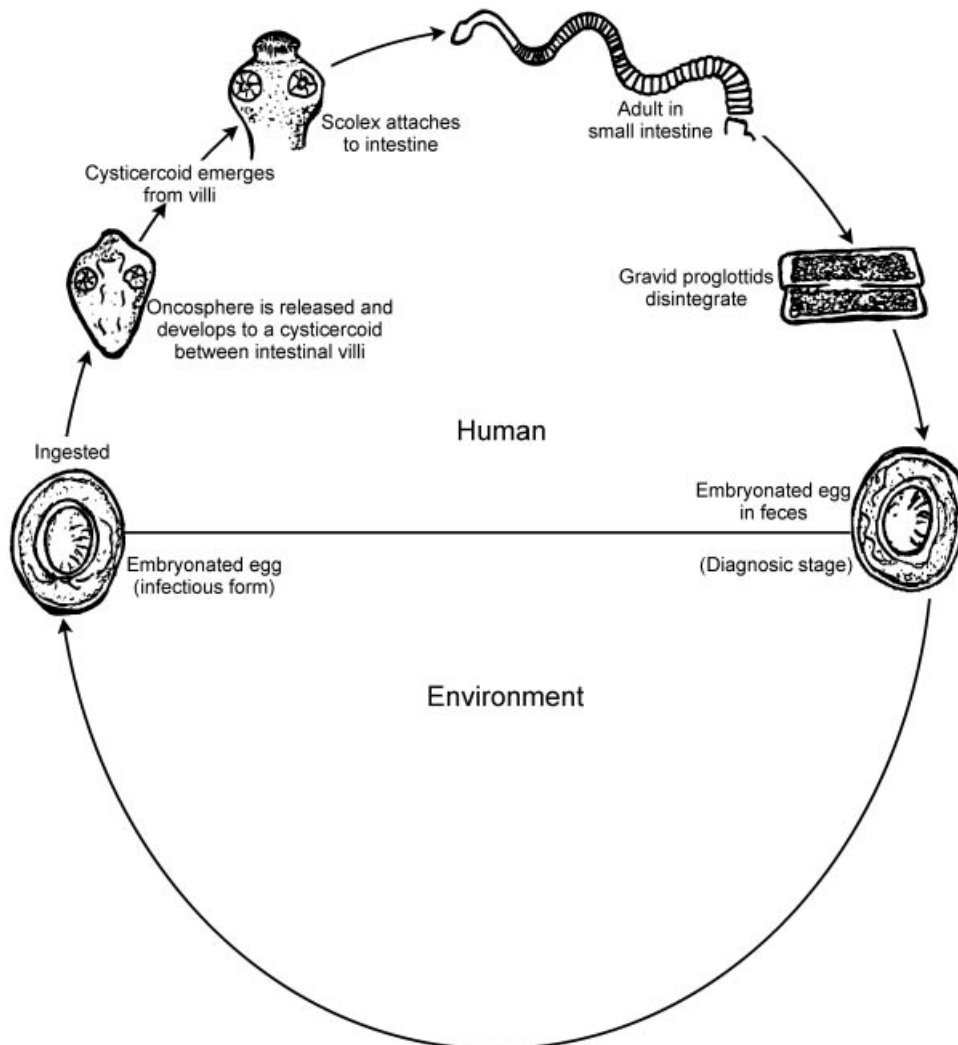


Fig. 23.16 Life-cycle of *Hymenolepis nana*

lower prevalence of this parasitosis observed in adults living in endemic communities. Experimental evidence has demonstrated that IgE and mast cells are involved in the expulsion of adult worms from the intestine (Watanabe *et al.*, 1994).

### CLINICAL MANIFESTATIONS

*Hymenolepis* infections are found mainly in children under 8 years of age (Mason and Patterson, 1994). It is estimated that the majority of infections are asymptomatic and are probably associated with a low number of parasites. Symptoms are vague abdominal distress in light infections, but this can be accompanied by abdominal pain, nausea, vomiting, weight loss, diarrhea and irritability in multiple infections.

### DIAGNOSIS

The diagnosis can be made on coprologic analysis of serial stool samples, by identification of the eggs, which are ovoid and do not have a striated outer embryophore, as they are not covered by a protective keratin shell. The adult worms may also be found in multiple infections, and can be identified by their length and armed rostellum.

### TREATMENT

Praziquantel at a dose of 25 mg/kg has been reported to cure 95% of infections. In countries where niclosamide is available, a dose of 2 g daily for 5 consecutive days is recommended.

## **DIPHYLLOBOTHRIUM LATUM (BROAD FISH TAPEWORM)**

### LIFE-CYCLE (FIGURE 23.17)

In contrast to the taeniid tapeworms, Diphylobothridae require two intermediate hosts to complete their life-cycle and have a free-living stage in freshwater. The scolex of *D. latum* is conformed by bothria and the worms can be very long (6–9 m), with 3000–4000 proglottids, which tend to be wider than long. A single worm can shed 1 million eggs per day. The eggs are not completely mature when released from the proglottids and, when deposited in freshwater bodies, take up to 12 days to mature. The egg hatches the embryo, which is released into the water as the coracidium, a free-swimming form which can be ingested by a small crustacean (copepod), where it develops into a proceroid larva measuring up to 600 µm long. When the copepod is ingested by a fish, the larvae dislodge and penetrate the intestinal wall of the fish, from whence they eventually lodge in muscle masses or viscera to become plerocercoid larvae. Plerocercoids measure 1–5 cm and may remain viable for the lifetime of the fish. The life-cycle is completed when a human ingests raw or undercooked

infected freshwater fish. Other definitive hosts are dogs, cats, pigs, wolves, foxes and bears. The worms attach to the small intestine and may survive for many years (Von Bonsdorff and Bylund, 1982).

### CLINICAL MANIFESTATIONS

Symptoms include abdominal pain, weight loss and a unique form of pernicious anemia, a consequence of the worms' capacity for taking up vitamin B<sub>12</sub> in the small intestine.

### EPIDEMIOLOGY

*D. latum* is found in various terrestrial and marine fish-eating carnivores. The adult worm also parasitizes humans. It has been reported in geographic areas with fresh-water lakes in the subarctic and Eurasia, in the Siberian rivers Ob and Yenisei and in the Baltic Sea. A high prevalence has been observed in the Volga basin and Finland, the lake district of Italy and

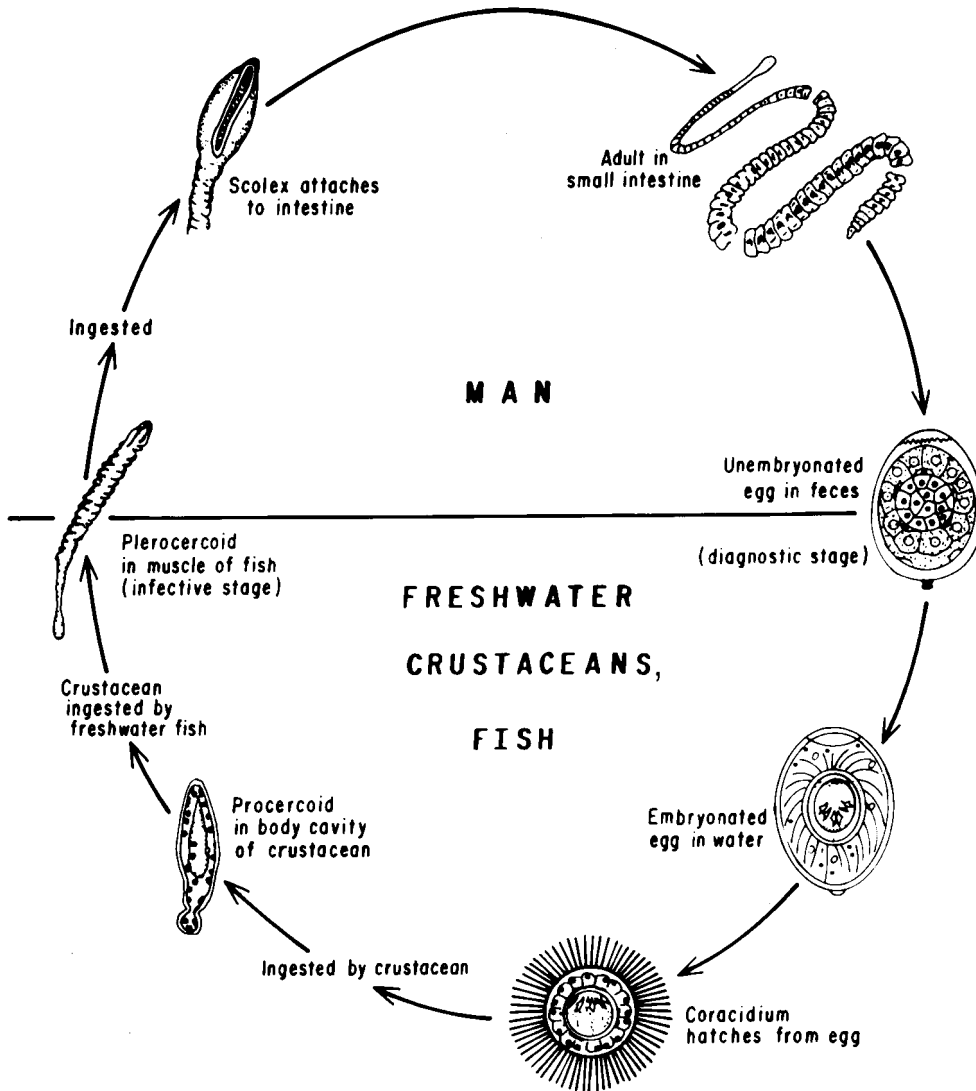


Fig. 23.17 Life-cycle of *Diphyllobothrium latum*

Switzerland. Immigration has transported the disease to North and South America. It has been reported in a number of fish species: pike, perch, ruff, rainbow trout and turbot in Chile, and whitefish and salmon in the USA.

#### DIAGNOSIS

The parasitosis should be suspected in persons with a history of eating raw or undercooked fish, by identification of proglottids and oval-shaped eggs with a characteristic operculum.

#### TREATMENT

The administration of 5–10 mg/kg praziquantel in a single dose has been shown to be effective.

#### PREVENTION

This tapeworm infection can be avoided by not ingesting raw or undercooked fish in known endemic areas. Direct drainage of sewage into freshwater lakes should be avoided.

## ACKNOWLEDGEMENTS

The authors express their thanks to Marie Therese Merchant and Lilia Robert for photographs and to Aurora Salazar for preparation of the manuscript.

## REFERENCES

- Allan JC, Mencos F, Garcia Noval J *et al.* (1993). Dipstick dot ELISA for the detection of *Taenia* coproantigens in humans. *Parasitology* **107**: 79–85.
- Allan JC, Velazquez M, Garcia Noval J *et al.* (1996). Epidemiology of intestinal taeniasis in four rural Guatemalan communities. *Am Trop Med Parasitol* **90** (2): 157–65.
- Anderson RM, May RM (1982). Population dynamics of human helminth infections: control by chemotherapy. *Nature* **297**: 557–63.
- Bao ME, Bogh HO, Kassuku AA *et al.* (1995). The prevalence of *Taenia solium* metacestodes in pigs in northern Tanzania. *J Helminthol* **69** (2): 113–17.
- Bittencourt PRM, Gracia CM, Gorz AM *et al.* (1990). High-dose praziquantel for neurocysticercosis: serum and CSF concentrations. *Acta Neurol Scand* **82**: 28–33.
- Botero D, Uribe CS, Sanchez JL *et al.* (1993). Short course albendazole treatment for neurocysticercosis in Columbia. *Trans R Soc Trop Med Hyg* **87**: 576–7.
- Bowles J, McManus DP (1994). Genetic characterization of the Asian *Taenia* a newly described taeniid cestode of humans. *Am J Trop Med Hyg* **50**: 33.
- Bruce-Conn D (1993). Ultrastructure of the gravid uterus of *Hymenolepis diminuta* (Platyhelminthes: Cestoda). *J Parasitol* **79** (4): 583–90.
- Chandy MJ, Rajshekhar V, Prakash S *et al.* (1989). Cysticercosis causing single, small CT lesions in Indian patients with seizures. *Lancet* **8634**: 390–1.
- Chang KH, Kim WS, Cho SY *et al.* (1988). Comparative evaluation of brain CT and ELISA in the diagnosis of neurocysticercosis. *Am J Neurol Res* **8**: 125–30.
- Chapman A, Vallejo V, Mossie KG *et al.* (1995). Isolation and characterization of species-specific DNA probes from *Taenia solium* and *Taenia saginata* and their use in an egg detection assay. *Clin Microbiol* **33**: 1283.
- Colli BO, Martelli N, Assirati JA *et al.* (1986). Results of surgical treatment of neurocysticercosis in 69 cases. *J Neurosurg* **65**: 309–15.
- Corona T, Lugo R, Medina R *et al.* (1996). Single-day praziquantel therapy for neurocysticercosis. *N Engl J Med* **334**: 125.
- Corona T, Pascoe D, González-Barranco D *et al.* (1986). Anticysticercus antibodies in serum and cerebrospinal fluid in patients with cerebral cysticercosis. *J Neurol Neurosurg Psychiatr* **49**: 1044–9.
- Corral I, Quereda C, Moreno A *et al.* (1996). Intramedullary cysticercosis cured with drug treatment. *Spine* **21**: 2284–7.
- Cruz I, Cruz ME, Carrasco F, Horton J (1995). Neurocysticercosis: optimal dose treatment with albendazole. *J Neurol Sci* **133**: 152–4.
- Dada EO, Adeiyongo CM (1993). Observations on the epidemiology of human taeniasis amongst the Goemi tribe of northern Nigeria. *Appl Parasitol* **34** (4): 251–7.
- Del Brutto OH, Santibañez R, Noboa CA *et al.* (1992). Epilepsy due to neurocysticercosis: analysis of 203 patients. *Neurology* **42**: 389–92.
- Del Brutto OH (1992). Cysticercosis and cerebrovascular disease: a review. *J Neurol Neurosurg Psychiatr* **55**: 252–4.
- Del Brutto OH (1993). The use of albendazole in patients with single lesions enhanced on contrast CT. *N Engl J Med* **328**: 356–7.
- Del Brutto OH, García E, Talamás O *et al.* (1988). Sex-related severity of inflammation in parenchymal brain cysticercosis. *Arch Intern Med* **148**: 544–6.
- Del Brutto OH, Sotelo J (1990). Albendazole therapy for subarachnoid and ventricular cysticercosis. Case report. *J Neurosurg* **72**: 816–17.
- Del Brutto OH, Sotelo J, Aguirre R *et al.* (1992b). Albendazole therapy for giant subarachnoid cysticerci. *Arch Neurol* **49**: 535–8.
- Díaz-Camacho S, Candil Ruiz A, Uribe-Beltrán M *et al.* (1991). Epidemiological study and control of *Taenia solium*: infections with praziquantel in a rural village of Mexico. *Am J Trop Med Hyg* **45** (4): 522–31.
- Díaz F, García HH, Gilman RH *et al.* (1992). Epidemiology of taeniasis and cysticercosis in a Peruvian village. The Cysticercosis Working Group in Peru. *Am J Epidemiol* **135** (8): 875–82.
- Dixon H, Lipscomb F (1961). *Cysticercosis: An Analysis and Follow-up of 450 Cases*. Medical Resource Council Special Report No. 299. London: HMSO.
- Earnest MP, Reller LB, Filley CM *et al.* (1987). Neurocysticercosis in the United States: 35 cases and a review. *Rev Infect Dis* **9**: 961–79.
- Eom KS, Rim HJ (1993) Morphologic descriptions of *Taenia asiatica* sp. *Korean J Parasitol* **31**: 1.
- Estañol B, Corona T, Abad P (1986). A prognostic classification of cerebral cysticercosis: therapeutic implications. *J Neurol Neurosurg Psychiatr* **49**: 1131–4.
- Estañol B, Kleriga E, Loyo M *et al.* (1983). Mechanisms of hydrocephalus in cerebral cysticercosis: implications for therapy. *Neurosurgery* **13**: 119–23.
- Fan PC, Chung WC, Lin CY *et al.* (1992). Clinical manifestations of taeniasis in Taiwan aborigenes. *J Helminthol* **66**: 118.
- Faust EC, Antoni JS, Odom V *et al.* (1938). A critical study of clinical laboratory techniques for the diagnosis of protozoan, cyst and helminth eggs in faeces. *Am J Trop Med Hyg* **18**: 169.
- García HH, Gilman RH, Tovar MA *et al.* (1995). Factors associated with *Taenia solium*: cysticercosis: analysis of 946 Peruvian neurologic patients. Cysticercosis Working Group in Peru (CWG). *Am J Trop Med Hyg* **52** (2): 145–8.
- Gemmel MM, Matyas Z, Pawlowski Z *et al.* (eds) (1983). *Guidelines for the Surveillance, Prevention, and Control of Taeniasis/Cysticercosis*. World Health Organization: Geneva.

- Graham CF (1941). A device for the diagnosis of *Enterobius* infection. *Am J Trop Med Hyg* **21**: 159.
- Grisolia JS, Wiederholt WC (1982). CNS cysticercosis. *Arch Neurol* **39**: 540–4.
- Groll E (1980). Praziquantel for cestode infections in man. *Acta Trop* **37**: 293.
- Jung H, Medina R, Castro N *et al.* (1997). Pharmacokinetic study of praziquantel administered alone and in combination with cimetidine in a single-day therapeutic regimen. *Antimicrob Agents Chemother* **41**: 1256–9.
- Keane JR (1982). Neuro-ophthalmologic signs and symptoms of cysticercosis. *Arch Ophthalmol* **100**: 1445–8.
- Kruger-Leite E, Jalkh AE, Quiroz H *et al.* (1985). Intraocular cysticercosis. *Am J Ophthalmol* **99**: 252–7.
- Küchenmeister F (1855). Offenes Sendschreiben an die k.k. Gesellschaft der Aerzte zu Wien. Experimentelles Nachweisen dass *Cysticercus cellulosae* innerhalb des menschlichen Darmkanales in *Taenia solium* umwandelt. *Wien Med Wochenschr* **5**: 1–4.
- Larralde C, Padilla A, Hernandez M *et al.* (1992). Seroepidemiology of cysticercosis in Mexico. *Salud Pub Mexico* **34**: 197–210.
- Lobato RD, Lamas E, Portillo JM (1981). Hydrocephalus in cerebral cysticercosis. Pathogenic and therapeutic considerations. *J Neurosurg* **55**: 786–93.
- López-Hernández A, Garaizar C (1982). Childhood cerebral cysticercosis: clinical features and computed tomographic findings in 89 Mexican children. *Can J Neurol Sci* **9**: 401–7.
- Lozano-Elizondo D, Barbosa-Horta, S. (1990). Tratamiento con albendazol de la cisticercosis intraocular. *Rev Mex Oftalmol* **64**: 15–28.
- Lumsden R, Voge M, Sogandares-Bernal F (1982). The metacestode tegument: fine structure, development, topochemistry and interactions with the host. In Flisser A, Beltran F, Larralde C *et al.* (eds), *Cysticercosis: Present State of Knowledge and Perspectives*. Academic Press: New York; 307–61.
- Martinez HR, Rangel-Guerra R, Arredondo-Estrada JH *et al.* (1995). Medical and surgical treatment in neurocysticercosis a magnetic resonance study of 161 cases. *J Neurol Sci* **130**: 25–34.
- Martinez HR, Rangel-Guerra R, Elizondo G *et al.* (1989). MR imaging of neurocysticercosis: a study of 56 cases. *Am J Neurol Res* **10**: 1011–19.
- Mason PR, Patterson BA (1994). Epidemiology of *Hymenolepis nana* infections in primary school children in urban and rural communities in Zimbabwe. *J of Parasitol* **80** (2): 245–50.
- Medina MT, Rosas E, Rubio F *et al.* (1990). Neurocysticercosis as the main cause of late-onset epilepsy in Mexico. *Arch Intern Med* **150**: 325–7.
- Merchant MT, Aguilar L, Avila G *et al.* (1998). *Taenia solium*: description of the intestinal implantation sites in experimental hamster infections. *J Parasitol* **84** (4): 681–5.
- Miller BL, Staugaitis SM, Tourtellotte WW *et al.* (1985). Intra-blood-brain barrier IgG synthesis in cerebral cysticercosis. *Arch Neurol* **42**: 782–4.
- Mobius G (1993). Epidemiologic studies of *C. bovis* and *T. saginata* infections in eastern and western Germany. *Deutsche Tierärztl Wochenschr* **100** (3): 110–14.
- Monteiro L, Almeida-Pinto J, Stocker A *et al.* (1993). Active neurocysticercosis, parenchymal and extraparenchymal: a study of 38 patients. *J Neurol* **241**: 15–21.
- Monteiro L, Martins da Silva A, Nunes B *et al.* (1991). Epilepsy in neurocysticercosis: electroclinical aspects in 138 patients. *Epilepsia* **32**: 104.
- Monteiro L, Nunes B, Mendoca D *et al.* (1995). Spectrum of epilepsy in neurocysticercosis: a long-term follow-up of 143 patients. *Acta Neurol Scand* **92**: 33–40.
- Nieto D (1982). Historical notes on cysticercosis. In Flisser A, Beltran F, Larralde C *et al.* (eds), *Cysticercosis, Present State of Knowledge and Perspectives*. Academic Press: New York; 1–7.
- Pawlowski ZS (1989). Efficiency of low doses of praziquantel in taeniasis. *Acta Trop* **48**: 83.
- Pawlowski ZS (1982). Epidemiology of *Taenia saginata* infection. In Flisser A, Beltran F, Larralde C *et al.* (eds), *Cysticercosis: Present State of Knowledge and Perspectives*. Academic Press: New York; 69–85.
- Pitella JEH (1997). Neurocysticercosis. *Brain Pathol* **7**: 681–93.
- Rajshekhar V (1991). Etiology and management of single small CT lesions in patients with seizures: Understanding a controversy. *Acta Neurol Scand* **84**: 465–70.
- Rajshekhar V (1993). Albendazole therapy for persistent, solitary cysticercus granulomas in patients with seizures. *Neurology* **43**: 1238–40.
- Ramos-Kuri M, Montoya RM, Padilla A *et al.* (1992). Immunodiagnosis of neurocysticercosis: disappointing performance of serology (enzyme-linked immunosorbent assay) in an unbiased sample of neurological patients. *Arch Neurol* **49**: 633–6.
- Rangel R, Torres B, Del Brutto OH *et al.* (1987). Cysticercotic encephalitis: a severe form in young females. *Am J Trop Med Hyg* **36**: 387–92.
- Ritchie LS (1948). An ether sedimentation technique for routine stool examinations. *Bull US Army Dept* **8**: 326.
- Robles C, Sedano AN, Vargas-Tentori N *et al.* (1987). Long-term results of praziquantel therapy in neurocysticercosis. *J Neurosurg* **66**: 359–63.
- Robles C (1982). Resultados tardíos en el tratamiento de la cisticercosis cerebral por praziquantel. *Salud Públ Mèx* **24**: 625–7.
- Salgado P, Rojas R, Sotelo J (1997). Cysticercosis: clinical classification based on imaging studies. *Arch Intern Med* **157**: 1991–7.
- Sanchez AL, Gomez O, Allebecj P *et al.* (1997). Epidemiologic study of *Taenia solium* infection in a Rural Village in Honduras. *Ann Trop Med Parasitol* **91** (2): 163–171.
- Santos R, Chavarría M, Aguirre AE (1984). Failure of medical treatment in two cases of intraocular cysticercosis. *Am J Ophthalmol* **97**: 249–50.
- Sarti E, Schantz PM, Plancarte A *et al.* (1994). Epidemiological investigation of *Taenia solium* taeniasis and cysticercosis in a rural village of Michoacan state, Mexico. *Trans R Soc Trop Med Hyg* **88** (1): 49–52.
- Sarti E, Schantz PM, Plancarte A *et al.* (1992). Prevalence and risk factors of *Taenia solium* taeniasis and cysticercosis in humans and pigs in a village in Morelos, Mexico. *Am J Trop Med Hyg* **46**: 677–85.



- Schantz PM, Moore AC, Muñoz JL *et al.* (1992). Neurocysticercosis in an Orthodox Jewish community in New York City. *N Engl J Med* **327**: 692–5.
- Schmidt GD (1986). *Handbook of Tapeworm Identification. Key to the General Taeniidae*. CRC Press: Boca Raton, FL; 221–7.
- Sciutto E, Fragoso G, Trueba L *et al.* (1990). Cysticercosis vaccine: cross protecting immunity with *T. solium* antigens against experimental murine *T. crassiceps* cysticercosis. *Parasite Immunol* **12**: 687–96.
- Simac C, Michel P, Andriantsimahavandy A *et al.* (1995). Use of enzyme-linked immunosorbent assay and enzyme-linked immunoelectrotransfer blot for the diagnosis and monitoring of neurocysticercosis. *Parasitol Res* **81**: 132–6.
- Sotelo J, Jung H (1998). Pharmacokinetic optimization of the treatment of neurocysticercosis. *Clin Pharmacokinet* **34** (6): 503–15.
- Sotelo J, Flisser A (1997). Neurocysticercosis: practical treatment guidelines. *CNS Drugs* **7**: 17–25.
- Sotelo J, Del Brutto OH, Penagos P *et al.* (1990). Comparison of therapeutic regimen of anticysticercal drugs for parenchymal brain cysticercosis. *J Neurol* **237**: 69–72.
- Sotelo J, Mariñ C (1987). Hydrocephalus secondary to cysticercotic arachnoiditis. A long-term follow-up review of 92 cases. *J Neurosurg* **66**: 686–9.
- Sotelo J (1997). Treatment of brain cysticercosis. *Surg Neurol* **48**: 110–12.
- Suastegui-Roman RA, Soto-Hernández JL, Sotelo J (1996). Effects of prednisone on ventriculoperitoneal shunt function in hydrocephalus secondary to cysticercosis: a preliminary study. *J Neurosurg* **84**: 629–33.
- Takayanagui OM, Lanchote VL, Marques MPC (1997). Therapy for neurocysticercosis: pharmacokinetic interaction of albendazole sulfoxide with dexamethasone. *Therapeut Drug Monitor* **19**: 51–5.
- Takayanagui OM, Jardim E (1992). Therapy for neurocysticercosis. Comparison between albendazole and praziquantel. *Arch Neurol* **49**: 290–4.
- Vázquez V, Sotelo J (1992). The course of seizures after treatment for cerebral cysticercosis. *N Engl J Med* **327**: 696–701.
- Verster A (1971). Preliminary report on the golden hamster as a definitive host of *Taenia solium* Linnaeus 1758 and *Taenia saginata* Goeze 1792. *Onderstepoort J Vet Res* **38** (1): 63–4.
- Von Bonsdorf B, Bylund G (1992). The ecology of *Diphyllobothrium latum*. *Ecology Dis* **1**: 21.
- Wadia N, Desai S, Bhatt M (1988). Disseminated cysticercosis. New observations, including CT scan findings and experience with treatment by praziquantel. *Brain* **111**: 597–614.
- Watanabe N, Nawa Y, Okamoto K *et al.* (1994). Expulsion of *Hymenolepis nana* from mice with congenital deficiencies of IgE production or of mast cell development. *Parasite Immunol* **16**: 137.
- Willms K (1998). Cestodes (tapeworms). In Gorbach SL, Bartlett JG, Blacklow NR (eds), *Infectious Diseases*, 2nd edn. WB Saunders: Philadelphia; 2481–99.



# Intestinal Trematodes

**Thomas R. Hawn and Elaine C. Jong**

*University of Washington Medical Center, Seattle, WA, USA*

## GENERAL CONSIDERATIONS

Although there are over 40 000 documented species of digenetic trematodes, only a limited number are capable of causing infection in humans (Malek, 1980). Approximately 50 of these species are intestinal trematodes, which occur worldwide and usually cause asymptomatic or benign infections (Table 24.1) (Bunnag and Harinasuta, 1989; Bunnag *et al.*, 1991; Chai and Lee, 1991; Chung and Soh, 1991; Waikagul, 1991; Waikagul *et al.*, 1997). These trematodes have not been intensively studied, possibly due to the mild nature of the majority of the infections. The life cycles of these flukes are similar and involve a definitive host and two intermediate hosts (Figure 24.1). The adult worm lives in the definitive host, where it secretes eggs that are released in feces. The ova hatch into miracidia, which infect the first intermediate host, which is often a mollusc. The miracidia transform into sporocysts, which successively transform into mother and daughter rediae and then into cercariae, which leave the snail in freshwater. The cercariae then infect a second intermediate host, where they encyst as metacercariae. Second

intermediate hosts are variable and include fish, snails, tadpoles, shrimp, dragonfly naiads and aquatic vegetation. The definitive host ingests the metacercariae, which then develop into adult worms to complete the life cycle.

Although there are many different species of intestinal trematodes with numerous variations of life cycles and hosts, the clinical features of infection, diagnosis and therapeutic options are not complicated (Table 24.2). Most of the infections are asymptomatic or only involve mild gastrointestinal symptoms (with exceptions noted below). While stool microscopy is the central tool for diagnosis, distinguishing the ova of various species is difficult and accurate identification often requires collecting the adult worm. The drug of choice for treating many intestinal trematode infections is praziquantel, although the US Food & Drug Administration considers its use investigational for these infections (Medical Letter, 1998). None of the intestinal flukes is known to be resistant to praziquantel but efficacy data are not available for most of them. This chapter will describe the organisms, epidemiology, pathogenesis, clinical features and treatment of some of the most important of these fluke infections.

## ***FASCIOLOPSIS BUSKI***

### DESCRIPTION OF THE ORGANISM

*Fasciolopsis buski* is one of the largest trematodes, with some organisms reaching 75 mm in

length and 20 mm in width (Table 24.1) (Malek, 1980). This fluke belongs to the Family Fasciolidae, which also contains the hepatobiliary flukes *Fasciola hepatica* and *F. gigantica*. It was

**Table 24.1** Intestinal trematodes in human infection: geographic location, hosts and source of infection\*

Species	Geographic location	Non-human definitive hosts	Source of infection
<b>Family Fasciolidae</b>			
<i>Fasciolopsis buski</i>	China, Taiwan, Thailand, Laos, Bangladesh	Pig, dog	Water plants
<b>Family Echinostomatidae</b>			
<i>Echinostoma ilocanum</i>	Indonesia, Philippines, Thailand, China	Dog, rat, mice	Snail
<i>E. hortense</i>	Korea, Japan	Dog, rat	Fish
<i>E. lindoense</i> (= <i>E. echinatum</i> )	Indonesia, Brazil	Rodent, birds	Snail
<i>E. malayanum</i>	Indonesia, China, Thailand, Philippines, Malaysia, Singapore	Rat	Snail, tadpole, fish
<i>E. revolutum</i> (= <i>E. caproni</i> )	Thailand, Indonesia, Taiwan	Chicken, goose, duck, rodent	Snail, tadpole
<i>E. jassyense</i> (= <i>E. melis</i> )	China, Romania	Unknown	Tadpole
<i>E. cinetorchis</i>	Japan, Korea, Indonesia	Rat	Tadpole
<i>Echinochasmus japonicus</i>	China, Korea	Cat, dog, rodent, chicken	Fish
<i>Echinochasmus perfoliatus</i>	Japan, Italy, Romania, Russia, Egypt, Taiwan	Cat, dog, pig, fox, rat	Fish
<i>Paryphostomum sufrartyfex</i>	India	Pig	Snail
<i>Hypoderaeum conoideum</i>	Thailand	Duck, fowl	Snail, tadpole
<i>Episthmium caninum</i>	Thailand	Dog	Fish
<i>Himasthla muehlensi</i>	Germany	Gulls, bird	Clam
<i>Echynoparyphium recurvatum</i>	Indonesia, Japan	Bird, rat, mammals	Tadpole frog
<b>Family Heterophyidae</b>			
<i>Metagonimus yokogawai</i>	China, Japan, Korea, Balkans, Russia, Spain, Taiwan, Philippines	Cat, dog, pig, pelican	Fish
<i>M. takahashii</i>	Korea	Cat, dog, rat, fowl	Fish
<i>M. minutus</i>	Taiwan	?	Fish
<i>Heterophyes heterophyes</i>	Egypt, Korea, China, Taiwan, Philippines, Mediterranean, Africa, Japan	Mammals, birds	Fish
<i>H. nocens</i>	Japan	Cat, dog, rat	Fish
<i>H. dispar</i>	Korea	Cat, dog	Fish
<i>Heterophyopsis continua</i>	Korea, Japan, China	Dog	Fish
<i>Cryptocotyle lingua</i>	Greenland	Cat, dog, rat	?
<i>Stellantchasmus falcatus</i>	Philippines, Thailand, Hawaii, Japan, Korea	Cat, dog	Fish
<i>Haplorchis yokogawai</i>	Taiwan, Philippines, Thailand, Indonesia, South China	Cat, dog	Fish
<i>H. taichui</i>	Taiwan, Philippines, Thailand, Pakistan, Philippines	Cat, dog ?	Fish Fish
<i>H. pumilio</i>	Taiwan, Philippines, Thailand, Egypt	Cat, dog, night heron	Fish
<i>Apophallus donicus</i>	USA	Cat, dog, rat, fox, rabbit	Fish
<i>Pygidiopsis summa</i>	Korea	Bird, cat, dog, rat	Fish
<i>Centrocestus armatus</i>	Korea, Japan	Cat, dog, rat, mouse, rabbit, heron	Fish
<i>C. canimus</i>	Thailand, Taiwan	Rat	Fish
<i>C. formosanus</i>	Taiwan, South China, Philippines	Cat, dog, rat, chicken, duck	Fish, frog
<i>C. kurokawai</i>	Japan	?	Fish
<i>C. cuspidatus</i>	Egypt, Taiwan	Rat, chicken	Fish
<i>C. longus</i>	Taiwan	?	?
<i>Stictodora fuscatum</i>	Korea, Japan	Cat, bird	fish
<i>Procerovuum calderoni</i>	Philippines	Cat, dog	Fish
<i>P. varium</i>	Japan	Cat, bird	Fish

Continued

Table 24.1 Continued

Species	Geographic location	Non-human definitive hosts	Source of infection
<b>Family Lecithodendriidae</b>			
<i>Phaneropsolus bonnei</i>	Indonesia, Thailand	Bat, monkey	Dragonfly naiads
<i>Prosthodendrium molenkampii</i>	Indonesia, Thailand	Bat, monkey, rat	Dragonfly naiads
<b>Family Plagiorchiidae</b>			
<i>Plagiorchis harinasutai</i>	Thailand	?	?
<i>P. javensis</i>	Indonesia	Bird, bat	Larval insects
<i>P. philippinensis</i>	Philippines	Bird, rat	?Larval insects
<i>P. muris</i>	Japan	Bird, dog, rat	?Snails, aquatic insects
<b>Family Paramphistomatidae</b>			
<i>Watsonius watsoni</i>	South-west Africa	Baboon, monkey	?Water plants
<i>Gastrodiscoides hominis</i>	South-east Asia, Kazakstan	Pig, rats, monkey	Aquatic vegetation
<b>Family Microphallidae</b>			
<i>Spelotrema brevicaeca</i> (= <i>Carneophallus brevicaeca</i> )	Philippines	Bird	Shrimp
<b>Family Diplostomatidae</b>			
<i>Fibricola seoulensis</i>	Korea	Rats	Snake, frog, tadpole
<i>Alaria americana</i>	North America	Wild carnivores	Tadpoles, frogs
<b>Family Nanophyetidae</b>			
<i>Nanophyetis salmincola salmincola</i>	North America	Dogs, foxes, coyote	Salmon and trout
<i>N. salmincola schikhobalowi</i>	Siberia	Dogs, foxes, coyote	Fish

\*Table adapted from Bunnag and Harinasuta (1989), Bunnag *et al.* (1991), Chai and Lee (1991), Chung and Soh (1991) and Waikagul (1991).

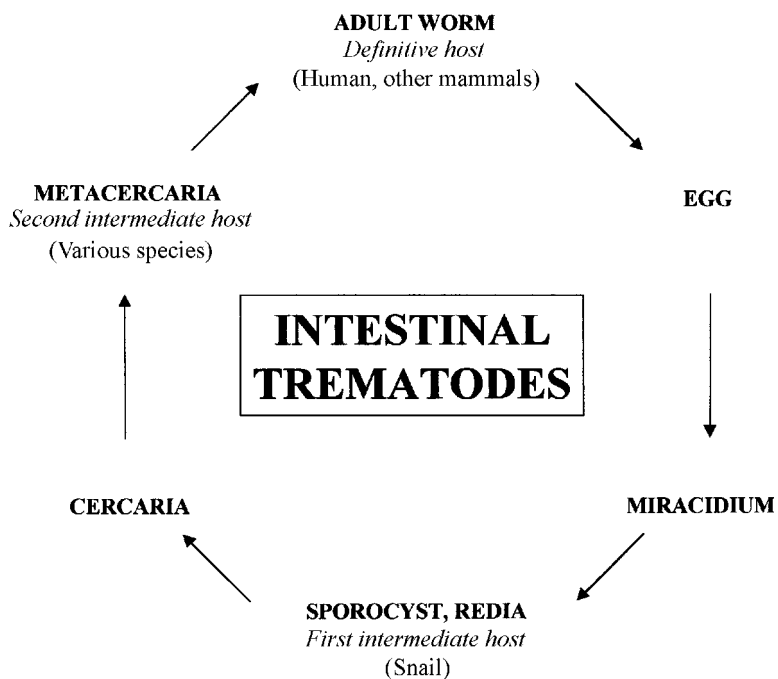


Fig. 24.1 Generalized life-cycle of intestinal trematodes. Each intestinal trematode life cycle stage is highlighted in bold letters with its accompanying host where indicated

**Table 24.2** Major intestinal trematode infections in humans: clinical features, organism size and treatment

Trematode	Clinical features	Average size		Treatment
		Adult (mm)	Egg ( $\mu\text{m}$ )	
<i>Fasciolopsis buski</i>	Asymptomatic or mild GI symptoms. Can be severe, more often in children	50 × 15	135 × 80	Praziquantel*
<i>Echinostoma</i> spp.	Asymptomatic or mild GI symptoms	10 × 1	110 × 70	Praziquantel*
<i>Heterophyes heterophyes</i>	Asymptomatic or mild GI symptoms. Occasional disseminated disease	1.4 × 0.4	29 × 16	Praziquantel*
<i>Metagonimus yokogawai</i>	Asymptomatic or mild GI symptoms. Occasional disseminated disease	1.5 × 0.6	29 × 15	Praziquantel*

GI, gastrointestinal; \*considered investigational for this use.

discovered by Busk in 1843 at an autopsy where the worms were found in the duodenum, and was originally named *Distomum buski*. The adult worm varies in length from 20 to 75 mm, with a width of 8–20 mm and a thickness of 2 mm (Figure 24.2). It contains testes which are highly branched, ovaries, a ventral sucker, an intestinal cecum and an excretory bladder. An average of 10 worms infect each human host and excrete approximately 10 000–20 000 eggs/day (Malek, 1980; Rahman *et al.*, 1981). The eggs are ovoid, operculated, have a thin shell and average 130–140  $\mu\text{m}$  in length and 80–85  $\mu\text{m}$  in width (Figure 24.3). They are excreted in the feces of humans or pigs, where they mature into miracidia over 3–7 weeks in freshwater. The miracidia hatch from the egg and infect the snail intermediate host (*Segmentina hemisphaerula* and *Hippeutis cantori*) where sporocyst, rediae and then cercariae develop after approximately 7 weeks. The cercariae encyst and form metacercariae on various water plants, including water caltrop, chestnut, morning glory, lotus and water hyacinth (Manning *et al.*, 1971). The metacercariae, which are visible with an average size of 2–4 mm, are ingested by the definitive host and excyst in the duodenum, where they mature over 3 months into adult flukes (Malek, 1980).

## PATHOGENESIS

In animal models, intestinal pathology includes small foci of petechial hemorrhage with mucosal edema and inflammation at the sites of attachment. In an autopsy study of a fatal human

infection with over 400 adult worms, the mucosa of the stomach and intestines was hyperemic without ulceration. There were also hemorrhagic lesions in the lungs (Viranuvatti *et al.*, 1953).

## IMMUNOLOGY AND MOLECULAR BIOLOGY

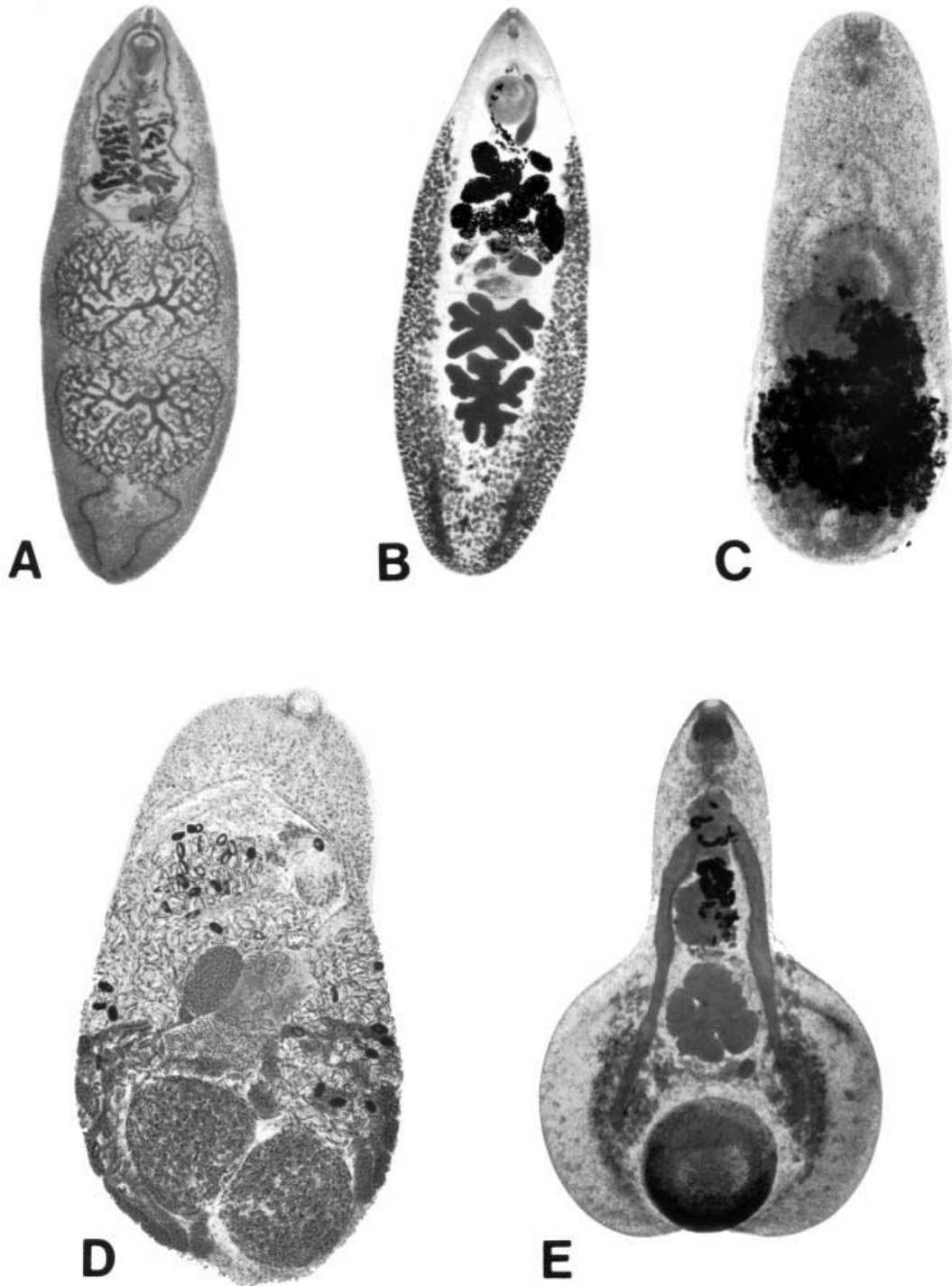
There are few substantive studies on the immunology and molecular biology of *F. buski*. In one study, the peak prevalence of infection was in the 10–15 year-old group, with very few cases in old age (Manning *et al.*, 1971). Elderly individuals continued to ingest metacercariae even though they had lower infection rates, which suggests that humans may acquire resistance.

## EPIDEMIOLOGY

*F. buski* is found in China and south-east Asia in areas where animal feces (mainly from pigs) contaminates water sources that contain aquatic vegetation that is consumed by humans.

## CLINICAL FEATURES

While *F. buski* has been associated with severe illness, the majority of infections are mild or asymptomatic. Diarrhea, abdominal pain and even death have been attributed to infection with heavy worm burdens. In one of the few controlled trials, 28 Thai individuals with *F. buski*



**Fig. 24.2** Adult intestinal trematodes. (A) *Fasciolopsis buski*, average size 20–75 × 8–20 mm. (B) *Echinostoma malayanum*, average size 2–20 × 1–1.5 mm. (C) *Heterophyes heterophyes*, average size 1–1.7 × 0.3–0.4 mm. (D) *Metagonimus yokogawai*, average size 1–2.5 × 0.4–0.75 mm. (E) *Gastrodiscoides* spp., average size 10 × 5 mm. Photographs courtesy of Professor Prayong Radomyos, Faculty of Allied Health Sciences, Thammasat University, Thailand

infection were compared to an uninfected group (Plaut *et al.*, 1969). Gastrointestinal symptoms such as nausea, vomiting, anorexia, abdominal pain, diarrhea, melena and weight loss were present in 89% of infected subjects, but also in 82% of controls. No symptoms distinguish *F. buski* infection in the majority of individuals. While symptoms are generally mild, clinical manifestations may be more severe in children with heavy worm burdens. Shah *et al.* (1973) described an outbreak of *F. buski* in India, where 11 of 34 children died. The children who died had heavier infestations and suffered from diarrhea, anorexia, edema and emesis of flukes. While there are potential confounding causes of death in this study, it does appear that *F. buski* can occasionally cause significant morbidity and mortality (Shah *et al.*, 1973).

### LABORATORY DIAGNOSIS

Examination of stool for eggs or adult worms is the only available diagnostic tool. The eggs are large in comparison to other helminth eggs and must be distinguished from *Fasciola* spp., as well as from *Paragonimus*, *Echinostoma* and *Gastrodiscoides* spp.

### CLINICAL MANAGEMENT

Praziquantel is the drug of choice for treating *F. buski*. Bunnag *et al.* (1983) treated 85 individuals with praziquantel at 15, 25 or 40 mg/kg in a single dose and had 100% cure rates, with stool

studies followed up to 56 days (Table 24.3). There was no control group for comparative cure rates in untreated individuals. Alternative treatment options are limited. Tetrachloroethylene is a suboptimal alternative, with lower efficacy and significant side effects. In one study, tetrachloroethylene was effective in eradicating worms in 9 of 11 subjects, with follow-up at 2 and 6 weeks (Plaut *et al.*, 1969). In a separate study, severe allergic reactions with tetrachloroethylene were observed in four of six children who were not pre-treated with antihistamines (Rabbani *et al.*, 1985). Niclosamide has also been tested and has minimal efficacy, with a 10–12% cure in one study compared to 77% for tetrachloroethylene ( $n = 40$  patients) (Suntharasamai *et al.*, 1974). Tetrachloroethylene also had severe side effects in this study, with nausea (85%), vomiting (70%) and vertigo (31%). Thiabendazole, mebendazole, levamisole and pyrantel palmoate were ineffective in one study (Rabbani *et al.*, 1985). Overall, praziquantel is the most effective and best tolerated of all available medications. While tetrachloroethylene is effective, it has significant toxicity and is not routinely available.

### PREVENTION AND CONTROL

Individuals should avoid ingestion of uncooked water plants in endemic areas. Since pigs are the main reservoir, water resource planning to avoid contamination by pigs may decrease transmission. The metacercariae are destroyed by drying, so interruption of the life cycle is not difficult.

## ECHINOSTOMA SPP.

*Echinostoma* species (*echinos* = spine, *stoma* = mouth) are predominantly found in animal reservoirs, with occasional infections of humans. The taxonomy of this genus is confusing, with reported numbers of species ranging from 61 to 114 with ongoing revision of classification schemes (Huffman and Fried, 1990). While the majority of species are found in birds and rodents, several species have been found in humans (Table 24.1) (Carney, 1991). There is a

significant body of literature on experimental *Echinostoma* infections, due to the ease with which it can be maintained in the laboratory.

### DESCRIPTION OF THE ORGANISM

Echinostomes are small elongated flukes, 2–20 mm in length and 1.0–1.5 mm in width (Figure 24.2) (Carney, 1991). The ‘spiny mouth’ is the



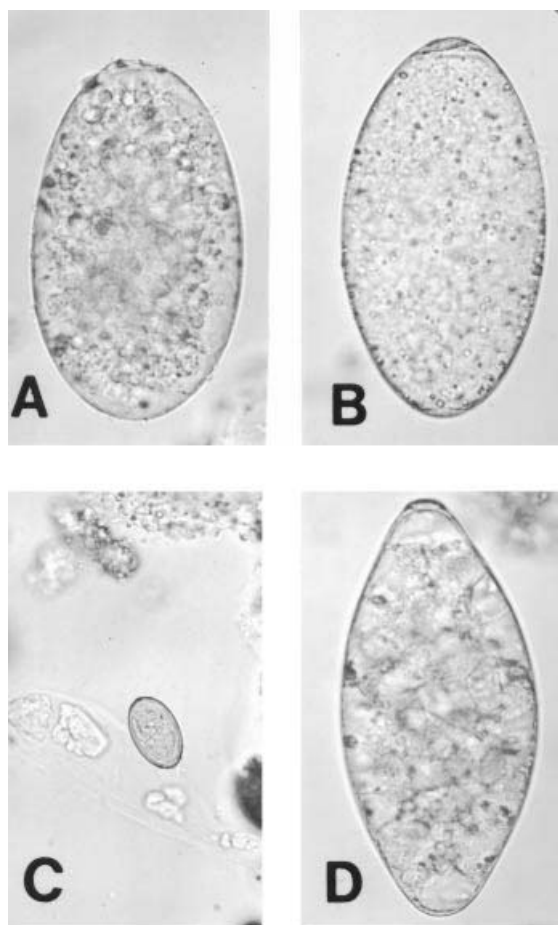
most characteristic feature and refers to one or two collars of spines surrounding the oral sucker. The number of spines varies from 24 to 49, with many species belonging to the 37-collared-spine group. The adult also contains testes, ovaries and a ventral sucker. The adult secretes eggs into the host's intestinal lumen which are then passed in the feces. The eggs are large, ovoid, operculated, have a thin shell and vary in length (88–130  $\mu\text{m}$ ) and width (53–90  $\mu\text{m}$ ) depending on the species (Figure 24.3) (Malek, 1980). After approximately 10 days a miracidium is formed, which hatches and infects a snail intermediate host, where it develops into a sporocyst, two generations of rediae and then cercariae. This stage then encysts as metacercariae in a variety of second intermediate hosts, including snails, fish, bivalves or tadpoles. The definitive host then ingests the metacercariae to complete the life cycle. Development in the definitive host from a metacercariae to an egg-secreting adult worm can be as rapid as 2 weeks (Malek, 1980).

### **PATHOGENESIS, IMMUNOLOGY AND MOLECULAR BIOLOGY**

In animal models, *Echinostoma* species cause inflammatory changes in the intestine, including edema, mucosal destruction and lymphocytic infiltrates (Huffman and Fried, 1990). While there have not been any significant studies on the immunology or pathology of human echinostomiasis, *E. caproni* has been intensively studied in animal laboratory models. Molecular studies are available for speciation and phylogenetic analysis (Fried and Huffman, 1996).

### **EPIDEMIOLOGY**

The majority of cases of echinostomiasis in humans occur in Asia, including Indonesia, Thailand, The Philippines, Taiwan, Japan, Korea, China, Malaysia and Singapore (Table 24.1). In addition, there have been reports of infection from Africa, Brazil, Romania, Russia, Italy and Egypt. Ingestion of molluscs, fish, clams or amphibians is the major risk factor. While most areas surveyed have low infection



**Fig. 24.3** Intestinal trematode eggs. (A) *Fasciolopsis buski*, average size 130–140  $\times$  80–85  $\mu\text{m}$ . (B) *Echinostoma malayanum*, average size 120–130  $\times$  80–90  $\mu\text{m}$ . (C) *Metagonimus yokogawai*, average size 27–28  $\times$  16–17  $\mu\text{m}$ . (D) *Gastrodiscoides* spp., average size 127–160  $\times$  60–75  $\mu\text{m}$ . Photographs courtesy of Professor Prayong Radomyos, Faculty of Allied Health Sciences, Thammasat University, Thailand

rates of less than 1%, there are hyperendemic areas with rates of over 50% (Carney, 1991).

### **CLINICAL FEATURES**

There are few descriptions of the clinical features of echinostomiasis. Most infections are asymptomatic, with no long-term morbidity. In human volunteers who were given 30 metacercariae orally, eggs were discharged from the feces on days 16–106 and peripheral eosinophilia was

**Table 24.3** Treatment of intestinal trematode infections\*

Drug	Dose (mg/kg) × duration †	N	Efficacy (%)	Reference	Side effects
<i>Fasciolopsis buski</i>					
Praziquantel	15 qd × 1	29	100	Bunnag <i>et al.</i> (1983)	Frequent: malaise, headache, dizziness
	25 qd × 1	28	100		
	40 qd × 1	28	100		
TCE	?mg qd × 1	13	77	Suntharasami <i>et al.</i> (1974)	Severe allergic reactions, nausea, vomiting, vertigo
Niclosamide	43–160 qd × 1	27	11	Suntharasami <i>et al.</i> (1974)	Minimal
TCE	0.1 qd × 1	66	99% Lower egg counts	Rabbani <i>et al.</i> (1985)	
TCE	0.2 ml qd × 1	11	82	Plaut <i>et al.</i> (1969)	
<i>Heterophyes heterophyes</i>					
Praziquantel	40 tid × 1	15	100	El-Hawy <i>et al.</i> (1988)	
	25 tid × 1	18	100		
	40 qd × 1	20	100		
	20 qd × 1	15	100		
	10 qd × 1	15	60		
Niclosamide	2 g qod × 3	40	78	Sheir (1970)	Occasional GI discomfort and urticaria
Niclosamide	2 g qd × 2	40	72		
Piperazine	100 qd × 1	22	55		
<i>Metagonimus yokogawai</i>					
Praziquantel	10 qd × 1	20	85	Rim <i>et al.</i> (1978)	
	20 qd × 1	50	88		
	20 qd × 2	10	100		
Niclosamide	100 qd × 1	10	30		
	100 qd × 2	12	67		
Bithionol	30 qd × 2	24	38		Photosensitivity, vomiting, diarrhea, abdominal pain, urticaria. Rare: leukopenia, hepatitis

\*None of the listed drugs are approved by the US Food & Drug Administration for these uses.

†Duration in number of days; TCE, tetrachloroethylene; qd, once a day; tid, three times a day; qod, every other day; GI, gastrointestinal.

noted (Huffman and Fried, 1990). While heavier infections may cause abdominal discomfort, diarrhea and anorexia, there have been no controlled studies to examine this issue (Maji *et al.*, 1993; Radomyos *et al.*, 1982). A potential outbreak of echinostomiasis was described in 19 American tourists visiting Kenya and Tanzania (Poland *et al.*, 1985). The eggs most closely resembled echinostomes, although no adult worms were recovered to make an unequivocal diagnosis. Symptoms included moderately severe abdominal cramps (12/18), diarrhea (10/18) and epigastric pain (7/18). The incubation period ranged from 2 to 62 days and eosinophilia was a common finding. Praziquantel provided rapid relief of symptoms.

## LABORATORY DIAGNOSIS

Diagnosis is by identification of eggs in feces. The unembryonated, operculated eggs of echinostomes can be difficult to distinguish from those of *Fasciola hepatica* and *Paragonimus westermani*. Identification at the species level requires recovery of the adult worm, which may be passed after anthelmintic treatment.

## CLINICAL MANAGEMENT

While praziquantel is the recommended drug for treating echinostomiasis, there is minimal

evidence regarding its efficacy (Maji *et al.*, 1993; Pungpak *et al.*, 1998; Radomyos *et al.*, 1982). Mebendazole and albendazole may also be effective (Cross and Basaca-Sevilla, 1986; Pungpak *et al.*, 1984).

## PREVENTION AND CONTROL

Infection with echinostomes can be prevented by avoiding raw or undercooked molluscs, fish,

clams and amphibians. While control programs are probably not necessary due to the mild nature of the infection, such measures would likely to be effective. Echinostomiasis was unintentionally controlled in an area of Indonesia that had previously had high infection rates (24–96%; Carney *et al.*, 1990) when a non-indigenous fish was introduced to a lake in the area that had echinostome-infected mussels, which were serving as the second intermediate host. The fish eliminated the mussels and human echinostomiasis disappeared as well.

## HETEROPHYIDIASIS

The Family Heterophyidae contains several species of intestinal trematodes, including *Heterophyes heterophyes*, *Metagonimus yokogawai*, *Stellantchasmus falcatus* and several *Haplorchis* species (Table 24.1). *H. heterophyes* (*heteros* = different; *phye* = shape) was discovered in Cairo by Bilharz in 1851, *M. yokogawai* (*meta* = posterior; *gonimus* = genitalia) was found by Kobayshi in 1908, and *Haplorchis* (*haploos* = single; *orchis* = testis) was described by Loos in 1896 (Grove, 1990). The majority of infections are mild or asymptomatic, although disseminated disease can occur with *M. yokogawai* and *H. heterophyes*.

## DESCRIPTION OF THE ORGANISM

*H. heterophyes* is a minute trematode with the adult worm, 1–1.7 mm in length  $\times$  0.3–0.4 mm in width (Figure 24.2) (Malek, 1980). The body is covered with tegumentary scales. The eggs are operculated, ovoid, light brown and measure 28–30  $\mu\text{m}$   $\times$  15–17  $\mu\text{m}$ . The adult *M. yokogawai* varies in length (1.0–2.5 mm) and width (0.4–0.75 mm) and is also covered with scale-like spines (Figures 24.2 and 24.3). The egg is similar to that of *H. heterophyes* and measures 27–28  $\mu\text{m}$   $\times$  16–17  $\mu\text{m}$ . The adult *Haplorchis yokogawai* measures 0.5–0.9 mm long  $\times$  0.3 mm wide and also has scales. The eggs measure 28–30  $\mu\text{m}$   $\times$  14–16  $\mu\text{m}$ .

The adult flukes reside in the intestine, where they secrete eggs that are passed in human feces. The eggs are ingested by the intermediate snail host, where they hatch into miracidia and then

develop into sporocysts and then rediae. This latter stage produces cercariae which encyst in various fish and develop into metacercariae. Mammalian and avian hosts acquire infection by ingesting raw or undercooked fish. Even metacercariae soaked in brine or wine remain infective for several days. These flukes are probably able to live for up to a year in their hosts, with reservoirs of infection in dogs, cats, foxes and some birds (Malek, 1980).

## PATHOGENESIS

Heterophyid flukes live attached to the intestinal mucosa, where they cause a mild inflammatory reaction with some necrosis. In one case of metagonimiasis, the worms were both free in the lumen and impacted in the villous spaces (Chi *et al.*, 1988). The lesions contained lymphocytes, plasma cells and eosinophils, with erosions, goblet cell depletion and edema. The worms are capable of invading into the submucosa, where the eggs may gain access to the bloodstream and cause disseminated disease.

## IMMUNOLOGY AND MOLECULAR BIOLOGY

No information is available on the immunology and molecular biology of these infections.

## EPIDEMIOLOGY

Heterophyid infections are found worldwide (Table 24.1). *H. heterophyes* is found in Egypt, Korea, China, Taiwan, Africa, Japan, The Philippines and the Mediterranean. *M. yokogawai* is found in China, Japan, Korea, Russia, Spain, Taiwan, the Balkans and The Philippines. Various *Haplorchis* species are found in Taiwan, Thailand and The Philippines. The flukes are present where there are fish-eating mammals and birds.

## CLINICAL FEATURES

The majority of infections are mild and asymptomatic, with heavier infestations possibly causing chronic diarrhea, abdominal discomfort, nausea and malaise (Goldsmith, 1978). Occasionally, intestinal infection can simulate an acute abdomen or appendicitis (Tantachamrun and Kliks, 1978). When heterophyid eggs disseminate hematogenously, visceral complications can ensue (Malek, 1980). Eggs can be found in the heart, brain, spinal cord, liver, lungs and spleen. Lesions in the myocardium led to heart failure in some patients, while brain involvement has been reported to cause seizures.

## LABORATORY DIAGNOSIS

Stool microscopy remains the cornerstone of diagnosis. It is difficult to distinguish the small,

operculated ova of the different heterophyids from each other and also from *Clonorchis sinensis* and *Opisthorchis* spp. Recovery of adult worms is necessary for more precise identification.

## CLINICAL MANAGEMENT

Praziquantel is the first-line drug for heterophyid infections, although there are only data available for treating some of the species. In Egypt, cure rates of 100% were achieved for *H. heterophyes* at most doses tested (Table 24.3) (El-Hawy *et al.*, 1988). At least 20 mg/kg in one dose should be administered, since a dose of 10 mg/kg only had a cure rate of 60%. Other drugs that have been used for *H. heterophyes* include niclosamide (72% cure rate, 40 patients) and piperazine (55% cure rate, 22 patients) (Sheir, 1970). Praziquantel's efficacy against *Haplorchis taichui* and *Haplorchis yokogawai* was demonstrated by the presence of these flukes in stool during a trial of treatment for *Opisthorchis* (Pungpak *et al.*, 1980). *M. yokogawai* is also susceptible to praziquantel, with high cure rates ranging from 85% (10 mg/kg for 1 dose) to 100% (20 mg/kg for 2 doses over 2 days) (Rim *et al.*, 1978).

## PREVENTION AND CONTROL

This is similar to measures used for other intestinal trematodes. Heterophyid infections can be prevented by avoiding the ingestion of raw or undercooked fish.

## OTHER INTESTINAL TREMATODES

### FAMILY LECITHODENDRIIDAE

The Family Lecithodendriidae contains *Phaneropsolus bonnei* and *Prosthodendrium molenkampi*, which are endemic in Thailand and Indonesia (Table 24.1). Many cases have been detected after examining stool of patients with opisthorchiasis who were treated with praziquantel (Radomyos *et al.*, 1994, 1998). The capacity for these organisms to cause symptoms in humans is not known. One interesting feature of the life cycle is that insects (dragonfly and

damsel fly naiads) serve as the second intermediate host. The eggs of these two species can be difficult to distinguish from other small trematode eggs, including *P. viverrini*, *Haplorchis taichui* and *H. pumilio* (Tesana *et al.*, 1991).

### FAMILY PLAGIORCHIIDAE

Three species of *Plagiorchis* have been reported in humans in south-east Asia and include *P. harinasutai*, *P. javensis*, and *P. philippinensis*

(Table 24.1). These parasites have been detected after the examination of stool in patients that were treated with praziquantel for opisthorchiasis. It is not known whether any of the *Plagiorchis* spp. cause significant disease in humans (Radomyos *et al.*, 1994, 1998).

**FAMILY PARAMPHISTOMATIDAE**

*Gastrodiscoides hominis* is present in south-east Asia, where it can infect humans. It attaches to the cecum and may cause diarrhea (Table 24.1). The adult worm averages 10mm in length and 5mm in width (Figures 24.2 and 24.3). Other definitive hosts include rodents, monkeys and pigs. Ingestion is probably from metacercariae on aquatic vegetation, although the details of the life cycle have not been completely elucidated (Waikagul, 1991).

**FAMILY MICROPHALLIDAE**

*Spelotrema brevicaeca* (also known as *Carneophallus brevicaeca*) have rarely been associated with human infection in The Philippines, where the second intermediate host is a shrimp (Table 24.1). No other species in this family causes infection in humans.

**FAMILY DIPLOSTOMATIDAE**

This family contains two species capable of causing infection in humans (Table 24.1). *Fibricola seoulensis* was found in the intestine of rats in Seoul in 1964, and later in a patient with abdominal pain and fever who had eaten raw snake 7 days previously. The presence of metacercariae in snakes has subsequently been verified and additional human infections have occurred in individuals who have eaten raw snake (Chai and Lee, 1991). A total of 26 human cases have been documented (Chung and Soh, 1991).

The second species in this family of human significance is *Alaria americana*, which is endemic in North America, where its usual definitive host is a wild carnivore. The life cycle involves snail and frog intermediate hosts. Humans acquire

infection by ingestion of mesocercariae, which are migratory larval forms that develop in tadpoles and frogs. While definitive hosts include canids and felids, other mammals can serve as paratenic or transport hosts in which the mesocercariae do not develop further. A fatal human case with disseminated organisms was reported from Canada in a young man who died within 9 days of acquiring the infection. Hundreds of mesocercariae were found in his liver, heart, kidney, brain, spleen, spinal cord and peritoneal fluid (Freeman *et al.*, 1976). Intraocular infections have also been reported. The route of infection may be via oral ingestion and migration to the eye or via direct penetration through the conjunctiva (McDonald *et al.*, 1994).

**FAMILY NANOPHYETIDAE**

Two subspecies within the Family Nanophyetidae are capable of causing infection in humans (Table 24.1). *Nanophyetes salmincola schikhalowi* is endemic in Siberia, where infection rates exceed 90% in some villages. The second subspecies is *N. salmincola salmincola*, which is endemic in the Pacific north-west of the USA. Both subspecies are acquired from ingestion of undercooked, infected fish, including salmon and trout (Fritsche *et al.*, 1989). There has also been a case report of infection acquired from handling fish (Harrell and Deardorff, 1990). Symptoms range from an asymptomatic state to various gastrointestinal complaints, including abdominal pain, diarrhea, bloating, nausea and vomiting. Praziquantel appeared to be effective in alleviating these symptoms and eradicating the infection. *N. salmincola* is also responsible for a fatal canine infection known as salmon-poisoning disease. The trematode serves as a transmission vector for *Neorickettsia helminthoeca*, which causes a rickettsial illness. There has been no evidence that this organism can be transmitted to humans.

**REFERENCES**

Bunnag D, Harinasuta K (1989). Liver, lung and intestinal trematode diseases. In Goldsmith R, Heyneman D (eds), *Medicine and Parasitology*, pp 459–83. East Norwalk, NJ: Appleton and Lange.

- Bunnag D, Radomyos P, Harinasuta K (1983). Field trial on the treatment of fasciolopsiasis with praziquantel. *SE Asian J Trop Med Publ Health* **14**: 216–19.
- Bunnag T, Bunnag D, Goldsmith R (1991). Intestinal fluke infections. In Strickland G (ed.), *Tropical Medicine*, pp 809–18. Philadelphia, PA: WB Saunders.
- Carney W (1991). Echinostomiasis-snail-borne intestinal trematode zoonosis. *SE Asian J Trop Med Publ Health* **22S**: 206–11.
- Carney W, Sudomo M, Purnomo (1980). Echinostomiasis: a disease that disappeared. *Trop Geogr Med* **32**: 101–5.
- Chai J, Lee S (1991). Intestinal trematodes infecting humans in Korea. *SE Asian J Trop Med Publ Health* **22**(suppl): 163–70.
- Chi J, Kim C, Kim J *et al.* (1988). Intestinal pathology in human metagonimiasis with ultrastructural observations of parasites. *J Kor Med Sci* **3**: 171–7.
- Chung P, Soh C (1991). Snail-borne parasitic zoonoses in Korea. *SE Asian J Trop Med Publ Health* **22**(suppl): 391–5.
- Cross J, Basaca-Sevilla V (1986). Studies on *Echinostoma ilocanum* in The Philippines. *SE Asian J Trop Med Pub Health* **17**: 23–7.
- El-Hawy A, El-Nasr M, Rahman M (1988). The cure rates of patients infected with heterophyiasis and treated with praziquantel versus niclosamide. *J Egypt Soc Parasitol* **18**: 437–42.
- Freeman R, Stuart P, Cullen J *et al.* (1976). Fatal human infection with mesocercariae of the trematode *Alaria americana*. *Am J Trop Med Hyg* **25**: 803–7.
- Fried B, Huffman J (1996). The biology of the intestinal trematode *Echinostoma caproni*. *Adv Parasitol* **38**: 311–68.
- Fritsche T, Eastburn R, Wiggins L *et al.* (1989). Praziquantel for treatment of human *Nanophyetus salmincola* (*Trogloremia salmincola*) infection. *J Infect Dis* **160**: 896–9.
- Goldsmith R (1978). Chronic diarrhoea in returning travelers: intestinal parasitic infection with the fluke *Metagonimus yokogawai*. *South Med J* **71**: 1513–15.
- Grove D (1990). In *A History of Human Helminthology*. Oxford, UK: CAB International.
- Harrell L, Deardorff T (1990). Human nanophyetiasis: transmission by handling naturally infected Coho salmon (*Oncorhynchus kisutch*). *J Infect Dis* **161**: 146–8.
- Huffman J, Fried B (1990). *Echinostoma* and echinostomiasis. *Adv Parasitol* **29**: 215–69.
- Maji A, Bera D, Manna B *et al.* (1993). First record of human infection with *Echinostoma malayanum* in India. *Trans R Soc Trop Med Hyg* **87**: 673.
- Malek EA (1980). In *Snail-transmitted Parasitic Diseases*. Boca Raton, FL: CRC Press.
- Manning G, Brockelman W, Viyanant V (1971). An analysis of the prevalence of *Fasciolopsis buski* in central Thailand using catalytic models. *Am J Epidemiol* **93**: 354–60.
- McDonald H, Kazacos K, Schatz H *et al.* (1994). Two cases of intraocular infection with *Alaria mesocaria* (Trematoda). *Am J Ophthalmol* **117**: 447–55.
- Medical Letter, Inc. (1998). Drugs for parasitic infections. *The Medical Letter* **40**: 1–12.
- Plaut A, Kampanart-Sanyakorn C, Manning G (1969). A clinical study of *Fasciolopsis buski* infection in Thailand. *Trans R Soc Trop Med Hyg* **63**: 470–8.
- Poland G, Navin T, Sarosi G (1985). Outbreak of parasitic gastroenteritis among travelers returning from Africa. *Arch Intern Med* **145**: 2220–21.
- Pungpak S, Bunnag D, Harinasuta T (1984). Albendazole in the treatment of opisthorchiasis and concomitant intestinal helminthic infections. *SE Asian J Trop Med Publ Health* **15**: 46–50.
- Pungpak S, Radomyos P, Radomyos B *et al.* (1998). Treatment of *Opisthorchis viverrini* and intestinal fluke infections with praziquantel. *SE Asian J Trop Med Publ Health* **29**: 246–9.
- Rabbani G, Gilman R, Kabir I *et al.* (1985). The treatment of *Fasciolopsis buski* infection in children: a comparison of thiabendazole, mebendazole, levamisole, pyrantel pamoate, hexylresorcinol and tetrachloroethylene. *Trans R Soc Trop Med Hyg* **79**: 513–15.
- Radomyos B, Wongsaraj T, Wilairatana P *et al.* (1998). Opisthorchiasis and intestinal fluke infections in Northern Thailand. *SE Asian J Trop Med Publ Health* **29**: 123–7.
- Radomyos P, Bunnag D, Harinasuta T (1982). *Echinostoma ilocanum* (Garrison, 1908) Odhner, 1911, infection in man in Thailand. *SE Asian J Trop Med Publ Health* **13**: 265–9.
- Radomyos P, Radomyos B, Tungtrongchitr A (1994). Multi-infection with helminths in adults from north-east Thailand as determined by post-treatment fecal examination of adult worms. *Trop Med Parasitol* **45**: 133–5.
- Rahman K, Idris M, Khan A (1981). A study of fasciolopsiasis in Bangladesh. *J Trop Med Hyg* **84**: 81–6.
- Rim H, Chu D, Lee J *et al.* (1978). Antihelminthic effects of various drugs against metagonimiasis. *Kor J Parasitol* **16**: 117–22.
- Shah P, Udani P, Manjarumkar P *et al.* (1973) *Fasciolopsis buski* infestation in children. *Ind Pediat* **10**: 721–4.
- Sheir Z (1970). Demographic, clinical, and therapeutic appraisal of heterophyiasis. *J Trop Med Hyg* **73**: 148–52.
- Suntharasamai P, Bunnag D, Tejavani S *et al.* (1974). Comparative clinical trials of niclosamide and tetrachloroethylene in the treatment of *Fasciolopsis buski* infection. *SE Asian J Trop Med Publ Health* **5**: 556–9.
- Tantachamrun T, Kliks M (1978). Heterophyid infection in human ileum: report of three cases. *SE Asian J Trop Med Publ Health* **9**: 228–31.
- Tesana S, Srisawangwonk T, Kaewkes S *et al.* (1991). Eggshell morphology of the small eggs of human trematodes in Thailand. *SE Asian J Trop Med Publ Health* **22**: 631–6.
- Viranuvatti V, Stitnimankarn T, Tansurat P (1953). A fatal case of infection with *Fasciolopsis buski* in Thailand. *Ann Trop Med Parasitol* **47**: 132–3.
- Waikagul J (1991). Intestinal fluke infections in south-east Asia. *SE Asian J Trop Med Publ Health* **22**(suppl): 158–62.
- Waikagul J, Wongsaraj T, Radomyos P *et al.* (1997). Human infection of *Centrocestus caninus* in Thailand. *SE Asian J Trop Med Publ Health* **28**: 831–5.

# Index

Numbers in *italics* indicate *figures*; those in **bold** indicate **tables**. Plates are denoted by 'p'.

---

- abdominal angiostrongyliasis 545
- Acanthamoeba* keratitis 281
  - clinical management 282
  - diagnosis 281
  - prevention 282
- Acanthamoeba* spp.
  - culture 273–4
  - epidemiology 276–7
  - history 269
  - immunology 275–6
  - life cycle 271, 272, 273
  - molecular biology 276
  - taxonomy 270–1
  - see also* granulomatous amebic encephalitis
- acanthopodia 272, 273
- acetylcholinesterases 570
- acid-fast stains 152, 157, 168, 187
- acidosis 62, 78
- acquired immunity and helminth vaccination 28
- acridine orange 73, 254
- actin
  - rearrangement on invasion by *Cryptosporidium parvum* 143–4
  - in *Toxoplasma gondii* motility 119
- acute dermatolymphangioadenitis (ADLA) 443
- acute necrotizing colitis 207
- adenolymphangitis (ADL) 436, 437
- adenopathy 440
- adhesins, *Trichomonas vaginalis* 247, 249
- adventitial layer, *Echinococcus granulosus* 593, 594, 598
- aflatoxins 413
- African Programme for Onchocerciasis Control (APOC) 474
- African trypanosomiasis
  - clinical features 327
  - clinical management 329
    - hemolymphatic stage 329–30
    - meningoencephalitic stage 330
  - history 17–18, 315, 335
  - immunology 320–1
  - immunopathology 321–2
  - laboratory diagnosis
    - antibody tests 329
    - antigen tests 329
    - parasite detection 327–8
  - organism *see Trypanosoma brucei*
  - prevention and control
    - disease suppression 331–2
    - vaccination 332
    - vector control 331
    - WHO recommendations 315
- agar plate culture of *Strongyloides stercoralis* 490
- age
  - at first infection related to  $R_0$  26
  - optimum for helminth vaccination, mathematical models 27–8, 29
- age prevalences
  - cryptosporidiosis 148
  - Entamoeba* infections 202, 204
  - intestinal nematode infections 565
  - malaria 68
  - schistosomiasis 377, 379
  - strongyloidiasis 488–9
  - toxocariasis 508
  - Trichomonas tenax* infections 257
- age-structured dynamic cost–benefit analysis model 34–5
- AIDS/HIV infection
  - cryptosporidiosis in 140, 147, 148, 150, 153–4
  - cyclosporiasis treatment 168
  - giardiasis in 225
  - granulomatous amebic encephalitis in 278, 279
  - isoporiasis in 156, 157, 158
  - microsporidiosis in 181, 185, 186, 190, 191
  - toxoplasmosis in 114, 125–6, 132–3
  - trichomoniasis and transmission risk of 248
  - Trypanosoma cruzi* brain abscesses in 344
  - visceral leishmaniasis in 293, 294, 303, 307
- airport malaria 68
- Alaria americana* **536**, 549, **637**, 645

- albendazole treatment  
   cutaneous larva migrans 539  
   cystic echinococcosis 604–5  
   cysticercosis 627  
   deworming randomized trial 36, 37  
   giardiasis 231, 232  
   intestinal nematode infection 578  
   loiasis 448  
   lymphatic filariasis 443  
   microsporidiosis 190  
   multivesicular/alveolar echinococcosis 605–6  
   strongyloidiasis 492  
   taeniasis 626  
   toxocarasis 515  
   trichinellosis 530, 531
- alveolar hydatid growth 594
- amastigotes  
   *Leishmania* spp. 288, 290, 291, 294  
     detection 304  
     pathogenesis 291, 292  
   *Trypanosoma cruzi* 336, 337, 338
- amebapores 201
- amebas  
   taxonomy 270–1  
   see also specific species
- amebic dysentery/colitis 206–7, 210, 211
- amebic liver abscesses 205, 207–8  
   diagnosis 208, 209, 210, 211  
   management 211
- amebic meningoencephalitis see primary amebic meningoencephalitis
- ameboid form, *Blastocystis hominis* 359
- American trypanosomiasis see Chagas' disease
- aminosidine see paromomycin
- amocarzine 472
- amphotericin B 281, 306, 307, 308
- Ancylostoma caninum*/*A. braziliense* 535–7  
   epidemiology 538  
   life-cycle 537–8  
   pathogenesis 538, 570  
   see also cutaneous larva migrans; eosinophilic enteritis
- Ancylostoma duodenale* 569, 570, 571
- André, Nicholas 2
- anemia  
   in babesiosis 103  
   in hookworm infection 571  
   in malaria 62, 79  
   in schistosomiasis 384, 390
- angiostrongyliasis  
*Angiostrongylus*/angiostrongyliasis 536, 543  
   *A. cantonensis* 543  
   *A. costaricensis* 543  
   clinical features 545  
   epidemiology 543, 544  
   laboratory diagnosis 545  
   life-cycle 544  
   pathogenesis 544–5  
   treatment 545–6
- anion-exchange centrifugation technique 328
- Annesley, James 12
- annual transmission potential (ATP) 464
- Anopheles* mosquitoes 55  
   control 87  
   house screening against 88  
   insecticide resistance 87  
   microsporidia in 187  
   in *Plasmodium* life-cycle 56  
   prevention of bites 88  
   variation and malaria transmission 67
- anticoagulants, hookworm 538, 570
- antigen detection tests  
   *Angiostrongylus* spp. 545  
   *Echinococcus* spp. 603, 604  
   *Entamoeba histolytica* 209–10  
   *Giardia lamblia* 229  
   *Schistosoma* spp. 394  
   *Strongyloides stercoralis* 492  
   *Taenia* spp. 625  
   *Toxocara* spp. 514  
   *Trichomonas vaginalis* 254  
   *Trypanosoma brucei* 329  
   *Wuchereria bancrofti* 441
- antigenic variation, mechanisms in *Trypanosoma brucei* 323, 324–5
- antimalarial antibodies 64
- antimalarial drug resistance 69, 78  
   chloroquine 54, 75, 76–7, p.vi  
   countries affected 89, p.vi  
   mis-diagnosed babesiosis 106  
   pyrimethamine–sulfadoxine 84  
   quinine 77  
   tests for 69, 74
- antimalarial drugs 81–6  
   see also specific drugs
- antimony dimercaptosuccinate 371
- ants 421
- apicoplasts 114
- appendicitis and *Enterobius* infections 574
- arecoline 603
- artemesinin 77, 81, 85
- artemether 81, 85
- artesunate 77, 81, 85
- Ascaris lumbricoides*  
   adult 567  
   classification 566–7  
   clinical features of ascariasis 568  
   control program, cost-effectiveness analysis 32–4  
   child-targeted treatment 34–5  
   eggs 567  
   epidemiology  
     genetic predisposition 568  
     transmission 567–8



- history 566
- see also* intestinal nematodes
- asthma and toxocariasis 513
- astrocytes 321
- atovaquone 109
- atovaquone–proguanil 75, 85, 90
- autoantibody production in trypanosomiasis 321
- autoimmunity in Chagas' disease 339
- autoinfection
  - capillariasis 575
  - strongyloidiasis 485
- avacuolar form, *Blastocystis hominis* 358
- axostyles 244, 256, 258
- azithromycin 154, 231
  
- Babesia* spp.
  - description 99–101
  - epidemiology 105–6
  - life cycle 101–3
  - mechanisms of injury 103–4
  - tick vectors 101
- babesiosis
  - clinical features 106–9
  - clinical management 109–10
  - history 14, 99
  - immunology 104
    - cell-mediated immunity 105
    - humoral immunity 104–5
    - phagocytosis 105
  - laboratory diagnosis 108–9
  - organisms *see Babesia* spp.
  - prevention and control 110
- bacitracin zinc 232
- bacterial infections
  - Dracunculus medinensis* tracks 557
  - in malaria 79
- Baermann method 490
- Balamuthia mandrillaris*
  - culture 274
  - epidemiology 276
  - history 269
  - life cycle 271, 272–3
  - taxonomy 270, 271
  - see also* granulomatous amebic encephalitis
- bancroftian filariasis *see* lymphatic filariasis: bancroftian filariasis
- basic reproductive number ( $R_0$ ) 22
  - estimation for microparasites 24
  - for macroparasite infections 27
  - and vaccination levels to eradicate diseases 24–5
- Bastianelli, Giuseppe 14, 16
- Bavay, A. 479
- Baylisascaris procyonis* **536**, 548
  - diagnosis 548–9
  - treatment 549
- Bayluscide 371
- beef tapeworm *see Taenia* spp: *T. saginata*
- behaviour changes in toxocariasis 510–11, 512
- bentonite flocculation test 530
- benzimidazole treatment
  - intestinal nematode infections 578–9
  - Trichinella* larvae elimination 530–1
  - see also* albendazole treatment; mebendazole treatment; thiabendazole treatment
- benznidazole 347, 348
- Bignami, Amico 14, 16, 53
- Bilharz, Theodore 11, 369
- biliary tract *Cryptosporidium* infection 150, 152–3
- Biomphalaria* snails 376
- birds
  - migration and cyclosporiasis outbreaks 167
  - pet, in *Encephalitozoon hellem* infections 186
- bis(glucathionyl)spermidine metabolism 317–18
- bithionol 419, **420**, 429, **642**
- blackflies as onchocerciasis vectors 458, 459
  - blood meals 466
  - control 472–3
  - dispersal and migration 466
  - geographical distribution of vector species 465
  - infective density determination 463–4
  - life-cycle 465–6
  - seasonality 466
- Blacklock, D.B. 458
- blackwater fever 63
- bladder cancer and urinary schistosomiasis 383, 391
- Blastocystis hominis*
  - clinical features of infection 362
  - clinical management of infection 364
  - chemotherapy 364
  - diet 364–5
  - epidemiology 361
  - history 355
  - immunology 361
  - laboratory diagnosis
    - culture 363
    - microscopy 362–3, p.vii
    - serology, not yet available 363
  - life-cycle 359–60
  - molecular biology and biochemistry 360
  - morphological forms 356, p.vii
    - ameboid 359
    - avacuolar 358
    - cyst 358–9
    - granular 357
    - multivacuolar 358
    - vacuolar 356–7
  - pathogenesis 360–1
  - prevention and control 365
  - taxonomy 355–6
- Blastocystis* spp. with animal hosts 356
- blindness
  - from onchocerciasis 467, 468
  - from toxocariasis 511–12

- blood concentration methods 327–8  
blood smears  
  acute Chagas' disease diagnosis 345  
  African trypanosomiasis diagnosis 327–8  
  babesiosis diagnosis 108  
  malaria diagnosis 71–3  
  *Plasmodium falciparum/Babesia* differentiation 100, 108  
blood transfusion  
  babesiosis transmission 106, 110  
  Chagas' disease transmission 340, 341–2, 349  
blood-borne filarial parasites 433, **434**  
  *see also Loa loa*; lymphatic filariae; *Mansonella ozzardi*; *Mansonella perstans*  
blood-stage malarial vaccines 91–2  
*Borrelia burgdorferi/Babesia microti* co-infection 106, 108, 109–10  
bottled water, safety 155  
bovine anti-*Cryptosporidium* hyperimmune colostrum 154  
*Brachiola* spp. 178–9, 187  
  life-cycles 172, 173, 180  
  pathogenesis **181**, 182  
bradyzoites 114, 115, 116, 122  
brain calcification in neurocysticercosis 623  
breast feeding, protective against *Giardia* 225  
broad fish tapeworm *see Diphyllbothrium latum*  
brood capsules, *Echinococcus* spp. 590, 591, 592  
Bruce, David 17, 18  
*Brugia malayi* 434, 436, 441  
*Brugia timori* 434–5, 441  
brugian filariasis 434, 436, 438  
*Bulinus* snails 376  
burden of disease estimation 28, 30–1  
bush yaws 298  
  
Calabar swellings 446  
Calcofluor M2R stain 187  
cancer risk with schistosomiasis 391  
*Capillaria philippinensis* 575  
  clinical features of infection 575–6  
  epidemiology 575  
  laboratory diagnosis 576  
  life-cycle 575  
  pathogenesis 575  
  treatment 576  
  *see also* intestinal nematodes  
capsule, fibrous of *Echinococcus granulosus* 593, 594, 598  
card agglutination tests for trypanosomiasis 329  
cardiovascular trichinellosis 527  
*Carneophallus brevicæca* **637**, 645  
Castellani, Aldo 18  
cats  
  ownership and toxocarasis risk 509  
  *Toxocara cati* life-cycle in 502, 503, 504  
  in *Toxoplasma gondii* transmission 115, 116, 133  
  
CD4<sup>+</sup> cells, in *Cryptosporidium parvum* immunity 146, 150  
cell detaching factor (CDF) 247  
cercariae  
  intestinal trematodes 635, 637, 638, 641, 643  
  *Schistosoma* spp. 372–3, 374, 377  
cerebral gnathostomiasis 542  
cerebral infection, microsporidia 176–7, 182, p.iv, p.v  
cerebral malaria 61–2, 64, 70, 71, 79  
cerebrospinal fluid (CSF) examination  
  African trypanosomiasis 328  
  granulomatous amebic encephalitis 280  
  primary amebic meningitis 280  
cervical cancer and *Trichomonas vaginalis* 248  
cestodes 613  
  history 9–10  
  *see also Diphyllbothrium latum*; *Echinococcus* spp.; *Hymenolepis nana*; *Taenia* spp.  
Chagas, Carlos 18, 336  
Chagas' disease  
  clinical features  
  acute disease 342  
  chronic gastrointestinal disease 343–4  
  chronic heart disease 343  
  in immunosuppressed patients 344  
  indeterminate phase 342–3  
  clinical management 347–8  
  antiparasitic drugs 346–7  
  heart transplantation 348  
  history 18, 335–6  
  immunology 339–40  
  laboratory diagnosis  
  acute disease 344–5  
  chronic disease 345  
  PCR 346  
  recombinant assays 346  
  organism *see Trypanosoma cruzi*  
  prevention and control 348–9  
chagoma 337, 338, 342  
chaos in measles epidemics 23  
chicle ulcers 298  
child-targeted treatment, cost-benefit analysis 34–5  
Chinese medicinal herbs, *Blastocystis hominis* treatment 364  
chlorination of *Cryptosporidium* oocysts 155  
chlorination of water  
  giardiasis prevention 233, 234  
  primary amebic meningoencephalitis prevention 282  
chlorine resistance  
  *Blastocystis hominis* cysts 365  
  *Cyclospora* oocysts 167  
  *Giardia* cysts 226  
chloroquine 54, **76**, 82  
  for amebic liver abscesses 211  
  prophylaxis 89, 90  
  resistance 54, 74–5, 77, p.vi

- for severe malaria 81
- cholangiocarcinoma 410, 413
- chondroitin sulphate A 59
- chromotrope stain 187, p.iv, p.v
- chronic trichinellosis 528
- chyluria 439, 444
- ciliary tufts, detached 254
- cinchonism 82
- ciprofloxacin 158
- circumsporozoite protein (CSP) repeat 91
- clindamycin 109, 131, 132–3
- clonorchiasis **412**
  - clinical features
    - acute infection 411
    - cholangiocarcinoma 413
    - chronic infection 411, 412
    - obstructive biliary disease 412
    - recurrent pyogenic cholangitis 412–13
  - control 414
  - laboratory diagnosis 413
  - organism *see Clonorchis sinensis*
  - treatment 413–14
- Clonorchis sinensis* 407, 409–10
  - epidemiology 410, 411
  - immunology 410
  - life cycle 408, 410
  - pathogenesis 410
- Cobbold, Thomas Spencer 3, 5, 11, 369
- Cochrane Parasitic Diseases Group 38
- cognitive impairment and intestinal nematode infection 562
- colitis, amebic 206–7, 210, 211
- colon cancer risk in schistosomiasis 381, 391
- colonic mucins 200
- colonic polyposis 389
- colonoscopy, amebic dysentery diagnosis 210
- colpitis macularis 253
- common variable hypogammaglobulinemia, predisposition to giardiasis 225
- community microfilarial load 469, 470
- complement
  - evasion by *Entamoeba histolytica* 200–1
  - killing of trichomonads 249
  - role in *Babesia* infection 103
- complex lymphedema therapy 444
- computed tomography (CT) scans
  - amebic liver abscesses 210, 211
  - fascioliasis 419
  - granulomatous amebic encephalitis 281
  - neurocysticercosis 623, 626
  - primary amebic meningoencephalitis 280
  - toxoplasmosis 126, 127, 128
- congenital toxoplasmosis 123–4, 125, 132
- contact-mediated cytotoxicity 247
- copper sulphate 371
- coproantigen detection in strongyloidiasis 492
- coracidia 629, 630
- corticosteroids 132, 516, 531
- cost–effectiveness analysis 31
  - dynamic models 32
    - age-structured 34
    - Ascaris lumbricoides* control program 32–4
  - cost per DALY 36
    - coverage and frequency of treatment 34–5
  - static models 31–2
    - cost per DALY 35
- cost–utility analysis 35–6
- costae 243, 244
- covert toxocarasis 502, 512
- CpABC 144
- creeping eruption *see* cutaneous larva migrans
- crustaceans *see* cyclops; snail hosts
- cryptosporidiosis
  - clinical features 149–51
    - in immunocompetent patients 149–50
    - in immunocompromised patients 150
    - relapsing diarrhea 150
    - repeated infections 150
    - in young children 151
  - clinical management 153
  - differential diagnosis 151
  - history 139
  - immunology 145
    - cell-mediated immunity 145–7
    - humoral immunity 147
  - laboratory diagnosis 151
    - PCR 152, 153
    - serology 153
    - stains 152
  - organism *see Cryptosporidium parvum*
  - prevention and control 154–5
  - treatment 153–4
- Cryptosporidium parvum* 139
  - classification 139–40, 142
  - epidemiology
    - infection and outbreak potential 148
    - prevalence 148
    - transmission 147–8, 149
  - future studies 155
  - genotypes 140, 142
  - life-cycle 141, 142
  - pathogenesis 142–5
- crypts of Lieberkuhn 587, 595, 615
- culture media
  - Blastocystis hominis* 363
  - free-living amebae 274
- cutaneous amebiasis 208
- cutaneous larva migrans
  - clinical features 538–9
  - diagnosis 539
  - pathogenesis 538
  - treatment 539

- cutaneous leishmaniasis *see* leishmaniasis, cutaneous
- cyclops 541, 555, 558
- cyclosporiasis  
 clinical features 167–8  
 clinical management 168  
*Cyclospora* spp. 165–6  
 epidemiology 166–7  
 history 165  
 immunology 166  
 laboratory diagnosis 168  
 prevention and control 168–9
- cyst wall proteins 223, 229
- cystic echinococcosis  
 clinical features 602  
 clinical management 604–5  
 diagnosis 603–4  
 pathogenesis 595–6  
*see also Echinococcus* spp.
- cysticercosis 620–1  
 clinical manifestations 624  
 diagnosis 624–5, 626  
 organism *see Taenia* spp: *T. solium*  
 pathology 621–4  
 prevention 627–8  
 treatment 626  
*see also taeniasis*
- cysts  
*Acanthamoeba* spp. 272, 275, 279, 281  
*Balamuthia mandrillaris* 273, 275, 280  
*Blastocystis hominis* 358–9, 362, 365, p.vii  
 in cysticercosis pathology 621–4  
*Endolimax nana* 214  
*Entamoeba* spp. 199, 213, 214  
*Giardia lamblia* 220–1, 223, 226, 229, 234  
*Naegleria fowleri* 271, 272  
*Paragonimus* spp. 421, 422  
*Toxoplasma gondii* 114, 115, 122, 127, 128  
*Trichinella* spp. 521, 523  
*see also* hydatid cysts
- cytoadherence  
 babesiosis 103  
 falciparum malaria 59
- cytokine mimicry 416
- DALYs *see* disability-adjusted life years
- Davaine, Casimir 3, 6
- DDT  
 blackfly control 472–3  
 mosquito control 87  
 sand fly control 308
- DEC *see* diethylcarbamazine citrate (DEC) treatment
- DEET *see* *N,N*-diethylmetatoluamide
- Demarquay, Jean 8
- dendritic cells 121
- dermatolymphangioadenitis, acute (ADLA) 443
- deworming, randomized trial 36–7
- dexamethasone 627
- diarrhea  
 of Cochin China 479, 480  
 relapsing 150
- Dicrocoelium* spp. 420–1
- Dientamoeba fragilis* 260  
 clinical features of infection 262  
 clinical management of infection 263  
 description 260–1  
 epidemiology 262  
 history 260  
 immunology 261–2  
 laboratory diagnosis  
 culture 263  
 microscopy 262–3  
 pathogenesis 261  
 prevention and control 263–4  
*see also other trichomonads*
- dietary management of *Blastocystis hominis* 364–5
- diethylcarbamazine citrate (DEC) treatment  
 loiasis 448  
 lymphatic filariasis 439, 443, 444, 445  
*Mansonella ozzardi* infections 450  
 in the Mazzotti test 470  
 onchocerciasis 471  
 perstans filariasis 449
- N,N*-diethylmetatoluamide (DEET) 88, 90, 110, 309
- differential agglutination test 130–1
- diiodohydroxyquin 263
- diloxanide furoate 211, 214
- Diphyllobothrium latum*  
 clinical features of infection 629  
 diagnosis and treatment 630  
 epidemiology 629–30  
 life-cycle 629
- directly transmitted infections,  $R_0$  estimation 24
- Dirofilaria* spp. **536**  
 clinical features of infection 547  
 diagnosis 547–8  
 life-cycle 547  
 treatment 548
- disability-adjusted life years (DALYs) 28, 30–1  
 in cost-utility analyses 35–6  
 in intestinal nematode infections 564
- disease mapping *see* epidemiology: emerging technologies
- disseminated strongyloidiasis 486, 489–90
- Distomum buski* *see Fasciolopsis buski*
- diurnal temperature difference maps 48–9
- DNA vaccines, malaria 92
- dog hookworms *see Ancylostoma caninum/A. braziliense*
- dogs  
*Dirofilaria immitis* infection 547  
*Echinococcus* spp. hosts 600, 601, 603, 606  
*Encephalitozoon cuniculi* transmission 186  
 in leishmaniasis control 309

- Metorchis conjunctus* infection 420  
*Toxocara canis* infection 503–4, 509, 510, 515  
*Toxoplasma gondii* transmission 117
- Donné, Alfred 12  
Donovan, Charles 19, 287  
doxycycline treatment 85  
  contraindicated in pregnancy 81  
  prophylaxis 76, 89, 90  
  severe malaria 81  
  uncomplicated malaria 75, 77
- dracunculiasis  
  clinical features 556–7  
  clinical management 557  
  history 553  
  laboratory diagnosis 557  
  organism *see* *Dracunculus medinensis*  
  prevention and control 557–8  
  seasonality 556
- Dracunculus medinensis* 553  
  epidemiology 556  
  history 6–7  
  immunology 555  
  life cycle 555, 556  
  pathogenesis 553–5
- drug resistance  
  metronidazole in *Trichomonas vaginalis* 255  
  nitroimidazole in *Giardia lamblia* 231  
  oxamniquine in schistosomes 396  
  praziquantel in schistosomes 395  
  *see also* antimalarial drug resistance
- Dujardin, Félix 3  
duodenal sampling for *Fasciola hepatica* 419  
Dutton, Joseph 17  
dysentery, amebic *see* amebic dysentery/colitis
- echinococcosis  
  cystic echinococcosis *see* cystic echinococcosis  
  history 585–6  
  immunology  
    definitive host 598  
    intermediate host 597–8  
  laboratory diagnosis  
    humans 603–4  
    non-humans 602–3  
  multivesicular/alveolar echinococcosis *see* multivesicular/alveolar echinococcosis  
  organisms *see* *Echinococcus* spp.  
  prevention and control 606
- Echinococcus* spp.  
  control  
    *E. granulosus* 606–7  
    *E. multilocularis* 607  
    problem of strain variation 607  
    vaccination 607–8  
  development  
    in the definitive host 590  
    *E. granulosus* 591–4  
    *E. multilocularis* 592, 593, 594  
    *E. vogeli*/*E. oligarthrus* 594–5  
    in the intermediate host 590–1  
  epidemiology 598  
    geographical distribution 588, 598–9  
    life-cycles and transmission patterns 599–601  
    molecular techniques 601–2  
  life-cycle 587  
  pathogenesis  
    adult tapeworms 595  
    *E. granulosus* larvae 595–6  
    *E. multilocularis* larvae 596  
    *E. vogeli*/*E. oligarthrus* larvae 596  
    strain/species differences 596–7  
  taxonomy 586, 588–9
- Echinostoma* spp. 636  
  clinical features of infection 638, 641–2  
  description 639, 640–1  
  epidemiology 641  
  laboratory diagnosis 642  
  life cycle 637, 641  
  pathogenesis 641  
  prevention and control 643  
  taxonomy 640  
  treatment of infection 642–3
- effective reproductive number (*R*) 22, 26  
eflornithine 330  
egg granulomas, *Schistosoma* spp. 376, 380, 381  
  in hepatosplenic pathology 381–2  
  immune responses to 385–7  
  in intestinal pathology 381  
  in neuroschistosomiasis 383  
  in pulmonary fibrosis 382–3
- eggs  
  *Ascaris lumbricoides* 567, 568  
  *Capillaria philippinensis* 575  
  *Diphyllobothrium latum* 629, 630  
  *Echinococcus* spp. 587, 590  
  *Echinostoma* spp. 641  
  *Enterobius vermicularis* 573, 574  
  *Fasciola hepatica* 408, 415, 418, 419  
  *Fasciolopsis buski* 638, 640, 641  
  *Gnathostoma spinigerum* 540, 541  
  *Heterophyes heterophyes* 643  
  hookworm 535, 537, 569  
  *Hymenolepis nana* 628, 629  
  identification of intestinal nematode 577–8  
  *Metagonimus yokogawai* 641, 643  
  *Opisthorchis* and *Clonorchis* spp. 408, 409, 410, 413  
  *Paragonimus* spp. 408, 421, 427, 428  
  *Schistosoma* spp. 372, 373, 374, 375  
    detection 392–4  
    granulomas *see* egg granulomas, *Schistosoma* spp.  
    hatching techniques 393  
    release 376

eggs (*cont*)

- Strongyloides fülleborni* 495
- Strongyloides stercoralis* 482, 484
- Taenia* spp. 614–15, 616, 617, 621, 625
- Toxocara* spp. 502, 503, 504, 509–10
- Trichuris trichiura* 572
- elephantiasis 8, 438, 440, 443–4
- ELISA detection
  - Blastocystis hominis* antibodies 363
  - cryptosporidiosis 153
  - Encephalitozoon* spp. antibodies 185
  - giardiasis 229
  - opisthorchiasis 413
  - strongyloidiasis 491
  - toxocariasis 514
  - toxoplasmosis 130
  - trichinellosis 530
  - visceral leishmaniasis 305
- emetine 198, 419, 420
- encephalitis in loiasis 446–7, 448
- Encephalitozoon* spp. *see* microsporidia: *Encephalitozoon* spp.
- encystation, *Giardia lamblia* 223
- endemic hemoptysis *see* paragonimiasis
- endemicity of malaria 67
- Endolimax nana* 214
- endoscopic retrograde cholangiopancreatography (ERCP) 153
- endoscopy for giardiasis diagnosis 230
- Entamoeba coli* 213
- Entamoeba dispar* 198, 212
  - epidemiology 213
  - laboratory diagnosis 213
  - molecular biology 212–13
  - pathogenesis 212
- Entamoeba histolytica*
  - clinical features of infection 205
    - asymptomatic colonization 205–6
    - cutaneous amebiasis 208
    - dysentery 206–7
    - liver abscess 207–8
  - diagnosis
    - antigen detection 209–10
    - colonoscopy 210
    - imaging 210–11
    - microscopy 208, 209
    - PCR 210
    - serology 210
  - epidemiology 204–5
  - history 12, 14, 197–8
  - immunology 201–2
  - life-cycle 199
  - management of infection 211
  - molecular biology 202–4
  - pathogenesis 200–1
  - prevention and control 211–12
  - taxonomy 198
- Entamoeba polecki* 214
- Enterobius vermicularis*
  - clinical features of infection 574
  - description 573
  - Dientamoeba fragilis* transmission in eggs 262
  - life-cycle 573–4
  - management of infection 574
  - pathogenesis 574
  - see also* intestinal nematodes
- Enterocytozoon bieneusi* *see* microsporidia: *E. bieneusi*
- eosinophilic enteritis 538, 539
- epidemic dynamics 22–3
- epidemic malaria 67–8
- epidemiology
  - burden of disease estimation 28, 30–1
  - classical
    - meta-analyses, examples 38–44
    - randomized trials, example 36–7
  - cost–effectiveness analysis *see* cost–effectiveness analysis
  - emerging technologies 44–5
    - applied to African trypanosomiasis 45–6, p.i, p.ii, p.iii
    - applied to lymphatic filariasis 46–9
  - population dynamics *see* population dynamics
  - see also specific parasites*
- epilepsy
  - in neurocysticercosis 624
  - and *Toxocara* titres 512, 513
- epimastigotes
  - Trypanosoma brucei* 318, 319, 320
  - Trypanosoma cruzi* 336, 337
- eradication therapy, malarial 75, 76
- erythrocytes
  - Babesia* infection 100, 103
  - Plasmodium* infection 55, 56, 57, 59, 60
- espondia 288, 298, 301
- estrogen, role in neonatal trichomoniasis 246, 252
- exchange transfusions 79, 109
- excretory–secretory (ES) antigens
  - hookworms 571
  - Toxocara canis* 505, 506
  - Trichuris trichiura* 572
- excystation, *Giardia lamblia* 223
- expression sites (ESs) in *vsg* genes 323
- eyeworm 446
- failure to thrive, giardiasis 228
- Fairley, Neil Hamilton 16
- falciparum malaria 70
  - see also Plasmodium falciparum*
- Fasciola gigantica* 420
- Fasciola hepatica* 414
  - description 415
  - epidemiology 416, 417

- history 10–11, 414–15  
 immunology 416  
 life-cycle 408, 415  
 pathogenesis 415, 416
- fascioliasis**  
 clinical features 417  
   acute hepatic phase 417  
   chronic obstructive biliary phase 417, 418  
   ectopic manifestations 418  
 laboratory diagnosis **418**  
   radiology 419  
   serology 418–19  
   stool analysis 418  
 laboratory features **417**, 418  
 organism *see Fasciola hepatica*  
 treatment 419–20
- Fasciolopsis buski** **636**  
 clinical features of infection 638, 640  
 description 635, 638, 639  
 epidemiology 638  
 laboratory diagnosis 640  
 life cycle 637, 638  
 pathogenesis 638  
 prevention and control 640  
 treatment of infection 640
- fatty acid binding protein Sm-14 397
- fenbendazole 515
- Fibricola seoulensis** **637**, 645
- filaria dance sign 442
- filarial fever 437
- filarial granulomata 439
- filariform larvae  
   hookworms 537–8, 569  
   *Strongyloides stercoralis* 483–4, 485, 488
- filter paper culture of *Strongyloides stercoralis* 490
- filtration of drinking water  
   cryptosporidiosis prevention 155  
   dracunculiasis prevention 558  
   giardiasis prevention 234
- fish**  
   *Capillaria philippinensis* transmission 575  
   *Gnathostoma* spp. transmission 541, 543  
   intestinal trematode transmission **636**, **637**, 641, 644, 645  
   *Metorchis conjunctus* transmission 420  
   *Opisthorchis* and *Clonorchis* spp. transmission 408, 410
- flagellate form, *Naegleria fowleri* 271, 272
- flotation techniques 577
- food-borne transmission  
   cryptosporidiosis 149  
   cyclosporiasis 165, 166–7  
   giardiasis 226  
   *see also specific foods*
- formol–ether technique 490, 577
- free-living amebas  
   taxonomy 270–1  
   *see also Acanthamoeba* spp.; *Balamuthia mandrillaris*; *Naegleria fowleri*
- free-living forms of *Strongyloides stercoralis* 481–2, 484
- Fujii, Y. 370
- fumagillin 189–90
- fungi, microsporidia related to 174, 184
- furazolidone **231**, 232, 364
- GAE *see* granulomatous amebic encephalitis
- Gal/GalNAc lectin, *Entamoeba histolytica* 200–1, 202, 204, 210, 212
- gametocytes, malarial 55, 56, 78, 92
- Gastrodiscoides hominis* **637**, 639, 641, 645
- gastrointestinal disease  
   *Blastocystis hominis* 360–1, 362  
   chronic Chagas' disease 339, 341, 343–4  
   strongyloidiasis 489
- gelatin particle agglutination test 491
- gene expression, *Entamoeba histolytica* 203–4
- gene sequencing, microsporidia 184
- genetic predisposition and *Ascaris* burden 568
- genitourinary schistosomiasis 390–1
- genome, *Entamoeba histolytica* 203
- genotypes of *Cryptosporidium parvum* 140, 142
- geographical information systems (GISs) 44–5, 49
- geophagia 504, 509, 511, 512
- Giardia lamblia*/giardiasis  
   antigenic variation 222–3  
   clinical features 227–8  
   chronic giardiasis 228  
   description 219–22  
   encystation and excystation 223  
   growth requirements 222  
   history 219  
   immune response 224–5  
   laboratory diagnosis  
     antigen detection assays 229  
     culture 230  
     drug sensitivity testing 230–1  
     duodenal sampling 229  
     ova and parasite examination 229  
     serology 230  
   management 231–3  
     asymptomatic infections 232–3  
     drugs 231–2  
     in pregnancy 233  
   resistance and relapse 233  
   pathogenesis  
     cytokine response 224  
     differences between isolates 223–4  
     trophozoite adherence to intestinal mucosa 224  
   predisposition to 225  
   prevention and control 233–4  
     in day care centres 234

- Giardia lamblia*/giardiasis (*cont.*)  
 species 222  
 transmission 225–6  
   cross-species 227  
   food-borne 226  
   person-to-person 226  
   travelers 226–7  
   water-borne 226  
 trophozoite analysis 222  
*Giardia*-specific antigen 65 (GSA 65) 229  
 gliding motility, *Toxoplasma gondii* 118, 119  
*Glossina* spp. 45–6, 323, 325, 326, 327  
 glucose-6-phosphate dehydrogenase (G-6-PD) deficiency  
 63, 64  
   primaquine therapy 76, 83  
 glutathione-S-transferases  
   hookworm 570–1  
   Sm-28 397  
*Gnathostoma spinigerum* **536**, 539–40  
   epidemiology 541  
   life-cycle 540–1  
 gnathostomiasis 541  
   clinical features 541  
     cerebral disease 542  
     visceral disease 541–2  
   diagnosis 542  
   management 542  
   organism *see Gnathostoma spinigerum*  
   prevention and control 543  
 Golgi, Camillo 14, 53  
 Göze, Johann 2, 9, 10, 585  
 GP63 293, 297  
 granular form, *Blastocystis hominis* 357, 359  
 granulomas, egg *see* egg granulomas  
 granulomatous amebic encephalitis (GAE) 277  
   clinical management 281–2  
   clinical signs and symptoms 277  
   laboratory diagnosis 280–1  
   organisms *see Acanthamoeba* spp; *Balamuthia mandrillaris*  
   pathogenesis 274–5  
   pathological features 278–80  
 Grassi, Battista 16, 479, 480  
 growth retardation *see* stunting  
 GSA 65 (*Giardia*-specific antigen 65) 229  
 guinea worm *see Dracunculus medinensis*  
 gynecophoral canal, *Schistosoma* spp. 371, 373  
 halofantrine 77, 81, 84  
 halzoun 418  
*Haplorchis* spp. **636**  
   description and life cycle 637, 643  
   epidemiology 644  
   treatment of infection 644  
 Harada–Mori method 490  
 heart disease, chagastic 338–9, 341, 343, 347, 348  
 helminths  
   cognitive impairment and infection with 562  
   global prevalences **30**, 564  
   population dynamics 27–8  
   sex bias in infection levels, meta analysis 38–41  
   *see also specific parasites*  
 hematoxylin and eosin stain 187, p.iv, p.v  
 hemoglobin S 64  
 hemozoin 62, 108  
 hepatitis B vaccine interference 387  
 hepatitis/schistosome co-infections 387, 391  
 hepatobiliary flukes 407, **411**  
   *Dicrocoelium* spp. 420–1  
   *Metorchis conjunctus* 420  
   *see also Fasciola hepatica*; *Opisthorchis* spp; *Clonorchis silensis*  
 hepatocellular carcinoma risk in schistosomiasis 382  
*Heterophyes heterophyes* **636**  
   description and life cycle 637, 639, 643  
   epidemiology 644  
   treatment of infection **642**, 644  
 heterophyidiasis  
   clinical features **638**, 644  
   laboratory diagnosis 644  
   organisms *see Haplorchis* spp; *Heterophyes heterophyes*; *Metagonimus yokogawai*  
   treatment 644  
 Hippocrates 53  
 history of parasitology  
   belief in spontaneous generation 1–2  
   chemotherapeutic agents 19  
   development of protozoology 12  
   establishment of the discipline 19  
   nineteenth century 2–3  
     Casimir Davaine 3, 6  
     early texts 3, 4  
     Thomas Spencer Cobbold 3, 5  
   origins of the discipline 2  
   *see also specific organisms*  
 HIV/AIDS *see* AIDS/HIV infection  
 HLA antigens and cysticercosis 621  
 HMS (hyper-reactive malarial splenomegaly) 61  
 homosexual males, *Entamoeba* infection 206, 213  
 hookworm platelet inhibitor 571  
 hookworms  
   classification 569  
   clinical features of infection 571  
   differentiation from *Strongyloides stercoralis* 482, 483  
   history 7–8, 568  
   immunology 570–1  
   life-cycle 569  
   skin penetration 569–70  
   pathogenesis 570  
   *see also Ancylostoma caninum/A. braziliense*  
 hormonal influence on *Trichomonas vaginalis* 246



- horse meat 526, 531
- host mediators in babesiosis injury 104
- host-adapted *Echinococcus* spp. 588, 589
- household clusters of strongyloidiasis 489, 493
- HSP70 genes 184
- hydatid cysts 587, 588
  - chemotherapy for 604–5
  - detection 603, 604
  - Echinococcus granulosus* 591–4, 595–6, 602
  - Echinococcus multilocularis* 592, 593, 594, 596
  - Echinococcus vogelii*/*E. oligarthrus* 594–5, 596
  - history 10, 585
  - protection from host immunity 597–8
  - surgical removal 604, 605
- hydatid disease *see* echinococcosis
- hydroceles 43, 438–9, 444
- hydrogenosomes 245–6, 258, 260
- Hymenolepis nana*
  - diagnosis and treatment 629
  - epidemiology 628
  - life-cycle 627–8
- hyper-reactive malarial splenomegaly (HMS) 61
- hypnozoites 54, 55, 75
- hypoglycemia in malaria 63, 70, 79
- IFN $\gamma$  *see* interferon gamma
- IgA response
  - giardiasis 225
  - strongyloidiasis 487
  - trichinellosis 524
- IgE assays
  - Toxocara* spp. 514
  - Toxoplasma gondii* 130
- IgE response
  - schistosome reinfection 388
  - strongyloidiasis 487
- IgG response, strongyloidiasis 486–7
- IgG<sub>4</sub> assays, filarial infections 442, 462
- IgM assays
  - Toxoplasma gondii* 123, 130, 131
  - see also* serological diagnosis
- IgM response
  - African trypanosomiasis 321
  - strongyloidiasis 487
- imidocarb 109
- immune evasion
  - Fasciola hepatica* 416
  - hookworms 571
  - Paragonimus* spp. 422–3
  - Schistosoma* spp. 384–5
    - disrupted by praziquantel 395
- immune modulation, chronic schistosomiasis 381, 386
- immune suppression
  - by *Onchocerca volvulus* 462
  - by *Trypanosoma brucei* 321
  - by *Trypanosoma cruzi* 339–40
- immune tolerance
  - in cysticercosis 621
  - in onchocerciasis 462, 463
  - in strongyloidiasis 487
- immunocompromised patients
  - cryptosporidiosis in 150, 154
  - granulomatous amebic encephalitis in 274–5
  - microsporidial infections in 180, 181, 189, 191
  - reactivation of *Trypanosoma cruzi* 344, 348
  - Strongyloides stercoralis* hyperinfection 485–6
  - toxoplasmosis in 124–6, 132–3
  - transfusion-associated Chagas' disease in 342
  - see also* AIDS/HIV infection
- immunotherapy for leishmaniasis 308
- imported malaria 68, 69
- incremental cost–effectiveness ratios 33–4
- inflammatory response, cysticercosis 621, 624
- innate resistance to malaria 64
- insecticidal control
  - blackflies 472–3
  - mosquitoes 54, 87
  - impregnated bednets 87–8
  - sand flies 308–9
  - tsetse flies 331
- insecticide resistance 473
- intensity of infection, intestinal nematodes 27, 28, 565–6
- interferon gamma (IFN $\gamma$ )
  - in cryptosporidiosis immunity 146
  - in leishmaniasis immunity 293, 294, 295, 296
  - mediation of *Trypanosoma brucei* immune suppression 321
  - in microsporidiosis immunity 183
- recombinant
  - Chagas' disease treatment 347
  - leishmaniasis treatment 306–7, 308
  - response to *Entamoeba histolytica* 202
  - stimulation of trypanosomal growth 321–2
  - in toxoplasmosis immunity 120, 121
  - in *Trypanosoma cruzi* immunity 339
- interleukin 1 (IL-1) 295
- interleukin 2 (IL-2) 295, 296, 339, 462
- interleukin 4 (IL-4) 295, 296, 462
- interleukin 5 (IL-5) 295, 296, 462, 463, 524
- interleukin 6 (IL-6) 462, 470
- interleukin 8 (IL-8) 152
- interleukin 10 (IL-10) 295, 296, 340, 462, 463
- interleukin 12 (IL-12) 121, 146, 295, 488
- intestinal ascariasis 568
- intestinal disease pathogenesis
  - Cryptosporidium parvum* 142–5
  - microsporidia 181, p.iv, p.v
- intestinal nematodes
  - entry to the host 566
  - epidemiology
    - global disease burden 564
    - infection intensity and transmission 565–6

- intestinal nematodes (*cont*)  
 history 561  
 laboratory diagnosis  
   egg identification 577–8  
   flotation techniques 577  
   formol–ether concentration 577  
   Kato–Katz technique 577  
   larval identification 578  
   simple fecal smears 576–7  
   specimen handling 576  
 life-cycles 566  
 pathogenesis  
   cognitive impairment 562  
   morbidity 563–4  
 prevention and control 580  
 species associated with human intestines 562, **563**  
 treatment 578–80  
*see also specific organisms*
- intestinal obstruction with *Ascaris lumbricoides* 568
- intestinal trematodes 635, 639  
 infecting humans **636–7, 638**  
 life-cycles 635, 637  
*see also specific organisms*
- intra-dermal test for paragonimiasis 427, **428**
- iodination of water 234
- iodoquinol 211, 364
- ipecac bark 198
- iron  
 effects on *Trichomonas vaginalis* 247, 249  
 loss in hookworm infection 570
- irradiated cercarial vaccines 387
- isosporiasis  
 clinical features 157  
 clinical management 157–8  
 epidemiology 156–7  
 history 156  
*Isospora belli* 156  
 laboratory diagnosis 157  
 pathogenesis and immunology 156  
 prevention and control 158–9
- ivermectin treatment  
 adverse reactions in loiasis 448, 472  
 cutaneous larva migrans 539  
 lymphatic filariasis 443  
*Mansonella ozzardi* infections 450  
 onchocerciasis 471  
   adverse reactions 472  
   mass treatment campaigns 474  
 strongyloidiasis 492
- Ixodes scapularis* life-cycle 101
- kala-azar 301–3
- Kartulis, Staphanos 12
- karyotypic analyses, *Blastocystis hominis* 360
- Katayama fever 370, 388–9
- Kato–Katz technique 392, 577
- Katsurada, Fujiro 11, 370
- keyhole limpet antibodies 394
- kinetoplasts  
*Leishmania* spp. 288, 289, 297  
*Trypanosoma brucei* 316, 318, 322, 330  
*Trypanosoma cruzi* 336, 346
- kissing bugs *see* triatomine vectors
- knob-associated histidine-rich protein (KAHRP) 62
- knock-out mice, egg granuloma studies 385, 386
- lactoferrin 152
- lactose malabsorption 228
- laminated layer, *Echinococcus* spp. 591, 593, 594, 598, 604
- Landsat Thematic Mapper 45
- larva currens 489
- larvae  
*Dracunculus medinensis* 553, 555, 556, 557  
*Echinococcus* spp. *see* hydatid cysts  
*Gnathostoma spinigerum* 541  
 hookworm 537–8, 569  
 intestinal nematode 566, 578  
 lymphatic filariae 434  
*Onchocerca volvulus* 458, 459  
*Sparganum mansoni* 546  
*Strongyloides stercoralis* 482–4  
*Taenia* spp. *see* metacestodes: *Taenia* spp.  
*Toxocara* spp. 502, 503, 504, 505  
*Trichinella* spp. 522, 523
- larvicidal control of blackflies 472–3
- latent microsporidial infections 183
- Laveran, Alphonse 14, 53, 479
- Leeuwenhoek, Anthony van 1–2, 10, 12, 13, 219
- Leidy, Joseph 19, 521
- Leishman, William 19, 287
- Leishmania* spp. 288, **289**  
 of the Americas  
   *L. (L.) amazonensis* 298  
   *L. (L.) chagasi* 296, 298–9, 302  
   *L. (L.) mexicana* 298  
   *L. (V.) braziliensis* 296, 298  
   *L. (V.) guyanensis* 298  
   *L. (V.) panamensis* 298  
   *L. (V.) peruviana* 298
- biochemistry 297  
 classification 288  
 cultivation 290, 291, 304  
 epidemiology 288, 297–8  
 immunology 293  
   interactions with macrophages 293–4  
   mouse models of cell-mediated immunity 294–6  
 life-cycle 290  
 molecular biology 297  
 morphological forms 288, 289, 291, 292  
 of the Old World  
   *L. (L.) aethiopica* 299

- L. (L.) donovani* 294–5, 296
  - L. (L.) dovani* 299–300
  - L. (L.) major* 295, 299
  - L. (L.) tropica* 299
  - L. (L.) infantum* 299–300
  - pathogenesis 291
    - cutaneous disease 291, 292–3
    - visceral disease 293
  - vectors 289, 290
  - leishmaniasis
    - cutaneous
      - diffuse 292, 301
      - immune response to 296
      - simple 300–1
      - treatment 307–8
    - diagnosis
      - leishmanin skin test 305
      - parasite identification and culture 304–5
      - serology 305
    - drug therapy 305–7
    - history 18–19, 287–8
    - immunology 296–7
    - leishmaniasis recidiva 292–3, 299, 301
    - mucosal 301, 302
      - treatment 308
    - organisms *see Leishmania* spp.
    - post-kala-azar dermal leishmaniasis 304
    - prevention 308–9
    - visceral 301–3
      - in AIDS/HIV infection 203
      - immune response to 296
      - treatment 307
    - viscerotropic 303–4
  - leishmanin skin test 305
  - leopard skin 467, 468
  - Leuckart, R. 457, 480, 585–6
  - leukovorin 131, 132, 133
  - levamisole 449, 579
  - Linnaeus, Carl 10
  - lipophosphoglycan (LPG) 293, 297
  - liposome-encapsulated amphotericin B 306, 307
  - liver abscesses, *Entamoeba histolytica* *see* amebic liver abscesses
  - liver function in malaria 63
  - liver infection
    - Fasciola hepatica* 415, 416
    - microsporidia 183
    - Paragonimus* spp. 422, 425
  - liver-trapping phenomenon 507
  - Livingstone, David 17
  - Loa loa* **434**
    - epidemiology 445–6
    - life-cycle 445
  - loiasis 445
    - clinical manifestations 446
    - complications 446–7
    - diagnosis 441, 447
    - organism *see Loa loa*
    - prevention 448
    - treatment 448
  - Looss, Arthur 7, 11
  - lovastatin 109
  - Low, George Carmichael 9, 16, 18
  - LPG (lipophosphoglycan) 293, 297
  - lumbar puncture 74
  - lung flukes *see* pulmonary flukes
  - Lyme disease concurrent with babesiosis 106, 108, 109–10
  - lymphatic filariae
    - epidemiology
      - Brugia malayi* and *B. timori* 434–5
      - Wucheria bancrofti* 435
    - life-cycle 434
  - lymphatic filariasis 433–4
    - acute manifestations 436–7
    - asymptomatic microfilaremia 436
    - bancroftian filariasis 434, 436
      - lymphedema of the limbs 438
      - male genital disease 438–9
    - brugian filariasis 434, 436, 438
    - chronic manifestations 437–8
      - adenopathy 440
      - chyluria 439
      - filarial granulomata 439
      - hydroceles 438–9
      - lymphedema of the genitalia 439
      - lymphedema of the limbs 438
      - tropical pulmonary eosinophilia (TPE) 439
  - diagnosis 440
    - antigen detection 441
    - imaging studies 442
    - microscopical detection and speciation 440–1
    - PCR 442
    - serology 441–2
  - disease mapping 46
    - at global and regional levels 46–8
    - at village level 48–9
  - history 8–9
  - microfilaraemia and chronic disease, meta-analysis 41–4
  - in movers to endemic areas 440
  - organisms *see* lymphatic filariae
  - pathology 435
  - prevention and control 445
  - treatment
    - acute manifestations 443
    - asymptomatic microfilaremia 442–3
    - chronic manifestations 443–5
    - dosage of DEC 445
    - lymphoscintigraphy 442
- macrophage inflammatory protein-1a 296

- macrophages, in immunity to *Leishmania* spp.  
293–6
- magnetic resonance imaging (MRI)  
granulomatous amebic encephalitis 281  
neurocysticercosis 622, 626  
primary amebic meningoencephalitis 280  
toxoplasmosis 126, 127
- malaria  
airport 68  
antimalarial drugs 81–6  
cerebral 60, 79  
clinical examination 74  
clinical features 69  
in children 71  
falciparum malaria 70  
*Plasmodium vivax/P. ovale/P. malariae* malarias  
70–1  
in pregnancy 71  
clinical management, in pregnancy 81  
clinical management, severe malaria 78  
anemia 79  
bacterial infections 79  
cerebral malaria 79  
chemotherapy 80–1  
circulatory collapse 79  
exchange transfusion 79–80  
follow-up 81  
hydration 78  
hypoglycemia 79  
renal function 78  
clinical management, uncomplicated malaria 74,  
77–8  
drug dosages 76  
eradication therapy, *Plasmodium vivax/P. ovale*  
malarias 75–6  
*Plasmodium falciparum* malaria 75, 76–7  
*Plasmodium vivax/P. ovale/P. malariae* malarias  
74–5  
control 86–7  
chemoprophylaxis in endemic areas 87  
early treatment 86–7  
vector control 87–8  
epidemiology  
*Anopheles* mosquito variation 67  
drug resistance 69, p.vi  
geographic distribution 66–7, p.vi  
patterns of clinical disease 68–9  
prevalence 66  
resurgence 66  
transmission modes 67–8  
history 14–16, 53–4  
immunity 63  
clinical, in endemic areas 64–5  
innate resistance 64  
non-specific 64  
specific (acquired) 63–4  
laboratory diagnosis 71  
microscopy 71–3  
PCR 73  
rapid antigen tests 73, 74  
serology 73, 74  
organisms *see Plasmodium* spp; *specific Plasmodia*  
pathology of clinical syndromes 61  
anemia 62  
cerebral malaria 61–2  
hypoglycemia 63  
pregnancy 63  
renal failure 62–3  
respiratory distress 62  
thrombocytopenia and coagulation 62  
prevention in travelers 88  
chemoprophylaxis 88–90  
presumptive treatment 90  
role of the spleen 60, 61  
splenectomized patients 71  
vaccine development 25, 91  
blood stage vaccines 91–2  
DNA vaccines 92  
pre-erythrocytic vaccines 91  
transmission-blocking vaccines 92  
Malarone® 76, 78, 86, 89, 90  
Manson, Patrick 6, 8, 9, 11, 16  
*Mansonella ozzardi* 434  
epidemiology 450  
life-cycle 441, 450, 461  
*Mansonella perstans* 434  
epidemiology 449  
life-cycle 441, 449, 461  
MAP-4 397  
mast cells in *Trichinella* expulsion 524  
Mazzotti test 470  
mebendazole treatment  
clonorchiasis and opisthorchiasis 414  
cystic echinococcosis 605  
eosinophilic enteritis 539  
intestinal nematode infections 578  
perstans filariasis 449  
strongyloidiasis 492  
toxocariasis 515  
trichinellosis 530  
mefloquine treatment 82–3  
prophylaxis 76, 89, 90  
severe malaria 81  
uncomplicated malaria 75, 77  
megadisease 339, 341, 343–4, 347–8  
meglumine antimonate 306, 307  
Melanesian ovalocytosis 64  
melarsoprol 330–1  
meningeal cysticercosis 624, 627  
mepacrine hydrochloride 54  
merogony, microsporidia 173, 174, 176, 178, 180  
meronts  
*Cryptosporidium parvum* 141, 142

- Cyclospora* spp. 166  
microsporidia 172, 173, 174–5, 176–7, 178–9
- merozoites  
*Babesia* spp. 100, 103  
*Cryptosporidium parvum* 141, 142, 147  
*Plasmodium* spp. 54, 55, 56, 58, 92
- meta-analyses 37–8, 44  
examples 38–44
- metacercariae, intestinal trematodes 635, 637, 638, 641, 643
- metacestodes  
*Echinococcus* spp. *see* hydatid cysts  
*Taenia* spp. 614, 615, 616, 617, 622
- Metagonimus yokogawai* **636**  
description and life-cycle 637, 639, 643  
epidemiology 644  
treatment of infection **642**, 644
- Metorchis conjunctus* 420
- metrifonate 396
- metronidazole treatment  
*Blastocystis hominis* infections 364  
*Dientamoeba fragilis* infections 263  
*Entamoeba polecki* infections 214  
giardiasis 231, **232**, 233  
invasive amebiasis 211  
trichomoniasis 254–5
- miconazole 281
- microfilariae  
*Dirofilaria* spp. 547  
*Loa loa* 445, 446, 448  
lymphatic filariae 433, 434  
detection and speciation 440–1  
killing with DEC 443, 444, 445  
microfilaremia 436  
*Mansonella ozzardi* 441, 450, 461  
*Mansonella perstans* 441, 449, 461  
*Onchocerca volvulus* 459, 460–1, 464  
detection 468, 469, 470
- microsporidia  
anisofilar polar tube group 174–5, 176, 177, 178, 179  
diplokaryotic group 174–5, 178, 179, 180  
*Encephalitozoon* spp. 171, 174–6, p.iv, p.v  
*Enterocytozoon bieneusi* 171, 174, 175, p.iv, p.v  
epidemiology  
*Encephalitozoon* spp. 185–6  
*Enterocytozoon bieneusi* 185  
other species 186–7  
questions 185  
transmission 184–5  
genera and species, listed 171–2  
life-cycles 172, 173  
molecular biology 184  
phylogeny 172, 174  
spores *see* spores: microsporidia  
microsporidiosis 171–95  
clinical management 189  
albendazole 190  
fumagillin 189–90  
other drugs 190–1  
TNP-470 190  
history 171  
immunology 183–4  
laboratory diagnosis  
microscopy 187, p.iv, p.v  
PCR 188–9  
serology 187–8  
organisms *see* microsporidia  
pathogenesis 180–3  
*Microsporidium* spp. 176–7, 178, **181**, 182  
migrating worms 535, **536**  
*see also specific species*
- miltefosine 307
- miracidia  
*Fasciola hepatica* 408, 415  
intestinal trematodes 635, 637, 638, 641, 643  
*Opisthorchis* and *Clonorchis* spp. 408, 410  
*Paragonimus* spp. 408, 421  
*Schistosoma* spp. 372, 373, 374
- miracil 371
- molecular karyotypes of microsporidia 184  
molecular taxonomy *see* phylogenetic analysis
- molluscicides 371
- monocyte chemoattractant protein-1 296
- monthly biting rate (MBR)/transmission potential (MTP) calculations 464
- mosquitoes  
control 87  
in *Dirofilaria immitis* life-cycle 547  
lymphatic filariae transmission 434, 435  
microsporidia infections in 186–7  
*see also Anopheles* mosquitoes
- mouse models  
*Giardia* infection 224  
leishmaniasis cell-mediated immunity 294–6  
schistosomal egg granuloma induction 385–6  
toxocariasis 510–11, 512  
trichinellosis immunity 523–4
- mucins, colonic 200
- mucosal leishmaniasis 301, 302
- multivacuolar form, *Blastocystis hominis* 358, 359, p.vii
- multivesicular/alveolar echinococcosis (MAE)  
clinical features 602  
clinical management 605–6  
diagnosis 603, 604  
pathogenesis 596  
*see also Echinococcus* spp.
- muscle biopsy for trichinellosis diagnosis 529
- muscle cysticercosis 624
- myocardial infection, microsporidia 182, p.iv, p.v
- myosins 118
- Nabarro, David 18

- Naegleria fowleri*  
 culture 273–4  
 epidemiology 276, 277  
 history 269  
 immunology 275, 276  
 life-cycle 271, 272  
 molecular biology 276  
 taxonomy 270  
*see also* primary amebic meningoencephalitis (PAM)
- nagana 17, 335
- Nanophyes salmincola* 637, 645
- natural-resistance-associated macrophage protein (*Nramp*) 294–5
- Necator americanus* 569, 570, 571
- neonatal trichomoniasis 246, 252
- neural paragonimiasis 424, 425, 429
- neurocysticercosis (NC) 617  
 clinical features 624  
 diagnosis 626  
 epidemiology 619–20  
 pathology 621–3  
*see also* cysticercosis
- neuroschistosomiasis 383
- neurotrichinellosis 527
- neutral thiol protease (NTP) 423
- neutrophil inhibitory factor, hookworm 570
- neutrophils in *Trichomonas vaginalis* infection 249
- niclofan 429
- niclosamide 629, 640, 642, 644
- nifurtimox 346–7, 348
- nitazoxanide 154
- nitric oxide 120, 121, 202, 294, 321
- nitroimidazole treatment  
*Blastocystis hominis* 364  
 giardiasis 230–2  
 trichomoniasis 254–5  
*see also specific drugs*
- nitrosamines 413
- normalized difference vegetation index (NDVI) 45, 46
- Normand, Louis 479
- Nosema ocularum* 173, 180, 181
- Nramp* (natural-resistance-associated macrophage protein) 294–5
- nurse cells 523
- nutrient malabsorption, chronic giardiasis 228
- obstructive biliary disease 412, 417, 418
- occupational risk of schistosomiasis 379
- ocular disease  
 cysticercosis 624, 627  
 dirofilariasis 548  
 gnathosomiasis 542  
 microsporidiosis 182  
 onchocerciasis 461–2, 467  
 toxocariasis *see* ocular larva migrans
- toxoplasmosis 124, 125
- trichinellosis 527
- ocular larva migrans  
 clinical features 511–12  
 epidemiology 510  
 history 501–2  
 laboratory diagnosis 514–15  
 treatment 515–16
- odds ratios 41
- Onchocerca volvulus*  
 life-cycle 458, 459  
 adult worms 458, 459–60  
 microfilariae 459, 460–1  
 strain differences 464  
 taxonomy 458
- onchocerciasis  
 clinical features 466–8  
 clinical management  
 amocarzine 472  
 historical 470–1  
 ivermectin 471–2  
 epidemiology 463  
 entomology 465–6  
 geographical variation 464  
 infective vector density 463–4  
 history 457, 458  
 immunology 462–3  
 laboratory diagnosis  
 Mazzotti test 470  
 skin snips 468–70  
 slit lamp examination 470  
 organism *see Onchocerca volvulus*  
 pathogenesis 461–2  
 prevention and control 472  
 mass ivermectin treatment 474  
 nodulectomy campaigns 474  
 vaccine development 475  
 vector control 472–3
- Onchocerciasis Control Programme 473
- onchocercomata *see* subcutaneous nodules: in onchocerciasis
- Oncomelania* snails 376
- oncospheres  
*Echinococcus* spp. 587, 590–1, 597  
*Taenia* spp. 614, 615, 616, 617
- O'Neill, J. 457
- oocysts  
*Cryptosporidium parvum* 139  
 elimination in drinking water 155  
 infection potential 148  
 in life-cycle 141, 142  
 PCR detection 152, 153  
 viability determination 153  
 virulence 145  
 visualization 151, 152
- Cyclospora* spp. 165, 166, 168

- Isospora belli* 156, 157, 158–9  
*Toxoplasma gondii* 115, 133  
 opisthorchiasis **412**  
   clinical features  
     acute infection 411  
     cholangiocarcinoma 413  
     chronic infection 411, 412  
     obstructive biliary disease 412  
   control 414  
   laboratory diagnosis 413  
   organisms *see Opisthorchis* spp.  
   treatment 413–14  
*Opisthorchis* spp. 407, 409–10  
   epidemiology 410, 411  
   life-cycle 408, 410  
   pathogenesis 410  
 oral rehydration solutions 144, 153  
 ova *see* eggs  
 oxamniquine 396  
 oxibendazole 578
- P270 249–50  
 PAIR technique 604  
 Pallas, Peter 2, 10  
 PAM *see* primary amebic meningoencephalitis  
 Papanicolaou staining 254  
 Papyrus Ebers 7, 369  
 paragonimiasis  
   clinical features 423, **424**  
     acute disease 423  
     extrapulmonary disease 425  
     pulmonary disease 423, 425  
   laboratory diagnosis **428**  
     hematology/biochemistry **426**  
     intradermal test 427  
     radiology 425, **426**, 427  
     serology 427  
     sputum and stool analysis 427  
   prevention and control 429  
   treatment 427, 429  
*Paragonimus* spp. 411  
   description 421, 422  
   epidemiology 423  
   history 421  
   immunology 422–3  
   life-cycle 408, 421  
   pathogenesis 421, 422  
 paramyocin 397  
 parasitemia estimation, malaria 72, 73  
 parasitic female form of *Strongyloides stercoralis* 480–1, 484  
 parasitology, history *see* history of parasitology  
 parasitophorous vacuoles 119, 120, 121, 142, 172  
 parenchymal cysticercosis 621, 623, 624  
 paromomycin treatment  
   cryptosporidiosis 153–4  
   *Entamoeba histolytica* infection 211  
   giardiasis **231**, 233  
   leishmaniasis 307, 308  
   trichomoniasis 263  
 PCR diagnosis  
   African trypanosomiasis 329  
   Chagas' disease 346  
   cryptosporidiosis 152–3  
   cyclosporiasis 168  
   *Entamoeba histolytica* infection 210  
   lymphatic filariasis 442  
   malaria 73  
   microsporidiosis 188–9  
   toxocariasis 514  
   toxoplasmosis 128  
   *Trichomonas vaginalis* infection 254  
 pentamidine isethionate treatment  
   African trypanosomiasis, hemolympathic stage 330  
   *Balamuthia* GAE 281–2  
   leishmaniasis 306, 308  
*Pentatrachomonas hominis*  
   clinical features of infection 259  
   clinical management of infection 260  
   description 244, 258  
   epidemiology 259  
   laboratory diagnosis 259–60  
   pathogenesis 259  
 pentavalent antimony-containing drugs 305–6  
 pepstatin A 570  
 periodic acid–Schiff (PAS) protocol 128  
 periodic fever 69  
 periodontal disease and *Trichomonas tenax* 256, 257  
 periorbital edema in trichinellosis 527  
 permethrin-treated bednets 87–8  
 personal water filtration devices 234  
 perstans filariasis 448  
   clinical manifestations 449  
   diagnosis 449  
   organism *see Mansonella perstans*  
   treatment 449–50  
 performic acid–Schiff stain 603  
 Peruvian bark 53, 54  
 Peyer's patches 225  
 phagocytosis of *Babesia* 105  
*Phaneropsolus bonnei* **637**, 644  
 phylogenetic analysis  
   *Cryptosporidium* spp. 140  
   *Echinococcus* spp. 586  
   *Plasmodium* spp. 54  
   *Trypanosoma brucei/T. cruzi* 316  
 pian bois 298  
 pinworm eggs in *Dientamoeba fragilis* transmission 262  
 pinworms *see Enterobius vermicularis*  
 piperazine 579–80, **642**, 644  
 piritrexam 109  
 piroplasmosis *see* babesiosis

- Plagiorchiidae* spp. 637, 644–5
- Plasmodium* spp. 56
- discovery 53
  - life-cycle
    - asexual stage 55
    - development in *Anopheles* mosquitoes 56
    - pre-erythrocytic stage 54, 55
    - sexual stage 55, 56
  - morphology 56, 57, 58
  - pathogenesis *see Plasmodium falciparum*: pathogenesis
  - taxonomy 54
  - transmissibility 25
  - see also specific species*
- Plasmodium falciparum* 53, 57
- gametocytes 55, 56, 57
  - genetic diversity 66
  - geographic distribution 66–7, p.vi
  - immune evasion 65
  - molecular biology 65–6
  - novel myosin (PfM-A) 118
  - pathogenesis 56
    - cytoadherence 59
    - role of the spleen 60, 61
    - rosetting 59, 60, 61
    - sequestration 57, 59, 61, 63
  - see also malaria*
- Plasmodium malariae* 58, 62–3, 70, 71, 75
- Plasmodium ovale* 58, 70, 75, 76
- Plasmodium vivax* 58
- antigenic diversity 65
  - clinical features of infection 70–1
  - geographic distribution 67
  - treatment 74–5, 76
- platelet inhibition, hookworms 571
- Pleistophora* spp. 173, 176, 177, 178, 179
- plerocercoid larvae 630
- Poisson probability maps 46, 48
- polaroplasts 172
- polycystic echinococcosis 596
- polyhexamethylene biguanide (PHMB) 282
- polymerase chain reaction diagnosis *see* PCR diagnosis
- population dynamics 21
- helminth infections 27–8
  - theory
    - basic reproductive number ( $R_0$ ) *see* basic reproductive number ( $R_0$ )
    - in design of disease control programs 26–7
    - dynamics of epidemics 22–3
    - implications for public health practice 24–6
- population genetics of *Toxoplasma gondii* 115, 116
- pork, trichinellosis transmission 522, 524, 525, 526, 531
- pork tapeworm *see Taenia* spp: *T. solium*
- portal hypertension in schistosomiasis 382
- post-kala-azar dermal leishmaniasis 304
- praziquantel
  - in animal baits 607
  - interference with *Schistosoma* spp. immune evasion 385
- praziquantel treatment
  - chlonorchiasis and opisthorchiasis 413–14
  - cysticercosis 627
  - Diphyllobothrium latum* infections 631
  - echinostomiasis 642–3
  - fascioliasis 419, 420
  - Fasciolopsis buski* infections 640
  - heterophyidiasis 642, 644
  - Hymenolepis nana* infections 629
  - intestinal nematodes 635
  - Nanophyetes salmincola* infections 645
  - paragonimiasis 427, 429
  - schistosomiasis 395–6, 397
  - sparganosis 547
  - taeniasis 626
- pre-erythrocytic malarial vaccines 91
- prednisolone 516
- prednisone 132, 531
- pregnancy
  - giardiasis 233
  - malaria 63, 71, 81, 90
  - toxoplasmosis 132, 133
  - trichinellosis 528
  - trichomoniasis 248
- primaquine treatment, malaria 83
  - contraindicated in pregnancy 81, 90
  - eradication therapy 75, 76
  - prophylaxis 76, 90
- primary amebic meningoencephalitis (PAM) 276
  - clinical management 281
  - clinical signs and symptoms 277
  - laboratory diagnosis 280
  - organism *see Naegleria fowleri*
  - pathogenesis 274
  - pathology 277, 278
  - prevention and control 282
- primate model, trichomoniasis 249
- procercoid larvae, *Diphyllobothrium latum* 629, 630
- procyclin 316, 322, 323
- proglottids
  - Echinococcus* spp. 587, 603
  - Hymenolepis nana* 628, 629
  - Taenia* spp. 614, 616, 617
  - detection 624–5, 626
- Programme for the Elimination of Onchocerciasis in the Americas (OEPA) 474
- proguanil 54, 76, 84, 89
- proguanil-atovaquone 86, 90
- promastigotes, *Leishmania* spp. 287, 292
  - culture 290, 291, 304
  - macrophage infection 293
- Prosthodendrium molenkampi* 637, 644
- protease activities
  - Entamoeba histolytica* 201



- hookworms 569–70
  - Toxocara canis* larvae 506
- protoscolecids, *Echinococcus* spp. 587, 590, 591, 592, 594
- pulmonary angiostrongyliasis 545
- pulmonary dirofilariasis 547, 548
- pulmonary flukes 407, **411**
  - see also *Paragonimus* spp.
- pulmonary migration of *Ascaris lumbricoides* larvae 568
- pulmonary paragonimiasis 423–5
- pulmonary toxoplasmosis 126
- pulmonary trichinellosis 527
- punctate keratitis in onchocerciasis 467
- pyogenic liver abscesses 208, 209
- pyrantel 579
- pyrimethamine, toxoplasmosis treatment 131, 132, 133
- pyrimethamine–dapsone 84
- pyrimethamine–sulfadoxine **75**, 77, 81, 84
- pyronaridine 86
  
- qinghaosu 85
- quinacrine **231**, 232
- quinidine 80, 82
- quinine treatment 54, 82
  - babesiosis 109
  - severe malaria 79, 80
  - uncomplicated malaria 75, 77
  
- $R_0$  see basic reproductive number ( $R_0$ )
- raccoons, *Baylisascaris procyonis* infection 548
- radical cure, malarias 75, 76
- radiography 603–4
- radioimmune precipitation assay, *Trypanosoma cruzi* antibodies 345
- randomized trials, example 36–7
- raspberries, *Cyclospora* outbreaks 165, 167
- rebound morbidity 387
- recurrent pyogenic cholangitis 412–13
- rediae, intestinal trematodes 635, 637, 638, 641
- Redi, Francisco 2, 10
- relapsing diarrhea 150
- remote sensors on satellites 44–5
  - diurnal temperature difference maps 48–9
  - tsetse fly distribution prediction 45–6
- renal complications in loiasis 446
- renal failure in malaria 62–3, 70, 78
- renal infection, microsporidia 181–2, p.iv, p.v
- renal lesions in schistosomiasis 383
- repeat sequences, *Plasmodium falciparum* DNA 65
- respiratory distress in malaria 62
- respiratory infection, microsporidia 176–7, 182
- retinochoroiditis in toxoplasmosis 124, 125, 132
- rhabditiform larvae
  - hookworms 569
  - Strongyloides stercoralis* 482–3, 484, 485
- ribosomes, *Entamoeba histolytica* 202, 203
  
- rifampin 281
- ring cysts 425, 427
- ring forms 55, 58
- river blindness see onchocerciasis
- RNA, *Entamoeba histolytica* 203
- Robles, R. 457
- ‘Roll Back Malaria’ campaign 86
- Romaña sign 342
- rosetting 59, 60, 61
- Ross, Ronald 15, 16
- Rudolphi, Carl 2–3, 10, 585
- rural/urban differences in toxocariasis prevalence 509
  
- Sabin–Feldman dye test 129
- salmonella infections and schistosomiasis 391
- salt, fortified with DEC 445
- sand flies 289, 290, 298, 308–9
- satellite data see remote sensors on satellites
- Sb<sup>v</sup>-containing drugs 305, 306
- Schistosoma* spp.
  - characteristics 371–2
  - epidemiology
    - geographical distribution 377, 378, **379**
    - influence of control programs 380
    - occupational risk 379
    - regional variation in morbidity 380
    - transmission 377, 379
  - hosts 377
  - life-cycle 373, 374
    - cercariae 372–3
    - eggs 372, 375, 376
    - inside the snail 372
    - lifespan 375–6
    - migration in veins 375
    - miracidia 372
    - schistosomulae 374, 375
    - snail intermediate hosts 376–7
    - worm pairs 375
- schistosomal complement-inhibiting protein (SCIP-1) 385
- schistosome dermatitis 388
- schistosomiasis
  - cancer risk 383, 391
  - clinical disease **380**, 388
    - acute 388–9
    - genitourinary 390–1
    - intestinal 389
  - diagnosis
    - current approach 391–2
    - egg-hatching techniques 393
    - liver biopsy 393–4
    - rectal biopsy 393
    - serology 394
    - stool samples 392
    - ultrasound 393
    - urine 392–3

- schistosomiasis (*cont*)
- hepatitis B or C co-infections 391
  - hepatosplenic disease 389–90
  - history 11–12, 369–71
  - immunology 384
    - egg granuloma induction 385–7
    - immune evasion 384–5
    - resistance to infection 387–8
  - organisms *see Schistosoma* spp.
  - pathology **380**
    - in children 384
    - egg granulomas 376, 380, 381
    - hepatosplenic 381–2
    - intestinal 381
    - neuroschistosomiasis 383
    - pulmonary fibrosis 382–3
    - urinary 383
  - prevention and control
    - historical 371
    - prospects 397–8
    - vaccines 396–7
  - salmonella infections and 391
  - treatment 394–5
    - historical 371
    - metrifonate 396
    - oxamniquine 396
    - praziquantel 395–6
- schistosomulae 374, 375
- schizonts, malarial 54, 55, 59, 60
- schizotrypanides 342
- sclerosing keratitis in onchocerciasis 467
- sequestration of *Plasmodium falciparum*-infected erythrocytes 57, 59, 61, 63
- serological diagnosis
- African trypanosomiasis 329, 332
  - Angiostrongylus* spp. infections 545
  - chronic Chagas' disease 345
  - cryptosporidiosis 153
  - cysticercosis 626
  - dirofilariasis 548
  - dracunculiasis 557
  - echinococcosis 604
  - Entamoeba histolytica* infections 210
  - fascioliasis 418–19
  - gnathostomiasis 542
  - leishmaniasis 305
  - lymphatic filariasis 441–2
  - malaria 73, 74
  - microsporidiosis 187–8
  - paragonimiasis 427, **428**
  - schistosomiasis 394
  - Sparganum mansoni* infections 547
  - strongyloidiasis 491–2
  - toxocariasis 513–14
  - toxoplasmosis 129, 130–1
  - trichinellosis 530
- seroprevalence studies, toxocariasis 507, **508**
- age and sex differences 508
  - location 508–9
  - ocular toxocariasis 510
  - risk factors 509
- severe combined immunodeficient (SCID) mouse model, amebic liver abscess 202
- sex bias in helminth infection levels, meta-analysis 38–41
- sexual abuse of children 252
- sexually transmitted infections
- prevalence **250**
  - $R_0$  estimation and importance 24, 25–6
  - see also specific infections*
- Shigella* and *Entamoeba* co-infection 205
- shikimate pathway 114
- Simulium* spp. *see* blackflies
- simvastatin 109
- skin
- changes in chronic lymphatic filariasis 438
  - lesions in onchocerciasis 461, 467, 468
  - manifestations in strongyloidiasis 489
  - penetration by hookworms 569–70
  - see also* cutaneous larva migrans; leishmaniasis: cutaneous
- skin snips 468, 469, 470
- sleeping sickness *see* African trypanosomiasis
- snail hosts
- Angiostrongylus cantonensis* 543, 544
  - Fasciola hepatica* 408, 415
  - Fasciolopsis buski* 638
  - Opisthorchis* and *Clonorchis* spp. 408, 410
  - Paragonimus* spp. 408, 421
  - Schistosoma* spp. 376–7
    - control programs 369
    - role in life-cycle 372, 374
- snake, raw 645
- socioeconomic impact of onchocerciasis 468
- sodium pentachlorophosphate 371
- sodium stibogluconate 306, 307, 308
- soil levels of *Toxocara canis* eggs 509–10
- soluble egg antigens 380, 381, 385
- Sonsini, Prospero 11
- Sowda 462, 467
- Sparganum mansoni*
- diagnosis 546, 547
  - epidemiology 546
  - life-cycle 546
  - pathogenesis 546–7
- Spelotrema brevicaca* **637**, 645
- SPf66 92
- spiramycin 131, 132
- spleen, role in malaria 60, 61
- splenectomized patients
- babesiosis susceptibility 107
  - malaria in 71

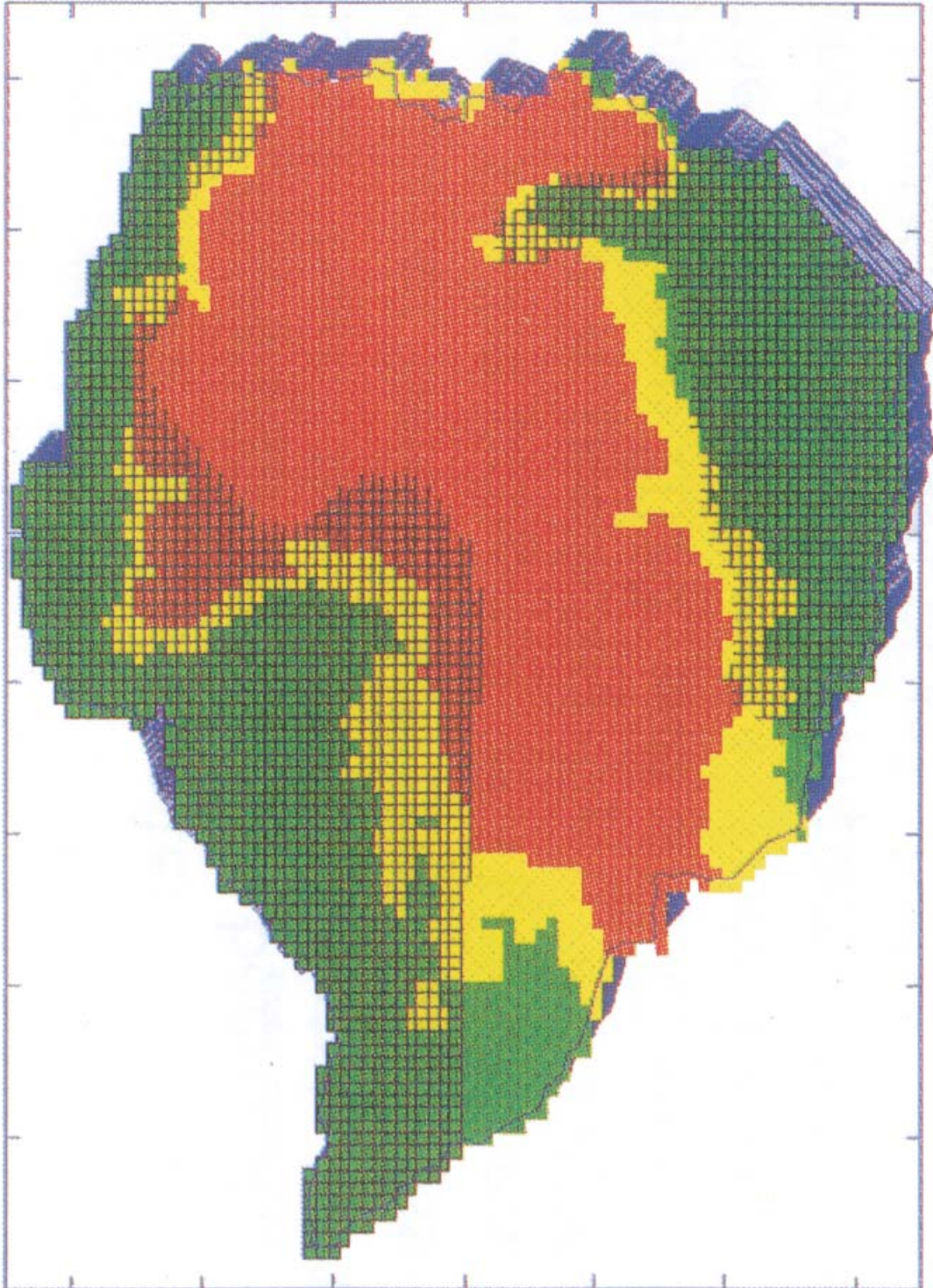
- splenomegaly in schistosomiasis 382, 390
- spontaneous generation 1–2
- spores, microsporidia 172
- anisofilar polar tube group 174–5, 176, 177, 178
  - detection of antibody to 187–8
  - diplokaryotic group 174–5, 178–9, 180
  - Encephalitozoon* spp. 174–5, 176, p.iv, p.v
  - Enterocytozoon bienersi* 174, 175, p.iv, p.v
  - PCR detection 188–9
  - transmission 184–5
- sporocysts
- intestinal trematodes 635, 637, 638, 641
  - Schistosoma* spp. 372, 374
- sporogony, microsporidia 173, 174, 176, 178, 180
- sporonts, microsporidia 172, 173, 174–5, 178–9
- sporozoites
- Babesia* spp. 102
  - Cryptosporidium parvum* 139, 141, 142, 147
  - Cyclospora* spp. 165, 166
  - malarial 54, 56, 65, 91
- squamous cell carcinoma of the bladder 383, 391
- Steenstrup, Johannes 3, 4
- stibophen 371
- stool concentration methods 151–2
- string tests 230, 419, 492
- Strongyloides fulleborni* 494
- clinical features of infection 494–5
  - epidemiology 494
  - laboratory diagnosis 495
  - treatment 495
- Strongyloides stercoralis*
- description
    - eggs 482
    - free-living females 481–2
    - free-living males 482
    - larvae, first and second stage rhabditiform 482, 483
    - larvae, third-stage filariform 483–4
    - parasitic females 480–1
  - differentiation from hookworms 482, 483
  - history 479–80
  - life-cycle 481, 484–5
    - autoinfection 485
  - pathogenesis 485
    - hyperinfection 485–6
- strongyloidiasis
- clinical features 489–90
    - gastrointestinal symptoms 489
    - pulmonary symptoms 489
    - skin manifestations 489
  - disseminated disease 486, 489–90
  - epidemiology 488–9
  - immunology 486
    - cytokines 487–8
    - humoral responses 486–7
  - laboratory diagnosis
    - non-stool samples 492
    - serology 491–2
    - stool examination 490
  - organism *see Strongyloides stercoralis*
  - prevention and control 493
  - treatment 492–3
- stunting
- in schistosomiasis 384
  - in *Trichuris trichiura* infection 572
- subcutaneous nodules
- in dirofilariasis 548
  - in onchocerciasis 459, 467, 469, 470
  - geographical variation 464
  - nodulectomy campaigns 474
  - in *Paragonimus skrjabini* infections 425
- sulfadiazine 131, 132, 133
- suramin 329, 470–1
- surgery
- cerebral paragonimiasis 429
  - cystic echinococcosis 604
  - gnathosomiasis 542
  - multivesicular/alveolar echinococcosis 605
- swollen belly disease 494
- Symmers's clay pipe stem fibrosis 382
- synthetic peptide assays 346
- systematic reviews *see meta-analyses*
- tachyzoites 114, 116, 119, 122
- detection 126, 127, 128, 130
- Taenia* spp.
- Asian *Taenia* 620
  - morphology
    - adults 613–14
    - eggs 614, 616
    - larvae 614, 615
  - T. saginata*
    - epidemiology 618, 619
    - life-cycle 615, 616, 617
  - T. solium*
    - epidemiology 619–20
    - life-cycle 616, 617–18
- taeniasis
- diagnosis 625–6
  - prevention 627
  - T. saginata* 620
  - T. solium* 620, 621
  - treatment 626
  - see also* cysticercosis
- Tasmania, *Echinococcus granulosus* control 606–7
- teguments
- cestodes 614
  - Schistosoma* spp. 385, 395, 396
- telomeric vsg genes 322–3
- temephos 473, 558
- tetrachloroethylene 640, 642

- tetracycline 263
- TGF  $\beta$  (transforming growth factor- $\beta$ ) 295, 339–40
- TH1 responses
- Cryptosporidium parvum* infections 146
  - Leishmania* spp. infections 295, 296
  - Schistosoma* spp. infections 386, 387
  - Trypanosoma brucei* infections 321
- TH1/TH2 balance in onchocerciasis 462
- TH2 responses
- Cryptosporidium parvum* infections 146
  - hookworm infections 570
  - Leishmania* spp. mouse model 295
  - Schistosoma* spp. infections 386, 387
  - Trichinella* spp. infections 524
- thiabendazole treatment
- cutaneous larva migrans 539
  - strongyloidiasis 492, 493, 495
  - toxocariasis 515, 516
  - trichinellosis 530–1
- thiol metabolism, trypanosomes 316–18
- thrombocytopenia in malaria 62
- tick vectors, *Babesia* 101–2, 110
- Tiedemann, Friedrich 8
- tinidazole 231, **232**
- tissue biopsies, *Toxoplasma gondii* detection in 127, 128
- tissue culture isolation of *Toxoplasma gondii* 128
- TNF $\alpha$  *see* tumor necrosis factor alpha (TNF $\alpha$ )
- TNP-470 190
- Todd, John 18
- toluidine blue 187, p.iv, p.v
- Toxocara* spp.
- life-cycle 502–3
    - T. canis* in the dog 503–4
    - T. canis* in paratenic hosts 504
    - T. cati* in the cat 504
  - morphology 502
  - pathogenesis 504
    - excretory–secretory antigens 505, 506
  - taxonomy 502
- toxocaral eye disease *see* ocular larva migrans
- toxocariasis
- clinical features
    - asthma 513
    - covert toxocariasis 512
    - epilepsy 512, 513
    - learning and behavioural abnormalities 512
    - ocular larva migrans 511–12
    - transient myositis 513
    - visceral larva migrans 511
  - covert 502, 512
  - epidemiology
    - of ocular larva migrans 510
    - ova in soil 509–10
    - rodents 510–11
    - seroprevalence studies *see* seroprevalence studies, toxocariasis
  - history 501
    - covert toxocariasis 502
    - ocular larva migrans 501–2
    - visceral larva migrans 501
  - immunology 506
    - antibody responses 506–7
    - liver trapping 507
  - laboratory diagnosis 511, 513
    - of ocular larva migrans 514–15
    - PCR 514
    - serology 513–14
  - organisms *see* *Toxocara* spp.
  - prevention 516
  - treatment 515
    - dogs 515
    - ocular larva migrans 515–16
    - visceral larva migrans 515
- toxoplasmosis
- clinical syndromes
    - acute disease in adults 122–3
    - congenital disease 123–4, 125, 132
    - disease in immunocompromised patients 124, 125–6
    - ocular disease 124, 125
  - control 133
  - diagnosis
    - brain imaging studies 126, 127, 128
    - isolation in tissue culture 128
    - mouse inoculation 128
    - PCR 128
    - serology 129, 130–1
    - tissue biopsies 126, 127, 128
  - differential diagnosis **129**
  - epidemiology 117
  - history 113–14
  - immunology 120, 121
  - therapy and management
    - congenital disease 132
    - drugs 131
    - immunocompetent patients 131–2
    - immunocompromised patients 132–3
    - in pregnancy 132
- Toxoplasma gondii* 113
- actin 119
  - classification 114
  - gliding motility 118, 119
  - inner membrane complex 119, 120
  - interactions with host cells 116, 118, 119, 120
  - life-cycle 114–15, 116
  - novel myosins 118
  - pathogenesis 121–2
  - plant-like characteristics 114
  - population genetics 115, 116
- Trachipleistophora* spp. 174–5, 176, 177, 178
- life-cycle 173
  - sites of infection **181**

- transforming growth factor- $\beta$  (TGF $\beta$ ) 295, 339–40
- transmission typing procedure 601
- transmission-blocking malarial vaccines 92
- transplacental transmission  
*Toxocara canis* larvae 504, 505  
*Toxoplasma gondii* 123
- trematode larva migrans 425
- triatomine vectors 336, 337, 338, 340, 345
- Trichinella* spp.  
differing clinical pictures 528–9  
life-cycle of *T. spiralis* 522  
pathogenesis of *T. spiralis* 523  
taxonomy 521, 522, 523
- trichinellosis  
clinical features 526  
cardiovascular manifestations 527  
convalescent phase 528  
enteric phase 526  
laboratory parameters 528  
myalgias 527–8  
neurologic manifestations 527  
ocular manifestations 527  
parenteral phase 526–7  
in pregnancy 528  
pulmonary manifestations 527  
severity and prognosis 528–9
- diagnosis  
clinical 529  
parasite detection 529  
serology 530
- epidemiology 524–6, p.viii
- history 8, 521
- immunology 523–4
- organisms *see Trichinella* spp.
- prevention and control 531
- treatment 530–1
- trichomonads 243  
ectopic infections 263–4  
*see also specific species*
- Trichomonas hominis* *see Pentatrichomonas hominis*
- Trichomonas tenax*  
description 244, 256  
ectopic infections 263, 264  
epidemiology 257  
immunology 257  
laboratory diagnosis 256, 257  
pathogenesis 256
- Trichomonas vaginalis*  
classification 245–6  
description 243–5  
ectopic infections 263, 264  
history 243  
immunology 248–9  
molecular biology 249–50  
pathogenesis 246  
hormonal influence 246  
roles in other conditions 247–8  
virulence factors 246–7  
survival outside the body 252
- trichomoniasis  
clinical features  
in men 253  
in women 252–3
- clinical management 254–5
- control 256
- epidemiology  
prevalence 250  
transmission 250–2
- laboratory diagnosis  
antigen tests 254  
culture 254  
PCR 254  
staining techniques 254  
wet-film examination 253–4
- organism *see Trichomonas vaginalis*
- prevention 255–6
- transmission  
non-sexual 251–2  
sexual 250–1  
to children 252
- Trichostrongylus* spp. 576  
*see also* intestinal nematodes
- Trichuris trichiura*  
clinical features of infection 572  
description 571  
history 571  
life-cycle 572  
*see also* intestinal nematodes
- triclabendazole 420, 429
- trimethoprim–sulfamethoxazole (TXS) treatment  
cyclosporiasis 168  
isoporiasis 158  
toxoplasmosis prophylaxis 133
- trimetrexate 109
- trophozoites  
*Acanthamoeba* spp. 272, 273, 275, 279, 281  
*Balamuthia mandrillaris* 272–3, 275  
*Cryptosporidium parvum* 141, 142  
*Entamoeba histolytica* 198, 199, 200, 201, 203  
detection 208, 209, 210  
*Giardia lamblia* 219–21, 222, 224  
culture and sensitivity testing 230–1  
*Naegleria fowleri* 271, 272, 274, 278, 280  
*Plasmodium* spp. 55, 58, 59, 60
- tropical pulmonary eosinophilia (TPE) 435, 439, 444
- tropical splenomegaly syndrome 61
- Trypanosoma brucei*  
biochemistry 316–18  
classification 315–16  
epidemiology  
East African trypanosomiasis 326–7  
endemic foci 325

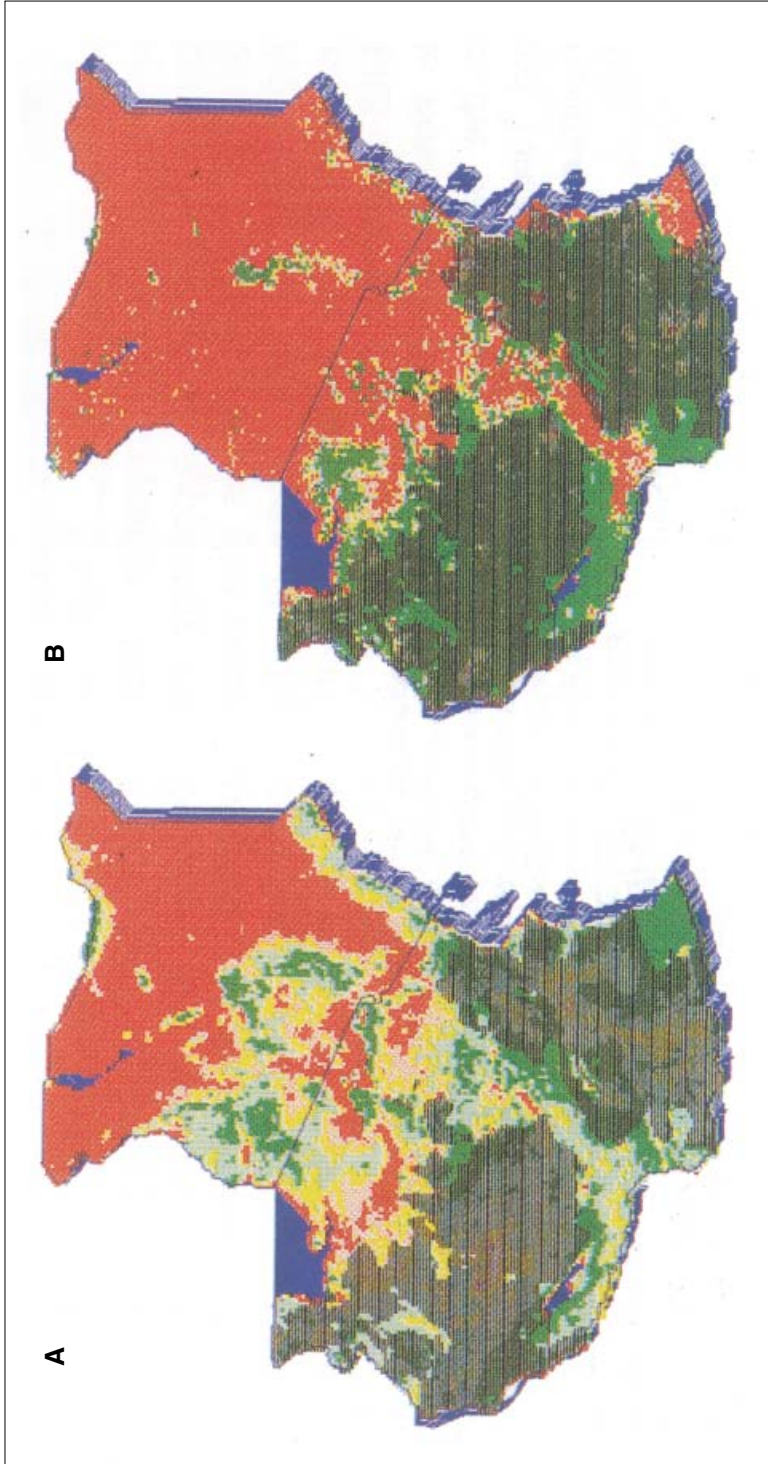
- Trypanosoma brucei* (cont)  
 epidemiology (cont)  
 epidemics 325  
 geographical distribution 325–6  
 remote sensing and climatic data 45–6  
 West African trypanosomiasis 326  
 life-cycle 318, 319, 320  
 molecular biology 322–3, 324–5  
 pathology 318, 320  
 phylogeny 316  
 structure 316  
 see also African trypanosomiasis
- Trypanosoma cruzi*  
 divergence from *Trypanosoma brucei* 316  
 epidemiology  
 epizootiology 340  
 in Latin America 340–1  
 in the USA 341–2  
 history 336  
 life-cycle 336–7  
 pathogenesis 337, 338–9  
 taxonomy 336  
 see also Chagas' disease  
 trypanothione metabolism 317–18  
 trypomastigotes  
*Trypanosoma brucei* 318, 319, 320  
*Trypanosoma cruzi* 336, 337, 338
- tsetse flies  
 control 331  
 distribution prediction 45–6, p.i, p.ii, p.iii  
*Trypanosoma brucei* vectors 318, 323, 325, 326–7  
 tubulin 221  
 tumor necrosis factor alpha (TNF $\alpha$ ) 120, 202, 294, 322, 470  
 Tyson, Edward 2, 9, 10
- ultrasound diagnosis  
 amebic liver abscesses 210, 211  
 clonorchiasis and opisthorchiasis 413  
 echinococcosis 604  
 fascioliasis 419  
 lymphatic filariasis 442  
 schistosomiasis 393  
 urban/rural differences in toxocariasis prevalence 509  
 urinary bladder lesions in *Schistosoma haematobium* infections 383  
 uta 298  
 Uvitex 2B stain 187, p.iv, p.v
- vaccination  
 eradication of diseases 24–5  
 impact on helminth population dynamics 27–8, 29  
 incomplete population coverage 27  
 vaccine development  
 African trypanosomiasis 332  
 amebiasis 211–12  
 echinococcosis 607–8  
 fascioliasis 416  
 leishmaniasis 309  
 malaria see malaria: vaccine development  
 onchocerciasis 474–5  
 schistosomiasis 396–7  
 toxoplasmosis in animals 133  
 vaccines, hepatitis B, interference from schistosomiasis 387  
 vacuolar form, *Blastocystis hominis* 356–7, 359, p.vii  
 vaginal schistosomiasis 390  
 var genes 59, 65  
 variant specific surface proteins (VSP), *Giardia lamblia* 222–3  
 variant surface glycoprotein (VSG), *Trypanosoma brucei* 316, 321, 322–3  
 vector-borne microparasites,  $R_0$  estimation 24, 25  
 vectors see specific vectors  
 ventricular cysticercosis 623–4, 627  
 vertical transmission of babesiosis 106  
 virulence factors, *Trichomonas vaginalis* 246–7  
 visceral gnathostomiasis 541–2  
 visceral larva migrans  
*Baylisascaris procyonis* infection 548  
 toxocariasis 501, 511, 515  
 visceral leishmaniasis see leishmaniasis: visceral  
 viscerotropic leishmaniasis 303–4  
 vitamin A 36, 37  
*Vittaforma corneae* 173, 178–80, 181, 187  
 VSG see variant surface glycoprotein (VSG), *Trypanosoma brucei*  
 vsg genes 322–3  
 VSP (variant specific surface protein), *Giardia lamblia* 222–3
- Warthin–Starry stain 187, p.iv, p.v  
 water treatment  
 cryptosporidiosis prevention 155  
 dracunculiasis prevention 558  
 giardiasis prevention 233, 234  
 water-borne transmission  
 cryptosporidiosis 147–8, 149, 153, 155  
 cyclosporiasis 166–7  
 giardiasis 226  
 microsporidia 185  
 schistosomiasis 377  
 whipworm, see *Trichuris trichiura*  
 world eradication campaign, dracunculiasis 557–8  
 World Health Organization Global Malaria Control Strategy 86  
 worm pairs, *Schistosoma* spp. 375  
 wormy individuals 27, 565  
 WR238605 86  
 Wucherer, Otto 7, 8  
*Wuchereria bancrofti* 8–9, 434, 435, 438, 441  
 zoonosis, leishmaniasis 288

PLATE I



**Figure 2.12** Discriminant analysis applied to the pre-1890 distribution of the tsetse *Glossina morsitans* in Zimbabwe. A single variable, the maximum of the mean monthly temperature, describes the overall distribution with an accuracy of 82%. The colours define the predicted probability of occurrence from low (red) to high (green) in the following bands: red = 0.00 – 0.349, pink = 0.35 – 0.449, red/yellow = 0.45 – 0.499, yellow/green = 0.50 – 0.549, pale green = 0.55 – 0.649 and green = 0.65 – 1.0. Reprinted from Rogers and Randolph, Distribution of tsetse and ticks in Africa, past, present and future. *Parasitology Today* 9: 266–71; © 1993, with permission from Elsevier Science





**Figure 2.13** The distribution of *Glossina morsitans* in Kenya and Tanzania (horizontal black lines) described using (A) a single variable, the maximum of the monthly normalized difference vegetation indices (NDVI 69% correct predictions), and (B) using nine additional climatological variables (84% correct predictions). Reprinted from Rogers and Randolph, Distribution of tsetse and ticks in Africa, past, present and future. *Parasitology Today* 9: 266-71; © 1993, with permission from Elsevier Science

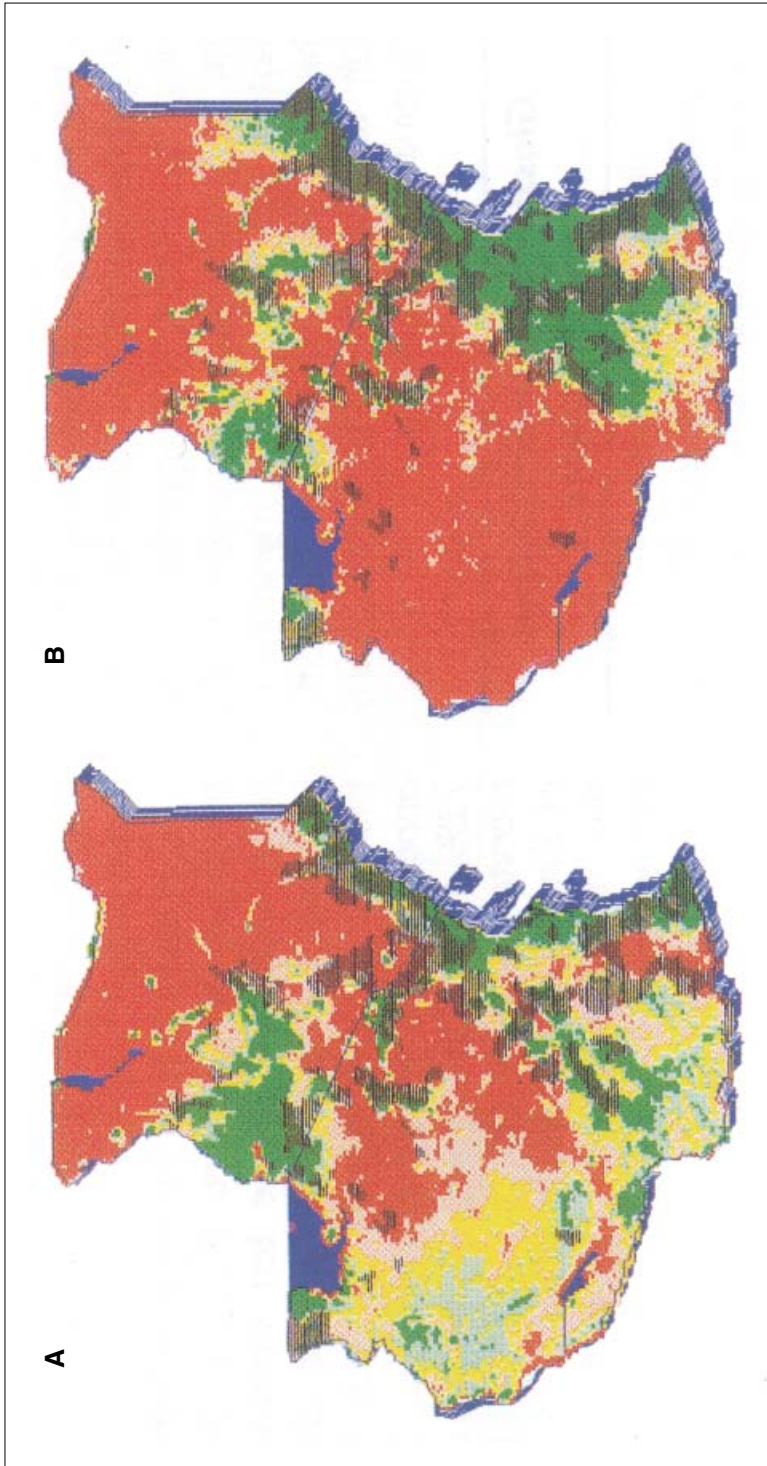
**Key to distribution maps**  
(Figures 2.12, 2.13 and 2.14)

Colour	Probability of occurrence
Red	0.00 – 0.349
Pink	0.35 – 0.449
Red/yellow	0.45 – 0.499
Yellow/green	0.50 – 0.549
Pale green	0.55 – 0.649
Green	0.65 – 1.0

+	}	
?	}	= Observed
=	}	





**Figure 2.14** The distribution of *Glossina pallidipes* in Kenya and Tanzania using (A) the minimum of the monthly NDVI (67% correct), and (B) nine additional climatological variables (79% correct predictions). Reprinted from Rogers and Randolph, Distribution of tsetse and ticks in Africa, past, present and future. *Parasitology Today* 9: 266–71; © 1993, with permission from Elsevier Science

PLATE IV

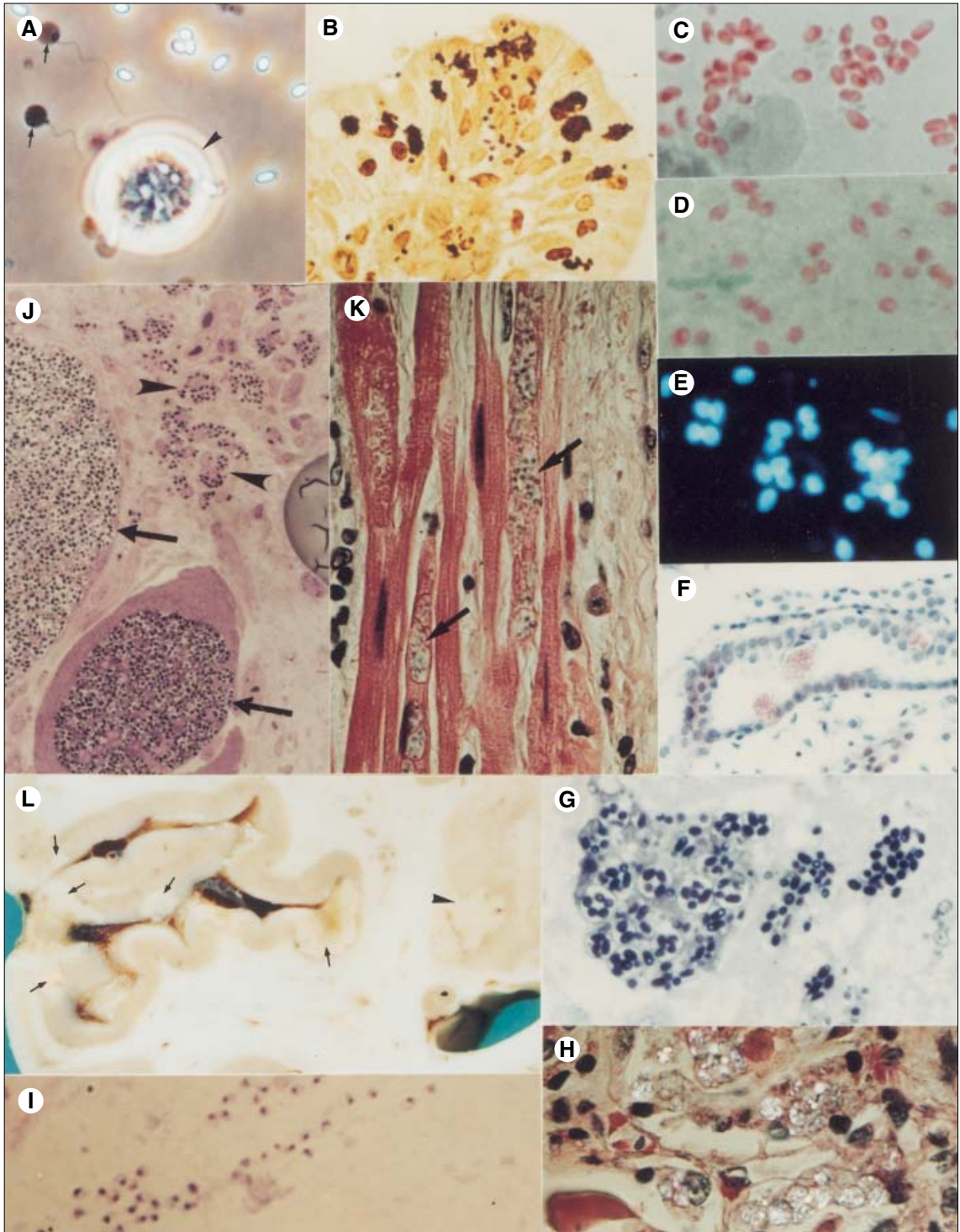


PLATE IV

**Figure 8.5** (A) Sporoplasms (arrows) of *Nosema* sp. from the lawn-grass cutworm *Spodoptera depravata* emerging from polar tubes after germination of spores still within an infected *Antheraea eucalypti* cell (arrowhead) *in vitro*. Bar = 10.0  $\mu\text{m}$ . From Iwano and Ishihara (1989), © Academic Press, reproduced by permission

(B) Warthin–Starry stain. Brownish-black spores of *Encephalitozoon intestinalis* lying individually and in groups in enterocytes and lamina propria of an AIDS patient. Original micrograph of Dr A.S. Field

(C) Chromotrope stain. Spores of *Encephalitozoon cuniculi* purified from *in vitro* culture. Original micrograph of Dr R. Weber

(D) Chromotrope stain. Spores of *Enterocytozoon bieneusi* concentrated from faeces of AIDS patient. Original micrograph of Dr R. Weber

(E) Uvitex 2B stain. Spores of *Enterocytozoon bieneusi* viewed by fluorescence. Original micrograph of Dr T. van Gool

(F) Ziehl–Neelsen stain. Pinkish-red aggregates of *Encephalitozoon cuniculi* in paraffin-embedded section of kidney of an AIDS patient. Original micrograph of Dr D. Woodrow

(G) Toluidene blue stain. Multiple sporophorous vesicles containing spores of *Trachipleistophora anthropophthera* in a giant astrocyte. Resin section of brain tissue from an AIDS patient. Original micrograph of Drs J.M. Orenstein and A.T. Yachnis.

(H) Haematoxylin and eosin stain. Partial polarization of spores of *Trachipleistophora anthropophthera* in a paraffin-embedded section of thyroid from an AIDS patient. Original micrograph of Dr J.M. Orenstein

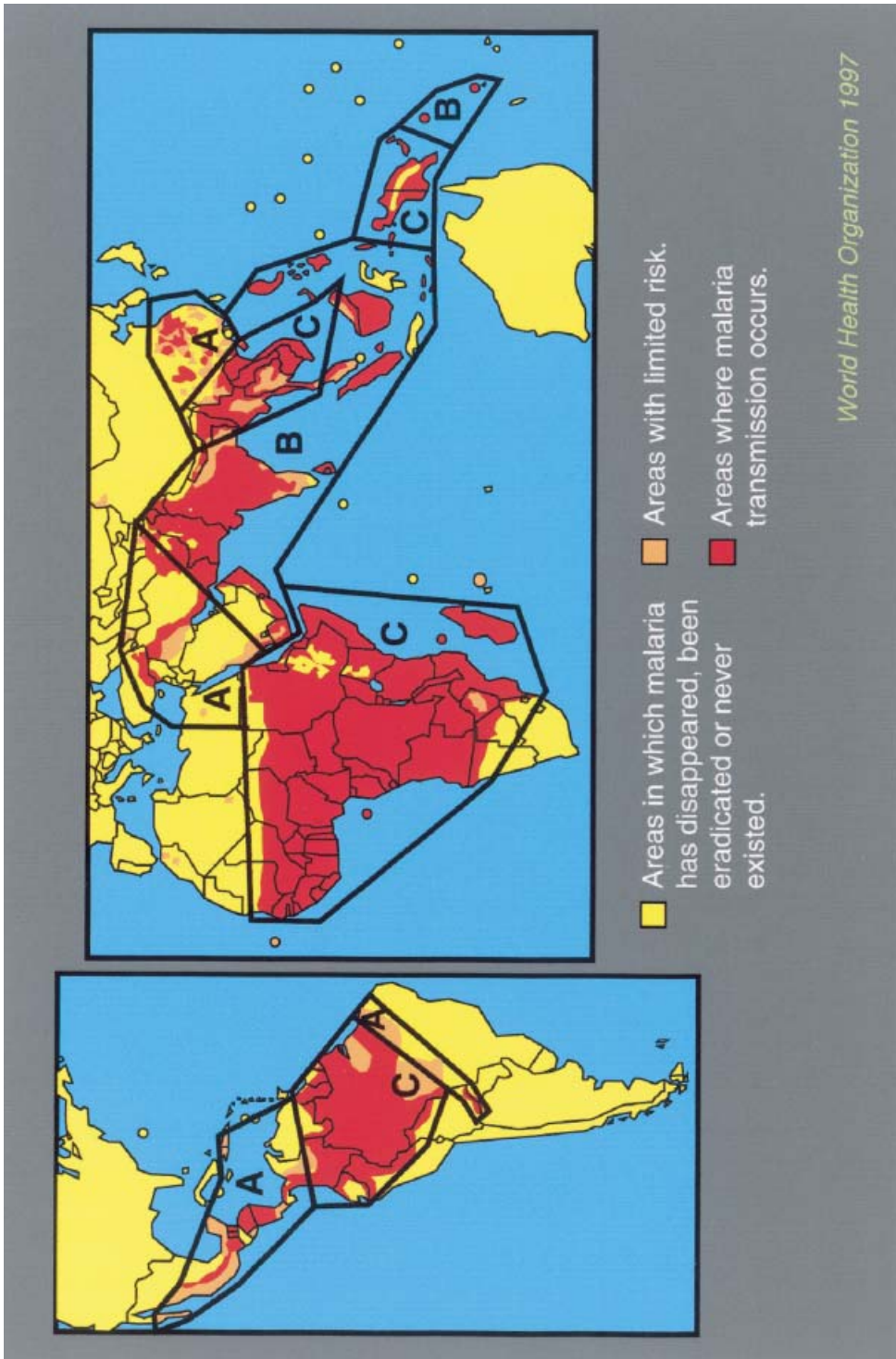
(I) Giemsa stain. Spores of *Enterocytozoon bieneusi* showing purple nuclei in a smear of a small intestinal biopsy from an AIDS patient. Original micrograph of Drs W.S. Hollister and E.U. Canning

(J) Toluidene blue stain. Resin section of skeletal muscle of an AIDS patient showing massive replacement (arrows) of sarcoplasm by sporophorous vesicles containing spores of *Trachipleistophora hominis*. Other spores have been phagocytised by macrophages (arrowheads). From Field *et al.* (1996), by permission of the American Society for Microbiology

(K) Haematoxylin and eosin stain. Spores of *Trachipleistophora anthropophthera* replacing the sarcoplasm of myocytes (arrows). Paraffin-embedded section of heart from an AIDS patient. Original micrograph of Dr J.M. Orenstein

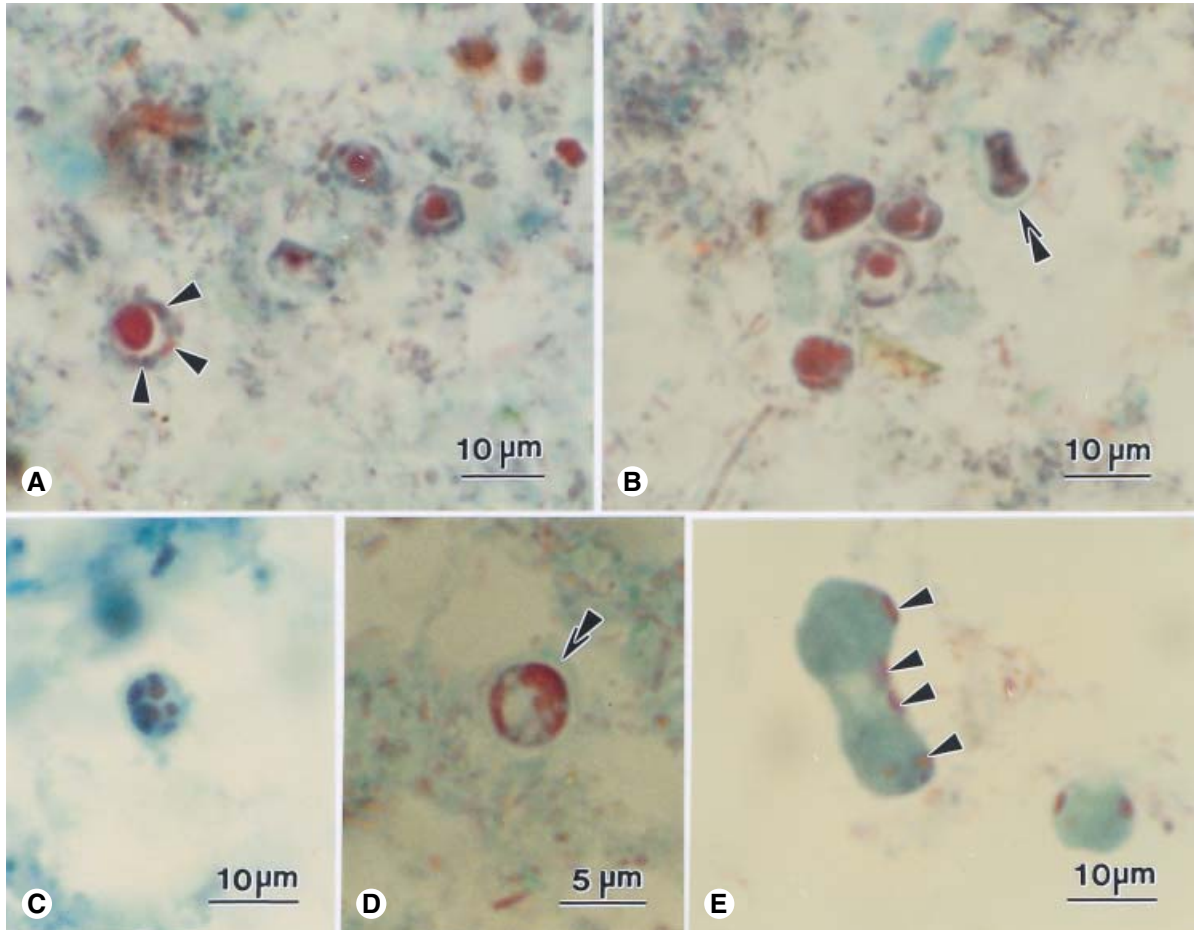
(L) Gross brain section showing opaque white patches representing sites of infection with *Trachipleistophora anthropophthera* in cerebral cortex (arrows) and thalamus (arrowhead) of an AIDS patient. From Yachnis *et al.* (1996), by permission of the *American Journal of Clinical Pathology*





**Figure 3.6** Map of malaria situation globally, highlighting drug-resistant areas. (A) *P. falciparum* absent or sensitive to chloroquine. (B) Low risk in most areas, although chloroquine-resistant *P. falciparum* malaria does occur. (C) Risk high in most areas of this zone in Africa and also in parts of the Amazon basin. Relatively low elsewhere. Multi drug-resistant *P. falciparum* malaria occurs. Adapted from World Health Organization (1998)

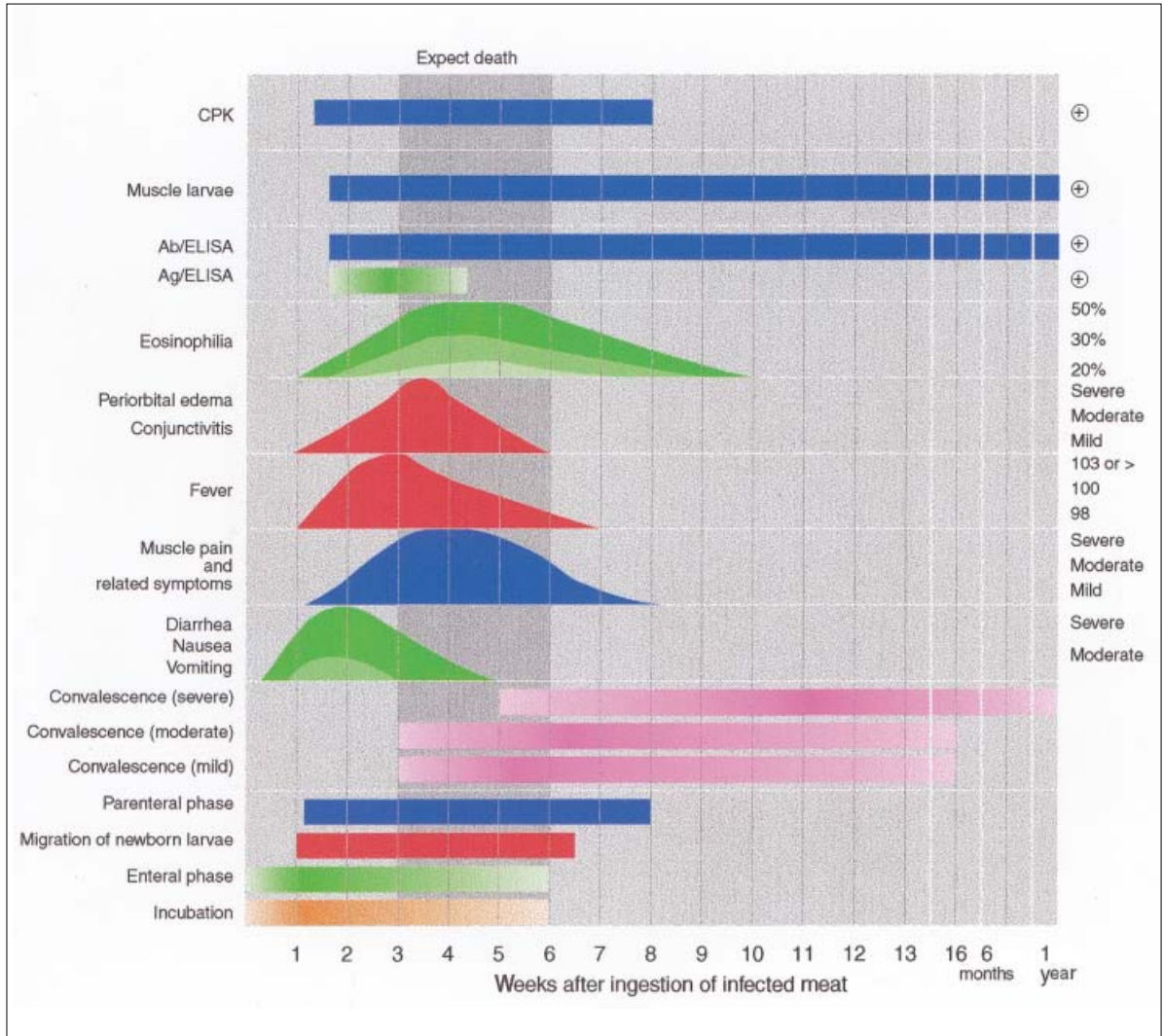
PLATE VI



**Figure 15.1** Light micrographs of *Blastocystis hominis* in trichrome-stained faecal smears.

- (A) Small multivacuolar and vacuolar forms, highlighting the difficulty in definitively clarifying which form is present in stained smears. Nuclei/mitochondria-like organelles are stained red (indicated by arrowheads).
- (B) Small multivacuolar forms, showing variability in morphology. A cyst form, with a green-staining cyst wall, is indicated by double arrowheads.
- (C) Multivacuolar form, showing discrete multiple vacuoles.
- (D) Cyst form, displaying a 'vacuolated' cytoplasm. The surrounding cyst wall stains green (indicated by double arrowheads).
- (E) Vacuolar forms, showing variability in cell shape. Nuclei/mitochondria-like organelles are indicated by arrowheads

PLATE VII



**Figure 19b.3** Temporal correlation of the clinical signs and symptoms, laboratory findings and diagnostic test results for patients suffering from mild (light color), moderate (more intense color) and severe (most intense color) clinical trichinellosis. The tables on the left indicate qualitative aspects of the infection (e.g. muscle pain, fever, etc.), while those on the right give some indication as to the quantitative measure of each. The colors chosen are matched to the stage of the infection (e.g. green indicates all signs and symptoms of the enteral stage of the infection). Faded colors indicate that that particular qualitative aspect is gradual in onset. The shaded portion (vertical shading between weeks 3 and 6) correlates with the period of infection in which the death of the patient usually occurs if the dose of parasite ingested is high enough to be lethal. Ab, antibody; Ag, antigen