

Renewable Energy and Climate Change

Volker Quaschnig



Renewable Energy and Climate Change

Renewable Energy and Climate Change

Volker Quaschnig

Berlin University of Applied Systems HTW, Germany

(Translator) Hedy Jourdan



A John Wiley & Sons, Ltd., Publication

First published under the title *Erneuerbare Energien und Klimaschutz* by Carl Hanser Verlag © 2008 Carl Hanser Verlag München

All Rights reserved.

Authorized translation from the 1st edition in the original German language published by Carl Hanser Verlag München.

This edition first published 2010
© 2010 John Wiley & Sons, Ltd

Registered office

John Wiley & Sons Ltd, The Atrium, Southern Gate, Chichester, West Sussex, PO19 8SQ, United Kingdom

For details of our global editorial offices, for customer services and for information about how to apply for permission to reuse the copyright material in this book please see our website at www.wiley.com.

The right of the author to be identified as the author of this work has been asserted in accordance with the Copyright, Designs and Patents Act 1988.

All rights reserved. No part of this publication may be reproduced, stored in a retrieval system, or transmitted, in any form or by any means, electronic, mechanical, photocopying, recording or otherwise, except as permitted by the UK Copyright, Designs and Patents Act 1988, without the prior permission of the publisher.

Wiley also publishes its books in a variety of electronic formats. Some content that appears in print may not be available in electronic books.

Designations used by companies to distinguish their products are often claimed as trademarks. All brand names and product names used in this book are trade names, service marks, trademarks or registered trademarks of their respective owners. The publisher is not associated with any product or vendor mentioned in this book. This publication is designed to provide accurate and authoritative information in regard to the subject matter covered. It is sold on the understanding that the publisher is not engaged in rendering professional services. If professional advice or other expert assistance is required, the services of a competent professional should be sought.

Library of Congress Cataloging-in-Publication Data

Quaschnig, Volker, 1969–

[*Erneuerbare Energien und Klimaschutz*. English]

Renewable energy and climate change / Volker Quaschnig.

p. cm.

Includes bibliographical references and index.

ISBN 978-0-470-74707-0 (cloth : alk. paper) 1. Renewable energy sources.

2. Climatic changes. I. Title.

TJ808.Q38913 2010

363.738'74–dc22

2009045463

A catalogue record for this book is available from the British Library.

ISBN 978-0-470-74707-0

Set in 10 on 12 pt Times NR by Toppan Best-set Premedia Limited
Printed in Singapore by Fabulous Printers Pte Ltd



Contents

- Preface..... xi**

- 1 Our Hunger for Energy 1**
 - 1.1 Energy Supply – Yesterday and Today 2
 - 1.1.1 From the French Revolution to the Early 20th Century 2
 - 1.1.2 The Era of Black Gold 4
 - 1.1.3 Natural Gas – the Newest Fossil Energy Source 7
 - 1.1.4 Nuclear Power – Split Energy 9
 - 1.1.5 The Century of Fossil Energy 12
 - 1.2 Energy Needs – Who Needs What, Where and How Much? 13
 - 1.3 ‘Anyway’ Energy..... 16
 - 1.4 Energy Supplies – Wealth Forever 19
 - 1.5 The End of Fission 21
 - 1.6 Oil Prices Today – Politics, Supply and Demand 22

- 2 The Climate Before the Collapse? 24**
 - 2.1 It Is Getting Warm – Climate Changes Today 24
 - 2.1.1 The Ice is Slowly Melting 24
 - 2.1.2 Natural Catastrophes Occur More Frequently 26
 - 2.2 The Guilty Parties – Causes of Climate Change 29
 - 2.2.1 The Greenhouse Effect 29
 - 2.2.2 The Prime Suspect: Carbon Dioxide..... 30
 - 2.2.3 Other Culprits 34
 - 2.3 Outlook and Recommendations – What Lies Ahead? 37
 - 2.3.1 Will It be Bitterly Cold in Europe?..... 39
 - 2.3.2 Recommendations for Effective Climate Protection..... 42
 - 2.4 Difficult Birth – Politics and Climate Change..... 42
 - 2.4.1 German Climate Policy..... 42
 - 2.4.2 International Climate Policy 44
 - 2.5 Self-Help Climate Protection 46

3	From Wasting Energy to Saving Energy and Reducing Carbon Dioxide	47
3.1	Less Efficient – Energy Use and Waste Today	47
3.2	Personal Energy Needs – Easily Saved at Home.....	50
3.2.1	Domestic Electricity – Money Wasted.....	50
3.2.2	Heat – Surviving the Winter with Almost No Heating.....	54
3.2.3	Transport – Getting Somewhere Using Less Energy.....	58
3.3	Industry and Co – Everyone Else is to Blame	61
3.4	The Personal Carbon Dioxide Record	62
3.4.1	Emissions Caused Directly by One’s Own Activities	62
3.4.2	Indirectly Caused Emissions	63
3.4.3	Total Emissions.....	65
3.5	The Sale of Ecological Indulgences.....	67
4	Carbon-Free Energy – Vision or Utopia?	70
4.1	Options for Carbon-Free Energy Supply.....	70
4.1.1	Efficient Power Plants – More Power with Less Carbon Dioxide.....	70
4.1.2	Carbon Dioxide Sequestering – Away with Carbon Dioxide.....	72
4.1.3	Nuclear Energy – Squeaky Clean.....	74
4.1.4	Combined Heat and Power – Using Fuel Twice	75
4.1.5	Saving Energy – Achieving More with Less	76
4.2	Renewable Energy Sources – No End to What is Available.....	77
4.3	Options for Protecting the Climate	79
4.3.1	Down with Primary Energy Needs.....	79
4.3.2	Electricity Generation Totally Without Nuclear and Fossil Power Plants.....	81
4.3.3	Insulation and Renewable Energies to Provide Heat	82
4.3.4	Increasing Efficiency and New Concepts for Traffic	83
4.4	Reliable Supply Using Renewable Energies	84
5	Photovoltaics – Energy from Sand	87
5.1	Structure and Function	88
5.1.1	Electrons, Holes and Space-Charge Regions	88
5.1.2	Efficiency, Characteristics and MPP	90
5.2	Production of Solar Cells – from Sand to Cell.....	92
5.2.1	Silicon Solar Cells – Electricity from Sand.....	92
5.2.2	From Cell to Module	94
5.2.3	Thin Film Solar Cells	95
5.3	Photovoltaic Systems – Networks and Islands.....	96
5.3.1	Sun Islands.....	96
5.3.2	Sun in the Grid	99
5.4	Planning and Design.....	103
5.4.1	Planned on the Grid.....	103
5.4.2	Planned Islands	107

5.5	Economics.....	109
5.5.1	What Does It Cost?.....	109
5.5.2	Incentive Schemes	111
5.6	Ecology	112
5.7	Photovoltaic Markets	113
5.8	Outlook and Development Potential.....	114
6	Solar Thermal Systems – Year-Round Heating from the Sun ...	116
6.1	Structure and Functionality	118
6.2	Solar Collectors – Collecting the Sun.....	120
6.2.1	Swimming Pool Absorbers	120
6.2.2	Flat-Plate Collectors	121
6.2.3	Air-Based Collectors.....	122
6.2.4	Vacuum-Tube Collectors.....	123
6.3	Solar Thermal Systems	125
6.3.1	Hot Water from the Sun.....	125
6.3.2	Heating with the Sun	128
6.3.3	Solar Communities	130
6.3.4	Cooling with the Sun	130
6.3.5	Swimming with the Sun	131
6.3.6	Cooking with the Sun.....	133
6.4	Planning and Design	133
6.4.1	Solar Thermal Heating of Domestic Hot Water.....	134
6.4.2	Solar Thermal Heating as Support Heating	136
6.5	Economics	138
6.6	Ecology	139
6.7	Solar Thermal Markets	140
6.8	Outlook and Development Potential.....	142
7	Solar Power Plants – Even More Energy from the Sun.....	144
7.1	Concentration on the Sun	145
7.2	Solar Power Plants	147
7.2.1	Parabolic Trough Power Plants.....	147
7.2.2	Solar Tower Power Plants	150
7.2.3	Dish-Stirling Power Plants.....	153
7.2.4	Solar Chimney Power Plants	153
7.2.5	Concentrating Photovoltaic Power Plants.....	155
7.2.6	Solar Chemistry	155
7.3	Planning and Design.....	156
7.3.1	Concentrating Solar Thermal Power Plants.....	157
7.3.2	Solar Chimney Power Plants	158
7.3.3	Concentrating Photovoltaic Power Plants.....	158
7.4	Economics.....	158
7.5	Ecology	160
7.6	Solar Power Plant Markets	161
7.7	Outlook and Development Potential.....	162

8	Wind Power Systems – Electricity from Thin Air	165
8.1	Gone with the Wind – Where the Wind Comes From.....	166
8.2	Utilizing Wind.....	168
8.3	Installations and Parks.....	173
8.3.1	Wind Chargers	173
8.3.2	Grid-Connected Wind Turbines	174
8.3.3	Wind Farms.....	178
8.3.4	Offshore Wind Farms.....	179
8.4	Planning and Design.....	182
8.5	Economics.....	184
8.6	Ecology	187
8.7	Wind Power Markets.....	188
8.8	Outlook and Development Potential.....	189
9	Hydropower Plants – Wet Energy	191
9.1	Tapping into the Water Cycle.....	192
9.2	Water Turbines	194
9.3	Hydropower Plants.....	197
9.3.1	Run-of-River Power Plants	197
9.3.2	Storage Power Plants	198
9.3.3	Pumped-Storage Power Plants.....	200
9.3.4	Tidal Power Plants	201
9.3.5	Wave Power Plants.....	202
9.3.6	Ocean Current Power Plants.....	203
9.4	Planning and Design.....	204
9.5	Economics.....	206
9.6	Ecology	206
9.7	Hydropower Markets	207
9.8	Outlook and Development Potential.....	209
10	Geothermal Energy – Power from the Deep	210
10.1	Tapping into the Earth’s Heat.....	210
10.2	Geothermal Heat and Power Plants.....	215
10.2.1	Geothermal Heat Plants.....	215
10.2.2	Geothermal Power Plants.....	216
10.2.3	Geothermal HDR Power Plants.....	218
10.3	Planning and Design.....	219
10.4	Economics.....	220
10.5	Ecology	220
10.6	Geothermal Markets	221
10.7	Outlook and Development Potential.....	222
11	Heat Pumps – from Cold to Hot	223
11.1	Heat Sources for Low-Temperature Heat.....	223
11.2	Working Principle of Heat Pumps.....	226

11.2.1	Compression Heat Pumps.....	226
11.2.2	Absorption Heat Pumps and Adsorption Heat Pumps.....	227
11.3	Planning and Design.....	228
11.4	Economics.....	232
11.5	Ecology	233
11.6	Heat Pump Markets	235
11.7	Outlook and Development Potential.....	236
12	Biomass – Energy from Nature	237
12.1	Origins and Use of Biomass.....	238
12.2	Biomass Heating.....	241
12.2.1	Wood as a Fuel	241
12.2.2	Fireplaces and Closed Woodburning Stoves	245
12.2.3	Firewood Boilers.....	245
12.2.4	Wood Pellet Heating	246
12.3	Biomass Heat and Power Plants	248
12.4	Biofuels.....	250
12.4.1	Bio-oil	251
12.4.2	Biodiesel	251
12.4.3	Bioethanol.....	252
12.4.4	BtL Fuels	253
12.4.5	Biogas.....	254
12.5	Planning and Design.....	255
12.5.1	Firewood Boilers.....	256
12.5.2	Wood Pellet Heating	256
12.6	Economics.....	259
12.7	Ecology	260
12.7.1	Solid Fuels	260
12.7.2	Biofuels.....	262
12.8	Biomass Markets	263
12.9	Outlook and Development Potential.....	264
13	The Hydrogen Industry and Fuel Cells.....	265
13.1	Hydrogen as an Energy Source	266
13.1.1	Production of Hydrogen	267
13.1.2	Storage and Transport of Hydrogen	269
13.2	Fuel Cells: Bearers of Hope	270
13.3	Economics.....	272
13.4	Ecology	273
13.5	Markets, Outlook and Development Potential	274
14	Sunny Prospects – Examples of Sustainable Energy Supply	276
14.1	Climate-Compatible Living	276
14.1.1	Carbon-Neutral Standard Prefabricated Houses	277

Contents

14.1.2	Plus-Energy Solar House.....	278
14.1.3	Plus-Energy Housing Estate.....	279
14.1.4	Heating Only with the Sun.....	279
14.1.5	Zero Heating Costs after Redevelopment.....	280
14.2	Working and Producing in Compatibility with the Climate.....	281
14.2.1	Offices and Shops in Solar Ship.....	281
14.2.2	Zero-Emissions Factory.....	282
14.2.3	Carbon-Free Heavy Equipment Factory.....	283
14.3	Climate-Compatible Driving.....	284
14.3.1	Waste Gas-Free Electropower.....	284
14.3.2	Travelling around the World in a Solar Mobile.....	285
14.3.3	Across Australia in Thirty-Three Hours.....	286
14.3.4	Game over CO ₂ !.....	287
14.4	Climate-Compatible Travel by Water or Air.....	288
14.4.1	Modern Shipping.....	288
14.4.2	Solar Ferry on Lake Constance.....	289
14.4.3	World Altitude Record with a Solar Aeroplane.....	290
14.4.4	Flying around the World in a Solar Plane.....	291
14.4.5	Flying for Solar Kitchens.....	292
14.5	Carbon-Free Electricity for an Island.....	293
14.6	All's Well that Ends Well.....	294
	Appendix.....	296
A.1	Energy Units and Prefixes.....	296
A.2	Geographic Coordinates of Energy Power Plants.....	297
	References.....	300
	Index.....	303

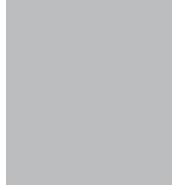

Preface

The problems of energy and climate change have finally ended up where they belong: at the heart of public attention. Yet the connection between energy use and global warming is something we have been aware of for decades. In the late 1980s the German federal government proclaimed climate protection to be one of its main targets. At the time numerous experts were already calling for a speedy restructuring of the entire energy supply. Despite the government's declaration, the official response was, at best, half-hearted. But the climate problem can no longer remain on the back burner. There is a growing awareness that climate change has already begun. The prognosis of the researchers studying what is happening to our climate is horrendous. If we do not pull the emergency cord soon, the catastrophic consequences of climate change will far exceed even our powers of imagination. The awarding of the Nobel Peace Prize to Al Gore, the US climate activist, and the Intergovernmental Panel on Climate Change, which has been urgently warning of the consequences for years, could be seen as a sign of helplessness rather than optimism about solving the problem.

At the same time as climate change is threatening our environment, new records for rising oil and natural gas prices show that the supplies still available will not be enough to cover our requirements for much longer and that other alternatives must be exploited as soon as possible.

And yet the solution is a simple one: renewable energy. Renewable energy could completely cover all our energy supply needs within a few decades. This is the only way to end our dependence on energy sources like oil and uranium, which are so costly both in financial terms and in the havoc they wreak on our environment, and satisfy our hunger for energy in a way that is sustainable and compatible with the climate.

However, the path we need to take to get to that point is still unclear to many. Many people still do not believe renewable energy offers a viable option. Some underestimate the alternative possibilities offered to such an extent that they predict a return to the Stone Age once oil and coal supplies have been fully depleted.

The aim of this book is to eliminate these prejudices. It describes, clearly and simply, the different technologies that exist and the potential for using renewable energy.

The focus is always on the interaction between the different technologies. The example of Germany shows the forms that sustainable energy supply can take and how it can be implemented. But the book is designed to show all readers, wherever they live, how they themselves can make a contribution towards building a climate-compatible energy economy. In addition to explaining different energy measures that individuals themselves can undertake, the book provides concrete planning aids for implementing renewable energy systems.

This book has been specifically written so that it offers essential information to a broad spectrum of readers. It introduces the different technologies to readers who are new to the subject but at the same time provides interesting background information to those who already have some knowledge about the field.

This book has been translated from the German version. It is an important supplement to the technical book 'Renewable Energy Systems', written by me and published by Hanser Verlag publishers. It is clear from the high level of interest generated by this technical book, which is now in its fifth edition in German and has been translated into English and Arabic, that a real need exists for literature on the subject of renewable energy. The feedback I have received from the book and from many of my lectures indicates that readers want something that offers an overview of the subject that is easy to understand but still comprehensive. This book should fill this gap and provide support in the development of sustainable energy supply.

Berlin, 2009

Prof. Volker Quaschnig

HTW Berlin – University of Applied Sciences

www.volker-quaschnig.de



1 Our Hunger for Energy

Most people have heard of the cult TV series *Star Trek*. Thanks to this programme, we know that in the not-too-distant future man will start exploring the infinite expanses of the universe. The energy issue will have been resolved long before then. The Warp drive discovered in 2063 provides unlimited energy that Captain Kirk uses to steer the starship *Enterprise* at speeds faster than light to new adventures. Energy is available in overabundance; peace and prosperity rule on earth and environmental problems are a thing of the past. But even this type of energy supply is not totally without its risks. A warp core breach can cause as much damage as a core meltdown in an ancient nuclear power station. Warp plasma itself is not a totally safe material, as the regular viewers of *Star Trek* very well know.

Unfortunately – or sometimes fortunately – most science fiction is far removed from the real world. From our perspective the discovery of a warp drive seems highly unlikely, even if dyed-in-the-wool *Star Trek* fans would like to think otherwise. We are currently not even close to mastering comparatively simple nuclear fusion. Consequently, we must rely on known technology, whatever its drawbacks, to solve our energy problems.

In reality, energy use has always had a noticeable impact on the environment. Looking back today, it is obvious that burning wood was less than ideal and that the harmful noxious fumes created by such fires considerably reduced the life expectancy of our ancestors. A fast-growing world population, increasing prosperity and the hunger for fuel that has developed as a consequence have led to a rapid rise in the need for energy. Although the resulting environmental problems may only have affected certain regions, the effects of our hunger for energy can now be felt around the world. Overconsumption of energy is the main trigger for the global warming that is now threatening to cause devastation in many areas of the world. However, resignation and fear are the wrong responses to this ever-growing problem. There are alternative energy sources to be tapped. It is possible to develop a long-term safe and affordable energy supply that will have only a minimal and

manageable impact on the environment. This book describes the form this energy supply must take and how each individual can contribute towards a collective effort to halt climate change. But first it is important to take a close look at the causes of today's problems.

1.1 Energy Supply – Yesterday and Today

1.1.1 From the French Revolution to the Early 20th Century

At the time of the French Revolution in 1789 animal muscle power was the most important source of energy. Around 14 million horses and 24 million cattle with an overall output of around 7.5 billion watts were being used as work animals (König, 1999). This corresponds to the power of more than 100 000 mid-range cars.



Power and Energy or the Other Way Around

The terms 'power' and 'energy' are closely linked, and for this reason they are often confused with one another and used incorrectly.

Energy is stored work; thus the possibility to perform work. It is identified by the symbol E . The symbol for *work* is W .

Power (symbol: P) indicates the time during which the work is to be performed or the energy used.

$$P = \frac{W}{t} \quad \left(\text{power} = \frac{\text{work}}{\text{time}} \right)$$

For example, if a person lifts a bucket of water, this is considered work. The work that is performed increases the potential energy of the bucket of water. If the bucket is lifted up twice as quickly, less time is used and the power is doubled, even if the work is the same.

The unit for power is the watt (abbreviation: W). (The fact that the abbreviation for watt is the same as the symbol for work does not simplify matters.)

The unit for energy is watt second (Ws) or joule (J). Other units are also used for energy. Appendix A.1 provides the conversion factors between the different units of energy.

As the required powers and energies are often very high, prefixes such as mega (M), giga (G), tera (T), peta (P) and exa (E) are frequently used (see Appendix A.1).

The second staple energy source in those days was firewood, which was so important that it probably changed the political face of Europe. It is believed today that the transfer of the Continent's centre of power from the Mediterranean to north of the Alps came about because of the abundance of forests and associated energy potential there. Although the Islamic world was able to maintain its position of power on the Iberian peninsula well into the 15th century, one of the reasons why it lost its influence was the lack of wood. The problem was that there was not enough

firewood that could be used to melt down metal to produce cannons and other weapons. This goes to show that energy crises are not just a modern phenomenon (Figure 1.1).



Figure 1.1 Firewood, draught animals, wind and water power supplied most of the energy needed in the world as late as the 18th century.

In addition to muscle power and firewood, other renewable energies were used intensively until the beginning of the 20th century. Between 500 000 and 600 000 watermills were in operation in Europe at the end of the 18th century. The use of wind power was also widespread, particularly in flat areas with a lot of wind. For example, the United Netherlands had around 8000 working windmills at the end of the 17th century.

For a long time fossil energy sources were only of secondary importance. Although coal from underground deposits was known to be a source of energy, it was largely avoided. It was not until a lack of wood in certain areas of Europe led to energy shortages that coal deposits began to be exploited. In addition, the higher energy density of coal proved to be an advantage in the production of steel. There was no stopping the development of this resource once the industrial revolution dawned. In 1800 60% of coal was used to provide domestic heat, but 40 years later far more coal was used in ironworks and other factories than in homes.



Fossil Energy Sources – Stored Solar Energy

Fossil energy sources are concentrated energy sources that evolved from animal and plant remains over very long periods of time. These sources include oil, gas, hard coal, brown coal and turf. The base materials for fossil energy sources could only develop because of their conversion through solar radiation over millions of years. In this sense, fossil energy sources are a form of stored solar energy.

From a chemical point of view, fossil energy sources are based on organic carbon compounds. Burnt in conjunction with oxygen, they not only generate energy in the form of heat but also always produce the greenhouse gas carbon dioxide as well as other exhaust gases.

In around 1530, coal mines in Great Britain were producing about 200 000 tons of coal annually. By 1750 it was about 5 million tons and in 1854 an astonishing 64 million tons. By 1900 three countries, Britain, the USA and Germany, had an 80% share of world production (König, 1999).



Renewable Energies – Not That New

The supplies of fossil energies, such as oil, natural gas and coal, are limited. They will be depleted within a few decades and then cease to exist. Renewable energy sources, on the other hand, ‘renew’ themselves on their own. For example, if a hydropower plant takes the power of the water from a river, the river will not stop flowing. The energy content of the river renews itself on its own because the sun evaporates the water and the rain feeds the river again.

Renewable energies are also referred to as ‘regenerative’ or ‘alternative’ energies. Other renewable energies include wind power, biomass, the natural heat of the earth and solar energy. Even the sun will eventually disappear in around four billion years. Compared to the few decades that fossil energy sources will still be available to us, this time period seems infinitely long.

Incidentally, renewable energies have been used by mankind for considerably longer than fossil fuels, although the current systems for using these fuels are vastly more advanced than in the past. Therefore, it is not renewable energies that are new but rather the knowledge that in the long term renewable energies are the only option for a safe and environmentally compatible energy supply.

At the end of the 20th century worldwide coal production reached almost 4 billion tons. With an overall share of less than 3% of the world market, Germany and Britain had lost their former position of supremacy in the coal industry. Today power stations use most of the available coal. China and the USA are currently the main coal-producing countries by a considerable margin.

1.1.2 The Era of Black Gold

Like coal, oil consists of conversion products from animal and plant substances, the biomass of primeval times. Over millions of years plankton and other single-celled

organisms were deposited in sea basins. Due to the lack of oxygen, they were unable to decompose. Chemical processes of transformation eventually turned these substances into oil and gas. On the other hand, the biomass that was originally deposited originated from the sun, which means that fossil energy sources like coal, oil and gas are nothing more than long-term conservers of solar energy. The oldest oil deposits are around 350 million years old. The area around the Persian Gulf where most oil is exploited today was completely below sea level ten to fifteen million years ago.

The oil deposits were developed much later than coal, because for a long time there were no practical uses for the liquid energy source. Oil was used in small quantities for thousands of years for medicinal and lighting purposes, but its high flammability compared to coal and charcoal gave it the reputation of being a very dangerous fuel. Petroleum lamps and later the invention of internal combustion engines finally provided a breakthrough at the end of the 19th century.

Industrial oil production began in August 1859. While drilling at a depth of 20 m near Titusville in the US state of Pennsylvania, the American Edwin L. Drake struck oil. One name in particular is linked with further oil exploitation in America: John Davison Rockefeller. In 1862 at the age of 23 he founded an oil company that became Standard Oil and later the Exxon Corporation and incorporated large sections of the American oil industry.

However, it was still well into the 20th century before fossil energy supplies, and specifically oil, dominated the energy market. In 1860 about 100 000 tons of oil were produced worldwide; by 1895 it was already 14 million tons. German government figures reveal that in 1895 there were 18 362 wind engines, 54 529 water engines, 58 530 steam engines and 21 350 internal combustion engines in use in the country (Gasch and Twele, 2004). Half the drive units even then were themselves still being operated using renewable energy sources.

There was a huge rise in oil production in the 20th century. In 1929 output had already risen to over 200 million tons and in the 1970s it shot up to over three billion tons (Figure 1.2). Today oil is the most important energy source of most industrialized countries. An average UK citizen, including small children and pensioners, uses around 1600 litres of oil per year. An average German citizen uses 2000 litres and an US citizen an astonishing 4000 litres. This amounts to 40 well-filled bathtubs.

Being too dependent on a single energy source can become a serious problem for a society, as history shows. In 1960 OPEC (Organization of Petroleum Exporting Countries) was founded with headquarters in Vienna. The goal of OPEC is to coordinate and standardize the oil policies of its member states. These include Algeria, Ecuador, Gabon, Indonesia, Iraq, Qatar, Kuwait, Libya, Nigeria, Saudi Arabia, Venezuela and the United Arab Emirates, which at the end of the 20th century together controlled 40% of oil production worldwide. As a result of the Yom Kippur war between Israel, Syria and Egypt, the OPEC states cut back on production in 1973. This led to the first oil crisis and a drastic rise in oil prices. Triggered by shortfalls in production and uncertainty after the revolution in Iran and the subsequent first Gulf war, the second oil crisis occurred in 1979 with oil prices rising to US\$38 per barrel.

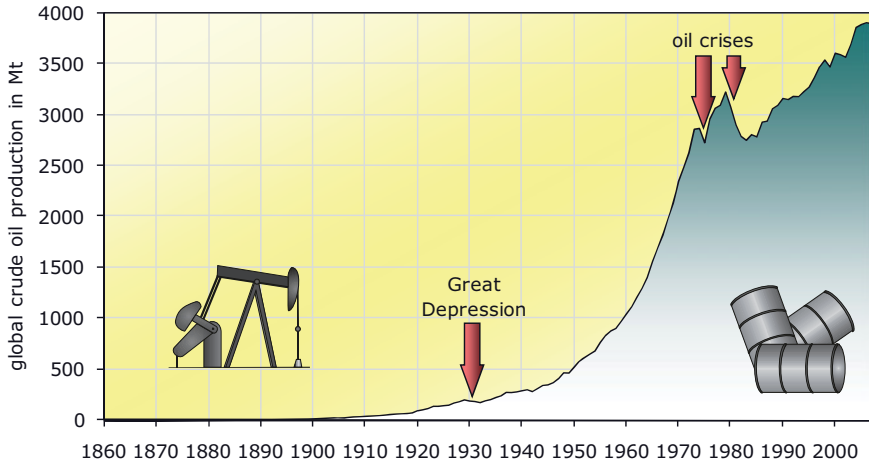

Figure 1.2 Oil production since 1860 (Quaschnig, 2007).

The drastic rise in oil prices set back world economic growth and energy use by about four years. The industrialized nations, which had become used to low oil prices, reacted with shock. Schemes such as car-free Sundays and programmes promoting the use of renewable energies were the result. Differences between the individual OPEC states in turn led to a rise in production quotas and a steep drop in price at the end of the 1980s. This also sharply reduced the commitment of the industrialized nations to use renewable energies.



From Alsatian Herring Barrels to Oil Barrels

Commercial oil production in Europe began in Pechelbronn in Alsace (now France) in 1735. Cleaned herring casks were used to store the oil, because in those days salted herring was traded in large quantities in barrels and so these barrels were comparatively cheap. As oil production increased, special barrels of the same size were produced exclusively for oil. The bottom of the barrels was painted blue to prevent any confusion with barrels used for food products. When commercial oil production began in the USA, the companies copied the techniques used in the Alsace region. This also included the standard size of herring barrels. Since then the herring barrel volume has remained the international measuring unit for oil. The abbreviation of barrel is bbl, which stands for 'blue barrel' and means a barrel with a blue base.

1 petroleum barrel (US) = 1 bbl (US) = 158.987 l (litres)

The dramatic collapse in the price of crude oil from almost US\$40 a barrel to US\$10 created economic problems for some of the production countries and also made it unattractive to develop new oil sources. In 1998 unity was largely restored again among the OPEC states. They agreed on lower production quotas in order to halt any further drop in prices. In fact, prices rose even higher than originally intended.

Now the lack of investment in energy-saving measures was coming home to roost. The economic boom in China and in other countries further boosted the demand for oil to such an extent that it was difficult to meet it. The consequence was that oil prices kept climbing to new record highs. Even though the oil price has fallen sharply again due to the current financial crisis, new record prices are expected again due to the limited supplies available.

Yet there have been some fundamental changes since the beginning of the 1980s. Energy use has decreased despite rapid and sustained economic growth. The realization has set in that energy use and gross national product are not inextricably linked. It is possible for prosperity to increase even if energy use stagnates or drops. Nonetheless, the chance to develop true alternatives to oil and use energy-savings options was missed due to the long period of continuous low oil prices. This is particularly apparent in the transport sector. Cars became faster, more comfortable, heavier and had more horsepower, but were only minimally more fuel-efficient. As a result of all the talk about climate change and high oil prices, the car manufacturers are now scrambling to incorporate features into their cars that have not been demanded in decades: fuel efficiency and low emission of greenhouse gases.

As important as it is as a fuel, that is not the only use for oil, because it is also an important raw material for the chemical industry. For example, oil is used as a basic material in the production of plastic chairs, plastic bags, nylon tights, polyester shirts, shower gels, scents and vitamin pills.

1.1.3 Natural Gas – the Newest Fossil Energy Source

Natural gas is considered to be the cleanest fossil energy source. When natural gas is burnt, it produces fewer harmful substances and climate-damaging carbon dioxide than oil or coal.

The base material for the creation of natural gas was usually green plants in the flat coastal waters of the tropics. The Northern German lowland plains were part of this area 300 million years ago. The lack of oxygen in coastal swampland prevented the organic material from decomposing and so it developed into turf. As time went by, new layers of sand and clay were deposited on the turf, which during the course of millions of years turned into brown and bituminous coal. Natural gas then developed from this due to the high pressure that exists at depths of several kilometres and temperatures of 120 to 180°C.

However, natural gas does not consist of a single gas, but rather a mixture of different gases whose composition varies considerably depending on the deposit. The main component is methane, and the gas also often contains large quantities of sulphur hydrogen, which is poisonous and even in very small concentrations smells of rotten eggs. Therefore, natural gas must often first be purified in processing plants using physiochemical processes. As natural gas deposits usually also contain water, the gas must be dried to prevent corrosion in the natural gas pipelines.

Natural gas was not seen as a significant energy source until relatively recently. It was not until the early 1960s that natural gas was promoted and marketed in large quantities. The reasons for this late use of natural gas compared to coal and oil is



Figure 1.3 Left: Building a natural gas pipeline in Eastern Germany. Right: Storage facility for 4.2 billion m³ of natural gas in Rehden, 60 km south of Bremen. Photos: WINGAS GmbH.

that extracting it requires drilling to depths of several thousand metres. It also requires complicated transport. Whereas oil initially was still being transported in wooden barrels, gas requires pressure storage or pipelines for its transport. Nowadays, pipelines extend for thousands of kilometres from the places where the gas is extracted all the way to where it provides gas heating to family homes (Figure 1.3). The world's largest gas producer is Russia, followed by the USA, Canada, Iran, Norway and Algeria.

However, the demand for natural gas is not constant over the whole year. In countries with cold winters the demand in winter is often double what it is in summer. As it is not economical to cut production by half in the summer, enormous storage facilities are necessary to balance the uneven demand between summer and winter. So-called salt caverns and aquifer reservoirs are used. Caverns are shafts dug in underground salt deposits from where the stored gas can quickly be extracted – for instance, to cover sudden high demand. Underground aquifer reservoirs are suitable for the storage of particularly large quantities of gas. In total, Germany has over 30 billion cubic metres of natural gas in storage. Environmentally compatible hydrogen is expected to play an important role in future energy supply in just a few decades' time. It might be possible to convert the current natural gas storage facilities to store the hydrogen.

1.1.4 Nuclear Power – Split Energy

In December 1938 Otto Hahn and Fritz Strassmann split a uranium nucleus on a simple laboratory bench at the Kaiser-Wilhelm Institute for Chemistry in Berlin-Dahlem, thereby laying the foundation for the future use of nuclear energy. The laboratory bench can still be admired today at the Deutsches Museum in Munich.

In the experiment a uranium-235 nucleus was bombarded with slow neutrons. The nucleus then split and produced two atomic parts, krypton and barium, as well as two or three other neutrons. With a large quantity of uranium-235, these new neutrons can also split uranium nuclei that in turn release neutrons, thus leading to a chain reaction. If enough uranium is available, the uncontrolled chain reaction will create an atomic bomb. If the speed of the chain reaction can be controlled, uranium-235 can also be used as fuel for power stations.

A so-called mass defect exists with nuclear fission. The mass of all the little pieces after the fission is less than that of the original uranium nucleus. A complete fission of one kilogram of uranium-235 produces a mass loss of a single gram. This lost mass is then completely converted into energy. An energy mass of 24 million kilowatt hours is thereby released. Around 3000 tons of coal would have to be burnt to release the same amount of energy.

After Hahn's discovery the use of nuclear energy was promoted mainly by the military. Albert Einstein, who emigrated to the USA in 1933 to escape Nazi persecution, sent a letter to US president Roosevelt on 2 August 1939 warning him that Hitler's Germany was making a serious effort to produce pure uranium-235 that could be used to build an atomic bomb. When the Second World War broke out on 1 September 1939, the American government set up the Manhattan Project with the aim of developing and building an effective atomic bomb.



Germany as an Example of Nuclear History

The Paris Treaty of 5 May 1955 allowed Germany non-military use of nuclear energy. Expectations for the nuclear industry ran high. A separate ministry for nuclear energy was created, and the first minister was Franz Josef Strauss. On 31 October 1957, Germany put its first research reactor, called the nuclear egg, into operation at the Technical University in Munich. In June 1961 the Kahl nuclear power station fed electricity into the public grid for the first time. In 1972 the Stade and Würgassen commercial nuclear power stations began to provide electricity, and with Biblis the world's first 1200 megawatt block went into operation in 1974. In 1989 the last new power station, Neckarwestheim, was connected to the grid. Until that point the federal government had invested over 19 billion euros in the research and development of nuclear energy. However, public concerns about the risks of nuclear energy continued to grow and prevented the building of new power stations. In 2000 Germany finally renounced the use of nuclear power, following the example of Austria, Italy, Sweden and Belgium. The last nuclear power station in Germany is scheduled to be disconnected from the grid in 2023. Despite more than 50 years of nuclear energy use in Germany, the problem of end storage for highly radioactive waste has still not completely been resolved.

The biggest problem turned out to be the ability to produce significant quantities of uranium-235 to maintain a chain reaction. If metallic uranium is refined from uranium ore, there is a 99.3% probability that it will consist of heavy uranium-235. This is practically useless for producing a bomb. It even has the characteristic of decelerating and absorbing neutrons, thus bringing any kind of chain reaction to a halt. Only 0.7% of available uranium consists of uranium-235, which must be enriched proportionally higher to create a chain reaction. No separation between uranium-235 and uranium-238 can be achieved by chemical means because chemically both isotopes are totally identical. Consequently, other solutions had to be sought. Ultimately, this separation succeeded through the use of a centrifuge because the isotopes have different masses.

The Manhattan Project cost more than US\$2 billion between 1939 and 1945. The desired results were finally achieved under the direction of the physicist J. Robert Oppenheimer: on 16 July 1945, two months after the capitulation of Germany, the first test of the atomic bomb was carried out in the US state of New Mexico. Using the bomb on Germany was no longer up for discussion, but shortly before the end of the Second World War the atomic bomb was dropped on the Japanese cities Hiroshima and Nagasaki – with the well-known aftermath.

The non-military use of nuclear energy came some years later. Although physicists like Werner Heisenberg and Enrico Fermi had been conducting tests in reactors since 1941, it was not until December 1951 in Idaho that the research reactor EBR 1 succeeded in generating electric current using nuclear energy.



- www.iaea.org/programmes/a2/
- www.facts-on-nuclear-energy.info

IEA Power Reactor Information System
Nuclear Power Fact File Poster
Campaign

Unlike the uncontrollable chain reaction that occurs when an atomic bomb explodes, nuclear fission in a nuclear power station should be controllable. Once a chain reaction has started, the number of new neutrons resulting from the nuclear fission must be kept to a limit. Each splitting of a uranium nucleus releases two to three neutrons, only one of which is allowed to split another nucleus. Control rods that capture the neutrons reduce the number of neutrons released. If this number is too high, the process gets out of control. The nuclear power station then starts to act like an atomic bomb and an uncontrolled chain reaction occurs. Technically, and this was the leading view at the time, nuclear fission can be controlled and undesired reactions eliminated.

The early euphoria that came with the use of nuclear energy died down when an accident occurred with a reactor on 28 March 1979 in Harrisburg, the capital of the US state of Pennsylvania. Large amounts of radioactivity escaped. Many animals and plants were affected and the number of stillbirths among the nearby population increased dramatically after the tragedy.

On 26 April 1986 another serious accident occurred with a nuclear reactor in Chernobyl, a city in the Ukraine. What was thought to be impossible happened: the

chain reaction got out of control and the result was a nuclear meltdown. The radioactivity that was released produced high radiation levels in places as far away as Germany. Many helpers who tried to contain the damage on site paid for their efforts with their lives and thousands of people died from cancer in the years that followed.

Another problem with the civilian use of nuclear energy is the disposal of radioactive waste. The use of uranium fuel elements in nuclear power stations produces large quantities of radioactive waste that will create a deadly threat for centuries to come. No safe way has yet been found to dispose of this waste.

Technically, the use of nuclear energy is fascinating and the prospect of generating electricity from relatively small amounts of fuel is very tempting. But there are serious risks involved. Germany has therefore agreed to a general decommissioning of its nuclear energy plants. Once the last nuclear energy plant has been switched off, the country's adventure into this field will have cost the German federal government alone more than 40 billion euros in research and development. Germany's most expensive leisure park has become a bizarre showpiece for the enormous bad investment in nuclear energy. The prototype for a fast breeder reactor was erected for around 4 billion euros in the North Rhine-Westphalian town of Kalkar. Due to concerns about safety, including those relating to the highly reactive cooling agent sodium, the nuclear plant was never put into operation. Today the Kernwasser Wunderland Kalkar leisure park is located in the industrial ruins of the nuclear plant (Figure 1.4).



Figure 1.4 The Kernwasser Wunderland leisure park is in the grounds of a fast breeder reactor in Kalkar that was never put into operation. Photos: www.wunderlandkalkar.eu.

Whereas Germany reluctantly turned its back on nuclear energy after many years of grappling with the potential it offers, other countries have taken a totally different stance. One example is France, which uses nuclear power to supply about 80% of its electricity needs. China is also enthusiastic about the use of nuclear and, due to

the efforts of former US president George W. Bush, plans to continue the development of nuclear energy are again on the table in the USA.

In 2007 there were 444 nuclear power stations in operation worldwide. Yet nuclear energy is relatively unimportant for the global supply of energy. Its share is similar to that of hydropower and much lower than that of firewood. If a major effort were made to replace the majority of fossil power plants with nuclear energy, uranium supplies would be depleted within a few years. In this sense, nuclear power stations are not a real alternative when it comes to protecting the environment – although this is how some politicians, and specifically the companies that would profit from the use of nuclear power, often like to present the option to the public.

In the long term there are high hopes for a totally new variant of atomic energy: nuclear fusion. The model for this technology is the sun, which releases its energy through a nuclear fusion of hydrogen nuclei. The aim is to duplicate this process on earth without the danger of triggering an undesirable chain reaction like Chernobyl. But there is a hitch to this plan: the particles must be heated to temperatures of several million degrees centigrade to initiate the momentum of nuclear fusion. There is no known material that can permanently withstand such temperatures. Therefore, other technologies, such as the use of strong magnetic fields to contain reaction materials, are being tested. These technologies have seen some success, but despite the enormous amounts of energy used for ignition, the reactors always go out by themselves.

Currently there is no one who can seriously predict whether this technology will ever actually work in practice. Critics point out that the proponents of nuclear fusion have been saying for years that it will take 50 years for a commercial functioning reactor to be connected to the grid. Despite the passage of time that 50-year time frame never reduces – the only thing about nuclear fusion that can be said with any certainty.

However, even if this technology became advanced enough to use, there are two good reasons for opposing the development of nuclear fusion. Firstly, this technology is decidedly more expensive than nuclear fission today. For economic reasons preference would be given to alternatives such as renewable energies. Greater investment in fusion testing means less investment in alternative energies. Secondly, the nuclear fusion plants produce radioactive substances and waste that present a risk.

1.1.5 The Century of Fossil Energy

Whereas traditional renewable energies covered most of the energy needs of mankind until the end of the 19th century, the 20th century can be seen as the century of fossil energy. By the middle of the century fossil fuels in internal combustion engines had almost completely replaced the classic systems for using renewable energies, such as windmills, water wheels and vehicles and machines driven by muscle power. Modern hydropower for the generation of electricity and biomass, which was mainly used as fuel, were the only renewable energies of any significance.

After the Second World War the demand for energy soared, and fossil energy sources were able to increase their share substantially. In 2007 fossil energies covered around 80% of the world's primary energy needs (Figure 1.5). Hydropower and nuclear energy had a share of around 6% and 5%, respectively, and biomass close to 10%. The other renewable energies amounted to less than 1% with geothermal energy – use of the earth's heat – having the largest share. At the beginning of the 21st century renewable energies such as wind power and solar energy, which until then had been used relatively little, started to record double-digit growth rates. It is expected that their share of worldwide energy supply will increase considerably in coming years.

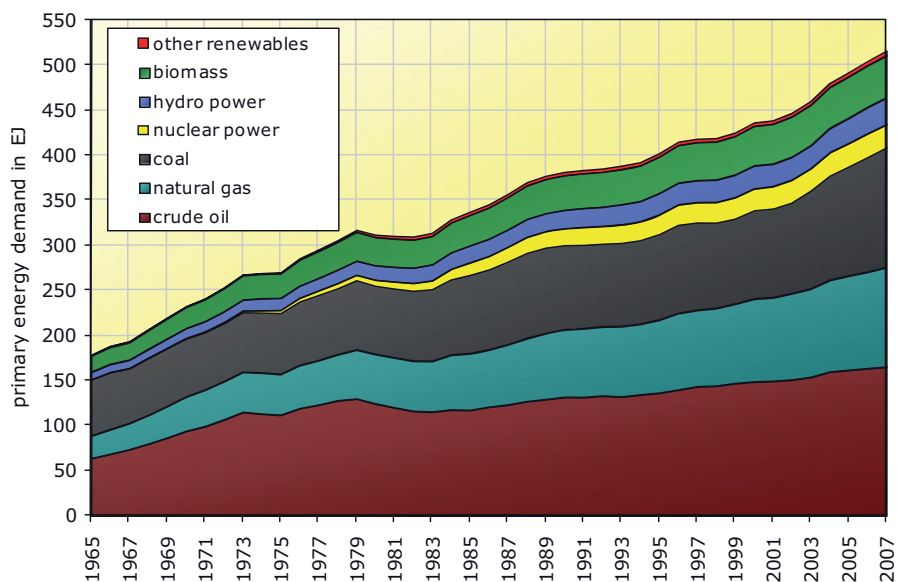

Figure 1.5 Development of primary energy demand worldwide since 1965.

1.2 Energy Needs – Who Needs What, Where and How Much?

Demand for energy is distributed unevenly across the world. Six countries, namely the USA, China, Russia, India, Japan and Germany, use more than half the available energy.

The USA alone needs one-fifth of the energy used in the world, even though only one-twentieth of the worldwide population lives there. If every citizen of India were to use as much energy as each American, global demand for energy would rise by about 70%. If all the people on earth developed the same hunger for energy as the Americans, demand would increase fourfold.



Energy Cannot be Used Up

Anyone who has taken physics at high school will have learned about the concept of energy conservation. According to this principle, energy cannot be consumed or produced but only converted from one form into another.

The car is a good example. The fact that cars consume too much is something we are keenly aware of each time we fill up with petrol. The petrol that a car needs, and we wince every time we pay for it, is a type of stored chemical energy. Combustion produces thermal energy. This is converted by an engine into kinetic energy and transferred to the car. Once all the petrol has been consumed, the car stops running. However, this does not mean that the energy has disappeared. Instead, due to the waste heat from the engine and the friction of the tyres and with the air, the energy has been dispersed into the environment. However, this ambient heat cannot be used any more; we are unable to produce petrol from ambient heat. When a car is driven, the usable energy content of the petrol is changed into an ambient heat that is no longer usable. This means that this energy is lost to us and thus consumed, even if this is not correct in terms of the laws of physics.

A photovoltaic system is a different matter. It converts sunlight directly into electric energy. It's often said that a solar system produces energy. From the point of view of physics, this is also incorrect. A solar system merely converts hard-to-use solar radiation into high-quality electricity.

When discussing which countries consume the highest amounts of energy, it is important to look beyond overall consumption figures. Population numbers also play an important role in any comparison. In absolute terms, India consumes more energy than Germany or the UK. But this is to be expected with a population of more than one billion people. Consumption per head in India is less than one-seventh of that in Germany or the UK. Although India is the country with the fourth highest use of primary energy in the world, its consumption per head is less than half the world average.



Primary Energy, Apple Energy and Orange Energy

If we compare our own electricity and gas consumption, we see that our consumption will almost always be higher if we heat our homes with gas. A comparison of the gas and electricity bills will not show much of a difference, though. Electricity and natural gas are two types of energy or energy sources that, like apples and oranges, cannot be compared directly like-for-like. Two to three kilowatt hours of gas have to be burnt in a power plant in order to produce one kilowatt hour of electricity from gas. The rest usually disperses unused into the environment as heat. When comparing different forms of energy, a distinction is therefore made between primary energy, secondary energy and useful energy.

Primary energy is energy in its natural and technically unconverted form, such as coal, crude oil, natural gas, uranium, sunlight, wind, wood and cow dung (biomass).

Secondary energy is energy in the form in which it is channelled to users. This includes natural gas, petrol, heating oil, electricity and district heating (the use of a centralized boiler installation to provide heat for several buildings).

Useful energy is energy in its eventual form, such as light for illumination, warmth for heating and power for machines and vehicles.

The different forms of energy are most frequently compared on a primary energy basis. More than 90% of the original energy content is lost during the conversion of primary energy to usable energy.

Figure 1.6 shows global primary energy needs per head. It is evident that the Western industrialized states and countries with large supplies of crude oil have a high rate of consumption. Prosperity and cheap energy prices boost consumption. When it comes to the geographical pattern of consumption, the map clearly shows that the countries with very high consumption – with the exception of Australia, New Zealand and South Africa – are all in the Northern hemisphere. Germany and France alone consume more than the entire African continent.

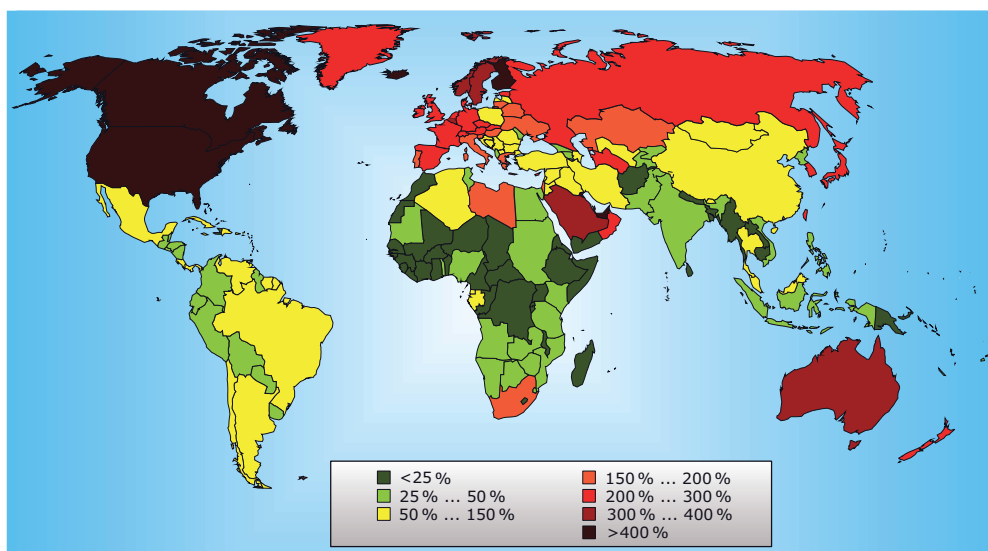

Figure 1.6 Primary energy usage per head related to the world average.

Countries with especially high energy consumption mostly use fossil energy sources to satisfy their energy needs. On the other hand, countries with particularly low energy needs rely to a large degree on traditional biomass. This includes firewood and other conventional animal or plant products, such as dried animal dung. More than two billion people worldwide use firewood and charcoal for cooking and heating. In Africa south of the Sahara about 90% of the population is totally dependent on fuels from traditional biomass.

Big differences also exist between the industrialized countries, however. Whereas many of them, such as Germany and the USA, use fossil fuels or nuclear energy to cover more than 80% of their primary energy requirements, certain other industrialized countries have already increased their share of renewable energy use considerably. The countries of the Alps, Norway and Sweden use a noticeably high proportion of hydropower. Biomass also plays a big role in some countries like Sweden and Finland. In Iceland the natural heat of the earth is the energy form with the highest share. Hydropower and geothermal energy together cover around 70% of Iceland's energy requirements.

Ethiopia, on the other hand, is a typical example of one of the poorest countries in the world. More than 90% of the energy it uses is still based on traditional biomass. Figure 1.7 shows the difference in how four countries use key forms of energy to cover their energy needs.

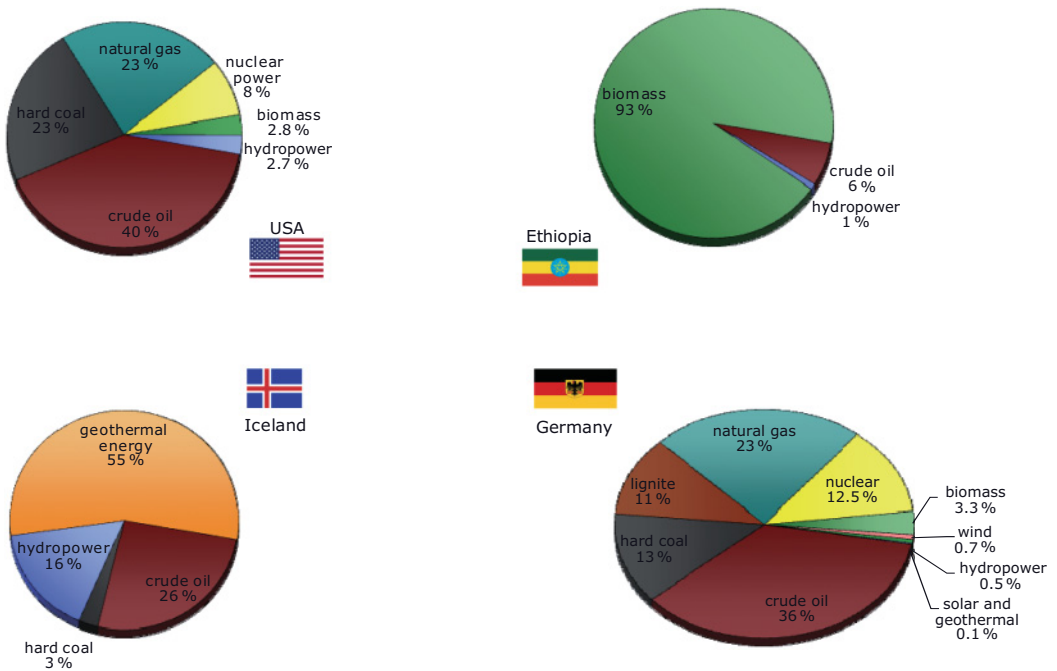

Figure 1.7 Percentage of different energy sources covering primary energy requirements in Ethiopia, Germany, Iceland and the USA in 2005.

1.3 'Anyway' Energy

According to statistics, only less than one percent of Germany's primary energy consumption was covered by solar energy in 2005. In the UK and the USA the percentage is even lower. The proportion of other renewable energies is also still quite low.

This makes it difficult for most of us to imagine that renewable energies will be riding to the rescue of the environment in a few years. In reality, however, renewable energies already constitute over 99% of German energy resources if one looks at the complete picture of energy use.

Winston Churchill supposedly said 'Do not trust any statistic that you did not fake'. It is widely believed that fossil fuel sources cover the lion's share of our energy needs. At least this is what all the usual statistics on energy claim. But it is only true if we define our energy requirements in a very narrow way.

The heat of a radiator, the light provided by a conventional light bulb and the driving energy of a ship's diesel engine generally form an integral part of our energy requirements. What is not included in any statistics on energy is the warming effect of the sunshine streaming through windows, the sunlight that illuminates houses and streets so that artificial lighting can be switched off during daylight, and the wind that can propel sailing boats right across the Atlantic. A heated greenhouse that uses artificial light to grow useful plants is included in the statistics on energy; on the other hand, a covered early planting of vegetables that uses only natural sunlight is not included. The floodlight illumination of a stadium during an evening football game falls under our energy needs. If the football game takes place in the bright sunlight, the statistics on energy will claim that the football arena that is brightly lit up by the sun actually does not need any light. If we switch on snow blowers to compensate for the ever-decreasing amount of snow available in ski areas, this becomes a case for the statistics, whereas natural snow is not. When we fill our drinking water storage containers using electric pumps, we have to pay for the energy used. If rain fills the storage containers, this is not considered in the statistics. The high amount of electricity needed to run electric dryers also increases energy use. On the other hand, if the washing is dried by the wind and the sun on a conventional clothesline, this does not constitute an energy need as far as the statistics are concerned.

Natural and technically unconverted forms of energy are not a component in our energy requirements in a conventional sense. Yet it should not make any difference where we derive the energy needed to heat our bath water, grow our plants or provide light. We take the availability of natural renewable energy forms such as solar energy so much for granted simply because they are there anyway and thus appear to have so little value that they do not even merit mention in the statistics. However, this distorts our impression of our energy requirements and puts the possibilities of renewable energy in a false light. This can be illustrated using the example of energy consumption in Germany.

Germany covers an area of 357 093 km² and the annual solar radiation is on average 1064 kilowatt hours per square metre. Germany therefore benefits from 380 trillion kilowatt hours of energy from the sun each year. This is about 100 times as much as the primary energy consumption recorded in the statistics for Germany and even more than the entire primary energy needs of the world. Part of this radiation heats the earth and the air; another part is converted into plant growth, thus producing biomass.

Around 800 millimetres or 0.8 cubic metres of rain fall per square metre in Germany. The annual rainfall for all of Germany adds up to 286 billion cubic metres. The sun evaporates this water before it reaches earth in the form of rain. One cubic metre of water requires 627 kilowatt hours to evaporate. This means the annual rainfall contains around 170 trillion kilowatt hours of energy.

About 2% of solar energy is converted through the movement of the wind. In Germany this amounts to around 8 trillion kilowatt hours. Sun, wind and water together produce around 567 trillion kilowatt hours of energy in Germany each year. Geothermal and ocean energy are not even included in these figures. If this quantity of energy were to drop even a few percentage points, the result would be drought and arctic winters (Figure 1.8).

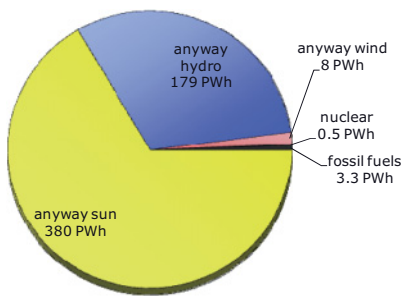

Figure 1.8 Total energy resources in Germany taking into account 'anyway' energy; that is, natural renewable forms of energy.

The statistics of 2007 listed Germany's primary energy requirements as being around 14 000 petajoules. This converts to close to 4 trillion kilowatt hours. Of course, the statistic includes solar energy, hydropower and wind energy. The proportion of all renewable energies combined in the requirement for primary energy totals 0.183 trillion kilowatt hours. This is the amount that technical installations convert into renewable energy. The natural forms of renewable energy that exist anyway are totally omitted from this statistic. This explains the small obvious statistical discrepancy for the previous calculation of 567 trillion kilowatt hours for renewable energy resources. The difference between this and conventional statistics is clarified in Figure 1.8, where the natural renewable forms of energy that previously were not recorded in the statistics are referred to as 'anyway' energy – in other words, energy that exists anyway.

Anyone who thinks that these calculations amount to statistical hairsplitting is wrong. As the facts about climate change have now become public knowledge, there is a general interest in replacing fossil fuels with renewable energies as quickly as possible. But many people are under the impression that this is difficult to implement and almost impossible to accomplish within a reasonable period of time. The claim that solar energy only constitutes an insignificant share of energy resources is repeated like a prayer wheel. If the claim were true, this scepticism would be justified. In fact, it is fossil and nuclear energies that make up 0.6% of the energy resources in Germany. And no one could seriously doubt that 0.6% is replaceable in the foreseeable future.

The eruption of the Tambora volcano in Indonesia in 1815 shows us what happens when even a fraction of ‘anyway energy’ is lost. The gigantic quantities of volcanic gases and dust that were emitted into the atmosphere reduced the amount of sunlight available in the following years. In 1816 and 1817 Europe experienced massive crop failures. Ten thousand people died of starvation. If something like this happened today, we would suffer similar consequences. A large proportion of the energy that safeguards our food supply comes from a natural source – the sun. The small and diminishing supply of fossil and nuclear energy could not come anywhere close to compensating for even relatively minor fluctuations in natural energy.

The question then is what is ‘anyway energy’ worth? In Europe in 2007 oil cost more than 4 cents (euro) per kilowatt hour before tax; natural gas was 2 cents and rising. Because solar radiation and wind power cannot be stored as easily as oil and natural gas, their value should be set at half that of natural gas, thus 1 cent per kilowatt hour. Hydropower, on the other hand, would be set at 1.5 cents per kilowatt hour because it is easier to store. The total value of ‘anyway energy’ can thus be valued at about 6.5 trillion euros per year. According to this calculation, anyway solar energy alone is worth around 4 trillion euros. And in the USA it is worth the equivalent of 100 trillion euros.

Natural renewable forms of energy in the order of 567 trillion kilowatt hours are not recorded as a separate entry in statistical calculations in Germany. This means that the public perception of the energy supply is distorted. We are left with the false impression that fossil and nuclear energy sources make up the major portion of our energy supply. In reality, the share from these sources is less than 1% and we should be replacing this with renewable energies as soon as possible to protect the climate. Natural renewable forms of energy to the value of around 6.5 trillion euros are available to us today free of charge. We cannot afford to ignore this option.

1.4 Energy Supplies – Wealth Forever

When we use fossil energy sources today, we are utilizing solar energy that was stored millions of years ago – but without the possibility of renewing this source in the foreseeable future. Yet our current hunger for energy is so great that most of the known fossil deposits will be used up during the 21st century. And suitable deposits of fuel uranium for conventional nuclear plants are also becoming rarer.

For decades pessimists have been warning about the imminent end to fossil energy reserves. Yet this end never quite seems to be in sight, and most people take no heed of the warnings. It was not until oil prices started their steep spiral in 2000 that the message that ‘black gold’ would one day run out sank home.

In the past constant technological advances in the exploitation of oil and natural gas have always resulted in a revision of the forecasts about how long reserves would last. The large coal reserves still available worldwide, in particular, could enable us to use fossil energy sources for decades or even another century.

But the number of new finds, specifically of oil, has declined substantially during recent years, and new supplies cannot be exploited fast enough to meet rising demand. In the long term oil prices will therefore continue to rise, even if brief dips in prices seem to signal an easing of the situation. On one hand demand is rising, whereas supplies tend to be dwindling; and on the other hand the effort needed to exploit new supplies is increasing along with the costs.

During the first commercial drilling in America in 1859 oil could be found at depths of 20m, whereas today drilling depths of up to 10000m are no longer uncommon. Significant technical progress has also been made in locating possible deposits, and so we know far more today about possible finds than we did several decades ago. However, this also makes it highly unlikely that any major new finds will be discovered.

At the current rate of production the known supplies in the USA and Great Britain will be depleted in about a decade. This increases the dependency, particularly of the industrialized nations, on a small number of producing countries. More than 60% of extractable oil supplies are found in the Middle East (Figure 1.9). The biggest oil producers in the region are Iraq, Iran, Kuwait, Saudi Arabia and the United Arab Emirates.

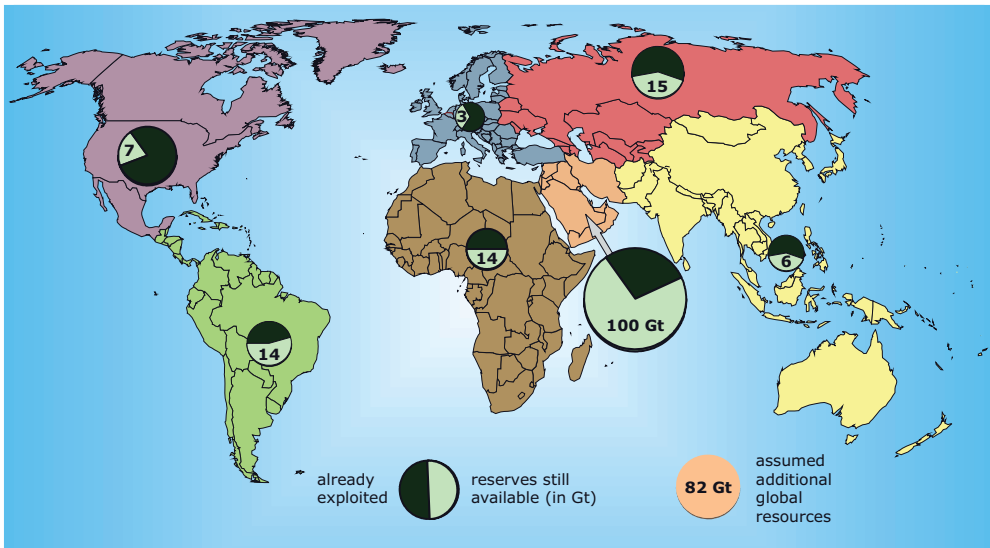

Figure 1.9 Distribution of oil reserves on earth by region. Status 2004.

This region has been the scene of major conflicts in recent years, and its large oil reserves are likely to increase tensions even further in the future. The dependency of the industrialized nations on the OPEC countries will also increase because these countries have almost three-quarters of the known reserves.

The current extent of availability can be calculated by dividing the known exploitable reserves by current production. In the case of oil, this is about 43 years (see

Figure 1.10). This availability could drop further if there is an increase in annual production. New deposits are being exploited in addition to known supplies. It is estimated that the reserves will increase up to one-half times due to these additional supplies. If production remains constant over the next few decades, the oil reserves will last another 65 years. However, it is certain that we will no longer be using oil as an energy source at the end of this century.

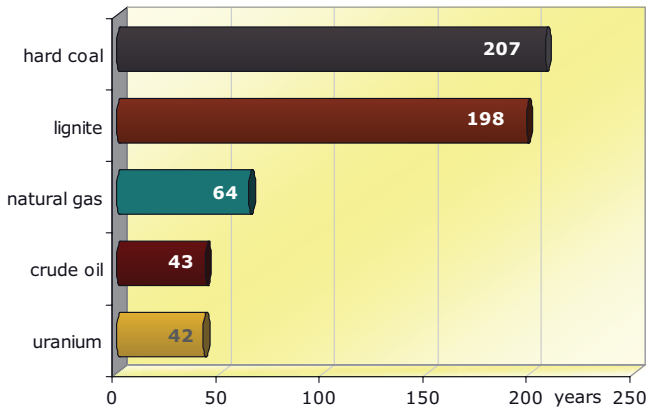

Figure 1.10 Extent of availability (in years) of known energy reserves based on current production.

The situation with natural gas and coal supplies is not quite so critical. Based on current production levels, the known gas supplies will be depleted in 64 years. In contrast to oil, the estimated additional supplies are considerably more extensive than those known to date. This is partly because the deposits are located at a lower depth than oil and also because industrial production and the search for new supplies began much later. However, due to the continuing high level of consumption, natural gas supplies will also be running out during this century. Coal is the only fossil fuel that may still be available at the dawn of the next century.

1.5 The End of Fission

A key point about fuel supply, and one that most people are unaware of, is that even uranium supplies are very limited. Although there is more uranium in the earth's crust than either gold or silver, less than one percent of the purest natural uranium can be used to create energy. Power stations can only use natural uranium after the useable part of uranium has been enriched with uranium-235.

The share of ore must be higher than average to enable an effective exploitation of natural uranium. Canada is the only country that has deposits with a uranium ore content of more than one percent. If the uranium ore content drops, considerably

larger amounts of it have to be mined for its degradation. This substantially increases the energy required to extract the ore and contributes to the costs.

Despite intensive efforts by some countries to develop nuclear energy, at 6% its share of worldwide primary energy supply is still relatively low. A few countries like France are using nuclear power stations to cover 80% of their electricity needs. However, even in France cars cannot be run on nuclear power, and only some houses use nuclear energy for heating. Consequently, nuclear energy only really constitutes 40% of the total primary energy supply, even in France.

The supplies of uranium would be depleted in just a few years if nuclear energy were used to replace all fossil energies, which would also mean developing nuclear automobiles and nuclear heating. Power stations could use other techniques, such as relatively risk-free fast breeders, to increase the amount of energy they are able to exploit, but this would do very little to change the fact that the supply of uranium is limited. Even the uranium supplies that can be exploited economically will run out in a few decades at the most – which does not make a convincing argument for building new nuclear power stations with a lifespan of 30 to 40 years. For these reasons alone nuclear energy is not a viable alternative to fossil energies.

1.6 Oil Prices Today – Politics, Supply and Demand

The low energy prices of the 1970s were the foundation not only of the economic miracle in several industrial countries, but of the massive rise in energy consumption. The founding of OPEC and the politically motivated limiting of production in 1973 led ultimately to a dramatic increase in oil prices. The shocked industrialized countries reacted with relative helplessness. In 1973 they founded the International Energy Agency (IEA) to coordinate their energy policies and ensure that the supply of energy remained secure and affordable.

The purpose of strategic oil reserves is to guarantee availability when the oil supply is interrupted and to stabilize prices. For example, Germany stockpiles 25 million tons of crude oil or crude oil products that can cover the country's oil requirements for 90 days. The US strategic petroleum reserve is the largest in the world and holds up to 99 million tons.

The commitment to developing the use of renewable energies also increased in the 1970s. However, a large number of failed mammoth projects showed that cost-effective and sustainable energy supply is not something that can be forced through; it can only be the outcome of long-term, ongoing development. Nevertheless, the oil crisis in the 1970s paved the way for the current boom in renewable energies.

The 1990s were marked by extremely low oil prices. As a result, efforts to save energy and to develop renewable energies stagnated. Due to booming global economic activity and extremely high demand, especially from China, oil prices reached new heights after the year 2000. Oil prices in 2006 were almost double what they were at the time of the oil crises in the 1970s (see Figure 1.11). Up to now this has only had a limited effect on the world economy. This can be explained by consider-

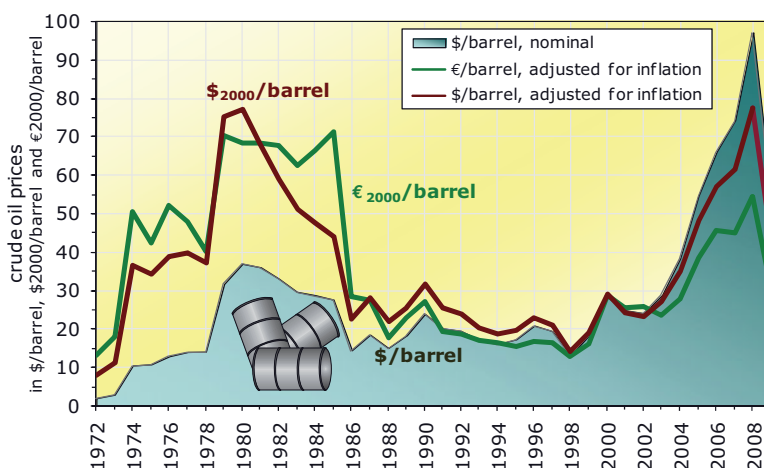

Figure 1.11 Development of oil prices in current prices and inflation-adjusted.

ing the inflation-adjusted oil prices. In 1980 one US dollar bought twice as much as it could buy in 2005. To this extent, the inflation-adjusted oil price at the time was also twice as high. Another reason is that the economy today depends considerably less on energy prices than at the time of the oil crisis. However, an unreasonably high oil price would have a massive impact on the world economy.

As the supplies of fossil energies begin to run out, oil, natural gas and coal prices will rise further. The dip in prices resulting from the financial crisis in 2008 at best offers a short breather. Another round of price increases is a certainty. Political risks and a growing reliance on certain countries rich in raw materials also conceal the considerable possibility of another sudden increase in prices. For economic reasons it is important that some urgency be given to developing an alternative energy supply beyond fossil or nuclear energy sources.

During the period of transition supply and demand will also allow a fluctuation in the prices of renewable energies, as was shown by the price increase for wood-burning fuels in 2006. However, in the long term the prices for renewable energies will continue to drop as a result of ongoing technical advances and more efficient production, whereas the prices for fossil energy sources and nuclear energy will continue to rise.

2

2 The Climate Before the Collapse?

We have known for a long time that the climate is changing. Numerous ice ages and warming periods have shown that the climate on earth is constantly undergoing change. In terms of human lifetimes, each of these periods lasted a relatively long period of time. In the more recent history of the earth, ice ages have occurred about every 100 000 years, always interrupted by much shorter warming times. Our current warming period, called the Holocene era, began about 11 700 years ago. As the previous warming periods on average lasted only about 15 000 years, we should be heading towards the next ice age.

The exact causes for the alternation between warming and ice ages can only be reconstructed to a point. Natural effects, such as changes in solar activity, changes in the geometry of the earth's orbit, vulcanism, changes in the ocean currents and the shifting of continental plates are considered the main causes of climate change. When multiple causes occur at the same time, very abrupt changes are possible. This explains the climate changes of the earth. In this sense, the global warming that we have observed in recent years is nothing out of the ordinary. What is unusual is that apparently for the first time it is living things on earth – namely, human beings – that are causing an abrupt change in climate.

2.1 It Is Getting Warm – Climate Changes Today

2.1.1 The Ice is Slowly Melting

Climate conditions on earth have been relatively constant for several thousand years. It is on this basis that our civilization, the places where we have settled and our agricultural regions have established themselves. During the last ice age areas that

today are densely populated would have been covered with thick layers of ice. And during the hottest periods in our climate's history our coastal cities would have been sunk metres deep below the ocean. If major changes to climatic conditions occur, they will undoubtedly have an even stronger impact on the face of the earth and our current conditions of life than any of the most dramatic historical events of the last few centuries.



Observed Climate Changes (Intergovernmental Panel on Climate Change, 2007)

- The global surface temperature rose by 0.74 °C between 1906 and 2005.
- Eleven of the last 12 years have been the warmest since records were kept.
- The increase in temperature during the last 50 years was twice as high as during the last 100 years. The warming of the Arctic has been twice as fast.
- The temperatures of the last 50 years have probably been higher than at any time in the last 1300 years.
- Glaciers are shrinking worldwide, as are the ice sheets on Greenland and Antarctica.
- Since 1993 the sea level has risen an average of 3.1 mm per year; during the 20th century this amounted to a total of 17 cm. More than half of this is due to the thermal expansion of the oceans, about 25% to the melting of mountain glaciers and around 15% to the melting of the arctic ice sheets.
- The frequency of heavy precipitation has increased.
- The frequency and intensity of droughts has increased since the 1970s.
- The frequency of extreme temperatures has increased.
- Tropical cyclones have become much more intense since the 1970s.

During the past 100 years the average temperature on earth has increased by a good 0.7 °C. At first glance this does not seem like much. However, this warming is not occurring at a uniform rate in all regions and is also not constant throughout the year. If temperatures fall into a normal range for ten months, then two months can follow at more than 4 °C above the average. In some regions of the world the temperature is already higher by 2 °C as an annual average (Figure 2.1).

As a result of global warming, the water in the oceans expands. Due to the rise in temperatures, more and more Arctic ice and the permanent ice of the glaciers also melt. As a result, the sea levels rise even higher.

The temperatures in the polar region rise even more quickly than in the rest of the world. The ice coverage in the Arctic has decreased by about 10 to 15% within 20 years (Figure 2.2). Along with the ice masses of the Arctic, many glaciers are also melting at a fast rate. The largest glacier in the world, the Bering Glacier in the Arctic region of Canada, has shrunk by more than 10 km during the past century.

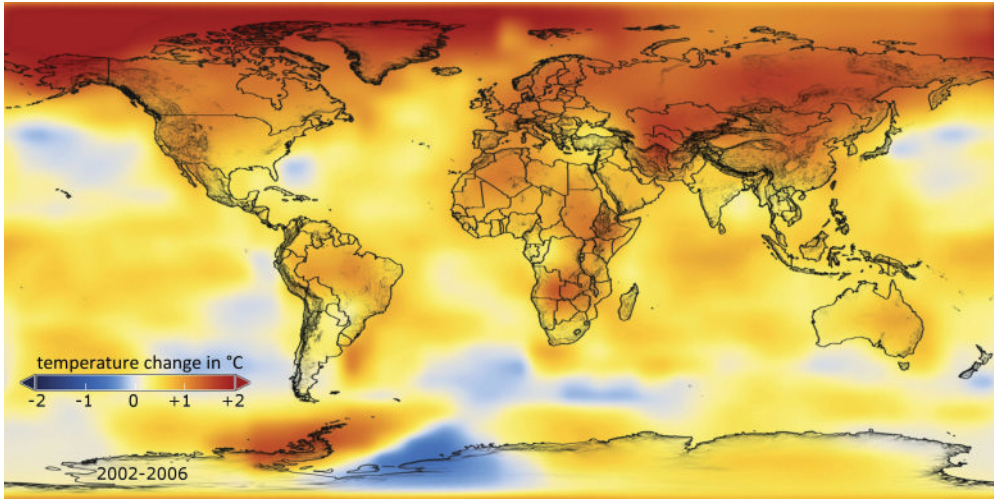

Figure 2.1 Temperature change from 2002 to 2006 compared to the long-standing average.

Source: NASA, svs.gsfc.nasa.gov.

Of the mountain glaciers in the Eastern Alps less than half the mass that existed in 1850 remains today.

2.1.2 Natural Catastrophes Occur More Frequently

As global temperatures rise, extremes in weather are also occurring. Major differences in temperatures cause storms to be more violent, rainfall to be heavier and high tides and flooding to be more frequent than before. The Munich Reinsurance company in Germany has long been concerned about the increase in natural catastrophes and resulting damage. In the event of loss or damage, reinsurance companies are responsible for covering part of the insured damage.

Economic as well as insured damage has risen sharply since the 1950s, as shown in Figure 2.3. Yet the graphics only include major catastrophes. Small local and medium-sized events are not included in the chart. There are two reasons for the rise: firstly, due to growing prosperity in the world, there is an increase in the number of valuable things that can be damaged when a natural catastrophe occurs. Secondly, the frequency and intensity of natural catastrophes has increased considerably.

Hurricane Katrina alone, which devastated the city of New Orleans in 2005, caused around US\$125 billion worth of damage and cost the lives of 1300 people (also see Figure 2.4).

Europe has also experienced an increase in extreme and devastating weather conditions. Examples include the 2005/2006 winter, which was the mildest since records began, and the record heat in the summer of 2003. Major heatwaves such as this one cause a decline in harvest yields.

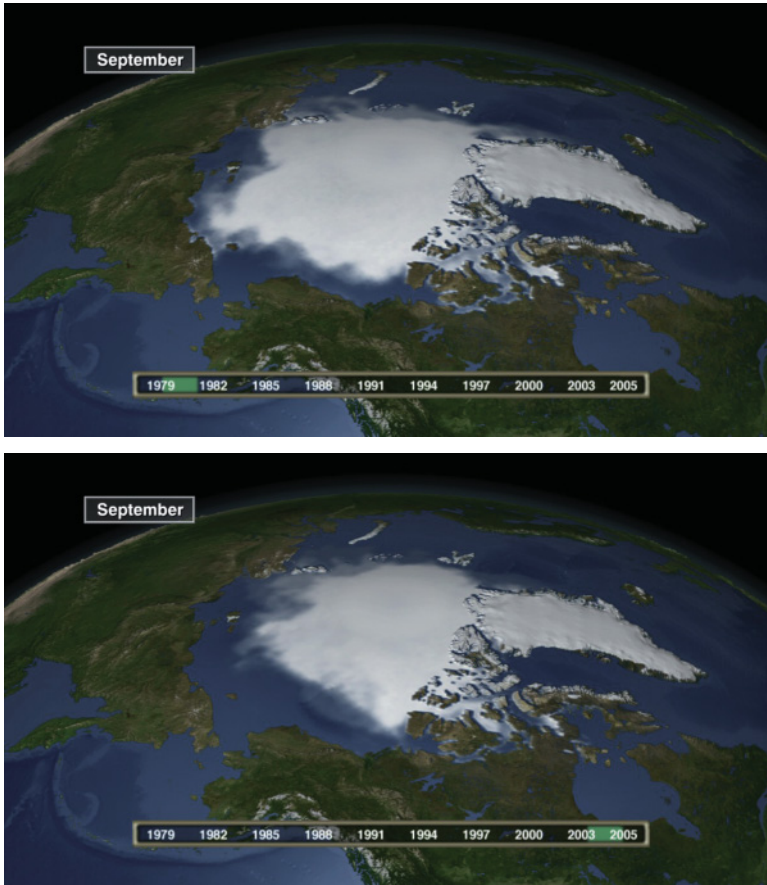

Figure 2.2 Arctic ice coverage in September, calculated for the years 1979 to 1981 (above) and for the years 2003 to 2005 (below). Source: NASA, svs.gsfc.nasa.gov.

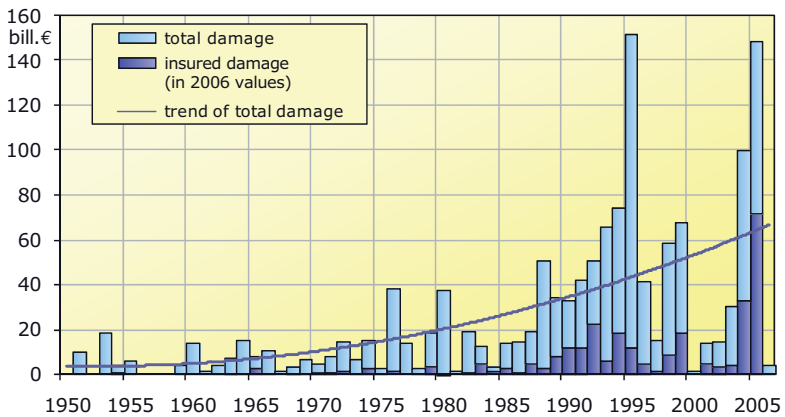

Figure 2.3 Total damage and insured damage due to major natural catastrophes worldwide. Data: Munich Re Group (Quaschnig, 2007).



Figure 2.4 Damage caused by hurricanes in the USA. Photos: Munich RE Group.



Examples of Major Natural Catastrophes

- **Winter 1990:** The storms Daria, Herta, Vivian and Wiebke kill 272 people in Europe and cause 12.8 billion euros in damage.
- **29 April 1991:** A storm tide resulting from the tropical cyclone Gorky hits Bangladesh. 138 000 people die. The material damage at 3 billion euros is comparatively low in this poor country.
- **12 December 1999:** Storm Lothar devastates large areas of Europe. 110 people die. The damage amounts to 11.5 billion euros.
- **August 2002:** Unusually heavy rainfall with up to 400 litres per square metre causes major flooding. In Germany, Dresden is one of the cities overcome by floods. In Europe overall 230 people lose their lives and the damage is 18.5 billion euros.
- **August 2003:** Europe's most extreme heatwave in recorded history takes 70 000 lives and causes damage close to 13 billion euros.
- **August 2005:** Hurricane Katrina wreaks havoc in the USA and destroys the city of New Orleans. 1322 people die as a result. The most expensive storm of all time causes US\$125 billion (around 100 billion euros) worth of damage.
- **September 2005:** Four weeks after Katrina, Hurricane Rita causes around 13 billion euros worth of damage. About 3 million people are evacuated to protect the population.
- **18 January 2007:** The storm Kyrill moves across Europe. The German railway halts all train travel in Germany for the first time in history.

Extreme weather events also bring about a rise in the death rate. In the summer of 2003 about 70 000 more people died in Europe than in a normal year, as a result of the excessive heat.

Although the financial damage resulting from natural catastrophes is still manageable at the moment in Europe, these figures are expected to rise dramatically by the end of the century. The German Institute for Economic Research DIW projects that

the overall cost to Germany alone for climate change will amount to around 3000 billion euros by the year 2100 (Kemfert, 2007) if global warming brings about a 4.5°C rise in temperature.

2.2 The Guilty Parties – Causes of Climate Change

2.2.1 The Greenhouse Effect

Without the protective influence of the atmosphere, earth's temperature would be around -18°C . This means we would be living on an ice-bound planet. Various natural trace gases in the atmosphere – such as steam, carbon dioxide and ozone – prevent the earth from emitting all incoming solar energy back into the universe. As in a greenhouse, these gases radiate part of this energy back to earth. This natural greenhouse effect is the basis for life on earth. As a result, the average temperature has settled at around $+15^{\circ}\text{C}$. During the last few millennia a balance has been created in the level of trace gases in the atmosphere, which has enabled life in the form that we know it today.

Many different possible causes of observed climate change have already been discussed. For a long time sceptics even questioned whether climate change was really taking place. Now that no one can really seriously claim that it is not getting warmer, there are some who are trying to push the blame onto natural effects – for example, on solar activity. Apparently solar activity during the last few decades has been higher than in all the previous 8000 years. It has been demonstrated that the amount of radiation that reaches the earth has indeed risen slightly. However, scientists rule out the possibility that this is what is causing the high level of warming today. At most, one-tenth of the observed increase in temperature is attributed to the rise in solar activity (Figure 2.5).

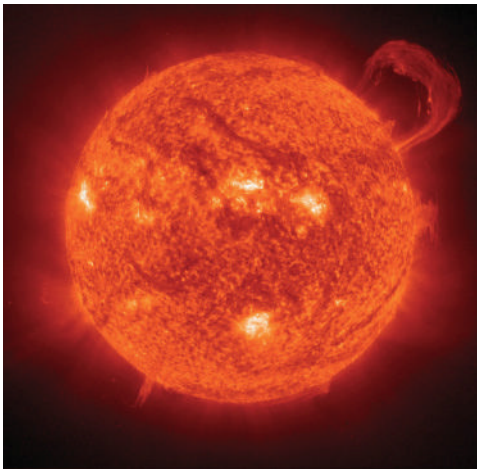

Figure 2.5 Changes in solar activity are responsible for only a fraction of global warming. Picture: NASA.

The most plausible cause of warming is that the proportions of the trace gases have changed significantly due to human influences. The concentration of gases that have been proven to cause global warming has increased considerably in recent decades. Therefore, man is causing an increase in the natural greenhouse effect. The greenhouse effect brought about by man is also referred to as an anthropogenic greenhouse effect (Figure 2.6). But this is not a particularly new theory.

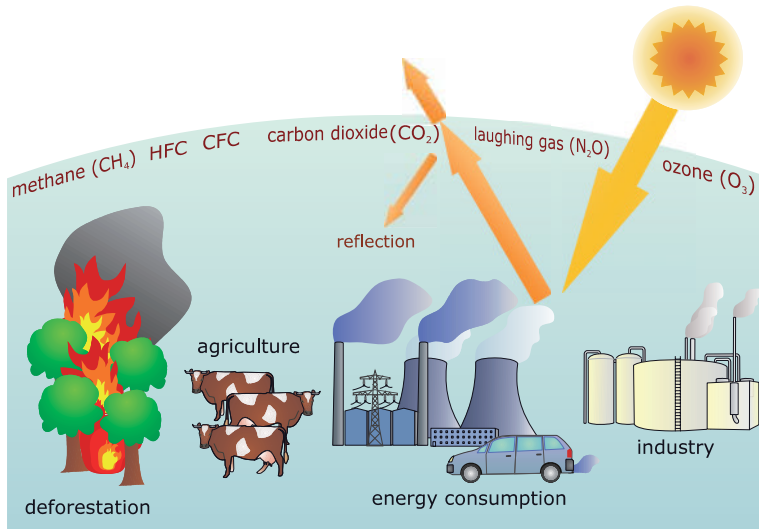

Figure 2.6 Causes of anthropogenic greenhouse effects due to human activities.

2.2.2 The Prime Suspect: Carbon Dioxide

In 1896 the Swedish scientist and Nobel prizewinner Svante Arrhenius already worked out that doubling the carbon dioxide content (CO₂) in the atmosphere (Arrhenius, 1896) would increase the temperature by 4 to 6°C. The connection between observed climate warming and the increase in carbon dioxide following industrialization was already being discussed in the 1930s. But at the time there was no way of confirming this connection. It was not until the late 1950s that scientists were able to prove that the concentration of carbon dioxide in the atmosphere was actually increasing (Rahmstorf and Neu, 2004). Today there is widespread proof that the increase in carbon dioxide concentration is one of the main causes of observed warming.



Are We Ruining the Air that We Breathe?

The air that we breathe out contains around 4% carbon dioxide – about 100 times more than the air we breathe in. Every year, we each release around 350 kg of carbon dioxide into the atmosphere. When we light a campfire using wood, we are also guilty of releasing carbon dioxide. However, plants, animals and people are

all part of a biogeochemical cycle. People take in carbohydrates and breathe in oxygen. They convert both substances into carbon dioxide, which they then breathe out again.

Plants in turn bond this carbon dioxide and provide our carbohydrates. Carbohydrates are organic compounds consisting of carbon, hydrogen and oxygen and are produced in plants through photosynthesis. For example, grains and noodles comprise 75% carbohydrates. It is even possible that the wheat in Italian spaghetti has converted the carbon dioxide that we breathed out during our last Tuscan holiday into carbohydrates.

When a plant burns, rots or ends up as a carbohydrate supplier, it generates just as much carbon dioxide as it previously extracted from the air. The natural cycles are therefore CO₂-neutral and do not lead to an increase in concentration. However, this does not apply to the holiday trip to Italy and the transport of Italian spaghetti to other countries.

Fossil energy use is the main cause of the increase in carbon dioxide concentration. If we burn fossil energy sources, this is regarded as oxidation from a chemical point of view. This reaction releases heat. We therefore use the effect of heat that results when the carbon from oil, natural gas and coal is combined with the oxygen from the air. The waste product we get in return is carbon dioxide – and we get it in enormous quantities: currently over 25 billion tons. The average human produces about 4000 kg per year. A corresponding amount of carbon dioxide would fill a cube with sides 13 m long, or around two million one-litre bottles.

As with energy consumption, the emissions in individual countries can vary a great deal (Table 2.1). For example, whereas someone from Mozambique would tip the scales at less than 100 kg, thus one-tenth of a ton of CO₂, per year, in China it is almost 4 tons per head. In Germany it is 10 tons, and in the USA just short of 20 tons. If the carbon dioxide generated by Germans each year were dispersed over the country's entire land area, every German would sink down into more than one metre of CO₂. In contrast, the carbon dioxide in Mozambique dispersed over the country would not even form a layer one millimetre thick.

Table 2.1 The ten countries on earth with the highest energy-related carbon dioxide emissions. Status: 2006. Data: IEA (International Energy Agency, 2008).

Country	Mil. t CO ₂	Mil. inhab.	t CO ₂ / inhab.	Country	Mil. t CO ₂	Mil. inhab.	t CO ₂ / inhab.
1. USA	5697	299	19.00	6. Germany	823	82	10.00
2. China	5606	1312	4.27	7. Canada	539	33	16.52
3. Russia	1587	143	11.14	8. Great Britain	536	61	8.86
4. India	1250	1110	1.13	9. South Korea	476	48	9.86
5. Japan	1213	128	9.49	10. Italy	448	59	7.61
World	28 003	6546	4.28	133. Mozambique	2	20	0.08

Yet it is not that long since we have been able to claim with absolute certainty that the amount of carbon dioxide in the atmosphere is increasing on a yearly basis. The Mauna Loa Observatory in Hawaii has only been measuring the concentrations of carbon dioxide continuously since 1958. At that time the concentration amounted to 315.2 ppm, the following year it was already up to 315.8 ppm. The unit ppm stands for 'parts per million'. Thus there were 315 parts of carbon dioxide per million parts of air. The small increase during the first year could also have been caused by a measurement error or natural fluctuations. It was not clear until the values began rising constantly in subsequent years that the amount of carbon dioxide was increasing – and at a growing rate. In 2008 the CO₂ concentration had already risen to 386 ppm.

But, in comparison with the enormous size of the atmosphere, the high carbon dioxide emissions that occur when fossil fuels are burnt are minute. Furthermore, some of the carbon dioxide is absorbed again by the oceans and the plants. So the question is how much our emissions can even change the composition of the atmosphere.

If we were to produce nitrogen instead of carbon dioxide when we use fossil energy sources, this would not pose a big problem. The reason is that our air consists of around 78% nitrogen and 21% oxygen but only 1% other gases – of which carbon dioxide makes up only a minuscule part. During the course of the earth's history, the composition of the air has by no means been consistent. However, in the past few thousand years a balance of less than 300 ppm has established itself. The proportion of carbon dioxide in the atmosphere was thus less than 0.03%. However, this is also the reason why we can even bring about any relevant changes. Small quantities can be increased comparatively easily.

A study of the climate of the past few millennia requires a different approach. The polar and Alpine ice sheets on earth have stored the history of the planet's climate. In the regions with permanent ice, fresh snow falls on the ice surfaces every year. Large quantities of air are trapped between the ice crystals. The new snow masses that form each year alongside the old ones increase the pressure on the old snow and ultimately press it down into pure ice. In the process the air does not escape totally but instead remains as small bubbles trapped in the ice. Today these air bubbles can be examined using modern techniques of analysis. The deposits of snow and the creation of ice repeat themselves each year with a regularity welcomed by scientists. All it takes is to drill a hole into the ice and draw up ice samples from deep down. This provides a silent witness to the past. The deeper one probes into the ice, the further back in history one is able to look.

Different drill core studies are unanimous in their finding that the concentration of carbon dioxide before the period of industrialization was around 280 ppm (Figure 2.7). But even the theory that high concentrations of carbon dioxide are a recurring phenomenon could be refuted. The studies showed that the proportion of carbon dioxide in the atmosphere is higher today than at any other point in the past 650 000 years (Intergovernmental Panel on Climate Change, 2007).

Once it was finally proven that carbon dioxide emissions are increasing, climate models were developed to establish a correlation between the burning of fossil fuels

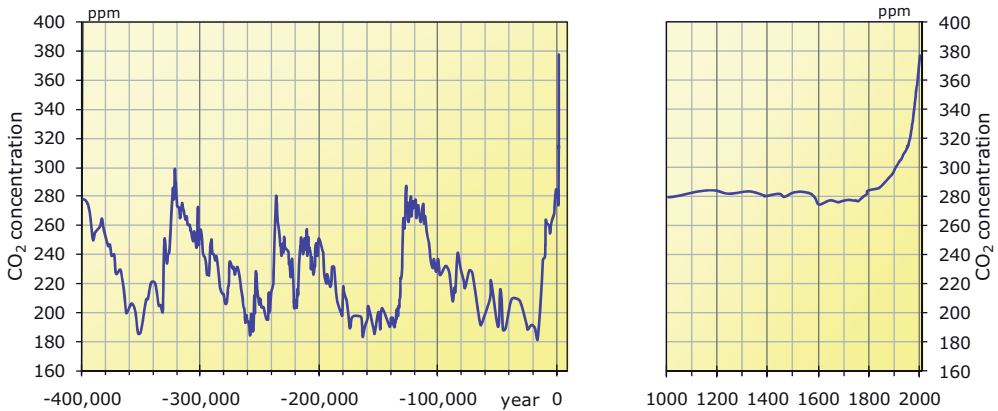

Figure 2.7 Development of carbon dioxide concentration in the atmosphere over the last 400 000 years and in the recent past. Data: CDIAC, cdiac.ornl.gov.

and the increase in CO₂. Sources other than the emissions caused by humans were not considered as reasons for the increase. The models show that the CO₂ concentration could still more than double, depending on the extent of the future consumption of coal, oil and natural gas.

This discovery raised another question, namely what the consequences of such drastic changes would be. In high concentrations carbon dioxide is unhealthy for humans and can even be life-threatening. However, to reach a level that would damage the health of humans, the concentration would have to increase a hundred-fold; to cause the danger of suffocation it would have to increase by a factor of 300. There is no way that we could reach such levels, even if we were to burn all the oil, natural gas and coal available. At least any acute danger to the lives of humans can be ruled out.

Direct measurements of temperature have existed for well over 100 years. A comparison of global temperature changes with energy-related CO₂ emissions shows a significant connection between the two (Figure 2.8). Yet sceptics find fault with this argument and point out that the temperatures actually fell slightly between the 1940s and the 1980s. Today there is an explanation for this. Aerosols from high dust and soot emissions in the burning of fossil energy sources reduce the solar radiation on earth. They act, so to speak, like sunglasses and thus create a cooling effect. Today modern filtering techniques have eliminated a major proportion of these emissions. This again decreases the sunglasses effect. However, CO₂ and the associated rise in temperature have remained.

As wood absorbs carbon dioxide during its growth, its burning is carbon dioxide-neutral. However, this is only the case if the same quantity of plants is used and burnt as can grow back again. Tropical rainforests are currently being burnt at a much faster rate than their rate of regeneration. An area of woodland the size of the United Kingdom is disappearing every 18 months. Some of the forests being burnt

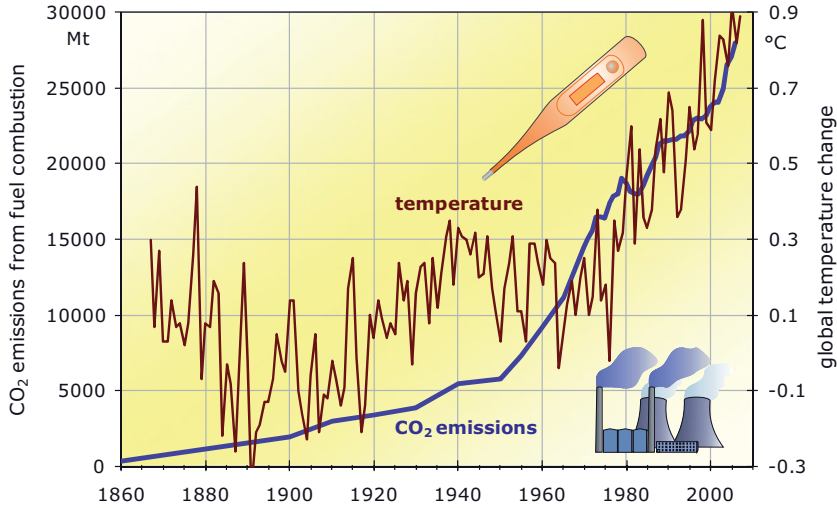

Figure 2.8 Progression of energy-related CO₂ emissions and global changes in temperatures since 1860.

are so large that they can easily be detected from space. If this does not change during the next few years, almost all the woodland in the world will be gone in about 100 years. During this time large quantities of carbon dioxide will be released, causing 10% of the greenhouse effect. However, the remaining CO₂ originates largely from the burning of fossil energy sources.

2.2.3 Other Culprits

Fossil energy use is not the only culprit. Agriculture, the clearing of rainforests and industry are also responsible for the additional greenhouse effect caused by people (see Figure 2.6).

Aside from carbon dioxide, there are other substances released through the actions of people that cause the greenhouse effect. Methane, hydrofluorocarbons (HFCs), ozone and nitrous oxide are some of the key ones. Although the concentration of these elements in the atmosphere is considerably lower than that of carbon dioxide, they have a much higher specific greenhouse potential.

The greenhouse potential of methane is 23 times that of carbon dioxide. This means that 1 kg of methane causes just as much damage as 23 kg of carbon dioxide. Methane is the second most important greenhouse gas. Through the influence of man the concentration of methane in the atmosphere has already more than doubled. Methane is also emitted during the exploitation of fossil energies. It escapes during natural gas extraction and coal mining, as well as from defective natural gas lines. Refuse disposal sites are another source for the emission of methane (Table 2.2).

Table 2.2 Characteristics of the most important greenhouse gases. (Status 2008)

	Carbon dioxide	Methane	HFC	Ozone close to earth	Laughing gas (nitrous oxide)
Chemical notation	CO ₂	CH ₄	diverse	O ₃	N ₂ O
Concentration in the atmosphere in ppm	385	1.77	<0.01	0.034	0.32
Concentration in the year 1750	280	0.75	0	0.025	0.270
Annual increase in concentration	+ 0.4%	+0.4%	Varies	+0.5%	+0.25%
Greenhouse potential compared to CO ₂	1	23	>1000	>1000	296
Duration in the atmosphere in years	5-200	12	Varies	<0.1	114
Reflection in W/m ²	1.66	0.5	0.35	0.35	0.16
Percentage of anthropogenic greenhouse effect	56%	16%	11%	12%	5%

Interestingly, agriculture releases the largest proportion of methane. Livestock rearing, decaying biomass and rice cultivation are the farming activities that produce the most methane. Unlike carbon dioxide, it is not integrated into a biological cycle. When ruminants digest green fodder, they create methane which they belch into the atmosphere. A single cow or a herd would not pose a problem for the climate, but the number of cattle worldwide is now so large that they represent a real threat to the environment. Meat consumption per head has increased dramatically during the past few decades, as has the number of people, so that there are now more than 1.3 billion cattle on earth.

Other greenhouse gases such as nitrous oxide (laughing gas) are created through farming due to an excessive use of nitrogenous fertilisers. Overall, agriculture contributes around 15% of the greenhouse effect caused by man.

Other key greenhouse gases include ozone, fluoride hydrocarbons (HFC and halons), steam and sulphur hexafluoride (SF₆). Air pollutants help to create low-level ozone. These pollutants originate in part from motorized traffic and, therefore, as a result of the burning of fossil fuels. The ozone problem has become a familiar one because of the health risk associated with summer smog. However, what is less known is the impact of the ozone on the greenhouse effect. SF₆ is used in the electricity sector but the amount causing a greenhouse effect is relatively minimal.



Will the Hole in the Ozone Layer Keep Making Earth Warmer?

The ozone hole and the greenhouse effect are both global environmental threats. Yet they have very little relationship to one another.

With the ozone a distinction must be made between the ozone layer at high altitudes and ozone at a low level. The natural ozone layer with the 'good ozone' is located in the

higher regions of the earth's atmosphere – more precisely, in the stratosphere at an altitude of 15 to 50 km. The UV light of the sun has been converting air oxygen (O₂) into ozone (O₃) there forever. The ozone layer absorbs most of the dangerous UV radiation. Certain gases, such as chlorofluorocarbons (CFC) – from old refrigerators, air conditioners and aerosol cans – decompose the ozone in the stratosphere. This is why the ozone content in the ozone layer has decreased rapidly in recent decades. A hole in the ozone formed, mainly over Antarctica. An increased amount of UV light now reaches earth and is contributing to an increase in skin cancer. International agreements have limited the use of CFC. Its use has been forbidden in new plants in Germany since 1995. In the meantime a slow recovery has been observed in the ozone layer.

Yet the ozone in the ozone layer is itself a cause of the natural greenhouse effect. For that reason the destruction of the ozone has actually produced a light cooling effect.

'Bad ozone' close to earth, on the other hand, occurs as a reaction to nitrogen oxides, oxygen and sunlight and causes the notorious summer smog. Ozone acts as an irritant and in large concentrations is very toxic. In the natural ozone layer above an altitude of 15 km this is not a problem, but it is a problem in the troposphere close to earth. Furthermore, the tropospheric ozone close to earth also contributes to the greenhouse effect. Unlike what happens in the ozone layer, the ozone concentration close to earth is increasing. To this extent the ozone close to earth is what is warming up the earth.

CFC was used as a coolant in air-conditioning systems and refrigerators. This not only contributed to the greenhouse effect but also damaged the ozone layer. As a result, the Montreal Protocol stipulated an end to CFC production worldwide, allowing long periods of transition. HFCs are often used today as a CFC substitute. These substances no longer use chlorine as an ingredient. Although this means that they can no longer damage the ozone layer, HFC is still a problem for the greenhouse effect. The HFC cooling agent R404A has a specific greenhouse potential of 3260. Therefore, 1 kg of R404A is just as harmful as 3.26 tons of carbon dioxide. But there are substitute substances available that are not damaging to the climate. Unfortunately, these are currently only being used in a limited number of areas.

Scientists have now developed a relatively good understanding of the different effects of individual greenhouse gases and other factors on the earth's warming. The greenhouse gases that result from the activities of people increase the reflection in the atmosphere and thus cause an increase in global warming. Figure 2.9 shows the contribution of the different gases. The rise in solar activity is also causing a slight increase in radiation. As described earlier, aerosols released through the activities of people and the resulting cloud formations provide a cooling effect. Even the ozone layer and changes in land use are producing a light cooling. If one juxtaposes the cooling and the warming effects, it is the warming that predominates. An increase in greenhouse gases and a decrease in aerosols through further improvements in air purification could even cause a considerable increase in warming over the next few years.

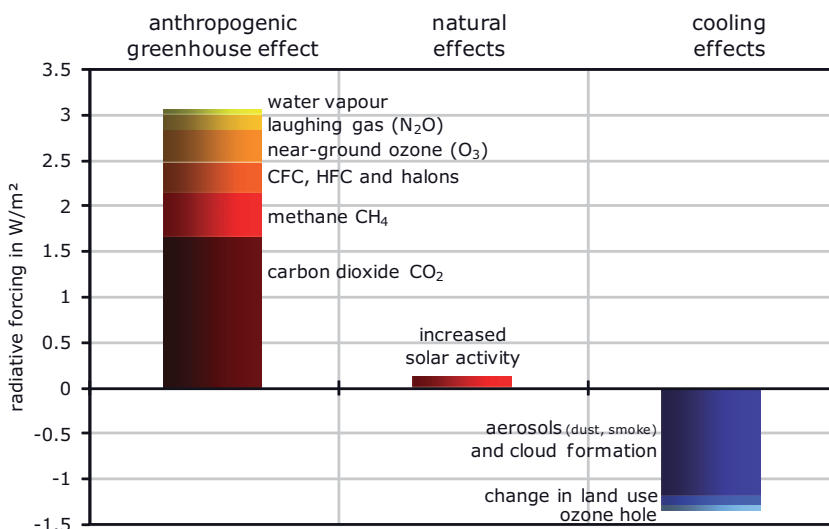

Figure 2.9 Causes of global warming. Data: IPCC (Intergovernmental Panel on Climate Change, 2007), www.ipcc.ch.

2.3 Outlook and Recommendations – What Lies Ahead?

No one can predict how many greenhouse gases will be emitted in the future. Climate models can, however, indicate the effects of different emission levels. For this purpose climate researchers have designed different models that describe the effects of changes in greenhouse gas concentrations. On the basis of these models, they developed complex computer programmes. To check a computer model, one first tries to reconstruct the changes of the past. So far this has been a successful approach and future projections have achieved a high quality.

The Intergovernmental Panel on Climate Change (IPCC) regularly publishes reports on climate change and studies the effects of climate. The environmental programme of the United Nations (UNEP) and the World Organization for Meteorology (WMO) initiated the IPCC in 1988. The most competent climate researchers in the world are involved in the preparation of the IPCC reports and, as a result, this group has a good reputation internationally.



- www.ipcc.ch Intergovernmental Panel on Climate Change
- www.unfccc.de United Nations Framework Convention on Climate Change

It is virtually impossible to predict parameters such as population growth or the point when climate protection measures will be implemented. Therefore, the

2 The Climate Before the Collapse?

calculations in the models are restricted to certain scenarios. These indicate what can be expected in the best case and the worst case scenarios. The conclusions of the climate researchers show that there is still time for us to have a drastic influence on future developments.

What is clear is that there is no way to stop climate change completely. However, determination and appropriate countermeasures can keep the consequences of climate change within a manageable limit and largely save the climate. If we do not change course during the next ten years, climate change will very quickly reach a point of no return with no hope of stopping it. Table 2.3 shows how we can still set

Table 2.3 Consequences of climate change – the climate can still be saved.

This is how the climate could develop if it were protected worldwide	This is what threatens us in the worst case scenario
<ul style="list-style-type: none"> ■ Greenhouse gas transmissions are reduced worldwide by at least 50% by 2050 and by almost 100% by 2100. ■ The average global temperature increase remains below 2°C. ■ Sea levels rise by 20 to 30 cm by 2100. ■ The ice in Greenland remains intact. ■ In the long term the rise in sea level remains around a metre or less. ■ Coastal regions and cities are saved through slight improvements in coastal protection measures. ■ The Gulf Stream weakens only slightly. ■ Heatwaves, periods of drought and extreme precipitation increase. ■ Migrations of populations are limited locally due to climate change. 	<ul style="list-style-type: none"> ■ All fossil energy sources are almost used up and worldwide greenhouse gas emissions show a definite further increase. ■ The increase in average global temperature reaches values of 5°C and higher. ■ Sea levels rise by a metre or more by 2100. ■ The entire ice mass in Greenland melts away, directly resulting in a 7 m rise in sea levels alone in the long term. ■ In the long term the sea level rises by more than 30m. ■ Entire coastal regions and cities such as Hamburg, Rotterdam and Miami sink into the sea. Even cities on higher ground could be threatened in centuries to come. ■ The Gulf Stream fails completely. The climate conditions in Europe undergo extreme changes. ■ Heatwaves, periods of drought and extreme precipitation increase dramatically and in some regions of the world threaten the foundations of life. ■ The consequences of climate change trigger a major migration of people who flee their homes due to climatic conditions. Global tension rises dramatically as a result.

the course today. In the worst case scenario, the entire mass of Arctic ice will melt away. The melting of the ice mass in Greenland alone could cause the sea level to rise 7m over the next several centuries. Figure 2.10 shows what the effect would be on Germany.

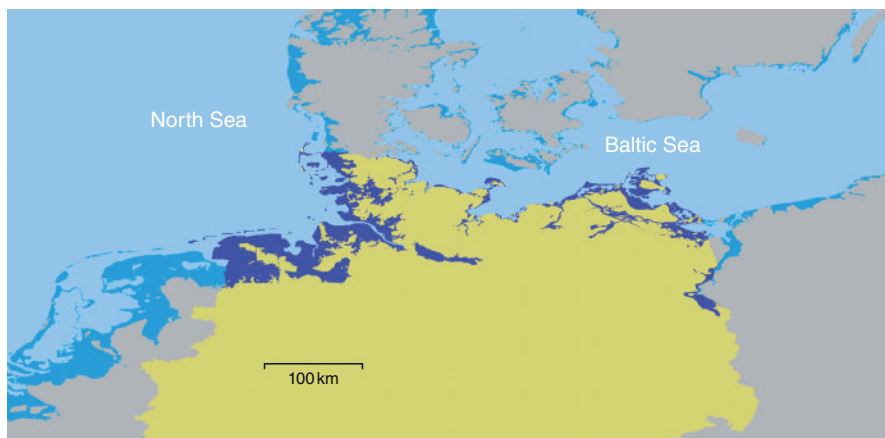

Figure 2.10 Threatened areas in Northern Germany if the sea level were to rise by 7m in the long term. Graphics: Geuder, DLR.

2.3.1 Will It be Bitterly Cold in Europe?

The American climate researcher Wallace Broecker wrote an article in 1987 titled ‘Unpleasant Surprises in the Greenhouse’. The article, which caused quite a sensation at the time, warned about potential surprises from the greenhouse effect that could affect us very seriously: global warming could, paradoxically, turn Europe bitterly cold.

While studying the history of the climate from ice drill cores in the Greenland ice mass, climate researchers determined that the world’s present climate is quite stable – but it has only been this way for about 10 000 years. The average yearly temperature on earth has never deviated more than one degree from the long-time average during this time. However, if one were to look back another 2000 years, one would find that major jumps occurred in temperatures even during short periods of only a few years. Until now it was always thought that temperature changes as well as the transition from ice ages to warming periods only happened very slowly. However, this opinion had to be corrected as a result of the drill core studies.

Today it is assumed that the climate tends to behave erratically on its own, thus making it a powerfully non-linear system (Rahmstorf, 1999). Linear systems are easy to understand. The stronger that the attraction is, the clearer the reaction is. For example, a water tap approximates a linear system. With two turns the amount of water that flows is double the amount of one turn. Climate is a complex non-linear system. It has the tendency of self-regulation and suddenly jumps into a different

2 The Climate Before the Collapse?

state when a critical point has been reached. The human body is another example of this. On its own the human body is able to keep its body temperature quite constant at 37°C, even during major changes in ambient temperature. However, if a person becomes seriously hypothermic, the body temperature quickly drops at a certain point.

The Sahara is an example of very erratic climate change. Several thousand years ago the Sahara was green. The vegetation there absorbed moist air from the Atlantic and monsoon rains. Due to very minor changes in the earth's orbit and in the inclination of the earth's axis, the conditions for the monsoon rains deteriorated over a period of thousands of years. The vegetation managed to survive until a certain point around 5500 years ago. But then within a short period the vegetation died and the Sahara turned into a dry desert. A new stable state then developed, which continues until today. The populations of large areas had to flee due to the dryness of the terrain. The Nile valley in Egypt became a place of refuge for the environmental refugees of the day. This contributed towards the creation of the Pharaonic high culture and was perhaps even the basis for the biblical stories that have been passed down through the ages.



■ <http://www.pik-potsdam.de/%7Estefan>

Internet page of climate researcher Stefan Rahmstorf at the Potsdam Institute for Climate Impact Research

The origins of the erratic climate changes that occurred many years ago are suspected to lie in changes in ocean currents, which continue to have a major effect on our climate even today. For example, Berlin and London are located further north than Quebec in Canada. A comparison of temperatures shows that Western Europe is about five degrees warmer than it should be considering its latitude. The reason for this is a gigantic self-regulating heat transport machine: the Gulf Stream.

In Central America the sun heats the water masses of the Caribbean Sea and the Atlantic. The Antilles Current and the currents from the Caribbean merge together to become the Gulf Stream, which is 50km wide and transports enormous masses of warm saltwater northwards along the American coast. These currents are so large they can be seen from space. From North America the current then moves straight across the Atlantic, continues along the European coast to Norway and ends in the European part of the North Sea (Figure 2.11). Some of the heat is absorbed by the air beforehand, and this air then moves with westerly winds towards Europe. This explains why winds from the west always promise relatively mild temperatures to some parts of Europe.

In the North Sea between Norway, Iceland and Greenland the warm saltwater comes together with colder, less salty water and cools off quickly. This water increases in density, becomes heavier and consequently sinks to the bottom quickly. In the North Sea 17 million cubic metres of water sink to a depth of 3000-4000m per second. This corresponds to around 20 times the entire capacity of all rivers on earth. The

water masses then return to Central America as cold deep water flow, to be heated up again there.

Due to climate warming, large quantities of meltwater (melted snow and ice) pour into the North Sea. This fresh water dilutes the warm saltwater. It has already been determined that the salt content has fallen considerably. If the salt content decreases even further, the weight of the water will not be sufficient in the future to allow it to sink down. The enormous Gulf Stream water pump would get out of step and very suddenly come to a halt.



Figure 2.11 Principle of the Gulf Stream.

Climate researchers suspect this was precisely the cause of the temperature jumps 11 000 to 12 000 years ago. After the ice age enormous amounts of meltwater from the melting glaciers poured through the St Lawrence River into the North Atlantic. It diluted the sea water with fresh water, so that the uppermost layer of sea water became noticeably less salty and the water lighter. Therefore, the water no longer sank to the depths, despite strong cooling. The Gulf Stream was ‘turned off’ and for many years large areas of Northern Europe and Canada were exposed to extreme cold and covered in ice. As a result, the amount of meltwater decreased again. The salt content of the water rose. The warm water heater, the Gulf Stream, started working again.

This is exactly the fate that we are facing again today. No scientist can accurately predict just how much global warming must increase before the Gulf Stream stops working. But the assumption is that the critical point will have been reached once worldwide warming increases by 3 °C. We already have increased the temperature by a good 0.7 °C. The consequences for us would be catastrophic. The climate would be erratic for years. Ultimately, it would be so cold and dry in Europe that any kind

of farming would be impossible. Yet, according to the calculations of the climate researchers, this new climate state would then remain stable again for thousands of years.

2.3.2 Recommendations for Effective Climate Protection

The only thing that could help to keep climatic effects at a manageable level and prevent some nasty surprises, such as the disappearance of the Gulf Stream, would be a speedy reduction in greenhouse gas emissions. By 2050 greenhouse gas emissions worldwide would have to be reduced to half of what they were in 1990.

The industrialized countries are currently causing the biggest per-head output of greenhouse gases. The developing and emerging countries justifiably want to catch up in terms of prosperity and energy demand. Therefore, the industrialized countries have to make the biggest contribution towards reducing greenhouse gas emissions.

Emission reduction targets were formulated for countries such as Germany, Great Britain and the USA as far back as the late 1980s. Today the need to meet these targets is even more critical (Enquete-Kommission 'Vorsorge zum Schutz der Erdatmosphäre' des 11. Deutschen Bundestages, 1990). Based on decisions made in 1990, the following targets have been set as a minimum goal for industrialized countries:

- Reduction in greenhouse gas emissions of 25 to 30% by 2005
- Reduction in greenhouse gas emissions of 40 to 50% by 2020
- Reduction in greenhouse gas emissions of 80% by 2050
- Reduction in greenhouse gas emissions of 90% by 2100

2.4 Difficult Birth – Politics and Climate Change

2.4.1 German Climate Policy

The realization that the consequences of an increase in climate warming represent a previously unknown type of threat for mankind finally struck home with the politicians in the 1980s. At the time the public was developing a keen awareness of the environment. Dying forests, respiratory illnesses due to air pollution and the risk of nuclear power were topics that had a big impact on people. It was no longer possible to ignore global environmental problems.

In 1987 the German Bundestag (Lower House of Parliament) appointed the cross-party Enquete commission to deal with the issue of protecting the earth's atmosphere. The commission studied the problems relating to climate change and drew up clear recommendations for reducing greenhouse gases (see above).

The first target of a 25% reduction by the year 2005 was adopted by the conservative government of Helmut Kohl. After reunification the policy was extended from

West Germany to the unified Germany. As we see today, this was a clever move. According to the statistics, there was a 17% reduction in CO₂ emissions by 2005. As a result, Germany likes to present itself as a forerunner in climate protection on the international stage. However, most of the CO₂ savings can be attributed to the effects of reunification. A major part of the industry in the former East Germany, with its high level of energy consumption and carbon dioxide emissions, collapsed. The output of greenhouse gases was thereby reduced to around half of what it had been, whereas in West Germany nothing much was changing in terms of climate protection.

After the change in government in 1998, the ‘Red-Green’ government, a coalition between the Green Party and Social Democrats, also adopted the climate protection targets for the year 2050. However, the measures introduced were not adequate for an effective climate protection policy that would make the targets realistic. The first target of a 25% reduction by 2005 was missed by a long shot (Figure 2.12). Even the current German government is not moving ahead quickly enough to reduce greenhouse gas emissions.

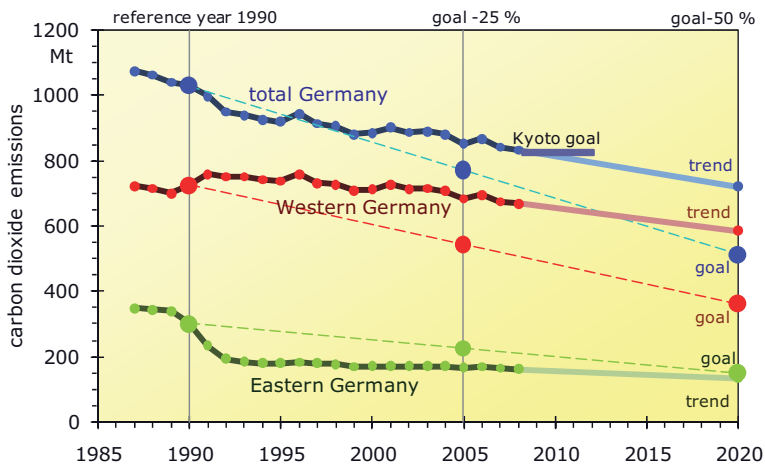

Figure 2.12 Energy and process-related carbon dioxide emissions in Germany.

On the international stage Germany had already qualified its climate protection targets in 1997. Under Angela Merkel, the environmental minister at the time, the government’s own target was a reduction of 25% by 2005. Within the framework of the Kyoto Protocol, a reduction target for greenhouse gases of only 21% was promised by the year 2012. In addition to carbon dioxide, the calculations of the Kyoto protocol take into account other climate gases, such as methane, nitrous oxide, HFC and CFCs. This clearly improves Germany’s chances of at least reaching the Kyoto target. It has had great success particularly in the reduction of methane emissions – for example, through recycling.

The United Kingdom was the only Western industrialised country to achieve a significant reduction in greenhouse gas emissions of about 15% between 1990 and 2005. Carbon dioxide emissions went down by 6% due to the change from coal to natural gas in some parts of the energy supply.

2.4.2 International Climate Policy

In 1979 the main theme at the first UN conference on world climate in Geneva was the threat to the earth's atmosphere. However, many special-interest representatives had their doubts about the essence of the threat. So it was initially agreed that further research would be needed before any particular measures could be considered.

In Rio de Janeiro in 1992 the members concluded for the first time that measures to protect the environment were now absolutely essential. The first targets for reducing greenhouse gas emissions were then agreed in 1997 in what was referred to as the Kyoto Protocol. Although these targets still do not go far enough, they have succeeded in putting international pressure on countries to implement the measures necessary to protect the climate.



The Kyoto Protocol

The first world summit on climate, the UN Conference for Environment and Development (UNCED), took place in Rio de Janeiro in 1992. One result of the conference was the Climate Framework Convention on Climate Change (UNFCCC), where the signatories made a commitment towards preventing dangerous anthropogenic disruption to the climate system, slowing down global warming and lessening its consequences.

This rather vague agreement was followed by the Kyoto Protocol, which was drawn up in 1997 at the third conference of the treaty states of the UNFCCC in the Japanese city of Kyoto. It obligates all the treaty parties listed in Figure 2.13 to reduce their emissions of greenhouse gases by an average of 5.2% by 2012 at the latest. However, different restrictions apply to individual states. The protocol actually allows certain countries, such as Spain, Portugal, Greece and Australia, to increase their emissions. The EU states should be able to achieve their targets together. This means that low-emitting EU states can compensate for the high emissions of other EU states.

In addition to carbon dioxide (CO₂), the following greenhouse gases are also being considered and converted into carbon dioxide equivalents: methane (CH₄), nitrous oxide (laughing gas, N₂O), partially halogenated chlorofluorocarbons (CFC), perfluorocarbons (PFC) and sulphur hexafluoride (SF₆). Measures initiated in other countries can also be counted as reductions. The Kyoto Protocol plans no restrictions for developing and emerging countries. The Kyoto Protocol came into effect in 2005. The USA is the only country that has not yet ratified it.

Most industrialized nations have so far shown meagre results in their tackling of climate warming. The only countries that have recorded definite reductions in greenhouse gas emissions are those that were formerly in the Warsaw Pact. The reason for this is due more to the economic upheavals of the 1990s than to a con-

sistent policy on climate protection. In the meantime CO₂ emissions have been rising again in these countries too.

In most Western countries emissions are increasing at the same levels as before (Figure 2.13). Spain is the worst culprit for this. Because its emissions in 1990, compared to countries like Germany and the USA, were still comparatively low, Spain was actually allowed an increase of 15%. However, by 2004 Spain's actual emissions had already risen by 51%. Only Germany and Great Britain have really succeeded in achieving significant reductions, although the bulk of the reductions in Germany are attributed to the upheavals in the former East Germany.

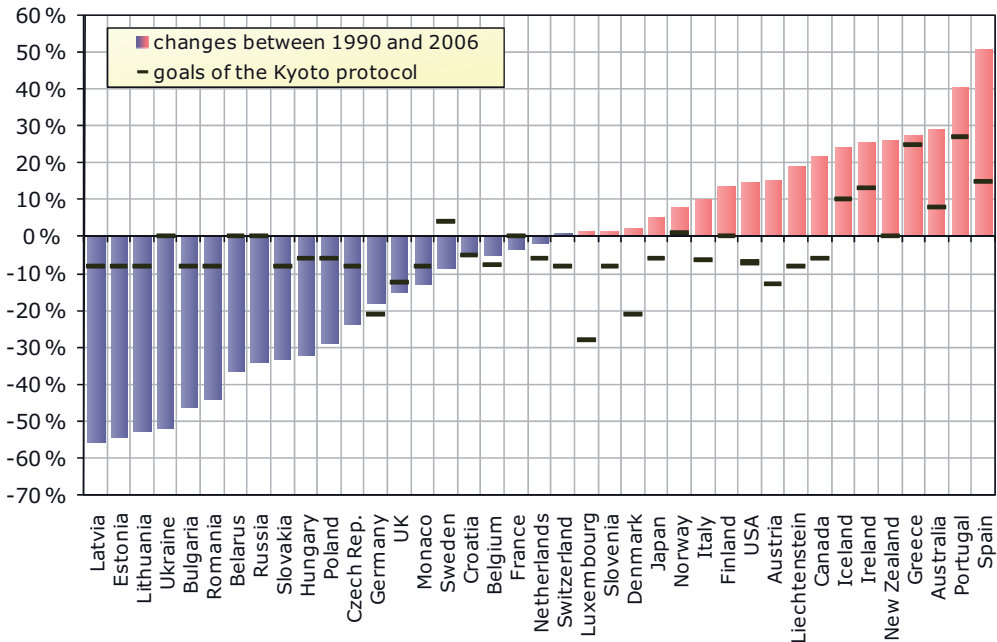

Figure 2.13 Changes in greenhouse gas emissions with no change in land use between 1990 and 2004 and targets from the Kyoto Protocol. Data: UNFCCC (United Nations Framework Convention on Climate Change, 2008).

The USA, which essentially sees no chance of achieving its targets for climate protection during the next few years, did not even ratify the Kyoto Protocol. Nevertheless, the very different major changes that individual countries have made shows just how much can be done to protect the climate. If these plans are taken seriously, a reduction in greenhouse gases of 50 to 80% by the year 2050 should be easily achievable.

2.5 Self-Help Climate Protection

The governments of most countries today are taking a half-hearted approach to addressing the issue of climate protection. Certain special-interest groups would invariably suffer financially if consistent policies were pursued in this area. Therefore, these groups are trying to use their political influence to delay any serious implementation of climate protection measures.

However, this is not a reason to fall into a state of lethargy. On the contrary: Everyone has the chance to make a contribution towards protecting the climate. Savings of 50, 80 or even 100% in greenhouse gas transmissions are easily achievable right now. If more and more people follow a good example, the results of their efforts will help to protect the climate. But a single measure on its own is not enough to stop global warming. Instead it will take a combination of many different kinds of measures. Renewable energies in particular can play a major role here, as this book will show.

Active climate protection does not demand any major sacrifices. If everyone tried to implement the following measures, it would be enough to save the climate:

- Avoid buying products made of tropical woods that do not come from sustainable sources. The FSC stamp can help in a purchase decision.
- Avoid equipment and appliances (refrigerators, air conditioning units, heating pumps) containing coolants with HFCs because they are responsible for more than 10% of the greenhouse effect. If this equipment is not available without HFCs (e.g. car air conditioning systems), the buyer should put pressure on the manufacturer.
- Be consistent in recycling, reduce the use of animal feed and increase the use of organic and local products.
- Be consistent in saving energy in all areas (See Chapter 3).
- Build and finance new renewable energy systems and installations (see Chapters 5 to 14).

3 From Wasting Energy to Saving Energy and Reducing Carbon Dioxide

In modern industrial societies energy is still available at relatively moderate prices and without any restrictions. Whenever we want it, we can consume as much energy as we like. However, the general increase in energy prices in recent years has brought about a new awareness of the value of energy. High energy consumption is making more and more of an impact on our finances. Yet the equation is very simple: saving energy also means saving money. But the concept of saving energy is not totally new.

Until the 1970s it was accepted that real economic growth and increasing prosperity would also require the use of more energy. The concept of saving energy developed when the oil crisis in the 1970s led to an explosion in oil prices and put a brake on growth. Numerous tips, appeals and stickers in the 1980s were aimed at encouraging citizens to save energy. In any event, the trend towards stopping energy waste was successful at the time. As prices started dropping again in the 1990s, the original goal was largely ignored and energy was again thoughtlessly wasted.

3.1 Less Efficient – Energy Use and Waste Today

High energy consumption is not a necessary prerequisite for maintaining our prosperity and living standard. In fact, energy use is coupled with enormous losses. Around 35% of the primary energy used is already lost in the energy sector through power plant waste heat or during transport even before it reaches the consumer. Various devices and machines then produce the desired usefulness, such as light, heat, and driving power for machines and vehicles. This too leads to high losses.

3 From Wasting Energy to Saving Energy and Reducing Carbon Dioxide

Light bulbs and vehicle combustion engines are particularly inefficient and transform around 80% of energy used into undesirable waste heat. Even ‘useful’ energy is often wasted, for example when lights are left on in empty rooms, poorly insulated buildings are heated or people drive round and round the block to find a parking space. If one looks at all the losses incurred, it emerges that at best only 20% of original primary energy is being used sensibly (Figure 3.1).

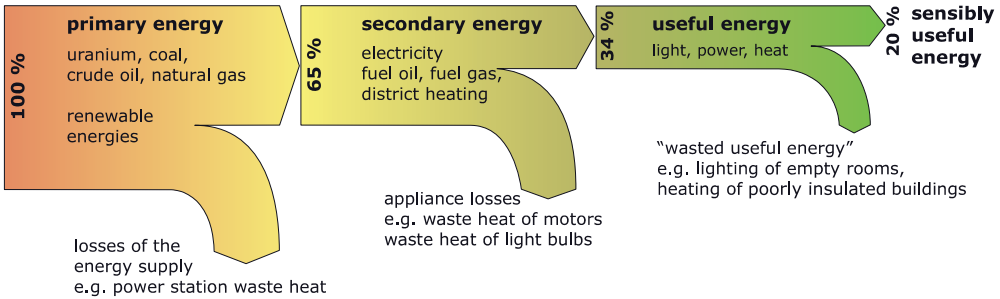

Figure 3.1 During transport or conversion around 80% of energy in Europe is lost or not used sensibly.

When it comes to certain aspects of the lifestyles of industrialized societies, the percentage of sensible energy use is even much smaller. However, the sort of person who tries to talk friends out of taking long flights or buying a new car with all the extras, or keeps telling his family to turn down the central heating, tends not to be very popular. The choice of one’s own lifestyle, finances permitting, is considered one of those individual freedoms that no one else has a right to influence. Therefore, saving the environment does not mean looking for scapegoats but instead seeking solutions that meet both lifestyle and environmental needs.

This does not mean that everyone can abuse his or her right to a certain lifestyle and thoughtlessly treat energy and the environment with disrespect. People who against their better judgement refuse to accept a technology that would enable them to retain their lifestyle but at the same time considerably reduce energy consumption and save the environment are acting irresponsibly. This also applies to policies that do not strive towards a speedy introduction of the most optimal technologies.

Many small steps that could help create an environmentally compatible society are also not being implemented due to a lack of knowledge or appropriate awareness. Many of the problems related to energy use are extremely complex. Optimal solutions to these problems often depend on a number of different factors.

For example, one issue that is often debated is whether a gas or an electric stove is more efficient. Compared to an electric stove, a gas stove produces more waste heat. Anyone who has ever scorched a potholder on a gas hob will be able to confirm this. Yet gas has the reputation of being the ecologically better alternative. Conventional coal-fired, natural gas and nuclear power plants for electricity genera-

tion do not work efficiently. More than 60% of the primary energy used in these facilities is lost as power plant waste heat (Figure 3.2). If the electricity used to boil a litre of water comes from a coal-fired power plant, it is releasing 156 g of carbon dioxide. In contrast, burning natural gas on a gas stove releases about 56 g of carbon dioxide. However, the losses that occur when gas is transported from the place of extraction to the end consumer are also a problem. Natural gas essentially consists of methane, which is considerably more damaging to the environment than carbon dioxide. Therefore, even the loss of a few grams can be harmful. If transport losses are at the rate of about 10%, a gas stove is still causing a lower rate of greenhouse gas emissions than an electric stove using coal-generated electricity. However, the pipelines in the areas where natural gas is exploited are sometimes in very poor condition. The use of natural gas from these sources can completely cancel out the advantages of gas stoves.

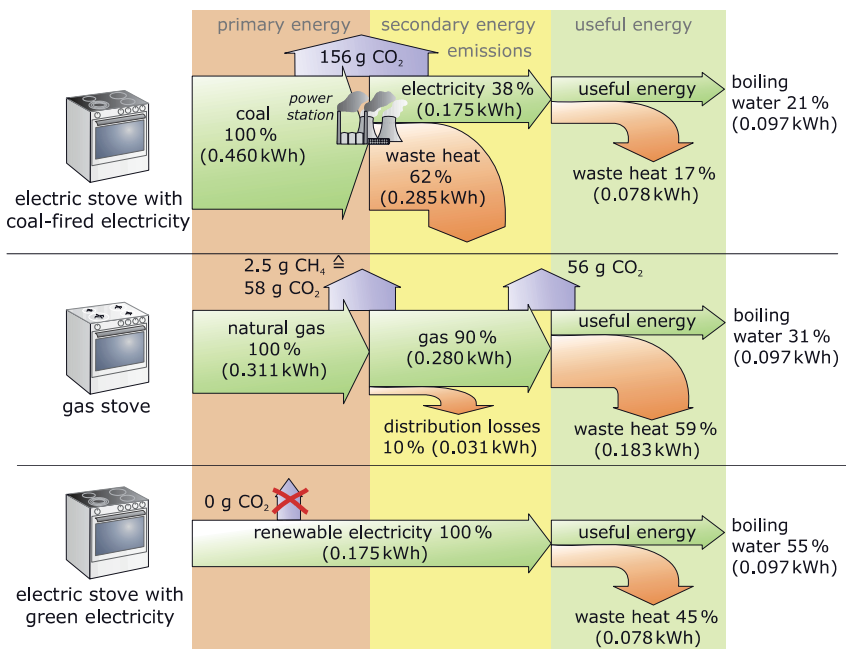

Figure 3.2 Energy and environmental effects from boiling water using an electric versus gas stove.

A gas stove should normally be a better alternative than an electric one – as long as the energy used is not supplied by fossil power plants. ‘Green’ electricity suppliers offer carbon-free electricity from renewable energy plants. Using this kind of electricity may make an electric stove more environmentally friendly than a gas stove. In Norway all electricity is supplied by renewable energy plants. In this case, electric stoves are generally preferred. Finally, the use of an electric kettle to boil water is

an efficient way to save energy and reduce carbon dioxide and puts the user ahead of the game. Anyone who worries generally about saving energy should first look at the areas that use the most energy. What will come as a surprise to many is that private households in Germany use more secondary energy than industry and the transport sector (see Figure 3.3). This applies to many countries in the world.

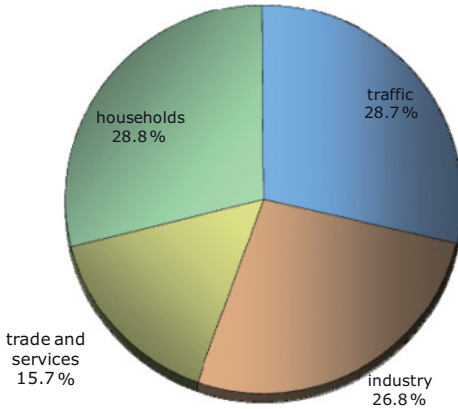

Figure 3.3 Percentage of different sectors in secondary energy consumption in Germany. Data: (Tscheutschler, Nickel and Wernicke, 2007).

This was not always the case. In 1990 industry was still the biggest consumer of secondary energy. Yet while industry reduced its secondary energy use by over 17% between 1990 and 2005, private households and the traffic sector increased their consumption by at least 10% during the same period.

The main cause of this increase in domestic energy consumption is the boom in sales of electrical devices and appliances. This increase is particularly noticeable in the areas of communication and entertainment electronics. Modern widescreen plasma televisions can easily use twice as much energy as an old cathode ray tube TV set. But there are also other hidden things that eat up energy. As the possibilities for saving energy in the household and transportation are particularly easy to implement, these options head the list of any analysis on energy savings.

3.2 Personal Energy Needs – Easily Saved at Home

3.2.1 Domestic Electricity – Money Wasted

Europeans take the supply of electric energy so much for granted that we find it hard to imagine doing without electricity even for a short time. Televisions, telephones, computers, lights, refrigerators, washing machines and even heating do not function without electricity. It is hard to grasp, then, that around two billion people, one-third of the world's population, have no access to electric power.

In Germany, an average three-person household consumes around 3900 kilowatt hours of electricity at a cost of about 750 euros per year. More than 10% of the carbon dioxide emissions from energy use in Germany come from the electricity needs of private households (Umweltbundesamt, 2007). Furthermore, inefficient electrical equipment accounts for a considerable percentage of electricity consumption. Anyone looking for ways to cut back on consumption can quickly find ways to save up to 30% of their outlay on energy, which equates to more than 200 euros a year. Therefore, protecting the climate can also pay off financially. An average US household consumes even more than 10 000 kilowatt hours per year. Hence, the saving potential is much higher there.



Standby Losses – Power Destruction Par Excellence

Many electrical devices work at low voltages. A transformer transforms down the mains voltage for this purpose. Most devices have a switchoff mechanism, but it usually only switches off part of the electronics in the lower voltage area. A transformer and often also major parts of the device electronics remain connected to the grid and continuously consume electricity, even when in a switched-off state. In this state they cause standby or open-circuit losses. As a result, over the course of a year a considerable amount of power can be consumed even though the appliance is not used very often. Power wasters like this can actually be identified using an energy consumption measuring device.

There are very few cases where, for technical reasons, a device should not be completely unplugged from the mains. Mains switches are a few cents more expensive than switches for the lower voltage area. When large numbers of devices are involved, a manufacturer can easily save thousands of euros without fearing a loss of sales by installing the cheaper switches. Open-circuit loss is currently not a major consideration in purchase decisions.

Computers and communication and entertainment electronics currently account for around one-fifth of electricity consumption in Germany and one-tenth in the USA. This kind of equipment often wastes obscene amounts of electricity. Many devices have high standby consumption, which means they consume electricity even when turned off. A device with standby consumption of only 5 watts uses a total of 43.8 kilowatt hours and costs 8 euros for electricity per year – just for the period when it is switched off and not being used at all. Some, usually older, devices even have standby losses of over 30 watts. On average each household in Germany wastes around 85 euros per year due to standby losses. The German federal environment office estimates that open-circuit losses in Germany cost about 4 billion euros per year and produce 14 million tons of carbon dioxide. This is more than seven times the amount of carbon dioxide emitted through energy use by the 20 million inhabitants of Mozambique.

This is something that is very easy to remedy. By using a switchable multipoint plug for their computer, television and stereo system, consumers can reduce their open-circuit losses in a switched-off state to zero. When buying new devices

or equipment, consumers should ask questions about open-circuit consumption values so that more pressure is placed on manufacturers to fit power-saving switches.

Around 10% of the electricity used in private households in Germany is for lighting (see Figure 3.4). In the USA the percentage is about the same. Here too a great deal of energy, and money, is wasted. Due to inertia and unfounded prejudice against energy-saving bulbs, millions of conventional electric light bulbs are still being used. This is not only damaging the environment but also hurting the pocket. Modern low-energy light bulbs produce the same amount of brightness using 80% less electricity. An 11-watt low-energy bulb saves about one cent an hour. If this kind of light bulb burns for two hours each day, the savings amount to seven euros a year. Over its lifetime a low-energy light bulb can save 100 euros and 300kg of carbon dioxide. Therefore, the higher purchase cost is rapidly recouped. Good-quality low-energy light bulbs also tolerate frequent on and off switching well. Tiny, dimmable light bulbs open up possibilities to all kinds of uses (Figure 3.5). A consistent approach to protecting the environment should include a gradual replacement of all light bulbs with low-energy bulbs. However, there is a growing trend to fit halogen lights. In terms of energy consumption, these lights are only marginally better than conventional bulbs and, consequently, not only expensive to buy but also to use. Energy-saving LED lights continue to be improved and will offer a viable alternative in the future.



Figure 3.4 Low-energy light bulbs save energy, carbon dioxide and cash and are now available in almost all sizes and styles. Photos: MEGAMAN, www.megaman.de.



Figure 3.5 Tiny, dimmable light bulbs open up possibilities to all kinds of uses.

Electric hot water boilers are not only inefficient but also expensive. Anyone who has an electric boiler should switch it off when leaving the house for long periods.

A considerable amount of energy can also be saved with large electrical appliances, such as washing machines, dishwashers, refrigerators and freezers. Efficiency should be an important criterion, especially in the selection of new appliances. Energy efficiency-class labels and the consumption values included with these labels provide an indication of the economy of use with different appliances.

Unfortunately, the energy-efficiency classes indicated are not always that clear at first glance. The washing machines, dryers and dishwashers with the highest efficiency are those with an A rating. With refrigerators and freezers the efficiency scale has been extended to include classes A+ and A++. The most efficient appliances in this category therefore have an A++ label. A person who chooses a refrigerator with a class A++ rating over a reasonably priced appliance in energy-efficiency class B can save 30 euros in electricity costs per year. With a 10-year lifetime for the appliance, this adds up to 300 euros. The higher price of efficient devices and appliances often pays for itself over the lifetime of the item. And the environmental benefits are greater. Compared to one in class B, an appliance in class A++ can save up to a ton of carbon dioxide.

If someone is not aware of how much energy a device or appliance is consuming, he or she can use an energy-saving monitor (available for hire or purchase) to test which appliances are energy wasters. It is advisable to take particularly inefficient appliances out of service as quickly as possible.

A savings potential also exists in the way household goods are used. If a refrigerator is standing right next to a stove, it has to work harder because of the stove's heat. Refrigerators with poor ventilation and iced-up freezer compartments also use a large amount of extra energy. A lid on a pot when cooking can save an appreciable amount of energy, as can a pressure cooker. Selecting the lowest temperature

possible on a washing machine or a dishwasher saves energy and money. With tumble dryers the laundry should first be spun at the highest spin speed available. But the good old clothesline is the best option for saving energy.

The following energy-saving tips summarize the key points discussed:

- Track energy guzzlers using an energy consumption measuring device.
- Switch off unnecessary electrical devices and lights.
- Switch off all devices with standby mode using a switchable multipoint switch.
- Replace light bulbs and halogen bulbs with low-energy bulbs (compact fluorescent lights) or LED lights.
- When buying electrical goods, pay attention to their energy consumption ratings.
- Always buy the most energy-saving household goods (energy efficiency class A, or A++ for refrigerators and freezers).
- Do not place freezers next to items that produce heat (ovens, radiators).
- Try to thaw frozen goods in a refrigerator.
- Defrost refrigerators and freezers regularly.
- Only run washing machines when they are full and operate them at the lowest possible temperature. When tumble drying clothes, use a high spin speed during the washing cycle.
- When cooking, use lids on pots and frying pans, or use pressure cookers.

3.2.2 Heat – Surviving the Winter with Almost No Heating

In many countries the lion's share of secondary energy consumption in private households goes for heating. Around three-quarters of secondary energy in households is used for this purpose. However, reducing heat in a home does not necessarily mean having to cope with frosty temperatures. With good insulation and modern building technology pleasant room temperatures can be achieved with energy savings of up to 90%. In other words, ten energy-efficient buildings can be kept warm with the same amount of energy it takes to heat the average poorly insulated old house. At the same time the carbon dioxide emissions and heating costs drop to one-tenth.

Many people live in rented accommodation. This can cause a dilemma, because energy-saving measures are usually linked to investment. This is a cost that the landlord first has to bear, with the renters becoming the beneficiaries – and because they didn't pay for the measures in the first place, they don't have any particular incentive to implement them. However, from the standpoint of saving energy, even actual homeowners lag behind when it comes to making use of the options that are available.

Yet not all energy-saving measures cost money. The following changes to heating behaviour can save a considerable amount of heat energy and, consequently, reduce heating costs:

- Do not select a room temperature that is higher than necessary. Each extra degree consumes around 6% more heat energy.
- Turn down the heat at night and when no one is at home.
- Close blinds, shutters and curtains at night.
- Avoid leaving windows open all the time to air rooms; instead briefly open windows completely a few times a day to bring in fresh air.
- Do not enclose, block or hide radiators behind curtains.

Even minor investments can help reduce energy use considerably. Appropriate measures can include draught-proofing windows and doors, and upgrading thermostat valves.

In terms of saving energy, a tremendous amount can be achieved in new-build homes or planned renovations. In the case of three-litre and passive houses, heating requirements can be slashed to as little as one-tenth of what is normally needed in conventional houses. The heating required in an average apartment block in Central Europe is around 150 to 200 kilowatt hours per square metre of living area per year ($\text{kWh}/(\text{m}^2\text{a})$). Old buildings with poor insulation can even show usage values of over $300\text{kWh}/(\text{m}^2\text{a})$. A new-build still needs around $100\text{kWh}/(\text{m}^2\text{a})$. In contrast, a three-litre house only needs $30\text{kWh}/(\text{m}^2\text{a})$, whereas a passive house gets by with even less than $15\text{kWh}/(\text{m}^2\text{a})$ (Figure 3.6). These figures can vary for other climate regions. However, in warmer countries there is a higher demand for cooling than for heating. The energy-saving possibilities with optimal insulation are similar.

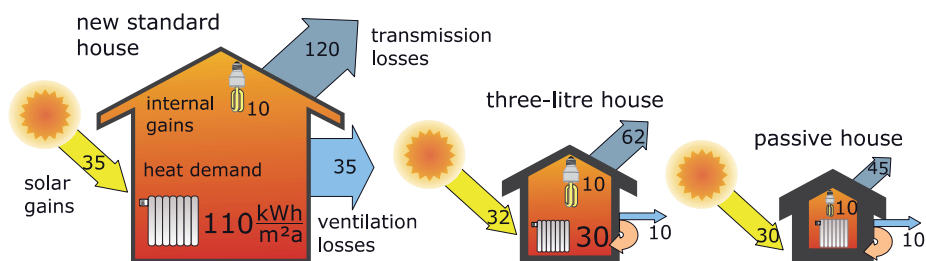

Figure 3.6 Comparison of heating requirements and heat loss in houses with different insulation standards in kilowatt hours per square metre of living area per year in Central European climates ($\text{kWh}/(\text{m}^2\text{a})$).



A Low-Energy House is Not Necessarily a Low-Energy House

Anyone interested in building a low-energy house will first have to grapple with a variety of different terms and concepts that sometimes confuse even the experts. The following should help to unravel some of this confusion.

Low-energy house – These are especially well insulated buildings that have low heating requirements. Most countries have not legally specified this concept. Normal new-builds are often unjustifiably labelled as being low-energy or energy-saving buildings.

Three-litre house – A three-litre house colloquially is a house that requires around 3 litres of heating oil per square metre of living area per year (approx. 30 kWh) in Central European climates. This corresponds to a primary energy requirement of around 60 kWh/(m²a), which also includes the efficiency of the heating system and hot water boiler.

Passive house – A passive house can manage almost without any heating at all. The annual heating requirement is less than 1.5 litres of heating oil (approx. 15 kWh) per square metre of living area. This equates to a primary energy requirement of less than 40 kWh/(m²a).

Building insulation and window type have an important effect on heating requirements (Figure 3.7). The U-value is a comparison value for the quality of heat insulation. This value indicates the heat loss per square metre of wall and window space and per degree of temperature difference between indoors and outdoors. Low U-values therefore mean low heat loss.

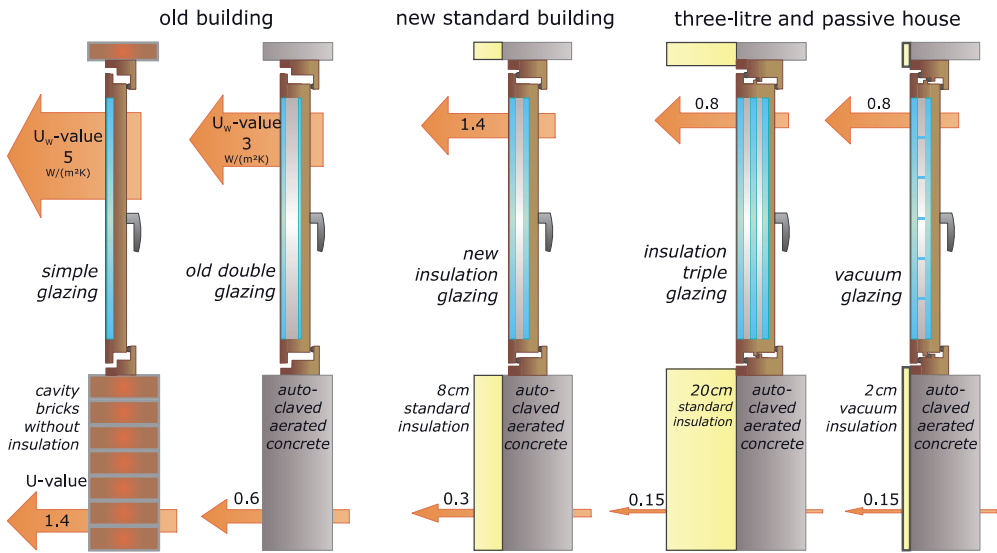

Figure 3.7 Effect of window type and insulation on heat loss.

Compared to non-insulated outer walls, walls with high-value heat insulation can achieve a reduction of the U-value by more than a factor of 10 in an optimal case. Conventional insulation against heat loss of around 20 cm would be required. This is easily achievable with prefabricated houses using wood frame construction. Vacuum-insulated materials with a thickness of around 2 cm that provides the same insulation results have recently been developed. With this type of insulation a core material of pyrogenic silicic acid is packed and evacuated into an airtight foil. It is important that the special foil of the vacuum heat insulation prevents any air from seeping in over long periods of time.

Along with the insulation of the walls, the structure of the windows is also an important element. Compared to conventional thermal double glazing, triple glazing can reduce heat loss from windows by over 40%. Vacuum glazing is a new technology on the market in which air is evacuated from the gap in the double glazing to create a vacuum. A perfectly sealed edge prevents any penetration of air. Small spacers between the layers of glass provide the necessary stability so that the exterior air pressure does not crush the two glass panels together. Spacers made of glass are hardly noticeable.

In addition to the type of glazing selected, the type of window frame is also important. The frame of a window can cause further heat loss. Therefore, for the U-value a differentiation is made between a U_G value (g for glass) for the actual glass panel and the lesser U_w value (w for window) for the complete window, including the frame. Some manufacturers only provide a general U-value. In most cases, they mean the U_G value.

Windows are not just sources of heat loss. They also let in sunlight, which in the winter helps to heat rooms. For an optimization of solar energy gain, south-facing windows in colder climates in the Northern hemisphere should be as large as possible, whereas those facing north should be smaller. Exterior shutters or blinds on the sunny side are important to prevent well-insulated buildings from becoming too hot in the summer.

Buildings with optimal insulation are comparatively airtight. For good air quality in the winter fresh air should be let into rooms frequently. But airing rooms also causes considerable heat loss. This is remedied through the use of controlled building ventilation systems (Figure 3.8). Ventilators blow fresh air into living areas and

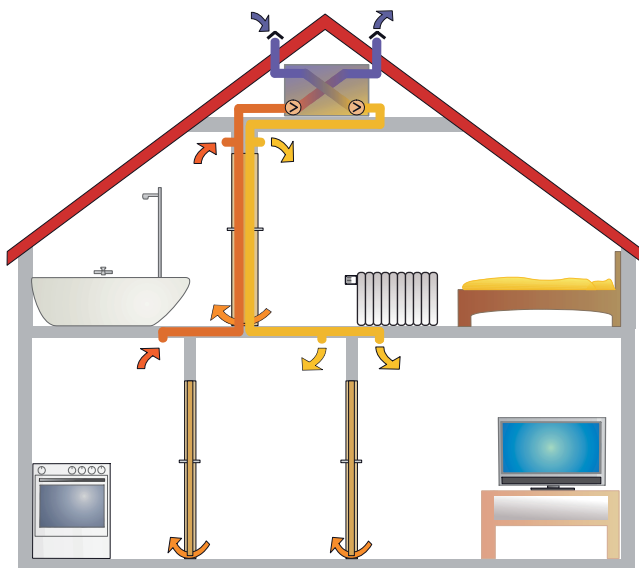

Figure 3.8 Principle of controlled ventilation with heat gain.

extract stale air from kitchens and bathrooms. The stream of fresh air is run from outside through a cross-heat exchanger past the vitiated air. The stale air emits up to 90% of its heat to the cold, fresh air from outside. So the heat remains in the building. The same system can be used to keep a building cool when outdoor temperatures are high.

Controlled ventilation is often perceived as having a negative effect on living conditions, but the opposite is actually the case. A gentle draught from such a system is barely noticeable. Constant optimal ventilation prevents dampness forming in walls or mould building up. An air filter in the ventilation system will keep out some of the pollutants in the outside air and also make it difficult for insects to get inside. Of course, anyone who feels that it is necessary can open the windows anyway – even if this is really no longer necessary from a practical point of view.

An air supply system can also be combined with a ground heat exchanger. This involves laying a pipe through the soil in the garden to supply incoming air. In winter the soil heats the fresh air and in summer it cools it.

An ultra high energy-saving house requires an outlay of additional costs, but over the years these costs pay for themselves as energy prices rise. In some countries, such as Germany, banks offer particularly good low-interest loans to promote energy-saving measures in new houses and in the renovation of old buildings. In principle, those who want to keep heating requirements carbon-neutral have the following options:

- Solar thermal systems
- Biomass heating
- Heat pumps using electricity from renewable energies
- Heating systems based on renewable hydrogen

Solar thermal systems usually supplement other types of heating. Later chapters in this book discuss these different variants in detail. As the potential for certain possibilities such as biomass heating is limited in many countries, the other options for saving energy described above should be implemented as far as possible before renewable energies are used.

3.2.3 Transport – Getting Somewhere Using Less Energy

The transport sector is responsible for about one-fifth of carbon dioxide emissions caused by energy use. Whereas it seems that major savings can be achieved relatively quickly with electricity use and in heat generation, the transport sector is more problematic. In recent years increased mobility and the travel bug have managed to cancel out any savings in the fuel consumption of cars and aeroplanes. Cheap airlines that sometimes offer plane tickets for the price of an underground fare and the trend towards petrol-guzzling SUVs are prime examples of this development. Added to this are the even longer distances involved in transporting goods around the world as a result of globalization.

Turning back the clock and reducing the number of cars, planes, trucks and ships would be a hopeless undertaking. Modern economies and modern lifestyles have become so fast-paced that they demand increased mobility. Holidays tend to be short, so air trips are necessary not to eat into travel time. Weekend breaks by air provide relaxation in hectic schedules. Our economic growth also is based on high levels of exports and reasonably priced raw materials, both of which are associated with long-distance transport.

Nevertheless, to reduce carbon dioxide emissions, we simply have to get from A to B using less energy. In the medium term, carbon-free transport must be available to cut out emissions completely.

Selecting the right means of transport is the best option for a quick reduction in energy requirements and emissions in traffic. For example, per passenger kilometre the secondary energy requirement of a train is less than one-fifth that of a car. To compare the two modes of transport, the energy consumption of the train is divided by the average number of passengers and the energy consumed recalculated into petrol.

Although the secondary energy consumption of a train is still less than that of a car by several orders of magnitude, the difference in carbon dioxide emission is not as dramatic (Figure 3.9). This is because about one-half of a train's electricity comes from coal-fired power plants that in turn produce large amounts of waste heat in generating the electricity. In Germany around 24% of a train's electricity comes from nuclear power stations and more than 10% from renewable energies. In countries that use a higher proportion of renewable energies in electricity generation, such as Norway, Austria and Switzerland, the carbon dioxide emissions of the trains are considerably lower than in Germany.

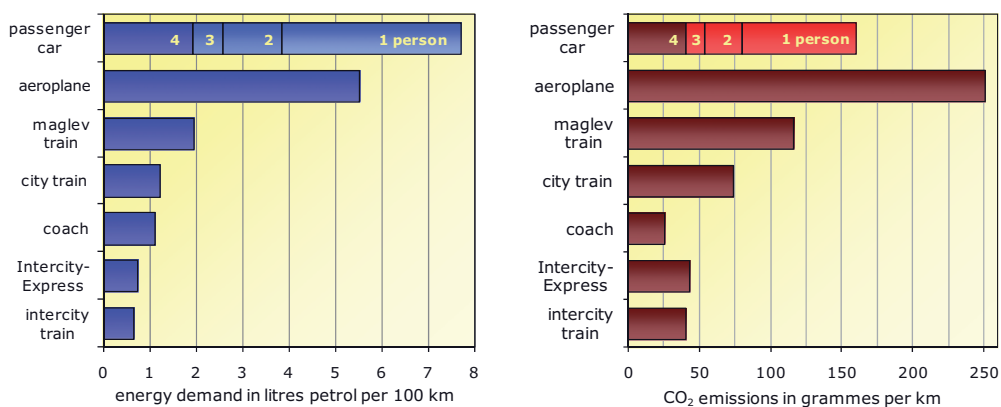

Figure 3.9 Secondary energy requirements and carbon dioxide emissions per person for different means of transport with an average use load (data for trains is estimated from the German electricity grid).

The calculations shown here are based on average values. The average carbon dioxide emissions of new cars in Europe are currently around 160g of carbon

dioxide per kilometre. Older vehicles and thirsty new cars have higher emissions, whereas economical small cars sometimes have considerably less. Carbon dioxide emissions can also be calculated based on the amount of petrol used. Emissions should be less than 80 g per kilometre by 2020 if we want to achieve the targets for saving the climate.

Not only the type of car but also the way in which it is driven has a major impact on how much petrol is consumed. The following energy-saving tips will enable savings of up to 30%:

- Check tyre pressure frequently and pump up tyres at a minimum to the pressure for a fully loaded vehicle recommended by the car's manufacturer.
- Change gear as early as possible, drive at a uniform speed and always anticipate what is ahead of you.
- Restrict maximum speed on motorways.
- Do not transport unnecessary ballast or unneeded roof luggage racks.
- Switch off air conditioning and other energy-consuming devices when they are not needed.
- For short distances try to walk or go by bicycle.



Determining Carbon Dioxide Emissions Based on Petrol Usage

Petrol $\frac{\text{Litre petrol}}{100 \text{ km}} \times 23.7 \frac{\text{g CO}_2}{\text{Litre petrol}/100} =$ $\frac{\text{g CO}_2}{\text{km}}$

Diesel $\frac{\text{Litre diesel}}{100 \text{ km}} \times 26.5 \frac{\text{g CO}_2}{\text{Litre diesel}/100} =$ $\frac{\text{g CO}_2}{\text{km}}$

The capacity utilization of a car has the biggest effect on energy use. On average three to four seats in a car are empty when it is being driven. With four people in a vehicle and careful driving, the carbon dioxide emitted per person can be even lower than with a train.

Capacity utilization also plays an important role with other forms of transport. As the capacity utilization of public local transport is on average lower than that of long-distance travel, the rate of carbon dioxide emissions is also higher. A coach filled to capacity is particularly economical in energy use. In contrast, heavy fast trains such as France's TGV can consume surprisingly high amounts of energy.

Air traffic produces the highest carbon dioxide emissions. Long-haul flights cause the most harm to the climate, because the exhaust gas of planes is more damaging when emitted at high altitudes. If this factor is calculated into carbon dioxide emissions, these rise to 400 g per kilometre.

The car industry is investigating numerous solutions to enable climate-neutral mobility in the medium and long term. These include:

- Biofuels
- Electric cars using renewable electricity
- Transmissions based on renewable hydrogen

Although the natural gas vehicles currently being marketed emit slightly lower levels of carbon dioxide than before, they really do not offer an alternative for protecting the climate worldwide. Biofuels may be able to replace oil relatively easily and are sometimes added to conventional fuels. However, the problem is that not enough biomass is available to provide an adequate supply. Even if all the farmland in places like Germany and Britain were used to plant the raw materials needed for biofuels, this would not come close to covering the current fuel needs of motor vehicles in those countries. On closer inspection, even renewable hydrogen poses some problems. (Biofuels and hydrogen will be covered in detail in Chapters 12 and 13, respectively.)

Until now the main obstacle to electric cars has been limited battery life. Long charging times and the short distances that can be driven on a single charge are preventing the widespread use of these cars. Considerable progress is currently being made in battery development, which could eventually make electric cars a viable option. However, these cars cannot offer a real alternative for saving the climate unless the electricity used to charge the batteries is also sourced from renewable power plants.

3.3 Industry and Co – Everyone Else is to Blame

It's widely believed that industry and the energy companies are mostly to blame for greenhouse gas emissions and so private individuals can't do much about the problem. But looking at the situation more closely, one sees that they are only complying with what the customers want. Therefore, in the final analysis it is the consumers who are responsible for the emissions because of the products they are demanding.

If all electricity customers were to change to suppliers or tariffs that only offer electricity from renewable energies, the power supply would very quickly be free of carbon dioxide. The only problem the energy suppliers would then have is being able to build enough renewable power plants as quickly as possible to accommodate all the sudden demand.

Due to their choice of products, consumers are failing to put pressure on the right places for a sustainable type of economy. The production of any type of product – whether a food item or consumer goods – requires energy and therefore causes carbon dioxide emissions. The higher one's personal consumption, the higher the use of energy and the higher the carbon dioxide emissions. Yet even those who swear off consumption completely will not be able to reduce their energy needs to zero, because food production produces quite high emissions.

Each consumer can have an important impact on indirect energy consumption through product selection:

- Try to buy only high-quality and durable products.
- Give preference to regional products.
- Select products that require less energy during the manufacturing process and produce lower emissions.
- Give preference to companies with environmentally friendly policies.

3.4 The Personal Carbon Dioxide Record

Even if users follow all the energy-saving tips provided, they will probably find that the carbon dioxide emissions they are responsible for are still quite high. This section enables readers to do a self-assessment by explaining how to calculate the carbon dioxide emissions an individual can personally cause.

3.4.1 Emissions Caused Directly by One's Own Activities

The easiest way to determine which emissions are the result of one's own activities is to look at how much oil, natural gas, petrol and electricity one has used. It is relatively simple to establish the amount of energy consumed per year by checking bills and invoices.

- Annual electricity bill
- Heating bills
- Number of kilometres driven and average petrol consumption
- Kilometres travelled using public transport
- Number of miles flown

Based on this information, the following calculation method can be used to determine the emissions resulting from one's own activities.

Specific consumption values may have to be adapted to a person's own particular circumstances. In electricity generation in Germany on average 0.616 kg of carbon dioxide are produced per kilowatt hour (kg CO₂/kWh) of electric power. The value in the USA is roughly the same. Those who get green electricity from renewable power plants can cut their emissions from electricity consumption to zero.





Emissions from heating can vary considerably. If heat is generated electrically, the emissions are the same as for the electricity. With modern natural gas heating 0.2 kg CO₂/kWh of heat is created; with modern oil heating it is 0.28 kg CO₂/kWh. With old, inefficient heating systems the emissions can rise from 0.25 to 0.35 kg CO₂/kWh. Heating with biomass at most generates indirect carbon dioxide emissions due to processing and transport. With wooden pellets the value is around 0.06 kg CO₂/kWh.

The carbon dioxide emissions specific to a person's own car can be calculated on the basis of average fuel consumption (see Planning Help, above). With air travel

an emissions calculator makes it relatively easy to calculate emissions precisely, according to air route.



A. Calculation of Annual Private Direct Carbon Dioxide Emissions

A.1	 electricity	$\frac{\boxed{} \text{ kWh}}{\boxed{} \text{ persons}}$	x	$\boxed{} \frac{\text{kg CO}_2}{\text{kWh}}$	=	$\boxed{} \text{ kg CO}_2$
A.2	 combustibles	$\frac{\boxed{} \text{ kWh}}{\boxed{} \text{ persons}}$	x	$\boxed{} \frac{\text{kg CO}_2}{\text{kWh}}$	=	$\boxed{} \text{ kg CO}_2$
A.3a	 passenger car	$\frac{\boxed{} \text{ km}}{\boxed{} \text{ persons}}$	x	$\boxed{} \frac{\text{kg CO}_2}{\text{km}}$	=	$\boxed{} \text{ kg CO}_2$
A.3b	 public transp.	$\frac{\boxed{} \text{ km}}{\boxed{} \text{ persons}}$	x	$\boxed{} \frac{\text{kg CO}_2}{\text{km}}$	=	$\boxed{} \text{ kg CO}_2$
A.3c	 airplane	$\frac{\boxed{} \text{ km}}{\boxed{} \text{ persons}}$	x	$\boxed{} \frac{\text{kg CO}_2}{\text{km}}$	=	$\boxed{} \text{ kg CO}_2$
						<hr style="border: 1px solid black;"/> $\boxed{} \text{ kg CO}_2$ <hr style="border: 1px solid black;"/>



■ https://www.atmosfair.com/index.php?id=5&no_cache=1&L=3

Atmosfair emissions calculator for air trips

3.4.2 Indirectly Caused Emissions

In addition to the emissions a person has caused directly, everyone is also indirectly responsible for other emissions. Energy is consumed in the production, processing and transport of foodstuffs, consumer goods and other products, and this in turn causes carbon dioxide emissions.

The public sector, including government offices, schools, the police, the fire brigade as well as the departments responsible for roadwork, also needs energy and therefore causes carbon dioxide emissions. About one-sixth of emissions are attributed to public consumption. This is an area where there are not many possibilities to make personal reductions.

About 1.2 tons of carbon dioxide per person are produced every year due to our individual food consumption. Figure 3.10 compares the greenhouse gas emissions of different foodstuffs. In addition to carbon dioxide, the chart takes into account

3 From Wasting Energy to Saving Energy and Reducing Carbon Dioxide

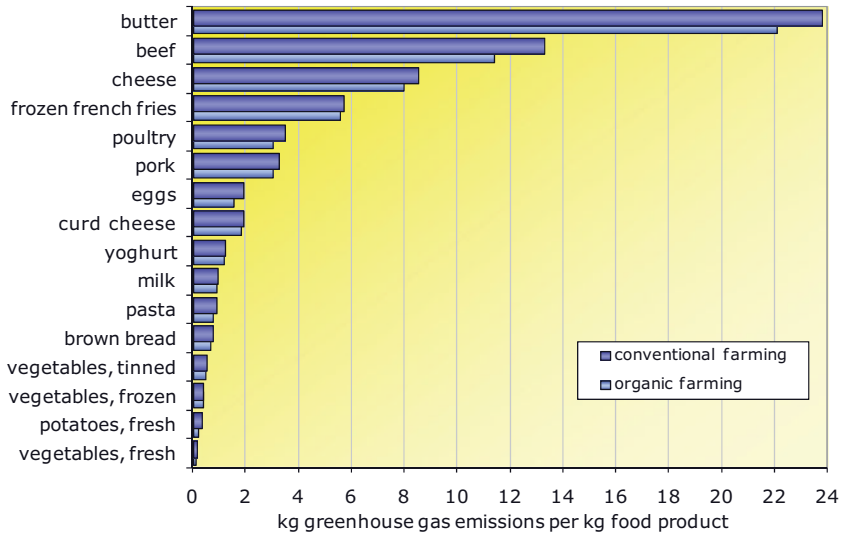

Figure 3.10 Greenhouse gas emissions converted into carbon dioxide equivalents for the production of different foodstuffs. Data: (Fritsche and Eberle, 2007).

other greenhouse gases such as methane and nitrous oxide and converts these values into carbon dioxide equivalents according to how harmful they are to the environment. Beef, butter and cheese do not come out favourably. Ruminant cows release large amounts of methane that have a high greenhouse effect. Subsequent freezing of the meat also adds to the energy toll, so that people who prefer frozen meat to fresh meat increase greenhouse gas emissions by another 10 to 30%.

The amount of processing that food requires also has a considerable effect on the climate. For example, fresh potatoes hardly tip the scales of greenhouse gas emission. However, the energy-intensive further processing required to make frozen French fries increases the greenhouse gas emissions contained per kilogram of food almost 30 times.

As women normally eat less than men and older people eat less than young people, clear differences exist from person to person. Going on a permanent diet is certainly not the right approach to reducing carbon dioxide emissions. However, people who buy seasonal products from local organic farms, reduce their consumption of meat and largely avoid tinned and frozen foods can significantly reduce emissions resulting from food intake. Reductions of up to 30% can easily be achieved this way. However, those who need a large number of calories because they do a lot of physical work or sport, and then obtain these calories mainly from frozen products and fast foods, could find they double their greenhouse gas emissions just from what they eat.

Personal consumption is responsible for around 2 to 3 tons of carbon dioxide. This is mostly from the production, storage and transport of all products that do not fall under the category of food supply. Included in this group are clothing, furniture, machines and equipment, paper products, cars and housing.



Each German uses about 240kg of paper each year, each Briton 200kg or more, and each US citizen around 300kg. The production of 1kg of new paper produces about 1.06kg of carbon dioxide. This means that almost 10% of personal consumption is attributed to the use of paper. The energy consumption with the production of recycled paper drops by around 60% and the carbon dioxide emissions by about 16%. Whereas recycled paper was very popular in the 1980s, many distributors no longer carry it at all – even though its benefits to the environment have not changed. The reason is weak demand on the part of the consumer because of unfounded claims that recycled paper destroys printers and copiers and is even damaging to one's health.

The rule generally is that anyone who is a consumer is also contributing to high emissions. On average around 4 to 5 kg of carbon dioxide are created for each euro spent by consumers. Here too there are many ways to make reductions. High-quality long-life products almost always produce low amounts of carbon dioxide. Although they are usually more expensive initially, in the long run they actually protect the wallet as well as the environment because of their long useful life. Increasing the use of natural materials may not always be less expensive but it does usually reduce greenhouse gas emissions. For example, building a new solid house is almost as expensive as putting up a prefabricated house. However, if wood frame construction is used for the prefabricated house, the additional use of wood as a building material will save around 20 to 30% in carbon dioxide emissions. As a result, the savings potential quickly runs into several tons.

In the following calculation method, the indirectly caused greenhouse gas emissions can be inserted in the spaces shown.



B. Calculation of Annual Indirect Carbon Dioxide Emissions

B.1		public consumption	<input style="width: 100px; height: 20px;" type="text"/> kg CO ₂
B.2		nutrition	<input style="width: 100px; height: 20px;" type="text"/> kg CO ₂
B.3		private consumption	<input style="width: 100px; height: 20px;" type="text"/> kg CO ₂
			<input style="width: 100px; height: 20px;" type="text"/> kg CO ₂
			<input style="width: 100px; height: 20px;" type="text"/> kg CO ₂



3.4.3 Total Emissions

Once the personal direct and indirect emissions have been determined, they can be added up to get a figure for all personal carbon dioxide emissions. Somewhat more than 10 tons of carbon dioxide are generated on average per head in Germany each

3 From Wasting Energy to Saving Energy and Reducing Carbon Dioxide

year. In Great Britain the figure is 8.9 tons and in the USA more than 19 tons. If other greenhouse gases, such as methane and nitrous oxide, are taken into account and converted into carbon dioxide equivalents based on how damaging they are to the climate, then the total greenhouse gas emissions in Germany increase to more than 12 tons per head per year. These results are, however, limited to carbon dioxide.



C. Calculation of Annual Total Personal Carbon Dioxide Emissions

A		private direct carbon dioxide emissions	<input type="text"/> kg CO ₂
B		indirect carbon dioxide emissions	<input type="text"/> kg CO ₂
			<input type="text"/> kg CO ₂

An even more precise calculation of personal emissions can be made using the emission calculators on the Internet. Figure 3.11 enables a comparison of one's own carbon dioxide emissions with the reduction targets and emissions of other countries. The colour scale in the figure shows how the emissions should be evaluated.

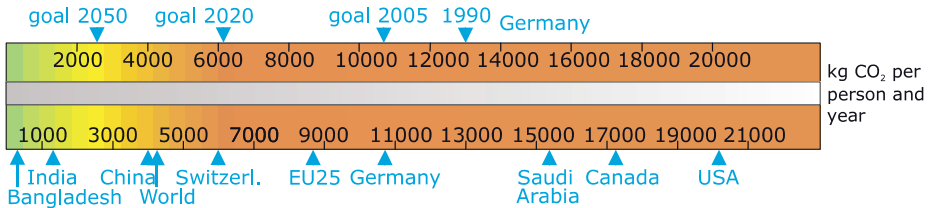

Figure 3.11 Scale of emissions of carbon dioxide per head and year.

If possible, global carbon dioxide emissions should be halved by the middle of the century. This means that in the meantime the activities of each inhabitant are allowed on average to produce less than 2000 kg of carbon dioxide.



- https://www.lfu.bayern.de/luft/fachinformationen/co2_rechner Online CO₂ calculator for Germany
- https://www.epa.gov/climatechange/emissions/ind_calculator.html US Personal Emissions Calculator
- <https://www.nef.org.uk/greencompany/co2calculator.htm> UK Simple Carbon Calculator

3.5 The Sale of Ecological Indulgences

We may be able to make major reductions in our own direct and indirect emissions. However, in most industrialized countries it will still be relatively difficult to move emission levels into the 'green' zone. Some emissions, such as those related to public consumption, lie well beyond one's personal sphere of influence. Other reductions can only be achieved through radical changes in lifestyle or relatively high investment.

People who still want to make further reductions can use the emissions trade to compensate for their own emissions. This idea is even being practised on a large scale by states that want to reduce their overly high emissions as part of their commitment at the international level. The modern emissions trade is slightly reminiscent of the Medieval church's practice of selling indulgences. However, as the expression 'sale of indulgences' has negative connotations, the term joint implementation (JI) was invented.

Whatever is planned on a grand scale at the state level, and has partially already been implemented, can also be done in the private sphere. For instance, you could give your neighbour an inexpensive low-energy light bulb as a gift. This bulb could save up to 300 kg of carbon dioxide emissions over its lifetime. If you gave away enough low-energy light bulbs, you could conceivably save your total emissions in another area – at least theoretically. The actual personal emissions continue to accumulate and would then have to be transferred to the emission results of your neighbour. In pure calculation terms, the neighbour's emission results would remain constant. However, if the neighbour's emissions are also too high, he will not have an easy option for reducing his emissions himself. Furthermore, due to the savings in electricity costs, the neighbour will end up with more money in his household budget. If he then invests this money in a couple of litres of petrol for an extra jaunt in the car, then the whole exercise has ended up being highly counterproductive.

The situation is different if a low-energy light bulb is given to a school in a developing country with emissions in the green zone. In this case the gift of the light bulb will reduce already low emissions even further. Naturally the prerequisite even here is that the school is not in a position to buy the bulb itself. If the school is already planning to buy a low-energy bulb as an example of reducing electricity costs, the bulb given as a gift will not really represent a savings effect. Practised on a large scale, this type of investment is called Clean Development Mechanism (CDM).

The following criteria should be included to ensure the success of climate protection projects:

- Carbon dioxide reductions through financing renewable energy plants or energy-saving activities.
- Implementation of an additional measure that would not necessarily have been carried out during the lifetime of a project.

- Guarantee of successful project implementation and plant operation during the entire project.
- Ongoing development and technology transfer after project completion.

It is difficult for a private individual to meet these criteria. However, various companies offer professional services for implementing climate-protecting projects. Even major projects are possible if a large number of customers join forces. However, an independent auditing authority should always be available to monitor that the process is being followed correctly (Figure 3.12). Atmosfair is an example of a company that offers a programme for offsetting emissions from plane trips. One of the projects in their programme involved replacing diesel stoves in large kitchens in India with solar mirrors.

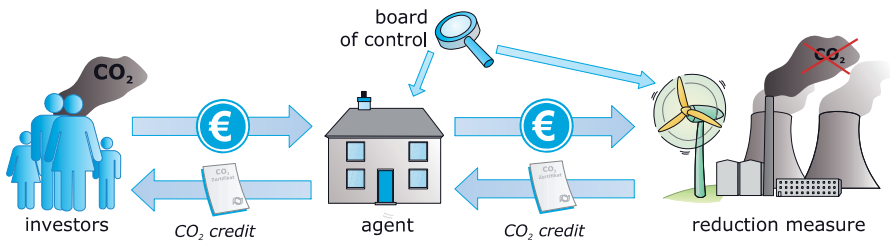

Figure 3.12 Principle of private trade in emissions.

Currently about 20 to 30 euros should be allocated to compensate for the emission of 1000kg of carbon dioxide with clean development projects. Thus it will cost a person 10 euros each month to prevent the emission of 5000kg per year. Protecting the climate is really not that expensive.



- www.atmosfair.com
- www.co2ol.de
- www.carbonneutral.com

Different suppliers for reducing carbon dioxide emissions through climate-protection projects

Naturally emissions can be offset through renewable energy projects at home. In countries such as Germany, for example, anyone who invests in a wind farm in a good location or installs a large photovoltaic system on an optimally orientated roof can even make a small profit. Germany's renewable energy law makes this possible. This law establishes the subsidy levels for electricity from renewable energy suppliers, such as wind farms, photovoltaic systems and biomass, geothermal and hydropower plants. These subsidy levels are normally higher than regular subsidies for electricity from conventional power plants. The energy supply company into whose grid the plants feed their electricity is allowed to split the extra costs among all its electricity customers (Figure 3.13). This means that all customers – whether

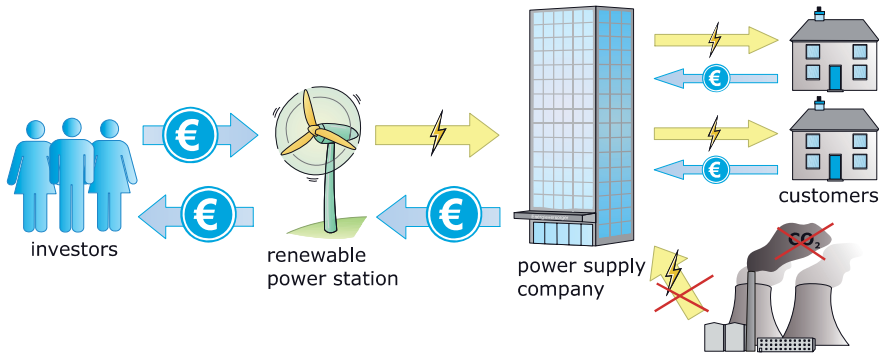

Figure 3.13 Principle of financing renewable power plants through the renewable energy law in Germany.

they want to or not – are helping to finance the renewable energy plants. The burden on the individual customer is therefore kept to a minimum. As a result of the renewable energy law in Germany, in 2008 the allocated extra costs of all renewable power plants amounted to around 1.10 euros per month per person.

The German renewable energy law is the most successful instrument worldwide for promoting the rapid development of renewable energy. It aims to involve everyone equally in the social task of restructuring the energy sector – be it as investor, operator of renewable energy plants or financier for the reimbursement of electricity from existing plants.

4

4 Carbon-Free Energy – Vision or Utopia?

Most of us who have calculated our personal carbon footprint have made the sobering discovery that our personal emissions are far too high. As the previous chapter shows, savings can be made in different areas. However, in most cases the possibilities open to individuals for reducing greenhouse gas emissions still do not make them nearly green enough. Investments in renewable energies can help to reduce emissions somewhere else. The climate can only be saved if in the long term all countries on earth reduce their greenhouse gas emissions to almost zero. However, there are many among us who just cannot imagine life without oil, natural gas and coal.

Yet a mere 300 years ago renewable energies made up the earth's entire energy supply. It is quite certain that the world's energy supply will once again be completely carbon-free 200 years from now. By then the last deposits of fossil energy sources will have been exhausted. As a result of an almost 500-year history of fossil energy use, the climate would have totally collapsed by then. If we want to prevent this happening, we must convert to carbon-free energy supplies long before then. At most we have about 100 years in which to do this (Figure 4.1).

4.1 Options for Carbon-Free Energy Supply

4.1.1 Efficient Power Plants – More Power with Less Carbon Dioxide

Representatives from the electricity sector like to quote efficiency gains in power plants as important milestones in the effort to achieve efficient climate protection.

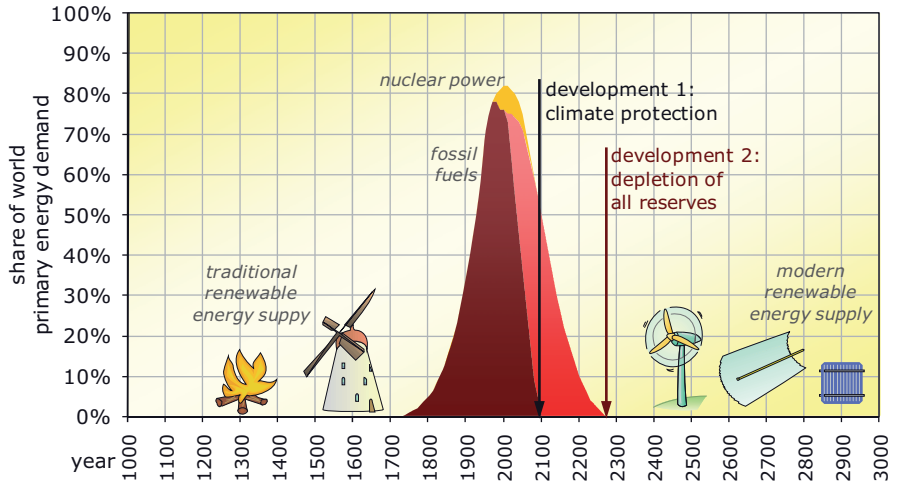

Figure 4.1 Development of the share of different energy sources in world primary energy demand and two future development possibilities.

In reality, enormous quantities of carbon dioxide could be saved if old ailing and poorly performing power plants were replaced with ultra-modern ones. Whereas old brown coal plants usually reached an efficiency of less than 40% in electricity production, new plants can easily reach 43%. Technically, efficiency of 48 to 50% is possible.

For example, with an efficiency of around 35%, the Jänschwalde power plant near Cottbus in Germany is one the oldest and most inefficient large power plants in eastern Germany (Figure 4.2). With an output of about 25 tons of carbon dioxide per year, this plant alone produces about 3% of all carbon dioxide emissions caused by energy use in Germany.



Figure 4.2 Jänschwalde brown coal power plant and opencast mining near Cottbus.

The newly built BoA 2/3 Neurath power plant on the edge of the city of Grevenbroich in Germany uses optimized technology and is an example of the efficiency that can be reached in a power plant. The 2.2 billion euro plant with efficiency of over 43% will be replacing some older power plants in 2010, thereby saving around 6 million tons of carbon dioxide per year. The main problem, however, is that the power plant will continue to emit around 14 million tons of carbon dioxide every year. As an example, this is far higher than the total carbon dioxide emissions caused by the 35 million people in Kenya. With an average lifetime of 40 years, even a large, efficient power plant quickly develops into an obstacle to progress when it comes to effective climate protection. By the time the Neurath power plant is supposed to be disconnected from the grid in 2050, industrialized countries like Germany should have achieved an 80% savings in carbon dioxide emissions overall. This is a level that not even the most efficient power plants can achieve. As with nuclear power plants, it is even possible that fossil power plants will be taken out of service earlier than planned to enable targets for climate protection to be met.

Another problem with coal-fired power plants is that they are relatively difficult to regulate. Brown coal-fired plants are usually designed for a base load. This means they work optimally when they are providing constant output for long periods of time. However, due to the increased use of wind power and solar energy plants, fluctuations in power are increasing in the grid. Building new coal plants does not make a great deal of sense for this reason alone.

4.1.2 Carbon Dioxide Sequestering – Away with Carbon Dioxide

As even a medium-term increase in efficiency in fossil power plants does not offer an alternative to the supply of climate-compatible energy, supporters of fossil energy plants have looked for arguments and ways to avoid coming under even more fire because of the damage caused to the climate.

Carbon dioxide sequestration is suggested as a way out of the dilemma. The idea behind it is simple and at first glance also appears highly plausible. The idea is that power plants of the future will no longer emit the carbon dioxide that occurs with the burning of coal and natural gas into the atmosphere but instead capture and store it in a safe place (Figure 4.3).

The following options are promising for the safe disposal of carbon dioxide:

- Manufacture of carbon-based building materials by the construction material industry.
- End-storage underground in depleted fossil deposits, in aquifers and in salt beds.
- Compression or dissolution in the ocean.
- Bonding through special algae in the ocean.

However, a critical examination of the options available produces some doubts that put a question mark on the disposal of carbon dioxide in general. The technology for sequestration and storage is still at the research stage. It will be several years

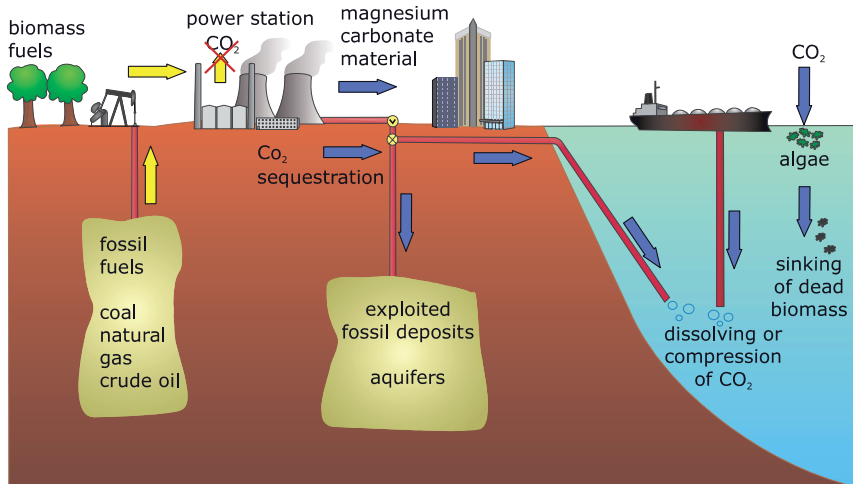

Figure 4.3 Options for end-storage of sequestered carbon dioxide.

until it is actually available to commercial installations. Currently only studies and prototype facilities exist. Commercial introduction is envisaged for the year 2020 (Vattenfall Europe, 2006). However, those promoting climate protection are demanding carbon dioxide savings of 40 to 50% by that time. Just from the standpoint of time this will not be possible with carbon dioxide sequestration. Furthermore it will be very difficult – if even possible – to upgrade the old power plants that would have been built in the meantime.

Carbon Dioxide-Free Coal-Fired Power Plants – Not Really Free of Carbon Dioxide



With the development of technologies for the sequestration and storage of carbon dioxide, grandiose claims are made that power plants will one day be carbon dioxide-free. Strictly speaking, however, even carbon dioxide retention techniques can never make a fossil power plant free of carbon dioxide. The burning of fossil energy sources in these power plants inevitably produces carbon dioxide. So-called carbon dioxide-free fossil power plants only separate carbon dioxide from other combustion gases so that it can be stored ultimately in a concentrated form outside the atmosphere. Carbon dioxide also escapes inadvertently during fuel processing, sequestration and storage. In the long term up to 10% of carbon dioxide, and in individual cases even more, reaches the atmosphere again.

The term ‘carbon dioxide-free coal-fired power plant’ is therefore misleading. A company in the solar sector actually sued an energy supply company for misrepresentation over its claims that carbon dioxide-free power plants were being built in Germany. The court ruled in favour of the solar company. Whether or not fossil power plants with carbon dioxide separation are carbon dioxide-free in legal terms is likely to be examined by other authorities.

Controversy also surrounds end-storage in the ocean. The possibility exists that the carbon dioxide will escape again into the atmosphere after a short period or will have an extreme but not yet identifiable effect on the ecological system of the oceans. This is an area that generally still requires extensive research. Other types of storage areas are not available everywhere or would quickly be exhausted. If all power plants in the world were required to dispose of their carbon dioxide in a way that would not damage the climate, it would take an enormous logistical effort to transport the carbon dioxide over what could sometimes be thousands of kilometres to end-storage depositories.

Probably the most important argument against global sequestration of carbon dioxide is the economic viability of doing so. Carbon dioxide sequestration generally reduces the efficiency of a power plant. Added to this is the cost of the transport and end storage of the carbon dioxide. It is difficult at present to estimate the exact cost involved. Many estimates predict that the cost increases for electricity from fossil power plants would be up to double present values (Intergovernmental Panel on Climate Change, 2005). For many countries in the world this would rule out even the possibility of carbon dioxide sequestration. In contrast, cost estimates for renewable power plants show that in many locations they would prove to be more economical than fossil power plants within a relatively short period – regardless of whether or not they have carbon dioxide sequestration.



■ www.ipcc.ch/ipccreports/srccs.htm

Background information on CO₂ separation and storage

4.1.3 Nuclear Energy – Squeaky Clean

Almost every discussion on climate ends up looking at nuclear energy as a possible saviour. The arguments against nuclear energy have already been explained in detail in previous chapters of this book. Even if the very conflicting evaluated risks of nuclear energy are disregarded, this solution does not offer an option for effective climate protection in the medium term. The main reasons for this are:

- The proportion of nuclear energy in the global primary energy supply is only around 6%. In terms of final energy consumption, the proportion is considerably lower.
- The amount of uranium that can be extracted economically is very limited. The price of uranium has already increased significantly in recent years.
- Nuclear energy plants are difficult to regulate and therefore are not suitable for joint operation with wind power and solar plants.
- Although nuclear energy is practically carbon-free it gives rise to other risks, such as nuclear accidents, terrorist attacks and the unresolved question of end storage.
- Nuclear fusion will not be ready for use for several decades and thus too late to save the climate; it is also difficult to regulate and is extremely expensive.

4.1.4 Combined Heat and Power – Using Fuel Twice

When it comes to increasing efficiency, combined heat and power (CHP) is often promoted as a promising candidate. Using electricity generated by conventional steam turbine power plants that burn brown and hard coal, the level of efficiency is between 35 and 45%. Modern gas and steam turbine power plants that use natural gas achieve up to 60%. However, this means that at least 40% of the primary energy fizzles out unused through the cooling tower of the power plant.

CHP, or cogeneration, plants use the heat from electricity generation effectively and are able to exploit up to 90% of the fuel. As a result, in an optimal case less carbon dioxide is produced than when electricity and heat are generated separately.

Many comparisons of cogeneration power plants that generate heat and electricity separately using fossil fuels show possible carbon dioxide savings of up to 50%. However, these comparisons usually pit CHP plants against antiquated electricity plants. If the comparison is made on the basis of optimal functioning plants on both sides, the carbon dioxide savings are reduced to a meagre 15 to 20% (Figure 4.4) – too little to save the climate. Furthermore, these savings are only possible with optimal plant operation. For example, in summer when a cogeneration plant is only supposed to generate electricity but not heat, it will have great difficulty in even coming close to the dream efficiency level of 90%. A cogeneration plant can sometimes end up producing even more carbon dioxide than a straightforward electricity power plant.

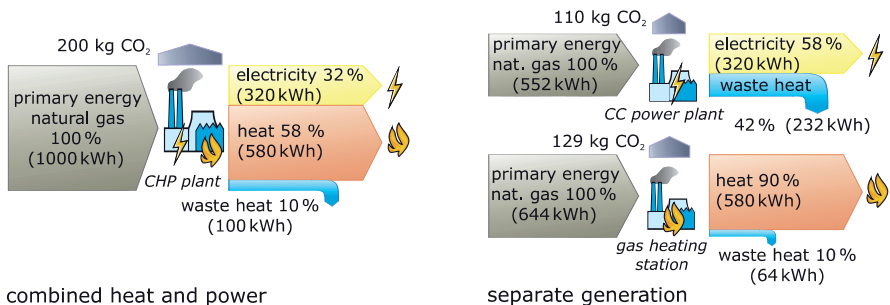

Figure 4.4 Comparison of primary energy requirements and carbon dioxide emissions between power-heat coupling and separately generated heat and electricity in modern power plants.

If, on the other hand, a sufficient requirement for heat exists over the entire year, cogeneration plants can help to reduce carbon dioxide. With cogeneration plants that use fossil fuels the savings for effective climate protection are too low. Those that use renewable energy sources, such as biomass and geothermal energy, are totally carbon-free and can continue to accelerate the switch to carbon-free energy supply.

4.1.5 Saving Energy – Achieving More with Less

As the last chapter showed, the options for saving energy are enormous – at least in industrialized countries like Germany. The situation is different in developing countries. Someone who does not even own an electric light bulb and lives in a house without heating will be in no position to save energy through energy-saving bulbs or building insulation. Figure 4.5 shows that per capita energy requirements generally increase with the per capita gross domestic product (GDP), which roughly mirrors the prosperity of a country.

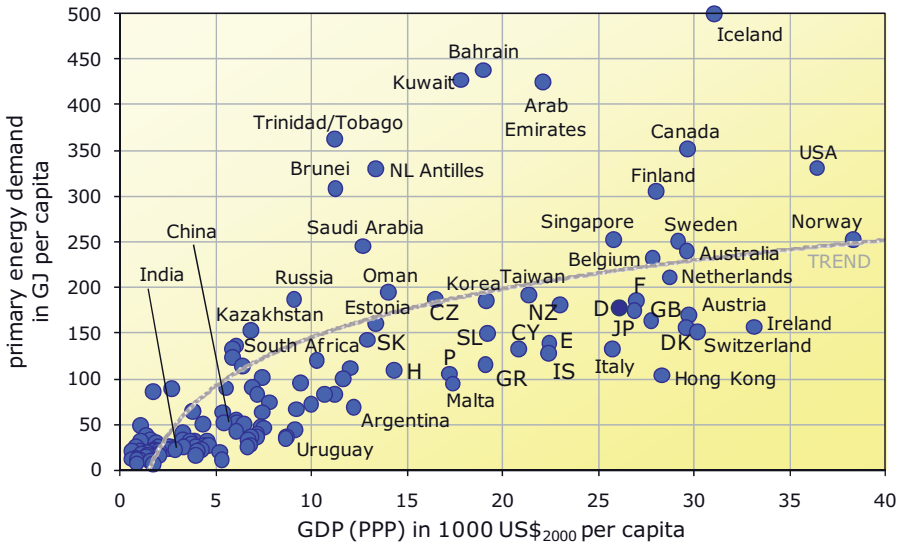

Figure 4.5 Per capita primary energy consumption based on gross domestic product (GDP) according to the purchasing power parity method (PPP) for different countries.

The differences between countries with the same GDP per inhabitant are considerable. Whereas the GDP per inhabitant in Canada and in Switzerland is almost identical, a Canadian consumes far more than double the primary energy of a Swiss person. In addition to the way people live and how they handle energy, the climate conditions and industrial structure of a country also play an important role in energy consumption. However, having high energy needs does not automatically equate to high greenhouse gas emissions. Although the per capita energy requirement of Iceland is clearly higher than that of Canada, its carbon dioxide emissions are substantially lower. This is due to the fact that Iceland covers most of its energy requirements carbon-free using hydropower and the natural heat of the earth.

Many countries in the world have a low level of prosperity and, consequently, a low demand for energy. Once the per capita energy requirements of China and India reach the same levels as Great Britain or Germany, this alone will more than double global demand. Considering the high growth rates of both countries, this would

seem to be only a matter of time. If the industrialized countries halve their energy needs in the meantime and the developing countries follow our example, this would help considerably in slowing down the rise in energy requirements.

Along with the growing per capita energy requirements in developing and emerging countries, the continuous rise in the world's population is also adding to the steady increase in energy demand. Between 1960 and 2000 the world population doubled, and energy requirements tripled. Worldwide energy demand has been increasing almost as quickly as the population since 1980 (Figure 4.6). If the world population continues to climb at this rate and reaches nine billion by 2050, this alone will mean a 50% increase in energy demand – even without any increase in per capita energy requirements.

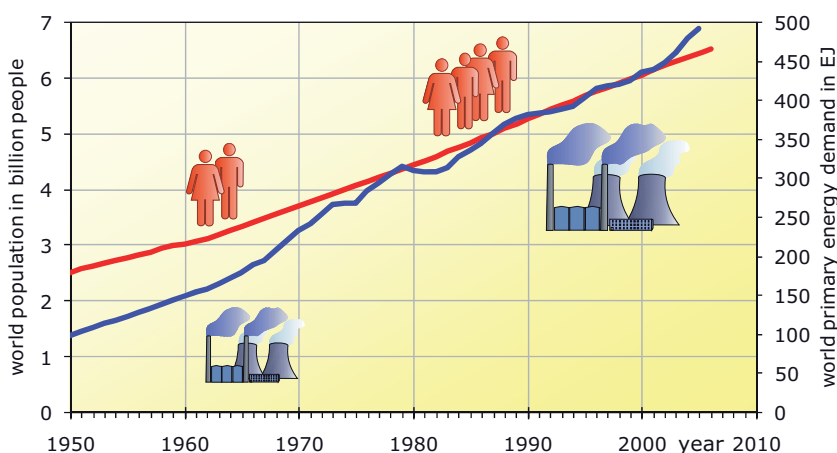

Figure 4.6 Development of worldwide primary energy demand and increase in world population.

These facts clearly show that energy-saving measures are enormously important in at least putting a brake on the increasing demand for energy worldwide. However, these measures alone will not be enough to achieve a major reduction in worldwide greenhouse gas emissions over the next 50 years. Along with implementing every conceivable measure to save energy, the most important thing will be to ensure that those energy requirements that cannot be eliminated are at least carbon-free. There is also a comprehensive solution to this: renewable energies.

4.2 Renewable Energy Sources – No End to What is Available

The options for supplying climate-compatible energy discussed above offer only limited possibilities for reducing carbon dioxide. The situation is totally different with renewable energy sources: these offer us almost unlimited potential.

Each year the sun radiates 1.5 quintillion kilowatt hours of energy towards the earth. The atmosphere swallows up around 30% of this energy but over one quintillion kilowatt hours are still able to reach the earth’s surface. Our current primary energy needs are around 125 trillion kilowatt hours worldwide. By the way, a quintillion is a 1 with 18 zeros, and a trillion has 12 zeros. Therefore, the amount of energy that reaches the earth’s surface from the sun each year is 8000 times more than the total primary energy requirement of the world. So we only need to use about one hour’s worth of the solar energy that reaches the earth’s surface in order to cover the energy needs of the whole of mankind for a whole year.

Natural occurrences convert some of the sun’s energy into other renewable forms of energy, such as wind, biomass and hydropower. In addition to these energy forms, we are also able to use the natural heat of the earth as well as tidal power derived from the motion of the moon in conjunction with other planets. All sources of renewable energy combined exceed the total fossil and nuclear fuels available on earth many times over (Figure 4.7). In less than one day the sun radiates more energy to the earth’s surface than we could ever use if we were to burn all the oil reserves available on earth.

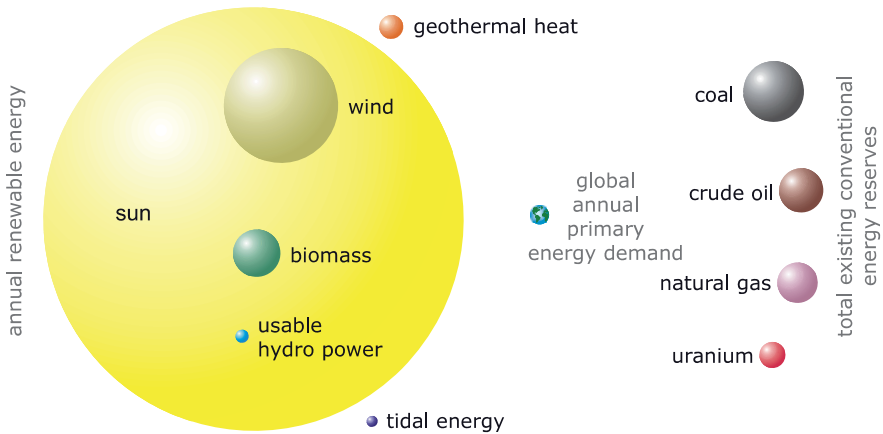

Figure 4.7 Comparison of annual renewable energy available and global primary energy requirement with the total existing conventional energy sources on earth.

In discussions on climate, some critics question whether renewable energies are even able to cover our energy requirements. But a brief glance at the facts just mentioned shows that these doubts can safely be cast aside. The variety of possible uses of renewable energies is enormous. A number of different types of power plants can provide almost any amount of electricity, heating or fuel desired (Figure 4.8). The following chapters of this book will present in detail the key technologies for using renewable energies.

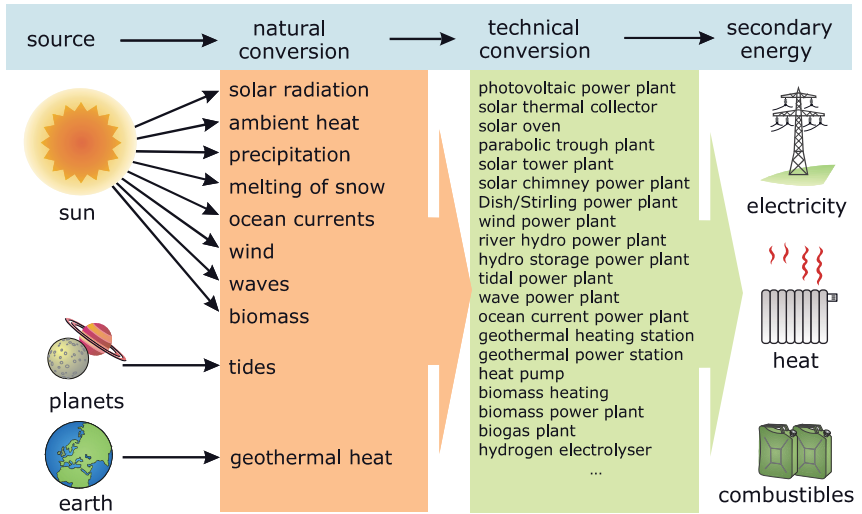

Figure 4.8 Sources of and possibilities for using renewable energies.

4.3 Options for Protecting the Climate

A typical scenario for protecting the climate of a country like Germany should first show the options available to make the energy supply carbon-free quickly, and identify the role renewable energies can play in this process. Compared to other countries, the possibilities for using renewable energies in Germany are far from optimal. However, if a highly populated industrialized country like Germany with only moderate potential could succeed in using renewable energies to supply its needs, then it should not be a problem at all for other countries. Germany is a trail-blazer here, which offers many advantages in the long term. The country is already reaping the benefits of its role, as renewable technologies are developing into a big export success for German industry.

4.3.1 Down with Primary Energy Needs

The total primary energy use in Germany has to fall for climate protection to be effective. Primary energy includes original forms of energy, such as coal, oil, natural gas and uranium – most of which are used in the energy sector. Some is also used for non-energy related purposes in other areas. For example, large quantities of oil end up in the plastics industry where it is used to make garden chairs, ballpoint pens and nylon tights. The majority of these products ultimately land in a rubbish tip. The rubbish that is burnt in refuse incinerators then produces carbon dioxide, which in turn contributes to the greenhouse effect. Although alternative raw materials such as natural bioplastics are now available, it is expected that during the next few decades fossil raw materials will play a major role in non-energy use. To be

effective in protecting the climate, Germany should be reducing its greenhouse gas emissions by 80% by 2050. However, if the non-energy part is largely left unchanged, this means that the energy sector will have to convert almost completely to renewable energies by then.

In energetic primary energy consumption in 1990 the combined fossil and nuclear energy share was almost 99%. In the same year renewable energies only contributed a maximum of 1% to energy requirements. The share covered by renewable energies then rose to over 7% by 2008 (Figure 4.9). So it is still a long road to 100% renewable energy supply.

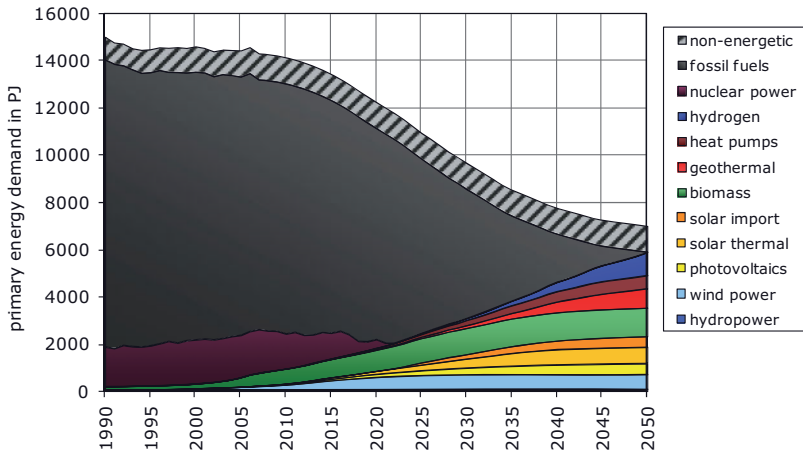

Figure 4.9 Possible development of renewable energy share in total primary energy consumption in Germany.

Between 1990 and 2008 nuclear energy had a share of between 10 and 14%. As a result of its opt-out decision, Germany is expected to end its use of nuclear energy between 2020 and 2025. Until then renewable energies will easily be able to replace the dwindling capacities. Whereas the primary energy requirement remained largely constant between 1990 and 2005, it will fall steadily because of more efficient energy use and a drop in population numbers by 2050. As power plant efficiency is not included in the calculation of primary energy consumption for electricity from wind, hydropower and photovoltaic plants in contrast to coal-fired and nuclear plants, primary energy consumption is also decreasing due to statistical effects. Overall the primary energy requirement could be more than halved in Germany.

The changes taking place in the energy sector in Germany are about 10 to 15 years too late to meet the targets for climate protection in 2020. Instead of the recommended 50% reduction in greenhouse gas emissions, a figure closer to 30% is more realistic. Keeping the country’s nuclear power plants open for longer would also not help to meet the targets set for 2020. Instead it would delay a reorganization of the energy sector without making a necessary contribution towards climate protec-

tion. However, the targets for 2050 can easily be achieved if a consistent course is followed until then.

Germany's energy in 2050 will probably come from a broad renewable energy mix (Figure 4.10). Because of the country's geographical situation, the potential for hydropower will be quite low. In addition to indigenous renewable energies, the import of reasonably priced solar power from sunny regions will probably also contribute towards providing safe and cost-effective energy.

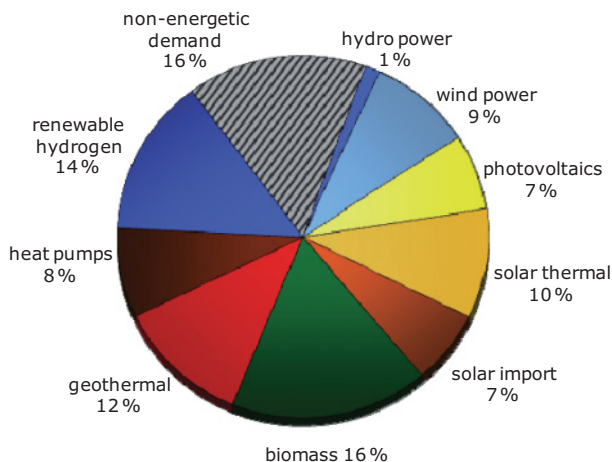

Figure 4.10 Possible share of renewable energies in primary energy consumption in 2050 in Germany.

4.3.2 Electricity Generation Totally Without Nuclear and Fossil Power Plants

Whereas a big decline is expected in overall primary energy use in Germany over the next few decades, electricity consumption will probably remain constant. The potential to reduce electricity requirements is also high. However, the trend towards always having more and more new electrical appliances and the increased use of heating pumps and electric cars will cancel out this potential.

The changeover to renewable energy supply has already begun in the electricity sector. In 1990 hydropower, with its share of around 3%, was the only energy source worth mentioning in this area. In the next 15 years this was followed by wind power, biomass use and, more recently, photovoltaics. These had already amassed a 15% share by 2008. Renewable energies should be able to replace nuclear energy by 2020, and by 2050 virtually cover all of Germany's electricity needs (Figure 4.11).

There may be little potential for hydropower in Germany, but wind power and photovoltaics do offer good possibilities. Theoretically, either wind power or photovoltaics alone could potentially satisfy the country's entire demand for electricity.

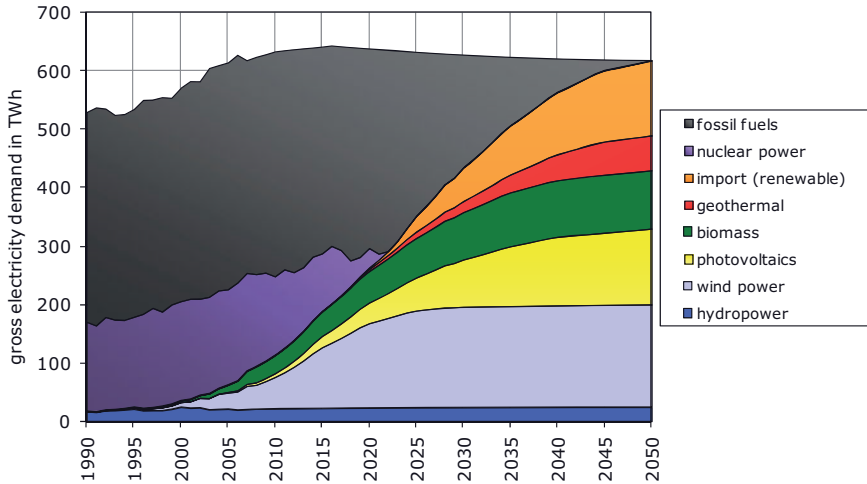

Figure 4.11 Possible development of share of renewable energies in gross power consumption in Germany.

In practice, however, this does not make much sense, because large and expensive storage would be necessary due to the fluctuating availability of wind power and solar radiation over the course of the year.

If different renewable energies are combined in a sensible way, then only small storage systems are necessary. At the same time wind power and photovoltaics could be providing around half the electricity supply by 2050. The development of biomass power plants is also limited, but biomass will clearly exceed the share now provided by hydropower. In the medium term geothermal power plants will also be able to make a contribution. Supplemented with the import of reasonably priced electricity from renewable power plants, renewable energies will enable demand to be covered with carbon-free electricity by 2050. Chapter 7 is therefore devoted to solar-thermal power plants, which offer an important option to the import of electricity. Fossil power plants and nuclear power plants will no longer be needed to provide safe and climate-compatible electricity supply in 2050.

4.3.3 Insulation and Renewable Energies to Provide Heat

It may be difficult to cut down on electricity consumption, but substantial reductions are possible when it comes to heating. The energy-saving possibilities offered by the buildings described in Chapter 3 make it probable that heating needs will be halved by 2050 compared to 1990 (Figure 4.12). What is important is that government strictly enforces modernization measures in existing buildings.

In 2007 the share of renewable energies in heat supply was around 6%. Among these renewable energies, biomass – i.e. firewood – had the greatest share by a long shot. However, the possibilities for using biomass in Germany are limited. Solar-thermal energy, geothermic energy and heating pumps could also play a bigger role

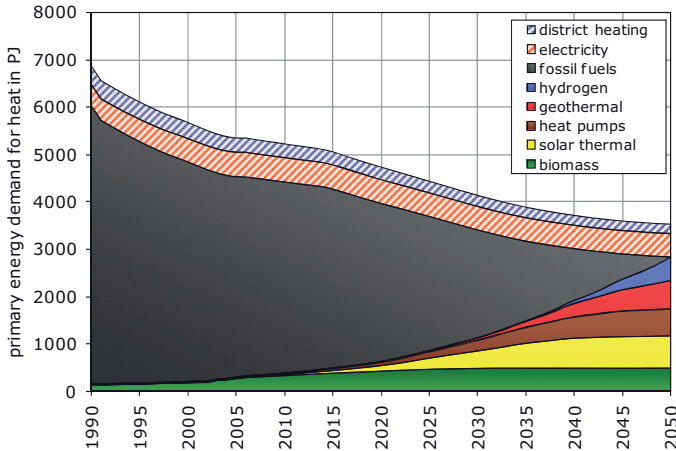

Figure 4.12 Possible development of share of renewable energies in primary energy requirement of the heat supply sector in Germany.

in the heat supply. In the long term hydrogen produced by renewable energies could be used to cover remaining requirements. If, as explained earlier, direct electricity and district heating could then be sourced from renewable electricity power plants, Germany would have a carbon-free heat supply by 2050.

4.3.4 Increasing Efficiency and New Concepts for Traffic

At present, the biggest challenge is introducing climate-compatible changes in the traffic sector. German car manufacturers have stubbornly resisted implementing measures to protect the climate. Some car bosses even claim that the savings being demanded would simply be physically impossible to implement. Yet, technically, modern cars are by no means energy-saving marvels. Even modern combustion engines only achieve 25% of average efficiency in an optimal case. At least 75% of the energy content dissipates unused as waste heat into the environment. If the Germans' strong attachment to powerful luxury cars could be taken out of the equation, there is a technical certainty that energy use could be halved.

New and innovative driving concepts, such as electric cars and fuel-cell cars, can increase efficiency levels, reduce energy use and, with renewable energies, slash carbon dioxide emissions to zero (Figure 4.13).

In the short term biomass fuel could cover some of the fuel requirements of conventional vehicles with combustion engines. However, the agricultural land available in Germany does not even come close to being able to provide enough biomass fuel to cover the entire requirement. And, in addition, some of the available biomass is needed to produce electricity and heat.

Due to considerable improvements in battery technology in recent years, electric cars will soon be ready for production. During this transitional period they are still

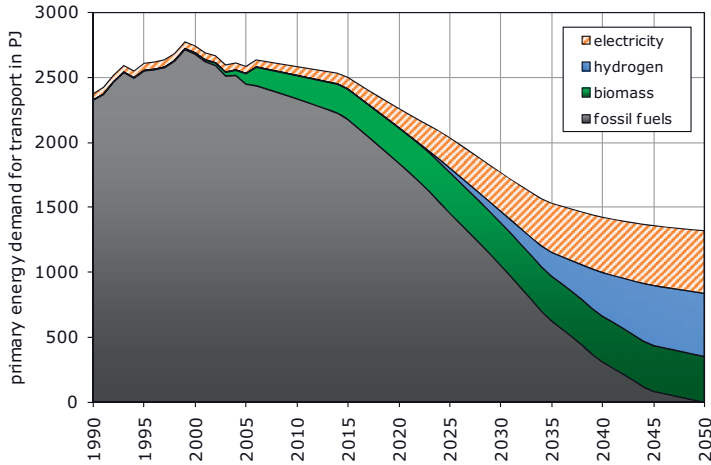

Figure 4.13 Possible development of the share of renewable energy in primary energy requirement of the transport sector in Germany.

partly being charged and driven with electricity from fossil power plants. However, carbon dioxide emissions from these vehicles will plummet as the proportion of renewable energies used to generate electricity increases.

Fuel-cell vehicles fuelled with renewable hydrogen will not come to the market until some time in the future. Although considerable progress is being made in fuel-cell technology, the structures for carbon-free production and the distribution of reasonably priced hydrogen are not yet in place. However, hydrogen technology will eventually play a role in protecting the climate. It could also help to ensure that the energy required in the road transport sector is carbon-free by the year 2050.

4.4 Reliable Supply Using Renewable Energies

Mathematically, on a yearly average renewable energies could cover the entire energy requirement. However, many people still question how electricity supply can be guaranteed – for example, if there is no wind blowing after the sun goes down. In this case, none of the photovoltaic and wind power plants would be able to generate electricity.

Renewable energies can guarantee electricity supply even when fluctuations occur provided a balanced mix of different renewable power plants is combined intelligently through a central control system (Figure 4.14). To prove this, various companies from the renewable energy sector initiated a combination power plant project in 2007.

This combination plant linked and controlled 36 wind, solar, biomass and hydro-power plants spread out all over Germany. It satisfied exactly one ten-thousandth

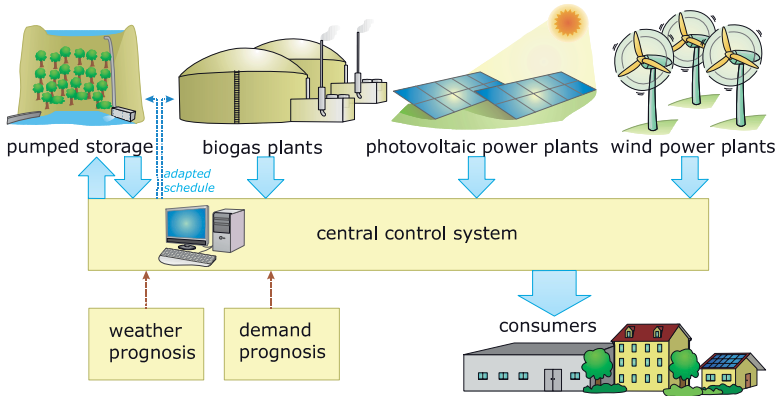

Figure 4.14 Principle of coordinating combined power plants to guarantee renewable electricity supply.

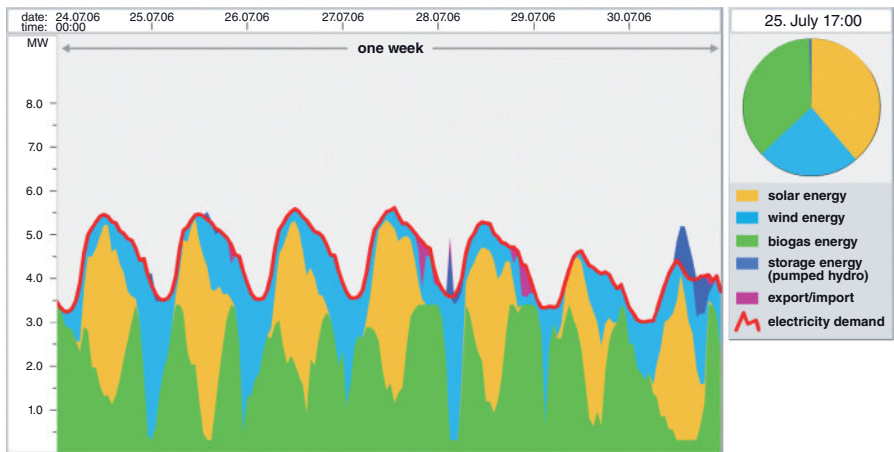

Figure 4.15 Proportion of different renewable power plants covering energy requirements during the course of a summer week with the combination power plant project. Source: www.kombikraftwerk.de.

of the actual German electricity requirement. To do so, a central control centre received information on load profiles as well as on current weather projections. If wind and solar plants do not create enough electricity, then other plants have to step in. In the case of a combination power plant, these would be biogas power plants and a pumped storage station. As biogas is easily stored, electricity can be generated at any time. Surplus supplies can then be stored temporarily in pumped storage stations or used to charge batteries for electric cars. There are very few cases when the production of wind and solar energy plants has to be cut back due to long

sunny and windy periods. During these hours a small proportion of the surplus is lost.

The results of the combination power plant project were very promising. They showed that on a small scale optimal coverage of most energy needs is possible (Figure 4.15). The desired reliability of energy supply was achieved. Therefore, there is no convincing argument why renewable energies cannot be used to cover all energy supply requirements using this approach in the near future.

5 Photovoltaics – Energy from Sand

The word ‘photovoltaics’ comes from the two words ‘photo’ and ‘volta.’ In this case photo stands for light and comes from the Greek *phōs*, or *photós*. The Italian physicist Alessandro Giuseppe Antonio Anastasio Count Volta, who was born in 1745, was the inventor of the battery and together with Luigi Galvani is considered the discoverer of electricity. There is not much that associates him with photovoltaics. However, in 1897, 70 years after Volta’s death, the measurement unit for electric current was named volt in his honour. Photovoltaics therefore stands for the direct conversion of sunlight into electricity.

While fiddling with electro-chemical batteries with zinc and platinum electrodes, the nineteen-year-old Frenchman Alexandre Edmond Becquerel found that the electric voltage increased when he shone a light on them. In 1876 this phenomenon was also proven with semiconductor selenium. In 1883 the American Charles Fritts produced a selenium solar cell. Due to the high prices of selenium and manufacturing difficulties, this cell was not in the end used to produce electricity. The physical reason why certain materials produce electric voltage when radiated with sunlight was not understood at the time. It was not until many years later that Albert Einstein was able to specify the photo effect that causes this. He eventually received the Nobel Prize for this work in 1921.

The age of semiconductor technology began in the mid-1950s. The semiconductor material silicon, which often occurs naturally, became all the rage in technology, and in 1954 the first silicon solar cell finally made its appearance at American Bell Laboratories. This was the basis for the successful and commercial further development of photovoltaics.

5.1 Structure and Function

5.1.1 Electrons, Holes and Space-Charge Regions

Understanding the relatively complicated way that solar cells work requires immersion into the most extreme depths of high physics. The small applied model shown in Figure 5.1 explains roughly the principle involved. There are two horizontal levels. The second level is located a bit higher than the first one. The first level has a large number of small hollows filled to the top with water. The water here cannot move by itself. Now someone starts to throw small rubber balls at the first level. If a ball hits a hole, the water splashes upwards and ends up on the second level. Here there are no hollows to contain the water. The second level is therefore inclined so that the water runs off and reaches the draining groove on its own. This groove is connected to the second level through a pipe and as the water flows through, it drives a small waterwheel with a dynamo. When the water reaches the lower level, it fills up the hollows again. The cycle can start all over again with new rubber balls.

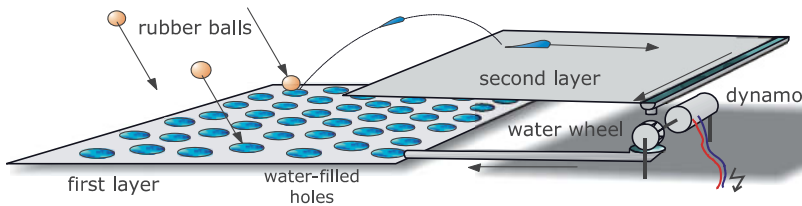

Figure 5.1 Model illustrating the processes of a solar cell.

However, we want to use solar cells not to produce a water cycle but to generate electric current to run electrical appliances. Electric current is created from the flow of negative-charge carriers, called electrons. These are the same as the water in our simple model. The solar cell needs a material in which two levels can be found: one level in which the electrons are firmly affixed like the water collecting in the hollows, and a second level where the electrons are able to move freely. Semiconductor materials normally have precisely these properties. Tiny particles of light, called photons in physics, correspond to the rubber balls and are able to raise the electrons to the second level.



Conductors, Non-conductors and Semiconductors

Conductors such as copper always conduct electric current relatively well but non-conductors such as plastics conduct almost no electricity at all. In contrast, semiconductors – as the name indicates – only conduct electric current sometimes, for example at high temperatures, when fed with electric voltage or when radiated with light. These effects are used in the production of electronic switches like transistors, computer chips, special sensors and even solar cells.

Organic semiconductors are available in addition to elementary semiconductors, such as silicon (Si), and compound semiconductors, such as gallium arsenide (GaAs), Cadmium telluride (CdTe) and copper indium diselenide (CuInSe₂). All these materials are used in photovoltaics.

The tilt in our simple model is important because it enables the cycle to function perfectly. Otherwise the water will not collect on its own in the rain gutter. With semiconductors the second level must also have an incline that enables the electrons to gather on one side. In contrast to our simple model, it is not gravity that is used to collect the electrons but instead an electric field, which pulls the negatively charged electrons to one side. In order to produce this field, a semiconductor must be 'doped'. One side of the semiconductor is deliberately contaminated with an element like boron and the other side with a different element like phosphorus. As boron and phosphorus also have a varying number of electrons, they produce the necessary incline. The crossing area is called a space-charge region. An electric field is created here, which pulls the electrons to one side. There external contacts collect them and they flow back to the first level through an external electric circuit. In the process they produce electrical energy.

Figure 5.2 shows the principal structure of a silicon solar cell. In technical jargon the different doped sides of the silicon wafer are called n-doped and p-doped silicon, respectively. Between the two areas is a barrier layer with the space-charge region. Light in the form of photons separates negatively charged particles (electrons) and positively charged particles (holes) and ensures that the electrons are able to move about freely at the second level. In contrast to the simple model shown, the holes also move. The electrons and holes are separated by the space-charge region. Thin front contacts collect the electrons on the front side of the cell.

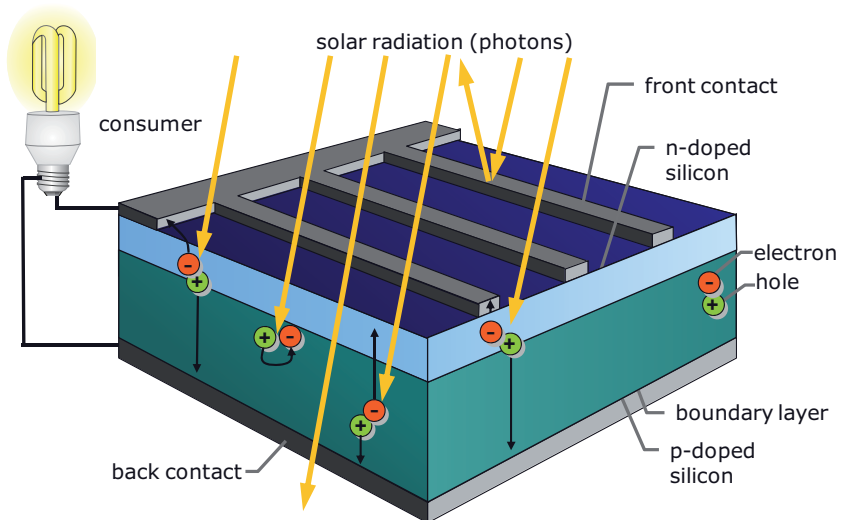

Figure 5.2 Structure and processes of a solar cell (Quaschnig, 2007).

However, not every light particle ensures that an electron is separated from the hole. If the energy of the photon is too low, the electron will fall back into the hole. On the other hand, if the energy of the photon is too high, only part of it is used to separate the electron from the hole. Some photons also move through the solar cell unused; others are reflected by the front contacts.

5.1.2 Efficiency, Characteristics and MPP

The efficiency of a solar cell specifies which part of the solar radiant power is converting the cell into electric power.



Solar Cell Efficiency

$$\eta = \frac{P_{el}}{\Phi} \quad \left(\text{efficiency} = \frac{\text{electrical power output}}{\text{incoming solar radiant power}} \right)$$

The higher the efficiency, the more electric power the solar cell can generate per square metre. In addition to the type of materials used, the quality of the manufacturing also plays a major role. Today silicon cells in mass production reach a maximum efficiency of over 20%. Close to 25% efficiency has already been reached in laboratories (Table 5.1).

Table 5.1 Efficiency of different solar cells.

Cell material	Max. cell efficiency (lab)	Max. cell efficiency (mass prod.)	Typical module efficiency	Surface req. for 1 kW _p
Monocrystalline silicon	24.7%	22.0%	15%	6.7 m ²
Polycrystalline silicon	20.3%	17.4%	14%	7.2 m ²
Amorphous silicon	12.1%	6.8%	6%	16.7 m ²
CIS/CIGS	20.0%	11.6%	10%	10.0 m ²
CdTe	16.5%	12.0%	7%	14.3 m ²
Concentrator cells	41.1%	36.5%	28%	3.6 m ²

Incidentally, conventional petrol engines do not reach a higher level of efficiency than silicon cells. Compared to the 5% efficiency of the first solar cells in 1954, technology has advanced considerably. If individual solar cells are packaged into photovoltaic modules, the efficiency drops somewhat due to the space necessary between the cells and the module frames. It is hoped that other materials can be used in future to produce further cost savings. In comparison with silicon cells, more

improvements in efficiency are needed in this area. Concentrator cells in which sunlight is concentrated through mirrors or lenses reach a very high efficiency but are considerably more expensive than normal silicon cells.

In addition to efficiency, there are other parameters that describe photovoltaic modules. The current-voltage characteristic is usually found in relevant data sheets. The maximum current I_{SC} flows with a short-circuited photovoltaic module. The short-circuiting is not dangerous to the module. The short-circuit current is limited and depends on the solar radiation intensity. If nothing is connected to the photovoltaic module, it is in open circuit and no electricity flows. It then adjusts itself to the open-circuit voltage V_{OC} . A photovoltaic module is unable to produce any power when in short circuit or open circuit. Between open circuit and short circuit the current depends on the voltage. The principal process of the curve is similar for all solar modules (Figure 5.3 and Table 5.2).

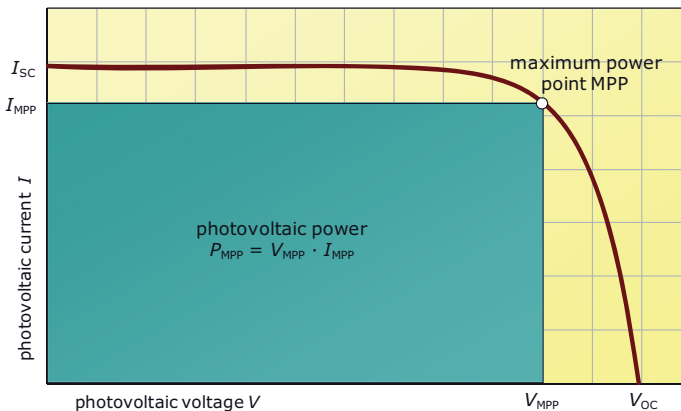

Figure 5.3 Current-voltage curve for a photovoltaic module.

In practice, the aim is to take maximum power from the photovoltaic module. This corresponds to the largest rectangle that can be slid under the curve. The top edge on the right of the rectangle on the curve is called the MPP (maximum power point). The voltage that belongs to the MPP is called MPP voltage, in short V_{MPP} . A photovoltaic module provides maximum power with this voltage. In practice, operation close to that of the MPP can be achieved, for example when a battery with voltage close to that of the MPP voltage is connected or where an inverter automatically adjusts the MPP voltage on the photovoltaic module.

The current of photovoltaic modules, and hence the power, drops according to the number of incoming photons, and thus the radiation intensity of the sunlight. If the solar radiation intensity is halved, then the power of the photovoltaic modules is also reduced by half. The power of photovoltaic modules also drops with high temperatures. If the temperature rises by $25\text{ }^{\circ}\text{C}$, the power of the crystalline solar cells falls by about 10%. Therefore, when photovoltaic modules are installed, care should be taken that they are always well ventilated and a draught cools the modules (Table 5.2).

Table 5.2 Important parameters for photovoltaic modules.

Parameter	Symbol	Unit	Description
Open-circuit voltage	V_{OC}	Volt, V	Voltage of PV module in open-circuit operation without connected load
Short-circuit current	I_{SC}	Ampere, A	Current of PV module in short-circuit operation with short-circuited module
MPP voltage	V_{MPP}	Volt, V	Voltage when a photovoltaic module produces maximum power
MPP current	I_{MPP}	Ampere, A	Current belonging to MPP voltage
MPP power	P_{MPP}	Watt, W	Maximum power a PV module can produce

Standard test conditions (STC) for the comparison of photovoltaic modules have been agreed internationally. Accordingly, the MPP power of solar cells and modules is determined on the basis of solar radiation intensity of 1000 watts per square metre and a module temperature of 25 °C. As radiation intensity is usually lower in practice and photovoltaic modules can warm up to 60 °C in the summer, the MPP power determined on the STC basis represents a maximum value. This value is achieved in very few cases and seldom exceeded. Therefore, this power also has the unit watt peak, abbreviated W_p .

5.2 Production of Solar Cells – from Sand to Cell

5.2.1 Silicon Solar Cells – Electricity from Sand

Silicon, the raw material for computer chips and solar cells, is the second most common element in the earth's crust after oxygen. However, in nature silicon occurs almost exclusively as an inclusion in quartz, sand and silicate rock or as silicic acid in the world's oceans. Even the human body contains around 20 milligrams of silicon per kilogram of body weight.

Pure silicon is usually extracted from quartz sand. Chemically, quartz sand is pure silicon dioxide (SiO_2). For silicon to be produced from it, high temperatures are used to sequester the oxygen atoms (O_2). This process is called reduction and is carried out in arc furnaces at temperatures of around 2000 °C. The result is industrial raw silicon with a purity of 98 to 99%.

Raw silicon has to be purified further before it can be used to produce solar cells. The Siemens method is the normal procedure followed. Hydrogen chloride is used to convert the raw silicon into trichlorosilane, which is then distilled. At high temperatures of 1000 to 1200 °C the silicon is then separated again into long bars. The polycrystalline solar silicon produced in this way has 99.99% purity (Figure 5.4).

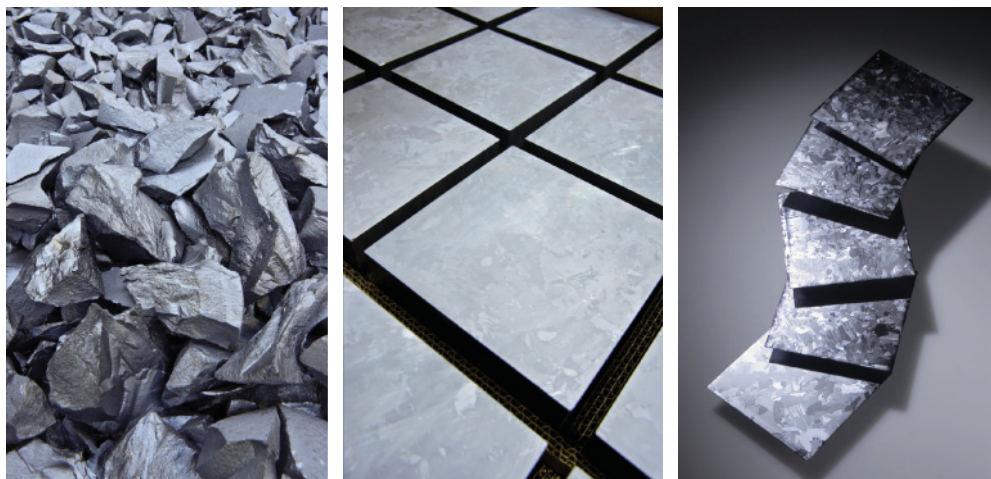

Figure 5.4 Polycrystalline silicon for solar cells. Left: Raw silicon. Middle: Silicon blocks. Right: Silicon wafers. Photos: PV Crystalox Solar plc.

The silicon is melted down again to produce semiconductor silicon for computer chips and monocrystalline solar cells. In the crucible process invented by Polish chemist Jan Czochralski, a silicon crystal is dipped into a crucible with a silicon melt and then slowly pulled upwards in a rotating movement. The melted silicon attaches itself to the crystal and a long, round silicon rod is created. In the process the silicon crystals align in one direction. This creates monocrystalline silicon. Most of the impurities remain in the melt crucible so that the semiconductor silicon is left with purities of over 99.9999%.

In the next step, band saws cut the long silicon rods into thin slices, called wafers. This sawing process produces major waste, and up to 50% of the valuable silicon material is lost as a result. The alternative is for two thin wires to be pulled through the liquid silicon melt. With this procedure, thin silicon wafers are formed between the two wires. Immersion in acid will remove sawing damage from wafers and smooth the surfaces. Several years ago silicon wafers had a thickness of 0.3 to 0.4 mm. To save material and costs, attempts are now being made to reduce the wafer thickness to under 0.2 mm. Technically, this is a major challenge as the ultra-thin wafers must not break apart.

The finished wafers are exposed to gaseous doping materials. This produces the p- and n-layers described earlier. A transparent anti-reflection layer of silicon nitride less than a millionth of a millimetre thick gives the silicon solar cell its typical blue colour. This layer reduces the reflection loss of the silver-grey silicon on the top side of the solar cell. The darker the cell appears, the less light the cell is reflecting (Figure 5.5).

The front and back contacts are then applied using screen printing. To reduce the losses to the opaque front contacts, some manufacturers conceal them under the surface or try to move them so that they are also on the back of a cell. Although

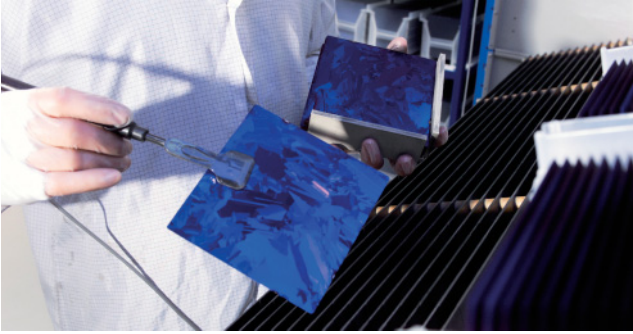

Figure 5.5 Polycrystalline solar cells with anti-reflection layers before the front contacts are applied. Photo: BSW, www.sunways.de.

this increases the efficiency of a cell, it is also a more complicated and expensive way to manufacture cells. The finished cells are then finally tested and sorted according to performance class for further processing into photovoltaic modules.

5.2.2 From Cell to Module

Silicon solar cells are usually square in shape. The length of the edge is measured in inches. Originally solar cells were typically 4 inches (approx. 10 cm) in length. In the meantime a measurement of 6 inches (approx. 15 cm) has established itself as the standard. Some manufacturers are already producing 8-inch (approx. 20 cm) solar cells. Large solar cells require fewer processing steps to be made into modules. However, the risk that the cells will break during further processing is also greater. The current increases with the size of a solar cell, whereas the voltage remains constant. The electric voltage of a solar cell is only 0.6 to 0.7 volts.

Practical applications clearly require high voltages. Therefore, many cells are interconnected in series to form solar modules. The front contacts of a cell are connected to the back contacts of the next cell using soldered-on wires. It takes 32 to 40 cells connected in series to produce a sufficiently high voltage to charge 12-volt batteries. Higher voltages are needed to feed into the grid through inverters. Solar modules with an even higher number of cells interconnected in series are available for this purpose.

Solar cells are very sensitive, break easily and corrode when in contact with moisture, so they must be protected. Consequently, they are imbedded in a layer of special plastic between the front glass panel and a plastic film on the back (Figure 5.6). Some manufacturers also use glass for the back. The glass provides mechanical stability and must be very translucent. The plastic material used for imbedding the solar cells consists of two thin films of ethylene-vinyl-acetate (EVA). At temperatures of around 100 °C these films bond with the cells and the glass. This process is called lamination. The finished laminate then protects the cells from the effects of the weather, especially moisture.

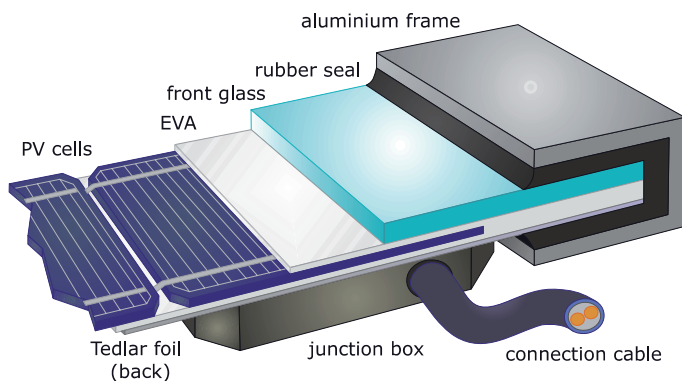

Figure 5.6 Structure of a photovoltaic module.

The connections of the solar cells are linked to a module connection box. Individual faulty cells or uneven shade can damage a PV module. Bypass diodes that compensate for affected cells when a fault occurs are designed to prevent any damage. These diodes are also usually integrated into the module junction boxes.

5.2.3 Thin Film Solar Cells

Crystalline solar cells require a comparatively large amount of costly semiconductor material. Different production methods using thin film cells are being tested to reduce the amount of material needed. Whereas crystalline solar cells reach thicknesses in the order of tenths of millimetres, thin film solar cells are thousandths of a millimetre thick. The production principle is similar even when different materials such as amorphous silicon (a-Si), cadmium telluride (CdTe) or copper indium diselenide (CIS) are used.

The base of thin film solar cells is a substrate that is usually made of glass. Plastic can be used instead of glass for the substrate to produce modules that are flexible and bendable. A thin TCO (Transparent Conductive Oxide) layer is applied to the substrate using a spraying technique. A laser or a micromiller then separates this layer into strips. The individual strips constitute the single cells within the later solar module. Like crystalline cells, these cells are also contacted in such a way that they are connected in series to increase the electric voltage. The long strips make it visually easy to distinguish thin film modules from crystalline solar modules (Figure 5.7).

The semiconductor and doping materials are then vaporized at high temperatures. When silicon is vaporized as a semiconductor material, the crystalline structure of the silicon is lost. This is then referred to as amorphous silicon. A screen-printing procedure then applies materials like aluminium to the back side contact. A layer of polymer seals the cell at the back to protect it from moisture.

The efficiency of thin film modules is currently still considerably less than that of crystalline photovoltaic modules. This means that a larger surface is required for

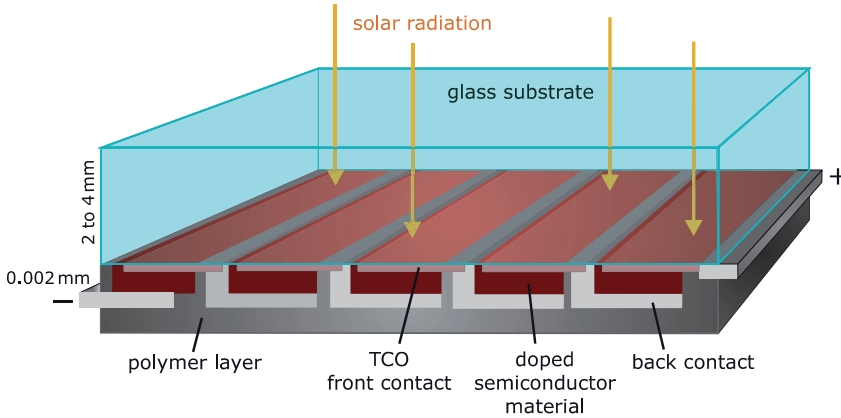

Figure 5.7 Cross-section of a thin film photovoltaic module.

the same power output, and, therefore, more assembly is required and the associated costs are higher. However, because less material is used, in the long term the cost of thin film modules could fall below that of crystalline modules. If the efficiency of thin film modules can also be increased, this technology could put an end to the current predominance of crystalline silicon solar cells.

In addition to thin film materials, other technologies are currently being tested. Pigment cells and organic solar cells could eventually offer a cost-effective alternative to current technologies. At the moment it is almost impossible to project which technologies will find acceptance in 30 or 40 years. But competition is bringing new life to the sector. Costs will continue to drop due to the competition of different technologies for photovoltaics. So in the medium term photovoltaics will be very important in the effort to provide low-cost and climate-compatible electricity supply.

5.3 Photovoltaic Systems – Networks and Islands

5.3.1 Sun Islands

With photovoltaic systems a distinction is made between island systems and grid-coupled systems. Solar island systems work autonomously without being connected to an electricity grid. For example, they are often used in small applications, such as wristwatches and pocket calculators, because in the long run they are less expensive than energy supplied by disposable batteries, and a network cable in this case would be highly impractical. Solar systems are also popularly used for small systems like car park ticket machines. In this case it is less expensive to install a photovoltaic system than to lay network cables and install a meter (Figure 5.8).

The big market for solar island systems is in areas that are far from an electricity grid. Globally, around two billion people have no access to electricity. Even in



Figure 5.8 Photovoltaic island systems offer advantages for many applications compared to grid connections.

industrialized countries there are towns that are very remote from the grid and where any kind of cabling would be extremely expensive. There are alternatives to using island networks to supply solar energy – such as diesel generators. A solar system often compares favourably in terms of cost and supply reliability, specifically in cases where demand for electricity is low. Nevertheless, the costs of photovoltaic island systems are still relatively high. Therefore, they are currently used mostly for small output requirements. For cost reasons, diesel generators and grid connections are usually given preference when a high demand for electricity exists.

Solar island systems are comparatively straightforward and can even be installed by people with limited technical skills (Figure 5.9). A battery ensures that supply is available at night or during periods of bad weather. For reasons of cost, lead batteries are normally used. In principle, 12-volt car batteries are also an option. Special-purpose solar batteries have a considerably longer lifetime but are also more expensive. As batteries can quickly be ruined as a result of leakage or overcharging, a charge regulator protects the battery. The battery, the power consumer and the photovoltaic module are connected directly to the charge regulator. It is important to make sure the plus and minus poles are not switched as this will cause a short circuit.

When the battery is nearly empty, the power consumer is switched off. Although the lack of electricity is a nuisance, this is better than a defective battery. As

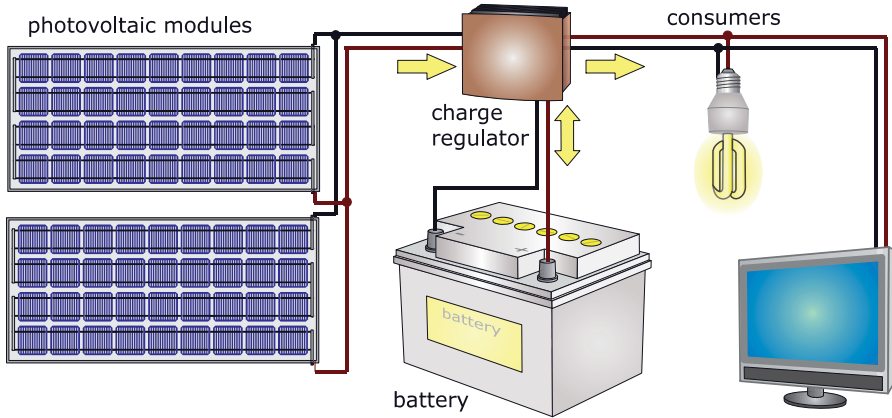

Figure 5.9 Principle of a photovoltaic island system.

soon as the battery reaches a certain charge level again, the charge regulator automatically switches the power consumer back on. Once the battery is fully charged, the charge regulator separates the photovoltaic module and prevents the battery from overloading.

The costs can be kept low if the power consumers are economical users. Battery voltage higher than 12 volts is recommended if power consumers have high requirements, as otherwise the losses in the lines will be too high. Island systems work on a direct voltage basis, so, if possible, only direct voltage power consumers should be utilized. Special refrigerators, lamps and even entertainment electronics are being offered with 12 or 24 direct voltage supply. If alternating voltage power consumers are operated, an island inverter first has to convert the direct voltage of the battery to alternating voltage.

Normal low voltages are usually relatively safe, at least as far as contact with the voltage is concerned. As batteries are pure bundles of power, improper handling can cause short circuits, fire or even explosions. Battery rooms should always have good ventilation as hydrogen gas can build up in them. Lead batteries contain diluted acid. As time goes by, water evaporates from the battery and the battery has to be refilled regularly. With maintenance-free batteries the water is bound in a gel and cannot escape.

A large array of photovoltaic modules can end up costing the same as a mid-range car, and even individual photovoltaic modules are quite expensive, so thieves are making life increasingly difficult for the operators of remote photovoltaic systems. Solar modules installed on remote roads are particularly vulnerable to theft. As island systems are usually installed in even more out-of-the-way places, the risk of theft is especially high. This risk should be minimized in the installation. Optimally, photovoltaic systems should not be visible from public roads. However, if this cannot be avoided, systems should at least be assembled in places that are difficult to access (Figure 5.10).



Figure 5.10 Typical places for using photovoltaic island systems. Left: Electricity supply to a village in Uganda. Right: Mountain hut. Source: SMA Technologie AG.

Small solar-operated systems can only contribute minimally, if even at all, to climate protection. On the other hand, photovoltaic-operated pocket calculators and watches help reduce the mountain of small spent batteries.

5.3.2 Sun in the Grid

Photovoltaic systems that feed into a public grid are built in a different way from island systems. First of all, they normally require a larger number of modules. With crystalline solar modules a top output of 3.5 to 5 kilowatts peak (kW_p) can be installed for a 25 square metre area. In Germany this generates between 3000 and 4000 kilowatt hours with the right kind of roof; in Southern Europe or better sites in the USA the figure increases to around 50%. This easily covers the electricity requirements of an average German household. An ideal surface can usually be found quite easily on the roofs of single-family homes (Figure 5.11).

As solar modules produce direct voltage but the public grid works with alternating voltage, an inverter is also required. An inverter converts the direct voltage of a photovoltaic module into alternating voltage. Modern inverters have high demands placed on them. They are required to have a high level of efficiency to ensure that only very little valuable solar energy is lost during the conversion into alternating voltage. Modern photovoltaic inverters achieve efficiency of close to 95% or even more. What is important is that efficiency is high even with a partial load, such as in cloudy weather. European efficiency describes average inverter efficiency based on Central European climate conditions, while CEC efficiency is for Californian conditions.

Inverters also have to monitor the grid constantly and switch off the solar feed when a general grid outage occurs. If the electric company wants to do work on the grid and needs to shut off the electricity to do this, the solar current still being fed in could harm the workers. If a public power outage occurs, owners of photovoltaic systems will unfortunately end up sitting in the dark even though there is nothing

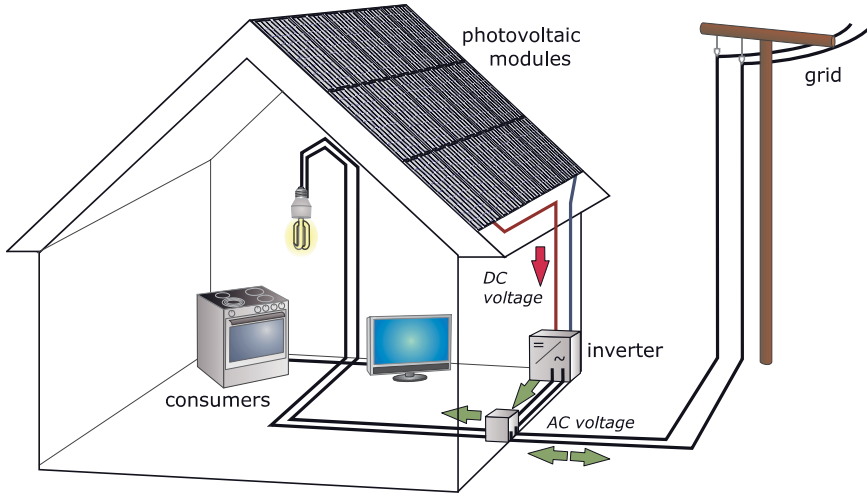

Figure 5.11 Principle of grid-connected photovoltaic system.

wrong with their solar system. Technically, a solar system can still be kept running in island operation if the grid fails. However, as power failures are very infrequent, hardly anyone makes the additional technical provisions that would be necessary.

An inverter does not only convert voltage. It also ensures that photovoltaic modules are working with optimal voltage and delivering the maximum possible power. The setting of optimal voltage is also called MPP tracking. When a system is planned, it is important that the number of photovoltaic modules is coordinated with the inverter. The leading manufacturers of inverters usually offer relevant design programmes free of charge.

Shading can also cause problems. Photovoltaic systems react sensitively and performance suffers even if only part of a system is in the shade. If two cells are in shade, the entire photovoltaic module can stop working. Therefore, a site that has minimal shade is more important for the installation of a system than an optimal orientation towards the sun.

Large grid-linked photovoltaic systems feed all generated electricity into the public grid. They function as pure solar power plants. With large systems it can be beneficial to track them towards the sun (Figure 5.12). Systems that use tracking can increase power output by 30% on an annual average. However, tracking also increases the investment cost and requires additional maintenance because of the mechanical parts required. Therefore, tracking pays particularly in situations where large, well-maintained systems are installed.

The neatest looking installations of photovoltaic systems are those on roofs and façades (Figures 5.13 and 5.14). Less building material is also needed for this type of installation, which is a cost advantage as these systems are still very expensive. Furthermore, compared to expensive marble façades, photovoltaics can sometimes turn out to be a real bargain.



Figure 5.12 The 'Gut Erlasee' tracked solar power plant in Bavaria, Germany, has a total output of 12 megawatts. Source: SOLON AG, Photo: paul-langrock.de.



Figure 5.13 Photovoltaic facade system. Photo: SunTechnics.

Some of the solar power can be used directly in the building where the system is installed. If the photovoltaic system produces more power than is needed, it feeds the surplus electricity into the public grid. However, if the output of the solar system is not sufficient to cover the building's own requirements, then the rest of the electricity that is needed is drawn from the grid. In a sense, the grid is like a storage unit. But the grid is not able to store electricity. When solar power is fed into a grid, then other power plants cut their production. As a result, solar systems reduce the emissions of existing power plants. If there is insufficient output, this then has to



Figure 5.14 Photovoltaic systems on single-family homes. Foto: SunTechnics.

be sourced from other power plants. These power plants do not necessarily have to be coal-driven, gas or nuclear plants. On the contrary, photovoltaic systems work compatibly with other renewable energy plants, such as wind power, hydropower and biomass plants.

An extra electricity meter is normally required to calculate the photovoltaic power. This meter calculates the quantity of electric energy that has been fed into the grid, which is then credited according to existing tariffs. If, as in Germany, the feed-in tariff for solar energy is higher than the normal tariff for electricity, it can make sense to feed all the electricity produced by a photovoltaic system into the grid through a feed-in meter and then to buy back some of the supply at the lower tariff. In other countries solar power is sometimes credited at a noticeably lower rate than normal electricity. If this is the case, it makes more sense to use the electricity generated through solar power first and only feed excess supplies into the grid.

Connecting to the grid in Germany is usually not a problem. An electrician is needed to connect the system and the relevant electricity supplier has to be notified. In addition to the connection protocol, technical documents relating to the photovoltaic system are submitted with the application. It is important that the system complies with the general regulations, and this is not generally a problem with current system suppliers. In most cases, a representative of the electricity supplier inspects the system. The reimbursement is handled automatically and is calculated according to the meter reading. The electric company and the operator of the photovoltaic system usually also sign a contract. However, this is not always a stipulation.

5.4 Planning and Design

5.4.1 Planned on the Grid

The first thing to do when planning a solar system is to check whether a system can even be installed. From the standpoint of planning laws, solar systems are structural items – even if they are simply screwed to the roof of a house. The authority responsible for local building regulations determines whether approval is necessary, and, if so, what type of approval. In most cases photovoltaic systems do not need approval from the local authority unless they are erected in the middle of a green field. Complications arise when the sites for such systems are subject to architectural conservation laws. A permit from the relevant authority is required if a solar system is to be installed on top of or near a protected building. In addition to obtaining planning permission, it is always a good idea to consult the building regulations and the development plans of the local authority. These plans will include any conditions that the local authority has stipulated for the construction of photovoltaic systems.

If there are no legal obstacles, the planning phase can start. If a photovoltaic system is to be installed on the roof of a house, it first needs to be determined which parts of the roof can be used for a solar-thermal system (see Chapter 6). As photovoltaic systems are sensitive to shade, it is recommended that the part of the roof used to generate solar power is shade-free. The installation should not be placed near chimneys, aerials and other roof structures.



Installable Photovoltaic Power

Once the type of solar module has been selected, an approximate calculation can be made of the installable photovoltaic power based on remaining roof area A and efficiency η (compare Table 5.1):

$$P_{\text{MPP}} = A \cdot \eta \cdot 1 \frac{\text{kW}}{\text{m}^2}.$$

The installable power on a useable area of 28.6 m^2 with a module efficiency of 14% (0.14) is

$$P_{\text{MPP}} = 28.6 \text{ m}^2 \cdot 0.14 \cdot 1 \frac{\text{kW}}{\text{m}^2} = 4 \text{ kW}_p.$$



The annual system yield can be calculated on the basis of this power output. What first needs to be determined is the supply of solar energy available. The map in Figure 5.15 shows the yearly total for solar radiation in Europe based on averages over many years. The radiation data for the USA can be found under <http://www.>

nrel.gov/rredc/. Fluctuations of over 10% in solar supply are possible between the individual years given.

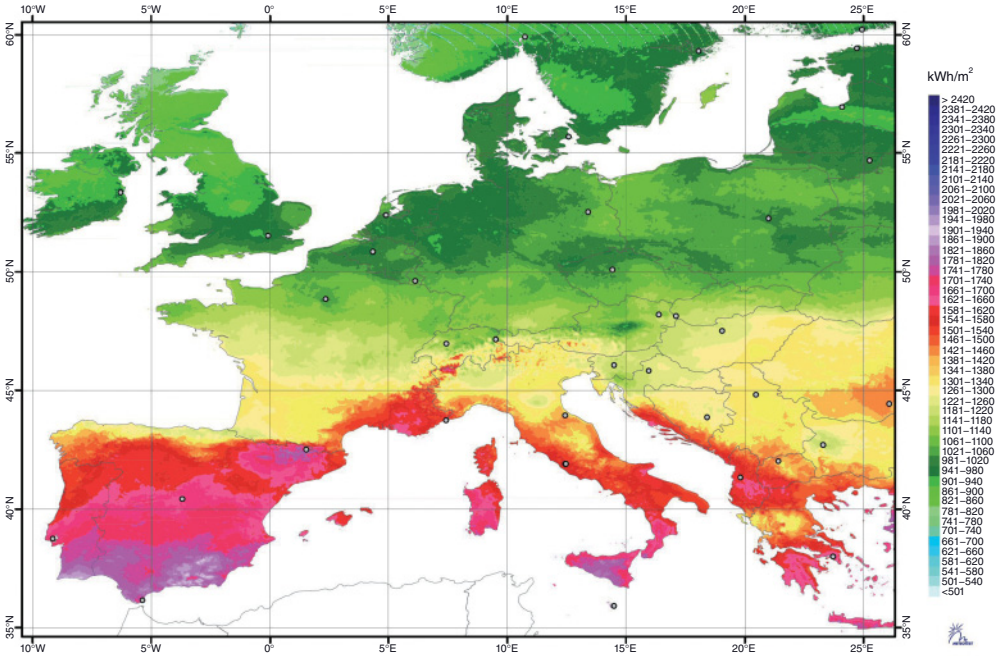

Figure 5.15 Average yearly totals for solar radiation energy in Europe. Source: Meeonorm, www.meteonorm.com.

However, the values only apply to the horizontal orientation of a system. If a system is mounted on a sloping roof, the roof determines the orientation of the system. In an optimal case, the roof would be tilted about 30° to the south in Europe and North America. With an optimal orientation towards the sun the supply of solar radiation increases by around 10%. However, good radiation values are still achievable even if the orientation is less favourable. Figure 5.16 shows the tilt gains and losses for all possible orientations for Berlin. These values can also be applied to other locations in Central Europe.

If a photovoltaic system is to be installed on a roof or in a green field, the photovoltaic modules can be orientated optimally 30° towards the south. If the solar modules are set up in several rows one behind the other, they will create shade for one another as the sun goes down. As a result, a distance at least twice the module height should be maintained between the rows of modules. In this case, however, only one-third of the area is useable. The loss due to shade then usually amounts to less than 5%.

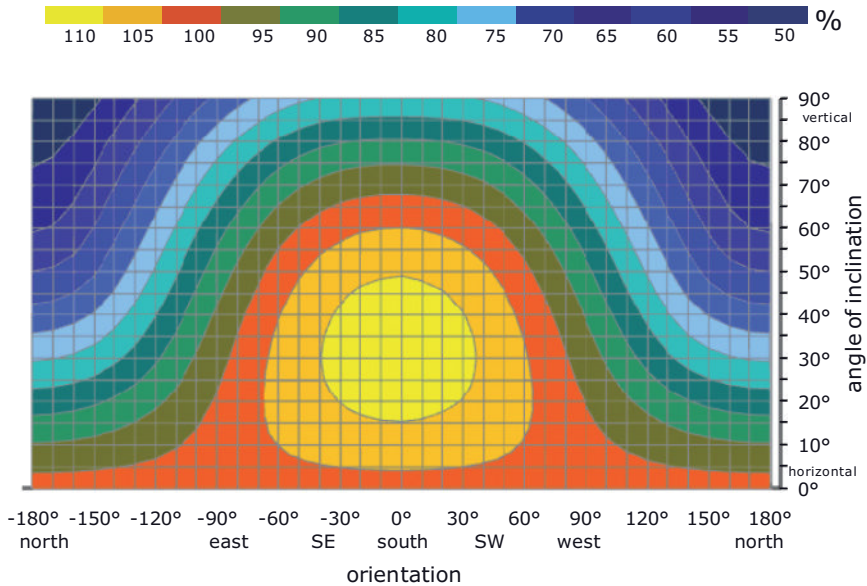

Figure 5.16 Change in annual solar radiation in Berlin depending on orientation and tilt angle of photovoltaic systems.

The proportion of solar radiation that photovoltaic modules convert into electric energy depends on the quality of the system. Solar modules rarely achieve the rated power indicated. Dust, bird droppings, increases in air temperature, line losses, reflection, inverter losses and other factors reduce performance. The relationship between real efficiency and rated efficiency is called performance ratio (*PR*). Table 5.3 lists the criteria for performance-ratio values for grid-connected photovoltaic systems.

Table 5.3 Performance ratio for grid-connected photovoltaic systems.

Performance ratio <i>PR</i>	Description
0.85	Top-quality system, very good ventilation, no shade, minimal pollution
0.8	Very good system, good ventilation, no shade
0.75	Average system
0.7	Average system with minimal losses due to shade or poor ventilation
0.6	Poor system with major losses due to shade, pollution or system failures
0.5	Very poor system with large areas of shade or defects



Electric Energy Yield of Photovoltaic systems

A rough calculation of the quantity of energy fed in annually by a grid-connected photovoltaic system can be made on the basis of the annual solar radiation H_{solar} in kWh/(m² a) from Figure 5.15, the losses or gains through orientation and tilt angle $f_{\text{orientation}}$ (Figure 5.16), the rated or MPP power P_{MPP} of photovoltaic modules in kW_p and the performance ratio PR (compare Table 5.3):

$$E_{\text{electric}} = \frac{H_{\text{solar}} \cdot f_{\text{orientation}} \cdot P_{\text{MPP}} \cdot PR}{1 \frac{\text{kWh}}{\text{m}^2}}$$

The yield of a photovoltaic system in Berlin that is orientated approximately 20° towards the south-southeast and tilted approximately 20° towards the south-southwest and has an MPP power of 4kW_p will be used as a sample calculation. The annual solar radiation according to Figure 5.15 is around 1020kWh/(m² a). According to Figure 5.16, the tilt gains are $f_{\text{orientation}} = 110\% = 1.1$ based on the south orientation. Based on the performance ratio of an average system $PR = 0.75$, the annual quantity of fed-in electric energy is:

$$E_{\text{electric}} = \frac{1020 \frac{\text{kWh}}{\text{m}^2 \text{a}} \cdot 1.1 \cdot 4 \text{ kW}_p \cdot 0,75}{1 \frac{\text{kWh}}{\text{m}^2}} = 3366 \frac{\text{kWh}}{\text{a}}$$

This corresponds approximately to the consumption of an average German household. Therefore, as a yearly average about 30m² of roof area is necessary for a household to cover its total electricity requirements using a solar system. The specific yield related to 1kW_p is often given for a system. In the example above, the total is 825kWh/(kW_p a).



The rough calculation of yield described here naturally incorporates certain inaccuracies. However, the order of magnitude of the system yield is correct. It can be used in the following section to examine the economic viability. Internet tools and computer programmes are available to conduct a more precise analysis. Professional firms also offer to carry out calculations of this type. In any case, if a large system is to be installed, it is advisable to get an expert to produce an appraisal on yield to avoid unpleasant surprises later on. Banks also often require a copy of the relevant appraisal.



- <http://www.valentin.de/onlineberechnung/pv>
- <http://www.nrel.gov/rredc>
- <http://re.jrc.ec.europa.eu/pvgis/>

PV online calculations
Renewable Resource Data Centre
Photovoltaic Geographical Information System PVGIS

It is not necessary for a grid-connected system to be large enough to cover the total electricity requirements of a household. Depending on the roof size and how much money is available, the system can turn out to be larger or smaller than optimally

needed. Many roofs have enough space for large photovoltaic systems that are capable of supplying more electricity than required and can, therefore, be optimal in protecting the climate. But even small systems can make a contribution.



From Thinking about Having a PV System on the Roof to Getting a Quote

- Determine orientation and tilt angle of roof.
Is the roof suitable from the point of view of orientation and tilt angle?
Recommendation: min. 100% according to Figure 5.16.
- Establish shading conditions on the roof.
Does my roof have little shade?
Recommendation: Take shaded areas into account during planning; also pay attention to chimneys, aerials and lightning conductors.
Identify available roof area with little shade.
- Calculate installable MPP power for the photovoltaic system.
Recommendation: Efficiency min. 12% in formula above.
- Calculate possible annual electric energy yield.
Use formula above or online tools.
- Request quotations.



5.4.2 Planned Islands

The design of photovoltaic island systems is fundamentally different from grid-connected systems. Island systems cannot rely on the public electricity grid if there is no sun. Instead these systems use sufficiently large batteries to avoid any power failures. However, in principle a battery is only used to bridge the days that are less than optimal. Therefore, photovoltaic modules also have to deliver as high a yield as possible during the months with the least sunshine. The recommendation for reliable operation in winter is to place photovoltaic modules at a steeper angle than is necessary with grid-connected systems, which are angled optimally for operation all year round. In Europe and North America a tilt of around 60° to 70° towards the south provides optimal solar yield in the month of December. The closer one gets to the equator, the less marked are the differences between summer and winter. In these parts of the world a flatter installation is also sufficient for winter operation.

The objective of island systems is not to achieve as high an output yield as possible but to provide reliable electricity supply to certain consumers. Consequently, the main criterion for the design of such a system is the estimated consumption level for the worst month of the year. In Europe and North America this is December. Furthermore, solar systems are equipped with a certain safety margin. In a normal case this should amount to an extra 50%. As with grid-coupled systems, the performance ratio PR takes into account the losses.

Table 5.4 Monthly and yearly totals of solar radiation in kWh/m² for different locations and orientations.

Location	Berlin		Madrid		Los Angeles	Cairo
	30° south	60° south	30° south	60° south	30° south	30° south
February	28	31	100	113	139	157
April	117	106	172	141	201	204
June	151	127	214	163	175	214
August	153	135	209	175	223	220
October	68	87	105	137	164	201
December	21	25	73	82	128	146
Year	1139	1042	1855	1675	2089	2310



PV Power Needed for Island Systems

The required MPP power P_{MPP} of a photovoltaic module can be roughly calculated based on the solar radiation $H_{solar,m}$ during the worst month in kWh/m² (Table 5.4), the electricity requirement $E_{demand,m}$ for the same month, a safety margin f_s of at least 50% and the performance ratio PR (on average 0.7):

$$P_{MPP} = \frac{(1 + f_s) \cdot E_{demand,m}}{PR} \cdot \frac{1 \frac{kW}{m^2}}{H_{solar,m}}$$

The battery should be dimensioned so that it is planned to be discharged to only half its power and can supply the total electricity requirements for a number of reserve days. In Central Europe up to five reserve days are enough to ensure reliable operation in the winter; in countries that get more sun only two to three reserve days would be enough. The required battery capacity is calculated on the basis of the battery voltage V_{bat} (e.g. 12 volts):

$$C = \frac{2 \cdot E_{demand,m}}{V_{bat}} \cdot \frac{d_r}{31}$$

For example, a photovoltaic system should be capable of operating an 11-watt low-energy light bulb in a summerhouse for three hours every day in the winter. The monthly electricity requirement for one month is then $E_{demand,m} = 31 \cdot 11 \text{ W} \cdot 3 \text{ h} = 1023 \text{ Wh}$. With a safety margin of 50% = 0.5 and a performance ratio of 0.7, a module in Berlin orientated towards the south and tilted 60° then has a required MPP power of

$$P_{MPP} = \frac{(1 + 0.5) \cdot 1023 \text{ Wh}}{0.7} \cdot \frac{1 \frac{kW}{m^2}}{25 \frac{kWh}{m^2}} = 87.7 \text{ W}$$

With four reserve days and a battery voltage of 12V, the battery capacity is calculated as follows:

$$C = \frac{2 \cdot 1023 \text{ Wh}}{12 \text{ V}} \cdot \frac{4}{31} = 22 \text{ Ah}$$



5.5 Economics

Photovoltaics is already an economically competitive technology in several niche applications. Small applications are often supplied with small batteries or button cells. Compared to household electricity prices of around 20cents/kWh in Germany, for example, the costs with photovoltaics can quickly explode to several hundred euros per kWh. It takes about 280 mignon cells to store one kilowatt hour using high-quality alkaline manganese batteries. Now, no one would ever think about buying 280 mignon cells to run a washing machine just once. However, with small applications we often tend to be willing to pay whatever it costs to buy batteries. It is often the infrequent use of these small applications that even makes using electricity affordable. Photovoltaics can compete with this type of high energy cost even under the cloudiest conditions. It is often an economic alternative even to large battery systems. However, photovoltaics will have to relinquish its niche role if it is to become effective in protecting the climate. This will only happen if it becomes a grid-connected system and replaces conventional power plants.

5.5.1 What Does It Cost?

A sensible minimum quantity of power for a grid-connected photovoltaic system is 1 kilowatt peak (kW_p). There is no upper limit; this depends only on the area available and the amount of money available. Fortunately, the prices of photovoltaic systems are dropping so much that they are out of date even before they are printed. This makes it difficult for any book to provide a current guideline to prices. In 2008 it took an investment of around 4000 euros for a completely installed $1-kW_p$ system. The price of the photovoltaic module itself only constitutes a part of the total system price. A good 60% of the investment goes towards the PV modules, while the rest is spent on inverters, mounting materials, the actual mounting and planning.

Whereas the lion's share of the cost with photovoltaic systems is in the installation, the payoff then comes through the electricity that is generated. The reimbursement is usually per kWh. The operating costs of photovoltaic systems are comparatively low. An estimated 2 to 3% of the investment costs each year will be spent on running costs, such as insurance, possible leasing, meter rental and reserves for repairs. The modules can normally be used for 20 to 30 years. Inverters, on the other hand, usually wear out earlier. Repairs and replacement parts should be included in the calculations at the outset.

Another factor that has a major effect on production costs is the return. Very few sensible people will invest their own capital in a photovoltaic system in the hope of at best receiving their invested capital back again over the lifetime of the system. An investment should at least be comparable with a savings account to make it attractive to large numbers of people. Even then a certain amount of idealism is required, because the risks associated with photovoltaic systems are

considerably higher than those with savings accounts. For example, a flash of lightning or a storm can completely destroy a system. If the insurance does not pay for the damage, the investment is then lost. Another thing that can happen is that the output is lower than projected. There may be various reasons for this. The PV system could be the victim of poor planning, over the years a tree could grow so that it shuts out the sun, a flock of birds could regularly be using the module for target practice or the solar radiation may be lower than during the previous 20 years due to fluctuations in the climate. Ultimately, it is the operator of the photovoltaic system who is responsible for dealing with all these risks. A return of at least 6% is therefore quite appropriate for an investment not driven by idealism.

Figure 5.17 shows the resulting production costs of a photovoltaic system based on net investment cost. The assumption made in the calculations is that 2% of the investment cost is for operating and maintenance costs each year and the economic lifetime of the system is 20 years. The different coloured lines represent the calculations for various specific yields. In Germany these are normally under 1000 kilowatt hours per kilowatt peak (kWh/kW_p). For a return of 6% the production costs are around 38 cents per kilowatt hour with a net investment cost of 3500 euros per kilowatt peak with a specific output of 1000 kWh/kW_p . An idealist might be satisfied with 25 cents per kilowatt hour and no return. If the output is 1500 kWh/kW_p at a location in California, at 25 cents per kilowatt hour a return of even 6% can be achieved.

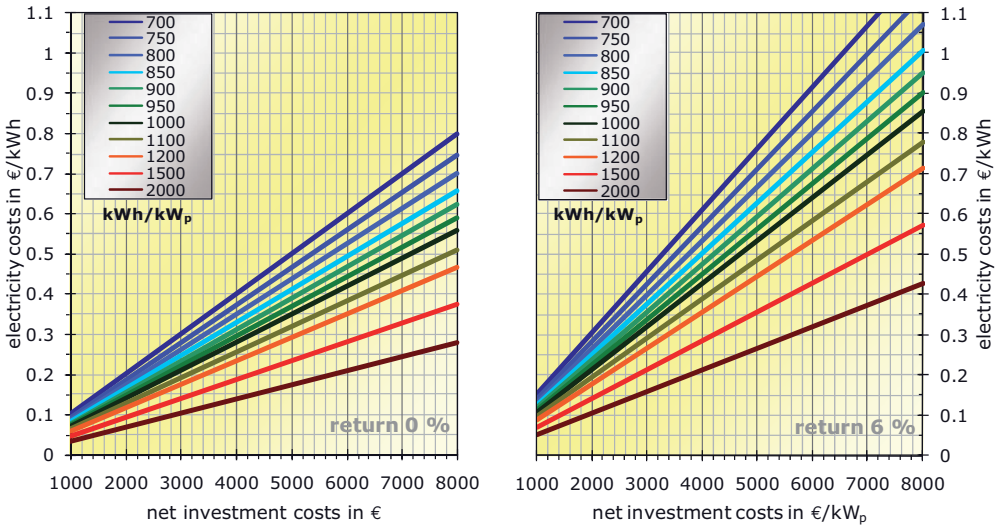

Figure 5.17 Electricity production costs based on net investment costs and specific yield for a return of 0% (left) and 6% (right).

5.5.2 Incentive Schemes

Whereas small-scale photovoltaic island systems are already competitive today, the energy production costs for grid-connected photovoltaic systems are in most cases still higher than normal market prices. It currently only makes sense to install large numbers of grid-connected photovoltaic systems if state incentive schemes are available. In Germany, compensation is regulated through the Renewable Energy Law (Erneuerbare Energien Gesetz, EEG). Other countries have also adopted the compensation principle. A fixed price is stipulated for each kilowatt hour a photovoltaic system feeds into the public electricity grid. The relevant electricity company pays this fee but is allowed to split any associated additional costs among all its electricity customers. The law is aimed at making solar power competitive. The law therefore provides an annual degression for systems in buildings. The compensation for new systems thus drops each year (Table 5.5). The increased compensation is guaranteed for 20 years after a system has been installed. After this, the fee drops to normal market prices.

Table 5.5 Compensation in Germany for grid-connected photovoltaic systems in cents/kWh based on the Renewable Energy Law.

Commissioning	2005	2006	2007	2008	2009	2010 ^a	2011 ^a	2012 ^a
Building systems	54.53	51.80	49.21	46.75	43.01	39.57	36.01	32.77
As of 30kW	51.87	49.28	46.82	44.48	40.91	37.64	34.25	31.17
As of 100kW	51.30	48.74	46.30	43.99	39.58	35.62	32.42	29.50
As of 1000kW	51.30	48.74	46.30	43.99	33.00	29.70	27.03	24.59
Façade bonus	5.00	5.00	5.00	5.00	0.00	0.00	0.00	0.00
Open space systems	43.42	40.60	37.96	35.49	31.94	28.75	26.16	23.81

^aCompensation rates for 2010 to 2012 can vary slightly depending on total installed power for the previous year.

The EEG law has succeeded in triggering a photovoltaic boom in Germany since 2004. Other countries, including Spain, have adopted the same type of law. There are countries that use other incentive models, such as prescribed quotas for renewable energies. However, compared to the German EEG, these models have not proven to be very successful.

If, as predicted, the costs go down, photovoltaics at certain locations could become economically competitive in less than ten years without an increase in compensation. Many countries that have high solar radiation levels experience a large increase in electricity demand because of air-conditioning systems used in the summer. Due to the associated high electricity costs in summer, photovoltaics can become economically viable even earlier in these countries. In many countries the high initial investment required to install photovoltaic systems is made easier because low-interest loans or grants are available. However, the conditions and programmes for these are often subject to change.



From the Quotation for a PV System to the Running Installation

- Find out about public grants and low-interest loans.
- Review economic feasibility based on quotations received (see Figure 5.17).
- Clarify connection conditions with the energy supply company.
- Arrange for the system to be installed by company specializing in photovoltaics.

5.6 Ecology

There is a persistent rumour that it takes more energy to produce the silicon for a solar cell than the cell could ever generate during its lifetime. No one knows where this rumour started. Presumably it was spread by opponents of solar technology before detailed studies on the subject were even available.

It is true that quite a lot of energy is needed to produce solar cells. Temperatures of well over 1000 °C are required in the production of silicon and for its subsequent purification. However, in contrast to conventional coal-fired, natural gas and nuclear power plants, no other energy supplies are needed in the operation of photovoltaic systems. Once a solar system is in operation, it begins to supply back the energy used in its production. Various scientific studies in the 1990s showed that in Germany it takes around three to four years for solar cells to regenerate the energy needed to produce them (Quaschnig, 2005), but less than two years in Southern Europe or at good US sites. Due to increased efficiency and decreases in cell thickness, these figures will now be much lower. With a lifetime of 20 to 30 years, a solar cell generates vastly more energy than that used to produce it.

Today a 0.3 mm-thick, 6-inch crystalline silicon solar cell weighs around 16 grams. The amount of energy needed to produce solar cells will continue to fall, because there is an active interest in drastically reducing the materials used, and, consequently, in reducing cost. For example, the amount of material used in thin film cells has already decreased considerably. It is expected that in the future solar systems will be able to make up the energy needed for their production in just a few months.

Various chemicals, some of them toxic, are used to produce solar cells. As with all chemical systems, care has to be taken that no chemicals escape into the environment. This should not be a problem with the modern production systems and high environmental standards that exist today.

An old solar system that is no longer useable, on the other hand, is considerably less problematic. Nevertheless it would be a shame simply to scrap old and unviable solar systems, because they contain valuable raw materials. The solar industry is therefore working on methods to recover these materials. Initial attempts at recycling solar cells seem promising. The solar modules are dismantled into their original parts, and new photovoltaic modules are produced from the reclaimed cells.

5.7 Photovoltaic Markets

Among the renewable energies that currently exist, photovoltaics offers the most possibilities for different uses. The advantage is the modular structure of these systems. Almost any desired generator size is possible, from the milliwatt range for supplying power to pocket calculators and watches all the way to the megawatt range for supplying public electricity. Pocket calculators supplied by photovoltaics were already in widespread use decades ago.

Whereas in 1980 85% of all solar modules were being produced in the USA, this share shrank to less than 10% by 2005. Japan, China and Germany have replaced America as the leaders in photovoltaics.

Large-scale systems that feed solar power into the public grid first became popular after successful marketing programmes in Japan and Germany. Government schemes in both countries boosted the production of photovoltaic modules and have contributed towards annual market growth rates between 20 and 40% since the early 1990s (Figure 5.18). In the meantime, other countries like Spain, Italy and the USA have also created attractive conditions for the installation of grid-connected photovoltaic systems.

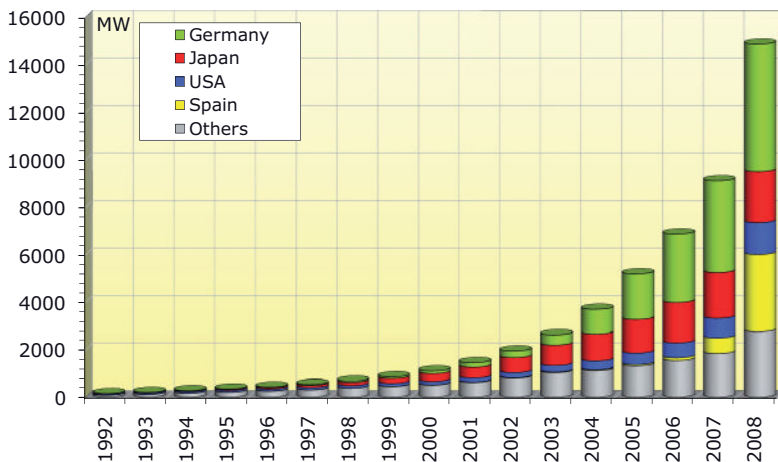

Figure 5.18 Development of overall photovoltaic power installed worldwide.

In Germany, the popularity of grid-connected photovoltaic systems did not begin until the early 1990s with the so-called 1000-roof programme. With the help of state schemes more than 2250 photovoltaic systems were erected, mainly by private households. When the programme was phased out, the use of photovoltaics began to stagnate. It was not until 2000 that fresh impetus was given through the introduction of the Renewable Energy Law.

With over 500 000 photovoltaic systems and an output of more than 5300 megawatts, Germany in 2008 had the most systems in operation by a considerable margin. These

systems fed 4.3 billion kilowatt hours of electric power into the grid, which was a 0.7% share of the overall electricity supply. Photovoltaics was thereby supplying more than one million households with carbon-free electricity. Photovoltaics companies in Germany generated a turnover of 7 billion euros and used it to create 48 000 future-orientated workplaces. The Federal Association for Solar Economy is counting on more than 100 000 workplaces by 2020 (Bundesverband Solarwirtschaft, 2009).

5.8 Outlook and Development Potential

Even if the quantity of solar power is still relatively small, in the medium term photovoltaics will be able to provide the largest share of environmentally compatible electricity supply. From a purely mathematical standpoint, it could be used to supply the world’s entire energy needs. This would only take a fraction of the surface of the Sahara Desert to accomplish. Even countries like Great Britain, Germany and France would be able to cover all their electricity requirements through photovoltaics. On the other hand, from a technical perspective it is not a good idea to rely solely on one technology for the future supply of energy. Photovoltaic systems work well in combination with other renewable energy systems, such as wind power, hydropower and biomass systems. A well-planned combination of systems will increase supply reliability and avoid the building of large storage systems to ensure sufficient supplies are available at night and during the winter.

Costs will have to drop further before large numbers of countries start using photovoltaics on a considerably larger scale than at present. Past experience has shown that major cost reductions are possible. Whereas the price of photovoltaic modules was still around 60 inflation-adjusted US dollars per watt in 1976, by 2007 it had already dropped to around 3 dollars per watt (Figure 5.19).

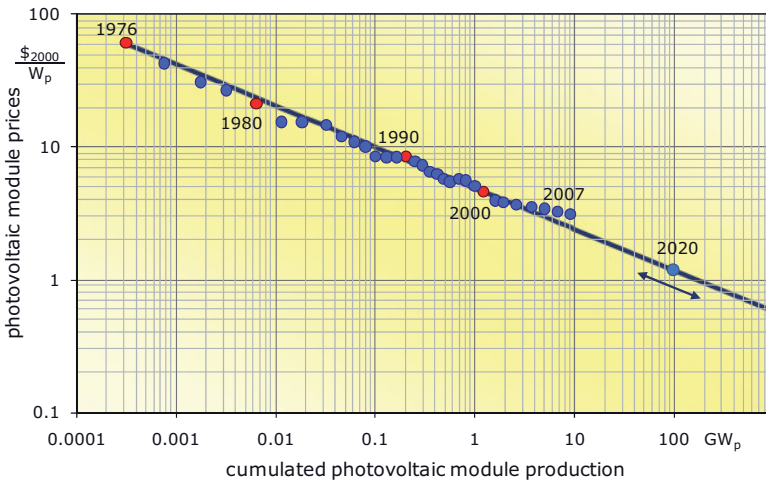

Figure 5.19 Development of inflation-adjusted photovoltaic module prices on the basis of total quantity of modules produced worldwide.

What is crucial for cutting costs is an increase in production. If production quantities rise, then costs will drop noticeably due to the effects of streamlined production and also because of technical advances. During the past 30 years cost savings of around 20% have been achieved due to a doubling in the total quantities of photovoltaic modules produced. There is nothing to indicate that this development will not continue. It is possible that the prices of photovoltaic modules could fall below US\$1 per watt by 2020. As a result, the current cost to generate electricity using photovoltaic systems would have shrunk to about one fourth.

This would then make photovoltaic systems very interesting to end users in Central Europe, even without the need for any government subsidy schemes. A photovoltaic system would be able to produce electricity more cost-effectively for household use than an energy supply company could deliver to the household. In the sunniest parts of the world photovoltaics could produce energy more cost-effectively than any conventional alternatives. For that reason, the main markets for solar energy in the long term will be in places other than Western Europe.

6

6 Solar Thermal Systems – Year-Round Heating from the Sun

The light and warmth of the sun give us a special sense of well-being, which is why summer is eagerly awaited in cool parts of the world such as Northern Europe. Most people in these countries are also lucky enough to be able to reproduce these conditions even in the depths of winter. Our homes and workplaces are heated to a comfortable level and well lit, and our water is heated so that we can enjoy hot baths and showers at any time. The luxury of always being able to set the desired temperature is taken for granted today, one of the most pleasant achievements of our prosperous society. It is difficult to imagine the period after the Second World War, when not enough fuel was available in the cold winters to maintain even reasonably bearable temperatures in our dwellings. However, our prosperity and fossil fuels have eliminated these conditions once and for all – not everywhere in the world but at least for us.

But even eliminating fossil fuels will in no way jeopardize our privilege of always being able to select the temperature we want. Solar thermal energy – the heat from the sun – is an important alternative. When sunlight shines through the windows, the power of the sun is already helping to warm up the building. For centuries the sun has been a major source of heat for our homes.

In 1891 the metal manufacturer Clarence M. Kemp from Baltimore was awarded the first patent in the world for a technical solar thermal system. This was a very simply constructed storage collector for heating water. In 1909 the Californian William J. Bailey introduced an optimized system concept that separated the solar heat collector from the water storage cylinder. Solar heating systems were marketed successfully in certain regions until the Second World War, after which the market collapsed because of competition from fossil fuel.



Figure 6.1 Modern solar thermal collector systems are an important alternative to conventional oil and natural gas heating. Photos: www.wagner-solar.com.

It was not until the oil crisis in the 1970s that solar thermal power was rediscovered. In the years that followed there were still many teething problems, and not all systems ran smoothly. Today a variety of solar thermal system variants are available, and these systems are much more sophisticated than in the past (Figure 6.1). In combination with optimized heat insulation and other renewable heating systems, such as biomass heating and renewably operated heat pumps, these systems can make an important contribution towards the supply of carbon-free heat.



Solar Collectors, Solar Absorbers, Solar Cells or Solar Modules – What Next?

These terms are often used interchangeably, so to avoid confusion it's important to be clear about what exactly they refer to.

A *sun collector* or *solar collector* is used to extract heat from the radiation of the sun. Thus, a collector always makes something hot. At the heart of a solar collector is a *solar absorber*. The solar absorber absorbs the radiation of the sun and converts it into heat. Solar collectors are used to heat domestic water supply, supplement room heating and produce high-temperature process heat. Thermal power plants can even generate electricity from high-temperature heat (see Chapter 7). However, even then solar collectors are first used to produce the heat.

A *solar cell* is a photovoltaic cell that converts solar radiation directly into electric energy (see Chapter 5). Although a solar cell can also get hot, it is different from a solar collector in the sense that this is an undesired side effect. The heat actually reduces efficiency during the production of electricity. A *solar module* consists of a large number of solar cells and also generates electric energy from sunlight.

6.1 Structure and Functionality

Solar thermal energy is a technology for converting solar radiation into heat. The field of application for this technology is extensive. The higher the temperatures are required to be, the more complicated the technical implementation. The principle is similar with all solar thermal systems. A solar collector first collects the sunlight. The term collector comes from the Latin word ‘collegere’, which means to collect. The main component of a collector is the solar absorber. It absorbs the sunlight and converts it into heat (Figure 6.2). It then transfers this heat to a heat transfer medium.

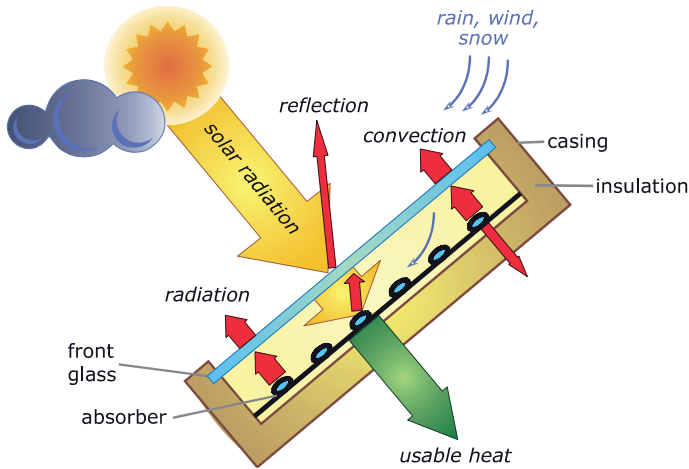

Figure 6.2 Processes in a solar flat-plate collector.

The heat transfer medium may simply be something like water, air or even oil or salt. Heat loss is unavoidable during the conversion. Part of the solar radiation is reflected and does not even reach the absorber. A certain amount of heat is lost before it can be transferred to the heat transfer medium. The trick is to construct a collector so that heat loss is as low as possible but the collector is still cost-effective to produce. Appropriate collectors should be used depending on the field of application and desired temperatures.

The efficiency curve describes the performance of a collector. Research institutes measure collectors under strictly defined conditions to determine the curve. These characteristic curves can then be obtained from the manufacturer of the collector or over the Internet.



- <http://www.spf.ch/spf.php?lang=en>
- <http://www.itw.uni-stuttgart.de>

SPF Collector Test Reports
ITW Kollektor-Testberichte (in German)



Collector Efficiency

The efficiency and efficiency curve of a solar collector can be determined using the three parameters η_0 , k_1 and k_2 . The optical efficiency η_0 describes which portion of sunlight is converted into heat by the absorber. The absorber itself or the front panel of glass actually reflects a portion of the sunlight before it can even be absorbed. Depending on the type of collector, optical efficiency is between 70 and 90%. The two loss coefficients k_1 and k_2 indicate how high the heat loss is in the collector. The hotter the collector is, the higher the heat loss and the less useful heat the collector can emit. High loss coefficients also mean high heat loss. The formula for collector efficiency is as follows:

$$\eta = \eta_0 - \frac{k_1 \cdot \Delta\vartheta + k_2 \cdot \Delta\vartheta^2}{E}$$

Here $\Delta\vartheta$ indicates the temperature difference between the collector and the environment and E the intensity of the solar radiation.

With an ambient temperature of 25 °C and a collector temperature of 55 °C, the result is a temperature difference of $\Delta\vartheta = 30$ °C, or 30 K. On a pleasant summer's day with a solar radiation intensity of $E = 800$ W/m², the calculation of a flat-plate collector with an optical efficiency of $\eta_0 = 0.8$ and the loss coefficients $k_1 = 3.97$ W/(m²K) and $k_2 = 0.01$ W/(m²K²) gives a collector efficiency of

$$\eta = 0.8 - \frac{3.97 \frac{\text{W}}{\text{m}^2\text{K}} \cdot 30 \text{ K} + 0.01 \frac{\text{W}}{\text{m}^2\text{K}^2} \cdot (30 \text{ K})^2}{800 \frac{\text{W}}{\text{m}^2}} = 0.64 = 64\%$$

A collector 4.88 m² in size then supplies 2500 watts of power. This is sufficient to heat 100 litres of water from 33.5 °C to 55 °C in one hour. ■

The collector efficiency curve describes the progression of efficiency based on the temperature difference between the collector and the environment (Figure 6.3). It shows that efficiency drops as the temperature rises until the collector reaches an efficiency of zero and finally cannot supply any more power.

Almost all thermal solar systems require storage in addition to a collector. There are very few cases when the sun shines at exactly the same time as heat is needed. Even a simple water tank can function as a thermal store and should be well insulated to reduce heat loss. The storage size depends mainly on the heat requirement and on how long the heat needs to be stored. Daytime storage cylinders for hot water systems in single-family homes are designed to bridge a few days of demand and usually only hold a few hundred litres. If, in addition to hot water, very large quantities of heat for heating are also to be stored, then seasonal heat storage cylinders are required. These store heat in the summer and then release it again in the winter. Large heat storage cylinders for small housing estates reach sizes of several hundred or even thousand cubic metres. Large storage cylinders generally have less specific

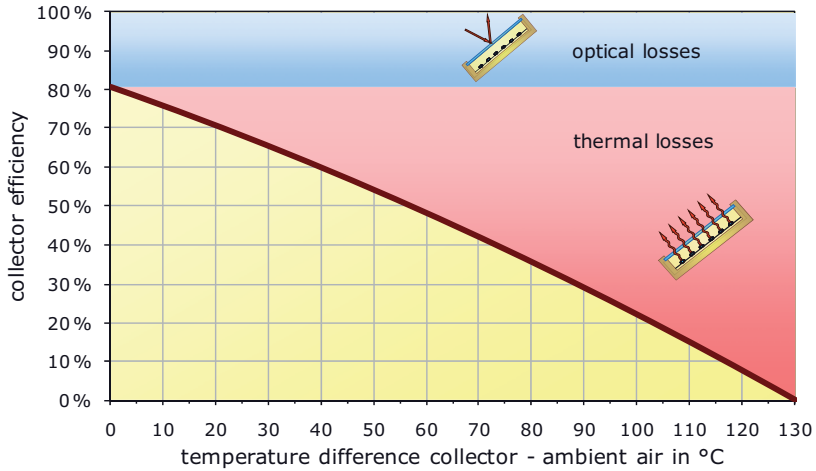

Figure 6.3 Collector efficiency curve.

heat loss than small ones. The storage volume increases considerably faster than the size of the storage surface. However, storage losses depend only on the size of the surface of the storage.

6.2 Solar Collectors – Collecting the Sun

6.2.1 Swimming Pool Absorbers

Different types of collectors are available for different purposes. The simplest type of collector consists of only one absorber. Placing a dark garden hose filled with water in the sun for a time produces enough heated water for a short but warm shower. A garden hose thus already has the characteristics of an absorber. In principle, a professional swimming pool absorber is also nothing more than a simple black plastic pipe that absorbs the sunlight almost optimally due to its dark colour. Weather-resistant plastics that cope well with UV light and chlorinated pool water are used for this purpose. The materials that are suitable are polyethylene (PE), polypropylene (PP) and ethylene-propylene-dien-monomere (EPDM). PVC should be avoided for ecological reasons. In winter it is futile trying to use a garden hose to extract warm shower water. The same applies to swimming pool absorbers. Although an absorber continues to absorb the sun's radiation, the heat loss in the absorber pipe itself is so great that hardly any heat can be drawn from the end of a pipe. Technically more sophisticated collectors are required to use the sun's heat during winter and the transitional periods of the year or when water temperatures should be warmer than the water in a swimming pool.

6.2.2 Flat-Plate Collectors

With flat-plate collectors a front panel of glass reduces heat loss considerably. Unfortunately, the front glass also reflects some of the sunlight. Therefore, when collector temperatures are very low, the efficiency of a swimming pool absorber can be higher than that of a flat-plate collector. However, flat-plate collector efficiency increases considerably as temperatures rise.

In summer there are times when solar thermal systems do not need any heat. For example, when a heat storage cylinder is completely full the system does not pump any more water through the collector. This is referred to as a collector standstill. The temperatures in collectors can easily rise above 100 °C. Very good flat-plate collectors reach standstill temperatures between 150 °C and 200 °C. This therefore rules out the use of plastic pipes for absorbers. The absorbers of flat-plate collectors usually consist of copper pipes fixed to a thin metal plate (Figure 6.4). The absorber itself is located in a collector enclosure that is well insulated at the back to minimize rear heat loss.

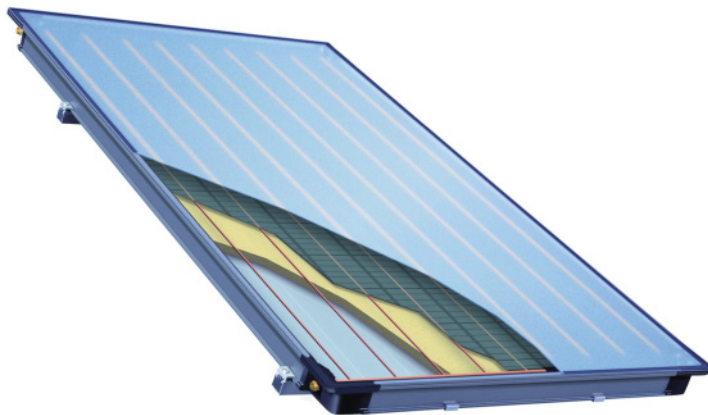

Figure 6.4 Cross-section of a flat-plate collector. Picture: BBT Thermotechnik GmbH.

Metallic materials by nature do not have a black surface that absorbs the sun's radiation well, so they need to be coated. The first option that is usually considered for the coating is black paint. Although temperature-resistant black paint is good for this purpose, there are other far better materials for absorber coating. When a black surface gets warm, it sends out some of the heat energy in the form of thermal radiation. This can be observed with an electric hot plate that has been switched on. One can feel the heat radiating from the hot plate without even touching it. The same effect occurs with a black-painted absorber. The absorber only radiates part of its heat to the water flowing through. Another part is emitted back into the environment as undesirable thermal radiation.

Thermal radiation losses can be minimized through the use of selective coatings (Figure 6.5). These coatings absorb the sunlight just as well as a black-painted plate.

However, they emit a much lower amount of thermal radiation. Materials for selective coatings can no longer simply be painted or sprayed onto a surface. More complicated coating methods are now necessary.

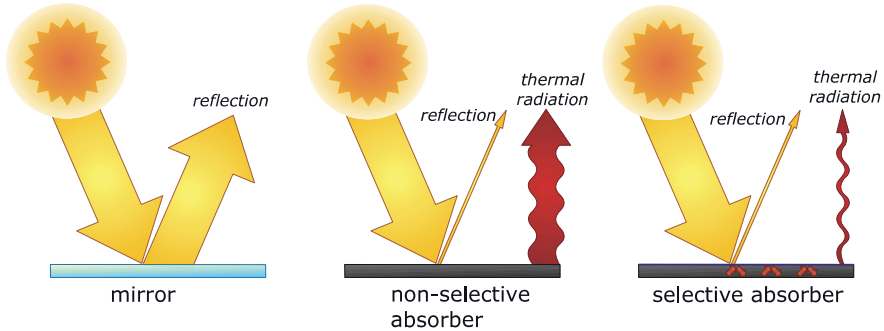

Figure 6.5 Principle of selective absorbers.

6.2.3 Air-Based Collectors

In most cases, solar collectors heat water. However, air and not water should be used to heat the air of rooms. With conventional heating systems, radiators or heating pipes installed under the floor transfer the heat produced from hot water to the air. Instead of water, air can also be transmitted by a solar collector.

As air absorbs heat considerably less effectively than water, much larger absorber cross-sections are required. Otherwise, in principle, air-based collectors differ very little from liquid-based flat-plate collectors. Figure 6.6 illustrates an air-based collector with perforated absorbers. An integrated photovoltaic module can deliver the

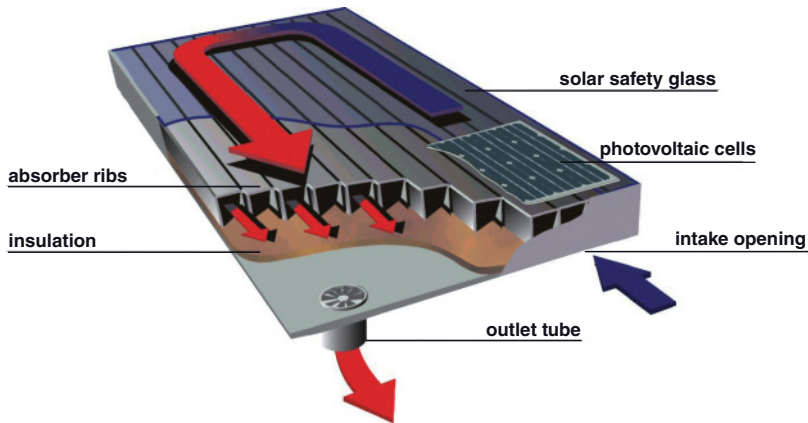

Figure 6.6 Cross-section of an air-based collector. Illustration: Grammer Solar GmbH.

electricity to drive the fan motor. Air-based collectors are a particularly interesting alternative as providers of support heating. However, heat storage is more difficult with systems that use air-based collectors.

6.2.4 Vacuum-Tube Collectors

With flat-plate collectors the air between the absorber and the front glass panel is the source of most of the heat loss. It causes convective heat loss and continuously transports the heat from the absorber to the glass panel. This then emits the heat unused back into the environment.



How a Blown-Up Plastic Bag Evacuates Its Air

The term vacuum originates from the Latin word ‘vacus’, which means ‘empty’ or ‘free’. A vacuum is generally thought of as space empty of matter. However, it is practically impossible to produce a totally air-less space on earth.

In technology and in physics a vacuum is interpreted merely as air pressure that is considerably lower than normal air pressure. To produce a vacuum, one uses a vacuum pump to pump the air out of a stable space. In principle, it is also possible to use one’s mouth to produce a rough vacuum – for example, by sucking the air out of a glass bottle. However, a plastic bag cannot be evacuated – at least not in any normal environment on earth. On the other hand, an almost perfect vacuum exists in space. If one opens an empty plastic bag in space and then closes it again, there will also be a vacuum in the blown-up bag. If one returns to earth with the bag, the ambient air pressure compresses it again.

Ambient air pressure originates through the power of the weight of air columns above the earth’s surface. The atmospheric air weighs around 10 tons per square metre of earth surface. The question is, why doesn’t this enormous pressure simply smash the glass of a collector? The answer is simple: the space under the glass is also filled with air, which produces the necessary counterpressure. On the other hand, if the air in the space behind the glass is evacuated, the glass will normally bend and shatter.

Heat losses can be reduced considerably if a vacuum exists between the absorber and the front glass because of the air movement in the collector. This is the principle used by vacuum flat-plate collectors. As the outer air pressure would press the front covering against the absorber, spacers are needed between the underside of the collector and the glass covering. The vacuum cannot be kept stable for a long period because penetration of air where the glass and collector housing intersect cannot be completely prevented. Therefore, vacuum flat-plate connectors must be evacuated again at certain intervals. This is done by attaching a vacuum pump to a special valve on the collector. These drawbacks were the reason why vacuum flat-plate collectors never became popular.

Another type of collector available is the vacuum-tube collector, which does not have the same disadvantages as the vacuum flat-plate collector. With vacuum-tube collectors, a high level of vacuum is completely enclosed in a glass tube.

Consequently, these collectors are considerably easier to produce and maintain for long periods than vacuum flat-plate collectors. The shape of the glass tubes enables them to withstand outside air pressure better so that metal rods are not necessary for support.

In the enclosed glass tube of a vacuum tube collector is a flat absorber, which is a flat metal absorber that has a heat pipe integrated in the middle (Figure 6.7 left). A lightly vaporizing medium like methanol is enclosed in this heat pipe. If it vaporizes due to the heat of the sun, the vapour rises upwards. The heat pipe sticks out of the glass tube at the top end. This is where the condenser, which condenses the heat medium again, is located. In the process, it transfers the heat energy over a heat exchanger to the water flowing through. After condensation the once-more liquid medium in the heat pipe flows downwards. For maximum functionality the tubes should be mounted with a certain minimum tilt.

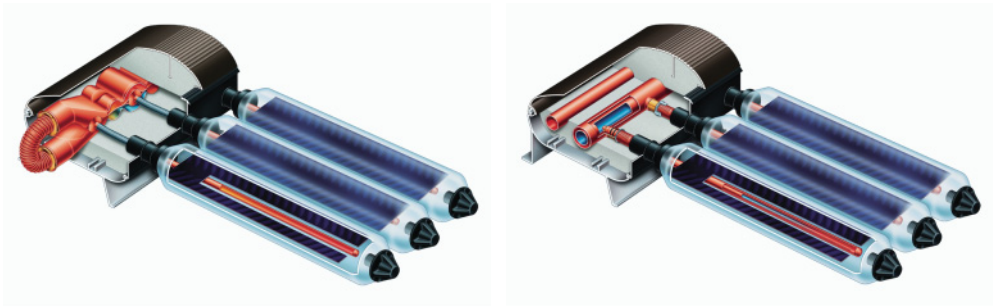

Figure 6.7 Vacuum-tube collectors. Left: Collector with heat pipe. Right: Tubes with direct flow. Illustrations: Viessmann Werke.

Vacuum-tube collectors with passing heat carrier pipes (Figure 6.7 right) are also available. With this system the heat carrier liquid flows directly through the collector. A heat exchanger is then not required and the collector does not necessarily have to be mounted at an angle.

Because hydrogen molecules are extremely small, atmospheric hydrogen cannot be totally prevented from penetrating the vacuum. With time this also destroys the vacuum. So-called getters, which can chemically bind the hydrogen that penetrates the vacuum over a long period of time, are built into a collector to prevent this from happening.

The advantage of vacuum-tube collectors is a very high energy yield, especially during the cooler seasons of the year. Compared to one with normal flat-plate collectors, a solar system with vacuum-tube collectors requires less space for the collector. The disadvantage is the substantially higher cost of the collector (Figure 6.8).

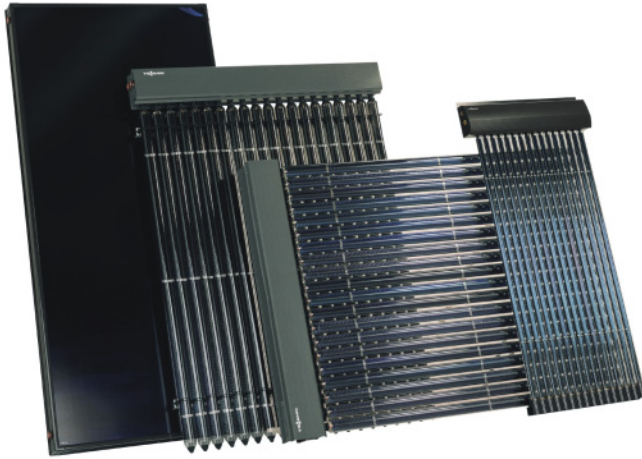

Figure 6.8 Comparison of flat-plate and vacuum-tube collectors. Illustration: Viessmann Werke.

6.3 Solar Thermal Systems

6.3.1 Hot Water from the Sun

6.3.1.1 Gravity Systems

The sun can be used to heat water to a high temperature. This is something we learned from Archimedes, who used a convex mirror to bring water to the boil as far back as 214 BC. That's not surprising, some will say, because Archimedes was not from Hamburg, London or Vancouver. In Southern Italy it is simply easier to use the sun's energy. This is quite correct, but only up to a point.

The temperatures in the Mediterranean region are much higher than in Germany, Great Britain or Canada and there is no worry there about frost damage to hot water systems. Systems that use solar energy to produce hot water can be constructed more simply and thus more cheaply in frost-free regions than in colder climates. However, even at high latitudes solar energy is an excellent option for producing desired heat.

Unfortunately, not all the people in sunny countries have received the message that they should be making use of solar energy. Thermal solar systems are common in Cyprus and Israel but not in Spain or the southern USA, although these areas also have a sunny climate. Gravity systems are mainly used in countries that do not get frost (Figures 6.9 and 6.10). A flat-plate or vacuum-tube collector collects the solar radiation and heats water that flows through the collector. A hot water storage

cylinder is installed at a higher level than the collector. As cold water is heavier than warm water, it sinks down from the storage cylinder to the collector. Here the water is heated by the sun and then rises to the top until it reaches the storage cylinder again. If no more solar radiation is available, the cycle stops until the sun starts it up again.



Figure 6.9 Left: Demonstration model of a gravity system. Right: Gravity system in Spain.

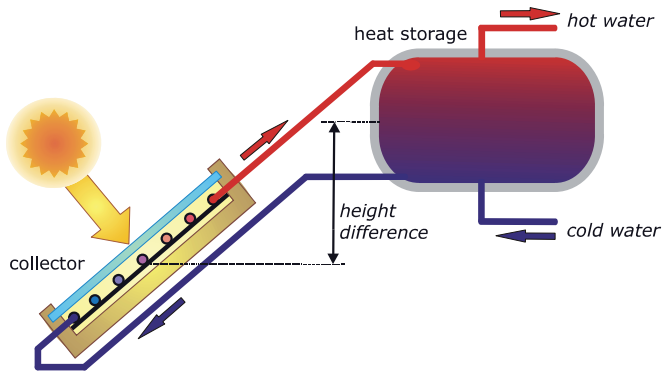

Figure 6.10 Solar gravity system (thermo-syphon system).

If properly designed, this kind of solar system can cover almost all the hot water needs of a family living in a warm, sunny southern climate. It is only during some of the sun-starved weeks of the year that the water will not completely reach desired temperatures. Either this is accepted in those countries or a supplemental heater, for

example, with natural gas, is installed. If on occasion the heat of the sun is not sufficient, a supplemental heater then takes over.

In China solar thermal systems for heating water have gained a high market share. In remote rural regions there is almost no access to fossil fuels. The inhabitants of these regions do not have the possibility of heating their water as and when required if there is no sun. China uses mainly vacuum-tube collectors because of the need to guarantee high supply reliability from solar systems.

6.3.1.2 Systems with Forced Circulation

A system should be technically optimized if the sun is to be used to produce hot water in areas with low outdoor temperatures. It would be too risky to heat up water for domestic use directly in a collector because the water would freeze in winter and therefore could destroy the collector. Consequently, the water that flows through the collector is mixed with an antifreezing agent. However, antifreezing agents cannot be used in the water supply as they have negative effects on health. A heat exchanger therefore separates the water circulation from the solar circulation and transfers the heat to a hot water storage cylinder. The storage cylinder is normally designed so that it can provide enough hot water for two to three bad days until a major supply of heat comes from the solar collector.

Flat roofs are less common in Central and Northern Europe and North America than they are in Southern Europe (Figure 6.11). Hot water storage cylinders are traditionally located in a basement or in a utility room. If the hot water storage is situated



Figure 6.11 Single-family house with photovoltaic system (left) and flat-plate collectors for heating water (right). Photo: SunTechnics.

below the collector, the water has to be pumped through the collector. A pump moves the water in a solar circulation through the collector and a control mechanism ensures that the pump only starts when the temperature of the collector is higher than that of the storage cylinder (Figure 6.12). A conventional boiler heats up the water during the transitional seasons and in winter so that a hot shower is possible all year round. It can happen that during the summer a solar collector will heat up an entire storage cylinder to a predetermined maximum temperature. This maximum temperature is usually set at 60 °C to prevent large deposits of lime from forming. If the cylinder is full, the control interrupts the incoming supply from the collector. Despite full irradiation from the sun, no more water will flow through the collector. The collector can then heat up to temperatures well over 100 °C and evaporate the water. If the expansion tank is large enough, it absorbs the expansion of the water volume.

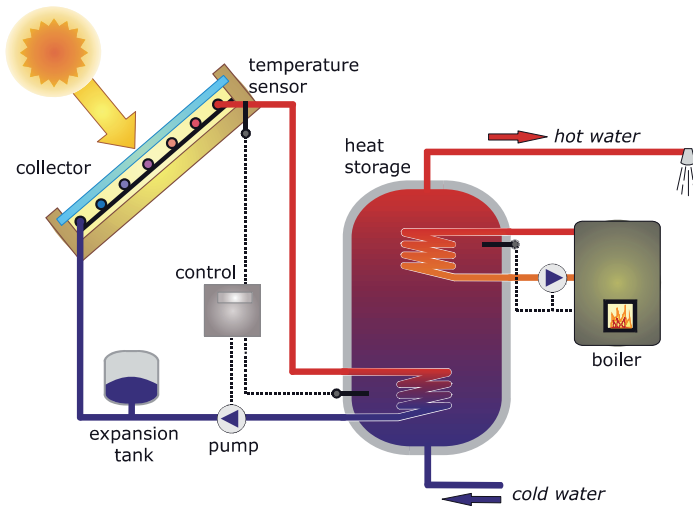

Figure 6.12 Pumped solar thermal system for heating domestic hot water.

6.3.2 Heating with the Sun

Solar thermal systems can be used to provide not only hot water but also heating. In principle, this only requires increasing the sizes of the collector and the storage cylinder and connecting them to the heating cycle. As no provision is normally made for domestic hot water in the heating cycle, two separate heat storage cylinders are needed – one for hot water and the other for drinking water. Combination boilers can integrate both storage elements and reduce heat losses (Figure 6.13).

In places like Germany and Great Britain the sun is only able to meet heating demand during the transitional periods of spring and autumn. Consequently, these systems are usually designed so that solar energy only serves as a supplemental heat supply. The output of the collectors is not sufficient to cover the heat needed during the winter. In principle, the sun could be used to cover all heating requirements. However, this would necessitate either an extremely large collector or an extremely

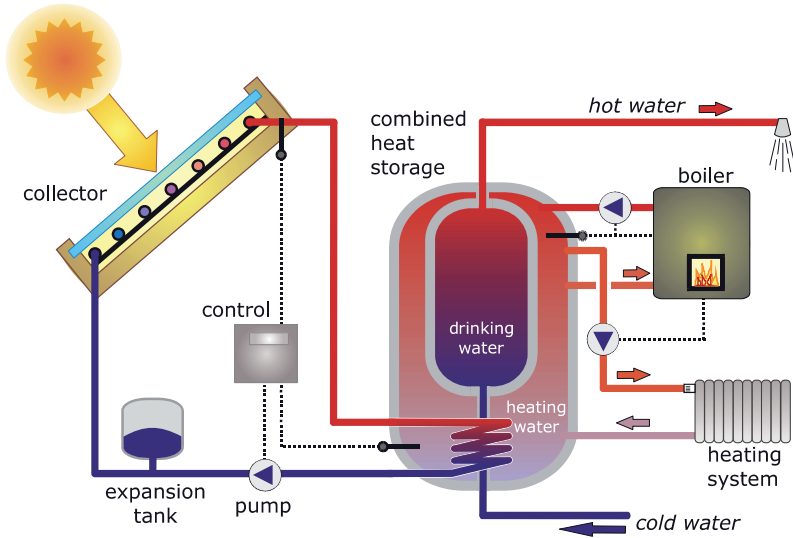

Figure 6.13 Solar thermal system for heating up domestic hot water and providing support heating.

large storage cylinder that stores thermal heat from the summer for the winter. The cost of the solar system would increase considerably as a result. Economically, it currently makes more sense to integrate only one storage cylinder with a few days' capacity into a system. This would enable between 20% and 70% of the heat requirement to be covered by the sun (Figure 6.14).



Figure 6.14 Large roof-integrated solar thermal system for heating water and providing supplementary heating. Photo: SunTechnics.

6.3.3 Solar Communities

If many houses in a community have solar collectors, these can be integrated into a solar district heat network. This can also involve setting up a large central collector complex. At the heart of such a heat network is a central heat storage tank. Its size helps to minimize heat losses, thus also enabling heat to be stored for longer periods. However, the extensive tube systems involved can result in disadvantages, such as higher costs and the possibility of major line losses. Some solar district heat communities have already been successfully installed (Figure 6.15).

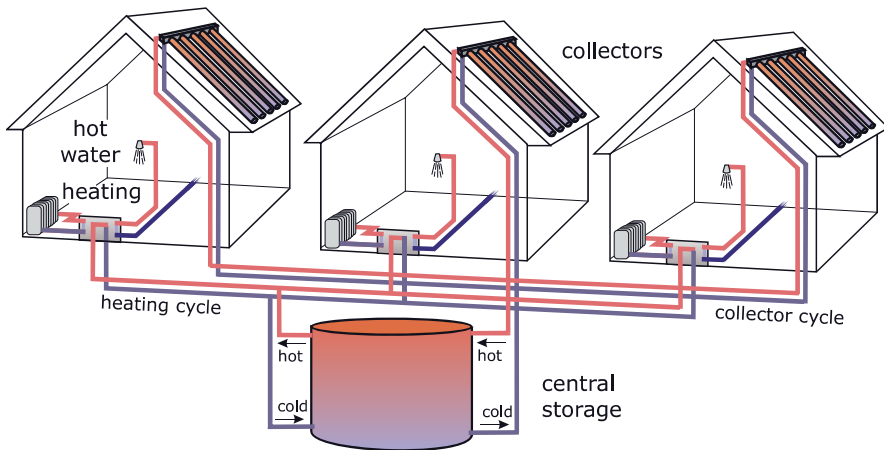

Figure 6.15 Solar district heat supply.

6.3.4 Cooling with the Sun

As paradoxical as it may sound, the heat from the sun can also be used to provide excellent cooling for buildings. In the hot and sunny regions of the world large numbers of energy-hungry air conditioning systems ensure that room temperatures are pleasantly cool. The sunnier and hotter it is, the greater the need for cooling. As the radiation from the sun increases, the output of a thermal collector also increases. In contrast with the requirement for heat, cooling load demand coincides almost perfectly with the supply of the sun.

Along with a large and efficient collector, an absorption-refrigerating machine is an essential element of a solar cooling system (Figure 6.16). In this context, the term absorption does not refer to a solar absorber. An absorption-refrigerating machine utilizes the chemical process of sorption. A chemist interprets sorption or absorption as the absorption of a gas or a fluid by another fluid. A popular example is the dissolution of carbon dioxide gas in mineral water.

Absorption-refrigerating machines use a sorbable cooling agent with a low boiling point, such as ammonia, which is later dissolved in water. Even aside from ammonia,

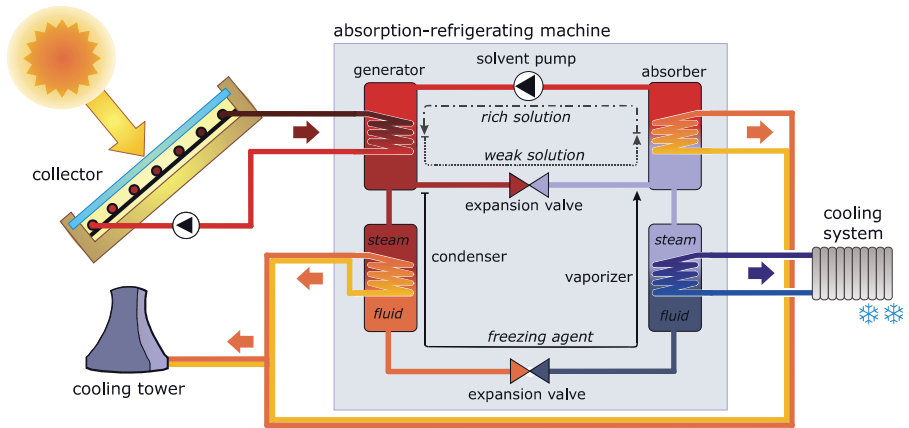

Figure 6.16 Principle of solar cooling with absorption-refrigerating machines.

water itself under low pressure can be used as a cooling agent. Lithium-bromide is then suitable as the solvent.

The cooling agent boils in a vaporizer at low temperatures. In the process it extracts the heat from the cooling system. The cooling agent then has to be liquefied again so that it can provide continuous cooling through renewed evaporation. With the help of a few tricks and an indirect way through sorption, the liquidation also succeeds through the use of solar heat.

The cooling machine absorber first mixes the cooling agent vapour with the solvent. This produces sorption that releases the heat. This heat is either used to heat the water or is transferred to a cooling tower.

A solvent pump transports the liquid solution, which has been enriched with a cooling agent, to the generator. The generator separates the cooling agent and the solvent on the basis of their different boiling points. Heat from efficient solar collectors is used for the boiling process. Temperatures of 100 °C to 150 °C are optimal. The separated vapour-formed cooling agent then enters a condenser, which liquefies the cooling agent. The condensation heat is also dissipated either as useful heat or over a cooling tower. The liquid cooling agent enters the vaporizer over an expansion valve and the solvent returns again to the refrigerating machine absorber. The cooling agent cools down considerably through the expansion in the expansion valve and can again deliver cooling to the cooling system over the vaporizer.

6.3.5 Swimming with the Sun

During the outdoor swimming season in Central Europe water temperatures normally reach 10 to 19 °C. The water is only warmer than this for a few days during the height of summer, although this period is becoming longer because of global warming. These water temperatures are a result of swimming pool water being heated by the sun. The following example shows how enormous the energy content of the sun is. The example uses Lake Constance, a popular lake for swimming that is visited by

millions of tourists annually. In winter the lake cools off quite considerably and in 1880 and 1963 it was even completely frozen over. In summer, in contrast, it reaches a temperature high enough to attract hordes of swimmers. If the entire supply of coal consumed in Germany each year were used to heat the water, it would only be enough to heat up the 50 cubic kilometres of water of Lake Constance just once to a temperature of 9°C. Looking at the USA, the whole US American primary energy supply of one year would only suffice to heat up Lake Michigan by less than 5°C on one occasion. The sun, on the other hand, can provide pleasant water temperatures without a problem and do it over many weeks.

Despite the heat of the sun, many bathers still find swimming pool temperatures too low in summer, so that pools are artificially heated. And because we only have to heat up a small swimming pool and not all of Lake Constance or Lake Michigan, many places pull out all the stops. In Germany there are about 8000 public outdoor and indoor swimming pools. In addition, there are around 500 000 private pools. In the USA there are about 8.6 million pools in total and 270 000 commercial pools. Several hundred million euros are spent each year alone on heating public pools. Yet alternatives are available that would definitely enable us to use the sun to save fuel costs and considerably reduce the emission of carbon dioxide.

Outdoor swimming pools are particularly suitable targets for the use of solar energy. Simple swimming pool absorbers heat up pool water directly. A pump conveys the water through an absorber and a simple control ensures that water is only pumped when the sun actually can heat it up (Figure 6.17). If the water were pumped through the absorber tube at night as well, this would result in the pool water being cooled again. A good half-square metre of solar absorber surface is needed per square metre of pool area. The surface space that is needed is often found on buildings near the swimming pool. Covering a pool at night can save further energy.

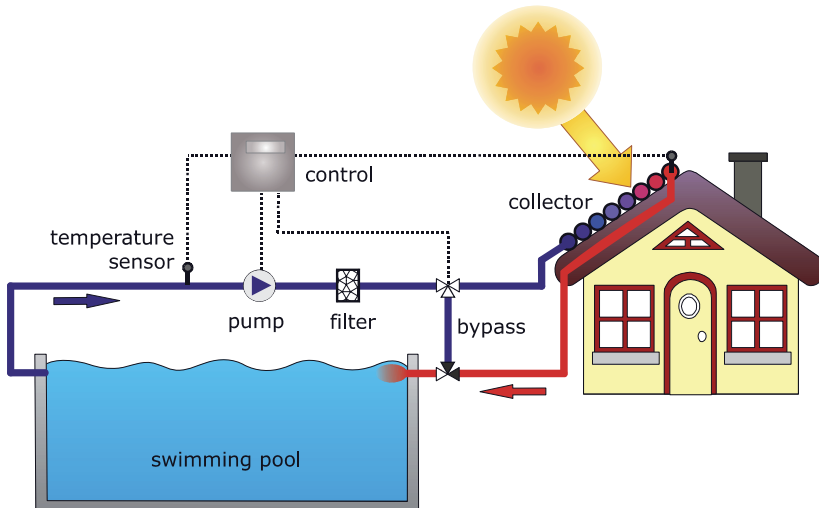

Figure 6.17 System for swimming pool heating using solar energy.

6.3.6 Cooking with the Sun

In many countries cooking is still often done on an open wood fire. About 2.5 billion people around the world use this traditional method to prepare their meals. From the energy point of view, however, an open fire is anything but efficient. Firewood does not last long. In many countries wood is cut down at a faster rate than trees can grow back. Furthermore, the smoke produced by open fires is responsible for many illnesses. In sunny countries solar cookers offer an alternative to traditional hearths.

A solar cooking box is a very simple cooking system: a wooden box painted black inside that is covered with a sheet of glass angled in the direction of the sun. This very simple solar collector is actually capable of heating water and food. However, it is not very efficient and the glass cover makes it difficult to prepare food. An efficient solar cooker is a neater solution. With a solar cooker, the cooking pot is situated in the middle of a convex mirror (Figure 6.18). The mirror is moved approximately every quarter-hour so that it is directed optimally towards the sun. With a mirror diameter of 140cm and good sun radiation, it is possible to bring three litres of water to the boil in about half an hour.



Figure 6.18 Solar cooker in Ethiopia. Photo: EG Solar e.V., www.eg-solar.de.

6.4 Planning and Design

Of all the solar thermal systems described, the systems that use solar heat to heat up domestic water and to supplement other heating systems are the most widely used. The planning tips are therefore limited to these two variants.

6.4.1 Solar Thermal Heating of Domestic Hot Water

6.4.1.1 Outline Design

In Germany, Britain and other temperate regions, solar thermal domestic hot water systems are normally designed so that on a yearly average the sun covers 50 to 60% of the hot water requirement. As the amount of sunshine in these regions fluctuates considerably during the year, a solar system can usually only cover the total hot water demand during the summer months. In the winter, the sun’s share can fall below 10% (Figure 6.19). A conventional heating system then has to cover the rest. In sunny regions like California and Southern Europe the solar share can easily reach more than 80%.

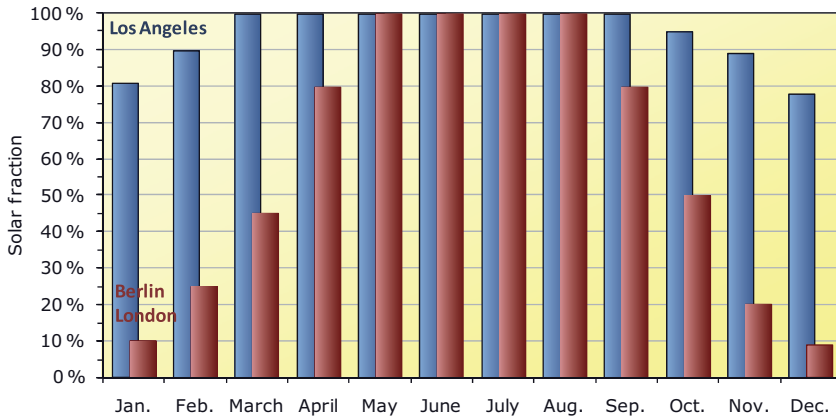

Figure 6.19 Typical solar share of solar thermal domestic hot water systems in Berlin, London and Los Angeles (5m² flat-plate collector in Berlin and London, 4m² in Los Angeles, 300 l storage cylinder, 2700 kWh hot water demand).

A simple rule of thumb for designing solar thermal systems to provide domestic hot water, based on the number of people in a household, is:

- **Collector size:** 1–1.5 m² flat-plate collectors per person
- **Storage size:** 80–100 litres per person

If vacuum-tube collectors are used, the collector size can be around 30% smaller. The collectors should not be less than three to four square metres in area because below this size the losses in the tubes increase to above average.

6.4.1.2 Detailed Design

Hot water requirements have to be determined before a detailed design can be drawn up. Ideally, the system should include a hot water meter that provides a direct reading of actual consumption or a record listing hot water use over a long period

of time. As a rule of thumb, requirements can be approximated based on a hot water temperature of 45 °C:

- **Low usage:** 15–30 litres or 0.6–1.2 kWh per person per day
- **Medium usage:** 30–60 litres or 1.2–2.4 kWh per person per day
- **High usage:** 60–120 litres or 2.4–4.8 kWh per person per day



Storage Size and Hot Water Demand

The storage size V_{storage} should be equal to about twice the total requirements of P persons with a daily requirement V_{person} per person:

$$V_{\text{storage}} = 2 \cdot P \cdot V_{\text{person}}$$

Based on the hot water requirement Q_{person} per person per day, the annual hot water requirement Q_{HW} for the supply of hot water can be calculated as:

$$Q_{\text{HW}} = 365 \cdot P \cdot Q_{\text{person}}$$

The storage size for a four-person household with an average consumption of 45 litres or 1.8 kWh of hot water per day would thus be:

$$V_{\text{storage}} = 2 \cdot 4 \cdot 45 \text{ litres} = 360 \text{ litres}$$

Typical storage sizes are 300 or 400 litres. A 400-litre storage would be more than adequate in this case. A 300-litre storage falls somewhat below the calculated requirement but is still sufficient. The annual heating requirement is:

$$Q_{\text{HW}} = 365 \cdot 4 \cdot 1.8 \text{ kWh} = 2628 \text{ kWh}$$



Collector Size

Once the size of the storage cylinder has been established, the collector size $A_{\text{collector}}$ is calculated. This calculation also requires the annual figures for radiation H_{solar} and tilt gains $f_{\text{orientation}}$ (see Section 5.4). With an annual solar fraction sf and an average system efficiency of 30% with systems using flat-plate collectors, the collector size $A_{\text{collector}}$ can be calculated as follows:

$$A_{\text{collector}} \approx \frac{sf \cdot Q_{\text{HW}}}{0,3 \cdot H_{\text{solar}} \cdot f_{\text{orientation}}}$$

In this formula a solar fraction of 0.6 should be chosen for European climates (e.g. Berlin or London) and 0.9 for very sunny climates such as California.

In the case of the above consumption, the collector size for flat-plate collectors should be calculated on the basis of a roof in Berlin orientated about 30 degrees towards the south-southwest and tilted by 30 degrees. The annual solar radiation in this case amounts to 1000 kWh/(m²a) and the southern orientation produces tilt

gains of $f_{\text{orientation}} = 110\% = 1.1$. As a result, the required surface for flat-plate collectors is calculated as

$$A_{\text{collector}} \approx \frac{0.6 \cdot 2628 \text{ kWh}}{0.3 \cdot 1000 \frac{\text{kWh}}{\text{m}^2} \cdot 1.1} = 4.8 \text{ m}^2.$$

The results of course depend heavily on the quality of the collectors and can vary considerably. Some online tools are available to help with system design (see *Web tips*). Sophisticated computer programmes are necessary to improve the detailed planning. Professional firms that specialize in this field should also be able to provide detailed system designs. In addition to determining the size of the collector and the storage, their services include the design of other components such as pumps, controllers and pipes.



- <http://www.valentin.de/onlineberechnung/solarthermie>
- <http://desire.htw-berlin.de>

Online calculations for solar thermal systems

6.4.2 Solar Thermal Heating as Support Heating

A large collector surface is needed if a solar thermal system is to provide support heating in addition to domestic hot water. In contrast to the supply of hot water, this option requires optimal building insulation to enable the sun to provide a larger share of the heat requirement. Whereas hot water use is relatively constant throughout the year, heating needs are concentrated in the winter months. However, the yield from solar collectors is low in the winter. Therefore, solar thermal systems that supply support heating are usually designed so that, in addition to hot water, they can cover only a portion of the heating required during the transitional period from March to October. In winter conventional heating systems essentially provide the heating required (Figure 6.20).

The size of the collector surface and the storage also affect the degree of solar coverage, and thus the proportion of heat covered by the sun. This also reduces the share a conventional heating system provides. If a fossil system fired with oil or gas is used, then the carbon dioxide emissions drop in accordance with the size of the solar system. However, a very large system also produces a higher surplus that cannot be used. Therefore, as a rule, large systems are less economical than small ones. So when it comes to design, one has to consider whether the priority is maximum input from the sun or economic viability.

The following two design variants provide the basis for an outline design in Central European climates:

Variant 1: Small system for good efficiency

- Collector surface with flat-plate collectors: 0.8 m^2 per 10 m^2 living area

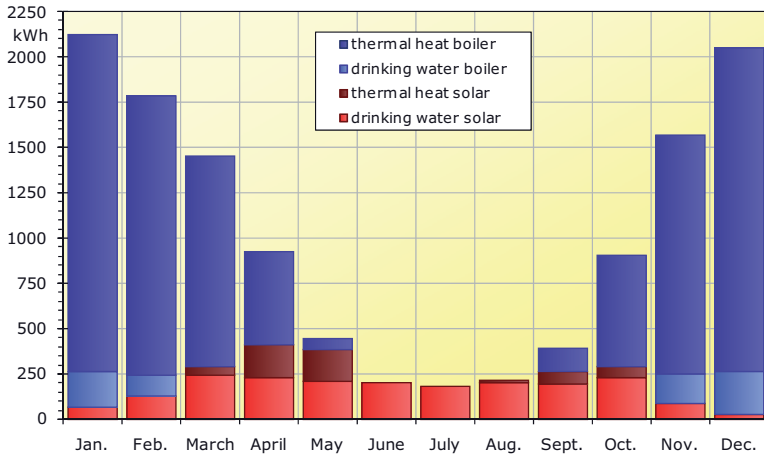

Figure 6.20 Typical progression of thermal heat and hot water requirements in Germany and proportion of solar system versus conventional heating based on the requirements of an old building with a total solar coverage of 20%.

- Collector surface with vacuum-tube collectors: 0.6m^2 per 10m^2 living area
- Storage size: at least 50 litres per m^2 of collector surface

Variant 2: Medium-sized system for higher share of solar coverage

- Collector surface with flat-plate collectors: 1.6m^2 per 10m^2 living area
- Collector surface with vacuum-tube collectors: 1.2m^2 per 10m^2 living area
- Storage size: 100 litres per m^2 of collector surface

An optimal design would of course also take into account the actual heat requirements. The difference in requirements between an old building and an energy-saving three-litre house is considerable. Table 6.1 shows simulation results for optimal systems that were dimensioned according to the outline design described.

Table 6.1 Solar coverage.

	Old building	Standard new-build	Three-litre house	Passive house
Heat requirement for hot water in kWh	2700	2700	2700	2700
Heating requirement in kWh	25000	11500	3900	1950
Solar coverage Variant 1 (small system)	13%	22%	40%	51%
Solar coverage Variant 2 (medium-sized system)	22%	36%	57%	68%

Assumes following: Berlin location, orientation 30° south without shade, 130m^2 living area, optimal flat-plate collector with combination storage.

Although the collector with the medium-sized system is double the size of the small system and the storage is four times larger, this does not mean that the solar cover-

age is twice as high. The insulation standard of a building has considerably more influence on the rate of solar coverage than these two elements. Optimal insulation options should be considered when there is an interest in increasing the amount of solar coverage as a way of contributing towards climate protection.



From Thinking about a Solar Thermal System on the Roof to Installing a System

- Determine orientation and angle of roof.
Is the roof suitable in terms of orientation and tilt angle?
Recommendation: a minimum of 95% according to Figure 5.15.
Does the roof have too much shade?
- Decide whether only water for domestic use should be heated or whether solar heating or cooling support is also desired.
- Implement outline design following rule of thumb.
- Possibly implement detailed design by hand or using simulation tools.
- Apply for appropriate approvals for listed buildings.
- Request quotations.
- Have professional company provide additional details for design.
- Apply for subsidies or low-interest loans.
- Award contract for the work.



6.5 Economics

Depending on type and design, between 200 and 350 euros per square metre should be estimated for flat-plate collectors and between 400 and 600 euros per square metre for vacuum-tube collectors in Central Europe. A 300-litre heat storage cylinder costs around 700 to 1100 euros. Installing a solar thermal system can be especially cost-effective in new buildings or when an existing hot water storage cylinder is old and has to be replaced anyway. The costs for a solar thermal system fall within a wide range. A system purely for domestic hot water with four square-metre flat-plate collectors and a 300-litre hot water storage cylinder can be acquired for as little as 2000 euros, not including installation. The average cost of a European system for a four-person household excluding installation is between 3000 and 3400 euros; a system including installation is around 5000 euros. Depending on the size of the collector, the cost of a system that provides support heating can be double or even higher. Government grants are sometimes available to help cover the costs.

Even if the investment costs for a solar thermal system are known, getting a handle on the economics is difficult compared to photovoltaics. The output of a photovoltaic system can be tracked accurately through an electricity meter and the state-

ment for the fed-in electricity will show in euros and cents whether a system is living up to the planners' promises.

The output of a solar thermal system can also be monitored with a heat volume meter. However, in practice these are hardly ever used because of cost. In very sunny countries a solar thermal system can cover total requirements. The cost-effectiveness is also usually high in these cases. In colder climates solar thermal systems are almost always supplemented by conventional heating systems, which make up for what the lack of sunshine cannot cover. No direct compensation is given for the heat output yield of a solar thermal system. A system only pays for itself indirectly through the savings in the fuel costs of the heating system. It is mainly the movement of fuel prices that establishes whether a system is paying for itself and at which rate. The higher fuel prices climb, the faster a solar thermal system will pay for itself. If, on the other hand, fuel prices fall, the economic viability of a solar system is less favourable.

Figure 6.21 shows the payback periods for a typical solar thermal system for heating domestic water. This is the time it takes for the fuel costs a system has saved to break even with the investment costs. If hot water is heated electrically for around 0.2 euro/kWh, the system will be amortized very quickly. The amortization becomes more difficult with particularly high-quality and expensive systems when fuel prices are low. In this case public grant programmes could be available to improve the economy of these systems.

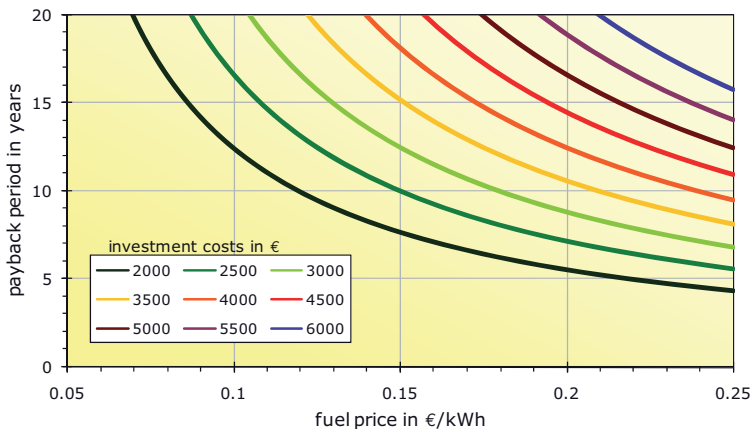

Figure 6.21 Payback periods for a solar thermal domestic hot water system with backup heating system (without interest rate effects and price increases; fuel savings: 2000 kWh/a; annual operating costs: 2% of investment costs).

6.6 Ecology

Solar thermal systems are among the most environmentally friendly renewable energy systems available. When they are used, they normally save on fossil fuels, such as oil and natural gas, and thereby contribute actively towards climate

protection. The collectors are mostly integrated into buildings and, consequently, do not require any extra land. The materials used in solar thermal systems – such as glass, copper and plastic – are for the most part just ordinary materials commonly used in standard construction. Materials that are a problem for the environment, such as PU-foam and PVC, are used in some solar collector systems, but most manufacturers of collectors consciously avoid them as a matter of principle.

Energy is needed to manufacture solar thermal systems. In Central Europe, it takes between six months and two years before a solar thermal system delivers the same amount of energy that was used in its production. This period is shorter in countries with a lot of sunshine. Many manufacturers place a great deal of emphasis on environmental protection and renewable energies during the production of thermal solar systems. The zero-emissions Solvis factory in Braunschweig, Germany, is an example.

Some attention needs to be paid to the size of electrical pumps in solar systems. These pumps require electric energy to operate. However, this requirement for auxiliary energy is usually smaller by many orders of magnitude than the energy saved by a solar system. Photovoltaic systems can be used to enable the auxiliary electric energy required by solar thermal systems to be covered directly by the sun.

Many solar thermal systems also use chemicals such as antifreeze or cooling agents. Typical antifreeze products like Tyfocor L have a minimal effect on water quality, and, therefore, are largely safe for the environment.

Special protective measures are required if ammonia is used for solar cooling in absorption-refrigerating machines. Ammonia is toxic and dangerous to the environment. Ammonia that escapes can bind to water. Lithium-bromide is also harmful to human health, but less so than ammonia.

6.7 Solar Thermal Markets

In terms of world markets for solar thermal collectors, one country puts all the rest to shame: China. Around 93 million square metres of collectors were installed in the country in 2006. These collectors deliver about 65.1 gigawatts of heat power. The Chinese collector market comprises more than 60% of the entire world market (Figure 6.22).

One of the main reasons for the booming solar market in China is the poor supply of electricity and gas in rural regions. Seventy-five percent of the 1.3 billion Chinese live in the country. In these rural areas solar thermal energy is often one of the least expensive alternatives for providing hot water, and sometimes the only one. With its widespread use of solar thermal energy, China has developed into a market leader in collector manufacturing. More than 1000 companies now produce and distribute solar collectors in China. Around 150 000 people were employed in the solar thermal energy (European Solar Industry Federation ESTIF, 2003) sector in the year 2000. In contrast to many other countries, China specializes in highly efficient vacuum-

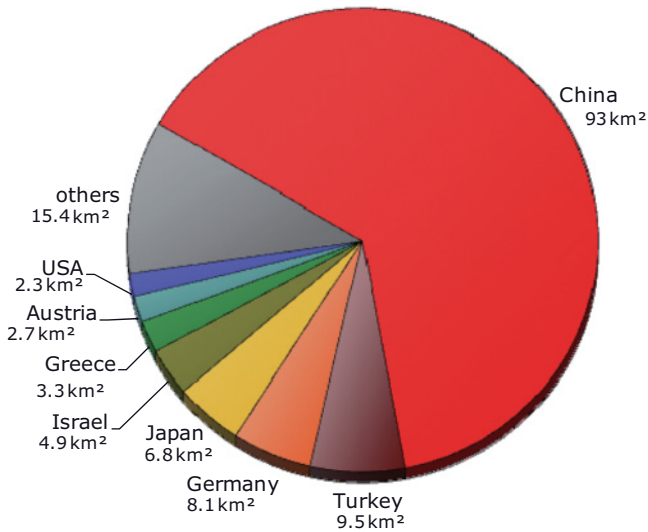

Figure 6.22 Total installed collector area in different countries without swimming pool absorbers. Status 2006. Data: (IEA Solar Heating and Cooling Programme SHC, 2008).

tube collectors rather than in simple flat-plate collectors. Due to the large number of units produced for the Chinese market, Chinese suppliers are very competitive internationally. Most of the vacuum-tube collectors sold in the world come from China.

In the European Union, Germany dominates the solar collector market. Countries with a lot of sunshine, such as Spain, Portugal and France, are still developing countries as far as solar thermal systems are concerned.

If one considers solar thermal collector area installed per head, small countries have the edge. In Cyprus almost every house has a solar thermal system on it. In 2008 this Mediterranean island had around 693 000 m² of collector area distributed among 778 000 inhabitants. There are nearly 900 m² of solar collectors per 1000 Cypriots. In Austria, in comparison, this figure is 388 m², and for Germany it is less than 135 m² per 1000 inhabitants. Sunny Spain fares even more poorly with just 30 m² per 1000 inhabitants, and in the United Kingdom the figure is a paltry 6 m². Local market conditions and acceptance by the population both have considerably more influence on the amount of installed collector area than the supply of solar radiation.

Germany is an example of how political conditions can affect markets. Until 2001 there was continuous market growth. In 2002 the market suffered a setback because of changes in incentive conditions and associated market insecurity (Figure 6.23), but has since recovered.

Altogether more than one million solar thermal systems with a total area of 11 million square metres were installed at the end of 2008. This constitutes more than 40% of the 27.2 million square metres in the European Union. In the same year the solar thermal sector in Germany accounted for 25 000 jobs. The solar systems are

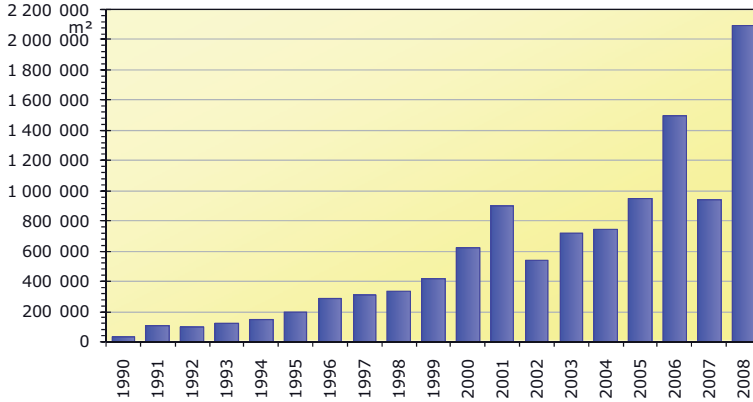

Figure 6.23 Annual newly installed collector area in Germany. Data: (Bundesverband Solarwirtschaft, 2009).

saving the emission of around one million tons of carbon dioxide each year. Although this is an impressive number, it still falls far short of saving the climate.

6.8 Outlook and Development Potential

During the past fifteen years the solar thermal market in Europe has increased more than tenfold. The European Solar Thermal Industry Federation (ESTIF) has formulated an ambitious target for Europe. According to ESTIF about one square metre of installed collector area per capita could be possible until 2020 and more than three square metres in the long term (Figure 6.24). This would be 60 times more than in 2008. The number of people employed in the European solar thermal sector could then increase to hundreds of thousands. The potential is considerably higher



Figure 6.24 Many roofs still have space for solar collectors. Photos: www.wagner-solar.com.

in the very sunny countries of the world. Here the solar thermal share could reach percentages in double figures. In addition to those aimed at heat production, systems that provide solar cooling will gain large market shares and in the long term displace conventional cooling systems. Due to the growth in the number of installations, it is anticipated that the costs of solar thermal systems will continue to drop slightly. However, it is not expected that the reductions in price will be quite as high as with photovoltaic systems.

7

7 Solar Power Plants – Even More Energy from the Sun

When we think of power plants, we usually imagine large central complexes with cooling towers and enormous chimneys emitting clouds of smoke. In terms of the concept itself, a power plant is merely a technical installation that converts a particular energy supply into electricity. A solar power plant produces electric energy from solar radiation. We have already learned about one type of solar power plant – photovoltaic power plants. In principle, a small photovoltaic system sited on a family home already constitutes a solar power plant. Because many people envisage a power plant as something much larger than a few square metres of solar modules, this chapter is devoted to really large-scale systems that generate electricity from sunlight.

Even photovoltaic systems can reach a size that easily competes with conventional power plants. Year after year new photovoltaic power plants have been exceeding records for size. Photovoltaic systems with 5 megawatts of power and module areas of around 40 000 m² have already been installed on the roofs of industrial buildings. However, existing roofs are usually not appropriate for higher output levels. If 50, 100 or even 1000 megawatts are to be installed in one location, this can only be done with open space systems mounted directly in the ground. Large photovoltaic power plants are technically very similar to the small systems on single-family houses, except that they are larger in scale. Thus this chapter only deals with large-scale solar power plants.

Concentrators can be used to increase the intensity of solar radiation. Photovoltaic cells with very high efficiency then convert the concentrated sunlight into electricity, as this chapter will explain. In addition to photovoltaics, other technologies for generating power from sunlight also exist. Solar thermal power plants convert solar radiation first into heat and then into electric energy. A number of different interesting and very promising technologies are available and are particularly suitable for the very sunny regions on earth because they need direct sunlight,

which is far less abundant in temperate climates such as that of Northern Europe.

7.1 Concentration on the Sun

Most of us remember as children trying to set fire to a sheet of paper or a piece of wood using a magnifying glass. Even this simple experiment makes us aware of the energy that concentrated solar radiation can produce. Theoretically, sunlight can be concentrated onto earth by the factor 46211 and, consequently, at its deepest point reach temperatures of 5500°C. In practice, concentration factors of over 10000 and temperatures of well over 1000°C have been reached. Large holes can easily be melted into steel plates using concentrated solar radiation in solar ovens. Solar ovens are also suitable for testing materials at high temperatures. Figure 7.1 shows a solar oven near Almería in Spain, which reaches an output of 60 kilowatts with full sun radiation.



Figure 7.1 Solar furnace near Almería in Spain. Large tracking mirrors direct the sunlight towards a convex mirror (top right) in the interior of a building.

For cost reasons, glass lens systems are normally ruled out for use as concentrators in large-scale technical applications. The reflector, which concentrates sunlight onto a focal point or at the focus, normally has the form of a parabola. Due to their long useful life, glass mirrors have proven to be reliable in practical application. The reflector has to be tracked so that the sunlight always comes in at a vertical angle.

A distinction is mainly made between single-axis and dual-axis tracking systems. Single-axis tracking systems concentrate the sunlight onto an absorber pipe at the focus, whereas dual-axis tracking systems concentrate it onto a central absorber close to the focus. The tracking can occur either over a sensor, which catches the optimal orientation to the sun, or through a computer that calculates the sun's position.



Archimedes – Inventor of the Convex Mirror?

The Greek mathematician Archimedes of Syracuse, who was born in 285 BC, is considered the inventor of the convex mirror. Using convex mirrors, Archimedes is said to have set fire to enemy ships while his country was at war with Rome. The truth of this legend has been hotly debated for the last 300 years, but it is now considered to have been unlikely. It would have taken very large and very precisely made mirrors, focusing on the ships over a very long period, to light the fires. Even if the legend is true, it did not do Archimedes much good. He was killed by the Romans when they captured Syracuse in 212 BC.

Parabolic trough collectors, which concentrate sunlight onto an absorber pipe, are normally used as line concentrators (Figure 7.2 left). If the concentrator is distributed over multiple mirrors each individually lined up in an optimal position towards the absorber pipe, this is called a Fresnel collector (Figure 7.2 right).

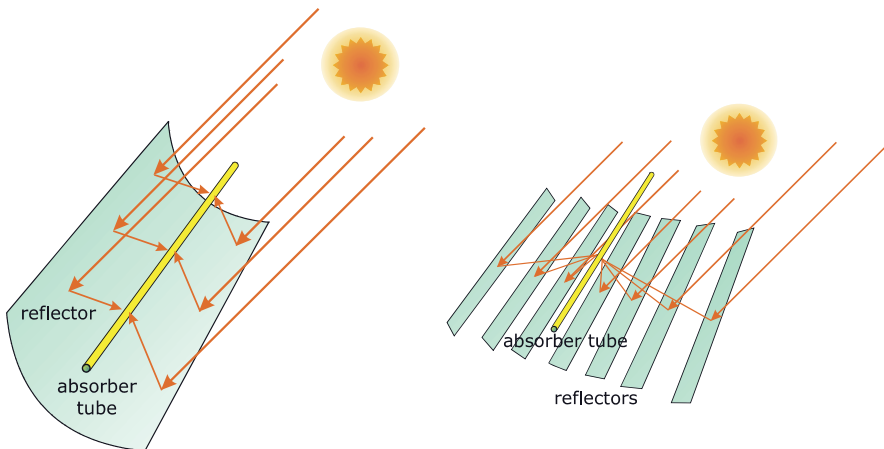

Figure 7.2 Single-axis tracked reflectors for line concentrators.

Convex mirrors are used for concentration onto a focal point (Figure 7.3 left). Distributed mirrors that are individually adjusted towards the sun can also concentrate the sun's radiation onto a central absorber (Figure 7.3 right).

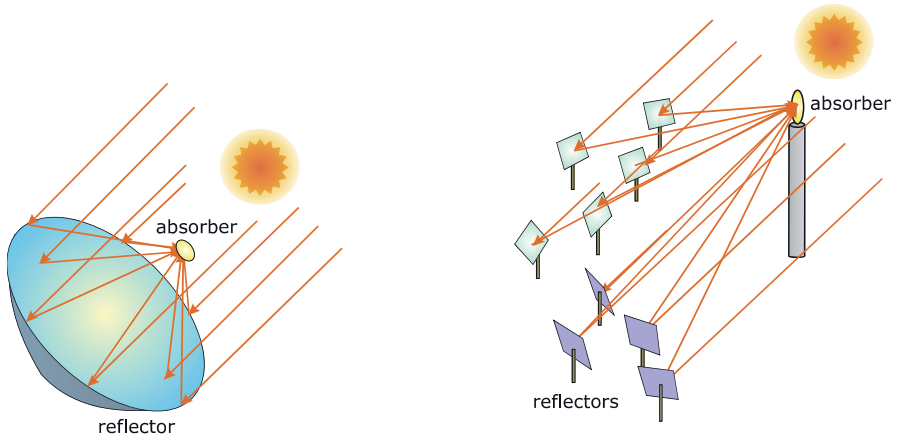

Figure 7.3 Dual-axis tracked reflectors for point concentrators.

7.2 Solar Power Plants

7.2.1 Parabolic Trough Power Plants

As the name indicates, in parabolic trough power plants large trough-shaped parabolic mirrors concentrate sunlight onto a focal point. The collectors are erected next to each other in a row several hundred metres long (Figure 7.4). Many parallel rows in turn form an entire solar collector field.



Figure 7.4 View of the Kramer Junction parabolic trough power plant in California (USA).
Photo: Gregory Kolb, SANDIA.

The individual collectors rotate on their longitudinal axis and in this way follow the course of the sun. The mirrors concentrate the sunlight more than 80-fold at the focal point onto an absorber pipe. This is embedded in an evacuated glass casing in order to reduce heat loss. A special selective coating on the absorber pipe reduces the heat radiated from the pipe surface. With conventional systems, a special thermal oil flows through the pipe, which heats up to temperatures of about 400 °C as a result of the solar radiation. The heat is transmitted over heat exchangers to a water steam cycle, vaporized and overheated again. The steam drives a turbine and a generator, which produces electric power. Behind the turbine it condenses again into water and through a pump again enters into the cycle (Figure 7.5). The principle of producing electricity using steam turbines is called the Clausius-Rankine process, named after its inventors. This process is also used in classic steam power plants, such as coal-fired plants.

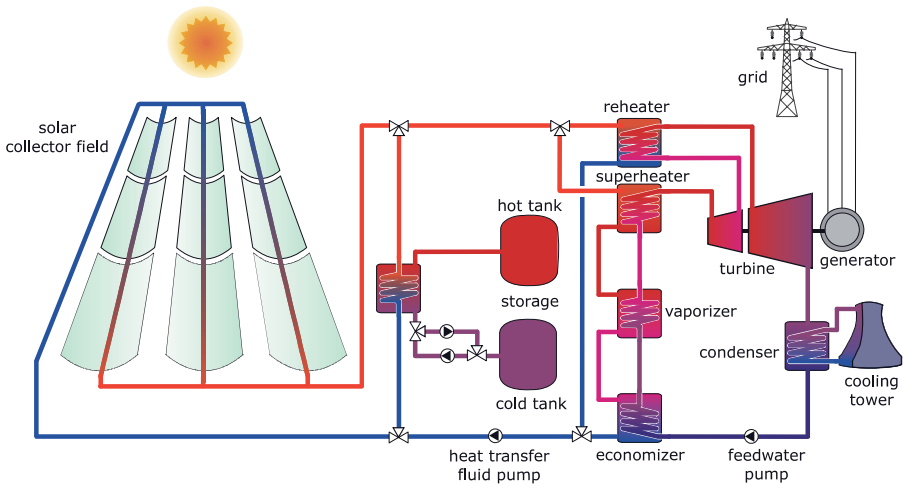

Figure 7.5 Parabolic trough power plant with thermal storage.

During periods of bad weather or at night a parallel burner can also be used to operate the water steam cycle. In contrast to photovoltaics, this guarantees a daily output of power. It also increases the attractiveness of and planning security in the public electricity supply. For totally carbon-free plant operation, either biomass or renewably produced hydrogen can be used as a supplementary fuel, or the burner can be eliminated entirely. Instead a thermal storage tank can be integrated. The solar field heats up the storage during the day using excessive heat. At night and during periods of bad weather the storage feeds the water steam cycle (Figure 7.6). The storage must be designed to handle temperatures above 300 °C. Molten salt is suitable as a storage medium for this temperature range.

The development of solar thermal parabolic trough power plants dates back to 1906. In the USA and near the Egyptian city of Cairo – at the time still under British rule – research facilities were set up and the first tests were successful. Based on

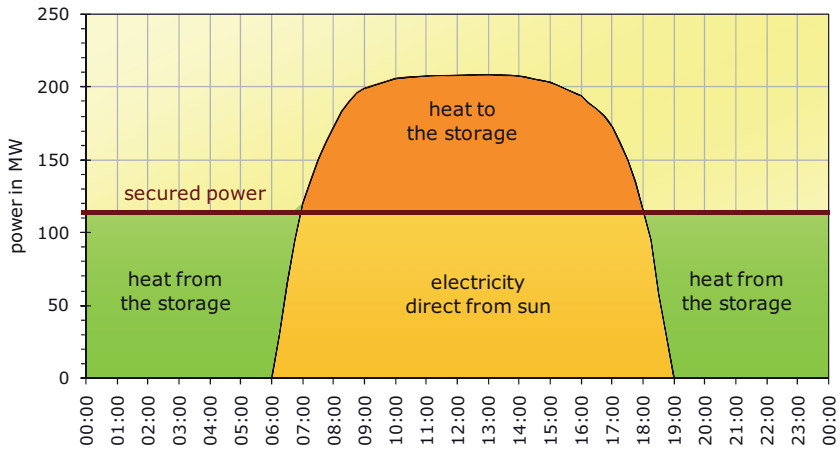

Figure 7.6 Solar thermal power plants with thermal storage can provide guaranteed output around the clock.

appearance, these trough facilities were incredibly similar to those used today. However, problems with materials and other technical difficulties ended this first attempt at large-scale technical generation of solar electric power in 1914, shortly before the start of the First World War (Mener, 1998).

In 1978 the foundations were laid in the USA for a resurrection of this technology. The Public Utility Regulatory Policies Act obligated American public electricity companies to buy energy from independent producers at clearly defined costs. After the surge in energy costs in the wake of the oil crisis, the electricity provider Southern California Edison (SCE) offered long-term feed-in conditions. The introduction of favourable tax advantages finally made the construction of plants worthwhile financially. The LUZ Company, which was founded in 1979, negotiated a 30-year contract for the feed-in of solar energy with SCE in 1983. In 1984 the first solar thermal parabolic trough power plant was built in the Mojave Desert in California. By 1991 a total of nine SEGS (Solar Electric Generation Systems) power plants with 354 megawatts of electric output were installed in an area of more than 7 km². These power plants feed around 800 million kilowatt hours into the grid each year, enough to satisfy the requirements of 60 000 Americans. Eight power plants can also be operated with fossil fuels, thus enabling them to supply electricity at night or during periods of bad weather. With these plants the annual natural gas portion of the thermal energy supplied is legally set at 25%. The total investment for the plants was more than US\$1.2 billion.

In the mid-1980s energy prices fell dramatically again. Then the tax exemptions also ran out at the end of 1990, and the LUZ Company went bankrupt even before construction could start on the tenth power plant.

A long lean patch then followed for the planners of solar thermal power plants. It lasted until 2006, when building work was started on new parabolic trough plants in Nevada in the USA and near Guadix in Spain.

Technical advances made in the meantime have helped to increase efficiency and reduce costs. One option was the use of direct solar steam. With this process water is vaporized at a high pressure by the collectors and heated up to 500 °C. This steam is led directly into a turbine, thereby rendering thermo oil and heat exchangers superfluous.



Temperature and Efficiency

The Achilles heel of solar thermal power plants is not the solar collector that concentrates the sunlight. Collectors easily achieve efficiency of over 70%. However, most of the valuable solar heat is lost during its conversion into electricity. The steam turbines used in this process in solar power plants barely manage to achieve 35% efficiency. In other words, 65% of the heat gained from the sun returns unused as waste heat into the environment. The efficiency of steam turbines results directly from the temperature difference of the steam between entry into and exit from the turbines. The exit temperature depends on the cooling and even at best is only minimally below the ambient temperature. With parabolic trough power plants, the entry temperature, contingent on the thermo oil, is currently just below 400 °C. With a temperature increase to 500 degrees or higher, the efficiency of turbines could easily reach 40%. But this is the maximum even for steam turbines. Combined gas and steam turbines, which operate at temperatures of over 1000 °C, achieve efficiency of up to 60%. Gas and steam turbines with high efficiency can be used, for example, in solar tower power plants.

One question that is often asked is whether simple pipe collectors can be used to generate electricity from general purpose water. In principle, this would be possible. However, due to the extremely low temperatures, efficiency would be too minimal to make this approach economically viable. Even the waste heat in the environment would have limited use. Solar power plants are normally situated in hot, sunny regions. However, a demand for gigantic quantities of low-temperature heat does not really exist in these areas.

7.2.2 Solar Tower Power Plants

With solar tower power plants, several hundred or even thousand rotating mirrors are arranged around a tower. Called heliostats, these mirrors are individually controlled by computer to track the movement of the sun and are orientated towards the top of the tower. They must be orientated precisely within a fraction of a degree so that the reflected sunlight actually reaches the focal point. A receiver is located here with an absorber, which, due to the highly concentrated sunlight, heats up to temperatures of over 1000 degrees. Air or molten salt transports the heat. A gas or steam turbine that drives a generator ultimately converts the heat into electric energy.

With the tower concept with open volumetric receivers (Figure 7.7), air from the environment is sucked by a blower through a receiver towards which the heliostats are orientated. The materials used for the receiver are wire mesh, ceramic foam or metallic or ceramic honeycomb structures. The receiver is heated up by the solar radiation and transfers the heat to the sucked-through ambient air. The sucked-in air cools the front side of the receiver. Very high temperatures only develop on the

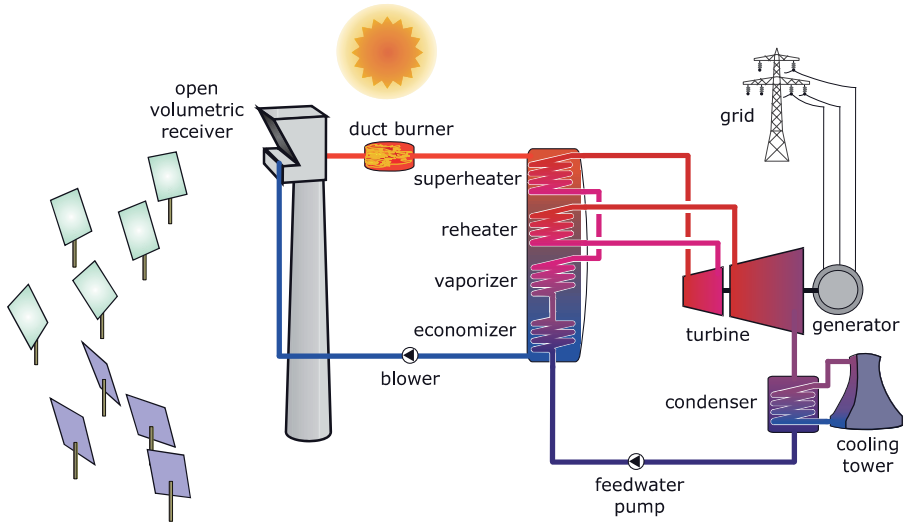

Figure 7.7 Solar tower power plant with open air receiver.

inside of the receiver. This so-called volumetric effect reduces radiant heat losses. The air, which is heated to temperatures between 650°C and 850°C , enters a waste-heat boiler that vaporizes and overheats the water, thereby driving a steam turbine cycle. If required, this variant of power plant can be fired over a channel burner using other fuels.

A more advanced version of the tower concept that uses a pressure receiver is now offering promising possibilities for the future (Figure 7.8). With this concept, the

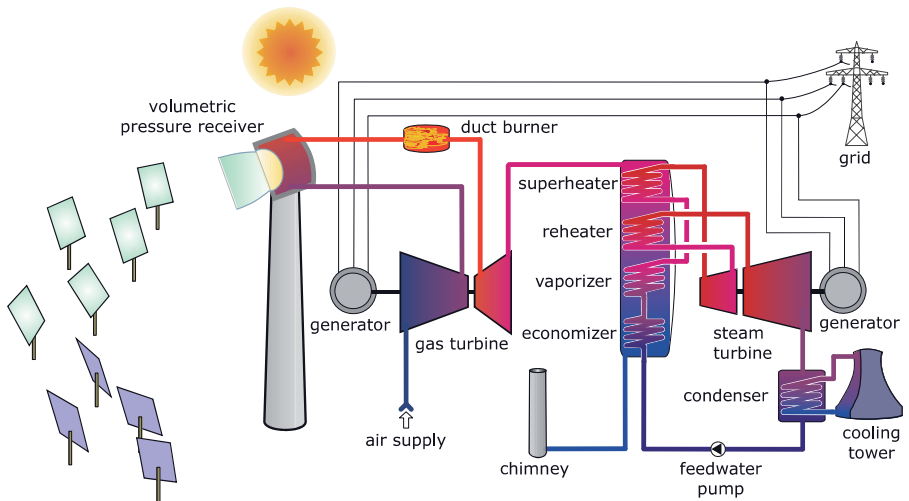

Figure 7.8 Solar tower power plant with pressurized air receiver.

concentrated sunlight heats the air in a volumetric pressure receiver at about 15 bars to temperatures up to 1100°C. A transparent quartz-glass dome separates the absorber from the environment. The hot air then drives a gas turbine. The waste heat of the turbine then finally drives the downstream steam turbine process. The first prototype has shown that this technology functions successfully.

With the combined gas and steam turbine process the efficiency of the conversion from heat to electric energy can be increased from about 35% to more than 50% with a pure steam turbine process. As a result, total efficiencies of more than 20% are possible with this type of conversion of solar radiation into electricity. These prospects justify the additional complexity and cost of receiver technology.

In contrast to parabolic trough power plants, there has not been much experience with commercial plants in the solar tower plant area. Research facilities that are optimizing system components and testing new components currently exist in Almería (Spain) (see Figure 7.9), Daggett (USA) and Rehovot (Israel).



Figure 7.9 Research site for a solar tower power plant at Plataforma Solar de Almería (Spain).

The first commercial solar tower power plant to be put into operation was the 11-megawatt PS10 tower plant near Seville in Spain in 2006. However, instead of heating up air, the receiver of this plant vaporizes water. Due to the low temperatures the efficiency of this power plant is still relatively low. In 2006 construction started on the 20-megawatt PS20 tower plant, also near Seville, and other solar tower plants are planned there.

Before it can be launched successfully in the market, the open air receiver technology developed in Germany first has to prove its suitability for practical use. This is currently being tested at a newly built solar tower plant in Jülich, Germany. With 1.5 megawatts of power this demonstration plant is considerably smaller than the commercial Spanish plants. The target in this effort is not the German power plant market but to promote the export of German technology to the sunny countries of the world.

7.2.3 Dish-Stirling Power Plants

Whereas trough and tower power plants are only economically viable in large-scale applications of many megawatts, the so-called Dish-Stirling systems can also be used in smaller units – for example, to supply remote villages or towns. With Dish-Stirling systems a convex mirror in the form of a large dish concentrates the light onto a focal point. To ensure that the light is concentrated as strongly as possible, the mirror is dual-axis tracked very precisely towards the sun.

A receiver is sited at the focal point. This receiver transfers the heat to the actual heart of the system: the Stirling engine. This engine converts the heat into kinetic energy and drives a generator that ultimately produces electric energy.

A Stirling engine can be driven not only by the heat of the sun but also through combustion heat. In combination with a biogas burner these plants can also generate electricity at night or during periods of bad weather. And the use of biogas also makes them carbon-neutral.

Some prototypes of pure solar systems have been built in Saudi Arabia, the USA and Spain (Figure 7.10). Compared to tower and trough power plants, the price per kilowatt hour with Dish-Stirling systems is still relatively high. The costs would be reduced considerably if large unit quantities could be mass produced.



Figure 7.10 Prototype of a 10-kW Dish-Stirling system near Almería in Spain.

7.2.4 Solar Chimney Power Plants

There is a big difference between solar chimney power plants and the thermal plants described earlier. While solar thermal power plants work by concentrating sunlight, solar chimney power plants function through the heating of air. The collector field is formed by a large flat area that is covered by a glass or plastic roof. A high chimney is located in the middle of the area, and the collector roof rises gently in

the direction of the chimney. The air is able to flow in unencumbered at the sides of the enormous roof. The sun warms the air under the glass roof. This air then rises upward, follows the gentle slope of the roof and then flows at great speed through the chimney. The airflow in the chimney then drives wind turbines that generate electric power over a generator.

The ground under the glass roof can store heat so that the power plant is still able to deliver power even after the sun has set. If hoses filled with water are laid in the ground, enough heat can be stored to enable the plant to provide electric power around the clock.

At the beginning of the 1980s a small demonstration plant with a rated power output of 50 kilowatts was built near Manzanares in Spain. The collector roof of this plant had an average diameter of 122m and an average height of 1.85 m. The chimney was 195 m high and had a diameter of 5 m. This plant was dismantled in 1988 after a storm knocked the chimney down. However, all the planned tests had been completed and the research plant lived up to expectations. It was the first successful demonstration of a solar chimney power plant.

Because the efficiency of solar chimney plants compared to other techniques is very low, these plants require large areas of land. Furthermore, the efficiency increases in line with the height of the tower. Therefore, to be economically viable plants must be of a certain minimum size. New power plant projects are currently being discussed in Australia, for example. Consideration is being given to a large-scale 200-megawatt plant with a tower height of 1000 m, a tower diameter of 180 m and a collector diameter of 6000 m. It is difficult to predict whether the building of new large-scale power plants will be financially viable. But based on a long-term view, solar chimney power plants in the desert regions of the world have the potential to be financially competitive compared to conventional plants (Figure 7.11).

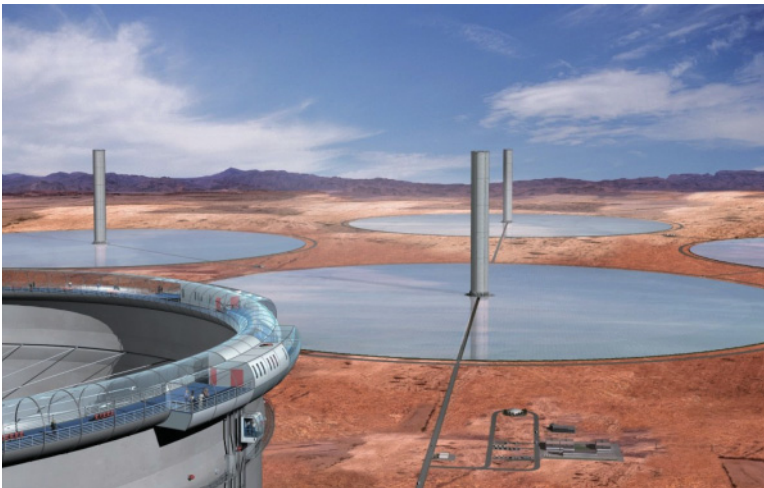

Figure 7.11 Computer animation of a solar chimney power plant park. The towers can also be used as viewing platforms. Illustration: Schlaich Bergemann Solar, Stuttgart.

7.2.5 Concentrating Photovoltaic Power Plants

Photovoltaic cells can also be operated by concentrating sunlight. The main point of this is that the concentration saves on valuable solar cell material. If sunlight is concentrated by a factor of 500, the size of the solar cell can then also be reduced by a factor of 500. The cost of the solar cell therefore becomes much less of an issue. This means materials that ordinarily would be too expensive without solar concentration could also be used. Concentrator cells therefore usually have higher efficiency than conventional photovoltaic modules.

There are many options for the concentration: for example, concentrator cells can be mounted in the focal point of parabolic troughs or convex mirrors. One of the main problems with this is efficient cooling, because, in addition to the electric energy of the solar cells, a large quantity of waste heat is produced. Flatcon technology takes a different approach. A flat Fresnel lens concentrates the sunlight onto a concentrator cell that is only a few square millimetres in size (Figure 7.12 below right). A copper plate on the back of the cell radiates the heat that accumulates extensively towards the back. A concentrator module comprises a large number of parallel cells. Many modules are then mounted together on a tracking device that orientates the modules optimally towards the sunlight.



Figure 7.12 Photovoltaic system with concentrator cells. Photo/graphics: Concentrix Solar GmbH.

7.2.6 Solar Chemistry

In addition to providing process heat or generating electricity, concentrating solar thermal energy can also be used for testing materials or in solar-chemical systems. For instance, there is a large solar furnace in the French town of Odeillo where a large number of small mirrors are mounted on a hillside. These mirrors reflect the sunlight to a convex mirror 54m in diameter, creating temperatures of 4000°C in the solar furnace, which is used for research and industrial processes. Solar furnaces have also been built in Almería, Spain, and Cologne, Germany.

In addition to producing chemicals at high temperatures, solar thermal energy can also be used to produce hydrogen. This does not require a circuitous route that starts with generating electricity, followed by electrolysis. At high temperatures hydrogen can be produced through a solar-chemical process. For example, the chemical system could be in the receiver of a solar tower. Hydrogen is treated as an important energy source, particularly in the transportation sector and in fuel cells. If a hydrogen economy ever becomes a reality, concentrating solar-chemical systems could play a major role in hydrogen production.

7.3 Planning and Design

As a rule, solar-thermal power plants are classic plants. Due to their size, they cost millions of euros. Solar plants are almost always planned and built by large corporations or industrial companies. The design of these plants is usually very complex. It takes teams of engineers a long time to do the detailed planning. One of the main goals is to optimize power plants from an economic point of view.

Private individuals are not likely to have any involvement in the planning of solar power plants, unlike the situation with small photovoltaic systems and solar thermal systems that heat tap water or provide supplemental heating. However, the rise in the number of solar power plants is presenting many opportunities for investment in this area. Therefore, it is worth taking a quick look at the planning aspects.

Because concentrating solar power plants suffer a major reduction in efficiency in the partial load area, the aim should be to build them mainly in countries that get a lot of sunshine. The regions currently of interest are those with an annual total global radiation of at least 1800 kilowatt hours per square metre (kWh/m^2). The optimal values are clearly those over 2000kWh/m^2 . These areas appear in red or pink in Figure 7.13.

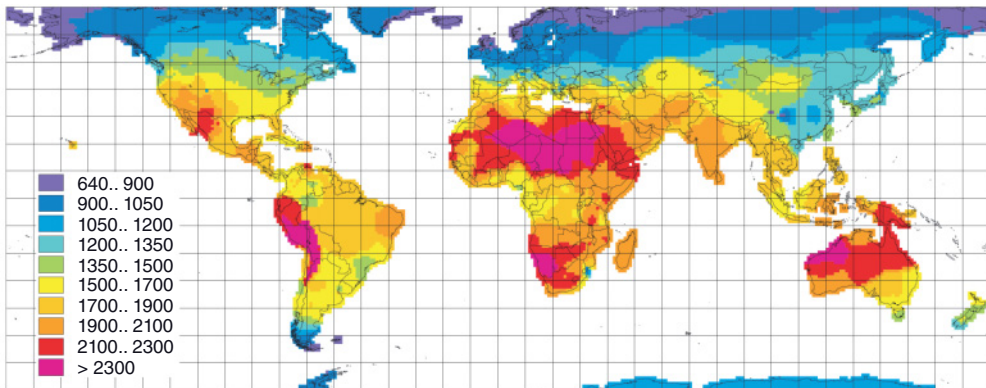

Figure 7.13 World map with annual totals for solar global radiation in Wh/m^2 . Source: Meteotest, www.meteonorm.com.

7.3.1 Concentrating Solar Thermal Power Plants

Concentrating solar power plants can only utilize the direct irradiance portion of the sun. This portion of irradiance can be reflected by mirrors and ultimately concentrated. For non-concentrating solar systems the global irradiance intensity, thus the sum of direct and non-directional diffuse sunlight, is important. The efficiency of these systems is therefore related to the global irradiance intensity. With concentrating systems the direct-normal radiation intensity on a surface orientated vertically towards the sun serves as a reference quantity (see Figure 7.14). In the technical jargon this is abbreviated to DNI, which stands for ‘direct normal irradiance’. The DNI values can lie somewhat below but also somewhat above the values for global radiation.

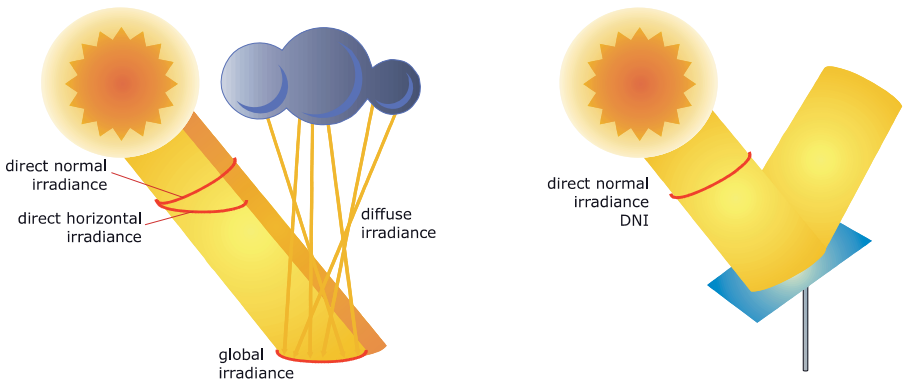

Figure 7.14 Differentiation of types of solar radiation.



Annual Electricity Production of Solar Power Plants

The annual output yield of a concentrating solar thermal system can be estimated using the average efficiency η , the annual total of solar direct-normal irradiance DNI and the aperture area A of the mirrors:

$$E_{\text{electrical}} = \eta \cdot A \cdot DNI.$$

With an efficiency η of $15\% = 0.15$, a solar thermal parabolic trough system with an overall aperture area of $500\,000\text{ m}^2$ at a Spanish location and a DNI of $2200\text{ kWh}/(\text{m}^2\text{ a})$ achieves an annual yield of:

$$E = 0.15 \cdot 500\,000\text{ m}^2 \cdot 2200 \frac{\text{kWh}}{\text{m}^2\text{ a}} = 165\text{ million } \frac{\text{kWh}}{\text{a}}.$$

This is sufficient to cover the electricity needs of around 50 000 Spanish households.

Another interesting aspect of planning is how the land is used. So that the mirrors do not throw shadows on one another, they can only be installed on about one-third of the available land area. The land area for a concentrating solar power plant must therefore be at least three times bigger than the surface area of the mirrors.

The mirror area should be coordinated optimally with the rest of the plant. If it is too small, the plant will constantly be running in partial-load operation. As a result, both efficiency and yield will drop. If the size of the mirror area is too large, a higher amount of solar radiation will fall onto the collectors than can ultimately be converted into electricity. In this case some of the mirrors have to be turned away from the sun.

The efficiency depends on the technology used. Dish-Stirling power plants and solar tower plants with pressure receivers can reach efficiencies of 20% or more. Solar tower or trough plants with steam turbines are currently at about 15% efficiency. An increase in DNI irradiance values also increases efficiency as a power plant will then be running for shorter periods in partial-load operation. In Germany efficiency in the order of 10% is all that can be expected from its solar thermal power plants – and this is based on moderate DNI irradiance values of about 1000 kWh/m² and by year. The annual yield from concentrating solar power plants in places like Spain would be roughly three times higher than in Germany or Great Britain.

7.3.2 Solar Chimney Power Plants

With solar chimney power plants the annual yield is calculated on an analogous basis. Instead of the DNI, the global radiation is used because these plants can also use diffuse sunlight. The total efficiency is only about 1% – and then only if the tower is more than 1000 m high. Thus the efficiency of a solar chimney power plant is directly correlated to the height of the tower. At half the optimal tower height the efficiency is also halved. The collector area would have to be doubled in size to achieve the same yield. In contrast to a concentrating power plant, a solar chimney plant can use the entire land area. No unused gaps are necessary to prevent shading.

7.3.3 Concentrating Photovoltaic Power Plants

The annual yield from concentrating photovoltaic power plants is also calculated analogously. Compared to non-concentrating photovoltaic plants, an efficiency of more than 20% is possible. As concentrating photovoltaic plants can only use the direct-normal irradiance portion, the yield in sunny countries rises overproportionally.

7.4 Economics

Solar thermal plants can currently generate electric power more cost-effectively than photovoltaic plants – at least in regions with high solar irradiation. In Germany at best the same electricity generation costs can be expected from both solar thermal

and photovoltaic plants. As a result, the operation of solar thermal power plants is less feasible for economic reasons (Figure 7.15).

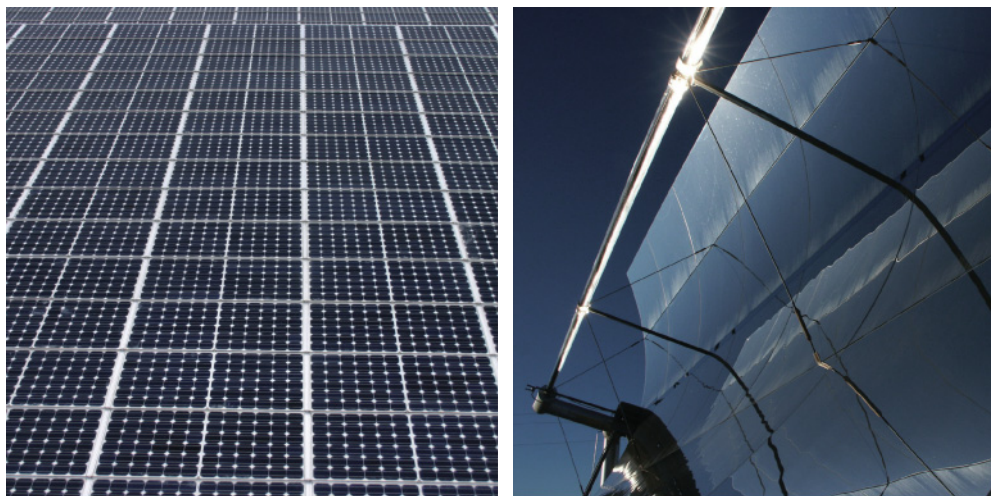

Figure 7.15 In sunny regions solar thermal power plants (right) can currently produce electricity more cheaply than photovoltaic power plants (left).

In Spain, the cost of generating electricity from parabolic trough and solar tower power plants in 2008 amounted to about 20 cents per kilowatt hour; at top locations in North Africa the cost was about 15 cents per kilowatt hour. So, although these power plants are less expensive than those using photovoltaics, they are considerably more expensive than conventional fossil or nuclear plants. As with photovoltaics, costs are expected to fall considerably when these plants start to be built on a large scale. Costs are already dropping fast as a result of the many new solar trough and tower plants being built. Within a decade solar thermal power plants could already be more economical than conventional plants.

In the case of solar chimney and Dish-Stirling power plants, there are no signs yet of a comparable rapid market development. Different studies show that these plants also have the potential in the long term to be competitive in electricity generation.

It is also calculated that concentrating photovoltaics plants will be able to generate electricity at a lower cost than normal photovoltaic plants in locations with high solar irradiation. Various suppliers have developed interesting systems over the past few years, but concentrating systems still have to prove their viability.

The advantage of photovoltaic systems compared to solar thermal systems is modularity. Photovoltaic systems can be built in any size wanted – ranging from milliwatts all the way to multi-megawatt plants several square kilometres in area. Solar thermal power plants are always dictated by the minimum output that is needed to make the plant economically viable. With Dish-Stirling power plants, this is around

10 kilowatts. All other solar thermal power plants should have a minimum output of 10 megawatts. Efficiency is increased even further if output levels are between 50 and 200 megawatts. Optimally, a system should be one square kilometre or more in total size to make it economically viable.

The main advantage of solar thermal systems is the simple integration of thermal storage. Small storage units used for a few hours only minimally increase the cost of generating electricity at solar thermal plants. However, they ensure that the power output of the plants can be guaranteed and, as a result, increase the availability and the value of electric energy.

7.5 Ecology

Solar power plants without fossil fuel backup facilities do not release any direct carbon dioxide emissions during operation. When a fossil fuel-fired parallel burner exists, as is the case with some solar thermal parabolic trough power plants, the natural gas portion should be kept to an absolute minimum. Due to the low temperatures, the efficiency of solar thermal plants for electricity generation is lower than that of optimized pure natural gas plants. This aspect is insignificant when power plants are run purely on solar power. However, if fossil fuels are burnt as well, the carbon dioxide emissions rise. It is accepted that the addition of fossil fuel will increase supply reliability and protect against frost. But the fossil portion should not exceed 10% to ensure effective environmental protection.

Some World Bank projects in developing countries are striving towards an integration of relatively small parabolic trough collector fields into conventional gas and steam power plants run on natural gas. Due to technical restrictions, the solar portion is clearly below 10% there. This type of ISCCS (Integrated Solar Combined-Cycle System) is not suitable for effective climate protection.

Compared to conventional photovoltaic systems, the production energy required for thermal solar power plants is lower. Within a year a solar power plant will deliver more energy than was originally used to produce the plant.

Unlike small photovoltaic and solar thermal systems, solar systems cannot be integrated into buildings. Instead they need large open areas of space comprising many hectares. Ideally, solar plants should be erected in thinly populated areas where the land is not needed for other purposes. Fortunately, many sunny regions on earth have these very characteristics. Very little grows in hot deserts where the sun shines almost all year round, and the human populations tend to be low. Solar thermal power plants built on suitable desert sites would easily be able to meet the electricity demands of the entire planet a hundred times over.

The main problem with thermal systems is the need for cooling water. Water is often a scarce resource in sunny regions. The small number of power plants installed until now have always been able to find local water reserves for the cooling. On a larger scale freshwater cooling in regions with little water is a problem. In principle, a solar thermal power plant can also operate with dry cooling. In this case, efficiency

drops a little and the costs increase slightly. On a long-term basis solar thermal power plants with dry cooling should also become economically interesting enough to resolve the cooling water issue. If solar thermal plants are installed near the sea, the water from the sea can provide effective cooling. The waste heat of solar thermal facilities can also be used to desalinate sea water. It should be possible to produce carbon-free electric energy and drinking water at the same time but until now this has not been done on a large scale.

7.6 Solar Power Plant Markets

The biggest markets for power plants exist in countries that have good solar radiation conditions and offer favourable energy credits. The main markets are currently in Spain and the USA (Figure 7.16).

The main reason for this is the favourable economic conditions in both countries. Energy credits for solar thermal power plants in Spain are high and above the typical market prices for electric energy. The USA uses Renewable Portfolio Standards (RPS). These vary from state to state and establish quotas for renewable energy plants. Plants are being built or planned in certain US states such as California and Nevada. Other sunny and hot US states could follow their example.

In addition to Spain, plans are underway to improve the economic conditions for solar thermal plants in other Mediterranean countries. Italy, Greece and countries in North Africa could soon be following Spain's example. In Germany the focus has been mainly on developing the appropriate technology. Germany is among the market leaders in the world, specifically in the area of components for solar thermal parabolic trough power plants. A prototype for a solar tower power plant in Jülich aims to showcase German technology and attract new export markets.

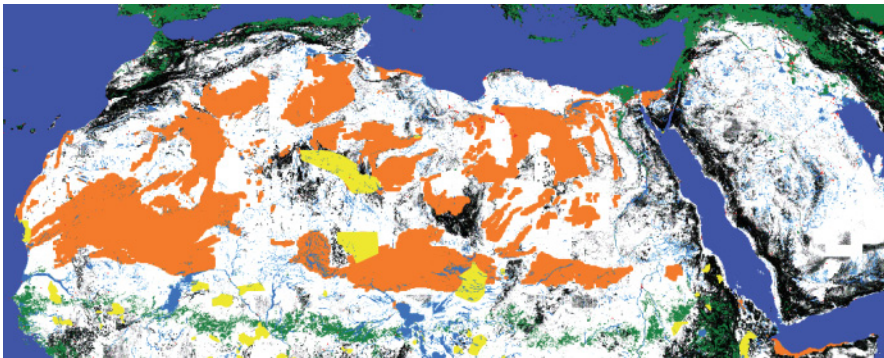

Figure 7.16 Construction of a parabolic trough collector prototype in Andalusia. Spain is currently one of the booming markets for solar power plants.

7.7 Outlook and Development Potential

Although the expansion in solar thermal power plants came to a standstill between 1991 and 2006, many new facilities are now either at the planning stage or under construction. The current boom in the area of solar power plants is likely to lead to cost reductions if there is a rapid rise in the power plant capacity installed world-wide. In about 10 years solar plants at some of the early locations could start becoming competitive with conventional power plants, even without the offer of higher energy credits. It is conceivable that power plants in the hot and sunny regions of the world will be fully competitive in about 20 years' time. Then, purely for cost reasons, solar power plants will be given preference in these countries over previous fossil and nuclear power plants.

By far the greatest potential for building solar power plants exists in North Africa. Even with a generous exclusion of unsuitable areas, such as sand dunes, nature reserves and mountainous and agricultural regions, about 1% of the remaining area of North Africa would theoretically be able to produce enough electricity to meet the demands of every country on earth. Figure 7.17 shows the areas that would be available. Other perfect solar sites could be found, for example, in the US deserts.



unusable regions:

inclination	geomorphology	hydrology	ocean
land utilisation	protectorate	population	usable

Figure 7.17 Suitable regions in North Africa for building solar power plants. Graphics: DLR.

In addition to the favourable costs of generating energy, solar power plants in North Africa also have long operating times. With the ability to provide a high number of full-load hours, the plants there can guarantee a higher reliability of coverage than those in Central or Northern Europe. North Africa also has many locations with top conditions for wind power plants.

The question is, how can reasonably priced electricity from Egypt or Mauretania help us to solve our energy problems? The solution to this problem is simple. The cheap electricity merely has to be transported to us. Figure 7.18 shows the top locations for obtaining this electricity and the possible transport routes to Europe.

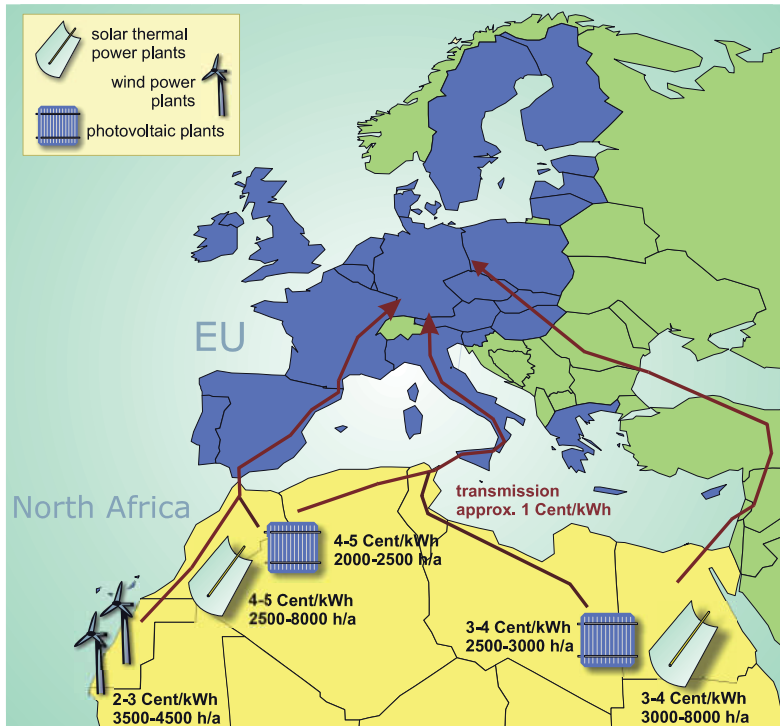

Figure 7.18 Possibilities for importing renewable energy from North Africa to the EU, along with long-term possible energy generation costs and full-load hours.

Technically as well as financially, the transport of this energy is already viable today through high-voltage-direct-current transmission. Transmission over a 5000 km-long cable with losses of less than 15% is possible. These losses would amount to around 0.5 cents per kilowatt hour, which must be added to the anticipated costs for electricity generation of 3 to 4 cents per kilowatt hour. Added to this is the cost of the lines, which works out to between 0.5 and 1 cent per kilowatt hour. Altogether renewable energy could be produced at 4 to 6 cents per kilowatt hour, transported to Europe and, in combination with photovoltaic, wind or solar thermal power plants, guarantee high supply reliability.

At least part of the electricity supply for Central Europe could be covered in the long term from power plants in Africa – and at a cost similar to our current electricity supply. However, this scenario brings concerns about a new dependency on the hot countries of North Africa.

Dependency on one particular state would not arise if power plants were distributed in a number of locations. Also, importing more than 20 to 30% of the total supply from one nation would not be wise from the point of view of supply reliability. To this extent, the risk would be a manageable one. For most of the poor nations of North Africa the raw material of solar energy could become a positive element in their economic development and, as a result, contribute towards political stability. Consequently, both sides would benefit from the import idea.

8 Wind Power Systems – Electricity from Thin Air

With all the different renewable energies available today, wind power is considered a model technology because it has transformed from something of a cottage industry to a billion dollar business within just a few years. During the mid-1980s wind power was still viewed as relatively unimportant, yet by 1994 there were already several thousand installations offering a total output of more than 3500 megawatts. By 2008, wind wheels turning worldwide were providing an impressive output of more than 121 000 megawatts. The result was the creation of more than 440 000 new jobs worldwide.

Yet the use of wind power is actually old hat and dates back many centuries. Years before the birth of Christ simple windmills were being used in the East for irrigation purposes.

Wind power was not exploited in Europe until much later. In the twelfth century post mills started to become popular for milling grain in Europe (Figure 8.1). These had to be rotated towards the wind, either manually or with the help of a donkey. In addition to milling grain, millers in those days also had the difficult job of managing the mill. When a storm approached, millers had to stop the mill in time so that they could remove the canvas from the vanes to prevent the power of the wind from destroying the mill. Wooden block brakes were used to stop the mechanism but these were not without their own dangers. In their hurry to stop the vanes of the windmill from turning, millers would sometimes apply the brakes too hard and start a fire because of the heat that developed on the wooden brake blocks. This is why so many windmills burned down at the time. Long periods with no wind were another problem for millers.

In the centuries that followed, mills underwent considerable technical change, as the Dutch windmill shows. In addition to milling grain, they were now also used to pump water and carry out other power-driven tasks. Technically sophisticated mills



Figure 8.1 Left: Historical post windmill in Stade, Germany. Photo: STADE Tourismus-GmbH. Right: Dutch windmill on the Danish island of Bornholm.

rotated automatically in the wind and could be braked safely. By the mid-nineteenth century 200 000 windmills were in use in Europe alone.

By the first half of the twentieth century steam-driven engines and diesel and electric motors had replaced almost all wind power systems. Wind power did not enjoy a resurgence until the oil crisis of the late 1970s. More and more sophisticated wind power plants are now offering a real alternative to fossil and nuclear power stations.

8.1 Gone with the Wind – Where the Wind Comes From

The sun is also ultimately responsible for the creation of wind. It bombards our planet with gigantic amounts of radiation energy, and the earth has to radiate this incoming solar energy back into space to save itself from continuous warming and ultimately burning up. However, more solar energy reaches the equator than earth radiates back into the universe. The path of sunlight to the South and North poles is longer than to the equator. This explains why the situation at the poles is the exact opposite. Considerably less solar radiation reaches the poles and more energy is radiated into space than is emitted by the sun. As a result, a gigantic amount of energy is transported from the equator to the poles.

This transport of heat occurs primarily as a result of a global exchange of air masses. Major air circulations around the world pump the heat from the equator to the poles. Gigantic circulation cells, called Hadley cells, develop (Figure 8.2). The earth's rotation deflects these currents. This in turn produces relatively stable winds that for a long time were crucial for sailing ships. In the tropical waters north of the equator a relatively stable and constant wind blows from the northeast. Unsurprisingly, it is called the Northeast Trade Wind. In contrast, the Southeast Trade Wind blows south of the equator.

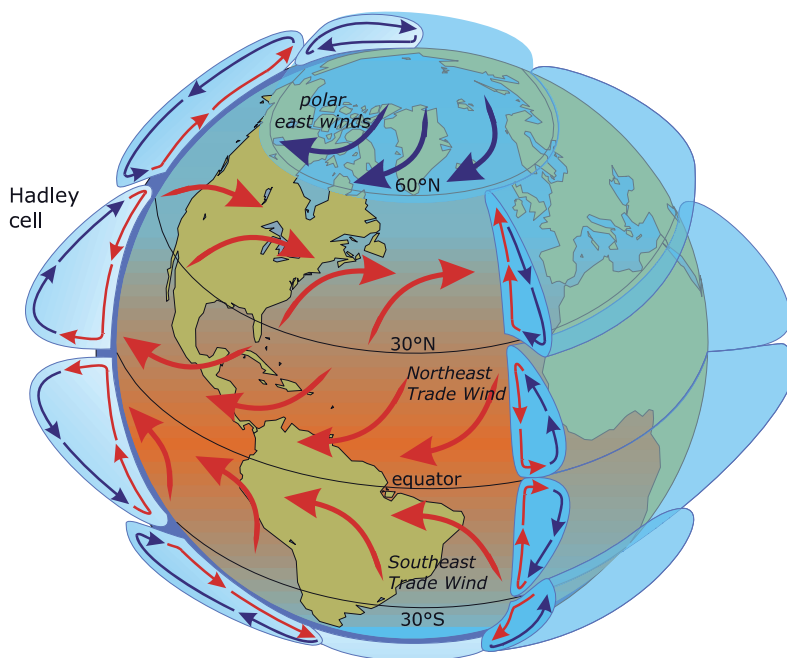

Figure 8.2 Global circulation and origins of different winds.

Local influences exist in addition to the global wind currents. As a result of the rotation of the earth, local areas of low and high pressure create wind movements that rotate around the low pressure point. This rotation runs counterclockwise in the Northern hemisphere and clockwise in the Southern hemisphere.

The so-called sea-land breeze occurs in areas near the coast. During the daytime the radiation from the sun warms up the land and the air above it much more than the ocean water. The warm air above the land rises up and colder air flows in from the ocean. At night this cycle reverses as land cools off faster than the ocean.

Head winds also occur in the mountains and in polar regions with cold air streaming down mountain slopes sometimes at very high wind speeds.

Around 2% of solar radiation in the world is converted into wind movement. Therefore, the energy supplied by wind equates to a multiple of the primary energy

demand of mankind. As is the case with water power, only a very small portion of this energy is usable. The largest supply of wind power is over the open seas where no obstacles slow the wind down. Over land the wind very quickly loses its speed due to the effects of rough terrain. For the same level of wind power as on the open seas it would be necessary to go to higher altitudes or use substantially larger tracts of land. Inland the effect on the wind due to the roughness of the terrain is no longer noticeable at altitudes higher than several hundred metres. As a result, wind use becomes more difficult as the distance from the coast increases. However, optimal locations also exist on hills and mountain tops inland.

The supply of wind energy on earth varies considerably (Figure 8.3). Whereas it could cover about one-third of demand in Germany, the potential in some countries is so vast that places like Great Britain could even export large quantities of wind power while covering all their own electric power needs. The best locations for wind power are usually where the wind hits land from the open seas without slowing down.

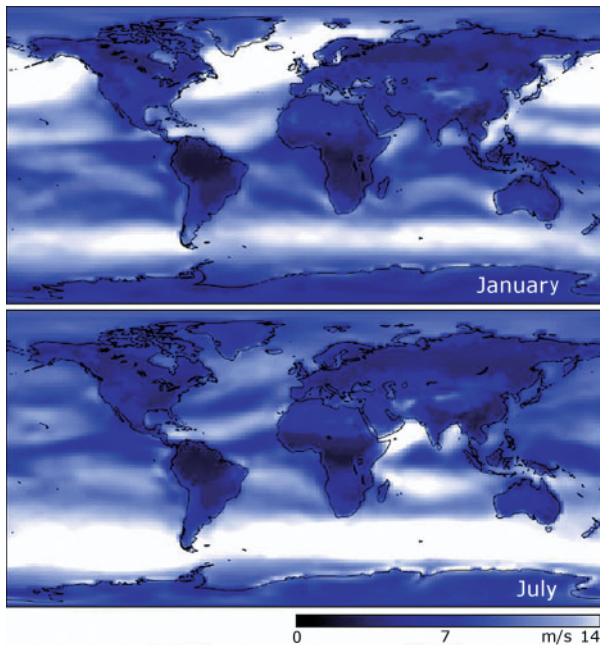

Figure 8.3 Average wind speeds worldwide.

Source: <http://visibleearth.nasa.gov>.

8.2 Utilizing Wind

Sailors have been using wind power as driving energy for centuries. However, one major characteristic of wind power is the strong fluctuation in the energy supplied. The capacity of the wind increases with the third power of wind velocity. Put more simply, this means that the capacity of the wind rises eightfold when wind speed doubles.



Wind Power

For a specific wind velocity v , the power of the wind P_{wind} is calculated by the area A for air density ρ :

$$P_{\text{wind}} = \frac{1}{2} \cdot \rho \cdot A \cdot v^3$$

With a wind velocity of 2.8 metres per second (m/s), which equates to 10 km/h or 6.2 mph, the wind with an air density of $\rho = 1.225 \text{ kg/m}^3$ on an area of 1 m^2 only reaches a relatively low capacity of

$$P_{\text{wind}} = \frac{1}{2} \cdot 1.225 \frac{\text{kg}}{\text{m}^3} \cdot 1 \text{ m}^2 \cdot \left(2.8 \frac{\text{m}}{\text{s}}\right)^3 = 13.4 \text{ W.}$$

With a wind velocity of 27.8 m/s, thus 100 km/h or 62.1 mph, the capacity rises a thousandfold and reaches 13.2 kW, which corresponds to around 18 PS (Figure 8.4).

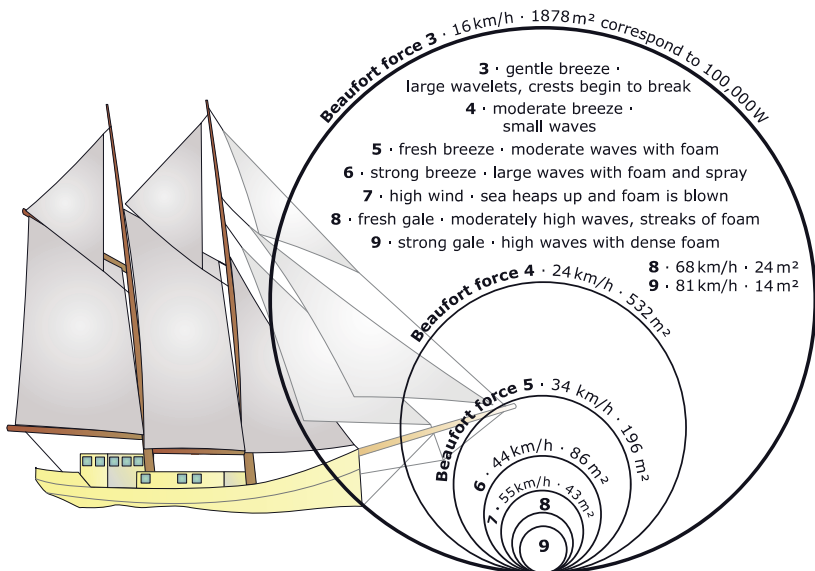

Figure 8.4 Area through which the wind reaches a capacity of 100 kilowatts at different wind speeds.

Meteorology still follows the practice of indicating wind velocity v based on the Beaufort scale (bft). The 12-level Beaufort scale was developed by the British Admiral Sir Francis Beaufort, who observed the sail behaviour of a naval frigate in different wind conditions and categorized it into different levels in 1806. The British navy officially introduced the Beaufort scale in 1838 (Table 8.1).

Table 8.1 The Beaufort wind scale.

bft	v in m/s	Name	Description
0	0–0.2	Calm	Smoke rises vertically
1	0.3–1.5	Light air	Wind direction only detectable by smoke
2	1.6–3.3	Light breeze	Wind noticeable, leaves rustle
3	3.4–5.4	Gentle breeze	Leaves and small twigs in constant motion
4	5.5–7.9	Moderate breeze	Wind moves branches and thin twigs, raises dust
5	8.0–10.7	Fresh wind	Small trees begin to sway
6	10.8–13.8	Strong wind	Large branches in motion, overhead wires whistle
7	13.9–17.1	Moderate gale	Whole trees in motion, noticeable difficulty in walking
8	17.2–20.7	Fresh gale	Wind breaks branches off trees
9	20.8–24.4	Strong gale	Minor structural damage
10	24.5–28.4	Heavy storm	Wind uproots trees
11	28.5–32.6	Violent storm	Heavy storm damage
12	≥ 32.7	Hurricane	Devastation occurs

10 m/s = 36 km/h = 22.4 mph.

Systems that use wind energy must cope with a strong fluctuation in wind supply. On the one hand, they have to use the energy supplied by the wind even when wind speeds are low; on the other hand, they should suffer no damage even when wind speeds are extreme. Therefore, most wind turbines move into storm mode when wind velocity is very high.



Wind Speed Records

The strongest gust of wind measured to date had a wind velocity of 412 kilometres per hour (114 metres per second, 256 mph) on 12 April 1934 on Mount Washington in the USA. The highest ten-minute average of 372 kilometres per hour (231 mph) was recorded on the same day on Mount Washington. Tornadoes reach even higher wind speeds. Radar has established wind speeds of around 500 kilometres per hour (139 metres per second, 311 mph) with the strongest tornadoes recorded thus far. At this rate the wind capacity per square metre totals more than 1.6 megawatts or over 2000 horsepower. This same effect would be achieved if four large lorries of 500 horsepower each were driven at full speed towards a one square metre surface. On this basis it is not difficult to understand the extremely destructive effect of tornadoes.

Modern wind turbines use part of the kinetic energy of the wind. In so doing, they slow down the wind. In principle, it is not possible to use all the wind’s capacity. This would require the wind to be stopped completely, and in this case the wind stream would come to a standstill. This was something the German physicist Albert

Betz recognized when he wrote in 1920 that maximum energy can be extracted from the wind if it is slowed down to one-third of its original speed. This is the only way in which theoretically 16/27 or 59.3% of the wind's potential energy is usable. Today this theory is called Betz' Law in honour of the man who made the discovery.

This power factor therefore identifies how much wind energy a wind turbine uses. Under ideal operating conditions, optimized modern wind turbines can use just over 50% of the energy contained in wind and convert it into electric energy. They therefore reach power factors of at least 50%, close to the maximum possible limit. The formula notation is c_p . The power factor is a typical parameter for wind turbines and is also found in the data sheets of many manufacturers of wind power generators.

If a wind turbine stops the force of the wind, it ends up changing the course of the wind's flow. Behind the wind turbine the braked wind flows through a large area. The course of the wind's flow widens (Figure 8.5).

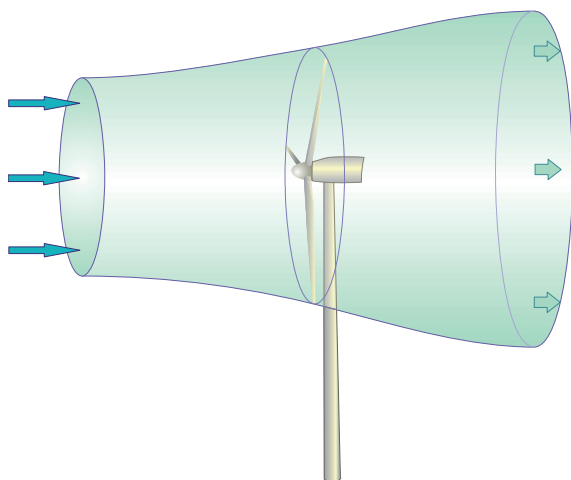

Figure 8.5 A wind turbine course of flow.

In wind use a distinction is made between

- Drag principle
- Lift principle

For example, the old Viking ships that were equipped with square rigs worked on the drag principle. The sail put up resistance to the wind and the wind pushed the sail, propelling the ship forward.

With the lift principle, which is also used by modern sailboats with fore-and-aft sails, considerably more energy can be drawn from the wind than with the drag principle. Consequently, modern wind turbines function almost exclusively on the basis of the lift principle. Among the different system concepts, the familiar rotors with a horizontal axle have been the most successful.

With these turbines, the wind flows from the front towards the rotor hub. Due to the relatively fast-rotating rotor blades, there is an airstream in addition to the actual wind and this airstream flows from the side onto the rotor blade (Figure 8.6). The rotor blade is then struck by a resulting wind that is composed of both the actual wind and the airstream.

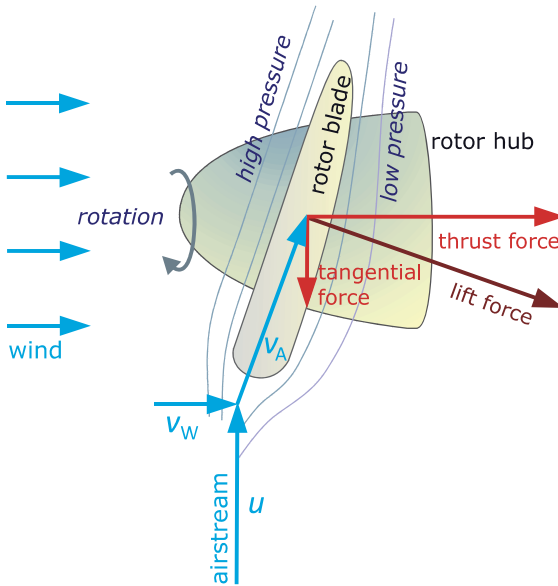

Figure 8.6 Functioning principle of a wind turbine with a horizontal axle.

The rotor blade now divides the wind. The resulting wind flows along the rotor blade. Due to the shape of the rotor blade, the wind has a longer distance to cover on the upper surface of the blade than on the lower surface. As a result, the flow widens and the air pressure decreases. Low pressure is created on the upper surface and high pressure is created on the lower surface. This difference in pressure then produces a lift force that reacts vertically to the resulting wind.

This lift force can be split into two components: the thrust force in the direction of the rotor axle and the tangential force in the direction of the circumference. Unfortunately, in most cases the thrust force is bigger than the tangential force. The thrust force is not very useful. It merely presses against the rotor blades and bends them. The construction of the rotor blades themselves must therefore be very stable so that they can resist the thrust power. Ultimately, the tangential force is responsible for the rotation of the rotors because it works along the circumference.

Modern wind turbines always try to optimize the volume of tangential force. This requires an optimal relationship between the actual wind velocity and the airstream. The rotation of the rotor affects the airstream. The rotation of the rotor blades enables an optimization of the angle at which the resulting wind approaches the blade. This deliberate rotation of the rotor blade is known as 'pitching'.

8.3 Installations and Parks

8.3.1 Wind Chargers

One of the applications for smaller wind power systems is charging battery systems. Technically, an island system with a battery functions in a similar way to a photovoltaic island grid, except that a wind generator is used instead of a photovoltaic module. Small wind power systems are particularly popular for use on boats (Figure 8.7), where they are often used to charge on-board batteries for anchored craft.



Figure 8.7 Small wind turbines used to charge battery systems.

Compared to photovoltaic island systems, island grids with wind turbines are technically more complex in their operation. If a battery is fully charged, the charge regulator of a photovoltaic system removes the photovoltaic module from the battery in order to prevent overcharging. Photovoltaic modules can cope with this without any problem. But it is a different case with wind generators that are only separated from the battery. If a wind generator does not have a load or a battery attached, high wind speeds can make the rotor blades revolve so fast that the generator is damaged. Therefore, some wind charge regulators switch wind generators with a fully charged battery to a heating resistance, thus restricting the number of revolutions.

The electric generators that wind turbines use are almost always alternating current or three-phase generators. However, a battery can only be charged with direct current. A rectifier converts the alternating current of the wind power system into direct current (Figure 8.8).

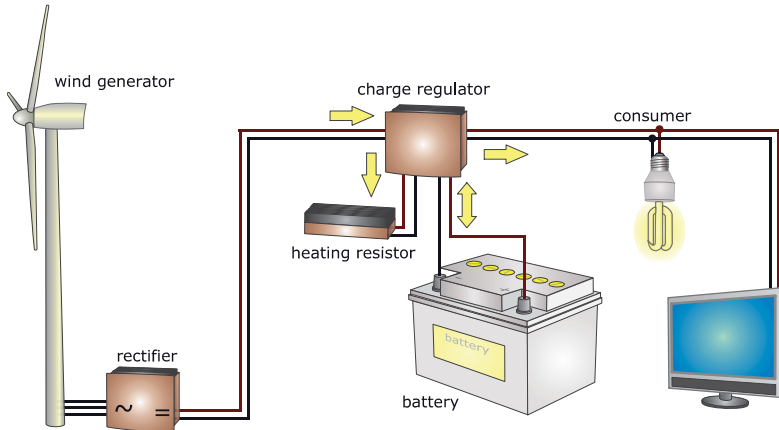

Figure 8.8 Principle of a simple wind island system.

Small wind turbines are usually mounted onto very low masts. The use of wind is usually not viable at sites that are far inland or where many trees, houses or other objects will obstruct its flow. Building regulations should also be checked beforehand to ensure that a wind system can be erected.

Storms generally pose a threat to wind generators. Large wind turbines therefore incorporate special storm settings. For cost reasons, small wind turbines often do not have any built-in storm protection. As a result, it is wise to dismantle the wind generator as a precautionary measure when large storms are forecast.

In addition to simple wind chargers, more complex island grid systems are available. These allow wind turbines to be combined with other renewable energy producers. In many cases, photovoltaic modules and wind generators work relatively well together. When there is too little sunshine, there is usually a strong wind or vice versa.

8.3.2 Grid-Connected Wind Turbines

Large wind turbines that feed into the public electricity grid have seen extensive technical development during recent years. In the 1980s the typical capacity of a wind system was 100 kilowatts or even less. The size of the rotors was still very modest at a diameter of less than 20 m (65 ft). In 2005 manufacturers were already developing prototypes for systems with 5000-kilowatt capacity, in other words 5 megawatts, and rotor diameters of 110 m (360 ft) and more. Today these systems

are ready for mass production. Compared to the size of the systems available today, the traditional windmills and sailing vessels seem like toys (Figure 8.9). They even dwarf large airliners such as the Boeing 747, which has a wingspan of about 60 m (195 ft), and the mega-airliner A380 with its 80 m (261 ft) wingspan. Apart from their size, the performance of modern wind turbines is also impressive. For instance, a single 6-megawatt system can supply all the electricity requirements for several thousand households in industrialized countries like Germany and Britain.

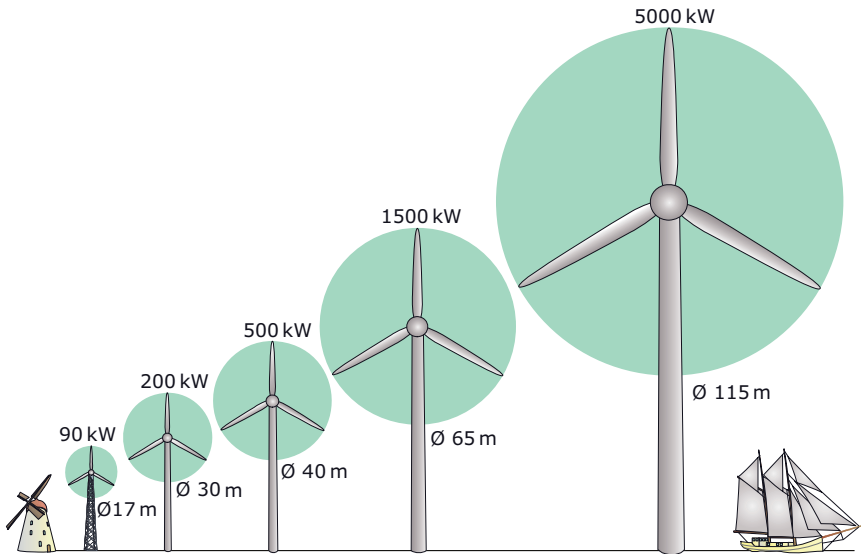

Figure 8.9 Size development of wind turbines.

However, there are physical limitations to increasing the size of wind turbines. As the size increases, there is a disproportionate increase in the material requirements. Furthermore, there are major logistical problems in transporting building parts for such gigantic structures. Based on current conditions it is therefore highly unlikely that turbines of over 10 megawatts will be built.

Wind power is currently one of the most effective technologies for combating climate change. Even the largest wind turbines can be erected in just a few days. A concrete foundation provides a secure base (Figure 8.10). In places with soft subsoil posts are used to support the foundation in the ground.

There are three different types of towers that can be used: tubular steel towers, lattice towers and concrete towers. Years ago lattice towers similar to electricity pylons were normally used. For aesthetic reasons tubular steel towers then became more popular. Because of rising steel prices and growing problems in transporting the large tubular segments needed for the biggest types of turbines, concrete and lattice towers are now being used more and more. As the size of the turbines grew so too

did the demands placed on crane technology. Today cranes are required to lift many tons of heavy loads to heights of more than 100 m.



Figure 8.10 Erection of a wind turbine. Top left: Foundation. Right: Tower. Below left: Rotor and nacelle. Photos: German WindEnergy Association and ABO Wind AG.

The nacelle (Figure 8.11) forms the heart of modern wind turbines. The nacelle is mounted to the tower in a rotatable state. The wind measurement device establishes wind velocity and wind direction. The so-called yaw drive then turns the turbine so that it faces the wind in an optimal position. The individual rotor blades are attached to the hub. A shaft starts up the movement of the rotor blades and powers the gears and the electric generator. The purpose of the gears is to adapt the slower rotation speed of the rotor to the faster rotation speed of the generator. Although the rotor of a 5 megawatt turbine 126 m in diameter only reaches a rotation speed of a maximum of 12 revolutions per minutes, the rotor blade tip moves at speeds of over 280 km/h.

Some manufacturers are also promoting wind turbines that do not use gears. Whereas the electric generator of a wind turbine with gears operates at a rotation speed in the order of 1000 revolutions per minute, a gearless generator rotates at the rotor rotation speed. Depending on the size of the wind turbine, this equates to between 6 and 50 revolutions per minute. A generator must be larger in size to use the relatively slower rotor rotation rate. The savings on the gearbox are thus cancelled out

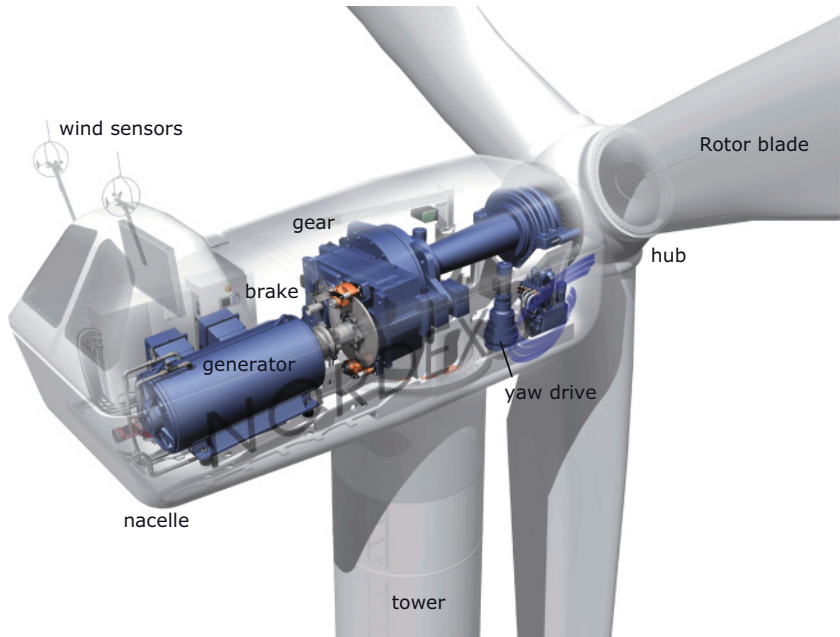

Figure 8.11 Structure and components of a wind turbine. Graphics: Nordex AG.

because of a considerably heavier and more expensive generator. However, until now both wind turbine concepts, that is, with or without a gearbox, have been equally successful in the turbine market.

Modern wind turbines adapt their rotation speeds to the wind speed. When wind speeds are low a turbine reduces its rotation speed, thereby making better use of the wind. Wind speeds of 2.5 to 3.5 m per second, that is, 9 to 13 km/h, are usually sufficient to start a turbine. Wind turbines reach their maximum capacity with wind speeds of around 13 m per second (47 km/h or 29 mph). If the wind speed increases more than that, a turbine begins to limit its speed. It pitches the rotor blades less favourably into the wind, thereby reducing the momentum. This enables the turbine to keep its output at a constant level.

When wind speeds are very high at more than 25 to 30 m per second (90 to 108 km/h), a turbine moves into storm mode. The yaw drive turns the entire turbine out of the wind and brakes hold the rotor firm.

As large wind turbines already produce high output, they usually feed their electric current directly into a medium-high voltage system. A transformer converts the generator voltage into the mains voltage.

Maintenance on wind turbines often requires an arduous upward climb for the technicians, so some turbines are equipped lifts (Figure 8.12). Modern wind turbines have a relatively low incidence of outages, and a turbine service life of 20 years can be expected.



Figure 8.12 Maintenance work on wind turbines. Source: REpower Systems AG, Photos: Jan Oelker, caméléon and Stéphane Cosnard.

8.3.3 Wind Farms

During the pioneering days wind turbines were often erected individually, whereas today they are almost always grouped in large wind farms (also known as wind parks). A wind farm consists of at least three turbines but can also have many more. For example, the Horse Hollow Wind Park erected in 2006 in Texas has 421 wind turbines with a total capacity of 735 megawatts. These wind turbines are capable of supplying electricity to 150 000 US households.

The main advantage of wind farms compared to individual turbines is the cost saving. Planning, erection and maintenance are considerably more economical. Large wind turbines usually have to have obstacle marking for air traffic. This includes a coloured mark on the rotor blade tips and navigation lights that come on when visibility is poor. With wind farms only the outer turbines have a marking. This saves money and improves the appearance of the farms (Figure 8.13).

The disadvantage of wind farms is mutual interference. If the wind turbines are sited close together, they can take the wind away from each other. The efficiency of the turbines at the back is then impacted. It is important that sufficient distance is created between the turbines in the main direction of the wind so that efficiency losses can be minimized. However, efficiency loss through mutual interference cannot be totally prevented. Wind farm efficiency takes into account losses from mutual interference, which is usually between 85 and 97%. This means that losses between 3 and 15% should be expected.

If wind turbines are too close to housing estates they can have a negative effect due to noise emission and a shadow being cast as the sun goes down. Turbines should ideally be erected several hundred metres from the nearest dwellings to avoid creating this effect.



Figure 8.13 Wind parks. Source: REpower Systems AG, Photos: Jan Oelker.

Because of the rules on required distances, it is already becoming increasingly difficult to find good sites for new wind farms in Germany and Denmark. Therefore, a greater planning effort is being made in the areas that are still available: the North Sea and the Baltic.

8.3.4 Offshore Wind Farms

With offshore wind farms the turbines are sited directly in the water. For maximum effectiveness the depth of the water should not be too great and the turbines should not be too far from the coast. Along with the enormous size of available area, offshore use also provides other benefits: the wind blows stronger and more evenly on open seas than on land. The power output per wind turbine increases at offshore sites and can be up to 100% higher than on mainland sites.

Offshore wind turbines differ relatively little from onshore ones. Generally, offshore turbines do not require a good deal of maintenance. Access to wind turbines on high seas is not possible in bad weather or when the sea is rough. Special ships are required for major maintenance work but can only be used if the water is relatively calm. Because offshore wind turbines stand in salt water, all components have to be well protected and corrosion-resistant.

Special ships with cranes erect the wind turbines out at sea (Figure 8.14). Special foundations are used to anchor the wind turbines to the seabed. With monopile foundations, a large steel pipe is driven many metres into the seabed. The stability of the bottom is important, and a more secure foundation is needed if the ground is too soft, which increases the cost. This problem may make it economically unfeasible to erect projects in shallow water.

Connecting offshore wind farms to the grid is also more difficult than on land. Sea cables link the different wind turbines to a transformer station, which looks like a small drilling platform. The transformer station converts the electric voltage of the



Figure 8.14 The Nysted offshore wind farm in the Baltic Sea off Denmark. Source: <http://uk.nystedhavmoellegpark.dk>. Construction of the wind farm. Photo: Gunnar Britse.

wind turbines into high voltage to keep transmission losses to a minimum. Direct-current transmission may also be necessary for installations that are far from shore, as losses with alternating-current sea cables can be considerable. A special converter converts the alternating voltage into direct voltage. On land it is converted back into alternating current. Normal high-voltage lines then transport the electricity to the users.



Offshore, Onshore and Nearshore

The term *offshore* refers to wind turbines that are sited in the open seas. Use of the terms *onshore* and *onshore wind farms* in respect of wind power is relatively recent and only become popular in tandem with the growth of offshore wind parks. Onshore means *on land* or *on the mainland*. In this sense onshore wind farms are all wind farms that are not standing in water. These simply used to be called wind farms.

As part of a test of offshore wind farms, some wind turbines were recently erected in the water just a few metres from the shore. Technically, these test facilities were really onshore wind turbines with wet feet. The term *nearshore wind turbines* has also been used to differentiate the turbines.

Numerous very large offshore wind farms have been erected in recent years. Denmark has been one of the pioneers in this field, followed by Britain. By contrast, Germany has been rather slow in moving ahead in this field. In part this is due to the major technical requirements involved. German offshore wind farms are supposed to be erected in comparatively deep waters of 20 to 50m at a distance of 30 to 100km from the coast (Figure 8.15). The biggest wind farms in Germany would ideally consist of several hundred turbines with outputs of several gigawatts. The investment cost would quickly add up to several billion euros.

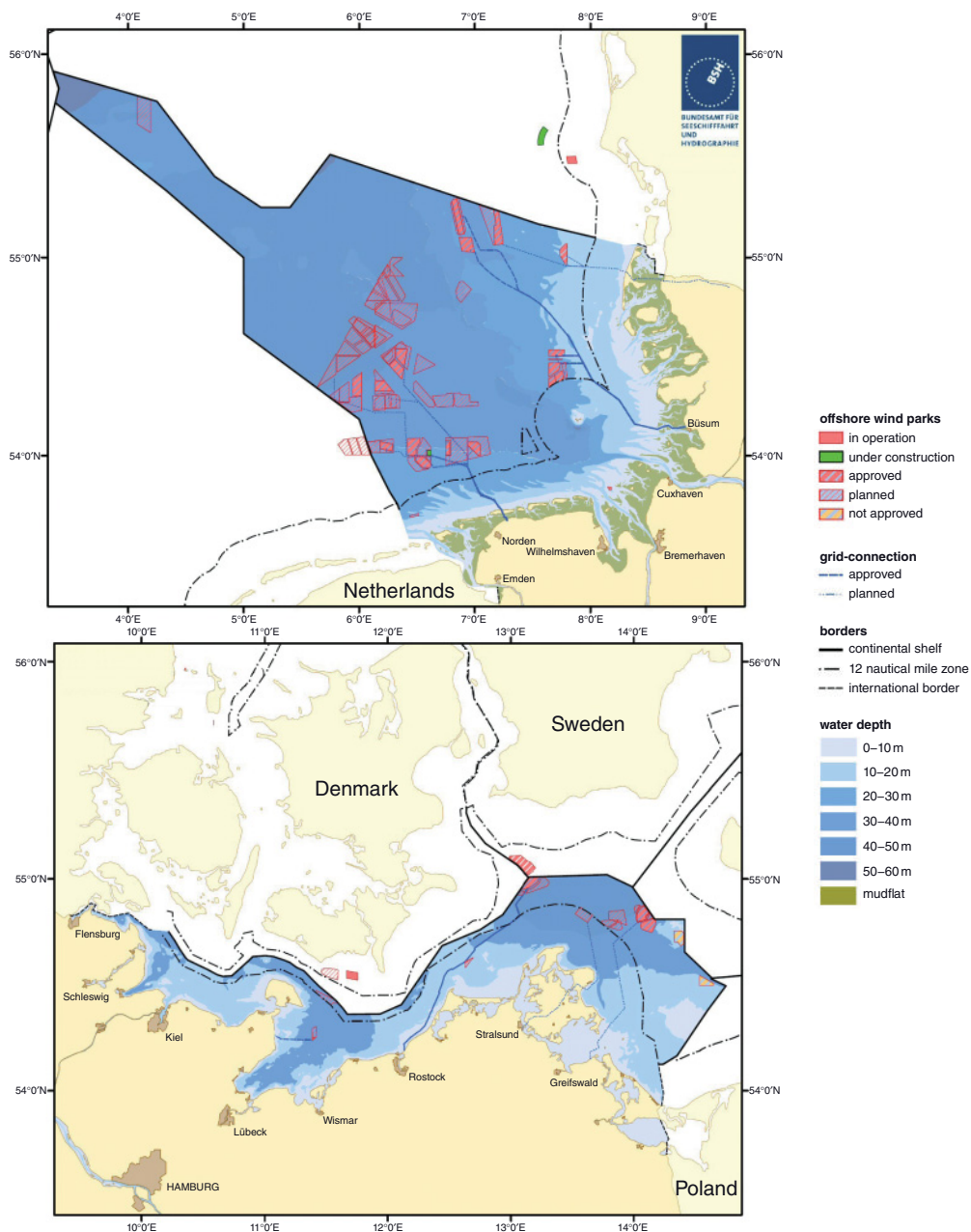

Figure 8.15 Planning for offshore wind farms in the North Sea and Baltic Sea off Germany. Source: Federal Maritime and Hydrographic Agency of Germany, www.bsh.de. Status as of January 2008.

From a legal point of view, coastal waters are divided into two areas. Territorial waters extend to 12 nautical miles (22.2 km) from shore. The exclusive economic zone then begins and stretches to a maximum of 200 nautical miles (370.4 km).

Wind farms planned for the exclusive economic zone have to be approved by the relevant authorities, who must check whether the planned farm will interfere with shipping or endanger the marine environment. If neither is the case, approval is granted for a fixed term.



■ www.offshorewind.net
■ <http://www.bsh.de/en>

North American Offshore Wind Project Information
German Federal Maritime and Hydrographic Agency

8.4 Planning and Design

Anyone who wants to erect a very small wind turbine in their garden must take into account local planning laws. Overall heights of up to 10 m are usually not a problem. It is also important to ensure that no neighbours will suffer from noise or overshadowing.

Obtaining approval for large wind farms is considerably more difficult. Wind farms can usually be erected only in specifically designated areas identified within the regional planning specifications of local authorities and municipalities. Planning and approval regulations vary depending on the local authority. The local planning department checks the basic feasibility of a wind farm based on a preliminary planning application. If everything is in order, the applicant can submit an official application for the project.

Applications with the relevant forms and explanatory notes can be obtained from the responsible local authority. In addition to checking the safety of the turbines and the location, the relevant authority looks into environmental compatibility and the effect of noise pollution and overshadowing.

Anyone embarking on the sometimes obstacle-strewn path of submitting an application should first ensure that the proposed location is technically and economically suitable for building a wind farm.

The prerequisite for optimal planning is having precise knowledge about the wind conditions at a chosen site, because even the smallest fluctuation in wind supply can have a considerable impact on output. If no measurement data on wind velocity are available for the immediate vicinity of the planned site, it is highly advisable that a measurement station be set up. This station will chart the wind speeds over at least one year. These results should then be compared to the long-term measurement data of other stations and, if necessary, corrected to provide a yearly average. In the case of commercial wind farms, reliable experts should be

called upon to carry out measurements and calculations and submit a wind survey report.

If usable information about the wind speed is available, computer models can be used to convert the calculations for wind conditions at nearby sites or for other heights. Data on shadowing caused by other wind turbines can also be incorporated into these calculations. The calculations should include the frequency distribution of the wind speed at the pitch level of a wind turbine.



Annual Energy Output of a Wind Turbine

The frequency distribution $f(v)$ indicates how often a wind velocity v occurs during the year. This usually involves compiling wind velocities at intervals of one metre per second (m/s). The performance characteristic of a wind turbine indicates the electric power $P(v)$ a wind turbine produces at wind velocity v . The builder of the installation usually provides the performance characteristics. The annual energy output E of a wind turbine is calculated on the basis of both characteristics: the corresponding value of the frequency distribution for each wind speed is multiplied by the performance characteristic and then all the results added:

$$E = \sum_i f(v_i) \cdot P(v_i) \cdot 8760 \text{ h} = \left(f\left(0 \frac{\text{m}}{\text{s}}\right) \cdot P\left(0 \frac{\text{m}}{\text{s}}\right) + f\left(1 \frac{\text{m}}{\text{s}}\right) \cdot P\left(1 \frac{\text{m}}{\text{s}}\right) + \dots \right) \cdot 8760 \text{ h}$$

The annual energy output for the characteristics from Figure 8.16 is

$$\begin{aligned} E &= (0\% \cdot 0 \text{ kW} + 4.3\% \cdot 0 \text{ kW} + 8\% \cdot 7.5 \text{ kW} + 10.8\% \cdot 62.5 \text{ kW} + \\ &\quad 12.3\% \cdot 205 \text{ kW} + 12.6\% \cdot 435 \text{ kW} + 11.9\% \cdot 803 \text{ kW} + 10.5\% \cdot 1330 \text{ kW} + \\ &\quad 8.6\% \cdot 2038 \text{ kW} + \dots) \cdot 8760 \text{ h} \\ &= 11\,685\,000 \text{ kWh} \end{aligned}$$

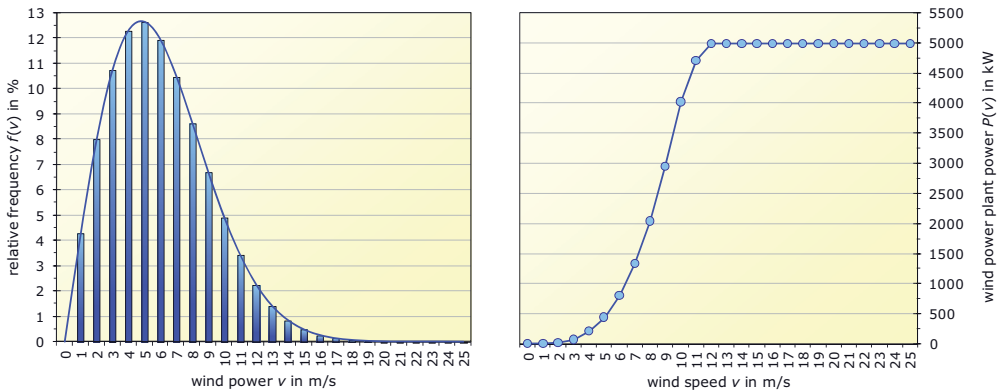

Figure 8.16 Left: Frequency distribution of wind speed. Right: Performance curve of a wind turbine.

With wind farms deductions are made for factors such as mutual interference (farm efficiency), turbine breakdowns and downtimes (availability) as well as a provision for other unanticipated losses. Various applications available online offer approximate calculations of turbine yield.

Professional planning departments use sophisticated computer programmes to develop even more detailed calculations. However, the principle of the calculations is always the same as that presented here. In addition to providing calculations on yield, the object of planning is to provide calculations on wind farm optimization. Different aspects are considered. Building higher towers and installing larger rotors will increase the output of an installation. However, this will also increase costs dramatically. The selection of a certain tower height and rotor size will ultimately provide the optimum installation from an economic point of view. Furthermore, losses caused by overshadowing can be minimized through minor changes in the positioning of individual turbines.



- http://www.volker-quaschnig.de/software/windertrag/index_e.html
- <http://www.windpower.org/en/tour/wres/pow>

Online output calculations for wind power plants

8.5 Economics

Very small wind generators can already be bought for a few hundred euros. A simple 60-watt wind generator for charging batteries costs about 500 euros. This price does not include the mast and installation. At about 8 euros per watt the costs of wind generators exceed even those of photovoltaic systems. Therefore, small wind systems only make economic sense at very windy locations and only then when electricity does not also have to be fed into a grid.

The costs per watt drop as the wind generator size increases. Around 900 euros per kilowatt (€/kW), thus around 90 cents per watt, should be included in the calculations for a grid-connected wind turbine in the megawatt range. The cost of the turbine, tower and installation is included in this price. The tower and the rotor blades account for around half of the cost (Figure 8.17).

The ancillary investment costs for planning, development, foundations and grid connections amount to about 30% of the wind turbine costs (Deutsches Windenergie-Institut GmbH DEWI, 2002) and need to be added on to the price. Around 1200 euros per kilowatt should be estimated for a turnkey wind farm. The project costs for a small farm with four turbines of 2.5 megawatts each will amount to 12 million euros. Depending on the location and the technology, these costs can vary considerably upwards or downwards. A figure of around 5% of the wind turbine costs should be allocated for annual operation and maintenance.

Wind farms are usually built by operating companies. A group of private investors extends about 20 to 30% of the cost of erecting the wind farm. The remaining

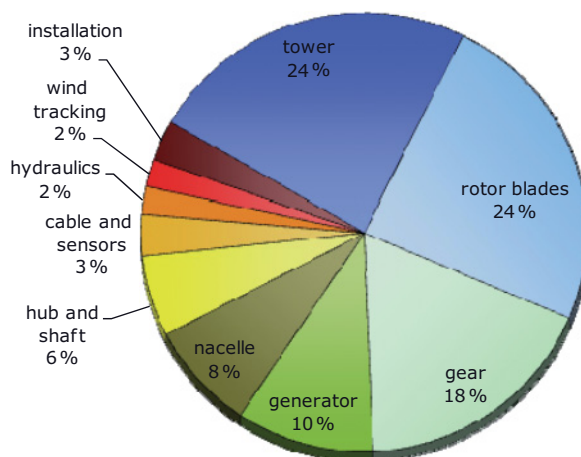

Figure 8.17 Distribution of costs for a 1.2-MW wind turbine (Bundesverband WindEnergie e.V. BWE/DEWI, 2008).

financing is obtained through bank loans. The feed-in compensation is used for repayment and redemption costs. The surplus funds are distributed among the investors. If everything goes according to plan, private investors will receive a return of 6 to 10%. If for whatever reason a wind farm does not achieve the output yield forecast, the investors can end up losing all the money they put into the project.

Offshore wind farms cost about twice as much as those on land. The prerequisite for these wind farms is a minimum size of several hundred megawatts. Depending on the distance from shore and water depth, costs can vary considerably between different farms.

In Germany the feed-in-tariffs for wind turbines are determined by the Renewable Energy Law (Table 8.2). These tariffs represent the current costs of wind power electricity. For onshore wind farms the law defines a basic compensation and a higher rate of compensation. Compensation for feed-in electricity is granted over a 20-year period. Wind parks at very favourable locations on land receive the higher rate over five years; at less optimal sites this compensation is extended over the

Table 8.2 Compensation in cents/kWh for wind turbines in Germany, based on the Renewable Energy Law.

In operation	2004	2005	2006	2007	2008	2009	2010	2011
Onshore higher-rate compensation	8.70	8.53	8.36	8.19	8.03	9.20	9.11	9.02
Onshore basic compensation	5.50	5.39	5.28	5.17	5.07	5.02	4.97	4.92
Offshore higher-rate compensation	9.10	9.10	9.10	9.10	8.92	15.00	15.00	15.00
Offshore basic compensation	6.19	6.19	6.19	6.19	6.07	3.50	3.50	3.50

entire 20 years. On the other hand, erecting wind turbines at poor sites is not encouraged. With offshore installations the compensation structure is similar, except that other rates of compensation do exist and the higher rate remains in effect for at least 12 years. The compensation increases at a minimal rate if wind turbines make a technical contribution to grid stability or when old wind turbines are replaced by new ones (repowering).

The profitability of a site is gauged by the number of full-load hours. A good inland site achieves about 2000 full-load hours per year. In other words, a wind turbine generates as much electricity at the site during the course of a year as if it were operating 2000 hours at full load in one continuous segment of time.

Wind turbines at poor inland sites reach noticeably fewer than 2000 full-load hours. It is easier to improve values in mountainous areas and at the coast. Offshore wind turbines can reach 3000 full-load hours or even more.

Figure 8.18 shows electricity generation costs for wind turbines based on different full-load hours. The assumption for all calculations is that the yearly operating and maintenance costs amount to 5% of the investment costs.

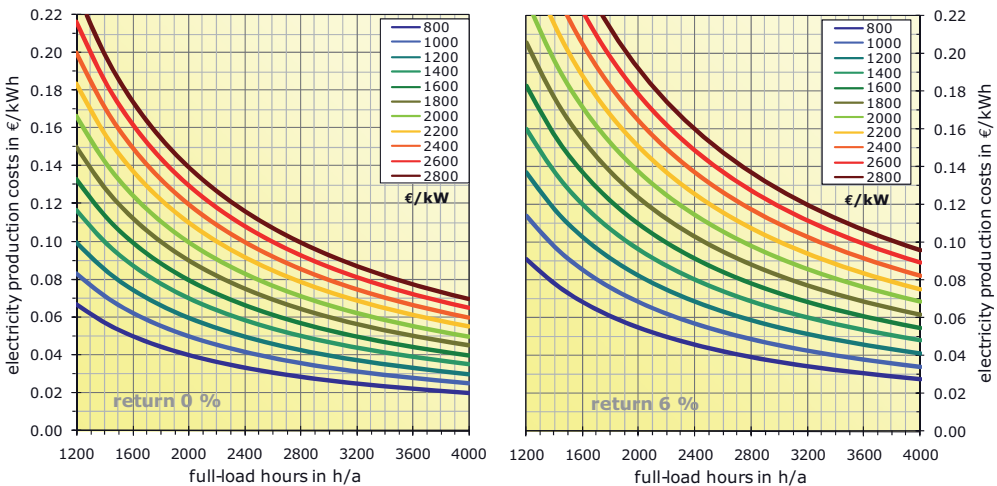

Figure 8.18 Electricity generation costs for wind turbines based on full-load hours and investment costs in €/kW. Assumption: Annual operating and maintenance cost proportion is 5% of the investment cost.

Consequently, on the basis of an inland site reaching 2000 full-load hours and with investment costs of 1200 euros per kilowatt (€/kW), the generating costs amount to 8 cents per kilowatt hour (0.08€/kWh) – resulting in an overall return of 6%. This is the minimum return that should be accepted to cover the financial risks involved.

For an offshore wind farm with 3400 full-load hours per year and investment costs of 2800€/kW, the generating costs are over 0.11€/kWh. As the risk involved for the first offshore wind farms is considerably higher than for those on mainland sites, the cost must be offset by a higher return. This will affect the economic feasibility of a project, which explains the hesitation to develop offshore wind farms before

2008. A reduction in the cost of energy generation is expected in future as investment and operating costs decrease and system yield is optimized.

8.6 Ecology

Because of their size, wind turbines are often visible even from great distances and therefore can create an eyesore in many places. Whether one finds wind turbines attractive or ugly is really a matter of personal taste. Nevertheless, the subject has become a major bone of contention. Whereas supporters swoon over the majestic appearance of these technical masterpieces, opponents fight against what they consider a blot on the landscape. There certainly are arguments that can legitimately be made against wind turbines. However, it is important to bear in mind that wind turbines are usually erected in areas that already bear many signs of human activity. Traditional windmills have been a common sight for many centuries, and are now regarded as picturesque additions to the landscape. Domestic livestock seems to get used to the turbines much more quickly than humans (Figure 8.19). It is incredible to think that around 190 000 high-voltage pylons and more than one million medium and low-voltage masts are less controversial in Germany than the 20 000 wind turbines there. The strong feelings about wind turbines may arise because people are less used to seeing them than the other power infrastructure that criss-crosses the European landscape.



Figure 8.19 Wind turbines in a rural landscape. Source left: German WindEnergy Association, Source right: REpower Systems AG, Photo: Jan Oelker.

Considered objectively, the negative effects can be kept to a minimum. Erecting wind turbines in conservation areas is just as much a taboo as it would be in residential areas. If wind turbines adhere to a minimum distance from residential areas, the

nuisance from noise or overshadowing will be very minor. These issues are part of the approval process in the planning of wind farms.

Wind power has very little effect on the animal world. Most animals get used to the turbines quickly. Birds usually detect the relatively slow-rotating rotors from a great distance and fly around them. Despite the claims made by the opponents of wind farms, birds very seldom fly into a turbine. The numerous window panes in residential buildings pose a far greater threat to the bird world than wind turbines.

The effect that wind power has on protecting the environment is very positive. In comparison to photovoltaics, the energy required for producing wind turbines is minimal. A wind turbine will recoup this amount within a few months. Depending on the site, it would save up to 1 kg of carbon dioxide per feed-in kilowatt hour.

8.7 Wind Power Markets

Denmark is rightfully considered the pioneer of modern wind power. The Danish teacher Paul la Cour built a wind turbine for generating electricity at the primary school in Askow as far back as 1891. When the current wind power boom began in the 1980s, Danish companies ranked among the leaders of this technology from the start. Today the Danish Vestas Group is one of the most successful wind energy companies in the world, employing around 20 800 staff worldwide in 2008 and achieving a turnover of 6 billion euros.

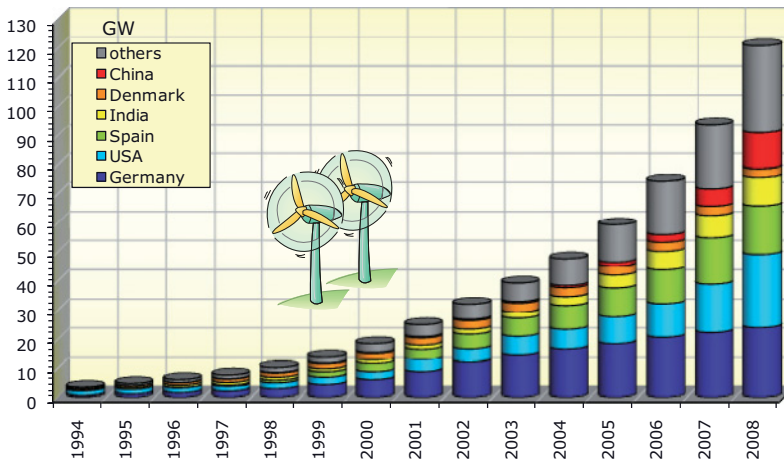

Figure 8.20 Development of wind power capacity installed worldwide.

The USA experienced its first wind power boom at the end of the 1980s, by which time it had already erected thousands of wind turbines in just a few years. However, the wind power market in the USA came to an almost complete halt in the early 1990s. Due to a legally regulated system of feed-in-tariffs, Germany then became

number one in the wind energy market in 1990s. As a result, Germany developed an internationally successful wind energy industry, with a turnover of 7.6 billion euros in 2007 and an export quota of over 83%.

Whereas the number of new wind farms in Denmark has dropped to almost zero in recent years, expansion in Germany is continuing. Germany, the USA, China and Spain are the key wind energy markets today. In Spain a legal system of feed-in-tariffs similar to that in Germany is ensuring continued expansion. The wind energy market in the USA is driven by tax write-offs and quotas for renewable energies. Due to changing conditions in the past few years, the market there has been very up and down.

India has also developed a steady wind energy market and, consequently, a flourishing wind energy industry. The Indian Suzlon Group is one of the biggest wind turbine manufacturers in the world. Numerous other countries have started to develop wind energy use during the last few years, and, as a result, high annual growth rates are anticipated in the wind energy sector (Figure 8.20).



- www.awea.org
- www.ewea.org
- www.gwec.net

American Wind Energy Association
European Wind Energy Association
Global Wind Energy Council

8.8 Outlook and Development Potential

Whereas only very few countries were players in the wind boom of the 1990s, many more have started to rely on wind energy in the meantime. Even today at good sites wind energy is able to compete with conventional fossil power plants. In contrast with the fluctuating prices for coal, natural gas and crude oil, the production costs for a wind turbine once it has been erected are quite constant. It is therefore anticipated that the high growth rates for wind power will be sustained worldwide.

Germany can be viewed as a prime example of a country that has fully exploited the potential of its wind energy. On the other hand, its market has been shrinking since 2002 (Figure 8.21). The reason is that the best inland sites have already been developed. Presumably wind turbines will be standing on all economically feasible and legally viable sites by 2015. As wind turbines have a service life of about 20 years, Germany is successively developing a new market segment: repowering. With repowering, new more efficient installations replace older and no longer viable smaller wind turbines. As a result, the installable wind energy output is increased on land. The total potential is a minimum of 30 000 megawatts. These installations could produce around 60 billion kilowatt hours per year, which equates to about 10% of current electricity demand.

Germany is beginning to develop offshore sites, a process that is expected to reach its peak in about 2020. Around 30 000 megawatts could be installed in the offshore areas by 2030. Due to the higher wind supply offshore, these installations would

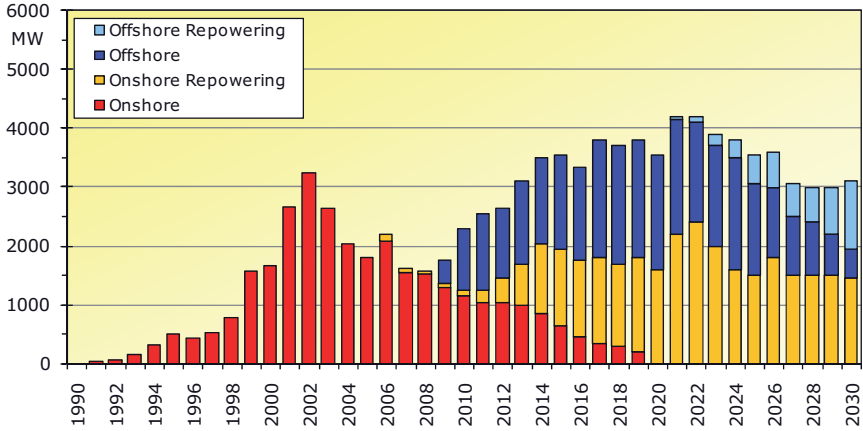

Figure 8.21 Development of newly installed wind power capacity in Germany and projects until 2030. (Data based on: Messe Hamburg Wind Energy, 2006)

produce around 100 billion kilowatt hours per year. Overall wind energy could cover between 25 and 30% of Germany’s electricity requirements by 2030.

According to the American Wind Energy Association (AWEA) about 20% of the US American electricity demand can be covered by wind power by 2030. To reach this goal the annual installations of new wind turbines in the USA would need to ramp up to more than 16 gigawatts by 2018 compared to 8.5 gigawatts in 2008. That would lead to a cumulative total power of 300 gigawatts. In contrast to Germany, more than 80% of the installation will be land-based.

The possible installations for the European Union are in the same range. The European Wind Energy Association (EWEA) projects that the total installed capacity by 2030, will be between 200 and 350 gigawatts. These figures provide convincing evidence that wind power will become one of the key pillars of a climate-compatible electricity economy. As other countries are in the process of following the US and Europe’s model, wind power could very possibly provide 25 to 35% of the world’s electricity needs by 2050.

9 Hydropower Plants – Wet Energy

In terms of numbers, there are far fewer water-powered systems today than there were at their heyday at the end of the eighteenth century. At that time between 500 000 and 600 000 watermills were turning in Europe alone (König, 1999). In those days France was the country that had the highest number, although thousands were also being used in other parts of Europe. Water wheels not only drive mills but also power a number of other work and tool machines. Flowing waterfalls were harnessed by watermills with turning wheels up to 18 m in diameter. At five to seven horsepower the average power of water wheels at that time was still comparatively modest (Figure 9.1).



Figure 9.1 Historic watermill in the Alps. Source: www.verbund.at.

As more and more mills were built on rivers and streams, the activity was strictly regulated and mill operators were instructed on how long mills could be used and how large they could be. This may have been an annoyance for them, but it was a good thing because it promoted technical development and ensured that optimal use was made of existing mills. This constant drive to improve gave rise to the modern, highly efficient turbines used in hydropower plants today.

The introduction of the steam engine slowly displaced water-powered systems. But, in contrast to wind power, the use of hydropower did not vanish from the scene with the exploitation of fossil energies. When widespread electrification began at the end of the nineteenth century, hydropower was still very much part of the scene. At the beginning small turbines were used to power electric generators, but the size of the systems grew rapidly.

9.1 Tapping into the Water Cycle

The colour of our planet is blue when seen from space. The reason is that 71% of the earth's surface consists of water. However, without the sun our blue planet would not be blue. Water, which gives the earth its characteristic appearance, would be completely solidified into ice. Because of the heat of the sun, 98% of water is fluid.



A Water-Powered System in the Rain Gutter?

The roof of a house collects many cubic metres of water each year. A rain gutter diverts the water without making any use of its energy. A water-powered system for each rain gutter could actually be a good idea.

The annual precipitation in Berlin amounts to around 600 litres per square metre, so that a 100 m² house roof would collect 60 000 litres or 6 000 10-litre buckets of water. Compared with a similar bucket on the ground, the content of a 10-litre bucket on a 10 m-high roof has a potential energy of 0.000273 kilowatt hours. Six thousand buckets together create around 1.6 kilowatt hours, just enough to boil water for 80 cups of coffee but unfortunately too little to make it worthwhile to harness. Thus considerably larger quantities of water than are available in a rain gutter are necessary to produce viable quantities of energy.

Altogether there are around 1.4 billion cubic kilometres of water on earth. Of this amount, 97.5% is salt water in the oceans and only 2.6% is fresh water. Almost three-quarters of the fresh water is bound in polar ice, ocean ice and glaciers; the rest is mainly in the groundwater and the soil moisture. Only 0.02% of the water on earth is in rivers and lakes.

Due to the influence of the sun, on average 980 litres of water evaporate from each square metre of the earth's surface and come down again somewhere else in the

form of precipitation. Altogether about 500 000 cubic kilometres of water collect in this way each year. This gigantic water cycle converts around 22% of all the solar energy radiated onto earth (Figure 9.2).

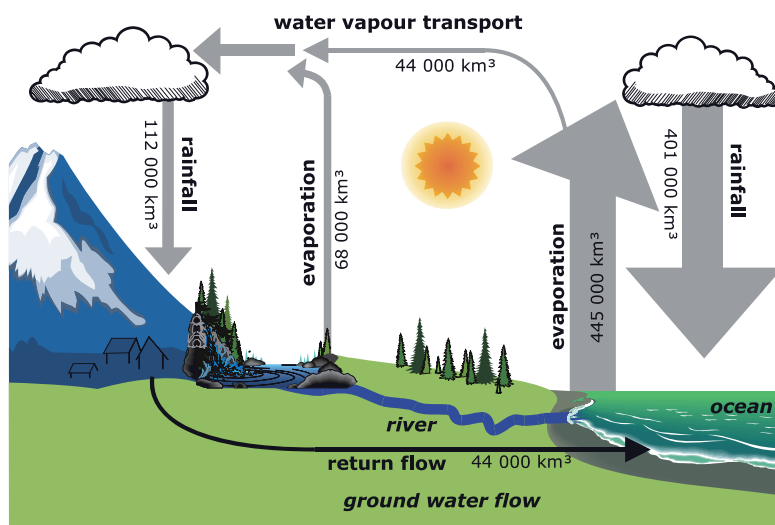

Figure 9.2 Earth's water cycle.

If the evaporation were concentrated onto a single square kilometre on earth, the water would come pouring out at a speed of over 50 km/h. The column of water would reach the moon in less than one year. Fortunately, however, the water remains spread on the surface of the earth, because otherwise we would not have any liquid water left in 3000 years.

The energy that is converted by the sun in the earth's water cycle is around 3000 times the primary energy demand on earth. If we were to stretch a tarpaulin at a height of 100 m around the earth, collect all the rainwater into it and use it to produce energy, we would be able to satisfy all the energy needs on earth.

Altogether 80% of precipitation comes down over the ocean. Of the 20% that falls on land, a large amount evaporates. Around 44 000 cubic kilometres of water reach the ocean again as return flow in groundwater or in rivers. This is still more than one billion litres per second. We could be making use of the energy of the water from this return flow without stretching large tarpaulins over the earth. This water could be delivering some of its energy on its way back to the ocean – energy that it first received from the sun. Yet the useable amount of energy that rivers carry with them comprises only a small fraction of the energy of the water cycle.

To convert water into power, it is not just the amount of water that is important but the height at which water is found. Water in a small mountain stream with

many hundreds of metres of difference in elevation can sometimes carry more energy than a large river that just has to descend from an elevation of a few metres to reach the ocean. About a quarter of the energy of water from rivers and lakes can theoretically be used. This equates to around 10% of the current primary energy requirement worldwide. Ocean currents and waves also contain useable energy.

9.2 Water Turbines

Water turbines form the core of water-powered systems and extract the energy from water. Modern water turbines have very little in common with the rotating wheels of traditional watermills. Depending on the head of the water and the water flow, turbines optimized for the respective operating area are used (Figure 9.3). These turbines reach a power of over 700 megawatts.

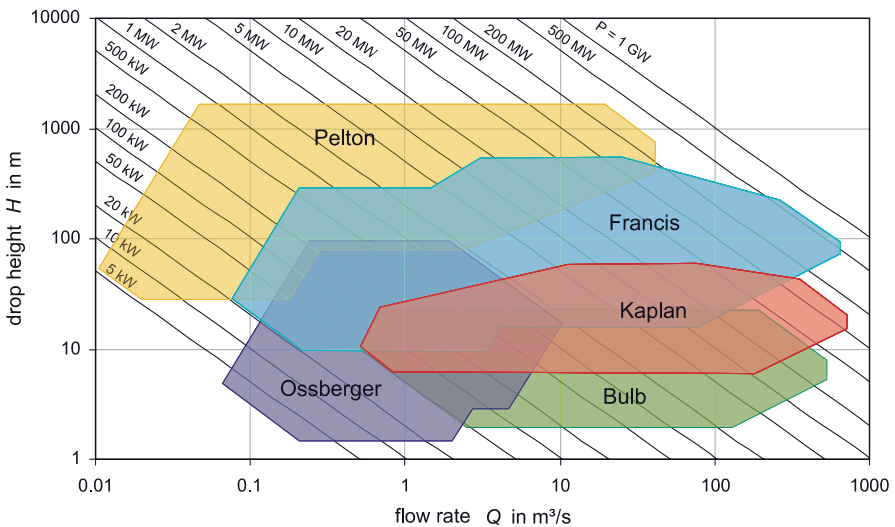

Figure 9.3 Operating areas for different water-powered turbines.

The Kaplan turbine, developed by the Austrian engineer Viktor Kaplan in 1912, is usually the first choice for low heads – for instance, for power plants on rivers (Figure 9.4). This turbine uses the pressure of the water at the different elevations of barrages. It has three to eight adjustable blades and looks like a large ship screw (propeller) that powers the flowing water. The efficiency of Kaplan turbines reaches values between 80 and 95%.

The bulb turbine (Figure 9.5) is similar to the Kaplan turbine, except that it has a horizontal axle and, as a result, is suitable for even smaller heads. The generator is

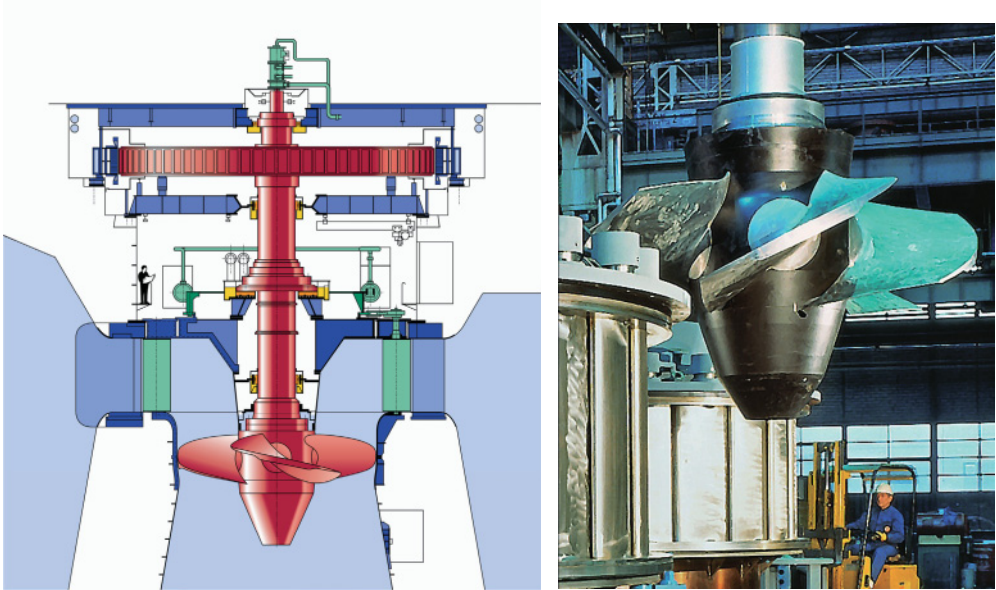

Figure 9.4 Drawing showing a Kaplan turbine with a generator (left) and a photo of a Kaplan turbine (right). Source: Voith Hydro.

placed in a bulb-shaped workroom behind the turbine, which explains why it is also referred to as a bulb turbine.

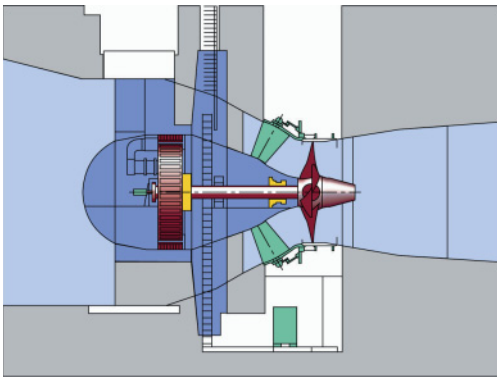

Figure 9.5 Bulb turbine with generator. Source: Voith Hydro.

The Francis turbine, which was developed by the Briton James Bicheno Francis in 1848, is used for larger heads of up to 700m. This turbine also uses the pressure difference of water and reaches efficiencies of over 90%. In principle, the Francis turbine can also be used as a pump and is therefore suitable as a pump turbine for pumped-storage plants (Figure 9.6).

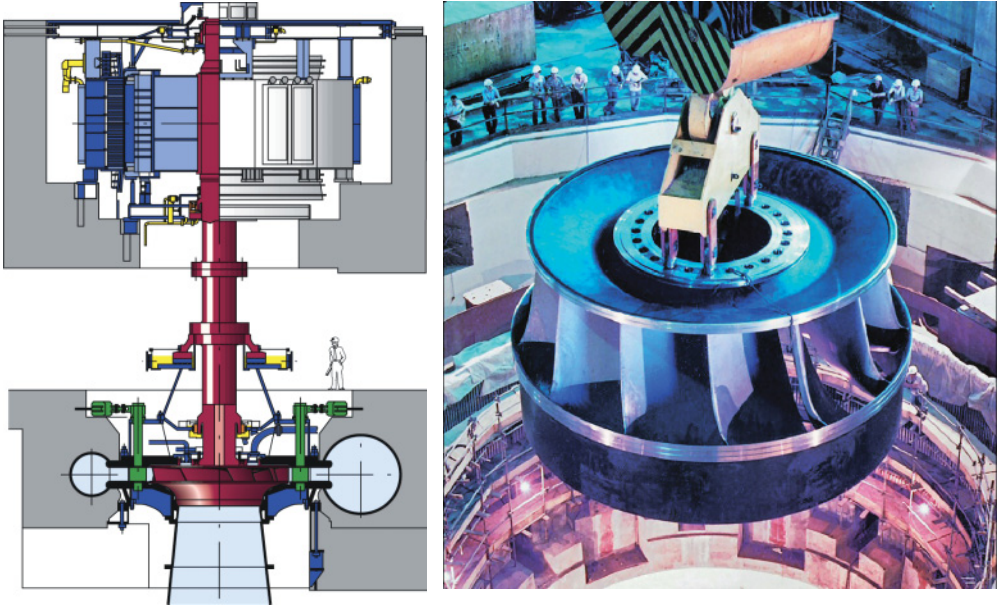

Figure 9.6 Francis pump turbine at Goldisthal pumped-storage plant (left) and a Francis turbine at the Itaipu plant (right). Source: Voith Hydro.

In 1880 the American Lester Allen Pelton developed the Pelton turbine. It is mainly designed for large heads and, consequently, for use in high mountains. This turbine can reach very high efficiencies of 90 to 95%. The water is supplied to the turbine over a penstock. The water then flows through a nozzle at very high velocity to spoon-shaped buckets (Figure 9.7).

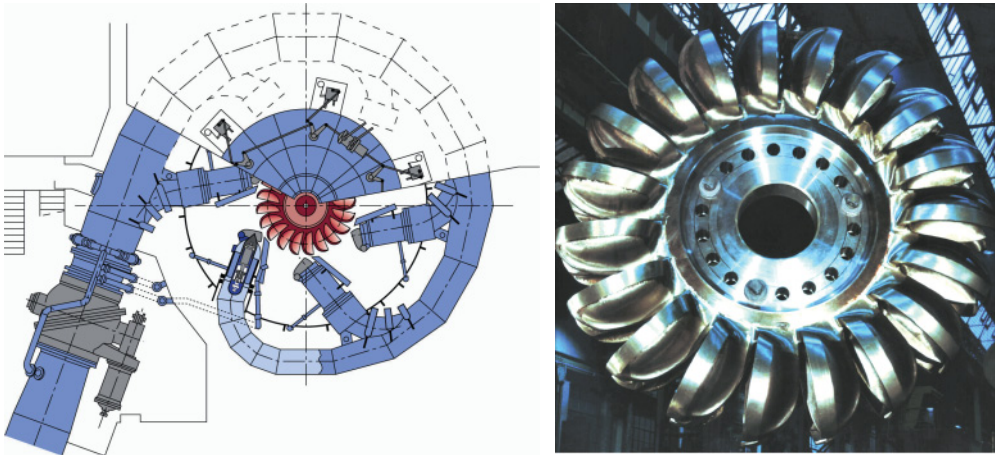

Figure 9.7 Drawing of a 6-nozzle Pelton turbine (left) and photo of a Pelton turbine (right). Source: Voith Hydro.

Small plants use the Ossberger turbine, which is also called a cross-flow turbine. These turbines reach somewhat lower efficiencies of around 80%. The turbine is divided into three parts that can be powered separately by water. This helps the system cope with fluctuations in the water runoff of small rivers.

9.3 Hydropower Plants

The energy that can be exploited from water essentially depends on two parameters: runoff volume and the head of the water. Almost all hydropower plants utilize natural elevation differences using technical equipment.

9.3.1 Run-of-River Power Plants

The natural course of a river itself concentrates large quantities of water. A run-of-river power plant can be built anywhere on a river where a sufficient difference in elevation exists (Figure 9.8). The weir then backs up the water. This creates a difference in elevation in the water's surface above and below the plant. At the top the water flows through a turbine that powers an electric generator. Grating at the turbine intake prevents rubbish and flotsam washed along by the river from blocking up the turbine. A transformer then converts the voltage of the generator into the desired mains voltage.

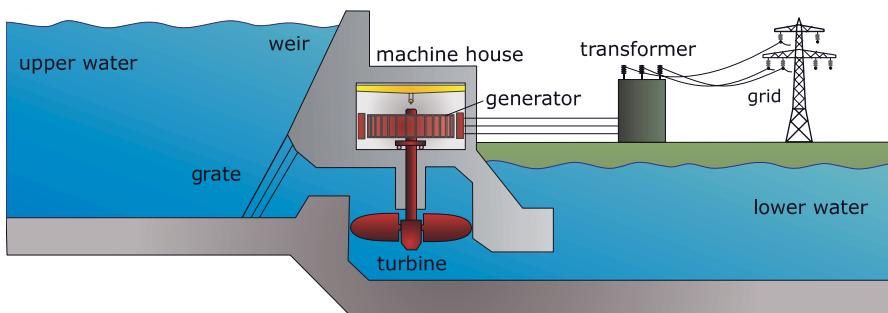

Figure 9.8 Principle of a run-of-river power plant.

Large hydropower plants are usually constructed so that multiple turbines can run in parallel. If the water flow drops during the dry periods of the year, some of the turbines can be shut down. The remaining turbines then still receive almost the full amount of water they need. This prevents the turbines from working in partial-load mode with poor efficiency. If, on the other hand, there is flooding and a river carries more water with it than the turbines can process, the surplus water has to be let out unused over a weir.

Barrages can present an obstacle for shipping and other forms of life on a river. Locks installed parallel to a barrage enable ships or boats to overcome the difference in water height. A certain amount of residual water flows through a fish bypass system next to the weir. This enables fish and other inhabitants of the water to move freely across the weir system.

Many plants, such as the run-of-river plant at Laufenberg on the Rhine (Figure 9.9), were built in the first half of the twentieth century. Existing plants that have been modernized have been able to improve performance. The best example in Germany is the Rheinfelden power plant, which was built in 1898 and is currently being modernized. The new facility, which is due to be completed in 2011, will increase power from 25.7 to 100 megawatts and more than triple electricity production. At the same time modern fish bypasses are improving the ecological situation.



Figure 9.9 Run-of-river power plant in Laufenburg, Germany. Photo: Energiedienst AG.

Europe has very strict environmental conditions for new energy plants and for those being modernized. Consequently, it is not anticipated that electricity generation from run-of-river power plants will increase substantially.

As the height difference in water levels with run-of-river plants is usually only a few metres, very few plants have an output of more than 100 megawatts of electric power. Run-of-river plants are also usually difficult to regulate. They supply electricity around the clock, but because the currents of a river cannot be controlled, surplus water remains unused if the power is not needed.

9.3.2 Storage Power Plants

Storage power plants produce high levels of power output. Dams store huge masses of water at geographically optimal locations. This type of dam makes it possible for

storage power plants to be built in the mountains (Figure 9.10). A high-pressure pipeline pumps the water into a machine house, where, due to the large head, enormous water pressure of up to 200 bars is created. In the machine house water powers the turbines that produce energy over an electric generator.



Figure 9.10 Storage power plants with reservoirs: Malta (left), Kaprun in Austria (right). Source: www.verbund.at.

It is not unusual to find dams over 100 m high. The highest dams on earth are over 300 m high. Reservoirs are often also used to store drinking water and to control flooding.

Storage power plants that are designed primarily to generate electricity have very high power output. Power plants that produce several hundred or even thousand megawatts are not unusual (Table 9.1).

Table 9.1 The largest hydroelectric power plants in the world.

Power plant	Country	River	Completed	Power output in MW	Dam length in m	Dam height in m
Three Gorges Dam	China	Yangtse	2009	18 200	2310	180
Itaipú	Brazil/ Paraguay	Paraná	1983	14 000	7760	196
Guri	Venezuela	Rio Caroni	1986	10 300	1300	162
Tucuruí	Brazil	Rio Tocantins	1984	7 960	6900	78
Grand Coulee	USA	Columbia River	1942	6 495	1592	168

Storage power plants can be constructed with a second basin located at a lower elevation at the machine house. Special pump turbines can then pump the water from the lower basin back up to the higher basin. This is called a pumped-storage power plant.

9.3.3 Pumped-Storage Power Plants

Pumped-storage power plants need very specific geographical conditions. To be built, they need two basins with a major difference in altitude between them. Some pumped-storage plants have a natural inflow where a river flows into the higher basin. Pumped-storage plants without a natural inflow are purely storage plants.

When electric power is needed, the water of the higher basin is pumped over an intake mechanism through a pressure pipe to the turbine, which drives an electric machine as the generator. Once the turbine has extracted the energy from the water, the water flows into the lower basin. A transformer there converts the voltage of the generator to mains voltage (Figure 9.11).

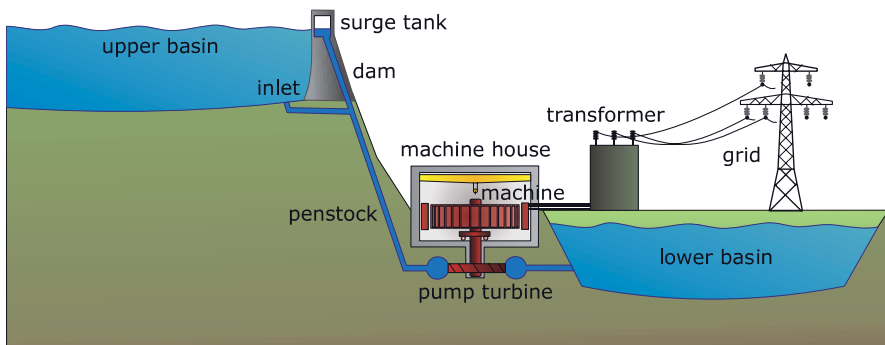

Figure 9.11 Principle of a pumped-storage power plant.

When electricity surpluses occur in the grid, the pumped-storage plant switches over to pumping operation. The electric machine then functions as a motor that drives the pump turbine. The pump turbine pumps the water from the lower to the higher basin once again. Major fluctuations in pressure can occur when the generator is switched to pumping operation, and, in an extreme case, these fluctuations can cause damage to the pressure pipe or other system parts. A surge tank regulates this change in pressure.

Pumped-storage power plants reach efficiencies of 70 to 90%. A good 70% of the electric energy that is necessary for pumping the water to the higher level can be replaced during the operation of the generator. Despite the losses, pumped-storage plants are very attractive economically. When a surplus of supply exists, electricity can usually be obtained very inexpensively. On the other hand, if electricity is in low supply, a plant can feed the energy back into the grid at a higher price.

Pumped-storage power plants have become much more common, particularly in recent years. Supply fluctuations frequently occur in the generation of wind power in particular. Large pumped-storage power plants can at least partially compensate for these fluctuations, thereby helping to improve integration of wind power into the grid.

The four generators of the Goldisthal power plant (Figure 9.12), which was commissioned in 2003, together have an output of 1060 megawatts. The accumulated dam volume of the upper basin is 12 million cubic metres. Based on this volume and with a medium head of 302 m, the power plant can work at full capacity for eight hours. This is sufficient to cover the power demands of over 2.7 million average households.



Figure 9.12 The Goldisthal pumped-storage power plant in Germany. Source: Vattenfall Europe.

9.3.4 Tidal Power Plants

Tidal waves are attributed to the interaction of the forces of attraction between moon, sun and earth. As a result of the rotation of the earth, the forces of attraction are continuously changing their direction. The water masses of the oceans follow the attraction. As a result, a tidal wave with a height difference of more than one metre can form on the open sea. Tidal waves caused by the moon occur approximately every 12 hours at some point on earth. In extreme cases, they can reach more than 10 m in height. Tidal power plants could use these changes in water level to generate energy.

In regions with a high tidal hub, a reservoir can be built so that water flows into it at high tide. The incoming water flows into the reservoir through a turbine in the dam wall, and at low tide it flows back again. The turbine and the connected

generator convert the energy of the water into electric energy. The energy output is not continuous, so that when the tide goes out output drops to zero.

Tides were used by tidal mills even during the Middle Ages. Worldwide there are only very few modern tidal power plants in operation today. The biggest and best-known one is the Rance power plant in France, which is situated on the estuary of the river of the same name and came into operation in 1967. It has a power output of 240 megawatts. The dam wall that seals off the 22 km² basin is 750 m long. The environmental impacts of the separation of the estuary from the ocean are considerable. Corrosion by salty sea water is also causing some problems.

Tidal power plants are comparatively expensive to operate, so it is not likely that many new plants will be built. Due to the relatively minor differences between ebb and flow, most countries do not have suitable locations for these plants.

9.3.5 Wave Power Plants

For decades high hopes have been pinned on the development of wave power plants. A study of the potential of wave energy indicates that large amounts of energy could be generated. However, only coastal regions with low water depths are appropriate for the use of wave energy. Due to the comparatively small useable sea areas available in many countries, this technology has relatively low potential.

Basically, a distinction is made between the following functions:

- Float ball systems
- Chamber systems
- Tapchan systems

Float ball systems use the energy potential of waves. A float ball follows the movement of waves. Part of the installation is anchored to the ground. The movement of the float ball can be used by a piston or a turbine.

With chamber systems, a chamber locks in air. The waves cause the water level to fluctuate in the chamber. The oscillating water level compresses the air. The displaced air escapes through an opening and powers a turbine and a generator. When the water column falls, the air flows back through the turbine into the chamber (Figure 9.13).

‘Tapchan’ is an abbreviation for ‘tapered channel’. In these systems, waves in coastal areas or on a floating object feed into a tapered and rising channel. An upper basin captures the waves. When the water flows back into the ocean, it powers a turbine.

Although numerous prototypes have been developed for wave power plants in recent decades, they have not yet caught on in a major way. The main problem is the extreme fluctuation in conditions at sea. On one hand, technical systems must be designed to save on materials and be cost-effective. On the other hand, storms with giant waves place extreme pressure on system survival. Many prototype installations have already fallen victim to storms. However, large companies have now become involved in the development of wave power plants, so it is likely that these problems will be solved in due course.

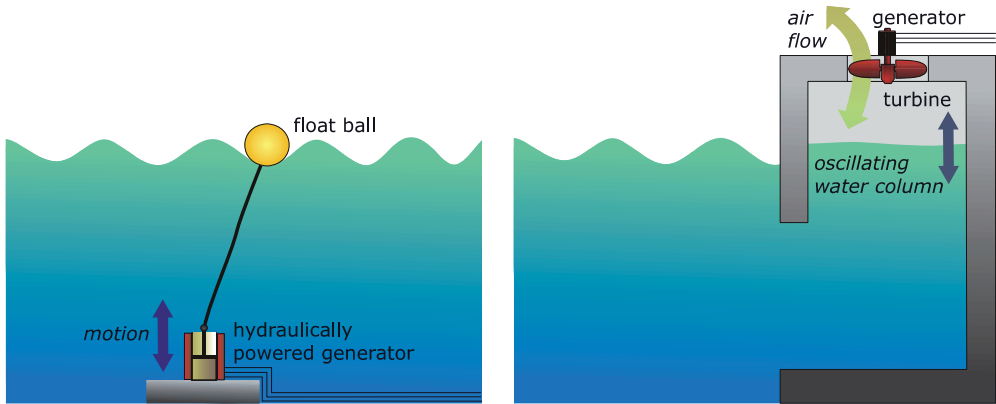

Figure 9.13 Principle of wave power plants. Left: Float ball system. Right: Chamber system.

9.3.6 Ocean Current Power Plants

Ocean current power plants have a structure similar to wind power plants, except that the rotors rotate below the water surface. A built-in hub mechanism raises the rotor to the water surface for maintenance. The first prototype was successfully installed in 2003 off the North Devon coast in England (Bard *et al.*, 2004) (Figure 9.14).



Figure 9.14 Left: Prototype system in Project Seaflow off the west coast of England. Photo: ISET. Right: Maintenance ship in a planned ocean current power plant park. Graphics: MCT.

In principle, the physical characteristics of wind power plants are similar to those of ocean current plants. The main difference is that, because water has a higher density than air, ocean current plants can achieve higher output yields than wind power plants even when the speed of currents is low.

Ocean current plants are limited to regions with relatively consistent high current speeds and moderate water depths of up to 25m. These conditions mainly exist on headlands and bays, between islands and in straits. Although shipping lanes often restrict this kind of use, major potential exists. As technological advances and the benefits of mass production are rapidly leading to cost reductions, in the medium term ocean current power plants could become another building block in the generation of a climate-compatible electricity supply.

9.4 Planning and Design

All types of hydropower plants require different and sometimes complex planning and design. It is only possible here to outline some of the basic planning aspects. The first requirement for a run-of-river power plant is the collection of information about the stretch of water where the plant is to be built. The most important parameter is the runoff of the river’s water over the course of a year – that is, the volume of water that flows through the river. Each river has its own typical annual flow characteristic that is influenced mainly by rain and melting snow. For further design purposes, the river runoff volumes are sorted to obtain an annual continuous curve. This indicates the number of days per year on which a river achieves or exceeds a certain runoff volume (Figure 9.15).

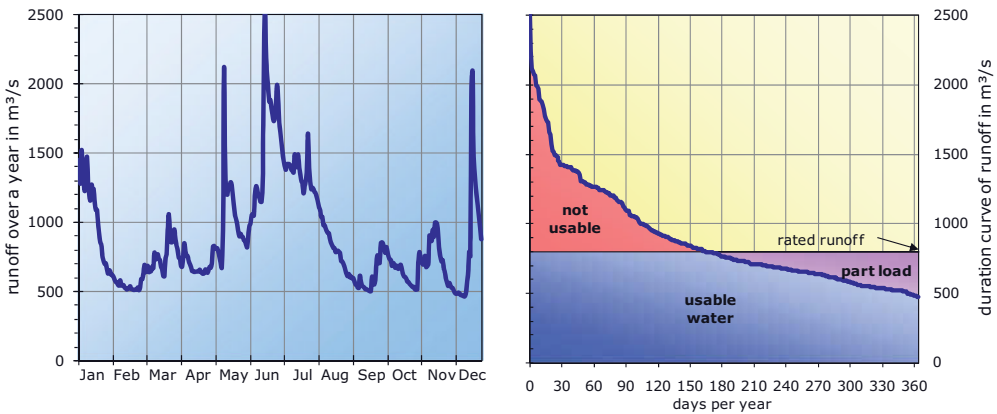

Figure 9.15 Annual flow characteristics and annual continuous curve for the Rhine runoff near Rheinfelden.

Then a rated runoff is established. This is the quantity of water a power plant needs to produce full output. If the runoff volume of the river rises above the rated runoff, the surplus water must be diverted unused over a weir. If a large quantity of electricity is to be generated, turbines with a high rated runoff should be selected. However, if the runoff volume of the river drops below the rated runoff, there will not be enough water to enable the power plant to provide its full output. The turbines will then either work at poor efficiency in partial load or individual turbines will be switched off and remain unused. A low rated runoff should be selected to ensure that optimal use is being made of the turbines. In practice, the rated runoff is determined based on a compromise between the maximum amount of power to be generated and optimal use of the turbine.



Power Output of a Run-of-River Power Plant

If the water runoff quantity Q and the head H of the water at a power plant are known, then the electric power output of a hydropower plant can be calculated relatively easily based on the efficiency η of the plant, the density of the water ρ_w ($\rho_w \approx 1000 \text{ kg/m}^3$) and the gravitational acceleration g ($g = 9.81 \text{ m/s}^2$):

$$P_{\text{el}} = \eta \cdot \rho_w \cdot g \cdot Q \cdot H$$

With an extension runoff quantity of $1355 \text{ m}^3/\text{s}$, a head of 10.1 m and efficiency of $79\% = 0.79$, the output for full load at the Laufenburg hydropower plant on the Rhine can be calculated as

$$P_{\text{el}} = 0.79 \cdot 1000 \frac{\text{kg}}{\text{m}^3} \cdot 9.81 \frac{\text{m}}{\text{s}^2} \cdot 1355 \frac{\text{m}^3}{\text{s}} \cdot 10.1 \text{ m} = 106 \text{ MW.}$$

At 5940 full-load hours per year, the power plant generates $106 \text{ MW} \cdot 5940 \text{ h} = 630\,000 \text{ MWh} = 630 \text{ million kWh}$. This is sufficient to cover the average electricity consumption of 180 000 households in Germany.

Approval granting water rights is required to build a hydropower plant. Normally approval is granted for 30 years, but it may be given for a longer time. The procedure for obtaining approval can take three to ten years. For large-scale power plants the approval also includes a test for environmental compatibility. The EU water rights guidelines stipulate that all water bodies in Europe must be kept in a ‘good state’. Although the water may be used, its ecological functioning must remain intact. In this context the current state of the water body concerned is also crucial. Therefore, it is much easier to gain approval to modernize a power plant on a stretch of water that has already been greatly altered than to build a new plant. Because of this, the chances of obtaining approval to build new large-scale hydropower plants are not very favourable.

9.5 Economics

Hydroelectric power plants are considered the most cost-effective option for supplying renewable electricity today. This applies mainly to older systems where the construction costs have largely already been amortized. The relatively high construction costs and long amortization periods for new sites substantially increase the cost of generating electricity.

For small plants fewer than five megawatts the investment in modernization amounts to between 2500 and 5000 euros per kilowatt; for the reactivation of a plant or a new plant it is between 5000 and 13 000 euros per kilowatt. The costs for larger plants are somewhat lower but depend greatly on local conditions. In addition to the investment and operating costs, large-scale hydropower plants have to pay a fee for water use in some countries.

With old medium-sized plants in the power range between 10 and 100 megawatts, the cost to generate electricity is less than 2 cents per kilowatt hour. For new plants this cost can increase up to 4 to 10 cents per kilowatt hour (Fichtner, 2003). The costs for small plants can even be higher.

9.6 Ecology

Hydropower plants are the most controversial of all the renewable power plants. Classic run-of-river, storage and tidal power plants in particular have a huge impact on the natural environment.

Due to the barrage system, bodies of stationary water form in places where water flowing over pebbles and boulders previously provided a suitable habitat for many different kinds of fish. As a result of the changes in their habitat, numerous fish and plants are becoming extinct. Another danger for fish is the hydroelectric turbines themselves. Although grating prevents large fish from entering the processing area of a plant, the metal bars of the grating let small forms of life slip through and become injured or killed by the turbines. The barrier systems are often an insurmountable obstacle for fish swimming in the water. Fish bypasses that run alongside the barriers help enormously in improving the freedom of movement for fish (Figure 9.16). Nevertheless, barrier systems are still an obstacle for certain types of fish.

Large reservoirs flood wide areas of land and destroy people's homes as well as natural habitat. Sinking biomass decomposes in water and releases large quantities of climate-damaging methane. This problem can be reduced considerably if reservoir basins are carefully cleared before they are flooded.

Breaches in walls are another danger with large dams. Normally dams are constructed so that they are largely earthquake-proof. But even the best construction is powerless against targeted terrorist attacks. Huge devastation will occur if the stored up masses of water pour into a valley all at once.



Figure 9.16 Left: Stream in the area of the Donaukraftwerk Freudenau power plant in Austria. Source: www.verbund.at. Fish bypass at Weserkraftwerk Bremen in Germany. © Weserkraftwerk Bremen GmbH.

The newly built Three Gorges dam in China is often cited as a negative example of the type of environmental damage hydropower plants can cause. Twenty cities and more than 10 000 villages, together housing more than one million people, were sacrificed for the building of this plant. It is still not clear what the ecological impact has been on the flooded area. It is expected that the many environmental sins of the past will come back to haunt those who live in the area, for example by contaminating the groundwater. The fear is that the 600 km-long reservoir is turning into a cesspit of sewage and industrial waste.

On the other hand, when it is finished, the Three Gorges dam will produce 84 billion kilowatt hours of electricity per year. This equates to more than one-sixth of total German demand. If modern coal-fired plants were used to generate the same amount of electricity, they would be emitting more than 70 million tons of carbon dioxide into the atmosphere each year. This corresponds to the total carbon dioxide emissions of Austria.

In this sense it is important to weigh the benefits and disadvantages of all hydropower plants. It is possible to build ecologically viable plants. The main thing is that ecological aspects are included in the equation along with protecting the environment and providing reasonably priced energy.

9.7 Hydropower Markets

About 17% of the electricity generated worldwide comes from hydropower plants. In 2004 Canada was still the leader in this field (Figure 9.17), but in the meantime it has been overtaken by China. The hydroelectric share of the power generated varies substantially from country to country. Whereas 100% of Norway's electricity comes from hydropower plants, this share is 84% in Brazil, 65% in Austria and

9 Hydropower Plants – Wet Energy

61% in Canada. The hydroelectric share for China and the USA is only 16% and 6%, respectively. At 4% Germany's share is relatively insignificant. In Europe, Norway, Iceland and Sweden have the highest percentage of hydroelectric energy, followed by the Alpine countries.

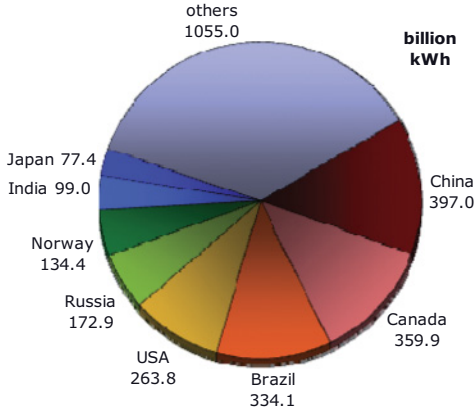

Figure 9.17 Generation of electricity from hydropower plants in different countries. Status 2005. Data: (US Department of Energy DOE, 2008).

The large-scale power plants have a massive output. The Itaipu facility in Brazil, with the highest output in the world (Figure 9.18), generates more electricity than all hydropower plants in Germany and Austria combined.



Figure 9.18 Aerial view of the Itaipu power plant. Photo: Itaipu Binacional, www.itaipu.gov.br.

9.8 Outlook and Development Potential

Among the different types of renewable energy generation, the use of hydroelectric power is the most developed. In the industrialized nations most of the potential has already been exploited. The potential for new large-scale plants now mainly exists in the developing and emerging countries. Classic run-of-river and storage hydropower plants could at best double the output of electricity generated worldwide. However, in the long term their share of energy production worldwide will decrease, because the demand for electricity will continue to rise.

Certain types of hydropower plants, such as wave and ocean current plants, which are not yet in use, show some promising potential for the future. However, substantial cost reductions are still needed before these types of power plants can make any major impact on the market.

The biggest advantage of hydroelectric energy is its relatively consistent output of power compared to solar energy and wind power. This aspect makes it easier to plan a mix of different renewable energies. With the share of renewable energies being used to generate electricity increasing, storage and pumped-storage power plants are also becoming important options due to their ability to offer consistency in electricity supply.

10

10 Geothermal Energy – Power from the Deep

When planet earth came into being four billion years ago, its form was considerably different from what it is now. At that time earth was in a partially melted state. It was not until about three billion years ago that the temperature of the earth's surface dropped to below 100°C and the earth's crust gradually began to harden.

It may not seem like it in the depths of a northern winter, but today our planet is anything but a cold ball. About 99% of the earth is hotter than 1000°C and 90% of the rest has temperatures of over 100°C. Fortunately for us, these high temperatures are almost exclusively found in the earth's interior. Every so often volcanoes produce impressive eruptions spewing molten matter from depths of up to 100 km (Figure 10.1). Different technologies of plutonic geothermal energy enable us to tap the heat of the earth's interior in a controlled way so that we can satisfy some of our heat and electricity demands.

10.1 Tapping into the Earth's Heat

Earth itself is made up of concentric (Figure 10.2) bands comprising the core, the mantle and the crust. The earth's core has a diameter of around 6900 km (4290 miles). A differentiation is made between the outer, liquid core and the inner core, which is made of solid matter. Maximum temperatures in the earth's core reach 6500°C, which is hotter than the surface of the sun.



Figure 10.1 Volcanic eruptions bring the energy from the earth's interior to the surface in a spectacular fashion. Photos: D.W. Peterson and R.T. Holcomb, US Geological Survey.

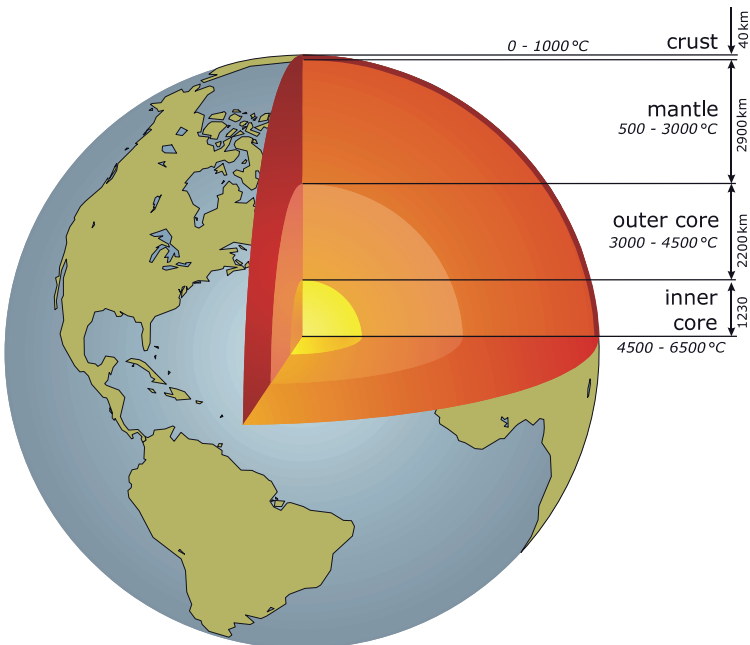

Figure 10.2 The structure of the earth.



Why the Earth's Inner Core is Not Liquid

The earth's inner core, which essentially consists of iron and nickel, has temperatures of up to 6500 °C. Under normal environmental conditions with an ambient pressure of one bar, these temperatures would make iron and nickel gaseous. The pressure rises as the depth into the earth's interior increases. This pressure reaches maximum values of four million bars. This extremely high pressure ensures that the outer core is liquid and the inner core is solid.

Eighty percent of the earth's core consists of iron. A small amount of the heat in the earth's interior comes from residual heat from the time earth was formed but a major part consists of radioactive decaying processes. The earth's mantle is around 2900 km thick. We are only able to reach the top part of the earth's crust.

The earth's crust and the uppermost part of the earth's mantle form the lithosphere. The thickness of the lithosphere varies from a few kilometres to more than 100 km. It consists of seven large and some smaller lithosphere plates (Figure 10.3). These rather brittle plates float in the asthenosphere, where matter is no longer solid. The plates are constantly in motion. Earthquakes and volcanoes frequently occur in areas where two plates collide. Thermal anomalies can also frequently be observed in these areas. High temperatures can occur there even at shallow depths, creating conditions that enable us to make particularly effective use of the earth's heat.

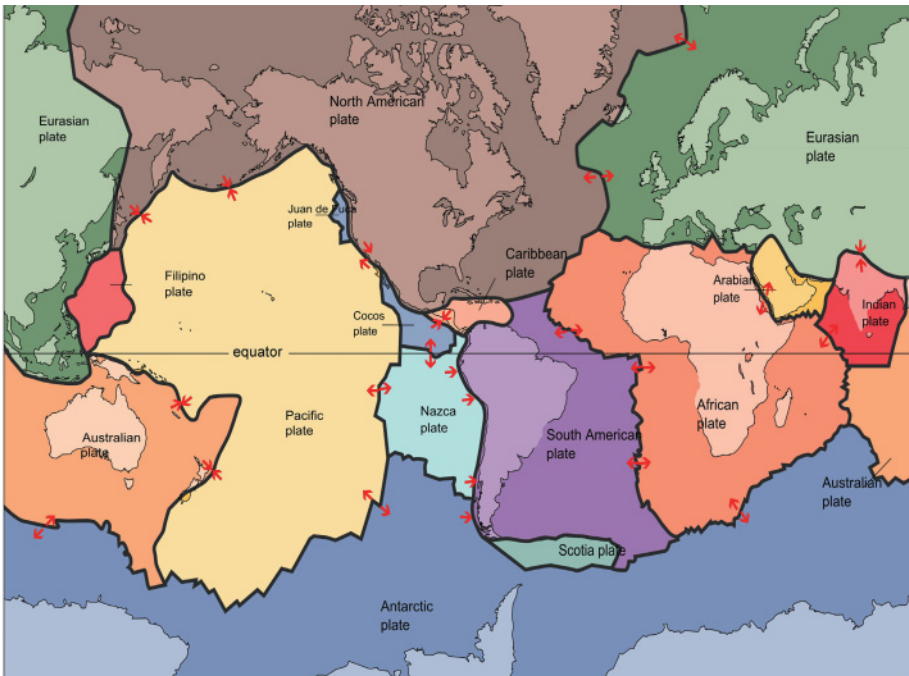

Figure 10.3 Tectonic plates on earth. Source: US Geological Survey.

Regions like Central Europe that are not near the borders of tectonic plates do not have optimal geothermal resources. This does not mean that high temperatures do not exist underground. However, compared to regions like Iceland where geothermal conditions are favourable, it takes drilling at greater depths to reach the same temperatures.

The best geothermal conditions in Germany are in the lowland plains of the Rhine (Figure 10.4). In this region temperatures of 150°C or more can be found at depths of 3000m. The average thermal depth gradient is around 3°C per 100m. On this basis, a temperature increase of 90°C could be expected at depths of 3000m. In Iceland temperatures like this occur at depths of just a few hundred metres.

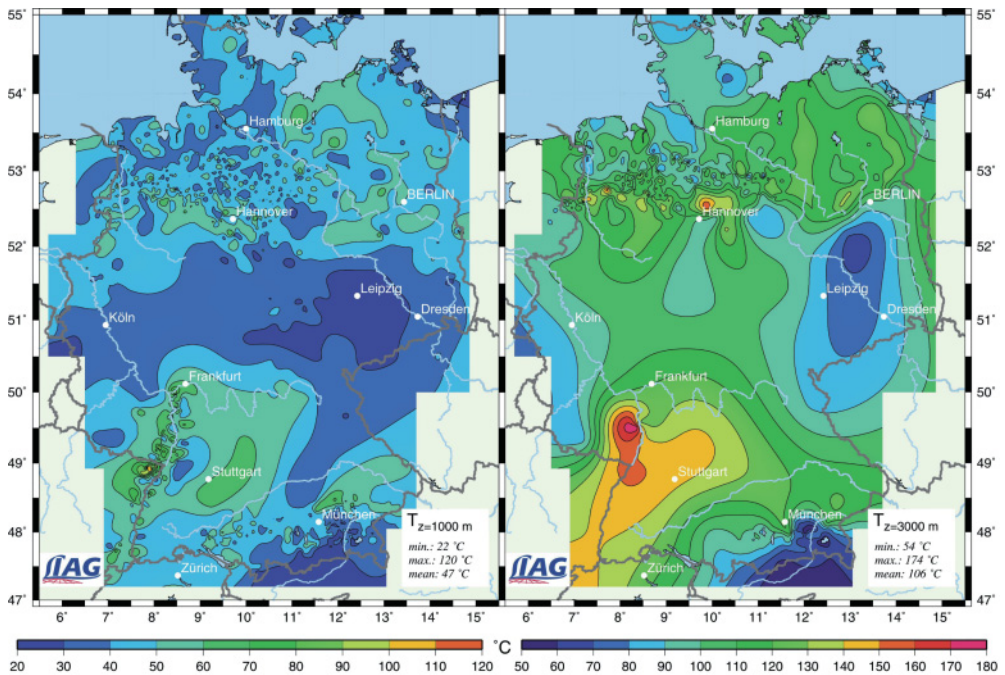

Figure 10.4 Temperatures in Germany at depths of 1000m and 3000m. Graphics: www.liag-hannover.de (Schellschmidt *et al.*, 2002).

Deep drilling is required to exploit the high temperatures. The technique for this type of drilling has long been familiar from oil extraction. Rotary drilling methods are employed, whereby motors drive a diamond bit into the depth. At very great depths, a drill bit cannot be driven in the conventional way over a drill string due to the increased strain caused by turning and friction. An electric motor or turbine therefore directly drives the drill bit.

The actual derrick (Figure 10.5) that holds the drill pipe is all that can be seen from the surface. Water is pressed into the borehole at pressures of up to 300 bars through the inside of the driller. This flushing of the mud forces crushed rock

material in the outer area between the bit and the borehole to the surface and at the same time cools the drill. The drilling drive can also be used to change the bore from its vertical position. This enables the boreholes that are sited close together on the surface to exploit a larger area underground.



Figure 10.5 Left: New and used drill bits. Right: Structure of a derrick. Photos: Geopower Basel AG.

Depending on the conditions underground, the walls of a borehole can become unstable. Steel tubes are inserted at large intervals and stabilized with a special cement to prevent the walls from collapsing. The drilling is then continued with a smaller drill bit. For many years the very high salt content of thermal water caused serious problems at many drilling sites. Salt attacks metal and very quickly causes corrosion. Today the use of specially coated materials has eliminated this problem.

The deepest drilling ever carried out was for research purposes on the Kola peninsula in Russia. This site had a depth of 12 km. In Germany the continental deep geothermal drilling in the Oberpfalz region reached a depth of 9.1 km. These drilling depths represent the technical limit today. The conditions at depths of 10 km are extreme, with temperatures of more than 300 °C and pressures of 3000 bars. Under these conditions rock becomes plastic and viscous.

Much shallower depths are required for geothermal use. The maximum drilling depth currently planned for large-scale sites is around 5 km. However, the techniques employed even at these depths are complicated and therefore expensive.

A distinction is made between the following in the exploitation of geothermal deposits:

- Hot steam deposits
- Thermal water deposits
- HDR (hot dry rock)

Hot steam and thermal water sources can be used directly for heating purposes or to generate electricity. If the underground consists only of hot rock, this can heat up cold water that is compressed into the depth.

10.2 Geothermal Heat and Power Plants

10.2.1 Geothermal Heat Plants

If boreholes already exist in a thermal water area, it is comparatively easy to develop a geothermal heat supply. In geothermal heat plants a feed pump fetches hot thermal water from a production well to the surface (Figure 10.6). As thermal water often has a high salt content, along with certain natural radioactive impurities, it cannot be used directly to provide heat. A heat exchanger extracts the heat from the thermal water and transfers it to a district heating grid. A reinjection well injects the cooled thermal water back into the earth.

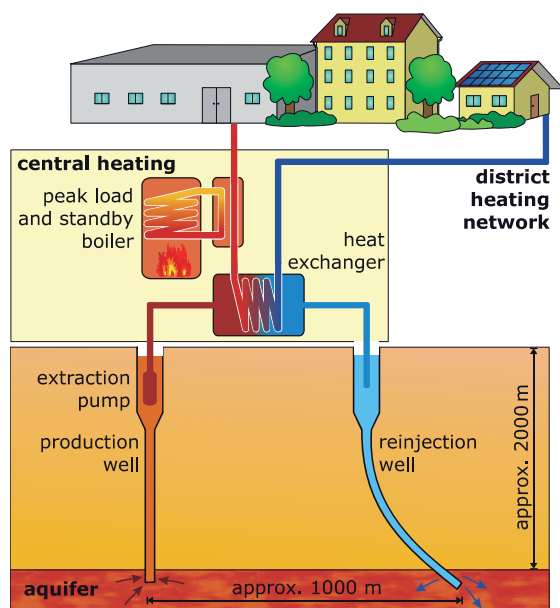

Figure 10.6 Principle of a geothermal heat plant.

Relatively low temperatures of 100°C or less are sufficient for heating purposes. Deep drilling depths are therefore not necessary.

A central heat system controls the amount of output depending on the heat requirement. If heat requirements are particularly high, a peak-load boiler can cover the heat peaks. A backup boiler is also helpful to guarantee reliable heat supply in case problems occur with the extraction pump or the well.

10.2.2 Geothermal Power Plants

Using geothermal energy to generate electricity is somewhat more complex than providing thermal heat. For one thing, the relatively low temperatures that power plant technology requires for thermal energy present new concepts such as:

- Direct steam use
- Flash power plants
- ORC (Organic Rankine Cycle) power plants
- Kalina power plants

Normal steam turbine systems can be used in geothermally optimal locations with temperatures between 200 °C and 300 °C. If hot steam deposits exist underground, they can be used directly to drive the turbines.

If hot thermal water is under pressure, it can be evaporated through an expansion stage. The steam from the water that is still hot can in turn be transferred directly to a steam turbine. This technique is called a flash process.

At temperatures of 100 °C or less geothermal water is not hot enough to vaporize water. A normal steam turbine using water as the work medium is not suitable in this case. An ORC (Organic Rankine Cycle) system is used instead (Figure 10.7).

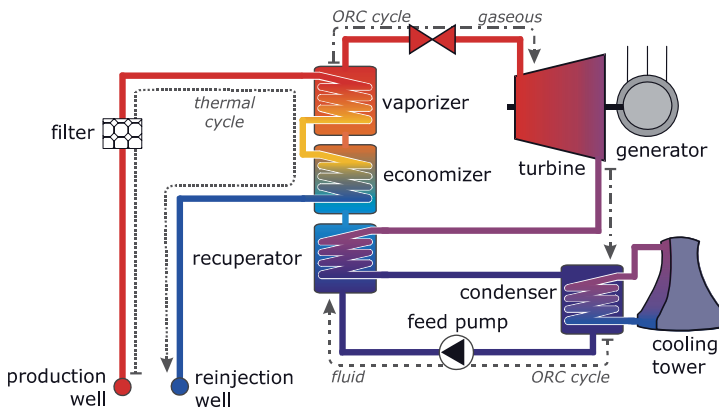

Figure 10.7 Principle of a geothermal ORC system.

A steam turbine also forms the core of this kind of system. However, instead of water, the steam turbine uses an organic material such as Isopentane or PF5050. A heat exchanger transfers the heat from the geothermal cycle to the organic working fluid. This material also evaporates under high pressure at temperatures lower than

100 °C. The steam from the organic material drives the turbine and expands in the process. The organic material is liquefied again in a condenser. A cooling tower dissipates the residual heat. A feed pump again puts the organic material under pressure and the heat exchanger completes the cycle.

The disadvantage of ORC systems is that they are relatively inefficient. At temperatures of 100 °C the efficiency is well below 10%. This means that at best 10% of the geothermal heat energy can be converted into electric energy. The Kalina process promises slightly higher efficiency. With this process a mixture of water and ammonia acts as the working material. However, not even the laws of physics can make this process a viable option. Generating electricity from geothermal energy is basically preferable and offers higher efficiency.

The first geothermal power plant in Germany is in Neustadt-Glewe between Hamburg and Berlin (Figure 10.8). This ORC plant, which was built in 2003, has 230 kilowatts of electric power. A geothermal heat plant, which was put into operation in 1994 with heat output of 10.4 megawatts, is located at the same site. The heat plant mainly generates electricity during the warm part of the year when there is a surplus of geothermal heat due to the low demand for thermal heat.



Figure 10.8 The Neustadt-Glewe geothermal heat power plant was the first plant to generate electricity from geothermal energy in Germany.

In late 2007 the second geothermal power plant in Germany was put into operation in Landau. It uses two boreholes to access 155 °C hot thermal water from a depth of 3000 metres. An ORC process designed for continuous all-year-round power generation uses this supply to generate around 2.5 megawatts of electricity.

The next power plant was built a short time later in Unterhaching near Munich. Hot thermal water with a temperature of 122 °C is extracted here from a depth of 3350m. This geothermal cogeneration plant with an electricity output of

around 3.6 megawatts is the first one to use the Kalina process. In addition, the plant feeds heat with a thermal capacity of 28 megawatts into a district heating grid.

Other countries such as the USA have been using geothermal power for more than 50 years and have much larger capacities. The Geysers, 116km north of San Francisco, is the largest dry steam field in the world. The construction on The Geysers began in 1960. Today 15 power plants there have a net electricity-generating capacity of about 725 megawatts, enough to power a city the size of San Francisco.



■ iga.igg.cnr.it
■ geothermal.marin.org

International Geothermal Association
Geothermal Education Office

10.2.3 Geothermal HDR Power Plants

At drill depths of up to 5000m temperatures are around 200°C, even in regions that do not benefit from optimal geothermal conditions, such as Germany, France and Switzerland. As a result, fully acceptable efficiency is achieved in power generation provided the depth is great enough.

Thermal water cannot usually be exploited at such great depths. What is mainly found is HDR (hot dry rocks). Artificial shafts are created in which water can be heated to extract the heat from the rocks. These shafts are made by compressing water at high pressure into a borehole. The heat expands the borehole, creates new fissures and expands existing cracks. This produces an underground fracture system that can extend to several cubic kilometres. A listening borehole monitors the activities.

This direct tapping of hot water deposits is also referred to as hydrothermal geothermal energy, whereas hot-dry-rock technology is also called petrothermal geothermal energy.

To generate geothermal energy, a pump transports cold water through an injection well into the depth. There the water disperses into the cracks and fissures of the crystalline rock and heats up to temperatures of 200°C. The hot water reaches the surface again through production wells and delivers the heat over a heat exchanger to a power plant process and district heating grid (Figure 10.9).

During the 1970s the Los Alamos laboratory in the USA conducted the first tests of the HDR method. A European research project on HDR technology has been underway in Soultz-sous-Fôrets in Alsace since 1987. Its goal is to implement a pilot power plant. In 2004 Geopower Basel AG was founded in Switzerland with the aim of building the first commercial HDR power plant, but work on the project was stopped in 2007 when small tremors occurred during the creation of the underground fractures.

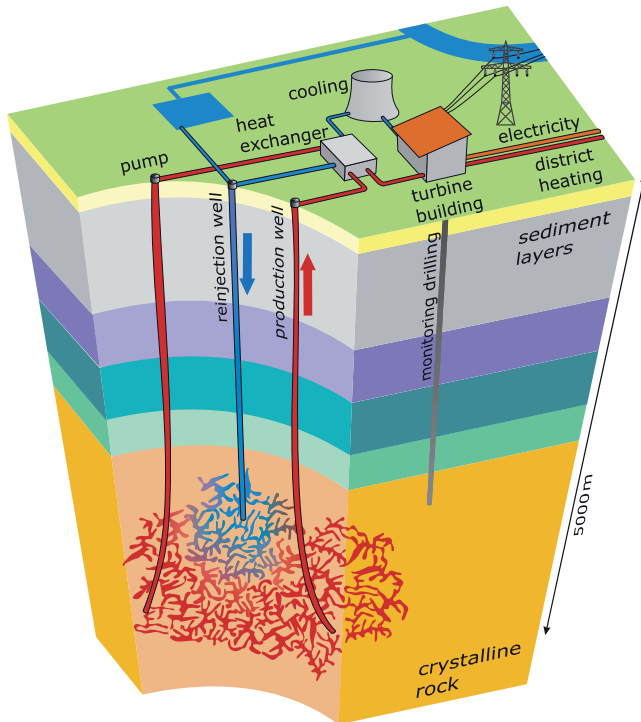

Figure 10.9 Diagram of an HDR power plant.

10.3 Planning and Design

The most important factor in planning geothermal power plants is the temperatures that can be achieved. The design of the heat exchangers, district heating grids and plant processes are all based on projected temperatures. Geologists try to determine in advance at which depths the desired temperatures can be found. To an extent they are able to rely on the knowledge gained from existing boreholes.

In addition to achievable temperatures, extractable water quantities also play a major role. Large volumes of water are needed to achieve high output. The diameter of the borehole as well as the pumps both have to be designed accordingly. Last but not least, it is important that the temperature of the thermal water is not allowed to drop too significantly during the extraction process. Large-scale power plants usually extract more heat from the depth than regularly flows back into an exploited area. Therefore, a slow cooling of the exploited area cannot really be prevented. The goal is to plan the intervals between the drilling so that the desired temperatures can be sustained for about 30 years. After this period the temperatures drop below the desired target values, and, as a result, the geothermal plant performance also decreases. A new site, which should not be more than a few kilometres from the existing site, must be developed if any further exploitation is planned.

10.4 Economics

Drilling is by far the biggest cost factor with deep geothermal energy. Yet it is not only the cost of the drilling itself that is the problem. The risks associated with it, especially on commercial projects, are something that should not be underestimated. Even the best geologists can never accurately predict what conditions will be like underground. Drilling costs shoot up immediately if drills unexpectedly hit crystalline hard rock instead of soft sedimentary rock. If, in addition, the temperatures underground are well below what was projected, a geothermal project can fail at an early stage.

Underground conditions can often spring other surprises. For example, during work on a geothermal project in Speyer in Germany, drillers not only found the thermal water they were hoping for but also discovered an oilfield 2000 m below the surface. So in addition to accessing hot thermal water of 160 °C, further drilling will also exploit this oilfield.

Even when drillings are successful, geothermal power plants have to spend up to half of all investment on the drilling activities themselves. Therefore, the cost of geothermal power is often considerably higher than that of electricity from wind and hydropower systems.

The renewable energy law in Germany also promotes geothermal power generation. In 2007 the feed-in-tariff for geothermal power plants with a power capacity of up to 5 megawatts was 15 cents per kilowatt hour. As this compensation was not high enough to motivate the building of large numbers of commercial plants, a planned revision to the renewable energy law is to raise this compensation to 20.5 cents per kilowatt hour. This compensation includes a bonus for simultaneous power-heat coupling and for petrothermal systems; that is, HDR (hot dry rock) power plants. With new plants this compensation will drop by 1% per year.

The costs in countries with good geothermal conditions are considerably lower than those in Germany. At drilling depths of a few hundred metres the drilling costs in those areas end up being very low. If, in addition, high temperatures exist close to the surface, some countries such as Iceland can even use geothermal heat to keep their pavements free of ice in winter (Figure 10.10).

10.5 Ecology

Geothermal cogeneration plants have little ecological impact. Most of the plant is located underground and is not visible, and therefore does not have a direct negative impact on people or landscape. Only the power plant complex is above ground. Like other heat plants, these also require cooling water for the plant processes. However, water is readily available at most geothermal sites.

What can cause problems are some of the working materials used in the generation of power. For instance, the material PF5050 used in ORC processes has a very high



Figure 10.10 The Nesjavellir geothermal power plant in Iceland. Photo: Gretar Ivarsson.

greenhouse potential. If 1 kg of this material reaches the atmosphere, it produces the same greenhouse effect there as 7.5 tons of carbon dioxide. However, alternatives, such as Isopentane, are available.

In the long term geothermal systems can cause a certain cooling of some localized areas under the ground. According to the knowledge available today, this has no effect on the surface.

Relatively little research has been done on the risk of seismic activities. Small tremors with an intensity of up to 3.4 on the Richter scale occurred in 2006 after geothermal drilling for an HDR power plant in Basel, Switzerland. During the drilling, water had been compressed at depths close to 5000 m. The tremors caused small cracks to buildings in the region, so work on the project was halted. The geothermal company involved has paid compensation for most of the damage.

As long as scientists are unable to predict accurately whether and when tremors can occur during the compression of water, HDR projects will pose a certain risk in densely inhabited regions. Hydrothermal geothermal projects that do not require fissures and cracks to be artificially created are comparatively safe in terms of any earthquake risk.

10.6 Geothermal Markets

China, the USA, Iceland and Turkey are the outright leaders when it comes to geothermal heat use. The USA and the Philippines have the highest power plant output for geothermal electricity generation (Figure 10.11). Providing more than 50% of the country's energy needs, geothermal energy in Iceland constitutes the

highest relative share of any country's total primary energy supply. However, as Iceland only has around 300 000 inhabitants and is not particularly densely populated, its absolute installed capacity is still lower than that in other countries.

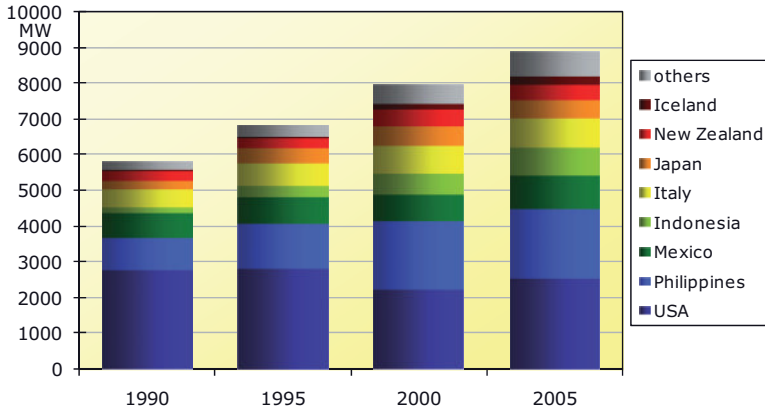

Figure 10.11 Installed geothermal power plant capacity worldwide. Data: IGS, iga.igg.cnr.it.

10.7 Outlook and Development Potential

Many countries are starting to develop the use of geothermal energy, but compared to other renewable energy technologies, such as wind power and photovoltaics, the annual growth rates for this energy source are quite modest.

The share of geothermal energy in the worldwide energy supply is therefore currently very low. But this technology has great potential. Another advantage of geothermal energy is its constant availability. Compared to the fluctuations in certain renewable energy sources – such as solar energy, wind power and hydropower – geothermal energy is not subject to any unpredictable daily or yearly changes in available supply. This makes geothermal energy an important building block in a carbon-free energy supply. As the share of renewable energies increases in overall energy demand, supply reliability will also become a big factor. This will help to raise interest in building new geothermal plants.

For economic reasons, countries with large geothermal resources will remain the leaders in the field. As prices for fossil fuels continue to rise, geothermal energy will also become more interesting to countries with moderate geothermal resources.

11 Heat Pumps – from Cold to Hot

Due to the steep rise in oil and petrol prices during recent years and rising public awareness of climate problems, alternatives such as wood pellet heating, solar thermal systems and heat pumps are becoming more prominent. Manufacturers of heat pump systems have seen a boom in sales since 2000.

Yet the whole principle behind the heat pump is far from modern. Lord Kelvin, a British physics professor, already proved the principle of the heat pump in 1852. He also recognized that a heat pump uses less primary energy to provide heat than a system that heats directly. A heat pump uses a heat source with low temperatures and increases it to a higher level of temperature (Figure 11.1). This process requires an electric, mechanical or thermal drive.

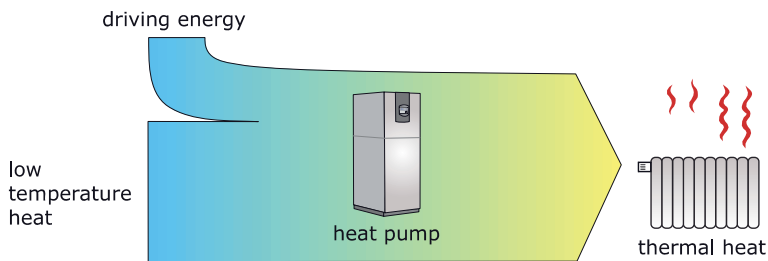

Figure 11.1 Energy flow with a heat pump process.

11.1 Heat Sources for Low-Temperature Heat

A heat pump is basically a machine in which a mechanically or electrically driven pump generates heat from a low-temperature source. This heat is then used to provide heating or to produce hot water. Before a heat pump can even function, a

low-temperature source must be available. The higher the temperature level of the heat source, the more efficiently the heat pump can work.

The following heat sources are available to houses (Figure 11.2):

- Groundwater (water/water)
- Ground, ground heat exchanger/collector (brine/water)
- Ground, earth probing device (brine/water)
- Ambient air (air/water).

The waste heat from industrial plants can also be used.

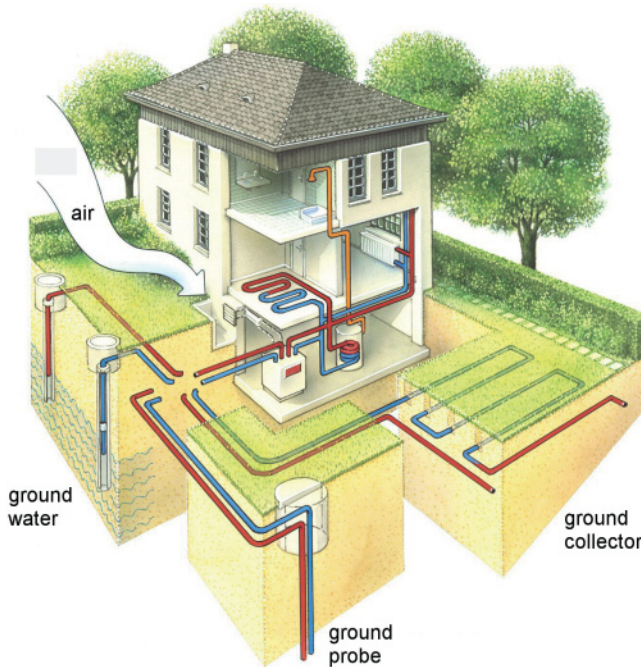

Figure 11.2 Heat sources for heat pumps. Illustration: Viessmann Werke.

Depending on the heat source, heat pumps fall into the categories of air/air, air/water, brine/water or water/water systems. The heat medium supplied is indicated in front of the oblique. In the case of ambient air, it is air. In the case of constantly frost-free groundwater, it is water. Because of the risk of frost, a mixture of water and antifreeze, called brine, flows through the pipes in the ground.

The transmitted heat medium is given after the oblique. In most cases, heat pumps heat up water for heating and domestic use. They are seldom used to heat the air for hot-air heating systems.

The higher the temperature of the heat source and the lower the temperature needed for heating, the less electric energy is required to drive the heat pump. Due to the low heating temperatures, underfloor heating is preferable to conventional radiators.



Coefficient of Performance (COP) and Annual Coefficient of Performance

The ratio of transient transmitted heat flow \dot{Q}_{heating} to transient, usually electric, drive power P is called the coefficient of performance ε :

$$\varepsilon = \frac{\dot{Q}_{\text{heating}}}{P} = \frac{\dot{Q}_{\text{heating}}}{\dot{Q}_{\text{heating}} - \dot{Q}_{\text{source}}}$$

The abbreviation for coefficient of performance is COP. The power output P and the refrigerating capacity \dot{Q}_{source} of the low-temperature heat source together produce the heat flow \dot{Q}_{heating} :

$$\dot{Q}_{\text{heating}} = P + \dot{Q}_{\text{source}}$$

If, for example, a heat pump with electrically driven power $P = 3 \text{ kW}$ produces heat flow of $\dot{Q}_{\text{heating}} = 9 \text{ kW}$, the coefficient of performance is $\varepsilon = 3$. The difference of $\dot{Q}_{\text{source}} = 6 \text{ kW}$ derives from the low-temperature heat source.

The coefficient of performance only applies to transient values. What is interesting is the annual average. This is called an annual coefficient of performance. ■

A high annual performance coefficient is essential for the ecological and economical operation of a heat pump. With an annual performance coefficient of 4, for example, a heat pump can cover a heating requirement of 10 000 kilowatt hours per year using 2500 kilowatt hours of electric energy. With an annual performance coefficient of 2, the requirement for electric energy rises to 5000 kilowatt hours.

Very good systems reach annual performance coefficients of about 4. In practice, the values are often below this. Table 11.1 shows typical annual performance coefficients for different types of heat pumps from a field test in Southern Germany.

Table 11.1 Typical annual performance coefficients for electric heat pumps (Lokale Agenda-Gruppe 21 Energie/Umwelt in Lahr, 2007).

Heat pump	Heat source	Annual performance coefficient with underfloor heating	Annual performance coefficient with radiators
Brine/water	Ground	3.6	3.2
Water/water	Groundwater	3.4	3.0
Air/water	Air	3.0	2.3

The heat pumps that draw their heat from the ground produced the best values. The annual performance coefficients for groundwater heat pumps were somewhat lower. The reason is that it takes more pumping effort to extract groundwater than it does to exploit heat from an enclosed brine loop in the ground. Furthermore, dirt traps

eventually accumulate in wells for groundwater, which further increases the amount of pumping energy needed. As ambient air temperatures in winter are lower than ground or groundwater temperatures, hot-air heat pumps work most efficiently at that time of the year.

11.2 Working Principle of Heat Pumps

All heat pumps need a refrigerant that is located in a closed loop. The refrigerant absorbs the low-temperature heat. The heat pump then heats up the refrigerant to a higher temperature, the heat of which is then used. Based on the working principles, a distinction is made between

- Compression heat pumps
- Absorption heat pumps
- Adsorption heat pumps

11.2.1 Compression Heat Pumps

Compression heat pumps are by far the most common type (Figure 11.3). The principle of these heat pumps is based on a refrigerant with a low boiling point that vaporizes when temperatures are very low and reaches high temperatures when it is compressed (Table 11.2). The heat supplied from the low-temperature source in the vaporizer is sufficient for vaporization.

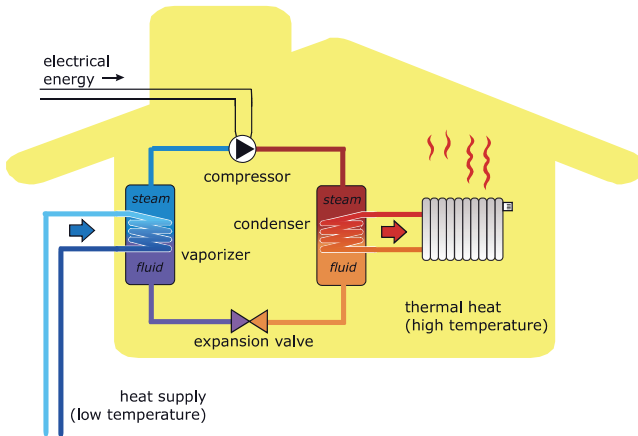

Figure 11.3 Principle of a compression heat pump.

A compressor (usually electrically driven) brings the vapour-forming refrigerant to a high operating pressure. During this process it heats up considerably. This process is similar to what happens with a bicycle pump when one uses one's thumb to stop

Table 11.2 Temperature ranges for popular refrigerants.

Abbrev.	Name	Boiling point at 1 bar	Condensation temperature at 26 bars
R12	Dichlordifluormethane	-30 °C	86 °C
R134a	1,1,1,2-Tetrafluorethane	-26 °C	80 °C
R290	Propane	-42 °C	70 °C
R404A	Mixture of different HFC	-47 °C	55 °C
R407C	Mixture of different HFC	-45 °C	58 °C
R410A	Mixture of different HFC	-51 °C	43 °C
R600a	Butane	-12 °C	114 °C
R717	Ammonia	-33 °C	60 °C
R744	Carbon dioxide	-57 °C	-11 °C
R1270	Propene	-48 °C	61 °C

the air escaping while energetically pumping a tyre. The heat of the heated refrigerant is then used as useable heat, usually for room heating or heating water. The heat is removed through a condenser that again liquefies the refrigerant. The refrigerant that is compressed expands over an expansion valve, cools off and is transferred to the vaporizer again.



The Turned-Around Refrigerator

Heat pumps are also used in refrigerators. They act like cooling machines. A vaporizer removes the heat from the interior of a refrigerator. The heat is emitted over cooling fins on the back of the appliance. The heat emitted there comprises the heat removed from the refrigerator and the electric driving energy of the refrigerator compressor. This explains why a room with an open refrigerator door cannot be cooled down in the summer. A refrigerator emits more heat from the back than it removes from the inside.

The first compression refrigerating machine was developed by the American Jacob Perkins in 1834. He used ether, which is no longer used today, as a refrigerant for his ice-making machine. The refrigerant ether has the disadvantage that in combination with atmospheric oxygen it forms a highly explosive mixture. This occasionally caused ether ice machines to explode.

11.2.2 Absorption Heat Pumps and Adsorption Heat Pumps

Like compression heat pumps, absorption heat pumps use low-temperature heat to vaporize a refrigerant. However, absorption heat pumps use a thermal compressor instead of the electrically driven compressor of compression heat pumps (Figure 11.4).

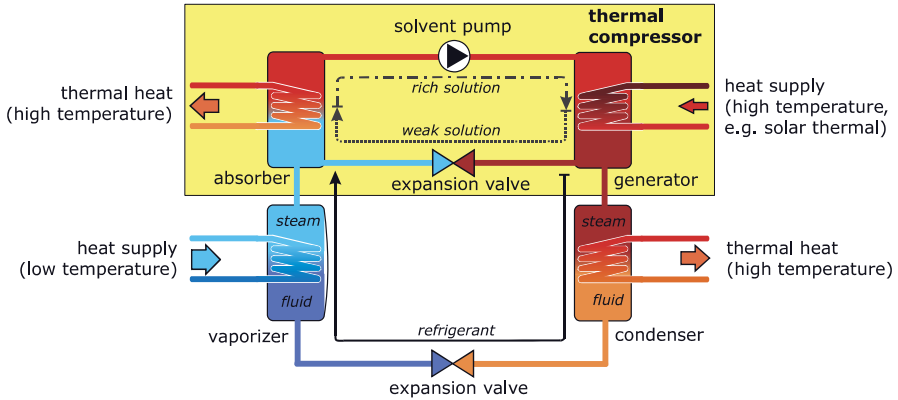

Figure 11.4 Principle of absorption heat pumps.

The function of a thermal compressor is to compress and heat the refrigerant. This happens through a chemical process of sorption, for example through the dissolving of ammonia in water. This was explained in the section ‘Cooling with the sun’ in Chapter 6. The heat released through sorption can be used as thermal heat.

A solvent pump transports the solution to the generator. The solvent pump, unlike the compression heat pump, does not build up high pressure, so a relatively low amount of electrically driven energy is needed. The generator now has to separate the water and refrigerant ammonia in the solution again to enable the sorption to take place once more. High temperature heat is needed for the expulsion. Solar heat and biogas can be used.

The high temperature heat supplied is well below the dissipated quantity of useful heat. The main advantage of absorption heat pumps is that they use a very small amount of valuable electric energy. They are particularly useful for large-scale applications. They are also used as refrigerating machines in refrigerators run with propane gas. The refrigerant ammonia is toxic and flammable. However, it is a widely used chemical and is considered easy to control.

Adsorption heat pumps, which only differ by two letters from absorption heat pumps, likewise use thermal energy as the driving energy.

What is meant by adsorption is that a gas like water vapour is added to a solid material, such as active coal, silica gel or zeolite. The process of adsorption, thus the bonding of the water vapour through the solid material, creates high temperatures that can be utilized by a heat pump. However, adsorption heat pumps are still at the research stage and therefore will not be covered in detail in this book.

11.3 Planning and Design

Today heat pumps are available for almost any heat capacity desired. Manufacturers usually provide advice on selection and design. The most important aspect in planning is the selection of a low temperature heat source and how to exploit it.

If a heat pump is to be installed in a water conservation area, no groundwater is allowed to be drawn. Approval for the use of a deep-ground probe to utilize the heat from the ground is only given in special cases as the brine could contaminate the groundwater if there is a leak. In Switzerland, for example, there are ground probes in water conservation areas where carbon dioxide (R744) replaces the brine.

Using ambient air as a heat source is the simplest and most cost-effective approach. This is not even a problem in water protection areas. No approvals are necessary to install and operate air/water or air/air heat pumps in these areas. All these heat pumps basically need are two openings in a house wall through which the ambient air can be fed to the heat pump (Figure 11.5). Condensation forms if the outside air is very cold and should drain off in a controlled way. Heat pumps can also easily be installed outdoors. Air/water heat pumps function at ambient temperatures as low as -20°C . A supplementary electric heater helps to ensure that necessary heating requirements are covered when temperatures are particularly extreme. A small buffer storage unit can optimize the operating times of a heat pump. The disadvantage of using ambient air is that the annual performance coefficients are relatively poor. Compared to other heat sources, it necessitates a higher use of electricity.



Figure 11.5 A heat-pump system. Source: BBT Thermotechnik GmbH.

Brine/water heat pumps, in other words heat pumps that extract heat from the ground, are the types that use the least amount of energy. Either ground collectors or ground probes are used to extract the heat. A ground collector usually comprises a set of plastic pipes that are laid in a snakelike pattern in the soil (see Figure 11.2). The optimal depth for the pipes is 1.2 to 1.5 m, and the gap between pipes should be about 80 cm.



Size of Geothermal Heat Collector

The length l and the area A of a ground collector is calculated from the required refrigerating capacity \dot{Q}_{source} of the low-temperature heat source and the extraction capacity \dot{q} per metre of pipe and the pipe gap d_A :

$$l = \frac{\dot{Q}_{\text{source}}}{\dot{q}} \quad \text{and} \quad A = l \cdot d_A.$$

If the heat capacity desired, for example, $\dot{Q}_{\text{heating}} = 10 \text{ kW}$, and the COP $\varepsilon = 4$, a refrigerating capacity of $\dot{Q}_{\text{source}} = 7.5 \text{ kW}$ is required. With dry sandy soil the extraction capacity is around $\dot{q} = 0.01 \text{ kW/m}$; with dry clay soil, 0.02 kW/m . As a result, on the basis of this example, the length of pipe needed for clay soil is calculated as

$$l = \frac{7.5 \text{ kW}}{0.02 \text{ kW/m}} = 375 \text{ m}$$

And with a pipe gap of $d_A = 0.8 \text{ m}$ the collector area is

$$A = 375 \text{ m} \cdot 0.8 \text{ m} = 300 \text{ m}^2.$$

If any doubt exists, it is recommended that the values be rounded off generously. As individual pipe lines should not exceed lengths of 100 m, the recommendation is that four circles of pipe, each 100 m in length, be used. ■

If sufficient space is not available in a garden or there is no desire to dig up a whole plot of land, ground probes can be used to reach the ground heat. Vertical boreholes can reach depths of 100 m. Constant temperatures of around $+10^\circ\text{C}$ or more exist at these depths all year round. U-shaped pipe probes are inserted into the boreholes through which the brine of the heat pump will later flow. The depth of the drilling and the number of probes depend on the heat requirement and the composition of the ground below. Geologists and specialized drilling firms can help with the specifications. Depending on the composition of the ground at the bottom, the potential extraction capacity is between 20 and 100 watts per metre. A rough estimate could be calculated at about 55 watts per metre. Therefore, about 5.5 kilowatts of refrigerating capacity could be extracted from a 100 m-deep probe. Several parallel probes with a gap of at least 5 to 6 m between them are necessary to achieve higher capacities (Figure 11.6).

In addition to the ground heat, heat from groundwater can be used. This requires a production well and a reinjection well. The reinjection well transfers the cooled groundwater back into the ground. It should be sited at least 10 to 15 m behind the production well, in the direction of the groundwater flow, so that the cooled water does not flow back to the supply drilling.

In many countries approval must be obtained from the responsible water authority before groundwater can be extracted. This approval is usually given under certain



Figure 11.6 Air/water source heat pump installed outdoors and not requiring drilling (left). Deep drilling for a water/water source heat pump (right). Photos: STIEBEL ELTRON.

conditions, except in water conservation areas. Permission is also often required to drill the ground probes for closed brine/water systems. Normally, the drilling company applies for the required approvals.



From the Idea of a Heat Pump to Owning One's Own System

- Determine possible heat sources:
 - Ground probe – Does deep drilling require approval?
 - Ground collector – Can a large section of the garden be dug up?
 - Groundwater – Is the house located in a water conservation area?
 - Air – Final solution if other sources are not available.
- Calculate heat requirement and heating capacity.
 - Can insulation help to reduce the heat requirement?
 - Can the required temperatures be reduced through underfloor heating or large radiators?
- Request quotations for heat pumps and, if necessary, for the drilling.
 - Tip: Only HFC-free heat pumps are optimal for protecting the climate.
- If necessary, have the drilling company obtain approval for drilling.
- Determine optimal energy tariff, and, if necessary, plan to have buffer storage unit.
 - Tip: Only green energy is optimal for protecting the climate.
- Arrange for system to be installed by a qualified company.

11.4 Economics

The heat pump sector has seen high growth rates in recent years, mainly for economic reasons. In 2009 the investment costs in Europe for a typical heat pump for a single-family home were between 8 000 and 12 000 euros. The costs of developing a heat source, which are in the order of 3000 to 6000 euros for ground collectors or ground probes, are additional to this.

The costs of conventional heating systems are not applicable to new buildings with heat pumps. For example, with gas heating, the costs can include a gas connection and a chimney in addition to the gas burner. Nevertheless, the investment costs for heat pump systems are usually considerably higher than for conventional gas or oil heating.

The advantage of heat pumps is the low running costs. Compared to conventional gas heating, there is no expenditure for gas meters, maintenance and chimney cleaning. The fuel prices, and hence also the expenditure on energy to operate a heat pump, are usually lower than in the case of oil and natural gas. The fuel price advantage with heat pumps depends partially on the annual coefficient of performance and energy tariffs. With electricity bought at a regular tariff and a moderate annual coefficient of performance of 3, the fuel costs for a heat pump could be even higher than those for natural gas and oil. With a good annual performance coefficient of 4, a heat pump offers advantages in fuel costs even based on the standard energy tariffs available since 2005 (Figure 11.7).

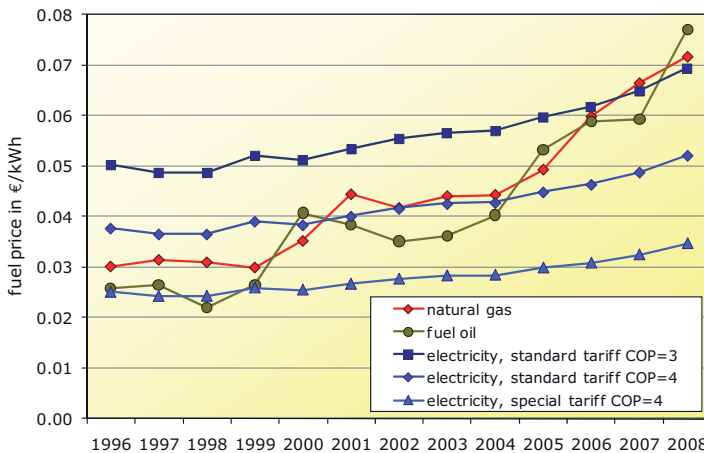

Figure 11.7 Development of domestic prices for natural gas, crude oil and electricity for the operation of heat pumps for different coefficients of performance (COP) in Germany.

A number of energy companies offer special tariffs for heat pumps. However, the operation of a heat pump often has to be interrupted during the times of the day when peak tariffs apply. A buffer storage unit is needed to bridge the heating

requirements during these periods. The heat pump should also have additional capacity to produce surpluses for these times. The special tariff is often one-third less than the standard tariff. If a special tariff can be applied to the heat pump, the fuel costs for the pump will normally be considerably lower than for natural gas or oil heating. Users who want to use climate-compatible green energy to run a heat pump will usually not benefit from any special tariffs.

Whether a heat pump pays for itself in the long term depends mainly on the development of gas, oil and energy prices. Biomass heating shows evidence of low fuel prices and is another alternative to oil and natural gas heating.



■ www.heatpumpcentre.org
 ■ www.ehpa.org

IEA Heat Pump Centre
 European Heat Pump Association

11.5 Ecology

Heat pumps are generally regarded as a positive use of the environment. But this is not always the case. The Achilles heel of heat pumps is the refrigerant. The range of refrigerants for compression heat pumps is broad. Chlorofluorocarbons (CFC) were often used during the first heat pump boom. Because of their negative impact on the ozone layer, their use has been banned in new systems.

Today hydrofluorocarbons (HFC), often called CFC equivalent substitutes, are mostly used. Although they are harmless to the ozone layer, they share another characteristic with CFC that is negative for the environment: both materials have extremely high greenhouse potential. As a result, even small quantities of between 1 and 3 kg of refrigerant in heat pumps for single-family homes are developing into an ecological problem.

If 2 kg of HFC R404A reaches the atmosphere, it develops the same effect on the climate there as 6.5 tons of carbon dioxide. This quantity of carbon dioxide is emitted during the burning of 32 500 kilowatt hours of natural gas. The same amount heats a standard new-build house for three years, and a three-litre house for no fewer than nine years. The energy needs of the heat pump itself are not even included in this balance sheet.

If a leakage occurs in a heat pump system, the refrigerants escape quickly because they evaporate under normal environmental conditions. On the positive side, HFC substances are neither toxic nor inflammable. However, in terms of climate-compatibility, the fast volatility of refrigerants turns out to be a problem. Not every heat pump will develop a problem whereby its entire content of refrigerant escapes into the atmosphere. However, refrigerant loss is unavoidable during the filling and disposal of a system and, due to continuous seepage, during regular operation. Nowadays standard heat pump suppliers seldom use refrigerants that can adversely affect the climate. At the same time heat pumps with R290 or propane as the

refrigerant are not showing performance data that is any worse than those with refrigerants containing HFC. Special safety measures must be taken due to the flammability of refrigerants R290, R600a and R1270, but for the most part these are easy to implement. In the past more pressure to use HFC-free refrigerants was obviously placed on the manufacturers of refrigerators and freezers than on those of heat pumps. As a result, in Europe refrigerants that are not harmful to the environment have become part of the standard range in this area for years, despite their flammability. In contrast, the HFC problem with heat pumps is hardly ever discussed. Most manufacturers publicize the HFC they use as being environmentally friendly. One manufacturer is even brazenly claiming on his homepage that the refrigerant R407C is HFC-free. The layperson will find it almost impossible to distinguish between appliances and devices that contain HFC and those that are HFC-free. Table 11.3 provides some further guidance in this area.

Table 11.3 Greenhouse potential of different refrigerants relative to carbon dioxide.

Abbrev.	Name	Material group	Greenhouse potential
R12	Dichlordifluormethane	CFC	6640
R134a	1,1,1,2-Tetrafluorethane	HFC	100
R404A	Mix of different HFC	HFC	3260
R407C	Mix of different HFC	HFC	1530
R410A	Mix of different HFC	HFC	1730
R290	Propane	HFC-free	3
R600a	Butane	HFC-free	3
R744	Carbon dioxide	HFC-free	1
R717	Ammonia	HFC-free	0
R1270	Propene	HFC-free	3

Suppliers of heating systems often list heat pumps in the ‘renewable energy’ category. But this is only correct up to a point. Although most of the useable energy of a heat pump is in the form of renewable low-temperature heat from the environment, the power almost always comes from an electrical socket. This power is delivered by regular energy suppliers that frequently offer special tariff conditions because of the high quantity of electricity purchased for heat pump systems. In many countries this electricity ends up coming from coal-fired or nuclear power plants. In Norway, however, hydropower plants generate almost all the electricity used in the country. This makes the heat pump there a completely renewable system. Some countries offer the option of changing to green energy suppliers. In this case, too, a heat pump system is completely renewable and therefore free of direct carbon dioxide emissions. However, it usually means that suppliers of heat pumps have to dig a bit more deeply into their pockets.

If conventional rather than green energy is used to operate a heat pump, the savings in carbon dioxide emissions are still relatively low due to the poor efficiency of fossil thermal power plants compared to modern natural gas heating (Figure 11.8). If the heat pump also uses a HFC refrigerant that impacts the environment, in an extreme case the environmental balance sheet can turn out to be even worse than with a modern heating system using natural gas.

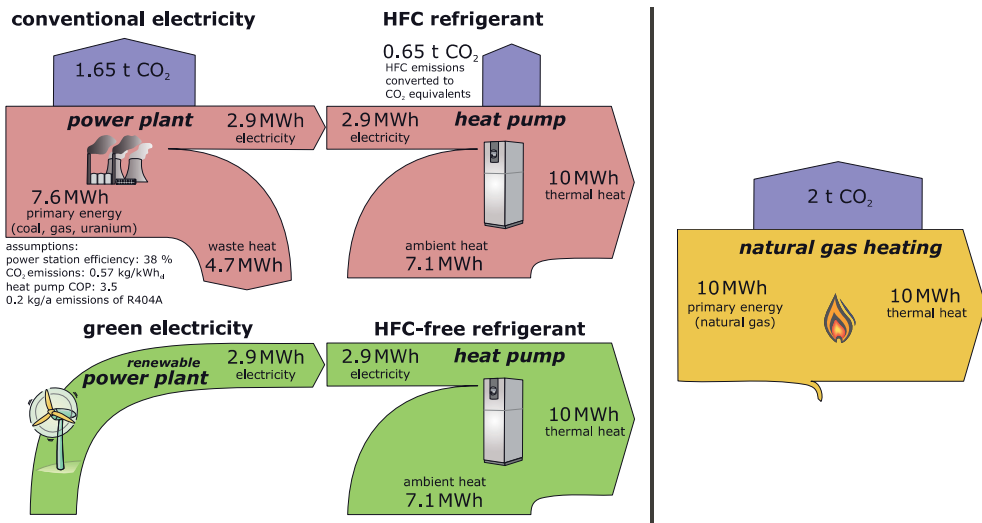

Figure 11.8 Environmental balance sheet on two heat pump heating options and natural gas heating.

11.6 Heat Pump Markets

After the first oil crisis in the 1970s, the heat pump sector experienced a real boom. However, due to technical problems, a drop in oil prices and a lack of environmental compatibility, the market for heat pumps collapsed almost completely by the late 1980s. The market did not revive until the mid-1990s and is currently experiencing high annual growth rates. Figure 11.9 shows the sales of heat pumps for Germany as an example of market development.

However, heat pumps are much more popular in certain other countries than in Germany, and around 450 000 were installed in the European Union in 2006. With 122 000 systems installed, Sweden has the biggest heat pump market by a large margin. In 2006, around 75% of all newly built single-family homes in Switzerland had heat pump heating. As the average carbon dioxide emissions resulting from the generation of electricity in Switzerland and Sweden are substantially lower than in Germany, heat pumps in those countries also have a much more favourable environmental balance sheet, in addition to cost advantages.

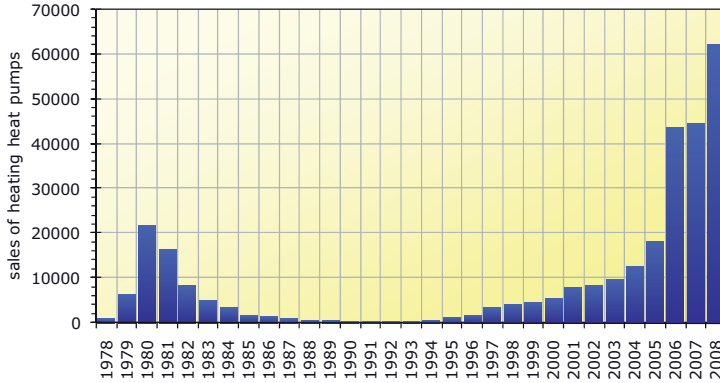

Figure 11.9 Sales of heat pumps for heating in Germany.

11.7 Outlook and Development Potential

The environmental balance sheet of heat pumps is improving continuously as a result of the steady increase in the share of renewable energies used to generate electricity. If in the medium term HFC-free alternatives start replacing refrigerants that contain HFC, which cause climate problems, from the ecological point of view the heat pump will develop into a very interesting alternative to conventional heating systems.

As renewable heating systems, such as solar thermal systems and biomass heating (see Chapter 12), can only cover a certain proportion of the heat requirement in many countries, the heat pump is an important component for carbon-free heat supply in the long term. Buffer storage can also be used to change the operating times of heat pumps. This would enable heat pumps to be partially centrally controlled, thus helping to reduce service peaks in the electricity network. With a high availability of wind power, for example, heat pumps would fill heat storage tanks and then draw the heat again at times when power supplies are low. These possibilities indicate that a further expansion of the heat pump market can be expected.

12 Biomass – Energy from Nature

Man has been using energy from firewood for the last 790 000 years – ever since Stone Age people discovered how to make fire (Figure 12.1). This makes biomass the oldest renewable energy source by a huge margin. In fact, biomass was the most important energy supply worldwide well into the eighteenth century. Even today some countries like Mozambique and Ethiopia use traditional biomass to cover over 90% of their primary energy needs.

As the use of fossil energy supplies grew, biomass use was almost non-existent in the industrialized nations. In 2000 the share of biomass in the primary energy supply in countries such as Britain, Germany and the USA was not even 3% .



Figure 12.1 People have been using the energy from firewood for thousands of years.

Biomass started to become popular again even in the industrialized countries when oil prices began rising dramatically at the beginning of the twenty-first century. In addition to its traditional use in the form of firewood, modern forms of biomass are now being exploited. Biomass is not only used to kindle simple open fires but also to operate modern heating systems and power plants for generating electricity as well as to produce combustible gases and fuels.

12.1 Origins and Use of Biomass

The term ‘biomass’ refers to a mass of organic material. It comprises all forms of life, dead organisms and organic metabolism products. Plants are able to create biomass in the form of carbohydrates through photosynthesis. The energy needed is supplied by the sun (Figure 12.2). Only plants carry out this process; animals can produce biomass only from other biomass. This is why all animals would starve to death without plants.

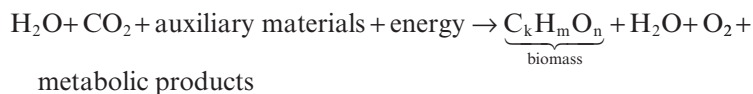

Figure 12.2 The sun is responsible for the growth of biomass on earth.



Origin of Biomass

Through photosynthesis plants convert carbon dioxide (CO_2), water (H_2O) and auxiliary substances like minerals into biomass ($\text{C}_k\text{H}_m\text{O}_n$) and oxygen (O_2):



In the simplest case, so-called oxygenic photosynthesis produces glucose ($\text{C}_6\text{H}_{12}\text{O}_6$):



Almost all the oxygen in the earth's atmosphere is formed through oxygenic photosynthesis. Therefore, the oxygen we need in order to breathe is a pure by-product of biomass production.

Biomass is distributed in many different forms throughout earth. In addition to solar energy, water is essential for the growth of biomass. Even the solar energy in the northernmost regions of the world is sufficient to create biomass. Regions with water shortages, however, have low biomass growth (Figure 12.3).

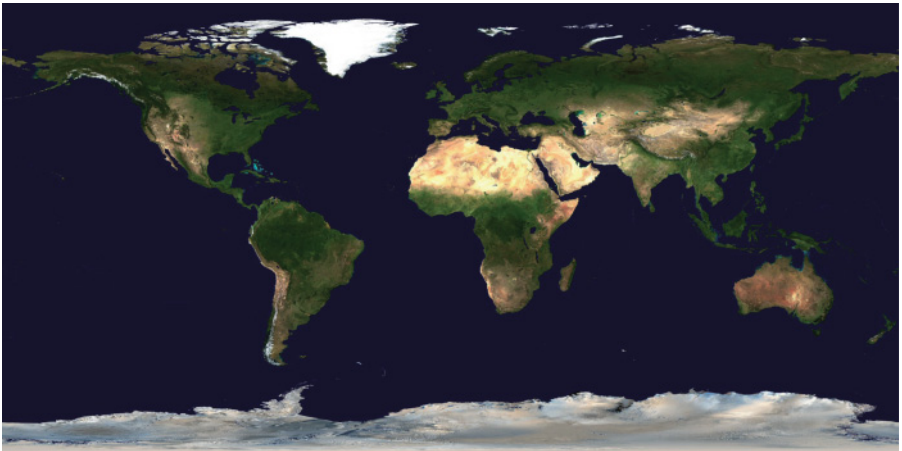

Figure 12.3 The view from space – vast areas of water cover the globe. Source: NASA.

Plants therefore convert sunlight into biomass using natural chemical processes. An efficiency can also be established for this process. As a result, land usage for biomass cultivation is comparable to other renewable energy technologies such as solar systems. A plant's efficiency is determined by dividing the calorific value of dried biomass by the solar energy that reached the plant during its growth phase.

On average, including deserts and oceans, the efficiency of biomass production on earth is 0.14% [Kleemann and Meliß, 1993]. Despite the comparatively low efficiency, biomass is created worldwide with an energy content that corresponds to about ten times our entire primary energy requirements.

Yet not all biomass can be used as energy. Human beings currently use around 4% of new biomass. Two percent goes into food and fodder production and one percent ends up as wood products, paper or fibre. Around 1% of newly created biomass is used as energy – usually in the form of firewood – and it therefore covers about one-tenth of the world's primary energy demand.

The plants that reach the highest efficiency during the conversion of sunlight into biomass are C4-plants. These plants have a rapid photosynthesis and, as a result, use solar energy particularly effectively. C4-plants include amaranth, millet, corn,

Table 12.1 Biomass potential in Germany (Kaltschmitt *et al.*, 2003).

	Useable quantity in millions of tons	Energy potential in PJ/a
Stalk-type (straw, grass)	10–11	140–150
Wood and wood residue	38–40	590–622
Biogas substrate (biomass waste and residue)	20–22	148–180
Purification and landfill gas	2	22–24
Energy plant mix	22	298
Total biomass potential	92–97	1198–1274

sugarcane and willow. Under optimal conditions these plants achieve efficiencies of 2 to 5%.

With biomass a distinction is made between the use of waste from agriculture and forestry and the selective cultivation of energy plants. In Germany studies have showed there is a total potential of around 1200 petajoules per year (Table 12.1). This equated to about 8% of Germany’s primary energy needs in 2005. The potential should be similar for other industrialized countries with a high population density. Even if extensive energy-saving measures are implemented, biomass can still only cover part of the energy demand.

There are many different possibilities for biomass use (Figure 12.4). The biggest potential exists with wood and wood products. Even waste from agriculture and forestry and biogeneous waste are important for the energy sector. In addition to waste use, special energy plants can be grown. However, as energy plants compete with food production for arable land, there is some controversy over large-scale cultivation of these plants.

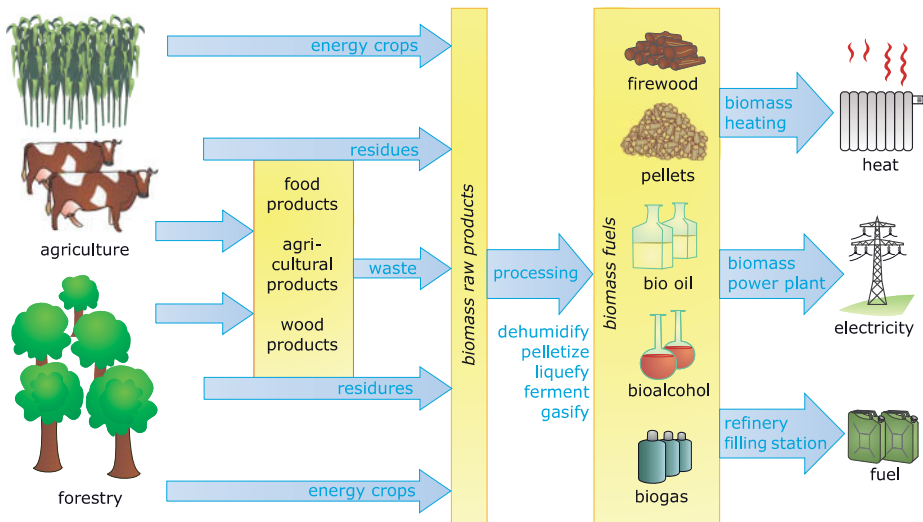

Figure 12.4 Possibilities for biomass use.

The next step is processing the biomass materials. These materials are dried, compressed, fermented into alcohol, converted into biogas, pelletized or processed into fuel in chemical plants. The aim of the processing is to produce useable biomass fuels.

This biomass fuel has the same spectrum of use as fossil fuels like coal, crude oil and natural gas. Biomass power plants can use biofuels to generate electricity; biomass heating can satisfy heating needs; and biofuels can be used to run cars and other vehicles.

The versatility of biomass use has led to a real interest in alternative fuels. In many industrialized countries like Germany and Britain, however, biomass falls far short of becoming a complete replacement for fossil fuels. Nevertheless, biomass fuels will play an important role in the renewable energy sector in the future.

12.2 Biomass Heating

With traditional biomass, the focus has been on the generation of heat for cooking and heating. Even today the use of biomass for heating is one of its key applications. Wood, straw and biogas are the commonly used fuels. Vegetable oils and bioalcohol are also used in some heating systems.

12.2.1 Wood as a Fuel

Wood is by far the main fuel used for biomass heating. It is available in different processed forms (Figure 12.5). As the first step, felled trees are cut to a common length to produce round wood. High-quality woods are not used as fuel but are processed further by the timber industry.

The round wood is then cut up, either by hand or by machine, to produce firewood. Wood scraps or inferior-quality wood may be processed into wood shavings, which can be made into wood briquettes or wood pellets. Special compression techniques are used to press the wood into the right shape for burning. The natural lignin of the wood serves as a binder, so no additional binders are required.

Because of their uniform shape and small size, wood pellets are an ideal fuel. They can easily be delivered in bulk tankers and then blown into special pellet stores. This eliminates the need for time-consuming manual loading. Automated feeding systems enable wood pellet heating systems to provide the same level of heat and ease of operation as natural gas or oil heating systems.

Some isolated quality problems existed in the early days of wood pellet production. Pellets that are the wrong size can get stuck in conveyor systems. If the pellets have not been compressed sufficiently, they can disintegrate too quickly and block up a system. Therefore, wood pellets should comply with European standards such as the Austrian Ö standard M 7135 or the German DIN plus standard. Wood pellets must conform to the following specifications:



Figure 12.5 Different processed forms of wood. From top left to bottom right: round wood, firewood, wood briquettes, wood pellets.

- Diameter: 5–6 mm; length: 8–30 mm
- Minimum calorific value: H_i : 18 MJ/kg or 5 kWh/kg
- Bulk stacked density: 650 kg/m³; raw density: larger 1.12 kg/l
- Water content: less than 10%; ash content: less than 0.5%
- Limit values for sulphur, nitrogen, chlorine and abrasion

The standards applied in the USA are generally less strict than those in Europe. The new standard CEN/TS 14961 applies to all future production of wood pellets. A pile of pellets weighing one ton takes up 1.54 cubic metres of space and has a calorific value of 5000 kilowatt hours. This equates to a calorific value of approximately 500 litres of heating oil. Therefore, two kilos of wood pellets can replace one litre of heating oil.



A Tree – the World Record Holder

An 80-year-old beech tree reaches a height of 25 m (82 ft). The crown of the tree has a diameter of 15 m (49 ft) and contains about 800 000 leaves. If the leaves were spread out lying next to one other on the ground, they would cover an area of about 1600 square metres (0.4 acres). This beech tree supplies the oxygen needs of

ten people and in the process absorbs large quantities of carbon dioxide. The 15 cubic metres of wood of this beech have a dry mass of 12 tons, of which around six tons are bound to pure carbon. This corresponds to the carbon content of 22 tons of carbon dioxide.

Yet even this massive beech is dwarfed by some tree species. The majestic sequoia reaches heights of up to 115 m (377 ft), diameters of 11 m (36 ft) with a circumference of over 30 m (98 ft) and volumes of 1500 cubic metres. Not only do trees reach an impressive size, but they can also live to a very great age. Some pine trees live for 5000 years. There is a special type of pine where the rootstock can even survive for more than 10000 years. New shoots that sprout from them ‘only’ live to about 2000 years. As a result, trees are presumed to be the oldest, highest and heaviest living things on earth.

If one were to compress wood shavings into a cube with sides each one metre long, the mass and calorific value of this cube would be considerably higher than a cubic metre of wood pellets. The reason is that a relatively large amount of air is trapped within a pile of pellets.

In technical jargon, the measure of capacity for one cubic metre of solid wood mass without any gaps is also called a solid cubic metre. When round wood or firewood is stacked very neatly, air gaps occur. The measure of capacity in this case is called stacked cubic metre. When firewood is thrown loosely on a pile, the air gaps increase. In terms of measure of capacity, this is referred to as bulk stacked cubic metre (BCM). The various measurements of capacity can be converted approximately into one another, with the exact factors depending on the type of wood and the shape the wood takes:

- 1 solid cubic metre = 1.4 stacked cubic metre = 2.5 bulk stacked cubic metres (BCM)

As we all know, wet wood burns poorly, because the calorific value of wood depends critically on water content. Damp wood is also heavier than dry wood. This means that not only the wood itself but also the water it contains has to be transported. The water evaporates when the wood burns. However, to evaporate, it needs energy—which in turn comes from the wood. The calorific value drops as a consequence.

Either the wood moisture or the water content is used to indicate the drying level. As both quantities have different parameters and their values therefore differ considerably, this can lead to some confusion. The water content describes the proportion of water in wet wood. On the other hand, the wood moisture indicates the mass of water contained in ratio to the mass of totally dry wood. If exactly half the weight of wood consists of water, the water content is 50% but the wood moisture level is 100%.

Completely dry wood with 0% water content is referred to as bone-dry wood. For example, bone-dry beech trees have a calorific value of five kilowatt hours per kilogram (kWh/kg). When wood is dried outdoors, its water content reduces to between 12 and 20%. The wood should be chopped as early as possible into small pieces, covered and then left to air dry for at least one year, but ideally two years. Wood

that has been allowed to dry in covered areas can even end up with water content of less than 10%. Even with 15% water content, the calorific value of beechwood is still 4.15 kWh/kg. With freshly cut wood with a water content of 50% the calorific value drops to 2.16 kWh/kg (Figure 12.6). Consequently, its calorific value is considerably less than half that of bone-dry wood.

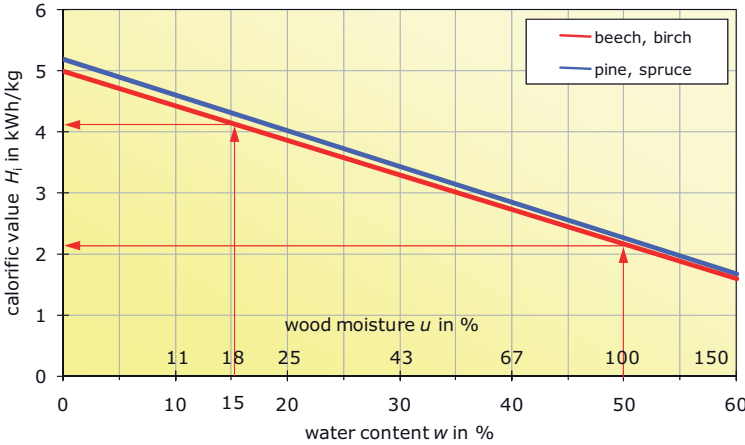

Figure 12.6 Calorific values of wood depending on wood moisture and water content.

This example shows that firewood should be well dried before it is burnt to extract the optimal energy content. The mass-related calorific value per kilogram differs minimally with different types of wood. On the other hand, the volume-related calorific value, thus the calorific value of a solid cubic metre or a stacked cubic metre, varies considerably (Table 12.2). Heavy wood like beech burns longer than light-weight spruce.

Table 12.2 Characteristics of different types of firewood.

	Calorific value dried	Density dried	Calorific value H_i with $w = 15\%$		
	H_{i0} in kWh/kg	In kg/solid cubic metre	In kWh/kg	In kWh/solid cubic metre	In kWh/stacked cubic metre
Beech	5.0	558	4.15	2720	1910
Birch	5.0	526	4.15	2570	1800
Pine	5.2	431	4.32	2190	1530
Spruce	5.2	379	4.32	1930	1350

In addition to providing poor calorific values, too much moisture in wood also has some other undesirable effects. High water content means that wood is being burnt under less than optimal conditions. As a result, it releases a high amount of harmful substances and produces unpleasant quantities of smoke and a pungent smell.

12.2.2 Fireplaces and Closed Woodburning Stoves

The classic biomass heating system is the fireplace. For centuries open fireplaces have been used to heat individual rooms. Yet this is a relatively inefficient use of firewood. Open fireplaces usually only reach 20 to 30% efficiency. This means that 70 to 80% of the firewood's energy escapes unused through a chimney. As romantic as old castles and palaces may seem, the use of open fires to achieve consistently pleasant room temperatures in draughty castle halls was an almost hopeless task.

With 70 to 85% efficiency, enclosed fireplaces and closed woodburning stoves are considerably more effective than open fireplaces (Figure 12.7). A glass panel in front of the stove can be opened to resupply it with wood and then closed after it has been lit. In principle, fireplaces can also be used to heat up domestic water.

Fireplaces and closed woodburning stoves are normally only used as supplementary heating systems because of the work involved in cleaning and lighting them, and replacing the firewood.

One of the main problems with fireplaces is that they need a relatively large amount of air. In addition to the air needed to enable a fire to burn well, large amounts of unused air escape through the chimney. A fresh air supply from outdoors to burn a fire is essential for well-insulated and airtight houses.



Figure 12.7 Enclosed fireplace and closed woodburning stove. Source: BBT Thermotechnik GmbH.

12.2.3 Firewood Boilers

The firewood boiler (Figure 12.8) is an option for those who want to heat with reasonably priced firewood and without the bother of a fireplace or stove. As these boilers are usually installed in a cellar, they do not have aesthetic merits of a fireplace. They have large containers for wood supplies that need to be stocked manually, and they can burn for several hours on a single load of wood.



Figure 12.8 Solid fuel boiler for heating with firewood. Source: BBT Thermotechnik GmbH.

Compared to the top burn-up of fireplaces where the flame rises upwards, many boilers work with the burn-up at the bottom or on the side. Air is fed into the boiler so that the flame is shown pointed either downwards or to the side. This increases burning time and cuts down on emissions. The controls, which mainly regulate air supply, ensure that a boiler is burning at an optimal level and adapt it to the heating requirement. Firewood boilers are available in different performance classes and reach maximum efficiencies of more than 90%. The efficiency of smaller boilers is usually somewhat less.

As firewood boilers cannot be regulated downward to any specific temperature desired, the installation of buffer storage is recommended. This will enable a boiler to work under optimal operating conditions at all times. The storage absorbs the excess heat and then continues to supply the heating needed after the firewood has burnt down. The combination of a firewood boiler with a solar thermal system is a good idea because the boiler can be switched off completely in summer when there is very little need for heating.

12.2.4 Wood Pellet Heating

Wood pellet heating systems offer by far the greatest ease of operation. The fuel is kept in a special pellet store, and an automated feed mechanism using either a feeding screw or a suction device transports the pellets directly to the burner. A screw conveys the pellets from the bottom part of the store. With a suction device similar

to a big vacuum cleaner the pellets are also sucked up from below. The suction hoses are very flexible and even enable the bridging of large distances between the store and the burner. As the suctioning of the pellets can be noisy, modern pellet boilers have a small hopper from which the pellets are conveyed to the burner through gravity or a small feeding screw. The hopper is then filled from the store via an automatic timer switch so that the pellet feeding system does not disturb anyone at night.

Optimally, the store would be in the cellar. It should be big enough to cover fuel requirements for one year. If a cellar is not available, the pellets can also be stored in special silos in a large utility room or in an adjoining shed. Waterproof tanks in the ground are also suitable for stocking pellets. Normally, the store will have two openings (Figure 12.9). The pellets are blown in directly through one opening from the tanker truck that delivers them. The displaced air from the blowing process escapes through the other opening. As the blowing-in of the pellets creates a great deal of dust, a filter traps the wood dust before the air is let out again.

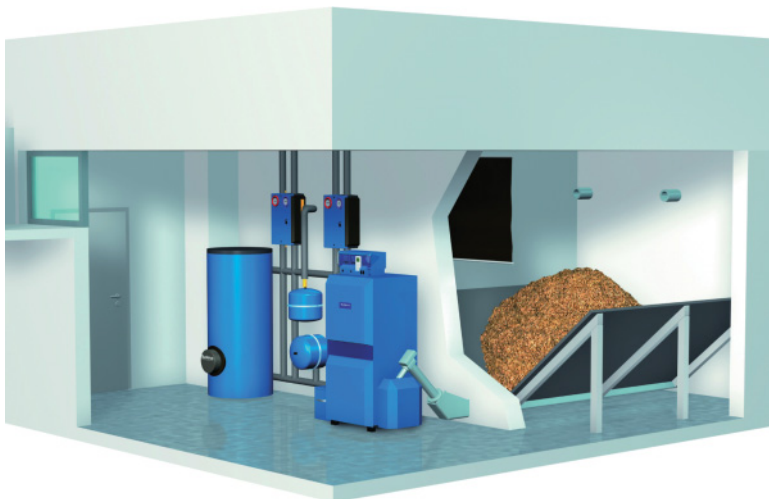

Figure 12.9 Wood pellet heating with pellet store. Source: BBT Thermotechnik GmbH.

The controls of pellet boilers always ensure that an adequate supply of pellets is available, thereby guaranteeing that the operation of the system is fully automated. The flame is also lit automatically by an electric hot-air blower. When the required heating level has been reached, the heating system switches off again independently. Another feeding screw transports the accumulated ashes to a special ash pan. Wood pellet heating therefore does not require any manual intervention for its daily operation. As with firewood boilers, buffer storage should be installed to reduce the frequency with which a fire has to be lit.

Wood pellet heating requires a very small investment of the user's time. The soot and ash residue has to be cleaned out of the pellet boiler room every second month or so. In addition, the ash pan should ideally be emptied once or twice a year. The ash can be used as fertilizer in the garden.

In addition to boilers designed for cellars, attractive pellet boilers are available for use in living areas (Figure 12.10). These boilers can be installed in sitting rooms and show a nice flame. Again, a suction device conveys the pellets from the store that would still be located in the cellar.



Figure 12.10 Pellet boiler for living area use with pellet store in a cellar (left). Source: Windhager Zentralheizung.

12.3 Biomass Heat and Power Plants

In addition to being burnt in stoves and boilers for heating systems in single homes and apartment blocks, biomass can also be used in large heat plants. A central heat plant consists of a high-performance boiler and a fuel store. The fuel store is usually big enough to ensure that independent operation can be guaranteed for several days or even weeks. A district heating grid then transports the heat to the consumers connected to the grid (Figure 12.11).

With centralized heat plants, individual consumers no longer have to worry about fuel procurement and system maintenance. These tasks are handled by the operator of the heat plant. The efficiency of large heat plants is often somewhat higher than that of small non-central systems. On the other hand, heat losses are higher because of the long pipes in the district heating grid. However, large heat plants fare considerably better when it comes to the emission of harmful substances. Compared to heating systems in single-family homes, large plants use more modern filtering

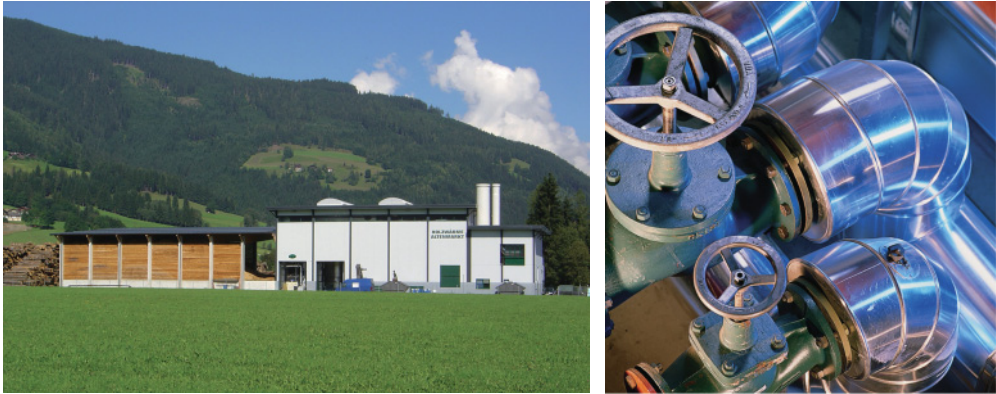

Figure 12.11 The Altenmarkt biomass heating plant in Austria and district heat distributors.

Source: Salzburg AG.

techniques and have stricter conditions on emissions. This ensures that combustion gases emit fewer harmful substances.

Electricity generation is another important application of biomass. Centralized systems that are used exclusively to generate electricity are called power plants. Biomass power plants function in a similar way to coal-fired power plants. The fuels used include wood residue, wood shavings and straw. A steam boiler burns the biomass and produces steam that drives a steam turbine and an electric generator. The principle of steam power plants is explained in the section on parabolic trough power plants in Chapter 7.

Compared to photovoltaic systems and wind turbines, electricity generated by biomass plants is not dependant on prevailing weather conditions. Biomass fuels are optimal for storage and can be used as and when needed. This makes biomass power plants a viable supplement to other renewable energy plants. They can guarantee electricity supply in situations when there is little wind or sun available at the same time.

In contrast to coal-fired plants that can output more than 1000 megawatts of power, biomass plants have a considerably lower output in the order of 10 to 20 megawatts. The use of biomass fuels is one of the main reasons for this. Biomass fuels usually come from the region where the particular power plant is located. If the output of the plant is too high, some of the biomass then has to be supplied from sources much further away.

Numerous new biomass power plants have recently been built all over the world. One example is the Königs Wusterhausen plant near Berlin, Germany (Figure 12.12). This power plant has an output of 20 megawatts and with 160 million kilowatt hours per year can cover the energy demands of around 50 000 households. For fuel it uses 120 000 tons of waste and wood residues from the Berlin region annually. The efficiency of this biomass plant is around 35%.



Figure 12.12 The Königs Wusterhausen biomass power plant in Germany (left) and a wheel loader for biomass fuel transport (right). Source: MVV-press photo.

Apart from its use in pure power plants, biomass is also appropriate for heat power plants. In addition to electricity, these plants produce heat which district heating grids distribute to consumers. Heat power plants generate both power and heat, which is known as power-heat coupling. Heat power plants normally use biomass fuel more effectively than pure power plants that only generate electricity. The important thing is that a buyer can always be found for the heat that is generated. Heat is not often needed during the summer months. During this time of the year a heat power plant may operate less efficiently than a power plant that is purely optimized to generate electricity.

Heat power plants are also built in lower output classes so that they can be suitable for industrial buildings, houses and apartment blocks. As these plants are usually offered in a modular configuration for a building-block style, they are referred to as cogeneration units. However, the efficiency of smaller systems is frequently lower than that of large centralized systems. In addition to solid fuels like wood shavings and pellets, cogeneration units use biofuels and biogas.

12.4 Biofuels

Fluid and gaseous biofuels are more versatile than wood. In addition to generating heat and electricity, biofuels can be used directly as fuel in the transport sector, replacing petrol and diesel. Production methods are available that can convert different biomass raw products into biofuels. Unlike with food production, the prefix ‘bio’ in this case does not stand for controlled organic cultivation with minimum effect on the environment. On the contrary, the raw materials for biofuels are usually produced using conventional farming methods.

12.4.1 Bio-oil

The biofuel that is the easiest to produce is bio-oil. Over 1000 plants with a high amount of vegetable oil are usable in the production of bio-oil. The most popular ones are rapeseed oil, soya oil and palm oil (Figure 12.13). Oil mills produce the vegetable oil directly through either pressing or extraction processes. The residue from the pressing can be reused as animal feed.



Figure 12.13 Oil-rich plants such as rapeseed and sunflowers are raw material for vegetable oil.
Photo left: Günter Kortmann, North Rhine-Westphalia Chamber of Agriculture.

Very few older precombustion chamber diesel engines can be run on vegetable oil without a problem unless they have been converted. Even engines like the Elsbett engine, which were specifically developed to run on vegetable oil, have not yet achieved any significant market share. Vegetable oil is somewhat tougher than diesel fuel and needs higher temperatures to fire. However, even normal diesel engines can be adapted and converted to run on vegetable oil.

12.4.2 Biodiesel

Biodiesel comes closer to having the characteristics of conventional diesel fuel than pure vegetable oil. Vegetable oil and animal fat are the raw materials used to produce it. The Belgian G. Chavanne applied for a patent for a method to produce biodiesel as early as 1937. Chemically, biodiesel is fatty acid methyl ester (FAME).

In Central Europe rape is normally used to produce biodiesel. Oil mills extract the raw material rapeseed oil from rapeseed seedlings. The by-product rapeseed animal meal usually ends up in the animal feed industry. Rapeseed oil methyl ester (RME) is then created from the rapeseed oil in a transesterification facility.



Production of Rapeseed Methyl Ester (RME)

For the production of RME, rapeseed and methanol together with a catalyst such as a caustic soda solution are placed in a reaction vessel at temperatures of about 50 °C to 60 °C. This produces the desired rapeseed oil methyl ester as well as glycerine:

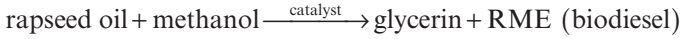

Biodiesel can be used as a substitute for fossil diesel fuels based on crude oil. It is offered by many petrol stations in Germany. The engine manufacturer's specifications should stipulate whether a vehicle can run on pure biodiesel. If an engine is not designed for use with this fuel, there is a danger that the biodiesel will eventually destroy the hoses and seals and cause engine damage. Small quantities of biodiesel can be mixed with conventional diesel without a problem, even without a release from the manufacturer. The European biofuel directive of May 2003 stipulates that countries across the EU must institute national measures to replace 5.7% of all transport fossil fuels (petrol and diesel) with biofuels by 2010.

However, the positive environmental impact of biodiesel is not undisputed.



- www.ebb-eu.org
- www.ieabioenergy.com

European Biodiesel Board
IEA Bioenergy

12.4.3 Bioethanol

Sugar, or glucose, starch and cellulose are used to produce bioethanol. The raw materials include sugar beet, sugar cane and grains (Figure 12.14). Sugar can be fermented directly into alcohol. On the other hand, starch and cellulose must first be broken down.



Production of Ethanol from Glucose

Glucose can be converted directly into ethanol in a hermetically sealed environment through fermentation with yeast:

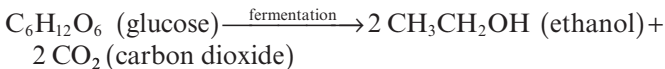

Carbon dioxide is a by-product of this reaction. As plants absorb carbon dioxide again during their growth, this reaction is actually not emitting any greenhouse gases. The result of the fermentation is mash with an ethanol content of around 12%.



Figure 12.14 Corn and other types of grains are raw materials for bioethanol production. Photos: Günter Kortmann, North Rhine-Westphalia Chamber of Agriculture.

Raw alcohol with a concentration of over 90% is extracted through a distilling process. Dehydration over molecular sieves then finally produces ethanol with a high degree of purity. The waste from the ethanol production can be processed into animal feed. The amount of energy required to extract the alcohol is relatively high. If this energy comes from fossil fuels, then the effects of bioethanol on the climate are not favourable. In extreme cases, the impact can even be negative.

Bioethanol can easily be mixed with petrol. An E number indicates the ratio of the mixture. E85 means that the fuel content is 85% bioethanol and 15% petrol. In some countries small quantities of bioethanol are added to petrol. This is not a problem if the ethanol portion is 5% or less. Normal petrol engines can even be run with an ethanol portion of 10% without requiring any modification. Engines must be modified for the use of ethanol for anything above that level.

In Brazil flexible-fuel vehicles are very popular. These automobiles can be filled with different mixtures including an ethanol portion of between 0 and 85%. Production facilities that use rye, corn and sugar beet as raw materials in bioethanol production have also been established in other countries.

12.4.4 BtL Fuels

In the case of pure vegetable oil, biodiesel and bioethanol, only the parts of a plant that are rich in oil, sugar or starch can be used to extract fuel. The second generation of biofuels is aimed at overcoming this drawback. The abbreviation BtL stands for ‘biomass-to-liquid’ and describes the synthetic production of biofuels. Various raw materials, such as straw, bio waste, wood residue and special energy-rich plants, can be used in their entirety in this process. The result is a major increase in the potential and possible land area yield for the production of biofuels.

The production of BtL fuels is relatively complex. The first stage is a gasification of the biomass raw materials. Through the addition of oxygen and steam a synthesis gas consisting of carbon monoxide (CO) and hydrogen (H₂) is produced at high temperatures. Different gas purification stages separate out carbon dioxide (CO₂), dust and other impurities such as sulphur and nitrogen compounds. A synthesis process converts the synthesis gas into fluid hydrocarbons.

The best-known synthesis process is the Fischer-Tropsch process developed in 1925. Named after its developers Franz Fischer and Hans Tropsch, this process is carried out at a pressure of around 30 bars and temperatures above 200 °C using catalyzers. During the Second World War this process was widely used in oil-poor Germany to extract much sought-after liquid fuels from coal. A different procedure then produces methanol from the synthesis gas and processes it further into fuel. During the final production processing stage the liquid hydrocarbons are separated into different fuel products and refined (Figure 12.15).

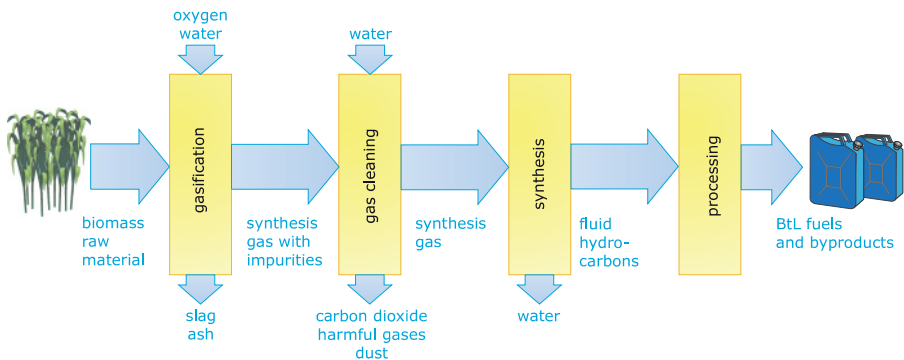

Figure 12.15 Principle of the production of BtL fuels.

BtL fuels have not yet reached a stage where they are ready for mass production. Various companies are currently setting up prototype facilities for producing synthetic biofuels. For example, Volkswagen and Daimler have reserved the brand names SunFuel and SunDiesel and are collaborating with the manufacturing firm Choren Industries. The main advantage of BtL fuels is that they can replace conventional fuels directly without the need for any engine modifications. However, BtL fuels are comparatively expensive because of the complex production procedures involved.

12.4.5 Biogas

In addition to its use in the production of liquid fuels, biomass can also be used in biogas plants to produce biogas. In this process bacteria ferments biomass raw materials in a moist, hermetically sealed environment. The centrepiece of a biogas plant is the heated fermenter (Figure 12.16). A stirring device mixes the substrate and ensures that homogeneous conditions exist. The biological decomposition

process mainly converts the biomass into water, carbon dioxide and methane. The biogas plant captures the gaseous components. The biogas extracted in this way consists of 50 to 75% combustible methane and 25 to 45% carbon dioxide. Other components include steam, oxygen, nitrogen, ammonia, hydrogen and sulphur hydrogen.

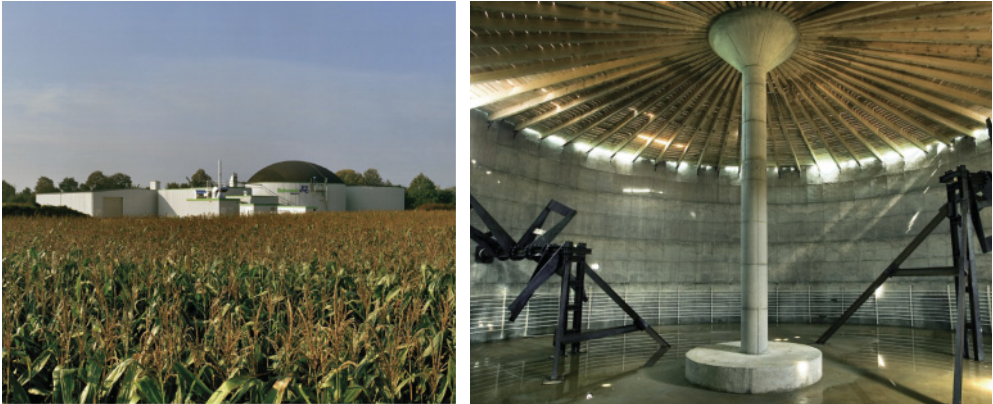

Figure 12.16 Biogas plant in a cornfield and view of interior with stirrer. Source: Schmack Biogas AG.

At further stages the biogas is purified and desulphurized. It is then stored in a gas storage tank. The biogas yield varies considerably depending on the type of biomass substrate. Whereas with cow dung the gas yield is around 45 cubic metres per ton, with corn silage the yield is at least 200 cubic metres per ton.

Biogas is used mostly in internal combustion engines. Petrol engines and modified diesel engines are both appropriate. If the engine drives an electric generator, it can produce electric power from biogas. The waste heat from the engine is also useable.

After further processing, biogas can be fed directly into the natural gas grid. This requires the removal of any trace gases, water and carbon dioxide. Green gas suppliers are now marketing feed-in biogas in some parts of Germany. Changing over to this type of gas supplier will actively promote the expansion of biogas production.

12.5 Planning and Design

The possibilities for using biomass are extremely diverse, and would merit an entire book all to themselves. Therefore, this section confines itself to the planning and design of firewood boilers and pellet heating systems. Both systems are especially relevant to single-family homes.

12.5.1 Firewood Boilers

Certain facts need to be determined before a firewood boiler is installed. Wood-fired systems may save on carbon dioxide, but they release harmful substances such as dust and carbon monoxide. As a result, the use of solid fuels is regulated in certain cities and towns. The local chimney cleaning company can be contacted to clarify these conditions. A firewood boiler also requires sufficient storage area for firewood and a suitable chimney for operation.

If no impediments to the installation exist, the next step is deciding on the dimensions of the firewood boiler system. The performance of the boiler should at least comply with the rated building heat load, in other words the maximum expected heat power requirement. A boiler has to run constantly when outdoor temperatures are extremely low. It is best to have a boiler large enough so that it only has to be filled up once a day under average heating conditions.



Boiler Output and Buffer Storage Size for Firewood Boilers

The minimal boiler rated output \dot{Q}_B results from the rated burning period T_B of one stocking of fuel and the rated building heat load \dot{Q}_H :

$$\dot{Q}_B = \dot{Q}_H \cdot \frac{6.4}{T_B}$$

With a building heat load of 10 kW, which corresponds approximately to that of a standard new single-family house, the rated output of a boiler based on a rated burning period of 2.5 h is:

$$\dot{Q}_B = 10 \text{ kW} \cdot \frac{6.4 \text{ h}}{2.5 \text{ h}} = 25.6 \text{ kW}$$

The necessary volume V_s of buffer storage can be approximated from the boiler rated output \dot{Q}_B and the rated burning time T_B :

$$V_s = \dot{Q}_B \cdot T_B \cdot 13.5 \frac{1}{\text{kWh}}$$

As a result, the buffer storage can absorb the total heat volume of a boiler with a fully stocked burning area. A boiler rated output of 29 kW and a rated burning time of 2.5 h results in a storage volume of

$$V_s = 29 \text{ kW} \cdot 2.5 \text{ h} \cdot 13.5 \frac{1}{\text{kWh}} = 979 \text{ l.}$$



12.5.2 Wood Pellet Heating

The general guidelines on firewood heating can also be applied to wood pellet heating. As pellet heating systems normally transfer fuel automatically to the burner,

there is no loss of comfort due to the frequent firing-up of the system during the day. The boiler rated output can therefore be designed specifically for the heat energy needs of a building. A buffer storage facility is still useful as it prevents a boiler from firing up too frequently and ensures that the heating is working at its rated load most of the time. The system then burns at an optimal level and produces a minimal emission of noxious substances.

Unlike firewood, wood pellets are usually stored in a special area within a building. It is not possible for the pellets to be stored outdoors as they will absorb moisture and may be damaged. An area of three to five square metres should normally be sufficient as the pellet store for a standard single-family new-build home. Older buildings need more space, whereas three-litre houses require considerably less.

The transport system for the pellets is on the floor of the store (Figure 12.17). A slanted shelf will ensure that the pellets slide down to the transport system even when the filling level is low. However, slanted shelves create a void that reduces the useable storage volume to about two-thirds of the space volume. As the price of wood pellets varies throughout the year, the store should hold at least a year's worth of fuel. Pellets can then always be bought at times when prices are low.

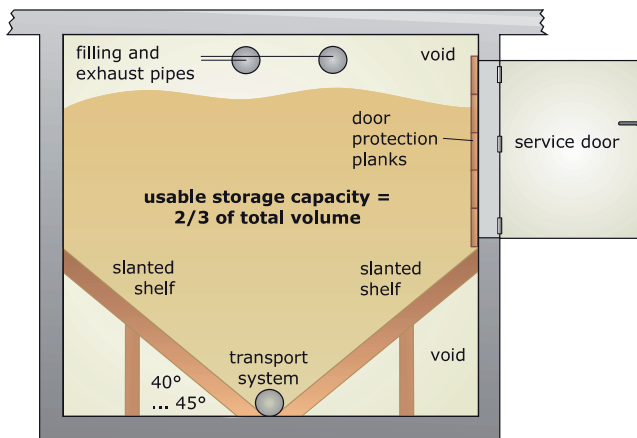

Figure 12.17 Cross-section of a wood pellet store.



Size of Wood Pellet Store

If the annual heat requirement Q_H of a house and the boiler efficiency η_{boiler} are known, this can be used to calculate the necessary store volume V_S including the void:

$$V_S = \frac{Q_H}{\frac{2}{3} \cdot \eta_{\text{boiler}} \cdot 650 \frac{\text{kg}}{\text{m}^3} \cdot 5 \frac{\text{kWh}}{\text{kg}}}$$

If the annual heat requirement is not known, an estimate can be made on the basis of 200kWh per square metre of living area for an average building, 100kWh/m² for a standard new-build and 30kWh/m² for a three-litre house based on Central European climatic conditions. The heat needed to provide hot water is added to this quantity.

On this basis, the heat required for a standard new-build with 130m² of living area is 13 000kWh. If 2000kWh is added for hot water, the total heating requirement is 15 000kWh. With an average boiler efficiency of 80% = 0.8 the store volume is then calculated as

$$V_s = \frac{15\,000 \text{ kWh}}{\frac{2}{3} \cdot 0.8 \cdot 650 \frac{\text{kg}}{\text{m}^3} \cdot 5 \frac{\text{kWh}}{\text{kg}}} = 8.7 \text{ m}^3.$$

A store with a floor area of 2 m × 2 m and a height of 2.17 m would be sufficient. This store can hold pellets with a pellet volume of $\frac{2}{3} \cdot 8.7 \text{ m}^3 = 5.8 \text{ m}^3$. The mass of the pellets amounts to $5.8 \text{ m}^3 \cdot 650 \text{ kg/m}^3 = 3770 \text{ kg}$. If more space than this is available, the store can be made larger. The cost of delivery quantities of 5 tons or more is generally lower than for smaller quantities. A store volume of around 11.5 m³ is necessary to store this quantity. It is important that optimal storage conditions exist so that the pellets do not suffer long-term damage due to high air humidity.



■ www.pelletheat.org

Pellet Fuel Institute



Steps to Installing Biomass Heating

- Determine type of fuel.
Cut wood/firewood – using one's own wood.
Wood pellets – for a fully automated mode of operation.
- Estimate heat requirement and heat output.
If necessary, base needs on previous heating system.
- Can the heat requirement be reduced through insulation?
- Dimension of store – is an adequate store available?
Is sufficient space available for buffer storage?
Is the chimney suitable for connecting biomass heating?
- Clarify regulations concerning system operation and residue removal, for example, by a chimney sweep.
- Request quotations for biomass heating

- Check into favourable financing conditions within the framework of other climate-protection measures, check and apply for available grants.
- Arrange for system to be installed by a registered company with expertise in this technology.

12.6 Economics

Trying to predict the long-term economic development of biomass fuels compared to fossil fuels is a bit like reading tea leaves. This is because of the fluctuation in wood pellet prices during recent years (Figure 12.18). Whereas in 2003 the prices for heating oil and wood pellets of a comparable calorific value were practically the same, in 2005 oil prices soared by 50%. This caused a boom in the demand for wood pellets, which the industry had a hard time meeting. In late 2006 the prices for wood pellets were even higher than comparable crude oil prices for a short time. The prices normalized a few months later and oil prices again rose sharply.

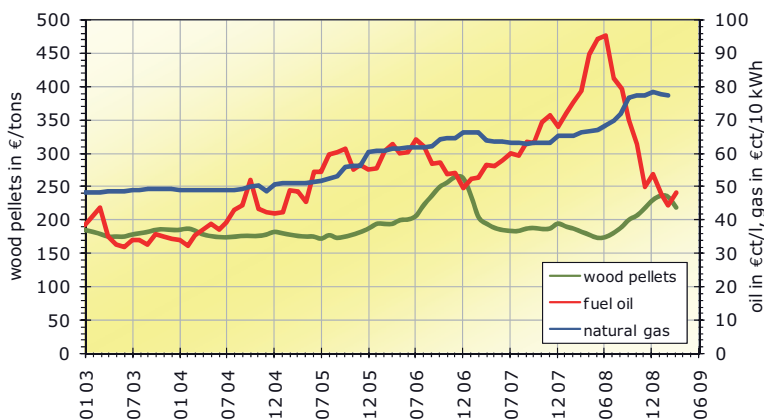

Figure 12.18 Comparison of end user prices for fuel oil, natural gas and wood pellets in Germany. Data: German Federal Statistical Office and German Energy Pellets Association.

The potential for producing wood pellets is far from enough to supply the total current heating market. If more and more customers start using wood pellets as fuel, the result will inevitably be a rise in prices. However, as fuel oil prices will also continue to move upwards in the long term, the price advantage of wood pellets could be maintained at a rising level.

Whether wood pellet heating makes economic sense depends primarily on the price difference compared to fuel oil and natural gas. An estimate for installing this kind of heating is around 15 000 euros, which is considerably more than it would be for oil or natural gas heating. However, with natural gas there is the additional cost of

a gas connection with new buildings. The cost advantage of wood pellets compared to oil and gas is in the lower running costs of pellet heating. Depending on usage and the price development of fuels, wood pellet heating can be amortized in just a few years. The fuel prices for log heating are lower than with pellet heating. The operating costs are therefore even lower.

The demand for biofuels is clearly increasing worldwide due to high oil prices and the simultaneous increase in energy demand. This is also putting additional pressure on food prices. Grain and corn prices have reached new records in recent years. This development has also raised some ethical issues. Is it right that the quantity of food products being processed into biofuels is increasing when more and more people are unable to afford basic food as it is? An alternative is offered by second-generation biofuels such as BtL fuels and biogas, which can be produced from the non-edible parts of plants.

The Renewable Energy Law in Germany regulates the feed-in-tariff rates for biomass power plants. These tariffs show the current rates needed to operate commercial biomass power plants. The tariffs can differ considerably depending on the biomass fuel used and power plant output. The maximum plant output eligible for compensation is 20 megawatts. In 2009 the feed-in-tariffs ranged from 4.16 cents per kilowatt hour for a 5-megawatt power plant using methane up to 11.67 cents per kilowatt hour for a 149-kilowatt biomass power plant. In addition, bonuses of up to 16 cents per kilowatt hour are given for power-heat coupling, the use of renewable waste and innovative plant technology. The amount of the tariff is based on the year a plant starts operation and is then valid for 20 years.

12.7 Ecology

Biomass has also come under fire for ecological reasons. For example, a farmer in Indonesia who sets fire to a hectare of rainforest in order to grow palm oil for biodiesel to sell to Europe or North America is certainly not helping to protect the climate. Priority should only be given to the sustainable production of biomass raw materials if biomass really is to offer a long-term ecological alternative to fossil fuels.

12.7.1 Solid Fuels

As explained earlier, biomass use is carbon-neutral. During its growth biomass absorbs as much carbon dioxide as it releases again when it is burnt. However, the prerequisite is that the use of biomass is sustainable. Therefore, the amount of biomass that is used should be no higher than what grows back again.

In many countries, solid biomass fuels such as wood and straw usually come from forestry or grain farming in nearby areas. Although the felling of trees, their transport and finally the processing into fuel creates indirect carbon dioxide emissions, these emissions are comparatively low. For cut wood from the direct vicinity they

are almost zero. If one takes into account the indirect carbon dioxide emissions that result from the production and the transport of wood pellets in an overall balance sheet, the carbon dioxide emissions from wood pellet heating are still around 70% lower than those of natural gas and more than 80% lower than those of oil heating (Figure 12.19).

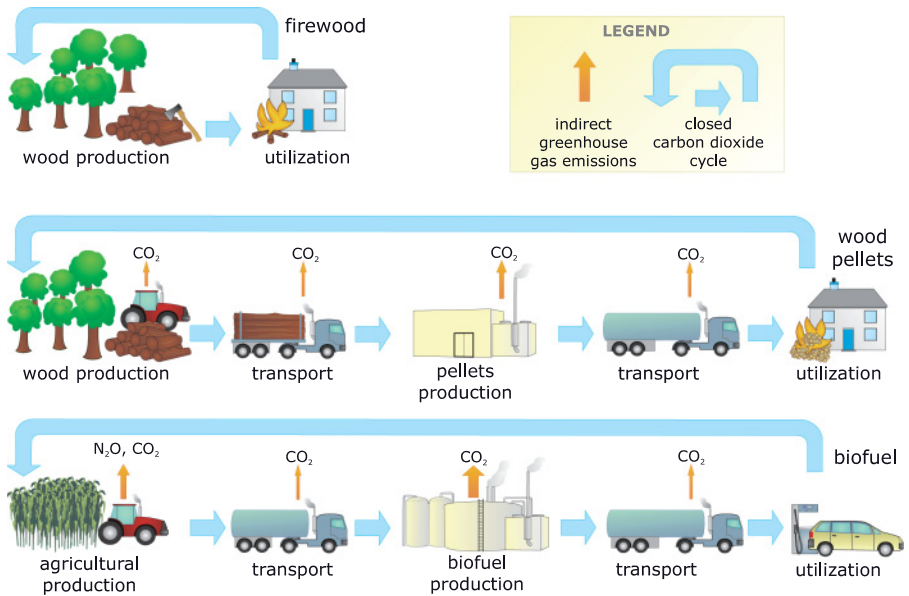

Figure 12.19 Environmental balance sheet for the use of biomass fuels.

The harmful substances that build up when biomass is burnt create far more of a problem than indirect carbon dioxide emissions. Whereas large biomass power plants have sophisticated filtering systems, single-family homes mostly use their heating systems without any filtering mechanism. The blackened chimneys of their fireplaces testify to this. Even if the carbon dioxide balance sheet turns out to be on the plus side, biomass heating can release all sorts of other harmful substances into the environment if it is not burnt properly. In Germany today the emission of harmful fine dust from wood-burning plants is already in the same order as that of motorized street traffic. Yet there are clear differences depending on the type of heating system used. Due to their poor efficiency, open fireplaces generally cause particularly high emissions. Therefore, the use of open fires is banned in many places.

When dry firewood or standardized wood pellets are used in modern boilers, the emission values with the same heat output can be 90% lower than with a fireplace. Different companies are now working on producing filters to prevent the emission of dust from small systems.

12.7.2 Biofuels

The ecological impact of biomass fuels is even more controversial than the harmful emissions for which they are responsible. Tractors and farm machinery emit carbon dioxide just by being turned on. Added to this is the amount of energy required to produce fertilizer and pesticides. Nitrogen fertilizers increase nitrous emissions, which are harmful to the environment. Even the processing of biomass raw materials to produce biofuels is energy-intensive. Huge quantities of carbon dioxide are created if the energy needed comes from fossil energy sources.

The real difficulty in evaluating biomass fuels and their ecological impact is illustrated by the example of biomass cultivation in tropical rainforest regions – a topic that has recently been a target of criticism. When tropical rainforests are cleared to cultivate biomass, considerable quantities of carbon dioxide are released through the usual slash and burn methods. The subsequent cultivation of raw materials for the extraction of biofuels then has a negative environmental impact for many years. In other words, from the standpoint of the environment, it would have been better to burn crude oil from the start.

On the other hand, the results of the production of bioethanol on existing farmland in Brazil are better than in Germany or the USA. Factories in Brazil mostly burn the sugarless residue of sugar cane and extract the energy from this for ethanol production. As a result, ethanol production there is largely carbon-neutral. Other countries use substantial quantities of fossil fuel to do the same thing. This can totally cancel out the climate benefits of bioethanol.

Another critical point with biomass fuels is the limited development potential. If all the available land in the world were devoted to growing biomass for biofuels, it would still probably not be enough to allow biofuels to replace total oil requirements. The second-generation fuels would not totally invalidate this argument but would at least defuse it. If one removes one’s own energy needs for fuel production, the net yield per hectare with BtL fuels is around three times higher than with biodiesel (Figure 12.20). The land utilization of solar systems is clearly more

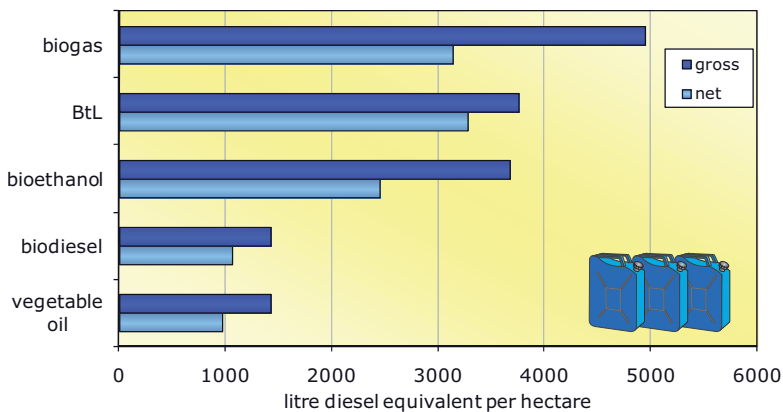

Figure 12.20 Fuel yield per hectare for different biofuels. (1 hectare = 2.47 acres).

efficient than this. In Germany and Great Britain a photovoltaic system with 15% efficiency can generate around 495 000 kilowatt hours of electric power per year on one hectare of land or 200 000 kilowatt hours per acre. This corresponds to a converted diesel equivalent of more than 50 000 litres per hectare.

12.8 Biomass Markets

Biomass use varies widely in different parts of the world. Biomass is by far the most important energy source in the poorest countries of the world and in some countries even constitutes more than 90% of primary energy needs (Figure 12.21). The reasons for this are mainly economic. Most people in these countries simply cannot afford crude oil, natural gas or electricity from coal-fired power plants. In most industrialized countries like Britain, Germany and the USA the biomass share is well below 10%. The only exceptions are countries like Finland and Sweden, which are densely wooded and sparsely populated.

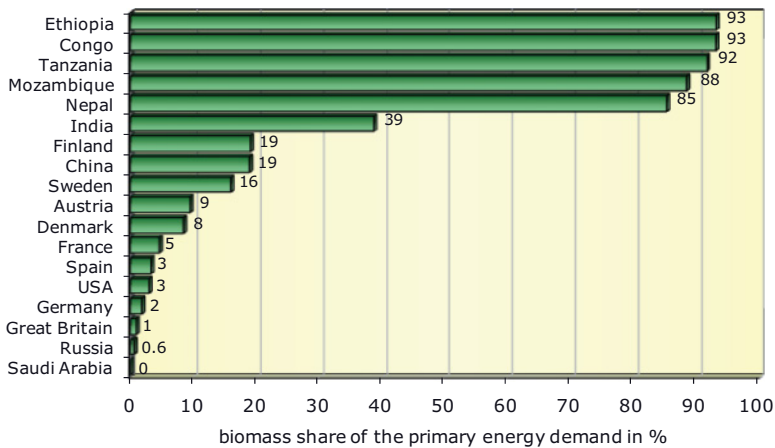

Figure 12.21 Biomass share of primary energy demand in different countries.
Status: 2001, Data: (International Energy Agency, 2003).

Biomass is used very differently by industrialized and developing countries. In many developing and emerging countries biomass is still used in the traditional way.

These countries see the main use of biomass as firewood for cooking. Industrialized countries, on the other hand, focus on the modern forms of biomass use. These include comfortable biomass heating systems, biomass power plants and biomass fuels. The proportion of modern biomass is also increasing in industrialized countries. For example, Sweden has set itself the goal of becoming independent of crude oil by 2020 mainly through an increase in biomass use. The potential is lower in more densely populated countries like Germany and Britain. But even in these countries a 10% biomass share in primary energy requirements is conceivable in the long term.

Germany can be used as an example showing the possible development. Between 1997 and 2007 the biomass share of end energy demand in Germany tripled and now makes up more than 5% of the total energy demand (Figure 12.22).

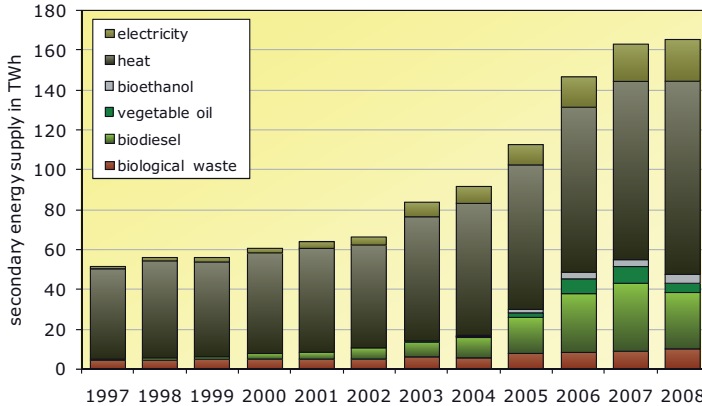

Figure 12.22 Development of biomass use in end energy supply in Germany.

Data: (German Federal Ministry for the Environment, Nature Conservation and Nuclear Safety, 2007).

12.9 Outlook and Development Potential

As the economies of the developing countries grow, the contribution of traditional biomass sources to their energy supply will fall. On the other hand, high oil prices and pressure to act on environmental protection measures will drive the use of modern biomass. Biomass is capable of directly replacing fossil energy sources without needing other technologies to do so. However, the potential of biofuels is not sufficient to replace oil completely. Furthermore, the eco-balance of some biofuels is hotly disputed. There are also ethical concerns about the growing competition with food production. BtL fuels and biogas could be an alternative on a smaller scale.

Biomass power plants will become increasingly important in meeting electricity demand, not least because these plants are able to compensate for some of the major fluctuations in output provided by wind turbine and photovoltaic systems. Biomass will also play a bigger role in providing heat energy. It will therefore remain one of the most interesting renewable energy sources for the future. Throughout the industrialized countries biomass has the potential to achieve a double-digit share of energy supply. Further developments in modern filtering systems are needed to address the problem of harmful substances and fine dust in biomass burning. However, special attention should be given to the sustainable use of biomass raw materials. This is the only way in which it can make a noticeable contribution towards protecting the climate.

13 The Hydrogen Industry and Fuel Cells

Generations of schoolchildren have been entertained by the oxyhydrogen reactions in chemistry class. When hydrogen is oxidized by oxygen from the air, the hydrogen gas explosively releases its stored energy. A spark is enough to ignite a mixture of hydrogen and normal air. In contrast to many other combustion processes, however, the reaction product is absolutely harmless from an environmental point of view. Hydrogen and oxygen simply react to pure water.

The proportion of electricity used in supplying energy is increasing all the time. Fuel cells can generate the much sought-after electric power from hydrogen. The only waste created is water. It is no wonder that the many people with a vision of a global hydrogen economy see it as the solution to our current climate problems. Hydrogen as a single energy source could at the same time help us to get rid of air pollution, acid rain and other environmental problems caused by the use of energy.

Jules Verne saw the potential of hydrogen as early as 1874, and the question is why a thriving hydrogen industry has not already developed. The answer is simple: hydrogen does not occur in a pure form in nature. Energy and a complex technical process are needed before it can be burnt again. This makes hydrogen expensive, and some production processes involved even create high greenhouse emissions. But even though a hydrogen industry is still only on the drawing board, and in the long term would certainly never satisfy total energy demand, it is still an interesting alternative energy source for some areas of application.



Jules Verne (1828–1905): 'The Mysterious Island'

'And what will they burn instead of coal?' asked Pencroft. 'Water,' replied Harding. 'I believe that water will one day be employed as fuel, that hydrogen and oxygen which constitute it, used singly or together, will furnish an inexhaustible source of heat and light, of an intensity of which coal is not capable. Water will be the coal of the future.'

13.1 Hydrogen as an Energy Source

Hydrogen is by far the most common component in our solar system and constitutes around 75% of the mass and more than 90% of all atoms. Our sun and the large gas planets Jupiter, Saturn, Uranus and Neptune consist primarily of hydrogen. Here on earth hydrogen occurs much less frequently. Its share of the total weight of earth is only about 0.12%. Although hydrogen occurs more frequently in the earth's crust, it practically never occurs even there as a pure gas. Hydrogen is almost always chemically bonded. The most frequent compound is water.

Hydrogen is the smallest and lightest atom. As an extremely light gas, hydrogen was used to fill the gas bags of airships like the Zeppelins during the first half of the nineteenth century. The Hindenburg disaster, where an electrostatic charge supposedly caused the hydrogen to ignite, brought a tragic end to the prospects of hydrogen use.

The main application of hydrogen today is in the chemical industry. As an energy source it is currently used on a large scale mainly in the aviation sector and in space travel. Hydrogen has occasionally been used to drive the jet engines of aeroplanes. In space travel liquid hydrogen is used as rocket fuel. For example, the launch of a space shuttle consumes about 1.4 million litres of liquid hydrogen weighing more than 100 tons. This is burnt along with the 0.5 million litres of liquid hydrogen that the shuttle carries with it. The combustion temperature is up to 3200 °C (Figure 13.1).



Figure 13.1 Hydrogen is by far the most common element in our solar system (left) and is already being used as an energy source for the launch of space shuttles (right). Graphic/Photo: NASA.

13.1.1 Production of Hydrogen

Hydrogen must first be produced in a pure form before the energy from it can be used (Figure 13.2). This requires an easily available inexpensive raw material containing hydrogen. Aside from water (H_2O), which consists of hydrogen (H) and oxygen (O), hydrocarbon compounds can also be an option. This is primarily natural gas, or methane (CH_4). Heating oil and coal consist of hydrogen (H) and carbon (C) but have a much higher proportion of carbon than natural gas.

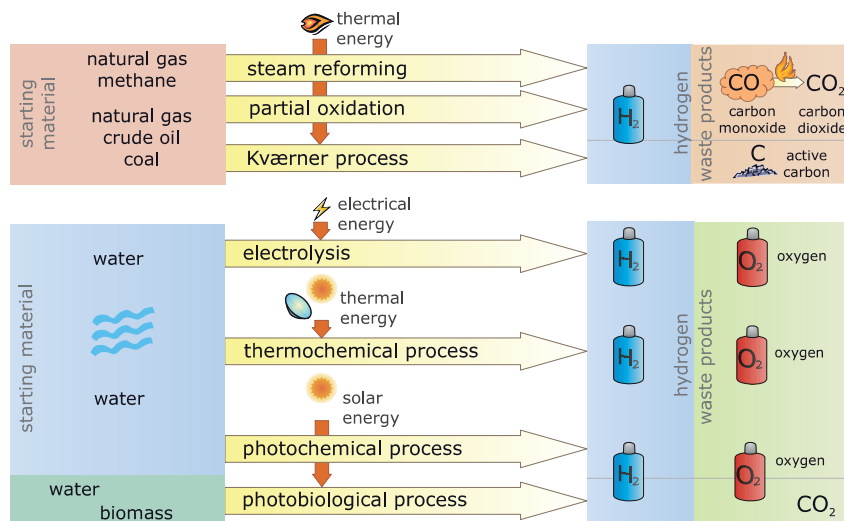

Figure 13.2 Procedure for producing hydrogen.

Current industrial methods for producing hydrogen almost exclusively use fossil fuels, such as natural gas, crude oil or coal, as the raw material. Methods such as steam reforming or partial oxidation to produce hydrogen from fossil hydrocarbons chemically separate the carbon. It then reacts to carbon monoxide (CO), which can be used energetically. The end product is carbon dioxide (CO_2). These methods for producing hydrogen are not real options for actively protecting the climate.

The Kvaerner method also uses hydrocarbons as the base material. However, the waste product that it produces is active coal – therefore, a pure carbon. A direct formation of carbon dioxide can be prevented with this method if the carbon is not burnt further.

Basically, all the methods mentioned to produce hydrogen from fossil energy sources are run at high processing temperatures. This requires large amounts of energy. If this energy comes from fossil sources, this will again lead to the emission of carbon dioxide. For climate protection it is usually better to burn natural gas or oil directly than to take the circuitous route of producing hydrogen and then using it as a supposedly environmentally friendly fuel.

Other methods are therefore necessary to produce hydrogen so that it is environmentally safe. The ideal way is with electrolysis. The German chemist Johann Wilhelm Ritter first used electrolysis to produce hydrogen as early as 1800. Using electric energy, electrolysis decomposes water directly into hydrogen and oxygen. If the energy comes from a renewable energy power plant, the hydrogen can be extracted free of carbon dioxide.

Alkaline electrolysis is an example (Figure 13.3). With this method two electrodes are dipped into a conductive watery electrolyte. This can be a mixture of water and sulphuric acid or potassium hydroxide (KOH). The anodes and cathodes conduct direct current into the electrolytes. There they electrolyze water into hydrogen and oxygen.

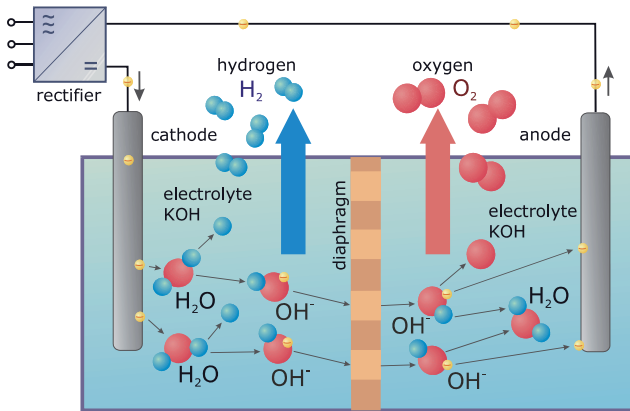

Figure 13.3 Principle of alkaline electrolysis.

Although electrolysis has already reached a high state of technical development as an environmentally compatible option for oxygen production, other alternative methods are also in development.

Thermo-chemical methods are an example. At temperatures above 1700 °C water decomposes directly into hydrogen and oxygen. However, these temperatures require expensive heat-resistant facilities. The required temperature can be reduced to below 1000 °C through different coupled chemical reactions. For example, concentrating solar thermal power plants can produce these temperatures, and this has already been successfully proven.

Other procedures include the photochemical and photobiological production of hydrogen. With these procedures, special semiconductors, algae or bioreactors use light to decompose water or hydrocarbons. These methods are also still at the research stage. The main problem is developing long-term stable and reasonably priced facilities.

13.1.2 Storage and Transport of Hydrogen

Once hydrogen has been produced, it has to be stored and transported to the consumer. In principle, we are familiar with the storage and transport of combustible gases from the use of natural gas. Hydrogen is an extremely lightweight gas with very minimal density but has a relatively high calorific value. Compared to natural gas, hydrogen with the same energy content requires much larger storage volumes although the stored hydrogen is much lighter.

Hydrogen can either be compressed, stored under high pressure or liquefied in order to reduce the necessary storage volumes. Under normal pressure hydrogen condenses but not until it reaches extremely low temperatures of minus 253 °C. A high amount of energy is needed to achieve such low temperatures. Twenty to 40% of the energy stored in the hydrogen is used to liquefy it. Liquid hydrogen is abbreviated as LH₂.

In principle, the same technologies used in the natural gas sector can be used for the liquidization, transport and storage of hydrogen. Hydrogen can be transported either in pipelines or in special tankers and freighters. Whereas pipelines usually transport the gaseous form, tankers are preferred for liquid hydrogen to reduce the volume. In contrast to hydrogen, natural gas already becomes liquid at minus 162 °C and is abbreviated as LNG (liquid natural gas) (Figure 13.4).



Figure 13.4 Experience from the natural gas sector can be used for storing and transporting hydrogen. Left: Liquid gas tanker. Right: Pipeline. Source: BP, www.bp.com.

Compressed gas or liquid gas tanks are used to store small quantities. Another disadvantage of hydrogen is the very small atomic portion, which makes it extremely volatile. Large quantities of hydrogen can be lost if it is stored in metal tanks for long periods of time, because it diffuses through the storage walls. Underground storage is recommended for large quantities of hydrogen, whereby it is compressed at high pressure into underground storage shafts and extracted when needed.

13.2 Fuel Cells: Bearers of Hope

Fuel cells are considered the key to the future energy use of hydrogen, because they can convert hydrogen directly into electric energy. Theoretically at least, this results in higher efficiency levels than with combustion in conventional thermal power plants.

The principle of fuel cells has been known for a very long time. There is some controversy about who actually invented the fuel cell. The German-Swiss chemist Christian Friedrich Schönbein conducted the first tests in fuel cell technology in 1838. The English physicist Sir William Robert Grove built the first fuel cell in 1839. Well-known scientists like Henri Becquerel and Thomas Edison were subsequently involved in its further development. A sufficiently advanced stage of development was finally reached in the mid-twentieth century, enabling NASA to make major use of fuel cells by 1963.

Since the 1990s fuel cell development has been moving ahead at full speed. Car manufacturers and heating companies have adopted the technology and are looking to profit from a positive image as a result.

Fuel cells basically involve a reversal of electrolysis. A fuel cell always contains two electrodes. Depending on the type of fuel cell, pure hydrogen (H_2) or a fuel containing hydrocarbons is fed through the anode and pure oxygen (O_2) or air as an oxidation material is fed through the cathode. An electrolyte separates the anode and cathode (Figure 13.5). As a result of this, the chemical reaction is controlled. Electrons flow over a large circuit and emit electric energy. The remaining positively charged ions diffuse through the electrolyte. The waste product is water.

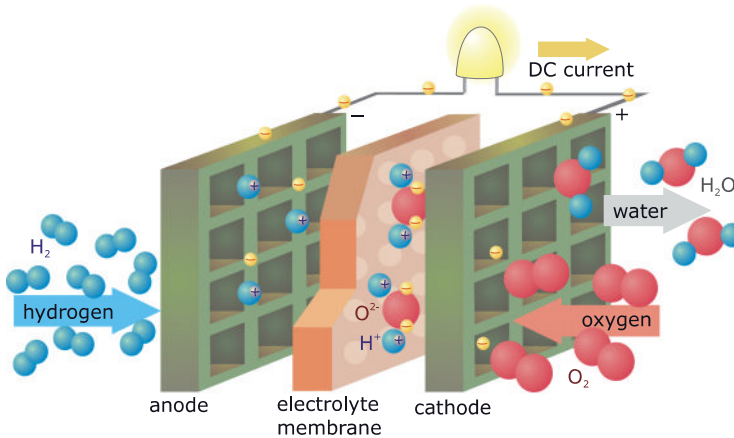

Figure 13.5 Working principle of fuel cells.

There are different types of fuel cells that essentially differ from each other based on electrolytes, the permissible fuel gases and operating temperatures. In practice, the following abbreviations are used to identify the fuel cell types:

- AFC alkaline fuel cell
- PEFC polymer electrolyte fuel cell
- PEMFC proton exchange membrane fuel cell
- DMFC direct methanol fuel cell
- PAFC phosphoric acid fuel cell
- MCFC molten carbonate fuel cell
- SOFC solid oxide fuel cell

Figure 13.6 shows the respective fuel gases and oxidation materials as well as the electrolytes and operating temperature ranges for the different types of fuel cells.

type	fuel gas (anode)	electrolyte	operating temperature	(oxidant) cathode
SOFC	hydrocarbons natural or biogas, ... hydrogen (H ₂)	ceramic YSZ: Yttrium stabilized zirconium oxide ZrO ₂ /Y ₂ O ₃	800... 1000°C	oxygen(O ₂) air
MCFC	hydrocarbons natural or biogas, ... hydrogen (H ₂)	alkali carbonate melt Li ₂ CO ₃ , K ₂ CO ₃	600... 650°C	oxygen(O ₂) air
PAFC	hydrogen (H ₂)	phosphoric acid H ₃ PO ₄	160... 220°C	oxygen(O ₂) air
DMFC	methanol	proton conductive membrane	60... 130°C	oxygen(O ₂) air
PEMFC	hydrogen (H ₂)	proton conductive polymeric membrane	60... 120°C	oxygen(O ₂) air
AFC	hydrogen (H ₂)	potash lye (KOH)	20... 90°C	oxygen(O ₂)

Figure 13.6 Differences between fuel cell types.

The proton exchange membrane fuel cell (PEMFC) is the one most frequently used today. In this fuel cell the electrolyte consists of a proton-conductive polymer film. The fuel gases flow through carbon or metal substrates which serve as electrodes. The substrates have a platinum coating that acts as the catalyzer. The typical operating temperature is about 80 °C. These cells do not require pure oxygen for operation but can also work with normal air.

Because hydrogen as an energy source is only available in limited quantities today, there is an interest in using fuel cells directly with energy sources like natural gas and methanol that are relatively easily available. At a preliminary stage a reformer uses a chemical process to break down hydrocarbons such as natural gas into hydrogen and other components. In the process a hydrogen-rich reformat gas is formed from which a gas purification stage is still needed to eliminate harmful carbon monoxide (CO) for the fuel cell.

Molten carbonate fuel cells (MCFC) and solid oxide fuel cells (SOFC) work at much higher temperatures. This enables gases containing hydrocarbons, such as natural gas and biogas, to be used directly without any previous reforming. The disadvantage of high temperatures is the long time required for starting up and switching off.

As the electric voltage of a single cell with values of around one volt is too low for most applications, a number of cells are usually connected in series to form a so-called stack (Figure 13.7).

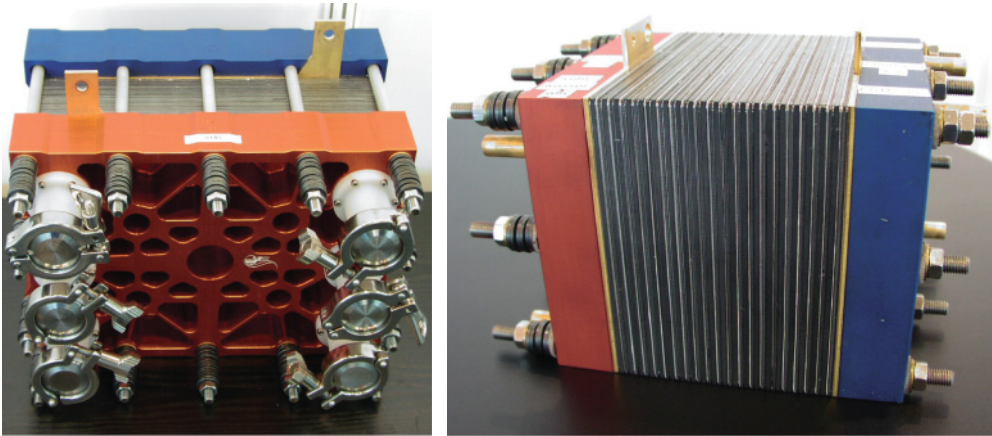

Figure 13.7 Prototypes for fuel cells.

The electric efficiency of fuel cells today is usually in the order of 40 to 60%. Values of more than 60% can be reached in individual cases. A fuel cell can therefore only convert a part of the energy contained in hydrogen into electric energy. Basically, the waste heat of fuel cells is also useable. Power-heat coupling, or the simultaneous generation of power and heat, raises the overall efficiency of a fuel cell and can increase it to over 80%.

Major advances have been made in fuel cell technology in recent years, and many companies are already offering commercial units. However, the number of units currently being sold is still relatively low. The price of fuel cell systems is still fairly high compared to other energy supply units. Furthermore, it will be necessary to increase the sometimes quite short service life of fuel cells if they are to have a broader appeal.

13.3 Economics

It currently costs about 4 cents to produce a kilowatt hour of hydrogen through the steam reforming of natural gas – assuming that natural gas prices are relatively reasonable. One litre of petrol has a calorific value of about 10 kilowatt hours.

Added to this would be the equivalent of hydrogen to one litre of conventional petrol at about 40 cents. At this point the hydrogen would not yet even have reached the tank for end user use. Including liquidization, transport and storage, the cost rises threefold from the given price to well over one euro. This makes it more than double the net petrol price in Europe.

Producing hydrogen in an environmentally compatible way through electrolysis using renewable energy is even more expensive. With a prototype facility using wind power for electrolysis, the equivalent of hydrogen to one litre of conventional petrol would cost 5 euros. With large-scale technical plants, a price of 2 euros could easily be achieved at the refuelling pump. Taxes and duties would have to be added to this.

The long-term hope is that hydrogen at top renewable sites using electricity from wind turbines, hydropower plants or solar thermal power plants will be available for delivery at the equivalent of less than 2 euros per litre of petrol. If the petrol price then rises well above 2 euros per litre, hydrogen at the pump would become competitive. Presumably it will be some years before we get to that stage.

In addition to its use as a fuel, hydrogen is also considered an option for the large-scale technical storage of electric energy. As relatively extensive losses always occur during the electrolysis, storage and reverse conversion of hydrogen (Figure 13.8), this type of use based on the current state of technology is only viable in isolated cases.

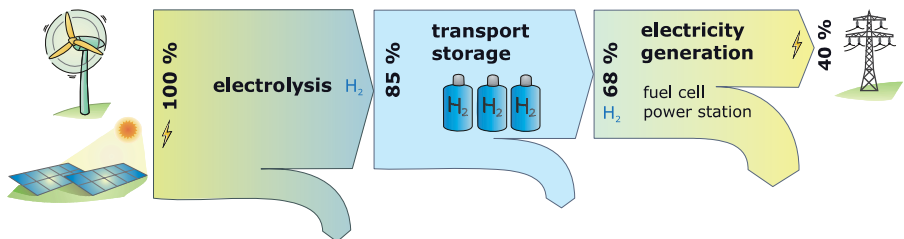

Figure 13.8 Losses when hydrogen is used to store electric energy, based on the current state of technology.

This also applies to generating electricity from hydrogen that is produced in distant areas and has to be transported to the consumer. The use of hydrogen in the electricity sector will only be economically viable if major technological advances are made in this area and power-heat coupling is used.

13.4 Ecology

The broad public perception of hydrogen as an energy source and fuel cells is favourable, mainly because water is the waste product when hydrogen is used.

However, what is important for the balance sheet on the environment is not what comes out at the end but what is put in at the beginning. When steam reforming is used to produce hydrogen from natural gas, around 300 g of carbon dioxide are created per kilowatt hour of hydrogen ($\text{g CO}_2/\text{kWhH}_2$); with partial oxidation of heavy oil this rises to even 400 $\text{g CO}_2/\text{kWhH}_2$ (Dreier and Wagner, 2001). This is clearly more than is created through the direct use of natural gas and crude oil. If hydrogen is extracted by electrolysis using average electric current in countries like Britain or Germany, the carbon dioxide figure rises to between 500 and 600 $\text{g CO}_2/\text{kWhH}_2$. Hydrogen as an energy source then ends up being far from ideal for the environment. For the climate balance sheet it ultimately makes more sense to continue driving petrol and natural gas-powered cars than to change over to those run on hydrogen.

Hydrogen only offers a true alternative if it is extracted using pure renewable energy sources, such as through electrolysis using energy from wind turbines and solar power plants. However, as long as hydrogen is produced using methods that can create carbon dioxide, it will at best be suitable for testing prototypes.

Many manufacturers are developing products that allegedly rely on clean hydrogen as an energy source and fuel cells for generating electricity. They owe us an explanation of how they intend to make sufficiently large quantities of reasonably priced carbon-free hydrogen available soon.

In the foreseeable future renewable energies will be able to compete fully with fossil and nuclear energy plants on the basis of open competition. As a result, the production costs for hydrogen produced with renewable electricity will drop. This will then enable hydrogen and fuel cells to become an interesting component of sustainable energy supply. Therefore, it is already a good idea to encourage the development of these technologies.

13.5 Markets, Outlook and Development Potential

Hydrogen production is currently at a total of 30 million tons worldwide. In comparison, crude oil consumption at 3953 million tons worldwide in 2007 was higher by several orders of magnitude. As the chemical industry uses the bulk of the available hydrogen, a market for it does not yet exist in the energy sector. The capacity for hydrogen production using renewable energies is very low, and there is also no infrastructure for the transport and storage of large volumes of hydrogen.

Only a small number of hydrogen refuelling stations currently exist to supply hydrogen for filling the tanks of hydrogen test vehicles (Figure 13.9). The cost of developing a comprehensive network of stations that could provide hydrogen fuel is estimated in the billions of euros in countries like Germany and Britain alone. In larger countries such as the USA this sum would be even higher. As long as hydrogen is still much more expensive than conventional fuels, the chances of this kind of investment are very low.



Figure 13.9 Many car makers and energy companies are banking on hydrogen. However, the network of hydrogen fuel stations is still extremely small and is only capable of filling up a few prototypes that use hydrogen. Photos: BP, www.bp.com.

Whereas electric drives with batteries charged using renewable energies offer an alternative for cars, climate-neutral concepts are still lacking for the powering of aeroplanes. Hydrogen could be the solution in this area. However, as planes operating on hydrogen also emit water vapour and produce condensation trails, which in turn contributes to the greenhouse effect, air traffic based on hydrogen would not be totally climate neutral.

Even if hydrogen remains a very interesting energy source, it will take at least 10 to 20 years before it can be used on a widespread scale.

A large number of fuel cell projects today are therefore relying on natural gas as an energy source. Even technical developments in fuel cell technology are progressing at a much slower pace than the product announcements in the 1990s may have led us to believe. A few commercial projects exist at the moment, but the number of units sold is still relatively low. Technical advances are also needed in the fuel cell area before a larger market can be exploited. Above all, a functioning renewable hydrogen industry is needed before fuel cells can become a truly climate-compatible alternative.

14

14 Sunny Prospects – Examples of Sustainable Energy Supply

The previous chapters covered the large spectrum of renewable energies available. Renewable energies will largely have to replace conventional energy sources during the next 50 years to keep the consequences of climate change within manageable limits. The modern use of these energies does not have years of tradition to fall back upon. Their applications are often new and unusual.

Yet climate-compatible energy supply is not pie in the sky. A life beyond fossil and nuclear energy sources is already possible today. This chapter shows the truth of this claim based on examples, some of them quite impressive, from a variety of very different areas.

14.1 Climate-Compatible Living

Despite the pressing need to protect the climate, low-energy dwellings such as three-litre houses and passive houses are still the exception rather than the rule. Most buildings that undergo restoration or renovation also fall short of meeting the standard for climate compatibility.

It is technically as well as economically easy to incorporate energy supplies that are low or neutral in carbon dioxide into new buildings in particular. It is far simpler to do this at the building stage rather than adapting the finished house in the future. Energy-saving adaptations are usually postponed so long that windows, roofs and outside walls are already due for refurbishment anyway. However, with well constructed new buildings this can take many years. If energy prices continue to rise over the next few years, then even new-builds with unnecessarily high requirements for energy will become very costly to run. Investing in high-quality insulation and renewable energy supply when a house is being built or

renovated means not having to worry about increases in energy prices in the years to come.

14.1.1 Carbon-Neutral Standard Prefabricated Houses

Most of the climate-protecting measures available in building construction are relatively unspectacular. The first example shows an average single-family home in Berlin with about 150 square metres of living space (Figure 14.1). It was built in 2005 using wood frame construction. Compared to solid construction, wood frame construction offers good insulation values even with thinner walls. With a house of this kind, 8 cm of additional outer insulation in a total of 32 cm reduce heat loss through the walls. The standard thermal windows were replaced using triple-glazed windows with a high insulation value. A controlled ventilation system with heat recovery reduces ventilation losses and increases comfort levels. These measures alone will enable this house to reach the standards of a three-litre house.



Figure 14.1 Left: Family home in Berlin with carbon-neutral energy supply. Right: Heating cellar with buffer storage tank, solar cycle pump, controlled heat recovery system and wood pellet boiler.

A wood pellet boiler and a 4.8 square metre solar thermal system cover remaining heating needs and supply hot water. A pellet store 5 square metres in size stores about 6 tons of wood pellets. This covers heat energy requirements for three years and is even enough to bridge periods when prices for fuels are particularly high. A 7.4 square metre photovoltaic system with output of one kilowatt peak feeds its power into the public grid.

The additional costs for the measures described compared to the minimum new-build standard in 2005 amounted to around 30 000 euros. The costs of wood pellets and electricity for the ventilation motors and heating pump are around 400 euros per year. The energy credits for feed-in solar power are roughly equal to this, so this house actually has no additional heating costs.

The only other energy costs are those for normal electricity consumption. A green energy supplier offers carbon-free electricity. The photovoltaic system saves even more carbon dioxide than is emitted during wood pellet production and the transport of the pellets. As a result, the energy supplied to this house is completely carbon neutral.

14.1.2 Plus-Energy Solar House

If the entire roof of a house with optimal insulation is equipped with solar panels, this can change a carbon-neutral house into a plus-energy solar house. An example is the house shown in Figure 14.2. Optimal heat insulation using cellulose, triple-glass solar glazing, a ventilation system with heat recovery and preheated air supplied from the ground reduce the heat energy needs by about 80% compared to a standard new-build.



Figure 14.2 Plus-energy solar house in Fellbach. The photovoltaic system feeds more energy into the public grid each year than the house needs for its own heating and electricity. Source: Reinhard Malz, www.fellbach-solar.de.

A brine-water heat pump with 1.1 kilowatts of electric power covers the remaining heat energy requirements of the house. The low temperature heat comes from two vertical earth probes sunk 40 metres into the ground. A 0.50-kilowatt heat pump would have been sufficient but is not available on the market.

The photovoltaic system with a power output of 8 kilowatts peak feeds at least 8000 kilowatt hours into the public grid. The volume of energy exceeds the energy requirement of the house, including the ventilation system and the heat pump. As a result, the energy supplied in this house is not only carbon neutral but also saves carbon dioxide in other areas due to the feed-in solar energy.

14.1.3 Plus-Energy Housing Estate

Houses that produce an energy surplus over the year and feed it into the grid do not have to be an exception. This is shown by the Schlierberg solar housing estate in Freiburg in Southern Germany. The architect Rolf Disch built 50 plus-energy houses on this estate. He has been integrating ecological enhancements and renewable energies into his projects for more than 30 years.

All houses in this development of terraced houses are orientated towards the south. The gaps between the terraces are designed so that the heat from the sun can stream into the houses through large south-facing windows in the winter. Balconies that jut out prevent the houses from heating up too much in the summer. These simple and cheap measures could reduce the energy needs of many new-build houses.

Optimal insulation that exceeds the standard and controlled living space ventilation with heat recovery are standard features of this particular housing estate. These features are designed to keep heat energy needs to an absolute minimum (Figure 14.3).



Figure 14.3 Schlierberg solar housing estate in Freiburg, Germany, with 50 plus-energy houses.
Source: Architekturbüro Rolf Disch, www.solarsiedlung.de.

A wood chip heat power plant covers the rest of the heat energy requirements and provides climate-neutral energy supply. A district heat grid transports the heat to the individual houses. The photovoltaic systems feed into the public electricity grid. The solar energy surplus produced by the houses makes them plus-energy homes.

The building materials were also chosen with ecology and sustainability in mind. The wood has not been chemically treated, solvent-free paints and varnishes have been used throughout and the water and electric lines are PVC-free.

14.1.4 Heating Only with the Sun

Many houses use solar thermal systems only to heat water in the summer and at best to provide heating support during the transitional seasons. It is hard to imagine

that houses in countries with cold winters could be heated with solar energy alone. But in recent years many single-family houses have proven that heating requirements can be covered by the sun even in Central Europe. The first multiple-family dwelling in Europe to be heated 100% with solar thermal heat was built in Burgdorf near Bern, Switzerland, in 2007 (Figure 14.4).



Figure 14.4 Left: First multiple-family dwelling in Europe to be heated 100% with solar thermal heat. Right: Installation of 276 m² roof-integrated solar collector. Source: Jenni Energietechnik AG, www.jenni.ch.

High-quality heat insulation and a ventilation system with heat recovery ensure that heat losses in this building are relatively low. The large 276 square metre roof is completely covered with solar collectors. An enormous hot water storage tank containing 205 000 litres is located in the centre of the building. The seasonal storage tank extends from the cellar to the loft. The collectors heat the storage tank with solar heat in the summer. In winter when the collectors cannot supply sufficient heat, the heat from the storage keeps the building toasty warm. Supplemental heat is not required.

Less than 10% of the total construction cost of around 1.8 million euros for the building was spent on the solar system. Yet aside from the small expenditure for electricity for the solar and heating cycle pumps, no additional heating costs are actually incurred. Heating costs are included in the rent, so that residents of the block do not have to worry about constant rises in energy bills.

14.1.5 Zero Heating Costs after Redevelopment

Practically all technical options can be incorporated into new-builds without a problem. The situation is considerably more complex with existing buildings that date from a time before protecting the environment was considered important.

Building renovations or the installation of a new heating system present the ideal opportunity to make enormous reductions in carbon dioxide. One example is the

zero-heating cost apartment block in Ludwigshafen, Germany, which was built in the 1970s and then renovated in 2007 to a technical standard comparable to today's levels (Figure 14.5).



Figure 14.5 Constant hikes in energy bills are a thing of the past for this zero-heating cost house in Ludwigshafen, Germany. Source: LUWOGÉ, www.luwoqe.de.

The result is a reduced heat energy requirement of around 80%, which now amounts to only about 20 kilowatt hours per square metre of living space per year. Thirty-centimetre thick outer wall insulation and triple-glazed thermal windows provide optimal building insulation. Controlled living space ventilation with heat recovery reduces ventilation heat losses. Solar thermal façade collectors provide for the hot water supply and a large grid-coupled photovoltaic system is located on the roof. The minimal remaining heating needs are covered electrically. The yield from the photovoltaic system should be roughly the same as the heating electricity costs. The tenants do not pay for any heating. Constant rises in heating costs are therefore also a thing of the past for this building. Taking into account all costs including upkeep and vacancy rates, the modernization measures have also turned out to be very lucrative for the investor. Both sides benefited from the climate-protection measures that were taken.

14.2 Working and Producing in Compatibility with the Climate

14.2.1 Offices and Shops in Solar Ship

The Sonnenschiff (Solar Ship) is located near the housing estate in Freiburg discussed above. The Sonnenschiff is a solar service centre that houses shops,

offices, medical practices and penthouse flats. The architect Rolf Disch also planned this complex as a plus-energy construction. Optimal insulation incorporating modern vacuum processes and intelligent ventilation with heat recovery help reduce heat requirements. In winter the sun streams through large windows right into the heart of the building, providing some of the heating. In summer canopies and blinds prevent the building from overheating. A wood chip heat power plant covers the minimal remaining heating needs. Photovoltaic systems are not simply mounted on the roof but are actually used instead of a conventional roof. As a result, the entire roof surface generates electric power (Figure 14.6).



Figure 14.6 The Sonnenschiff or solar ship contains two shops, a bistro, offices and medical practices. Source: Architekturbüro Rolf Disch, www.solarsiedlung.de.

An intelligent solution has also been devised for transport connections. The complex has its own tram stop and conveniently sited parking areas for bicycles, thereby offering alternatives to motor car use. The electric cars of a car-sharing firm are allocated preferred parking spaces and can be charged using solar power generated by the complex itself. The Sonnenschiff complex has put into practice the concept of working and living carbon-free and contributing to climate-compatible mobility.

14.2.2 Zero-Emissions Factory

It is also relatively easy for factories to operate without emitting carbon dioxide. An example is the Solvis zero-emissions factory in Braunschweig, Germany, which produces solar and pellet systems. High-quality heat insulation and waste air recovery in the factory have resulted in energy savings as high as 70% compared to conventional structures. Optimal use of daylight and low-energy office machines have halved electricity needs. Solar collectors and photovoltaic systems generate 30% of the electricity and heating required (Figure 14.7). A rapeseed oil block-heating plant covers remaining energy needs, thereby ensuring that all energy supply is completely carbon-free.

Large amounts of heat often escape through the open shed doors of factories during the loading and unloading of heavy goods vehicles. This factory keeps heat losses at a minimum because the loading and unloading zones are situated inside the building. A direct connection to local public transport, parking facilities for bicycles and showers for cyclists provide employees with a climate-compatible workplace.



Figure 14.7 Solvis zero-emissions factory in Braunschweig, Germany. Source: SOLVIS, www.solvis.de.

14.2.3 Carbon-Free Heavy Equipment Factory

The ‘factory of the future’, completed in May 2000 by Wasserkraft Volk AG, is the first energy self-sufficient carbon-free heavy equipment factory built in Germany. The administration building is mainly built of timber from the Black Forest area. The entire building including the factory floor is very well insulated. The offices are orientated towards the south, and the factory has generous overhead lighting.

This construction enables maximum use of daylight and the incoming sunlight covers some of the heating needs. A 30 square metre sun collector on the administration building actively uses solar energy. At the heart of the factory’s energy supply is its own hydropower plant with 320 kilowatts of output (Figure 14.8). The turbines integrated into the building use natural water from the nearby Elz River. The waste heat from the generator covers about 10% of the heat requirement. Three heat pumps with a heat output of 130 kilowatts extract heat from the groundwater and supply the remaining heat energy.

The hydropower plant generates an annual surplus of around 900 000 kilowatt hours of electric energy, which the factory feeds into the public grid. This makes it not only a carbon-free factory but also a plus-energy one that supplies additional ecological electricity.



Figure 14.8 The administration building at the Wasserkraft Volk AG factory of the future in Gutach, Germany, has its own hydropower plant to generate carbon-free power. Source: WKV AG, www.wkv-ag.de.

14.3 Climate-Compatible Driving

The colourful, glossy brochures produced by leading car manufacturers are full of impressive assertions about how much they are doing to protect the environment. However, with many manufacturers it is difficult to discern any real innovation in creating carbon-free means of transport. Cars that run on natural gas and hybrid cars make only a marginal difference in reducing carbon dioxide emissions if one looks at the recommendations for reductions set as a standard for protecting the climate. The sustainable cultivation potential with biomass fuels is too low to meet total needs and there is simply not enough carbon-free hydrogen being produced to advance the innovation of hydrogen automobiles.

Plug-in hybrid vehicles or pure electric cars could offer an alternative in the short term. Plug-in hybrid vehicles are normally refuelled through a power point and for emergencies have a combustion engine that can also be run on biofuel. Pure electric cars only run on electricity. If the electricity is supplied by renewable power plants, no carbon dioxide is emitted while the vehicle is being driven.

14.3.1 Waste Gas-Free Electropower

Two examples from the USA confirm that electric cars do not have to be dull and utilitarian. The companies Tesla Motors and Commuter Cars are currently developing really innovative vehicles (Figure 14.9).

Tesla Motors offers a 185 kilowatt electric engine for acceleration from 0 to 100 km/h in less than four seconds. A modern lithium-ion battery enables a range of 390 km on one battery charge. The battery service life should last up to 160 000 km. It takes three and a half hours to charge the battery.



Figure 14.9 Modern electric cars are now far from boring. Photo left: Tesla Motors, www.teslamotors.com. Right: Commuter Cars, www.commutercars.com.

Whereas a combustion engine achieves an average efficiency of less than 30%, an electric engine reaches an impressive 90%. The consumption is therefore only around 13 kilowatt hours per 100km, which converts to 1.3 litres of petrol per 100km. Even with electricity from fossil power plants the carbon dioxide emissions of this electric sports car are below those of a fuel-efficient small car with a combustion engine. If the electricity used for refuelling is sourced from a green electricity supplier, this type of car can be driven without emitting any carbon dioxide whatsoever.

The Tango car from Commuter Cars also accelerates from 0 to 100 in four seconds. The range is between 100 and 250km. The charging time is normally three hours but a fast charge option is available that takes ten minutes to recharge for an 80km distance.

Both vehicles are currently only produced in very small numbers, and they cost around 70 000 euros. But these examples show that climate-compatible alternatives do exist. If the large car manufacturers made a serious effort to develop these alternatives, climate-neutral driving would finally become a reality.

14.3.2 Travelling around the World in a Solar Mobile

Solar cars have a reputation of being at best suitable for driving to the postbox and back. They are usually not trusted to be driven for long distances under extreme conditions. To highlight the problems of climate change, a Swiss man, Louis Palmer, set off on the first trip round the world in a solar-operated taxi in July 2007. Palmer had been dreaming about the idea of a solar taxi since 1986. In 2005 he finally succeeded in implementing the project, known as 'Taxi', thanks to the help of numerous sponsors and technical support from the Swiss Technical University in Zurich (Figure 14.10).



Figure 14.10 In July 2007 Louis Palmer of Switzerland began his trip around the world in a solar energy-operated vehicle. Photos: www.solartaxi.com.

His route took him over 50 000 km through 50 countries on five different continents in 15 months. On the trip he and his team took advantage of numerous stops and events to introduce solar techniques and provide impetus for the use of new climate-friendly technologies. After taking a test drive many interested people in the countries visited became enthusiastic about the technology.

The solar taxi is designed as an electric car. It has a 5-metre trailer that is surfaced with six square metres of solar cells. A new type of battery stores the electricity, thereby enabling the car to be driven at night and when there is no sun. The daily range is about 100 km. If long distances are to be driven, the battery is recharged using additional solar energy from the grid. A photovoltaic system was installed specifically for this purpose on a roof in Bern, Switzerland.

14.3.3 Across Australia in Thirty-Three Hours

The World Solar Challenge is proving that solar cars are already capable of extremely high performance. This event has been taking place regularly in Australia since 1987 and is the most rigorous race in the world for solar cars. The race follows a route on public roads for around 3000 km right across Australia – from Darwin in the north to Adelaide on the south coast. The racing teams try to cover as great a distance as possible between the hours of eight in the morning and five in the afternoon.

The vehicles battling for first place in the race are technical masterpieces. The size of the batteries is restricted by the rules and the only energy allowed is what is supplied by solar modules that are mounted directly onto the vehicles. Powerful solar cells with efficiencies of well over 20% provide the necessary drive energy. The cars are optimized for aerodynamics and trimmed to a minimal weight. As a result of constant technical advances and more and more efficient solar cells, the average speeds of the winners have been increasing steadily. In 2005 it was



Figure 14.11 In 2007 the solar car from Bochum University reached average speeds of 73 km/h during the 3000 km race. Photos: Bochum University of Applied Sciences, <http://www.hs-bochum.de/solarcar.html>.

102.7 km/h. As Australia imposes speed limits on public roads, it will not be possible from a practical standpoint to increase this speed much further. Therefore, in 2007 the rules were changed to include limiting the size of the solar generator to six square metres and stipulating a seated position for the driver.

Teams from all over the world have been participating in the competition for many years. In 2007 the Solarworld No. 1 racing car from Bochum University of Applied Sciences reached fourth place (Figure 14.11). It took the team from Bochum around 41 hours of pure driving time to cover the 3000 km distance. The winning car Nuon Nuna II from the Netherlands just needed 33 hours.

14.3.4 Game over CO₂!

The German solar company SOLON AG presented a 100% carbon-free mobility concept in 2007 with the slogan ‘Game over CO₂!’. The central element of this concept is a new electric motorbike developed by the Vectrix company in the USA.

The two-seater reaches a peak speed of 100 km/h. Its good acceleration behaviour enables it to move quickly, particularly in city traffic. The nickel-metal-hybrid battery provides a range of 55 to 90 km of driving and can be recharged in two hours.

At the filling station of the future, which already operates successfully in a number of cities, tracked photovoltaic modules are used to charge the electric motorbikes (Figure 14.12). In the meantime the electric bike is being produced in unit quantities. Even if purchasers do not have a solar filling station nearby, they can operate the motorbike carbon-free using a photovoltaic system on a house roof or with renewable electricity from a green energy supplier. The Internet page www.game-over-co2.de makes very interesting reading, even for non-bikers.

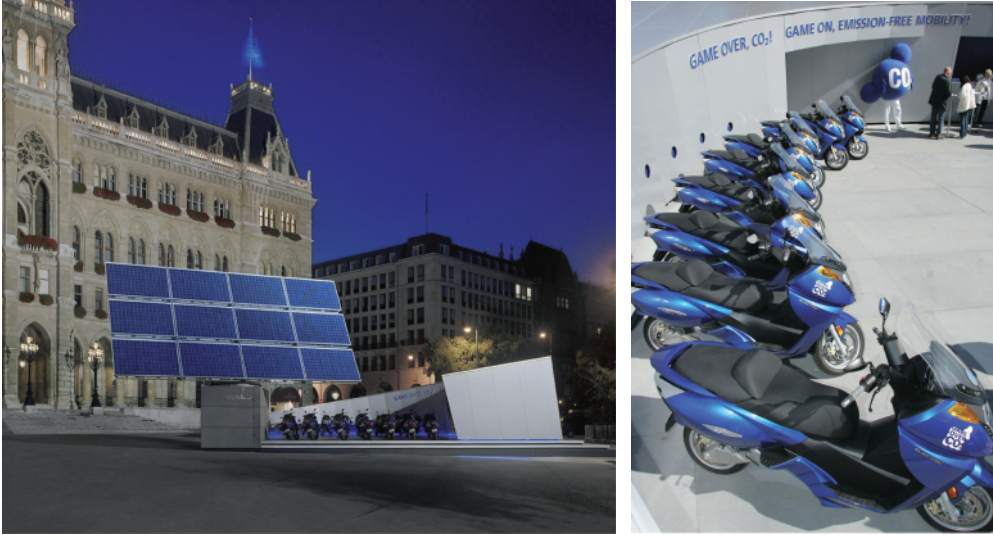

Figure 14.12 The filling station of the future was launched in Austria in 2007. It refuels electric motorbikes with carbon-free solar power. Photos: SOLON AG for solar technology. Photographer of photo left: www.marcusbredt.de.

14.4 Climate-Compatible Travel by Water or Air

14.4.1 Modern Shipping

As a result of globalization, goods are being shipped over ever-longer distances. A large part of the increase in transport is being handled by commercial shipping. The carbon dioxide emissions per transport kilometre are significantly lower with shipping compared to air freight. Nevertheless, shipping is also contributing noticeably to the greenhouse effect. Two to three percent of all global carbon dioxide emissions are attributed to shipping – and the rate is rising.

Until the middle of the nineteenth century, sailing ships dominated freight and passenger traffic at sea. Steamships then came along and had the advantage that they did not have to depend on wind conditions to keep to their timetables. They gradually replaced sailing craft, which today are used almost exclusively for leisure and sporting activities.

Yet new types of concepts exist that make wind power useable in combination with conventional ship propulsion. The German inventor Anton Flettner developed a cylindrical rotor to propel ships in the 1920s. However, this drive did not catch on at the time. New ship prototypes are currently in development, including the Flettner rotor combined with a conventional ship diesel drive, aimed at reducing fuel requirements from 30 to 40%.

Another interesting concept is based on modern power kites (Figure 14.13). A starting and landing system automatically lowers and raises the power kite and the cabling rope. The kite flies at a height between 100 and 300 m. The wind conditions at this height are higher and more constant than on the deck of a conventional sailing ship. The cabling rope, which is made of modern synthetic material, is attached to the forepart of the ship and transfers the driving force there to the ship. The steering of the kite is completely automated. Through a shortening or lengthening of the steering lines, a power kite can be controlled like a paraglider and orientated with optimal precision depending on wind direction, wind intensity and a ship's course. With a sail surface of up to 5000 square metres, the power output should reach up to 5000 kilowatts or 6800 HP. On a yearly average a power kite should be able to reduce fuel requirements, and consequently carbon dioxide emissions, by 10 to 35%. Under optimal conditions savings of up to 50% are sometimes possible.

Modern wind drives can therefore make a considerable contribution towards reducing carbon dioxide emissions. Emissions in shipping can even be eliminated completely if biofuel or renewably produced hydrogen is used to cover the rest of the fuel requirements of conventional ship drives.

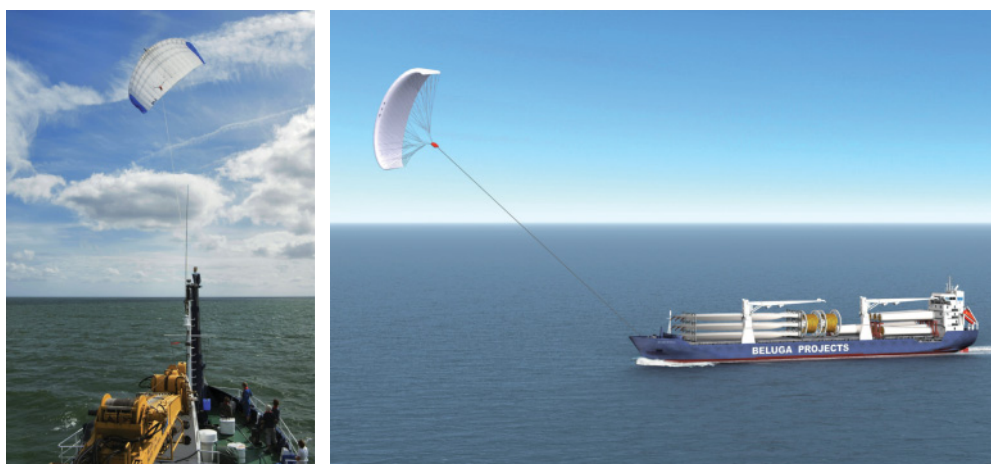

Figure 14.13 Modern automatically controlled power kites can reduce the fuel requirements of conventional shipping by up to 50% and, when combined with biofuels, even make it carbon-free. Photos © SkySails, www.skysails.de.

14.4.2 Solar Ferry on Lake Constance

Solar boats offer climate-compatible travel on water even if there is no wind, especially for short distances. The Helio solar ferry on Lake Constance has been connecting the German town of Gaienhofen to Steckborn in Switzerland since May 2000 (Figure 14.14). The 20 m ship can carry 50 people, and electric engines with an output of 8 kilowatts each provide for a maximum speed of 12 km/h. The batteries of the boat ensure a range of 60 to 100 km of travelling distance. The roof of the boat consists

of an optically very successful photovoltaic system that produces an output of 4.2 kilowatts, which provides most of the power needed for charging the batteries.

In addition to its climate-compatibility, this solar boat also offers other environmental benefits. It runs very quietly and, unlike conventional diesel engine ships, does not emit unpleasant exhaust fumes. The construction of the ship only causes minimal waves and, as a result, does not contribute towards any further erosion on the lake's shores.



Figure 14.14 The Helio solar ferry has been crossing Lake Constance since 2000. Photos: Bodensee-Solarschiffahrt, www.solarfaehre.de.

14.4.3 World Altitude Record with a Solar Aeroplane

Hot-air balloons were the first flying machines people used. Fire from firewood or straw produced the hot air needed for the carbon-neutral powering of a balloon. Today hot-air balloons are usually powered by natural gas burners. However, these balloons are highly unsuitable for freight transport or regular services. Without exception, propeller and jet-powered airplanes rule commercial aviation. The kerosene used is produced from oil, so the prospect of climate-friendly air travel is still a long way off.

But an unmanned light aeroplane called Helios, after the Greek sun god, shows that fossil fuels and flying do not have to be inextricably linked (Figure 14.15). The plane was developed by NASA and the California company AeroVironment and had its maiden flight in 1999. A total of 62 130 silicon solar cells with an efficiency of 19% are located on the wings, which have a span of 75.3 m and a depth of 2.4 m. These solar cells deliver the energy for 14 electric engines with a total output of 21 kilowatts. Powerful lithium batteries enable the plane to fly even after sunset.

Due to the low power output, the flight speed at low altitudes did not even reach 45 km/h. However, the performance of this aeroplane is not attributed to its speed but to its flying altitude. Flying over Hawaii at an altitude of 29 524 m on 13 August

2001, this plane set a world record for non-rocket-operated planes. Sadly, on 29 May 2003 it broke apart during a test flight and plunged into the Pacific Ocean near Hawaii.



Figure 14.15 NASA's Helios aeroplane, powered only by solar cells, set a new world record for altitude in 2001. Photos: NASA, www.dfrc.nasa.gov.

14.4.4 Flying around the World in a Solar Plane

The Swiss psychiatrist, scientist and adventurer Bertrand Piccard is hoping to have more luck with his solar aeroplane. He is mainly known for his trip around the world in a hot-air balloon in 1999. His newest project is called Solar Impulse. What he wants to do is circle the world in a glider that is powered only by solar energy. This undertaking is designed to be an effective PR exercise in proving the technical possibilities offered by renewable energies. Unlike the NASA Helios aeroplane, this will be a manned flight (Figure 14.16).

The planned start date is sometime in 2011. The first prototype of the aeroplane has already been built. It has a wingspan of around 61 m, weighs 1500 kg and is designed to fly at an average speed of 70 km/h. The main considerations in the construction of the plane were the incorporation of optimal aerodynamic properties and extreme lightness in weight. The wing surfaces are totally covered with solar cells. These supply enough energy to power the aeroplane without the need for any additional energy. During the day high-performance batteries store some of the solar energy so that the plane can also fly at night.

Whereas the prototype is only constructed for a 36-hour flight, a second aeroplane is being developed with enhanced capabilities to enable several days of flying time for flights around the world. This is necessary for crossing the Atlantic and bridging other large distances. During the daytime the solar power propels the aeroplane to heights up to 12 000 m. Powered by the solar energy stored in the batteries, the plane will then be able to hold steady at an altitude of around 3000 m until the morning.

Five stopovers are planned during the flight around the world. Each leg of the flight should take four to five days, which is as much as can be expected from one pilot. During stopovers the pilot will be changed and promotional activities will be organized.

With technical advances in batteries and a resulting anticipated reduction in weight, the aeroplane could be used for longer flights with two pilots. This would then bring a non-stop trip around the world in a solar aeroplane into the realm of possibility.



Figure 14.16 Bertrand Piccard of Switzerland aims to fly the aeroplane Solar Impulse round the world in 2011. Photos © Solar Impulse/EPFL Claudio Leonardi.

14.4.5 Flying for Solar Kitchens

Based on current technology, it does not seem likely that solar aeroplanes will ever be able to replace large conventional planes. Even with highly efficient solar cells, the space available on the surface of the wings is not large enough to provide sufficient driving energy for planes carrying loads of several hundred tons. With the exception of a very limited possible use of biofuels, there are no options offering complete climate-compatible air travel. In the long term renewably produced hydrogen offers an alternative to fossil fuels.

Until then the only carbon-free alternative available is no air travel at all. Modern communication technologies and more and more interesting leisure activities in close proximity to where people live are helpful alternative options to travel. But the solarium around the corner is not really a substitute for a winter break in a sunny resort. It makes it even more difficult to stick to one's principles if cheap flights are offered at the same price as a ticket for the local city train.

Section 3.5 of this book showed that, as an interim solution, investments in other areas can reduce as much carbon dioxide as created by an unavoidable flight. The carbon dioxide emissions of a flight from Berlin to New York and back can be offset for around 100 euros. As part of its programme, the non-profit company Atmosfair offers measures designed to compensate for emissions and at the

same time recommends considering videoconferencing and travel by train as alternatives.

For example, Atmosfair had large solar thermal systems installed in temples, hospitals and schools in different projects at 18 locations in India. One of the projects is a solar kitchen for a Hindu place of pilgrimage, Sringeri Mutt. Diesel burners had been supplying the energy to prepare meals for thousands of pilgrims until modern solar mirrors replaced them as part of the project (Figure 14.17). The mirrors bundle sunlight onto a pipe and heat the water, which is then fed to the kitchen. A cleverly devised steam system ensures that the kitchens can still function even after sunset. Another aim of the project is to implement a transfer of technology to local enterprises. The systems for all 18 projects were made by an Indian manufacturer and by 2012 should be offsetting a total of around 4000 tons of carbon dioxide emissions from air travel.



Figure 14.17 Solar-mirror systems financed through contributions from environmental protection funds replace conventional diesel burners in large kitchens in India. Source: atmosfair, www.atmosfair.com.

14.5 Carbon-Free Electricity for an Island

The combination power plant project described in Chapter 4 showed that completely carbon-free and reliable electricity supply based on renewable energies is technically possible if different renewable plants work together on a complementary basis. The prerequisite for renewable electricity supply is a large-scale grid interconnection, which is available almost everywhere in densely populated industrialized countries. Smaller grids in remote regions can also guarantee supply using individual renewable electricity power plants combined with storage facilities.

One example is the Utsira community in Norway. Around 215 inhabitants live here on a 6km square island 18km west of the Norwegian mainland. In a pilot project

started in 2004 two 600-kilowatt wind turbines are providing ten of the households with their complete supply of electricity (Figure 14.18). The electricity demand in Norwegian households is generally rather high as it is also often used to provide electric heating.



Figure 14.18 Two wind turbines on the Norwegian island of Utsira guarantee a carbon-free electricity supply for ten households. Source: Norsk Hydro ASA, www.hydro.com.

In contrast with a large interconnected grid system, this type of island grid offers some major technical challenges. For example, if two houses switch on their electric heating at the same time, major fluctuations will occur in the grid. Although the region is very windy, for safety reasons the wind turbines do not deliver any electricity during the rare periods of calm or when extreme storms occur. A reliable electricity supply also has to be available for these periods.

For this purpose a module for energy storage was tested in Utsira for future energy supply. When surplus capacity exists, an electrolyzer converts the wind power into hydrogen and oxygen. When the wind turbines supply too little electricity, a 60-kilowatt fuel cell makes up the difference using the stored hydrogen. In addition, when minor fluctuations occur, a flywheel storage device provides for a stable grid. For cost reasons the testing of the hydrogen storage technology was first limited to two years and was then extended in 2006.

14.6 All's Well that Ends Well

The variety of possibilities for using renewable energies described in this book, not least the examples in this chapter, have shown that it is actually unnecessary to endanger our future existence through an unrestrained use of crude oil, natural gas, coal and nuclear energy. The effects of fossil energy on the world's climate are already noticeable. The consequences of climate change will soon be beyond our

control if we do not take the bull by its horns and radically restructure our energy supply.

Renewable energies can already guarantee complete, affordable and climate-compatible coverage of our energy requirements. There is no basis for the widespread fear that the lights will go out if we cannot use oil, natural gas, coal and nuclear energy. On the contrary, increasing the use of renewable energies will make us more and more independent of the conventional energy sources that are now in short supply and steadily becoming more expensive. The use of renewable energies will also help to end some of the conflicts that are taking place at the moment.

The question that remains is why we are still using renewable energies on such a small scale. There are many reasons for this. First of all, the wider public is not being made sufficiently aware of the possibilities offered by renewable energies. An increase in information sources such as this book will, it is hoped, gradually close this gap in knowledge. On the other hand, everyone is hoping that the problem will somehow solve itself, many people do not really feel responsible or they have already given up hope. However, it is up to each and every individual to make a contribution and to demand the necessary measures from the politicians. If all of us start to use the possibilities open to us to save energy and use renewable energies, we will still be able to stop climate warming and establish a sustainable energy supply contribution.

Appendix

A.1 Energy Units and Prefixes

The legal unit of energy is called a watt second (Ws) or joule (J). The most common units of energy are normally measured in kilowatt hours (kWh). Table A.1 summarizes the units commonly used in the energy sector. Table A.2 shows the elements and prefixes for energy units.

Table A.1 Conversion factors between different units of energy.

	kJ	kcal	kWh	kg coal equivalent	kg oil equivalent	m³ natural gas
1 kilojoule (1 kJ = 1000Ws)	1	0.2388	0.000278	0.000034	0.000024	0.000032
1 kilocalorie (kcal)	4.1868	1	0.001163	0.000143	0.0001	0.00013
1 kilowatt hour (kWh)	3600	860	1	0.123	0.086	0.113
1 kg coal equivalent	29.308	7000	8.14	1	0.7	0.923
1 kg oil equivalent (oe)	41.868	10000	11.63	1.428	1	1.319
1 m ³ natural gas	31.736	7580	8.816	1.083	0.758	1

Table A.2 Elements and prefixes.

Prefix	Abbrev.	Value	Prefix	Abbrev.	Value
Kilo	k	10 ³ (thousand)	Milli	M	10 ⁻³ (thousandth)
Mega	M	10 ⁶ (million)	Mikro	μ	10 ⁻⁶ (millionth)
Giga	G	10 ⁹ (billion)	Nano	N	10 ⁻⁹ (billionth)
Tera	T	10 ¹² (trillion)	Piko	P	10 ⁻¹² (trillionth)
Peta	P	10 ¹⁵ (quadrillion)	Femto	F	10 ⁻¹⁵ (quadrillionth)
Exa	E	10 ¹⁸ (quintillion)	Atto	A	10 ⁻¹⁸ (quintillionth)

A.2 Geographic Coordinates of Energy Power Plants

Most energy power plants are so large that they are easy to detect in satellite images. The free software Google Earth enables satellite images with a high resolution to be viewed on one's own computer at home. The following list shows the coordinates of some interesting systems and power plants. The coordinates can be entered directly into Google Earth but must comply with the following format:





+51° 23' 23", +30° 05' 58"

This stands for 51°23'23" N and 30°05'58" E. Negative prefixes are used with S and W.





■ earth.google.co.uk
Google Earth start page and free download







Conventional Energy Power Plants

	51°23'23" N 30°05'58" O	Shut down nuclear energy plant in Chernobyl with 4 blocks each with 1000MW. A reactor accident occurred in Block IV on 26.4.1986. Today a cement sarcophagus encloses the damaged reactor.
	51°45'47" N 6°19'44" O	Fast breeders at Kalkar ; built for 3.6 milliard euros and never put into operation. Today the Wunderland Kalkar leisure park is situated on the grounds of the former nuclear energy plant.
	51°50'00" N 14°27'30" O	Jänschwalde brown coal-fired power plant containing 6 blocks each with 500MW. Built between 1976 and 1989. With an output of 25 million tons of carbon dioxide per year, this power plant has the highest emissions of any plant in Germany.
	51°04'30" N 6°27'00" O	Garzeiler II brown coal opencast mine. Around 1.3 tons of brown coal are to be extracted from an area of 48 square kilometres by 2045. As a result, 12 towns with 7600 inhabitants are to be relocated.



Photovoltaic Systems

	48°08'08" N 11°41'55" O	2.7-MW roof PV system with 21 900 PV modules on the new Munich exhibition centre . Built in 1997, expanded in 2002 and 2004.
	39°49'55" N 4°17'55" W	1-MW open space PV system with 7936 PV modules in Toledo, Spain. Built in 1994.
	52°31'29" N 13°22'05" O	Roof-integrated PV system on the main train station in Berlin . 780 photovoltaic modules supply an output of 189kWp.

Solar Thermal Power Plants

	37°05'42" N 2°21'40" W	Plataforma Solar de Almería European test centre in Spain with solar tower and parabolic trough test fields.
	42°29'41" N 2°01'45" O	Solar melting furnace in Odeillo (France), completed in 1970. With 20 000-fold concentration, 63 heliostats with a total area of 2835 square metres reach temperatures of almost 4000 °C.
	34°51'43" N 116°49'41" W	Solar thermal power plant at Daggett (California, USA). SEGS I with 13.8MW from 1985 and SEGS II with 30MW from 1986 plus 10-MW Solar Two solar tower-test power plant from 1998.
	35°00'58" N 117°33'40" W	Solar thermal power plant at Kramer Junction (California, USA). SEGS III to SEGS VII each with 30MW from 1987 to 1989.
	35°01'56" N 117°20'50" W	Solar thermal trough power plant at Harper Lake (California, USA). SEGS VIII and SEGS IX each with 80MW from 1990 to 1991.
	35°48'00" N 114°58'35" W	Solar thermal trough power plant Nevada Solar One (Nevada, USA) with output of 64 MW, commissioned in 2007.







Wind Farms

	55°41'32" N 12°40'14" O	Middelgrunden offshore wind farm (Denmark) with 20 wind turbines each with 2MW. Built in 2001.
	32°13'48" N 100°02'50" W	Horse Hollow Wind Energy Centre near Abilene, Texas (USA). 421 wind turbines supply 735MW. Built in 2006.

Hydropower Plants

	25°24'27" S 54°35'19" W	Itaipú hydropower plant (Brazil/Paraguay). 20 turbines supply a total output of 14GW. The dam wall is 7760m long and 196m high.
---	----------------------------	--

A.2 Geographic Coordinates of Energy Power Plants

	30°49'10" N 111°00'00" O	Three Gorges Dam in China. Built between 1993 and 2006. 26 turbines supply output of 18200 MW.
	36°00'58" N 114°44'16" W	Hoover Dam (Nevada-Arizona, USA). Built between 1931 and 1935. Height of dam wall 221 m. Total of 17 turbines with an output of 2074 MW.
	47°33'22" N 8°02'56" O	Run-of-river power plant Laufenburg on the Rhine in Germany. Completed 1914. Electricity output 106 MW.
	47°34'12" N 7°48'46" O	Rheinfelden run-of-river power plant on the Rhine in Germany. First run-of-river plant in Europe, built in 1899. Currently being modernized and enlarged.
	50°30'34" N 11°01'16" O	Pumped storage power plant Goldisthal in Thüringen, Germany. The upper basin contains 12 million m ³ of water. The power plant output is 1060 MW.
	48°37'08" N 2°01'11" W	Rance tidal power plant (Saint-Malo, France). Completed in 1966. 24 turbines supply 240 MW.



References

Arrhenius, S. (1896) On the influence of carbonic acid in the air upon the temperature of the ground. *The London, Edinburgh and Dublin Philosophical Magazine and Journal of Science*, **5**, 237–276.

Bard, J., Caselitz, P., Giebhardt, J. and Peter, M. (2004) Erste meeresströmungsturbinen-pilotanlage vor der englischen küste. Tagungsband Kassler Symposium Energie-Systemtechnik.

Bundesverband Solarwirtschaft (ed.) (2009) *Statistische Zahlen der deutschen Solarwirtschaft*, BWS, Berlin, www.solarwirtschaft.de.

Bundesverband WindEnergie e.V. BWE/DEWI (2008) Investitions- und Betriebskosten, <http://www.wind-energie.de/de/technik/projekte/kosten>.

Deutsches Windenergie-Institut GmbH DEWI (2002) *Studie zur aktuellen Kostensituation 2002 der Windenergienutzung in Deutschland*, Deutsches Windenergie-Institut GmbH DEWI, Wilhelmshaven.

Dreier, T. and Wagner, U. (2001) Perspektiven einer Wasserstoff-Energiewirtschaft. *BWK*, **53** (3), 47–54 und 52 (2000) Nr. 12, 41–54.

EnergieAgentur NRW (2006) *Stromcheck für Haushalte*, EnergieAgentur NRW, Wuppertal, www.energieagentur.nrw.de.

Enquete-Kommission ‘Vorsorge zum Schutz der Erdatmosphäre’ des 11. Deutschen Bundestages (ed.) (1990) *Schutz der Erdatmosphäre*, Economica Verlag, Bonn.

European Solar Industry Federation ESTIF (ed.) (2003) *Sun in Action II*, ESTIF, Brüssel, www.estif.org.

Fichtner (2003) Die Wettbewerbsfähigkeit von großen Laufwasserkraftwerken im liberalisierten deutschen Strommarkt. Bericht für das Bundesministerium für Wirtschaft und Arbeit.

Fritsche, U.R. and Eberle, U. (2007) *Treibhausgasemissionen durch Erzeugung und Verarbeitung von Lebensmitteln*, Öko-Institut Darmstadt.

- Gasch, R. and Twele, J. (eds) (2004) *Wind Power Plants*, Earthscan, London.
- German Federal Ministry for the Environment, Nature Conservation and Nuclear Safety (ed.) (2007) *Renewable Energy Sources in Figures*, BMU, Berlin, <http://www.erneuerbare-energien.de/inhalt/3860/>.
- IEA Solar Heating and Cooling Programme SHC (ed.) (2008) *Solar Heating Worldwide 2008*, IEA SHC, Graz, www.iea-shc.org.
- International Energy Agency, IEA (ed.) (2003) *Renewables Information 2003*, IEA, Paris, www.iea.org.
- International Energy Agency, IEA (ed.) (2008) *Key World Energy Statistics 2008*, IEA, Paris, www.iea.org.
- Intergovernmental Panel on Climate Change, IPCC (ed.) (2005) *Carbon Dioxide Capture and Storage*, Cambridge University Press, New York, www.ipcc.ch.
- Intergovernmental Panel on Climate Change, IPCC (ed.) (2007) *Climate Change 2007: The Physical Science Basis*, IPCC, Genf, www.ipcc.ch.
- Kaltschmitt, M., Merten, D., Fröhlich, N. and Moritz, N. (2003) *Energiegewinnung aus Biomasse*, Externe Expertise für das WBGU-Hauptgutachten, http://www.wbgu.de/wbgu_jg2003_ex04.pdf.
- Kemfert, C. (2007) Klimawandel kostet die deutsche Volkswirtschaft Milliarden, in *Wochenbericht des* (ed. KF Zimmermann), DIW, Berlin, pp. 165–169.
- Kleemann, M. and Meliß, M. (1993) *Regenerative Energiequellen*, Springer Verlag, Berlin.
- König, W. (ed.) (1999) *Propyläen Technikgeschichte*, Propyläen Verlag, Berlin.
- Lokale Agenda-Gruppe 21 Energie/Umwelt in Lahr (ed.) (2007) *Leistungsfähigkeit von Elektrowärmepumpen*, Zwischenbericht, Lahr.
- Mener, G. (1998) War die Energiewende zu Beginn des 20. Jahrhunderts möglich?, in *Sonnenenergie Heft*, DGS, pp. 40–43.
- Messe Hamburg WindEnergy (ed.) (2006) *Wind Energy Study 2006*, Messe Hamburg WindEnergy, Hamburg.
- Munich Re Group (ed.) (2006) *Topic Geonatural Catastrophes 2006*, Munich Re Group, Munich, www.munich-re.com.
- Quaschnig, V. (2007) *Regenerative Energiesysteme*, Hanser Verlag, München, 5. Auflage.
- Quaschnig, V. (2005) Energieaufwand zur Herstellung regenerativer Energieanlagen, <http://www.volker-quaschnig.de/datserv/kev>.
- Rahmstorf, S. (1999) Die Welt fährt Achterbahn, in *Süddeutsche Zeitung* 3./4.
- Rahmstorf, S. and Neu, U. (2004) *Klimawandel und CO₂: haben die 'Skeptiker' recht?*, Potsdam-Institut für Klimafolgenforschung, Potsdam, www.pik-potsdam.de.
- Schellschmidt, R., Hurter, S., Förster, A. and Huenges, E. (2002) Germany, in *Atlas of Geothermal Resources in Europe* (eds S. Hurter und R. Haenel), Office for Official Publications of the EU, Luxembourg, pp. 32–35.
- Tscheuschler, P., Nickel, M. and Wernicke, I. (2007) Energieverbrauch in Deutschland, in *BWK Heft* (ed. VDI), Springer, VDI, pp. 6–13.

References

Umweltbundesamt (ed.) (2007) *Stromsparen ist wichtig für den Klimaschutz*, Umweltbundesamt, Berlin.

United Nations Framework Convention on Climate Change UNFCCC (ed.) (2008) *National Greenhouse Gas Inventory Data for the Period 1990–2006*, UNFCCC, Posen, www.unfccc.de.

US Department of Energy DOE (ed.) (2008) *Annual Energy Review 2007*, US Department of Energy DOE, Washington, <http://www.eia.doe.gov/emeu/aer>.

Vattenfall Europe (ed.) (2006) *The Vattenfall CO₂-Free Power Plant Project*, Vattenfall, Berlin.



Index

- absorber 117, 146
 - coating 121, 148
 - selective 122
 - swimming pools 120
- absorption heat pump 227
- adsorption heat pump 228
- air collector 122
- alkaline electrolysis 269
- annual coefficient of performance 225
- anyway energy 16
- Archimedes 146
- arctic ice coverage 27
- atomic bomb 9

- barrel 6
- battery capacity 108
- Beaufort wind scale 170
- Betz power factor 171
- biofuel 270
- biodiesel 251
- bioethanol 252
- biogas 254
- biogas plant 255
- biomass 237
 - ecology 260
 - economics 259
 - fuels 250
 - heating 241
 - heating plant 249
 - markets 263
 - potential 264
 - power plant 250
- bio-oil 251
- BTL fuel 253

- bulb turbine 195
- bulk-stacked metre 243
- bypass diodes 95

- C4 plant 239
- calculation
 - battery capacity 108
 - collector efficiency 119
 - collector size 135
 - firewood boiler output 256
 - heat pump COP 225
 - hydropower plant output 205
 - installable photovoltaic power 103
 - photovoltaic efficiency 90
 - photovoltaic system yield 106
 - solar power plant output 157
 - storage size 135
 - wind power 169
 - wind power annual yield 183
 - wood pellet store size 257
- calorific value of wood 244
- carbon dioxide 35
 - balance sheet 63
 - biomass use 261
 - concentration 33
 - countries of world 31
 - food stuff 64
 - Germany 43
 - hydrogen production 274
 - paper consumption 65
 - petrol use 60
 - sequestration 72
 - traffic 59
- carbon dioxide-free power plants 73

- CFC 36, 233
- chamber system 202
- Chernoby I 10
- clean development mechanism 67
- climate change 24
- climate protection 42
- coefficient of performance 225
- collector 118, 146
- collector efficiency 119
- collector size 135
- combined heat and power 75
- compression heat pump 226
- concentrating photovoltaic 155
- concentration, solar radiation 157
- concentrator cell 155
- controlled ventilation 57
- convex mirror 146

- dam 199
- damage from natural catastrophes 27
- deep drilling 213
- depth geothermal energy 210
- depth gradient 213
- derrick 214
- design
 - firewood boiler 256
 - heat pump 228
 - hydropower plant 204
 - photovoltaics 103
 - solar heating support 136
 - solar power plants 156
 - solar thermal system 133
 - solar-heating of drinking water 134
 - wind power 183
 - wood pellet store 257
- direct-normal radiation intensity 157
- Dish-Stirling power plant 153
- DNI 157
- domestic water heating 125
- drag principle 171
- drilling
 - depth geometrics 213
 - heating pump 231

- Earth's core 210
- ecology
 - biomass 260
 - geothermal energy 220
 - heat pump 233
 - hydrogen production 273
 - hydropower 206
 - photovoltaics 112
 - solar power plant 160
 - solar thermal system 139
 - wind power 187

- economics
 - biomass 259
 - geothermal energy 220
 - heat pump 232
 - hydrogen 272
 - hydropower 206
 - photovoltaics 109
 - solar power plant 158
 - solar thermal system 138
 - wind power 184
- efficiency
 - biomass growth 239
 - biomass power plant 249
 - collector 119
 - fireplace 245
 - firewood boiler 246
 - fuel cell 272
 - open fireplace 245
 - ORC power plant 217
 - photovoltaics 90
 - steam turbine process 150
- electric car 284
- electric stove 49
- electricity generation costs
 - hydro power 206
 - photovoltaic 110
 - solar power plant 163
 - wind power 186
- electricity import 163
- electrolysis 268
- emissions trade 67
- energy consumption 13
- energy efficiency class 53
- energy 2
 - primary 14
 - reserves 20
 - saving 47
 - savings tips 54

- fast breeder reactor 11
- fireplace 245
- firewood boiler 245
- fish bypass 207
- Flatcon technology 155
- flat-plate collector 121
- float ball system 203
- fossil energy sources 4
- Francis turbine 195
- frequency distribution 183
- Fresnel collector 146
- fuel cells 270
- fuel yield per hectare 262

- gas stove 49
- geothermal depth gradient 213

- geothermal energy 210
 - ecology 220
 - economics 220
 - HDR power plant 218
 - heat plant 215
 - heat pump 223
 - markets 221
 - planning 219
 - power plant 216
- global wind circulation 167
- Goldisthal power plant 201
- gravity solar system 125
- green electricity 49
- greenhouse effect 30
- greenhouse potential
 - greenhouse gases 35
 - refrigerants 234
- Greenland ice 39
- gross domestic product 76
- ground collector 229
- Gulf Stream 41

- Hadley cell 167
- Harrisburg 10
- HDR, hot dry rock 218
- heat pipe 124
- heat pump 223
 - absorption 227
 - adsorption 228
 - coefficient of performance 225
 - compression 226
 - ecology 233
 - economics 232
 - heat sources 223
 - planning 228
 - markets 235
 - refrigerant 227, 234
- heat sources for heat pumps 224
- Helios solar aeroplane 290
- HFC 34, 234
- hot dry rock power plant 218
- Hurricane Katrina 28
- hydrogen 266
 - ecology 273
 - economics 272
 - markets 274
 - production 267
 - storage 269
- hydropower 191
 - ecology 206
 - economics 206
 - markets 207
 - ocean current power plant 203
 - pumped-storage power plant 200
 - run-of-river power plant 197
 - storage power plant 198
 - tidal power plant 201
 - turbines 194
 - wave power plant 202
- ice age 24
- ice coverage 27
- IPCC 37

- Jänschwalde lignite power plant 71
- joint implementation 67

- Kalina process 217
- Kalkar power plant 11
- Kaplan turbine 195
- kites 289
- Kvaerner process 267
- Kyoto protocol 44
- Kyryll storm 28

- laughing gas 35
- LH2, liquid hydrogen 269
- lift principle 171
- line concentrator 146
- liquid hydrogen 269
- lithosphere 212
- low-energy house 55
- low-energy light bulbs 52

- Manhattan project 9
- markets
 - biomass 263
 - geothermal energy 221
 - heat pump 235
 - hydrogen 274
 - hydropower 207
 - photovoltaics 113
 - solar power plants 161
 - solar thermal system 140
 - wind power 188
- maximum power point 91
- methane 34
- module price development 114
- molten carbonate fuel cell 272
- monocrystalline silicon 93
- MPP, maximum power point 91

- natural catastrophes 27
- natural gas storage 8
- nuclear energy 9
- nuclear fusion 12

- ocean current power plant 203
- offshore wind power 179

- oil
 - barrel 6
 - crisis 22
 - prices 23
 - reserves 20
- OPEC 5
- open fireplace 245
- open-circuit voltage 91
- ORC power plant 216
- orientation
 - photovoltaic system 174
- oxygenic photosynthesis 238
- oxyhydrogen reaction 265
- ozone 34
- ozone layer 35

- parabolic trough power plant 147
- partial oxidation 267
- passive house 56
- Pelton turbine 196
- PEMC, proton exchange membrane 271
- performance ratio 105
- petrothermal geothermal energy 218
- photosynthesis 238
- photovoltaic module 95
- photovoltaics 87
 - concentrator cell 155
 - ecology 112
 - economics 109
 - efficiency 90
 - functionality 88
 - grid-coupled system 99
 - island grid system 96
 - markets 113
 - module price development 114
 - optimal orientation 104
 - production 92
 - planning 103
 - thin film 95
- planning
 - biomass heating 256
 - firewood boiler 256
 - geothermal system 219
 - heat pump 228
 - hydropower plant 204
 - photovoltaic system 103
 - solar heating of drinking water 134
 - solar heating support 136
 - solar power plant 156
 - solar thermal system 133
 - wind power 182
- plug-in hybrid car 284
- plus-energy solar house 279
- point concentrator 147
- polycrystalline solar cell 92
- power factor 171

- power plant
 - biomass 248
 - brown coal 71
 - carbon dioxide-free 73
 - combined heat and power 75
 - combined renewable 85
 - concentrating photovoltaic 155
 - Dish-Stirling 153
 - geothermal 216
 - hot dry rock (HDR) 218
 - hydro 197
 - Jämschwalde 71
 - Neurath 72
 - nuclear 12
 - ocean current 203
 - Organic Rankine Cycle (ORC) 216
 - parabolic trough 147
 - photovoltaic 99
 - pumped-storage 200
 - run-of-river 197
 - SEGS 149
 - solar chimney 153
 - solar tower 150
 - storage hydro 198
 - tidal 201
 - wave 202
 - wind 177
- power-heat coupling 75
- primary energy 48
- primary energy requirements
 - biomass share 263
 - climate protection scenario 80
 - development worldwide 13
 - energy sources 16
 - heat supply 83
 - per head 15
 - transport sector 84
- production
 - biodiesel 251
 - bioethanol 252
 - BtL fuel 253
 - hydrogen 267
 - RME 251
 - solar cell 92
- proton exchange membrane fuel cell 271
- pumped-storage power plant 200
- PV, see photovoltaics 87

- receiver 150
- reduction targets 42
- refrigerant 227, 234
- refrigerating machine 227
- renewable energy import 163
- Renewable Energy Law 69
 - biomass power plants 260
 - geothermal power plants 220

- photovoltaics 111
- wind power 185
- renewable energy supply 84
- RME 251
- rotor blade 172
- round wood 242
- run-of-river power plants 197
- sailing ship 288
- sales of indulgences 67
- sea level rise 38
- secondary energy 48
 - consumption 50
 - traffic 59
- SEGS power plant 149
- selective absorber 122
- selective coating 121, 148
- semiconductor 88
- short-circuit current 91
- silicon 87
- solar
 - absorber 120
 - activity 29
 - car 285
 - cell 88
 - chemistry 155
 - collector 121
 - cooker 133
 - cooling 130
 - district heating 130
 - domestic water heating 125
 - energy 78
 - energy import 163
 - ferry 289
 - filling station 288
 - heating support 128
 - kitchen 292
 - mobile 285
 - oven 145
 - plane 290
 - share 134
 - swimming pool heating 131
- solar power plant 144
 - concentrating photovoltaic 155
 - Dish-Stirling 153
 - ecology 160
 - economics 158
 - markets 161
 - parabolic-trough 147
 - photovoltaic 99
 - planning 156
 - solar chimney 153
 - solar tower 150
- solar radiation energy
 - Europe 104
 - worldwide 156
- solar radiation types 157
- solar thermal system 116
 - design 133
 - domestic water heating 125
 - ecology 139
 - economics 138
 - heating support 128
 - markets 140
 - planning 133
 - power plants 144
- solar tower power plant 150
- solar-heated multiple-family house 279
- solid cubic metre 243
- solid oxide fuel cell 272
- stacked cubic metre 243
- standard test conditions 92
- standby losses 51
- STC, standard test conditions 92
- steam reforming 267
- steam turbines 148
- Stirling motor 153
- storage hydro power plant 198
- storage size 135
- stratosphere 36
- swimming pool absorber 120
- swimming pool heating 131
- tectonic plates 212
- temperature change 34
- temperatures, depths in Germany 213
- thermo-siphon solar system 126
- thin film photovoltaic module 174
- three-litre house 56
- tidal power plant 201
- tilt gains 105
- tower power plant 150
- tracking PV modules 100
- trade wind 167
- traffic 59
- transport sector 58
- trough power plant 147
- turbine
 - bulb 195
 - Francis 196
 - Kaplan 194
 - Ossberger 197
 - Pelton 196
 - wind 177
- uranium supply 12
- useful energy 48
- U-value 56
- vacuum flat-plate collector 123
- vacuum glazing 57

- vacuum insulation material 56
- vacuum tube collector 123
- ventilation system 57
- volumetric receiver 150

- wafer 93
- warming period 24
- water circulation on earth 192
- water turbine 194
- wave power plant 202
- wind global circulation 167
- wind power 165
 - design 182
 - charger 173
 - ecology 187
 - economics 184
 - farm 178
 - grid-coupled systems 174
 - island system 174
 - lift principle 171
 - markets 188
 - offshore 179
 - park 178
 - planning 182
 - turbine 174
- wind speed records 170
- wind speed, velocity 169
- window 56
- wood 242
 - wood briquettes 242
 - wood frame construction 56
 - wood moisture 244
 - wood pellet heating 246
 - wood pellets 242
 - prices 259
 - standard 241
 - wood-burning stove 245
- world population 77
- World Solar Challenge 286

- zero-emissions factory 283
- zero-heating cost house 280