

AT MICROFICHE
REFERENCE
LIBRARY

A project of Volunteers in Asia

People's Workbook

by Robert Berold et. al.

Published by:

Environmental and Development Agency
Box 62054
Marshalltown
2107 Johannesburg
SOUTH AFRICA

Available from:

same as above, or
Stichting TOOL
Entrepotdok 68A/69A
1018 AD Amsterdam
THE NETHERLANDS
Reproduced by permission.

Reproduction of this microfiche document in any
form is subject to the same restrictions as those
of the original document.

People's Workbook

working together to change your community



Getting Water From Well.

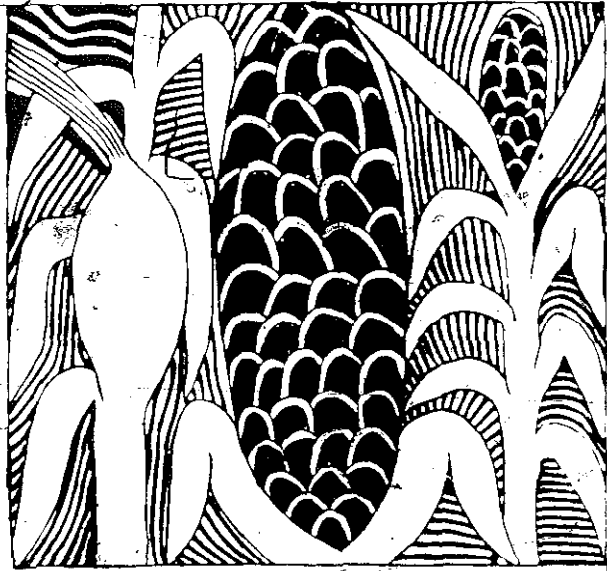

Field of Millet's in 1981.



People's Workbook

People's Workbook is published by the Environmental and Development Agency (EDA)
Box 62054, Marshalltown, 2107 Johannesburg, South Africa phone: 011 8341905
© Environmental and Development Agency 1981 ISBN 0 620 05355 0

Editors : Robert Berold, Collette Caine

Art Editor : Mary Anne Berold

Writers : Robert Berold, Collette Caine, David Cooper,
Ben Cousins, Sally Roberts, Melinda Silverman

Illustrators : Colleen Cousins (agriculture), Louise Naude (water),
Percy Sedumedi, Mieke Wesseling (health, legal rights,
building)

History Cartoon : Dick Cloete (research/script), Andy Mason (cartoon/
script), Biddy Partridge (lettering)

Classified section : Morice Smithers

Cover : John Muafangejo

Handwriting : Judy Clare, Roland Roding

Captions : Patti Henderson

Typing : Francie Norman

Layout : Mary Anne Berold, Thelma Cloete, Mieke Wesseling

Reproduction : The Graphic Equalizer

Printed and bound by : Sigma Press (Pty) Ltd, Pretoria

Distribution/Evaluation : Maano Tswana

People's Workbook was subsidised by grants from World University Service and
Inter Church Aid. A loan for printing costs was given by Inter Church Aid.

Thanks to everybody who helped us with this book:

Gavin Andersson, Paul Axelrod, Charles Bentley, Richard Bolus, Carol Cardoso,
Jillian Cargill, Beulah Cassim, Rob Collins, Sister Cora, Piers Cross,
Caroline Cullinan, Paul Daphne, Rick de Satge, Marge Dorling, Sheena Duncan,
Ross Duncan Brown, Anton Eberhard, Barbara Emanuel, Shelley Epstein, Herman
Fourie, Irwin Friedman, Wally Gilbert, Zoe Gilbert, Jenny Griffiths, Elin
Hammar, Prue Hosack, Kevin Humphrey, Marianne Kaplan, Deborah Katz, Liz Kistner
Roland Kingwill, Peter Kies, Bokellang Khave, Lesley Lawson, Mike Lazenby,
Learn and Teach, Peter Lee, John Lowes, Goodman Mabote, Caswell Makana, Sue
Milton, Frank Moran, Sue Moxley, June Niddrie, Tessa Oertle, Kathleen Parnell,
Jan Raats, Robyn Rafel, Anne Raynal, Giles Roques, Susan Rosenberg, Shelley
Sacks, Andrew Scott, Jo Smeddle, Wendy Taylor, Jane Tyrer, Paul Weinberg,
David Whittaker, Gareth Williams, Woodworkers Co-operative, Jenny Wright,
Merrick Zwarenstein, Anthony Zwi.

Thanks to the books from which we borrowed ideas or illustrations: East African
Crops, Liklik Buk, Radical Technology, Self-sufficiency, Small Water Supplies.

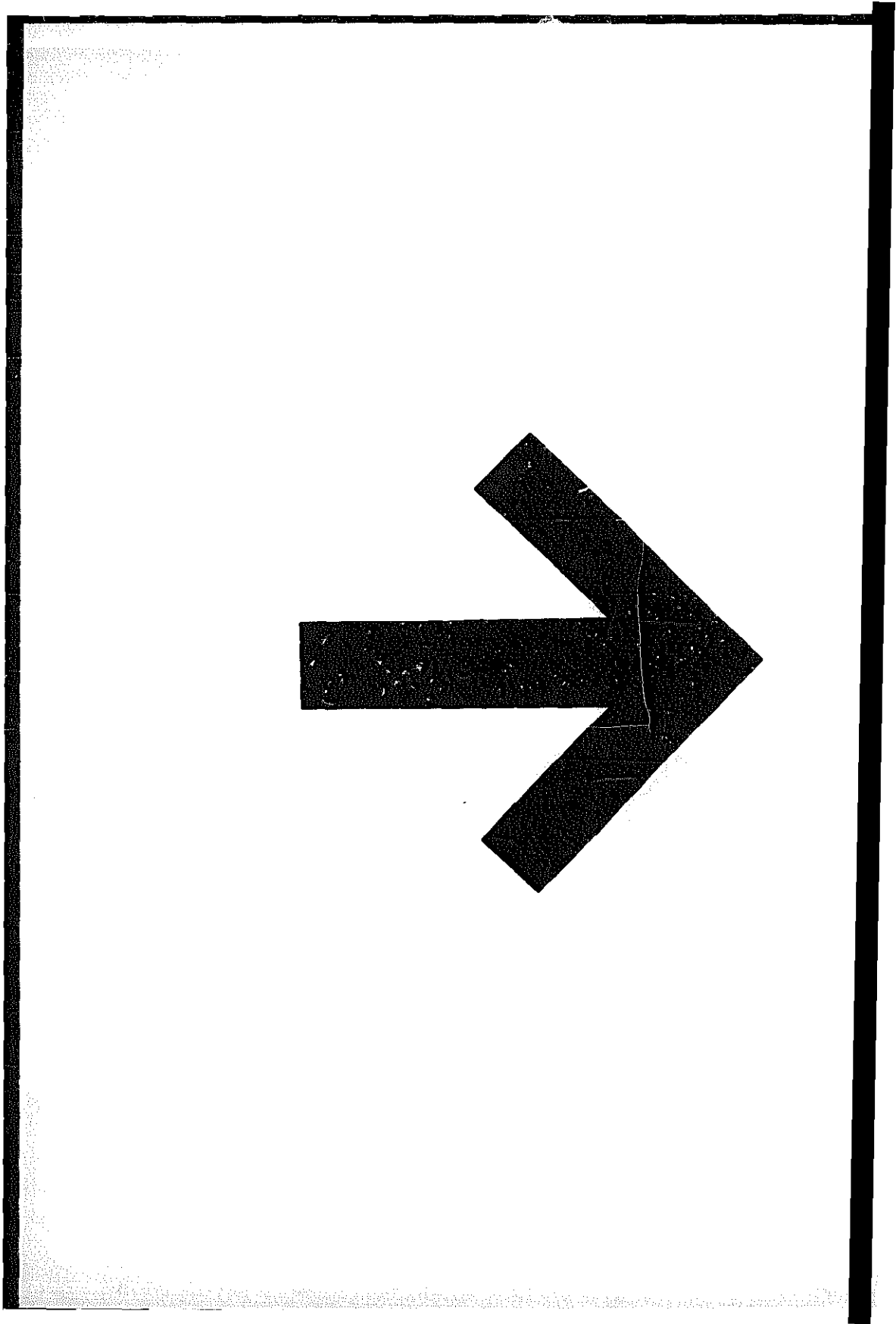

price (including postage and general sales tax)

South Africa : R10,00
All other countries : R11,00

A subsidised price is available for people who cannot afford this price. Write to EDA for details.

The History Cartoon will be published as a separate booklet.

Linocut prints of the front cover (without title) and the back cover can be ordered from the artist for R15,00 each (including postage). The front cover print is 41 x 41cm and the back is 41 x 59cm. Write to John Muafangejo, Box 57, Windhoek, 9000, Namibia.

EDA is an organisation which works with small village groups on agriculture, water supply, and other projects. We help communities organise themselves.

We started in 1977 with 3 people. There are now 16 people in the organisation. Some are based in rural villages, others travel to communities from our offices in Johannesburg and Pietermaritzburg. Our activities are:

■ Village workers. EDA people based in villages organise small groups to work in community gardens to plant trees, keep poultry, buy seeds and basic foods in bulk and improve water supply. They try to involve the whole community in making decisions about these activities. When they start production groups, they try to organise them as co-operatives.

■ Agriculture. EDA agricultural workers travel to villages and community groups to give advice and organise improvements in agriculture. They help communities order seeds and fruit trees and to sell their produce. They also run some research experiments to find out the best agricultural methods for the poor conditions that rural people live in.

■ Water supply. EDA water supply workers work on spring protection, small irrigation projects and hand drilled borehole projects in communities.

■ Publications. We publish a magazine, Link, 6 times a year, field reports by village workers and other publications on development in South Africa.

■ Community Health. We work to improve health in South Africa by trying to make all people working in health aware of the social and political causes of ill health. We do this through meetings and seminars with health workers and through different publications.

■ Education. We work closely with literacy groups. Most of our education work is in writing history which is easy for people to read and tries to give a true picture of South African history, especially the history of black people and their resistance against oppression.

■ Resources. We give information to many groups working in rural areas. We run a non-profit book service and we have a library from which people can borrow books. We have helped to train people in water supply work and motor mechanics. We also organise seminars to discuss problems of rural areas. We do not lend or grant funds to community groups, but we try to help projects find funds from other organisations.

Contents

Introduction	7
Vusi Goes Back	9



<u>Agriculture</u>	31
<u>Homestead farming</u>	32
Growing vegetables	33
Sowing guide for vegetables	38
How to grow tomatoes	42
How to grow onions	46
How to grow spinach	48
Making compost	50
Trenches	52
Tool hire to buy scheme	53
Keeping pigs	56
Slaughtering a pig	59
Keeping rabbits	62
How to keep chickens	64
Chicken diseases	74
Interview: chicken co-operative	76
Ducks and geese	78
Dairy goats	80

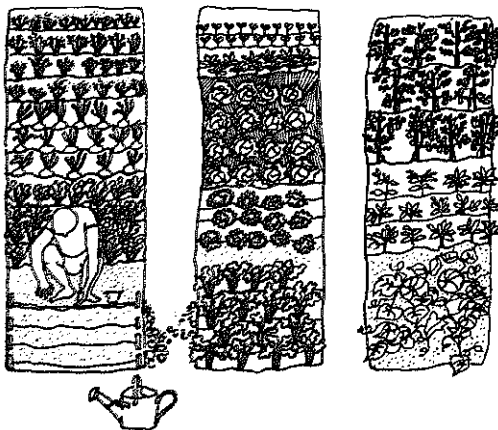

How to produce a lot of food from a small garden	83
Beekeeping	85
Selling to a market	88
Interview: fruit sellers	88
Interview: farm school	90

<u>Crops</u>	93
Know your soil	97
Land preparation	100
Contour banks	101
Draft power	103
Working animals	106
Animal tools	109
Tractors	111
Interview: tractor hire scheme	113
Intercropping	117
Planting in rows by hand	118
Chemical fertilisers	120
Controlling pests and diseases	122
How to weigh and measure	124
Irrigation	134
Fencing	137
Storing and milling	139
Agricultural extension officers	142
Maize	133
Interview: maize farmer	147
Sorghum	148
Interview: sorghum farmer	150
Potatoes	151
Sweet potatoes	153
Beans	155
Cowpeas	157
Soyabeans	158
Groundnuts	160
Pumpkins	162
Squashes	163
Cassava	164
Sunflowers	166
Wheat	168
Interview: wheat farmer	169
Lucerne	170
Cotton	172
Interview: cotton farmer	174
Tobacco	176
Interview: tobacco farmer	179
Sugar cane	180

<u>Trees</u>	183
Planting trees	184
Pruning	186
Apples	188
Peaches	188
Apricots	189
Plums	190
Pears	190
Nuts	191
Mulberries	192
Figs	192
Grapes	192

Interview: fruit farmer	194
Citrus	195
Guavas	196
Mangoes	197
Avocados	198
Bananas	199
Pawpaws	200
Pineapples	200
Pests and diseases	202
Trees for animal food	204
Trees for wood	206
How to make a mud stove	210
Hayboxes	216
Interview: using mud stoves	216
Using the sun	218
Interview: solar cooking	218
Preventing soil erosion	220

<u>Animals</u>	223
Cattle	224
Cattle Diseases	228
Interview: cattle farmer	232
Interview: dairy farmer	233
Dairy cattle	234
Sheep	236
Interview: sheep farmer	239
Goats	240
Rotational grazing and pastures	240
Winter feeding	243
Farm records	245

Water 250



Interview: pump committee	251
Rain water	252
Interview: using underground tanks	254
How to protect a spring	256
Wells and boreholes	262
Drilling a borehole by hand	264
Hand dug wells	268
Pumps	269
Interview: making hand pumps	272
How to make a hand pump for irrigation	274
Water storage	284
Dams	286
Fishing	288
Making water safe to drink	289

Health 291

<u>Pregnancy and childcare</u>	293
Having your baby at home	300
Breastfeeding	306
Artificial feeding	309
Eating the right food	311
Interview: nutrition rehabilitation	312
Under 5 clinics	314
Childhood illnesses	316
Malnutrition	317
Gastro-enteritis	318
Measles	322
Whooping Cough	322
Thrush and cystitis	323
Headlice	324
Scabies	324
Worms	326
Ringworm and eczema	327
Interview: village health workers	328
First aid	330
Burns	332
Interview: health worker training	334
Poisoning	336
Wounds	336
Bites	336
Broken bones	340
Serious illnesses	341
Tuberculosis (TB)	341
Pellagra	341
Alcoholism	341
Venereal disease (VD)	341
Cancer of the cervix	341
High blood pressure	341
Malaria	341
Tetanus	341
Bilharzia	341
Typhoid	341
Cholera	341
Birth control	35
Contraceptives	35
Interview: abortion	35



Legal Rights

357



Pass laws	358
Migrant worker contracts	362
Interview: pass laws	364
Trade unions	368
Interview: trade unionist	370
Unemployment insurance	375
Workmens' compensation	377
Domestic workers' rights	378
Pensions and grants	379
How to budget	382
Birth certificates	386
Adoption	387
Marriage laws	388
Divorce laws	389
Dealing with the Police	390
Making a will	391
Hire purchase	393

Working in Groups

399

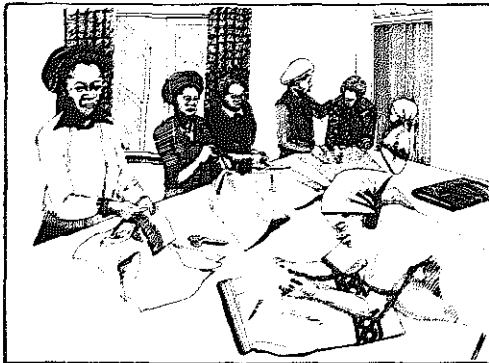

Making clothes	404
How to make a blanket jacket	408
Sewing machines	411
How to thread a sewing machine	412
Interview: sewing group manager	416
Knitting	418
Dyeing	418
Blockprinting	420

How to make shoes and sandals	422
Making candles	432
Interview: production group workers (1)	433
Interview: production group workers (2)	435
Fixing cars	437
Making furniture	442
Interview: woodworkers co-operative	456
Education	461
Learning to read and write	462
Interview: literacy group	464
Interview: community newspaper	466
Interview: museum	468
Interview: popular theatre	470

Building

473

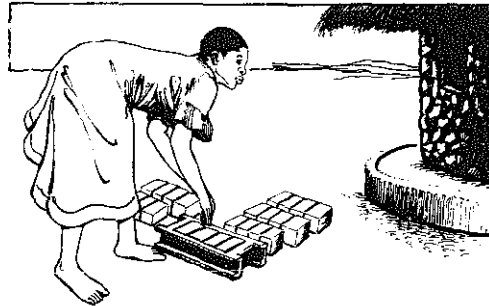

Interview: traditional builder	475
Where to build	476
How to make a water level	479
Foundations	481
Walls	484
Making bricks	487
Soil cement	488
How to build a wall	489
Doors and windows	492
Floors	494
Roofs	494
Using the sun to heat water	495
How to build a creche	496
Interview: creche	502
How to build a flyproof pit toilet	504
Farm buildings	509

Suppliers, Advice Organisations, Books

Suppliers	512
How to organise a seed buying group	531
Food buying groups	533
Advice organisations	534
Books	545
Starting a library	546
Index	556

Introduction

We wrote this book to give people in the rural areas of South Africa some of the information they need to help organise their communities and improve their lives.

Most people in rural areas are poor and short of food and land. Many are unemployed. Many cannot read or write. In this book we have tried to show how these things have happened. To improve things in rural areas there will have to be big changes like redistributing land and changing the migrant labour system. Only when people have the basic things they need, like having enough food and water, will some of the problems of rural areas be solved. It will take a lot of organisation and struggle to get rid of diseases like malnutrition and gastro-enteritis. But in the meanwhile there are some things people can do to prevent these diseases in their communities.

It takes a lot of cooperation and organisation for people to work together. Sometimes people have to be trained, for example health workers. Sometimes everybody has to collect money to buy something, for example a water pump. Or everybody has to join together to demand that the government does things, for example build a road or a school. Throughout this book we have given examples of how people have struggled to do these things, how they have tried to organise themselves, and how they have succeeded or failed.

We believe that the best kind of organisation is democracy : when everybody has an equal say and people decide together what they want to do. Democratic organisations are stronger because everybody is involved.

Rural communities in South Africa have suffered. They have been broken up by the migrant labour system. People have been moved and resettled to barren places. Because of these problems, it is difficult for people to organise democratic groups. We think that the information in this book will be useful for people trying to form such groups.

Some of the ways people could use this book could be:

- People who can read and write can read the book to people who can not read.
- People who are learning to read and write English can use the book for lessons.
- People can start a group to read the book, or to read parts of it, and then discuss and try out some of the information.

We believe that everybody can share in doing things, not just nurses, extension officers and teachers. Some people think that only people who have been educated in schools know how to do things.

In different articles in the book we say you can ask your nurse or agricultural extension officer to do things to help you. These people are supposed to help communities, but sometimes they can not because they have not been trained properly or because they do not have funds for proper equipment. If you are a nurse or an extension officer reading this book, you should work with your community to demand better training or equipment from the government. The government's money comes from the work and taxes of the people and they have a right to demand things.

We would like many people to use this book. If you think it would be more useful in other South African languages we could translate it, or translate parts of it. If we write it again we would like to improve it, and we would welcome any comments you want to make.

Vusi Goes Back

Vusi goes back to visit his family in the Transkei, and finds that his people are suffering. His grandfather takes him back in time, to the days of his forefathers, and he discovers why...

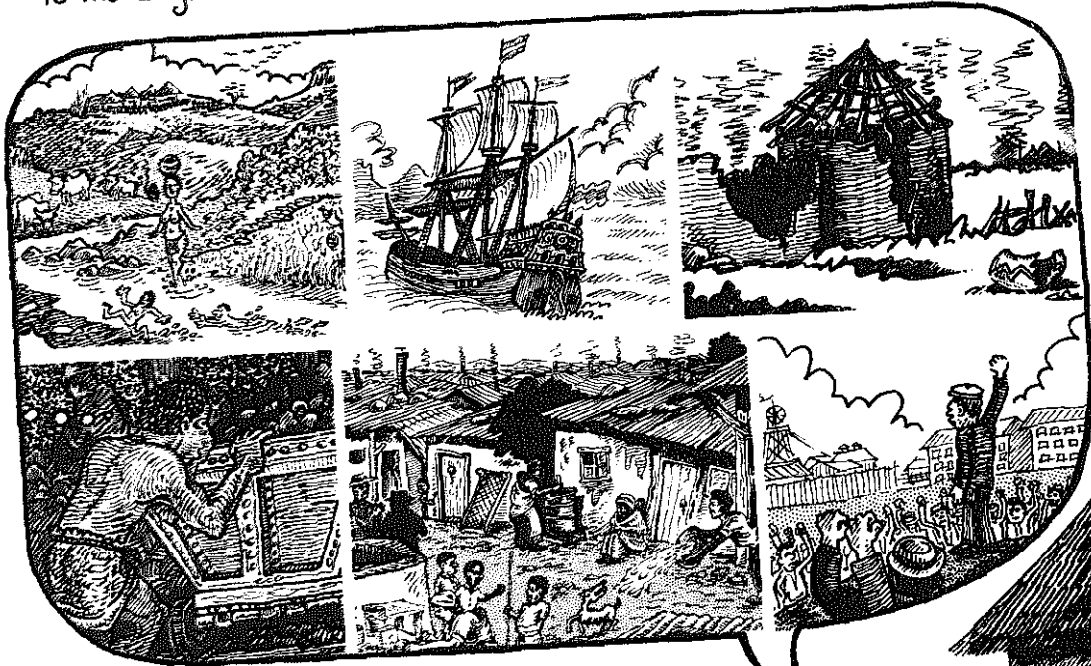

Vusi Goes Back



Friday afternoon at Park station.

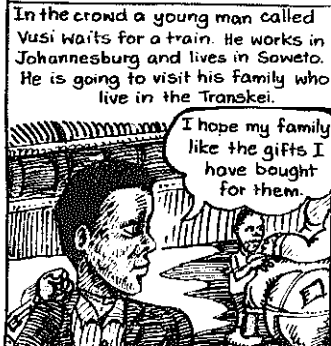

In the crowd a young man called Vusi waits for a train. He works in Johannesburg and lives in Soweto. He is going to visit his family who live in the Transkei.

I hope my family like the gifts I have bought for them.



The train soon leaves the city behind.

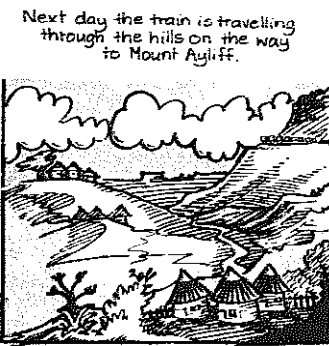

Next day the train is travelling through the hills on the way to Mount Ayliff.



Vusi travels the last part of the journey by bus.

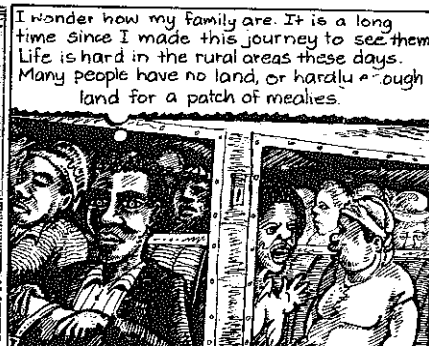

I wonder how my family are. It is a long time since I made this journey to see them. Life is hard in the rural areas these days. Many people have no land, or hardly enough land for a patch of mealies.

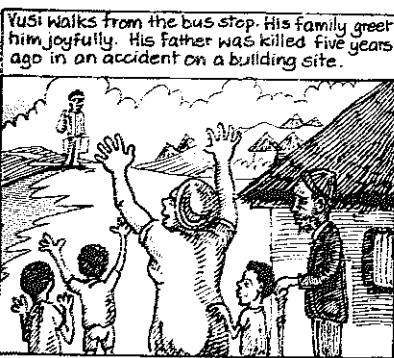

Vusi walks from the bus stop. His family greet him joyfully. His father was killed five years ago in an accident on a building site.



After he has given them the presents he has brought, they sit down to eat. It is good to see you, my son. It is a long time since you were here last.

I am happy to be with you again.

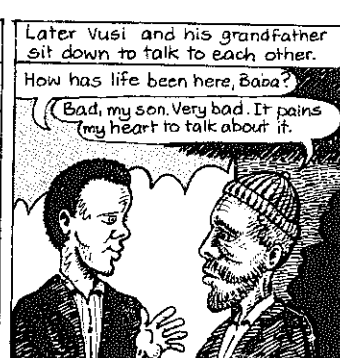

Later Vusi and his grandfather sit down to talk to each other.

How has life been here, Baba?

Bad, my son. Very bad. It pains my heart to talk about it.

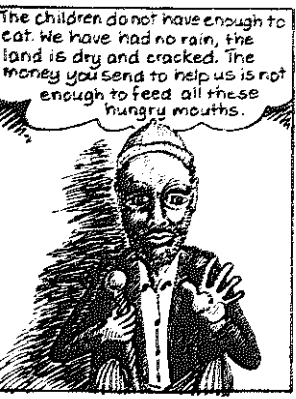

The children do not have enough to eat. We have had no rain, the land is dry and cracked. The money you send to help us is not enough to feed all these hungry mouths.

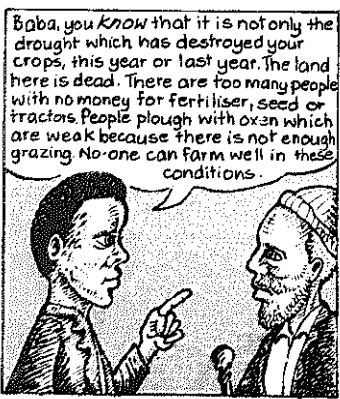

Baba, you know that it is not only the drought which has destroyed your crops, this year or last year. The land here is dead. There are too many people with no money for fertiliser, seed or tractors. People plough with oxen which are weak because there is not enough grazing. No-one can farm well in these conditions.



Things were not like this in the days of our forefathers. In those days people had enough to eat.

Every family had land in those days. The boys and young men watched over the cattle and sheep. These animals gave meat, milk and skins for food and clothing.



The people also got meat and skins from hunting. Long ago the country was full of animals.



The women spent much of their time in the fields. They grew many crops to feed the people.



The people in the villages produced all the food they needed. They made clothes from skins and pots from clay. From reeds and grasses they made mats and baskets.



People got the things they were not able to make for themselves by trading with other villages.



In some areas people mined iron and copper. They used the metals to make hoes, axes, spearheads, knives, bangles and beads. The iron workers traded these things for cattle, skins, grain and tobacco from other villages.

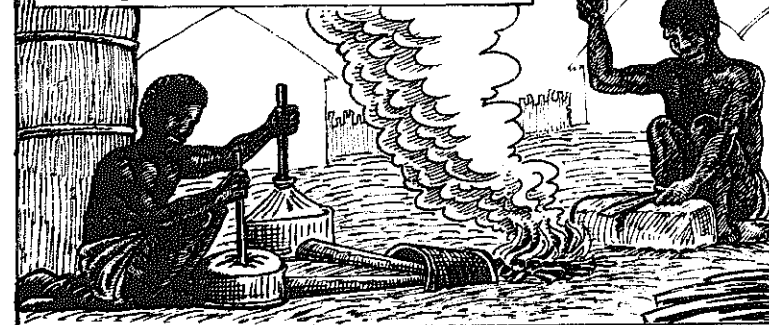

Long ago people owned the land together. The chief and his council ruled but they answered to the people. Not like today when the chief is a civil servant who answers to a government that cares little for our problems.

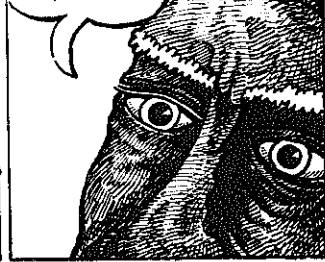

It is true, what you say, Baba. But all this was a long time ago. People also had many problems then. Although there were a lot less people on the land they were not able to live in peace. Look at all the fighting at the time of the Mfecane.



You are right, Vusi. No time is without troubles. But you must understand why there was so much fighting at the time of the Mfecane. It was a time of great changes for the people of Africa.



Trade with Arabs and with whites who came across the sea was increasing. These traders brought beads and cloth to exchange for the ivory, skins and cattle which the people of Africa produced. As trade increased, people competed to control the trade and enjoy its profits.



This was happening at a time when the population had greatly increased. There were arguments over control of hunting grounds and mines. People also argued over land and grazing and water for their growing herds. Such questions are never settled without a struggle. Our people needed to create new forms of government to meet these changes.



A terrible drought in Zululand made things worse. Fighting between chiefdoms spread right across Zululand and beyond. Those who lost their land in Zululand like the Ndwane, Hlubi and Ndebele people fled to the highveld. Without land or cattle, they attacked those living on the highveld. The fighting spread right across Southern Africa.



This was a terrible time for many people, Vusi. But out of the disorder and fighting there came a new order. The African people created new forms of government to solve the problems caused by trade and population growth. Out of the fighting came larger, more powerful chiefdoms like the Zulu chiefdom of Shaka and the Sotho chiefdom of Moshoeshoe. The people under their rule lived without fear. After the fighting there were no longer so many small groups of people, but a few large kingdoms like the Sotho, Tswana, Zulu, Pedi and others.



Baba, I can see that you have thought much about the history of our people.

That is true, Vusi. But after the fighting there must still have been many people who lived in small groups. What happened to them?



These people were left weak and divided by the fighting. They struggled to protect themselves. They lost their cattle in raids. They were unable to plant and harvest their crops. The white invaders who entered the country from the Cape at this time found them an easy prey.

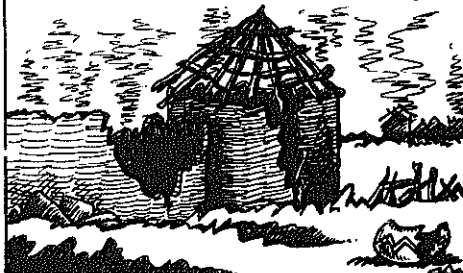

So that is where the white man enters the story!

Right! Until this time the whites had not spread beyond the Cape. But this is a long story. The sun has set and it grows cold. Let us go inside. We can continue our talk there.



Vusi and his grandfather remain awake by the fireside talking long after the rest of the family have gone to sleep.

The first white settlers were sent to grow crops and herd cattle to supply food to the trading ships.



I know. They were sent in 1652 by the Dutch East India Company. We learnt the white man's history at school.

It is a pity you did not pay more attention to the history of the African people, passed down from generation to generation.



At first when the Dutch came to the Cape



the black people who lived there, were happy to trade with them. These were the Khoikhoi people. The Dutch traded to get cattle from them.

But the Khoikhoi became angry when the Dutch people started taking their grazing lands round Table Mountain. The settler farmers prevented the Khoikhoi from grazing and watering their cattle. In less than ten years war broke out between the Khoikhoi and the settlers.



This was the first of many struggles by the black people to regain their lost land. In the wars that followed, the Khoikhoi lost not only their land, but their herds and flocks as well.



Although the Khoikhoi fought bravely, they were often divided amongst themselves. Some even fought for the white settlers who promised them a share of the captured cattle.

So that is how the Khoikhoi lost their land.

Yes Vusi. Divisions amongst our people have often led to weakness.



Five generations after their arrival the settlers had taken over all the lands from Table Mountain to the Fish River. Without land, cattle or sheep, many Khoikhoi were forced to become labourers on the white farms. They herded the stock and filled the soil that had once been theirs.



The settlers did not stop at the Fish River... Every son of a Boer settler wanted a farm as big as his father's. And the Boers had many sons.



Along the banks of the Fish River and beyond lived the Xhosa speaking people, our forefathers. Now they faced the threat of the advancing settlers. But that is another story, Vusi. I can see you are tired and it is late for an old man like me. Let us sleep.

But you will tell me more of our people's history, eh Baba?

Yes Vusi, tomorrow.

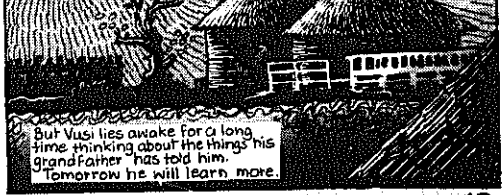

But Vusi lies awake for a long time thinking about the things his grandfather has told him. Tomorrow he will learn more.

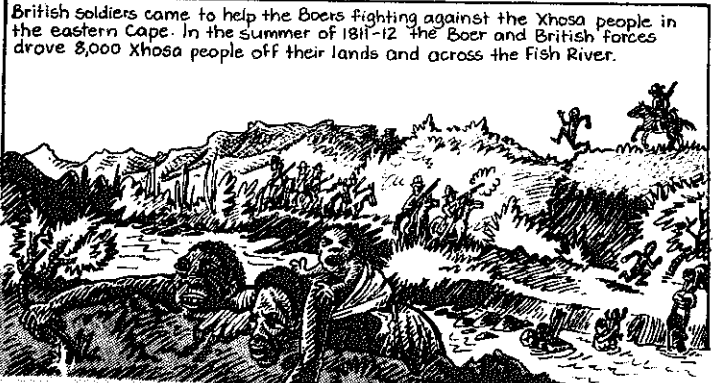
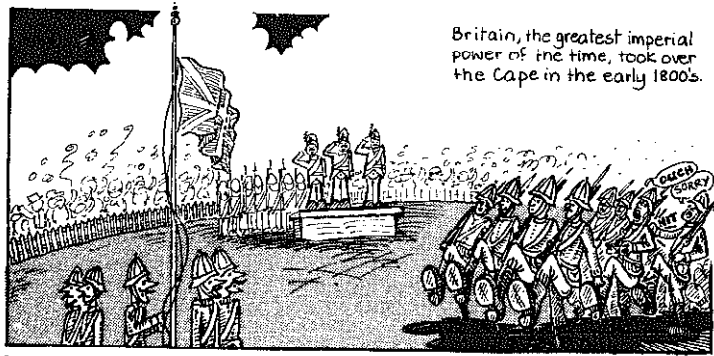
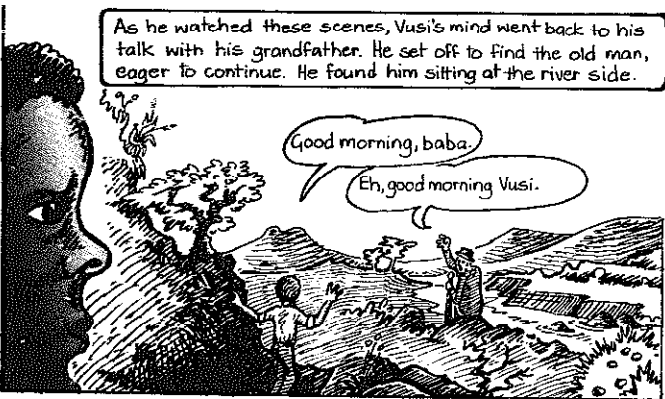
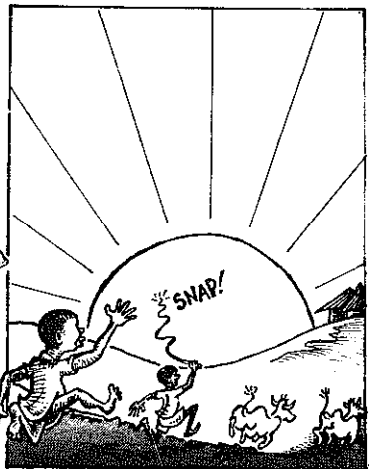

Like the Khoikhoi, rivalries between chiefdoms divided the Xhosa. They lost more and more of their land to the Boers and the British settlers who came to the Eastern Cape. The struggle that began there continues today. My forefathers fought in those wars. What they lost, I have lost.



All I have to show for my hard life of labour are three cows and a few goats. But you are more fortunate than many, Baba.

Yes, Vusi. That is the sad truth. Our people no longer enjoy the life I spoke of last night. Now the land is scarred like the body of an old warrior. These dongas are the scars of too many people trying to live off this poor soil that is left to us. Our children starve, Vusi.

But it is the same everywhere in South Africa, Baba.



Yes Vusi, wherever the white settlers spread into the lands of the African people, taking that land for themselves. The Cape did not satisfy them for long. In the Cape the Boers were angry that the British did not send more soldiers to help them fight. There was also the question of slaves. The settlers were used to having many slaves to work on their farms.



But the British government wanted to free the slaves.



They thought it was better to control wage labour with passes and contracts.

But the settlers did not want to pay for their labour. They preferred slave labour.



But the British freed the slaves and used passes and labour contracts to control workers. The Boers began to move away from the Cape to find new land and be free of British control.



They moved north, crossing the Orange river with their wagons, taking their families and animals with them.



They knew that there were good grazing lands and many animals to hunt further north.

That was the great trek, Baba? We learnt about that at school.



They taught us that the Voortrekkers were very brave people, Baba. But they said that the black leaders, like Dingaan, the Zulu chief who killed the trekker leader, Piet Retief, were very treacherous.

They call a man who was trying to protect his country from invasion treacherous, Vusi. But they do not reach about the bravery of the African people who fought to protect their land.

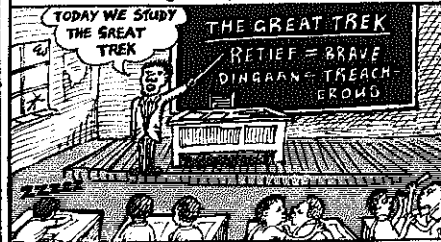

Tell me their story, Baba.

The trekkers got land easily between the Orange and Vaal rivers, from people weakened by the Mfecane. Some chiefs allowed the trekkers to graze their cattle. They hoped to get protection from the trekkers' guns. But instead they lost their land and their independence. Their people had to give tribute in cattle and crops to the whites. The fertile lands of Natal attracted many trekkers. Dingaan, the Zulu king, knew about the fighting in the Eastern Cape. He knew the settlers had taken the land of the African people and turned them into servants. So Dingaan tried to stop the settlers going to Natal.

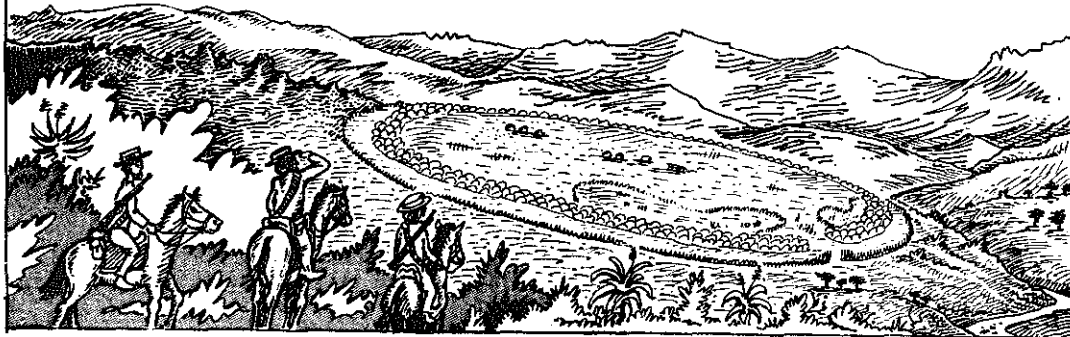

Dingaan had the trekker leader Piet Retief put to death and sent the Zulu army to drive out the trekkers.

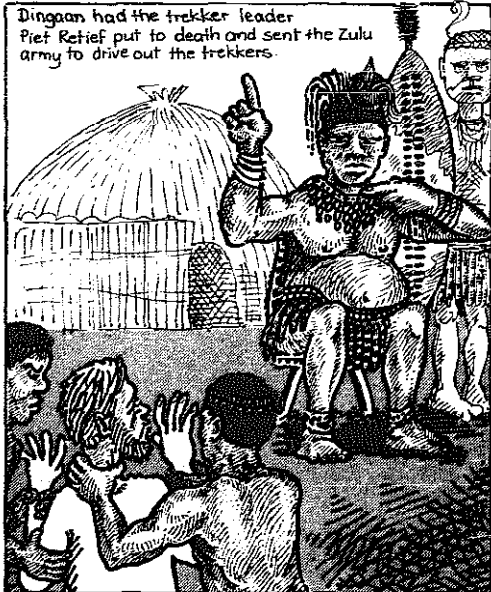

Protected by laagers of wagons, the trekkers used their guns to drive off the Zulu army. In the fighting that followed, thousands of Zulu soldiers were killed. Their bravery counted for little against the might of the trekkers' guns. The Zulu people had to allow the trekkers to settle in that part of Natal south of the Tugela river. The trekkers took many thousands of Zulu cattle after the war.

But these trekkers did not enjoy their stay in Natal for long. The British wanted to control the harbours of Southern Africa to protect their trade. They also feared that trouble between the black people of Natal and the trekkers was going to affect the Cape. So in 1842 the British took over Port Natal. Rather than live under British rule the trekkers set off once more to find land, this time north of the Vaal river.





The trekkers did not have an easy time in the north. There were powerful chiefdoms across the Vaal river. Like the Tswana chiefdoms in the west and the Pedi and Swazi in the east, these chiefdoms and others like the Venda fought well against the Trekkers. They got guns to fight with and this took away some of the advantage of the trekkers.

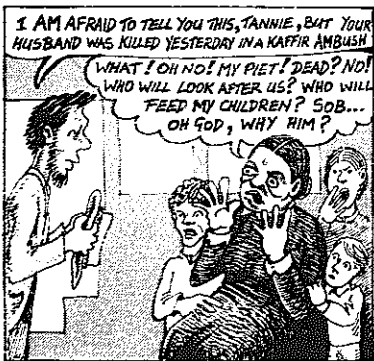

This strong resistance caused many problems for the trekkers. Their economy was weak compared to that of the African chiefdoms across the Vaal.

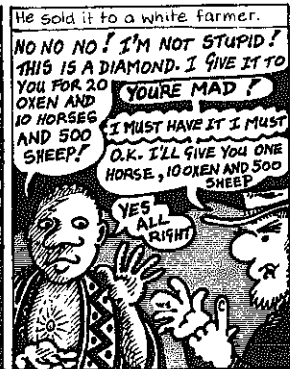
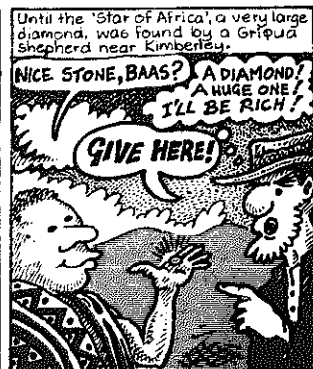
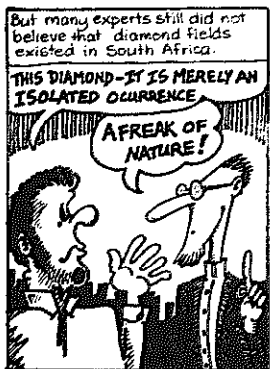
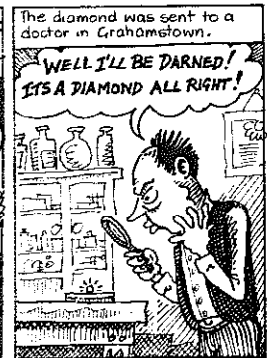
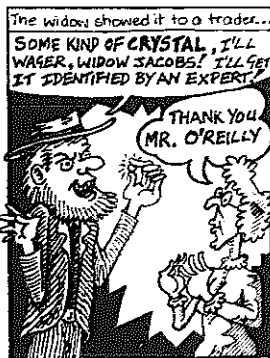
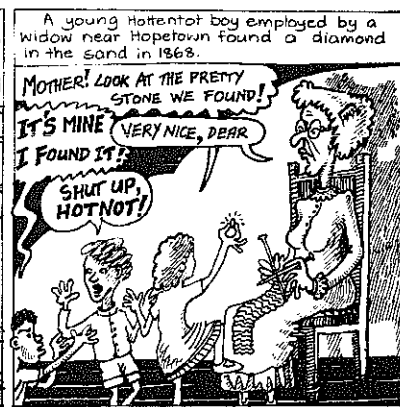
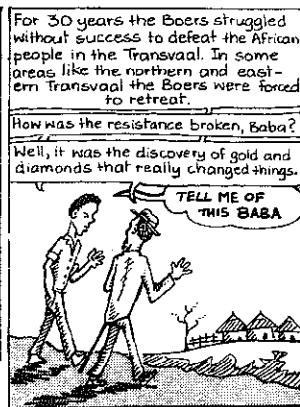

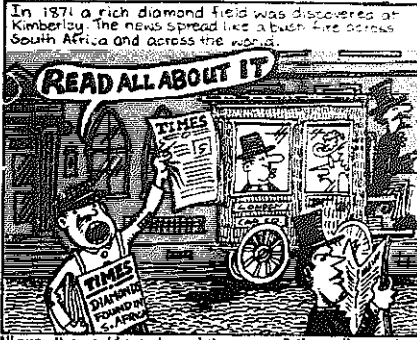

In 1871 a rich diamond field was discovered at Kimberley. The news spread like a bush fire across South Africa and across the world.

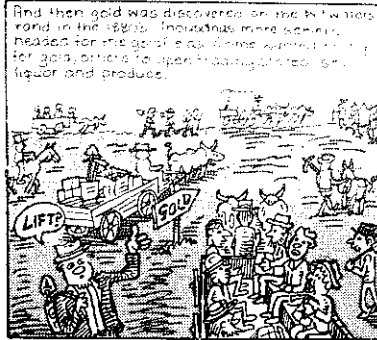

And then gold was discovered on the banks of the Vaal river in the 1880s. Thousands more came, headed for the gold fields. Some arrived with liquor and produce.



So there were now people mining for gold and diamonds. The British government wanted to control the mining and the diamonds in the gold fields. It took a long time to get the mining laws passed. That meant they upset the Boers.



The settlers wanted black people to work in the new diamond and gold mines. But not many black people were interested. They were too busy herding cattle and growing crops.



Some people who had lost their land went to work on the mines. Others came for a while to earn money to buy guns to defend their land against the white settlers.



The settler governments did not allow black people to buy guns, but they needed wage labour on the mines, and there were always whites eager to make money selling guns to the workers illegally.

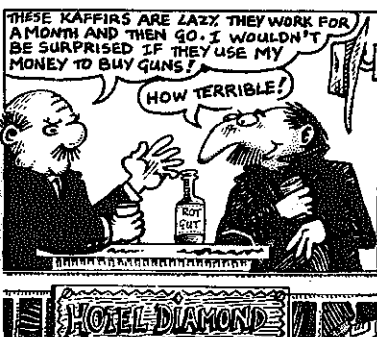

British capitalists had already invested a lot of money in the mines. They knew that without black labour there would be no profits. They complained to the British government.

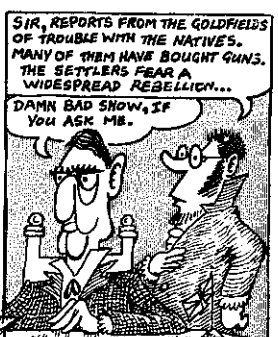

The British interest in gold and diamonds helped the settlers. The British government decided to give the settlers its support.

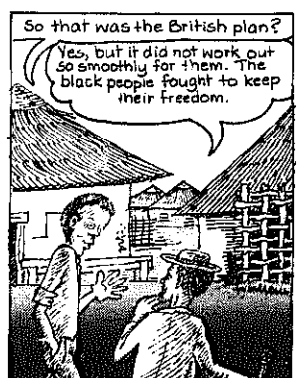
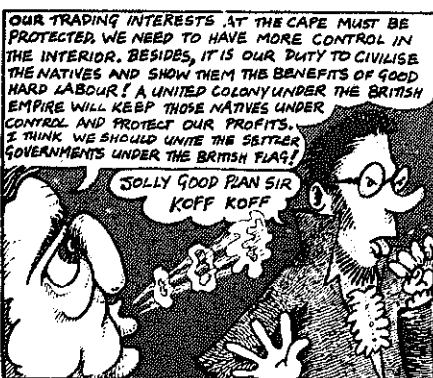
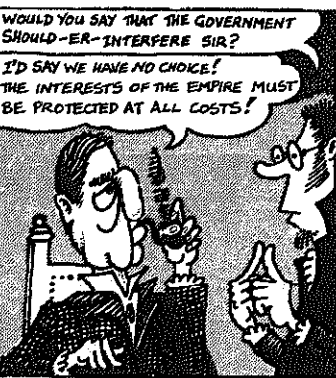

THE BRITISH ARE DEFEATED. LET US GATHER UP OUR DEAD AND WOUNDED, AND RETURN HOME TO WASH THE BLOOD FROM OUR SPEARS.

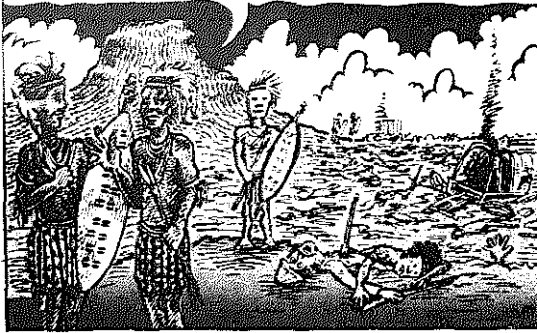

The British government sent troops to help the settlers defeat the African chiefdoms. At Isandlwana the Zulu army defeated the British.

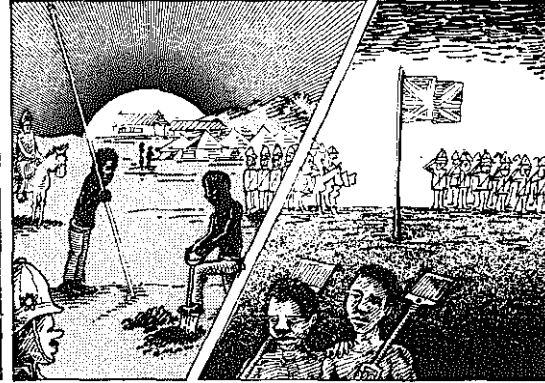

Other groups like the Pedi and Venda also fought for their freedom. But in the end most of the black people had to accept the rule of the settlers. Thus the African people of South Africa lost their independence.



THESE UITLANDERS MUST NOT BE ALLOWED TO THREATEN OUR INDEPENDENCE



THESE BOERS STAND IN THE WAY OF PROGRESS!



The Boers also resisted British rule in South Africa. Paul Kruger, president of the Transvaal republic, feared that foreigners were going to take over his republic. But the mine owners and capitalists wanted Britain to take over. War broke out between the British and the Boers in 1899, over who was to control South Africa.

But it was a white man's war. Both sides agreed that black people must provide labour in South Africa. After the British won the war, all the whites joined together to control labour.

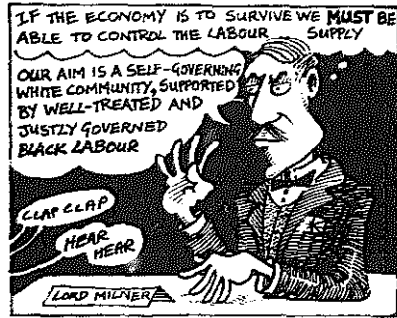

IF THE ECONOMY IS TO SURVIVE WE MUST BE ABLE TO CONTROL THE LABOUR SUPPLY

OUR AIM IS A SELF-GOVERNING WHITE COMMUNITY, SUPPORTED BY WELL-TREATED AND JUSTLY GOVERNED BLACK LABOUR

CLAP CLAP HEAR HEAR



YOU HAVE NOT PAID YOUR TAXES!

THEN YOU HAD BETTER EARN SOME!

BUT I DO NOT HAVE MONEY!

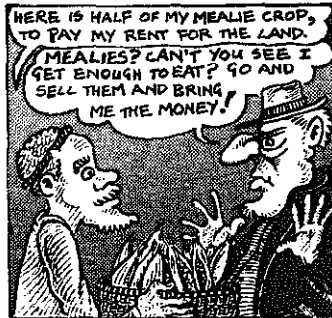

HERE IS HALF OF MY MEALIE CROP, TO PAY MY RENT FOR THE LAND.

MEALIES? CAN'T YOU SEE I GET ENOUGH TO EAT? GO AND SELL THEM AND BRING ME THE MONEY!

At first the settlers had many difficulties finding lots of cheap labour. They set out to solve this problem using the support that British power had given them.

To try and get labour the settler governments made Africans pay taxes. They hoped Africans would have to work for whites to get the money for taxes.

But most African people made their living by farming the land. Many white landowners rented land to African farmers. This was easier than farming for themselves.

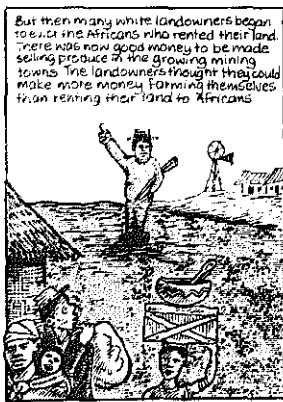
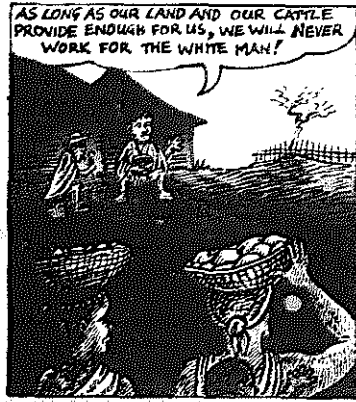

But then many white landowners began to let the Africans who rented their land. There was now good money to be made selling produce in the growing mining towns. The landowners thought they could make more money farming themselves than renting their land to Africans.



I remember the case of my uncle who rented land from a white man near Aliwal North. He was quite wealthy for those times. He sold wool on the auctions at Port Elizabeth.

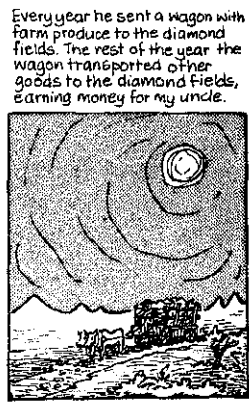

Every year he sent a wagon with farm produce to the diamond fields. The rest of the year the wagon transported other goods to the diamond fields, earning money for my uncle.

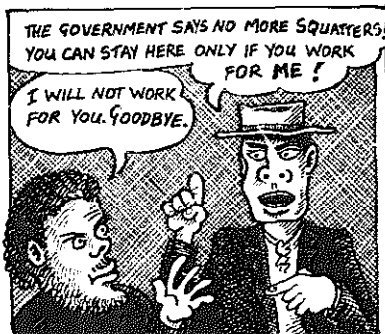

Then in 1909 the squatter act was passed in the Cape. The white landowner told my uncle he could no longer rent the land. He had to become a labourer for the landowner or leave.

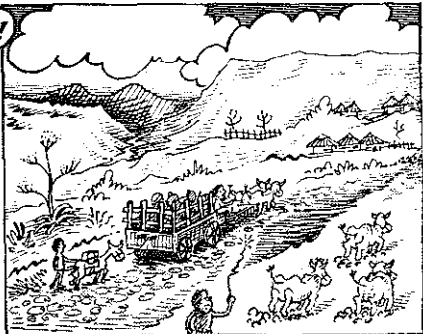

My uncle returned here to Mount Ayliff. There were already many people living here and he was unable to find grazing for all his sheep and cattle.

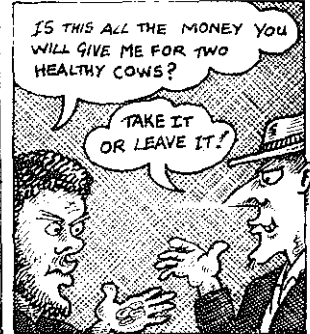

He was forced to sell many of his sheep and cows to white farmers who paid him very little for them.

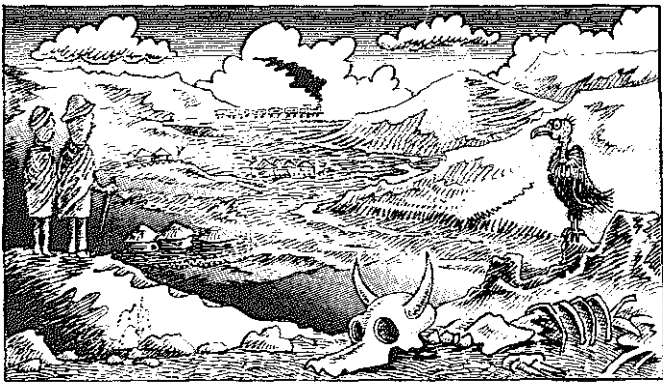

It was difficult to farm in the reserves. Lack of land was not the only problem. After the railways were built it became too expensive and slow to transport goods by ox wagon. But the railways went through white areas and did not touch the reserves. There were also terrible stock diseases of that time, like rinderpest. Many people lost their cattle and were unable to plough or transport goods to town.

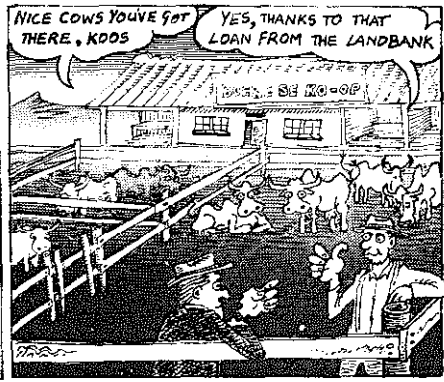

The government helped the white farmers a lot. After Union in 1910 the government spent money on agricultural colleges to train white farmers. Co-operatives marketed their produce and the land bank lent them money. There were none of these things for African farmers.

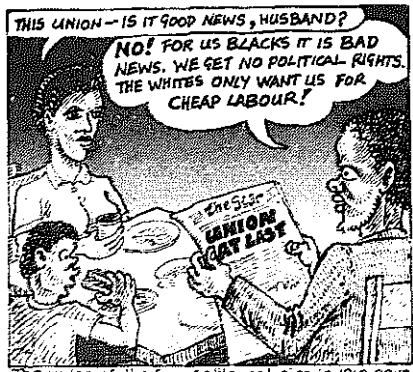

The union of the four settler colonies in 1910 gave black people no cause to celebrate.



In 1912 the black people met in Bloemfontein to form the South African Native National Congress to fight for their rights. Later the name was changed to the African National Congress.

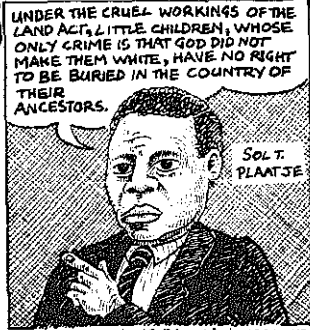

The next year the 1913 Land Act was passed. Today the land is still divided between black and white according to this Act: 13% for blacks and 87% for whites.

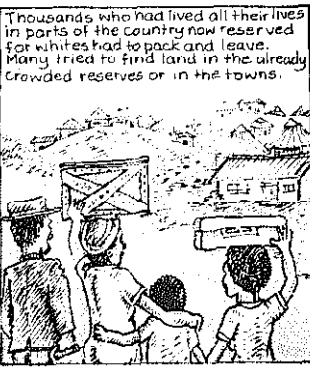
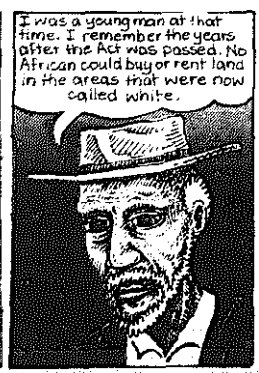
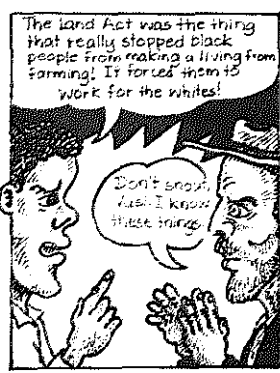

Thousands who had lived all their lives in parts of the country now reserved for whites had to pack and leave. Many tried to find land in the already crowded reserves or in the towns.



In the reserves there was little land to plant crops or graze livestock. Many of the newcomers only had enough land for a house and small garden.

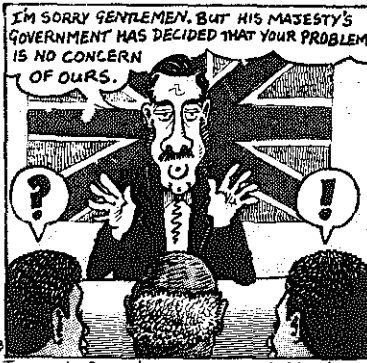

The newly formed congress appealed to the government. They even sent people to England to speak to the British government. But it was useless.



The Land Act forced blacks to become labourers and the British government did nothing! And in South Africa we were told to go to work for the white man. There were a few with enough cattle and land to continue farming. But not many.

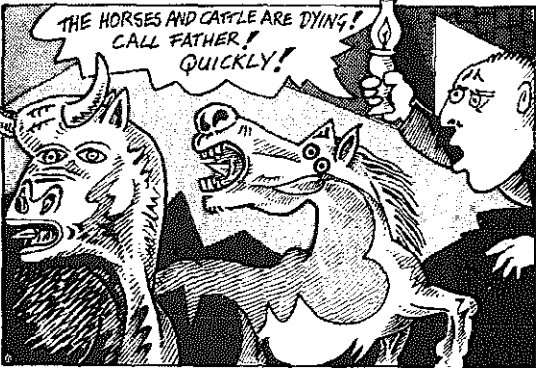

I can still remember, Vusi, one night. It was like a terrible dream. I heard noises in the kraal and went to see. My father's horses and cattle were dying of east coast fever. It was in 1917. It was a bitter blow to him. We had just built up our herd after the rinderpest.

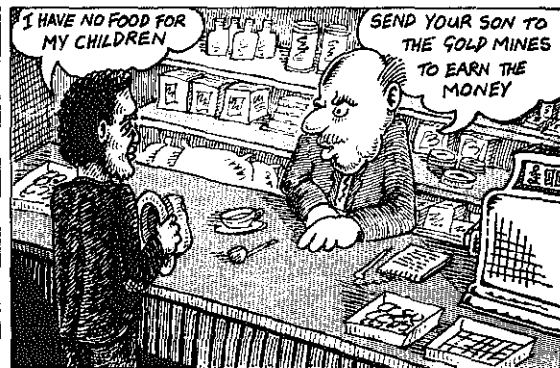

We now found ourselves very poor. To buy food my father had to borrow money from the white store owner. The store owner was a labour agent for the gold mines. He refused to lend us money unless I took a contract to work on the mines.

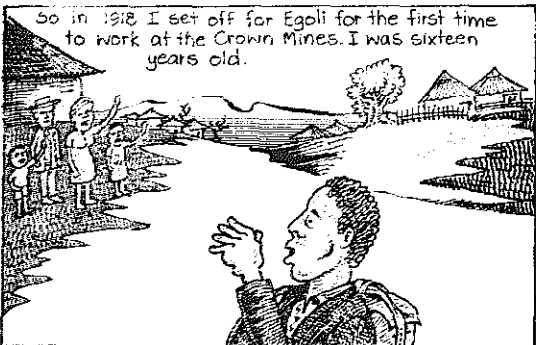

So in 1918 I set off for Egoli for the first time to work at the Crown Mines. I was sixteen years old.

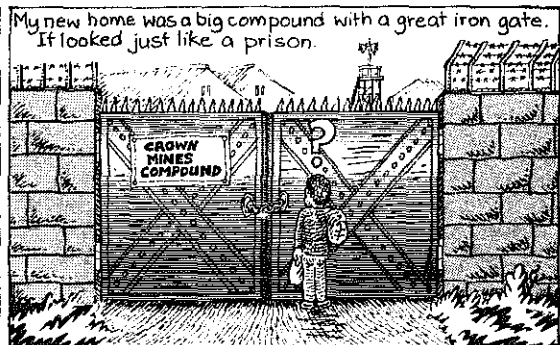

My new home was a big compound with a great iron gate. It looked just like a prison.

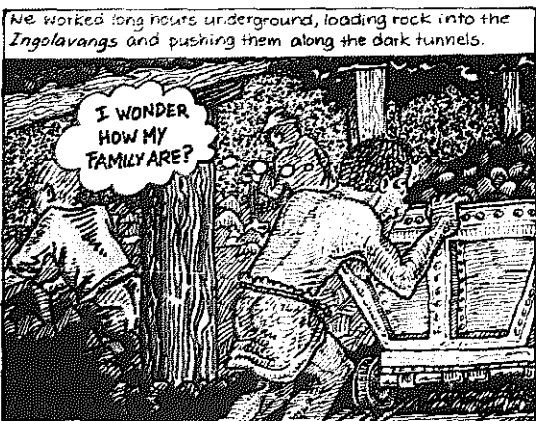

We worked long hours underground, loading rock into the Ingolavangs and pushing them along the dark tunnels.



At night we slept crammed like animals into the crowded compound. Was this the city of gold?



I arrived at a time when there were many strikes in the mines and factories. Workers on the mines and in the city were demanding better pay and conditions. They were organising trade unions to secure their demands. Many of our leaders were sent to jail.

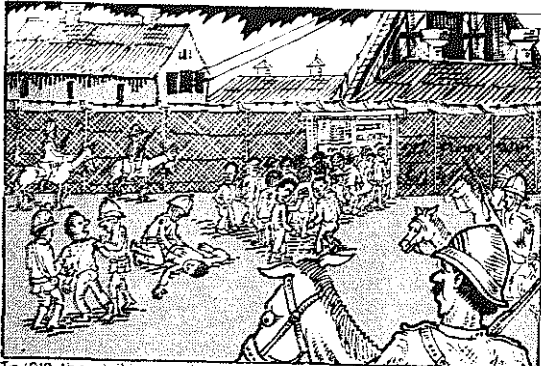
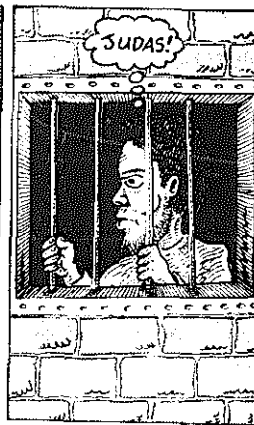

In 1918 the striking workers wanted a shilling a day increase. At Crown Mines we also tried to strike. But the mine owners called the police. Mounted police forced us to go underground at gun point.



After the strikes we were promised more money, but nothing happened. In 1920 we went on strike again. There were also big strikes at other mines. Police broke the strikes, and many of us went to prison.



Meanwhile the reserves became poorer each year. When I returned from my first contract I saw what was happening.

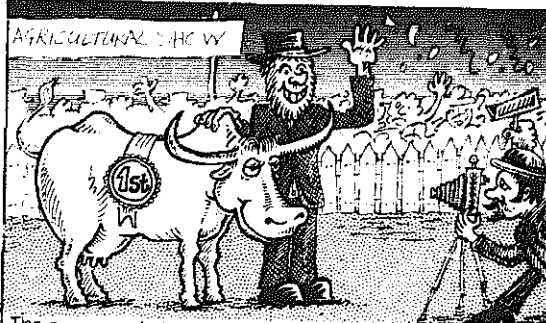

The government did little to help us. Taxes from the gold mines went to help the white farmers. Nothing was given to those who dug the gold.

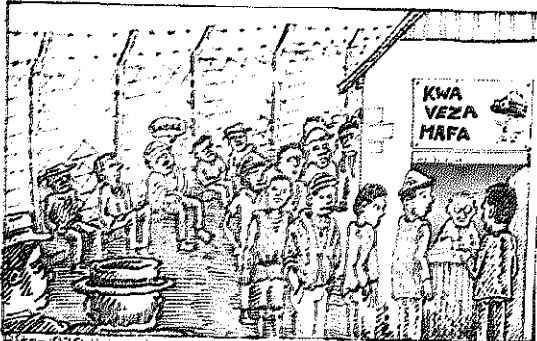

After 1920 things became more difficult for the workers. There was a terrible drought that year. Many more people left the overcrowded reserves to find work in the towns. This helped the mine owners. They could dismiss workers who threatened to strike and easily find new workers.

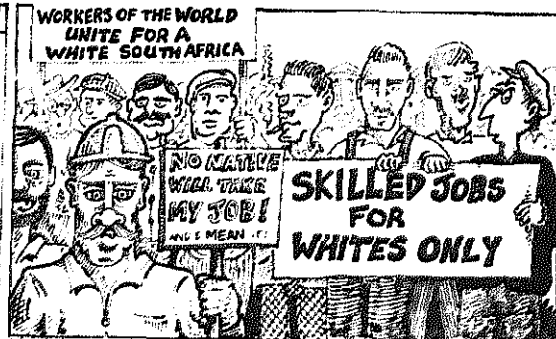

We did not only have to fight the bosses in those years. There were also the white workers. They did not want the mine owners to give better paid jobs to black workers. They used their political power to get their trade unions recognised and to make sure that only whites would be allowed to do better paid jobs.

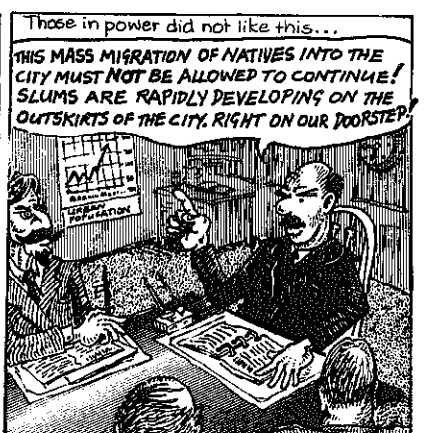
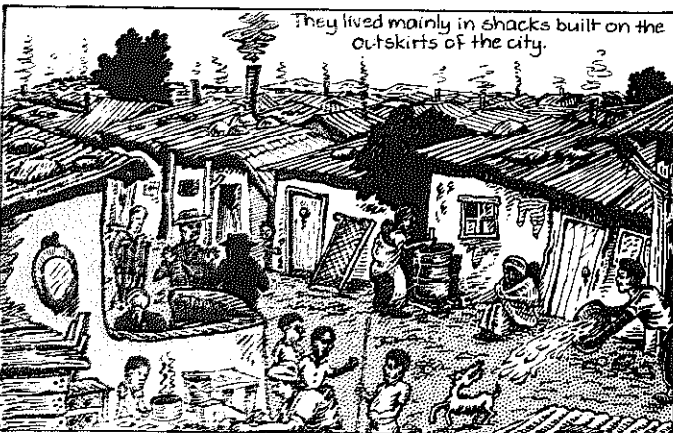
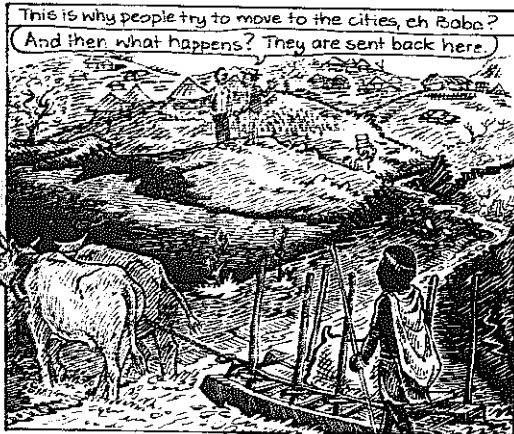
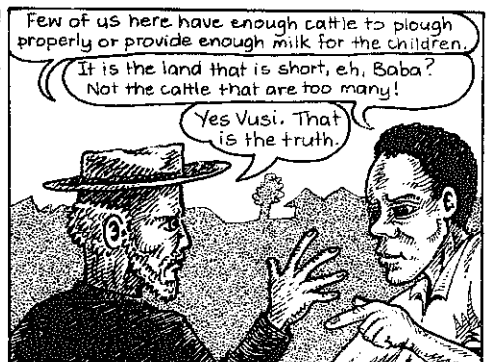
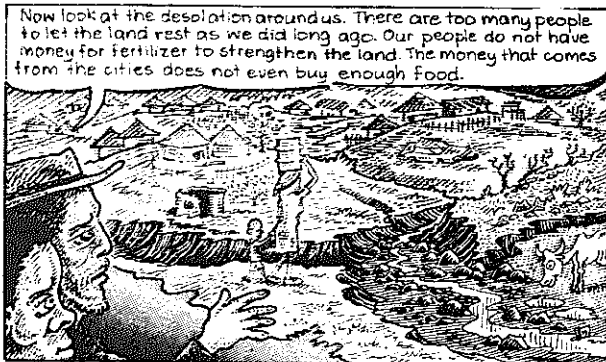
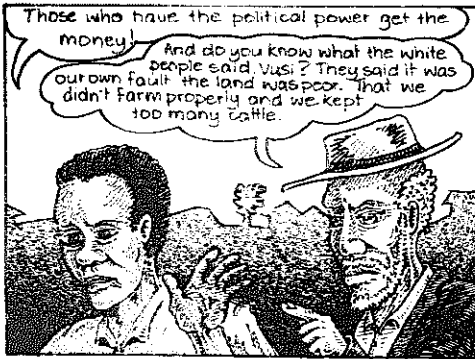

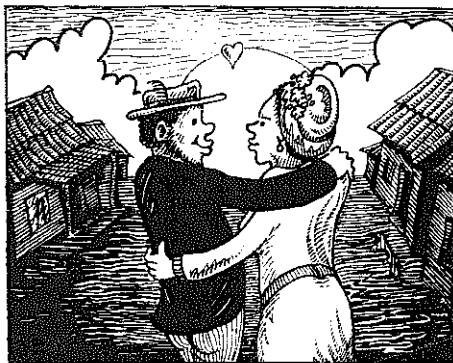
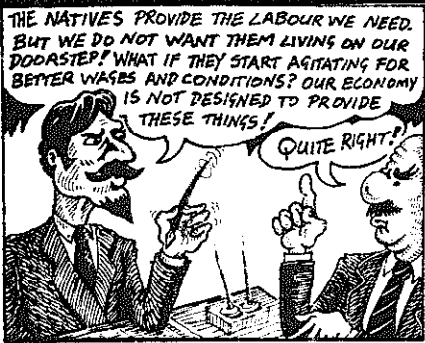

I remember when your father gave up trying to farm this land and moved to the city. He lived in Sophiatown where he met your mother.



Her family had been evicted by a white farmer in the western Transvaal. Your parents had a hard struggle when you were born.

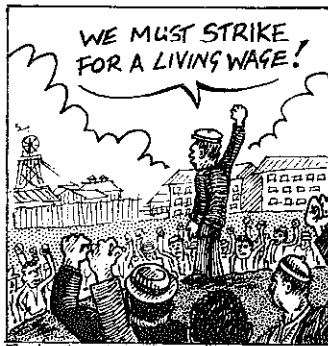
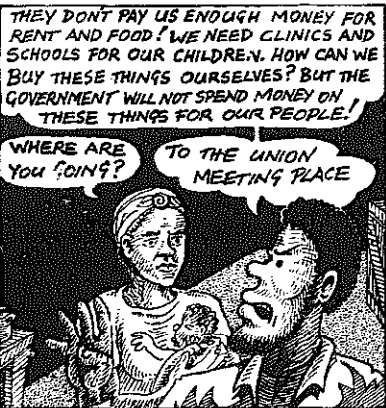

The trade unions demanded higher wages for black workers. There were many strikes in the 1940's. In 1946 50,000 black workers went on strike.

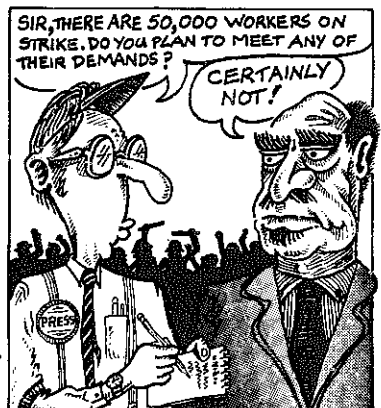

The Smuts government asked the police to break the strike by using violence. They drove the men into the compounds and locked them in so they could not meet together. In the end the miners were forced to go back to work.



Many men were killed and injured by the police.



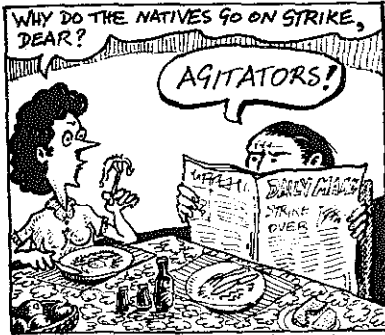

The whites were alarmed at the demands of the black workers.

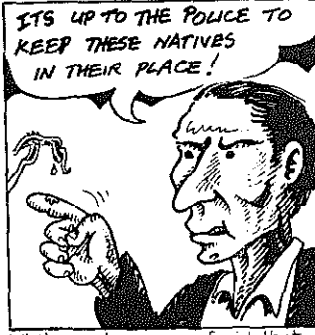

White workers were afraid that Africans would get their jobs.



Capitalists were afraid they might lose their cheap labour.



Many whites supported the National Party and voted it into power in the 1948 general election.

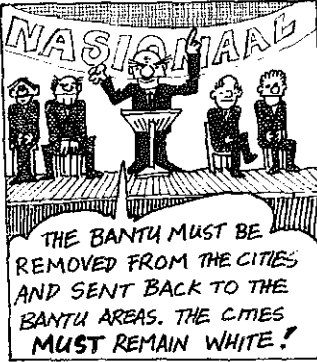

The new government promised its voters to take a hard line with the demands of black workers.

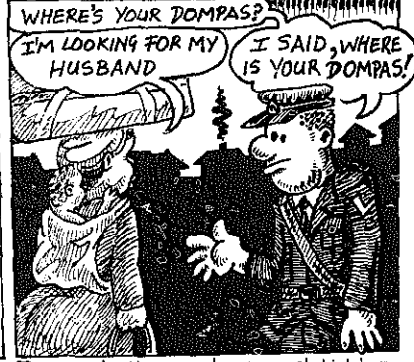

They made the pass laws much tighter to try and stop people moving. They made African women carry passes.

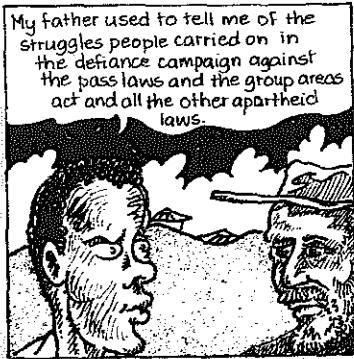

My mother has also told me about the great gathering at the Union buildings in 1956 when 20,000 women gathered to protest against having to carry passes.

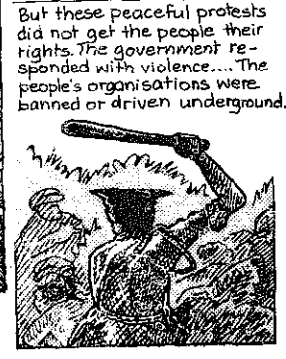

In the rural areas the government introduced the Bantu Authorities. The chiefs and headmen were paid high wages to support and promote apartheid among the people.

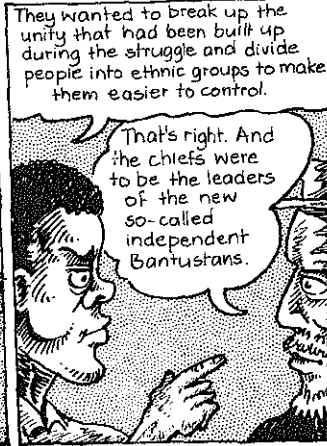

They wanted to break up the unity that had been built up during the struggle and divide people into ethnic groups to make them easier to control.

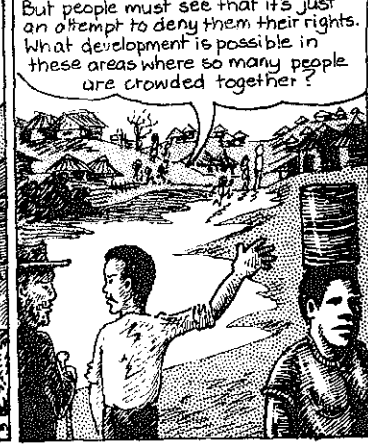

But people must see that it's just an attempt to deny them their rights. What development is possible in these areas where so many people are crowded together?

For years our people have resisted what the government calls 'development' in the Bantustans. Let me tell you what 'development' has meant to the people of this village. Today we live in what they call a 'betterment scheme'.



Before the 1960's when the betterment scheme came, we did not all live together in one village as we do now. Our homestead was in a valley further up in the mountains. Your uncle had a homestead on the other side of the valley and there were also homesteads of other people we knew well in the valley. Our fields were close to the homesteads and it was easy to do work in the fields and at the homestead in one day. Because we knew all the people in the other homesteads in the valley, we were able to organise to do big jobs together. For instance we could join up to get teams of oxen for ploughing.

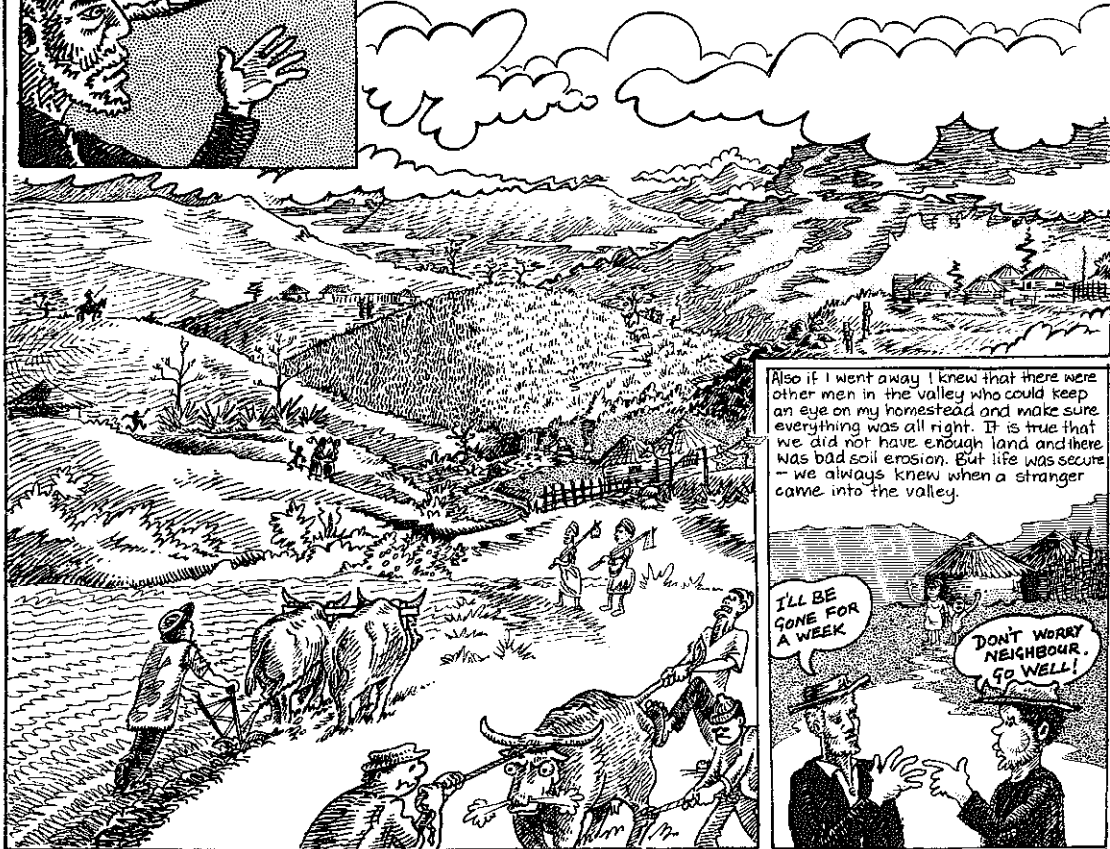

Also if I went away I knew that there were other men in the valley who could keep an eye on my homestead and make sure everything was all right. It is true that we did not have enough land and there was bad soil erosion. But life was secure - we always knew when a stranger came into the valley.

I'LL BE GONE FOR A WEEK.

DON'T WORRY NEIGHBOUR. GO WELL!



Then one day the commissioner came and told us we would have to move to a new village. No one had asked us about this, or tried to find out what would suit the way we lived. The only person they spoke to was the chief. But how could he say no to those who paid his salary?

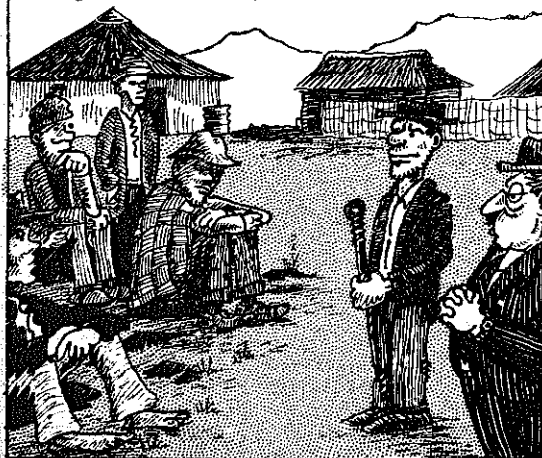

All we were told was that we would be able to farm better. They said that the best land was going to be used for farming and grazing cattle. But people were very suspicious.

IT'S A TRICK!

THE GOVERNMENT HAS NEVER HELPED US BEFORE. WHY SHOULD THEY BE HELPING US NOW?



When people heard that they were only going to be allowed to keep a small number of cattle, they refused to move. So how did the government make the people move?



Well, some time later they came back with many police on horses. The people who refused to move were arrested and their houses burnt down. After that, people were afraid and they moved to the new village.



In some other areas there was even more resistance and the people fought against the police and the chiefs. But even in these areas the people had to move in the end.



In the new village we were not allowed to choose where we wanted to live. We found that our old neighbours lived right at the other end of the village. The people who lived near us were strangers. This made it much more difficult to work together.



Our fields are also not close to each other and what's more they are far from the house. One cannot organise housework and field work together any more.



Living next to strangers is also a problem. When a man has to leave his house and go to town, who will look after his family?

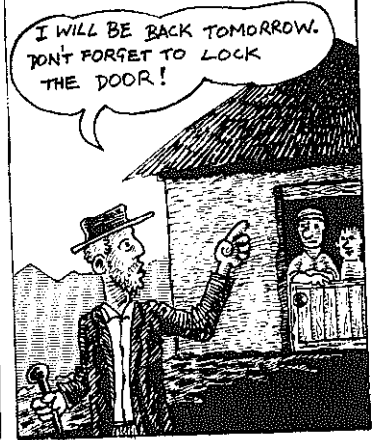



How much land did people get in the new village?

Not enough to live on, that is for sure. In fact there were not enough plots in the new village for all the people who used to live in the area.

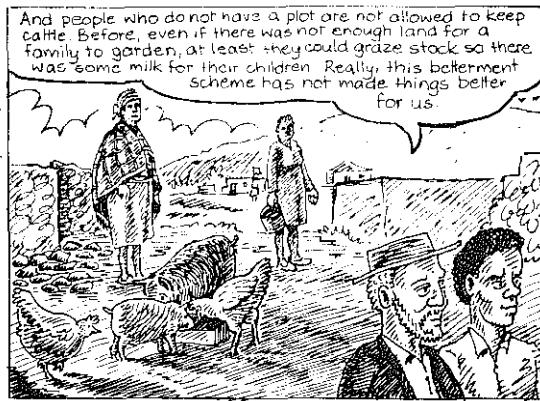

And people who do not have a plot are not allowed to keep cattle. Before, even if there was not enough land for a family to garden, at least they could graze stock so there was some milk for their children. Really, this betterment scheme has not made things better for us.

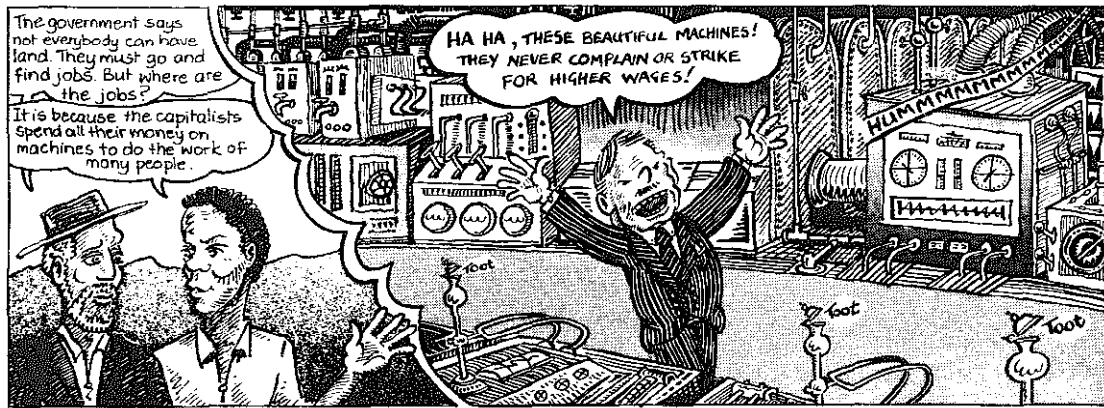

The government says not everybody can have land. They must go and find jobs. But where are the jobs?

It is because the capitalists spend all their money on machines to do the work of many people.

HA HA, THESE BEAUTIFUL MACHINES! THEY NEVER COMPLAIN OR STRIKE FOR HIGHER WAGES!

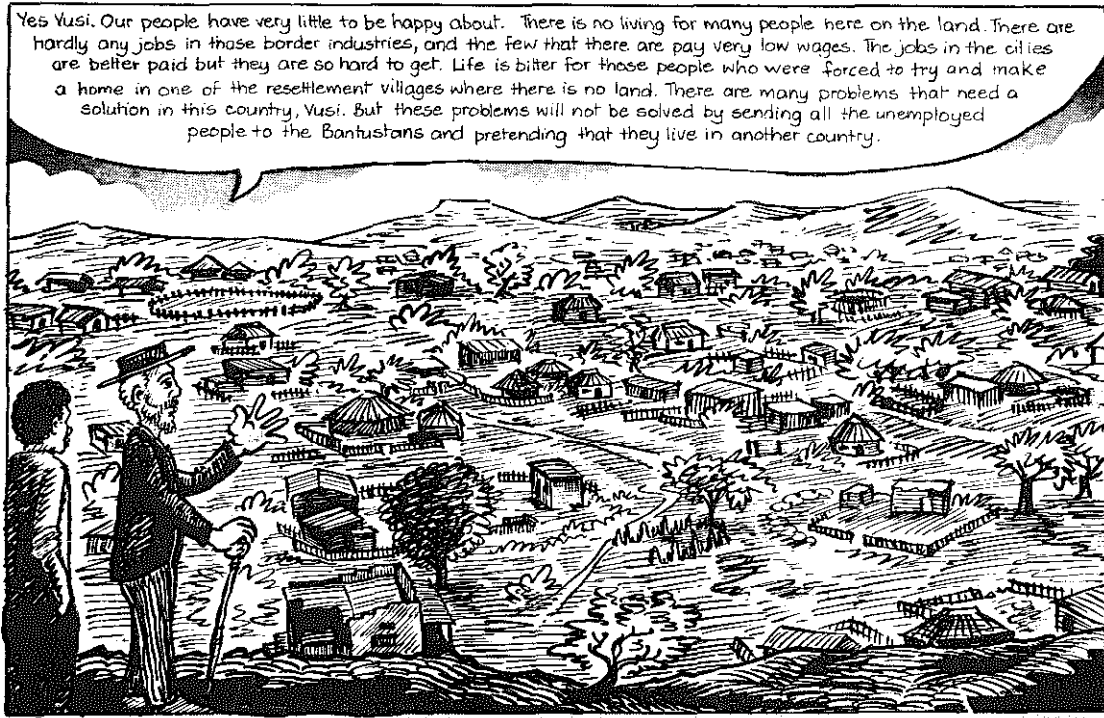

Yes Yusi. Our people have very little to be happy about. There is no living for many people here on the land. There are hardly any jobs in those border industries, and the few that there are pay very low wages. The jobs in the cities are better paid but they are so hard to get. Life is bitter for those people who were forced to try and make a home in one of the resettlement villages where there is no land. There are many problems that need a solution in this country, Yusi. But these problems will not be solved by sending all the unemployed people to the Bantustans and pretending that they live in another country.

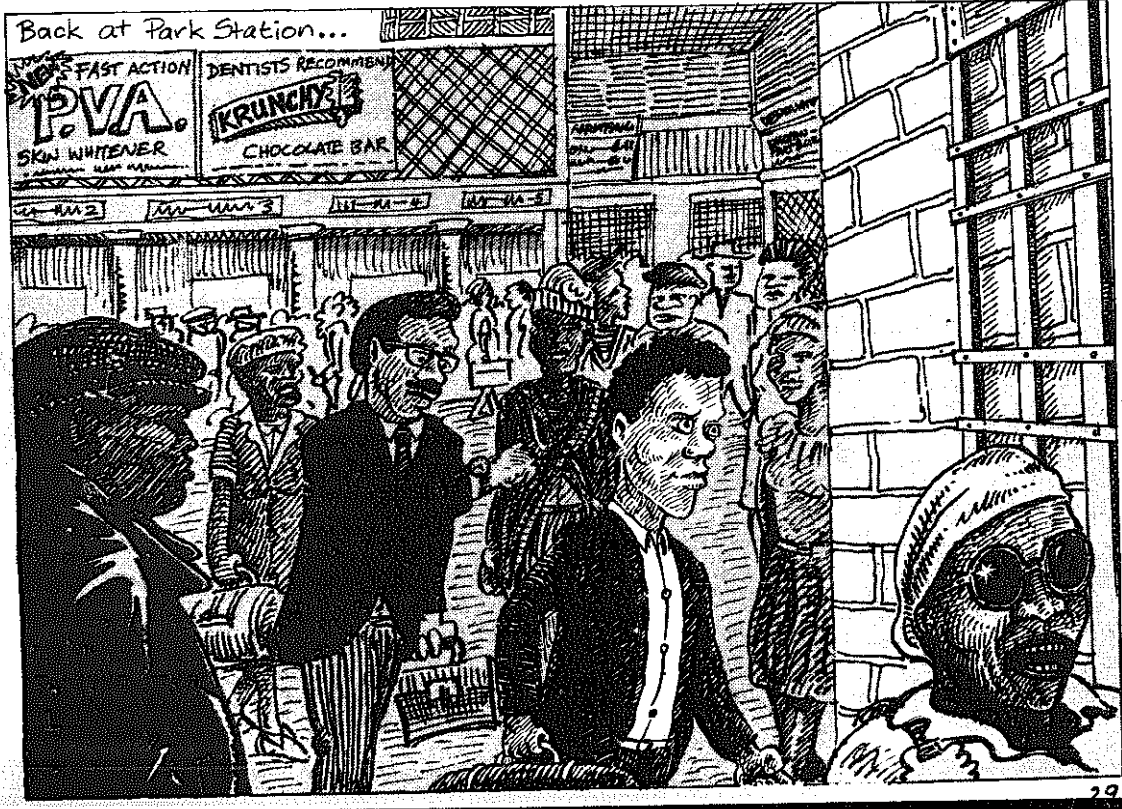
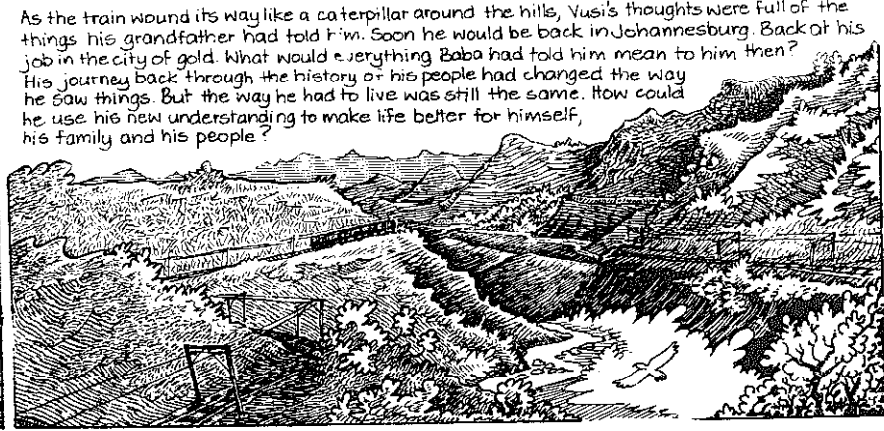
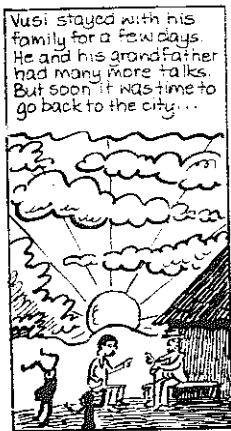
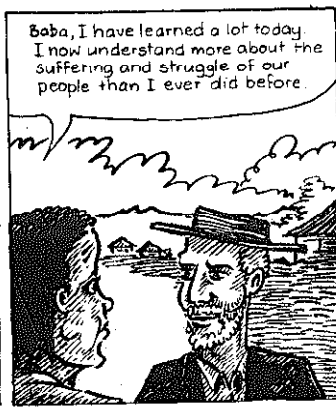
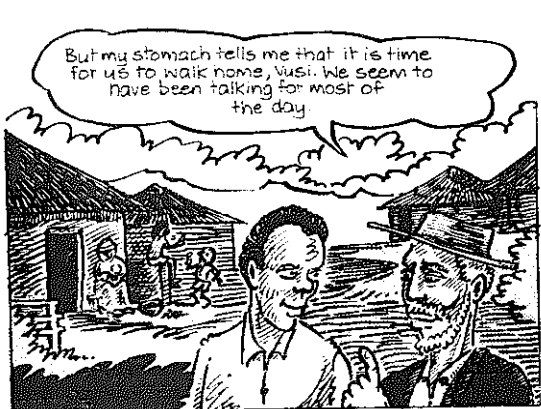

Agriculture Introduction

People in the black rural areas of South Africa have many problems which make it very difficult or impossible for them to improve their farming. The biggest problem is that more than 70% of the people have only 13% of the land. This causes overcrowding, overgrazing, soil erosion and landlessness.

Black farmers have not always had these problems. Before white settlers came, black people farmed all over southern Africa. Of course, they also had problems like drought and diseases which killed their animals and crops, but it was easier to overcome these problems because they had a lot of land. In those days, people were also more organised for farming. For example, men did not have to spend a lot of time working away from home. At first, white settlers knew nothing about farming in southern African conditions, so they did not farm as well as black farmers. The new towns and mines provided markets for black farmers and they lived well. But whites needed them as labourers in mines, farms and towns, not as independent farmers. So in 1913, they made laws stopping black people from using most of the country's land.

- **Landlessness:** In many places people have no land, except for their homestead gardens. Those with fields are lucky if they have 2 hectares. This land is often in poor condition.

- **Poverty:** Food, clothing, housing and education use up all the money sent from migrant workers in towns. There is no money left for farming, so people cannot afford to plough properly, buy good seed, or use fertilisers.

- **Migrant labour:** With men away, it is difficult to get all the farming work done. Women and children have too much to do and can not cope with all the work.

- **Ox power:** Because the veld is overgrazed, cattle are weak at the end of the winter. Ploughing has to wait until after the first rains, so that the cattle can eat the new grass and become strong enough for ploughing. Then planting is late and people get less crops.

- **Tractors:** Tractors are owned by people who want to make the biggest profit they can. Most farmers can only afford to hire them for ploughing. They cannot afford to hire them again for harrowing, discing and cultivating.

- **Credit, marketing, and advice:** White farmers can easily get credit and loans. They have co-operatives close by which help them with buying and marketing. They have well trained extension officers to help them. Black farmers have none of these advantages.

Whatever project your group starts, it is important to start small and only get bigger as you succeed. For example, if the group wants to try new seeds, it is important to test and compare seeds, by planting them next to each other in small plots. Farmers can also buy things like seed, tools, ploughs, planters and harrows together and then share them.

Anyone working in communities must try to include the people who have no cattle or land in farming projects. They are the poorest in the village and survive only on money sent by family members working in town.

Some people think that landless people are backward when they do not want to take part in farming projects. But things like keeping chickens and rabbits need money, and money can be lost if the scheme fails. Even vegetable gardens need money for fencing, tools, and water. Poor people do not want to take part in farming schemes if they think they will lose their money.

It can help if you get grants or loans from trust funds (see Where to get funds p539). It is also important that the organisations giving money make sure they are not just helping some people become richer instead of helping the landless people in the community.

Agricultural projects for people who have land are easier to organise. These people are already farming, and they know what their problems are. They know if they need better seed, or more ploughs and planters, or food for their cattle during the winter.



Agriculture

Homestead Farming

Many people in rural areas have no land, not even one or two hectares. These people can not do any farming. They have to get all their food from money which is sent from migrant workers in the towns.

Some people have homesteads, small pieces of land around their houses where they can grow vegetables or fruit trees or keep chickens. Growing vegetables needs good soil and water, and usually villages are built on the worst land, and water is far away. Even though it is difficult, people try to grow things at their homesteads because they can work and look after their house at the same time. Women can look after their children and cook, as well as working on their gardens.

People used to have their fields near to their homes. This changed when betterment schemes were started in rural areas. In the betterment schemes, people were moved to a new area. The best land was used for crops, the land which was not so good was used for grazing camps for animals, and the worst land was used for villages.

These betterment schemes brought many new problems. People did not want to move from places where they had been

living for a long time because they knew those places well. They had built their homes there, planted trees, improved the soil and built dams and fences. When they were moved to the betterment schemes, they were given small compensation for their old homesteads, they were given small fields on the betterment schemes and they had to get rid of some of their animals. Many people fought so they would not be moved.

When people got to the betterment schemes, they found that they sometimes had to travel a long way from their homesteads to their fields. Others, especially those who were moved later, found that they could get a plot for a homestead, but no fields. Sometimes half the families in a village have no land at all except their homesteads.

Agricultural extension officers think they have to work with people in their fields, but people still prefer to work in their homesteads and try to grow food there. If new betterment schemes are planned, it will be much better for villages to be built on good land, so that people can use their homesteads properly.

In this part of the book we write about farming you can do around your home.

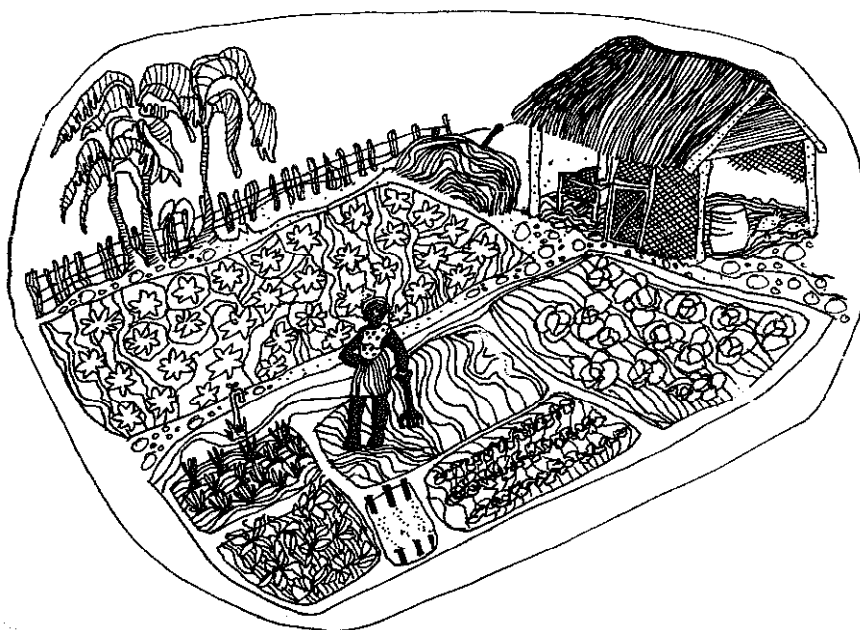

Growing Vegetables

Vegetables are important for your health. They are expensive and difficult to get in many places. It is better to grow your own vegetables in a home garden or join with other people to start a community garden.

Land

A small garden, 10m long and 10m wide, can give vegetables all year round if you look after it well.

In some places people do not have this land or their land is far from water. In these places people can join together to make communal gardens where they share a big piece of land near a river or spring. In some communal gardens everybody shares the work and the crops, and in others each family has their own plot in the garden. Even in town you can sometimes find a school or church yard to make a communal garden.

Fencing

Vegetables have to be fenced to keep animals out, especially goats. Wire fencing is the best, but the most expensive. It is cheaper and easier to fence one big communal garden, than many small gardens. You can use straight wire, barbed wire or chicken mesh. You will also need strong wooden posts to hold the wire. Fences can also be made out of wood. Bluegum branches give long straight poles. Reeds can be woven together. Thorn bushes can be piled up to make a fence. Bamboo and hedges last a long

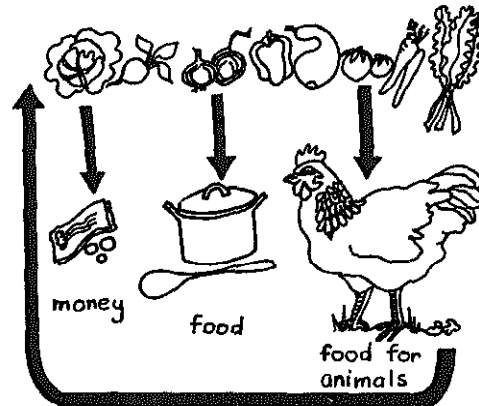
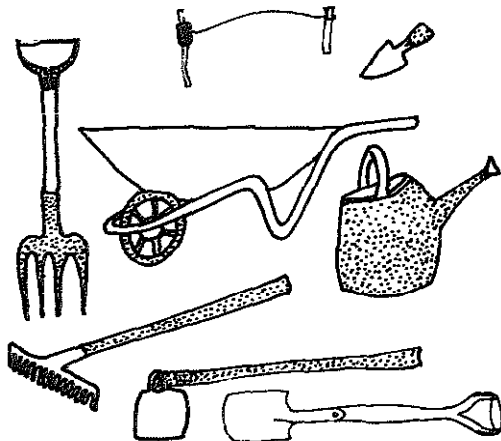

manure for your garden

time and are cheap to grow. Alces, prickly pears, sisal and honey locust trees all make good hedges.

Water

Water is scarce in most rural areas but vegetables need plenty of water. The water supply section of this book tells you how to irrigate cheaply, with small dams or with cheap pumps. You can use gardening methods which need less water like mulching (p 36), terracing (p101) and composting (p50).

Tools

The most important tools for vegetable gardening are a spade, a fork, a hoe, a rake and a watering can. Most people cannot afford to buy all these tools, so it helps everybody if you start a tool hire scheme (see p53).

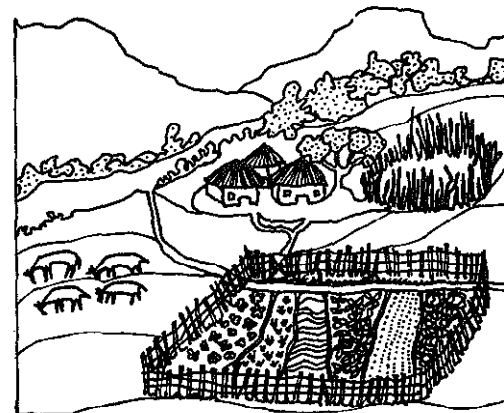

Digging the garden

Choose a flat place with the best soil, such as an old cattle kraal. Clear away big trees, tree stumps and big stones. Take out grass roots otherwise they will grow again. Keep the grass and tall weeds for compost. Then fence the garden. Dig the soil one spade deep and dig in any compost or manure you have. You can also dig trenches or if the garden is on a slope, make terraces (p101). If possible find out what kind of soil you have (see Know your soil p 97). If your soil is acid you must add lime.

Laying out the garden

Laying out the garden in plots of the same size makes it easier to plan crop rotation. Weeding and other work in the garden is easier if the plots are long and narrow, about 5m long and 1m wide. Then you can make paths in between and you do not have to stand on the soil where the vegetables are growing.

Crop Rotation

There are 4 families of vegetables:

- ▶ Root crops - carrots, beetroots, onions
- ▶ Leaf crops - cabbages, cauliflowers, spinach
- ▶ Legumes - beans, peas
- ▶ Fruit crops - tomatoes, potatoes, peppers, chillies

For example, tomatoes, potatoes, peppers and chillies all belong to the same family, so they are attacked by the same pests and diseases. If you grow any of these vegetables in the same soil every year, they will be attacked by diseases like bacterial wilt and pests like rootknot eelworm. You must let the soil rest by growing other kinds of vegetables after growing tomatoes, potatoes, peppers and chillies. This is called crop rotation. It improves the soil and helps to prevent disease.

grow a different family of vegetables in each bed

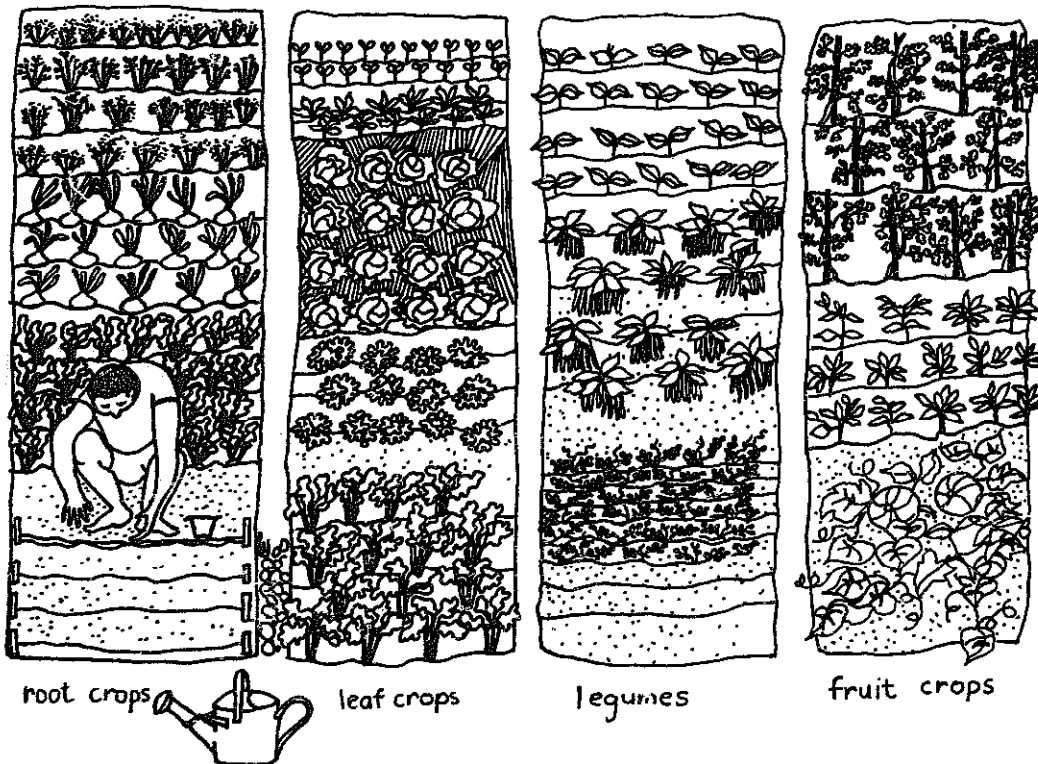

Intercropping (see p117)

Another way of improving the soil and preventing diseases is to plant different vegetables next to each other. For example beans or peas make their own nitrogen plant food, so if you grow them next to spinach, the spinach will also get nitrogen.

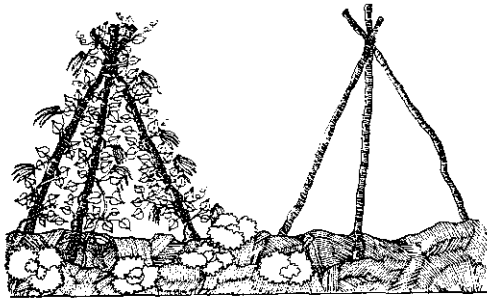

planting beans and lettuces together

Sowing seed

Seed is expensive. Do not waste seed by growing more than you need. If you are sowing root crops, legumes, maize or pumpkins, sow only 3 times as many plants as you need. Then thin the rows of seedlings to get the plants the right distance apart. If you are sowing seeds first in a seedbed and then transplanting, you should sow only twice as many plants as you need. For example if you want 20 cabbages, sow 40 seeds. Then choose the 20 strongest seedlings to transplant.

Before you sow the seed, break up the lumps in the soil with a rake. Put the seed in holes or rows about five times as deep as the size of the seed. Water the seeds softly with a watering can. Then cover with grass to prevent the soil drying out. Water your seeds every day. As soon as you can see them growing through the soil, make a space in the grass for the plant to grow through.



1

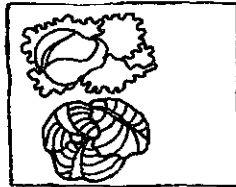

2



3

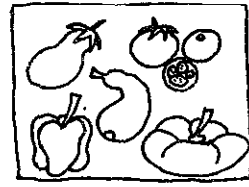

4

a simple rotation :

divide your garden into 4 equal parts

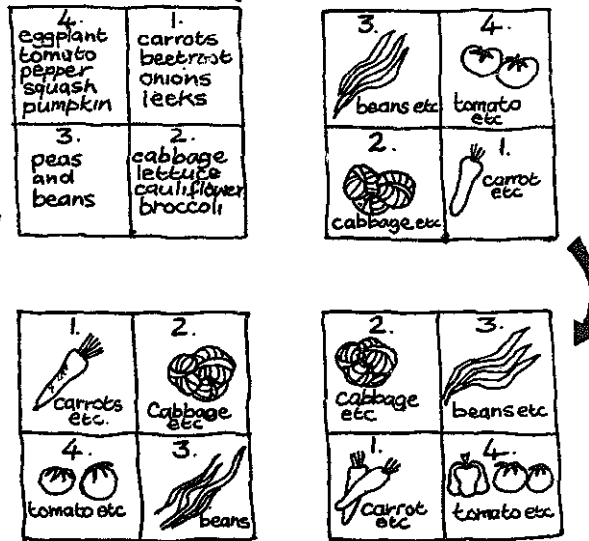

the next time you plant, move each family of vegetables to the next bed

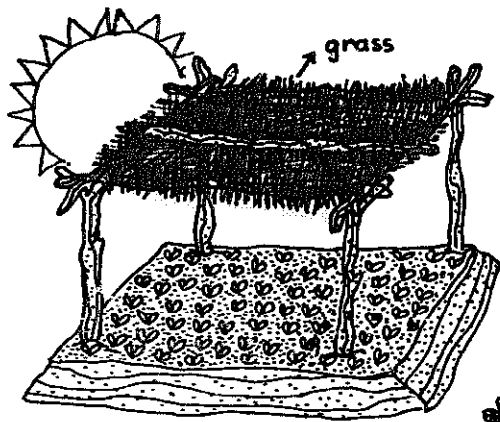

plant in fertile soil and shade plants from the hot sun

Seedbeds

Some seeds like beans, pumpkins and carrots can be planted straight into the ground where you want them to grow. Others like tomatoes, onions and spinach will grow stronger if they are planted in seedbeds for the first 6 weeks. A seedbed is a small part of the garden with very rich soil and a roof to shade the seeds. Dig in compost or kraal manure six weeks before planting. Make a roof with branches or grass to protect the seedlings from hot sun. Plant the seeds in rows and water them twice a day for the first week and then once a day until they are 3 weeks old. From 3 to 6 weeks water them every 4 days and slowly take the grass off the roof until they are ready to transplant.

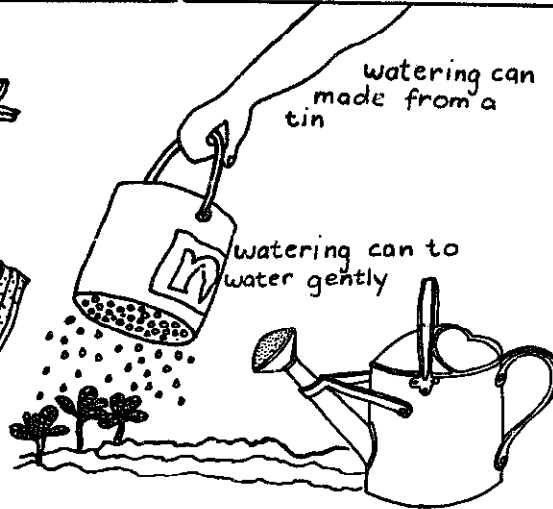

Thinning

Vegetable plants are weak when small. Plant many seeds and thin them later. Thinning is taking out some plants so that others can grow better. It may seem like a waste of plants, but you will get more vegetables if the plants are not crowded. Thin the plants two or three times as they grow until they are at the right spacing (see sowing guide p38).

Mulching

Mulch is a cover of grass and leaves which prevents the sun from drying out the soil. Mulching improves the soil and prevents a hard crust being formed on the soil. Do not let your mulch touch the plant, otherwise it will cause disease.

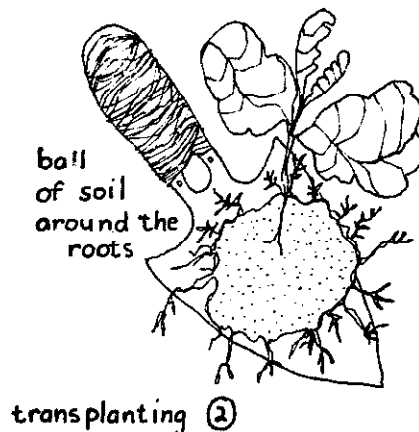
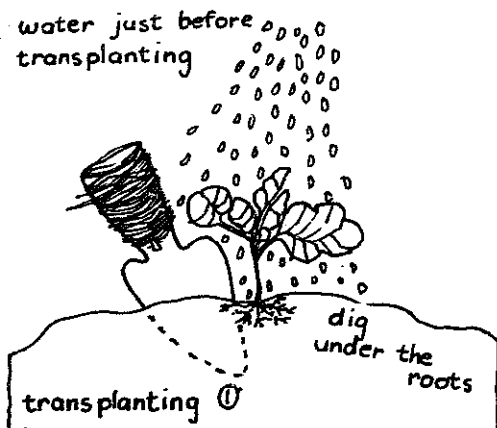

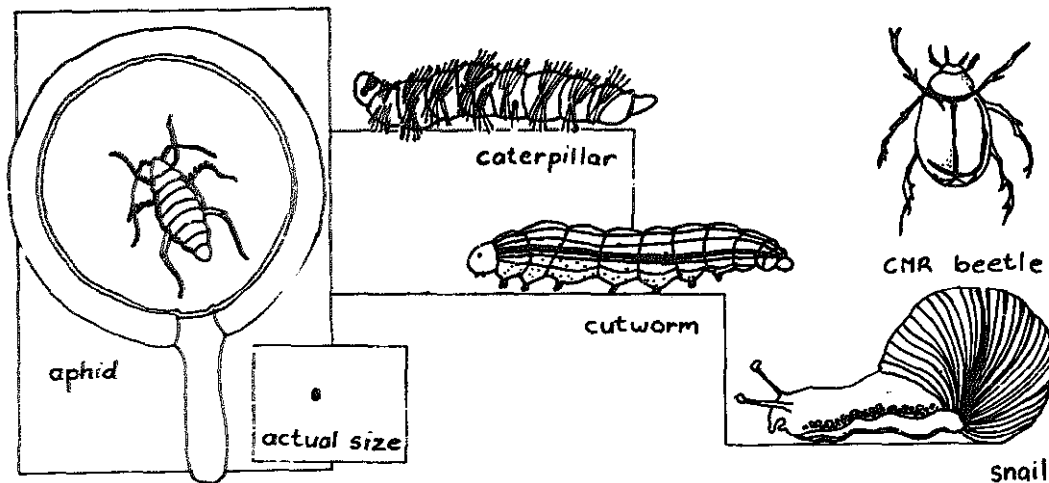

Watering

Give the plant enough water so that the soil is wet at least 25cm deep. Spray water gently onto your vegetables. If you water too heavily the water makes a hard crust on the soil. Use a fine spray on a watering can or put your finger over the end of a hosepipe, or make holes in the bottom of a tin, and fill the tin from a bucket. The best times to water are early morning or late afternoon when the sun will not dry out the soil so quickly.

Weeds

Weeds fight for the soil, water and sunlight your vegetables need, so taking out the weeds is very important especially when vegetables are young. You can use weeds to make compost. Use

a small hand fork or trowel to weed by hand, close to the vegetables.

Pests and Diseases

Try to prevent pest and disease problems by making the soil rich with compost, using crop rotation and burning all diseased leaves. Keep a sharp lookout for caterpillars, beetles, aphids and cutworms, and remove them by hand before there are too many. All insects can be killed by dropping them into a tin containing a little paraffin. Only use chemicals if all other methods fail (see pests and diseases p 122). With some vegetables like tomatoes and potatoes which get lots of diseases, do not wait until you see the disease. It is better to spray early to prevent the disease.

branch for shade

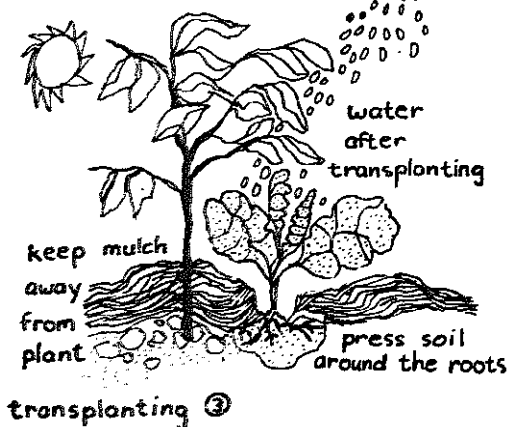

mulching

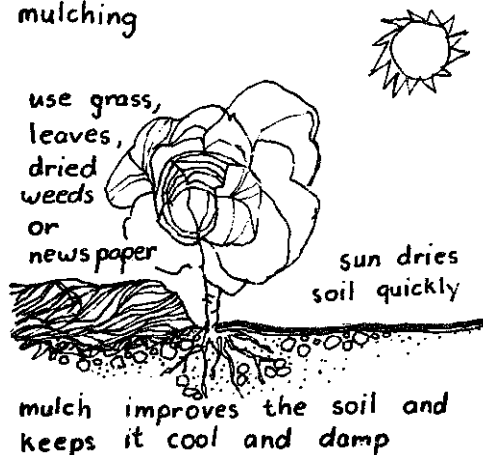

SOWING GUIDE FOR VEGETABLES

Vegetable	When to plant		seed per 10 sq. m
	Frost Areas	Frost Free Areas	
Beans - Bush	August to January	February to September	80g.
Beans - Runner	August to December	February to August	50g.
Beetroot	August to October January to March	February to July	8g.
Cabbage	November to February July to March	February to June	3g.
Carrots	August to October January to March	February to August	3g.
Cauliflower	December to February	February to March	3g.
Celery	September to December	February to March	5g.
Chillies or Green Peppers	August to October	January to April July to October	3g.
Lettuces	January to March August to September	March to May	3g.
Mealies (Green & Sweetcorn)	September to November	July to November	20g.
Onions	February to March	February to March	4g.
Peas	July to September	March to June	80g.
Potatoes	August to January	February to July	800g.
Pumpkins/ (Calabashes)	September to November	February to August	3g.
Radishes	August to November February to April	February to September	4g.
Spinach	August to April	February to June	7g.
Squash (Gems)	September to November	February to August	30g.
Swiss Chard	August to October January to March	February to August	7g.
Tomatoes	August to November	January to July	2g.
Turnips	August to September January to April	February to June	4g.
Watermelons	September to November	July to August	4g.

see measuring seeds (p. 129)

sowing depth	Spacing		Time to harvesting
	in rows	between	
see how to weigh and measure (p.124)			
40mm	50mm	450mm	50 to 70 days
40mm	100mm	900-1200mm	60 to 80 days
20mm	70mm	200-400mm	60 to 80 days
20mm	350-500mm	700-1000mm	60 to 120 days
10mm	50mm	300-500mm	60 to 80 days
10mm	450mm	700-1000mm	90 to 120 days
10mm	300mm	600-900mm	100 to 130 days
10mm	400-600mm	900-1000mm	± 100 days
10mm	100mm	400-600mm	50 to 85 days
50mm	900mm	200-300mm	70 to 100 days
10mm	70mm	100-300mm	60 to 200 days
30-70mm	50-70mm	300-600mm	65 to 90 days
150mm	300-750mm	1000mm	± 150 days
20mm	500-1000mm	2000-3000mm	100 to 120 days
20mm	50mm	300-500mm	20 to 45 days
20mm	200mm	500-600mm	45 to 65 days
20mm	500-700mm	1200-1500mm	50 to 65 days
20mm	200-300mm	600-900mm	90 to 110 days
10mm	400-500mm	1200-1800mm	70 to 90 days
10mm	80mm	500mm	40 to 70 days
50mm	450-600mm	1500-2000mm	80 to 100 days

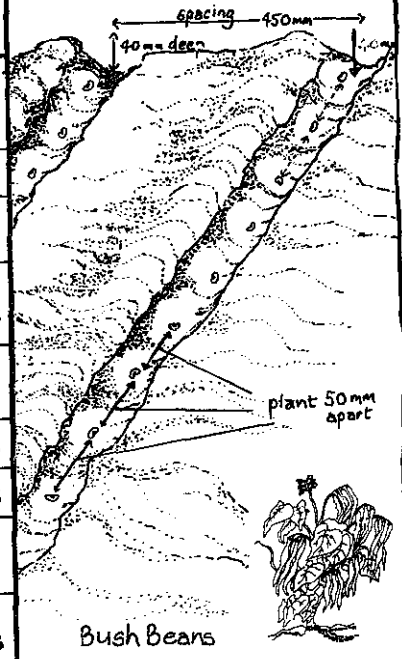

Bush Beans



Root Crops (carrots, beetroot, turnips)

Do not put fresh compost or manure straight onto root crops. It makes them grow many thin roots. Dig in compost a month before planting.

▶ Carrots grow best in cooler months, and are not killed easily by frost. They prefer loose loamy soils. Prepare their seedbed well and water regularly.

▶ Beetroot grows best in cool wet places but can also grow in hot places. It can grow in salty soils. It needs a lot of compost and manure. Before sowing, soak the seeds for 2 hours, then dry them for 2 hours.

▶ Turnips are fast growing. They prefer cool weather, so sow them in autumn and winter. Harvest them while they are still small. The leaves are nutritious and make good spinach.

▶ Onions need well drained soils. They take a long time to grow. March is the best month for sowing. Do not plant where legumes grew last year because the nitrogen left in the soil by the legumes makes the onion leaves grow thick and they are easily attacked by diseases (see How to grow onions p 46).

Leaf Crops (cabbages, lettuce and spinach)

Leaf crops need plenty of compost or manure and good soil.

▶ Cabbages grow all year round, but most varieties, except expensive hybrid varieties, suffer in the hottest months.

▶ Cauliflowers are damaged by very hot and very cold weather. They need fertile soils, and lots of compost.

▶ Spinach. The best kind of spinach is Swiss Chard. It gives a bigger crop than ordinary spinach and is easier to grow. It is much more nutritious than cabbage, which does not have many vitamins. Swiss Chard grows best in cooler months and is not killed by frost. The more you pick the outside leaves, the more the spinach grows. It has few pests and diseases and you can pick it for up to 7 months (see How to grow spinach p 48).

▶ Chinese cabbages need plenty of water. They are quick growing. You can eat them raw, or cooked as spinach. Sow seeds straight into the ground.

▶ Lettuces need plenty of water and thick mulch. Do not allow them to dry out. They grow best in cool weather. Soak seeds in water in the sun for 4 hours before sowing. In winter, sow the seeds in seedbeds and transplant. In summer you do not need seedbeds. Sow them straight into the ground and thin the rows.

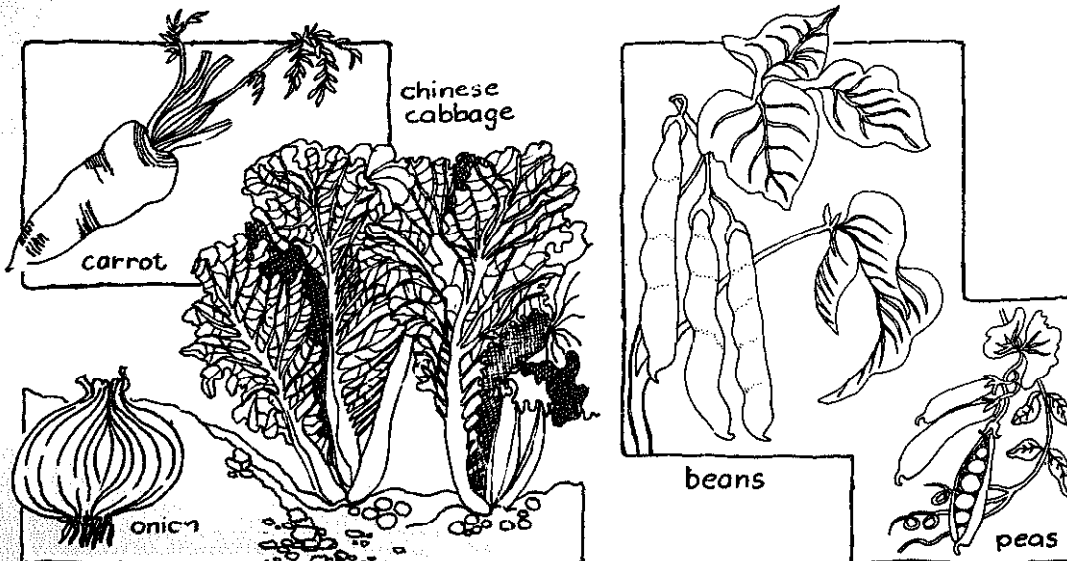

Legumes (peas and beans)

Legumes make their own nitrogen plant food. Other plants can use the nitrogen, especially when legume roots are left in the soil after the plants have been picked. In a crop rotation plan it is good to plant legumes before leaf crops because leaf crops use up a lot of nitrogen.

- ▶ Bush beans (dwarf beans) are easy to grow and quick to mature. If you want green beans, pick them when the pods are 10cm long. For dry beans pick them after the plant dies.
- ▶ Runner beans take longer to grow than bush beans, but they produce more. You can grow them in a very small space. Make tripods of poles 1,5m long for them to grow up.
- ▶ Peas can be intercropped with spinach or cabbage. Grow them up poles to make picking easier.

Fruit Crops (tomatoes, peppers, pumpkins)

Fruit crops need plenty of potassium, which can come from wood ash.

- ▶ Pumpkins and squashes are easily killed by frost and need warm weather, but if the weather is too hot, they will not produce any fruit. They need regular watering. To reduce attacks on the seeds by pests, sprout the

seed before sowing. Soak the seed overnight and leave in a wet cloth until it sprouts, then plant it straight away.

▶ Potatoes (see p 151) are easy to grow, especially in cool places. Plant them in early summer or in frost free areas. In winter potatoes need a lot of manure and water. Use certified seed to prevent disease.

▶ Tomatoes - see How to grow tomatoes (p 42).

▶ Chillies grow on bushes which only have to be planted every 4 years. They grow well in hot places. Plant them around the edge of your garden. They can be dried and ground up to make chilli powder.

▶ Eggplants, also called brinjals, are easily killed by frost and take a long time to grow. They need lots of compost and water. Transplant when 10-15cm high in the seedbed.

▶ Green peppers need warm weather but they get sunburnt easily. You can prevent sunburn by growing in double rows. Peppers need plenty of compost and water. Transplant 7-8 weeks after sowing. Be very careful because green pepper plants are easily damaged by transplanting.

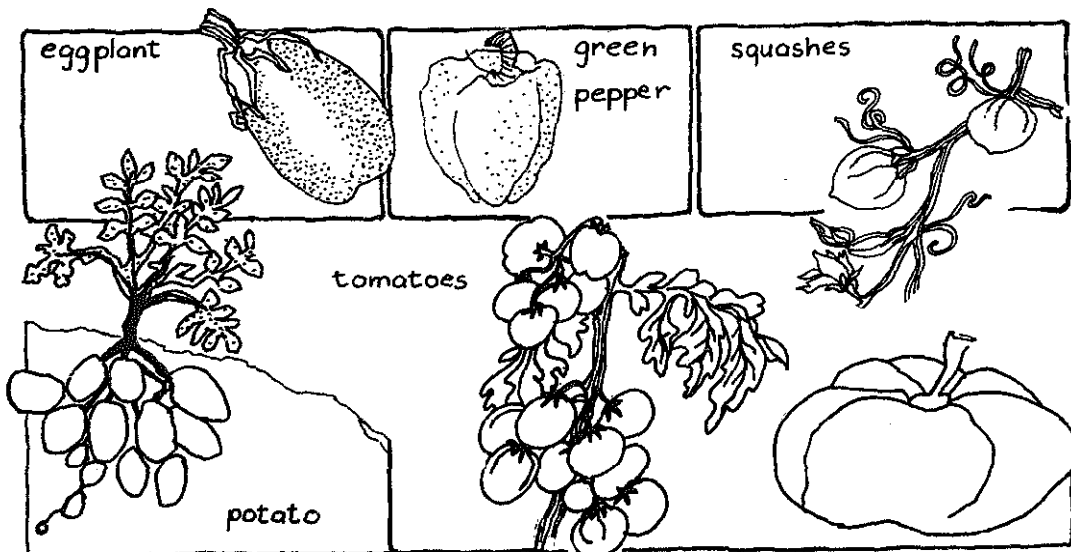

Legumes (peas and beans)

Legumes make their own nitrogen plant food. Other plants can use the nitrogen, especially when legume roots are left in the soil after the plants have been picked. In a crop rotation plan it is good to plant legumes before leaf crops because leaf crops use up a lot of nitrogen.

► Bush beans (dwarf beans) are easy to grow and quick to mature. If you want green beans, pick them when the pods are 10cm long. For dry beans pick them after the plant dies.

► Runner beans take longer to grow than bush beans, but they produce more. You can grow them in a very small space. Make tripods of poles 1,5m long for them to grow up.

► Peas can be intercropped with spinach or cabbage. Grow them up poles to make picking easier.

Fruit Crops (tomatoes, peppers, pumpkins)

Fruit crops need plenty of potassium, which can come from wood ash.

► Pumpkins and squashes are easily killed by frost and need warm weather, but if the weather is too hot, they will not produce any fruit. They need regular watering. To reduce attacks on the seeds by pests, sprout the

seed before sowing. Soak the seed overnight and leave in a wet cloth until it sprouts, then plant it straight away.

► Potatoes (see p 151) are easy to grow, especially in cool places. Plant them in early summer or in frost free areas. In winter potatoes need a lot of manure and water. Use certified seed to prevent disease.

► Tomatoes - see How to grow tomatoes (p 42).

► Chillies grow on bushes which only have to be planted every 4 years. They grow well in hot places. Plant them around the edge of your garden. They can be dried and ground up to make chilli powder.

► Eggplants, also called brinjals, are easily killed by frost and take a long time to grow. They need lots of compost and water. Transplant when 10-15cm high in the seedbed.

► Green peppers need warm weather but they get sunburnt easily. You can prevent sunburn by growing in double rows. Peppers need plenty of compost and water. Transplant 7-8 weeks after sowing. Be very careful because green pepper plants are easily damaged by transplanting.

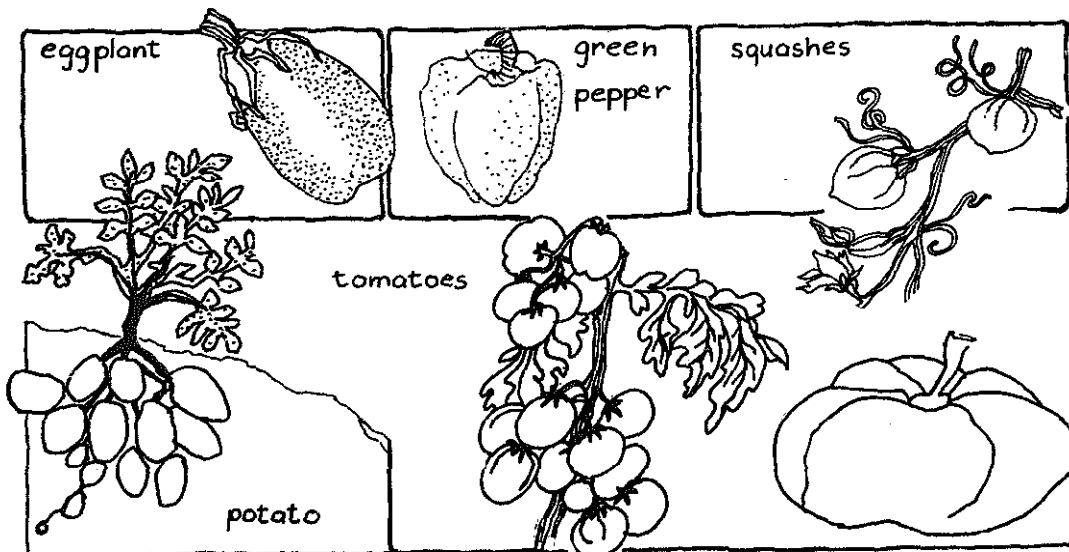

HOW TO GROW TOMATOES

Tomatoes are tasty and nutritious. They give you minerals and vitamins A and C, especially when you eat them raw.

Tomatoes are not easy to grow. But if you control pests and diseases you can grow lots of tomatoes in a small garden:
4-5 kg a plant or more.

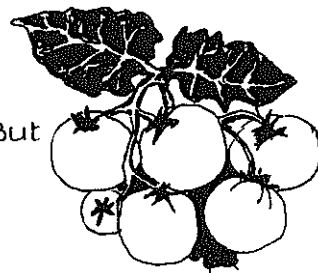

WHEN AND WHERE

- In frost free places you can grow tomatoes all year round, but winter tomatoes should be planted before April for good yields.
- In other areas only sow them when the danger of frost has passed.
- Tomatoes like warm dry places. If your area is too hot or too wet, tomatoes can become sunburnt or get fungus diseases.
- Tomatoes grow well in most soils but slightly acid drained or sandy soils are best.

RECOMMENDED VARIETIES:

Lowveld: Homestead FM 61, Manapal, Heinz 1370, St Pierre.
Middle and Highveld: Manapal, St. Pierre, Homestead Tuinbos, Indian River.
Natal: Red Khaki, Roodeplaat Premier, Heinz 1370, Manapal.
E. Cape: Manapal, Indian River, Red Khaki, Heinz 1370.
Winter rainfall: Red Khaki, Manapal, Moneymaker, Heinz 1370.
O.F.S: Manapal, St. Pierre, Homestead FM 61, Roodeplaat Premier, Indian River.

PREPARING THE SEEDBED

- Make the seedbed in a warm sunny place, protected from frost. Make sure tomatoes, potatoes, green peppers, and tobacco have not grown in this place for at least 3 years.
- Spread kraal manure, 1 bucketful per sq metre and dig well in, or use 2-3-2 (22) fertiliser at 30g per sq metre.
- Use a rake to prepare the seedbed.
- Sow seed in moist soil, in furrows 1cm deep.
- Sow thinly so you do not waste seed.

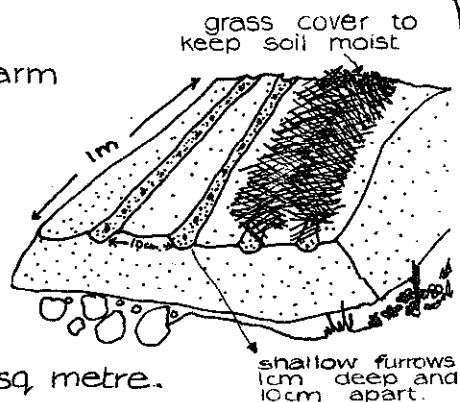

CARE OF THE SEEDBED

- Try to grow short strong plants.
- Sow thinly and do not give them too much water.
- When seedlings are growing well, one good watering a week is enough.
- Thin rows until the plants are 2 to 3 cm apart



unthinned rows - tall weak plants



thinned rows - short strong plants



Shade frame - remove shade as seedlings grow

PREPARING THE SOIL FOR THE YOUNG PLANTS

- Dig deeply to make sure the water sinks into the ground.
- Dig in compost or manure at 2 buckets per sq m, or 2-3-2 (22) fertiliser at 30g per sq m and superphosphate at 80g per sq m.

dig as deep as fork can go

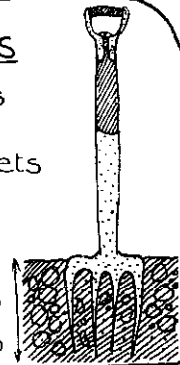

TRANSPLANTING

- Transplant when the tomatoes are 10 to 12cm high.
- Transplant in the late afternoon and water straight away.
- Mulch the soil and shade plant with a leafy branch for a few days.
- Make the rows 60cm to 100cm apart. Plants 40 to 60cm apart in the rows.



keep soil around roots



WATERING AND PRUNING

WATER once a week, and give each plant a bucket of water. Try not to water the leaves or let soil splash onto the plant - this can give them diseases.

PRUNING is the removal of side-shoots when they start to grow, so that only one stem grows. Remove the side shoots when they are small - do this at least once a week. This will give nice big tomatoes.

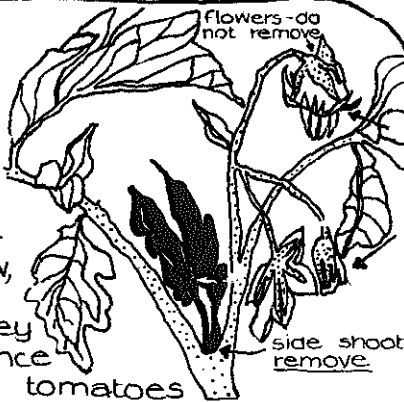

MULCHING AND STAKING

A MULCH is a layer of organic material (grass, leaves, weeds) on the surface of the soil. If it is at least 10cm thick it will:

- Keep water in the soil
- Protect soil structure.
- Stop weeds growing.
- Prevent soil splashing onto leaves when watering.
- Keep the soil cool in summer.

STAKING keeps the plant standing up so that the tomatoes do not lie on the ground.

- Use a strong stick 1.5m long pushed deeply into the soil.
- Tie the plant loosely with string

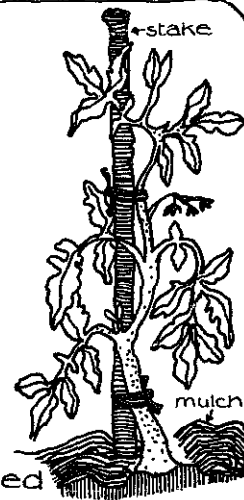

DISEASE CONTROL

To prevent diseases:

- You must use crop rotation (see p34).
- Do not water leaves.
- Remove and burn all sick plants.
- Mulch heavily.
- Smokers must wash hands before handling plants to avoid virus diseases from tobacco.

Spraying: spray plants every 7 to 10 days with fungicides like Dithane M45 or Virikop (Copper oxychloride)

Bacterial Wilt: Plants wilt suddenly as though cut with a knife. There is nothing you can do about this disease. Burn plants and do not plant tomatoes, peppers, potatoes or tobacco in the same place for 5 years.

LATE BLIGHT

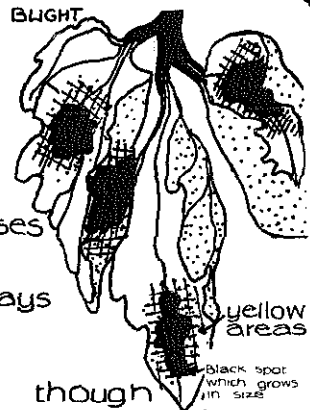

PESTS OF TOMATOES

EELWORMS are very small organisms in the soil which feed on roots, and make the roots swell up.

To control eelworms use crop rotation, growing khakiweed just before growing tomatoes.



CUTWORM: a grey or brown worm which cuts through plant stems at night.

To control cutworm:

- Dig down next to plants, and kill them
- Bait with Dipterex in maize meal before planting.

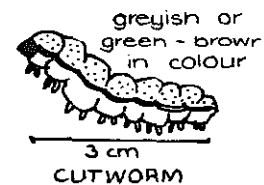

BOLLWORM: light green to brown caterpillar with broad yellow bands. Lays small white eggs on leaves. Eats holes in tomatoes.

To control bollworms, take them off and kill them or spray them with Dipterex.

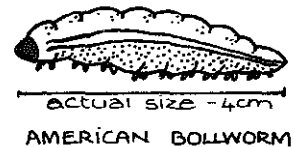

HARVESTING

Tomatoes can be picked ripe or unripe. Do not pick tomatoes when they are dark green.

Pick them when:-

- Pale green: The fruit will ripen in about a week. Ripen in a warm place - does not have to be in the light.
- Light red: almost fully ripe.
- Red or ripe: do not leave on the plant after this.



turning pale green at this end.
TOMATO STARTING TO RIPEN

HOW TO GROW ONIONS

Onions are easy to grow but they take a long time. If you plan your garden well you can get enough onions to last you for the whole year.



Jan. Feb. Mar. April May June July Aug Sept Oct. Nov. Dec.

Onions do not grow well in acid soils or heavy clay soils. They grow best in well drained sandy soils. If your soil is too acid, put on lime.

VARIETIES

The best varieties are De Wildt, Bon Accord, Pyramid and Texas Grano. For the Cape, where there is rain in winter, plant Australian Brown or Caledon Globe.

FERTILISERS

Dig in half a wheelbarrow full of manure or compost for every sq. metre, or dig in two handfuls (80g) of 2:3:2 (22%) fertiliser per sq. metre.

PLANTING

There are two ways of planting onions:

DIRECT SOWING: you will get more onions and they will be ready quicker. But direct sowing takes more work because you will have to prepare the soil very well with a rake - the onions will not grow up well in rough soil:

- water well, every day.
- take out all the weeds.
- mulch.

Make the rows 40cm apart. When the onions start to grow, thin out the small ones until the plants are about 8cm apart



SOWING IN A SEEDBED

Sow the onion seeds in rows, making the rows 10cm apart. Water them well and take out all the weeds. When they are about 8 weeks old they will be as thick as a pencil, and ready for transplanting.

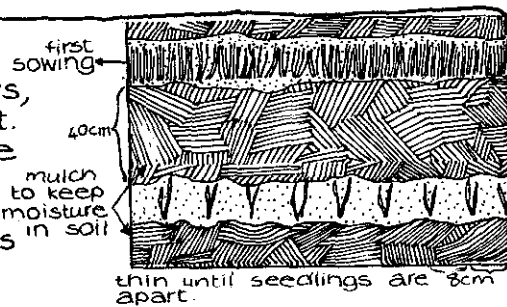

To transplant, make rows 40cm apart.

Plant the onion plants 8cm apart in the rows so that they are as deep in the soil as they were in the seedbed. Cut off the ends of the roots and the tops of the leaves - this will give you bigger onions.

PESTS AND DISEASES

Thrips are very small insect pests which eat the leaves and make silver marks on them. You can kill the thrips with MALATHION poison.



actual size

Downy Mildew is a disease which makes pale green spots and sometimes purple spots on the leaves. The leaves can turn yellow and die. You can get rid of the disease with DITHANE M45.

HARVESTING

The onions are ready for harvesting about 8 months after planting. You will know the onions are ready when the leaves become yellow and fall over.

Hold the leaves and pull the onions out of the ground. Leave them to dry in the sun for 3 days, covering each onion with the leaves of another onion so that they do not get sunburnt.

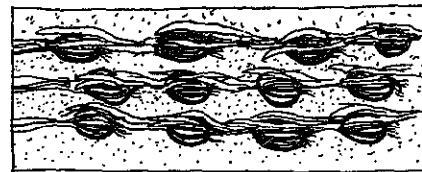

leaves covering onions when in sun for 3 days

Then tie them together in bunches by their leaves and hang them up in a cool dry place.

HOW TO GROW SPINACH

The best kind of spinach to grow is SWISS CHARD. It grows best during Autumn, Winter and Spring because during summer it can easily get leafspot disease.

VARIETIES

There are two kinds of SWISS CHARD Spinach, LUCULLUS and FORDHOOK GIANT

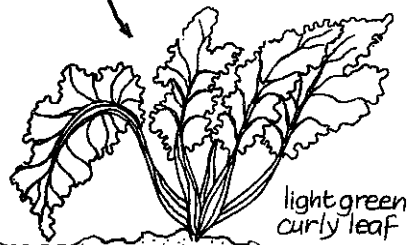
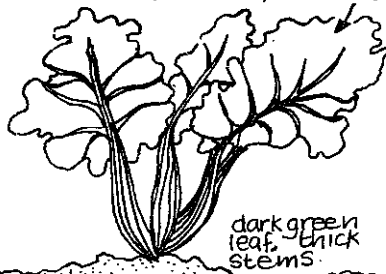

PLANTING

There are two ways of planting spinach:

DIRECT SOWING: Sow the seed about 1cm deep, using your finger to make a hole for each seed. Weed and water well and thin out the plants until they are about 25cm apart

SOWING IN A SEEDBED: Make rows 10cm apart and sow the seed. Water well and take out all the weeds. Keep thinning out the spinach plants until they are 2cm apart and 10cm high. Transplant on a cool day, in rows 30cm apart with 25cm between plants.

If the plants are more than 10cm long when you transplant, cut off half the leaves. Water the young plants twice a day and give them shade, until they are growing well.

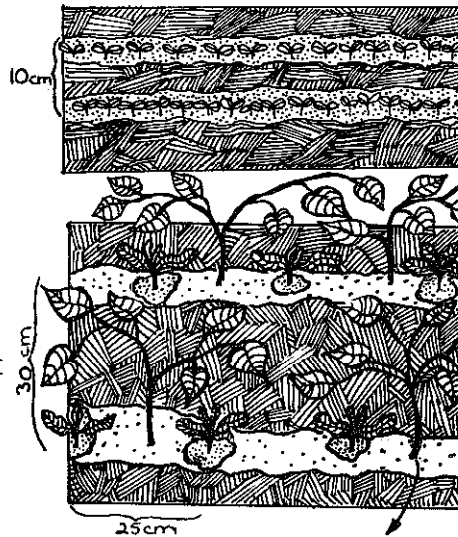

FERTILISERS

Dig in half a wheelbarrow full of manure or compost per sq metre, or one big handful (60g) of 2:3:4 (24%) per sq. m.



Put fertiliser on top of the soil (top dress) with liquid manure or LAN 28%.



To make liquid manure put half a sack of manure in a 200l (44 gallon) drum full of water for two weeks.

To make enough top dressing for one sq metre, make a watering can ^{1/4} full with liquid manure and fill it up with water. If you are using LAN as a top dressing, put on 20g per sq metre.

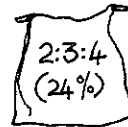

Top dress every 2 to 3 weeks while you are harvesting the spinach.

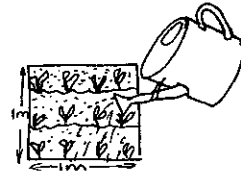

HARVESTING

You can start to pick spinach about 60 days after planting. Cut off the outside leaves with a sharp knife 4cm above the ground. The more you cut spinach the better it will grow. You can keep cutting the spinach for 3 to 4 months.

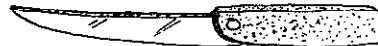

DISEASES

The most common disease of spinach is LEAF SPOT.

It is worst during hot wet weather.

Control it with CAPTAN or DITHANE M45



Small light brown spots with dark edges - a "scorched" appearance
Control with CAPTAN

Making Compost

What is compost?

Soil is made up of a living part and a dead part. The dead part is made of sand and clay. The living part is called humus and is made up of millions of very small living things - so small that you cannot see them. These things are called micro-organisms and help plants to grow. Manure, weeds, grass, vegetable wastes, fruit peelings, tea leaves, eggshells, leaves and sawdust will all rot and form humus. Dead plants and animals and animal manure also rot in the soil and turn into humus. All organic matter (everything that was living) breaks down into humus.

Why make compost?

Making compost is one of the best ways of increasing the amount of humus in the soil. Compost also helps the soil to hold more water. Crops fed with compost grow stronger and are not so easily attacked by diseases and insect pests.

Why doesn't everyone make compost?

Making compost is hard work and takes time. A farmer who grows crops over a large area of land will not usually have enough organic matter to make enough compost: 30 tons is needed per hectare. So it is better to make compost just for your vegetable garden. You need about 2 buckets full per sq. metre. Fallen leaves, kitchen waste from neighbours, grass and weeds and

manure from the veld and roads can all be added to the compost. It is a lot of hard work, but it is worth it.

What happens in a compost heap?

In the compost heap there are millions of micro-organisms. These micro-organisms eat the organic matter and breed very quickly. They die when the plants are all compost. The dead micro-organisms are plant food. To do their job well, micro-organisms need four things - air, water, warmth and food.

► Air - compost must have a lot of air, so the organic matter must not be too squashed or full of water.

► Water - the organic matter should be kept wet and not be allowed to dry out.

► Warmth - you can keep the compost warm by making it in a box, making it in a pit, or covering it with sacks.

► Food materials - make sure the organic matter is a good balance of energy food (carbon) and body building food (nitrogen). Carbon is contained in grass, hay, plant stalks and branches. Nitrogen is contained in manure, urine and chemical fertiliser. Compost heaps often do not work because the balance of carbon and nitrogen is wrong. Make sure that at least a tenth of your heap has nitrogen - either animal manure or grass soaked in urine from kraals or chicken houses.

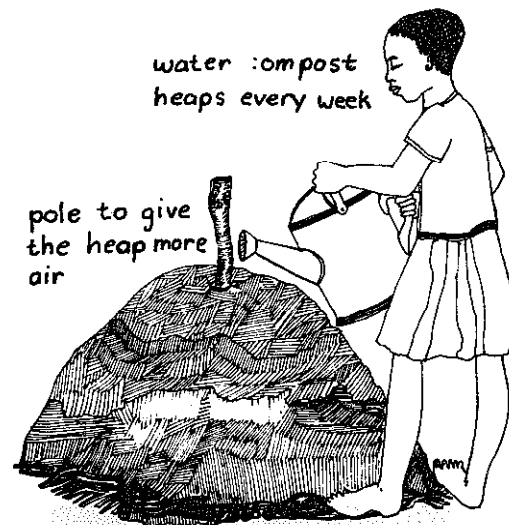
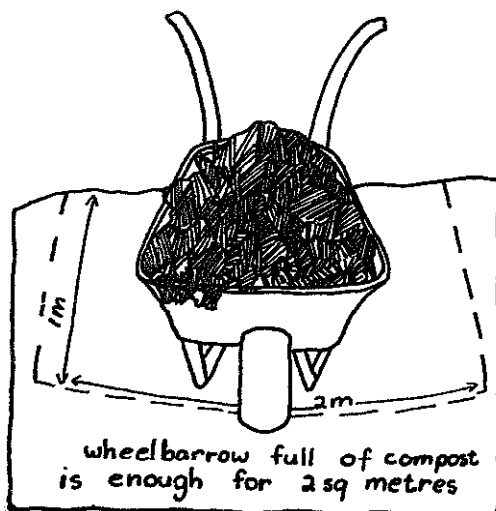

① fill the first pit with waste

② after six weeks turn the compost into the second pit fill the first pit again

③ turn both pits after another six weeks

④ After 5 months the compost is ready

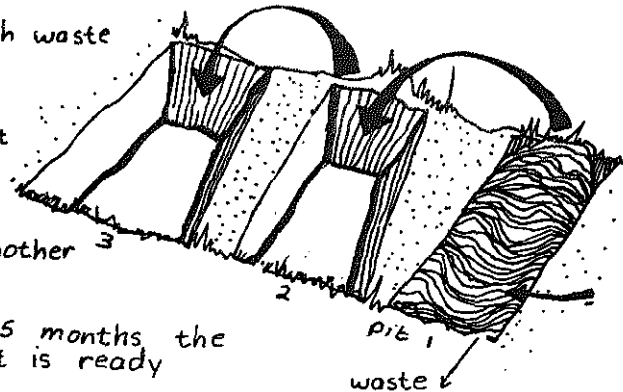

The compost heap will get very hot - hot enough to kill weed seeds and plant diseases. After 6 weeks dig the compost heap so that the compost on the outside gets into the middle.

pit. When you build your toilet, choose a place where you would like a fruit tree to grow when the toilet pit is full.

When is compost ready?

After about 3 months the compost is black and crumbly and smells sweet. Good compost has lots of earthworms. The earthworms are helping to turn the organic material into humus.

How to use compost

Compost is the best fertiliser for vegetables. You need at least half a wheelbarrow full (2 buckets full) for 1 sq metre. As soon as you put the compost on, dig it in very well otherwise it will not work properly.

Composting human wastes

Compost can be made in pit toilets but you have to wait for at least a year to make sure the human wastes are rotted and will not spread disease. Instead of digging up the compost you should plant a fruit tree at the

Most people do not have enough compost. If you do not have enough to put on the whole garden, use the compost for your seedbeds. If you are using compost for field crops, it is better to use up what you have on a small part of your field than to spread it thinly over the whole field.

layers in a compost heap

5cm animal manure or compost

25cm green waste

5cm soil or compost

25cm green waste

5cm animal manure or compost

25cm green waste

15cm thick layer of branches to let air in

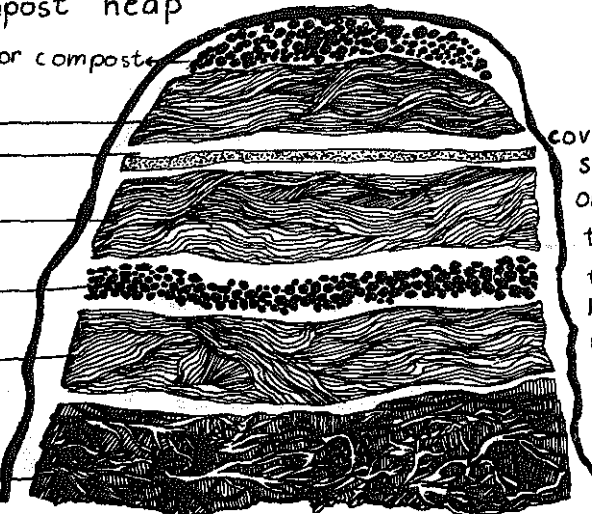

cover with sacks or plastic to keep the heap wet

Trenches

Trenching is a way of improving the soil so it holds more plant food and water. There are 3 kinds, french trenches, mock trenches and deep trenches. Before making trenches, divide up your garden into plots. Make each plot 2m wide and 10m long. Leave paths between the plots.

French Trenches

To make French trenches you need a spade and a fork. Start on one side of a plot and dig a trench 25cm wide and 25cm deep. Put the soil behind you, not on the plot. Then loosen the soil at the bottom of the trench with a fork. Then make another trench next to the first one, again 25cm wide and

25cm deep. Put the soil from this trench into the first trench. Now loosen the soil in the second trench with the fork. Dig the third trench, put the soil from the third trench into the second and so on, until you have opened the last trench in the bed. Fill the last trench with the soil from the first trench.

Rake the soil and put on compost or manure very lightly - only into the top 3cm or so of soil.

French trenches make it easier for plant roots to grow deeply into the soil. They will work for a long time. You do not have to make new trenches every year.

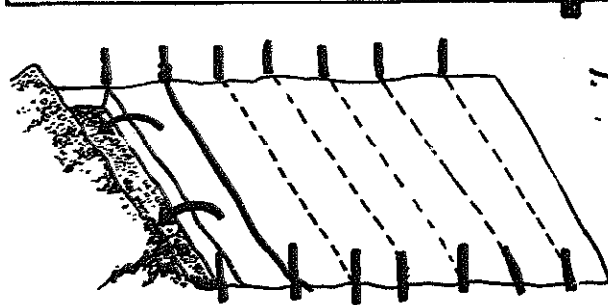
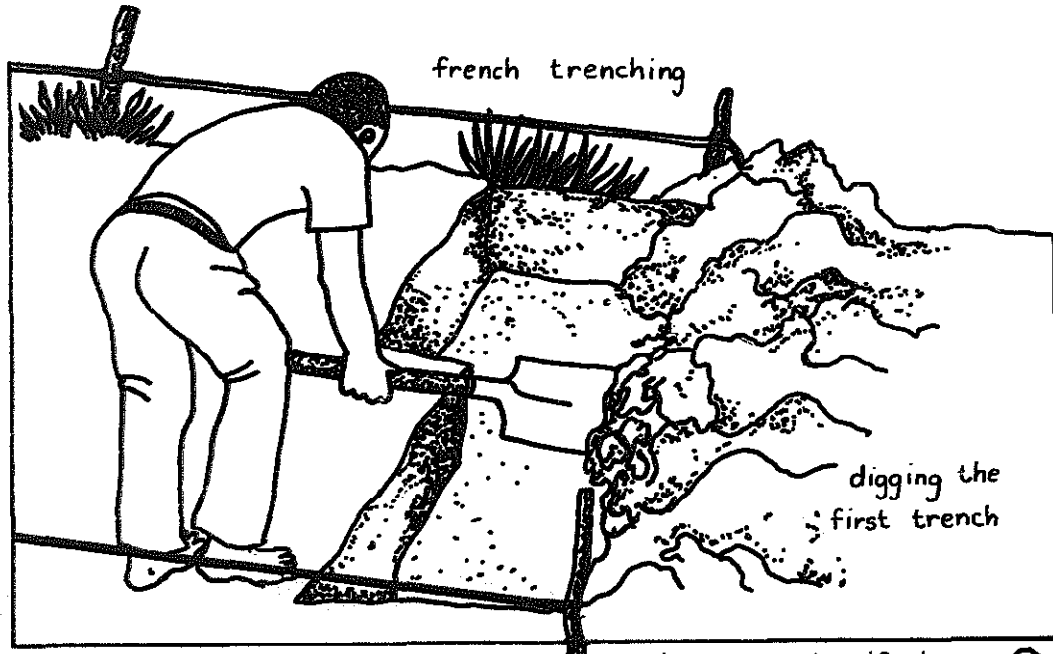

soil from the second trench is moved into the first

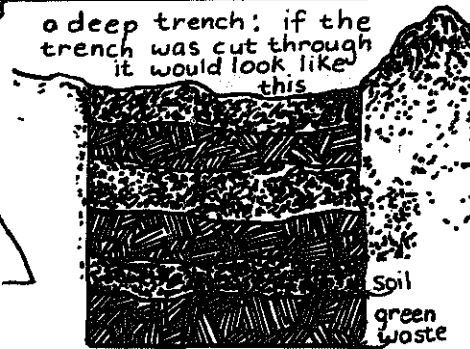

Mock Trenches

Make mock trenches in the same way as French trenches, but instead of loosening the soil at the bottom of each trench, put in a 25cm thick layer of dry grass, compost, or vegetable waste. You must make the mock trenches more than 6 weeks before planting to give the organic matter a chance to rot down and improve the soil. The rotted organic matter also holds water well.

Deep Trenches

Make deep trenches 2 months or more before planting. Make wide trenches, as big as each plot, 50cm to 1m deep. Dig out all the soil in the plot. Put the top soil, the first 25cm, on one side and the other soil on the other side. Put a 25cm layer of organic matter: grass, weeds, kitchen waste,

paper, in the bottom of the trench. Then put on a 25cm layer of soil from the bottom of the trench. Add more organic matter and soil layers until the trench is almost full. Then put in some top soil so that the soil is level with the ground. Allow the trench to stand for at least 2 months. As the organic matter rots, the soil will settle, leaving a hole. Fill the trench up with the rest of the top soil. When you plant, add compost and manure. Once a deep trench has been made it works for 10 years. But it takes a lot of work. In a big garden it is better to use French or mock trenches.

Try planting the same vegetables in plots with trenches and plots without trenches. You will see for yourself that trenches are a good way of improving the soil without chemical fertilisers.

TOOL HIRE-TO-BUY SCHEME

Many people cannot afford to buy garden tools. You can start a tool hire to buy scheme with other people in your community. You will need money to buy 10 forks, 10 spades, 10 rakes, 10 knives or other tools. You will need about R250. If you write to E.D.A. we will tell you where you can borrow the money to start.

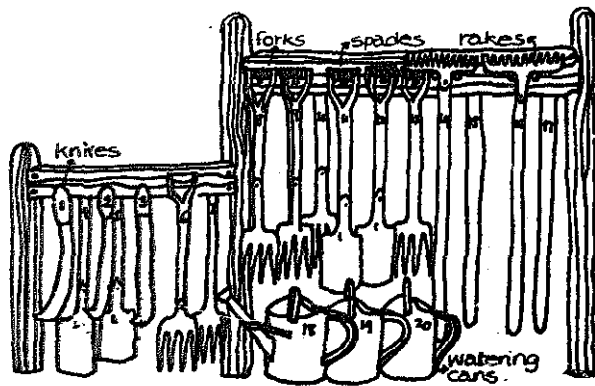

You can elect a committee: The committee chooses one person to look after the tools and to keep records. You will also need a place to keep the tools.

Each tool has a number painted on it. When a person wants to hire a tool, he or she goes to the person looking after the tools and pays to hire the tool for a week.

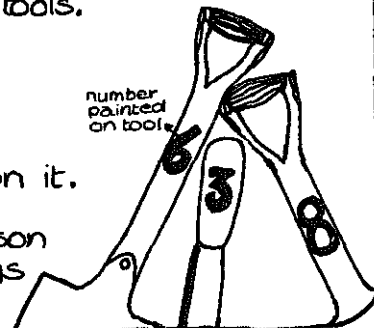

The toolkeeper must keep good records. Each time a person pays to hire a tool, it must be written down twice:

One page shows all the tools that have been hired out and who is using them. Cross off the name when the tool is returned.

LOZITHA TOOL HIRE SCHEME

SPADES:
 number 1: Mr. ~~Shabangu~~ E. Shabangu
 2: C. Mduli
 3: E. Zizane N. Dlamini
 4: P. Ndlovu

FORKS:
 number 1: M. Ndutsho S. Zwane
 2: etc. etc. etc.

E. SHABANGU		4.	
DATE:	TOOL:	R	C
20.9.80	SPADE	0	30
1.10.80	SPADE	0	30
7.10.80	SPADE	0	30
15.10.80	SPADE	0	30
etc. etc. etc.			

Each person has a page which shows how much he or she has paid to the tool hire scheme.

As soon as Mr Shabangu has paid the same amount for hiring that he would have paid to buy the tool, he becomes the owner. If a spade costs R6.50, he would have to hire the spade for 22 weeks (30c a week) to become the owner. The money he has paid for hiring is used to buy a new spade for the tool hire scheme.

The committee must open a bank account and pay the money into it regularly so that money is always available to replace tools that have been paid off.

The committee must have meetings so that they can check the toolkeepers records and report to the community about how the scheme is working.

It is best for one person to be the toolkeeper. A new toolkeeper should be elected each year so that more people in the community can get experience in running a tool hire scheme.



meetings held to check toolkeepers records.

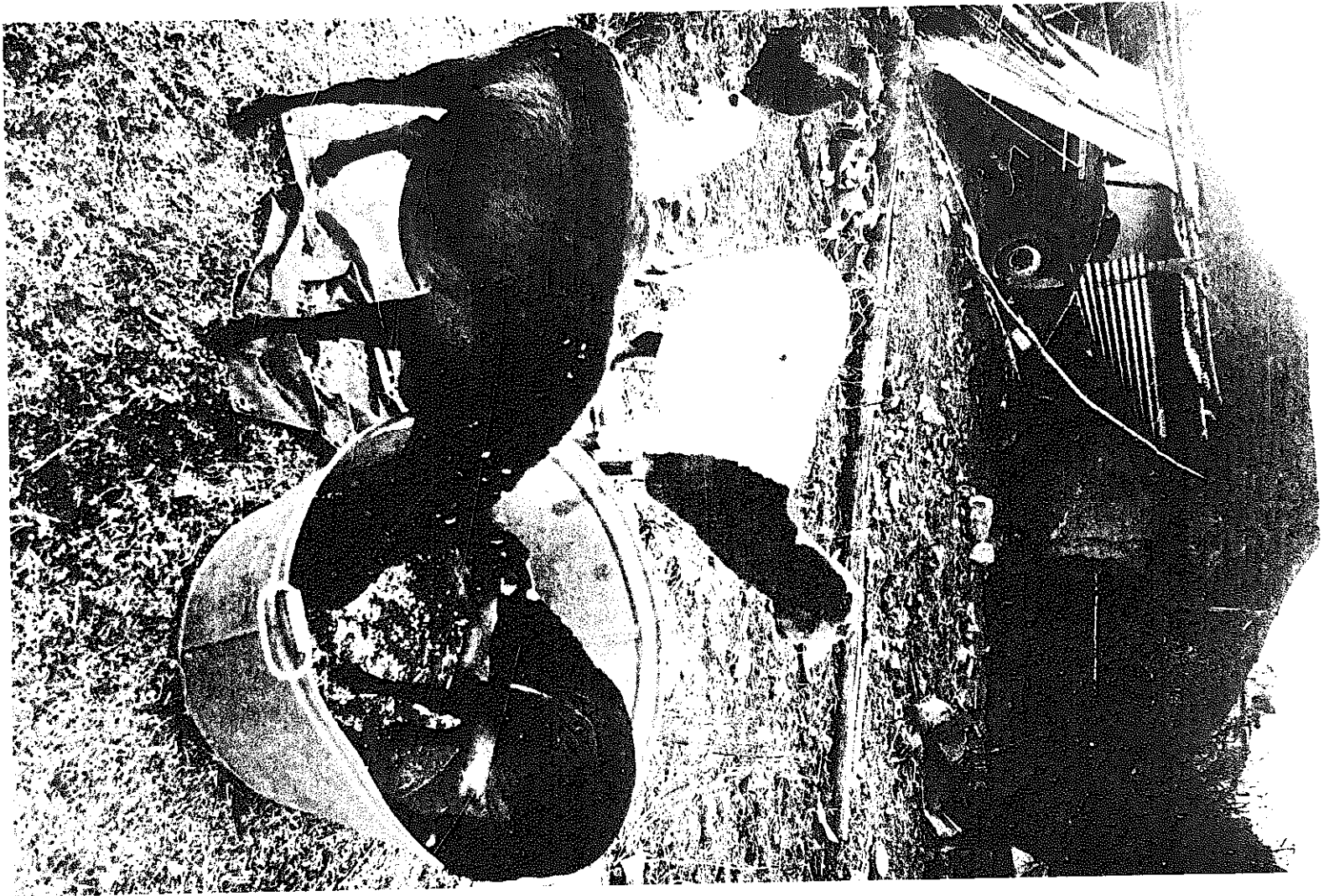

Keeping Pigs

Pigs eat household and garden wastes, give good manure for compost, and find their own food. They do not get sick easily.

Breeds

Locally bred pigs are usually strong and survive well in the area they come from, but they will not grow as well as commercial breeds. The most common commercial breeds are Large White and Landrace. A cross between locally bred (usually black) pigs and commercial (usually white) pigs can give a cross bred pig which is strong and grows fast.

Feeding

Pigs eat almost anything. The cheapest way to feed them is with household and garden scraps. Give them all kitchen waste, leftovers from plates and dirty dishwater, outer leaves of cabbages, carrot tops, and weeds. Collect food scraps if you can from your neighbours. Put your pig onto land which grew root crops like potatoes or carrots - the pig will dig up all the pieces left behind.

To get good quality meat from your pig, you must give it protein. You can get protein from offal, beer dregs or skim milk. In summer your pigs will love to eat lots of wild spinach (morogo, imifino). Pigs also need extra minerals which they can get from bonemeal.

Weight and Growth

Do not let your pigs get too fat, because then their meat will not be good. For good quality meat make sure the pig gets enough protein in the growing period (weaning to 30kg), and then in the finishing period (30kg to 60kg) make sure that you cut down on the amount of food.

During the growing period give your pig as much food as it can eat. If possible it should be able to eat whenever it wants to. One sixth of the food must be protein.

Once a pig weighs 30kg you must start cutting down its food and giving it less protein. Feed it twice a day, as much as it will eat in 20 minutes. This is a rough guide only - if it starts looking thin and hungry, feed it more, if it is getting too fat, feed it less. Continue feeding in this way until it reaches slaughter weight of 60kg. Your pig should take 3½-4 months to reach 30kg. A pig will usually weigh 60kg at 6 months. But it will take longer if it is underfed or unhealthy.

One way of planning the growth of your pigs is to buy young pigs (weaners) at times when more food is available. If you have cows, get piglets when the cow is giving milk so they can get skim milk. The fastest growth stage can be timed for the harvesting of potatoes or sweet potatoes, or timed for the fruit season if you can get fruit.

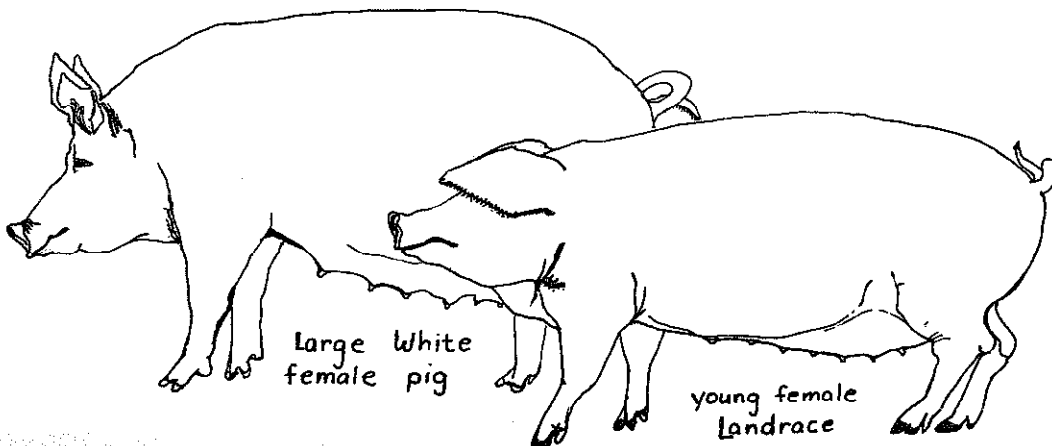

feeding young pigs:

for the first 3 weeks they only suck their mother's milk

at 3 to 8 weeks give them extra food like cooked vegetables, milk and pig meal. Use a creep feeder so that the mother cannot eat their food.

Wean the piglets at 8 weeks. After weaning, feed them as much as they can eat until they weigh 30kg.

Slaughter pigs at 60kg. Between 30kg and 60kg give them less food. They must not get too fat.

Breeding

If you are keeping a young female feed her in the same way as other pigs until she is old enough to mate. This will be when she is about 8 months old. When she is ready for mating (comes on heat) double her food then slowly bring her back to normal amounts, watching carefully to see that she stays in good condition. She will give birth 3 months, 3 weeks and 3 days after mating.

Three weeks before she gives birth, start increasing her food to double quantities and continue to feed her this amount until the piglets are weaned. Between birth and weaning she

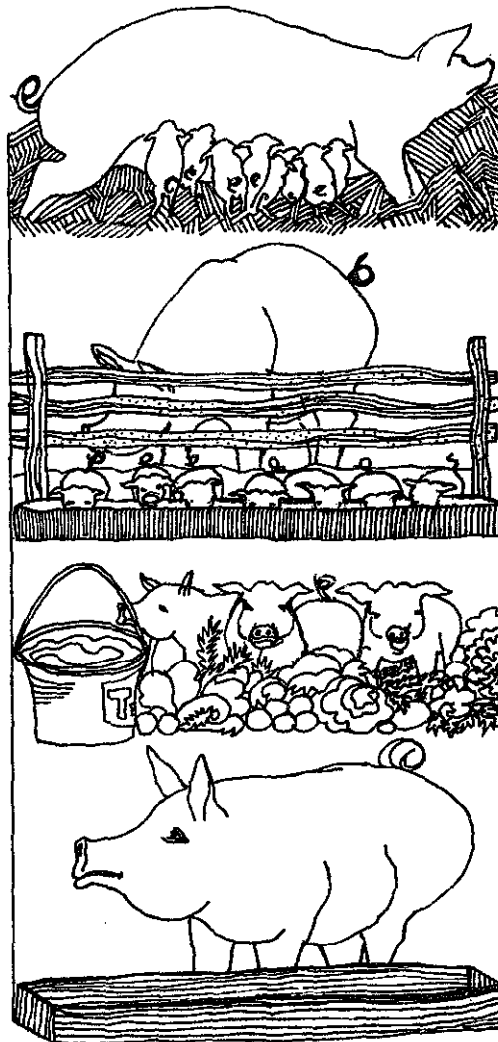

should get 250g of bonemeal per piglet every day in addition to her doubled food otherwise she will not make enough milk.

The piglets should eat solid food from 3 weeks, so that when they are weaned at 6 to 8 weeks they are eating well and in good condition. Weaning is the time piglets are most likely to get sick or die. The food must be tasty and easy for them to eat - vegetables should be cooked soft and mashed up, and milk should be added if possible. Each day put out as much as they will eat, and clean the feeder every day so the food is fresh for them.

Housing

Pigs are very strong and very clever, so make your pig house strong. The pig house must have a roof to give shade, because pigs cannot sweat to keep themselves cool like other animals. The house should also keep the pigs dry and warm when it is cold and rainy. Allow the pigs 1 sq metre each if they are under 40kg, and 2 sq metres each if they are heavier.

It is important not to let pigs wander around wherever they like because if they find human shit they will eat it. Pigs get tapeworm from eating shit, and if people eat the meat they can also get tapeworm.

Other ways of keeping pigs:

- Moveable pig house. If pigs stay in one place they will get worms and lice, so it is good to move them. You can make a moveable house from 6m logs held together with iron rods at the corners. With a moveable house, pigs will also be able to get food by digging in the ground.

- Tying pigs up. Sometimes people tie pigs to a tree or a stake, with a rope around their necks. This is not a good idea, because a pig's neck is nearly as thick as its head, and it can slip out. If the rope is too tight, it can hurt the pig. It is better to use a body harness.

- Pigs can also be kept in a well fenced field, but they must sometimes be moved because of worms and lice.

moveable pig house of strong poles

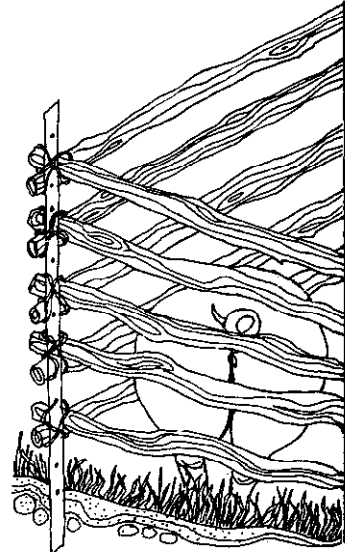

Disease and Parasites

Pigs do not get sick easily. The most common problems are skin diseases, worms and diarrhoea in young pigs. Pigs will, if they can, roll in mud and earth with great delight. They have a good reason to do this because they get Vitamin A in this way which prevents them suffering from skin problems.

pig house with thatched roof

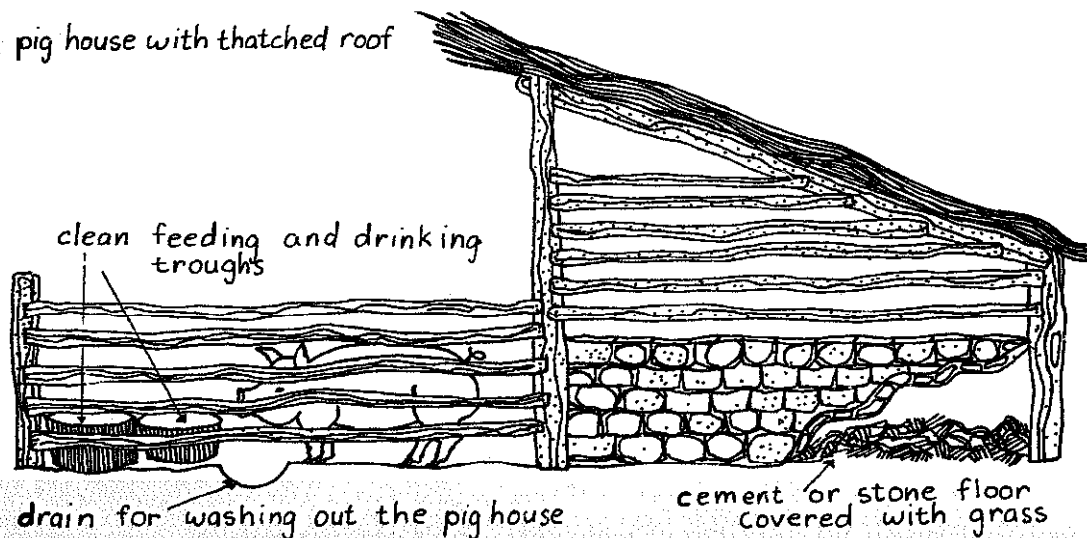

If a pig is suffering from worms, it will have a swollen belly, diarrhoea, and it will not grow well. This is a common illness in young pigs and to prevent it you must deworm all your piglets after weaning. Use deworming medicine such as Repzine or Peratox.

Weaning is a big change for the young piglet and if it does not eat well it will be weak and get sick. Often it will get diarrhoea - watch out for this and treat it straight away otherwise the piglet will get weak and die. To get rid of diarrhoea using Kemzol or Diazol medicine. Your pigs will have less health problems if you keep the pig house clean.

Selling and Slaughtering

There are many different ways you can decide on how many pigs to keep. You can keep one or two females, use a neighbour's male, and sell some of the piglets or keep them all to fatten. If you have three or more females, you can keep your own male. It depends on how many pigs you want to keep at any one time. Some people like to keep one pig at a time and after slaughtering buy a new 8 week old pig.

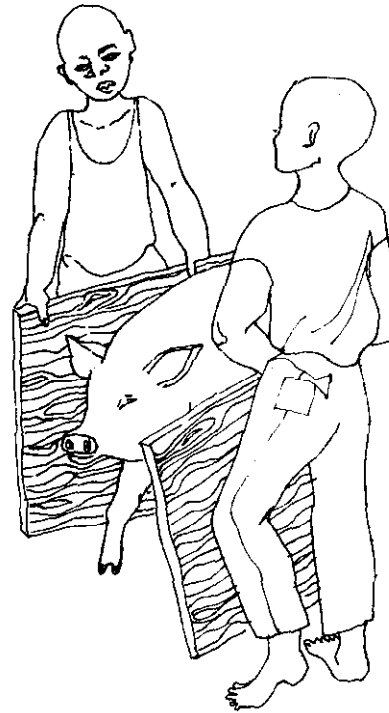

herd pigs with wooden boards or corrugated iron

Slaughtering a Pig

Pigs are ready for slaughtering when they are 6 to 8 months old. Kill the pig by hitting it on the head with a heavy hammer and then cutting its throat with a long pointed knife. Keep the blood for the compost heap.

Cleaning

Have half a 200 litre drum of boiling water ready. Wash the pig very well with soap and warm water, and then stand it on its knees. Put a layer of hessian sacking over it and pour boiling water onto the sacking. Use a piece of wood to hit the sacking all the time. Do this until when you lift the sacking the hair can be pulled out easily. Then remove the sacking and scrape the skin firmly with kitchen spoons. Shave off the remaining short hairs with a razor. Finally, soap and wash the pig again.

use a sack and boiling water to take the pig's hair off



Butchering

Cut off the head just under the chin, and wash the neck. Cut through the skin, fat and bone of the breast with a sharp carving knife from the neck down. Over the belly it is best to keep two fingers under the point of the knife to avoid cutting open the intestines and stomach. Remove the gall bladder carefully from the liver. Keep the large intestines and bladder for sausages. The large intestines break easily so be careful. Turn them inside out to scrape them. The small intestines should be scraped flat on a smooth plank or slab without turning inside out. Use the blunt side of a knife as a scraper.

Then hang up the carcass with hooks fixed into holes cut in the back legs above the feet. Let the pig cool before cutting it in half down the back with a hacksaw.



All parts of the pig can be used. You can make sausages, bacon, ham and pork. The meat can be smoked, dried, bottled or pickled. All parts of the pig you do not want to eat can be pickled, cooked and fed to chickens. You do not need to throw anything away.

Using the Meat

Sausages - to make sausages use twice as much lean meat as fat. Mince the meat and mix the meat and fat well. Add lots of spices, black pepper, allspice, cloves, chillies and lots of garlic. Spices stop the sausages from going rotten. Stuff the sausage mixture into the intestines after you have scraped them clean and washed them. Hang the sausages to dry for a week in a cool windy place, and then smoke them.

Bottled pork - this is made with good lean meat and some fat, cooked with onions. Put it into glass sealing jars with rubber rings. Tighten the lids and take the jars off the stove as soon as they boil. Boil them again 24 hours later, without loosening the lids, for 20 minutes.

Pickled pork - pickle hams, bacons, rolled bits of fat and skin. For 20-40kg of meat, use this recipe for pickling juice: 20 litres boiled water, 250g saltpetre, 250g sugar, 5kg salt, 125g black pepper, 125g allspice, 200g coriander, 125g mace. The brine soaks into the meat 1cm a week - so a 10cm thick bacon needs 10 weeks of pickling. After pickling, hang the meat up for 24 hours and then smoke it.

Brawn - this is made by boiling the head, feet, ribs and bones for a long time with herbs and spices. Cook for long enough for the meat to fall off the bones. To prepare the head for cooking cut it down and across into quarters with a saw or axe, and remove teeth, eyes and non-meat parts. Remove the nails from feet by dipping them into boiling water on a wire and pulling them off with pliers.

Drying - rub a little saltpetre into the meat, then rub in salt and sugar, then bury it in a drum full of salt for about 2 weeks.

200 litre oil drum with top and bottom cut off

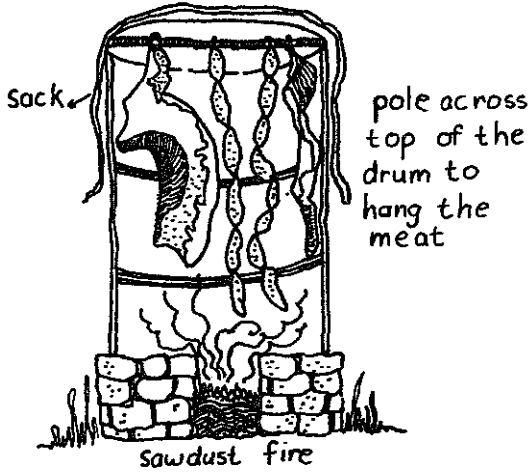

Smoking - use 4kg of sawdust from wood which does not contain sticky gum. For example wattle is good for smoking but pine is not. Build a round stone wall as high as your knee. Put a 200 litre drum, open at both ends on the wall and light a fire underneath. Fit a rod tightly inside the top of the drum and hang all the meat on the rod. Before putting in the meat, light the sawdust by burning paper or leaves on top of it. The smoker must be out of the sun and wind. Cover the top with a sack and a wood or metal cover. After smoking hang the meat in a cool dark place, otherwise it will go bad. Smoked sausages and hams will keep for a long time, but do not keep bacon for too long or it will go hard.

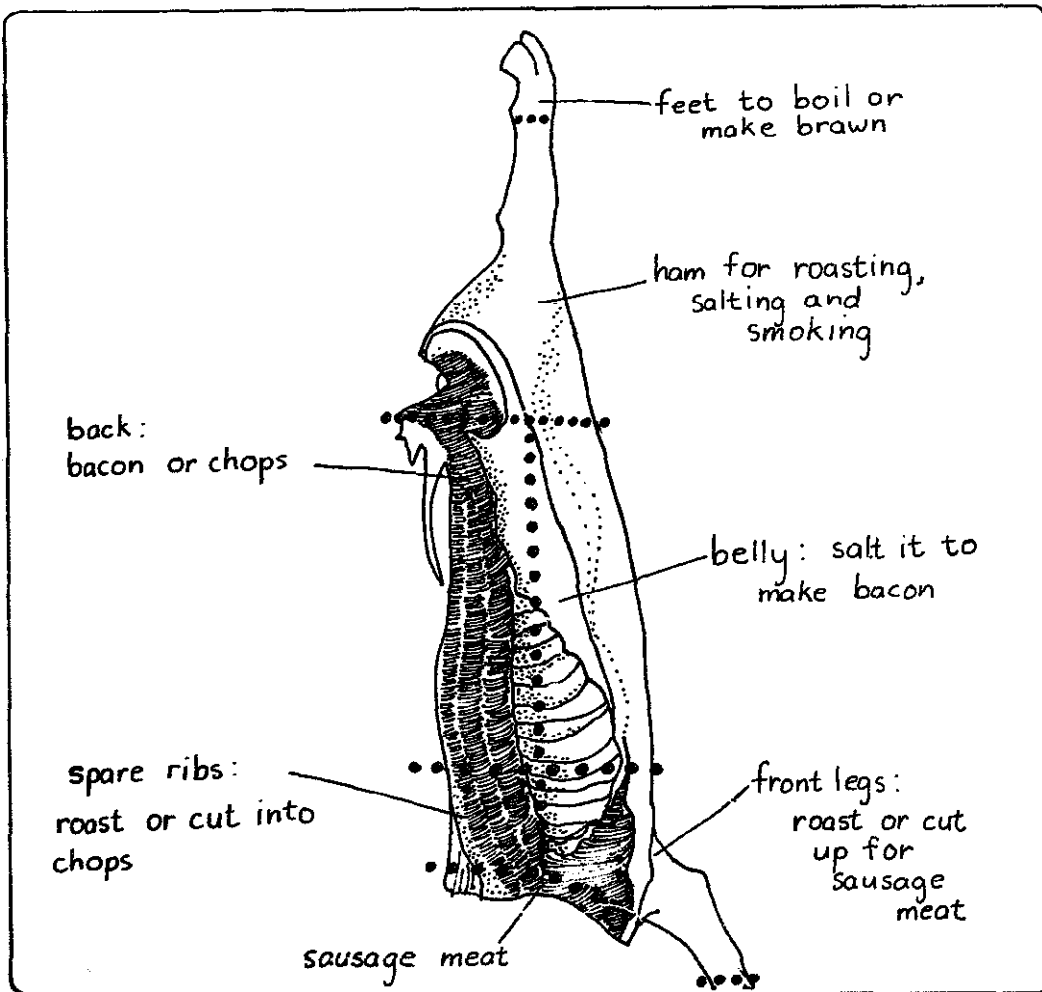

Keeping Rabbits

Rabbits do not cost much to keep, and they breed quickly. One male and two females will breed enough to give you meat throughout the year. Rabbit manure is high in nitrogen and very useful in a vegetable garden.

Breeds

The four most common breeds for meat are:

- ▶ New Zealand Red - a light brown-red colour with an average adult weight of 3,5kg. Although it is the smallest breed, it is the quickest to reach slaughter weight of 2kg.
- ▶ New Zealand White - completely white colour with an average adult weight of 5kg.
- ▶ California - white with black nose, ears, feet and tail. Average adult weight 4,5kg.
- ▶ Flemish Giant - grey-brown in colour, with average adult weight of 6kg.

Feeding

You should give your rabbits different foods like:

- Root crops like carrots, turnips and radishes. If you have lots of rabbits you should grow radishes for them. Radishes grow all the year round and can be picked 3 weeks after planting.
- Fresh green grass, green maize leaves, cabbage leaves, lettuce, lucerne and weeds, blackjacks and dandelions are all good food for rabbits. Do not feed rabbits dry grass or leaves because they can be poisonous. Potato plants, tomato plants, and spinach leaves are all poisonous for rabbits and should not be fed to them.
- Starch foods like mealie meal, por-

ridge and bread are food for fattening rabbits before you slaughter them. Rabbits also like good quality hay.

- Give rabbits plenty of clean water.

Rabbit pellets are sold by milling companies, but they are very expensive. Rats like the pellets, so you will have to ratproof your rabbit house and your store room. We do not recommend pellets because they are too expensive for small farmers.



Housing

Keep rabbits off the ground in wire mesh or wooden cages, supported on poles. If the cages are on the ground, the rabbits will dig their way out. A cage for one rabbit should be 1 sq metre and for a female with babies 1,5m x 1m. The cages should have a roof over them - this can be a thatch roof supported by wooden poles. You will also need nesting boxes, so that the mother can make a warm place for her babies, which are born without fur. Make the nesting boxes about 50cm square.

New Zealand red

New Zealand white

California

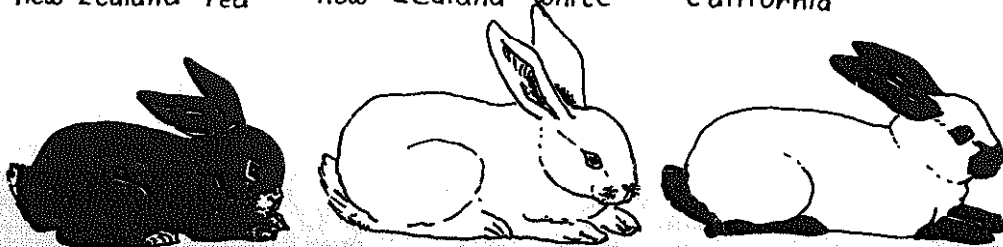

wooden cage with nesting box

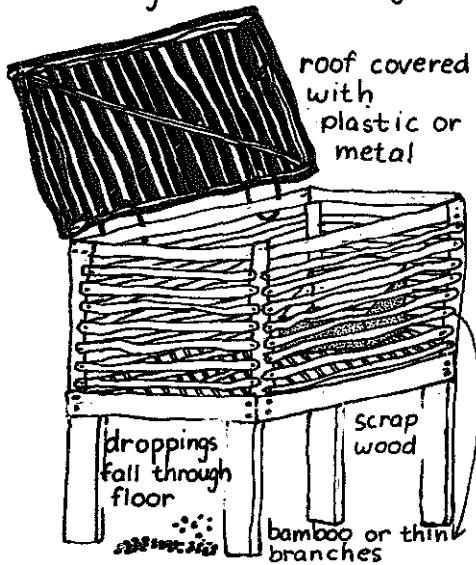

nesting box

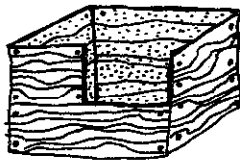

Records

Rabbit breeders should keep good breeding records. You should keep a record like this one for each female.

Name: Rabience			Date of Birth: 25.2.79			
Dam: (mother) Duda			Sire: (father) Whitey			
Litter Number	Mating Date	Buck	Kindling Date	Live	Dead	Average weight at 6 weeks
1.	1.8.79	George	2.9.79	8	1	1.9 kg
2.	3.11.79	George	4.12.79	8	0	2.1 kg

Slaughter

The best time to kill rabbits for meat is when they weigh about 2kg, which will be at about 4 months. You should be able to sell the meat for R2. Kill a rabbit by hitting it hard on the back of the head with an iron bar. Skin it by hanging it up by its legs. Cut around and down the inside of each

thigh and down the belly with a sharp knife. Loosen the skin and pull it down. Cut around the head and front feet and pull the skin off. Dry the skins in the sun but do not rub salt or chemicals into them. Make them soft by rubbing them up and down in your hands or over a smooth stone.

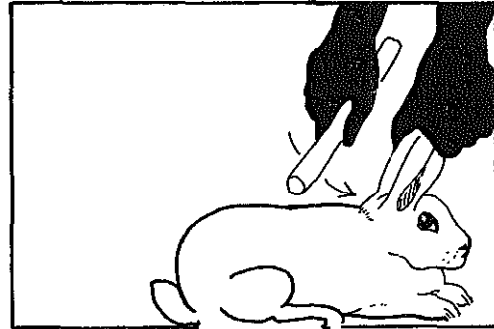

skinning a rabbit

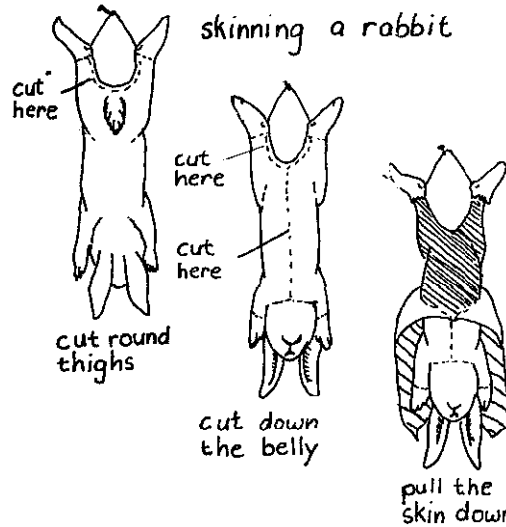

Breeding

To mate rabbits take the females to the males. This is important because if you take the male to the female, she may fight with him. Leave them together for two days to make sure they mate properly, then take the female back to her cage. After 12 days take the female back to the male again. If she refuses to mate this time, it means that she is probably pregnant. The babies will be born about 31 days after a successful mating. You should leave the female with her babies for 6 weeks. She can be mated again 2 weeks later. If you do this a female can give birth 4 times a year.

HOW TO KEEP CHICKENS

Most people keep a few chickens for eggs and meat. The chickens scratch around for their own food and are easy to look after. You can also keep lots of chickens and sell the meat and eggs.

In this article we discuss how to make money from keeping chickens. You must buy young chicks, feed them with special chicken food and give them medicines to prevent diseases.

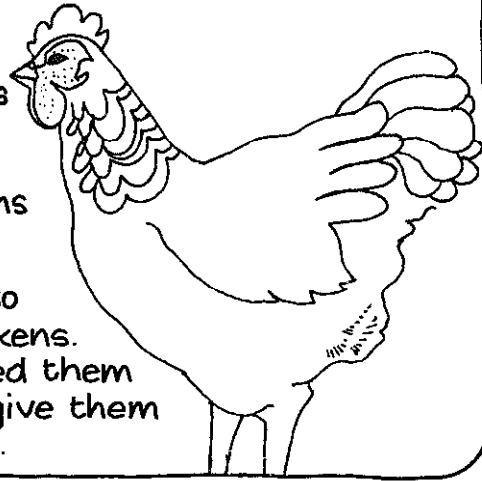

Buying Day-Old Chicks

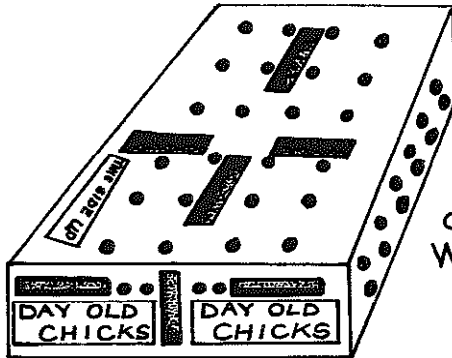

If you are keeping lots of chickens, you should buy day-old chicks. You can order them from chicken suppliers. Write to them for a free price list.

There are two kinds of chickens. Chickens for meat are called broilers and chickens for eggs are called layers. Broilers are usually light breeds like White Leghorn. Layers are usually heavier breeds such as:

- New Hampshire - light brown
- Rhodes Island Red - dark reddish brown
- Black Australorp. x White Leghorn - black and white
- Plymouth Rock - grey and white

When you order, you have to tell the supplier what sexes you want. They can be all males, all female or mixed sexes (some male and some females). All males are the cheapest, mixed sexes are more expensive, and all females are the most expensive. If you want to sell meat and eggs, buy mixed sexes.

Tell the supplier your name, address, nearest station, nearest telephone, how many chickens you want, what breed, and what sexes. You usually have to order at least 100 day-old chicks at a time. The supplier will send them by railway or bus. It is very important to know exactly when and where they will arrive otherwise they can die. You should ask the supplier to phone you to tell you when the chickens will arrive. Send a letter like this to the supplier:

*% Engcobo Restaurant,
P.O. Box 23,
Engcobo,
Transkei.
20 July 1980.*

*T. A. Serfontein,
30 Van der Hoff Rd.,
Potchefstroom,
2520.*

Dear Sirs,

I want to order 100 day-old chickens Rhode Island Red, mixed sexes. I enclose a crossed postal order for R20.00. This is the price from Farmer's Weekly.

Please write to us at the above address and telephone Mrs. Mviko at Engcobo No 12, to tell us when we must fetch the chickens at Engcobo Station.

Yours sincerely,

*Miss J. J. Msengane (Secretary)
Engcobo Chicken Co-operative.*

Before the chickens arrive, get these things ready. They must all be cleaned with Jeyes Fluid.

- Drinking dishes.
- Feeding dishes.
- Clean grass for the floor.
- Chick food.

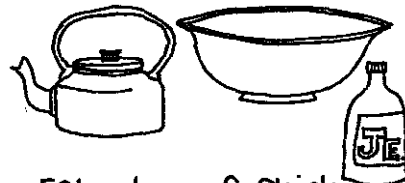

If you have ordered layers, buy a 50kg. bag of Chick Starter Mash 18% protein. If you have ordered broilers, buy a 50kg. bag of Broiler Starter Mash 22% protein.

Looking After Day-old Chicks

Keep the day-old chicks far away from full-grown chickens. Older chickens can give them diseases. In hot weather, chicks do not need extra warmth. Keep them in a room inside a box like this:

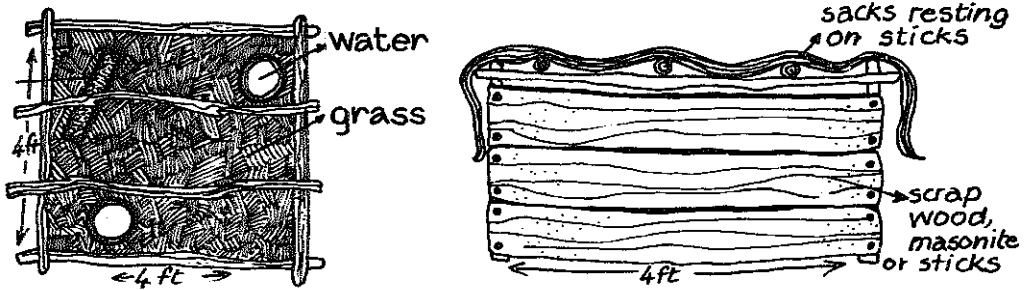

In cold places, or in winter, you must make a warm place for the chicks. You can make a heater with an oil drum cut in half.

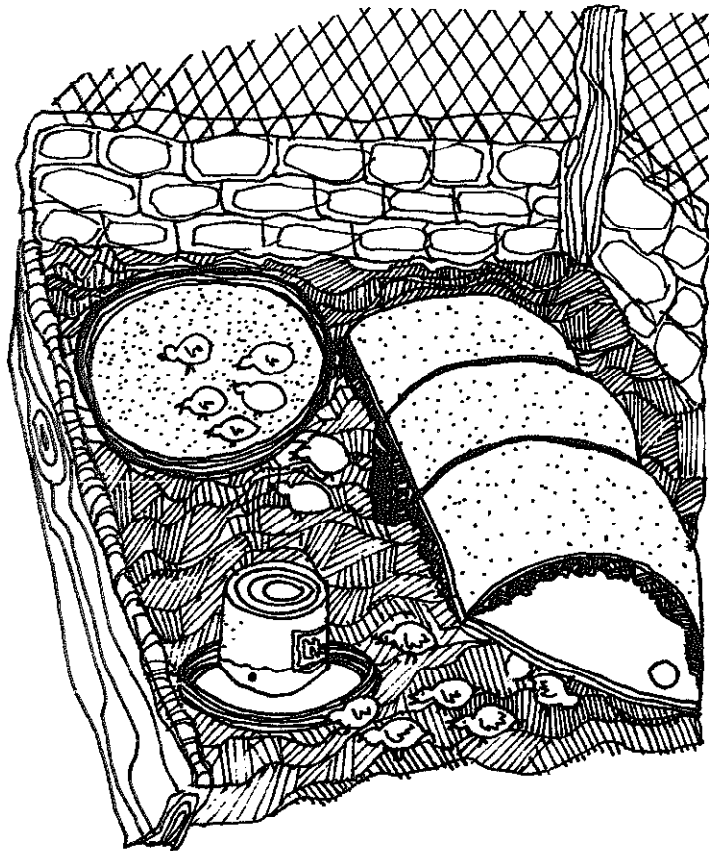

Ask your local garage to cut it for you with a cutting torch, or cut it with a hammer and cold chisel. You will need 2 half drums for 100 chickens. Cover the outside of each half drum with thick dry grass. Hold the grass in place by tying sacks over it. Put a paraffin lamp inside the drum as a heater. Put a brick under one side of the drum so that the chickens can get in and out. Use wood to keep the chickens close to the heater.

- Keep the glass and the wick of the lamp clean so there is no smoke. If the glass gets black from smoke, the lamp will not give enough heat. Also the smoke makes the chicks sick.

- You can make the oil drum heater hotter or cooler by lowering or raising the side which is held up by the brick.

You can tell if the heat is right by seeing how close the chicks stay to the lamp. Take the heater away when the chickens are 4 weeks old if it is winter or when they are 2 weeks old if it is summer. For a few days before you take the heater away let the chicks get used to the cold by lifting the brick and lowering the flame.

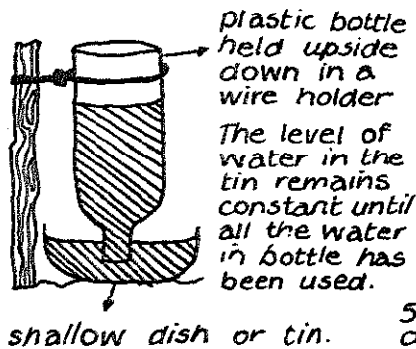
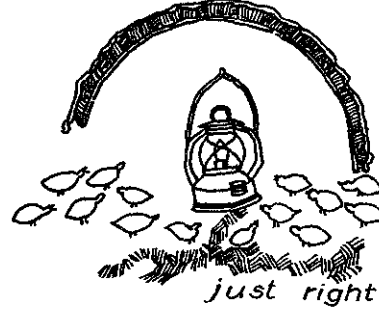
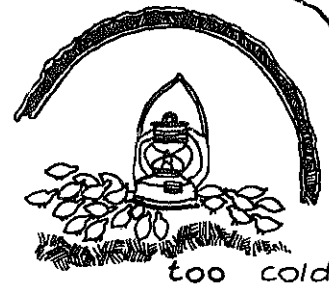

- The feeders and drinkers must be big enough for at least half the birds to feed at one time.

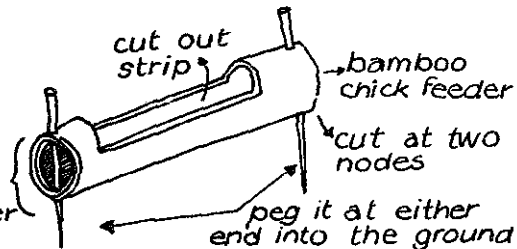

As the chicks grow give them bigger feeders and drinkers.

Ask your local garage to cut it for you with a cutting torch, or cut it with a hammer and cold chisel. You will need 2 half drums for 100 chickens. Cover the outside of each half drum with thick dry grass. Hold the grass in place by tying sacks over it. Put a paraffin lamp inside the drum as a heater. Put a brick under one side of the drum so that the chickens can get in and out. Use wood to keep the chickens close to the heater.

- Keep the glass and the wick of the lamp clean so there is no smoke. If the glass gets black from smoke, the lamp will not give enough heat. Also the smoke makes the chicks sick.

- You can make the oil drum heater hotter or cooler by lowering or raising the side which is held up by the brick.

You can tell if the heat is right by seeing how close the chicks stay to the lamp. Take the heater away when the chickens are 4 weeks old if it is winter or when they are 2 weeks old if it is summer. For a few days before you take the heater away let the chicks get used to the cold by lifting the brick and lowering the flame.

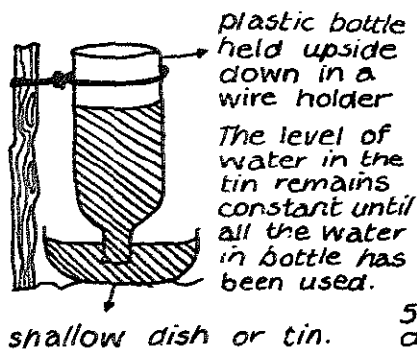
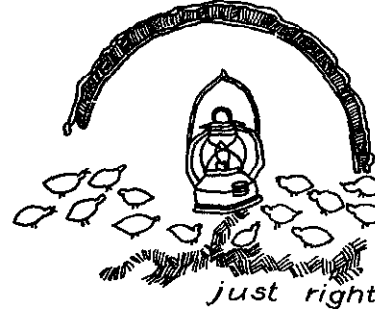
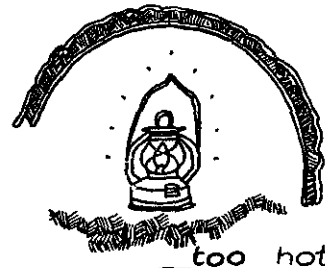
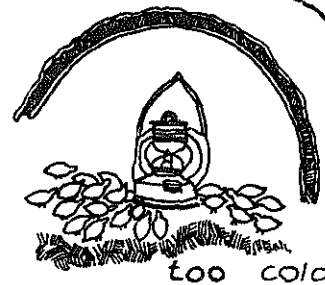

plastic bottle held upside down in a wire holder
The level of water in the tin remains constant until all the water in bottle has been used.

shallow dish or tin.

5-8 cm diameter

- The feeders and drinkers must be big enough for at least half the birds to feed at one time.

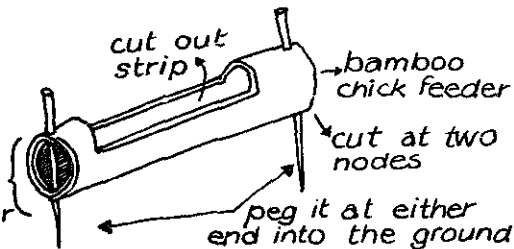

cut out strip

bamboo chick feeder

cut at two nodes

peg it at either end into the ground

As the chicks grow give them bigger feeders and drinkers.

Housing

Chicks do not need expensive housing. The chick house must be easy to clean and dry. There must be enough fresh air.

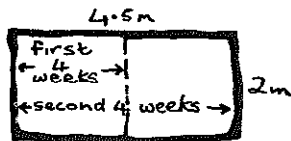
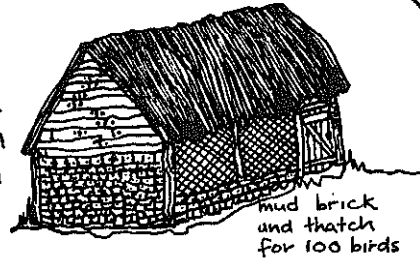

Between 2 and 4 weeks old, 100 chicks need 4,5 square metres of space. After 4 weeks, they need 9 square metres.

BROILER CHICKENS

Broiler chickens are sold for meat. When you keep broiler chickens, you have to make them fat as quickly as possible and sell them when they are 8 weeks old. This means feeding them well. In 8 weeks each chicken should eat about 3,5kg of mash - that is about 7 50kg. bags for 100 chicks.

You can feed them:

- Broiler mash only, or
- Broiler starter mash for the first 4 weeks and broiler finisher mash for the second 4 weeks. When you change from starter mash to finisher mash, mix them together for 3 days so the chickens get used to the new food.

The chickens must have fresh food and water all the time. Weigh them if you can. At 2 weeks, a broiler should weigh 230 grams, at 4 weeks, 650 grams, at 6 weeks 1,2 kg. and at 8 weeks 1,8kg.

Costs and Selling

Broilers can sell for about R1,20 per kg. - that is R2 for an 8 week old broiler which weighs 1,8kg. For example, say you ordered 100 birds. 5 died, and you sold 95 for R1,80 each when they were 8 weeks old.

Your sales were: $95 \times R1,80 = R171$

Your costs were:

Day-olds	R18
Feed	R10
Paraffin	R2
Transport	R5
	<u>R95</u>

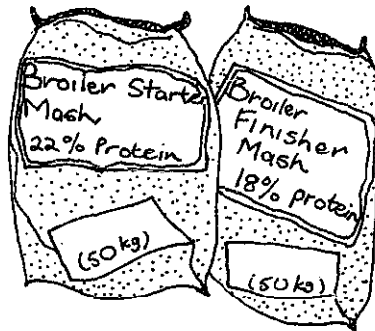

Your profit is: $R171 - R95 = R76$

CHICKENS FOR EGGS (LAYERS)

If you are keeping chickens for eggs, take the males away from the females when they are 6 weeks old. You can tell which are the males because they have longer legs and bigger combs.

Sell males at 8 weeks old as broiler chickens.

Feeding 6 to 20 weeks

Between 6 and 20 weeks, feed your layers with Chick Grower Mash 15% protein. For 100 layers, you need this much mash:

<u>Age (weeks)</u>	<u>Feed for light breeds(kg)</u>	<u>Feed for heavy breeds(kg)</u>
6	4,0	4,5
7	4,0	4,5
8	4,0	4,8
9	4,5	5,0
10	4,5	5,2
11	5,0	5,4
12	5,0	5,7
13	5,4	5,9
14	5,4	6,1
15	6,0	6,4
16	6,0	6,6
17	6,4	6,8
18	6,4	7,0
19	6,8	7,3
20	6,8	7,5

Housing: 6 to 20 weeks

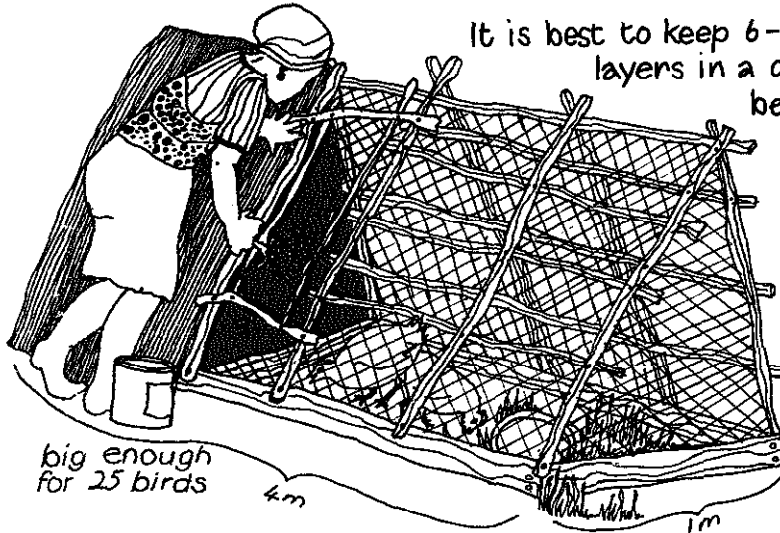

It is best to keep 6-20 week old layers in a cage which can be moved onto a new piece of ground every day.

A cage like this is big enough for 20 chickens.

The chicken manure can be left to fertilise the field, or you can pick it up and use it for a vegetable garden.

After 20 weeks

After 20 weeks move the chickens to a laying house. They start to lay eggs when they are 22 to 24 weeks old.

Some suppliers sell chickens about 20 weeks old, ready to lay. They are called point-of-lay chickens.

Laying Houses

There are two kinds of houses for laying hens - deep litters and outside runs. Deep litters are better because they need less space and less fencing.

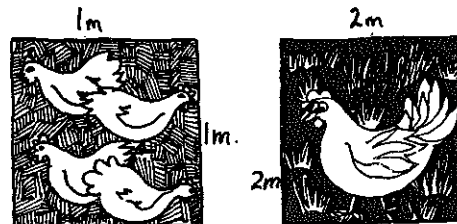

In a deep litter you can keep 16 hens per 4 sq. metre; in an outside run, you can only keep 1 hen per 4 sq. metres.

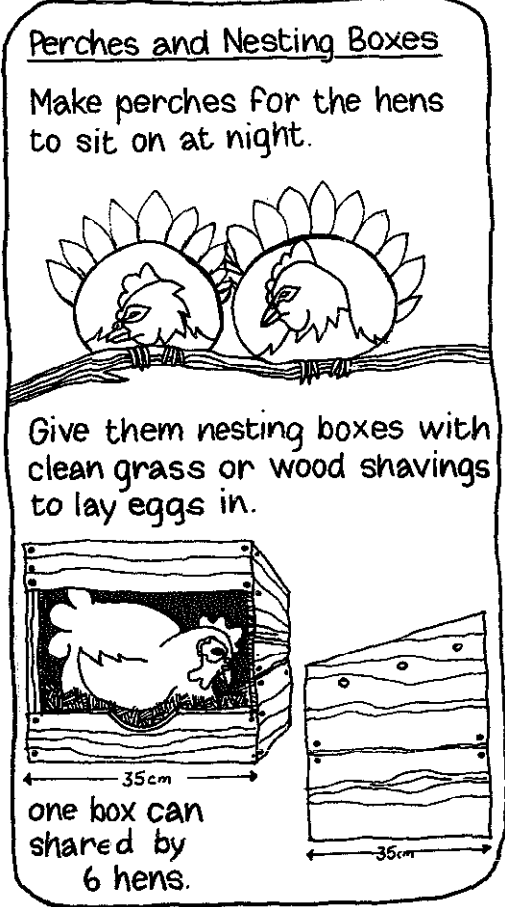
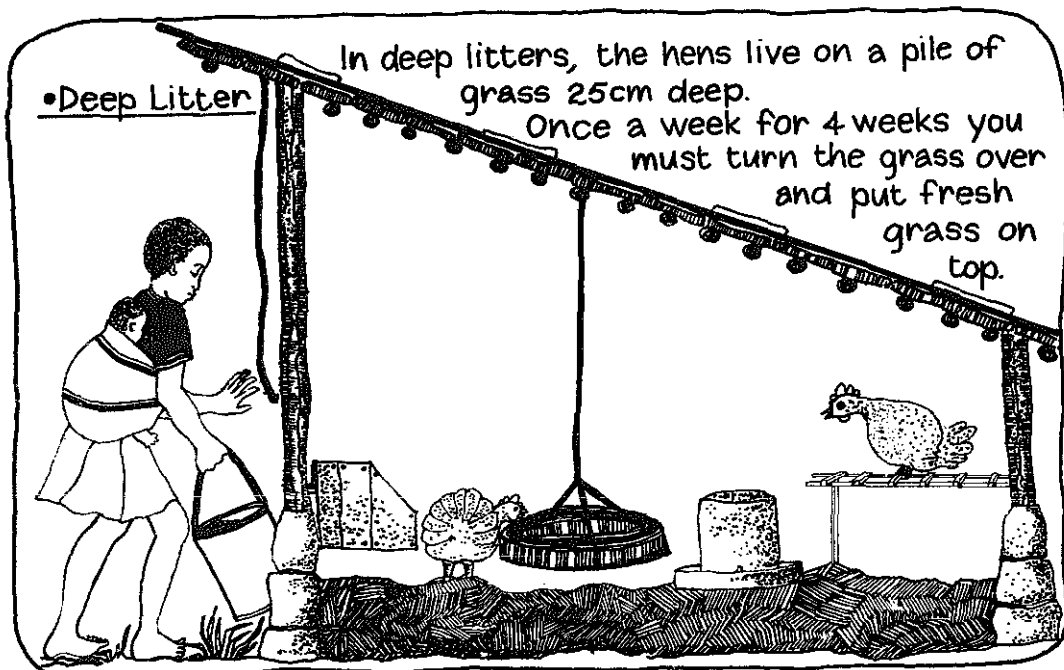

Feeding Laying Hens

In the first week after you move the hens to the laying house, start to mix layers mash 16% protein into their growers mash. Mix in more and more layers mash and less and less growers mash, until all their food is layers mash.

Give them enough food for each hen to have half a cup of mash per day. If they are in an outside run scatter yellow mealie meal in the run every day so they scratch for it and dig for worms and insects. If you grow vegetables, give them fresh comfrey, cabbage, or lettuce leaves. Give them enough clean water every day.

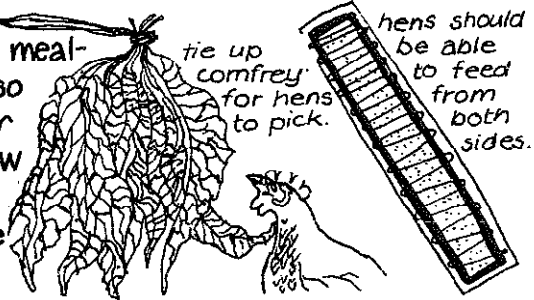

Good Laying Hens

has a large, glossy red comb

has large bright eyes

has a large, moist and light coloured (not bright yellow)-vent

has skin that has faded from bright yellow to pale yellow.

A good laying hen looks thin and strong. If it is fat it means it is not laying eggs.

has pelvic bones that are thin, soft and separated. The distance between them should be 3-4 fingers.

pelvic bone

If a hen does not look or feel like this it must be sold or eaten. It is too expensive to feed hens which do not lay eggs.

The illustration shows a hen on the left with arrows pointing to its comb, eyes, and vent. On the right, a woman is shown from the waist up, holding a hen and examining its pelvic area. Arrows point from the woman's hands to the pelvic bones and the space between them.



Chickens lose their old feathers and grow new ones once a year. During this time they do not lay eggs.

Record Book

Keep a record book to see how many eggs your hens are laying. Then you can work out how much to sell your eggs for.

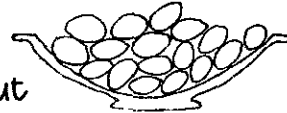

A laying hen should lay at least 4 eggs a week in the first year. If you look after your hens well, they will lay 4 eggs a week in the second year too. Most people who sell eggs get new laying hens every year.

EGG RECORD BOOK 								
1980	M	T	W	Th	Fr	S	Sun	WEEKLY TOTAL
1-4	10	7	9	8	11	7	6	58
8-4	9	6	9	5	6	5	6	47
15-4	6	8	9	9	10	5	5	52
22-4	8	9	10	10	9	8	8	62
29-4	8							
6-5								
13-5								

HATCHING YOUR OWN BABY CHICKS

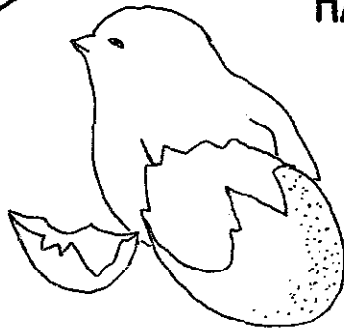

If you want to get your own chickens, leave some eggs for a hen to hatch.

Make a nesting box inside the chicken house for each mother hen to hatch her chicks in.

Put sticks in front of the box so that the mother hen cannot get out to eat the baby chickens' food. Make sure that wild birds and animals like dogs, cats, snakes and jackals cannot get inside the chicken house.

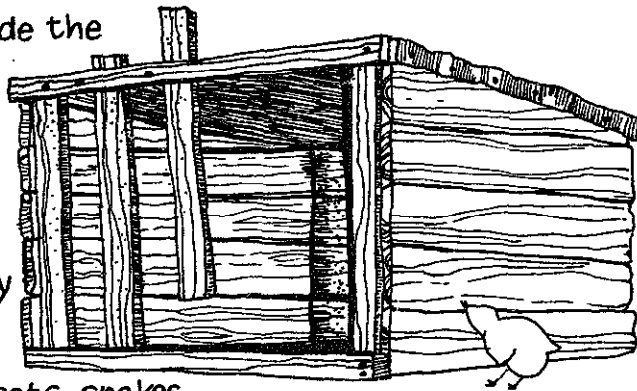

Chicken Diseases

You can tell a chicken is sick when:

- It does not eat.
- It keeps away from other chickens.
- It does not move around much.
- It has a bent-over back.
- It has loose feathers which do not lie down flat.

Take the chicken away from the others. Put it in a cage by itself so that the others do not get the disease.

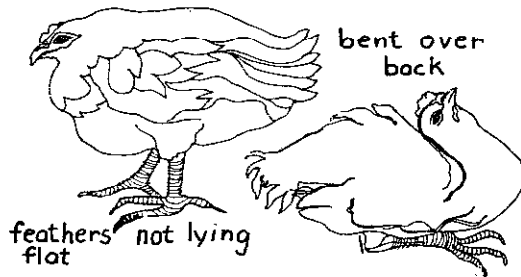

Newcastle Disease

These are the signs of Newcastle Disease:

- ▶ Quick breathing.
- ▶ Gurgling or rattling noise in the chickens throat.
- ▶ Stiff leg or wing.
- ▶ Diarrhoea.
- ▶ Laying less eggs.

This disease can not be cured. You have to kill all the chickens. After killing all the chickens, clean the chicken house and all the feeders, drinkers, nesting boxes and perches with Jeyes Fluid. You can eat the chickens that did not look sick.

You can stop young chickens from getting Newcastle Disease by giving them medicine. The medicine must be kept in a fridge until you are ready to use it. Ask your local store if you can keep it in their fridge. As soon as it is out of the fridge it will only work for 3 hours so you must use it quickly.

There are 3 kinds of medicine to prevent young chickens getting Newcastle disease:

- Hitchner B1 - buy this vaccine and a 30ml eyedrop bottle full of sterilised water at a chemist or farmers co-operative. It costs about R2 and is enough for 1000 chickens. If you have only a few chickens, share the medicine with other people.

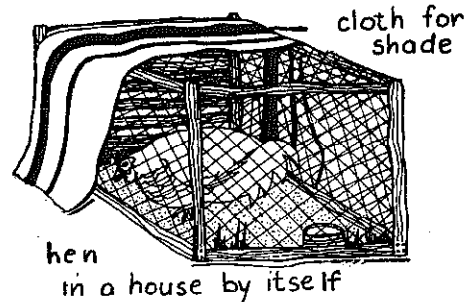

- Give the chicks this vaccine when they are 10 days old.

Put all the chicks in a box.

- Half fill the vaccine bottle with the sterilised water from the eyedrop bottle. Shake it well then pour the mixture into the eyedrop bottle and shake it again.

- Put 1 drop into only 1 eye of each chick. You must finish using the vaccine in 3 hours.

- When you have finished, burn all the vaccine you have not used. If you throw it on the ground, it can give other chickens Newcastle disease.

- La Sota - give chicks La Sota vaccine in the same way as Hitchner B1 when they are 1 month old.

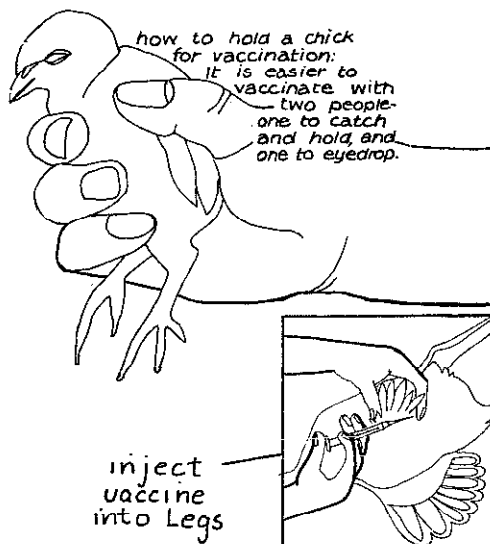

- Komarov - this is the strongest vaccine for preventing Newcastle disease and must be injected into the chickens' legs when they are 2 months old. For 500 chickens, buy 1 bottle of Komarov vaccine, a 3ml

syringe with 0,2ml marks and 100 ml of sterilised water. All this will cost about R2.

■ Fill the syringe with sterilised water then squirt the water into the vaccine bottle. Shake the bottle then fill the syringe with the mixture and squirt it all into the bottle of sterilised water. Shake it well.

■ Inject each chicken in the top of only 1 leg with 0,2ml of vaccine. You must finish using the vaccine within 3 hours otherwise it will not work.

■ 2 people must work together, 1 holding the chicken, the other injecting. Ask an experienced person to help you the first time.

Coccidiosis

This disease is common in chickens from 2 to 8 weeks old. If a chicken has Coccidiosis:

- ▶ Its droppings become watery and you may see spots of blood in them.
- ▶ It looks weak.
- ▶ It eats less.
- ▶ It stays close together with the other chickens with its head down and its feathers untidy.

To get rid of Coccidiosis, put Sulphamezathine 16% solution medicine in their drinking water. Add 60ml of this medicine and 9 teaspoons of sugar into 5 litres of water (See How to weigh and measure p 130). Give the chickens this water for 3 days. Then give them plain drinking water for 2 days and then water with medicine and sugar for another 3 days.

Roup - this disease is very common and makes the chickens cough and become weak. It spreads very quickly so treat it straight away in the same way as treating coccidiosis.

Fowl Pox Disease

If a chicken has this disease, lumps grow on its head and inside its mouth. It is a very common disease and can easily come from other people's chickens.

To get rid of Fowl Pox, paint the lumps with Tincture of Iodine every day until they go away.

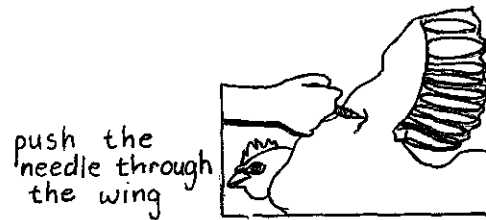

To prevent Fowl Pox, inject all your chickens with Fowl Pox medicine when they are 8 weeks old. In the box with the medicine you will get a needle and a bottle of glycerine:

- Mix the medicine with the glycerine.
- Dip the needle into the medicine.
- Push the needle through the wing near the body. As you push it through, the medicine will be wiped off the needle inside the wing.
- After one week, look for a red mark where the needle went in - this means the injection worked.

Chronic Respiratory Disease

This disease is common when chickens are in overcrowded places without enough fresh air. When a chicken has this disease:

- ▶ There is thick yellow pus under its eyelids.
- ▶ Thick liquid runs from its eyes and nostrils.
- ▶ It has puffy eyes.
- ▶ It sneezes and coughs.
- ▶ It becomes weak.

don't put too many chickens in chicken house. They need air

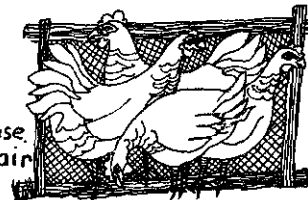

If your chickens get Chronic Respiratory Disease, give them a bigger place with more fresh air. Put all the sick ones in a warm, airy place and give them Terramycin Powder in their drinking water.

- Before you buy the Terramycin Powder, look at the date on the box. If the date has already passed, the powder will be too old and will not work.
- Mix 2 teaspoons of powder into 5 litres of water. Make sure the chickens drink this water quickly.

The transport is our big problem in the villages

In 1978 a group of women started a chicken co-operative in eMnxhe, a village near Cala in the Transkei. We spoke to one of the members Mam Thembu Hlayu.

● How did your group start?

In April last year some of us started to meet every week, because we wanted to get busy with something that would bring us some money. We also wanted to learn something new.

● Why did you decide to raise chickens?

Chicken meat is popular here, and people have to go into town by bus to buy chickens.

● Why did you choose to work as a group?

We thought if we put our money together, then we can order a lot of chickens and they will be cheaper that way. A community worker said that her organisation would also borrow us some money so that we could start off. She ordered the first chickens and food and fetched them from the station in her car. The transport is our big problem in the villages.

● Where do you get your chickens from?

We have tried different places. It is still very hard to know which place is best for us, because many of our first lot of chickens died - but maybe that was because

it was so cold. They are only one day old when they put them on the train. We order 100 or 200. We paid R17 to R24 per 100 plus railage. We have ordered from East London, Potchefstroom and King Williams Town. The chicken mash we buy from the agricultural extension officers in town but sometimes that is not fresh, or when it is finished we have to get it from the co-op in Elliot. It is expensive food, and still we must pay transport.

● Where do you keep the chickens?

We take turns to keep the chickens in our houses. Some of our husbands do not like us working in a group because they say it is a waste of time when we should be at home. Four of us have had a chance but my home is where we keep them most of the time. My husband does not mind too much. In winter, for about 2 weeks we make a small hok hear the fire or under the table, and put down dry grass, and every night they go back in their boxes. We burn a paraffin lamp the whole night and whenever it is cold. Only when they are older or it is warm outside we let them into a big hok outside.

We started off working in twos, each on our own day, once in the morning, once at night to wash the water troughs, change the food, sweep and lay down fresh grass. We also bring left over cabbage leaves, imifino or chopped grass.

● Why don't you keep them in a house of their own?

We have thought of using an old school rondavel but some people think that others will steal the chickens during the night, because the houses are too far away.

We asked the headman and the agricultural officer if the group could use a piece of land to build a hok on and to grow lucerne on. Now the agricultural officers is interested and said we must choose a place near a stream, but that place is too far from our houses. We are not sure what to do about this.

● When and where do you sell your chickens, and how do you decide on a price?

We just sell them from the house when they are 4 weeks old. In town they are usually sold for R1,50 so our price is R1,50. This way we still make a profit.

● Do you ever struggle to sell them all?

Sometimes there are 20 or 30 left, so we just buy them ourselves. But now the other people in the village have also got the addresses for importing chickens, and we are worried that we will not be able to sell all our chickens now. So we must start to grow our own chicken food to cut costs. The agricultural officer wants to make a law that only groups, not individuals, can import chickens. This makes the other people angry.



● What do you do with the money you make?

We keep money to order the next chickens with and to pay railage. Half a sack of chicken mash usually lasts for 4 weeks for 100 chickens so we keep money for that. Sometimes we buy antibiotic medicine from the agricultural officer or Condy's Crystals or olive oil when the chickens look weak or sick, but it is expensive.

We have been saving the left over money although some of the members want to take their share every time. So then we have a meeting and decide that we will be stronger if all the money is saved, for things like building materials, or new feeding troughs. We had a

concert one Sunday. The children sang, and we made vetkoek and cooldrink. That made about R30. We will start sharing some of the left-over money every time we have sold chickens and save some as well. We are trying to decide if we must put our money in the bank or in the building society. We hear about different ones on the radio, so each person has their own idea.

● Do you keep records of money you spend, and how often do you have meetings?

There is a chairlady, secretary and treasurer. The chairlady calls the meetings. The secretary writes and reads out the minutes, writes the letters to order chickens and keeps the

addresses of suppliers. The treasurer keeps cash slips and writes how much money we sent out, and how much we get back when we sell chickens. Usually they go to town to buy medicines or to arrange with the agricultural officer to bring the chickens from the railway station, which is far away and the bus will not deliver them.

At first we met every week to talk and look at the chickens, and decide how best to work. But now we meet about every month, at selling time or when chickens arrive. Two of our first members left for Cape Town. Another one lives too far away and so hardly ever see her. Others don't always come to meetings.

Ducks and Geese

Ducks and geese are in some ways better than chickens. Some breeds can produce as many eggs as chickens, are cheaper to house, and eat snails and weeds. They are cheap to keep because they can get up to three quarters of their food from the veld. The only thing you need for ducks and geese that you do not need for chickens is a pond, but this need not be large.

Breeds

Ducks: For egg production, the best breeds are Indian Runners and Khaki Campbells. For meat, the best breeds are Pekins and Mallards. Pekins can be eaten at eight weeks. Their feathers are useful for pillows and they produce eggs when well fed. Mallards are small birds which do not give as much meat as other breeds, but they breed faster.

Muscovy ducks are very good for small farmers because they breed so well. They have four laying seasons a year, and are very fertile. You can eat them at 10 to 12 weeks, when the drake (the male) weighs 4kg. Their feathers can be plucked, but you must be careful not to leave them bare, because this can make them sick during the breeding season. If you are thinking of selling

feathers, it is probably better to get white Muscovies than black because white feathers always get a better price. You can start Muscovies very cheaply, by getting just one male and three females.

Geese are strong birds which can live by eating grass. They are also very good 'watchdogs'. The best breed is the ordinary white hybrid farm goose.

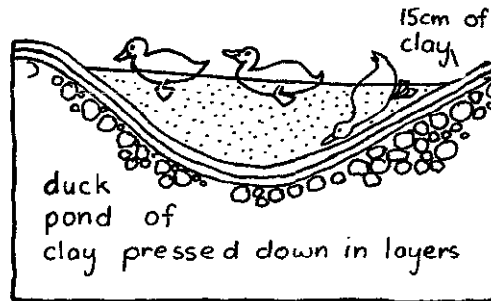

Water

You can keep ducks on streams, dams or ponds, but do not let ducklings into deep water until they are big enough to get out easily. Small concrete ponds are quite easy to make and you can also make a pond by putting an iron bathtub into a hole in the ground.

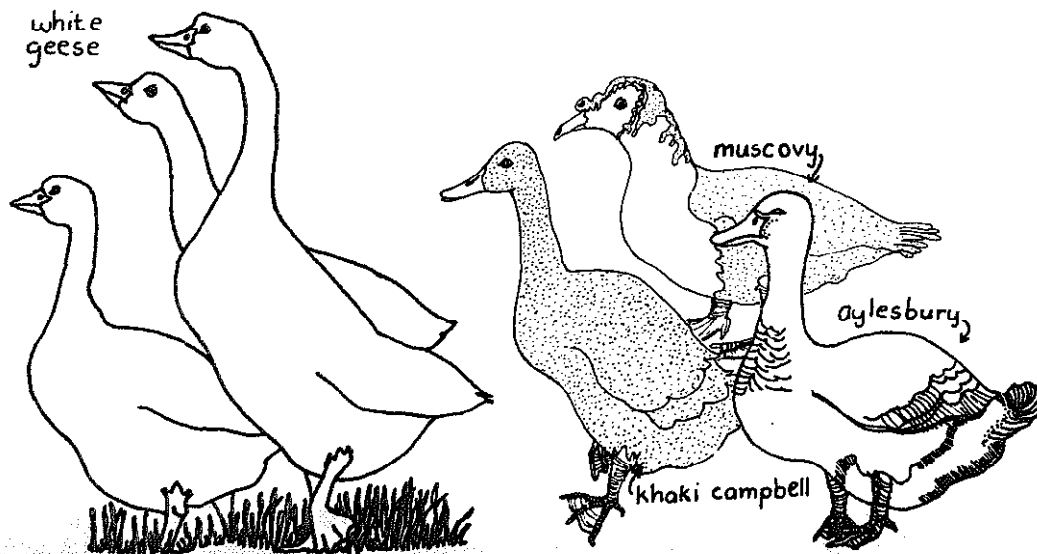

Feeding

Ducks and geese can feed themselves from the veid, but you should also feed them kitchen and vegetable scraps. If birds are laying eggs, they must get better food. You should give each duck 200g per day of ordinary chicken laying mash, about 60g in the morning and 140g in the evening. Laying mash is expensive, but you can make your own feed with 140g bran and $\frac{1}{2}$ cup of fish meal or $\frac{1}{2}$ cup skim milk in the evening for protein. Always give your ducks clean drinking water. Dirty water and dirty feeding dishes cause diarrhoea.

Housing

You must keep your ducks and geese in a shed at night because of attacks by animals. Ducks lay their eggs before 10 in the morning, so locking them up at night makes it easy to collect their eggs in the morning. Housing can be very simple. The important thing is that the ducks are given dry straw. If ducks are kept in damp, cold places at night, they often become lame (unable to walk).

Geese lay eggs for 20 weeks every year. Lock them up in the afternoon when they lay their eggs.

Looking after young birds

The important thing about looking after young geese and ducks is to give them a warm, dry home. They must not be allowed to start swimming as soon as they have been born. In summer, do not let them in the water for at least 4 days, in winter for 3 weeks. Young ducks and geese must have shade at all times.

Breeding Geese

If geese are housed in healthy conditions they can lay eggs for six to eight years. You can get more young geese by taking away the first lot of eggs and giving these to a broody Muscovy duck to sit on. The first 2 eggs are usually infertile and can be used for cooking. The goose will then lay a second lot of eggs, and this time let her sit on them. Geese breed in pairs so you must have the same number of males and females if you want all the females to have babies. You should choose mates at least two months before the breeding season, which starts in August. Once geese have been mated they should not be separated as this could stop them from breeding for the whole of the breeding season.

duck house of
thatch and
scrap
wood

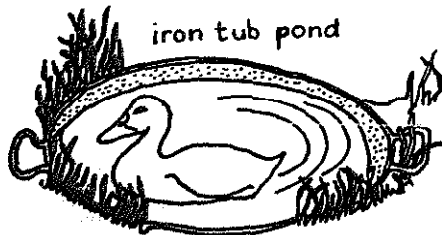

iron tub pond

oil drum
laying
box

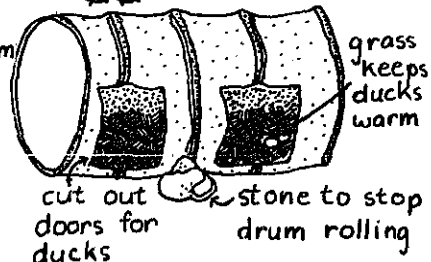

grass
keeps
ducks
warm

cut out
doors for
ducks

stone to stop
drum rolling

Dairy Goats

If you do not have enough money to buy a milk cow, you can get fresh milk from a milk goat. Goats can be fed more cheaply than cows and a good milk goat will give 2 to 4 litres of milk a day. The trouble with goats is that they have to be tied up or they eat everything in your garden.

Breeds

The most common breeds of milk goats in Southern Africa are Saanen and Toggenberg. Saanen goats are pure white and do not usually have horns. Toggenberg goats are light brown with white patches on their faces and legs.

Purebred Saanen and Toggenberg goats are expensive. They need good housing, good feeding and a lot of care to survive and give milk properly. They get tick diseases easily.

To avoid these problems, you should use crossbreeds. Get two or three females of any breed, and mate them with a pure bred male from another farmer. Crossbred goats are better because if the mothers are local breeds, they will not get diseases easily and they will have strong kids. Crossbreeds are also better than purebred goats because they can give milk as well as meat. A local breed crossed with a Saanen will give you milk and meat, but not as much milk as a purebred Saanen.

Fencing (see p127)

If there are any holes in a fence or under a fence, goats will find them and get through. If the fence is badly made, goats will destroy it quickly. Any fence for holding goats must be 1,2m high and for big male goats 1,5m high. Thick wattle sticks tied 15cm apart, or sisal plants make good fences. Chicken wire reinforced with barbed wire is also good, but expensive.

wattle fence at least 1,2m high

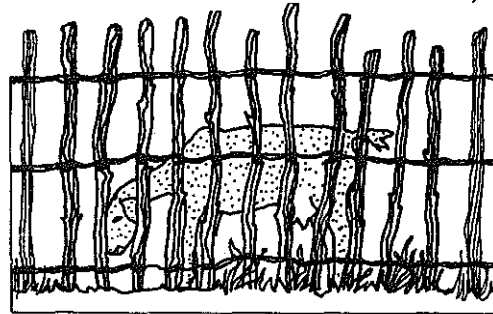

Tethering

Tethering means tying up goats so that they can only move around in a small space. The best method is a running tether. It is a leather dog collar tied to a 2m dog chain which slides up and down a thick 14 gauge wire. Each end of the wire is tied to an iron stake. The running tether lets the goat move

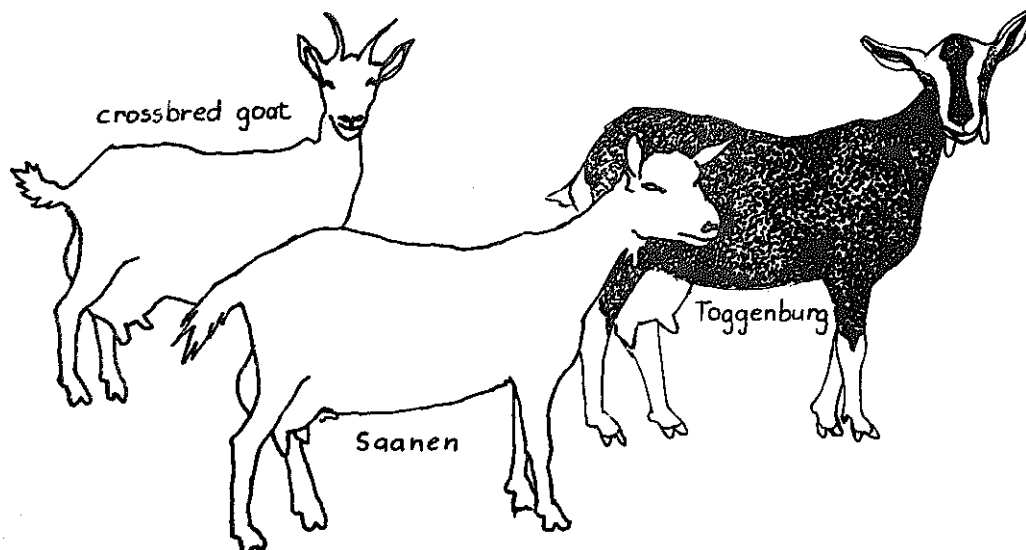

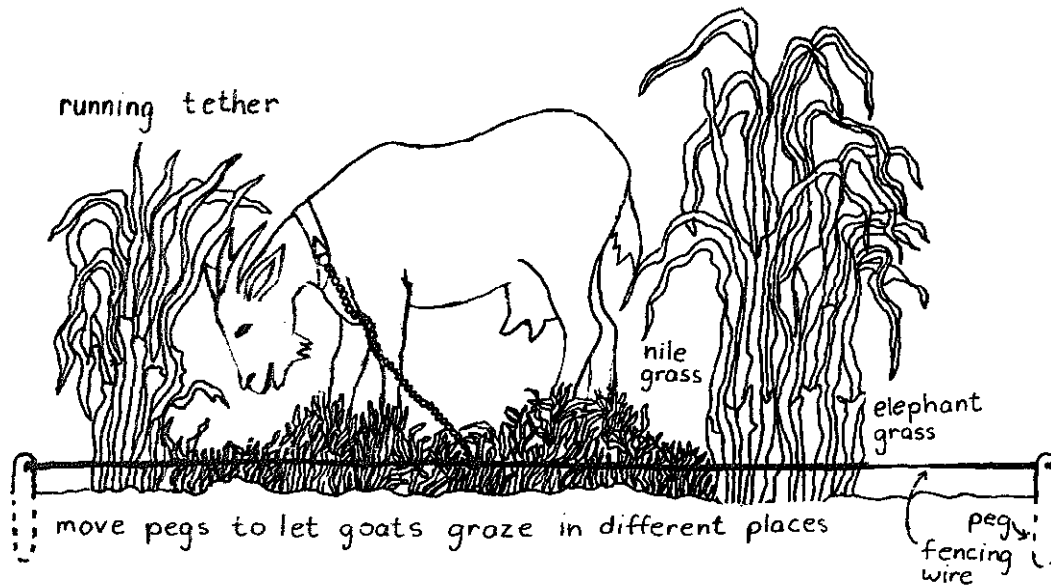

up and down along the wire to find the food it wants. At different places along the tether there should be shade and water. Make the wire at least 10m long.

Housing

Goats like dry weather so make sure they have a dry place to go when it rains. Build them a goat house with a wall and a roof.

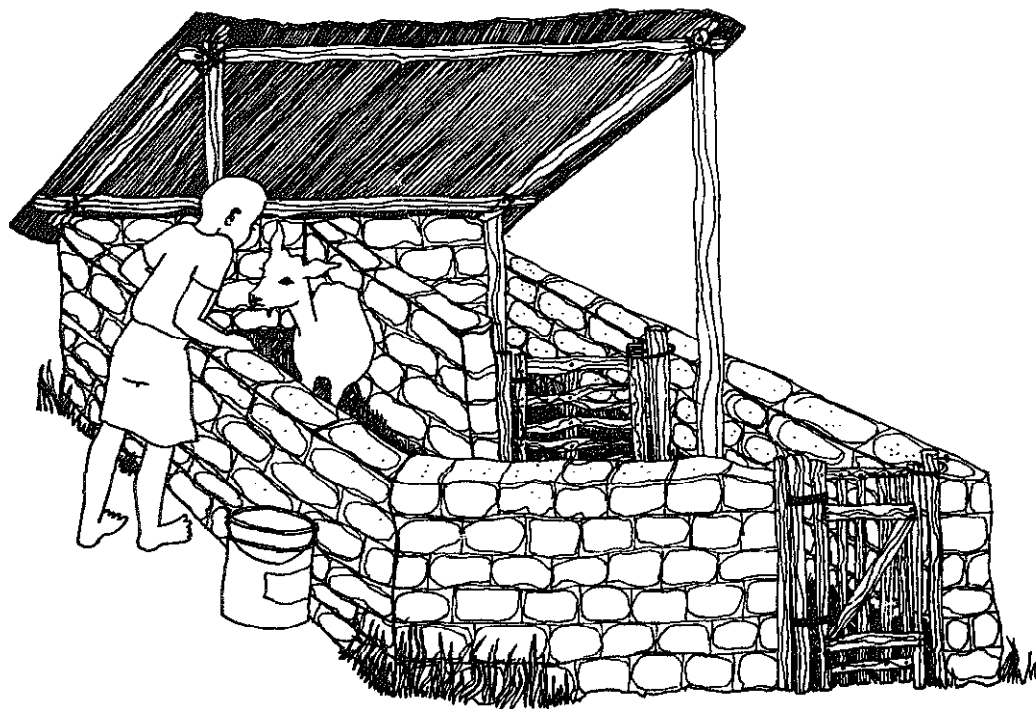

Feeding

Goats can eat grass, but they prefer eating leaves off trees and bushes. They are good animals for places with lots of bushes. They need to eat a lot of roughage - leaves, small branches and thornbushes. Goats also eat vegetable scraps, mealie stalks and anything else green. Leucaena and acacia (p204) are also good foods.

You should give your goat 1kg to 2kg of dairy concentrate each day. The more concentrate you give it, the more milk it will give (see p 233).

Breeding

Goats will breed about once a year. You can breed goats in the spring (September-November) or in the autumn (February-April). The goat will be pregnant for about 5 months and give birth to 1 to 3 kids.

The goat should give birth in a clean, warm, dry place. The kids should be allowed to suckle milk for the first three days. After this, the kids can be allowed to suckle one teat as soon as you have milked the other. Or they

can be fed from a bucket. This is easier than a bottle. To start a kid on bucket feeding, get some milk on your hand, and let the kid suck your finger. While it is doing this, pull its mouth to the bucket. It will soon learn to drink from the bucket. It should be fed twice a day for 8 weeks, and then gradually stop. Keep the female kids for milking and the males for meat.

Milking

A good milk goat can give 2 to 5 litres of milk a day for 6 to 10 months after giving birth. There are two important things about milking goats - be regular and be clean. Being regular means milking the goats at exactly the same time twice a day every day. If you milk at 6am one day, you should milk at 6am every day, not at 5am or 7am. Never miss a milking - this can cause mastitis (p 234) a very painful disease which can stop the goat from making milk.

Always be sure that everything, including the goat is clean when milking. This reduces the chances of disease both for the goats and for the people drinking the milk.

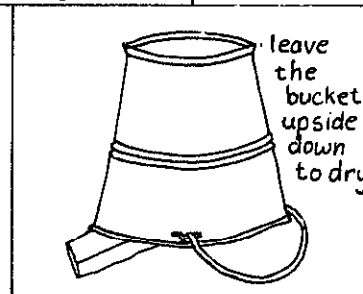
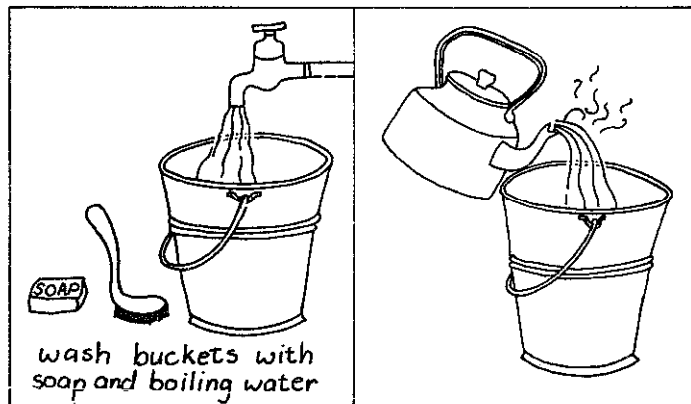
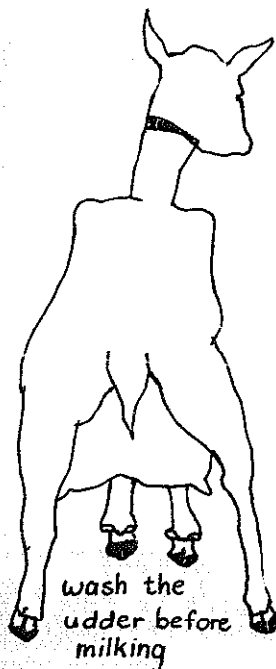

HOW TO PRODUCE A LOT OF FOOD FROM A SMALL GARDEN

Every week from a garden 12 m. long and 12m. wide you can get 10kg. vegetables, 5 dozen eggs, and 2kg. rabbit meat. The running costs can be as low as 8 to 10c per kg. of vegetables, 5 to 6c per egg. Building costs are very low if you use scrap materials.

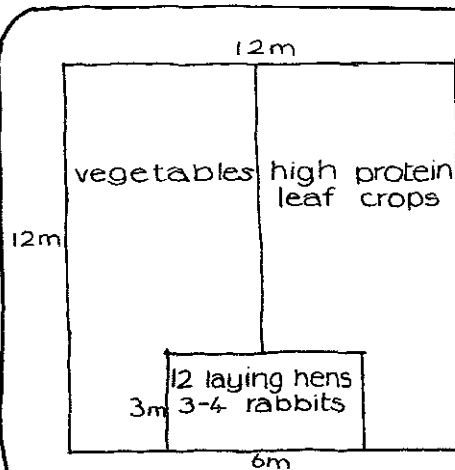
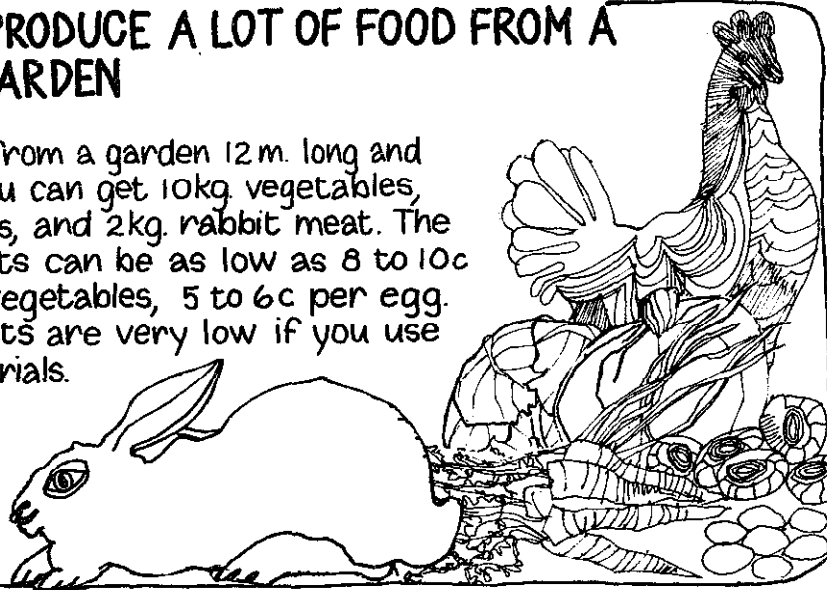

Planning the Garden

- The livestock part has 4 breeding rabbits in cages with 12 laying hens on deep litter.

- Half the garden grows vegetables all year round. The other half of the garden grows high protein leaf crops to feed the livestock.

- Water: About 200 litres (1 oil drum full) is needed every day.

The Livestock House

The livestock house is a small building 3m. wide x 6m. long x 2m. high. It should be airy and give shade and shelter. The walls are made of wire netting and the roof of thatch. Use scrap wood to cut down costs.



Crops for Livestock (50 sq.m)

• Comfrey is a fast growing high protein crop which grows all the year round. It is easy to grow from root cuttings of other comfrey plants. It grows best with manure or deep litter. Plant the comfrey 1m. apart. You can cut it many times in the summer. You can grow 1 ton of comfrey on 50 sq.m. Feed it to the rabbits and chickens instead of hay.

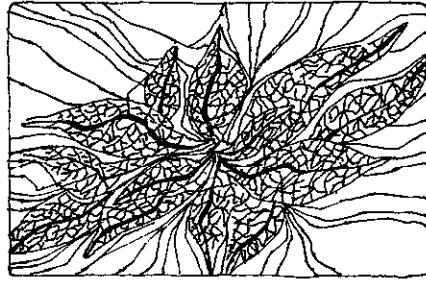

• Kale is a nutritious leaf crop of the cabbage family. It is not killed by frost and will grow well in winter. Plant kale between the rows of comfrey. Plant two crops to get plenty of green food through the winter.

Vegetables (50sq m)

Use deep litter from the livestock unit and compost made from grass and weeds, to improve your soil and give you vegetables all the year round.

Divide the garden into different plots for different types of vegetables and rotate them to reduce diseases

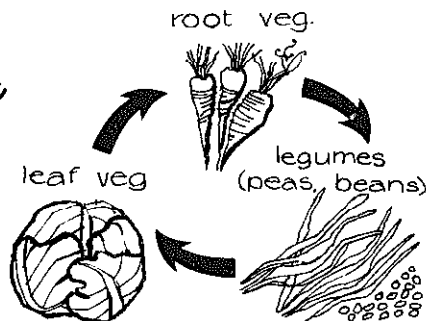

Costs

- Wire mesh:
R20 to R25 for a house 6m x 3m and cages.
- 12 laying hens:
You can buy point of lay chickens for R2,50 to R3 each = R30 to R36. They are cheaper if you buy ones 5 to 6 weeks old, 80c to 90c each = R12 to R24.
- 4 Rabbits:
between R15 and R25 per year.

Ways of Starting Cheaply



- Start by growing vegetables only. Sell the vegetables to get money to buy 5 week old chickens and 8 week old rabbits.
- While the vegetables are growing, build the livestock house from scrap wood, grass and wire mesh.
- Have comfrey or kale ready to feed to chickens and rabbits when they arrive.
- Buy 1 male and 1 female and breed your own rabbits.

You can start with as little as R25 and slowly build up your intensive garden.

Beekeeping

The best way to learn about bees is to ask somebody who keeps bees. In this article we discuss only some of the things you need to know about beekeeping. If you want to do it you should read other books (see p 548) and get advice from experienced beekeepers.

Not many people keep bees because it is difficult to start, and many people are afraid of bees. To start keeping bees does not cost much and you do not have to pay to feed them, because they can get their food from any plants or trees nearby.

To keep bees you will have to either buy (see Bees p 518) or find a wild swarm. You will need equipment like a beehive, a smoker and protective clothing. You can make all of these yourself.

Beehives

The simplest kind of beehive is a wooden box with sticks across the top for the bees to build their honeycombs on (See Making beehives p455). Most beekeepers use 3 or 4 of these boxes, one on top of the other. You can start

with only 2, and add more later. The bottom of the box is called the brood chamber. It has wire mesh called a queen excluder on top. The holes in the wire are big enough for all the bees except the queen bee to get through.

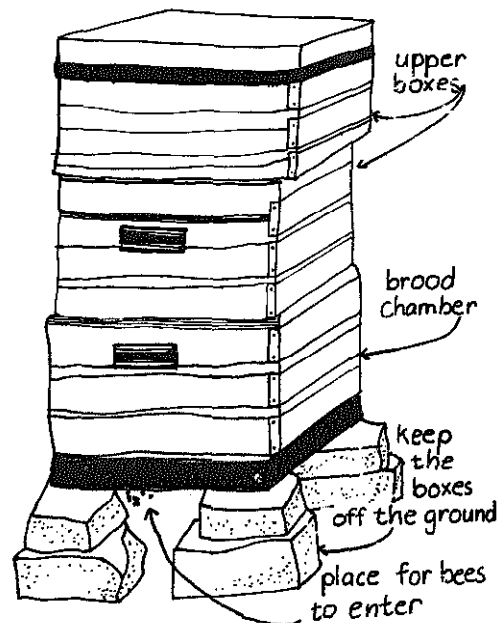



queen bee



drone bee



worker bee

The queen bee is about twice as big as the other bees and must stay in the brood chamber to lay eggs. All queen excluders are the same size and fit all the different kinds of hives you can buy.

Where to put the hive?

Your hive must be in a place that has enough food for the bees. Bees can feed on any plant which has flowers. Trees, crops, wild flowers, aloes and clover are all good for bees. Hives should be in quiet shady places. If children or animals are near the hive, it should be fenced off, otherwise the bees may get angry and attack. Place the hive on bricks so that it is off the ground. Cut down weeds and long grass around the hive. Bees need water in summer, but do not give them water in a bowl because many will drown. It is better to leave a wet cloth near the hive.

Catching the Swarm

Bees usually make hives (nests) in trees. You can catch them using a box or bag. If the hive is hanging from a branch you may be able to cut off the branch and let the hive fall into the box. Otherwise you can drive them into the box with a smoker. If their hive is somewhere where you cannot easily reach it, you will have to find the queen bee and put her in the box, then the other bees will follow her. Ask an experienced beekeeper how to do this.

Taking out the honey

Bees make honey to feed themselves, so do not take all the honey out of the hive at the same time. Never take honey from the brood chamber because the queen lays her eggs here. If you take out this honey you will have no new bees to carry on the hive next year. Most beekeepers also leave the honey in the box above the brood chamber and take the honey from the other boxes.

You must wear gloves and a veil over your face. The best clothes are white and loose fitting like white overalls. The smell of sweat will make the bees angry and they will sting you, so your clothes should be cool.

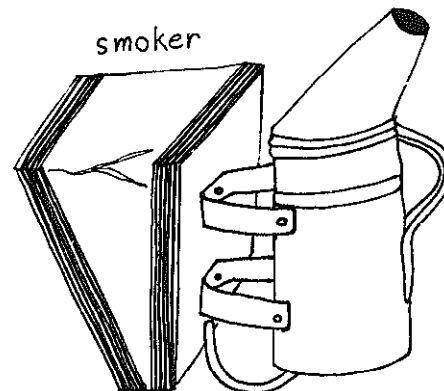
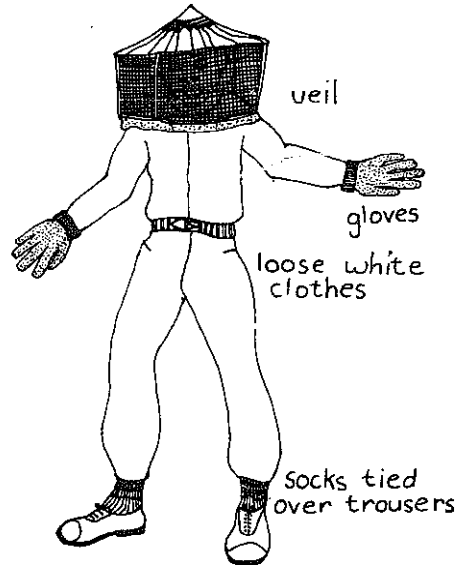

Before you try to take out the honey, test out the smoker until you find something that stays alight for half an hour. Dry pine needles or leaves are best. You will not be able to light the smoker again if it goes out while you are taking out the honey.

Do not work with bees on an overcast or rainy day, because they become much more angry in this weather, especially after it has been raining for some days.

Take out the honey in the late afternoon or after dark if you have a friend to hold the torch. During the day the bees will fly up and cause trouble. At night they will just move down to the bottom of the hive.

To open the hive, blow a little smoke in the entrance at the bottom, then take off the cover at the top. Wait for about a minute, then take off the lid and blow smoke into the top of the hive so that the bees go down. Work gently and do not bump the hive or squash any bees. If you are nervous the bees will attack you.

Start with the frame next to the side. If it has honey, brush the bees off and put it in a box covered with a cloth to keep bees from going back to it. The frames will be stuck to the hive walls by wax. You must use a hive tool to get them off the hive wall.

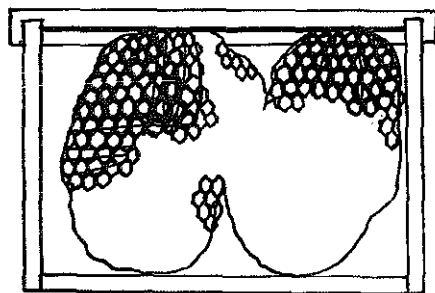

honey comb on a frame

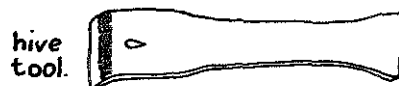

When you take out the frames, put in empty frames.

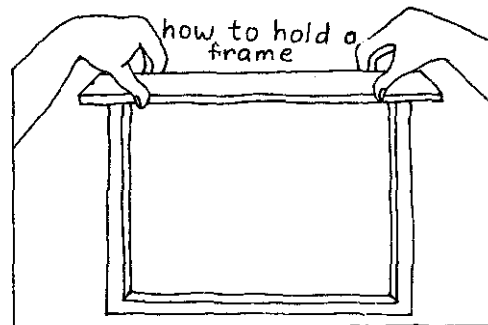

When all the new frames are in the hive, put back the cover and lid, making sure you do not kill any bees.

Getting the honey from the wax honeycombs

The easiest way to separate the honey from the wax is to put the whole honeycomb into a bowl in the oven and heat it at a very low heat. If the oven is too hot, it will spoil the honey. The wax will melt and come to the top. Take the bowl out of the oven and when the wax is cold and hard, take it off and keep it for polish. The honey will be underneath.

Another way is to cut all the cells open with a knife and put the whole sticky mess in a cloth. Hang it up in the sun with a bowl underneath. Honey will drip out for a whole day. Squeeze the bag to get the rest out.

There are other ways of separating the honey, but they need machines. Keep the wax for polish.

Starting new hives

Bees breed around September each year. In every hive at least 1 to 8 new queens are born and they leave the old hive to start new ones. You can start new hives with the new queens.

What to do if bees sting you

Do not try to pull out a bee sting, because it has a tiny bag of poison in it and the poison will go into your skin. It is better to scrape the sting off with a knife or by pinching your skin tightly from underneath the sting (See insect bites p 339 for more information about bee stings).

Selling to a market

Small farmers with enough land sometimes get a good crop and harvest more than their families need for the year. Then they sell their extra crop to people in their village or to a market in town. Some crops like sugar cane, tobacco, cotton, sunflowers and chillis can only be sold to markets in town, or to factories.

Working out costs

Before selling your crop you must work out how much it cost you to produce. You need to know two things - how much you harvested and how much you spent.. For example Thanduzolo Mjeza grows maize. He spent a total of R40 to grow his crop. He harvested 12 bags. To find out how much each bag cost to produce, divide his cost by the number of bags. $R40 \div 12 = R3,33$. Each bag cost R3,33 to produce.

Another example is Jozanna's Hoek Poultry group which has 100 laying hens. In 1 week the hens eat 1 70kg bag of laying mash, costing R9,70. In 1 week they lay 420 eggs (35 dozen). So each egg costs $R9,70 \div 420 = 2,3$ cents. A dozen eggs costs $2,3c \times 12 = 27,6c$. This cost helps the group to know what to charge for their eggs.

Working out selling prices

The next thing the farmers have to decide is what to charge for their maize or their eggs. They need to ask:

► What is the local price of the same produce in the local shop or cafe? How much is a dozen eggs or a bag of maize?

► Are there transport costs involved in selling?

If they have to transport the eggs or the maize they should try to transport a lot of eggs or bags of maize at one time. This makes the transport costs cheaper for each dozen eggs or bag of maize.

If the chicken group wants to sell all their eggs they must sell at a cheaper price than the cafe.

Who is going to sell?

It is best if small farmers sell their crops themselves. Then they do not have to pay someone to sell for them. In a group, each member can take a turn to do the selling. This must be worked out carefully because different members may sell in different places, not knowing where the other members have been selling. Then the people buying get angry. The group should agree on the way to organise their selling so that everyone understands how the selling works.

It is often easy for groups to sell to shops. The shopkeeper then puts up the price before he sells to the people. The shopkeeper is a middle man who usually does not do much work to get money. This is why people often do not like shopkeepers. So if the group wants to help the people in a village they should avoid selling to shopkeepers if possible. People will support a group if it sells to the people instead of selling through shops.

People do not want to sell because they are afraid

Many people in rural areas try to get money for their families from selling fruit and vegetables. It is difficult for them because they can not get trading licences like the shop owners and the police tell them they are illegal and arrest them. We spoke to Alice Shuma, Lizzie Mabobo and Maria Sinwamandi who sell vegetables near Elim in the Northern Transvaal.

● Alice, how long have you been selling bananas here?

I have been selling for 4 years. I come and sell bananas every day, from the morning till about 5 o'clock in the afternoon. I buy a box, but I don't really know how many there are in a box. I sell them 4 for 10c. The price is always the

same. The amount that I sell is about R40 per month.

● Where do you get the bananas from?

We buy the bananas from the farmer who comes on Mondays and Thursdays. Sometimes he brings bananas that are already going rotten but we can't

do anything about that. We must just accept them. The oranges I get in Louis Trichardt. One pocket is R1,80 and I get 60c profit. I also sell tomatoes which we buy from the farmers also. We are poor and the children want to go to school. That is why I am doing this because it does help. My husband gets R45 every two months for his pension.

● Lizzie, how long have you been selling?

I have been selling bananas for 1 year in Elim. Before that I was working in Joburg. I was sewing clothes for a firm and getting R25 per week. I was living in Meadowlands with some relatives. I was there for 4 years and I came here 2 years ago. My husband is still working for Ellerines as a driver.

● How much money do you make from the bananas?

I think I am making about R50 per month from selling these bananas. I sell 8 boxes a week. Each box costs R2,25 and I sell the bananas for 20c for 8.

● Thanks Lizzie. Maria, how long have you been here?

I have been selling bananas for 8 years - since my husband died. We buy bananas for R2,50 a box and the box is not full. We all buy from the same farmer. Some of us go there to fetch the bananas and then it is cheaper because we don't have to pay for the farmer's petrol. I sell the

bananas for 20c for 8. I don't know how much I sell but it does help because it helps my children at home. This is the only way that I get money.

Anybody who wants to sell bananas can just come and sell if they want to. People do not want to sell because they are afraid.

● Why are they afraid?

There is a lot of police trouble. We used to sit here and sell fruits and the police tell us that we must sell on the other side of the fence. We did that and they still arrested us again. We did go and pay the licenses, about R60 altogether, each of us. We have got papers to show that we paid that. But they won't give us

the licenses until we have built a market. We paid money for the market to the Commissioner - R30 each. We thought that was for the building but they told us it's just for the licence. But what about the R60 we already paid for the licence? We just want to go on selling and to collect enough funds, and then we can build. We fail to build because we have got kids and the kids must go to school and so on. We used to pay R10 if we were arrested but now it is R20. The police were here last month. They come here, we run away, the police take the bananas because we have to leave them. We remain crying, because we have kids and we must buy mielie meal and if our kids go around stealing they will be arrested again.



Even my father, he's going to listen to me

Before John Pape started the School for Appropriate Farm Technology at Lobamba in Swaziland he was an Agriculture teacher at a school. He found that schools did not really teach people how to farm, it only gave them a rough idea about farming. He wanted to teach young people how to make a living as small farmers.

The Farm School started in January 1979, on land belonging to the Catholic Church, with the money from the Swazi government and overseas church organisations. In the first year students do practical work, growing field crops, market gardening, dairying, keeping pigs and poultry and farm building. A few hours a day are spent in the classroom studying basic agricultural science, arithmetic and keeping farm records and accounts. In the second year the students choose one project like vegetable growing or dairying. The school's first group of students have just finished and have left to start farming on their own. We asked John how the school had been going after 2 years.

● Do students make enough money to live on from their work?

Yes, last year all the students earned money. Not one of them lost money. They all have to pay for their own inputs like seed and fertiliser. Our best vegetable growing student earned over R100/month on 300 sq metres. Or take the dairy. They ran the dairy, maintained the pastures, organised winter feeding, sold milk, cream, yoghurt and cottage cheese, and kept all their own records and accounts. We applied a 15% tax on their gross takings which we put back into the school. They shared the profit and never got less than R50 per month each. Of course they did not have to pay back the capital, which with the 4 cows, was about R8 000.

● Is it realistic to teach dairy farming when so much capital is needed?

We have estimated it will cost R3 500 to set

up a man with a small dairy with two cows. He would earn R200 to R250 a month in gross takings, with a profit of R100 to R150. We would lend him the capital from our loan fund. Of course it costs much less for a lad who wants to become a vegetable farmer. The most he could hope to manage would be a tenth of a hectare. He would need only R500 to cover fencing, tools and other inputs, assuming of course that he had water.

● Now that you can give loans to your students will this solve their financial problems?

No, I think that the real problem is marketing. We're in a very privileged position here as regards markets - we are near all the big hotels, we have our own transport, and of course most of the marketing is done by our teaching staff. When our students go home it will not be so easy to find markets. The biggest problems with agriculture in Swaziland is the lack of help for marketing.



If people can't market they won't produce. This applies to dairy farming as well. We could set up hundreds of dairymen in the bush milking their 3 or 4 cows, but many of them wouldn't be able to get rid of the milk, particularly in the summer.

● Do you train women to be farmers?

We have 6 women students here. We believe that we must train women farmers because they have such an important place in African agriculture. One of the drawbacks is that women in Swaziland

are not given land. Perhaps a trained woman farmer would be regarded as an exception. But our women students will probably all be returning to farm family land which isn't being used productively at the moment.

● Don't you think that many of the problems of small farmers here come from the relationship between the Swaziland and South African economies?

Yes, we're completely tied to South African agriculture. If vegetable prices drop on the Johannesburg market, our

prices have to drop too. And when South African egg producers decide to dump eggs here, there is nothing we can do. But as to how one goes about changing it all, we just don't have time to think about it. One is totally blinkered by the day to day pressure of work. My thinking extends to calculating how many cabbages I have to deliver to Ezulweni on Friday. That's about all one has time to think about when you're working 12 hours a day. But one day we'll have the time to think about these things.



We spoke to two students at the Farm School, 'Size 4' Zwane and Amos Dlamini, who have just finished the two year course.

● Amos, why did you come to the farm school?

I was working as a clerk then I saw that it was not enough money for my needs and then I thought that if I come here I'll get knowledge and I can go home and get more money. When I was working I was getting R60 per month and here at the Farm School I earned more.

● Will you get land to farm when you leave here?

Well according to Swazi law, a man who is not married can not get land - so if a son is going to farm, he must get land from his father.

● Will the women students also get land from their fathers?

If in fact they can get enough knowledge and they get married, they can instruct their husbands. I don't think they can get their own land - they can just help the farmers in things like weeding.

● What do you mean, help the farmers? Isn't it true that the women are the real farmers of Swaziland?

Well, it's a bit true.

● OK well let's talk about your work here at the farm school. Size 4, did you also specialise in vegetable growing?

No, I specialise in dairy. We were four students doing dairy.

● Do you think you could set up your own dairy?

But of course.

● Wouldn't it take a lot of money?

The money they've spent on this place is R8 000 with four cows so maybe if I can have two cows I can spend about R4 000.

● Will you be able to make enough money to live with only two cows?

Well, that's my aim, but at this time I'm just planning. The problem is that my neighbours all milk their own beasts. I can try to sell at Shiselweni but it's too small and the trouble with Nhlanguano is that it's too far away. At the farm school it is easy to sell our milk and cream because we

are the only dairy in this place. Our gross income has been R500 per month so we used to get approximately R300 profit.

Of course marketing milk is difficult, because according to Seswati custom married women can't buy milk. If I can't market milk, I know I can get enough money if I grow beans and maize and vegetables and sell them to my neighbours. If I have transport I can sell vegetables to those people making small markets on the road like at Mahlanya.

● Don't big commercial farmers also sell their produce at Mahlanya?

Yes, they also come to sell to those hotels around here, even from South Africa.

● Do you discuss these marketing problems at school?

No, we are just taught how to grow things. We didn't discuss these problems details. I think it can be a good thing if a person can learn that.

● What will you do if you have problems like this after you start to farm?

Well, when someone finds some problems he can come back here to ask some help. I think one teacher, Mandla, will be moving around - so far they haven't been doing that.



Crops

Crops need good weather, good land and money spent on seed, fertiliser and land preparation. Most farmers do not have these things. Their biggest problem is not enough land. Most only have 1 or 2 hectares for the whole family. They cannot borrow money from banks and they do not get the right advice from extension officers. They cannot get the big harvests of rich farmers who have all these things. These problems will be solved only when land is redistributed and all farmers have enough land to live well.

But even with these problems, there are a few things small farmers can do to produce more crops with what they have now. With the little money they have, they can choose the best crops, plough as early as they can, plant at the best times and try different crops which may be better for their area.

Choosing a Crop

There are many crops which are well adapted to difficult conditions, such as sorghum, cowpeas, jugo beans, sweet

potatoes, amadumbe and some pumpkins. We do not think people should stop growing these crops. They may be better than crops which big farmers grow because they are more sure to give food for families. Before choosing a crop, think about your own experience as well as the advice you get from extension officers.

- ▶ Maize is the most popular dryland crop. It gives a bigger harvest than most crops and it does not have many diseases.
- ▶ Sorghum, millet and sunflowers grow in less fertile soil than maize and need less rain, but they are easily damaged by birds and hail.
- ▶ Beans and cowpeas are legumes and help to keep nitrogen in the soil. Cowpeas are better than beans for dry places.
- ▶ Groundnuts and jugo beans are good crops for sandy soils and need hot weather and good rain. They are easily killed by frost.



- ▶ Wheat can grow in winter or in cool places in summer.
- ▶ Sweet potatoes are good for hot dry places.
- ▶ Potatoes can give big crops, but they have disadvantages. They suffer from many diseases, the seeds are expensive and the leaves and stalks cannot be used for animal food after harvesting.
- ▶ Pumpkins and squashes give big crops, they are easy to sell and you can store them for a long time. The leaves cannot be used for winter feeding of cattle.

Choosing seed

In most black rural areas, the weather and the soil make growing crops difficult. The crops which people have planted in these places for a long time have become adapted to these bad conditions. So their seed can be better than the seed that you can buy, which is grown by seed companies on good soils using lots of fertiliser. Farmers should not think that seed from a shop is always better than their own seed. If you buy seed, choose open pollinated seed. If you use hybrid seeds you need to spend a lot of money on fertiliser and insecticides if you want a good harvest.

Choosing fertiliser

In most of the soils in Southern Africa there is not enough phosphorous, so it is usually more important to add phosphorous than any other fertiliser. It does not help to put nitrogen or potassium unless there is enough phosphorous. If you can not afford to buy a lot of fertiliser you will get better results from phosphorous fertilisers like superphosphate and rock phosphate than from more expensive mixed fertilisers like 2:3:2. If your soil is too acid, you must put on lime. Do a soil test (see p 97) to find out how much lime you need.

If you can not afford to buy fertiliser for all your land, you should put the right amount on some of your land and none on the rest, because if you spread the fertiliser too thinly it will be useless.

Kraal Manure

Kraal manure is as good as the chemical fertiliser you buy, but you need a lot to put on a big field. Most small farmers only have enough kraal manure for vegetable gardens. If you have some left to spread on your fields, put about one shovel per square metre. Do not spread it too thinly. You can mix kraal manure and fertiliser together.



Crop Rotation

Crop rotation is moving your crops every year instead of planting them in the same land every year. The easiest way to do crop rotation is to divide your field into four parts, and move the crops to a different part each year. In the first year plant a grain crop like maize in the first part, a different grain crop like sunflowers or wheat in the second part, a legume like beans in the third part and a root crop like sweet potatoes in the fourth part of the field. You can also include pasture grass like clover in a crop rotation.

Crop rotation helps to prevent pests and diseases. Pests of each crop stay in the soil. If you move your crops every year they will not be attacked so easily because a pest of one crop will not usually damage a different crop.

Another advantage of crop rotation is the use of different plant foods. For example, legumes leave nitrogen in the soil. Grain crops need nitrogen, so they grow better in a field which was used for legumes last year.

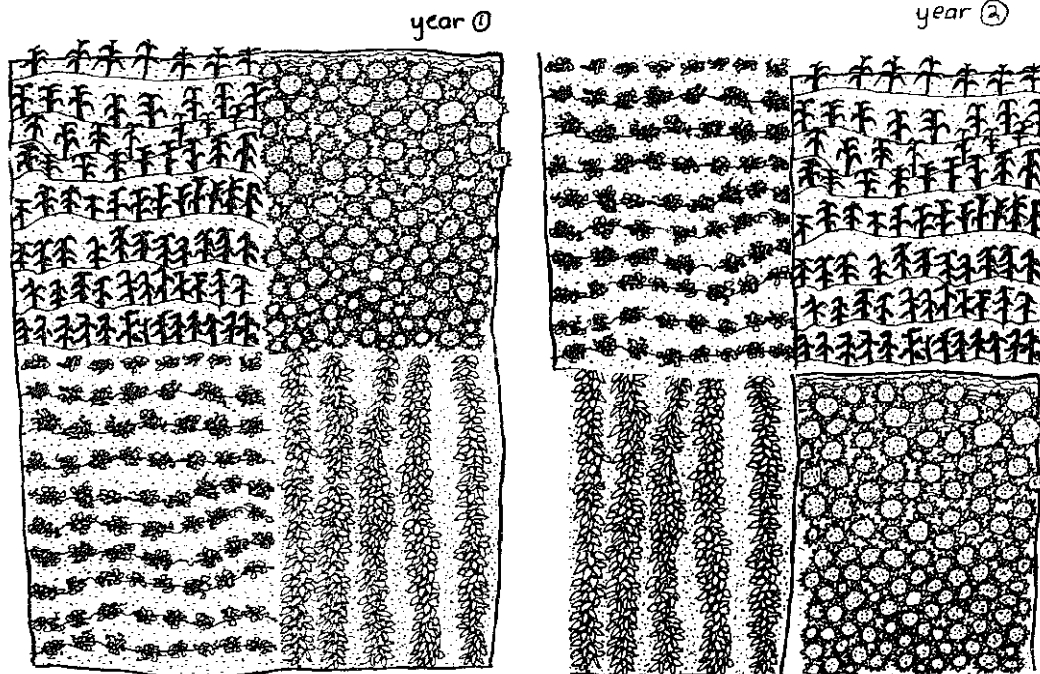

Divide field into 4 parts and rotate crops

Intercropping

Intercropping (see p 117) is growing two crops in rows next to each other. It helps both crops to grow better. For example, you can grow pumpkins and beans between rows of mealies, or millet and sorghum together.



sorghum

beans

Ploughing

Early ploughing soon after harvesting has many advantages. If you do not plough early, the soil becomes hard and you have to wait for the rains to make it soft before you can plough. If you plough early you can plant early and get better crops.

It is difficult for most small farmers to plough early and to plough well because:

- Cattle are weak in winter. They do not get enough food because there is not enough land for them to graze. Letting cattle eat from the fields after harvesting does not usually make them strong enough for ploughing. Other methods of winter feeding such as hay (see p 244) are expensive. So farmers have to wait until the summer rains.
- Men usually do the ploughing with oxen. Most men are away working in towns and on the mines during the year, so the ploughing has to wait until they come home in December.

● If you are hiring a tractor, you cannot always get your field ploughed at the right time. The people who own tractors want to make a lot of money quickly, so they usually rush to finish everybody's ploughing and often do not plough well.

One way of ploughing early is to cut the dry stalks of the old crop and tie them in bundles. Stand the bundles in rows in the field and plough the land between these rows. Use the stalks to feed your cattle.

Planting

If you plant early you will get bigger harvests. If you have to plant late, choose seeds which will grow quickly. Planting in rows will give you a bigger harvest and make weeding easier. You can plant in rows with a seed planter pulled by oxen or tractor, or by hand using a hoe (see p 118). Planting in rows is a much better method than scattering seed, because it makes weeding easier, and all the plants grow up together.

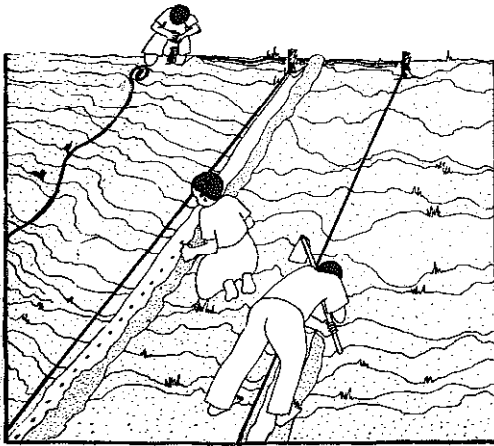

planting in rows by hand

Weed early. If you do not weed early, all the plant foods and water in the soil will be used up by the weeds and your crops will suffer. You can weed by hoe or with a cultivator pulled between the rows by oxen or tractor. Using a cultivator is quicker than a hoe, but be careful not to damage the roots of your crops.

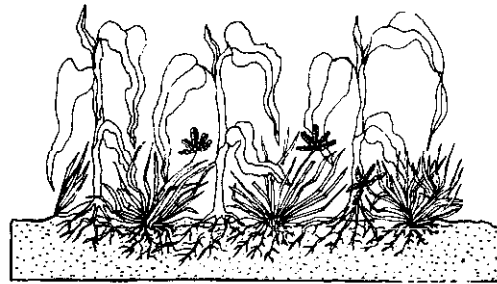

weeds take plant food away from crops

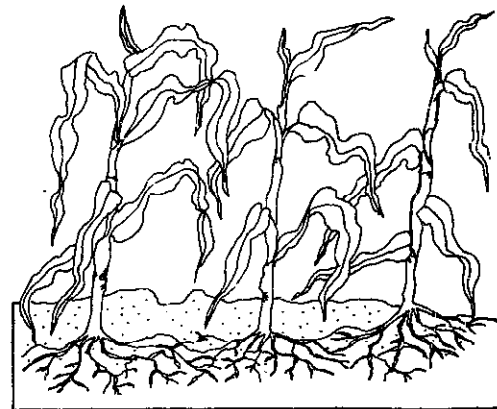

For maize, time of harvesting is not so important. But for some crops, time of harvesting is important. For example you should harvest sorghum, sunflower, millet and beans just before the seeds are dry. If you wait too long, the seed can fall out or be eaten by birds.

All crops must be stored after harvesting in a cool, dry place which rats cannot get into.

Double Cropping

In some places you can grow two crops during the summer. For example, you can grow early maize and late beans, or early potatoes and late maize. In some places you can plant maize in the summer and wheat in the winter.

Double cropping takes a lot of the plant foods out of the soil. You must use chemical fertilisers or manure otherwise the land will become tired and crops will not grow well in future years.

Know your soil

All plants get their food from the soil. They need plant foods like nitrogen, phosphorous and potassium as much as they need rain and sun. If you know what plant foods are in your soil you will know which crops will grow best and how much compost or fertiliser to put on.

Different soils hold water in different ways. Sandy soils let water pass through them easily. They are sometimes called well-drained soils. Clay soils do not let water pass through easily. They hold water like a sponge and they are sometimes called heavy soils. Some crops grow better in clay soils and others grow better in well-drained soils.

Another important thing to know about your soil is how acid it is. Soils are usually more acid in rainy places than in dry places. To make your soil less acid, you have to add lime.

Sand, Silt and Clay

All soils are a mixture of sand, silt and clay.

● Sand makes the soil loose. In sandy soils, water and air can get into the soil easily and the roots of plants can grow down into the soil easily.





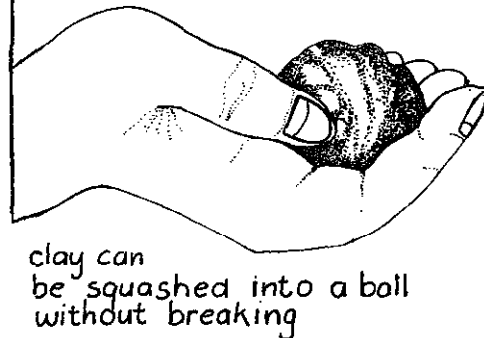
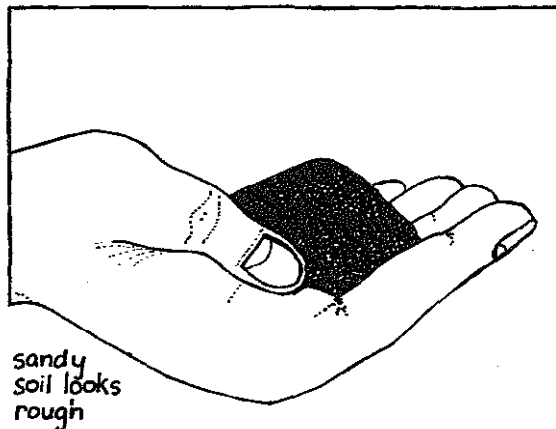

● Silt is very fine sand. It holds water and plant foods better than rough sand. It is easily washed out of the soil. The fine sand on the banks of rivers and dams is silt washed out of the soil by the rain.

● Clay is the sticky part of the soil which holds it together. Clay holds water in the soil. The best soils, called loams, are an equal mixture of sand, silt and clay.

If a soil has too much clay in it, it is called a heavy soil, because it is very heavy to dig and plough. Some crops can not grow in clay soils because the clay holds so much water that their roots die. Clay becomes very hard when it is dried by the sun. It is difficult for young plants to grow through the hard clay crust. Very sandy soils are also not good for crops because they can not hold the plant foods and water which crops need.

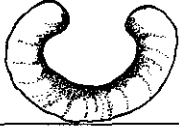

You can tell how much sand, silt or clay is in your soil by how it feels. Wet some soil and roll it into a ball between your hands, then roll it into a sausage. You can tell what kind of soil it is from this chart:

WHAT SOIL LOOKS LIKE	WHAT SOIL FEELS LIKE	WHEN ROLLED INTO A SAUSAGE	SOIL SAMPLES	THE SOIL IS
VERY SANDY	VERY ROUGH	CANNOT BE ROLLED INTO A SAUSAGE		VERY SANDY
QUITE SANDY	ROUGH	CAN BE ROLLED INTO A SAUSAGE BUT IT CANNOT BEND		SANDY
HALF SANDY AND HALF SMOOTH	ROUGH	SAUSAGE CAN BEND A LITTLE		SANDY LOAM
MOSTLY SMOOTH	A LITTLE SANDY, QUITE SMOOTH BUT NOT STICKY	SAUSAGE CAN BEND ABOUT HALF WAY ROUND		LOAM OR SILT LOAM
MOSTLY SMOOTH	A LITTLE SAND, QUITE SMOOTH AND STICKY	SAUSAGE CAN BE BENT MORE THAN HALF WAY ROUND		CLAY LOAM OR SANDY CLAY
SMOOTH	SMOOTH AND STICKY	SAUSAGE CAN BEND INTO A RING		CLAY

Rain and plant foods

In rainy places, soils have less plant foods in them than dry places. Sandy soils usually need a lot of manure or chemical fertilisers because the plant foods have been washed out by the rain.

Clay soil in a dry place usually has more plant foods than clay soils in a rainy place.

Soil Tests

The way to find out what plant foods are in your soil is to do a soil test. First mark 30 different places all over your field.

taking samples for a soil test

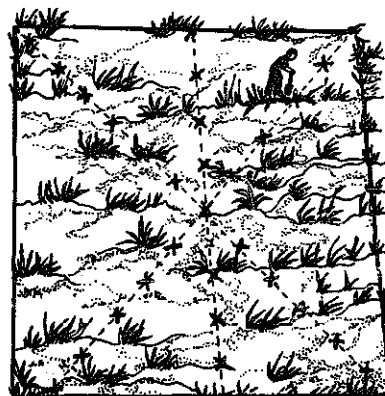

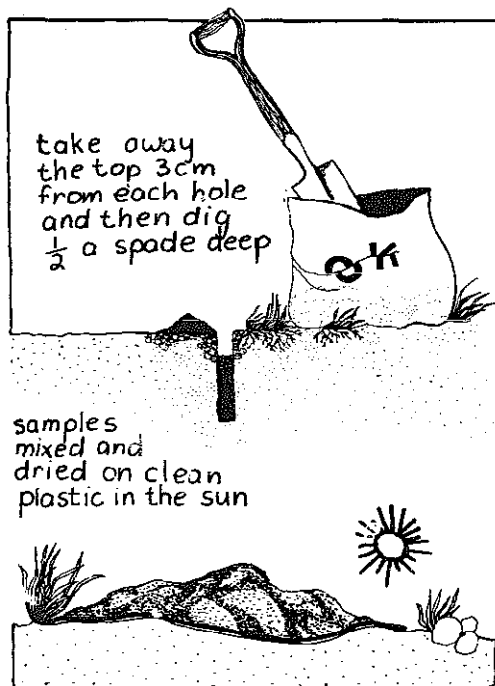

send 2 tins full for testing

Box 41
Lobamba
Swaziland

Dear Sir,

I want to plant maize and cotton this year. My land slopes down to the river. The rainfall in this area is about 850 mm a year. The colour of the soil is reddish brown. It is from 25 to 35 cm deep. Last year I cropped 40 bags of maize from 2 hectares. Please advise me.

Yours faithfully
J.D. Khumalo

When you have collected soil from the 30 holes, mix it all well together breaking all the lumps. Then leave the soil in the sun on clean plastic or sacks to dry for about 2 days. Put about 1kg of this soil (2x500ml oil tins full) in a clean plastic bag. Send it to be tested by the government agricultural department or by a fertiliser company (see p 121). In your letter tell them how much rain falls in your area, what crops you want to grow, how deep the soil is, what colour it is, and if your land is flat or on a hill. The people who do the tests will tell you what kind of fertiliser to use, and how much. You do not have to put on as much as they recommend: Use about 2/3 of what they recommend. If you get good results, you can use the full recommendation.

Most soils in Southern Africa are short of phosphorous. It is cheaper to put on phosphorous (superphosphate or rock phosphate) than mixed fertilisers like 2:3:2.

All soils can be improved by crop rotation and by adding lots of kraal manure and compost. Ploughing in lots of grass, mealie stalks and other plants is also good for the soil.

Soil Acidity

In places where there is a lot of rain, plant foods like calcium, magnesium and potassium are washed out of the soil and it becomes very acid. Crops can not grow well in very acid soils.

Soil acidity is measured in pH numbers. If the pH is less than 7, the soil is acid. If it is higher than 7, it is alkaline. If the pH is exactly 7, the soil is neutral- not acid or alkaline. Most crops prefer slightly acid soils with a pH of 6,5 to 6,8. A few crops, like potatoes like more acid soils, with a pH of 6. If soil has a pH below 4, it will be impossible to grow good crops without putting on lime.

Cabbages	grow in pH between 5,0 and 6,0
Tomatoes	grow in pH between 5,5 to 7,0
Carrots	grow in pH between 5,5 to 6,0
Onions	grow in pH between 6,0 to 7,0
Maize	grows in pH between 5,5 to 7,5
Groundnuts	grow in pH between 5,3 to 7,5
Cotton	grows in pH between 5,0 to 6,0
Tobacco	grows in pH between 5,5 to 7,5
Wheat	grows in pH between 6,0 to 7,5

Land Preparation

Try to plough as soon as you can after the spring rains when the soil is still soft. It is best to have long fields so your animals can have long pulls, before they turn and plough the other way.

Mark out sections so that the tractor or animals do not waste time moving a long way between furrows with the plough out of the ground. With animals these sections should be 20 metres wide. You should complete ploughing one section before moving to the next. Working in sections also makes it easier to plan crop rotations.

There are two ways of ploughing a piece of land with a single furrow plough.

• The first way you start in the middle of a section and plough round and round until you have ploughed the whole section. Plough a setting furrow in the middle of the first section. Then come back ploughing over the same furrow, making sure you have ploughed all the ground underneath. Then find the first furrow, now covered with earth, and plough along its wall. Return along the wall of the second furrow. From there you continue ploughing round and round until you are at the end of the section, 10 metres from the setting furrow. Then go 10 metres from the end of the section you have just ploughed and plough out a new setting furrow. If this method is carried on every year the soil is built up in a ridge in the middle of the land. This way is helpful for badly drained soils, but it is not good if you want a flat field or if you are irrigating.

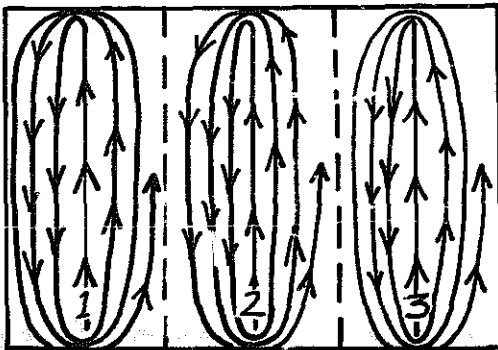

• The second way of ploughing is to start down the sides and go round and round until you reach the middle. If this way is used every year it will also not make your field flat. It is best to change your way of ploughing every year or always use one way but every year move your setting furrow 10 metres. If you have a reversible plough you will have less problems. You can turn around and come back on the same furrow.

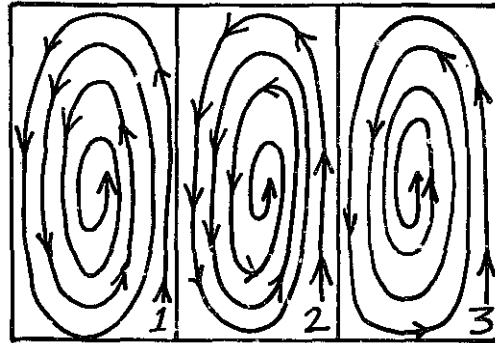

Deep ploughing

Ploughing can make the soil hard underneath, because the cutting edge of the plough makes a smooth layer under the top of the soil. This layer is called a plough pan. After a few years the plough pan becomes hard and plant roots and water cannot get through it.

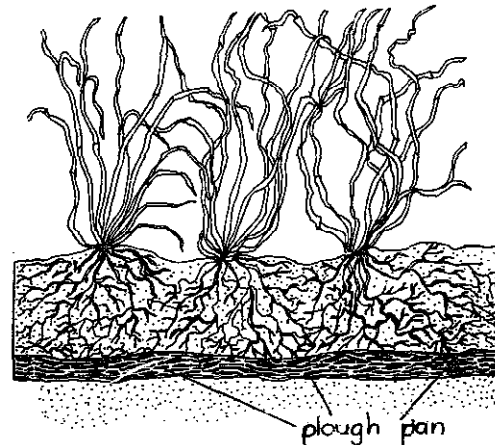

Plough pans are a big problem in wet clay soils. You can sometimes prevent them by waiting until the soil dries out before you plough. To break up the plough pan you can use ripping or deep ploughing.

● Ripping is breaking up the hard layers of soil by pulling a ripper across the field. The spikes of the ripper cut deep into the soil. When the rains come, water can go deep into the soil. The old plants and stalks are left on the top of the soil like a mulch.

● Deep ploughing is another way to break up hard layers. Try to hire a tractor every 3 or 4 years for deep ploughing. You can use oxen for deep ploughing, but must plough at the end of summer, when the oxen are still strong.

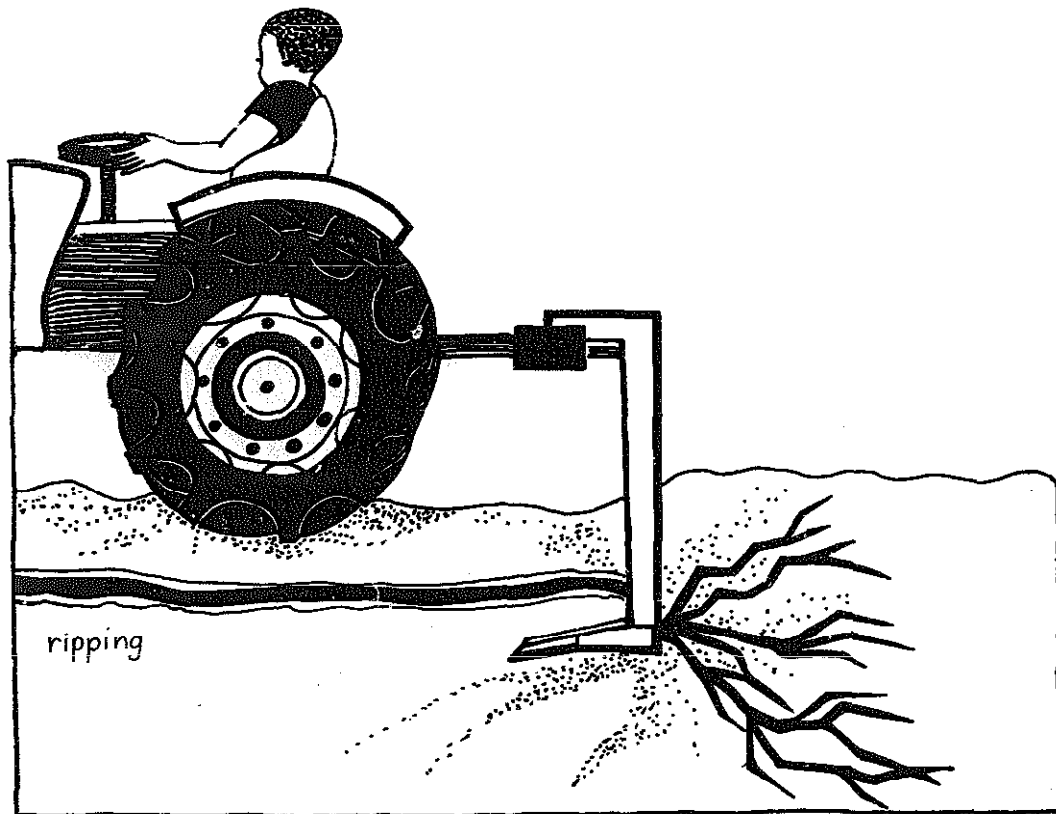

Contour Banks

If your field is on a hill, even if it is a gentle slope, you should plough furrows across the side of the hill. Then rain water will be held in the furrows. This helps to stop soil erosion. But it is even better to build contour banks to lead the water safely away.

The contour banks join drainage channels which take water down the hill. Before you start you have to plan the drainage channels and the contour banks carefully so that they can hold water from the heaviest rains.

Get help from an experienced person like an extension officer who knows how to use a dumpy level, or write to EDA.

Drainage channels

Drainage channels are places where rain water runs down the hill. They must be built before the contour banks. It is best to use natural channels like beds of streams. If there are no natural channels, you have to build channels. The channels must be wide enough for water to

flow away slowly and protected so that they will not erode. Protect by planting the sides of the channel with grass and growing reeds in the floor. If the hill slopes very steeply, build small stone walls (see soil erosion p 220) to slow the water down. Plant reeds or grass behind the walls. Put stones or reeds on the floor of the channel until the grass grows.

Making the contour banks

It is best to make contour banks the same distance apart all the way along. Each contour should be 3 to 5 metres wide and $\frac{1}{2}$ a metre high. They should

slope very gently towards the drainage channel. The slope can be worked out by your extension officer. It depends on the kind of soil and on how much water the contour will hold. The ends of the contours, where they join with the drainage channel, must be made stronger by laying stones on the contour walls. Plant grass on the contours to protect them.

Make contour banks using a plough to heap up the soil. You might have to make them bigger with a spade.

Make a channel at the back of the contour bank to lead the water away.

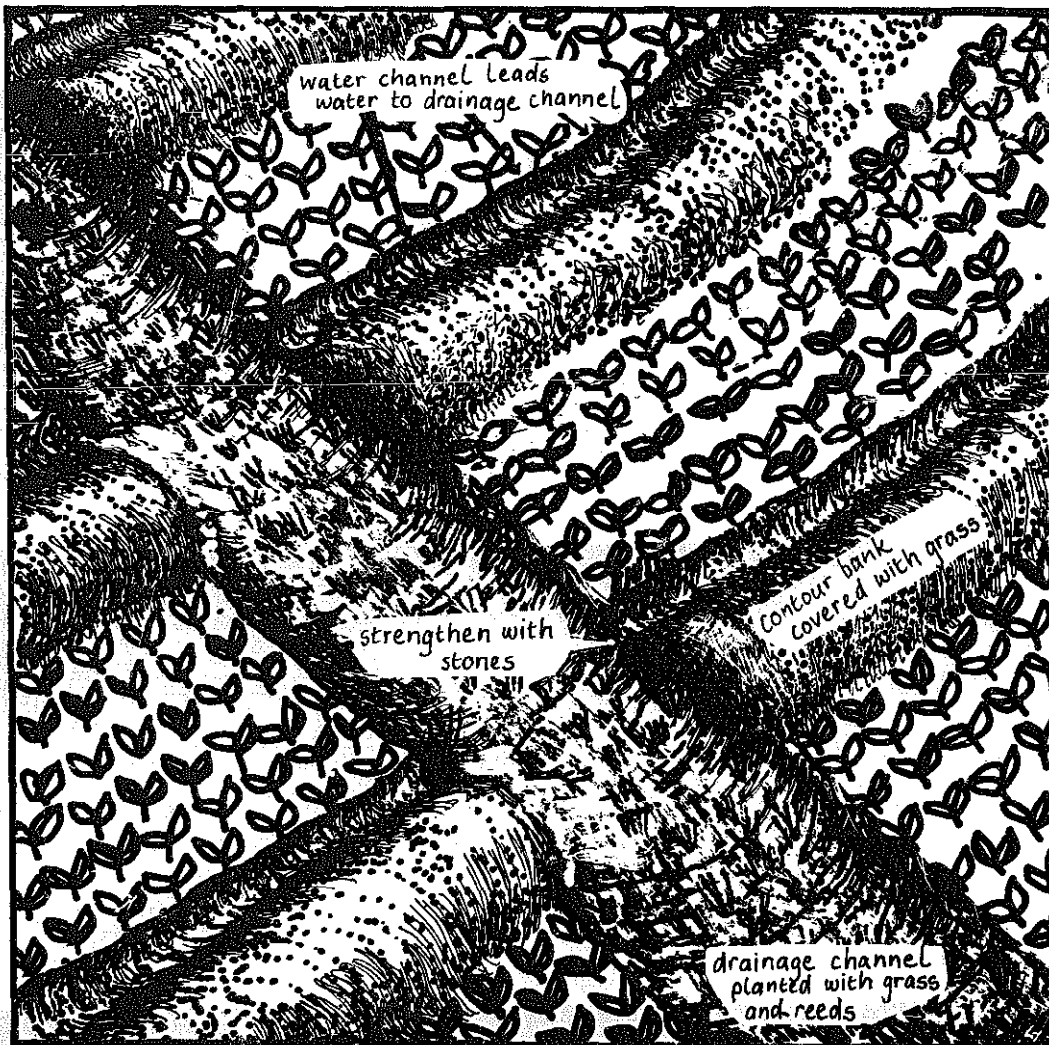

This channel must always be kept clean. Every year, clean out the soil which has collected in it and put it on the contour bank.

Cut-off drain

At the top of the field make a cut-off drain to stop water running into the field and washing the contours away. The cut-off drain must be wider than the field, so that water can not run into the field from the sides. The end of the cut-off drain, where it joins the drainage channel, must be planted with grass and made strong with stones.

Terraces

If the hillside is very steep, it is not enough to make contour banks. You must make terraces. Terraces are 1m deep steps in the hillside, looking like stairs going up the side of the hill. The walls of the terraces have to be made stronger with stones or by planting grass.

Each terrace must slope back a little into the hillside, so when it rains, water does not spill over the edge of the terrace. Terraces must slope gently to a drainage channel like contour banks. There must be a channel at the back of each terrace to lead water away.

Draft Power

Today it is difficult for people to plough with animals. There is not enough grazing during the winter. Oxen are only strong enough to pull the plough after the rains have fallen and the grass is green again. This means that planting is late. When planting is late, the harvest is small. People hope that tractors will solve their ploughing problems. They hire tractors, but tractor owners charge a lot of money. People sometimes have to spend more money on hiring tractors than they get from selling their crops.

Others buy second hand tractors, thinking that they will save money, but buying old or weak tractors can give a lot of trouble. Then people have to sell their cattle to pay for



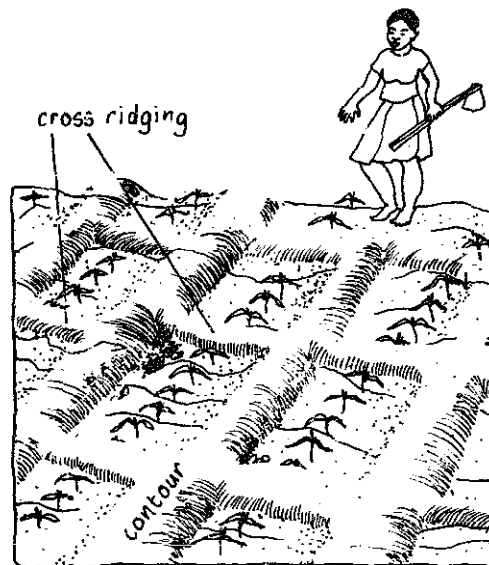

Cross ridging





Cross ridging is a different kind of contouring used to save water in dry areas. Make the contours with a ridger, with each contour as wide as the rows of your crops. Then along the ridges, make cross ridges every 2 or 3 metres. These cross ridges make little dams. Whenever it rains, the rain water stays in the cross ridges. They can easily be made with a hoe at the same time that you are weeding.



repairs. In the end they can have a broken tractor and no cattle.

If you have less than 10 hectares, it is better to use animals for ploughing. You can hire a tractor to do deep ploughing and ripping, but you can do all the rest of the work with animals. For 10 hectares you will need 6 to 8 oxen, 2 big horses or 2 mules. For 2 hectares, you only need 4 oxen, 1 horse or 1 mule. If you can afford it, spend some money on winter feeding, so that your animals are ready to plough when the rains come. Even if you have to spend nearly as much money as you do on tractors, animals still have some advantages. They give manure to improve the soil. They reproduce, which even the best tractors can not do.

	 TRACTOR	 OXEN	 DONKEYS	 HORSES	 MULES
How much they can work per day.	A small tractor of 25 horsepower will plough 2 hectares per day. A 35HP will plough 3 to 4 hectares per day.	4 oxen will plough $\frac{1}{2}$ hectare per day. 8 oxen will plough more.	4 donkeys will plough $\frac{1}{4}$ hectare per day.	2 horses will plough $\frac{1}{2}$ hectare per day.	2 mules will plough $\frac{1}{2}$ hectare per day.
Pulling strength.	Very good	Good	Bad	Good	Quite good
How much people have to work with them.	Tractors work very quickly. But you can spend a lot of time doing repairs and looking for spares.	You have to work hard to work with animals. Sometimes it seems you sweat as much as they do. You have to find them, catch them and harness them before work begins. If they are badly trained they can make you tired and angry.			
What they can do.	Tractors can do many things. They can plough, cultivate, harrow, mow and plant. They can drive saws, pumps and hammermills.	Animals can plough, cultivate, harrow, mow and plant but they are slower than tractors. They are not used for pumping and hammermilling.			
What they do to the soil.	The weight of tractors makes the soil become hard. Deep ploughing can damage the soil.	Animals work more gently with the soil, their weight does not make the soil hard. They do not turn the soil too deeply.			
How many years can they work for?	10 to 15 years. Only 7 if worked hard.	6 years. Do not reproduce.	10 years. They reproduce.	12 to 15 years but they reproduce.	10 to 15 years. Do not reproduce.
Buying costs	R800 for the cheapest new tractor. R4,000 for a 2nd hand tractor and you are never sure what you are buying.	Small oxen R250. Strong big oxen over R400.	R50 or even less.	Percherons, Shires and full-sized work horses over R500. Trained 16-hand work horses R300. Boereperde R150 to R250.	R200 - R400.

	 TRACTOR	 OXEN	 DONKEYS	 HORSES	 MULES
Feeding and fuel.	Diesel and oil is expensive though tractors do not eat your grass.	Needs good grazing and extra food when working.	Can live on poor grazing though they work better when well fed. Need extra food while working.	Needs good pasture and extra food when working.	Can live on poor grazing though they work better when well fed. Need extra food while working.
Looking after them.	Fuel, repair and maintenance cost about R6 per hour for ploughing and R4 per hour for lighter work.	Oxen need less looking after than horses, but they still need enough food. Prevent disease by injections and dipping.	Do not get diseases easily. Their feet have to be checked and sores treated. They work better if you look after them well.	Looking after horses is not expensive but it takes time. You have to clean horses, file their feet, treat sores, give them food. Horses get diseases more easily than other animals.	Do not get diseases easily. Their feet have to be checked and sores treated. They work better if you look after them well.
Skills you need to work with them	You have to know how they work and how much they can do. This depends on the soil. You need patience and a knowledge of the soil.	All animals work better if you are patient and friendly. They work badly if you are frightened or cruel. Horses and mules usually work with one person. Oxen and donkeys usually work with two or three people.			
Disadvantages	Expensive to buy and run. Difficult to repair.		Do not listen and do not plough well. Better for carrying loads on their backs	Horses kick and bite if they are not looked after well.	Kick and bite and do not listen.
Advantages.	Can do many things and work fast.	They can pull strongly. They give you manure.	They live off very little, produce manure and reproduce.	Intelligent and friendly. They give you manure.	They are strong and work in difficult conditions, like steep fields. They give you manure.

Working Animals

Try to buy draft animals from the district where you live. These animals will be used to the weather and will not get tick diseases so easily. People usually sell their worst animals so you must be awake when you buy. Try and find out the real reason for the animal being sold.

You should learn what healthy and sick animals look like. For example if an animal has a dull coat, it is not very healthy. If it has a skin disease it has probably not been cared for well. Check to see how the animal breathes. Check the animal's muscles and bones, to see if it has a strong back, chest and legs. Check the legs for swellings, twists or old wounds and the feet for hardness or splitting. If you are buying 2 animals to work together, make sure that they are about the same size.

One of the most difficult things to work out is the animal's age. The best way to do this is by checking the teeth. If the teeth are worn down it means the animal is old or it has had bad grazing. It means the animal will not be strong enough to work for more than a year or two. You can tell how old oxen are by the roughness of the horns. Young cattle have smooth horns. Some sellers sandpaper horns to make you think the animal is young.

The best way of overcoming many of these problems is to buy young animals. The younger an animal is, the easier it will learn and you will have many

years to work together. Start training animals at about 2 years old. If you are buying a male horse or donkey it is better that they are castrated, unless you want to breed with them.

It is very important to know an animal's character when you are buying it. The best way is to watch it working with the owner. Be careful not to buy animals with bad habits or animals that are too wild. An animal that has been trained heavily with a whip will not learn quickly and it will be frightened of people.

Caring for working animals

Working animals need extra food every day. Without extra food they will not stay strong and work hard. Working donkeys and mules need to graze for half a day and get hay at night, as well as 1kg of crushed maize or sorghum mixed with bran. They need clean water every day. Oxen need good grazing. Every night they need 2,5kg bran mixed with 2,5kg mealie meal or sorghum or 5kg of good hay. They also need a mineral supplement, like salt and bonemeal.

Give the animals water at the end of the day and not while they are working or hot and sweaty because water can cause stomach pains. You can cut 200 litre drums in half to make good feeding and watering troughs. They must be cleaned every day. Give your animals clean water because they can get diseases from dirty water.

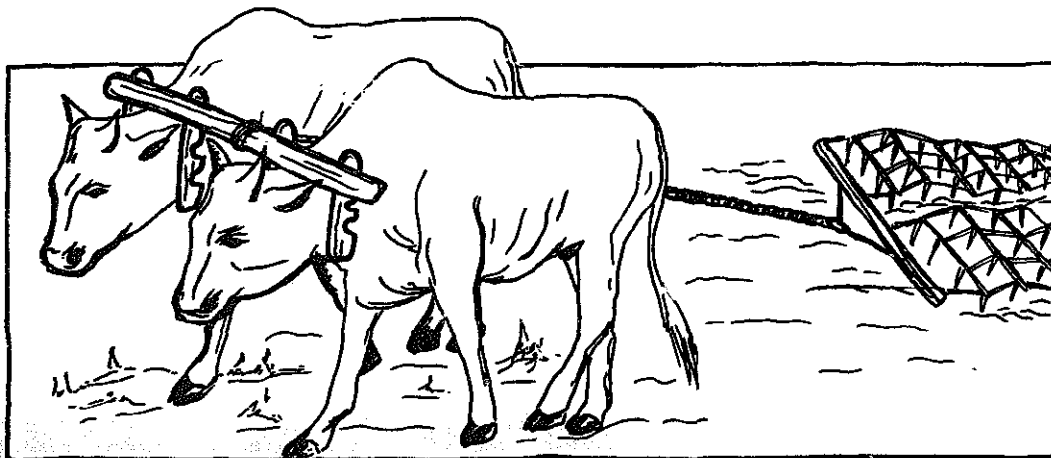

Health

Working animals need plenty of rest. If you have enough animals it is best if they spend one day working and one day resting. If an animal lies down you should not beat it. It is only showing it is tired and needs to rest. Check your animals' feet regularly. Lift them up to see if there are any stones or splinters stuck underneath. Clean out the manure from their feet with a nail or stick. Do not work an animal which is not walking properly. If there is a swelling on the leg pour cold water on it to cool it down. Check your animals regularly for tick diseases and worms (see p 228, 230)

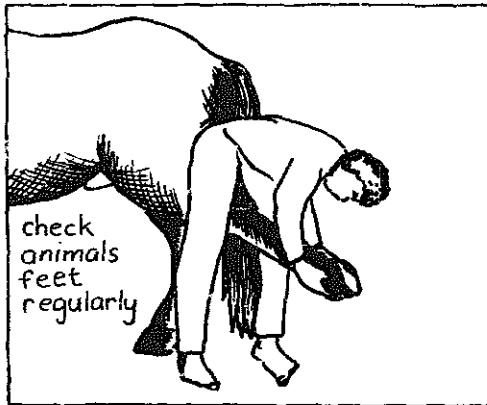

Training animals

If animals are treated like people, with kindness and friendliness, they are easy to train. Give each animal a simple clear sounding name. Feed it by hand so it gets used to people. Do not be frightened because the animal can tell if you are frightened and you will not be able to train it.

Young animals are the easiest to train. An ox is only strong enough to be harnessed and trained at 3 years, mule at 2-2½ years and a donkey at 18 months. It is easier to train a young animal with an older animal that is already trained. The trained one will teach the new one and hold it in if it tries to get out of the harness.

If the animal you are training is still wild, get 3 people to help you catch it with a rope. Then you can harness it. In the first week of training let

the animal get used to the harness by walking it around for 3 hours. Then you can start with commands. Do the action of the command to teach the animal. For example, pull in the reins as you call 'stop'. Words and whistles are the best commands. Beating an animal is not good. If you are losing your patience rest a while and begin again later or the next day. Donkeys and oxen sometimes lie down when they are tired. Let them rest. Teach the animal one thing at a time otherwise it gets confused. Teach it to stop, go, walk straight ahead, turn right and left. Tying two animals' heads together with a loose rope will teach them about working in pairs. Donkeys and oxen should learn in pairs and later on be hitched up with another pair. After a week, when the animal is used to the harness, get it used to pulling by tying a log to the harness.

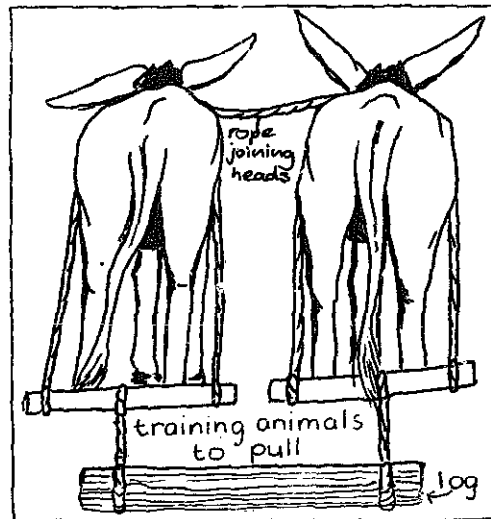

Then you can attach tools to the harness. Ploughing is the most difficult so once they can plough they can do all the other things. Start with the plough very shallow and gradually go deeper. Teach the animals to walk in the furrows so that all the land is ploughed evenly.

Oxen can be trained in six weeks if they are handled well. After that if they still do not want to be trained, sell them.

Harnessing.

You need this equipment to harness an animal.

For donkeys:

- ▶ A halter or head rope
- ▶ A bit
- ▶ A neck rope
- ▶ A yoke or chest strap
- ▶ Rope or chain for traces

When you harness an animal check that it is comfortable. Check that nothing is pinching its skin. Talk to the animal while you are harnessing it. Let it know where you are, so you will be safe from kicks and bites.

Donkeys, horses and mules will pull best from their chest and shoulders, so a chest strap is the best harness. Leather donkey straps cost about R18. You can make one yourself out of an old car tyre. Cut one broad strap for around the chest and one for over the shoulder, with a strap going under the stomach to hold the harness in place. You need 2 pulling ropes, 2 steering ropes and 2 chest strap support ropes with loops. These stop the steering ropes from dragging. The rope is passed over the donkey's neck and tied with a loop hanging either side. Tie shaft support ropes where the shoulder and chest straps meet.

Some tools do not have shafts. They need a wooden pole to keep the pulling ropes apart. If you are using two animals, you need another wooden pole so that they pull equally. Tie the animals' heads loosely together.

For oxen:

- ▶ 2 yokes
- ▶ Full set of skeis and spares
- ▶ Strong reins, long and short
- ▶ Strong, well made straps
- ▶ A plough and trek chain
- ▶ Logs of different weights
- ▶ Sharp knife
- ▶ A whip that makes a crackling sound

Oxen are harnessed with neck yokes or head yokes. They can do more work with head yokes, but old oxen sometimes have difficulty using them. A double neck yoke has a double clamp and is used for ploughing. The trens, which holds the trek chain to the yoke, can be lengthened or shortened with the clamp if one of the oxen is stronger than the other. You can use nails instead of clamps. Hammer about 6 nails, 100 mm apart into the middle of the yoke. Adjust the chain with the clamps or the nails so that the oxen pull the plough straight.

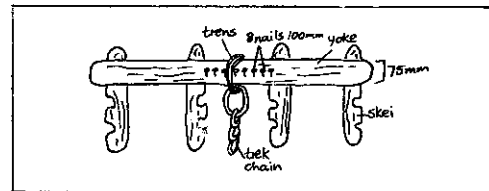

The single neck yoke is good for light jobs like cultivating. It is easy to train animals with this yoke.

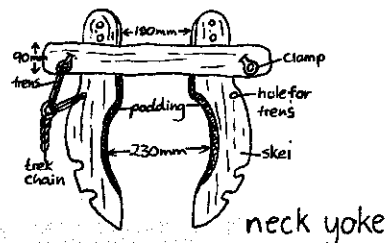
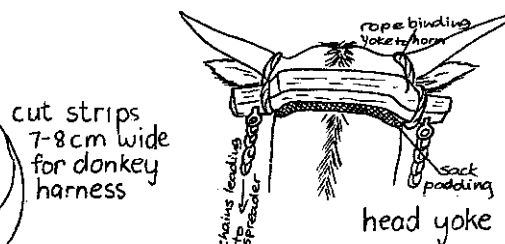
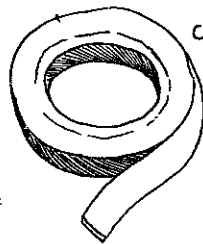
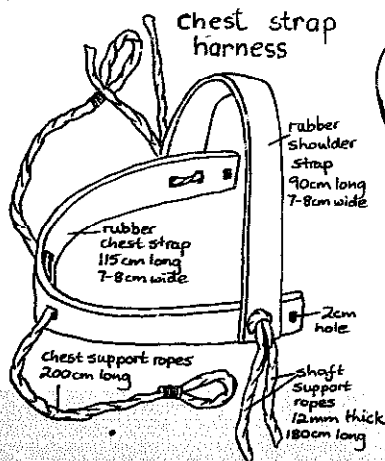

Animal Tools

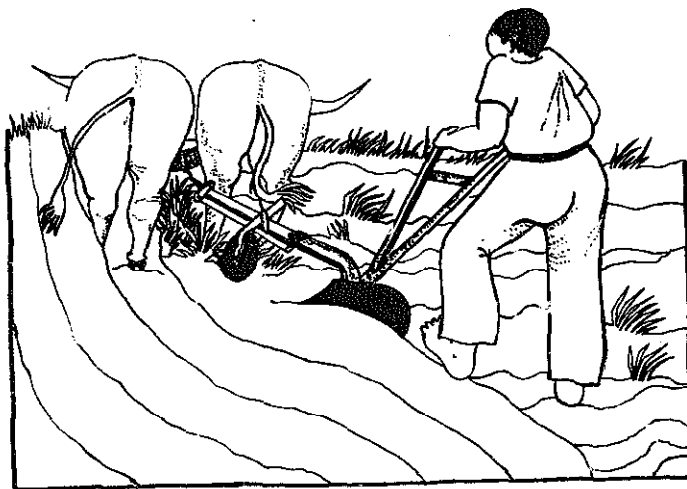

single furrow plough

The most common animal tool is the single fixed furrow plough. It can plough 25cm deep. A single furrow plough costs about R80. You can also get reversible ploughs. These ploughs make work easier because you do not have to move round the field to plough. You can reverse the plough and walk down the same furrow you have been on. These ploughs cost about R120 but they are worth the extra money.

There are two kinds of adjustments on ploughs, making the plough go deeper, and adjusting the plough for the number of animals:

- To make the plough deeper, lift up the drawbar by loosening the bolt. Another way to make it deeper is by shortening the wheel assembly.



rough uneven field

spiked tooth harrow

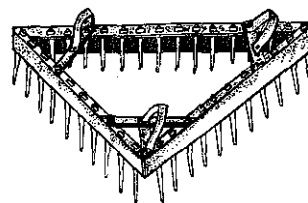

- Adjust the plough for one animal by moving the horizontal adjustments towards the ploughed land side.

When the adjustments are right it will be easy to hold the plough. Hold it straight up otherwise the soil will not be turned properly.

Harrows

Harrows break up lumps in the soil and make the land flat. They help water and air get into the soil. The most common harrow is the spiked tooth harrow. There are 3 kinds of spiked tooth harrows: diamond, triangular and zig-zag. You can buy the diamond and zig-zag in sections. You will need 2 sections, which cost about R150 new. You can also buy them second hand.

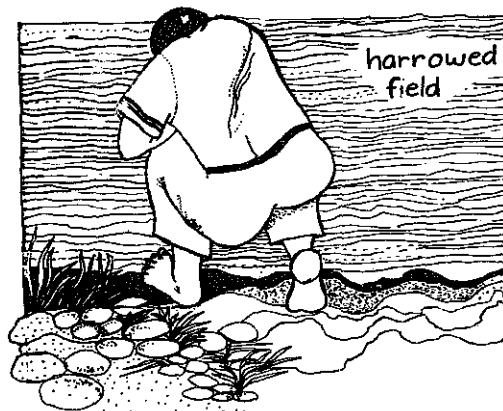

harrowed field

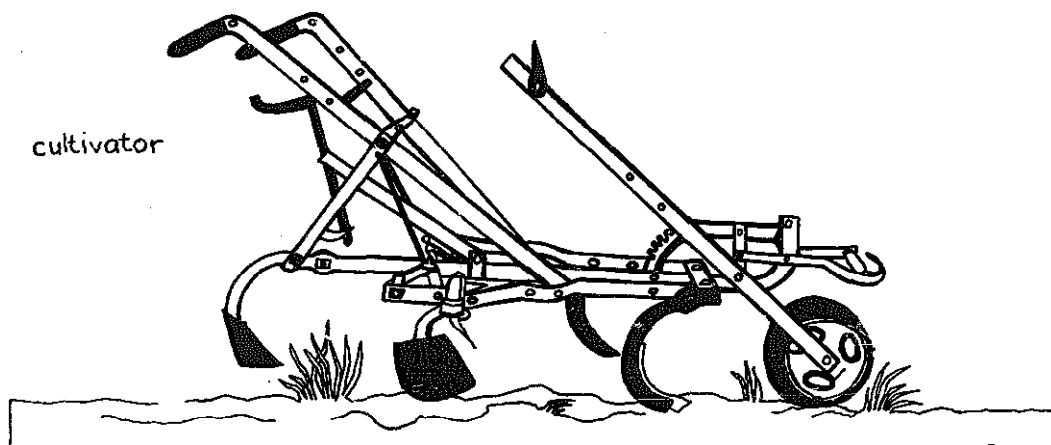

Sometimes the harrows are too light, especially for clay soils. The back of the harrow lifts off the ground so the front of the harrow has to do all the work. Some farmers put logs on the back, but this can make hard work when you have to lift the harrow.

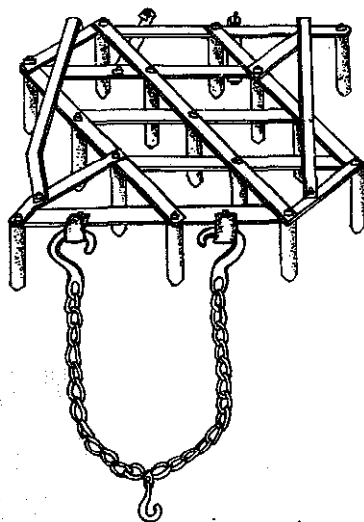

zigzag harrow

Planters

Planters are tools which make a small furrow and drop seeds in. The planter presses the seeds well into the ground and covers them up with a thin layer of soil. Some planters put fertiliser in the furrow with the seed. The Safim planter, which is the most common in Southern Africa, drops fertiliser and seed down the same

pipe. This damages the seed. If you want to use fertiliser when you plant, plant in rows by hand (see p118).

Cultivators

Cultivators are used to dig up the weeds between the rows of crops. Many farmers cultivate by hand with hoes, but often there are not enough people to do all the work. It is better to use an ox cultivator. Try to cultivate early because weeds use up a lot of plant foods from the soil which your crops need.

It is best to buy a cultivator which you can adjust to fit the row spacing of your crops.

Cultivators have hillers, sweeps, tines and scufflers. Cultivators with hillers are good for crops like potatoes, groundnuts and cotton because they make furrows for irrigation. Cultivators with scufflers are the lightest to use and are best for vegetable growing.

Toolbars

In Botswana, a toolbar for oxen called a Makonosotle is used by many farmers. It is a frame with two wheels. A plough, planter or trailer can be put on the frame. The frame is also the right size for carrying drums of water. When you plough, the wheels keep the plough straight in the furrow, so you do not need a person to hold the plough straight.

Tractors

Most farmers in South Africa can not afford tractors. Usually only a few people in the area have tractors and they hire them out at high prices. Tractors do not solve farmers' problems. Often they spend more money on ploughing than they get for selling their crop. It is better if a group of farmers join together and buy a tractor.

Tractors can do many things: plough, ridge, plant, harrow and cultivate, drive pumps and hammermills and transport loads with a trailer. Tractors are powerful, and compared to animals they work very quickly. But they are also very expensive to buy and expensive to service and repair. There are many things which can go wrong.

Usually when farmers groups are thinking about buying a tractor they think only about the buying price. But this is only about half of the real price. Over its life they will pay as much for repairs to the tractor, as they paid for the new tractor. In its first and second year the repair costs are not high, maybe 5%-10% of the purchase price. But by the time the tractor is 5 years old, more things start going wrong and repairs become more and more expensive.

A group of farmers buying a new or second hand tractor should discuss these things first:

- ▶ What is the tractor going to be used for?
- ▶ Will it be hired to other people or will it work the group members' fields only?
- ▶ How many hectares is it expected to work?
- ▶ Does the group have members with mechanical experience?
- ▶ Who will drive it?
- ▶ How far away is the dealer/garage for spare parts?
- ▶ If a trained mechanic has to travel to the village for large repairs what will he charge for transport?

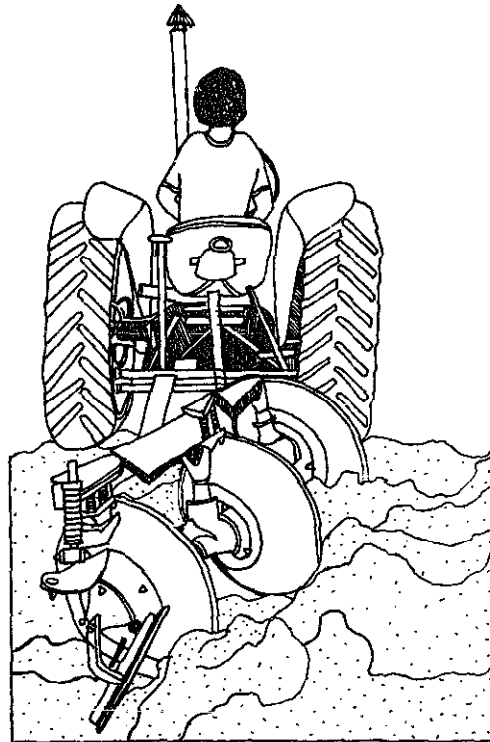

The tractor must be the right size for the work it has to do. For example if your place has hard soil the tractor must be big enough to rip the the land. But if you are a small group of farmers who want to work 10 hectares intensively then buying a big tractor is a waste of money.

Sometimes the land is too large for one tractor. For example a group of 40 farmers wants to buy a tractor. At the local garage there is a second hand Massey Ferguson 35 with a 3 furrow plough. The garage wants R5 000, but the farmers can not afford to pay more than R50 each. This means they will have to find another 60 members before they can buy the tractor. Then they need money to buy diesel, ploughshares, pay for repairs so they might have to get even more members. If they buy the tractor it will not be able to cope with all the members' lands, and the members will start to fight about who will get the tractor first. It would be better for the group of 40 farmers to save up until they have enough money and keep the group small.

Tinkabi Tractors

Some people in Swaziland thought about the problems people had with big tractors and built a cheaper tractor that was simple to drive and maintain. This tractor, called a Tinkabi, costs less than R4 000 with tools. It is different from other tractors in these ways.

- ▶ There is no electrical system. The tractor is handstarted. It has no lights so it cannot work at night.
- ▶ It has no gears, gearbox, clutch or differential. Instead the engine drives a hydraulic pump that pushes oil to wheel motors. The driver just pushes a lever to move the tractor forwards or backwards.
- ▶ The implements are designed for the tractor and bolt on to the tool bar which is raised and lowered by hand.

The disadvantage of the Tinkabi is that it can only pull a single furrow 12 inch plough, so it is very slow. It is only as strong as a good team of oxen. It cannot plough in hard ground or rip the land, and it takes about 1½ days to plough a one hectare field. Another disadvantage is that it uses ox planters which are not very good, especially when fertiliser is used.

The Tinkabi is still a good tractor for a small farmer because:

- ▶ It is easy to maintain.
- ▶ It is good for milling grain and pumping water.
- ▶ It is good for carting although it is slow travelling on roads.

For ploughing, the Tinkabi is alright for an individual but it is too slow for a group to share. Because it is so good for milling and pumping water, a farmers' group may want to buy a Tinkabi to do these things and to help the work of a big tractor.

Driving tractors

Tractors are dangerous if the driver is not well-trained or experienced.

In the field be sure tractor implements are put on and adjusted properly or they will strain the tractor. All implements must be level, with sides the same height off the ground. To set a plough, get the right wheels of the tractor into the furrow, then set the plough so it is level. Before you get off the tractor, always let the implements down onto the ground. On the road do not try and change gear going down hill. Drive slowly and carefully, not at top speed.

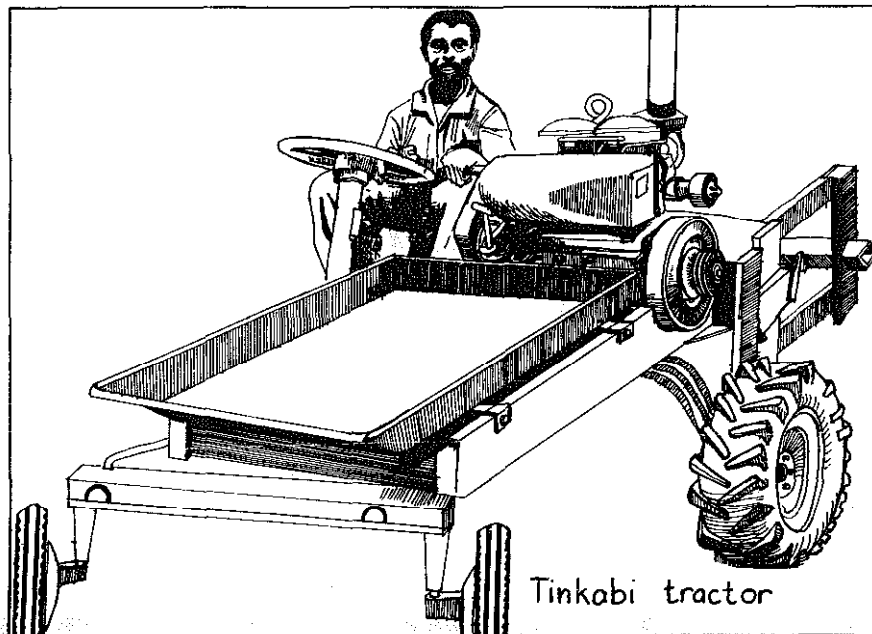

Transporting

Use your tractor only for transporting full loads otherwise you will waste money on tractor tyres and diesel. Use ox or donkey carts for small loads.

Hammermilling

Hammermilling is popular with people. It saves them a lot of work and makes cheaper and healthier mealie meal than the mealie meal from the shops. Try to organise people in the community so that they all bring their grain to the hammermill at the same time. Keep the hammermill running and mill all the grain. It is not good to keep stopping and starting the hammermill: it wastes fuel and strains the tractor.

Hiring tractors

When you hire a tractor, find out how much you are being charged. If the charge is per morgen or per hectare, check your field is as big as the tractor owner says it is (see p 127). Tractor owners often overcharge.

Try to have your field ploughed when the soil is soft. Make sure that the plough is set properly and that the ploughing is deep or you will get a poor crop next year. If people hiring a tractor organise themselves into groups, they can prevent tractor owners from exploiting them. They can demand a good service so that tractor owners plough at the right time and do not overcharge them.

The repairs will add up to the cost of the new tractor

Bill McKinlay has organised government tractor hire schemes in Uganda, Botswana and Swaziland. We spoke to him when he was working as Mechanisation Officer in the Zombodze Rural Development Area in Swaziland.

● How did the tractor scheme in Swaziland start?

We started in 1975 with 10 tractors. We decided to make them all the same model, which made training the drivers a lot easier. Now there are a total of 27 tractors hired to farmers by the Rural Development Areas department in Swaziland. We now have a workshop and trained people. So far we've managed to avoid the problems which most tractor pools in developing countries suffer from.

● What kind of problems?

Well I'm speaking from experience in Uganda and Botswana. The Ugandan government bought 1000 tractors for a tractor pool during the first year of independence. The service was nationwide and this resulted in tractors spending a lot of time going from one place to another.

Here in Swaziland, certain areas have been chosen as Rural Development Areas (RDA's). In these areas the government gives full support to farmers, including tractors. Each RDA keeps its own tractors. I've been pleasantly surprised by this, because my experience in other countries has shown that politicians start to interfere, particularly round election times, and want to know why tractors are not in their area. You can't have a successful scheme if the tractors are chasing all over the countryside. Even within the RDA boundaries we have problems, such as drivers not being able to find a farmer who has hired the tractor. Or if a tractor gets a puncture 25km from here, the driver has to communicate with us, we have to go down there, and the whole operation takes a day. These problems are unavoidable.

● How much is your service used?

Last year, we hired tractors to about 75% of the farmers in this RDA, a total of 2069 farmers. The average use of the tractors was just under 3 hours per farmer. We charge much less than the private tractor owners, but there is still work for them too, especially during the peak period between August and November.

● When do you find the farmers want the tractor for ploughing?

Something I've noticed this year is that we've had a tremendous increase in demand for ploughing before the rains. This is good for us, it means that there's steady work for the

tractors over a longer period. And it's good for the farmer, because ploughing early allows moisture to get into the soil. Ploughing early also starts the life cycle of insects and weeds, so that by the time the farmer plants, some insects have already passed their harmful stage, and the weeds are already growing. Then a farmer can plant and weed at the same time, without weeds competing with the young plants.

● Do you drop the hire charge during the slack period?

Yes, we drop our tariff by 50c an hour, and then put it up again on 1st September. During the offpeak periods, farmers often hire tractors for transporting building materials.

● What advice would you give to an individual or a co-operative wanting to buy a tractor?

There are a number of important things to think about. The first thing is, if you don't have a lot of experience with tractors, you can expect mechanical breakdown. So I would say that one of the most important things is to have a parts dealer and mechanic close to where you are. This limits your choice of tractor, but it's very important. Our figures show that if a driver is not experienced, a tractor will give only about 450 hours use, or even less, before there is some kind of breakdown. The difference between driving 10km and 100km for a service becomes quite important. For a man or co-operative without experience in using a tractor, we have found that over the life of the tractor the repairs will add up to the cost of the new tractor. In the first year, repairs cost only 1 to 2%, but in the fifth year they reach 30 to 40%. A set of back tyres for a tractor is now R500 for two tyres and tubes. You can expect to go through those in about two years: this is R40 a month, just for tyres. That's a lot of money for small farmers. If a group of farmers is starting a tractor hire scheme, they should always put money into a fund to pay for a new tractor, and include this fund in their hire charges. This fund should also take into account the fact that tractor prices will be increasing.



Buying a second-hand tractor

If you are buying a second hand tractor from a garage, ask if there is a guarantee. There should be a guarantee, even if it is only for 3 months. If you are buying from a rich farmer try to find out why he is selling the tractor. Ask the tractor driver if the tractor has given a lot of trouble.

Here are some things you can test to tell if there is something seriously wrong with the tractor. If you have no experience with tractors, take a friend with you who has experience and can do these tests:

▶ Check the air filter. If it is a disposable paper filter it will have two rubber seals glued at both ends of the cartridge. Check that these seals will not let air through. If they do it means that dust may have been leaking past the filter and has gone into the engine. If there is dust in the engine it is very serious.

▶ Check carefully for oil and fuel leaks. You might not see any straight away because at garages tractors are steamcleaned and degreased before they are sold.

▶ Turn on the ignition. On most tractors there are lights, one for oil pressure, the other to show that the alternator is charging. They should both go on when the key is turned.

▶ Start the engine: both lights should go out. If they do not go out, then do not buy the tractor unless the garage repairs this fault.

▶ Warm up the engine: check that the temperature gauge works.

▶ Listen to the engine as it warms and watch the exhaust. If the engine does not run completely smoothly and there is blue white smoke coming out of the exhaust it probably means that something is wrong with the fuel injection system. This can be very expensive to repair. If the tractor blows a lot of dark smoke the piston rings could be worn. This usually means the tractor needs a complete engine overhaul.

▶ Press the clutch and see how far you have to push it down before you can change gear. If it is difficult to get into gear, check to see if you can take up any slack through the clutch adjustment mechanism. If you cannot it probably means that the clutch plates will have to be renewed soon.

▶ Release the handbrake, let out the clutch and see how smoothly the tractor starts to move. Use all the gears in both ranges. Check that the gear lever is not too loose in any gear and check that it does not jump out of gear.

▶ In low range put the tractor in first gear and open the throttle to 2 200 rpm. Stand on the brakes. This will be the same for the engine as pulling a plough. Listen for any squeal or whine from the gearbox or differential, or any tapping noises. These noises mean that there is bad wear in the engine, such as broken gear teeth or damaged selectors. Gearbox and differential repairs are very expensive.

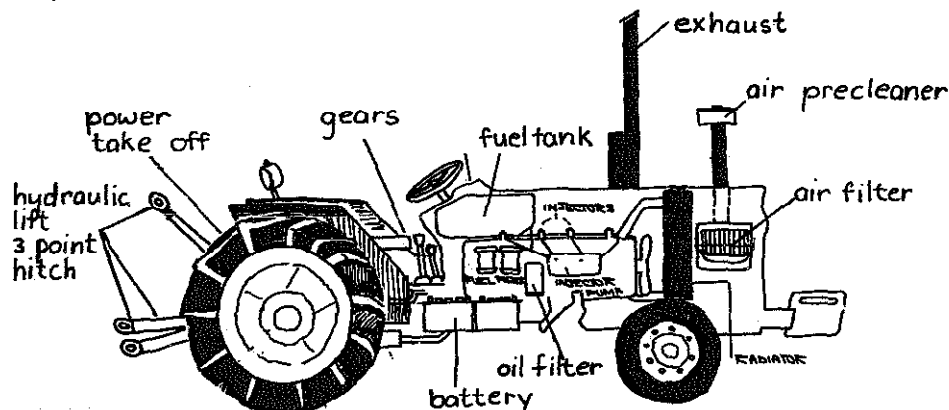

▶ Check the hydraulic filter. There are two types, one is disposable like an air filter, the other is a magnetic rod which picks up any metallic dirt in the system. Check if the filter is dirty. If it is dirty, test the hydraulic lift system very carefully.

▶ Check the hydraulic lift system. You will need a plough to check that it works properly. This can be a problem if you are buying from a garage. Ask if you can borrow a plough or bring your own to check the lift. It must be smooth and not jerk. When the plough is lifted it must stay at the same height even with the engine at idle. It is even better if you can check the lift in a field. The plough must not dig itself under the ground or drag on the top of the ground.

▶ Check to see if any hoses are becoming rotten.

▶ Check the grease nipples. If they are clean it probably means that the tractor has not been maintained regularly.

▶ Check that the power take off works.

▶ When you have run the tractor for a while and the engine is hot, check again for oil and diesel leaks.

Make a list of all the things that are wrong and which need fixing. Work out the cost of repairs. Then decide if you still want to buy the tractor. Show the list to the garage owner to see if you can get a better price for it.

Whether you buy a second hand or new tractor be sure you get an operator's manual. Read this carefully. It will tell you how to get the best use from the tractor. If you want to do a lot of repairs yourself, buy a workshop manual. It will tell you how to do almost all repairs. The workshop manual is expensive, sometimes as much as R100. It must be ordered from the factory.

■ Make out a service chart on a piece of paper to cover the next 1000 hours that the tractor works.

Maintaining your tractor:

Every day	Clean the air pre-cleaner and check the oil.
Every 50 hours	Grease the hydraulic lift nipples, kingpin nipples, front axles, brake and clutch nipples. Check and clean air filter cartridge/oil bath. Drain condensate from first fuel filter. Tighten all nuts and bolts, check for leaks. Check battery, clean connections with baking soda and water.
Every 100 hours	As for every 50 hours. In addition check the alternator fan belt tension.
Every 200 hours	As for every 50 and 100 hours. In addition drain oil, change oil filter and first fuel filter. Check and top up if necessary gear box, differential, and hydraulic oil levels.
Every 400 hours	As for every 50, 100 and 200 hours. In addition clean hydraulic filter if magnetic type or replace it if disposable type. Replace second fuel filter.
Every 1000 hours	As for every 50, 100 and 200 hours. In addition get a trained mechanic to set tappets and calibrate injectors and to see if it needs any other servicing or repairs.

Intercropping

Intercropping is planting 2 or 3 different crops together in the same field. It is a method used by farmers in many parts of Africa. There are lots of reasons why intercropping can help you to get better crops.

- Some crops grow well together without making the soil weak because different crops use up different plant foods in the soil.

- Growing two or three crops together does not give weeds a chance to grow.

- Sometimes intercropping helps to control pests and diseases.

- Intercropping means that you will always harvest one crop even if the other crop grows badly.

- Harvesting is done at different times for each crop, so there is not so much

work at the same time.

- Planting. To get good harvests from intercropping, you must plant different crops at the same time. Do not plant them at different times, otherwise the intercropping will not work.

Planting for intercropping can be done by scattering seed or by planting in rows. For scattering, mix the seeds together before planting. For planting in rows, plant maize in one row, beans in the next row, and so on, or plant maize and beans in the same row. Planting in the same row is good for runner beans, because they can grow up the maize plants.

Crops which grow well together are:

- ▶ Maize and cowpeas.
- ▶ Maize and groundnuts.
- ▶ Maize and sugar beans.
- ▶ Maize and pumpkins.
- ▶ Sorghum and millet.
- ▶ Sorghum and sugar beans.
- ▶ Maize and sweet potatoes.
- ▶ Sugar cane and beans.
- ▶ Cotton and beans.

Intercropping can also be done with trees or crops which take more than 1 season to grow. For example, you can plant maize with fruit trees, sisal or cassava. You can harvest the maize while the other crop is still growing.

Crops which grow with intercropping do not need as much fertiliser as crops which grow alone. If you do use fertiliser you need only use superphosphate.

Agricultural scientists have not done many tests on intercropping harvests in Southern Africa although it is a popular method. In Swaziland scientists have found that harvests of intercropped maize and beans were only a little bigger than when they were grown on their own. Perhaps the popularity of intercropping among small farmers is not bigger harvests, but just being sure that you will get at least one crop.

If you are worried that intercropping does not work, why not try it on a small piece of land and see for yourself if it is better.

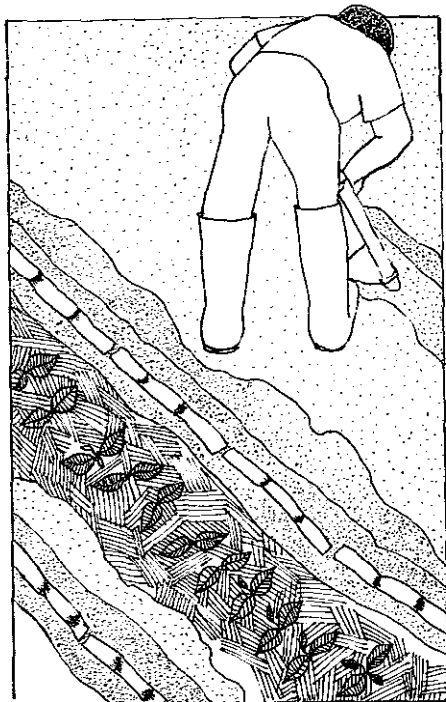

intercropping beans and sugarcane

Planting in Rows by Hand

Planting crops in rows is much better than scattering seed. It uses less seed and the plants all grow up to the same height. Weeding is much easier because a cultivator can be used between the rows.

Many farmers scatter seed because they do not have a tractor or oxen to plant with. Sometimes they wait until they can hire a tractor and this forces them to plant late. If you have no oxen or tractor you should think about planting in rows by hand. It is a quick and easy method.



weeding is much easier if you plant in rows

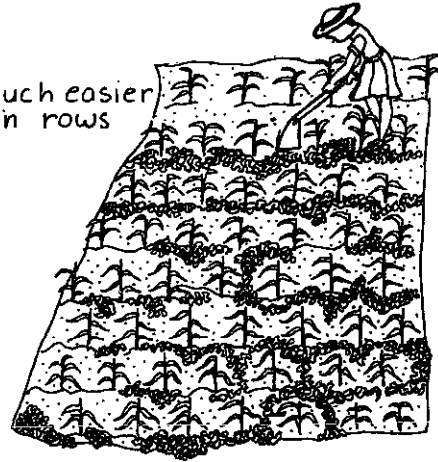

Four people can easily plant one hectare in a day. You can plant with only two people, but it will take longer.

What you need:

- ▶ A hand hoe for digging the furrow.
- ▶ Good string or baling twine - 3 pieces of about 100m long.
- ▶ 6 strong wooden pegs to tie the string onto.
- ▶ 2 measuring sticks about 1m long for measuring the distance between the rows.
- ▶ 2 measuring sticks to check how deep to plant and how far apart.

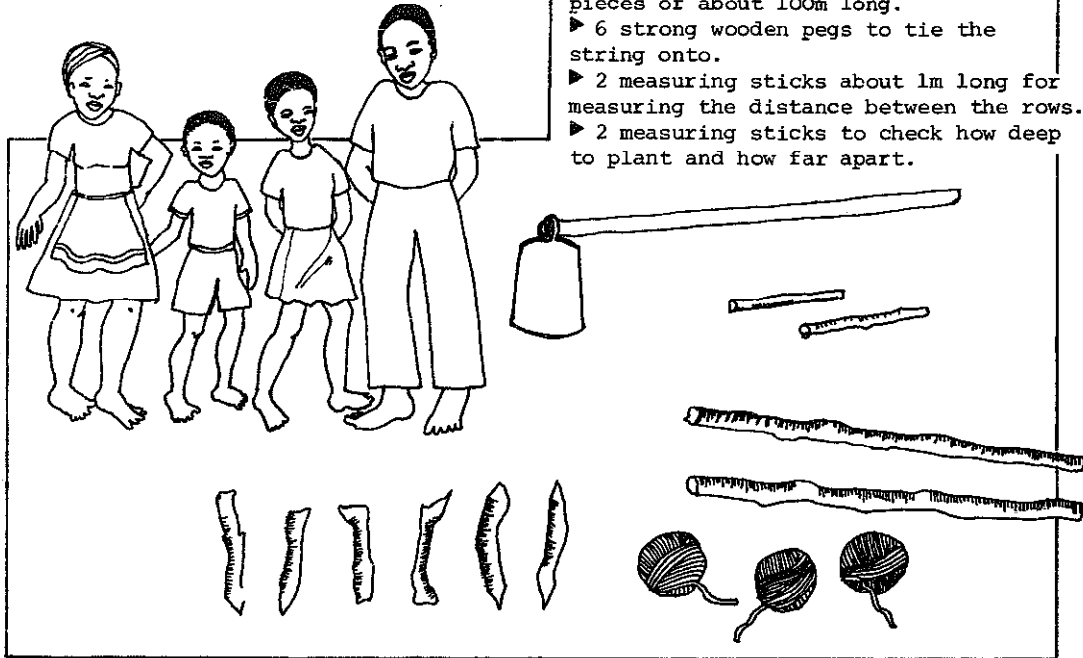

What to do:

● Hammer 2 pegs into the ground where you want the first row to be. Tie string to them and pull it tight.

● Put the 1m measuring sticks next to the first row so that you can see where to make the second and third rows. Use the other strings and pegs to make the second and third rows.

● Now planting can start. Two people open up the rows with a hoe. The other two people put in the seed and then move the string and pegs to make the next rows.

● Another way is to make a hole for each seed with a stick or a hoe.

● Use one small measuring stick to make sure that the rows are deep enough for the seed, and use the other to make sure

that the seeds are the right spacing apart in the rows.

● After planting the seed, put back the soil and walk along the row to tramp the soil down. If you are using fertiliser, make the row a bit deeper. Put the fertiliser and cover it lightly with soil before planting the seeds.

● You can save a lot of time by making rows with a plough or cultivator before planting by hand. If you do this you do not have to mark the rows with string. Making the rows with a plough then putting in fertiliser and seeds by hand will give better crops than using an ox planter to plough and plant at the same time. Ox planters drop fertiliser and seeds down the same pipe. The fertiliser drops right on top of the seeds and damages them.

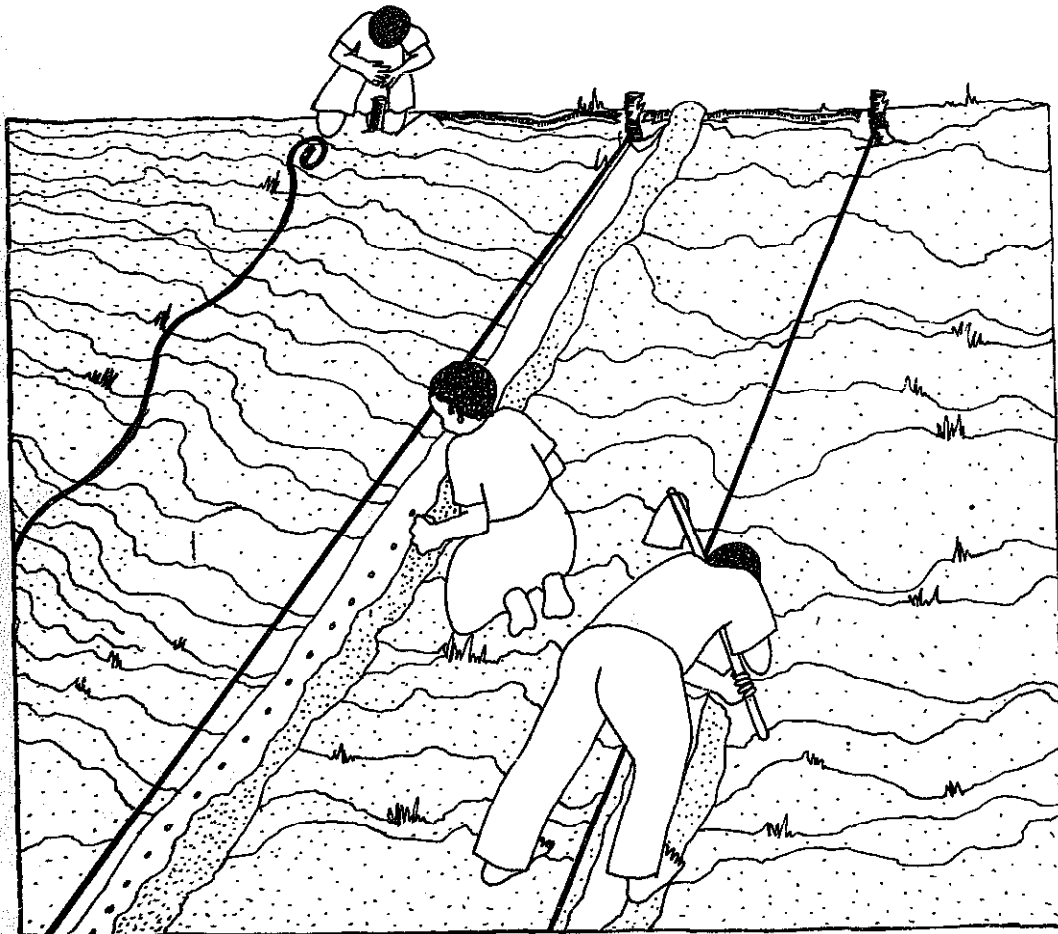

Chemical Fertilisers

Chemical fertilisers give crops all the plant foods they need. But they are not as good for crops as natural fertilisers like compost and manure because they do not make humus (see p 50). The more you care for your soil, using crop rotation and early ploughing and planting, the less fertiliser you have to buy.

Fertilisers give the soil the 3 important plant foods: nitrogen, phosphorous and potassium. Many fertilisers have other plant foods such as zinc which is important in the growth of young plants.

Using fertilisers will cause weeds to grow much faster, so good weeding is very important, otherwise the weeds will use up all the fertiliser and there will be none left over for the crops. If you use chemical fertiliser, you must have enough labour to do the weeding.

Fertiliser names

Fertilisers have numbers, such as 2:3:2(24%). The first three numbers are the amounts of nitrogen, phosphorous and potassium. For example, 2:3:2 means that there are 2 parts of nitrogen, 3 parts of phosphorous, and 2 parts of potassium.

The percentage in brackets tells you how much nitrogen, phosphorous and potassium is in the fertiliser. For example if the percentage in brackets is (24%) this means that 24% of the fertiliser in the bag is nitrogen, phosphorous and potassium. The other 76% of the fertiliser is chemicals

which are not plant foods. So each 50kg of 2:3:2 has 24% of 50kg = 12kg of plant foods. Of this 12kg, $\frac{2}{7} \times 12 = 3,4\text{kg}$ is nitrogen, $\frac{3}{7} \times 12 = 5,2\text{kg}$ is phosphorous, $\frac{2}{7} \times 12 = 3,4\text{kg}$ is potassium.

Which fertiliser to use?

The kind of fertiliser to use will depend on your soil and the crop you want to grow. In South Africa, almost all the soils are short of phosphorous. It is important to put on enough phosphorous before putting on nitrogen or otherwise it will be wasted. In this book we recommend using superphosphate as fertiliser. For the same money you can buy more superphosphate than other fertilisers and this will make your plants grow better than a small amount of more expensive fertilisers.



Some crops and soils need mixed fertilisers:

- ▶ 2:3:4(24%) has a lot of potassium and is used mostly for potatoes and on soils which are short of potassium.
- ▶ 3:2:1(26%) is used on sandy soils for grain crops like maize and wheat which need a lot of nitrogen.
- ▶ 5:1:5(25%) is used on sugar cane for top dressing.



nitrogen

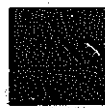

phosphorous



potassium

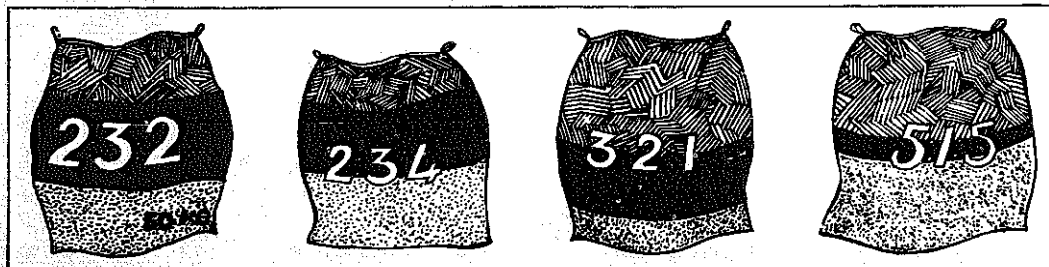

Some fertilisers have only nitrogen with no phosphorous or potassium. Some people use them to get bigger crops of maize, wheat and vegetables. The 3 most common nitrogen fertilisers are:

- ▶ LAN (limestone ammonium nitrate) has 30% nitrogen. Sprinkle LAN on the soil and it will be washed into the soil when it rains. Dig it in if there is no rain after 3 days. LAN is often used as a top dressing. It is sprinkled on top of the soil after you can see the plants are growing well. It works best in sandy soils.
- ▶ Urea has 50% nitrogen. Dig it into the soil as a top dressing. The nitrogen feeds the plants slowly, over a longer time than LAN.
- ▶ Ammonium sulphate is a better nitrogen fertiliser than LAN for alkaline soils because it gives crops nitrogen without making the soil more alkaline.

nitrogen fertilisers



Soil Acidity and Lime

It does not help to add fertiliser to acid soils. You must first put on lime. Sprinkle the lime on top of the soil and then plough it in. Plough it in at least 6 weeks before planting so that it mixes well with the soil. Acid soils need about 1000kg of lime per hectare. You only need to put on lime every 3 to 5 years

Putting on fertiliser

Fertilisers must be put on properly to give good results:

- Lime must be sprinkled and ploughed in at least 6 weeks before planting.
- Superphosphate can be put into the rows when you plant. If you are using more than 600kg superphosphate per hectare, plough it in.

- ▶ In wet places with sandy soils (see know your soil p 97) use 7 to 10 bags superphosphate per hectare.
- ▶ In wet places with clay soils use 5 to 8 bags per hectare.
- ▶ In dry places with sandy soils, use 5 to 8 bags per hectare.
- ▶ In dry places with clay soils, use 3 to 5 bags per hectare.
- ▶ If you are using mixtures like 2:3:2 put it into rows when you plant. Use the amounts recommended above.

- Nitrogen fertiliser like LAN and Urea should be put on 6 to 8 weeks after planting.

When putting fertiliser into the rows, make sure there is some soil in between the fertiliser and the seed otherwise the seed can be damaged. Ox planters are bad for putting on fertiliser, because they put the seed and the fertiliser in the same place. Planting in rows by hand is better (see p 118). If you are putting on fertiliser at the time of planting, mix it with kraal manure. This makes a balanced plant food and prevents the young plants from being damaged. If you put on fertiliser at the time of planting, do not put it straight onto the rows of seed. It is better to put it next to the rows.

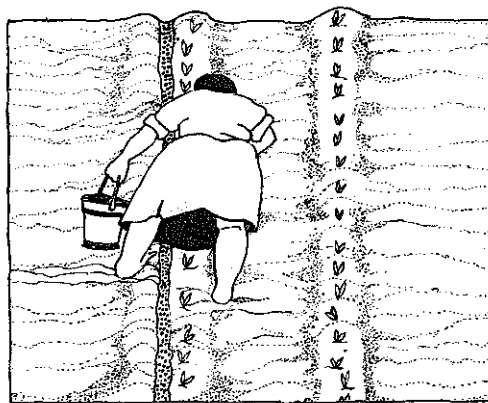

If you can not afford to buy fertiliser for all your land, you should put the right amount on some of your land and none on the rest, because if you spread the fertiliser too thinly it will be useless.

Controlling Pests and Diseases

There are two ways of controlling pests and diseases - natural control and chemical control. Natural control means controlling pests without chemicals. It uses methods like crop rotation (see p 94), ploughing old plants into the soil so that insects can no longer breed in them, and using good seeds. Chemical control is using poisons to kill pests. Sometimes chemicals cause new problems - for example if you use a chemical poison to kill one kind of insect on your crops, the same poison can also kill helpful insects and birds.

Natural Control

When plants grow naturally in the veld, many kinds grow together. You never find one kind of plant growing alone. Pests and diseases cannot spread because they cannot easily find plants of the same kind growing together.

But in farming many plants of the same kind are grown in the same field. If pests and diseases of that crop attack through the whole field, they can easily spread.

- Crop rotation - many pests and diseases can be prevented if crops are healthy and are growing in soil which has lots of humus and plant foods. If you grow the same crop every year on the same land, there will be more pests and diseases than if you rotate your crops

- Seeds - many diseases stay in the seed after harvesting. When you plant the seed next year, the new crops will get the disease. So it is important to use seed which you are sure has no disease. This is very important for potatoes. For some crops you can buy special seeds which will not get certain diseases (disease resistant seeds).

- Choosing crops - try to grow crops which you know will not get diseases in your area. For example in hot places potatoes get many diseases but sweet potatoes do not. So it is better to grow sweet potatoes. If you are in a hot place it is better to grow cowpeas than bush beans because bush beans get diseases in hot places.

- Time of planting - different pests and diseases attack crops at different times of the year. For example, potatoes suffer from late blight disease in hot, wet weather. If you plant early in summer, when it is cool, this disease will not do so much damage. Insect pests breed most during the hottest weather. If you plant early, you will miss the worst time for insects.

- Ploughing after harvesting - many insect pests grow from an egg into a worm, and then from a worm into a moth. The moth lays eggs which hatch into more worms on the plant. For example, stalkborer moths breed in old mealie stalks. If the mealie stalks are ploughed into the soil after harvesting, the moths can no longer breed and the pest is controlled.

Other methods of natural control are usually too much work for field crops, but they are good for vegetable gardens:

- Natural enemies - some insects eat insects which destroy crops, for example ladybirds eat aphids. You can encourage natural enemies by leaving trees and other plants growing around your garden.



- Light traps - use light traps to kill the moths of stalkborers and cutworms. Put a paraffin lamp on a plate of water in your garden. The moths will fly to the lamp and drown in the water.

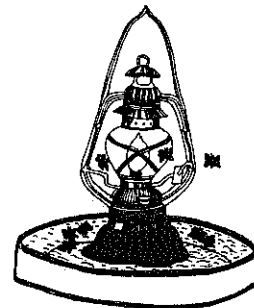

■ Home-made poisons - nicotine from cigarettes can kill aphids, caterpillars and other insects. To make nicotine poison, boil 1 cup full of cigarette ends in 5 litres of water for 30 minutes. Strain the liquid through a piece of cloth and add a big spoon of chopped up soap. When you use the poison, mix 1 litre of poison with 1 litre of water. The soap helps the poison to stick to the leaves. Put on the poison with a hand sprayer or by flicking it on with a grass brush. After putting it on do not pick the vegetables for at least four days and then wash them very carefully before eating. Nicotine is very poisonous and can kill people if they drink it, so store it in a safe place.

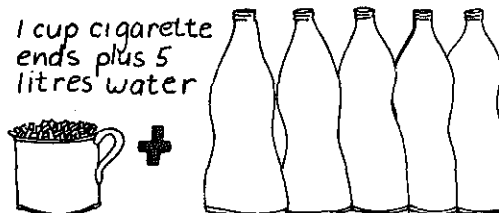

You can make a strong garlic spray by chopping up 3 large garlies, soaking them for 2 days in liquid paraffin, adding a big spoon of chopped up soap and mixing it with 10 litres of water. This garlic spray is supposed to kill most insects. Spray it or flick it on with a brush.

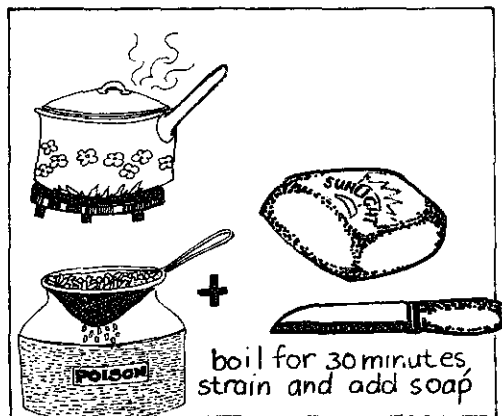

Chemical Control

You can buy very strong chemical poisons for killing insects pests, but the problem is that they also kill other insects and birds. Some chemical poisons stay in the soil and kill all insects and worms for many years. These poisons must always be used carefully, because they are dangerous. If people eat or breathe some poisons by mistake they can get very sick and even die.

It is better and cheaper to grow crops without chemical poisons, but sometimes pests and diseases become so bad that you have to use chemicals.

● Choosing a poison. There are many different chemical poisons. In the pages on each crop we advise which poisons to use. Ask someone who knows about poisons such as an experienced farmer. Buy a poison which you can get locally and which is easy to use. Do not buy very expensive poisons because they are the ones which are the most dangerous.

● How much poison to use. Poisons are very strong, so you usually have to mix them with water before you use them.

It is important to read the labels of poisons carefully, and to use exactly the right amount. You can measure poisons with a bottle cap (see p 128).

● When to use poisons. Put on poisons as soon as you find lots of insects. Look carefully because some insects and insect eggs are very small. For example aphids are hard to find. They are very small and live underneath leaves, so you must know where to look for them. Stalkborer worms hatch from eggs laid by white moths. When you see lots of white moths, wait for 10 days and then put on the poison. The eggs hatch after 10 days so the stalkborer worms are killed straight away.

● Spraying. Most poisons must be sprayed onto the crops. There are many different sprayers to choose from (see p 521). For crop spraying use one which you carry on your back and is easy to pump. Ask the shop or your agricultural extension officer what size sprayer is best for your crop and the poison you want to use. Make sure the sprayer does not leak because the poison can get into your skin and make you sick.

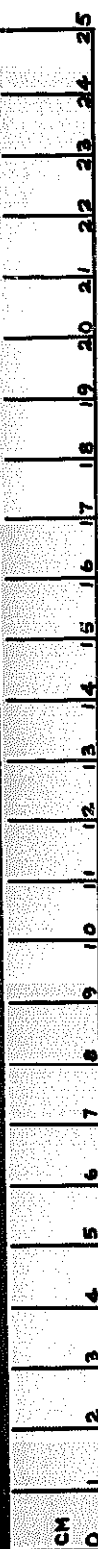

HOW TO WEIGH AND MEASURE

Here we explain how to weigh seed, fertiliser, and chicken mash, measure the size of your fields and the row spacing of your crops. You do not have to buy tape measure and scales.

- millimetres = mm
- centimetre = cm
- metre = m
- square metre = sq m
- hectare = ha
- gram = g
- kilogram = kg
- millilitre = ml
- litre = l

Measuring sticks

Make measuring sticks to measure spacing in rows and spacing between rows. Use the ruler on the side of this page to make measuring sticks.

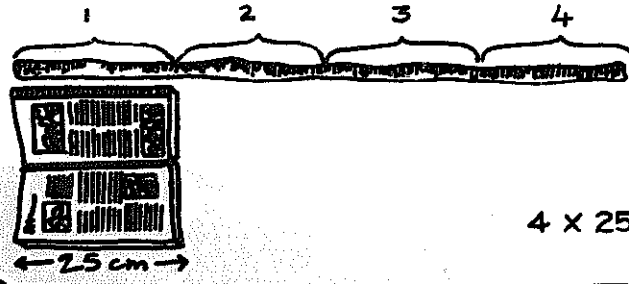

$$4 \times 25\text{ cm} = 100\text{ cm} = 1\text{ metre}$$

How long is your field?

Many people measure how long their fields are by pacing. It is not a good way to measure unless you know exactly how long your paces are. Even if you know, it is difficult. For example, if your pace is 82cm and a field is 113 paces long, you have to multiply $113 \times 0,82m = 92,66m$. This arithmetic is difficult.

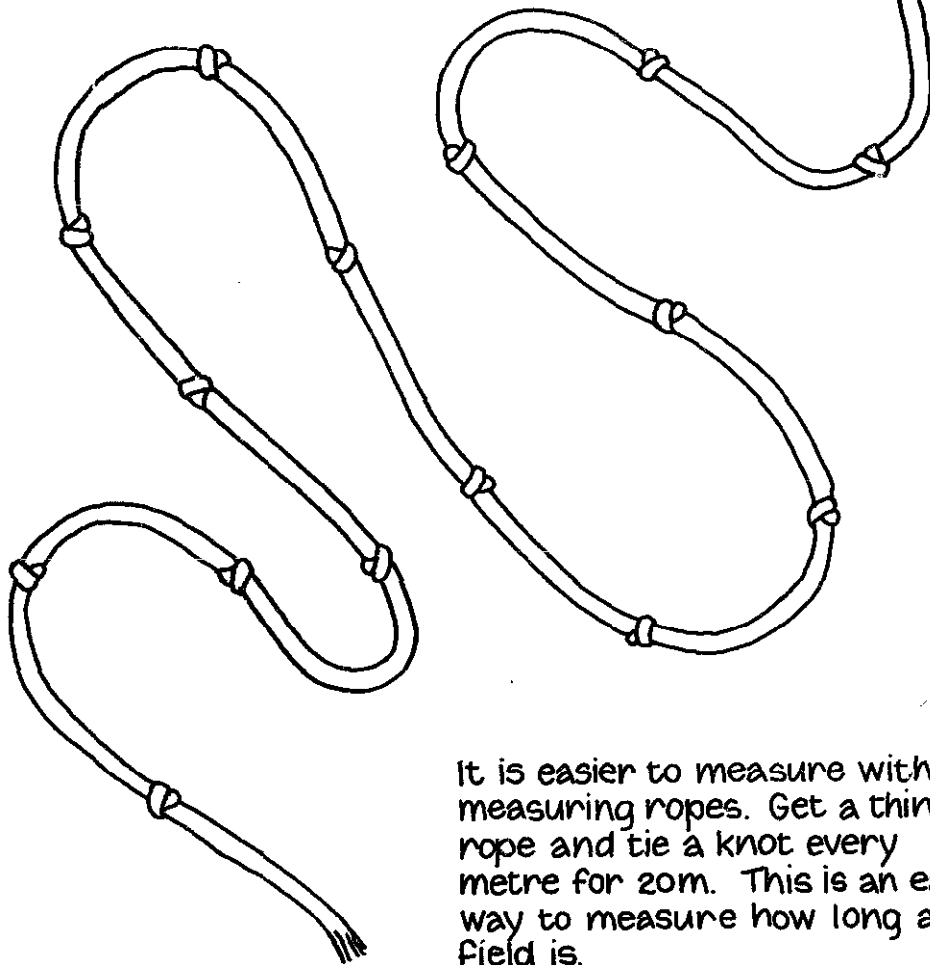
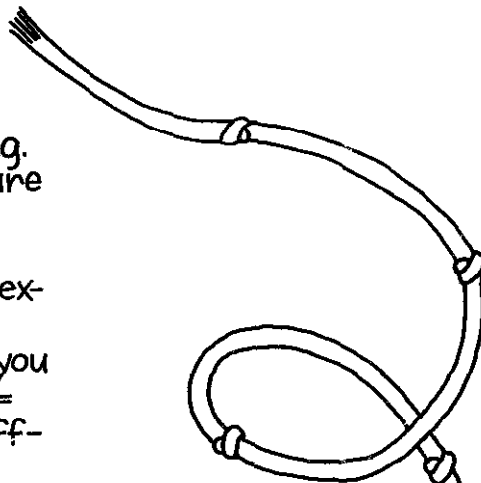

It is easier to measure with measuring ropes. Get a thin rope and tie a knot every metre for 20m. This is an easy way to measure how long a field is.

How big is your field?

When you hire a tractor the owner charges you per hectare. It is important to measure your field properly so that you are not overcharged. Many people on betterment schemes were told the wrong sizes for their fields, so even if you have been told the size of your field, measure it again.

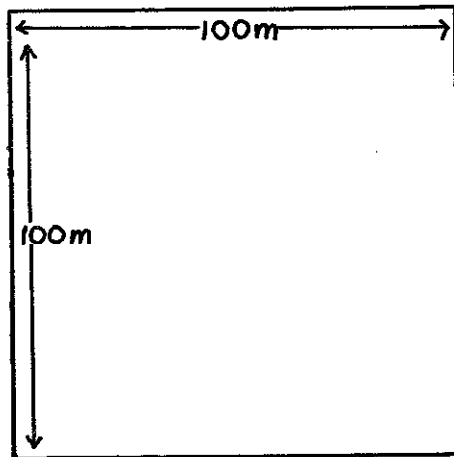

Land is measured in hectares. One hectare is 10,000 sq m, about as big as a soccer field. A hectare is 100m long and 100m wide. One hectare is 100m x 100m, or 50m x 200m, or 40m x 250m, or any other measurement that makes 10,000 sq m.

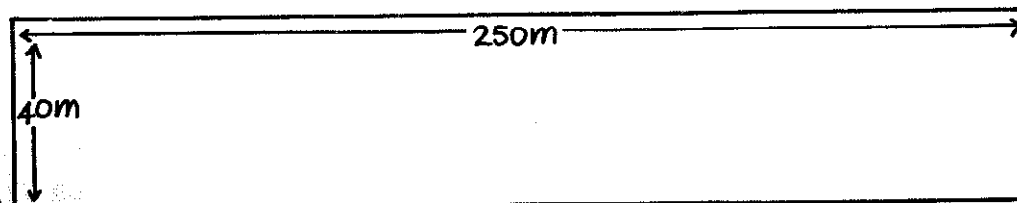
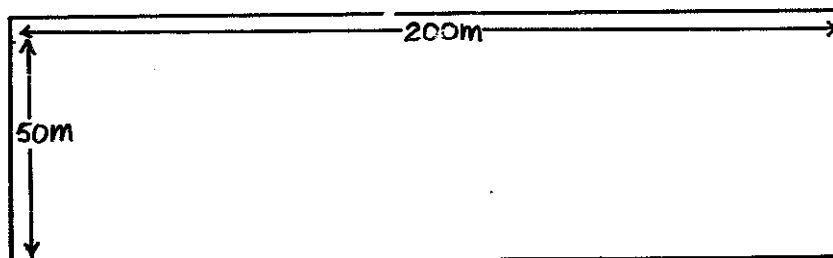

Other names for sizes of land are acres and morgen. One acre is 4,900 sq yards and a morgen is 10,000 sq yards. If your field has square corners like this,

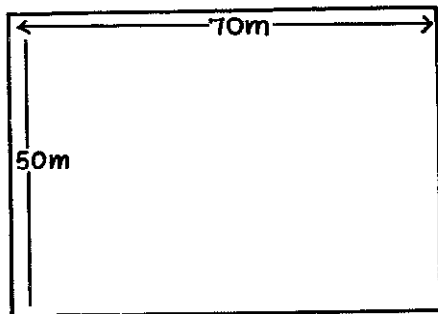

then measuring area is easy

Just measure the long side and the short side and multiply them. For example,
 $70\text{ m} \times 50\text{ m} = 3,500\text{ sq m}$.
 This is about one third of a hectare.

When the land you want to measure does not have square corners, you must divide it up into a lot of narrow strips. Most people plough their land in straight lines the same distance apart. You can use the ploughed furrows to divide the land up into strips. Mark strips 5m apart. Then measure how long each strip is,

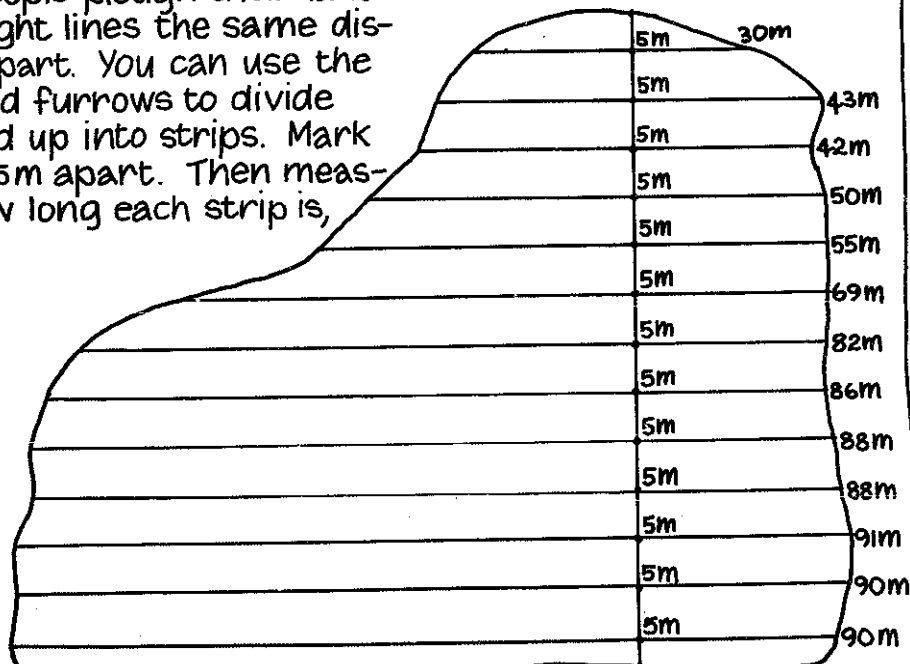

add up all the lengths and multiply by 5. It can take a long time to measure a field, but it is very useful. If you know how big it is, you will know how much seed and fertiliser to use, and how much to pay for ploughing.

30	X	5	=	150
43	X	5	=	215
42	X	5	=	210
50	X	5	=	250
55	X	5	=	275
69	X	5	=	345
82	X	5	=	410
86	X	5	=	430
88	X	5	=	440
88	X	5	=	440
91	X	5	=	455
90	X	5	=	450
90	X	5	=	450

Total 4520 sqm
= 0,45 hectare

Weighing

Here is a way of measuring seeds, fertiliser and poisons, using containers which everybody can find - a 500ml motor oil tin and the screw top of a cold drink bottle.

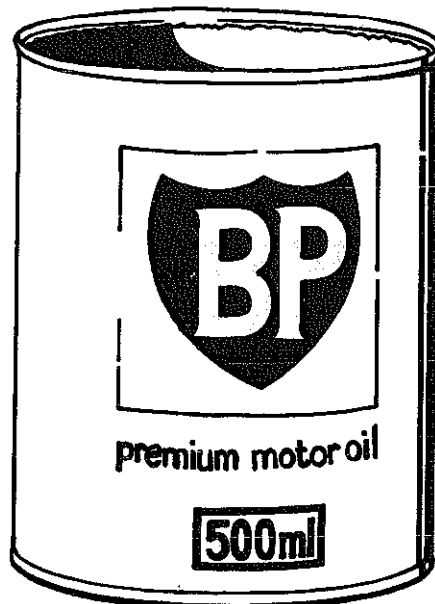

Twist some wire round the screw top so you can hold it like a spoon.



Measuring liquids

A screw top filled up holds 5ml of liquid. This is the same as most teaspoons.

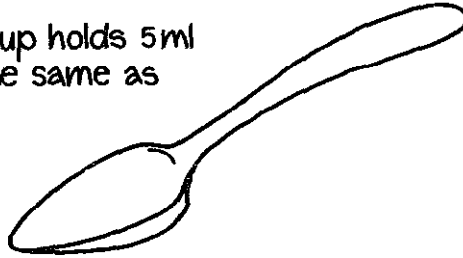
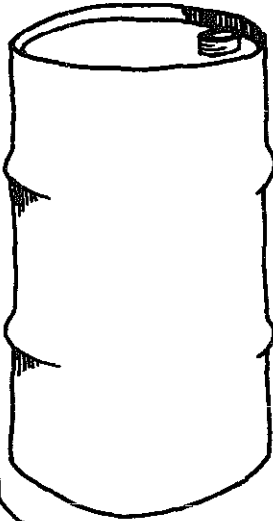

For bigger liquid measures, use 500ml and 1 litre cold drink bottles, 20 litre paraffin tins and 200 litre (44 gallon) oil drums.



Measuring seeds

The sowing guide on p.38 gives seed recommendations per 10 sqm. You can work out the number of screw tops full of seed per 10 sqm.

For the most popular vegetables, they are:

<u>Seed</u>	<u>Screw tops/10 sq m</u>
Cabbage	1
Carrots	10
Onion	2
Spinach	3
Tomatoes	1

Measuring poisons

Some poisons are powders, measured in grams. Other poisons are liquid, measured in millilitres. We have worked out how many screw tops full of poison you need for different pests and diseases.

If you can get old injection syringes from the clinic, they are useful for measuring liquid poisons. (1 cc = 1 ml)

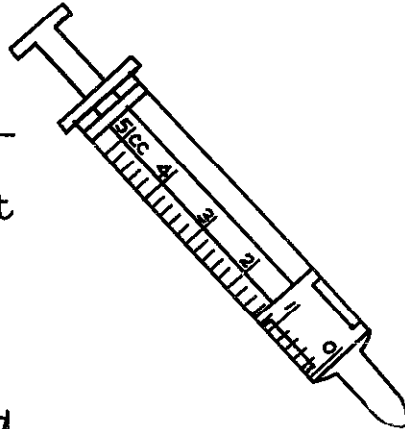

It is important to work carefully with poisons because they are very dangerous. Use a different screw top to measure each kind of poison, and do not use these tops to measure anything else. Keep the poisons and the screw tops in a safe place away from children and food.

<u>Poison</u>	<u>Grams or ml per screw top</u>
Malathion (liquid)	5 ml
Thiodan (powder)	2 g
Dipterex (powder)	1,5 g
Dithane (powder)	2 g for diseases

Pest or Disease	Name of Poison	How to Put On	Recommended g. or ml per 10 sq m	Screw tops per 10 sq m
Aphids	Malathion	Spray	2,5 ml with 2 litres water	½ top
Bollworms	Thiodan	Spray	20g with 20 litres water	10 tops
Caterpillars	Malathion	Spray	2,5 ml with 2 litres water	½ top
Cutworms	Dipterex	Bait	3g with 1 kg mealie meal	2 tops
Stalkborer	Thiodan	Scatter powder	40g	20 tops
Thrips	Malathion	Spray	1,75 ml with 2 litres water	⅓ top
Blight and leaf spot	Dithane	Spray	20g with 10 litres water	10 tops
Downy mildew	Dithane	Spray	30g with 10 litres water	15 tops

Measuring fertilisers

Most farmers put on fertiliser when they plant their crops in rows.

We have worked out how many motor oil tins of fertiliser you will need for every 100m length of row.

This has been worked out using the row spacing recommended in this book for each of the crops.

If your rows are closer than our recommendation, you will use more fertiliser.

Crop	Recommended Fertiliser	Recommended kilograms per hectare	Motor oil tins per 100m of row
Beans	2:3:2	200 kg	3 tins
Maize	Superphosphate Lime	Clay soil 200 kg	3 tins
		Sandy soil 400 kg	6 tins
		Acid soil 500-1000 kg	8-16 tins
Sorghum	Superphosphate	200 kg	3 tins
Wheat	Superphosphate	300 kg	4½ tins
	Lime	150 kg	2½ tins
	Urea	150 kg	3½ tins

Not all rows will be 100m long, so change the recommendation for your needs.

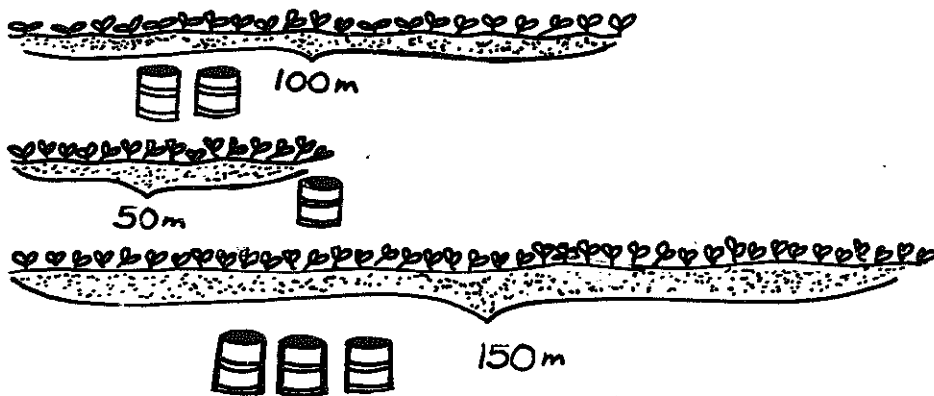

For example, we recommend 2 tins of 2:3:2 fertiliser for a 100m row of haricot beans. If your row is 50m long, you will only need 1 tin. If your row is 150m long, you will need 3 tins.

Most fertilisers, except for urea, weigh the same. A motor oil tin of 2:3:2, lime, superphosphate or LAN weighs about 635g. An oil tin full of urea weighs 440g.



Measuring food for cattle and chickens

Cattle need salt and mineral licks. You can use motor oil tins to measure these.

A full oil tin holds 550 g of salt and 520g of bone meal.

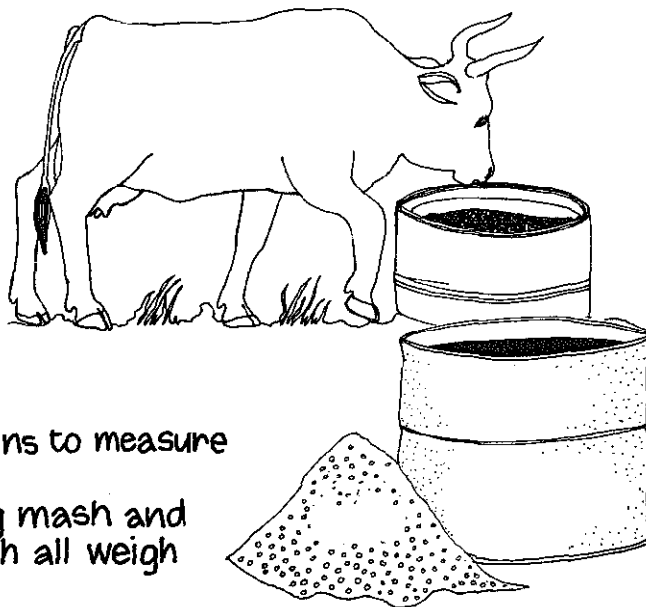

You can also use oil tins to measure chicken food.

Starter mash, laying mash and broiler finishing mash all weigh the same.

A full oil tin holds 300g of chicken mash.

Irrigation

Irrigation needs good soil. Very sandy or very clay soils are not good for irrigation because they do not hold water well. Sandy soils must be watered often because the water drains out easily.

It is best to give clay soils a lot of water, but not too often, otherwise they become too wet.

The best soils for irrigation are sandy loams. They hold water but also drain well. The soil should be 1 metre or more deep and if possible it should not be too flat so that the water can drain off.

How much water?

Clay soils hold water and plant foods. They do not have to be watered often, but when they are watered, they must be watered for a long time. Sandy soils do not hold water well, so they must be watered more often. But they must not be watered for too long, otherwise they wash plant foods out of the soil.

- ▶ Sandy soils need 38mm per hour.
- ▶ Clays need 5mm per hour.
- ▶ Clay loams need 8mm per hour.
- ▶ Loams need 18mm per hour.
- ▶ Sandy loams need 25mm per hour.

To put 5mm water on a plot 10m square, you need 500 litres (2½ oil drums full of water).

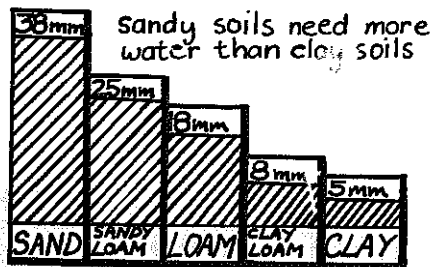
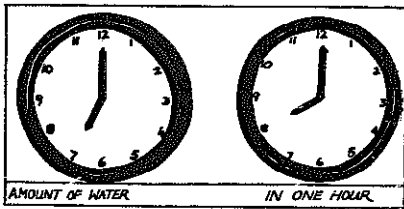

When to water

The time to put on irrigation water is when the soil is half wet. Clay soil is half wet when the soil feels dry but you can press it into a ball. When you drop the ball it does not break. Sandy soil is half wet when you can press the soil into a ball, but it breaks when you drop it.

Another way of telling when to irrigate is to see if the plants are starting to wilt. This is not always a good way, because when plants wilt they get damaged. The plants may also be wilting because they have a disease.

A better way of telling when to irrigate is to work out how much water is being lost by the plants and soil. This is called evapotranspiration. Ask the extension officer on your irrigation scheme to work out the evapotranspiration and tell you how much to irrigate.

Irrigation water

Irrigation water can come from rivers, streams, springs and boreholes. Unlike rain, this water sometimes has a lot of salts in it. These salts can damage your soil so badly that nothing will grow. Ask your extension officer to find out what salts are in your irrigation water. He can send a sample of the water to the Department of Agricultural Technical Services in Pretoria and they will test it.

Use a 20 litre container to work out how much water you are getting. On a 10m square plot, 7200 divided by the time (seconds) to fill the container equals the millimetres you get per hour.





use a siphon
to move water
from canal to
field

Flood Irrigation

Flood irrigation is using canals to lead water out of a river or a dam. Most irrigation schemes use this method. If canals are very long it is best to line them with concrete, but unlined canals on small schemes work well too, especially in clay soils. Water is led from the canal onto the field through an outlet pipe or by using siphon tubes.

Fields which are flood irrigated must have a gentle and even slope. The field should be less than 200m long for clay

soils and shorter for sandy soils. There must be a drainage canal at the end of the land to take away extra water. You should always measure how much water you are putting onto the field.

Basin Irrigation

Basin irrigation is a good way of irrigating fruit trees. This method uses small flat fields with low earth walls around it. The field is quickly flooded to give the right amount of water.

basin irrigation

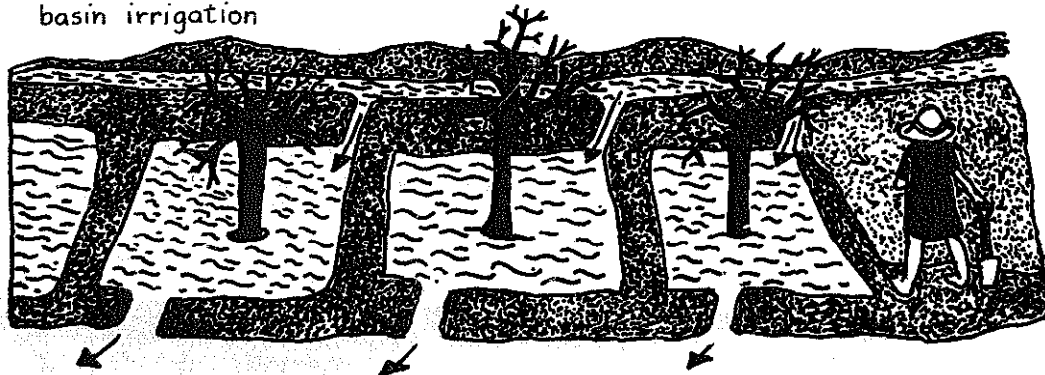

pipe irrigation

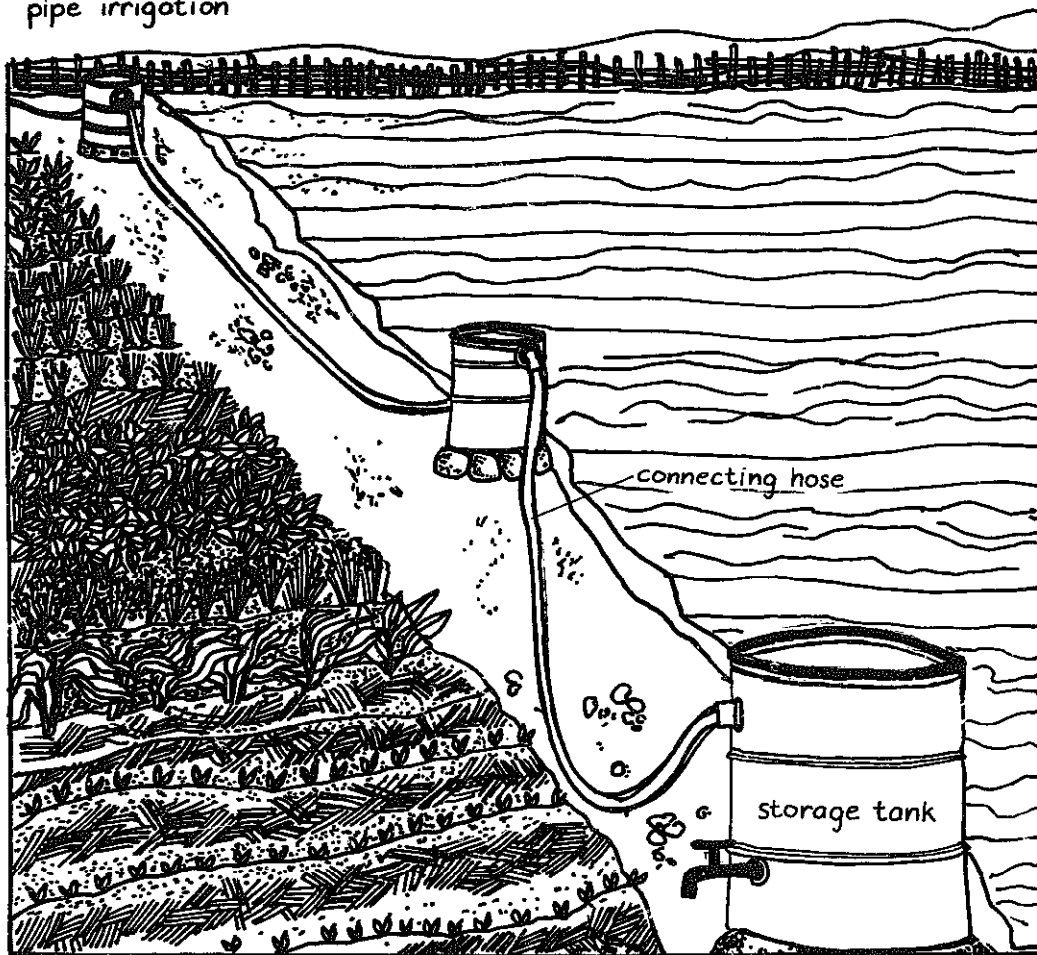

Pipe Irrigation

This is the simplest and cheapest way of irrigating small fields, especially if you use a garden sprinkler with the hosepipe. The slope of the land is not so important, because you can easily move the water from one place to another. This cannot be done for flood irrigation.

If a group of people is sharing the water, for example, a communal garden, then it is a good idea to use small storage tanks so that people can take water to their plots by bucket or hosepipe. 200 litre oil drums make good tanks. The water is pumped into a pipe which joins all the drums together. The number of drums depends on how much water you need.

Crops under irrigation

Most crops grow well under irrigation. Crops need the most water when they are growing fast and when they are flowering and beginning to make fruit. They do not need so much water when they are young or when they are ready to harvest.

Vegetables, fruit trees and cash crops like tobacco and cotton grow well under irrigation. Other crops, like carrots and groundnuts, can be damaged if they are watered too much. If you are on an irrigation scheme, try to grow crops which you can eat or sell locally. Do not grow crops to sell in town because marketing is difficult, especially for 1 farmer. It is easier to sell in a group.

Fencing

Fencing is expensive. But it is better to fence a small field well than trying to save money by fencing a large field badly. Good fences can be grown from plants like sisal or made from thorn trees. These fences are much cheaper than wire ones.

Goats are the most difficult animals to keep out. If a fence keeps out goats it will keep out any animal.

Growing Fences

Sisal is easy to grow from cuttings of other sisal plants. Pull whole shoots from a sisal plant, put them in the ground, and they will start growing. Plant them about 1m apart so that they grow thickly together. After about 10 years the sisal gets thin and it must be planted again.

It is impossible for animals to climb through sisal fences. The disadvantage of sisal is that it uses water which the crops need and it takes about 2 years before it is big enough to keep animals out.

Cactuses are also good to grow for fences. Plant the kinds with sharp spikes because sheep and goats like to eat the smooth kinds. Some cactuses, like prickly pears, give fruit which people can eat.

In places where there are thorn trees, you can pile branches to make a fence while the sisal or cactuses are growing.

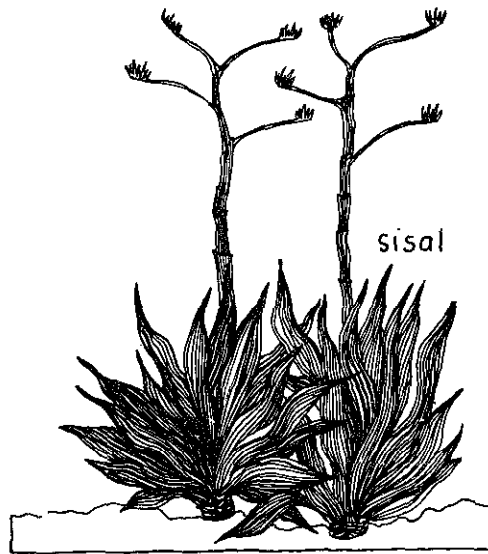

Barbed Wire Fences

Barbed wire fences are expensive. You need at least 7 strands of barbed wire to keep out goats, and deeply planted fence posts. These fences can cost R60 per 100m.

Start by putting in all the corner posts. These must be 15cm thick wood poles or 10cm thick steel pipes. Make a hole 20cm square and 60cm deep. Put the pole in, and pack small stones tightly around it.

For long fences plant 2 poles at each corner to make the fence stronger. The poles must be 1m apart, with a bar across them. The wire is tied to the back pole.

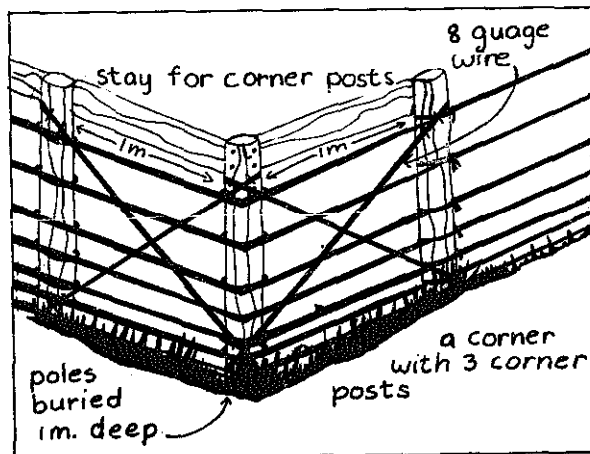
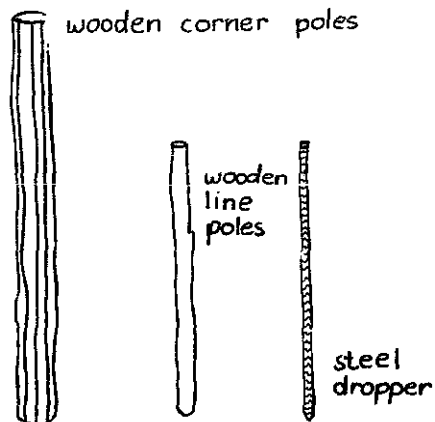

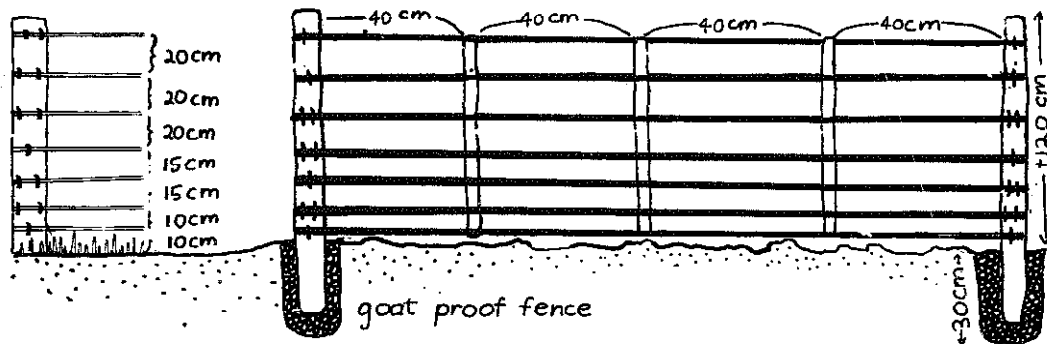

A fence must be 1,0m high to keep out goats. The bottom wire must be 10cm from the ground, the 2nd wire 10cm higher, the 3rd and 4th wires 15cm higher, and the top 3 wires each 20cm higher.

When the corner posts are in, put in the other fence poles. These are steel, or wood 10cm thick. Put them in 1,6m apart, in holes 30cm deep. When all the poles are in the ground, tie the lowest wire to the first corner post, roll it out to the next corner post, and tie it as tightly as you can. If the fence is more than 50m long, tighten it with a wire strainer. If it is shorter, you can use pliers. Turn the wire around the corner post twice to prevent it from slipping loose. Then tie it tightly to all the other fence poles using ordinary wire.

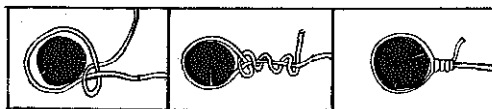
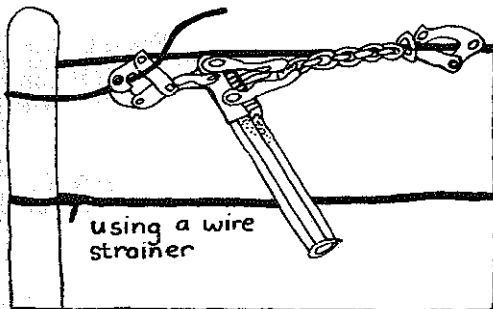

tie wire so that it does not slip

Then tie the second wire from the bottom, and then the third, and so on. After 2 days tighten all the wires again.

The next step is to put in the smaller poles, called droppers. These are tied to the fence to make it tight. Use 3 droppers between the fence poles so that the droppers are 4 metres apart. The droppers are made of wood 2,5cm thick, or steel. They are not put in the ground.

Other Fences

Another way to make fences is to use plain wire but put jackal wire at the bottom of the fence. This way uses only 5 wires and less droppers, but jackal wire is expensive.

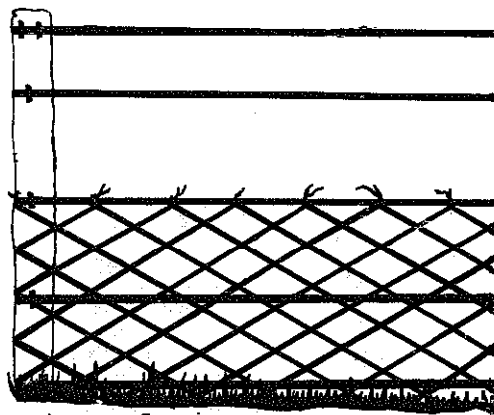

jackal fencing

Some people use thorn tree branches at the bottom of barbed wire fences to stop animals getting through.

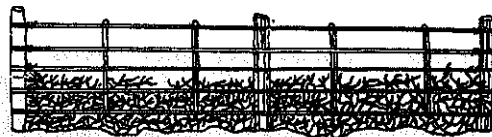

Gates

Gates must be wide enough for a tractor with implements to drive through. They must be hung straight and close to the ground to stop animals getting underneath. Cover them with chicken wire to stop goats getting through.

Steel gates have bolts which have to go into holes in the gate post. Mark the place for the holes carefully by holding the gate in the position you want it so that you can lock it easily.

You can also make a gate out of wooden poles and wire. You need two 7cm thick gate posts and number 8 gauge wire.

Tighten strands of wire across these poles, and put droppers 50cm apart across the length of the gate. To open and close the gate, hook a wire ring over the top of the last pole and a wire ring under the bottom of the pole. There must be no place for animals to get through.

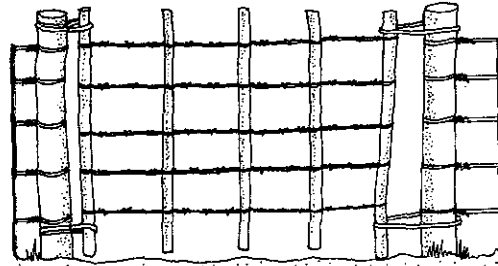

gate made from droppers and barbed wire

Storage and Milling

All crops must be dried before they can be stored.

Dry maize or sorghum in a house built on strong gumpoles with the floor 1m off the ground. The house should be less than 2m wide so that air can blow right through it. Build it so that the wind blows against the long side. Make the sides of wire fencing, chicken wire or reeds and the floor of fencing poles. Make a big roof so that rain can not get in the sides. Nail tin collars around the gumpoles to stop rats climbing up.

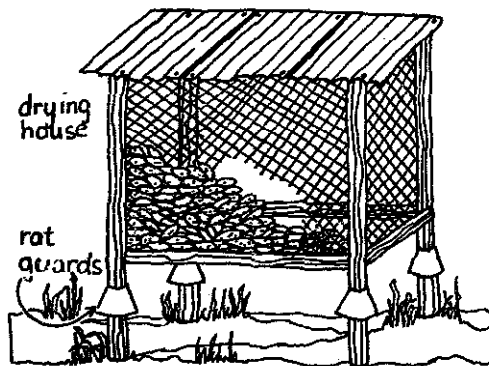

Some crops must be threshed after they have been dried, to separate the pods from the parts you can eat. Insects can get into the crops when they are being threshed. Get rid of these insects by spreading the grain out in

the hot sun so that the insects get hot and fly away. Then let the grain cool before storing it.

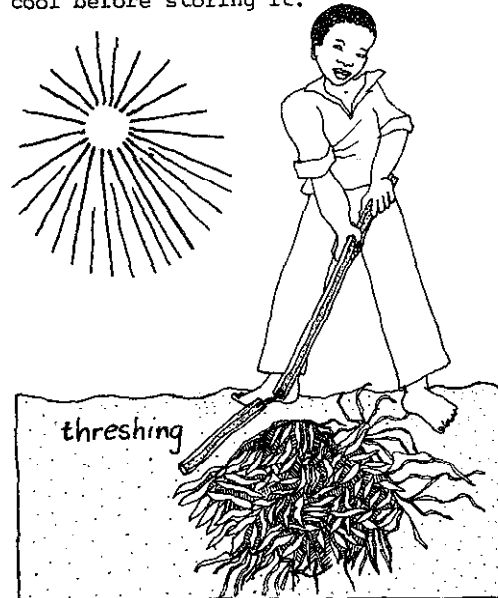

Store Rooms

If you use a store room, make sure it is clean and dry. Sweep the whole room well, brushing the roof, walls and poles to make sure there are no insects when you put the new crop in. Scrape bark and splinters off all the wood because insects breed under them. Dust the floor, walls and roof with Malathion 1,5%.

Storage containers

If you use storage containers keep them off the ground. This prevents damage by rats, and helps air to dry the grain. Put metal storage containers or pots on bricks, put storage bags on wooden poles and hang storage baskets from the roof. Take old containers out of the store room.

● Storage baskets: to prepare the baskets, brush them inside and outside with a stiff brush and remove all pieces of old grain. Leave in the hot sun for a few days, then dust them inside and outside with 1,5% Malathion.

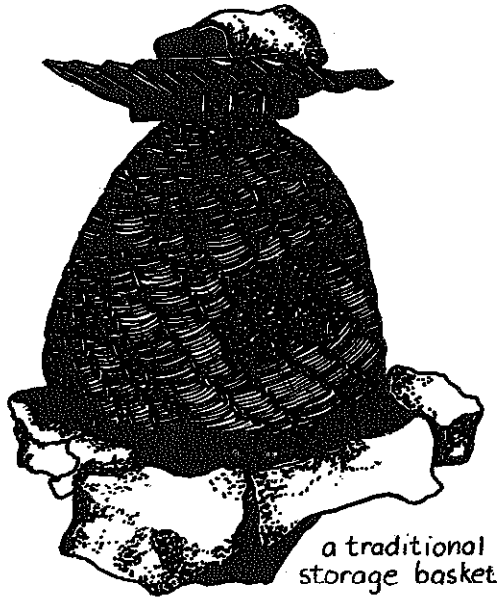

● Jute sacks: Sew up any holes then shake them well and put them in boiling water for 5 minutes to kill all insects. Dry them well in the sun.

● Tins, drums and clay pots. Brush them well and then wash them. Let them dry in the sun for a few days. Fill them as full as possible and close the tops tightly.

Storage Tanks

If you use big tanks of steel or bricks which hold up to 30 bags of grain, you should be able to get grain out of the bottom of the tank. Getting it out of the top is difficult.

Clean the tank well. Use 100g Malathion (1,5%) for each 80kg of grain to kill insects. Mix the grain and Malathion well with a shovel. Check with an extension officer that you are using the right amount of Malathion.

You can also use the traditional way of burning aloe bushes and mixing the ash with the grain. It is not as good as Malathion but it does help to stop insects.

Milling

Many people still grind by hand, using a hollow log and a wooden pole, or using a grinding stone. It is very hard work. It is easier to grind the grain when it is wet, but then you have to eat it within a few days. You can buy hand grinders (see suppliers p 519) to grind your grain, but these are also a lot of work.

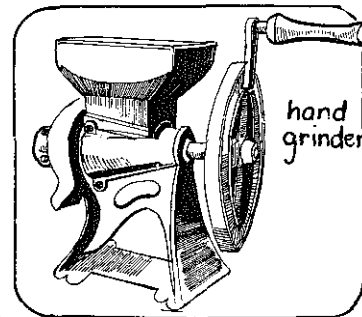

Most people take their grain to be ground by a hammer-mill. After hammer-milling, the grain meal will start to go bad after about 10 days, so you should only hammer-mill as much as you need for a week.

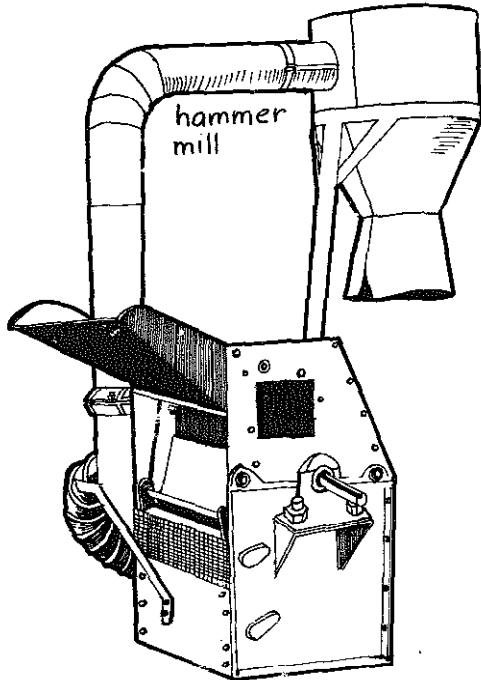

Your own hand-ground or hammer-milled mealie meal is much healthier than the refined mealie meal and baker's cones which you buy in shops.

Refined mealie meal from shops lasts long because in factories they take out the parts of the mealie which makes the mealie meal go bad first. But this is the most nutritious part of the mealie meal.

Hammer-milling as a community project

Some villages share their own hammer-mill. Even with the extra costs, it is cheaper for communities to mill their own grain than to buy from a mill. You do not need a tractor to drive it, a small petrol engine will work as well.

Sharing a hammer-mill helps everybody in the community because everybody eats mealie meal. Even if the community does not grow enough mealies, they can buy bags of mealies and mill them. This mealie meal will be 1/3 cheaper than the mealie meal you buy.

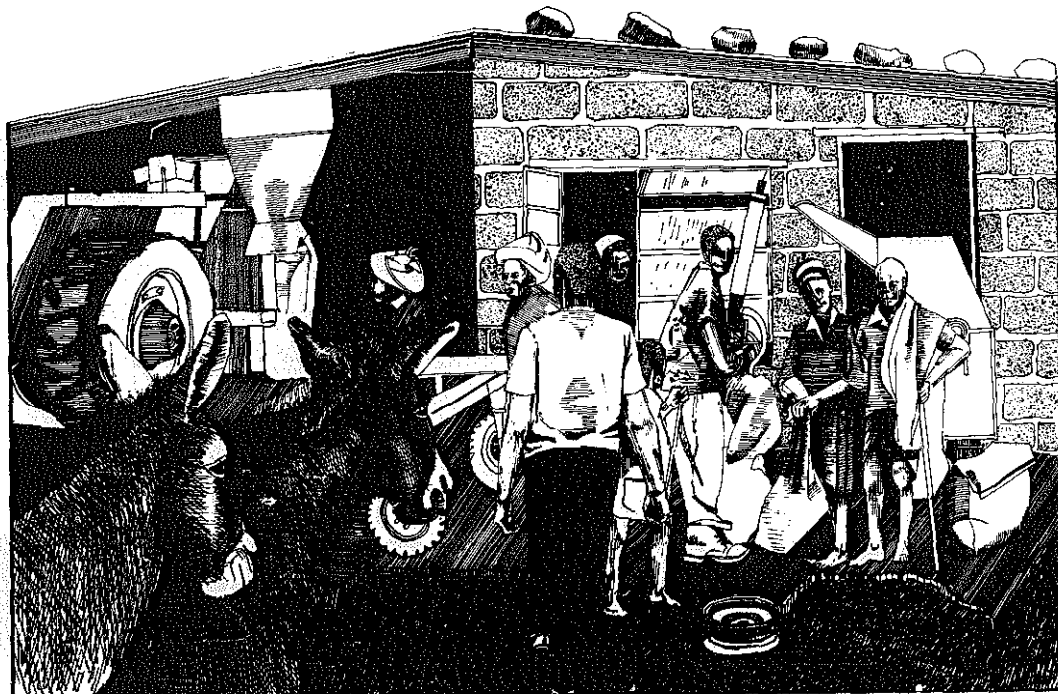

Agricultural Extension Officers

The work of agricultural extension officers is to help farmers to improve their crops and animals. In South Africa there is a big difference between extension work for white farmers and black farmers. Extension officers who work with white farmers deal with farmers who have enough land and money.

Black extension officers get the same kind of training, but the farmers they work with usually have little land or money.

Good extension officers try to respond to community needs, rather than just carry out government policies. But often there is a conflict between the needs of a community and the policy of the government. Then extension officers are forced to choose between community and government. If the community and the government want the same thing, and then a lot of work can be done by extension officers.

Training

Extension officers are often frustrated when they advise farmers on seeds or fertilisers or tractors. These things are too expensive for many small farmers, so often the advice of the extension officers is only useful to rich farmers. Groups of poorer farmers can not get credit for these things. There is no Land Bank to help black farmers with credit.

Many students training to be extension officers are not very interested in agriculture. They see extension work as a kind of teaching job. This leads to many problems, because some people think that education means they will not have to work with their hands. It is common to see a healthy young extension officer giving instructions to a group of old women labouring in a field.

It is wrong for extension officers to see themselves as teachers. Extension work should mean knowing how to do things like measuring fields, fertilisers and crops, making fences, knowing about diseases and giving medicine to animals. Many extension officers have been taught about these things but have never actually done them.

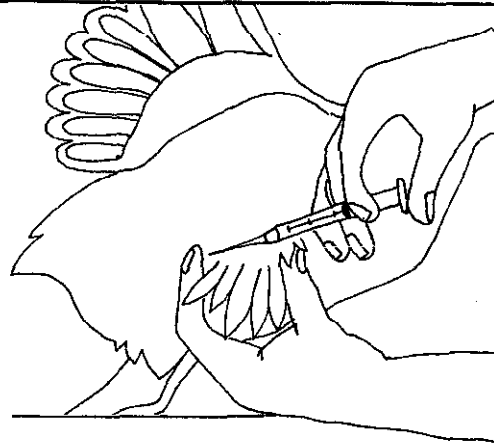

There is nothing in the extension officers' training which helps them understand why most black farmers are so poor. There is nothing in their classes about the history of black agriculture. They are not taught that black farmers used to be successful but that they were forced off their land and made to go and work on mines and farms.

In their training, the extension officers are not taught to work with women. They are taught that men are the decision makers. But in fact most men are migrant workers in the towns. Women not only hoe the fields and reap the crops, they also decide when and what to plant.

Good extension officers manage to overcome the bad parts of their training. They work most with groups in the community who have the greatest needs. They understand from talking to farmers that problems cannot be solved in the way they have been taught, so they look for different ways. To help the people without land, they help people to do things at their homesteads, for example with the poultry groups, gardening groups and fruit trees. This kind of organisation is the best way for extension officers to serve the community.

Sometimes this means that extension officers have to go against their training and against government policy, but it is sometimes only in this way that improvement and change can happen. When extension officers become community organisers, their work can really help people.

Maize

Maize is by far the most important crop in Southern Africa. It can grow everywhere except in very dry places. Yellow maize grows in drier places and less fertile soils than white maize, but it is not as popular as white maize.

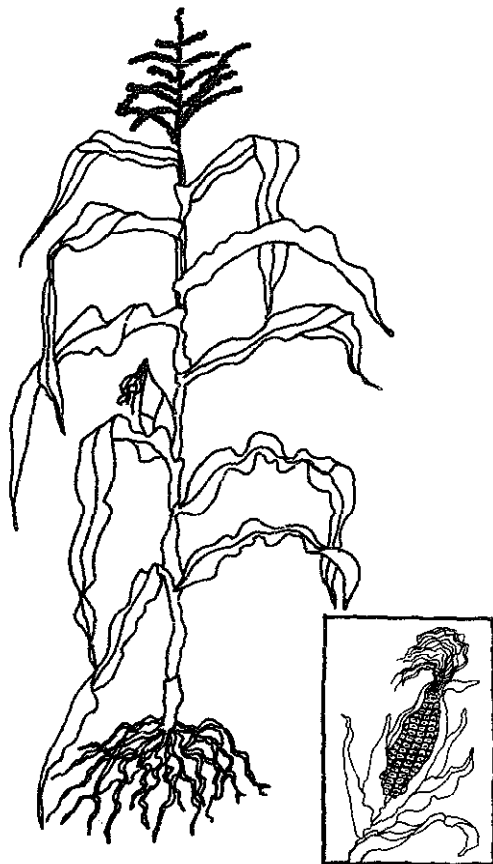

Seeds

It is important to choose the right maize seed. There are two kinds of seed, hybrid and open-pollinated. Maize grown from hybrid seed is not good for planting next year but maize grown from open-pollinated seed can be used for seed again. Hybrid seed gives bigger crops, but it is more expensive, it needs more fertiliser, and it needs special conditions. Only rich farmers can afford to use it. For small farmers, it is better to use seeds from your own mealies or to buy open-pollinated seeds.

The best open-pollinated seeds are Mostert seeds - Goudveld (yellow) and Kalahari Early Pearl (white). Other white open-pollinated seeds are Hickory King, Silver King and Potch Pearl.

If you want to use hybrid seeds, buy seeds that will be good for your area. Some hybrid seeds are drought resistant, some are pest resistant, some give bigger crops, some are good for storage and some grow more quickly than others. Some hybrids such as PPK x 64R and Saffola SA4, SA5 and SA100 (all yellow) are cheaper than others and need less fertiliser. All Pioneer hybrids (PNR) are good. PNR44 and PNR88 (yellow) have a short growing season. PNR353 and PNR95 (white) give bigger crops. Other good hybrids are SR52 for hot wet areas, and SSM32.

Land preparation

With maize, early ploughing is very important. It buries old mealie stalks and weeds and gives them time to turn into compost and fertilise the soil. Early ploughing also prevents cutworm and lets the first spring rains wet the soil well. You should plough as soon after harvesting as possible and before the soil dries out. Cut the maize stalks and stack them on the side of the field to give you space to plough. Whether you use oxen or a tractor, plough as deeply as possible. A single furrow plough (see p109) can be used for this, but use a disc plough on very sandy or stony soil. If your soil becomes very hard, try to rip the land (see p 101) every 2 or 3 years. With ox ploughing, try to plough the land a second time just before planting.

Maize needs a well-harrowed seedbed to grow well.



Planting

Time of planting is very important. Maize has a long growing season, about 120 days (4 months) and it can be damaged by drought if it is planted late. Unless you are using a hybrid seed which is specially for late planting you must plant in September, October or November. Drought damage is worst when the maize starts to tassel (hair grows on the top of the plant).

How deep you plant depends on your soil. The more sandy the soil is, the deeper you should plant the seeds. Make the rows 1m apart (in dry places, 2m apart) and space the seeds 20-30cm apart in the row. You will need 25kg of seeds per hectare.

Planting in rows is better than scattering. If you do not have a tractor or oxen you should plant in rows by hand (see p 118), especially if you are using fertiliser. Ox planters put the fertiliser right on top of the seed, damaging the seed so it will not grow well. With hand planting you put the fertiliser in the furrow, cover it with a little soil, put the seed on then cover it up with more soil. Whichever method you use, make sure the soil is damp so that the seed gets a good chance to grow.

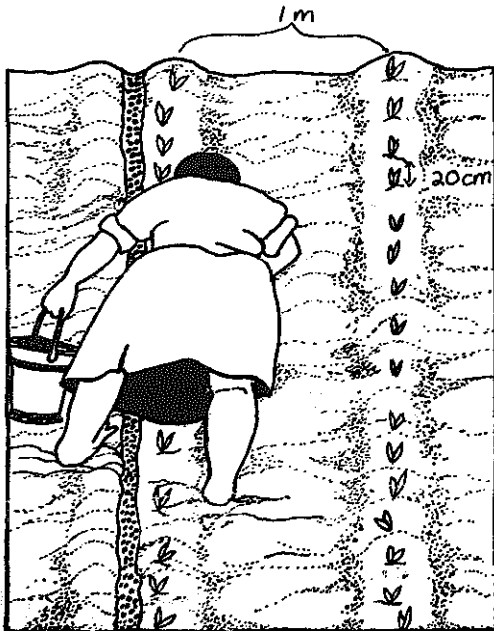

put fertiliser in the soil next to the rows of maize

Fertilisers

Organic fertilisers - compost and manure - are good for maize, but small farmers usually do not have enough for a large maize field. Use organic fertilisers first on your vegetable garden and if you have any left, use it on a small part of your maize field. Do not spread it out thinly over the whole field. Manure must be ploughed into the land about 6 weeks before planting. If there is only a little, use it when planting.

If you want to use chemical fertilisers, you should ask your extension officer for help. Ask him to do a soil test so that you will know what fertiliser to use and how much.

Chemical fertilisers are very expensive. The cheapest chemical fertiliser for maize is superphosphate. This will give your soil phosphorous, a plant food which is often missing from soils in Southern Africa. For black soils, use 200kg of superphosphate per hectare. For lighter, sandier soils, use 400kg per hectare. You will need more for rainy places (see Know your soil p 121). On acid soils, plough in 500kg-1 ton of lime per hectare about 6 weeks before planting.

Working out how much superphosphate is needed



how to find
8.3% of 50 KG

$$\frac{8.3}{100} \times \frac{50}{1}$$

$$= \frac{8.3}{2} = 4.15 \text{ KG}$$

Maize needs 20 KG of P per hectare.
If the soil test shows that there is 10 KG of P present in the soil you should add 20 KG of P per hectare to get a good crop of maize.
20 KG = 5 x 4.15 KG.
So you should buy 5 bags of SUPERPHOSPHATE 8.3% (50 KG)





scattering lime
before planting

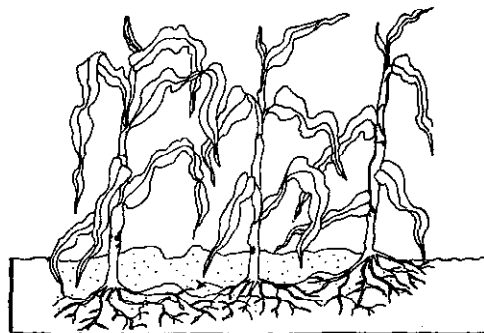

pull out witchweed early
because it spreads fast

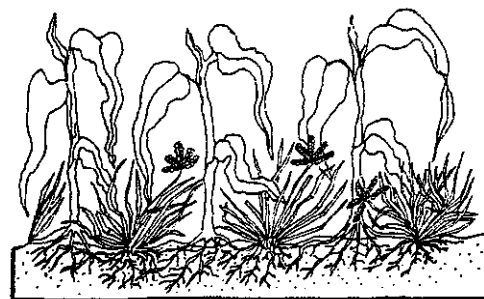

Using fertiliser also makes weeds grow well. If you do not take out the weeds, they will use up all the fertiliser. To get a big crop it is even more important to weed than to put on fertiliser.

Weeding

As soon as you see lots of weeds, take them out. If you weed well early, you will not have to weed so much later. You will get a bigger crop on a smaller field which you weed well, than on a larger field which you do not weed properly.

When weeds are small, use a hoe or an ox-drawn harrow and when weeds are bigger use an inter-row cultivator. You can buy chemical poisons to kill weeds, but we do not think they are good for small farmers because they are very expensive and can cause a lot of damage to the maize plants if they are not used properly.

Witchweed is very difficult to get rid of. Control it by crop rotation with legumes, wheat or grasses.

Harvesting and Storage

Time of harvesting is not very important. You can leave the cobs on the plants until they are dry because this prevents them from going rotten during storage. You can store the maize on or off the cobs in a dry place with no rats. You can store it in traditional grain baskets, or in bags hanging from the roof. You can also store it in a wire cage lifted off the ground on poles. Mix a little aloe ash or Malathion poison with the stored maize to kill the small insects called weevils which live in food.

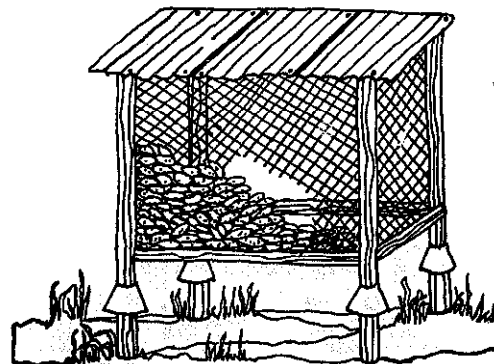

Pests

▶ Cutworm eat the stalks of very young plants so that they look like they have been cut with a knife. If you expect that you will get cutworms, use cutworm poison straight after planting. Otherwise wait until you are sure cutworms are eating your young mealies before putting on poison. To make enough poison for 1 hectare mix 100g of Thiodan (WP) + 20kg bran + 20 litres water; or use 60g of Dipterex (WS) + 15kg bran + 20 litres water (see weights and measures p 130). Sprinkle this poison onto the land in the evening. When mixing the poison wear rubber gloves or wash your hands very well afterwards.

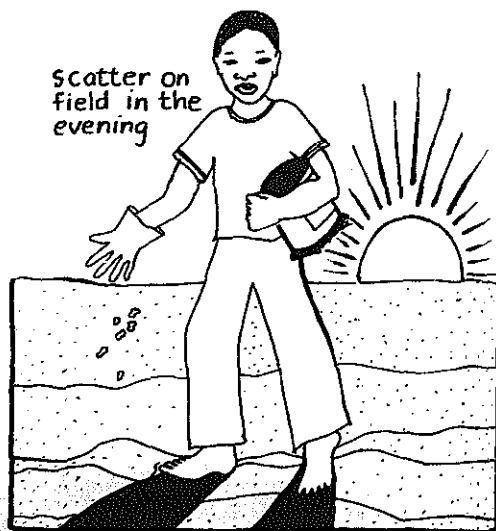
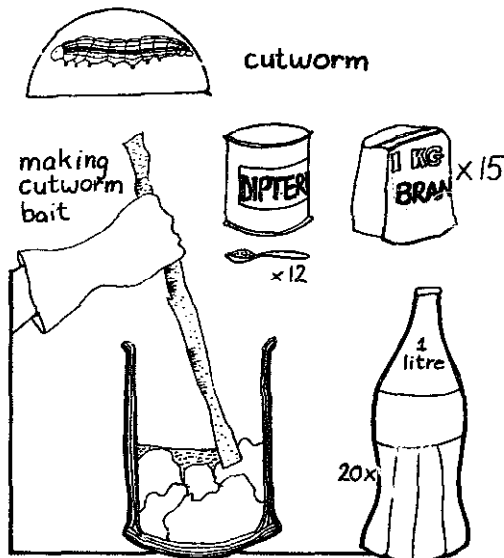

▶ Stalkborer is another worm which does lots of damage to maize. It hatches from worm eggs when the plant is 4 to 6 weeks old. White moths lay the eggs in the top leaves of maize plants. If you see these moths, put on poison. For 1 hectare use a very weak mixture of Thiodan EC, 50ml in 250 litres of water. Follow instructions on the bottle carefully. Pour one teaspoon into the top of each plant in your field. Or use a bottle with a hole in the top, and shake some of the mixture into the top of each plant. Another way of getting rid of stalkborer is by putting a few grains of poison powder into the funnel of each plant. You can use Dipterex or Sevin or Thiodan, about 3kg per hectare.



▶ Black maize beetle eat very young plants. To kill them mix 9g Bexadust with every 10kg of seed that you plant.

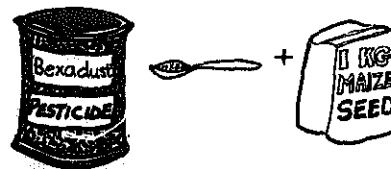

We buy seed together through our farmers' association

Joseph Pindela has 3 hectares of land near Sterkspruit in the Transkei. He worked as a migrant labourer until 1962. Since then he has been farming full time.

● When did you start farming?

I had to leave my job in Cape Town in 1962. I returned here to my home village.

● What crops do you grow?

I grow maize and beans on 2 hectares. I prefer to plant them separately, although when I grow them together I think they grow better.

● What seed do you use?

I buy SA4 hybrid from the co-op. I find this seed very good. It costs about R5 per season. We buy seed together through our farmers' association.

● How do you prepare the land?

In winter I plough the roots in by tractor. We use tractors only for ploughing - everything else is with oxen. We plough for the second time in November and then we plant in rows using a planter pulled by 2 oxen. It takes 2 days to plant my 2 hectares. We put kraal manure in the furrows before planting the seeds. Sometimes we harrow the lands after the second ploughing.

● How do you weed?

When the weeds are very small we use a harrow. Once the crop is bigger

we start using a cultivator. We cultivate maybe 4 to 5 times before harvesting. Of course we also hoe by hand. We try to weed as early as possible before the weeds get too big.

● What equipment do you have?

I have a plough, a planter, a cultivator and an ox cart. I hire a harrow from my neighbours. We hire out my planter for R2 a day. I have a team of oxen which makes it easier for me to work my land, but others have to share to make up a full team.

● Do you have any problems with diseases and insects?

In hot dry weather we have had trouble with insects. The cutworm treatment has worked alright. But so far the poisons we have tried for stalkborer have been useless.

● When do you harvest?

We start in May and it usually takes us about

a month. We cut the whole stalk off with a sickle and then make stacks. They dry in about 2 weeks and then we take them to the house in a cart. There we break the mealies off and store them in a wire cage on sticks. It is off the ground so the rats can't eat them. We only take out the mealies when we need them to eat.

● Do you have enough mealies to last for the whole year?

Yes, in a good year I do. Sometimes I sell some - like last year I sold 9 bags in the village. Last year I also sold 2 bags of beans.

● Can you make enough money to live from only 2 hectares?

Not really. We make nothing from our lands because we have to spend R15 per hectare for ploughing, and then milling is very expensive - we pay 80c per 20 litre tin for milling.



Sorghum

Sorghum is a traditional staple food in Southern Africa. It is an important crop because it is not easily killed by drought and in dry areas it can give a bigger harvest than maize. It can grow well on less fertile soils and wet clay soils, where other crops will not grow. But sorghum is easily damaged by hail, birds and insects.

There are two types of sorghum. White sorghum is used for porridge and red sorghum is used for beer. Red sorghum is not as easily damaged by birds as white sorghum. Many people do not like eating red sorghum because it tastes bitter.

Seeds

Hybrid sorghum seeds are expensive and will not produce a big harvest unless they get enough fertiliser. It is better to buy open-pollinated seed or use local seeds. These seeds can be used again next year, whereas sorghum grown from hybrid seeds cannot be used again.

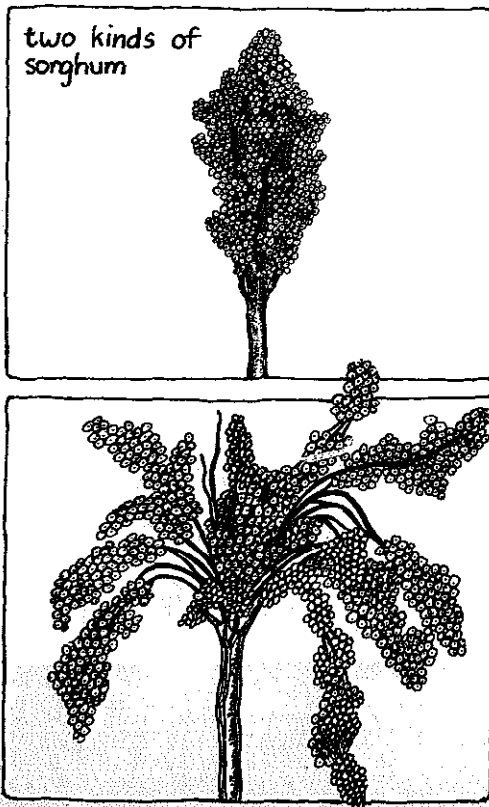

Planting

Sorghum can be planted later than maize because it is not so easily damaged by frost. In the Transvaal you can plant as late as January. But it is best to plough and plant early, in time for the rains in October and November. If you have any money to spend on fertiliser, use 4 bags (200kg) of superphosphate per hectare at the time of planting.

Plant sorghum in rows by hand or scatter seed evenly over the field. For row planting make the rows 1m apart and plant the seeds 15cm apart in the rows. If you plant them more than 15cm apart, the plants will branch at the top and you will get more sorghum on each plant. But if the seeds are planted 15cm apart weeds will not get a chance to grow. Plant the seeds 3cm deep in clay soils and 5 cm deep in sandy soils.

If you are scattering the seeds, cover them carefully with a little soil, using a hoe. 3kg of seed is enough for 1 hectare, but we recommend 7kg per hectare to make sure that the seeds grow well. 7kg of seed in 1 hectare give you about 30 000 plants - between 10 and 20 bags when harvested.

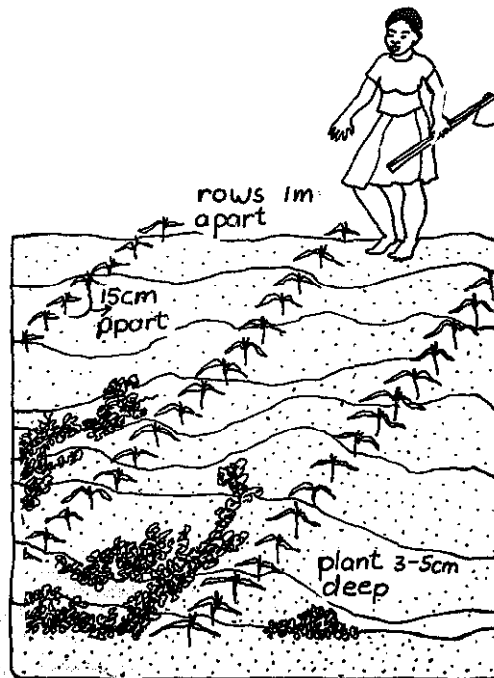

Weeding

Early weeding will give you a bigger crop. When the plants have just started growing, you can weed using a harrow without damaging them. Later, weed with a hoe or cultivator. The roots of sorghum plants spread out over the whole field, so do not dig too deeply when weeding because you will damage the roots. The worst weed of sorghum is witchweed. It must be pulled out by hand. The best way to prevent it is by crop rotation.

Rotation and Intercropping

Sorghum grows well in a crop rotation. Rotate it with crops like wheat, maize, sunflowers and beans. Only grow sorghum in the same field every 4 years.

Many farmers intercrop sorghum with beans or millet. Harvests from intercropping are bigger than harvests from sorghum growing alone.

Pests

American bollworm and aphids are the worst insect pests. You can poison them with Thiodan. The only trouble with Thiodan is that it kills many insects, including the natural enemies (see p122) of these pests. Use 1,2 litres Thiodan mixed with 200 litres water for 1 hectare.

Stalkborer also attacks sorghum. For 1 hectare, mix 50ml Thiodan EC in 250 litres of water, per hectare. Put 1 teaspoonful in the funnel of each plant.

Another pest is sorghum midge. You can prevent it by planting early.

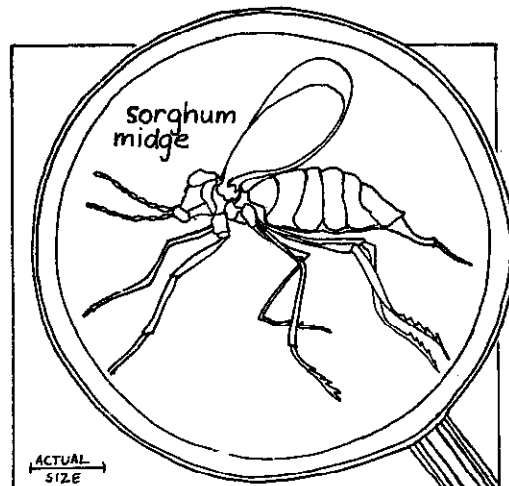

Birds like to eat the sorghum while it is young and soft. The only thing you can do is to chase the birds away. Red hybrid sorghum does not suffer so much from bird damage because the birds do not like the bitter taste.

Harvesting

Try to harvest as early as possible because damage by hail can be very bad when the crop is ripe. Harvest by cutting off the sorghum heads with a sickle. If you want to plough straight after harvesting, cut the sorghum stalks and stack them on the side of the field. Dry the heads in the sun, then thresh by beating the heads. Store the grain in a cool, dry place.

Sorghum can be ground up and used to make porridge or beer. Dry sorghum plants make a very good food for sheep and cattle, so leave them in the lands as a winter food for these animals.

When we get a chance we go and chase the birds away

Nokuphela Mvelase lives in Sunduza village in the Transkei. She moved there three years ago after her husband's death, and now farms a small piece of land with her son and daughter-in-law.

● How much land do you have?

We have about 2 hectares along the river. The soil is good and we always plant sorghum. My son decided how we should use the land. We hire a tractor to plough the land when we think it

is time. This year it was in September. We plant about one week after ploughing. This year we used an explanter. We borrowed the planter and cattle from some relatives in Sehidini. Before we had to scatter the seeds because we didn't have any cattle.

● What kind of seed do you use?

We kept our own seed, this white sorghum, from last year. It's better to plant in rows because it takes less seed. We used a big bucket (20kg) this year, and it's starting to grow very nicely. If we are lucky the crop will be good.

● Do you pick out the best seed from last year for planting?

No, all our seed is the same. Others must choose the seeds from the best plants because they grow many different kinds together. For us it's all right to plant any seeds because they are all good.

● When do you cultivate?

We do all the weeding by hand. We begin when the sorghum is about 6

inches high. We only weed one time. It's a lot of work for us because we are only three. There's nobody who can help us. The big trouble here is birds.

They eat a lot of our crop, but there's nothing we can do. When we get a chance we go and chase the birds away. Some people have tried tying plastic to the sorghum to keep the birds away, but we have not tried that. We don't have any problems with insects.

● When do you harvest?

Usually we harvest in May or June, as soon as the sorghum is dry enough. We cut the heads off with a sickle or big knife and put them in bags. Then we make a place in the middle of the field for threshing. Others come

to help us with the threshing. We help each other. Threshing is the work of men. They beat the sorghum heads with long sticks so the grains of sorghum fall out. Then they winnow the sorghum. The women do the work of sweeping on the threshing floor. We store the sorghum in bags at home.

● How do you grind the grain?

We use the hammermill when it comes here. It is very expensive. We pay 80c for a tin (20 litres). I also use a grinding stone.

● Do you sell any of your sorghum?

No we don't have enough. Last year we only got 10 bags, because we planted very late. We even have to buy from the shop, so how can we sell?



Potatoes

Potatoes are becoming popular and many farmers are growing them instead of maize and sorghum. They can give big harvests but they get diseases very easily. Potatoes grow well in sandy loam soils (see p 97) but not in clay soils.

You should not grow potatoes in hot wet places. This kind of weather will give the potatoes diseases. If you do not get frost in your area it is better to grow potatoes in winter, because potatoes get more diseases in summer.

Seeds

You can use ordinary eating potatoes for seed but you will get a much better crop from certified seed. Certified means that the seed has been checked by government inspectors, so it does not have diseases. The most common certified seed is called "A" seed. Prices for "A" seed are usually about R6 for a 30kg bag.

The most common potato seeds in Southern Africa are BPI, Up To Date and Sackfiller. Sackfiller seeds do not get diseases so easily and give bigger crops, but they will go bad if you store them for too long. We recommend BPI because they are good

and you can get them everywhere.

Land Preparation

Plough the land early so that you can plant early. The land must be ploughed deeply but it does not need to be harrowed.

Planting

Planting early helps to prevent disease. If there is rain, you can plant as early as August.

For a few weeks before planting, keep the seed potatoes in a warm dry room. They will start to grow little white shoots. When you are ready to plant, sort the seed potatoes into small and large sizes. Some people cut them in half if they are very big, but they get more diseases if you do this.

You need 25 bags of seed potatoes per hectare. Plant the seed potatoes 25cm deep in rows 1m apart. Small seed potatoes must be about 30cm apart and big ones about 60cm apart in the rows. Put the soil back in the rows using a hoe (see planting in rows by hand p 118) or by pulling a log over the land. The potato plants will come up in about 10 days.

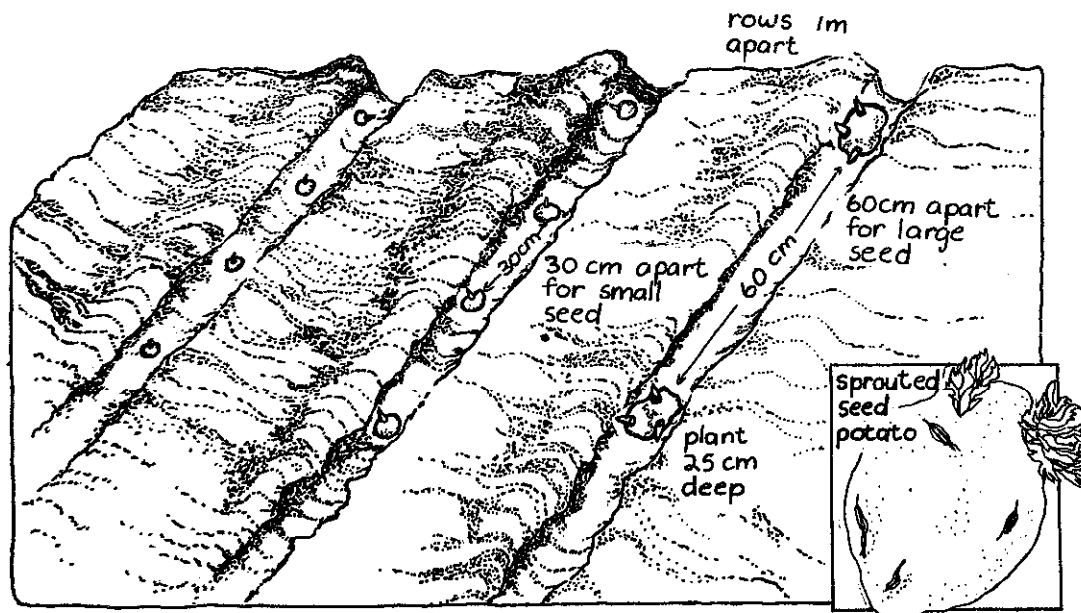

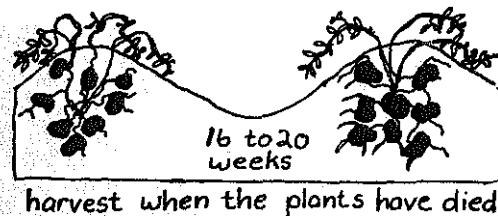
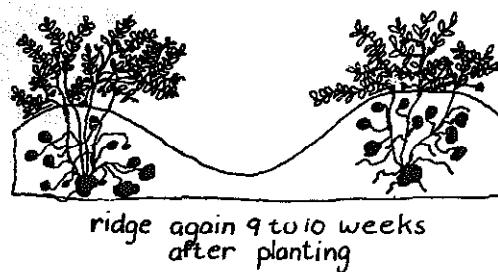
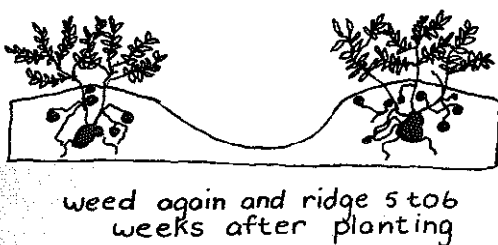
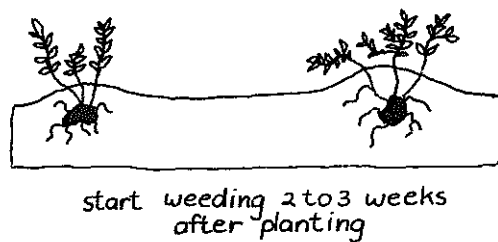
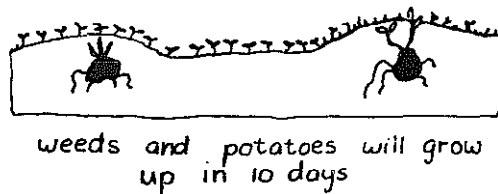
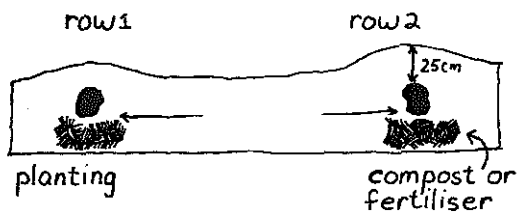

Fertilisers

Fertilisers will help you get a good crop. The best fertiliser for potatoes is a mixture of manure and super-phosphate. If you do not have manure, use 8 bags of 2:3:4 (24) fertiliser per hectare. You will get an even better crop if you spread LAN on your field (see Fertilisers p 121) when the potatoes start flowering.



Weeding

Weed early otherwise the weeds will use up all the plant foods in the soil and the potatoes will not get enough. Once the potatoes are growing well, you will only have to weed in between the rows.

Ridging

Ridging is making a heap of soil around the plants. You usually make these heaps while you are weeding. If you do not ridge around the plants, the sun will turn the potatoes green. Ridge by hand or with a single furrow plough or a ridger.

Harvesting

Harvest potatoes after the tops have died. This is usually about 5 months after planting.

The best way to store potatoes is by leaving them in the ground and digging them up when you need them. However you cannot do this if there is a lot of rain because the potatoes will rot in the ground. Store them inside in a dark, cool place, or outside by covering them with straw and making sure they stay dry.

Pests and Diseases

The worst disease of potatoes is late blight. You can prevent late blight by planting early, because it is worst in hot weather. But once your potatoes have the disease you must use a chemical poison. You can use these poisons:

▶ Dithane M45: for 1 hectare, mix 1kg with 500 litres of water.

▶ Maneb: for 1 hectare, mix 1kg with 500 litres water.

▶ Mildane: for 1 hectare, mix 2,5kg with 500 litres water.

▶ Bordeaux mixture: for 1 hectare, mix 8kg with 500 litres water. Spray it on every two weeks during the rainy summer weather.

Sometimes aphids are a problem on potatoes but it costs too much to kill them with a chemical poison. If you just have a small number of potatoes, for example, in a vegetable garden, you can kill them with nicotine spray or garlic spray (see p 123).

Rotation

Always grow potatoes in a crop rotation (p 94) otherwise they will get eelworm disease. Rotate with maize, sorghum, wheat or beans, with beans just before potatoes in the rotation.

Do not grow potatoes on the same land more than once every four years.

Sweet Potatoes

Sweet potatoes grow best in the hot rainy parts of Southern Africa, but they can also grow in cool or dry places. They grow in slightly acid sandy soils, but not in wet clay soils or in alkaline soils. If you have very acid soil, add lime to make it less acid.

Sweet potatoes grow well in rotation with crops like maize, sorghum, wheat, sunflowers and vegetables. Do not grow them on the same land more than once every three years.

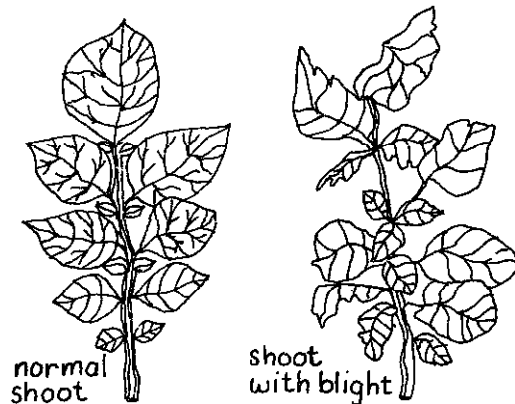

Seeds

To grow sweet potatoes, you first have to plant seed potatoes. The seed potatoes grow shoots called vines. Pull out these vines and plant them over the whole field. Always try to get vines from plants without diseases otherwise you will not get a good crop.

You can get vines in two different ways:

► The best way is to buy healthy seed potatoes and plant them in early spring. The best varieties are Mafutha, Impaia, Wildebeest and Brondal. Two months after planting the seed potatoes pull out the vines and plant them over the whole land. Throw away the plants which are growing badly and any plants with yellow leaves.

► The other way is to leave some sweet potatoes from last year in the ground. Vines will grow after the first rains, and can be used for planting. This way is not as good as getting vines from seed potatoes.

Planting

Plant straight after the first rains in October or November. In areas

without frost you can plant in January. Plant in rows by hand after ploughing. You can also plough and plant at the same time, planting in the ploughed rows so that when you make the next row the soil will cover the vines. Do not plough or plant deeper than 25cm, because your sweet potatoes will grow long and thin. Make the rows 1m apart and plant the vines 40cm apart in the rows. Make sure the end of the vine sticks out of the ground, then press down the soil around the vines by walking along the row.

Weeding and Ridging

You only need to weed once before the weeds become too strong. Ridging is heaping the soil up around the plant, using a hoe. It will give you a bigger harvest.

Pests and Diseases

Pests are not a bad problem for sweet potatoes. The most serious problem is virus disease spread by aphids. Prevent it by using disease-free seed to grow vines. Weevils can also be a problem. You can control weevils by making sure that no plants grow from sweet potato plant which have been left in the ground from last year.

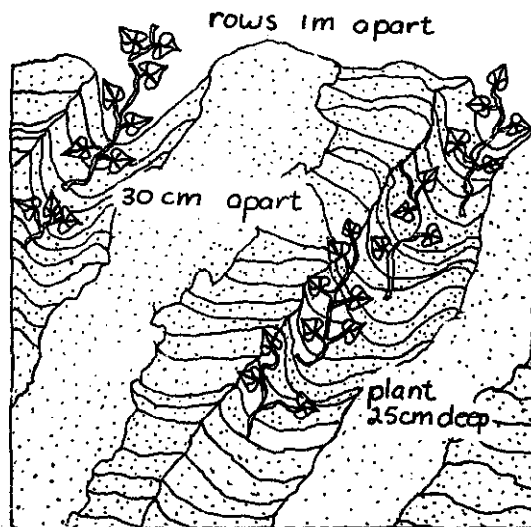
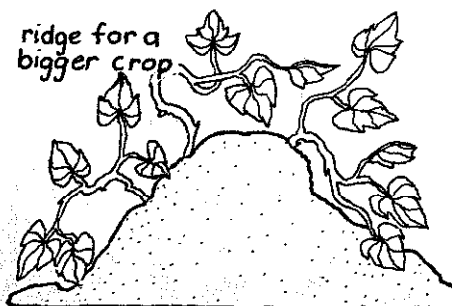

Harvesting

Sweet potatoes can be harvested as soon as they are big enough. To make harvesting easier, first cut off the vines and keep them for cattle feed. Then dig up the sweet potatoes with a fork or hoe.

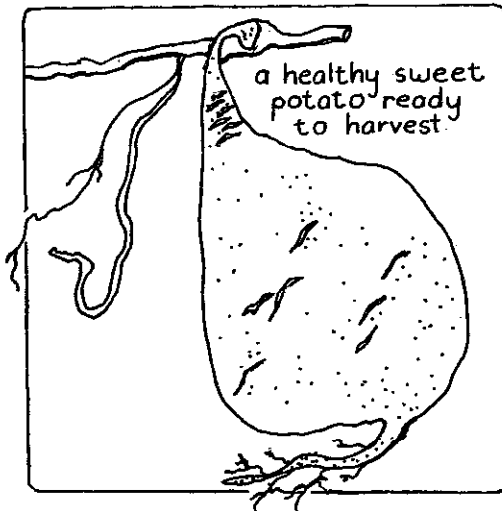

After harvesting, leave the potatoes lying on the ground for a few days. This helps them last longer without going bad. But do not leave them out on the ground on cold nights because cold weather can damage them.

Storage

To store sweet potatoes for a long time first leave them in a warm damp room, and then store them in a damp place. You can make sure they do not go bad by covering them with wet sacks or by sprinkling water on the floor of the store room so it is always damp. If you do not have a store room, you can leave them in the ground without cutting off the vines and dig them out when you need them.

Sweet potatoes are popular and easy to sell. If you want to sell them to a market, you will get a better price if they are washed and sorted into different sizes.

Beans

Beans are easy to grow. They have lots of protein and help to give people the protein they need if most of their food is mealies. Beans grow quickly and are ready to eat 3 to 4 months after planting.

Beans grow well on sandy loam soils, but not on very sandy and very clay soils. They grow best in places with lots of rain, like the highveld, Natal and the Eastern Cape. In places with only a little rain you need irrigation to grow beans well. In dry places and on very sandy soils, it is better to grow groundnuts or cowpeas because beans will be killed by drought.

Seeds

Most people use their own seeds which they keep from last year's crop. This is a good idea, but after about 3 years the bean seeds start to get weak. It is worth buying new certified seed once every 3 years to make sure your beans are strong.

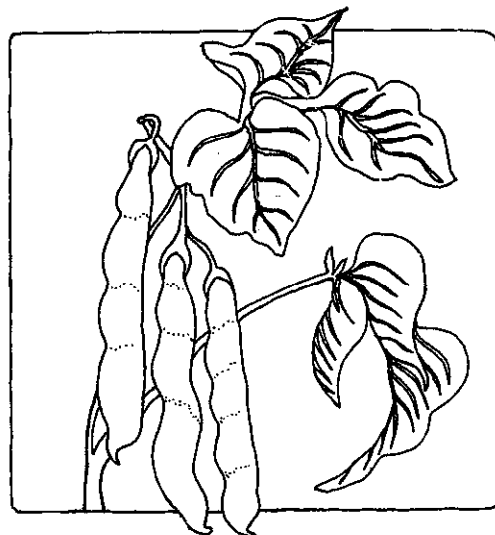

The seed sold at most trading stores is not certified. It is better to buy certified seed directly from suppliers (see p 514). Most certified seed suppliers are in the Eastern Transvaal and Natal.

The most popular kinds of beans are:

- ▶ Sugar beans - light brown beans with little dark brown spots.
- ▶ Haricot - large white or small white.
- ▶ Natal yellow - yellowish brown.
- ▶ Dual purpose beans - can be eaten fresh or dried. The best kinds are Canadian Wonder and Contender.
- ▶ Victory - a small brown bean

Planting

Bean seeds are big so they can be planted in roughly ploughed soil. Plant them about 10cm deep, or even deeper in sandy, dry soils. Plant in rows 60cm apart, with the bean seeds 15cm apart in the row.

Fertilisers

Beans grow well if you plough kraal manure or chemical fertilisers into the soil. Use 8 bags of 2:3:2(22) per hectare. It is best to get a soil test (see p 98) to find out exactly how much fertiliser to put on. Some farmers inoculate the bean seeds, but we do not think this improves the crop very much.

Intercropping

Beans are good to intercrop (see p 117) with maize, sorghum, bananas and cassava. Plant the beans and the other crop at the same time.

Weeding

Weed early, otherwise the beans will be weak. Weeding must be done by hand or with donkeys. The rows are too close together for oxen.

Harvesting

Harvest when the pods turn brown and the beans inside are hard. If you harvest later, the shells break open and the beans get damaged by rain and insects. After picking the pods off, you can plough the whole plant back into the soil or you can use the tops of the plants for cattle and plough the roots into the soil.

Before threshing, dry the pods well. Thresh the beans by beating the pods with a long thin stick, then winnow to let the wind blow away the pods and stalks.

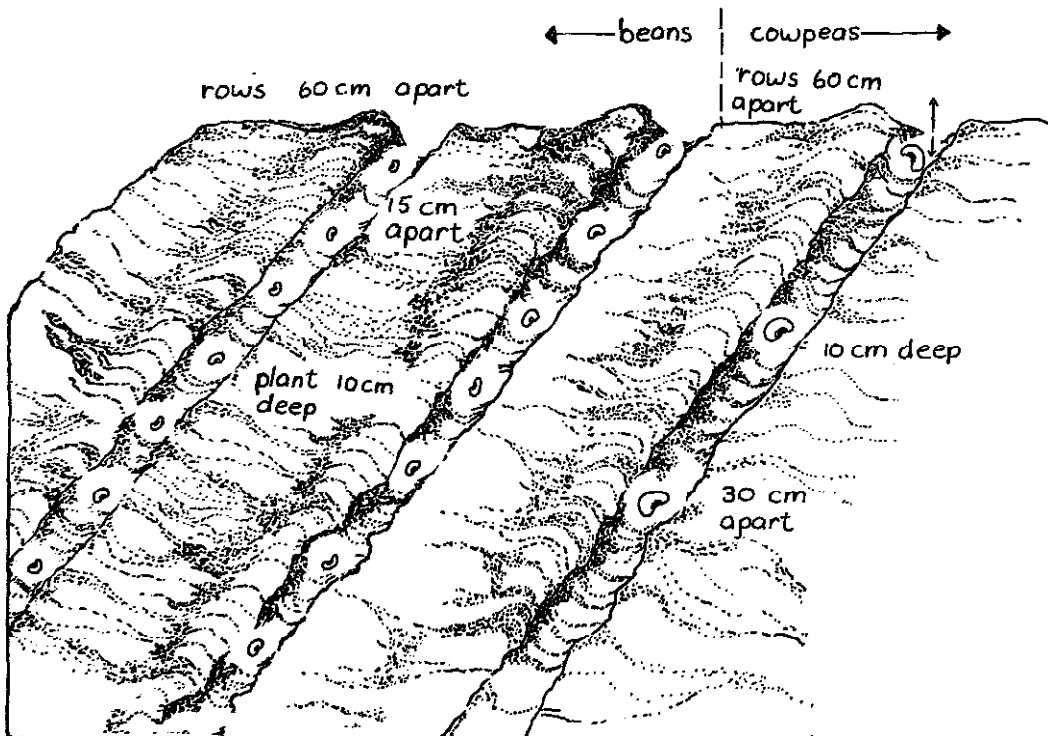

Pests and Diseases

Beans are attacked by many pests, especially in hot places. Most insects can be killed by picking them off the plants by hand and dropping them in a tin of paraffin or standing on them. But if there are too many you will have to use a chemical poison.

- The worst pests are aphids. To get rid of aphids use nicotine spray (p 123). If this does not work use Rogor EC. For 1 hectare, mix 150ml Rogor EC in 200 litres of water and spray it on to the plants. Do not spray after the pods start to turn yellow.
- Cutworms can be prevented by early ploughing or you can kill them with Dipterex 95WP. For 1 hectare, mix 30g of the poison with 10kg mealie meal and 10 litres of water. On small plots you can dig out cutworms and kill them.
- CMR beetles eat bean flowers. You can pick them off the plant by hand and kill them. You can also kill them by spraying with Malathion. For 1 hectare, mix 500ml Malathion with 200 litres of water. You can also use 75ml Parathion EC mixed with 100 litres of water.



- Red spiders attack the leaves. Use Rogor EC to kill them. For 1 hectare, mix 200g Rogor with 200 litres water.
- American bollworms can be very serious pests. Kill them with Thiodan EC. For 1 hectare, mix 250g in 100 litres water. If there are only a few worms, pick them off by hand.

The most common diseases are angular leaf spot, anthracnose and rust. All these diseases make yellow spots or marks on the leaves. These can all be treated with Dithane M45 80WP. For 1 hectare, mix 400g Dithane with 200 litres water.

Cowpeas

Cowpeas grow better than beans in hot places, even when there is only a little rain.

You can use your own cowpea seeds, but it is better to buy improved seeds when you plant for the first time. The most popular improved seeds are Dr Saunders and Basotho White.

Plough and plant cowpeas the same as beans. Make the rows 60cm apart and plant the cowpeas 30cm apart in the rows. They do not need fertilisers. Like beans, cowpeas are good for intercropping with maize or sorghum.

The worst pests are pod borers and blossom beetles. Try to pick them off the plant by hand if there are not too many. Otherwise use the same poisons as beans.



Many people like to grow cowpeas and use the leaves for spinach. The cowpeas are ready for picking in 5 months and the leaves can be picked all the time.

Soyabeans

Soyabeans have more protein in them than any other crop or vegetables. They are one of the most nutritious foods and they are easy to sell. They need as much rain as maize and they do not grow well in acid soils.

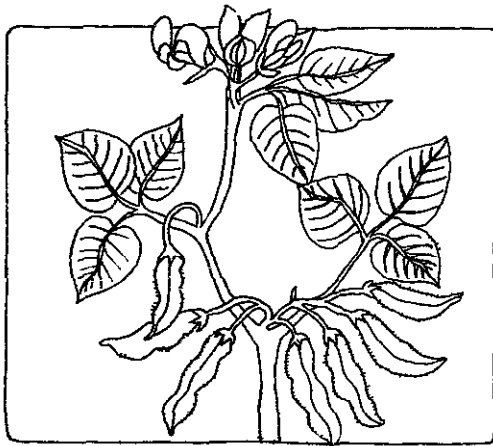

Seeds

The most popular soyabean seeds are Geduld, Welkom and Masterpiece. These are long season seeds which take about 150 days (5 months) to grow. Usuthu and Kent are short season seeds. They still grow well if you plant them late, but they are more expensive.

Fertilisers

If the soil is too acid you must add lime. This is more important than using any other fertiliser. Use 1 ton of dolomitic lime for 1 hectare.



If you have money for other fertiliser, use phosphate. You can plough in rock phosphate such as Langfos or Saaifos before planting, or you can add super-phosphate at the time of planting. If you use manure or compost, plough it in six weeks before planting.

Land Preparation

Soyabeans will not grow in rough soil, so it is important to prepare the soil well. If possible you should plough, disc and harrow the soil.

Inoculation

You will get a bigger crop after the first year of growing soyabeans if you inoculate the seed with Rhizobia. Pour a mixture of sugar water, powdered milk and Rhizobia over the seeds in a dark place just before planting. Plant the seed within two hours in wet soil, otherwise the inoculation will not work. You only need to inoculate the seed once. If you grow soyabeans in the same land again you do not have to inoculate the seeds.



inoculating soyabeans

Planting

Young soyabean plants are easily damaged by hot weather, so plant them in September.

It is best to plant in rows by hand (see p 118). If you use a tractor or ox planter, make sure the seeds do not get broken.

Plant in rows 1 metre apart with the beans 10cm apart in the rows and 3cm deep. Use 70kg of seed per hectare.

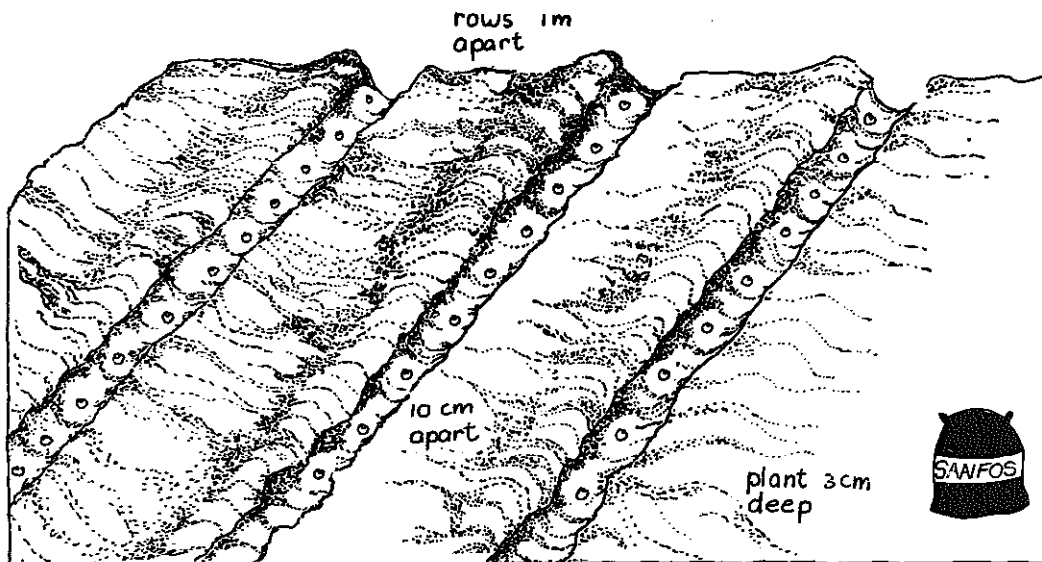

Weeding

It is important to weed early, starting about 4 days after planting. Use a rake or a light harrow. You do not need to weed again later unless the weeds are very bad.

Pests and Diseases

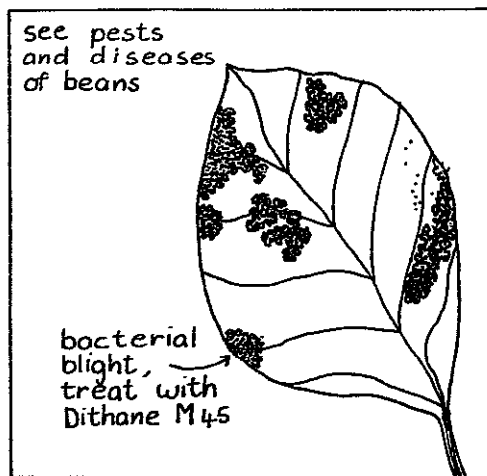

Crop Rotation

Soyabeans are good to rotate with maize, wheat or sorghum. Ploughing in the soyabean stalks after harvesting adds nitrogen to the soil and helps to prevent some of the diseases of these crops.

Harvesting

Soyabeans are ready for harvesting when the seeds are hard and the pods are brown. Cut the plants off with a hoe, and then pick off the pods. Thresh with long thin sticks, and winnow to let the wind blow away the pods and stalks. You can also leave the plants in the fields as a good sheep food, or hammermill the dry stalks for cattle food. After harvesting plough the roots into the soil.



Groundnuts

Groundnuts (peanuts) grow well in the hot, dry places in Southern Africa. They can easily be killed by frost and they take a long time to grow, so plant early to make sure that frost does not kill them.

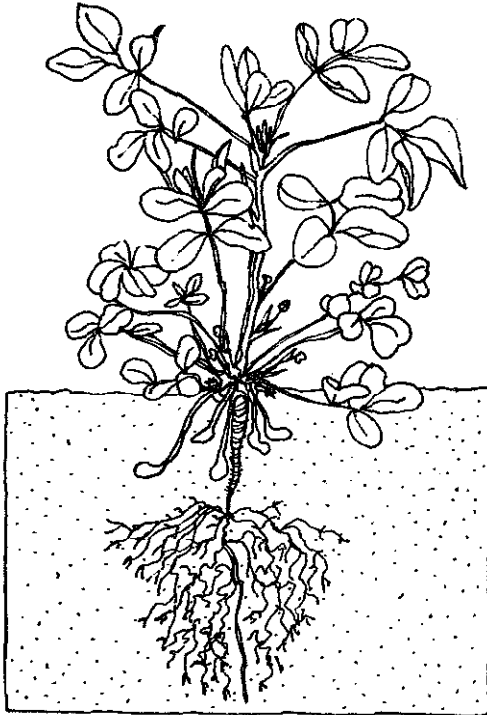

Seeds

The most popular seeds are Valencia, Virginia and Natal Common. Virginia grows well only under irrigation.

Small seeds are better than big seeds because their shells do not break so easily. Store the seeds in a cool place otherwise they will be damaged by heat. You can protect the seeds from diseases by dipping them in poison. For 100kg of seed, mix 200g of Dithane M45 or Bordeaux in 200 litres of water.

Land Preparation

Groundnuts grow well on most soils except heavy clays. Very sandy soil is the best, but it must be fertile. Do not plant groundnuts in soils where wheat stalks have been ploughed in because groundnuts can get crown rot disease from the wheat stalks.

If possible, plough early and harrow the land before planting.

Fertilisers

Groundnuts are legumes so they make their own nitrogen in the soil. They usually only need superphosphate or rock phosphate fertiliser. Ask your extension officer what fertiliser to use. On acid soils you sometimes need lime. If you grow groundnuts in a crop rotation, you will not need so much fertiliser.

Planting

Groundnuts take 4 months to grow. If you plant early there will be no danger of frost before the time of harvesting. Plant in November or straight after the first good rains in summer. If you plant the seeds closely together, they will not be attacked so easily by pests and diseases. Make the rows 30cm apart, and plant the seeds 10cm apart in the rows. Plant them 8cm deep in dry sandy soil, 6cm deep in sandy loams and 4cm in clay soil. Use 25kg of seed per hectare.

Weeding

The plants will start coming up after about 10 days. This is the time to take out the small weeds with a harrow. Weed again by hoe or cultivator a few weeks later. When you weed, do not dig deeply otherwise you will damage the roots. After 6 weeks the groundnuts will be strong enough so that weeds will not damage them.

Pests and Diseases

The worst pests of groundnuts are American Bollworms and aphids. To kill American Bollworms, use Thiodan EC. For 1 hectare, mix 2 litres of Thiodan EC with 200 litres of water. For aphids, use Malathion WP (25%). For 1 hectare, mix 1kg of poison in 200 litres of water. You can also use a home made nicotine spray (see p 123).

To get rid of leaf spot disease, use Dithane M45 WP (80%). For 1 hectare, mix 2kg of poison in 200 litres of water.

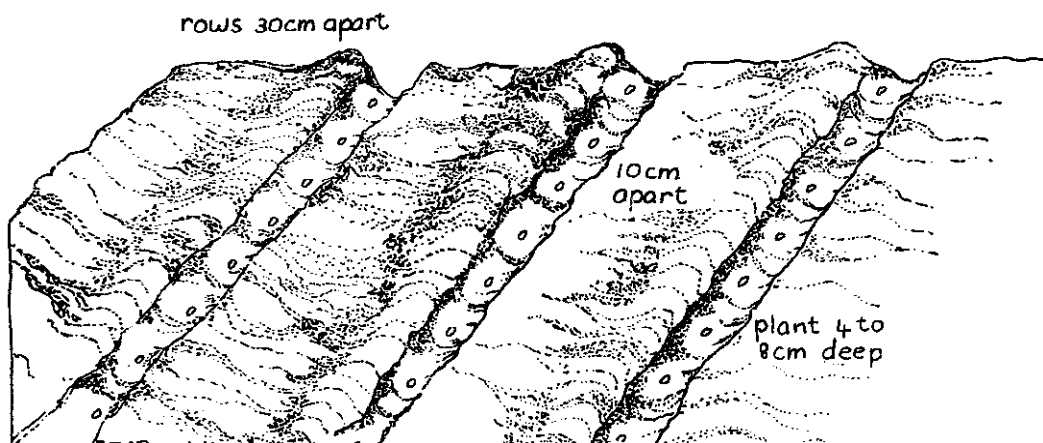

Harvesting

Harvest groundnuts when the leaves turn yellow. Dig around the plants with a hoe and then pull them out. Leave the plants to wilt for 2 to 8 hours, then stack them to dry. Leave the stack for 6 weeks, and protect it so the plants do not get wet. In dry weather you can lay the plants out in rows.

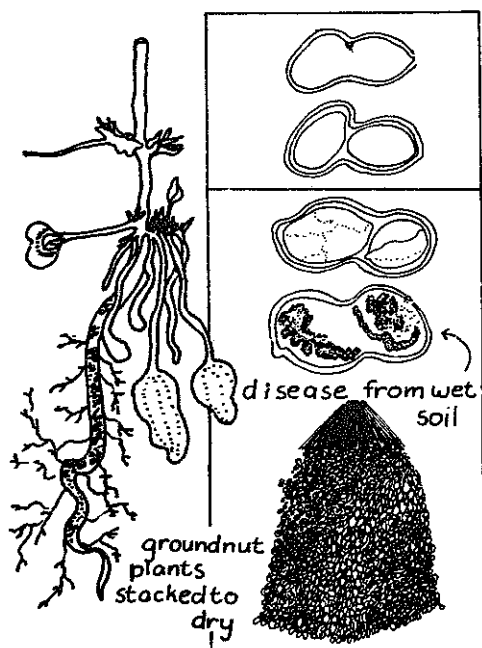

After 6 weeks, the nuts will be dry inside the shells. Make groundnut hay (p 244) with the stalks and leaves. Groundnut hay is very good for cattle.

Crop Rotation

Always grow groundnuts as part of a crop rotation. It saves fertiliser and helps to control disease. Grow them in soil used last year for maize, millet, sorghum, sunflower or pasture grass, but not in soil used for potatoes, lucerne, soyabeans or cotton. In a crop rotation, groundnuts should be planted in the same soil only once every 4 years. If you plant them in the same soil without waiting 4 years, they will get diseases.

After groundnuts have been harvested, the soil is loose and bare, and can easily be eroded in winter. If you grow a winter crop such as oats, rye, a legume, or winter pasture grass on the same land, it will cover the soil and prevent erosion. In most crop rotations, the stalks left after harvesting are ploughed into the soil. Groundnut stalks and leaves are good for animal food so do not plough them in. To keep the soil in the crop rotation fertile, plough in manure before planting.

Groundnuts under Irrigation

If you grow groundnuts under irrigation you can get double the crop you get in dryland farming. Plant 50kg of seeds per hectare. Do not irrigate too much because it will damage the pods. Do not grow groundnuts in fields next to tomatoes or potatoes because water from groundnut irrigation will cause bacterial wilt disease in these crops. Plant another crop such as maize between the groundnuts and these crops.

Pumpkins

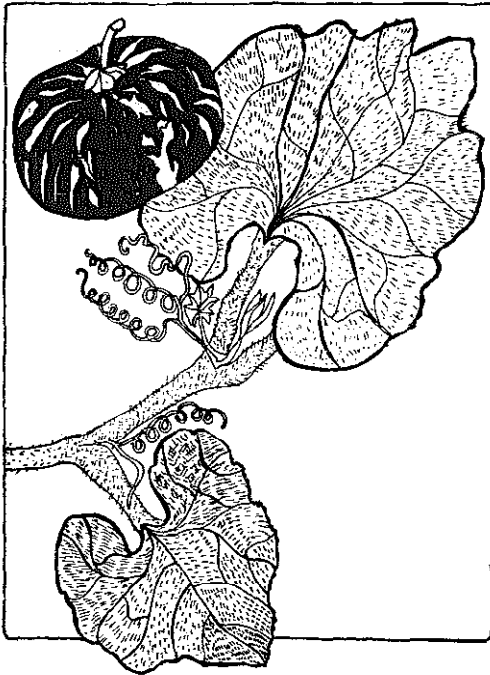

Pumpkins grow well all over Southern Africa. They usually grow in summer but they can grow in winter in warm places. Cucumbers, watermelons, calabashes and marrows are part of the same plant family as pumpkins and grow in the same way. All of them grow best in sandy, well drained soils.

Seeds

The best pumpkin seeds are Plat Wit Boer, Queensland Blue, Golden Hubbard and Green Hubbard. If you use your own seed from last year you must dry it well. Try to buy improved seed every four years.

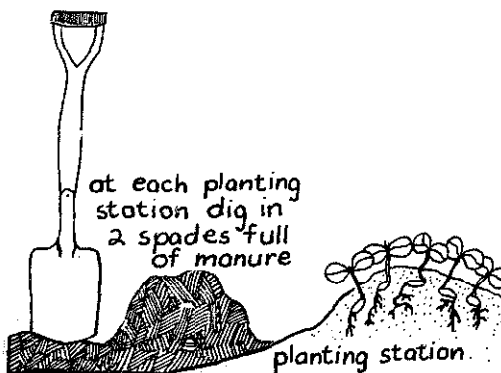

Land Preparation

Plough the land in winter, so that when the rains come, the water will go deep into the soil. Ploughing in winter also helps to stop cutworms from breeding.

Pumpkins must be planted in little heaps of soil called planting stations. Make the row 2m apart with the planting stations 90cm apart in the rows.

Fertilisers

At each planting station, dig in two spades full of kraal manure. If you do not have kraal manure dig in 500g of a mixed fertiliser like 2:3:2 (22%).

Ask your extension officer what fertiliser you need. If the soil is very acid, put on lime. If the soil is short of phosphate, put on superphosphate.

Planting

Plant pumpkins early in summer when you are sure that the frost is finished. Plant 6 seeds about 4cm deep in each planting station. If you have big pumpkin seeds or if the soil is sandy, plant them deeper. If it has not rained when you plant, water each planting station.

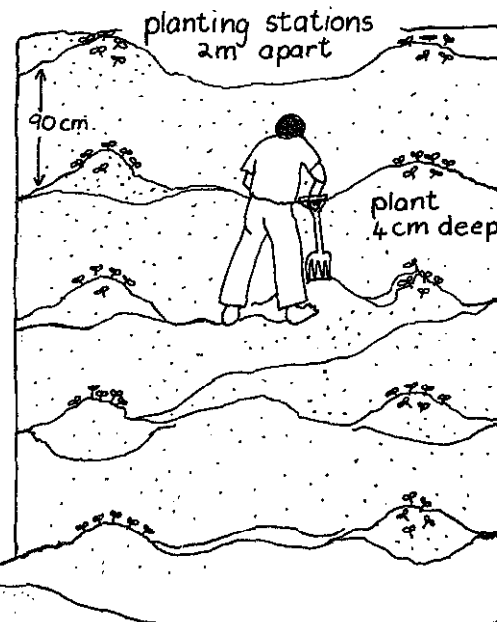

Intercropping

Pumpkins are good for intercropping with maize, sorghum or beans. Many people mix pumpkin and maize seeds and scatter them together on the land. If you are planting in rows, plant a row of pumpkins next to a row of maize. In very hot places you should plant the pumpkins after the maize so they will be shaded by the maize plants.

Weeding

Pumpkins must be weeded early. Take out the weeds in the planting stations by hand, and the weeds between the rows with a cultivator.

Pests

Pumpkins have many pests. Try to control pests by natural methods.

- ▶ Pests breed if you grow pumpkins on the same land every year. It is better to grow pumpkins in a crop rotation
- ▶ Plant in September or October if possible because that is when there are not so many insects.
- ▶ Cutworms breed in pumpkin plants in the soil after harvesting. To prevent them from breeding, take out all the old plants and weeds before planting.

If the pests are very bad, you can use chemical poisons. You can kill pumpkin fly with Malathion. For 1 hectare, mix 58g of Malathion WP in 18 litres of water with 1kg sugar. Sprinkle the poison on the leaves once a week and after rain. To get rid of cutworm with poisons (see p 122, 146).

Harvesting and Storage

As soon as the plant starts to die you can harvest the pumpkins. This will be about 4 months after planting.

Store the pumpkins by standing them on their sides in a dry place. Throw away any pumpkins which start to go bad.

Marketing

It is easy to sell pumpkins to your neighbours, but selling in town is usually not so easy. Pumpkins are big and heavy and cost a lot of money to take to town. Also, many big farmers grow pumpkins during summer to sell in town, and small farmers cannot get a good price. You will get a better price if you sell in town during winter, when pumpkins are in short supply.

Squashes

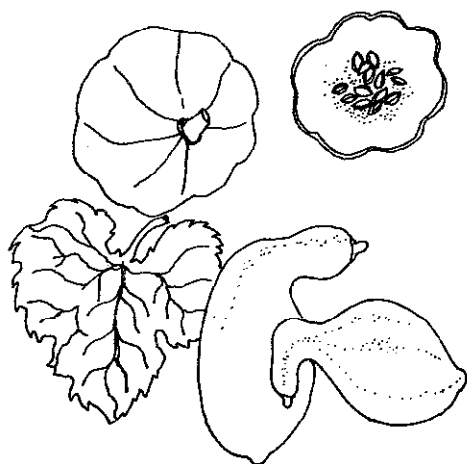

Squashes are one of the most nutritious vegetables. They like the same soil and weather as pumpkins.

Seeds

The best seeds are Little Gem and Table Queen. You can use your own seeds from last year by leaving about three squashes on the plants after harvesting. After a month the seeds inside will be hard. Pick the squashes, take out the seeds, and store them in a cool, dry place where there are no mice or insects.

Planting

This is the same as for pumpkins, but make the rows 1,5m apart instead of 2m. Weeding and pest control are the same as for pumpkins.

Three months after planting, the squashes are ready for picking. Be careful not to break off the stem when you pick the squashes.

Cassava

Cassava is a very popular crop in many parts of Africa, although it is not so well known in Southern Africa. In countries like Tanzania and Kenya people eat it as their most important food, like we eat mealie meal. Cassava bushes have roots like sweet potatoes. People eat the roots and the leaves.

Cassava can grow in places with very hot dry weather and sandy soils where even crops like sorghum die. It grows for many years and is never killed by drought.



Seeds

Cassava grows from small pieces of cassava plants called cuttings. There is no company or nursery selling cassava that we know, but there are many small farmers, especially in hot areas, who grow cassava and will sell cuttings. There are 3 or 4 kinds of cassava growing in South Africa and Swaziland. Sometimes the same kind has a different taste depending on the soil where the cassava grows. The red kind tastes bitter and the white kind usually tastes sweet.

To make cuttings, cut pieces each 20cm long from the stem of a cassava plant which has been growing for one year and has a thick stem. You can get up to 20 cuttings from one plant. Take cuttings from the bottom and middle of the stem but not from the top. Do not take cuttings from diseased plants because then your new plants will also get disease.

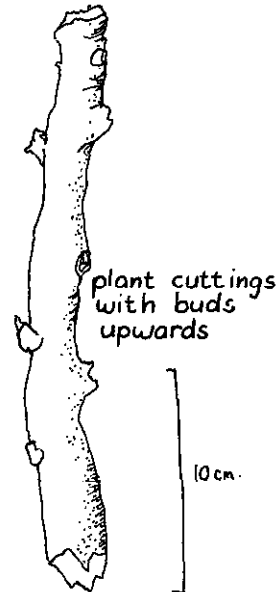

Fertilisers

Cassava does not really need any fertiliser. If you can afford to buy fertiliser put on potassium and phosphate after the cassava has been growing for one year.

Planting

You can plant cassava any time between September and February. If you plant early, you will get a bigger crop at the end of the first year.

Plant the cuttings by pushing them halfway into the soil. Make sure you plant them the same way up that they were growing on the plant. If you want to grow a whole field of cassava, plant it in rows 1,5m apart with the cuttings 1,5m apart in the rows. Most small farmers plant cassava in between rows of maize or beans.

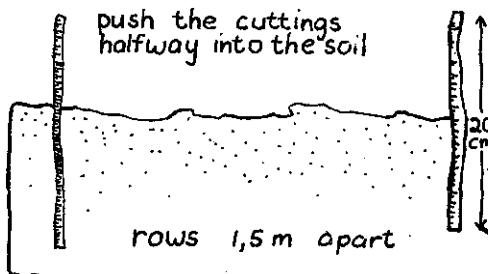

Weeding

After planting, it is important to take out all weeds until the cassava is 3 months old. After 3 months the cassava plants are big enough to keep sun off the weeds and the weeds will die. In winter the cassava leaves die, so every year in spring you must weed until the cassava leaves are big enough to keep the sun off the weeds.

Pests and Diseases

Cassava does not get many pests or diseases. The worst disease is cassava mosaic virus. This makes the leaves become yellow and the plant and roots do not grow. The only thing you can do is pull out the sick plants and burn them. To prevent diseases, always take cuttings from healthy plants.

Harvesting

Cassava can be harvested after it has been growing for about 1 year. Most people leave the cassava in the ground and pull out plants when they want to eat them.

After 1 year a cassava plant will give about 4kg of roots and after 2 years, about 8kg. The roots of plants older than 2 years sometimes grow tough. If cassava is not harvested for many years, it grows as tall as a tree.

To pull out the plant, first cut off the stems with a panga. Then take away the soil around the roots with a hoe and pull them out.

Cooking

Cassava roots contain a poison, so you must cook them carefully. Peel them before boiling and do not eat too much boiled cassava at the same time.

To make cassava porridge, cut the raw cassava roots into pieces and dry them in the sun. Drying gets rid of all the poison. Then grind the pieces into cassava meal to make porridge. Many people mix groundnuts or fish into cassava porridge. Cassava leaves can be eaten too, boiled like spinach. They have lots of protein.

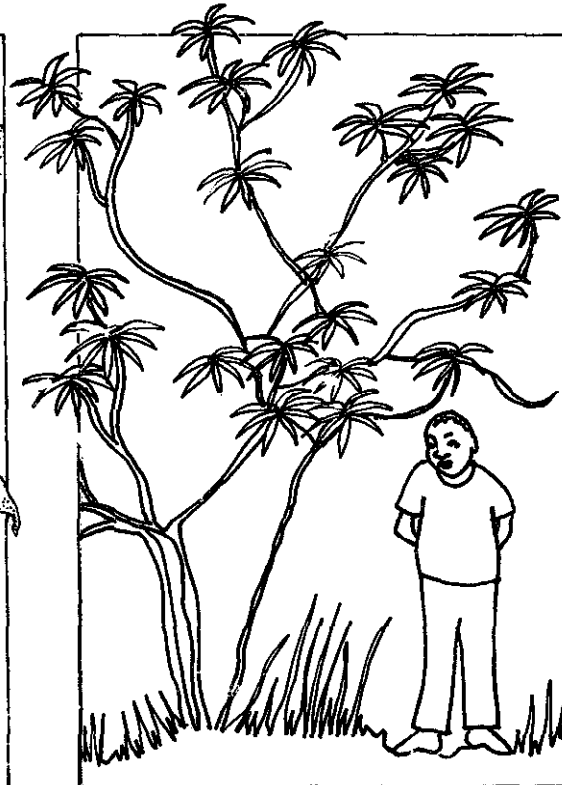
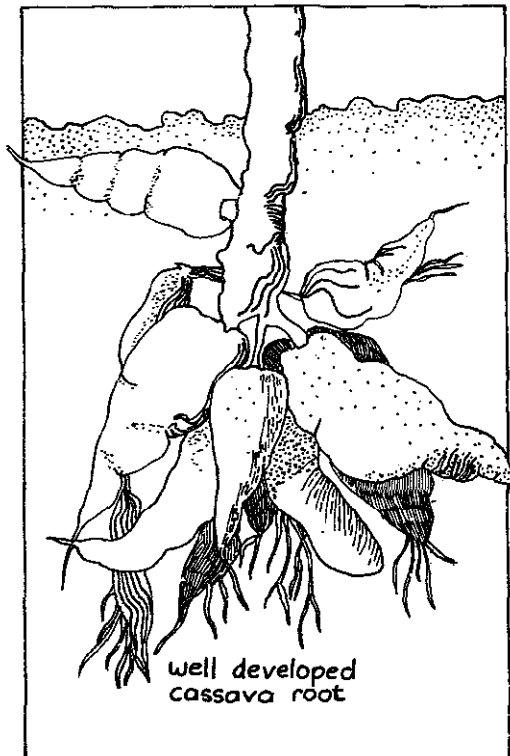

Sunflowers

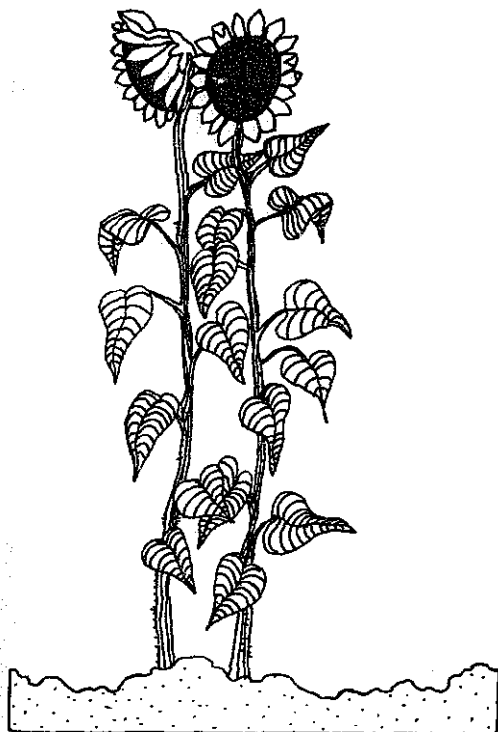

Sunflowers grow well in places where there is only a few months of rain during the summer. They have a short growing season, so they are good to grow when the rains come too late for maize and sorghum. They are not easily killed by drought and will give a good crop in years when maize is killed by drought. They are easily damaged by birds and hail.

Sunflowers grow well in soils which are not acid. If your soil is acid, you must put on a lot of lime. This is expensive and it might be better to try another crop.

Seeds

You can use hybrid or open-pollinated sunflower seeds. The hybrids will give a bigger crop and will not get rust disease easily. But we do not recommend them for small farmers because they are more expensive and you must buy new hybrid seed every year. Gunson G0101 and Gunson G0104 are good open-pollinated varieties. You can plant seed from your own sunflowers for the next crop.

Fertilisers

Do not plant sunflowers in acid soils unless you can afford to put lime on the soil. Sunflowers do not usually need other fertiliser. Sometimes there are plant foods called Molybdenum and Boron missing from the soil. Ask your agricultural extension officer if your soil does not have these plant foods because sunflowers need them.



Planting

You can plant sunflowers any time between September and late January. You do not have to prepare a fine seedbed. Plant straight after ploughing, about 5kg of seed per hectare. This will give 25 000 plants in dry areas and 35 000 in rainy areas. Plant in rows 1m apart or by scattering the seed. Do not plant them more than 30cm apart in the rows or some of the flowers will grow too big and will not dry out in time for harvesting.

Weeding

It is very important to weed when the plants are young. You can use a hoe or a cultivator. When the sunflowers are big the weeds will not grow because they will not get enough sun.

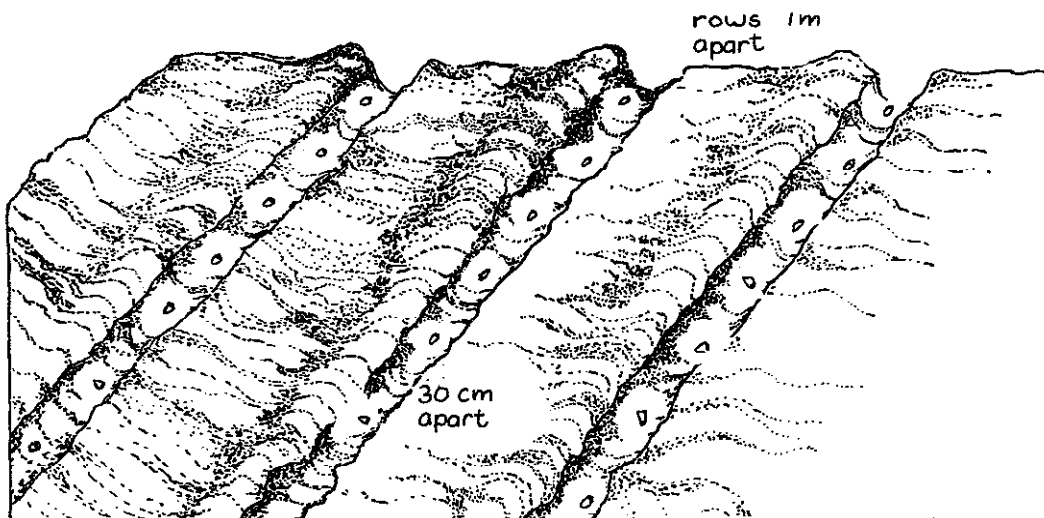

Pests and Diseases

The worst disease of sunflowers is rust. Rust is a dark brown powder on the heads of the sunflowers. It can be prevented by crop rotation (see p 94).

Birds are a big problem, especially in a small field because they can eat the whole crop. It is better to plant in big fields. Many small farmers can plant their sunflowers together in a big field and divide the crop between them, or they can plant in small fields close to each other. Try to harvest as early as possible because bird damage is worst when the sunflowers are ripe.

Harvesting

The easiest way to harvest is by cutting the heads off with a sickle when they have just turned brown and hard. Hold the head up when you cut, otherwise the seeds fall out. Take the seeds off by shaking the head or by hitting it against something hard. Leave the seeds in the sun for a week, until they are completely dry. The empty heads when crushed make a very good chicken food. Make a cattle food by mixing them with maize stalks or dry grass. Cattle will not eat the sunflower stalks, so just plough them into the land to improve the soil. You can also use them in your vegetable garden for runner beans or tomatoes to grow up.

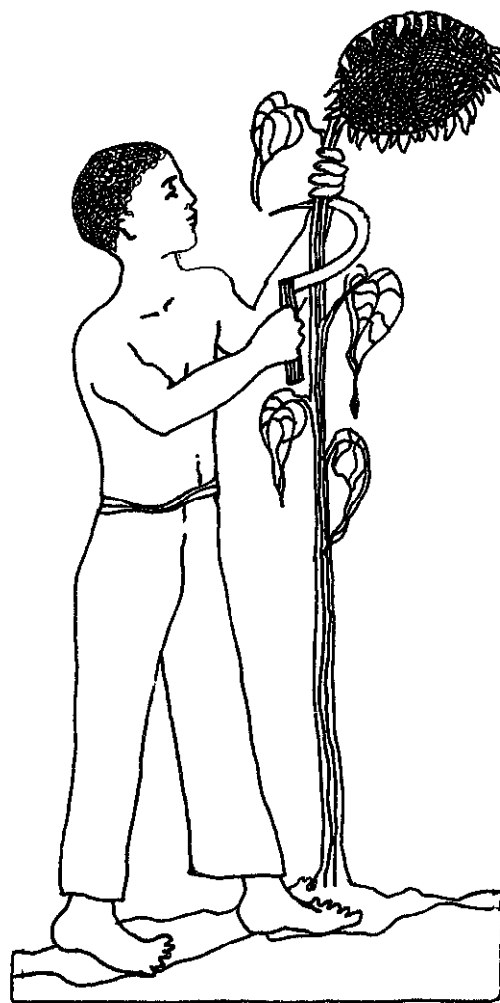

Wheat

Wheat is a good winter crop and a summer crop for cold places. It grows well in sandy soils but not in clay. It is easy to sell wheat and bread made with your own wheat flour is healthier than bread you buy from shops.

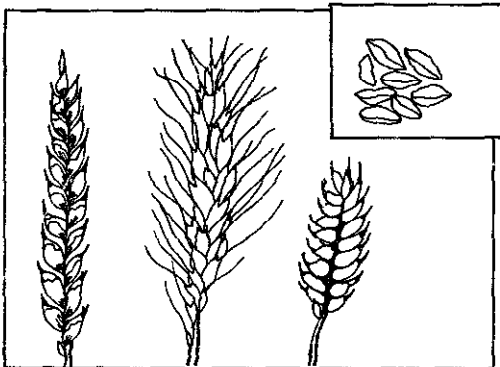

Seeds

Winter wheat should be planted from mid-April until the end of May. The best seeds are Belinda B and Scheepers 69. You need 20kg of wheat seeds per hectare.

Spring wheat should be planted from mid-August until the end of September. The best seeds are Benita and SST3. You need 60kg per hectare.

Summer wheat should be planted in January. The best seeds are Elize and SST3. You need 90kg per hectare.

You can use your own seed but it is better to buy new seeds every 4 years otherwise your wheat will get diseases.

Land Preparation

Land for wheat must be well prepared. The seeds are small, so they need a fine seedbed to grow properly. Plough in old wheat plants to help control diseases. Harrow the land before planting.

Fertilisers

If you have enough manure or compost, dig in 1 ton per hectare. If you do not have enough for your whole field use what you have on a smaller part of your field. Do not spread it thinly to cover your whole field.

If you can afford chemical fertiliser, the most important is phosphate. Plough in 600kg of raw rock phosphate, Langfos or Saaifos, per hectare, 6 weeks before planting. Or you can put on 300kg superphosphate per hectare at the time of planting.

Nitrogen will help you to get a bigger crop, but only after you have been growing wheat in the same field for more than 2 years. Put on 150kg of LAN or Urea per hectare when the wheat has started to make a few stems.

Planting

It is best to plant with a wheat drill. This is a special wheat planter pulled by ox or tractor, which plants the seeds in rows 30cm apart. You can also plant by scattering the seed, then harrowing the land.

Push down the soil to help the seed grow better, by pulling a roller or a log over the land.



Weeding

You must weed wheat by hand because the wheat grows too close together to use a cultivator. Big farmers use chemical poisons to kill weeds but they are too expensive for most small farmers.

Winter Wheat

Winter wheat can grow in places where there is no rain in winter. It uses water left in the soil from the summer rain.

To help keep water in the soil you must plough early, before the end of summer. Early ploughing gets rid of weeds, which use up all the water in the soil. In places where there is enough rain in summer you can grow maize in summer and winter wheat in winter.

Pests and Diseases

The worst disease of wheat is wheat rust, especially in warm places. Spraying chemical poisons to get rid of wheat rust is usually too expensive for small farmers. It is better to prevent wheat rust by growing wheat in a crop rotation or buying special seed which cannot get wheat rust.



Harvesting and Storage

Make sure the wheat is dry before you harvest, otherwise it can go bad when it is stored. Harvest using a sickle. Thresh the wheat by beating the heads against the floor, then winnow by throwing the threshed wheat into the air and letting the wind blow away the chaff. Store the wheat in a cool dry place.

In May I will plough the maize land to plant wheat ...

Mr Mxothwa Mfuyo is a member of the Matakana Farmers Association in the Herschel district of the Transkei. He worked in Pretoria on the railways for 27 years and moved back to Matakana in 1976 when he became ill, and was forced to leave his job. He started to farm wheat in 1978 because his pension does not give him enough money to live on. He takes any jobs he can find and when we interviewed him he had a job as labourer on a dam which was being built near Matakana. He works 6 days a week, sometimes as much as 12 hours a day.

● How much land do you have?

Actually it is not my land, it is the land of my family.

● Why did you decide to grow wheat?

Well, I decided to grow wheat because if you only grow maize it can die and then you have got nothing.

● How do you prepare your land?

I plough with oxen. I borrow oxen from my neighbours. They charge me R13 a hectare for ploughing and harrowing. Last year I ploughed in June and scattered seed and harrowed the land. I've got 2 fields. In this one I'm planting peas and in this other one I'm growing maize. In May I will plough the

maize land to plant wheat and in August I will harvest the peas and plant maize in that field. This is good for the land - they call it crop rotation.

● Where did you buy seed?

I used 1 bag for 1 hectare. I bought a bag of wheat for R8,50 from the shop here. The seed was good. I'll keep my own seed for next year.

● How do you harvest? I harvest in January. My wife and my brother help me. We were harvesting for about 3 weeks. We cut with a sickle and leave it lying on the ground for one day to dry. Then we tie the wheat together in bunches until we are ready to thresh. When we are ready to thresh we



sweep a place nicely clean on the side of the field. We bring the wheat to this place. We make a heap big as a house. We bring all the cattle - it can even be 20 cattle - to walk over the wheat. We lift the wheat with pitchforks so that the cattle can walk over it. It takes about 1 day to thresh. We take out all the stalks with our pitch-

forks. Then the cattle walk on the grain again. After that we use spades to winnow the grain. We throw it into the air and the wind blows the rubbish away. We do this again before the wheat is threshed and then we hit it with sticks to make sure all the wheat is off. Sometimes if the wheat is wet, you must use the cattle four times.

● How do you store the wheat?

We store it in bags at home. We keep most of the wheat to eat ourselves and we sell some to people in the village. This year, I think we will get 10 bags. My brother and I share the crop because we work together on the land, ploughing, planting and harvesting.

Lucerne



Lucerne is a good food for cattle, sheep, pigs, chickens and rabbits. It grows well in all parts of Southern Africa. You only have to plant lucerne once every 5 to 10 years and you can harvest it every summer.

Lucerne likes well-drained sandy soils with low acidity. In places where there is lots of rain the soil is usually too acid, and you might have to spend a lot of money on lime.

Land Preparation

Plough lucerne land very well, because the crop will be growing for 5 to 10 years. Plough at least 3 times during spring and summer.

Do not grow another crop on the lucerne land during that summer otherwise the land will be too dry for the lucerne. Plant at the end of summer. Disc or harrow before planting to help the seeds grow up well.

Fertilisers and Inoculation

Lucerne needs a lot of potassium and phosphate. In most soils you need to plough in one ton of rock phosphate per hectare before planting. This will last about 5 years. After 5 years you must top dress (see p 120) every year with phosphate and potassium or with manure. Lucerne will grow better if you inoculate the seeds with Rhizobia. Mix the Rhizobia with sugar and powdered milk and pour the mixture over the seeds a few hours before planting. See p158 for how to make Rhizobia mixture.

Planting

You can plant lucerne any time in summer, but it is best to plant at the end of summer when there will not be so many weeds. Scatter about 15kg of seeds per hectare. If the soil is very dry, use more seeds. To cover up the seeds drag a plank or an upside-down harrow across the land. Make sure all the seeds are about 2cm deep in the soil.

Weeding

You do not need to weed lucerne, because it grows so thickly that weeds do not get a chance to grow. If you get any big weeds, pull them out by hand.

Harvesting

Cut the lucerne when it starts to flower, which is every 40 to 50 days in summer. Do not cut shorter than 10cm otherwise you will damage the plant. After the end of February, leave the lucerne to flower and grow so that the roots will grow strong for next year.

It is better to cut the lucerne for animals than to let animals graze in the lucerne field. If animals graze in the lucerne before it has been growing

for 2 years the plants will be damaged and they will not grow for their full life of 10 years. After the lucerne has been growing for more than 2 years you can let animals graze in the lucerne field for 2 to 3 hours a day. If animals eat only lucerne they can get a sickness called bloat. To prevent bloat, give animals some hay or dry grass before they graze on lucerne.

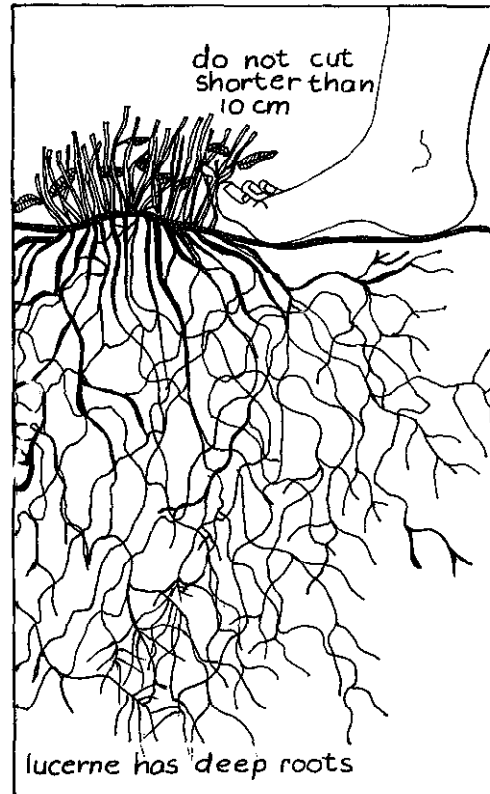

Drying

If you are storing lucerne for winter feeding you must dry it otherwise it will rot. You can dry small amounts by putting it in the sun on chicken wire. Use sticks or rocks to lift the chicken wire off the ground so that air can get underneath. You can also dry the lucerne by leaving it in the field after cutting, but you must keep turning it over. Drying usually takes about 3 days. You will know that lucerne is ready for storing when the stems are dry and the leaves rattle when you shake them.

Cotton

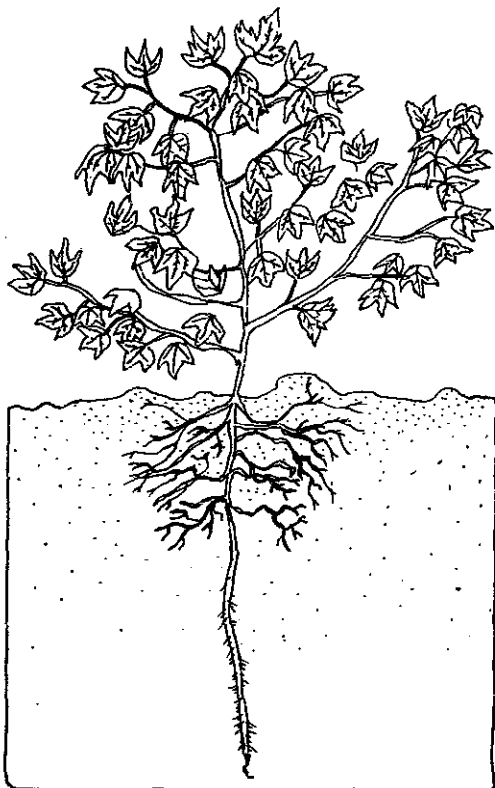

If you grow cotton you have to sell it to a cotton factory. This helps you in some ways. The factories usually give you fertiliser and seed on credit so you do not have to pay for these things until after you sell them your cotton. This credit is important for black cotton farmers because they cannot borrow money from the Land Bank like white farmers. But the problem is that you are forced to sell to the factory even if you don't like the price the factory gives for your cotton.

Before you start to grow cotton, go to the factory to find out what the cotton price will be, if they will buy it and if they will sell you seed and fertiliser on credit. Make a plan for them to collect your cotton when it is picked.

Cotton grows well in hot places like Natal and Northern Transvaal where there is no frost before April. It grows best when there is lots of rain, but even when there is no rain cotton does not die. Cotton likes sandy,

well-drained soils but it can also grow in salty soils (see Know your soil p 99).

Cotton needs a lot of work especially when it is time for picking.

Seeds

Treated seeds have chemicals on them which prevent diseases. It is best to buy treated seeds every year. They are more expensive, but if you use untreated seeds your cotton may get more diseases. The most popular treated seeds are Albar 637, and Clarcot CSZ. Deltapine S826 is usually grown under irrigation. Albar 637 and Clarcot CSZ do not get blackarm disease or angular leaf spot disease.

Fertilisers

Cotton does not need fertilisers if it is growing on good soil. If your soil is sandy ask your agricultural extension officer to find out if you need urea or superphosphate. For 1 hectare, you will need about 4 bags (200kg) per hectare of superphosphate and $\frac{1}{2}$ bag (30kg) of urea. Only use urea if you are planting early, before December. Fertiliser will not help you get a bigger harvest if you plant late.

Land Preparation

Cotton gets diseases easily. Do not leave plants in the land or even plough them in after harvesting, because diseases will stay in the soil and the next time you plant cotton it will get diseases. Cut all the plants left on the land and burn them. The government does not allow any farmers to have cotton plants in their fields for June, July and August.

Plough the land well, six weeks before planting, and harrow just before planting.

Planting

Plant early, at the end of September. Planting time is important. In Tanzania farmers who planted a month late only got half as much cotton as farmers who planted at the right time.

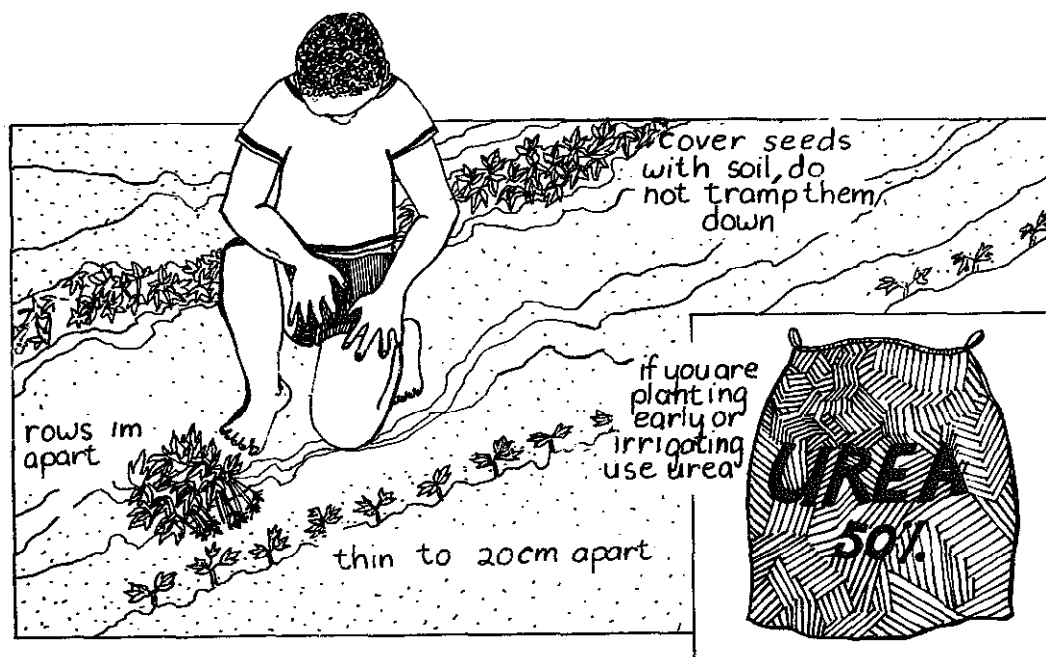

Make the rows 1 metre apart and plant cotton seeds close together. Cover up the seeds with soil but do not tramp them down. After 3 weeks take out the weaker plants so that the stronger plants are about 20cm apart. Use 30kg of seed per hectare.

Weeding

It is very important to take out weeds when the plants are young. You can weed by hand using a hoe. If you use a cultivator pulled by ox or tractor be careful not to bend the plants.

Pests and Diseases

Pests and diseases are very big problems for cotton farmers. They are the main reasons for bad cotton crops. You can control most diseases by using seeds which have been treated against diseases and by taking all the cotton plants out of the land after harvesting.

Find out from the cotton factory which are the best poisons to use. Spray to control pests when the cotton is between 2 and 4 months old.

The worst insect pests are:

► Bollworms. Choose 20 plants in your field and look at them every day. When you can see more than 10 bollworm eggs on these 20 plants you have to spray the whole field. Spray with Thiodan EC or Gusathion A+. For 1 hectare mix 1 litre of poison with 200 litres of water.

bollworm

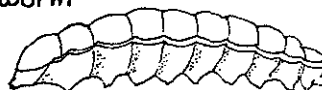

► Red Spider Mites are such small insects that you can only see them if you look very carefully. When they are eating the cotton plant the leaves turn yellow and then red. Spray with Thiodan EC or Gusathion A+. For 1 hectare mix 1 litre of poison with 200 litres of water.

► Stainers. These insects make the cotton bolls turn a brownish colour. Spray them with Gusathion A+. For 1 hectare, mix 1 litre of Gusathion with 200 litres of water.

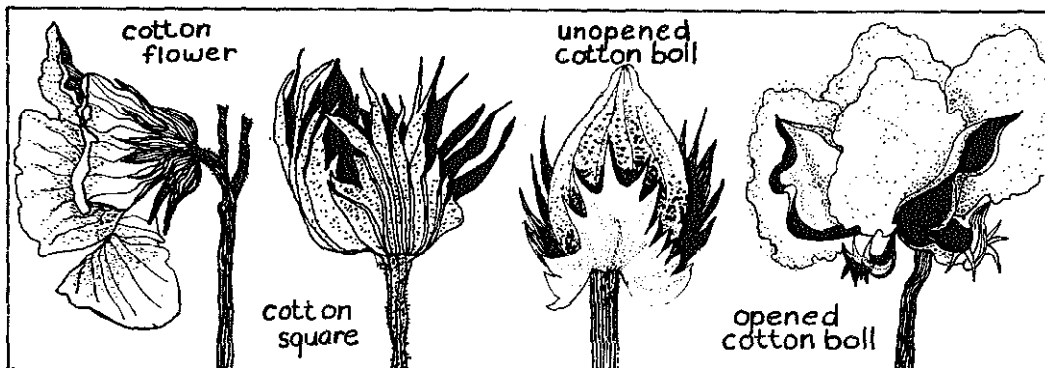

Irrigation

Cotton is a good crop to grow on irrigation schemes. It needs about 25mm of water a week. If you irrigate cotton, you must use urea fertiliser at planting time and again six weeks after planting. Ask your extension officer what other fertiliser you need for your soil.

Harvesting

The cotton bolls will be ready to pick about 4 months after planting. Pick the bolls as soon as they open. Do not wait for all the plants to be ready

before you start picking. If you wait too long, some of the bolls will fall off.

Marketing

After picking, sort out the dirty bolls from the clean ones. Put the dirty bolls and the clean ones in different bales.

Bales weigh about 160kg each, so transporting to the factory can be a big problem. Sometimes factories collect the bales if many farmers in one place grow cotton.

You can't eat cotton but it can bring you a profit

Aaron Rakona lives near Metz in the Eastern Transvaal. He started growing cotton two years ago. He also grows gem squashes, mangoes and oranges which he sells at the Johannesburg market.

● Why did you start growing cotton?

My friend told me that cotton was a good crop for summer times, better than mealies. He said you can't eat cotton, but it can bring you a profit. So I took his advice last year. I had about 15 hectares of cotton. The rain at the beginning wasn't so good and I couldn't irrigate it because that place was dry. But during February we had good rains, my cotton came up. The first bolls, I lost them but I managed to harvest about 8 bales.

● How do you prepare the land?

The first thing before summertime we subsoil the land and then rip, and then later we go back to plough the land, and disc it for the seedbed. Then we take a sprayer by tractor, we take the medicine that the cotton suppliers recommend and we spray the ground so that no weeds will come up - by the way, it's called weed control. On the first rains, after 15 October, we plant the cotton. We irrigate first and then plant.

● What seed do you use?

We use a bag of seed per hectare. The seed comes from the cotton mill. It costs R70 a bag. We don't have to pay for the seed. They take it off from our money when we sell the cotton to the mill. They also give us fertiliser. We use six pockets per hectare.

● So you thin the cotton plants?

If you plant it very thin it sometimes doesn't come up. We don't want to risk that, so it is better if it's more and then you thin it up. We thin them about 3 to 4 inches apart so they become nice. After thinning you skoffel between the rows.

● How much do you irrigate?

My machine stays in one place for 1½ hours, so that's about half an inch of water. If it rains I don't need to irrigate.

● And when do you start spraying?

Just when it is about 2 weeks old. We use insecticide provided by the mill. This is to kill the American Bollworms, the small things behind the leaves of the cotton. They make the cotton very thin. After the first spraying, we spray every week or every fortnight. We carry on spraying until the cotton is starting to flower, after 3 months. After another 90 days we can start to harvest the cotton.

● Who does the harvesting?

Harvesting is a big job. We get womer, and we pay them 4c for every kilo. We give them a contract when they pick cotton. We use the plastic crates to pick it in, then we weigh it and load it straight onto a trailer. Some of the womer make up to 70c a day. I transport the womer every day - it is about 7 miles from their home to my lands. I do a lot of travelling and that is why the government have given me a permit for petrol.

● What yield do you expect this year?

Last year I got 4 bales per hectare. A bale weighs about 200kg. The cotton mills weigh it, grade it, then give me the price. They give me the picking costs to come and pay my workers

and the other money they keep to cover up the expenses for me - seed, fertiliser and insecticides. Last year I got about R76 a bale. The price was 38c a kilo. This year it is around 40-42c.

● So you think that cotton is quite a profitable crop?

Really I don't have the wish of growing mealies in the summertime. I have a wish for cotton because I've seen with cotton it's very simple and you can even do it if you haven't got enough funds. The company will finance you and then you can make a profit.

● Is there anybody else working with you?

I am working with my son. He's a teacher but he only comes to help me during the holiday.

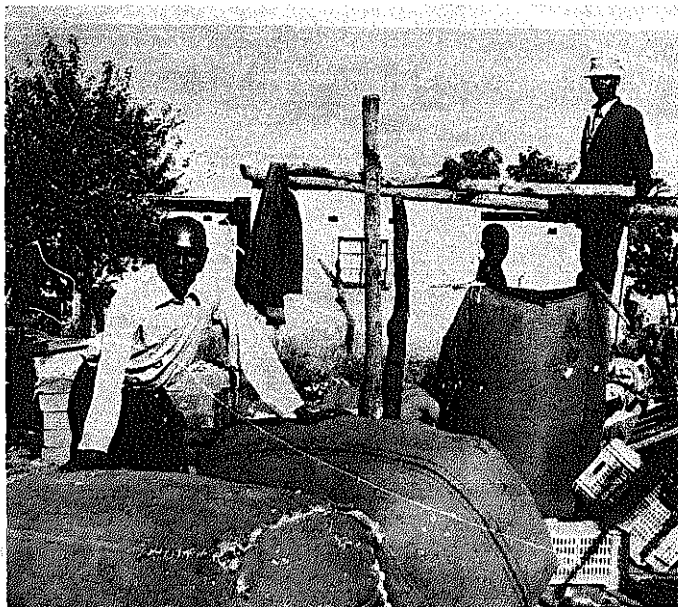

Tobacco



Tobacco can grow anywhere in Southern Africa where there is enough rain for maize and no frost from July to March. Most small farmers cannot grow tobacco to sell to cigarette factories because the factories need a tobacco which is cured (dried slowly) in heated flue barns. Small farmers grow tobacco for snuff and for smoking in pipes. It can be cured more easily than cigarette tobacco.

Seeds

Many small farmers use their own seeds. If you buy seeds use Piet Retief or Groot Swazi for smoking tobacco and O.S.B. for snuff.

Preparing the Seedbed

Tobacco must be planted in seedbeds and then transplanted in fields. Plant the seeds in August and then transplant to your field in October. If you make 10 seedbeds, each 1 metre wide and 10 metres long, you will have enough plants for 1 hectare. Make your seedbeds in a sunny place where there is well-drained soil.

You have to make a fire on top of the seedbed before planting to kill diseases in the soil. Put on branches or maize cobs as high as your knee to make the fire. After the fire has burnt to ashes, take away the ash and use it on your compost heap. Make sure there are no weeds in the seedbed, or growing near it. Rake the seedbed very well and protect it from the wind. Fertilise each 10 sq metre seedbed with 1kg of 2:3:2 fertiliser. Rake the fertiliser into the soil just before planting the seeds.

Tobacco seeds are very small. Mix one level teaspoonful of seeds into a watering can full of water and sprinkle the water over each 10sq metre seedbed. Another way is to mix the teaspoonful of seeds with two handfuls of fine mealie meal and scatter the mixture on each seedbed by hand.

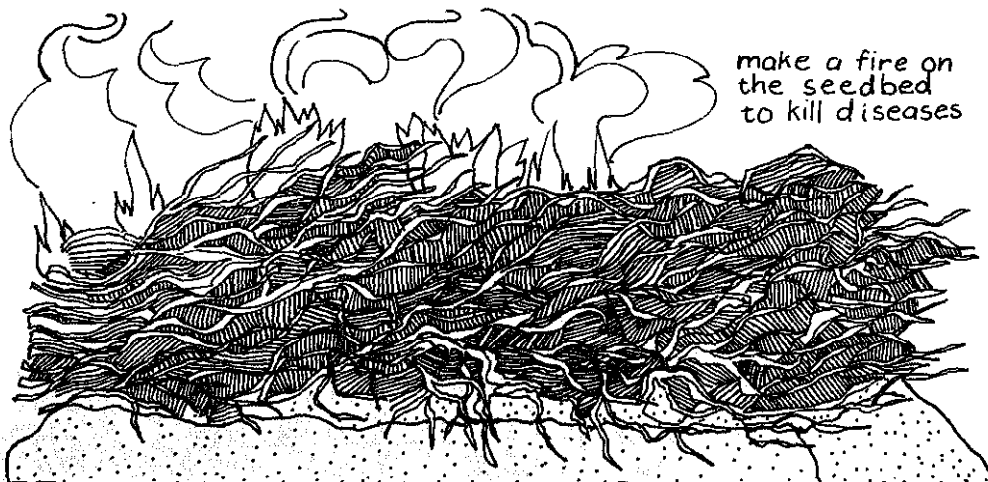

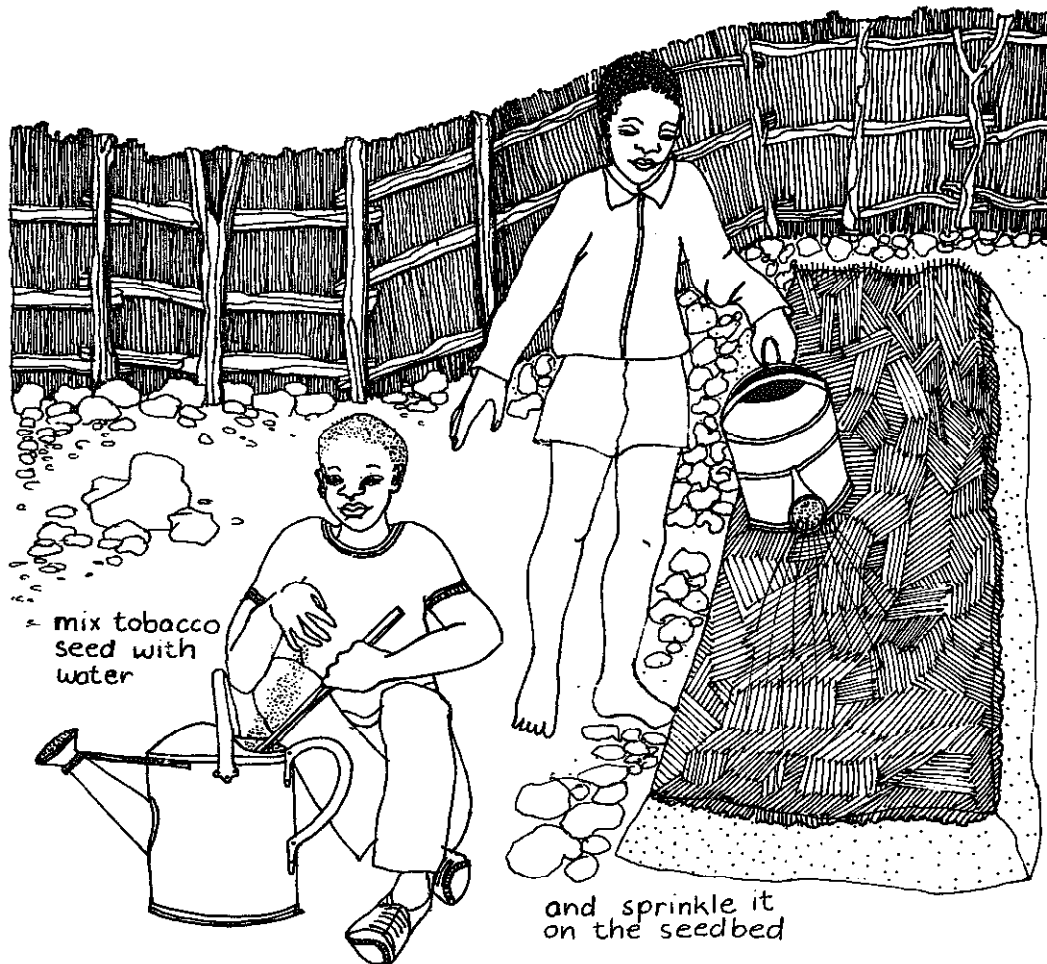

mix tobacco
seed with
water

and sprinkle it
on the seedbed

Do not rake the seed in. Let it lie on top of the soil. Water the seedbeds twice a day. Do not make them too wet otherwise the tobacco will get disease.

Fertilisers

If your soil does not have enough phosphate, plough in 6 bags (300kg) of superphosphate per hectare at the time of planting.

Nobody knows which is the best fertiliser for small farmers who grow tobacco from their own seeds. We think that 2:3:4(27) chlorine-free fertiliser would be good to try out. Try using only one bag on a small part of your tobacco field, about 20m x 50m. If you

have cattle, you could put kraal manure on your tobacco field. Whichever fertiliser you try, make sure it does not have any chlorine in it, because chlorine can damage tobacco.

Pests and Diseases

Tobacco gets many pests and diseases. To control pests in the seedbed, poison them by spraying with Orthene every two weeks. Mix 20g of Orthene in 15 litres of water for each 10 sq metre seedbed. To prevent diseases in the seedbed, put on Captab 50% WP poison every two weeks. Mix 30g of Captab with 15 litres of water for a 10 metre seedbed. Start using Captab 3 weeks after the tobacco plants come up out of the soil.

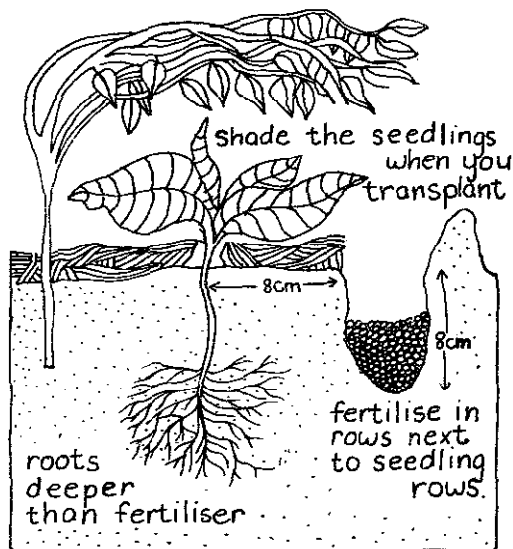

Transplanting

Transplant from the seedbed to your field after about 12 weeks. Make the rows 1,5 metres apart, with the plants 50cm apart in the rows. The young plants are easily damaged by the hot sun, so transplant them in the evening or early in the morning. Be careful not to damage the roots when you are transplanting. If you plant before the summer rains, give each plant 2 litres of water when you transplant.

Weeding

Take out the weeds as soon as they start to grow. When the plants are growing well, weed in between the rows but be careful not to damage the tobacco roots.

Irrigation

If you grow tobacco in an irrigation scheme, make sure the water does not contain a lot of chlorine.

Harvesting

Tobacco is ready for harvesting about 2½ months after transplanting. When a quarter of your tobacco field has flowered, cut off the tops of all the plants. This makes the leaves grow bigger. Cut off new stems when they grow.

Harvest the tobacco when the leaves closest to the ground start getting brown patches on them. Every 2 weeks about 6 leaves will be ready to pick.

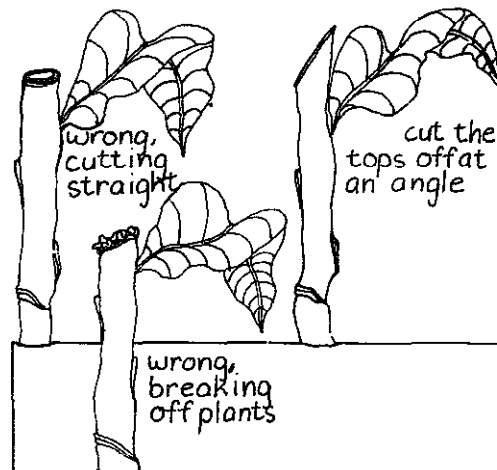

Curing

Curing means drying the tobacco slowly. Tobacco must be cured so that it burns properly when you smoke it, has a good flavour, and stays fresh for a long time. You can cure the tobacco by hanging the ripe plants close together in a barn so that the leaves just touch each other. Let them dry slowly until the stalks in the middle of the leaves are dry. This can take up to 8 weeks.

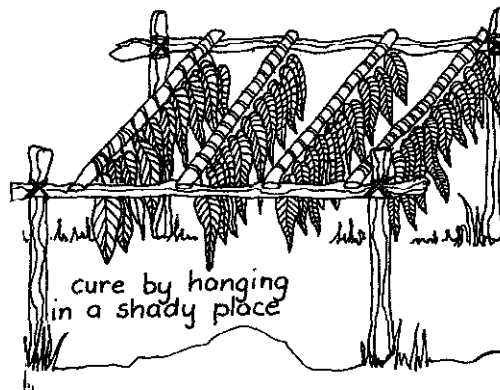

Crop Rotation

Grow tobacco in rotation with crops like maize or sorghum. It is not good for rotating with potatoes, tomatoes or pumpkins because these vegetables can give diseases to tobacco.

People take this tobacco and sell it on the mines

Elliot Sifumba grows tobacco in his garden. He lives at Matakana in the Herschel district of the Transkei.

and I get about R100 a bag. The men who go to work on the mines like this tobacco too much. When people from this place go to the mines they take this tobacco with them and sell it there. It's my best crop.

● Where do you get your seed from?

After I came from Johannesburg I got a cup of seed from my mother-in-law. After that the tobacco made its own seed and every year I keep some.

● How do you grow tobacco?

You have to plant the seed in seedbeds. You must dig and rake the

seedbed very well and give it lots of water. I liked to transplant the tobacco in November. I plant them one foot apart and give them lots of water. I cut the tobacco four times in the year. After flowering, I cut off the whole plant, and then it grows again. Every time after I cut I take out all the weeds.

● How do you cure the tobacco?

I take off the leaves and dry them in the sun for one day. Then I put them in a bag for three days. After that I hang them up inside my house for about a week. Then the tobacco is ready for selling.

● When did you start growing tobacco?

I started in 1961, when I came from Johannesburg. I worked in Johannesburg for more than twenty years as a carpenter and builder. Now I am a farmer here and I do some building work.

● How much land do you have?

At my home I have a small garden. This is where I grow the tobacco. I also have 5 hectares of fields and I grow maize, sorghum and beans. I can't grow tobacco in the fields because it takes too much water. Here at home I have my own windmill so I have enough water for the garden.

● What kind of tobacco do you grow?

This is tobacco for pipes. They all like it. It is easy to sell it



Sugar Cane

Sugar cane grows well in hot wet places like Natal and the Eastern Transvaal. Many farmers like sugar cane because:

- ▶ It is not easily killed by drought or diseases.
- ▶ You plant it only once every ten years.
- ▶ You can plant it and harvest it for long periods during the year.
- ▶ It is a good crop for growing on hills because it does not need ploughing every year.
- ▶ It can grow on many different soils.

The disadvantages of sugar cane are that it needs lots of hard work and farmers must sell the cane to a sugar factory, which controls the price.

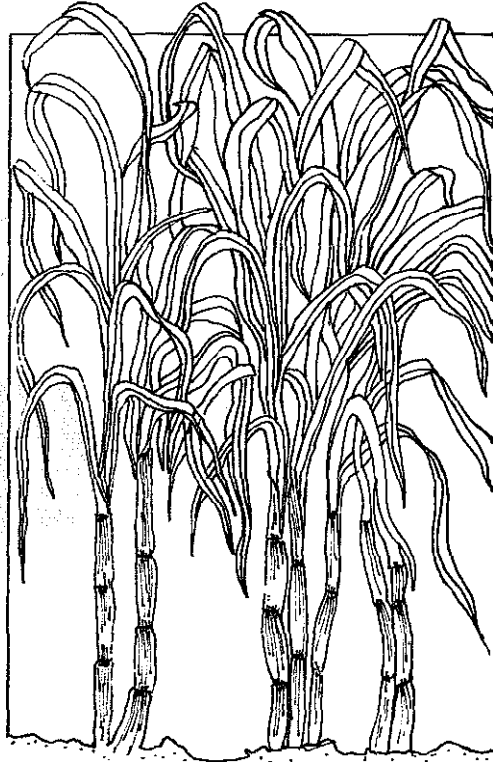

Seeds

Sugar cane grows from pieces of cane stem about 30cm long called setts. The Sugar Association at Mount Edgecombe (see p 515) will advise about the best kind to grow in your area. You can get setts from other sugar growers. Make sure you buy from a good sugar farmer, otherwise you might buy setts which have diseases.

Land Preparation

Land preparation must be good because sugar cane grows in the same field for 10 years. Prepare the land by ploughing twice and discing twice with a tractor. You can use oxen instead of a tractor, but you need a full team of strong oxen. Try to finish ploughing 6 weeks before planting.

Sugar cane is easily damaged by fire and many farmers lose their whole crop because of fires. To prevent veld fires from spreading to your sugar cane you must make a fire-break all around your field. A fire-break is a path as wide as a road with no grass, trees or dry crops growing on it. You can grow crops like beans, pumpkins, or sweet potatoes because they do not catch fire.

Fertilisers

Ask your extension officer if your soil needs lime or superphosphate. Put on fertiliser when you plant. You can help to fertilise the soil by adding filter cake, which is left over when the sugar has been taken out. You can get filter cake cheaply from the sugar mill, but transport may be expensive.

Put on a top-dressing of 5:1:5 fertiliser 6 weeks after planting. Use 300kg per hectare.

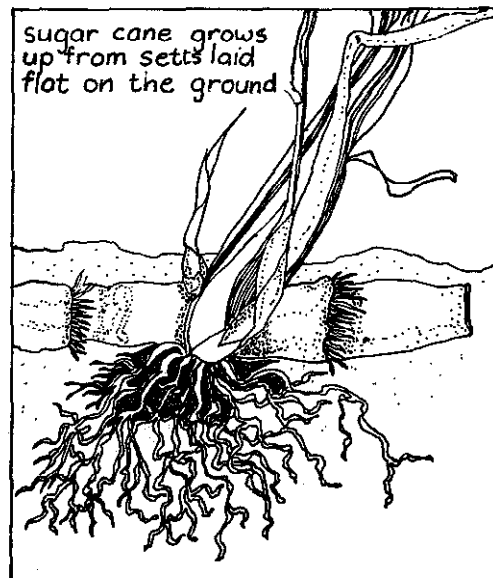

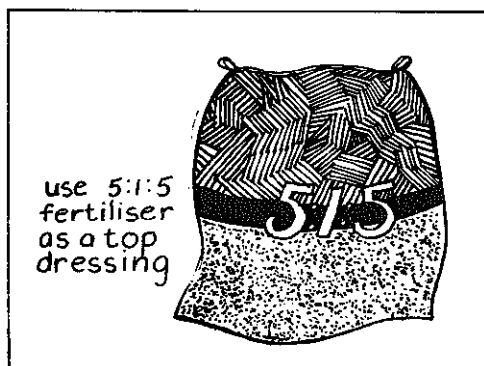
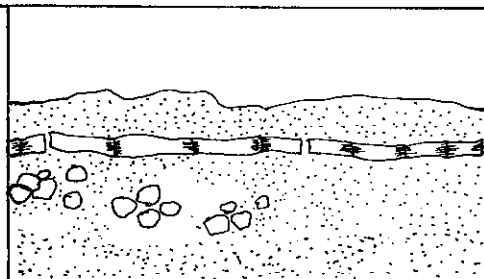
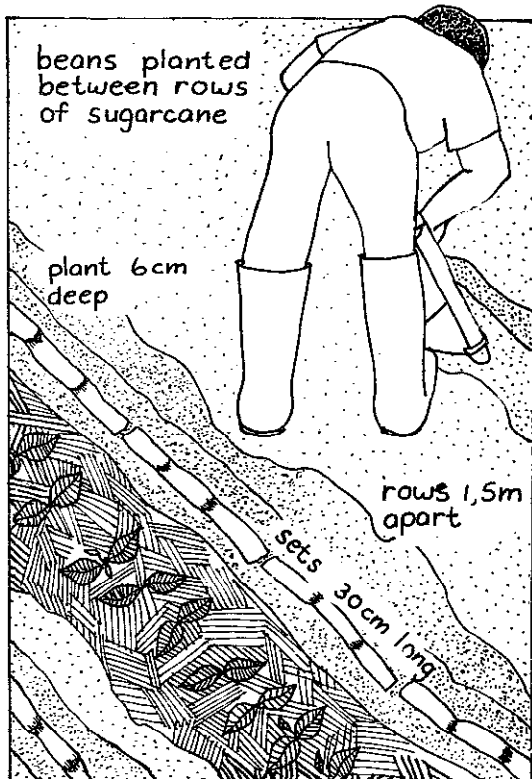

Planting

You can plant any time from September to March. Make rows 1,5 metres apart with a hoe or plough.

The day you get the cane for planting, cut the setts with a sharp knife dipped in Dettol, and dip them in a mixture of hot water and medicine which you get from the sugar mill. This is called heat treatment. If you are growing sugar cane for the first time, find out how to do heat treatment from an experienced sugar farmer.

Plant the setts 6cm deep in a long line so that all the ends touch each other. If your soil is not good, or if the setts are not from good quality cane, plant them so that the ends cross over each other.

Weeding

It is very important to take out all the weeds, especially when the sugar cane is young. Later the cane shades weeds so they cannot grow.

Pests and Diseases

The best way to control pests and diseases in sugar cane is by ploughing and planting properly and using setts from good sugar cane.

The worst diseases are smut and ratoon-stunting. Smut is when a long, thin silver coloured shoot with black spots grow from the top of the sugar cane. You can stop it from spreading to your whole field by cutting the tops off all the diseased cane and burning them.

Ratoon-stunting makes the sugar cane weak but it does not die. You can only see it after two or three years when you have finished all the work of ploughing and planting. You cannot get rid of the disease once the plant is growing. You can help to prevent ratoon-stunting by heat treatment before planting.

You must fence your field until the cane is one year old, because cattle like to eat young sugar cane.

There are many insects which attack sugar cane.

▶ Numicias are small green insects which suck the leaves and make them turn yellow. Get rid of them by poisoning with Thiodan. For 1 hectare use 30kg of Thiodan powder, sprinkled onto the leaves.

▶ Stalkborers are worms which eat the stems of the cane. The worms come out of eggs laid by white moths in the place where the leaves join the stem. When you see the moths put on Thiodan (see p 123).

Harvesting

The first harvest can be about one year after planting. You can harvest from May to December. After this you can harvest the sugar cane every 18 months.

Cut off the cane at the bottom with a caneknife. Then cut off the leaves and the tops of the cane. Spread out the leaves and tops in between the rows to make a mulch to fertilise the soil. Green tops can be used for cattle food.

Some farmers burn the cane before harvesting. Burning helps to kill pests and diseases and makes the cane easier to cut. The problem with burning

is that you must deliver all the sugar cane to the mill straight after burning and harvesting. If it arrives at the mill more than 2 days after burning you will get a lower price.

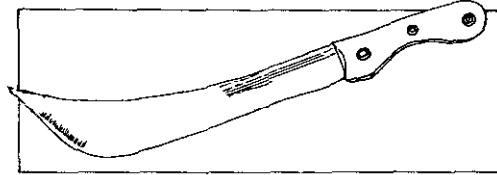

After cutting the new crop starts to grow straight away. You can improve the new crop by top-dressing with 5:1:5 fertiliser as soon as it is starting to grow well. Use 300kg per hectare.

The Sugar Mill

To sell sugar cane you must first sign a contract with a sugar mill. The mill will give you a quota. This tells you how much cane they will buy from you, so that you know how much to harvest. They pay different prices depending on how much sugar is in the cane.

The mill tells farmers when to deliver their sugar cane. Farmers take the cane to the loading zone and trucks from the mill collect it from there.

Trees



People need trees for food, for building, firewood and for shade. Trees also give shade and food for animals. Growing trees is important for small farmers because:

- Trees can grow on hills and in rocky places.
- Trees are not easily killed by drought because they have roots which can get water from deep in the soil.
- Trees stop soil erosion and improve the soil.
- Trees can be planted to protect fields and houses from the wind.

But there are many reasons why tree farming is not easy for small farmers. People only want to plant trees if they feel settled on their land. Most trees take a long time to grow. Fruit trees take at least two years before

they get fruit. Most people in South Africa can not own land and they are not sure when they are going to be moved to another place. They can not take their trees with them.

Some villages grow trees for everyone to use for firewood. This needs the whole village to work together to get the land, plant the trees and put up fences to protect the trees against goats. Everyone in the community has to agree about sharing the work and sharing the wood or the fruit when the trees grow.

In this part of the book we talk about growing your own trees for fruit and nuts, growing food for animals, and growing trees in a village woodlot for firewood.

Planting Fruit Trees

Before you plant, work out where to plant. Fruit trees grow big, up to 10m high and 7m wide in their branches and roots. Try to plant them in a place where they can grow to their full size. Do not plant too near a house or the trees can damage the foundations of the house and make too much shade.

When to plant

For trees which lose their leaves in the winter like peaches and grapes, plant in the winter. For trees which do not lose their leaves, like mangoes and oranges, plant at any time of the year, but summer is best.

Spacing trees

Before you plant, work out how far apart the trees will be:

- ▶ Plant trees like peaches, plums, apricots, figs, guavas and pawpaws about 3m away from each other.
- ▶ Plant citrus, mangoes and nut trees 7m away from each other.
- ▶ Plant avocados 10m away from each other.

Digging holes

Dig a hole 60cm square and 60cm deep about 4 weeks before you want to plant the tree.

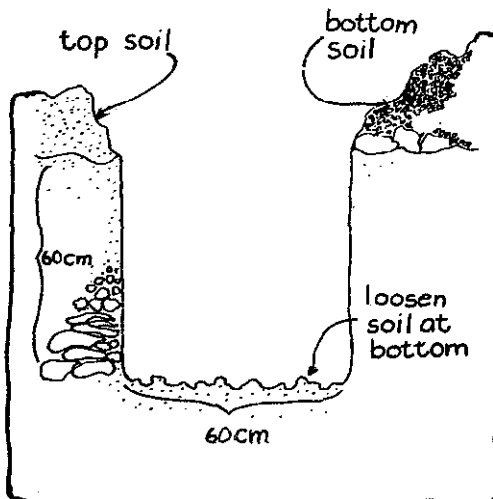

The hole must be square so that the roots will grow towards the corners and then spread out into new soil. If the hole is round, the roots will grow round in a circle and the tree will not grow well. Dig out the top 30cm of soil and put it on one side of the hole. Then dig out the bottom 30cm of soil and put it on the other side. Loosen the soil at the bottom of the hole.

Then mix the top soil with half a wheelbarrow full of compost or manure and put it into the bottom of the hole with top soil from another place. Use the soil from the bottom of the hole to make a dam around the tree to keep in the water. Water the hole for a few days before you plant the tree.

If you make the hole when you plant, do not put in manure or compost. Rather put the manure or compost on top as a mulch.

Planting

Trees come from a nursery in plastic containers or with bare roots from open ground. If the tree comes in a container, take off the plastic, and keep the soil around the roots when you plant. Stand the tree in water for about 2 hours before planting. Plant the tree in the hole as deep as it was growing before. You can tell this from the soil mark on the trunk.

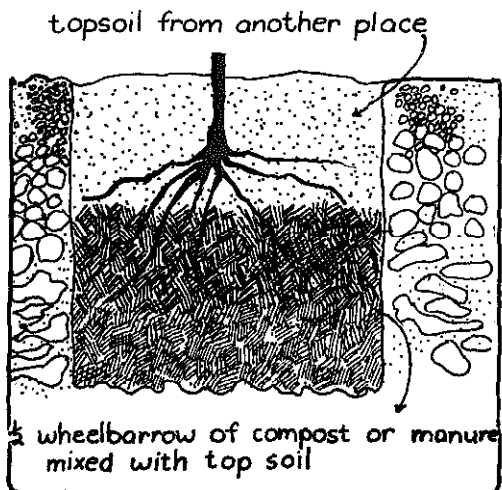

If you got the tree with bare roots some of the roots may be split or damaged. Cut these off with sharp clippers. Spread the roots out sideways from the trunk. Put two or three spades of soil on top of the roots and then shake the trunk so that the soil fills up the places between the roots.

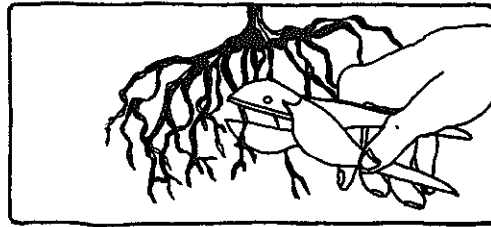

Tramp the soil down well, making sure the tree stays up straight.

Fill the dam round the tree with water and then fill it up with a mulch of dry grass and leaves. Do not let the mulch touch the trunk of the tree otherwise the stem can get diseases from the wet mulch.

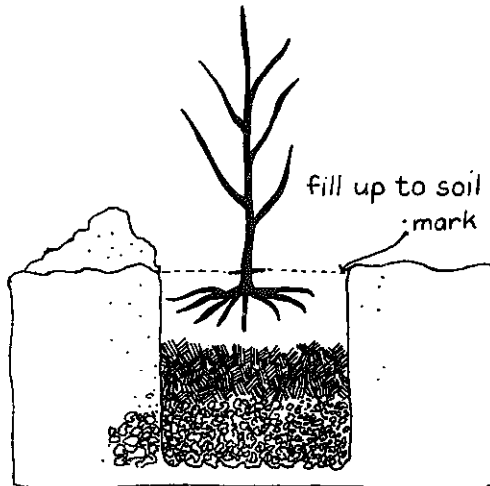

Looking after young trees

Every 3 months, put on 2 or 3 spades full of compost or manure as a mulch, or put on a 500ml tin full of fertiliser like 2:3:2. Spread the compost or fertiliser on the ground as wide as the leaves are growing.

Every week for the first year, give your trees 2 buckets of water. After that, water them every 2 weeks unless there is a lot of rain. Some trees, such as citrus, need a lot of water. Water them every week. It is better to give trees a lot of water once every week than a little every day.

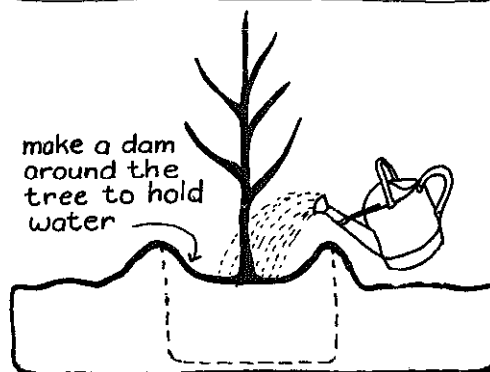

To help the tree grow up straight, tie it to a strong stick pushed into the ground. Protect the trunk of the tree with a piece of cloth or rubber, and do not tie the string too tight.

Using cuttings and pips

Grapes, figs and mulberries will grow if you cut off a young branch and put it in warm wet soil. Choose a strong branch and cut it just below a bud and push it halfway into the ground (in the same way as cassava p164).

All trees grow from pips but trees planted from pips take a long time to get fruit. It is not good to use pips from nursery trees because nursery trees are grafted and the trees which grow from their pips will have weak roots. Rather use pips from old strong trees.

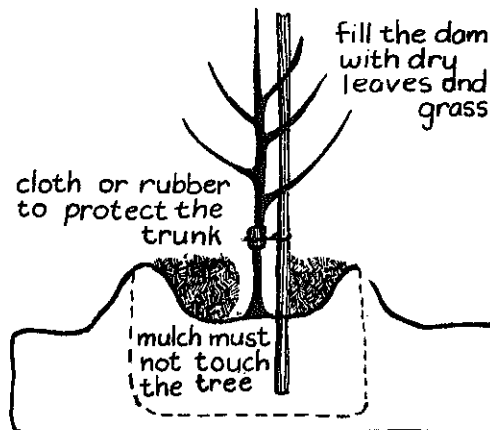

Pruning

Pruning is cutting some branches off a tree so that others will grow better and will get enough sun. Pruning fruit trees which lose their leaves in winter like apples, peaches and pears, makes them healthier and they give better fruit. Prune these trees in winter when they have no leaves and no fruit. Always prune on dry days because on rainy days, the trees can get diseases more easily.

What you need

- ▶ Secateurs - for cutting off small thin branches.
- ▶ Saw - for cutting off big branches.
- ▶ Jik or Jeyes Fluid - for washing the secateurs and saw after pruning each tree. If you prune a tree with a disease without washing your tools, the disease will spread to the other trees.

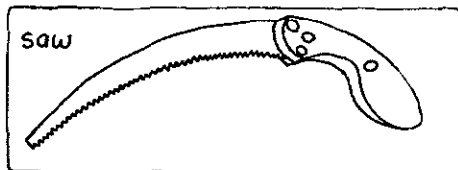
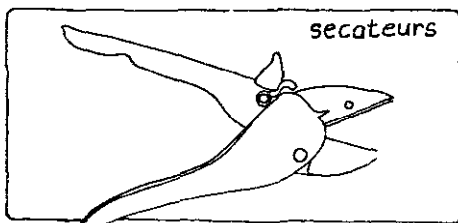

How to cut

Never break off a branch. Always use secateurs or a saw. Cut off thin branches sideways just above the bud.

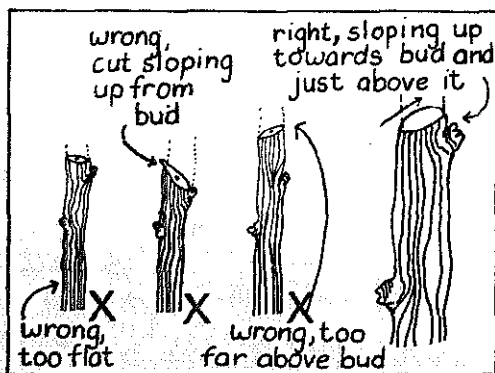

When you cut off a thick branch, cut about 10cm from the trunk, at an angle so that water can run off. If you cut too far away, the remaining piece of branch can get a disease and the tree can die. If you cut too near, you will damage the bark of the tree.

Do not cut off a thick branch with one cut. If you make one cut from underneath, the saw will get stuck. If you make one cut from the top, the branch might break and tear off some bark. The right way to cut is with 2 cuts, like this:

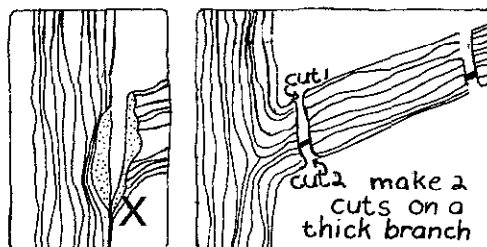

To stop the tree from bleeding and getting a disease, put tree sealer on the place where you have cut off branches. You can buy tree sealer like Africol Tree Wound Paste or you can use the thick glue which comes out of pine and blue gum trees. Never use ordinary paint.

Planting and Pruning

Trees are weak after you plant them because their roots take time to get used to the new place. It helps the roots to grow strong if you prune the tree after planting. Cut off the top of the tree and all small thin side branches, but do not cut off thick strong branches.

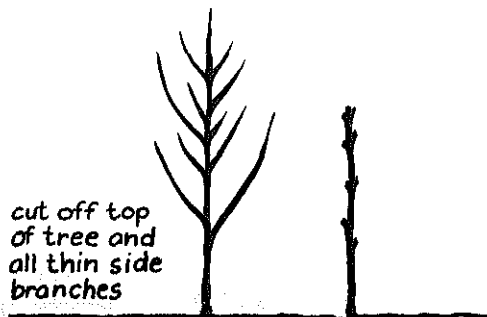

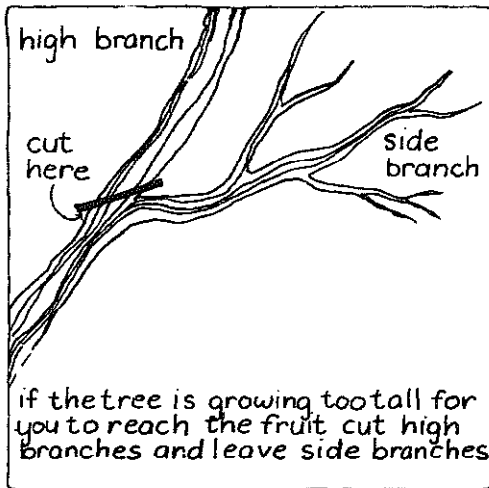

Pruning in the First Winter

During the first winter after planting leave the 3 or 4 strongest branches and cut off all the other branches. The strongest branches will have small branches growing on them. Leave one small branch every 30cm and cut all the others off. The tree should be pruned so that it will get sun on all its branches.

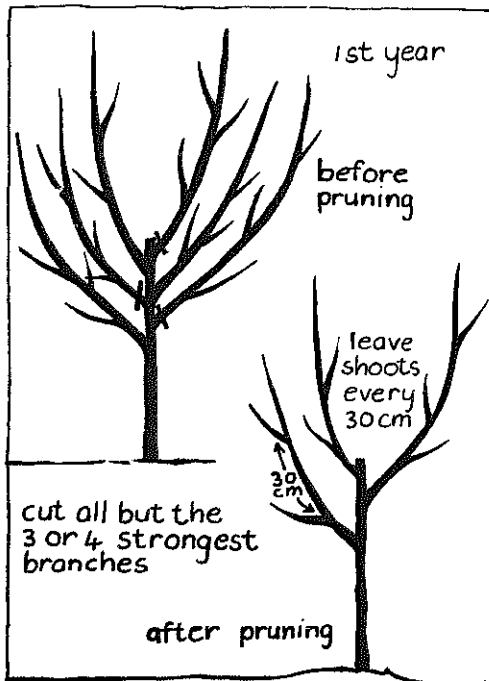

Pruning in the Second Winter

Cut off all the small branches lower than your knee and all new branches growing towards the middle of the tree.

Pruning in the Third Winter

Cut off all dead branches and all new branches growing in the middle of the tree.

Prune like this every year until the tree has stopped growing. After this, prune only if the tree gives lots of small fruit. Pruning will help to produce less but bigger fruit.

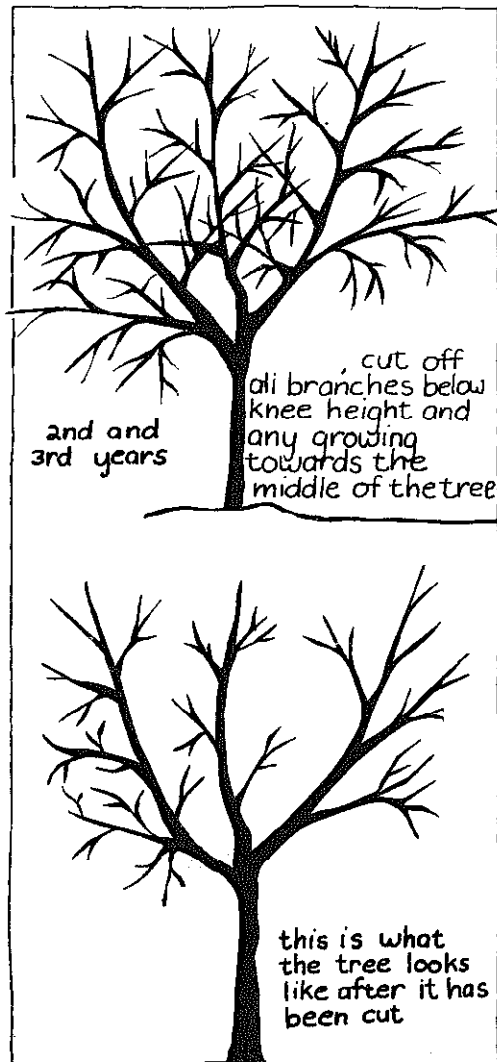

Apples

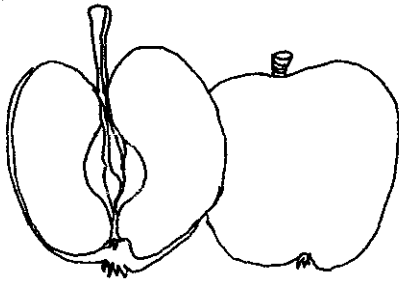

Apples grow best in places where the winters are cold. They can grow in any well drained soil.

Varieties

For apples to grow well, you must plant 2 different varieties in the same place. If you plant only one variety, the trees will usually get flowers but no apples.

These varieties grow well in cold places:

Dutch Striped - can grow by itself, ripens in March.

Golden Delicious - ripens in March. Plant with Starking or Granny Smith.

Granny Smith - ripens in April. Plant with Golden Delicious.

Starcrimson - ripens in January. Plant with Granny Smith or Golden Delicious.

Starking - ripens in January. Plant with Golden Delicious or Granny Smith.

Ohenimuri - Starking or Golden Delicious

Rome Beauty - can grow on its own

These varieties grow well in warm places:

Ohenimuri - grows in warm or cold places, ripens in March. Plant with Starking or Golden Delicious.

Rome Beauty - grows by itself, ripens in March.

Tropical Beauty - ripens in January. Plant with Rome Beauty.

Planting

Plant apple trees in winter.

Pests and Diseases

Apples have many pests and diseases, but it costs a lot of money to treat them with poisons. Pests and diseases are worse in warm areas. If you do not have enough money for poisons it is better not to try to grow apples in warm areas.

Pruning

In the first year, leave 3 or 4 strong branches and cut all the others off. See Pruning p186.

Picking

Pick the apples before they are ripe. They are ready to pick when they are easy to twist off. The apples on the top and sides will be ready before the ones in the middle. Store them in a dark dry place. Feed rotten apples to pigs or use them for compost.

Peaches

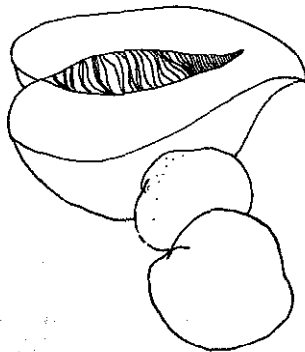

Peaches can grow everywhere in South Africa. The best peaches grow in places where the summers are hot and

the winters are cold. They need well-drained soil, and they die if the soil stays wet for a long time after rain.

Varieties

There are three kinds of peaches - white, yellow and yellow clingstone.

White - The best varieties for places where winters are not very cold are Boland, Earlibelle, Killikrankie (good for hot places) and Rhodes. The best varieties for places where the winters are very cold are Babcock, Culembourg, Early Dawn and Van Riebeeck.

Yellow - For places where winters are not cold, the best varieties are Du Plessis, Ingwe and Safari. In places where winters are cold grow Clocolan, Golden Amber and Jubilee.

Yellow Clingstone - For warm places, the best varieties are Kakamas, Keinios, Oom Sarel and Professor J. Neethling. For cold places, plant Elberta Cling, Imparani and Woltemade.

Planting

Plant peach trees in winter.

Pruning

If the tree is one straight trunk without side branches when you plant it, cut it off so that it is as high as your knee. Next winter, leave the 4 strongest branches and cut the others off. These will become the main branches of the tree. If the tree already has side branches when you plant it, do not prune it until next year.

Prune peach trees every winter. Cut off all new branches underneath the 4 main branches. Cut off the new branches from the top 15cm of the main branches, but do not cut off the ends of the main branches. Leave

all thin branches which have three buds and cut off those which have only one bud. When the small peaches are as big as a fingernail, pick some of them off so that they are about 10cm apart. This will give you bigger peaches.

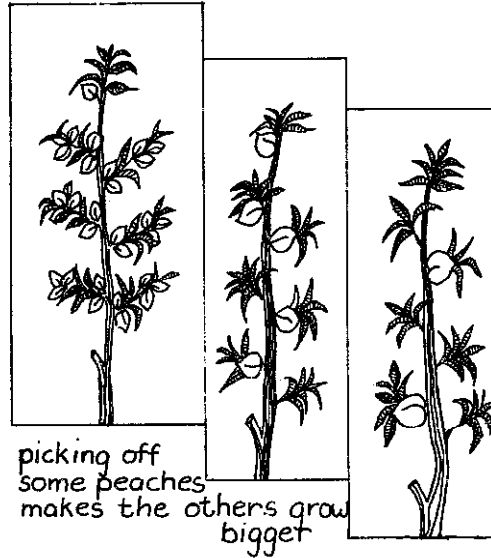

Harvesting

Peaches do not get ripe after they have been picked, so pick them when they are ready to eat.

Apricots

Apricots grow well in places where it is not very hot in summer and where there is not too much frost or wind in winter. They grow in any well drained soil.

Varieties

The best apricots for places with summer rain are the ones which get ripe in November and December like Alpha, Bulida and Peeka. In places with winter rainfall the best varieties are Early Cape, Piet Cellie and Royal.

Planting

Plant in winter. If the apricot tree has only one long trunk, cut it back so it is as high as your knee.

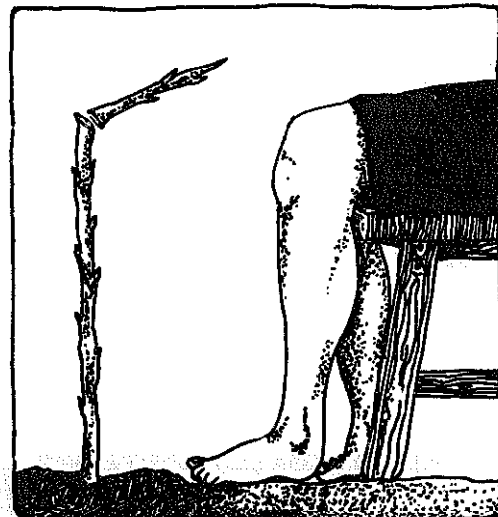

Plums



Plums are very easy to grow. They grow everywhere in South Africa where there is well-drained soil.

Varieties

Some plums grow best if you plant 2 different kinds together. Others grow well if you plant only one kind.

Varieties which should be planted together are:

Eldorado with Santa Rosa.
Mariposa with Methley or Red Ace.
Red Ace with Santa Rosa or Wickson.
Santa Rosa with Methley or Wickson.
Songold with Santa Rosa or Eldorado.

Plum trees which grow alone are:

Chalcot, Golden King, Harry Pickstone and Methley.

For places with cold winters, the best varieties are Red Ace, Santa Rosa and Songold.

Pruning and Planting

Plant in winter. Prune plum trees in the same way as peach trees.

Harvesting

Plums can be picked before they are ready to eat and will get ripe if you keep them in a dark place.

Pears

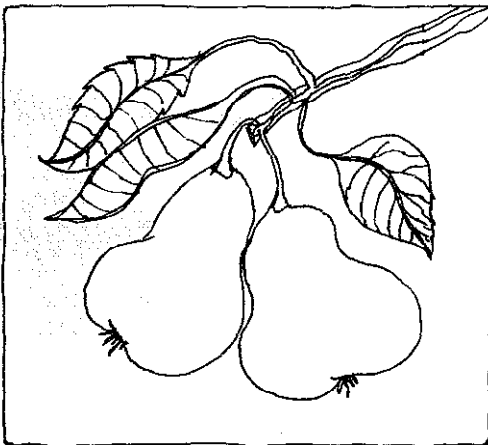

Pears grow best in places where the winters are cold and the summers are not very hot. They grow in any soil except very sandy soil which dries out too quickly. They do not grow well in alkaline soil (see Know Your Soil p 99).

Pear trees take six years before they start to give fruit.

Varieties

Plant 2 different varieties of pears next to each other so that you will get lots of fruit.

Beurre Bosc with Bon Chretien.
Clapp's Favourite with Packham's Triumph.
Comici with Bon Chretien or Beurre Bosc
Keiffer with La Conte.
Packham's Triumph with Clapp's Favourite or Bon Chretien.
Winter Nelis with Bon Chretien or Beurre Bosc or Packham's Triumph.

La Conte can be planted by itself.

The best varieties for warmer places are Keiffer, Packham's Triumph and La Conte.

Planting

Plant pear trees in winter.

Pruning

Prune in the same way as peaches.

Harvesting

You must pick pears before they get ripe. They will get ripe if you keep them in a dark place. If you leave them to ripen on the tree they will get soft and dry inside.

Nuts

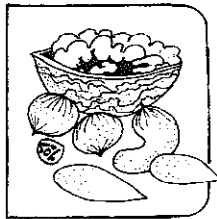

Nuts are very good food and can give you oil and protein. The most popular nuts from trees are almonds, pecans and walnuts.

Almonds

Almonds grow in places where the summers are not too hot and wet. They take 3 years before they get nuts. You must grow 2 different varieties of almond trees next to each other to get a big crop. These are the different varieties which grow well together.

Jordan with Non Pareil or Paper Shell (early).

IXL with Britz (late).

Drake's Seedling with Princess or Texas Prolific (late).

In very cold places, grow late varieties so that they will not be damaged by frost.

Pecans

Pecan nuts grow everywhere in South Africa where winters are not very cold and the wind is not too strong. They grow very big, with deep roots, so you should not plant them in rocky places.

The best varieties for the Transvaal are Chocton and Desirable. The best for Natal is Ukulinga. Pecan nut trees take about 5 years before they get nuts.

Walnuts

Walnuts grow well in any soil which is not too sandy or too brack (see Know Your Soil p 97). They grow best in places where winters are cold, but not where there is late frost. There is only one variety of walnut tree in South Africa. Walnut trees take about 7 years before they get nuts.

Planting

Plant nut trees in winter. For pecan nut trees, do not cut the roots but make the hole deep enough to fit the roots in.

Pruning

Pecan and walnut trees do not need pruning. Prune almond trees in the same way as peach trees.

Harvesting

Nuts are ready for picking when they start falling off the tree or when the shells start to crack open. Keep them in a cool, dry place and eat them when they are dry.

Mulberries

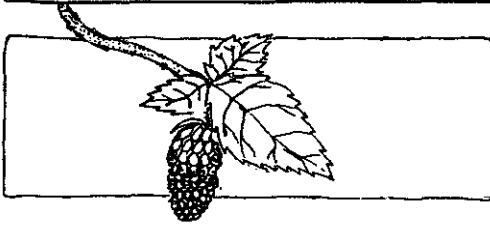

Mulberries grow well in all parts of South Africa where there is well drained soil. They are easy to grow because they do not need any pruning

and are not attacked by any pests or diseases. The mulberries are ripe when they are black and easy to pick.

Varieties

The Cape variety has big tasty mulberries but the trees do not grow very big. They grow well in warm places. English, which ripens early, and Queensland, which is fast growing, are best in cooler places.

Figs



Figs can grow almost anywhere. They need well drained, alkaline soils. If the soil is too acid, put on lime (see Know your soil p 97).

Varieties

In places where there is summer rain, the best varieties are Castle Kennedy, New Brunswick and Kadota. In places with winter rainfall the best varieties are Adam Fig, Cape Brown, Cape White, White Adriatic and White Genoa.

Planting and Pruning

See How to plant a tree. Plant fig trees in winter. Do not prune the trees for the first few years. After that, prune them a little every winter.

Harvesting

Pick the figs when they feel soft. Wait for the figs to get ripe on the trees, because they will not get ripe after you pick them. They are ripe when no white stuff comes out of the stem when you pick them.

Grapes



Grapes grow everywhere in South Africa. They grow best in sandy, well drained soils with lots of compost.

Varieties

The best varieties for summer rainfall areas are Barlinka, Bien Donne, Muscat Hamburg (good for dry places), Golden City, Earlihane, Pirobella, Queen of the Vineyard and Catawba. The best varieties for winter rainfall areas are Flaming Tokai, Alphonse Lavelle, Barbarossa and Catawba.

Planting

See How to plant a tree. Plant the grape vines next to a fence so they will grow up it. Make a heap around the trunk to protect it. Grapes need water all the year round. Mulch around the trunk to keep the soil damp.

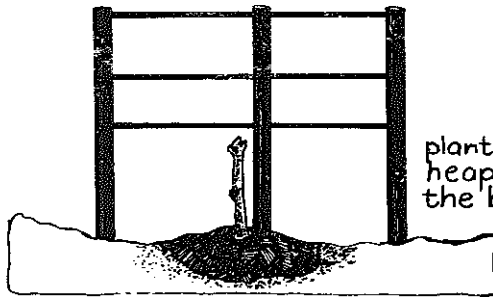

plant in winter
heap soil around
the bottom

Pruning

As soon as the grape vine has been planted, cut the top off so that there are two buds above the ground. Next winter, after the vine has been growing for one year, choose the strongest of the two branches and cut it off so that there are two buds left on it. Cut the other branches off as near to the trunk as you can. This will make the grape vine grow quickly.

Next summer, there will be two branches growing from the two buds. When the branches are 20cm long cut off the weak one and tie the strong one to a pole. As this branch grows, tie it loosely to the stake every 20cm, until it grows as high as you want it. Then cut off the top. Two branches will grow where you cut it. Tie these two branches to the fence. If you want more branches to spread out from these branches, cut them in the same way. The grape vine will stay in this shape if you prune it every winter.

During the first two years, leave only one bunch of grapes on the vine and cut all the others off. This will make the roots of the vine grow strong.

To make the grapes bigger and sweeter, cut some bunches off and leave the others.

Pick the grapes when they are ready to eat. They will not get ripe after they are picked.

pruning in 1st year

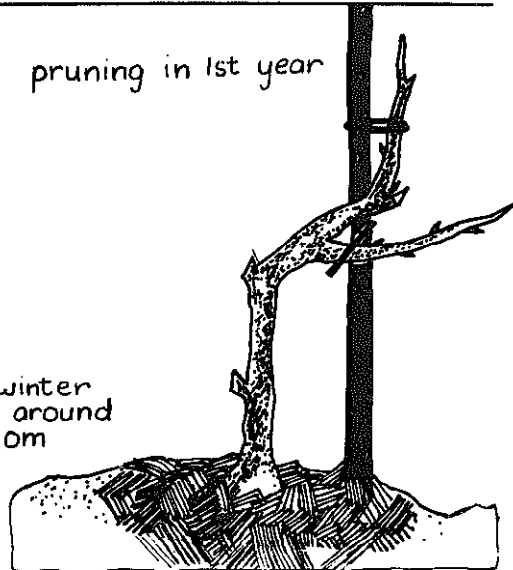

pruning in 2nd year



pruning in 3rd year

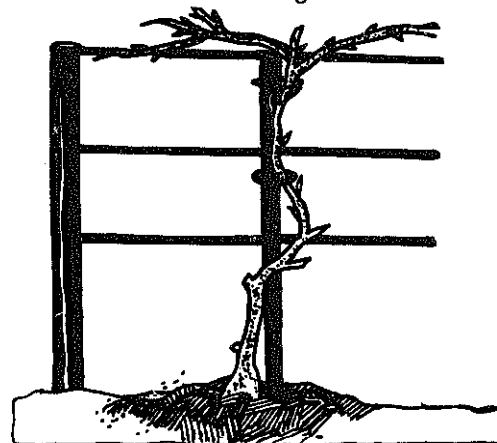

Selling is our biggest problem

Mr Mochubedu and his family live in Sekhukhuneland in the Eastern Transvaal. Most people in the area have been resettled into betterment villages at the bottom of the hills, but about thirty families have chosen to stay in the hills. There is a lot of rain and many strong springs. The soil is quite fertile and grazing land is good. There is much less erosion in the hills than in the betterment villages.

● Did you terrace the land?

No, most of the work was done by my father, but all of the children helped. When we wanted to plough the land we had to move all the stones away. The land was too steep so we built walls from the stones and then ploughed the soil against the stones.

● How did you know where to build the walls?

My father saw it somewhere. We built the walls across the hill and we made a place for the rain to run away. It was easy because we joined it up to the little stream from the spring. My father also built a little dam below the spring. The spring has water all the time, sometimes we water the fields from the dam. It is not enough to water the fields well, it just helps a bit when there is no rain.

The trees are just scattered about the land so it would be too difficult to water each one. We give them water when we give to the rest of the land.

● What fruit trees do you grow?

The most trees I have are peaches and grapes, about twenty peach trees and six grapes. They were planted by my father. When the old trees die I take trees which grow from pips on the ground. I plant them in a trench with manure. After two years I take the trees out in the winter and plant them in deep holes. I dig the holes up to here (waist). At the bottom of the holes I put flat stones and then I put in soil mixed with manure. The peach trees give me a good crop every year. The problem is that they are all the same kind. They all get ripe in January and February. Lots are wasted because it's hard to sell them all at the same time.

● What about grapes?

I am growing more grapes. I take cuttings from the old ones and plant them in the soil in July. It takes about 4 years before they get grapes. Grapes are easy. There's no diseases, it's only the birds and the sun can damage them. I put a bag on every bunch of grapes to protect it. The grapes get ripe at the same time as the peaches. They are easier to sell but it's a long way to carry them to the village.

● What other fruit trees do you have?

There are 2 apricot trees and 4 orange trees. We grow them from pips. The apricots get ripe in November and the oranges in July. We just eat them ourselves, we don't sell them so much.

● Do you use fertilisers and insect sprays?

No, whenever there is rotten fruit on the ground I dig it in, so I don't use any kraal manure. I spray them three times a year to stop fruit flies. I get the medicine from the co-operative in Burgersfort. I never prune the trees. They are 20 years old, but they are still well.

● Who picks the fruit?

Usually I sell the peaches on the trees - people come and buy them and pick for themselves. I charge R2,50 for a big box. This year there were not so many people coming to pick, so I shared the crop with sellers. They sell the peaches in the villages at 3 for 10 cents.

● What are your biggest problems?

Selling is our biggest problem. We are far away from people so it is difficult to sell. We can get 15 big boxes a year from each tree but we waste half of it because there is nobody to buy. Well we don't mind because it is still better living here. This land is fertile and we can live alright.

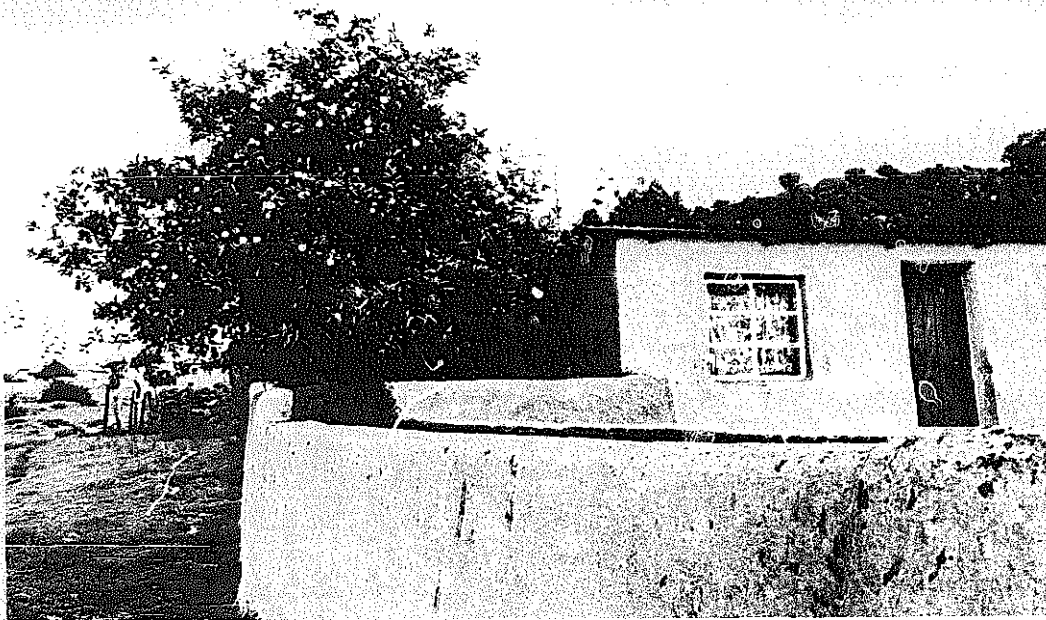

Citrus Trees



Citrus trees are oranges, naartjies, lemons and grapefruits. They grow in well drained soils in places where there is not much frost in winter.

Citrus trees need more water than other fruit trees. If there is no rain when they are flowering or when the fruit starts to grow, give them plenty of water every 3 weeks. Put a mulch (see p 36) round the bottom of each tree to stop the soil from becoming too dry.

Oranges

The best varieties are Palmers's Navel, Clanor and Valencia Late. Palmer's Navel is ready for eating in the beginning of winter, Clanor is ready in the middle of winter and Valencia Late is ready at the end of winter.

Lemons

The best varieties are Eureka (thin skin) and Cape Lemon (thick skin).

Naartjies

The best varieties are Cape Naartjie, Ellendale and Groenskil.

Grapefruits

The best varieties are Marsh's Seedless and Red Blush, which is pink inside.



Planting and Pruning

Citrus trees can be planted at any time of the year. Their trunks can easily be damaged by the sun, so wrap them in sacks or newspapers, or paint them with whitewash until there are enough leaves to shade them. Citrus trees do not need pruning, except for cutting off the dead branches.

Fertiliser

Fertilise citrus trees 3 times a year with 3:2:3 fertiliser, like this:

Year	July	December	March
1	100g	300g	500g
2	700g	900g	1,1kg
3	1,3kg	1,5kg	1,7kg
4	1,9kg	2,1kg	2,3kg
5	2,5kg	2,5kg	2,5kg

After 5 years continue giving 2,5kg of fertiliser 3 times a year.

You should also give each citrus tree 75g of Epsom salts 3 times a year.

Harvesting

Oranges are ready to pick when the skin changes from green or yellow to orange. Lemons and grapefruit are ready when the skin is yellow. Naartjies are ready when the skin becomes dark orange.

Collect all the fruit which falls off the trees and give it to pigs or put it in your compost heap. Do not leave rotting fruit on the ground because worms and insects will breed in it and spread to the fruit still on the trees.

Guavas

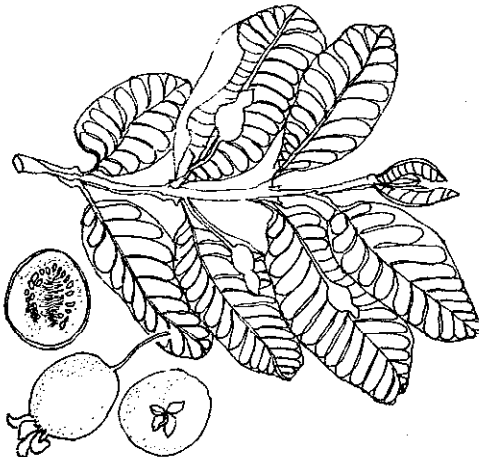

Guavas can be grown where there is no heavy frost in winter. They are rich in Vitamin C, which helps protect your body against illnesses. Guava

trees keep their leaves all the year round, so they are good for very hot places where you need shade in summer and winter.

Varieties

The best varieties are Fan Retief and White Guava.

Planting and Pruning

Plant guava trees at any time. In October, when all the guavas are harvested, prune the trees. Leave about six buds on each branch.

Harvesting

Guavas get ripe from May to September. They are ready to pick when the skins are yellow.

Mangoes

Mangoes grow well in hot dry places and they are not easily killed by drought. They do not grow in places where the winters are cold because young trees are killed by frost. They can grow in all soils, even stony and sandy soils where other fruit trees will not grow.

Varieties

You can buy mango trees from nurseries for about R1,50 or you can grow your own from a pip. It is better to grow your own because it will grow stronger and live longer, although it will take usually longer to get fruit.

If you buy mango trees from a nursery, you can get them with stringy or smooth pips. The best varieties with stringy pips are Sabre, Kidney and Peach. The best varieties with smooth pips are Haden, Kent, Zill and Fascell. You cannot grow good mango trees from smooth pips.

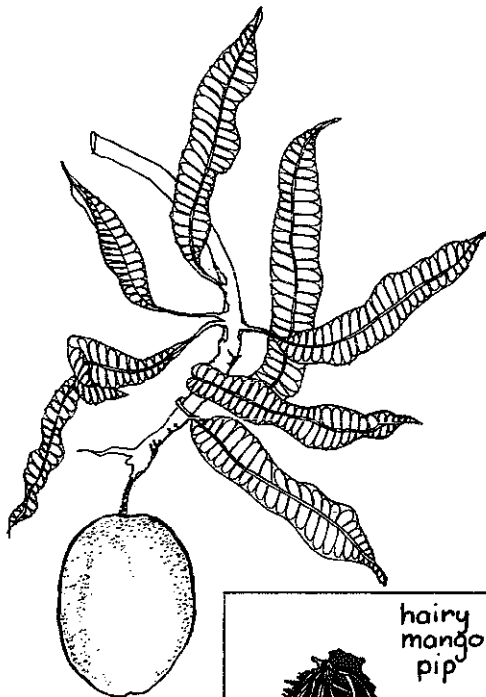

To grow mangoes from a pip, carefully take the hairs and the skin off the pip. Keep it in between two pieces of wet sack until it starts to grow. This will take about a month.

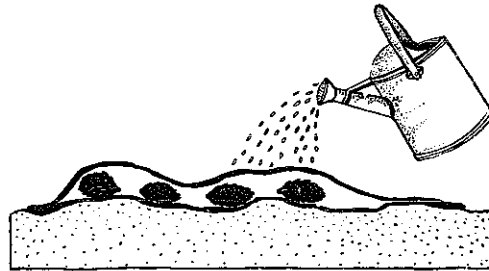

Then plant it in a plastic bag full of soil. Let it grow as high as your knee.

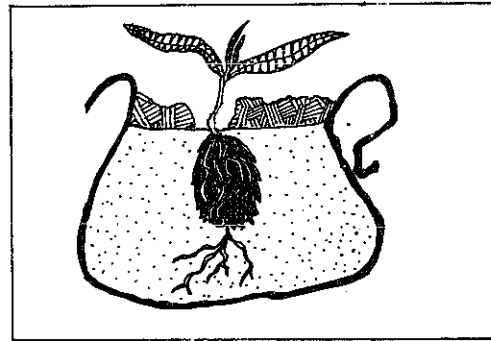

Then you can plant it in the ground (See Planting Trees). Plant it 10m away from the other trees, because they grow very big.

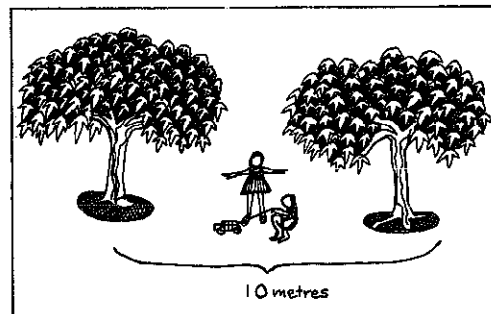

Harvesting

Pick mangoes after the skin starts to become orange. Do not pick too many at the same time because they get ripe after you pick them.

Avocados

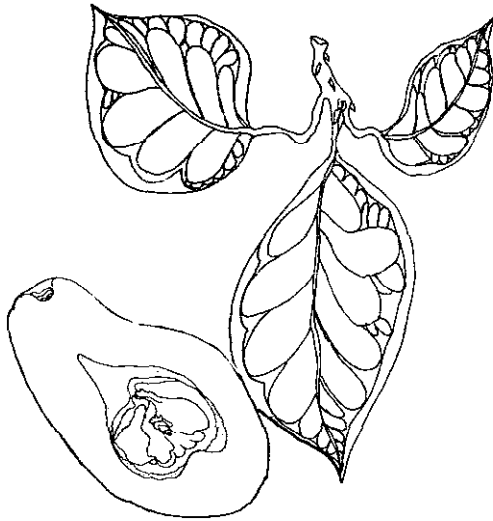

Avocados are good trees to grow because avocado pears are rich in protein and energy giving food. They grow best along the coast from Natal to the Eastern Cape and in hilly places in Natal and the Transvaal. They do not grow well in very hot or very cold places, because they are damaged by hot dry winds and frost. Avocado trees need well drained slightly acid soils (see Know your soil p 99) and lots of rain.

You can buy avocado trees from nurseries for about R3 or you can grow your own from a pip. It is better to grow your own because it will grow stronger and live longer, although it will take longer to get fruit.

Plant the pip in a plastic bag or a large tin filled with a mixture of soil and compost. Take the brown skin off the pip first and push it into the soil with the pointed end down and the flat end sticking out of the soil. Cover the soil with grass and water it every day.

When the tree is as high as your knee plant it in the garden. Keep the soil around the roots when you plant.

Varieties

It can take 10 years for avocado trees grown from pips to give fruit. If you buy trees from a nursery the best varieties are:

- ▶ Fuerte - which gives fruit from April to October.
- ▶ Edranol - fruit from July to August.
- ▶ Hass - fruit from August to December. Hass is a black-skinned avocado and gets fruit after 3 years.

Planting

Plant trees at any time. Dig the hole at least 4 weeks before planting. Avocado trees grow very big so plant them at least 10 metres from other trees.

Harvesting

You can pick avocados ripe or unripe. After picking, they get ripe in 7 days.

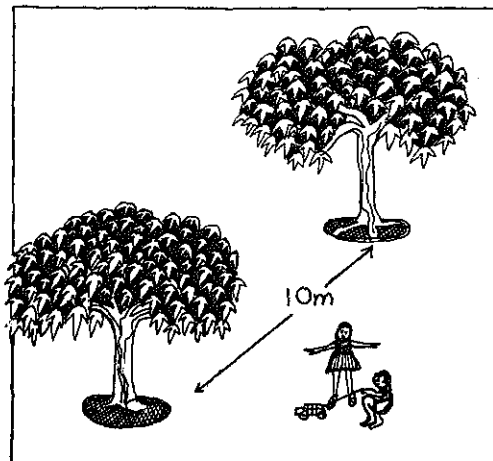
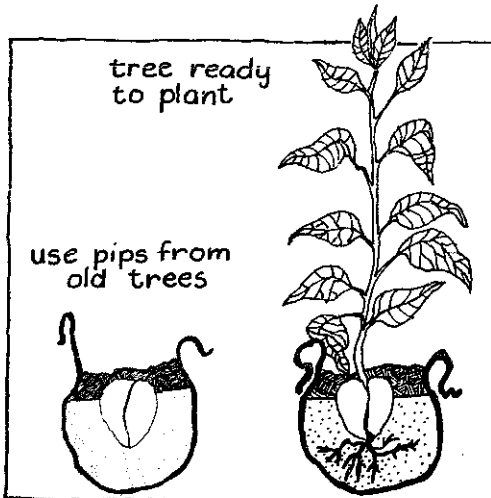

Bananas

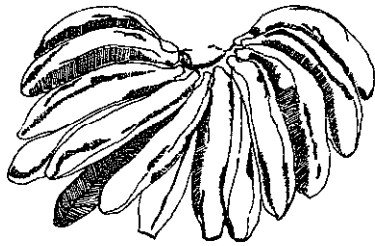

Bananas cannot grow in cold places. They grow best along the Natal coast and in the hot frost-free areas of Northern and Eastern Transvaal. They need lots of rain. They have short roots so they need soils such as clay soils which stay wet for a long time after rain.

Varieties

You can grow banana trees by planting the suckers which grow around the bottom of old trees. You can also buy banana trees from nurseries. They will give you more bananas but they will not be as strong as the trees you grow yourself from suckers. The best varieties are Dwarf Cavendish and Williams.

Planting

New banana trees grow from suckers which grow up round the trunks of old trees. The suckers are joined to the trunk of the tree under the ground. The best suckers to use for new trees have thin leaves and are about as high as your knee.

Cut the sucker away from the old tree and take off all the roots and leaves. It is important to take off the roots because banana suckers often have eelworm disease. After you have taken the roots off you should make sure there is no eelworm by dipping the suckers into eelworm poison like DRCP.

Plant the suckers in spring or summer. Dig a hole 70cm square and deep enough for the sucker to be buried by 15cm of soil. If you are growing lots of banana trees, plant them in rows 3m apart, with the trees 2m apart in the rows. You can plant beans and sweet potatoes in between the trees.

Pruning

Four months after planting, cut out all the suckers except one. This sucker will take over from the old tree and give you bananas next year. The suckers you have cut will grow up again. After another 4 months cut all these suckers except one. Now you will have the old tree with a big sucker and a small sucker.

Harvesting

Pick the bananas when the sides start to become round but before they become soft. After you have picked the bananas, cut off the top of the old tree so that it is as high as your shoulder. Put the old leaves and pieces of stem around the bottom of the plant. This stops weeds and is good for the soil.

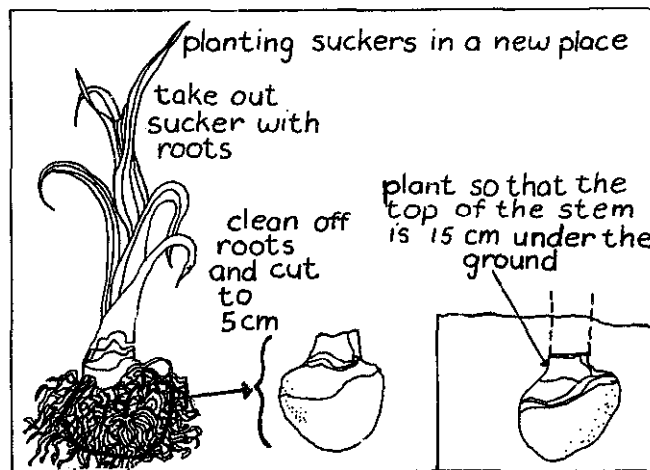
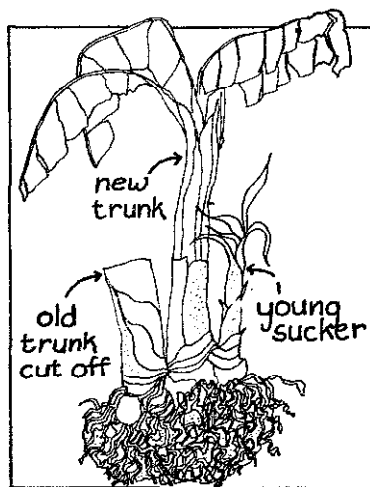

Pawpaws



Pawpaws grow well in hot, frost-free places and are not easily killed by drought. They grow best in well-drained soil which is not too acid.

Pineapples

Pineapples grow best in hot places. The hotter the weather, the sweeter the fruit will be. Pineapples are not killed by drought, but they are easily killed by frost.

Pineapples can grow on any well drained soils. They do not usually need fertilizer unless the soil is sandy.

Varieties

There are two kinds of pineapples in South Africa, Cayenne and Queen. Cayennes are better for small farmers because they give bigger fruits and bigger harvests than Queen pineapples.

It is easy to grow pawpaw trees from pips. Wash the pips from some ripe pawpaws and dry them in a shady place. Store them in a tightly closed container in your house until planting time in December. Plant 5 pips in each hole. Do not use any compost or manure in the holes. The trees will get pawpaws only if there are male and female trees planted near each other. You can tell the difference between male and female trees because they have different flowers. They start flowering when they are about as high as your waist. After the trees flower for the first time, leave 1 male tree for every 20 females and take out all the others. They should be about 3m apart after thinning out.

Pawpaw trees have soft trunks, so be careful not to damage them when you are weeding. They do not need any pruning. They will get bigger fruits if you water them every 2 weeks in dry weather. The soil around the trees must not stay wet for a long time otherwise they get foot-rot disease and die.

Harvesting

Pawpaws get ripe from September to May. Pick them when they start to turn yellow, but before they get soft. Do not pick too many at the same time because they get ripe after you pick them. Some people pick pawpaws when they are green and cook them like marrows.

To grow pineapples, you must cut off a part of a pineapple tree and plant it. You can use the branches from the side of the stem (slips) or the new stems (suckers) which grow from the ground. Slips must be longer than 30cm, and suckers longer than 60cm.

Tops of pineapples can also be used, but they take longer to produce pineapples. Leave the slips or suckers upside down in the sun for 2 weeks to dry out before planting otherwise they will rot. If you want to plant pineapples in rows, make the rows 1,2m apart, with the pineapples 25cm apart in the rows.

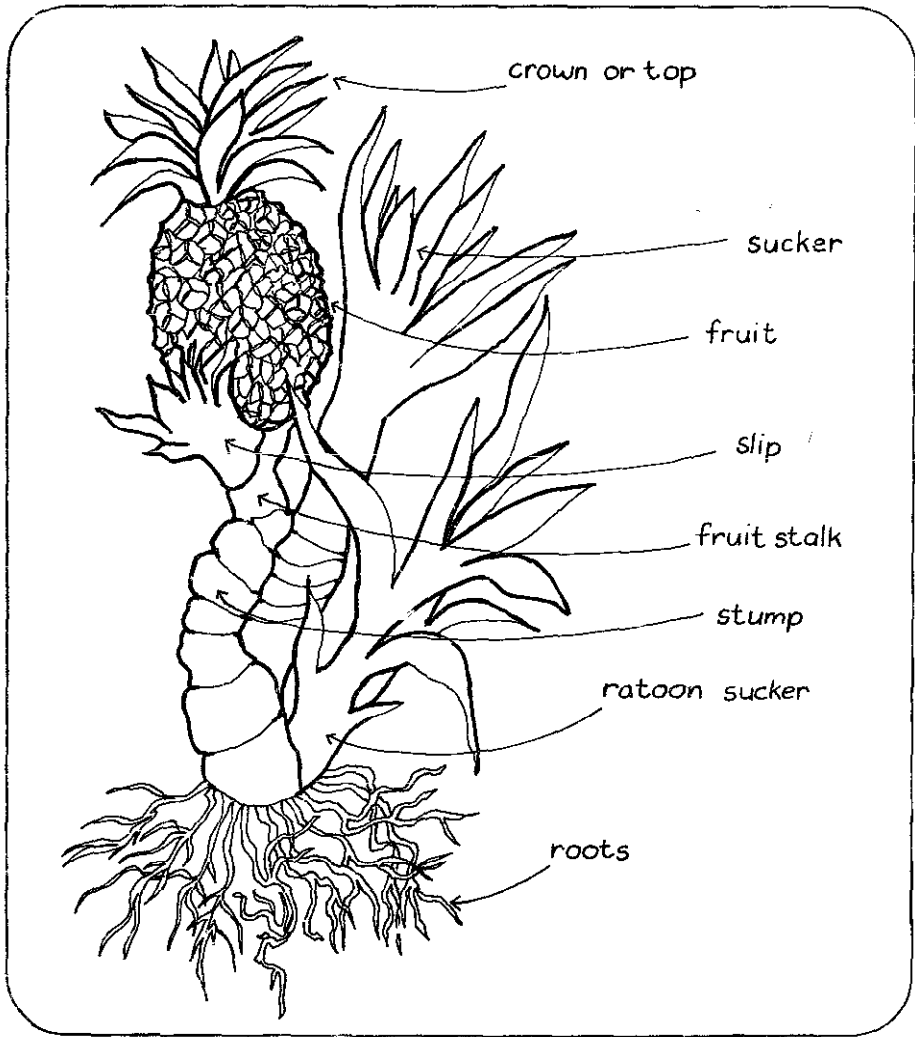

Harvesting

You can harvest the fruits when half the skin has turned yellow, about 20 months after planting. 12 months later the plants give a second crop, usually not as good as the first. After this, plough the fields and plant another crop in the crop rotation (see p 94).

Pests and Diseases

Pineapples do not get many pests or diseases. The worst disease is nematode disease which lives in the soil and destroys the roots. Prevent this disease by using crop rotation.

Pests and Diseases

Pests

Pests of fruit trees have natural insect enemies: for example ladybirds and praying mantises eat aphids and other pests. You should only use chemical poisons when pest problems are really bad because poisons also kill these useful insects. When you spray trees, spray so that all the leaves are wet. Chemical poisons are harmful to people, so do not let anyone eat the fruit for at least 2 weeks after you have sprayed the tree. Always wash the fruit carefully before you eat it.

These are the most common pests and the poisons you can use to get rid of them:

■ Aphids are very small green insects which attack apples, apricots, bananas, citrus, pawpaws, peaches, pears and plums. They suck the juice out of leaves and spread diseases. You can get rid of aphids by spraying them with home-made nicotine or garlic poisons (see p 125). If you buy poison, use Malathion. Mix 2,5ml ($\frac{1}{2}$ a bottle cap) of Malathion with 2 litres water (see measuring poisons p130).

■ Fruit beetle. These big black and yellow beetles eat ripe fruit. You

cannot spray poisons onto ripe fruit because then it will be harmful to eat. The best way to get rid of the fruit beetles is to pick them off the fruit and kill them by dropping them in a tin of paraffin. You can also kill them by pouring sugar water mixed with poison into tins and hanging the tins in your fruit trees. Mix 4kg of Dipterex or 30ml of Malathion with 1kg of sugar in 10 litres of water. The beetles will drink this poison instead of eating the fruit.

■ Codling moths are grey moths which lay eggs on leaves and fruit of apples, apricots, pears and walnuts. The eggs become worms which get inside the fruit and eat it. To kill the moths, spray the fruit trees every 2 weeks from the time the flowers fall off, until 2 weeks before you pick the fruit. Make a spray with 8ml ($1\frac{1}{2}$ caps) of Lebaycid in 10 litres of water.

■ Fruit flies are small flies which make holes in fruit like peaches, pears, guavas, grapes and mangoes and lay eggs in them. The eggs become worms which eat the fruit and make it rotten. For peaches, spray with Lebaycid poison 30, 20 and 10 days before harvesting. Mix 8ml ($1\frac{1}{2}$ caps) Lebaycid in 10 litres of water.

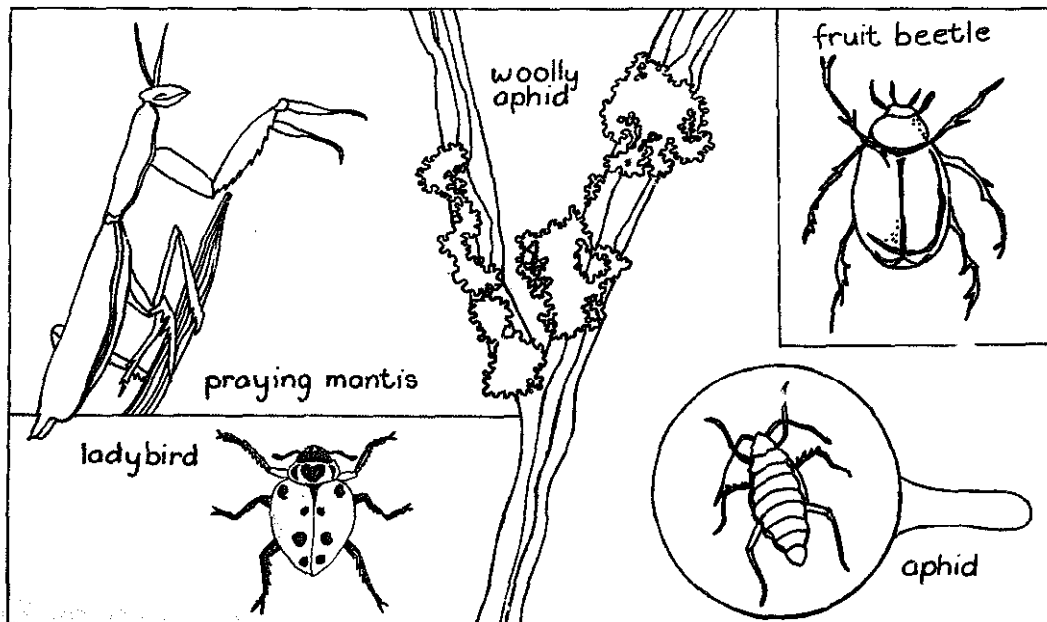

■ Citrus psylla are small yellow insects which eat the leaves of citrus trees. The leaves look lumpy and the trees do not grow well. To get rid of citrus psylla, spray new leaves with Oleum and then spray them again after 10 days. Use 80ml (16 caps) of Oleum in 10 litres of water.

■ Red Spider mites are very small red insects which attack apples, bananas, peaches and pears. They look like very small spiders and spin webs under the leaves. The leaves become yellow and fall off. You can control red spider mites by taking out weeds and other plants with hairy leaves growing around fruit trees because the insects breed in these plants. You can also spray them with Malathion, 2,5ml (½ a cap) mixed with 10 litres of water.

■ Scale are very small flat insects which live on leaves and branches. They are so small that they look like coloured spots - grey, red, brown or black. Some kinds of scale can kill fruit trees. You can get rid of scale by spraying with Malathion as soon as you see the coloured spots. Use 2,5ml (½ a cap) of Malation in 10 litres of water. To prevent scale, spray Oleum onto your trees in winter. Use 500ml Oleum mixed with 10 litres of water.

Diseases

Fruit trees get many diseases and it is sometimes difficult to know which disease your tree has. Most diseases make the fruit change colour or get rotten. If you are not sure what kind of disease it is, ask your extension officer. These are some of the most common diseases:

■ Leaf curl disease makes the leaves of peach trees curl up. They get fat, and sometimes they become pink. Leaves sometimes curl up because of aphids or because the tree is very dry - this is not the same as leaf curl disease. To control leaf curl, spray the tree with Virikop poison. Use 50g of Virikop in 10 litres of water.

■ Powdery Mildew attacks apples, peaches, pears and grapes. It is a whitish powder on the leaves and fruit. Spray with Virikop.

■ Rust is a disease of apricots, avocados, peaches, plums and mangoes. The leaves get white or brown powdery spots which become yellow around the edges. Rust is worst in rainy weather, and when it is hot and wet. As soon as you see rust spots, dust with Copper/Sulphur dust, every 10 days and after rain, until 4 weeks after the spots go.

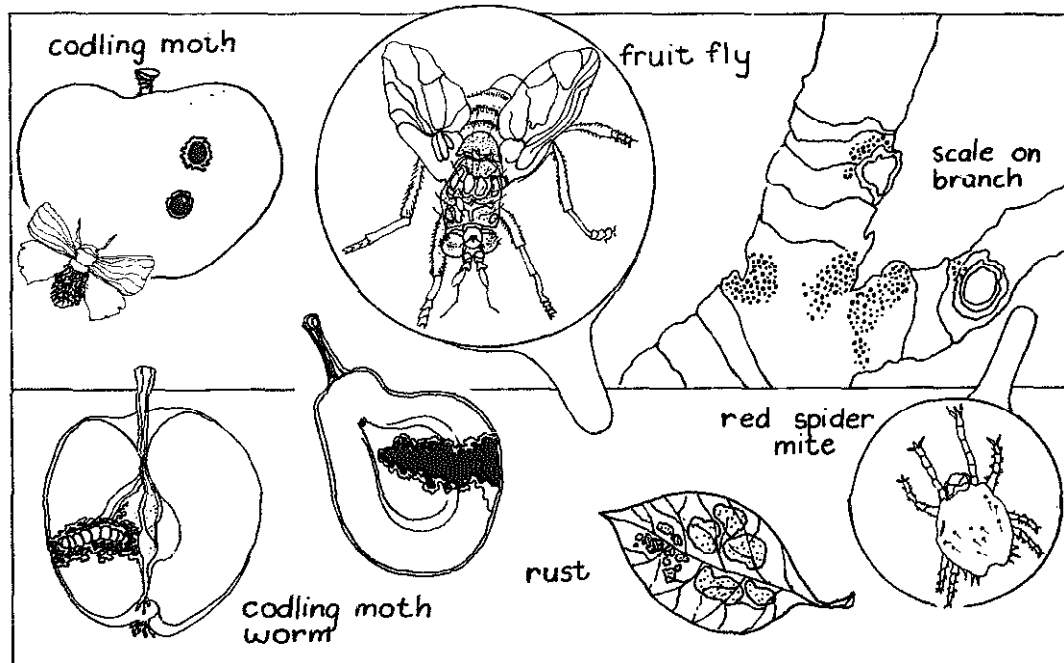

Trees for Animal Food

Many people think that grass is the only food for cattle. But some trees can give better food than grass.

Cattle are often weak at the end of winter because they do not have enough grass. If they could get food during winter they would stay strong and be ready for ploughing at the beginning of summer. Cattle can get a lot of food from the pods and bark of fodder trees like Acacia, Honey Locusts, Carobs and Leucaena.

These trees can get their water from deep in the ground so they do not die in drought when grass dies. The roots also hold the soil together and this helps to stop erosion. They give shade to cattle and keep nitrogen in the soil so that grass grows better.

Acacia

Acacia grows wild all over Southern Africa. People spend a lot of time chopping down or burning Acacias. It would be better to leave these trees alone because they improve the soil and they give twigs, leaves and pods which animals can eat.

Acacias are thorn trees with leaves that look like feathers and small round flowers. There are three kinds of Acacias:

- Umunga (Soetdoring) has straight white thorns and thin pods which break open while the pods are on the tree.

- Monga (Swarthaak) has hooked thorns like the claws of a cat and wide flat pods which are red when they start growing.

- Umsasane (Haak-and-Steek), has both of these kinds of thorns on one tree. The pods are curled.

Sometimes Acacias grow so close together that there is not enough grass for cattle. The best spacing for Acacias is 15m apart. If Acacias are closer you should chop the smallest trees down to give the grass a chance to grow. Leave all the tall trees. If the Acacias are too far apart, you should plant new trees. To plant trees collect seeds which have not been damaged by insects. Pour hot water over them and then plant 10 together in the same hole. Protect the young trees from goats by making a thorn fence. When the trees are big enough goats can eat the leaves without killing the tree.

Cattle Food from Acacia

Cattle food can be made from Acacia pods, leaves and small branches. During the summer, cut off the small leafy branches which are too high for the animals to eat. Dry them and hammermill them to make silage (see Winter Feeding p 244). Only use branches which are thinner than your finger because thicker branches do not make good food.

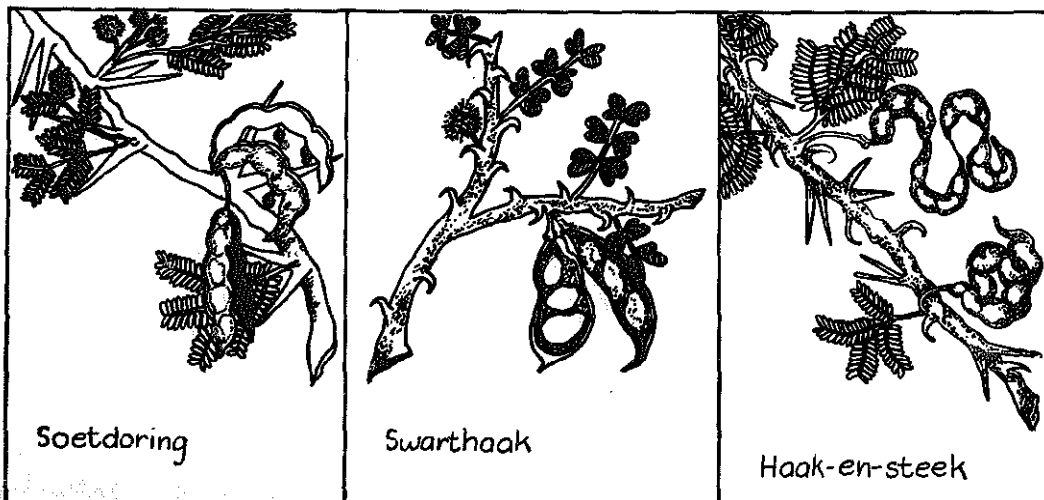

The pods are the best part of the Acacia for animals. In July and August collect the ripe pods when they are brown and dry. Do not collect green unripe pods because they are poisonous for animals. Grind up the pods by hand or in a hammermill as soon as you have collected them. If you store them without grinding, insects will get inside the seeds. Store the Acacia meal in a dry place until you need it. When you feed the Acacia meal to your animals, wet it a little. If you wet it too much it will go sour and make the animal sick. Acacia meal is not rich enough to give animals all the food they need. You will have to give them other animal foods like bran, mealie meal and salt.

Use the hammermilled branches when they are fresh or you can keep them until winter. To make a good winter food, add a bucket of water and a big jam tin of molasses to each bag of milled Acacia branches. Pour the mixture into a hole in the ground, press it down, and cover it up. It will be ready to use during winter.

Leucaena

Leucaena is a bush or a tree which does not grow wild in South Africa, but you can buy it in a nursery. It is a good protein-rich animal food which can be eaten either off the bushes or dried as hay. It is good for cattle and sheep and goats but

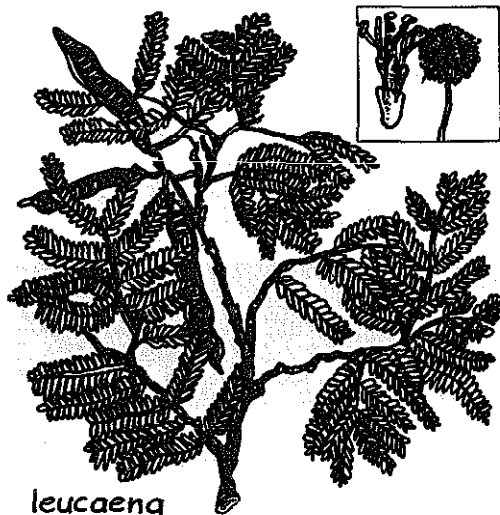

it is poisonous for pigs, chickens, rabbits and horses. However Leucaena must not be more than one third of the food of cattle, sheep or goats because they get sick and lose their hair.

Leucaena grows best in hot rainy places but it is not easily killed by drought. It does not grow in acid soils. Leucaena has a lot of nitrogen. It improves the soil and the leaves can be used as fertiliser.

Carob

Carob trees have pods which can be eaten by most animals. They grow better in warm places, and in cold places they must be covered and protected from frost for the first 4 winters. (Scientific name: Ceratonia Siliqua)



carob

Honey Locust

This tree can grow up to 30m tall, and has big flat brown pods which are sweet inside. The pods are good for cattle and goats. You can buy Honey Locust trees at nurseries. They are not easily killed by frost or drought. (Scientific name: Gleditsea triacanthos)

Horseradish

This is a fast growing tree for warm areas. The pods, flowers and leaves can be fed to animals. (Scientific name: Moringa oleifera)

Trees for Wood

Everybody needs fuel for cooking food and heating their homes. In the past when there was enough wood, people used the dead trees for firewood and did not cut down the living trees. But now that black rural areas are so overcrowded, people are short of wood. Women have to spend hours collecting wood, and as more trees get chopped down they have to walk further and further away.

There are a lot of forests in South Africa, but they are owned by the government or by factories which make paper or wooden planks. They are not for people to use for firewood. People use coal and paraffin for cooking and heating, but these fuels are getting more expensive all the time. Some people burn cow manure, then they have no manure to fertilise their land.

There are some things that people can do for themselves so they do not have to spend so much time or money on fuel:

- Villages can grow their own trees for wood. They have to fence a big place near the village and plant fast growing trees. After 5 years they can start cutting down the trees and plant new ones.
- People can also try to use ways of cooking which save fuel, like mud stoves, hayboxes, or cooking with the sun. When you cook on an open fire only a small part of the heat is used by the pot. Most of the heat just warms up the room. If you cook in a mud stove, the stove keeps the fire inside to heat the pots, so you need much less wood to cook with.



Woodlots

It is best to plant a lot of trees in a woodlot. Then you can fence the woodlot to protect the trees from goats. This is cheaper than fencing every tree.

If your village is part of a betterment scheme, there is supposed to be a place for a woodlot near your village, but it is not always planted. Find out from your extension officer if there is land for a woodlot.

What trees to plant

► Gums are the best trees to grow in most places because they grow fast and make good firewood and building wood.

► Wattles also make good firewood and building wood, but it is not a good idea to plant them because they spread

down to rivers and streams and make the streams dry up.

► Pines are good trees to grow in cold places where there is some rain, but they grow more slowly.

► Cypresses are better than pines in cold dry places. Cypresses and pines both give soft wood, good for making planks.

► Pseudo acacias are strong trees which grow anywhere. They can be good for planting along dongas and on rocky hillsides.

► Poplars grow well in wet places and next to rivers.

These trees are all good for woodlots. See which are the right trees for your soil and weather.

NAME OF TREE	SCIENTIFIC NAME	WHAT KIND OF SOIL CAN IT GROW IN?	HOW DRY CAN THE PLACE BE?	HOW COLD CAN THE PLACE BE?
Port Jackson Willow	Acacia cyanophylla	Poor	Dry	Warm (no frost)
Green Wattle	Acacia decurrens	Poor		Cool
Black wood	Acacia melanoxylon	Good	Medium	Cool
Deodar	Cedrus deodara	Good	Dry	Cold
Arizona cypress	Cupressus glabra	Good	Dry	Cold
Mexican cypress	Cupressus lusitanica	Good	Rainy	Cool
Himalaya cypress	Cupressus torulosa	Medium	Dry	Cold
White gum	Eucalyptus alba	Medium	Medium	Warm
Saligna gum	Eucalyptus grandis	Good	Rainy	Warm
Camden Woollybutt	Eucalyptus macarthurii	Medium	Medium	Cold
Spotted gum	Eucalyptus maculata	Medium	Medium	Warm
Yellow box	Eucalyptus melliodora	Medium	Dry	Cold
Black iron bark	Eucalyptus sideroxylon	Poor	Dry	Cool
Patula pine	Pinus patula	Medium	Medium	Cool
Slash pine	Pinus elliottii	Medium	Medium	Cold
Chir pine	Pinus roxburghii	Medium	Dry	Cold
Loblolly pine	Pinus taeda	Medium	Rainy	Warm
Semi evergreen grey poplar	Populus Canescons	Poor	Dry	Cool
Pseudo acacia	Robinia pseudo acacia	Poor	Dry	Warm to Cool

Planting trees

It is better to plant small trees than to grow trees from seed. Ask your agricultural extension officer to help you order trees, or you can order them yourself from the government forestry department (see p 522).

With some trees, like cypress and pseudo acacia, you can collect the young trees which grow from seeds underneath the old trees.

The best time to plant trees is from December to March. Trees should not be planted in dry soil, so plant them straight after a good rain.

You do not have to dig deep holes. Dig up the soil where you want to plant the tree and take out all the stones. Plant the trees 2m apart in rainy areas and 2½m apart in dry areas. Dig a hole 1m square and 25cm deep for each tree. For a woodlot you can plough land instead of digging holes.

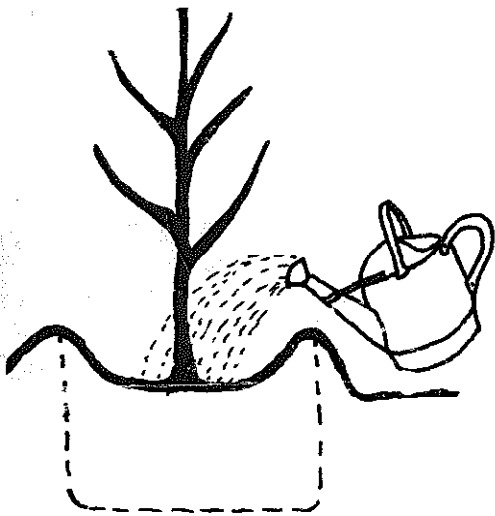

Weeding and pruning

While the trees are growing, weed all the ground underneath and dig out any grass. You can stop weeding when the trees are as tall as a person.

Put a mulch of grass and manure after planting. If some of the trees die after planting, take them out and plant new ones.

When the trees are 6m tall, prune them by cutting off all the branches up to 3m high. This will make them grow faster. You do not have to prune them again.

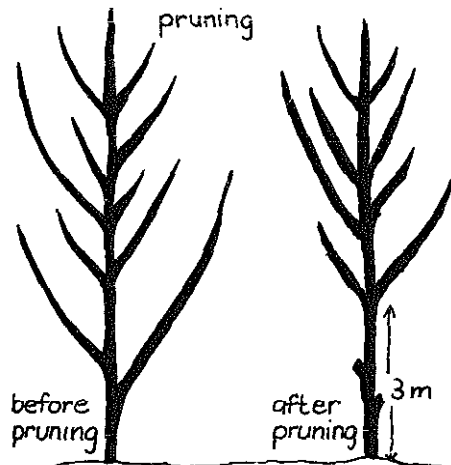

Cutting down trees

- ◀ Gums can be cut down after 6 years, but you get more wood if you wait until 10 years.
- ◀ Cut poplars and wattles after 4 years.
- ◀ For pines you must wait much longer, about 15 years.

Poplars, gums, wattles and pseudo acacia will make a lot of new trunks on each tree after the first trunk is cut. Cut the smallest ones off, leaving about 4 to grow. Small trunks make straight poles which are good for fencing and building.

Taking out stumps

Once the poles which grow from the stumps have been cut, the stumps must be pulled out. You can do this by hand with picks and axes, by digging around the stump and cutting the roots. You can also pull the stumps out using chains pulled by oxen or a tractor.

If new trees grow from the old stumps, pull them out while they are still small.

Do not plant new trees in the old holes. It is better to plant between the rows of the old stumps.

Woodlots as a community project

Woodlots are good community projects because the work can be shared by everybody. There are many jobs to do: ploughing and digging, ordering the trees, fencing, weeding, checking there is no damage from goats, and then cutting down the trees and planting again.

If you plant fast growing trees like gums, you can cut trees every year if you plan well. Divide the woodlot into 6 plots and plant them all at the same time. After 6 years, cut all the trees in the first plot and replant that plot or let new poles grow on the stumps. In the second year, cut down the trees in the second plot, and so on. When you come back to the first plot the trees will be big enough to cut again. In this way you can have trees every year. Try to get

as much land as you can, because trees take a long time to grow.

Other places to plant trees

As well as planting woodlots, also plant trees in places where crops will not grow like steep slopes, places with poor soils, and along dongas. If you plant trees near a donga, you must protect the donga against soil erosion (see p 220) otherwise the trees can cause even worse erosion. Another good place to plant trees is between rows of houses and along roads and paths, to protect people and crops from the wind.

The big problem with planting trees in these places is that every tree or small group of trees must be fenced. It is cheaper to plant small groups of trees and fence each group.



HOW TO MAKE A MUD STOVE

Anyone can make their own stove out of mud. It looks and works like a coal stove you buy in a shop.

The mud stove can burn wood or coal. It saves wood because it only uses half as much wood as cooking on an open fire. It is much safer than an open fire because children can not fall in and get burnt.

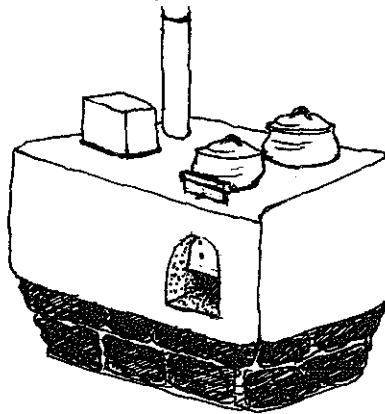

You make the stove out of a solid block of mud about the same size as a coal stove. When the mud is nearly dry you cut out a place to make the fire and you cut out holes to put the pots in. You make tunnels inside the mud to join the potholes to the fire place. You need a lot of soil and clay to make the mud for the stove, and it takes a lot of work to transport it and mix it. But you do not have to pay anything except for the stove pipe, which costs about R6.

The stove we are writing about here is big enough for two food pots and a tin for hot water. You can use the fire place as an oven to bake bread and cakes.

THE FOUNDATION

Make the foundation out of big stones stuck together with mud in between. You can also use concrete blocks. Build the foundation as high as your knee.

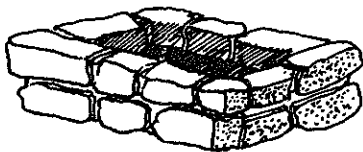

The foundation.

TOOLS

You need a sieve, a shovel, a plank, and a long knife like a panga. You must buy the pipe before you start building the stove because you need it to cut the holes. The best size is 4 inch pipe.

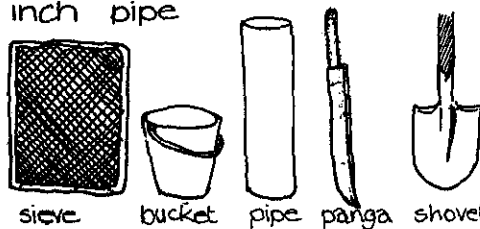

sieve bucket pipe panga shovel

CHOOSING THE SOIL

It is very important to use the right soil. If you use the wrong soil your stove will crack and it might even fall down. The right soil is a mixture of sand and clay, with twice as much sand in the mixture as clay. You can use the same soil you use for plastering walls, but add a little more clay. To see if the soil is right, make 3 mud bricks with different mixtures of sand and clay and dry them in the sun. The best mixture is the one that does not crack. You will need about 3-4 oil drums full of soil. Sieve the soil if it has stones in it.

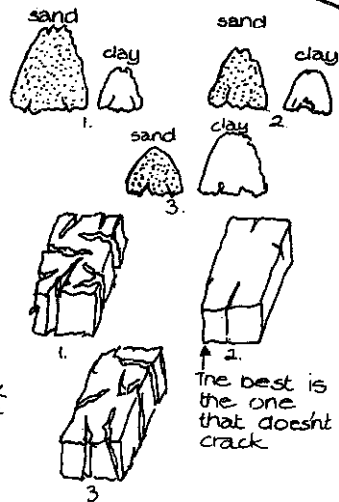

MAKING THE MUD BLOCK



Put one layer on each day. Each layer is as thick as your hand.

Make the mud block in layers, letting each layer dry for one day before you put the next layer on top. If you make the block too quickly, it will not get dry inside and it will crack. Use half an oil drum of sand and clay mixture for each layer, adding enough water to make the mud feel like thick porridge. Put on each layer with a shovel. It should be as thick as your hand. Scrape your fingers in the mud to make it rough, and throw mud on the sides to make them straight. It is better that the top is rough so that the next layer can stick on well.

Let the layer dry for one day. In hot dry weather you can make two layers a day, one in the morning and one in the afternoon. After six layers the block will be the right height, just below your waist.

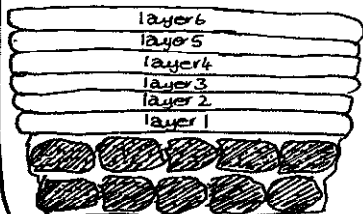

Now you can make the block smooth. Use your hand to make the sides smooth and straight and use a plank to make the top smooth and flat. Let the mud block dry until it is hard and you can not push your finger into it easily.

MAKING THE POT HOLES AND FIRE PLACE



Put your pots where you want them on the stove and draw places for the pot holes with your finger. The hottest place will be on top of the fire place. Use this place for your mealie meal pot.

The pot holes must not be too close to each other because this will make the mud weak and it will crack. Make the pot holes two hands away from each other and 3 hands away from the side of the stove. Draw the shape of the fireplace opening on the mud. It should be two hands from the top and one hand from the foundation.

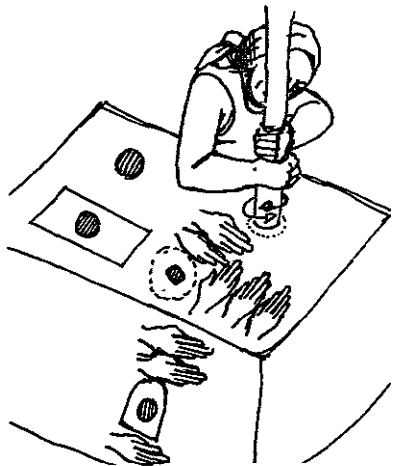

Now take a piece of stove pipe, wet it on the outside and twist it into the mud to cut out the pot holes. Do not push down on the top of the stove with your hands when you do this. The mud will come out of the pot hole inside the chimney pipe. Make the pot holes as deep as your elbow if you put your arm inside. Drill a hole for the chimney half as deep as the other holes. Drill a hole sideways into the stove for the fire place. The hole for the fire place should join up with the hole for the first pot. Keep wetting the chimney pipe to make it cut better.



Wet the panga and cut the slots for the heat control doors. The front slot must be 2 hands away from the edge of the stove

Wet the knife and use it like a saw, pushing up and down. If you just pull through the mud it can break the stove.

MAKING THE TUNNELS

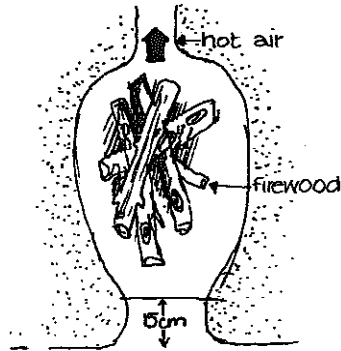

Let the stove dry for another day. Dig a tunnel straight into the fire place opening in the shape you have drawn. After you get past the slot for the heat control door, you can make the fire place bigger and rounder inside, so it can fit big pieces of wood. Make the floor of the fire place slope down a little bit, but do not make the roof of the place any higher, or it could fall down.

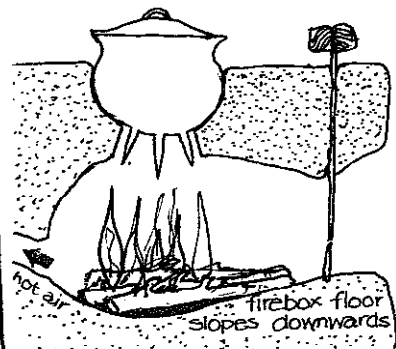

Now make tunnels to join the pot holes to each other. You do this by putting your hand down into one pot hole and digging out the mud until you reach the next pot hole. Make the tunnel big-enough so you can put your hand through easily. Make a small hill under each pot hole. This forces the heat up to make the pots hotter.

FITTING THE POTS

Using a spoon, carefully dig the mud out from each pot hole so that it is nearly big enough for the pot. When the hole is nearly big enough, wet the outside of the pot and twist it in the hole so that it fits tightly. Do not push downwards when you do this otherwise the mud will break. Make each pot hole deep enough so that the pot sits halfway down. For the hot water tin, make a deep hole so that the tin is right down in the tunnel. Put a stone underneath so that the tin does not block the smoke to the chimney.

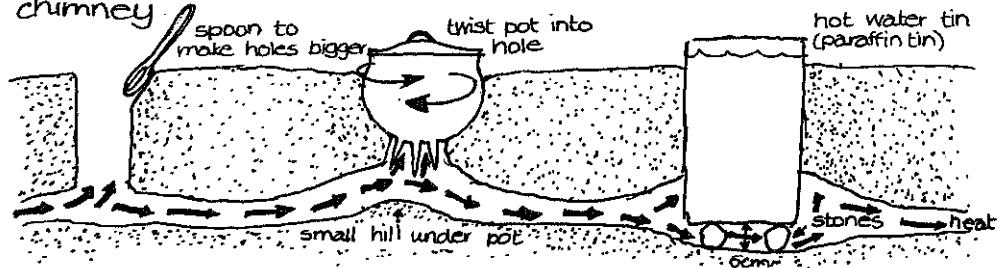

MAKING THE HEAT CONTROL DOOR

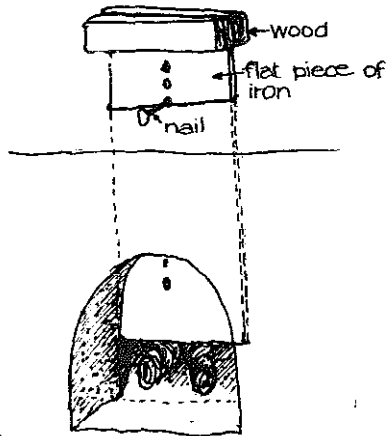

You can make the heat control door with a flat piece of tin. Cut the tin to fit the slot you have made. Make handles with pieces of wood, and make holes using a nail so you can make the door higher or lower. This controls the heat. When you have finished cooking at night you can close the heat control door, and in the morning the fire will still be burning and ready for cooking.

FITTING THE CHIMNEY

Put the chimney in the chimney hole. Make sure that it does not go right down to the bottom of the tunnel, otherwise the smoke will not get into the chimney.

Make the top of the chimney higher than the roof of your home so that the fire burns better. If you have a grass roof put mud or cement around the chimney to stop the grass from catching fire.

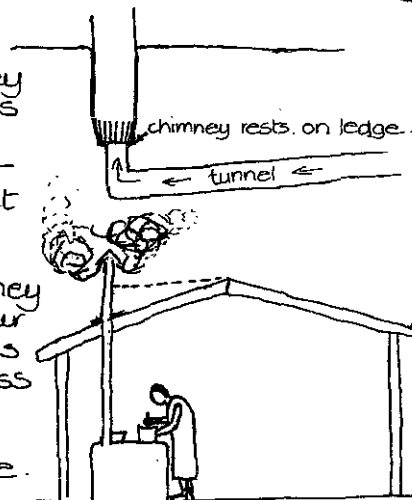

FINISHING THE STOVE

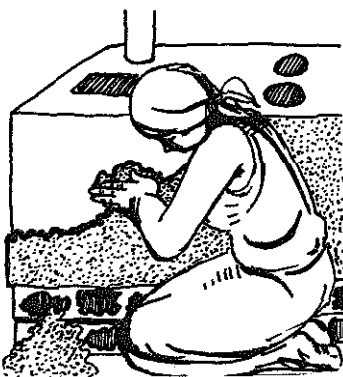

Leave the stove to dry for a week. Then light a small fire to help it dry properly inside. Now it is ready to use for cooking. You can plaster the stove with cow dung and polish it with ash or stove polish. You can also paint the stove with whitewash.

plastering the stove

IF THE STOVE CRACKS

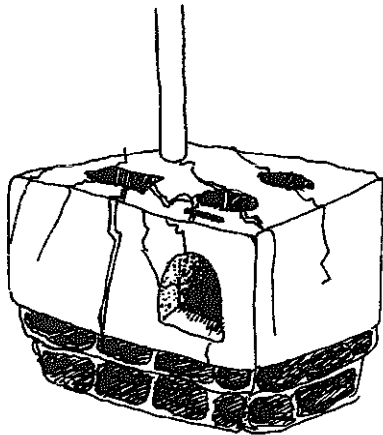

deep cracks

If the stove cracks, plaster it with mud or cow dung and you can carry on using the stove. Sometimes the cracks are so deep that smoke comes out and you must make another stove. This means you did not use the right soil, or you made the stove too quickly so it did not dry well. It may also mean that the holes are too close together or the fire place roof is too thin. Break up your stove, sieve the soil, and this time add more sand. Also work more slowly to make sure it dries properly.

DIFFERENT STOVE SIZES

You can make many different sizes of stoves from mud. You can make them for one pot, two pots or many pots. In a clinic or a school hostel you can make a stove for very big pots. If you write to EDA we will come and show you how to build a stove. You can start a club to build stoves and buy stove pipes cheaply.

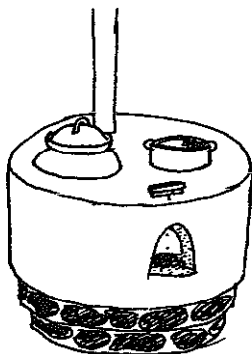

2 pot round stove

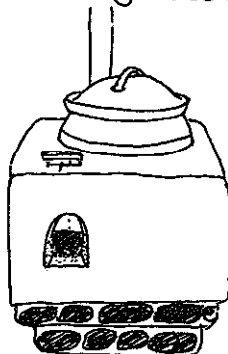

1 pot stove

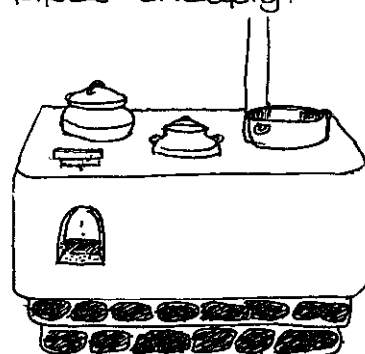

3 pot stove

Hayboxes

A haybox is a way of keeping food hot inside a pot, so that the food can carry on cooking without a fire. The simplest way to make a haybox is to fill a wooden or cardboard box with dry grass, or newspaper, or old pillows. Make a place just big enough for your pot. You can make a better haybox by making two cushions bigger than your pot, so they cover your pot completely, one on top and one underneath. The best thing to put inside the cushions is polystyrene, the soft white plastic from apple boxes. Break it into very small pieces. If you can not get polystyrene, you can use sawdust or small pieces of newspaper or wool. Do not make the cushions too full, otherwise they will not fit easily over the pot.

To cook, bring the food to the boil and put the pot inside the haybox.

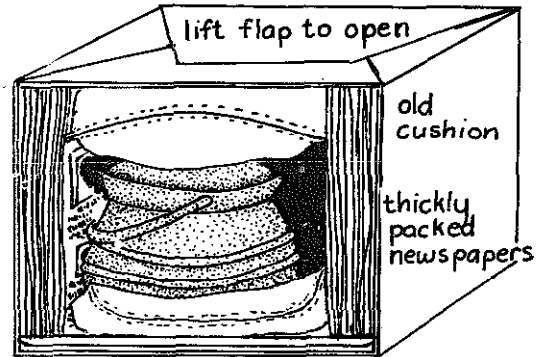

cardboard box cut open to show pot inside

Cooking is slow. Rice takes about one hour, and stews about 6 hours. But slow cooking can be useful. You can put a pot of boiling porridge in the haybox at night, and when you wake up in the morning, the porridge will be cooked and still hot.

They have helped us a great lot

Members of women's clubs around Bochum in the Northern Transvaal have built mud stoves in their homes. We spoke to two members of the Westphalia Women's Club. The first was Mrs Molinise, and then we spoke to Mrs Sefhoka.

● Do you like these stoves?

They have helped us a great lot. We do all our cooking at once and our children are no longer suffering with making fires on the floor as they used to.

● Mrs Molinise, how many stoves have you built in your village?

We have built six.

● Do these stoves belong to Westphalia members only?

Yes, but we tell other people about the stoves. People here seem very keen but they don't come to ask us for demonstrations all they do is just talking and talking.

● Could you tell me how you built this stove?

I first mixed soil with cow dung which is the only mixture for building the stove. I then started building using the big oval shaped stone for flattening although I was using the troffel for plastering. The next step is to make the fire place and three round

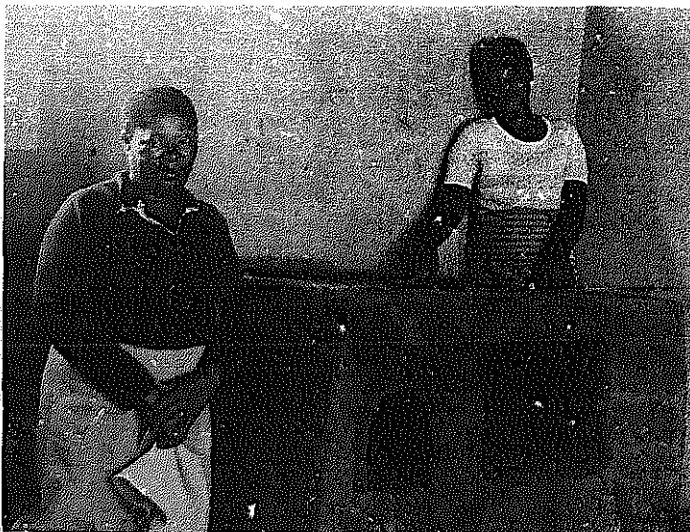

holes which will serve as plates for cooking. From hole one to hole three through to the chimney there is a small tunnel through which the smoke will go out.

● Doesn't smoke come out from the cooking plate holes?

There is no smoke coming out from these holes because I cover them with iron sheets.

● I see you have made an oven here too?

There is a small hole below the fire place and another one below one of the three holes for cooking. These two holes join to the oven.

● Do you buy chimneys?

No mine is made out of big milk tins.

● Do you use coal for making fire?

No, only wood. The heat lasts about a week.

● Do you know what makes the heat to last so long?

I think it is because of the soil mixture that is mud. Mud is hard and strong and it keeps the stove hot everytime.

● Mrs Sephoka, have you also built a mud stove at home?

Yes, of course.

● Can you tell me how you built it?

Before building I collected stones and soil which is blackish in colour.



● Why do you use the blackish soil?

I use blackish soil because it is stronger and more clean than the surface soil. I mix it with water only. Then I collect stones for the foundation where I am going to start building the stove.

● How do you estimate the height of the stove?

The height of the stove should be the same as that of the ordinary coal stove. I then bore a hole on my left side which is going to be the fire place. I used a chisel to make this hole. I did that when the stove was not yet completely dry. There are three round shaped holes I made for cooking and these are covered by iron sheets. I made a tunnel from the first place which is near the fire place to the third plate. I have made a small hole at the wall of the fire place and at the second plate which is at the centre. These two holes are the ones

which carry heat to the oven.

● How do you control the heat?

I have made a square iron sheet to close the tunnel when the fire no longer smokes so that heat shouldn't escape.

● Do you have a place in the stove for the ash?

No I don't have a place for that. What I do when taking the ash out, I put the iron sheet which serves as a dust pan. Sometimes I don't even remove the ash I just put it aside on both sides of the fire place when making fire again. I have made my chimney with milk tins.

● Why didn't you mix your soil with cow dung?

I wouldn't dare do that mistake because when the stove becomes too hot it will crack. Cow dung destroys the stove because it is also used for making fire. I would like my stove to last longer.

Using the Sun

We can use the sun's heat, called solar energy, for cooking, heating water, and drying crops. Cooking and heating with the sun takes longer than a fire, and it can only work when the sun is shining. But the sun's energy is free.

Solar cookers

The most common kind of solar cooker looks like a big dish which is shiny like a mirror inside. The cooking pot hangs in the middle of the dish. When the sun shines, the shape of the dish makes all the heat shine onto the pot, and it becomes hot enough for the food inside to get cooked.

In summer, the cooker takes 45 minutes to boil 3 litres of water, and in winter 1½ hours. It has to be moved every 20 minutes to face the sun otherwise it does not cook properly.

This cooker costs about R40 to make. Half of the cost is for the shiny plastic. You can make a cheaper solar cooker using aluminium foil, but it does not work so well.

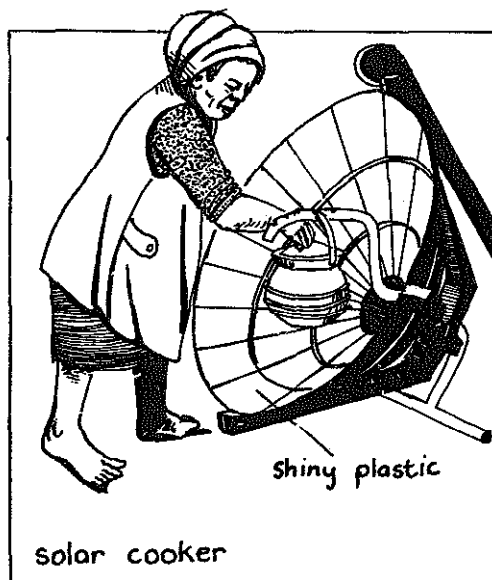

Solar ovens

The solar oven is a different kind of solar cooker. It is a box with thick walls so that heat can not get out easily. The box is painted black inside and the sloping side is glass, which faces the sun. It works because glass lets heat in one way, but does not let it out the other way. This is why a car becomes hot inside if it is parked in the sun with the windows closed.

Heat from the sun is trapped inside the oven, so that it becomes hot enough inside to cook. You can make the oven hotter by adding mirrors or shiny metal sheets on the front to catch more of the sun's heat.

This solar oven costs about R20 to make. It does not get as hot as the other solar cooker, but it gets hot enough inside to cook food slowly. If you make it well, it is hot enough to bake bread. It only has to be moved once every hour, not every 20 minutes like the other cooker.

Write to EDA for plans for solar cookers, solar ovens, and solar water heaters (see Making a solar crop drier p 454).

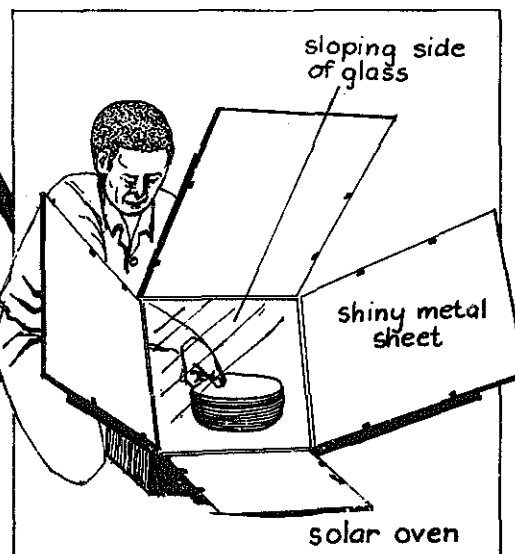

Some say this big mirror can pull lightning to the house

Cooking with the sun is a new idea to most people. We spoke to Mrs Zikalala who lives at Nkomokazini near Estcourt. She had been using a solar cooker for 5 months.

● How much do you use it now?

Sometimes I am away from my home selling clothes. This is how I support my children. Then my older daughters use it if the weather is right. In winter we used it about 3 days per week, but now it is about 5 days per week.

● Have you had any problems with it?

Yes, you know this thing has to stay outside. If my older daughters are at school and I am working in the fields we

can't leave food cooking. It is dangerous to leave food outside because someone can put poison in it. But if you leave food cooking on the stove it is safe because you can lock the house.

● What have your neighbours said about the cooker?

They want it. But some others say that this big mirror can pull lightning to the house. But I told them that you can cover it the same way we do with our mirrors.

● Has your cooker saved any money?

Yes, especially for wood and coal. Now that it is summer I am no longer buying lots of wood and coal. Whenever it is sunny I cook for free but if it is cloudy I use my primus stove. Of course, paraffin is expensive but wood is even more expensive.

● Do you cook all your meals on this solar cooker?

No, we still use the primus stove in the morning for porridge and tea and at night to warm up food. We have always done most of our cooking in the middle of the day, so now if it is sunny, we use the solar cooker. In the afternoon the sun has become too weak to cook.

● Did you use it in winter too?

Yes, we still saved some money during winter. Even though the cooker takes longer to cook things in winter.

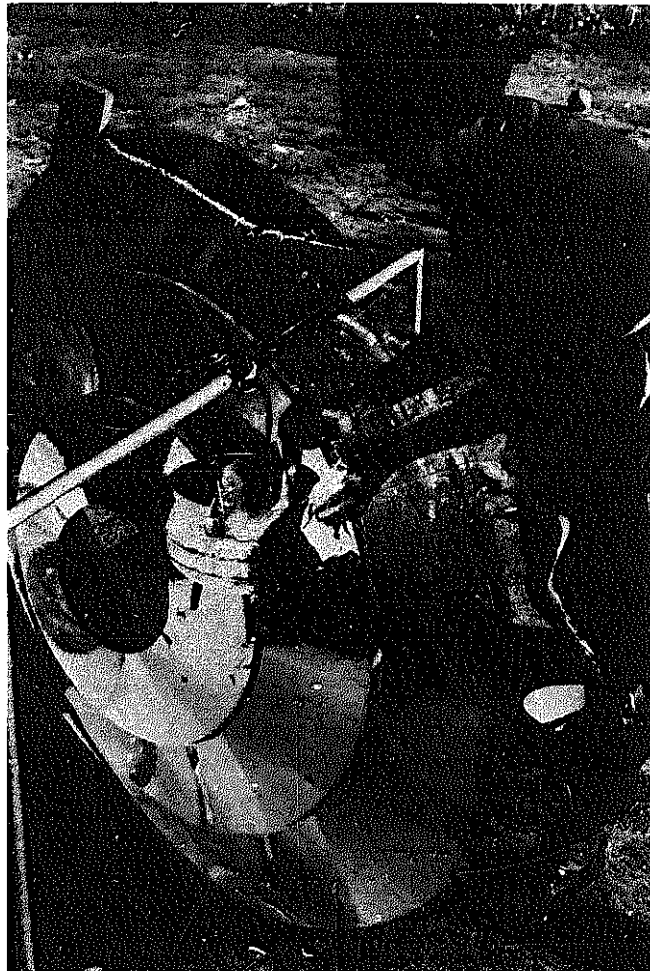

Preventing Soil Erosion

Soil erosion starts when there is overgrazing. When all the grass has been grazed, rain can easily wash away the top layer of soil and grass. The soil becomes hard and cannot hold water. When it rains more soil is washed away even faster and causes more erosion. More and more soil is washed away and dongas form.

In South Africa many parts of the land have been damaged by soil erosion. It is worst in black rural areas because there is overcrowding. There are too many animals so there is overgrazing.

Preventing erosion always takes a long time. A lot of work has to be done before erosion is stopped. In places where there are already big dongas, preventing overgrazing is not enough. You have to build walls and dams so that dongas do not get worse.

Start with the little dongas called gullies, which lead into the big dongas. These gullies are sometimes quite small, only about 2 metres wide and knee deep.

The first thing to do is to put stones into the soil at the top of the gully, where it is just starting to erode. Put stones into the walls of the gully, and into the soil around the gully.

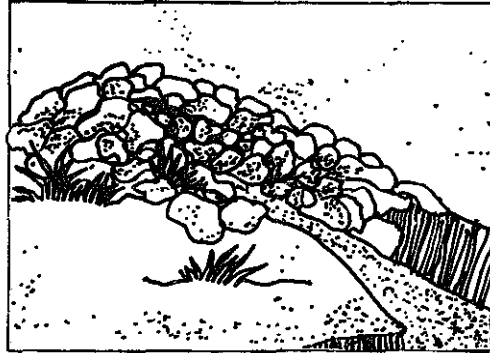

Stones packed into the top of a small gully

Further down the gully, where it is knee deep, build a wall to slow down the flow of the water. To do this dig a trench across the gully 30cm deep and cut into the wall of the gully on each side. Make the width of the trench the same as the depth of the gully. For example, if the gully is 1m deep the trench must be 1m wide. Build up a wall of stones in the trench. Make the wall a little lower in the middle than at the sides. You do not have to use cement to build the wall, because it is just to slow down the water, not to make a dam. If you are short of stones you can make an earth wall, but put stones on the outside of the wall so that it cannot erode. Build

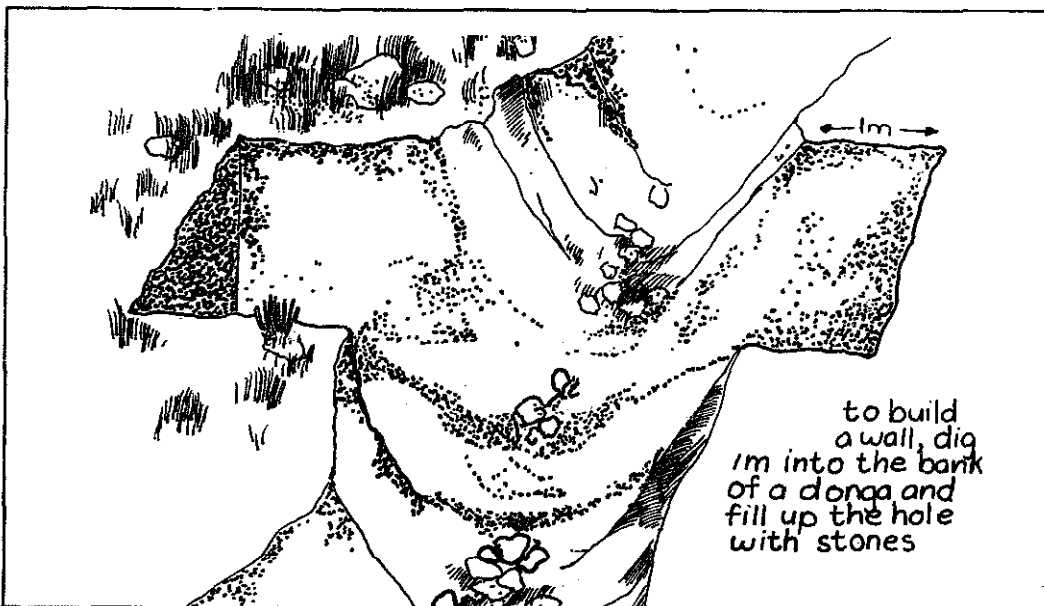

to build a wall, dig 1m into the bank of a donga and fill up the hole with stones

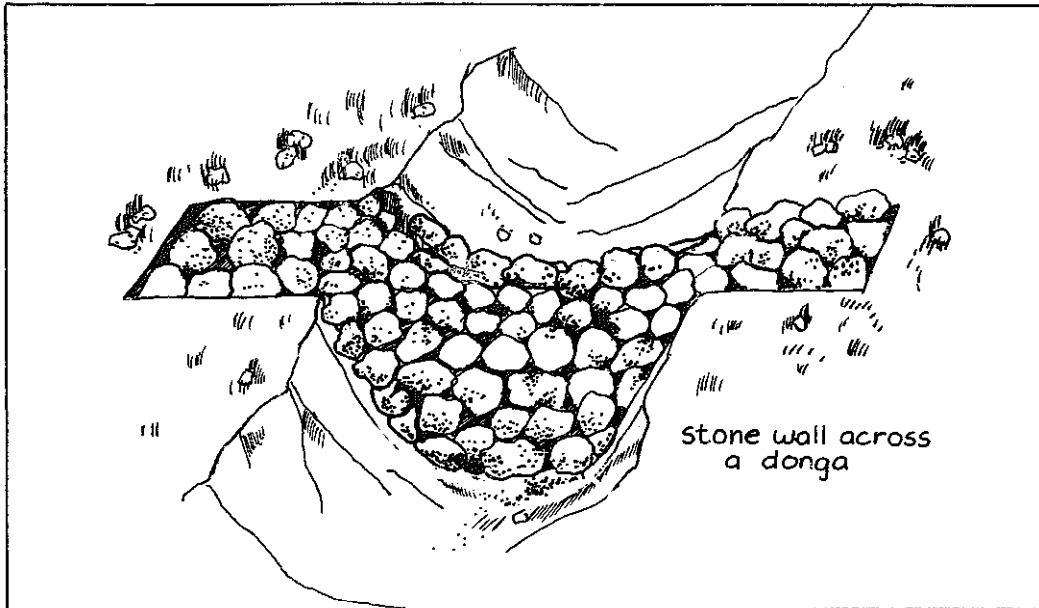

a pipe inside the earth wall near the bottom to let water through and put small stones around the entrance to stop sand from blocking up the pipe.

Plant reeds in each gully on both sides of the wall. The reeds help to hold the soil and slow down the water.

The next thing to do is to move to the bigger dongas, and build bigger walls, in the same way. If the donga is very long, 4 or more walls may be needed. Always start at the top and work down hill.

This is a lot of work. In one valley there may be one big donga, with 10 smaller dongas leading into it and 50 gullies which are eroding. The tops of all 50 gullies have to be protected and walls built across each gully.

After rain a lot of soil will stay behind the walls. Plant reeds or grass in this soil and on the floor of the dongas. Do not plant grasses which cattle or sheep eat because this will cause more damage to the donga. Plant useful grasses like thatching grass.

After a year if the reeds and grass have grown well, the donga will stop eroding. Then you can plant small trees (see Trees for wood p206).

next to the donga. The best trees for dongas are poplars and pseudo acacia. Protect the hole where you have planted the tree by putting stones around the top.

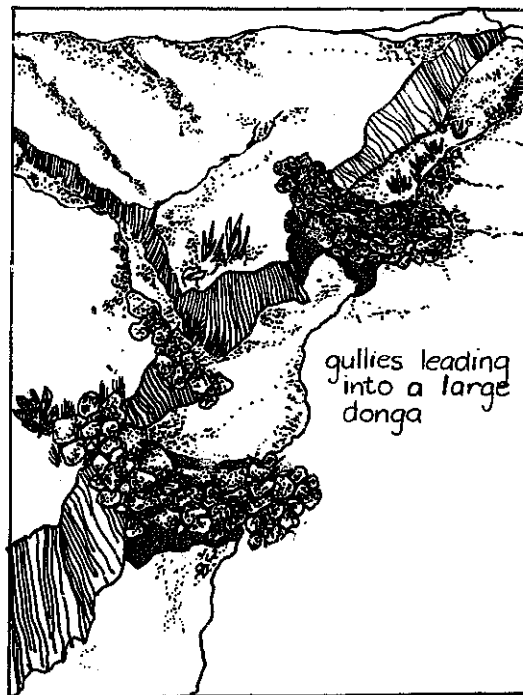

Overgrazing

At the same time try to prevent overgrazing. Use rotational grazing and if possible keep less animals. Do not let animals graze near the edges of the dongas. Plant shrubs, berry bushes and sisal near the edges and do not plough the land right up to the edges.

Dams in dongas

Do not build dams in large dongas because the walls are easily washed away. If a donga is small and deep make a dam (see p 286). Plant grass like Kweek or Kikuyu on the dam wall to hold the soil. Build an outlet pipe into the bottom so that water is let out into the channel below. Grow reeds in the channel to prevent erosion.

Erosion from contours

A broken contour can cause bad erosion. Repair broken contours with rocks and soil and strengthen them by planting grass.

Erosion is worst where the ends of the contours lead into the drainage channel. Strengthen these places by putting stones into the soil. Protect drainage channels in the same way as you protect gullies.

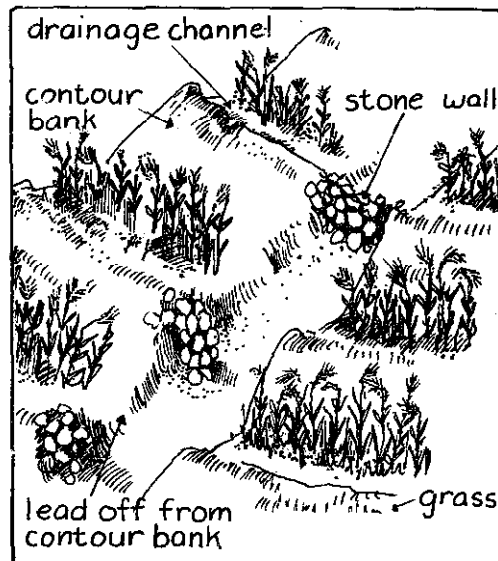

Animals

One of the biggest problems for small farmers in black rural areas is the lack of grazing. Some people say there is overgrazing in black rural areas because black farmers do not know how to look after cattle properly. But the real cause of overgrazing is the overcrowding of people and cattle.

Animals were not always so crowded onto the land. Long before white settlers came to South Africa, people kept oxen, pigs, sheep and goats for meat and skins. In the Transvaal, women hoed with iron hoes, and in the Cape they used wooden digging sticks. The Khoi people in the Cape used to ride oxen and transport things on their backs.

White settlers brought steel ploughs and ox wagons. Black farmers soon started using these things, and in the 19th century black farmers were ploughing a lot of land with oxen. Most of the land bought by black people near the end of the 19th century was bought by successful farmers who had farmed a lot of land with oxen and steel ploughs.

At the end of the 19th century a terrible disease called Rinderpest killed many cattle. Soon after this another serious disease called East Coast Fever killed many cattle in Natal and the Eastern Cape. In some areas the government sold donkeys to people to replace their cattle. People ploughed with donkeys, but the donkeys did a lot of damage to the land, eating grass right down to the roots. Some areas which are badly damaged today, like Msinga in Natal, were first damaged by donkeys overgrazing the land.

Many farmers had to stop farming, and were forced to look for jobs on the mines or to work for white farmers. They used the money they got from working in the mines to build up their herds of cattle again. Some farmers rented land from white farm owners. They made a lot of money selling to the mines and to people in towns. They used this money to buy land outside the reserves.

Then they were faced with a new problem. The 1913 Land Act forced black people to move into the reserves. Overcrowding of people and animals started the process of erosion. At about the same time, the government started controlling serious animal diseases, including tick diseases. The control laws stopped people from moving their animals freely onto rented grazing land. This together with the Land Act, meant that animals could not be moved out of the reserves. Grazing land was becoming scarce, and there was more overgrazing and erosion. But people did not want to kill their animals because they produced milk, meat and skins, and they reproduced and multiplied. People preferred to buy animals than to put their money into banks, because animals gave them a better return for their money.

When betterment schemes were started in the 1950s, people were forced to keep less animals. Only a certain number of large and small animals were allowed on each betterment scheme. Many people had to sell all their animals, or only keep a few, when they moved onto betterment schemes. Today many people have no animals at all.



Cattle

Keeping cattle used to be important for black people in South Africa for many reasons. Cattle gave milk, meat and leather and pulled ploughs so that crops could be grown. But now that people are forced to live in such crowded places, there is not enough land for cattle to be healthy. Only a few rich black farmers have large herds of cattle. Many people have a few cattle which are often thin and weak, and do not get lots of calves. Most people have no cattle at all.

The most important thing about keeping cattle is to be sure they have enough to eat. This means having enough grazing camps for summer and enough hay or silage for winter.

Breeds

If you breed cattle properly you can get a bigger, stronger herd. Local cattle like Nguni, Afrikander and Tswana are very strong and can survive in hot dry places. They can grow fast if they get enough to eat. In hot places it is best to keep these breeds.

The only imported breed which is good for hot places is the Brahman. Other imported breeds come from cold wet places like Europe, so in cool wet areas in South Africa a cross between imported breeds and local breeds

gives good strong cattle. A bull of an imported breed like Brown Swiss, Hereford and Simmentaler can be crossed with local cows. Crossbred cattle will give more milk and meat than local breeds and will survive better in South African conditions than pure imported breeds.

Buying a Bull

You need only one bull for 30 cows. One good bull can give you many improved calves, and one bad bull can weaken your whole herd. So choose the bull carefully. Look for a bull 2 to 4 years old with strong legs, strong back and shoulders, wide across its back legs. Ask to see some of his calves so you can tell if he is a good bull.

You need a different bull every 5 years, otherwise he will start mating with his own calves. This weakens the herd. Bulls can be used until they are 10 to 12 years old, so instead of buying a new bull after 5 years, swop bulls with another farmer.

Bulls are expensive, and most small farmers do not have enough cows to need their own bull. It is a good idea for a few farmers in a village to buy a bull together and share it.

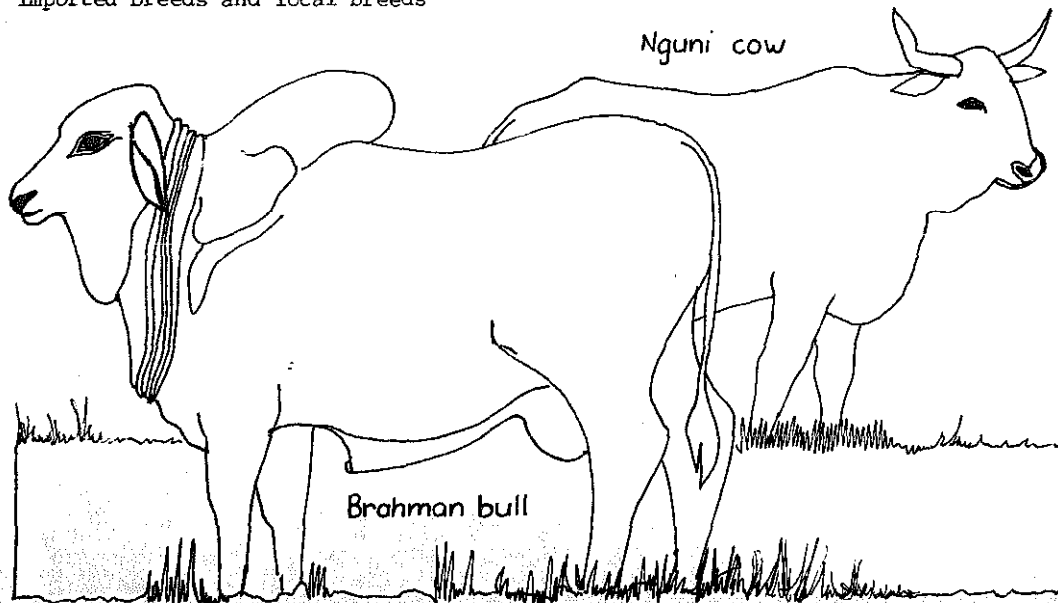

Bulls must be healthy and well fed. Dip them regularly to make sure they do not have any ticks. In winter, give them mealie meal as extra food. Give them exercise so they do not get too fat, otherwise they will not mate well. Herd them often so they get used to people and are not wild.

Bulls should only run together with cows during the mating season.

Buying Cows

If you want to buy cows buy young cows 6 to 10 months old or older cows as long as they are fertile. Sometimes people try to sell cows because they are old or infertile. Buy a cow which is pregnant or has a calf. Look for cows which are quiet and tame with good udders, strong backs, and strong legs.

You can tell a cow's age by the number of teeth she has. A cow with a full mouth of teeth or some fallen out is old, and she will not give any more calves. Buy cows which have 2, 4 or 6 top teeth.

Mating

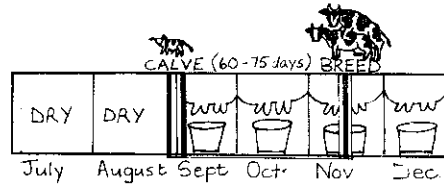
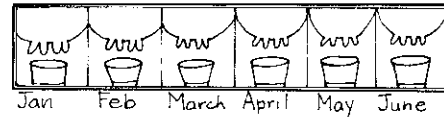

Cows can start mating when they are 1½ to 2 years old. The best time for them to mate is December or January so when the calves are born 9½ months later, it is spring and there is lots of green grass.



A cow should be mated every year, so after being pregnant for 9½ months she must rest for 2½ months before mating again. This means that she must not mate the first 2 times she comes on heat after giving birth. Coming on heat means she is ready to mate. These are the things you will see if a cow is on heat:

- ▶ She stands still when other cows climb onto her.
- ▶ She tries to climb onto other cows.
- ▶ She becomes restless.
- ▶ She has a red and swollen vulva with clear liquid coming out.

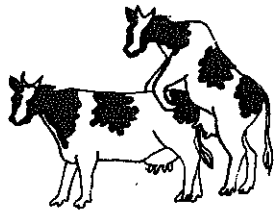
If a cow has not given birth within 2 years, she is probably infertile. If she is old, sell her. If she is young she may be infertile because she is short of food or short of minerals like calcium and phosphorous. Feed her well and give her a salt and bonemeal lick to make up a shortage of minerals. If she is still infertile sell her.

0-6 HOURS.	6-10 HOURS	10-20 HOURS	20-30 HOURS	30-36 HOURS
TOO EARLY	GOOD	BEST TIME TO BREED	GOOD	TOO LATE
				
COMING INTO HEAT	TRUE HEAT	AFTER HEAT		
Attempts to ride other cows. Smells other cows. Vulva moist, red and slightly Swollen Mucous discharge from vulva.	Stands to be ridden. Makes a lot of noise. Rides other cows. Nervous and excitable. May hold milk back. Clear mucous from vulva.	Will not stand to be ridden. Smells other cows. Becomes quieter and less nervous. Clear discharge from the vulva.		

Giving Birth

When cows are about to give birth keep them near your home so they are easy to watch. They usually do not need any help and give birth in less than 2 hours without problems. Usually the calf's front legs come out first, then its head, then its body.

If the cow has not given birth within 2 hours, try to help her. Wash your arms well with soap and water to prevent giving the cow a disease. Put the cow in a cattle brace so she cannot move, with poles under her belly to support her. Then feel inside her womb to check how the calf is lying. If the calf's tail is next to the opening of the womb, do not try to turn the calf around because it can easily die.

Call somebody with a lot of experience to help. If the calf's head is facing the opening of the womb, feel where its front legs are. One of them might be hooked under the calf's stomach. Free the leg by pushing the calf back gently by the neck and then pulling the leg up next to its head.

Sometimes the calf is stuck because the back legs are hooked under its stomach. Check that the back legs are not hooked. If they are, straighten them gently. Sometimes the legs are not hooked, but the cow is too weak to push. Help her by pulling the calf by the head or the shoulders. Never pull the calf by its legs. Sometimes the calf is upside down in the womb. It cannot be born upside down. Get an

experienced farmer to help you to turn it over very gently inside the womb.

Soon after the calf has been born, the afterbirth will come out. If it does not come out after one day, ask an experienced person to help you take the afterbirth out of the cow's womb. Burn the afterbirth, or dig a pit and bury it.

Calves and Milking

An hour after being born, the calf should stand up and begin to suck. If it does not stand up, help it. Do not take the cow's milk for the first week. It has extra food in it to help prevent the calf getting diseases.

Many farmers do not milk their cows. They let the calf stay with its mother until it is 6 to 8 months old. Some farmers like to get milk from their cows. One way to do this is to keep the cow away from her calf at night. In the morning, before letting the calf go out with the cow, milk 2 teats (or only one teat if the cow does not have much milk). After milking, the calf can stay with the cow for the day and suck the rest of her milk. After 7 months, take the calf away from the cow for a few months. After this, the calf will stop drinking its mother's milk. This is called weaning. From the time you keep the cow and calf apart, you can take all the cow's milk. Make sure weaned calves are well fed, or they will get very thin. If possible give them a little mealie meal every day.

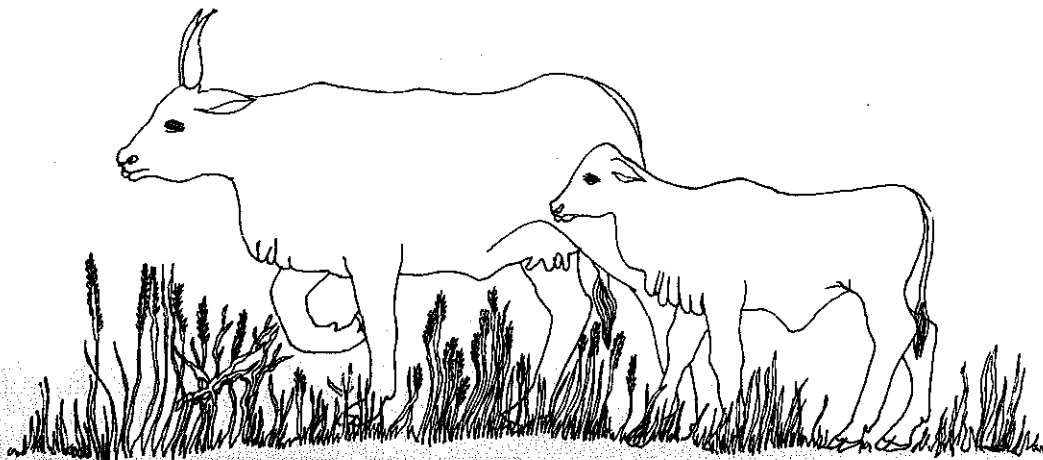

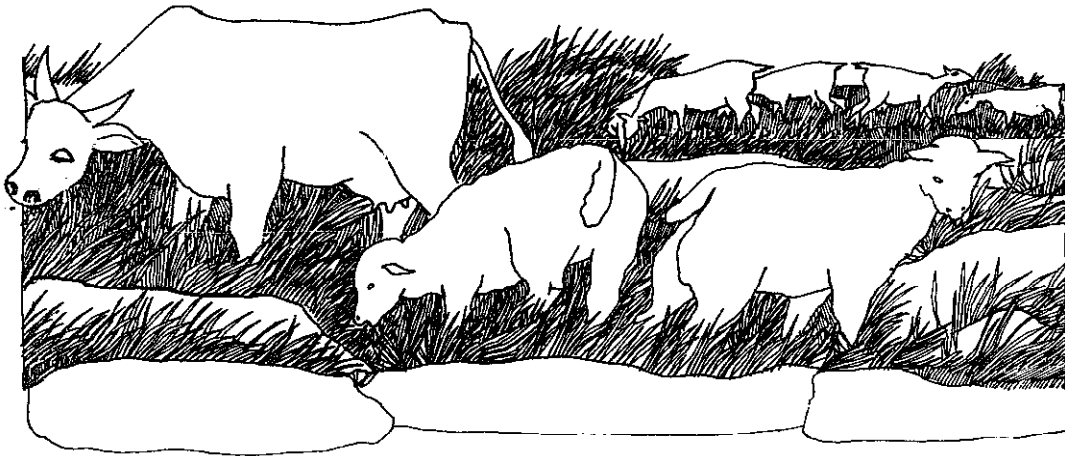

Castration

Bull calves should be castrated between 2½ months and 18 months old. The best time is 3 months, because when the bulls are older castration is much more painful. However young bulls grow quicker if they are not castrated, so farmers who want to sell 2 year old oxen castrate their bulls as late as possible. If you are castrating bulls to have oxen for yourself, you should castrate them early, because over 4 or more years, the oxen grow to the same size as those which were castrated late.

It is best to do castration with a burdizzo. It crushes the tubes which carry the bull's sperm inside the testicles. The burdizzo does not cut the skin of the testicles, so the bull does not bleed. If you use a knife, make sure it is very sharp. Sterilise it by boiling it in water for 10 minutes.

Feeding

Cattle need good food throughout the year. In summer they can get most of their food from the veld. They must get a supplement of salt and bonemeal to make sure they have enough minerals. Cows should always get enough food when they are pregnant and when calves are sucking their milk.

In winter, cattle can eat mealie stalks, pastures, or veld which has not been grazed during the summer.

A Rumevite lick helps them to get enough nutrition. Sometimes in winter they will need extra food like hay or silage.

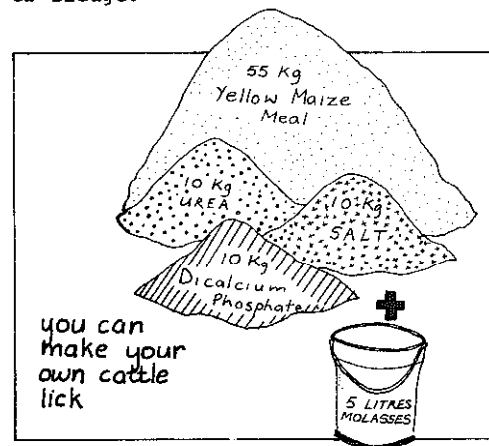

Selling Cattle

The best age to sell cattle is when they are about 3 years old. Sell them at the end of summer when they are healthy and strong. In some places the government has fattening ranches where people can take their cattle to get special food to make them fat for selling. Ask your stock inspector about stock sales and fattening ranches.

Sell all cows which do not give birth for 2 years in a row and sell all oxen which you do not need for ploughing. If you sell to an abattoir, make sure your cattle have no diseases, or you will not be paid for them.

EARTAG NO: 36		BREED: Brahman x Nguni		ORIGIN: Magagula		VALUE R200		PURCHASE DATE: 4/10/79	
DATE OF BIRTH: June 1977				SIRE (father) Br 24		GRANDSIRE: Brahman 13		OTHER INFORMATION has not calved before. Dehorned at 6 months.	
DATE OF DISPOSAL:				Lomvula DAM (mother)		G. SIRE: ? G. DAM: ?			
REASON:									
THE COW			THE CALF			REMARKS			
DATE SERVED	BULL	DATE CALVED	SEX	WEIGHT	DISPOSAL	Calving - no problems.			
2/1/80	Br 115	12/9/80	Female	40kg.					

Keep a record like this for each animal

Cattle Diseases

Cattle get many diseases, especially when they do not have enough food and water and when they are not vaccinated or dipped regularly.

It is better to vaccinate your cattle against diseases than to try to cure them when they are already sick. Vaccinations are injections which prevent animals from getting diseases. They can not cure diseases.

You should vaccinate all your cattle every year against Anthrax and Black-quarter and vaccinate all female calves once against Contagious Abortion. In places where many cattle suffer from other diseases, you should also vaccinate your cattle against these diseases. Government stock inspectors usually vaccinate animals and you can also get vaccine medicines from Onderstepoort (see p 523), from farmers co-operatives and chemists.

Most vaccines must be kept cold in a fridge until they are used. Read the label carefully to find out if the vaccine must be kept in the fridge.

Check that the date on the box has not passed. If the date has already passed, the medicine will not work. The label will also tell you how to mix the medicine. If it must be mixed with water, buy sterilised water from a chemist or farmers co-operative.

Make sure the vaccination needles are very clean by boiling them in water for at least 5 minutes. Clean the needle after injecting each animal by dipping it into methylated spirits. This stops diseases spreading from one animal to another.

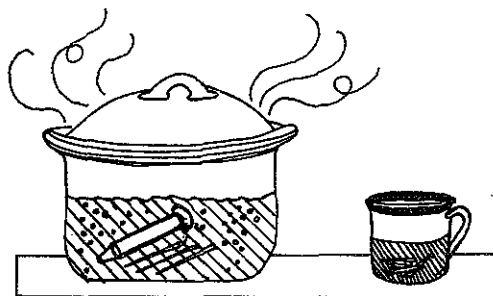

boil syringes and needles

There are 3 ways to give injections:

- Intramuscular - into the muscle on the rump. Be careful to inject at least 10cm away from the backbone.
- Subcutaneous - under the skin of the neck. Ask an experienced person to help you the first time.
- Intravenous - into a vein. This should be done by an experienced person.

Some diseases, like Anthrax, spread very quickly and can kill a whole herd of cattle. Other diseases, caused by ticks and worms, make cattle weak and they have weak calves.

You can see if an animal is sick because it stands away from other cattle, it does not want to move or eat, its skin looks dirty and its eyes are not shiny. Sometimes it has diarrhoea and coughing and its temperature is high. Move the sick animal away from the others and call the stock inspector. If you have antibiotic medicine like Reverin or Terramycin, inject the sick animal.

If the sick animal dies, do not eat the meat until you know why it died. Some animal diseases can also kill people who eat the meat. Report all animals which die suddenly to the stock inspector, who will tell you why they died and how to stop the disease from spreading to other cattle. These are the most common diseases of cattle in Southern Africa:

- Anthrax is a very painful disease which kills cattle quickly. Usually you will see blood coming out of the nose and anus of the dead animal. Do not touch this blood or cut open the animal because Anthrax can kill people. If the dead animal has Anthrax you have to burn it. It is a law in South Africa that all cattle must be vaccinated against anthrax every year.

- Foot and mouth is a disease which can spread quickly to all your animals. You will see white sores inside the mouths of your cattle and spit running out of their mouths. They walk as if they have sore feet. Animals with foot and mouth disease do not die but they are weak for a long time. Report foot and mouth disease to the stock inspector straight away before it spreads to other cattle.

- Blackquarter disease kills cattle, sheep and goats younger than 3 years. The animals get sick and one or two of their legs become stiff and sore. They die within 2 days. When you cut open the animal you will see that the meat on the stiff legs looks dark. There is nothing you can do if your

animals get blackquarter. You can prevent it by vaccinating all your animals when they are 6 months, 7 months, 1½ years and 2½ years old.

- Contagious abortion is a disease which makes cows give birth between 5 and 8 months instead of at 9½ months. The calves are usually born dead. If you find a cow with a dead calf, take her away from the other cows until she has finished giving birth and the afterbirth has come out. There will be reddish liquid coming out of the cow's vagina. Clean the cow very well and burn the dead calf, the afterbirth and everything you used to clean the cow. Burn the grass where the cow gave birth because if other cows come to the place, they will also get the disease. Keep the cow apart from all other cows for a month afterwards, otherwise other cows can get the disease. Ask your stock inspector to do a blood test to check if other cows have contagious abortion.

Contagious abortion can make cows and bulls infertile. You can prevent it by vaccinating female calves before they are 6 months old. Do not vaccinate any bulls.

- Tetanus is a disease which makes animals very stiff so they can not walk and can not eat. Usually they die. Tetanus comes from dirty injection needles, dirty castrating tools or a dirty wound. If a sick animal is very stiff, call the stock inspector straight away. To prevent animals getting tetanus, boil injection needles and castrating tools and put iodine onto all wounds.

- Lumpy Skin Disease gives cattle lumps on their skin. There is no medicine to cure the disease, but the cattle will get better if you feed them well. You can prevent the disease with a vaccination once a year before the rains start. You can get the vaccine from Onderstepoort.

- Calf scours is a disease of young calves. They get yellow diarrhoea, become very hot and breathe quickly. They usually die. Many calves get this disease because they are fed from dirty buckets, especially when they do

not drink their mother's milk for the first week after they are born. The best way to prevent calf scours is to let the calves drink milk from their mothers. You can milk the cows first, then let the calves drink (see Calves and Milking p 226). If the calves are not drinking milk from their mothers, you can help to prevent calf scours by washing their feeding buckets with Jeyes Fluid or Savlon mixed with water.

You can cure calf scours by giving the sick calves Kemzol medicine and lots of clean water to drink.

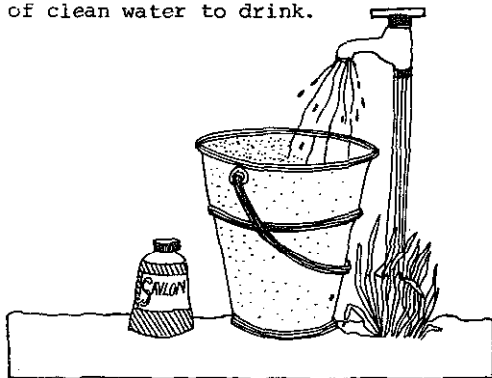

● Ophthalmia (pink eye) is a disease of the eyes which can make animals blind. The animal stays out of the sun, a lot of water and sometimes yellow pus comes out of its eyes. Treat the disease as soon as possible, by putting Terramycin Eye Powder into the eyes every day. You can also put a few drops of Reverin in the corners of the eyes. Keep the skin underneath the eyes clean and dry.

● Dry Gall Sickness is a disease which cattle get when they eat only dry grass in winter and do not have enough water. They become constipated. To cure Dry Gall Sickness make a medicine of 2,5 litres of water mixed with 250g of salt and 500g of sugar. Put it into a bottle and pour it carefully into the animal's mouth so it does not choke. After 3 hours give it 2 cups (500ml) of vinegar and after another 3 hours, give it 2 more cups of vinegar.

Animals do not get this disease if they have enough water to drink during winter.

Tick diseases

Many animals suffer and die from diseases carried by ticks. You should get rid of ticks regularly by dipping your animals or washing or oiling them with tick poison. The most common tick diseases are:

● Gall Sickness is spread by many different kinds of ticks. It makes the animals hot and constipated and they do not want to eat. The skin inside their mouths looks pale yellow. Inject them straight away otherwise they can die after 2 days. Use Terramycin or Reverin every day for 3 days. If you cut open animals which have died of Gall Sickness, the meat looks yellow.

● Redwater makes animals hot and they do not want to eat. When they pass water, it is red. Inject the sick animals with Berenil or Phenamidene medicine, otherwise they will die.

● Heartwater is spread by Bont ticks. The animals get hot and do not want to eat. They breathe slowly. Later they fall over onto their sides and move their legs. Inject them straight away with Terramycin or Reverin once a day for 3 days, otherwise they will die.

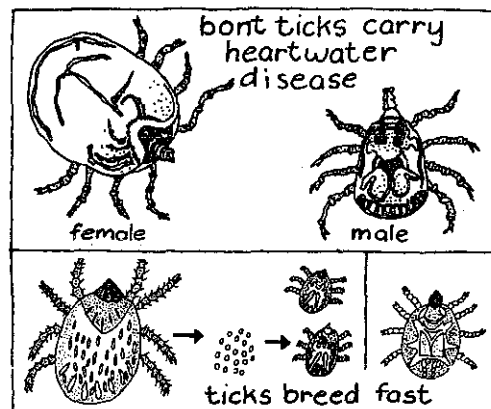

● East Coast Fever is a very serious disease which makes cattle die after about 2 weeks. They get hot, do not want to eat and a lot of spit comes out of their mouths. They become constipated and then get diarrhoea. If your cattle get this disease, call the stock inspector straight away.

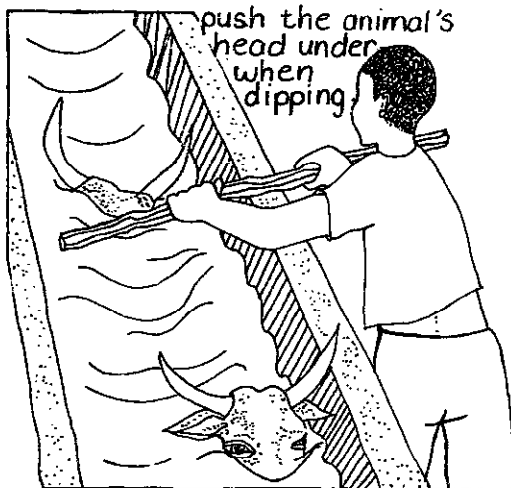

Dipping

You can prevent many diseases if you dip your cattle in a poison to kill ticks. In most places there are government dipping tanks which everybody can use. In hot places, cattle should be dipped once a week in summer and every 2 weeks in winter. In cooler places, they should be dipped every 2 weeks in summer and only once during winter. If there is no dipping tank nearby, mix Bacdip poison with water and wash your cattle with it. You can also use tick oil or grease. Wash or oil well the ears, neck, udder or scrotum and under the tail.

Worms

Worms cause a lot of suffering to cattle. They live inside the animals and make them weak. The most common worms are roundworms, tapeworms and flukes. You can get rid of worms by

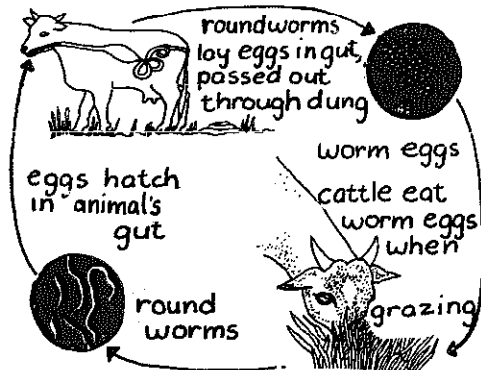

giving your animals worm medicine at the beginning, in the middle and at the end of the rainy season for cattle less than 4 years old. If you can not afford worm medicine for all your cattle, give it only to those younger than 4 years.

- Roundworms make cattle thin and weak, even when they have enough to eat. Give them Tramisol, Ripercol or Thibenzole medicine.
- Tapeworms live in the stomachs of animals and eat their food, making them weak. Calves with swollen stomachs often have tapeworms. Give them Lintex medicine.
- Flukes are small worms which live in wet places like the banks of rivers or dams. Liver fluke makes animals constipated and weak. Conical fluke gives animals diarrhoea with blood in it. Use Zanil medicine to get rid of liver fluke and Lintex to get rid of conical fluke.

One week after you give animals worm medicine, move them to a new place to graze, and do not use the old grazing camp for 3 months. This will be enough time for the worm eggs in the soil to die. To prevent worms in calves, keep their kraal dry by putting dry grass and mealie stalks on the floor whenever it gets wet. To prevent animals getting flukes, keep them away from wet places and give them water in drinking troughs.

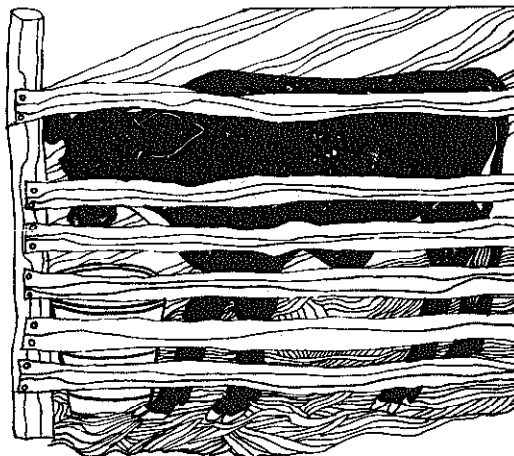

I think that cattle farming is the best thing in the bushveld

Mr Seokatsa has been farming cattle for 2 years at Eldorado near Bochum in the Northern Transvaal. He worked in Johannesburg for 12 years and returned to take over his father's land when he died. He has a brother who farms nearby and another who works in Johannesburg.

● Why did you decide to farm with cattle?

I love animals and I think it is a good way to make a living. When I left to work in Johannesburg I had only three cows but I used my savings from when I worked, so now I have 80 cattle. Most of them we bought on local sales and from neighbours. My 2 bulls are Brahmans - one is purebred and the

other is a three quarters. So far I have 20 calves and 60 cows. Each year I get about 14 calves.

● Where do the cattle graze?

I hire grazing from a nearby white farmer. He charges me R1,50 each per month for the big cows. I think it is worth it to pay this because I get good grazing. We use rotational grazing. They graze in 5 camps, 1 at a time. So they get enough grazing all year. I don't milk the cows because if I do that the calves will suffer. Also, the cows are far from my home. I employ a man to live on the farm and look after the cattle. I use good breeding cows and bulls so I get good calves. I

sell them when they are 18 months old for about R180 each at local stock sales. All the bull calves we castrate at 18 months, just before selling.

● Do you have winter feed?

The cattle graze on the veld all year round. With rotational grazing they never run short of food. I give Rumevite blocks in winter and salt and bonemeal in summer to make sure the animals stay in good condition.

● How do you prevent diseases?

Diseases are not a problem because we dip the cattle every month. In summer and winter we give them Thibenzole to get rid of worms.

● What other farming do you do?

I have about 70 goats and 30 sheep which graze on the village land. I also have 5 hectares of dryland where I grow maize and beans. At my home I have a strong borehole where I am irrigating a garden of vegetables to sell locally. I use hired labour for most of the work. They get R18 per month and food. There are many people around here looking for work.

I think that cattle farming is the best thing here in the bushveld. I hope to have a herd of 150 cows. Then I will choose the best breeding animals to give me a good living.

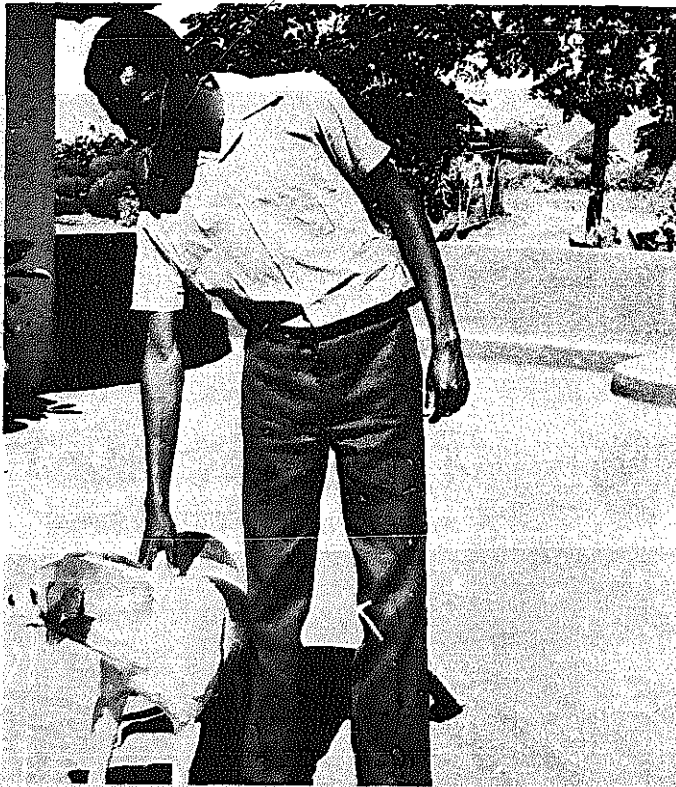

If we work together we have a better market

Mr Malasi is a member of Tugela Dairy in the Herschel District of the Transkei. Tugela Dairy is one of the few dairies set up by the government in 1951 which is still open. It has 15 members.

● When did you join?

I was one of the first members when this dairy started. I joined with four cows. The government gave us a Brown Swiss bull, and now all my stock comes from those first cows. Of course we change the bull every three or four years. My first cows were Jersey types, but by now they are almost Brown Swiss. They give a lot of milk. When we began our dairy we used the old Post Office in Herschel, and then later the government helped us to build a new dairy and a separating room. First we sold our cream to a cheese factory in Aliwal North and we got quite a lot of money, but since 1975 we send our cream to Bloemfontein, and the money is much worse. Our biggest problem is that the people here don't like

skim milk, so we have a lot of wastage. That's why we'd like to improve our dairy with more equipment and sell fresh milk.

● How do you work together with the other members in the dairy?

Without the others I could not manage. We want to supply milk to the whole community, so if we work together we have a better market than each of us working alone. Being in a group helps us with bulls. We still have our own cows and most of the work with the cows we do on our own. At the moment our money from the dairy is low. I get only about R20 per month from my fifteen cows.

● How do you feed your cows?

We do not have any pastures. My cows just eat the veld. In the winter they have to live by eating the mealie stalks left in the fields. Every morning when I milk the cows I give them a handful of dairy meal.

During the winter I give them a little bit more. I buy Rumevite blocks - in the winter they eat a lot of that. I give them salt and bonemeal too. It would be very good if we had more food in winter because the cows get very thin. Sometimes we buy lucerne, but it's expensive and we can't afford enough.

● So you have many problems with diseases and ticks?

Yes, ticks are a big problem because we do not have a dip here. I inoculate my cattle against all the dangerous disease like Anthrax, Contagious Abortion, Gall Sickness and Red-water. I keep antibiotic medicine and if they get sick, I use that. The other disease problem is ophthalmia, but I beat that with terramycin medicine. Sometime ago I lost a few cows because of some disease I had never seen before, but usually I can control diseases because I know what they look like.

● You must be proud of your healthy calves ...

Yes, without calves this dairy would be useless. My cows are very fertile and calve every year. I decide how much milk the calf can drink according to its health. If the calf is healthy then I leave only one teat for it to drink. Otherwise if it's a bit thin it gets two teats. I castrate all the bull calves. I let them grow up until three or four years then I sell them in local stock sales, but they never give us a good price.

● Do you only have cows, or do you farm other animals as well?

Yes, I have a few sheep and goats, and about 7 hectares of land. I grow wheat, sorghum, mealies and a bit of beans. This year the crops have failed because of a bad drought. The winter is going to be hard, because there is no food for us or the animals.

Dairy Cattle

Long ago, milk from cows was one of the most important foods in South Africa. People had many cattle and enough land for grazing. Today, people do not have grazing land. Most of our milk comes from big dairy farmers who have special breeds of cows which give a lot of milk. These farmers grow or buy expensive food for their cows. They also have expensive milking machines.

Breeds

Jersey, Friesland, Guernsey and Ayrshire are the breeds which give most milk. If you are a small farmer, it is better to have breeds which can give you meat as well as milk. The most popular of these breeds are Brown Swiss, Simmentaler and Drakensberger.

Feeding

Dairy cows need extra food all year round so that they can make milk. If they do not give enough milk, it is usually because they are not getting enough food. In spring and summer, dairy cows can get most of their food from good grazing veld or from fields planted with pasture grass (see p 240). In autumn and winter you can feed them hay or silage (see Winter Feeding p 244) or food from trees like acacia and honey locust (see p 204).

making a concentrate

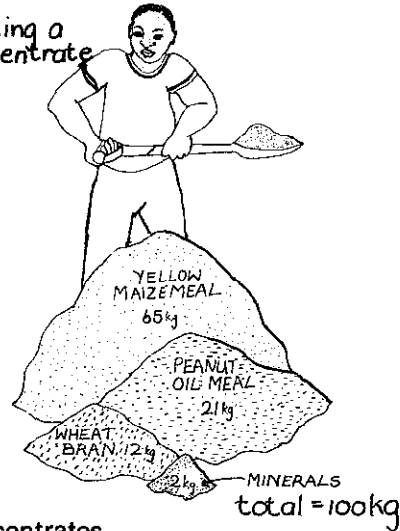

Concentrates

If you do not have hay or silage you can give your cows dairy concentrates to keep them healthy. It is expensive to buy concentrates. It is cheaper to make your own by mixing mealie meal with salt, bonemeal, bran or molasses and a protein food like oil cake meal, lucerne meal, or fish meal. Give your cow 1kg of concentrates for every 3 litres of milk she can produce. You can also feed your cows a supplement food like Rumevite. This enables them to eat more dry grass during winter.

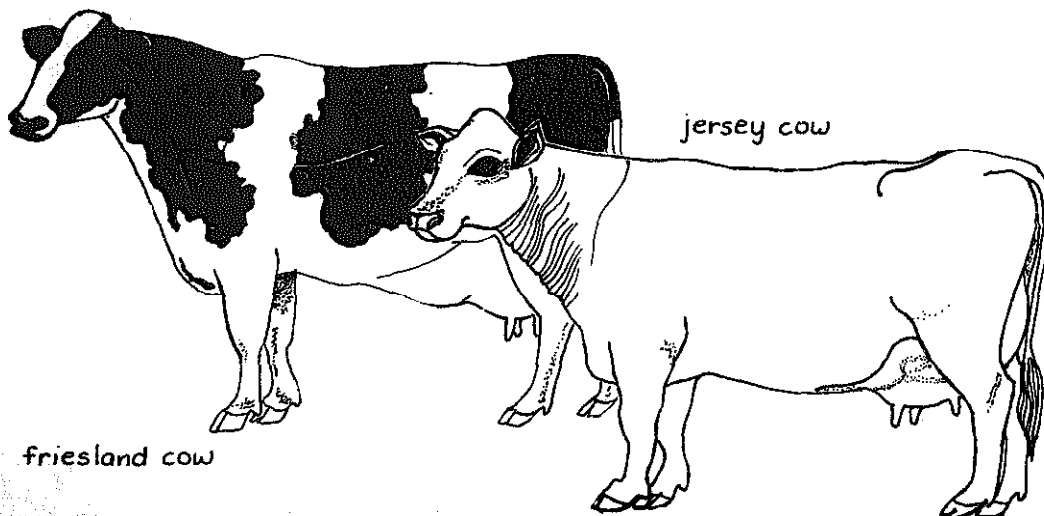

1981 breed cows at different times to get milk all the year round

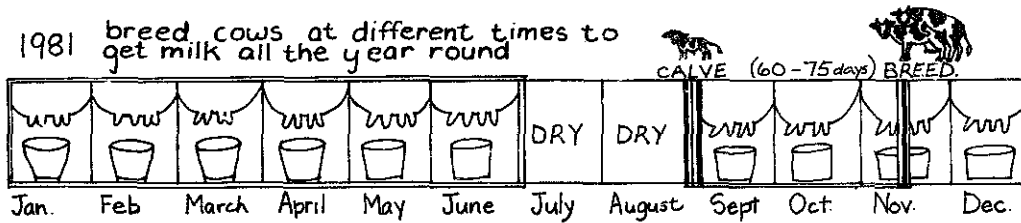

Minerals

Dairy cows need a lot of calcium and salt. Make sure they always have a salt mixture which they can lick whenever they want to. These are 2 mineral licks which you can mix for your cows:

Dicalcium phosphate	5 cups
Molasses	1 cup
Salt	4 cups
Bonemeal	6 cups
Salt	4 cups

If your cows do not come on heat or do not get pregnant, it probably means that they are short of minerals.

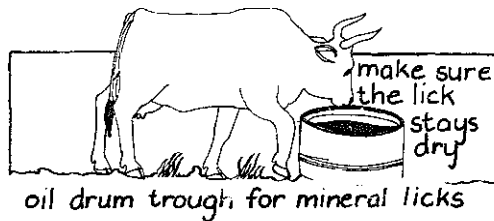

oil drum trough, for mineral licks

Drying off

Dairy cows should give birth every 12 months. About 2 months before the cow gives birth, she should be dried off. This means you must stop milking the cow so that her body can rest and be strong for feeding the new calf. During these 2 months, feed the cow well with 3kg of concentrates a day for breeds like Ayrshire or Friesland and 2kg a day for dual-purpose breeds like Brown Swiss or Drakensberger.

Just before and just after birth give her some bran as a laxative. Make sure she gets a mineral lick during the time she is dried off.

Milking

Dairy cows should be milked by the same person at the same time every day. Keep the udder as dry as possible and wash it only if it is very dirty. Test the first milk in each teat for strings or lumps by letting the milk run down the back of your hand. If there are any strings or lumps, it means that the cow has a disease called mastitis. You can get rid of mastitis by squeezing ointment up the teat which has mastitis. Use Pendiclox medicine. If mastitis is bad, that part of the udder will become hard and swell up, and you have to rub it and milk the cow 2 or 3 times a day. To prevent mastitis, wash your hands well before you milk the cow and make sure all buckets and other tools are very clean.

Weigh the milk each cow gives every day and write it in a book. This will help you to know how much extra food the cow needs. If the milk gets less you must give the cow more food and make sure she is not getting sick.

Tick Diseases

Dairy cows should not be dipped in a cattle dip. To get rid of ticks, use tick grease or tick oil. Check for ticks every time you milk the cows.

keep a milk record like this for every cow every week

NAME OF COW (or NUMBER) Ntfombi (aa)								
WEEK BEGINNING	MON	TUES	WED	THURS	FRI.	SAT	SUN	TOTAL
5/7	MORNING	8.3l	8.0l	8.1l	8.2l	8.2l	8.0l	9.0l
	EVENING	6.0l	7.2l	7.0l	6.8l	6.9l	7.0l	6.6l
	TOTAL	14.3l	15.2l	15.1l	15.0l	15.1l	15.0l	15.6l

Sheep

Sheep are good animals to keep with cattle because they eat grass which is too short for cattle to eat. They eat bushes which cattle do not eat. They can live well in mountains and in very dry areas, but if there are too many sheep on the same land for a long time they can eat all the grass and cause soil erosion. It is better to divide the land into camps and use rotational grazing (see p 240).

Usually sheep must be kept in a kraal at night to prevent them being stolen or getting attacked by wild animals. But if you are sure they will be safe, leave them out to graze at night.

Sheep are nervous animals and need to be treated gently. They are not as strong as cattle and you should not force them to run too fast or hit them with sticks and whips.

Breeds

These are the most popular breeds:

- Merino sheep give the best wool and good meat, but they need good grazing.
- Imported breeds like Romney, Dorset Horn and Suffolk give good meat and some wool, but need good grazing.

- Dorper sheep give good meat and rough wool. They can live in dry places with poor grazing. They are the most popular sheep for small farmers.

- Karakul sheep live best in very dry places like Namibia. Karakul lambs are killed to sell the skins.

It is important to have a good male (ram) so that he will produce strong lambs. You will need one male for every 40 to 100 females (ewes). If you buy a male, look for the one which holds its head up high, which has strong legs, a strong back and a wide face with a square jaw. For wool sheep, make sure the male's wool is long, thick and curly, and nearly white in colour.

Mating

It is best to keep the male away from the females when it is not time for mating. The best time for mating is from November to January or March to May. Sheep are pregnant for 5 months, so the lambs will be either born from May to July or from August to October when there is grass in the veld and the weather is not too hot or too cold. The females should be 1 to 1½ years old when first mated.

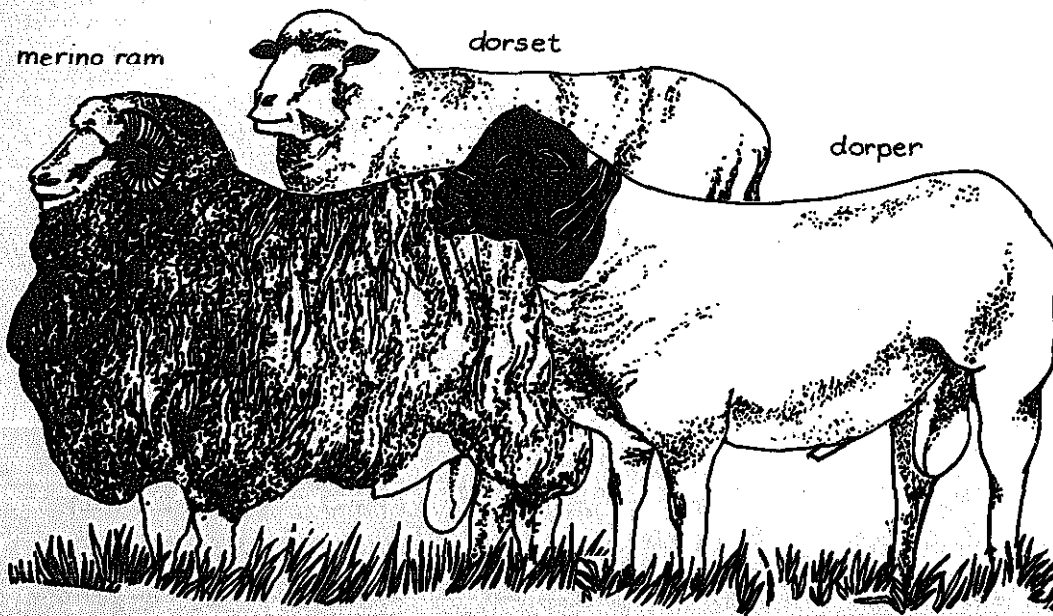

Giving birth

Carefully watch all females about to give birth. They usually give birth easily and do not need any help. The birth is sometimes difficult when the male is a crossbreed and the lambs are very big. Then you can help by pulling out the lambs when the female has started to give birth. Sometimes you have to unhook the front legs (the same as with cattle see p 226). Some breeds of sheep like Suffolk give birth to twins. If your sheep are giving birth in a kraal, make sure it is dry.

After giving birth let the mother have plenty of green grass to eat so that she makes enough milk. Lambs can be weaned when they are 4 to 5 months old. Take them away from their mothers and put them in another camp. Give them enough good food to eat or they can get sick. You can put a few old females with the lambs to keep them together.

Docking and Castrating

Cut off (dock) the tails of all lambs when they are 6 weeks old. Cutting off their tails prevents many diseases and worms which come from dirt around tails. It also makes mating easier for females when they are older. If you use a knife, make sure it is very sharp and sterilise it by boiling it in water for 10 minutes. You can also use rubber rings for docking tails. The rings make the tail fall off without bleeding and the lambs do not suffer so much pain.

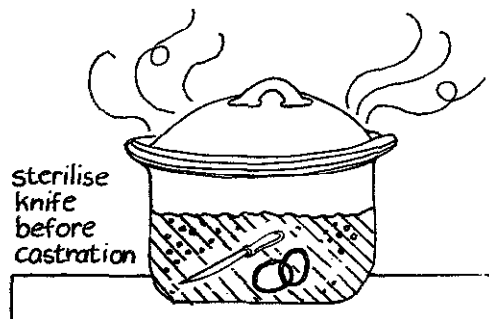

Male lambs should be castrated at 6 weeks. You can use a sterilised knife or rubber rings. If you use a ring, make sure that both testicles are in the skin under the ring, otherwise the lamb will not be properly castrated.

Diseases

Sheep get worms easily. Give them worm medicine at least once a month during summer, and once every 2 months during the rest of the year. Use Thibenzole or Tramisol medicine.

Tapeworms live inside lambs' stomachs and eat their food. To get rid of tapeworms, give lambs Lintex medicine when they are 6 weeks old and again when they are 3 months and 6 months old.

Use a spoon to give worm medicine. Push the sheep's head up and hold its mouth open until it has swallowed all the medicine. One week after giving the worm medicine, you must move the sheep to a new grazing camp, so that the worm eggs in the grass of the old camp can die. After 3 months the sheep can go back to the old camp.



hold sheep's head up to give worm medicine

Sheep must be vaccinated every year to prevent them from getting Anthrax, and every 6 months to prevent Pulpy Kidney disease and Blue Tongue disease. Lambs must be vaccinated against Quarter Evil every 6 months until they are 2 years old. Try to use a clean boiled needle for each vaccination. Usually sheep are vaccinated under the skin between the leg and the stomach. You can get vaccination medicine from Onderstepoort (see p 523). Do not use the medicine after the expiry date written on the box otherwise it will not work.

All sheep must be dipped every 2 weeks between October and February to stop them from getting sheep scab. If there is no dipping tank where you live, use Bacdip to get rid of ticks. Wash with Bacdip around the tail, in the ears, and around the udder or testicles.

Clean the wool around the sheeps' tails regularly. Kill worms under the tail with a little Bacdip or Jeyes Fluid mixed with water.

Shearing

Most farmers shear their sheep once a year, at the beginning of summer. It is important to use a clean shed and to sort the wool carefully because clean wool gets a better price than dirty wool. Put the long clean wool in one pile, the short clean wool from the sides and stomach in another pile,

and all the dirty wool in another pile. Put each pile in bales and send the full bales to the wool sales in East London, Durban or Butterworth. Most small farmers do not have enough wool to fill a bale, so shear with other farmers and sell their wool together.

Selling for Slaughter

Sell all females which do not have lambs every year, and old females with no teeth. Sell males when they are fully grown, between 2½ and 3½ years old. You can sell the sheep at stock sales or directly to the abattoir. If you sell to an abattoir make sure the sheep have no disease, or the meat will be condemned after slaughter and you will be paid nothing. The best time to sell sheep is at the end of summer, when they are well fed and healthy.



We use the grazing camps rotationally

Klaas Mangwana is the headman of Jozanna's Hoek location in the Herschel district of the Transkei. He has been farming sheep for 20 years. He returned from working in Johannesburg to take over his father's sheep.

it to the wool market in East London by railway. The agriculture department gives us equipment for shearing and helps us with selling our wool.

● How many sheep do you have now?

My father started off with 25 sheep he bought from the white farmers in Lady Grey. Now I have 201 sheep. 110 are ewes, 3 are rams and the rest are castrated males. I bought the rams from the Department of Agriculture in Umtata.

● When do you mate the rams with the ewes?

In September to November. The lambs come in May. Last year I got only 63 lambs from my 110 ewes, because it was a very dry year. It's a pity that my neighbours don't take their rams out from the ewes at the same time, so I have to employ a herdboys to keep their rams away from my ewes. During winter I plant barley and the pregnant ewes can eat the barley for a few hours every day.

● What do you do about diseases?

I innoculate them against Pulpy Kidney and Blue Tongue every six months. If any sheep gets sick, I inject it with Reverin and see if it gets better. The sheep are dipped 3 times a year, once in September and twice in October. I also give the lambs medicine for tape worm when they are three months old and for other worms I give them Thibenzole every month for the whole year.

● Do you give the sheep a lick?

Yes, we use Rumevite in the summer as well as in the winter. We used to use salt and bone meal, but now we don't.

● Do you use rotational grazing?

Yes, in the mountains there are camps for the summer and here in the location there are camps for the winter. We open the location camps on the first of July. We use the camps rotationally and we spare one camp each year.

● Do you shear the sheep every year?

Yes, every year in September. All the people in the village shear together. We help each other in a sort of co-operative. We sort the wool out into different classes, like belly wool, sides and backs. Then we put it in bales and send

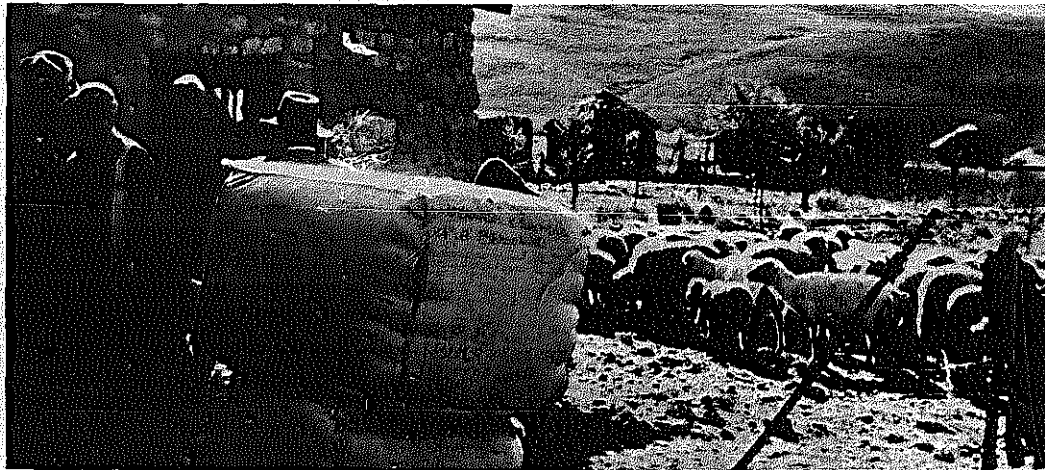

Goats

People like to keep goats because they are very strong and do not get diseases easily. They can find food in very dry and eroded areas, where cattle and sheep cannot live. Goats eat bushes and grass in the veld which other animals do not eat. However, goats can do a lot of damage by eating vegetables, crops and trees. If people keep goats, everyone in the community has to spend time and money on fencing gardens, fields and young trees.

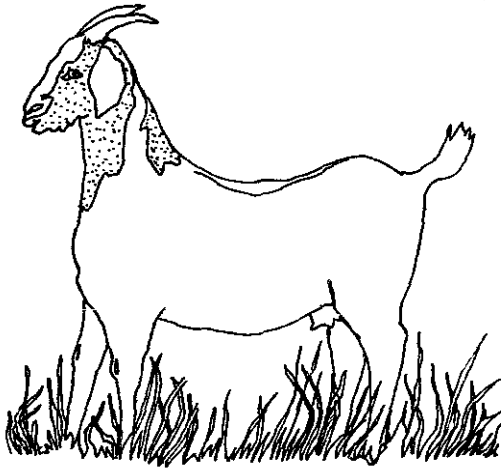

Breeding

Most small farmers use local mixed breeds because they are very strong and can eat anything. You only need to keep special breeds if you want to use goats for milk (see p 80). Milk breeds need good grazing and extra food, and they struggle to live in the dry eroded rural areas of South Africa.

You can improve your goats by choosing your best male goats as breeding rams. Swap breeding rams with farmers from other villages every 3 years, otherwise they start to breed with their own kids. Keep the males away from the females when it is not mating time.

Let the goats mate twice a year, from November to December and from April to May. Mate them all at the same time so that the kids are all born at the same time and it is easy to look after them. The females are ready to mate when they are 1 year old.

Sell or slaughter all females that do not have any kids. Use the kids of the most fertile females for breeding whenever you sell old or infertile females.

Diseases

Ticks and worms do not make goats sick easily, but the ticks can get onto cattle and sheep and give them diseases. Because of this, goats must be dipped regularly. To prevent worm diseases give them worm remedy once a year, especially young goats.

Selling

The best meat comes from young goats, which you can sell for higher prices than old goats. When the males are 3 months old, keep the ones you want for breeding, and sell all the others. If you want to keep males which you are not going to use for breeding castrate them when they are 3 months old.

Rotational Grazing

Veld must be looked after well so that the grass and soil are not damaged and animals can get enough food. Soil and grass help each other. If grass is overgrazed by animals, the sun will dry up the soil, so that grass roots cannot hold it together. When grass can not hold the soil, it can be eroded away by the rain. When the soil is eroded, grass will not grow again and animals will have less food.

There are two kinds of veld grass,

sourveld and sweetveld:

- Sourveld grasses grow in rainy areas with acid soils. Some of the sourveld grasses are very tasty for animals but the very sour grasses are not. If a herd of cattle grazes the same veld for a long time, they will eat the more tasty grasses and leave the others. After some time the tasty grasses will all be eaten and the sour grasses will remain. These grasses are not good food for animals.



● Sweetveld grasses grow in drier places where soil is not acid. Where there is sweetveld, cattle can graze the whole year, and they will not get thin even during the dry season.

Grazing Camps

The best way to help the good grasses grow is to use rotational grazing. This is dividing the grazing area into camps of the same size. The animals move to a new camp every 2 or 3 weeks so that the grasses are not overgrazed.

Rotational grazing does not mean that more animals can be kept on the veld. It just means that the veld gives animals more food. If too many animals are on the veld, there will be overgrazing and soil erosion, even if you use rotational grazing.

You should have at least 4 camps, but it is better to have more.

The camps should be fenced, but you can also do rotational grazing without fences if you herd the cattle.

It is good for cattle, sheep and goats to graze together because they eat different grasses. 6 sheep eat as much grass as one cow or ox.

The size of the camps depends on how much land you have and the type of veld. In sourveld, camps can be smaller than 50 hectares. In mixed veld, camps can be 80 hectares. In sweetveld, camps can be 100 hectares or much bigger. Cattle need 1 hectare each in sourveld and 4 hectares each in sweetveld. For example, say that a village has 800 hectares in a place where there is sweetveld, then the number of cattle you can have on the land is $800 \div 4 = 200$. You can divide the 800 hectares into 10 camps each 80 hectares. All 200 cattle can graze in one camp until the time comes for them to move to the next camp.

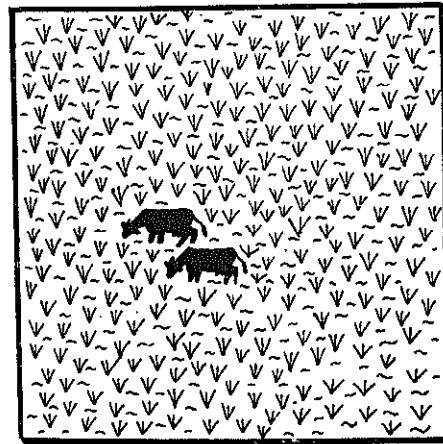
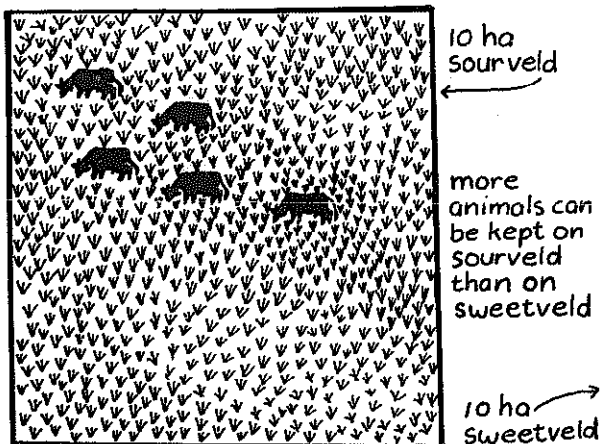

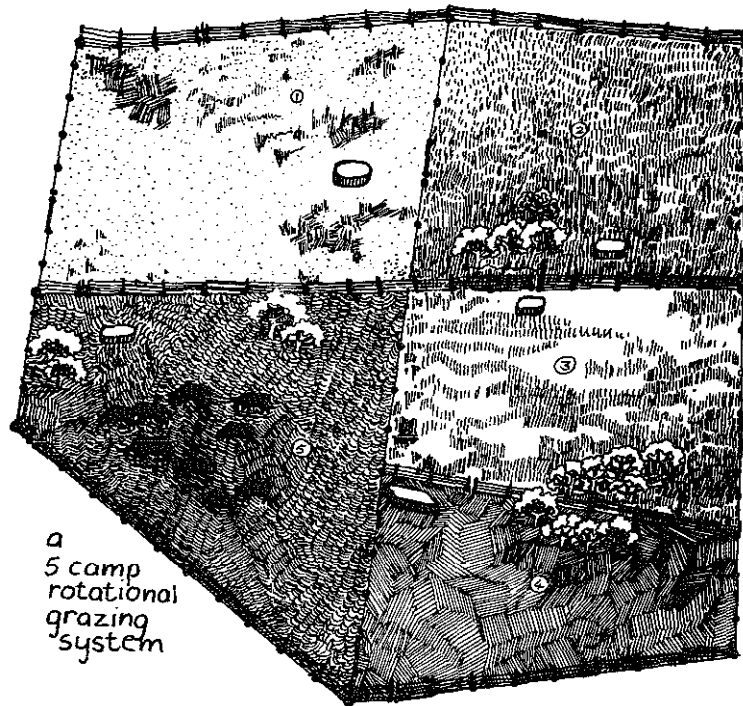

a
5 camp
rotational
grazing
system

How long in one camp?

A good way to tell when to move animals to the next camp is to check on some of the tasty grasses. When nearly half of the leaves of these grasses have been eaten off, it is time to move the cattle to the next camp. Then tasty grasses will never be grazed too short and they will always have a chance to grow well. At the same time the sour grasses will hardly be eaten at all. As the years pass, they will die out, leaving more room for the tasty grasses. In this way the veld gives better and better food.

An easier way of deciding how long to leave animals in one camp is to move them when grass that has been eaten starts to grow again. This is usually after 10 to 15 days of grazing.

Every year leave one camp empty for the whole year. Then the grass can grow seed and new grass from these seeds gets a chance to grow. After some years you will have more grass in all the camps. For example in a 5 camp system, move the cattle through 4 camps one by one, and leave the 5th one ungrazed for the whole year.

Burning

The one camp that has been rested for the whole year will have a lot of dead grass. In sweetveld or mixed veld, you can get rid of this dead grass by letting the animals graze it. In sourveld, it is better to burn the dead grass.

It is very important to burn at the right time - when the first spring rains come. Never burn grass in the autumn or winter. It makes the veld look nice and green in the spring, but it damages the veld.

only burn sourveld, never mixed or sweetveld

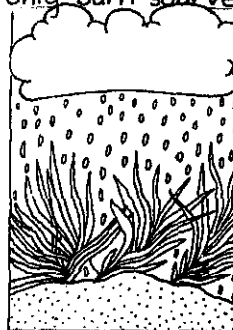

after the first rains
burn your grass



Pastures

Farmers who want to look after their cattle well must give them extra food. Some farmers make hay and silage, others plant pastures for their cattle to graze. Most pasture grasses grow for some years. They are called permanent pastures.

It is good to grow pastures as part of a crop rotation because they improve the soil. It is also good to grow different pasture grasses together, for example, growing legumes like clover with other grasses. The legumes put nitrogen in the soil.

Pastures need a lot of plant food but they also get a lot of manure from grazing animals. So they do not need to be fertilised as much as crops. If you are planting a permanent pasture, plough the land very well, because the pasture will grow for 5 to 10 years.

These are some popular pasture grasses:

- ▶ Eragrostis curvula is good for rainy places. It can be grazed or used for making hay.
- ▶ Kikuyu is good for dairy cows. It needs lots of rain or irrigation.
- ▶ Clover and cocksfoot grass grown together make a good mixed pasture.
- ▶ Cenchrus Ciliaris is good for drier places.
- ▶ Smuts fingergrass grows well in difficult conditions because it makes a lot of seed.
- ▶ Oats, barley and rye are good crops to plant for winter grazing for dairy cows or any animals with young.
- ▶ Japanese radish can grow in winter in cold places.
- ▶ Babala and Napier fodder grow only for one summer but give a lot of good grass for grazing or hay.

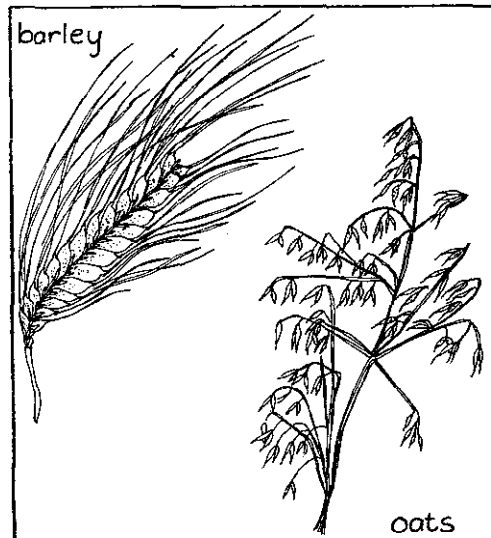
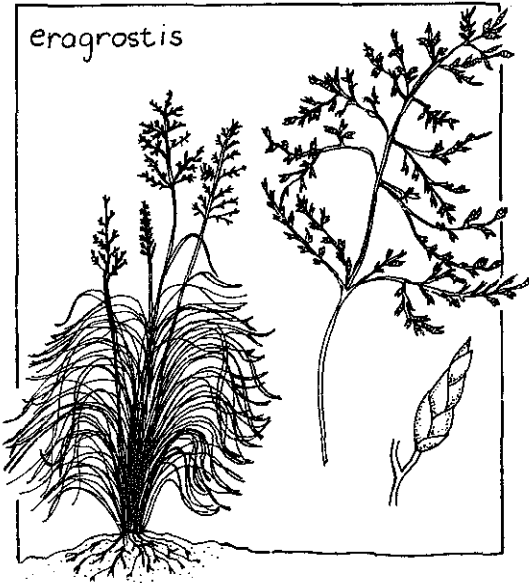

Winter Feeding

Animals need extra food in winter when there is not enough grass in the veld. If you feed oxen during winter, they will be strong enough to plough as soon as the rains come.

Mealie Stalks

Mealie stalks are a good cattle food. Many farmers leave them in the fields after harvesting for cattle to eat

during winter. If you do this, some stalks are wasted because cattle walk on them. It is better to cut the stalks after harvesting and leave them in piles next to your field. Cattle can eat the stalks straight from the piles or you can give them to cattle in their kraal at night. The stalks left over in the kraal will mix with manure and rot to make compost.

Hay

If you cut grass during summer and dry it properly, you can give it to your animals during winter. This dried grass is called hay. It is much better for animals to eat hay than to eat dry grass from the veld in winter.

Some farmers plant pasture grass for hay, like *Eragrostis Curvula*, Teff, Blue Buffalo, Sudan grass and Lucerne (see p 170). Farmers in black rural areas usually do not have enough land to grow pastures. They need the land to grow food for themselves.

The best hay comes from grass which has not been grazed during the summer. Cut the grass before the end of February, on a dry sunny day. Wait for the grass to dry in the early morning sun. Use sharp sickles or pangas to cut it low down, just above the soil. After cutting, rake the grass into rows. Raking the grass into rows helps it to dry slowly. If you cut it in the morning, rake it in the afternoon. If you cut it in the afternoon, let the sun dry it the next morning before you rake it.

Drying the grass slowly makes good hay, not too wet and not too dry. If it is too wet it will become rotten and if it is too dry it will not make good winter food.

Turn the raked grass over once a day for about 2 days until it is ready to make into haystacks. It is ready when:

- ▶ It does not feel cool when you press it against your cheek.
- ▶ You can easily break a bunch of grass when you twist it.
- ▶ The outside of a stalk of grass does not come off when you scratch it with your fingernail.

You can store the hay in a shed or can make haystacks outside. The sides of the haystack must be steep and smooth so that rain can run off. Make the haystacks smooth by raking them with a rake or a hay fork. Stop the rain from wetting the hay by covering it with plastic or thatching grass. If rain gets inside the haystack, the hay will be no good for winter feeding.



Silage

Silage is an animal food made from grass or the green stalks and leaves of crops like maize, sorghum, groundnuts and lucerne. The green crops are put in a hole in the ground and covered up to keep the air out. The silage ferments like beer. It is only worth making silage if you make a lot, because much is wasted. You can only feed the middle of the silage to animals. The top and the sides dry out, and you have to throw them away.

Making silage is a lot of work. You have to harvest the crop and then chop it up into small pieces about as big as your thumb. Big farmers have many labourers, tractors and hammermills to do the work for them but small farmers have to chop up the silage by hand. Work quickly so that you finish making the silage in one week. Dig the hole at least 1 metre deep and 2 metres wide. The floor must slope a little so that water can drain out at the bottom. Press the silage down very hard using cattle or a tractor. Then put 15cm of grass on top and cover the grass with 15cm of soil. The silage will be ready after about 4 weeks.

Try to give each of your cattle 5kg to 10kg of hay or 10kg to 15kg of silage every day. Dairy cattle need twice as much. Sheep with lambs need 2kg of hay or silage a day.

Farm Records

Farm records tell farmers how well they are farming:

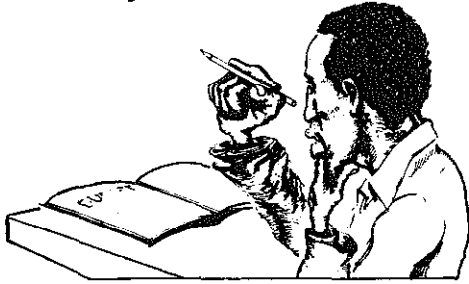

plan what to do next year, how much money you need to spend on seed and fertiliser, and how much you will probably harvest.

- When you keep records of crops every year, you can see what was the best time to plant or what was the best seed to use. From your crops records you can

- Animal records can tell you which animals are giving birth and which are not, and how much milk or wool or eggs each animal is giving. They will tell you how much you are spending on food and medicines and whether it is worth spending this money. The records will tell you which animals you should sell and which you should keep.

- Financial records tell you how much money you are spending on each crop or animal, and how much money that crop or animal is making for you.

Crop records

Keep a record like this every year for each field. Work out the costs of all these things in your financial records. The aim of crop records is to have a

record of each piece of land over many years. Give a name or a number to each field or plot in your land, and measure how big it is. Then make a record chart like this:

Crop	MAIZE	POTATOES	BEANS
field number	1	2	3
size in hectares	3	2	4
Ploughing	tractor	tractor	oxen
seed used	SA 4	BP 1	speckled sugar beans
weight of seed	60 kg	50 x 30 kg pockets	100 kg
date seed planted	20 October	10 August	9 December
fertilizer	2:3:2 200 kg	2:3:2 400 kg	none
insecticide	25 kg dipterex granules	20 litres dithane	none
times of weeding after planting	2 weeks	2 weeks	2 weeks
	5 weeks	5 weeks	5 weeks
	8 weeks	8 weeks	8 weeks
harvest	40 x 70 kg bags	1000 x 15 kg pockets	30 x 90 kg bags

Animal records

Animal records are more complicated than crop records. It is best to keep 3 kinds of records:

The card for each animal looks like this.

NAME OR NUMBER		BREED	BOUGHT FROM	DATE BOUGHT	VALUE
36		Brahman X Ngumi	Magugula	4/10/80	R200
DATE OF BIRTH: 30 June 1978		FATHER: B. 24		OTHER INFORMATION	
DATE SOLD OR SLAUGHTERED:		MOTHER: Lamvula		Dehorned at 6 months	
REASON:					
MATING		CALF			REMARKS
DATE	BULL	DATE OF BIRTH	SEX	WEIGHT	WHEN SOLD
2/1/81	Br 115	12/9/81	Female	40 kg	
					No problems calving

The animal register looks like this:

YEAR 1981	ANIMAL	NUMBER AT BEGINNING OF YEAR	NUMBER DIED OR SLAUGHTERED	NUMBER SOLD	NUMBER BOUGHT	NUMBER BORN	NUMBER AT END OF YEAR
	Cattle : Bulls	1					1
	Cows	3				2	5
	Oxen	2					2
	Sheep : Males						
	Females	4				2	6
	Goats	8	2			4	10
	Chickens	26	6	6		9	23

The production register tells you what your animals are producing:

YEAR	COWS MILK (Litres)			SHEEPS WOOL (Kg)			CHICKENS EGGS (dozen)		
	AMOUNT	SOLD TO	FOR	AMOUNT	SOLD TO	FOR	AMOUNT	SOLD TO	FOR
JANUARY	201 L	Ndlouu Cafe	40¢/litre R8,00				15 doz	Ndlouu Cafe	60¢/doz R9,00
FEBRUARY	151 L	"	R6,00				15 doz	"	R9,00
MARCH	151 L	"	R6,00	20 Kg	WOOL SALES	R10,50	16 doz	"	R9,60
APRIL	101 L	"	R4,00				15 doz	"	R9,00
MAY	51 L	"	R2,00				13 doz	"	R7,80
JUNE	-		-				14 doz	"	R8,40
JULY	-		-				14 doz	"	R8,40
AUGUST	-		-				14 doz	"	R8,40
SEPTEMBER	201 L	Creche	R8,00				12 doz	"	R7,20
OCTOBER	201 L	Creche	R8,00				12 doz	"	R7,20
NOVEMBER	201 L	Creche	R8,00				15 doz	"	R9,00
DECEMBER	201 L	Creche	R8,00				15 doz	"	R9,00

Financial records

Financial records are a way of showing your crop and animal records in money so that you can see how much money you spent and how much you made. For example, let us take the crop and animal records we have shown already and make them into financial records.

	MAIZE	POTATOES	BEANS
COSTS			
Fertilizer	R 32	R 104	R 45
Seed	R 31	R 307	R 78
Cost of Ploughing	R 63	R 52	R 32
Poisons	R 10	R 59	—
Payment for Weeding	—	R 10	—
Payment for Harvesting		R 20	R 10
Transport	R 5	R 103	—
Other costs	—	1200 bags @ 5c = R 60	—
TOTAL COSTS	R 141	R 715	R 165

	MAIZE	POTATOES	BEANS
RETURNS			
Value of crops used at home	40 bags @ R 8.50 = R 340	—	10 bags @ R 7.20 = R 72
Sales to market	—	1000 pockets @ R 2.05 = R 2050	20 bags @ R 7.20 = R 144
TOTAL RETURNS	R 340	R 2050	R 216
PROFIT or LOSS <small>(Total Returns - Total Costs)</small>	R 199	R 1335	R 51

Financial record for animals:

	CATTLE	SHEEP	GOATS	CHICKENS
COSTS				
Food	R25 Dairy Meal	—	—	R88
Licks	R11	R2	R2	—
Medicines	R6	R9	—	R4
Equipment	—	—	—	R10
Animals Bought	—	—	—	—
Costs of Selling Products	—	—	—	R5 (eggboxes)
TOTAL COSTS	R42	R11	R2	R107

RETURNS				
Products Sold	R58 (Milk)	R10.50	—	R102
Animals Sold	—	—	—	6 birds @ R3 = R18
Value of products used at home	60 litres @ 40c per litre = R24	—	2 Goats @ R30 each = R60	3 birds @ R3 = R9
TOTAL RETURNS	R82	R10.50	R60	R129
PROFIT or LOSS (Total Returns - Total Costs)	R40	R-0.50 (Loss)	R58	R22

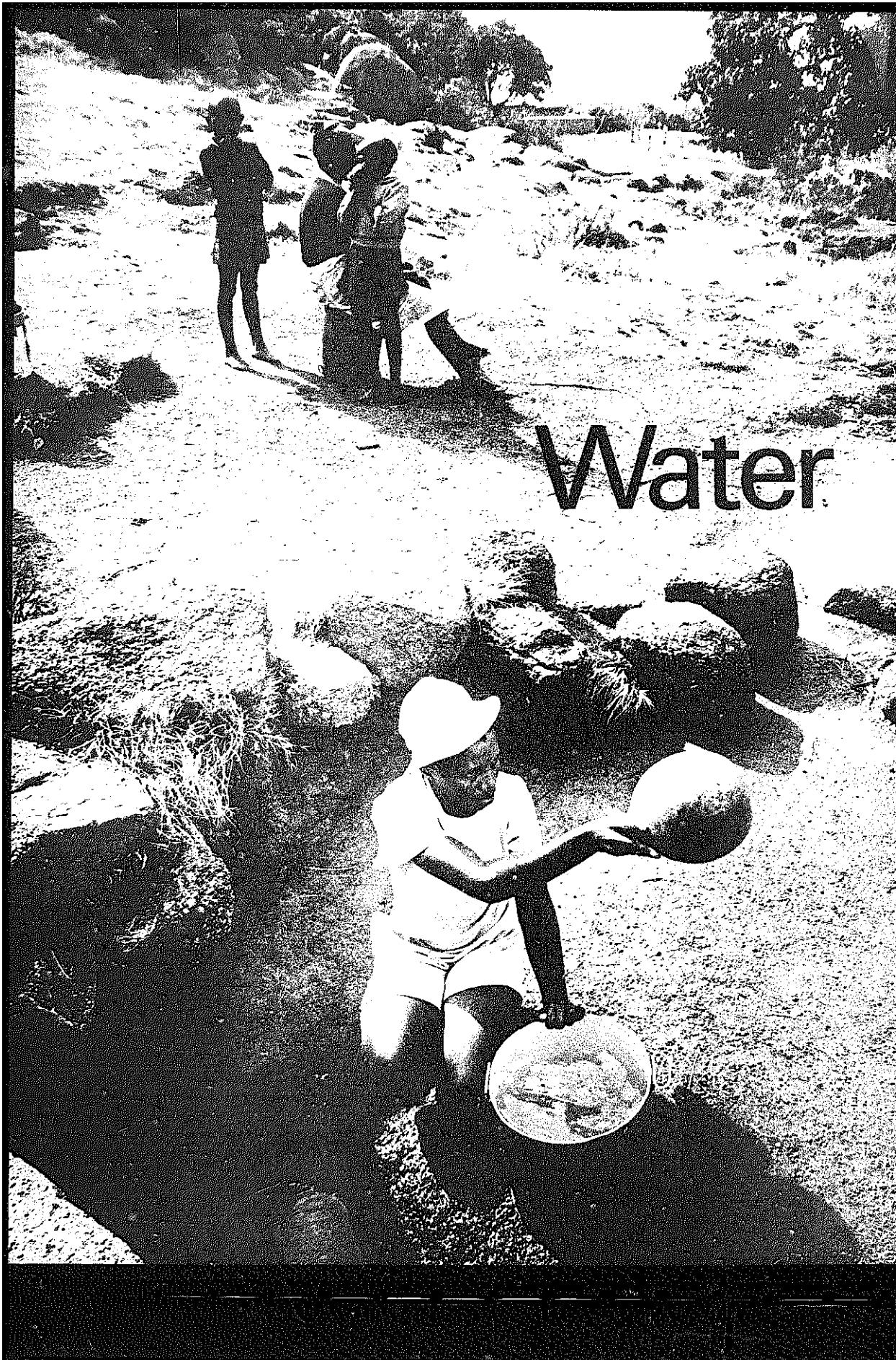

Water

Water Introduction



Many villages in South Africa have no water. In these places women and children have to walk a long way every day with their buckets to fetch water for drinking and washing. They can not carry enough for watering vegetable gardens and this is one of the reasons why many people can not grow any of their own food.

Other villages have a spring or borehole or river close by. But the water is often dirty because cattle drink there and people wash there. Then, diseases like gastro-enteritis, typhoid and cholera can get in the water. Sometimes the pump or windmill is broken and there is nobody to fix it. Or the pump does not work well so people have to wait for a long time every day to fill their buckets.

Every community needs:

- ▶ Clean water, so that people do not get diseases.
- ▶ Water close by, so that people do not have to spend hours every day collecting water.
- ▶ Enough water for people to clean up messes and dirt in their houses. Water just for drinking is not enough.

In this part of the book we write about how to get clean water. There are some cheap ways to do this. For example, people can build small dams to collect rain water, or they can build a wall around a spring to keep the spring water clean and fresh. If the water is not deep in the ground and there are no rocks, you can drill a borehole with a hand drill but if the water is deep in the ground, you have to hire a borehole machine and this costs a lot of money. Find out from other people around you which drilling companies are honest.

Water supply as a community project

Most water supplies in South Africa are built by the government. They do not train people from the village how to look after the pump or borehole or how to fix it if something goes wrong. The pump belongs to the government, so nobody wants to look after it. It is better for a community to make their own water supply. Then they will know how to fix it if anything goes wrong. If you want to organise water supply in your community, you must ask:

► What is the water going to be used for? Do you need it just for drinking and washing? If you need it for gardening, you will need much more, and a spring or small well may not give enough. You may need a deeper borehole.

► Who is going to pay for the water supply? Will the government pay if the community does the work? Sometimes people prefer to pay for themselves, because then the water supply belongs to them and nobody else can say what they must do with it.

Another problem is that most men are working in towns and on mines and farms for most of the year so they cannot help with the heavy work so the community might have to pay people to do some of this work.

The best way to answer these questions is for everyone in the village to discuss the water supply together.

There will have to be many meetings to decide what kind of water supply to use. The meetings can decide to form a water supply committee. The meetings can also decide how the work will be shared.

Costs

There are two kinds of costs:

► The biggest costs are for the equipment, like hiring drilling machines and buying pumps and cement and sometimes paying people from the community who will do the work.

► It is important to collect money for running costs. If a pump breaks, there should be money to fix it.

Sometimes the equipment costs are very high and you have to get this money from the government or other organisations like church groups or trusts (see p 539). But it is good if the community pays for some of the costs themselves, even if they only pay for the maintenance costs.

Training

Some people in the community must be trained to look after the water supply and fix it if anything goes wrong. EDA can train people to do some maintenance and to repair things. The whole village should decide which people can be trained so that the people who have been trained will work for everybody.

Selling water is quite common in Lebowa

The Lutheran Church in the Northern Transvaal pays for boreholes and hand pumps if villages do not have enough drinking water. Each village chooses a pump committee. They collect money every month so that there is money to repair the pump. EDA spoke to 2 people from pump committees in villages near Pietersburg. In Masidibu we spoke to Rev A.C. Kgashane of the Lutheran Church.

● Why did you apply to the church for a borehole instead of the Lebowa government?

The Lebowa government only makes boreholes for very large communities. They won't do it just for a small village as we have here. There are only 37 families in this village.

● When did this scheme start?

We started in 1973 when I arrived to take over this church. It was very difficult for us to get water. We had to buy water for 60c a drum

and with that water we had to do washing and everything. People who have tractors do this selling of water, getting water from far and selling it. Selling water is quite common in Lebowa.

● How do people participate in this project?

They pay for maintaining the pump. A committee was elected and then they decided that each family must pay 40c per month. People pay the 40c willingly, because they have got a good explanation of what is going to be done with their money - first of all



the maintenance of the pump, and later when things go on well, their money will buy the pumping machine so that they can get water easily.

● What maintenance do you have to do?

Well this is a Mono pump which works like a screw, unlike those up and down pumps, so it

doesn't require much maintenance, just oiling.

The pump does break sometimes and then we get Afgate from Pietersburg to come and fix it.

● Will you be able to put an engine on this pump, or will you have to get a new pump?

No we can use the engine on this pump, we have to make it slower with gears. When we get the engine, the intention of the committee is to build a big dam out there, and next to the dam we're deciding to make a garden.

People from around here admire this community because we organise our own pump, unlike other boreholes which have no committee. If those boreholes happen to be broken they take some months to be fixed.

Rain Water

All water comes from the rain. When it rains the water sinks into the ground, filling up rivers and underground streams. The rivers and streams flow down into the sea. Water from the sea and rivers rises up to make clouds and the clouds make rain again.

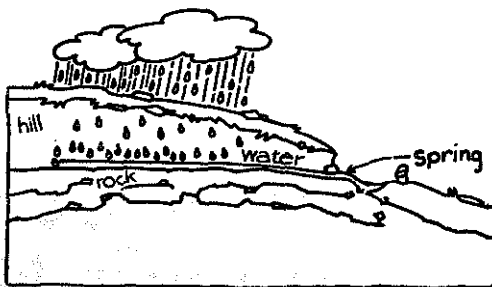

Rain water sinks into the ground until it is stopped by a layer of rock or clay. Then it flows along the layer of rock or clay underground. Sometimes this layer of rock or clay meets the side of a hill. Then the water comes out as a spring. If the layer does not come out on a hillside, the water stays underground and you have to dig a borehole to reach the water.

If there are no springs where you live and there is not enough rain to collect rain water, you should see if you can find a place to drill a borehole by hand. This should be close to a river, or in low places like valleys. You can usually tell places where there is water under the ground because there will be more trees and green plants.

Rain water is always clean, so it can be used for drinking. You can collect rain water from the roof of a house, or by using underground tanks.

Rain water from a roof

It is easy to collect rain water from a corrugated iron roof with gutter pipes and a tank. The size of the tank depends on how much it rains where you live. If it rains all year round, you will not need such a big tank because the tank will fill up quickly. But if it does not rain much, then you should get a big tank - 5000 or 10 000 litres. Make sure the water in your tank is clean by doing these things:

- ▶ Clean your roof and gutters regularly.
- ▶ Make the gutters slope smoothly towards the tank. Sometimes there are bumps and bends in the gutters. Pools of water stay there after it rains, and mosquitoes breed in them.
- ▶ Put wire mesh over the entrance pipe to the tank and over the outlet pipe, then no insects can get into the tank.
- ▶ Make sure that there is a proper drain away from the tap at the bottom of the tank. Press stones into the

ground or make a concrete channel so it is not always muddy around the tap.

- ▶ Do not drink the water from the first rain after the dry season, because this water will have a lot of dirt from the roof and gutters. Use this water for your garden.

Underground Tanks

You can collect rain water from big flat rocks or from sloping roads, by building a low wall along the rock or road and making it slope towards an underground tank.

This method works well for houses which have a threshing floor. You can make the threshing floor slope so that the rain runs out at one corner. This is the place to build the tank. The walls of the threshing floor are like gutters, stopping the water running over the sides.

You can make an underground tank by digging a hole in the ground and plastering it with cement and chicken wire. Another way is to plaster the hole with layers of mud, with a sheet of plastic between each layer. This has to be done carefully, because the plastic sheets can easily tear. Underground tanks must have a roof and a small pump to pump the water out of the tank.

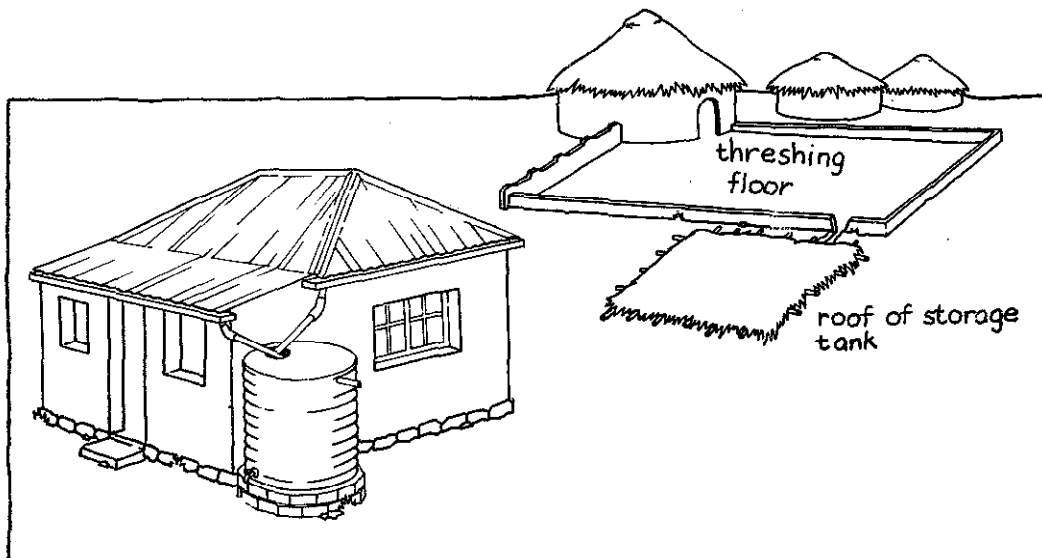

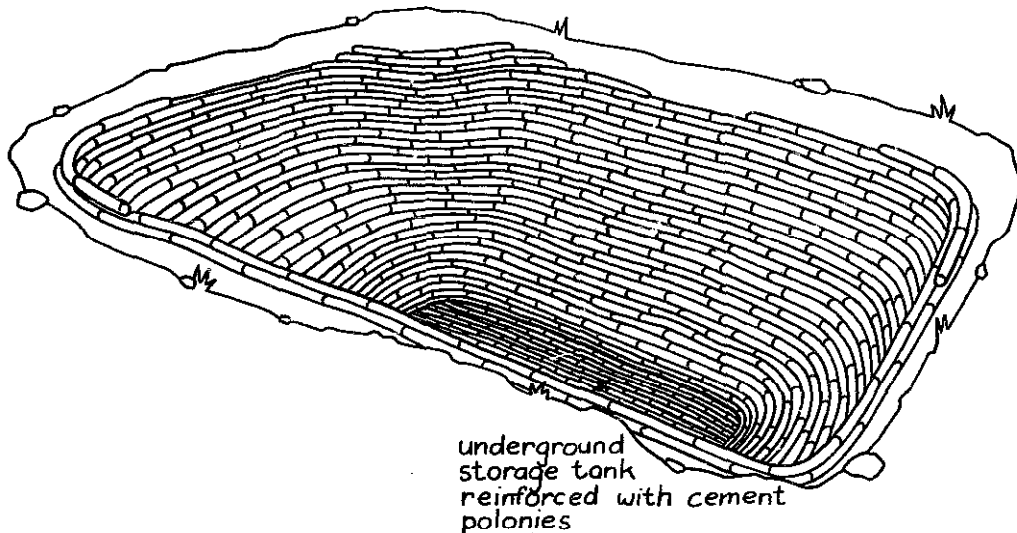

If the oxen cannot drink, people plough late

Vernon Gibbard has built many underground rain water collection tanks in Botswana. We asked him how they were built and how they worked.

● Where did you get the idea to build these tanks?

I first came across these in Sudan in 1966. They traditionally use underground collection tanks. At that time some people were experimenting with mud and concrete. I then started making some of them here.

● Can you explain how they are made?

You first dig a hole in the ground in a place where it's fairly easy

to catch flood water. The catchment area around the tank should have sloping sides. In Botswana the best runoff catchment areas are the roads. So we made a little dam across a road, and the water running down the road flowed into the underground tank.

The first thing we put on the sides and floor was a strong insecticide for termites because they eat polythene plastic - we used Dieldrin. If we thought the roots of surrounding plants would break into the lining, which happened, we took the plants out. Then we put mud on the surface, about as thick as porridge, and while it was wet we put on a sheet of plastic 150 microns thick. That's pretty thin but not the thinnest you

can get. Then on top of this plastic another layer of mud, then another layer of plastic. Then, doing it the proper way, you have a layer of plastic tubes, 4 inches in diameter and 2 to 3 feet long, filled with any sand or soil. These are laid in mud. Then that layer gets covered with mud, then another layer of plastic, another layer of mud, another layer of plastic. That is the waterproof lining. Now to protect the lining from damage, we put in another layer of these plastic tubes, we called them polonies, but now the mixture inside is 1 cement:14 sand. We filled them with a dry mixture, made holes in them, and soaked them in water. This is a very simple form of concrete reinforcing. It stops sharp

stones breaking the plastic.

● How long do they last?

There is one we built in Zimbabwe in 1968 and it still holds water every year. Often where they have broken it is because cattle break them down. One that I built in my house in Serowe, for drinking water, leaked after a while because tree roots broke through it. But for a year and a half all the household water supply came from this tank.

● What about putting a cover over the top?

Yes, this is very important. If the tank is not covered, the water will evaporate. Here in Botswana as much as 2 metres can evaporate in a year. It's much better to cover it, and the simplest cover is to strain some steel wire across and lay on some matting made from mabela stalks, hessian or anything like that, anything that provides shade to stop evaporation.

● How do you clean the water?

Usually the water that runs off the open veld is very safe to drink. But if your catchment is in a village and the village has latrines, I wouldn't be too happy about drinking that water. You should use some sort of chlorine treatment or filter.

● Have you made these tanks for cattle to drink from?

Yes, in fact the original idea was for watering cattle. People can not plough until there is enough water at the lands for the ox team. If the oxen cannot drink, people plough late, and the crop yields are very low. And boreholes are not really the answer either. All over Botswana the story is the same: the borehole is broken down, the rods are broken, the engine won't start, there's no diesel and even if there is, people can't afford it.

An ox drinks 20 to 30 litres a day, so you can work out from the rainfall in your area the size of catchment area you need to water a team of oxen. It's not that big. In the Kalahari you get 300 litres of water for every square metre of

catchment: this will water an ox for 2 weeks. So you probably need 1000 square metres of catchment for a team of oxen. If you use cement for the catchment area it does make it expensive. But the catchment doesn't have to be perfect. If it leaks say 10% that doesn't matter, whereas if the tank lining loses 1% you lose the water in no time.

● Do you still think this is one of the cheapest methods to collect water?

Yes, but the plastic price is much higher now, because it's made from oil. There are methods I would like to try which would be easier and quicker, for instance using cement and chicken wire.



HOW TO PROTECT A SPRING

A spring is underground water which comes out of the ground. It is usually on the side of a hill. Rainwater sinks into the ground, and is stopped by a layer of rock or clay. The water flows along the layer and comes out of the ground at the source or eye of the spring.

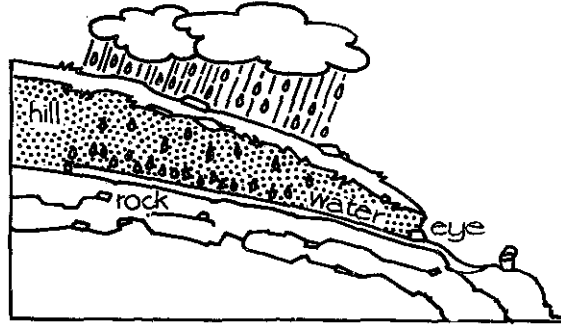

An unprotected spring is unhealthy. The water can carry diseases from people and animals. A properly protected spring gives cleaner, healthier water.

Protecting a spring is a good water supply project for a community. It is quite cheap compared to other kinds of water supply like boreholes. No special equipment or skills are needed. Everyone can take part in the work. The spring itself without the tank will cost R50 to R100.

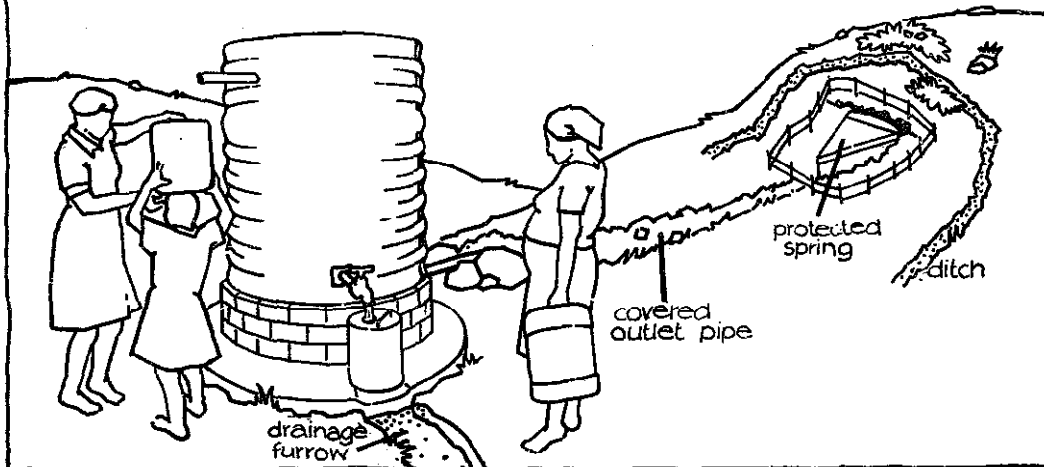

You protect a spring by casting a concrete "V" shaped wall around the source, and putting on a roof. A pipe leads water from inside the wall to a tank which fills up during the night. In the day people can fetch water from the tank.

There are springs in many different places, like rocky hillsides, river banks and marshes. Change the method given here to suit each spring.

MATERIALS

To lead water from the spring to the tank (outlet pipe):

- One length 40mm (1½") black plastic pipe. The length depends on how far the tank is from the spring.

For the overflow pipe:

- One 20mm (¾") black plastic pipe.

To cover the ends of the inlet and overflow pipes:

- A piece of fly screen, 50cm long and 50cm wide.

Wooden planks for "v" moulds. For a box with 1 metre sides you need:

- Four 1 metre planks 300mm wide and 25mm thick.
- One 4m plank 50mm wide and 25mm thick.
- One 4m plank 75mm wide and 25mm thick.

To nail the wood together for the "v" moulds:

- 100 nails 40mm (1½") long.

To cast the concrete "v" and roof:

- 2 or 3 bags of cement

For a concrete roof you will need some 8mm thick reinforcing bars. For a tin roof you can use corrugated iron or galvanised flat iron. A concrete roof will last longer but it is more difficult to make.

DIGGING THE FOUNDATION

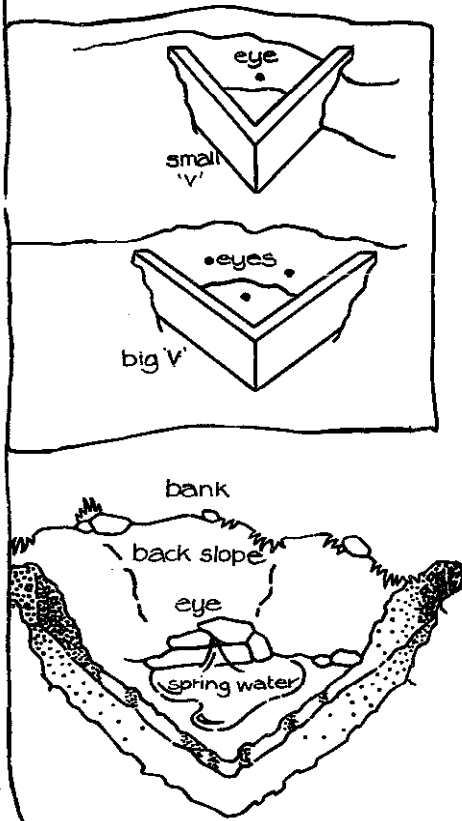

- Work out what size the concrete 'V' wall must be. If the spring has more than one eye, make the 'V' wide enough so that all the eyes are inside it. But try to keep the 'V' small, so that the wall is cheap and easy to roof over.
- Dig a shallow trench in front of the spring a little wider than the thickness of the wall, and 20cm deep. If you have to cast the wall on rock, break the rock with a chisel or crowbar to roughen it; (the concrete will stick better) Dig about 1/2m into the slope on either side. This will support the wooden moulds, and make the concrete wall stronger.
- Level the ground inside the 'V' and clear the back slope. Do not clear around the eye itself. This can easily damage the eye.

LAYING THE OUTLET PIPE

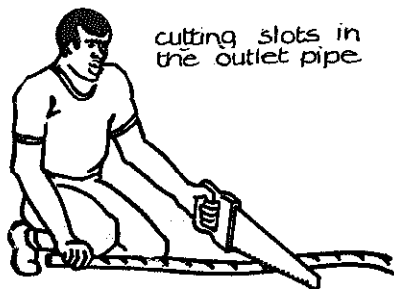

- Dig a trench for the 40 mm PVC outlet pipe, from the point of the 'V' to the place where you will put a tank.
- Cut slots in one end of the pipe
- Wrap fly screen around the slotted end, and tie it on with wire.
- Lay the pipe in the trench, with the slotted end inside the 'V'. This end must be lower than the eye of the spring and slightly raised from the floor with small stones.

MAKING THE WOODEN MOULDS

- Make two wooden moulds to fit into the 'V'-shaped trench. Join the planks with nails at the corners.
- Oil the inside of the moulds with old engine oil, so that they will be easy to take off later.

- Put the moulds into the trench. Keep them in place with rocks on both sides. Join the moulds with a few 12cm wood blocks. The blocks must be higher than the top of the concrete.

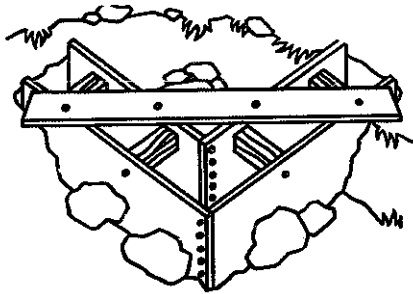
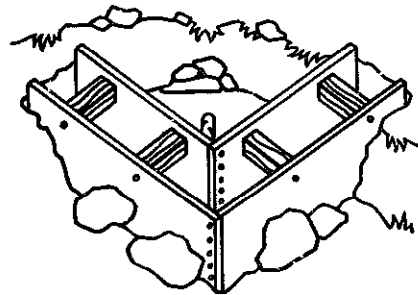

- Nail a length of the 75cm wide plank across the moulds, to hold them steady.

- For the overflow pipe you must cut a length of the plastic pipe to exactly the thickness of the wall. Put a rag inside it to keep the concrete out. Wedge it between the moulds so that it is about 10cm above the eye of the spring. After the wall is dry you should fix a piece of fly screen over the hole inside the wall with cement.

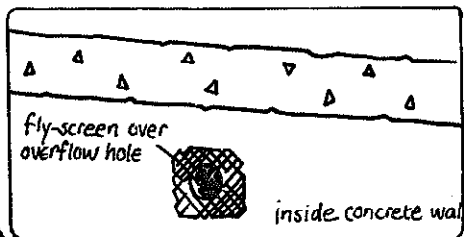

CASTING THE CONCRETE WALL

- Make a 6:3:1 concrete mix (6 parts gravel: 3 parts sand: 1 part cement). The wall will be weak if the concrete is too wet.
- Pour concrete between the wooden moulds. Stamp the concrete with a stick so that it settles evenly.
- Leave the moulds on for at least three days. Wet the concrete every day. It must dry slowly, so that it does not crack.

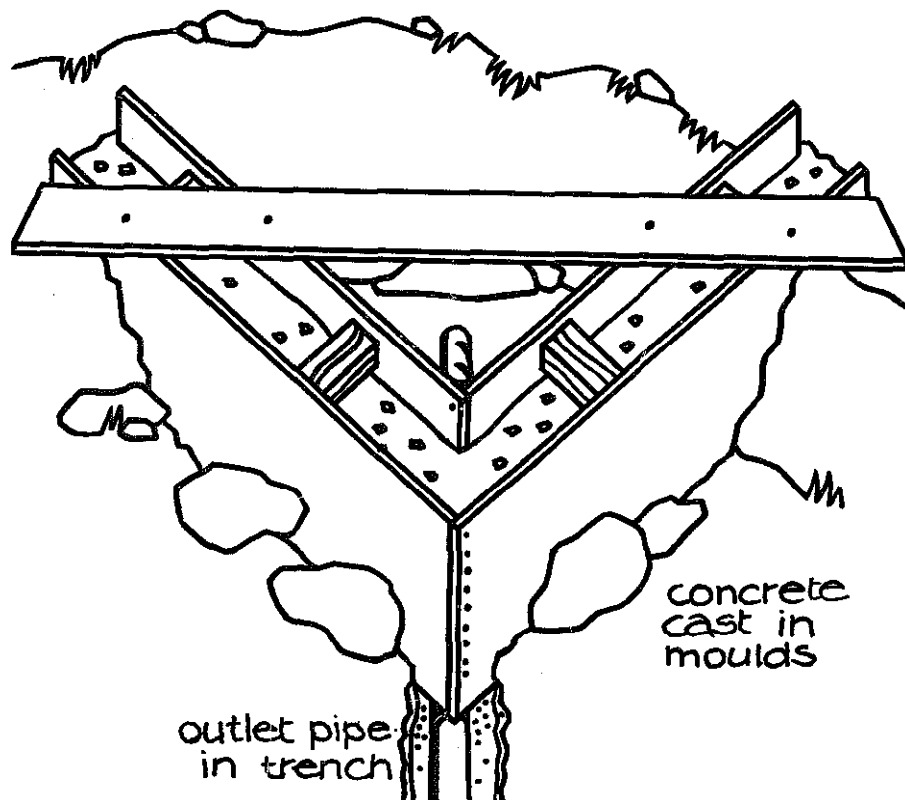

- Build mud walls inside the moulds so that the water can go out through the outlet pipe. This keeps the foundation dry.
- Remove the moulds after three days. If the water comes out of the bank of the spring (not the ground) cast a concrete floor. Pour concrete 10cm thick inside the wall. The floor will stop spring water from sinking into the ground.

MAKING THE ROOF

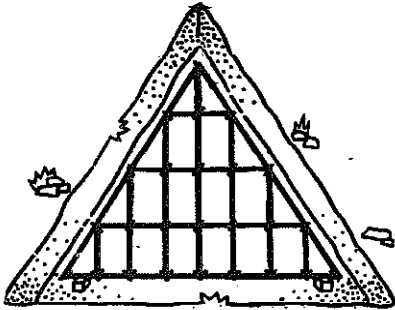

- Work out what size the roof must be. If the sides are longer than $1\frac{1}{2}$ metres, or if you do not know how to work with reinforced concrete, make the roof by nailing sheet metal onto a wooden frame. Otherwise make the roof of reinforced concrete. On level ground, dig a hole the same size as the roof must be. The roof will be 15cm thick.

- Make a frame from reinforcing rods. Tie the rods 15cm apart with wire.
- Rest the frame on stones inside the hole, so that it is 5cm off the ground.
- Pour a 4:2:1 concrete mix (gravel, sand, cement) into the hole. Leave the roof to dry for a week, before putting the roof on. Wet it each day, so that it dries slowly.

BUILDING THE BACK WALL

Build a wall against the back slope, as high as the concrete wall.

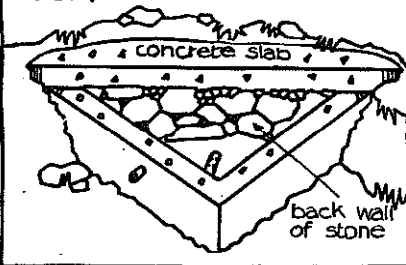

- Build it with rocks and stones so that water can flow through. Put gravel near the top.
- Cast a 10cm thick concrete slab on top of the stone wall, back against the slope. Support the concrete in front with a wooden plank.
- When this slab is dry, put the roof on. The roof is heavy enough to stay on by itself.

- Seal the gap between the roof and the slab with bitumen used for waterproofing tanks.

KEEPING THE SPRING CLEAN

Dig a trench around the spring 10m above it and round the sides. The trench should be 1 metre wide and 40cm deep. The soil should be thrown onto the downhill side. This will prevent rainwater from damaging the spring.

- Fence the area around the spring to keep animals away.
- Once a year, open the roof of the spring and clean inside.
- Toilets and rubbish pits can make the water unhealthy. They should be further than 50m from the spring.

Wells and Boreholes

If there are no springs where you live, and you need more water than you can get from the rain, you have to dig a well or make a borehole.

Where to dig a well

Find out if there are any old wells in the area. It is much easier to clean out an old well than to dig a new well. If there are no old wells, find a place where the water is not very deep and where there are no big rocks. A good place is in a valley or near a river. It may seem like a waste of time to dig a well next to a river, when you can get water straight out of the river. But water from the well will be cleaner than water from the river, because water is cleaned when it passes through sand and under the ground. Also the well will give water in winter when the river has dried up.

The soil where you want to dig the well is important. Water cannot pass through clay soil easily so if you dig a well in clay soil the water will only flow slowly into the well. Sandy soils let water pass through easily so the well fills up quickly.

Another thing to think about is pollution. If the well is close to pit toilets and places where cattle drink, disease can get into the water. Dig the well at least 50 metres from these places. If you can, dig the well on ground higher than pit toilets, so diseases can not get into the well through underground water.

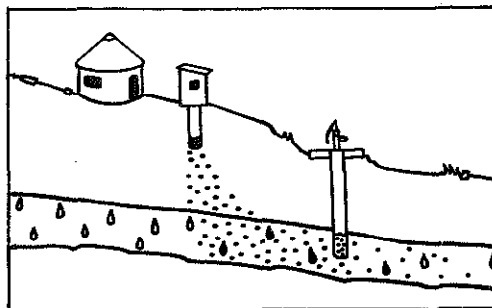

pit toilet above the well
pollutes the well

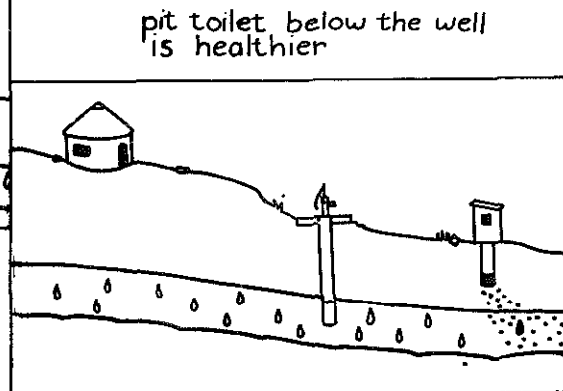

pit toilet below the well
is healthier

Different kinds of wells

The 3 most common kinds of wells are hand-drilled boreholes, hand-dug wells and machine-drilled boreholes.

■ Hand-drilled boreholes can only be made about 15m deep, and only in places where there are no rocks or big stones. They are sometimes called tubewells because when the hole has been drilled, a steel tube is put in to stop the sides from falling in. A pump is put inside the tube, with a pipe called a well screen on the bottom of the pump. The well screen has small cuts in it, so that water can be sucked into the bottom of the pump but sand can not get in.

■ Hand-dug wells are better for soils which do not let water pass through them quickly, like clay or very fine sand. If you put a tubewell into these soils, it will not fill up quickly enough. You need a wider well so that more water can get in, and more water can be stored.

It is slow hard work to dig a well. It is also dangerous to dig deeper than 2m because the walls can fall down. It is expensive, because you have to strengthen the sides with reinforced concrete.

■ Machine-drilled boreholes are the most expensive way of getting water. But if the water is more than 20m deep this is the only way to reach it (see suppliers p 524).

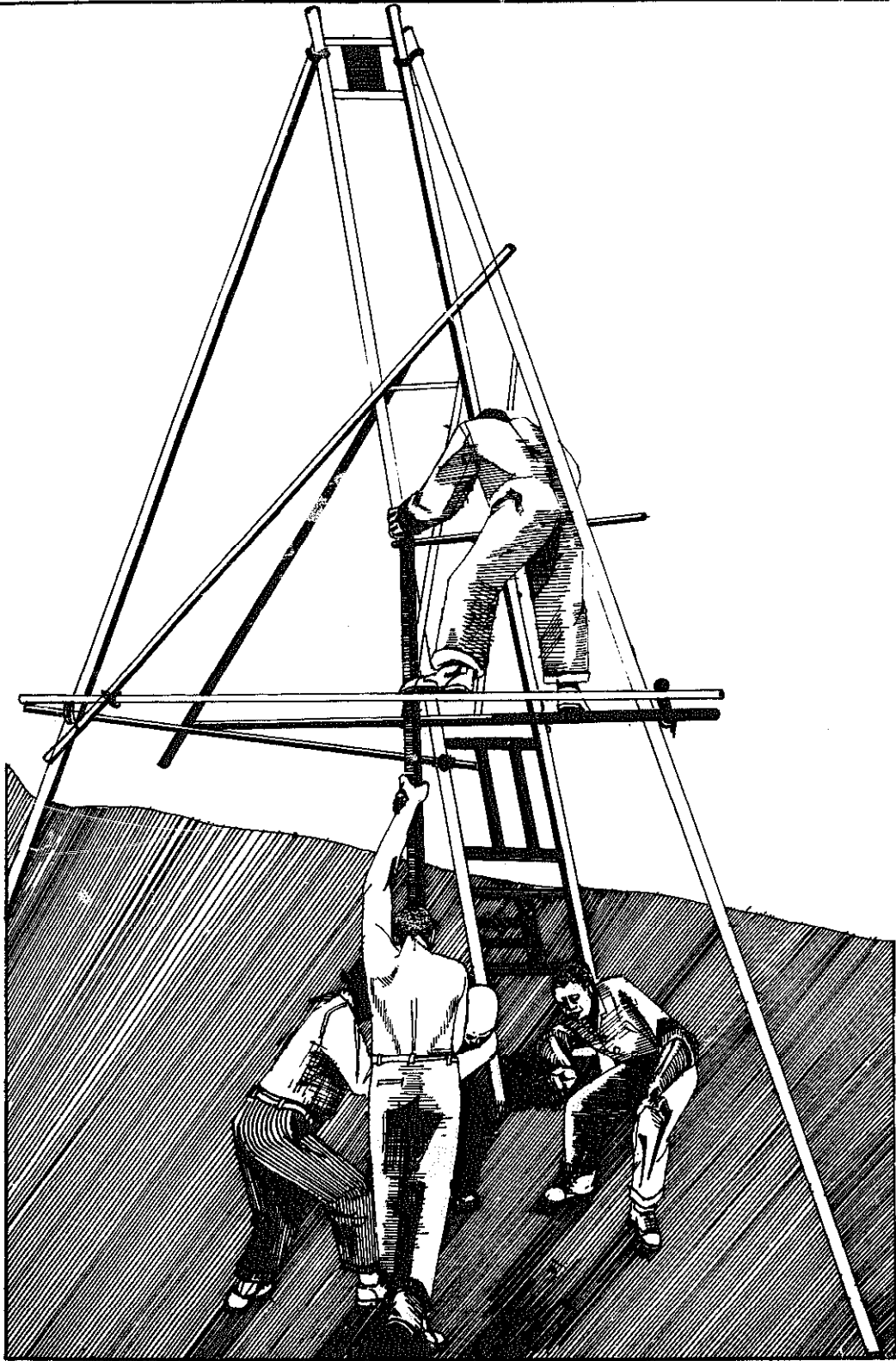

Drilling a borehole by hand

To drill a borehole by hand you need a tripod and casing. This equipment is expensive, but it can be used to make many wells. It can not drill holes deeper than 15m, and it can not drill in places where there are big rocks. EDA has plans for making all the equipment. Write to us if you want plans or if you want to borrow our drilling equipment. We have only tried it out on a few boreholes in South Africa. It has worked quite well so far but it is not perfect.

The tripod

A tripod is a tall frame used for raising and lowering equipment in and out of the borehole. It is used to hold the drill straight and to put the casing and the hand pump into the hole. EDA's tripod is made from scaffold poles. It can be broken into smaller pieces to make transport easier. A cheaper tripod could be made, using gum poles, but we have not tried this out yet.

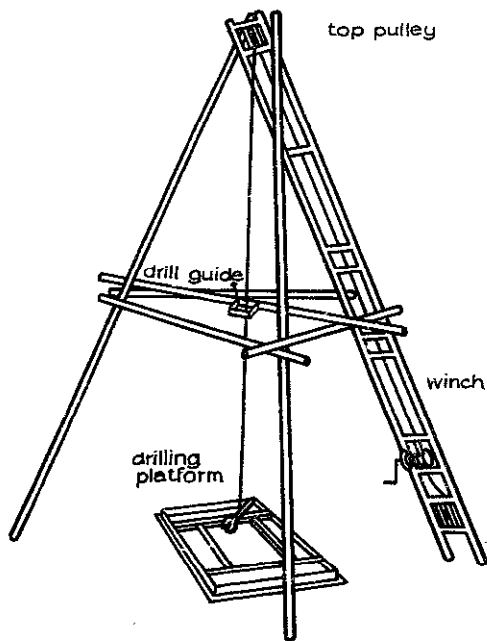

The drill set

The drill set is made up of drill stems, a handle and three drill bits. The drill is turned into the ground by two people, while two people sit on the handle to make it heavy.

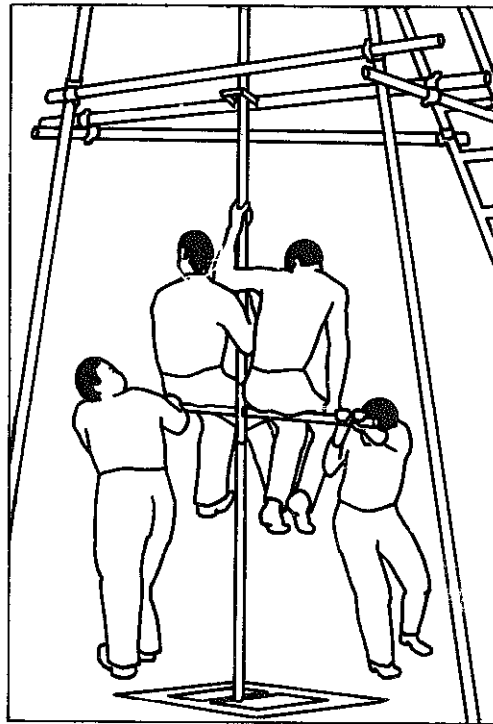

Three kinds of bits are needed for drilling in different soils:

- ▶ The sawtooth bit is used for hard soil.
- ▶ The riverside bit is used for sandy soil.
- ▶ The spiral bit is used for loose or wet soil.

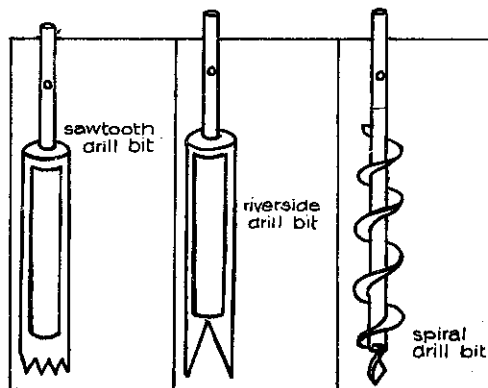

Drilling the hole

The drill set makes a hole 10cm wide. The drill bit has to be lifted out of the ground every time it gets full, about every 20cm. As the hole gets deeper, extension rods are added. Every time the drill is emptied, all the extension rods have to be lifted up and taken apart. The soil is emptied by hammering the drill bit, and scraping it inside with a stick.

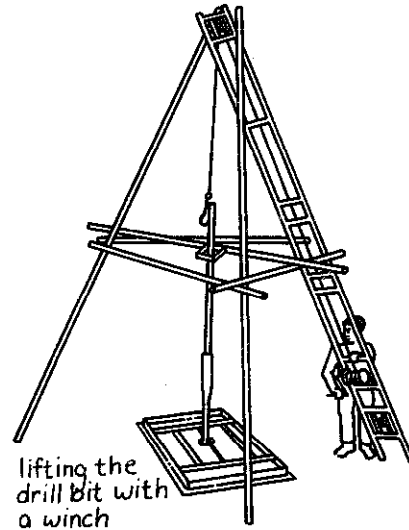
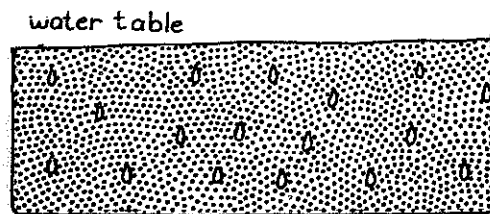
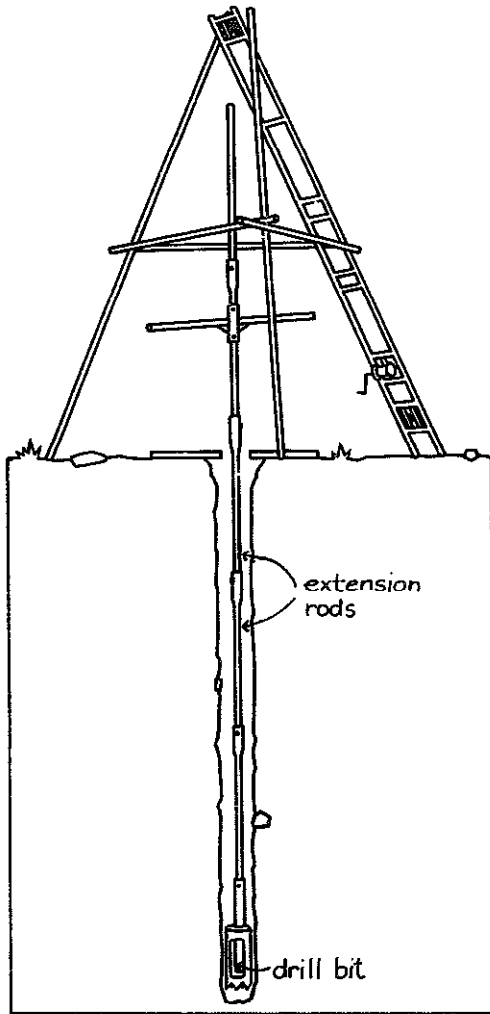

lifting the drill bit with a winch

The drill bit sometimes sticks in the hole. To get it out you have to hook the steel cable through the drill and pull it out using the winch handle.

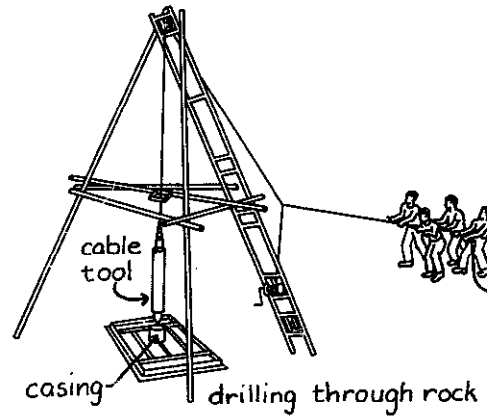

If you hit big rocks you have to start a new hole. If the rock is not thick you can sometimes break it with a cable tool. A cable tool is a heavy piece of steel which you use to crack the rock. The tool is lifted and dropped by about 15 people. The broken pieces of rock are taken out with a bailer. It is very difficult and slow work.

When you reach water

When you reach water you can no longer use the drill set. Wet soil falls out of the drill, and the walls of the hole start to fall in. Now you must use the casing and bailer. The bailer takes out the wet soil and the casing keeps the hole open so the sides do not fall in.

To make a casing, join some 10cm diameter steel pipes with sockets. The casing must be long enough to reach the bottom of the hole. A heavy pipe is used to hammer the casing into the hole. Steel casing is expensive, about R10 per metre. EDA is trying out using plastic casing, which is much cheaper.

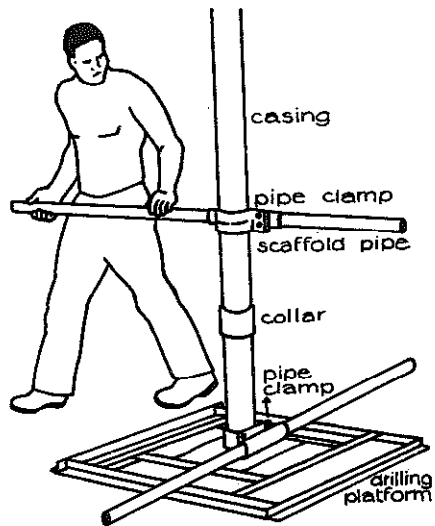

The bailer is a steel pipe with a flap valve at the bottom end. It is used to take out soil from the casing. The valve opens when you drop the bailer into the wet soil. When you pull it up, the valve closes and keeps the soil inside.

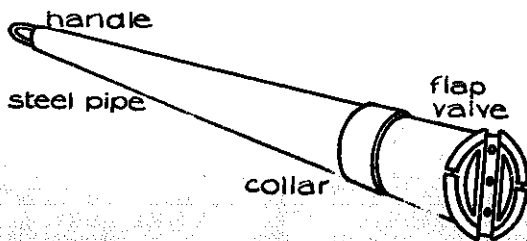

The right depth for the hole is 4 metres below the water table + the depth that the water table drops in the dry season. This extra depth is the same depth that the water drops in nearby wells or pools.

When you are near the bottom, sand will flow back into the casing. When this happens, pour water into the casing and bail some more.

Test pumps

When the hole is deep enough, a test

pump is used to find out how much water there is. Slide the test pump into the casing. Lift up the casing 2m with a car jack. Now the well screen of the test pump will be sticking out of the casing. Then pump the well for an hour without stopping. If it does not dry up, there is enough water, and a hand pump can be put in. If the well dries up, dig deeper with the bailer, then do another pump test. If it dries up again, there is not enough water. You will have to dig a wider well or drill a deeper borehole with a machine.

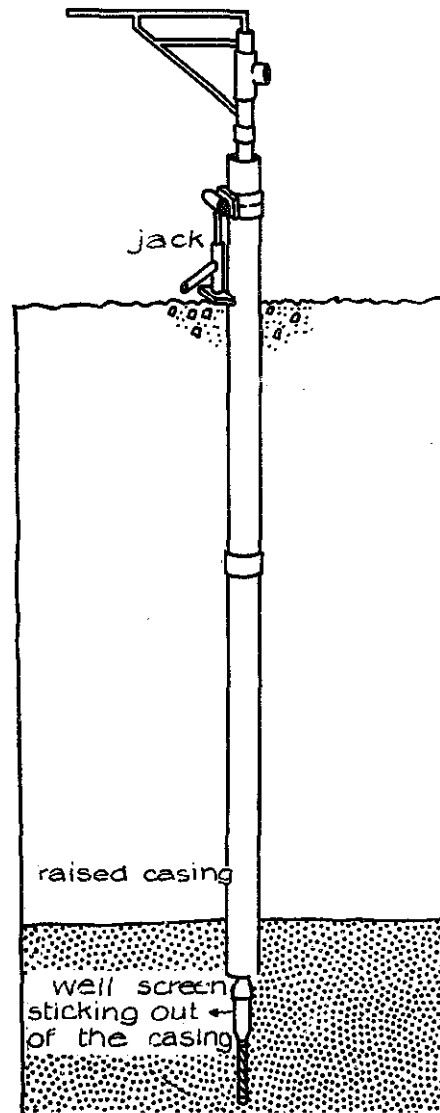
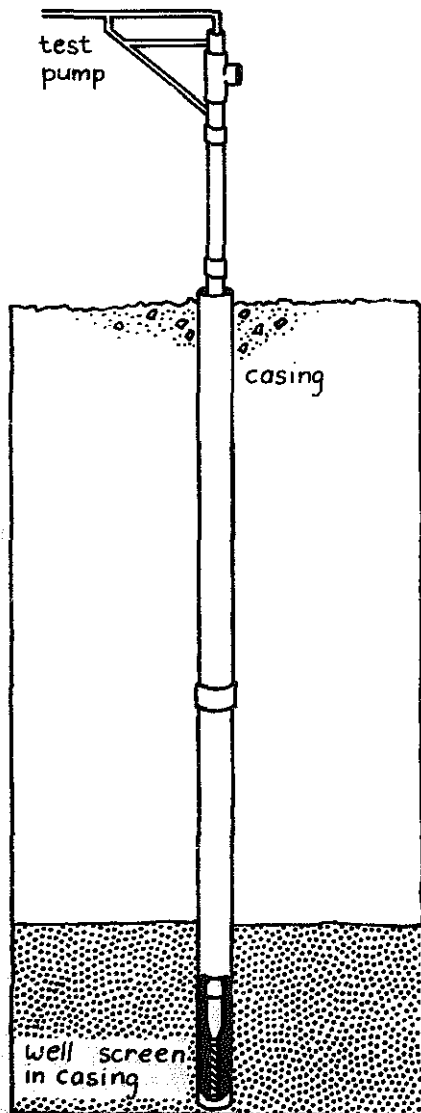

Hand-dug wells

Clay soils and fine sand do not let enough water pass through to fill up a hand borehole quickly. In these soils you have to dig a wider well with picks and shovels. Making a hand dug well is dangerous because the sides can fall in. You have to strengthen the sides with concrete.

A lot of equipment is needed:

- A tripod to lower and raise people and equipment into the well.

- Steel moulds to cast concrete rings.
- Cement and reinforcing rods.

It is probably cheaper to drill a deep borehole with a machine than to make all this equipment for one well. But for 10 or more of these wells, it is worth making this equipment because it can be used many times. EDA has detailed plans for the equipment. Write to us if you want plans or if you want to borrow our equipment.

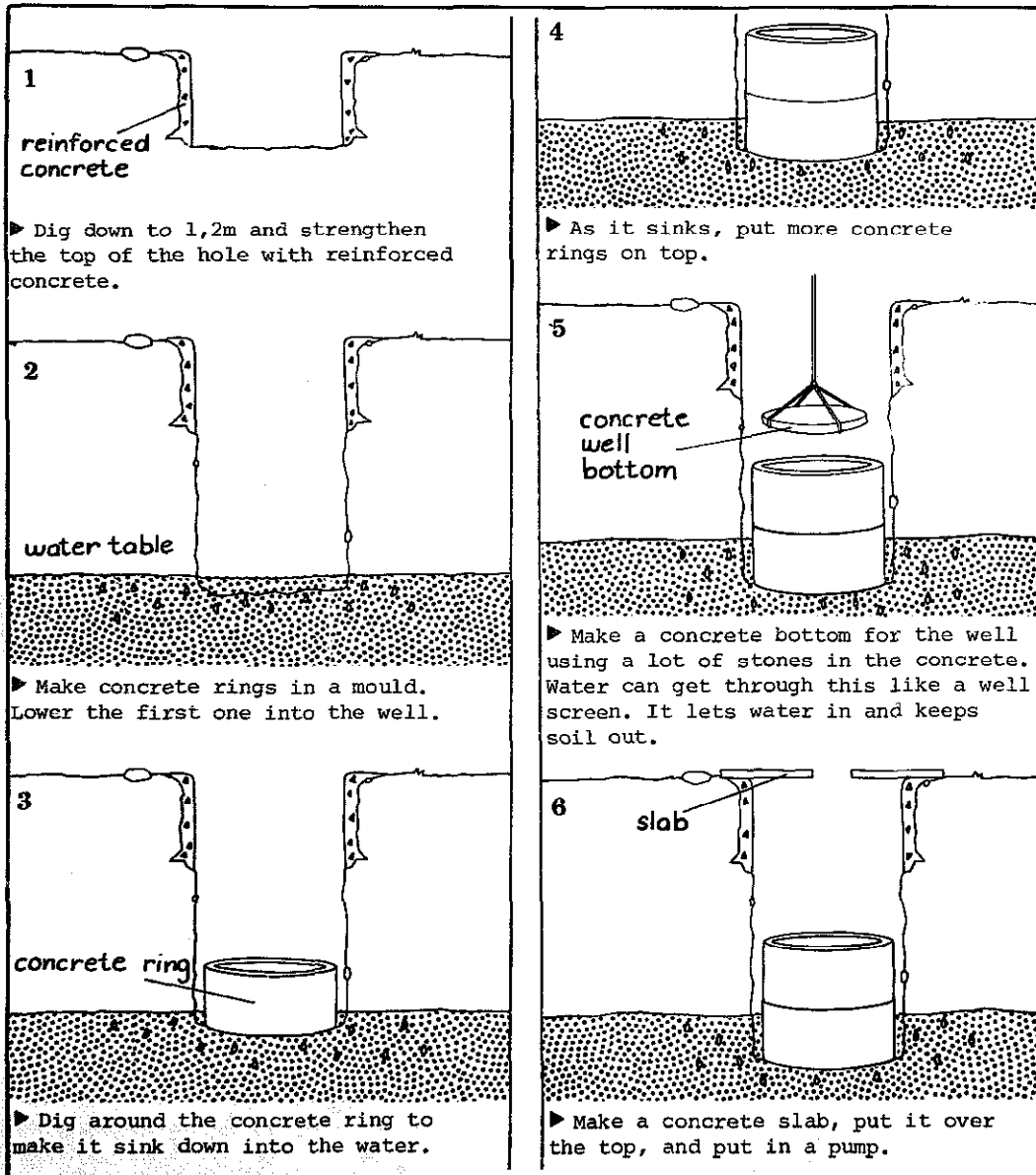

Pumps

Hand pumps can give you enough water for washing and drinking. If you need water for cattle or for irrigating crops, you will need bigger pumps like windmills or engine driven pumps.

Whichever pump you buy, it has to be maintained in good working order. All pumps will break down if they are not maintained. So before you buy a pump, find out how difficult the maintenance will be. If it is too difficult to do by yourself, find out if there is an agent nearby who can maintain the pump.

Another thing to think about is cost. When you work out costs add the costs of maintenance, repairs and the cost of petrol or diesel to the price of the pump.

Hand Pumps

A hand pump has a piston which moves up and down inside a casing. The piston is joined to a handle at the top of the pump by connecting rods. Every time the piston moves up it lifts up some water. At the bottom of the pump there is a valve which stops water from flowing out of the pump.

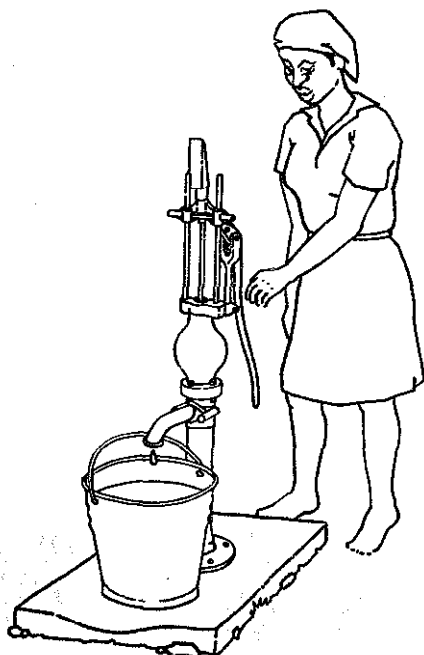

You can build your own hand pump or you can buy one. The cheapest hand pump you can buy costs over R200 for the working parts and R4 per metre for the connecting rods and borehole casing.

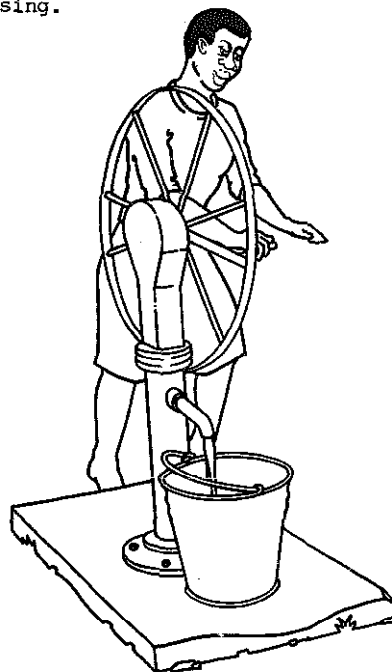

There is another kind of hand pump called a Mono pump. This pump lifts water using a rubber screw at the bottom of the casing. Mono pumps work quite slowly and they are more expensive than other pumps, about R400 for the working parts and R10 per metre for connecting rods and casing. But they do not break as easily as other hand pumps. It is easy to add a motor on to a Mono pump, but it is not so easy with other hand pumps.

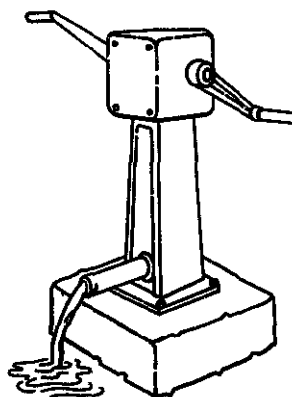

Sometimes you need to pump water to a vegetable garden next to a river or a dam. On p274 we give plans for a suction pump.

Windmills

Windmills are expensive. Big ones cost over R10 000 and the small ones cost over R1 000. But the wind is free and windmills save a lot of fuel costs. They must be put up in windy places such as hillsides where there are no trees. They also need tanks to store the water.

If water is not very deep, you can make your own windmill from oil drums. This kind of windmill is called a Savonius rotor. It does not pump as much as windmills that you buy, but it can pump enough water every day for a vegetable garden. Write to EDA for plans of this pump and other windmills.

Ram Pumps

Ram pumps are cheap and strong and can last for many years. You can

build your own ram pump or buy one. The bought ram pumps can pump more water, but they cost about R350. A home made ram pump costs only about R50.

Ram pumps get their power from water flowing through them. They can not pump water from boreholes. They can pump from a river or stream, but only if you can find a place near the stream where there is a drop of at least 2 metres. This does not have to be a straight drop like a waterfall. It can be a slope of 1 in 5.

Ram pumps work day and night without stopping and without any fuel costs.

Write to EDA for plans showing how to make your own ram pump and how it works.

Motor Pumps

There are many pumps with diesel or electric motors. If you have electricity it is better to use an electric pump. They do not break down as easily as diesel pumps.

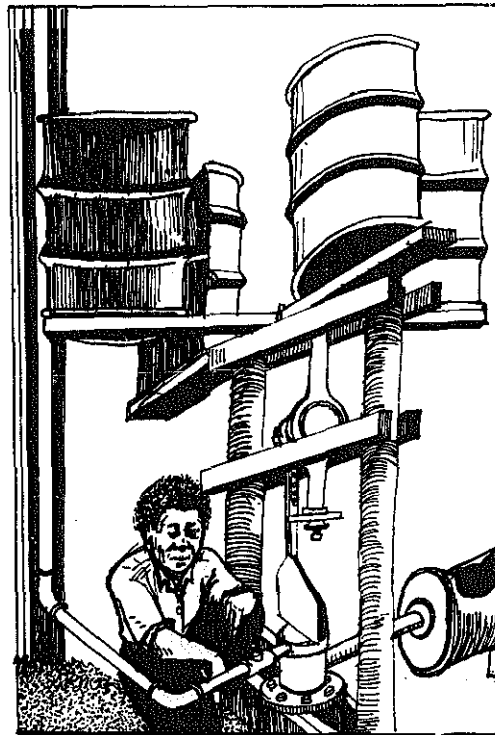
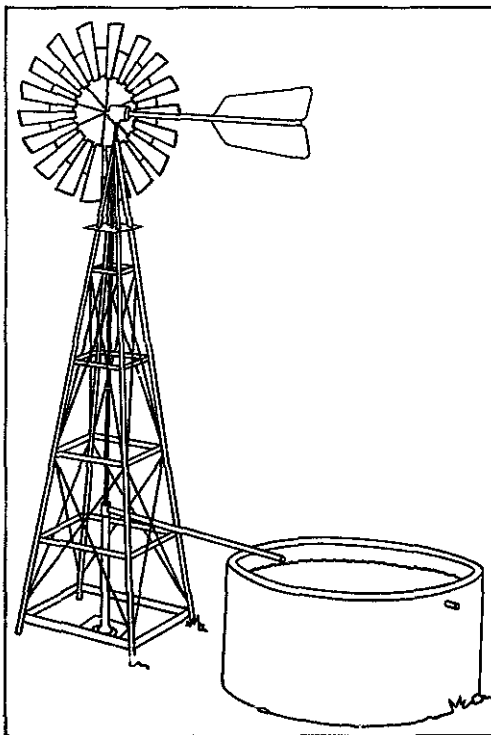

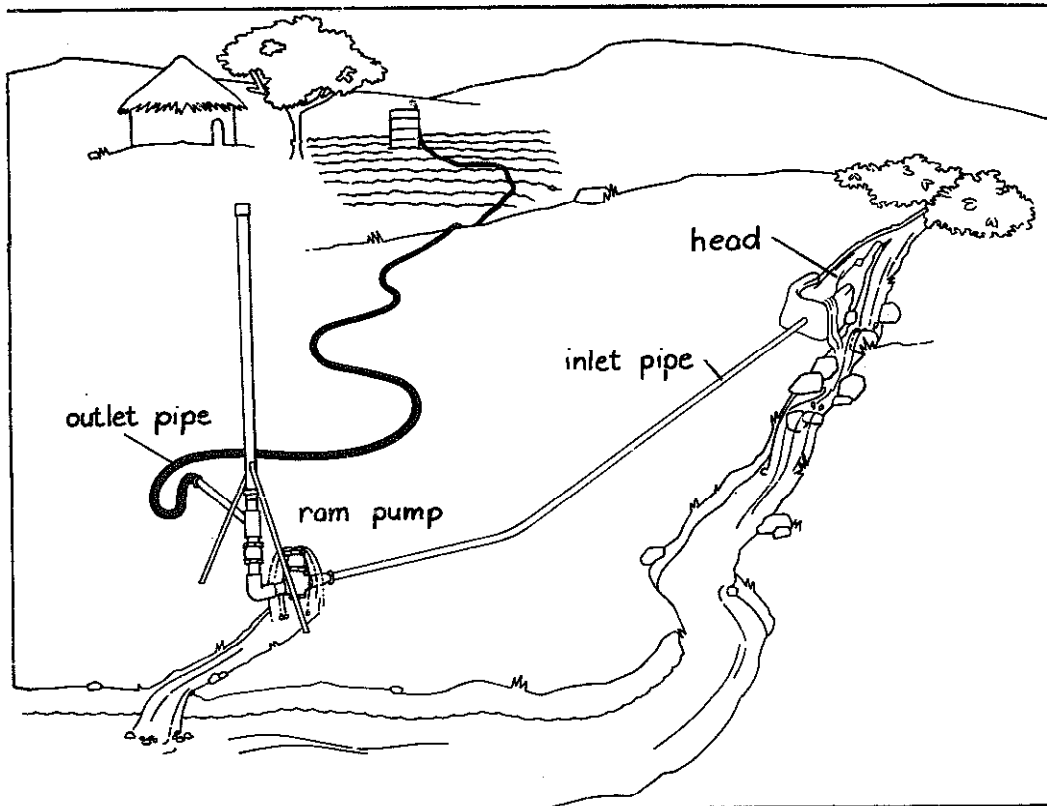

If you want to buy a motor pump, you must tell the suppliers exactly how the pump has to be used. Then they can help you to choose the best pump. You must tell them:

- ▶ How much water you want to pump.
- ▶ How high and how far is the place where the water must be pumped to.
- ▶ If you are pumping from a borehole, how deep the borehole is.
- ▶ If you are pumping from a river, how high and how far the pump will be from the river. To work out heights you can use a spirit level or a water level (see p 479) and a measuring stick marked in metres. Pumps can not suck water higher than 8 metres.
- ▶ Most pumps get damaged if they pump water with a lot of mud and sand in it. If you are pumping very muddy water, take a sample to the supplier if possible. You may have to use a more expensive pump which will not be damaged by sand in the water.

Centrifugal pumps are used to pump from rivers or dams. Inside the centrifugal pump is a part which pumps by moving round very fast.

There are many different centrifugal pumps. The cheapest ones are about R200.

■ Reciprocating pumps work with an up and down action, like a hand pump. They pump higher than centrifugal pumps of the same power, but they do not pump as much water as centrifugal pumps. They are usually fitted on top of boreholes.

■ Submersible pumps can only be used with electricity. The whole pump and engine is under water. These pumps are used for deep boreholes. They are expensive, but they do not break down much.

When you buy a motor pump make sure you can get spare parts, and find out if there is an agent close to you who can fix the pump if it breaks down. Speak to everyone you know who uses a pump, before buying one. If the pump is going to be shared by a community, decide how you will share the costs of diesel and maintenance before you buy the pump.

Nothing works first time

We spoke to Robert MacNamara when he was working with EDA's water supply group about some hand pumps which EDA built for irrigating vegetable gardens.

Well nothing works first time. It took a long time to get this pump to work properly. One of the problems was that the hose wasn't stiff enough and didn't go back to its round shape. So we put in rubber loops made from pieces of car tyre to stiffen it. After this we spent two months getting the valves and pump handle to work properly. We spent many hours in a dirty river in Johannesburg struggling to get everything right. When we thought the pump was working properly we took it to be tested by a farmer in Swaziland, John Ntjalitjali. He has a vegetable garden near a river. We gave it to him free because we thought it might break down. We were right, it broke down two days later. We then made a stronger handle and better valves. We also made the pump so that John could easily fix the inside of the pump himself if it broke.

● Has it broken?

No, it hasn't broken yet, and he has been using it for 8 months. He pumps four 44 gallon drums (800 litres) full each day. We dug a pit half-way up the river bank and he pumps the water from there. It is easier to pump from this pit than from the river. It takes about 3 hours to pump enough water for the 300 sq metre garden. But we were still a little disappointed. The pump is tiring to use, it does not pump water very high and it cannot suck water properly if it is higher than 1,5m from a river.

It is also expensive. It costs R80 and the pipe to lead water to the garden costs R30.

● So you decided to make a piston pump?

Yes it took a while to get it right. To test the pump we used it to suck water from the flooded basement of the EDA building. It sucked water 3½ metres high - much higher than the rubber hose pump. We took this pump to John Ntjalitjali's place and did a lot of pumping tests. We also compared it to the rubber hose pump. Testing took a few weeks, because we had to change parts of the pump. After we had finished it was obvious that the piston pump was better than the rubber hose pump. As well as sucking and pumping higher it is less work to use and pumps more water.

● Why did you test it there?

We did the first tests with one person so that we could test it out properly before using it in communities. If these pumps work properly we will make more of them and offer them to communities. We want to make the pump in such a way that the people using it can fix it themselves without any special tools and so that the parts that wear out will be cheap to replace. At the moment we think that the full cost of the pump, complete with 60 metres of 2,5cm plastic pipe will be between R100 and R120.

● Why did you decide to make these hand pumps?

The people at Mdukutshani in Msinga asked us if we would make a diaphragm pump using a car tyre. We decided it would be difficult to make it with a tyre and thought it would be better to make it with rubber mine hosing. The good thing about a rubber hose is that it does not wear out if you pump dirty water.

● Did it work well?

It doesn't cost anything, only my energy

We visited John Ntjalitjali and asked him about the pump EDA had given to him for testing.

● John, whose land are you farming here?

It is my father's land.

● What do you grow?

Carrots, spinach and tomatoes. But I haven't started selling anything yet.

● What did you expect to do about water when you first started farming here?

It was a problem how I was going to take water out to the garden. Then I was lucky, another man said he would help me to take water to the garden. He came to me and said he had a pump and lent it to me.

● What do you think of the pump, do you find it works well for you?

Yes, this pump works very well.

● Which one is better, the rubber hose one or the piston one?

The one that I got later, the piston pump. It is better because when we are pumping up the hill the water still comes out and it is quicker than the other one. It takes me about two hours to water the garden when there is no rain.

● Will you eventually replace it with a diesel pump?

No I prefer this one because it doesn't cost anything, only my energy. I do all the pumping myself.

● Don't you find it gets tiring after a while.

No, I can manage it.

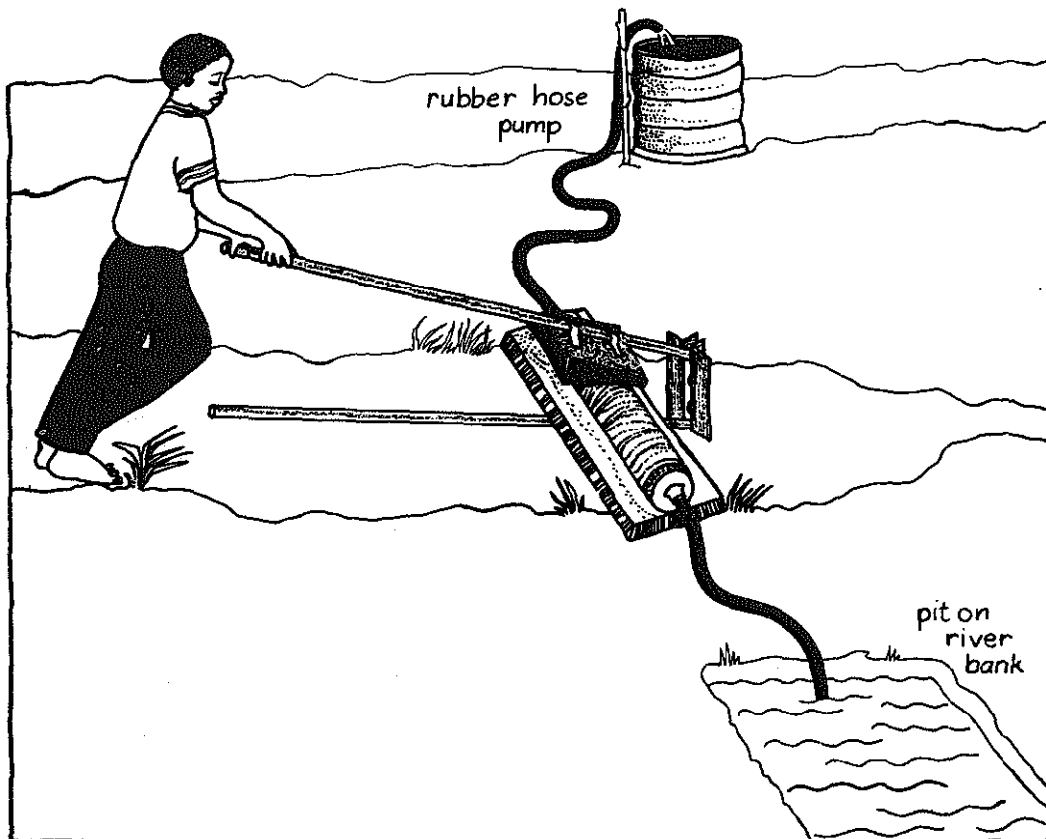

HOW TO MAKE A HAND PUMP FOR IRRIGATION

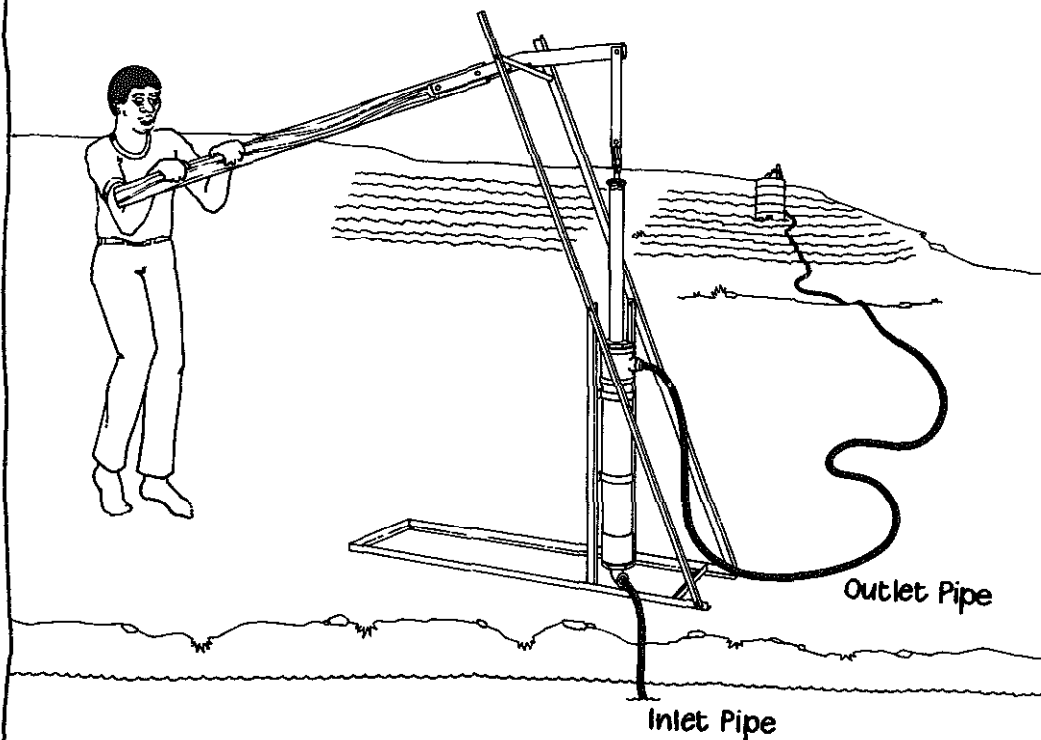

This pump can be used to pump water from a river to a vegetable garden. It can suck up water from a shallow well, if the well is less than 3m. deep. It can pump 15m. high.

The pump costs R70 and the outlet pipe costs 50 cents a metre. To make the pump you need a workshop with an electric drill and a welder. EDA can make pumps for communities who do not have the equipment or the experience to make their own. If you want to make a pump for a well deeper than 3m, write to us for plans.

How It Works

The pump uses valves to lift water. Each valve is made of a plastic disc with holes in it, and a rubber flap.

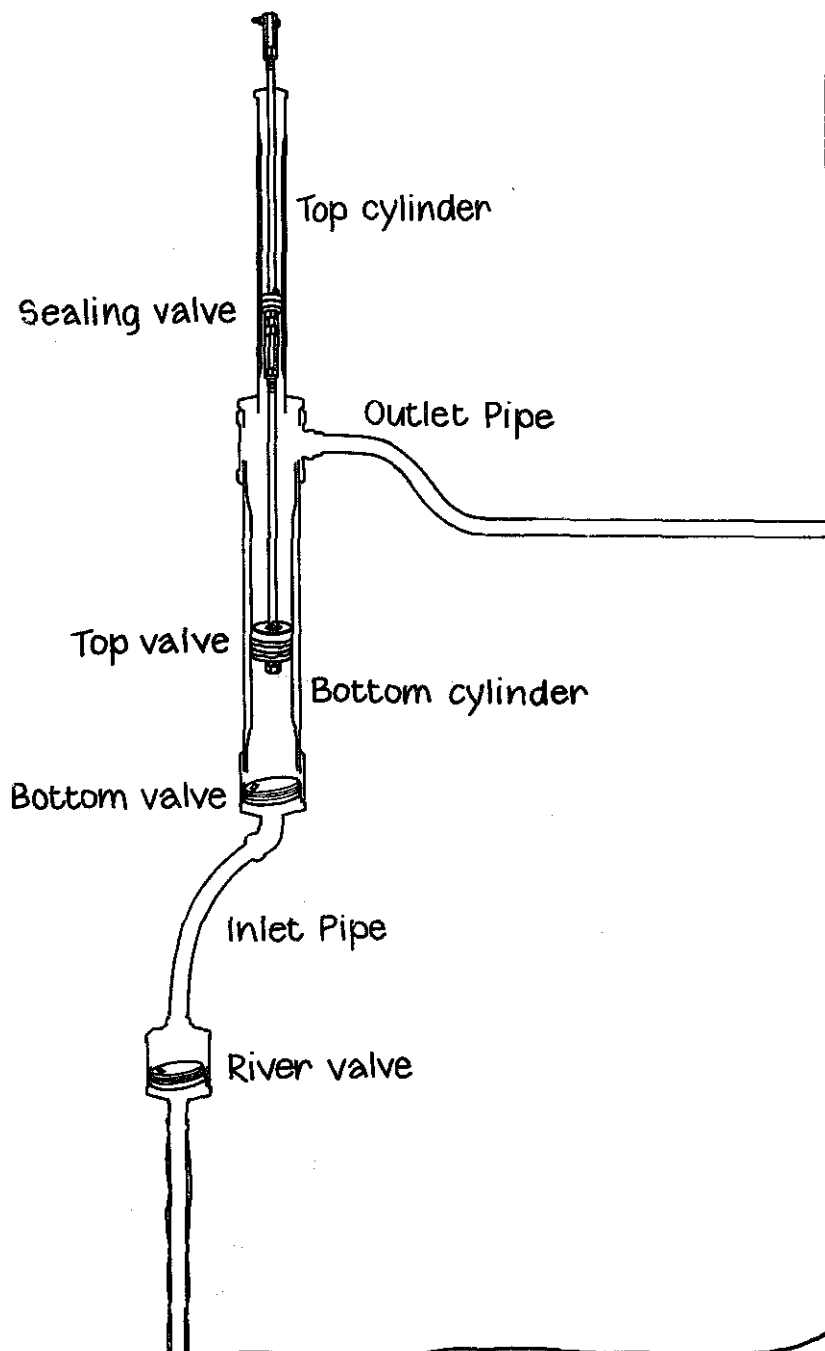

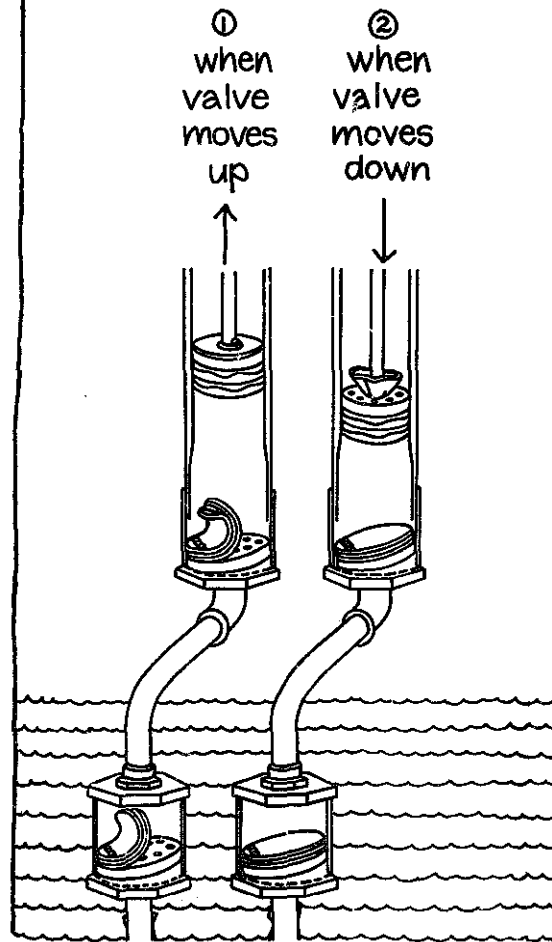

① When you push the handle, the top valve slides up. The flap on the top valve closes and the flaps on the bottom valve and the river valve open. Water is sucked up through the holes in these valves. The flaps let the water flow up but it cannot flow down again.

② When you pull the handle, the top valve slides down, its flap opens, and water passes through the holes. The flaps close on the bottom valve and the river valve.

③ When the top valve is lifted again, the water above it is lifted up and forced out through the outlet pipe.

The sealing valve in the top cylinder makes sure that there is water in the bottom cylinder all the time. Without the top cylinder, too much air would get in and the pump would not work.

Making the Pump

What you need

Rod socket, 12 mm galvanised.
Nut, 12 mm galvanised

Borehole rod, 12 mm galvanised
both ends threaded, 0,5 m long

Brass nut and bolt, 2 mm

Leather cup
Plastic disc, 12 mm thick
polypropylene
Leather cup
Plastic disc
3 Nuts
Rod socket
Nut

Borehole rod, 0,5 m long

Brass nut and bolt

3 inner tube flaps
Plastic disc
Leather cup
Plastic disc
Leather cup
Plastic disc
2 Nuts

(inside the reducing bush
3 inner tube flaps
and plastic disc)

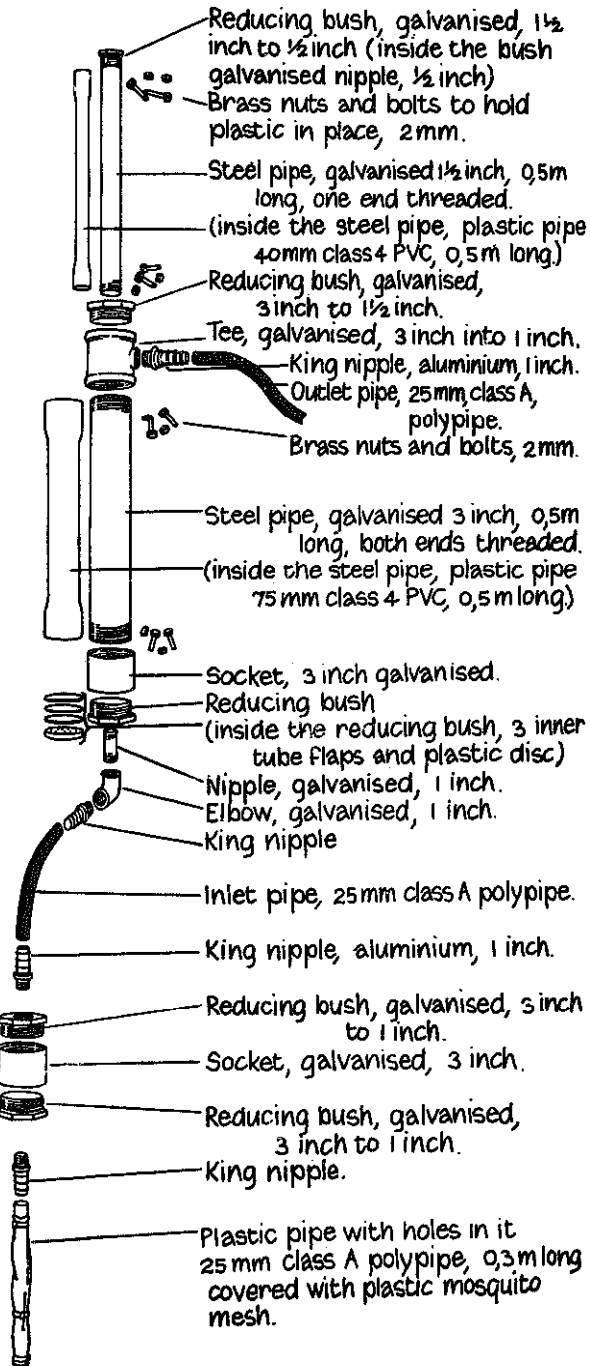

Making the plastic sleeves

For the bottom cylinder, cut a 30 cm length of 7.5 cm PVC pipe. Boil it in old motor oil. While it is still soft, squash one end with a funnel of sheet metal to make the end more narrow. Use a piece of sheet metal 15 cm square. Make it into a funnel 7.5 cm wide at the bottom and 6 cm wide at the top.

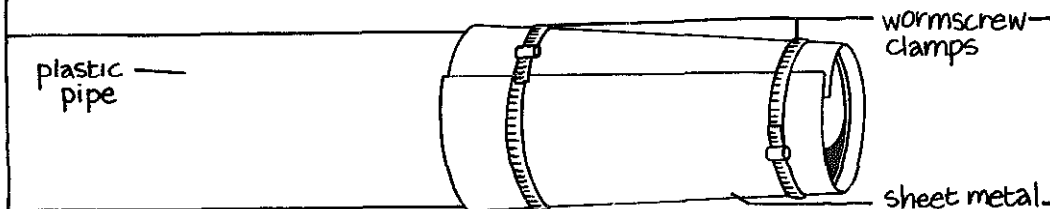

Then cut a 50 cm long piece of 7.5 cm PVC pipe. Boil one end of the pipe until it is soft. Put it inside the 3 inch steel pipe. Push and hammer the 30 cm PVC pipe into the soft end of the 50 cm pipe so that it presses tightly against the inside of the steel pipe.

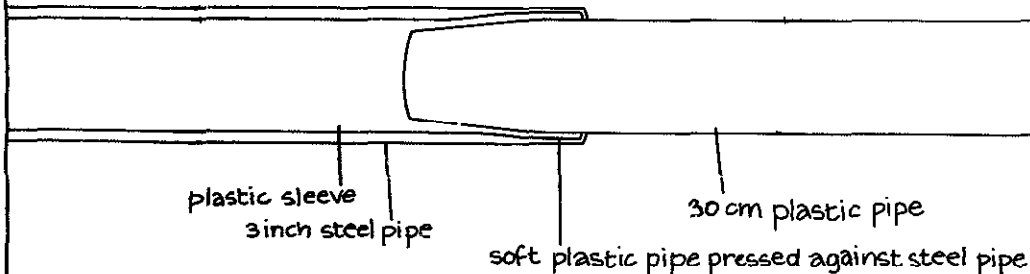

Then take out the 50 cm pipe, boil the other end, and open this end inside the steel pipe in the same way.

When both ends have been opened out, take the pipe out and spread bath sealer over both ends. Then push and hammer it back into the steel pipe. Drill 2 holes through the steel and the plastic pipes at the top end. Use 2 mm brass nuts and bolts to hold the plastic pipe in place.

Make the plastic sleeve for the top cylinder in exactly the same way, but here you can use a cold drink bottle instead of a funnel to widen the ends.

Weld the 1½ inch to ½ inch reducing bush to the unthreaded end of the cylinder; then smear bath sealer onto the plastic pipe and put it in the cylinder. Hold it in place with brass screws.

Making the valves

The valves are made from 12 mm thick polypropylene. You can only buy this plastic in 2 sq. metre sheets which are enough for 5 pumps but EDA can send you a strip of plastic for one pump.

Copy these shapes and glue them onto the plastic. You need 3 discs for the top valve, one for the bottom valve, one for the river valve and 2 for the sealing valves. First drill the holes, then cut out the discs with an electric drill routing attachment.

- 1 bottom valve disc
- 1 river valve disc

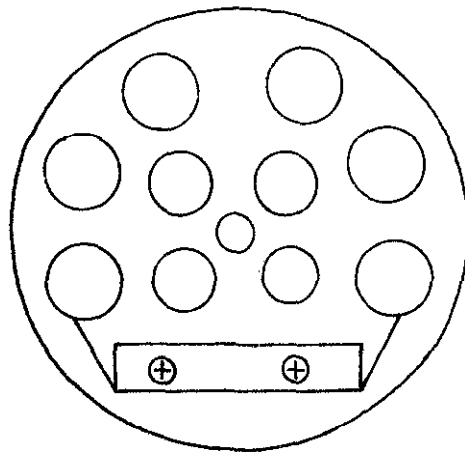

diameter 74 mm.
centre hole 7mm.
6 holes 13mm. } for water to
4 holes 10mm. } pass through.
2 holes 5mm for screws.

3 top valve discs

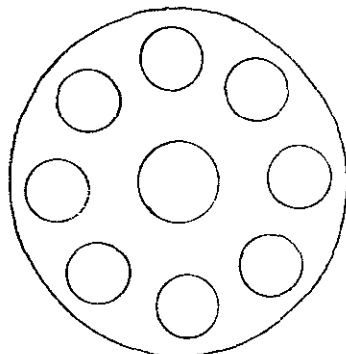

diameter 56 mm.
centre hole 13mm for
the borehole rod.
8 holes 10mm for water
to pass through.
3 holes 2mm for screws.

2 sealing valve discs

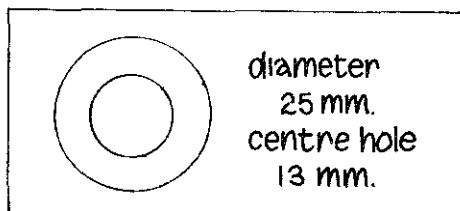

diameter
25 mm.
centre hole
13 mm.

The top valve and the sealing valves

Make 2 leather cups by cutting 85mm diameter leather discs. Put these discs between the 3 plastic discs. Hold them all together with 3 self tapping screws 2mm thick and 36mm long. Then cut 3 56mm diameter rubber discs from a car inner tube. Drill a 13mm centre hole. Measure the thickness of the completed top valve and drill a hole into the end of the borehole rod this deep. Fit a brass nut and bolt into this hole, slide on the completed valve, and tighten it on with 2 nuts. Join the other end of the borehole rod to a borehole socket.

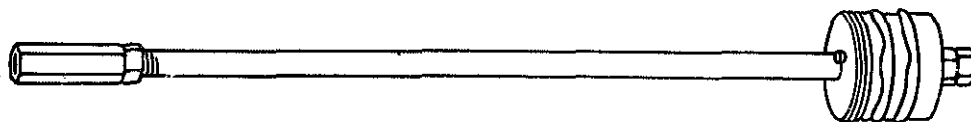

To make the sealing valve, make 2 leather cups from 45mm diameter leather discs. Slide on the 2 leather cups between 3 plastic discs. Slide the completed sealing valve onto the top section of the borehole rod, and connect the sealing valve to the borehole rod.

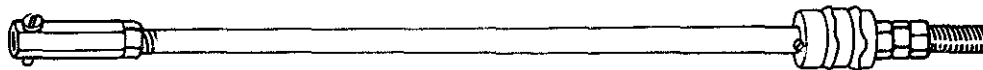

The river valve and bottom valve

These valves are exactly the same. For each valve cut 3 rubber flaps of 75mm diameter from a car inner tube. Cut a piece of plastic to hold the flaps onto the disc. Drill 5mm holes through the inner tube flaps and the piece of plastic. Hold them together with 4mm bolts and nuts. Cut a washer from car inner tube to fit around each valve. Knock each valve into its reducing bush, so that it fits tightly.

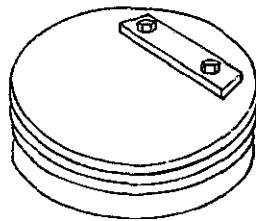

Putting the pump together

Push the top valve into the 3 inch pipe. Slide the T piece over the sealing valve and screw it into the 3 inch pipe. Screw the reducing bush into the T. Slide the 1½ inch pipe over the sealing valve and screw it into the reducing bush.

Making the handle

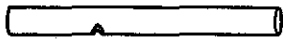

Cut a 0,5m length of scaffold pipe.
Cut a notch 14 cm from one end.

Bend the pipe at the notch and drill
a 8mm hole through at one end.
Weld a 23 cm length of ½ inch pipe
across the bent part of the pipe.

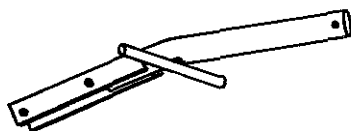
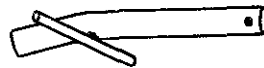

Cut 2 40cm lengths of 50mm steel
plate. Weld these plates to the
scaffold pipe. Drill 2 13mm holes
in each plate.

Cut a 30cm length of 30mm wide flat
iron. Drill 2 8mm holes.

Join one end of the flat iron to the
handle.

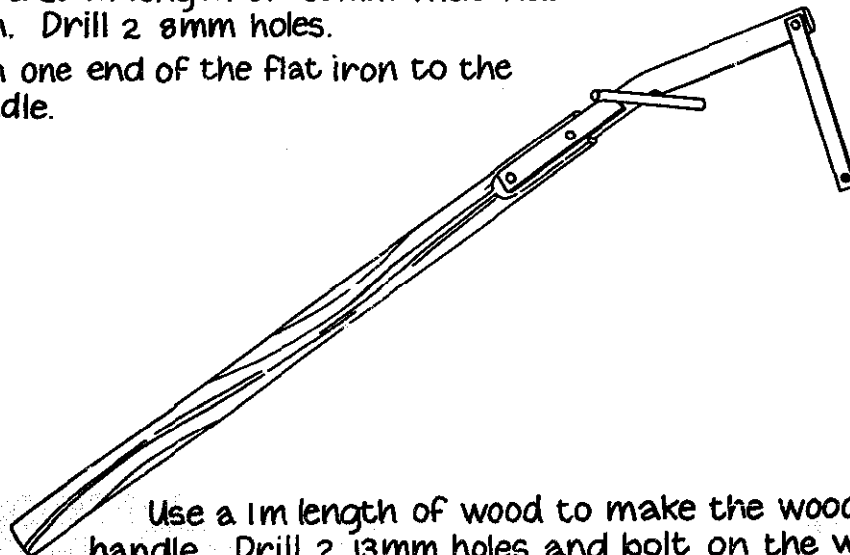

Use a 1m length of wood to make the wooden
handle. Drill 2 13mm holes and bolt on the wooden
handle.

Making the pump stand

Cut angle iron, weld and drill 13mm holes. Attach the pump to the stand with 3 inch galvanised pipe straps.

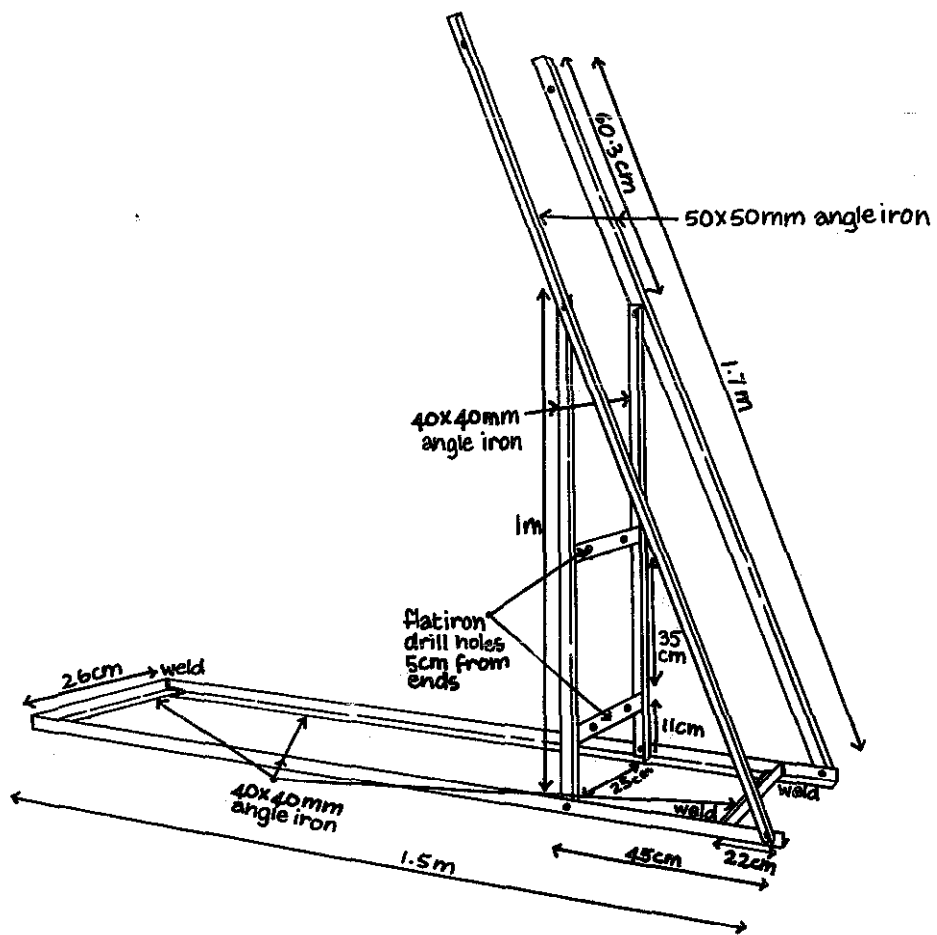

Water Tanks

The storage tank should be big enough to hold water for one week. Then if there are repairs to the pipes or the pump, people will not run out of water. Drinking water must be stored in a covered tank to make sure it is kept clean.

The pipe from the water supply to the tank can be ordinary black plastic pipe. This comes in different thicknesses. Measure the height from the water source to the tank. When you buy the pipe, tell the supplier this height so that you get the right pipe.

Round tanks are better to build than square tanks. Square tanks need reinforcing at the corners which makes them more expensive.

Brick Tanks

If you are an experienced builder, you can build your own round tank from bricks.

- ▶ Dig out the loose topsoil where you want the tank. Do not build on dry soil.
- ▶ Hammer a peg in the middle of the tank and mark out circles for the foundation trench.

▶ Hammer in pegs 1,5m apart on the circles you have marked out.

▶ Lay the outlet pipe before you build the foundations. Dig down 25cm and fill the trenches with a mixture of 1 part of cement, 8 parts of stone and 8 parts of sand. Put on wet sacks so the foundations dry slowly. After 2 days put bitumen over the foundations.

Making the Floor

Build up the wall 2 layers of bricks high. Lay a ring of 8 gauge wire between each layer of bricks. Stamp the soil down hard and put on a concrete mixture of 2 parts of cement, 7 parts of stone, and 7 parts of sand.

Lay the concrete 10cm thick. Pour water on the floor so that it does not dry too quickly.

You can also make a floor from stones. First put on a 8cm layer of sand. Use round stones as big as your hand. Push the stones into the sand so they are all touching. Pour water over them so that the sand fills the spaces between the stones. Make a mixture of 1 part of cement and 3 parts sand and lay it over the stones, 5cm thick.

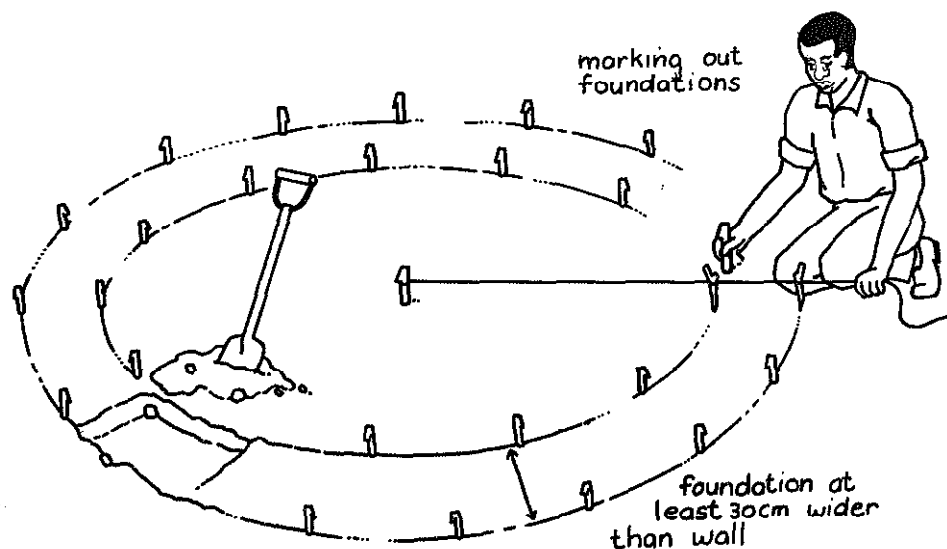

Building the Walls

Do not build the wall out of hollow cement blocks. Use bricks or solid cement blocks. Build the wall 1 block thick or 2 bricks thick.

Build three pipes into the wall. The outlet pipe, where you put the tap, must be built 15cm above the bottom. The inlet pipe must be just below the top of the tank. The overflow pipe must be just below the level of the inlet pipe.

Plaster the walls inside with two layers of plaster, each 10mm thick. Use a mixture of 1 part cement and 3 parts sand for the plaster.

Some people build underground brick tanks. This keeps the water cooler and it helps to make the walls of the tank stronger. If you build the tank under

the ground, make the walls 30cm higher than the ground, so that dirt can not run into the tank when it rains. Make a roof for the tank in the same way as the roof for a spring box (p).

Ferrocement Tanks

Ferrocement is cement strengthened with chicken wire. You can build light and cheap tanks this way. The Valley Trust in Natal (see p 539) has built some ferrocement tanks and can give plans and advice.

You can make smaller cement jars by filling a bag with sawdust and plastering it with cement. When the cement is hard you can take the bag out and use it to make other jars. The jars can be used for storing water or food. Write to EDA for instructions on how to make the bag and the jar.

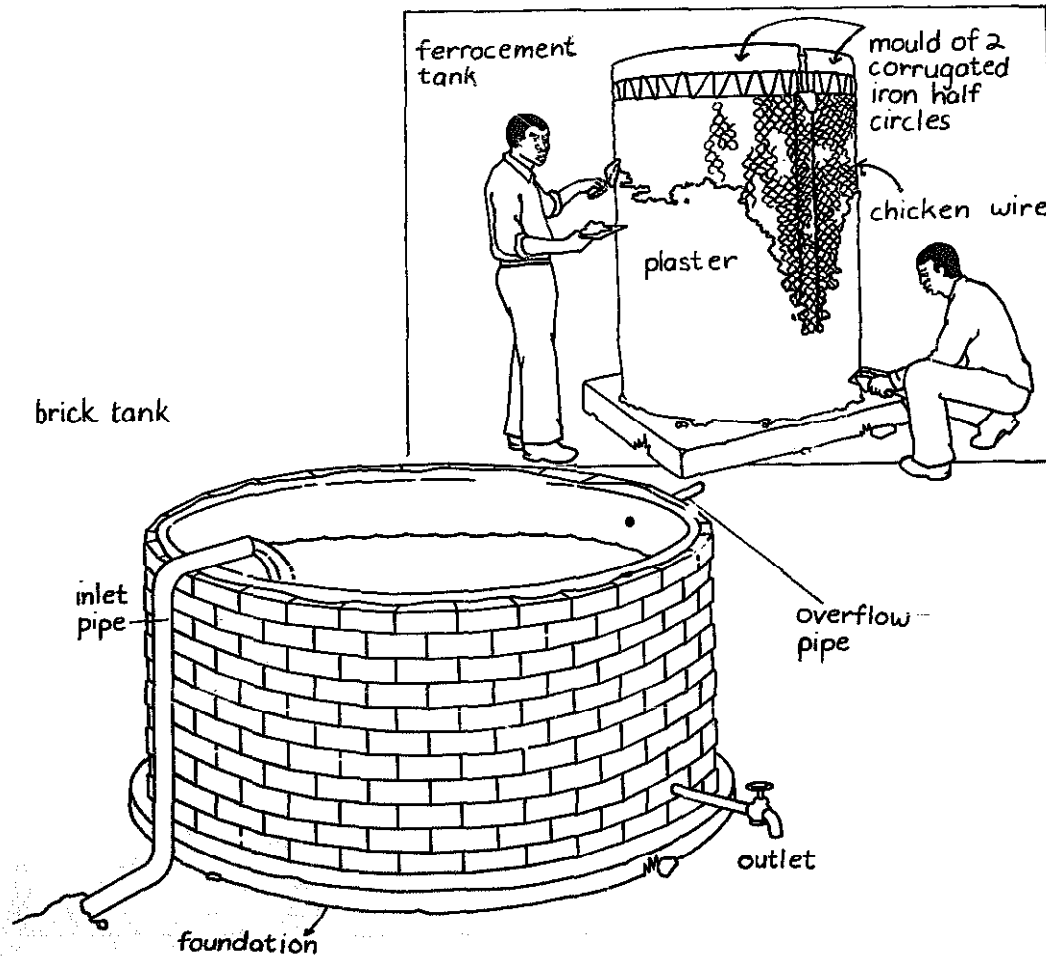

Dams

Building a dam is not easy. You have to build it in the right place and have the right soil. Dams can be very dangerous if they are not built well. If they are washed away by floods, they can cause a lot of damage to people, animals and buildings.

Where to make a dam

The best place for a dam is a deep but narrow valley or donga with a slow running stream.

It is better to build a dam above a village than below it. Then when people wash, they will wash in the stream coming out of the dam, not the stream going into the dam. This will help to keep the water in the dam clean.

How big must the dam be?

Stretch a string across the place where you want to build the top of the dam wall. Hang another string

from the middle of this string. This will tell you how high the dam wall will be, or how deep the water in the dam will be. It should be more than 2 metres, otherwise the dam can become dry or fill up with sand too quickly.

If you want to find out how much water the dam will hold, use a spirit level or a water level (see p 260) to find the place where the stream is level with the top of the dam wall. Measure the distance between this place and the dam wall. Then the amount of water the dam will hold in cubic metres is approximately $\frac{1}{6} \times$ this distance \times the length of the wall \times the height of the wall.

Ask your extension officer to help you work out the catchment area. All rain that falls on the catchment area flows downhill into the dam. The catchment area must be at least 15 times the area of the dam, otherwise the dam will fill up too slowly.

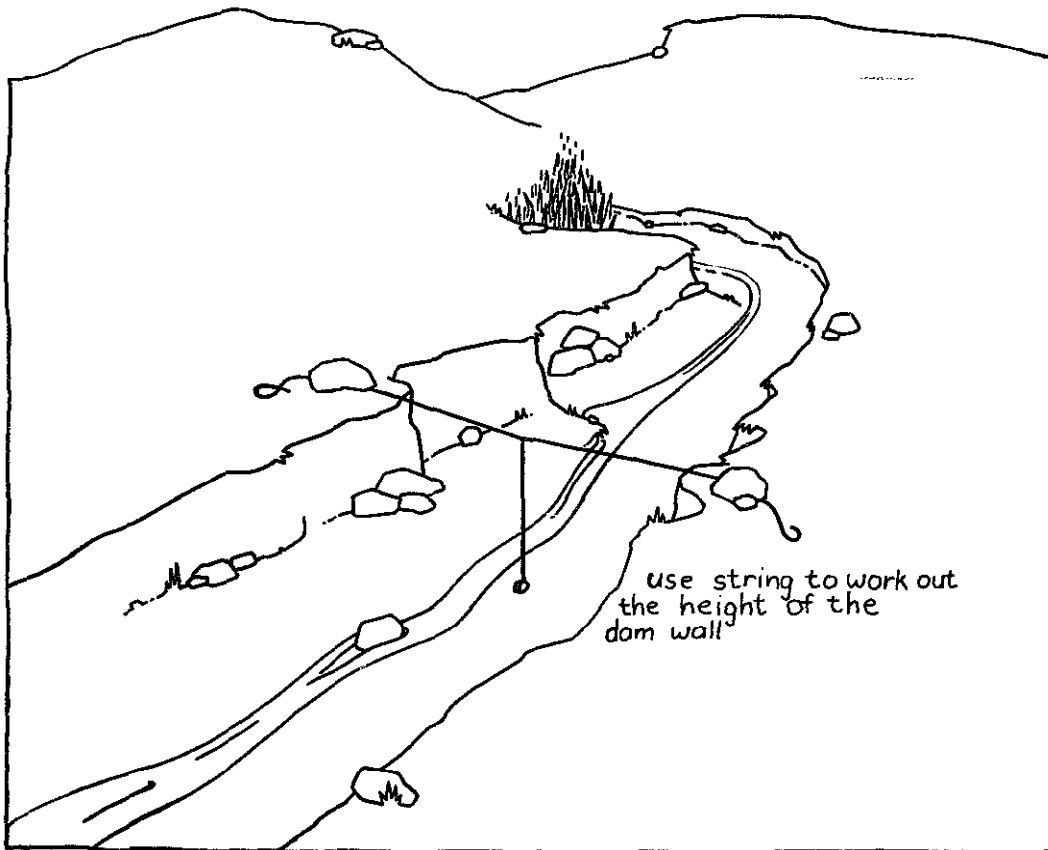

Building the dam wall

The best soils for earth dams are sandy loams (see know your soil p 97). They have a small amount of clay in them, which helps to make the wall strong.

When you have found the right soil, make the foundation of the wall. The wall must be built on rock or clay soil. If the wall is built on silt or sand, the water will slowly empty out from under the wall.

To build the wall, first clear away plants and top soil using a tractor or an ox-drawn scraper. Then build the dam wall in layers, putting on 30cm of soil at a time. The soil must be damp and each layer must be tramped down by walking some oxen over it a few times. The dam wall must slope gently.

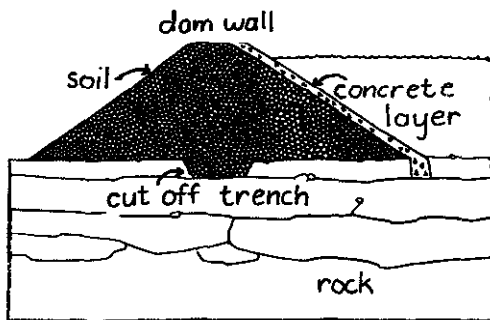

If the ground where you want to build the wall is not rock or clay you have to dig a long trench, called a cut-off trench. The cut-off trench must be in the middle of the dam wall, and dug down to rock or clay. If you can not find rock or clay, ask an engineer for advice on how deep the cut-off trench must be. The cut-off trench must be filled with the same soil that will be used for building the dam wall.

Making the Spillway

A spillway is a place on the side of a dam wall a little lower than the rest of the wall. When the dam is full after heavy rains, the water can flow out at the spillway instead of flowing over the wall and causing erosion.

Make the spillway on the side of the wall where the floor of the dam is lowest. Press stones into the bottom and sides of the spillway to prevent erosion. Make a channel, also lined with stones, to carry the water from the spillway back to the stream on the other side of the dam wall. Plant grass and reeds in the spillway and on both sides of the dam wall.

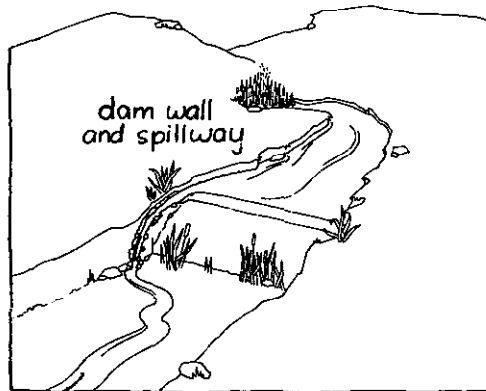

Rockfill Dams

Rockfill dams are dams made out of rocks, with a layer of concrete or clay to stop water passing through the dam wall. They have stronger walls than earth dams and they do not need spillways. After heavy rains, the water can flow over the dam wall without washing it away. Rockfill dams must be built with very big rocks, which can not be washed away. Such big rocks are difficult to build with. But if there are a lot of big rocks near where you want to build the dam, it may be worthwhile to make a rock-fill dam.

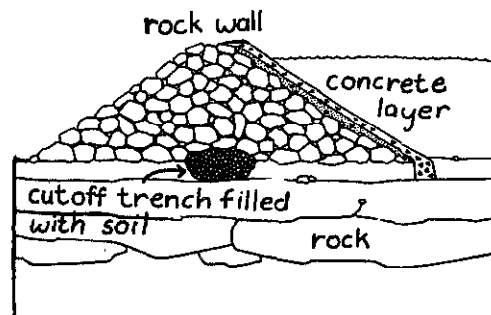

Fishing

If you live near the sea, or near a dam or river, you should learn how to catch fish. The best way to learn about fishing is to find people who know about fishing. They will be able to show you how to catch fish, and where the best places for fishing are.

Fishing Lines

The easiest way to catch fish is with a fishing line. All you need is some nylon fishing line with a fish hook on one end. You do not need a fishing rod. Put some earthworms or stiff mealie meal onto the hook so the fish will bite the hook.

Tie a small stone or a piece of iron onto the line to make it heavier. Then swing it around your head a few times and throw the end with the hook into deep water. This is where the fish are. When you throw the line in, make sure that nobody stands close to you.

When you feel a pull on the line, it means a fish is biting. Let it bite hard, then give the line a quick pull to hook the fish. If you have hooked the fish you will feel it on your line. Pull the line in and take the fish off the hook.

You can catch more fish if you tie many short lines and hooks onto a long piece of fishing line and leave it in the water. Tie one end of the line to a rock or a tree on the side of the dam and tie a heavy stone on the other end, to make it sink into the water.

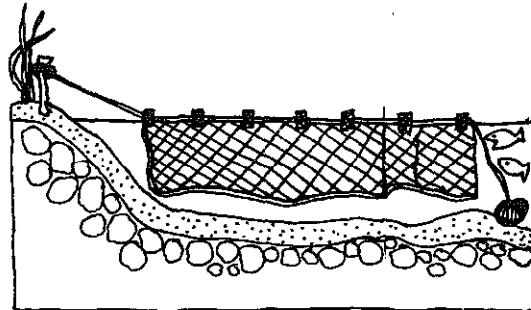
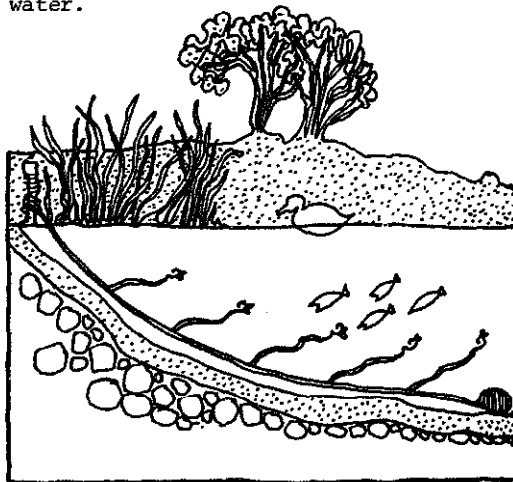

Nets

Nets catch more fish than fishing lines, but you need a permit for a net. Ask for a permit from the Nature Conservation Section of the Department of Agriculture in your district.

There are lots of different kinds of nets. One of the easiest to use in dams is a gill net. A gill net is made of thin nylon line. The top of the net has corks tied to it to make it float on the water. The bottom has weights to make the net hang down in the water. The net stays in the water all night. When fish try to swim through the net, their heads are caught in the holes and they cannot get out. Next morning you take them out of the net.

Fish Traps

Fish traps made from reeds or chicken wire are also good for catching fish. Make a wire funnel and a wire drum with about 1 metre of chicken wire.

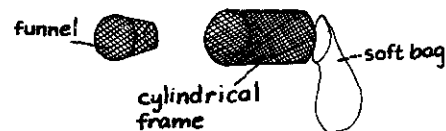

Put the funnel inside the drum with a small mealie meal sack on the other end of the drum. Hang some mealie meal inside the trap. Tie the trap to a log so that it does not sink to the bottom of the water and tie the log to a rock or a tree on the side of the dam.

You can leave the trap in the water for a few hours or for the whole night. The fish will swim in to get the mealie meal and then they will not be able to get out.

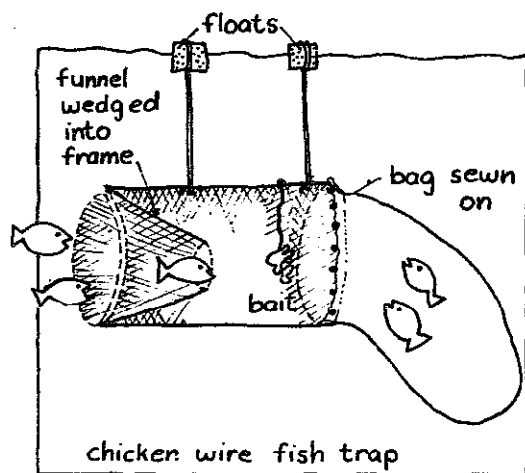

It is easier to catch fish in summer than in winter. Sometimes after the first summer rains you can see thousands of fish swimming up a river. This happens only a few days in the year. They are going up the river to breed. At this time you can even catch fish with your hands, or with buckets, or by hitting them with sticks. Do not try to catch all the fish. Let some go and breed so there will be young fish next year.

Making Water Safe to Drink

Diseases like bilharzia, cholera, typhoid and gastro-enteritis are all caused by germs in water. To make sure water does not have these germs, it must be cleaned before you can drink it or wash with it.

Boiling

Boiling is the best way to make water safe to drink. It kills all the germs which carry diseases. But it takes a long time and uses up a lot of fuel. The water must be boiled well for 10 minutes. Store the water in the same pot you boiled it in.

If you have to boil a lot of water, you can make a boiler with an oil drum. Make a fire place for the oil drum turned on its side. Screw a tap into the bottom opening, and make an opening in the top for steam to come out.

Cooking Fish

You must clean and cook fish well otherwise you can get worms (see p 326). Before you cook a fish you must clean it. Cut the fish underneath with a sharp knife from the middle to the head. Then take out all the parts that you do not want to eat.

Most fish are covered with scales. If you want to boil or fry the fish, scrape off the scales with a sharp knife. If you want to cook the fish on a fire, leave the scales on. The fire should not be too hot. When the fish is cooked, you can peel the scales and skin off easily.

Storing Fish

Fish start to go bad about 2 or 3 days after they have been killed. They will last longer if you put some salt on them and hang them up to dry.

You can keep fish fresh by keeping them alive. If you have a small pond, or a drum of water, put the fish into it. Do this soon after you catch the fish, otherwise it will die.

Disinfection

Disinfection is using chemicals to kill all the germs in the water. Often people disinfect water after it has been filtered, to make sure it is completely safe.

The most common chemical for disinfection is chlorine. This method has to be done carefully by somebody with experience. For disinfecting a large water supply, chlorine is put into the water as a gas. But for small communities, it is best to use chlorine tablets which are sold to clean swimming pools.

Filtration

Filtration is passing water through very fine sand to get rid of germs. It is a good way to make water safe if boiling is too difficult. It can get rid of most germs, including bilharzia. But for water which might

carry serious diseases like cholera, typhoid and gastro-enteritis filtration is not enough, you must boil the water before drinking it.

The most common filtration method is a slow sand filter. The filter is a tank with fine sand in it. The water filters through the sand to another tank. After some time, tiny plants start to grow in the sand, and these make a fine strainer which stops germs passing through the filter. You can make a small sand filter with an oil drum or a larger filter in a brick tank.

Settling

If your water supply gives muddy or dirty water, you can get much cleaner water using a settling tank. This is a large covered tank where the water can stand still. The sand and silt settle down to the bottom of the tank and the water becomes clear.

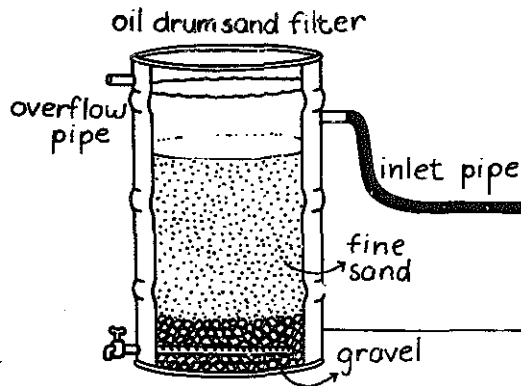

An oil drum can be a small settling tank. If you leave water to stand in a drum for 2 days it will be clear and many of the germs will be killed. After 2 days you have to take the clean water out of the settling tank and fill it again with dirty water.



Health

Health Introduction

Most people in South Africa do not get good health care. Many get sick and die from diseases like TB and malnutrition. Rich people get sick from diseases like heart attacks and ulcers, but poor people die from these diseases.

Because there is such a big difference between rich and poor people in South Africa, diseases of poor people are much more serious.

A lot of other health problems happen because of the violence used to keep up the system; problems like alcoholism, stabbings, shootings, suicides, car accidents, factory and mine injuries.

People are forced to live in overcrowded places without clean water so they get diseases like cholera, typhoid and gastro-enteritis. Those who have jobs get only a little money and they can not send enough money home to buy food. Those who stay at home often do not have land to grow food. Even if they do have land, they do not have money to pay for ploughing, seeds and water pumps. Many people do not have enough food and suffer from malnutrition.

Black people are forced to live only in certain places in South Africa. They must stay where the government tells them to and because of pass laws they are not free to live and work where they want to.

Many years ago, there was enough land for everybody. People could keep

cattle without overgrazing. When there was drought, there was enough extra food to last until the rains came.

When the whites came to South Africa they took over lots of the land. Black people were forced to live in crowded places and work on the farms and mines and later in the factories. This was the beginning of the migrant labour system which controls workers and breaks up families today.

Many people get sick and die because they have no proper health care. There is a shortage of clinics, nurses and doctors. Even without expensive education, there could be proper health care in rural areas. In some other countries in Africa where there are not enough doctors and nurses, a few people in every village are trained to be health workers. This type of health care is used in only a few villages in South Africa. Health care is done by mothers and grandmothers who struggle to look after children. When they take their children to the clinics the nurses often tell them they are bad mothers who will not work and do not know how to look after children. Some nurses do not understand that sickness is not always a mother's fault. It can be because of no money, no jobs, no houses and no clean water. Many of the things which make people's health suffer will not be solved until everybody has these things.

People also need information about how to be healthy and this part of the book is for people who are working to keep themselves and their communities healthy.

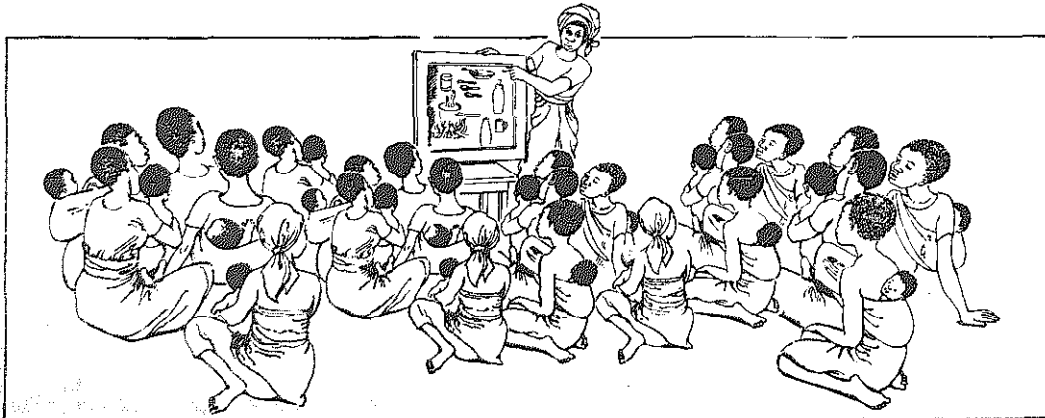



Pregnancy and Childcare

Pregnancy is a time when it is important to look after yourself well so that you will be strong and have a healthy baby. You need to eat well and rest more than usual. For many women this is not possible because they have to work hard until the time of the birth, then go back to their jobs soon afterwards. Some are poor and can not afford good food. Others get pregnant when they are still at school and have to leave their studies or struggle to carry on with their school work as well as look after a baby.

Women should try to plan their pregnancy so they will be able to stop working for a few weeks before and after the birth, if possible. They should use contraceptives during the time they do not want to get pregnant. During their pregnancy, they should go regularly to ante-

natal clinics and try to be as healthy as they can.

After the child's birth there is a lot of work for the whole family. Children need love and care and for many South Africans it is a struggle to provide these things. Most families are poor and split up because parents have to go far away from home to find work. The money they get is not enough to give their children food, clothes and education.

These problems will only be solved when we change the way we live and work. But even if we are short of things we need for bringing up children well, we can look after them better if we know how to feed them best on the money we have, how to use clinics and how to prevent and cure children's sicknesses.

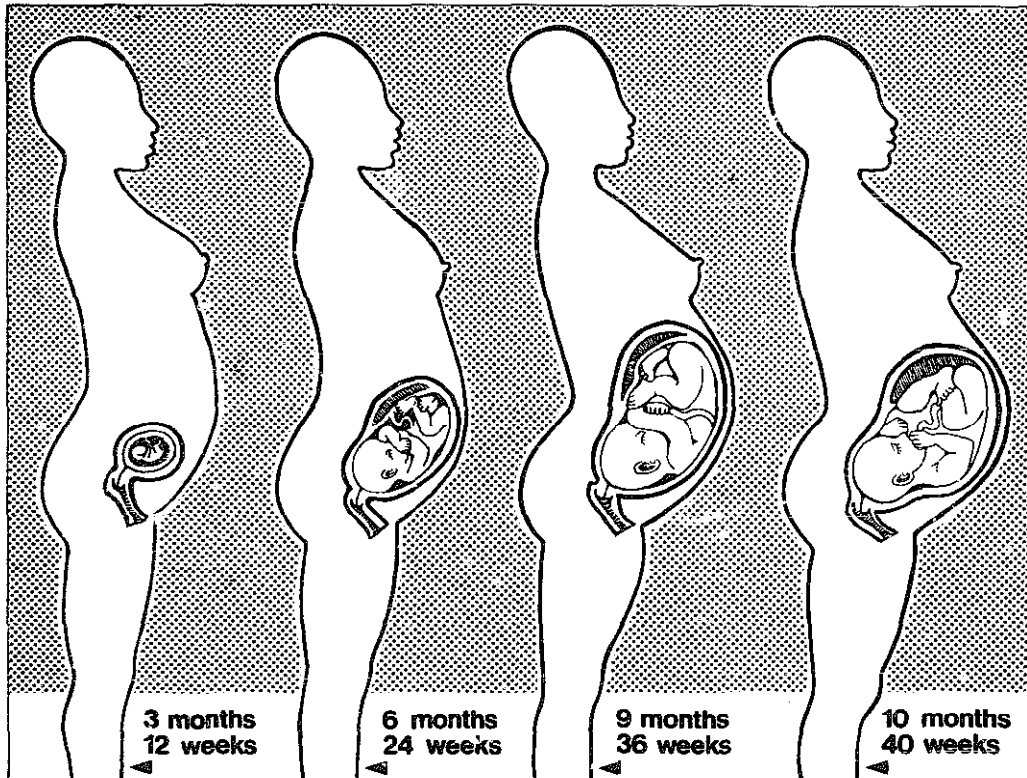

How you become pregnant

Babies grow from the ovum of a woman and sperm of a man. The ovum and the sperm join together inside the woman's body when the man and the woman have sex.

Once a month, an ovum is made inside the woman's body and goes into her womb. This usually happens 12 to 16 days after the woman's period started. This is about the time when the woman is most fertile and most likely to become pregnant.

The man's body makes sperm all the time. The sperm comes out of his penis during sex. If the sperm and the ovum meet and join, they begin to grow into a baby inside the woman's womb. Now the woman is pregnant and the baby grows inside her for nine months.

Every month the woman's body makes the womb soft inside, so that if she becomes pregnant, the baby will have

a soft place to grow. If the woman does not become pregnant, the soft inside of the womb is not needed and it comes out of the vagina as blood. This is called menstruation or a period. When a woman becomes pregnant the soft inside of the womb stays, so she does not have periods.

How to know if you are pregnant

During pregnancy you will not have monthly periods. But if your period is late for one month, it does not always mean you are pregnant. If you miss 2 periods, go to the clinic to find out if you are pregnant.

At about this time, your body begins to change. Your breasts become sore to touch, they grow bigger and the nipples become darker. You will pass water more often. You may feel like vomiting during the day, especially when you wake up in the morning. This is called morning sickness.

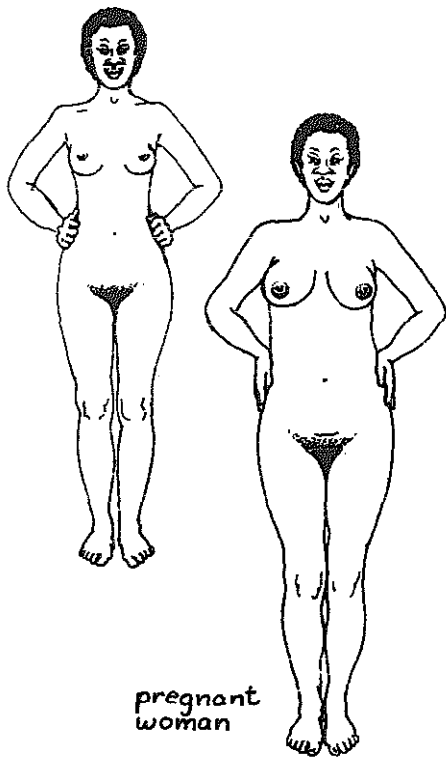

pregnant woman

Morning Sickness

With most women this starts in the 6th week of pregnancy and lasts until about the 9th week, then usually stops.

There is no cure for morning sickness. Many women feel better if they eat or drink something before they get up. You can leave something to eat and drink next to your bed when you go to sleep. You should not take any pills to stop morning sickness, because they can harm your baby. Eat small meals without fat or oil and do not eat spicy foods like aachaar or chillies.



Constipation

Constipation is when you can not shit when you go to the toilet. If you suffer from constipation you should try to eat rough foods such as unrefined mealie meal and whole wheat bread instead of refined mealie meal and white bread. Mealie meal from shops is refined. If you grind your own mealie meal or get it milled by a hammermill it is unrefined. You should also try to eat as much fruit as possible, but not bananas. You should not take any medicines (laxatives) or enemas to get rid of the constipation because these could harm your baby.

Stomach Pains

You may feel sore pains in your stomach from the baby's head pressing on your bones. If the pains are very sore, go to the clinic. You should feel the baby moving inside you. If you never feel the baby move, go to the clinic.

Varicose Veins

Varicose veins are swollen veins in your legs. If your veins are very swollen, you should go to the clinic. You should try to rest for at least one hour each day with your feet higher than your head. The best thing for varicose veins is walking because this keeps the blood moving in your legs. The varicose veins will get much worse if you stand or sit too much. Wear tight socks or stockings and sleep with the bottom of your bed on a brick to make it higher than the top of the bed. Many women have varicose veins when they are pregnant, but they go away after the baby is born.

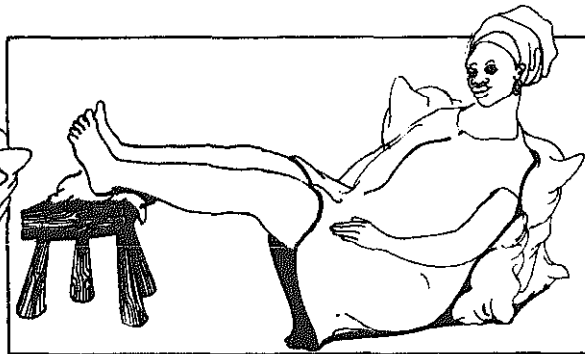

Piles

Piles are swollen veins around your bottom. They are caused by constipation and are sometimes very painful. To get rid of piles you have to get rid of the constipation. If the piles are very painful go to the clinic.

Swollen Feet and Ankles

If your feet and ankles become swollen (fat) you must go to the clinic for blood pressure tests. You must also rest as much as possible with your legs stretched straight out in front of you.



Heartburn

Heartburn is also called indigestion. It feels like a burning pain in your chest. The heartburn will not be so sore if you eat 3 or 4 smaller meals a day instead of 1 or 2 big meals. Drinking milk helps some women with heartburn. Others feel better if they sleep almost sitting up with their head on some pillows or a rolled up blanket.



Discharge

A discharge is when wet stuff comes out of your vagina. It is normal to have more discharge than usual during pregnancy. If it looks clear, there is nothing to worry about. Some discharges like thrush (see p 323) make you very itchy. If the discharge looks green or like sour milk, or if it smells bad, it means there is an infection and you must go to the clinic.

Urine Infection

Many pregnant women get infection of their urine. If you have a burning pain when you pass water and if you pass water more often, go to the clinic. This infection can cause the baby to be born early if you do not get medicine from the clinic for it.

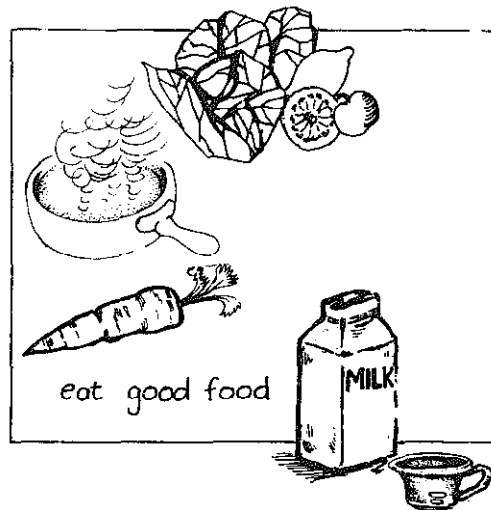

Food

Try to eat the best foods you can, so that you will be strong and have a healthy baby. You should eat as much protein, vegetables and fruit as possible. Be careful not to put on too much extra weight because after the baby is born you will stay fat.

Try to drink at least 2 cups of milk every day. Milk gives your body the extra protein and calcium it needs so that the baby will grow well. Look at nutrition (p311) for more information on healthy food.



Smoking
and
drinking
are bad
for your
unborn
baby

Smoking and Drinking

Smoking is dangerous to everyone's health, but is even worse for pregnant women. If you smoke when you are pregnant, it will also be dangerous to your baby's health. The poisons from the cigarette go into your body and also into the body of the unborn baby. Women who smoke have smaller babies which get sick more easily. Even if you are a regular smoker it would be better if you stopped smoking while you are pregnant, for the sake of your baby.

Drinking liquor can also be dangerous during pregnancy. When you are pregnant try not to drink anything such as beer or strong liquor which could harm your baby.

Sex

You can have sex during pregnancy as long as it is comfortable. Many doctors think that sex during the last month of your pregnancy can make the baby be born early.

Clothes

Clothes for pregnant women are called maternity clothes. These clothes should be loose and comfortable.

It is important to wear a bra which holds up your breasts well. Do not wear high-heeled shoes because they will make your back and feet sore. Rather walk barefoot or wear flat or low-heeled shoes.

Rest and Exercise

Try to rest as much as possible when you are pregnant. You can carry on with your housework or with another job, but try to rest for about an hour every day with your legs up.

Many women suffer a lot of pain during birth. There are special exercises for pregnant women which make the birth of the baby less painful. These exercises make your stomach muscles stronger and teach you how to relax during the birth.



rest with
legs up
one hour
a day

wear a bra,
Loose fitting
clothes and
flat shoes

Medicines

When you are pregnant it can be dangerous to take any medicines even things like cough mixture or headache pills. Only take medicines given to you by a doctor or nurse. If you are already taking medicine when you become pregnant, check with the doctor or nurse to make sure it is safe to carry on taking them during pregnancy.

Sometimes pregnant women also need pills to keep their blood strong. They are called iron pills and you can get them from the ante-natal clinic.

Money

Having a baby costs a lot of money. You need money for transport to the clinic and hospital. You need money to buy clothes for the baby. Most South Africans are short of money. It is difficult to save money for having a baby. In some countries like Mozambique and Tanzania, the government helps pregnant women with money. In South Africa, pregnant women do not get support from the government or employers. Many women lose their jobs because they become pregnant. If you have serious problems with money when you are pregnant you can sometimes get help from your local social worker.

If you have a job where you pay money every week to the Unemployment, Insurance Fund, you can claim your wages while you take time off to have a baby. Look at U.I.F. (p 375) to find out about maternity benefits.

If possible, try to stop working during the last 2 months you are pregnant. It is very tiring to work during this time.

Going to the Clinic

Clinics have special days for pregnant women. They are called ante-natal days. While you are pregnant you should go to the ante-natal clinic one day a month.

The work of the ante-natal clinic is to:

- Make sure you and your unborn baby are as healthy as possible during your pregnancy.

- Find out any diseases which could cause problems in pregnancy, for example venereal disease. Many women do not know they have a disease until they go for a check up at the ante-natal clinic.

- Find out and prevent any problems which could happen during the birth of the baby.

Some women need special ante-natal treatment to make sure that they stay well during pregnancy and have a healthy baby:

- ▶ Women who have had a miscarriage before.
- ▶ Women who have had a baby by Caesarian operation.
- ▶ Women who have had twins.
- ▶ Teenagers.
- ▶ Women over 35 years.



Serious Problems during Pregnancy

If any of these things happen to a pregnant woman it means that she could lose her baby and she might even die. She must go to the clinic or hospital straight away.

- ▶ Bleeding from the vagina.
- ▶ Swelling all over the body, not only the feet and ankles. If a pregnant woman has swelling and fits, it is very serious.
- ▶ Birth pains (labour pains) start or 'waters' break many weeks before the baby should be born.
- ▶ Bad headaches or very sore stomach pains.

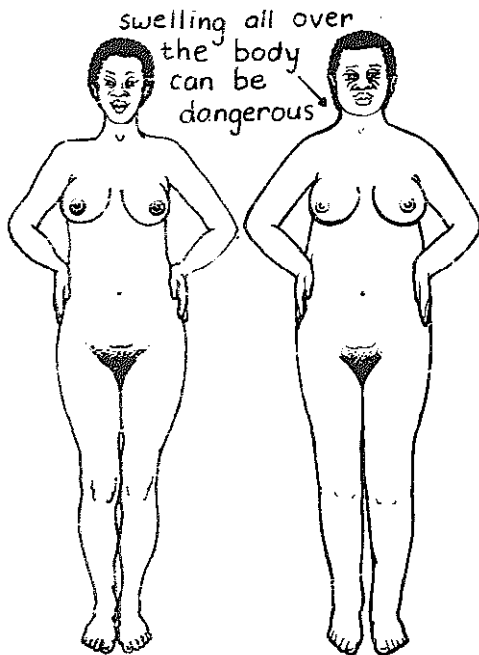

Women who have had any of these diseases must also have ante-natal treatment:

- ▶ High blood pressure
- ▶ Sugar diabetes
- ▶ Bladder or kidney infection
- ▶ Heart disease

It is very important that these women go to the ante-natal clinic right through their pregnancy. Many problems could be solved if every pregnant woman went to the ante-natal clinic every month.

At the ante-natal clinic, ask the nurse whatever you want to know about pregnancy, childbirth or looking after babies. The nurse's job is to help mothers, so ask her any questions you have.

Giving Birth

Every woman can have her baby in a clinic or hospital. At the clinic there are nurses and doctors to help if anything goes wrong. When you go to the ante-natal clinic they will tell you when to come in to have your baby. You will know when the baby is ready to be born when any of these things happen:

- ▶ A little blood and sticky mucus comes out of your vagina.
- ▶ Your 'waters' burst - a lot of water comes out.
- ▶ You feel cramps (sore pains) one after another, with the same amount of time in between them. At first they will be more than 20 minutes apart, later they will become quicker.

If you are already at the clinic or hospital or if you can get there within a few hours your baby can be born there. If not, you will have to give birth to your baby at home.

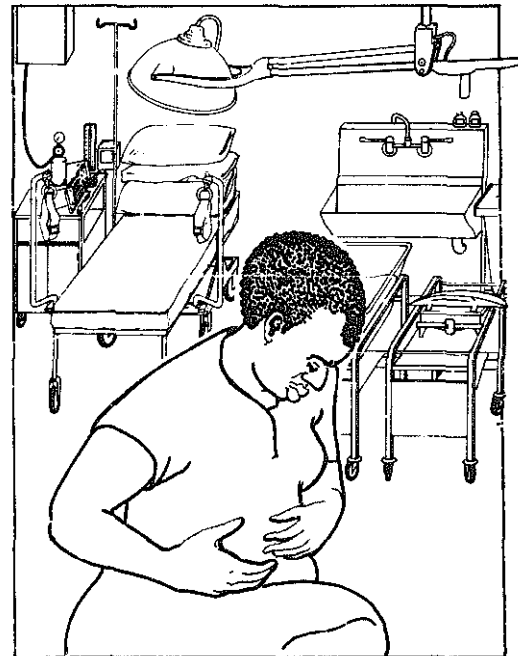

HAVING YOUR BABY AT HOME



There are some good things about having your baby at home. Your family and friends will be there, and you will feel more comfortable in your own home than at a clinic or hospital. But there will be no doctors or nurses to help you if anything goes wrong during the birth. It is much safer to have your baby at a hospital or clinic and if the birth goes well, you will be home in one or two days.

Sometimes, especially with women who have already had children, there is no time to get to the clinic or hospital. Then the baby must be born at home.

As soon as you know the baby must be born at home, get these things ready:

- Clean sheet
- Newspapers
- Boiling water
- Clean cloths
- Two clean towels
- Sharp scissors or sharp knife or new razor blade
- Two pieces of string

If the nurse will come to the house, send someone to call her. Call the other women, the midwives, who will help with the birth. Some will look after the mother and others will look after the baby.

Spread the clean sheet and the newspaper on a bed or on the floor. If there are any plastic bags, cut them open and spread them under the sheet and newspapers.



Put the scissors, knife or razor blade and the two pieces of string into the boiling water. These must be very clean because they will be used to tie and cut the umbilical cord which joins the baby to the mother.



Wash the mother with a clean cloth which has been soaked in boiling water. If you have Dettol or Savlon, put a little bit into the water.

The mother should lie or sit down on the sheet in a comfortable position. She should hold her knees up towards her chest and breathe normally.

When the strong pains come, she must breathe deeply and slowly. She must not try to push the baby out yet. The midwives must not rub the mother's stomach or try to push the baby out. They must sit with the mother and comfort her.

The pains will get stronger and quicker. Every time there is a strong pain it is because the womb is stretching open to let the baby out. This is called the first stage of labour and can last up to 12 hours. This stage lasts longer in women who are giving birth for the first time.

The second stage of labour is the time when the baby is born. This stage usually takes about 20 minutes. The 'waters' usually break and the mother feels that she wants to push the baby out. Many mothers vomit and feel restless at this time.

The birth opening of the mother stretches open and you can see the baby's head.

When the head starts to come out, the mother must push hard. The midwives must speak gently to the mother and encourage her to push hard. They must never shout at her or get cross with her if she cannot push the baby out.

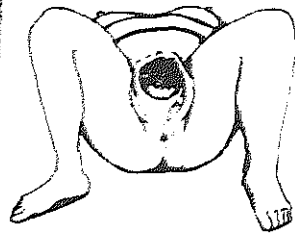
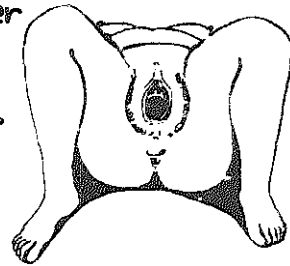

When the baby's head is nearly out, the mother's vagina is stretched tight. It is easy for the skin of the vagina to tear open if the baby comes out too fast.

To stop the skin from tearing, the midwife must put one hand on the vagina to help the baby's head come out slowly. The mother must take many small breaths and must not push hard. This also helps the skin not to tear.



The head usually comes out with the face downwards and is usually the hardest part of the baby to push out.

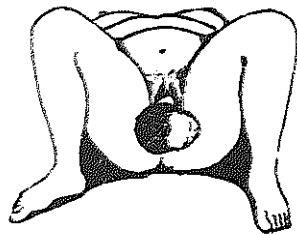

The midwife must never pull the baby's head out, because this can hurt the baby. The baby's body must turn round for the shoulders to come out.

If the shoulders get stuck, the midwife can help by holding the baby's head down to let one shoulder out.

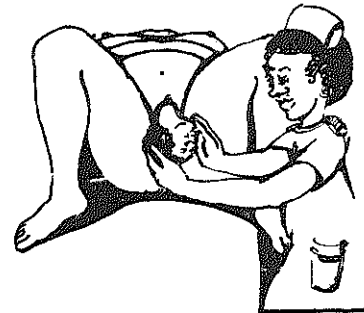

Then she can raise the head a little so that the other shoulder comes out.

The end of the second stage of labour is when the baby's body is out of the mother. The baby is still attached to the mother by the umbilical cord. This cord comes from the placenta (afterbirth) which is still inside the mother.

The last stage of labour is when the placenta comes out.

As soon as the baby is born, make sure it is breathing.

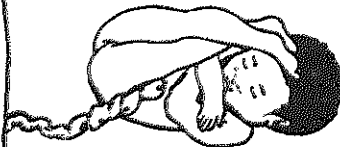

Some people think you have to smack the baby's bottom to make it cry. This gives it a big shock.

It is better for the baby to be quiet just after it has been born. If the baby cries or takes a big breath it shows that it is breathing well.

If the baby is not breathing, hold it with its head downwards. Holding the baby in this way makes anything blocking its mouth and nose come out. If the baby still does not breathe, suck its nose to get out anything blocking it. Then blow very softly into the baby's mouth until it starts breathing well.

If there is anything wrong with the baby's breathing, take it to the clinic very quickly.

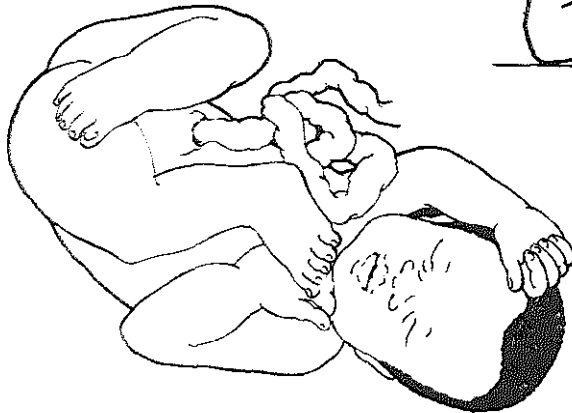

You can see that the baby is healthy if its tongue is bright pink and if its hands and feet become pink when it starts moving.

You will see that the cord which joins the baby and the mother is fat and beating like a heart. Do not cut it yet. Wait. After one minute the cord will stop beating and will become thin and white. Tie one piece of string in the middle of the cord and then tie the other one about 3 cm away. Tie the strings tight enough so that the cord will not bleed when you cut it. Cut the cord between the two pieces of string with the new razor blade or boiled knife.



Wrap the baby in something clean and warm, like a towel. To make towels warm, put them around a hot kettle. Now you can wash the baby with warm water. Make sure that the baby does not get cold.

The baby can begin to drink its mother's milk straight away. This is good for the baby and the mother. When the baby sucks on the mother's breasts it helps the womb to get tight and this means there is less bleeding. This first breast milk will make the baby strong.

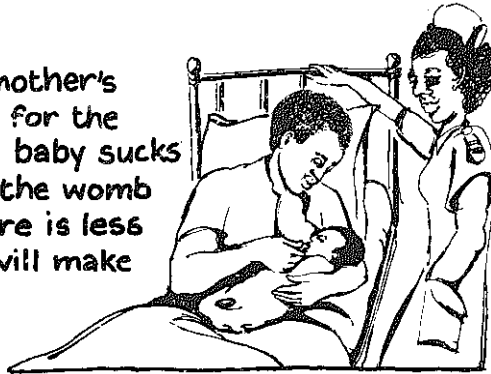

Now the mother must try to push out the placenta which is still inside her. This should come out after 20 or 30 minutes. If it does not come out after 40 minutes, there is something wrong and you must call the nurse.

The mother will feel a pain inside her when the placenta comes out of her womb. The cord will suddenly become longer. Then she must push the placenta out. When the placenta has come out, rub the mother's stomach a little with your hands until you feel the womb inside get tight. If the mother bleeds a lot, it is very important to fetch the nurse quickly. While the nurse is on her way, it will help to stop the bleeding if you rub the mother's stomach a little harder.



When the baby has been washed and wrapped up warmly, give it to the mother so that it can suck her breasts again.

Wash the mother and put a clean cloth over her vagina. Give her something to drink, then let her and the baby rest.



LOOKING AFTER A NEWBORN BABY



Newborn babies need lots of care. They must be kept warm and fed often. They must learn to suck and their mothers must learn how to breastfeed them. If the baby's life starts well it will be healthier when it grows bigger.

You will know if the baby is healthy if he or she feeds and sucks well and sleeps for a few hours after feeding. New babies should pass water and do dark green shits within 24 hours after being born. Most babies lose weight for a few days after they are born, but then they start to gain weight. Take the baby to the clinic as soon as possible to be weighed, so you will know if it is healthy and gaining weight. If the baby gets yellow a few days after being born, take it to the clinic quickly.

Put methylated spirits on the baby's cord 3 times a day until the cord falls off.

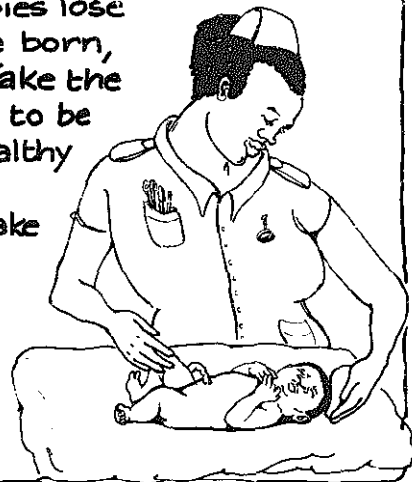

Breastfeeding



There are 2 ways of feeding your baby. The best way is breastfeeding.

The other way is feeding with a cup and spoon or a bottle. It is only good for mothers who can not breastfeed.

- Breast milk cannot give the baby germs, but bottles or a cup and spoon can. Many babies get sick and die because of germs from dirty bottles and spoons.
- Breast milk does not cost money.
- Breast milk does not need mixing with water. It is always ready whenever the baby is hungry.

The best food that a baby can get is breast milk. It has everything that the baby needs to become healthy and strong and to protect it against sicknesses.

How to breastfeed

Breastfeeding can begin as soon as the baby is born. The baby can start to suck about 10 minutes after being born. The sucking will help the mother's womb to become small again and to stop bleeding.

For the first few days, the milk which comes out of the breasts will be yellow. This yellow milk is very good for the baby to drink. This milk has things in it which stop the baby from getting sick. After the third or fourth day, it will begin to look white. It does not look as thick as cow's milk, but it is much better for the baby than any other milk or food.

You must feed your baby whenever it is hungry, usually every few hours. Before and after feeding wash your breasts. The baby must suck on each breast for 5 to 10 minutes. If it sucks longer the nipples will become sore.

Make sure your breast does not cover the baby's nose. If the baby's nose is covered, it will not be able to breathe.

Breastfeeding should carry on until the baby is about nine months old. At the age of nine months, the baby will be old enough to learn how to drink from a cup. But if you have enough breast milk and enough time, it is good to carry on breastfeeding until you want to stop.

If you are still breastfeeding one child when your next baby is born, you must stop breastfeeding the older child and breastfeed your new baby. But make sure that the other child gets enough food to make up for the breast milk. Look at page 311 to see how to feed children well. If you have to go back to work before you have stopped breastfeeding the baby can still drink your breast milk.

You can squeeze milk out of your breasts and leave it for somebody to feed to the baby while you are at work. This milk must be kept in a cool place or in a fridge. You can still breastfeed the baby before you leave for work in the morning and

after you come home at night. If there is no cool place and the breast milk goes sour someone must feed the baby other milk while you are at work. You can breastfeed the baby whenever you are at home.

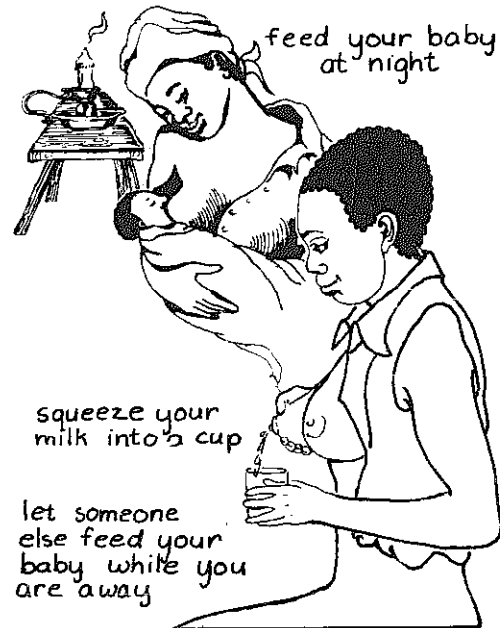

Problems with breastfeeding

When you start to breastfeed your baby, your breasts can become full and sore. To stop the soreness, rub your breasts and squeeze out some milk before the baby begins to suck.

Make sure that the baby does not suck on the nipple only. The baby must take part of the breast around your nipple into its mouth. This will help the milk to come out and your breast will not be so sore.

Mothers with large nipples sometimes find that breastfeeding is painful because the baby has to suck hard to get milk. These mothers must squeeze hard around the nipples to get some milk out before the baby starts sucking.

Some mothers' nipples are small and flat so the baby cannot suck easily. It is important for these mothers to carry on with breastfeeding. The more the baby sucks, the more milk will come.



Do not let your nipples stay wet in between feeds, otherwise they will crack and become sore. If milk comes out of the breasts when your baby is not drinking, press your hands against your nipples for a few minutes. Put a clean cloth inside your bra to soak up the milk and change it when it is wet.

Sometimes your breasts become red and sore and they feel hot. This can make you feel sick with a headache and hot and cold all over. You may also feel like vomiting. When this happens we say that the breasts are inflamed. You must go to the clinic to get medicine. Put a clean cabbage leaf inside your bra. This will help to make the inflammation go away. Put a new cabbage leaf in after every feed. If only one breast is inflamed, you can still feed the baby from the other breast. If both breasts are inflamed try to carry on feeding your baby as much as you can. If the baby is not getting enough milk, feed it with cow's milk until your breasts are not sore.

Some mothers think that if they stop breastfeeding for a few days, the breast milk is bad and they cannot breast feed their babies again. This is not true. The milk inside the breasts is always fresh, so even if you have not been breastfeeding for a few days the milk is fresh and good for the baby.

Usually your breast milk is enough food for your baby. But if the baby seems hungry all the time, it may be that you do not have enough milk. If this happens give the baby other milk as well as breast milk.

This is how you can see if you have enough breast milk. Press your nipple between your finger and thumb. If the milk does not squirt out, it means that your body is not making enough milk for your baby. So you must feed your baby with other milk as well as all the breast milk you have.

Usually, if your baby seems happy and is gaining weight, it means you have enough breastmilk. Sometimes, the milk comes slowly for the first few days after birth. Usually, the more you breastfeed, the more milk your body makes.

Many people believe that if you have sex during the time your are breastfeeding, the milk will be poisoned. Many older people say this is true. In the olden days it was a good way of stopping people from having too many babies one after the other. This belief forced people to wait until they were not breastfeeding before they started having sex and becoming pregnant again. Today we have other ways of preventing pregnancy without stopping sex, so it is alright to have sex if you are breastfeeding. Some women who have sex when they are breastfeeding do not become pregnant, but it is not a sure way of preventing pregnancy. Look at p 352 to find out how to prevent pregnancy.

Winds and Colic

When babies suck milk they also suck in air. When the baby has finished drinking sit it up straight and rub its back so that the air, called 'winds', come out. If you do not do this, the winds will give the baby a sore tummy. Sometimes when the winds are very bad the baby cries all the time, and has a lot of pain. This is called colic. Doctors do not know the cure for colic.

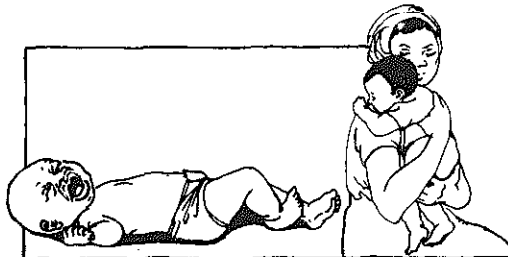

Artificial Feeding

Artificial feeding is giving a baby milk with a bottle or a cup and spoon. Many different kinds of milk are used for artificial feeding. Fresh milk, powdered milk, skimmed milk, condensed milk, and special baby milks like Nespray, SMA, Lactogen or S26 all come from cows. Special baby milks are more expensive but fresh cow's milk is just as good and breast milk is the best of all. The factories which make baby milks want to get your money. They advertise on the radio and they have pictures at clinics and shops and in books. These pictures show beautiful healthy babies. They make you think that if you buy that milk your baby will also be beautiful and healthy.

Some mothers cannot breastfeed. They have to go back to jobs in places far away from where the baby is staying. Others do not have enough breast milk to feed the baby. So these mothers must use artificial feeding.

Artificial feeding is expensive. You must buy milk and bottles or cups and spoons, and Jik bleach to keep them clean. Many mothers can't afford these things, so babies get sick with runny tummy and vomiting from dirty bottles. They can even die. Many mothers have to spend a long time going to collect extra water for washing bottles and firewood to boil water.

What you need

You will need a bottle or a cup and spoon for feeding the baby. It is better to use a cup and spoon because it is very difficult to keep a bottle clean.

Try to wash all the feeding things very well with soap and water every time you use them. If you have enough time and money, you should also sterilise the feeding things every day. Sterilising means making them very clean by soaking them in bleach so all the germs are killed.

Put 1½ litres of boiled water and 4 teaspoons (see How to weigh and Measure p 129) of bleach into the bucket. Make new bleach water every day.

you must buy many things for artificial feeding



Put all the things used for feeding the baby into this water, and leave them there for one hour. After one hour they will be ready for feeding the baby. Rinse them in water before feeding.

You must sterilise before every feed. As soon as the baby has been fed wash all the things with soap and then sterilise them. When the baby is six months old you do not need to sterilise feeding things. But they must still be washed well with soap.

Powdered Milk

Powdered milk is cow's milk which has been dried in a factory so that it doesn't have any water in it. You make it into milk for your baby by adding water. Until your baby is 9 months old, use only full-cream powdered milk. After 9 months you can use skimmed milk. There are many kinds of powdered milk, all with different names. Some are more expensive than others, but they are nearly the same, they all come from cows. You should buy the cheapest one. Then you can spend the money on other good food for the baby like fruit and eggs.



mixing milk feed

How to mix powdered milk

You must mix the powdered milk with boiled water which has been cooled down. If you do not boil the water your baby can get sick. Most tins have a plastic spoon inside for measuring the milk powder. Mix one spoon of powder with every 25ml of water. Baby bottles have lines marked on them and each line is 25ml. If you are feeding with a cup and spoon, mix 6 teaspoons with $\frac{1}{2}$ cup of water. Do not add more water to the milk powder. This will make the milk too weak and the baby will get sick. Many mothers do not have enough money to buy milk so they add more water to make the milk last longer. Then the baby is just drinking water, and will get sick. Do not add too much milk powder to the water because this will make the milk too strong and the baby will get a runny stomach.

Powdered milk is not as sweet as breast milk, so you must put in some sugar for babies until they are 3 months old. Put in 1 flat teaspoon of sugar for every 100ml of water you mix.

Where to get powdered milk

If you can get powdered milk or baby food from the clinic it is better than buying it from the shop. Some mothers can get milk free of charge from the clinic if they are very poor. Ask the clinic nurse about cheap milk and free milk. The government helps some clinics to pay for milk, so that the clinic can sell it cheaply to people. It is in a plastic bag not in a tin because bags are cheaper than tins.

Fresh Milk

Babies can drink fresh cows milk, but it must be kept very cool so that it does not go sour. Fresh milk is too strong for a new baby so it must be mixed with water which has been boiled first.

Until the baby is 1 month old, the mixture must be 2 parts cow's milk to 1 part water. After the baby is 1 month old, it can start to drink fresh cow's milk without water. To make the milk easier for the baby to drink, it must be heated for a few minutes and then cooled down just before the baby drinks it.

Tinned Milk

Evaporated milk, like Carnation and Ideal, can also be used for feeding babies. Read the instructions on the tin and be careful not to make the milk too weak or too strong.

Condensed milk is too sweet for babies, so it is not good for them.

Starting to eat other foods

Many mothers give little babies porridge. This is not good because they get sick and have runny tummies. They are not ready to eat porridge or baby cereals like Nestum or Cerelac until they are about 4 to 6 months old. The baby can start to drink fruit juices as well as cows milk when it is about 2 months old. Squeeze the juice out of any fruits you have and give them to the baby by spoon. Do not give babies sugar water to drink because it gives them a runny tummy. If the baby is hungry or thirsty, give it milk. Make sure the cup and spoon are very clean.

If you can get vitamin medicine like Vidalin free from the clinic, give your baby 1 teaspoon a day

Give the baby 1 new food at a time. wait for about a week before giving the baby another new food.

When the baby is about 3 months old it can start to eat mashed fruit and vegetables and eggs. Mash the food up with a fork so that it is very soft

and has no lumps. If the food is not mashed the baby can choke. Do not waste money on special baby foods like Purity. Rather buy vegetables for the family and mash a little for the baby.

At about 4 months, the baby can start to eat porridge. Feed it mealie meal porridge, not special baby porridge like Nestum or Cerelac. These baby porridges are expensive. Rather buy mealie meal and spend the extra money on fruit or vegetables or eggs. Always breastfeed before giving the baby porridge. Mix peanut butter or chopped up peanuts or 1 teaspoon of oil with the porridge.

At 6 months old, the baby can start to eat bread, beans and peas as well as porridge, mashed fruit and vegetables, eggs and milk.

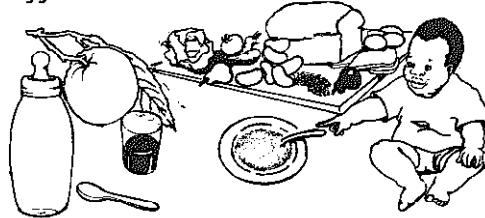

After 9 months, the baby can drink skimmed milk instead of full-cream milk.

Eating the right food

For children and adults to be healthy they must eat different kinds of food every day. If you eat only 1 kind of food, for example only mealie-meal, you will get sick with malnutrition diseases like kwashiorkor and pellagra. Many South Africans suffer from these diseases because they do not have enough food.

There are 3 kinds of food you need every day. To grow properly you need some food every day from all 3 kinds. If you eat foods from only 1 or 2 of the groups, you will be sick and weak and you will not grow properly.

■ Energy foods (carbohydrates and fats). These are foods like mealie-meal, bread, sugar, fats and oil. They give you energy to work and to grow.

■ Building foods (proteins). These are foods like milk, beans, eggs, peanuts, chicken, fish and meat. They help your body to grow strong.

■ Protection foods (vitamins) are foods like fruit and vegetables. They protect your body from sickness. Vegetables with dark green leaves like imifino or morogo and spinach are the best protection foods. They are better than light green vegetables like cabbage. Yellow vegetables like pumpkins, squash and carrots and yellow fruit like pawpaws and bananas are also good protection foods.

For example, these foods will make a child healthy if he or she eats them every day.

- 1 cup mealie meal
- 2 slices brown bread
- 2 cups milk
- 2 spoons dry beans or peanuts
- 2 spoons samp
- 3 spoons cooked spinach or imifino/morogo.

If your child eats these foods every day, he or she will grow well and be strong and healthy.

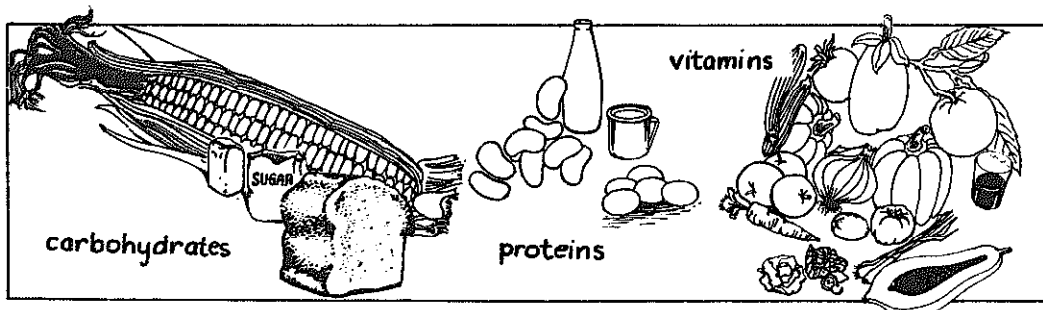

Kwazonke uphill: Feed yourself so you can be healthy

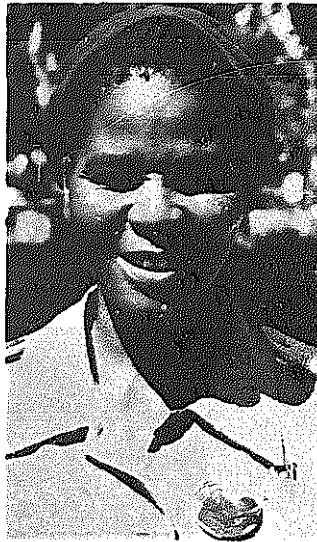

Pumla Lwana is a sister at All Saints Hospital in the Transkei. She runs the Nutrition Rehabilitation Unit. When children with malnutrition are discharged from the hospital, they go there to get well. The work of the unit is to educate mothers to feed their children better.

● Why do you call this place Kwazup?

The place is called Kwazonke Uphile, meaning 'feed yourself so you can be healthy' although we call it Kwazup for short. Now here at our

Kwazup we try to have a place where the mothers of malnourished children can come in with their children. If they are too sick they first have to be treated at the hospital. They come in with their mothers so that the mothers can see what we do here and then carry it on in their own homes.

● What do you teach them here?

They do all the work themselves - they collect their own wood for fires, stamp their own mealies. They sleep on whatever they prefer - some prefer beds, some prefer grass mats, some prefer empty sackings. The reason we do this is we want them to feel at home, we're trying to make the conditions resemble their home conditions. We cook outside with iron pots. We encourage this because it resembles the type of pots they are used to, and moreover there is iron in the pots which they need for their bodies. When we talk to them about protein foods, we talk about beans, eggs, and Jabula soup, because Jabula is the cheapest soup. We don't talk about meat because we use meat in our homes very occasionally, like when we slaughter a pig. When we talk about vitamins we talk about imifino, spinach and pumpkin. When we talk about starch it's maize, brown bread and potatoes. We give only three examples of each type of food and tell them that for your child to grow well,

the child must have all three types of food. We tell the mother that if she leaves out one of the three types of food it's like breaking one leg off a cooking pot. When one leg breaks, you cannot use that pot anymore, it's just fit to be thrown away, like your child, if you leave out one type of food, your child will be fit to be buried.

● Do you encourage them to use powdered milk?

We try to avoid it. We base our feeding on what the women can produce themselves through eggs and gardening. We show them how to use their own cow's milk, if they have a cow, or even goat's milk. But we do demonstrate the mixing of milk powder so that whoever hasn't got fresh milk can know how to mix powdered milk without blunders. We encourage powdered skim milk, which is cheaper than full cream powdered milk and has more protein. We use Pronutro as well because those who have no garden will need it when they go home while they are establishing their gardens.

● Do you only teach them about food?

We also teach them handwork. We encourage them to use their own material so that when they go home they can say to their friends 'I made this myself'. We prefer to use what people think is useless, and make that useful. For instance we've got a tree here which gives us some

seeds. We make necklaces from those seeds. We're trying to make them self reliant. For instance this stone here is a grinding stone. We don't want to use mealie meal, we want to grind our own mealies on the stone, then we can get the whole maize, not this white sifted maize. The aim of the Kwazup is that the women enrich each other, they talk to each other when going to the river and the fields.

● Do mothers come straight here after they are discharged from the ward?

Sometimes they want to go and arrange matters at home after they've been discharged from the wards. When they come back I compare the weights and see what's been happening at home. This tells me how much the mother has grasped of what she was told by the staff nurse in the wards. In fact if anybody from the Kwazup asks for permission to go home for a week, I grant that willingly because this is a sort of followup. If the child's weight has improved at home during that week I don't have to keep that one in because she knows what she's doing. She can go home the same day if there's a bus.

● How many mothers are staying, and how many houses do you have?

We use four houses. From 1972 to 1974 we used to have this place full up to 25 people, but these days we only

have 10 to 15. It could be a good sign. It could also be that they don't want to go to the clinics with their swollen babies because they know they will be sent to the Kwazup. But once they are here they look very happy. I can hear them dancing even from my house. The doctors here say there is definitely less malnutrition in this district because of the Kwazup.

Some of the women used to abscond. They used to abscond like anything, about six abscondings in the same week, sometimes as many as ten. Now we only have about three abscondings a year.

● Do you get more children admitted in the winter?

Yes I think so. From March to May last year we didn't have any admissions. I think it's because everything's green and there are a lot of wild vegetables, green mealies and pumpkins. When things start going off about June, we start getting admissions. Last year we had about five in June.

● Do you teach agriculture?

Oh I'm sorry I forgot to mention it. We teach them gardening. When you talk about gardening they say "We have no materials for fencing". I say, "Why don't you buy materials". They say, "We have no money". So we show them how to use stones and mud to



make walls, how to chop down trees to make fencing. It doesn't have to be a big garden, just something about the size of a small room. I'm trying to plant into their minds the idea that they should go and collect manure outside in the veld. Fortunately the soil here is very fertile, we grow a lot of mealies here. It keeps us going all the year round.

● Does the agricultural extension officer for this area follow up the women from the Kwazup at all?

The problem is that his area is All Saints. He visits everyone in All Saints, but the other locations do not belong to him. Now the thing is that very few of the women who come to the Kwazup are from All Saints, because they're so close to the hospital. They feed well, so we don't have more than one woman a year from All Saints.

Under 5 Clinics

The work of Under 5 Clinics is to make sure that babies grow up to be strong, healthy children.

You must take your children to the under 5 clinic from the time they are born until they are five years old. This will help them to grow well and will help to stop them from getting diseases like TB, tetanus, measles and malnutrition. Each time you go to the clinic they will weigh your child to see if he or she has grown a little bit since last time. If the child has not grown there is something wrong and the clinic nurse will try to help you. Take babies every month until they are about 6 months old. Then take them every 2 months until they are 2 years old. Then every 4 months until they are 5 years old.

Some clinics give free vitamin medicines which help children to grow strong. Some sell milk and baby porridge cheaply or give it free to mothers who can not afford it. Ask at your clinic about these things.

Road to Health Chart

When you take your baby to the clinic for the first time, the nurse will write a card and give it to you. This card is called Road to Health Chart. On one side of the chart there are 2 lines which look like a road. Every time you take the child to the clinic, the nurse weighs it and writes the weight on the card. If the weight is right for the child's age, it will be inside the 2 lines of the road. This means the child is eating well and growing properly. If the weight is too low, the nurse will write it underneath the lines of the road. This means the child is not growing well. If you take your children to the clinic regularly, you will know straight away if they start to lose weight and stop growing. Take babies every month until they are about 6 months old. Then take them every 2 months until they are 2 years old, then every 4 months until they are 5 years old. If you take your children regularly until they are 5 years old, and not only when they are sick, it will help to stop them getting sick.

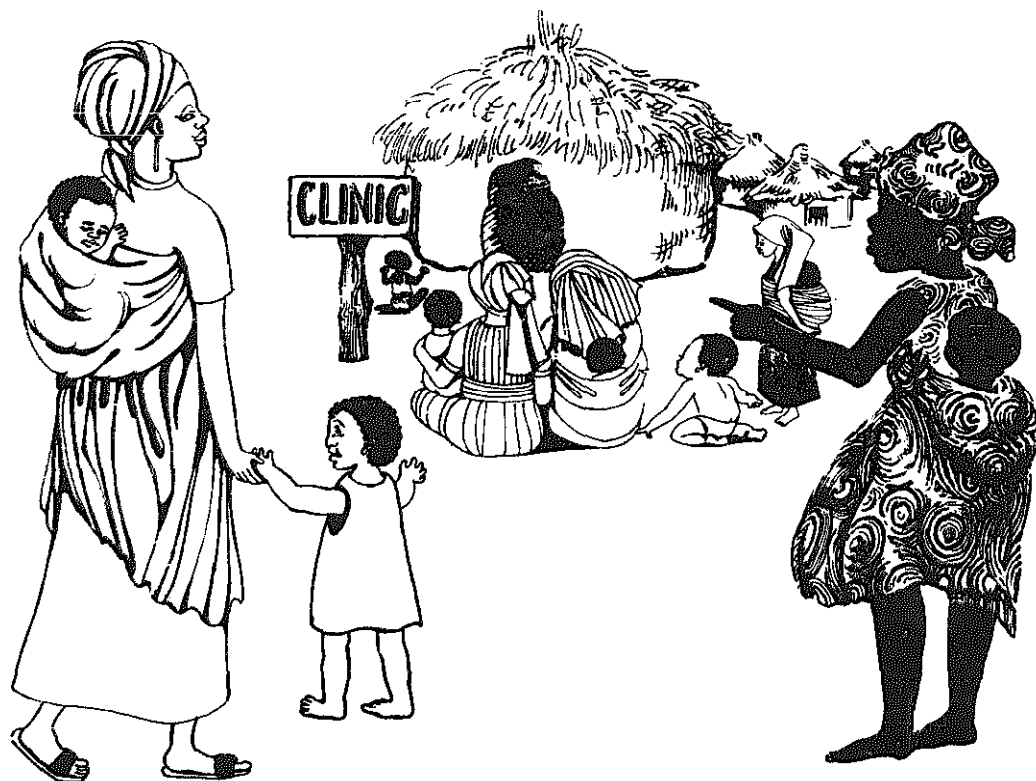

This Road to Health
Chart is from
Johannesburg:

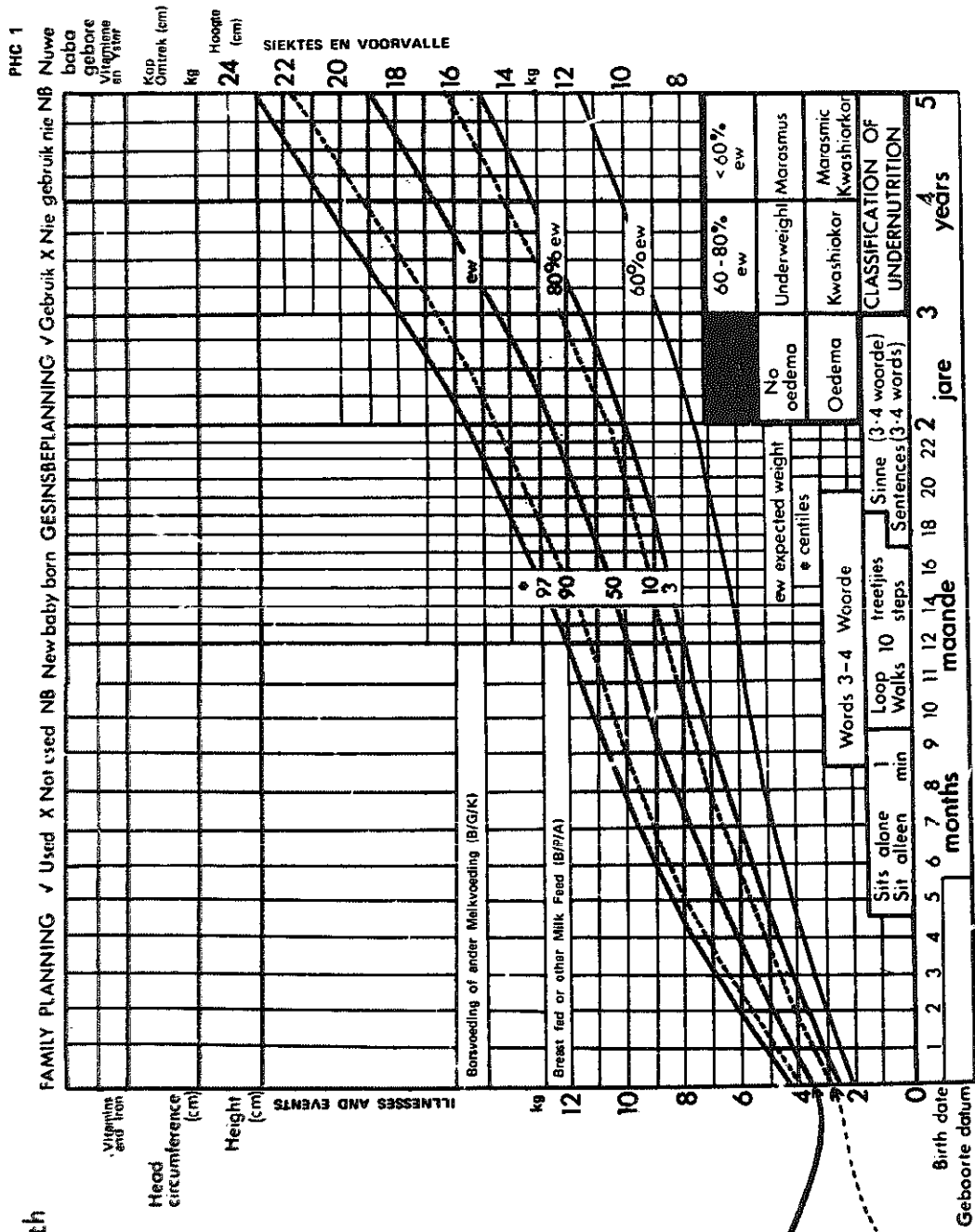

If your baby weighed 3.5kg. at birth, his weight should always be above this line.

If your baby weighed 2.9kg at birth, her weight should always be above this line.

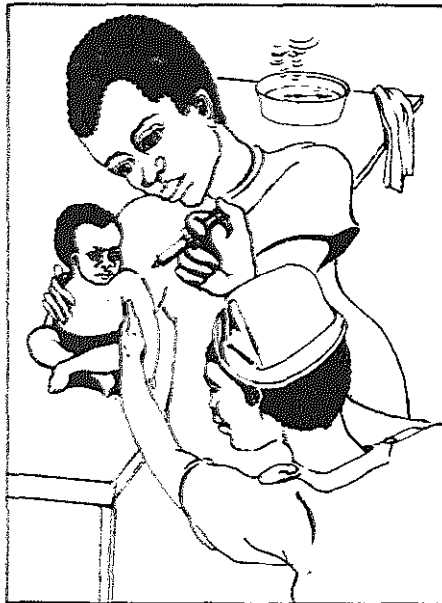

Immunisation

Under 5 clinics also give injections and medicines called immunisations to prevent children from getting diseases like TB, polio, measles and whooping cough. These diseases are very dangerous to children but they will never suffer from them if they are immunised.

Sometimes the immunisation makes the baby sick for a few days. But it is better to be sick for a few days than get very sick from the disease.

Disease	Age
TB	Before 1 months, 6 years, 12 years.
Diphtheria	3 months, 4½ months, 6 months, 2 years, 6 years.
Whooping Cough	3 months, 4½ months, 6 months.
Tetanus	3 months, 4½ months, 6 months, 2 years, 6 years.
Measles	6 months, 1 year
Polio	3 months, 4 months, 5 months, 2 years, 6 years.

Children must get different injections at different ages. For most sicknesses, you must have more than one injection.

When your child goes to school, the teacher will ask for his clinic card.

Sometimes, if children do not have this card, they cannot go to school.

It is very important for all children to go to the Under 5 Clinic until they are 5 years old and ready to go to school.

Childrens Illnesses

Every year thousands of babies and children in Southern Africa die from sicknesses such as malnutrition, TB, measles, diarrhoea and vomiting.

Children only die of these diseases in places where people are very poor and are suffering from a shortage of land, jobs, food and money. Many families in our country are suffering because they do not have these things. These problems will have to be solved before we can get rid of these sicknesses. All these sicknesses are caused by poverty.

It will be a big struggle to solve these problems and might take a long time. In the meantime, there are some things which parents and other people in the community can do to help stop these diseases from spreading. For example, we can make sure children do not die from serious illnesses like measles and tetanus by taking them to the clinic for free immunisations. We can also help to stop children from getting a runny stomach, and vomiting by keeping dirt and flies away from food and eating things and by digging flyproof pit toilets (see p 504).

Malnutrition

Malnutrition is another name for starvation. It is when a child does not get enough food or when a child does not get the right kinds of food. There are two kinds of malnutrition in Southern Africa. They are marasmus and kwashiorkor.

Marasmus

Marasmus is when children do not have enough food. Their whole bodies look very thin and they are very weak. They are so weak that they cannot move a lot or play like healthy children. They often look old and wrinkled like old people and their skin is dry. Their faces are very thin with sunken cheeks and big eyes.

Kwashiorkor

Kwashiorkor is when children get food, but do not get the right food. For example, they eat only mealie-meal with no vegetables and no protein like milk, beans or eggs. They look fat because their bodies are swollen, especially the stomach and legs. The skin gets sores and starts to peel off. Their skin gets pale and they get sores at the corners of their mouths. The hair may become reddish and straight and break easily. These children are also weak and they seem to be a little bit mad. They cry a lot and do not want to eat. They get a runny stomach often.

Sometimes children have malnutrition which looks like marasmus and kwashiorkor together. They have thin legs

and arms and fat, swollen stomachs. When you take them to the under 5 clinic to be weighed, you see the child has not grown since the last time it was at the clinic. When the nurse writes the weight on the Road To Health Chart, it is not inside the lines of the road, it is underneath. The child also seems weak and often gets sick with a runny stomach, vomiting and colds and easily gets serious diseases like measles and TB. Sometimes they get sores on their legs and at the corners of their mouths and their hair gets thin and reddish in colour. Sometimes they seem unhappy and cry a lot.

You can help to prevent kwashiorkor and marasmus if you:

- Make sure that all your children, not just your baby, have enough good food. This means that children must not just have mealie meal, they must have different kinds of foods like milk, fruit and vegetables as well as mealie meal.
- Immunise children against diseases like TB and measles. Children with malnutrition catch these diseases very easily.
- Stop runny stomach and vomiting sickness by keeping everything clean.
- Never give children enemas.
- Go to the clinic regularly to see if your children are growing well. Carry on with the clinic until they are five years old.

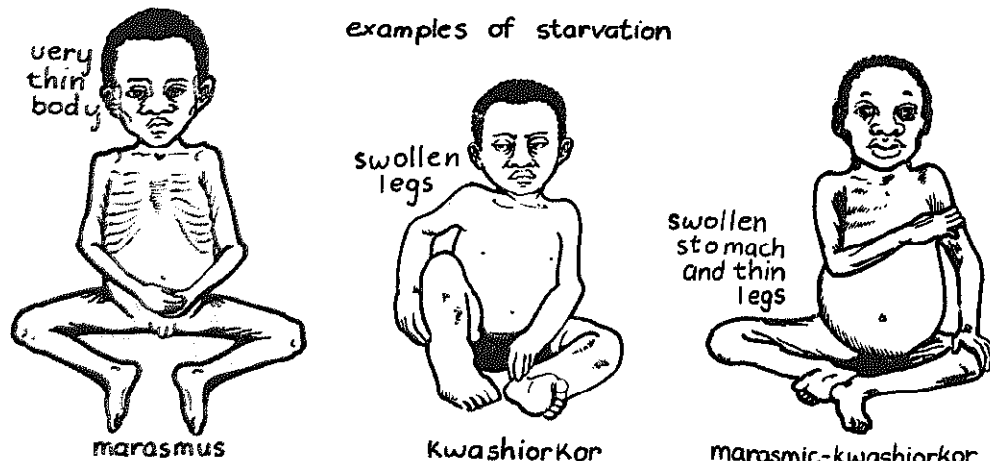

GASTRO-ENTERITIS

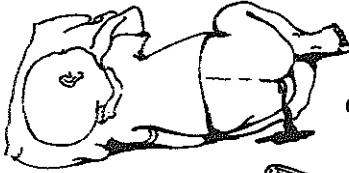

Gastro-enteritis is a serious sickness of small children. It makes them have diarrhoea (runny tummy) and vomit.



People get gastro-enteritis in places where there are flies, rats and lots of dirt.



Many people in South Africa are forced to live in such places. They are overcrowded, they do not have proper houses and toilets and they do not have enough water to keep things clean.

How gastro-enteritis spreads

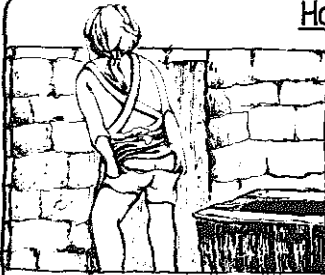

• People who have gastro-enteritis go to the toilet but do not wash their hands when they have finished.

• Then they prepare food. The gastro-enteritis passes from their dirty hands to the food.



• Gastro-enteritis can also get onto food from flies.



• Another person eats the food and also gets the sickness.



• Flies can leave gastro-enteritis on cups, feeding bottles and spoons so many babies get gastro-enteritis



Babies who are breast fed do not get

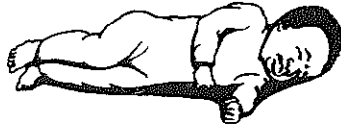

gastro-enteritis so easily.

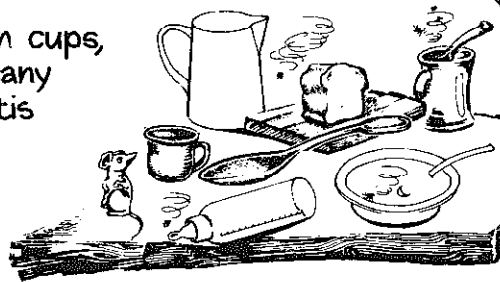

• You can also get gastro-enteritis from dirty river water. People who live near rivers often put their rubbish into the river.

Sometimes they hit in the river. When other people drink the water they get gastro-enteritis.



What To Do

When children get gastro-enteritis they lose a lot of water and salt because of diarrhoea and vomiting. The most important thing is to make them drink more water and salt, otherwise they can die.

Day 1: Make medicine by adding 1 pinch of salt, 1 pinch of cooking soda (bicarb) and a teaspoon of sugar to a cup of boiled water which has been cooled down. A pinch is when you pick up some salt or soda between your thumb and your first finger. You must boil the water for 15 minutes, otherwise the child can get more sick.

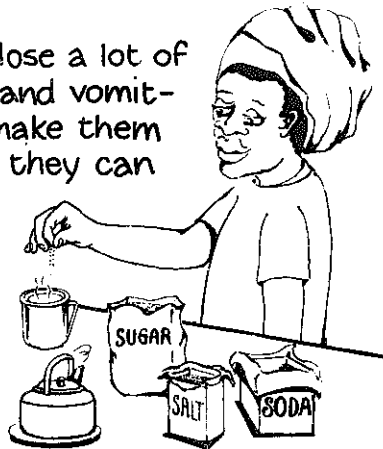

Children die from gastro-enteritis because all the water comes out of their bodies with the vomiting and diarrhoea. Their bodies dry out. To stop the drying out you must give the child this medicine during the whole day and night for 3 days.

As one cup is finished, make another cup. Even if the child is not thirsty and does not want to drink the medicine, force the child to drink.



If you are giving the medicine to a baby, use a spoon.



You can see if the child's body is drying out because it will have dry skin and tongue, a soft sunken place on top of its head, sunken eyes, or if its skin stays up in a lump when you pinch it. If a child has any of these things wrong, go to the clinic straight away.



Day 2: On the second day carry on giving the child this medicine during the whole day and night. If the child does not get better on this day, he or she must get to the clinic.

The child can also drink milk or soup but must not eat anything.

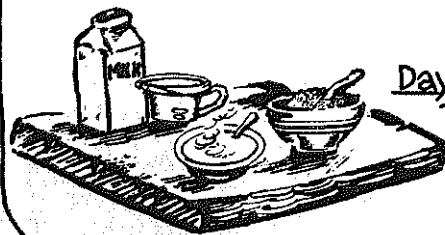

Day 3: Carry on giving the medicine. The child can also drink milk or soup and can eat some porridge.

How to prevent Gastro-enteritis

- Boil all drinking water from rivers, open wells and springs.



- Always wash your hands after you go to the toilet.



- Keep flies away from food by covering it up.

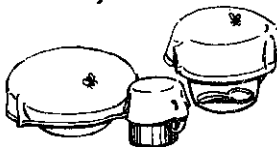

- Never shit near a place where you get water. It is much healthier to make a pit toilet.



- Do not empty rubbish into rivers.

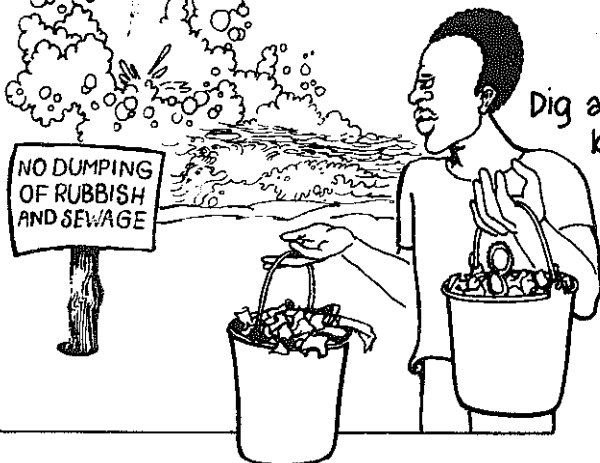

- Dig a rubbish pit and bury rubbish.



- Breast feed your baby if possible.
- Keep all baby things like bottles and spoons very clean.

Measles

Measles is a very dangerous sickness for children in Southern Africa. If children who are already suffering from TB and malnutrition also get measles, they become very sick and can even die. Many of our children have TB and malnutrition because their families are forced to live in overcrowded houses and do not have enough money for good food. In other countries where children do not suffer from TB and malnutrition, measles is not a serious sickness.

What it is

Measles starts like a bad cold. The child is very hot, has a runny nose, sore throat, sore eyes and a cough. The child feels very unhappy and cries a lot and may have a runny tummy. Inside the mouth is very sore and after two days you can see small white spots which look like salt on the gums.

After another two days you will see red spots behind the ears and on the neck. Then you will see small spots on the face and body. The last place to get spots will be the arms and the legs.

After the spots come, the child begins to get better. The spots start to go away after 5 days.

What to do

The best thing to do is to take all children with measles to the clinic. At the clinic they will give the child medicine. When you get home it is very important that the child rests in bed and has lots to drink and good food to eat. It is easy for children with measles to die if they do not have food to make them strong.

If the child feels hot and has pains, give him or her Panado medicine. You can buy Panado from a chemist if you cannot get it at the clinic. It is very good for children with a hot fever. Wash the child with lukewarm water to cool them down and get rid of the hot fever. If he or she has sore ears or a sore tummy go to the clinic straight away. Do not let any other children go near the one who has measles, otherwise they will also get measles.

How to prevent Measles

All children can have an injection at the clinic which will make sure they never get measles. They must have the injection when they are 6 months and 1 year old. This injection is free at the clinic and all babies must have it.



Whooping Cough

Whooping cough is a sickness of young children. It makes them cough so that they can not breathe properly. If children get their 3 DPT injections at the clinic, they will not get whooping cough or spread it to other children.

What it is

First the child gets a cough and a runny nose for about 2 weeks. Then for the next 4 weeks the cough gets worse. The child coughs for such a long time that she or he cannot

breathe properly. Sometimes the child's lips go blue and thick. Stuff comes out of the child's mouth.

When the child breathes in after a cough he makes a noise like crying. When little babies up to 3 months old get this sickness, they do not always cough. They sometimes just go blue around the lips and stop breathing for a minute.

This sickness makes children weak so they can easily get malnutrition.

What to do

The best thing to do is take every child for 3 immunisation injections (see p 316). Children who are immunised usually do not get whooping cough. If a child who has been immunised does get whooping cough, the coughing will not be very bad and will not last for a long time.

You must keep the child in bed lying on its tummy with its head down. If its head is down, the child will not choke when coughing. Take the child to the clinic to get medicine as soon as it gets whooping cough.

Probably if a child is not immunised she or he will get whooping cough.

Thrush and Cystitis

Many women get thrush, especially during pregnancy or when they take birth control pills. Thrush is a white itchy discharge from the vagina which does not smell bad. Babies often get thrush from their mothers when they are born. With babies, thrush is white spots inside their mouths.

What to do

The easiest way to get rid of thrush is with a mixture of Gentian Violet and water. You can get a small bottle of Gentian Violet at the chemist or clinic.

Babies

Put a few drops of Gentian Violet into the baby's mouth every day. If you are breastfeeding the baby put Gentian Violet on your nipples.

Women

Put a mixture of half Gentian Violet and half water into a very clean plastic squeeze bottle. Squirt this mixture into your vagina three times a day for five days. The trouble with Gentian Violet is that it is a dark purple colour and can stain skin and clothes.

If you do not want to use Gentian Violet, you can use vinegar. Make a mixture with one cup of vinegar and three cups of water. Put it into a very clean squeeze bottle. Squirt this into your vagina three times a day for ten days.

If the infection does not begin to go away in three days, go to the clinic.



use gentian violet to cure thrush

Cystitis

Thousands of women suffer from cystitis. It is a painful bladder infection which makes a burning pain when you pass water. You feel like passing water all the time and sometimes the burning pain is so bad that you can not walk.

What to do

Chop up some fresh parsley or use dried parsley and mix it into a pot of hot water. Drink this parsley tea one cup after another. The burning pain will start to get better after one day of drinking the parsley tea. After 2 days the cystitis will be better. You can also buy citro-soda medicine at the chemist to stop the burning, but it might not work as well as parsley tea. You can go to the clinic for pills.

Cystitis comes back again and again. If you suffer from it, grow some parsley in a pot or in your garden or keep some dried parsley in a bottle.

Headlice

Headlice are very small insects which live on your head and make it very itchy. They lay headlice eggs on your hair.

What to do

Put paraffin all over your hair right down the skin. Make sure that you are away from fires and cigarettes when you do this.

Leave the paraffin on for about two hours and then wash it off with soap.

After ten days, do this again, to make sure that all the headlice eggs are also killed.



Scabies

A person who has scabies has many red pimples all over the body. The pimples are very itchy especially at night. Sometimes the pimples have yellow pus in them.

Scabies is caused by a very small insect. It is so small that you cannot see it and you cannot feel it when it goes into your skin. When it gets into your skin it lays its eggs there and this makes your skin very itchy. When you scratch, the scabies spreads all over your body.

Usually, if one person in a family has scabies, everyone in the family will catch it. If you touch the person or if you touch their clothes or blankets you get scabies. If some people in a community get scabies, it can quickly spread to everybody. To get rid of scabies, every family must treat it at the same time.



What to do

The best medicine is Ascabiol cream which you can get at any chemist or clinic. With this cream you can get rid of scabies in 2 days.

Day 1: Just before going to bed put the Ascabiol cream all over you, even where you can't see pimples, but not on your face. Let it dry. The next morning wash yourself very well. Wash the sheets, blankets and clothes you had on during the night. Leave your mattress outside in the sun if possible. Wash all the clothes you have worn since you first got scabies.

Day 2: Before going to bed put the cream on again and wash it off when you get up. This time you don't have to wash all your blankets and clothes.

The cream is very strong and can sting. When you put it onto your genitals, add water to the cream before using it so that it will not be too strong.

Another treatment is to wash yourself, all your clothes, sheets and blankets with Tetmasol soap. This treatment is not as good as Ascabiol, but it is cheaper.



infected sores

If the scabies pimples get pus (yellow stuff) in them, they are infected. All infected sores must be cleaned 3 times a day with salt water and painted with Gentian Violet or Mercurochrome. Both of these medicines are cheap at stores and chemists. If the infection does not get better, go to the clinic for pills.



wash all clothes you have worn since you got scabies

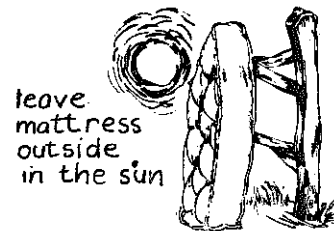

leave mattress outside in the sun



Worms

Many people in South Africa are forced to live in overcrowded places without proper houses and toilets. It is easy for people who live in these places to get worms.

Round worms Dogs, pigs and other animals often have round worms which live inside them and lay worm eggs which come out with the animals' shit. These worm eggs are so small that you can't see them, but children can get them on their hands when they play outside. If they don't wash their hands before they eat, the worm eggs get into their mouths with their food. The eggs then grow into worms in their tummies.

If children do not wash their hands after going to the toilet, the worm eggs will go onto the food that they touch. If other people eat the food they will also get worms.



round worm



Tape worms People get tape worms from the meat of pigs, cows and other animals. The tape worm eggs are in the meat and if it is not cooked well, a person eats the tape worm eggs and they grow into tape worms inside him or her.

Tape worms grow very long inside your stomach. Sometimes a small piece, about as big as your baby finger nail, breaks off and you find it in your pants. Tape worms can be dangerous and make you very sick, so get medicine quickly or go to the clinic.

Thread worms Thread worms live inside people. Sometimes they are called pin worms. They lay worms outside your anus. This makes your bum itchy and when you scratch, the worm eggs get onto your hands. When you touch food, the worm eggs get onto the food. If you eat the food you get more thread worms. If other people eat the food, they also get thread worms.

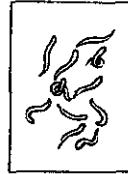

thread worms

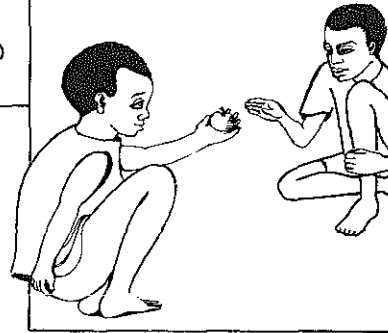

Hook worms Hook worm eggs come out in shit from people and animals. They stay on the ground in shady places, but they are so small that you can not see them. When you walk on the ground with bare feet, they get into the skin of your feet. Hook worms make you pale and weak with a sore stomach.

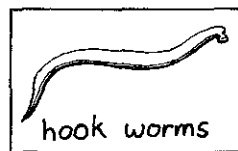

hook worms

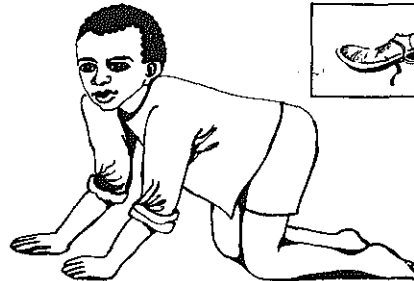
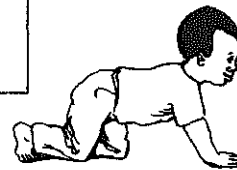

What to do

The best medicine is Vermox pills, but it is expensive. Children with worms must take two pills a day for three days.

Worm syrup is a cheaper medicine but it does not kill all kinds of worms. Read the bottle to see how much to take. If you take too much it is poisonous.



wash hands before eating and after going to the toilet

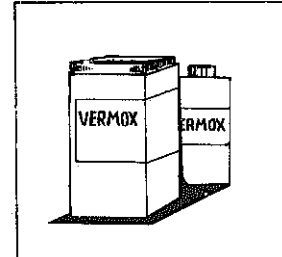

Ringworm and Eczema

Ringworm and Eczema are skin diseases that make you itch. When you scratch the itchy skin, it makes the disease spread to other places on your body.

Ringworm makes a round itchy place on your skin in the shape of a ring. Sometimes children get ringworm on their heads. You can see it because the hair stops growing. Usually people get ringworm from touching other people who have ringworm, but you can also get it from dogs, cats, and cattle. You can sometimes get rid of ringworm by washing the itchy places very well every day with soap and water. Otherwise you must go to the clinic or chemist to get medicine to put on the itchy places.

Eczema makes itchy patches on your body. These patches get so itchy that you cannot help scratching and sometimes you cannot even sleep. Some doctors think that eczema is caused by worrying. To get rid of eczema, go to the clinic to get medicine to put on it.

ringworm

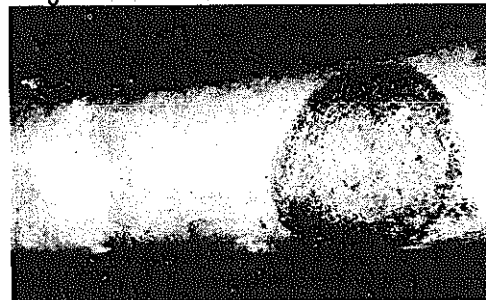

eczema

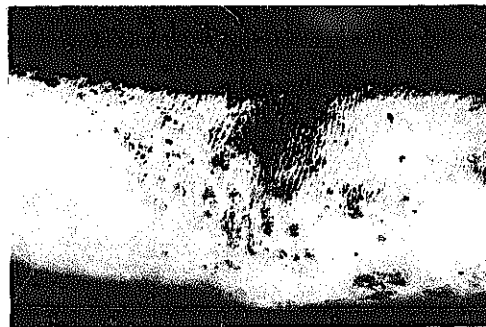

They want to be healthy but the trouble is water

At a small village in the North Eastern Transvaal, a group of eight people have been trained as village health workers. Each health worker is responsible for looking after the health of a number of families in the village. We spoke to two of the workers, Emma Mojapelo and Gladys Masukukwane.

● How did the village health worker scheme start and how did you come to take part in it?

The students from SAVS at Wits University came to have a meeting. Those who were interested in health work went to the meeting. Eight of us volunteered.

● What happened after the first meeting?

Then they had some classes. Two medical students from SAVS came in November and December. They taught us about diarrhoea, vomiting, pellagra, kwashiorkor, and then TB and measles and some other infectious diseases of small children.

● And first aid?

Yes, about bleeding and accidents and burns and all that.

● Do you get much malnutrition here?

Yes, but diarrhoea and vomiting, it's more.

● What do you do for diarrhoea and vomiting?

They showed us how to make that stuff. We make it with sugar and salt and water. We feed it with a mug. If somebody has got a child with diarrhoea and vomiting they come to us. We do that mixture for them, and show them how to make it.

● What is the most serious disease you have?

Kwashiorkor. In children and in old people as well. They get swelling and red lips, then funny hair.

● Why do the children get kwashiorkor?

There's many reasons. Some people say they can get vegetables but they haven't got money. Some don't know how to feed babies.

● What do you do with the children who suffer from malnutrition?

We send them here to the clinic on Thursdays - it's only one day a week. If they have to stay in they go to Subiaco Clinic.

● And what about pellagra?

We tell them what to eat, we haven't got medicine for that. It means they are not eating properly.

We tell them about eating vegetables, especially spinach. The trouble is water. A piece of land we have got, but not water. Just a few small groups of people have got boreholes.

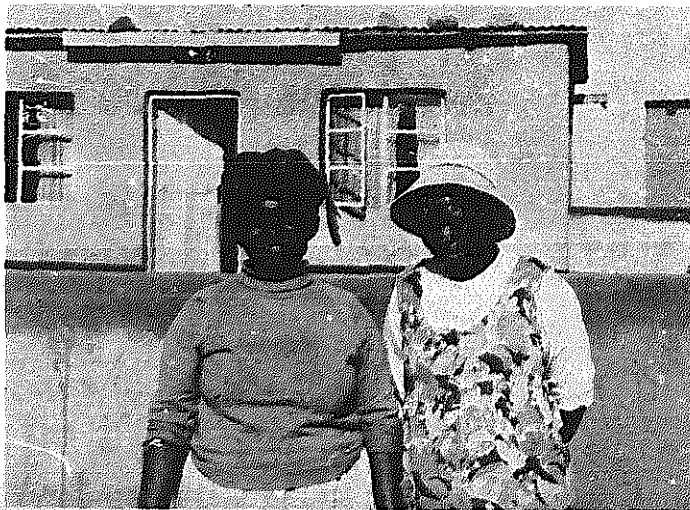

People like to grow vegetables. They want to be healthy but the trouble is water.

● What do you do if you find somebody with TB or measles?

We send him to the clinic and then sometimes he goes to the hospital.

● What else do you treat?

If people have an accident they come to us. We keep some bandages and other things in our houses. They know they can come to us at any time - day or night.

● Where do you get supplies of medicine?

We don't keep medicine - just some bandages and other things.

● Does it take up much of your time to be a health worker?

No, we enjoy it. We don't get paid, we just do it because we enjoy it.

● Will you train other people?

Yes, sometimes we go to visit them there and tell them what to do. We go house to house.

● Before the village health workers, what did people do if they needed some first aid or some other help?

Some went to town. If they were bleeding they didn't know what to do.

We also teach people how to make rubbish pits and how to dig pit latrines. They just dig a pit and then build a little house on top. They make a toilet out of cement. It's much healthier, if there's no toilets you get a lot of diseases, especially diarrhoea and vomiting.



People like to grow vegetables. They want to be healthy but the trouble is water.

● What do you do if you find somebody with TB or measles?

We send him to the clinic and then sometimes he goes to the hospital.

● What else do you treat?

If people have an accident they come to us. We keep some bandages and other things in our houses. They know they can come to us at any time - day or night.

● Where do you get supplies of medicine?

We don't keep medicine - just some bandages and other things.

● Does it take up much of your time to be a health worker?

No, we enjoy it. We don't get paid, we just do it because we enjoy it.

● Will you train other people?

Yes, sometimes we go to visit them there and tell them what to do. We go house to house.

● Before the village health workers, what did people do if they needed some first aid or some other help?

Some went to town. If they were bleeding they didn't know what to do.

We also teach people how to make rubbish pits and how to dig pit latrines. They just dig a pit and then build a little house on top. They make a toilet out of cement. It's much healthier, if there's no toilets you get a lot of diseases, especially diarrhoea and vomiting.



First Aid

When people are injured in road accidents or in factories or stabbed in fights, it can take a long time for them to get to a clinic or hospital. Sometimes they die before they get there.

If you know first aid, you can help somebody who has been injured by keeping the person breathing and keeping their heart beating. You can treat them for shock and bleeding before they get to a clinic.

If the person is not breathing

The first thing to do when somebody has an accident is to make sure they are breathing. If the person has stopped breathing, you must get them breathing quickly because they can die within 5 minutes.

- ▶ Lie the person flat on their back and loosen their clothes.
- ▶ Make sure there is nothing blocking the mouth or throat.
- ▶ Turn their head sideways to let spit or blood run out.
- ▶ Hold their chin up in your one hand, take a deep breath, put your mouth over their nose and blow air in. At the same time press your other hand on their stomach so that it does not fill up with air when you blow in.
- ▶ Then take your mouth away and let the air come out of their nose.
- ▶ When all the air has come out, start again.
- ▶ Do not stop until the injured person starts breathing alone or until you get to hospital.

If the person's heart has stopped

If somebody has had a serious accident or a heart attack, their heart might stop beating. You can tell if it is beating by feeling if the blood is pumping in the neck below the jaw or in the wrist above the thumb. If there is no heart beat:

- ▶ Lie the person on their back on the floor.
- ▶ Kneel next to the person and put your one hand over the other, where their heart is, on the left side of their chest.
- ▶ Press down on the heart as hard as you can. Lift your hands and press down hard again. Press and lift your hand once every second until the heart starts beating or until you get to hospital. Your hands are working like a pump on the person's heart.

If somebody's heart is not beating and they are not breathing, you must do heart pumping and mouth to nose breathing at the same time. It is much easier if 2 people can do this together - one can pump the heart while the other does the breathing. But if you are alone, you have to do both things yourself:

- ▶ In between every breath, while the air is coming out of the person's nose, press the heart 5 times before you breathe into the person's nose again.
- ▶ Sometimes you have to carry on doing this for an hour before the person starts breathing.

Try to get to hospital or call a nurse to help you as quickly as possible.



If the person is unconscious

If somebody is unconscious it looks as if they are asleep and can not wake up. People usually become unconscious after heart attacks, getting knocked out in a fight, after poisoning or if they are very drunk. If an unconscious person is not breathing and if the heart is not beating, give them mouth to nose breathing and pump their heart. Turn the person onto their side with their head facing down. Do not give the person anything to drink.

make sure that the person does not choke on their tongue

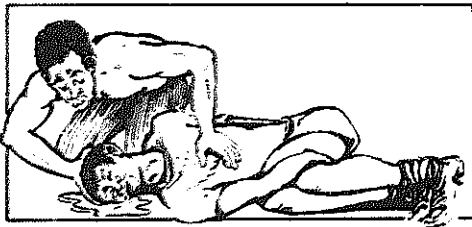

turn the head to face down

Take them to hospital quickly because if somebody is unconscious they are usually very seriously injured.

If the person has shock

People get shock after they have lost a lot of blood or have been badly burnt or had a heart attack or been poisoned. You will know if somebody has shock if their skin becomes cold and sweaty, their heart starts to beat very quickly and they seem to be weak and confused.

If somebody has shock:

- ▶ Make the person lie down with the feet higher than the head. If the person is bleeding from the head, let them lie with their head up to stop the blood.
- ▶ Cover them with a blanket.
- ▶ Give them a little water, but nothing else to eat or drink.
- ▶ Get them to a clinic or hospital as quickly as possible.

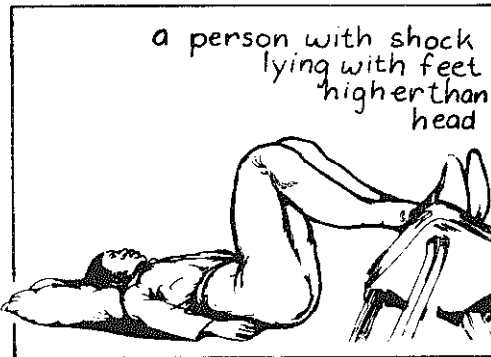

If the person is choking

If somebody swallows something it can stick in their throat and block up the air pipe, then they choke. This often happens to children. If somebody is choking and can not breathe:

- ▶ Stand behind the person and put your arms around their waist, with your fists on their stomach below their ribs.
- ▶ Press hard into their stomach pushing upward at the same time.
- ▶ The thing blocking their throat should come out but if it does not, press their stomach again and again until it does.

If this does not work, do mouth to nose breathing.

If a person is choking press them hard under the ribs

If a baby is choking hang them upside down

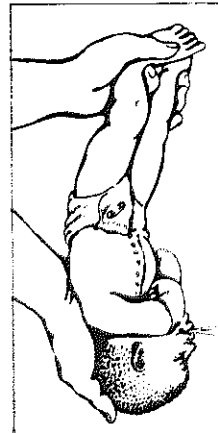

Burns

Many young children fall in fires and get burnt. Sometimes a child pulls a pot of boiling water over itself and gets burnt. In rural areas people make fires on the ground to cook on and to keep warm because they cannot afford to buy stoves. Burns from fires are very serious and sometimes children die.

If you know what to do as soon as somebody gets burnt you can stop the burn from becoming worse.

One thing you can do to stop children getting burnt at home is to build a mudstove (see p 210). They work very well, they don't cost anything, and they protect your children from fires.

Sometimes a whole room can catch fire from a paraffin stove or a candle. When this happens many people can get burnt.

What to do

The first thing to do is to put out the fire on the person's clothes. Let them roll in sand or use a blanket to stop the flames. If the burn is very deep, or big, the person must go to the clinic straight away. If children with serious burns do not go to the clinic quickly, they can die.

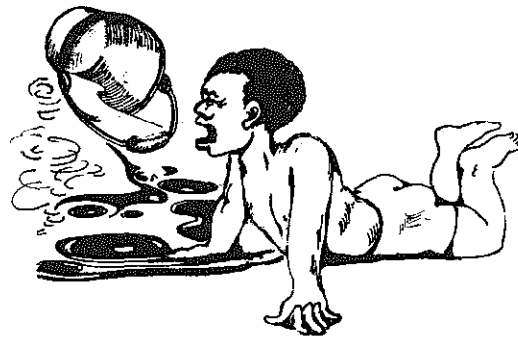

If the burn is small, or not very deep, you do not have to go to hospital.



if the burn is bigger than a Rand coin, go to hospital

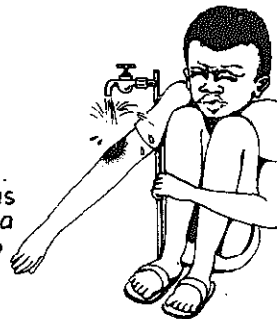

► Pour lots of cold water over the burn. Put the burn in cold water for 10 minutes to cool it down.

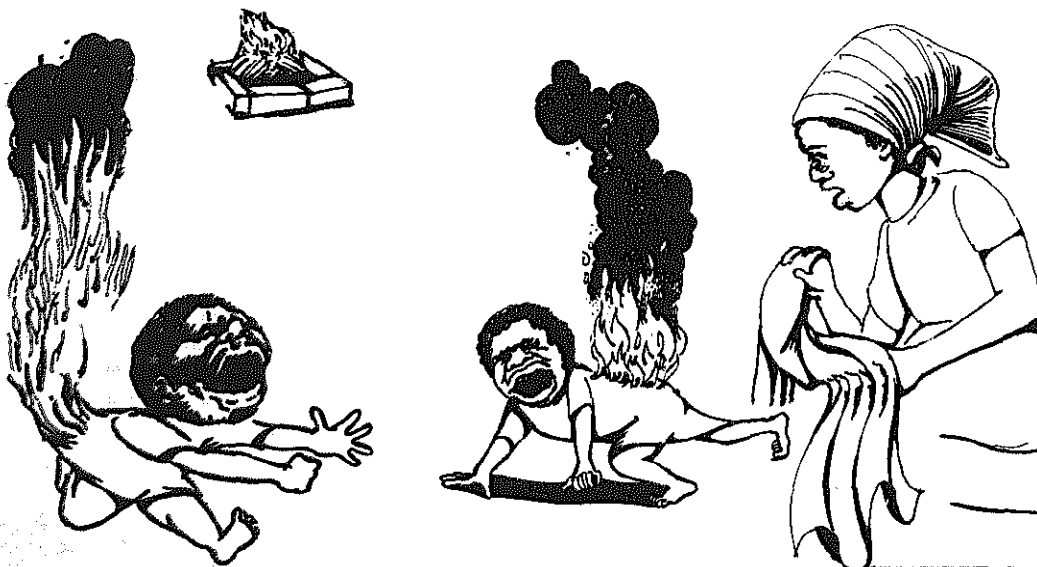

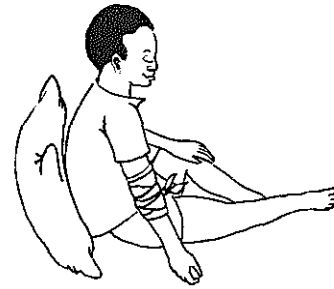

- ▶ Put antiseptic liquid like Dettol or Savlon onto the burn. You must first mix the antiseptic with water otherwise it will be too strong.
- ▶ Do not put oil, sand, eggs, butter, condensed milk, vaseline or anything else onto the burn. It is better to leave the burn with nothing on it. The burn will get blisters and they will help to protect it and keep it clean. Do not break the blisters unless they get yellow pus inside.
- ▶ Keep the burn clean by covering it with a clean cloth or bandage. If the burn is very small, leave it uncovered so that it can dry.
- ▶ Try to change the cloth every day until the burn has healed.

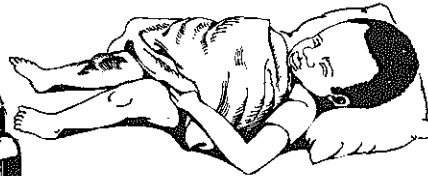

- ▶ If the burn becomes red, very painful and swollen with yellow pus in it, this means it is infected. Put Gentian Violet medicine onto the infected burn. You can buy it at most stores or get it from the clinic.



We stopped and helped him because we knew First Aid ...

At Elim Hospital near Louis Trichardt in the Northern Transvaal, there is a big programme to train village health workers. The programme was started about 5 years ago to train people in villages who volunteered to look after those who were sick with trachoma, an eye disease which is very common in the area. Care group workers have been trained to treat people with other common sicknesses like gastro-enteritis and malnutrition and to encourage other ways of improving community health, like building pit toilets. The care group workers are trained by teachers called motivators, who are based at the hospital and travel around the district, visiting each group about once every two weeks. We spoke to one of the motivators, Florence Mangan, a, who teaches First Aid to the care groups.

● How did you become a care group motivator?

You know, I am not from this place. I was staying in Johannesburg, then one weekend we came to visit here. On the way we found a man who was bleeding very badly because he cut himself with an axe. He was cutting a tree, then the axe slipped and his hand was nearly cut off.

Then we stopped and helped him because we knew first aid because we were trained with St John's Ambulance in Johannesburg. You know, we just used to help if there were some soccer matches at Orlando stadium or if there was an accident. Then we realised, no, our people are suffering too much here because there's nobody who can help them. Then we decided to come up here. It was me and Kosina Mashaba. We came to the hospital and they hired us as care group motivators because we wanted to teach people this first aid.

● How do you teach first aid to the village health workers?

Ja, most of our people are not literate, so we don't teach them a lot at a time. If we see that they understand, then we jump to the next thing. First we taught them about stopping bleeding. You know, many children hurt themselves with stones and so on. Then we taught them sling bandages. When we come back for the next lecture, we ask them first "Do you still remember what I taught you?" Then some of them

say that others were hurt already and they stopped the bleeding. So that way we can see that it has been working.

● What else do you teach?

Now we want to teach them about poisons because there's too many of them who leave paraffin in a cold drink bottle, then the child comes to drink that bottle. They rush to the clinic but sometimes the child can die. Then we told them how to dilute the poison in the child's stomach with milk, giving the child lots of milk or otherwise making the child to vomit to get the poison out. They were very much happy to learn such things.

The other time we taught them about burns. Many children are suffering from burns in this place because of cooking with open fires. The child crawls to the fire or falls in that fire and pulls a pot of water over himself. Before we taught them they used to do many funny things like putting fish oil on the burns, breaking the blisters to let the water out. Then we showed them that they must put cold water on the burn, then cover it with a gauze bandage and keep it clean.

● Do you teach anything else besides First Aid?

Yes we do tell them about oral rehydration for diarrhoea. We have packets which are at the hospital and we just show the care group members how to mix the

packet with a mug of water. We first make them taste what it is like because if you are going to give this medicine to a child, you must know what does it taste like.

● Is this method successful?

Yes, when we go back they tell us they used the packets and helped a lot of children and even grown ups too. Sometimes a child gets sick with diarrhoea and vomiting or kwashiorkor or marasmus then they become dehydrated and you have to make this mug and give it to the child for the whole day. That is what we

tell them. Even the ones who can't read know what to do. On the packets there are some pictures, not writing, to tell you how to mix up the medicine in the packet with water and when to give it.

● Is this the only medicine you give them?

No, it isn't the only one - in trachoma we also give them the trachoma ointment and teach them how to use it. The members of the care groups have got homes which they visit - one maybe visits about 10 families around her place to see if there's any trachoma. Then she gives them

ointment. They are used to it because when they suffer with eyes, they just call one of the care group members. Because if they go to the clinic they must pay - the medicine from the care groups is free.

● Do you think the health care group scheme is successful?

Very much successful. Everybody wants to join the care groups and when somebody's got sore eyes or bleeding, they just go to the care groups. Before, everybody thought that it was only nurses who could treat them if they were sick but now they know they can go to the care groups.

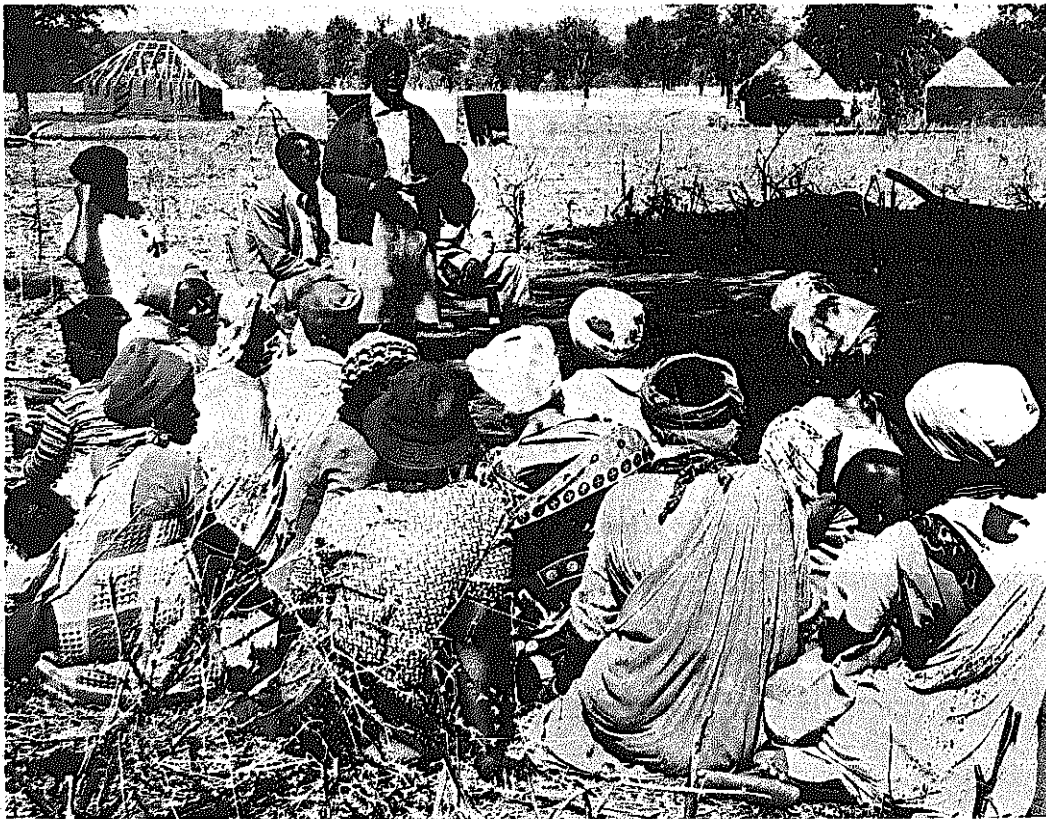

Poisoning

Some poisons can make you sick or kill you straight away, for example caustic soda or poisons for killing pests on crops. Children sometimes drink paraffin or eat poisonous berries and they get very sick. Other things are only poisonous if you take too much, like alcohol and cigarettes.

Anybody who has been poisoned must go to the clinic as quickly as possible. Even if the person does not feel sick he must go to the clinic because some poisons take a long time to make you feel sick.

Always try to take some of the poison to the clinic to show to the nurse. Then she will know what to do.

What to do

If the person has swallowed a poison which has a strong smell like petrol or paraffin, or a poison which burns, like caustic soda, they must not vomit. Give them lots of milk to drink. If there is no milk, give them beaten eggs or flour mixed with water.

For all other poisons, make the person vomit. Stick your fingers down the person's throat. When the person vomits he must be awake with his head downwards.

How to prevent Poisoning

It is much easier to prevent poisoning than to help somebody after they are already poisoned.

► Keep all medicines and poisons away from children. Lock them away in cupboards or put them in high places.

keep poisons
away from
children

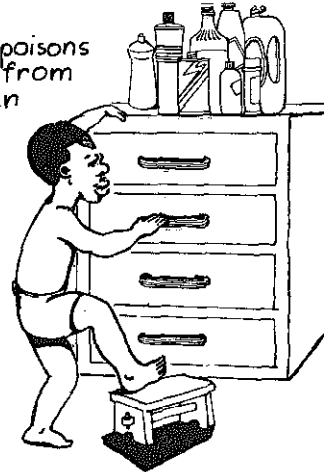

- Give children the right amount of medicines such as cough mixtures and aspirins. Read the bottle or the box to find out how much to give.
- Teach children to know which plants are poisonous.
- Do not leave poisons like petrol and paraffin in old cold drink bottles.
- Wash all fruit and vegetables to clean off the insect poisons which farmers put on them.
- Do not eat any food that smells bad because it might be poisonous. If you are not sure if something is bad, cook it very well before you eat it.
- Never eat tinned fish or meat if the tin looks fat. This means there is poisonous air inside and if you eat the fish or meat, you can die.
- Many people poison themselves with liquor and tobacco. Liquor damages your liver, brain and stomach. Cigarette smoke poisons your lungs and can help to cause bronchitis, heart disease and cancer. Cigarettes waste your money and damage your health.

Wounds

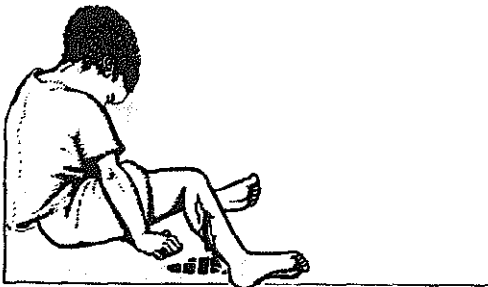

A wound is when you are hurt and bleed. Wounds can be serious because you can lose a lot of blood and die. Wounds can also become swollen and very sore.

Many wounds are caused by children falling over and by car accidents and by people getting hurt at work. Many serious wounds in South Africa

are caused by fighting because we have a very violent society. The system makes many people poor and they are forced to rob and steal. Many people are frustrated and they become angry and want to fight with everybody especially if they are drunk. This is why so many wounds are from stabbing and shooting and people beating each other up. Some wounds must be treated in hospital. Others can be treated at home.

What to do

- ▶ Let the person lie or sit and comfort them so that they are calm and not frightened.
- ▶ Cover them with a blanket if the weather is cold, but not if it is warm.
- ▶ Do not give the person anything to eat or drink.
- ▶ Lift up the part of the body which is bleeding so that the blood will stop. For example if the person has a wound in their arm, lift the arm up high. If the person has a stab wound in the shoulder, let them sit up.
- ▶ Clean the dirt out of the wound with water. If you have any Savlon or Dettol, put a little bit in the water.



- ▶ After cleaning the wound, put a clean cloth over the wound and press it down. Tie the cloth onto the wound with a clean bandage or cloth.



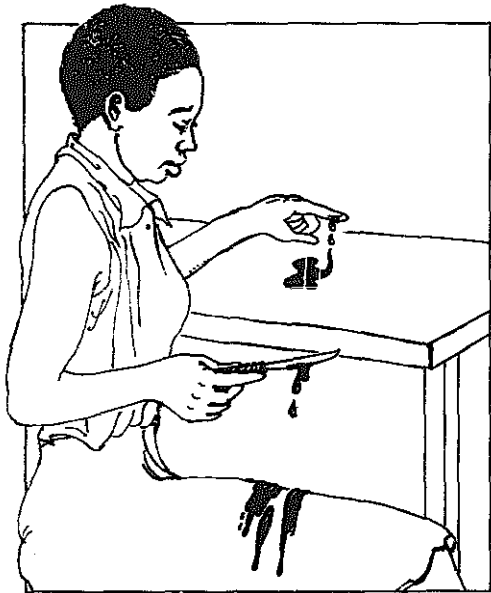

Wounds on the head, neck, chest and stomach are very serious and the person must go straight to hospital. These wounds, and big wounds anywhere on your body, need stitches.

All wounds, even small cuts, caused by something dirty like a dirty knife or an old tin, can cause tetanus. Tetanus is a very serious sickness (see p 347). Go to the clinic to get an injection so that you will not get tetanus.

Antiseptics like Dettol and Savlon are good for cleaning wounds because they kill germs. Germs are in the air and if they get into the wound it will become infected. It will become red and sore and may have yellow pus in it. If a wound becomes infected wash it with salt water and put Gentian Violet on it every day until it heals.

Bites

Snake Bites

Snake bites must be treated as quickly as possible. If it takes a long time to treat the bite, the snake poison will spread all through your body.

If somebody gets a snake bite they must go to the clinic. The nurse will give them an injection to stop the snake poison from spreading through their blood. If they cannot get to the clinic quickly, do these things while they are on the way or while they are waiting to go.

- ▶ Keep the person calm and still. If he or she moves a lot and becomes frightened, the poison will spread more.
- ▶ Try to find out what kind of snake it was. There are different treatments for different snake poisons.
- ▶ If it is very painful, give the person disprin or aspirin or any other headache pills.
- ▶ Make sure the person is breathing well. Let them lie or sit with their head downwards so that the spit can run out of their mouth. This prevents choking.

For some snakes there are also other things you must do:

For Cobra bites: In South Africa, the cobras you usually find are Rinkhals, Black Mambas and the Cape Cobras.

The poison of these snakes goes into the person's blood and makes the body become stiff. The person cannot move their arms and legs. Sometimes people vomit and cannot swallow. The Rinkhals spits poison. If the poison gets into somebody's eyes, wash it out very well with water. The person should go to the clinic as quickly as possible. Do not tie anything around the arm or leg to stop the blood because this can do more damage than the snake poison.

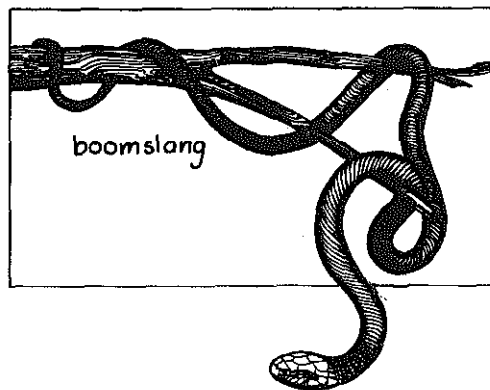

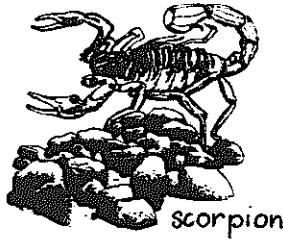

scorpion

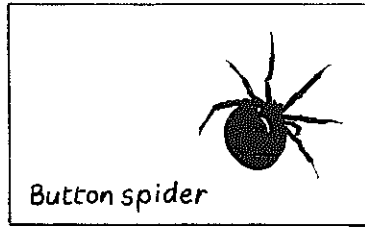

Button spider

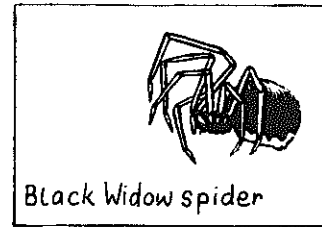

Black Widow spider

For Adder bites: The most dangerous adders are Puff Adders and Night Adders.

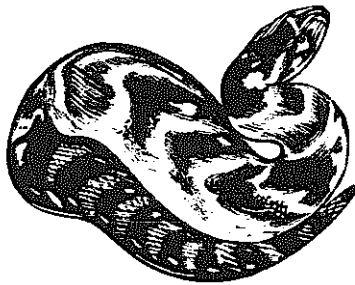

adder

The poison of these snakes stays near the bite mark and it becomes swollen and painful. You can suck the poison out of the bite, and spit it out of your mouth. Be careful not to swallow any of the poison.

For Back-fanged snakes: Back-fanged snakes are snakes like Boomslangs and Skaapstekers. The poison from these snakes goes into the person's blood and they bleed from the nose and mouth and inside the body. There is nothing you can do except take the person to the clinic.

Insect Bites

Some insect bites, for example scorpion and spider bites, are as dangerous as snake bites. Sometimes, people get bites when they are asleep. They know they were bitten when they can see a swelling. Anybody who gets a bite or a painful swelling must go to the clinic.

► The most dangerous scorpions are the ones with big tails and small claws.

► The poisonous spiders in South Africa are Button Spiders and the Black Widow Spiders.

► Bee stings are sore, but for most people they are not usually dangerous. To help the swelling go down, put a piece of raw onion on the sting. You can also mix earth and water and put it onto the sting. There are some people who get very sick when a bee stings them. They can even die from a bee sting. If somebody starts to get very sick and swells up after a bee sting, they must go straight to the clinic to get injections.

Animal Bites

People are sometimes bitten by dogs, baboons, meerkats, cows or other people.

Sometimes these bites can be serious because you can get tetanus (see p 347) or the bites can become infected. Clean the wound and go to the clinic to get an injection for tetanus. Do not put animal hairs or anything else into the bite wound. Some animals get a dangerous sickness called rabies. These animals seem to be a bit mad and have fits before they die. If they bite you, you can also get rabies and die. You must go to the clinic for injections if an animal like this bites you. If you see any animals acting like this, catch them and kill them and tell your local nurse or agricultural extension officer about it. Ask them to send the brain of the sick animal for tests to see if it had rabies.

If you want to travel with your animals, make sure before you go that they have injections to stop them from getting rabies. Ask your agricultural extension officer about rabies injections.

Broken Bones

People get broken bones after car accidents, hard falls and fights. You will know if somebody has a broken bone if:

- ▶ The broken part is swollen or out of shape.
- ▶ The person can not move the broken part or it is very sore to move it.
- ▶ It is very sore if you press on the broken part.
- ▶ The person heard a cracking sound when the bone broke.

Do not move the person. If the bone is sticking out of the skin, wash the wound with warm, salty water and clean any dirt off. Put iodine or gentian violet on the wound and cover it with a clean cloth.

If the bone is out of place and causing a lot of pain, see if you can help to stop the pain by moving it a little. But if the broken part is not causing too much pain do not move it - wait until you get to the clinic.

Take the person to the clinic or hospital as quickly as possible to get the broken bone set in plaster.



To prevent the broken bones from moving while you are on the way to the clinic, tie them in a splint. Make a splint by tying 2 pieces of wood longer than the broken arm or leg to each side of the broken bone with clean pieces of cloth. Put other pieces of clean cloth in between the broken bones and splint to make it softer. Tie the splint on tight enough so that the broken bones can not move about, but not so tight that the arm or leg becomes more painful.

Serious Illnesses

Many people in South Africa suffer and die from diseases like TB, typhoid, tetanus, pellagra, high blood pressure, VD and malaria.

Diseases like TB and tetanus would be prevented if the health services made sure that everybody was immunised. Malaria would be prevented if everywhere in the country where there was a danger of malaria, places were sprayed with poison so mosquitoes could not breed. Typhoid would be prevented if people were not settled in places where there was not enough clean water. TB would not spread so much if people did not live in overcrowded places. People would not suffer from Pellagra if they got enough food. VD would not spread so much if families were not split up by the migrant labour system.

What can people do now in their communities to help prevent and treat these diseases?

If they have no health service, they can join together to ask the authorities for a clinic in their community. Some people in the community can learn about health and diseases, so that they can see as soon as somebody starts getting a serious disease. If the problem is a shortage of clean water or food, maybe the people can work together to get wells or boreholes, and make gardens to grow vegetables.

Organising things to improve health in a community takes a long time and a lot of hard work. Write to us at EDA if you would like us to help you start a community health project.

Tuberculosis (TB)

TB is a sickness of poor people who do not have enough food and who live in overcrowded, unhealthy places. Black South Africans are forced to live like this and many suffer from TB.

When somebody starts to get sick with TB, he or she will have:

- ▶ a cough which lasts for a long time. This cough is usually bad just after the person wakes up in the morning.
- ▶ a fever (feeling hot and sick) in the afternoon and sweating at night.
- ▶ a pain in the chest or in the top of the back.
- ▶ no hunger and will get thin and weak.

TB is a slow sickness. Many TB sufferers do not know they have TB until other people see they are getting thin and coughing. After somebody has been sick with TB for a long time, he or she may have:

- ▶ blood coming out when coughing or spitting.
- ▶ swelling underneath the nails and the nails become round instead of flat.
- ▶ swelling of the glands in the neck.

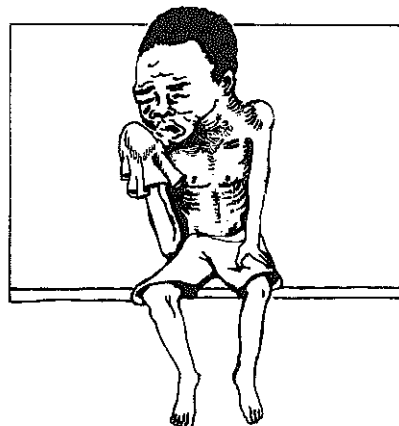

What to do

If you have any of these things wrong, you must go to the clinic or hospital to get a test for TB. They will take X-ray photographs of your chest and if you do have TB, they will give you lots of pills and injections. These medicines will make you feel better but do not stop taking them until they are all finished, otherwise the TB can come back. Sometimes you must take medicines for 2 years before the TB is finished. But after you have had medicine for 2 weeks, you can not pass TB to other people, even if you cough near them.

As well as taking pills, if you are suffering from TB, you must eat well. You must try to eat as much protein - beans, peanuts, eggs, chicken, fish and meat - as well as fruit and vegetables as you can afford. You should also try to rest as much as possible.

If your work is heavy, try to get a lighter job until you are completely better. If possible, take 1 or 2 weeks sick leave when you start taking the TB medicine. Your employer should give you this sick leave.

How to prevent TB

If you have got TB the TB germs are in your cough. For the first 2 weeks after you start taking TB pills, do not cough onto other people. Always cover your mouth when you cough. If possible, sleep away from other people

for the first two weeks, so that if you cough in your sleep, the TB germs will not get onto anybody else. After taking the pills for 2 weeks your cough will not make other people get TB as long as you carry on with the pills.

If one person in the house gets TB, the others should all go for tests. It is easy for the TB to spread quickly and everybody in the house will get it. All babies must have a TB injection when they are born to help stop them getting TB. They can still get TB even if they have this injection, but it will not be so serious and will get better quickly. It is easy for somebody to get TB for a second time if he or she does not eat well. The most important thing in preventing TB is eating well.

Pellagra

Pellagra is a kind of malnutrition in adults. It makes the skin dry and cracked. The skin looks shiny and then peels off, especially on parts of the body which are in the sun a lot, such as the arms, the back of the legs and the back of the neck. Sometimes the skin on the face becomes dark and thick. It looks like a greasy rash. A person with pellagra can also have diarrhoea and seem a little bit mad.

Pellagra is very common in South Africa, where people eat a lot of maize (mealies, mealie-meal and samp). Many people are poor and cannot afford to eat beans, vegetables, eggs or meat. Many alcoholics also suffer from pellagra because they do not eat well.

What to do

You do not need medicines to cure pellagra. It goes away if you eat nutritious foods. Try to eat beans, lentils, peanuts, green vegetables, fruit, eggs, cheese, fish, chicken and meat. These foods give you proteins and vitamins which you need (see p 311). If you have very bad pellagra it can help if you take Brewer's Yeast pills. You can buy these at some stores and at all chemists.

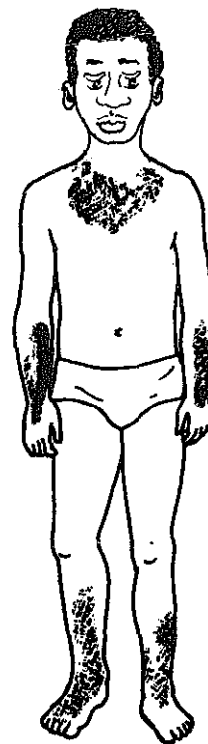



Alcoholism

Alcoholism is a disease which makes you need drinks like beer, brandy, gin and wine all the time. You feel you can not live without liquor and you become weak and often act like a mad person.

In South Africa alcoholism is a serious disease which many suffer from.

It is impossible to cure people of a disease which is caused by the problems in the society without changing the society. To cure many sufferers of alcoholism, our society will have to change. For example, there will have to be jobs for more people, better wages and schools, hospitals, houses and food and clean water for everybody.

Alcoholism also causes other diseases.

Cirrhosis of the liver makes your liver stop working. After drinking for a long time, your liver becomes so weak that it can not work anymore. Many alcoholics at first feel a pain in the right side of their stomach and vomit when they eat and drink, especially after drinking liquor. Then they get thinner and thinner and start to vomit blood, which means the disease is already bad. Sometimes their bodies swell up so it looks as if they are full of water. They look very sick and can not breathe easily. If they do not go to the clinic or hospital they will die soon. They must stop drinking alcohol and eat foods with proteins and vitamins (see p 311).

Pellagra is another disease which many alcoholics suffer from. It is a kind of malnutrition. Alcoholics get it because they drink instead of eating. Many alcoholics are poor and can not afford food as well as liquor. Others do not like to eat, they only want to drink.

If you want to help somebody to be cured of alcoholism, you should talk to them about their problems and suggest that they go to one of the organisations which helps alcoholics like Alcoholics Anonymous (see p 538).

It is very difficult to be cured and alcoholics need help and support from their families and friends while they are trying to give up drinking.

Venereal Disease (VD)

There are many different kinds of VD which are common in South Africa. Many men and women become sick with VD and some even die. Many people can not have babies because their bodies have been damaged by VD. People get VD by having sex with another person who already has VD. Many people have VD but they do not know it because some kinds of VD seem to get better quickly so the people do not go to the clinic. They do not know that the VD is still in their bodies and will make them very sick later.

Gonorrhea

Gonorrhea is a very common kind of VD in men and women. In a man, it feels like a burning pain in your penis, and sometimes yellow stuff comes out. This happens about 2 days after sex with someone who has gonorrhea. It is very difficult for a woman to know if she has gonorrhea. Sometimes there is a burning pain when you pass water, but usually there is no pain. Most women find out they have gonorrhea only when a man they have had sex with catches it and gets sick and tells them.

The man and the woman must go to the clinic for pills and injections. If they do not go to the clinic, the

sickness will get worse. Sometimes the pain goes away by itself but this does not mean that the VD is cured.

They must still go to the clinic. If you do not go to the clinic the gonorrhoea can come back many years later and can make women sterile (they can not have babies).

Syphilis

This kind of VD is very serious and can make you die after many years.

There are 3 stages in syphilis. In the first stage people get a small hard lump usually in the women's vagina or on the man's penis. This lump is not painful and changes into a flat raw sore after a few days. The sore is not painful and will go away by itself after a few weeks. This does not mean that the syphilis is better. In the second stage, 3 to 6 months later, you get hot and cold fevers and spots on your skin, sometimes on the arms and back of the neck. This will also go away by itself. But syphilis stays in your body and damages your heart and brain even though you cannot feel it. After a long time, maybe even 20 years, the syphilis will come back and you can get heart disease and go mad. Then it is too late and the syphilis

cannot be cured. If you think you have any of these things wrong, go to the clinic straight away.

Chancroid

This is another kind of VD which is very common in South Africa. It is a sore on the vagina or penis which is soft and very painful. Chancroid makes the glands in the top of your legs where they join your body swell up with pus and this is very painful.

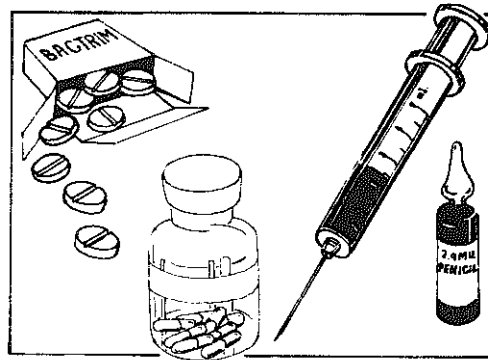

Pelvic Inflammatory Disease (PID)

PID is a venereal disease which women suffer from. It feels like pains in the lower part of your stomach. In some women the pains are there all the time but are not very sore. In other women the pains come and go but are very bad. PID is often a late stage of gonorrhoea. Anybody who has stomach pains should go to the clinic.

VD Clinics

If you think you have VD, go to the clinic straight away. It does not matter how young or how old you are. If you find out that you have VD, you should tell all the people you have had sex with because they may also have VD. Even if they do not feel sick they should go to a clinic for a VD test.

Cancer of the Cervix

Cancer of the cervix (the mouth of the womb) is the most common cause of death among black South African women over the age of 40. It is a very serious disease which can be cured if it is treated early, but which you die from if you do not have early treatment.

Many women do not know they have cancer of the cervix because they do not feel pain until the cancer is already serious and it is too late to cure it. Some women have pains in their stomach and back. Others bleed after sex or have a discharge which smells bad. These can all be signs of cancer but also of other diseases. If you have any of these things wrong, go to the clinic for a check up.

Pap smear tests

It is possible to find out if somebody has cancer of the cervix by doing a pap smear test. To do this the woman lies down and a nurse puts a special stick inside her vagina and gently scrapes some skin off the mouth of her womb. This takes only a

few seconds and does not hurt. The clinic staff looks at this skin with a special machine called a microscope and they can see if a cancer is starting.

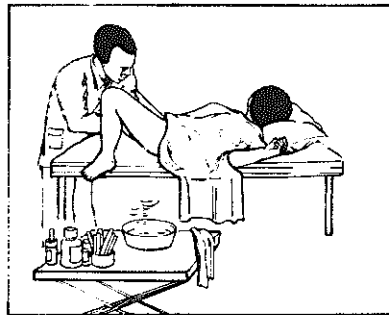

It is easy to cure this cancer if it is found early. The woman has an operation to cut out the part of the cervix which has cancer. If the cancer was new, the woman will still be able to have babies after the operation.

All women should ask their clinic for a pap smear test every 2 years.

High Blood Pressure

Many people in South Africa suffer from high blood pressure. It is a dangerous disease because you can have it for many years without knowing it. You only find out when high blood pressure causes heart problems, kidney problems, or a stroke.

You have high blood pressure if you have these things wrong:

- ▶ Lots of headaches.
- ▶ Weakness.
- ▶ Getting very tired and finding it hard to breathe after exercise.
- ▶ Sometimes getting a pain in your left shoulder or chest.

What to do

If you think you have high blood pressure go straight to the clinic for a blood pressure test. If you

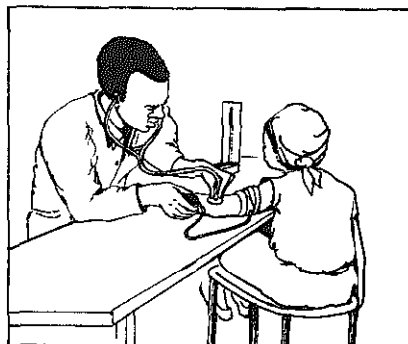

have high blood pressure, they will probably tell you at the clinic to stop smoking, lose weight, and to stop eating salt and sugar. Whenever you have a checkup at the clinic, ask them to take your blood pressure.

Malaria

Malaria is a disease which gets into your blood when malaria mosquitoes bite you. Malaria mosquitoes breed in hot places like the Eastern and Northern Transvaal, Swaziland and parts of Mocambique and Zimbabwe.

What it is

When you have malaria, you usually get a hot and cold fever every day. First you get very cold and shiver for up to 1 hour. Sometimes you also have a headache. When the shivering stops, you get very hot for a few hours. You feel weak and sometimes talk nonsense and act like a mad person. After that you start to sweat and the fever goes away. After the sweating you feel weak but not very sick.

The first attack lasts about 2 weeks, and then you get better. But it can come back again after a few weeks or months.

What to do

Anybody who starts to get malaria fever must go to the clinic to get pills. Sometimes the fevers do not come every day. Even if you have one fever, go to the clinic to be tested for malaria.

How to prevent Malaria

Malaria is a problem in hot places where there are many mosquitoes. The only way to get rid of malaria is to kill all the mosquitoes. This costs a lot of money, so only the government can do it for everybody.

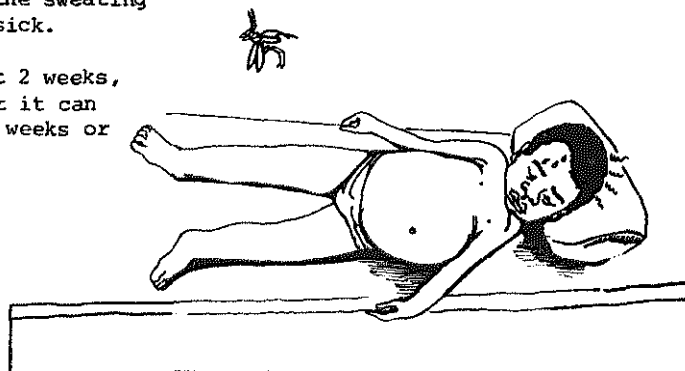

If you want to prevent malaria in your own community there are some things you can do.

▶ Clean up pools of water so that mosquitoes will have no place to live and breed.

▶ If there are no malaria control workers in your area, ask your health department to kill mosquitoes. They will spray mosquito poison near your homes to stop the mosquitoes from breeding and spreading malaria.

Tetanus (Lockjaw)

Tetanus is a very serious sickness which makes the body go stiff all over. If tetanus is not treated at hospital immediately the sick person can die. People get tetanus from dog bites, stab wounds, and cutting themselves with something rusty or dirty. Children often get tetanus if their ears are pierced with dirty needles.

Many babies die of tetanus because they are born at home and tetanus gets into the place where the cord is cut. Tetanus lives in cow dung and babies born on floors covered with cow dung or who have cow dung put onto their stomach when the cord is cut, can easily get tetanus. Another way babies get tetanus when they are born at home is from having the cord cut with razor blades or knives which have not been boiled.



What Tetanus is

▶ When you have tetanus you cannot swallow easily.

- ▶ Then your jaw gets stiff and you cannot open your mouth easily.
- ▶ Then your neck gets stiff.
- ▶ The rest of your body gets stiff.
- ▶ Then your jaw and other parts of your body can suddenly get very stiff and tight. This is called a spasm. These spasms can happen when somebody moves you or touches you, or makes a loud noise or a bright light, for example by lighting a match near you.

When babies get tetanus they start to cry all the time and cannot suck. Then they start to get stiff and can not breathe easily.

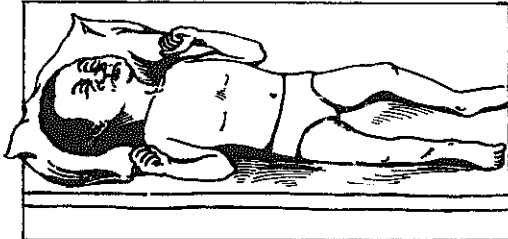

What to do

If a person gets tetanus they can die after a few days. If somebody's jaw is stiff or if a baby is crying and will not suck, take them to hospital straight away.

How to prevent Tetanus

At your clinic you can get an injection so that you will never get tetanus. Everyone, especially children should have this injection (see p 316). When a baby is born, keep the cord clean and dry. Boil the razor blade or knife before you cut the cord with it. Never put cow dung on the baby's stomach after the cord is cut.

Older children and adults should go to the clinic for tetanus injections when they are injured and bleeding.

Bilharzia

Bilharzia is a disease which can make you sick for many years. Many people do not know they have had bilharzia for a long time until they get very sick from it. It is very common in the Transvaal and Natal and the bilharzia spreads to other places in snails which live in river water.

What it is

Usually people know they have bilharzia if there is blood in their urine. They see a few drops of blood in their urine at the end of passing

water. They feel tired and have no energy to do work.

What to do

Anybody with blood in their urine must go to the clinic for bilharzia tests. The bilharzia usually gets better if the person has medicine.

How to prevent Bilharzia

Do not pass urine into rivers or drink river water before boiling it. Do not swim in bilharzia water.



Typhoid

Typhoid is a very serious sickness. It can make many people sick at the same time. It usually spreads where people are short of water and toilets. Typhoid germs live in shit. If there are no toilets, people shit near rivers

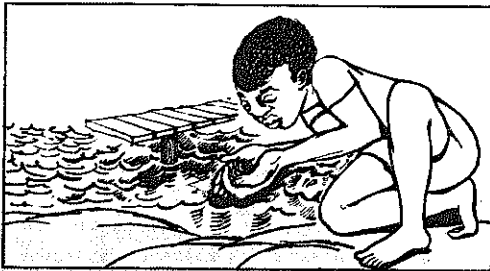

and the typhoid gets into the water. If there is not enough water, people do not wash their hands after going to the toilet and the shit gets on their food.

Typhoid usually starts when people have problems with water, such as after a drought or a flood, or after many people have been moved from their homes and resettled in a new place without proper homes and toilets. When this happens, people struggle to keep clean. They have only a little water and sometimes they do not have enough wood to boil water before drinking it.



What it is

The first two weeks of typhoid are the most dangerous. Many people die in the first or second week. During the first week, you feel like you have bad flu, with a headache and sore throat. You get a fever and feel hotter each day. You have something wrong with your tummy. Sometimes you have vomiting and runny tummy, sometimes you have constipation.

During the second week, the sickness changes. You shiver and feel weak. You may begin to talk nonsense and act like a mad person. Many people with typhoid die during the second week of the sickness. If they do not die, they begin to get better very slowly during the third week.

What to do

Anybody with typhoid must go straight to the clinic for medicines.

How to prevent Typhoid

To help prevent typhoid, be sure that shit does not get near food and water.

Cholera

Cholera is a serious sickness which can make a whole community become sick. People who get cholera often die, especially if they are also suffering from malnutrition.

In rural areas in South Africa, people are short of water and toilets. If somebody with cholera shits near a river or a well where people get water, the sickness will spread. The people will get cholera if they drink the



Always wash your hands after going to the toilet and never shit near rivers or wells where people get water. The best thing is for everybody to make deep toilets (see p 504).

Typhus

Typhus seems like typhoid but it is caused by bites from fleas, ticks and lice. Typhus begins like flu and after a week, you get fevers and ache all over. After 3 or 4 days you get a rash all over your body except on your face, then you start to get better. To prevent typhus, get rid of fleas and lice (see p 324) and make sure your animals do not have fleas or ticks (see p 229).

water or if they eat food which has been washed in the water.

People with cholera have a very runny stomach. First their shit is brown and watery, then it becomes white like mealie-meal in water. Their stomachs get swollen and sometimes they vomit and their hands and feet become cold. Their bodies start to get dried out, their tongues get very dry and when you pinch their skin it stays up in a lump.

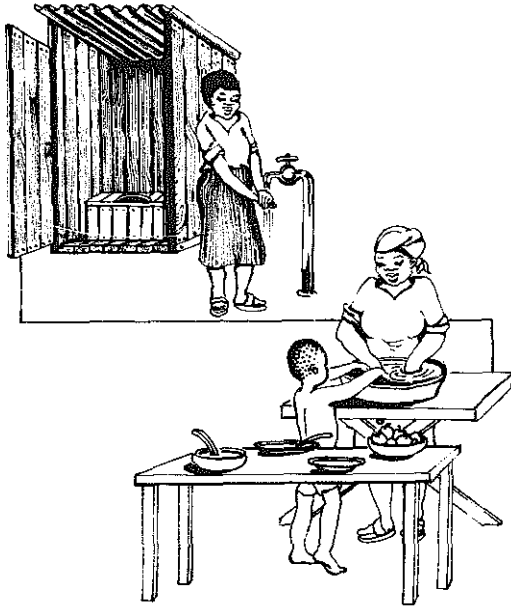

What to do

Make the sugar and salt medicine for gastro-enteritis (see p 318) and let the sick person drink as much as they can. Take them to the clinic or hospital straight away before the sickness spreads to other people.

How to prevent Cholera

Cholera can only be prevented if people are not overcrowded and if they have enough clean water and proper toilets. This will only happen when things in South Africa change, but this may take a long time. If you live in a place where there is a danger of cholera, try to prevent it by always washing food in water which has been boiled and washing your hands before cooking or eating and after going to the toilet.

Birth Control

Every three months Nomsa goes to the clinic for her birth control injection. She gets washed and dressed and takes a bus to the clinic. She's been having the injection for 2 years. Her first injection was straight after her son Themba was born. At the hospital they told her that the injection was better than the pill. She got pregnant with Themba while taking the pill. They said it must be because she had forgotten to take the pill and she believed them. Anyway she didn't like the pills because her husband used to beat her up if he found them and threw them into the fire. He said she was trying to make him a fool, not a man, by not having children.

Now when she has the injection he doesn't know about it, although he does sometimes shout at her that she can't give him more children. She doesn't want any more children because she can not afford to feed them and buy clothes for them.

With the injection she knows that she won't get pregnant but she feels fat and unhappy. Some people say it's because of the injection. She tried getting a job in the kitchens but they say her baby is too small and cries too much. She thinks she'll get a job when the child is 3 years and she can put him in a creche. Sometimes she thinks about going to her home in Newcastle to stay with her sister and her children. She stayed with her sister when she had her first-born.

She had no money to support herself and her child. He got sick with measles and died of malnutrition. After he died, she started to take the pill and went to Johannesburg to look for a job. After she got pregnant with Themba while she was taking the pill, she started with injections. She thought if she had no more children she could bring up Themba better so he would not suffer from malnutrition. This is what they told her at the family planning clinic. But even though she has only 1 child now, she still can not find a job.

What will happen to her? Maybe she will find a job and earn some money and support her child well. Maybe she will never find a job and she will stop the



injection and have children so they will support her when she is old.

There are many people like Nomsa in South Africa. They do not know what to do about family planning. The family planning clinics have pictures showing that small families can afford to live better and that having lots of children makes you suffer. But pensions are so low that you still need children to support you when you get old. Before you go to the family planning clinic try to think for yourself if a bigger or smaller family is better for you. Think about how many children you want and how you will support them. Think about who will help with farming and other work at home and then think about which contraceptives will be best for you.

This part of the book explains different kinds of contraceptives to help you decide which one is best for you. For example, contraceptives like the injection which work best to stop babies may not be the best for your health.

When you go to the family planning clinic, try to make sure you get the contraceptive which is best for you. Ask for a full check up including a blood pressure test, an internal examination, and a pap smear test to check for cancer of the neck of the womb. If you have a full check up, it will help you to decide which kind of birth control will be best for you.

Contraceptives

Condoms

A condom is a very thin rubber bag which the man puts onto his penis before sex. Anybody can buy and use condoms, but they are not the best method of preventing pregnancy. When the man's semen spurts out, it stays inside the condom and cannot make the woman pregnant. He must hold onto the condom to make sure that it does not come off inside the woman.

The right time to put on the condom is just before the man's penis goes into the woman's vagina for the first time. As soon as the man's semen spurts out into the condom, he must bring his penis out of the woman.

Condoms can help in stopping people from getting VD. You get VD when your sexual parts touch the sexual parts of another person who has VD. With a condom, the sexual parts do not touch each other so much, so VD does not spread.

Some people do not like condoms because putting them on interrupts lovemaking and they make sex feel different.

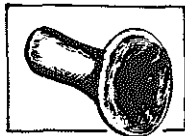

condom



Mucus method

This method is not very sure, but it is allowed by the Catholic Church. The mucus (sticky stuff) which comes out of your vagina feels different at different times of the month. By feeling the mucus every day, you can tell which days you can get pregnant. These fertile days are usually about 8 days in a month. If you have sex on any of the other days in the month, you will probably not get pregnant.

Every day when you are not having a period wash your hands very well and feel the mucus from your vagina. For about the first week after your period the mucus will be sticky like wet clay. It will not stretch. On these days you can have sex without getting pregnant. From about the 10th day to the 18th day after your period started, your mucus will be slimy like raw egg. It will stretch between your fingers. This mucus means you are fertile and can become pregnant.

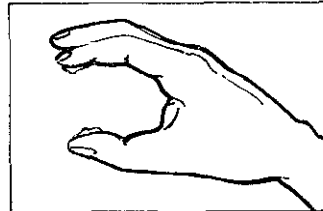

sticky mucus

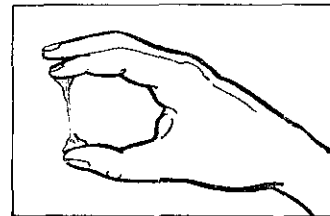

stretchy mucus

Some women are not fertile in the middle of their menstrual cycle, so it is important to feel the mucus every day. Sometimes, like when you are sick or worried, you might have fertile, stretchy mucus more than once. You must not have sex on any of these days otherwise you might become pregnant.

The mucus method works best for women who have regular menstrual cycles, for example women whose periods always start 28 days after the last period and who are fertile during the middle of their cycle. It only works if you make sure you do not have sex on the days when you are fertile. This can be very difficult, especially if you do not live with your man and are not sure when you will be together. Men and women must co-operate to use this method. Before you start, you must both agree not to have sex on the fertile days. It can take a few months to get used to checking your mucus, so during this time you should use another contraceptive method as well, like condoms or a diaphragm.

Diaphragms

A diaphragm is a round ring with a very thin piece of rubber stretched across it. Women must go to the clinic to get the right size diaphragm because each woman needs a different size. Before sex, you put the diaphragm into your vagina so that it covers the entrance to the womb (the cervix). This stops the man's sperm from getting into the womb to make you pregnant. Before you put the diaphragm in, you must put special cream on both sides of it, otherwise you can still get pregnant.

You must keep the diaphragm inside your vagina for 8 hours after sex. The sperm stays alive inside your vagina for about 8 hours, so if you take the diaphragm out too soon, you might become pregnant. If you have sex again before 8 hours has passed, put some spermicide into your vagina without taking out the diaphragm. You can buy spermicide, which is a cream to kill the sperm in your vagina, in tins or tablets from the family planning clinics or chemists.

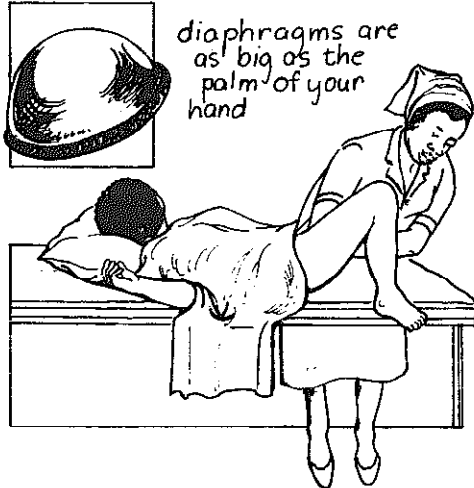

Loops

A loop is a small plastic thing which the nurse at the clinic puts inside your womb. When the loop is inside your womb, a baby cannot start to grow there. It stays inside your womb until you want to become pregnant. When you take it out, you can become pregnant straight away. But some women can become pregnant even if they have a loop.

If you want to be very sure that you do not get pregnant with a loop, you can use a spermicide cream to kill the sperm during your most fertile time - about 10 days after your period ended.

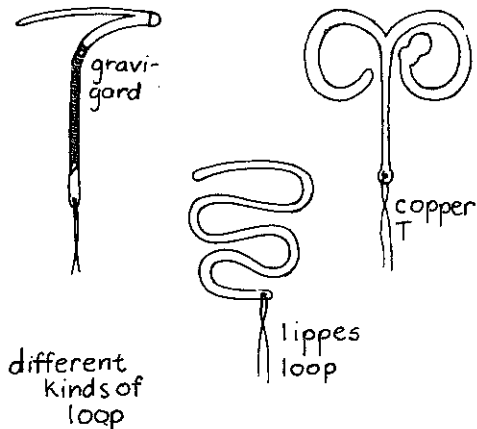

The loop can come out of your womb without you feeling it, and you can become pregnant. To check if the loop is still in place, feel for the little strings which hang down from the loop into your vagina. With all loops which have copper wire on them like Multiloads, Copper T's and Gravigards, you must go to the clinic every 3 years to take out the old loop and put in a new one. Loops which do not have copper wire, like the Lippes loop, can stay in until you want to take it out. Some women do not like loops because they can make periods painful with heavy bleeding. Loops are usually not good for young teenagers or women who have not had children. They cause more infections which can make you sterile than any other contraceptives.

Birth Control Pills

Many women take pills to stop them from getting pregnant. You get these pills from the clinic. One packet has 28 pills and you must take one pill every day.

Pills are a sure way of birth control. If you take a pill every day, you will not become pregnant. When you want to become pregnant, stop taking pills. You might not become pregnant straight away because it might take

a few weeks or even a few months for the pills to stop working but after that you will usually be able to become pregnant.

If you forget to take your pill one day, you must take two pills the next day. If you forget for two days in a row then you have sex, you can become pregnant. If you do forget for more than one day, you must use another birth control method until you have your next period. Then you can start the pills again.

Pills make some women feel sick. They feel like vomiting when they first start taking pills. This sick feeling usually lasts for only one or two months and then it goes away. If it does not go away, go to the clinic and ask for a different kind of pill.

There are many different kinds of birth control pills. Some can be dangerous for women older than 40, especially if they smoke. Women older than 40 should use another method like a loop. Some pills, called mini-pills, are for women who are breast feeding. It is very important to take mini-pills at the same time every day and never to forget for even 1 day. Pills make some women get fatter because the pills make them feel hungry and they eat more. If you see that you are getting fat because of taking pills, you must try to eat less.

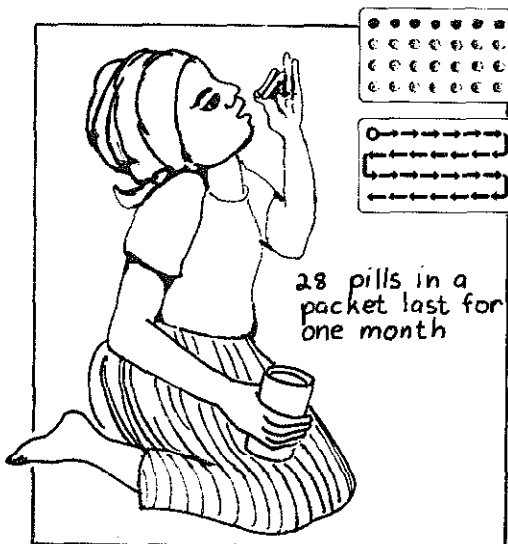

Birth Control Injections

Birth control injections stop you getting pregnant for at least 3 months. Every 3 months you must go to the clinic for another injection.

The injections change women's periods. Usually bleeding comes 3 or 4 times a month for the first few months, then stops for several months. Many women worry about what happens to the blood if they do not have periods. The injections stop your body from making menstrual blood, so there is no old blood staying inside your body.

The injections used in South Africa are Depo Provera and Nur Isterate. South African women of all ages have these injections, but in some countries they are not allowed because nobody is sure how safe they are for women's health. Injections should not be given to young women or women who want to have children in the future. With some women it can take up to 2 years after they stop the injection before they can get pregnant. Injections should only be given to women who have finished having babies or who have serious diseases like TB and must not get pregnant for at least 2 or 3 years.



Sterilisation

Sterilisation is an operation for men or women which stops them from having children. Usually it is for men and women who already have children and are sure that they do not want to have any more children in the future.

When men have the operation the small tubes inside their testicles which carry the sperm are cut and tied, so that the semen does not have sperm in it. The semen comes out just like before but it cannot make a woman pregnant. The operation does not make sex different for the man or the woman.

For women, the tubes which carry the ovum are cut and tied. The ovum cannot get into the womb so the woman cannot become pregnant. The operation does not make sex different for the woman or the man. The monthly periods are not changed but some women have heavier periods a few years after the operation

People who have these operations must be very sure they will never want to change their minds and

have children in the future. The operations are very expensive and difficult to change back. Usually people who have sterilisation can never have children in the future.

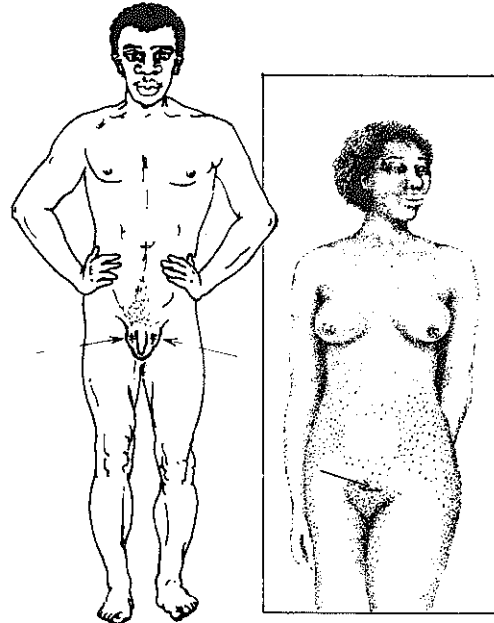

you will be cut here

The biggest problem with illegal abortions is infection

Abortions are illegal in South Africa. In other countries they are legal so they are done in hospitals like other operations. Even though abortions are illegal in South Africa, many women want them, so they have illegal abortions.

Illegal abortions cost a lot of money. They are usually dangerous because they are not done in a very clean place like a hospital and the woman can get an infection. More than 6 000 women went to Baragwaneth Hospital in 1979 with infections and illnesses resulting from illegal abortions.

We spoke to a doctor who treated many women who got sick after illegal abortions.

● What is the most common problem with illegal abortions?

From the cases that we treat here, I would say that the biggest problem is infection. Many people try to do abortions with dangerous things like pieces of wire coat hangers and knitting needles. They put these things into the woman's vagina to try to push them into the womb and make the womb bleed. Most of the things have not been boiled before use, so they are not clean enough and

cause infection inside her body. When the woman comes to hospital with this kind of infection we sometimes have to do a hysterectomy, which is a big operation to remove the whole womb. Then the woman can never have children again.

Most of the people doing these abortions do not know enough about women's bodies. They sometimes stick the wire into the wrong place and cut a hole in the womb. It makes the woman bleed very badly. Usually, by the time most of the women come

to hospital they are very sick. Some die as a result of this kind of abortion.

● What are the other problems?

Even more dangerous than using an instrument is using something like Dettol, or Jeyes Fluid, or Sunlight soap. We see many women here who come in very sick after squirting something like this into their vagina. Many of them die. Sometimes we can save them, if they diluted the stuff with water. But there isn't much hope for the ones who did not add water. They just die in 2 or 3 days. It causes kidney failure and there is nothing we can do in the hospital to cure them. Those who use soap and water have a better chance of living, but it is still very dangerous to try this for abortion.

● Are these the most common kinds of illegal abortions?

I have heard of some abortionists who use a safer method. They open the woman's vagina wide with something like a cardboard toilet roll holder smeared with vaseline. While the vagina is open, they put in one of these thin plastic catheter

tubes. They fit in onto a large syringe, about 50cc. They pull the syringe and the air pulls out the blood inside the womb, so it's like menstruation starting. Sometimes we treat a woman who had this kind of abortion, but then we just need to scrape out the womb to stop the bleeding.

Usually there are no complications, but I have seen one or two cases like this where an infection has been caused, probably because the plastic tube was not boiled in water first.

● Have you treated any women who have taken drugs to cause an abortion?

Yes, we do see quite a number of women who have tried this. They take all kinds of things. Some get drugs from traditional herbalists. Usually it doesn't work to cause an abortion, they just get very sick and the baby can be damaged. Some women take heavy laxatives or purgatives, but this does not usually cause an abortion, it just makes them feel very sick.

Others take malaria tablets, which is worse because they can cause serious liver damage. I know of one woman who died as a result of this.

Other women take about 10 contraceptive pills a day for 5 days after they have had sex without contraception. This usually works although it makes the woman very sick. It can also cause problems later because if the woman stays pregnant her child can have something wrong with it when it grows up.

Another thing which many women do - but which is not really abortion - it is more like contraception, is to go to a clinic to have a loop inserted. This method is almost certain to work, especially if they do it the day after they have had sex without contraception. The danger is if a woman does this when she knows she is pregnant. It is easy for the nurse to stick the loop through the womb because it gets soft during pregnancy. Then the woman bleeds a lot and has to have an operation.

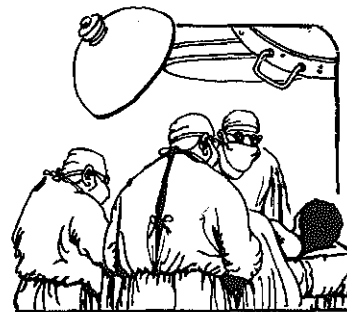

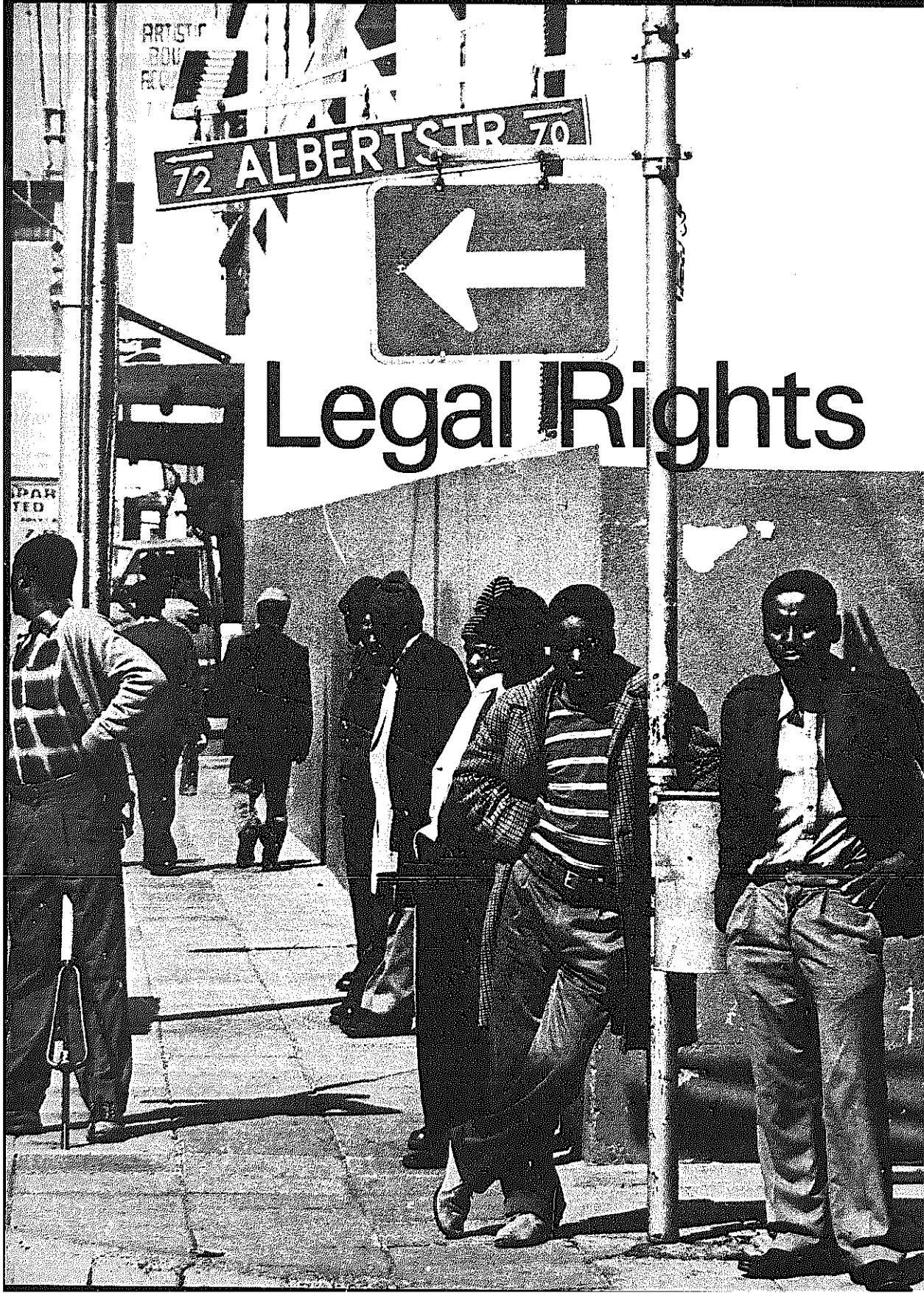

72 ALBERT STR 70

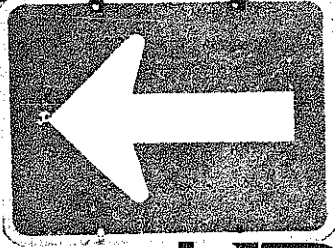

Legal Rights



Legal Rights Introduction

In South Africa black people live under oppressive laws which control them from the time they are born until the time they die. There are laws which say where you must live, what kind of education you must have, who you can marry, what kind of job you can get, how long you can have the job for, if you can join a trade union, whether you can get a pension when you are old, who can get your possessions when you die. Most of these laws force people to work for low wages and make many people unemployed. If there are many unemployed people, it is difficult for those who are employed to fight for better wages and working conditions. As soon as they complain or strike, the bosses know they can fire them and employ others who are waiting at the factory gates.

The most hated laws are the pass laws, which make people into criminals for living with their families or being somewhere to look for a job. People

are told they are not citizens of South Africa, but of other places called 'homelands' which they have sometimes never seen before and where it is difficult to survive.

There are no laws in South Africa which say that people have a right to work without being exploited, or that they can live where they want, or that they can live with their families, or that everyone must get clean water and enough food, or that everyone must have decent housing. When people try to fight for these things which every human being should have, they get arrested or banned. In this part of the book we write about some of the laws that control people so that you can understand them and know where to get advice about them. This does not mean that we think that the laws are right.

In South Africa it is difficult to live as a human being without breaking the law.

Pass Laws

The lives of all black South Africans are ruled by pass laws which say where they can live and work. If somebody is in the wrong place or if they are not carrying their reference book they can be arrested and fined or sent to jail. In other countries there are no pass laws. People are free to live and work where they like.

In South Africa, people have suffered under the pass laws for a long time. More than 200 years ago people who worked for white farmers in the Cape had to have trek passes - a letter from the farmer to allow them to move off his farm and travel somewhere else. They were arrested for travelling without a trek pass. When workers started to go to the mines, about 100 years ago, they had to carry passes when they travelled and they were arrested if they were outside the mine compounds without a pass.

In 1952 as part of the Defiance Campaign, thousands of people burnt their passes to show how they hated the pass laws. Many were arrested and

sent to prison. In 1956, when the government extended the pass laws to include women, more than 20 000 women marched in Pretoria to protest against the new law.

Today, every person over the age of 16 has to have a reference book or a passport. There is no difference between a reference book and a passport from a place like the Transkei or Bophuthatswana - you are still under the same pass laws and must get a stamp from the pass office to show where you can live and work.

The pass laws help the government and employers to control where people live and work. People who are unemployed or sick or old or who are involved in political organisations or trade unions can be sent to the 'homelands' places they have sometimes never seen before.

Whether you are a migrant worker or somebody who lives and works in town, it can help you if you know the pass laws and demand the few rights you

have under them. In this part of the book we write about what the stamps in your reference book mean, how to apply to change them at the pass office, how to sign a contract, and what to do if you are arrested for the pass laws. Many people suffer more because they do not know their rights. If you understand the law you can demand your rights.

Section 10(1)A rights

People who have lived in one town since they were born have a legal right to live and work in that place in terms of Section 10(1)a of the Urban Areas Consolidation Act.

People who have Section 10(1)a rights can live and work anywhere in the administration board area where they were born. They do not have to register when they change to another job in the same area.

People who were born in town but went to school in a rural area still have section 10(1)a rights if they can prove that they always returned home to town for school holidays and that they returned to live in town as soon as they left school.

When you apply for Section 10(1)a you must have a birth certificate to prove you were born in town and letters or permits to prove you have always lived in town. For example, you must have had your name on a residents permit or a lodgers permit to show that you have lived in a black township for most of your life. If you do not have these permits, you must get letters from people who have known you for many years to say you have been living in town all that time. You can get these letters from relatives living in town, your parents' employers, school principals and church ministers. All these letters must be stamped by a commissioner of oaths (see p 538) before you take them to the pass office.

Section 10(1)B rights

People who were not born in town, but who have been registered in one job in one town for more than 10 years, have a legal right to live and work in town in terms of Section 10(1)b of the Urban Areas Consolidation Act.

They can bring their wives and children to live with them in town.



To get Section 10(1)b rights, you must prove that:

- You have been registered in the same job for 10 years.
- You have been registered in different jobs for 15 years.
- You have had a permit to live in a hostel or black township for 15 years.
- You must also prove that you have never been sentenced to imprisonment of more than 6 months or to a fine of more than R500.

People who have been registered on migrant labour contracts with an employer for 10 years or with more than one employer for 15 years, can also have Section 10(1)b rights. If you are a contract worker and you have been refused Section 10(1)b, you should contact the Black Sash (p 537) and they will find a lawyer to go to court with you and help you fight for these rights. Many contract workers are refused Section 10(1)b rights, so even after working in town for many years, they never get the right to bring their families to town and live with them.

Section 10(1)c rights

Section 10(1)c rights are for families of people who have Section 10(1)a or b rights. You are entitled to Section 10(1)c rights if you are:

- Living in a black township with your husband who has 10(1)a or b rights. When you apply for section 10(1)c rights, you must take your marriage certificate and your husband's reference book to the pass office.
- An unmarried daughter living in a black township with your father or mother who has Section 10(1)a or b.
- A son under the age of 18 years living in a black township with your mother or father who has Section 10(1)a or b

When you apply for your Section 10(1)c rights, you must take your mother's or father's reference book showing their 10(1)a or b stamp. You must also take a letter from your mother or father saying they are your parents. This letter must be stamped by a commissioner of oaths (see p 538). If the pass office refuses to give you section 10(1)c rights, go to the Black Sash for help.

Section 10(1)D rights

People who sign contracts to work in town for 1 year get section 10(1)d permits. They can live in town while they are registered with the contract job, but if they leave the job, they usually have to go back to the rural area where they registered at the labour office. Some people are registered as 10(1)d but are not on 1 year contracts. Many of these people should be 10(1)a or b but do not know how to get this registration. If it is refused they should go to the Black Sash. People whose registration stamps have DW10 written onto them will probably be endorsed out to the 'homelands' if they try to change jobs.

Farm Labour

Some people find that they can not register for jobs in town. Their reference books are stamped "Farm Labour" or "Landbou" and this means they can only register for jobs on farms. It is very difficult for these people to get the stamps changed but they can get help from the Black Sash if they want to try.

Appeals

If a labour officer refuses somebody Section 10(1) rights or refuses to register somebody in employment, the person has a legal right to appeal to the Chief Commissioner for the decision of the labour officer to be changed.

If somebody gets a stamp in their reference book which says:

- ▶ Ordered to leave the prescribed area within 72 hours.
 - ▶ Ordered to report to the Magistrate at for residence.
 - ▶ Ordered to report to the District Labour Bureau at.....
- that person can also appeal to the Chief Commissioner to change the stamp.

The appeal must be made straight away in an affidavit (see p 538) at the Chief Commissioner's office in the same district where the labour officer made the decision. For example if the decision was made by the labour officer in Pietersburg, you must appeal to the Commissioner's office in Pietersburg.

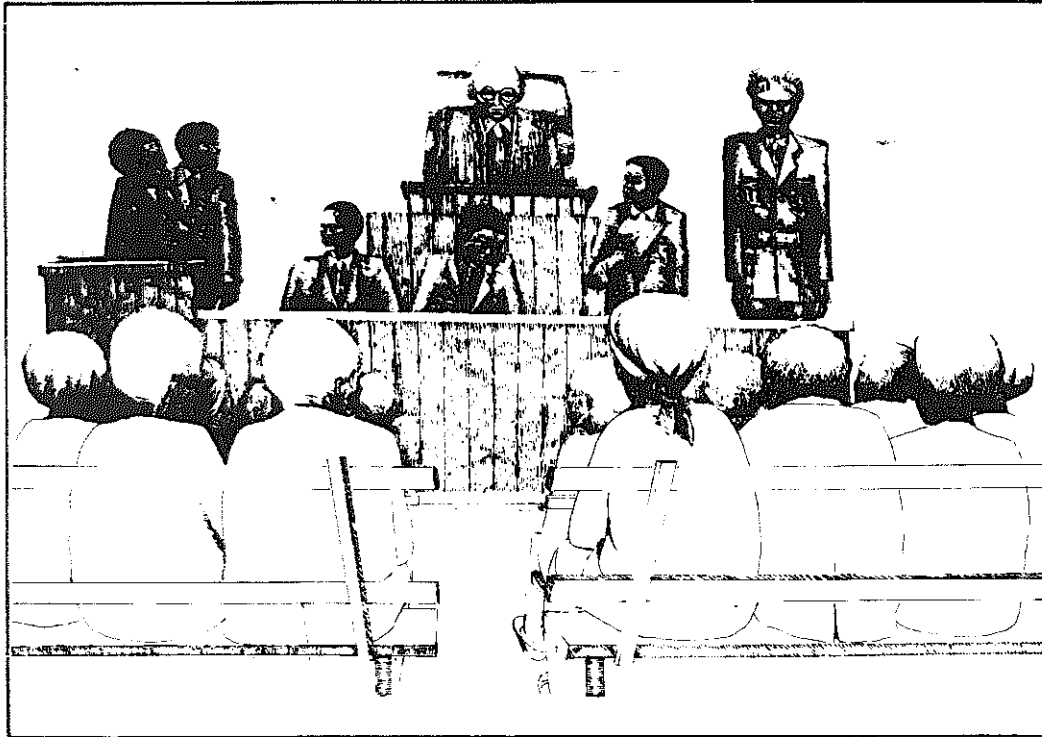

Passports

Since the 'independence' of the Transkei, Vondaland and Bophuthatswana, all Tswana, Venda and most Xhosa people have been issued with passports instead of reference books. The passports are just the same as reference books and the people are under the same section 10 laws. People with passports have the same legal rights as people who have reference books.

People from other countries like Lesotho, Zimbabwe, Swaziland, Botswana or Mozambique have no legal rights in South Africa. They should go to the Black Sash if they have problems with their passports or work contracts.

Arrests

This is what to do if you are arrested: Tell the first official who interviews you that you want to see a lawyer. Then phone a lawyer, or if you are in the Johannesburg area phone the Becker Street Advice Office (see p 537) which gives free legal help to people arrested for the pass laws.

If you have to go to court before you have spoken to a lawyer tell the commissioner that you plead not guilty, that you want a lawyer and that you ask for your case to be postponed. You do not have to answer any questions in court except to give your name and address. If you are asked any other questions, say that you want to see a lawyer before you answer questions.

Ask the commissioner to release you on bail. Bail money is a deposit and you will get it all back when your case is finished if you keep the receipt. If he agrees he will tell you how much the bail is and you can ask for permission to phone somebody to bring the money to court.

As soon as you have paid the bail you will be released and can go straight to a lawyer or the Becker Street Office. If the Commissioner refuses bail you can ask to phone a lawyer or the Becker Street office from the court cells or from prison. The police or officials can not refuse you a chance to have a lawyer.

Migrant Worker Contracts

Migrant workers are people who have to go away from home to work. When they come to town, they are not allowed to bring their families with them. Most of them live in hostels. Their employers pay them as single people, not as breadwinners who have to support their families.

The government and employers like the system of migrant labour, because it is much cheaper for them. It is difficult for migrant workers to organise trade unions or to fight for housing and better education.

All migrant workers have to go to the labour bureau in their home place and sign a migrant labour contract to work in another place. The contracts are for working on a mine, or working in a factory in town, or as a farm labourer or a domestic worker. Very few women get migrant labour contracts, it is mostly men.



The workers usually cannot choose the kinds of jobs they want. Often the labour bureau only has one kind of job. For example, if the bureau in your area only has farm labourer jobs you must be a farm labourer. You can not sign a contract there for any other kind of job.

Migrant workers can live in town for as long as their contract lasts. All other workers in town without contracts are illegal unless they have Section 10(1)a, 10(1)b or 10(1)c rights or are registered in a job. People with these Section 10 rights are allowed by the

government to live and work in town because they have lived and worked there for a long time (see p 360).

There are very few laws to protect migrant workers. Here we try to explain some of these laws but sometimes you will need advice from a lawyer (see legal advice p 537).

What to do at the Labour Bureau

In most rural districts the labour bureau is at the commissioner's office or the magistrates' court. People looking for jobs have to wait at the labour bureau for an employer or recruiting agent. Recruiting agents have licences from the government to recruit workers in one place and to find them jobs in towns or on farms or mines.

At the labour bureau the employer and the worker both sign the contract. If workers cannot write, they put their thumb print on the contract to show they have signed. The kind of job, the place where the job is and the wages are all written in the contract.

Usually there are not enough jobs for all the people who want to work. Sometimes people have to wait for months or even years at the labour bureau before they find a job. Many people have to take jobs they do not like. Many workers are told about the job and the wages, but when they get to town, they find that it is a different job with lower wages.

The time to agree or disagree with the wages and the type of job is before you sign the contract. Before you sign, try to make sure you know what job and what wages are written in the contract. If you complain only after you get to the job, the employer can cancel the contract and send you home.

The employer has to pay R1 to the magistrate when he signs the contract. This is called the attestation fee. Some employers take this R1 off the worker's wages, but this is illegal. The employer must pay for all transport and accommodation but it is legal for him to take this money off the worker's wages.

What to do when you get to town

When you get to town, you must take your reference book to the pass office to be stamped. When you have the stamp, it is legal for you live and work in town.

After you have been examined by the doctor at the pass office they will keep the contract and the F card, and sign the E card and give it back to you. You must give the E card to your employer. The pass office will stamp your reference book to say that you are allowed to stay in town until the end of your contract with that employer.

What happens when the contract finishes

Migrant labour contracts usually last for one year, but some are for 18 months or longer. At the end of the contract, workers must go back to the labour bureaus in the rural areas to sign new contracts.

Some employers want workers for only one year. They like to employ new workers every year. The workers whose contracts have finished must then go back to the labour bureaus to look for new jobs. Other employers like to employ the same workers for another year. They renew the contract by sending the worker to the pass office just before the old contract finishes to fetch a call-in card. On the call-in card, the employer writes the new conditions of employment - what kind of work, hours of work and wages. When the contract finishes, the worker goes back to the labour bureau in the rural area with the call-in card. It is

important that all workers look carefully at their call-in cards so that they know what their new work conditions will be.

The worker gives the call-in card to the labour bureau and signs a new contract. Then he goes back to town and gets a stamp at the pass office for another year. The employer, the labour bureau and the pass office all get copies of the contract but the worker never gets a copy. Always try to write down or remember what the contract says in case your employer tries to cheat you. If you can, get a photocopy made on a machine in an office or a CNA bookshop.

What to do if you are fired

Some employers fire workers before the end of their contracts. If this happens, it is the worker's right to get all the wages he would have earned until the end of his contract in January 1982. Sometimes people have to leave their jobs because the factory needed less workers. If this happens to you before your contract ends, you can look for another job. While you are looking, it is legal for you to be in town. If you find another job, your previous employer will not have to pay all the wages to the end of your contract. But he must pay you for the time you were unemployed. If you resigned or were fired because your boss said you were lazy or drunk or stayed away from work or because you did not do your job well, you will not be legally allowed to look for another job. You must return to the place where you signed the contract.

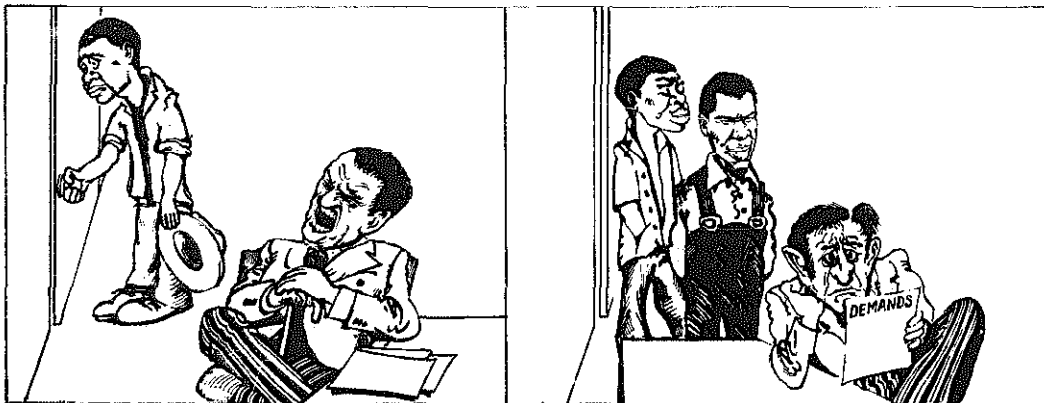

Changing the contract for a new job

You must get a letter from your new employers saying that they want to employ you. You must also get a letter from your previous employers saying it is alright if you transfer to the new job. If your previous employers refuse to give you a letter tell them that if they do not give you a letter they will have to pay you all the money to the end of your contract. If they still refuse, go and see a lawyer. The new job must be the same kind of work as the old job. For example if you were working for a builder before you will only be allowed to register with another builder. If you were a waiter in a hotel or restaurant the new job must also be in a hotel or restaurant.

Take the letters from your new employer and your old employer to the pass office in town where you were registered. If the pass office agrees to transfer your contract, they will stamp your reference book to say that you are allowed to stay in town and work for the new employers.

Sometimes the pass office refuses to transfer the contract. They stamp

your reference book and you must leave town within 72 hours (3 days). If you do not leave, you can be arrested and endorsed out.

If this happens you can make an appeal to the Black Commissioner but you must do this within one week. If the appeal is refused you can do nothing to force the labour officer to register you.

Unemployment Insurance for migrant workers

While you are working on contract, your employer sends some money from your wages every week to the Unemployment Insurance Fund in Pretoria. You can claim this money when you become unemployed (see UIF p 375).

It is easy to see that the system of migrant labour helps employers, and makes workers suffer. Migrant workers have very few rights but it is important for them to stand up for the rights they do have. If you are a migrant worker and you need legal advice about your job or your pass, you can contact the advice organisations listed on p 537.

When the pass laws can be finished, South Africa will be a very nice place

We spoke to Moleko Galiboe who has served many jail sentences and has been forced to work many times as a convict labourer on farms.

● Why do you think there are pass laws?

I think they are just for the government to make money. Every day at the pass courts there are hundreds of people and lots of them are paying fines. I'm sure every day they are making too much money at the courts. When the pass laws are finished, the government is going to be poor. It's just to make money, it's a business. When they catch me and I don't have money to pay the fine, I'm just working

free for the government. They sell me to the farms. I work to the farms for nothing, just free labour. Then when my 3 months is finished and I go back to Joburg they catch my brother and they sell him to the same farm. They've always got too much prisoners working free on the farms.

● When did you get a pass for the first time?

In 1964, when I was 16 years. I was at my home at Lichtenberg by that time.

When I was a small boy my grandfather used to tell me stories about these passes. He came to Joburg to work for 6 months. When he was going home, he must give another man the same pass, he come to work in Joburg for 6 months. The passes that time didn't have photos, just your name, so you can just borrow somebody's pass.

Then the law changed in 1950 something, then we got these dcompasses with photo. I used to see my father's. The new passes started in 60s, after the republic then the passes were too hot.

● Where did you work after you got your first pass?

First I started a job near to home in the town of Lichtenberg, making some bricks. Then in '65 I came to Joburg with the husband of my mother's younger sister. he was working to the Railways then he took me to the offices of the Railways and they made an application to Lichtenburg to employ me. I went home and waited for so 3 weeks then my papers were fixed up and I was registered with Railways in Joburg.

I worked there 65, 66, 67, 68, 69 then I left in 1970 after they transferred me to Kazerne to the goods shed. That work was too heavy so I left it. That time the contracts were not ending every once a year like now. It was just a stamp (ii) then you were registered until you left the job.

● Where did you work after the Railways?

I just stayed in Joburg working for building contractors. Since I came to Joburg I didn't go back to work at home anymore. It's more than 16 years I've been here now. All that time I was not registered - more than 9 years up until 1980, I couldn't find anybody to register me in the job. I didn't have a right place to stay, just staying with friends somewhere in town. I was always arrested for the pass.

● When were you caught for the first time?

The same 1970 after I left the railways. When I went to court they told me I'm not allowed to be in Joburg more than 3 days, I plead guilty or no? Well what can I say because I am guilty. They sent me to jail at Modder B for 15 days, then sent me home with a bus with a policeman, handcuffed. We were 2 going to Lichtenburg. But others were going to Malawi, others to Zambia, others to Botswana, others to Durban, to the whole country. That first time when we got at Lichtenburg, this policeman asked me am I coming back to Joburg with him.

Because he's a policeman I told him no, I'm staying at home now. He says "You mustn't be afraid for me, man. When you coming back I'm not going to catch you. It's just my job to bring you home. If we go back together I don't mind.

When they can catch you again next time, I'm still going to bring you home again, but it's better when we don't fight, just go back together." Then we buy some liquor and sit in the same bus and drink from Lichtenburg to Joburg. Then at Joburg he's taking his way, I'm taking my way.

That time when they were sending us home it was no good. Now they don't do that anymore, they sell you to the farms for 60 days, 80 days, sometimes 100 days. But before, when you were waiting to go home, after jail at Modder B, for 11 days, 6 days remission, maybe you could wait at the police station for 2, 3 weeks, even a month, then they didn't count that days. You are no more a prisoner, but you are still locked up and watched. You were just lonely, waiting for a partner from your home place so they can send 2 of you home with a police. Sometimes 4 people with 1 policeman, handcuffed to each other on the way in the bus. Tomorrow morning that police is taking us to Bantu Commissioner at Lichtenburg. They say to us, "Don't go anymore to Joburg, go home". Then all of us are just following the same policeman back to Joburg.

● Don't the policemen mind if you come back straight away?

Well, some of them you want to give them trouble because they are too

inquisitive. Like the other one, he just want to show the people he's a policeman and we were 2, he just handcuffed us and take us like things, not like people. I told him, "No, you must know, we are also feeling like you, don't think we are stupids, because we are also fighting for our lives." Then he said we mustn't talk too much.

Then when he was talking with another ausi, I just took the handcuffs out of my hands because he didn't make them tight. I told my friend handcuffed with me to just keep quiet. He said, "Oh no, I can't help this dog, I'm not your bodyguard, he's the one who is your bodyguard. When you can run away, I can't say nothing". Then at Carletonville I just ran away while the policeman was talking with other people at the back of the bus. I just asked another man who was getting off the bus for a place to

sleep then tomorrow morning I come back to Joburg. When that policeman delivers only one prisoner, they said he's not a good policeman, they fired him from the job. After that I saw him when he came to look for a job at the same firm where I was working.

● Why didn't you try to get another contract to work in Johannesburg?

The law was difficult that time. You couldn't get a contract in Lichtenburg to come and work in Joburg. Only if you've got somebody, a white man, who can send application for you but I didn't have somebody to do that.

They were strict with passes. It was the time when people were sentenced to 3, 4 months, after 19 when they stopped to send people home. The government was paying lots of money to send people home to the whole Africa, Malawi, Zimbabwe, Mozambique. Then they said

it's better to catch the people and put them in jail. After he comes out of jail, tomorrow we can catch him again, send him to the farms, then let him work free for 3 months.

● When were you sent to the farms for the first time?

That time, they sold us from Modder B. I see the registration number of the van is TAZ, Brits. When they unload us there at Brits, they give us porridge with a soup of cabbage water. The second day we go to the tobacco field. The induna showed us the job weeding with a hoe. Then we were carrying on but by mistake I cut off one tobacco leaf. This induna said I must eat it. I told him no, it's going to make me sick, man. It's just a green tobacco leaf. I can't eat it. He asked me I want to fight. I said no, I'm not Curtis Cokes.

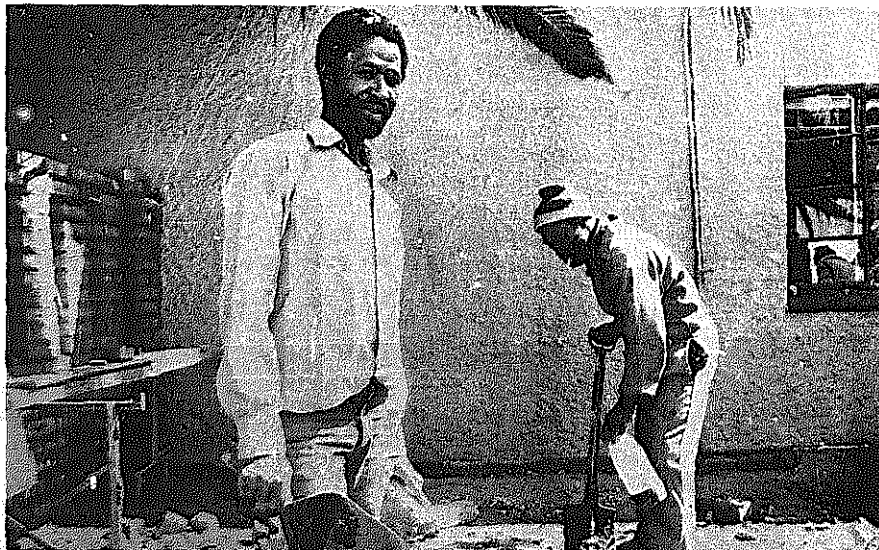

Then at breakfast time the owner of the farm came he was very angry. That induna showed his boss "Dis daai", pointing me. Oh, I was sent for dead that day. I asked that man to kill me. "Nee baas, moenie my so slaan nie, dis beter jy moet my dood maak". I told him I've got a operation, he said "Let me see". I lift my T shirt, then he just kicks me like a horse, in the operation. I just fall down, just like a pumpkin falling off a roof. I stayed down. After a long time, he thought he killed me. Then I wake up, when he see I reserved my life, he shout me "Staan op, eet jou pap". Then he hit me again, I ate the food. Oh I nearly died that time. They just left me locked up, I couldn't work. Then the following day the owner of the farm came, said "O, lewe jy nog?" Then the following day I went to the fields. Another prisoner cut the tobacco by mistake and the same foreman told him "Goba" (bend over). Then he hit him in the middle of the back heavily with the hoe. He fell over, lying there for about six minutes. Then at breakfast time, that prisoner came to find me. He gave me a zol then said "No, you and me we must escape from this place". I asked him "Are you brave my friend. Let's go, man. We better die with the police than here."

When breakfast was finished, we were the first to go to the fields,

then we ran away, across the fields without shoes. We ran about 10 kilometres, after that we just walked about another 5 kilometres then we were on a koppie and we saw the same induna coming after us. I told my friend, "Don't run away, there's lot of stones here, let us fight now. Better we kill him here". But my friend he ran away. Then the induna came up to me. I said "Come, come closer, I'm just gonna kill you with my hands". He just turned away, running after my friend. He caught him and while they were fighting, I ran away to another farm. There the people hide me, give me food, then the following day I came back to Joburg. Since that time, if they buy me at Modder B, I just get in the truck, then at the stop street, I jump out and run away. That same farmer from Brits bought me for the second time. I saw TAZ number, then just jumped out of the truck, ran away.

● Did you ever work for the whole sentence?

Yes, one priest from a mission farm bought me. When they sold me, it was Thursday and tomorrow is Good Friday. When we came to the farm, I found the place is nice and this man is not cruel, I should stay here and also have a little rest. I was fined 60 days, R40 then I didn't have that R40.

● Don't they give you a chance to get the money to pay the fine?

No, even if you've got some phone numbers, they don't allow you to phone. I just worked for that 2 months at that farm. They were busy building a church, then I plastered it inside. They like me at that place because I was plastering, painting the church and growing some mealies in the fields. They kept prisoners like people, not like animals. One place I was feeding chickens. It was nice there and we were treated like people. Another one, past Benoni, bought me to feed these big pigs, big like an ox. I refused, said no these pigs are gonna eat me. Then I also ran away, came back to Joburg.

● If you run away, don't they make you serve the old sentence when you get arrested next time?

No, they are too busy there at Modder B with new people, they haven't got time to check old people. Sometimes if I escaped today, next week they catch me again. When they put me in the van then take me to Newlands, Parkview or Brixton, the black police just look at my face then write my name, don't even ask me. They know me very well.

● Did you never just pay the fines?

Well I didn't have money, but before if I did have the money I paid R35. Today you can have to pay R120, R150 and R200. Before it was just the Rhodesian people, Mozambique people paying so much.

● How did you get registered in the end?

I suffered too much for passes, so I looked for somebody who can register me. Then my friend was a builder, I went to help him then the man of that house said he better register me with him. I said I can be so happy. Then he made the application to register me as a gardener. He filled in the forms, I went to Lichtenberg and they registered me. Now it's 2 years I didn't have trouble because my pass is fixed up. Only trouble now is because I'm registered a gardener but I'm a builder. Now I can't get my papers to be a builder. What I can see

is that maybe after another 5 years they'll see there's too many black builders then the whites will get jealous again and say no, to be a builder you must have papers. Then all the builders like me with garden boy papers will get no jobs. That's my trouble now.

● How do you think things would be if there were no pass laws?

South Africa is a bad world, but when the pass laws can be finished it will be a very nice place. It is going to be like a new world. I don't think there'll be any trouble if a lot of people come to the towns

because anybody can use his brains and his hands, but pass laws is making trouble. When this apartheid is not pushed out of the way, the whole land is just going to burn by the fire. The trouble is apartheid.

● What can people do to protect themselves from pass laws?

There's nothing they can do but at least I can say the black people are changed. They are no more scared and worried. They are already fighting, carrying on jiving. They know these bad things are going to be finished soon.

Trade Unions

Trade unions are workers organisations which fight for better conditions in work places and to improve the lives of workers in the rest of society. Workers join together in trade unions so they will be strong enough to win their struggles against their bosses - the owners of factories, mines, farms and other work places.

South Africa has no laws to force bosses to pay workers decent living wages. Bosses are interested in making money. They want people to work hard for low wages. When a few rich people own the factories and the majority of people work in them and are poor, there are always struggles between them. The bosses exploit the workers and try to control them and the workers try to get higher wages and better conditions.

Workers can only become strong enough to force bosses to pay them higher wages and improve working conditions if they join together to form trade unions. One worker alone is weak.

If one worker makes demands, he or she will just be fired and replaced by somebody who is unemployed. But if many workers join together, they can strike to force the bosses to give in to their demands. Bosses do not like strikes because they lose money if the workers are not working.

In South Africa, it is especially difficult for workers to fight for their rights. Labour laws and pass laws help the government and bosses to control workers and make it hard for unions to organise workers. It is illegal for black workers to go on strike and if they do strike, they can be arrested, fired or sent back to rural areas. Their trade union representatives can be detained and banned.

History of trade unions

The history of trade unions in South Africa shows that it has always been a struggle for unions to organise and fight for workers rights. When people first started to work on the mines and

farms, there were no unions. The first unions to organise unskilled workers were big general workers unions like the Industrial and Commercial Workers Union (ICWU). In the 1920s, the ICWU had more than 100 000 members who worked in all kinds of jobs all over the country. Later, workers formed unions in different industries such as the African Mine Workers Union which organised a strike on the mines in 1946. Thousands of miners went on strike for higher wages and were forced back to work by police with guns. At that time, black and white workers were allowed to belong to the same unions, but after 1947, they had to make separate unions, even if they worked in the same factories. This helped to divide the black and white workers and make it more difficult to fight for the same rights. Many black workers refused to join these separate or 'parallel' unions, so they formed their own, unregistered unions. Many of these belonged to the South African Congress of Trade Unions (SACTU) which was formed in 1955 as part of the Congress Alliance. SACTU unions had no rights to organise or to call strikes, but they did so and many times forced the bosses and the government to give in to the workers demands. In 1960, other organisations in the Congress Alliance were banned and SACTU leadership was smashed - many of its members and leaders were banned or exiled, and trade union organisation suffered for many years.

In the early 1970s, unions started to grow stronger again. In 1973, thousands of workers in Natal went on strike in the biggest wave of action by workers for many years. Since then, there have been many strikes involving hundreds of thousands of workers all over the country. The government has been introducing new laws every year to control unions. These laws force unions to register with the government and to take part in Industrial Councils where they have to negotiate about wages, conditions and strikes with representatives of their bosses and the government. All the new laws make it more difficult for unions to organise and fight for the real needs of their members.

For many workers, especially migrant workers, it is difficult to be trade unionists. If they strike, they are sent home and sometimes stay for a long time without jobs or money. But despite these hardships, migrant workers are strong members of many unions.

For workers in many kinds of jobs, there is no trade union and they are badly exploited. Farm workers have no unions and many of them work for very low wages in terrible conditions. If they complain, the farm owners fire them and force them to leave the farm. Domestic workers also have no trade unions. They each work in their employer's house and it is not easy for them to join together to get better wages and improved conditions. It is important for workers in these jobs to know about unions and to try to stand together and start unions to fight for their rights (see p 540).

Unions must be democratically organised if they want to be strong. The union members, not its leaders and officials must control it. Workers must be included in all the decisions of the union. Everybody must understand clearly what the union's aims are and how the union is going to reach these aims. Everybody in the union, members and organisers, must be disciplined and united in fighting for these aims.

Community support

Unions must also try to get the support of the community. They need this support to fight for their aims. For example, if a union calls a strike and people in the community understand the reasons for the strike, they will not take the strikers' jobs. There are many unemployed people in South Africa and bosses want them to take the jobs of striking workers so they will not have to pay higher wages or agree to the other demands of the strikers. If the union has wide support, it can force the bosses to give in. A union also needs community support if it calls a boycott. If the whole community supports the union and boycotts the products made by the factory, or boycotts the services, like

buses, the bosses might be forced to listen to the workers.

Most South Africans are poor because the owners of factories, mines and

farms do not pay them enough to live on. The government is on the side of the bosses, not the workers. It is important for workers to join unions and fight for their rights.

They know you are waking the people up, that's why they don't like unions

In the middle of 1980 about 10,000 workers at the Johannesburg City Council went on strike for more pay. Most of them were earning about R30 a week. They belonged to the Black Municipal Workers Union and most of them were migrant workers on contract from the Transkei. A week after going on strike they were all fired, and their contracts were cancelled. They were sent home in buses by the police and their union leaders were detained. Many of them have been unemployed since then. The Union has taken the City Council to court to get their jobs back.

We spoke to one of the fired workers, Themba Mbandlwa, who is among those fighting for his job back.

● How did you come to work for the Johannesburg City Council?

Well my father got a job for me because he worked there. He had a long service with the Johannesburg City Council, more than 28 years before he took a pension. He is a Baca nation so when he started there he was a driver of mules - that's something like a donkey and like a horse, just inbetween. They were using mules for taking the rubbish from the suburbs. It was before they got

these big lorries. Then the municipality told the people that if they have got a son, even 2 or 3, he can get a job under the father's name, so I started to come to work in April 1975. I was 18 years by that time.

Then in 1977 I got to go home to get married. I lived 4 months at home then I came back to work inside the power station at Orlando assisting the turbine drivers. Then I transferred to be a security guard at the very same power station.

● When did you join the Union?

I think in May 1980 there had come some people from the Johannesburg City Council to talk to us about this union - this other one they call it something like Johannesburg Municipal Workers Union. They came there with a white man from the city council then he introduced them to us - one was a senior clerk in Selby, the others were traffic cops. They told us the city council say we may have a union but there was something I didn't understand nicely. They said we should pay 25 cents per week and that they can take the money from our wages before we get them. Then we didn't like that thing. Then we

see no, these people are just like the people from Matanzima's independence. They are not for us, they are a just a government movement. We used to see that when they had a meeting, you could get off work at 3 o'clock and get in the buses from municipality free of charge to get to that meeting. Then we said no, we can't join this union.

● How did the Black Municipal Workers Union start?

Some 2 chaps came to live in the compound at Orlando Power Station. We didn't understand why because one was an electrician and there's nobody who is an electrician who can live in the compound. By the way, he had a car so he could go home to his house, but he just stayed there with us, never more sleeping at home. Then these two started having meetings with other electricians then they called all of us to a meeting to discuss what is the use of a union. Then we said we want it, all of us. They told us if there is an injury in the work, the Union can help you to get some money. Then if something happens like the municipality fires you without no reason you

understand well, they can take the municipality to court. Some plenty people were suffering because of things like drinking in the lunch-time then getting fired with no notice, nothing. That's why we had want a union to talk for us.

Then we talked about wages. We told them it is alright because some people have been working there a long time. They've got a lot of experience. They can teach a white man to do a job. The black people are not educated but they know plenty of jobs and they don't get paid for doing these jobs. You just get the same money if you start work today or if you worked for 20 years, or 31 years. That's why we wanted a union - to help us.

● How much were workers earning?

That time we were earning R33 per week - other were getting R31. One thing they robbed us - we worked 8 hours every Saturday, that is to say 6 days a week. But we got paid for only 4 hours overtime. When we asked them about that they said no, it's just a City Council law, they can't do nothing about it. Sometimes you had to work overtime but without pay. If you complain, the compound manager just fires you.

● What did the union do?

We wanted the city council to negotiate with our union and they just refused. Then those chaps who were our headmen in the union, that is to

say our representatives, told them that if they refused, they would call a strike.

Then we told the representatives they must tell others in all the compounds about that strike. If it is only a strike at Orlando they can fire us and get plenty people from the other compounds to do the jobs - 10 from here, 20 from there - then they can fix us. So we told them they must tell the others at other compounds to fill in forms to be the union's members, then after that we can call the strike to all of us - all the black municipality workers. We said, alright now, we must unite, we must come together to say one thing. Then they called a general meeting at the city hall. The city council refused the



workers to go to that meeting, but we did go - all of us. Then we elected the executive committee, Mr Mavi to be president and Mr Dlamini to be the Secretary and Mr Martin Sera to be vice-president. Before that Mr Mavi and Mr Dlamini used to drive buses.

After that meeting, the compound manager chased those others who had explained the union to us from the compound. But we still had meetings. Then the executive committee tried to negotiate with the Johannesburg city council, but they refused. Then they said we should call a strike to get that increase which was reported in the radio and the newspaper, in the Star I think. It said we must get it in July, but we didn't get that increase.

Then the executive committee said we should strike, but we refused. We told them the others must first join the strike and be ready to follow us if the City Council fires us. Then one week after that, on 24th or 25th July or so, we started striking on Thursday morning. I was doing night shift and overtime, from 6 to 6. Everybody, even the white people working in the power station, even the big boss, the Chief Engineer, knew the strike was going to start that day.

Then those who were on night duty came off shift, but nobody released them. Then the

corporals of the security guards said all of us must get on duty - even the ones who were working at night. So we didn't go on strike, we just changed our clothes and went back to the job. Then the union representatives went to the compound manager and said they wanted his boss, but he said we must first go to work, then they can talk to us. So they said, if he can't talk, he must call his boss the Chief Engineer, Electricity Department.

Then the union leaders came to us security guards and asked us why we are on duty. They asked didn't we also want more money? We get slaves wages, but we still doing nonsense here? We explained to them, no our corporals told us we must not strike. Then we all just go to our rooms and take off our uniforms. Then the other white security guards came on duty.

● Didn't they bring in the police?

Yes, first there came Mr Barnard - he refused what we want. He said he can reply to us in 6 weeks. We told him to reply us now or find somebody who can do that. He said he will fire all of us if we don't go back to work. He went away then came back with the police - some CID's with phones, you know walkie-talkies - they left other police with guns hiding behind the power stations - plenty of them were black and some whites with guns.

Then he read out all the electricians names and said they must get out of the compound in 5 minutes. And the rest of us must get in our rooms and start our cooking or do something else. We just told him if they chase the electricians they are the people who represent us, so that means they chase us. Then we all came out of the compound - about 600 of us, and just gathered outside. Then it was the weekend and we just went to Soweto to stay with people until Monday. We didn't want to go back to the compound.

After the weekend all the other compounds also came on strike. On Monday we had a meeting in Soweto and the police told us with a loudspeaker the meeting was illegal and that we must go to Selby compound to get our money then go home. We went on foot to Selby - just in peace you know with no trouble.

● The Selby workers were already on strike?

At Selby we found plenty others on strike - I think about 10 000 or so. Then this Mr Fanie Botha from government in Pretoria and Mr David de Villiers from Johannesburg City Council management committee came to tell us they can not talk to us about what we want if we do not go back to work. They said we must have representatives to talk with them and we told them yes we have got a union to talk for us, but they just refuse to talk to them.

Then we heard from the radio if we don't go back to work, they'll fire us.

Then plenty of the camouflages came with guns and that car which has got tear gas, the spray one. I know the tear gas from that time of the black power in 1976 and 1977. There's one thing you can do to help you is to put a wet lap on your face.

I went to the other compounds, one at Doornfontein and I saw some people still working there so I went to the union's office to report them but I found the police there. I went back to Selby to find out, oh we are fired now. There were plenty people there because everybody was on strike except those working at Doornfontein and Kempton Park - they call it Kelvin Power Station. I think the union did not have time to get to Kelvin to talk to the workers there before the strike.

● What happened to all the fired workers?

After they fired us they took us in buses to City Deep Old Mine compound and arrested us and kept us there till the following day without food. We just heard our things from our lockers were in plastic bags in a lorry. I lost a lot of my things, blankets, shoes, clothes, radio, school certificates, bank book, plenty things. But I left my money with my wife in Central Western Jabavu, because she just had a baby; it was 1 month old by that time.

The the police put us in Putco buses with our things and escorted us to home for Transkei. We just went quietly singing our songs from home. We were just happy to be going home. We thought even if we had died, we would have died for the truth.

When we got to the border we didn't stop at the offices of Republic of SA, they just let us go through. We just stopped at Matanzima's offices and they asked us what happened.

Then at Umzimkulu we reported to the magistrate. There were plenty plenty people municipality workers from Umzimkulu, 11 buses full. He said no they can't fire you for wanting money there's nothing wrong with that. Then he called the chiefs from our places to go to Umtata and then to Johannesburg to discuss what happened so they can take us back to our

jobs. So they did that and the city council told them they would take us back without breaking our contract. We waited a long time, but nothing happened. Then they reinstated some others, but not us from Orlando - they didn't like us.

● What had happened to union representatives then?

I heard Mr Mavi and others were arrested for organising the strike - something like that. Then they were charged but some state witnesses made a perjury - they told lies in the court - so they were released. Then the union took the municipality to court to get the wages for the time we were at home. It is still carrying on now at the moment. It's more than 1 year now since we lost our jobs. Plenty of the workers are back in Johannesburg but without contracts - just doing some piece jobs.



● Do you think it was good to have a union?

Yes because if you hadn't any union, we were treated badly in the jobs. I can say, the only way we can fight is to go on strike. As we are black people, many places where we work we are robbed. We must have some people who can talk for us to get better wages and working conditions. Everybody, even a domestic in a house must have a union to tell them how to report robbing wages or getting chased away without a pension when you are old.

Some other things unions can't do, but they wish to do something like changing laws that treated us bad. But at this stage when they talk about that, they are arrested. They ban you, arrest you, detain you, even kill you because they know you are waking the people up that's why they do not like unions.

That's how some people from other countries can help - some unions and factories like Leyland of London or others in holland can have a boycott and make them not treat people like this. I think it can help.

● Do you think you won by striking?

Yes I think so. Plenty people to get on strike must win. At the moment we have lost - we haven't got jobs, our children are hungry, we've lost our belongings ... but I just hope it will come, I don't know when. Our union will win. Then the municipality will pay us our money and give us our jobs back. Anyway it doesn't matter what they do, we will still carry on, because the truth can't change, but false can change. That's what I can say.

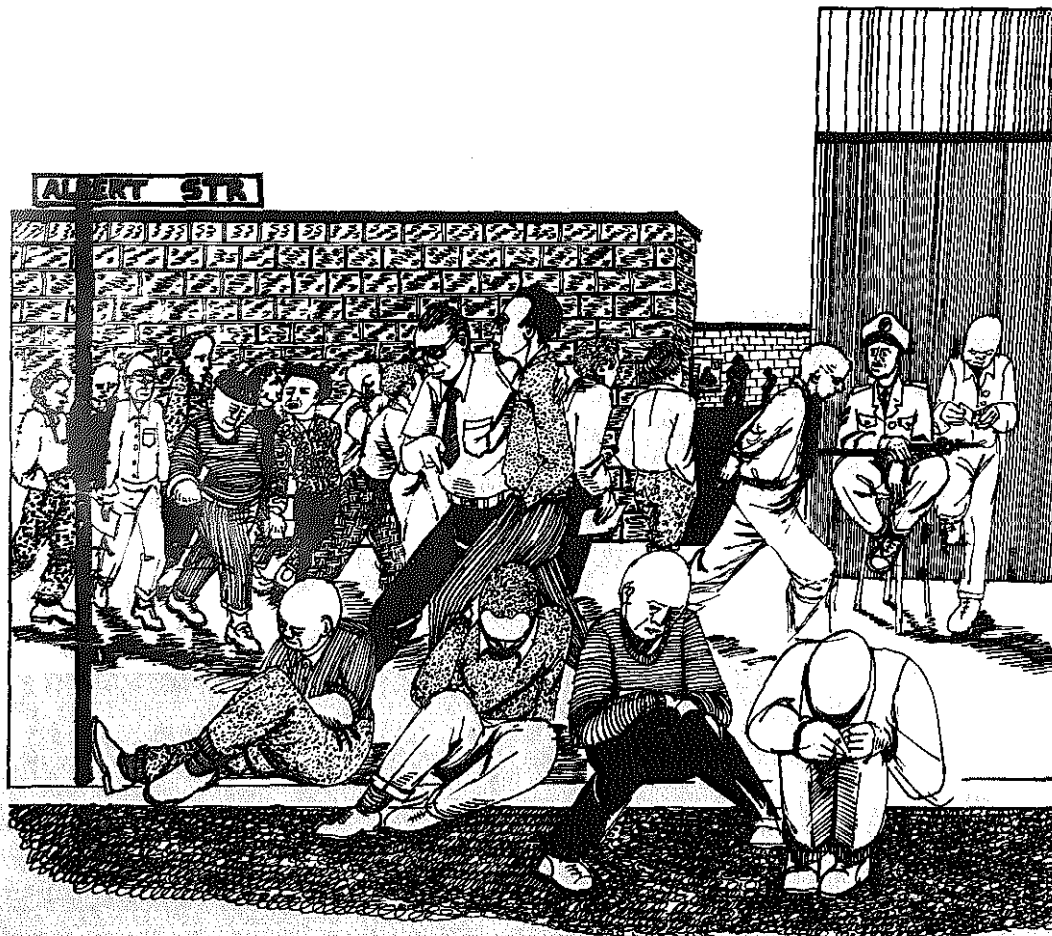

Unemployment Insurance

Many people in South Africa are unemployed. They want to work, but there are no jobs for them. Factory owners prefer to use machines than people because machines do not go on strike or complain about work conditions. Because of this, many people are unemployed. The government wants to help the factory owner, not the people. So they do not make jobs for unemployed people.

Some unemployed people can get help from the Unemployment Insurance Fund (UIF). UIF also helps workers in other ways. It gives money to workers when they get pregnant or sick and it gives money to the family of a worker who has died.

Where does UIF money come from?

Every week, employers take some money from the wages of each worker. The employers send this money to UIF in Pretoria. The money which each worker pays to UIF is written on the worker's payslip every week. Some UIF money comes from employers. All employers pay money to UIF for every worker in their factories. Some UIF money also comes from the government.

Who can get money from UIF?

- ▶ Workers who lose their jobs and cannot find work.
- ▶ Workers who get sick and cannot work for a long time.
- ▶ Workers who are pregnant or who have just had babies.
- ▶ The family of a worker who has died.

These workers can not get UIF money :

- ▶ Domestic workers, farm workers and most mineworkers.
- ▶ Some people who work for the government or railways.
- ▶ Workers from countries outside South Africa like Botswana, Lesotho, Malawi, Mozambique, Swaziland or Zimbabwe.
- ▶ People who come from the Transkei and BophuthaTswana can not get money from UIF in Pretoria. Contract workers from BophuthaTswana can get money from the BophuthaTswana authorities. Workers from Vendaland can get UIF money from Pretoria until September 1982.

How to get money from UIF

Every worker who pays money to UIF must have a Blue Card. The employer keeps the Blue Card and writes on it the wages and how much the worker pays to UIF. You must take your Blue Card to the pass office or labour bureau to claim your UIF money. If you live and work in town and have Section 10 rights, you can get UIF money from the Pass Office or from the labour Department. You must go to the Pass Office within 3 days of leaving your job. If you work in town on contract you can only get UIF money from the labour bureau in the rural area. You must go there within one month after leaving your job.

At the Pass Office or the Labour Bureau you must register as a work-seeker, even if you do not have your Blue Card. Being a workseeker means that you are allowed to look for a job. You must get a "special" stamped

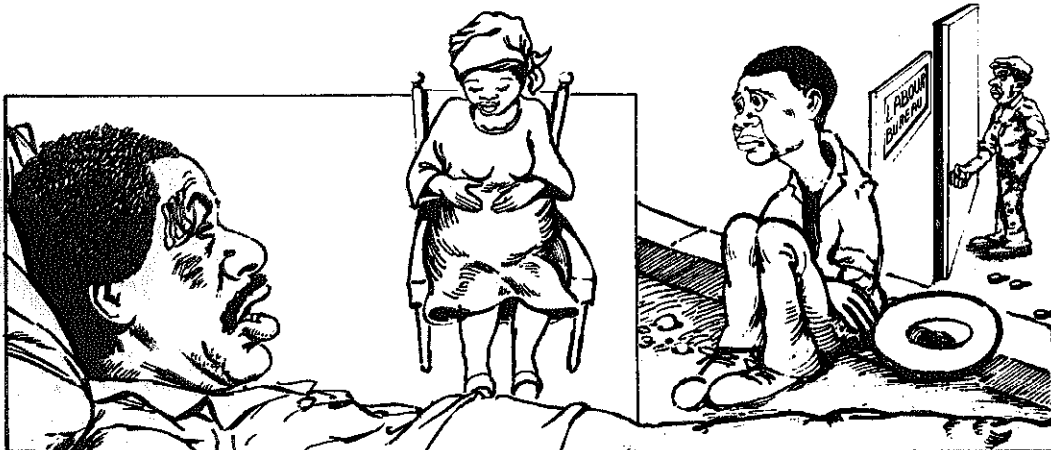

in your pass, and the pass office or labour bureau will send you to factories to look for work. They will give you a form which you must take to every factory. If there is no work for you, the employer at the factory signs the form. Then the pass office or labour bureau will see that you went to all the factories to look for work. If you cannot find work after one week, you can ask for a springbok. This means that you looked for a job for a week but could not find one.

If you have section 10 rights you can go with your springbok to the Black Affairs Commissioner or the labour department to get your UIF money. If you live in a rural area, you can go to the labour bureau or the magistrate's office with your springbok to get your UIF money.

When you go there you will get another form to fill in. This form asks about all your jobs for the last 5 years.

Before UIF gives money they want to know why you left your last job. When you leave your job, your employer writes a number on your Blue Card. The number tells UIF why you left. Number 1 means that you left your job because you wanted to leave. Number 2 means you left because your employer did not need you anymore. Number 3

means you left for another reason. Employers write Number 3 when they fire you because they are unhappy with you. Maybe it is because you went on strike or because the employer thinks you were lazy or drunk. UIF does not like to give money to workers who have 1 or 3 on their Blue Cards. Sometimes they make people with 1 or 3 wait a few months before giving them UIF money.

If UIF gives you your money, they will send you a letter telling you to collect your UIF money from the same office where you got your springbok.

For how long does UIF pay?

If a worker has paid money to UIF for more than 3 years, they will pay him or her for up to 26 weeks. After that, the worker cannot get any more money from UIF. If a worker has paid money to UIF for 1 or 2 years or less, UIF only pays them for 1 or 2 months.

UIF for sick workers and pregnant workers

UIF gives money to workers who are sick for 3 weeks or longer if they have paid money to UIF for at least 13 weeks in the previous year. UIF gives money to workers who lose their jobs because they are pregnant if they have paid money to UIF for at least 18 weeks before they are fired. UIF pays the fired worker nearly half of her wages during the last 2 or 3 months of pregnancy and during the first 1 or 2 months after the birth.

UIF for the family of a worker who dies

UIF gives some money to the family of a worker who dies, if the worker paid UIF for at least 13 weeks during the 5 years before he or she died. The family has to get many forms and letters and send them to UIF in Pretoria. They must send these forms within 3 years after the worker's death.

Many workers have problems with UIF. There are some organisations which can help workers with these problems (see advice organisations listed on p 537).

U.F. 74

UNEMPLOYMENT INSURANCE ACT.
1966.
WERKLOOSHEIDVERSEKERINGSWET,
1966.

**CONTRIBUTOR'S RECORD CARD
BYDRAER SE VERSLAGKAART**

Under Regulation II — Krugters Regulasie II

This card must be retained by the employer while the contributor remains in his employ. On termination of a contributor's employment the employer must complete the relative portion of the card and hand it to the contributor.

Hierdie kaart moet in besit van die werkgewer bly terwyl bydraer in sy diens is. By beëindiging van 'n bydraer se diens moet die werkgewer die betrokke dele van die kaart invul en dit aan die bydraer oorhandig.

FOOD MARK - 1980 11/18

Workmen's Compensation

A worker who gets sick or hurt at work can get money from Workmen's Compensation. All employers pay money to the Workmen's Compensation Fund in Pretoria. If a worker gets sick because of his work or if he has an accident at work, he can get money from Workmen's Compensation.

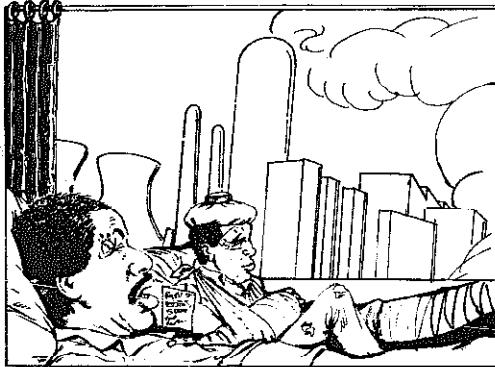

Who can get Workmen's Compensation?

All industrial workers can get money from Workmen's Compensation. Agricultural workers, domestic workers and prisoners who work while they are in prison can not.

What does Workmen's Compensation pay for?

- Workmen's Compensation gives money to the worker for the time that he or she can not work.
- Workmen's Compensation pays for the doctor and medicines.
- If a worker is killed at work, Workmen's Compensation pays for the funeral and gives money to the family of the worker.

How much does Workmen's Compensation pay?

Workmen's Compensation pays the worker $\frac{3}{4}$ of his wages. For example, if a person earns R100 a month, Workmen's Compensation will pay out R75 a month while he or she is not at work. Workmen's Compensation will pay for all the doctors and medicines while the worker is away from work.

If a worker is seriously hurt at work so that he can never work again, for example if his leg is cut off in an accident, he will get money from Workmen's Compensation every month for a year. Sometimes he can get money for longer than 1 year.

How to get money from Workmen's Compensation?

The sick worker and the employer must fill in forms and send them to Workmen's Compensation in Pretoria. Most employers keep these forms at their factory office.

Then Workmen's Compensation writes a letter to the worker telling him or her where to collect the money. Sometimes Workmen's Compensation sends the money to the employer to give to the worker. Sometimes they send the money to the Black Affairs Commissioner and the worker must go there to fetch it. Usually, Workmen's Compensation sends the money to the post office near the worker's home. If the worker has a migrant worker contract, he or she must go to get the money at the post office in the rural area. The worker gets a post office book and can draw some money every month.



The money from Workmen's Compensation does not come quickly. Most workers wait a long time after the accident to get their money. Sometimes workers borrow from their employers while they are waiting and Workmen's Compensation pays the employers back.

What happens when the Workmen's Compensation money is finished?

If the money from Workmen's Compensation is finished and the worker is still too sick to work he or she can get a Disability Grant from the government. A person who has a Disability Grant gets some money from the government every 2 months for the rest of his or her life.

What to do if you have problems with Workmen's Compensation

Some workers have trouble when they try to get money from Workmen's Compensation. Sometimes, the employer does not want to tell Workmen's Compensation about the accident. Sometimes Workmen's Compensation sends the money to the employer and the employer does not want to give it to the worker.

Sometimes the employer tells Workmen's Compensation that the worker did not get sick because of the job. If Workmen's Compensation believes the employer, they will not give money to the sick worker. Any worker who has problems with Workmen's Compensation can get help from the advice organizations listed on p 537.

Domestic Workers' Rights

Domestic workers are one of the most exploited groups of workers in South Africa. They do not have trade unions to help them fight for their rights. Usually they do not even have contracts. In many other kinds of work, for example in factories, employers are forced by the government to pay a minimum wage. Trade unions can fight for this minimum wage to be increased. But there is no minimum wage for domestic workers. Every domestic worker makes their own agreement about wages with their employer and some workers are forced to take very low wages.

Domestic workers cannot get money from Workmen's Compensation if they become sick for a long time or if they are injured at work. They cannot get money from the Unemployment Insurance Fund when they become unemployed or pregnant.

Most domestic workers do not get sick leave. In other kinds of work, employers have to pay workers who are sick and to give them time off until they are better. Many domestic workers do not take time off when they are sick because they know they will lose their jobs or will not be paid for the time they are sick.

Domestic workers do not have the right to paid leave and many have to take unpaid leave if they want to have a holiday. If you are a domestic worker you should try to make a written agreement with your employer about your holiday pay. Then if you are fired, your employer will have to pay you holiday pay, otherwise you can take them to court.

There is no law about giving notice to domestic workers. Most domestic workers who are fired are told to leave their jobs straight away, without getting notice pay. When you start work as a domestic worker,

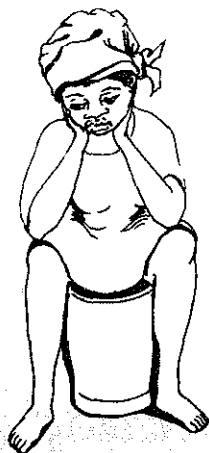

make an agreement with your employer to give you notice according to how often you get paid. For example, if you are paid every month, the notice must be 1 month. If you are paid every week, the notice must be 1 week. If your employer will not pay you notice pay you can take them to court whether you have an employment contract or not.

In some places, for example in Pretoria, the F card which the employer signs when registering a domestic worker, says the notice period is only 1 day. Employers do not have to sign this F Card if they want to give longer notice.

People registered as domestic workers have lots of problems getting any other kind of job. For example, if a domestic worker trains to be a typist or a clerk, she or he will probably not be allowed to change their job registration even if they find one of these jobs.

There is no trade union for domestic workers but if you have difficulties getting notice pay or holiday pay from your employer, contact the Domestic Workers Association (see p540). This association has branches throughout the country and will fight for domestic worker's rights.

Pensions and Grants

Many old and disabled people suffer because they can not get pensions and disability grants. Even those who do get them can not survive on the little money they get.

More than half of the people who should get government pensions do not get them because of problems like not having a birth certificate, not having a reference book or living illegally in town. Often they can not afford to pay the bribes which chiefs and other government employees want before they will give people their pensions.

Other people have problems getting their pensions from company pension funds when they retire. Some employers send the money to the administration offices and the worker never gets it. Those who get company pensions still suffer because they can not also get a government pension. Sometimes the company pension is very little, so even after having it taken off their wages for many years, these pensioners get no more than others who get government pensions. It is everybody's right to be looked after when they are old, so pensions should be enough to live on, not the little money they are now.

The money which the government uses for pensions comes from workers' taxes,

so they are giving you back what you have already paid to them.

Who can get pensions?

Women older than 60 and men older than 65 years can get old age pensions from the government. The maximum pension of R40 per month is only granted if the person gets less than R10,50 per month, for example from members of their family working in town, or from their own work. If the person gets more than R10,50 per month, he or she will not get the maximum pension. It will be less, depending on how much money they get. If the person gets more than R20,50 per month, they will not get any pension.

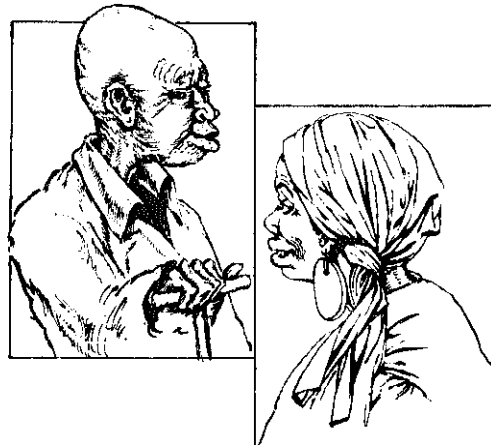



You can not get a pension if you are:

- In prison, in a TB hospital, in a hospital for other infectious diseases, like leprosy or in a mental hospital.
- Already getting any other pension or allowance which is more than R20,50 per month, for example from Workmen's Compensation.

Applying for old age pensions

Go to the offices of the Commissioner if you live in town or to the magistrates offices if you live in a rural area. If there is a social worker at the offices ask them to help you fill in the application forms for a pension. When you are granted a pension, you will get a red stamp in your reference book.

Take a letter from your chief or headman to say you can apply for a pension. Sometimes you can not get a pension without his permission if you live in a rural area.

Pensions are paid out every 2 months. There are pension pay out posts in each rural district, where the pensions are paid for a few days each month. Usually pensioners have to wait in queues for 1 or 2 days to get their pension. In some places people are forced to buy a place in the queue so that they can get their pensions. Sometimes they have to bribe the clerks paying the pensions, otherwise they refuse to pay. If this happens the pensioners should go to the magistrate to report it straight away.

Free medicines

Pensioners do not have to pay for treatment or medicines at clinics and hospitals if they show their reference books to prove they are old age pensioners. They can also get free spectacles and hearing aids. Pensioners have to pay only R2 instead of R8 when they buy a radio licence.

Company pension funds

At some factories there are pension funds which are for monthly paid workers only; at others there are pension funds for permanent workers only and contract workers can not belong to them. Usually the money you pay to the fund is a percentage of your wages and it is taken out of your wages by the company.

The government saves a lot of money if workers belong to a company pension scheme and then the government does not have to spend money to look after old people. If you belong to a company pension scheme, you can not get a government pension.

Employers also like company pension schemes because they can take off the money they pay into pension funds from the tax they pay. The employers also like it because it helps them to control their workers. Workers will not leave their jobs or strike because they know that if they stay in the same job for many years they will get a bigger pension.

Government pensions are paid out of tax which you pay all your working life. Everybody knows the government pension is not enough to live on, and many people think that company pensions will pay you more when you are old. But your company pension is usually only about 60% of your wages. If it was difficult to live on low wages, it will be even more difficult to live on your company pension. It would be better if everybody got bigger pensions from the government instead of having to join company pension funds.

Blind and disability grants

People who are blind, crippled, mentally retarded or suffering from diseases like TB which take a long time to get better can get grants from the government until they are well enough to work. If they are permanently disabled they can get grants for their whole life.

Only people over 18 years of age can get disability grants. You must get forms from the local social worker and get them filled in by

a doctor at the local hospital. You must also get a letter from your local chief or headman to take to the social worker when you apply. The payments are the same as for old age pensions.

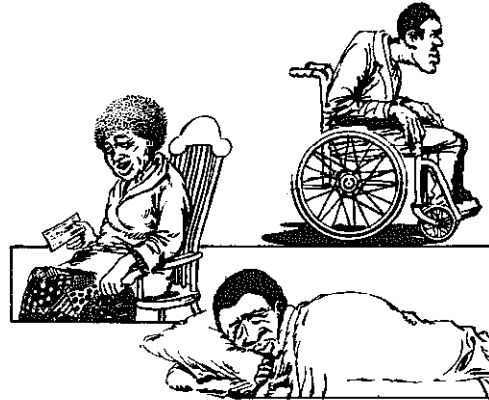

Maintenance grants

Maintenance grants are paid to people who can not support their families. They are even more difficult to get than pensions or disability grants.

These people can get maintenance grants:

- The wife of a man who gets a disability grant.
- The wife of a man who is disabled but has been refused a disability grant.
- A widow who can not support her school-going children younger than 16 years.
- A woman who has been deserted by her husband, but only if the court has issued a statement saying the man can not be prosecuted because he is physically or mentally disabled.

How to Apply

Apply at the administration offices or magistrates court. Maintenance grants are paid once a month, usually on the first Tuesday of the month. You will get R4,25 for each of your first 4 children, but nothing more if you have any others. Take all your documents like marriage certificate, childrens birth certificates, and divorce papers and a letter from your local chief or headman if you live in a rural area.

HOW TO BUDGET

Working out how to spend and save your money is called budgetting. If you budget, you can find out exactly how much you can spend.

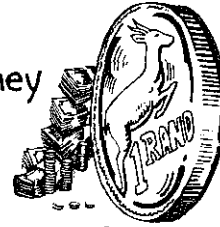

Income and expenses

To budget, you have to know your income and expenses.

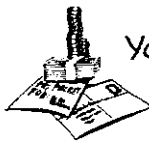

Your income is the money you get, your wages.

Your expenses are everything you spend your money on.

Most people get their income every week or every month. If you are not sure when you will get your money or how much it will be, it is more difficult to budget. This is a problem for many people living in rural areas because they get money from family members working in town. They do not know when the next money will come so they cannot budget easily.

Some expenses, like food, clothes and transport, are things which you need to live. Other expenses like newspapers and radios make life better but you can live without them. You must first budget for the things you need and if there is any money left over, you can spend it on other things you want, or you can save it.



Expenses come at different times.

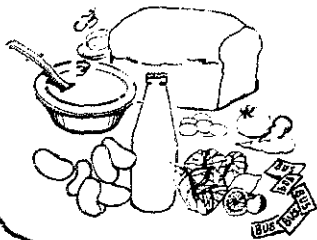

Food and transport must be paid for every day or every week.

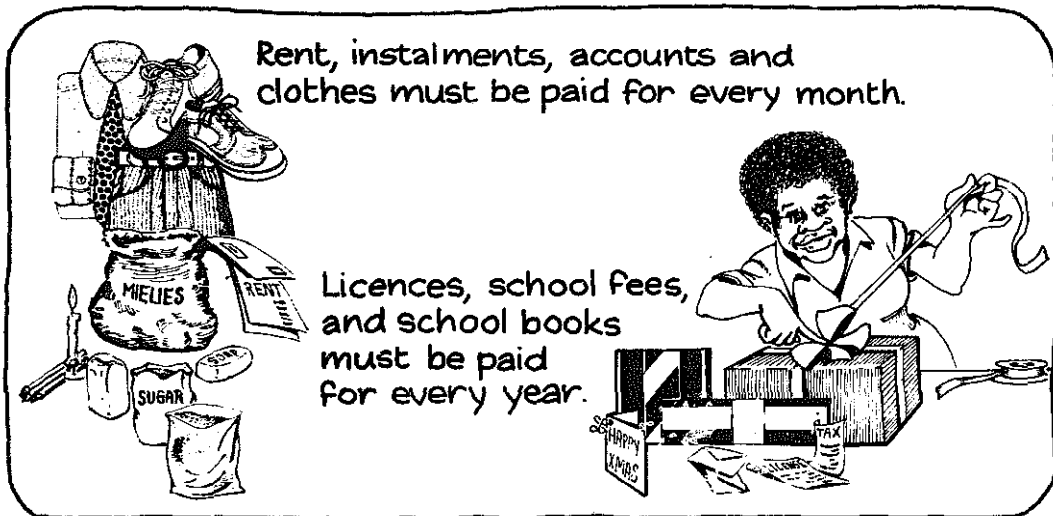

Working out your monthly income

It is best to work out your budget every month. First write down your monthly income. If you get paid every week, you must multiply your weekly wage by 4 to find out how much your monthly wage is. For example, if you get R35 per week, your monthly wage is R140.

If you earn R35 a week	then R35 x 4 (weeks per month)	your monthly income is R140
-------------------------------------	---	--

Write down any other income in the family. For example, somebody may get a pension or somebody may send money home.

Working out your monthly expenses.

Then write down your monthly expenses. These will be all the daily and weekly expenses, the monthly expenses and a part of the yearly expenses added together to give you your total monthly expenses.

Daily expenses - Multiply all your daily expenses by 30 because there are 30 days in a month. For example, if you buy bread every day for 24c, multiply 24c x 30

and find that you spend R7,20 per month on bread.

If you spend 24c on bread 	You must multiply 24c \times 30 (days in a month)	You get R7.20
daily expense		monthly expense

Weekly expenses - Multiply all your weekly expenses by 4, to get your monthly total.

For example:

Weekly expenses	Price		x 4	Monthly expenses	
	R	c		R	c
Groceries	3	00		12	00
Meat	2	00		8	00
Vegetables	1	50		6	00
Coal	2	50		10	00
Paraffin		75		3	00
Soap & washing powder		80		3	20
Busfare	5	00		20	00
				<u>60</u>	<u>20</u>

Monthly expenses - these are all the things you pay once a month.

For example:

Monthly expenses	R	c
Rent	21	60
Instalment on stove	7	00
Account for school uniforms	6	50
Club	2	00
	<u>37</u>	<u>10</u>

Yearly expenses - If you save some money every month, you will have enough to pay your yearly expenses at the end of the year.

For example:

Yearly expenses	Cost		÷12	Monthly expenses	
	R	c		R	c
Radio licence	8	40			70
School books	43	00			358
	51	40			428

So if you save R4,28 every month, you will have R51,40 at the end of the year to pay your yearly expenses.

Working out your monthly budget

Now that you have worked out your daily, weekly, monthly and yearly expenses, you can add them together to find out your total monthly expenses.

For example:



Rent		R21 60
Food	Meat	8 00
	Groceries	12 00
	Vegetables	6 00
	Milk	7 50
	Mealimeal	16 00
	Bread	7 20
Transport	Busfare	20 00
Cleaning things	Soap & Washing powder	3 20
Cooking & Lighting	Paraffin	3 00
	Coal	10 00
Accounts	School Uniforms	6 50
Instalments	Stove	6 74
½ th annual expenses (to be put aside)		4 28
TOTAL MONTHLY EXPENSES		R134 02

Now you know your income and expenses, you can work out how much money you have left every month to save or to spend on things you want. The money left over after you have taken away your expenses from your income is your balance.

For example:

Budget for November	R	C
Income	140	00
Expenses	134	02
Balance	5	98

You can save the R 5,98 or you can spend it on things you want.

Sometimes you find that your expenses are more than your income. If this happens, you have to borrow money or go without things you need. When you know you are overspending, you will have to decide what to stop spending money on. If you have spent money on things you can do without, cut these out first. Then cut down on other things until your expenses are less than your income.

Birth Certificates



Many people do not have birth certificates. When they go to register for a job or to get a pass book, they can not prove where they were born. Sometimes the pass office just tells people they belong to the Transkei, Vondaland or BophuthaTswana because of their surname or language. If a person gets a pass stamped with one of these places, it is difficult for him or her to get registered for a job in town.

Parents should get birth certificates from the Commissioner's Office for their children as soon as they are born. If they are registered before

one year, it is free, but after one year you must pay R2,50. The Commissioner will want to know where the child was born, who the child's parents are and the date of birth.

If the baby was born at home, you must get letters from two women who were present at the birth. The letters must say that they know the child, they know where he or she was born, where the birth took place, who were the parents and other details about

the person. The letter must be stamped by a commissioner of oaths (see p538).

If the baby was born in hospital, you must know the date of birth. Check the name the hospital gave the baby, because they make mistakes. If there are mistakes it is difficult to get the right birth certificate.

Anybody who wants help in getting a birth certificate can contact any Black Sash advice office (see p 537).

Adoption

Adoption is bringing up a child who is not your own child. When people adopt a child it is usually a child who belongs to their family, for example when the child has been abandoned by its parents or when its parents have died. If the child's parents are your relatives, adoption is quite easy.

You can make an application for adoption with the social worker at the administration offices or the magistrates offices. These adoptions do not take long and the social worker usually lets the child live with you while you wait for the adoption to become legal. Even if you are a single woman you can adopt a child who belongs to your family and who is already living with you. Many grandmothers whose husbands have died are allowed to adopt their grandchildren. Many do this so that the grandchildren can take over their grandmother's house when she dies.

If you are applying to adopt a child whose parents have died, you must have a death certificate from the district surgeon in the area where the parents died and the birth certificate of the child. The younger the child, the easier it will be to adopt it. If you are applying to adopt the child of an unmarried mother after the mother has died, you must have permission from the father's family if you know who the child's father is. You will not be allowed to adopt the child if the father or his family is claiming the child.

If there are problems, adoption can take a long time, up to a few years. Sometimes you have to go to the place where the child was born to get a birth certificate. Then you have to go to the place where the parents died to get a death certificate. This can take a lot of time, but do not be discouraged. Ask the social worker for help and if you still have problems, go to the Black Sash advice office.

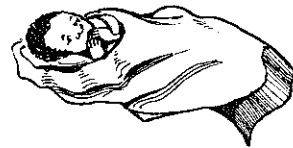

People sometimes want to adopt a child because they cannot have children themselves. This is more difficult. You have to speak to the social worker at the commissioners office or magistrates office and explain that you can not have a baby. Usually both the man the woman have to be examined by a doctor to find out why you can not have a child. Sometimes the doctor gives the woman or the man medicines so they will have a baby. If there is nothing the doctor can do to help you have your own baby, apply to adopt a child. It might take a long time and you will have to prove to the social worker that you will be able to support and look after a child.

When they find a baby for you, you will have to go to court to sign adoption papers and the social worker will visit you sometimes to see if the child is happy.

Marriage Laws

You can get married by customary law or by civil law. Both kinds have advantages and disadvantages. Many South Africans have both a customary law marriage, and a civil marriage in church or court.

Customary Law marriage

A customary law marriage is getting married according to traditional African customs. The man must usually give lobola to the woman's family before the marriage is accepted. There are many disadvantages for women who marry by custom only:

- When her husband dies, the wife can not inherit his money or the things he owned. The husband's nearest male relative will inherit nearly everything. The wife only inherits her house property: the home, fields, cattle and other things which were given to her by the head of the husband's family when they married. House property also includes the money which the wife and children earn. It is the responsibility of the husband's nearest male relative to look after and support the wife if she was married by customary law.

- If the husband leaves the wife he married by customary law, he can marry somebody else without getting a divorce. So the first wife will have no protection. She will not get maintenance from the husband, and he will be able to claim back the lobola from her family.

Civil Law marriage

A civil law marriage is when you get married in church or in court. To get married in church or court a woman must have the written permission of her father or legal guardian. If she lives in the Cape or Orange Free State, she only needs this permission if she is younger than 21 years. If the father or guardian refuses permission, tell the commissioner or magistrate or get advice from the Black Sash (see p 538).

There are 3 kinds of civil law marriages:

- In community of property.
- Out of community of property without an ante-nuptial contract.
- Out of community of property with an ante-nuptial contract.



Unless you tell the priest or magistrate which kind you want, you will be married out of community of property without an ante-nuptial contract. Different kinds of marriages have different advantages and disadvantages:

■ In community of property:

In this kind of marriage the wife's property and the husband's property are joined. They each own half of everything they have. If the husband dies without making a will, or if they get divorced, the wife gets half of the property they both owned. The disadvantage is that the husband can do things without the agreement of the wife, but the wife can not do things unless her husband agrees. For example her husband has to sign things like hire purchase agreements. She can not buy things without his permission.

If you want to marry in community of property, you must tell the magistrate or person who is going to marry you at least one month before the wedding.

■ Out of community of property without an ante-nuptial contract:

This is the most common form of marriage and you will be married in this way unless you ask for one of the other ways.

In this kind of marriage, the husband and wife each own the property which they had before the marriage and which they each bought during the marriage. But the husband has control over the wife. For example, she must have his

permission to sign hire purchase agreements or to open a bank or building society account.

If they get divorced or if the husband dies, the wife keeps her own property.

But if the husband dies without making a will, the wife gets only the things she would get if she was married by customary law. Most of the husband's property will be inherited by his nearest male relative.

■ Out of community of property with an ante-nuptial contract:

In this kind of marriage the husband and wife keep their own property during and after the marriage and the wife can do things like sign hire purchase agreements without her husband's permission. If the husband dies without making a will, his property will be inherited by his nearest male relative and the wife will keep her own property.

The ante-nuptial contract must be signed before the wedding in front of a lawyer and usually costs about R50.

Marriage certificates

If you were married in church or in court, you will get a marriage certificate. At the top of the certificate there will be a number like 2360/1976/188, and another number in the top right hand corner of the certificate. It is a good idea to write these numbers somewhere. If you lose the certificate, you can tell the commissioner's office the numbers and get another copy.

Divorce Laws

Married people suffer many problems and tensions and many get divorced. Before getting divorced, try to talk about the problems in your marriage with somebody like a marriage guidance counsellor (see p 538).

The cheapest way to get divorced is for the couple to go to the commissioner or magistrate with their marriage certificate and explain why they want to get divorced. If he agrees with your

reasons, he will tell you to come to court on a certain day. Sometimes he will send you a letter to tell you the day to come to court. If you do not go to court on that day, you can be fined. If you can not go, you must send a letter to say why. Then the magistrate or commissioner will make another day for the divorce case.

Usually the case costs about R15 and you will get a divorce certificate.

The certificate will say who must look after the children if you have any. Usually it is the mother, but the father is the legal guardian and he is allowed to see them at any reasonable time. The children keep the father's surname.

If you were married in community of property, the divorce court also decides what property the husband and wife get after the divorce.

Legal Help

You can go to any lawyer to advise you about your divorce. If you can not afford to pay, you must tell this to the lawyer the first time you go to see him or her. You can ask the lawyer to apply to the Legal Aid Board for the

fees. If the lawyer refuses, go to the Legal Aid Board in town or the Legal Aid Officer at the magistrate's court and ask for legal advice (see p 537).

Getting married again

People who were married by civil law in church or court can not get married by civil law again unless they have been divorced, or if their first husband or wife has died. Many people do not know it is a crime to marry again without being divorced. If a man marries again before getting divorced, the second marriage is not legal and the second wife has no protection from the law if her husband abandons her and their children. The man can also go to jail.

Making a Will

A will is a letter which tells your family what you want them to do with your money and possessions after you die. Every adult should make a will, whether they are young or old. If you die without a will it can be a lot of trouble for your family because sometimes they have to wait a long time before they can get your possessions and it may cause many family fights.

It is easy to make a will and does not cost anything. You must first decide who you want to leave your things to. Most people leave their things to their husband or wife and their children, but you can leave your things to anybody you want. After you die, the people you name in the will must get your things. Even if people fight after you die, there is nothing they can do to change your will.

The next step is to decide who you want to be the executor of your will. The executor is somebody who is responsible for dividing up your things according to your will after you die. You can choose anybody to be your executor. It is best to choose a wise person whom you trust. Before you write the will, ask them if they agree to be the executor.

Your will must be signed by 2 witnesses who are not named in your will. The witnesses must both watch you signing your name on every page of the will. They must both sign their names next to your signature on every page.

If you change your mind about your will you can make a new one. The last will you make is the one which is legal, even if it is different from your earlier wills. Do not worry if you lose your will because you can make a new one.

If you write something in your will which can not be done because it is against the law, for example, if it is against marriage laws, it will be corrected by the commissioner or the magistrate after you die.

Keep your will in a safe place and tell your family where it is in case you die suddenly. Some people give their will to the executor to look after.

The will must be neatly written without mistakes and easy to understand. If you make any mistakes the first time you must write it again until there are no mistakes. This is how to write the will:



I, _____ ; identity number _____,
 (full name)

of _____
 (full address)

declare this to be my last will and testament. I revoke all former wills.

I appoint as executor _____, identity number _____,
 (name)

of _____
 (full address)

I bequeath my entire estate to either my husband/wife _____,
 (name)

identity number _____, of _____
 (address)

or, failing him, to my children for equal distribution among them.

(This means that if you die first, your husband or wife will get all your possessions. But if he or she dies first, your children will each get an equal share of your estate.)

If you own a house you must name the person you want to give the house to, otherwise it will be sold and the money will be divided among all the people in the will. You must write:

I bequeath the house at _____
 (address)

to _____ ; identity number _____
 (full name)

Dealing with the Police

Questioning

- ▶ Ask to see the policeman's identity document. Every policeman, uniformed or plain clothes, must carry this card, which has his name and photograph.
- ▶ If he shows you his identity card, you must give him your name and address. If you refuse, you can be fined or sent to jail.
- ▶ Tell the police you want to see a lawyer before you answer questions.
- ▶ You do not have to give any other information except your name and address, it is your right to remain silent.
- ▶ The police are not legally allowed to assault you for not answering questions. If they do assault you and you make a statement, you must:
 - tell a senior policeman
 - insist on seeing a doctor
 - tell your lawyer
 - tell the magistrate when you appear in court.

Searches

Body searches:

- ▶ A policeman may search any man at any time or place.
- ▶ A policeman may not search a woman. Women can only be body searched by a policewoman or any other woman who has been asked by the police to do so.

House searches:

- ▶ The police may search any house with or without a search warrant. A search warrant is a paper signed by a magistrate or a Justice of the Peace giving the police permission to search the place at the address on the warrant.
- ▶ If you refuse the police entry, they are allowed to force their way in to search the place.
- ▶ The police can take anything away but they must give you a receipt with each thing they take written on it.

Arrests

● Arrests with a warrant

- ▶ A warrant of arrest is a paper signed and stamped by a magistrate or a Justice of the Peace giving the police permission to arrest you. It has your name on and says why you are being arrested.

- ▶ Always ask the policeman to identify himself and to show you the warrant of arrest.

● Arrests without a warrant

- ▶ A policeman can arrest you without a warrant after he has identified himself and told you why you are being arrested.

The police are allowed to shoot and kill people who resist arrest or try to escape.

After the arrest

- ▶ After you have been arrested, they can keep you at a police station for 48 hours before taking you to court.

- ▶ Tell the police you want to see a lawyer because it is your right.

- ▶ If you can not afford to pay a lawyer, ask the police to phone the Legal Aid Board or any other organisation which you know about (see p537) which will arrange a lawyer for you free of charge.

- ▶ Do not sign any statements until you have seen a lawyer.

- ▶ If you can not read and write, tell the police and do not put your thumbprints on any statements which they write for you.

- ▶ If the police assault you because you will not sign a statement, you must:
 - tell a senior policeman
 - insist on seeing a doctor
 - tell your lawyer
 - tell the magistrate when you appear in court.

HIRE PURCHASE

If you want to buy something expensive like furniture, a stove or a fridge and you do not have enough money to pay cash for it, you might decide to buy it on hire purchase. When you buy on hire purchase, you do not pay the full price straight away. You pay a cash deposit and the rest of the price in monthly instalments.

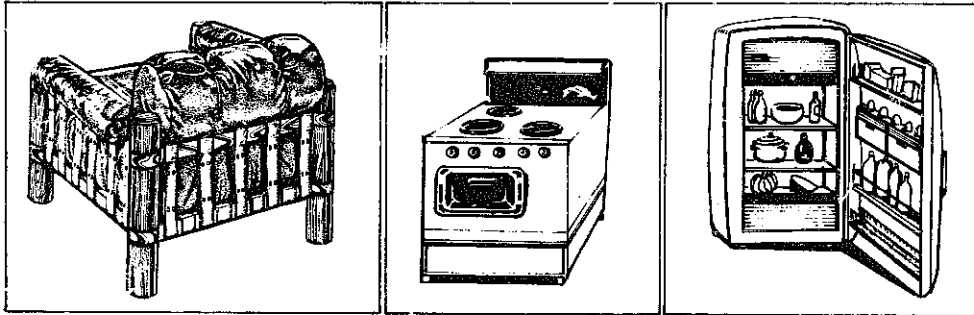

There are many things to know and think about before you buy anything on hire purchase. Hire purchase helps people because they could not afford some things if they had to pay cash for them. But it is also important to know that buying on H.P. costs more than paying cash.

For example:

This is an advertisement for a bedroom suite.

BEDROOM SUITE
only R270

DEPOSIT: R27
R12,25 per month over 24 months

The advertisement features a central illustration of a bedroom suite including a bed, a desk, and a chair. The text is positioned around the illustration, with the headline and price at the top, and the deposit and payment details at the bottom.

Look at the cash price: it is R270.

Now look at the H.P. price: it is R27 deposit and R12,25 p.m. for 24 months.

The advertisement does not give a total for the H.P. price. If you work out this total you will find how much more it costs to buy the bedroom suite on hire purchase.

Working out the H.P. total!

First, multiply the monthly instalments by the number of instalments you have to pay.

For example if you are paying back over 24 months (2 years):

$$\mathbf{R12,25 \times 24 \text{ is } R294}$$

Then add the deposit. This will give you the total hire purchase price.

$$\mathbf{R294 + R27 = R321}$$

If you take away the cash price from the hire purchase price, you will see it costs R51 more to buy the same bedroom suite on hire purchase.

$$\mathbf{R321 - R270 = R51}$$

At the shop they make it sound like there are no problems when you buy things on hire purchase, but there are many things to be careful about.

Let us say that you want to buy the bedroom suite on H.P. You pay the R27 cash deposit and then you sign a hire purchase agreement. The agreement says that you will pay the rest of the money, plus interest in monthly instalments for the next 24 months. Until you have paid all the instalments the bedroom suite belongs to the shop. It does not belong to you until you have finished paying for it.

After you have signed the H.P. agreement, you are forced by law to pay the monthly instalments. The shop can take you to court if you do not pay for one month. The court can let the shop repossess your bedroom suite because you have not paid your instalment. This means that the shop can take back the bedroom suite without paying back any of the money you have already paid in deposit and instalments. Then the shop can sell the bedroom suite to somebody else.

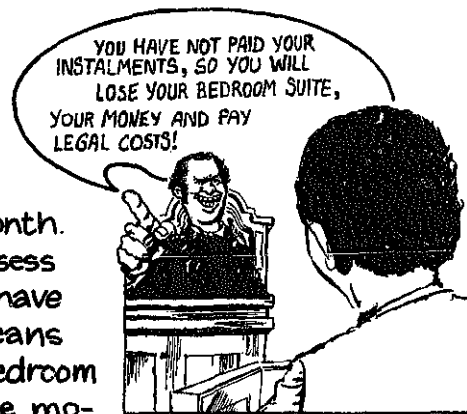

Before you sign the H.P. agreement, it is very important to make sure that you will have enough money every month to pay the instalments.

Signing the H.P. agreement

Hire purchase agreements are difficult to understand, so you should take a long time to read them carefully before you sign them. Ask the sales assistant to explain anything which you do not understand.

The first part of the form is information about you - your name, address, where you work, what job you do, how many children you have and so on.

There will be a question in the first part of the form asking if you have ever been insolvent. This means if you have ever been taken to court because you could not pay your debts. There is usually a question about trade references. This means you must give the names and addresses of other shops or businesses that know you and which will say that you are able to pay your instalments. You can give the name of your employer.

It is easier to buy something on hire purchase if you have already got other hire purchase agreements at stores which will give you a good reference.

The second part of the form is about the things which you want to buy. For example, it will describe the bedroom suite you are buying.

The last part of the form is about how you will pay.

• the first thing you write down is the cash price of the bedroom suite:

R270

• then you write down how much cash deposit you are paying:

R27

• then you take the deposit away from the cash price to find how much you must pay in monthly instalments. This is called the Balance:

$$\mathbf{R270 - R27 = R243}$$

• then you add the interest which you will pay. Different shops charge different interest. Let us say, for example, you are paying 21% interest, then

$$\mathbf{21\% \text{ of } R243 = R51}$$

Sometimes the interest is called the finance charge.

• now add the finance charge to the balance:

$$\mathbf{R243 + R51 = R294}$$

R294 is the total you must repay in 24 months. To find out how much you will pay per month, divide

$$\mathbf{R294 \text{ by } 24 = R12,25}$$

You will also write down on this part of the form when and where you will pay the monthly instalments.

The rest of the H.P. agreement is printed in very small type and uses language which is very difficult to understand.

Some of the things written on the agreement usually mean:

- You do not own what you have bought until the last instalment is paid, and you cannot sell it until you have finished paying.
- If you do not make your payments on time, the shop can charge you extra interest on the money you owe.
- You are responsible for the things you buy and if they are lost or damaged it is up to you to repay or replace them.
- If you do not pay your debts, the shop can go to court to take back the things from you but the shop cannot repossess the things without a court order. You should be careful not to sign any extra forms which give the shop permission to repossess the goods without a court order.

Read everything very carefully before signing. You must make sure that you get a copy of the hire purchase form to keep for yourself. You must also make sure that the things described on the H.P. agreement are the ones you want to buy.

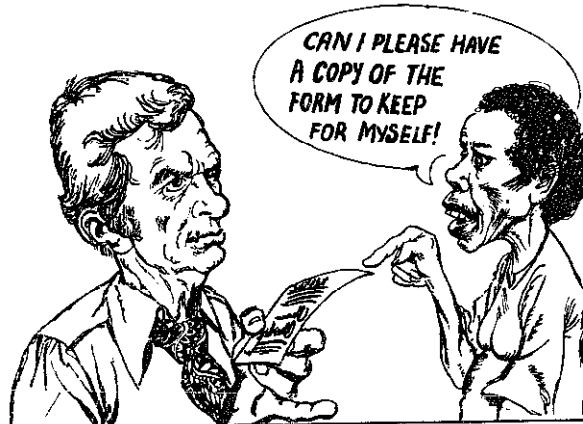

The shop usually asks for somebody else you know to sign for any hire purchase agreement. The person who signs the guarantee for you is promising to pay the instalments if you fail to pay them.



- Remember that you have to pay every cent once you have signed the agreement. Make absolutely sure that you can afford it before you sign.

- Never buy anything on hire purchase from somebody you do not trust.

- Make sure you read everything on the agreement before you sign it.

- Make sure that you understand

everything on the hire purchase agreement before you sign it. Get someone else to go along with you to help you fill in all the details properly before you sign.

- Make sure you have a copy of the agreement and keep it in a safe place.

- Make sure that you are satisfied with everything the salesman tells you. If he makes any promises to you, ask him to give them to you in writing.

BUYING CLUBS

One way of buying something expensive without using hire purchase is by forming a buying club. A number of families, say about 10, can start a buying co-operative together. Every month each family would give the co-operative a certain amount of money, say R12. This money is put together and every family gets a turn to have all the money for one month. For example, 10 families giving R12 a month, makes R120 a month. In this way every family would get a chance to buy something expensive about once a year without having to use the more expensive hire purchase system. There are no finance charges or repossessions. Buying clubs are one way people can join together and help one another.

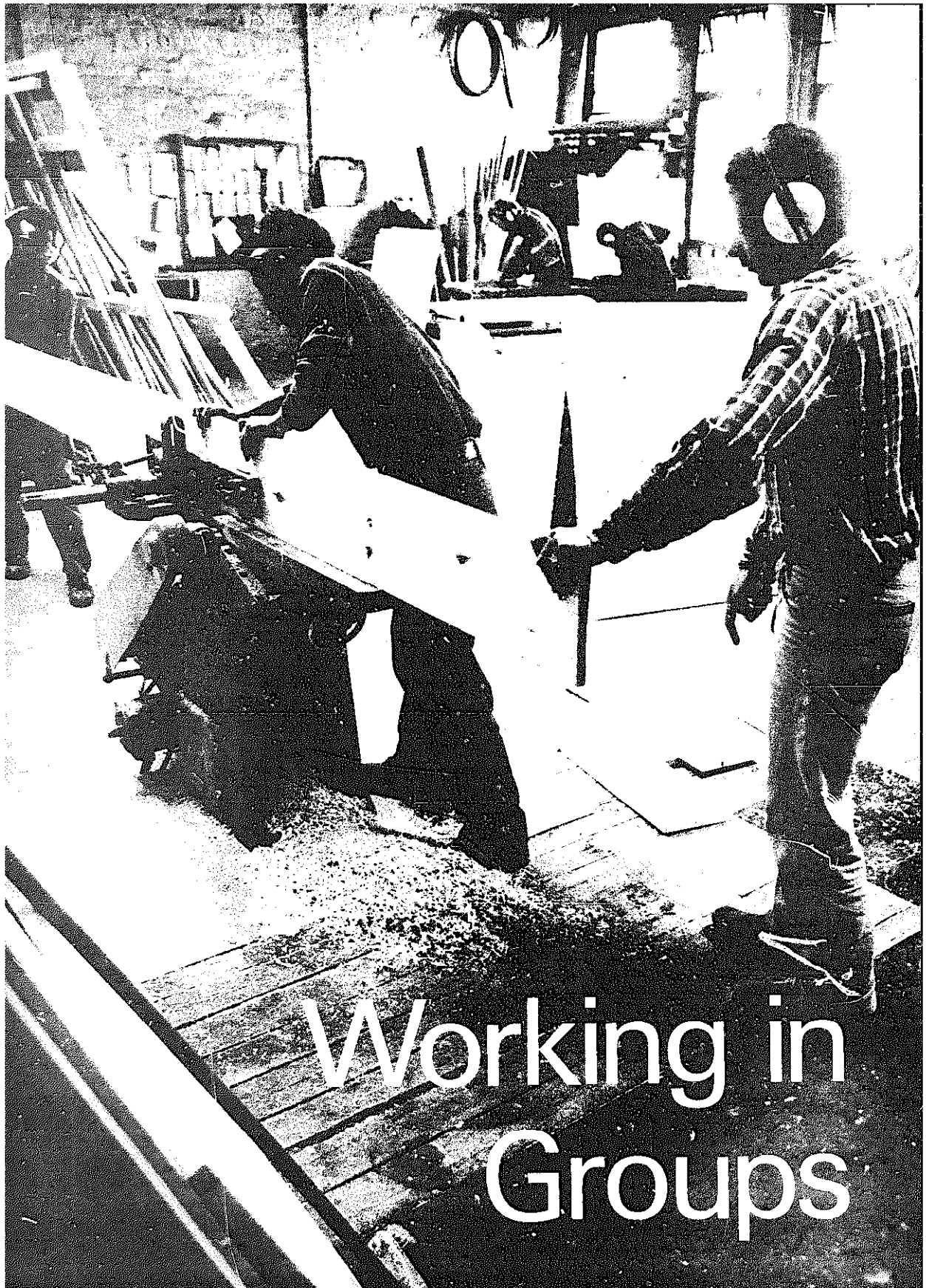

Working in Groups

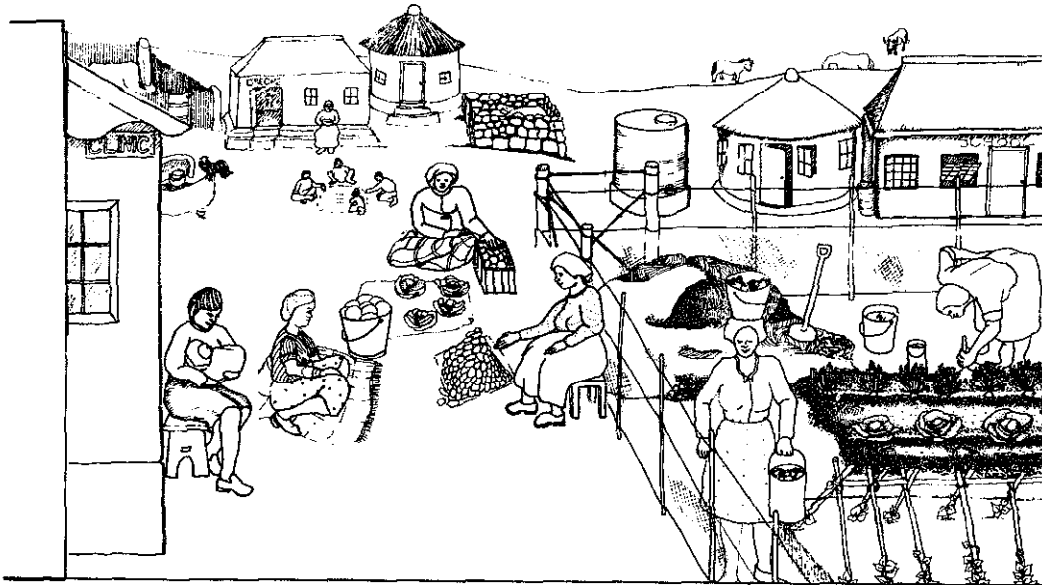

A production group is a group of people who make things together. In this part of the book we write about things which production groups can make without machines or factories. There are many reasons why people want to start production groups. Many people in South Africa can not find jobs. They want to work but there are not enough jobs. Other people want to work for themselves. They are tired of working all day for bosses who make money and pay them very low wages. When they join production groups they learn new kinds of work and they learn how to organise themselves. They learn how to share money, how to do book-keeping and how to work together.

Some people work without a boss, but they do not like to work in production groups. They say it is better to work alone and keep all the money they make for themselves. But most people like to work in groups because they can share ideas and work out problems together. Also, joining a group helps people to buy tools, machines and materials. They could not afford to buy these things alone.

Joining a group helps people to solve problems which they could not solve alone. For example, if some mothers start a sewing group, they might all have the problem of what to do with their children while they are sewing.

They might start a creche and take turns to look after the children.

When you work for a boss you have to do what the boss tells you to do. But when you work in a co-operative group, you decide for yourselves what to do. In a co-operative, everybody can work things out together. Then they know why they are doing things and what the problems are.

As a co-operative group, there are many questions you will have to ask:

- ▶ What are you going to make?
- ▶ Can you get a place to work in?
- ▶ How much rent must you pay?
- ▶ How much will the group members have to pay for transport to get to and from work?
- ▶ How will you sell the things you make?
- ▶ How much money does each member of the group need?
- ▶ How much will you have to sell your products for to make enough money to pay these wages?
- ▶ How will the group be organised?
- ▶ Can you sell your products more cheaply than they are sold for in shops? To work out your selling price, you must add up all the money it costs to make your products - costs of raw materials, transport, electricity, machines, rent, repairs, tools and wages.

It is important to try to answer all these questions before you start working together. These are some of the things you should discuss:

Deciding what to make

It is very important to make things which other people want to buy. Many groups fail because they make things which people do not want or can not afford. If your group does not know what to make find out what people near you already use and need. Find out what skills the people in the group have. Then see if the skills you have can be used to make things people need. If people need things which you do not know how to make, you must decide if you can learn how to make them or if you must give up the idea of making them.

Different kinds of production groups

In some groups, all the members do the same work in the same place every day. In other groups, all the members work in the same place every day, but each person does their own work. Other groups can not find a place for all the members to work together, so each

person does the same work at home and the group meets once or twice a week. Other groups join together only to buy materials and to sell their products.

Where to work?

You should try to find a place which you can use free or rent. If you do not need a lot of space, you could work in somebody's house. Ask community workers, church ministers, teachers or anybody else to help you to find a place to work in. Make sure it locks because equipment costs a lot of money.

Who can join the group?

It is important that all the people in the group can be friends and work well together. If all the people in the group have the same needs and the same problems, it is easier for them to work together. It also helps if all the members can work together for the same hours every day.

Do not start with too many people. It is better to start small and then when the group is strong you can bring in more people.



Planning

There are many things that you have to talk about and work out before you start working.

The group must make a time for planning every week. Every week you must make plans for the next week. But you must also have meetings when you make plans for a longer time, for 3 months, 6 months or 1 years time.

If the group does not finish the things it planned, look very carefully at how the group has been working to find out why. Sometimes you will find that the time you gave in your plan was too short. It could also be that the group is working too slowly, the members do not come every day on time, or they are talking all the time and not working. Maybe they have not learnt enough skills to work faster. If this is the reason you must see if you all need some more training.

Administration

There is a lot of administration work to do in a production group:

- ▶ One person has to go around before meetings to each person in the group and find out if there is anything that they want to talk about in the meeting. This list of all the things that people want to talk about is called the agenda. The same person must write down everything that happens in meetings. This is called taking minutes. In the weekly and monthly meetings the whole group sits together to discuss the things on the agenda. The group can choose a chairperson to lead the meeting. Each member of the group can have a chance to be the chairperson.
- ▶ When a group is big, with 15 to 60 members, it is better to have a committee. This committee is made up of people chosen and accepted by all the members. The committee is not like a boss, because it cannot make any big changes without the agreement of all the members. Each committee member must be given a job to do. For example:
 - ▶ One person must be in charge of getting materials and transport.
 - ▶ One person must do the bookkeeping.
 - ▶ One or two people must do the selling and taking orders.

Deciding about money

The group members must not pay all the money from sales to themselves. They have to keep some of the money to buy tools, repair machines and buy materials every month. After that, all the members can get their wages. It is best if everyone gets the same wages.

Sometimes there is still some money left over. In a business this extra money is called profit and it goes into the boss's pocket. In a group, everyone decides together what they want to do with the extra money. Some groups use this money to buy more equipment or to buy something for the community, for example to buy a water pump or cement for building a creche. Other groups use the money to help another production group to start or they use it to start a pension fund.

Try to decide how you want to use the extra money at the beginning when the group is still working out its plans. There can be big fights later if you do not all decide in the beginning.

Bookkeeping

Bookkeeping tells you about all the money the group makes and spends. It is not difficult to learn bookkeeping. You can learn by correspondence, but it is much quicker to get someone to teach you using the group's own books.

Marketing

Marketing is usually the biggest problem of all. Here are some important questions to ask about marketing, before you start making things:

- Who will buy the things you make?
- How will you take them to the place where you want to sell them?
- How will you sell the things? In a shop? At the side of the road? From door to door?
- How do you expect people to pay - in cash, layby or to pay a deposit and the rest when they collect?
- If you sell things to a shop how much will the shopkeeper sell them for?
- How will you advertise the things you make? Will you put up posters and notices in churches, schools and other places? Will you print a cheap cata-

logue or will people just tell each other about the things that you make?

There are some special shops that try to help co-operative groups. They sell materials cheaply to groups and help them to sell what they make. The Zakhe shop is in Cape Town (see p 530) and Race Relations shops are in most big towns. Try to find out about shops like this in your area.

It is best to make something that the people in your community need and to sell your own things. Tell people why they should buy things made in the community instead of factories. Ask the ministers in the churches to tell their congregations about groups that are trying to make their own work without exploiting workers.

It helps if you give your group a name. People will remember you by this name. It also helps if you make a small picture design that shows what your group does. Then people remember your group more easily. Some groups have a rubber stamp made with their name and their picture on. They stamp it on all the things they make and on all their advertisements.

Make samples or take photographs of the things you make, so that you can show them to people before they order. This will help you to get orders.

Making a constitution

When people work together it is very important to have a constitution that tells them clearly what their rights and responsibilities are. Without a constitution, there can be trouble.

For example, someone in a sewing group wants to leave the group and take one of the sewing machines away with them. They say it is their right because they worked with the group and they made part of the money that the group used to buy this machine. Other members of the group say 'No, it is not right to take away the machine. We bought the machine together. A person who is leaving cannot take it away.' The members are confused now, they do not know who is right. If the

group has no constitution they will have to have a meeting and decide about this problem. If they had started off with a constitution, that all the members had agreed to and signed, they would not have this problem. The constitution must say clearly what happens if you leave the group. Then there can be no fights. Nobody can say that they did not agree to this or that. The signature of each member shows that they agreed to accept all these conditions and responsibilities. They cannot say they did not agree.

Other kinds of things that a constitution can say:

- All group members get equal income.
- There is a minimum income for all members.
- What happens to the money left over after all the wages, materials and repairs have been paid.
- How much money must be kept for tools and repairs.
- How long the training period is.
- How the group decides if someone must leave or someone can join.

There are many other things you may need to write into your constitution. If you have any difficulties, ask advice from another co-operative group or one of the organisations which helps co-operatives.

Meeting other groups

It helps to meet with other production groups. Your group may have problems that they do not know how to solve. They can hear how another group solved nearly the same problems. Now they see that an answer is possible.

Ask an organisation which helps co-operatives (see p 530) if they know other groups near you. Sometimes they can help you with marketing.

Production groups are doing something important for everyone in the community. It is important for people to see that some people can make their own jobs and solve their own problems without a boss.

Making Clothes

Many production groups make clothes. Some make clothes like school uniforms and jerseys which they sell in their communities. Others make hand-printed and embroidered dresses and shirts which they sell to craft shops. In this part of the book we write about sewing by hand and by machine, knitting, printing and dyeing materials and on pages 525 to 536 we give information about buying materials and selling the clothes you make.

Choosing material

Cotton is one of the cheapest materials. It lasts a long time and is easy to make clothes with. Thick cotton materials like Fasco and sail cloth are good for making children's trousers. Calico, Daydawn, Sungleam and German prints are thin cotton and are nice for making summer shirts and dresses.

Some materials shrink when you wash them. It is best to wash any material before you cut or sew it. Wash cotton in hot soapy water and iron it before you cut it.

Winter materials, like wool and serge are expensive, but they last a long time. They are good for making coats, jackets and other clothes which you can keep for many years.



Paper patterns

Paper patterns help you to cut the material to the right size so you do not waste it. You can make your own paper patterns or you can buy them.

If you are sewing for somebody you know, you can cut a newspaper or brown paper pattern the same shape as a garment which fits the person. Make the paper pattern a little bigger than the garment so you will have enough material to sew seams and hems.

If you are making clothes to sell, you do not know who will buy them, so you can not measure the person to make a paper pattern. You can buy paper patterns in shops for different sizes. On the back of the pattern packet you will see how much material you must buy.

Shop patterns are often hard to understand. If you are using one for the first time, try to find somebody who can explain to you how to use the pattern. Some paper patterns are for people who are learning to sew and they are easier to understand. Butterick "See and Sew" or Simplicity "Jiffy" are easy patterns.

Patterns are expensive to buy, usually about R2,50 each. It is a good idea for a group of sewers to choose a pattern and buy it together to save money.

How to understand patterns

Here are the meanings of some words you will find on patterns:

- Right side of material. This is the side of the material where the pattern is brightest. This is the side which will be the outside of the garment when it is finished.

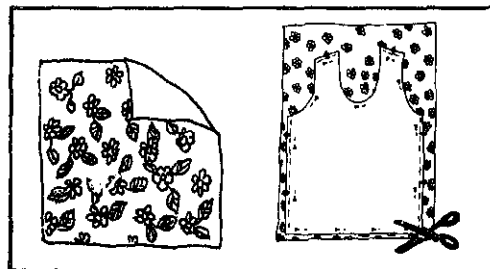

■ **Wrong side of material.** This is the side where the pattern is not so clear. It is the inside of the garment. Sometimes it is hard to see which is the right side and which is the wrong side. Usually the right side of the material looks neater and smoother than the wrong side.

■ **Fold-lines.** These are lines marked on the pattern which tell you where to fold the material to make a collar or a cuff or pockets. Mark these lines on your material by tacking along them and folding the material along the tacking stitches.

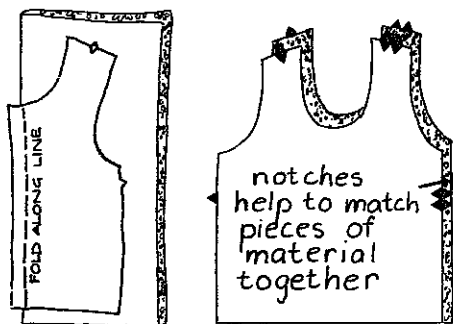

■ **Notches.** These are the black marks like this ▲ and this ▲▲ which are around the edge of the pattern. When you cut out the material from the pattern, cut out the notches too. Match the notches when you sew the different pieces of material together.

■ **Pleats.** The material is folded over and sewn into place. Pleats are usually made in skirts so that the person can walk easily.

■ **Tucks.** A tuck is like a small pleat. Tucks are used in the waist of trousers and in skirts.

■ **Facing.** This is a piece of material sewn onto the inside of a neck or armhole so that the opening is strong and neat.

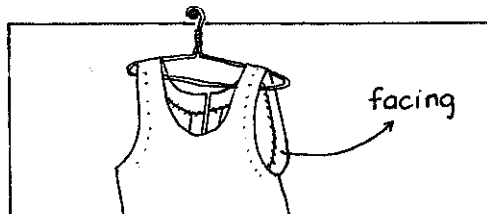

■ **Interfacing.** This is the same shape as a facing, but a little smaller. It fits inside the facing and does not show. Interfacing is used to make collars and cuffs stronger. It is always inside the facing, so you can not see it when the garment is finished. Interfacing can be made from any extra material you have or you can buy special interfacing in the shop. The shop interfacing can be ironed inside the facing.

■ **Underlap and overlap.** At the slit of an open cuff, a strip of material is sewn onto each side to cover the raw edges. The underneath strip is the underlap and the top strip is called the overlap.

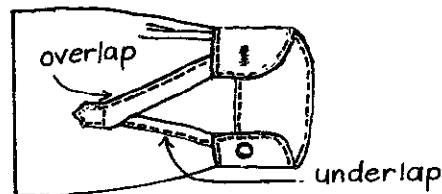

■ **Yoke.** A yoke is the top part of a shirt or a dress.

■ **Seam allowance.** This is the material about as wide as your thumb which will be inside the seam when you have sewn it.

■ **Tack.** This means you must sew the material with big tacking stitches.

■ **Sew or stitch.** This means you must sew the material with small back-stitch or with machine stitch.

■ **Topstitch.** This is a machine stitch or backstitch which sews together all the layers of material and shows on the right side of the material. Topstitch makes the edges of collars, necklines of sleeves lie flat. Topstitch can also be used for decorating, for example on a pocket.

■ **Press.** After you sew a seam or any two pieces of material together, you must press them with a warm iron. The garment will be flat and easier to sew if you press each seam as you sew it. Sometimes, homemade clothes look untidy because the inside seams have not been pressed well.

Different stitches

■ Tacking stitches are quick and easy to do. They hold the material together before you sew it with a machine or with a strong backstitch. Thread your needle as long as from your hand to your elbow. Put the right sides of the material together and make the stitches as wide as your finger. When you have tacked all the pieces of the garment together, you can try it on to see if it fits. Pull out the tacking stitches when you have sewn the pieces together with a machine or backstitch.

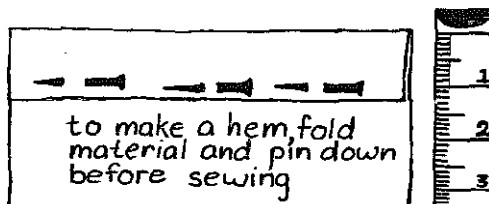

■ Backstitches are small, strong stitches that look like machine stitches. Use them for sewing seams or darts. A seam is where 2 pieces of material join together. Before you sew a seam, pin the edges of the material so that they stay together while you sew them. Sew on the inside of the material, so that when you turn it the right way, you can not see the stitches. To start backstitches, sew 2 small stitches, one on top of the other. Then put your needle into the material where your last stitch ended and bring it out a distance of two stitches in front. All the stitches join together to make one line. Finish off with two stitches.

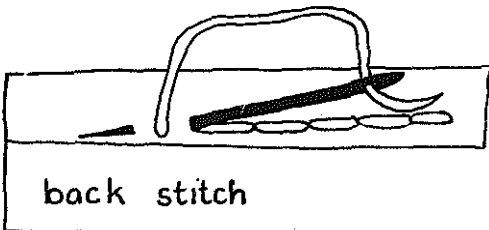
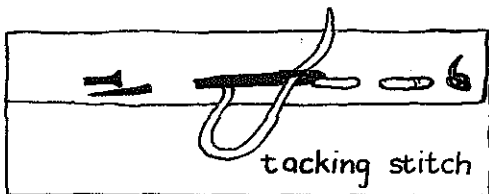

■ Hemming stitches are for hems at the bottom of dresses, skirts, sleeves and trousers. The stitches are small and slanting. Always sew the hem on the inside of the garment. Catch only a few threads of the material on the right side of the garment, so that hemming stitch does not show.

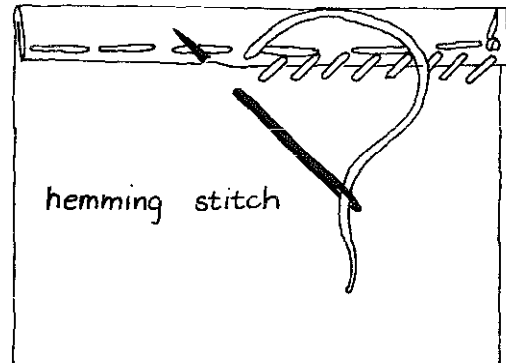

■ Darning stitches are for repairing holes. Use darning wool for holes in woollen socks and jerseys and darning cotton for holes in cotton shirts and dresses. The darning wool or cotton must be the same as the material you are darning. Use a thick darning needle and do not pull the stitches too tight. Sometimes it is easier to put a ball or something hard under the hole. Start with two stitches at the edge of the hole. Sew small stitches in the material around the hole. Sew first one way and then the other so that the hole is closed.

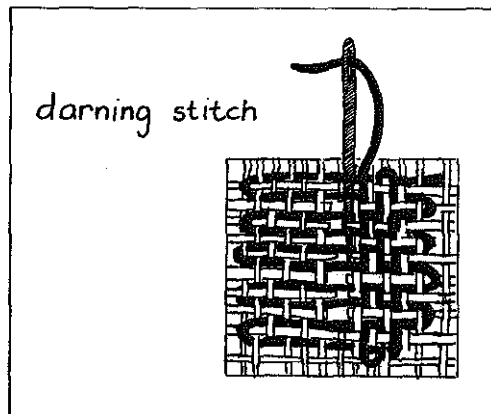

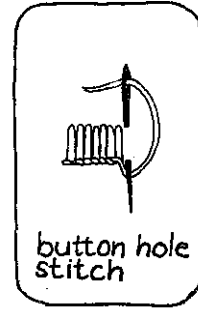
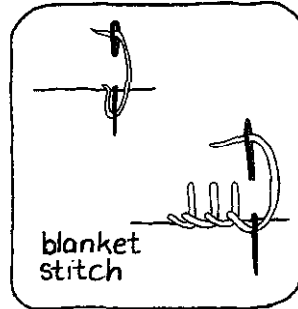
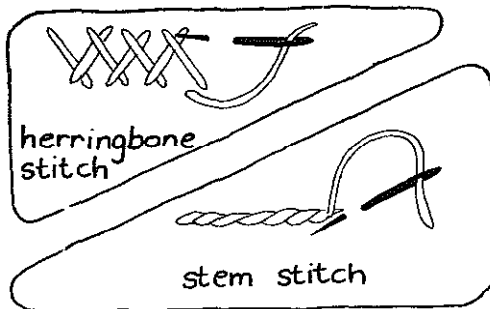

Decorative stitches are done on the right side of the garment.

■ Herringbone stitches look like crosses. You can sew herringbone stitches on bias binding to make a border on a dress or shirt. Some people sew hems with herringbone stitch.

■ Stem stitches look like a rope. They are good for pillow cases and bedspreads.

■ Blanket stitches are for around the edge of a blanket or thick material to make sure that it does not fray.

■ Slip stitches look like hemming stitches. They are for finishing off belts, collars, pockets on the right side of the garment.

■ Button hole stitches: Button hole stitches are the same as blanket stitches, but closer together. Sew with a long thread and do not make the stitches too loose or too tight. The material must stay flat all the time. At the end of the button hole near the edge of the material, spread the stitches out in a curve. At the other end of the button hole, make straight stitches.

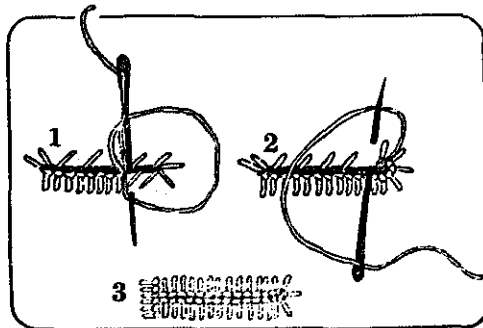

Buttons

If the button holes are sideways, you must sew the button on so that it comes through at the end of the hole where the stitches are curved. Mark the place with a pin. If the button holes are lengthways, the button must come through in the middle of the hole.

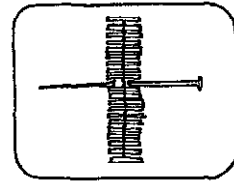
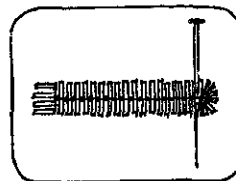

If you are sewing buttons on thick material, sew over a match. Then pull the match out and wind the cotton around and around the loose stitches.

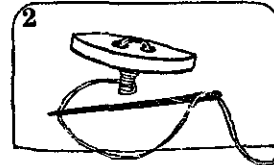
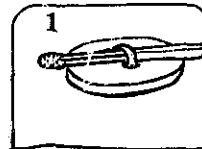

Zips

Sew in zips first with tacking stitches. Then sew the top side with back stitches.

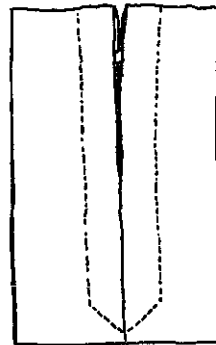
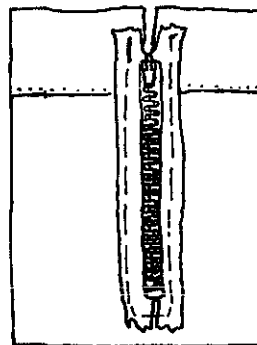

HOW TO MAKE A BLANKET JACKET

This is how to make a warm winter jacket out of a blanket.

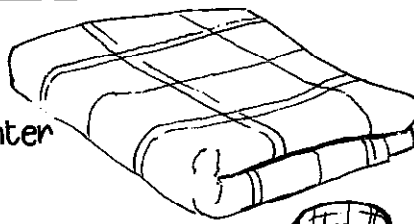

First make the pattern: Draw the pattern pieces on brown paper or newspaper the same size you want the jacket. In the drawing you will see two numbers on each line of the pattern. The smaller number is how many centimetres the lines must be if you are making the jacket for a woman. The large number (in brackets) is for the man's size. Copy all the dots from this drawing onto your pattern and cut out the pattern.



Use a centimetre ruler or tapemeasure.

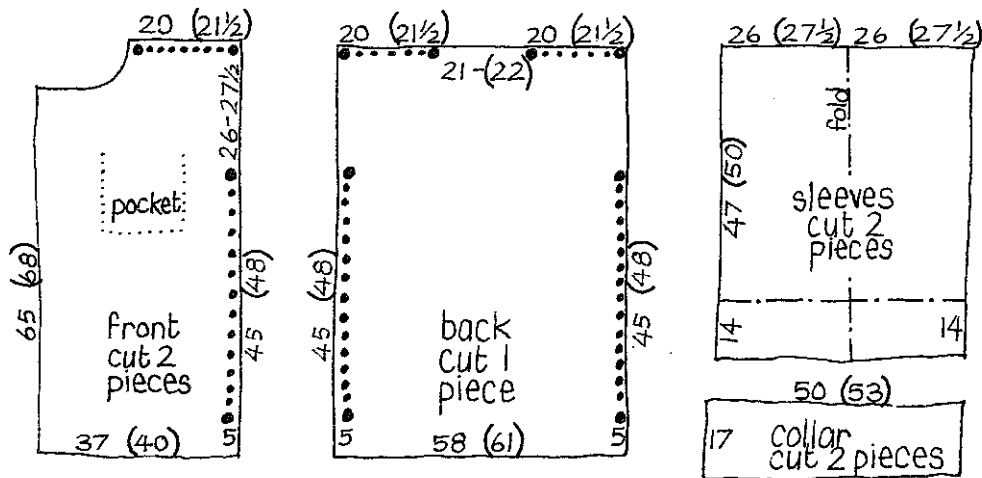

Pin your paper pattern onto the blanket and mark the dots from the pattern onto the blanket with pins or a double tacking stitch. Cut the pieces out carefully, especially if you are using a cheap blanket because it tears very easily.

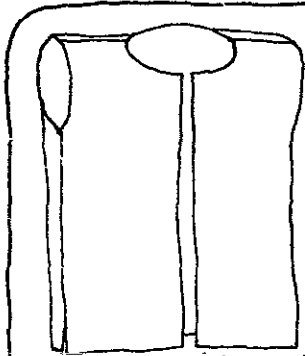

Pin the jacket front pieces to the back piece at the shoulder seams and side seams so that the right sides are on the inside. The right side of the material is the part which will be on the outside of the jacket when it is finished. Sew in between the dots where the dotted lines are on the pattern.

Make two rows of machine stitching or back stitch by hand at each seam. A machine that can sew zig-zag will make the seams even stronger. The shoulder seams need to be very strong, so it is best to sew wide tape or a strip of cotton cloth on the inside of the shoulder seams.

Fold over the sleeve and sew down the long edge. Turn it so that the right side faces out and the seam is inside. Do the same for both sleeves. Pin the sleeves into the armholes and machine- or backstitch them into place

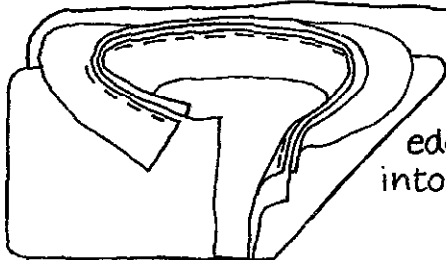

Pin one collar piece onto the inside and one on the outside of the neck edge. Machine- or back-stitch them into place.

Bring both sides of the collar up, turn in the edges and slip stitch together.

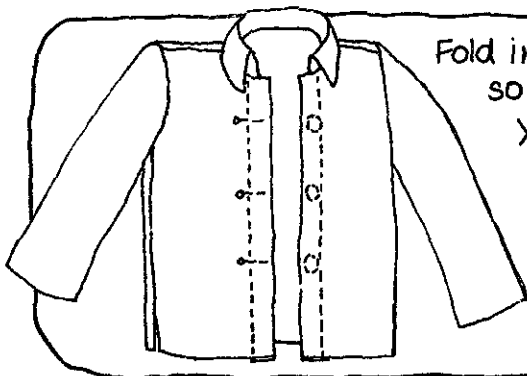
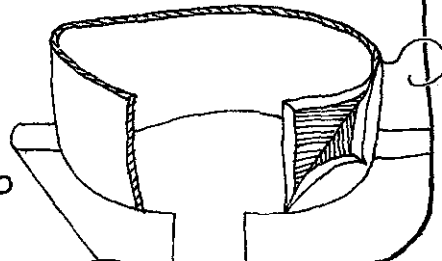

Fold in the two edges of the jacket front so that there is a flap as long as your little finger underneath. Machine- or back-stitch this flap onto the inside of the jacket with two rows of stitching.

Mark where you want the buttons and buttonholes.

You can make loops for the buttons instead of buttonholes. Cut three strips of blanket each 14 cm long and 4 cm wide. Fold in the edges and then fold the strips into loops. Slip stitch the ends together.

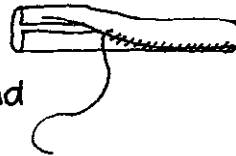

Cut three squares of blanket 6 cm long and 6 cm wide. Take one loop folded in half and one square and pin them onto the inside of the jacket front, so that the ends of the loop are under the square.

Turn in the edges of the square underneath, and sew down by machine.

Do the same for the other two loops and sew on the buttons.

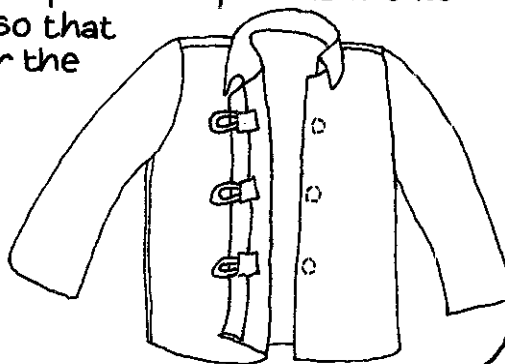

If you want pockets, cut out squares. Fold and sew the top edges down. Pin the pockets onto the inside or outside as you wish and sew them down with a double row of stitching. At the top right- and left-hand corners of each pocket, make the corners strong by sewing a triangle at the top of each side seam.

Hem-stitch all the edges of the jacket by hand.

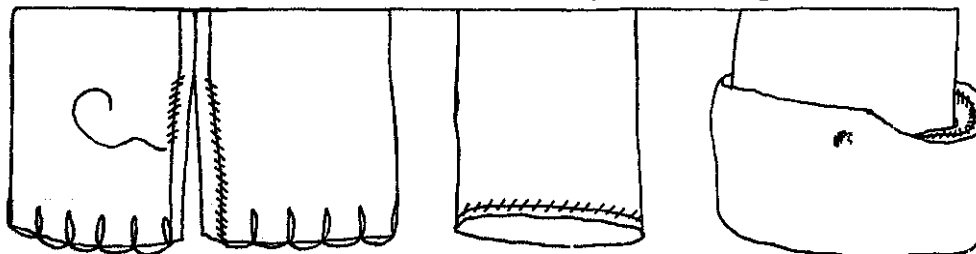

Fold in the edges of the sleeve seams and hem stitch them down so that you can turn back the cuffs.

Sewing Machines

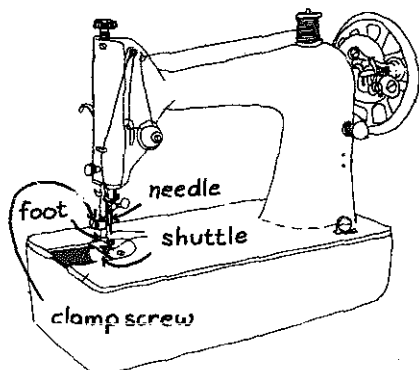

Sewing machines can be worked by hand, with your feet (treadle machines) or with electricity. They are expensive so make sure you buy a machine which works well and can sew the things you want to make. Second-hand machines usually cost about R100 to R150 and new machines up to R500.

When you go to buy a second-hand machine, take a piece of material and some cotton with you. The seller must always let you try out the machine so that you can see how it sews.

Sometimes second-hand machines are cheap, but when they break down you can not find spare parts for them. Find out if you can get spare parts before you buy the machines. If you buy a second-hand Singer machine, you will probably get a 6 months guarantee. This means that if the machine breaks down within the first 6 months, the shop will fix it free of charge. Other kinds of sewing machines often do not have guarantees on second-hand machines, but you should always ask for one.

When you buy a machine from a shop you can ask them for lessons to show you how to use it. If you buy it new, the lessons will be free. If the machine is second-hand you might have to pay about R4 per lesson. If you buy a machine from somebody else, not from a shop, you must ask the person to show you how to use it.

All sewing machine shops have books about how to use and look after their machines. You can write and ask for one of these books for your machine (see sewing machine suppliers p 525).

Looking after a sewing machine

Your machine will last a long time if you look after it well.

▶ Always cover it with a cloth or keep it in its case when you are not using it.

▶ Leave the foot of the machine down with a piece of cloth under it when you are not sewing. This helps to keep dust out of the machine.

▶ Every time you start sewing, make a line of stitches on this piece of cloth to test whether everything is working well.

▶ Always keep the machine well oiled and clean.

Cleaning - do not leave the needle in while you clean the machine because it might get broken or hurt you. To take it out, turn the wheel until the needle is at its highest position. Take off the reel of thread at the top of the machine. Loosen the needle clamp screw so that you can take out the needle.

Take out the bobbin and the bobbin case from the shuttle. If your shuttle is long, press the lever to make the bobbin case jump out of the machine. If your shuttle is round, lift the lever and take out the bobbin case. Use a piece of cloth to wipe away all the dust, cotton and fluff from the inside and the outside of the machine.

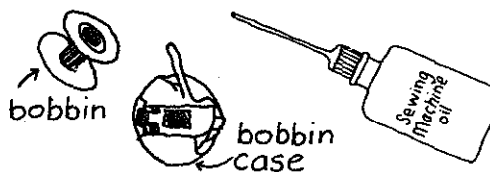

Oiling - Always keep your machine well oiled with special sewing machine oil. Do not use other oils like 3 in 1 oil. They are not good for sewing machines.

On the top of the machine, you will see small oil holes. Put 1 drop of oil into each hole. After oiling the machine, sew a few rows of stitches on a scrap of material. If there is too much oil in the machine, it will come out onto this material.

HOW TO THREAD A SEWING MACHINE

Sewing machines must be threaded from the top through the needle and from the bottom through the bobbin and the shuttle.

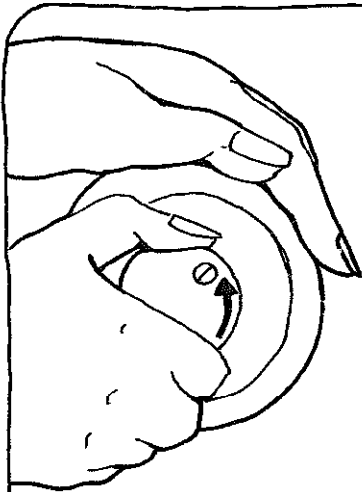

First you must wind the thread onto the bobbin, put the bobbin into the bobbin case and then put the bobbin case into the shuttle inside the machine.

This is how to wind the thread onto the bobbin.

First, loosen the clutch on the wheel then put the bobbin onto the bobbin winder.

Thread the cotton from the top reel onto the bobbin as you see in this picture.

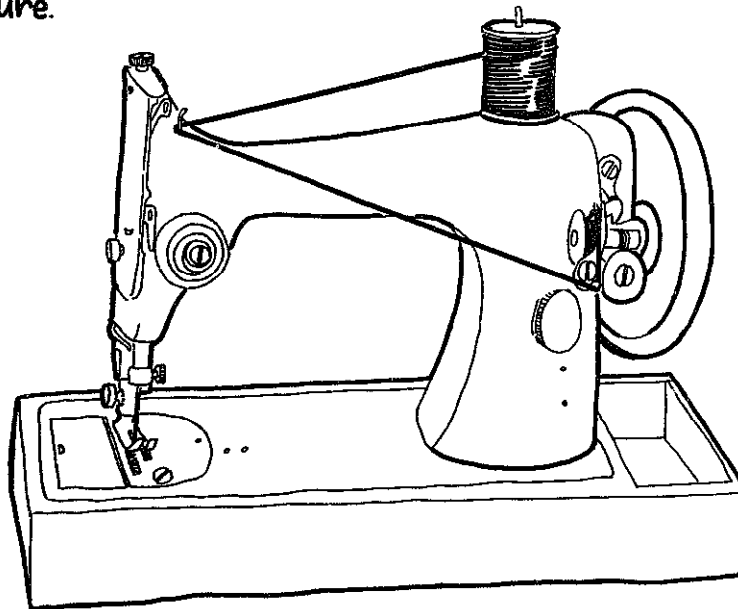

Now turn the wheel and wind the cotton thread onto the bobbin until it is full.

Tighten the clutch.

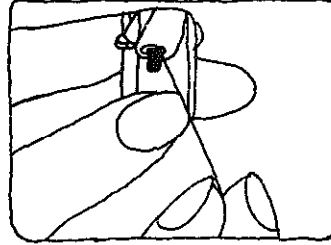
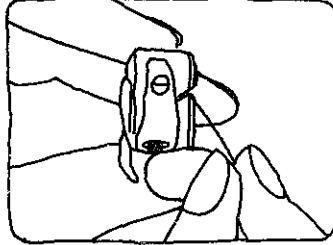
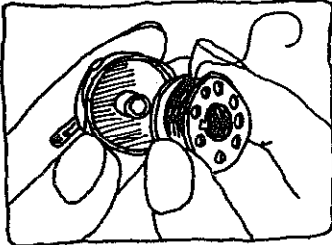

Put the bobbin into the bobbin case and pull the thread out.

Put the bobbin case into the machine.

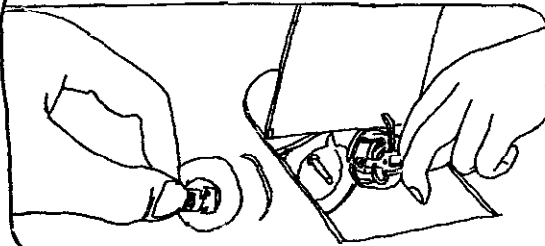

Now you must bring the thread from the bobbin up through the little hole on top of the bobbin case.

This is how to thread the machine from the top through the needle.

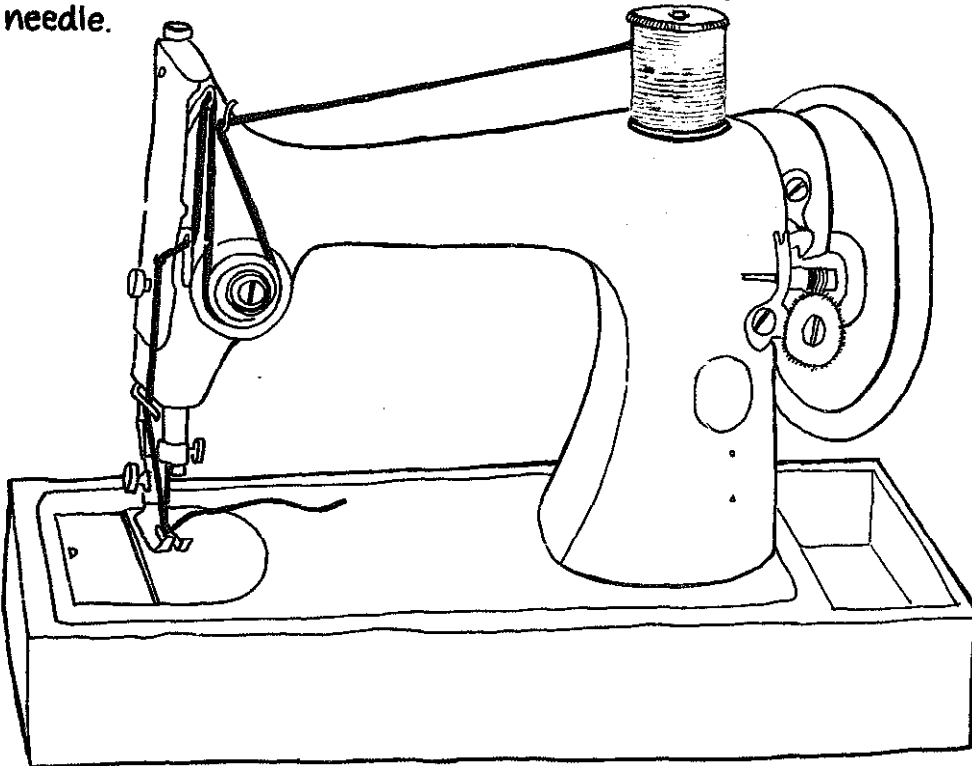

Hold the thread that goes in the needle in your left hand. With your right hand, turn the wheel slowly towards you. The needle will go into the hole and hook up the thread from the bobbin case. When the needle comes out of the hole, it will bring with it the thread from the bobbin case.

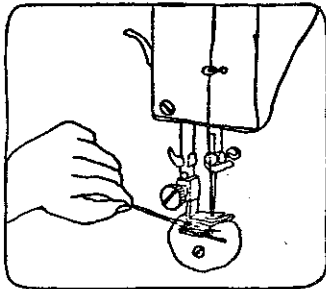
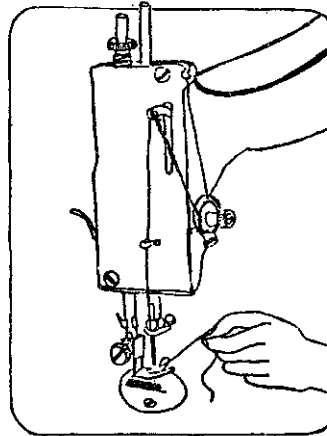

Pull both the threads behind the needle, away from you.

Now your machine is threaded and you are ready to sew. It is a good idea to sew a row of stitches on an old scrap of material to test whether the machine is sewing well.

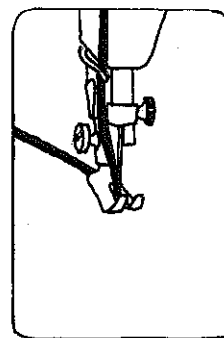
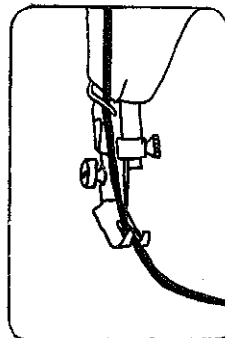

Sewing Machine Problems

► If the machine gets stuck and the needle will not move up and down, the ends of the cotton are knotted underneath, where the bobbin is. Take out the bobbin and shuttle, pull out loose bits of cotton and fluff, undo the knots and put the shuttle back. Close the machine and try sewing again.

► If the cotton keeps coming out of the needle, or if the machine is missing stitches or if the cotton

breaks at the needle, check to see if you have threaded the needle from the wrong side or screwed the needle in the wrong way. The cotton must go in from the smooth side of the needle. Near the hole in the needle, one side is smooth and the other side has a dent in it. The flat side of the top of the needle should fit against the flat side of the hole at the needle clamp screw. Push the needle right up as far as it will go.

► If the cotton from the bobbin is breaking it may not be properly wound onto the bobbin. Also check if there is dust or fluff in the bobbin case. Clean and oil the shuttle.

► If the top stitches are too loose, tighten the tension screws on top. Tighten them a little at a time and test sew after every tightening. Test if the bottom tension is too tight by loosening the little screw on the shuttle. It is always better to change the top tension to fix a problem, and not to adjust the bobbin tension. In very old machines the spring in the tension screw may stop working and you must buy a new one.

► If the stitches on top are too tight, first loosen the tension screw on top and test how the machine sews. If it is still too tight, it may be the bobbin tension underneath that is too loose. Tighten it a little and then test sew again.

► If the thread from the top of the machine keeps breaking, it could be for any of these reasons:

- the machine could need a new needle. Needles easily get bent and it is better to put in a new needle than to break another part of your machine. Other parts are expensive but needles are cheap.
- the top tension could be too tight. Loosen the tension screw a little bit and then do some test sewing to see if it is better.
- the cotton could be too thick for the needle. Always use the same thickness or thicker cotton on top as in the bobbin. For example use No. 60 in the bobbin and No. 50 on the top. Never use thin on top and thick cotton on the bobbin.

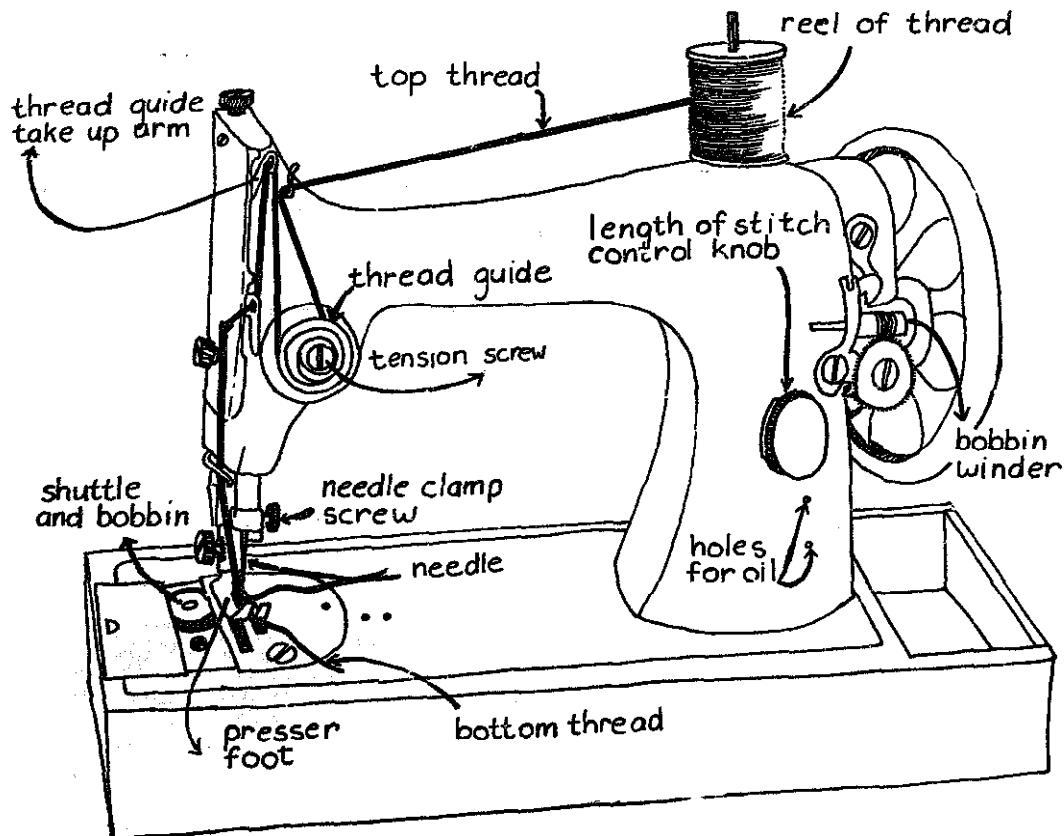

► If the machine is missing stitches and is making a knocking sound when you sew, it is probably because your needle is blunt. Put in a new needle.

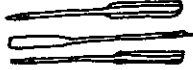

► If the needle is bent, put in a new one. Do not pull the material hard while you sew, let the machine pull the material through.

► If the needles in your machine break easily, you may be using the wrong kind of needle for the size of cotton you are using. For example, if you use thick cotton with a very thin needle, the needle will break. Check that the presser foot is screwed on straight.

► When you sew very thin material, like muslin, thin calico or silky materials, use a no. 9 needle and thin cotton made of cotton mixed with polyester no. 100 to 150. This very thin cotton only works well on sewing machines that are made for sewing stretchy materials, otherwise they often twist and get knots while you are sewing. Cotton materials, shirt material and towelling need a size 14 needle, and a no. 60 cotton. Thick cotton cloth, canvas, thin woollen material and serge need a size 16 needle and no. 40 cotton.

If none of these are wrong, the machine's motor might be broken. Take it to a machine shop to be fixed. Shops charge a lot to fix machines so if you work in a production group using sewing machines or if you live far from town, it will help to know how to service machines (see sewing machine suppliers p 525).

There are no problems with the differences in wages because they realise that their work is different

Many production projects are not organised co-operatively and the workers are not involved in decision making. Managers and workers do not share the work and managers are usually paid much more than workers.

When we did this interview with her, Mrs Ndamse was in charge of Vusisiwe Home Industries, based in Umtata in the Transkei. She gave us the point of view of a manager of a production group.

● How did you start Vusisiwe?

I was the director of the womens section of Black Community Programmes. These girls came to me and asked that I should train them in sewing. After some months I saw that they were doing well and I decided to start some home industries. So the girls could try to make a living by selling the goods which they sew. They were very interested. In fact I have had many more coming to look for training. Unfortunately I do not have the space, so I have not been able to do that. In fact it is very clear that this type of training is needed in the Transkei, because there is not much con-

centration on this type of thing. There is very bad unemployment amongst women and things are getting worse. Independence has not improved anything, it has made things worse, because people are being thrown away from the Republic.

● What do you make here?

We produce school uniforms and dashikis, afro-look shirts and cotton frocks and childrens frocks and knitted articles as well. In knitting the girls have to produce about 3 articles a day on machines. The people who sew produce 2 to 3 articles a day. There are 6 knitters and 8 sewers. There are 3

field workers, a secretary, an instructress and myself. The production is limited at the moment, because we don't have much money to buy the materials we need. The workers are fortunately all Christians, but they don't have to be Christians to belong here. They are all literate and the level of education goes from Std 5 up to matric. Wealth wise they are all strugglers, just ordinary people. They are all paid by monthly wages and their salary is from R40 upwards. People are paid according to the standard of their work and so far the highest wage is R60. The instructress and the field workers get R160 and I myself get about R500. The girls are paid from the money the

project makes and the field workers and the other staff are paid with funds which we raise from outside.

● Aren't there problems with such a difference in wages?

There are no problems with the difference in wages because they realise that their work is different. They know that they are paid according to what they produce.

● Do the workers learn project administration?

No, there is no attempt to train workers for administration or any other aspects of the project. I make most of the decisions with the committee, which is made up of men. If the workers

have particular wishes they tell the instructress and she then comes to me. The workers themselves wouldn't be able to carry on with the project if the rest of us fell away. I haven't had the money or the time to train them although I have often told them that for their production it is very vital that they must know where the material is bought, and that it has to be sold, and how to sell it.

These girls not only need to come and sew but they need some more education. As soon as we have more space we may be able to do this. They have shown interest in the line of cookery and nutrition and they do offer themselves to go and help at private functions.



Knitting

The best way to learn to knit by hand is watching somebody who knows how to knit. It is much easier to learn this way than to learn from a book.

Wool

You can buy many different kinds of wool. The best wool, but also the most expensive is pure wool which comes from a sheep. It costs about R2 for a 50g ball. The cheapest wool, called acrylic, does not come from sheep, it is made in factories. Acrylic wool is not as warm as pure wool and does not last as long. It costs about 50c for a 50g ball and about R5,00 for a 500g ball.

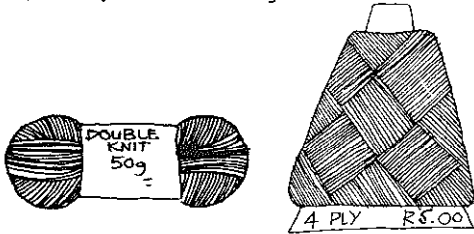

An easy thing to make if you are learning is a blanket made of lots of small knitted squares. Use any leftover pieces of wool and sew them together with wool and a thick needle.

Knitting by machine

If you can knit on a machine, you can make jerseys and blankets to sell. It is quicker to knit by machine than by hand, but knitting machines are very expensive.

There are two types of knitting machines: single-bed and double-bed. Both kinds can do stocking stitch, which is the stitch used in most jerseys. But only the double-bed machines can do automatic rib-stitch, which is the stitch used for the bottoms of jerseys and the ends of sleeves.

If you want to buy a second-hand knitting machine, you must test it before you buy it to make sure that it works properly. Ask for an instruction book to show you how to use the machine and how to knit different patterns. If you can not get an instruction book, write to the factory and ask them to send you a book (see p 525).

It is very hard to learn how to knit on a machine unless somebody shows you. Shops which sell these machines give lessons on how to use them, but they charge about R4,00 per lesson.

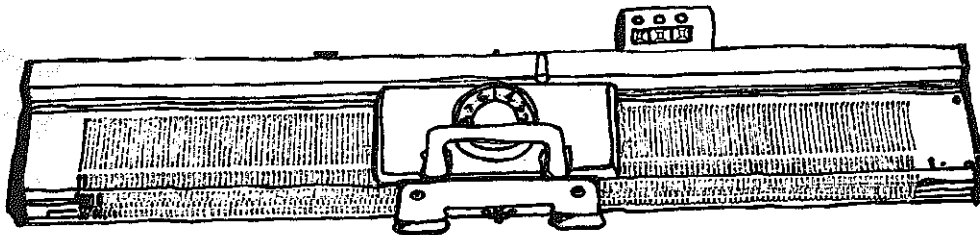

knitting machine

Dyeing

Different materials need different kinds of dye. You can dye natural materials like cotton and wool with home-made plant dyes or with synthetic dyes which are made in factories. You can dye factory-made materials, like nylon and polyester, with synthetic dyes which you can buy in chemists or trading stores. You need a big pot or tub to mix the dye in and for some dyes, you need a stove to heat the dye mixture. You can get advice about dyeing from ITSIDU (see p 526).

Plant dyes

Plants and trees like khakibos, onions, blue gum leaves and acacia tree bark can be used to make dyes. They usually make pale colours but you can never be sure which colour you will get because every plant or tree will give a different colour dye. When you pick plants for making dye, collect seeds and plant them so that more plants will grow. If you cut bark from a tree, do not take too much at one time. If you remove too much bark the tree can die.

Lichens are very small plants which grow on rocks. They look like fungus or like algae. There are many colours of lichens and they are very good for making dyes.

Collect the flowers, leaves, roots, tree bark, berries or lichens which you want to use. Boil them with water for about 1 hour until the dye is dark in colour.





Before you put wool or cloth material into the dye, you must soak it in a mordant. The mordant makes the material ready for dyeing. The most common mordants are powders like cream of tartar, washing soda and alum or water which has been boiled with metals like iron, chrome and tin. If you do not soak material in a mordant, the dye will run out when you wash the material. You can buy washing soda and cream of tartar in shops and supermarkets in town and you can buy alum, which is used in swimming pools, from hardware stores.

You can make your own iron, chrome or tin mordants by boiling some of these metals with water. To make iron mordant, boil 4 litres of water with 2 cups of vinegar and 1 cup of rusty nails for one hour. Leave it to stand for 24 hours and then pour off the water. This water is iron mordant.

After you have soaked the material in the mordant, you must rinse it out well. Then put the material into the dye and simmer it on a low heat until it is the colour you want.

If you do not want to use all the dye at the same time, store it in a container with a very tight lid. Add 1 teaspoon of Sodium Benzoate before you put the lid on. It will help to stop the dye from going bad. You can buy Sodium Benzoate from a chemist. When you want to use the dye again, make sure it does not smell bad. If it does, throw it away. If it does not smell bad, but has mould growing on the top it is still alright to use.

Different dyes need different mordants:

DYE	MORDANT	COLOUR
	Aloe roots	Dark red
	Bamboo leaves	Pale green
	Blue gum leaves	Yellow
	Cabbage (red)	Lavender
	Carrot leaves	Yellow
	Grenadilla skins	Brown
	Khakibos	Green/Khaki
	Mulberries (ripe)	Purple
	Onions	Deep yellow
	Tumeric	Golden yellow
	Wattle flowers	Yellow
		Greenish-brown
		Khaki

Synthetic Dyes

■ All-purpose dyes are sold in small round tins at chemist shops and can be used to dye pure cotton materials like fiasco or calico. Materials which are mixtures of cotton and polyester will not hold synthetic dye. It will run out when you wash them. The instructions for how to use these dyes are inside the plastic wrapper on the tin.

■ Acid dyes are for wool. They are sold in big tins but you can write to factories which make them and ask for free samples (see p 526). It is a good idea to get as many samples as you can because they are free and can dye a lot of wool.

This is how to dye 50g of wool with acid dye:

Soak the wool overnight in cold water. The following morning, put 2 tablespoons of salt in a pot with 3 litres of cold water. Mix 1 teaspoon of acid dye with a little water in a cup until there are no lumps. Put the dye into the water in the pot. Stir it until all the dye is mixed in. Put the wet wool into the dye and boil it slowly. Cook it for about 1 hour on a very low heat. Then rinse the wool well until the water is clear and leave it in the shade to dry.

■ Reactive dyes are used for dyeing cotton, linen, hessian and sisal. They are not for wool or man-made materials like polyester. You can get reactive dyes for mixing in cold

water or hot water. The cold water dye is easier to use and it works better. Reactive dyes come in big tins from factories and it is expensive to buy a whole tin. You need about 1g of dye for 1 metre of materials, so if you only want a small amount, order it from ITSIDU (see p 526).

It is better to buy material which is ready for dyeing, otherwise you will have to wash it in special chemicals to get all the starch and oil out before you start dyeing it. The dye will not work well if the material has starch or oil in it.

This is how to dye 500 metres of material:

Mix 500g of dye powder in 1 litre of water which is about 30°C - about the same temperature as your hand. Put the material in a bath of water - about 10 litres of water for every 1 kg of material. Add the dye to the water and material and mix it in well. Move the material around until the water is all the same colour and all the material is covered. Then add 500g of salt and 40g of washing soda or soda ash or sodium carbonate, stirring all the time.

Leave the material in the dye for 30 minutes to 1 hour. Take it out when it is the colour you want. The longer it is in, the darker the colour will be. Rinse it in cold running water until the dye stops running out. Then wash it with soap and rinse it well.

Blockprinting

Block printing is using a block of wood or lino to print onto paper or material. You carve a pattern onto the wood or lino and cover it with ink or dye. Then you press the block onto the paper or material. You can use block printing for printing clothes, printing posters, or printing cards.

Block printing is one of the cheapest ways to print. It does not need expensive equipment like silkscreening. You can make many copies of a poster or a pattern with the same block.

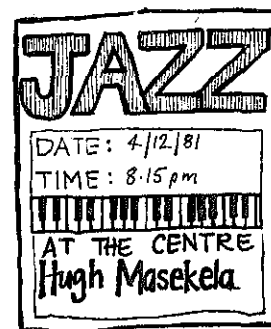
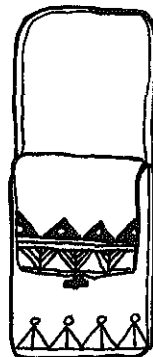

What you need

You can buy tools and materials for block printing at craft shops or you can make your own if you know what the tools look like (see p 528).

These are the tools you will need:

- ▶ Cutting tools
- ▶ Roller
- ▶ Piece of glass
- ▶ Thick, waterproof ink
- ▶ Flat, smooth block of wood or lino.

If you use wood it must be very smooth and easy to cut.

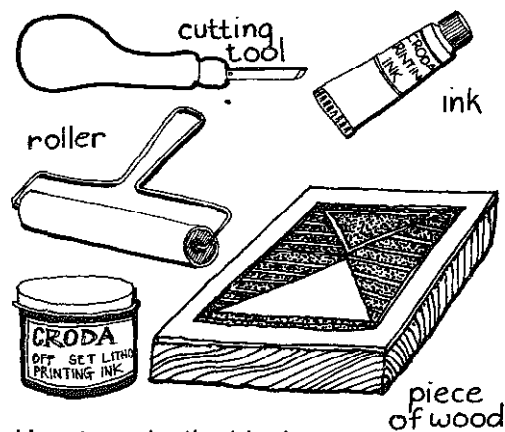

How to make the block

Draw your pattern onto the wood or lino. It is best to make simple, clear designs without too many details. Cut out the design. Only the pieces of the pattern which are not cut away will be printed. Cut a little at a time because if you cut away too much your block will be spoilt and you will have to start again. Always cut downwards and away from yourself because the tools are very sharp and dangerous.

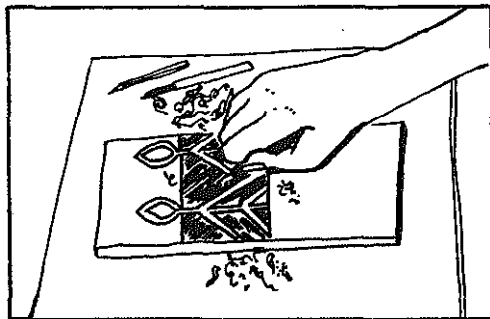

When you have made the block you are ready to make your first print.

How to print with the block

Put the material or paper you want to print on a smooth, flat surface. Put some ink or dye onto the glass and roll the roller in it. If you do not have a roller, you can use an old brush or a piece of felt to put the ink onto the block. Do not put too much ink or dye onto the glass because it dries very quickly. Roll the roller over the design on the block. Put the block onto the paper or material, and press it down hard. You can hit it softly with your fist or a light hammer but be careful not to move the block because this will smudge the pattern. When you have made the first print, you can see if you want to change the design on the block by cutting away more of the wood or lino. Each time you want to print you must put ink or dye onto the block.

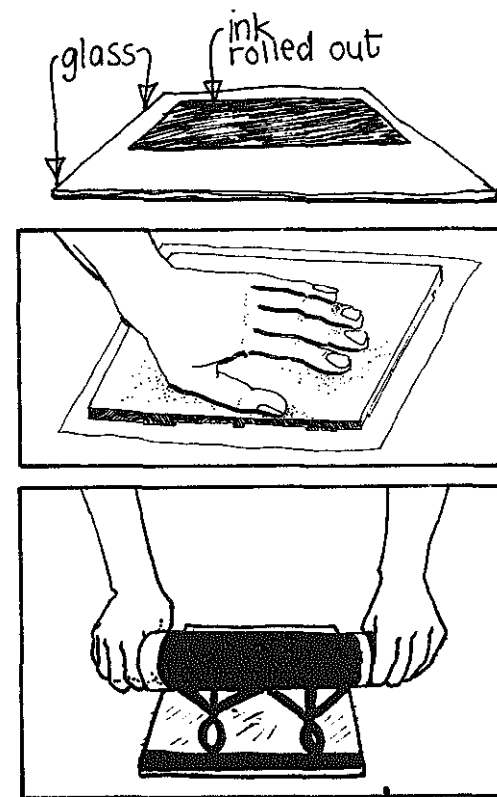

Always clean the block and tools very well when you have finished printing. If you look after them well and clean them each time you use them, they will last a long time.

HOW TO MAKE SANDALS

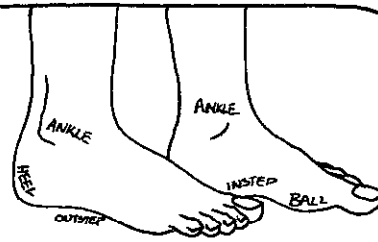
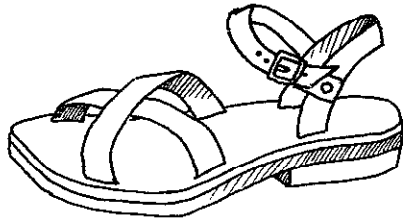

Making leather sandals is not difficult. The methods we give here are the same for all styles.

Materials and Equipment

Here is a list of the materials you will need. You have to get some of them from a leather shop.

- Leather - any leather about 3mm thick will do, but vegetable tan kip side or shoulder is best.
- Glue - Tivodour 55 or any good contact adhesive.
- Crepe sole rubber - this is soft rubber which you buy in a sheet. Old car tyres can also be used for soles.
- A hammer.
- An anvil.
- Revolving punch.

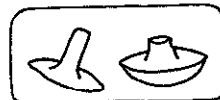
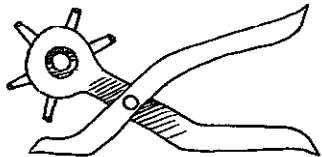

- Cap rivets.
- A steel ruler.

- Coarse sandpaper.
- An old brush.

These things are not essential, but are good for finishing shoes off:

• Skiver

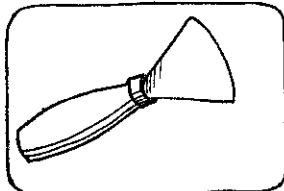

• Edge beveller

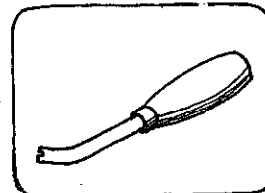

- Spirit dyes and methylated spirits

Making the Sole

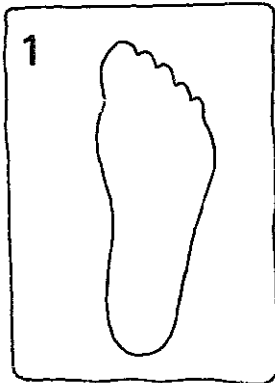

1. Put your foot on a sheet of paper and ask someone to draw closely around it.

2. Draw an outline around this drawing, 6mm wider at the toe and the heel, and 3mm wider around the rest of the foot.

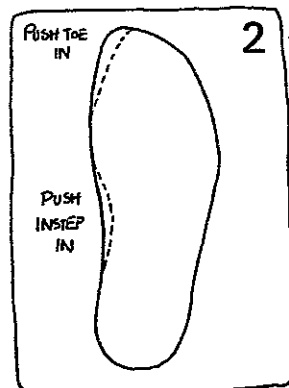
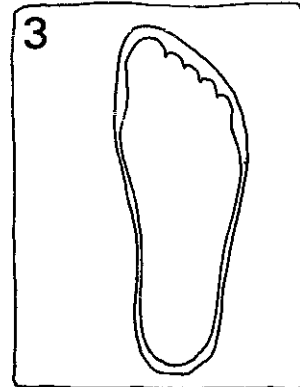

3. A foot inside a sandal is narrower than a bare foot. Make the sole narrower like this. Do not change the length.

4. The drawing of the sole should be like this

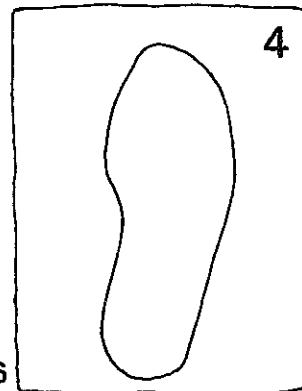

• Cut out the paper sole and draw around it on your leather. Cut the leather holding the knife straight up.

Where to Put the Straps

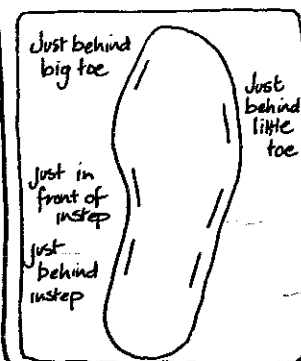

• Put your foot on the sole and mark the places where the straps go into the sole.

• The marks must be at least $\frac{1}{2}$ cm from edge of sole. The front four are 3cm long. The back two are 2cm long.

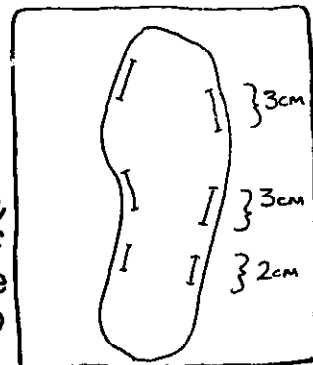

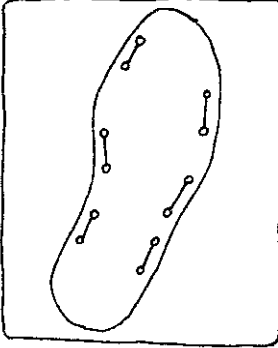

• Punch holes at the ends of each mark, using the smallest punch on the revolving punch machine.

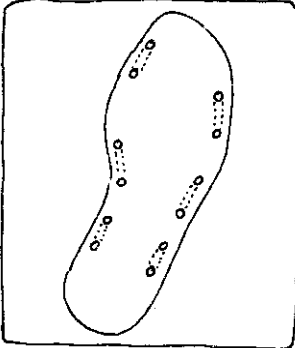

• Cut slots like this, from hole to hole.

Measuring the Straps



- Put your foot on the sole and measure across your foot from slot to slot.
- The front straps and the heel strap will go through the slots you have cut under the sole. So you must add about 6cm onto the measurements of these straps.

- Make the ankle strap 4cm longer than the measurement.

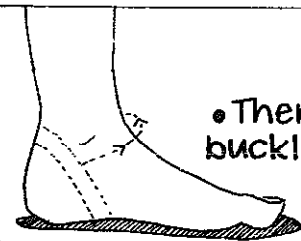
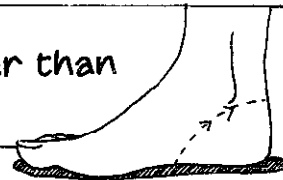

- There must be a strap 8cm long to hold the buckle, which will come from the heel strap.

Dyeing and Bevelling

You do not have to do this step, but it makes the sandals look better. An edge beveller takes the sharp edges off a piece of leather. Bevel the top and bottom of the straps, and the top of the sole.

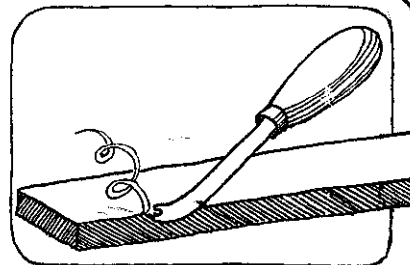

If you are using vegetable tan leather you can stain it with a colour. Use a scrap of sheepskin or towel soaked in spirit dye. Gently rub the top surface, but do not stain the rough side. If the dye is too dark dilute it with methylated spirits. Dye will not wash off your skin easily, so wear gloves.

Glueing the Straps

- Pull the straps through the front and the back slots. Pull them up by the extra measurement. The straps must go at an angle to rest flat against the foot. Do not do the middle straps yet.

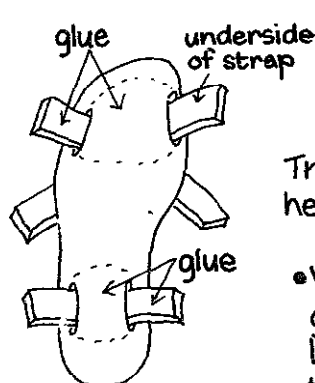
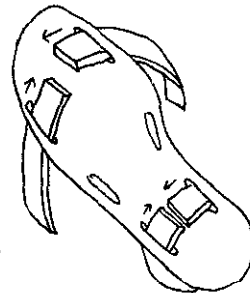

- Fold straps over to the rough side. Brush glue onto the straps and the sole. Allow 15 minutes to dry.

Try the sandal on to make sure the heel strap fits around your heel.

- When the glue is dry, press the glued parts together and hammer lightly. Use a scrap of leather between hammer and sandal to prevent marking.



Glueing the Front Straps

Put your foot on the sole, cross the front straps over your foot and put them into the two middle slots in the sole. Pull till the straps are tight. It is better if they are tight than loose because they will stretch. Mark the strap where it passes through the sole. Glue in the same way as the other straps.

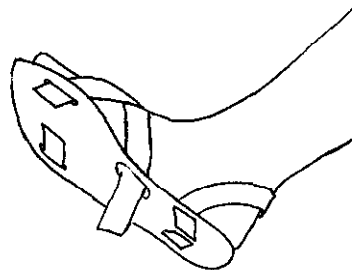

Skiving



The straps glued to the underside are too thick and must be shaved thin at the ends. The best tool to

use is a skiver. This tool is expensive but very useful.



You can also use a sharp knife, but it is not as good. Keep your skiver sharp with an oilstone.

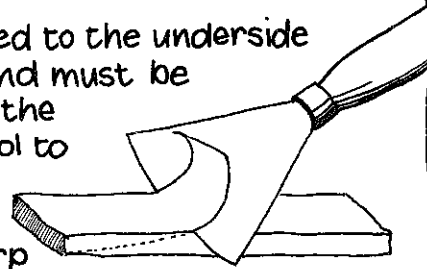

The Ankle Strap

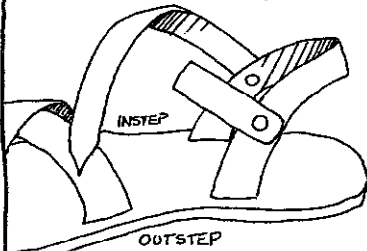

The ankle strap goes over the ankle from the instep side. Use cap rivets to fasten the ankle strap to the heel strap.

- Punch holes in both straps.
- Push the pointed part of the rivet into the hole from the bottom.
- Push the other part into the hole from the top.
- Press together and hammer on anvil or stone until the rivet is flat.

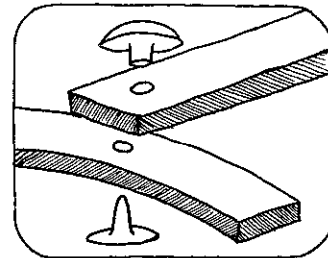

Buckling

The buckle strap goes on the outstep side.

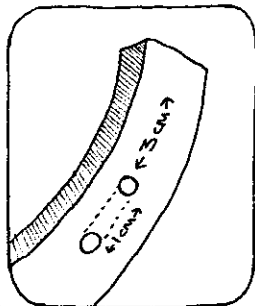

• Punch holes at the end of the buckle strap like this. Cut on the dotted lines.

• Skive the end of the strap on the rough side of the leather.

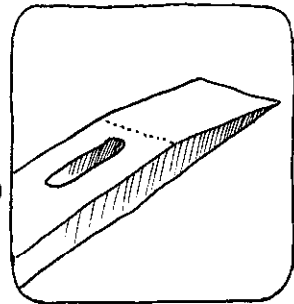

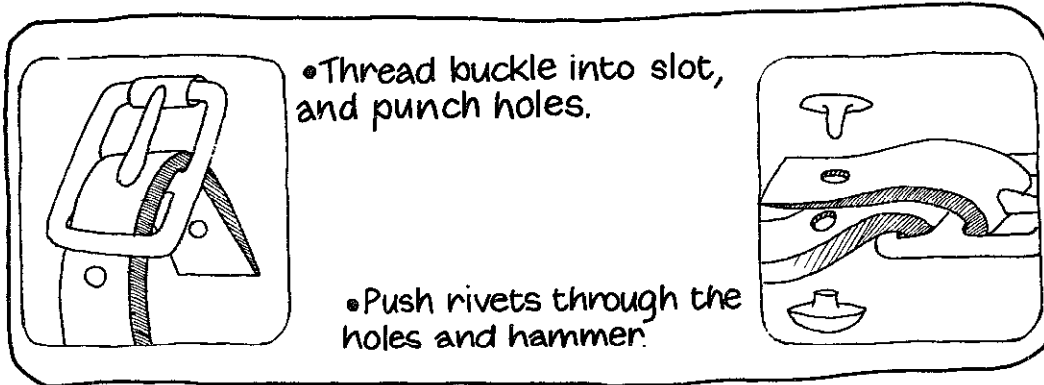

• Thread buckle into slot, and punch holes.

• Push rivets through the holes and hammer.

Soling

Car Tyre Sole:

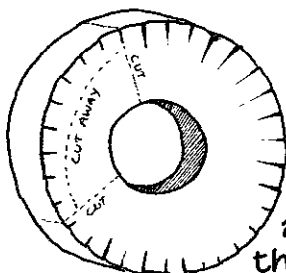

Choose a tyre that is not too worn, and not more than 3cm thick.

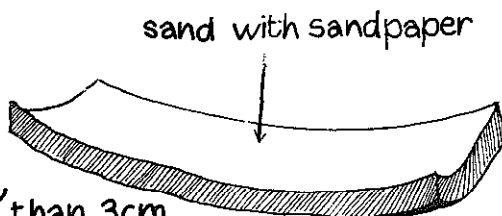

Cut a piece long enough for both sandals like this. Throw away the walls of the tyre, leaving the tread surface for the soles. Clean the inside well, and sand it with coarse sandpaper.

Then, whether you are using soling rubber or car tyre:

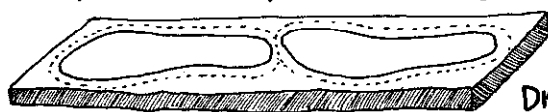

• Put the sandals on the soling rubber.

Draw an outline around them onto the rubber. Cut 12mm outside of this line.

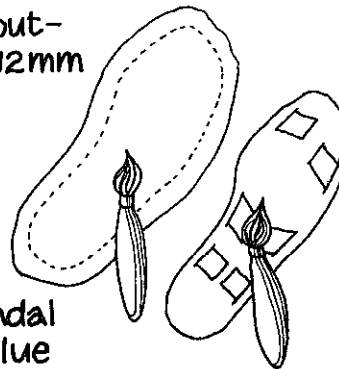

To stick sandal to sole:

• Brush glue onto the bottom of the sandal and onto the rubber. Make sure the glue covers the whole surface. Allow 15 minutes for drying.

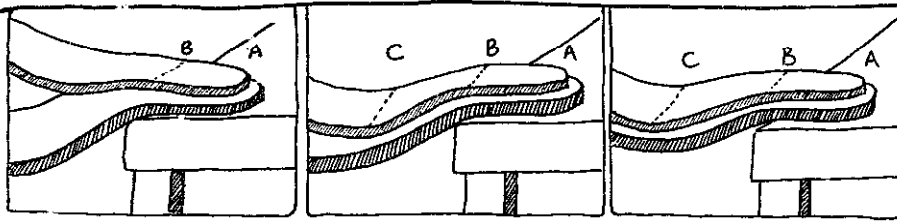

Crepe soles (the Straps are not shown in these drawings)

- Using the edge of a table, put the sandal on the rubber up to B. Press it down with your fingers.
- Bend the rubber down from B to C and let the sandal follow. Press down up to C, keeping C to toe apart.
- From C to toe, bend rubber up again. Keep the sandal and the rubber apart. When it is right stick the sandal and press. Hammer lightly.

This method makes the sole bend like your foot. You cannot bend a car tyre sole. Just stick it flat and hammer it.

To cut off extra rubber use a new blade. Hold your knife straight and pull it through the rubber at the edge of the sandal. Go slowly and carefully - it is very easy to cut yourself.

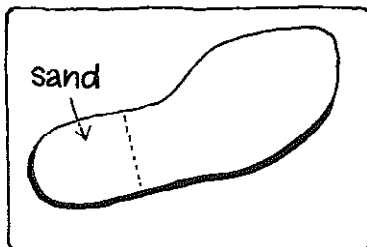
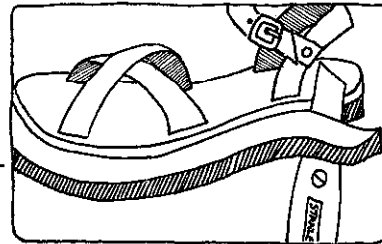

Cut heels from rubber. Sand area on sole where heel will go. Glue both surfaces, stick flat when dry and hammer. Trim as before. The car tyre sole does not need a heel.

Finish the sandal by putting on dubbin to soften the leather and make it last longer. Then put on shoe polish.

HOW TO MAKE SHOES

Materials and Equipment

As well as all the things you used for sandals, you need:

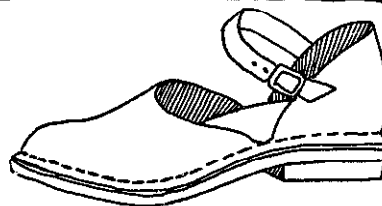

- Egg-eyed harness needles.
- 8 cord waxed linen thread.
- Nylon lacing twine or any strong linen thread of similar thickness.
- Leather - You must use vegetable tan kip side or shoulder. Do not use chrome tan.

The Sole Shape

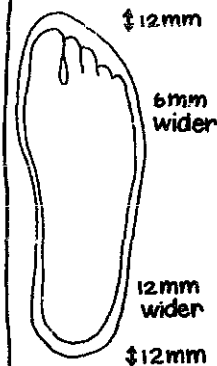

- Make the sole 12mm longer at the toe and 12mm longer at the heel. The width must be 6mm wider than the foot, except at the heel, where it must be 12mm wider.
- Once again, the toe and instep must be narrowed to give a rounder toe shape, and closer fit at the instep. Remember that a foot is squashed inside a shoe.

The Uppers (top part of shoe)

Front Upper:

The widest part of front upper (C to D) must be about $1\frac{1}{3}$ the width of the sole at the widest part, for an average foot. For example, if A to B = 9cm, then C to D = 15cm. The length G to C = G to E and G to D = G to F. G is the centre of the shoe.

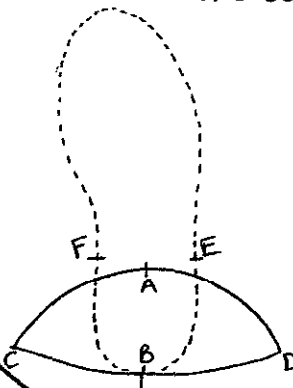
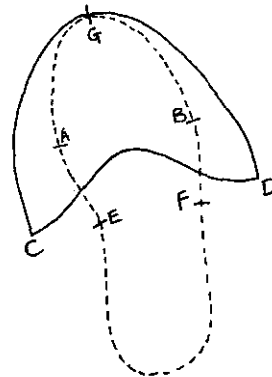

Back Upper (heel)

A to B must be the height of the heel from ground level, to where the ankle begins. B is the centre of the heel. B to C = B to F. B to D = B to E. C to D should not be a straight line, but a gentle curve, so that the heel piece will slope inwards.

Make both your patterns on paper, and then draw them onto leather.

Punching the Holes

- Using the smallest hole on your punch, punch holes around the edges. The centre of each hole should be 5mm from the edge, and 8mm apart. Mark the centre holes.

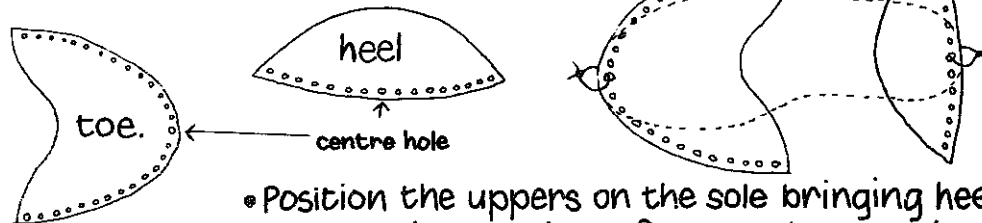

- Position the uppers on the sole bringing heel centre and toe centre of uppers to meet heel centre and toe centre of the sole. Punch a hole through into the sole, 5mm from the edge.

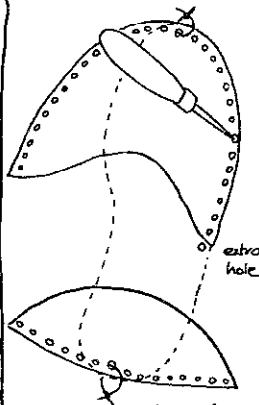

Thread string through holes and tie it.

- Use something sharp to mark through the holes in the uppers to the sole. Do this by pulling uppers over, so that one edge meets the edge of the sole. Then pull the other side over. Do the same with the heel piece. After the last hole put an extra hole in the sole so you can stitch over the edge to make it strong.

The Stitching

The best stitch to use is a lock stitch. It is done with two needles on each end of a piece of thread which pass through the same hole.

The thread should be 4 times the length of the stitching. Pull the thread through the holes so that there are equal lengths on either side.

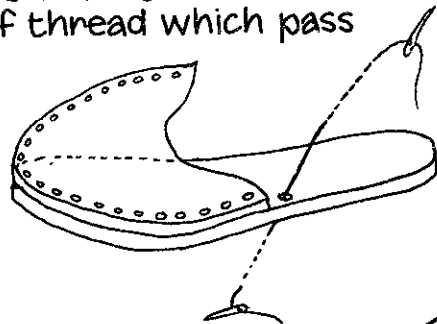

Pull each stitch as tight as you can. To end the stitching, tie a knot under the sole. Make sure the top thread is pulled to the same side of the hole each time. Your stitching should look like this,

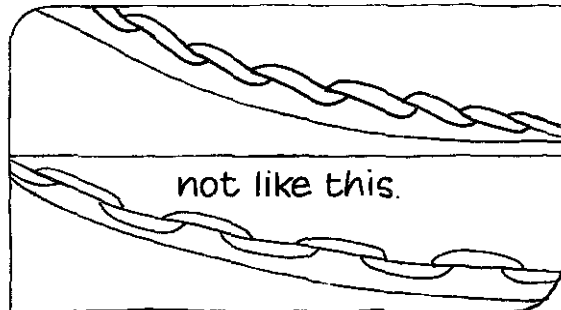
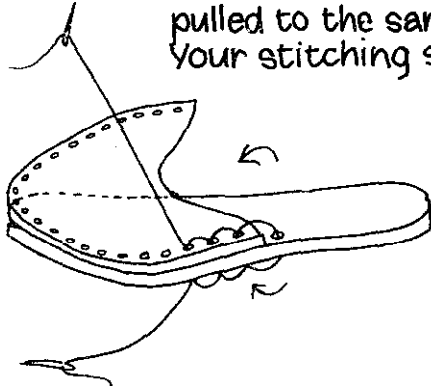

Glueing the Soles

- To flatten the stitching, hammer the edges of the shoe on a flat surface. Make sure you place a piece of leather in between the hammer and shoe. To hammer the centre part of the shoe properly, you should use a shoemakers anvil so that you can hammer the shoe from underneath.



shoemakers
anvil

- Glue soles and heels the same way as sandals.

Buckle and Strap

Fasten the buckle and strap the same way a sandals. Make sure they are below the ankle bone, otherwise they will hurt.

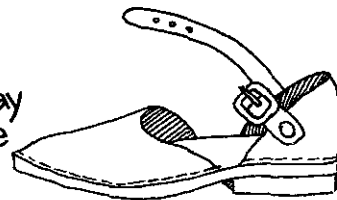

Stretching Toe and Heel

The uppers of the shoe are flat. They need to be stretched to fit the foot better. Wet the shoe until the top leather is completely wet. Then push with your hands, or stuff newspaper inside till you are satisfied with the shape. Allow it to dry. The leather will be hard when dry, so use Dubbin to soften and protect it. When the dubbin is well soaked, use polish to give the shoes a shine.

Making Candles

Most South Africans use candles for lights. They are expensive if you have a big family and need many candles every week.

Some production groups make good quality candles and sell them in their communities. They are called dipped candles because they are made by dipping a piece of wick into melted wax. Dipped candles are more expensive than shop candles but they last longer, burn brighter, and do not make smoke or smell bad.

What you need

You need about R100 for the first materials which you can order from EDA.

- ▶ 40kg paraffin wax.
- ▶ 4kg stearic acid.
- ▶ Wick - the string which burns inside the candle.
- ▶ 1 container to melt wax in. You can use old fire extinguishers which you can buy for about R2 each from most scrapyards in big towns. Ask the scrapyard or a garage to cut off the top to make a melting container.
- ▶ 20 wire jigs.
- ▶ A thermometer in a brass case.
- ▶ A rope or plank to hang the candles on while they dry.
- ▶ A gas or paraffin stove.

How to make the jigs

A jig is a hanger which holds the wick while you dip it into the wax.

■ Hammer 5 long nails into a piece of wood, and cut the heads off the nails.

■ Cut 20 pieces of wire 60cm long and 20 pieces of wire 50cm long.

■ Take one of these pieces of wire and bend it around the nails.

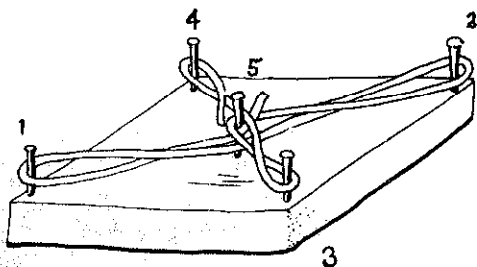

Start at nail 1, bend the wire around nail 2 and then up around nail 3. Then bend it back to nail 4 and up around nail 5. Bend the rest of the wire back around nail 1 and make it into a hook to hang the jig up with.

■ Now take the jig off the frame and bend the corners down.

■ A jig must have a top and a bottom. Make the bottoms of the jigs with the 50cm long pieces of wire. Bend them around the nails in the same way, but do not make a hook.

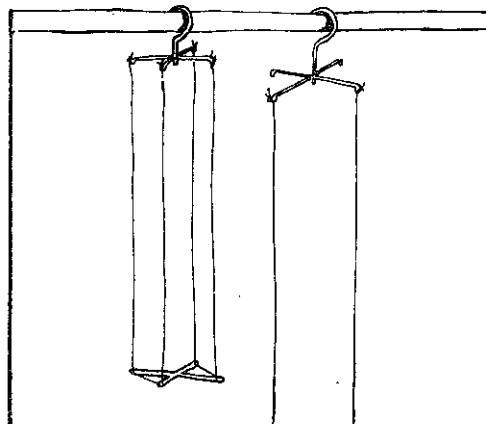
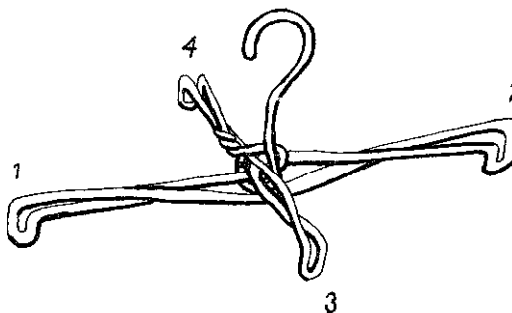

Tie 4 pieces of wick, long enough to make 4 candles, to the tops and bottoms of the jigs.

Preparing the wax

Cut the wax into small pieces with an axe or a knife. Make sure no dirt gets onto the wax. Melt the wax and the stearic acid so that it nearly fills up the container. Use a mixture of 10 parts wax and 1 part stearic acid.

Heat the wax on a gas or paraffin stove until it is 70°C. Check the temperature with the thermometer. The temperature of the wax is very important. If you make the wax too hot, it will not stay on the candle. If you make the wax too cool, it will make lumps on the candle.

It is very dangerous to make the wax too hot, because it can catch fire. Wax fires are very difficult to put out.

If a wax fire starts, put a cover on top of the container and try to turn off the stove.

Dipping the candles

Dip one jig at a time into the wax. When all the jigs have been dipped once, dip them again. Each time you dip the candle into the wax it will become a little thicker. Carry on until the candles are thick enough.

Hang the jigs onto the rope or plank. When you have finished dipping the candles and they have become hard, cut them off the jigs.

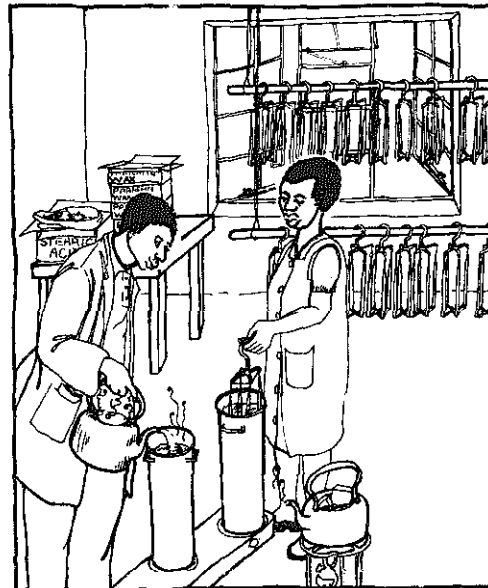

On the floor underneath the hanging jigs, put down some wide planks or plastic sacks to catch the drips from the candles. You can scrape this wax off and use it again. You can also scrape old wax off the jigs and melt it again to make more candles.

The problem is money because we are underpaid

Workers in many craft projects become unhappy with the way the projects are run. The workers are never asked about what they want, even though the project is to help the people. We spoke to some workers at a project in the Northern Transvaal.

● Mary, how did you join the project?

In 1971 I was in hospital very ill. I was approached by the superiors of the project when I was in hospital. They wanted to know with who I was staying with. I told them that I was staying alone because my husband is deceased. They then promised me this work I am doing now.

We don't get enough money and we are not happy about that. I will just have to work here even if the money is not enough because I am just about to get my pension due to old age. There are many

people who are looking for work but they don't want to work here because of the little money but ultimately you find them here because there is no other place where they can work as you can see we are far from town.

My work is to do table mats and sewing dresses which are ordered by the whites living in town and I also sew curtains. I really do a lot of things. All the articles I am able to produce I was taught by our manager here. I am enjoying this kind of work. I am able to do every work as long as I

am shown how to go about it. What I have not done in this factory is to sew carpets and if time can allow me to do so, I would be very grateful.

Workers in town are more united than us because if they are not satisfied with money, they approach the manager or stage a demonstration. Here we are afraid to do that because some of the workers will tell you that they are satisfied with the little they get. People here are not united I can rest assure you, nothing will come right.

● Josina, how do you find the work?

I go well along with the people I am working with. We don't know about the problems of this factory because we are not told about them and we don't even ask. This is a Mission place but it is not a true Mission, it is just the name. The owners of this Mission are not suffering but we are the ones who suffer we don't get the food we are suppose to get. For instance when I was in hospital I was given a prescription of the meal I must eat, but I am failing to prepare that because I don't have money.

● What kind of problems do you mean?

The biggest problem we as workers have is money because we are underpaid. I think if we know how much these products are sold and for how much they are sold, we would stand up and ask our manager why we are not paid enough money.

● Alice, when did you join the project?

I joined in 1971. When I first came they gave me R1 per month because I was still learning weaving. I started to get more money when the instructor left. The manager asked me to do it and she gave me R20 a month from then. My job was to help the women to do the spinning, the weaving, dyeing, everything to do with the making of the carpets I know about it. These days my pay is worked out according to how much work the other people are doing. If they are working well, I get more and then if they work slowly or badly I get less. I do some weaving myself, I keep the records in the books of the work, and I help the people who don't know how to do the weaving and other things.

So my pay is between R20 and R30 per month. There is no other place that I get money. I really don't know how we can all stay alive on that money. One bag of mealie meal costs R16. But our nation does not eat a lot of things - we just eat morogo all the time. One bag of mealie meal can only last for less than 1 month. All



we eat is porridge and morogo. I haven't got money to buy bread and meat. I haven't thought of asking for a piece of land because I don't know who could work on it. My mother-in-law is too old and also we don't have water. My children are too young to work in the garden or they are at school and I must struggle to pay for their school fees.

● How much do other workers at the project earn?

I try to tell the people that they must work harder so that we can all get more money. But I never get more than R30 per month and I don't know how they work out the wages. They tell us that all the money we make must go to buy wool and things like that.

● Do you discuss these things at meetings?

We don't have meetings here, I think there should be and then we can sit together and talk about what is going on. I don't know what the other people here think about it. There are many of them who have never been to school and they don't think about such things.

We don't know what happened to democracy

When the workers in a community project are exploited and not consulted about anything, they become very dissatisfied. We spoke to some workers at a pottery and textile project in Botswana.

● Who owns this project?

When I first came here I wanted to know who the project actually belonged to. I asked that question for about 6 months and couldn't get the right answer. I was under the impression that it belonged to the Catholic church. Then Father told me that he wanted the centre to belong to the village. Then I asked the people around here whom they thought the project belonged to and they thought it belonged to the church. I was also told that at the end of the year the profit is divided in the following way: 50% of the profit goes to the centre, 25% to the village for development

and 25% is shared out amongst the workers. I asked people whether any money had come to the Village Development Committee and they did not think anything like that had happened.

● What other problems does the project have?

The manager was not happy with some designs of the pottery so they were changed. This made the potters and artists rather angry. In January of this year there was a real squabble at the centre. I was sacked and the trainee manager from the textiles was sacked. We thought that Father would be a good intermediate, but he took sides with the manager. People were unhappy when I had to leave, because there is a feeling that the centre should be localised and that a black person should take over, whether from Botswana or not does not really matter. The workers themselves would like to see the project to be localised.

People become very confused with the expatriates coming and going all the time. The expatriates are being paid by their organisations but the workers are paid by piece work, so their salary varies, but in the textiles it is very low. At the pottery it is a bit better. If someone works very hard he can earn up to R50 or R60. The average is about R40 a month. If someone makes a plate which sells for about R5 the person who made it may only get 15c. I think the manager gets about R200 or R250 a month and his wife gets something too. They get allowance for their kids, they have a free house and can use the project vehicle for free. I myself get R131 a month. According to the manager our things sell for so much because of the oil price. We are using diesel for firing the kiln. Wood firing would not be suitable for the future, because of the policy of people starting to own land.

We spoke to another worker in the textile section.

● Do you see any future in the workshop?

I think the workshop will close eventually. We have a problem in our manager, who has less if any interest at all in our workshop. He even expects us to market our products. We sometimes stay for a month without materials and he would give us flimsy excuses. He does things secretly. He does not care to consult us. His main interest lies within the pottery workshop because it brings in money. We have nothing much to say to you as workers, because we do not have the knowledge of how the place is run. We are just flowing with the tide and I promise you that it is only the management that has an idea and can tell you whether this project is growing or collapsing. Although we do see the problems

and would like to help in solving them, management tackles the problems on their own. Most of our suggestions are ignored - we are in the dark.

● How do you intend solving your problems?

If we could we would. We have made suggestions and we do have ideas. One possibility would be to get a black person or people to lead us provided they are human enough to listen to other people. It does not necessarily mean that blacks are better than whites, but a black person would be more sympathetic, because of language, pigmentation and cultural ties with us. It may be better with a black person. The first group of whites that started with us were more human. They used to consult us although they were not very sincere, but were better than the present lot. This white man pushes us to the extent of hating

white people. These expatriates are not that useful, because they come and leave after two years, before they can establish a proper relationship with us. They have lied to us. They were supposed to come and impart their knowledge to us, but they have not done so. It has happened many times before that expatriates sit on their positions through selfishness and don't impart their skills to the people they were supposed to come and help. It is not that we are morons, no effort is put into imparting the skills to the locals.

● Who does this project belong to?

What can we say, because we know nothing about this centre? All we know is that it was founded by the priest. Maybe it belongs to the manager. It is alleged that there is a board, a group of inefficient old men, who can do nothing without Father. Last week there was supposed to be a board meeting and only two of them turned up. They exist by name only. One other solution would be to get young people to be represented on the board of directors and the Village Development Council. But, no, they will not agree, because they are threatened by changes in society. We have not had board elections for a long time. We don't know what happened to democracy. It is only a game of manipulation going on.

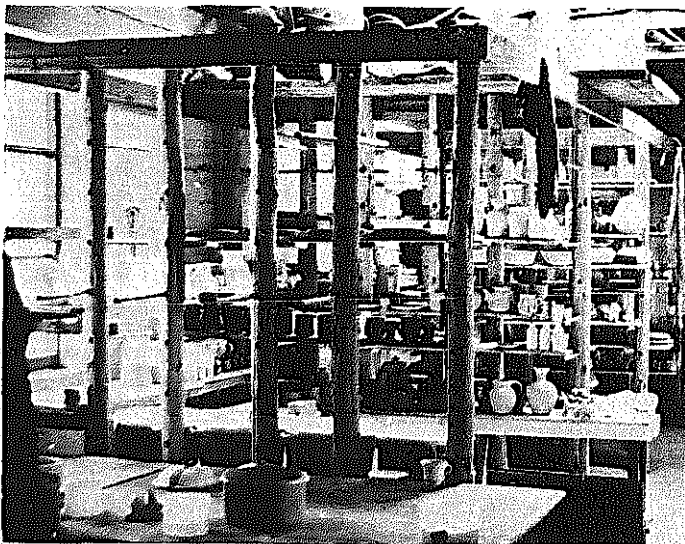

Fixing Cars

In this article we only discuss what to look for if you are buying a second hand car and what to check for if your car breaks down. To explain even simple motor mechanics we would need a whole book.

Buying a second hand car

Before you buy a car, decide what kind you want. Then look in the newspapers for at least a month to see how much that car is selling for. Then you will know if you are being overcharged.

Beware of a car which is too cheap. It usually means there is something badly wrong with it. Never trust the kilometres on the speedometer, because it is very easy to turn a speedometer back to a low number.

It is better to buy a car with manual gears than an automatic. Automatic cars are more expensive to repair, and they cannot be push-started or towed when the battery is flat.

Buy a car that you know is popular. These cars are popular because they are cheap to run and simple to fix. If a car is popular, it is usually easy to get spare parts for it.

Checking the car

If you do not know much about cars, take a friend with you who does. Ask the owner if you can drive the car for 20km. Offer to pay for petrol.

■ Take the car out on a bad bumpy road. If there are bad rattles in the suspension, they are going to be expensive to fix.

■ Listen for whining noises from the gearbox and back axles. These mean that something is badly worn.

■ Test the clutch by trying to start the car on a steep hill. If the engine goes very fast while the car is only going slowly, the clutch is slipping. You can expect to have expensive repairs in the future.

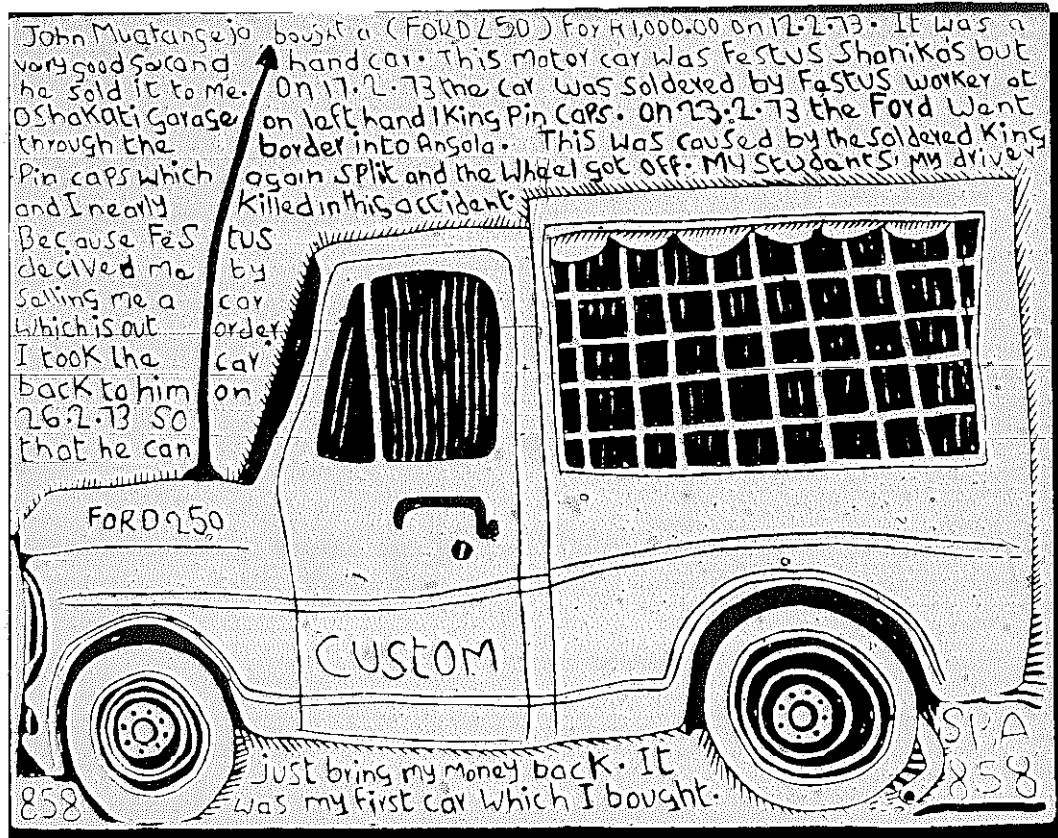

- Hold the front wheels and try to shake them hard. If they move easily, this means the car has worn bearings and worn suspension joints.
- Test the shock absorbers by pushing down hard on the bumper with your foot. The car should only bounce once. If it bounces more than once, the shock absorbers are worn.
- Check if there is any smoke coming out of the exhaust. If the smoke is black, it means you are probably going to have trouble with the bearings. If the smoke is blue it means the cylinders inside the engine are worn. The exhaust pipe should be a medium grey colour inside.
- Check the whole exhaust system for holes and rust.
- Check that all the electrical parts are working. If any of these things are wrong, it means expensive repairs. Find out how much money they will cost before you buy the car.

Roadworthy Certificates and Licensing

Every time a car changes owners, it must be tested by the traffic department at the municipality to check that it is safe to drive. If it passes the test, it gets a roadworthy certificate. All the faults we have discussed can make the car fail the roadworthy test.

These faults also have to be fixed:

- ▶ Cracked or scratched windscreen, even small cracks and scratches.
- ▶ Doors and windows that do not open or close.
- ▶ Torn seats.
- ▶ No spare wheel or jack.
- ▶ Steering wheel too loose.
- ▶ Headlamps and lights not working.
- ▶ Leaking petrol tank or pipes.
- ▶ Oil dripping from under the engine or gearbox.

If you are not sure if your car will pass the test, take it to a garage which does roadworthy testing.

After you have got the roadworthy certificate, licensing is easy. But if you buy a car which has not been licensed for a few years, you will have to pay the license fees for all those years.

Third Party Insurance

You have to get third party insurance. If you do not and you have an accident which is found to be your fault, you might have to pay many thousands of rands. You can buy this insurance from insurance companies and banks.

If you want to drive or tow a car without insurance, get a temporary permit. This lasts 3 days and costs 75c.

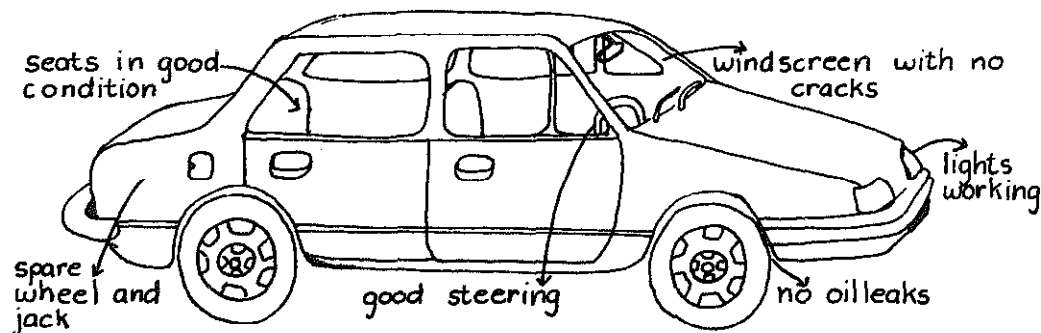

some things to look for in a 2nd hand car

GST

When you buy a car, you have to pay G.S.T. If you pay the G.S.T. to the seller, he must give you a letter to say you have paid G.S.T. Otherwise you must pay G.S.T. to the Receiver of Revenue. You can not license the car until you have paid G.S.T.

If your car breaks down

There are two main reasons why cars break down while you are driving:

- The engine is not getting any petrol.
- Something is wrong with the electrical system.

If the engine is not getting enough petrol, you should check these things:

- Check you have petrol in the tank.
- Check the carburettor. Some carburettors have a small glass window. If you can not see any petrol through this window, it means the fuel pipes are blocked somewhere. If the carburettor does not have a glass window pull the fuel lead off the carburettor. Start the engine. If petrol does not pump out of the fuel pipe it is blocked. First take off the fuel filter and check that it is not blocked. If there is a filter in the petrol pump, also check it is not blocked. If these filters are not blocked, the fuel pipes must be blocked. Blow through them to unblock them. If this still does not work, check that all the screws on the carburettor are tight. If this does not work, you or a mechanic will have to take the carburettor apart.

If your car has stopped because of an electrical problem:

- Start it with the ignition. If it does not start, it means that you have a flat battery or something is wrong with the leads from the battery. Check that the main battery lead to the starter motor is tight.
- If all these things work, check that there is a spark in the spark plugs. Take off the spark plug lead and wrap a piece of cloth around it or hold it with insulated pliers, so you can hold it without getting a shock. Hold the lead very close to but not touching any part of the engine and turn on the starter. You will see if there is a spark. If there is no spark, check that the leads are properly on all the spark plugs and properly on the distributor cap. Try to get a spark again.
- If there is still no spark, check that the wire to the distributor is right.
- If there is still no spark, check that the lead from the middle of the distributor to the coil is properly in place. Open the distributor cap and check that the rotor is not badly burned. Check that the carbon spring contact onto the rotor is on.
- Check the points to see if they are opening or closing properly.

If the electrics still do not work, it means that something is wrong with the condenser or the coil. These have to be fixed by a mechanic.

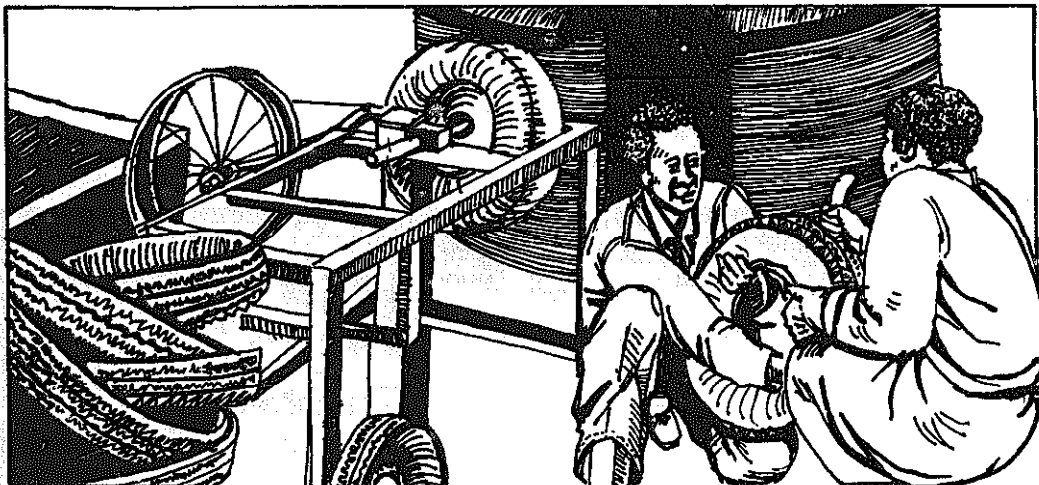

Tools

It is easy to do some maintenance on your own car, such as changing the filters and setting the timing. But other maintenance needs a mechanic. Try and read some books on basic car maintenance (see p 545) or ask people who know.

You do not need to get many tools. These tools will be enough for most car repairs:

▶ Spanners. You do not need a whole set. The most useful spanners are the ones which are ringed on one end and open and flat on the other end. Different cars use different spanners: Older British cars use Whitworth spanners, American cars use SAE spanners, and Japanese and European cars use metric spanners. If you can afford it, get some socket spanners. Use these spanners carefully because it is easy to break bolts with them. Never use cheap spanners, they are useless. Use a good make like Gedore.

▶ Pair of insulated pliers.

▶ Medium sized (10 inch) shifting spanner.

▶ Different sizes of screwdrivers, flat and Phillips (star).

▶ A good vice grip.

▶ Heavy hammer. Use a ball pein - flat on one side and round on the other side.

▶ Feeler guage for setting points.

▶ Insulation tape.

▶ Grease gun and grease for wheel bearings.

To do car repairs you need a place to work. Try to use a concrete floor or hard ground. People can be badly hurt by working under cars which have been jacked up on grass or soft ground. Always try to stand car on trestles. Bricks or concrete blocks can break easily.

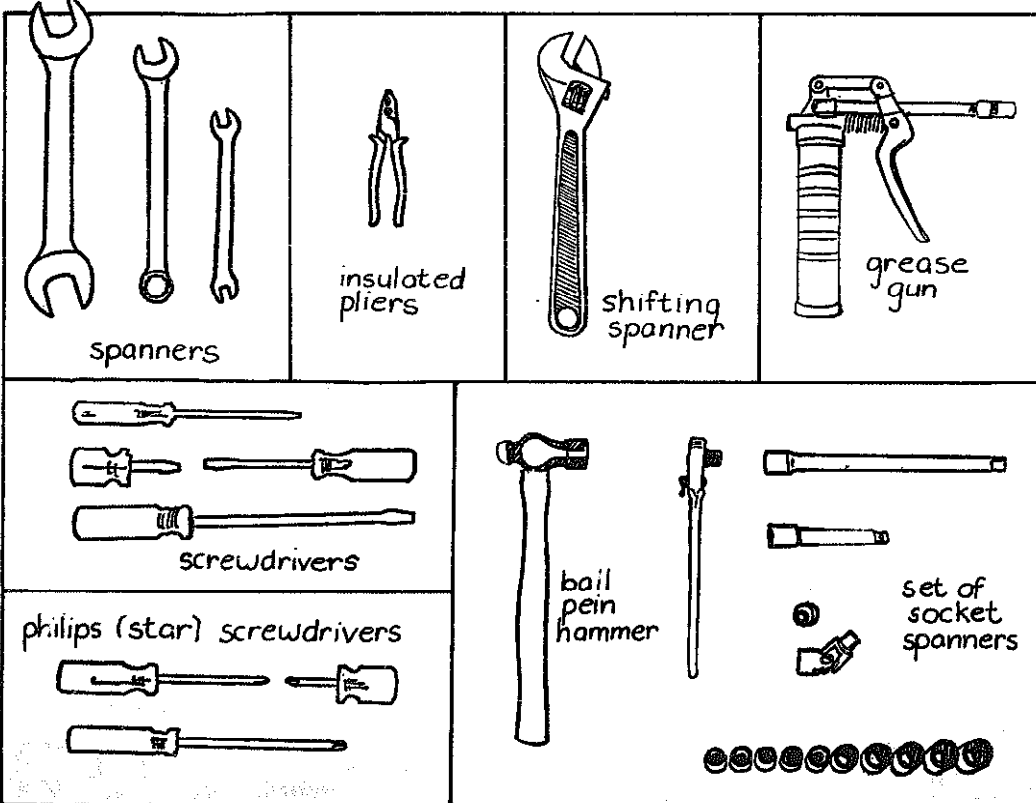



Using a scrap yard

All big towns have scrapyards full of old cars and broken machinery. There are two kinds of scrapyards, motor scrapyards and general scrapyards.

You can get most of your spare parts, except for things like spark plugs and points, from motor scrapyards. Their spares that are often as good as new and half the price of new spares. Take your old broken part when you go to the scrapyard, so you can get the right part. Check the replacement part very carefully, because some parts are changed every year. Also at the motor scrapyard you will find nuts, bolts, washers, springs, wire, light bulbs and other useful things.

General scrapyards are good places to find any kind of metal, not just motor spares. There are 3 kinds of metal found in these scrapyards: offcuts from factories, used machines and rubbish.

■ **Offcuts.** Factories often waste a lot of metal. Pieces cut off in the factory are sold to scrapyards. These offcuts are useful to anyone making things out of metal.

■ **Used machines.** Many factories throw old machines away when they get new machines. Often these machines, or most of their parts, are as good as new. You can get machine parts very cheaply, because in a scrapyard the parts are sold according to the weight of metal. You don't pay for the workers' labour that went into making the part. So it is possible to get machine parts at one hundredth of the new price, or even less.

■ **Rubbish.** Things like old corrugated iron and old car bodies. Potter's kick wheels can be made from the front hub and stub axle of cars, with the wheel filled with cement. Tanks for dipped candles can be made from fire extinguishers with tops cut off.

Making Furniture

With just a few woodwork tools, costing less than R100, you can make many things: beds, tables, benches, tool-boxes, doors, windows, wheelbarrows, crop driers, beehives. It is better if you join together with other people. Then you can help each other to make things and buy the tools together to save money.

Buying tools

Get good tools. Even though they are expensive, they will last much longer than cheap tools. This set of basic tools cost about R80.

- ▶ Cross cut saw
- ▶ Hammer
- ▶ Screwdriver
- ▶ Set square with angles of 45° and 90°
- ▶ Ruler
- ▶ Hand brace and bit
- ▶ Wooden mallet
- ▶ Chisel - ½ inch

You can add these tools when you have more money:

- ▶ Plane - a large plane such as a Stanley No 5½.
- ▶ Vice - try to get one second hand. In this article we show you how to make your own.
- ▶ G clamps - 1 pair of 8 inch G clamps.
- ▶ Sash clamps - 1 pair of 30 inch sash clamps.
- ▶ Saws - to cut along the grain of the wood you need a rip saw. For cutting joints you need a tenon saw.
- ▶ Screwdriver - if you will be using screws often, get a spiral ratchet screwdriver, which turns as you push it.
- ▶ Pin hammer.
- ▶ More chisels - ¼ and ¾ inch.
- ▶ Measuring instruments - a scribe and chalk line.
- ▶ Carpenters square - for measuring across the wide pieces of wood.

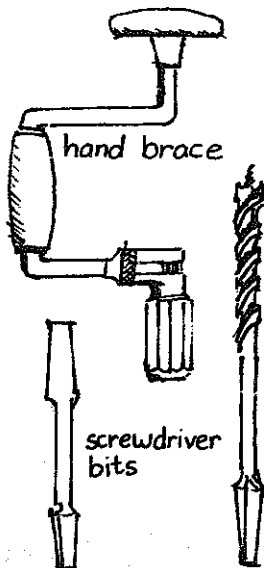
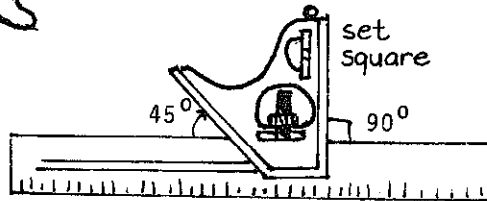
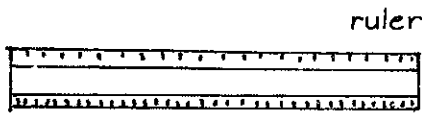
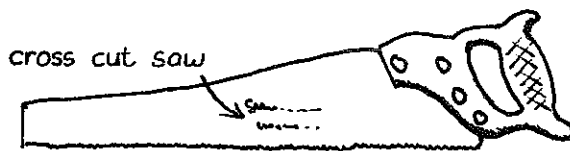

screwdriver



chisel

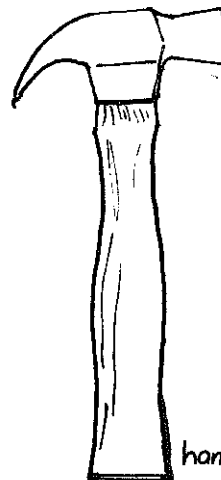

mallet

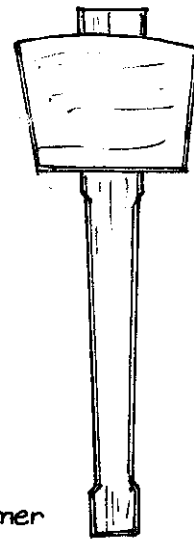

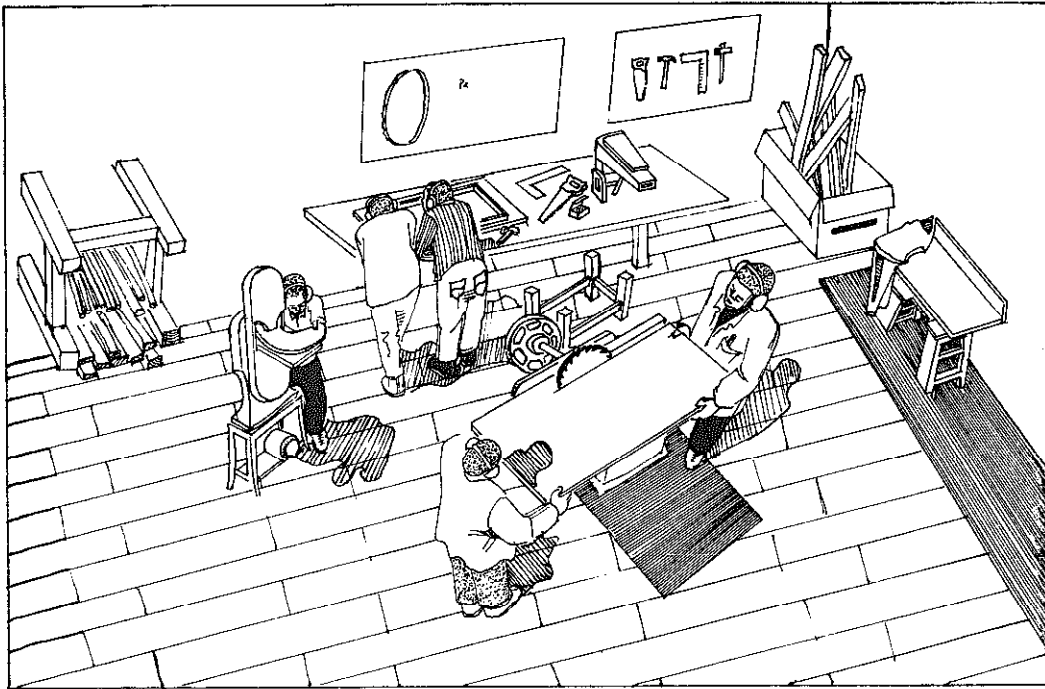

Where to get wood

Try to get second hand wood from demolishers and scrapyards. Your local store or railway station may have second hand packing cases. A cheap wood for furniture is SA pine. Hardwoods are better but they are more expensive and not so easy to find. Do not use chipboard. It is made from wood scraps held together with glue and it will blunt your tools.

Before you start

Try to plan your job carefully. Measure twice before you cut. After you have made a mistake you might not be able to fix it.

Use wood to hit wood and metal to hit metal. Hit a chisel or a dowel rod with a wooden mallet, not a hammer. If you use a hammer it will damage the wood. But if a metal clamp sticks and you have to hit it, use a hammer.

Screws, nails and joints

Carpenters only use nails for rough work. Nails do not hold wood together very strongly. They are stronger

if you hammer them in at different angles. Then the pieces of wood can not pull straight apart.

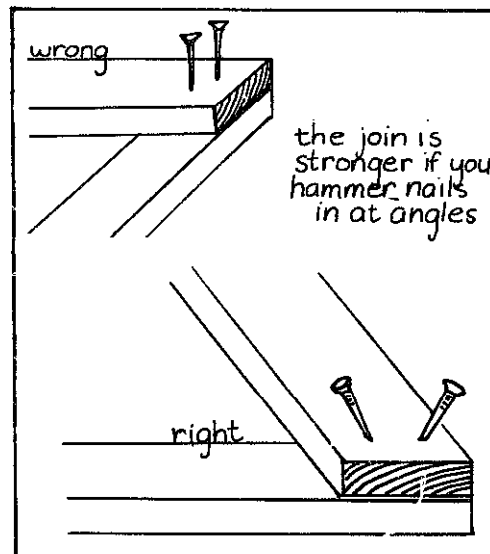

Screws are better than nails, because the spiral thread of the screw holds the pieces of wood together. But screws can split wood if they are not straight. Also, when screws rust inside wood, they can damage it.

The best way to join wood together is using joints and dowels. Joints are cuts in the wood made so that the two pieces fit together closely. Dowels are round sticks of wood which hold the joints together instead of screws.

These are the most common joints:

■ Lap joints. These joints are square cuts to make pieces of wood fit into each other. Lap joints are joined together with screws and glue.

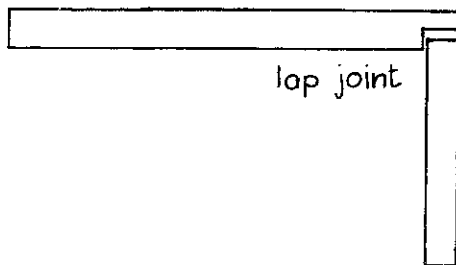

■ Butt joint. Make this joint with nails and screws. You can also use glue if the wood is smooth.

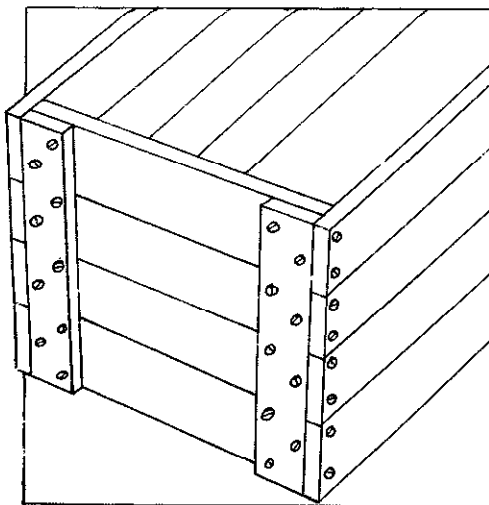
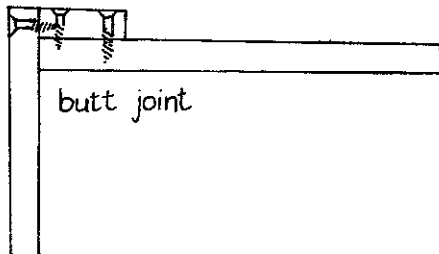

■ Mortice and tenon joints are used to make strong frames like tables, windows and doors. Make the tenon a third as thick as your wood. For example, if your wood is 32mm thick, make the tenon about 10mm thick.

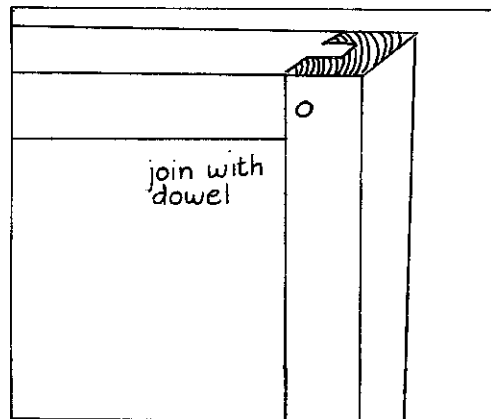
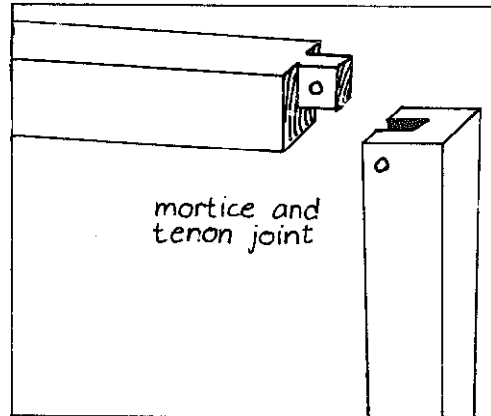

■ Dovetail joints are used for making strong corners.

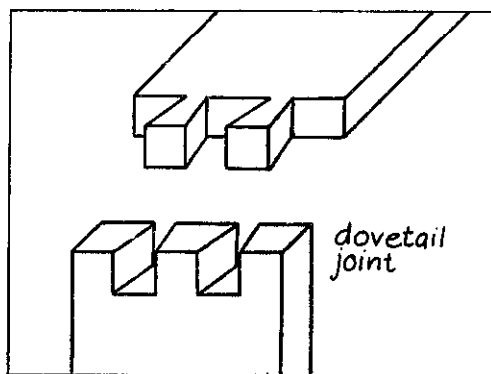

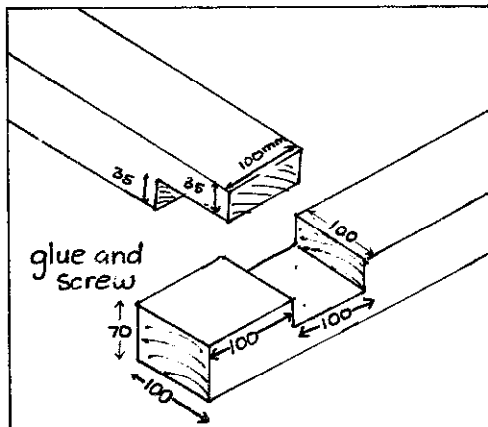
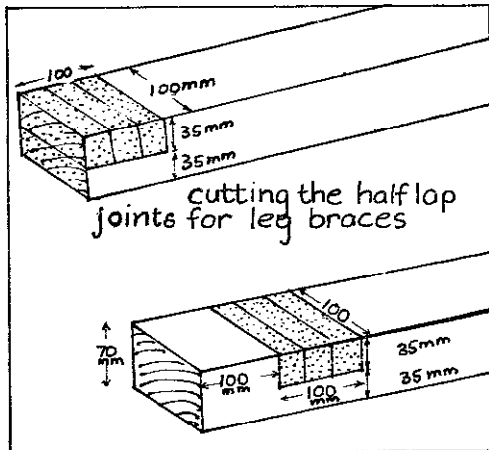
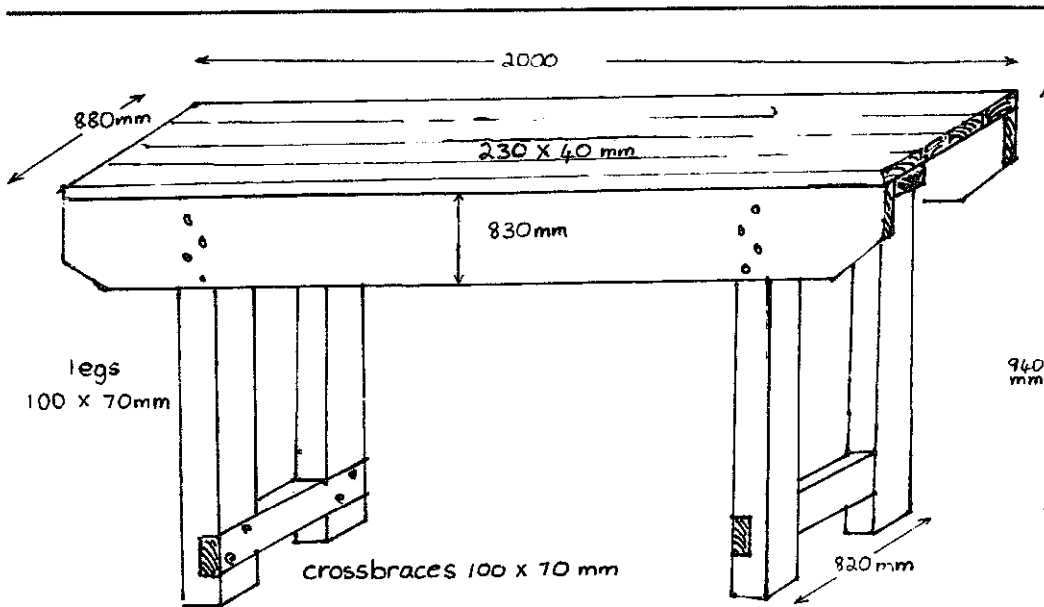

Making a workbench

The first thing to make is a strong workbench out of heavy wood. Join the crosspieces to the legs with half lap joints to strengthen them. You must make the half lap joints well so that they fit together properly. Use 3 saw cuts to make each half lap, and cut out the waste wood with a chisel. Screw and glue all the joints together. Make the top stronger with some support planks on the side. You can fit planks across the bottom crosspieces to make a shelf. This also helps to make the workbench stronger.

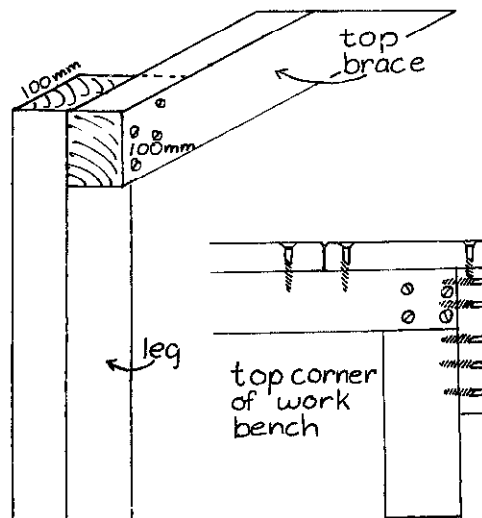

Making a Vice

Vices are expensive to buy. You can make your own which you can build onto your workbench. You need:

- ▶ 4 pine crosspieces 76mm thick and 50mm wide, with each crosspiece 50cm longer than the width of your workbench.
- ▶ 1 upright piece 76mm thick and 50mm wide, the same height as the workbench.
- ▶ Three 8 inch bolts with washers.
- ▶ An inner tube from an old car or bicycle tyre.

2 crosspieces must be fixed across the top of the legs of the workbench, and 2 at the bottom. Drill 3 holes each in

the top crosspieces and 1 each in the bottom crosspieces. Fix them onto the workbench legs with screws. Drill holes in 2 blocks of wood, but not in the middle of the blocks and drill holes in the top and bottom of the upright piece. Bolt the blocks to the upright piece. Then tie the rubber tube tightly halfway up. Cut a wedge from 76mm x 50mm wood. Make it 200mm long, 12mm thick on one side and 8mm thick on the other side. You will have to try out different wedge holes at the top and different wedges to get the vice to work properly. Moving the blocks around helps to adjust the vice.

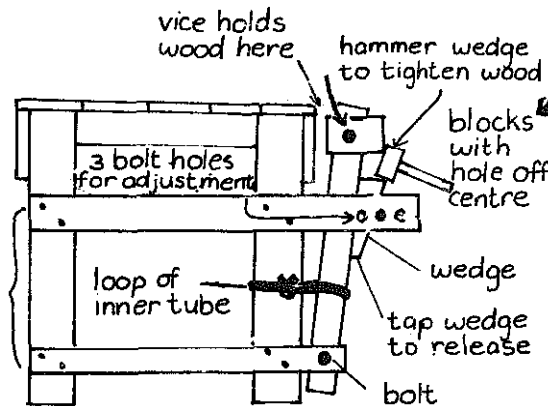
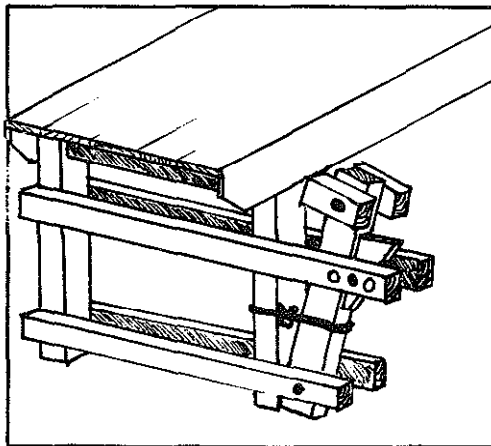

Making Boxes

People use wooden boxes for many things such as toolboxes, wooden trunks, seats, breadboxes and drawers. You can join the sides of boxes with butt joints, lap joints, or dovetail joints.

place with sash clamps and tighten them well. Use a carpenters square or a set square to make sure the corners are all square. Drill holes for screws, not too deep, otherwise the screws will not hold properly. Just drill a hole big enough for the end of the screw to get in. Undo the clamps when the glue is dry.

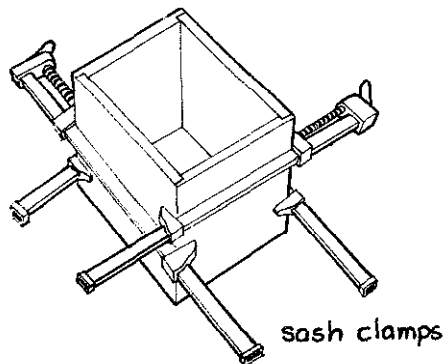

To join a box together with lap joints, put glue on all the parts that will be touching each other. Hold the box in

Boxes which are used for toolboxes or trunks need to be very strong. You can strengthen them in different ways:

- Screw strips of wood 2cm thick and 7cm wide all round the sides at the bottom.
- Screw 2 pieces of wood 3cm thick and 5cm wide underneath to protect the bottom of the box when it slides on the floor.
- Screw a piece of wood onto the back just below the hinges to support the lid of the box when it opens. Then the hinges can not be pulled out easily.

Making a Trestle Table

The easiest tables to make have tops resting on trestles. To make a table top, join some planks together with glue and clamp them tight with a sash clamp. Use 2 planks screwed across the other planks underneath to make the top stronger.

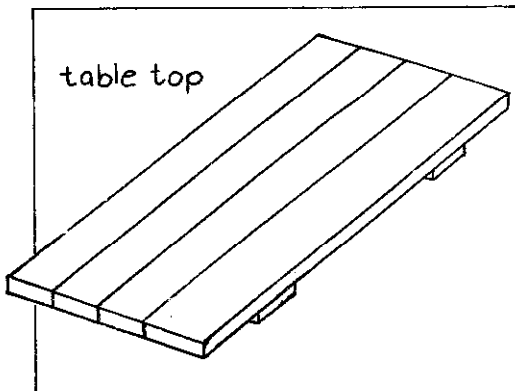

There are different ways of making trestles.

■ The simplest kind of trestle is made of 2 frames joined with butt hinges. Each frame can be screwed together. Use a string or a strip of wood to keep the bottom of the trestle the right distance apart for the height of the table. Most tables are 750mm high.

■ Another kind of trestle has 3 legs. This is a frame joined together with half lap joints with a third leg half lapped at an angle to the top of the frame. This trestle uses less wood than the others.

■ The trestle will be even stronger if you make it with 4 legs. Lap each leg into the top of the trestle at an angle. Join the crosspieces together with mortice and tenons and dovetail half laps. You do not have to use any screws for this trestle.

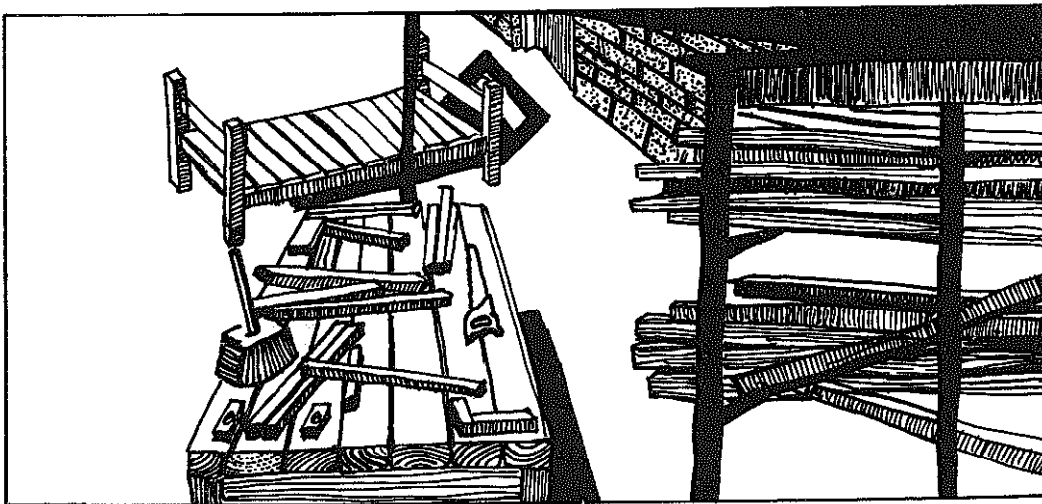
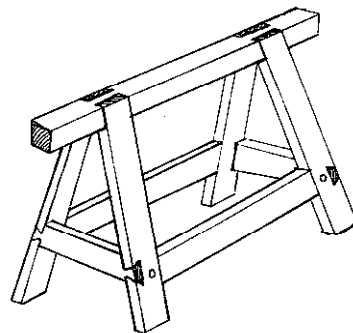
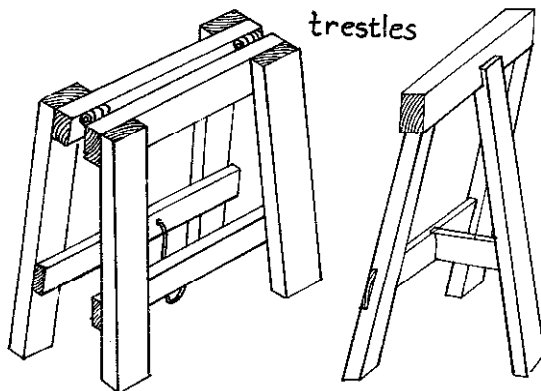

Tables

Make strong frames for tables using mortice and tenon joints. A cross piece across the bottom will strengthen the frame. Make the legs from 45mm x 45mm or thicker wood.

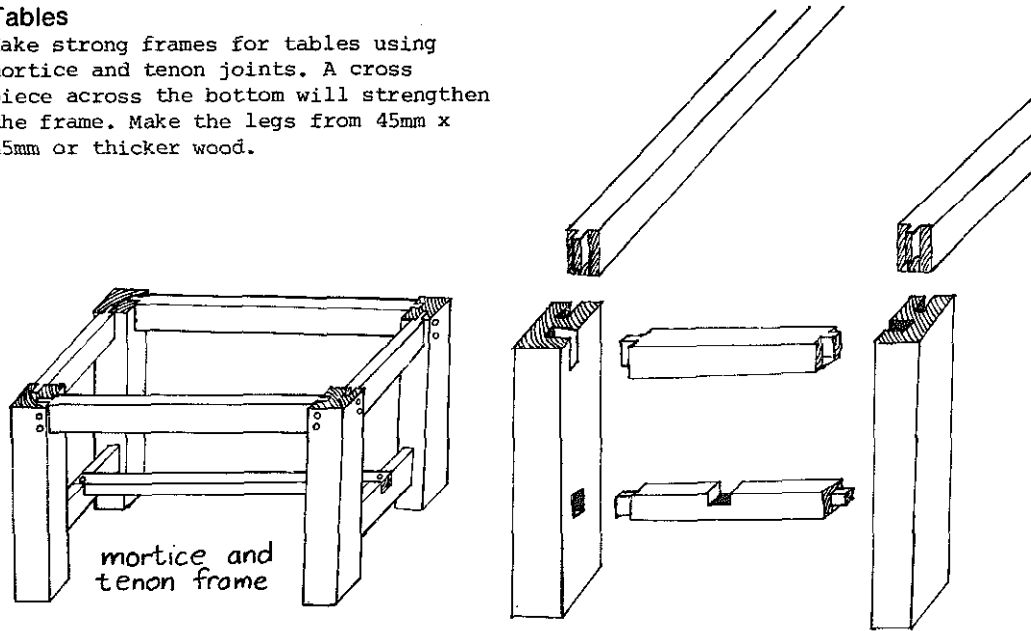

Kitchen Units

A good way to make small tables or kitchen units is to use dovetails on the top of the legs and fit the dovetails into the table top. To make the dovetails, first make the 3 cuts down the grain, and then make the 3 cuts across the grain.

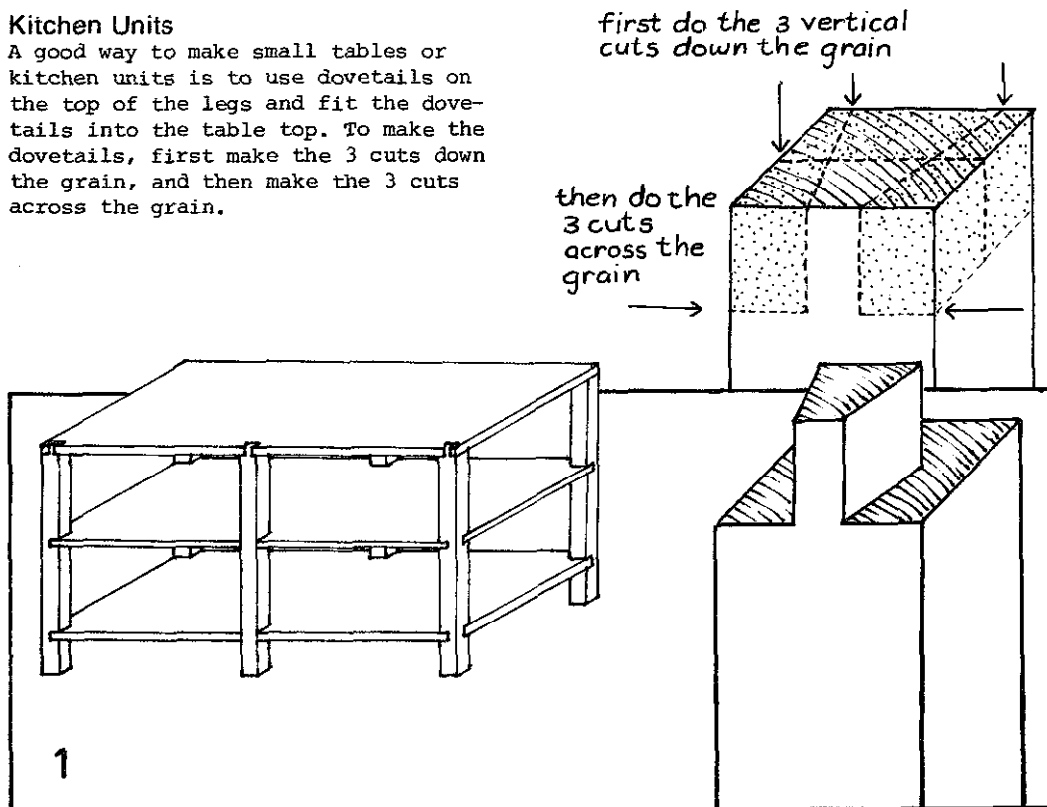

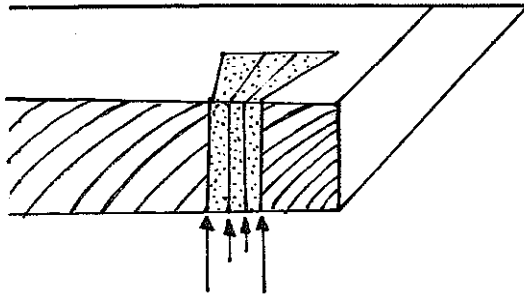

Use the dovetail you have just cut to mark the place for the dovetail in the table top. Make 4 saw cuts for this place, making sure that the outside cuts are in exactly the right place. Use a chisel to cut out the waste wood.

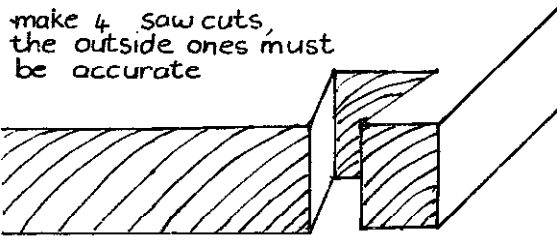

make 4 saw cuts, the outside ones must be accurate

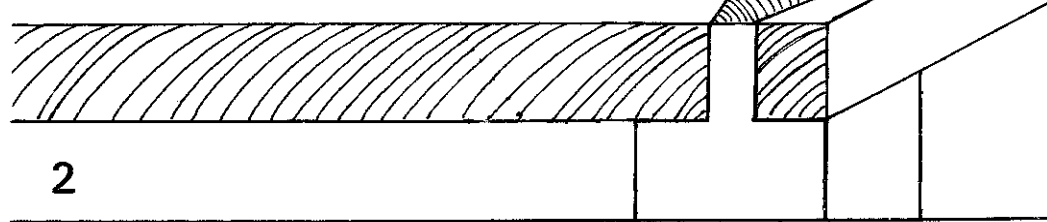

2

Kitchen units should be 850mm high. To put one or more shelves underneath a table or a kitchen unit, you have to make two half laps in each of the legs. Use the thickness of the shelf to mark where to cut the first half lap. Do not cut the second half lap as deeply as the first one because it will weaken the leg. Cut it only half as deep.

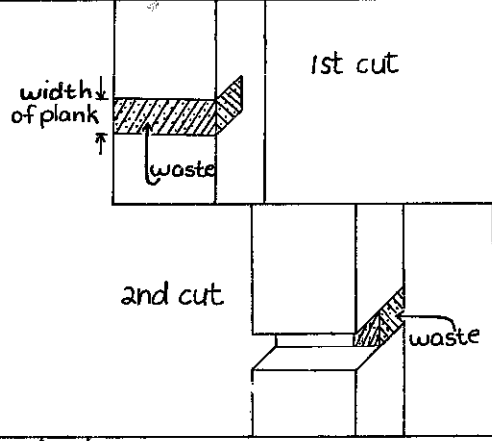

single half lap on the middle support for the counter/shelving

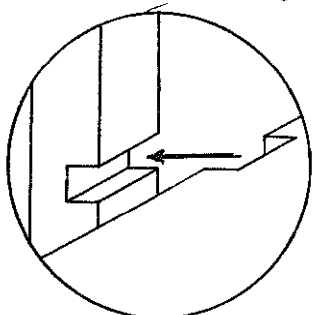

3

double half lap

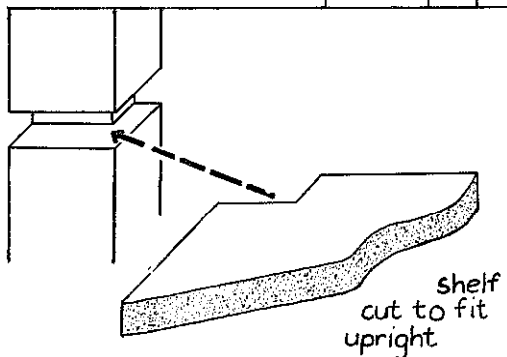

Door and Window Frames

Use a through mortice and tenon to make door and window frames.

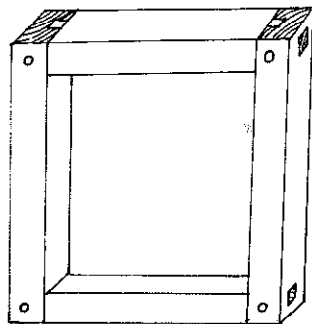
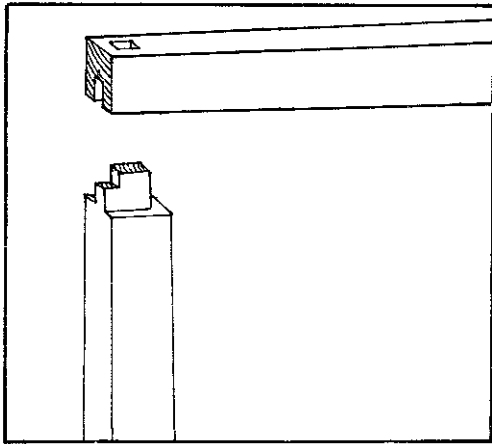

Benches

Chairs are quite difficult to make so we are describing how to make benches instead. Benches should be 450mm high, with the legs divided into 2 parts at the bottom so the bench does not wobble. Do not let the seat stick out far over the legs otherwise the bench can tip up if somebody sits on the end.

■ The simplest kind of bench has 2 side supports and the seat screwed into the legs.

■ You can make a bench stronger by using through mortice joints on the legs to join them to the seat. Hammer a wedge into the mortice joint to make sure it is tight.

■ You can make all benches stronger by bracing the legs with a crosspiece underneath or diagonal bracings.

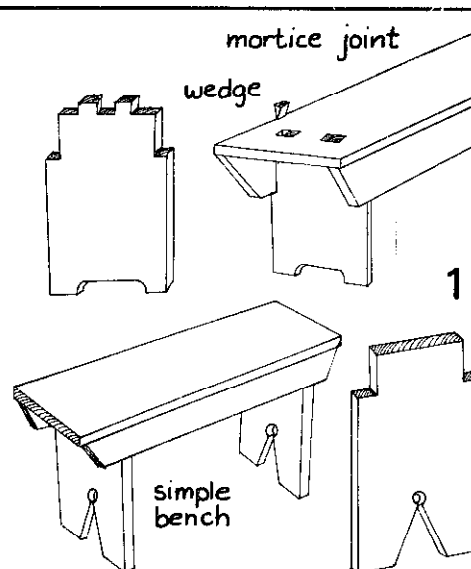

Beds

Bolted beds are easy to take apart and move. Two big bolts called carriage bolts hold each corner. The bed has slats across it to support the mattress. The sides of the bed can rest on the ground or you can put on legs.

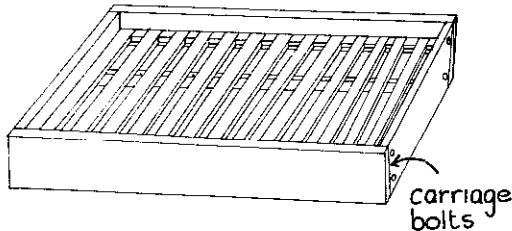

- Measure the size of your mattress before you build the bed. Buy a standard mattress because it is cheaper than a special size. For a double bed, the standard mattress size is 1870mm x 3180mm.
- Make the bed about 20mm bigger than the mattress, so there is room to fold the blankets underneath.
- Make the sides of the bed from 32mm or 22mm thick planks.
- Make at least 14 slats each 22mm thick and 100mm wide. Make the space between the top of the bed and the slats about 40mm, so that the mattress stays in place.
- Use eight 12mm diameter carriage bolts. Countersink holes for the heads of the bolts so they do not stick out.

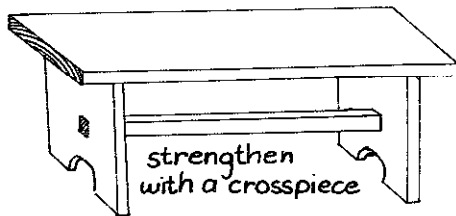
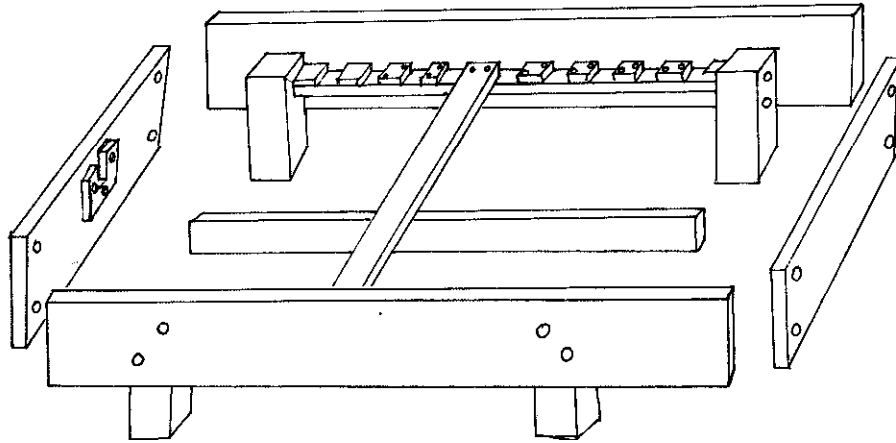

2

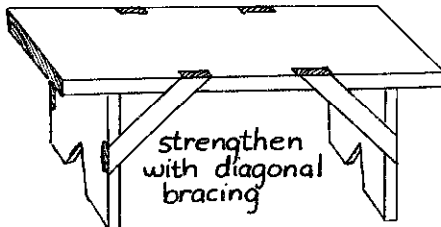

- You can make a bench without bracing by using a single support under the seat. The joints have to fit very well otherwise the bench will rock and roll. If the bench is longer than 1,8m it will need another leg in the middle.

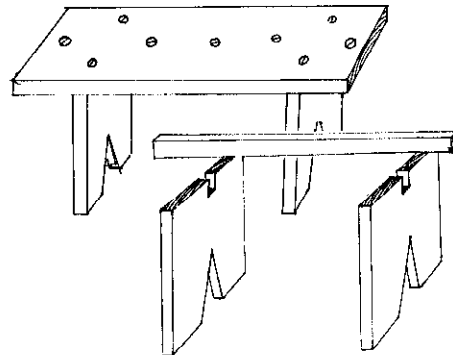

Protecting Wood

There are 3 ways to treat wood to give it a good finish and make it last longer:

- Oiling is good for wood because it soaks in well and stops the wood from drying out. Use raw linseed oil for light coloured wood and teak oil for dark wood. Put on oil whenever the wood becomes dry, especially on outside woodwork which gets dried out by the sun and wind. You can clean oiled wood by scrubbing it with soap and water. Oiling is much cheaper than other finishes.
- Polyurethane is a clear sealer which you paint onto the wood. It dries into a hard plastic coating. It is good to use on soft woods like pine, especially for table tops and kitchen

units. Then you can cut on the table top without damaging the wood. Put on at least 2 coats of polyurethane, for hard surfaces put on 4 or 5 coats. For the first coat, mix 2 parts polyurethane with 1 part of turpentine. This makes the first coat soak into the wood.

- Varnishes come in many colours and finishes. Ask a hardware shop to show you different varnishes.

Woodwork for farmers

There are many things farmers need to make out of wood. You can use scrap wood to make chicken houses and feed troughs, gumpoles to make pig pens. Here are 3 useful things people can use at their homesteads: a solar crop drier, a wheelbarrow and a beehive.

Making a Wheelbarrow

The first step in making this wheelbarrow is to make the wheel:

- ▶ Lay two layers of planks across each other. Make sure that the planks are right next to each other. Then nail the two layers together. Bend the ends of the nails over to keep the planks together.
- ▶ Mark a circle for the wheel with radius 22,5cm on one side. Use a piece of wood with nails hammered 22,5cm apart at each end.
- ▶ Cut out the wheel with a saw. As you cut, take off the waste around the edge with a chisel. Smooth the outside of the wheel with a plane or chisel.

- ▶ Nail a strip of rubber to the outside of the wheel to protect the wood.

The next step is to make the axle with a piece of hardwood, like bluegum, 30cm long and 5cm square. It must be dry otherwise it will shrink and become loose in the wheel.

- ▶ Mark a 5cm square hole in the centre of the wheel. Drill a small hole and make it square using a mallet and chisel. Do not cut the hole too big, because the axle must fit tight.
- ▶ Round the ends of the axle. Now you can attach the axle to the wheel. Nail blocks of wood to the axle and the wheel.

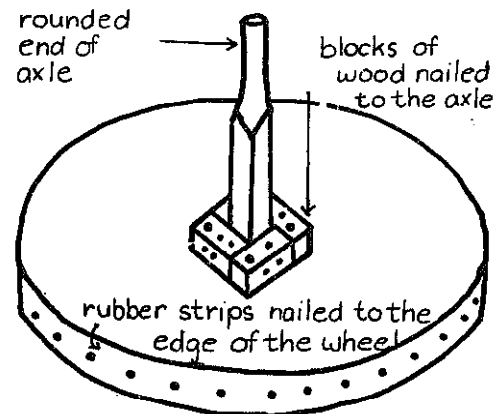
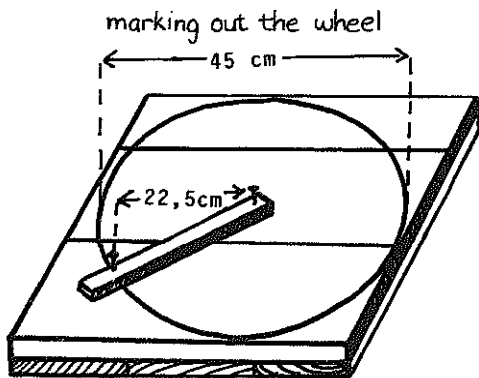

Then make the handles of the wheelbarrow with 2 strong pieces of wood 160cm long. Use bluegum branches or wood 5cm square. The axle shows you how far apart the handles must be at the front. Nail the planks for the base of the wheelbarrow onto the handles. Make the bottom 60cm long and 70cm wide, the handles 70cm apart where they are held. Make sure to leave a space for the wheel to fit between the base and the axle. Make each leg for the wheelbarrow from 2 pieces of wood about 95cm and 45cm long. Use cross pieces between the legs to strengthen them.

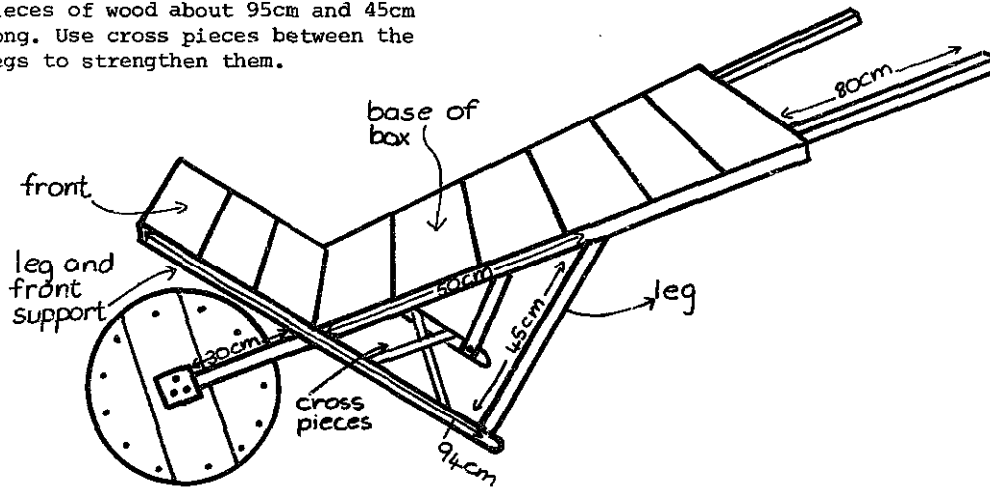
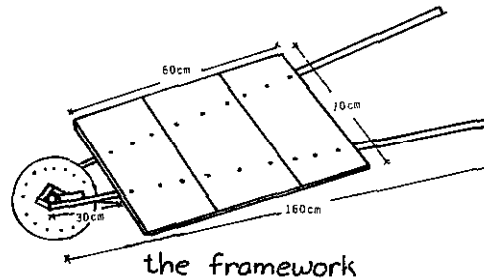

The final step is to put on the wheel:

- ▶ Turn the wheelbarrow upside down and lay the wheel in place. The axle should be long enough to rest on the handle poles without sticking out. Screw or nail a block of wood to the handle poles behind each end of the axle. The blocks act as bearings.
- ▶ Now you need a piece of wood that will cover the end of the axle, the bearing block and the outside edge of the handle. Screw or nail this piece of wood in place.
- ▶ Put grease or animal fat on the end of the axle and the bearing block.
- ▶ Nail a strip of tin or rubber to the bearing block. Take it over the end of the axle and nail it to the handle pole to hold the axle in place. This piece must not be too tight or it will be difficult to turn the wheel.

You can use the wheelbarrow without sides to carry full sacks or building blocks. If you want to carry soil or other loose material put sides on.

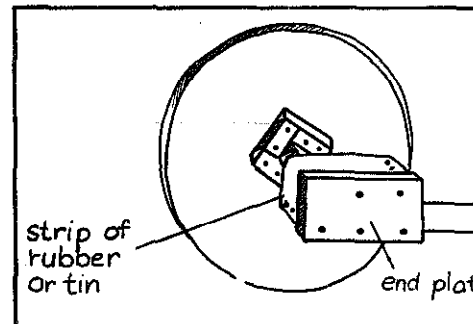
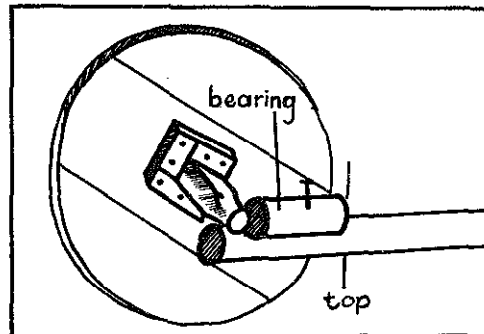

Making a Solar Drier

This drying box for fruit and vegetables works in the same way as a solar oven (see p 220).

▶ The floor is a box 8cm deep and 80cm square, filled with sawdust, newspaper or dried grass so that it does not let heat out of the bottom.



- ▶ Cut the front piece of the box and drill the air holes
- ▶ Cut the side pieces of the box. They must be higher at the back than at the front so that the lid of the box slopes to face the sun.
- ▶ Screw on 2 strips of wood about halfway up the side pieces. These strips will hold up the drying tray.

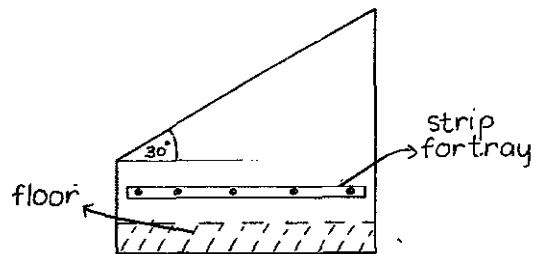

▶ Put the box together: screw the side pieces to the floor with the wooden strips on the inside. Screw the front piece to the base and the side pieces. Fit the back cross piece in place and screw it to the side pieces. Paint the inside walls and floor with blackboard paint.

▶ Cut the cross piece for the top of the box at the back. Drill air holes in the plank and cover them with mosquito mesh to keep out fruit flies.

▶ Make the drying tray out of wire mesh with a wooden frame.

▶ Make a door for the back to fit the space between the back cross piece and the floor. The door must have hinges and fit tight to keep out fruit flies. Paint the inside of the door black.

▶ Paint the outside of the solar drier with a light coloured enamel paint.

▶ Put on the top. It is best to use fibreglass because plastic sheeting is not very strong and glass can get broken. Put rubber strips between the fibreglass and the box to stop rain getting in. A sheet of fibreglass 1m long and 50cm wide costs about R5.

To dry fruit first cut it into pieces and put it in boiling water for one minute. Put the fruit in cold water to cool, then put it into the drying box. Most fruit takes a day to dry. Peaches, apricots, pears, plums and apples are all good for drying.

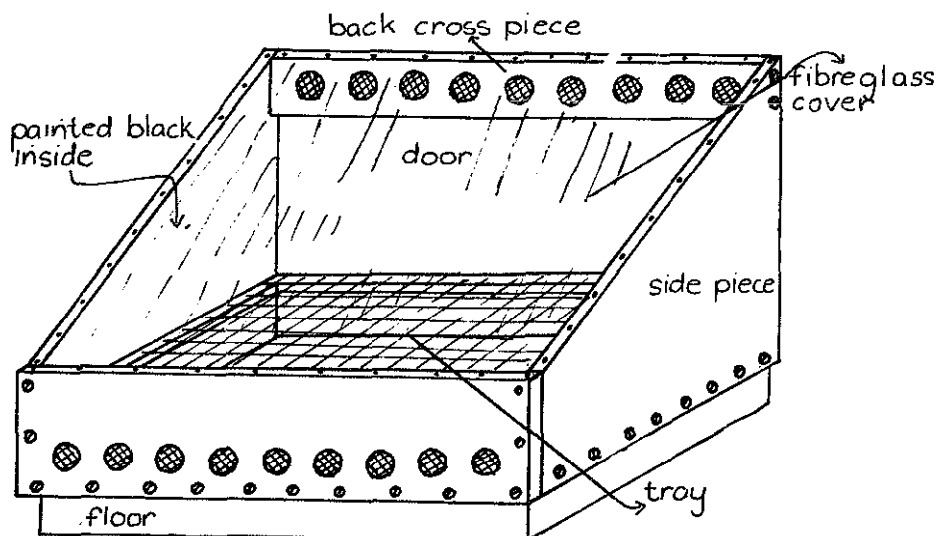

Making a beehive

Beehives are simple boxes which can be made with butt joints. The bottom box, where the queen bee lays her eggs, is called the brood chamber. Honey is taken from the boxes above the brood chamber, called supers (see Beekeeping p85). The brood chamber is a little bigger than the supers.

Make the base of the brood chamber of 25mm thick wood. Make it a little bigger on one side so that the bees have a place to land when they enter the hive. The entrance of the hive must be a doorway 3cm high and 10cm wide. The bees enter the hive through the brood chamber.

Bees make their honey on wooden frames inside the hive. There are 10 frames in each of the boxes. The frames hang on wooden strips which are screwed and glued inside the top of each box. Glue small wooden blocks on top of the strips as spacers to keep the frames in the right position.

Make the lid of the hive of a wooden frame covered with aluminium sheeting. The aluminium reflects the sun and keeps the bees cool.

Beehives and beehive parts are standard sizes. It is best to make your hive to the standard size so it is easy to use the standard parts. These are the sizes:

▶ Brood chamber, inside measurements 485mm long, 375mm wide, 265mm deep.

▶ Supers, inside measurements 485mm long, 375mm wide, 145mm deep.

▶ Queen excluder (fits over brood chamber) 510mm long, 410mm wide.

▶ Brood chamber frames, outside measurements 485mm wide, 235mm deep. Inside measurements 430mm wide, 205mm deep.

▶ Super frames, outside measurements 485mm wide, 135mm deep. Inside measurements 430mm wide, 205mm deep.

▶ Distance between frames 8mm.

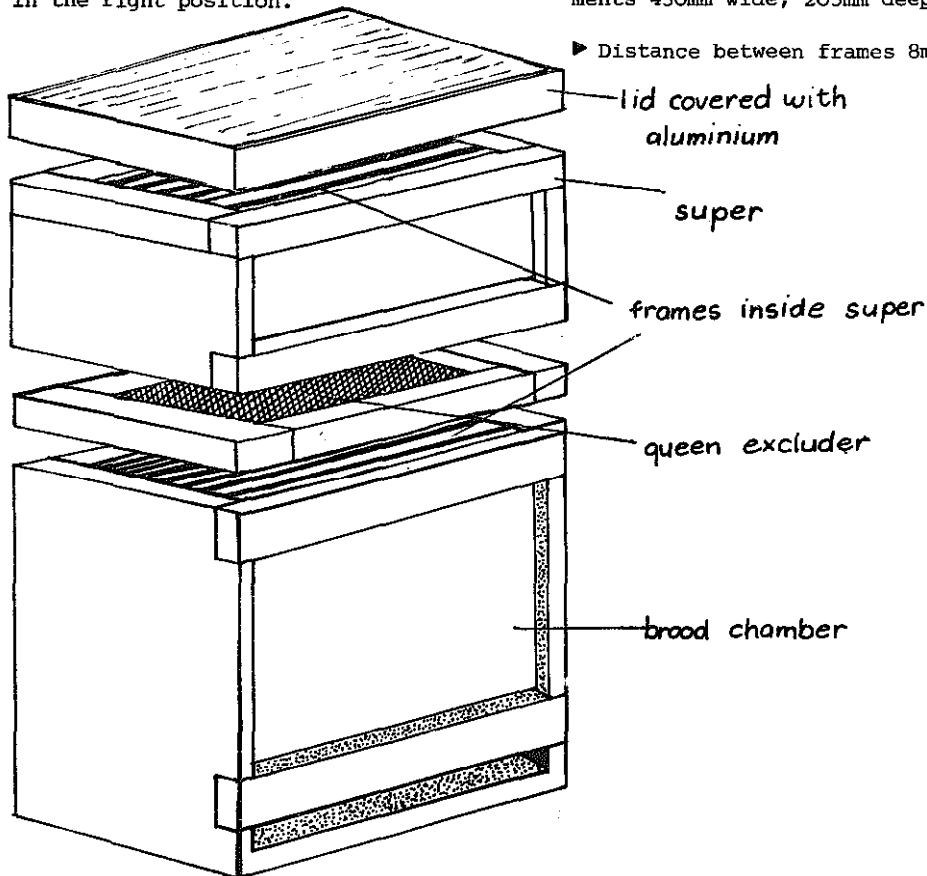

We all participate in every level of production

The Woodworkers Co-operative is a group of carpenters who believe that a co-operative is much more than a group of people sharing their income. We interviewed them at their factory in Newtown.

● When and how did the Woodworkers Co-operative start?

It started off in 1979 as two groups with 2 people in each. One group was working in a backyard in Johannesburg and the other was working in Alexandra. Then the 4 of us got together and rented a workshop in Newtown, and as the pressure of work built up we brought in more people, so that now we are 8.

We applied to the Rural and Community Development Trust for a loan - they lent us R2 500 and guaranteed a loan of R2 500 from the bank. Up to now we've paid off R2 000. We preferred a loan to a grant because we want to exist through our own labours. Grants are never just for free, they always have extra ties attached. A loan is a measure of how effective one can be - if you can pay it back, it's possible for other groups to start off on loans as well.

● Why did you decide to form a co-operative?

We felt it would be a better, more enjoyable way of working, a way in which workers can have more control over their work and be able to learn more about all aspects of production.

Most workers are excluded from the way factories work. Worker control is an abstract idea to most workers, it's beyond most workers to think about taking over a factory. Some

people in unions have used our co-operative as an example to say these guys work this way, there's no reason why other factories can't work like that. In our factory we all participate in every level of production - producing things, fixing machines, making quotes, working on admin, cleaning, cooking food, answering the telephone.

But although we organise our factory differently from other factories, we identify with the workers' struggle in those factories and we try to help workers in those factories both financially and in other ways.

Being in the co-operative gives us time to do other things, things which we would not be able to do in factories. We are able to lead a fuller life in our communities, for example. We don't see the way we work as divorced from the rest of our lives.

● How do you see the co-operative fitting in with the broader society?

I'm sure the main aim is to make links with other organisations. It's important that we function fully in our communities, and this includes participating in any struggles going on in those communities. A co-operative is not just concerned with sharing money, it has to do with political principles and directions as well.

● Did you have a lot of discussion when you started the co-operative?

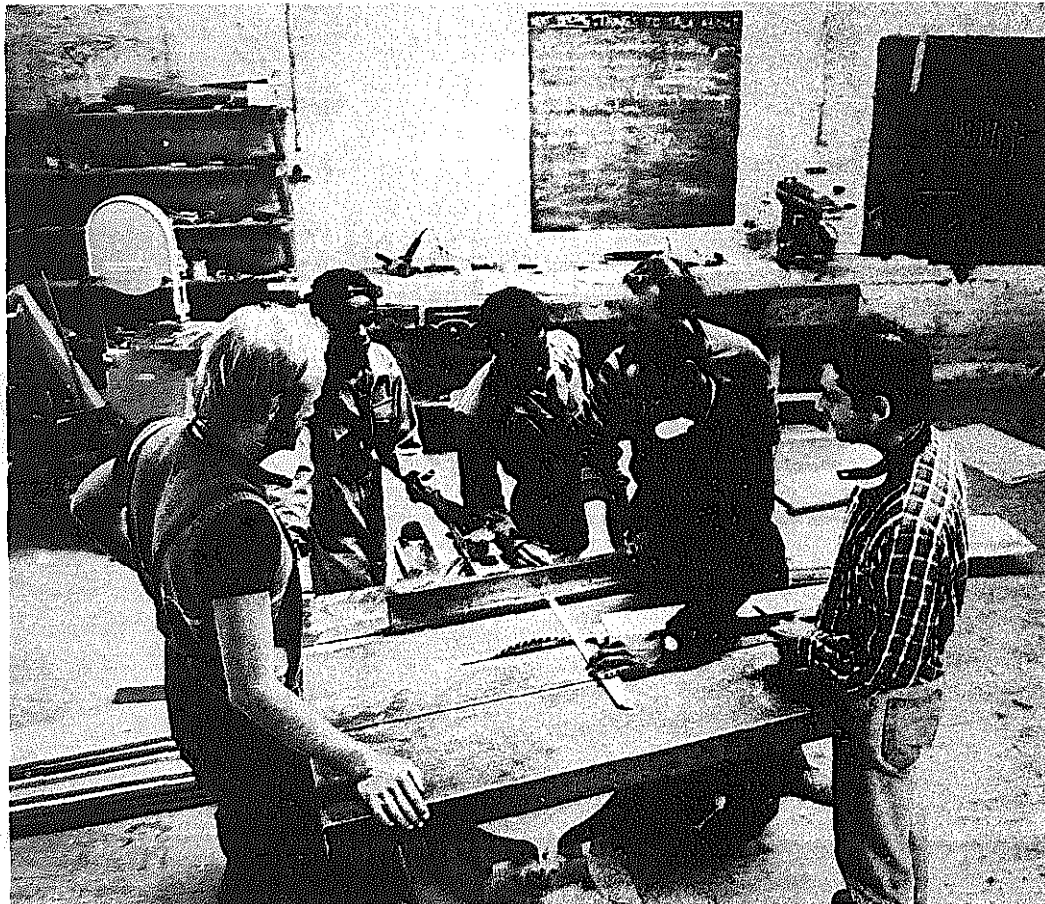

Yes, in the beginning we needed to discuss so much that we often had very little time for production. I remember once sitting here in meetings every day for a whole week. Now we have *one big meeting* every two weeks and small discussions nearly every day.

● Did you have the same structure right from the beginning?

No, in the beginning we didn't have much of an idea. Things were quite loose. We all did different kinds of jobs. What happened was the skilled guys took the

skilled jobs, but this meant that the unskilled people didn't learn skills, so we were getting a division of labour. We decided to rotate and share work. Not only does this teach you skills, it teaches you how to work with other people. When we make things on a production line we work differently from other factories, we have rotation in the production line as well.

● Who do you make things for?

We want to make things for workers. We'd like to supply them with good

quality furniture at low prices. But we have to take on some jobs like office partitions and shopfitting. We came up with charging at different rates, charging working class people at low rates and rich people at higher rates.

● Couldn't you make furniture for working class people cheaper by using production lines instead of working on orders as you are doing now?

We would have to compete with large scale production by big capitalist companies, and also have somebody doing marketing.

This is a whole area we haven't worked out. We already do production line runs of beds and benches. These runs will probably get bigger, but we want to grow slowly. We don't really want to get into retail marketing, warehousing and all that.

● What happens if you make a mistake on a quote, like under-estimating the time for a job?

We have had lots of problems, finding out that we have taken longer than we thought when we quoted. But when we give a quote we have to stick to it as a matter of principle, otherwise we don't get a good name. We need to find a way to give ourselves more flexibility, to take into account the uncertainty on quotes.

● How do you decide on salaries?

When we joined, all were getting R140. Then at the beginning of 1980, some of us with dependents found we were not coping. We agreed to sit down and write our needs. After that, we all came together and looked at each person's needs. We agreed to raise our salaries to R180 per month. Two people who didn't have dependents remained at R140. Then as time went on, we had the same problems again. We discussed it again and agreed to increase all our salaries. We wanted to meet all the demands, so we agreed on a minimum and maximum scale, R200 as a minimum and R250 as a maximum. A person with one dependent receives the minimum (R200) + R20, and

then R10 for each dependent, up to the R250 maximum. We also consider other income. For instance, I'm not getting R250, because even though I've got three children, my wife is earning a little salary so we have to take it into account.

We also have an allowance that people working in the co-operative can go to meetings which have something to do with other organisations outside the co-op, during work time. Then those guys who were at the meetings should report back so that we can all develop and know what is happening outside.

● How many hours do you work?

Everyone works the same, 40 hours per week, although here again it depends on circumstances. We all have one day off per month, although two of us have two days off per month because their families are far away, and one of us takes extra time off to help in a creche. If people have something urgent to do they're allowed time off and it's paid. But now people are questioning whether we don't need to be more disciplined and make up the time we take off.

● How do you decide to take a new member?

Well in the past, one of us has known the person, although just now we have an application from somebody we don't know. Before, we just took somebody if he seemed like a nice guy,

although now we'd say he must be committed to working in co-operatives. Then we all agree to talk to him and hear what he has to say. Then if he is the right kind of person, we take him on.

● What do you do if a person doesn't fit in?

Well we've never had that, but I think we would discuss with him about differences. If we see that those differences are major, we could take a certain stand. Let's say he's a spy or he acts against our principles all the time, well we can decide to tell him to leave the co-op. But I can say we haven't had that.

● But you've had people leaving?

Well, one had to leave because at that time the co-op was not earning, people were not getting paid, so he had to leave. Then another had to leave because he was going to stay in Mabopane, and it would cost a lot to travel. I think there was more, but we don't know what his problems were. We would have been prepared to pay extra money because he had to travel a long way, and we would also have agreed to him coming in later and leaving earlier. But it never came up for discussion until after he left then came back after a long time, which suggests he didn't actually want to resolve it.

● If someone leaves, what about his share in the tools and machines?

We don't believe tools belong to individuals, so the tools belong to the co-op. If this co-op decides to dissolve, the tools must be taken over by people who want to work co-operatively, or given to another co-op.

● It sounds like you've worked out your problems quite well. Have you never had any chaos?

Oh yes, the first big job we did was a shop-fitting job. There was a deadline and we were working a 12 to 16 hour day, some of us even handling 24 hours a day. We were working night shifts, working 6 days a week. It was just shit. We didn't even have time to have meetings. After that we had a lot of criticisms of ourselves for being so involved in the job that we didn't even meet and discuss.

Lots and lots of problems occurred during that time and we actually agreed we wouldn't ever be working like that anymore. Now we have more experience, we would set aside say half a day a week for meetings when we would draw up a production timetable, so that whatever the job, we would have time for discussion.

We've still got quite a lot of other problems. A criticism many people have of us is that we are quite slow. We try to please people by quoting too optimistically and then we cannot fulfil our commitments. We still haven't mastered this aspect of production.

● Do you think that any factory can be made into a co-operative, or just a small scale factory like yours?

I don't think scale has anything to do with it. Any factory can be re-organised co-operatively, but beyond a certain point it can not be done unless there is a change in the whole society.

● But you think that small co-operatives like yours can survive in a capitalist economy?

We survive because we're not making profits for a group of owners, we're paying only for labour and material costs. Yes, it's true that if we were competing against big capitalists for all our production, it would be hard to survive. But it is a trap to start thinking too much in terms of competing. You can't change capitalism by competing with capitalists. The problem is not to compete, but to change the existing system.



This list of co-operative principles was drawn up by the woodworkers for their own members and as a guide for other co-operatives.

● Everyone has an equal say and equal control in the running of the factory and policy of the co-operative. No job is more important than another. Division of labour must be firmly fought and done away with altogether.

● The co-operative does not aim to make profit to share amongst its members. All surplus should be used to enable more people to join the co-op or to facilitate the formation of other co-operatives.

● Salaries are set according to the needs of the workers in the co-op and are determined by all the workers.

● All policy is decided by the co-op workers through consensus at meetings. On important matters, everyone must speak on the issue, silent consent is not enough.

● Machines and tools: the means of production:
- These are all owned by the co-operative. If anyone leaves that person has no right to any of the tools. If the co-operative dissolves the tools should go to another co-op, or if one does not exist, they must be sold and the money given to worker organisations with similar

principles to the co-operative.

- People who join the co-op with tools, vehicles, etc. are not entitled to special status. The tools must be given, sold or lent for a certain period to the co-op. This must be cleared up immediately the person joins the co-op. The person is not entitled to any special position or any more money because of providing these things.

● There must be no reliance on outside funding. It is alright to take a loan in order to buy machines and tools to get going but this must be repaid. The co-op must establish a way of working that is efficient and enables the workers to earn their living. It must be fully independent financially.

● We must try to spread the idea of working co-operatively to other people and other industries. If a person leaves the co-operative to set up another one on the same lines, that person must receive the full support of the co-op.

● The co-operative is committed fully to the struggle of the workers to take control of all aspects of their lives. We cannot take a neutral position in this struggle. We will always strive to maintain links with other working class organisations and community organisations involved in the struggle, and contribute to it in all the ways that we can.

Education

Everybody knows that the education system in South Africa is oppressive. Most children go to school for only a few years and some never learn to read and write. People are told that they can not get on in life because they are not 'educated'. It seems as if going to school is the only kind of education which is good and that somebody who has been to school is wise and clever. But there are many other kinds of education as well as school. In South Africa, the education most people get from schools is not to make them wise or to use their knowledge to improve life. It is to teach them to fit into the system.

From the time Bantu education was introduced in the 1950's, people opposed it. They saw that this education was only to train black people for less-skilled jobs with low wages. The white-owned factories and mines needed workers who could read and write and do simple arithmetic.

Black people did not get enough education to do more skilled work. It is worse in rural areas because there are very few properly trained teachers and a shortage of school buildings, books and other equipment.

In the past few years students have boycotted schools and demanded changes. Their demands have been supported by parents and teachers. In rural areas and towns, schools have been closed down for many months because students were demanding better classrooms, better teaching and the end of Bantu education.

Some people say the education system must change to make one equal education for everybody, blacks and whites. Others say you can not have equal education in an unequal society. They say the whole society must become equal, not only education. Some people say if the same money was spent on black education as on white education, the problems would be solved. But money is not the only thing in education. Schools also influence the way people learn to think. In white schools, students are taught to believe they are superior to black people. For example they are taught that South African history began in 1652 with the arrival of white settlers. The history of black people in South Africa for many hundreds of years before whites came is not taught. Nor is the history of black peoples' resistance in defence of their land or the fact that black people's labour



has helped to make South Africa a rich country. In black schools it is the opposite: black children are taught that they are inferior to whites.

Other African countries, like Mozambique, Angola, Botswana and Tanzania are trying to change their old education systems which were like Bantu Education: they just taught people how to work for their rulers. For example, in Mozambique the new education system breaks down the division between people who work with their hands and people who do not. There is a big programme to teach reading and writing to adults who never had a chance to go to school when they were young. The local people are also involved in the day-to-day running of schools. Farmers teach children farming and teachers and students help farmers with their work in the fields. Teachers and students also take part in community activities and this is part of their education. In South Africa, many changes would have to be made before there could be a

good education system for all the people. It would be important for students, teachers and parents to control their own education in schools. It would be important to teach reading and writing to the hundreds of thousands of adults who never went to school. It would be important to change school books so that children would not get wrong ideas.

To make these changes there would have to be changes in the whole society. But there are some things communities can do in the present system like starting adult literacy classes or starting libraries or small newspapers. These things can help to improve everybody's education. In this part of the book we write about these kinds of education. We are not writing about school education. You can get information about school courses from organisations like the Education Information Centre (see p 536) which gives free information to anybody about schools, technical colleges, bursaries and scholarships.

Learning to read and write

In South Africa, where most people are poor and there are not enough schools, many adults can not read or write. Some of them did not go to school because their families were too poor. Others went to school for a few years but had to leave to start work. Most of these people work in jobs in factories, mines or farms where they never get a chance to learn how to read and write or to improve their education.

In some other African countries governments have started education programmes to teach adults literacy (reading and writing) and other subjects. People go to classes at their factories or farms or near their homes in the evenings. In South Africa there are a few adult education organisations (see p 535) which teach people to read and write English and other South African languages.

It is usually not good for a school teacher to teach an adult literacy

group. Schoolteachers might try to teach adults as if they are children, but adults who are learning literacy are not children. They might have more responsibilities and experience of life than the teacher. It is not like school where the teacher is supposed to know everything and the students are there to learn what the teacher tells them.

We think the best way to teach literacy is to have a small group of about 8 learners with one teacher who has done a training course in teaching literacy. The teacher should encourage all the members of the group to discuss things. The teacher should sit together with the learners, not like in school where the teachers stands in front of the students. The teacher must ask the group what kind of things they want to learn.

Each lesson starts with a discussion. The teacher's job is to encourage people to talk freely in the group.



One way to do this is for the teacher to bring a book, record or picture and get the group to talk about it. For example, the teacher can bring a picture of thugs attacking somebody. Everybody discusses it - some say what they think about thugs, others say why people become thugs, others talk about how the problems caused by thugs can be solved. While people are talking, the teacher listens for the most common words, then teaches the people how to read and write them. For example, if the group is learning to read and write Zulu, they can start by learning the word for help, ukusiza. The work is made up of 4 sounds: u/ku/si/za. The teacher explains that each of these sounds belongs to a family. There are 5 families of sounds, called vowels, a, e, i, o, u. Then the teacher writes down the vowel sounds like this:

a : ka, sa, za
 e : ke, se, ze
 i : ki, si, zi
 o : ko, so, zo
 u : ku, su, zu

Then the group tries to make other words with the same sounds, for example, ku/sa/sa (tomorrow) and u/ku/za (to come).

If the group is learning to read and write Sotho, they could start with a word like "tiro" meaning work. The teacher would write down the vowel sounds like this:

a : ta ra
 e : te re
 i : ti ri
 o : to ro
 u : tu ru

When everybody understands how vowel sounds make words, they can write down the words. Faster learners can help people who are struggling. Then the group members could make other words with the same sounds, like ru/ta, teach and ta/ro, three.

All the members of the group say the words together and learn which sounds and writing go together.

After some lessons the members will be able to write about the discussion they had at the beginning of the lesson. Then the teacher corrects each person's writing and discusses their mistakes with them. If all the learners are making the same mistakes the teacher prepares the next lesson to correct these mistakes. The group can also start reading any books, magazines and newspapers which are easy to read. It is also a good idea for the members of the group to read each others stories, especially if it is difficult to find easy books.

When people can read and write their own language, they sometimes want to learn English. The same method is used to teach English as to teach African languages, with discussions and writing stories. The discussions help people to improve their speaking English because they have to struggle together to say things in English.

In a literacy group, people can learn more than just reading or writing. By discussing they learn from each other. For example, people might join a literacy group and discuss the problem of not having a place to leave their children when they come to the classes. They might decide to start a play group for the children. Or people might be learning literacy in a factory and discuss the low wages they get. They might decide to join a trade union to fight for better wages. Or people might be learning literacy in a village and discuss the problems they have with vegetable gardening. They might decide to join together to start a gardeners association to buy seeds cheaply or share tools.

Literacy can help people to know and do many things. If you want to start a literacy group, contact one of the organisations listed on p 535.

My madam said you mustn't learn English you must learn how to cook

We spoke to some people who have a literacy group in Martindale, Johannesburg. Most of the people in the group are domestic workers. An organisation called Learn and Teach helped them to start their literacy group. Learn and Teach holds training courses for literacy co-ordinators and provides reading materials for literacy groups

● Julia, can you tell us how you started the group at Martindale?

Yes, in 1975 I went to Damelin College, but it was very far from me because I stay in Westdene. So I met Henrietta, I asked her can she put me through somewhere. So Henrietta is go to Learn and Teach. They asked me if I can open the school because I want to learn to write English and speak very well. They trained me and afterwards I opened this school. I went to Father and Father gave me this place.

● You mean the church in Martindale?

Yes I came here and I spoke to him. I said Father can't you help me. He say why? I said

because I can't see. He said what do you mean? I said I need your help because I want to learn English and read and write, because when you look for a job you can't speak English, you can't speak Afrikaans. So Father says, with pleasure. So he opened the church.

● Who else started with you?

It was me, Henrietta, Arthur, Maria, Florina and Fikile.

● Did you start learning English then?

No, they told me when I began I must teach people in a vernacular group. Then afterwards I can find somebody who can teach in English. Then I started with the verna-

cular group. After that more and more people came. Then I asked to learn English. Then they said it is alright.

● Why did you want to learn English?

Because a lot of things happen. Sometimes you go to the office, you have to sign something, they give you a form and I feel I am oppressed because I don't know how to write English very well. That's why I want to learn English.

● Has coming to the class helped you?

Very much. Since I started to learn English I have improved really.

● Do you think we could make the classes better?

You know to learn depends on the person. If you want to learn, you must just take books and read and read. But then you don't understand. When you come to the class you can ask somebody next to you. You can ask somebody and it can help. Or you ask the co-ordinator. I always read and write, read and write, sometimes I don't understand. I feel depressed, I sit, I think what must I do. Then I say, Ah, I will ask at school. I come here and I ask Susan. Susan she always helps.

● Thanks Julia. Susan, can you tell us how you started coming to the group?

Well I can't remember when I started. If I'm not wrong it was in November last year. Anyway I went

to visit my friend at Newlands. On the way I met another friend. So I greeted her and we talked to each other. I asked her how far is she going. She said I'm sorry I'm late. I am going to evening classes. Whereabouts? She says Martindale Church. I wondered because I also attend church there, but I didn't know anything about this. This was interesting to me so I asked her more about it what you have to do to join? She said no you don't have to pay anything. You just buy your books and then you join us. I asked her how many times do you go to school. She said thrice a week, Tuesday, Wednesday and Thursday. I said to her, this is interesting. What are you learning? She said it depends - Sotho if you are just starting and then we have got English. I said I am more interested to learn English because I understand a bit of Afrikaans but I am not good in English. In Afrikaans you can go nowhere in places like Zimbabwe, Malawi and Zambia and I

feel very bad if I find people speak English and I don't understand. I asked my friends who are the co-ordinators. She said white people. I said that is just the right people who I will learn and gain a lot from. So I said I am sure I am going to start to learn and join them next week, what time do you start. She said we are supposed to start at seven and we finish at half past nine. Really this was interesting to me.

I could not wait - when will Tuesday come, when will Tuesday come? Tuesday has come and I find a lot of people. It was really a group, not like today. More than 30 or 40 people I should say, or even 50. There were many groups. When you start you always start in the beginners group. Then when they see that you know something then they ask where do you want to be. No I want to be in the English group. Ok don't waste your time, just go. And I find that I really enjoy it. I wish that



they could continue after 9.30 and only stop at 10. Still even today I find that although I make a lot of mistakes, I have gained a lot. I can understand many words which I did know but I didn't understand the meaning - but today I know.

● Why do you think that it is important to have white people as co-ordinators?

Well English is their language, the English people's language.

● Do you think that a black person can also be a good co-ordinator?

I don't mean actually that a black person is not also good. But white people, it is your language and you are born with that language.

Even whites if they want to learn from black people, if they want to learn our language they will think a black person is going to teach them better than the white. We are born also with our language.

● Thanks, Maria will you tell us how you joined the group?

I come from Mafeking. When I joined the group last year I was with a madam in Westdene. Now one day my madam she tell me where I'd heard about the classes. I tell her that I heard from Julia. Julia she tell me I can learn how to speak English. Now she answered to me. She said you mustn't learn English, you must learn how to cook. I tell her yes, I will learn hoe to cook. She says when you finish,

you must tell me I will give you all the money for the books. Now one day I get a telegram. My uncle it was dead. Then I tell my madam I am going to home now because my uncle she is dead. My madam she answered to me - she shout - and read the telegram. She say it is not your's this telegram it is your sister's telegram. I answered yes this my sisters telegram from my father - my sister and me it is the same thing. My father he can't write two telegrams because it is too much money. I said I am going. She said you are not going. She said if you go you must pack up everything and go get out, I don't like you anymore. So I packed up and left. Now I have found another job. That's why I started yesterday at the classes again.

Our aim is to help the community by being the voice of the community

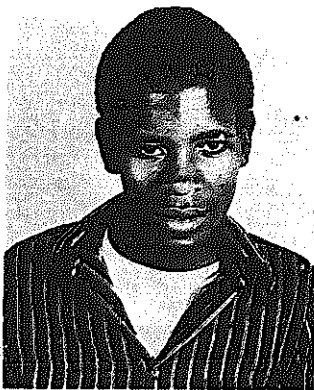

The Grahamstown Voice - Ilizwe laseRhini - is a small community newspaper run by Delta, a students group at Rhodes University, together with other students in Grahamstown. We spoke to Lindile Jela, who has worked on the newspaper for a few years.

● How do you decide what to write?

Well, first of all you have to know what news is. And you have to know what will appeal to people. As an example of news we wrote about the Joza evictions, we wrote

what was happening with interviews and pictures. We write about sports, music concerts and conferences because these appeal to people. We write what is really taking place in Grahams-town and surrounding districts.

● How much do you write about the causes of these removals?

Well, we have to discuss these articles first. For example, in one issue we had an article written by an anonymous guy because he didn't want his name used. Then we had a letter by

another guy, quite a political letter, and after discussion we decided to take some pieces out. We don't want the newspaper to be banned.

● How do you compare Grahamstown Voice with commercial newspapers? Do you think you're trying to do the same thing as they are?

We are trying to reach their standard. But we are also doing a different thing. Most of the people here know the news, so we have mainly educational articles like poetry and letters. It is not something solely for the news. Our aim is to help the community by being the voice of the community. We write the grievances of the community and we try to develop the talents of the community.

● Who is going to read about these grievances, the authorities?

We don't know if the authorities actually read the newspaper but a lot of people buy it, including whites in town. But it's important to just state our grievances openly among ourselves.

● How do you do the production?

We work at the Delta office at Rhodes. We haven't yet got our own equipment. The typewriters belong to Rhodes students and we use a camera belonging to a student. We are trying to get our own equipment through donations. There

are ten to twenty people working on the paper. We do all the subediting ourselves.

● How do the finances of the paper work?

We print about 1000, sometimes 800. We sell the paper at 5c, so we make R40 to R50. But our printing costs are about R120, so there is still quite a shortfall. The difference is made up by Delta and by advertising. We sell advertising at R20 for half a page. The paper has eight pages.

● Do you think that this idea could be copied in other communities? Do you know of any other community newspaper?

Yes, I'm sure it could be done. When we had a youth convention many of the people from Port Elizabeth were interested in the newspaper so now we're sending copies to Port Elizabeth. They told me they'd like to start one in PE. I don't know of any other community newspapers, but I'm sure it could be done in other communities.

GRAHAMSTOWN

VOICE

MAY 1980 VOL 4 NO 2

ILIZWI LASE RHINI

"KHULULANI UMANDELA"

Intshakazo e nyanyama ukukhululani kwenkokheli yabo ubeliso...
Ikwatsetha ukuthi onke abantu abavelwe ngenxa yezobopolitika kumantso Afrika bakhululane.

Umandele wasibandakanya no-NC ngo1914 waza kwenzeka wananakheba enkulu kulo mntsho, kunye noUliver Tumbo (oyinkokheli ebambileyo enqanndle kweli ngoku), noWalter Sisulu (owavelwe oMhobo Inland), noAnton Lembede (owavelwe ngo1947). Kwezi int: Youth League.

Ngo1992 ubuyinkokheli ngozo- laro ongenabaphithiphithi.

SCHOOLS BOYCOTT

The nation-wide schools boycott which started recently is a protest against the attitude, unequal education which the government has imposed upon the black people of South Africa.

Pupils in Cape-Town schools were already protesting early in the year, although not in the form of actual boycotts. Student leaders called meetings of students, teachers and parents. They were angry because they were tired of their poor facilities, second-hand books and poor education.

same education
They did not like the school being divided along racial lines. They wanted the same education for all South Africans.

Three teachers at one school were dismissed because they supported the pupils' demands. Student pressure forced the authorities to transfer the principal at that school and at another school where the principal refused to listen to complaints.

After Easter, because the authorities ignored the pupils' demands, the pupils started boycotting classes. All the Cape Town schools joined in - Coloured, Indian and African. TURN TO PAGE 2

Eli photo, eliqulewe yiMandela Forst, eliqulewe amagama abantu abangaphesheya kw-0000 abalikhawo bekwenza oko bephithiphithi ngabasekuganyeni. Makha le kusafika amawaka-wana amagama. Ngoku eli photo lifikelele nane-Rhini.

eyaphikisa izintsho ezintsho lisa gomantso Afrika.

abasekuganyeni abaphendulele noko ngalo: uMantsele mbantso abangama 9 900 bavelwelela kumibhe izigwebu ezaye zakhorhwa. owo ngalo nyaka uMandela wavelwe umlomo. IDUMELA: KWIFHEKHA LADI-P

Showing the past helps people move towards the future



The old school at Mochudi in Botswana has been turned into a museum and is becoming a popular place for young and old people to learn about their history and heritage. We spoke to the museum organiser, Sandy Grant.

● How popular is the museum?

Last year we had over 3000 visitors. It is very reassuring to see the pleasure of the old people when they come up here. Of course, they don't say much to me, but you can see from watching them that they like it. And kids are coming in too, in increasing numbers. And I think it's encouraging too that the 20 year olds are beginning to drift in - young couples coming here on a Sunday afternoon.

● How do you think the museum contributes to development?

As a development project, its function is educational. But a museum is not just to preserve the past. We include both historical and present day exhibits, to establish a link between the past and the present. Our museum is a way of teaching history. We wanted to create a new kind of school, one that could be of interest to everyone, young and old.

● You've organised other activities here too ...

Yes, we've organised shows of traditional music. We wanted to

involve the older men who are still using such instruments as the nkokwane, the serankuri and lesiba. These are the most difficult people to contact because many are living at the cattle posts. We weren't sure how popular it would be, but a tremendous number of people came, and we can now be sure that we will have more shows. It's difficult because traditional musicians are becoming harder and harder to find.

Another thing we want to do again is hold more meetings like the one we had on the future of Mochudi. The meeting was called "The Future of Mochudi - Town or Village". I think this was the first time that local people had ever been invited to take part in this kind of discussion. About 70 people attended. People talked about the kind of town they wanted and about some of the issues now facing them. Many people are in the grip of economic forces they don't understand, which they've never had a chance to stand back from and analyse. The discussion varied from the ridiculous to the very impressive.

One of the things we discussed was the layout that people wanted for the village. We were fortunate to have Graeme Hardie here, an architect who has been studying traditional architecture in Mochudi. He showed us models of semi-circular and square grid layouts - opinion was evenly divided on which was preferable, but there

was some lively discussion. We should have a seminar like this every year - this is what people would like.

● Where do you get the things in the museum from?

It's a matter of going from house to house to look for them. Originally we couldn't buy anything because we had no money. Even now we can't pay much, but we pay a small amount where possible because people need the money. If an object is still usable then we think it's fair to pay for it, but if it's broken or unusable, then we don't pay for it.

You have also renovated some traditional homesteads?

Yes, we wanted to show an example of a lapa done in completely traditional style, to be a study centre and a place where museum visitors can stay. Well, we have done one, and people are delighted by it. We've done it in the proper traditional style, but it's a heavy business. We need to modify it. Next time, perhaps we will do it using some non-traditional materials, it will be a bit easier.

● Do the people in Mochudi think the museum belongs to them?

That's a hard question. They may think it's mine, because they see me going up and down here six days a week. I think we've got to make the point that the museum is theirs, even

to the extent of getting primary school classes to pick up the cans and rubbish lying outside when they visit here.

● Do you think this kind of museum could be reproduced in other parts of Southern Africa? You seem to be very lucky, for instance, to have had Isaac Shapera's old photographs of Mochudi.

I think there's a lot of scope for museums like this. The archives of newspapers, libraries and government offices are bulging with photographs, letters and documents. This is a very vivid way of teaching history. Show people their own past and you help them to see how to move towards the future.



The sun is up, there is work to do

Popular theatre is being used in Botswana to get across new ideas in farming, education and health care. We spoke to Adrian Kohler of Laedza Batanani, the first popular theatre group.

● How did the use of popular theatre to promote development start in Botswana?

It came out of a communication breakdown with agricultural extension workers. When they gave a talk on better agricultural methods or stock dipping, people did not come. In the north it was worse because villages were spread out. So a councillor there who was worried about this, thought that perhaps singing, praise poetry

and dancing could be used to put across the message. Then Ross Kidd of the Botswana Extension College developed the idea and introduced puppets and drama as well and they have been a great success. That started in 1974. Every year they hold a campaign where a team interviews each village then analyses which problems can be made into popular theatre by extension workers. For example, problems like the need for toilets, water supplies, attending VD clinics. Big problems like unemployment and working on the mines were considered impossible for the extension workers to handle because there is so little that people can do about these things. This campaign was called the "Laedza Batanani" campaign. This means "the sun is up, there is work to do".

Laedza Batanani started as a group of performers going from village to village. The trouble with this was that the performers were outsiders to the village, so that not much action was resulting from the performances. Then in 1979 there was a big popular theatre workshop in Molepolole to introduce popular theatre to extension workers from all over the country. There were four of us teaching, someone from Nigeria doing drama, someone from Tanzania for dancing, someone from Radio Botswana to teach singing, and myself for puppets. We did performances about many things: weak leadership in the village, too much beer drinking, VD, unemployment, TB, lack of co-operation between the village councillors and the headmen.



● Can you describe one of the plays?

Yes, in a village north of Molepolole there is a river dividing the village, and there are no bridges across. In the rainy season, kids who live on the other side can't go to school. The villagers thought the bridge was an important project. Because the leadership was weak, no one could come to a decision - everyone was drinking. Things were pretty bad. Also there were no toilets in the village and a lot of flies. So we made a play about a village which had a weak leadership, with all the men drinking. One day a father finds his daughter at the shebeen. He's shocked and says "You should go home, you're embarrassing me seeing you here drinking". So she says "Well, you're drinking too, aren't you? What's the difference?" In fact she is a prostitute, and this makes him even more shocked. So he goes away to think and then he calls his friends together and says "Things are bad in this village, we must do something". So they hold a meeting to discuss what they can do. The chief hears about the meeting and sends a messenger to stop it. The messenger says "This is an illegal meeting, you must break it up". So they catch hold of him and tie him to a chair and say "You're going to listen to what we're talking about" and of course they convert the chief's messenger. So the chief's authority is overthrown,



and the village develops very well. They build a bridge and have a big celebration. In fact the real chief of the village saw this play. Some people said they were offended by the appearance of a prostitute, but nobody was offended by the criticism of the chief. In another village there was a question of somebody stealing village development funds. People had collected money to build an extra classroom in the school. The chairman of the village development committee needed to pay the school fees for his child and just borrowed the money and intended to pay it back. But his cattle died, so he couldn't sell anything and the money was missing. Well, in fact, this person was in the audience watching the play and

when it came to the discussion group afterwards, the people pointed him out and he got up and ran away!

● So you do some kind of research first?

Yes, we usually spend a day interviewing and collecting information.

● Do you have any problem combining puppets, dancing, singing and live drama?

No, not really. Sometimes for instance, we get a puppet to introduce the live characters as they come on. Sometimes the puppet speaks directly to the audience and starts them singing or clapping. At the end of the play, we sometimes compose a song and dance about something in the play.

● Do you think that popular theatre can replace the Kgotla structure?

Well, the kgotla structure is very rigid. Elders speak first, women speak absolutely last and they sit apart. There's a definite order of speaking. I imagine young people feel they haven't got a voice there. I don't think the theatre can replace the kgotla, but it can give a voice to young people and women who never had a voice in the kgotla.

I've seen how effective this kind of theatre can be because the characters are based on real live characters, it has a kind of power. In one play, for example, they

were discussing beer brewing, particularly during kgotla meetings, which was preventing people from attending.

A man from the audience got up with a tin full of broken eggs. He walked to the middle of the stage, put his tin down and shook the hands of the actors, saying "I'm really glad you brought this point up because I've just come from one of these places, and they've broken every one of my eggs, and he picked up his tin to show the audience. Usually the audiences are amazed by the accuracy of the plays.

● Do you think the plays are popular because they are presented by strangers?

We don't really know yet. We're putting the emphasis on local groups at the moment. The idea is that each village will set up its own group, and we will act as resource people. Then Laedza Batanani will hold workshops lasting one or two days in different villages. But it may be necessary to also keep a group of specialists to show others what can be achieved. I would like to set up one group here in Gaborone, say at the Botswana Agricultural College, which I can work with throughout the year. Such a group would be more skilled artistically, but not necessarily better than the local groups in promoting development.

Building

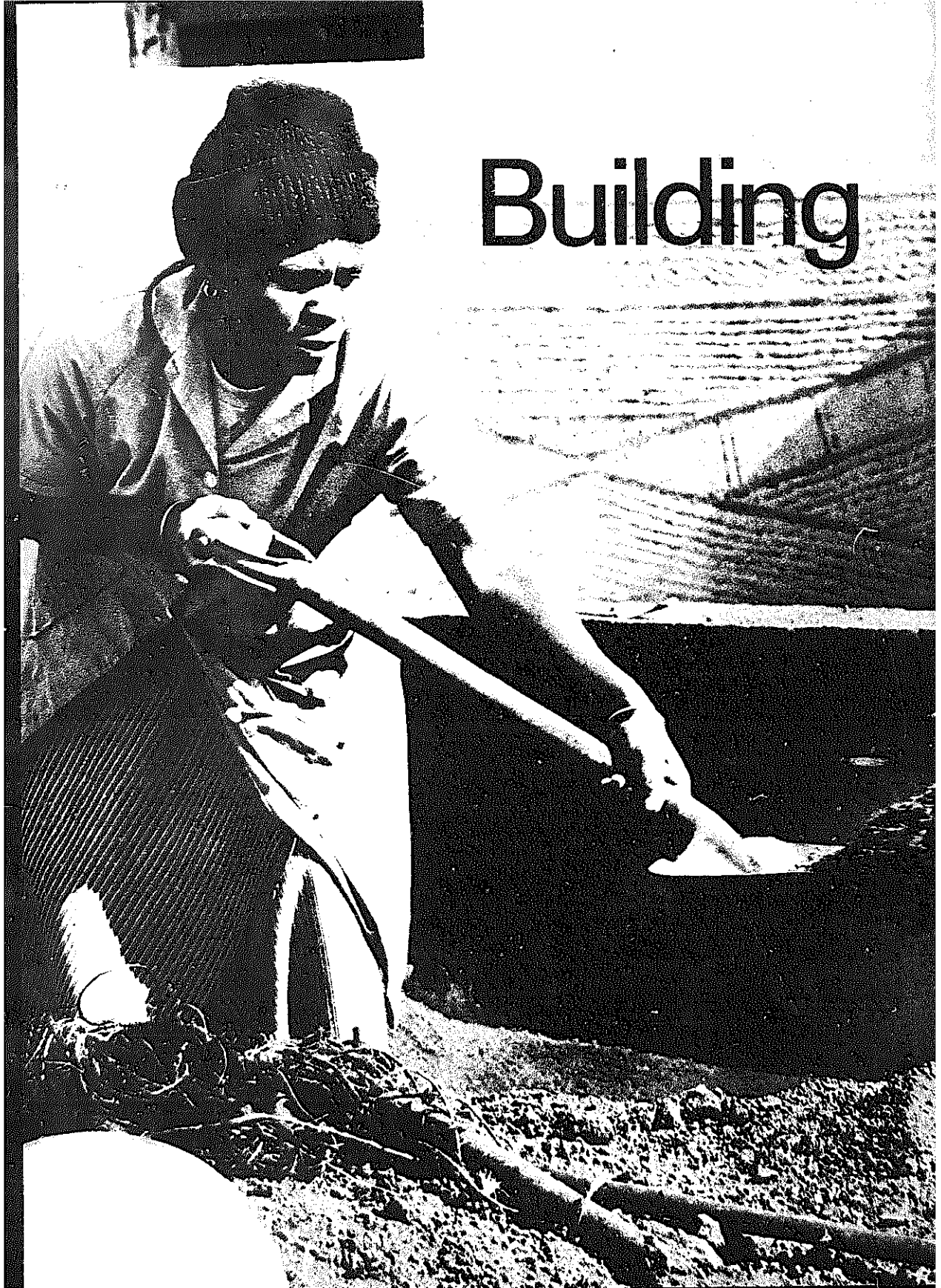

Building Introduction

There is a serious shortage of housing and land for black South Africans. Many live in overcrowded slums in towns or rural areas. Others are resettled and dumped in places where there is nothing - not even fields or water.

There is enough land in South Africa for everybody but a few people own and control the land and force the majority of people into barren and overcrowded places. Many workers from rural areas want to live in town near their jobs, but they can not get permits to rent or buy houses. Migrant workers are not allowed to build houses in town so they build houses in the country which they go to a few times a year, sometimes only once a year. Often they build houses like the ones in town with square rooms and corrugated iron roofs.

It is expensive to build these town style houses in rural places and some people save for many years before they can afford to build. Others build one room at a time, struggling to buy building materials and pay builders.

It is much cheaper to build a traditional house than a town-style house. You can find most of the building materials like mud, poles and thatching grass locally. You only have

to pay for transport or pay people to help you make bricks, fetch water and cut grass.

There are different kinds of traditional buildings all over the country. In the past people built houses with only the materials they could find nearby and they tried out different kinds of buildings until they found the best. For example in places where it is very hot during the day and very cold at night, people built stone houses. During the day the sun made the walls hot and the house stayed warm at night. In other places where it is hot in the day and the night, people left a space between the walls and the roof so that wind could blow through and make the house cooler.

We think the best way to build is to use traditional and modern methods together. For example building houses with cement blocks for walls and thatched roofs or building school classrooms with mud brick walls and corrugated iron roofs.

In this part of the book we write about using old and new methods. We also give some ideas about making buildings for everybody in the community, for example a creche for young children.



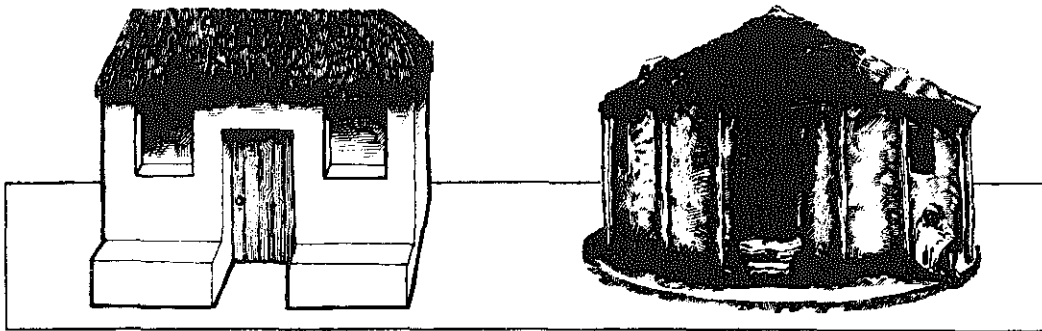

Young people have forgotten how to do their own work

Traifina Molefe lives in a house which she built in Mochudi, Botswana about 30 years ago. She used traditional methods, mud for the walls and thatch for the roof. Since that time Traifina has built two other houses using traditional methods. One is at the cattle post and the other at her fields. We spoke to her about the traditional way of building.

● Why do you think people stopped building in the traditional way?

Young people have forgotten how to do their own work. They don't want to build houses themselves. They are not like the people in the old days, our mothers and foremothers were very strong people. It's the same with thatching. You see thatching is better than tin. With thatching people weren't lazy, they would do it. They used to cut the grass by

themselves, build the walls by themselves, so it was cheap. You can chop down your own poles without buying them and you can cut your own grass, but you can't make your own tin.

● How do people learn to thatch?

Well, if I am a thatcher, I can't do all the thatching by myself. I can't put the needle through and be inside and outside to take the needle on the other side. So I will need an

assistant. That is how people learn from one another. Now I know only two who can still do thatching here in Mochudi. These two are small boys who learnt thatching from the old people.

● In the old days did everybody do their own thatching?

No, not everybody. Those who didn't know how to thatch would go and ask somebody else to do it. There were always people who were thatchers. Now the thatchers do it for money. In the old days they also did it for money, but only a little.

● Is thatching expensive?

In the old days it was cheap - 8 pula for one roomed house. Now they would charge 60 pula to thatch my house and I would have to buy the grass and the rafters.

● How did you make the walls of your house?

I just used my hands. You must use the mud bricks when they are wet so they dry well together in the wall. Mud is very strong and cool. The only problem is termites, but not rain. Rain won't do anything to the house if it is properly built.

Sometimes you can put plaster to keep away the termites. You can also put clay bricks on top of the mud walls to stop the termites going into the rafters.

● How did you build your house at the cattle post?

My house at the cattle post I built myself, the walls and the thatching. I moulded the bricks and my son cut the rafters. I used a different thatch. I just pulled the grass out with the roots, shake the dust and used it like that. It's not nice and neat like the thatching on my house here.

The Building Site

The building site is the place where you are going to build. Try to work out the best way to use the site.

The first thing to think about is the direction of the sunshine. In Southern Africa the sun shines from the north. So the side of the building which faces north will be warm and bright. The side which faces south will be cooler and darker. Try not to build on a hill which slopes from the south up to the north. The hill will make a shadow over the building and make it cold.

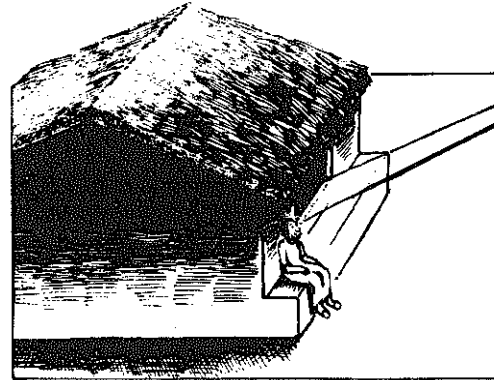

North facing buildings get more sun

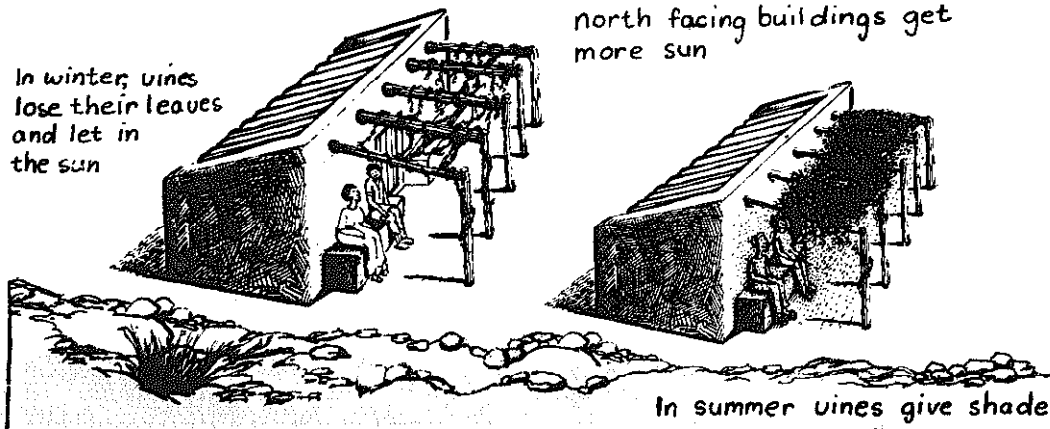

In winter, vines lose their leaves and let in the sun

In summer vines give shade

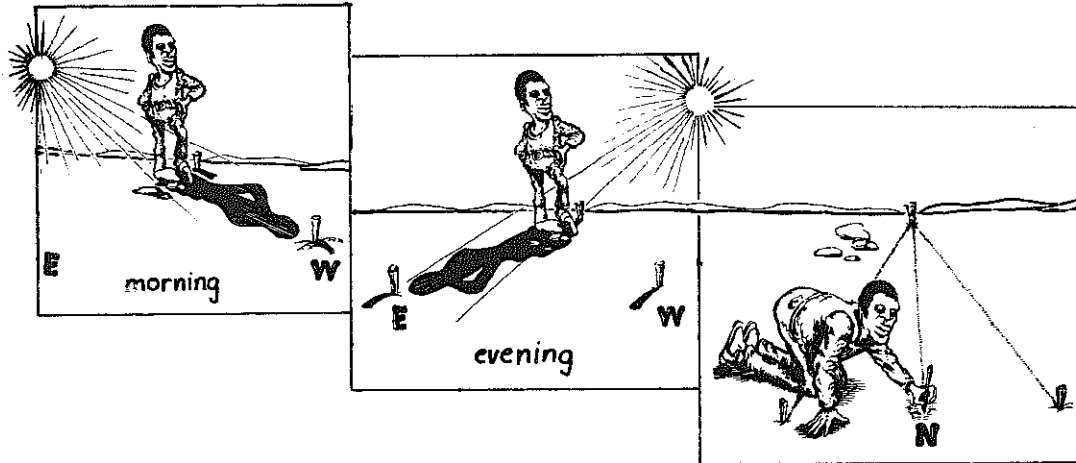

How to find north

You can use the sun's shadows in the morning and the afternoon to find north. At sunrise, mark your shadow with 2 pegs. Put the first peg in the ground where you are standing and the second peg at the end of your shadow.

At sunset, stand at the same place and mark your shadow with the third peg.

Draw 2 lines from these 2 pegs to the first peg. Then draw a line halfway between them. This line is the north direction.

Wind

Wind blowing through a building cools it, but it also brings a lot of dust.

If you want to protect the building from the wind, make the shorter side of the building face the wind. Do not put any doors or windows on this side. Plant trees to protect the building from the wind. The wind blows in one direction most of the time. You can tell this direction from the way trees and bushes grow to one side, or by asking people who have lived there for a long time.

Checking for water

Find out if there is any water on the site. Check for old springs or river beds or dried up streams. Do not build in these places because they may fill up with water after heavy rain and damage your house.

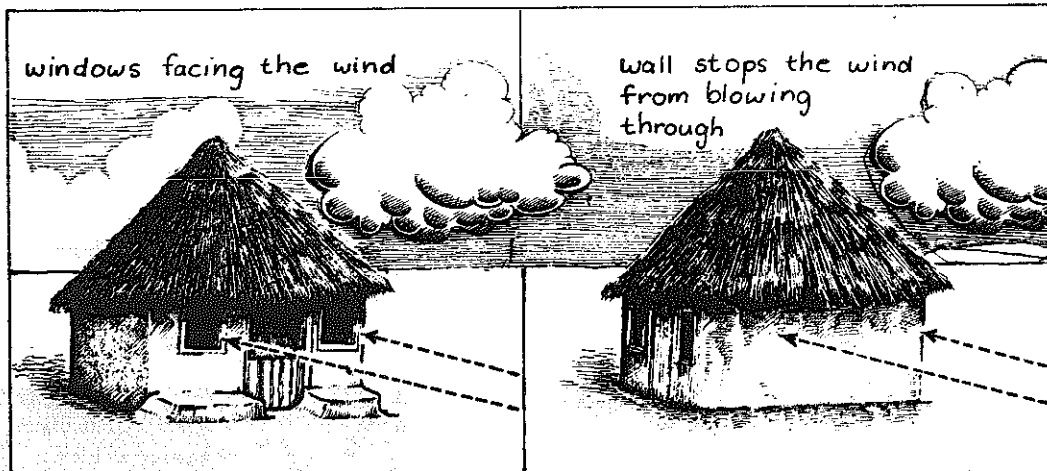

Building in stages

If you do not have the time or the money to build the whole building quickly, you can decide to build in stages. You can start off by building only a small part of the building and then adding on more rooms as you need them. Or you can first put up the roof on wooden poles and build some of the rooms. You can build the other rooms later when you have more money.

Setting out

Setting out is marking lines on the ground where all the walls will be. To do this you need:

- ▶ A long measuring tape.
- ▶ A ball of string.
- ▶ Wood or steel pegs 30cm long.
- ▶ A big hammer.

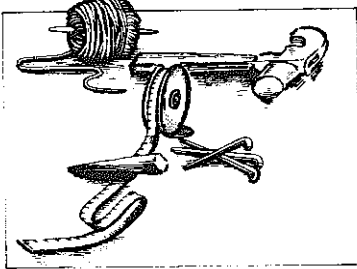

The first thing to do is to mark the front wall of the building. Hammer in 2 pegs where you want the front corners of the building. Stretch a piece of string between the pegs. This is the front of the building.

Now mark out the corners. You will need 3 people for this. One person stays at the corner peg holding the end of the measuring tape and the 12m mark against the peg. The second person holds the 3m mark of the tape and walks along the line of the front wall until it is tight. The third person holds the 8m mark of the tape and walks until it becomes tight on both sides. At this place he or she hammers a peg into the ground. Stretch string between this peg and the corner peg. This line is the side of the building.

You can draw this line longer if the side of the building is longer than 4m. Now do the same thing to get the corner between the front of the building and the other side.

After you have marked out the front and the 2 sides, join the ends of the 2 sides to mark the back of the building. Check that the front and the back are the same length.

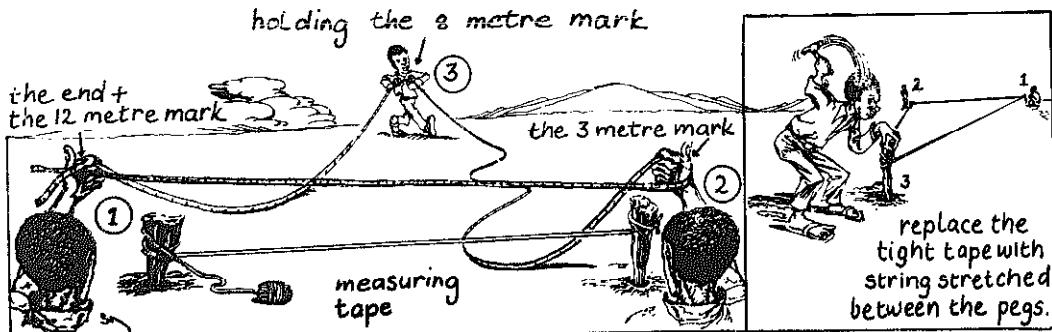
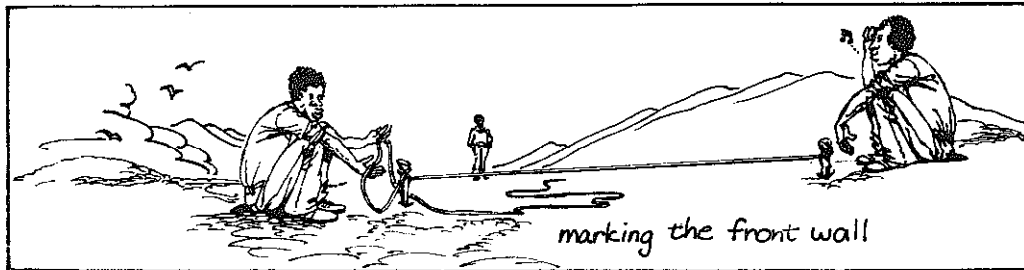

HOW TO MAKE A WATER LEVEL

Spirit levels are expensive to buy. It is much cheaper to make a water level. You can use a water level in the same way as a spirit level.

You will need:

- A straight wooden plank 1,1m long.
- 2½ m of thin clean plastic tube (try to get some from a hospital or clinic).
- Brackets for holding the tube on to the plank. You can make these from scrap pieces of tin, such as beer cans.
- A piece of metal tubing which fits tightly inside the plastic tube.

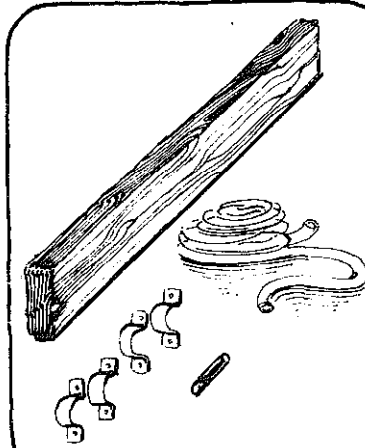

Half fill the tube with water so that the water fills halfway up the two short sides. Then join the two ends of the tube with the piece of metal tubing. Soak the ends of the plastic tube in warm water until they become soft and then stretch them over the piece of metal tubing.

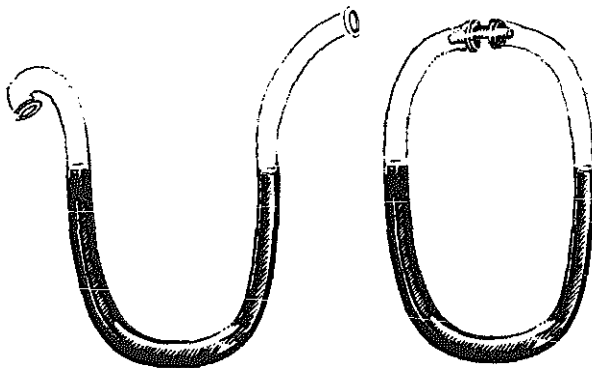

Connect the tube to the plank with the brackets, so that the distance between the short sides of the tube at each end of the plank is exactly 1 m.

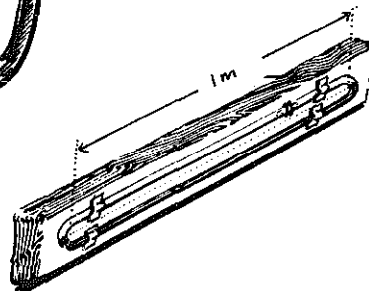

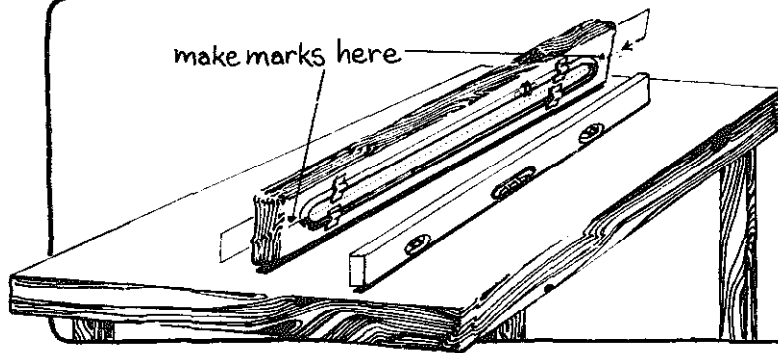

Now lay the plank on its edge on a surface which you know is completely flat and level. Borrow a spirit level to check that it is flat. Make marks on the plank next to the water levels on each side of the tube. Measure the distances between these marks and the bottom of the plank. These two distances should be equal. Draw a line between the two marks.

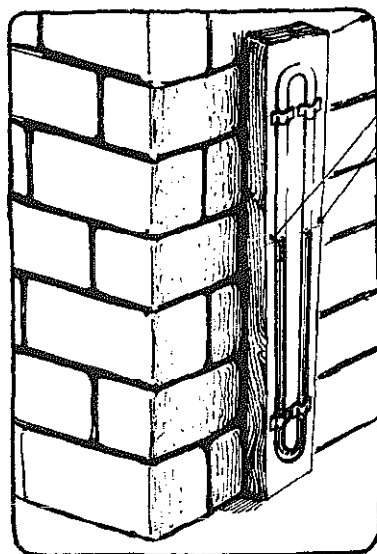

make marks here

Now hold the plank against something which you know is perfectly straight up. Again check it with a spirit level. Mark the water on both sides. As before, measure the distances between the bottom of the plank and the marks on both sides - these distances must be equal. Draw a line between these two marks.

How to use the level

To check if something is flat, the water on both sides of the tube must line up with the long line on the plank.

To check if something is straight up, the water must line up with the short line on the plank.

Foundations

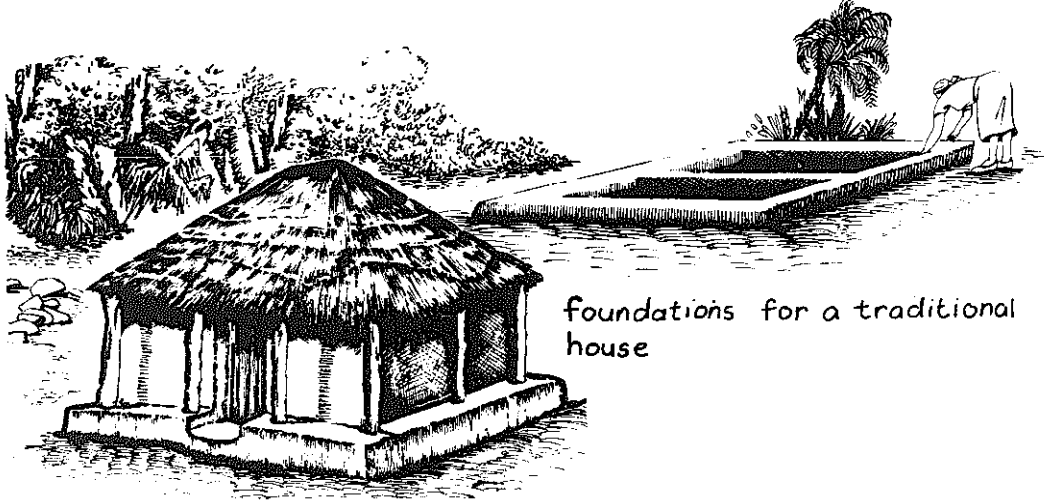

foundations for a traditional house

Walls must be built on foundations. Foundations stop the walls from cracking and they help to stop the walls becoming damp and weak.

There are many different kinds of foundations. You can build foundations under the ground by digging trenches and filling them with rocks or concrete. Traditional houses have foundations above the ground which are used as seats around the outside of the house. They need less work because you do not have to dig trenches.

If you build foundations below the ground, build foundations which will be strong enough for the kind of walls you want to build:

- Concrete foundations are good for any kind of wall.

- Rock foundations are good for mud, stone, brick or block walls. The rocks must be covered with a thin layer of concrete for brick or block walls.

- Foundations for wooden frame buildings. The wooden poles must be creosoted and put into the concrete when it is still wet.

Concrete Foundations

Concrete foundations are trenches filled with concrete. The trenches have to be level otherwise the wall will crack. But if you build a long level trench on a slope it will be very deep on one side and shallow on the other side. On a slope it is better to make the foundation in steps. Each step must be level.

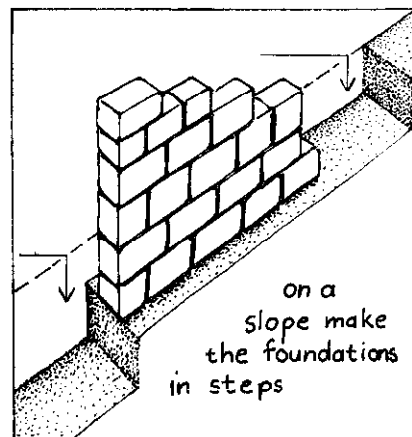
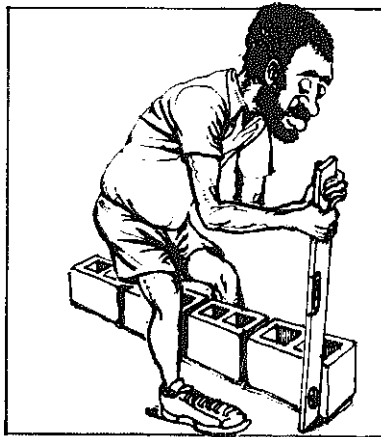

Mark the corners with bricks. Tie string between the bricks and mark the line of the trenches with a pick or spade. Make the trenches 8cm wider than the walls on both sides. 8cm is the width of a brick on its side.

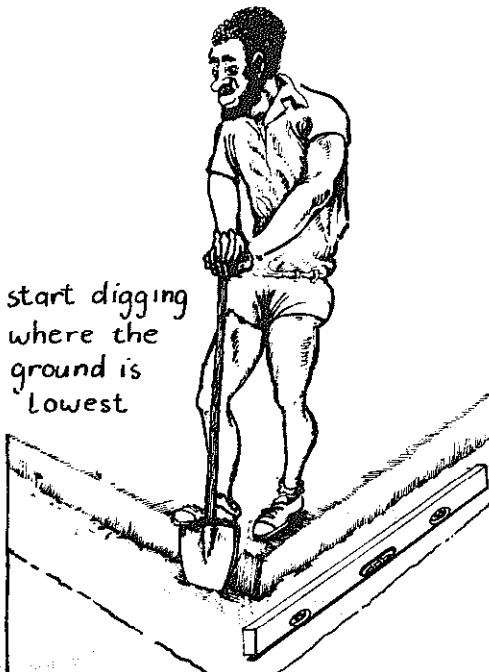
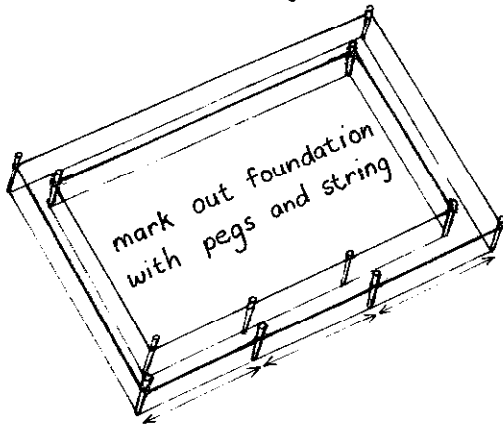
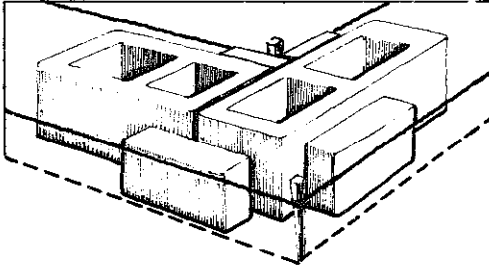

Start digging the trench at the lowest corner of the building. The bottom of the trench must be flat and 30cm below the ground. Check that the bottom is flat with a spirit level or water level.

When the trench is 45cm deep, make a step up of 15cm. The trench will now be 30cm deep. Keep digging so that it is flat and level. When it becomes 45cm deep again, make another step of 15cm.

Hammer in pegs all along the trench so that the peg tops are 15cm above the floor of the trench. Use a level to check that the tops of all the pegs are level.

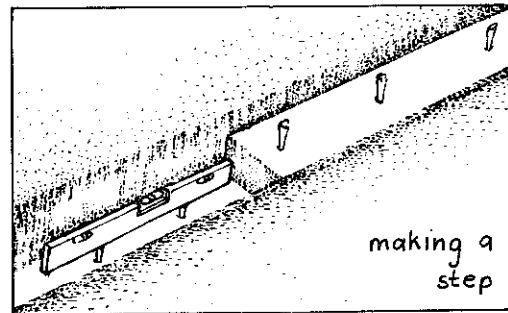

Now mix the concrete. Mix one bucket of cement with 4 buckets of clean river sand and enough water to make it easy to mix. Then mix in 7 buckets of stones. Wet the trench and pour in the concrete, starting with the lowest part.

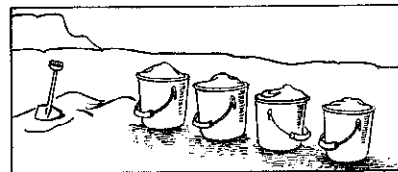
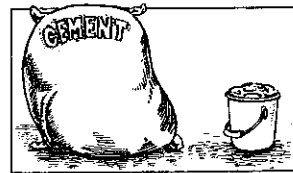

Use a spade to squash out all the air bubbles in the concrete. Level the concrete to the top of all the pegs inside the trench with a plank.

If there are steps in the trenches, you must also have steps in the concrete. Put bricks on the concrete you have poured, 30cm away from the step, before you pour the next layer. The bricks will keep the corners of the steps square and stop the concrete from running down the step.

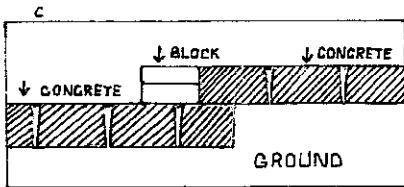
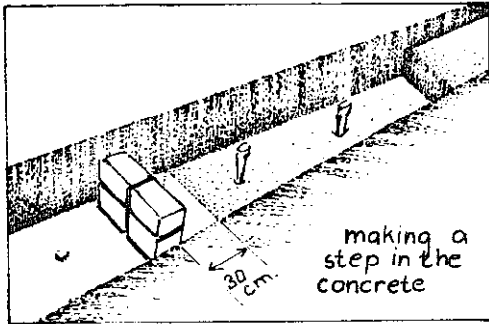

If concrete gets dry and hard too quickly it will crack. So after you have poured in the concrete, keep it wet for three days. Cover it over with wet cement bags, old plastic bags, corrugated iron or wet grass.

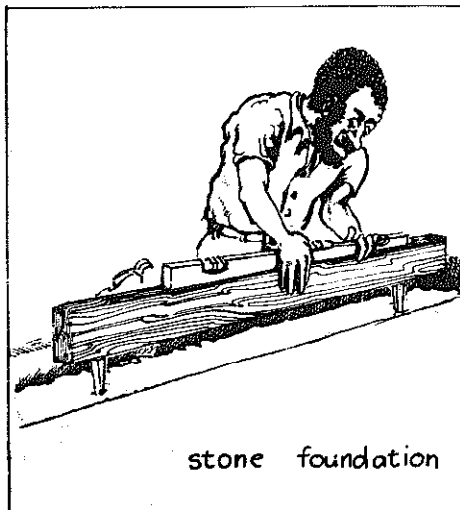

Stone Foundations

Stone foundations are almost the same as concrete foundations, except the trenches are filled with stones not concrete. You need a bigger trench, about 60cm wide and 60cm deep. Mark lines in the ground and start digging trenches at the lowest corner, the same as for concrete foundations. If the site slopes you will have to cut 20cm high steps into the trenches. Hammer pegs into the trench so that the peg tops are 20cm high. Check that the tops of the pegs are level. Fill the trench with stones to just below the tops of the pegs. Hammer the stones down with gumpoles so that they are tightly packed together.

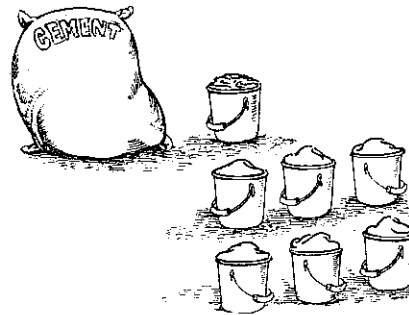

Mix one bucket of cement with six buckets of clean river sand. Add a little water so that the mixture is like thick porridge. Pour it over the stones up to the tops of the pegs then level it with a plank.

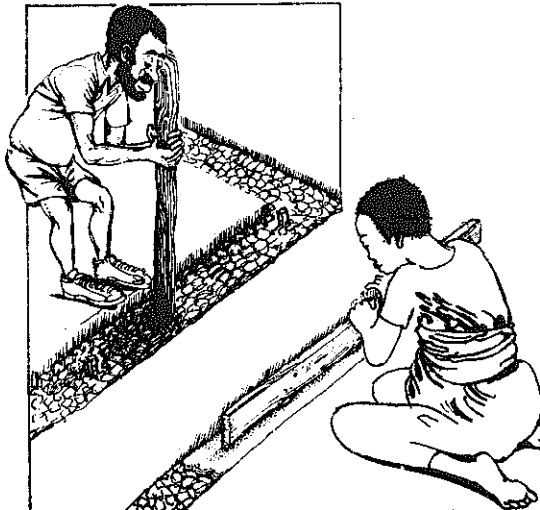

Foundations for buildings with wooden frames

Many people make buildings with mud walls between wooden poles. The best wooden poles are gum poles. To prepare the gum poles cut notches in the thicker end of each pole, 25cm from the bottom. Then soak the notched ends in creosote for a week.

To put in a gum pole, dig a hole 40cm square and 40cm deep. Fill the bottom of the hole with 5cm of gravel or small stones. Put in the creosoted end of the gum pole and check that it is straight up with a spirit level. Put in another 10cm of stones and pack it down tight. Then pour in concrete up to the ground. The gravel lets rain water drain away from the pole so that the pole does not rot. The notches help the concrete hold the pole strongly in the ground.

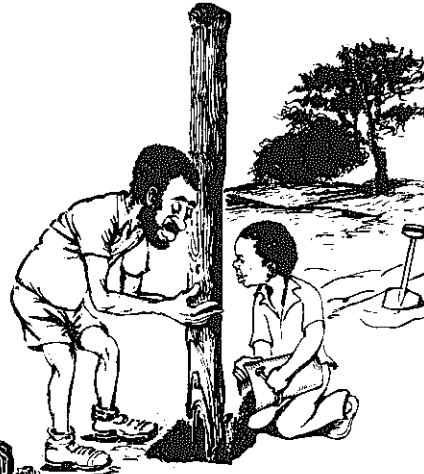

fill the hole with stones and concrete

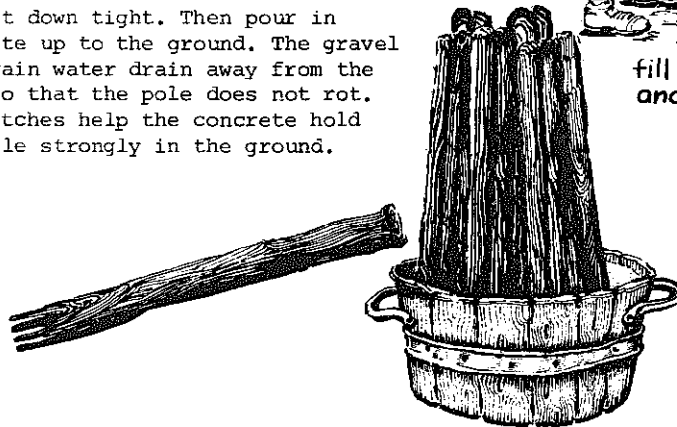

soak gum poles in creosote

Walls

You can build walls out of many different materials: poles and mud, stone, cement blocks, factory bricks, mud bricks, soil cement bricks, rammed earth. In South Africa there are many people who are so poor that they are forced to use old corrugated iron or even cardboard for walls.

● Cement blocks are either hollow or solid. The hollow blocks are better than the solid blocks. They are cheaper and the air in the hollow parts helps to stop the building from getting too hot or too cold and damp. So the hollow parts should not be filled. You can make cement blocks yourself with a hand mould or with a block making machine (see suppliers p 530). Mix 1 bucket of cement with 10 buckets of sand. The less water you use, the stronger the blocks will be. There should be just enough water for the mixture to stick together.

Cement blocks must always be kept damp while they are hardening. After you have taken the blocks out of the mould, cover them with plastic, grass, newspaper or old cement bags. Do not leave the blocks to dry in the sun, because this makes them weak and they will crack.

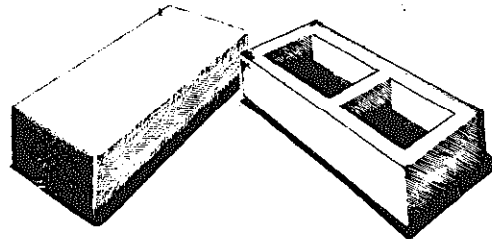

● Bricks which have been made in a factory are very strong, but they are expensive. Building with bricks takes longer than with cement blocks. All walls on the outside of the building should have two layers of bricks.

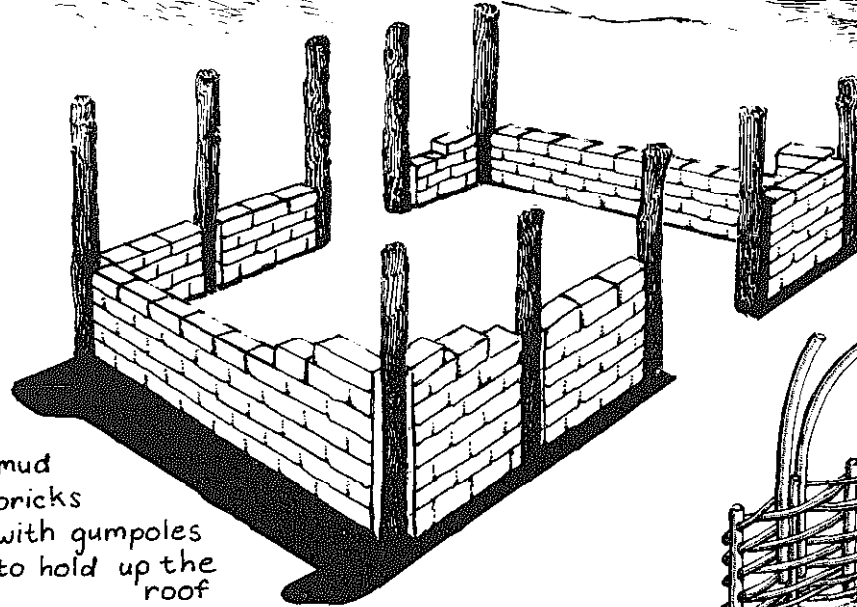
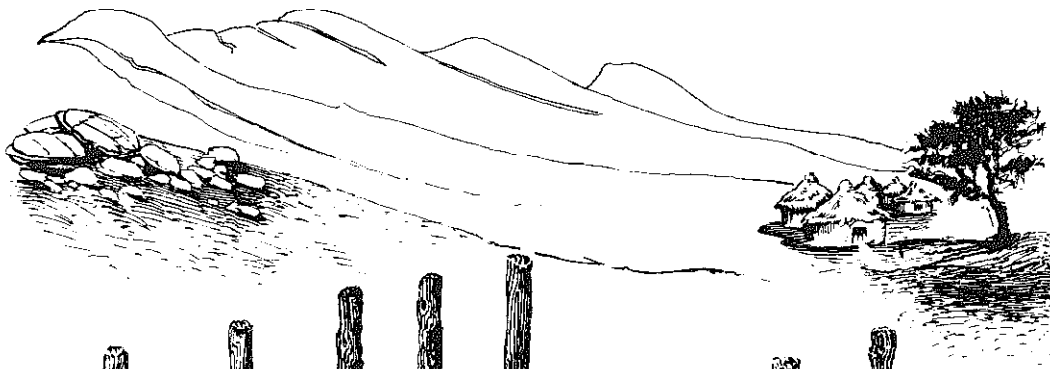

mud bricks with gumpoles to hold up the roof

● Sun-dried mud bricks are cheap and easy to build with, but these bricks are sometimes weak. Mix dry grass or dung with the mud to make the bricks stronger. If the mud bricks are not strong you can use gumpoles to hold up the roof, and build walls out of mud bricks in between.

● Wattle and daub buildings are made of wooden poles and branches. You weave the branches in and out between the poles and then fill the holes with stones and mud. Some people stretch chicken wire on the inside and the outside of the poles. They fill the space between the two layers of 12 gauge chicken wire with stones and mud and then plaster the building.

● Stone buildings can be strong and cheap if there are lots of stones nearby. Make sure to use a level as you build to check that all the walls are straight up.

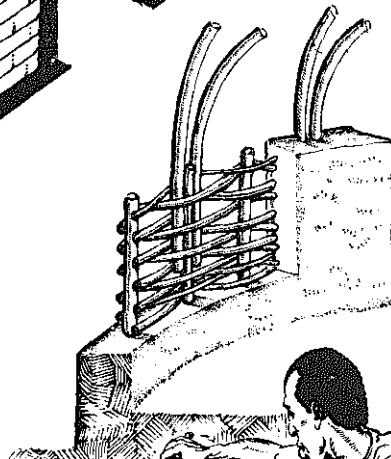

wattle and daub

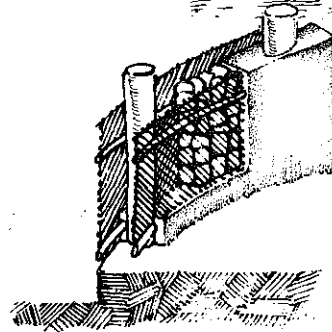

chicken wire makes wattle and daub walls stronger

● Rammed earth is a cheap method of building, but the walls can be weak if you do not have good soil. You can make the soil stronger and more waterproof by adding cement (see soil cement p 488). To build with rammed earth, you have to make a shutter, which is a box for making the wall. The shutter is wider at the top than the bottom. The long sides of the

shutter are two planks. It must be easy to take apart, so use wing nuts to join the sides. Put the shutter over the foundations and fill it with wet soil. Ram down the soil with a gumpole. When the soil has been rammed down hard, undo the shutter. Set it up again on top of the layer of wall you have just made. Leave openings for doors and windows.

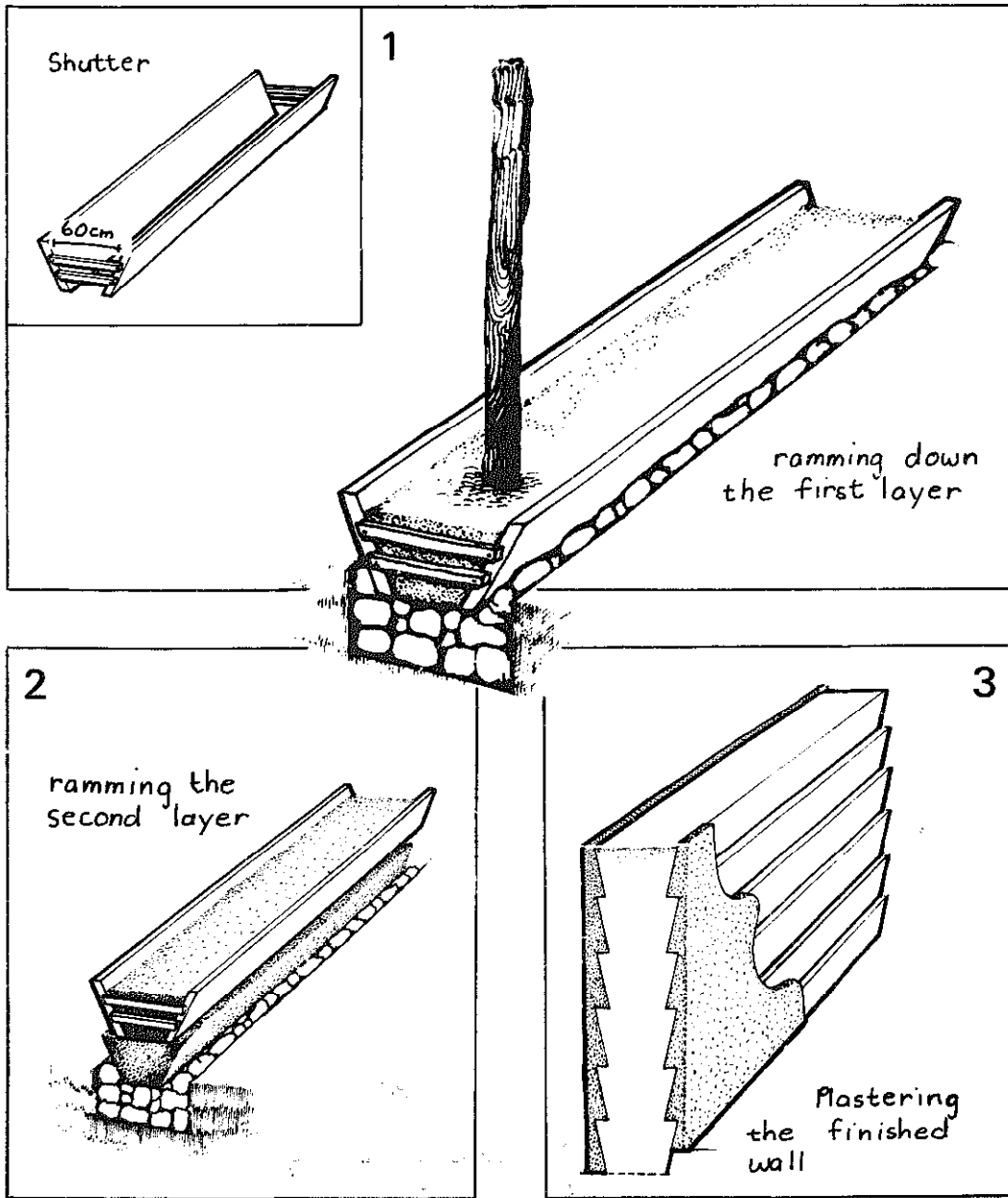

Making Bricks

People in many places in Southern Africa make baked bricks which are cheaper than concrete blocks and just as strong.

The best soil for bricks is clay. To find clay you usually have to dig down 1m. You can check if the soil is clay by feeling it (see know your soil p 97). Test the quality of the clay by making a few bricks. Dry them in the sun then put them in the hot coals of a fire for a few hours. If the clay is good, the bricks will bake very hard, and they will not become soft if you put them into water.

Mix the clay for bricks using one bucket of water for every 3 buckets of clay. Some people also mix coal or ash into the clay. Mix the clay and water by squashing the mud with your feet.

When the mud is well mixed, make the bricks in a wooden mould, which makes 2 or 3 bricks at a time. Put the bricks out to dry in the sun for 3 to 4 days, turning them over once a day. If it rains, use plastic sacks or corrugated iron to cover the bricks.

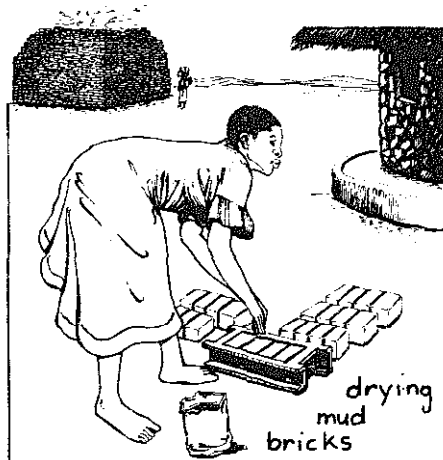

When you have dried 5000 to 10 000 bricks in the sun, make them into a stack. First make a low wall two bricks high, about 6m long and 3m wide. Leave gaps between the bricks so that air can get in. Put in wood or coal as high as the wall. Then lay bricks right over the top in layers. Leave small spaces between the bricks for the hot air to get through.

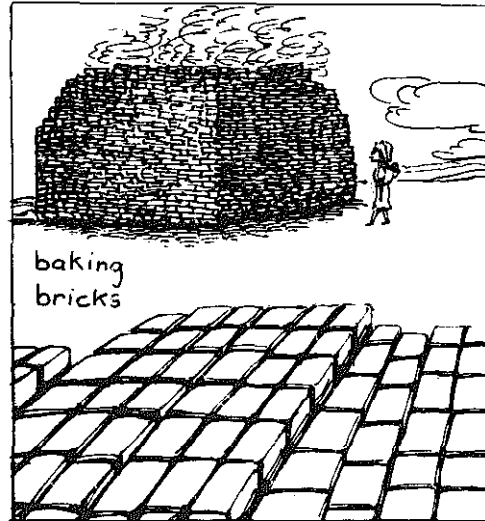

Plaster the outside of the stack with mud. Some brickmakers put old baked bricks on the outside. Light a fire in many places and let it burn for a long time, 3 to 14 days until the bricks are hard. The time depends on the quality of the clay. The baking will give you 2 kinds of bricks: red bricks from the outside of the stack, and blue bricks from the inside, nearer the fire. The blue bricks will be harder and stronger.

If something is wrong with your bricks, it could be one of these reasons:

▼ If bricks are dried too quickly in the sun, they crack. If the sun is too hot, cover the bricks with grass while they are drying and keep them damp.

▼ If the bricks break after baking, it could be because there were stones in the clay. You can take the stones out by using a sieve, but it is difficult to sieve clay. You might have to look for a better clay, without stones.

▼ You can check if your bricks have been baked enough by putting a few in water. If they get soft and swell up, they have not been baked enough. If this happens, put them back in the stack to bake again. This time add more wood or coal.

▼ If the bricks break when you drop them on the ground, it means your soil is too sandy, or you have not baked them for long enough.

Soil Cement

You can make mud bricks stronger by adding a little cement. This mixture is called soil cement. The cement makes the bricks hard and stops them from cracking.

Soil cement is good for building in places where it is expensive to transport sand. The best soil to use is a sandy loam (see p 99). With this soil you can use 1 part of cement with 20 parts of soil. With more clay soils you need more cement. For example, 1 part cement to 12 parts soil. There are different tests you can do to work out exactly how much cement and soil to use. Write to EDA if you want to know how to do these tests.

The strongest soil cement bricks are made with a machine like a Cinva Ram press or an Ellson Universal Brick Press (see suppliers p 530). In the Ellson machine the loose soil cement is squashed into a hard brick when you pull on the handle of the machine.

For most soils you need 2 to 4 bags of cement per 1000 bricks. 4 or 5 people can make between 1500 and 2000 bricks per day doing the jobs of sifting, mixing, operating the machine and stacking the bricks. 2 people can make about 1000 bricks a day.

If you are building a community centre or more than one house, it is cheaper to use soil cement than concrete blocks, even with the extra cost of the machine. These machines are strong and will last for many years without needing repairs.

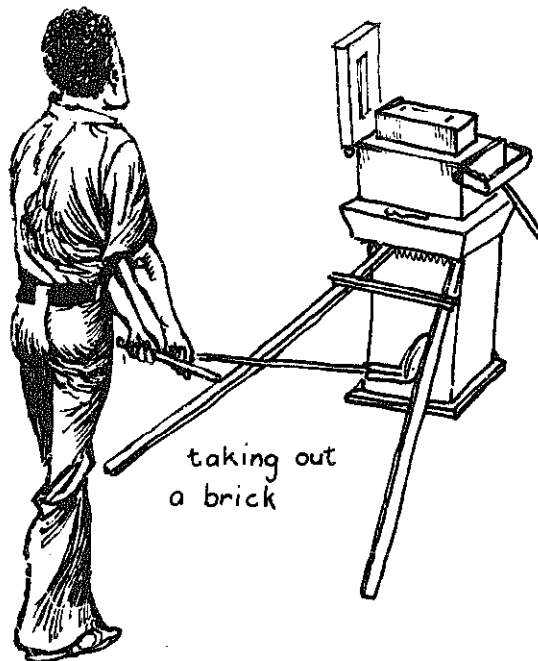
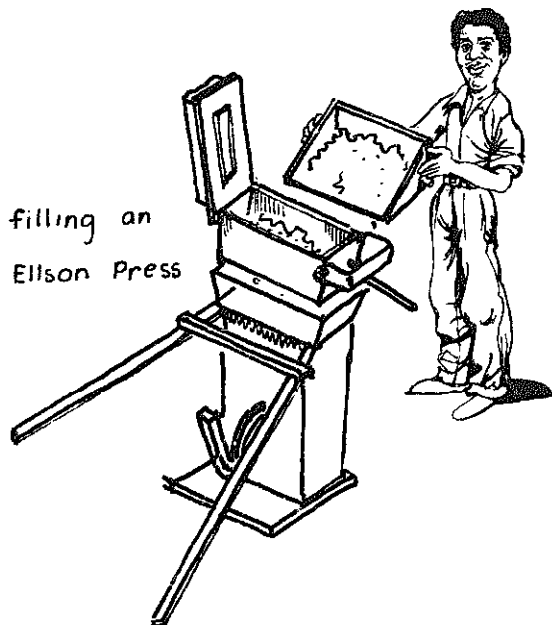
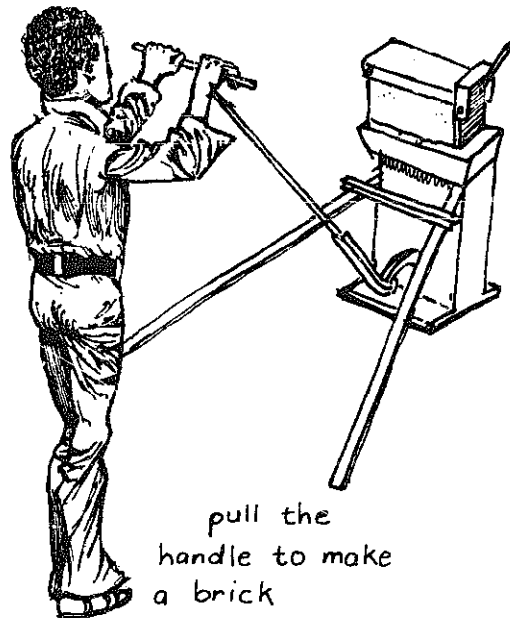

HOW TO BUILD A WALL

This wall is built from concrete blocks, but you use the same method to build with bricks.



First spread a layer of daga 2cm thick on top of the foundation. Use 1 bucket of cement mixed with 10 buckets of sand, and just enough water so it sticks together.

Lay the corner block first. Use the strings around the building to check that the block is straight.

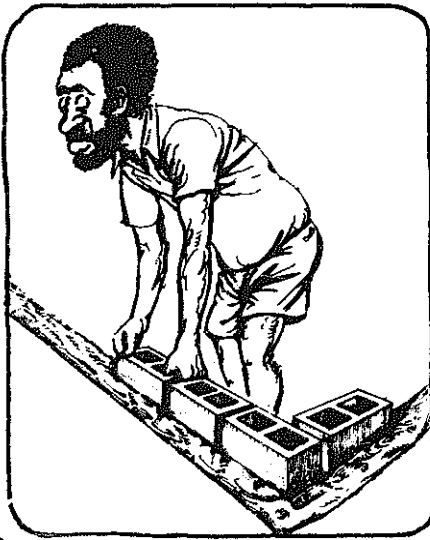

Then lay the first layer of blocks. (For a brick building, make the outside walls 2 bricks thick)

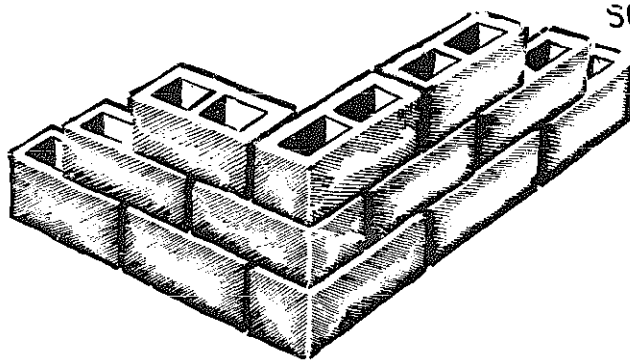

Start each layer at the corner. Each corner block must face a different way from the corner block below it.

The first layer of blocks must go right around the building.

Only leave openings for doors in the second or third layers.

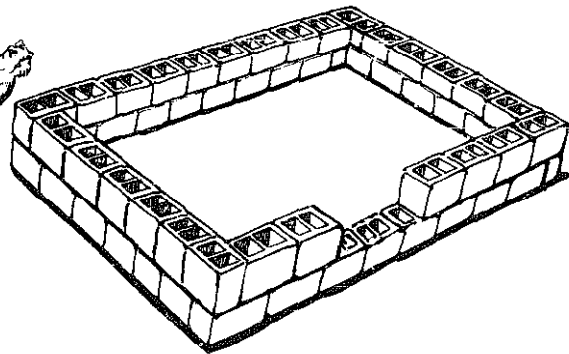

When the wall is 15cm high, lay a damp proof course. This is a strip of plastic between 2 layers of blocks to stop water rising in the walls. You can buy damp proof course or you can use plastic from old fertiliser bags.

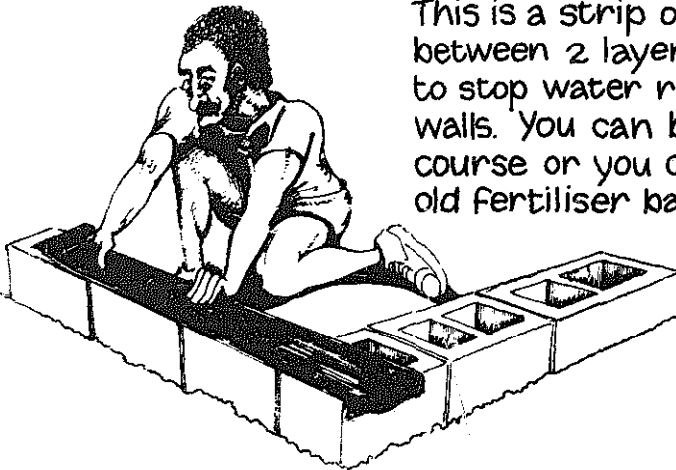

For the second layer and every layer on top of it, spread two strips of daga on the edges of the blocks. (For brick walls do not use strips. Spread daga right over the bricks.)

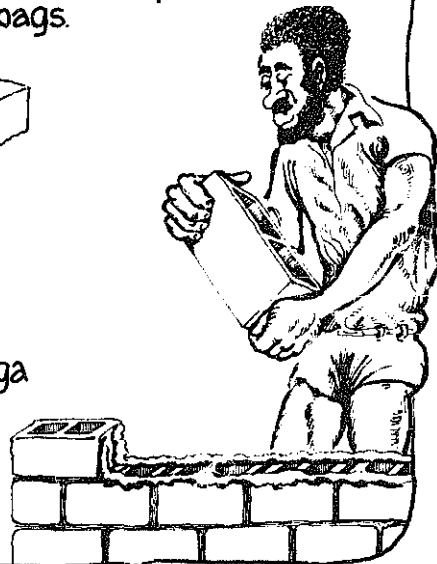

Gently drop each block onto the daga.
Fill up with daga between the sides.

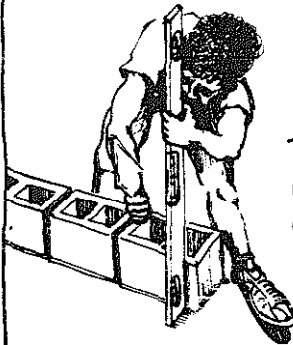
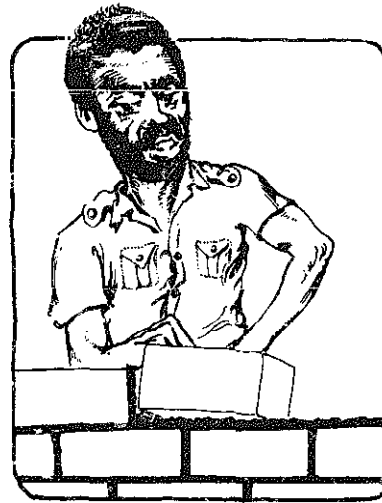
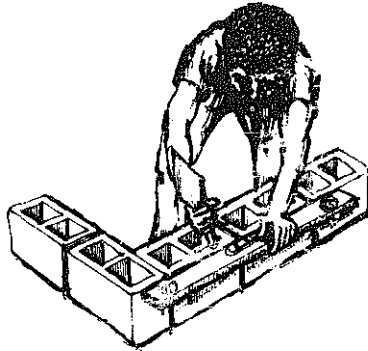

Tap each block down with the back
of the trowel to make it level. Check
each layer of blocks is level in 3
directions: along the wall, across
the wall, and straight up.

As you tap the block to make it level,
the daga is squeezed out. Cut off
the extra daga with the trowel.

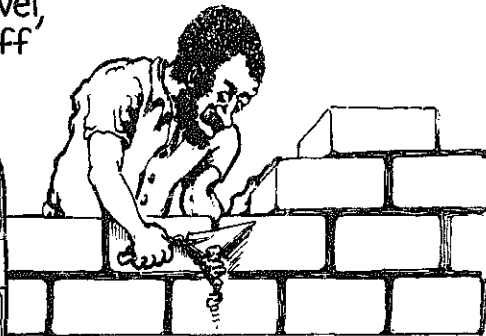

As the wall becomes higher,
keep checking that it is level
and straight up.

Doors and Windows

Before you build the walls of the building you must know where you want the doors and windows. The door and window frames have to be built in as you lay the blocks or bricks. Windows and wooden door frames are not strong enough to hold up the wall above them. You have to build in lintels to hold up the walls above doors and windows.

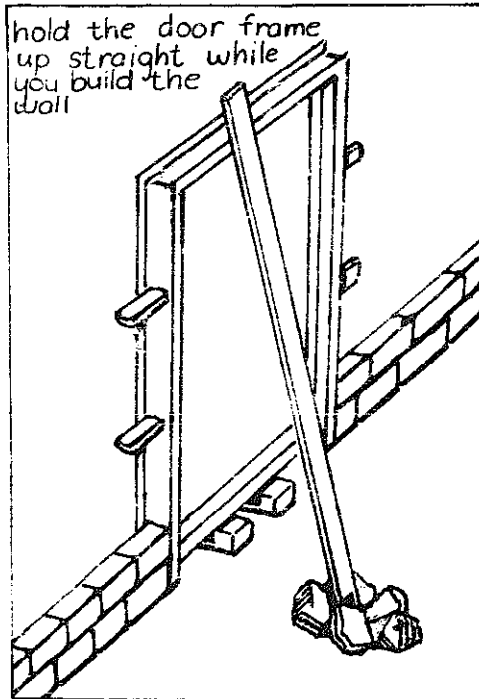

Putting in a steel door frame

Steel door frames are expensive, but if you use one you do not need a lintel.

The top of the door frame must line up with a layer or blocks or bricks. You can work out where the top layer of bricks or blocks will be by making a gauge rod. This is a plank which has marks as wide apart as each layer of bricks or blocks. Line up the top of the door frame with one of the marks on the gauge rod.

The bottom of the door must be below the floor level inside, but higher than the ground level outside the door. This will stop water coming into the building.

Use bricks and planks to hold the door up straight while you are building the wall.

Lintels

If you are not using a steel door frame, you have to make or buy a lintel. You can buy concrete lintels from building material suppliers (see p 530). They are easy to use but expensive. They have the same thickness as a brick so if you use them in a brick wall you just carry on building the next layer of bricks on top of the lintel. If you use a concrete lintel in a block wall you will have to make some half blocks to lay on top of the lintel so that they are level with the other blocks. You can make half blocks by only half filling the block mould with the cement sand mixture.

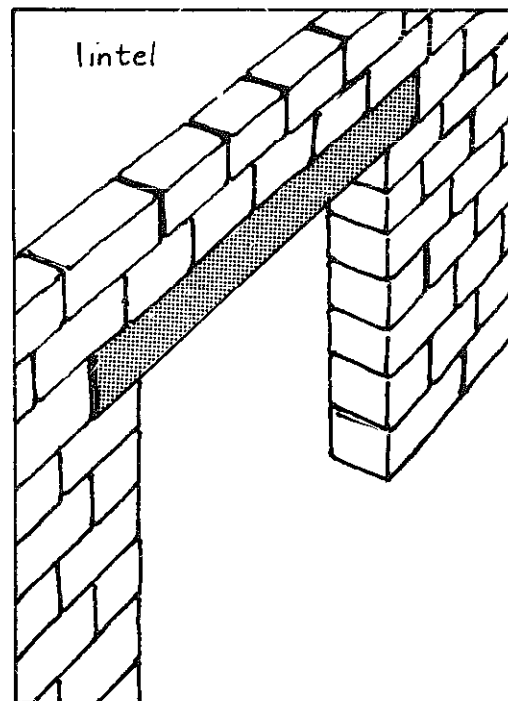

Making a lintel

If you are building a brick wall you can use brickforce to make a lintel. Brickforce is made of wire and you can buy it from building yards. To use brickforce, you first put in a wooden plank where you want the lintel. Build a layer of bricks on top of the plank. Lay a piece of brickforce twice as long as the opening across the bricks. Build 2 more layers of bricks and lay 2 more pieces of brickforce. When the cement is hard you can take away the plank.

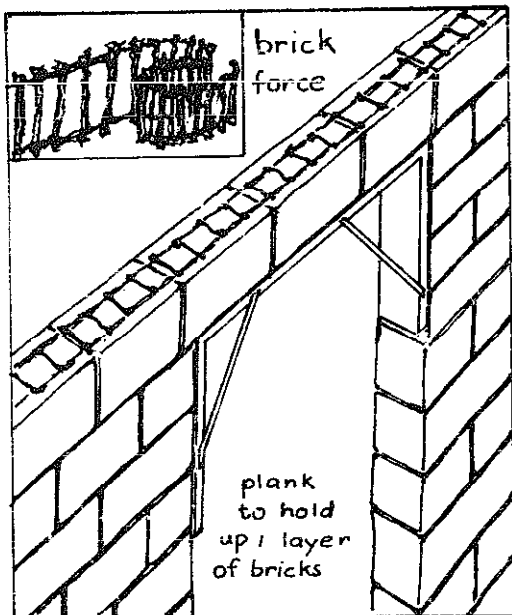

If you are building with sundried mud bricks, you can use a wooden lintel 4cm thick. If you are building with wattle and daub or gumpoles, nail or tie the lintel to the wooden poles.

Building window frames into walls

When you have reached the level of a window, use a gauge rod to measure where the row of bricks where the top of the window will be. Line up the top of the window with one of the marks on the gauge pole. Prop up the bottom of the window with pieces of wood. If the window has a steel frame, build the straps on the side into the wall.

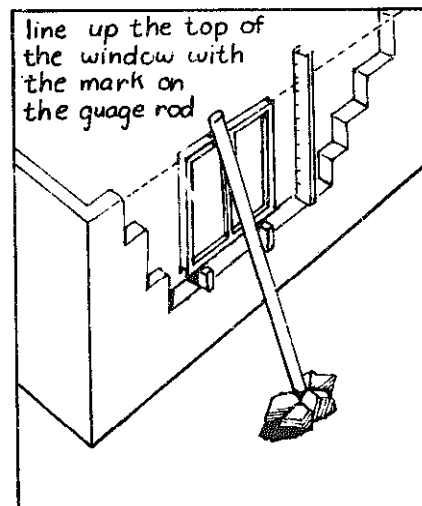

Another way to make your own lintel is to make a long box out of wooden planks and lay reinforcing rods in it. Fill it up with concrete and take away the planks when the lintel is hard.

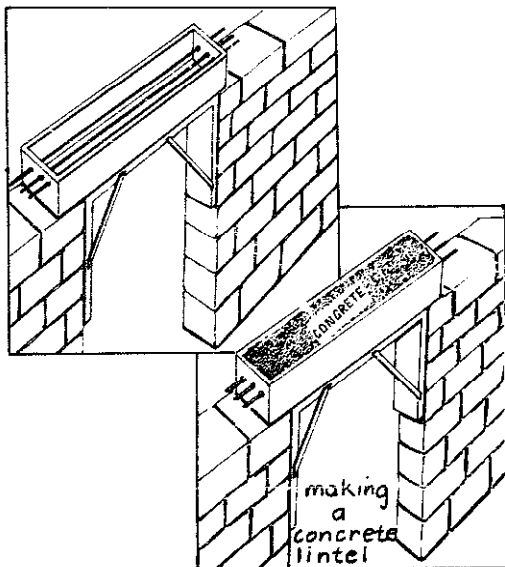

You can also use U-blocks and wire to make a lintel. Lay U-blocks across a plank over the opening. Then lay 2 bars of reinforcing steel or 10 pieces or wire in the bottom of the U-block and fill the hollow with concrete.

Wooden doors and doorframes

It is usually cheaper to make a door than to buy one. Outside doors must be carefully made to keep out the rain and the wind. The best way of making them is with tongue and groove boards about 5cm thick. An experienced carpenter can make them for you. Inside doors do not have to be made with tongue and groove joints, you can just nail them together.

Make the door frame when you already have the door. There must be 3mm space between the door and the top of the frame. Cut the edge of the door with a chisel so that the hinges fit flat into the edge of the door. Screw the hinges into place.

Floors

Mud floors are cheaper than concrete floors, but they are not as strong. They have to be plastered often with cow dung.

Concrete Floors

Make the concrete floors after you have built the walls and put on the roof. Fill the floor with stones and broken bricks and hammer them down hard until the floor is level with the ground outside. Then hammer down another layer of stones and broken bricks 10cm thick. Use a straight

plank and a level to make sure the layer is hammered flat. If there are big spaces between the bricks and stones, fill these with river sand, otherwise you will waste concrete.

Use a concrete mix of 1 part cement, 2 parts sand and 4 parts stones. Wet the floor and pour the concrete about 7cm thick. Cast the concrete in squares. Each square should be as wide as the plank you are using for levelling. Keep the concrete wet with old cement bags or wet grass, so that it will not crack as it gets hard.

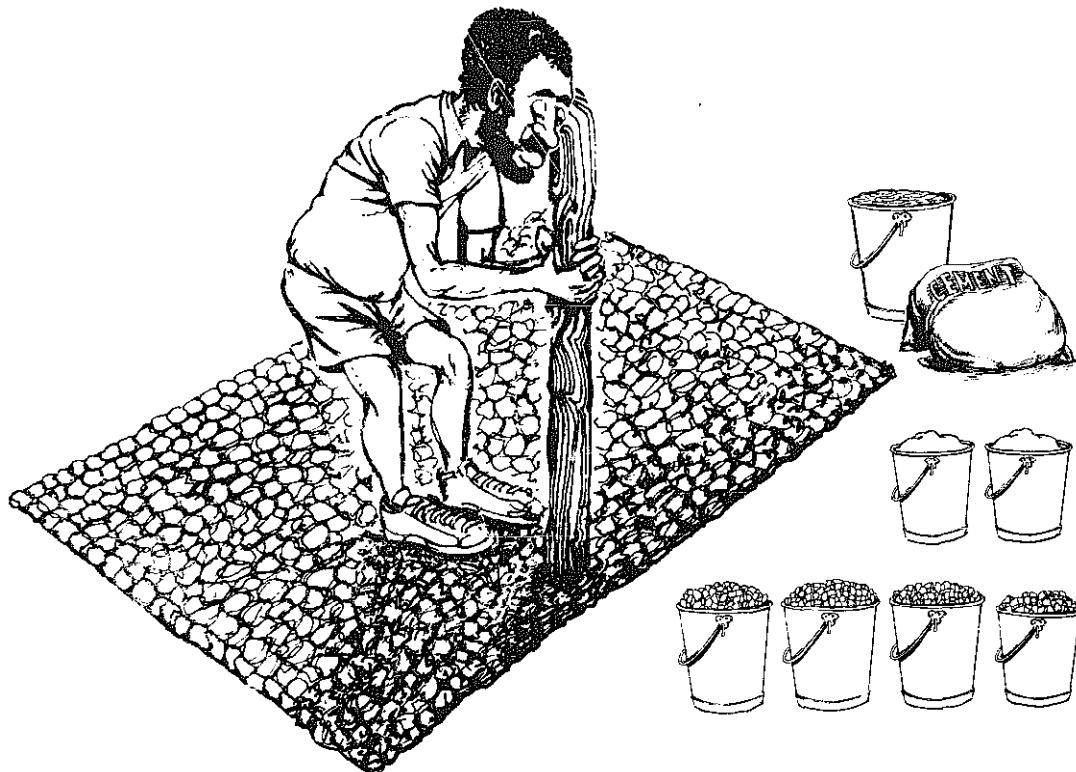

Roofs

In most places in Southern Africa, thatch is good for roofs because it keeps the building cool in summer and warm in winter. Roof sheeting like corrugated iron and asbestos is easier to use and it lasts longer. But it makes the building very hot in summer and very cold in winter.

If you are going to use thatch you must make a roof frame with trusses

and purlins. Trusses are strong wooden planks or poles which hold up the roof. Purlins are thin pieces of wood which are nailed to the trusses. The thatch is sewn onto the the purlins.

When people thatch a small building they usually make the whole truss and purlin structure on the ground first and lift it onto the walls. The trusses should be 1m or less apart.

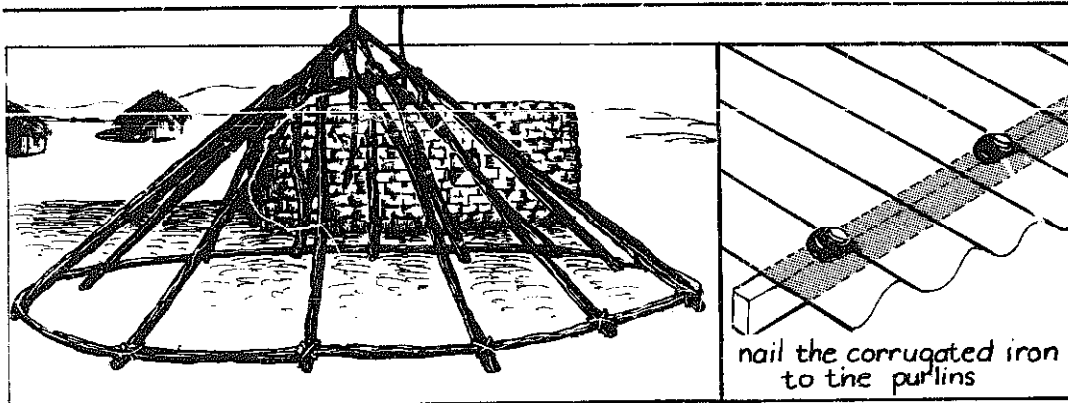

You must build wire into the walls to tie the rafters down. Each wire must be 1½ m long and must be built into the wall 60cm from the top. Put in one piece of wire for each truss pole.

If you are using roof sheeting you can make a roof with trusses or you can make a flat roof. For a flat roof you need planks of wood or gum-poles. Make the walls on one side of the building higher than the other side, so that the roof slopes and rain can run off. Build the trusses across from the low wall to the high

wall. If you are using planks they must be straight up, not flat.

Nail the roof sheeting to the purlins with roof nails and washers. The washers stop water coming through the nail holes. Hammer the roof nails into the higher bumps of the roof sheeting, not the lower bumps where water collects.

Ceilings make buildings cooler in summer and warmer in winter. Make them by nailing strips of wood 40cm apart to the rafters. Nail ceiling board or cardboard to these strips.

Using the sun to heat water

Solar water heaters warm up water for cooking and washing. They work in the same way as the solar oven. A box is insulated, painted black inside, and slopes towards the sun. The top of the box can be glass but it is better to use fibreglass because glass gets broken easily. On the bottom of the box there is a corrugated iron sheet painted black and on this sheet there are a number of water pipes joined together. When the sun shines, the black sheet becomes hot and heats up the water inside the pipes.

The other part of the water heater is the storage tank. You can use a 200 litre drum. Galvanised drums are best because ordinary drums rust.

As the water is heated inside the pipes, it rises up into the drum, and colder water comes into the pipes from the drum. Then the water is

heated again. Water flows slowly round and round in this way, getting hotter all the time. Water will not boil in a solar water heater, but it can get too hot to put your hand in. It is quite expensive to build, about R200, but it can last for many years without giving trouble.

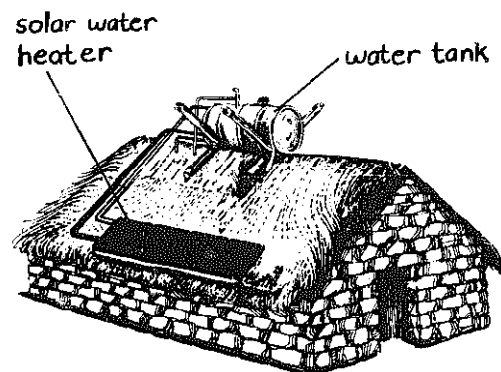

HOW TO BUILD A CRECHE

Many mothers have to leave their children with somebody while they are working. In some villiages the whole community has worked together to build a creche where many children can play together. Here we give some plans for a creche.

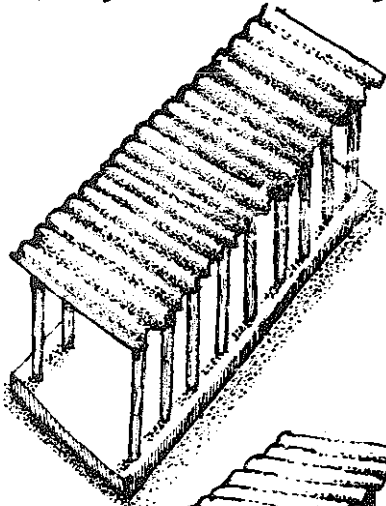

Even if you do not have much money, you can collect money while the creche is being built. You can start building at the end of winter, and put the roof up first. Then the children can play under the roof in summer and be protected from sun and rain.

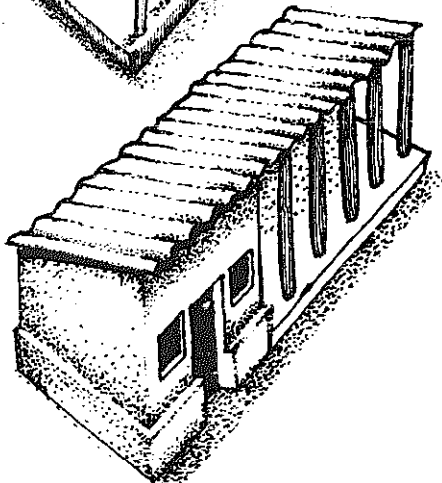

At the end of summer you can start building the walls so that the children can have a warm place for the winter.

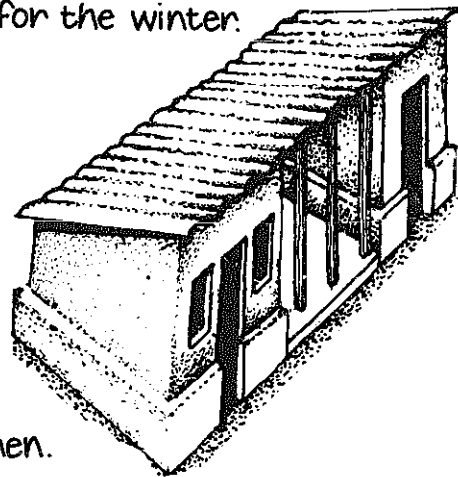

The next year you can add a kitchen.

Plan of the Creche

How to read the plan

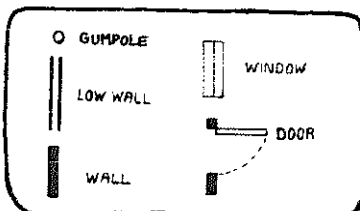

Side view

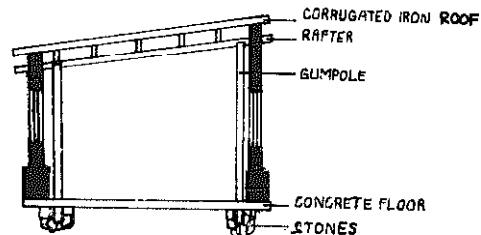

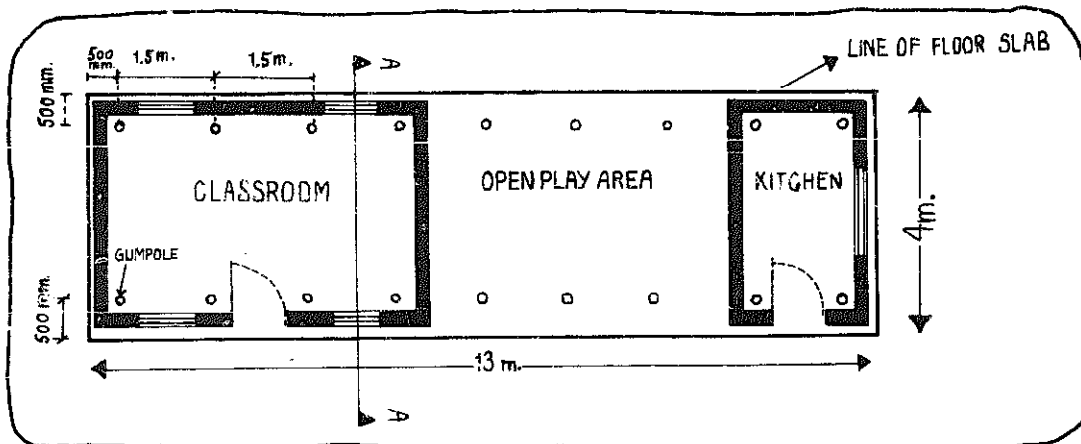

What You Need

For the floor

The floor is 4 m wide, 13 m long and 15 cm thick. For this you need:

- | | |
|--|--------------|
| • 9 cubic metres of stone
(45 oil drums full) | R 55 |
| • 5 cubic metres of sand
(25 oil drums full) | R 25 |
| • 100 bags of cement | R 350 |
| | R 430 |

If you live near a river you can collect the sand and stones and save R 80.

To mix the concrete for the floor you need 4 parts of stones, 2 parts of sand, 1 part of cement. Add water until it is as thick as porridge.

For the roof poles

To hold up the roof you need 18 15 cm diameter gumpoles. 9 must be 3 m long and the other 9 must be 2½ m long. Each gumpole costs about R 5, so altogether they will cost R 90.

If the gumpoles have not been treated you must dip the bottom (thicker) end of the pole in a tin of creosote for about 2 weeks. This will make the pole waterproof and protect it from insects.

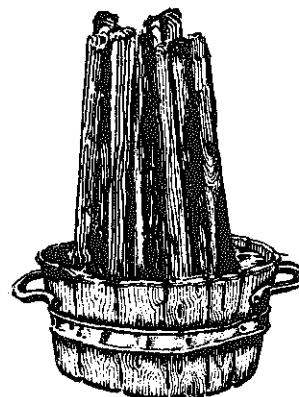



Cut a notch 2 cm around each pole 40 cm from the bottom. This will stop the wind pulling the pole out of the floor.

Make a cut 15 cm deep at the top end of the pole to support the rafter.

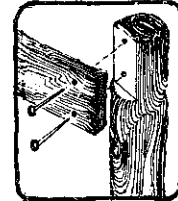

Setting Out

Before making the floor you must set out the building. Mark an area 4 m wide and 13 m long. The long side must face north (see p. 477). Use pegs and string to make the corners square (see p. 478). Hammer in a peg at each corner.

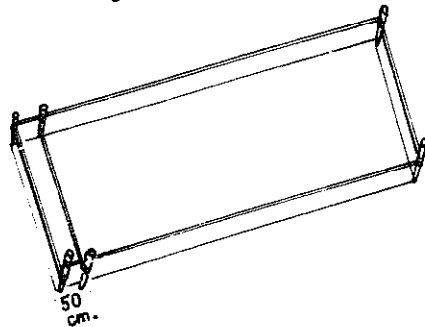
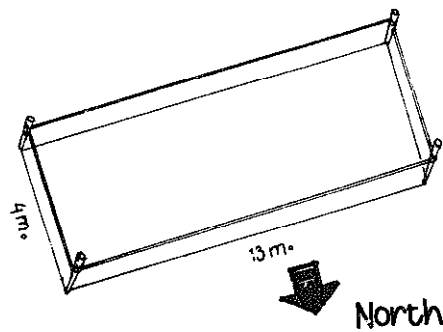

Hammer in two more pegs on the long sides, 50 cm from the corners. Tie a string between these two pegs.

From these two pegs measure another 1.5 m. Hammer in two more pegs and tie a string between them.

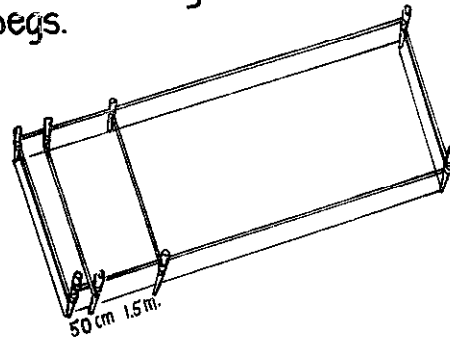

Keep hammering two pegs every 1.5 m until you are 50 cm from the other end.

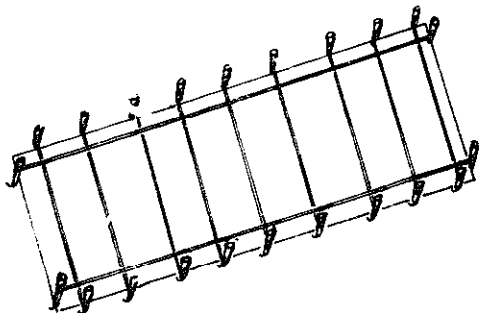

Now along both the short sides measure in 50 cm from each corner. Hammer in 4 pegs and stretch string between them.

At each place where the strings cross there must be a gumpole. For each gumpole dig a hole 30cm deep. Use a level to check that each gumpole is straight up. Fill the hole with stones. Put the 3m poles on the north side and the 2½ m poles on the south side.

Making the Floor

Make a box around the whole floor with planks 4 m long, 15cm wide and 38mm thick. Later, you can use these planks for the rafters. Hammer pegs on both sides of the planks to keep them straight up. If there are any spaces underneath the planks, fill them up with mud.

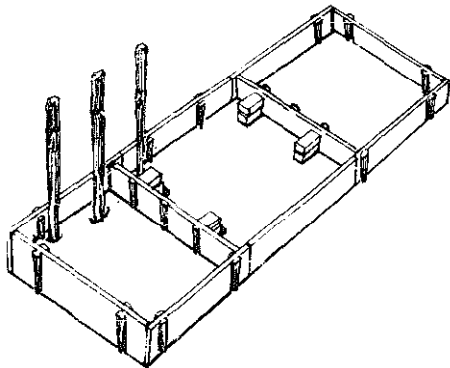
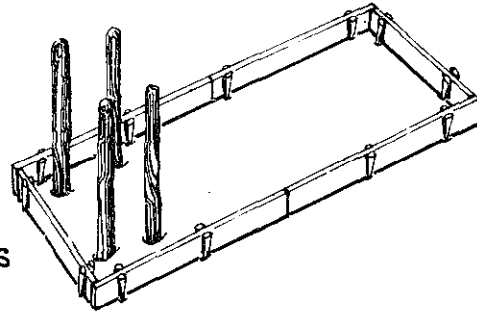

Now put another plank 3m away from one corner. Hammer in pegs inside to keep it straight up and use cement blocks to hold it up on the outside. Do the same thing on the other side, so that you can make the two ends of the floor at the same time.

Now pour the concrete. Use more concrete than you need and level the top of the floor, using a plank to remove extra concrete. When you have finished levelling the floor, cover it with plastic or old cement bags so that it does not dry too quickly. After 2 days the concrete will be hard and you can make the middle 2 parts of the floor. Make them level with the dry parts of the floor.

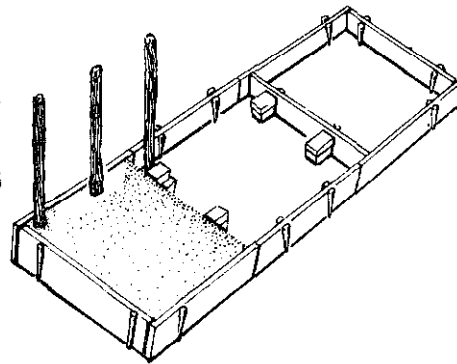

Making the Roof

To make the roof you need

- 9 rafter planks 4m long, 15cm wide and 38mm thick. Each rafter costs about R4. R36
- Purlins 5cm wide and 38mm thick. 65 altogether R40
- Roof nails and lead washers R5
- Galvanised hoop iron ties 2mm thick R5
- Corrugated iron 52 sq. m R200
R286

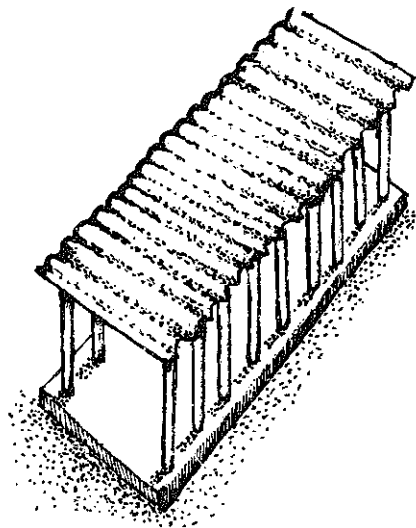

If you use second-hand corrugated iron you can save a lot of money

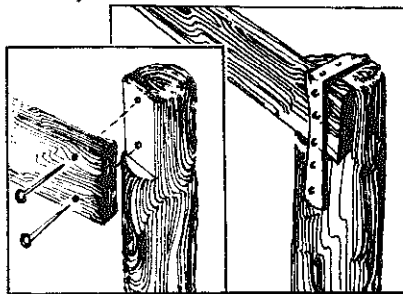

Nail the rafters to the gumpoles where you have made cuts. Strap the rafters to the poles using the hoop iron ties.

Then nail on the purlins, 80 cm apart.

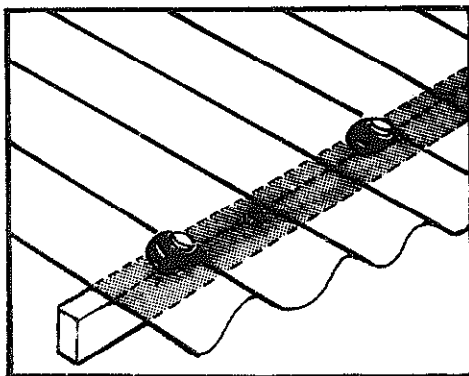
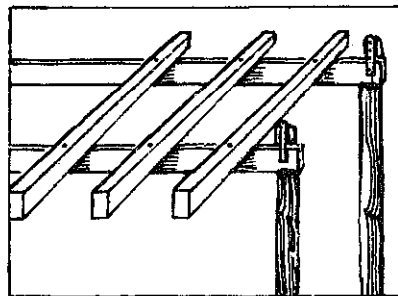

Lay the corrugated iron across the purlins and nail it down firmly. Nail through the top bumps of the corrugated iron, where water does not collect.

Building the Walls

You can use hollow cement blocks, bricks or mud to make the walls. For cement blocks, use a mixture of 10 parts of sand to 1 part of cement.

To build one playroom and the kitchen you will need about 200 bags of cement and 30 cubic m. (150 oil drums) of river sand. This will cost about R800. If you collect your own sand you can save R200.

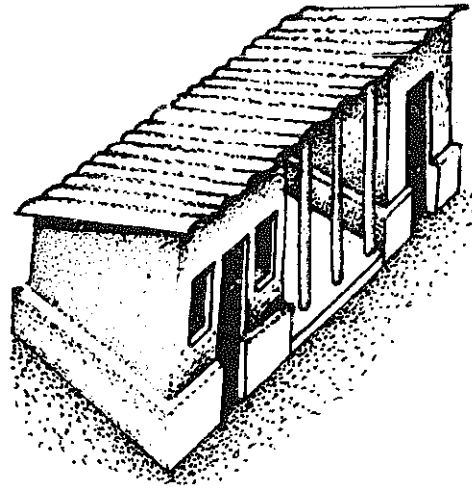

You will also need daga to lay the blocks. Use a mixture of 10 parts sand to 1 part cement. Use finer sand than the concrete mixture. You will need 20 bags of cement and 4 cubic metres (20 oil drums) of sand, which costs about R80.

Steel door and window frames are very expensive so it is better to make wooden ones (see p.450) or to buy second hand steel ones.

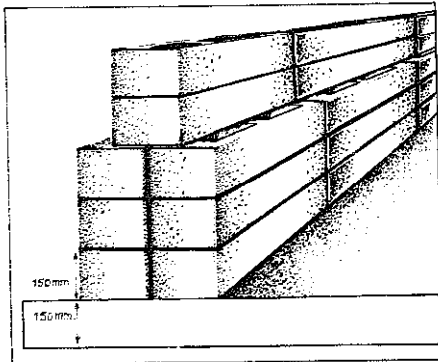

The creche has a thick floor so you can build foundations on top of the floor. Make the foundations 3 blocks high and 2 blocks thick. Lay the blocks on the top of the floor.

Keep checking to see that the walls are level and straight up. Leave spaces 90cm wide for the door and spaces for the windows.

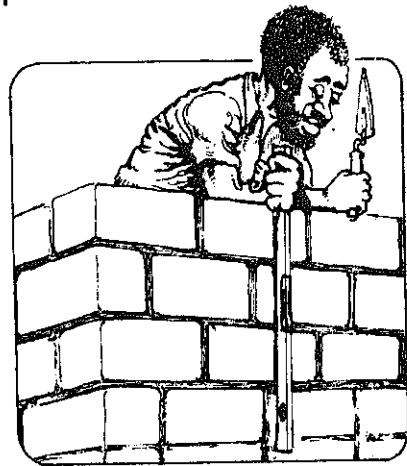

Finishing The Building

There are many things you can do to finish off the building. The creche committee can decide which is the most important:

- You can add gutters to collect rainwater.
- You can plaster the inside of the building.
- You can put up a ceiling to keep out the heat in summer and the cold in winter.
- You can build a wall around the creche to keep the children safe.
- You can plant trees near the building to give shade in the summer.
- Build small pit toilets for the children and playground equipment: a sandpit, swings, ladders to climb trees.

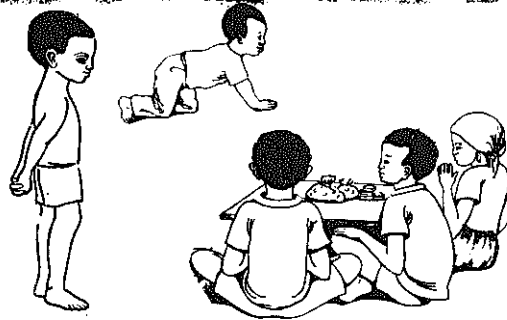

- You can add a verandah on to the sunny side of the building.

We thought that this was a good idea because of all the working mothers in our community

In Makotopong, a village near Pietersburg, some women are building a play creche for their children. Many of these women have to work in town and they need a safe place for the children while they are away. While the creche is being built, two women who do not have jobs look after the children for one hour a day at the church. They teach the younger children singing and dancing and the

older children how to read, write and count. When the new creche is finished the teachers will also teach the children outdoor games.

We asked the members of the Makotopong Play Centre Committee to tell us about their building project.

- Where did you first get the idea of this creche?

In 1977 a man from the Lutheran Church came to tell us about creches overseas, where many women also go out to work. We thought this was a good idea because of all the working mothers in our community.

Then in 1979, Sister Knappe from the Lutheran Mission called meeting at the church to discuss a creche. All the working mothers with young children were invited and we elected a committee.

● What did they do?

The most important job for the committee was to start collecting money. The church helped us with donations of toys and cupboards. They also gave us some old clothes and we had a jumble sale. We made R173 from the clothes. Then we wrote a letter to a trust explaining why we needed a creche. The trust sent us R100. We also organised a concert with the school children. There was some singing and dancing and the parents came to watch. We made R19 from the concert. Later the trust sent us another R500. We hired a builder

in December 1979, but he let us down because he had other jobs and was too busy. When we saw that he was not starting on the building we decided to hire another builder. We have paid him R40 so far and when he finishes the walls and floor we will pay him another R60. We are also paying R50 to another builder who is working on the roof.

● Have the community helped with the building work?

Yes, the mothers are very keen. They help to collect stones and sand for the blocks and foundations. They also help to draw water and carry it to the site. The priest at our church also helped us. He transported building materials for free. When the main building has been finished the women are going to build a big lapa wall in front.

The children will be able to play outside in summer and on warm winter days. The mothers are also going to build a pit toilet nearby so that the children can learn about hygiene. We want to start a vegetable garden like the vegetable garden that Sister Mamabolo has planted at the clinic.

● What do you think the problems will be in the future?

The big problem is money. We pay the teachers R5 a month each, but this is too little. We will also need more money to run the play centre because we think more children will come. So far the children pay 20c a month each and we use this money for paper and crayons but we do not know if it will be enough in the future. We will have to think of a plan to overcome the problem of money.



HOW TO BUILD A FLYPROOF PIT TOILET

Pit toilets usually smell bad and have many flies. This toilet gives almost no flies or bad smells.

How it Works

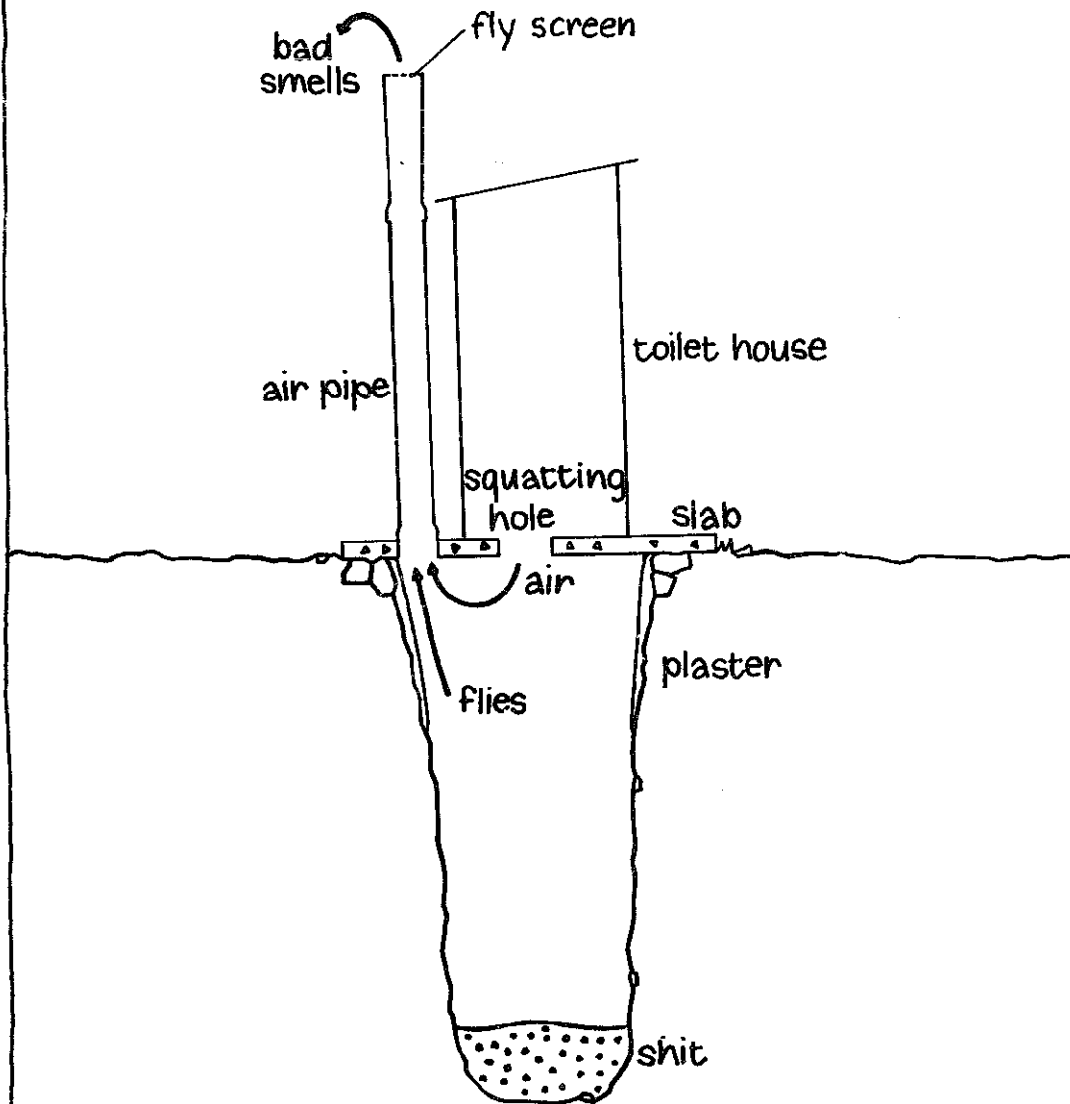

The toilet has an air pipe covered with a fly screen. Bad air rises out of the pit up this pipe. The toilet house is dark inside so flies try to fly up towards the light at the top of the pipe. Then they are trapped by the fly screen and die from being dried out.

What You Need

For the slab

2 buckets of cement (1 bag)
4 buckets of sand
8 buckets of small stones
25 m. of 6mm. steel reinforcing rod

For plastering the top of the pit

2 buckets of cement (1 bag)
10 buckets of sand

For the air pipe

1,8 m. length of 15 cm. diameter asbestos vent pipe and collar.
0,75 m. length of 15-20 cm. tapered asbestos pipe.
30 cm. x 30 cm. piece of fibreglass gauze or plastic fly screen.
2,5 litres of bitumen paint.

For the toilet house

You can build the toilet house with a variety of materials, but it is important that the house is dark inside.

If you make it from ferrocement:

3 buckets of cement. (1½ bags)
7 buckets of river sand.
7 buckets of pit sand.
6 x 2 m. lengths of corrugated iron for moulds
6 m. x 2 m. chicken wire.
15 m. of 8 gauge wire.

If you make it from cement bricks:

80 cement bricks.
2 buckets of cement. (1 bag)

If you make it from corrugated iron:

12 x 2 m. lengths of corrugated iron.
some 2 inch nails.
4 x 2 m. planks or poles.
4 x 1 m. planks or poles.

For the roof

You can make the roof with thatch, ferrocement or corrugated iron.

For the toilet seat

You do not really need a toilet seat. You can just have a squatting hole. It is easier to keep clean than a seat. If you want a seat you can build one with planks or buy a plastic moulded seat.

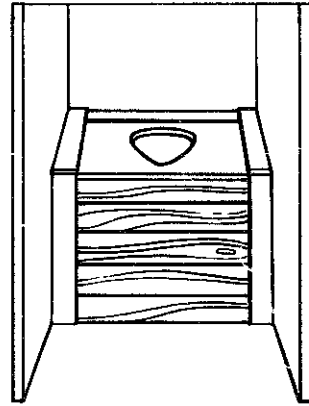

Digging the Pit

stick knocked into the ground

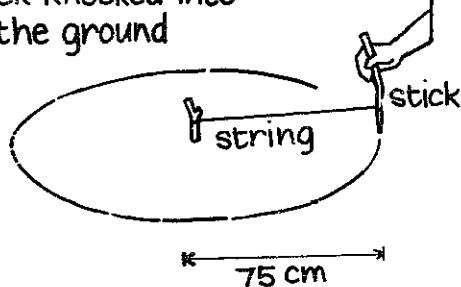

The pit should be at least 3 m. deep. Mark out a circle 1,5 m. in diameter, in a sunny place.

If you are digging in sandy or loose soil be careful that the pit does not fall in while you dig it.

Strengthen it by cutting back 15 cm. into the soil at the top of the pit and putting rocks around the edge. You can use cement or anthheap soil to bind the rocks. Plaster the top 1 metre of the pit. This stops rainwater eroding the top of the pit

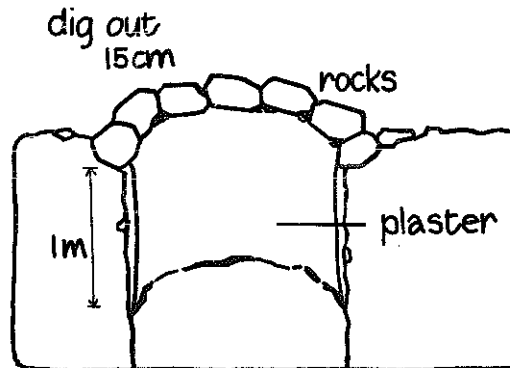

The Slab

You need to make a 7,5 cm. thick circular slab, with a diameter of 2 m. The slab has two holes - one for the air pipe and one for the squatting hole.

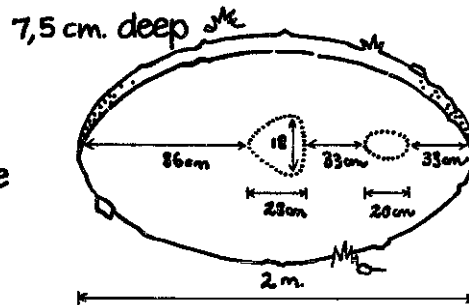

Mark out a circle on the ground with 2 m. diameter. Dig down 7,5 cm. Mark the places where the holes will be.

Use 10 cm. wide tin to make shapes for the squatting hole and the air pipe.

squatting hole

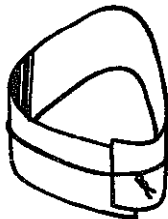

air pipe hole

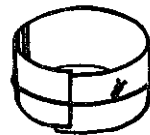

Make a grid with 6 mm. reinforcing bars. Cut the bars with a hacksaw and tie them together with wire. Fasten 4 wire loops around the grid. This will hold the toilet house when it is built on the slab.

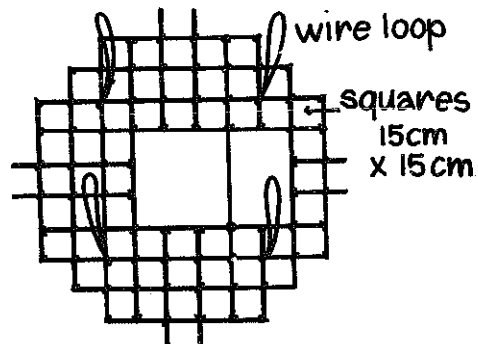

North

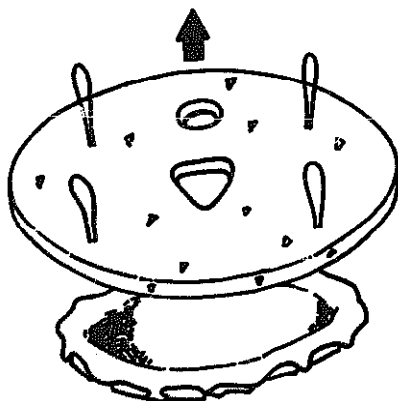

Mix the cement for the slab. Put the tin shapes in position. Fill the hole for the slab half way up (4 cm) with cement. Put in the the grid and fill up the hole with the rest of the cement. After a day put sacks on top of the slab and keep it wet for a week to stop the slab from cracking. Lay plaster on top of the rocks around the pit, and lay the slab over it so that it will be air tight. Lay it so that the air hole faces north.

The Toilet House

Whichever way you make the toilet house, make sure there are no cracks for light to get in.

If you build it out of ferrocement, make a mould with corrugated iron and planks. Tie chicken wire tightly to the outside of the mould with some 8 gauge wire. Plaster the outside of the mould. Leave this layer for an hour then plaster another layer on. The ferrocement should be about 5 cm. thick. Remove the mould after 3 days, but keep wetting the walls so that they will be strong.

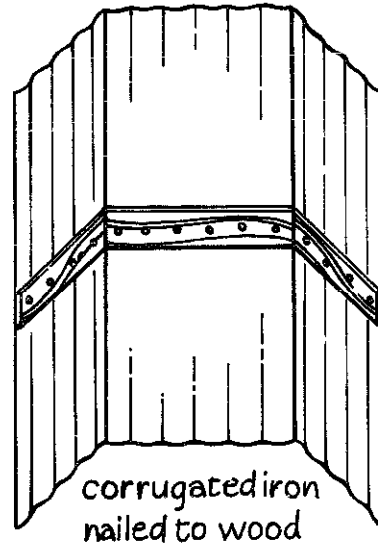

If you want to use corrugated iron, build a frame of wood and nail the corrugated iron to the frame. You can also make the toilet house from mud bricks, cement bricks or split poles.

Make a door out of wood or corrugated iron. Make the roof from thatch, corrugated iron or ferrocement.

The Air Pipe

Join the two sections of pipe with cement and leave it for 2 days. Glue the fly screen to the 200 mm. end of the pipe. Put the pipe over the air hole in the slab and cement the bottom to the slab.

Paint the slab inside the toilet house and a metre up the walls with bitumen paint. Also paint the inside of the roof and the air pipe.

Looking after the toilet

- Keep the slab clean and wash it down regularly.
- Check that the fly screen is clean and not broken.
- Pour a bucket of water down the pipe regularly to clear out insect nests and cobwebs.
- Repaint the slab regularly.
- Make a new toilet when the pit is filled to 30 cm. below the slab. Move the slab and the toilet house to a new place and plant a tree over the old pit.

Farm Buildings

Farmers need cheap, strong buildings for keeping animals and for storing tools, fertilisers, seeds and harvested crops. Many of these farm buildings can be built cheaply, using traditional local materials. Simple improvements, using traditional materials, will make farm buildings last longer and do not cost a lot of money.

Walls

▲ Mud and pole walls are strong enough for chicken houses and storage sheds.

▲ Wood offcuts can be used to make walls strong enough for many farm buildings. Paint all the wood, including the edges, with creosote or old motor oil to make it last longer.

▲ Cement blocks are expensive but make strong walls which are quick to build and last for a long time (see p 384).

Roofs

Make roofs of farm buildings steep so that the rain will run off quickly.

▲ Thatching grass makes very good roofs for animal houses because it

is cool in hot weather and warm in cold weather. The biggest problem with thatch is that insects like lice breed in the thatch. Spray the roof well with Jeyes Fluid every time you disinfect the house.

▲ Corrugated iron is strong and lasts for a long time but is very expensive. Make sure it is nailed down tightly so that strong winds cannot blow it off.

▲ Roofing Felt can be nailed onto a roof made out of flat wooden planks to keep out the rain. Paint the roofing felt with bitumen aluminium paint to make it last longer.

Floors

▲ Stamped earth floors are usually good enough for farm buildings. Build drains outside the building to make sure that rain water cannot drain onto the floor under the walls.

▲ Concrete floors are the strongest but the most expensive. Use a mixture of 1 part cement, 3 parts sand and 6 parts stone. Make the concrete 10cm thick.

▲ Soil cement (see p 488) makes good floors in chicken houses.

Chicken Houses

Chickens need houses which give them plenty of air and sunlight, but protection from wind and rain. The roof must have a steep slope and must be bigger than the house on all sides to make sure that rain can not get inside. The walls should be solid for the first 75cm above the ground up, so that wind can not blow through the bottom. Use mud bricks, stone, planks or concrete blocks to build the bottom of the walls. The top part of the walls should be chicken wire or thin poles about 5cm apart. To protect the chickens in stormy weather you can tie old chicken mash sacks or pieces of plastic to the walls. The floor of a house for broiler chickens should be of concrete or soil-cement so that you can wash and disinfect it. In a house for laying hens the floor can be stamped earth, covered with a deep litter of grass, woodshavings or sawdust.

or corrugated iron strongly nailed to poles buried in the ground. These poles should be soaked in creosote or motor oil and buried 70cm deep.

The best floor is concrete so that it can be washed out. Build a water channel leading to a liquid manure pit. Do not make the concrete floor too smooth or slippery.

Milking shed

The size of the milking shed will depend on how many cows the farmer has, but for most small farmers, a shed for milking one cow at a time is big enough.

The shed must have a concrete floor so that it can be washed out every day. The floor must not be too smooth or slippery. Build a water channel that leads to a liquid manure pit.

Pig Houses

Pigs need strong, well-built houses with a warm, dry place to sleep, a place to eat their food and a separate place to urinate and shit. The walls can be made of stone, planks

Storage Sheds

Storage sheds must have strong walls and doors and they must be dry. The best way to keep them dry and free from damp is to use dampcourse (see p 490).

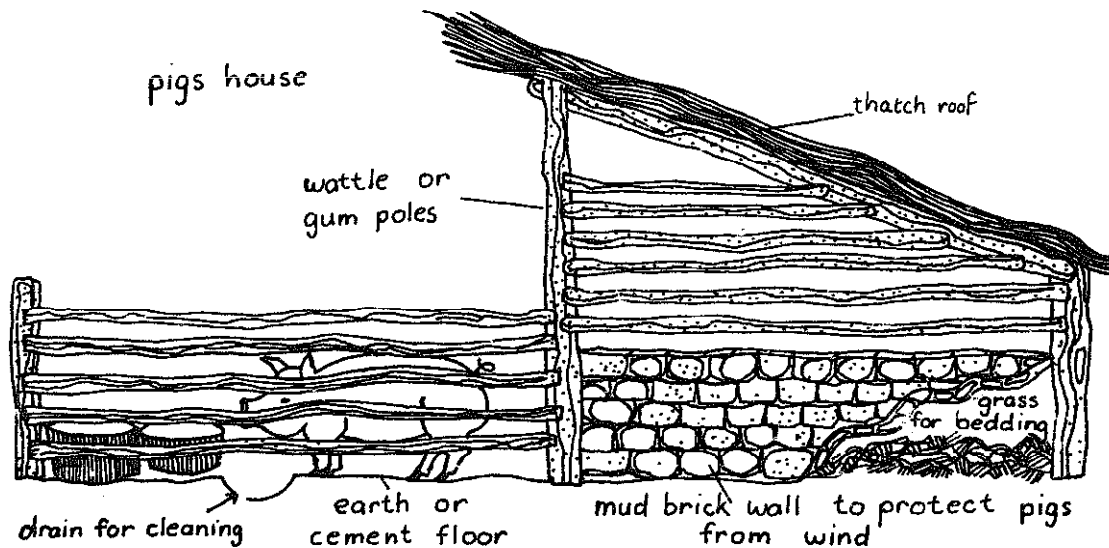

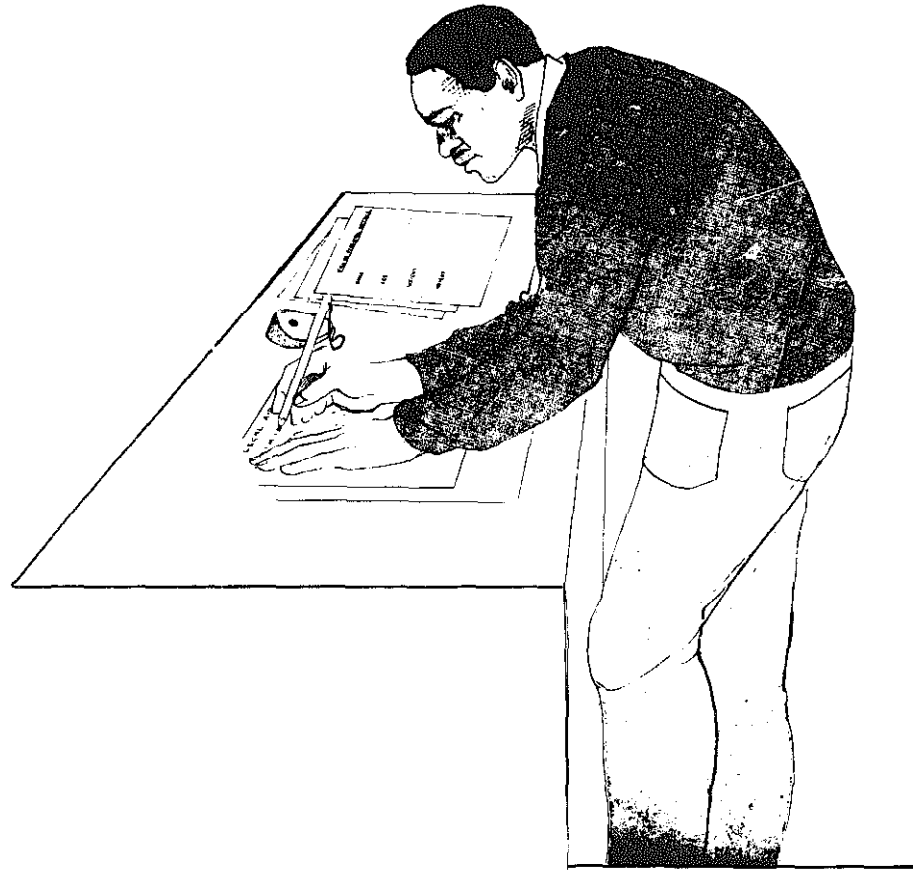

Suppliers Organisations Books

Suppliers

In this part of the book we tell you where you can buy things. Usually the cheapest places to buy are in towns. People in rural areas often have to pay more from local shops.

Most of the suppliers we list here are factories which make the things that people in rural areas use. Some of them can sell to you, but most of them sell to shops and sales agents in towns. You can write to them to get addresses of their branches and sales agents nearest to you.

Suppliers want to make money. They help people if it will help them to sell more products and make more money. Some suppliers will help you even if you don't buy, but most do not like to waste time helping you if you do not buy from them. Time means money to them.

So when you write to them, write clearly, try to explain exactly what you want. Write your name and address clearly so they know who they are writing to.

Prices and Catalogues

We have not given prices in this section, because prices change all the time. Most suppliers send free price lists. Sometimes they also send free catalogues which have pictures of all their products so that you can see exactly what you are buying. When you write to a supplier, ask them for a free price list and catalogue. For some products, like textiles or leather, you can ask the supplier to send you samples as well.

Bulk Discounts

At most shops, if you buy a lot of things at the same time, they will give you a bulk discount. That means they will sell to you cheaper. For example if you buy one spade a shop might charge you R4, but if you buy 10 spades they might only charge you R3 each. If you are making school uniforms and you need buttons think about how many uniforms you will make in one year and buy buttons for all those uniforms at the same time. You will save money because the shop will sell the buttons to you cheaper.

Many people do not have enough money to buy a lot of things at the same time. If you are short of money, try to buy together with other people to get discounts.

Some suppliers and wholesalers will only sell to you if you buy a lot of things. If you only want to buy a little, they ask you to buy from shops or supermarkets.

Other Discounts

Some suppliers will give you a discount if they know you well or if they know you are a non-profit organisation. If your group is a non-profit organisation, ask the supplier if they will give you an extra discount.

Cash Discounts

Most suppliers like to get cash when you order. Always ask the supplier if there is a discount for cash.

How to pay

There are 3 ways that you can pay.

- Cash in advance. This means that you send the money first, and then the supplier sends the things you ordered. This is the best way to buy because there are no problems between you and the supplier. This way makes sure you do not have problems with money because of ordering goods and not being able to pay for them.
- Cash on Delivery (COD). This means that the supplier sends the things to you by post or by train. When the goods come you pay the railways or the post office and they send the money to the supplier. Suppliers do not like COD because often people do not collect the goods. Then the railways have to send them back and the suppliers have to pay for the transport.
- Having an account with the supplier. This means that they will send the goods to you first and you will send the money later, usually within 30 days. This gives you time to sell your products and then pay for the things you ordered. Most suppliers will not open accounts unless they know some of the project

members well or have been selling to you on a cash basis for a long time. But even if you do have an account there can be problems. If you do not sell your products, you will not be able to pay the supplier in time. If this happens the supplier can take you to court to get the money or refuse to sell to you anymore. Therefore it is good to have an account only if you know for sure that you will be able to pay for the things in time.

How to send money

When you pay by post, never send cash in your letter. Always send a postal order or a cheque if you have a bank account. Postal orders or cheques must be crossed; this means that you draw 2 lines across the top left hand corner. Then nobody except the supplier can cash it and get the money.

Always send your postal order or cheque in a registered letter. You register the letter at the post office. It means that the supplier must sign for it, so the postal order will not get lost and nobody can steal it.

It is always better to send exactly the right money. If you do not send enough, they will have to write and ask you for more. This means that you will have to wait longer for your order. If you send too much, they will not know if they should send the change to you or if they should send more things than you ordered. Try to write or phone first and find out exactly how much the things will cost.

General Sales Tax (GST)

GST is tax for the government. Whenever you buy something that you will use for yourself like food or clothes you have to pay GST. But if you buy something and use it to make something else which you are going to sell, you don't have to pay GST. The person who buys what you make will give the GST money to you, and then you must send it to the government. If you are in the Transkei, Venda or Bophuthatswana you do not have to pay sales tax when you buy from suppliers.

If you are making things to sell and your sales are more than R5 000 per year you have to register with your local magistrate and get a GST number.

When you buy materials to make your products, you give your number to the suppliers and they won't charge you GST. There are some suppliers who will only sell to places that have GST numbers.

If you have a GST number, your customers must pay GST to you when they buy things from you. At the end of every month you must send a GST form to the government with all the GST money you have collected in that month. If you want to find out more about GST or if you want to get a GST number go to your local magistrates office. They will tell you what to do and where to go.

White farmers co-operative

In all white farming areas, there are big co-operatives for white farmers to buy and sell goods. They are owned by the farmers so the things they sell are usually cheaper than other shops. Often they have mechanics to repair tractors and other machines. Usually only members of the co-ops are allowed to buy from them and to use the services. Black farmers can not be members but some co-ops close to black rural areas are allowed to sell some things to black people who are not members. They can only sell things to black people which are not sold at local shops. They can also let black people use their repair services.



SEEDS

Name: Distins Sagseeds.
 Postal Address: P.O. Box 2060, Johannesburg, 2000, Transvaal.
 Street Address: 104 Bree Street, Newtown, Johannesburg, 2001.
 Telephone: 011 8345561
 Products: Vegetable, fruit and flower seeds.

Name: Gunsons Seeds.
 Postal Address: Box 9861, Johannesburg, 2000, Transvaal.
 Street Address: Elizabeth House, 18 Pritchard St., Johannesburg, 2001.
 Telephone: 011 8343671
 Products: Seeds for pasture grasses like lucerne and erogrostis, seeds for crops like ma. e, sorghum, sunflowers and soyabeans. The grass seeds are in bags of 1kg and more; the crop seeds in bags of 50kg.
 Services: They will send information about pastures or crops to anybody who writes to them.

Name: Mostert
 Postal Address: Box 93, Balfour 2410, Transvaal.
 Street Address: 91 West Street, Balfour.
 Telephone: 01562 107
 Products: Open pollinated mealie seeds. 50kg bags of Kalahari, Topbrid and Goudveld.

Name: Pioneer
 Postal Address: Box 19, Greytown, 3500, Natal.
 Telephone: 03342 454/462
 Products: Mealie, sorghum and sunflower seeds in 2kg, 5kg, 10kg and 50kg bags.
 Services: They will send information about growing crops if you write to them.

Name: Noord Transvaal Ko-operatief
 Postal Address: Box 598, Potgietersrus, 0600, Transvaal.
 Street Address: 2nd Street, Industrial Site, Potgietersrus.
 Telephone: 01541 2112
 Products: Vegetable and crop seeds in small and big quantities.

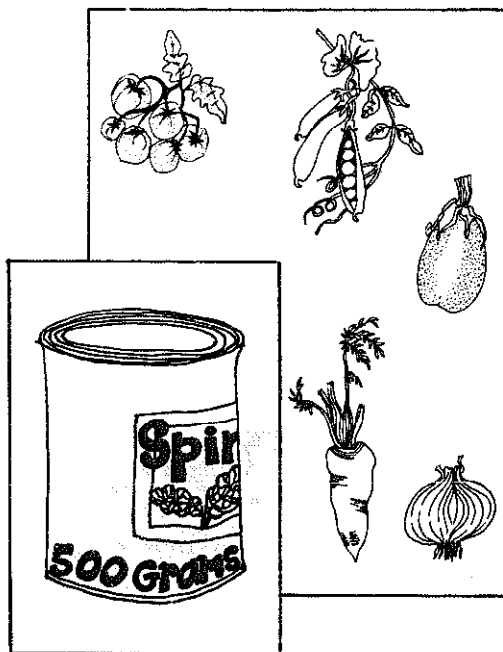

These 2 companies, Clark and H. Lewis, are suppliers of cotton seed on a contract basis. They supply seed and other requirements including finance, technical advice and assistance to cotton farmers. The farmers are then under contract to sell their cotton to the company. Write and ask them for more details of this scheme.

Name: J.L. Clark Cotton Co (Technical Advisory Service)
 Postal Address: Box 7787, Johannesburg, 2000, Transvaal.
 Street Address: Lamplo House, 1st Street, Booysens Reserve, Johannesburg.
 Telephone: 011 8386973
 Products: Cotton seed.

Name: H. Lewis and Co Ltd
 Postal Address: Box 5353, Johannesburg, 2000.
 Street Address: Trust Bank Bldg, Voortrekker St, Kcmpton Park, 1621.
 Telephone: 011 8441005
 Products: Cotton seed

Name: Potato Growers Association
 Postal Address: Box 6, Creighton, 4600, Natal.
 Telephone: 03382 2041
 Products: Certified A Grade B.P.I. seed potatoes.

Name: Ciba Geigy
 Postal Address: Box 92, Isando, 1000, Transvaal.
 Street Address: 72-74 Steel Road, Spartan, Kempton Park.
 Telephone: 011 9759830
 Products: Mealie and sorghum seed in 2kg, 5kg, 10kg and 25kg bags. They do not sell directly to the public, so write and ask them where to buy their products.
 Services: Write and ask for their free booklet which explains in pictures how to grow and look after seed, and how to use fertiliser.

Name: Delmas Co-op
 Postal Address: Box 21, Delmas, 2210, Transvaal.
 Street Address: Sarel Cilliers Street, Delmas, 2210.
 Telephone: 01572 201/209.
 Products: Bean seeds, animal feeds.

Name: Saffola
 Postal Address: Box 49, Kempton Park, 1620.
 Street Address: Farm Hartbeesfontein, Kempton Park.
 Telephone: 011 8441005
 Products: Mealie, sunflower and sorghum seeds.

Name: Tobacco Research Institute
 Postal Address: Private Bag X82075, Rustenburg, 0300.
 Telephone: 01421 93149
 Products: Tobacco seed. You cannot buy direct from the institute. Write and ask for the nearest place you can buy from.
 Services: They give information on how to grow tobacco and what kind of tobacco seeds to use.

Name: Transvaal Potato Co-operative
 Postal Address: Box 516, Bethal, 2310, Transvaal.
 Street Address: 37a Kerk Street, Bethal
 Telephone: 01361 2113
 Products: Seed potatoes

Name: Ivanhoe Farming Company
 Postal Address: Box 23, Nottingham Road, 3280, Natal.
 Telephone: 033312 2 or 033312 83
 Products: Certified and uncertified seed potatoes.

Name: Advance Seed
 Postal Address: Box 414, Krugersdorp, 1740, Transvaal.
 Street Address: Corner Jacobs/Neimapius Sts, Chamdor 1740
 Telephone: 011 7625261
 Products: Wheat seeds and other crop seeds.
 Services: They will give advice to anybody who writes to them.

Name: McDonald's
 Postal Address: Box 238, Pietermaritzburg, 3200, Natal.
 Street Address: 63 Boshof Street, Pietermaritzburg, 3201.
 Telephone: 0331 22191
 Products: Vegetable, fruit and pasture grass seeds, poisons, sprayers; fertilisers; garden tools.
 Services: They will send information on seeds and crop protection if you write to them.

Groundnut seeds are sold by co-operatives. The co-operatives that we give here are the main co-operatives in the areas where groundnuts grow.

Name: South Western Co-operative
 Postal Address: Box 5, Leeudoringstad, 2640

Name: North Western Co-operative
 Postal Address: Box 107, Lichtenburg, 2740, Transvaal.
 Telephone: 01441 2101

Name: Central Co-operative
 Postal Address: Box 31, Klerksdorp, 2570, Transvaal.
 Telephone: 018 21151

Name: Northern Transvaal Co-operative
 Postal Address: Box 29, Nylstroom, 0150, Transvaal.
 Telephone: 01531 2101

Name: S.A. Sugar Association
 S.A. Cane Growers Association
 Small Cane Growers Fund
 Postal Address: Box 507, Durban, 4000, Natal.
 Street Address: 814 Norwich Union House, 6 Durban Club Place, Durban.
 Telephone: 031 311902
 Services: You can write to any of these organisations to find out about sugar cane growing, and how to borrow money to start growing cane. Write to this organisation if you want technical information about sugar cane growing

Name: S.A. Sugar Research Station
 Postal Address: P.O. Mount Edgecombe, 4300, Natal.
 Street Address: Mount Edgecombe, Natal.
 Telephone: 031 591805

Name: Mayfords Seeds.
 Postal Address: Box 4037, Johannesburg, 2000, Transvaal.
 Street Address: 40 Pim Street, Newtown, Johannesburg, 2001.
 Telephone: 011 8385193
 Products: Vegetable seeds and flower seeds.
 Services: They will send information about growing vegetables to anybody who writes to them.

Name: Sam Smith
 Postal Address: Box 1141, Pretoria, 0001, Transvaal.
 Street Address: 4 Von Wielligh Street, Pretoria.
 Telephone: 012 462791/467496
 Products: Seed potatoes.

Name: Kirchoffs
 Postal Address: Box 6786, Johannesburg, 2000, Transvaal.
 Street Address: Archimedes Street, Kramerville, Sandton, 2199.
 Telephone: 011 8021060
 Products: Seeds, sprayers and other gardening equipment, poisons.
 Orders must be for at least R5.

Name: Roode-Lyon
 Postal Address: Box 3323, Pretoria, 0001, Transvaal.
 Street Address: 333 Mitchell Street, Pretoria West.
 Telephone: 012 32353
 Products: Vegetable and flower seeds.

Name: Straathofs
 Postal Address: Box 10239, Johannesburg, 2000, Transvaal
 Street Address: 38 Stiemens Street, Braamfontein, 2001.
 Telephone: 011 392121
 Products: Vegetable and flower seeds.
 Discounts: They give discounts to church and community organisations.

BUYING FARM PRODUCE

The following companies buy farm products like grain crops, meat, animal skins and wood. If your local shops are paying low prices for your products, write to these companies and ask what their price is. It is sometimes much higher than local shops. When plenty of people want to sell to the same shop, the price usually goes very low. These companies sometimes help you arrange transport, sometimes you must make your own plan to get the things to them. In some places, agricultural extension officers help people to transport their products to the railway station. The companies will buy only clean, good quality products with no diseases.



GRAIN

Name: Kahn and Kahn
Postal Address: Box 5681, Johannesburg, 2000, Tvl.
Street Address: 46 Pim Street, Newtown, Johannesburg.
Telephone: 011 8346001 or 8346002 or 8346003

Name: S. Schmidt
Postal Address: Box 9809, Johannesburg, 2000, Transvaal.
Street Address: 139 Brae Street, Newtown, Johannesburg.
Telephone: 011 838 4774

FRUIT AND VEGETABLES

Name: W.L. Ochse & Co (National Fresh Produce Market)
Postal Address: Box 108, City Deep, Johannesburg, 2000, Transvaal.
Telephone: 011 6132231

MEAT

Name: Meat Central
Postal Address: Box 3451, Johannesburg, 2000, Transvaal.
Street Address: 32 Marina Avenue, City Deep, Johannesburg.
Telephone: 011 6131991

SKINS AND HIDES

Name: Meat Board
Postal Address: Box 1357, Pretoria, 0001, Transvaal.
Street Address: 556 Vermeulen Street, Pretoria.
Telephone: 012 281851

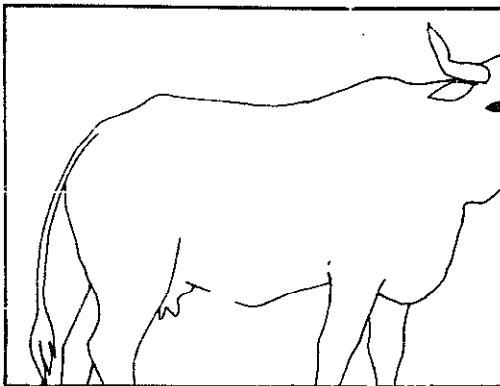

WOOD

Name: National Association of Plywood, Timber, Board and Chipboard Manufacturers.
Postal Address: Box 4581, Johannesburg, 2000.
Street Address: Allied Building, Cnr Bree and Rissik Streets, Johannesburg.
Telephone: 011 235791

RABBITS

These organisations give free advice on rabbit breeding. When you write to them ask specific questions so that they know exactly what you want to know. You can find out from all three clubs where to buy rabbits. They say that it is not good to start with too many rabbits in the beginning. You should start small and become bigger as you learn. It is very easy for rabbits to die and for you to lose all your money if you are not experienced.

Name: Bossert Abattoir
Postal Address: Box 31448, Erasmia, 0023, Transvaal.
Street Address: 101 Doornrandjie (near Hartbeespoort Dam).
Telephone: 012 401628
Products: New Zealand White and Californian rabbits

Name: Rosch Rabbitry
Postal Address: Box 277, Walkerville, 1876, Transvaal.
Telephone: 011 9461040
Products: Californian rabbits
Services: They have a booklet with useful information for people who are starting to keep rabbits.

Name: Transvaal Rabbit Club
Address: Box 594, Bedfordview, 2008, Transvaal.

Name: Natal Rabbit Club
Address: Box 39042, Escombe, Queensburgh, 4070, Natal.

Name: Cape Rabbit Club
Address: 36 Daffodil Way, Pinelands, 7405, Cape.

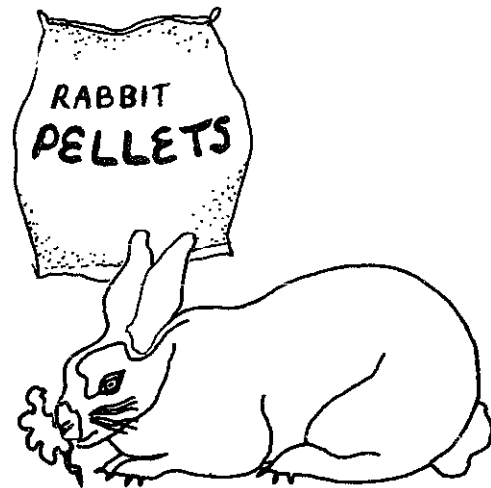

Name: Diamond Stud Rabbitry
Postal Address: Box 29375, Sunnyside, 0132, Transvaal.
Street Address: Plot 22, Rietfontein, District Bronkhorstpruit, Transvaal.
Telephone: 012 475659
Products: Rabbits. They do not like to send rabbits by rail because the rabbits do not like it and suffer, and because if something goes wrong they can easily die. They like people to come and buy from them.
Services: They will send information to anyone who is interested in keeping rabbits. If you have questions you can write and ask.

CHICKENS

If you want to keep chickens, you must decide if you want them for eggs or for meat. Chickens for eggs are called layers and chickens for meat are called broilers.

Most people buy day-old chicks. You can also buy 4-week-old chickens and point-of-lay chickens, which are about 23 weeks old and ready to start laying eggs. Day-olds are much cheaper than older chickens. Male day-old chickens are the cheapest. Mixed sexes (males and females) are more expensive and all females are the most expensive. Suppliers send chickens by train or by railway bus in a cardboard box with enough food and water for a few days.

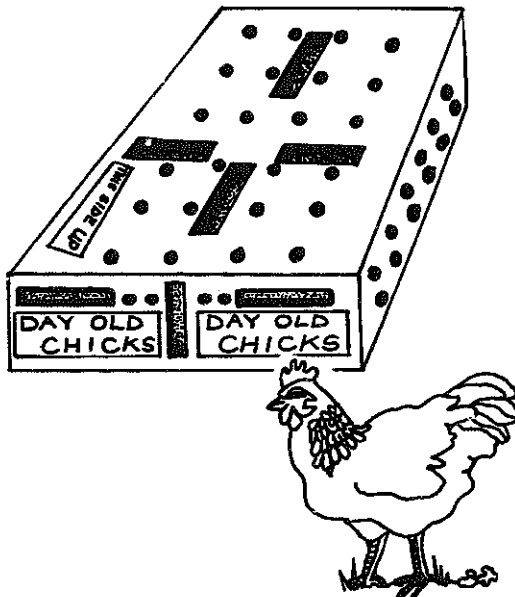

How to Order Chickens

- * Write to any of these suppliers or phone them to find out their prices
- * They will write back to tell you the prices.
- * Send them your order with a cheque, postal order or money order to pay for them. Do not send money in a letter. Register the letter if you can (at the post office).
- * Give the supplier your address, the name of the nearest railway siding or bus stop, and a telephone number, so they can phone you if there are any problems and if the station wants to phone you. If the chickens are sent to a bus stop you must pay the transport costs when you order. The supplier will tell you how much it costs. If they come by train, then you pay transport costs when they arrive. The transport costs become cheaper if you order more. For example, for 25 4-week-old chickens, the transport costs R4,50, from Potchefstroom to a village near Louis Tritzhardt. If 100 4-week-old chicks are sent the transport costs R10,00. So for four times the number of chicks, they only pay twice the amount for transport.
- * The supplier will tell you the exact date that they will send the chickens or the day that they will arrive. Make sure that you are there when they arrive otherwise the railways will take them back or they will die if they are just left there.

Name: Pailala Chix
 Postal Address: Box 39062, Bramley, 2018, Transvaal.
 Telephone: 012 641015
 Products: Day-old broilers.
 Discounts: Ask for a discount if you buy more than 100 chicks at a time.

Name: S.A. Poultry Association
 Postal Address: Box 1202, Honeydew, 2040, Transvaal.
 Street Address: Vesting Centre, Honeydew.
 Telephone: 011 7952051
 Services: They give information and advice to anybody about keeping poultry.

The following chicken farms belong to the same company.

Branches: Baphiring Farms, P.O. Mabaalstad, Transvaal.
 Gazankulu Hatcheries, Box 592, Tzaneen, 0850, Transvaal.
 Heidel Farms, Box 116, White River, 1240 Transvaal.
 Saunders Hatchery, Box 1116, Gaborone, Botswana.
 Swazi Egg and Poultry, Box 210, Mbabane, Swaziland.
 Products: Day-old broilers and layers

Name: Haagpers Poultry Farms
 Postal Address: Box 115, Potchefstroom, 2520, Transvaal.
 Telephone: 01481 25048
 Products: Day-old broilers and layers; 4 week-old layers. Their minimum orders are 50 day-old chicks or 25 4-week old layers.

Name: Deimas Kuiken
 Postal Address: Box 336, Delmas, 2210, Transvaal.
 Telephone: 01572 ask for 622
 Products: Day old layers.

Name: Hyper Hatchery
 Postal Address: Box 1098, Pietermaritzburg, 3200, Natal.
 Street Address: 24 Clough Street, Pietermaritzburg.
 Telephone: 0331 52306
 Products: Day-old layers.
 Discounts: Discount for more than 50 chicks.
 Services: They give advice about keeping chicks.

Name: Vredebest Farms
 Postal Address: Box 11, Klapmuts, 7625, Cape.
 Telephone: 0251 5453
 Products: Day-old broilers and layers and point of lay chickens.

Name: Amber-Link Chick Sales
 Postal Address: Box 492, Randfontein, 1760, Transvaal.
 Telephone: 011 6651120
 Products: Day old-chicks.

Name: Bergvlei Chickens
 Postal Address: Box 65182, Benmore, 2010, Transvaal.
 Telephone: 011 7021672/3,4/5/6
 Products: Day-old chicks

Name: Serfontein Chickens
 Postal Address: 30 Van der Hoff Road, Potchefstroom, 2520, Transvaal.
 Telephone: 01481 4022
 Products: Day-old, 2 week and 1 month old broilers and layers. Minimum order is 2..
 Services: They will give information about keeping chickens. They can send you booklets in English or Afrikaans about keeping chickens.

Name: Clearsprings Hatchery
 Postal Address: P.O. Klipheulle, 7303, Cape.
 Telephone: 0251 28901/9
 Products: Day-old chicks

Name: Gaymans Poultry Breeding Farm
 Postal Address: Box 28840, Sandringham, 2131, Transvaal.
 Telephone: 011 6082088
 Products: Day-old broiler chicks only

Name: Neomar Chickens
Postal Address: Box 111, Gonubie, 5256, E. Cape.
Telephone: 0431 951814
Products: 2, 3 or 4 week old broilers.
Discounts: For 100 or more chickens.

Name: Springbok Chicks
Postal Address: Box 30, Gonubie, 5256, E. Cape.
Telephone: 0431 951414 and 951633
Products: 4-week old and point of lay chickens

DUCKS AND GEESE

Name: M. Dorling
Postal Address: Box 47, Tarlton, 1749, Transvaal.
Telephone: 011 6693698
Products: Ducks: Black East Indians, Muscovies,
Geese: Indian Runners
Services: They will give advice and information
about ducks and geese.

Name: Farm Fare
Postal Address: Box 473, Bellville, 7530, Cape.
Telephone: 021 952331
Products: Day-old ducklings. You have to order at
least 100 at a time. They have a booklet
about keeping ducks.

BEEES

To keep bees, you need a hive where the bees can make honey and special equipment like a smoker, and clothes which will protect you from getting stung. It is not expensive to start beekeeping. One hive with bees, some equipment and protective clothes, will cost you about R60. It is even cheaper if a group of people buys beekeeping equipment together. If you need information about beekeeping, write to the SA Federation of Beekeepers Associations, Box 14336, Verwoerdburg, 0140. They will give you information or tell you where you can get it.

Name: Distins Sagseeds
Postal Address: Box 2060, Johannesburg, 2000, Transvaal.
Street Address: 104 Bree Street, Newtown, Johannesburg 2001.
Telephone: 011 8345561
Products: Beekeeping equipment

Name: Wilgespruit Apiaries
Postal Address: Box 358, Roodepoort, 1725, Transvaal.
Telephone: 011 7633262
Products: Bees, hives, smokers, other equipment.
Services: They have a training course which anybody can go to. They teach people how to keep bees and how to make honey. Write to them for information about the course.

Name: Even-Run Apiary Products
Street Address: 340 Boom St, Pietermaritzburg, 3201, Natal.
Telephone: 0331 51016

Name: Highveld Honey Farms
Postal Address: Box 11079, Rynfield, 1514, Transvaal.
Street Address: Plot 185, Uys Street, Rynfield, Benoni.
Telephone: 011 8491990
Products: Beekeeping equipment, hives, bees.
Services: They will give you advice about beekeeping and equipment.

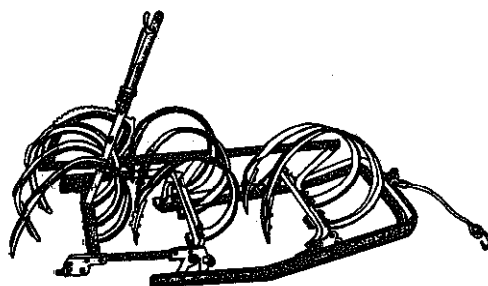
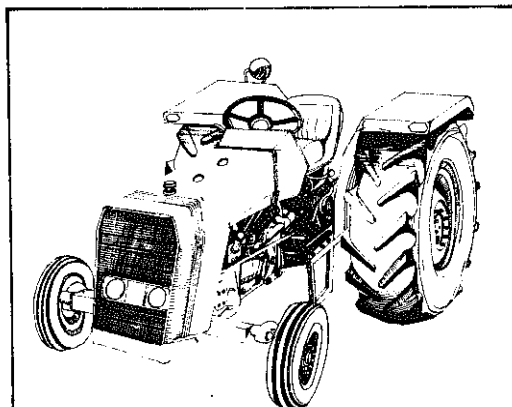

OX AND TRACTOR EQUIPMENT

Name: SAFIM
Postal Address: Box 677, Vereeniging, 1930, Transvaal.
Street Address: Steel Road, Vereeniging.
Telephone: 016 211171
Products: Ox-drawn agricultural implements,
tractor implements.
Services: They give advice about equipment and
machinery.

Name: Leers
Postal Address: Box 192, Eppindust, 7475, Cape.
Street Address: Dacres Avenue, Epping, Industria 2, 7460
Cape.
Telephone: 021 542471
Products: Hand and tractor drawn agricultural implements
spraying equipment and cement mixers.
Services: Repair of products.

Name: E.H. Johnson
Postal Address: Box 7536, Johannesburg, 2000.
Street Address: 258 Brunel Road, Tulisa Park, 2197.
Telephone: 011 6132146
Products: SAFIM agricultural implements as well as
other equipment such as grinders and
maize shellers.
Services: They do not sell directly to the public.
They will tell you where to buy their
products and what prices you should pay
at your local dealer.

Name: Nardisa
Postal Address: Box 11199, Germex, 1409, Transvaal.
Street Address: 14 Arkin Street, Industria East,
Germiston, 1401-
Telephone: 011 516721/2/3
Products: Nardi agricultural implements.

TRACTORS

Name: Tinkabi Tractors
Postal Address: Box 450, Manzini, Swaziland.
Telephone: 0194 52141
Products: Tinkabi tractors.
Methods of

Services: They do repairs on all their products.
They also have a free training course to teach to repair Tinkabi tractors.

Name: Agricultural Machinery Consultants
Postal Address: Box 1840, Kempton Park, 1620, Transvaal.
Street Address: 126 Plane Rd, Spartan, Kempton Park, Transvaal.
Telephone: 011 9701220/1
Products: New and second hand Deutz agricultural machinery.

Name: Massey Ferguson
Postal Address: Box 677, Vereeniging, 1930, Transvaal.
Street Address: Steel Road, Vereeniging.
Telephone: 016 211171
Products: Agricultural implements, tractors.
Services: They have a free training course to teach driving and maintenance to people who buy or use their tractors. Ask your local dealer or write to them for more information, or telephone their training centre, 016 45022.

Name: Ford Motor Company
Postal Address: Box 788, Port Elizabeth, 6000, Cape.
Street Address: 55 Albany Road, Port Elizabeth, 6001.
Telephone: 041 392010
Services: They have a free driving and maintenance course for people who use their tractors. Write to them or ask your local dealer for information about it.
Products: Ford tractors and implements.

Name: Fiat SA (Isando Industries)
Postal Address: Box 401, Isando, 1600, Transvaal.
Street Address: Brewery Road, Isando.
Telephone: 011 365566
Products: Fiat, Yanmar tractors and implements
Services: They have a free driving and maintenance course for owners of their tractors. Write to them for details or ask your local dealer.

Name: Malcomess Ltd
Postal Address: Box 80, Isando, 1600, Transvaal.
Street Address: Montez Road, Isando, Transvaal.
Telephone: 011 365311
Products: New and second-hand Landini tractors.

Name: John Deere
Postal Address: Box 198, Nigel, 1490, Transvaal.
Street Address: 29 Van Riebeeck Street, Nigel.
Telephone: 011 7392385
Products: Tractors, agricultural machinery.
Services: Write and ask them about their tractor driving and maintenance.

Name: S.A. Wonder Agricultural Implements
Street Address: Montez Road, Isando, Johannesburg.
Telephone: 011 361466
Products: Tractors, agricultural implements.

Name: Leyland SA (Pty) Ltd
Postal Address: Box 33269, Jeppestown, 2043, Transvaal.
Street Address: Annuity House, 16a Rissik Street, Johannesburg.
Telephone: 011 8369491
Products: Leyland tractors and trucks.
Services: Tractor driving and maintenance course.

Name: International Harvester
Postal Address: Box 12, Isando, 1600, Transvaal.
Street Address: Diesel Road, Isando.
Telephone: 36 2751
Products: Tractors, trucks, agricultural implements.
Services: They run a training course in tractor maintenance.

TILLERS

These are two-wheeled tractors that can plough, plant and cultivate. They are good for vegetable farmers, but are too light for field crops.

Name: Agris
Postal Address: Box 60177, Langlaagte, 2102, Transvaal.
Street Address: Chanken Bldg, Cnr Proserpine & Jill Sts, Langlaagte.
Telephone: 011 356192
Products: Tillers, agricultural implements.

Name: Frank Mangold
Postal Address: Box 9064, Johannesburg, 2000, Transvaal.
Street Address: 29 Village Rd, Selby, Johannesburg, 2001
Telephone: 011 838-2531/838-2703/838-6868
Products: Tillers, agricultural implements.
Services: They have a servicing centre and a spares shop for their products. You can write to them to find out what the prices of their products should be from your local dealer and what is the best to buy.

HAMMERMILLS

Name: Wilbur Ellis
Postal Address: Box 4258, Cape Town, 8000, Cape.
Street Address: Durham Avenue, Salt River, 8001, Cape.
Telephone: 021 552965
Products: Hammermills

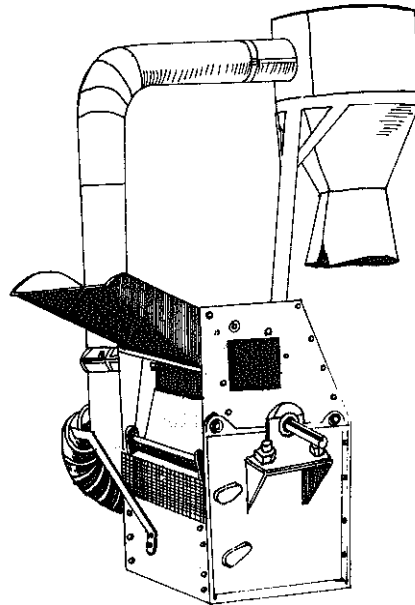

Name: Drotsky Hammermills
Postal Address: Box 3775, Alrode, 1450, Alberton, Transvaal.
Street Address: Juyn St, Alrode, 1450, Alberton, Tvl.
Telephone: 011 8641601
Products: Hammermills

Name: Conac Holdings
Postal Address: Box 653, Pietermaritzburg, 3200, Natal.
Street Address: Oldfield Rd, Mkhondeni, Pietermaritzburg, 3201.
Telephone: 0331 63215
Products: Hippo hammermills, maize shellers, feed mixers.
Services: Repairs are done by their dealers.

Name: Tricomf
Postal Address: Box 31755, Braamfontein, 2017, Transvaal.
Street Address: Tricomf House, 37 Stanley Ave, Auckland Park, Johannesburg, 2092.
Telephone: 011 7265355
Products: Fertilisers, saafos rock phosphate.

Name: Fedmis
Postal Address: Box 781811, Sandton, 2146, Transvaal.
Street Address: 5 Esme Lane, Sandown.
Telephone: 011 8363131
Products: Fertilisers.

Name: Maurice Flor
Postal Address: Box 7176, Johannesburg, 2000, Transvaal.
Street Address: 6 Pim Street, Newtown, Johannesburg, 2001
Telephone: 011 8345021
Products: Fertilisers, animal feeds, poisons.
Services: They will advise people how to use their products. They will also sell in small quantities which the big factories will not do.

HANDTOOLS/GRINDERS/SHELLERS

Name: African Hoe Company
Postal Address: Box 477, Springs, 1560, Transvaal.
Street Address: 61 Watt Rd, New Era Industrial Sites, Springs, 1560, Transvaal.
Telephone: 011 8132027
Products: Hoes, picks, hammers and other tools.

Name: E.H. Johnson
Postal Address: Box 7536, Johannesburg, 2000, Transvaal.
Street Address: 258 Brunel Rd, Tulisa Park, 2197.
Telephone: 011 6132146
Products: Bentall Maize Grinder, maize de-shellers
Services: They do not sell to the public, but they will tell you where you can buy from if you write to them.

Name: Frankel and Seehof
Postal Address: Box 18516, Dalbridge, 4014, Natal.
Street Address: 19 McDonald Rd, Durban, Natal.
Telephone: 031 255226
Products: Small farming equipment such as ploughs and hoes, small tools and fertilisers.
Payment: They only sell to people who have a GST number (see p 513). They like to sell big quantities.

Name: Fertiliser Society of South Africa
All fertiliser companies are members of this society.
Postal Address: Box 1821, Pretoria, 0001, Transvaal.
Street Address: Van Erkom Building, Pretorius Street, Pretoria.
Telephone: 012 283642
Services: This society can tell you what fertiliser to use and where you can buy it.

Name: Universal Lime Suppliers
Postal Address: Box 7559, Johannesburg, 2000, Transvaal.
Street Address: 302/3 Union Centre, 31 Fritchard Street, Johannesburg, 2001.
Telephone: 011 8382841
Products: Lime

FERTILISER

Fertilisers are expensive. Before using them ask your extension officer to do a soil test for you. If he cannot help you, write to EDP and tell us how much land you have, what you are growing and how much you can afford to spend on fertilisers. We will try to advise you about what fertiliser to use. The prices of fertilisers are controlled by the government so prices will be almost the same everywhere. Fertilisers made by different companies are almost all the same. For example, a 2:3:2 mix made by one company will be the same as a 2:3:2 made by another company.

Name: wonder/Efekto
Postal Address: Box 787, Silverton, 0127, Transvaal.
Street Address: 153 Derdepoort Rd, Silverton, Pretoria.
Telephone: 012 861101
Products: Fertilisers (including liquid fertiliser) insect poisons and weed killers. They also sell sprayers and tools.
Discounts: Orders over R100 are railed free of charge. 2% discount for cash.
Services: They will give you advice about what fertilisers and insect poisons to use and how to use them.

Name: Pistorius and Co
Postal Address: Box 1838, Pretoria, 0001, Transvaal.
Street Address: 1855 Volkskas Centre, Pretorius Street, Pretoria.
Telephone: 012 217777
Products: Lime.
Services: If you write to them they will advise you about what lime to use and how to use it. They usually sell lime in 18 or 39 ton trucks. Farmers usually need between 2 and 6 tons per hectare.

Name: Miskor
Postal Address: Box 50004, Randburg, 2125, Transvaal.
Street Address: 5th Floor, Trust Bank Bldg, Hill Street, Randburg.
Telephone: 011 484428
Products: Rock phosphates (Langfos, Calmafos and others).
Services: If you write to them with information about your soil, they will advise you about what phosphate to use.

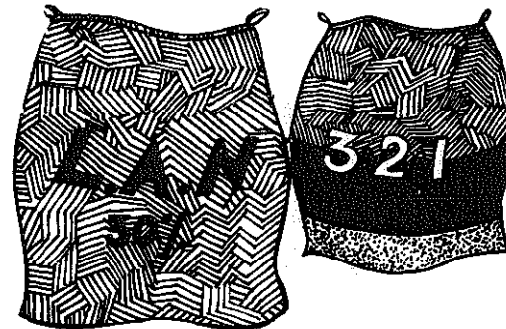

CHEMICAL POISONS

Chemical poisons are expensive and dangerous. You should not use them unless other methods of getting rid of insects have failed. The following companies make poisons. Write to them and ask them for information about what poisons you should use. You will have to tell them what kinds of things you are growing and what kinds of insects you want to kill. They will tell you where you can buy poisons.

Here is a list of common poisons and the companies which make them:

Thiodan: Hoechst, Box 8692, Industria, 2042, Transvaal.
Telephone: 011 6734100

Sevin: Union Carbide Corporation, Box 8194, Johannesburg, 2000, Transvaal.
Telephone: 011 217387

Dithane: Rohm and Haas, 7 J Bright Ave, Germiston 1401, Transvaal.
Telephone: 011 514662

Mildane and Orthene: Fisons, Box 8841, Johannesburg, 200, Transvaal.
Telephone: 011 9762121

Maneb, Rogor EC, Molybdenum and Gusathion A+: Tricmf Farmers Organisation, 72 Stanhope Place, Durban, 4001, Natal.

Bordeaux mixture: Vetsak, Box 260, Isendo, 1600, Transvaal.
Telephone: 011 368211

Malathion and Parathion: S A Cyanamid, Box 7553, Johannesburg, 2000, Transvaal.
Telephone: 011 538830

Dipterex: Farnchem, Box 267, Kempton Park, 1620, Transvaal.
Telephone: 011 9763010

Boron: ICI, Box 11270, Braamfontein, 2017, Transvaal.
Telephone: 011 7254800

Captab 50% WP: Agroservice, Box 31171, Braamfontein, Transvaal.
Telephone: 011 381871

Fig medicines, Repvine, Kemzol, Diazol: Repvet, 108 Main Reef Road, Benrose, 2094, Transvaal.

These companies sell chemical poisons in small quantities and spraying equipment.

Name: Distins Sagseeds
Postal Address: Box 2060, Johannesburg, 2000, Transvaal.
Street Address: 104 Bree Street, Newtown, Johannesburg.
Telephone: 011 7253520
Products: Chemical poisons and sprayers

Name: Mc Donalds
Postal Address: Box 238, Pietermaritzburg, 3200, Natal.
Street Address: 63 Boshof Street, Pietermaritzburg.
Telephone: 0331 22191
Products: Chemical poisons and sprayers

Name: Kirchhoffs
Postal Address: Box 7756, Johannesburg, 2000, Transvaal.
Street Address: Archimedes St, Kramerville, Johannesburg
Telephone: 011 8021060
Products: Chemical poisons, spraying equipment.
Payment: Orders must be for at least R5.
Services: They will give you advice on what to use and how to use it.

Name: Maurice Flior
Postal Address: Box 7176, Johannesburg, 2000, Transvaal.
Street Address: 6 Pim St, Newtown, Johannesburg.
Telephone: 011 8345021
Products: Chemical poisons in 500g to 25kg sizes.
Services: They will give advice on what to use and how to use it.



TREES

The Department of Forestry offers 10 free trees to every school in South Africa, except for the Transkei, Vandaland and Bophuthatswana. Schools in these areas can buy trees, but can not get any free of charge. Principals should write to the address below to ask for the 10 trees. The school can ask for a specific kind of tree, but if the Department decides that that kind of tree will not grow well in that area, they will send something else. The school should give their address and the name of the nearest manned railhead. They should also give a phone number, so that the railways can phone and say when the trees have arrived.

Director-General,
Water Affairs, Forestry and Environmental Conservation (Information Section),
Private Bag X447,
Pretoria,
0001.

Telephone: 012 282911 extension 627.

You can also write to the above address or phone them if you want to find out the nearest plantation where you can buy trees. The Forestry Department does not deal with fruit trees.

FRUIT TREES

Fruit Trees From EDA

EDA has a non-profit service to distribute fruit trees to community groups for planting at homesteads, orchards and irrigation schemes. The idea of the scheme is to help community groups to buy trees cheaply. Orders should be for at least 30 trees.

The trees come from different nurseries and can be mailed to anywhere in South Africa. The deciduous trees - apples, pears, plums, peaches, apricots, figs, mulberries, grapes and pomegranates - are sent during June, July and August. They are wrapped in bundles in sawdust and plastic and must be kept wet otherwise they will die. As soon as they arrive, plant them in a trench until they are distributed. The citrus trees - oranges and nartjies - are sent during summer and should be planted into holes straight away. The other trees - mangoes, avocados, pawpaws and guavas - are also sent in summer in plastic bags filled with soil and should be planted as soon as they arrive. Most of the trees will bear fruit 1 or 2 years after planting. There are many varieties of these trees. If you write to us, we will send you a catalogue showing which varieties are available. The prices change all the time, but they are cheaper than buying from a nursery. Write to EDA for more details.

If you are buying lots of trees at the same time, it is cheaper to buy from a wholesale nursery. Most of the following are wholesale nurseries. Ask for a discount when you order.

Name: Floradale Nursery
Postal Address: Box 2073, Beacon Bay, East London, 5025 Cape.
Telephone: 0431 472420/472414
Products: Trees and plants
Services: They give advice on what trees are suitable for your area and how to grow them.

Name: George Carter
Postal Address: Box 292, Pietermaritzburg, 3200, Natal.
Telephone: 0331 28761
Products: Trees and seeds.
Services: They give advice on what trees to grow and how to look after them.

Name: Bill Carter's Nursery
Postal Address: Box 302, Tzaneen, 0850, Transvaal.
Telephone: 01523 20094
Products: Citrus, avocados, mangoes, pawpaws.

Name: Springfield Nursery
Postal Address: Box 376, Vereeniging, 1930, Transvaal.
Telephone: 016 281990
Products: Deciduous fruit trees

Name: Stephens Nursery
Postal Address: Box 17, Tweespruit, 9770, OFS.
Telephone: 05682 1902
Products: Deciduous fruit trees

Name: Halls Nursery
Postal Address: P.O. Mataffin, 1205, Nelspruit, Transvaal.
Telephone: 01311 24221
Products: Citrus, avocados, mangoes, pawpaws, guavas

Name: Letsitele Nursery
Postal Address: Box 1, Letsitele, 0885, Transvaal.
Telephone:
Products: Citrus.

Name: Messina Nursery
Postal Address: Box 36, Messina, 0900, Transvaal.
Telephone: Tshipise 1622
Products: Citrus,

Name: South African Plant Improvement Organisation
Postal Address: Box 86, Ceres, 6835, Cape.
Telephone: 023312 917 or 937
Products: They sell disease free deciduous fruit trees to certain nurseries around the country. Write and ask where you can get these trees in your area.

Name: Fruit and Fruit Technology Research Institute.
Postal Address: Private Bag X5013, Stellenbosch, 7600, Cape.
Telephone: 02231 2001
Services: They will give you advice about fruit trees to grow in winter rainfall areas.

Name: Horticultural Research Institute
Postal Address: Private Bag X293, Pretoria, 0001.
Telephone: 012 821601
Services: They will give you advice about fruit trees to grow in summer rainfall areas.

ANIMAL FOODS

Name: Rumevite
Postal Address: Box 286, Bedfordview, 2008, Transvaal.
Telephone: 011 6165360
Products: Protein and phosphate licks for cattle and sheep, animal foods. They do not sell to the public, only to shops and co-ops. They will tell you who your nearest supplier is.
Services: They will send you information about what food to use.

Name: Kynoch Feeds
Postal Address: Box 1095, Kempton Park, 1620, Transvaal.
Telephone: 011 9759548
Products: Animal food and licks.

Name: Maurice Flor
Postal Address: Box 7176, Johannesburg, 2000, Transvaal.
Street Address: 6 Pim Street, Newtown, Johannesburg.
Telephone: 011 8345021
Products: All kinds of animal food and licks, like bone meal, oil cake, protein and mineral licks.
Service: They will give advice to people about what to feed their animals.

Name: Epol
Street Address: Premier Centre, 37 Quinn Street, Newtown, Johannesburg.
Telephone: 011 8362187
Products: All kinds of animal and poultry food.
Services: They will send you information about animal foods. They say that it is cheaper to buy locally. They will tell you where to buy from and how much you should pay.

ANIMAL MEDICINES

Name: Veterinary Research Institute
Postal Address: P.O. Onderstepoort, 0110, Transvaal.
Telephone: 012 554141
Products: They sell all types of vaccination medicines for animals and poultry.
Services: They give advice on all types of animal sicknesses and medicines. They have many pamphlets and booklets about diseases and vaccines which you can write and ask for.

When you order, you must make sure that you give a full address for them to send the vaccine to, and that you fetch it from the station or busstop as soon as it arrives. Vaccination medicine has to be cold and if it stays in a warm place for a long time or if it is not used quickly, it will not work. You must have a cold place like a fridge ready to keep the medicine in, or you must use it straight away. They do not like to send very small orders. Try and buy together with friends so that you can make a bigger order.

The following places also make animal medicines but they do not sell directly to farmers. If you write to them, they will give you information about their products and about where you can buy them. You can get most of their products at white farmers' co-operatives.

Name: Millborrow
Postal Address: Box 325, Germiston, 1400, Transvaal.
Telephone: 011 432562

Name: Coopers
Postal Address: Box 677, Spartan, 1620, Transvaal.
Street Address: 68 Rigger Rd, Spartan, Keupton Park, 1620.
Telephone: 011 9751146

Name: Agricura
Postal Address: Box 55, Silverton, 0127, Transvaal.
Telephone: 012 861101

Name: Hoechst
Postal Address: Box 8692, Johannesburg, 2000, Transvaal.
Street Address: 3 Caxton St, Industria, Johannesburg, 2001.
Telephone: 011 6734100

Name: Shellchem
Postal Address: Box 494, Johannesburg, 2000.
Street Address: Shell House, Smit St, Braamfontein, Johannesburg.
Telephone: 011 7250211

Name: Bayer
Postal Address: Box 1366, Johannesburg, 2000
Street Address: Wrench Rd, Isando, Johannesburg.
Telephone: 011 362811

Name: Repvet
Street Address: 108 Lower Main Reef Road, Benrose, 2094, Transvaal.
Telephone: 011 6182510
Products: Animal medicines. equipment such as castrators and ear markers.
Services: They will send information pamphlets and answer any questions about their products.

Name: Chemveld
Postal Address: Box 261285, Excom, 2023, Transvaal.
Street Address: 36 Durban Street, Johannesburg.
Telephone: 011 297474

Products: Animal medicines.
Services: They will give advice if you write to them.

WATER PUMPS AND EQUIPMENT

Name: Stewarts and Lloyds
Postal Address: Box 8924, Johannesburg, 2000, Transvaal.
Street Address: 36 Simmonds Southway, Park Central, Johannesburg.
Telephone: 011 8361111
Products: Windmills, pumps, pipes, engines and other equipment and tools.
Services: They send somebody to repair and maintain their products and also supply any information you need.

Name: African Gate and Fence Works
Postal Address: Box 7544, Johannesburg, 2000, Transvaal.
Street Address: 188 Bree Street, Newtown, Johannesburg.
Telephone: 011 8388077
Products: Pipes and pipe fittings, pumps, and other water supply equipment. They also sell other steel products like fencing.

Name: Mono Pumps
Postal Address: 13 Engwena Road, Sebenza, Edenvale.
Telephone: 011 6094150
Products: Pumps.
Services: They send somebody to do all repair and maintenance work on their pumps.

Name: Drums and Oils
Postal Address: Box 83018, South Hills, 2136, Transvaal.
Street Address: 8 Steele Rd, Steeldale, Johannesburg.
Telephone: 011 6135512 or 6136227
Products: Reconditioned 44 gallon oil drums, R7 to R10 each. You have to order 10 drums or more drums.

Name: Cape Gate
Postal Address: Box 31136, Braamfontein, 2017, Transvaal
Street Address: 33 de Beer Street, Braamfontein, Johannesburg.
Telephone: 011 392951
Products: Steel wire, barbed wire, fencing and gabions. Gabions are wire boxes filled with stones to fill in dongas and to reinforce embankments.
Services: If you write to them they will advise you about making fences and using gabions.

Name: FIP (Africa)
Postal Address: Box 7090, Johannesburg, 2000, Transvaal.
Street Address: 28 Durban St, City and Suburban, Johannesburg.
Telephone: 011 372560
Products: PVC pipes and pipe fittings. PVC is a strong, hard plastic. PVC fittings can be fitted onto metal pipes. Write to them for price lists and book explaining their products, written in English, Afrikaans, Sotho, Zulu and Xhosa.

Name: Durban Drum Co.
Postal Address: Box 12074, Jacobs, 4026, Natal.
Street Address: 144 Bluff Road, Jacobs, Durban.
Telephone: 031 491236
Products: Reconditioned oil drums.

Name: S Burde & Co
Postal Address: Box 11357, Johannesburg, 2000, Transvaal.
Street Address: 2 Quinn St, Newtown, Johannesburg.
Telephone: 011 8382652
Products: Water tanks, guttering, corrugated iron. If you pay extra they will paint the inside and bottom outside of a tank to make it last longer.

Name: Matheson and Brenner
Postal Address: Box 104, Isando, 1600, Transvaal.
Street Address: Anvil Road, Isando, Transvaal.
Telephone: 011 365235
Products: All kinds of pumps

Name: House of Irrigation
Postal Address: Box 1138, Krugersdorp, 1740, Transvaal.
Street Address: 15 Pillans Street, Chandor, Transvaal.
Telephone: 011 7621111/2
Products: Irrigation equipment.
Services: They will give you advice about irrigation equipment.

Name: P. Andrag & Son
Postal Address: Box 364, Bellville, 7530, Cape.
Street Address: 10 Moederdam Road, Bellville, Cape Town.
Telephone: 021 971851
Products: Irrigation equipment.
Services: They will give you advice about irrigation equipment.

Name: Midmacor
Postal Address: Box 38322, Booysens, 2016, Transvaal.
Street Address: 60 Trump Street West, Selby, Johannesburg.
Telephone: 011 8360721
Products: Motors, pumps and generators. Honda petrol equipment; Mats diesel equipment, Homelite equipment.
Services: Write and ask for information about pumps and generators to use.

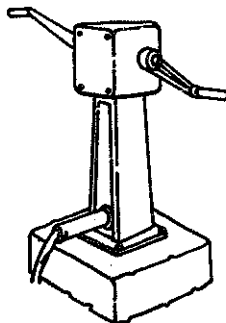

Name: Kawasaki
Postal Address: Box 9951, Johannesburg, 2000, Transvaal.
Street Address: 5 Ruargh, Park Central, Johannesburg.
Telephone: 011 8386407
Products: Kawasaki motors, pumps and generators.
Services: Write and ask them for advice about pumps.

These companies sell pumps made by the National Pump Company. They have all kinds of pumps, including hand pumps.

Name: Stewarts and Loyds
Postal Address: Box 1195, Johannesburg, 2000, Transvaal.
Street Address: 36 Simmonds Southway, Park Central, Johannesburg.
Telephone: 011 8361111

Name: G. North
Postal Address: Box 3751, Alrode, 1451, Transvaal.
Street Address: 77 Jurie St, Alrode, Alberton, Transvaal.
Telephone: 011 8642860

Name: African Gate and Fence Works
Postal Address: Box 7544, Johannesburg, 2000, Transvaal.
Street Address: 188 Bree Street, Newtown, Johannesburg.
Telephone: 011 8388077

BOREHOLES

There are two ways that you can get a borehole:

* Speak to your local extension officer or government official. The government is supposed to make sure that everybody in the country has enough clean water. They can test the ground to see if there is water there, and they will organise to have the hole drilled.

It is important that people stand together as a community when they ask the government to do something for them. This is the only way to make sure that the government does the things that it is supposed to do. Before you go to them, work out how many people there are, how much water you will need, and how many taps you want.

* If you do not get it done by the government, you can have it done by a private company. This will cost a lot of money.

There are 3 kinds of drilling contractors:

- Some will test for the water themselves and if they think there is water there, they will start drilling. If they do not find water after they have started drilling, they will not make you pay for the work they have done. There are not many contractors like this.
- Some do the testing and the drilling, but even if they do not find water, they will make you pay for the work that they have done.
- Others do not do the testing; they will drill where you tell them to drill, and if they don't find water, they will still make you pay.

Always try to make sure that there is water there before the company starts to drill, otherwise you may have to pay for the work and still not have any water.

Always make sure that you understand what you are signing before you sign any agreement with a contractor.

WINDMILLS

These two companies sell windmills. If you write to them, they will tell you about the different sizes and kinds of windmills and about which one would be best for your needs.

Name: **Stewarts and Lloyds**
 Postal Address: Box 8924, Johannesburg, 2000, Transvaal.
 Street Address: 36 Simmonds Southway, Park Central, Johannesburg.
 Telephone: 011 8361111
 Products: Climax windmills.

Name: **Southern Cross**
 Postal Address: Box 627, Bloemfontein, 9300, FOS.
 Street Address: Nuffield Street, Bloemfontein
 Telephone: 051 77001
 Products: Windmills

Name: **Industrial Sewing Machine Co.**
 Postal Address: Box 8697, Johannesburg, 2000, Transvaal.
 Telephone: 011 237331
 Products: New and second hand industrial sewing and knitting machines and other equipment such as overlock machines and steam irons.

Services: They will advise sewing groups about what machines to buy. If you write to them, you must tell them if you already have machines and what kind they are, how much you are producing at the moment and if you make basic styles or if you change your styles all the time. They also have a book about their machines which they can send to you. They sell spare parts for their machines and have a repair service. Sometimes they send a mechanic to show people how to look after their machines.

PRODUCTION MATERIALS

In this part of the book, we list places where groups which make things like clothes, beadwork, grasswork and woodwork can buy some of the materials they need. The list is small, but we would like to make a bigger list with more suppliers. Please write to EDA or to Raw Materials Services, P.O. Box 93118, Yeoville, 2143, if you know about other suppliers. If you buy from any of the suppliers in this list, please write to us and tell us if you got good prices and good service.

Name: **Berzack Bros.**
 Postal Address: Box 4470, Johannesburg, 2000.
 Street Address: 2 Nugget Street, Johannesburg.
 Telephone: 011 294621
 Products: Industrial sewing machines and equipment.

Services: They sell spares for their machines and they do repairs.

Name: **Bellstedt**
 Postal Address: Box 1668, Durban, 4000, Natal.
 Street Address: 161 Gale Street, Durban, 4001.
 Telephone: 031 316465
 Products: Industrial sewing machines and equipment.
 Services: They sell spares and do repairs.

SEWING AND KNITTING MACHINES

Sewing and knitting machines are usually the same price everywhere, so it is better to buy them from a shop near to you. If you think your local shop is charging too much, write to the main suppliers and ask them what the prices should be.

You must make sure that you buy the kind of machine that you need. Some groups use household machines, others use industrial machines which are used in factories. They are stronger and last longer, but they are usually more expensive. You can write to any of these suppliers and they will try and help you to decide what kind of machine you need.

Name: **Elna Sewing Machine Centre**
 Postal Address: Box 652, Johannesburg, 2000, Transvaal.
 Street Address: Randhof Centre, Selkirk Avenue, Randburg, 2194, Transvaal.
 Telephone: 011 789-1976
 Products: New and second-hand Elna sewing machines.

Name: **Empisal**
 Postal Address: Box 7119, Johannesburg, 2000, Transvaal.
 Street Address: Manners Mansions, 166 Jeppe Street, Johannesburg.
 Telephone: 011 297335
 Products: New and second-hand Empisal sewing and knitting machines.

Name: **National Sewing Centre**
 Postal Address: Box 4937, Johannesburg, 2000.
 Telephone: 011 8368934/8382889
 Products: New and second hand Kenmore and Pfaff sewing machines and Passap knitting machines.
 Discounts: They will sell machines to small sewing groups at special cheap prices. If you write to them, you must prove that you are a sewing project and you must say that you saw their name in this book.
 Services: They have a free training course to teach people how to use their machine.

Name: **SASKOR (South African Sewing and Knitting Machine Distributors)**
 Postal Address: Box 61277, Marshalltown, 2107, Transvaal
 Telephone: 011 8382371
 Products: Janome and Bernina sewing machines, Janome knitting machines, knitting wool.
 Services: They will answer any questions that people have about sewing.

Name: **Singer**
 Postal Address: Box 38177, Booyens, 2016, Transvaal.
 Street Address: 55 Rissik Street, Johannesburg, 2001.
 Telephone: 011 6824210 or 011 8386241
 Products: New and secondhand Singer sewing and knitting machines.
 Discounts: If you buy 5 or more machines at a time.
 Services: They give sewing training courses in Johannesburg and in Soweto.

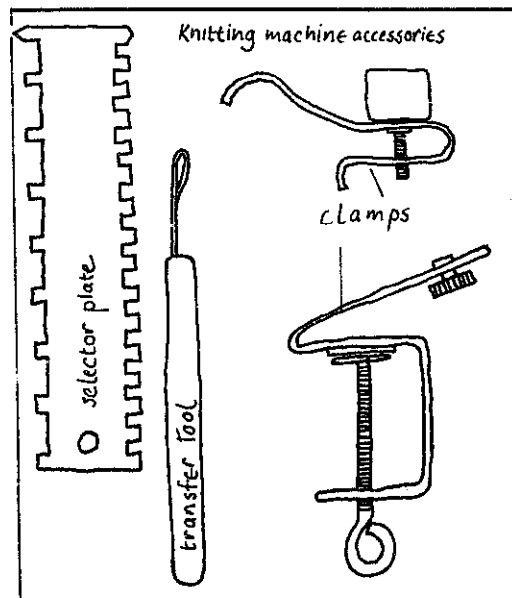

TEXTILES

Most textile firms will only sell textiles in very large amounts. They usually sell their textiles to wholesalers who sell it to shops. Some wholesalers will sell to you, although sometimes they also sell only large amounts. We have given the names of some of the manufacturers of textiles. If you write to them, they will tell you the names of wholesalers where you can buy their textiles. We have also given the names of some wholesalers.

Name: Berg River Textiles
Postal Address: Box 306, Paarl, 7620, Cape.
Street Address: Cape Town Office, Design Centre Bldg, 234 Loop Street, Cape Town, 8001.
Telephones: Paarl: 0251 222211 Cape Town: 021 457440

Name: Consolidated Fine Spinners and Weavers Limited.
Postal Address: Box 32002, Mobeni, 4060, Natal.
Street Address: Warrington Road, Mobeni.
Telephone: 031 422501
Products: Canvas, poplins, drills, denims, trouserings, dress fabrics, curtaining and lining, twills, sateens, bed sheeting, collar linings, shirtings, flannelettes.

Name: Good Hope Textiles
Postal Address: Box 105, King Williams Town, 5600, Cape.
Street Address: Sweetwaters Mill, Hargreaves Ave, King Williams Town.
Telephone: 0433 2133

Name: Umzinto Textiles Mills
Postal Address: Box 4623, Durban, 4000.
Street Address: Textile Road, Umzinto.
Telephone: 031 723344
Products: Textiles for clothing including Tetrex.

Name: Da Gama Textiles (Good Hope Textiles, Cyril Lord, Linofra Knitted Fabrics)
Postal Address: Box 753, East London, 5200, Cape.
Street Address: Cyril Lord House, Arnoldon, East London.
Telephone: 0431 451124
Products: Cotton, polyester cotton. Brand names: Daydawn, Pasco, Three Falcons, Sungleam, Sunflow, Tots and Teens, Edenrose, Michelle, Kingmaid, Cool Candy, Beauty, Jacaranda, Mimosa, Forget me not, Fuchsia, Acacia, Estelle, Amberglo, Orchid.

Name: Frankel & Seehof
Postal Address: Private Bag X9, Bramley, 2018, Transvaal
Street Address: Freeway Centre, Louis Botha Ave, Wynberg Johannesburg.
Telephone: 011 7862320
Products: All kinds of textiles, wool, sewing accessories and knitting needles. They prefer to sell to buyers who have GST numbers (see p 513). But they may sell to you if you prove that you are a sewing project.

Name: Hebox Textiles
Postal Address: Box 10, Hammarsdale, 3700, Natal.
Street Address: Anderson Road, Hammarsdale, Natal.
Telephone: 0325 61112.
Products: Cotton, polyester, wool, acrylic, viscose.

Name: Intermediate Technology Small Industries Development Unit.
Postal Address: Box 93, Elim Hospital, 0960, Transvaal.
Street Address: Shirley Farm, Elim Hospital.
Telephone: 01552 703

Products: * Small quantities of textiles, threads, printing and dyeing materials at low prices.
* Building and sanitation materials supplied in Northern Transvaal.
Services: They will give detailed advice to groups involved in printing, dyeing and sewing and selling textiles and sometimes help to train members of groups doing this kind of work.

TEXTILE WHOLESALEERS

Name: Trust Wholesalers
Postal Address: Box 10106, Johannesburg, 2000, Transvaal
Street Address: Indent House, 130 President Street, Johannesburg. Telephone: 011 377803.

SEWING ACCESSORIES

Sewing accessories are things like cotton, scissors, binding, lining, buttons, needles, wool, hooks, eyes and zips.

Name: Barbour Threads
Postal Address: Box 6578, Johannesburg, 2000, Transvaal.
Street Address: 32 Laub St, New Centre, Johannesburg, 2001.
Telephone: 011 8343336
Products: Industrial and household cottons.

Name: Natal Thread
Postal Address: Box 14, Hammarsdale, 3700, Natal.
Street Address: Kelly Road, Hammarsdale.
Telephone: 0325 62171
Products: All kinds of sewing thread

Name: Union Zippers
Postal Address: Box 5122, Johannesburg, 2000, Transvaal.
Telephone: 011 295361
Products: YKK zippers. Prices are nearly the same everywhere, so it is better to buy locally. You should only order from them directly if you want to buy a large amount of zips.

Name: Perlzip
Postal Address: Box 34009, Jeppestown, 2043, Transvaal.
Telephone: 011 6141045
Products: Zips and narrow fabrics like bias binding.

Name: S.A. Bias Binding
Street Address: 264 Main Street, Johannesburg, 2001, Transvaal.
Telephone: 011 6181100.
Products: All kinds of binding, dress size numbers, webbing.



Name: Butt Trim
Postal Address: Box 7362, Johannesburg, 2000, Transvaal.
Telephone: 011 375223
Products: Buttons and other sewing accessories. They will only sell to buyers who have a GST number. If you do not have a GST number, you must write to their other company, Monica Novelties. They will send you samples of their products free of charge.

Name: Monica Novelties
Postal Address: Box 4477, Johannesburg, 2000, Transvaal.
Telephone: 011 372858
Products: All sewing and knitting accessories. They will not sell in small amounts. Ask them what the smallest amount is when you write to them.

Name: Frankel and Seehof
Postal Address: Private Bag X9, Bramley 2018, Transvaal.
Street Address: Freeway Centre, Louis Botha Ave., Wynberg, Johannesburg.
Telephone: 011 7862320
Products: Everything you need for sewing except sewing machines. They usually only sell to buyers who have a GST number. If you do write to them, tell them that you are a sewing project.

Name: Burlap Sales
Postal Address: Box 36042, Belgravia, 2009, Transvaal.
Telephone: 011 237417
Products: Hessian in 30m rolls.

Name: Knitting Wool Centre
Postal Address: Box 42381, Fordsburg, 2033, Transvaal.
Telephone: 011 8387612
Products: Knitting machine wool. They will send samples if you write and ask for them.

Name: Wool Centre
Postal Address: Box 11179, Johannesburg, 2000, Transvaal
Street Address: 26 Davies Street, Doornfontein, Johannesburg.
Telephone: 011 299658
Products: Machine and hand knitting wool and accessories.
Discounts: They give a discount if you buy between 4 and 9 cones at a time and a bigger discount if you buy more than 10 at a time.

Name: Patons
Postal Address: Box 33, Randfontein, 1760, Transvaal.
Street Address: Desert St, Industrial Sites, Randfontein
Telephone: 011 6935100
Products: Knitting wool and yards. Brand names: Patons, Beehive, Sirdar, Jaeger, Copley-Lotus, Red Heart, Lister-Lee, Target. They will give advice about knitting or wool.

Name: Coates
Postal Address: Box 347, Randfontein, 1760, Transvaal.
Street Address: 4 Wol Street.
Telephone: 011 6935130
Products: All kinds of sewing threads. They will not sell to the public, so write and ask them to tell you the addresses of places where you can buy.

Name: Union Spinning Mills
Postal Address: Box 4032, Port Elizabeth, 6014,
Street Address: Berwick Street, Neave Industrial Township, Port Elizabeth, 6001.
Telephone: 041 45411
Products: Knitting wool and yarns.

The following are companies that supply wool. They do not usually sell to the public so write and ask them where* to buy their products.

Name: Sirdar Wools
Street Address: 5 Melbourne Road, Durban, 4001, Natal.
Telephone: 031 68031

Name: Shepherd Wools and Yarns
Postal Address: Box 1085, Johannesburg, 2000, Transvaal.
Telephone: 011 234342

Name: Lister and Co.
Postal Address: Box 1748, Cape Town, 8000, Cape.
Street Address: 77 Harrington Street, Cape Town.
Telephone: 021 433543

Name: Rcmayarns
Postal Address: Box 12012, Jacobs, 4026, Natal.
Street Address: Milner Street, Jacobs, Durban.
Telephone: 011 483584
Products: Fiesta, Arena, Pinguin wools.

PATTERNS

Name: Simplicity Patterns/Style Patterns
Postal Address: Box 9172, Johannesburg, 2000, Transvaal.
Telephone: 011 8366111
Products: All kinds of sewing and knitting patterns.
Discounts: 30% discount if a project buys 10 or more patterns at a time.
Services: Every four months, they publish a free catalogue of new patterns which they will send to you if you write to them. They also have a very big catalogue of all their patterns which they publish every 3 months. It is not free, but they will send old catalogues free. They sell a sewing training kit with an instruction book which together cost R11,50.

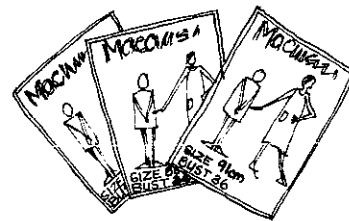

GLASS BEADS

Glass beads are very expensive and not easy to get. We have given the names of some of the places that sell glass beads. You must order the size and colour. It is better if you send a sample, so they will be sure of what you want.

Name: Greenstein and Rosen
Postal Address: Box 6809, Johannesburg, 2000, Transvaal.
Telephone: 011 8387771
Products: Glass beads, fishing line which can be used for threading beads onto, bead needles. This company will not send beads unless the order is for more than R50.

Name: Market Wholesalers
Street Address: 24d President Street, Johannesburg, 2001 Transvaal.
Telephone: 011 8381939
Products: Glass beads, bead needles, fishing line, hooks and eyes, copper, brass and other wire for bracelets, plastic beads.
Discounts: If orders are for more than R50 at a time.

Name: W.G. Brown
Postal Address: Box 986, Durban, 4000, Natal.
Street Address: 54 Queen Street, Durban.
Telephone: 031 319621
Products: Glass beads and other materials for bead work. They want people to order at least R50 worth at a time.

PRINTING

Name: Coates
Postal Address: Box 276, Robertsham Transvaal.
Telephone: 011 6806500
Products: Silkscreening and blockprinting ink. They sell in tins which is much cheaper than in tubes.
Discounts: If you buy 15kg or more at a time.

Name: Mander-Kidd
Postal Address: Box 53099, Troyeville, 2139, Transvaal.
Telephone: 011 6146111
Products: Silkscreening ink. They will make blockprinting ink if you send them a sample of the colour that you want and order for at least 20kg.

Name: Chemosol
Postal Address: Box 6508, Johannesburg, 2000, Transvaal.
Telephone: 011 373763
Products: Silkscreening products.
Services: They will give advice and information to anybody who writes to them.

Name: Bishop Merchandising
Postal Address: Box 1775, Durban, 4000, Natal.
Telephone: 031 64737/324691
Products: All silkscreening equipment

These shops sell all kinds of art equipment including the equipment you need for block printing.

Name: Schweikerdt
Postal Address: Box 697, Pretoria, 0001, Transvaal.
Street Address: 89 Queen Street, Pretoria.
Telephone: 012 793713 or 012 798281
Products: All kinds of art materials.
Services: They give advice on what material to use and how to use them.

Name: P.W. Story
Postal Address: 18 Foundry Lane, Durban, 4001, Natal.
Telephone: 031 326466
Products: All kinds of art materials.

Name: Maskew Miller
Postal Address: Shell House, Waterkant Street, Cape Town, 8001, Cape.
Telephone: 021 224151
Products: All kinds of art materials.
Services: They give advice about their products.

These people and projects can give you advice about silkscreen and block printing.

Name: Tiakeni Textiles
Postal Address: Box 93, Elim Hospital, 0960, Transvaal.
Street Address: Shirley Farm, Elim Hospital.
Telephone: 01552 703

Name: Lydia Pele
Street Address: 682a Madubane St, Zone 1, Meadowlands, 1852, Johannesburg, Transvaal.
Telephone: 011 9491641

Name: Pippa Kohly
Postal Address: 85 Ararat Street, Westdene, 2092, Johannesburg.
Telephone: 726-5471

LEATHERWORK

This is a list of places where you can buy leather, leatherwork tools and equipment. If possible, send samples of what you want when you order. They sell some of their products only in large amounts. If you want to buy a small amount write and ask them where the nearest supplier is to you

Name: Edendale Tannery
Postal Address: Box 6, Edendale, 4505, Natal
Street Address: Station Road, Edendale, Pietermaritzburg, Natal.
Telephone: 0331 81406

Name: Johannesburg Tanning Co
Postal Address: Box 65328, Benmore, 2010, Transvaal.
Street Address: Charles Street, New Brighton, Johannesburg.
Telephone: 011 7831100

Name: King Tanning Co
Postal Address: Box 117, King Williams Town, 5600, Cape.
Street Address: Bridge Street, King Williams Town.
Telephone: 0433 2431

Name: Mountain View Tannery
Postal Address: Box 18030, Hercules, 0030, Transvaal.
Street Address: 1105 Mignon Street, Mountain View, Pretoria.
Telephone: 012 776051

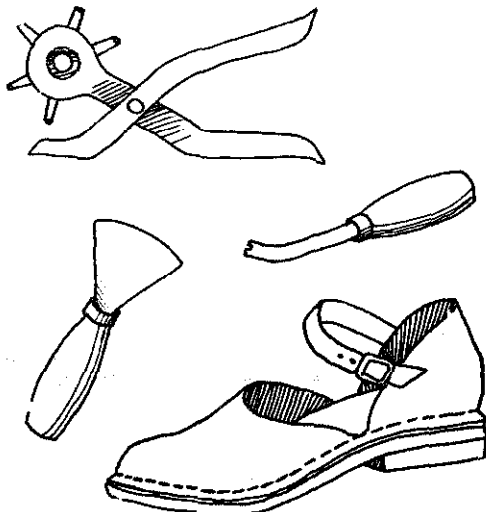

Name: Mossop and Son
Street Address: Belmont Road, Rondebosch, 7703, Cape Town.
Telephone: 021 695755

Name: Sutherlands Tannery
Street Address: Flessislaer, Pietermaritzburg, 3201, Natal.
Telephone: 0331 81144

Name: Western Tanning Co
Postal Address: Box 501, Wellington, 7655, Cape
Street Address: The Hermon Road, Wellington, Cape.
Telephone: 0251 31177

Name: Silverton Tannery
Street Address: 309 Derdepoort Road, Silverton,
Telephone: 012 864881 Pretoria.

Name: Freinkels
Street Address: 126 President Street, Johannesburg.
Telephone: 011 298885/239218
Products: Leather, new and secondhand leather machinery, tools, polishes and accessories needed for leatherwork.

Name: United S.A. Leather
Street Address: Delmark House, 123 Market Street, Johannesburg, 2001.
Telephone: 011 299536
Products: Leather and leatherwork tools and accessories.

Name: Anglo-Continental Agencies
Postal Address: Box 37452, Overport City, 4067, Natal.
Street Address: Suite 7003, Overport City, Durban.
Telephone: 031 289322
Products: Leather and artificial leather for making things like shoes, belts and handbags.

Name: Bienkingskop, Eggers & Company
Postal Address: Box 639, Port Elizabeth, 6000, Cape.
Street Address: 1 Bagshaw Street, North End, Port Elizabeth.
Telephone: 041 545412
Products: Leather and leather hand tools.

Name: Paul Moeller
Postal Address: Box 4924, Johannesburg, 2000, Transvaal.
Street Address: Ground Floor, Access City, 22 Staib Street, New Doornfontein, Johannesburg.
Telephone: 011 231736
Products: All kinds of leatherwork machinery, especially sewing machines.

WOODWORK AND METALWORK

Name: Dion Mail Order
Postal Address: Private Bag 36, Auckland Park, 2006, Transvaal.
Telephone: 011 7868018/7862070
Products: Hand tools for woodwork. Easiweld Home welding and brazing systems and metalwork electric drills. They have a mail order catalogue which costs R2,00.

Name: Geerlings
Postal Address: Box 4050, Luipaardsvlei, 1743, Transvaal
Street Address: 7 Adcock St, Chamdor, Krugersdorp.
Telephone: 011 7624271
Products: All kinds of secondhand woodworking and sheetmetal machinery. After you order a machine, they recondition it, so it sometimes takes a long time before you get it.

Name: Afrox
Postal Address: Box 5404, Johannesburg, 2000, Transvaal.
Street Address: Afrox House, Webber Street, Johannesburg
Telephone: 011 8362971 or 8363111
Products: Handipak Gas brazing outfit and all kinds of welding and gas equipment

Name: Rutherfords
Postal Address: Box 3802, Johannesburg, 2000, Transvaal.
Street Address: Cor Eloff St Ext & Roper St, Johannesburg.
Telephone: 011 8384525
Products: Woodworking machinery, pumps, hand tools.

Name: Carlton Paint and Hardware
Postal Address: 1 Village Road, Selby, Johannesburg, 2001, Transvaal.
Telephone: 011 8347764
Products: All hardware and tools.

Name: David Illing Company
Postal Address: Box 772, Durban, 4000, Natal
Street Address: 17 Mona Road, Durban.
Telephone: 031 379314
Products: Tools of all types.

Name: Keystone Trading Company
Postal Address: Box 4770, Johannesburg, 2000, Transvaal.
Street Address: Freeway Centre, First Ave, Wynberg, Sandton, 2199.
Telephone: 011 7863434
Products: All kinds of tools

POTTERY

We have not written about pottery in this book because we think the equipment is too expensive for small groups and marketing is very difficult. Here are some pottery suppliers which you can write to about pottery equipment.

Name: Pottery Supplies and Engineering
Postal Address: Box 13087, Knights, 1413, Transvaal.
Telephone: 011 515163
Products: All pottery equipment: electric kilns, pottery wheels, pottery glazes and clay.

Name: Shaw Tec
Postal Address: Box 135, Durbanville, 7550, Cape.
Street Address: Spes Bona Road, Fisantekraal, Durbanville.
Telephone: 021 964421
Products: All pottery equipment, glazes and clay.

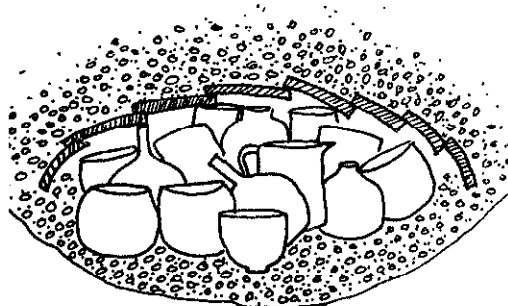

Name: Craft Equipment
Street Address: 3a Glynn Street, Cape Town, 8001, Cape.
Telephone: 021 453542
Products: Pottery wheels.

Name: Ferro
Postal Address: Box 108, Brakpan, 1540, Transvaal.
Products: Glazes, underglazes, stains, pottery tools, clay. They do not sell small amounts of some of their products. Ask them what the smallest amounts are when you order.
Services: They give information about pottery and pottery materials. Telephone: 011 589020

Name: Johnson Matthey
Postal Address: Box 14078, Wadeville, 1422, Transvaal.
Telephone: 011 345750/1
Products: Glazes, underglazes, stains, pottery tools, clay.

Name: Harrison Mayer
Postal Address: Box 12043, Jacobs, 4026, Natal.
Telephone: 031 481561
Products: Pottery supplies.

These shops try and help projects by selling their products for them. They cannot sell everything, so you should not rely on them only to sell your things.

Name: Self Help Associates for Development Economics (SHADE)
Postal Address: Box 5065, Horison, 1730, Roodepoort, Tvl.
Street Address: Pigeon St. Extension, Horison, Roodepoort
Telephone: 011 7631270

Name: African Art Centre
Address: Old Mill, Printing Office Street, Pietermaritzburg, 3201, Natal.
Telephone: 0331 21795
Address: Guildhall Arcade, Gardiner Street, Durban, 4001, Natal.
Telephone: 031 316810
Address: Auden House, 68 De Korte Street, Braamfontein, 2001, Transvaal.
Telephone: 011 7244441
Address: 256 Oxford Street, East London, 5201, Cape.
Telephone: 0431 29909

Name: Inqualife
Address: 1 West Street, Westgate, Johannesburg, 2001, Transvaal.
Telephone: 011 836651

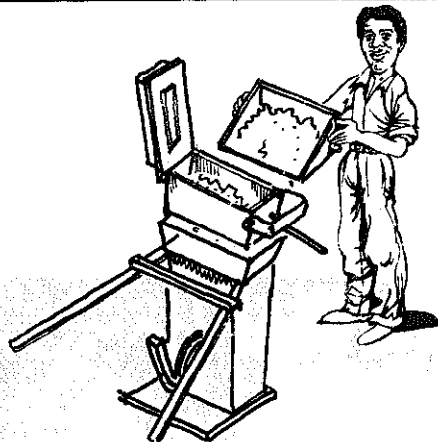

Name: Itekeng
Address: 36 Hyde Park Corner, Hyde Park, Johannesburg, 2196, Transvaal.
Telephone: 011 7885197

Name: Artcraft
Address: The Rondavel, 58 Oak Street, Greytown, 3500, Natal.
Telephone: 03342 1048

Name: Campus Craft
Address: Senate House, University of the W. Watersrand, Jorissen Street, Braamfontein, 2001, Johannesburg, Transvaal.
Telephone: 011 394011 extension 8576

BUILDING

Building materials are usually big or heavy so they are expensive to transport. It is cheaper to try to buy them locally than to order them from a supplier in town. Try the local white farmers' co-operative or ask local building firms where they buy their materials.

Name: Ellison Equipment
Postal Address: Box 8100, Johannesburg, 2000, Transvaal.
Street Address: 13 End St Ext,
Telephone: 011 296997
Products: Hand operated brick and block making machines.

Name: Ehrenberg Engineering.
Postal Address: Box 38078, Booyens, 2016, Transvaal.
Street Address: 55 Booyens Rd, Booyens, Johannesburg.
Telephone: 011 8366273
Products: Brick and block making machinery. These machines have motors so they are more expensive than the hand operated machines.

Name: Little Wonder Brick Machines
Postal Address: Box 2053, Stellenbosch, 7600, Cape.
Street Address: 141 Dorp Street, Stellenbosch.
Telephone: 02231 2845
Products: Brick-making machines.

Name: Blaikie-Johnstone
Postal Address: Box 936, Durban, 4000, Natal.
Street Address: 10 Quality Street, Moleni, Durban.
Telephone: 031 422011
Products: All kinds of building materials and supplies.
Services: They give advice about building.

Name: H L & H
Postal Address: Box 47, Johannesburg, 2000, Transvaal.
Street Address: 39 Wolmarans Street, Braamfontein, Johannesburg.
Telephone: 011 282020
Products: All kinds of building materials and supplies.
Services: They give advice about building.

Name: Federated Timbers
Postal Address: Box 25632, Denver, 2027, Transvaal.
Street Address: Main Reef Road/Kruger St, Denver, Johannesburg.
Telephone: 011 6161961

Products: All kinds of building materials and supplies.
Services: They give advice about building. They also sell a book costing R1,60 which gives advice about building and building materials.

HOW TO ORGANISE A SEED BUYING GROUP

It is much cheaper to buy one big tin of seed and divide it between the people in a group than for everybody to buy seed in small packets.



For example; 500g of spinach seed costs R2.75 if you buy it in a tin. But if you buy 500g of spinach seed in small packets, it costs R11.25. Each small packet has 20g of seed and costs 45c.



Another example is tomato seeds. A 100g tin of tomato seeds costs R4.70. But 100g of tomato seeds in small 6g packets costs R7.20.

Your group can save a lot of money if you buy seed in tins. It is easy to sell the seed a little at a time. Everybody can buy as many teaspoons of seed as they need for their gardens. After selling the seed you will have enough money to buy another tin. Use these prices:



- Big seed (spinach, beetroot) 10c for 3 teaspoons
- Medium seed (cabbage, onions, carrots) 10c for 2 teaspoons
- Small seed (tomatoes) 10c for 1 teaspoon

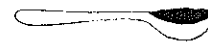
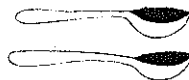

If you use these prices you will be able to buy another tin, with some money left over. You can use this money to buy things the group needs like stamps, pens, or paper.

Before you start the seed buying scheme, you must have a meeting of everyone who wants to buy seed. The meeting must choose one person who will look after the seed and sell it. They must choose another two people who will check on the money.

BUYING AND SELLING THE SEED

The group must then write to a seed shop (see seed p) and ask for a price list, which the seed shop will send free. The group decides from the price list what seeds they want to buy. Then they must write a letter and send the money for the seed. They must send extra money for posting: The post office will tell them how much. It depends on how heavy the parcel will be.

<p>Mayford Seeds P.O. Box 4037 Johannesburg 2000</p> <p>Dear Sir,</p> <p>We would like to order the following seeds from your price list:</p> <p>1x500g tin onion Caledon Globe R5.50 2x500g tin spinach Large White R5.50 2x100g tins tomatoes Heinz 1370 R10.20</p> <p style="text-align: right;">4% sales tax R21.20 Parcel Post .85 TOTAL <u>R22.65</u></p> <p>We enclose our postal orders for R22, 65.</p> <p>Yours sincerely J Mamba Secretary, Ngcina Seed Club</p>	<p>P.O. Box 82 Siteki Swaziland</p>
---	---

The person who looks after the seed must keep it in a cool dry place. The lids of the tins must be tightly closed. Every time somebody buys seed the seller must 'the buyers' name in the book and the buyer must sign it. Or the seller can write a receipt and the buyer can sign it.

The seed seller can also keep a sales book. Under each type of seed, each sale is written down.

DATE	NAME OF BUYER	NUMBER OF TEASPOONS	SEED BOUGHT	MONEY		SIGNATURE OF BUYER
				R	c	
1.7.80	Zwane	2	tomatoes		10	Charlie
1.7.80	Ndlovu	3	spinach		10	Thompson
	"	2	tomatoes		10	T. Banda
2.7.80	Hlangwane	4	tomatoes		20	M. Mamba
5.7.80	Dlamini	4	onions		20	P. Mamba

STARTING THE SCHEME

To start the scheme, you must have money to buy the first tins of seed. You can collect the money from the people in the group, or you can apply for a loan or a grant (see p 539).

One way of collecting money from the group is to ask everyone joining the group to pay a membership fee. Then the membership fees are used to buy the first seed.



Food Buying Groups

Food is much cheaper if people buy together in big quantities from factories or markets then share it out. For example, if 3 families who live in town go to the market to buy a big bag of oranges, it costs 99c. There are 60 oranges in the bag, so each family gets 20 oranges for 33c. If they go to the shop, oranges are 5c each. To buy 20 would cost R1,00. To buy 60 would cost R3,00. Buying 1 bag at the market and sharing can save the group R2,00.

Another group of people who live in the country can order a 25kg bag of powdered milk. They pay R80 and share the milk between 25 people. Each person gets 1kg of milk for R3,20. To buy 1kg of powdered milk in the

shops costs R5,80, so buying a big bag and sharing saves each person R2,60.

Groups must be well-organised to buy food in bulk and share it. They must collect money to buy the food. They must know how to write letters to factories and to make sure the food is delivered by train or bus. If they fetch it they need a car or a truck and they must work out how much the petrol costs. They must also work out a plan to divide up the food so that everybody in the group gets some. They must keep accounts of how much money they collect and how much they spend. They have to organise themselves so that everybody shares the work.

Some groups buy things every week or every month. For example if a group of people buy vegetables together, they can go to the market every week. If they buy 50kg bags of mealie-meal, or 25kg bags of powdered milk they might only buy once a month or once every 2 months.

Buying Groups can have 3 or 4 members. They can be much bigger with 50 or 100 members.

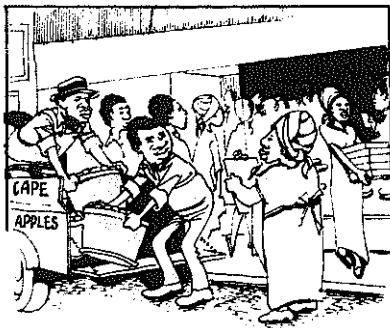

Advice Organisations

The following organisations help people with advice, training, facilities and resources.

COMMUNITY ORGANISATION

Things which governments in other countries do, like giving all communities enough clean water or building schools, are not done in South Africa, so people organise community groups to do these things. It is often difficult because it takes a lot of money and hard work and sometimes groups need legal advice to help them fight for these things. The following organisations help community groups to do things.

Name: Environmental and Development Agency
(See p 3).

Name: Churches Urban Planning Commission (CUPC)
Postal Address: Box 5, Hanover Park, 7782, Cape.
Street Address: 16 Astley St, Mowbray, 7700.
Telephone: 021 672898 or 692771

They run community work projects and work with action committees, production and consumer co-operatives. Their projects are:

- * Casinploy - an advice organisation for employers and employees which finds people jobs. It helps to set wages and working conditions for workers like domestics who are not covered by Industrial Council agreements and do not have trade unions.
- * Ulwazo Christian Association which develops new syllabuses and teaching methods for schools. They also teach people who have left Bantu and Coloured education schools.
- * Genadendal Rural Project which helps with adult education and handicrafts.
- * Conference centre in Muizenberg
- * Meeting room at their Mowbray offices which people can use for seminars and workshops.
- * Training courses for community workers 3 times a year.

Publications

- * CUPC News is published 3 times a year.
- * Literature on community work.

Name: Association for Rural Advancement (AFRA)
Postal Address: Box 2517, Pietermaritzburg, 3200, Natal.
Street Address: 203 Loop Street, Pietermaritzburg.
Telephone: 0331 20052

They are concerned with forced population removals in Natal and KwaZulu. They publicise what is happening and help communities which are fighting against being moved or have already been resettled. This help includes information about what is happening in other parts of South Africa, contact with other groups, contact with lawyers and support to community organisations. At present AFRA employs four part time workers. They are slowly building up contact with lawyers who are prepared to take up cases of resettlement, farm labour and evictions.

Publications and Resources

- * AFRA publishes "AFRA Reports", in English and Zulu, about 8 times a year, which focus on resettlement issues.
- * They have a resource library, consisting mainly of newspaper cuttings, maps, articles and field reports, dealing with resettlement and rural communities in Natal.
- * They also have a slide collection on resettlement.
- * They also publish fact sheets dealing with legal rights of rural people, for example on eviction, impounding of stock and compensation.

Name: Young Women's Christian Association (YWCA) World-affiliated.
Postal Address: Box 31560, Braamfontein, 2017, Transvaal.
Street Address: 404-408 Dunwell House, 35 Jorissen St, Braamfontein, Johannesburg.
Telephone: 011 398212

They try to improve the lives of women in education, work and the church.

- * They work with communities in literacy, nutrition, pre-school learning, day-care centres, home industries, community gardens and poultry farming.
- * They educate people about women's rights and human rights and promote co-operation and communication between people.

Publications and resources

- * They published a booklet called The Rights of Women
- * They have other books which you can borrow if you write and ask.

Name: Grassroots Publications
Postal Address: Box 181, Athlone, 7760, Cape.
Street Address: Cor Burg & Shortmarket Sts, 328 South West House, Cape Town.
Telephone: 021 432117

Workshops are organised for community and worker groups in the field of media development.

Publications

Grassroots, a community newspaper

Name: Delta
Postal Address: Delta/SRC, Rhodes University, Grahamstown 6140, Cape.
Telephone: 0461 2023 7122

Delta is a community action organisation at Rhodes University. They have worked with community projects and a newspaper called Grahamstown Voice which writes about community problems in Grahamstown.

Publications and Resources

- * Grahamstown Voice newspaper.
- * Reports about wages and the cost of living in Grahamstown.
- * Resource library with articles and books on subjects like community health, rural development and education.

Name: Diakonia
Postal Address: Box 1879, Durban, 4000, Natal.
Street Address: 21 St Andrews St, Durban, 4001, Natal.
Telephone: 031 312609 or 312645 or 312600 or 312681

- * Training courses in community organisation.
- * Housing programme, focussing on the problems and issues involved in the housing crisis.
- * Involving the church in a supportive role in workers issues.
- * Helping set up credit unions.
- * Making whites aware of the problems in South Africa.

Publications and Resources

- * Diakonia News, published 6 times a year.
- * Slide and tape shows on topics such as resettlement, unemployment and domestic workers.

Name: South African Voluntary Service (SAVS)
Postal Address: Box 97, Johannesburg, 2000, Transvaal.
Street Address: c/o SRC, University of the Witwatersrand, 1 Jan Smuts Ave., Johannesburg.
Telephone: 011 394011

SAVS is a student organisation which helps community organisations, especially with building projects. They have also helped to run a health care project in a rural clinic.

Name: Community Research Unit (CRU)
Postal Address: Box 48303, Qualbert, 4078, Natal.
Street Address: Suite 3, A.I. Kajee Building, 59 Victoria Street, Durban, 4001, Natal.
Telephone: 031 62050

- * Research into community issues.
 - * Training of researchers.
 - * Planning projects.
-

Name: Zakhe Co-operative Development and Resource Organisation
Postal Address: Box 143, Landsdowne, 7780, Cape.
Street Address: 1 and 2 Town Centre, Hanover Park, 7764.
Telephone: 021 644591

- * Zakhe runs part-time training programmes for co-operative organisers and field workers.
- * They help people with all kinds of co-operatives such as consumer co-operatives, production co-operatives and credit unions.
- * They have a course in basic economics which anybody can join.
- * They give advice on co-operative planning, administration, marketing and quality control.
- * They help projects to find funds.

Publications and resources
They have a library on co-operatives.

EDUCATION AND TRAINING

The following organisations run courses or give advice on many different kinds of education and training. If you are not sure which kind of information you need or if the information you need is not in this book, write for advice to the Education Information Centre

Name: Bureau of Literacy and Literature
Postal Address: Box 31030, Braamfontein, 2017, Tvl.
Street Address: 4th Floor, De Korte House, 46 De Korte Street, Braamfontein, Johannesburg.
Telephone: 011 7247226

- * Training for literacy teachers and literacy programme managers in 13 African languages and English and Afrikaans up to Std 4 level.
- * Participants in South Africa and Namibia, many of whom are in the rural areas.
- * A literacy programme with the Prison Service.

Publications and Resources
Information about training literacy teachers.

Name: Natal Adult Education Project (NAEP)
Street Address: 7 Crawford House, 111 Berea Rd, Durban, 4001.
Telephone: 031 312158

They teach groups of people to read and write in Zulu and English and train literacy teachers.

Name: Edendale Lay Ecumenical Centre
Postal Address: Box 63, Plessislaer, 4500, Natal.
Street Address: Lot 60, Plessislaer, Pietermaritzburg.
Telephone: 031 81618

- * Youth Project
 - * Skills training classes
 - * Training for domestic workers
 - * Agricultural project which has training courses in agriculture, nutrition, fish farming and organic methods
 - * They have a conference centre which anybody can use.
-

Name: Careers Research Information Centre (CRIC)
Postal Address: Box 78, Claremont, 7735, Cape.
Street Address: 7 Roscommon Rd, Claremont.
Telephone: 021 611058 or 611059

CRIC is a non-racial, non-profit organisation which helps people make decisions about careers. The service is free. People can write, telephone or go to their offices. They also run seminars and workshops on guidance in schools and other organisations.

Publications and resources
* Careers Information File which has information sheets about training and different careers. These can be bought cheaply by anyone.
* Newsletter

Name: Community Video Resources Association
Postal Address: c/o College of Music, University of Cape Town, Rondebosch, 7700, Cape.
Telephone: 021 691373

- * They have a training course in making and showing video films for community organisations in the Western Cape.

Publications and Resources

- * Video equipment for filming and showing.
 - * Video films which can be borrowed
 - * Information and advice to anyone interested in video films.
-

Name: GROW
Postal Address: Box 47100, Parklands, 2121, Transvaal.
Street Address: 6 Fourth Ave., Parkhurst, Johannesburg.
Telephone: 011 453772

- * A self-help scheme to encourage people to grow vegetables in their gardens, using organic methods. Their slogan is 'Don't feed your dustbin - feed your soil'. This is to encourage people to use kitchen waste to make compost and improve the soil for their vegetables.
- * They have a seed program which helps people to buy seeds cheaply.
- * GROW are part of the Organic Soil Association which is at the same address. The Organic Soil Association promotes organic gardening methods. They have a publication called SOIL NEWS and a shop which sells whole foods and books on organic growing and healthy eating.

Publications and Resources
* Simple teaching posters in 10 South African languages.
* Health education posters.
* A publication called 'Grow to Live' (see books)

Name: Human Awareness Programme (HAP)
Postal Address: Box 3221, Johannesburg, 2000, Tvl.
Street Address: 103 Kenlaw House, 27 de Beer St, Braamfontein, 2001.
Telephone: 011 396595

Consultation and training to help organisations and individuals concerned with change in South Africa, especially to help whites to prepare for change.

Publications and resources
* A regular newsletter about developments in the field of social change.
* A reference service on current research.
* Films and slide shows on subjects like trade unions, labour legislation, resettlement, South African history, and black political affairs.

Name: SRC Resource Centres
Postal Address: University of Cape Town, Private Bag, Rondebosch, 7700, Cape.

University of Witwatersrand, 1 Jan Smuts Ave, Braamfontein, Johannesburg 2001.

Projects and Programmes/Publications and Resources

A resource library of books, publications and articles dealing with alternative approaches to education, health, history, politics, development, culture, media, technology etc. They are going to build up a collection of photographs, posters and slide/tape shows which can be borrowed. The resources are available to anyone who asks. They welcome links with, and enquiries from, other centres.

Name: South African Council for Higher Education (SACHED)
Postal Address: Box 11350, Johannesburg, 2000, Transvaal.
Street Address: 6th Floor, Colstaven Building, 54 Simmonds Street, Johannesburg.
Telephone: 011 8341341 or 8341342

Formal and non-formal education programmes. Branches in Cape Town, Durban and Pretoria. To be opened in Port Elizabeth and Grahamstown. Write to Johannesburg for the addresses. They run Turret College, which is a correspondence college for Joint Matriculation Board course and Pitman's commercial courses.

Publications and resources

- * The Reader, a simply written newspaper.
- * Upbeat and Turret, two educational magazines (see magazines).
- * History course for high school students.

Name: South African Council for Higher Education (SACHED)
Postal Address: 5 Church St, Mowbray, 7700, Cape.
Telephone: 021 568615

Educational programmes to help school and university students with their studies and school teachers with teaching aids. The aim is not only to help students pass exams, but also to give them a meaningful education which they can use in their community when they have finished studying. These programmes include a maths course, an English course, tutorials in various subjects, an African studies course and English and history teaching aids for school teachers. They have just started a part-time further studies course for post-matric students who are working.

Publications and Resources

They publish and distribute educational books and distribute the publications of the SACHED branch in Johannesburg. They have a library and other educational resources which are available for use by community groups.

Name: Interchurch Media Programme (IMP)
Postal Address: Box 9942, Johannesburg, 2000, Transvaal.
Street Address: 1st Floor, Khotso House, 42 de Villiers Street, Johannesburg.
Telephone: 011 237586/7

They run courses in communication and media and help people to understand the role of mass media (newspapers, radios, films) in society.

Publications and resources

- * They have tape recording and film equipment which anybody can use or hire cheaply.
- * They have films and slide/tape shows on social issues.
- * They publish a regular newsletter, IMPART.



Name: Learn and Teach
Postal Address: Box 11074, Johannesburg, 2000.
Street Address: SARB House, 80 Commissioner Street, Johannesburg, 2001, Transvaal.
Telephone: 011 6182885

- * They teach people to read and write in African languages and English.
- * They train literacy teachers in African languages and English.
- * They give advice on adult education.

Publications

Learning materials in English and seven African languages including books on UIF, Workmens' Compensation, and South African history (see books) and a book of literacy codes (pictures to stimulate discussion in literacy classes).

Name: Self Help Associates for Development Education (SHADE)
Postal Address: Box 5065, Horison, 1730, Roodepoort
Street Address: Pigeon St Extension, Horison, Roodepoort
Telephone: 011 7631270

- * They have training programmes and educate people about consumer and producer co-operatives and credit unions.
- * They run a free 3 months sewing course in Johannesburg to train members of sewing groups.
- * They also train sewing groups in rural areas. Somebody from SHADE goes to stay with the groups for about 3 months to train them in sewing.
- * They run marketing training for production groups and help groups to find local and overseas markets.
- * They arrange scholarships for a 6 months diploma course in Canada in community development and co-operative training.

Publications and Resources

* Training materials for co-operative education in English, Zulu, Tswana, Sotho and Tsonga.

Name: South African Institute of Race Relations (SAIRR)
Postal Address: Box 97, Johannesburg, 2000, Transvaal.
Street Address: Auden House, 68 de Korte St, Braamfontein.
Telephone: 011 7244441

Branches: 5 Long Street, Mowbray, 7700, Cape.
Telephone: 021 666645

Oxford Street Shopping Centre, Oxford Street, East Londong, 5201.
Telephone: 0431 23610 or 23678

8 Guildhall Arcade, 35 Gardiner Street, Durban, 4001.
Telephone: 031 316810

* Education Information Centre: They give information to anybody about bursaries, scholarships and educational institutions. They also do career guidance, aptitude tests and help skilled workers to find jobs. They run JC and matric classes during the winter holidays and sometimes arrange classes for individual students.

* Research Department: They publish the Race Relations Survey each year. They also do research and publish papers on topical issues.

* Domestic Workers Education Project.

* Open School: They are a community arts project which runs classes in subjects like fine art, drama, writing, pottery and karate.

* The Institute has several shops where small production projects around the country can sell their products.

Publications and Resources

- * Books, magazines and other resources dealing mainly with race relations and related subjects in South Africa.
- * They have a library which includes a big collection of newspaper clippings.
- * Write and ask for a list of their publications.

LEGAL ADVICE

Most South Africans have only a few legal rights but many suffer because they do not know about even the few rights they do have. Others do not fight for their rights because they can not afford to get a lawyer and go to court.

Here is a list of some organisations and private lawyers who give free legal advice and fight cases free of charge.

Name: Black Sash
Addresses: Khotso House, 42 de Villiers St,
Johannesburg, 2001, Transvaal.
Telephone: 011 372435

St Columba's Church, 29 Schoeman Street
Pretoria, 0002

St Saviours Church, Loop Street (off
Commercial Road), Pietermaritzburg, 3201.

Central Court, 2 Gale Street, Durban,
4001.

7 Long Street, Mowbray, Cape Town, 8001.

Trinity Church, Oxford Street, East
London, 5201.

Raglan Road (Old Health Clinic) Opposite
Chan Henry, Grahamstown, 6140.

The Black Sash is a women's protest organisation and political pressure group whose aims are to promote justice democracy and human rights for all in South Africa, and to further the political education of South Africans. They run advice offices where members work voluntarily to help people who have problems with the pass laws.

Publications and Resources

- * SASH, a quarterly magazine.
 - * Pamphlets, booklets, brochures and fact papers on topical issues.
-

Name: Dependents' Conference
Postal Address: Box 31190, Braamfontein, 2017, Transvaal
Street Address: Khotso House, 42 de Villiers Street,
Johannesburg.

The Dependents' Conference is a division of the S.A. Council of Churches which helps families affected by security laws, by:

- * Paying for legal costs.
 - * Counselling people involved in political trials, banned persons and released political prisoners and their families.
 - * Providing some support for families of prisoners.
 - * Arranging prison visits for relatives of political prisoners.
-

Name: Legal Aid Bureau
Address: Arop House, Von Brandis Street,
Johannesburg, 2001.
Telephone: 011 294872

Legal Aid Bureau gives free legal help and is the best place to go for advice about housing and race classification problems.

Name: Legal Resources Centre
Address: Second floor, Innes Chambers, President
Street, Johannesburg, 2001.
Telephone: 011 374751

Legal Resources Centre helps people to fight cases in court which will set a legal precedent. This means cases which courts in South Africa have not dealt with in the past. For example, LRC fought a case in which a man who had worked in town for many years was refused permission to buy a house in town and bring his family to live there. They won the case so now many other people who have the same problem know that if they fight their cases in court they will win. All the help which LRC gives is free.

They also have a free law clinic at:

Room 323, Voortrekker House, corner Hoek Street and De Villiers Street, Johannesburg, 2001,

Telephone: 011 295356

This law clinic is run by 2 retired lawyers and is open from 8,30 to 11,30 on Monday, Tuesday, Wednesday, Thursday and Saturday mornings.

Name: Legal Aid Board
Address: Liberal House, 56 Marshall Street,
Johannesburg, 2001.
Telephone: 011 8360421

Legal Aid Boards are set up by the government to give free legal aid to people who can not afford to pay lawyers. They do not deal with pass law cases but will handle assault cases, theft cases and suing. There are Legal Aid Board offices in big towns and in small towns there is a Legal Aid officer at the regional magistrate's court offices. Legal Aid will find a lawyer for you, or if you have your own lawyer but can not afford to pay the fees, you can ask your lawyer to apply to the Legal Aid Board for the fees.

Name: Becker Street Advice Office
Address: 2nd floor, Pillan Building, corner Becker
Street and President Street, Johannesburg 2001.
Telephone: 011 8382593

This advice office was set up by the South African Council of Churches to give free legal advice to anybody arrested for a pass law offence. The office is open from 7,30 to 2,30 Monday to Friday.



Name: NUSAS Law Directive
Street Address: c/o Law Students Council, University of Cape Town, Rondebosch, 7700, Cape
Telephone: 021 698531

Branches: c/o Law Students Council, University of the Witwatersrand, Jan Smuts Ave Johannesburg 2000.
Telephone: 011 394011 Ext. 736

c/o Law Students Council, University of Natal,

The National Union of South African Students (NUSAS) has organisations at the above universities which help community and worker groups who need legal advice. The advice is free and they will also produce booklets or pamphlets or give talks and slide shows about legal matters.

There are also law clinics where people can get free legal advice at the following universities:

- * University of the Witwatersrand
- * University of Cape Town
- * University of Natal

COMMISSIONERS OF OATHS

A commissioner of oaths is somebody who can stamp and sign letters and papers to say that what you have written is true. When you fill in forms or write letters for magistrates or black commissioners or administration boards, they usually have to be signed by a commissioner of oaths. All of these people are commissioners of oaths:

Post office clerks
Magistrates
Lawyers
Black commissioners
Policemen

Commissioners of oaths can not charge for signing documents for you. It is free.

HEALTH

Health services in South Africa are controlled by the government and many communities do not have the clinics, nurses and medicines which they need for health care. These communities often have to look after their own health. The organisations we list here are non-government and help people to work together to improve health in their communities and in the whole country.

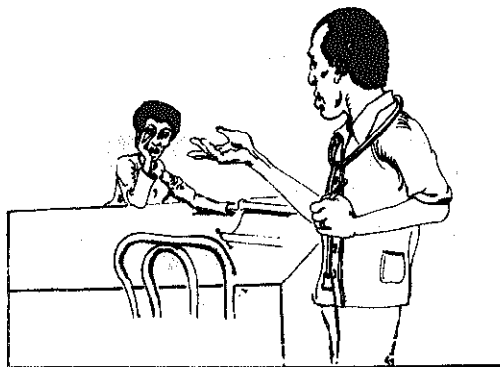

Name: Alcoholics Anonymous (AA)
Street Address: 66 Rissik Street, Johannesburg, 2001
Telephone: 011 377870

Alcoholics Anonymous helps anybody who wants to stop drinking. They have trained advisers who talk to people who have drinking problems and hold meetings at their branches all over the country. You can get the addresses of the branches from the Johannesburg office. Their service is free.

Publications

They have books and pamphlets about alcoholism which they will send to you.

Name: Imqualife
Postal Address: Box 509, Johannesburg, 2000, Transvaal.
Street Address: 1 West St, Westgate, Johannesburg, 2001.
Telephone: 011 836651

* Imqualife sells food like milk powder, peanut butter, soup powder, high protein biscuits and soya protein cheaply. They have a shop in Johannesburg and also send food to other places by train or bus.

* They sell food to farmers who want to improve their workers' rations.

* They sell christmas hampers to employers and make up monthly food parcels for employers to send to the families of workers or retired workers.

* They also sell to buying clubs, missions, clinics and school feeding schemes.

* They give advice on nutrition and have booklets of recipes.

Name: Compassion
Street Address: 1 Harris Rd, Rondebosch, 7700.
Telephone: 021 693689

* Promoting and selling wonderboxes for cooking and baking. The wonderboxes cost between R6,50 and R9,00 depending on the size. Wonderovens cost R8 and are used for baking on open fires or primus stoves.

* Promoting the use of soybeans as a substitute for meat and milk. Teaching people how to make soya milk.

Publications

* They have information about wonderboxes and wonderovens and how to make them and also how to grow and cook soybeans.

Name: Kupugani
Postal Address: Box 2113, Pietermaritzburg, 3200.
Street Address: 412 Main City Building, Longmarket Street, Pietermaritzburg, 3201, Natal.
Telephone: 031 51813

Branches:

8 Longmarket Street, Pietermaritzburg, 3201, Natal.
Telephone: 031 54433

15 Durham Avenue, Salt River, 7925, Cape.
Telephone: 021 472240 or 472241 or 472242

* They sell food cheaply to help fight malnutrition in South Africa. They have the same services as Imqualife.

Name: Family Life Centre - Marriage Guidance
Postal Address: 8th Floor, Old Arcade, 100 Market St, Johannesburg, 2001.
Telephone: 011 8332057/8/9

- * Family counselling.
- * Marriage and divorce counselling.
- * Youth counselling.
- * Counselling for people before they get married.

Publications

Booklets about families, marriage, divorce, sex and other related subjects.

Name: Health Care Trust
Street Address: 17 Main Rd, Mowbray, 7700, Cape Town.
Telephone: 021 691389

- * Training of village community health workers.
- * Research into industrial health.
- * Trying to educate people about the relationship between health and society.

Publications and Resources

- * Frontline On Health, a magazine for health workers such as nurses (see Books and Magazines).
 - * Booklets on noise, lead poisoning, gastro-enteritis and cotton dust disease.
 - * A Xhosa version of Community Action Brings Health (see Books and Magazines).
 - * A library of books and articles on health and society.
 - * Slide tape shows and posters.
-

Name: People Opposing Women Abuse (POWA)
Postal Address: Box 93416, Yeoville, 2143, Tvl.
Telephone: 011 7835027

- * POWA is an organisation concerned about the abuse of women in our society. It is affiliated to the Mental Health Society of the Witwatersrand. They help women who have been raped or beaten.
 - * They want to make people aware of such violence against women.
 - * They run training courses for anybody who wants to join POWA.
-

Name: Rape Crisis
Postal Address: Box 11486, Vlaeberg, 8018, Cape.
Telephone: 021 215400

- * They help the rape victim and her family over a number of months or years. They advise her on how to report the rape to the police and go to the police or court with her. They advise her about medical care, for example what to do if she gets venereal disease.
- * They talk about rape to groups like clubs, schools and hospitals.
- * They run training courses for members joining Rape Crisis and train community workers, doctors, nurses, lawyers, social workers and others who deal with rape.

Publications and resources

- * A library of articles and books.
 - * The film about rape called 'A Scream From Silence'.
 - * Pamphlet about rape.
-

Name: Rape Crisis
Postal Address: Box 38584, Overport, Durban, 4091, Natal.
Street Address: Lifeline Centre, Adrian Rd, Durban, 4001.
Telephone: c/o Lifeline 031 333 333

- * They give support and practical help to rape victims and their families.
 - * They educate women's groups, schools, service organisations, doctors, nurses, social workers, authorities and the public about rape.
 - * They work for changes in the medical and legal treatment of rape.
 - * They organise self-defence classes for women.
-

Name: South African National Tuberculosis Association (SAMTA)
Postal Address: Box 10501, Johannesburg, 2000, Transvaal.
Street Address: 621 Leisk House, Cnr Bree & Rissik Sts, Johannesburg.
Telephone: 011 299626

SAMTA tries to help control and prevent TB by training TB health educators, by educating communities and by doing research. They run a training course for health workers every 3 months.

Publications and Resources

- * SAMTA News and SAMTA Health Magazine.
 - * Posters, leaflets, health education kits, films and slides.
-

Name: Valley Trust
Postal Address: Box 33, Botha's Hill, 3660, Natal.
Street Address: Zulu Reserve Rd, Botha's Hill, 3660.
Telephone: 031 751930

- * Health care through better nutrition. They train people in nutrition and health education, agriculture, fish farming, poultry keeping and water supply.
 - * They have field workers in the Botha's Hill area working on these things.
 - * They run training courses in vegetable gardening and health for up to 10 people at a time. The charge is usually R4 per person per day, but it can be made cheaper if people cannot afford this.
-

Publications and Resources

- * Literature on agriculture, water supply, health education.
 - * Advice and information service.
-

Name: Family Planning Association
Street Address: 412 York House, 46 Kerk Street, Johannesburg, 2001.
Telephone: 011 8381440

Johannesburg Merlen House, Simmonds Street, Johannesburg, 2001.
Telephone: 011 8343562 or 8360740

Branches: 46B Brister House, Main Street, Port Elizabeth, 6001, Cape.
041 27287

43 Werd Muller Centre, Main Road, Claremont, 7700, Cape.

705 Commercial City, Commercial Rd, Durban, 4001, Natal.

- * Family planning and education
 - * Family planning clinics
 - * Cancer screening and pap smear tests for R1
 - * Pregnancy tests
 - * Training people for family planning and health work.
-

Publications and resources

library on family planning and related topics

WHERE TO GET FUNDS:

In this part of the book we give the names of some of the local organisations which give money for projects and bursaries for education and training.

The fund-raising laws in South Africa do not allow projects to raise money from overseas or from street collections. But you can raise funds from local companies, organisations or individuals.

If you want to get money from overseas, you have to sign contracts, the same as if you were a company doing business with an overseas company. If you would like more advice about entering into a contract with an overseas financing partner, contact EDA.

Name: The Anglo American and De Beers Chairmans Fund
Postal Address: Box 61567, Marshalltown, 2107.
Telephone: 011 8388111 Extension 5155 or 5303

They give money to education and community development projects. They like projects to have a clear idea of how they want to develop. They prefer to support the projects of organisations that aim to be self-reliant.

Name: Desmond Leech Bequest
Postal Address: c/o Syfrets, Box 61058, Marshalltown, 2107.
Telephone: 011 8336415

The Desmond Leech bequest gives financial assistance to community projects that encourage self-reliance and promote community involvement.

Name: Inter-Church Aid
Postal Address: Box 31190, Braamfontein, 2017, Transvaal
Street Address: Khotso House, 42 De Villiers Street, Johannesburg, 2001.
Telephone: 282251

They give funds and loans to projects working in health, agriculture, water supply, home industries, education and culture. Projects do not have to be linked to churches.

Name: African Bursary Fund (South African Council of Churches)
Postal Address: Box 39110, Braamfontein, 2017, Transvaal
Street Address: Khotso House, 42 de Villiers St, Johannesburg.
Telephone: 011 282251 or 282252 or 288253

They give bursaries to students in rural areas. The bursaries cover books, school fees, boarding fees, examination fees. They also give some university and technical college bursaries. It is best to apply early, before the end of August.

Name: SAMST and SASET Trust
Postal Address: 17 Main Road, Mowbray, 7700, Cape Town.
Telephone: 021 691389

* South African Medical Scholarships Trust (SAMST): They give grants and loans for students of medicine and related studies and to paramedical trainees.
* South African Students Education Trust (SASET): They give scholarships and loans for students studying at teacher training colleges or universities.

Name: Loewenstein Trust; P.M. Anderson Trust
Postal Address: Netboard, Box 61056, Marshalltown, 2107.
Telephone: 011 8367771

* Loewenstein Trust: They give bursaries and grants to charitable and educational organisations.
* P.M. Anderson Trust: They give bursaries for any South African university for any courses.



Name: Rural and Community Development Trust
Postal Address: Box 32205, Braamfontein, 2017, Johannesburg.
Telephone: 011 6488111

They give grants and loans to small community projects mainly in rural areas. They assist projects in organisations and financial planning. Projects can apply in any South African language.

ADVICE FOR WORKERS

This is a list of the most important organisations which can advise workers. There are many trade unions which we have not listed, but if you write to the ones we have given, they will send you the information you need. Many workers' have problems which need advice from lawyers, so you should also read about legal advice organisations.

Name: Domestic Workers and Employers Project (DWEF)
Addresses: 101 Kenlaw House, 27 de Beer Street, Braamfontein, 2017, Johannesburg.
Telephone: 011 396757

St Andrews Centre, 21 St Andrews Street, 4001, Durban.
Telephone: 031 318322

5 Long Street, Mowbray, 7700, Cape Town.
Telephone: 021 666645

- * They run a counselling office where domestic workers may make complaints which are investigated.
- * They publish recommended wages for domestic workers.
- * They help to organise Centres of Concern where domestic workers may come to learn skills and meet people.
- * They run weekend leadership training courses for domestic workers.

Publications

- * Domestic Workers: A Handbook for Housewives.
- * Domestic Workers: A Guide for Employers
- * Huisbedienendes: 'n Handboek vir Huisvroue
- * Newsletters
- * Reports on Centres of Concern.

Name: Industrial Aid Society (IAS)
Postal Address: Box 261119, Excom, 2023, Transvaal.
Street Address: 409 Lekton House, 5 Wanderers Street, Johannesburg.
Telephone: 011 235820

- * They have a complaints service where workers can bring complaints connected with their work.
- * They help people to claim wages, unemployment benefits, workmens compensation, pension refunds.
- * They help people with problems about their contracts.
- * They advise workers how to join unions.

Resources and Publications

- * They can give information and advice on:
 - Health and safety at work
 - Pensions
 - Cost of living
 - Unemployment benefits
 - Laws affecting workers
 - Contracts and migrant workers
 - Education
- * They have books and Government Gazettes and other information on most of the laws covering workers, for example Industrial Council Agreements and Wage Determinations.

Name: Johannesburg Organisation to Boost Self-help (JOBS)
Postal Address: Box 4769, Johannesburg, 2000, Transvaal.

Street Address: 703 Metro Centre, 266 Bree St, Johannesburg, 2001.
Telephone: 011 291916/7

* Jobsenter - a free employment service.
* Centre for Development Skills - training and guidance for work-seekers and self-help projects.

TRADE UNIONS

Name: South African Allied Workers Union (SAAWU)
Address: 94 Tasmin Centre, 122 Victoria Street, Durban 4001, Natal
Telephone: 031 69217

Address: 816 Lekton House, 5 Wanderers Street, Johannesburg 2001, Transvaal.
Telephone: 011 294176

Address: 214 Kemp Square, 11 West Street, Kempton Park, 1620, Transvaal
Telephone: c/o 294176

Address: 1st Floor, Union Arcade, Union Street, East London, 5201, Cape
Telephone: 0431 26899

SAAWU is a general workers union which organises workers in all industries. At present, it organises workers in the following industries: electrical engineering, hotels and flats, iron and steel, mines, printing, road, sea and air transport, baking, food, textiles, chemicals, sugar, sweets, beverages, carpets and floor coverings, stevedores, municipalities, building cleaning services, shops and offices, and other industrial, commercial and distributive concerns. SAAWU also organises blind workers and runs a hawkers association, a commuters association and a youth workers union. They are also organising farm workers, domestic workers and unemployed workers.

Name: General Workers Union (GWU)
Address: Benbow Buildings, Beverley Street, Athlone, 7764, Cape.
Telephone: 021 670870

Address: 164 Main Gate Street, Durban 4001, Natal.
Telephone: 031 32 1928

Address: Court Chambers, 263 Main Street, Northend Port Elizabeth, 6001, Cape
Telephone: 041 54 1584

Address: 1st floor, Union Arcade, Union Street, East London, 5201, Cape
Box 7002, East London, 5200, Cape
Telephone: 0431 26899

GWU used to be called the Western Province General Workers Union, WPGWU. It is a general workers union which organises workers in all industries, including meat workers, stevedores, textile workers and construction workers.

Name: Federation of South African Trade Unions (FOSATU)
Address: 1 Central Court, 125 Gale St, Durban, 4001, Natal.
Telephone: 031 69215

Address: 302 Sacta House, 277 Bree St, Johannesburg 2001, Transvaal.
Telephone: 011 235878

Address: 7 Fines Building, 28 Voortrekker St, Benoni, 1500, Transvaal.
Telephone: 011 543663

Address: 2 Goodhope St, Bellville, South, 7530, Cape.
Telephone: 021 951412

Address: 234 Caledon St, Maitenhage, 6230, Cape.
Telephone: 0422 29403

Address: 9 Lotus Building, Cottrell St, Port Elizabeth, 6001, Cape.
Telephone: 041 46010

Address: Room 22, CNA Building, Merriman Avenue, Vereeniging, 1930, Transvaal.
Telephone: 016 224743

This is a federation of unions. Some of the industrial unions that are part of FOSATU are in the following industries: chemical, food and sweets, engineering, glass, jewellers and goldsmiths, metal workers, motor assembly and rubber, textile, paper and wood and transport.

Name: Council of Unions of South Africa (CUSA)
Address: 2nd floor Estromin House, Simmonds/Pritchard Sts, Johannesburg, 2001, Tvl.
Telephone: 011 8345012

This is also a union federation. They have unions organising in the following industries: building and construction, food and beverages, laundry, drycleaning and dyeing, chemicals, steel and engineering, transport, and motor assembly.

Name: Commercial, Catering and Allied Workers Union of South Africa (CCAWUSA)
Address: Hotel, Liquor and Catering Trade Union 2nd Floor, Khotso House, 42 de Villiers St, Johannesburg, 2001, Transvaal.
Telephone: 011 230531 or 230532

These two unions organise workers in the commercial, catering, liquor, hotel and allied trade.

Name: Domestic Workers Association (DWA) (Cape Town)
Address: 7 Church St, Cape Town, 8001, Cape.
Telephone: 021 228936/222116

DWA is organising domestic workers and is trying to start a domestic workers trade union.



Name: Industrial Aid Centre
Address: 312 Trevor Building, Voortrekker St.
Vereeniging, 1930, Transvaal.
Telephone: 016 224743

This is an aid organisation that assists workers with legal and other problems related to their jobs. They are also organising workers in all industries through the Orange Vaal General Workers Union.

Name: Industrial Health Research Group
Postal Address: Department of Sociology, UCT, P.O.
Rondebosch, 7700, Cape.
Street Address: Department of Sociology, University of
Cape Town, Rondebosch, Cape Town.
Telephone: 021 698531 x 395

This group is writing a book about health and safety in places where people work. It is being written for workers and for worker organisations

Name: South African Domestic Workers' Association.
Address: 101/3 Kenlaw House, 27 de Beer Street,
Braamfontein.
Telephone: 39-6757

Address: St Andrews Centre, St Andrews Street,
Durban, 4001.
Telephone: 31-8322

Address: 5 Long Street, Mowbray, 7700.
Telephone: 66-6645

SADWA was launched in the Transvaal and Natal in early 1981. The membership fee is R3,00 per year. Meetings are held throughout the year.

Name: General Allied Workers Union (GAWU)
Address: 2nd floor Abbey House, 51 Commissioner St.,
Johannesburg, 2001, Transvaal.
Telephone: 011 8344559

This is a general workers union. It organises all unorganised workers including scooter drivers, cleaners, domestic workers, mine workers, manufacturing workers (eg brush and broom workers, glass workers), security guards, railway workers, jute bag workers, etc.

Name: Food and Canning Workers Union
Address: African Food and Canning Workers Union
101 City Centre, 18 Corporation Street,
Cape Town, 8001.
Telephone: 021 22459

Address: 816 Lekton House, 5 Wanderers Street,
Johannesburg, 2001.
Telephone: 011 235836

Address: 1st floor, Union Arcade, Union Street,
East London 5201, Cape
Telephone: 0431 26899

Address: 94 Tasmin Centre, 122 Victoria Street,
Durban, 4001, Natal.
Telephone: 031 69217

These unions organise workers in the food and canning and allied industries.

Name: Black Municipal Workers Union (BMWU)
Address: 207 Cambridge House, 59 Sauer St.,
Johannesburg, 2001, Transvaal.
Telephone: 011 8342268

BMWU organises all workers in the Johannesburg municipality.

Name: National Federation of Workers (NFW)
Address: 1004 Valley Centre, 44 Lorne St, Durban
4001, Natal.
Box 47011, Greyville, 4023, Natal.
Telephone: 031 64847

This is a general workers union which will organise in all industries. At the moment, they are active in liquor and catering, building and allied trades, iron, steel and metal, and they are organising domestic workers.

Name: General Workers Union of South Africa (GWUSA)
Motor Assembly Combined Workers Union of South Africa (MACWUSA)
Address: 623 Main St, Northend, Port Elizabeth,
6001, Cape.
Box 2924, Northend, 6056, Cape.
Telephone: 041 544245

GWUSA is a general workers union, organising in all industries including bakeries, building, metal, textiles, etc. (excluding the motor industry). MACWUSA organises all workers in the motor and allied industries.



CONFERENCE CENTRES

Below we list some of the conference centres in South Africa. They are open to all races and to all groups for all kinds of meetings. The prices we have given change from time to time so write to them for further information.

Name: Xavier Youth Centre
Address: 324 Lansdowne Rd, Lansdowne, 7700, Cape Town, Cape.
Telephone: 021 642055

Maximum number of people: 35
Provided: People should take their own food and bedding. Kitchen facilities include crockery and cutlery, dining room and 2 meeting halls, seating a total of 130 people and a church hall.
Booking: 2-3 months in advance for weekends and holidays.
Price: R3 per person per day on weekends, cheaper during the week.



Name: Smuts Hostel and Happy Haven Hostel
Address: Mr Grasiff, Glen Cottage, Glen Road, Cairn, 7995, Cape.
Telephone: 021 823679

Maximum number of people: Smuts Hostel - 64; Happy Haven Hostel - 55. Camp site for 30 tents
Provided: Smuts Hostel has a gas stove and a deep freeze. Happy Haven has a coal stove. Visitors must take their own food, cooking and eating utensils and bedding.
Booking: At least two months in advance for weekends.
Price: R50 for Happy Haven Hostel for weekends. R65 for Smuts Hostel for weekends. R15 for Happy Haven for weekdays. R20 for Smuts Hostel for weekdays.

Name: Monastery Retreat House
Address: P.O. Marianhill, 3601, Natal.
Telephone: 031 723355

Maximum number of people: 60
Provided: Full board during the week. Not available for weekends.
Booking: At least 6 months in advance.
Price: R9,00 per person per day.

Name: Isinamva
Address: Transkei Community Development Centre, Box 72, Mount Frere, Transkei, Cape.
Telephone: Mount Frere 502

Maximum number of people: 50
Provided: Food and bedding
Booking: 2-3 months in advance.
Price: Please phone them to get prices.

Name: Maryland Centre
Address: Summit Rd, Hanover Park, 7700, Cape.
Telephone: 021 677342

Maximum number of people: 62
Provided: Full board.
Booking: 6 months in advance.
Price: R8 per person per day.

Name: St Ansgars
Address: Box 59, Roodepoort, 1725, Transvaal.
Ontdekkers Rd, Roodepoort.
Telephone: 011 7631826

Maximum number of people: 60
Provided: There is a kitchen but groups must bring their own food and cooking utensils.
Booking: 3 months in advance.
Price: R2 per person per night with own bedding. R3 per person per night, bedding provided. R5 per day for use of kitchen.

Name: St Peters Conference Centre
Address: Box 10, Hammanskraal, 0400, Transvaal.
Telephone: 012012 33

Maximum number of people: 110
Provided: Full board
Booking: 2 weeks in advance
Price: R8 per person per day.

Name: Hout Bay Round Table Camp Site
Address: Colin Bird, Hout Bay/Llandudno Round Table Box 12, Hout Bay, 7872, Cape.
Telephone: 021 17146 (Colin Bird during business hours).

Maximum number of people: 25 to sleep.
Provided: dormitories, lecture room and kitchen facilities and utensils for groups to do their own catering. People should take their own bedding.
Booking: 12 months in advance for long weekends and holidays. Off season bookings one month in advance.

Name: Red Acres Retreat Centre (Howick)
Address: Private Bag 3007, Pietermaritzburg, 3200, Natal.
Telephone: 031 33293 (weekday afternoons only) 03321 2289 (other times)

Maximum number of people: 60
Provided: Full board or groups can take their own food and bedding.
Booking: Up to 12 months in advance. Otherwise phone anytime for possible cancellations.

Name: Koinonia Conference Centre
Address: Old Main Road, Botha's Hill, Natal.
Box 88 Botha's Hill, 3660, Natal.
Telephone: 031 751956 (Call-box 031 751237)

Maximum number of people: 120 altogether spread over 3 different sites.
Provided: Full board or groups can take their own food and bedding. One blanket and one pillow per person is provided. People should take other bedding in winter because it is very cold.
Booking: At least 12 months in advance for weekends and holidays, deposit R25. Not available over Christmas.
Price with food: Groups of 1 - 29: R6,50 per day per person. Groups of 29 - 44: R5,50 per day per person. Groups of 45 - 72: R4,50 per day per person.
Price without food: R2,00 per person per day.

Name: St Peters Lodge
Address: Box 49027, Rosettenville, 2130.
Telephone: 011 261874

Maximum number of people: 34
Provided: Full board. Centre can seat 60 people in the dining room; there are two conference rooms of 70 and 40 seats, and two chapels of 75 and 16 seats.
Booking: At least two months in advance. Centre is closed for 2 weeks at Easter and at Christmas.
Price: R11 per person per day.

Name: Eagles Ridge
Address: Box 127, Stutterheim, 4930, Cape.
Telephone: 04362 324

Maximum number of people: 50
Provided: Full board. They have a wine and malt licence.
Booking: A few months in advance by telephone.
Price: Room with bathroom: R15 per person per day.
Room without bathroom: R13 per person per day.

Name: Camp Jonathan
Address: c/o W. Freer, Camp Jonathan, Eston, Natal.
Box 296, Richmond, 3780, Natal.
Telephone: 033222 2411

Maximum number of people: 150
Provided: Full board or groups can bring their own food and bedding. There are sporting facilities, including a swimming pool.
Booking: It is best to book at least 12 months in advance for weekends and holidays.

Name: Vital Link P E C C
Address: Box 5200, Walmer, 6065, Cape.
Marine Drive (17 kms from Port Elizabeth centre. There is no public transport to the site).
Telephone: 041 361363

Maximum number of people: 40 in bunk beds; places to put up tents.
Provided: Facilities for cooking; hall, piano, tables and chairs. Groups must bring their own food and cooking things and bedding.
Booking: 3-4 months in advance. They do not allow any alcohol on the premises.
Price: R1 per person per day. R1 per day for use of gas stove.

Name: Wilgespruit Fellowship Centre
Address: Box 81, Roodepoort, 1725, Transvaal.
Pigeon St Ext, Horison, Roodepoort, Tvl.
Telephone: 011 7632650

Maximum number of people: 80
Provided: Full board or groups can bring their own food and bedding. The centre can be used for day picnics.
Booking: 3-6 months in advance.
Price: Day picnics: Adults - 30c Children - 15c.
Full board: R8,25 per day.

Name: Lutheran Youth Centre
Street Address: 8th Ave., Athlone, Cape Town.
Postal Address: Box 113, Athlone, 7760, Cape.
Telephone: 021 672886

Maximum number of people: 60
Provided: Full board. They ask people from Cape Town to bring their own bedding. There is a lecture room, library, a dining room which seats 100, a church hall which seats 300 and 4 dormitories with 16 beds each.
Booking: One month in advance.
Price: R5 per person per day.

Name: Waverley Hills
Address: Box 66, Uitenhage, 6230, Cape. 25 kms from Uitenhage and 40kms from Port Elizabeth (on the road towards Humansdorp).
Telephone: 0422 5429

Maximum number of people: 34
Provided: Full board. There is a swimming pool and nature walks.
Booking: 4-6 months in advance. Please phone in the evenings between 6 and 7pm.
Price: R8 per person per day. R1 extra for bedding.

Name: KwaNzimela Conference Centre
Address: Private Bag 802, Melmoth, 3835, Natal.
KwaMagwaza Farm, near Melmoth.
Telephone: 035422 290

Maximum number of people: 96
Provided: Full board and lodging. It is a cold place so take warm clothing and an extra blanket. Chapel for 60 people. Meeting hall for 80. 2 Committee rooms. Lounge for about 20. A library.
Booking: 3-6 months in advance. Write and ask for the KwaNzimela application form.
Price: R7,25 per person per day.

Books and Magazines

The only books that most people read on subjects like history, agriculture and health are those which are prescribed as textbooks by schools or training colleges. Here we give a list of some of the many other books and magazines on these subjects and other subjects. Many of these books are expensive so you may decide to buy them for a library. We have not given prices because prices of books often change and are soon out of date. Write to ask about prices before you order.

Ordering books

Book suppliers prefer people to send a postal order or a cheque when they order books. If you order books or magazines from an overseas publisher or book supplier, you first have to write and ask them to send you an invoice. Then you have to take the invoice to a bank and get a foreign bank draft, which is a cheque in overseas currency. Only then can you order the book. It usually takes about 8 weeks.

You can also order overseas books through bookshops, although you will have to pay more than if you order directly.

Overseas Book Suppliers

All these suppliers will send free booklists and catalogues if you write to them.

■ Catholic Institute for International Relations (CIIR), 1 Cambridge Terrace, London NW1 4JL, U.K.

Books and pamphlets on the church, politics and development.

■ Development Education Centre (DEC), 121 Avenue Rd, Toronto, Ontario, M5R 2G3, Canada

Books and pamphlets on development from many countries.

■ Intermediate Technology Development Group (ITDG), 9 King St, London WC2E 8HN, U.K.

Books on appropriate technology and the magazine *Appropriate Technology*.

■ Institute for Food and Development Policy (IFDP), 2588 Mission St, San Francisco, California 94110, U.S.A. Books on development, land reform, and the political causes of food shortages in underdeveloped countries.

■ Ross Institute, London School of Hygiene and Tropical Medicine, Keppel Street, London WC1E 7HT, U.K.

Booklets on tropical diseases and water supply and treatment.

■ Foundation for Teaching Maths at Low Cost (TALC), 30 Guildford St, London WC1N 1EH, U.K.

Books on health care. Special low prices for health workers.

■ Third World Publications, 151 Stratford Rd, Birmingham, B11 1RD, U.K.

Wide selection of books and pamphlets about Africa, Asia and Latin America.

■ Volunteers in Technical Assistance (VITA), 3706 Rhode Island Avenue, Mount Rainier, Maryland, 20822, U.S.A.

Books and pamphlets on simple technologies. You can also write to them for advice on technical problems.

■ Volunteers in Asia (VIA), Box 4543, Stanford, California, 94305, U.S.A.

Books on appropriate technology.

■ World Health Organisation (WHO), 1211 Geneva 27, Switzerland

Books and magazines on health, from simple to very scientific publications.

■ Zed Press, 57 Caledonian Rd, London, N1 9DN, U.K.

Books on politics and the struggle against imperialism in underdeveloped countries.

EDA Book Service

EDA has a non-profit book service. We charge 10% to 20% extra on to the price we pay for books. This extra amount covers postage, packing and sales tax as well as helping to pay for the work of running the book service. Most bookshops add 60% or even more to the prices they pay for books, so books from EDA are cheaper.

Magazine Centre

We have written 'Order from Magazine Centre' for some books. Magazine Centre is a big technical bookshop which sells books on how to make things and how to maintain and repair things. If you tell them exactly what you are interested in, they will send you a list of books on that subject. Their address is Magazine Centre, Box 4190, Johannesburg, 2000. If you say you are ordering a book which you read about here, they will give you a 5% discount.

Starting a Library



There are very few bookshops in rural areas and buying books in town is expensive. Most people only read school books and church books. But there are many other kinds of books - books which teach people how to do things and make things, book about history and politics, and novels and stories. If you have a library, many people will be able to read the books without buying them. A library is a place for books and magazines. It can also be used as a place to meet, to hold discussions, and to study.

There are many different kinds of libraries. You can have a library with books on subjects like agriculture or carpentry which can be used by people who need this information for their work. Or you can have a general kind of library, with books on all subjects. The first thing to do is decide who the library is for. Is it only for people who have been to high school? Is it for people who need information about their work? Is it for children and adults who are learning to read and write? Many people would be interested in books on education, history, politics - because these subjects are not covered properly in school books. Such a library could also have fiction and poetry by African writers which are not taught in schools. It could also have newspapers and magazines which write about peoples' real problems and interests.

The Library Room

The room should be big enough for people to sit comfortably to read. It must have a strong floor so that it can carry the weight of the bookshelves. It must have windows for air and light.

You might be able to find a suitable room at a school or church, or you might have to build it yourself. You will need a cupboard or a bookshelf for the books and tables and chairs.

Getting Books

Books are expensive and most communities do not have enough money to buy them. There are organisations which can help with grants to libraries or donations of books, such as the British Council and the US Information Service. EDA has its own library and we can give you information on books about rural development. Some churches and big libraries can get you second hand books. If you have been given lots of second hand books, try to organise a group of library members to look at them and decide whether they should go into the library, because many donated books are useless and nobody will read them.

Running the Library

Somebody must be in charge of the library. This can be one person, or the work can be shared by a group of people. They must keep a record of all the books being borrowed, make sure that people return them on time, send out books by post (if the library includes a postal service) and put books in order on the shelves. A library should not be open without the librarian being there, so it depends on the librarian what time the library will be open.

There are different systems you can use. A simple way is to use a card for each person. Each person gets a card the first time he or she borrows a book. The librarian fills in this card and keeps it in a safe place. Whenever that person borrows a book, the librarian must write on the card, the author, title of the book and the date. In 2 weeks when the person brings the book back, this must be crossed out.

BOOKS

HISTORY OF SOUTH AFRICA

Gold and Workers - A People's History of South Africa
By Luli Callinicos, Ravan, 1981, 113 pages
Order from Ravan Press or EDA
Simply written history of South Africa up to 1924. Well illustrated with photographs. A second volume from 1924 to the present is planned.

History of South Africa
By Learn and Teach, in booklets about 40 pages each
Order from Learn and Teach or EDA
These booklets are written for adults learning to read and write, but they are a good introduction to South African history for anybody. The booklets published so far deal with South Africa up to colonial times. Available in English, Zulu, Sotho, Tswana, Xhosa, Tsonga, Pedi and Venda.

African Studies Course in 8 volumes
by Sached
Order from Sached
Africa from precolonial times to the present. 5 volumes on African history, 1 on Women in Africa, 1 on African Literature, 1 on South African history. Written for a Standard 8 reading level.

Southern Africa since 1800
by Donald Denoon, Longmans, 1972, 242 pages
Order from EDA or any bookshop
Introduction to Southern African history suitable for high school students. Deals with precolonial African states, white settlement, the development of capitalism in mining, agriculture and manufacturing and how this development has affected economic and social relationships between races.

Power to the People
by Peder Gouwenius, Zed Press, 1981, 140 pages
(banned for distribution in South Africa)
Cartoon history of South Africa up to 1960. Deals mainly with postcolonial developments, especially political struggles against white supremacy. A second volume from 1960 up to the present is planned.

POLITICS

From Rhodesia to Zimbabwe
by Catholic Institute for International Relations, 9 booklets about 50 pages each
Order from Catholic Institute for International Relations or EDA
Written before Zimbabwe's independence, these booklets look at ways in which Zimbabwe could change towards a better distribution of land and wealth. The titles are:
* Alternatives to Poverty
* The Land Question
* The Unemployment Crisis
* Skilled Labour and Future Needs
* The Informal Sector
* Beyond Community Development
* The Struggle for Health
* The Food Problem
* Education for Employment

How Europe Underdeveloped Africa
by Walter Rodney, Howard University Press, 1974, 288 pages
(banned for distribution in South Africa)
A radical analysis of the effects of colonialism by an African historian.

The Creation of World Poverty. An Alternative to the Brandt Report
by Teresa Hayter, Pluto Press, 1981, 128 pages
Order from EDA or any bookshop
Describes how western capitalist countries came to dominate Asia, Africa and Latin America: first by looting, then by controlling trade and destroying local production, then by multinational industrialisation which brought them high profits through cheap labour.

African Population Relocation in South Africa
by Gerhard Mare, SAIRR, 1980, 109 pages
Order from SA Institute of Race Relations
Thousands of South Africans are moved every year from white farms and black spots and resettled in rural slums. This book analyses why and where this is happening.

Land, People and Power - The Question of Third World Land Reform
by Oxfam Canada, 1977, 80 pages
Order from Development Education Centre or EDA
The food crisis in the underdeveloped countries is not because of bad farming but because most rural people have very small plots or no land at all. This book discusses different kinds of land ownership and how they can be changed. Case studies from Guatemala, India and China.

The Wealth of Some Nations
by Malcolm Caldwell, Zed Press, 1977, 113 pages
Order from Zed Press or EDA
Explains how the exploitation of the third world and the energy crisis in western capitalist countries are closely linked. Analyses the economics of food production and concludes that third world agriculture is more efficient than western agriculture and has a better chance of survival in the future.

South African Publishers

- Ravan Press, Box 31134, Braamfontein, 2017.
Books by South African writers and Staffrider magazine. Write and ask for their catalogue.
- South African Institute of Race Relations (S.A.I.R.R.) Box 97, Johannesburg 2000.
Books and pamphlets about subjects affecting race relations.
- South African Council for Higher Education (SACHED), Box 1135, Johannesburg, 2000.
Education organisation which publishes educational magazines and school correspondence courses.
- Learn and Teach, Box 11074, Johannesburg, 2000.
Educational organisation which teaches people to read and write. They publish post-literacy reading books and a magazine. Write and ask for a catalogue.
- Foundation for Social Development (FSD), 7 Roscommon Road, Claremont, 7700.
Booklets on legal rights.

How Capitalism Works
by Pierre Jalee, MR Books, 1977, 128 pages
Order from EDA or any bookshop
A simply written economic analysis of western capitalist societies.

Mozambique and Tanzania - Asking the Big Questions
by Frances Moore Lappe and Adele Beccar-Varela, IFDP, 1980, 128 pages
Order from Institute for Food and Development Policy or EDA

Looks at the differences between development policies in Mozambique and Tanzania. Concludes that Mozambique's socialism is stronger because society in Mozambique is democratic at national and local levels.

REFERENCE BOOKS

Appropriate Technology Sourcebook
by Ken Darrcw, Kent Keller and Rick Pam, Volunteers in Asia, 1981, 816 pages (in 2 volumes)
Order from Volunteers in Asia or EDA
Describes about 500 books and plans on appropriate technology and rural development. Not so good on political analysis but good on technical subjects.

The Farmers Encyclopedia/Boere-Ensiklopedie
Edited by Buckland Publishers, 1210 pages
Order from Magazine Centre or any bookshop
Out of date, written in English and Afrikaans and difficult to read but the only book that deals with all aspects of farming in South Africa.

Village Technology Handbook
by VITA (Volunteers in Technical Assistance), 1978, 387 pages
Order from VITA or EDA
Collection of plans and instructions on appropriate technology, from hand-operated washing machines to drilling wells. The most complete section is on water supply. The book has no information or case studies on how any of this equipment worked.

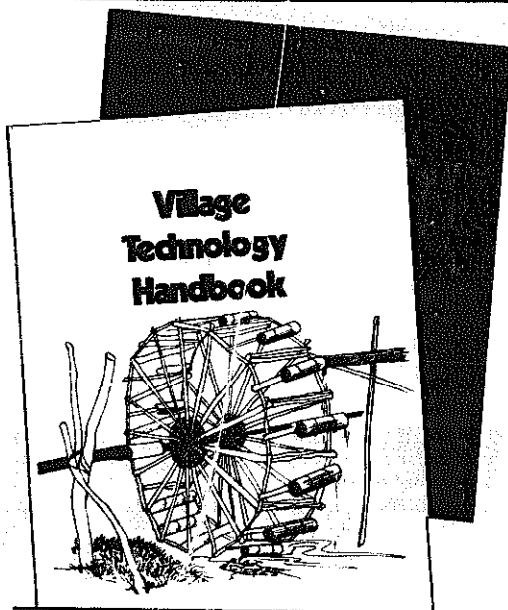

HOMESTEAD FARMING

Vegetable Gardening in South Africa
by Jack Hadfield, Purnell, 1967, 227 pages
Order from EDA or any bookshop
Information about varieties, times of sowing and transplanting, soils, pest and disease control and harvesting of different vegetables.

All About Tomatoes
by Vincent Wager, Purnell, 1976, 88 pages
Order from EDA or any bookshop
All about growing tomatoes.

Grow To Live
by Marie Roux, 1981, 44 pages
Order from EDA or Organic Soil Association, Box 47100, Parklands, 2121, Johannesburg
Enthusiastic introduction to organic gardening methods for small urban gardens.

Raising Chickens and Rabbits
by Chiro Youth Movement, 1976, 100 pages
Order from EDA
Low cost methods which have been used in rural communities. Also available in Zulu.

The Butchershop in the Backyard Handbook
by Lennart Blomquist, 1975, 58 pages
Order from EDA
Zimbabwean book on raising goats, sheep, ducks, chickens, rabbits and pigs intensively at low cost.

The ABC and XYZ of Bee Culture
by AI Root and Co, 1970, 726 pages
Order from Magazine Centre
Detailed reference book on all aspects of beekeeping, but difficult to read.

A Beekeeping Handbook
by B. Clauss and L. Tiernan, KRDA, 1980, 65 pages
Order from EDA or KRDA, Private Bag 7, Molepolole, Botswana
Botswana book on how to keep bees and how to make simple beekeeping equipment such as hives out of cardboard boxes reinforced with cowdung, and smokers from tin cans. Well illustrated with photographs.

The VFC Intensive Unit
by Dudley Hall, 24 pages
Order from Young Farmers Club Association, Box 8188-Causeway, Salisbury, Zimbabwe or EDA
How to grow food and raise small livestock in 100 sq m garden. Half the garden is used for vegetables, the other half to grow food for chickens and rabbits.

CROPS

East African Crops
by J.D. Acland, Longmans/FAO, 1971, 252 pages
Order from EDA, ITDG or any bookshop
There are no good books on crops for small farmers in South Africa. This book was written for farmers in East Africa but it deals with most crops grown in South Africa. Well written and illustrated with full information on land preparation, planting, cultivation, pest and disease control and harvesting for each crop.

Biological Pest Control
by Albert Lindle, 1976, 88 pages
Order from EDA or Organic Soil Association, Box 47100,
Parklands, 2121, Johannesburg
Introduction to organic methods of pest control (using no
chemical poisons) for South African conditions.

Some Principles of Irrigation
by DPH Giles and J. Browning, University of Botswana,
Lesotho and Swaziland, 1974, 33 pages
Order a photocopy from EDA
Swaziland booklet on irrigation methods for small farmers
and extension officers.

Small Scale Irrigation
by Peter Stern, ITDG, 1979, 152 pages
Order from ITDG or EDA
Explains different methods of irrigation for small farmers,
how to make irrigation channels, how to find out how much
water you need for your crop and your soil.

Appropriate Technology for Grain Storage
by Community Development Trust Fund of Tanzania, 94 pages
Order from Economic Development Bureau, Box 1717, New
Haven, Connecticut, 06507, USA or from EDA
Successful use of literacy teaching to design grain
storage bins with villagers in Tanzania. Efficient
storage bin designs. An example of how to work with
communities on their technical problems.

Agricultural Publications
by Agricultural Technical Services
Order from your extension officer or Division of
Agricultural Information, Private Bag X144, Pretoria,
0001

The S.A. Department of Agriculture and Forestry publishes
papers on every crop, vegetable and tree. New papers are
published all the time which give the latest research
information. They are quite difficult to read and written
for farmers who have enough money to spend on fertilisers,
seed and poisons, but some papers are useful for small
farmers. Most of the papers are free. Their publications
list is free and it gives all their books and papers, with
prices.

The Agricultural Engineering Division also publishes
papers on using agricultural machinery, irrigation and
other subjects. Write to them for a list of their publi-
cations: Division of Agricultural Engineering, Private
Bag X515, Silverton, 0127.

Two useful books from Agricultural Technical Services are:

Pesticides and Fungicides, 1978, 210 pages
It gives a complete list of all agricultural chemicals
sold in South Africa to kill pests and diseases of vege-
tables, fruit and crops.

Farm Records
A complete set of farm records including rain, livestock,
livestock products, crop and cash records. The set comes
with instructions on how to keep records and blank record
sheets.

TREES AND FUEL

Fruit Growing in South Africa
by Zoe Gilbert, Purnell, 1978, 200 pages
Order from EDA or any bookshop
Useful reference book on all fruit varieties in South
Africa. Not very easy to read.

Stocking Up
edited by Carol Hopping Stoner, Rodale Press, 1977, 532
pages
Order from Magazine Centre or any bookshop
Preserving fruit, vegetables and meat by freezing,
bottling, drying and smoking. Recipes for making jam,
pickles, cheeses and yoghurt.

Forest Farming
by J Sholto Douglas and Robert de J. Hart, Watkins,
1976, 196 pages
Order from Magazine Centre or any bookshop
This book shows how farmers can grow trees to help their
soil, and crops and to give fruit, nuts and animal food.

Lorena Owner-Built Stoves
by Lanto Evans, Volunteers in Asia, 1979, 90 pages
Order from Volunteers in Asia or EDA
Describes how to make woodburning stoves from Lorena, a
mixture of clay and sand. Designs for different sizes of
stoves. Well illustrated, step by step instructions.

Solar Cooker Construction Plans, 1980, 26 pages
Order from EDA
This solar cooker was designed at the University of Natal
and has been tested by EDA and other organisations (see
p218). Can be made with hand tools.

Introductory Guide to Solar Energy
by W.N. Cawood and P.A. Billingham, 1977, 39 pages
Order from National Building Research Institute, Box 395,
Pretoria, 0001
Describes how solar water heaters work. Shows how to make
your own water heater using a radiator panel.

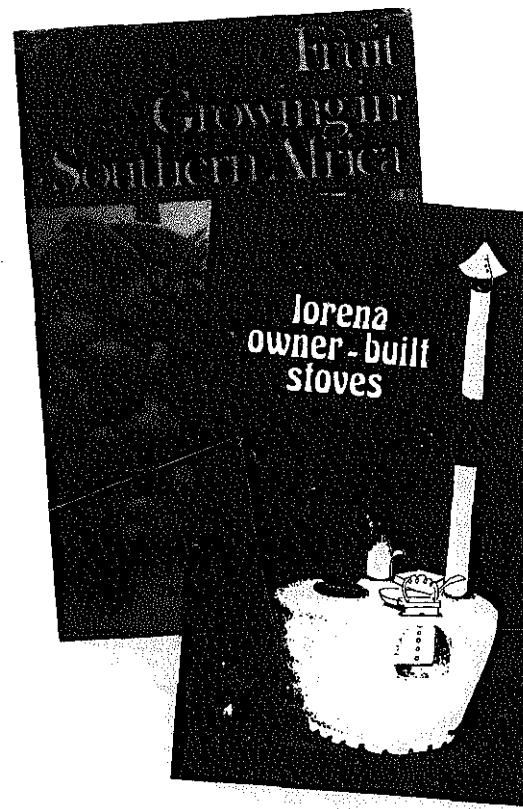

ANIMALS

Handbook of Stock Diseases
by H.O. Monnig and F.J. Veldman, Tafelberg, 1980, 420 pages
Order from Magazine Centre or any bookshop
How to recognise and treat all cattle diseases. Also available in Afrikaans.

Dairy Farmer's Veterinary Book
by Norman Barron, Farming Press, 1976, 256 pages
Order from Magazine Centre or any bookshop
Dairy cattle diseases and how to treat them. Written for farmers in England, but much of the information is useful for farmers in Southern Africa.

WATER

Small Water Supplies
by R. Feachem and S. Cairncross, Ross Institute, 1978, 78 pages
Order from Ross Institute or EDA
A brief introduction to community water supply, wells, pumps, dams, springs, pipes, storage and water treatment. Not enough information to work from without other more detailed books.

Water Supply for Rural Areas and Small Communities
by E. Wagner and J. Lanoix, World Health Organisation 1959, 340 pages
Order from World Health Organisation or EDA
Detailed book of water supplies and treatment. Includes planning, water testing, construction and training people to operate and maintain the water supply.

Hand Dug Wells
by S. Watt and W. Wood, ITDG, 1977, 60 pages
Covers all aspects of digging wells by hand. Explains different construction methods and all the equipment you need.
Order from ITDG or EDA

Tanzanian case study on how to set up a well construction project, construct hand dug wells, make tubewells by machine or by hand, and design pumps. Not much technical detail, but useful for planning water projects. Very clearly illustrated with colour photographs.

Farm Reservoirs
by Portland Cement Institute, 1973, 36 pages
Order from Portland Cement Institute, Box 168, Halfway House, 1685
Clear instructions on how to make different reservoirs, and how to calculate materials and costs.

Handbook of Basic Instructions for Dam Construction
by Department of Conservation and Extension, Zimbabwe, 43 pages
Order a photocopy from EDA
A technical manual for extension officers. Describes where and how to build earth dams and concrete weirs.

Shallow Wells
by D.H.V. Consulting Engineers, 1978, 190 pages
Free; order from DHV Consulting Engineers, Box 85, Amersfoort, Holland

Water Health and Development
by Richard Feachem and others, Trimed, 1978, 267 pages
Order from ITDG or EDA
An evaluation of water supply policy in Lesotho. Shows the links between water supply and complex politics of Lesotho. Concludes that health can be improved if families get enough water for household hygiene, but not if there is only enough for drinking and washing.

Hand Pump Maintenance
by Arnold Pacey, Oxfam, 1977, 38 pages
Order from ITDG or EDA
This book describes how to organise and train people in rural communities to look after hand pumps.

Ferrocement Tanks and Their Construction
by S.B. Watt, ITDG, 1978, 118 pages
Order from ITDG or EDA
Ferrocement is cement reinforced with chicken wire. It is strong, light and waterproof and easier to work with than concrete, bricks or sheet metal. This book shows how to make water tanks from ferrocement using a corrugated iron mould.

HEALTH

Self-Help in Health
by Department of Health, 1979, 297 pages
Free; order from South African Department of Health Private Bag 63, Pretoria, 0001
Patronising and out of touch with the realities of rural areas and the social causes of disease, but has some useful information for example on first aid. Has a list of all hospitals and clinics in South Africa.

Political Economy of Health
by Lesley Doyle, Pluto Press, 1979, 360 pages
Order from EDA or any bookshop
How health care systems are related to political and economic structures. Deals with National Health Service in Britain and health services in colonised countries.

Where There is No Doctor
by David Werner, MacMillan, 1980, 403 pages
Order from TALC or EDA
A village health care handbook which covers the recognition and treatment of all health problems from common sicknesses and delivering babies to serious illnesses. Simply written and fully illustrated. The writer believes that health care can be done by many people in communities, not just doctors or nurses.

Nutrition for Developing Countries
by M. King, F. King, D. Morley, L. Burgess, and A. Burgess, Oxford, 1972, about 300 pages
Order from TALC or EDA
Good nutrition is eating the right foods. This book discusses how a community can find out who is malnourished and what they can do to help them.

Health by the People
edited by K. Newell, World Health Organisation, 1975, 206 pages
Order from World Health Organisation or TALC or EDA
Case studies of attempts to set up democratic health services in several countries. The case studies are about both national and local community health services.

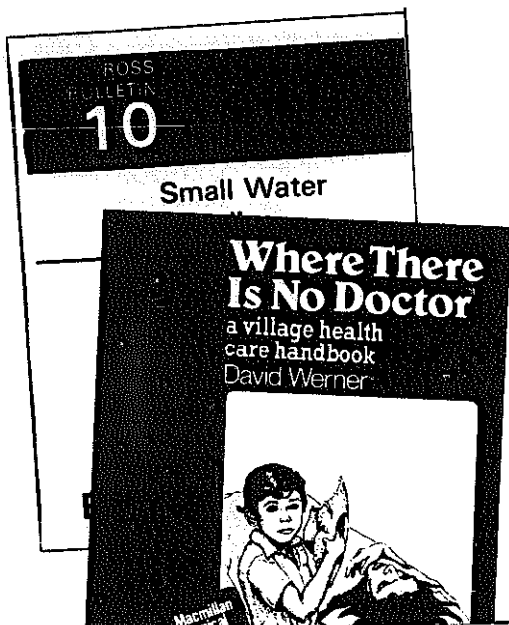

Our Bodies, Ourselves (A Book by and for Women)
by Boston Women's Health Collective, Simon and Schuster,
1979, 383 pages
Order from EDA or any bookshop
Their experiences as women by a feminist group in Boston,
USA. The women discuss many aspects of their lives -
growing up, relationships with people, sex, children,
working, oppression, health and getting to know and under-
stand their bodies.

Ourselves and Our Children
by The Boston Women's Health Book Collective, Random
House, 1978, 288 pages
Order from EDA or any bookshop
Written by parents. Discusses how parents can share
responsibility for their children, the problems when
their children are at different ages, also problems of
divorced parents.

Child-to-Child
by Audrey Aarons and Hugh Hawes, MacMillan, 1979, 104
pages
Order from TALC or EDA
In many rural communities young children are looked after
by older children. This book is about teaching children to
look after younger children's health.

Community Action Brings Health
published by Shawco, 1978, 82 pages
Order from EDA
A guide to how people in communities in South Africa,
especially urban squatter communities, can act togeth-
er to improve their health. Information about nutrition,
first aid, child care. Also available in Xhosa and Afrik-
aans.

Primary Child Care: A Manual for Health Workers
by M. King, F. King and S. Martodipoero, Oxford, 1978,
315 pages
Order from TALC or EDA
Written for village health workers and clinic nurses.
Describes common child illnesses and how a community
can act to prevent them. Useful section on how to set up
a clinic including the equipment and drugs you need.

The Birth Control Book
by Howard Shapiro, Penguin, 1977, 367 pages
Order from EDA or any bookshop
Written for American and English women; gives very
detailed technical information about all kinds of birth
control. Honest about advantages and disadvantages of
each kind. Details of latest research and case studies.

Small Excreta Disposal Systems
R. Peachem and S. Cairncross, Ross Institute, 1978
54 pages
Order from Ross Institute or EDA
Different types of pit toilets and waterborne sewerage
systems, and how to design them for rural communities.

A Field Guide to the Snakes of Southern Africa
by V.F.M. FitzSimons, Purnell, 1974, 221 pages
Order from Magazine Centre or any bookshop
How to identify snakes and treat snakebites. Complete
description and habits of all snakes found in Southern
Africa.

LEGAL RIGHTS

Your Legal Rights
by S.A. Catholic Bishops Conference, 1979, 16 pages
Order from S.A. Catholic Bishops Conference, Box 941,
Pretoria, 0001
Describes what your rights are if you are arrested, sear-
ched, or detained. Written in English, Afrikaans, Zulu
and Sotho.

Filling in Forms
by Learn and Teach, 1979, 41 pages
Order from Learn and Teach or EDA
For adults learning to read and write. How to fill in
forms which ask for personal information like forms from
the government, banks, hire purchase.

Documents
by Grassroots Advice Project, 23 pages
Order from FSD or EDA
How to get documents like passports, identity documents,
birth certificates, death certificates and marriage
certificates.

Domestic Workers
by Sue Gordon, SAIRR, 1973, 60 pages
Order from S.A. Institute of Race Relations
This book was written to help employers understand the
problems of domestic workers. Has sections on pass laws,
wages, holidays and days off, and how to help domestic
workers to learn new skills.

Unemployment and the UIF
by Learn and Teach, 1979, 85 pages
Order from Learn and Teach or EDA
Why there are so many unemployed people, how to get un-
employment insurance fund money, and some of the problems of
getting it.

Accidents and Sickness at Work
by Learn and Teach, 1979, 63 pages
Order from Learn and Teach or EDA
How factories can be made safe, what accidents happen at
work. What to do if there is an accident. How to get
money from Workmen's Compensation. The problems of getting
money.

Workmens Compensation

by Fosatu and Centre for Applied Legal Studies, 1981, about 75 pages
Order from Centre for Applied Legal Studies, University of the Witwatersrand, 1 Jan Smuts Avenue, Johannesburg
Deals with all aspects of claiming compensation for accidents at work, including claims for people such as domestic workers and miners not covered by the Workmens Compensation laws. Has a section specially for lawyers on cases and judgments. Ask about Fosatu Health and Safety Books: on Health in Foundries, and on the Factories Act.

Hire Purchase

by Grassroots Advice Project, 45 pages
Order from FSD or EDA
The advantages and disadvantages of buying on hire purchase with advice about signing HP contracts and what to do if the goods are repossessed.

Insurance

by Grassroots Advice Project, 63 pages
Order from FSD or EDA
Detailed information about all kinds of insurance - life, funeral, industrial, third party insurance etc. Lists most of the big insurance companies.

Rights of Women

by YWCA - World Affiliated, 1977, 25 pages
Order from YWCA, Box 31580, Braamfontein, 2017, Johannesburg.
A simply written booklet giving advice to black South African women on subjects such as marriage, divorce, housing, being a widow.

The African Women's Handbook on the Law

by Carole Cooper and Linda Ensor, SAIRR, 1980, 41 pages
Order from S.A. Institute of Race Relations
Information about womens' legal rights in marriage, divorce, housing, job registration, employment, and other issues which most women have to deal with in their everyday lives.

Divorce

by Grassroots Advice Project, 15 pages
Order from FSD or EDA
Explains how to get a divorce, and where to get legal advice. It is aimed at readers like social workers, priests and others in communities who advise people considering divorce. Quite easy to read.

Social Pensions and Grants

by Grassroots Advice Project, 65 pages
Order from FSD or EDA
Information about getting pensions and grants from the government. Mainly about the Western Cape, although some of the information will be useful to people in other parts of South Africa. List of useful addresses in the Cape for people who need help with pensions and grants.

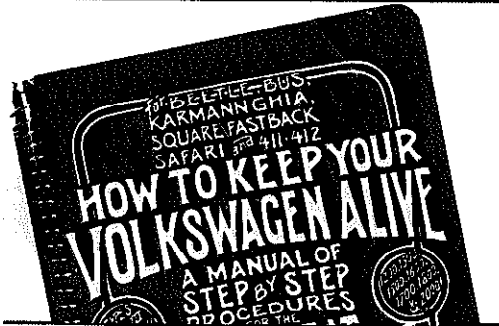

WORKING IN GROUPS

Casting New Moulds: First Steps toward Worker Control in a Mozambique Steel Factory
by Peter Sketchley and Frances Moore Lappe, IFDP, 1980, 60 pages
Order from Institute for Food and Development Planning or EDA

The problems of reorganising a large foundry and steel-rolling mill after independence, after many skilled technicians had fled the country. Honest discussion of attempts by workers to gain confidence in their organisational and other skills, starting for many of them with learning to read and write.

A Guide to Sewing for the Family

by Lesley Tyson, 34 pages
Order photocopy from EDA
Malawi handbook on sewing. Simple stitches and designs.

Reader's Digest Complete Guide to Sewing

by Reader's Digest, 1976, 528 pages
Order from Magazine Centre or any bookshop
Expensive, but has everything about sewing: tools, stitches, patterns, how to service and repair sewing machines. Easy to read, good illustrations.

African Designs from Traditional Sources

by G. Williams, Dover, 1971, 200 pages
Order from Magazine Centre or any bookshop
Traditional designs from all parts of Africa, from floors, walls, clothes and carvings. Useful for block printing or dressmaking.

First Steps in Village Mechanisation

by George Macpherson, Tanzania Publishing House, 1975, 232 pages
Order from ITDG or EDA
Basic woodwork and metalwork with hand tools. Designs for simple furniture. Chapters on making animal-drawn implements and making harnesses.

Reader's Digest Do-It-Yourself Manual

by Reader's Digest, 1978, 585 pages
Order from Magazine Centre or any bookshop
How to make and repair things in building, carpentry, plumbing and electricity. Expensive, but clearly written and well illustrated.

How to Keep Your Volkswagen Alive - A Manual of Step by Step Procedures for the Compleat Idiot

by John Muir, John Muir Publications, 1979, 364 pages
Order from Magazine Centre
How to fix VW's or Kombis for people who know nothing about cars. This book is written for ordinary people, not mechanics, but it has as much information as a workshop manual.

Car Workshop Manuals

Order from Magazine Centre
Workshop manuals are available for all cars. When you order, tell them the make, the model and the year of the car you are working on.

Auto Service and Repair

by Martin Stockel, Goodheart-Wilcox, 1978, 864 pages
Order from Magazine Centre or any bookshop
Basic manual for repairing all makes of cars. Easy to read and very well illustrated with drawings and photographs.

EDUCATION

Guinea-Bissau '79: Learning by Living and Doing
by IDAC, 1979, 53 pages
Order from EDA

A brief illustrated introduction to education in an African country after the struggle for independence. Describes how literacy and education programmes are worked out with the participation of all the people.

Teaching Reading and Writing to Adults
by International Institute for Adult Literacy Methods,
1977, 646 pages
Order from IIALM, Box 1555, Tehran, Iran or EDA
A collection of papers about literacy methods. Different theories and approaches.

The Politics of Literacy
Edited by Martin Hoyles, Writers and Readers, 1977, 211 pages
Order from EDA or any bookshop
Literacy can be repressive or liberating. It is repressive when people are taught, through education systems which try to control and force them to accept the ideas of a ruling class. This book discusses how this happens in the teaching of literacy and education generally, and how literacy can be liberating under good social conditions.

The Reader
by Learn and Teach, 1978, 84 pages
Order from Learn and Teach or EDA
Written by people who were learning to read and write in English. The stories are about themselves, how they live, and their problems. Useful for people learning to read. Also available in Zulu, Sotho, Tswana, Xhosa, Tsonga, Pedi and Venda.

Popular Theatre booklets
by Bosele Tshwaraganang Publications
Order from Institute of Adult Education, University College of Botswana, Private Bag 0022, Gaborone, Botswana
Publications on using theatre in rural communities to organise people. Mostly about experiences in Botswana, with one on popular theatre in Latin America and one on popular theatre in Asia.

BUILDING

Bricklaying is Easy
by Muller and Retief, 1973, 71 pages
Order from Magazine Centre or any bookshop
Simple guide to bricklaying published for the South African Brick Association

Architecture for the Poor
by Hassan Fathy, University of Chicago Press, 1973, 233 pages
Order from Magazine Centre or any bookshop
Designing houses in communities by consulting people, finding out their needs, and using local materials, by an Egyptian architect.

A Manual on Building Construction
by H. Dancy, ITDG, 1975, 360 pages
Order from ITDG or EDA
Deals with all aspects of building, including carpentry, roofing and sheet metal work.

Construction of Buildings
by Robin Barry, Granada, in 5 volumes
Order from Magazine Centre or any bookshop
Everything about modern building: foundations, floors, walls, doors and windows, roofs, fireproofing, water-proofing, heating, ventilation, drainage, water supply, electrical installation. Expensive, but useful for libraries or technical schools.

NOVELS AND POETRY

There are many novels and poetry books written by South Africans. Many of these books are published by Kavan Press. Most writers from other parts of Africa are published by Heinemann African Writers Series. You can order these books from S.A. Institute of Race Relations or from Sached. Write to them for a list of African Writers Series books and their prices.

MAGAZINES

POLITICS

Social Review
8 issues a year
Order from Social Research Agency, 8 Church St, Mowbray, 7700, Cape Town
Simply written articles on political, social and economic issues in South Africa.

Link
6 issues a year
Order from EDA
EDA's magazine. News and articles about rural community projects and issues. Articles on agriculture, health, water supply, development theory and South African history.

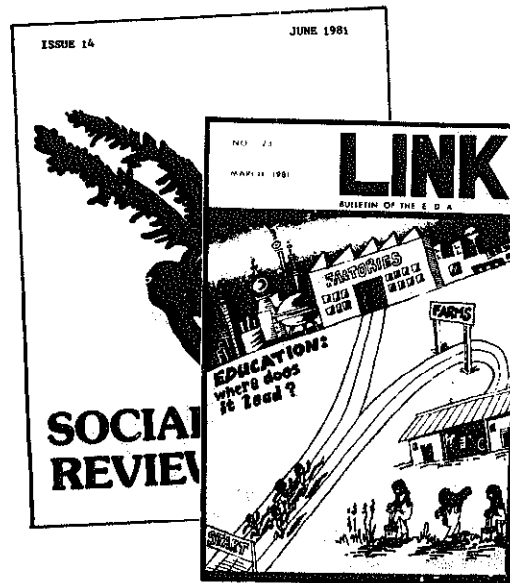

Work In Progress

5 issues a year
Order from Work In Progress, Box 93174, Yeoville, 2143, Johannesburg
Useful up-to-date information on strikes, community action, exploitation and state control in South Africa.

New Internationalist

Monthly
Order from New Internationalist, Montagu House, High St, Huntingdon, PE18 6EP, Cambridgeshire, UK or EDA.
A Third World magazine. Deals with problems of underdeveloped countries: poverty, unemployment, health, agriculture, political struggles and imperialism.

S.A. Labour Bulletin

8 issues per year
Order from S.A. Labour Bulletin, Box 18019, Dalbridge, 4014, Durban.
In depth articles on workers' struggles in South Africa. Analyses strikes, labour laws, position of domestic workers and migrant workers.

Africa Now

Monthly
Order from Pan-African Publishers, 50 Pall Mall, London SW1Y 5JQ, U.K. or EDA.
In depth news and analysis of African politics, society and culture. Surveys of different African countries.

Ideas and Action for Development

6 issues a year
Free: order from Hunger Campaign/Action for Development Food and Agriculture Organisation of the United Nations, Via della Terme di Caracalla 00100, Rome, Italy or EDA.
Articles on development ideology and education from many underdeveloped countries.

NEWSPAPERS

Grassroots

10 issues a year
Order from Grassroots, Box 181, Athlone, 7600.
Community newspaper from Cape Town. News of community organisations and struggles for a better life in communities.

**Saspu National**

Monthly
Order from Saspu, 10 South Court, 40 Jorissen Street, Braamfontein, Johannesburg, 2001.
National student newspaper. Has news about workers' struggles, community action resettlement and student issues. Carries news not usually found in commercial newspapers.

Grahamstown Voice

6 issues a year
Order from Delta, SRC, Rhodes University, Grahamstown, 6140
Community newspaper produced by students in Grahamstown (see p466).

LITERACY MAGAZINES

Learn and Teach

Every 6 weeks
Order from Learn and Teach
An easy to read magazine in English. Articles on health, work, stories by learners, legal advice, reading and writing exercises in easy English.

The Reader

Monthly
Order from Sached
Magazine for people learning to read and write English. Local news, news from other African countries, education, sport and entertainment.

Turret

Weekly
Order from Sached
Education magazine for adults. Includes formal education lessons for matric students as well as non-formal education on subjects like African history and literature and health.

Upbeat

Monthly
Order from Sached
Educational magazine for high school students. Does not include formal education lessons, but general information which is useful for school and general knowledge.

OTHER MAGAZINES

Spare Rib

Monthly
Order from Publications Distribution Co-operative, 27 Clerkenwell Close, London EC4, England or EDA.
A women's liberation magazine written by a collective in England. Has news of interest to women fighting sexual, racial and economic oppression. Mainly about women's issues in England but has some articles on women's struggles in underdeveloped countries.

Women's Voice

Monthly
Order from Publications Distribution Co-operative, 27 Clerkenwell Close, London, EC4, England or EDA
A women's liberation magazine which focuses on the struggle of women in Third World countries, especially in Asia and West and Central Africa.

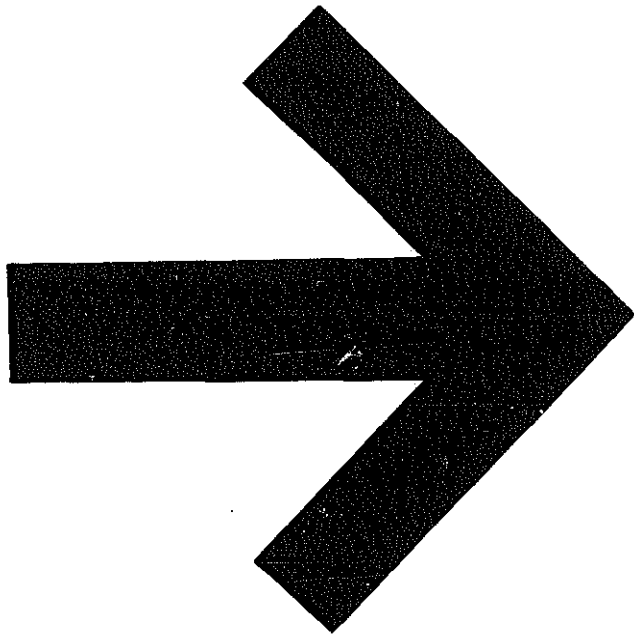

Staffrider
4 issues a year
Order from Raven Press, Box 31134, Braamfontein, 2017,
Johannesburg
Poetry, short stories, photos and graphics by South
African writers and artists.

Medu
A few issues a year
Order from Medu, Box 1356, Gaborone, Botswana
Stories and poems and graphics from a group of exiled
South African writers and artists in Botswana.

Molo Songololo
10 issues a year
Order from Molo Songololo, 330 South West House, Short-
market Street, Cape Town, 8001
A community newspaper for children. Articles and drawings
by and for children, in all South African languages.

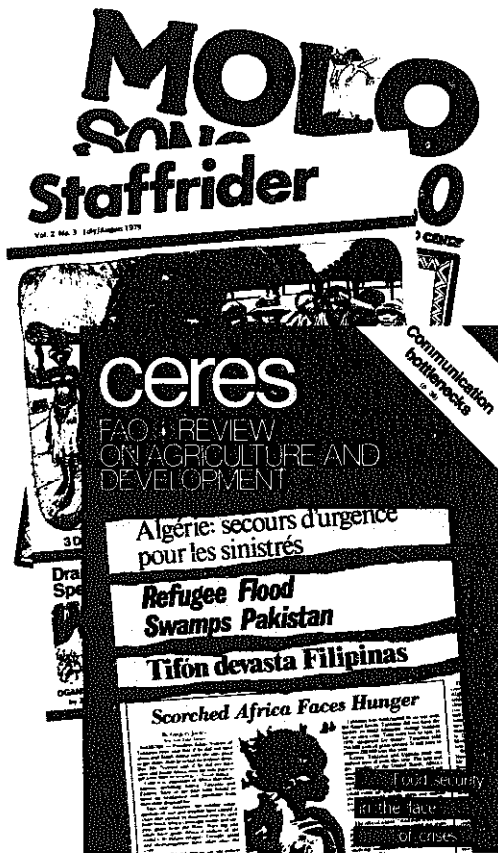

AGRICULTURE

Ceres
6 issues per year
Order from Food and Agriculture Organisation of the
United Nations, Via della Terme di Caracalla 00100, Rome,
Italy, or EDA
In depth articles on agriculture and underdevelopment:
land reform, imperialism, literacy, community organisation
and how they effect agriculture in the third world.

Farmers Weekly
Weekly
Order from Farmers Weekly, Box 32083, Mombeni, 4060, Natal
Aimed at rich farmers, it sometimes has useful articles
for small farmers. Good classified section on where to
get supplies.

HEALTH

Critical Health
4 issues per year
Order from Medical Students Council, Wits Medical School,
Esselen St. Johannesburg, 2001
Articles on health and health care in South Africa in
the context of political and economic issues which affect
the health of the majority of the people.

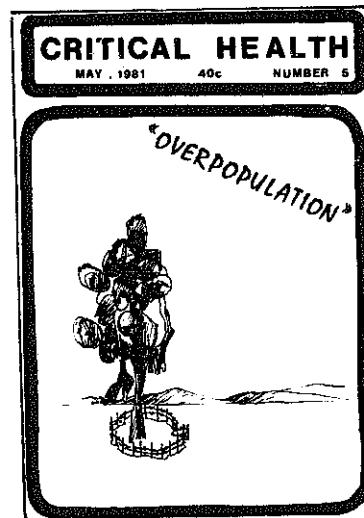

Frontline on Health
4 issues a year
Order from Health Care Trust, 17 Main Rd, Mowbray, 7700,
Cape Town
Written for health workers. Looks at the relation
between health and social structures in Africa, particu-
larly in South Africa.

Contact
6 issues a year
Free: Order from Christian Medical Commission, 150
Route de Ferney, 1211 Geneva 20, Switzerland
Health issues, particularly primary health care. Case
studies from different countries.

TECHNOLOGY

Appropriate Technology
Monthly
Order from ITDG or EDA
Published by the Intermediate Technology Development
Group (ITDG) in U.K. Has designs and descriptions of small
scale technology and new technical developments from many
countries. Useful but tends to take technology out of its
social context.

Index

A

Abortion 355
Acacia Trees 204
Adoption 387
Alcoholism 343
Alkaline soil 97
Almond nuts 191
American Bollworms 131
Ammonium Sulphate 122
Angular Leafspot Disease 157, 172
Anthracnose Disease 157
Anthrax 228, 237
Aphids 122, 131, 202
Apples 188
Apricots 189
Arrests 392
Artificial feeding 309
Avocados 198

B

Bacterial Wilt Disease 34, 160
Bananas 199
Basin Irrigation 135
Beans 34, 93, 117, 156
Beds 451
Beehives 45
Beekeeping 85
Beestings 87, 339
Beetroot 38
Benches 450
Bilharzia 348
Bird Damage 148, 167
Birth 300
Birth Certificates 386
Birth Control 351
Bites 338
Blackarm Disease 172
Black Maize Beetle 146
Blackquarter Disease 228
Blight 131, 153
Blind Pensions 381
Bloat Disease 171
Block Printing 420
Blood Pressure 346
Blossom Beetle 157
Blue Tongue Disease 237
Body Searches 392
Bollworms 131
Bones 340
Bordeaux mixture 153, 160
Boreholes 264
Bottlefeeding 309
Boxes 446
Breastfeeding 307
Bricks 485
Budgetting 382
Burdizzo 227
Burns 332
Butt Joints 444
Buying Clubs 398, 533

C

Cabbages 34
Calabashes 152
Calf Scours 229
Cancer of the Cervix 345
Candles 432
Captab poison 177
Carbohydrates 311
Carob trees 204
Carrots 34
Cars 437
Carts 113
Cassava 117, 164
Castration 227, 286
Caterpillars 37, 122
Cattle
- bulls and mating 225
- calving 226
- castration 227
- dairy 234
- diseases 228
- licks 227
- milking 235
- winter feeding 224
Cauliflower 34
Cement bricks 384
Centrifugal Pumps 281
Chaff 169
Chemical Fertilisers 120
Chemical Poisons 122
Chickens 64
- diseases 74
- housing 510
Chillies 34
Chlorine
- in soil 177
- in water 290
Cholera 289, 349
Citrus psylla 203
Citrus Trees 195
Clay Soil 97, 134
CMR Beetles 156
Colic 308
Community Newspapers 466
Company Pension Funds 387
Compost 50
Concentrates 233
Concrete Floors 494
Concrete Foundations 481
Condensed Milk 310
Condoms 352
Contagious Abortion Disease 228
Contour Banks 101
Contraceptives 352
Controlling Pests and Diseases 122
Corrugated Iron Roofs 494
Cotton 172
Cowpeas 117, 157
Creche - how to build 496
Crop Rotation 34, 94, 122

Crops 93
Cross Ridging 102
Cucumbers 162
Curing Tobacco 178
Cut-off Drains 102
Cutworms 37, 122
Cystitis 323

D

Dampcourse 510
Dams 286
Dairy cattle 233
Dairy Goats 80
Death Benefits 376
Diarrhoea 318
Diesel Pumps 270
Dipping Cattle 229
Dipterex Poison 131
Diphtheria 316
Disability Grants 381
Dithane Poison 131
Divorce Laws 389
Docking 237
Domestic Workers 378
Doors 450, 493
Double Cropping 96
Dovetail Joints 444
Downey Mildew 131
Draft Power 103
Drainage Channels 101
Dry Gall Sickness 230
Ducks 78
Dyeing 418

E

East Coast Fever 229
Eczema 327
Eelworm Disease 34
Eggplants 41
Electric Pumps 270
Energy Foods 311
Evapotranspiration 144
Extension Services 142

F

Farm Buildings 509
Fencing 137
Ferrocement Tanks 285
Fertilisers 120
Figs 192
Filtration 289
Fire breaks 180
First Aid 330
Fishing 288
Flood Irrigation 135
Floors 491
Flukes 230

Foot and Mouth Disease 229
Foot Rot Disease 200
Foundations 481
Fruit Beetles 202
Fruit Crops 41

G

Gall Sickness 229
Garlic Poison 123
Gastro-Enteritis 318
Geese 79
Gentian Violet
- for infected sores 333
- for thrush 323
Goats 240
Grants 379
Green Peppers 41
Groundnuts 160
Guavas 196
Gusathion A+ Poison 173

H

Hammermills 113
Hand Drilled Boreholes 264
Hand Dug Wells 268
Hand Pumps 269, 274
Harrowing 109
Harvesting 96
Hay 244
Hayboxes 216
Headlice 324
Heartwater Disease 229
Heat Treatment 181
Hire Purchase 393
Honey Locust Trees 205, 233
Horseradish Trees 205
Humus 50, 122
Hybrid Seeds 143

I

Immunisation 316
Infected Sores 325, 333
Inflamed Breasts 308
Inoculation 158, 171
Intercropping 117
Irrigation 134
Insect Bites 339

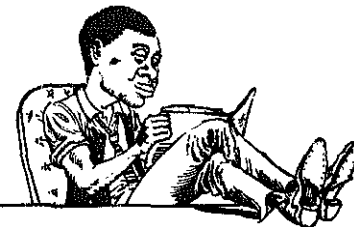

K

Kitchen Units 448
Knitting 418
Know Your Soil 97
Kraal Manure 94
Kwashiorkor 317

L

Ladybirds 202
LAN Top Dressing 121
Land Bank 172
Land Preparation 100
Langfos 168
Lap Joints 444
Late Blight 153
Leaf Crops 40
Legal Rights 357
Legumes 41, 160
Lettuces 40
Leucaena 205
Leaf Spot Disease 131
Lemons 195
Libraries 546
Light Traps 122
Lime 98, 132
Lintels 492
Liquid Measures 129
Liquid Manure Pits 510
Literacy 462
Loams 98, 134
Lucerne 170, 233, 244
Lumpy Skin Disease 228

M

Machine Drilled Boreholes 262
Maintenance Grants 381
Maize 143
Makonosotle Toolbar 110
Malathion Poison 157
Malnutrition 312, 317
Mangoes 197
Maneb Poison 153
Manure 94
Marasmus 317
Marriage Laws 388
Marrows 162, 200
Mastitis 234
Maternity Benefits 376
Measles 322
Measuring
- animal food 133
- chicken food 133
- fertilisers 131
- land 125
- liquids 129
- poisons 130
- seeds 129
- slopes 479

Migrant Labour Contracts 362
Mildane Poison 153
Milk for babies 309
Milking Sheds 510
Millet 93
Milling 139
Mono Pumps 269
Mortice and Tenon Joints 444
Motor Pumps 270
Mucus Method 352
Mud Bricks 485
Mud Stoves 210
Mud Walls 484
Mulberries 192
Mulching 36
Museums 468

N

Naartjies 195
Natural Pest Control 122
Nematode Disease 201
Nicotine Poison 123
Nitrogen 41, 97, 120
North- how to find 477
Numicias 182
Nutrition 312
Nuts 191

O

Onderstepoort 231
Onions 46
Open-pollinated Seeds 94
Ophthalmia 230
Oranges 195
Orthene Poison 177
Ox Power 103

P

Parathion EC Poison 157
Pass Laws 358
Pastures 243
Pawpaws 200
Peaches 188
Peanuts 160
Pears 190
Peas 41
Pellagra 342
Pensions 379
pH numbers 99
Phosphates 97, 120
Pig Houses 510
Pigs 56
Pineapples 200
Pink Eye Disease 229
Pipe Irrigation 136
Pit Toilets 504
Plant Foods 99, 120

Planting 96, 122
 Planting in rows by hand 118
 Planting Stations 162
 Play Centre 496
 Ploughing 95, 122
 Plough Pan 100
 Plums 190
 Pod Borer 157
 Poisoning 336
 Poisons 130
 Polio 316
 Popular Theatre 470
 Porridge 310
 Potassium 97, 120, 171
 Potatoes 41, 151
 Powdered Milk 309
 Praying Mantis 202
 Pregnancy 294
 Production Groups 400
 Protection Foods 311
 Protein 311
 Pruning 186
 Pulpy Kidney Disease 237
 Pumpkins 41, 117, 162
 Pumps 269
 Purifying Water 289
 Purlins 494

Q

Quarterevil Disease 237

R

Rabbits 62
 Rabies 339
 Rain Water Tanks 254
 Rammed Earth 486
 Ram Pumps 270
 Ratoon Stunting Disease 181
 Reciprocating Pumps 271
 Red Spider Mites 157, 173, 203
 Redwater Disease 229
 Rehydration Medicine 320
 Reverin medicine 228
 Rhizobia Inoculant 158, 171
 Ridging 152
 Ringworm 326
 Road to Health Chart 315
 Roadworthy Certificates 438
 Rock Foundations 481
 Rogor Poison 157
 Roofs 494
 Rootknot Eelworm Disease 34, 151
 Rotational Grazing 240
 Roundworms
 - in cattle 236
 - in people 326
 Runny Stomach 318
 Rust Disease 157, 167, 169, 203

S

Saaifos 168
 Scabies 324
 Scrapyards 441
 Seams 405
 Seedbeds 36
 Setting Out Buildings 478
 Sevin Poison 146
 Sewing Machines 411
 Sheep 236
 Sheep Scab Disease 237
 Shoes- how to make 422
 Shutters 486
 Silage 244
 Silt 99
 Sisal
 Slaughtering 59, 63
 Slopes 479
 Smut Disease 181
 Snake Bites 338
 Snuff 176
 Soil 97
 - acidity 99, 121
 - cement 488
 - erosion 220
 - tests 99
 Solar
 - cookers 218
 - driers 454
 - ovens 218
 - water heaters 495
 Sperm 294, 355
 Spider Bites 339
 Spinach 48
 Spirit Level 479
 Spring Portection 256
 Sprinkler Irrigation 136
 Squashes 163
 Stainers 172
 Stalkborer 122, 131, 146

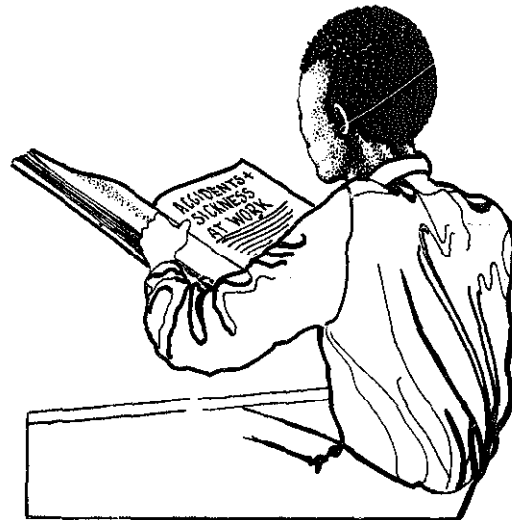

Sterilisation 355
Sterilising Bottles 309
Stitches 406
Stone Foundations 481
Storage Sheds 510
Storing Crops 139
Submersible Pumps 271
Sugar Beans 117
Sugar Cane 180
Sunflowers 166
Sweet Potatoes 153

T

Tables 447
Tape Worms
- in cattle 231
- in people 326
Terracing 103
Tetramycin Medicine 230
Tetanus
- in cattle 229
- in people 338, 347
Thatch Roofs 475, 509
Thiodan Poison 131
Third Party Insurance 438
Thread Worms 326
Thrips 131
Thrush 323
Tick Diseases 230, 238, 240
Tobacco 176
Tomatoes 42
Tractors 111
Trade Unions 368
Treated Seeds 172
Trenches 52
Trusses 494
Tuberculosis (TB) 341
Tubewells 262
Turnips 37
Typhoid 348
Typhus 349

U

U-block lintels 493
Under 5 Clinics 314
Underground Tanks 254
Unemployment Insurance Fund 375

Urea 120, 132
Urine Infection 296, 323

V

Vaccinations 228
Venereal Disease (VD) 344
Vice 446
Vitamins 311
Vomiting 318

W

Walls 484
Walnuts 191
Watermelons 162
Water 250
- level 479
- purification 289
- storage 284
- tanks 254, 284
- tests 134
Wattle and daub 485
Weeding 37, 96
Weighing and Measuring 124
Wells 262, 268
Wheat 168
Wheelbarrows 452
Whooping Cough 322
Wills 391
Wind Direction 477
Windmill Pumps 270
Windows 450, 493
Winnow 169
Winter Feeding 243
Witchweed 145
Wooden Frame Buildings 484
Woodlots 207
Wool Sales 238
Workbench 445
Working Animals 106
Workmens Compensation 377
Worms
- in cattle 231
- in goats 240
- in people 326
- in pigs 57
- in sheep 237
Wounds 336



Men are working in town. They are working in mine 1981.

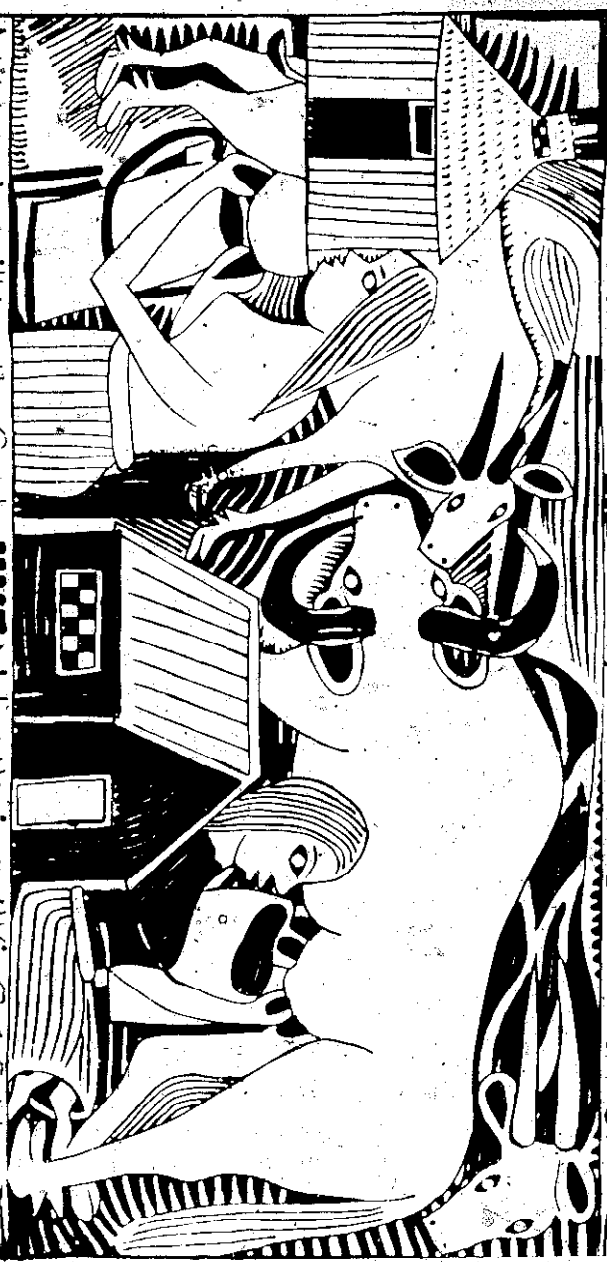

A woman is milking the goat. A woman is milking a cow.



The women are feeding chickens. A woman cuts down a tree.