

AT MICROFICHE REFERENCE LIBRARY

A project of Volunteers in Asia

Towards Village Industry: A Strategy for
Development

by: Liv Berg, Krisno Nimpuno, Tony van
Zwanenberg, et al.

Published by:

Intermediate Technology Publications Ltd
9 King Street
London WC2E 8HN
United Kingdom

Paper copies are 3.25 British pounds

Available from:

Intermediate Technology Publications Ltd.
9 King Street
London WC2E 8HN
United Kingdom

Reproduced by permission of Intermediate
Technology Publications Ltd.

Reproduction of this microfiche document in any
form is subject to the same restrictions as those
of the original document.

TOWARDS VILLAGE INDUSTRY

A strategy for development
Berg, Nimpuno, van Zwanenberg

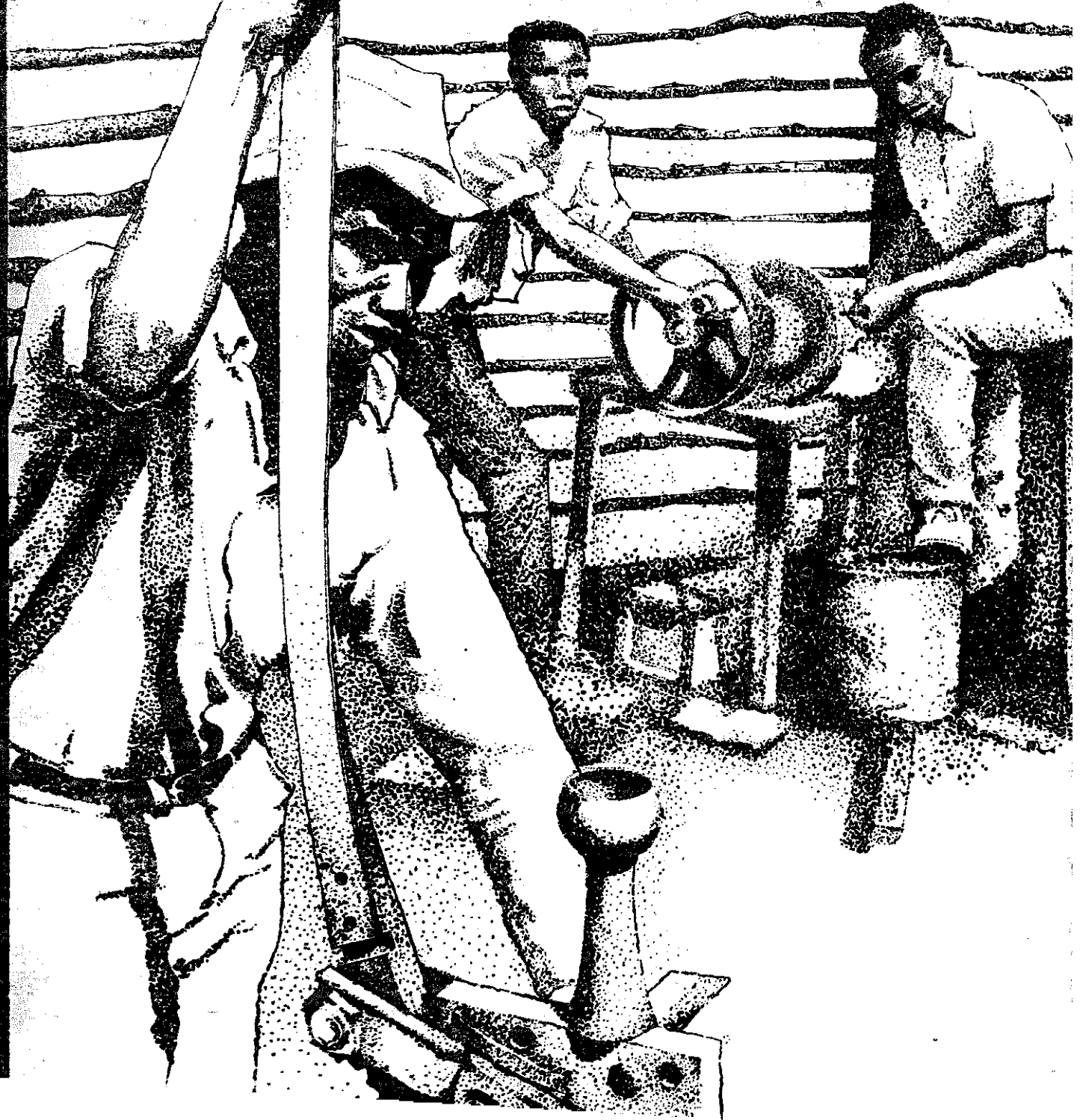

Many of the young rural population of the third world have been lured to the towns and cities by the promise of employment. The trades and skills which existed in the small village environments have, in many cases, fallen into disuse, or been lost and forgotten because there is no one to learn them. The demand for simple tools and equipment is declining too with the introduction of mass-produced and imported goods. Village manufactured goods are either no longer required or considered to be inferior.

It is the premise of this book that successful rural development requires the development of both the agricultural sector and the small-scale, village-based productive industries. These two main areas of development will complement and support each other with a supply and demand situation where each satisfies the needs of the other.

Rural development on this basis is generally agreed to be the key to economic stability and growth, but how this is to be achieved is quite a different matter.

The authors base this book on their experience in Tanzania. It outlines the present situation in Tanzania, cites many examples of existing rural industries and goes on to explain how those industries can be developed and new ones can be introduced. The village workshop and smithy play the vital role in this strategy and detailed plans for setting up such workshops, the tools which must be purchased, the production techniques and goods that should be produced, are carefully laid out.

Liv Berg trained as an industrial designer. She spent some time in Tanzania researching this book and taking photographs from which many of the drawings in *Towards Village Industry* have been adapted. Krisno Nimpuno was born in Indonesia but has lived for a long time in Sweden. He is an architect by profession, and has worked in Kenya, Tanzania and Mozambique as a Government Adviser on Rural Development. Roger van Zwanenberg wrote his PhD thesis on *Kenyan Labour History* in 1969. From 1971 to 1975, he lectured in Universities in Nairobi and Dar-es-Salaam. He is the author of *Colonial Capitalism and Labour in Kenya* and *An Economic History of Kenya and Uganda from 1800 to 1970*. In the latter book, he was very much concerned with the concept of intermediate technology.

ISBN 0 903031 52 3

Intermediate Technology Publications Ltd,
9 King Street, London WC2E 8HN, U.K.

TOWARDS VILLAGE INDUSTRY A STRATEGY FOR DEVELOPMENT

**LIV BERG
KRISNO NIMPUNO
ROGER van ZWANENBERG et al**

**Exclusive Distributor
ISBS, Inc.
P.O. Box 555
Forest Grove, OR 97116**

Intermediate Technology Publications Ltd.

ACKNOWLEDGEMENTS

The printing of this publication has been made possible by generous grants from the Claremont Trust, the Episcopal Church of Scotland and three anonymous donors.

We gratefully acknowledge their help.

Published by Intermediate Technology Publications Ltd,
9 King Street, London WC2E 8HN, U.K.

©Intermediate Technology Publications Ltd. 1978

ISBN 0 903031 52 3

Printed by the Russell Press, 45 Gamble Street, Nottingham NG7 4ET.

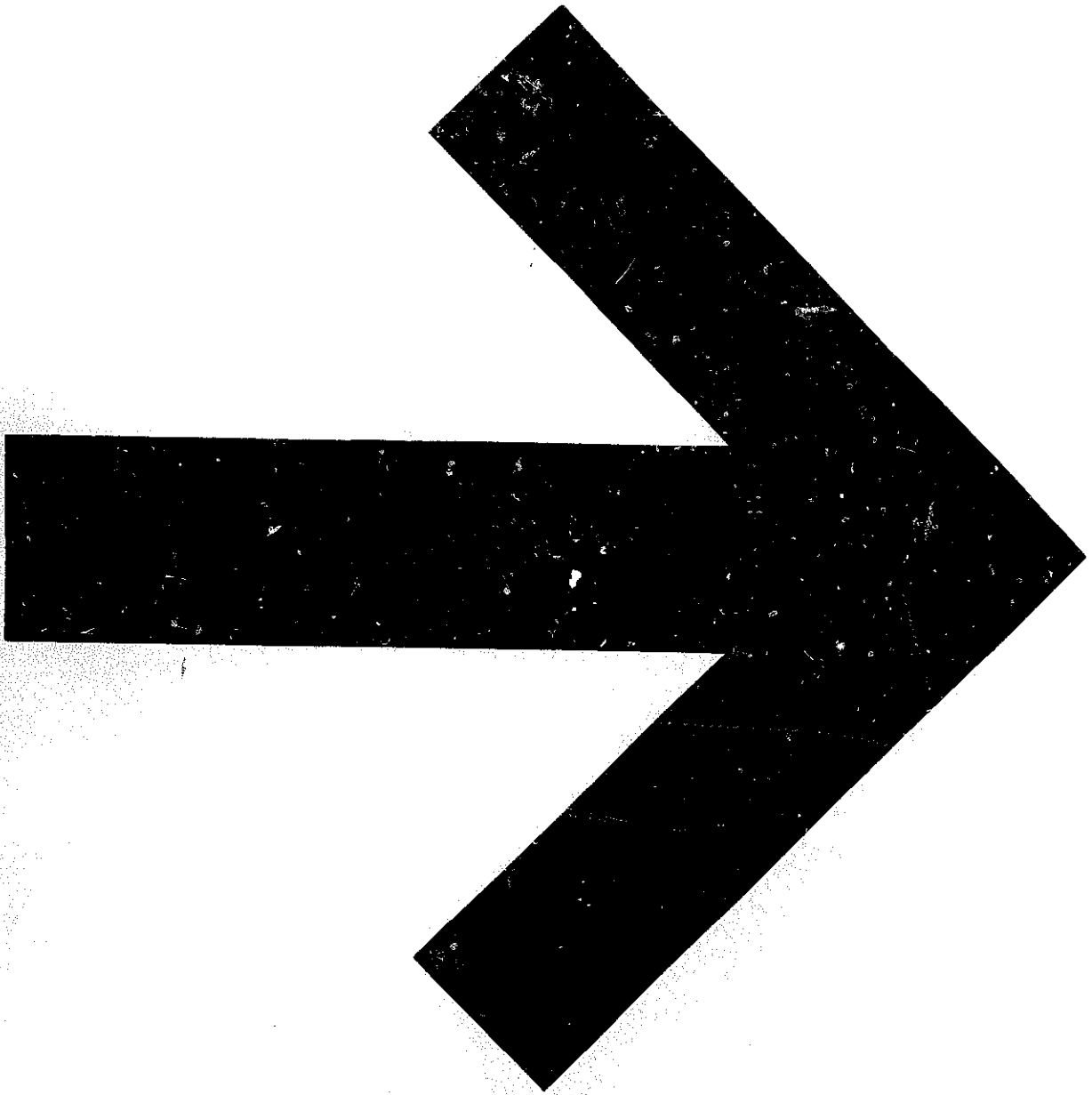

CONTENTS

Introduction	Rural Industrialisation <i>R. van Zwabenberg</i>	5
Chapter 1	Community Development and Small Industry <i>K. Nimpuno</i>	7
Chapter 2	Pre-capitalist Industry in Eastern Africa <i>R. van Zwabenberg</i>	13
Chapter 3	Recycling Industry <i>L. Berg</i>	19
Chapter 4	Workshops Today <i>K. Nimpuno</i>	27
Chapter 5	Small Scale Production – The Contemporary Situation <i>L. Berg</i>	37
Chapter 6	Training for Production <i>K. Nimpuno</i>	51
Chapter 7	Village Workshop Equipment <i>H. Toilin & B. Oscarsson</i>	55
Chapter 8	Village Workshop Design <i>K. Nimpuno</i>	69
Chapter 9	Village Workshop Construction <i>K. Nimpuno</i>	73
Chapter 10	Official View on Rural Industry <i>K. Nimpuno</i>	79
Chapter 11	Towards Village Industry <i>K. Nimpuno</i>	85

INTRODUCTION

Rural Industrialisation

Roger van Zwaneberg

One of the major problems facing many of the third world countries today is how to create a strategy which will lead towards rapid economic development and industrialisation. While few people would disagree with such a statement, there is a great deal of argument over how this industrialisation will be achieved. It is the premise of this book that the industrialisation of the rural areas plays a vital role; mechanisation of agricultural production and rural industry will have to develop together. To the authors, this line of argument appears self evident given the conditions of so many third world countries. Yet in reality what is actually happening is, with minor exceptions, quite the opposite: industrial growth has tended to hug the city areas and the industries have tended to be capital intensive, large scale monopolies. The villages and towns in the rural areas are rarely increasing in wealth and in some places there is an actual decline. Nomadic pastoralism provides an obvious example of economic decline. The pattern of growth is now well documented; rural industrialisation is a sad joke.

There is little doubt that most forms of rural industrialisation have been hampered by a general dependency on foreign multinational industrial capital which has tended to suck community resources from the countryside into the urban areas. The consequence of this pattern of urban economic growth is that development economists have become concerned with decentralising industry. However, the concept of rural industrialisation is not part of their panacea, as dependency on multi-national capital does not allow for it.

An alternative form of industrialisation has largely been argued in terms of 'appropriate technology'. This concept has been used by some third world observers seriously concerned with unemployment and poverty. Appropriate technology is by definition a technology which uses locally available raw materials and power resources. It minimises imported goods, uses existing indigenous skills, simple imported techniques and avoids over-complex and expensive training. Appropriate technology should be labour rather than capital intensive, and minimise the use of finance or foreign capital. Overall it has so many advantages that it is difficult, at first sight, to understand why it has not been adopted everywhere.

Unfortunately, the appropriate technology argument is by itself fallacious. Technology never comes alone; it is packaged as part of a social organisation designed to produce goods. It may seem obvious that technology is part of institutions and, as institutions are tied up with national politics, the choice of technology is always determined by the character of the political system.

The beginning of industrial growth in Africa and Asia, as we know it today, was undertaken by the colonial governments, so the colonial industrial package included multinational capital. Since independence it is the design of the industrial package that has altered, rather than the package itself. Most independent national governments have retained close ties with western capital so that multinational and conglomerate commercial and industrial capital still dominates most third world industrialisation. Consequently, the predominant choice of knowledge, technique and organisation has been determined by these forces.

But is there any choice of technology for most third world countries? Any choice is a political question, we emphasise this again and again throughout this book. Any choice of technique is also based on knowledge and this ought to be in accordance with the existing social structure and human resources. Choices of technology ought to be made according to man's existing technical abilities, so that new productive institutions are part of an existing situation, rather than imposed from outside.

Foreign capital, in the form of imported industry, tends to bring its own organisational structure and technology with it. Rather than adapting to suit the local conditions, these industrial forms of investment are transplanted as complete units which give, and take, very little to or from the local economy. In principle, this should not affect the use of domestic capital for rural expansion and development. In practice, however, it does because governments are keen to provide services, e.g. electricity, buildings, water supply, roads and other facilities, specially to encourage foreign industries into the country. This leaves little or no money at all for rural domestic investment, while the foreign investments do not benefit the small local communities either. We would go further and suggest that multinational capital is in direct conflict with rural industrialisation, although it might be extremely hard to provide substantive proof. The problem is that so long as multinational capital remains so dominant, it is extremely hard to conceive an appropriate technology strategy which could begin to transform the life of the people.

We ought to add here that rural industrialisation is not the panacea for all the ills of underdeveloped countries today as some idealists would appear to believe. It is not that the ideas of the appropriate technologists are redundant, many of the aims which we noted above are worthwhile, but appropriate technology or rural industrialisation has to be seen within a total socio/political strategy.

There are many levels or forms of industrialisation which, in most situations, have to be tackled simultaneously. Some forms of industrialisation have to be capital intensive, and, for small

countries with very low levels of industrialisation, have to be based on imported technology: an electricity generating plant for a large city is an obvious example. In no way can rural industrialisation become the only form of industrial strategy. The extent of any single territory's dependence on urban or rural capital and on labour or capital intensive industry must depend on the existing social and economic conditions.

This book is concerned with village industry, although we do discuss small scale production in urban areas. Our primary concern is with cottage type production — with crafts which are an integral part of agriculture and the lives of the people of the countryside. Situations within countries, as well as between countries, vary widely according to a range of criteria, from labour skills to religion and we realise this. Our concern is with the poorest countries, with areas where even the basic labour skills are in short supply, scrap materials are not always to be found, labour is grossly underutilised, and where the simplest of tools is not available. In any situation, however, the local resources will eventually determine the possibilities.

This book provides a brief analysis of what is happening today in terms of small scale production, and a practical guide to ways of improving village production. We begin with a short historical chapter which shows what village industry used to exist, how it was destroyed by the advent of colonialism, if not completely, then certainly deprived of its old importance, and why it cannot be revived today for contemporary needs. We then show what is happening in terms of recycling industry, in other words how people earn their living by producing articles in demand from scrap. Our focus here and in the following chapter has been on Tanzania where the attitude towards small scale production has been helpful. In chapters four and five we show what has been happening in Tanzania through the government support in encouraging small scale modern industry. The last four chapters provide the arguments and the design outline which would allow any single body to design, equip and produce goods from a village workshop; in brief, a do-it-yourself village workshop. Our aim is, in the long term, that people will find this book practically useful and that it might go some way towards industrialisation in the third world which is desperately needed.

We assume, of course, that people wish to be self-reliant in the sense that they are not dependent on foreign private capital whose dominant motive is profit. Unless technical innovation can come from the people themselves, there is no such thing as an appropriate technology because only the people themselves can decide on what is appropriate. A rural industrial strategy makes sense in countries where a large number of people live off the land and use traditional techniques of

production, or even where substantial numbers live in shanty urban areas and work outside of government or foreign institutes. Widespread rural industrial strategies can lead to the growth of new skills and therefore initiate the conditions for industrial change: precisely the conditions which foreign capital cannot create. Rural industrialisation would generate a widespread popular knowledge concerned with the material manipulation of the environment. The more industrially backward, which simply means the lower the level of technical skills, the greater the importance of all small industrial projects. Village industrialisation could create the atmosphere for manipulative technical knowledge which is so often lacking at present.

China is the country which perhaps exemplifies the principles we have in mind, although it is worth adding that we are not holding China up as the example to be followed. To follow China would be to follow Chinese history and would obviously be absurd. China realised the importance of heavy and capital intensive industry but she regarded the development of her agriculture as her main task. For China, agriculture was not simply the production of crops but also the creation of rural industries integrated into the needs of rural people. The emphasis on rural industry is essential to the eradication of poverty in rural areas.

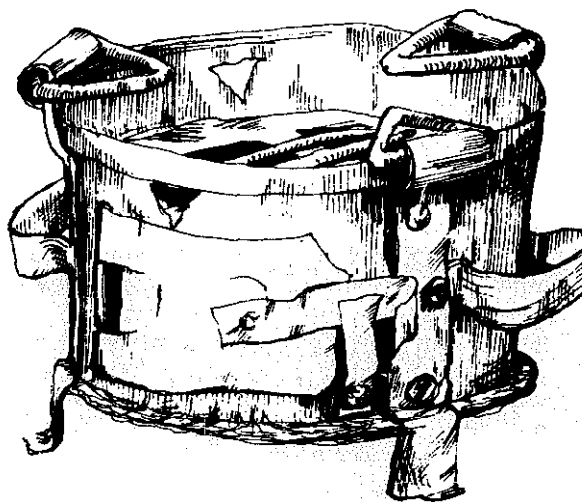

Crude stove made from scrap metal.

Community Development and Small Industry

by Krisno Nimpuno

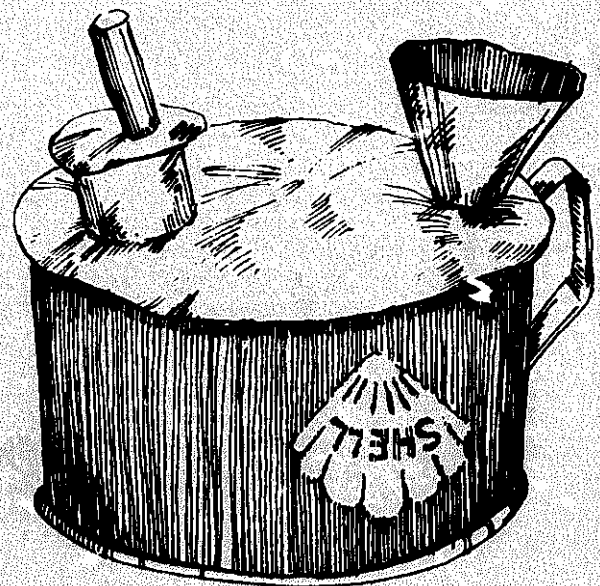

CHAPTER 1

Community Development and Small Industry

Krisno Nimpuno

Rural development is a complicated process involving many different factors simultaneously. It is naturally more than just economic development, and certainly more than merely increasing agricultural production. The term community development, itself, indicates that the central objective is emancipation of the whole rural society but very few rural development programmes have the integrated approach required to attain this goal.

It is noteworthy that rural development programmes under apparently different political systems contain largely the same elements which would indicate that, despite ideologies, certain elements are believed to be essential for rural development. Agricultural programmes, schools, health services, technical training, home management, and child care are all found in rural development programmes. That they do not in themselves constitute any guarantee for progress can be concluded from the difference in success of one programme and another. These differences indicate the crucial role of the political system under which a rural development programme is applied. Some essential factors, often missing from community development, are the mobilisation of the whole population, and co-ordination and integration of all development programmes.

These factors are difficult to obtain in a capitalist framework where competition and conflict of interests are the dynamics of development. The successes of a few "progressive farmers" do not offer the others any viable alternative to mass movements and do not stimulate selfless communal efforts. The failure of social mobilisation and absence of communal co-operative efforts seem to be a common and major obstacle to community development.

A rural development programme needs to be executed by the people themselves to become successful. The inclusion of all the essential projects is but one step on the long road towards development. The programme has to be carried out by the community and it is communal effort rather than a particular project which results in progress. This means that progress takes place in the mind before it materialises. Community development under duress is therefore a contradiction just as exploitation discourages people from great efforts. Social mobilisation rather than merely popular participation should therefore be recognised as the main strategy for community development. Social mobilisation does not concentrate on the popular execution of the project but starts with rallying the people behind the cause with full understanding and agreement for its aims. Co-ordination between different projects

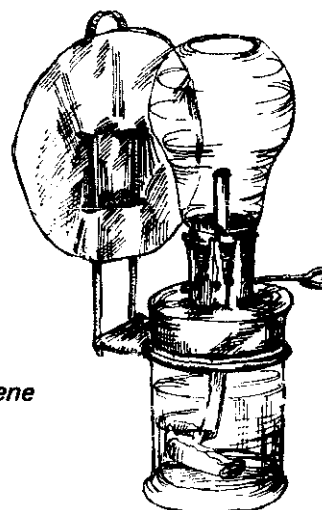

A kerosene lamp.

and integration of the whole development programme will be possible once the people have agreed to it.

Rural industrialisation is not an alternative form of overall industrialisation but is a precondition for agricultural development. David Philips mentions:

"The development of village workshops aims at the strengthening of the village economy, especially agriculture, and does not dispute the need for other types of industries at other levels."*

The establishment of workshops in a rural area does not, by itself, result in the development of a rural industry nor will it noticeably increase the standard of living if it is introduced unrelated to the other developments. This limitation of goals determines the character of the rural industry projects. Many small rural industry programmes fail to integrate into the rural conditions. There are many examples of rural small industry projects, for which the raw material comes from elsewhere, and which are producing goods that are of little use in the village and will have to be marketed elsewhere. Such types of small industry obviously become very vulnerable in a village economy because of their dependence on outside markets and supply. The new rural industry should naturally relate completely to the setting, try to satisfy the needs of the village to start with and, if possible, use the raw materials which are locally available. The first production priorities are agricultural tools, buildings and installations.

Which roads are then open to a successful rural industry as a part of community development? To answer that question one first needs to understand the conditions in the rural areas and to decide the priorities for development.

*Unpublished report for the Tanzanian Small Industries Development Organisation, Dar es Salaam, 1975.

Conditions

The rural areas in the developing countries have tremendous difficulties to overcome. Often there is only subsistence farming which has a very low productivity yield. There is very little capital available and, in some cases, such as East Africa, a great lack of skills. An additional obstacle is the low population density which makes it more difficult to use human labour as an effective national resource. The two main problems are acquisition of knowledge and capital accumulation. These are the real obstacles to progress. Very little capital can be brought in from outside and because practically the whole nation has the same needs it is quite inadequate. Capital accumulation is a central problem in village development and the income of the villagers is so low that they cannot enlarge production. They simply cannot afford machines, fertiliser etc., neither can they pay for experts.

Indeed, the most important element for the development of industry is knowledge. Although some traditional industries in Tanzania have been highly developed in the past, very little, if any, of that remains as a living tradition today. The development of skills, rather than the provision of physical facilities, is the bottleneck.

The most attractive method to develop these skills is indeed education through production. The gradual training process is then a productive period, instead of a too costly investment because there are only limited resources to draw from. The existing elementary subsistence farming creates little surplus available for investment.



*Wooden-handled
knife.*

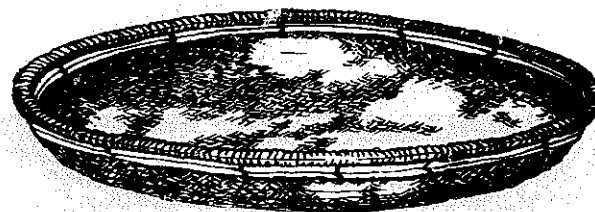

Shallow basket woven by craft workers.

To Develop Village Industry

With these conditions in mind, it becomes clear why the development of small industry in so many community development programmes has failed. The effort has often been to create a mini-type of large industry with hardly any roots in the village economy. From the start production is often export oriented, and lack of administrative experience and marketing knowledge is a great drawback. The producer seldom has any realistic idea about the needs and wishes of his unknown customer. He will therefore have to produce mechanically and cannot design or adapt his products in a creative way to suit the changing needs of his far away client. It has been argued that UDC's should move away from import and export orientation towards an integrated domestic economy.

Export industry needs capital even if it is only export between two regions, and lack of capital hampers many small industries. The guideline is still too often to earn through export instead of to earn through import substitution and contribution to agricultural development.

Outside capital, moreover, often comes in with so much pressure and so many strings that the beneficial effects are all too often doubtful. If labour can be put to use it will create capital locally. Skills can be developed through training programmes.

Although occasionally outside contributions might be given, it is primarily the local resources which will have to be used for development. Here again, integration is the key word: develop the existing resources. Education should be a constant activity for all and training should be production oriented. At every stage, education should provide the knowledge needed for the next step in development. The slogans, "learning while doing", "producing while developing", "learning to produce", symbolise how we view the needs of rural industry.

The emancipation of the whole community is the aim in contrast to merely focusing on a few successful members of society. Capital formation should not be measured as the sum of the individual accumulated amounts but as the total of resources at the disposal of the whole community. The consequences are apparent for all elements of the

community development programme. The school is not to be a road towards individual success, or a career institute, but the source of collective knowledge. Information acquired by one individual can be beneficial to the whole community. The community development programme should therefore generate such knowledge and energy to move the society and it should not propel a few individuals into privileged positions. The first need is therefore to adapt education to the immediate needs of the community and to create an industry that will reinforce the economic base of the community. This means, in the rural areas, strengthening and supporting agriculture. In the following pages we will develop this view. The basic assumption that village industry should play a subordinate role is vital. With the scarcity of resources in the rural areas of the less developed countries (LDC's), such a clear focus is not a luxury but a necessity.

Industrial strategy at the village level should aim at:

- developing agriculture, e.g. through infra-structural works and by providing agricultural tools
- substituting the import of consumer goods
- manufacturing the means of production for processing agricultural products.

Such industry is subordinate to the main economic potential in the village, i.e. agricultural. It is the mobilisation of some of the local resources for the development of agriculture. There cannot be any doubt that the agricultural sectors need such support.

Agriculture can only be developed if better tools and methods are available. Irrigation, ploughing, the use of fertilizers and all other aspects of agricultural development depend heavily on technical support which is not available in the villages today.

Rural industrialisation can provide a major contribution, but if rural industrialisation has an independent aim, then all kinds of resources would have to be mobilised towards its development, in competition with the main economic sector of agriculture. This has often been the case and some attempts at rural industrialisation have resulted in conflicting interests between agricultural and industrial development.

Rural development demands many different goods and services which can only be obtained if agricultural production creates a surplus. Agricultural activities have a special rhythm which limits the possibility of a sudden leap forward just by increasing efforts without changing the methods. It is here that rural industrialisation can offer short cuts by contributing to the creation of agricultural surplus, utilising untapped resources and saving some expenditure. The production of

new tools, the improvement of the agricultural infrastructure, the utilisation of seasonally unused labour, the replacement of imported goods with local products all contribute to accumulation of capital and development of the agricultural sector. This is why rural industrialisation should be so clear in its objectives.

Any industrialisation dependent on the import of raw material and export of finished products to towns can even detract from the basic development of the village. Such an industry does not easily adjust to the scarcity of labour during harvest time nor utilise the unemployed during the dry season. It is dependent on the same village supply and transport system as agriculture and competes with it. It also has to adjust the quality of the products to the taste of a far away customer. This export-oriented industry becomes entirely

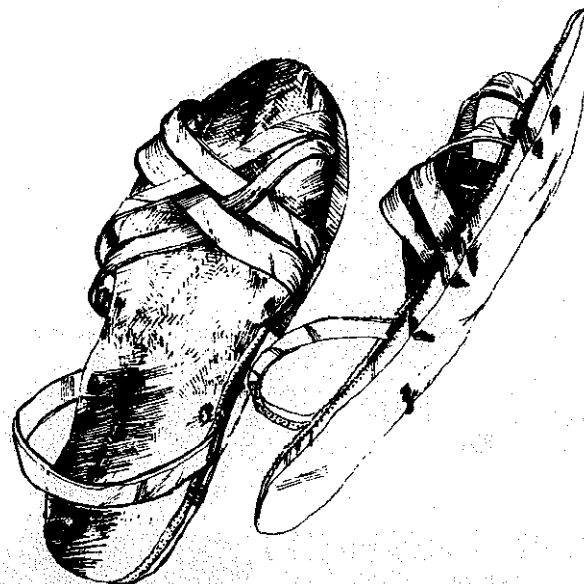

Locally made open sandals, sold in the market.

part of the money economy and will need credit facilities and administrative capacity. It is, however, not uncommon in rural development projects and it can be seen, in many cases, that its contributions to the rural development are disappointing.

The agricultural processing industry in Tanzania today is mainly organised outside the agricultural sector. Its contribution to the village economy is therefore very limited, and serves mainly as a purchaser of agricultural surplus but not as an integrated development vehicle for the rural society.

The workers in this industry are usually employed as full time industrial labour. The peasants producing the raw material are simultaneously seasonally underemployed. In the West Lake region in Tanzania, approximately 1,000 workers are employed on estates or in agricultural processing industries. The employment in other



Typical open workshop.

industrial sectors amounts to 400 persons out of a population of about 700,000 people. West Lake is a region which is relatively well off in Tanzania. In most other regions — with the exception of Kilimanjaro and coastal areas — the agro-industrial activities are even less.

Obviously, the economic potential of the country is almost totally unexplored as yet. Today's under-productive agriculture cannot produce a significant surplus without solid technical support.

The great factor to be determined now is the planning strategy. The most obvious observation is that agricultural development has only just begun and is, as yet, unable to utilise the available production factors economically. The greatest waste factor is labour. For example, transport of water for household or agricultural use is one of the greatest consumers of labour. As land is still abundant, labour is the main factor determining the volume of agricultural production. However, this labour is only needed during short periods for planting and harvesting; for the rest of the year, labour is under-utilised. An industrial occupation during this time would mobilise an unused productive force. Apart from providing full time employment, if this workforce were producing agricultural equipment, it would be of further benefit to the farming sector by increased agricultural production.

China has been eminently successful in this respect. During the winter, there is massive productive activity especially in the field of construction. Road works, silos and irrigation works completed then save labour and improve agricultural productivity during the busy summer period.

Similar possibilities exist in East Africa. There is a great need for roads, dams, water works, stores, silos and landscape development which would all improve agricultural production. Agricultural implements, furniture, mills, peelers and transporters are also urgently required. The primary skills needed are obviously metal craft, woodwork and masonry. These skills are essential to most forms of production and can contribute directly to agricultural development. The strategy should be to direct available resources towards improvements for the benefit of agriculture. The motivation of the population to participate will therefore be natural and each success will contribute to the acceptance of the belief that development lies in their own hands.

Discussing the choice of technology for developing countries. H. Dickinson in *Dissemination of Appropriate Technologies*, points out that the choice of technology is as important as the aim of technical development itself:

"In all kinds of production it is necessary to find a technology that can meet the production requirements whilst making the fullest use of immediately available resources."

Nowhere has this been better understood and applied than in China. Some very poor villages decided to develop themselves and become self-reliant. Tachai, for instance, developed itself in such a tremendous way that the landscape changed totally within a few years. By drawing on all available labour during the winter, agricultural land was created where none existed before. At Tachai they worked right through the winter and into the spring in freezing wind and snow. They threw up 38 retaining walls across the ravine . . . The spaces in back were filled with earth. They built about 1.5 hectares of farmland on this ravine.

One of the participants relates that the villages created the technology and industry themselves. They made their own explosives and since 1971 blasted away 36 hilltops.

Although knowledge plays such an important role, injections of knowledge into infertile soil will not lead to anything. However, once a choice has been made and an awareness of the possibilities of self-development is alive, then development can become a self-sustaining force. Dickinson observes:

"The central problem of finding appropriate technologies for the development of poor countries lies in giving the poor access to scientific and technical knowledge in a form that reflects their needs and is assimilable by them."

Dickinson is an outsider, but obviously concerned and knowledgeable. One of the participants, Kuo Feng Lien, saw technological development as a by-product of self-development which is a side

of the coin that many outsiders can accept but often underrate. He recalled that in the most critical period they worked in the fields in the daytime and, at night, built houses. They quarried their own building stones, fired bricks, and made lime.

The determination of the Chinese has come about through certain conditions which cannot be duplicated. Co-operative effort in any society will quickly collapse should the participants discover that some people profit more from the collective endeavours than others. It has to be perfectly clear to all what it all will lead to.

In many respects, these experiences could be relevant to the countries of East Africa. The social and historical conditions are different from those in China but, if petty personal profit is eliminated and communal efforts become beneficial to all, then agriculture could be developed by creating a technical base and an agricultural surplus.

In East Africa, rural development has to carry an extra burden of new structural changes in the countryside. Major villageisation movements are concentrating the formerly scattered population in planned villages. These centres attempt to develop a social and administrative service structure which greatly influence the life of the villagers. The establishment of schools, health facilities, water supply, and co-operatives are dynamic developments which are bound to impress upon the villager that life can change and that he can play a role in this process. Millions of people are in the process of establishing themselves in villages in order to develop the agricultural potential of the country. At the same time, successful industrialisation depends on this very group of people. The two factors for industrial development mentioned earlier — skills and equipment — are extremely scarce and will have to be developed from practically nothing. The only possible starting point is to develop the available labour and the little agricultural surplus that can be created.

Although, in the future, there might be potential for sophisticated types of small industry, at the moment the priority is to produce simple industrial goods for agricultural or household consumption. It is possible to start the basic production of every day consumer goods as a substitute for the present imports. Some of these goods can be made with the minimum of tools, skills and raw materials. Learning while doing can lead to successively improved products. Increased skill will utilise better equipment successfully and a workshop can improve the quality and quantity of its output.

The first step in industrialisation is to utilise the almost totally unskilled, but readily available labour with minimal capital investment. In East Africa, there is very little rural craft tradition and the gradual development of skills within this group should therefore be given equal priority.



Construction work involving the whole village.

A village industry, which utilises unused labour to develop itself and acquires the necessary equipment step by step, can reach high levels of production and sophistication without the necessity for any large investments.

A considerable number of people in the West are interested in small scale technology for Third World countries and there is a growing amount of literature available. Much of this work is "idealistic", however, and assumes, "if only people would understand, if we can get our message through", that logical argument is enough. We think this approach is unrealistic and ignores the role of political and economic interest. Our list of recommended reading is therefore short.

Bibliography

- Cooper & Serovitch *"The Channels and Mechanism for the Transfer of Technology from Developed to Developing Countries"*. UNCTAD, TD/B/AC. N/5.
- Jens Muller *"Choice of Technology in Undeveloped Countries: Exemplified by Road Construction in East Africa"*. The Technical Institute of Denmark 1973 and The Institute for Development Research, Copenhagen.
- UNCTAD *"Transfer of Technology"*. TD/106 November 1971.
- H. Dickinson *"Dissemination of Appropriate Technologies"*. Edinburgh, 1974.

Pre-Capitalist Industry in Eastern Africa

by Roger van Zwanenberg

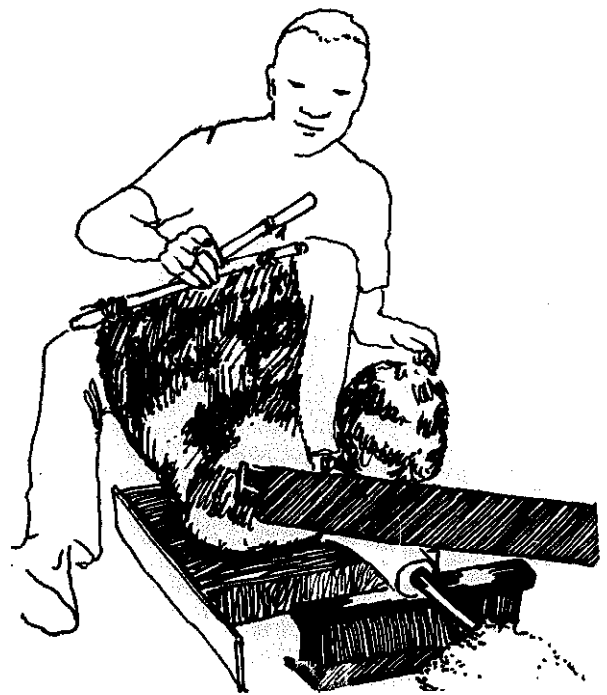

CHAPTER 2

Pre-Capitalist Industry in Eastern Africa

Roger van Zwanenberg

There was an abundance of manufacturing and agricultural industries in the old precolonialist societies of East Africa. The distinction between agricultural and industrial production was somewhat arbitrary, however, as both activities were an integral part of a complete pattern of life. Present day society often divides the world into distinct categories, but the old society did not understand things in this manner: the world was taken as a whole. If we are to understand some of the essential characteristics of traditional industrial production as it was, we need to see the process within the whole structure of that society.

To understand the basic economic framework in which industry played a part, a common misconception must be dispelled. Generally speaking, East African peoples do not appear to have been self-sufficient before the colonial economy.* Most of the peoples in the region certainly provided most of their food needs in the years when rainfall was sufficient. Some relied on the local conditions to produce some foods and exchanged with next door neighbours for others. Few people could provide for all their material needs and even fewer could provide means of defence. Scarcely anybody could provide for himself when the rains failed for more than a year. As a result, nearly everybody established patterns of trade, friendship and kinship relations with people in the nearby vicinity where there was no ethnic connection, but the people had a different means of production and other goods. These relationships had two advantages: they provided a regular mutual exchange of goods not otherwise regularly available and they also formed a social bond which could mean the difference between life and death in years of drought and famine. These established relationships originally arose either through the history of settlement, or economic specialisation. It is the importance of the role of economic specialisation on which we shall focus here.

East African undergraduate research into economic history found that most areas produced a particular commodity according to its resources.

**There is a whole range of terms in the literature which imply that the old societies were economically self-sufficient, for instance the notions of "primitive" or "traditional" are two. "Bourgeois" social science, especially in the field of sociology and political science, has assumed self-sufficiency in the old societies without having done the historical field work. Marxist scholars are little better, they argued that colonialism removed the independence of the old societies, also without the evidence of any field work. The Marxist argument assumes self-sufficiency if one equates it with independence. In both cases, the arguments are usually made without the necessary historical work, while historians have tended to be interested in other problems.*

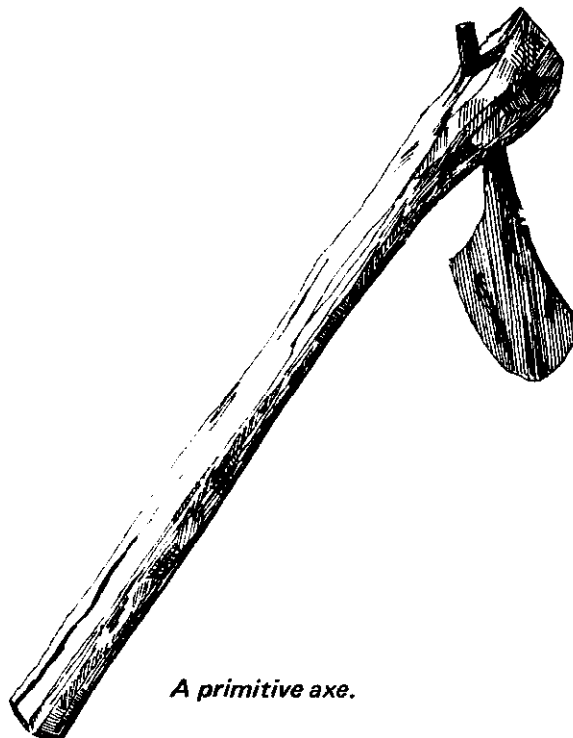

A primitive axe.

One area might specialise in a salt which was sweet tasting, a second in iron hoes, a third fish traps, a fourth poison for arrow heads, a fifth shields from buffalo hides, while others might have produced a rough cotton material. From recent research nearly every localised area seems to have produced something special, although in many cases the product was agricultural or pastoral. I can best illustrate this process of economic interdependence from personal research done on the Eastern coast of Lake Victoria.

My work began in Samia in the north, where the people mined ore, smelted it, and then produced heavy iron hoes. Samia hoes were famous throughout the region a hundred years ago, for their durability. Samia traders would take some of the hoes down to the coast to Port Victoria or even further to Usenge. At Port Victoria the people were great boat builders, (they still make them in the old Baganda style today and they are in regular use along the Eastern coast of the Lake). Here hoes might be exchanged for dried fish, another local produce. The hoes would then travel south down the coast via boat owners from either Port Victoria or Usenge. The latter specialised as middlemen, collecting the hoes in exchange for goats, and then selling them further south at the islands of Mfangano or Rusinga at a rate of exchange which in the end left them with considerably more goats than they started with.

The people on the islands of Mfangano and Rusinga specialised in cattle breeding. They

exchanged their animals for goods which were not available, like the Samia hoes. The islanders apparently had an old policy which forbade animals to be imported from the mainland and, in this way, maintained a water barrier against animal diseases. The people of the islands bought their boats from the Port Victoria people and their salt from Kaksingiri, opposite the islands on the mainland. Kaksingiri salt was manufactured from saline deposits which arose from the earth in Kaksingiri Bay. The salt was constructed in cone shapes, wrapped in banana leaves, and then carried to Karungu in Suri Bay further south where the process of specialisation and exchange was continued.

The peoples who lived along the Eastern coast of Lake Victoria in the nineteenth century and before, produced a range of manufactured articles. Salt, hoes, and boats were only the main produce of specialisation; others included dried fish, dried bananas, all kinds of weapons and medicines, musical instruments, and so on. Few peoples, indeed, were self-sufficient in all of these goods so the only way to obtain them was to produce something in excess of family needs. Small scale industrial production of local specialities, through the exploitation of local resources and skills, provided the basis for a complex system of exchange relationships with a wide range of peoples. In times of dire famine and want these relationships were used to pawn or exchange a child or two in return for food. The child might be left for some years if the family in question could not provide the means to get the child back. Such forms of exchange appear to have been a common way of dealing with famine although it was not, I might add, a form of selling one's own children into slavery. It was based on the reciprocal understanding that the child could be returned as a right under the appropriate circumstances, and that the favour itself might be reciprocated at some future date when the tables were turned. Industrial production, exchange and social relationships were part of a whole existence.

The principles of this pattern of production and exchange can, I believe, be generalised throughout most of East Africa, at least insofar as to assert that nearly everybody depended on many others for everyday consumer goods, and on a few special friends in times of real need. While I know of no one who has done the type of research over many different areas referred to above, the small scale researches of University students do provide a strong indication of localised economic interdependency based upon localised manufacturing skills.

In many cases, the skills themselves were very much dependent on the character of the local resources. The research by Helge Kjekshus into iron and salt production indicates the variety of

techniques in use very clearly.* Magadi salt was a rough soda, obtained from the lakes of Manyara and Natron, which was used for boiling and tobacco preparation. A sweeter, edible salt was obtained from a number of lakes of Balangda in Mangati and Eyasi. Salt from these lakes seems to have involved very little preparation as it was collected in lumps.

Salt for eating could also be obtained from springs and special soils. In both cases the salt could only be obtained by a process of purification which removed the salt from the earth or the water. The techniques of purification varied from one area to another. In the case of salt springs, the water had to be evaporated while earth salt had to be filtered. As Kjekshus notes, with the high quality of the salt and widespread trade that centred on the area as a result, the salt springs around Uvinsa have attracted special attention from scholars (and earlier from European travellers). Salt obtained from the earth appears to have been in abundant supply. Kjekshus notes a number of places where such production and trade occurred including areas of Unyamwezi, Uha, Maasai, south of Lake Natron, in the Pagani Valley and in the Kahe plains south of Kilimanjaro, for example.

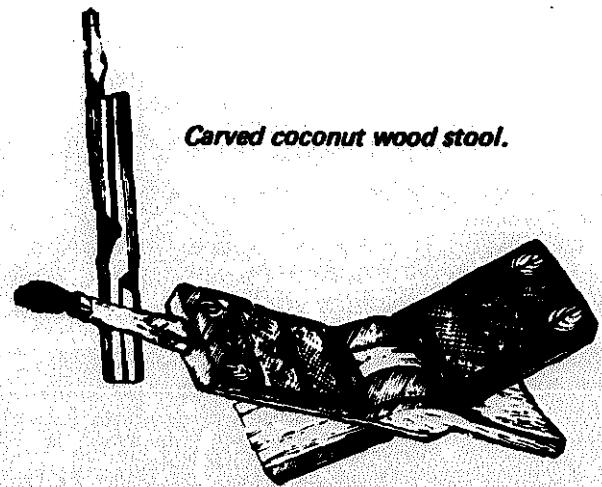

Carved coconut wood stool.

Only certain types of manufacturing production were specialised. Other types like tanning, stool carving, and pot making tended to be more widespread and generalised even within kinship groups. The skills and material for hut making were widely available and were commonly practised among family groups. Pot making was a speciality of women almost everywhere although limited by the availability of suitable clays. Tanning hides was a skill which depended on the supply of dead animals but, as almost everybody herded some beasts, the skins were not the main problem.

**Helge Kjekshus' work on precolonial industry at the University of Dar es Salaam is by far the most extensive so far. His work was based almost entirely on German and English published sources from the early colonial period.*

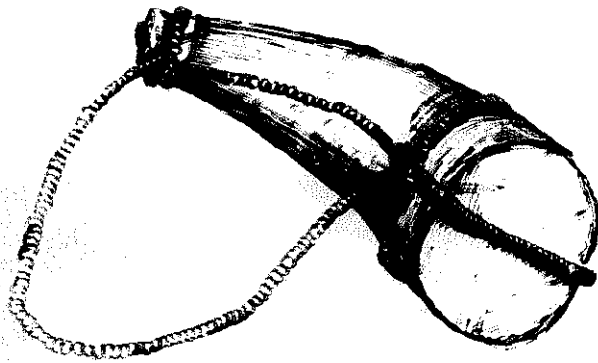

Milk carrying vessel.

It is important therefore to realise that there was a wide range of manufacturing skills in different parts of the countryside which had evolved over long periods of time. These old techniques are now considered either redundant by those who are mesmerised by the apparently "modern" western technology or, on the other hand, potentially "appropriate" by those who are mesmerised by the romantic independence of past ages. Neither view is particularly useful as neither considers the production of manufactured goods within the context of their history. In the past, production of the goods we have briefly discussed, and the techniques that were used were an integral part of the knowledge and understanding available at that time. It was not a question then of whether they were developed or not which is, after all, a contemporary issue or value from which we judge the utility of production. In ore-colonial East Africa, the critical issue was reproduction. If production supported the reproduction of the system, of the family and clan, then we have a measure for evaluating the utility of the goods in question. The questions we must ask are not, therefore, whether the old skills can be revitalised, or whether the old skills which are still left can be developed in some way or another, but whether the old skills are redundant in the face of the contemporary techniques of agricultural production. In the past, the old skills automatically related to the needs of agricultural and pastoral production in a world which was almost unrecognisable in comparison to the present one; in a sense, therefore, the question of whether the old skills are still useful is the same old question of the past but in the contemporary context. Can these old skills be related to the development of the rural communal village schemes of the 1970s and 80s?

The colonial period answered many of these questions for us as so many of the old skills have ceased to exist. Nobody today tans hides for clothes. Yet there is one industry left, which we analyse in different forms throughout this book, and that is the metal industry. In the past

the production of iron goods and weapons was extremely important for the well being of a community: people would travel long distances to obtain iron made goods for digging the ground and for defence weapons. The iron hoe in East Africa symbolises life and, when used as a symbol in elections, assured the candidate of success.

In some areas of East Africa the village smith still exists, producing agricultural tools. In Kenya, we found that this particular skill was dying out; in the Samia area previously mentioned there were few smiths still in production as the people in the area could obtain imported agricultural tools, so the smith produced for the poorest peasants only. As a result, there were few shillings to be made from smithing and no young people were being apprenticed.

On the other hand, in Tanzania we know of two areas where smithing is still widespread and this would seem to reflect the fact that imported agricultural tools have not been made widely available. In the Bukoba region of northwest Tanzania (where the iron industry goes back for at least two thousand years, according to recent archaeological excavations) there is still, today, an active iron smithing industry which produces a range of spears and knives and a full range of agricultural tools. The workplace of the smith is under a small grass-roofed hut-like structure which is, to all intents and purposes, in the open air. Although the technologies are relatively simple by comparison with the iron and steel technologies which have been developed in the west over the last two hundred years, the iron workers in East Africa show a thorough knowledge of their material and are in some cases capable of producing work of considerably delicacy, e.g. arrow heads.

The bag bellows, still used in some parts of East Africa.



We have illustrated a number of bellows which can be found in different parts of East Africa wherever the blacksmiths' arts are still practised.

According to Helge Kjekshus, who has worked in this area, the bag bellows were used interchangeably for smelting or forging, and can be found throughout present-day Tanzania and Eastern Africa. The drums or bowls bellows illustrated was made in pairs from a single block of wood hollowed out to form two separate bowls.* The top of the bowl, as can be seen in the picture, has been covered with the skin of the underbelly of a goat (the softest part of the hide). The stick on the top of the skin acts as a rod to pull the skin up and down to push the air into the furnace. This bowl bellows can also be found in areas throughout the region. Both types of bellows can still be found wherever smithing is carried on. As mentioned however, smelting is now a lost art which does not seem to have been practised for many decades.

We should now discuss whether the traditional smith, where he still exists, should be encouraged to adapt to contemporary needs. The village smith in much of Western Europe was an essential part of the industrial revolution and of feudal society before that. With the demise of the horse and cart, however, over the first thirty years of the 19th century, and later with the growth of standard fixtures and fittings, demand for the individual work of the village smith died. Today there are hardly any village smiths to be seen. But, and this point should be made quite clear, we are not suggesting that LDCs should even think about copying the patterns of industrial growth that the Western nations followed. The European village smith was never the kingpin that held the edifice of village industrialisation together, he was simply one of the technicians which held rural production together. The village iron worker in this context was not an innovator or an entrepreneur in any sense. He simply provided for the needs of the village. Like so many other workers in the 19th century, he was not in a technical situation where he could adapt to the competition from factory production, so his skills became redundant, like the textile workers before him.

The problem of basic technical skills is acute in much of East and Central Africa. It is not a question of praising or blaming the character of society in the nineteenth century or before, but the sort of manipulative skills which are needed throughout a society for an industrial revolution to occur are usually absent. The village blacksmith must form part of the learning process in conjunction with a formal educative process if people, and particularly young people, are to learn manipulative skills. At the present time, the vast majority

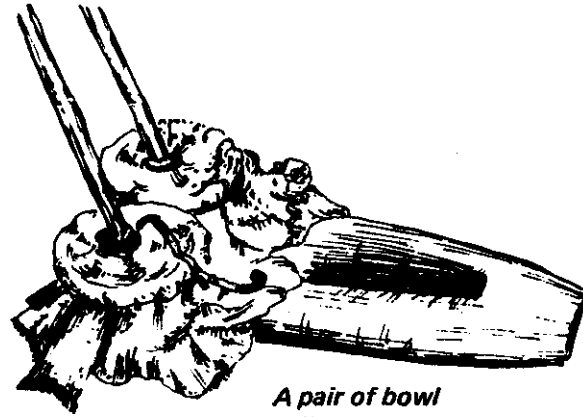

A pair of bowl bellows made from a single block of wood.

of existing craftsmen are well able to copy an existing design, but have not been able to create new designs for themselves. This is the crux of the problem: the creation of a new idea, and the ability to carry it through involves a self-confidence which appears, from the examination we have made in this study, to be lacking.

The factor which stands out in the many stories of Chinese village life, and appears time and again, is the collective ability of the village to adapt their environment to the needs of a new society and whether one calls this adaption revolution or entrepreneurship, it is the creative response to overcome bottlenecks in the productive process. This ability still appears to be lacking among the Tanzanian fundis. The old East African smith was working for hunters and peasants as a maker of weapons and tools. The role of the village blacksmith is not simply to supply the needs of the existing village, but to act as the centre of the hub of the self-generating process. He must be the centre of new ideas and of new ways of producing and designing things.* If he hasn't this spark of creativity, then surely he will disappear, as so many other smiths have done already in Africa in the last 75 years of this century. For the future needs of the people of the villages it matters not a jot whether the old existing smiths should be revived or whether new men with some simple tools and skills are found. The people who can best use their talents and creativity for their fellows are needed to begin with.

**For a further discussion on the contemporary production of these bellows, see Liv Berg on Recycling Industry.*

**See Chapter 7 where we propose the equipment requirements of an expanded village workshop for a blacksmith.*

Recycling Industry

by Liv Berg



CHAPTER 3

Recycling Industry

Liv Berg

One of the most obvious types of production in less developed countries is manufacture from waste products. Different kinds of refined materials go back into production i.e. are recycled. It is a common sight to see children playing with toys made from the rubber of flip flop sandals. Everywhere where people cannot afford to buy imported manufactured goods, local ingenuity provides alternative products made from materials which would otherwise be thrown away. The existence of recycling industries has usually been ignored by governments, although a few countries have paid some attention to the importance of recycling and have striven towards developing these industries. All over Asia, with its long craft tradition, waste material continues to be used for production. The People's Republic of China is one example which now has recycling industries on a highly technically advanced level as well as on more simple levels.

There are many factors which may explain the existence of recycling industries. The majority of the citizens in developing countries are poor, the wages are low and a large group of the inhabitants are not yet fully integrated in the monetary sector. Consumer demand is naturally limited by the availability of cash incomes. Yet changes in living conditions, as people move rapidly into urban environments, create a new need for both consumer and production goods. Urbanisation enforces a different social pattern with a new form of consumption. Meanwhile, in the rural areas, the change from subsistence to cash crop farming requires more improved agricultural implements for the poor majority. Fundamentally, these commodities have to be low-cost to respond to the demand.

Recycling industries tend to be small, diverse and extremely hard to enumerate. They hardly affect the GNP and, as a result, have been neglected by governments. Members of the administration do not buy goods from these industries so that there is no reference to the immediate needs of the majority of citizens i.e. the poor. Further, as this kind of industry is not very spectacular and accumulation of capital is low, only the police are concerned to move on those who steal their raw materials.

Production from waste material is found in two kinds of industries in Tanzania: a) small industries, and b) cottage industries. The small industry can be defined as an industry equipped with simple, often non-electrified tools and machines with little division of labour. The proprietor (or proprietors) is both an entrepreneur and an artisan who works alongside his workers, companions and/or assistants. The cottage industry uses family labour and



Open carpentry workshops like this one are often found in towns in the space between two houses. Raw materials and equipment have to be stored in the owner's house and brought to and from the workshop every day. The workshop roof usually covers only the small workbench so during the rainy season the materials and finished products are often subject to water damage.

traditional skills; it has been little influenced by Western technology. Most recycling industries are situated in the bigger urban centres, especially in Dar es Salaam, and are mainly the small industrial type. In the rural areas, both cottage and small industries are found.

Tanzania has, like so many less developed countries, a shortage of refined raw materials. Although she has natural assets of iron and coal, the infrastructure does not yet allow exploitation. It is scrap iron and tin that provides a widespread section of blacksmiths and tinsmiths, with materials for producing kerosene lamps, charcoal stoves and other simple household

implements. On the other hand, the forests are lumbered and furnish the local industries with wood for manufacturing timber, chipboard and plywood which, together with recycled wooden products, form the raw materials for the carpentries.

Waste material, suitable for reproduction, is naturally concentrated in urban areas where the capital intensive industries are situated. It is these industries which are dependent on imported refined material adapted to the imported machinery. The production techniques create wastage which is not profitably usable, for technical reasons, within the capital intensive industry, e.g. pieces of iron from the casting process, waste tin from canneries, etc. Broken machines, machine components, and discarded equipment also supply the recycling industries with raw material.

The point is this: goods which are designed for Western technology, which can be imported or made in third world countries, are usually intentionally designed to last for short periods of time. Flip flop sandals provide an excellent example of a product bought by the poor which rapidly wears out or breaks and cannot be repaired. The user has to buy another pair, or walk barefoot. Flip flop sandals are typical Western consumer goods which have no spare parts, they have to be replaced when something breaks, and their price is considerably higher than in the West. This kind of product supplies some of the waste which is then recycled.

In Kenya there is an obvious trend towards a further concentration of recycling industries, particularly in Nairobi from where the finished products are distributed to the countryside. The recycling industries which produce implements for the poor are paradoxically dependent upon the consumption of the rich. On the same level of understanding, there is a contrast in the technology of production that is used.

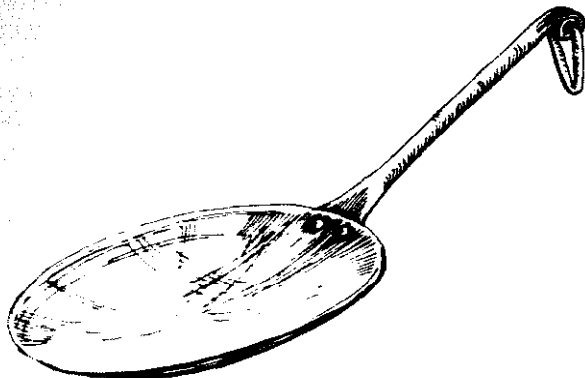

This frying pan, made from the lid of an oil drum, is a common household implement. The design is well thought out, albeit rather shallow so food could spill out rather easily. It is, however, well made and durable.

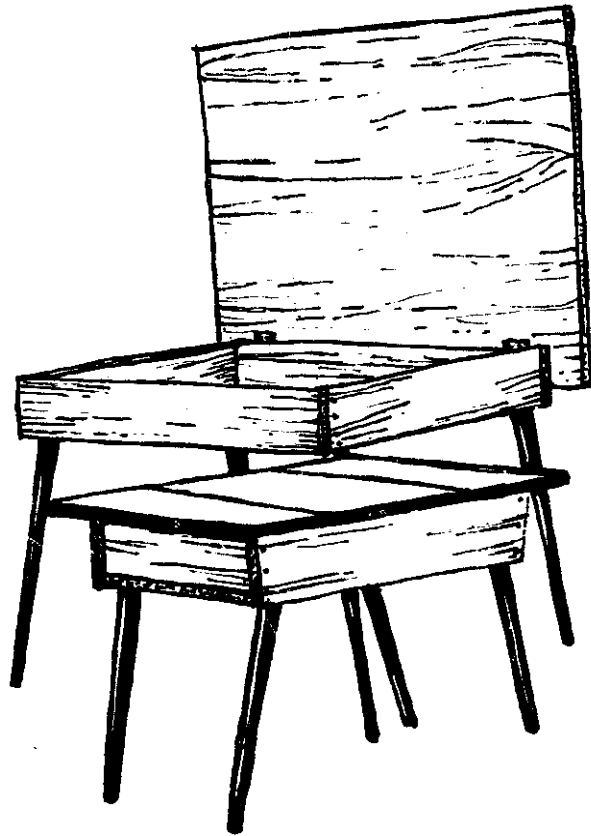

Tables like these also function as boxes for storage purposes. They are made with old wooden legs and formica-covered tops. These tables are a good example of a product made by a carpenter lacking sufficient know-how: the joints are only nailed together; general construction is weak; the legs are all at different angles to the frame, so the table is unsteady and the final finish is generally careless.

Another factor which encourages the use of recycled material is the problem which the craftsmen face in obtaining new raw material. New raw materials in Tanzania are distributed through the state trading corporation. The state trading corporation is interested in supplying material in rather large quantities. For example, the smallest quantity of chipboard they will deal in is 5 sheets which cost Shilling 475 (£25 approx.) or 5 sheets of formica which cost Shilling 475 (£25 approx.). From our investigation, one craftsman with two assistants would take two days to produce one coffee table which would sell at Shilling 190 (or £10 approx.), and he could make eight coffee tables using each sheet of formica. These craftsmen did not have the turnover, nor the storage space to purchase these quantities of new raw material and, as a consequence, they did not have the available cash either.

Small industries with low productivity and low income are forced to buy materials from local

trading companies which charge comparatively high prices for selling in small quantities. This situation sometimes makes it impossible to compete with mass-produced goods. For example, the price of a mass-produced plastic bucket in the shops is slightly higher than that charged for the tin-sheet material required for a bucket; the soldering and labour brought the price of a metal bucket locally-made from sheet metal above the price of its plastic counterpart.

Often the economy of the craftsman is so precarious that the customer has to buy and bring the material himself. As a result of the high charges for new materials, the craftsman has to stop his production until an order is obtained, or else use waste material which is obtained either free or very cheaply.



This scoop is another example of unskilled work. The handle is very weak and has not been fixed firmly enough to the scoop so it is very likely to bend and break off.

The products of the recycling industry tend to lack an attractive finish and are often poorly constructed. As a result, the poorer members of society are forced to accept poorly designed and constructed articles for their homes.

Recycling industries can be divided into groups based on the raw materials they use. With very few exceptions there are three types of waste material which are recycled at the workshops: metal, wood

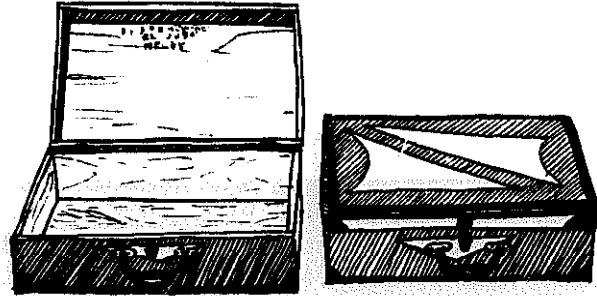

Although this suitcase has a Western design, it is painted in locally attractive colours and patterns. This case was well finished and made from packing-case material (plywood) which is durable, although heavy.

and rubber, although plastics and glass are also recycled.

Metal

Metal recycling is found all over the country. The smelting process has been replaced by scrap-metal. Blacksmithing has been common all over Africa for many hundreds of years and, among poorer people, blacksmiths still work using scrap metal alongside the old traditional techniques of cottage industries. During the pre-colonial period, many blacksmiths remained important people — they controlled both the manufacture of war weapons and tools for agricultural production. The blacksmith himself, as well as the actual operation of smithing, was surrounded by religious ritual and mysticism.

Blacksmithing (within metalwork) is the only method practised at cottage industries in the Dodoma area investigated. The traditional blacksmiths use only scrap iron for production and they have a low productivity with a limited range of goods. They produce agricultural tools, such as hoes, sickles, axes, and a small number of other tools which often still include spears and arrows for the village men to use against wild animals.

The products are extremely simple, but we felt effective, traditional tools which are made by craftsmen with a thorough knowledge of their profession. These products are often superior in quality and solidity to mass produced items. An example which may illustrate this is the production of hoes at Ubungo Farm Implements in Dar es Salaam. The design of the hoe was the same as the handmade hoe, but quality differed at the time of our study. It could very well be a temporary error at the UFI production, but the farmers in the villages we visited complained about the quality of the mass produced hoes. We checked the hoes and found that the hardening process was not carried out correctly. The surface at a fracture was coarse-crystalline, which makes the material brittle and decreases its durability.

The most important raw materials for recycling in the small industries come from wrecked cars, oil drums, engine compartments, and cans. Along the roads in Tanzania wrecked cars are left to be corroded by rust, and heaps of scrap are found in every town, often in the workshop area; however, the best use is not made of scrap heaps.* This may be explained by the character of the production process involved in the use of scrap iron which is time-consuming and requires considerable muscle power. Alongside their production, some workshops have specialised in bringing in scrap, and selling it to other workshops in the area. Different methods are used in the recycling process, e.g. battering, cutting, smithing, punching, and soldering. The scrap materials in metal workshops are used for two different purposes. Some is used as it is for tools, and some for production material. Scrap is often used as tools by the metal workers. For example, machine components are used for metal chasing, nuts for punching, carsprings for bending, pieces of railway rails as anvils, and so on. The list would be very long. On the other hand, carpenters do not use any tools made from scrap — they use imported tools. The critical point is that the metal workers could be making tools for the carpenters but are not. Once again, imported goods are preferred to locally-made products.

Scrap is also used to make products, most of them household implements such as frying pans, kerosene lamps or cooking pots. Some agricultural or gardening tools are also manufactured from scrap, e.g. hoes and watering cans.

**There is an NDC programme to establish a plant in 1977 to reroll scrap.*

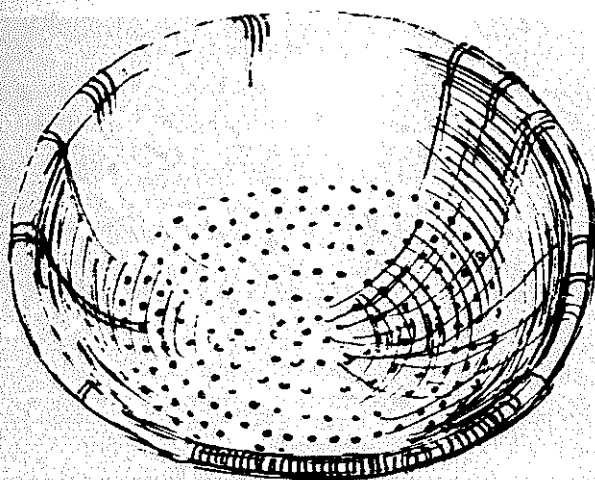

This chased metal colander has had the holes punched out by using a big hard nail. It is well made but has to compete for sale with many similar products, both imported and locally made.



Craftsmen often sit outside their workshops hammering away at pieces of oil drum which may be made into karais, (big round bowls). Too often, his tools are old machine components with a piece of iron bar for a hammer and as a result the work is hard, time consuming and the end product difficult to market.

Scrap products are purely made of one type of material, like scrap iron or cans or tinsheet metal. The same design is usually found whether the raw material is new metal or scrap. The metal products are not made in a combination with another type of material such as wood.

Production

The same types of product are manufactured all over Tanzania without differentiation in design. Little product development occurs and few innovations have been made during the last years. The range of products is limited and can be divided into consumer goods and producer goods. The former group dominates. Production goods do not contribute to development in other sectors of the economy. Basically, the type of goods produced is wrong. One man's luxury is, of course, another man's need. Yet it doesn't require much imagination to see that production of things like educational equipment for children in schools or hand tools for agriculture, which are needs, could easily be produced in a village workshop from

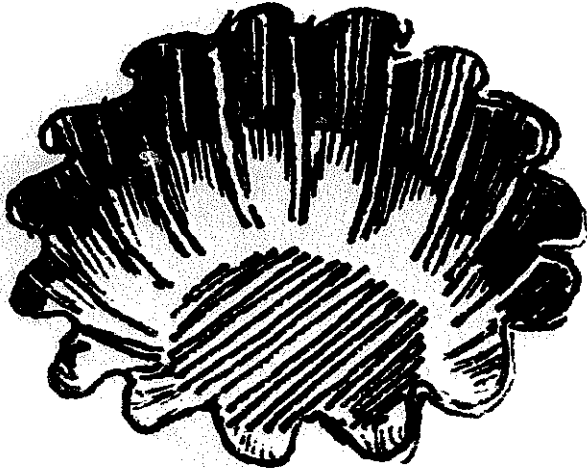

This is a baking mould made out of sheet tin. The mould is used for baking sweet cakes, common in the West but rare in Africa.

scrap, rather than the luxury goods we illustrate here. Wooden rulers, wood planners and desks, illustrated on pages 58-60 are products we found that were made in a village.

Meta! Equipment

The simple handtools we found were imported goods of the western type. The only indigenous tools found were different types of air-bellows, although Asian models do occur.

Traditionally, craftsmen sit on the floor. There are no shelves for storing and tools are thrown on the hard concrete floor among raw and waste materials. Their tools are carelessly maintained, which contributes to reducing their durability. Some more technically advanced manual equipment is still in use from the German period.

Wooden Equipment

Even in the wood sector, the tools are imported. One can find a few attempts to make tools, like planers, handles for hammers etc., but most workshops have self-made work benches even if they are not functional and durable.

The majority of shops tend to reflect the negative attitude towards small and cottage industries production, as handmade indigenous products are looked upon as being bad products. The privately owned shops and even the co-operative shops buy and sell mostly mass produced goods whether imported or locally made. The artisans generally have to sell their own products directly to customers from their workshops or else to businessmen, who distribute them at markets for local products. The workshops are therefore in towns situated in the areas where there are local markets.

The small industries have failed to face the

severe marketing problems. They get orders from the governments for often considerable amounts of goods and, if these orders are not obtained, the medium and good quality goods are bought by shops which have special show rooms where the products are sold. However, most recycled based products are not recognised to be of medium or good quality. So most small industries using new materials at least have a secure outlet for their products. Recycling producers, however, have a real problem of where to sell their goods, even to small private shops.

In order to finance the development of newly established workshops in the Ujamaa villages, one or two items ordered by the government or parastatal organisations are being produced over a long period. Therefore, village needs have to be satisfied from outside, as the skilled craftsmen have full time jobs with the orders.

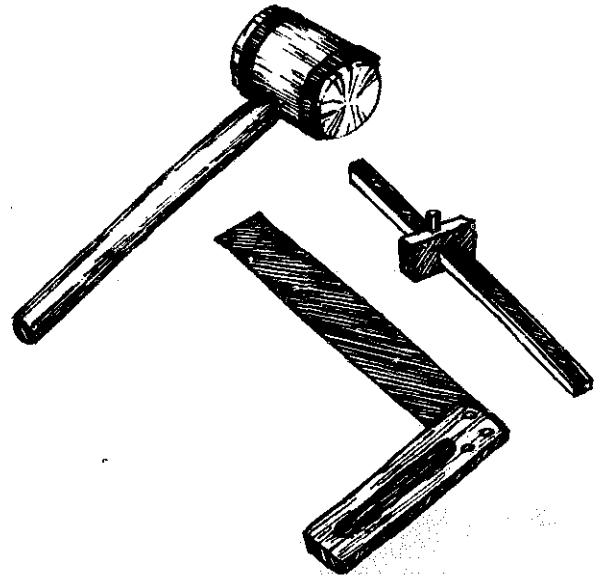

These tools illustrate that high quality products can be produced locally in simple workshops without the necessity for sophisticated machinery. The examples here were made in an Ujamaa village in Dodoma, Tanzania. Made from local wood and scrap metal with only a simple set of manual tools, the products are functional, durable and of great use to both metal workshops and carpentries.

Carpentries

The most common recycled wood stuff in packaging material is more or less exclusively manufactured abroad. This includes plywood, sisalsacks, waste-paper and wood. The wood is soft, light, and suitable for packaging as it is cheap and not heavy. It is hardly suitable for making the furniture which it is recycled for. The nails, screws, etc. with which the packaging is joined together are used

again by the craftsmen. Other parts required for the finished product are purchased, e.g. mass production metal such as hinges and ironmongery.

The wastewood is used for different types of furniture, mainly for private use, but it is also used for suitcases, small boxes etc. The wastewood is used entirely for production of new items. A small sector in the bigger cities is manufacturing products such as window frames and doors for the building

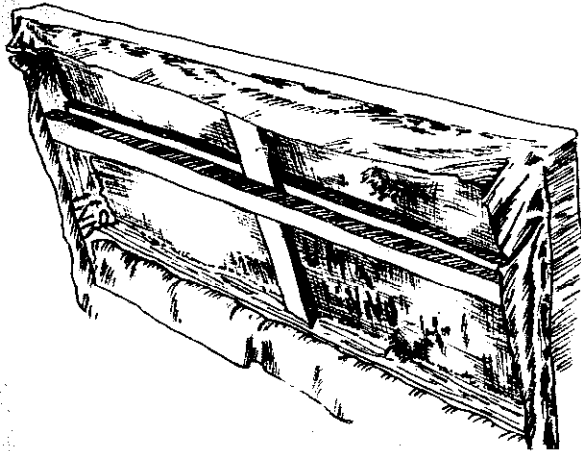

This is the underside of a sofa which has not been finished properly. The padding is of woodshavings and old bedsprings while the underside cover is made from old sacks or plastic bags.

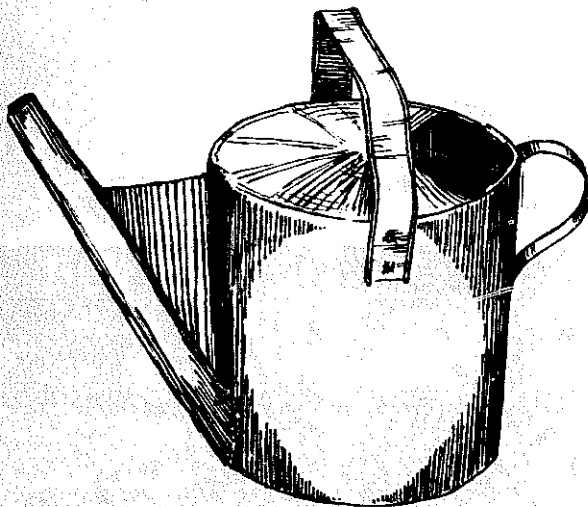

Many small metal workshops produced watering cans like this in hundreds, upon orders from the Tanzanian government. It is another example of a Western product being totally unsuitable for direct transfer. These cans were designed for small domestic garden watering in places where water is generally in abundance. In Africa, water is relatively scarce and often has to be transported over a long distance so this can does not solve the main problem — the transport of water. An Indian type of yoke would be much more practical and efficient.

industry. Despite the fact that Tanzania is rich in forests and also has a local production of semi-manufactured wooden products, the use of wastewood is optional in towns. In more remote areas no wastewood is available and all carpentry production is based on new wood.

All kinds of furniture are made of wastewood: chairs, coffee tables, beds, sofas and armchairs. The product can be entirely made of recycled material but also in combination with new materials, such as formica. A recycled sofa can be made from pieces of boards forming the frame, a piece of plywood as a base plate, springs and fibre wood or wastepaper for the padding which is covered with sisal sacks and finally topped with recycled plastic fabric.

Other goods made from wastewood include suitcases, small boxes, and carvings for the export and tourist industries.

Rubber

Dodoma is the centre for recycling tyres to make sandals and ropes. The situation for the shoemakers has deteriorated in recent years because only a small quantity of old tyres is presently available in Dodoma. The shoemakers have to go to Dar es Salaam to collect their raw materials. One can find three or four different models of sandals which, in general, are very well made. The equipment used is extremely simple, often consisting of not more than four tools: one or two knives, a grinding stone and a small hammer. The sandals are sold by the craftsmen themselves at the cattle markets and sidestreets in the main urban areas.

Marketing

The possibilities of marketing products vary from area to area. Many products manufactured in Dar es Salaam, for example charcoal stoves, frying pans, are no longer marketable there, but the same product is in stable demand in other areas. However, the non-marketable products are not exported from Dar es Salaam. These small industries are severely hampered by marketing problems; they are mostly too small to be considered creditworthy by any bank. The craftsmen often show no knowledge of the market; they are mostly illiterate and quite often possess only a limited craft professional know-how. These factors eliminate product development or adaption to market demand to a great extent. Many continue to produce a non-marketable product and become more and more dependent on their cultivated plot for subsistence. In the area investigated, some workshops producing kerosene lamps had an average income of 15 shillings a week. Part of the problem is that too many of these craftsmen are oriented to imitate imported consumer goods. This development of



This basket made out of knitted tin strips is a typical example of a luxury oriented product which does nothing to help the development of the community. The price is too high for most of the local population, yet it is not a sophisticated enough product to be sold for export as craftwork.

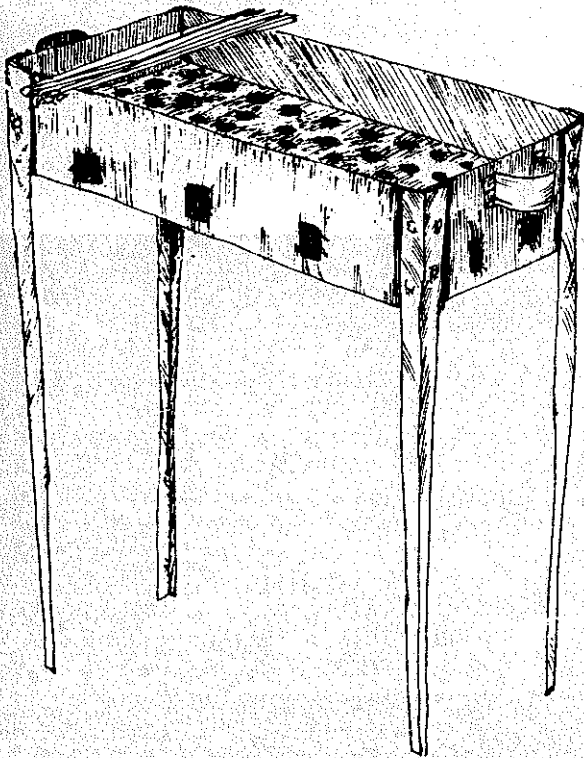

In the towns there are many charcoal grills like this one in the streets. They are used for cooking and selling grilled meat. The grill is functional and widely used.

production has left a major area of demand unfilled.

Many of the goods in production are imitations of Western products, which are designed under quite different production conditions, i.e. capital intensive mass production. Most western products have a built-in planned obsolescence which can never be transferred to a labour-intensive craft production. This is because 'a design' is the way physical components are related or connected to each and this relationship is based on production techniques, hence design for mass production and hand production must be different. The imitation can only be of inferior quality, and it rapidly deteriorates. As a result, there has grown up a widespread belief that a mass produced western product is better than one that is locally made. Given the production conditions just described, the people are correct.

It is worth adding here that there is something essentially sad when western mass produced goods are more valued than craft goods. In the West, craft skills are today more valued as the goods are expected to last longer and have been made by a man who has understood his material and who has cared about the quality of his work. The opportunity to produce long-lasting craft goods depends largely on design and experience, both of which can be learnt.

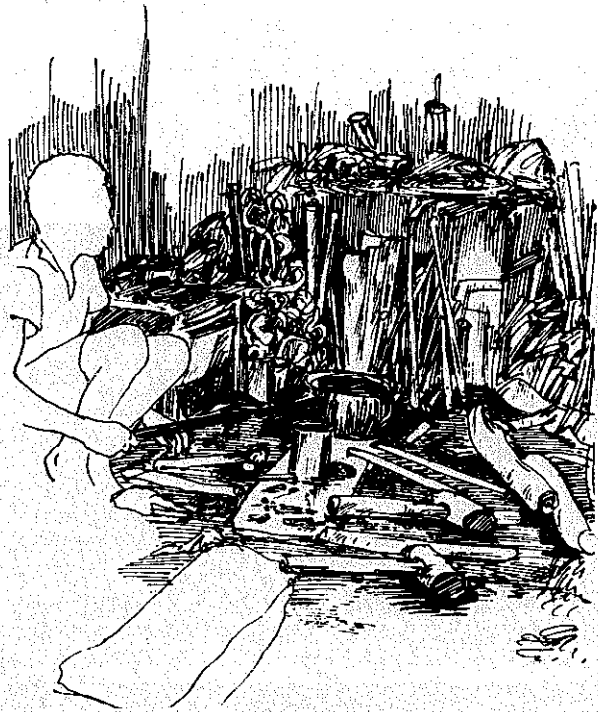

This chaotic workshop, which does not even have a proper workbench, is typical of the workshops we visited. Efficiency would greatly improve with the addition of a few simple facilities, properly used.

Workshops Today
by Krisno Nimpuno

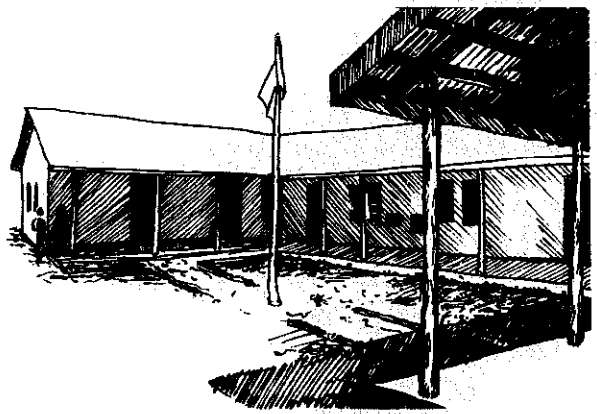

CHAPTER 4

Workshops Today Krisno Nimpuno

Industrial development and technical education go hand in hand. Both are closely inter-connected so that the form of one will be related to the other. Nowhere in Africa was the colonial power concerned with educating the people for an industrial future so there are few people today with the technical skills necessary for rapid industrial growth. In Tanzania (the country which provided us with the main body of empirical data), elementary technical training was given, at the time of independence, in only two secondary schools in Moshi and Ifunda. The Dar es Salaam Technical College had also been set up to train middle level technicians.

The need for elementary crafts training became increasingly important during the mid sixties and requests from urban industry led to the establishment of vocational training under the Ministry of Labour. A new programme was initiated in 1968 with assistance from ILO and, during the first phase (1968-1973) of the project, the main components of the programme were:

- a national vocational training council,
- a pilot training centre,
- an in-plant training programme for apprentices and upgrading,
- a trade testing unit.

The pilot training centre, the Dar es Salaam Vocational Training Centre, is still the only adequate formal educational institution for training skilled craftsmen. The Centre was established in June 1968 with UNDP/ILO assistance, and is still being developed. Students are accepted after full primary education, and enter four-year courses (one year at the Centre plus three years on the job) in mechanical, electrical, and civil engineering, or one-year courses in other trades (drillers, blasters, operators of wheel-loaders and bulldozers). At the present time, 31 firms and organisations have entered into contract with the Ministry of Labour for inplant and upgrading training of their apprentices; more than 5,000 candidates were trade-tested during 1973.

Apart from the Dar es Salaam Vocational Training Centre, there are about 30 small training centres and evening classes operated by religious groups and a few para-statal organisations. Two new vocational Training Centres — in Mwanza and Tanga — began construction with World Bank/IDA* assistance in 1975. These training schemes are all oriented towards urban industrialisation. During the early sixties, a few attempts were made towards rural industrial training. These were often initiated

by voluntary agencies or religious organisations and each developed according to its own particular circumstances, in isolation from each other. As technical skills were so scarce in the country and are very much needed in agricultural development, these Rural Development Projects often included crafts training in their programme. The success of some of the rural development programmes, such as Lushoto Integrated Development Programme (LIDEP), contributed to the decision made in the late sixties to establish Government Rural Training Centres. This decision signified a great step forward in this field and aimed at opening one RTC in each of the country's 21 districts. It will, however, take a long time before this is the case. Crafts training in these centres today mainly consists of six to twelve week courses in elementary woodwork and metalwork, aiming at the elementary needs of a village. In the meantime, the government decided to expand technical training over a broad front. Two new technical secondary schools — Tanga and Mtwara — were opened and a major change, the vocational training programme for secondary education, was introduced to include some forms of technical training in most teacher training colleges and secondary schools. As a result of this vocational programme, practically all secondary schools and Teacher Training Colleges (around one hundred in all) will have workshops in a few years time.

At the primary school level, there were also programmes to the same end with the Model Primary School, also called Community Education Centre, as the foremost attempt to restructure the character of the school. Execution of this programme would bring basic workshop capacity to all Tanzanian communities. If the whole programme is executed, then several thousand workshops will be constructed.

These changes in the educational programme have made workshops a very important element in school planning. The workshops are a part of the training facilities but have a productive function as well. The two vital questions are now whether these institutions will, indeed, have a productive function and whether the present gap between existing crafts and imported technology can be closed.

The existing workshops in schools have been designed with little consideration for the Tanzanian situation and are therefore almost identical to workshops in European or Asian schools: as a purely educational, not a productive unit. The utilisation rate of these expensive spaces is very low, although the capacity of the school workshops could be mobilised for actual production. The workshops in rural areas, both inside and outside the educational institutions, could be designed with greater consideration for the prevailing economic and technological conditions.

*Robert Matthew, Johnson-Marshall & Partners IDA Education Project 1967, Nigeria.

First, however, the workshop construction programme within the national education system needs to be examined.

The Diversification Programme

After independence in Tanzania, initial efforts in the field of education were geared towards a rapid expansion of secondary education. This was more evident during the first seven years of independence, i.e. 1961-1968. The reasons for the expansion were very clear — to meet the urgent need for middle and high-level manpower to man the economy.

But there seemed to be a missing link. Although there was a large deficit of manpower with the desired technical and other practical know-how when the secondary school graduates came out, they had none of this practical knowledge. It is true that most of the secondary school leavers had learnt a lot but this was mainly less useful academic, or what others prefer to call rote or "book", knowledge.

The core explanation for the above situation seemed to lie fundamentally with the type of syllabuses used for secondary education, which were inherited from the colonial system. It is true that some modifications and revisions were made here and there, especially during 1962-1966, but basically the system and structure of the syllabuses did not undergo any major changes.

It was only after the Arusha Declaration in February 1967 and the policy statement on Education for Self-Reliance that any real attempts to change the syllabuses to fit in with the new policy of socialism and self-reliance were made.

In this policy statement President Nyerere said:

"In fact we inherited a system of education which was in many respects both inadequate and inappropriate for the new state. It was, however, its inadequacy which was most immediately obvious. So little education had been provided that in December 1961, we had too few people with the necessary educational qualifications even to man the administration of Government as it was then, must less to undertake the big economic and social development work which was essential."

The declaration called for a number of education policy changes. The first aspect to be taken up was self-reliance activities aiming at a change of attitude as well as contributing to the costs of education.

"All schools, but especially secondary schools and other forms of higher education, must contribute to their own upkeep; they must be economic communities as well as social and educational communities. Each school should

have, as an integral part of it, a farm or workshop which provides the food eaten by the community, and makes some contribution to the total national income."

The Minister of National Education, in June 1969, commented on the Second Five Year Plan and defined it as a Plan for Revolutionary Change:

"aimed at:

- a change in the nature of the educational system
- steps towards education for all
- a drive towards greater equality of opportunity."

The plan strongly promoted growth of the secondary education system with the construction of seven new schools and extensions to twenty-four existing schools.

The Minister declared:

"I believe that this trend towards vocational subjects, which are important to the economy of Tanzania, will not only infuse a new sense of purpose into the studies of our secondary school children, but will also make possible, in due course, a shortening of the period of vocational training, thus securing economies in both time and money.

We are also making great efforts to promote a new attitude in our schools toward the service of the community, and the dignity of manual labour. Everything possible must be done to replace the discredited values of competitive individualism by the co-operative socialist ideal; to show that secondary education, at this stage of our national development is never to be regarded as a personal right, but always as a debt to be paid to the community by service."

In the Second Five Year Plan the policy of diversifying the secondary school curriculum was one of the main features of the capital development programme in secondary education. The policy entailed the provision of special facilities in a number of schools for Agriculture, Crafts, Commerce, Home Economics and Technical Education and was later developed under the heading "Diversification Programme".

The programme aimed in the first stage at the transformation of the lower stage of the secondary schools, forms I-IV, and a proposal was made that all schools would offer at least two of the above mentioned specialisations or biases. This programme would provide all students with some practical skills so that the majority of pupils leaving the schools after form IV, who were not selected for the second stage of the secondary education, could play a productive role in society.

This policy of establishing special facilities in

order to impart a more practical bias to secondary education is also a deliberate attempt to implement the policy of education for self-reliance. It is preparation for the practicalities of life through a practical education. The emphasis on any one practical subject is likely to vary in accordance with the situation of the school.

The first facilities for the diversification of secondary education were constructed at the beginning of 1973. Preparations were made for a further execution of the programme and external assistance was sought for the construction of a great number of units.

The Norwegian Government was the first donor to respond. An agreement for the construction of 20 agricultural units was signed, and negotiations for further assistance for 20 commercial units and six home economic units were started. The next stage is scheduled to include 9 technical schools, 7 additions to schools for conversion into technical education institutions and 30 craft units to be added to existing schools. The last of these methods

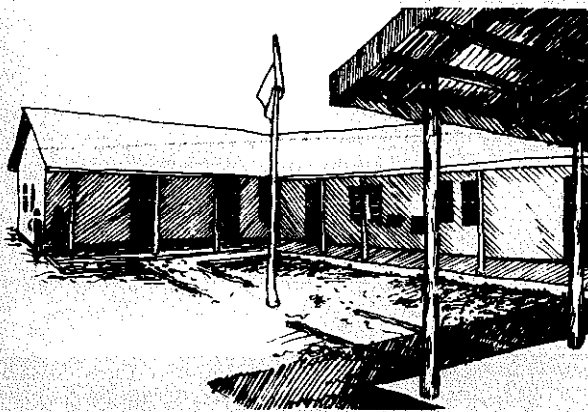

A secondary school.

is very suitable for the dual purpose of production and training. That is, it can be very successful as a method of instruction, as can be seen from an experiment conducted in Sri Lanka. A striking example of the application of production line in an industrial arts class was provided in Nalanda College, Colombo, where a group of some 40 students were manufacturing a single desk and chair. The design itself was based on the probability that it would be manufactured in industry on a production line basis and all timber members were thus fixed at 2cm thick and either 15 or 7.5cm wide. The boys organised themselves to plane the timber, to cut to length using jigs, to assemble using jigs, to stop, to paint and finally to check.

The furniture moves along the line, the boys remain working at one place.

This learning experience is most valuable as it involved the boys in planning; they all quickly discovered a lot about production lines, and also developed one or more psycho-motor skills.

Although this system seems to be attractive for Tanzania, as yet no definite opinion has been given on the choice of method. Perhaps the most important conclusion to be drawn about the designer from a study of this situation is that spaces for industrial arts should be much less tightly tailored to the needs of specific subject fields than was the case in the past. Just as in design for industry, the trend is towards 'general purpose' factories, so, in secondary schools, the trends should be towards general purpose spaces for all industrial arts teaching and learning.

The Choice of Equipment

Industrial development and the need for technical skills are often associated with advanced training and production of a high technical level. This is clearly demonstrated by the national educational policy of Tanzania which, as yet, concentrates on theoretical skills rather than on craft training and development. Indeed, a review of the curriculum and facilities for craft training in secondary schools and at college level reveals that few practical skills are taught and theoretical training is receiving the greatest emphasis.

The technical training given to primary school teachers in the colleges of National Education (formerly called Teachers Training Colleges) is even more clearly out of step with technical and educational reality. To train teachers on advanced electrical lathes, if they are to be sent to the non-electrified villages, seems a waste of time — but such is the case at the moment.

The equipment purchased for the workshops in schools has been rather sophisticated. Standard sets of hand tools have been provided for and a wide range of power tools, some of mechanically quite advanced type, were ordered from overseas. During visits to the schools it was often found that little of the equipment was in use, and, in several cases, the workshops had not been used for the intended purpose at all.

The study of present village technology and possible improvements would seem to be more adequate.

The type and quantity of equipment used in the workshops determines, to a large extent, the layout of the room. In conventional carpentry, where few or no power tools are used, the floor space needed for one craftsman is just that which is needed for a side bench, the workbench, and some storage space.

If power tools are used, there is a dramatic

increase in the amount of space needed. It is not only the additional area taken up by the machines themselves but, these usually being stationary, considerable space has to be provided to allow proper movement and positioning of the material to be machined.

TAMTU, the machine testing unit of the Ministry of Agriculture, which has workshops in Arusha, has given considerable attention to this subject and Macpherson, who summed up those experiences in a book on the subject, states that a set of less than 50 hand tools are sufficient to execute any kind of standard carpentry and metal work.* He shows a picture of all these tools on a cow skin, and states that all the Tamtu Farm implements can be made with these tools only. His ideas are noteworthy because the financial effect of a limited equipment purchase would be considerable. Indeed, we noted that in the large Tacoga factory in Dar es Salaam, only the rough cutting of the timber is done with machines, but all the actual furniture making is executed in halls without any power tools. What is needed is to develop the skill of the craftsman, and no machine can replace skill.

Visits to other industries and schools confirmed this impression. The power tools were very seldom used. A large number were found to be inoperative for lack of spare parts and maintenance. In most of the exceptional cases where the machines were used, it was often for work that could be done more effectively with hand tools. In the Rural Training Centres we were repeatedly told that no power tools were used. In Mabungai Rural Training Centre, mechanical tools were available but not used. For primary schools and rural workshops, there seems to be little reason to use power tools. Not only is there no power, but it will take a long time before it will be generally provided. More important, however, is the level of craftsmanship which would not be enhanced much by such equipment.

Machines are only of any help if one wants to reduce the physical effort and do the job quicker. But this can only be done if the artisan knows the material and the machine. There is only one way to get to know the material and that is to work it manually for a considerable time. After that, one can learn how to utilise a machine in the proper way. The most pressing need at this moment is not to reduce production time and physical effort, but to start production. The trouble with the introduction of mechanical tools is clearly illustrated by the time needed to learn how to use them properly.

In the Rural Training Centres, the craftsmen get only three months, or about 200 hours, of training. During that period, they learn the basic skills of

*G.A. Macpherson, *First Steps in Village Mechanisation*, Tanzania Publishing House.

carpentry or metal work. Craft training in a specialised secondary school entails 14 periods per week or about 1200 total hours in the four year period. The students have to learn the subjects from the very beginning, as few Tanzanians have been exposed to technology and handicrafts during their childhood years. They have to learn metal work, woodwork and building crafts from scratch. A European welder will have no less than 500 hours training before he is considered ready to produce. The European student has, therefore, an advantageous background, technically speaking, and a longer training. The moral is clear.

A wood lathe takes 150 hours of training to be handled. A metal lathe will need 400 hours. To work effectively with mechanical tools requires all the skills needed for hand tools, plus many extra hours to handle the complicated machines.

None of the training institutes discussed here has a syllabus that allows for so many periods with the result that the students do not have the time to learn to master the machines. The time so badly needed for learning to handle hand tools is spent on a great variety of machines without providing skill. It will also take a long time before there are teachers with good mastery of mechanical tools.

In view of the above, it seems to be wise to introduce a few basic mechanical tools at the craft schools now and concentrate mainly on hand tools. More elaborate equipment could be introduced at a later stage. The introduction of power tools at the primary level seems to be unrealistic. Even if electrical current became available in a few villages, there is no possibility of allocating the time needed for training in the use of these tools.

As it is now, there is insufficient time to learn more than very elementary metal or woodwork in the Rural Training Centres. The time factor would be no more favourable in the case of the Community Education Centres.

Buildings and Functions

The workshops built under the Second Five Year Plan are large span rooms with great ceiling height. The workshops have a floor space unobstructed by columns and spans of eight to eleven metres. The ceiling height is usually over four metres. The walls are of concrete blocks between steel or concrete columns with wire mesh windows or, in some cases, open sides. Most workshops have one long wall with side benches but no other fixed furniture.

The roof is usually made of asbestos sheets without a ceiling and the floor consists of concrete scree. Some of the workshops visited had very small spans and it seemed that this cheaper construction was quite adequate both for production and instruction as long as only a few power tools were used. Workshops of 4.50m depth can be very effective. A production line arrangement along the

length of the workshop has successfully been tried in Sri Lankan schools as described earlier in this chapter. The question of choice between open spaces, covered areas and closed or semi-enclosed rooms also deserves attention and study.

For craft education the Nairobi IDA team notes that the problem once again is to devise a room which will cater for the wide range of related subjects. The two most important points to be borne in mind by designers are (1) space before fittings and (2) ample natural lighting with sky-lighting if possible.

A textbook on the subject gives a rather elaborate description of different types of spaces and shows the following common accommodation requirements for workshops (or industrial arts laboratories):

- Storage space for raw material,
- Storage space for finished work,
- Storage space for tools and small movable equipment,
- A work room for the teacher,
- An area in which a group of students can watch a demonstration given by the teacher,
- Space for fixed machinery,
- Work spaces for individuals (not at machinery),
- Common work places to which all students may come,
- A space for students to plan projects (making drawings, estimates, etc),
- A place for changing to working overalls and for washing at the end of the period,
- Storage space for students' books and belongings.

The designer is firstly concerned with the space needed for each of the sub-elements of accommodation listed above and, secondly, with their arrangement in relation to the activities in the workshop.

To our mind, many of these functions can be combined, and not all need a building. The cost of mechanical equipment itself and the consequent need for more space is another factor.

The study also states that the industrial arts facility is probably the most expensive element in a general secondary school. It requires special furniture, water services and often gas and three-phase power. The equipment, whether it be a set of carpenter's hand tools, a potter's wheel or metal lathe, is always costly. Above all, teachers trained in this field are often in very short supply and, unless wisely used, will prove an expensive and recurrently wasteful asset.

Workshops in secondary schools, we found, are usually standing unutilised during the greater part of the week. The scheduled teaching time, commonly forty periods a week, constitutes only

a fraction of the time which could be used. Even so, workshops are scheduled to be used for only thirty per cent of the teaching periods before the school is built. This is certainly true in Tanzania, and similar observations have been made elsewhere. Robert, Matthew & Partners report, in connection with IDA Education Project 1967 in Nigeria, that the workshops will be used for only twelve out of the weekly forty periods. This is a waste of crucial national resources which can occur when misplaced conventional thinking regards schools as institutions unrelated to the daily national struggle for progress.

Two elements are therefore indispensable in the planning of school workshops: the educational facilities in less developed countries should be available both for productive purposes by the school itself, and also by the community around it. The design of workshops should reflect strict physical needs only and utilise all opportunities to economise.

The textbook agrees on the point stating that it follows from a consideration of these factors that all industrial arts facilities must be very carefully tailored to the precise needs in respect both of utilisation during the week and of size in relation to occupancy. In other words there must be neither too many industrial arts laboratories nor must they be too large. The old traditions of providing, for example, a separate wood working shop and a separate metal working shop, irrespective of the size of the school and the number of periods taught in these subjects, must be critically reviewed and, where such an arrangement is found wasteful, alternative solutions sought.



Plan of a simple school workshop teaching unit, with common floor space for wood and metal work.

The idea of using covered spaces has successfully been tried in East Africa for building construction workshops and agricultural workshops. The Tamtu prototype for a village workshop is an example.

The Nairobi IDA team writes that a suggestion put forward is that the Art/Craft Room should be divided into a clean and a dirty working area. The former should be a totally enclosed space whilst the latter should be a covered area, easily washed down with a hose and very flexible in use.

There are actually only a few functions which really require an enclosed space. It might be desirable that the whole workshop area be fenced, for security reasons, and if that is done the workshop area can consist largely of covered areas.

Space Requirements

General workshop in agricultural units in Tanzania:

total floor area 80.9 sq.m.
no. students 20
area/pupil ratio 4

In Tanzania the classes of forty students are usually divided into two groups of twenty students for workshop training. In Asia this number is considered too high and it is recommended that only 10 pupils be trained at the same time. The following area allowances are recommended in the Asian study.

Per Place Areas for Work Spaces in Multi-purpose Industrial Arts Laboratories:

Field of Activity	Area per place in m ²
Wood working	6.10
Metal working (fitting and sheet metal)	6.50
Electricity/electronics	4.25
Spinning and weaving	8.75
Ceramics (pottery and clay craft)	6.25
Leather work	4.00
Masonry	4.25

Mr C. Mannerschmidt, IDA Regional Mission, East Africa recommends:

Painting 5-6m² per student
Motor mechanics 15-20m² per student

Pupil areas in Workshops in Nigerian Secondary Schools (sq.m.):

Location	Workshop Area	No. Pupils	Area/Pupil Ratio
Owo	558	50	11.1
Sapele	446	48	9.3
Enugu	260	21	12.4

(Robert Matthew, Johnson-Marshall & Partners IDA Education Project 1967, Nigeria).

For all these figures it should be noted that training workshops require a far greater floor area than a pure production workshop.

In the Dar es Salaam Co-operative workshops (Kisarawe), for example, the complex of workshops is divided into units of 12-15 sq. metres. The teams renting these cubicles number 2-5 people. The workshops here are for production and storage. As some teams are quite large and the climate in Dar es Salaam is quite hot, much of the work takes place outside in front of the workshop itself. The area/person ration becomes very small if only the building itself is counted in the area figure: 3-5 sq. metres per person.

It is certainly difficult to give a general figure

for the area requirements for purely productive workshops. Much depends, naturally, on the use of handtools or powertools. For simple workshops with handtools only, we would say that an area of 4-6 sq. metres should be sufficient.

Today's Workshop Design

The design of workshops differs widely. The majority of schools have workshops with the following type of structure:

- Floors of concrete on hard-core with cement finish.
- Frames of concrete columns and concrete ringbeams with blockwork fillings, in some exceptional cases load bearing concrete block-walls are used.
- Spans 9-12 metres with corrugated asbestos cement sheets on steel or timber trusses.
- No ceiling and free height 3.50-4.59m.
- Doors and factory-made flush doors and window openings are usually covered by wire mesh.

The layout and section shown on the next page are the prototype design for an agricultural unit of secondary schools. A total of thirty such units has been built.* The units have a classroom laboratory side and a general workshop section, which is to serve for general technical training. This type is fairly representative for workshops in schools, although many designs have much larger and greater room height. The workshops of some of the rural development projects visited were much smaller in size, but still close to the described standard.

In the different workshops of the Lushoto Integrated Development Project (LIDEP), such as Mabugai or Mlola, we found floors of cement on hard core, masoned concrete block columns with blockwood filling, spans approximately 7-9 metres, corrugated iron sheets on timber trusses, no ceiling and a free height of 400 metres, and doors and wire mesh in timber window frames. There was no storage for raw material and no tool racks.

The workshops for the Vocational Training Centres are large high-roofed areas of concrete floor. The free height is over 5 metres and the prefabricated columns and trusses span over 15 metres.

The SIDO and the Kisarawe workshops are very much simpler. There are some central workshops with floor areas of about 100 sq.m. in area. The large workshops are concrete block buildings with a roof height of 300 metres. The small workshops are built with steel frames and fillings of concrete blocks or asbestos cement sheets. The roofs are made of corrugated iron sheets and are 2.5-3.0

*The prototype design was made by Cappelen and Rodahl, Oslo, in co-operation with the Ministry of National Education.

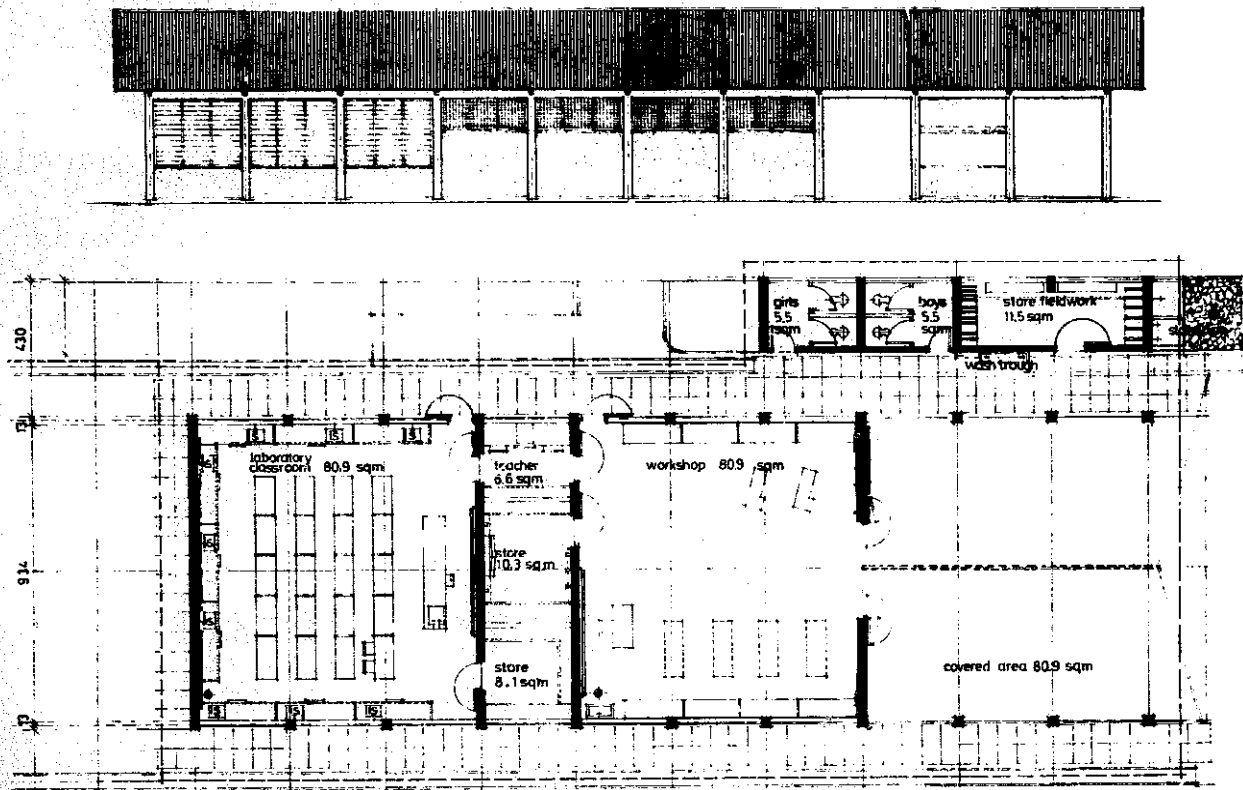

Plan and layout of the Kisarawe design made by Cappelen & Rodahl of Oslo, for the Ministry of National Education for an agricultural unit of a secondary school.

metres high. In SIDO's Dodoma centre, there are some central workshops with machinery in halls of 110 sq.m. large with a free height of 300 metres, surrounded by a large number of smaller workshops where the actual co-operative production takes place. The smaller spaces measure 12-20 sq.m. each and are made with walls of concrete blocks and corrugated iron roofs with a height of 2.5 metres.

TAMTU has developed a village workshop prototype although it has not yet had any field applications. The workshop measures 40 sq.m., is mainly constructed with large bush poles, and has four 3.50m high steel tube columns to bear the corrugated iron roof. The floor is made of rammed earth and the back also consists of iron sheets. The other sides are fenced in with wire mesh. The work benches are partly made of round wood. There are storage shelves along the back wall and the workshop has roughly one side for woodwork and the other side for metalwork.

The self-help workshops in Dodoma and Ujama villages we visited were made of sun-dried mud blockwalls with cement plaster, cement screed floors and corrugated iron roofs with 5 metres span.

Some of the villages had already started a craft programme long before any building was available

and production was located under large, shady trees in most cases.

A traditional village blacksmith would only need a dozen square metres roofed area. A thatched roof on poles with a height of 1.60 metres would be sufficient to house the master smith with his apprentices. They would work squatting and would not have any storage space except the smith's house where he would store the expensive tools, such as the bellows, at night.

Beyond this large range of construction varieties and sizes one can find all kinds of large industrial workshops in prefabricated concrete, spanning 20 or 30 metres. The larger private and state industries do not differ very much in construction from similar enterprises in Europe.

For an architect, however, it is striking that all these industries and workshops totally lack any form of internal planning. The layout of machines and work benches bears little relation to the production flow. There is no clear zoning allowing for a separation of finished goods, half-finished products and raw materials. Consequently, the working conditions are far from optimal and it becomes extremely difficult to plan production and oversee the progress of work. The most serious short-coming is probably the lack of a system for the storage of tools, products and raw

materials which simply results in an inefficient production situation.

The first lesson learned from a study of these workshops is therefore the need for a careful internal layout of the workshops.

The School Workshop Programme

In the diversification programme each secondary school will have at least two out of the five following biases:

- Home Economics
- Commercial
- Crafts
- Technical
- Agricultural specialisations.

The last three biases include workshops to provide the requisite facilities.

For a craft school the programme entails:

- 1 wood workshop
- 1 metal workshop
- 1 roofed area for building construction.

For a technical school the buildings include:

- 2 wood workshops
- 1 sheet metal workshop
- 1 plumbing workshop
- 1 painting shop
- 1 welding and forging workshop
- 1 motor vehicle workshop
- 1 electricity workshop.

Agricultural units include:

- 1 general workshop (wood and metal)
- 1 covered area.

During the Second Five Year Plan the Diversification Programme of Secondary Schools was started with the construction of about thirty agricultural units – conversion of two schools into technical schools and facilities for crafts education in four schools. This is as seen above, however, only the start of the programme. A great number of workshops are to be built in secondary schools in the next few years.

Seven colleges of national education are to have an agricultural unit as well, in order to train the teachers who will later teach this subject.

In community education centres there are also elaborate workshop facilities.

- 1 wood workshop
- 1 metal workshop
- 1 building construction area
- 1 textile and sewing department.

It is not known yet how many primary schools will be developed into community education centres, but the figures which have been discussed exceed one thousand. At this moment, eight units are under construction in Dodoma region. It is

Four views of the technical school at Alcado.



Alcado front



Alcado back



Alcado right view

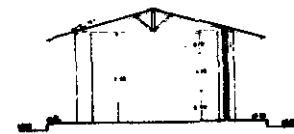

Cross section 1. 2



Alcado left view

Key:

1. Metal work shop
2. Masonry and concrete work
3. Wood work shop
4. Textile and leather work
5. Office
6. Store
7. Forge
8. Teaching assembly
9. Assembly yard

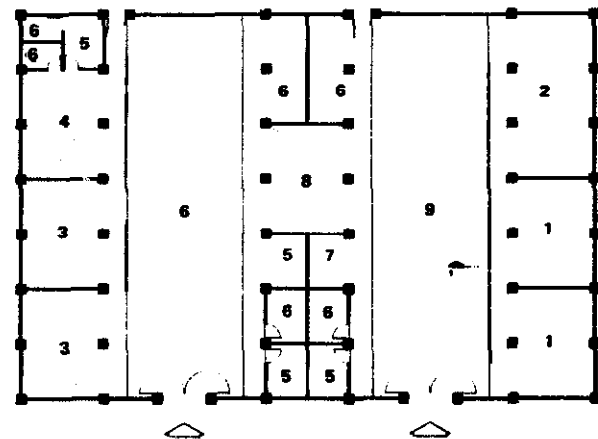

Internal layout of the school at Alcada.

clear that craft training will become a major element in Tanzanian education and the question of the type and equipment of the workshops is therefore highly critical.

Type of Instruction

In Tanzania each school should have, as an integral part of it, a farm or a workshop not only for training purposes but also to gear the students towards a productive attitude, indeed to begin production during their education. Consequently, this will affect the choice of methods of instruction.

The Asian handbook gives the following description:

"An instructional method refers to a teaching procedure designed to reach pre-determined learning goals. Industrial arts teachers make extensive use of several types of teaching methods such as demonstrations, questioning, class discussions, lectures and self-instructional devices.

A common way of organising material for industrial arts teaching is to break the subject matter to be taught into small units which form a correct sequence for instructional use . . . From the standpoint of class organisation and teaching procedure, projects may fall into several different classifications. In an individual project, all operations and processes are performed by a single person. A group project is undertaken by several students or a whole class. The term project here may also cover services performed as, for instance, planning and designing a tool panel. Mass production projects differ from the group project in that they offer opportunities for stimulating methods of production and will give participants a limited view of mass production techniques."

Conclusion

In Chapter 5 the design and construction of village workshops is discussed with the intention of demonstrating simple, inexpensive and functional facilities where rural industrialisation can begin.

It seems to us that it is very important to inform villages about the elementary steps to achieve development on a self-reliance basis. However, before any one starts to invest heavily in new facilities, it is a simple step to investigate whether there are already unused facilities available. It is not uncommon in LDCs to find that, in spite of the scarcity of capital, duplication of investment occurs time and again. In a report on the Regional Development Potentials for West Lake Region, J. Muller mentioned that the small town of Gera has two craft training institutions, 500 metres apart, which duplicate the same kind of training. Trade schools, rare as they are in Tanzania, should

obviously train and simultaneously be an active development force in the community. Towns with a full trade school must regard themselves as very privileged, but the above is an example of two such institutions, in the same small town, which do not even seem to communicate with each other, let alone become the driving development factor for the area.

As we have seen in this chapter, there is already an impressive array of workshops in operation and under construction within the schools of Tanzania. The difficulty is their organisational and sectoral self-isolation. The first application for funds which the Ministry receives from the headmasters of newly-built schools is for the construction of a fence. Although a lot of rhetoric can be heard about serving the community, little practical integrated action can be detected in reality. The presidential calls for production in schools are met by internal agricultural and industrial production activities totally unrelated to the community around the school. The workshops are standing idle most of the time, the actual training hours being a fraction of the workshop capacity while even less utilisation occurs outside the scheduled study hours. This is not unique and certainly not limited to Tanzania: in Nigerian schools the workshops are only utilised during twelve out of a possible forty teaching periods per week. For instance, at Iringa/Kierruu College of National Educational in Tanzania, a space utilisation survey showed "that less than forty persons, or perhaps only half, utilise the workshop at one sitting. This block is therefore very much underutilised". The report only refers to scheduled hours. The workshops were designed for sixty pupils and, in one case, it was later found that the workshop with the most sophisticated equipment had, in fact, been padlocked for over a year.

With the ambitious diversification drive of primary and secondary education, it becomes of even greater importance to take the potential of school workshops into account. Workshops are the most expensive spaces in a school and if Tanzania can mobilise the educational workshops for production and non-formal training, it will make giant strides in a short time. It is difficult for the community to force its way into the educational institutions through all the bureaucratic and inter-departmental barriers, but to do so would be entirely in line with the proclaimed national policy and with the ideological path of Tanzania towards an integrated socialist development.

Small-scale Production—the Contemporary Situation

by Liv Berg

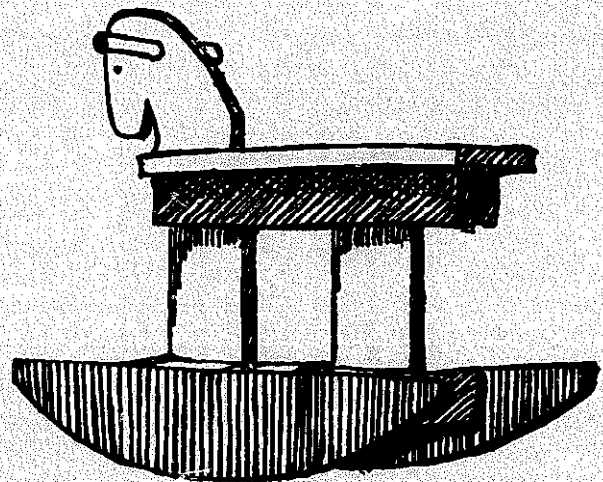

CHAPTER 5

Small Scale Production – The Contemporary Situation

Liv Berg

This chapter is largely a descriptive account of small scale production of commodities made from wood or metal in the informal sector of Tanzania. Our research was by no means as systematic as we would have liked and it is freely admitted that one random survey of metal workshops and carpentries in the Dodoma and Dar es Salaam urban areas may not be as representative as we would have wished. Nonetheless, these workshops are not enumerated in official returns of any kind and so the only possible kind of sample we could take was random. The reader must, therefore, judge whether our observations appear to correspond with his own experience and we hope that this will be the case.

In Dar-es-Salaam during Spring 1975 we visited 60 different metal workshops and 80 carpentries but there were, of course, very many more. Dodoma is a smaller town although when it becomes the capital city, it will grow very rapidly indeed. Here, we visited 30 metal workshops and 19 carpentries, which represents a near complete coverage of this type of productivity in the area. In every case, we interviewed the employees and the owners of the workshops and we feel that, on the basis of previous experience with this kind

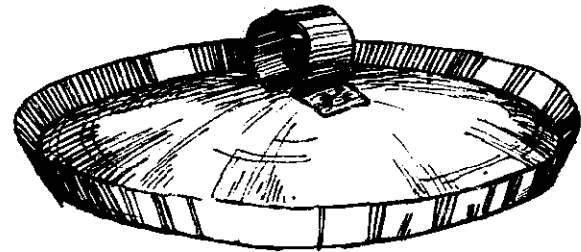
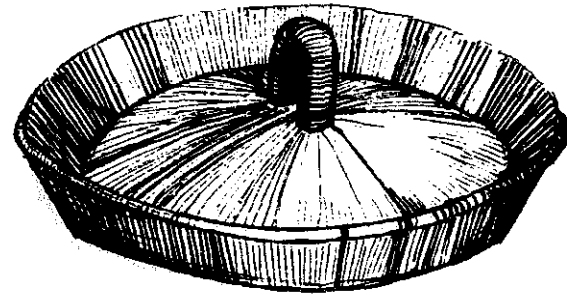

In the past, a pot cover was made of clay but, nowadays, there are some metal ones being produced although the design has not changed at all. The same design should never be used for different materials and, in this case, the original is much better than the copy because it was designed for the optimum durability of clay, not metal.



In an attempt to make this kerosene lamp more attractive to potential customers, the shape has been changed by adding another can and a pipe to the original. As a result, the lamp is very dangerous because the centre of gravity has been transferred to the top of the lamp so when the can is filled with kerosene, it is very likely to fall over.

of production, on the whole our observations represent a wide section of small scale production in Tanzania and East Africa.

Metal Workshops

We counted forty different kinds of products being produced by the metal craftsmen we interviewed. Surprisingly, only a minor proportion of the output was tools for agriculture and only the old village blacksmiths in the Dodoma area were producing wrought agricultural implements on a regular basis. This section of the economy cannot produce anything like the amount of agricultural tools required by the farmers, given the tiny number of people employed and the traditional techniques of production in use. The majority of the goods we saw being produced could usefully be described as luxuries – items such as ice-cream moulds, orange spoons or baking moulds.

*“The development trend has been stagnant and directed towards production of relatively luxury goods.”**

Essential goods produced can be classified into 6 household items, 6 pieces of agricultural equip-

**Jens Müller: Regional Planning for Small Industries in Tanzania, Institute for Development Research, Copenhagen, Denmark.*



Jembes are in great demand all over the country. Presently, Tanzania imports roughly half the jembe requirements because very few are made locally, despite the fact that the know-how, material and equipment are readily available. The collander and cheese grater represent typical examples of local small scale products being manufactured, despite the urgent need for productive equipment.

ment and some products for building construction. Five of the agricultural implements, such as jembes and sickles, were produced by village blacksmiths. We saw not more than twenty craftsmen and eight assistants under training producing these goods and during harvest-time, some of these workshops were closed.

Tanzania has mass-produced jembes (the ubiquitous digging tool of Eastern Africa) at a firm called Ubungo Farm Implements (UFI). UFI, however, does not have the capacity to satisfy the demand for different kinds of jembes, so the shortage is made up by imports. An estimate of equipment demands gives figures which by far outnumber the capacity for production from national equipment.

"Tanzania's farm tools input will have to rise from the present rate of 10 per cent to 40 per cent if the national animal draught programme is to succeed . . . Regions had made an estimate of 150,639 ox-ploughs, track chains, ox harrows, ox planters, ox cultivators, ox-ridges, ox/donkey carts, hand maize shellers, groundnut shellers, winnowers, hand hoes, pangas, wheelbarrows and tractors."

This is contained in a 31 page special report issued in January, 1976 by the five-man Farm Tools Committee. In the *Daily News*, January 22,

1976 Tanzania's farm implements annual production was reported as follows:

"UFI — ox-ploughs, 10,000; spare parts 35,000; axes 80,000; pangas 300,000; hoes 180,000.

TAMTU — kifarua ploughs 24; seeder attachments 24; mali planters 24; interrow cultivators 36; ox carts 36; donkey carts 36; four wheel wagons 12; winnowers 12; hand planters 144 and ox cart axles 60."

Of the total production of 40 products at the small metal workshops, 28 products (70%) have marketing difficulties in Dar es Salaam. The same products were mentioned over and over again for being difficult to market during our interviews with the craftsmen. Either the market is already filled with superior made imported goods or the products were mentioned over and over again as being difficult to market during our interviews: ready market include charcoal stoves, kerosene lamps and cooking pots. Most people's houses do not have electricity so these goods provide for an important need for cooking and light at a cheaper price than any imported alternative. One-third of the metal workshops produced charcoal stoves and kerosene lamps.

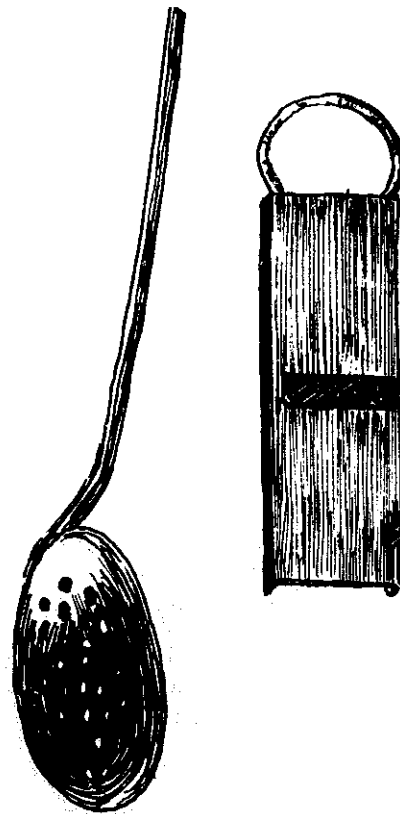

The collander and cheese grater represent typical examples of local small scale products being manufactured, despite the urgent need for productive equipment.

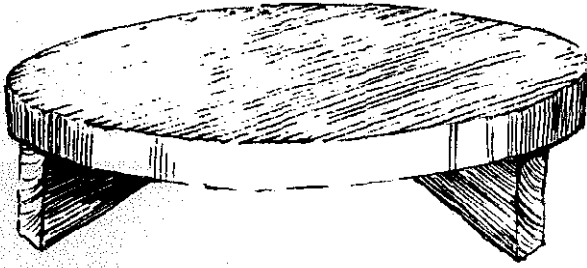

The craftsman who made this stool probably had the traditional carved stool made from a single piece of wood in mind when he made this. The traditional stool has much greater durability than this one, although similar quality could have been achieved if the legs had been joined to the seat more securely.

Wood Workshops

The wood workshops produce a variety of furniture, mostly for private use. They also produce office furniture, such as chairs and desks for offices, on special orders from the government. Some of the workshops we saw were producing school desks. The same proportion were producing semi-manufactured articles such as window frames and doors for the building industry, while 11% made suitcases and/or small boxes.

Even the wood section of small scale industries tends to be luxury-oriented. For instance, a sofa or an armchair is not a necessity for the vast majority of people in Tanzania where an average wage is around 500/- per month in the urban areas. The custom in the countryside is to use small wooden stools. Today, simple wooden chairs have become common. Other types of furniture are definitely more useful, e.g. beds, meat safes, and cupboards. The shape of the furniture also reflects its luxury-orientation and the functional approach has hardly been studied. The carpenters are producing no producer goods at all.

The majority of the furniture manufactured consists of goods which show the status of the user, rather than simplify daily life. The furniture designs are copies from western magazines of Inkrin Design, so the photographs do not show either the dimensions or constructed parts of the furniture. This is the main reason why the carpenters fail to produce quality furniture and remain uneducated in ergonomics and construction of western furniture. But what is worse is that western furniture has been designed to suit western urban dwellings in a cold climate. Compare the small over-crowded rooms in Tanzania where furniture competes with people for room.

Small Industries Development Organisation

The Tanzanian government has been conscious of the need to encourage small scale industrial

production; many third world countries have set up parastatals to supervise, direct, and encourage small scale private production in industry. It succeeded the stated vehicle for small scale industrial promotion today in Tanzania is SIDO (Small Industries Development Organisation), a parastatal organisation which was founded at the end of 1973. The NSIC (National Small Industries Co-operation Ltd.) which was established in 1965 and went into operation towards the end of 1967. NSIC was a subsidiary of NDC (National Development Corporation) and the Workers Development Corporation. NSIC supported relatively few small industries in urban areas. Special workshops were built and established on industrial estates, and craftsmen were encouraged to rent a small area.



Carpenters can be seen producing meat safes in almost all urban areas. Some are made from waste-wood and some from new materials; some are well made, some not. The details may differ but the basic construction is the same.

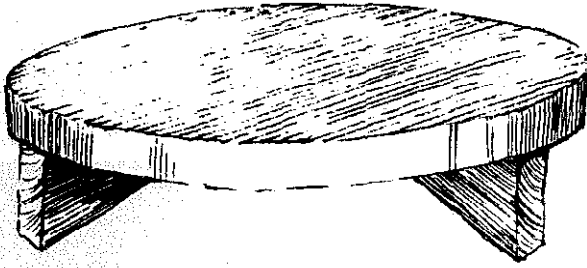

The craftsman who made this stool probably had the traditional carved stool made from a single piece of wood in mind when he made this. The traditional stool has much greater durability than this one, although similar quality could have been achieved if the legs had been joined to the seat more securely.

Wood Workshops

The wood workshops produce a variety of furniture, mostly for private use. They also produce office furniture, such as chairs and desks for offices, on special orders from the government. Some of the workshops we saw were producing school desks. The same proportion were producing semi-manufactured articles such as window frames and doors for the building industry, while 11% made suitcases and/or small boxes.

Even the wood section of small scale industries tends to be luxury-oriented. For instance, a sofa or an armchair is not a necessity for the vast majority of people in Tanzania where an average wage is around 500/- per month in the urban areas. The custom in the countryside is to use small wooden stools. Today, simple wooden chairs have become common. Other types of furniture are definitely more useful, e.g. beds, meat safes, and cupboards. The shape of the furniture also reflects its luxury-orientation and the functional approach has hardly been studied. The carpenters are producing no producer goods at all.

The majority of the furniture manufactured consists of goods which show the status of the user, rather than simplify daily life. The furniture designs are copies from western magazines of Inkrin Design, so the photographs do not show either the dimensions or constructed parts of the furniture. This is the main reason why the carpenters fail to produce quality furniture and remain uneducated in ergonomics and construction of western furniture. But what is worse is that western furniture has been designed to suit western urban dwellings in a cold climate. Compare the small over-crowded rooms in Tanzania where furniture competes with people for room.

Small Industries Development Organisation

The Tanzanian government has been conscious of the need to encourage small scale industrial

production; many third world countries have set up parastatals to supervise, direct, and encourage small scale private production in industry. It succeeded the stated vehicle for small scale industrial promotion today in Tanzania is SIDO (Small Industries Development Organisation), a parastatal organisation which was founded at the end of 1973. The NSIC (National Small Industries Co-operation Ltd.) which was established in 1965 and went into operation towards the end of 1967. NSIC was a subsidiary of NDC (National Development Corporation) and the Workers Development Corporation. NSIC supported relatively few small industries in urban areas. Special workshops were built and established on industrial estates, and craftsmen were encouraged to rent a small area.



Carpenters can be seen producing meat safes in almost all urban areas. Some are made from waste-wood and some from new materials; some are well made, some not. The details may differ but the basic construction is the same.

1972, and the hand grinding machine and other machines were all out of order six or seven times a year. We were told by the foremen that no Tanzanian had been trained by NSIC for repairing the machines, but a German expert from a company in Dar es Salaam was available for major repair work which, however, is of little help when there might be a wait of several months for spare parts.

"There is almost no use made of common facilities by the metal workers, since the machines supplied free from India proved to be of wrong type."*

The same report tells us that only 5 units used the machines and they were used less than 1 hour per week.

The craftsmen were charged one shilling a minute for using the machine, except for the shearing machine which was free. Craftsmen from outside were charged shs 1.50 per minute.

The machines for wood work were also gifts from the Indian government. These were a lathe, a

planer, a circular saw, belt sander, drill (both metal and wood), bandsaw, tenoning machine, morticeing machine, and a grinder. Four of the machines had been out of order for over a year. The belt sander had not been used since 1972 because the sandpaper for the machine was not available and, as with the metal work machines, no one knew how to repair those which broke down. The lathe was seldom out of order and could be repaired by a company in town. Yet only four craftsmen knew how to master it and it was mainly used by them. The planer had once been repaired by themselves and was used five hours a day, but it broke down about four times or so a year and was repaired by a private company in town. Each time it took about two months to repair. The drill was the only tool often used by outsiders. It was used for about one hour a day and breaks down about twice a year. The grinder is only used for sharpening the knives for the lathe and has never been out of order. The craftsmen are charged 25 cents per minute. If we compare the figures with an earlier survey, we can see that conditions have not changed much: all machines were utilised about 58 hours per week but, during that survey, the bandsaw had not broken down and was used about

**The National Small Industries Corporation of Tanzania: An examination of current plans and prospects: Livingstone University College, Dar es Salaam.*

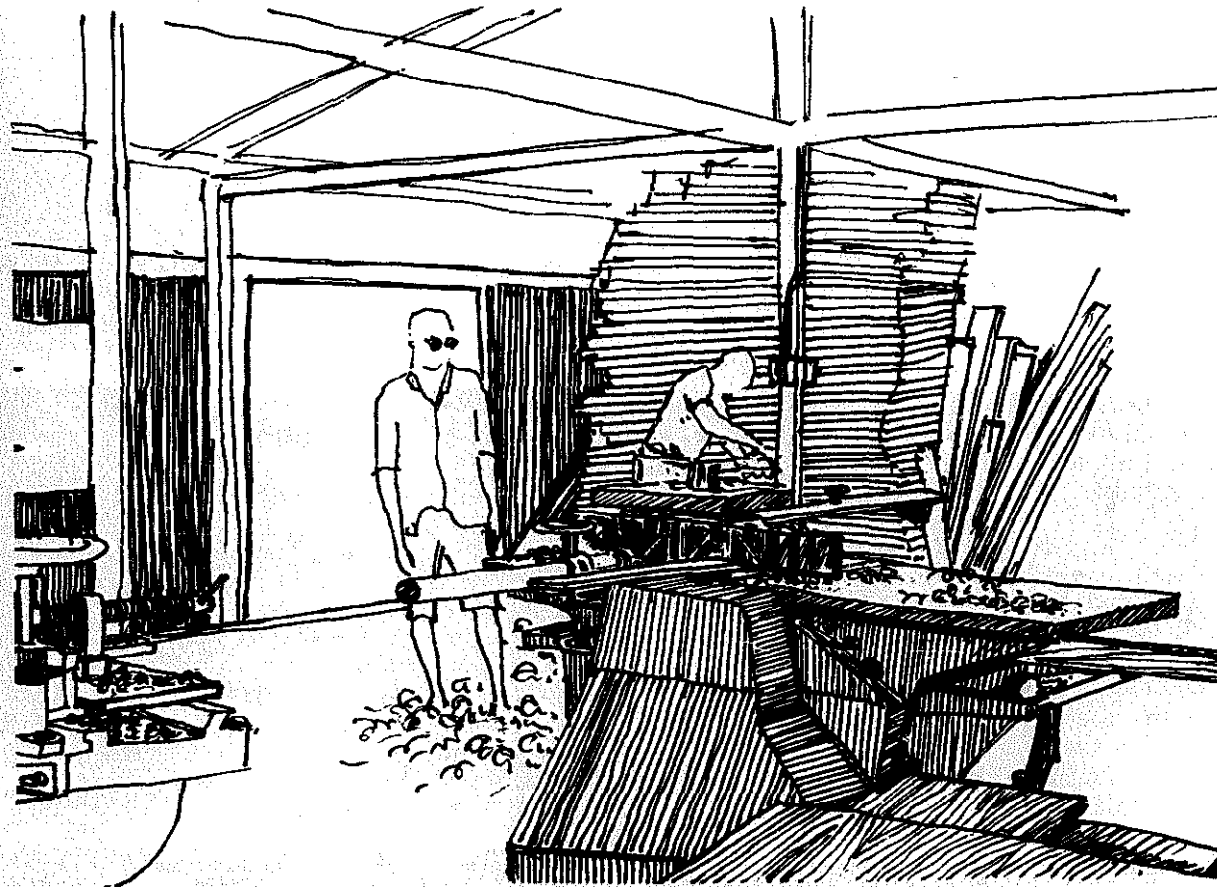

Sophisticated machines can be rented by individual craftsmen but few are skilled enough to operate them. Broken dusty machines are a far more common sight than machines in operation.

4 hours a day.*

The machines were mainly used for articles ordered by the government. The hiring charges, as well as lack of know-how, may contribute to the underutilisation of the machines. Despite the high percentage of broken down machines, some form of use for production at the workshops went on all the time. The foremen told us that specially-trained artisans operated the machines under some kind of supervision. Other artisans had not been properly trained.

"The two craft teachers provided through Indian aid have clearly done little since their arrival, either in relation to making existing products or to the development of additional products, as is required for metalworkers for instance."*

The same report states that 92.5% of the artisans declared that they had learnt nothing from the management of NSIC. No one claimed to have learnt 'quite a lot'. These figures are compared with reports from 17% of the craftsmen who declared they had learnt quite a lot from other workshops in the same area which indicates how much could have been done by NSIC and how little was done for the craftsmen renting the units.

A similar situation was found at the common facility metalworkshop at Dodoma. Here, the machines had been in operation for about a year yet, at the metalwork workshop, four of the fourteen were already out of order at the time of our visit. These were the handpress, spot welder, bench shearing machine and the benchgrinder. We were informed that the electric hand drill broke down about once a week mainly due to lack of knowledge on how to use it. The welding transformer had been repaired several times. The circular cutter, the swaging machine and the shearing machine had each been repaired once. But the bending roller, the edge folder, the angle grinder, the grooving machine and the fanforger have only needed minor maintenance. The edge-folder and the circular cutter were, at the time of the study, in use less than one hour a month. The bending roller, the shearing machine, the swaging machine and the welding transformer were used for one to two hours a day and the angle grinder, the grooving machine and the electric hand-drill one to two hours a week.

At the common facility woodwork shop in Dodoma the situation was different. None of the five machines had had any severe breakdowns. Minor breakdowns were repaired by a Dutch expert who has now left. The planer and the circular saw could be in operation for three hours

**The National Small Industries Corporation of Tanzania: An examination of current plans and projects: Livingstone University College, Tanzania.*

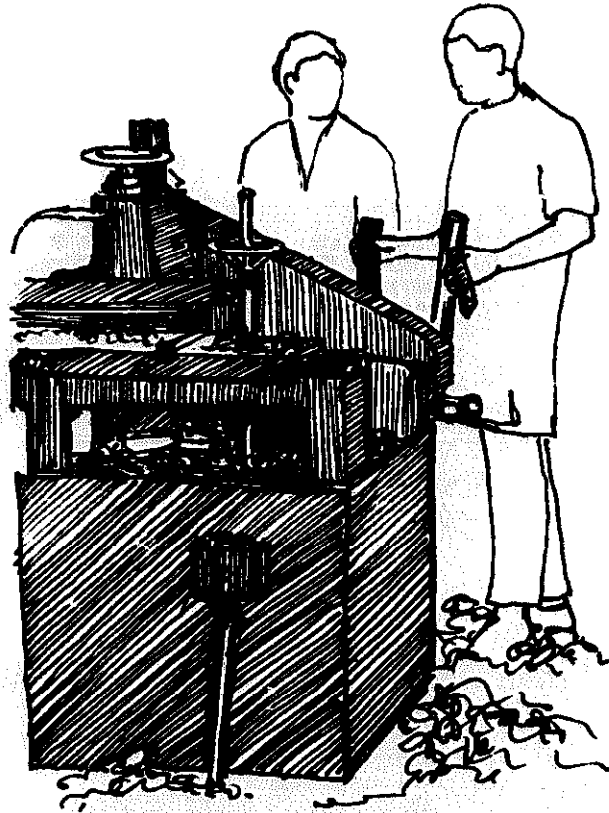

Machines can never replace skilled craftsmen, yet machines cannot be operated without a certain amount of skill. Normally small industries cannot afford to invest in machines but they can be rented in some of the cities. The hiring is under the supervision of a foreman but he is frequently too busy to do his work properly. Machine-operating training is very often not available either.

a day, the bandsaw one hour, and the lathe could be periodically used for one hour per week. The sharpening machine is used for the knives of the lathe. At these workshops the repairs were made by the Dutch expert, but severe and critical breakdowns were too difficult for him to manage. The duties of the Dutch technician have been taken over by the local technician whom he trained. All carpenters in the area used some of the machines but this was not the case with the metal workers. The craftsmen were charged 35 cents per minute for electric power machinery and outside craftsmen one shilling.

The questions we asked were whether the use of such type of electrically powered machines is the proper base for improving the skill of comparatively unskilled craftsmen and whether this type of workshop will lead to the mass experience which is required by developing countries. We concluded that widespread technical knowledge is unlikely to be created as long as new forms of foreign depen-

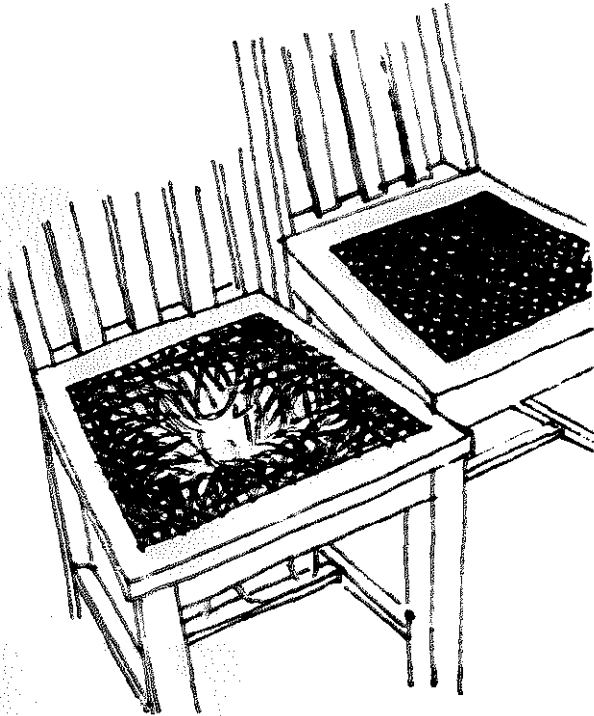

The two chairs above were found in a carpentry in Dar es Salaam. The chair on the left had a broken seat while that on the right showed no faults at all. Although they were made in exactly the same way, the seat on the left chair was made from imitation plastic rattan strings while the right chair used the original, local, rattan. It is hard to understand why the plastic imitation was used at all, given that the price for the raw materials is exactly the same and that the local rattan is of vastly superior quality.

dependency are created – dependency on foreign imported spare parts and foreign technical knowledge for repairs. We do not argue that machines should not be used. Machines can be time and money saving, but machines which break down quite often, in many cases due to lack of know-how of their use or endless waits for spare parts, do not necessarily save time and money.

“Developing countries experience grave difficulties in maintaining, servicing and repairing their technical equipment and fleet of vehicles. Distances between the manufacturer and the purchaser are usually very great, and the transmission of orders depends on the means of communication available. Operating instructions, data on mechanical equipment, and spare parts catalogues are not always available or printed in the language of the country concerned. Regular customer services are still lacking in many developing countries. Furthermore, the delivery of spare parts can be delayed, not only through the complicated communi-

cations to the foreign supplier but also through the obstacles for obtaining the necessary import permits and custom clearance etc, as well as through an inefficient transport system within the country.”*

The initial cause of this problem was the gift of the tools. Governments, like people, rarely refuse gifts, yet the question of suitability had not been thoroughly tested. It seemed to us that, given the base of existing technical knowledge, this was not the way forward towards widespread and localised technical skills.

“Special problems have arisen in Tanzania and her regions because donor countries, to a large extent through bilateral assistance programmes, have shipped to her a variety of machine makes, all of which differ considerably from one another in their servicing and maintenance requirements as well as in their spare parts.”*

Spare parts, maintenance and service is not a problem unique to small scale industries, it covers

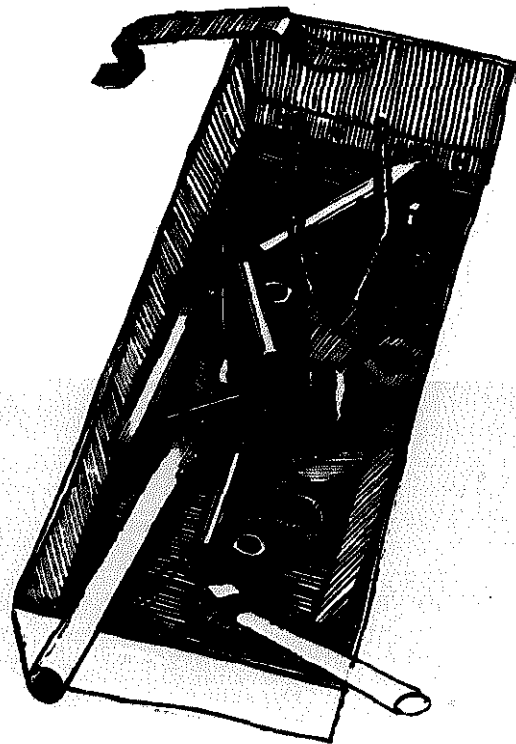

Often a small box like this is the only storage facility that metal craftsmen have for putting away their tools.

*The Development of Small Scale Industry in Mwanza Region: Gerhard Hultcrantz.

most sectors using foreign equipment in developing countries. Neither is the situation unique to Tanzania. The same problem appears in Africa, Asia and Latin America.

It is encouraging to see that the Tanzanian government tends to look upon the promotion of small scale industries as an integral part of the general rural development effort. The government also emphasises the complementary role of small scale industries to medium and large scale undertakings. However, in this book we concentrate on the less developed small scale industries, which are just a part of the entire promotion of all kinds of small scale industries.

In the TANU* Directive on Small Industries of February 1974 their importance is pointed out in the following way:

1. Small scale industries are necessary in a society, long exploited, which does not have much sophisticated know-how or capital. Since many small scale industries do not require much know-how and capital, they can be started and run by the people themselves, especially if they do so on a socialist basis.
2. In Ujamaa and development villages, agriculture dependent on the rainy seasons does not provide full-time employment in agriculture. Small scale industries can meet some of their employment needs and help to diversify their activities throughout the year.
3. Small scale industry is required to help curb high unemployment by engaging the people in productive activities.
4. Small scale industry will help Tanzania realise the objective of bringing about the technical revolution in the rural areas.

**The former political party Tanganyika African National Union.*

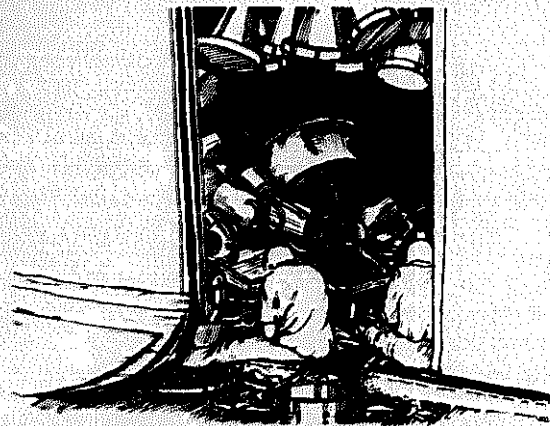

Craftsmen are often forced to sit outside because of the lack of design planning in their workshops. This place produces watering cans, chicken feeders and buckets made from galvanised metal sheets.

5. Small scale industries are essential to the implementation of a policy of self-reliance, and to eliminating some of the disparities which now exist between rural and urban conditions.
6. If small scale industries are developed systematically, the cost of production will be reduced.

This general policy is more specially expressed in SIDO Guidelines No.1/74: Promotion and Strengthening of Small Scale Industries.

1. Initiative for starting small industry lies with the people themselves. SIDO will undertake planning and co-ordination of programmes on a national level.
2. SIDO will provide services including advice on marketing, training, economic and technical research, planning, etc.
3. SIDO will not finance, but will advise industries and their investors on ways and means of making finance available.
4. It is planned to establish a decentralised industrial extension service throughout the country. In the interim, as the service develops, it will operate mainly from SIDO headquarters in Dar es Salaam. Some of the important services now available are:

i. Technical and Economic Services:

- On-the-spot technical assistance and guidance
- Best use of raw materials and substitutes
- Preparation of model schemes and feasibility studies
- Advice on the scope of new industries
- Sources of finance
- Techno-economic surveys of areas or regions
- Construction of industrial estates

ii. Marketing Services:

- Collection of data
- Advice on distribution of product
- Administration of a limited hire purchase scheme on machinery and equipment
- Advice on export markets and quality control of products
- Sales promotion

iii. Technical Training Services:

- Support non-governmental institutions in training in relevant skills
- Conducting technical courses
- Organising production-cum-training centres
- Management training
- Advice on all training matters, scholarships, overseas training, etc.

iv. Management Consultancy:

- Industrial management
- In-plant studies

- Ad hoc advice on specific problems
- Advice for cost reduction, economy in use of raw materials, etc.

In order to be able to give a more complete picture of metal workshops and carpentries, we turned to small scale production in the private sector. Here, we have analysed the tools and technology in use for both metal and wood work, the design of the workshops, and the raw materials in use.

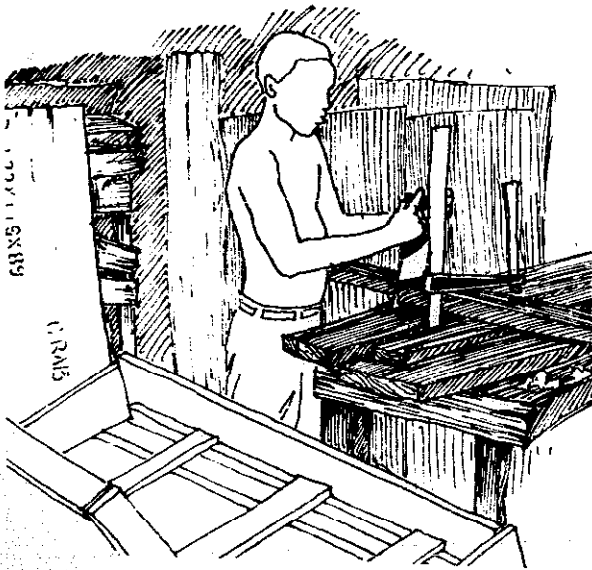

Imported tools are commonly used in the wrong way. This saw should be held in one hand and moved slowly to and from the body horizontally. This man is sawing up and down, gripping the saw with two hands. By using this method, the saw will deteriorate rapidly, as well as produce a less satisfactory result.

Raw Materials

Metal Workshops. The metal workshops used all kinds of scrap metal as well as imported sheet metal (galvanised iron sheets), and galvanised wire. Ninety per cent of the workshops in our sample used scrap in their production; the other 10% only used it rarely. The cottage industries in the countryside only used scrap, and only one Ujamaa village which we visited used sheet metal. The others based their production on scrap, mainly car springs, which was obtained free. In Dar es Salaam and Dodoma the craftsmen had to collect the scrap themselves, and some of the craftsmen at the Kisarawe Street Project also collected scrap to sell to their colleagues. Many workshops used both scrap and new material, depending on availability, as one product could be made either of both materials, or of totally recycled material, or of new material.

Carpentries Only 50% of the carpentries we

studied used recycled wood. Some of the wood workshops used recycled plastics and sacks, when they were available. In rural areas, only new wood was used in production, as no recycled wood was available. It seemed that as soon as recycled wood was available, the carpenters used every single piece.

When the carpenter used new wood, it was domestically grown timber. The most common timber in use was munings (hard wood), mvole (hard wood), Mkangangazi (rather soft), and mpado (soft wood). Other locally produced materials were chipboard (produced in Tanga), hardboard, and plywood which had to compete with the imported plywood of better quality. Formica is not locally produced, but commonly used by carpenters in combination with recycled wood. The formica was imported from China and Germany and most craftsmen ordered just enough for the job in hand. Hinges, screws, fittings, nails etc. had to be imported and then bought from private retail shops. Rattan was locally manufactured, yet many products were made using synthetic rattan strings (plastic) which were both more expensive and less durable. Armchairs and sofas were often covered with these plastics, which were unsuited to the hot, climatic conditions of Tanzania. Preferences for such materials had been conditioned by beliefs about the superiority of foreign products. The plastic covers could easily have been replaced by locally made rattan material. Formica could be totally avoided by reconstructing the design, and hinges, handles etc. could be produced locally.

The strategy for the development of small industries must focus on production using local resources not only on grounds of price but also on grounds of integration of the economy (shadow price). Short-run consumer choice may favour imported synthetic materials but long-run public interests does not.

Tools and Technology

Handtools. The number and type of tools varied widely from small industry to small industry, but their origin differed between metal workshops and carpentries. The carpenters used imported tools; only 10% had any type of tool which was locally made, and they had only personally constructed one or two pieces of equipment. On the other hand, the metal workshops used different pieces of scrap for tools, but even here the majority used imported tools.

Carpentries No workshop had more than 23 different kinds of handtools. The average number of different tools was ten. The most common tools we saw were hammers, saws, chisels, files, set-squares, rasps, screwdrivers, drills and planers. The number of different types of tools have no

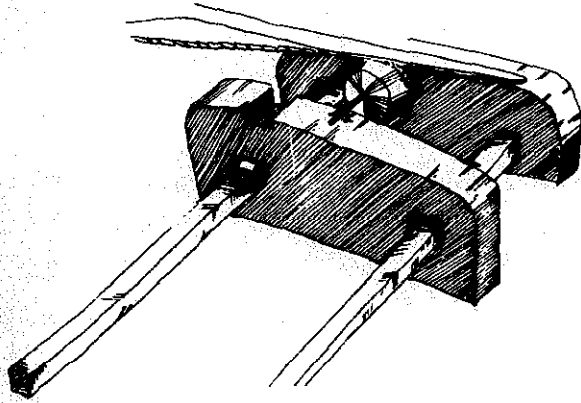

An indigenous lathe, looked upon by many as merely a picturesque traditional leftover. But wood can be turned on this simple lathe without the use of electricity, imported machinery or foreign expertise and it is easy to repair, maintain and operate.

correlation to the use of the tool. For example, one workshop had eight saws (of the same type) but no tool for any form of measurement. Only 62% of the wood workshops we visited had a set-square and only 33% had a carpenter's rule or an equivalent tool, yet both of these are definitely necessary to a carpenter. Other tools which we found there which simplify work were screw-vice and clamps.

The locally made tools were usually manufactured by the carpenter himself, but only for his own use. The quality of these tools was generally as well made as the mass-produced imported tools in use, and some of them were even of a superior quality. Only one of the tools which we saw was found to have had its origin back in the old African pre-capitalist culture, that was the lathe. An electric machine was added to the lathe to increase efficiency. The lathe is only used for manufacturing the Pemba-stool, the only traditional furniture found in production in the investigated workshops. The same type of lathe, manually operated, is used by the people, and this was invented in the 3rd century BC in Egypt.

Metal Workshops At the metal workshops far more scrap was used for tools than among the carpenters. Every investigated workshop used scrap pieces of different lengths as anvils. Yet at 10% of the workshops they had also bought imported mass produced anvils. Nuts and self-made punches were found at almost all the workshops. Joints for pipes, casted metal components for machines, etc., were used for shaping the workpiece, and car springs were used as hammers, but all the workshops we saw had at least one pair of scissors for cutting sheet metal and not one of these was locally made. All workshops also had at least one soldering iron, some of which were locally made,

or rather self-made. The imported ones were of bad quality and broke easily. Not everyone owned a compass but of the ones in evidence, many were locally produced. Four of the craftsmen had made their own hammers for blacksmithing. Other common tools in use were different types of pliers, tongs, files, soldering torches, and a manual machine for profiling sheet metal. All of these were imported. The machine for profiling was first introduced during the German period and most of them are still in use.

The village blacksmith was one of the few craftsmen in whom one could trace pre-capitalist skills. He was equipped with a very limited range of simple tools (often not more than five or six) but these were made and designed personally by him, and these designs were often hundreds of years old. These tools were fully adapted to the production process, which in some ways made them superior to many of the imported tools.

Lack of first class manual tools prevents the development of small industries which cannot be replaced by sophisticated machines. In certain cases sophisticated machines are well-grounded as complements, but the base must be manual tools which are adapted to the production processes used by the skilled craftsmen. Most of these basic tools can be made locally with existing knowledge and equipment.

Workshop Design

Interior Design of Workshops Most workshops have been built in Tanzania without any planning of the interior design which makes it extremely difficult for the craftsmen to work properly. The workshops must be built with a planned space inside and equipped with work benches, store spaces for raw materials, tools and equipment, finished products, etc. The floor should not be used to serve all these purposes. No shelves or other equipment with storing functions are available in Tanzania if they are not specially ordered.

Metal Workshops The metal craftsmen sit directly on the floor or the ground which ergonomically is completely wrong, as the workpiece is placed between the legs, which makes the working position very tiresome, and also reduces the muscle power required. Yet no single workshop had work benches. Twenty per cent had some kind of table (usually of the wrong height), which was used for no special purpose.

Thirty per cent had boxes for the tools, but they were too small for storage. Only 1% had any storage space for raw materials (i.e. a big shelf), no-one had any special shelves for finished products and 10% used the space under the floor, from which the products hung.

Due to the complete lack of planning of the workshop function, many of the craftsmen had to

sit outside the workshops to find space enough to work, as the floor was encumbered with materials and tools. Thus the workshops were not used as workshops but only as store rooms.

Wood Workshops Work benches were far more common at the carpenters. Ninety-nine per cent had some kind of work bench, although many of them were very unstable with incorrect dimensions. The work benches were, in general, placed outside the workshop in the open air. Fifty-five per cent of the shops had one or two boxes for tools (but not big enough for all tools) and a few also had a cupboard for their equipment. Thirty-two per cent used the space under the floor for storing timber, which is quite well-grounded. However, other carpenters used the floor and had no special place for material in use such as screws, glue, nails, hinges, handles etc. At one Ujamaa village the store room for raw materials and ready products was located about 100 yards from the workshop.

In short, workshop design, although not a major problem in itself, requires an understanding of the process of production and required improvement.

Skilled Craftsmen

The small industries in Tanzania are small in terms of the numbers of workers in any single workshop. The cottage industries in the villages are even smaller and the craftsman generally works alone or with his son or a relative.

Both of these industries are structured in the wider society as co-operatives or private ownerships, with the latter using employees and/or assistants. Co-operatives are more often established by the carpenters. The workshops in Ujamaa villages have been formed as co-operatives.

Metal Workshops In Dar es Salaam the average number of assistants per metal workshop was just over four. A few of the workshops co-operated for short periods of time and in some cases shared a workshop without any other form of co-operation. Some of these had as many as ten assistants while at the other end of the scale, eight workshops had only one assistant.

At the Dodoma project all the metal workshops were shared by craftsmen, but only one workshop actually shared their workload. The workshops outside the SIDO project were very small, as were the ones within the Dodoma project and other workshops in town. Only 16% had any assistants at all. In Dodoma all the assistants were sons or close relatives, but in Dar es Salaam only one-third of the assistants were related to the master. In Dar es Salaam many of the assistants were not even ethnically related to the master. Sometimes the assistants received a small salary but it was not uncommon for them to pay for their own training.

The following table shows the training of metal workers:

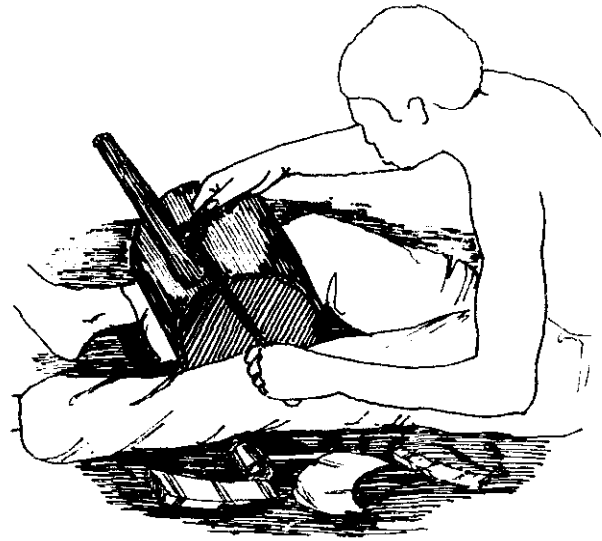

With no workbench available, this craftsman had to sit on the floor to solder a watering can.

Training of Metal Workers (1975)

Town	Through former employment	Formal training schools	Trained by assisting their father	Trained by assisting a craftsman	Self-educated
Dar es Salaam	38%	5%	15%	42%	—
Dodoma	8%	—	35%	15%	42%

The figures show that former employment played a major part in Dar es Salaam, where most industries were situated. Only 5% of the assistants had received any formal education. Almost half the number of the metal workers in Dodoma had learnt their skill by working alongside more experienced metal workers who had their workshops in the streets. One can see from the table that kinship plays a more important role in recruitment in Dodoma than in Dar es Salaam.

The blacksmiths were the only metal workers who had a thorough knowledge of their skills, while the craftsmen not working with indigenous techniques were less skilled. The average number of different products that a metal craftsman could manufacture in Dar es Salaam was 3.8, while the average number for Dodoma was 3.3. (The blacksmiths were excluded from these figures).

Average number of different products made by metal workers:

Town	More than 10 products	5-10 products	Less than 5 products
Dar es Salaam	4.4%	37.20%	58.3%
Dodoma	5.5%	23.5%	71.0%

The above table shows that only a small number

of the craftsmen can be called skilled: this group are poly-technicians, able to design their own models, and manufacturing products from a prototype without difficulties.

The group of craftsmen with the capacity to create five to ten products cannot themselves create new products and have to be taught to make a new model. For instance, their knowledge of certain techniques was limited to the products which they had been trained to manufacture. The majority were mono-technicians and the same techniques were used for all the products they knew how to manufacture. The shape of the products differed but the production processes were the same for all items. Often their technical knowledge was limited to cutting, bending, soldering, punching and rivetting though a few of them knew a little about blacksmithing.

The majority group (able to make only up to five products) were purely mono-technicians with an extremely limited knowledge. They often did not know more than how to cut, bend and soft-solder or rivet. However, they could not use these techniques to manufacture anything other than the particular product which they had been taught.

Their limited knowledge was reflected in the quality of the products. Only 11% of the Dar es Salaam products were well-made items, in our opinion. These craftsmen who did make a quality product did not suffer from the severe, marketing problems which affected the majority who found tremendous difficulty in selling their products, as carelessly-made products could not compete with alternatively expensive imported articles.

In Dar es Salaam half of the middle group (five to ten products) produced quality products, and only 33% had problems selling them. This group produced mainly sheet metal work ordered by the government. In Dodoma the majority (90%) manufactured well made products which were easy to sell. The most skilled group (more than 10 products) produced totally high-quality work, and also manufactured products ordered by the government, (watering cans, chicken feeders, etc.).

In the Ujamaa villages which we visited, most metal craftsmen had been trained in the traditional arts of blacksmithing, although there is every indication that this skill is dying out as many villages did not utilise the services of the knowledgeable blacksmiths. However, the quality of the products manufactured at these small village workshops were often, in our opinion, superior to the production in towns. Yet the existing workshops were too small to satisfy all the villages' needs and imported agricultural tools were widely used.

Wood Workshops In Dar es Salaam the average number of assistants per shop was only two. Some workshops had five assistants and two had none at

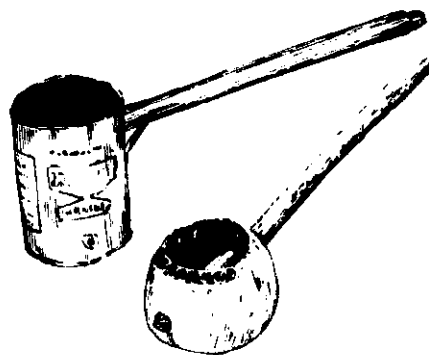

Until just a few years ago, water ladles of coconut shells were made along the East African coast. Today, many spoons are made of waste tin but these are less durable than the old variety.

all. In Dodoma each skilled carpenter had, on average, less than one assistant. At the Dodoma SIDO project the three co-operatives of altogether 32 skilled carpenters had 15 assistants, but the small workshops in town had only one or two assistants each. In the Ujama villages three to four were under training at each wood workshop.

Training of the carpenters

Town	Former employment	Formal training by schools	Trained by father	Trained by assistant craftsman	Self-educated
Dar es Salaam	45%	14%	21%	16%	4%
Dodoma	20%	11%	37%	27%	5%

Twice as many carpenters as metal workers had received formal training at school, but the majority of carpenters in Dar es Salaam had learnt their skill from former employment. In Dodoma the biggest group had been taught by their fathers. The products at the carpentries cannot be grouped in the same way as for metal products, where the designs do not change from one type of product to another. But a coffee table or an armchair may have dozens of designs. Generally, our observations showed that either the workshops were manufacturing padded furniture like sofas and armchairs, or furniture such as meat safes, chairs, tables, etc. Only a few workshops can make both types.

The workshops can be divided into three groups, according to the skills employed by the carpenters to join wood together. There were those who nailed their joints, those that nailed and glued, and those that used wooden dowells (see Table).

	Dar es Salaam %	Dodoma %
Group 1 Only using nails	40	39
Group 2 Using nails and glue	33.5	39
Group 3 Dowelling and glue	26	22

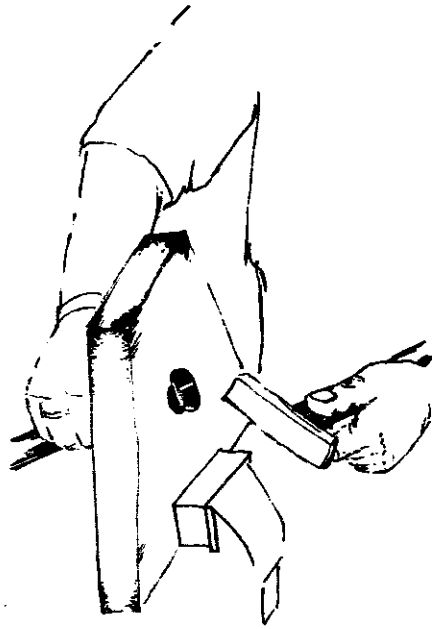

With some designs only nailing is suitable.

With some designs only nailing is suitable. Nailing combined with glue raises the durability and a joint with dowelling is a method which should be used with existing designs and materials to achieve durability.

The knowledge of the skill differed among the carpenters, but compared with the metal workers the standard was better, as the carpenters had been forced to produce many different designs of the same kind of furniture, as customers often have individual ideas of how their furniture should look.

There are big differences in the incomes of the carpenters, but comparing metal craftsmen and carpenters, carpenters earn more money. A few can even afford to own a car, but many remain dependent on the cultivation of their shamba. The poorest craftsmen do not earn much more than approximately 60 shillings a month, which hardly enables them to purchase the necessary equipment for their trade.

Conclusion

Small-scale production is obviously not the only important industry, but one very important sector in the process of industrialisation. This argument was clarified in a Party directive in 1973 on small industries 'Agizo Juu ya Viwanda Vidogo Vidogo Nchini'. The objective was defined as being the creation of a technological revolution in the rural areas based on control of industry by the people, using existing skills and materials and avoiding heavy capital expenditure. The inherited colonial structure cannot be eliminated without an industrial strategy which aims at self-reliance instead of reinforcing the foreign ties, which would repeat

present exploitations. During the first ten years of independence, Tanzania replaced some imported consumer articles with goods which were made locally. Imported machinery and imported intermediate products continued to flow into the country and so, therefore, did imported technical expertise. It is now widely recognised that substitution does not constitute an adequate industrial policy. Local labour and local natural resources remain largely untapped. The new industries do not create local skills and research facilities (national technological potential). The development of local technology remains in abeyance.

A policy based on import substitution industries often continues to manufacture copies of western designs, whether the production is for luxury-consumption or not. To develop widespread local technical skills, products must be designed for optimal use from local material and of local skills, and adapted to suit the raw material and the consumer. The aims must be clear to avoid solutions which do not really solve the problems. For example, a chicken feeder which is at present produced at many metal workshops will not raise the production or number of chickens. The chicken feeders cannot store chicken food, and it is even likely that the seeds go mouldy or rotten. What is needed to raise the quality of the chickens or to increase the number is perhaps another, better kind of chicken food which could be obtained if, for example, improved agricultural tools are used. The production must serve the needs of the people and it is the people who understand the needs. Technology can never lead ideology.

The technology used must be based on a state which is familiar to the craftsmen. The belief that a sophisticated machine assists the craftsman is a myth. A machine of this kind always requires a highly trained operator, who can be assisted by the machine because of his skill and not vice versa. An advanced machine can never replace education, rather it requires more advanced training.

As many areas in Tanzania are still without electricity, training must be based on equipment applicable to the condition of the people. Small plants which rely on manual power all over the countryside will not simply reduce distribution costs to avoid imported advanced machinery, but they will critically raise the level of technical skills so that the movements to use power tools can be done easily, efficiently and smoothly. Powered machinery has a tendency to break down, which causes supply shortages. We are arguing for a harmony between raw materials, human skill and technology, and we hope to begin the struggle towards industrialisation from the view of human skills and not western technology. As skills grow, technology and raw material exploitation will follow.

Training for Production

by Krisno Nimpuno

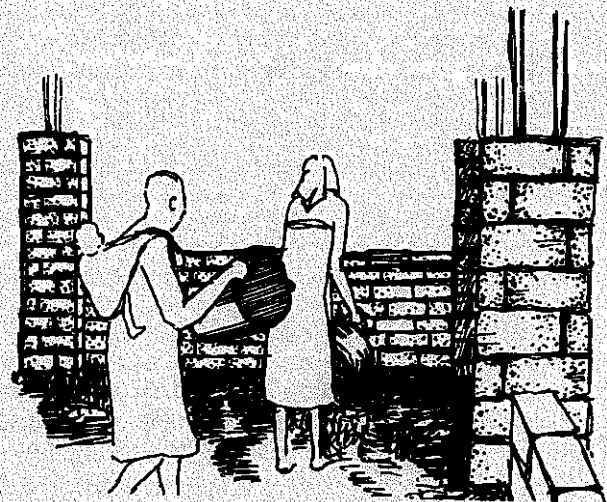

CHAPTER 6

Training for Production Krisno Nimpuno

The development of village workshops as part of rural industrialisation in the Third World must involve an ongoing education process. In Tanzania, President Nyerere's slogan "learning by doing" symbolises the process of education which we think will be essential if the village workshop idea is to succeed. Learning by doing means that the process of learning technical skills must be undertaken as part of the process of creating the village workshop itself. The objective of the village workshop is not to train a few technical experts, but intended to raise the technical level of the entire rural population: only with this end can agriculture be truly transformed over the long term.



Rural Workshop.

The conditions in Tanzania show in stark reality why such a process is so essential. Not only are ninety per cent of the people living off the land, but the population is unbelievably scattered over vast areas so that, despite a programme of villageisation, the structural transformation of the countryside can only be undertaken through an immense co-operative effort by the people themselves. And any co-operative effort needs to be informed through its own local technical knowledge, rather than external or expatriate technical know-how.

The methods we have in mind can only be undertaken by the people learning new skills as they work by themselves, without help from craft teachers. There are thousands upon thousands of people and it is not economically possible to provide sufficient craft teachers for them all.

Although we emphasise the ultimate aim of co-operation in training for production, anyone with field experience will know of existing "co-operatives" which help to create conditions for

small capitalists. Education and training are not neutral. In any socially stratified situation, which is normal, however poor the people are it is the relatively wealthy and more powerful who have been able to take advantage of education, credit, and any other new facilities which may have been designed to benefit everyone.

The process whereby the co-operative movement can simply support and re-emphasise an existing social hierarchy has been well documented in many parts of the world; for instance, in India and Kenya, where the wider economic relations are, broadly speaking, capitalist, but in Tanzania the same type of process has also occurred. Sometimes it was hoped that the knowledge obtained by the selected peasants would sooner or later have a spill-effect upon the rest of the population; in general, however, the select peasants were meant to develop into modern capitalist farmers."

In India co-operation, in theory at least, is supposed to be a combination of the weak so as to give them the power of union against the strong. In practice, however, the co-operatives are in the hands of the dominant village families, who turn the movement to their own advantage. Co-operatives are only one of several means by which the more powerful families exercise influence and authority over the mass of smallholders and labourers.

This is relevant to all aspects of rural development, and special to those sectors which hold the key to future advancements. One of these sectors is rural industry and this is particularly true for the educational aspect of technological development. If the educational resources are very scarce and competition for education is hard, then the weakest members of the village are likely to be excluded. As educational resources are indeed extremely limited in LDCs the efforts to achieve a high educational standard will have to be very limited in scope and quantity. The stratifying effect will then be difficult to avoid. This is one of the reasons why a very broad approach to technical training in the villages is preferable to 'quality training' which has a heavy reliance on theoretical knowledge.

The conditions of poverty and need are one thing, but the reality of the workers in the fields may be quite another. The condition of the people may cry out for a collective solution. Academically, we may argue that it is the 'rational choice', but we all know that such belief is not enough. The co-operative movement widely becomes an important avenue for the development of a rich peasantry, and this general movement is supported and directed by the local government bureaucracy. When this situation occurs, contact between the village and the regional bureaucracy becomes hampered and the development initiatives from the people are nullified. Local government officials

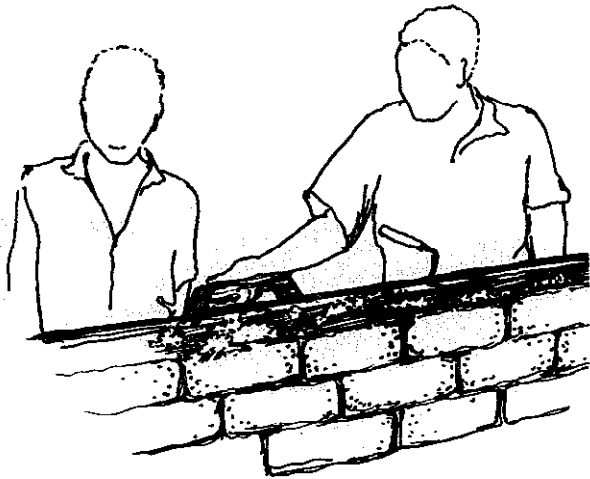

Learning by doing is always preferable to theoretical training.

and the leaders of the co-operative movement tend to form a bond, in one form or another, which has been documented time and again. The middle and poor peasants are ignored in the process.

In this type of situation, village production tends to be focused through the leaders of an external market outside the village, rather than on the internal needs of the area. The choice of industry is determined by external demand of the market, rather than by the needs of the village. What follows is a series of consequential problems, technique, raw materials, spare parts, credit marketing, etc, which have nothing to do with developmental needs of the village.

Lack of integration of village industry with its immediate environment therefore results in large operational difficulties and retards the growth potential because it does not allow for a constant low level training as a part of the production progress. It may not sound very progressive, but the policy of aiming low and moving slowly, in our belief, constitutes the only rapid and effective road towards a strong rural industrialisation. It is a question of economising the productive and educational factors. It has been said that a criterion must be established to ensure that goods produced are really those which allow for the best satisfaction of a given need at the lowest cost and with the least trouble.

It does not make sense to grab a villager and send him for training in order to achieve a production which does not appear to him to be related to his needs. Such rural planning over the head of the peasants is self-defeating and in a study on the subject it was noted that only about twenty villagers were recruited without reference to previous industrial or any other skills and without any preparation for any special kinds of activities. The only effect to turn the place into an 'industrial' village was made by sending a private

entrepreneur to the village who knew how to make sisal mats.

Industrial development is, so far, a remote perspective for the average villager and a short training in crafts does not help much to alter his views if it is not made immediately useful for his own daily needs. The educational technological and productive orientation of the rural industrialisation programme should fully reflect this elementary reality. To bury the joy of creative activity under a long vocational training will only increase the present gap between the pupil and the subject. Learning by doing, training while developing one's own conditions, avoids such pitfalls. The slow method is not spectacular for the urban expert but his private reaction is really not very relevant. Rural development is, to a large extent, a question of self-discovery. In crafts it is vital that the craftsman, his tools and the material he works become one, and it is doubtful that such self-discovery and vocational harmony can be achieved abruptly.

As we see it, the village will have to be organised into groups or brigades, each having a responsibility for different tasks in the village economy. It is through these brigades that industrial training will occur. There will be a storage brigade which will build the silos; cleaners, weighing and packaging brigades perhaps, and other groups will develop skills in woodworking, metalwork and construction. We would envisage a brigade for gardens, cattle sheds and charcoal burning too, according to the needs of the village.

Education Through Training

If the educational method is learning by doing, then the lessons and the workshop production become one and the same. The formulation of the production programme then becomes the formulation of an educational programme. The programme should first aim at teaching the handling of the basic tools. In the chapter on the village workshop equipment, a basic toolkit is described which is adequate for most elementary craft-work, and which will help the apprentice to get to know his material and tools.

There are two suitable areas which can be used to acquire the most basic technical experience and which can form the starting point for the training. The construction of the workshops themselves offer ample opportunity for practical exercises and can become a suitable medium for craft training. The construction of a very simple building offers a great choice of exercises. Another area which can be immediately earmarked for this purpose is maintenance and repair of all the simple tools in the village. This aspect of the training programme is vital because it teaches elementary respect for the industrial products, and will provide the pupil

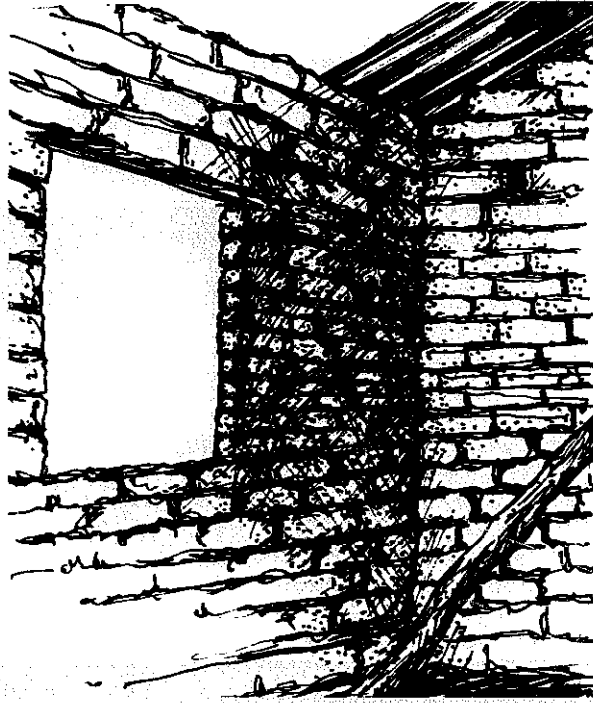



A knowledge of housebuilding can be gained when the workshop is built.

with a certain feeling for the mechanics of the tool and the characteristics of the material. Repair work will, in addition, enable the future craftsman to acquire a basic technical understanding which, at a later stage, he will need for design and development work.

It is essential that the study programme constantly shows the relationship between the separate manual sequences and the composite final product. Craft training usually needs a very high teacher input because it must first give the apprentice an intellectual understanding of the work sequence; thereafter, the training leads to the manual mastery of that sequence. An important development in the field of craft training in recent years has been the use of a systematic sequence of visual aids to accompany and illustrate practical exercises. Three-dimensional models have been used with great success too. A drawback of this is the great cost of the models and the very considerable storage place required. Educational models can, however, be made as a part of the workshop's training programme and, in the course of a few years, a minor collection of models can demonstrate the most crucial points to be made.

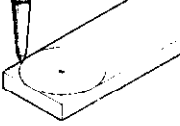
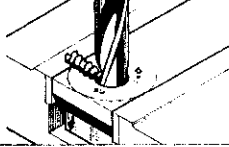
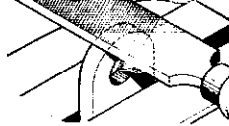
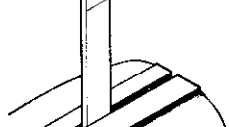
Another form of educational visual aids, i.e. charts, can be even more effective. Large coloured drawings in perspective can show both the tool and the material in a step by step development of the piece. A Dutch foundation has been commissioned by the Dutch government to develop vocational teaching material along these lines. The

	Centre dot to make circles permanent	Centre punch. Hammer
	Clamp work with wooden packing in drilling vice Drill two 10 mm holes (use cutting fluid)	Drilling machine. Drilling vice Wooden packing. Wear drill (10 mm)
	File round to scribed lines	Vice clamps Bastard hand file
	Clamp strip in vice with vice clamps. The innermost scribed line should coincide with top edge of vice	Vice. Vice clamps
	Bend strip Strike as close to bending line as possible.	Vice clamps. Hammer.

Visual aid chart.

charts have a minimum of text and come in units of eight pages. Each unit of eight charts demonstrates one separate sequence.* A special English Language manual is available. The material covers metal and woodwork training and has been made for rural vocational training in LDCs.

A realistic approach to village craft development combines education and work with the immediate needs of the villages so that training is based on learning by doing and is assisted by adequate visual aids. The training programme can be guided by a type of government service similar to the agricultural extension services. In Tanzania, there is already a basic network for such technical service in the rural training centres and in the district construction teams. The development of rural technology will need much less government guidance and incentive if such educational preparation is available and the institutions existing can be mobilised for technical extension work. The main question is then to choose the right educational strategy.

***For those requiring further details of these materials for their programmes, the address of the publisher is:**

INTEHCONTINENTAL Educational Media N.V., PO Box 42, Aerdenhout, The Netherlands.

A brochure is available giving background information, specification of subjects and prices. Addresses of schools and centres where this material is already in use is also obtainable from the publisher.

Village Workshop Equipment

by H. Tollin and B. Oscarsson

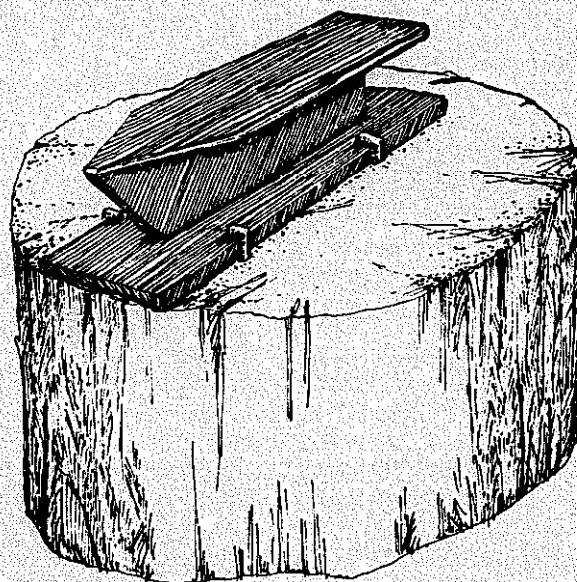

CHAPTER 7

Village Workshop Equipment Bertil Oscarsson and Hans Tollin

Development of Village Workshops

One of the aims of creating workshops in villages is to reduce the amount of imported goods needed, as well as reliance on the technical expertise of expatriates. It is the village people themselves who must guide and support these movements through their own initiative. To improve agricultural development, it is important that farming implements produced are of a practical design. It is also important that these implements should, to a large extent, be produced and repaired in the villages. It is obvious that locally produced tools reduce cost and ensure suitability for local needs. Moreover, they can be made when necessary and their production is part of the movement towards new technical skills. This kind of goal provides a basis for planning and setting up the village workshops.

Development will require a better organised type of workshop than is available in most villages today as few are able to produce their own tools and farming implements. The foundation of the type of workshop we have in mind will make use of and develop local resources, knowledge and ideas.

The Central Workshop

We foresee that village industrialisation will create a series of workshops. The hub will be a central workshop which will contain repair facilities, a forge, metal and wood working facilities, so it is important that different craft skills operate under one roof. The possibilities for creating new products will be enlarged if the blacksmiths, metal and wood craftsmen work together and make use of each other's knowledge and ideas. Critical thinking with new ideas and experimentation can be encouraged when people with diverse skills are brought together.

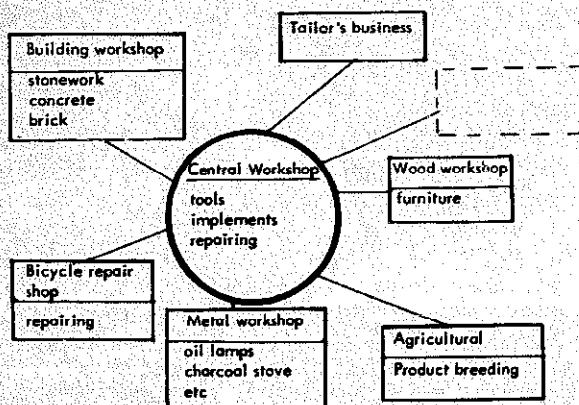

The most important investment in the Central Workshop is a proper forge where scrap iron can be turned into new tools and implements of various kinds. The forge is the key to independent production development. In the forge there should be a forge-hearth, anvil, forging tools and a water or oil bath. Each of the parts is equally important to a blacksmith's work. Most of the traditional forges which we saw in the villages of today are too small to produce implements or tools and do repair work for current needs. Among existing village blacksmiths, the fire is too small for the work that will be required — a larger forge with a better capacity is needed.

The old iron forges produced and smelted small quantities of iron ore while, today, large quantities of the metal will have to be worked.

Workshop development cannot be founded on the old techniques. It is important to pay great attention to building up the forge in the central workshop. If the forge is not developed, then the opportunities to produce implements and tools will not exist and a situation will arise where imported tools dominate village production again.

The central workshop should function as the creative centre of the village. It is important that they are flexible in the sense that they are not locked into certain methods or products which may prevent further development. To run parallel with the central workshop, it would be useful to set up metal and wood workshops for production of consumer products over a period of time. These workshops should be run separately but co-operate continuously with the central workshop. For instance, the central workshop could produce the tools for the consumer based workshop needs.

Another important connection to the central workshop is a unit for building operations. Other professional and productive groups could even be linked to the central workshop according to the needs of each village. The kind of pattern we envisage would look something like the flow chart on this page.

To build up and run the central workshop successfully, planning, tools, materials and training are all areas which need to be studied carefully.

The Central Workshop — Planning

How large the workshop should be depends on the planned activities and estimated capacity. The number of craftsmen, forge-hearths, work benches, storage facilities and tools needed will depend on the quantity of products in demand and supply. It is therefore most important that the workshop activities are carefully planned before building begins. It is necessary to plan the workshops' tools, working spaces, storing spaces, windows and air circulation. The spaces must be in accordance with the work operations and there must be

good facilities for keeping tools, material and products. In the central workshop, the following equipment will sooner or later be necessary:

- Tools (minimum toolkit)
- Storing facilities
- Forge-hearth
- Anvil
- Work bench
- Lathe
- Welding set

Building up Tools for the Central Workshop - Basic Minimum Toolkit

It is important to avoid unnecessary and expensive tools so a list of the basic minimum toolkit is of great help when planning a central workshop. The basic minimum toolkit we show here is based upon the tools we saw during our investigations, described earlier in this book, at the Kisarawe Street workshops in Dar es Salaam and Ujamaa villages in the Dodoma region.

Tools with a broad area of usage are needed for building up the central workshop. The tools will be used to forge iron, and in wood and metal work. Some of the tools will be more difficult to make than others, for instance the screw-vice and the grinding machine. In the course of time, and as skills develop, the workshop workers will be able to create a kit of tools which will be more advanced and of a higher quality than can be purchased. Yet still, some tools will have to be bought.

Two important factors to keep in mind when buying tools is that they should be of a high quality and, secondly, that they can be repaired when they finally wear out or break. For instance, if the handle of a saw breaks, it is an advantage if a new one can be made instead of buying a new saw.

Another important thing is to make a list of priorities: the needs of the situation have to be sized up and a decision made as to which tools to buy first, second, and so on. It may be necessary to buy a saw now and a drill later on when money allows. It is vital that tools are bought in a systematic manner. The same method of priorities, of course, concerns all purchases. As the capacity of the workshop improves in time, the purchase of tools should be phased out and tool-making self-sufficiency aimed at. But, in any event, the number of tools that have to be bought will depend on the production demand and number of craftsmen available. For production in the central workshop, steps 1-3 are fundamental, step 4 is optional.

Step 1

These tools are absolutely vital and fundamental to the central workshop. They cover most of the necessary work for basic forging, wood work and

metalworking. This kit is needed initially to build up the central workshop, i.e. to make the forge-hearth, workbench, etc, and for starting actual production. All of the tools here are essential and, if any are missing, certain important types of work cannot be carried out. The number of each type

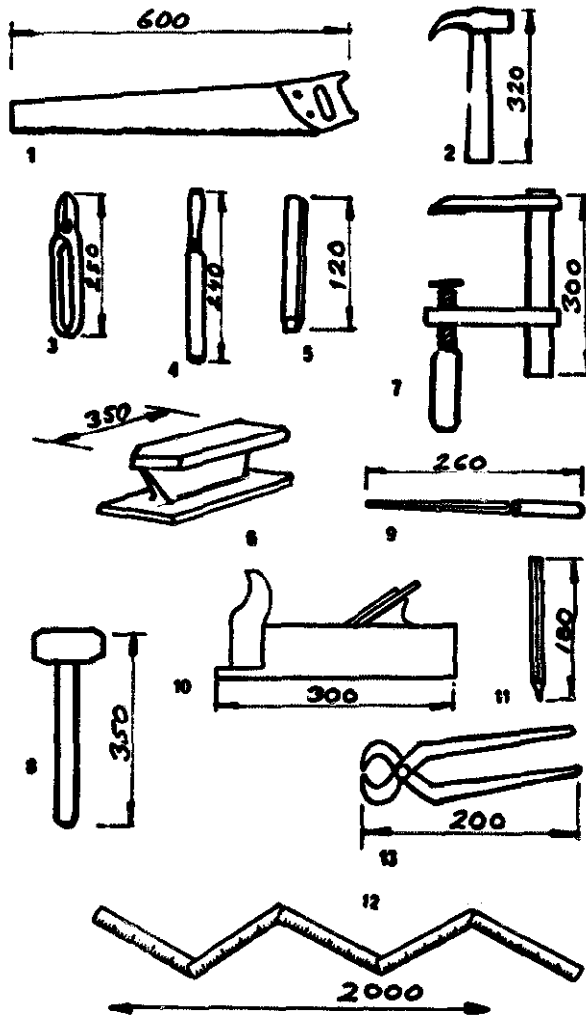

The basic minimum toolkit: Step 1

1. Saw
2. Hammer
3. Tin snips
4. Chisel - for 15mm wood
5. Cold chisel
6. Anvil
7. 'G' clamp - 300mm
8. Forging hammer
9. File - for metal, triangular
10. Plane
11. Pencil
12. Carpenter's rule
13. Pinchers
(size in approx mm)

of tool can vary as long as it is surplus to the minimum. For example, if five craftsmen are (one blacksmith, two metal and two woodworkers) going to start up a central workshop, the tool set should be:

- 1 saw
- 2 hammers
- 1 tin snips
- 1 anvil
- 2 'G' clamps – 300mm
- 1 forging hammer
- 1 triangular file
- 1 plane
- 4 pencils
- 2 carpenter's rules
- 1 chisel for 15mm wood
- 2 cold chisels
- 1 pair pliers

(The triangular file is for sharpening tools, e.g. the saw, tin snips, chisels, etc.)

If the number of tools is reduced, then satisfactory work cannot be done. Additionally, if there are too few tools, then situations will arise where several men want to use the same tool at the same time. This kit is the bare minimum of tools for tight budgets and it is best if the craftsmen can each have their own hammer, carpenter's rule, and pencil and even better if he can afford to have some other tools of his own.

Step 2

The tools illustrated above are complementary to Step 1 (the basic minimum toolkit) and will improve and simplify production. When beginning purchase of this set of tools, it is not necessary to buy all of them at once. However, this step in developing the workshop toolkit should be completed before beginning purchase of further tools and equipment.

Step 2

- 14. Soldering iron
- 15. Whet stone – for sharpening tools
- 16. Pliers
- 17. File – half round
- 18. Set square
- 19. Hacksaw – with blades
- 20. Brace
- 21. Bits – set of 6
- 22. Rasp – for wood
(size in approx mm)

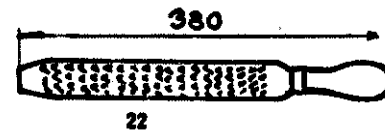
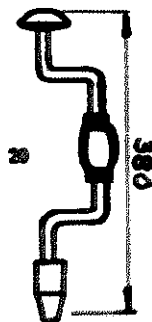
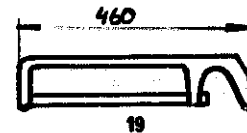
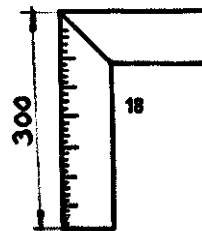
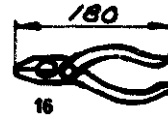
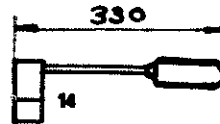

Step 3

These tools are not essential for building up the central workshop but they are necessary for further development. Steps 1-3 are important and complementary to each other so, before planning to buy any of the tools in Step 4, make sure that these are completed and plans for the future of the workshop are made during the first three fundamental steps.

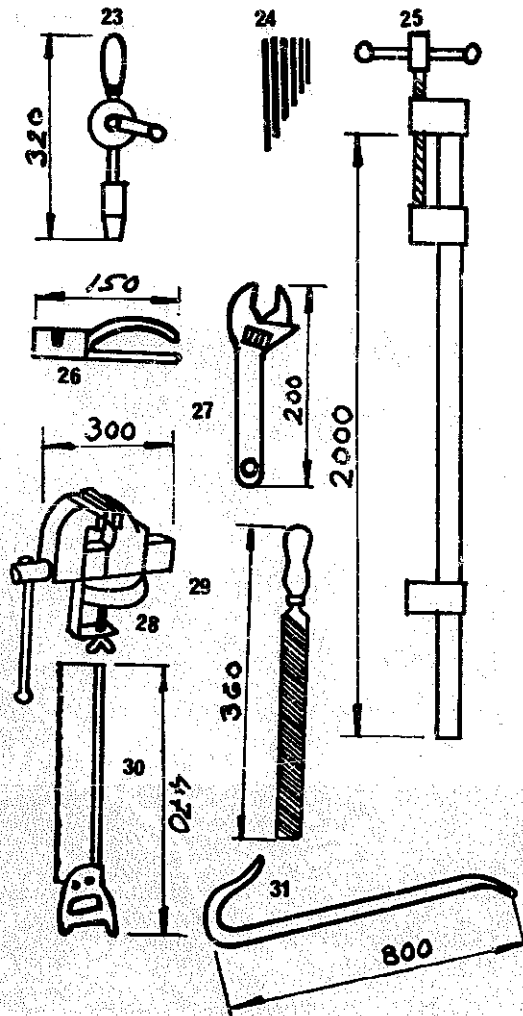

Step 3

- 23. Hand drill
- 24. Bits – set of 6
- 25. Clamp – 2000mm
- 26. Saw set
- 27. Adjustable spanner
- 28. Screw vice
- 29. File – for metal
- 30. Tenon saw
- 31. Wracking iron
(size in approx mm)

Step 4

Here are some examples of tools which further broaden production. These tools are only necessary if there is a real need for them. As the central workshop produces more tools, the economic possibilities of investing in more advanced tools are enlarged.

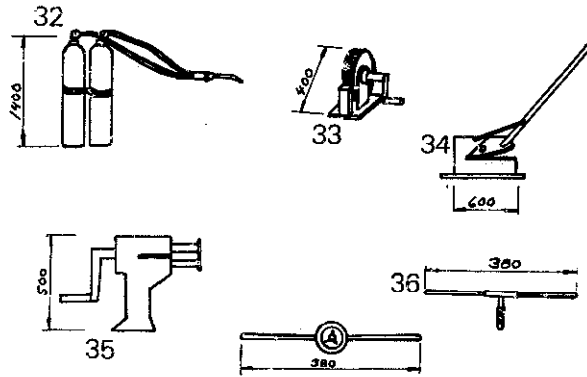

Step 4

- 32. Welding set
- 33. Grinding machine – manual
- 34. Plate shears
- 35. Lap machine
- 36. Tools for threading
(size in approx mm)

Producing in the Central Workshop

Here are some examples of tools which can be made in the central workshop using the tools in the basic minimum toolkit:

Welding Set

If a welding set is available, then there are many possibilities open for the construction of machines and farm equipment. Welded metal parts will give much greater durability and strength to even the simplest of designs. Welding is also a simpler working method than riveting or screwing metal parts together and a welding set which will also cut thick sheets of metal is a big advantage.

However, welding sets are expensive and it is difficult to transport the gas cylinders, although it is possible to produce acetylene gas simply, in which case only the oxygen needs to be obtained. The acetylene gas can be produced by mixing carbide with water. The example on the opposite page is a carbide welding set from Indonesia; it has an ample capacity but must only be used in the open air because there is a high risk of explosion from gas accumulating in confined areas.

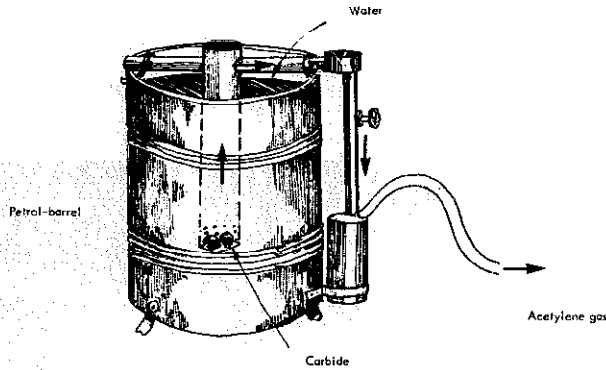

Carbide welding set from Indonesia.

Lathe

Another possibility for broadening the production scope of the workshop is the acquisition of a lathe which can be used for a variety of operations and much simplifies production details. A development of the traditional lathe enables production of more complicated items, such as screw threads for clamps and other tools and implements.

Work Bench

To improve working conditions and product quality, the workshop should have proper work benches which should be steady, well-dimensioned, with the facility for a clamp, and also large enough to carry the tools in use at the time of working.

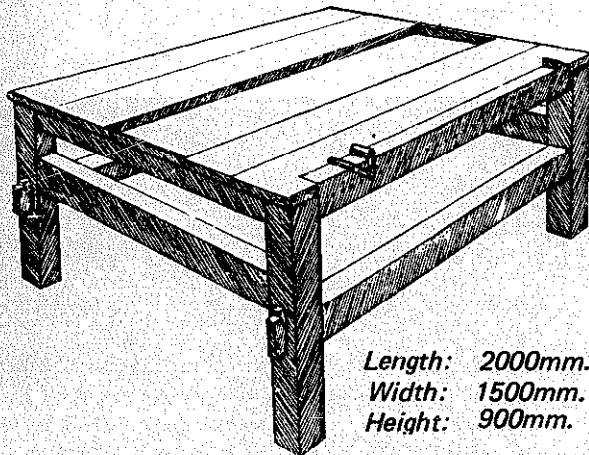

Length: 2000mm.
Width: 1500mm.
Height: 900mm.

The wooden frame is in three parts and the pegs must be made of a hard wood, or else forged metal.

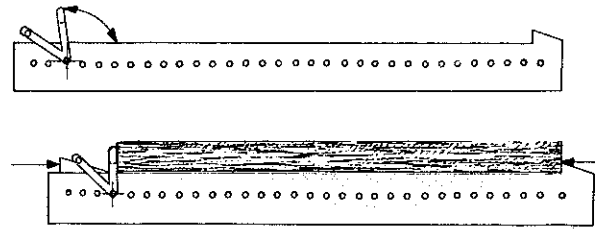

The piece of wood is fixed into position by hammering in the wedge, then one can start working. The clamp must be of stable construction to cope the pressure arising while using the plane.

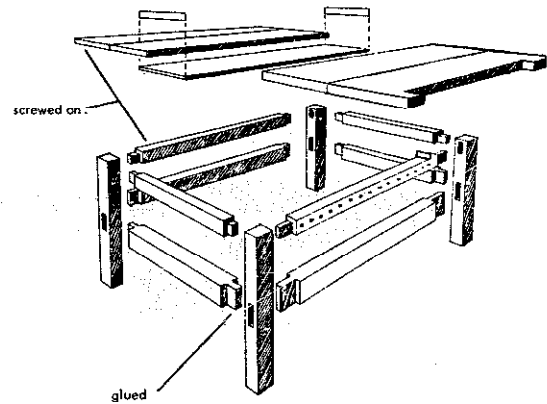

Method of Assembly.

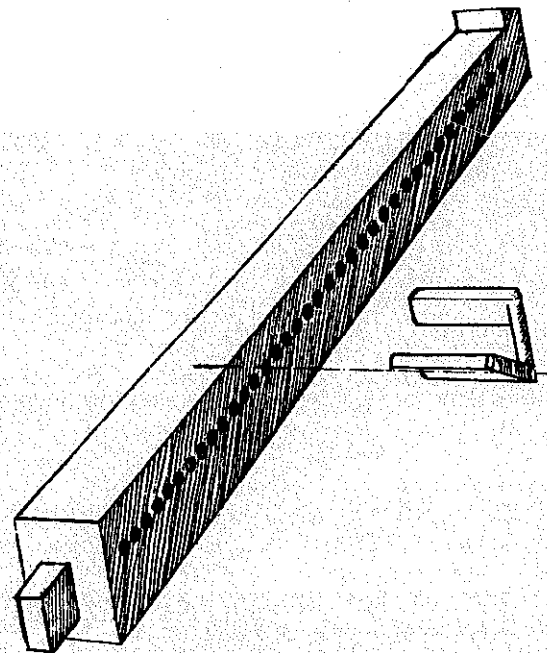

The above is a good alternative to the screw clamp and can be made in the central workshop.

Anvil

The anvil is intimately connected with the forge-hearth. Red-hot iron is shaped and beaten on the anvil so it should be placed immediately next to the forge-hearth so that work can begin before the metal cools down.

For a good working position and maximum efficiency the anvil should be placed above floor level, for instance on a log as illustrated. The anvil is fixed firmly to the log with forged iron nails. Imported anvils can be bought but a piece of old train rail makes an excellent anvil with slight modifications as shown below. Iron beams are also suitable for use as anvils.

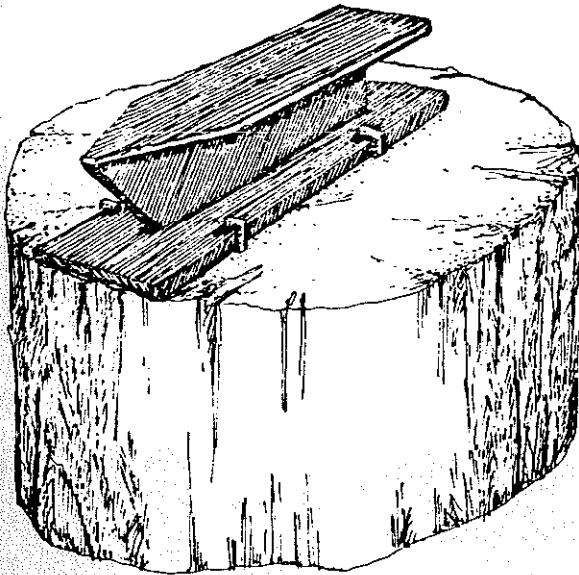

Ideally, the anvil should be of such a height that the blacksmith can just place his fist on top of it when standing up.

Storage Facilities

Good storage facilities for raw materials, completed products and tools are necessary for the workshop. This is necessary to prevent damage to the raw materials, from damp etc, to reduce wear on tools, which will wear out quickly if they are just left around or thrown on the floor, and to keep the finished products in good condition. Wooden shelves can be put up very easily for storing products and materials and tools should also be kept on shelves or special boards as illustrated below. This method makes it easy to find tools and they can be checked and maintained regularly.

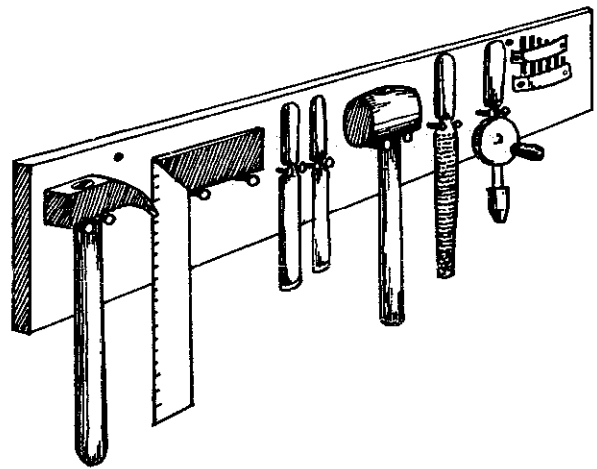

The tool-board makes a check list: you can see at a single glance if tools are missing.

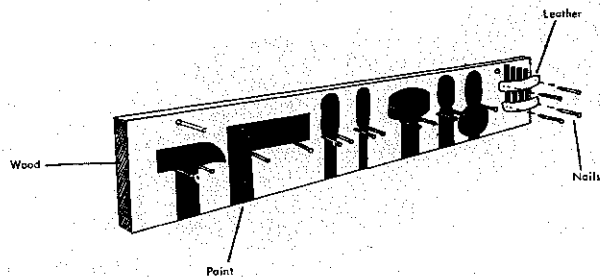

The position of the tools on the hanging board is marked by a painted outline, as shown. The tools can then be easily replaced in the correct position.

The Forge-Hearth

The forge-hearth consists of an empty petrol barrel, metal sheet, bellows and a tempering stove. From the bellows a pipe is drawn through the barrel and emerges in the centre of the furnace.

The stones or bricks form a chamber above the air exit and metal to be heated is put into this chamber in order to reach red hot temperatures. The tube from the bellows to the fireplace should be removable so that the ash can be taken out at intervals.

The frame is fastened into the ground so that it is steady and will not lift when the bellows are being operated.

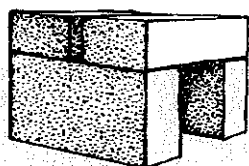
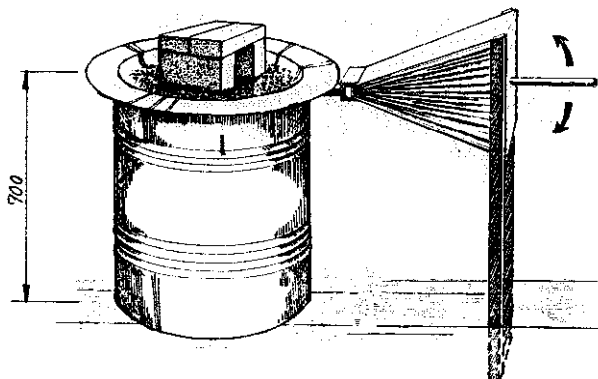

Stone or fireproof brick chamber (tempering stove).

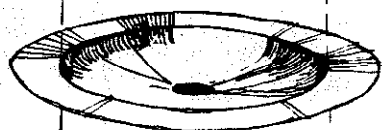

Shaped sheet metal with hole for the metal air tube.

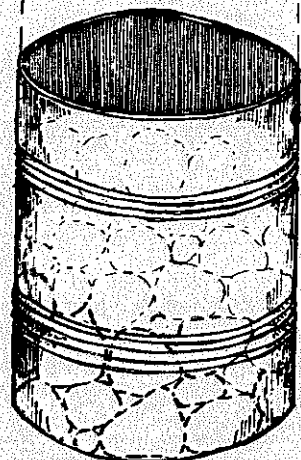

Metal tube from bellows.

Old petrol or oil drum.

Fill base of the forge hearth with gravel or stones to make it steady.

Many other aspects could be included in the analysis, for instance, the good points of the product should be entered. After such an examination, one has a basis on which to think about the product, criticise it, and try to suggest improvements to the design. One could usefully carry out the same analysis on the industrial design of the spoon so that the old and new designs could be compared. This is one way to improve design and usefulness.

The Central Workshop – Raw Materials

The raw materials used for production in the central workshop should, we think, be primarily recycled and local materials. This means that it is important to undertake experiments with raw materials which can be found in the district and which, perhaps, have not been used before. It might be found, for instance, that raw materials already used for one thing could be used to make other products. Experiments with raw materials are essential. In the end, good material is necessary for making the tools that will be produced. When manufacturing tools from recycled materials, it is important to use the right quality material for the purpose. For instance, a chisel must be made from steel which will produce an edge that will last and keep sharp.

Tools.

1. Forning hammer
2. Knife
3. Pliers
4. Tongs
5. Bradawl
6. Cold chisel
7. Punch
8. Carpenters guage
9. Shelves
10. Chisel – for wood
11. Screw driver
12. Set square
13. Axe
14. Soldering iron
15. Compass
16. Hammer
17. Wooden club
18. Plane
19. 'G' clamp
20. Clamp

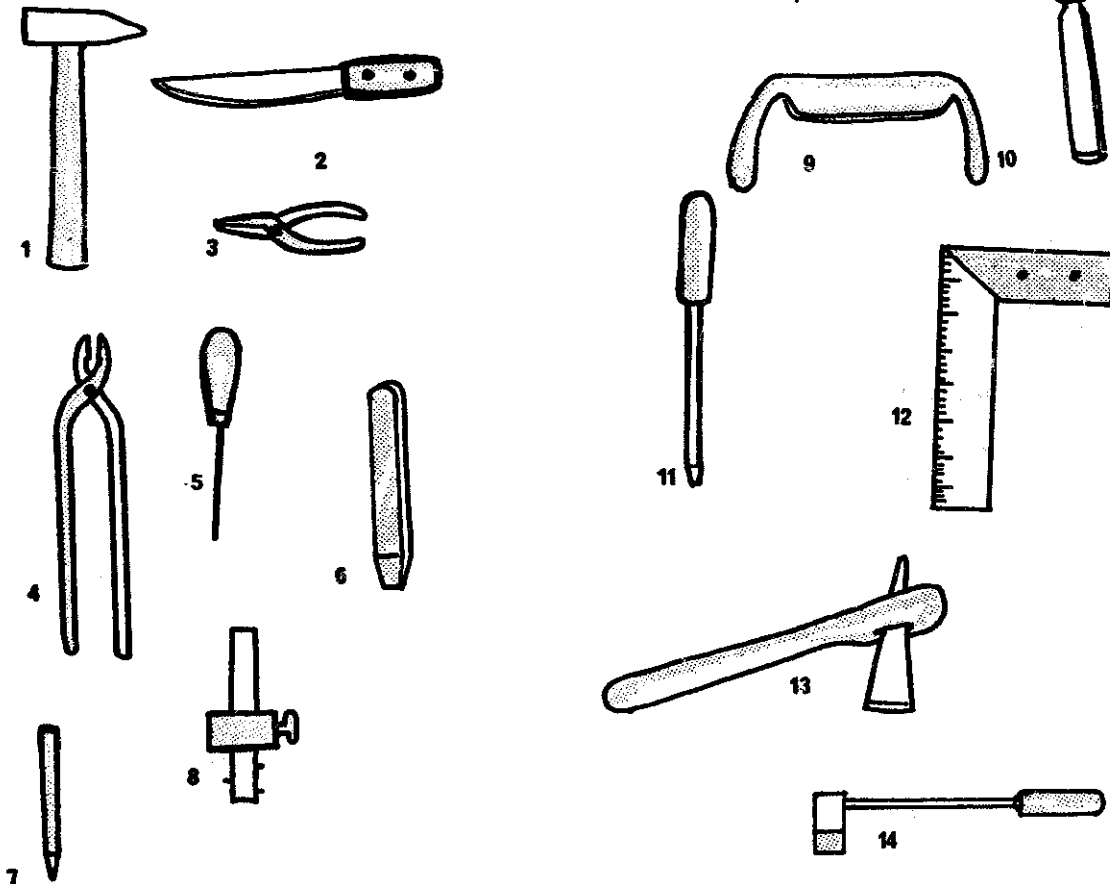

15

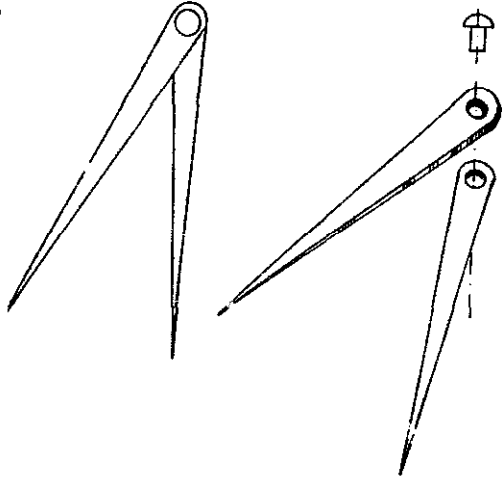

Metal

Planes should be made from a hard variety of wood which will not wear out easily. The blades are made from metal.

The legs must be stable but the diameter of the rivet holes should be a little larger than the rivet itself so that the legs can turn without too much resistance.

18

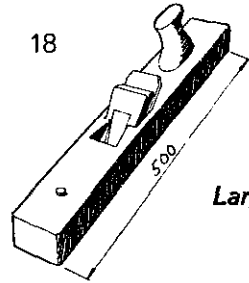

Large plane

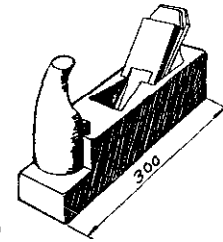

Small plane



Wood



Metal



Plane blade.

17

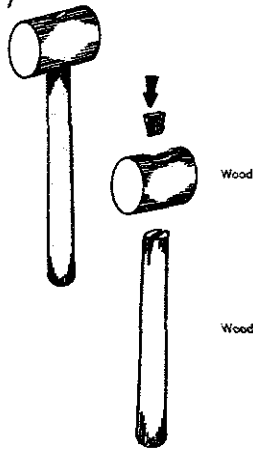

Wood

Wood

16

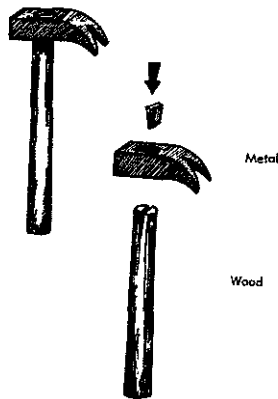

Metal

Wood

A piece of laminated car spring can be used for making the plane blade.

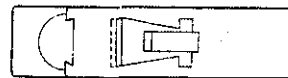
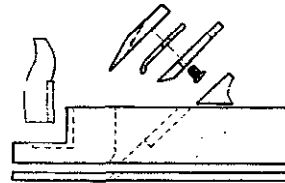

The wooden wedge is hammered into the wedge slit cut in the handle so that the hammer/club head can be fixed on securely. If a handle gets broken, then a new one is made and fastened on in the same way.

15

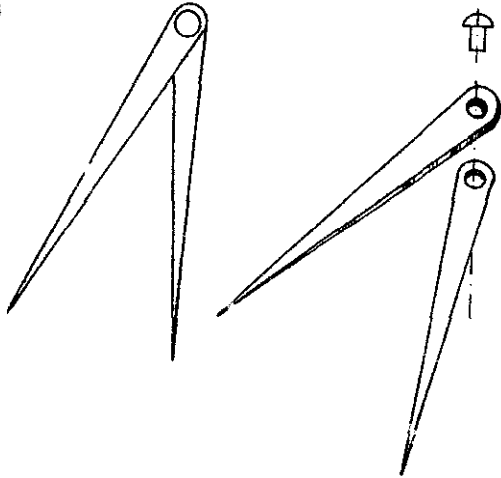

Metal

Planes should be made from a hard variety of wood which will not wear out easily. The blades are made from metal.

The legs must be stable but the diameter of the rivet holes should be a little larger than the rivet itself so that the legs can turn without too much resistance.

18

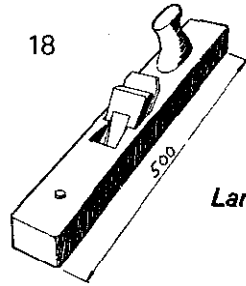

Large plane

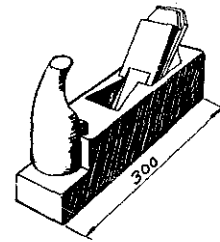

Small plane



Wood

Metal

Plane blade.

17

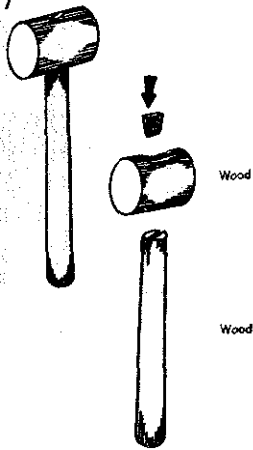

16

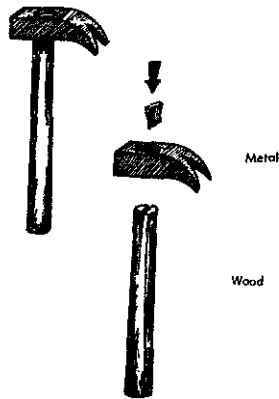

A piece of laminated car spring can be used for making the plane blade.

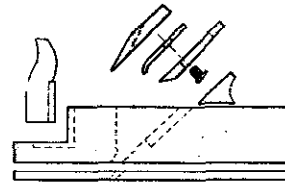

The wooden wedge is hammered into the wedge slit cut in the handle so that the hammer/club head can be fixed on securely. If a handle gets broken, then a new one is made and fastened on in the same way.

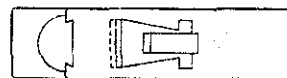

(size in approx mm)

Farming Implements

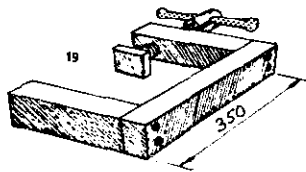

All parts are wooden.

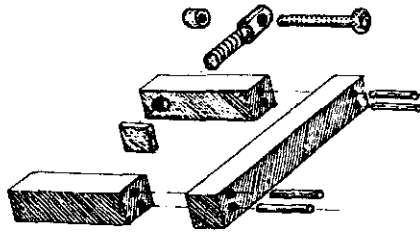

The round pegs are made from hard wood or metal. They must be fitted carefully, and glued and beaten into the holes, then the parts are tightened together with a "G" clamp. If the workshop has a lathe the wooden screw can be made, or it can be made by hand if not.

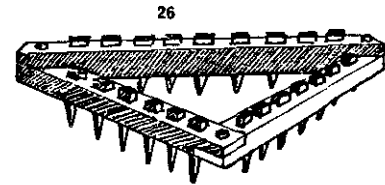
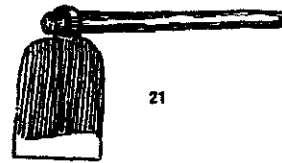

Produced at Kibaha Education Centre

- 21. Hoe
- 22. Hoe
- 23. Adze
- 24. Scythe
- 25. Spade
- 26. Harrow
- 27. Wheelbarrow
(size in approx mm)

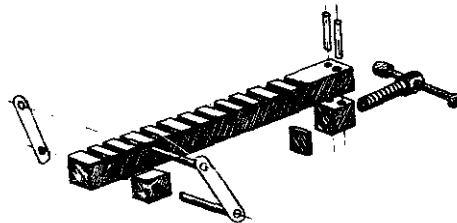
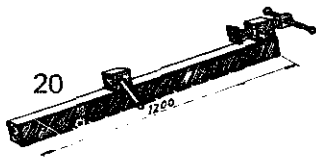

The mount is made of metal.

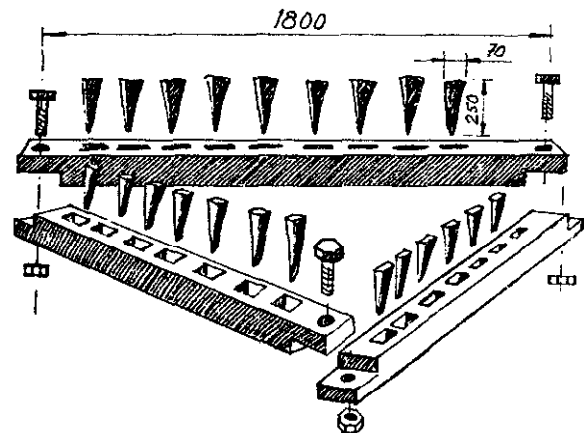

The wooden frame is in three parts and the pegs must be made of a hard wood, e.g. ebenholtz, or else forged metal.

This wheelbarrow, made entirely of wood, is glued and nailed together.

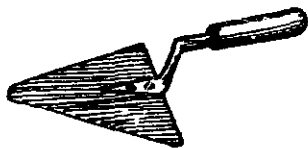
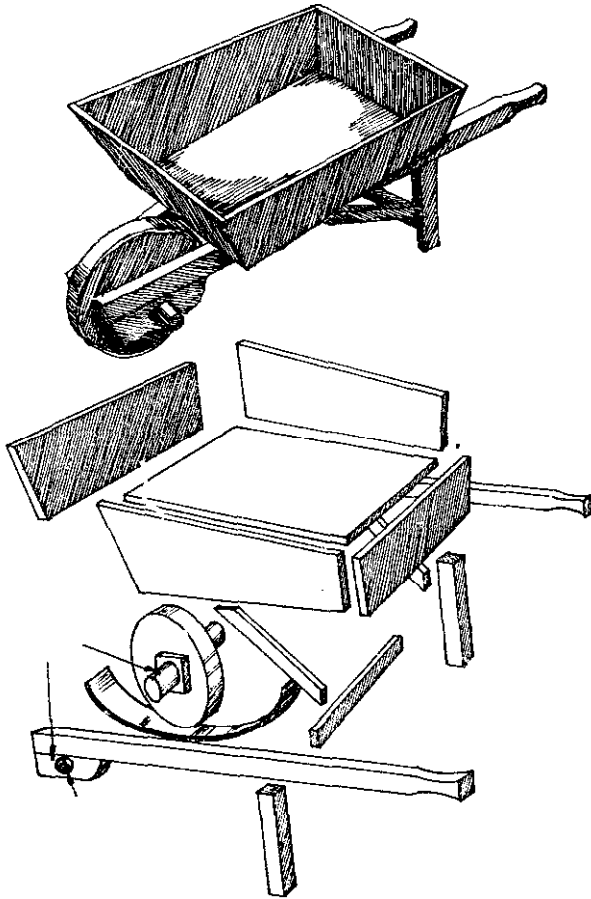

Building tools

- 28. Mason's trowel
- 29. Level

29

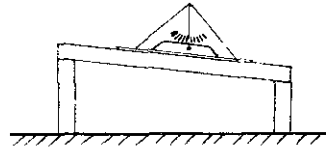

This table is sloping – look at the level.

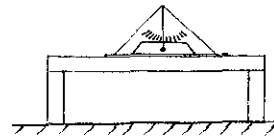

This table is straight.

The triangular sheet is glued firmly into the slit in the bottom plate.

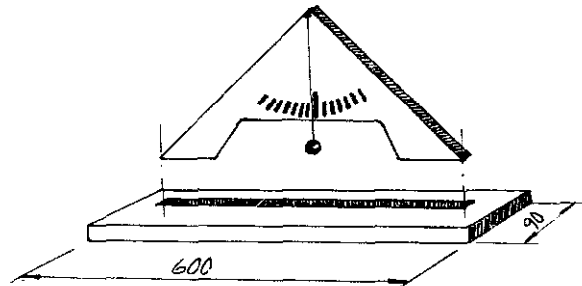

The level should be made carefully with straight sides and straight angles, using hard wood for the bottom plate.

Village Workshop Design

by Krisno Nimpuno

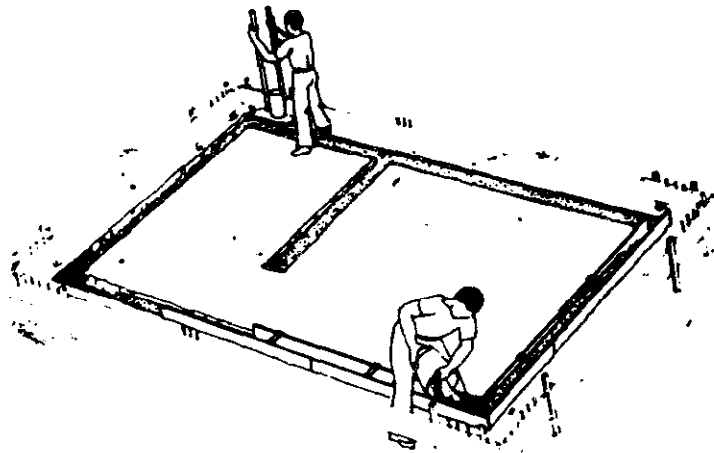

CHAPTER 8

Village Workshop Design Krisno Nimpuno

The question of construction of simple workshops is, in itself, a problem of the same nature as the question of developing village industry. The construction requires manpower, technology and design. It is therefore already a reflection of a whole range of choice to be tackled in relation to the development of the village industry itself.

In 1973, the Ministry of National Education of Tanzania decided to build village primary schools integrated with all other public institutions in the village. These schools — to be called Community Education Centres (CEC's) — would become educational as well as productive development centres. The design and construction of their workshops can serve as a useful example of how the choice of technology for construction has already constituted a step towards village industry development.

The CEC's were originally intended to become mobilisation centres in a broad social and economic sense. The development of agriculture was to be promoted here through the agricultural co-operative, with silos, bulking and loading facilities, and some processing equipment. A number of workshops had been included in the programme to build the foundation for agricultural mechanisation and for the development of village industries. It was especially in connection with the design and construction of the workshops that the question of design for mobilisation arose. If a policy of self-reliance was to be followed, then the role of the workshops as technological development vehicles would be self-evident. From here the construction would be co-ordinated for all future buildings, and guidance in carpentry, building construction and metalwork could be given.

It would then also be logical to use the construction of the first workshop itself as an exercise in crafts training. Building construction projects in the village would become a form of adult education and the construction project itself, the crafts school.

It would be useful to start with the construction of the workshops but the very concept would be equally applicable to the remaining parts of the CEC construction programme. Pursuing this idea — focusing first on the workshops — helped to clarify the concept of the social mobilisation in relation to construction work. It would not only rely on popular project participation as a central project theme: mobilisation, instead of the mere utilisation of labour power, would become the heart of the matter.

Let us therefore look into the design principles for the workshops as pursued at the design stage of the CEC project.

Building Costs and Design

The rapid increase in building costs in Tanzania was already a matter of great concern when the oil crisis added to the problem. In the case of the Community Education Centres, it did not play an exclusively negative role for it helped to convince the bureaucrats that self-help construction had to be accepted, although it required a type of communication, during the project, which does not come naturally to a ministry. The CEC's were to be financed with World Bank (IDA) funds and executed by 'mobile teams'.* The IDA agreement allocated shs 20 per square foot, shs 215 per square metre, and construction costs of shs 238,400 per CEC. The cost developments since the drafting of the agreements, however, have been very dramatic.

Construction Costs in Secondary Schools in T. Shs per Square Metre

	Feb. 1970 ¹	Mar. 1973 ²	Oct. 1973 ³
Workshops	500	700	1,250
Classrooms	500	700	1,000
Staff Houses	500	720	900

1. Tarime SS — 2nd IDA worksheets
2. Maswa SS — 4th IDA agreement
3. Dar es Salaam

A preliminary estimate in October, 1973 put the construction costs for each CEC at shs 735,250 if conventional materials and methods were used. A UNESCO study noted, a year later, that application of the CEC's on a national scale to achieve universal primary education would amount to the staggering sum of shs 296,500,000 (US\$42,000,000) or double the Government's entire development expenditure for all educational and training installations.

At this cost level the question of the viability of this construction programme had to be reconsidered and alternative construction methods had to be studied.

A Ministry paper recommended, in October, 1973 at the time of the CEC sketch design work, that craft buildings in Dodoma area would be calculated to cost shs 1,265 per square metre. For a series of agricultural teaching units tendered under the Norwegian assistance programme a year later, these calculations proved to be quite correct. The costs of labour usually accounted for 40% of the contract costs in buildings with quite a good conventional standard of building. In less sophisticated constructions, the labour costs would be a much higher percentage of the total costs. The savings in self-help projects would

*Full-time construction teams employed by the Ministry of National Education.

therefore be very substantial. The IDA agreement (drafted several years before) allowed shs 215 per square metre for the CEC projects. It was obvious that it was hardly worthwhile to try to organise 'mobile construction teams' under these financial conditions or to use conventional construction methods. The costs would become prohibitive: self-reliance construction had become an economic necessity.

The most common construction method in the area for such projects was sun dried mud blocks with cement or lime plaster and a corrugated iron roof. A study of self-reliance projects in the same district showed the usefulness of this technique: in Buigiri village, the villagers built a 1,500 square metre community centre entirely on a self-reliance basis. Two grants of shs 8,000 each paid for the iron sheets and for some of the cement and timber that was not available locally. This construction method was not allowed by the bureaucrats and the World Bank as a "permanent" construction. The fact that the nearby Mpwapwa College of National Education in the same district had been built in the same fashion, and now after forty years still functioned well, was conveniently ignored.

The soil cement technique, however, offered a compromise. The Building Research Unit was conducting tests in Dar es Salaam, but the technique had not yet been applied to any Tanzanian project. Laterite soil (the well-known African red soil) can be stabilised in various ways to become a durable construction material. The most reliable method is to mix the soil directly with cement, lime or asphalt and press it into small building bricks. It is a very labour intensive technique which requires some training. On the other hand, one should consider that it is technically very close to the work with sun dried blocks. This choice would therefore be suitable for a self-reliance project and one could expect that most of the villagers would be able to master the soil cement block construction technique in the course of the project. A more difficult method is monolithic in-situ pouring of stabilised soil which is now gaining popularity in India. The mid-west American homesteads were often built in this way and in Alberta Province, Canada, one can still find good examples of such forms.

In many respects, the design became a compromise, but the simple technology and the great popular participation that it made possible, clearly marked the economic relevance of choosing a technology specially for self reliance work.

The final construction costs seemed to hover around shs 350 per square metre. The final bill for the other workshops built simultaneously for the same Ministry amounted to shs 1,200 to shs 1,600 per square metre. The greatest gain cannot be calculated in shillings: the villagers continued to use the soil cement technique after the completion

of the CEC and started to build their own houses with it.

The choice of technology in building construction projects is therefore a vital issue in community development. The very process of executing community facilities with total participation of the community in all aspects of the project creates a strong sense of identification. This in itself is already an important action for development.

It should be clear that there should be control over these facilities so that all will benefit fully from it once it has been put to use. In view of the noticeable and well documented stratification which takes place in developing villages, it might therefore be the best policy to place the control over these facilities in the hands of the poorest members of the community. This is one of the very few methods which should guarantee that the facilities will not be monopolised by the bureaucracy and the more affluent villagers. Such development quickly teaches the weakest members of the community that their efforts are likely to be more beneficial for others than for themselves and that is always the end of social mobilisation.

Another conclusion is that the development of local techniques, the introduction of gradual improvements and modest innovations convey an awareness of development and progress. This is a process which should not exclude anyone. The policy of 'betting on the strong' which, for so long, has been used by bodies like the World Bank, contradicts the principles of community development. The involvement of the entire population in technological development is as important as the direct project objectives.

Village Workshop Construction

by Krisno Nimpuno

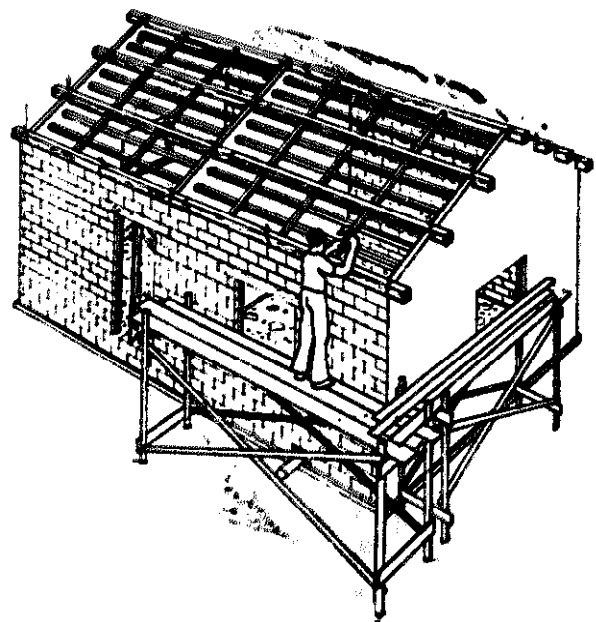

CHAPTER 9

Village Workshop Construction

Krisno Nimpuno

Village workshops are the buildings where craftsmen execute their work. They are a supporting facility which does not determine the work but can influence it. A well designed environment can increase the efficiency of the producer and so become a production factor – but it is the proficiency of the craftsman with his tools that shapes the work. Buildings so easily become status symbols and are all too often taken as signals that prosperity has arrived already. Politicians attach great value to the inauguration of a building, but the effective performance of the function it is to house is much more difficult to achieve than the mere erection of the building.

In village development projects, the same tendencies can be observed. Community centres, co-operative shops, health centres and schools become the visible proof of progress but it takes a long time for outsiders as well as for villagers themselves to answer the question of the effects of development objectively. In the type of community development sketched earlier, it is, however, the production and not the institution that counts.

The model for development as proposed here is the accumulation of skills through production and training, rather than through western-type formal education. It is therefore natural that the design and construction of the workshops follow the same pattern. That means the buildings for village workshops should start modestly but have potential for the growth and development of the facilities. It would indeed be the most logical and creative policy to use the construction of the workshops as the first training for the craftsmen who will man them in the future. The workshop then becomes a superb expression of the spirit of self development and learning by doing. Constructing the workshop becomes practical adult education.

Consequently, the workshop design must be based on very elementary construction skills and it can be expected that the resulting building will become anything but a conventional status symbol. There is great difference in quality and standard between the various types of workshop buildings already in Tanzania.

- The village blacksmith has just a thatched roof to protect him from the rain and sun.
- The self-help village workshop is a mud block building with an iron roof.
- TAMTU's village prototype workshop has only a back wall with shelving and an iron roof.
- The co-operative workshops of SIDO are overloaded, but simple, stone buildings.
- Workshops in schools, besides two or three

times the area per person ratio, have concrete floors, high roofs and flush doors.

One is almost tempted to say that the more expensive the workshop building becomes the less is produced. However, one should not believe that craftsmen are not interested in their working environment but one should be clear about priorities. From a small industry study in Kenya, we are told that the dependence on supply of physical input factors is a key factor and also that clients pointed out that cheap, but orderly built sheds, arranged on a prepared site, located as near as possible to the market would benefit them more than access to power and water.

Responses suggest that changes in their economic and physical environment should be given priority.

Our interviews with Tanzanian craftsmen point to the same conclusions.

We set out to look for a workshop design that met these basic specifications, simple in design and construction, cheap, functional and with the potential for expansion and standard improvement. The workshop construction, itself, is to stand for the basic principles behind the idea of village industry and community development. SIDO consultant David Philips expressed it generally for small industry:

“Labour-intensive industry of relatively simple technology and utilising local manpower and materials is consistent with this objective of mobilisation of local resources and, at the same time, is most likely to favour small scale production.”

This argument should be as true for the workshop construction as it later is for workshop production. The workshop is meant to support the agricultural sector in the first place and is therefore to be regarded as one of the major communal services of the village. It is essential to understand that the village workshops are to be both the security factor for agricultural development in all its various local manifestations and, at the same time, agricultural development will provide the stimulus and demand for the creative expansion of the village workshop.

It is quite possible to start the workshop with a simple rammed earth floor and use the workshop for some time like that. When more funds are available, one can finish the floor by adding a concrete slab directly on top of the rammed floor. Although many types of roof construction are possible in rural areas, corrugated iron roofs have a great number of advantages for workshops. Their construction is very light and durable; the material is easy to transport and simple to erect; and it gives a cheap and permanent solution. The main disadvantage for its application to rural workshops

is that the supporting timber construction has to be quite straight, preferably made of sawn timber. There are other disadvantages to this type of roofing but poor thermal insulation and the noise caused by rain are not very important in open buildings, as most workshops are.

Corrugated iron roofs can be built with little slope of say 1:3 or 1:4. For workshops, standard pitched roofs for spans over 3 metres, or mono-pitched roofs for smaller spans, will give the simplest and most economic solution. Other forms of roofing such as asbestos, cement sheets, aluminium sheets or tiles will, in most cases, be far more expensive and more difficult to erect. Timber shingles and thatch require a very high pitch to the roof and are therefore not very economic in large spans. More maintenance is also required in these traditional constructions.

Many traditional wall constructions such as from sun dried bricks, wattle and daub or stone workshops. Mud-based constructions should be protected against erosion by rainwater. This can be achieved by plastering, with a lime sand mortar but additional wall protection through a wide roof overhand is necessary. In mud constructions with a timber lattice core, one should preserve the wood against insect attacks, by using dieldrin to treat the timber.

Burnt bricks are excellent, if available, while soil cement blocks are rapidly gaining recognition as a suitable material in remote areas, as the main ingredient, soil, does not require transport, but is found on the construction site. In many remote areas, concrete blocks will turn out to be an expensive solution, but are quite easy to manufacture and to mason. All the materials mentioned here have quite good thermal insulation characteristics and provide permanent constructions for modest costs. Of these only burnt brick walls are rainproof and the other constructions should, if possible, be plastered.

Walls separate and demarcate the different areas of the building and protect the rooms inside from the weather. For most workshops in the tropics, the shielding function of the walls is not as essential as that of the roof. A partly open space is often acceptable and a dwarf wall in combination with wire netting will, in many cases, give an economic and pleasant solution. Such an open design requires a special construction of columns to bear the roof. If full walls are used, on the other hand, then the walls can also carry the roof.

Workshops do not always need to be fully enclosed and, since open covered spaces are often quite practical and economic, a construction with columns instead of walls has many advantages. Concrete columns of 30cm diameter are sufficient for single storey workshops. An attractive solution for rural areas is columns masoned from bricks or

soil cement blocks around a hollow core which later can be filled with concrete or rammed soil cement.

The purpose of the foundation is to provide the walls and columns with an even and solid footing to avoid cracks and sagging. One storey buildings can be constructed where the ground is reasonably firm without too much clay. A strip foundation is sufficient if it is made by digging a trench of 30-60cm deep, dependent on the firmness of the ground. The trench should be 30cm wider than the wall it is to support and 40cm wider than the columns it is to carry. The bottom of the trench is filled with a 20cm layer of stones compacted with enough sand to fill the cavities in this layer of so-called hard core. The next step is a concrete strip of 15cm thick or a masoned foundation strip of three layers of good quality burnt brick with a very strong sand: cement mortar. An alternative is to fill the entire trench with hard packed soil, cement poured and rammed in layers of not more than 10cm at a time.

The floors in a village workshop, as mentioned previously, can be simple rammed earth without finish although a stronger top layer is to be preferred. A hard core with a cement screed of 3cm concrete makes a very satisfactory floor. Soil cement is less advisable since it has a low resistance to mechanical wear.

Simple Steps in Workshop Construction



1. Clear the construction site of all vegetation and large stones and then level the surface. It is recommended that the top soil be removed.

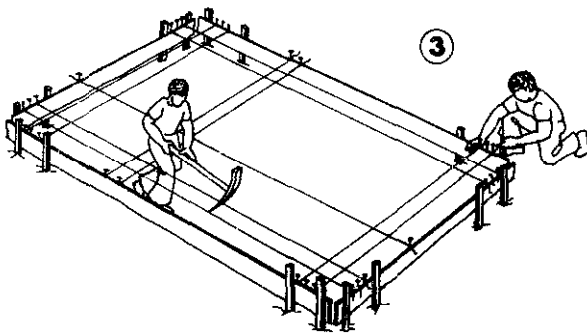

3. Fix wooden boards at a distance of 30cm from foundations or 45cm from the walls. Fix strings over the exact position of the foundation. The trench can now be dug between the strings and should have vertical sides and a flat floor.

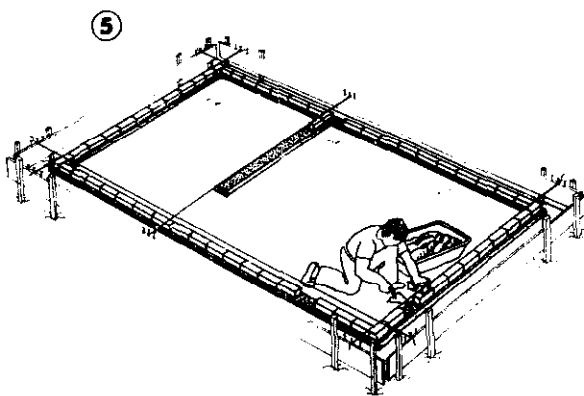

5. The wall and columns can now be masoned.

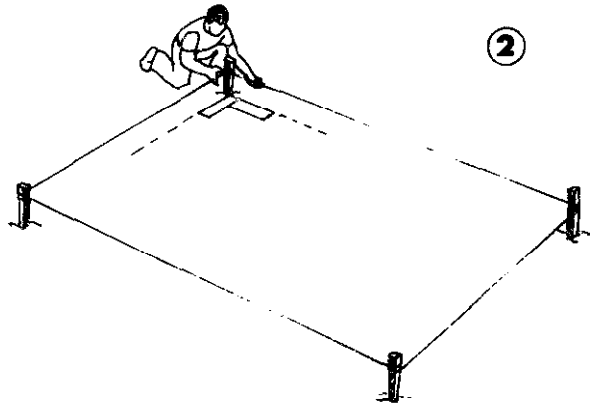

2. Set out the building and use pegs and strings to indicate the building's ground contours.

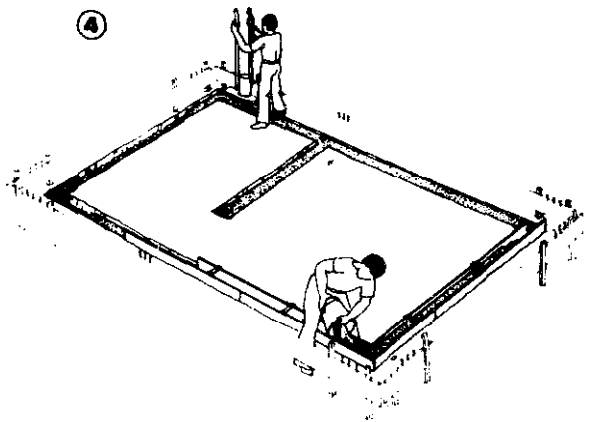

4. The trench is first to receive a rammed hard core level of 20cm thick and a concrete strip of 15cm thick. As an alternative, soil cement can be poured and rammed in layers of 10cm at a time to fill the entire trench.

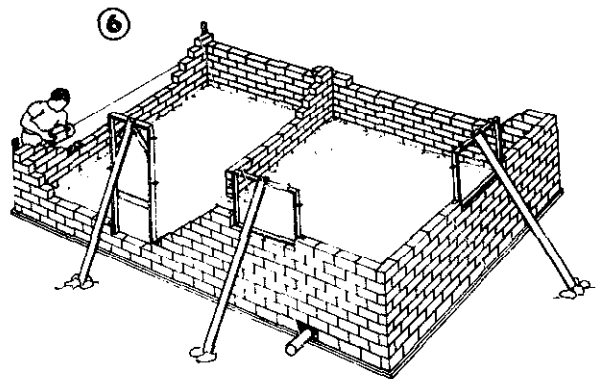

6. When reaching the proper height, frames for doors, windows, shutters or wire netting can be fixed into place. The walls are then masoned around the frames which should be anchored into the masonry.

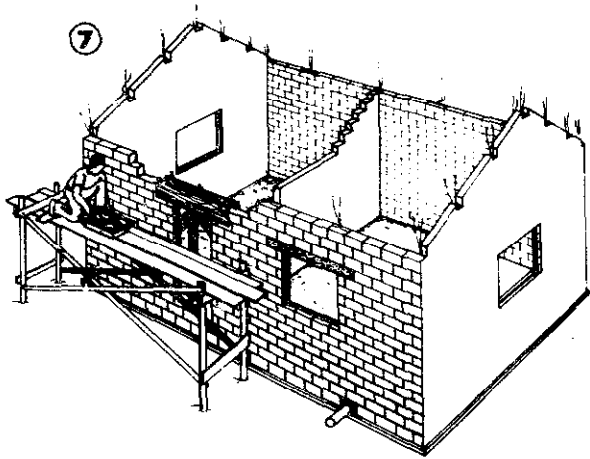

7. The frames should be protected against the weight of the wall above by timber or concrete lintels extending into the masonry at both sides.

8. The simplest roof support consists of rafters which are laid directly on the walls anchored with steel wire. For large spans, trusses are necessary. Anchorage to the supporting columns or walls is essential to prevent the roof from blowing off.

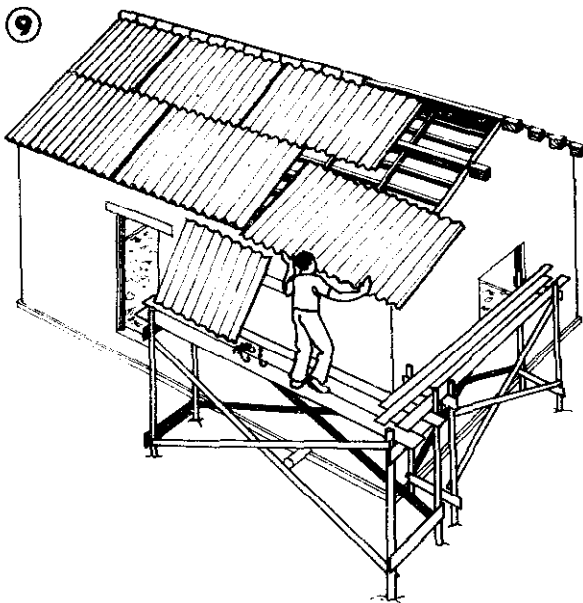
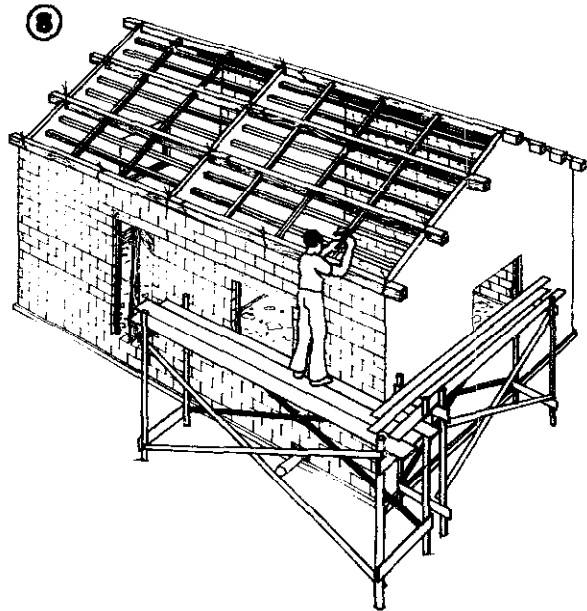

9. A lattice of timber is fixed on the rafters and the iron sheets are then nailed to it.

10. The floor is now built by ramming the earth and a layer of hardcore, and finished with a 3cm layer of cement screed.

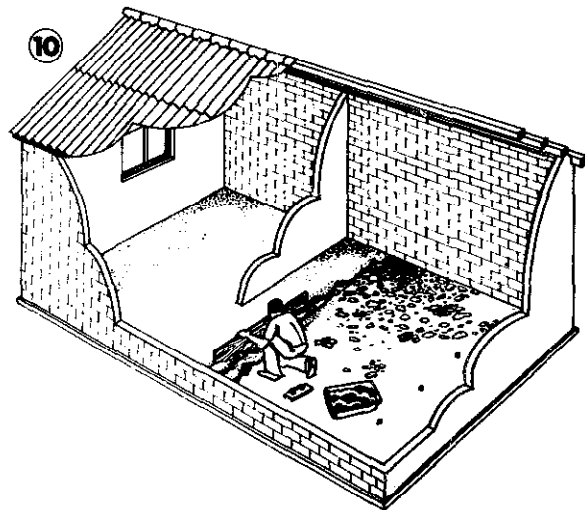

The Official View on Rural Industry

by Krisno Nimpuno

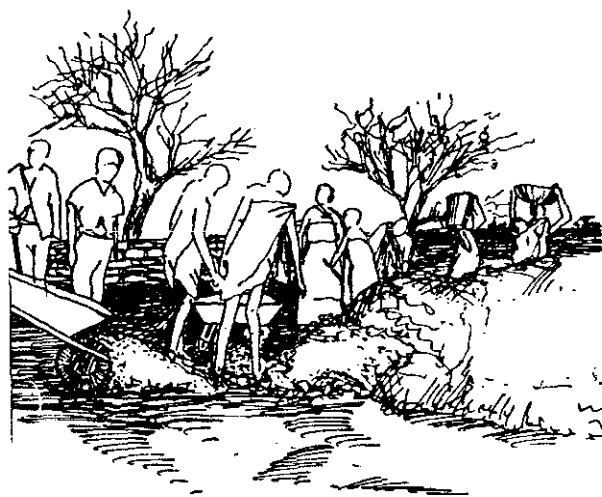

CHAPTER 10

The Official View on Rural Industry

Krisno Nimpuno

All the countries of East Africa are committed to rural development although different strategies are followed. The governments of Kenya and Uganda have pursued quite a different lands and settlement policy to that of Tanzania. But rural reform community development programmes and rural industry schemes have received increasing priority in all the countries of East Africa and also in Ethiopia, Somalia and Mozambique.

There are not only differences in policy between the various countries in the region, but each individual country still struggles with the formulation of the goals and methods in rural development. The priorities change from time to time and even during the same period one can see discrepancies in policy implementation between different government agencies and between different departments within the agencies.

The sheer vastness of the task of promoting rural development makes such differences unavoidable. It therefore becomes difficult for an observer to perceive what the policy is. Contradictions between declared intentions of the government and what can be seen of the programmes in the villages are often striking. One of the reasons is probably that the policy decisions are taken at a very high and central level but few of the implementors possess the theoretical and practical skills required for finding suitable technical solutions out in the field, wholly in line with the policy.

Another common difficulty is that solutions are selected without an evaluation of the consequences of national application. If a pump is simple, effective and cheap it might be very good for every peasant to own. But the question is also can it be made for two or three million peasants, and how much would that cost in total? This perspective of continuously looking at technical solutions from the national point of view is often lacking. Finding solutions which can be applied to all villages and villagers is very difficult.

In the following pages we will look at the official picture of rural development in Tanzania as reported in the national newspaper the *Daily News*. Quotes from official speeches, news items and articles illustrate the hopes, intentions and also confusion in the field of village industrialisation. The quotes cover the period of July 1975-March 1976 which in many aspects represented a period of renewal in rural development policies. In the preceding two years a massive villagisation programme had moved over half the population into new villages. The ministries of agriculture and industry came under new leadership during this time. The task of concentrating the rural population into collective villages had been accomplished and

now the question of production had to be faced. Would it be possible to increase the agricultural output? This vital question would confirm the success or failure of the basic strategy of the last decade of national policy.

It was found that the Small Industry Development Organisation (SIDO) would have to stimulate and assist the rural industries, but that it would take a considerable time before the impact of these workshops would be felt.

The Ubongo Farm Implements factory in Tanzania, built with Chinese assistance, was the only significant producer of agricultural tools. The Ministry of Agriculture ran a half-forgotten Machine Testing Unit (TAMTU) in Arusha with a design development, which during a number of years had developed agricultural implements with appropriate technology and village workshops in mind as the intended production policy.

These three government agencies suddenly found themselves in the centre of publicity and were called upon to take the lead in agricultural mechanisation. The public discussions during this period contributed much to raise the general awareness of the importance of a gradual approach to development. In Tanzania the talk is no longer of using tractors everywhere, but hundreds of thousands of ox-ploughs. This is a major step forward and it is only now that one starts to realise the enormous dimensions of the task of agricultural mechanisation.

A first estimate of equipment demand gave figures which by far outnumbered the capacity of the national equipment.

"Tanzania's farm tools input will have to rise from the present rate of 10-40% if the national oxenisation programme is to succeed. And this will have to be accompanied by a corresponding annual 15% rise in farming — from 5.20%. This is contained in a 31-page special report issued yesterday by the five-man Farm Tools Committee, which was set up towards the end of last year to assess the programme's requirements. Regions had made an estimate of 150,639 ox-ploughs. The estimated requirements include ox-ploughs, track chains, ox harrows, ox planters, ox cultivators, ox ridges, ox donkey carts, hand maize shellers, groundnut shellers, winnowers, hand hoes, pangas, axes, fork jembes, wheel barrows and tractors."

Daily News, January 21, 1976

This equipment contrasts with the national production capacity.

"The country's farm implements annual production capacity is as follows:

UFI: ox-ploughs 10,000; spare parts 35,000; axles 80,888; pangas 300,000; hoes 180,000.

TAMTU: Kifaru ploughs 24; seeder attachments

24; mali planters 24; interrow cultivators 36; ox carts 36; donkey carts 36; four-wheel wagons 12; winnowers 12; hand planters 144 and ox cart axles 60."

Daily News, January 22, 1976

The production capacity for ox-ploughs is only 10% of the projected needs.

Development from Poverty

The increasing economic difficulties in the LDC's are obviously a major factor in determining the change in development strategy. Realising that not only the gap between the poor and the rich nations is widening but also that the economic differences between the classes within each country, the leaders of Tanzania are now most articulate in expressing their priorities.

"Meanwhile the people's demands stand unchanged. We want food. We want to enjoy a higher standard of living. And the only way through which we can attain this is by employing better tools. Our level of living would not be determined by the amount of, say, cotton or maize we produce, but by the tools we use — the stage of our technology."

Daily News, December 5, 1975

The effects of the oil crisis and the recession in the industrialised countries have been considerable in many LDC's and are increasingly reflected in the speeches of the politicians.

President Nyerere very strongly re-emphasised the urgency of a sound rural development and in his address to Parliament he said:

"Our aim is self-reliance. We have got to a position where we can withstand adverse external economic changes without disaster, and where we have sufficient reserves of food, raw materials and foreign exchange to carry us over bad harvests or unavoidable shortages of particular essential commodities."

Daily News, July 21, 1975

Kenya has likewise expressed concern and it seems that elements from Tanzania's policy begin to appear in Kenyan thinking under the pressure of the harsh economic realities.

"The Kenyan Vice President, Mr Daniel Arap Moi, in his opening speech, highlighted the devastating effects on Africa's industrialisation by external events and urged the ministers to study the situation in order to promote Africa's self-reliance in industrialisation. Mr Moi urged a new approach in rural industrialisation, adaptation of technology and the development

of appropriate technology, keeping in mind the inter-relationship between industry and other sectors."

Daily News, January 25, 1976

One or two years earlier, the word appropriate technology would certainly not have been used by Kenyan ministers.

It is striking that the general tone of public addresses has become so much more urgent. Whereas the national policy in former years was presented as the wholly voluntary choice, it now seems that the options are narrowing. President Nyerere reminded the Parliament that:

"In other words, we have to make a great effort to increase production in all sectors in the coming year. We have to use our existing resources of men, of skill and of our factors of production to the utmost. We must use our land more extensively and more intensively — getting more production from each hectare. We are desperately short of foreign exchange; we have very little money for development. Once again we have to remind ourselves that to plan is to choose."

Daily News, July 21, 1975

And when the economic realities grow harsher there is a greater need for considering all steps in production in the light of the overall situation.

"The Minister for Industries, Ndugu Cleopa Msuya, has called upon workers in industries throughout the country to manufacture goods by using raw materials obtainable within the country. He made the call when he toured the Kobo Match Corporation factory at Moshi. He said to achieve the nation's goal of self-reliance it was also necessary to have hard working people who could draw proper working plans. Use local industrial materials . . ."

Daily News, January 22, 1976

The links between the production in different economic sectors and the strategy of creating investment capital is now time and again discussed in a daily newspaper. A remarkable development indeed, as not so many years ago such topics would have been impossible at that level.

"While the country badly needs foreign exchange, it is equally important that increased production of our cash crops should be able to feed local industries and act as catalysts for the establishment of small scale industrial concerns."

Daily News, December 6, 1975

This development is also possible because of the long tradition of popular involvement in planning in Tanzania, and the effects of the crisis

can therefore be channelled into constructive strategy discussion . . .

Labour Intensive Production

Although agricultural mechanisation is the clear theme in the Tanzanian rural development policy, it has been pointed out that it cannot be achieved by a capital intensive policy as the capital is not there. The gradual approach now advocated constitutes a great step forward in spelling out the details of the Ujamaa policy.

"The Minister for Agriculture, Ndugu Joseph Mungai, recently said that no field worker would be awarded a certificate if he did not know how to teach oxen how to pull ploughs. He announced that all agricultural training institutes in the country would now offer agro-mechanisation as an essential subject for field workers."

Daily News, August 19, 1975

The theoretical basis for the long term development strategy has for a number of years been prepared by planners in the University of Dar es Salaam. It must be a great satisfaction for some of them, who — like Professor Thomas — left the country a few years ago, to see that those ideas now have become part of the national thinking. All this Clive Thomas summed up in his two iron laws:

- "1. Domestic resource use must be made to converge with domestic demand. Instead of producing raw materials for foreign markets and importing consumer and intermediate goods, the economy must produce its own requirements.
2. Domestic demand must converge with domestic needs. Instead of producing the requirements of the few, the economy must produce the goods that are needed by the masses. This transformation could only be implemented by the enthusiasm of the workers and locals, for it requires much greater production, in industry and especially agriculture. Greater production has to be achieved without much use of foreign exchange, since agriculture has to earn foreign exchange to build basic industries."

Daily News, August 7, 1975

The people are advised to change their own conditions, solve their own problems instead of expecting the government to do it all for them.

"The villages have to use the opportunities for proximity so as to develop themselves on a village basis. And most important of all — because it is the foundation of everything else

— they have to increase village production. Agricultural output has to be increased and village industries have to be started. The government can help in these things but it cannot replace the efforts of the people. Village self-reliance is essential. It should be a matter of pride of the villagers, and for the nation if a village provides services for itself without government financial assistance, for the only money government has is that which it collects from the people by taxation. Government financial help should therefore be reserved for things which village people cannot do for themselves. Where the people decide against setting up subsidiary villages the existing villages could divide themselves into smaller communities which will work together for some purposes and join the rest of the village for others."

Daily News, September 24, 1975

A gradual but broad development in agriculture is the basis for the national progress — self-reliance in all fields and at all levels is now more than ever the key to the future.

"Industries cannot be separated from agriculture. On the one hand industry must provide the inputs and tools for agriculture. On the other hand increased agricultural production will be needed to feed the working class. Moreover, during the initial period, agriculture will have to be the main source of foreign exchange to establish basic industries. So, in the short run, a basic industry strategy implies continuing production of agricultural products for sale in world markets, though in the long run this will not be so necessary. Basic industries must, with very few exceptions, use raw materials available locally and not imports."

Daily News, August 7, 1975

Decentralisation

The Ujamaa policy is now bringing the whole rural population together in villages. Centralisation at the local level is to be the key to the division of labour which is needed in the mechanisation of agriculture.

At the same time the government has, at the central level, pursued a policy of decentralisation so that decision making will be close to the people. The ability to solve problems locally requires decentralisation both in political terms and in terms of industrial capacity. President Nyerere has stressed this time and again in recent months.

"All our new villages will, sooner or later, require simple wood and metal repair workshops for ploughs, milling machines, and so on.

"Dispersal of our industrial production

throughout the country is also possible if we make our technology appropriate to our needs. We have talked a great deal about promoting small and cottage industries; the trouble is that we give it so little practical encouragement."

Daily News, July 21, 1975

In some cases decentralisation was even expressed as a policy which is to limit the growth of heavier industries. Nanjappa the Indian adviser to SIDO:

"... advocated decentralisation, the establishment of 'low key' industries, development of artisan skills, a limitation of industry around the cities, and incentives for those wanting to set up units in backward areas."

Daily News, December 16, 1975

We do not believe that development should be one-sided. Small industries do not all by themselves hold the key to national progress, but it is encouraging that rural industry has become an accepted and practised part of the national development.

"The main burden of development and expansion of employment will have to be borne by the part of the economy in which agriculture is the preponderant activity: i.e. the rural sector. Nevertheless, in most instances, development aid has hitherto concentrated on the modern sector which means, in effect, importing and financing highly sophisticated technological processes from industrially advanced countries to developing countries."

Daily News, July 24, 1975

The importance of utilising the labour power fully is stressed.

"The employment-intensive approach seeks to concentrate on the traditional, especially rural, sectors of the economy and their gradual modernisation, as well as the development and utilisation of increasingly productive and relatively labour-intensive or appropriate technologies, with a view to the reduction of inequalities by expanding employment opportunities, and by raising the levels of productivity and income of the people deriving their livelihood from them."

Daily News, July 24, 1975

The ILO Director General pointed that these conclusions clearly are based on the most recent agricultural experiences:

"The need for a change of focus is underlined by the stagnation in recent years of agricultural production. The objective of the present Development Decade was to increase the

agricultural output by 4% per annum but, during 1971, this was estimated to have been only 1%, while in 1972 no gain was recorded. In fact the report says food production per head in the developing countries as a whole is now below the average 1961-1965 level."

Daily News, July 24, 1975

The total reliance on the introduction and development of a modern agriculture has not proved to be realistic. Modern mechanised agriculture can only exist in a well-developed technical environment. The different sectors of the national economy are very much integrated. Change in one sector only, or of a few individuals does not achieve the aim of national development. Rural development is therefore a programme of massive change.

"It is imperative that farmers abandon their traditional mode of agricultural production and adopt the use of improved seeds of the major food grains. In the same respect, farmers have to make do with locally made farm implements so as to reduce the necessity of importing in view of ever-rising costs of imported development goods."

Daily News, December 6, 1975

It is remarkable to hear these voices now, for as late as 1973 most proponents of small industries talked mainly about producing tourists souvenirs and handicraft items for export. This has now totally changed.

"The Minister for Industries, Cleopa Msuya, said: 'Villages, districts and regions must set up small scale industries which will process essential commodities by using local raw materials ...' He said most of our industries failed to satisfy the demand of the people ... He therefore added that the people must observe the country's aim of strengthening the economy by using locally obtained resources in wealth production on self-reliance basis."

Daily News, January 6, 1976

The link between agriculture and technology at the very base is now clearly accepted.

"It was important for this country to understand that the standard of living of her masses would mainly be determined by the level of agricultural technological development."

Daily News, December 12, 1975

The Level of Technology

The abandonment of the tractors for all thinking has been very clearly spelled out by a series of articles in December 1975 by a "son of a peasant":

"The leaders have said that the peasant won't

be asked to buy a tractor plus its whole range of implements. No, instead we are going to ask him to take a step forward and join his friends who have advanced a little further in agricultural technology. We are going to introduce to him locally made and cheap farm implements as a means of making him a more effective land tiller for his and the nation's benefit."

Daily News, December 2, 1975

These articles drew attention for the first time to the simple designs produced by TAMTU. The president had a few months earlier used the terms appropriate technology and advanced technical self-reliance in the villages.

A few days earlier the limitations of the government agencies were indicated by Nyerere.

"Mwalilu said that the Small Industries Development Organisation (SIDO) must be strengthened so that it can give more help to village initiatives. He said donkey or ox carts could carry crops from the farms to the storage or collecting points, from one village to another. This would be cheaper and more reliable instead of depending on lorries. He called on scientists at the University and elsewhere to help in finding alternative raw material components for factories, at least as a second-best, short-term measure."

Daily News, July 21, 1975

Parliament was told by the President:

"The villagisation policy now makes it easier for us to advance through technologies appropriate to self-reliance. To talk of a village carpenter when there is no village does not make much sense. But when the tables and chairs he makes do not have to be carried for miles across the bush and when the barrow which needs repairing is only along the street, then a village craftsman can provide services which ease the work and improve the life of the peasants."

Daily News, July 21, 1975

The consequences of these messages is that the technical skills of the thousands of peasants who will become craftsmen will determine the technological policy in agricultural mechanisation. The supply of even the most simple tools becomes a great problem considering the thousands and thousands of peasants needing them.

"It should not mean the closure of TAMTU's production unit. We cannot at this stage afford, in the process, to lose even the little production that is already going on. Let's defy the Bible a bit by making sure that as far as farm tools are

concerned we cannot allow even the little production that is being done to be taken away from us."

Daily News, December 4, 1975

It is now also experienced that expansion in one sector easily leads to reductions in another.

"The Ubongo Farm Implements (UFI) General Manager Ndugu H. Kida, came out with an announcement that his firm was to raise the plough production figure from 2,000 to 12,000 pieces. He added that this mark was going to be hit through cutting down the production of hand hoes from 700,000 to 400,000. So one can safely say that Tanzania has declared to sever ties with primitive agriculture and open up new links with improved technology within her means."

At the beginning of this chapter we saw that the need for ploughs was over ten times the number which can be produced now. The very fact that the production of hand hoes has to be reduced must be seen as a doubtful development. But hoes can indeed be made in very simple workshops in the villages and this example justifies the development of very simple crafts everywhere, in fact right in each village. This awareness has now come to Tanzania and the country is prepared to review its economy in this light.

"The situation with the Agricultural and Industrial Supplies Company (AISCO) has never been worse. As we know, tractors and other heavy agricultural machinery cost this nation a lot of her hard earned foreign exchange. Worse still is the fact that because of the world economic situation, the price of these inputs has gone up terribly. Under these circumstances, one would have thought that subsequently these types of equipment would be subject to scrutiny before they are imported into the country. But until we know there has been no serious contact between our importers of the equipment (AISCO), and keep our eyes on which type of tools are competent within our conditions, one finds that machinery and equipment are imported without having been tested to find their suitability to our local conditions."

Daily News, December 3, 1975

It is against this background that we attempt to formulate a proper development programme for rural workshops. In the previous chapters we have discussed the production planning, design and equipment of village workshops in order to supply the technical information needed to implement the policy in the quotes from the *Daily News*.

Towards Village Industry

by Krisno Nimpuno

