

# **AT** MICROFICHE REFERENCE LIBRARY

A project of Volunteers in Asia

## Tools and Their Uses

by: US Bureau of Naval Personnel

Published by:

Dover Publications  
180 Varick Street  
New York, NY 10014 USA

Paper copies are \$ 2.75.

Available from:

Dover Publications  
180 Varick Street  
New York, NY 10014 USA

Reproduction of this microfiche document in any form is subject to the same restrictions as those of the original document.

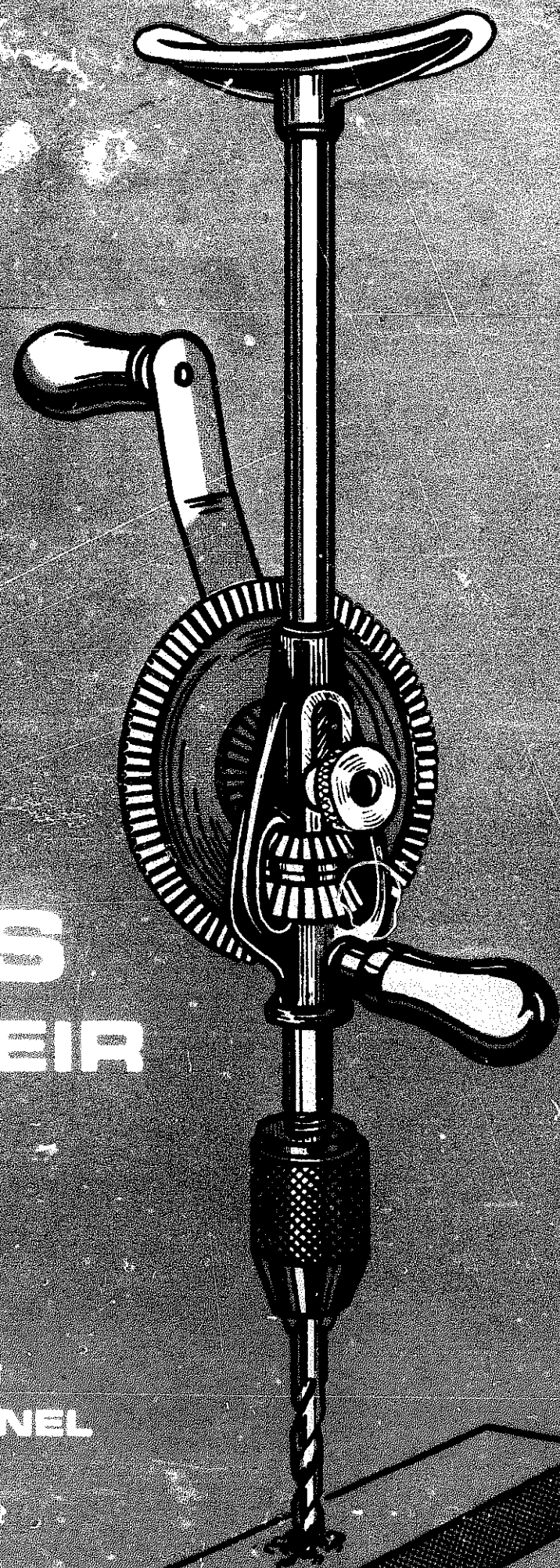

# TOOLS AND THEIR USES

PREPARED BY  
THE BUREAU OF  
NAVAL PERSONNEL

## DOVER BOOKS EXPLAINING SCIENCE AND MATHEMATICS

- POPULAR SCIENTIFIC LECTURES OF HERMANN VON HELMHOLTZ,  
edited by Morris Kline. (20799-4) \$2.00
- THE DOMAIN OF NATURAL SCIENCE, E. W. Hobson. (21966-6)  
\$3.00
- THE STRANGE STORY OF THE QUANTUM, Banesh T. Hoffmann.  
(20518-5) \$2.00
- THE MOTH BOOK, W. J. Holland. (21948-8) \$5.00
- ELECTRONS, ATOMS, METALS AND ALLOYS, William Hume-  
Rothery. (61046-2) \$3.50
- SCIENCE AND MUSIC, Sir James Jeans. (61964-8) \$2.00
- ARITHMETIC REFRESHER FOR PRACTICAL MEN, A. A. Klaf.  
(21241-6) \$3.00
- CALCULUS REFRESHER FOR TECHNICAL MEN, A. A. Klaf.  
(20370-0) \$2.75
- TRIGONOMETRY REFRESHER FOR TECHNICAL MEN, A. A. Klaf.  
(20371-9) \$3.00
- THE ATOMIC NUCLEUS, M. I. Korsunsky. (61052-7) \$2.50
- EXPERIMENTING WITH THE MICROSCOPE, Dieter Krauter.  
(21847-3) \$2.00
- THE MUSHROOM HANDBOOK, Louis C. C. Krieger. (21861-9)  
\$3.95
- PRACTICAL STATISTICS, Russell Langley. (22729-4) \$3.00
- INTRODUCTION TO PHOTOGRAPHIC PRINCIPLES, Lewis Larmore,  
(21385-4) \$2.00
- CHANCE, LUCK AND STATISTICS: THE SCIENCE OF CHANCE,  
Horace C. Levinson. (21007-3) \$2.50
- MAGNETISM: AN INTRODUCTORY SURVEY, E. W. Lee. (22665-4)  
\$2.50
- PIONEERS OF SCIENCE AND THE DEVELOPMENT OF THEIR SCIENTIFIC  
THEORIES, Sir Oliver Lodge. (20716-1) \$2.50
- A GUIDE TO MUSICAL ACOUSTICS, H. Lowery. (21628-4) \$1.25

(continued on back flap)

# TOOLS AND THEIR USES

PREPARED BY THE BUREAU  
OF NAVAL PERSONNEL

Do you have trouble with tools—find that they wear out too quickly, find that you can't decide which tools to buy or which tools to use for a specific job, find that little things continually go wrong? The only way to learn to use tools, of course, is by using them, but first you have to know which tools to use and why.

This manual, originally prepared for the use of naval personnel, was designed to present the basic hand and power tools that the ordinary person is likely to use. Through a wealth of diagrams, clear explanations, safety tips and operating instructions you will soon learn the basics of choosing tools and using them as they were meant to be used. Nearly every hand tool you are likely to use around the house is described in the first chapter: hammers, wrenches, screwdrivers, wood saws, planes, wood chisels, metal chisels, dies, drills, files, hacksaws, punches, reamers, taps, clamps, vises, pliers, knives. Chapter two covers the common power tools: drills, grinders, sanders. Chapter three covers measuring tools from rules and tapes to calipers, micrometers and squares with detailed instructions on how to use each one. Chapter four describes the common nails, screws, bolts, nuts, rivets and other fasteners you are likely to use. Chapter five describes grinders and shows how to sharpen and care for screwdrivers, chisels, drills and snips. The final two chapters cover such miscellaneous tasks and tools as metal cutting operations, stripping insulated wire, and soldering techniques.

By the time you finish you should know the names, general uses and correct operation of all the basic tools, fasteners and measuring devices you are likely to need around the house. You should be able to select tools for a basic kit for doing simple home repairs. You should be confident in beginning to use tools for yourself to perform all those simple but necessary repair jobs that need to be done. Most important, however, you will begin to feel comfortable around tools and begin to realize why they are truly man's best friends.

Unabridged republication of the original (1971) edition of *Rate Training Manual 10085-B*. 329 figures. 15 tables. xii + 179pp. 6½ x 9¼.

22022-2 Paperbound

## A DOVER EDITION DESIGNED FOR YEARS OF USE!

We have made every effort to make this the best book possible. Our paper is opaque, with minimal show-through; it will not discolor or become brittle with age. Pages are sewn in signatures in the method traditionally used for the best books, and will not drop out, as often happens with paperbacks held together with glue. Books open flat for easy reference. The binding will not crack or split. This is a permanent book.



(continued from front flap)

- VISUAL ILLUSIONS: THEIR CAUSES, CHARACTERISTICS AND APPLICATIONS, M. Luckiesh. (21530-X) \$2.00
- PHYSICS EXPERIMENTS FOR CHILDREN, Muriel Mandell. (22033-8) \$1.25
- THE FOURTH DIMENSION SIMPLY EXPLAINED, Henry P. Manning. (20711-0) \$2.50
- THE FRIENDLY STARS, Martha Evans Martin and Donald H. Menzel. (21099-5) \$1.50
- MATTER AND MOTION, James Clerk Maxwell. (60188-9) \$2.00
- SKYSHOOTING: HUNTING THE STARS WITH YOUR CAMERA, R. N. Mayall and M. W. Mayall. (21854-6) \$2.75
- THE NATURE OF LIGHT AND COLOUR IN THE OPEN AIR, M. Minnaert. (20196-1) \$3.00
- THE CONCEPT OF HEAT AND ITS WORKINGS SIMPLY EXPLAINED, Morton C. Mott-Smith. (20978-4) \$2.00
- THE CONCEPT OF ENERGY SIMPLY EXPLAINED, Morton C. Mott-Smith. (21071-5) \$2.00
- PRINCIPLES OF MECHANICS SIMPLY EXPLAINED, Morton C. Mott-Smith. (21067-7) \$2.00
- CHEMISTRY EXPERIMENTS FOR CHILDREN, Virginia L. Mullin. (22031-1) \$1.25
- MUSIC OF THE SPHERES: THE MATERIAL UNIVERSE FROM ATOM TO QUASAR, SIMPLY EXPLAINED, Guy Murchie. (21809-0, 21810-4) Two-volume set \$5.00
- THE ORIGIN OF LIFE, Alexandr I. Oparin. (60213-3) \$2.00
- SPINNING TOPS AND GYROSCOPIC MOTION, John Perry. (20416-2) \$1.50

Paperbound unless otherwise indicated. Prices subject to change without notice. Available at your book dealer's or write for free catalogues to Dept. Bex, Dover Publications, Inc., 180 Varick Street, New York, N. Y. 10014. Please indicate field of interest. Each year Dover publishes over 150 classical records and books in art, music, philosophy, literature, humor, science, languages, mathematics, and other areas. *Manufactured in the U.S.A.*

# **TOOLS**

## **AND THEIR USES**

Prepared by  
**the U. S. Navy**  
(Bureau of Naval  
Personnel)

**DOVER PUBLICATIONS, INC.**  
**NEW YORK**

Published in Canada by General Publishing Company, Ltd., 30 Lesmill Road, Don Mills, Toronto, Ontario.

Published in the United Kingdom by Constable and Company, Ltd., 10 Orange Street, London WC 2.

This Dover edition, first published in 1973, is an unabridged and unaltered republication of the work originally published by the United States Government Printing Office in 1971 as Rate Training Manual NAVPERS 10085-B.

*International Standard Book Number: 0-486-22022-2*  
*Library of Congress Catalog Card Number: 72-93611*

Manufactured in the United States of America  
Dover Publications, Inc.  
180 Varick Street  
New York, N. Y. 10014

## PREFACE

The purpose of this manual is to provide naval personnel with an informative handbook. It contains data pertinent to a variety of tools and may be used as a supplement to other training manuals.

The satisfactory performance of modern technical equipment used by the Navy depends, to a great extent, upon adherence to approved maintenance procedures and the proper use of the correct tools.

The objectives of this manual, then, are to aid in the maintenance effort by

(a) providing descriptions, general uses, correct operation, and approved maintenance procedures for those handtools and power tools commonly used in the Navy.

(b) indoctrinating all personnel engaged in maintenance work with the importance of good workmanship.

(c) preventing and minimizing personal injury and equipment damage by emphasizing good safety practices.

Upon completion of this manual, you should be able to identify tools and fastening devices by their correct names; cite the specific purposes and uses of each tool; describe the correct operation, care and maintenance required to keep the tools in proper operating condition; and finally, perform accurate measurements.

Chapter 1 describes impact tools (hammers, mallets, and sledges), twisting and turning tools (wrenches and screwdrivers), woodcutting tools (wood saws, planes, wood chisels), metal cutting tools (chisels, dies, drills, files, hacksaws, punches, reamers, taps), holding tools (clamps, pliers, and vises), miscellaneous tools (knives, mechanical fingers, inspection mirrors), safety equipment (gloves, goggles, hard hats), and safety rules.

Chapter 2 describes pneumatic and electrically powered tools. Drills, sanders, grinders and scalers are some of the tools discussed.

Certain tools are especially useful for measuring purposes. For this reason, rules, tapes, calipers, micrometers and squares, together with techniques for using them are placed in Chapter 3.

Although fasteners are not properly classified as tools, they are used extensively with tools. Chapter 4 describes such fasteners as bolts, cotter pins, nails, nuts, rivets, screws, special speed fasteners (Dzus and Camloc types), and several methods for safetying some of these components.

Chapter 5 discusses abrasive wheels and methods for grinding and sharpening chisels, drills, punches, and snips.

Metal cutting operations using the chisel, drill, reamer and several types of thread cutters are described in Chapter 6.

The final chapter describes miscellaneous tasks the student may encounter. These include bending and flaring tubing, removing broken bolts, studs and taps, stripping insulated wire, and several soldering techniques and lubrication procedures.

As one of the Navy Training Manuals, this book was prepared by the Training Publications Division, Naval Personnel Program Support Activity, Washington, D.C., for the Bureau of Naval Personnel.

Special assistance has been rendered by various Navy personnel specially cognizant of the handtools and portable power tools used, and the work operations in which they are chiefly employed.



## SUGGESTIONS FOR USING THIS BOOK

Many people do not know how to study. The following suggestions might improve your study habits and enable you to learn more from this book.

- Set up a regular study plan. It will probably be easier for you to stick to a schedule if you can plan to study at the same time each day. If possible, schedule your studying for a time of day when you will not have too many interruptions or distractions.
- Before you begin to study any part of the training manual intensively, become familiar with the entire book. Read the preface and the table of contents. Check through the index. Thumb through the book without any particular plan, looking at the illustrations and reading bits here and there as you see things that interest you.
- Look at the training manual in more detail, to see how it is organized. Look at the table of contents again. Then, chapter by chapter, read the introduction, the headings, and the subheadings. This will give you a pretty clear picture of the scope and content of the book. As you look through the book in this way, ask yourself some questions: What do I need to learn about this? What do I already know about this? How is this information related to information given in other chapters? How is this information related to the qualifications for advancement in rating?
- When you have a general idea of what is in the training manual and how it is organized, fill in the details by intensive study. In each study period, try to cover a complete unit—it may be a chapter, a section of a chapter, or a subsection. The amount of material that you can cover at one time will vary. If you know the subject well, or if the material is easy, you can cover quite a lot at one time. Difficult or unfamiliar material will require more study time.
- In studying any one unit—chapter, section, or subsection—write down the questions that occur to you. Many people find it helpful to make a written outline of the unit as they study, or at least to write down the most important ideas.
- As you study, relate the information in the training manual to the knowledge you already have. When you read about a process, a skill, or a situation, try to see how this information ties in with your own past experience.
- When you have finished studying a unit, take time out to see what you have learned. Look back over your notes and questions. Maybe some of your questions have been answered, but perhaps you still have some that are not answered. Ask one of your senior petty officers or shipmates for assistance. Without looking at the training manual, write down the main ideas that you have gotten from studying this unit. Don't just quote the book. If you can't give these ideas in your own words, the chances are that you have not really mastered the information.
- Think of YOUR future as you study Navy Training Manuals. You are working for advancement to third class or second class right now, but someday you will be working toward higher rates. Anything extra that you can learn now will help you both now and later.

- If you desire information about a specific tool or operation, simply refer to the index at the alphabetical end of the book and then turn to the pages to which you are directed by that index.

Always keep in mind that a knowledge of the tools and their fundamental uses is the preliminary step in mastering the basic handtool skills. The next step is careful practice until you have mastered the various skills involved. The end result must be that you become capable of performing required operations, and of meeting the standards established in your rating qualifications. To accomplish this final result, you must first **STUDY** the tools and skills; then, you must **PRACTICE** the skills; and finally, you must **DEMONSTRATE** the skills.

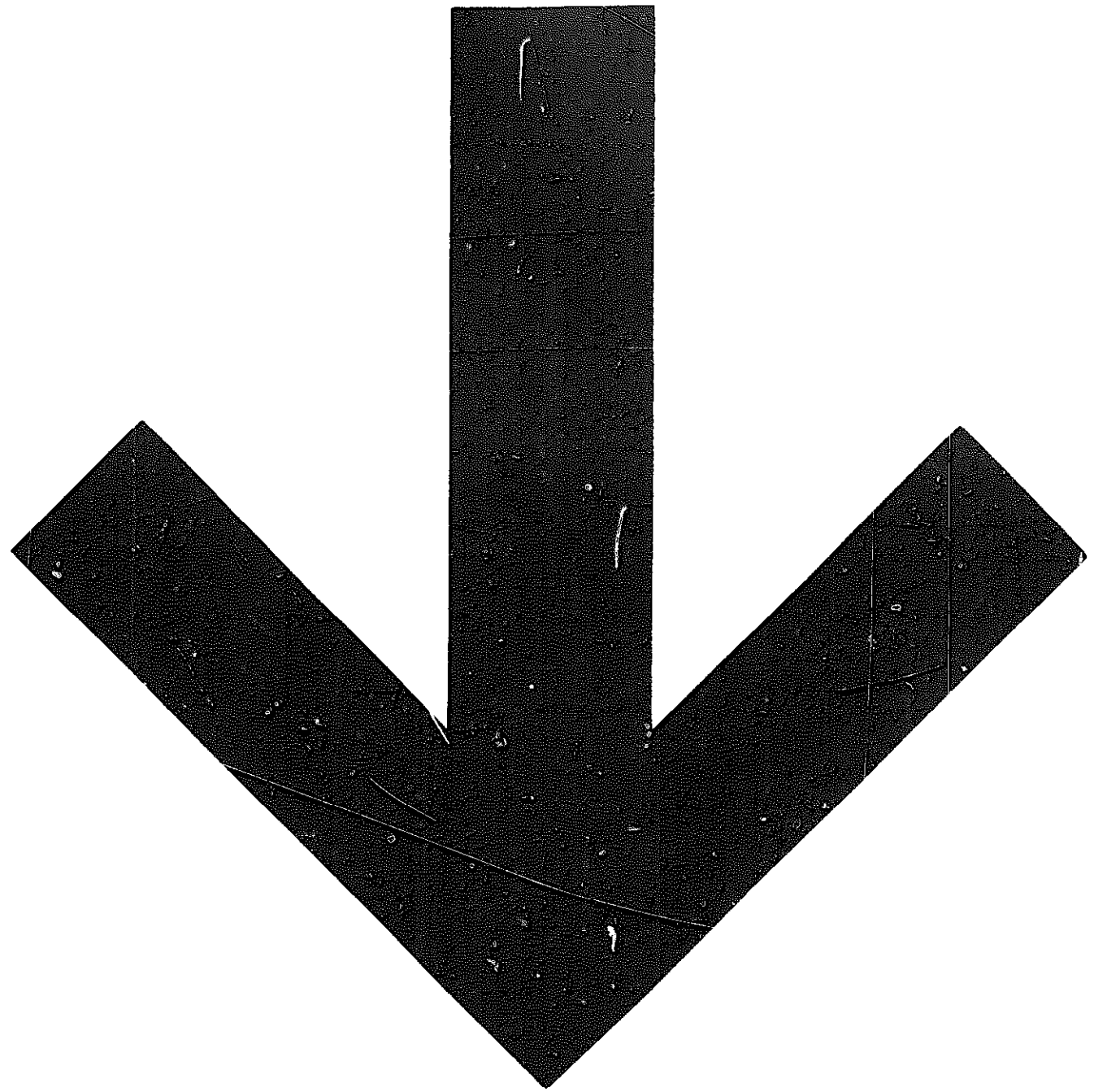

# CONTENTS

CHAPTER	Page
1. Common Handtools .....	1
2. Common Power Tools .....	61
3. Measuring Tools and Techniques .....	78
4. Fastening Components and Procedures .....	112
5. Grinding Operations .....	126
6. Metal Cutting Operations .....	141
7. Miscellaneous Tasks .....	159
INDEX .....	176

## CREDITS

Illustrations indicated below are included through the courtesy of the designated companies and publishers. Permission to use these illustrations is gratefully acknowledged.

<u>SOURCE</u>	<u>FIGURE</u>
Buckingham Mfg. Co.	6-28
General Motors Corp.	1-7
Imperial Brass Mfg. Co.	6-38 6-40 7-1 7-3
Rockwell Mfg. Corp.	2-6 2-7 2-8 2-11
Ingersoll-Rand Corp.	2-14 2-16
Cleveland Twist Drill Co.	1-41
New York State Education Dept.	1-21 1-22
Eugene Dietzgen Co.	3-72
Delmar Publishers Inc.	4-5

## CHAPTER 1

# COMMON HANDTOOLS

Tools are designed to make a job easier and enable you to work more efficiently. Tools are a craftsman's best friend. (A craftsman is a master of any one of a number of trades such as a machinist, carpenter, hull technician, builder, or steelworker.) If the tools are not used properly or cared for, their advantages will be lost. Without them a craftsman is as helpless as he would be without his eyes. In fact, he would be more helpless, for a blind mechanic or craftsman skilled in the use of good tools and having them available, can do more than the most expert mechanic without tools.

Regardless of the type of work to be done, a craftsman must have, choose, and use the correct tools in order to do his work quickly, accurately, and safely. Without the proper tools and the knowledge of how to use them, he wastes time, reduces his efficiency, and may even injure himself. This chapter explains the specific purposes, correct use, and proper care of the more common tools you may encounter in your Navy career.

### THE MOST VALUABLE TOOLS IN THE WORLD

What would you pay for **THE MOST VALUABLE TOOLS IN THE WORLD**? These tools can help you grip, grasp, push, twist and help you operate equipment. Furthermore, these remarkable tools can distinguish temperature variations and are sensitive to touch. It is impossible to purchase such tools . . . they are your **HANDS**.

These fabulous tools are subject to injury by being caught in machines, crushed by objects, or cut by a variety of sharp edged tools such as chisels, knives, or saws. Additionally, your hands can be damaged by being burnt, fractured or sprained unless you are always alert.

Why? Because they cannot **THINK** for themselves. **PROTECT THEM**. They are invaluable. **KEEP ALERT** while you work. **THINK** as you work. **THINK** before you make adjustments to machinery. Has the electric power been

turned off? Are the required guards on the machinery? Is the object on which you are going to work properly secured and clamped?

Protect your hands from injury as directed by the applicable safety instructions whenever you use tools. You will be working under severe handicaps without the full use of both hands. Make it a habit to **FOLLOW ALL SAFETY RULES**.

### TEN COMMANDMENTS

Obey the ten commandments of safety:

1. **LEARN** the safe way to do your job before you start.
2. **THINK** safety, and **ACT** safety at all times.
3. **OBEY** safety rules and regulations—they are for your protection.
4. **WEAR** proper clothing and protective equipment.
5. **CONDUCT** yourself properly at all times—horseplay is prohibited.
6. **OPERATE** only the equipment you are authorized to use.
7. **INSPECT** tools and equipment for safe condition before starting work.
8. **ADVISE** your superior promptly of any unsafe conditions or practice.
9. **REPORT** any injury immediately to your superior.
10. **SUPPORT** your safety program and take an active part in safety meetings.

In addition to the above, there are other good tool habits which will help you perform your work more efficiently as well as safely.

### TOOL HABITS

"A place for everything and everything in its place" is just common sense. You can't do an efficient, fast repair job if you have to stop and look around for each tool you need. The following rules, if followed, will make your job easier for you.

## TOOLS AND THEIR USES

**KEEP EACH TOOL IN ITS PROPER STORAGE PLACE.**—A tool is useless if you cannot find it. If you return each tool to its proper place, you'll know where it is the next time you need it.

**KEEP YOUR TOOLS IN GOOD CONDITION.**—Protect them from rust, nicks, burrs, and breakage.

**KEEP YOUR TOOL ALLOWANCE COMPLETE.**—If you are issued a tool box (fig. 1-1), each tool should be placed in it when not in use. If possible, the box should be locked and stored in a designated area. Note: Never leave the handbox adrift where it could become a missile and cause injury to personnel. An inventory list retained in the box and checked after each job will help you keep track of your tools.

**USE EACH TOOL ONLY ON THE JOB FOR WHICH IT WAS DESIGNED.**—If you use the wrong tool to make an adjustment, the results will probably be unsatisfactory. For example, if you use a socket wrench that's a trifle too big, you'll round off the corners of the wrench or nut. If this rounded wrench or nut is not replaced immediately the safety of your ship may be jeopardized in an emergency. Does this sound exaggerated? Remember . . . for want of a nail, a kingdom was lost.

**KEEP YOUR TOOLS WITHIN EASY REACH AND WHERE THEY CANNOT FALL ON THE FLOOR OR MACHINERY.**—Avoid placing tools anywhere above machinery or electrical apparatus. Serious damage will result if the tool falls into the machinery after the equipment is energized.

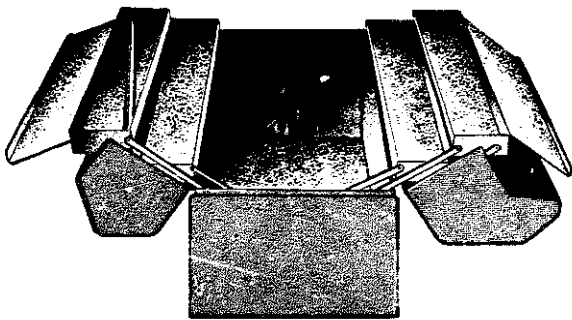

56.37(44B)  
Figure 1-1.—Standard Navy toolbox.

**NEVER USE DAMAGED TOOLS.**—A battered screwdriver may slip and spoil the screw slot, damage other parts, or cause painful injury. A gage strained out of shape will result in inaccurate measurements.

Remember, the efficiency of a craftsman and the tools he uses are determined to a great extent by the way he keeps his tools. Likewise, he is frequently judged by the manner in which he handles and cares for them. Anyone watching a skilled craftsman at his work notices the care and precision with which he uses the tools of his trade.

The care of hand tools should follow the same pattern as for personal articles; that is, always keep hand tools clean and free from dirt, grease, and foreign matter. After use, return tools promptly to their proper place in the toolbox. Improve your own efficiency by organizing your tools so that those used most frequently can be reached easily without digging through the entire contents of the box. Avoid accumulating unnecessary junk.

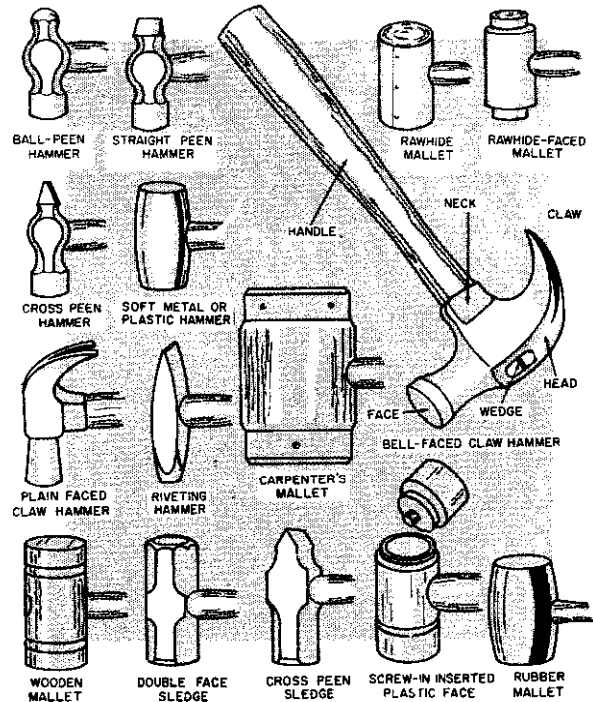

5.5(44B)A  
Figure 1-2.—Hammers, mallets and sledges.

STRIKING TOOLS

Hammers, mallets, and sledges are used to apply a striking force. The tool you select (fig. 1-2) will depend upon the intended application.

HAMMERS

A toolkit for nearly every rating in the Navy would not be complete without at least one hammer. In most cases, two or three are included since they are designated according to weight (without the handle) and style or shape. The shape (fig. 1-2) will vary according to the intended work. The carpenter's hammer is designed for one purpose while the machinist's hammer has other primary functions.

Carpenter's Hammer

The primary use of the carpenter's hammer is to drive or draw (pull) nails. Note the names of the various parts of the hammer shown in figure 1-2. The carpenter's hammer has either a curved or straight claw. The face may be either bell-faced or plain-faced, and the handle may be made of wood or steel. The carpenter's hammer generally used in the Navy has a curved claw, bell face, and wooden handle.

Machinist's Hammer

Machinist's hammers are mostly used by people who work with metal or around machinery. These hammers are distinguished from carpenter hammers by a variable-shaped peen, rather than a claw, at the opposite end of the face (fig. 1-2). The ball-peen hammer is probably most familiar to you.

The ball-peen hammer, as its name implies, has a ball which is smaller in diameter than the face. It is therefore useful for striking areas that are too small for the face to enter.

Ball-peen hammers are made in different weights, usually 4, 6, 8, and 12 ounces and 1, 1 1/2, and 2 pounds. For most work a 1 1/2-pound and a 12-ounce hammer will suffice. However, a 4- or 6-ounce hammer will often be used for light work such as tapping a punch to cut gaskets out of sheet gasket material.

Machinist's hammers may be further divided into hard-face and soft-face classifications. The hard-faced hammer is made of forged tool steel while the soft-faced hammers have a head made from brass, lead, or a tightly rolled strip

of rawhide. Plastic-tipped hammers, or solid plastic with a lead core for added weight, are becoming increasingly popular.

Soft-faced hammers, (fig. 1-2) should be used when there is danger of damaging the surface of the work, as when pounding on a machined surface. Most soft-faced hammers have heads that can be replaced as the need arises. Lead-faced hammers, for instance, quickly become battered and must be replaced, but have the advantage of striking a solid, heavy nonrebounding blow that is useful for such jobs as driving shafts into or out of tight holes. If a soft-faced hammer is not available, the surface to be hammered may be protected by covering it with a piece of soft brass, copper, or hard wood.

Using Hammers

Simple as the hammer is, there is a right and wrong way of using it. (See fig. 1-3.) The most common fault is holding the handle too close to the head. This is known as choking the

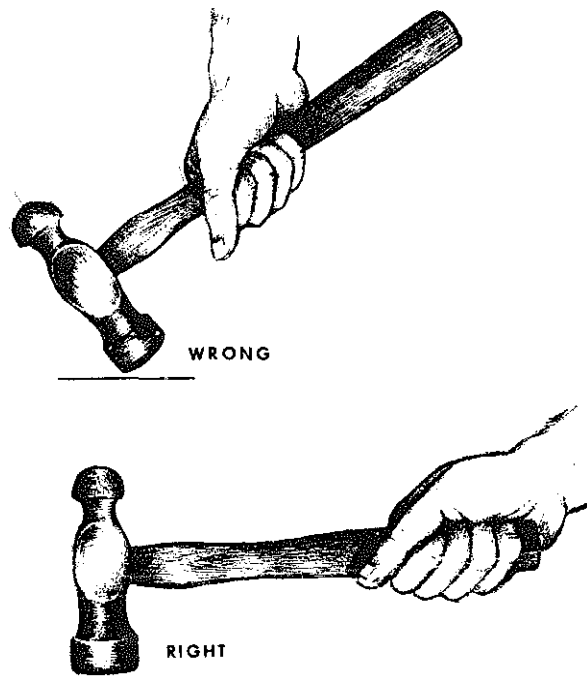

5.5.1(44A)

Figure 1-3.—Right and wrong way to use a ball-peen hammer.



## TOOLS AND THEIR USES

hammer, and reduces the force of the blow. It also makes it harder to hold the head in an upright position. Except for light blows, hold the handle close to the end to increase the lever arm and produce a more effective blow. Hold the handle with the fingers underneath and the thumb along side or on top of the handle. The thumb should rest on the handle and never overlap the fingers. Try to hit the object with the full force of the hammer. Hold the hammer at such an angle that the face of the hammer and the surface of the object being hit will be parallel. This distributes the force of the blow over the full face and prevents damage to both the surface being struck and the face of the hammer.

### MALLETS AND SLEDGES

The mallet is a short-handled tool used to drive wooden-handled chisels, gouges, wooden pins, or form or shape sheet metal where hard-faced hammers would mar or injure the finished work. Mallet heads are made from a soft material, usually wood, rawhide, or rubber. For example, a rubber-faced mallet is used for knocking out dents in an automobile. It is cylindrically shaped with two flat driving faces that are reinforced with iron bands. (See fig. 1-2.) Never use a mallet to drive nails, screws, or any object that may cause damage to the face.

The sledge is a steel headed, heavy duty driving tool that can be used for a number of purposes. Short-handled sledges are used to drive bolts, drift pins, and large nails, and to strike cold chisels and small hand rock drills. Long-handled sledges are used to break rock and concrete, to drive spikes, bolts, or stakes, and to strike rock drills and chisels.

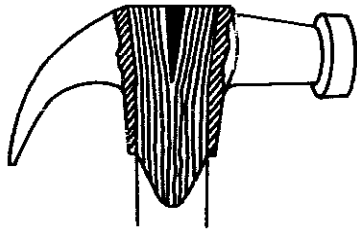

5.5(44B)B

Figure 1-4.—Handle expanded in hammer head by wedges.

The head of a sledge is generally made of a high carbon steel and may weigh from 6 to 16 lb. The shape of the head will vary according to the job for which the sledge is designed.

### MAINTENANCE OF STRIKING TOOLS

Hammers, sledges, or mallets should be cleaned and repaired if necessary before they are stored. Before using, ensure that the faces are free from oil or other material that would cause the tool to glance off nails, spikes, or stakes. The heads should be dressed to remove any battered edges.

Never leave a wooden or rawhide mallet in the sun, as it will dry out and may cause the head to crack. A light film of oil should be left on the mallet to maintain a little moisture in the head.

The hammer handle should always be tight in the head. If it is loose the head may fly off and cause an injury. The eye or hole in the hammer head is made with a slight taper in both directions from the center. After the handle, which is tapered to fit the eye, is inserted in the head, a steel or wooden wedge is driven into the end of the handle that is inserted into the head. This wedge expands the handle and causes it to fill the opposite taper in the eye. Thus the handle is wedged in both directions as shown in figure 1-4. If the wedge starts to come out, it should be driven in again to tighten the handle. If the wedge comes out, replace it before continuing to use the hammer. If you cannot get another wedge right away, you may file one out of a piece of flat steel, or cut

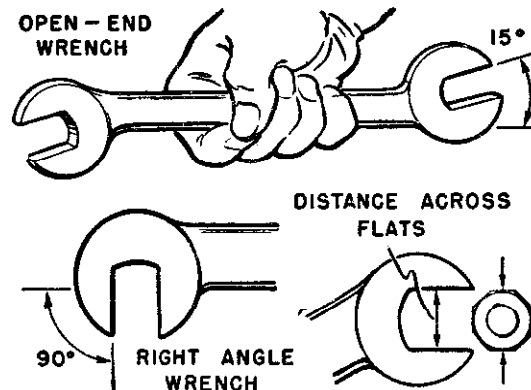

1.16.1

Figure 1-5.—Open-end wrenches.

one from a portion of the tang of a wornout file. The tang is the end of the file that fits into the handle.

### SAFETY PRECAUTIONS

Hammers are dangerous tools when used carelessly and without consideration. Practice will help you learn to use a hammer properly.

Some important things to remember when using a hammer or mallet follow:

- Do not use a hammer handle for bumping parts in assembly, and never use it as a pry bar. Such abuses will cause the handle to split, and a split handle can produce bad cuts or pinches. When a handle splits or cracks, do not try to repair it by binding with string or wire. **REPLACE IT.**

- Make sure the handle fits tightly on the head.

- Do not strike a hardened steel surface with a steel hammer. Small pieces of steel may break off and injure someone in the eye or damage the work. However, it is permissible to strike a punch or chisel directly with the ball-peen hammer because the steel in the heads of punches and chisels is slightly softer than that of the hammerhead.

### TURNING TOOLS (WRENCHES)

A wrench is a basic tool that is used to exert a twisting force on bolt heads, nuts, studs and pipes. The special wrenches designed to do certain jobs are, in most cases, variations of the basic wrenches that will be described in this section.

Some ratings will naturally have more use for wrenches in doing their jobs than other ratings; however, practically all ratings, including clerical, will have occasion, from time to time, to use wrenches. It is necessary, therefore, that all hands have a basic understanding of the description and uses of wrenches.

The best wrenches are made of chrome vanadium steel. Wrenches made of this material are light in weight and almost unbreakable. This is an expensive material, however, so the most common wrenches found in the Navy are made of forged carbon steel or molybdenum steel. These latter materials make good wrenches, but they are generally built a little heavier and bulkier in order to achieve the same degree of strength as chrome vanadium steel.

The size of any wrench used on bolt-heads or nuts is determined by the size of the opening between the jaws of the wrench. The opening of a wrench is manufactured slightly larger than the bolt head or nut that it is designed to fit. Hex-nuts (six-sided) and other types of nut or bolt heads are measured across opposite flats (fig. 1-5). A wrench that is designed to fit a 3/8-inch nut or bolt usually has a clearance of from 5 to 8 thousandths of an inch. This clearance allows the wrench to slide on and off the nut or bolt with a minimum of "play." If the wrench is too large, the points of the nut or bolt head will be rounded and destroyed.

There are many types of wrenches. Each type is designed for a specific use. Let's discuss some of them.

### OPEN-END WRENCHES

Solid, nonadjustable wrenches with openings in one or both ends are called open-end wrenches. (See fig. 1-5.) Usually they come in sets of from 6 to 10 wrenches with sizes ranging from 5/16 to 1 inch. Wrenches with small openings are usually shorter than wrenches with large openings. This proportions the lever advantage of the wrench to the bolt or stud and helps prevent wrench breakage or damage to the bolt or stud. One exception exists.

Aircraft today are built in a very compact manner; and generally, many of the hydraulic

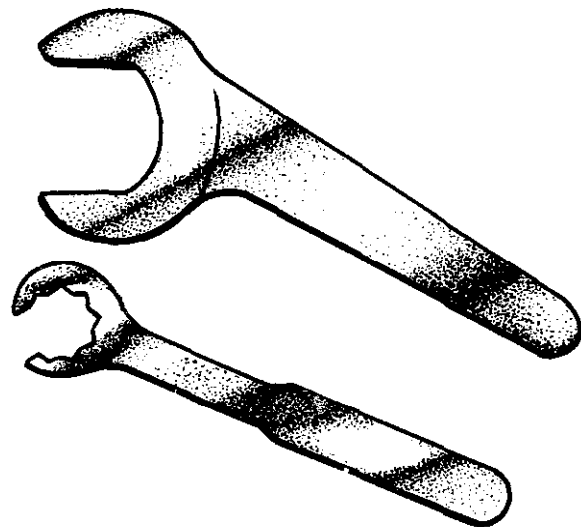

1.16(44B)A

Figure 1-6.—Hydraulic wrenches.

TOOLS AND THEIR USES

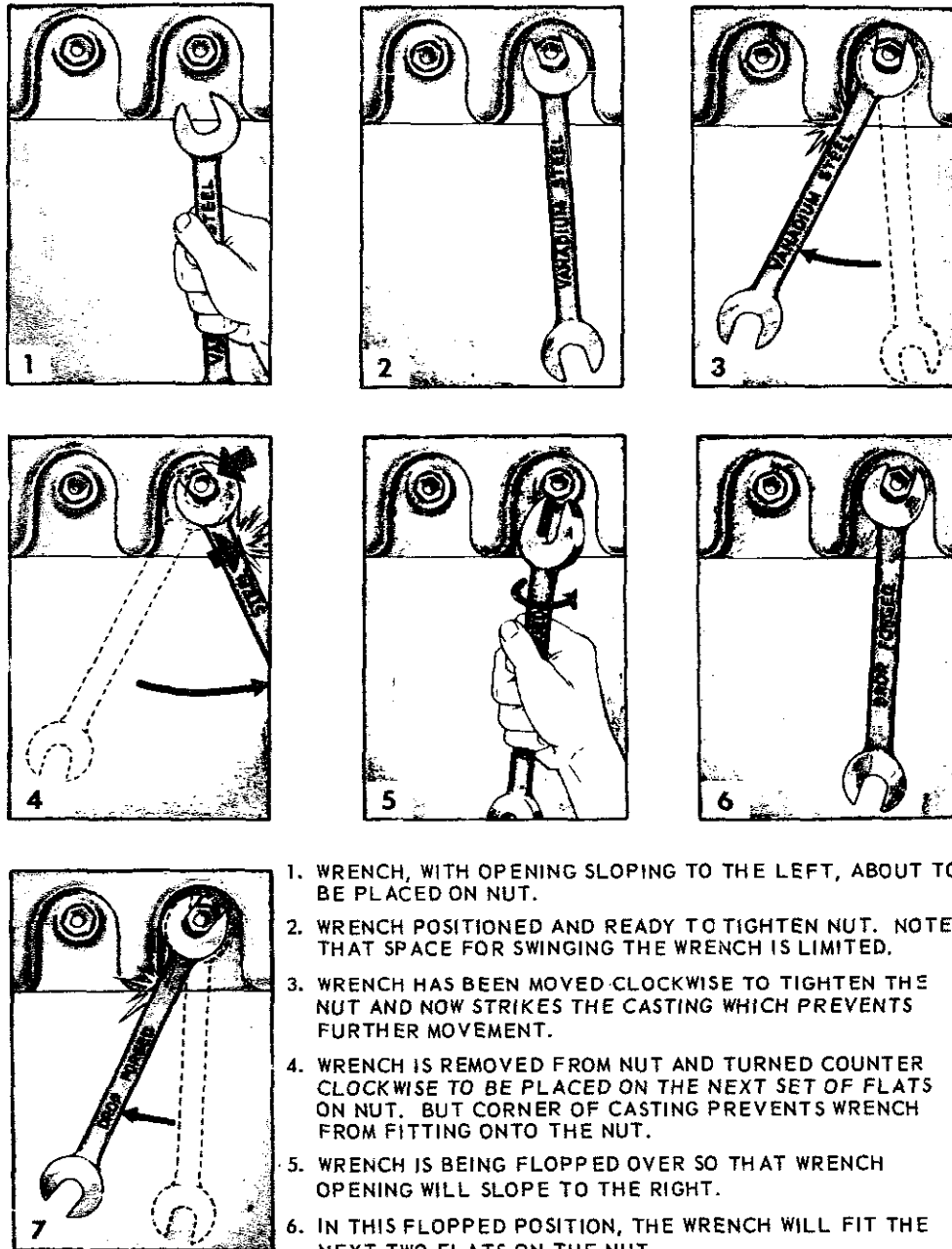

1. WRENCH, WITH OPENING SLOPING TO THE LEFT, ABOUT TO BE PLACED ON NUT.
2. WRENCH POSITIONED AND READY TO TIGHTEN NUT. NOTE THAT SPACE FOR SWINGING THE WRENCH IS LIMITED.
3. WRENCH HAS BEEN MOVED CLOCKWISE TO TIGHTEN THE NUT AND NOW STRIKES THE CASTING WHICH PREVENTS FURTHER MOVEMENT.
4. WRENCH IS REMOVED FROM NUT AND TURNED COUNTER CLOCKWISE TO BE PLACED ON THE NEXT SET OF FLATS ON NUT. BUT CORNER OF CASTING PREVENTS WRENCH FROM FITTING ONTO THE NUT.
5. WRENCH IS BEING FLOPPED OVER SO THAT WRENCH OPENING WILL SLOPE TO THE RIGHT.
6. IN THIS FLOPPED POSITION, THE WRENCH WILL FIT THE NEXT TWO FLATS ON THE NUT.
7. WRENCH NOW IS PULLED CLOCKWISE TO FURTHER TIGHTEN NUT UNTIL WRENCH AGAIN STRIKES CASTING. BY REPEATING THE FLOPPING PROCEDURE, THE NUT CAN BE TURNED UNTIL IT IS TIGHT.

1.16(44B)BX

Figure 1-7.—Use of open-end wrench.

installations are in close spaces. During certain phases of hydraulic maintenance it may be impossible to swing an ordinary wrench due to its length. Ordinary wrenches that are normally available increase in length as their size increases. Thus, when a large size wrench is needed, the length of the wrench sometimes prevents its use, due to the space available to swing the wrench. The Bonney wrench shown in figure 1-6, is an open-end wrench that may be used to great advantage due to its thickness and short length. This wrench is normally procured in the larger sizes, although it is available in a range of sizes to fit all aircraft hydraulic fittings.

Open-end wrenches may have their jaws parallel to the handle or at angles anywhere up to 90 degrees. The average angle is 15 degrees (fig. 1-5). This angular displacement variation permits selection of a wrench suited for places where there is room to make only a part of a complete turn of a nut or bolt. If the wrench is turned over after the first swing, it will fit on the same flats and turn the nut farther. After two swings on the wrench, the nut is turned far enough so that a new set of flats are in position for the wrench as shown in figure 1-7.

Handles are usually straight, but may be curved. Those with curved handles are called S-wrenches. Other open-end wrenches may have offset handles. This allows the head to reach nut or bolt heads that are sunk below the surface.

### BOX WRENCHES

Box wrenches (fig. 1-8) are safer than open-end wrenches since there is less likelihood they will slip off the work. They completely surround or box a nut or bolt head.

The most frequently used box wrench has 12 points or notches arranged in a circle in the head and can be used with a minimum swing angle of 30 degrees. Six and eight point wrenches are used for heavy, 12 for medium, and 16 for light duty only.



1.16.2

Figure 1-8.—12-point box-end wrench.

One advantage of the 12 point construction is the thin wall. It is more suitable for turning nuts which are hard to get at with an open-end wrench. Another advantage is that the wrench will operate between obstructions where the space for handle swing is limited. A very short swing of the handle will turn the nut far enough to allow the wrench to be lifted and the next set of points fitted to the corners of the nut.

One disadvantage of the box-end wrench is the loss of time which occurs whenever a craftsman has to lift the wrench off and place it back on the nut in another position in case there is insufficient clearance to spin the wrench in a full circle.

### COMBINATION WRENCH

After a tight nut is broken loose, it can be unscrewed much more quickly with an open-end wrench than with a box-wrench. This is where a combination box-open end wrench (fig. 1-9) comes in handy. You can use the box-end for breaking nuts loose or for snugging them down, and the open-end for faster turning.

The box-end portion of the wrench can be designed with an offset in the handle. Notice in figure 1-9, how the 15-degree offset allows clearance over nearby parts.

The correct use of open-end and box-end wrenches can be summed up in a few simple rules, most important of which is to be sure that the wrench properly fits the nut or bolt head.

When you have to pull hard on the wrench, as in loosening a tight nut, make sure the wrench is seated squarely on the flats of the nut.

**PULL** on the wrench—**DO NOT PUSH**. Pushing a wrench is a good way to skin your knuckles if the wrench slips or the nut breaks loose unexpectedly. If it is impossible to pull

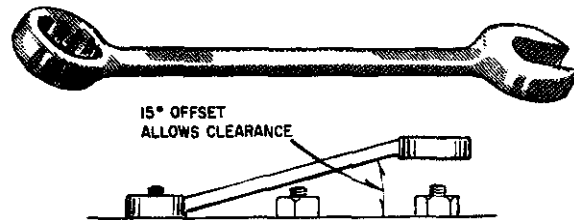

1.16.3(44B)

Figure 1-9.—Combination wrench.

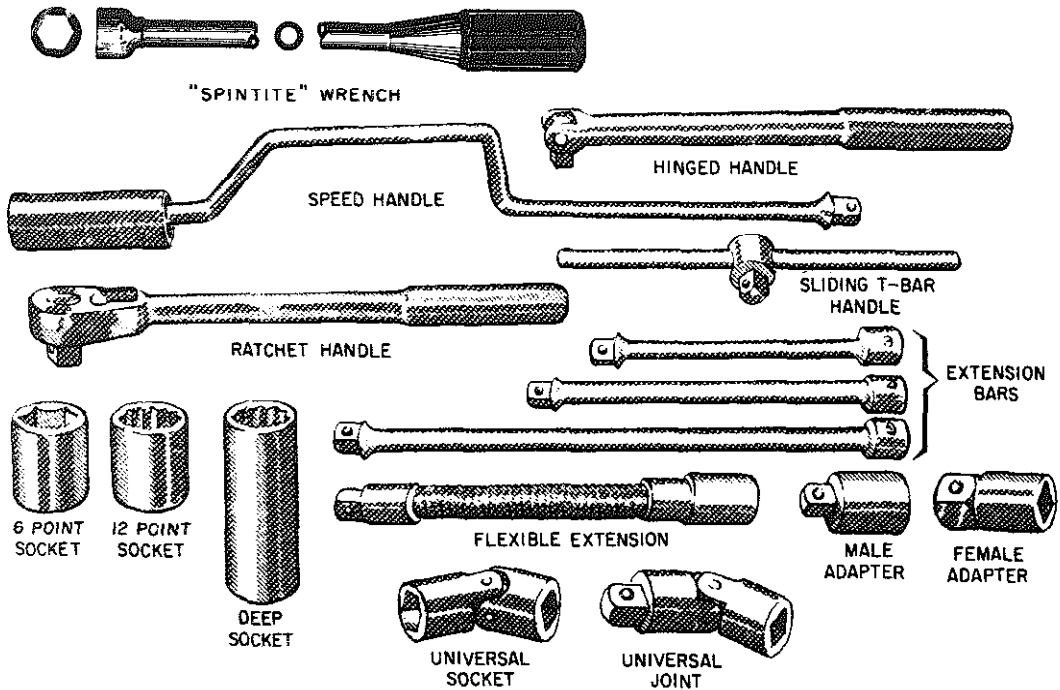

44.3(44B)

Figure 1-10.—Socket set components.

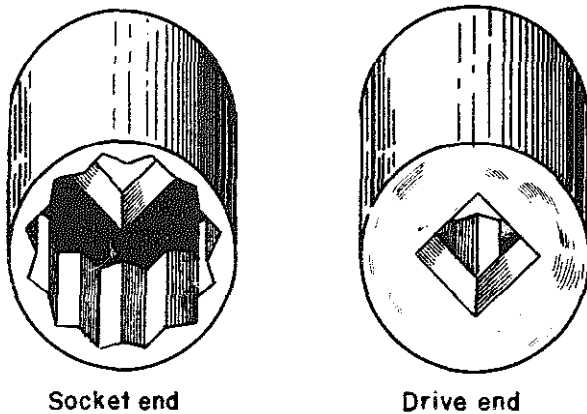

Figure 1-11.—12-point sockets.

44.4

the wrench, and you must push, do it with the palm of your hand and hold your palm open.

Only actual practice will tell you if you are using the right amount of force on the wrench.

The best way to tighten a nut is to turn it until the wrench has a firm, solid "feel." This will turn the nut to proper tightness without stripping the threads or twisting off the bolt. This "feel" is developed by experience alone. Practice until you have mastered the "feel."

### SOCKET WRENCH

The socket wrench is one of the most versatile wrenches in the toolbox. Basically, it consists of a handle and a socket type wrench which can be attached to the handle.

The "Spintite" wrench shown in figure 1-10, is a special type of socket wrench. It has a hollow shaft to accommodate a bolt protruding through a nut, has a hexagonal head, and is used like a screwdriver. It is supplied in small sizes only and is useful for assembly and electrical work. When used for the latter purpose, it must have an insulated handle.

A complete socket wrench set consists of several types of handles along with bar extensions, adapters, and a variety of sockets (fig. 1-10).

### Sockets

A socket (fig. 1-11) has a square opening cut in one end to fit a square drive lug on a detachable handle. In the other end of the socket is a 6-point or 12-point opening very much like the opening in the box end wrench. The 12-point socket needs to be swung only half as far as the 6-point socket before it has to be lifted and fitted on the nut for a new grip. It can therefore be used in closer quarters where there is less room to move the handle. (A ratchet handle eliminates the necessity of lifting the socket and refitting it on the nut again and again.)

Sockets are classified for size according to two factors. One is the size of the square opening, which fits on the square drive lug of the handle. This size is known as the drive size. The other is the size of the opening in the opposite end, which fits the nut or bolt. The standard toolbox can be outfitted with sockets having 1/4-, 3/8-, and 1/2-inch-square drive lugs. Larger sets are usually available in the tool-room for temporary checkout. The openings that fit onto the bolt or nut are usually graduated in 1/16-inch sizes. Sockets are also made in deep lengths to fit over spark plugs and long bolt ends.

### Socket Handles

There are four types of handles used with these sockets. (See fig. 1-10.) Each type has special advantages, and the experienced worker chooses the one best suited for the job at hand. The square driving lug on the socket wrench handles has a spring-loaded ball that fits into a recess in the socket receptacle. This mated ball-recess feature keeps the socket engaged with the drive lug during normal usage. A slight pull on the socket, however, disassembles the connection.

**RATCHET.**—The ratchet handle has a reversing lever which operates a pawl (or dog) inside the head of the tool. Pulling the handle in one direction causes the pawl to engage in the ratchet teeth and turn the socket. Moving the handle in the opposite direction causes the pawl to slide over the teeth, permitting the handle to back up without moving the socket. This allows rapid turning of the nut or bolt after each partial turn of the handle. With the reversing lever in one position, the handle can

be used for tightening. In the other position, it can be used for loosening.

**HINGED HANDLE.**—The hinged handle is also very convenient. To loosen tight nuts, swing the handle at right angles to the socket. This gives the greatest possible leverage. After loosening the nut to the point where it turns easily, move the handle into the vertical position and then turn the handle with the fingers.

**SLIDING T-BAR HANDLE.**—When using the sliding bar or T-handle, the head can be positioned anywhere along the sliding bar. Select the position which is needed for the job at hand.

**SPEED HANDLE.**—The speed handle is worked like the wood-worker's brace. After the nuts are first loosened with the sliding bar handle or the ratchet handle, the speed handle can be used to remove the nuts more quickly. In many instances the speed handle is not strong enough to be used for breaking loose or tightening the nut. The speed socket wrench should be used carefully to avoid damaging the nut threads.

### Accessories

To complete the socket wrench set, there are several accessory items. Extension bars of different lengths are made to extend the distance from the socket to the handle. A universal joint allows the nut to be turned with the wrench handle at an angle. Universal sockets are also available. The use of universal joints, bar extensions, and universal sockets in combination with appropriate handles makes it possible to form a variety of tools that will reach otherwise inaccessible nuts and bolts.

Another accessory item is an adapter which allows you to use a handle having one size of drive and a socket having a different size drive. For example, a 3/8- by 1/4-inch adapter makes it possible to turn all 1/4-inch square drive sockets with any 3/8-inch-square drive handle.

### TORQUE WRENCHES

There are times when, for engineering reasons, a definite force must be applied to a nut or bolt head. In such cases a torque wrench must be used. For example, equal force must be applied to all the head bolts of an engine. Otherwise, one bolt may bear the brunt of the force of internal combustion and ultimately cause engine failure.

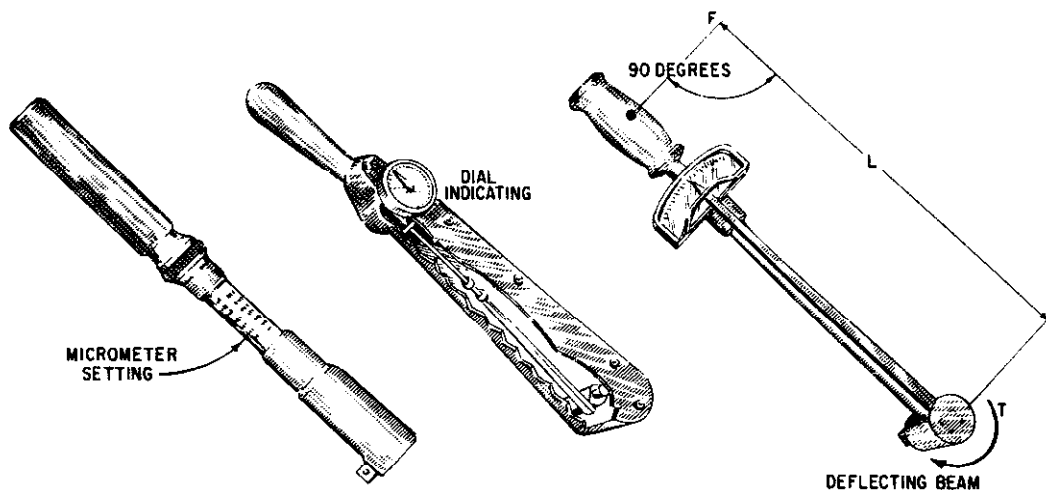
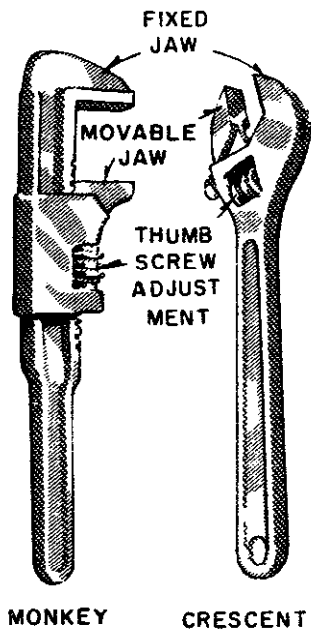

Figure 1-12.—Torque wrenches.

5.9



MONKEY      CRESCENT

44.6(44)B

Figure 1-13.—Adjustable wrenches.

The three most commonly used torque wrenches are the Deflecting Beam, Dial Indicating, and Micrometer Setting types (fig. 1-12). When using the Deflecting Beam and the

Dial Indicating torque wrenches, the torque is read visually on a dial or scale mounted on the handle of the wrench.

To use the Micrometer Setting type, unlock the grip and adjust the handle to the desired setting on the micrometer type scale, then re-lock the grip. Install the required socket or adapter to the square drive of the handle. Place the wrench assembly on the nut or bolt and pull in a clockwise direction with a smooth, steady motion. (A fast or jerky motion will result in an improperly torqued unit.) When the torque applied reaches the torque value, which is indicated on the handle setting, a signal mechanism will automatically issue an audible click, and the handle will release or "break," and move freely for a short distance. The release and free travel is easily felt, so there is no doubt about when the torquing process is complete.

Manufacturers' and technical manuals generally specify the amount of torque to be applied. To assure getting the correct amount of torque on the fasteners, it is important that the wrench be used properly in accordance with manufacturers' instructions.

Use that torque wrench which will read about mid-range for the amount of torque to be applied. **BE SURE THAT THE TORQUE WRENCH HAS BEEN CALIBRATED BEFORE YOU USE IT.** Remember, too, that the accuracy of torque-measuring depends a lot on how the threads are cut and the cleanliness of the threads. Make

sure you inspect and clean the threads. If the manufacturer specifies a thread lubricant, it must be used to obtain the most accurate torque reading. When using the Deflecting Beam or Dial Indicating wrenches, hold the torque at the desired value until the reading is steady.

Torque wrenches are delicate and expensive tools. The following precautions should be observed when using them:

1. When using the Micrometer Setting type, do not move the setting handle below the lowest torque setting. However, it should be placed at its lowest setting prior to returning to storage.
2. Do not use the torque wrench to apply greater amounts of torque than its rated capacity.
3. Do not use the torque wrench to break loose bolts which have been previously tightened.
4. Do not drop the wrench. If dropped, the accuracy will be affected.
5. Do not apply a torque wrench to a nut that has been tightened. Back off the nut one turn with a non-torque wrench and retighten to the correct torque with the indicating torque wrench.
6. Calibration intervals have been established for all torque tools used in the Navy. When a tool is calibrated by a qualified calibration activity at a shipyard, tender, or repair ship, a label showing the next calibration due date is attached to the handle. This date should be checked before a torque tool is used to ensure that it is not overdue for calibration.

**ADJUSTABLE WRENCHES**

A handy all-round wrench that is generally included in every toolbox is the adjustable

open-end wrench. This wrench is not intended to take the place of the regular solid open-end wrench. Additionally, it is not built for use on extremely hard-to-turn items. Its usefulness is achieved by being capable of fitting odd-sized nuts. This flexibility is achieved although one jaw of the adjustable open-end wrench is fixed because the other jaw is moved along a slide by a thumbscrew adjustment (fig. 1-13). By turning the thumbscrew, the jaw opening may be adjusted to fit various sizes of nuts.

Adjustable wrenches are available in varying sizes ranging from 4 to 24 inches in length. The size of the wrench selected for a particular job is dependent upon the size of nut or bolt head to which the wrench is to be applied. As the jaw opening increases the length of the wrench increases.

Adjustable wrenches are often called "knuckle busters," because mechanics frequently suffer these consequences as a result of improper usage of these tools. To avoid accidents, follow four simple steps. First, choose a wrench of the correct size; that is, do not pick a large 12-inch wrench and adjust the jaw for use on a 3/8-inch nut. This could result in a broken bolt and a bloody hand. Second, be sure the jaws of the correct size wrench are adjusted to fit snugly on the nut. Third, position the wrench around the nut until the nut is all the way into the throat of the jaws. If not used in this manner, the result is apt to be as bloody as before. Fourth, pull the handle toward the side having the adjustable jaw (fig. 1-14). This will prevent the adjustable jaw from springing open and slipping off the nut. If the location of the work will not allow for all four steps to be followed when using an adjustable wrench, then select another type of wrench for the job.

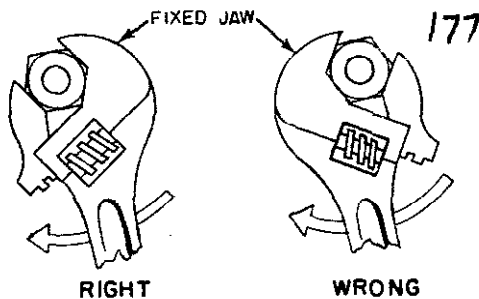

1.16.6(1)

Figure 1-14.—Proper procedure for pulling adjustable wrenches.

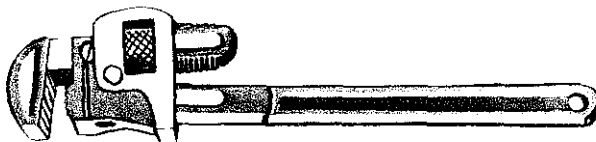

Pipe Wrench (Stillson)

When rotating or holding round work an adjustable pipe wrench (Stillson) may be used (fig. 1-15). The movable jaw on a pipe wrench is

44.6

Figure 1-15.—Adjustable pipe wrench.



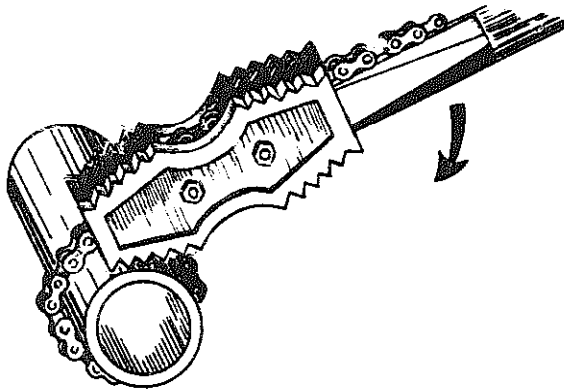

Figure 1-16.—Chain pipe wrench. 44.7

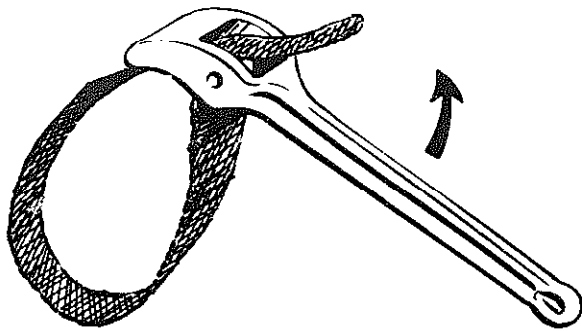
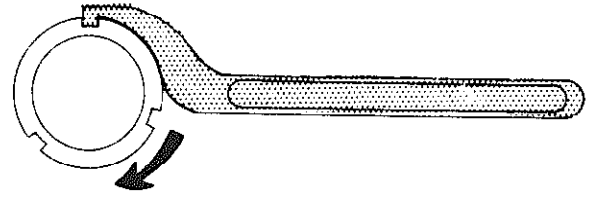

Figure 1-17.—Strap wrench. 44.208

pivoted to permit a gripping action on the work. This tool must be used with discretion, as the jaws are serrated and always make marks on the work unless adequate precautions are observed. The jaws should be adjusted so the bite on the work will be taken at about the center of the jaws.

**Chain Pipe Wrench**

A different type pipe wrench, used mostly on large sizes of pipe, is the chain/pipe wrench (fig. 1-16). This tool works in one direction only, but can be backed partly around the work and a fresh hold taken without freeing the chain. To reverse the operation the grip is taken on the opposite side of the head. The head is



HOOK SPANNER



ADJUSTABLE HOOK SPANNER

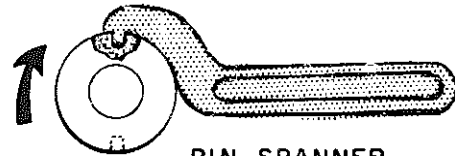

PIN SPANNER

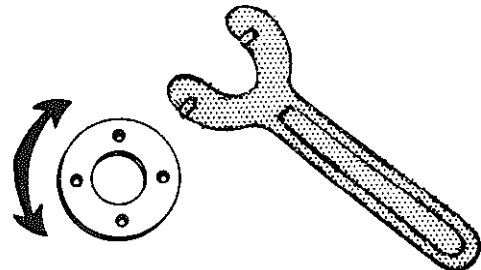

FACE PIN SPANNER

1.17:44.8

Figure 1-18.—General-purpose spanner wrenches.

double ended and can be reversed when the teeth on one end are worn out.

**Strap Wrench**

The strap wrench (fig. 1-17) is similar to the chain pipe wrench but uses a heavy web strap in place of the chain. This wrench is used for turning pipe or cylinders where you do not want to mar the surface of the work. To use this wrench, the webbed strap is placed

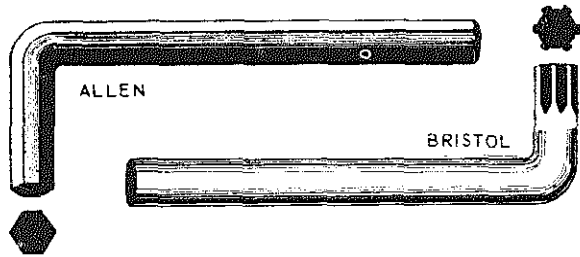

1.17.1-.2  
Figure 1-19.—Allen and Bristol type wrenches.

around the cylinder and passed through the slot in the metal body of the wrench. The strap is then pulled up tight and as the mechanic turns the wrench in the desired direction, the webbed strap tightens further around the cylinder. This gripping action causes the cylinder to turn.

#### SPANNER WRENCHES

Many special nuts are made with notches cut into their outer edge. For these nuts a hook spanner (fig. 1-18) is required. This wrench has a curved arm with a lug or hook on the end. This lug fits into one of the notches of the nut and the handle turned to loosen or tighten the nut. This spanner may be made for just one particular size of notched nut, or it may have a hinged arm to adjust it to a range of sizes.

Another type of spanner is the pin spanner. Pin spanners have a pin in place of a hook. This pin fits into a hole in the outer part of the nut.

Face pin spanners are designed so that the pins fit into holes in the face of the nut (fig. 1-18).

When you use a spanner wrench, you must ensure that the pins, lugs, or hooks make firm contact with the nut while the turning force is transferred from the wrench to the nut. If this is not done, damage will result to either personnel, tools, or equipment.

#### SETSCREW WRENCHES (ALLEN AND BRISTOL)

In some places it is desirable to use recessed heads on setscrews and capscrews. One type (Allen) screw is used extensively on office machines and in machine shops. The other type (Bristol) is used infrequently.

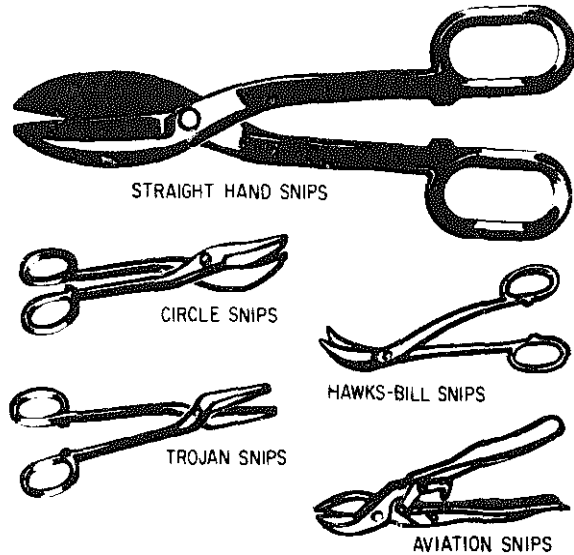

Figure 1-20.—Snips.

44.10

Recessed head screws usually have a hex-shaped (six-sided) recess. To remove or tighten this type screw requires a special wrench that will fit in the recess. This wrench is called an Allen-type wrench. Allen-type wrenches are made from hexagonal L-shaped bars of tool steel (fig. 1-19). They range in size up to 3/4 inch. When using the Allen-type wrench make sure you use the correct size to prevent rounding or spreading the head of the screw. A snug fit within the recessed head of the screw is an indication that you have the correct size.

The Bristol wrench is made from round stock. It is also L-shaped, but one end is fluted to fit the flutes or little splines in the Bristol setscrew (fig. 1-19).

#### NONSPARKING WRENCHES

Nonsparking wrenches are wrenches that will not cause sparks to be generated when working with steel nuts and bolts. They are generally made from a copper alloy (bronze). However, they may be made from other non-sparking materials.

Nonsparking wrenches must be used in areas where flammable materials are present. These tools are used extensively when working around gasoline-carrying vehicles and when working around aircraft or explosives.

## TOOLS AND THEIR USES

### SAFETY RULES FOR WRENCHES

There are a few basic rules that you should keep in mind when using wrenches. They are:

1. Always use a wrench that fits the nut properly.
2. Keep wrenches clean and free from oil. Otherwise they may slip, resulting in possible serious injury to you or damage to the work.
3. Do not increase the leverage of a wrench by placing a pipe over the handle. Increased leverage may damage the wrench or the work.
4. Provide some sort of kit or case for all wrenches. Return them to it at the completion of each job. This saves time and trouble and facilitates selection of tools for the next job. Most important, it eliminates the possibility of leaving them where they can cause injury or damage to men or equipment.
5. Determine which way a nut should be turned before trying to loosen it. Most nuts are turned counterclockwise for removal. This may seem obvious, but even experienced men have been observed straining at the wrench in the tightening direction when they wanted to loosen it.
6. Learn to select your wrenches to fit the type of work you are doing. If you are not familiar with these wrenches, make arrangements to visit a shop that has most of them and get acquainted.

### METAL CUTTING TOOLS

There are many types of metal cutting tools used by skilled mechanics of all ratings. As you become better acquainted with your rating,

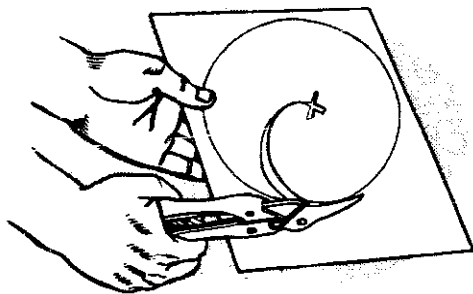

11.253X  
Figure 1-21.—Cutting an inside hole with snips.

you will probably discover many tools that you use for cutting metal that are not described in this text. In this text, only the basic hand metal cutting tools will be considered.

### SNIPS AND SHEARS

Snips and shears are used for cutting sheet metal and steel of various thicknesses and shapes. Normally, the heavier or thicker materials are cut by shears.

One of the handiest tools for cutting light (up to 1/16 inch thick) sheet metal is the hand snip (tip snips). The STRAIGHT HAND SNIPS shown in fig. 1-20 have blades that are straight and cutting edges that are sharpened to an 85-degree angle. Snips like this can be obtained in different sizes ranging from the small 6-inch to the large 14-inch snip. Tin snips will also work on slightly heavier gages of soft metals such as aluminum alloys.

Snips will not remove any metal when a cut is made. There is danger, though, of causing minute metal fractures along the edges of the metal during the shearing process. For this reason, it is better to cut just outside the layout line. This procedure will allow you to dress the cutting edge while keeping the material within required dimensions.

Cutting extremely heavy gage metal always presents the possibility of springing the blades. Once the blades are sprung, hand snips are useless. When cutting heavy material use the rear portion of the blades. This procedure not only

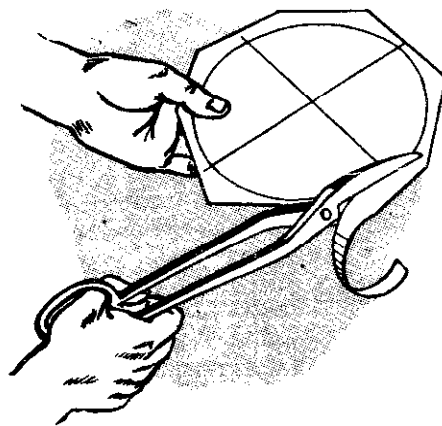

11.252X  
Figure 1-22.—Cutting a disk out of sheet metal.

avoids the possibility of springing the blades but also gives you greater cutting leverage.

Many snips have small serrations (notches) on the cutting edges of the blades. These serrations tend to prevent the snips from slipping backwards when a cut is being made. Although this feature does make the actual cutting easier, it mars the edges of the metal slightly. You can remove these small cutting marks if you allow proper clearance for dressing the metal to size. There are many other types of hand snips used for special jobs but the snips discussed here can be used for almost any common type of work.

#### Cutting Sheet Metal with Snips

It is hard to cut circles or small arcs with straight snips. There are snips especially designed for circular cutting. They are called **CIRCLE SNIPS**, **HAWKS-BILL SNIPS**, **TROJAN SNIPS**, and **AVIATION SNIPS** (fig. 1-20).

To cut large holes in the lighter gages of sheet metal, start the cut by punching or otherwise making a hole in the center of the area to be cut out. With an aviation snips, as shown in figure 1-21, or some other narrow-bladed snips, make a spiral cut from the starting hole out toward the scribed circle and continue cutting until the scrap falls away.

To cut a disk in the lighter gages of sheet metal, use a combination snips or a straight blade snips as shown in figure 1-22. First, cut away any surplus material outside of the scribed circle leaving only a narrow piece to be removed by the final cut. Make the final cut just outside of the layout line. This will permit you to see the scribed line while you are cutting and will cause the scrap to curl up below the blade of the snips where it will be out of the way while the complete cut is being made.

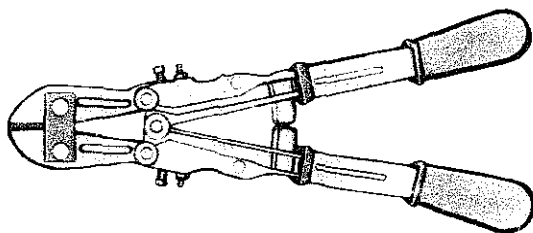

44.12

Figure 1-23.—Bolt cutters.

To make straight cuts, place the sheet metal on a bench with the marked guideline over the edge of the bench and hold the sheet down with one hand. With the other hand hold the snips so that the flat sides of the blades are at right angles to the surface of the work. If the blades are not at right angles to the surface of the work, the edges of the cut will be slightly bent and burred. The bench edge will also act as a guide when cutting with the snips. The snips will force the scrap metal down so that it does not interfere with cutting. Any of the hand snips may be used for straight cuts. When notches are too narrow to be cut out with a pair of snips, make the side cuts with the snips and cut the base of the notch with a cold chisel.

#### Safety and Care

Learn to use snips properly. They should always be oiled and adjusted to permit ease of cutting and to produce a surface that is free from burrs. If the blades bind, or if they are too far apart, the snips should be adjusted.

Never use snips as screwdrivers, hammers, or pry bars. They break easily.

Do not attempt to cut heavier materials than the snips are designed for. Never use tin snips to cut hardened steel wire or other similar objects. Such use will dent or nick the cutting edges of the blades.

Never toss snips in a toolbox where the cutting edges can come into contact with other tools. This dulls the cutting edges and may even break the blades.

When snips are not in use, hang them on hooks or lay them on an uncrowded shelf or bench.

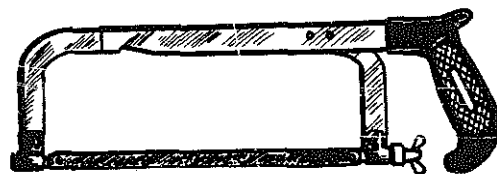

ADJUSTABLE



SOLID

1.19(44)

Figure 1-24.—Hacksaws.

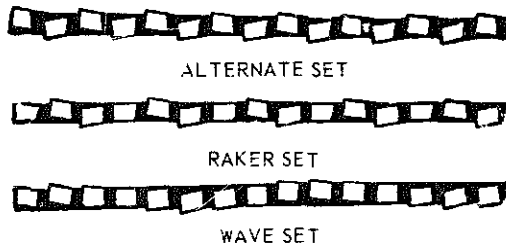

28.40(44)

Figure 1-25.—"Set" of hacksaw blade teeth.

14 TEETH PER INCH

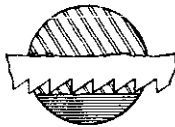

FOR LARGE SECTIONS OF MILD MATERIAL

18 TEETH PER INCH

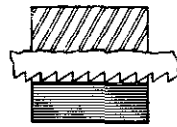

FOR LARGE SECTIONS OF TOUGH STEEL

24 TEETH PER INCH

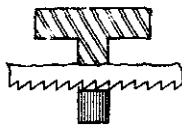

FOR ANGLE IRON, HEAVY PIPE, BRASS, COPPER

32 TEETH PER INCH

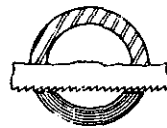

FOR THIN TUBING

KEEP AT LEAST TWO TEETH CUTTING TO AVOID THIS



44.167

Figure 1-26.—Selecting the proper hacksaw blade.

**BOLT CUTTERS**

Bolt cutters (fig. 1-23) are giant shears with very short blades and long handles. The handles are hinged at one end. The cutters are at the ends of extensions which are jointed in such a way that the inside joint is forced outwards when the handles are closed, thus forcing the cutting edges together with great force.

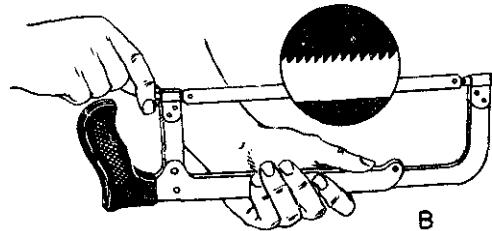
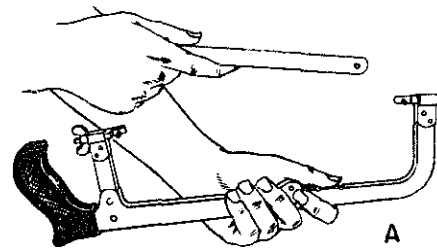

44.168

Figure 1-27.—Installing a hacksaw blade.

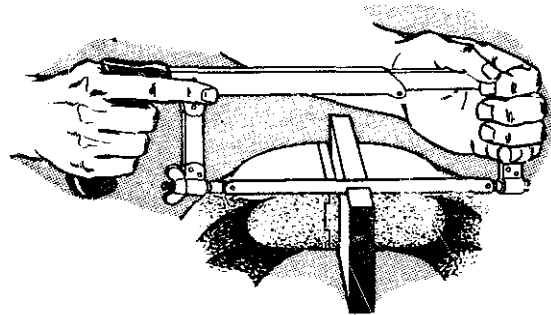

11.4

Figure 1-28.—Proper way to hold a hacksaw.

Bolt cutters are made in lengths of 18 to 36 inches. The larger ones will cut mild steel bolts and rods up to 1/2 inch. The material to be cut should be kept as far back in the jaws as possible. Never attempt to cut spring wire or other tempered metal with bolt cutters. This will cause the jaws to be sprung or nicked.

Adjusting screws near the middle hinges provide a means for ensuring that both jaws move the same amount when the handles are pressed together. Keep the adjusting screws just tight enough to ensure that the cutting edges meet along their entire length when the jaws are closed. The hinges should be kept well oiled at all times.

When using bolt cutters make sure your fingers are clear of the jaws and hinges. Take care that the bolt head or piece of rod cut off does not fly and injure you or someone else. If the cutters are brought together rapidly, sometimes a bolt-head or piece of rod being cut off will fly some distance.

Bolt cutters are fairly heavy, so make sure that they are stored in a safe place where they will not fall and injure someone.

## HACKSAWS

Hacksaws are used to cut metal that is too heavy for snips or boltcutters. Thus, metal bar stock can be cut readily with hacksaws.

There are two parts to a hacksaw; the frame and the blade. Common hacksaws have either an adjustable or solid frame (fig. 1-24). Most hacksaws found in the Navy are of the adjustable frame type. Adjustable frames can be made to hold blades from 8 to 16 inches long, while those with solid frames take only the length blade for which they are made. This length is the distance between the two pins that hold the blade in place.

Hacksaw blades are made of high-grade tool steel, hardened and tempered. There are two types, the all-hard and the flexible. All hard blades are hardened throughout, whereas only the teeth of the flexible blades are hardened. Hacksaw blades are about one-half inch wide, have from 14 to 32 teeth per inch, and are from 8 to 16 inches long. The blades have a hole at each end which hooks to a pin in the frame. All hacksaw frames which hold the blades either parallel or at right angles to the frame are provided with a wingnut or screw to permit tightening or removing the blade.

The SET in a saw refers to how much the teeth are pushed out in opposite directions from the sides of the blade. The four different kinds of set are ALTERNATE set, DOUBLE ALTERNATE set, RAKER set, and WAVE set. Three of these are shown in figure 1-25.

The teeth in the alternate set are staggered, one to the left and one to the right throughout the length of the blade. On the double alternate set blade, two adjoining teeth are staggered to the right, two to the left, and so on. On the raker set blade, every third tooth remains straight and the other two are set alternately. On the wave (undulated) set blade, short sections of teeth are bent in opposite directions.

## Using Hacksaws

The hacksaw is often used improperly. Although it can be used with limited success by an inexperienced man, a little thought and study given to its proper use will result in faster and better work and less dulling and breaking of blades.

Good work with a hacksaw depends not only upon the proper use of the saw, but also upon the proper selection of the blades for the work to be done. Figure 1-26 will help you select the proper blade to use when sawing metal with a hacksaw. Coarse blades with fewer teeth per inch cut faster and are less liable to choke up with chips. However, finer blades with more teeth per inch are necessary when thin sections are being cut. The selection should be made so that, as each tooth starts its cut, the tooth ahead of it will still be cutting.

To make the cut, first install the blade in the hacksaw frame (fig. 1-27) so that the teeth point away from the handle of the hacksaw. (Hand hacksaws cut on the push stroke.) Tighten the wingnut so that the blade is definitely under tension. This helps make straight cuts.

Place the material to be cut in a vise. A minimum of overhang will reduce vibration, give a better cut, and lengthen the life of the blade. Have the layout line outside of the vise jaw so that the line is visible while you work.

The proper method of holding the hacksaw is depicted in figure 1-28. See how the index finger of the right hand, pointed forward, aids in guiding the frame.

When cutting, let your body sway ahead and back with each stroke. Apply pressure on the forward stroke, which is the cutting stroke, but not on the return stroke. From 40 to 50 strokes per minute is the usual speed. Long, slow, steady strokes are preferred.

For long cuts (fig. 1-29) rotate the blade in the frame so that the length of the cut is not limited by the depth of the frame. Hold the work with the layout line close to the vise jaws, raising the work in the vise as the sawing proceeds.

Saw thin metal as shown in figure 1-30. Notice the long angle at which the blade enters the saw groove (kerf). This permits several teeth to be cutting at the same time.

Metal which is too thin to be held, as shown in figure 1-30, can be placed between blocks of wood, as shown in figure 1-31. The wood provides support for several teeth as they are

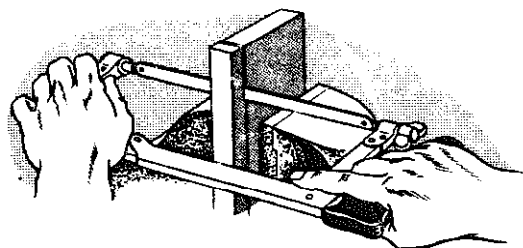

44.169

Figure 1-29.—Making a long cut near the edge of stock.

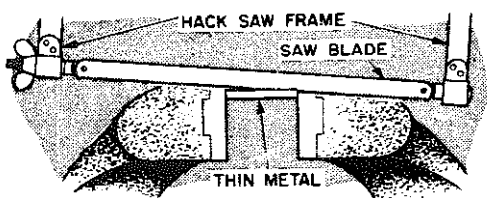

44.170

Figure 1-30.—Cutting thin metal with a hacksaw.

cutting. Without the wood, as shown at B in figure 1-31, teeth will be broken due to excessive vibration of the stock and because individual teeth have to absorb the full power of the stroke.

Cut thin metal with layout lines on the face by using a piece of wood behind it (fig. 1-32). Hold the wood and the metal in the jaws of the vise, using a C-clamp when necessary. The wood block helps support the blade and produces a smoother cut. Using the wood only in back of the metal permits the layout lines to be seen.

To remove a frozen nut with a hacksaw, saw into the nut as shown in figure 1-33, starting the blade close to the threads on the bolt or stud and parallel to one face of the nut as shown in figure 1-33A. Saw parallel to the bolt until the teeth of the blade almost reach the lockwasher. Lockwashers are hard and will ruin hacksaw blades, so do not try to saw them. Figure 1-33B shows when to stop sawing. Then, with a cold chisel and hammer, remove this one side of the nut completely by opening the saw kerf. Put an adjustable wrench across this new flat and the one opposite, and again try to remove the frozen nut. Since very little original metal remains

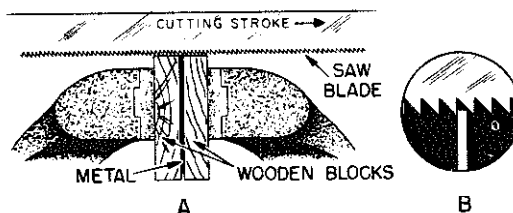

44.171

Figure 1-31.—Cutting thin metal between two wooden blocks.

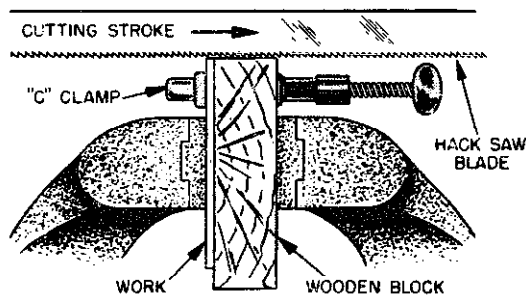

44.172

Figure 1-32.—Cutting thin metal using wood block with layout lines.

on this one side of the nut, the nut will either give or break away entirely and permit its removal.

To saw a wide kerf in the head of a cap screw or machine bolt, fit the hand hacksaw frame with two blades side by side, and with teeth lined up in the same direction. With slow, steady strokes, saw the slot approximately one-third the thickness of the head of the cap screw as shown in figure 1-34. Such a slot will permit subsequent holding or turning with a screwdriver when it is impossible, due to close quarters, to use a wrench.

#### Hacksaw Safety

The main danger in using hacksaws is injury to your hand if the blade breaks. The blade will break if too much pressure is applied, when the saw is twisted, when the cutting speed is too fast, or when the blade becomes loose in the frame. Additionally, if the work is not tight in the vise, it will sometimes slip, twisting the blade enough to break it.

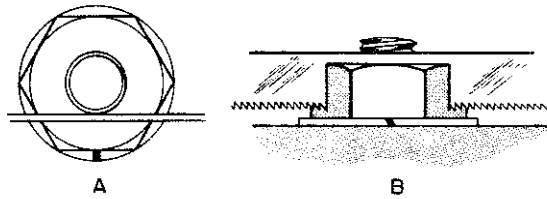

44.174  
Figure 1-33.—Removing a frozen nut with a hacksaw.

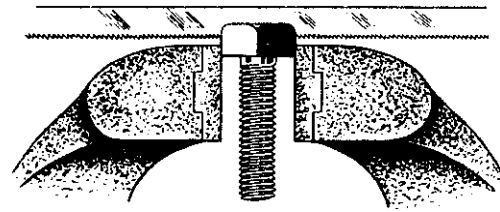

44.173  
Figure 1-34.—Cutting a wide kerf in the head of a capscrew or bolt.

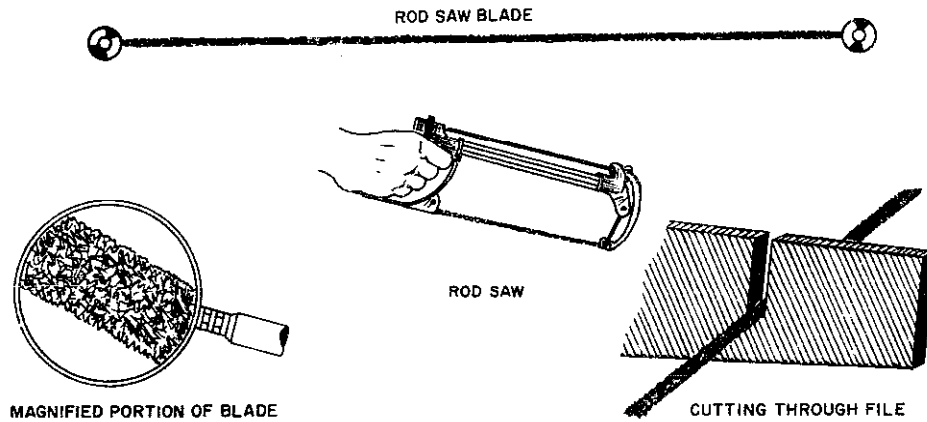

29.15(44B)X  
Figure 1-35.—Rod Saw and operations.

### ROD SAWS

An improvement in industrial technology provides us with a tool that can cut material an ordinary hacksaw can't even scratch. The rod saw (fig. 1-35) acts like a diamond in its capability of cutting hard metals and materials such as stainless steel, Inconel, titanium, and carbon phenolics.

The rod saw cuts through material by means of hundreds of tungsten-carbide particles permanently bonded to the rod (see magnified portion of fig. 1-35). The rod saw cuts through stainless steel and files with ease.

A unique feature of this saw is its capability of cutting on the forward and reverse strokes.

### CHISELS

Chisels are tools that can be used for chipping or cutting metal. They will cut any metal that is softer than the materials of which they

are made. Chisels are made from a good grade tool steel and have a hardened cutting edge and beveled head. Cold chisels are classified according to the shape of their points, and the width of the cutting edge denotes their size. The most common shapes of chisels are flat (cold chisel), cape, round nose, and diamond point (fig. 1-36).

The type chisel most commonly used is the flat cold chisel, which serves to cut rivets, split nuts, chip castings, and cut thin metal sheets. The cape chisel is used for special jobs like cutting keyways, narrow grooves and square corners. Round-nose chisels make circular grooves and chip inside corners with a fillet. Finally, the diamond-point is used for cutting V-grooves and sharp corners.

As with other tools there is a correct technique for using a chisel. Select a chisel that is large enough for the job. Be sure to use a hammer that matches the chisel; that is, the larger the chisel, the heavier the hammer. A heavy



TOOLS AND THEIR USES

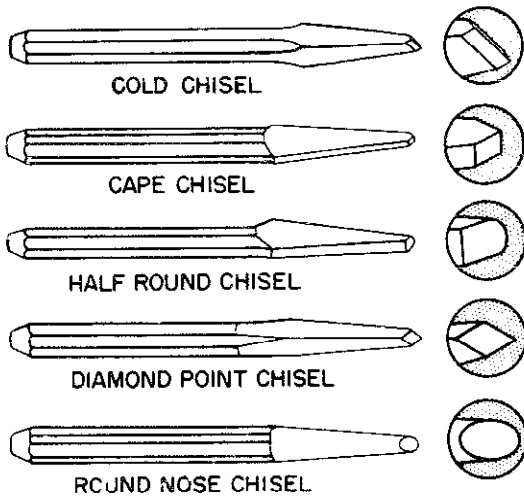

29.9M

Figure 1-36.—Types of points on metal cutting chisel.

chisel will absorb the blows of a light hammer and will do virtually no cutting.

As a general rule, hold the chisel in the left hand with the thumb and first finger about 1 inch from the top. It should be held steadily but not tightly. The finger muscles should be relaxed, so if the hammer strikes the hand it will permit the hand to slide down the tool and lessen the effect of the blow. Keep the eyes on the cutting edge of the chisel, not on the head, and swing the hammer in the same plane as the body of the chisel. If you have a lot of chiseling to do, slide a piece of rubber hose over the chisel. This will lessen the shock to your hand.

When using a chisel for chipping, always wear goggles to protect your eyes. If other men are working close by, see that they are protected from flying chips by erecting a screen or shield to contain the chips. Remember that the time to take these precautions is before you start the job.

FILES

A toolkit for nearly every rating in the Navy is not complete unless it contains an assortment of files. There are a number of different types of files in common use, and each type may range in length from 3 to 18 inches.

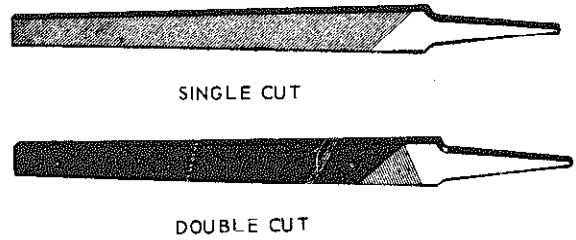

A. SINGLE AND DOUBLE-CUT FILES

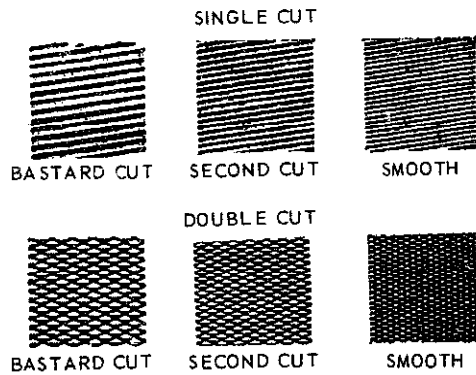

B. DESIGN AND SPACING OF FILE TEETH

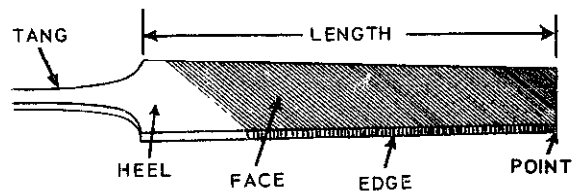

C. FILE NOMENCLATURE.



D. CROSS-SECTIONAL SHAPES OF FILES

1.20(44B)A

Figure 1-37.—File information.

Grades

Files are graded according to the degree of fineness, and according to whether they have single- or double-cut teeth. The difference is apparent when you compare the files in figure 1-37A.

Single-cut files have rows of teeth cut parallel to each other. These teeth are set at an angle of about 65 degrees with the centerline. You will use single-cut files for sharpening tools, finish filing, and drawfiling. They are also the best tools for smoothing the edges of sheet metal.

Files with crisscrossed rows of teeth are double-cut files. The double cut forms teeth that are diamond-shaped and fast cutting. You will use double-cut files for quick removal of metal, and for rough work.

Files are also graded according to the spacing and size of their teeth, or their coarseness

and fineness. Some of these grades are pictures in fig. 1-37B. In addition to the three grades shown, you may use some DEAD SMOOTH files, which have very fine teeth, and some ROUGH files with very coarse teeth. The fineness or coarseness of file teeth is also influenced by the length of the file. (The length of a file is the distance from the tip to the heel, and does not include the tang (fig. 1-37C).) When you have a chance, compare the actual size of the teeth of a 6-inch, single-cut smooth file and a 12-inch, single-cut smooth file; you will notice the 6-inch file has more teeth per inch than the 12-inch file.

Shapes

Files come in different shapes. Therefore, in selecting a file for a job, the shape of the finished work must be considered. Some of the cross sectional shapes are shown in figure 1-37D.

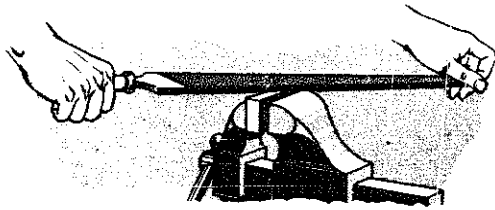

A. CROSSFILING A PIECE OF MILD STEEL

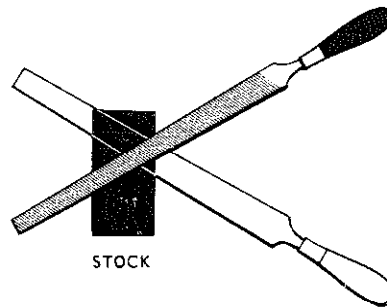

B. ALTERNATING POSITIONS WHEN FILING

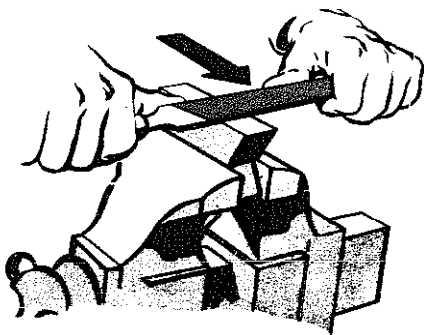

C. DRAWFILING A SMALL PART

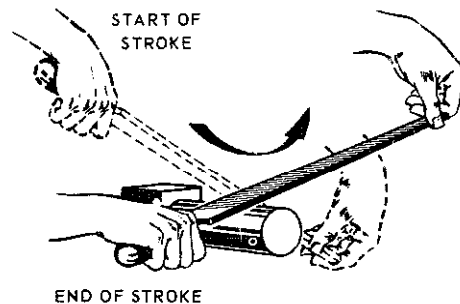

D. FILING ROUND METAL STOCK

1.20(44B)B

Figure 1-38.—Filing operations.

## TOOLS AND THEIR USES

**TRIANGULAR** files are tapered (longitudinally) on all three sides. They are used to file acute internal angles, and to clear out square corners. Special triangular files are used to file saw teeth.

**MILL** files are tapered in both width and thickness. One edge has no teeth and is known as a **SAFE EDGE**. Mill files are used for smoothing lathe work, drawfiling, and other fine, precision work. Mill files are always single-cut.

**FLAT** files are general-purpose files and may be either single- or double-cut. They are tapered in width and thickness. **HARD** files, not shown, are somewhat thicker than flat files. They taper slightly in thickness, but their edges are parallel.

The flat or hard files most often used are the double-cut for rough work and the single-cut, smooth file for finish work.

**SQUARE** files are tapered on all four sides and are used to enlarge rectangular-shaped holes and slots. **ROUND** files serve the same purpose for round openings. Small round files are often called "rattail" files.

The **HALF ROUND** file is a general-purpose tool. The rounded side is used for curved surfaces and the flat face on flat surfaces. When you file an inside curve, use a round or half-round file whose curve most nearly matches the curve of the work.

Kits of small files, often called "Swiss Pattern" or "Jewelers" files, are used to fit parts of delicate mechanisms, and for filing work on instruments. Handle these small files carefully because they break easily.

### FILING OPERATIONS

Using a file is an operation that is nearly indispensable when working with metal. You may be crossfiling, drawfiling, using a file card, or even polishing metal. Let's examine these operations.

When you have finished using a file it may be necessary to use an abrasive cloth or paper to finish the product. Whether this is necessary depends on how fine a finish you want on the work.

**CROSSFILING.**—Figure 1-38A shows a piece of mild steel being crossfiled. This means that the file is being moved across the surface of the work in approximately a crosswise direction.

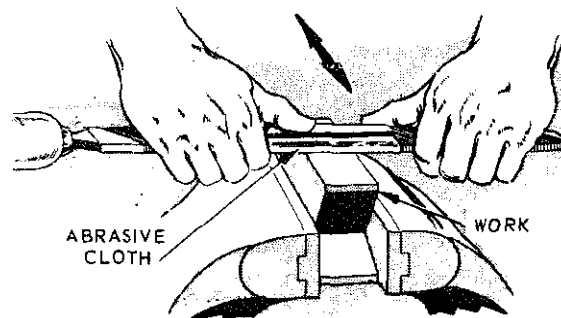

A. POLISHING METAL WITH ABRASIVE CLOTH WRAPPED AROUND A FILE

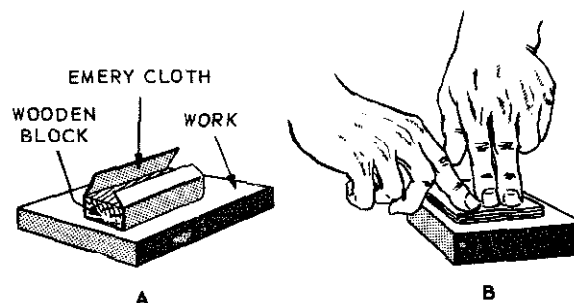

B. ALTERNATE METHODS FOR POLISHING METAL SURFACE

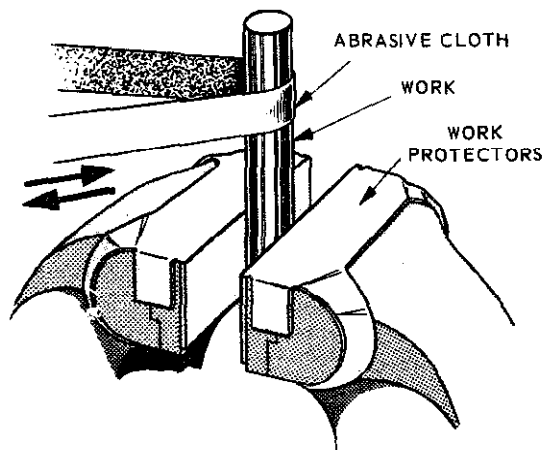

C. POLISHING ROUND METAL STOCK

44.135:136

Figure 1-39.—Polishing operations.

For best results, keep your feet spread apart to steady yourself as you file with slow, full-length, steady strokes. The file cuts as you push it—ease up on the return stroke to keep from dulling the teeth. Keep your file clean.

Figure 1-38B shows the alternate positions of the file when an exceptionally flat surface is required. Using either position first, file across the entire length of the stock. Then, using the other position, file across the entire length of the stock again. Because the teeth of the file pass over the surface of the stock from two directions, the high spots and low spots will readily be visible after filing in both positions. Continue filing first in one position or direction and then the other until the surface has been filed flat. Test the flatness with a straight edge or with prussian blue and a surface plate.

**DRAW FILING.**—Draw filing produces a finer surface finish and usually a flatter surface than crossfiling. Small parts, as shown in figure 1-38C, are best held in a vise. Hold the file as shown in the figure; notice that the arrow indicates that the cutting stroke is away from you when the handle of the file is held in the right hand. If the handle is held in the left hand, the cutting stroke will be toward you. Lift the file away from the surface of the work on the return stroke. When draw filing will no longer improve the surface texture, wrap a piece of abrasive cloth around the file and polish the surface as shown in figure 1-39A.

**USE OF FILE CARD.**—As you file, the teeth of the file may "clog up" with some of the metal filings and scratch your work. This condition is known as **PINNING**. You can prevent pinning by keeping the file teeth clean. Rubbing chalk between the teeth will help prevent pinning, too, but the best method is to clean the file frequently with a **FILE CARD** or brush. A file card (fig. 1-40) has fine wire bristles. Brush with a pulling motion, holding the card parallel to the rows of teeth.

Always keep the file clean, whether you're filing mild steel or other metals. Use chalk liberally when filing nonferrous metals.

**FILING ROUND METAL STOCK.**—Figure 1-38D shows that, as a file is passed over the surface of round work, its angle with the work is changed. This results in a rocking motion of the file as it passes over the work. This rocking motion permits all the teeth on the file to

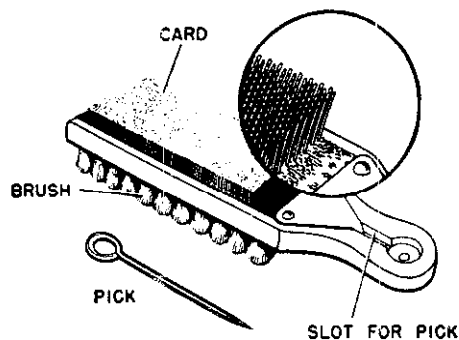

44.11

Figure 1-40.—File cleaner.

make contact and cut as they pass over the work's surface, thus tending to keep the file much cleaner and thereby doing better work.

**POLISHING A FLAT METAL SURFACE.**—When polishing a flat metal surface, first draw file the surface as shown in fig. 1-38C. Then, when the best possible draw filed surface has been obtained, proceed with abrasive cloth, often called emery cloth. Select a grade of cloth suited to the draw filing. If the draw filing was well done only a fine cloth will be needed to do the polishing.

If your cloth is in a roll, and the job you are polishing is the size that would be held in a vise, tear off a 6" or 8" length of the 1" or 2" width. If you are using sheets of abrasive cloth, tear off a strip from the long edge of the 8" by 11" sheet.

Wrap the cloth around the file (fig. 1-39A) and hold the file as you would for draw filing. Hold the end of the cloth in place with your thumb. In polishing, apply a thin film of lubricating oil on the surface being polished and use a double stroke with pressure on both the forward and the backward strokes. Note that this is different from the drawfiling stroke in which you cut with the file in only one direction.

When further polishing does not appear to improve the surface, you are ready to use the next finer grade of cloth. Before changing to the finer grade, however, reverse the cloth so that its back is toward the surface being polished.

Work the reversed cloth back and forth in the abrasive-laden oil as an intermediate step between grades of abrasive cloth. Then, with the

solvent available in your shop, clean the job thoroughly before proceeding with the next finer grade of cloth. Careful cleaning between grades helps to ensure freedom from scratches.

For the final polish, use a strip of crocus cloth—first the face and then the back—with plenty of oil. When polishing is complete, again carefully clean the job with a solvent and protect it, with oil or other means, from rusting.

Figure 1-39B(A) shows another way to polish in which the abrasive cloth is wrapped around a block of wood. In figure 1-39B(B), the cloth has simply been folded to form a pad from which a worn, dull surface can be removed by simply tearing it off to expose a new surface.

**POLISHING ROUND METAL STOCK.**—In figure 1-39C, a piece of round stock is being polished with a strip of abrasive cloth which is "seesawed" back and forth as it is guided over the surface being polished.

Remember that the selection of grades of abrasive cloth, the application of oil, and the cleaning between grades, applies to polishing regardless of how the cloth is held or used.

#### Care of Files

A new file should be broken in carefully by using it first on brass, bronze, or smooth cast iron. Just a few of the teeth will cut at first, so use a light pressure to prevent tooth breakage. Do not break in a new file by using it first on a narrow surface.

Protect the file teeth by hanging your files in a rack when they are not in use, or by placing them in drawers with wooden partitions. Your files should not be allowed to rust—keep them away from water and moisture. Avoid getting the files oily. Oil causes a file to slide across the work and prevents fast, clean cutting. Files that you keep in your toolbox should be wrapped in paper or cloth to protect their teeth and prevent damage to other tools.

Never use a file for prying or pounding. The tang is soft and bends easily. The body is hard and extremely brittle. Even a slight bend or a fall to the deck may cause a file to snap in two. Do not strike a file against the bench or vise to clean it—use a file card.

#### Safety

Never use a file unless it is equipped with a tight-fitting handle. If you use a file without the

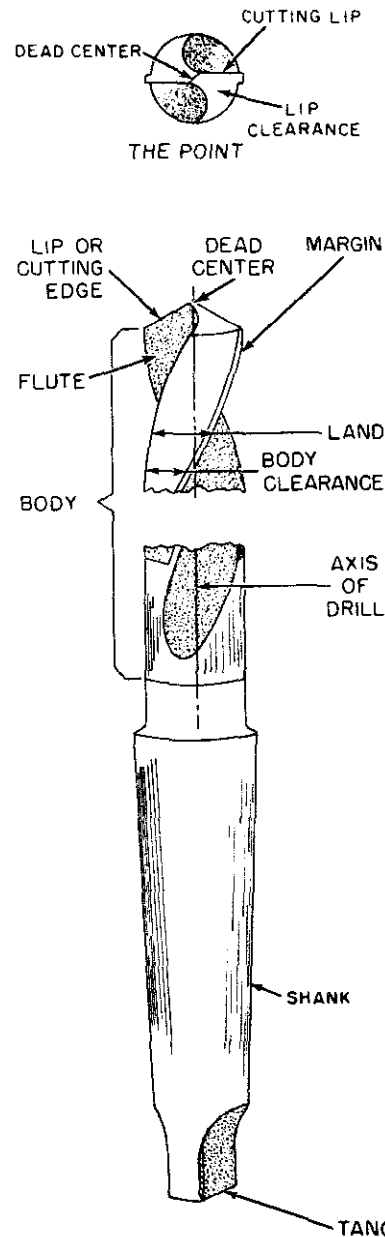

44.20(11)CX  
Figure 1-41.—Twist drill nomenclature.

handle and it bumps something or jams to a sudden stop, the tang may be driven into your hand. To put a handle on a file tang, drill a hole in the handle, slightly smaller than the tang. Insert the tang end, and then tap the end

of the handle to seat it firmly. Make sure you get the handle on straight.

## TWIST DRILLS

Making a hole in a piece of metal is generally a simple operation, but in most cases is an important and a precise job. A large number of different tools and machines have been designed so that holes may be made speedily, economically, and accurately in all kinds of material.

In order to be able to use these tools efficiently, it is well to become acquainted with them. The most common tool for making holes in metal is the twist drill. It consists of a cylindrical piece of steel with spiral grooves. One end of the cylinder is pointed while the other end is shaped so that it may be attached to a drilling machine. The grooves, usually called FLUTES, may be cut into the steel cylinder, or the flutes may be formed by twisting a flat piece of steel into a cylindrical shape.

The principal parts of a twist drill are the body, the shank, and the point (fig. 1-41). The dead center of a drill is the sharp edge at the extreme tip end of the drill. It is formed by the intersection of the cone-shaped surfaces of the point and should always be in the exact center of the axis of the drill. The point of the drill should not be confused with the dead center. The point is the entire cone-shaped surface at the end of the drill.

The lip or cutting edge of a drill is that part of the point that actually cuts away the metal when drilling a hole. It is ordinarily as sharp as the edge of a knife. There is a cutting edge for each flute of the drill.

The lip clearance of a drill is the surface of the point that is ground away or relieved just back of the cutting edge of the drill. The strip along the inner edge of the body is called the margin. It is the greatest diameter of the drill and extends the entire length of the flute. The diameter of the margin at the shank end of the drill is smaller than the diameter at the point. This allows the drill to revolve without binding when drilling deep holes.

The shank is the part of the drill which fits into the socket, spindle, or chuck of the drill press. Several types exist (fig. 1-42).

A tang is found only on tapered-shank drills. It is designed to fit into a slot in the socket or spindle of a machine. It may bear a portion of the driving torque, but its principal use is to

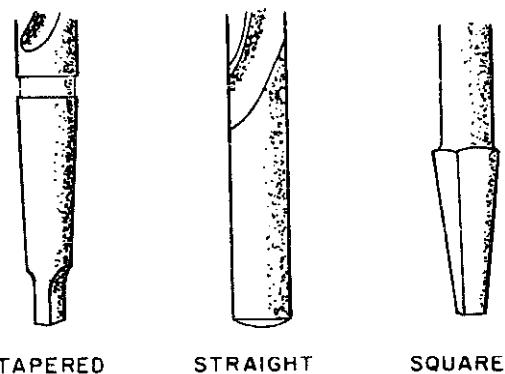

44.20(44B)

Figure 1-42.—Representative shanks.

make it easy to remove the drill from the socket of the driving machine.

Twist drills are provided in various sizes. They are sized by letters, numerals, and fractions.

Table 1-1 illustrates the relationship, by decimal equivalents, of all drill sizes (letter, number, and fractional) from number 80 to 1/2 inch. Note how the decimal sizes increase as the number of the drill decreases.

Sets of drills are usually made available according to the way the sizes are stated; that is "sets of letter drills" or "sets of number drills." However, twist drills of any size (letter, number, or fraction) are available individually if desired.

The maintenance of twist drills and more about how to use them on specific jobs are discussed later.

## COUNTERSINKS

Countersinking is the operation of beveling the mouth of a hole with a rotary tool called a countersink (fig. 1-43). The construction of the countersink is similar to the twist drill. There are four cutting edges, which are taper ground, to the angle marked on the body.

A countersink is used primarily to set the head of a screw or rivet flush with the material in which it is being placed. Countersinks are made in a number of sizes. One size usually takes care of holes of several different sizes. That is, the same countersink can be used for holes from 1/4 inch to 1/2 inch in diameter. Remove only enough metal to set the screw or rivet head flush with the material. If you

TOOLS AND THEIR USES

Table 1-1.—Decimal Equivalents of Drill Sizes

Drill	Decimal	Drill	Decimal	Drill	Decimal	Drill	Decimal
80	0.0135	49	0.073	20	0.161	H	0.266
79	0.0145	48	0.076	19	0.166	I	0.272
78	0.016	5/64	0.078125	18	0.1695	J	0.277
1/64	0.0156	47	0.0785	11/64	0.171875	K	0.281
77	0.018	46	0.081	17	0.173	9/32	0.28125
76	0.02	45	0.082	16	0.177	L	0.29
75	0.021	44	0.086	15	0.18	M	0.295
74	0.0225	43	0.089	14	0.182	19/64	0.296875
73	0.024	42	0.0935	13	0.185	N	0.302
72	0.025	3/32	0.09375	3/16	0.1875	5/16	0.3125
71	0.026	41	0.096	12	0.189	O	0.316
70	0.028	40	0.098	11	0.191	P	0.323
69	0.0292	39	0.0995	10	0.1935	21/64	0.328125
68	0.031	38	0.1015	9	0.196	Q	0.332
1/32	0.03125	37	0.104	8	0.199	R	0.339
67	0.032	36	0.1055	7	0.201	11/32	0.34375
66	0.033	7/64	0.109375	13/64	0.203125	S	0.348
65	0.035	35	0.11	6	0.204	T	0.358
64	0.036	34	0.111	5	0.2055	23/64	0.359375
63	0.037	33	0.113	4	0.209	U	0.368
62	0.038	32	0.116	3	0.213	3/8	0.375
61	0.039	31	0.12	7/32	0.21875	V	0.377
60	0.04	1/8	0.125	2	0.221	W	0.386
59	0.041	30	0.1285	1	0.228	25/64	0.390625
58	0.042	29	0.136	A	0.234	X	0.397
57	0.043	28	0.1405	15/64	0.234375	Y	0.404
56	0.0465	9/64	0.140625	B	0.238	13/32	0.40625
3/64	0.046875	27	0.144	C	0.242	Z	0.413
55	0.052	26	0.147	D	0.246	27/64	0.421875
54	0.055	25	0.1495	E	0.25	7/16	0.4375
53	0.0595	24	0.152	1/4	0.25	29/64	0.453125
1/16	0.0625	23	0.154	F	0.257	15/32	0.46875
52	0.0635	5/32	0.15625	G	0.261	31/64	0.484375
51	0.067	22	0.157	17/64	0.265625	1/2	0.5
50	0.07	21	0.159				

44.209

remove too much material the hole will enlarge and weaken the work.

Select the countersink with the correct lip angle to correspond with the screw or rivet head being used. These countersinks can be turned by any machine that will turn a twist drill.

REAMERS

Reamers are used to enlarge and true a hole. The reamer consists of three parts—the body, the shank, and the blades. The shank has a square tang to allow the reamer to be held

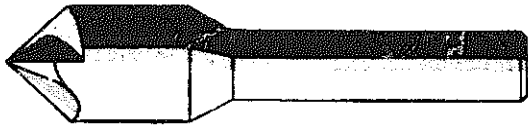

28.59(44)

Figure 1-43.—Countersink.

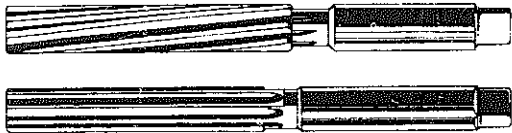

5.10.1

Figure 1-44.—Above—solid spiral flute reamer. Below—solid straight flute reamer.



5.10.2

Figure 1-45.—Expansion reamer.

with a wrench for turning. The main purpose of the body is to support the blades.

The blades on a reamer are made of steel and hardened to such an extent that they are brittle. For this reason you must be careful when using and storing the reamer to protect the blades from chipping. When you are reaming a hole, turn the reamer in the **CUTTING DIRECTION ONLY**. This will prevent chipping or dulling of the blades. Great care should be used to assure even, steady turning. Otherwise, the reamer will "chatter," causing the hole to become marked or scored. To prevent damage to the reamer while not in use, wrap it in an oily cloth and keep it in a box.

Reamers of the types shown in figure 1-44 are available in any standard size. They are also available in size variations of .001" for special work. A solid straight flute reamer lasts longer and is less expensive than the expansion reamer. However, the solid spiral flute reamer is preferred by craftsmen because it is less likely to chatter.

For general purposes, an expansion reamer (fig. 1-45) is the most practical. This reamer can usually be obtained in standard sizes from



CENTER PUNCH

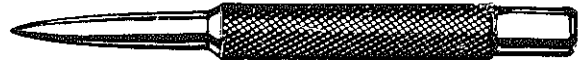

PRICK PUNCH



DRIFT OR STARTING PUNCH



PIN PUNCH

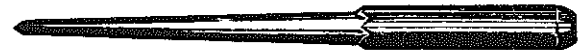

ALINING PUNCH



HOLLOW SHANK GASKET PUNCH

1.18(44B)

Figure 1-46.—Punches.

1/4 of an inch to 1 inch, by 32nds. It is designed to allow the blades to expand 1/32 of an inch. For example, the 1/4-inch expansion reamer will ream a 1/4-inch to a 9/32-inch hole. A 9/32-inch reamer will enlarge the hole from 9/32 of an inch to 5/16 of an inch. This range of adjustment allows a few reamers to cover sizes up to 1 inch.

Reamers are made of carbon steel and high-speed steel. In general, the cutting blades of a high-speed reamer lose their keenness more quickly than a carbon steel reamer. However, after that keenness is gone, it will last longer than the carbon reamer.

## PUNCHES

A hand punch is a tool that is held in the hand and struck on one end with a hammer. There are many kinds of punches designed to do a variety of jobs. Figure 1-46 shows several types of punches. Most punches are made of tool steel. The part held in the hand is usually octagonal shaped, or it may be knurled. This



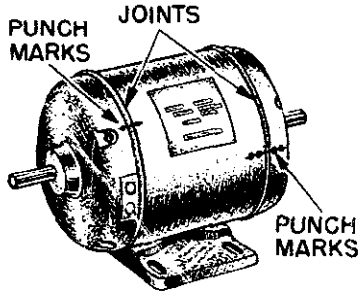

28.32

Figure 1-47.—Punching mating parts of a mechanism.

prevents the tool from slipping around in the hand. The other end is shaped to do a particular job.

When you use a punch, there are two things to remember:

1. When you hit the punch you do not want it to slip sideways over your work.
2. You do not want the hammer to slip off the punch and strike your fingers. You can eliminate both these troubles by holding the punch at right angles to the work, and striking the punch squarely with your hammer.

The center punch, as the name implies, is used for marking the center of a hole to be drilled. If you try to drill a hole without first punching the center, the drill will "wander" or "walk away" from the desired center.

Another use of the center punch is to make corresponding marks on two pieces of an assembly to permit reassembling in the original positions. Before taking a mechanism apart, make a pair of center punchmarks in one or more places to help in reassembly. To do this, select places, staggered as shown in figure 1-47, where matching pieces are joined. First clean the places selected. Then scribe a line across the joint and center punch the line on both sides of the joint, with single and double marks as shown to eliminate possible errors. In reassembly, refer first to the sets of punchmarks to determine the approximate position of the parts. Then line up the scribed lines to determine the exact position.

Automatic center punches are useful for layout work. They are operated by pressing down

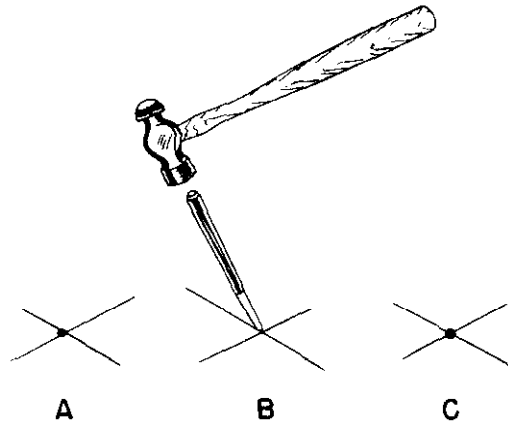

44.83

Figure 1-48.—Marking the intersection of lines with a prick punch.

on the shank by hand. An inside spring is compressed and released automatically, striking a blow on the end of the punch. The impression is light, but adequate for marking, and serves to locate the point of a regular punch when a deeper impression is required.

The point of a center punch is accurately ground central with the shank, usually at a 60-90 degree angle, and is difficult to regrind by hand with any degree of accuracy. It is, therefore, advisable to take care of a center punch and not to use it on extremely hard materials. When extreme accuracy is required a prick punch is used. Compare the point angle of the center and prick punches.

To make the intersection of two layout lines, bring the point of the prick punch to the exact point of intersection and tap the punch lightly with a hammer. If inspection shows that the exact intersection and the punchmark do not coincide, as at A in figure 1-48, slant the punch as shown at B and again strike with the hammer, thus enlarging the punchmark and centering it exactly. When the intersection has been correctly punched, finish off with a light blow on the punch held in an upright position. C shows the corrected punchmark.

DRIFT punches, sometimes called "starting punches," have a long taper from the tip to the body. They are made that way to withstand the shock of heavy blows. They may be used for knocking out rivets after the heads have been

chiseled off, or for freeing pins which are "frozen" in their holes.

After a pin has been loosened or partially driven out, the drift punch may be too large to finish the job. The followup tool to use is the **PIN PUNCH**. It is designed to follow through the hole without jamming. Always use the largest drift or pin punch that will fit the hole. These punches usually come in sets of three to five assorted sizes. Both of these punches will have flat points, never edged or rounded.

To remove a bolt or pin that is extremely tight, start with a drift punch that has a point diameter that is slightly smaller than the diameter of the object you are removing. As soon as it loosens, finish driving it out with a pin punch. Never use a pin punch for starting a pin because it has a slim shank and a hard blow may cause it to bend or break.

For assembling units of a machine an **ALINEMENT** (alining) punch is invaluable. It is usually about 1 foot long and has a long gradual taper. Its purpose is to line up holes in mating parts.

Hollow metal cutting punches are made from hardened tool steel. They are made in various sizes and are used to cut holes in light gage sheet metal.

Other punches have been designed for special uses. One of these is the soft-faced drift. It is made of brass or fiber and is used for such jobs as removing shafts, bearings, and wrist pins from engines. It is generally heavy enough to resist damage to itself, but soft enough not to injure the finished surface on the part that is being driven.

You may have to make gaskets of rubber, cork, leather, or composition materials. For cutting holes in gasket materials a hollow shank **GASKET PUNCH** may be used (fig. 1-46). Gasket punches come in sets of various sizes to accommodate standard bolts and studs. The cutting end is tapered to a sharp edge to produce a clean uniform hole. To use the gasket punch, place the gasket material to be cut on a piece of hard wood or lead so that the cutting edge of the punch will not be damaged. Then strike the punch with a hammer, driving it through the gasket where holes are required.

#### TAPS AND DIES

Taps and dies are used to cut threads in metal, plastics, or hard rubber. The taps are used for cutting internal threads, and the dies



TAPER PIPE



TAPER HAND

CHAMFER LENGTH



PLUG HAND—NATIONAL COARSE



BOTTOMING HAND

11.5.1

Figure 1-49.—Types of common taps.

are used to cut external threads. There are many different types of taps. However, the most common are the taper, plug, bottoming, and pipe taps (fig. 1-49).

The taper (starting) hand tap has a chamfer length of 8 to 10 threads. These taps are used when starting a tapping operation and when tapping through holes.

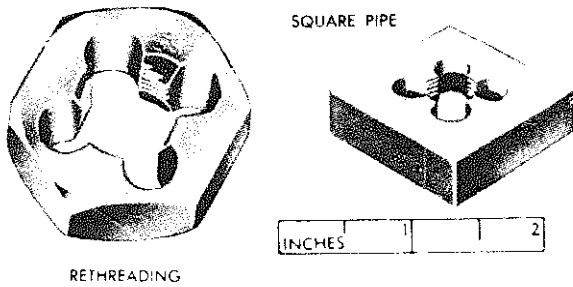

Figure 1-50.—Types of solid dies. 11.5.4

Plug hand taps have a chamfer length of 3 to 5 threads and are designed for use after the taper tap.

Bottoming hand taps are used for threading the bottom of a blind hole. They have a very

short chamfer length of only 1 to 1 1/2 threads for this purpose. This tap is always used after the plug tap has already been used. Both the taper and plug taps should precede the use of the bottoming hand tap.

Pipe taps are used for pipe fittings and other places where extremely tight fits are necessary. The tap diameter, from end to end of threaded portion, increases at the rate of 3/4 inch per foot. All the threads on this tap do the cutting, as compared to the straight taps where only the nonchamfered portion does the cutting.

Dies are made in several different shapes and are of the solid or adjustable type. The square pipe die (fig. 1-50) will cut American Standard Pipe Thread only. It comes in a variety of sizes for cutting threads on pipe with diameters of 1/8 inch to 2 inches.

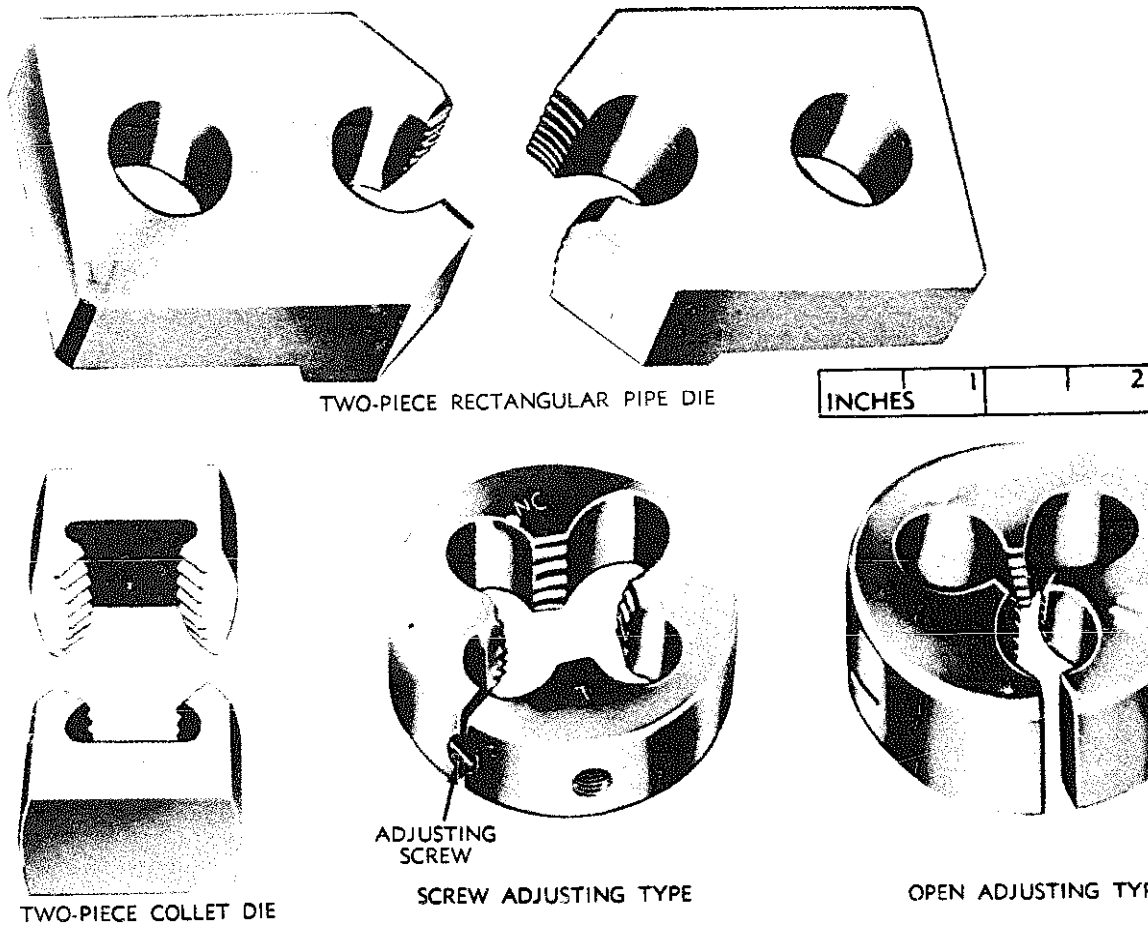
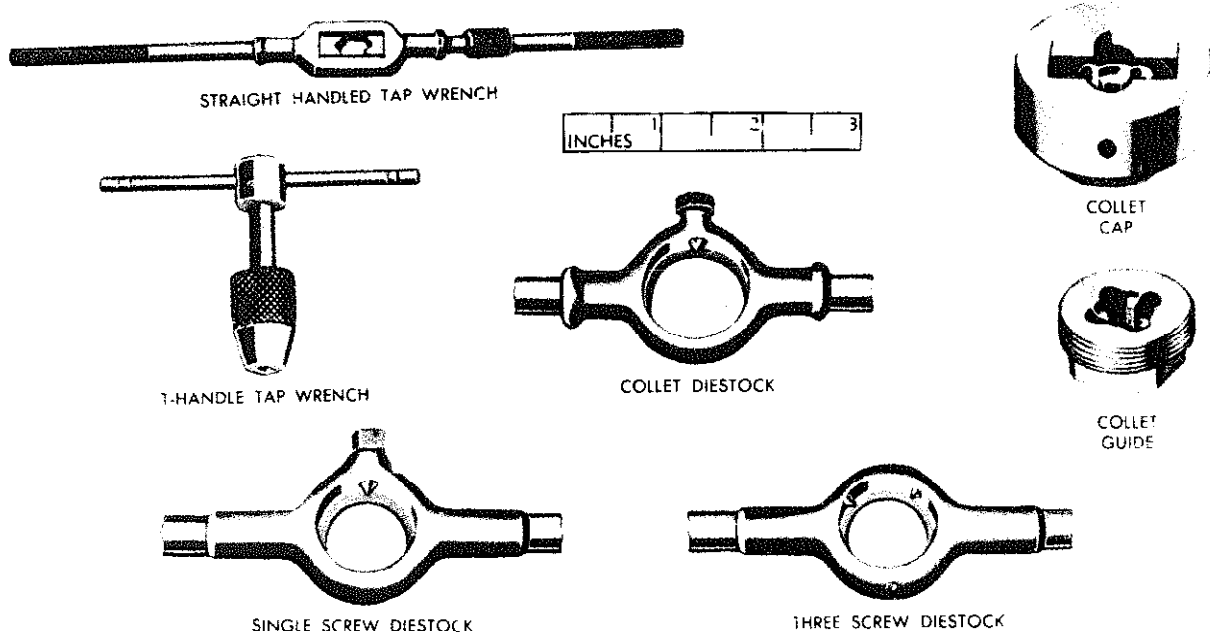
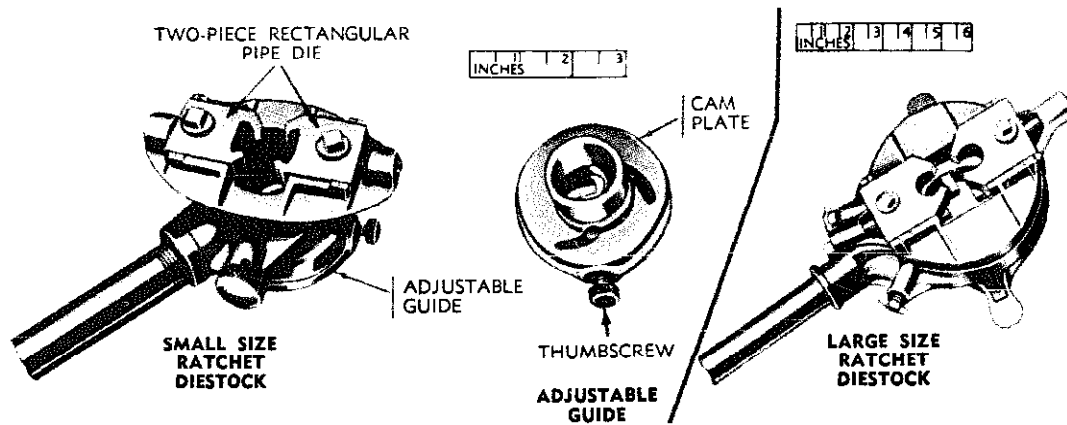

Figure 1-51.—Types of adjustable dies. 11.5.2



11.5.6

Figure 1-52.—Diestocks, diecollet, and tap wrenches.



44.31

Figure 1-53.—Adjustable die guide and ratchet diestocks.

A rethreading die (fig. 1-50) is used principally for dressing over bruised or rusty threads on screws or bolts. It is available in a variety of sizes for rethreading American Standard Coarse and Fine threads. These dies are usually hexagon in shape and can be turned with a socket, box, open-end, or any wrench that will fit. Rethreading dies are available in sets of 6, 10, 14, and 28 assorted sizes in a case.

Round split adjustable dies (fig. 1-51) are called "Button" dies and can be used in either hand diestocks or machine holders. The adjustment in the screw adjusting type is made by a fine-pitch screw which forces the sides of the die apart or allows them to spring together. The adjustment in the open adjusting types is made by means of three screws in the holder, one for expanding and two for compressing the

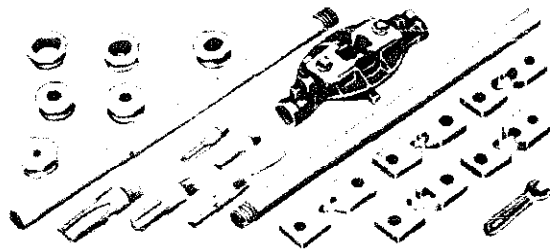

PIPE THREADING SET WITH RECTANGULAR ADJUSTABLE DIES, DIESTOCK, WRENCH, GUIDES AND TAPS

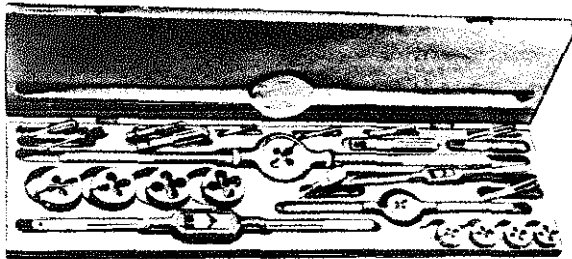

BOLT AND SCREW THREADING SET WITH ROUND ADJUSTABLE SPLIT DIES, DIESTOCKS, TAPS, TAP WRENCHES, AND SCREWDRIVERS

44.32

Figure 1-54.—Threading sets.

dies. Round split adjustable dies are available in a variety of sizes to cut American Standard Coarse and Fine threads, special form threads, and the standard sizes of threads that are used in Britain and other European countries. For hand threading, these dies are held in diestocks (fig. 1-52). One type die stock has three pointed screws that will hold round dies of any construction, although it is made specifically for open adjusting-type dies.

Two piece collet dies (fig. 1-51) are used with a collet cap (fig. 1-52) and collet guide. The die halves are placed in the cap slot and are held in place by the guide which screws into the underside of the cap. The die is adjusted by means of setscrews at both ends of the internal slot. This type of adjustable die is issued in various sizes to cover the cutting range of American Standard Coarse and Fine and special form threads. Diestocks to hold the dies come in three different sizes.

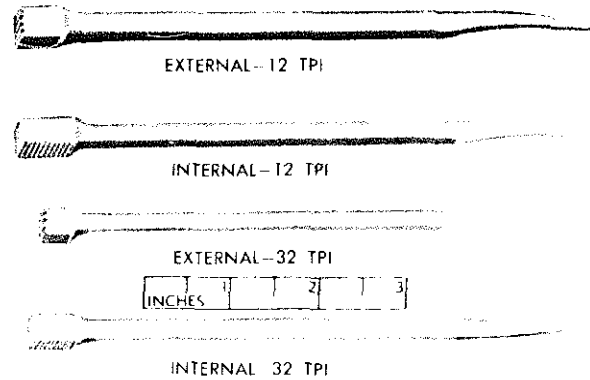

44.33

Figure 1-55.—Thread chasers.

Two-piece rectangular pipe dies (fig. 1-51) are available to cut American Standard Pipe threads. They are held in ordinary or ratchet-type diestocks (fig. 1-53). The jaws of the dies are adjusted by means of setscrews. An adjustable guide serves to keep the pipe in alignment with respect to the dies. The smooth jaws of the guide are adjusted by means of a cam plate; a thumbscrew locks the jaws firmly in the desired position.

Threading sets are available in many different combinations of taps and dies, together with diestocks, tap wrenches, guides and necessary screwdrivers and wrenches to loosen and tighten adjusting screws and bolts. Figure 1-54 illustrates typical threading set for pipe, bolts, and screws.

Never attempt to sharpen taps or dies. Sharpening of taps and dies involves several highly precise cutting processes which involve the thread characteristics and chamfer. These sharpening procedures must be done by experienced personnel in order to maintain the accuracy and the cutting effectiveness of taps and dies.

Keep taps and dies clean and well oiled when not in use. Store them so that they do not contact each other or other tools. For long periods of storage, coat taps and dies with a rust-preventive compound, place in individual or standard threading set boxes, and store in a dry place.

#### THREAD CHASERS

Thread chasers are threading tools that have several teeth and are used to rethread

(chase) damaged external or internal threads (fig. 1-55). These tools are available to chase standard threads. The internal thread chaser has its cutting teeth located on a side face. The external thread chaser has its cutting teeth on the end of the shaft. The handle end of the tool shaft tapers to a point.

### SCREW AND TAP EXTRACTORS

Screw extractors are used to remove broken screws without damaging the surrounding material or the threaded hole. Tap extractors are used to remove broken taps.

Some screw extractors (fig. 1-56A) are straight, having flutes from end to end. These extractors are available in sizes to remove broken screws having 1/4 to 1/2 inch outside diameters. Spiral tapered extractors are sized to remove screws and bolts from 3/16 inch to 2 1/8 inches outside diameter.

Most sets of extractors include twist drills and a drill guide. Tap extractors are similar to the screw extractors and are sized to remove taps ranging from 3/16 to 2 1/8 inches outside diameter.

To remove a broken screw or tap with a spiral extractor, first drill a hole of proper size in the screw or tap. The size hole required for each screw extractor is stamped on it. The extractor is then inserted in the hole, and turned counterclockwise to remove the defective component.

If the tap has broken off at the surface of the work, or slightly below the surface of the work, the straight tap extractor shown in figure 1-56 may remove it. Apply a liberal amount of penetrating oil to the broken tap. Place the tap extractor over the broken tap and lower the upper collar to insert the four sliding prongs down into the four flutes of the tap. Then slide the bottom collar down to the surface of the work so that it will hold the prongs tightly against the body of the extractor. Tighten the tap wrench on the square shank of the extractor and carefully work the extractor back and forth to loosen the tap. It may be necessary to remove the extractor and strike a few sharp blows with a small hammer and pin punch to jar the tap loose. Then reinsert the tap remover and carefully try to back the tap out of the hole.

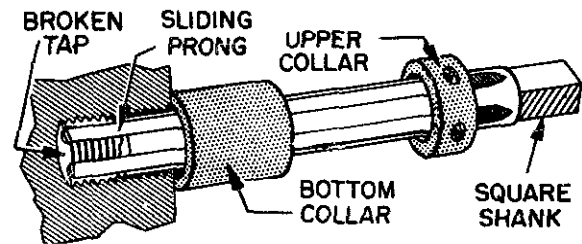

A. STRAIGHT TAP

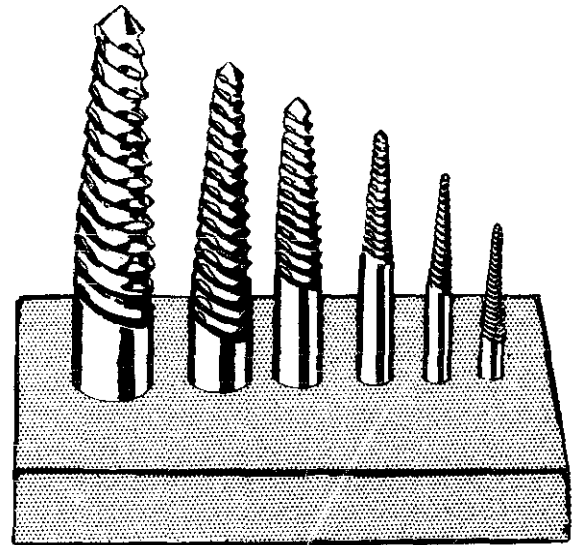

B. SPIRAL SCREW

4.37:44.191

Figure 1-56.—Screw and tap extractors.

### PIPE AND TUBING CUTTERS AND FLARING TOOLS

Pipe cutters (fig. 1-57) are used to cut pipe made of steel, brass, copper, wrought iron, and lead. Tube cutters (fig. 1-57) are used to cut tubing made of iron, steel, brass, copper, and aluminum. The essential difference between pipe and tubing is that tubing has considerably thinner walls. Flaring tools (fig. 1-58) are used to make single or double flares in the ends of tubing.

Two sizes of hand pipe cutters are generally used in the Navy. The No. 1 pipe cutter has a cutting capacity of 1/8 to 2 inches, and the No. 2 pipe cutter has a cutting capacity of 2 to 4

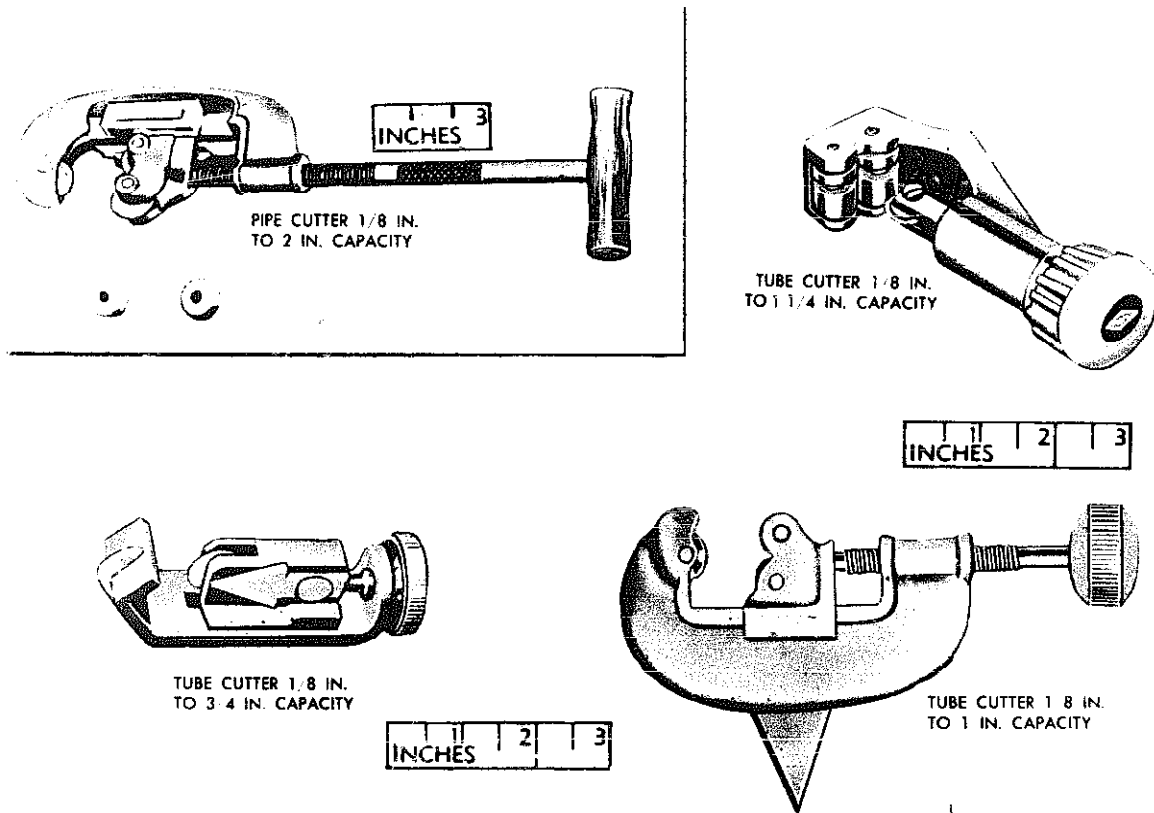

44.36

Figure 1-57.—Pipe and tubing cutters.

inches. The pipe cutter (fig. 1-57) has a special alloy-steel cutting wheel and two pressure rollers which are adjusted and tightened by turning the handle.

Most TUBE CUTTERS closely resemble pipe cutters, except that they are of lighter construction. A hand screw feed tubing cutter of 1/8-inch to 1 1/4-inch capacity (fig. 1-57) has two rollers with cutouts located off center so that cracked flares may be held in them and cut off without waste of tubing. It also has a retractable cutter blade that is adjusted by turning a knob. The other tube cutter shown is designed to cut tubing up to and including 3/4 and 1 inch outside diameter. Rotation of the triangular portion of the tube cutter within the tubing will eliminate any burrs.

FLARING TOOLS (fig. 1-58) are used to flare soft copper, brass, or aluminum. The single flaring tool consists of a split die block that has holes for 3/16-, 1/4-, 5/16-, 3/8-,

7/16-, and 1/2-inch outer diameter (o.d.) tubing, a clamp to lock the tube in the die block, and a yoke that slips over the die block and has a compressor screw and a cone that forms a 45° flare or a bell shape on the end of the tube. The screw has a T-handle. A double flaring tool has the additional feature of adapters that turn in the edge of the tube before a regular 45° double flare is made. It consists of a die block with holes for 3/16-, 1/4-, 5/16-, 3/8-, and 1/2-inch tubing, a yoke with a screw and a flaring cone, plus five adapters for different size tubing, all carried in a metal case.

#### WOODCUTTING HANDTOOLS

A man working with wood uses a large variety of handtools. He should be familiar with these tools, their proper names, the purpose for which they are used, and how to keep them in good condition.

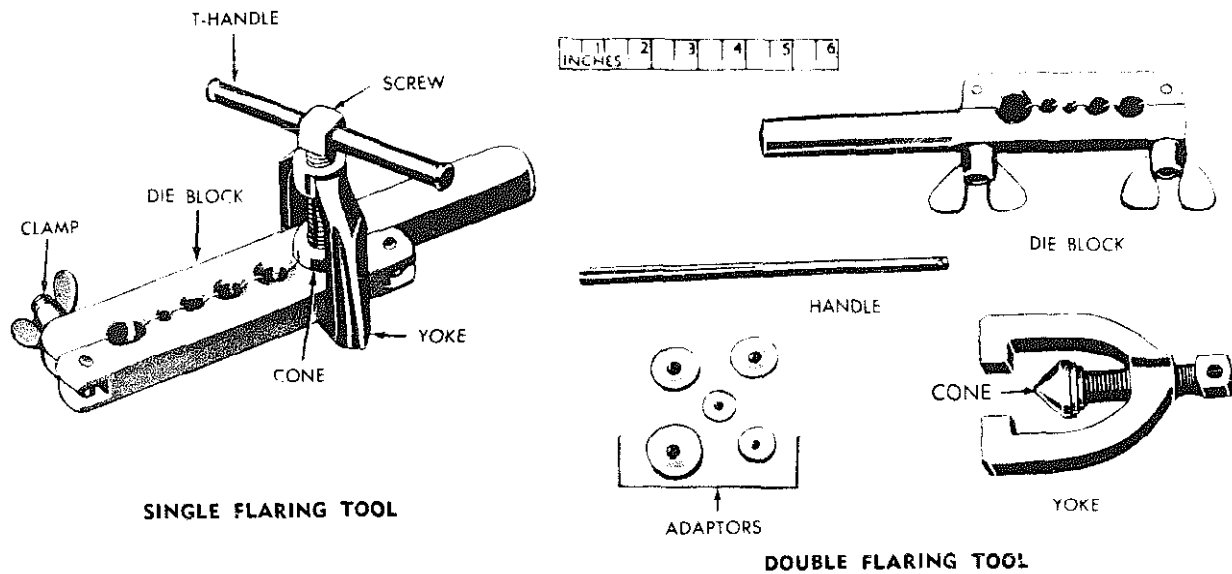

Figure 1-58.—Flaring tools.

44.37

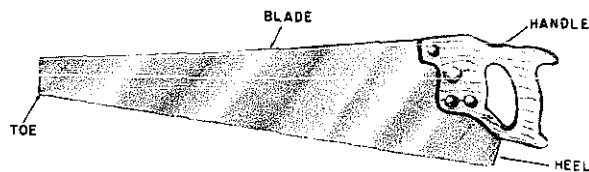

Figure 1-59.—Nomenclature of a handsaw.

29.15(44)

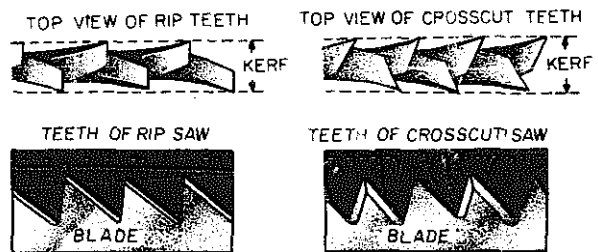

Figure 1-61.—Comparing rip and crosscut-saw teeth.

29.15(44B)



Figure 1-60.—"Set" of hand saw teeth.

29.15A

In this section of the text, only the basic woodcutting tools are covered. It includes tools that any man in the Navy may have the occasion to use during his career.

**HANDBSAWS**

The most common carpenter's handsaw consists of a steel blade with a handle at one end.

The blade is narrower at the end opposite the handle. This end of the blade is called the "point" or "toe." The end of the blade nearest the handle is called the "heel" (fig. 1-59). One edge of the blade has teeth, which act as two rows of cutters. When the saw is used, these teeth cut two parallel grooves close together. The chips (sawdust) are pushed out from between the grooves (kerf) by the beveled part of the teeth. The teeth are bent alternately to one side or the other, to make the kerf wider than the thickness of the blade. This bending is called the "set" of the teeth (fig. 1-60). The number of teeth per inch, the size and shape of the teeth, and the amount of set depend on the



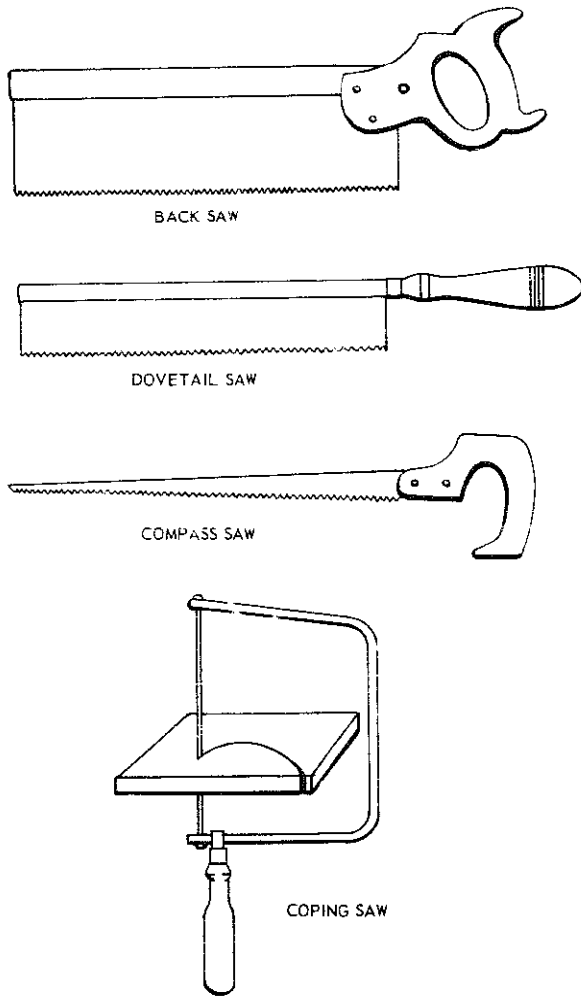

BACK SAW

DOVETAIL SAW

COMPASS SAW

COPING SAW

29.20-.22

Figure 1-62.—Special saws.

use to be made of the saw and the material to be cut. Carpenter's handsaws are described by the number of points per inch. By custom, there is always one more point than there are teeth per inch. A number stamped near the handle gives the number of points of the saw.

#### Cross-cut and Rip Saws

Woodworking handsaws designed for general cutting consist of RIPSAWS and CROSSCUT saws. Ripsaws are used for cutting with the grain and crosscut saws are for cutting across the grain.

The major difference between a ripsaw and a crosscut saw is the shape of the teeth. A tooth with a square-faced chisel-type cutting edge, like the ripsaw tooth shown in figure 1-61, does a good job of cutting with the grain (called ripping), but a poor job of cutting across the grain (called crosscutting). A tooth with a beveled, knifetype cutting edge, like the crosscut saw tooth shown in the same figure, does a good job of cutting across the grain, but a poor job of cutting with the grain.

#### Special Purpose Saws

The more common types of saws used for special purposes are shown in figure 1-62. The BACKSAW is a crosscut saw designed for sawing a perfectly straight line across the face of a piece of stock. A heavy steel backing along the top of the blade keeps the blade perfectly straight.

The DOVETAIL saw is a special type of backsaw with a thin, narrow blade and a chisel-type handle.

The COMPASS saw is a long, narrow, tapering ripsaw designed for cutting out circular or other nonrectangular sections from within the margins of a board or panel. A hole is bored near the cutting line to start the saw. A KEY-HOLE saw is simply a finer, narrower compass saw.

The COPING saw is used to cut along curved lines as shown in figure 1-62.

#### Saw Precautions

A saw that is not being used should be hung up or stowed in a toolbox. A toolbox designed for holding saws has notches that hold them on edge, teeth up. Stowing saws loose in a toolbox may allow the saw teeth to become dulled or bent by contacting other tools. Some right and wrong methods of using and caring for a saw are shown in figure 1-63. Be sure to read the captions for each section of the illustration.

Before using a saw, be sure there are no nails or other edge-destroying objects in the line of the cut. When sawing out a strip of waste, do not break out the strip by twisting the saw blade. This dulls the saw and may spring or break the blade.

Be sure that the saw will go through the full stroke without striking the floor or some other object. If the work cannot be raised high enough

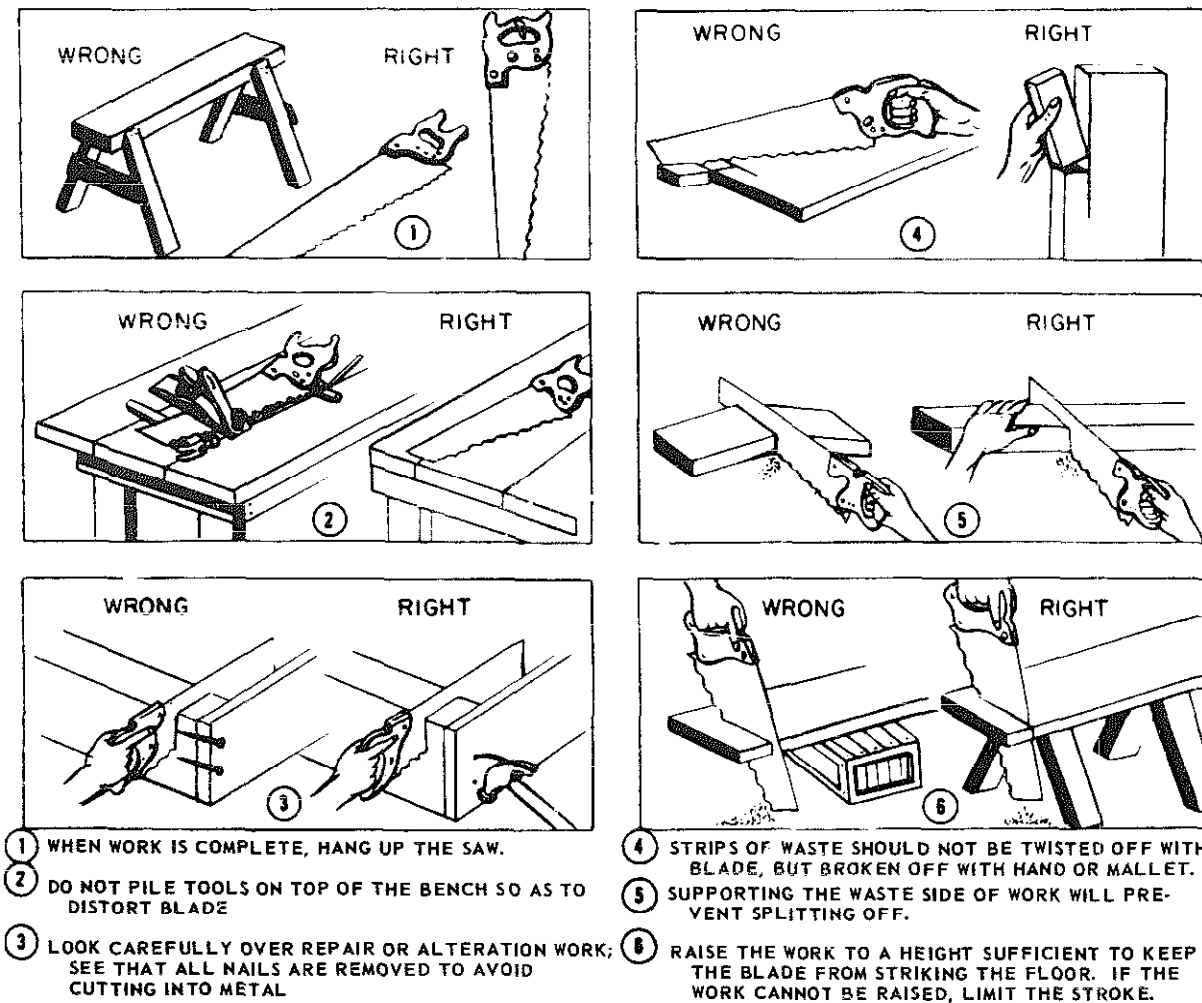

44.14

Figure 1-63.—Care of handsaws.

to obtain full clearance for the saw, you must carefully limit the length of each stroke.

#### Using A Hand Saw

To saw across the grain of the stock, use the crosscut saw, and to saw with the grain, use a rip saw. Study the teeth in both kinds of saws so you can readily identify the saw that you need.

Place the board on a saw horse (fig. 1-64), or some other suitable object. Hold the saw in the right hand and extend the first finger along the handle as shown in the figure. Grasp the board as shown and take a position so that an

imaginary line passing lengthwise of the right forearm will be at an angle of approximately 45 degrees with the face of the board. Be sure the side of the saw is plumb or at right angles with the face of the board. Place the heel of the saw on the mark. Keep the saw in line with the forearm and pull it toward you to start the cut.

To begin with, take short, light strokes, gradually increasing the strokes to the full length of the saw. Do not force or jerk the saw. Such procedure will only make sawing more difficult. The arm that does the sawing should swing clear of your body so that the handle of

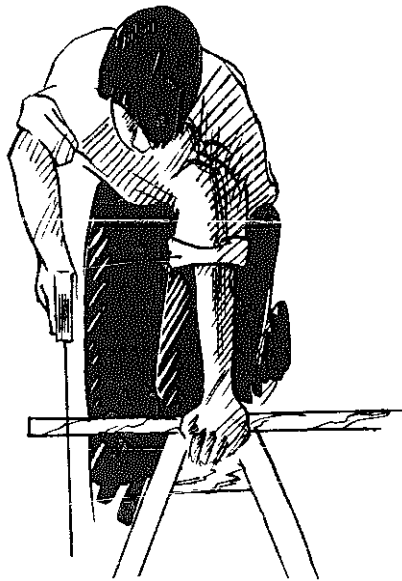

44.101

Figure 1-64.—Proper position for sawing a board to size.

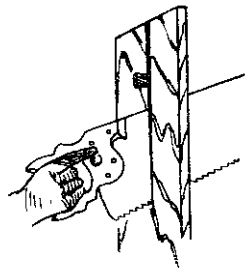

44.102

Figure 1-65.—Using a wedge in a saw kerf to prevent binding.

the saw operates at your side rather than in front of you.

Use one hand to operate the saw. You may be tempted to use both hands at times, but if your saw is sharp, one hand will serve you better. The weight of the saw is sufficient to make it cut. Should the saw stick or bind, it may be because the saw is dull and is poorly "set." The wood may have too much moisture in it, or you may have forced the saw and thus have caused it to leave the straight line.

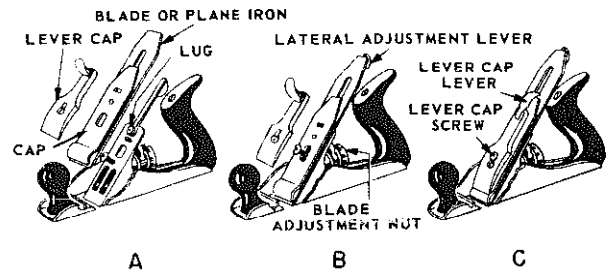

29.12A

Figure 1-66.—Parts of a bench plane.

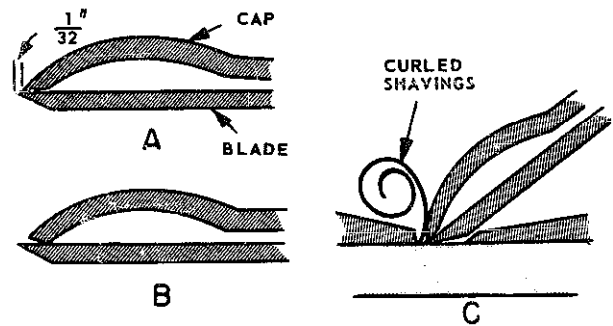

29.12B

Figure 1-67.—Plane iron and plane iron cap.

Keep your eye on the line rather than on the saw while sawing. Watching the line enables you to see instantly any tendency to leave the line. A slight twist of the handle, and taking short strokes while sawing, will bring the saw back. Blow away the sawdust frequently so you can see the layout line.

Final strokes of the cut should be taken slowly. Hold the waste piece in your other hand so the stock will not split when taking the last stroke.

Short boards may be placed on one sawhorse when sawing. Place long boards on two sawhorses, but do not saw so your weight falls between them or your saw will bind. Place long boards so that your weight is directly on one end of the board over one sawhorse while the other end of the board rests on the other sawhorse.

Short pieces of stock are more easily cut when they are held in a vise. When ripping short stock it is important that you keep the saw from sticking, so it may be necessary to take a squatting position. The saw can then take

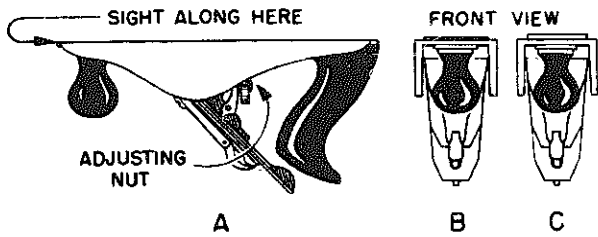

29.12C  
Figure 1-68.—Manipulation of the adjusting nut moves the plane iron up or down.

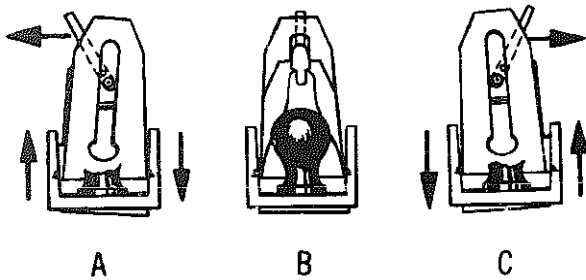

29.12D  
Figure 1-69.—Effect of manipulation of the lateral adjustment lever.

upward direction and thus work easily. When ripping long boards it will probably be necessary to use a wedge in the saw kerf to prevent binding (fig. 1-65).

### PLANES

The plane is the most extensively used of the hand shaving tools. Most of the lumber handled by anyone working with wood is dressed on all four sides, but when performing jobs such as fitting doors and sash, and interior trim work, planes must be used.

Bench and block planes are designed for general surface smoothing and squaring. Other planes are designed for special types of surface work.

The principal parts of a bench plane and the manner in which they are assembled, are shown in figure 1-66. The part at the rear that you grasp to push the plane ahead is called the handle; the part at the front that you grasp to guide the plane along its course is called the

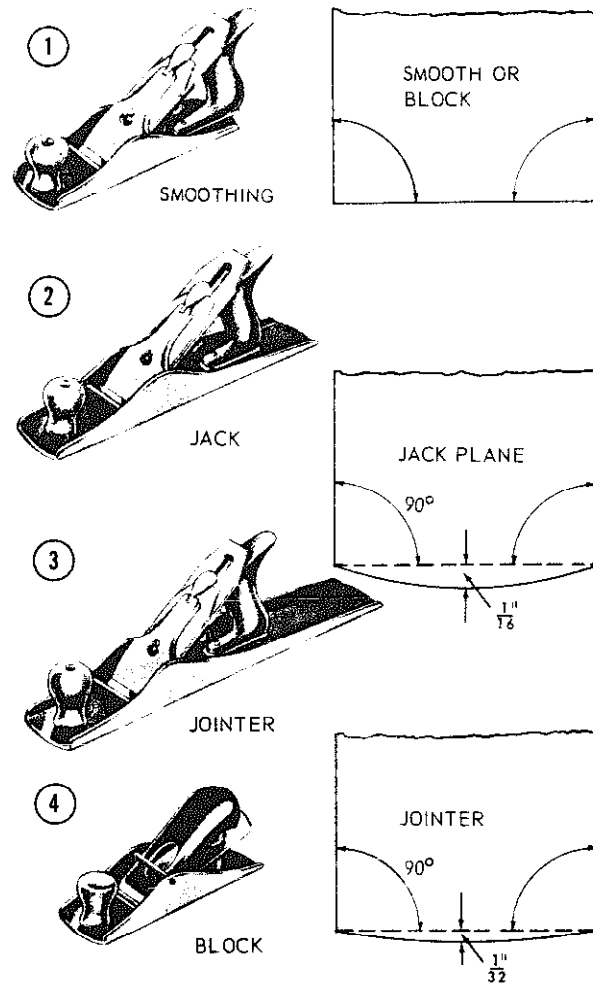

29.12  
Figure 1-70.—Types of bench planes and block plane.

knob. The main body of the plane, consisting of the bottom, the sides, and the sloping part which carries the plane iron, is called the frame. The bottom of the frame is called the sole, and the opening in the sole, through which the blade emerges, is called the mouth. The front end of the sole is called the toe; the rear end, the heel.

A plane iron cap, which is screwed to the upper face of the plane iron, deflects the shaving upward through the mouth, as indicated in figure 1-67C, and thus prevents the mouth from becoming choked with jammed shavings. The edge of the cap should fit the back of the iron as shown in figure 1-67A, not as shown in

figure 1-67B. The lower end of the plane iron cap should be set back 1/32 in. from the edge of the plane top, as shown in figure 1-67A. The iron in a bench plane goes in bevel-down.

The edge of the plane iron is brought into correct cutting position by the manipulation of first the ADJUSTING NUT and next the LATERAL ADJUSTMENT LEVER, as shown in figures 1-68 and 1-69. The adjusting nut moves the edge of the iron up or down; the lateral adjustment lever cants it to the right or left. To adjust the plane you hold it upside-down, sight along the sole from the toe, and work the adjusting nut until the edge of the blade appears. Then work the lateral adjustment lever until the edge of the blade is in perfect alinement with the sole, as shown in figures 1-68B and 1-69B. Then use the adjusting nut to give the blade the amount of protrusion you want. This amount will depend, of course, upon the depth of the cut you intend to make.

There are three types of bench planes (fig. 1-70): the SMOOTH plane, the JACK plane, and the JOINTER plane (sometimes called the FORE plane or the GAGE plane). All are used primarily for shaving and smoothing with the grain; the chief difference is the length of the sole. The sole of the smooth plane is about 9 in. long, the sole of the jack plane about 14 in. long, and the sole of the jointer plane from 20 to 24 in. long.

The longer the sole of the plane is, the more uniformly flat and true the planed surface will be. Consequently, which bench plane you should use depends upon the requirements with regard to surface trueness. The smooth plane is, in general, smoother only; it will plane a smooth, but not an especially true surface in a short time. It is also used for cross-grain smoothing and squaring of end-stock.

The jack plane is the general "jack-of-all-work" of the bench plane group. It can take a deeper cut and plane a truer surface than the smooth plane. The jointer plane is used when the planed surface must meet the highest requirements with regard to trueness.

A BLOCK PLANE and the names of its parts are shown in figure 1-71. Note that the plane iron in a block plane does not have a plane iron cap, and also that, unlike the iron in a bench plane, the iron in a block plane goes in bevel-up.

The block plane, which is usually held at an angle to the work, is used chiefly for cross-grain squaring of end-stock. It is also useful,

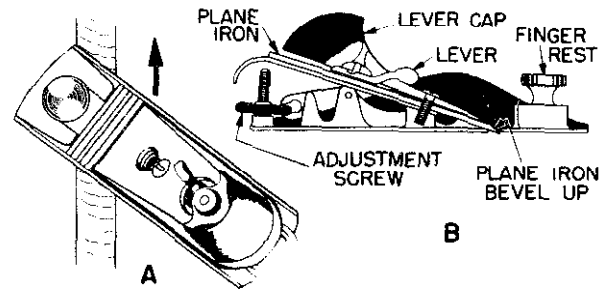

29.12E

Figure 1-71.—Block plane nomenclature.

however, for smoothing all plane surfaces on very small work.

### BORING TOOLS

When working with wood, you will frequently be required to bore holes. It is important, therefore, that you know the proper procedures and tools used for this job. Auger bits and a variety of braces and drills are used extensively for boring purposes.

#### Auger Bits

Bits are used for boring holes for screws, dowels, and hardware, as an aid in mortising (cutting a cavity in wood for joining members) and in shaping curves and for many other purposes. Like saws and planes, bits vary in shape and structure with the type of job to be done. Some of the most common bits are described in this section.

AUGER bits are screw-shaped tools consisting of six parts: the cutter, screw, spur, twist, shank, and tang (fig. 1-72). The twist ends with two sharp points called the spurs, which score the circle, and two cutting edges which cut shavings within the scored circle. The screw centers the bit and draws it into the wood. The threads of the screw are made in three different pitches: steep, medium, and fine. The steep pitch makes for quick boring and thick chips, and the fine or slight pitch makes for slow boring and fine chips. For end-wood boring, a steep- or medium-pitch screw bit should be used because end wood is likely to be forced in between the fine screw threads, and that will prevent the screw from taking

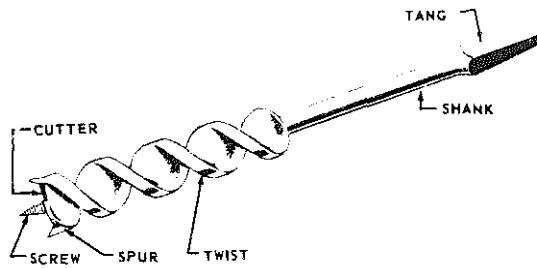

44.20  
Figure 1-72.—Nomenclature of an auger bit.

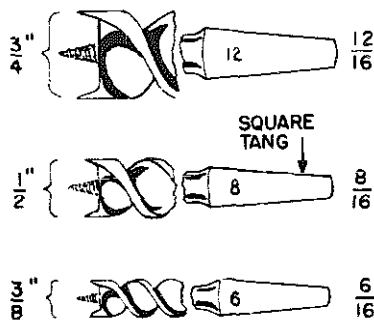

44.20F  
Figure 1-73.—Size markings on auger bits.

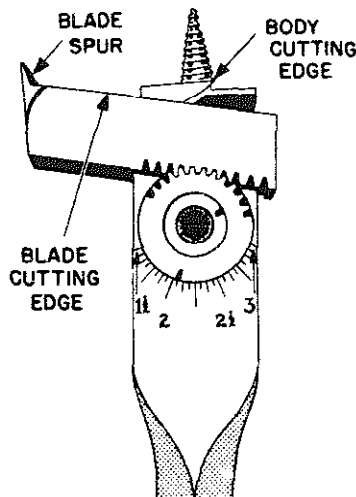

44.21A  
Figure 1-74.—Expansive bit.

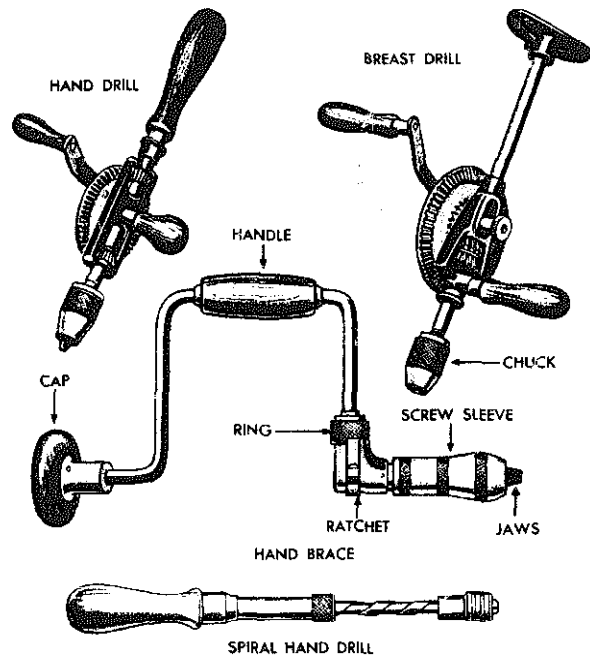

4.33;44.20(44B)  
Figure 1-75.—Brace and drills.

hold. The twist carries the cuttings away from the cutters and deposits them in a mound around the hole.

The sizes of auger bits are indicated in sixteenths of an inch and are stamped on the tang (fig. 1-73). A number 10 stamped on the tang means 10/16 or 5/8 in.; number 5 means 5/16 in. and so on. The most common woodworkers auger bit set ranges in size from 1/4 to 1 in.

Ordinary auger bits up to 1 in. in diameter are from 7 to 9 inches long. Short auger bits that are about 3 1/2 inches long are called DOWEL bits.

EXPANSIVE auger bits have adjustable cutters, for boring holes of different diameters (fig. 1-74). Expansive bits are generally made in two different sizes. The largest size has three cutters and bores holes up to 4 inches in diameter. A scale on the cutter blade indicates the diameter of the hole to be bored.

#### Braces and Drills

The auger bit is the tool that actually does the cutting in the wood; however, it is necessary that another tool be used to hold the auger bit and give you enough leverage to turn the bit.

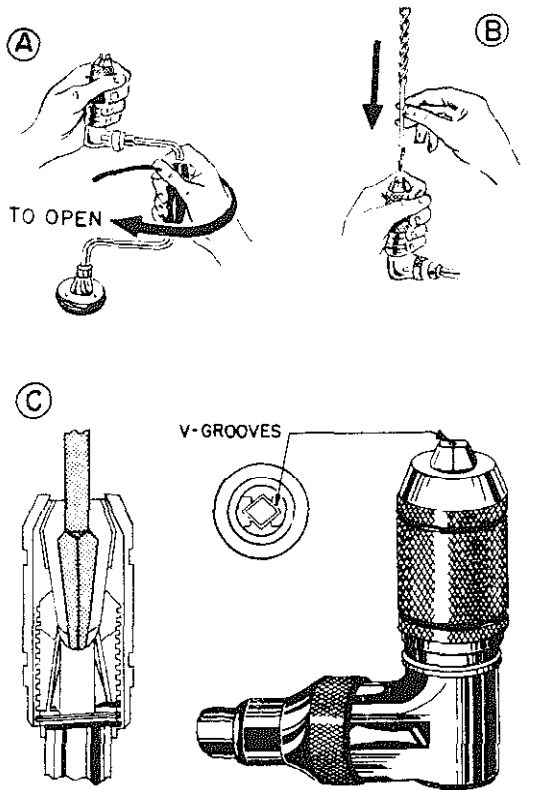

44.20G  
Figure 1-76.—Placing an auger bit in a chuck.

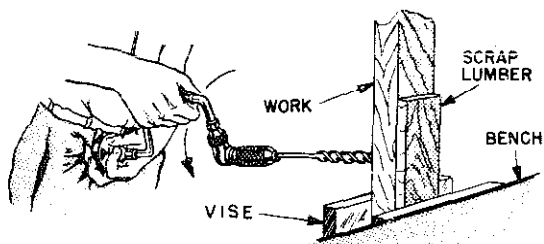

44.20H  
Figure 1-77.—Using scrap lumber to prevent splintering when boring.

The tools most often used for holding the bit are the carpenter's brace, breast crill, and push drill (fig. 1-75).

**BORING THROUGH HOLES IN WOOD.**—To bore a hole in wood with an auger bit, first

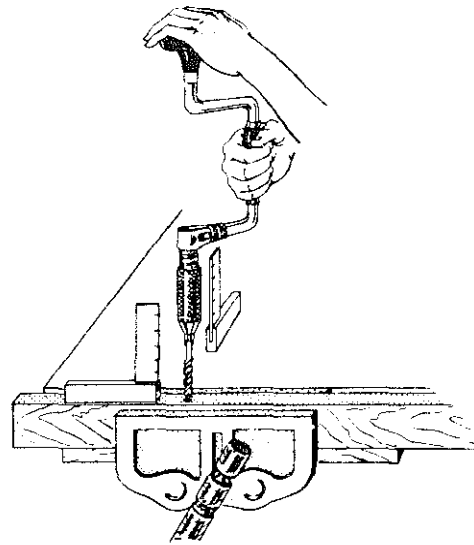

44.20K  
Figure 1-78.—Method of sighting in for perpendicular hole.

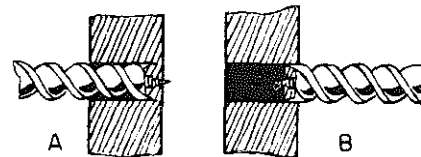

44.20L  
Figure 1-79.—Boring a through hole by reversing direction.

select the proper fit indicated on or near the square tang. Then you insert the auger bit into the chuck (fig. 1-76).

To chuck the bit, hold the shell of the chuck (fig. 1-76A), as you turn the handle to open the jaws. When the jaws are apart far enough to take the square tang of the bit, insert it (fig. 1-76B), until the end seats in the square driving socket at the bottom of the chuck. Then tighten the chuck by turning the handle to close the jaws and hold the bit in place.

With a chuck having no driving socket (a square hole which is visible if you look directly into the chuck), additional care must be taken to seat and center the corners of the tapered shank in the V grooves of the chuck jaws. (See figure 1-76C.) In this type of chuck the

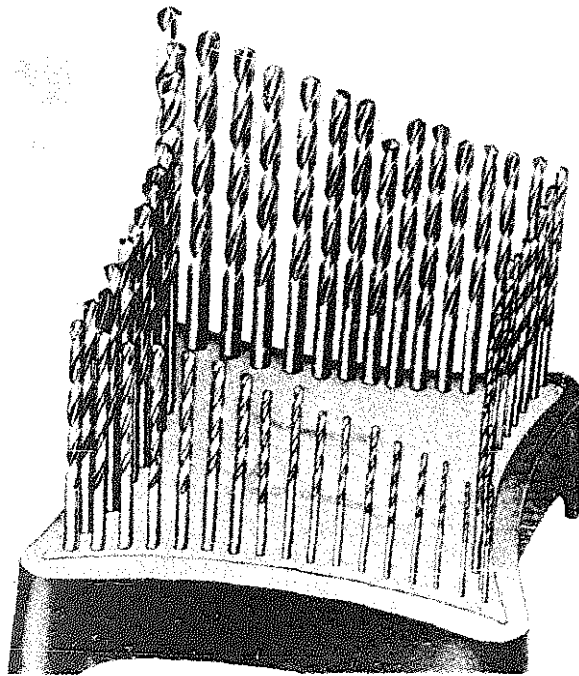

44.20(4)  
Figure 1-80.—Twist drills (Sizes No. 1 to No. 60).

jaws serve to hold the bit in the center and to prevent it from coming out of the chuck.

After placing the point of the feed screw at the location of the center of the hole you will bore, steady the brace against your body, if possible, with the auger bit square with the surface of the work.

To bore a horizontal hole in the stock held in the bench vise, hold the head of the brace with one hand, steadying it against your body, while turning the handle with the other hand. Scrap stock behind the job will prevent splintering (fig. 1-77).

When it is not possible to make a full turn with the handle of the bit brace, turn the cam ring, shown in figure 1-75, clockwise until it stops. This will raise one of the two ratchet pawls affording clockwise ratchet action for rotating the bit. For counterclockwise ratchet action, turn the cam ring counterclockwise as far as it will go.

To bore a vertical hole in stock held in a bench vise, hold the brace and bit perpendicular to the surface of the work. Placing a try-square

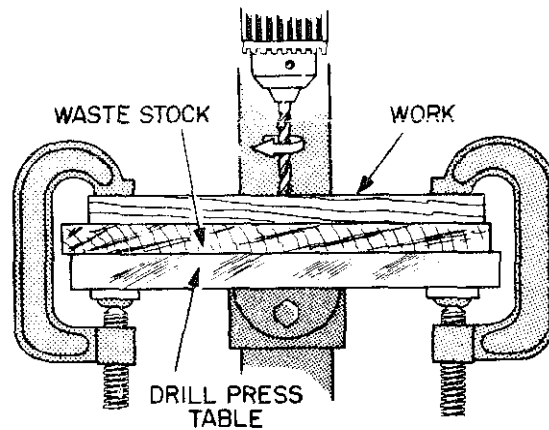

44.20R  
Figure 1-81.—Drilling a hole in wood with a twist drill.

near the bit, alternately in the two positions shown in figure 1-78, will help you sight it in.

Another way to bore a through hole without splitting out on the opposite face is to reverse the bit one or two turns when the feed screw just becomes visible through this opposite face (fig. 1-79A). This will release the bit. Remove the bit while pulling it up and turning it clockwise. This will remove the loose chips from the hole. Finish the hole by boring from the opposite face. This will remove the remaining material which is usually in the form of a wooden disk held fast to the feed screw (fig. 1-79B).

#### DRILLING HOLES WITH A TWIST DRILL.—

An ordinary twist drill may be used to drill holes in wood. Select a twist drill of the size required (fig. 1-80) and secure it in the chuck of a drill.

In figure 1-81, the twist drill has been chucked. Notice that the job is secured to the table with a pair of C-clamps. Beneath the job is a block of wood. In drilling through wood, a backup block is used to ensure a clean hole at the bottom of the job.

Figure 1-82 shows a hole being drilled with a breast drill. Turn the crank handle with one hand as you hold the side handle with the other hand. This will steady the breast drill while feed pressure is applied by resting your chest on the breast plate shown in figure 1-82. Notice, too, that the breast drill has a high or a low



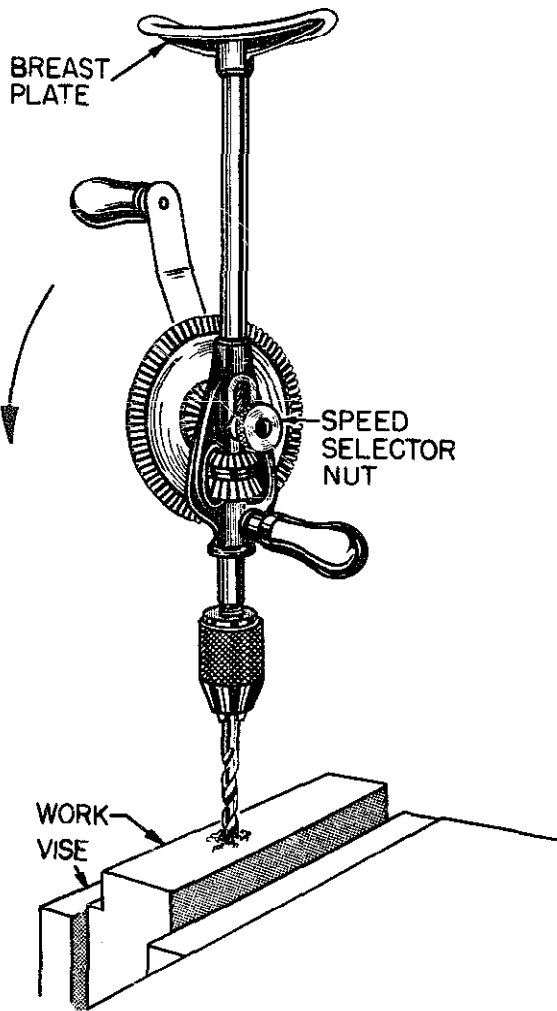

4.33A  
Figure 1-82.—Drilling a hole with a breast drill.

speed available, according to the setting of the speed selector nut. When drilling a horizontal hole, apply feed pressure by resting your body against the breast plate.

In drilling a horizontal hole with the hand drill shown in figure 1-83, operate the crank with the right hand and with the left hand guide the drill by holding the handle which is opposite the chuck end of the drill.

**DRILLING HOLES WITH A "PUSH" DRILL.**—Figure 1-84A shows the Stanley "Yankee" automatic drill which is often called a "push" drill.

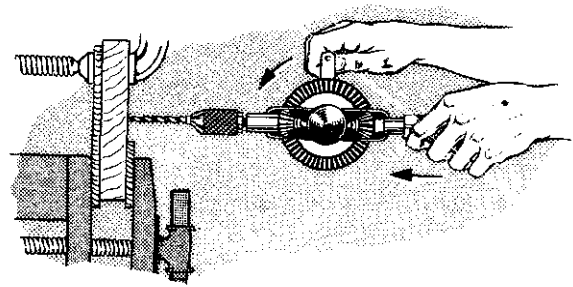

4.34A  
Figure 1-83.—Drilling a hole with a hand drill.

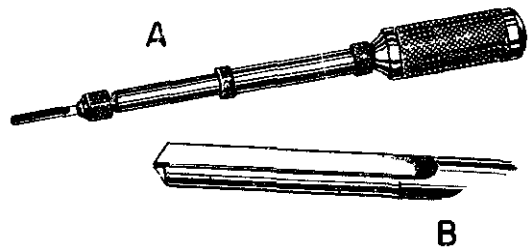

44.116  
Figure 1-84.—Push drill and drill point.

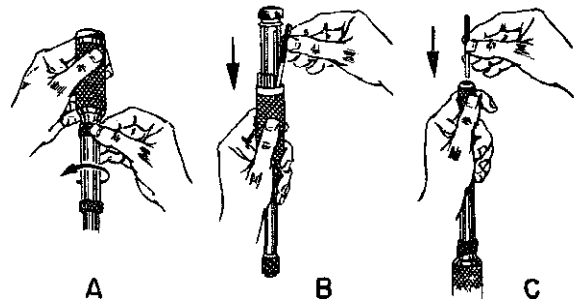

44.117  
Figure 1-85.—Selecting a drill for use in a push drill.

This drill can be used to drill either horizontal or vertical holes when the accuracy of the right angle with the work is not critical.

The drill point used in push drills (fig. 1-84B) is a straight flute drill. Sharpen its point on the grinder and provide only slight clearance behind the cutting edge. It will drill holes in wood and other soft materials.

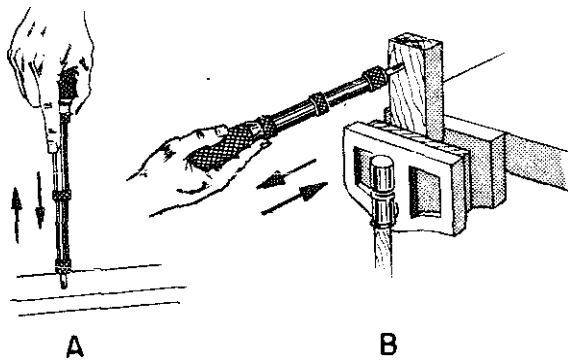
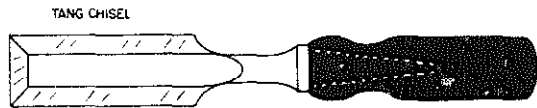
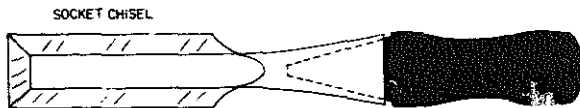

Figure 1-86.—Drilling horizontal and vertical holes with a push drill.

44.118



THE SHANK OF THE CHISEL HAS A POINT THAT IS STUCK INTO THE HANDLE. THE POINT IS CALLED A TANG AND THE CHISEL IS CALLED A TANG CHISEL.



IF THE SHANK OF THE CHISEL IS MADE LIKE A CUP, THE HANDLE WILL FIT INTO IT. THIS IS CALLED A SOCKET CHISEL.

Figure 1-87.—Tang and socket wood chisels.

29.9B

To select a drill for use in a push drill, hold the handle of the drill in one hand and release the magazine by turning the knurled screw as shown in figure 1-85A. This will permit you to drop the magazine. Figure 1-85B, shows the drill magazine lowered to expose the drills from which the proper size can be selected.

To chuck the drill, loosen the chuck several turns and insert the drill as far as it will go. Turn the drill until it seats in the driving socket in the bottom of the chuck. Then tighten the chuck to hold the drill in place. (fig. 1-85C).

To drill a vertical hole with this drill (fig. 1-86A), place the job on a flat surface and operate the push drill with alternate strokes up

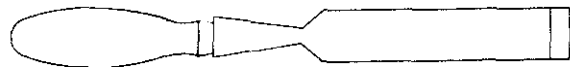

SOCKET FIRMER CHISEL



TANG PARING CHISEL

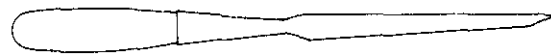

MORTISING CHISEL

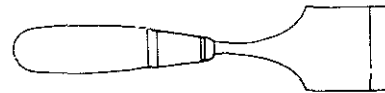

BUTT CHISEL

29.9C

Figure 1-88.—Shapes of common types of wood chisels.

and down. If it is necessary to hold the work in place while it is being drilled, use some mechanical means if you can. If you must hold the job with your hand, grasp the material as far as possible from where the drill is drilling.

In drilling horizontal holes with the push drill, as in figure 1-86B, secure the job in a vise. The back-and-forth strokes rotate the drill, advancing it into the work on the forward stroke as the drilling proceeds. The index finger, extended along the body of the tool, will help guide the drilling at right angles to the work.

#### WOOD CHISELS

A wood chisel is a steel tool fitted with a wooden or plastic handle. It has a single beveled cutting edge on the end of the steel part, or blade. According to their construction, chisels may be divided into two general classes: TANG chisels, in which part of the chisel enters the handle, and SOCKET chisels, in which the handle enters into a part of the chisel (fig. 1-87).

## TOOLS AND THEIR USES

A socket chisel is designed for striking with a wooden mallet (never a steel hammer), while a tang chisel is designed for hand manipulation only.

Wood chisels are also divided into types, depending upon their weights and thicknesses, the shape or design of the blade, and the work they are intended to do.

The shapes of the more common types of wood chisels are shown in figure 1-88. The **FIRMER** chisel has a strong, rectangular-cross-section blade, designed for both heavy and light work. The blade of the **PARING** chisel is relatively thin, and is beveled along the sides for the fine paring work. The **BUTT** chisel has a short blade, designed for work in hard-to-get-at places.

The butt chisel is commonly used for chiseling the **GAINS** (rectangular depressions) for the **BUTT** hinges on doors; hence the name. The **MORTISING** chisel is similar to a socket firmer but has a narrow blade, designed for chiseling out the deep, narrow **MORTISES** for mortise-and-tenon joints. This work requires a good deal of levering out of chips; consequently, the mortising chisel is made extra thick in the shaft to prevent breaking.

A **FRAMING** chisel is shaped like a firmer chisel, but has a very heavy, strong blade designed for work in rough carpentry.

A wood chisel should always be held with the flat side or back of the chisel against the work for smoothing and finishing cuts. Whenever possible, it should not be pushed straight through an opening, but should be moved laterally at the same time that it is pushed forward. This method ensures a shearing cut, which with care, will produce a smooth and even surface even when the work is cross-grained. On rough work, use a hammer or mallet to drive the socket-type chisel.

On fine work, use your hand as the driving power on tang-type chisels. For rough cuts, the bevel edge of the chisel is held against the work. Whenever possible, other tools such as saws and planes should be used to remove as much of the waste as possible, and the chisel used for finishing purposes only.

These are a few basic precautions that you should observe at all times when using a chisel.

- a. Secure work so that it cannot move.
- b. Keep both hands back of the cutting edge at all times.

- c. Do not start a cut on a guideline. Start slightly away from it, so that there is a small amount of material to be removed by the finishing cuts.

- d. When starting a cut, always chisel away from the guideline toward the waste wood, so that no splitting will occur at the edge.

- e. Never cut towards yourself with a chisel.

- f. Make the shavings thin, especially when finishing.

- g. Examine the grain of the wood to see which way it runs. Cut with the grain. This severs the fibers and leaves the wood smooth. Cutting against the grain splits the wood and leaves it rough. This type of cut cannot be controlled.

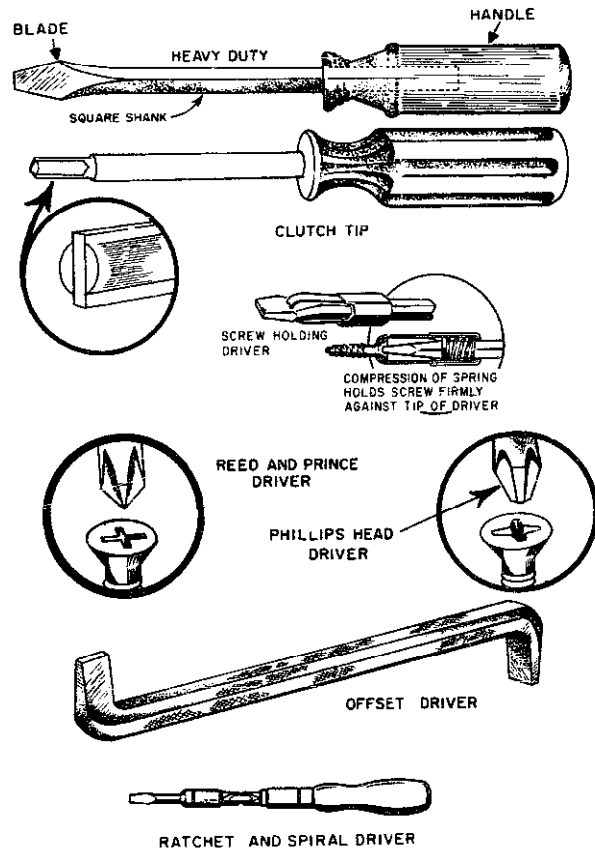

1.14(44B)A

Figure 1-89.—Screwdrivers.

SCREWDRIVERS

A screwdriver is one of the most basic of basic handtools. It is also the most frequently abused of all handtools. It is designed for one function only—to drive and remove screws. A screwdriver should not be used as a pry bar, a scraper, a chisel, or a punch.

STANDARD

There are three main parts to a standard screwdriver. The portion you grip is called the handle, the steel portion extending from the handle is the shank, and the end which fits into the screw is called the blade (fig. 1-89).

The steel shank is designed to withstand considerable twisting force in proportion to its size, and the tip of the blade is hardened to keep it from wearing.

Standard screwdrivers are classified by size, according to the combined length of the shank and blade. The most common sizes range in length from 2 1/2 in. to 12 in. There are many screwdrivers smaller and some larger for special purposes. The diameter of the shank, and the width and thickness of the blade are generally proportionate to the length, but again there are special screwdrivers with long thin shanks, short thick shanks, and extra wide or extra narrow blades.

Screwdriver handles may be wood, plastic, or metal. When metal handles are used, there is usually a wooden hand grip placed on each side of the handle. In some types of wood- or plastic-handled screwdrivers the shank extends through the handle, while in others the shank enters the handle only a short way and is pinned to the handle. For heavy work, special types of screwdrivers are made with a square shank. They are designed this way so that they may be gripped with a wrench, but this is the only kind on which a wrench should be used.

When using a screwdriver it is important to select the proper size so that the blade fits the screw slot properly. This prevents burring the slot and reduces the force required to hold the driver in the slot. Keep the shank perpendicular to the screw head (fig. 1-90).

RECESSED

Recessed screws are now available in various shapes. They have a cavity formed in the

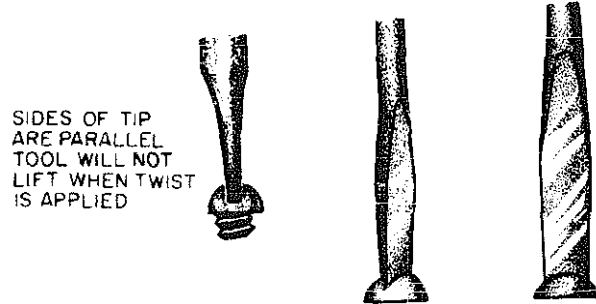

1.14(44B)B

Figure 1-90.—Positioning screwdrivers.

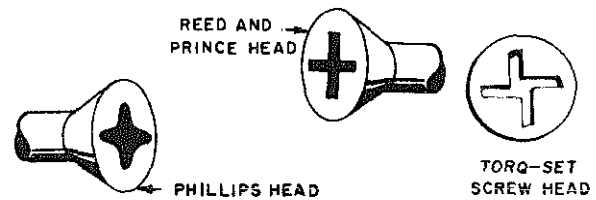

29.123(44B)

Figure 1-91.—Comparison of Phillips, Reed, and Prince and Torq-Set screwheads.

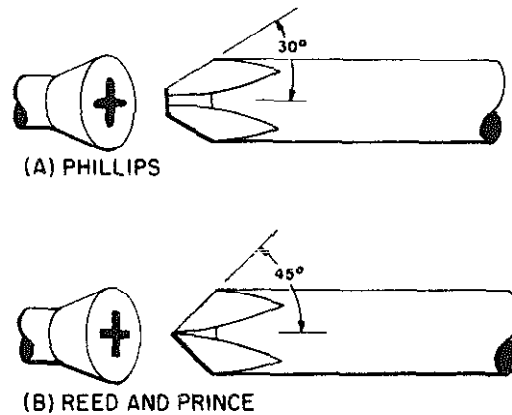

1.14(44B)C

Figure 1-92.—Matching cross-slot screws and drivers.

head and require a specially shaped screwdriver. The clutch tip (fig. 1-89) is one shape, but the more common include the Phillips, Reed and Prince, and newer Torq-Set types (fig. 1-91). The most common type found is the

## TOOLS AND THEIR USES

Phillips head screw. This requires a Phillips-type screwdriver (fig. 1-89).

### Phillips Screwdriver

The head of a Phillips-type screw has a four-way slot into which the screwdriver fits. This prevents the screwdriver from slipping. Three standard sized Phillips screwdrivers handle a wide range of screw sizes. Their ability to hold helps to prevent damaging the slots or the work surrounding the screw. It is a poor practice to try to use a standard screwdriver on a Phillips screw because both the tool and screw slot will be damaged.

### Reed and Prince Screwdriver

Reed and Prince screwdrivers are not interchangeable with Phillips screwdrivers. Therefore, always use a Reed and Prince screwdriver with Reed and Prince screws and a Phillips screwdriver with Phillips screws, or a ruined tool or ruined screwhead will result.

How do you distinguish between these similar screwdrivers? Refer to figure 1-92.

The Phillips screwdriver has about 30-degree flukes and a blunt end, while the Reed and Prince has 45-degree flukes and a sharper, pointed end. The Phillips screw has beveled walls between the slots; the Reed and Prince, straight, pointed walls. In addition, the Phillips screw slot is not as deep as the Reed and Prince slot.

Additional ways to identify the right screwdriver are as follows:

1. If it tends to stand up unassisted when the point is put in the head of a vertical screw, it is probably the proper one.
2. The outline of the end of a Reed and Prince screwdriver is approximately a right angle, as seen in the illustration.
3. In general, Reed and Prince screws are used for airframe structural applications, while Phillips screws are found most often in component assemblies.

### "Torq-Set" Screws

"Torq-Set" machine screws (offset cross-slot drive) have recently begun to appear in new equipment. The main advantage of the newer type is that more torque can be applied to its head while tightening or loosening than

any other screw of comparable size and material without damaging the head of the screw.

Torq-Set machine screws are similar in appearance to the more familiar Phillips machine screws.

Since a Phillips driver could easily damage a Torq-Set screwhead, making it difficult if not impossible to remove the screw even if the proper tool is later used, maintenance personnel should be alert to the differences (fig. 1-91) and ensure that the proper tool is used.

**OFFSET SCREWDRIVERS.**—An offset screwdriver (fig. 1-89) may be used where there is not sufficient vertical space for a standard or recessed screwdriver. Offset screwdrivers are constructed with one blade forged in line and another blade forged at right angles to the shank handle. Both blades are bent 90 degrees to the shank handle. By alternating ends, most screws can be seated or loosened even when the swinging space is very restricted. Offset screwdrivers are made for both standard and recessed head screws.

### RATCHET SCREWDRIVER

For fast easy work the ratchet screwdriver (fig. 1-89), is extremely convenient, as it can be used one-handed and does not require the bit to be lifted out of the slot after each turn. It may be fitted with either a standard type bit or a special bit for recessed heads. The ratchet screwdriver is most commonly used by the woodworker for driving screws in soft wood.

### SAFETY

- Never use a screwdriver to check an electrical circuit.
- Never try to turn a screwdriver with a pair of pliers.
- Do not hold work in your hand while using a screwdriver—if the point slips it can cause a bad cut. Hold the work in a vise, with a clamp, or on a solid surface. If that is impossible, you will always be safe if you follow this rule: **NEVER GET ANY PART OF YOUR BODY IN FRONT OF THE SCREWDRIVER BLADE TIP.** That is a good safety rule for any sharp or pointed tool.

### PLIERS

Pliers are made in many styles and sizes and are used to perform many different

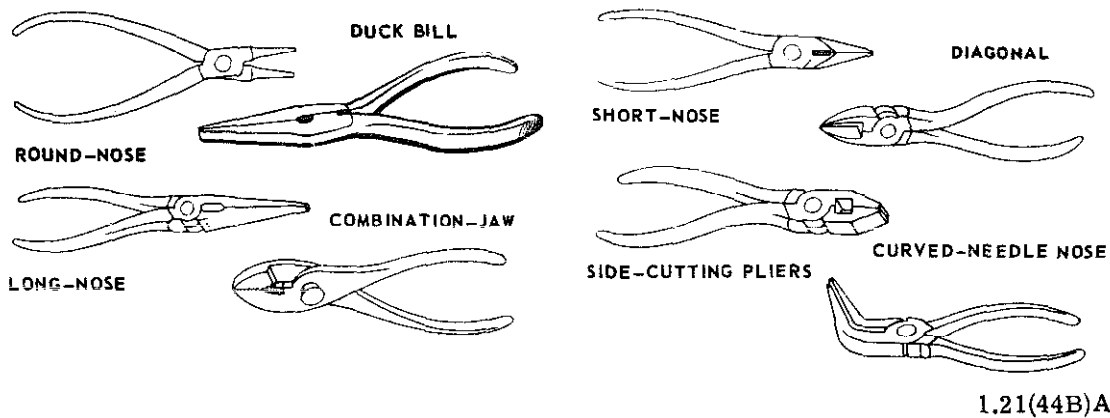
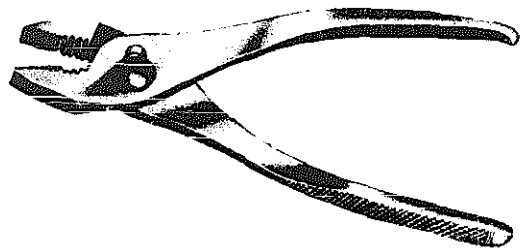

Figure 1-93.—Pliers.



1.21.4A

Figure 1-94.—Slipjoint pliers.



1.21.4B

Figure 1-95.—Slipjoint combination pliers.

operations. Pliers are used for cutting purposes as well as holding and gripping small articles in situations where it may be inconvenient or impossible to use hands. Figure 1-93 shows several different kinds.

The combination pliers are handy for holding or bending flat or round stock. The long-nosed pliers are less rugged, and break easily if you use them on heavy jobs. Long-nosed pliers commonly called needle-nose pliers are especially useful for holding small objects in tight places and for making delicate adjustments. The round-nosed kind are handy when you need to crimp sheet metal or form a loop in a wire. The diagonal cutting pliers, commonly called "diagonals" or "dikes," are designed for cutting wire and cotter pins close to a flat surface and are especially useful in the electronic and electrical fields. The duckbill pliers are used extensively in aviation areas.

Here are two important rules for using pliers:

1. Do not make pliers work beyond their capacity. The long-nosed kind are especially delicate. It is easy to spring or break them, or nick their edges. After that, they are practically useless.

2. Do not use pliers to turn nuts. In just a few seconds, a pair of pliers can damage a nut. Pliers must not be substituted for wrenches.

#### SLIP-JOINT PLIERS

Slip-joint pliers (fig. 1-94) are pliers with straight, serrated (grooved) jaws, and the screw or pivot with which the jaws are fastened together may be moved to either of two positions, in order to grasp small- or large-sized objects better.

To spread the jaws of slip-joint pliers, first spread the ends of the handles apart as far as possible. The slip-joint, or pivot, will now move to the open position. To close, again spread the handles as far as possible, then push the joint back into the closed position.

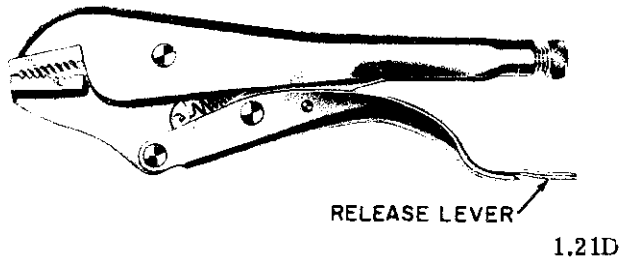

Figure 1-96.—Vise grip pliers.

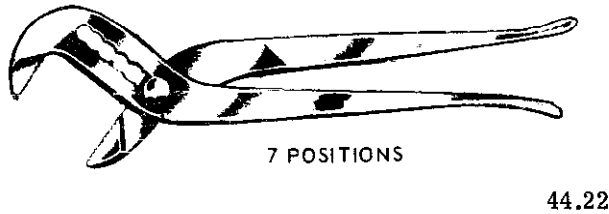

Figure 1-97.—Water pump pliers.

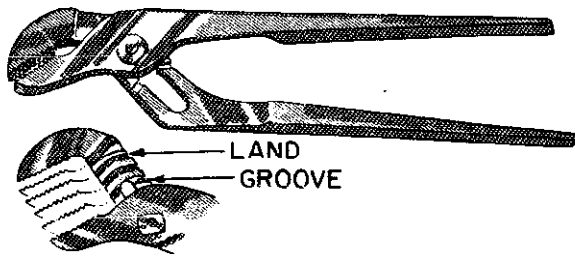

Figure 1-98.—Channel-lock pliers.

Slip-joint combination pliers (fig. 1-95) are pliers similar to the slip-joint pliers just described, but with the additional feature of a side cutter at the junction of the jaws. This cutter consists of a pair of square cut notches, one on each jaw, which act like a pair of shears when an object is placed between them and the jaws are closed.

The cutter is designed to cut material such as soft wire and nails. To use the cutter, open the jaws until the cutter on either jaw lines up with the other. Place the material to be cut as far back as possible into the opening formed by the cutter, and squeeze the handles of the pliers together. Do not attempt to cut hard material such as spring wire or hard rivets with the combination pliers. To do so will spring the

jaws; and if the jaws are sprung, it will be difficult thereafter to cut small wire with the cutters.

#### WRENCH (VISE-GRIP) PLIERS

Vise-grip pliers (fig. 1-96), can be used for holding objects regardless of their shape. A screw adjustment in one of the handles makes them suitable for several different sizes. The jaws of vise-grips may have standard serrations such as the pliers just described or may have a clamp-type jaw. The clamp-type jaws are generally wide and smooth and are used primarily when working with sheet metal.

Vise-grip pliers have an advantage over other types of pliers in that you can clamp them on an object and they will stay. This will leave your hands free for other work.

A craftsman uses this tool a number of ways. It may be used as a clamp, speed wrench, portable vise, and for many other uses where a locking, plier type jaw may be employed. These pliers can be adjusted to various jaw openings by turning the knurled adjusting screw at the end of the handle (fig. 1-96). Vise-grips can be clamped and locked in position by pulling the lever toward the handle.

**CAUTION:** Vise-grip pliers should be used with care since the teeth in the jaws tend to damage the object on which they are clamped. They should not be used on nuts, bolts, tube fittings, or other objects which must be reused.

#### WATER-PUMP PLIERS

Water-pump pliers were originally designed for tightening or removing water pump packing nuts. They were excellent for this job because they have a jaw adjustable to seven different positions. Water-pump pliers (fig. 1-97) are easily identified by their size, jaw teeth, and adjustable slip joint. The inner surface of the jaws consists of a series of coarse teeth formed by deep grooves, a surface adapted to grasping cylindrical objects.

#### CHANNEL-LOCK PLIERS

Channel-lock pliers (fig. 1-98) are another version of water-pump pliers easily identified by the extra long handles, which make them a very powerful gripping tool. They are shaped approximately the same as the pliers just described, but the jaw opening adjustment is

effected differently. Channel-lock pliers have grooves on one jaw and lands on the other. The adjustment is effected by changing the position of the grooves and lands. The Channel-lock pliers are less likely to slip from the adjustment setting when gripping an object. The channel-lock pliers will only be used where it is impossible to use a more adapted wrench or holding device. Many nuts and bolts and surrounding parts have been damaged by improper use of channel-lock pliers.

### DIAGONAL PLIERS

Diagonal cutting pliers (fig. 1-93) are used for cutting small, light material, such as wire and cotter pins in areas which are inaccessible to the larger cutting tools. Also, since they are designed for cutting only, larger objects can be cut than with the slip-joint pliers.

As the cutting edges are diagonally offset approximately 15 degrees, diagonal pliers are adapted to cutting small objects flush with a surface. The inner jaw surface is a diagonal straight cutting edge. Diagonal pliers should never be used to hold objects, because they exert a greater shearing force than other types of pliers of a similar size. The sizes of the diagonal cutting pliers are designated by the overall length of the pliers.

### SIDE-CUTTING PLIERS

Side-cutting pliers (sidecutters) are principally used for holding, bending, and cutting thin materials or small gage wire. Sidecutters vary in size and are designated by their overall length. The jaws are hollowed out on one side just forward of the pivot point of the pliers. Opposite the hollowed out portion of the jaws are the cutting edges (fig. 1-93).

When holding or bending light metal surfaces, the jaw tips are used to grasp the object. When holding wire grasp it as near one end as possible because the jaws will mar the wire. To cut small diameter wire the side cutting edge of the jaws near the pivot is used. Never use sidecutters to grasp large objects, tighten nuts, or bend heavy gage metal, since such operations will spring the jaws.

Sidecutters are often called electrician or lineman pliers. They are used extensively for stripping insulation from wire and for twisting wire when making a splice.

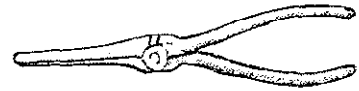

(A)



(B)



(C)

1.21(44B)C

Figure 1-99.—Pliers. (A) Duckbill; (B) needle nose; and (C) wire twister.

### DUCKBILL PLIERS

Duckbill pliers (fig. 1-99A), have long wide jaws and slender handles. Duckbills are used in confined areas where the fingers cannot be used. The jaw faces of the pliers are scored to aid in holding an item securely. Duckbills are ideal for twisting the safety wire used in securing nuts, bolts, and screws.

### NEEDLE-NOSE PLIERS

Needle-nose pliers (fig. 1-99B), are used in the same manner as duckbill pliers. However, there is a difference in the design of the jaws. Needle-nose jaws are tapered to a point which makes them adapted to installing and removing small cotter pins. They have serrations at the nose end and a side cutter near the throat. Needle-nose pliers may be used to hold small items steady, to cut and bend safety wire, or to do numerous other jobs which are too intricate or too difficult to be done by hand alone.

NOTE: Duckbill and needle-nose pliers are especially delicate. Care should be exercised when using these pliers to prevent springing, breaking, or chipping the jaws. Once these pliers are damaged, they are practically useless.

### WIRE-TWISTER PLIERS

Wire-twister pliers (fig. 1-99C), are three-way pliers, which hold, twist, and cut. They



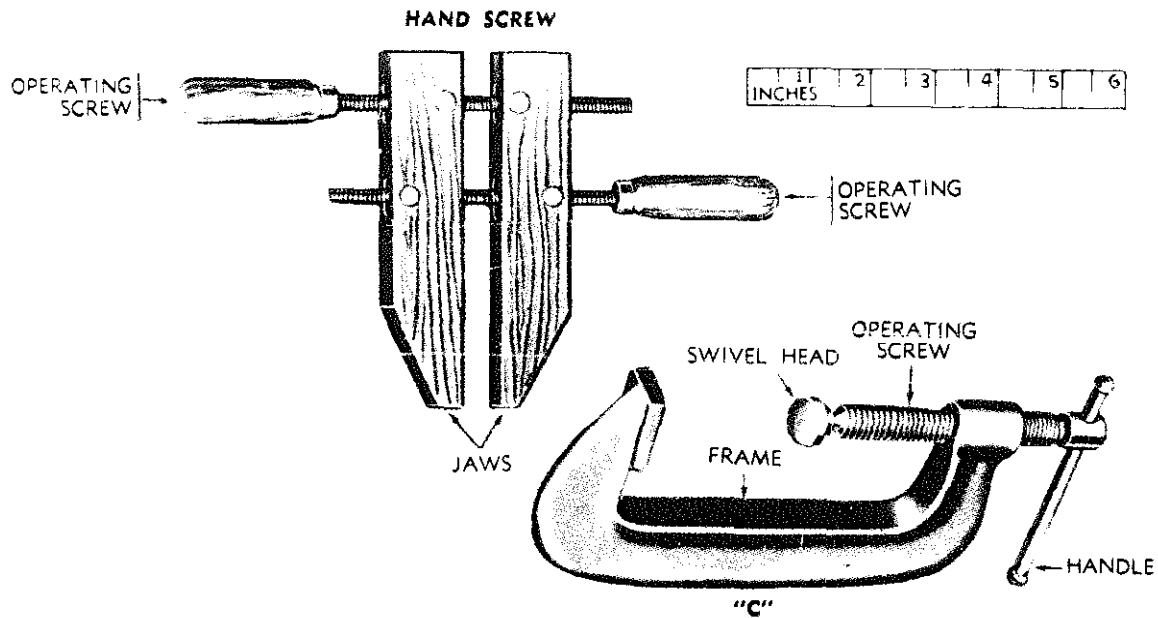

Figure 1-102.—C-Clamp and handscrew clamp.

29.11A

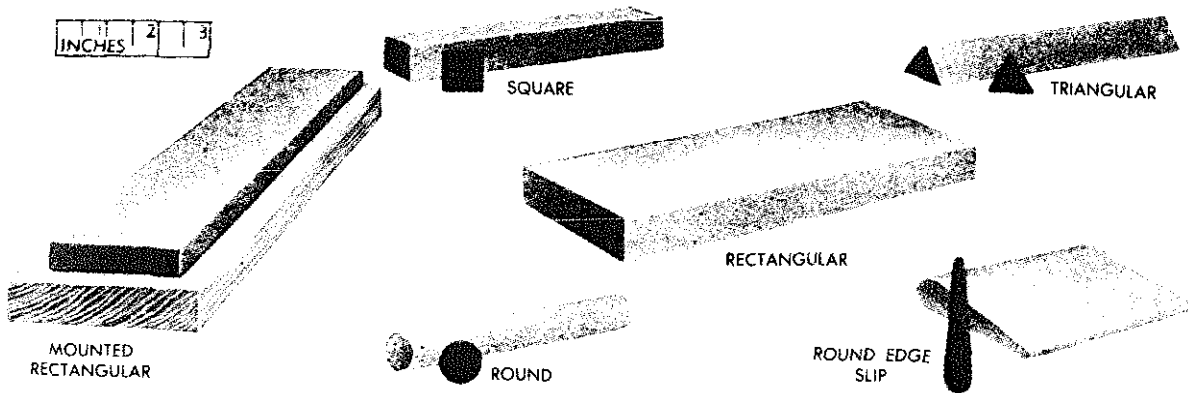

Figure 1-103.—Shapes of sharpening stones and oilstones.

44.35

open the crimped portion of the head and remove the head from the ball end of the screw. Replace with a new head and crimp.

**SAFETY PRECAUTIONS**

When closing the jaw of a vise or clamp, avoid getting any portion of your hands or

body between the jaws or between one jaw and the work.

When holding heavy work in a vise, place a block of wood under the work as a prop to prevent it from sliding down and falling on your foot.

Do not open the jaws of a vise beyond their capacity, as the movable jaw will drop off,

causing personal injury and possible damage to the jaw.

### SHARPENING STONES

Sharpening stones are divided into two groups, natural and artificial. Some of the natural stones are oil treated during and after the manufacturing processes. The stones that are oil treated are sometimes called oilstones. Artificial stones are normally made of silicone carbide or aluminum oxide. Natural stones have very fine grains and are excellent for putting razorlike edges on fine cutting tools. Most sharpening stones have one coarse and one fine face. Some of these stones are mounted, and the working face of some of the sharpening stones is a combination of coarse and fine grains. Stones are available in a variety of shapes, as shown in figure 1-103.

A fine cutting oil is generally used with most artificial sharpening stones; however, other lubricants such as kerosene may be used. When a tool has been sharpened on a grinder or grindstone, there is usually a wire edge or a feather edge left by the coarse wheel. The sharpening stones are used to hone this wire or feather edge off the cutting edge of the tool. Do not attempt to do a honing job with the wrong stone. Use a coarse stone to sharpen large and very dull or nicked tools. Use a medium grain stone to sharpen tools not requiring a finished edge, such as tools for working soft wood, cloth, leather, and rubber. Use a fine stone and an oilstone to sharpen and hone tools requiring a razorlike edge.

Prevent glazing of sharpening stones by applying a light oil during the use of the stone. Wipe the stone clean with wiping cloth or cotton waste after each use. If stone becomes glazed or gummed up, clean with aqueous ammonia or drycleaning solvent. If necessary, scour with aluminum oxide abrasive cloth or flint paper attached to a flat block.

At times, stones will become uneven from improper use. True the uneven surfaces on an old grinding wheel or on a grindstone. Another method of truing the surface is to lap it with a block of cast iron or other hard material covered with a waterproof abrasive paper, dipping the stone in water at regular intervals and continuing the lapping until the stone is true.

Stones must be carefully stored in boxes or on special racks when not in use. Never lay them down on uneven surfaces or place them

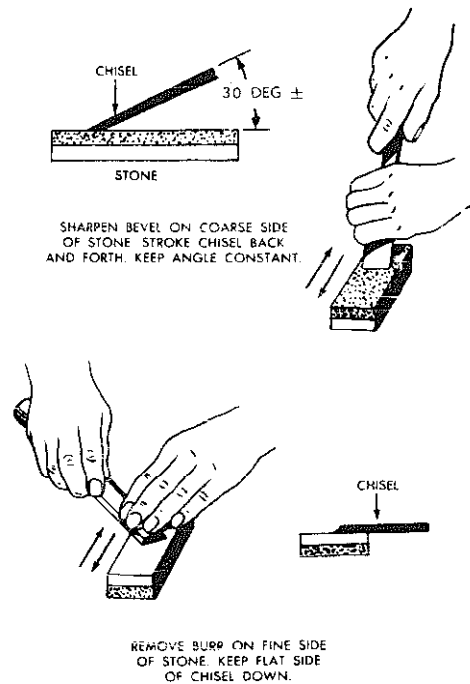

29.9N

Figure 1-104.—Sharpening a woodworker's chisel.

where they may be knocked off a table or bench, or where heavy objects can fall on them. Do not store in a hot place.

### SHARPENING A WOOD CHISEL

To sharpen a wood chisel with a sharpening stone, use a common oilstone that has coarse grit on one side and fine grit on the other (fig. 1-104). Make sure the stone is firmly held so that it cannot move. Cover the stone with a light machine oil so that the fine particles of steel ground off will float and thus prevent the stone from clogging.

Hold the chisel in one hand with the bevel flat against the coarse side of the stone. Use the fingers of your other hand to steady the chisel and hold it down against the stone. Using smooth even strokes, rub the chisel back and forth parallel to the surface of the stone (fig. 5-18). The entire surface of the stone should be used to avoid wearing a hollow in the center of the stone. Do not rock the blade. The angle of the

## TOOLS AND THEIR USES

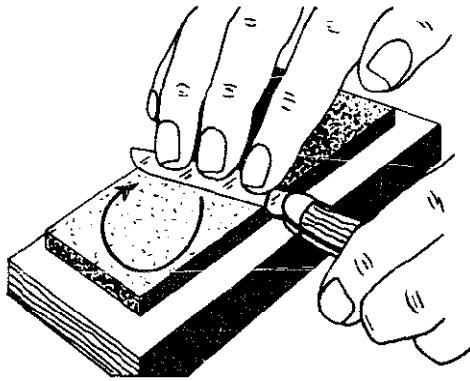

44.137

Figure 1-105.—Sharpening a pocket knife.

blade with the stone must remain constant during the whetting process.

After a few strokes, a burr, wire edge, or feather edge is produced. To remove the burr, first take a few strokes with the flat side of the chisel held flat on the fine grit side of the stone. Be careful not to raise the chisel even slightly; avoid putting the slightest bevel on the flat side, for then the chisel must be ground until the bevel is removed.

After whetting the flat side on the fine grit side of the stone, turn the chisel over and place the bevel side down and hold it at the same angle as used when whetting on the coarse side of the stone. Take two or three light strokes to remove the burr.

To test the sharpness of the cutting edge, hold the chisel where a good light will shine on the cutting edge. A keen edge does not reflect light in any position. If there are no shiny or white spots it is a good edge.

### SHARPENING A POCKET KNIFE

Pocket knives may be sharpened on a medium or fine grade sharpening stone with a few drops of oil spread on the surface. Hold the handle of the knife in one hand and place the blade across the stone. Press down with the fingers of the other hand and stroke the blade following a circular motion as shown in figure 1-105. After several strokes, reverse the blade and stroke the opposite side, following the same type of motion. Use a light even pressure. A thin blade overheats quickly and can



SHOP



POCKET



PUTTY

44.210

Figure 1-106.—Knives.

lose its temper. The wire edge or burr that may be left on a knife blade after whetting may be removed by stropping both sides on a soft wood block, canvas or leather.

### MISCELLANEOUS TOOLS

Tools described in this section may be encountered at some time in your Navy career. They may not necessarily be found in any particular toolkit but may be stored in a central toolroom, to be checked out when needed. This section of the text will give you some tips on their nomenclature, where and how they can be used, and some safety precautions to be observed when using these tools.

### KNIVES

Most knives are used to cut, pare, and trim wood, leather, rubber and other similar materials. The types you will probably encounter most frequently are the shop knife, pocket knife, and the putty knife (fig. 1-106).

The shop knife can be used to cut cardboard, linoleum, and paper. It has an aluminum handle and is furnished with interchangeable blades stored in the 5-inch handle.

Pocket knives are used for light cutting, sharpening pencils, cutting strings, etc. They are unsuited for heavy work. Multi-purpose knives have an assortment of blades designed for forcing holes, driving screws and opening cans, as well as cutting. The blades are hinged and should be contained within the case when

not in use. They are spring loaded to keep them firmly in place when open or closed.

A putty knife is used for applying putty to window sash when setting in panes of glass. The blade has a wide square point available in different lengths and widths.

Safety with knives is essential. Do not use knives larger than can be safely handled. Use knives only for the purpose for which they were designed. Always cut away from your body. Do not carry open knives in your pocket or leave them where they may come into contact with or cause injury to others. Put knives away carefully after use to protect sharp cutting edges from contacting other hard objects.

### MECHANICAL FINGERS

Small articles which have fallen into places where they cannot be reached by hand may be retrieved with the mechanical fingers. This tool is also used when starting nuts or bolts in difficult areas. The mechanical fingers, shown in figure 1-107 have a tube containing flat springs which extend from the end of the tube to form clawlike fingers, much like the screw holder. The springs are attached to a rod that extends from the outer end of the tube. A plate is attached to the end of the tube, and a similar plate to be pressed by the thumb is attached to the end of the rod. A coil spring placed around the rod between the two plates holds them apart and retracts the fingers into the tube. With the bottom plate grasped between the fingers and enough thumb pressure applied to the top plate to compress the spring, the tool fingers extend from the tube in a grasping position. When the thumb pressure is released, the tool fingers retract into the tube as far as the object they hold will allow. Thus, enough pressure is applied on the object to hold it securely. Some mechanical fingers have a flexible end on the tube to permit their use in close quarters or around obstructions (fig. 1-107).

**NOTE:** Mechanical fingers should not be used as a substitute for wrenches or pliers. The fingers are made of thin sheet metal or spring wire and can be easily damaged by overloading.

### Flashlight

Each toolbox should have a standard Navy vaporproof two-cell flashlight. The flashlight

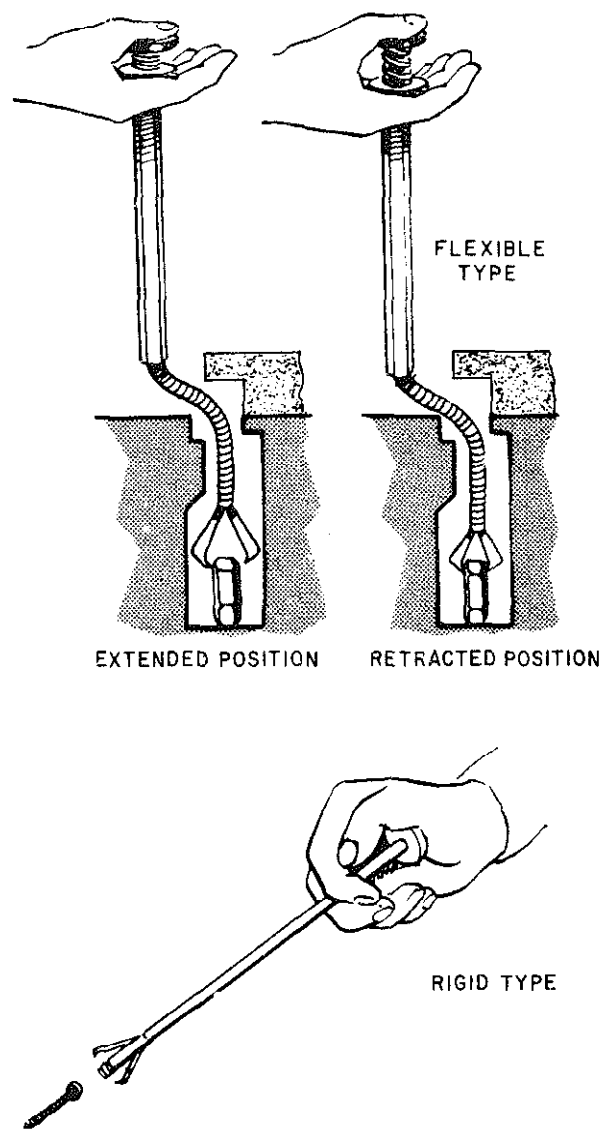

44.211  
Figure 1-107.—Mechanical fingers.

is used constantly during all phases of maintenance. Installed in both ends of the flashlight are rubber seals which keep out all vapors. The flashlight should be inspected periodically for the installation of these seals, the spare bulb, and colored filters which are contained in the end cap. **NOTE:** Do not throw away the filters; they will be necessary during night operations.

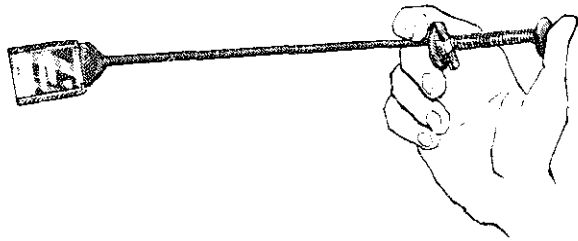

44.212

Figure 1-108.—Adjustable inspection mirror.

INSPECTION MIRROR

There are several types of inspection mirrors available for use in maintenance. The mirror is issued in a variety of sizes and may be round or rectangular. The mirror is connected to the end of a rod and may be fixed or adjustable (fig. 1-108).

The inspection mirror aids in making detailed inspection where the human eye cannot directly see the inspection area. By angling the mirror, and with the aid of a flashlight, it is possible to inspect most required areas. A late

model inspection mirror features a built-in light to aid in viewing those dark places where use of a flashlight is not convenient.

PERSONAL SAFETY EQUIPMENT

To protect you from danger, protective equipment such as safety shoes, goggles, hard hats and gloves are issued. The use of this equipment is mandatory on certain jobs. Their use is a **MUST** and there is no question about that. **Be sure to USE THEM on any job WHERE they are REQUIRED.** They can protect you from a lot of harm.

SAFETY SHOES

Some safety shoes are designed to limit damage to your toes from falling objects. A steel plate is placed in the toe area of such shoes so that your toes are not crushed if an object impacts there.

Other safety shoes are designed for use where danger from sparking could cause an explosion. Such danger is minimized by elimination of all metallic nails and eyelets and the use of soles which do not cause static electricity.

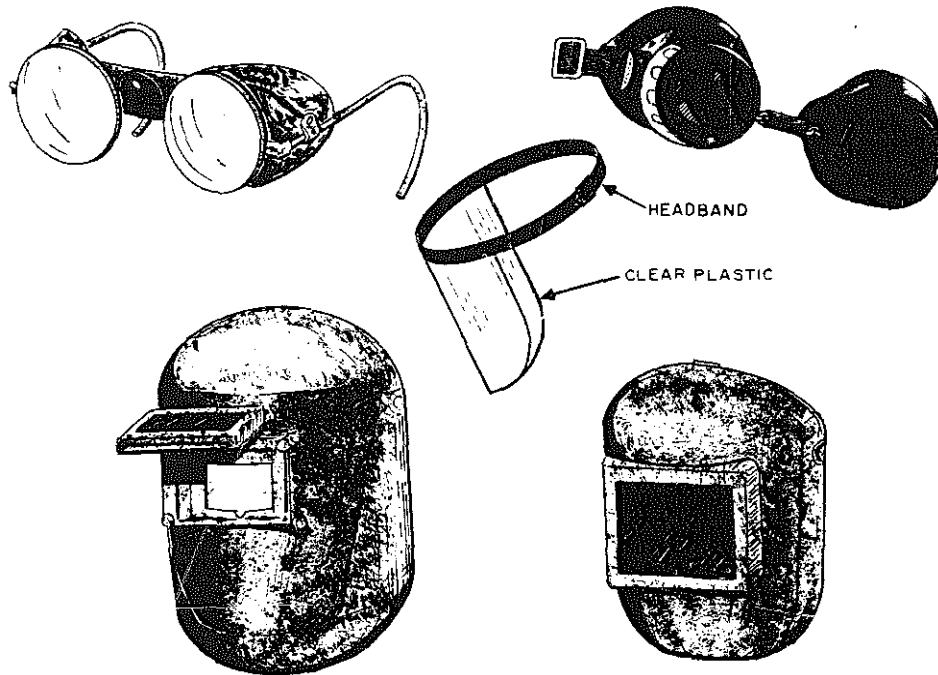

29.200

Figure 1-109.—Eye protection devices.

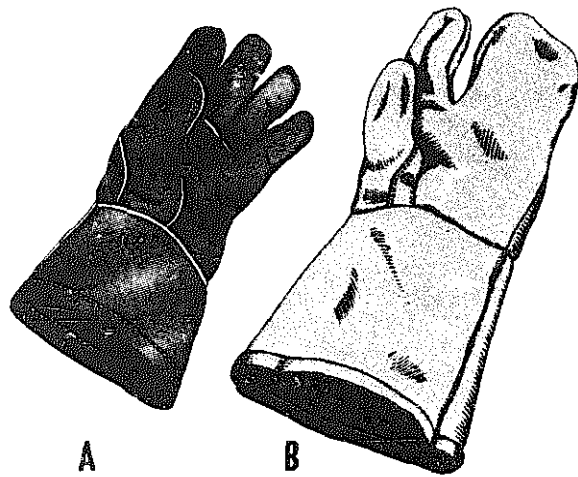

29.201  
Figure 1-110.—Gas and electric-arc welding gauntlet gloves.

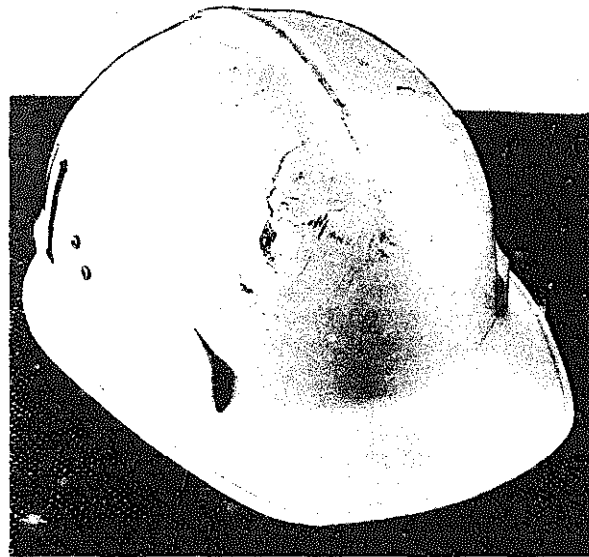

26.203  
Figure 1-112.—Hard hat.

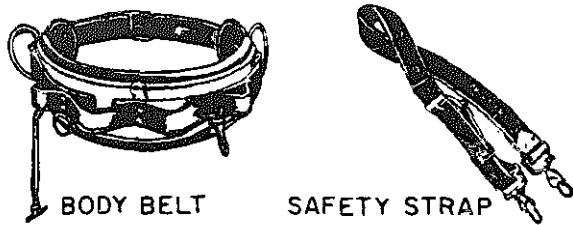

29.239.1  
Figure 1-111.—Safety equipment.

### GOGGLES

Proper eye protection is the utmost importance for all personnel. Eye protection is necessary because of hazards posed by infrared and ultraviolet radiation, or by flying objects such as sparks, globules of molten metal, or chipped concrete and wood, etc. These hazards are everpresent during welding, cutting, soldering, chipping, grinding and a variety of other operations. It is **IMPERATIVE** for you to use eye protection devices such as helmets, handshields and goggles (fig. 1-109) during eye-hazard operations.

Appropriate use of goggles will limit eye hazards. Some goggles have plastic windows which resist shattering upon impact. Others

are designed to limit harmful infrared and ultraviolet radiation from arcs or flames by appropriate filter lenses.

Remember, eye damage can be excruciatingly painful. **PROTECT YOUR EYES.**

### GLOVES

Use gloves whenever you are required to handle rough, scaly, or splintery objects. Special flameproof gloves are designed for gas and electric welding, to limit danger and damage from sparks and other hot flying objects (fig. 1-110). Personnel in the electrical fields are usually required to wear insulating rubber gloves.

Be sure to follow all regulations prescribed for the use of gloves. Gloves must not be worn around rotating machinery unless sharp or rough material is being handled. If such is the case, **EXTREME CARE SHOULD BE EXERCISED** to prevent the gloves from being caught in the machinery.

### SAFETY BELTS AND STRAPS

The "safety strap" and "body belt" shown in figure 1-111 are what might be called your extra hands when you work aloft. The body belt,

## TOOLS AND THEIR USES

strapped around your waist contains various pockets for small tools. The safety strap is a leather or neoprene impregnated nylon belt with a tongue-type buckle at each end. While you are climbing you will have the safety strap hanging by both ends from the left ring (called a "D" ring because of its shape) on the body belt. When you are at working position, you unsnap one end of the safety strap, pass it around the supporting structure so there is no danger of its slipping (at least 18 inches from the top of the part on which it is fastened), and hook it to the right "D" ring on the body belt.

The safety strap must be placed around a part of the structure which is of sufficient strength to sustain a man's weight and his equipment, and must rest flat against the surface without twists or turns. It must not be placed around any part of a structure which is being removed. Men climbing poles at shore stations must be sure to place the straps beneath arms and braces of the poles, wherever possible.

Before placing your weight on the strap, determine VISUALLY that the snap and "D" ring are properly engaged. Do not rely on the "click" of the snap-tongue as an indication the fastening is secure.

The body belt and safety strap require inspection before use. Look for loose or broken rivets, cracks, cuts, nicks, tears or wear in leather, broken or otherwise defective buckles, such as enlarged tongue-holes, defects in safety-belt snap hooks and body belt "D" rings. If you discover any of these or other defects, turn in your equipment and replace it.

Perform maintenance periodically in accordance with applicable procedures. Remember that leather and nylon belts are treated in different manners.

### PROTECTIVE HELMETS

Protective helmets (hard hats) come in a variety of shapes. They may be made of tough

polyethylene or polycarbonate, one of the toughest hat materials yet developed. Many a man has had his life saved because he wore a protective hat (fig. 1-112). When a falling object struck the hat the shock-absorbing suspension capabilities minimized damage to the man's head.

Regular hard hats are required to have a degree of insulation resistance such that personnel, other than electrical, may be protected from accidental head contacts with electrical circuits and equipment at comparatively low voltages (less than 2200 volts).

Electrical workers requiring head protection incidental to their duties or to the working environment, particularly those engaged in transmission or distribution line installation and repair must wear insulating safety helmets or all-purpose protective helmets which must be capable of withstanding 20,000 volt minimum proof-tests.

### BUILT-IN SAFETY EQUIPMENT

In previous paragraphs we discussed a variety of safety equipment furnished by the Navy. Don't forget about your own built-in safety equipment, however.

You have EYES to see danger, EARS to hear warnings, FEET to get away, BRAINS to know when danger is near, HANDS to help you remove or correct unsafe conditions, and a VOICE to warn your shipmates of unsafe acts. Use this safety equipment advantageously to limit accidents.

Above all, remember your ABC's.

ALWAYS

BE

CAREFUL

## CHAPTER 2

# COMMON POWER TOOLS

Power tools are so commonplace in the Navy that men in all ratings use some power tools at one time or another. This chapter of the text will be devoted to the more common types of electric and air-driven power tools and equipment. Upon completion, you should be able to identify them, discuss applicable safety measures, and describe the general operating practices and care of these tools.

### SAFETY

Safe practices in the use of power tools cannot be overemphasized. There are several general safety measures to observe in operating or maintaining power equipment.

- First of all, never operate power equipment unless you are thoroughly familiar with its controls and operating procedures. When in doubt, consult the appropriate operating instruction or ask someone who knows.
- All portable tools should be inspected before use to see that they are clean and in a proper state of repair.
- Have ample illumination. If extension lights are required, ensure that a light guard is provided (fig. 2-1).
- Before a power tool is connected to a source of power (electricity, air, etc.), BE SURE that the switch on the tool is in the "OFF" position.
- When operating a power tool, give it your FULL and UNDIVIDED ATTENTION.
- Keep all safety guards in position and use safety shields or goggles when necessary.
- Fasten all loose sleeves and aprons.
- DO NOT DISTRACT OR IN ANY WAY DISTURB another man while he is operating a power tool.
- Never try to clear jammed machinery unless you remove the source of power first.
- After using a power tool, turn off the power, remove the power source, wait for all rotation of the tool to stop, and then clean the tool. Remove all waste and scraps from the

work area and stow the tool in its assigned location.

- Never plug the power cord of a portable electric tool into an electrical power source before ensuring that the source has the voltage and type of current (alternating or direct) called for on the nameplate of the tool.

- If an extension cord is required, always connect the cord of a portable electric power tool into the extension cord before the extension cord is inserted into a convenience outlet (fig. 2-2). Always unplug the extension cord from the receptacle before the cord of the portable power tool is unplugged from the extension cord. (The extension cord and the power cord can each be no longer than 25 feet in length. Extra extension cords should be limited, wherever possible, to maintain allowable resistance to ground.)

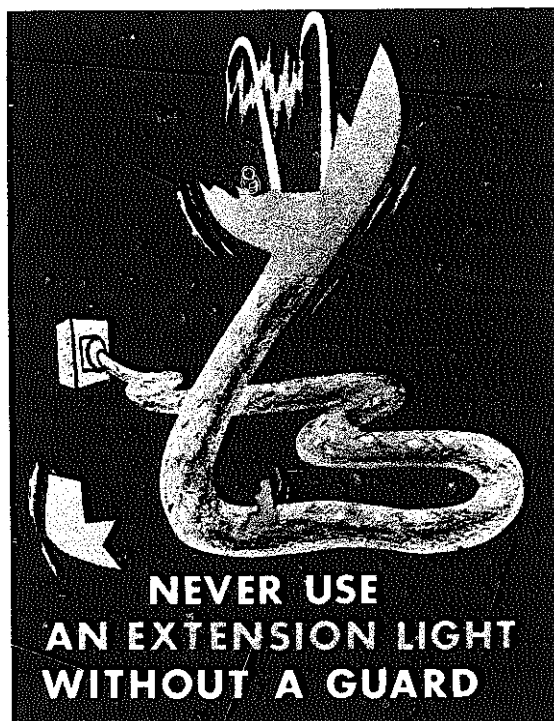
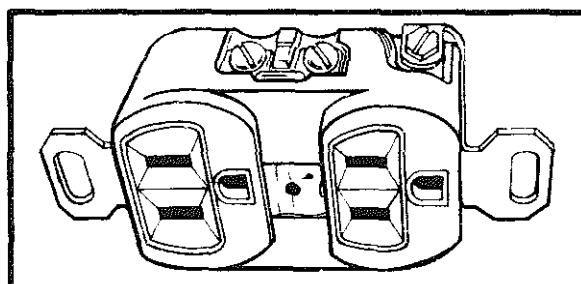
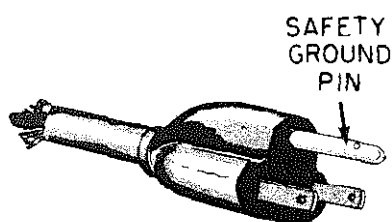

Figure 2-1.—Safety poster. 40.67(67B)A





**USE THE CORRECT PLUG !**



**MAKE CERTAIN THAT THE TOOLS YOU USE HAVE A SAFETY PLUG AND CORD WITH INTEGRAL GROUNDING CONDUCTOR.**

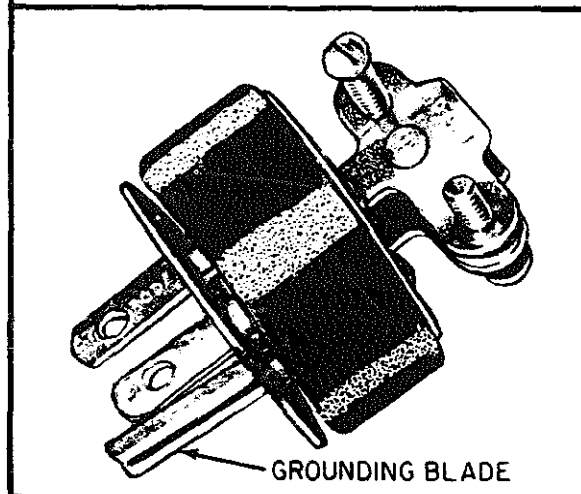

Figure 2-2.—Grounding plugs and convenience outlet. 40.67(67C)A:5.13

● Be sure to use a grounded plug and 3-conductor cord. Figure 2-2 shows a permanently molded type of grounded plug and also one used for replacement purposes.

The purpose of the properly grounded conductor in the 3-conductor cord is to minimize the possibility of electrical shock. The end of the grounding conductor within the tool or equipment is connected to the metal housing by the manufacturer, and the other end is connected to the grounding blade or pin of the grounded plug. In this manner, the grounding conductor simulates the mounting bolts of permanent equipment; namely, it joins the metal case of portable electric equipment to the metal of the ship's hull.

One exception to the use of 3-conductor grounded cord concerns plastic-cased tools (drills, sanders, grinders, etc.) that have been developed to eliminate the risk of electric shock. In these tools the shafts and chucks are isolated electrically from the drive motors. **DO NOT** replace the two-conductor cable on plastic-cased tools with 3-conductor cable **IF** the plastic-cased tool has an information plate on it stating that "grounding is not required"!

● Be sure that power cords do not come in contact with sharp objects. The cords should not be allowed to kink, nor should they be allowed to come in contact with oil, grease, hot surfaces, or chemicals.

● When cords are damaged, they should be replaced.

● Portable cables should be of sufficient length that they will not be subjected to longitudinal stresses or need to be pulled taut to make connections.

● Electrical portable cables should be checked frequently while in service to detect unusual heating. Any cable which feels more than comfortably warm to the bare hand placed outside the insulation should be checked immediately for overloading by competent electrical personnel.

● See that all cables are positioned so that they will not constitute tripping hazards.

● Electricity must be treated with respect and handled properly (fig. 2-3). If water exists anywhere in the vicinity of energized equipment—be especially cautious, and wherever possible, deenergize the equipment.

● Always remember:

1. **ELECTRICITY** strikes without warning.
2. Every electrical circuit is a **POTENTIAL SOURCE OF DANGER** and **MUST BE TREATED AS SUCH**.
3. Make no electrical repairs yourself unless you are qualified to do so.

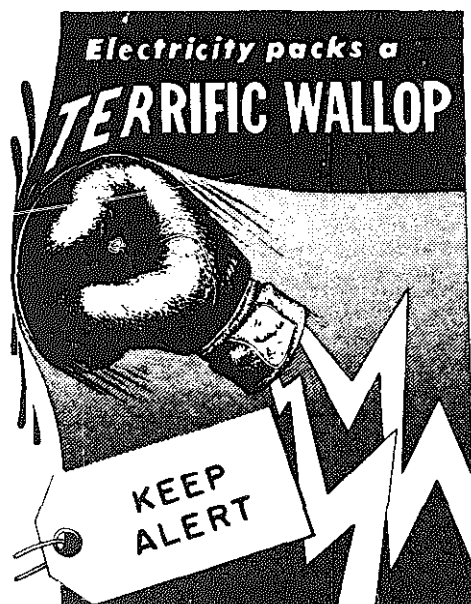

40.67.3(111A)

Figure 2-3.—Know what you are doing.

4. Sparking electric tools should never be used in places where flammable gases or liquids or exposed explosives are present. Pneumatic tools are used in these areas.
5. The power should always be disconnected before accessories on tools are changed.

• Shipboard conditions are particularly conducive to electric shock possibilities because the body may contact the ship's metal structure. Extra care is therefore needed, especially when body resistance may be low because of perspiration or damp clothing. Insulate yourself from ground by means of insulating material covering any adjacent grounded metal with which you might come into contact. Suitable materials include dry wood, dry canvas, dry phenolic material, several thicknesses of dry paper, or rubber mats. **ALWAYS REPORT ANY SHOCK RECEIVED** from electrical equipment. Minor shocks often lead to fatal shocks later on.

#### PORTABLE ELECTRIC POWER TOOLS

Portable power tools are tools that can be moved from place to place. Some of the most

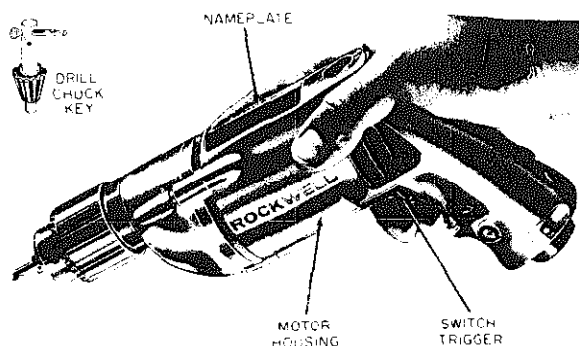

4,35A

Figure 2-4.—1/4-inch portable electric drill.

common portable power tools that you will use in the Navy are electrically powered and include drills, sanders, grinders and saws.

#### DRILLS

The portable electric drill (fig. 2-4) is probably the most frequently used power tool in the Navy. Although it is especially designed for drilling holes, by adding various accessories you can adapt it for different jobs. Sanding, sawing, buffing, polishing, screw-driving, wire brushing, and paint mixing are examples of possible uses.

Portable electric drills commonly used in the Navy have capacities for drilling holes in steel from 1/16 inch up to 1 inch in diameter. The sizes of portable electric drills are classified by the maximum size straight shank drill it will hold. That is, a 1/4 inch electric drill will hold a straight shank drill up to and including 1/4 inch.

The revolutions per minute (rpm) and power the drill will deliver are most important when choosing a drill for a job. You will find that the speed of the drill motor decreases with an increase in size, primarily because the larger units are designed to turn larger cutting tools or to drill in heavy materials, and both these factors require slower speed.

If you are going to do heavy work, such as drilling in masonry or steel, then you would probably need to use a drill with a 3/8 or 1/2 inch capacity. If most of your drilling will be forming holes in wood or small holes in sheet metal, then a 1/4-inch drill will probably be adequate.

The chuck is the clamping device into which the drill is inserted. Nearly all electric drills

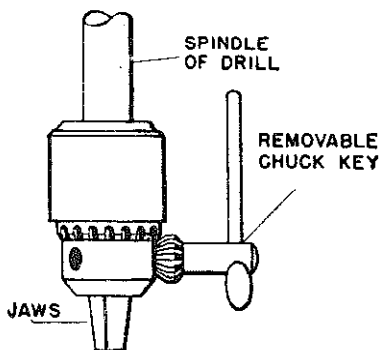

44.46

Figure 2-5.—Three jaw chuck and chuck key.

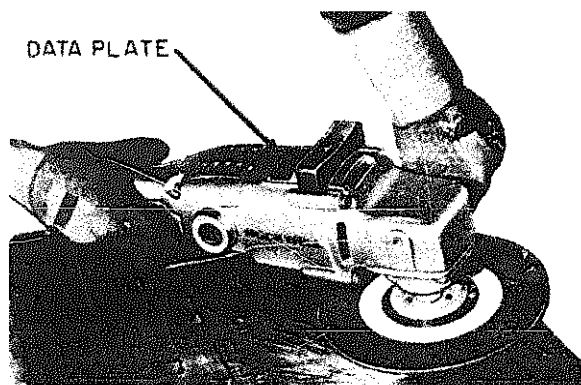

44.49X

Figure 2-6.—Portable electric sander.

are equipped with a three-jaw chuck. Some of the drill motors have a hand-type chuck that you tighten or loosen by hand but most of the drills used in the Navy have gear-type, three-jaw chucks which are tightened and loosened by means of a chuck key, shown in figure 2-5. Do not apply further pressure with pliers or wrenches after you hand tighten the chuck with the chuck key.

Always remove the key IMMEDIATELY after you use it. Otherwise the key will fly loose when the drill motor is started and may cause serious injury to you or one of your shipmates. The chuck key is generally taped on the cord of the drill; but if it is not, make sure you put it in a safe place where it will not get lost.

All portable electric drills used in the Navy have controls similar to the ones shown on the

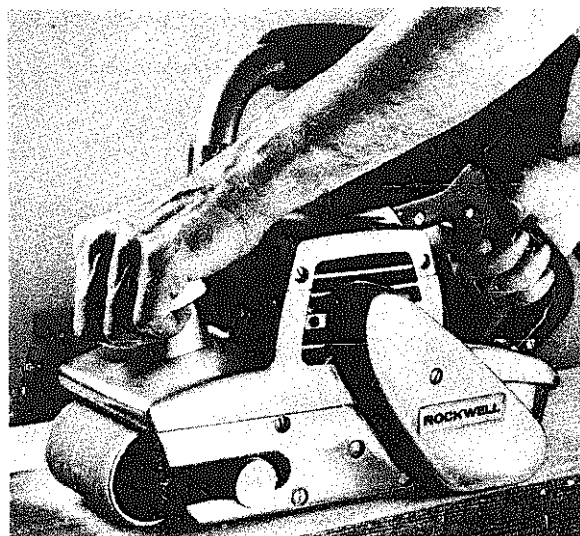

29.139X

Figure 2-7.—Portable belt sander.

1/4-inch drill in figure 2-4. This drill has a momentary contact trigger switch located in the handle. The switch is squeezed to start the electric drill and released to stop it.

The trigger latch is a button in the bottom of the drill handle. It is pushed in, while the switch trigger is held down, to lock the trigger switch in the "ON" position. The trigger latch is released by squeezing and then releasing the switch trigger.

## SANDERS

Portable sanders are tools designed to hold and operate abrasives for sanding wood, plastics and metals. The most common types found in the Navy are the DISK, BELT, and RECIPROCATING ORBITAL sanders.

### Disk Sander

Electric disk sanders (fig. 2-6) are especially useful on work where a large amount of material is to be removed quickly such as scaling surfaces in preparation for painting. This machine, however, must not be used where a mirror smooth finish is required.

The disk should be moved smoothly and lightly over the surface. Never allow the disk to stay in one place too long because it will cut into the metal and leave a large depression.

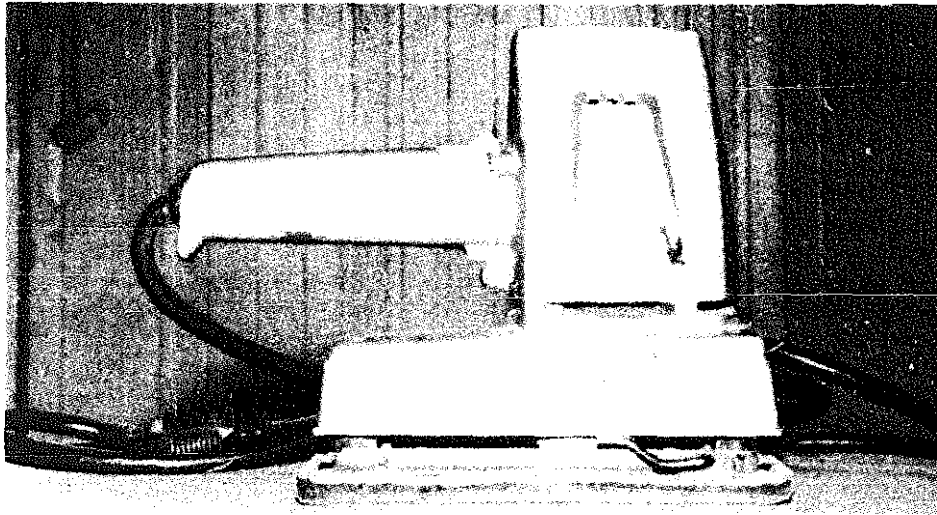

44.50X

Figure 2-8.—Orbital sander.

#### Belt Sander

The belt sander (fig. 2-7) is commonly used for surfacing lumber used for interior trim, furniture, or cabinets. Wood floors are almost always made ready for final finishing by using a belt sander. Whereas these types of sanding operations were once laborious and time-consuming, it is now possible to perform the operations quickly and accurately with less effort.

The portable belt sanders use endless sanding belts that can be obtained in many different grades (grits). The belts are usually 2, 3, or 4 inches wide and can be easily changed when they become worn or when you want to use a different grade of sanding paper.

The first thing to do when preparing to use the sander is to be sure that the object to be sanded is firmly secured. Then, after the motor has been started verify that the belt is tracking on center. Any adjustment to make it track centrally is usually made by aligning screws.

The moving belt is then placed on the surface of the object to be sanded with the rear part of the belt touching first. The machine is then leveled as it is moved forward. When you use the sander, don't press down or "ride" it, because the weight of the machine exerts enough pressure for proper cutting. (Excessive

pressure also causes the abrasive belt to clog and the motor to overheat). Adjust the machine over the surface with overlapping strokes, always in a direction parallel to the grain.

By working over a fairly wide area, and avoiding any machine tilting or pausing in any one spot, an even surface will result. Upon completion of the sanding process, lift the machine off the work and then stop the motor.

Some types of sanders are provided with a bag that takes up the dust that is produced. Use it if available.

#### Orbital Sander

The orbital sander (fig. 2-8) is so named because of the action of the sanding pad. The pad moves in a tiny orbit, with a motion that is hardly discernible, so that it actually sands in all directions. This motion is so small and so fast that, with fine paper mounted on the pad, it is nearly impossible to see any scratches on the finished surface.

The pad, around which the abrasive sheet is wrapped, usually extends beyond the frame of the machine so it is possible to work in tight corners and against vertical surfaces.

Some models of the orbital sanders have a bag attached to catch all dust that is made from the sanding operation. Orbital sanders (pad sanders) do not remove as much material as

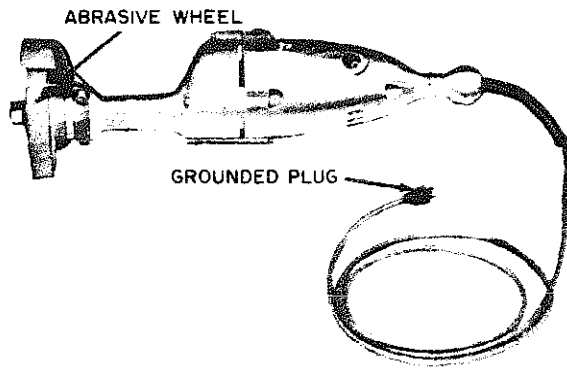

44.51

Figure 2-9.—Portable grinder.

fast as the belt sander or disk sander but do a better job on smoothing a surface for finishing. If both a belt or disk sander and an orbital sander are available you should use the belt or disk sander for rough, preliminary work and the orbital sander for finishing. The sandpaper used on the sander may be cut to size from a bulk sheet of paper or may be available in the correct size for the sander you have. The paper is wrapped around a pad on the sander and is fastened to the pad by means of levers on the front and rear of the sander. The lever action fasteners make changing the paper easy and quick.

#### PORTABLE GRINDERS

Portable grinders are power tools that are used for rough grinding and finishing of metallic surfaces. They are made in several sizes; however, the one used most in the Navy uses a grinding wheel with a maximum diameter of 6 inches. (See fig. 2-9.)

The abrasive wheels are easily replaceable so that different grain size and grades of abrasives can be used for the varying types of surfaces to be ground and the different degrees of finish desired.

A flexible shaft attachment is available for most portable grinders. This shaft is attached by removing the grinding wheel then attaching the shaft to the grinding wheel drive spindle. The grinding wheel can then be attached to the end of the flexible shaft. This attachment is invaluable for grinding surfaces in hard to reach places.

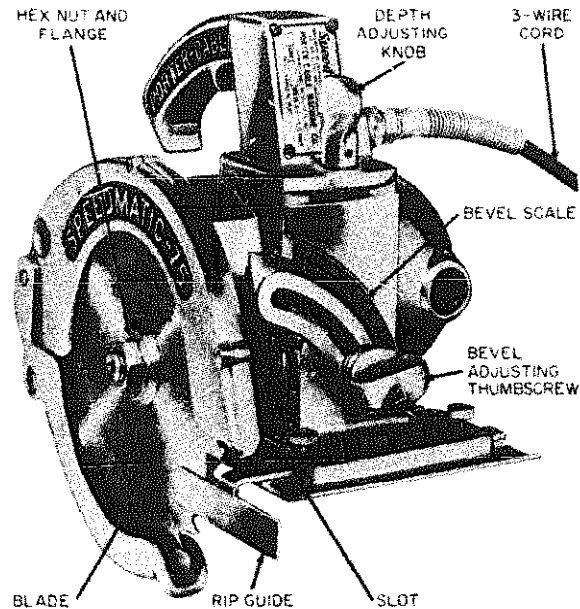

29.133

Figure 2-10.—Portable electric circular saw.

The wheel guard on the grinder should be positioned so that abrasive dust and metal particles will be deflected away from your face.

Before you turn the grinder on, make sure the abrasive grinding wheel is properly secured to the grinder spindle and not cracked or damaged.

#### PORTABLE CIRCULAR SAW

The portable circular saw is becoming more and more popular as a woodworking tool because of the time and labor it saves, the precision with which it works, and its ease of handling and maneuverability.

Because of the many types of portable circular saws in the Navy supply system, and the changes being made in the design of these saws, only general information will be given in this section. Information concerning a particular saw can be found by checking the manufacturer's manual.

The sizes of portable electric saws range from one-sixth horsepower with a 4-inch blade to one-and-one half horsepower with a 14-inch blade. They are so constructed that they may be used as a carpenter's handsaw, both at the job site or on a bench in the woodworking shop.

The portable electric saw (fig. 2-10) is started by pressing a trigger inserted in the handle and stopped by releasing it. The saw will run only when the trigger is held.

Most saws may be adjusted for cross-cutting or for ripping. The rip saw guide shown in figure 2-10 is adjusted by the two small knurled nuts at the base of the saw. When the guide is inserted in the rip guide slot to the desired dimensions, the nuts are then tightened to hold it firmly in place.

In crosscutting, a guideline is generally marked across the board to be cut. Place the front of the saw base on the work so that the guide mark on the front plate and the guide line on the work are aligned. Be sure the blade is clear of the work. Start the saw and allow the cutting blade to attain full speed. Then advance the saw, keeping the guide mark and guide line aligned. If the saw stalls, back the saw out. **DO NOT RELEASE** the starting trigger. When the saw resumes cutting speed, start cutting again.

Additional adjustments include a depth knob and a bevel thumbscrew. The depth of the cut is regulated by adjusting the depth knob. The bevel adjusting thumbscrew is used for adjusting the angle of the cut. This permits the base to be tilted in relation to the saw. The graduated scale marked in degrees on the quadrant (fig. 2-10) enables the operator to measure his adjustments and angles of cut.

The bottom plate of the saw is wide enough to provide the saw with a firm support on the lumber being cut. The blade of the saw is protected by a spring guard which opens when lumber is being cut but snaps back into place when the cut is finished. Many different saw blades may be placed on the machine for special kinds of sawing. By changing blades almost any building material from slate and corrugated metal sheets to fiberglass can be cut.

To change saw blades, first disconnect the power. Remove the blade by taking off the saw clamp screw and flange, using the wrench provided for this purpose. Attach the new saw blade making certain the teeth are in the proper cutting direction (pointing upward toward the front of the saw) and tighten the flange and clamp screw with the wrench.

**CAUTION:** Do not put the saw blade on backwards; most blades have instructions stamped on them with the words "This Side Out."

**THE PORTABLE ELECTRIC SAW IS ONE OF THE MOST DANGEROUS POWER TOOLS**

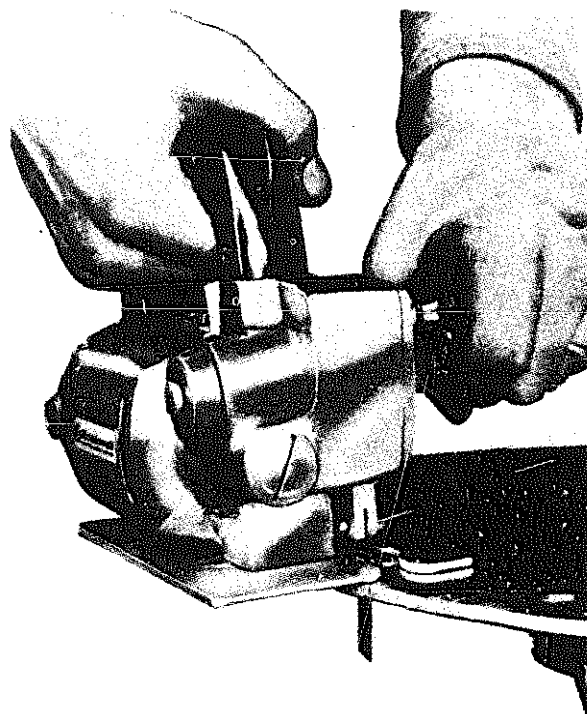

44.213X  
Figure 2-11.—Saber or bayonet saw operations.

**IN EXISTENCE WHEN IT IS NOT PROPERLY USED.** Make sure the board you are sawing is properly secured so it will not slip or turn. After making a cut be sure the saw blade has come to a standstill before laying the saw down.

When using an electric saw remember that all the blade you can normally see is covered; the portion of the blade that projects under the board being cut is not covered. The exposed teeth under the work are dangerous and can cause serious injury if any part of your body should come into contact with them.

Make sure the blade of a portable circular saw is kept sharp at all times. The saw blade will function most efficiently when the rate of feed matches the blade's capacity to cut. You will not have to figure this out—you will be able to feel it. With a little practice you will know when the cut is smooth and you will know when you are forcing it. Let the blade do its own cutting. The tool will last longer and you will work easier because it is less fatiguing.

## TOOLS AND THEIR USES

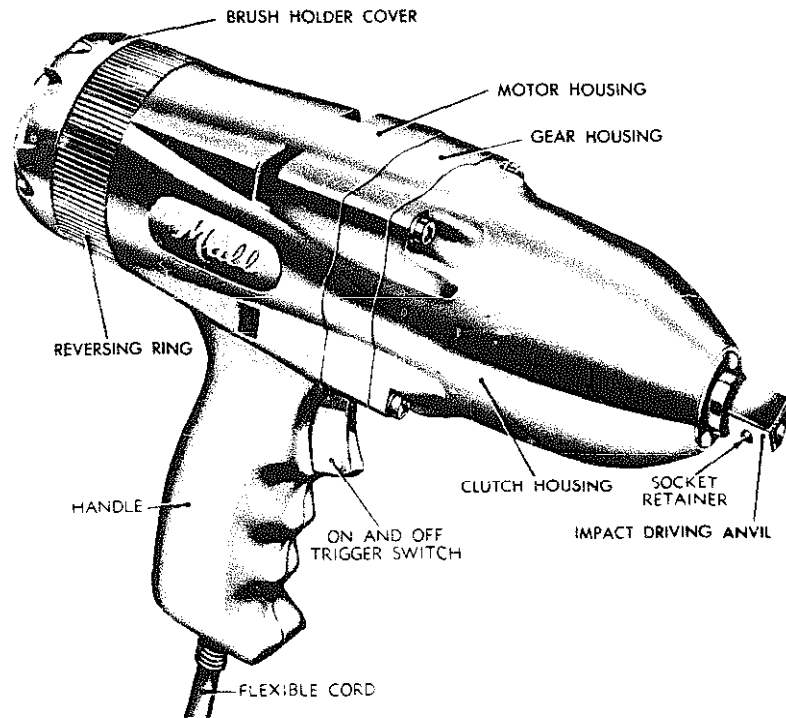

Figure 2-12.—Reversible electric impact wrench.

44.53

### SABER SAW

The saber saw (fig. 2-11) is a power driven jigsaw that will let you cut smooth and decorative curves in wood and light metal. Most saber saws are light duty machines and are not designed for extremely fast cutting.

There are several different blades designed to operate in the saber saw and they are easily interchangeable. For fast cutting of wood, a blade with coarse teeth may be used. A blade with fine teeth is designed for cutting metal.

The best way to learn how to handle this type of tool is to use it. Before trying to do a finished job with the saber saw, clamp down a piece of scrap plywood and draw some curved as well as straight lines to follow. You will develop your own way of gripping the tool, and this will be affected somewhat by the particular tool you are using. On some tools, for example, you will find guiding easier if you apply some downward pressure on the tool as you move it forward. If you are not firm with your grip, the tool will tend to vibrate excessively and this will roughen the cut. Do not force the

cutting faster than the design of the blade allows or you will break the blade.

### ELECTRIC IMPACT WRENCH

The electric impact wrench (fig. 2-12) is a portable hand-type reversible wrench. The one shown has a 1/2-inch square impact driving anvil over which 1/2-inch square drive sockets can be fitted. Wrenches also can be obtained that have impact driving anvils ranging from 3/8 inch to 1 inch. The driving anvils are not interchangeable, however, from one wrench to another.

The electric wrench with its accompanying equipment is primarily intended for applying and removing nuts, bolts, and screws. It may also be used to drill and tap metal, wood, plastics, etc., and drive and remove socket-head, Phillips-head, or slotted-head wood, machine, or self-tapping screws.

Before you use an electric impact wrench depress the on-and-off trigger switch and allow the electric wrench to operate a few seconds, noting carefully the direction of rotation.

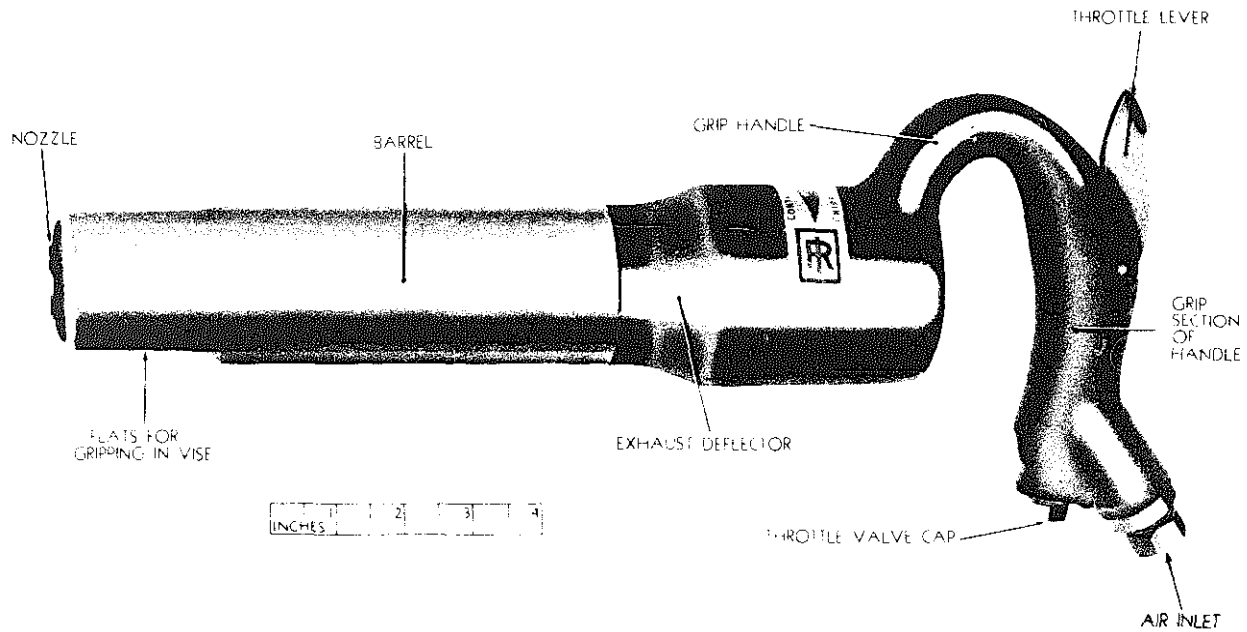

Figure 2-13.—Pneumatic chipping hammer.

Release the trigger switch to stop the wrench. Turn the reversing ring located at the rear of the tool; it should move easily in one direction (which is determined by the current direction of rotation). Depress the on-and-off trigger again to start the electric wrench. The direction of rotation should now be reversed. Continue to operate for a few seconds in each direction to be sure that the wrench and its reversible features are functioning correctly. When you are sure the wrench operates properly, place the suitable equipment on the impact driving anvil and go ahead with the job at hand.

#### PORTABLE PNEUMATIC POWER TOOLS

Portable pneumatic power tools are tools that look much the same as electric power tools but use the energy of compressed air instead of electricity. Because of the limited outlets for compressed air aboard ship and shore stations, the use of pneumatic power tools is not as widespread as electric tools. Portable pneumatic tools are used most around a shop where compressed air outlets are readily accessible.

#### SAFETY

In operating or maintaining air-driven tools, take the following precautionary measures to protect yourself and others from the damaging effects of compressed air.

- Inspect the air hose for cracks or other defects; replace the hose if found defective.
- Before connecting an air hose to the compressed air outlet, open the control valve momentarily. Then, make sure the hose is clear of water and other foreign material by connecting it to the outlet and again opening the valve momentarily.

**CAUTION:** Before opening the control valve, see that nearby personnel are not in the path of the air flow. Never point the hose at another person.

- Stop the flow of air to a pneumatic tool by closing the control valve at the compressed air outlet before connecting, disconnecting, adjusting, or repairing a pneumatic tool.



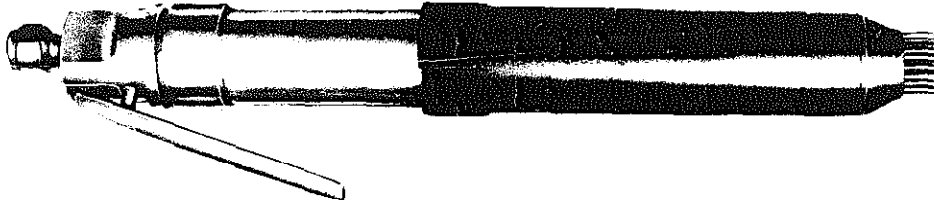
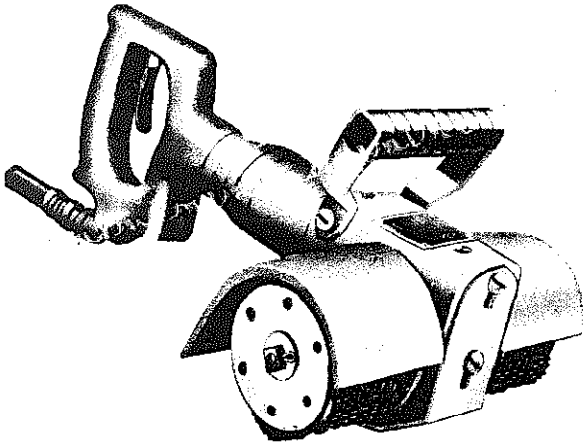

Figure 2-14.—Needle impact scaler.

44.214X



3.209

Figure 2-15.—Rotary impact scaler.

### PNEUMATIC CHIPPING HAMMER

The pneumatic chipping hammer (fig. 2-13) consists basically of a steel piston which is reciprocated (moved backward and forward alternately) in a steel barrel by compressed air. On its forward stroke the piston strikes the end of the chisel, which is a sliding fit in a nozzle pressed into the barrel. The rearward stroke is cushioned by compressed air to prevent any metal-to-metal contact. Reciprocation of the piston is automatically controlled by a valve located on the rear end of the barrel. Located on the rear end of the barrel is a grip handle, containing a throttle valve.

The throttle valve is actuated by a throttle lever which protrudes from the upper rear of the grip handle for thumb operation. Projecting from the butt of the handle is an air inlet. The handle is threaded onto the barrel and is prevented from unscrewing by a locking ring. Surrounding and retaining the locking ring is an

exhaust deflector. This deflector may be located in any of four positions around the barrel in order to throw the stream of exhaust air in the desired direction.

The pneumatic hammer may be used for beveling, calking or beading operations, and for drilling in brick, concrete, and other masonry.

Chipping hammers should not be operated without safety goggles and all other persons in the immediate vicinity of the work should wear goggles.

While working never point the chipping hammer in such a direction that other personnel might be struck by an accidentally ejected tool. When chipping alloy steel or doing other heavy work, it is helpful to dip the tool in engine lubricating oil about every 6 inches of the cut and make sure the cutting edge of the tool is sharp and clean. This will allow faster and easier cutting and will reduce the possibility of the tool breaking.

When nearing the end of a cut, ease off on the throttle lever to reduce the intensity of the blows. This will avoid any possibility of the chip or tool flying.

If for any reason you have to lay the chipping hammer down, always remove the attachment tool from the nozzle. Should the chipping hammer be accidentally started when the tool is free, the blow of the piston will drive the tool out of the nozzle with great force and may damage equipment or injure personnel.

### NEEDLE AND ROTARY IMPACT SCALERS

Needle and rotary scalers (figs. 2-14 and 2-15) are used to remove rust, scale, and old paint from metallic and masonry surfaces. You must be especially careful when using these tools since they will "chew" up anything in their path. Avoid getting the power line or any part of your body in their way.

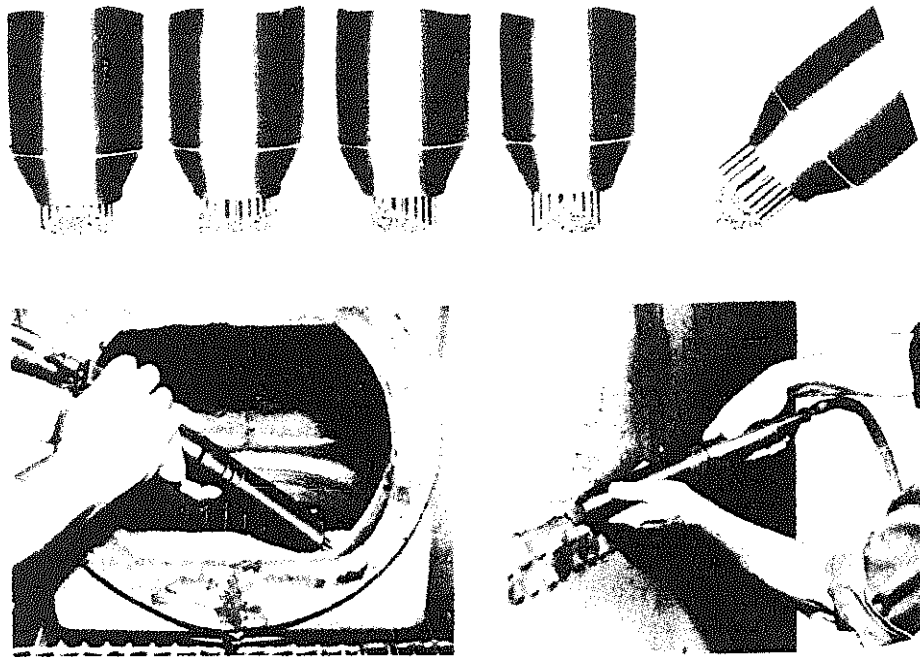

Figure 2-16.—Needle scaler operations.

44.215X

Needle scalers accomplish their task with an assembly of individual needles impacting on a surface hundreds of times a minute. The advantage of using individual needles is that irregular surfaces can be cleaned readily. See the operations and how the needle scaler self-adjusts to the contour of various surfaces in figure 2-16.

The rotary scaling and chipping tool, sometimes called a "jitterbug," has a bundle of cutters or chippers for scaling or chipping (fig. 2-15). In use, the tool is pushed along the surface to be scaled and the rotating chippers do the work. Replacement bundles of cutters are available when the old ones are worn.

**BE SURE YOU ARE NOT DAYDREAMING** when you use the rotary scaler.

#### PORTABLE PNEUMATIC IMPACT WRENCH

The portable pneumatic impact wrench (fig. 2-17) is designed for installing or removing nuts and bolts. The wrench comes in different sizes and is classified by the size of the square anvil on the drive end. The anvil is equipped with a socket lock which provides positive

locking of the socket wrenches or attachments. The wrench has a built-in oil reservoir and an adjustable air valve regulator which adjusts the torque output of the wrench. The torque regulator reduces the possibility of shearing or damaging threads when installing nuts and bolts to their required tension.

Nearly all pneumatic wrenches operate most efficiently on an air pressure range of 80 to 90 psi. A variation in excess of plus or minus 5 pounds is serious. Lower pressure causes a decrease in the driving speeds while higher pressure causes the wrench to overspeed with subsequent abnormal wear of the motor impact mechanisms.

The throttle lever located at the rear of the pneumatic wrench provides the means for starting and stopping the wrench. Depressing the throttle lever starts the wrench in operation. Upon release, the lever raises to its original position stopping the wrench.

The valve stem is seated beneath the pivot end of the throttle lever. Most wrenches have a window cut in the throttle lever so that the markings on the upper surface of the valve stem will be visible. Two letters, "F" and "R," have been engraved on the head of the

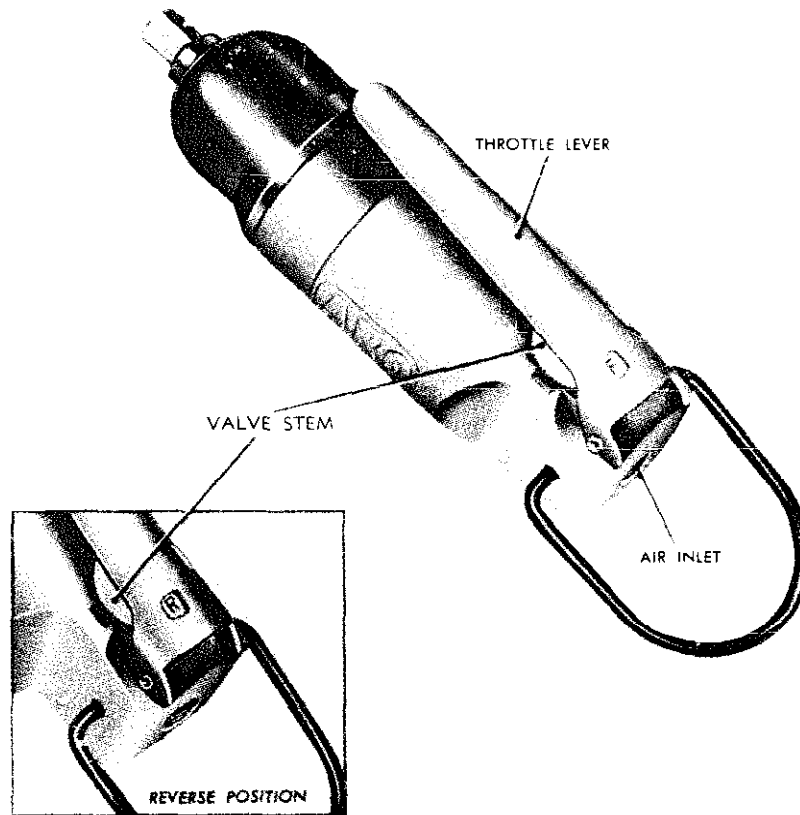

44.56

Figure 2-17.—Portable pneumatic impact wrench.

valve stem to indicate the forward (clockwise) and reverse (counterclockwise) rotation of the anvil. To change from forward to reverse rotation, or vice versa, turn the valve stem 180° until the desired marking is visible through the window in the throttle lever. When the valve stem is in proper position, the valve stem pin engages a recess on the under side of the valve stem, preventing accidental turning of the stem.

The air valve regulator is located at the bottom and towards the rear of the wrench. Using a screwdriver and altering the setting of the air regulator up to 90°, either to the right or left, reduces the torque from full power to zero power.

Before operating the pneumatic impact wrench make sure the socket or other attachment you are using is properly secured to the anvil. It is always a good idea to operate the wrench free of load in both forward and reverse directions to see that it operates properly. Check the installation of the air hose to

make sure it is in accordance with the manufacturer's recommendation.

#### COMMON POWER MACHINE TOOLS

Small power machine tools are, generally speaking, not portable. All work that is to be done must be brought to the shop where the machine is set up. Only the most common types of power machine tools will be discussed in this chapter. The drill press and the bench grinder may be found in several shops aboard ship or on shore stations. They are tools that are not confined to operation by men of any one particular rating but may be used by men of several ratings.

#### DRILL PRESS

The drill press (fig. 2-18) is an electrically operated power machine that was originally designed as a metal-working tool. Available

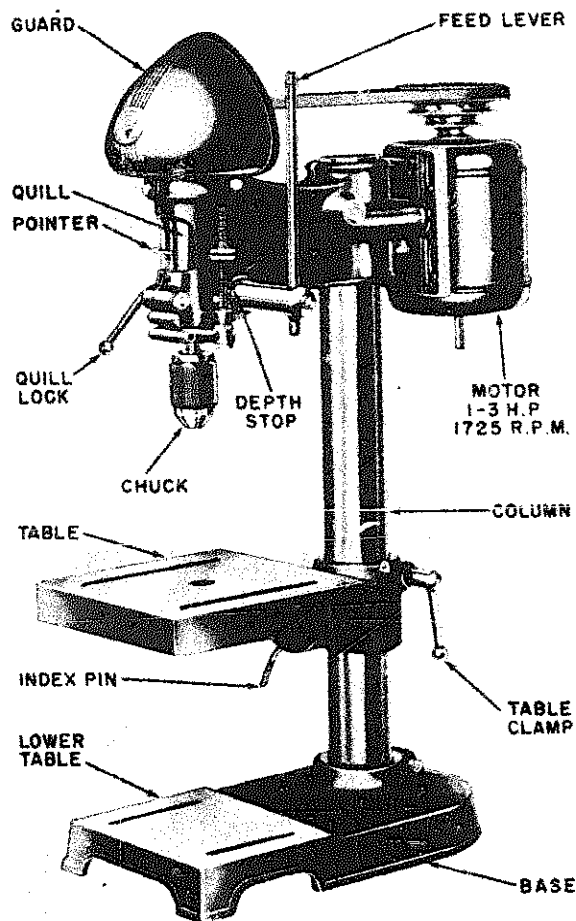

Figure 2-18.—Drill press. 4.29

accessories, plus jigs and special techniques, now make it a versatile wood-working tool as well.

There are two basic types of drill presses used in the Navy; the bench-type and the upright-type. These are basically the same, the difference being in the mounting. As the names suggest, the bench-type drill press is mounted on a work bench and the upright-type drill press is mounted on a pedestal on the floor.

Drill presses are manufactured in a number of sizes. Only the small size drill press will be discussed in this text. The drill presses most commonly found in shops in the Navy have a capacity to drill holes in metal up to 1 inch in

diameter. The driving motors range in size from 1/3 hp to 3 hp.

The motor is mounted to a bracket at the rear of the head assembly and designed to permit V-belt changing for desired spindle speed without removing the motor from its mounting bracket. Four spindle speeds are obtained by locating the V-belt on any one of the four steps of the spindle-driven and motor-driven pulleys.

The controls of drill presses are all similar. The terms "right" and "left" are relative to the operator's position standing in front of and facing the drill press. Forward applies to movement toward the operator. Rearward applies to movement away from the operator.

The power switch (fig. 2-19) is located on the right side of the head assembly. The power cord is placed in the power receptacle and the motor started by placing the switch in the "ON" position.

The spindle and quill feed handle (fig. 2-19) is located on the lower right-front side of the head assembly. Pulling forward and down on any one of the three spindle and quill feed handles, which point upward at the time, moves the spindle and quill assembly downward. Release the feed handle and the spindle and quill assembly will return to the retracted or upper position by spring action.

The quill lock handle (fig. 2-20) enables the drill press to be used as a milling tool and is located at the lower left-front side of the head assembly. Turn the quill lock handle clockwise to lock the quill at a desired operating position. Release the quill by turning the quill lock handle counterclockwise. However, in most cases, the quill lock handle will be in the released position.

The head lock handle (fig. 2-20) is located at the left-rear side of the head assembly. Turn the head lock handle clockwise to lock the head assembly at a desired vertical height on the bench column. Turn the headlock handle counterclockwise to release the head assembly. When operating the drill press, the head lock handle must be tight at all times.

The head collar support lock handle (fig. 2-19) is located at the right side of the head collar support and below the head assembly. The handle locks the head collar support, which secures the head vertically on the bench column, and prevents the head from dropping when the head lock handle is released. Turn the head

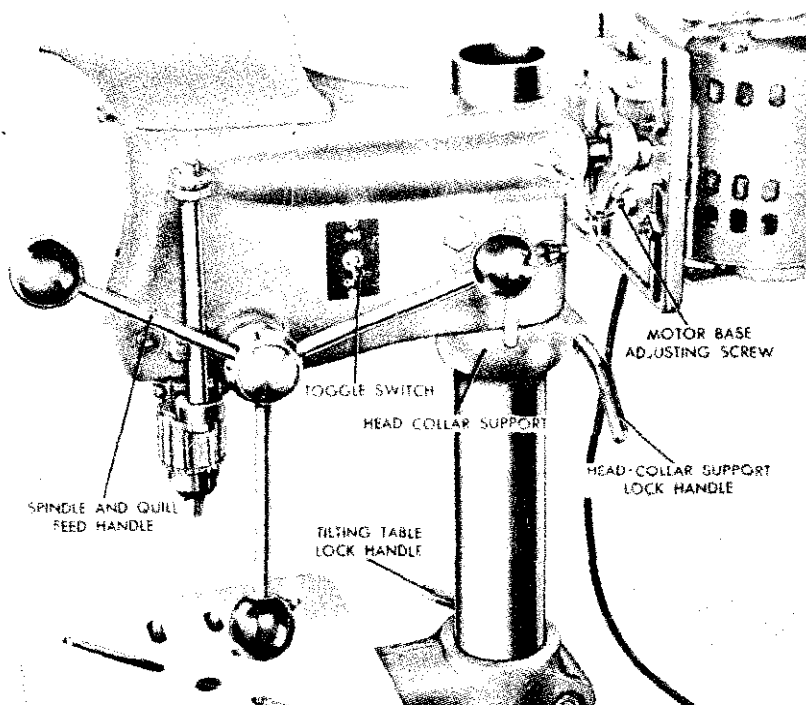

4.29

Figure 2-19.—Drill press controls—right side view.

collar support lock handle clockwise to lock the support to the bench column and counterclockwise to release the support. When operating the drill press, the head collar support lock handle must be tight at all times.

The tilting table lock handle (fig. 2-19) is located at the left-rear side of the tilting table bracket. Turn the tilting table lock handle counterclockwise to release the tilting table bracket so it can be moved up and down or around the bench column. Lock the tilting table assembly at desired height by turning the lock handle clockwise. When operating the drill press, the tilting table lock handle must be tight at all times.

The tilting table lockpin (S, fig. 2-21) is located below the tilting table assembly (T, fig. 2-21). The lockpin secures the table at a horizontal or 45° left or right from the horizontal position. To tilt the table left or right from its horizontal position, remove the lockpin and turn the table to align the lockpin holes. Insert the lockpin through the table and bracket holes after desired position is obtained.

The depth gage rod adjusting and locknuts (BB and CC, fig. 2-21) are located on the depth gage rod (Z, fig. 2-21). The purpose of the adjusting and locknuts is to regulate depth drilling. Turn the adjusting and locknut clockwise to decrease the downward travel of the spindle. The locknut must be secured against the adjusting nut when operating the drill press.

When operating a drill press make sure the drill is properly secured in the chuck and that the work you are drilling is properly secured in position. Do not remove the work from the tilting table or mounting device until the drill press has stopped.

Operate the spindle and quill and feed handles with a slow, steady pressure. If too much pressure is applied, the V-belt may slip in the pulleys, the twist drill may break, or the starting switch in the motor may open and stop the drill press. If the motor should stop because of overheating, the contacts of the starting switch will remain open long enough for the motor to cool, then automatically close to resume normal operation. Always turn the toggle switch to "OFF" position while the motor is cooling.

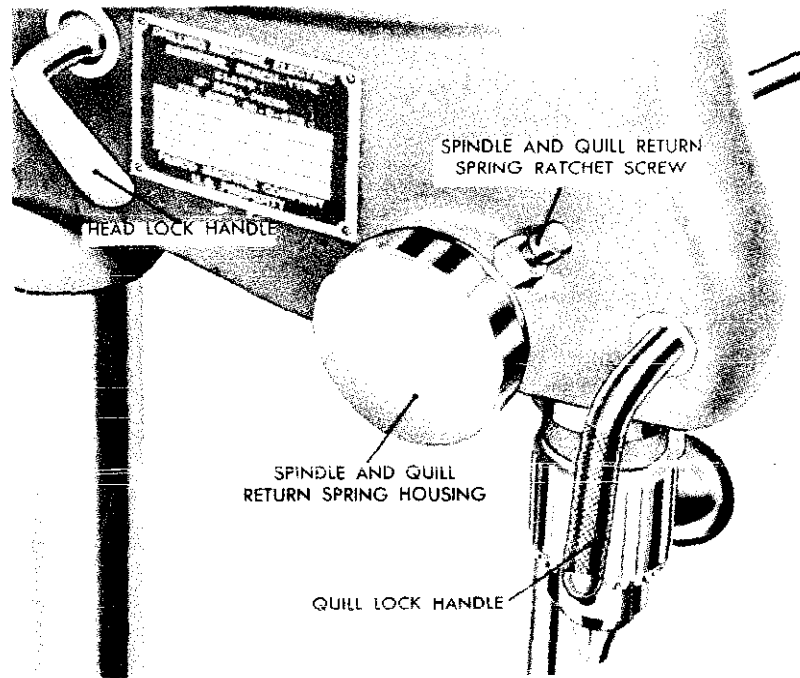

44.60

Figure 2-20.—Drill press controls—left side view.

Check occasionally to make sure all locking handles are tight, and that the V-belt is not slipping and adjust as necessary in accordance with the manufacturer's manual.

Before operating any drill press, visually inspect the drill press to determine if all parts are in the proper place, secure, and in good operating condition. Check all assemblies, such as the motor, head, pulleys, and bench for loose mountings.

While the drill press is operating, be alert for any sounds that may be signs of trouble, such as squeaks or unusual noise. Report any unusual or unsatisfactory performance to the petty officer in charge of the shop.

After operating a drill press, wipe off all dirt, oil, and metal particles. Inspect the V-belt to make sure no metal chips are imbedded in the driving surfaces.

#### BENCH GRINDER

The electric bench grinder (fig. 2-22) is designed for hand grinding operations, such as

sharpening chisels or screw drivers, grinding drills, removing excess metal from work, and smoothing metal surfaces. It is usually fitted with both a medium grain and fine grain abrasive wheel; the medium wheel is satisfactory for rough grinding where a considerable quantity of metal has to be removed, or where a smooth finish is not important. For sharpening tools or grinding to close limits of size, the fine wheel should be used as it removes metal slower, gives the work a smooth finish and does not generate enough heat to anneal the cutting edges.

When a deep cut is to be taken on work or a considerable quantity of metal removed, it is often practical to grind with the medium wheel first and finish up with the fine wheel. Most bench grinders are so made that wire brushes, polishing wheels, or buffing wheels can be substituted for the removable grinding wheels.

To protect the operator during the grinding operation, an eye shield and wheel guard are provided for each grinding wheel. A tool rest is provided in front of each wheel to rest and

TOOLS AND THEIR USES

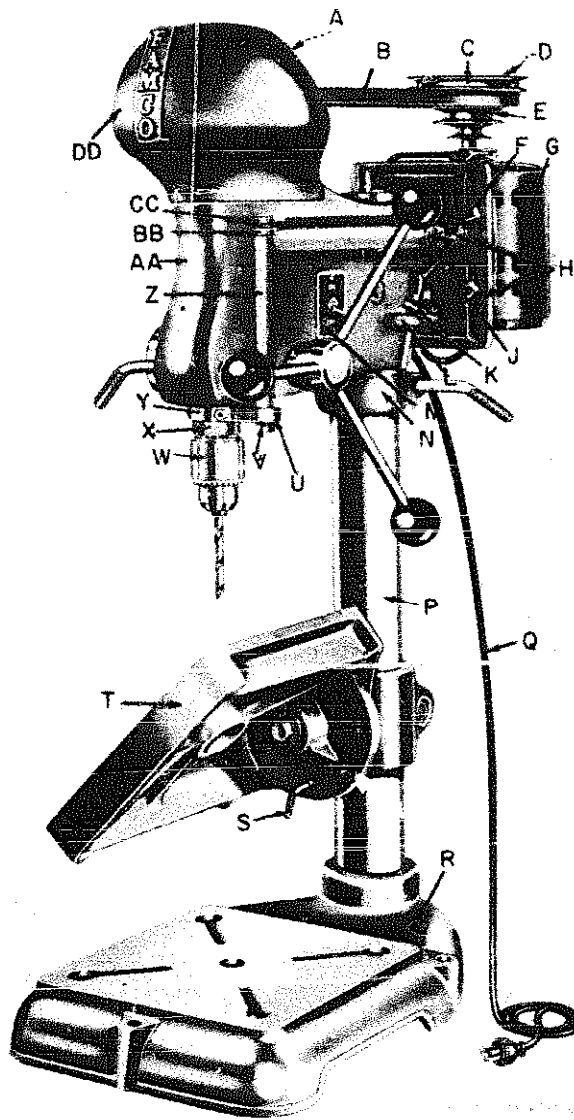

- A SPINDLE DRIVEN PULLEY
- B V-BELT
- C MOTOR DRIVE PULLEY
- D 1/8 SQ x 1 SQ-END KEY
- E NO 10-24 x 5/8 HDLS SET SCREW
- F MOTOR BRACKET STUD THUMBSCREW
- G MOTOR
- H MOTOR BASE AND BRACKET ASSEMBLY
- J 1/4-20NC 2 x 1 SQ-NECK RD-HD CAR-RIAGE BOLT AND 1/4-20NC-2 SQ NUT
- K DRILL CHUCK KEY
- L DRILL CHUCK KEY BRACKET
- M TOGGLE SWITCH PLATE
- N HEAD COLLAR SUPPORT
- P BENCH COLUMN
- Q CORD
- R BENCH BASE
- S TILTING TABLE LOCKPIN
- T TILTING TABLE ASSEMBLY
- U DEPTH GAGE ROD BRACKET
- V HEX NUT
- W DRILL CHUCK
- X CHUCK KNOCKOUT COLLAR
- Y SPINDLE AND QUILL ASSEMBLY
- Z DEPTH GAGE ROD
- AA HEAD ASSEMBLY
- BB DEPTH GAGE ROD ADJUSTING NUT
- CC DEPTH GAGE ROD LOCKNUT
- DD SPINDLE DRIVEN PULLEY GUARD

Figure 2-21.—Drill press nomenclature.

4.29

guide the work during the grinding procedure. The rests are removable, if necessary, for grinding odd-shaped or large work.

When starting a grinder, turn it on and stand to one side until the machine comes up to full speed. There is always a possibility that a wheel may fly to pieces when coming up to full speed. Never force work against a cold wheel; apply work gradually to give the wheel

an opportunity to warm. You thereby minimize the possibility of breakage.

Handle grinding wheels carefully. Before replacing a wheel always check it for cracks. Make sure that a fiber or rubber gasket is in place between each side of the wheel and its retaining washer. Tighten the spindle nut just enough to hold the wheel firmly; if the nut is tightened too much the clamping strain may

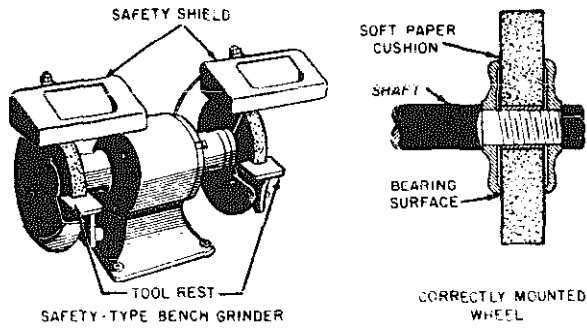

Figure 2-22.—Bench grinder and wheel.

exceed the manufacturer's recommended speed for the wheel.

When grinding, always keep the work moving across the face of the wheel; grinding against the same spot on the wheel will cause grooves to be worn into the face of the wheel. Keep all wheel guards tight and in place. Always keep the tool rest adjusted so that it just clears the wheel and is at or just below the center line of the wheel, to prevent accidental jamming of work between tool rest and wheel.

Wear goggles, even if eye shields are attached to the grinder. Keep your thumbs and fingers out of the wheel.

damage the wheel. When selecting a replacement wheel, ascertain that the grinder will not





## CHAPTER 3

# MEASURING TOOLS AND TECHNIQUES

In performing many jobs during your Navy career, you will be required to take accurate measurements of materials and objects. It is common practice in the Navy to fabricate material for installation on a ship or in the field. For example, suppose you need a box of certain size to fit a space in a compartment. You would have to take measurements of the space and send them to a shop where the box would be built. This example suggests that the measurements you took and those taken in the process of building the box must be accurate. However, the accuracy of the measurements will depend on the measuring tools used and one's ability to use them correctly.

Measuring tools are also used for inspecting a finished product or partly finished product. Inspection operations include testing or checking a piece of work by comparing dimensions of the workpiece to the required dimensions given on a drawing or sketch. Again, the measurements taken must be accurate and accuracy depends on one's ability to use measuring tools correctly.

After studying this chapter, you should be able to select the appropriate measuring tool to use in doing a job and be able to operate properly a variety of measuring instruments.

### RULES AND TAPES

There are many different types of measuring tools in use in the Navy. Where exact measurements are required, a micrometer caliper (mike) is used. Such a caliper, when properly used, gives measurements to within .001 of an inch accuracy. On the other hand, where accuracy is not extremely critical, the common rule or tape will suffice for most measurements.

Figure 3-1 shows some of the types of rules and tapes commonly used in the Navy. Of all measuring tools, the simplest and most common is the steel rule. This rule is usually 6 or 12 inches in length, although other lengths are available. Steel rules may be flexible or non-flexible, but the thinner the rule, the easier it

is to measure accurately because the division marks are closer to the work.

Generally a rule has four sets of graduations, one on each edge of each side. The longest lines represent the inch marks. On one edge, each inch is divided into 8 equal spaces; so each space represents 1/8 in. The other edge of this side is divided into sixteenths. The 1/4-in. and 1/2-in. marks are commonly made longer than the smaller division marks to facilitate counting, but the graduations are not, as a rule, numbered individually, as they are sufficiently far apart to be counted without difficulty. The opposite side is similarly divided into 32 and 64 spaces per inch, and it is common practice to number every fourth division for easier reading.

There are many variations of the common rule. Sometimes the graduations are on one side only, sometimes a set of graduations is added across one end for measuring in narrow spaces, and sometimes only the first inch is divided into 64ths, with the remaining inches divided into 32nds and 16ths.

A metal or wood folding rule may be used for measuring purposes. These folding rules are usually 2 to 6 feet long. The folding rules cannot be relied on for extremely accurate measurements because a certain amount of play develops at the joints after they have been used for a while.

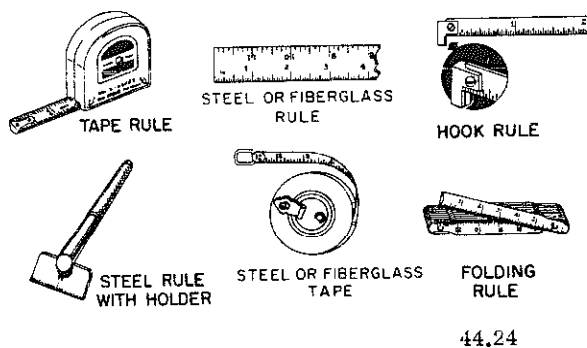
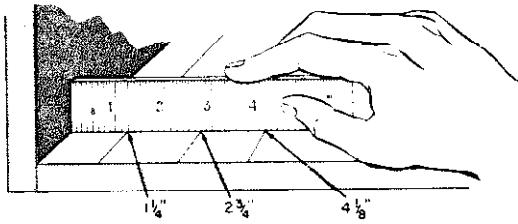
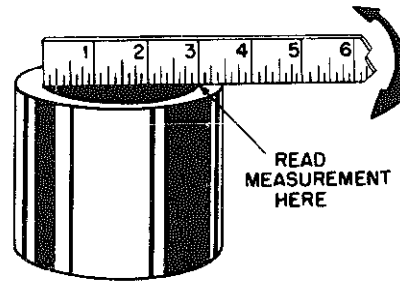

Figure 3-1.—Some common types of rules.



44.66  
Figure 3-2.—Measuring with and reading a common rule.



44.68  
Figure 3-5.—Measuring the inside diameter of a pipe.

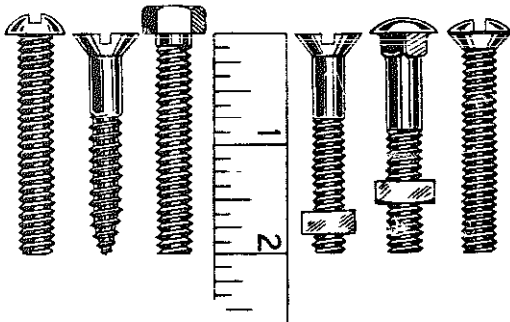

29.124A  
Figure 3-3.—Measuring the length of a bolt or screw.

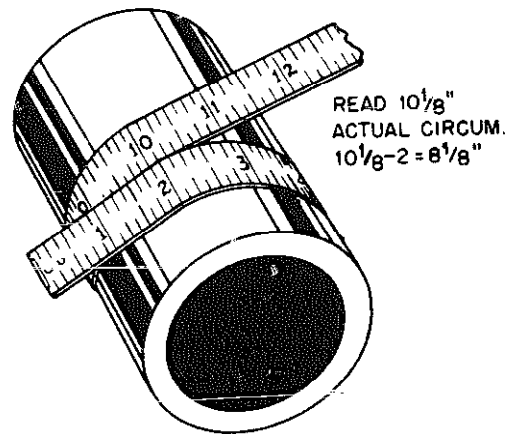

44.69  
Figure 3-6.—Measuring the circumference of a pipe with a tape.

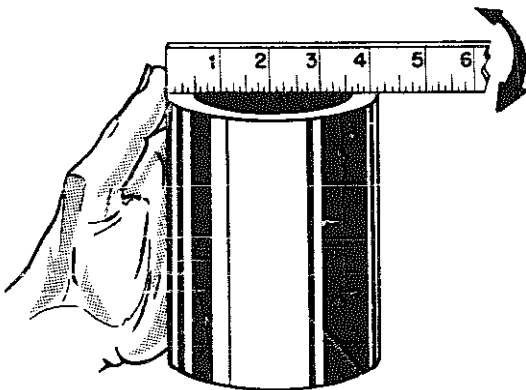

44.67  
Figure 3-4.—Measuring the outside diameter of a pipe.

when extended. Long, flat tapes require support over their full length when measuring, or the natural sag will cause an error in reading.

The flexible-rigid tapes are usually contained in metal cases into which they wind themselves when a button is pressed, or into which they can be easily pushed. A hook is provided at one end to hook over the object being measured so one man can handle it without assistance. On some models, the outside of the case can be used as one end of the tape when measuring inside dimensions.

#### MEASURING PROCEDURES

Steel tapes are made from 6 to about 300 ft. in length. The shorter lengths are frequently made with a curved cross section so that they are flexible enough to roll up, but remain rigid

To take a measurement with a common rule, hold the rule with its edge on the surface of the object being measured. This will eliminate parallax and other errors which might result

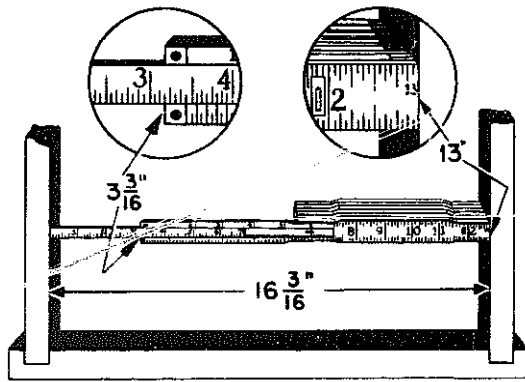

44.26.6

Figure 3-7.—Using a folding rule to measure an inside dimension.

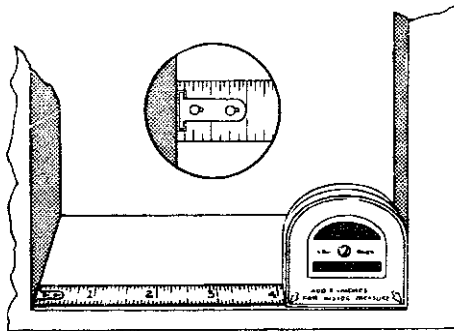

44.24.1A

Figure 3-8.—Measuring an inside dimension with a tape rule.

due to the thickness of the rule. Read the measurement at the graduation which coincides with the distance to be measured, and state it as being so many inches and fractions of an inch. (Fig. 3-2.) Always reduce fractions to their lowest terms, for example, 6/8 inch would be called 3/4 inch. A hook or eye at the end of a tape or rule is normally part of the first measured inch.

#### Bolts or Screws

The length of bolts or screws is best measured by holding them up against a rigid rule or tape. Hold both the bolt or screw to be measured and the rule up to your eye level so that your line of sight will not be in error in reading the measurement. As shown in figure 3-3, the

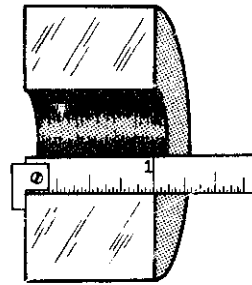

44.70

Figure 3-9.—Measuring the thickness of stock through a hole.

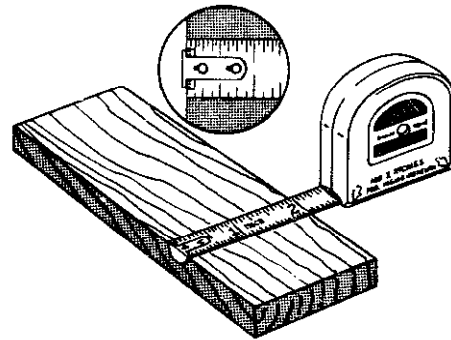

44.24.1B

Figure 3-10.—Measuring an outside dimension using a tape rule.

bolts or screws with countersink type heads are measured from the top of the head to the opposite end, while those with other type heads are measured from the bottom of the head.

#### Outside Pipe Diameters

To measure the outside diameter of a pipe, it is best to use some kind of rigid rule. A folding wooden rule or a steel rule is satisfactory for this purpose. As shown in figure 3-4, line up the end of the rule with one side of the pipe, using your thumb as a stop. Then with the one end held in place with your thumb, swing the rule through an arc and take the maximum reading at the other side of the pipe. For most practical purposes, the measurement obtained

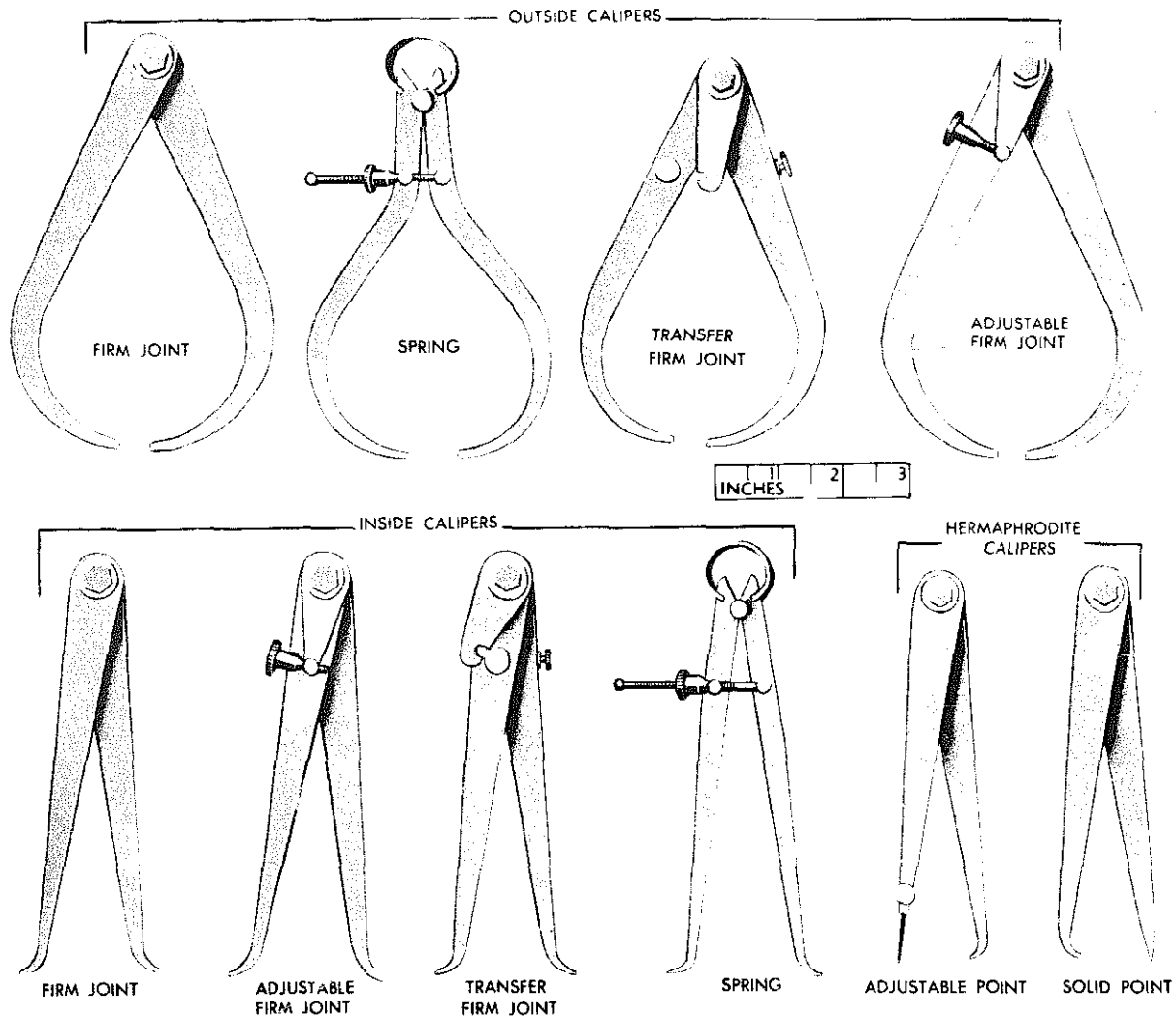

Figure 3-11.—Simple calipers—noncalibrated.

4.17A

by using this method is satisfactory. It is necessary that you know how to take this measurement as the outside diameter of pipe is sometimes the only dimension given on pipe specifications.

#### Inside Pipe Diameters

To measure the inside diameter of a pipe with a rule, as shown in figure 3-5, hold the rule so that one corner of the rule just rests on the inside of one side of the pipe. Then, with one end thus held in place, swing the rule

through an arc and read the diameter across the maximum inside distance. This method is satisfactory for an approximate inside measurement.

#### Pipe Circumferences

To measure the circumference of a pipe, a flexible type rule that will conform to the cylindrical shape of the pipe must be used. A tape rule or a steel tape is adaptable for this job. When measuring pipe, make sure the tape has been wrapped squarely around the axis of the

pipe (i.e., measurement should be taken in a plane perpendicular to the axis) to ensure that the reading will not be more than the actual circumference of the pipe. This is extremely important when measuring large diameter pipe.

Hold the rule or tape as shown in figure 3-6. Take the reading, using the 2-inch graduation, for example, as the reference point. In this case the correct reading is found by subtracting 2 inches from the actual reading. In this way the first 2 inches of the tape, serving as a handle, will enable you to hold the tape securely.

#### Inside Dimensions

To take an inside measurement, such as the inside of a box, a folding rule that incorporates a 6- or 7-inch sliding extension is one of the best measuring tools for this job. To take the inside measurement, first unfold the folding rule to the approximate dimension. Then extend the end of the rule and read the length that it extends, adding the length of the extension to the length on the main body of the rule. (Fig. 3-7.) In this illustration the length of the main body of the rule is 13 inches and the extension is pulled out  $3 \frac{3}{16}$  inches. In this case the total inside dimension being measured is  $16 \frac{3}{16}$  inches.

In figure 3-8 notice in the circled insert that the hook at the end of the particular rule shown is attached to the rule so that it is free to move slightly. When an outside dimension is taken by hooking the end of the rule over an edge, the hook will locate the end of the rule even with the surface from which the measurement is being taken. By being free to move, the hook will retract away from the end of the rule when an inside dimension is taken. To measure an inside dimension using a tape rule, extend the rule between the surfaces as shown, take a reading at the point on the scale where the rule enters the case, and add 2 inches. The 2 inches are the width of the case. The total is the inside dimension being taken.

To measure the thickness of stock through a hole with a hook rule, insert the rule through the hole, hold the hook against one face of the stock, and read the thickness at the other face. (Fig. 3-9.)

#### Outside Dimensions

To measure an outside dimension using a tape rule, hook the rule over the edge of the

stock. Pull the tape out until it projects far enough from the case to permit measuring the required distance. The hook at the end of the rule is designed so that it will locate the end of the rule at the surface from which the measurement is being taken. (Fig. 3-10.) When taking a measurement of length, the tape is held parallel to the lengthwise edge. For measuring widths, the tape should be at right angles to the lengthwise edge. Read the dimension of the rule exactly at the edge of the piece being measured.

It may not always be possible to hook the end of the tape over the edge of stock being measured. In this case it may be necessary to butt the end of the tape against another surface or to hold the rule at a starting point from which a measurement is to be taken.

#### Distance Measurements

Steel or fiberglass tapes are generally used for making long measurements. Secure the hook end of the tape. Hold the tape reel in the hand and allow it to unwind while walking in the direction in which the measurement is to be taken. Stretch the tape with sufficient tension to overcome sagging. At the same time make sure the tape is parallel to an edge or the surface being measured. Read the graduation on the tape by noting which line on the tape coincides with the measurement being taken.

#### CARE

Rules and tapes should be handled carefully and kept lightly oiled to prevent rust. Never allow the edges of measuring devices to become nicked by striking them with hard objects. They should preferably be kept in a wooden box when not in use.

To avoid kinking tapes, pull them straight out from their cases—do not bend them backward. With the windup type, always turn the crank clockwise—turning it backward will kink or break the tape. With the spring-wind type, guide the tape by hand. If it is allowed to snap back, it may be kinked, twisted, or otherwise damaged. Do not use the hook as a stop. Slow down as you reach the end.

#### SIMPLE CALIPERS

Simple calipers are used in conjunction with a scale to measure diameters. The calipers most commonly used in the Navy are shown in figure 3-11.

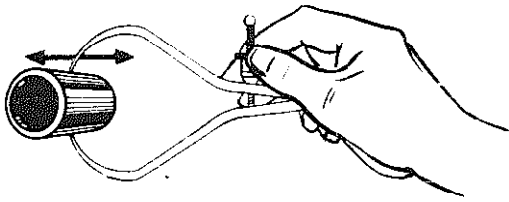

4.17B

Figure 3-12.—Using an outside caliper.

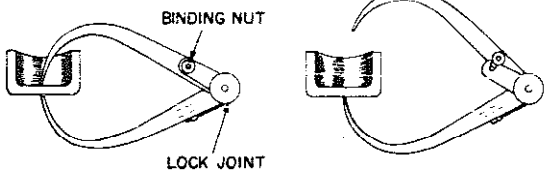
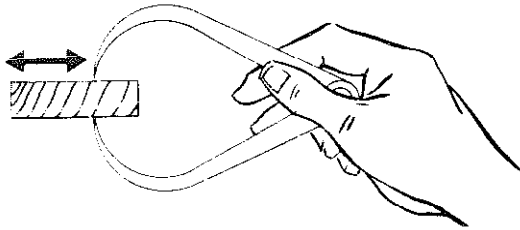

A

B

4.17C

Figure 3-13.—Measuring the thickness of the bottom of a cup.

Outside calipers for measuring outside diameters are bow-legged; those used for inside diameters have straight legs with the feet turned outward. Calipers are adjusted by pulling or pushing the legs to open or close them. Fine adjustment is made by tapping one leg lightly on a hard surface to close them, or by turning them upside down and tapping on the joint end to open them.

Spring-joint calipers have the legs joined by a strong spring hinge and linked together by a screw and adjusting nut. For measuring chamfered cavities (grooves), or for use over flanges, transfer calipers are available. They are equipped with a small auxiliary leaf attached to one of the legs by a screw. (Fig. 3-11.) The measurement is made as with ordinary calipers; then the leaf is locked to the leg.

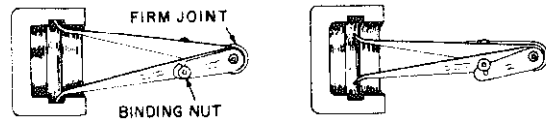

A

B

4.17D

Figure 3-14.—Measuring a hard to reach inside dimension with an inside caliper.

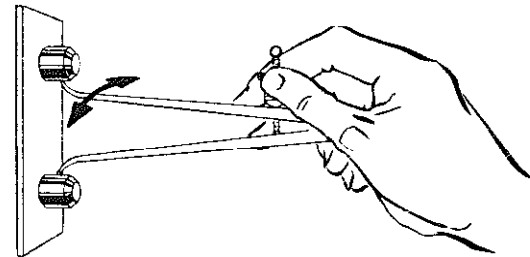

4.17E

Figure 3-15.—Measuring the distance between two surfaces with an inside caliper.

The legs may then be opened or closed as needed to clear the obstruction, then brought back and locked to the leaf again, thus restoring them to the original setting.

A different type of caliper is the hermaphrodite, sometimes called odd-leg caliper. This caliper has one straight leg ending in a sharp point, sometimes removable, and one bow leg. The hermaphrodite caliper is used chiefly for locating the center of a shaft, or for locating a shoulder.

#### USING CALIPERS

A caliper is usually used in one of two ways. Either the caliper is set to the dimension of the work and the dimension transferred to a scale, or the caliper is set on a scale and the work machined until it checks with the dimension set up on the caliper. To adjust a caliper to a scale dimension, one leg of the caliper should be held firmly against one end of the scale and the other leg adjusted to the desired dimension. To adjust a caliper to the work, open the legs wider than the work and then bring them down to the work.

**CAUTION:** Never place a caliper on work that is revolving in a machine.

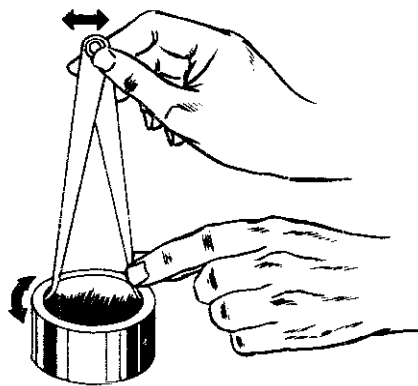

4.17F

Figure 3-16.—Measuring an inside diameter with an inside caliper.

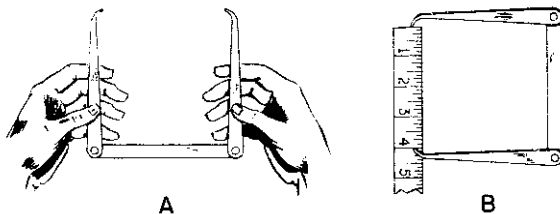

Figure 3-17.—Setting a combination firm joint caliper. 44.97

#### Measuring The Diameter of Round or The Thickness of Flat Stock

To measure the diameter of round stock, or the thickness of flat stock, adjust the outside caliper so that you feel a slight drag as you pass it over the stock. (See fig. 3-12.) After the proper "feel" has been attained, measure the setting of the caliper with a rule. In reading the measurement, sight over the leg of the caliper after making sure the caliper is set squarely with the face of the rule.

#### Measuring Hard to Reach Dimensions

To measure an almost inaccessible outside dimension, such as the thickness of the bottom of a cup, use an outside transfer firm-joint caliper as shown in figure 3-13. When the proper "feel" is obtained, tighten the lock joint.

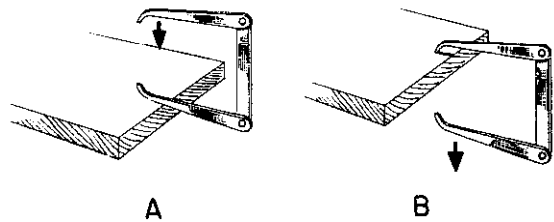

44.97A

Figure 3-18.—Decreasing and increasing the setting of a firm joint caliper.

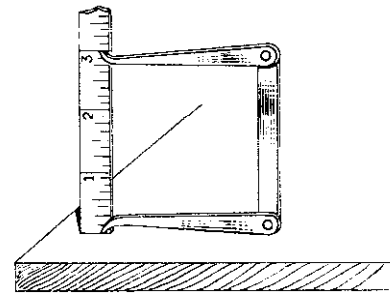

44.97B

Figure 3-19.—Setting a combination firm joint caliper for inside measurements.

Then loosen the binding nut and open the caliper enough to remove it from the cup. Close the caliper again and tighten the binding nut to seat in the slot at the end of the auxiliary arm. The caliper is now at the original setting, representing the thickness of the bottom of the cup. The caliper setting can now be measured with a rule.

To measure a hard to reach inside dimension, such as the internal groove shown in figure 3-14, a lock-joint inside caliper should be used. The procedure followed for measuring a hard to reach outside dimension is used.

#### Measuring The Distance Between Two Surfaces

To measure the distance between two surfaces with an inside caliper, first set the caliper to the approximate distance being measured. Hold the caliper with one leg in contact with one of the surfaces being measured. (See fig. 3-15.) Then as you increase the setting of the caliper, move the other leg from left to right. Feel for

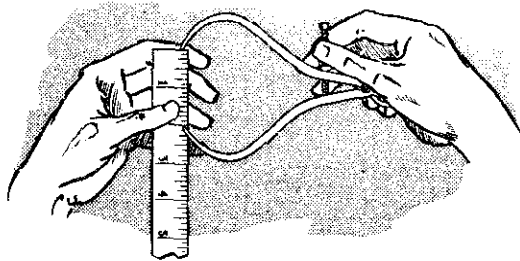

4.17G  
Figure 3-20.—Setting an outside spring caliper.

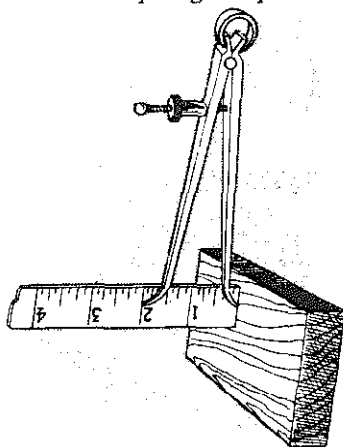

4.17H  
Figure 3-21.—Setting an inside spring caliper.

the slight drag indicating the proper setting of the caliper. Then remove the caliper and measure the setting with a rule.

#### Measuring Hole Diameters

To measure the diameter of a hole with an inside caliper, hold the caliper with one leg in contact with one side of the hole (fig. 3-16) and, as you increase the setting, move the other leg from left to right, and in and out of the hole. When you have found the point of largest diameter, remove the caliper and measure the caliper setting with a rule.

#### Setting A Combination Firm Joint Caliper

To set a combination firm joint caliper with a rule, when the legs are in position for outside measurements, grasp the caliper with both hands, as shown in figure 3-17A, and adjust

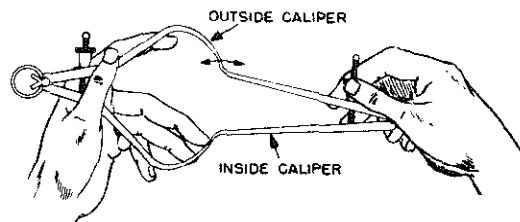

4.17K  
Figure 3-22.—Transferring a measurement from an outside to an inside caliper.

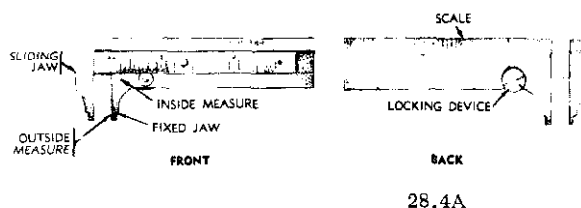

28.4A  
Figure 3-23.—Caliper square (slide caliper).

both legs to the approximate setting. By adjusting both legs, the shape of the tool will be approximately symmetrical. Thus it will maintain its balance and be easier to handle.

Check this approximate setting as shown in figure 3-17B. Sight squarely across the leg at the graduations on the rule to get the exact setting required.

If it is necessary to decrease or increase the setting, tap one leg of the caliper, as shown in figure 3-18. The arrow indicates the change in setting that will take place.

When the caliper is set for inside measurements, the same directions for adjusting the setting apply. Figure 3-19 shows how the end of the rule and one leg of the caliper are rested on the bench top so that they are exactly even with each other when the reading is taken.

#### Setting Outside And Inside Spring Calipers

To set a particular reading on an outside spring caliper, first open the caliper to the approximate setting. Then, as shown in figure 3-20, place one leg over the end of the rule, steadying it with index finger. Make the final setting by sighting over the other leg of the



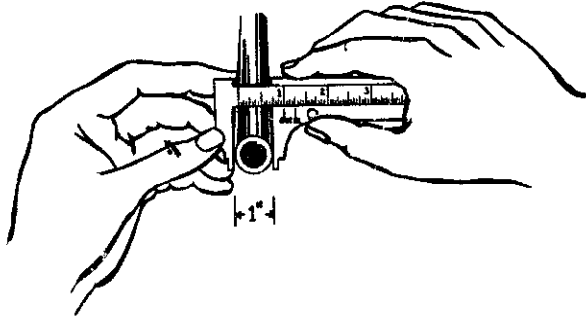

44.71  
Figure 3-24.—Measuring an outside dimension with a pocket slide caliper.

caliper, squarely with the face of the rule at the reading, and turning the knurled adjusting nut until the desired setting is obtained.

To set an inside spring caliper to a particular reading, place both caliper and rule on a flat surface as shown in figure 3-21. The rule must be held squarely or normal ( $90^\circ$  in both directions) to the surface to ensure accuracy. Adjust the knurled adjusting nut, reading the setting on the rule with line of sight normal to the face of the rule at the reading.

#### Transferring Measurements From One Caliper To Another

To transfer a measurement from one spring caliper to another, hold the calipers as shown in figure 3-22. Note that one of the man's fingers is extended to steady the point of contact of the two lower caliper legs. In this figure the inside caliper is being adjusted to the size of the outside caliper. As careful measurements with calipers depend on one's sense of touch, which is spoken of as "feel," calipers are best held lightly. When you notice a slight drag, the caliper is at the proper setting.

#### CARE

Keep calipers clean and lightly oiled, but do not overoil the joint of firm joint calipers or you may have difficulty in keeping them tight. Do not throw them around or use them for screwdrivers or pry bars. Even a slight force may spring the legs of a caliper so that other measurements made with it are never accurate. Remember they are measuring instruments and

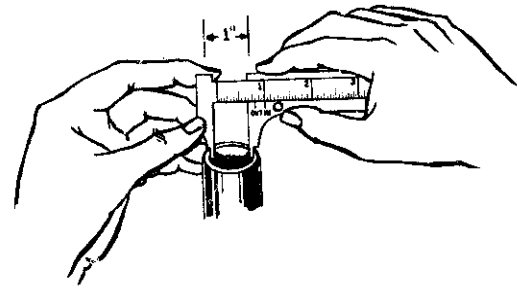

44.72  
Figure 3-25.—Measuring an inside dimension with a slide caliper.

must be used only for the purpose for which they are intended.

#### SLIDE CALIPER

The main disadvantage of using ordinary calipers is that they do not give a direct reading of a caliper setting. As explained earlier, you must measure a caliper setting with a rule. To overcome this disadvantage, use slide calipers (fig. 3-23). This instrument is occasionally called a caliper rule.

Slide calipers can be used for measuring outside, inside, and other dimensions. One side of the caliper is used as a measuring rule, while the scale on the opposite side is used in measuring outside and inside dimensions. Graduations on both scales are in inches and fractions thereof. A locking screw is incorporated to hold the slide caliper jaws in position during use. Stamped on the frame are two words, "IN" and "OUT." These are used in reading the scale while making inside and outside measurements, respectively.

To measure the outside diameter of round stock, or the thickness of flat stock, move the jaws of the caliper into firm contact with the surface of the stock. Read the measurement at the reference line stamped OUT. (See fig. 3-24.)

When measuring the inside diameter of a hole, or the distance between two surfaces, insert only the rounded tips of the caliper jaws into the hole or between the two surfaces. (See fig. 3-25.) Read the measurement on the reference line stamped IN.

Note that two reference lines are needed if the caliper is to measure both outside and inside dimensions, and that they are separated

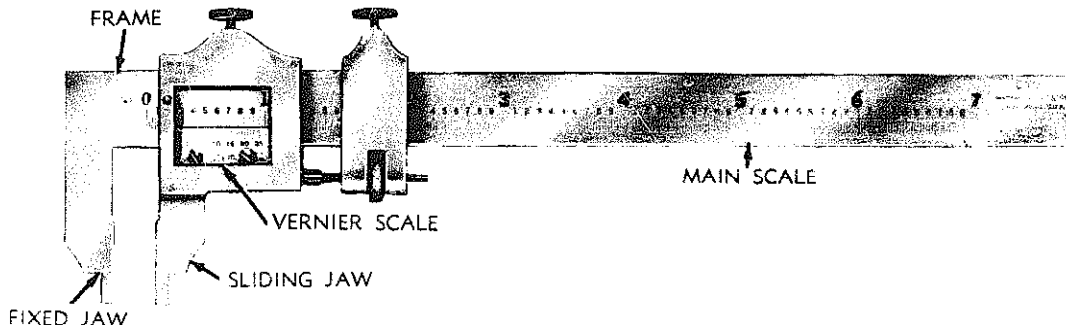

28.4B

Figure 3-26.—Vernier caliper.

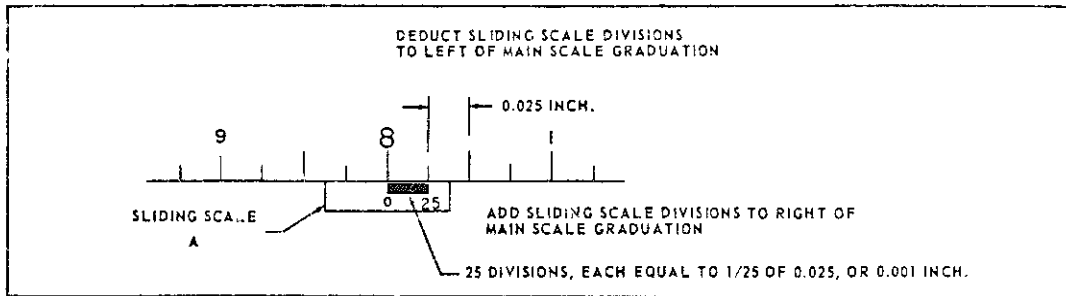

29.266A

Figure 3-27.—Vernier scale principle.

by an amount equal to the outside dimension of the rounded tips when the caliper is closed.

Pocket models of slide calipers are commonly made in 3-in. and 5-in. sizes and are graduated to read in 32nds and 64ths. Pocket slide calipers are valuable when extreme precision is not required. They are frequently used for duplicating work when the expense of fixed gages is not warranted.

#### VERNIER CALIPER

A vernier caliper (fig. 3-26) consists of an L-shaped member with a scale engraved on the long shank. A sliding member is free to move on the bar and carries a jaw which matches the arm of the L. The vernier scale is engraved on a small plate that is attached to the sliding member.

Perhaps the most distinct advantage of the vernier caliper, over other types of caliper, is the ability to provide very accurate measurements over a large range. It can be used for

both internal and external surfaces. Pocket models usually measure from zero to 3 in., but sizes are available all the way to 4 ft. In using the vernier caliper, you must be able to measure with a slide caliper and be able to read a vernier scale.

#### PRINCIPLES OF THE VERNIER SCALE

It would be possible to etch graduations 1/1000 inch (0.001) in. apart on a steel rule or sliding caliper as shown in figure 3-27. This enlarged illustration shows two graduated scales. The top scale has divisions which are 0.025 inches apart. The small sliding lower scale has 25 0.001 inch graduations which can divide any of the main scale divisions of 0.025 inch into 25 parts. When the first graduation marked "0" on this small scale aligns with a graduation on the main scale, the last, or 25th will also align with a graduation on the main scale as shown. Consequently, the small 0.00

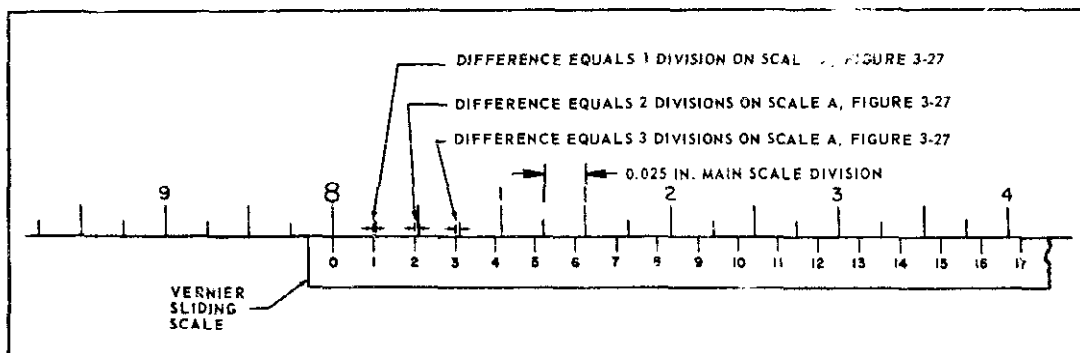

29.266(44B)A

Figure 3-28.—Expanded view of the vernier scale.

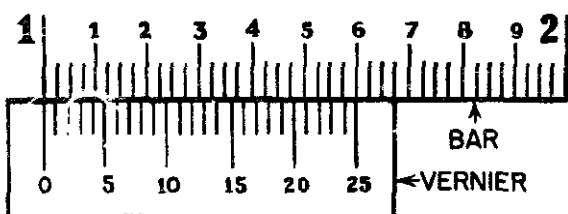

29.266(44B)B

Figure 3-29.—English-measure vernier scale.

graduations are not significant in this position. But when the zero graduation does not align with a graduation on the main scale, it can be readily determined how many thousandths the zero missed the 0.025 inch graduation by counting the misaligned graduation at either end of the small scale. When the zero or index line on the sliding scale does not quite reach the graduation, the amount of misalignment must be subtracted, but when it passes the 0.025 graduation from which the reading is made, it must be added. This illustrates the simple arrangement to increase the accuracy of a common scale. Unfortunately, the 0.001 inch graduations are not too legible and so the system is not practical. A vernier arrangement overcomes this problem.

#### VERNIER SCALE ARRANGEMENT

The main difference between the vernier scale and the arrangement shown in fig. 3-27 is the spacing of the 25 divisions. Instead of 25 graduations crowded within the space of one

main scale division, the vernier graduations are arranged at intervals exactly 0.001 inch less than the main scale graduations, as shown in fig. 3-28. This arrangement results in an accumulation of misalignments starting with the first vernier graduation past the zero so that each may be marked as shown with a number representing the space in thousandths to the next upper scale graduation. For example, if the zero index line would be moved past the 8 inch graduation until the vernier graduation number 5 aligned with the next main scale graduation, the exact reading would be 8 inches plus 0.005 or 8.005 inches.

#### READING A VERNIER CALIPER

Figure 3-29 shows a bar 1 inch long divided by graduations into 40 parts so that each graduation indicates one-fortieth of an inch (0.025 inch). Every fourth graduation is numbered; each number indicates tenths of an inch (4 x 0.025 inch). The vernier, which slides along the bar, is graduated into 25 divisions which together, are as long as 24 divisions on the bar. Each division of the vernier is 0.001 inch smaller than each division on the bar. Verniers that are calibrated as just explained are known as English-measure verniers. The metric-measure vernier is read the same, except that the units of measurement are in millimeters.

In figure 3-30, insert A illustrates the English measure vernier caliper. Insert B shows an enlarged view of the vernier section. As you can see in this figure, when the zero on the vernier coincides with the 1-inch mark, no other lines coincide until the 25th mark on the vernier.

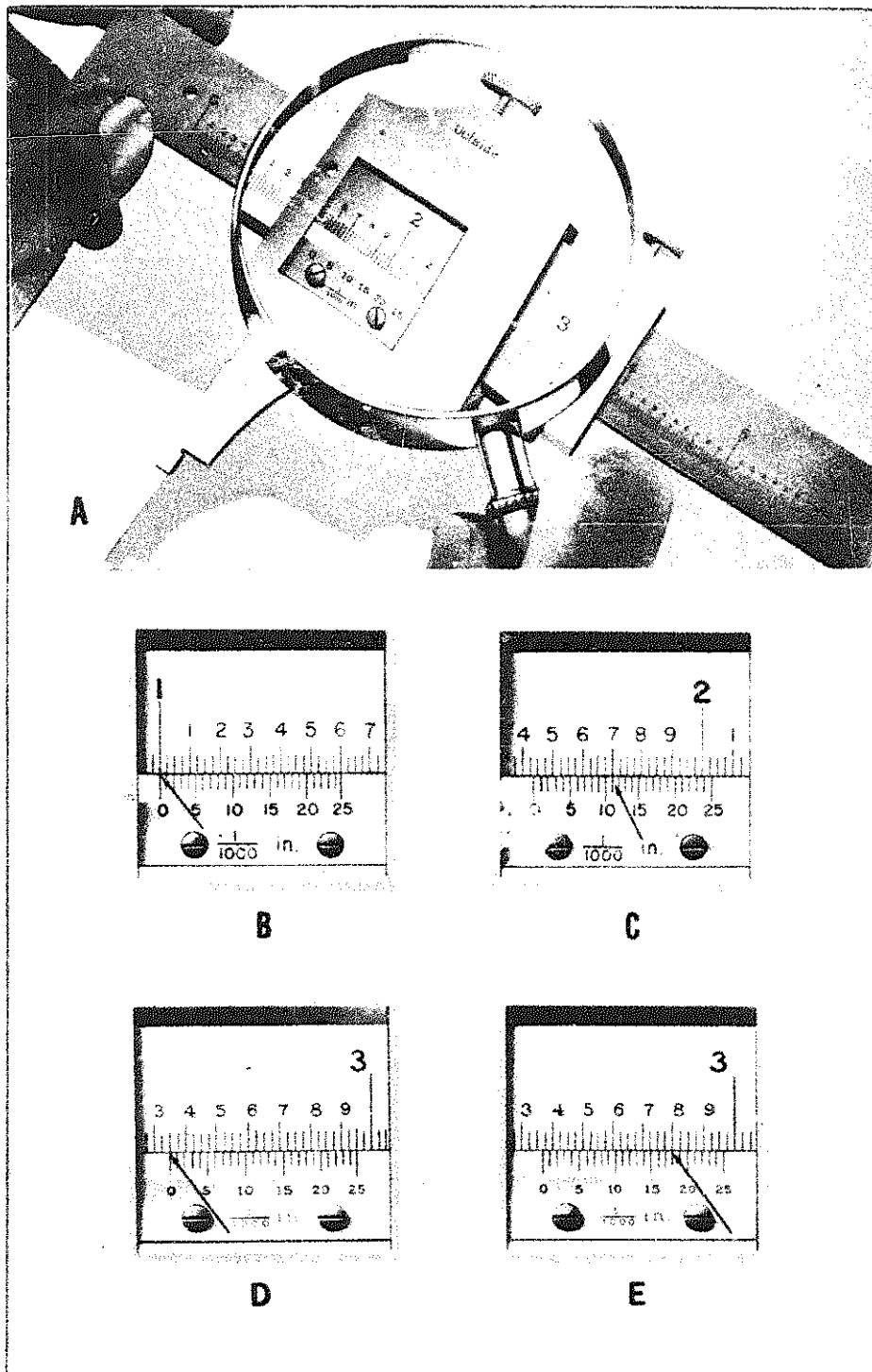

Figure 3-30.—Vernier caliper.

29,266B