

**AT** MICROFICHE  
REFERENCE  
LIBRARY

A project of Volunteers in Asia

Farm Shop and Equipment

by: Delbert P. Schwab, revisor

Published by:  
Cumberland General Store  
Route 3, Box 479  
Crossville, TN 38555 USA

Paper copies are \$ 1.50.

Available from:  
Cumberland General Store  
Route 3, Box 479  
Crossville, TN 38555 USA

Reproduction of this microfiche document in any form is subject to the same restrictions as those of the original document.

(Revised)

March 1953

# FARM SHOP AND EQUIPMENT

Revised by DELBERT P. SCHWAB

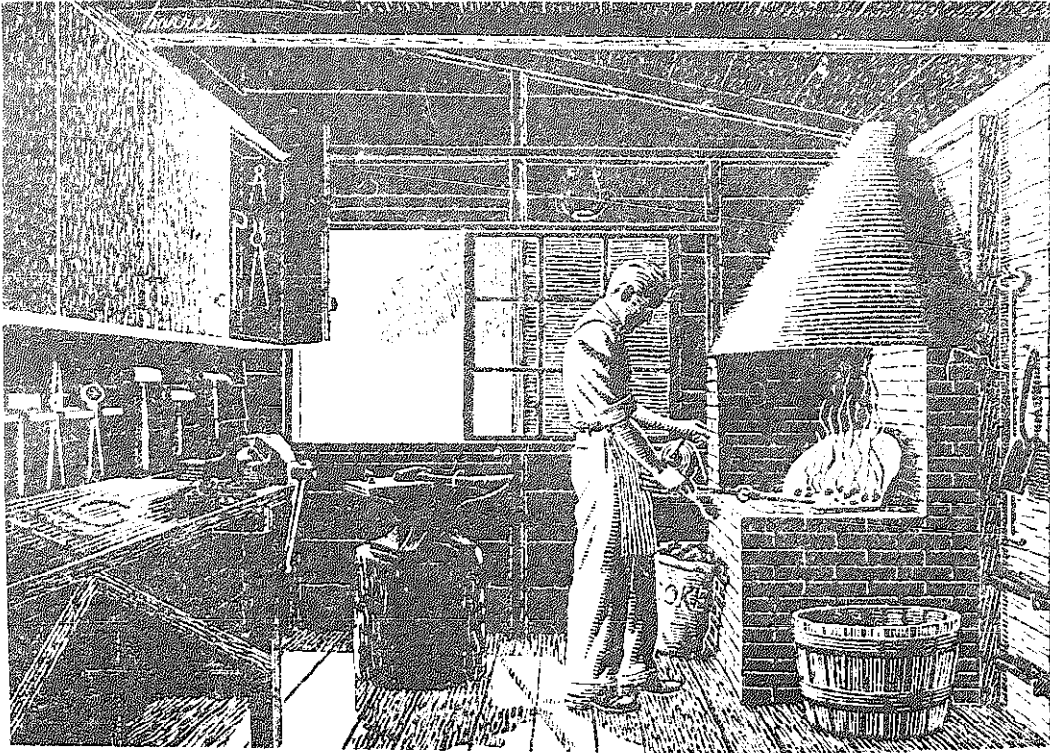

Farm machinery is important to self-sufficiency. Effective care and repair of farm machinery requires an organized farm shop, as well equipped as possible, to supplement the work of repair shops, blacksmiths, etc.

Every farmer has about the place an assortment of tools. It is now more important than ever before that he should carefully get this assortment together, put it in good shape for service and keep it in such manner that lost or misplaced items will show up at once.

This publication offers suggested assortment of tools, special tools, and how to keep and care for them.

# THE FARM SHOP

The purpose of the farm shop is to provide a dry, well-lighted shelter for small tools used in the necessary construction and repair work on the farm, and a comfortable, conveniently arranged work room in which some of this work may be done.

This is a mechanical age in farming; nearly every kind of farm work is being done with the aid of some mechanical labor-saving device. Farm buildings are subject to deterioration and mechanical injury, and all machinery will in time wear out or get broken. Therefore, a considerable amount of repair work is necessary, and every farmer does more or less of this repair work himself.

## IMPORTANCE OF FARM SHOP

It is impossible to estimate in dollars the value of a good farm shop that is properly equipped and attended. Reliable sources estimate an annual saving of \$5.47 per each \$100.00 of investment in farm machinery alone, where the farmer makes all minor repairs and adjustments. This annual saving, on a farm equipped with \$2,000 worth of machinery, would pay for the shop equipment within 4 to 6 years.

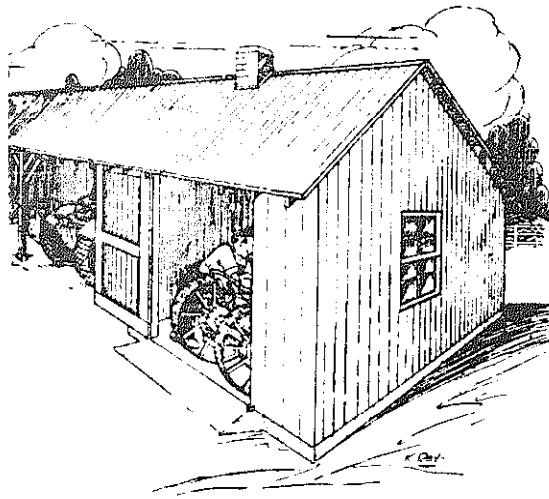

Fig. 1--Machinery Shed.

## THE INCREASING NEED

A further indication of the increasing need for good farm shops is the increasing use of tractors and other power equipment in farming. In 1945, the Census shows there were over 24,000 tractors on Tennessee farms, while in 1950 the tractor population exceeds 55,000. There has been a corresponding increase in many other items of equipment found on the farm.

It will be more profitable in the future if repairs and depreciation on this expensive farm equipment can be kept to a minimum by systematic home repair and maintenance made possible by the possession of a farm shop equipped with the proper tools to make repairs quickly and at a reasonable cost.

## LABOR AND MONEY SAVING ADVANTAGES

To summarize, the farmer who has the ability and actually does his simpler farm shop work saves:

1. In cash outlay.
2. Valuable time by doing repair work in shop during rainy or bad weather.
3. By doing emergency shop work during rush seasons.
4. By adjusting or adapting tools and equipment to fit the farm needs.
5. By making certain tools, appliances, or conveniences that may be needed and otherwise are not available.

6. By eliminating travel and expense of taking shop work away from the farm to be done.

#### WHAT WORK SHOULD BE DONE IN THE FARM SHOP?

While some farmers find a welder an excellent addition to their farm shop, most farmers do not find it advisable to attempt the more difficult shop jobs, such as welding, sharpening plowshares, lathe work, and cabinet work, for one of two reasons: either they lack the ability to do the job properly, or there is not enough such work to justify the investment that would be necessary for tools.

A large amount of farm equipment is now built on the precision principles followed in the manufacturing of an automobile and it would scarcely be worth while for a farmer to attempt to keep a shop adequately equipped to do major overhaul jobs on such machinery. However, there is such a difference between the hourly farm wage and the hourly mechanic's wage, that a farmer cannot afford to have mechanics do many of the simpler repair jobs. Therefore, a modest repair shop equipped to do these simpler jobs would be most desirable. A repair shop equipped for the complex major overhaul jobs would not be advisable unless the farmer has the mechanical inclination and can do repair work for his neighbors as well as his own, thus justifying the expenditure for the necessary equipment.

Each individual must use his own judgment as to whether it is best to attempt the more difficult shop jobs himself or to hire them done; but in the case of the more ordinary repair and construction jobs there is little choice. The farmer must usually do these jobs himself or they will not be done.

#### COMMON TYPES OF SHOP WORK

The kind of shopwork to be done must be definitely in mind if one is to decide intelligently on the design of the shop building and select the list of tools and materials to be purchased. The following list is not complete, but is representative of the kinds of shopwork done profitably by farmers.

**Woodwork.** Construction of small buildings, and equipment, such as poultry houses, nests, feed bins, troughs, self-feeders, gates and hayracks, building forms for concrete work, removing rotted or broken parts of buildings and fitting new pieces, making and fitting new tongues, double-trees and other wood parts on implements, and fitting new handles in hand tools.

**Ironwork.** Simple jobs in forging, such as cutting, bending, and shaping braces, drilling, thread cutting, removing worn and broken parts from implements and replacing them with new parts, making

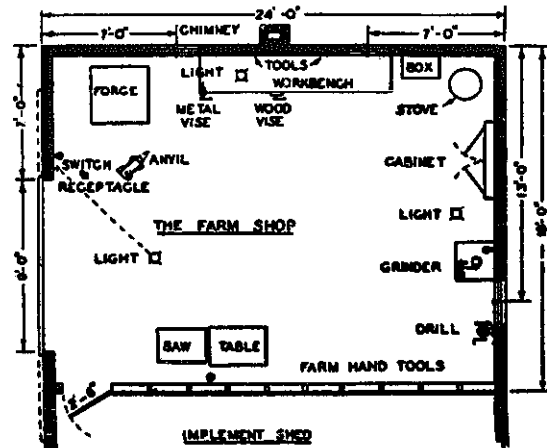

Fig. 2—Floor Plan for Shop in End of Machinery Shed. (See your County Agent for complete Plan, No. 5595, which contains bill of material and similar arrangement.)

adjustments to take up wear, and making adjustments in the field for different working conditions.

**Concrete Work.** Building foundations, floors, walks, tanks, troughs, posts and the like.

**Fencing.** Setting posts, fitting braces and gates, stretching and fastening wire.

**Repair of Electrical Appliances, Automobiles, Trucks, and Tractors.** Adjusting bearings and other parts to take up wear, grinding valves, replacing worn parts and making other minor repairs and adjustments.

**Repair of Field Machinery.** The emergency repair of plows, planters, binders, mowers, combines, and other farm machinery, and the occasional complete overhauling of this equipment.

**Well Work.** Pulling and repairing pipes and rods and replacing worn leathers and valves in cylinders.

**Pipe Fitting.** Installation of water pipes (mostly 1/2-inch, 3/4-inch, 1-inch sizes).

**Soldering.** Repair of tinware, gutters and downspouts, and electric wiring.

**Babbitting.** Rebabbitting bearings on machinery.

**Belt Lacing.** Relacing or fastening belts for power machinery.

**Ropework.** Rope splicing and knot tying.

**Harness Work.** Cleaning and oiling, sewing and riveting new parts, and replacing hame staples.

**Lubrication.** Every moving part of machinery should be amply supplied with the correct kind and grade of lubricant.

**Painting.** Painting small buildings, equipment and implements, coating plow moldboards and other bright parts with heavy oil, varnish, or paint to prevent rust, and boiling wood wheels in linseed oil.

**Tool Sharpening.** Sharpening mower knives, axes, saws, chisels, drill bits, and other tools.

**Horse Shoeing.** Or removing horse shoes and trimming hoofs to prevent injury until shoeing can conveniently be done.

#### DESIRABLE FEATURES IN A FARM SHOP

1. Shelter space sufficient to work on any one machine.
2. Protection from rain, from cold, ventilation from heat and smoke.
3. Good natural and artificial lighting.
4. Concrete or packed earth floor.
5. Wall space, cupboards, or drawers for tools. (Fig. 4)
6. Shelves, racks, bins, for parts, bolts, nails, etc.
7. Source of power for grinding, sawing, drilling, etc.
8. Space around every power tool to permit work on big pieces.
9. A central and convenient location.

Farms employing four or more head of work stock should consider the plan shown in Figs. 1 and 2 a minimum for their needs. For smaller farms, space in an existing building, providing safety from sparks and forge fires, can be used. It should contain bench, vise, anvil, tool grinder and such other equipment as space permits.

## MINIMUM EQUIPMENT AND TOOL ARRANGEMENT

First essentials are: vise and effective set of hand tools.

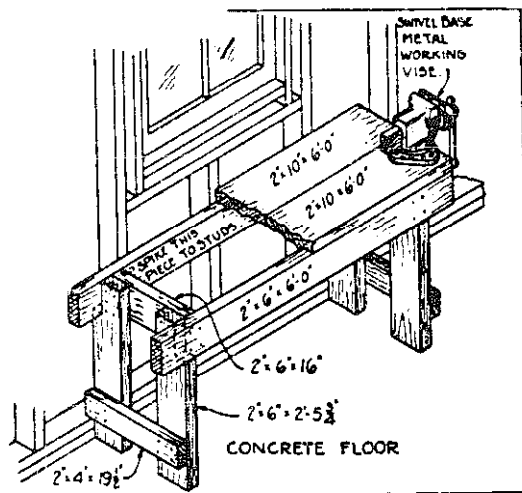

Plan for Shop Bench

Fig. 3—After the shop building or space has been provided, the first essential is a good work bench.



Fig. 4—This arrangement encourages keeping hand tools in one central location.

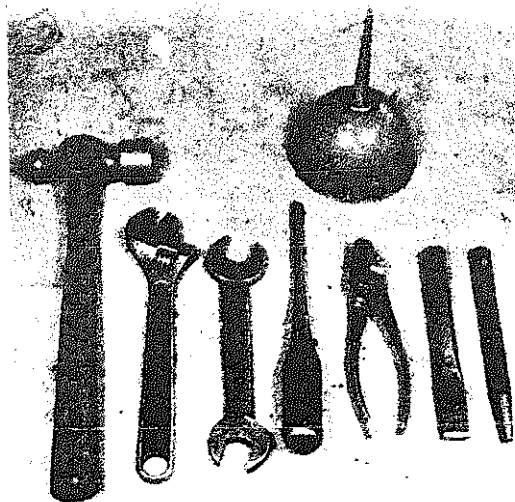

Fig. 5—Every farm needs this minimum set of tools that can be carried to the field with the mower, planter, drill, etc.

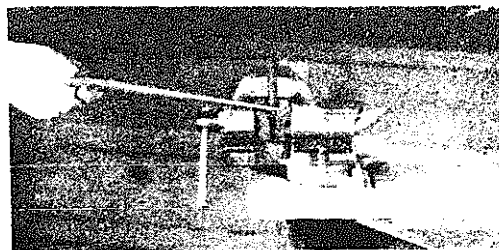

Fig. 6—When buying a vise, consider one with swivel base and pipe vise jaws.

## WELDING

There are now two types of welding equipment in common use, the electric arc and the oxy-acetylene. The arc welder is faster and costs less to use, but lacks the range and flexibility found in oxy-acetylene equipment. At present, equipment for either type, including any necessary accessories, can be reasonably purchased.

### Electric Welder

On most rural lines, an electric welder of 180 amperes is sufficient for normal repair work on the farm. While the arc welder is best adapted for the fabrication and repair of steel parts, with a little experience a person can learn to weld cast iron, aluminum, and other metals with it.

### Oxy-Acetylene Welder

In some areas of Tennessee, the oxy-acetylene welder can be used without renting tanks as done by most professional welding shops, garages, etc., and paying a demurrage or fee for each day over 30 days the tank is kept. There is a lease arrangement for small users of gas whereby a long-term lease is given on the tanks and when the tank is empty, the operator exchanges the tank and purchases only the gas. A person may purchase these tanks, but he is required by law to keep record of the tanks bearing the serial number registered in his name. For the small user with only two tanks, this means he may be without gas for a period of ten days to two weeks while the empty tanks are being re-charged or refilled. For most, the long-term lease is the most desirable arrangement.

The oxy-acetylene welder is particularly valuable as a tool to braze or bronze-weld and to cut steel and iron. Where a person has sufficient work to justify both arc and oxy-acetylene welders, each welder complements the other. For the average farmer who can justify only one welder, the electric arc welder is always ready to use, economical to operate, and can be used for nearly every type of welding needed on the farm. A welder is usually a sound investment on farms where there is a considerable investment in machinery, as many broken parts can be repaired on the farm rather than a time-taking trip into town to a garage.

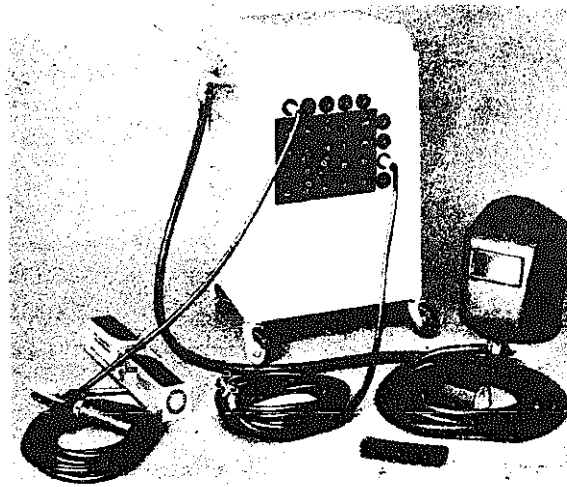

Fig. 7—A complete electric arc welder unit suitable for farm shop use.

Possibly the most essential farm shop equipment—and equally important as the vise and drill—is the grinding equipment.

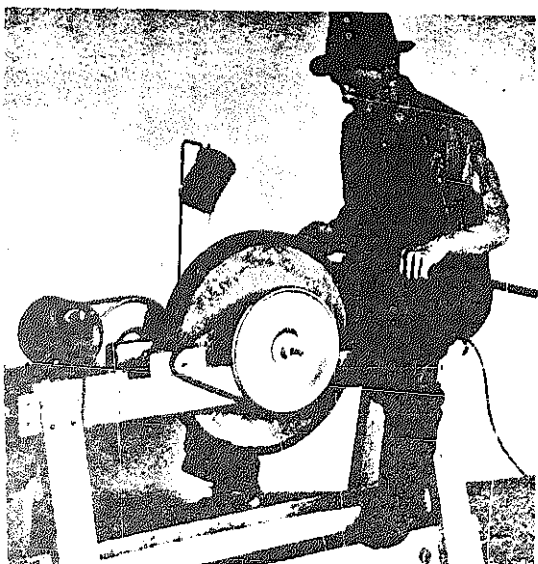

Fig. 8—Electrically Operated Grindstone.

One type of grindstone is shown in Fig. 9, suitable for light grinding. Another, Fig. 11, suitable for a variety of tool grinding jobs. The grinder in Fig. 12 will do all grinding work, from the fine tools to plow shares and mower sickles.

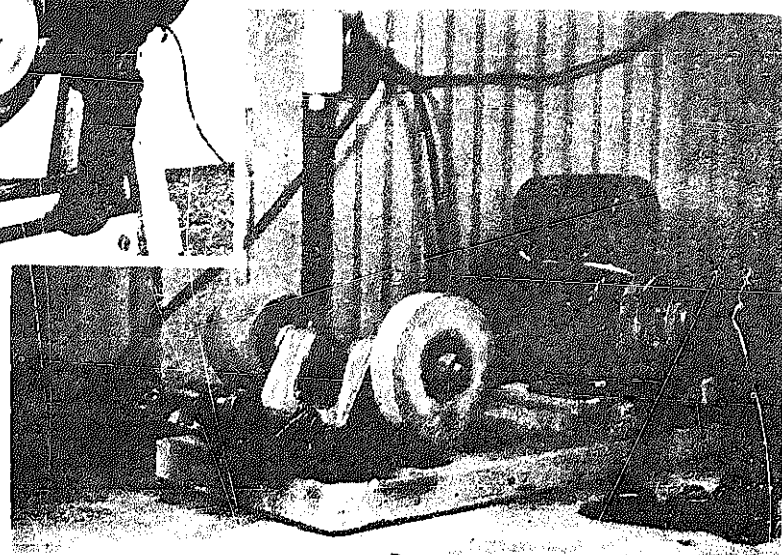

Fig. 9—A good and inexpensive electric grinder with tool grinding wheel, sickle grinder, and disk holder equipment, pulled by a portable farm electric motor.

It must be remembered that large grinding wheels cannot be driven at high speeds; the most satisfactory, safe speed for grinding wheels from 4" to 16" is indicated in table below.

Diameter of Wheel	Surface Speed of 4000 feet	Surface Speed of 5000 feet	Surface Speed of 6000 feet
Inches	R.P.M.	R.P.M.	R.P.M.
4.....	3,820	4,775	5,730
5.....	3,056	3,820	4,584
6.....	2,546		3,820
7.....	2,183	2,728	3,274
8.....	1,910	2,387	2,865
10.....	1,528	1,910	2,292
12.....	1,273	1,592	1,910
14.....	1,09	1,364	1,637
16.....	955	1,194	1,432



# WITH THIS KIT OF TOOLS MOST FARMERS AND MANY OTHER FARM REPAIRMEN



END WRENCHES



CRESCENT SINGLE END



ADJUSTABLE PLIERS



BREAST DRILL

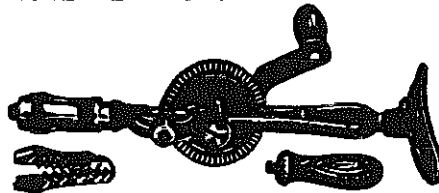

DRILL BITS

3/16 - 1/4 - 3/8 - 1/2

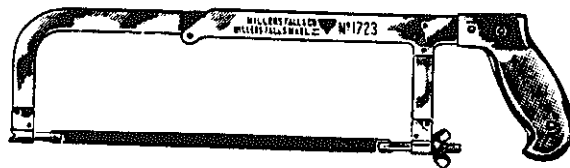

BOLT CUTTER

STEEL WIRE SCRATCH BRUSH



"SNAP-ON" SOCKET WRENCHES

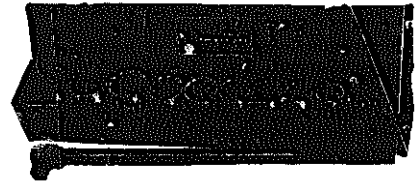

SOLDERING IRON



TINNERS' SNIPS

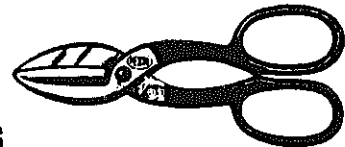

MASON'S TROWEL



SOLID DRIVE PUNCH

1/4 x 8"



ALIGNING



PI



(SEE LIST C  
TOOL



# ARM MACHINERY PARTS CAN BE PUT ON REPAIRS CAN BE MADE

"C" CLAMP

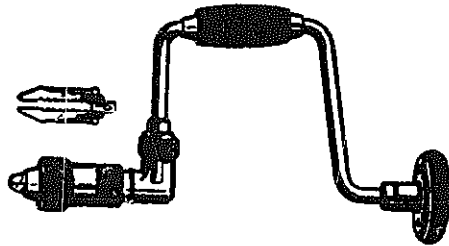
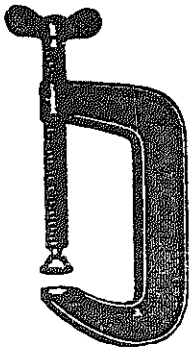

AUGER BITS



1/4 - 3/8 - 1/2 - 5/8 - 3/4

PIPE WRENCHES  
STILLSON PATTERN

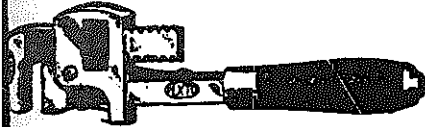

FLAT FILE



1/2 - 3/4 CHISEL



1 POUND CLAW  
HAMMER



6-8  
POINT  
HAND SAW



RIVET SET-



CARPENTER'S  
CHISEL



PUTTY KNIFE



DUAL PURPOSE GRINDER

OR DRIFT PUNCH



N PUNCH



OTHER SUGGESTED  
ON PAGE 14)

The next essential in a farm shop is drilling equipment.

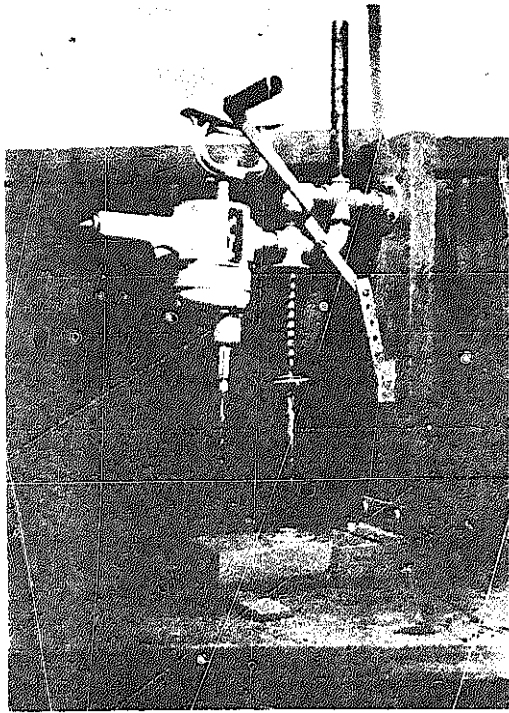

Fig. 10—A most satisfactory drilling equipment is the electric drill, which can be mounted on a homemade stand as shown, or detached from the stand and used any place in the shop.

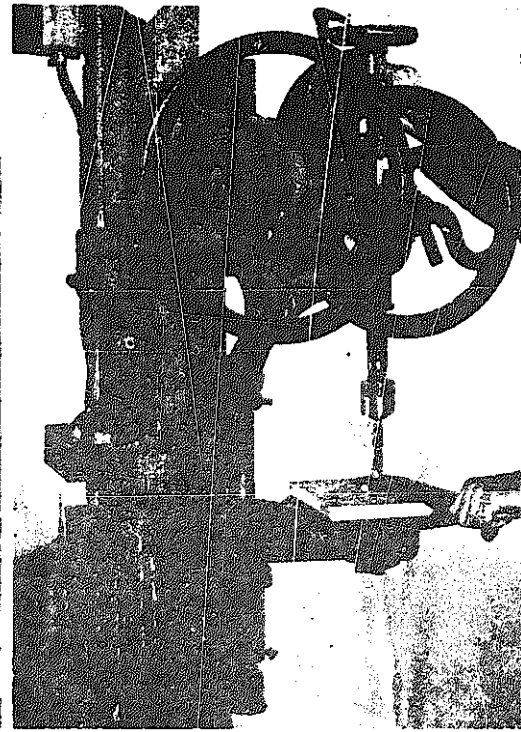

Fig. 11—The old conventional post drill is the least expensive type and can be provided with adjustable chuck for any type round shank bit.

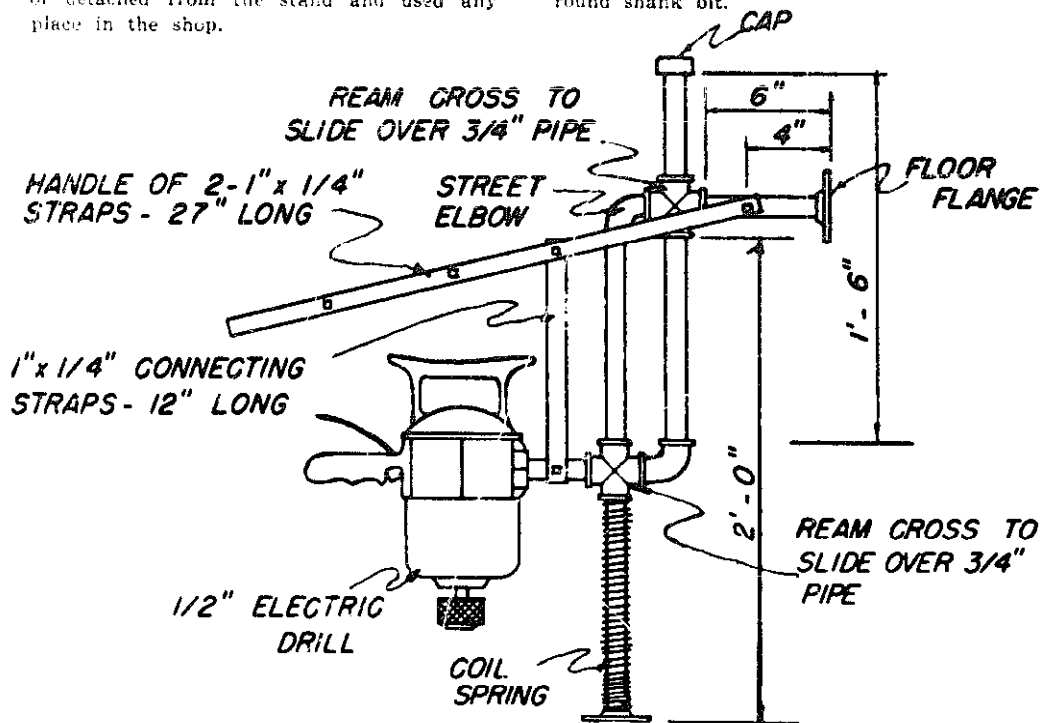

Fig. 12—Stand for Electric Drill.

Note Drill in Fig. 13 on same plan

### SHARPENING AND GRINDING BITS

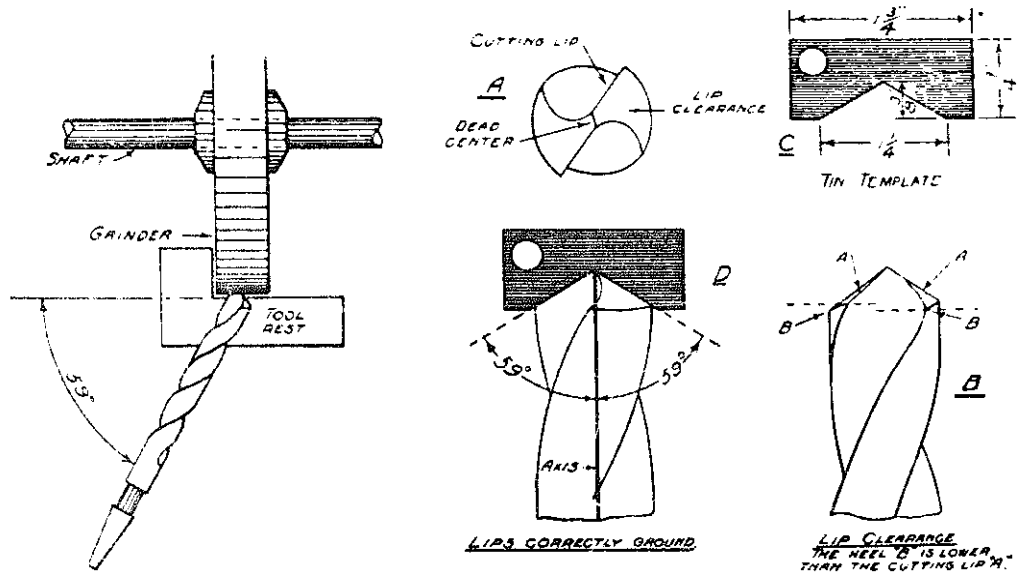

Fig. 13—Details for Holding, Grinding, and Testing a Drill.

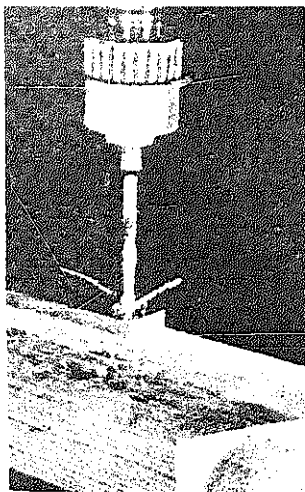

Fig. 14—How a Drill Should Cut.

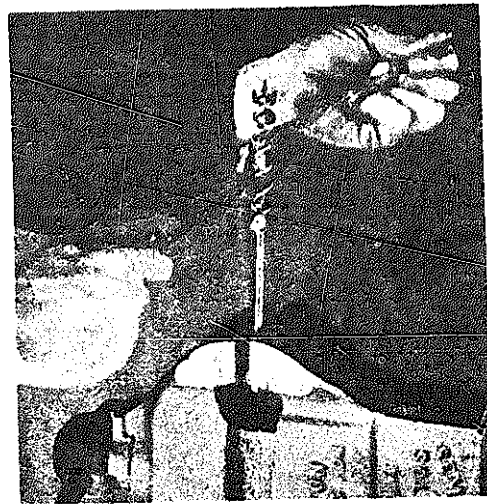

Fig. 15—Cleaning an Auger Bit with steel wool.

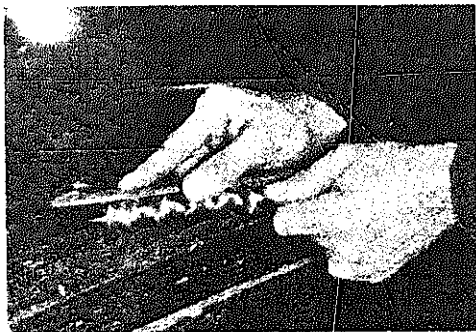

Fig. 16—Filing the Outside of the Spur of an Auger Bit (let file touch screw and lip gently).

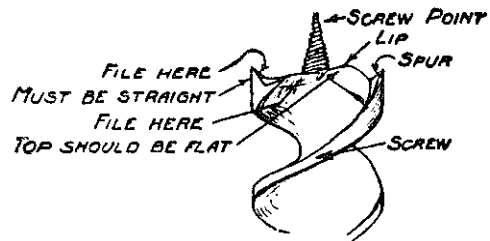

Fig. 17—Parts of an Auger Bit and where to file.

## A PRACTICAL FORGE UNIT FOR THE MORE EXTENSIVE FARM SHOP

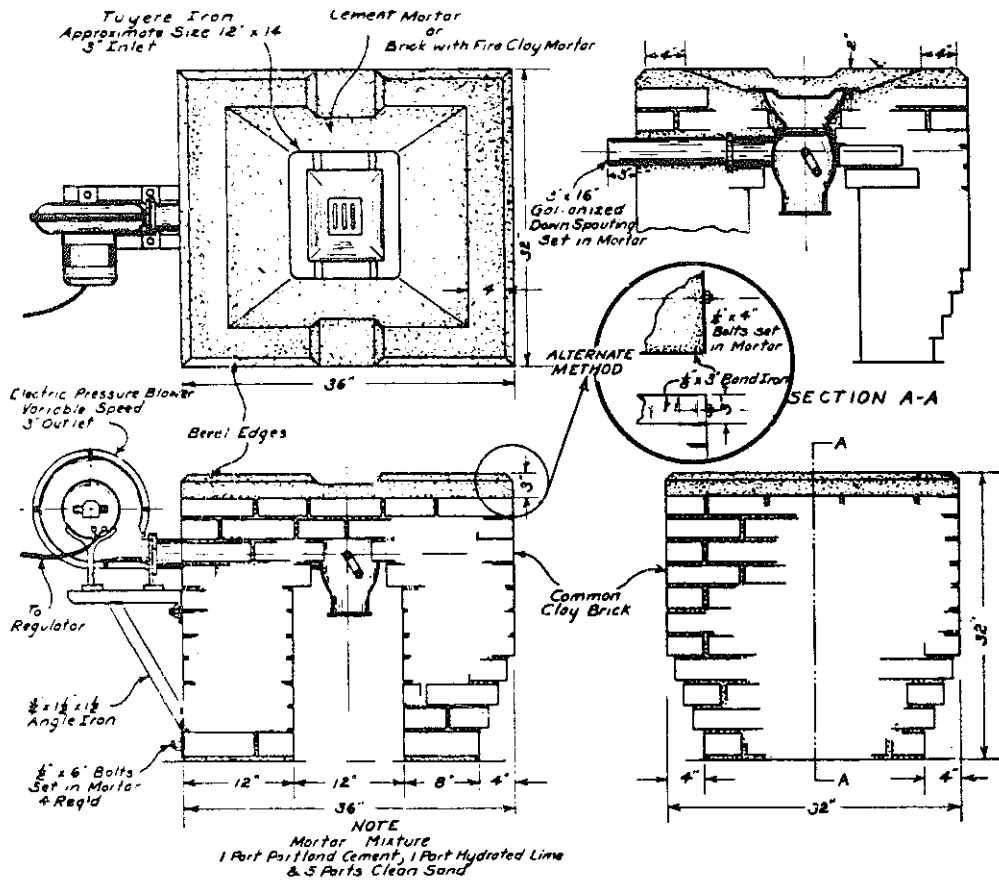

Fig. 18—Effective repair work on larger farms can hardly be done without the forge.

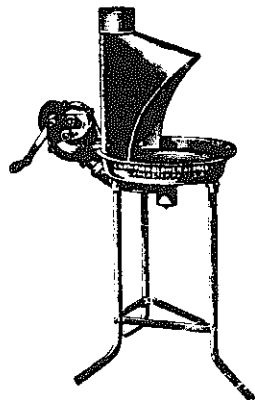

Fig. 19—A small forge useful for light work.

Good arrangement shown in small insert—anvil no more than 2' from forge and post vise at right.

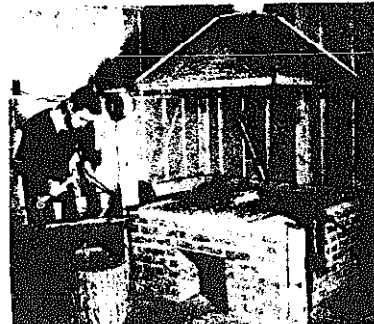

Fig. 20—Farm shops, either with or without forge equipment, are not complete without blow torch for soldering or heating stubborn bolts and pins, warming up cold braces and iron parts of farm machinery for bending or straightening.



## USE OF THE HAND HACK SAW

Notice proper method for holding hack saw.

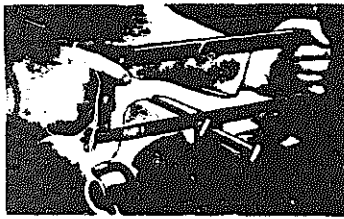

Fig. 21—When cutting off bolts, remember to screw nut all the way up on the threads first. Then when bolt is cut, unscrewing nut will straighten any battered threads.

How to Select Hack Saw Blades—It is very important in cutting metal with hand hack saw blades, for the best efficiency, to use a blade with the proper number of teeth per inch for the material to be cut. The following diagrams will clearly illustrate.

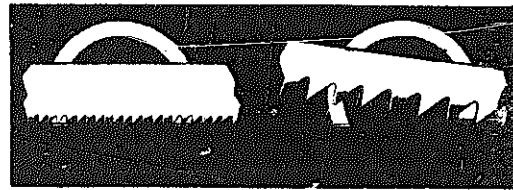

Fig. 22—Left, two or more teeth cutting at all times. Right, coarse teeth straddle the work with a tendency to strip teeth. Blades with 32 teeth per inch are best for cutting sheet metal, thin tubing, conduit. It is essential to have as many teeth contacting the material as possible on thin metals. For general work where one frame and blade is used for most all purposes, a blade with 18 teeth per inch is recommended.



Fig. 23—Left, plenty of chip clearance, blade will not clog. Right, teeth too fine, no chip clearance. For cutting round bars of soft metals or large sections it is best accomplished by using blades with 14 teeth per inch.

## OTHER MISCELLANEOUS EQUIPMENT

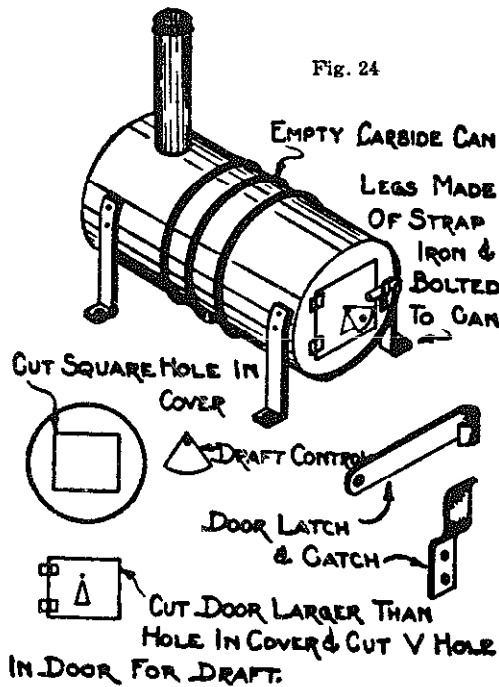

Fig. 24

No farm shop is complete without a stove, sawhorse, and tool box. (Figures 24, 25, 26)

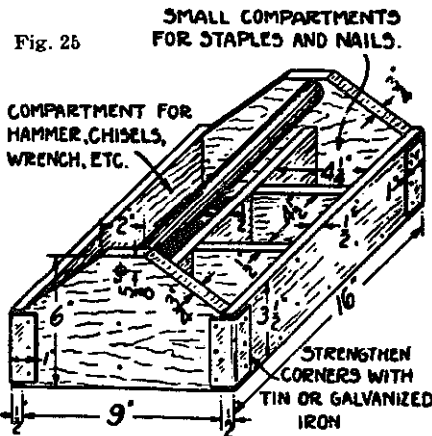

Fig. 25

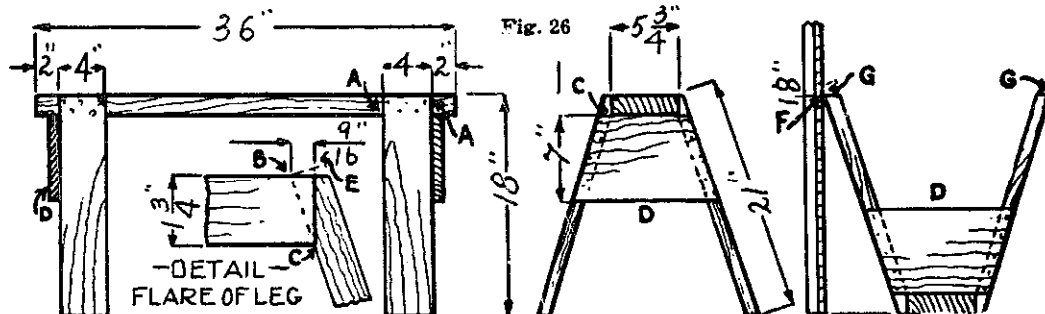

Fig. 26

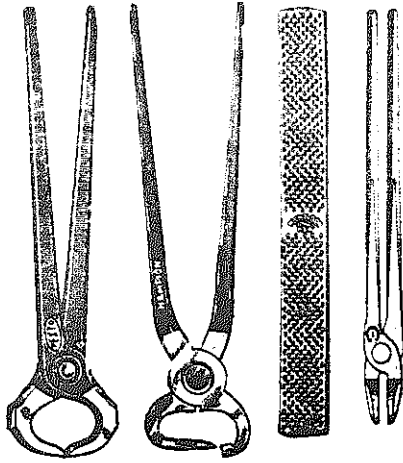

Fig. 27—It is convenient to have pinchers for removing horse shoes, clippers for trimming, and file and rasp for shaping, even if the horse shoeing job is not done on the farm.

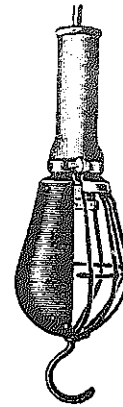

Fig. 28- For work on farm machinery on darker days, an extension cord with lamp reflector and bulb protector is most useful shop equipment.

Other Special Tools for those who do motor work—a set of "snap-on wrenches" is a good investment. Those who find a great deal of **Blacksmith Work** desirable would want: other tongues, shop hammers, anvil hardies, screw plate, and other horse shoeing tools.

Where the most use is made of tools in **Carpenter Work**, in addition to tools on page 9, a plane, good steel tape, and other tools can be added.

If **Plumbing Work** is a constant necessity, pipe vise, other pipe wrenches and a set of pipe threaders are a good investment.

Fencing on some farms may call for special pliers, stretchers, etc.

Concrete and Stone Work is another job that may call for other tools.

Figs. 29 and 30—It is always useful to have a place to keep paint, glue, and such products together, and also advisable to have a series of shelves for storing screws, washers, bolts, nuts, and paint products.

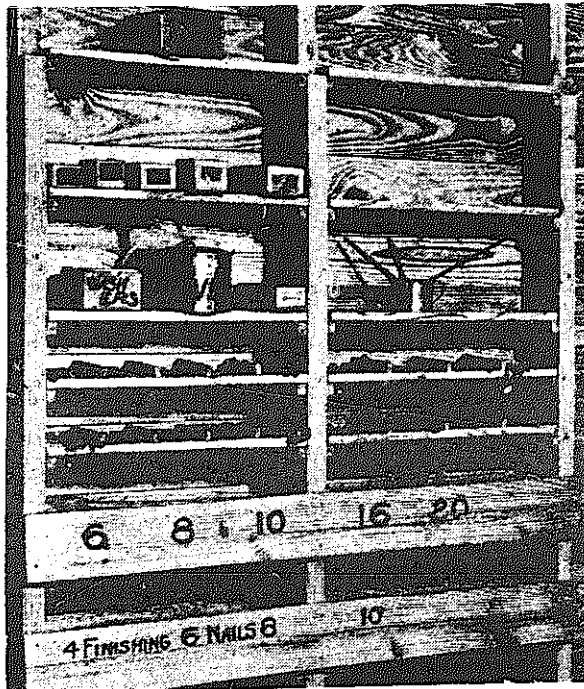

### MAKING A COLD CHISEL

The accompanying drawings and notes outline the steps needed in making a cold chisel and a rivet punch. Follow each step carefully and **WATCH THE COLORS CLOSELY**.

Rivet punches made from tool steel are not tempered. Only center punches are tempered, following the same procedure as given for tempering cold chisels. Punches may be made from any piece of ordinary steel, but chisels should always be made from good tool steel,  $\frac{3}{8}$ "x7" octagonal stock.

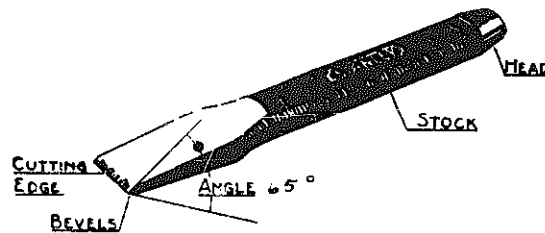

Fig. 31—Cold Chisel.

**STEP 1** Forge the piece to the form shown above being careful not to heat the piece above a cherry red. Do not work the piece below a dull red heat.

**STEP 2** Sharpen and finish the chisel, see Fig. 35. A templet can be made by filing a notch in a piece of thin galvanized iron with an ordinary three-cornered file.

**STEP 3** Polish the point the full length of the bevel.

### Hardening and Tempering

**STEP 1** Heat the piece to a cherry red, through a distance of about 2" from point.

**STEP 2** Hold the piece vertically, and dip the point in cold water, chilling it about  $\frac{3}{4}$ " back. The point will thus be cold and hardened, while at some distance back from the point the piece will still be quite hot.

**STEP 3** Immediately brighten the surface of the point with emery cloth or a piece of sandstone.

**STEP 4** Watch the bright surface very closely. Colors will gradually move down from the heated portion. First will be seen a light straw, then a dark straw, then a light brown, followed by a dark brown. When the dark brown has reached the end of the piece, quickly place the cutting edge  $\frac{1}{8}$ " back in cold water and the required temper will have been secured. Keep the point cool until the entire piece has come to a black heat, when it may be cooled slowly by dipping it in water. Never cool it rapidly until the body of the chisel is above a black heat.

**NOTE:** The above method may be followed in tempering center punches, drills, etc. The colors after brown are: purple, light blue, full blue, dark blue, and then a sort of a grey black which fades into the original color of the steel. The point should be the hardest part of the chisel for if there are harder portions farther back, the chisel is liable to break at that point.

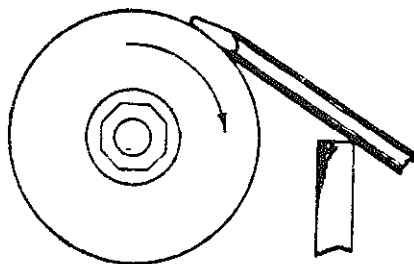

Fig. 32—When grinding tools move right and left and up and down.

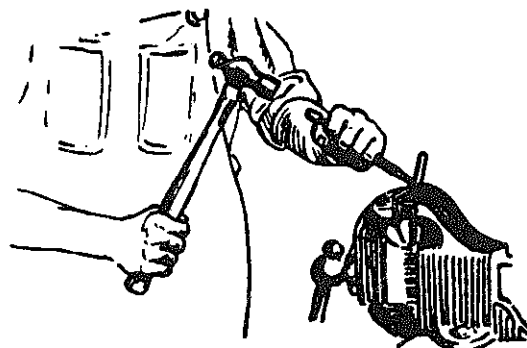

Fig. 33—To cut rod or small bar stock to rough size, nick it on opposite sides and bend it until it breaks. Note proper method of holding chisel and hammer.



## METALS OF FARM MACHINES

The following table lists the major kinds of metals used in farm machinery, how to identify them, why the manufacturer used the particular metal, common causes of failures, and recommended method of repair. It is best to refer to a welder's handbook to get the necessary procedure, treatment, and type of rod to use before attempting to weld any of these metals.

Metal	Machine Parts Commonly Made of This Metal	How to Identify and Characteristics	Why Used and Common Failures	Recommended Treatment of the Material & Repair
<b>Cast Iron</b> (Gray) (White)	Mower Frame, Wheels, Gears, & Sprockets on old models. Paws and Holders. Planter plates. Plow points. Drill Cups and Shoes. Lever Bases; Disk Spools and Bearing Cases.	Rust very lightly. Hard to cut. Easy to drill. Shaving crumble and dark to light gray. No oil when drilling. Breaks very easily when hammered or bent. Shows mold marks, very rigid.	Easy to mfg. in irregular shapes. Holds bearings & other parts with little wear, vibration or loss of alignment. When does wear hard to restore shape.	Difficult to weld. Brazes easily; when brazing, heat entire casting; allow to cool slowly. Straight or curved castings may be spliced with hot roll steel. Brad — Bolt together.
<b>Malleable Cast Iron</b>	Shoes of Mower. Cutter Bar, Planter & Drill. Seed Cups, Lever castings, clevises, bearing cases.	Nearly the same as cast iron except may bend slightly. Will stand some hammering.	Wears well, but faster than cast. Has greater tensil strength. Will hold thread for stud bolts.	Same as cast iron —not as brittle. Can be threaded; soft on outside and can be cut more easily.
<b>Wrought Iron</b>	Old machines have some in bolts & braces.	Rust resistant, soft to drill, cuts easy.	Will work easy. Can be bent to any shape, high tensil strength.	Weld by any process. Threads and forges easy.
<b>Cast Steel</b>	Mower yoke; gears and sprockets on new machines; draw-bar brackets. Some plow points.	Hard to drill and cut. Rusts slowly, takes very high polish. Rigid and high tensil strength.	Can be made in different shapes easily. Expensive. Wears slowly; dependable.	Welds by any process. Holds thread well. Can be heated and re-shaped or forged slowly. Temper carefully.
<b>High Carbon Steel</b>	Plow beams. Mower cutter bar springs. Disc. Planter shoes. Chisels, drills, and wrenches.	Shows rust quickly. Hard to drill or cut. Tempers well. Holds shape well. High tensil strength.	Expensive. Can be tempered to suit tough job. May wear some.	Welds by any process. Carefully. Can be re-tempered, but not too often. Can forge slowly. Holds thread well.
<b>Soft Center Steel</b>	Plow points; wing and other machines on wearing points.	Same as cast or high carbon steel.	Same as cast steel; will break.	Same as cast steel; but forge and temper more carefully.
<b>Cold Roll Steel</b>	Shafting & frame where straight pull tensil strength required.	Shows rust easy. Easy to cut, drill and forge. Bends easy. Cold.	Good wearing quality as rotating shaft. Cheap, but cuts easy with grit.	Weld by any process. Shape or forge easy. Cannot be tempered.
<b>Hot Roll Steel</b>	Angle & Channel iron frames where twisting and strain occur.	Same as cold roll but usually made in strips and angles.	Good wearing and rigid quality, but will break and fatigue.	Same as cold roll but may temper slightly.
<b>Brass &amp; Bronze</b>	Found in replaceable bearings.	Wears well. Bright copper color.	Replaceable. Easy dentured or broken.	Cheaper to replace than repair.
<b>Babbit</b>	Serves as lining for cast iron bearings.	Lead color—easily cut	Wears well. Melts with heat.	Cheap to replace small bearings.