

# **AT** MICROFICHE REFERENCE LIBRARY

A project of Volunteers in Asia

Hydroponics: The Bengal System

by: J. Sholto Douglas

Published by:  
Oxford University Press  
2/11 Ansari Road  
Daryaganj, New Delhi 2  
India

Paper copies are \$ 6.00.

Available from:  
Whole Earth Household Store  
Building D  
Fort Mason Center  
San Francisco, CA 94123 USA

Reproduced by permission of the Oxford University Press.

Reproduction of this microfiche document in any form is subject to the same restrictions as those of the original document.

SHOLTO DOUGLAS

# HYDROPONICS

## The Bengal System

With Notes on Other Methods  
of Soilless Cultivation

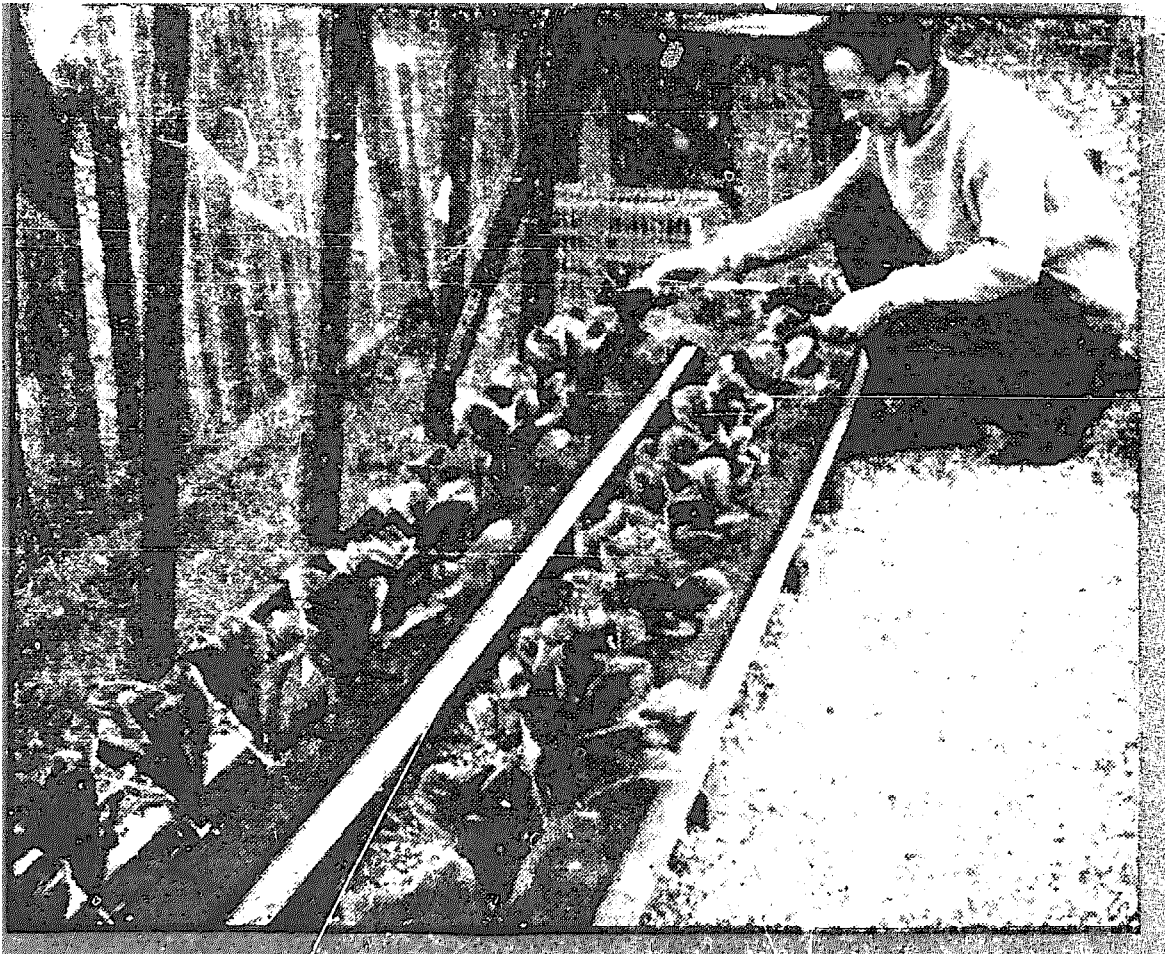

Fifth Edition

**HYDROPONICS** — the soilless cultivation of plants — provides a possible solution to some of the vital food problems which face the world today. Given the basic requirements of a minimum supply of water this is a science which can be practised successfully, producing impressive crop yields on roof-tops, in city gardens and back-yards, in village fields and in barren areas where orthodox soil culture has proved unfruitful or uneconomic.

The author is the originator of the Bengal system of hydroponics, and this book gives full instructions for the setting up of apparatus, the choice of aggregate and formulae, and the general technique of soilless culture. The system has proved highly successful in many countries; and both the amateur gardener and the large commercial grower will find this book of invaluable assistance in raising crops of rice, vegetables, fruits, and other food-stuffs. It also contains useful information on the growing of flowers without soil.

The worldwide popularity and usefulness of this work, now in its fifth edition, has prompted the author to once more fully revise the text and add a new chapter on other systems of gardening and farming without soil, providing interested readers with more material of the kind that they would require to conform to particular local conditions. A large number of new diagrams and photographs illustrate and enliven the text.

## Some Press Opinions

'An illustrated and pleasing little book by the originator of the Bengal system of soilless cultivation marks the coming of age of hydroponics. It incorporates the results of field-work at the State Experimental Farm, Kalimpong, discusses foreign developments, general techniques and botanical aspects, and points the way to great possibilities.'

*Stateman*

'Mr Douglas explains lucidly all that one would like to know about the subject.'

*Times of India*

'The chapters are excellently arranged and the matter treated in a very clear manner. The instructions are brief and clear without being complicated with unnecessary details and explanations. The illustrations are interesting and attractive. Altogether the book is one which all garden lovers in India and specially those who have taken some interest in hydroponics, should possess and treat as a basis for their experiments. The author has succeeded in cutting down expenses quite considerably and brought hydroponics within reach of the common man in India. This is an achievement.'

*Journal of the Bombay Natural History Society*

'In addition to full instructions for the setting up of the hydroponicum and its operation, the publication contains short notes on other systems of soilless culture and a brief, non-technical account of the elements of plant nutrition and deficiency symptoms, which would be found useful by the amateur gardener as well as the commercial grower.'

*Current Science*

'... Mr Douglas has rendered a distinct service in writing this popular and non-technical text. . . . The instructions which he gives are clear and concise and the illustrations are attractive.'

*Phytomorphology*

'The author has made every effort in this book to deal with the subject from a practical standpoint and give sufficient details so that everyone—from householder to large scale commercial grower—will be able to find adequate guidance and full working instructions for present and future requirements.'

*Indian Express*



1. Roots of tomato seedling grown in hydroponic aggregate

*To my Mother*

'And we make by Art in the same Orchards and Gardens, Trees and Flowers, to come earlier, or later, then their Seasons; And to come up and beare more speedily then by their Naturall Course they doe. We make them also by Art greater much then their Nature: and their Fruit greater and sweeter and of differing Tast, Smell, Colour, and Figure, from their Nature.'

**Francis Bacon (1561-1626)** in *New Atlantis*

# HYDROPONICS

*THE BENGAL SYSTEM*

*WITH NOTES ON OTHER METHODS  
OF SOILLESS CULTIVATION*

**Fifth Edition**

J. SHOLTO DOUGLAS

DELHI

OXFORD UNIVERSITY PRESS  
LONDON NEW YORK

*Oxford University Press*

OXFORD LONDON GLASGOW NEW YORK  
TORONTO MELBOURNE WELLINGTON CAPE TOWN  
IBADAN NAIROBI DAR ES SALAAM LUSAKA ADDIS ABABA  
KUALA LUMPUR SINGAPORE JAKARTA HONG KONG TOKYO  
DELHI BOMBAY CALCUTTA MADRAS KARACHI

© Oxford University Press 1959

*First published 1951*

*Second edition 1955*

*Third edition 1959*

*Fourth edition 1970*

*Fifth edition 1975*

*Reprinted (with new photographs) 1976*

*Reprinted 1977*

Printed in India  
by Pramodh P. Kapur at Rajbandhu Industrial Co., New Delhi 27  
and published by R. Dayal, Oxford University Press  
2/11 Ansari Road, Daryaganj, New Delhi 2



## PREFACE TO FIRST EDITION

**P**UBLIC interest in the Bengal System of hydroponics recently assumed such large dimensions that a popular, practicable, and non-technical text dealing with the method has been urgently called for. This book is a direct result of those pioneer experiments and efforts which originated the present development of the soilless cultivation of plants in India.

The evolution of a system of hydroponics suitable for general use in this subcontinent was beset with many difficulties, but thanks to the zealous co-operation of many enthusiasts throughout the country final success was ultimately achieved.

Further research will have to be undertaken in the coming years to improve and modify the science, but it can now be stated with confidence that the Bengal system of hydroponics has entered the world of practical horticulture.

It is hoped that this volume will prove useful to all those who desire to grow plants without soil.

Kalimpong,  
West Bengal  
February 1949.

J.S.D.

## PREFACES TO SECOND AND THIRD EDITIONS

**I**N order to meet the continued demand for this book, a second edition is being issued. The opportunity has been taken to incorporate a few additions to the text, and to discuss the further developments that have occur-

## P R E F A C E

red during the past five years. The simplified methods of soilless cultivation, first introduced in Bengal, have now spread far and wide throughout the world, and there are today a great number of hydroponics operating most successfully in all types of climate.

Hydroponics has been accepted as a practical proposition; it has been found to be profitable in almost any conditions, and it has been proved to be invaluable as a means of food production in countries or areas which have not enough fertile soil to feed their population. Plantations and estates are utilizing the system to grow better seedlings, gardeners obtain good results with all kinds of flowers, and agricultural scientists and workers are able to conduct more efficient trials with experimental crops in soilless beds.

The progress of hydroponics has been greatly aided by the patient efforts of all those amateur and professional growers who have so painstakingly co-operated in its development. Extension work is proceeding at an ever-increasing rate, as more and more people become aware of the immense possibilities of soilless cultivation of crops.

The third edition of *HYDROPONICS—THE BENGAL SYSTEM* contains certain additional material relating to the further research studies that have been made in various areas during the period 1955-7. Some more notes about commercial work, as well as a few extra comments on the operation of household units, are also included.

Written at London in May 1955  
and at Messina in November 1957.

J.S.D.

## P R E F A C E T O F O U R T H E D I T I O N

**B**y a happy chance it has been possible to prepare this new edition of *HYDROPONICS—THE BENGAL SYSTEM* for publication in time to coincide with the fortieth anni-

## P R E F A C E

versary of the original publication of the results of the first large scale trials in soilless culture of plants undertaken by Dr W. F. Gericke in California. It was these early experiments that laid the foundation for today's world wide use of hydroponics.

Looking back over the years, and remembering the period when crop growth without soil was virtually unknown outside certain scientific circles, and comparing that former situation with the quite different position obtaining now, all of us who have been privileged to play any part in the development or extension of soilless cultivation may perhaps be permitted to express some quiet satisfaction. This does not mean, of course, that anyone should rest on his laurels. Many specific problems await further investigation, and new needs arise almost daily, for there are many who have not yet heard of hydroponics, despite the strenuous efforts to publicize it that have been made during the past four decades.

So the task ahead is by no means an easy one. In the fields of basic research, advisory and extension activities, and practical guidance and demonstration, constant and unremitting perseverance is called for.

This is vital work, in which every person using or interested in soilless culture can participate, by practical demonstration, passing on of knowledge or information, or even by simply telling others of the value and purpose of hydroponics. To be able to help fellow human beings in such a way is not only charity, but also a matter of enlightened self-interest. For, as the poet Donne so rightly said: 'No man is an Island, entire of itself.' Today, we live in a contracting world of rapidly rising population. When one part of this world starves or suffers from food shortage, all the other parts of it must be affected to greater or lesser degree, now or in the future. Universal peace and prosperity will not come until every single person on the Earth is assured of regular and adequate

## P R E F A C E

nourishment. In achieving this goal as quickly as possible, hydroponics has an immensely important part to perform. It is therefore up to all of us, who have been fortunate enough to become aware of the uses and potentialities of crop growing without soil, to pass on our knowledge whenever or wherever we can.

The fourth edition of *HYDROPONICS—THE BENGAL SYSTEM* has been enlarged slightly, and contains some new material, but in order to preserve the essential character of the book as a record of work done, much of the original text has been allowed to remain unaltered. This will, it is hoped, provide interesting background reading. At the same time, a considerable amount of additional information on recent developments and new applications of hydroponics has been included. Of necessity, any book which sets out to cater for a wide and varied public has to attempt to cover the needs of different types of readers. Therefore, every effort has been made to deal with the subject from a practical standpoint and give sufficient details so that everyone—from householder to large scale commercial grower—will be able to find adequate guidance and full working instructions for present or future requirements.

Once again, this book is offered to the public in the hope that it will continue to prove useful to all those who wish to grow, or are growing, plants without soil.

Lyme Regis,  
November 1968.

J.S.D.

## P R E F A C E T O F I F T H E D I T I O N

**T**HIS edition of *HYDROPONICS—THE BENGAL SYSTEM* bears an addition to the sub-title. Readers will notice that the words *With Notes on Other Methods of Soilless*

## P R E F A C E

*Cultivation* have been appended. The reason is that as soilless cultivation is now so widely used throughout the world, increasing numbers of requests have been received during the last few years for advice and information on what may be called rather more sophisticated ways of constructing and operating hydroponic units. Consequently, it was felt that it would be appropriate at this juncture—when a new edition of the book is needed—to include extra details in the text regarding some other systems of gardening and farming without soil. This is not to say that the original and simple Bengal system is in any manner unsatisfactory or lacking in value—indeed it has well stood the test of time—but purely to provide any interested readers with more material of the kind that they would require to conform to particular local conditions. As we all know, experience perfects technique and skills. Hydroponicists should not hesitate to adapt and modify their growing units in accordance with circumstances and select whatever method they consider will best serve their purposes. So, to all readers, old and new, good crops and happy operations.

Ickenham,  
February 1974.

J.S.D.

## ACKNOWLEDGEMENTS

For permission to reproduce illustrations the publishers are indebted to the following:

Government of Abu Dhabi (No. 4).

Publicity Department, Government of West Bengal (Nos. 5, 7, 8, 9, 10, 14, 20, 27 and 40).

Shri B. G. Vaze (No. 6).

Professor R. H. Stoughton, D.Sc., V.M.H. (Nos. 11 and 15).

## A C K N O W L E D G E M E N T S

- Hydroponic Research, India (No. 12) .  
Hydroponic Research, West Bengal (No. 13) .  
L. Dobson Esq. (No. 16) .  
The Rohm and Haas Company, Philadelphia, U.S.A. (No. 17) .  
The U.S. Army and Dr N. W. Stuart (No. 18) .  
The Reinhold Publishing Corporation, New York (Nos. 19, 25  
and 26 from Ellis and Swaney's *Soilless Growth of Plants*) .  
Professor G. Rivoira (No. 22) .  
Hydroponics Inc., Indianapolis (Nos. 30, 31, 32 and 33) .  
Agricultural Extension Service, University of Florida (No. 34) .  
Hydroponic and Fish Investigation Unit, Sibpur (No. 35) .  
The American Potash Institute Inc., Washington, D.C., U.S.A.  
(No. 37) .  
The Agricultural Research Service of the United States of  
America (No. 38) .  
Captain S. R. Mullard, The Mullard Horticultural Engineering  
Co., Ltd., Englefield Green (No. 39) .  
The Editor, P. A. Features Ltd., London E.C. 4 (No. 41) .  
R. A. Smith Esq. (No. 42, from *Exploration of the Moon*, published  
by Frederick Muller Ltd.) .  
Dr G. S. Davtyan (No. 43) .  
The Editor, *Garden News* (Nos. 46 and 47) .  
The author provided photographs for Nos. 1 (Frontispiece) , 2, 3,  
21, 23, 24, 29, 44, 45, 48 and 49 and for all the drawings. The two  
drawings on pages 90 and 139 have previously appeared in the  
*Gardener's Chronicle* and are reproduced by courtesy of Mr Roy Hay;  
the drawing on page 155 has appeared in *Farm Implement and  
Machinery Review* and is reproduced by courtesy of the editor and  
the two drawings on pages 109 and 110 are adapted from a paper by  
Dr Y. Hori and reproduced by his kind permission.

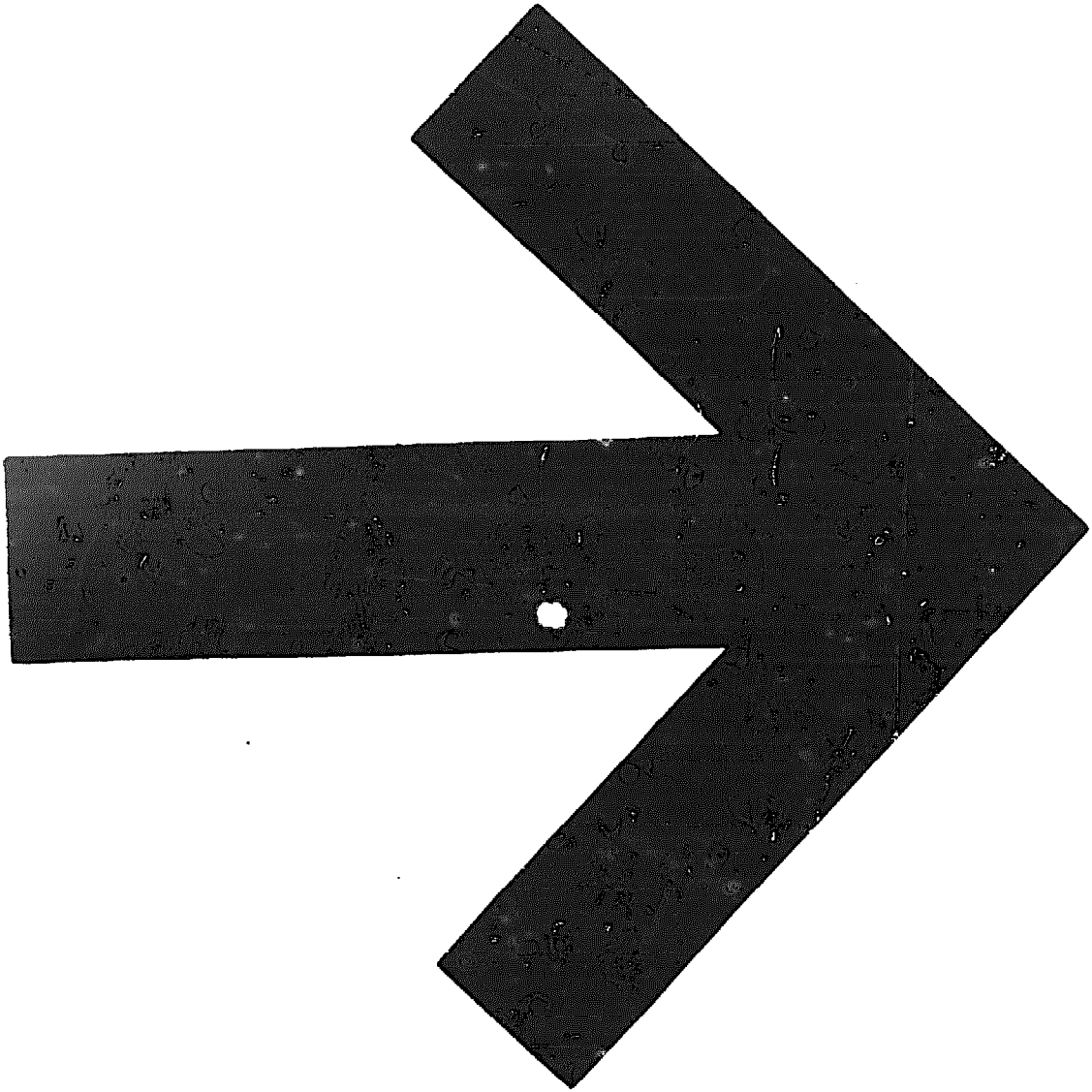

# CONTENTS

1. INTRODUCTION 1  
Early experiments. The birth of hydroponics. Further research. Advantages. Higher yields. World developments. The problem in India. Work in Bengal. Great possibilities. Some criticisms answered.
2. HOW PLANTS GROW 17  
Life processes. Water. Light. Air. Mineral salts. Support for the roots. Behaviour during growth.
3. APPARATUS 27  
The site. The trough. The growing medium. The appliances. The water supply. The chemicals.
4. NUTRIENT MIXTURES 48  
The choice of a formula. Selection of salts. The basic formula. In case of difficulty. Computation made easy. Technique of preparation. Rate of application. Desirable variations. Acid balance. Tabloid nutrients. Other mixtures. Slow-release fertilizers. Solution theory. Points of interest.
5. THE SYSTEM IN PRACTICE 78  
The first hydroponicum. Sowing of seed. Applying the nutrients. What to do with tablets and slow-release mixtures. Watering. During wet weather. Cropping area. Checking up. Staking and spraying. Reports from different localities.
6. GENERAL TECHNIQUE 93  
Planting. Intercropping. Seasonal variations. Improving a growing medium. Points to watch in household culture. Supports. Pests. What to do if things go wrong.



## CONTENTS

7.	<b>NOTES ON OTHER METHODS</b>	105
	Solution culture. Sand culture. Aggregate culture. Mixed aggregate culture. Miscellaneous culture devices.	
8.	<b>COMMERCIAL POSSIBILITIES</b>	121
	Chief benefits. Cheaper than soil. Smaller space requirements. Growth speeded up. No weeding. Freedom from diseases. Improved quality. Out-of-season crops. Some production statistics. Costs. Estimated revenue. High returns.	
9.	<b>COMMON DEFICIENCIES, PESTS AND DISEASES</b>	133
	Learn to know each plant. Chlorosis. Damping-off. Leaf-curl. Staggers. Nematodes. Other infections. Beware of neglect.	
10.	<b>MISCELLANEOUS NOTES</b>	139
	Heating. Weights and Measures. Regeneration of seed. Method of making non-erodible mud plaster. Alkali-puddled clay. Food values. Is hydroponics unnatural? Effluents. Algae culture. Root hormones and chromosome doubling. Effects of various other substances. Grass and sprouted forage. Artificial lighting. Three useful compounds. Treatment of seed. Hydroponics helps forestry and plantation industries. What actually constitutes hydroponics. Mechanization. Saucers in the parlour. Keeping records.	
11.	<b>THE FUTURE OF HYDROPONICS</b>	160
	What the Bengal System means. Need for demonstration centres. Social implications. Still cheaper ways. Floriculture. Plans for tomorrow.	
<b>APPENDICES</b>		
	A. List of Institutions and Organizations engaged in or connected with soilless culture research	167
	B. Bibliography	174
	<b>INDEX</b>	178

# ILLUSTRATIONS

## PHOTOGRAPHS

1. *Frontispiece.* Roots of tomato seedling grown in hydroponic aggregate. Note the compact form and number of fine rootlets.

*Between pages xvi and 1*

2. Hydroponic tomato crop.
3. Young cabbage plants in hydroponics.
4. Aubergines or garden eggs thriving in Abu Dhabi hydroponic farm.

*Between pages 16 and 17*

5. A close-up of young summer vegetable seedlings, showing aggregate.
6. Work in progress on a hydroponic installation in Western India.
7. Applying fertilizers to a hydroponic trough operated on the Bengal system.

*Between pages 32 and 33*

8. Hydroponic oats. Excellent crops of this cereal can be easily raised in soilless cultures for emergency feeding purposes.
9. Young beetroot in an experimental trough at Kalimpong. Stones used as aggregate are of  $\frac{1}{2}$ " grade.
10. An excellent specimen of hydroponic lettuce.
11. A fine crop of hydroponic tomatoes under glass.
12. Hydroponic plants growing in troughs made from non-erodible mud plaster.
13. Wheat seedlings in an early experimental sector employing cinders.

*Between pages 48 and 49*

14. Broad beans are a useful soilless crop in backyard or roof-top boxes.
15. Young tomato and lettuce plants intercropped in the hydroponicum at Reading University. Note the method of supporting the vines on a series of upright strings.

## I L L U S T R A T I O N S

16. The Bengal system in Tanzania. A view of the soilless culture beds at Geita, near Lake Victoria.
17. Photomicrograph of ion-exchange resin of 40-mesh size.
18. Construction of a five-acre soilless unit in Japan.
19. A hydroponicum with overhead shading in the tropics.

*Between pages 64 and 65*

20. Rice plants flourishing in a hydroponicum at 3,000 ft.
21. Hydroponic vegetables raised in West Bengal for home food supplies
22. View of tomato crop in a commercial hydroponic unit, Sardinia.
23. Rex Begonias in hydroponic unit. These flowers do very well in soilless gardening.
24. Herbs for housewives in simple home soilless unit.
- 25, 26. Two views of large-scale soilless units.

*Between pages 80 and 81*

27. Hydroponically produced maize presents an impressive sight against the soft cloud of a northern India sky.
28. Using tablets in hydroponics.
29. View of a small pilot grass production unit at IWOSC Pinner (U.K.) trials in 1968. The two troughs in the front have just been seeded with pre-soaked rye grain (left) and rye-grass (right). Those at the back are awaiting sowing. The wire mesh grid and the substratum are visible.
30. How an automatic hydroponic green forage unit looks inside. The cutaway section reveals the tiers of growing trays and the solution tanks. Such soilless 'grass factories' give immense yields.
31. A factory-built installation for producing hydroponic grass and sprouted forage. Seed and grain is being poured into the hopper on the right, while on the left the auger device delivers the day's ration of greenfood. Normally, it takes under a week to turn the dry grain into palatable and succulent fodder for livestock.
32. A prize winning dairy cow enjoys her meal of hydroponic grass.
33. Fresh grass for farm animals. Roots, foliage and seed—all are edible, so there is no waste. Livestock love this feed.

## ILLUSTRATIONS

*Between pages 96 and 97*

34. A newly-built soilless unit in Florida.
35. Pineapples flourishing in hydroponic garden pots.
36. Giant Plants growing in CO<sub>2</sub> enriched atmosphere in a hydroponic space colony unit (Artist's impression).
37. Hydroponic flowers.
38. Chrysanthemums growing in a gravel aggregate.
39. A fine fuchsia flourishing in a mixture of vermiculite and sand.

*Between pages 112 and 113*

40. A view of soilless beds, Calcutta.
41. A smiling housewife feeds her tomato plants with nutrient salts on the roof of her flat, with ease and comfort.
42. Design for a hydroponicum under lunar conditions prepared for the British Interplanetary Society. Soilless culture will be the only means of supplying space travellers with fresh greenstuff.
43. Tower hydroponics: A unit in Armenia.
44. Flowers: Cockscombs grown without soil.
45. Radishes grown in home soilless unit. Note polythene lining to simple wooden boxes.
46. Nutrient film layflats with lettuce crop.
47. Small submersible electric pump for layflats.

*Facing page 128*

48. A pet rabbit enjoys a tasty meal of hydroponic grass.
49. Ideal hobby for children. A young girl attends to her hydroponic plants.

## FIGURES

Water culture	2
Solution culture	4
Essentials of Plant Growth and how these are supplied in the Bengal System of Hydroponics	18
Sand culture	27
Aggregate culture	30
Simple types of containers for the home	31
A hydroponic trough, Bengal system	33

## ILLUSTRATIONS

Features of a soilless culture trough	35
Geehen's Chart	41
Three kinds of trough	79
Portable device for producing fresh water from brine or saline ground-water in soilless units	86
Water supply in terrace cultivation	89
Matting shades in the hydroponicum	90
Rooting of Cuttings in Hydroponics	95
Protection of hydroponic troughs against weather	100
Some troubles and their possible causes	104
Sub-irrigation layout and design	109
Trough Construction	110
Simple household aggregate culture	111
A type of ring culture	112
Design for a nutrient film lavflat unit	116
Nutrient film method	117
Example of tier of shelving and lighting strips for indoor hydroponics	119
Hydroponics in the greenhouse	126
A cheaply made conservatory for hydroponics	138
A heated hydroponic trough with cloche protection	139
Design for simple hydroponic green feed outfit	149
How mesh grids provide support for germinating grains or seeds	151
A spreading machine for use in soilless cultivation	155
Tractor and Spreader for Bengal system	156
Layout for a Hydroponic Demonstration Unit	161

## CHANGE OF NAME AND ADDRESS

p. 73, II 5 & 6

*for* Trace Element Fertilizers Ltd. 118 Ewell Road, Surbiton, Surrey, England.

*read* Sustanum Sales Company Ltd. 29 High Street, Hemel Hempstead, England.



2. Hydroponic tomato crop

3. Young cabbage plants in hydroponics



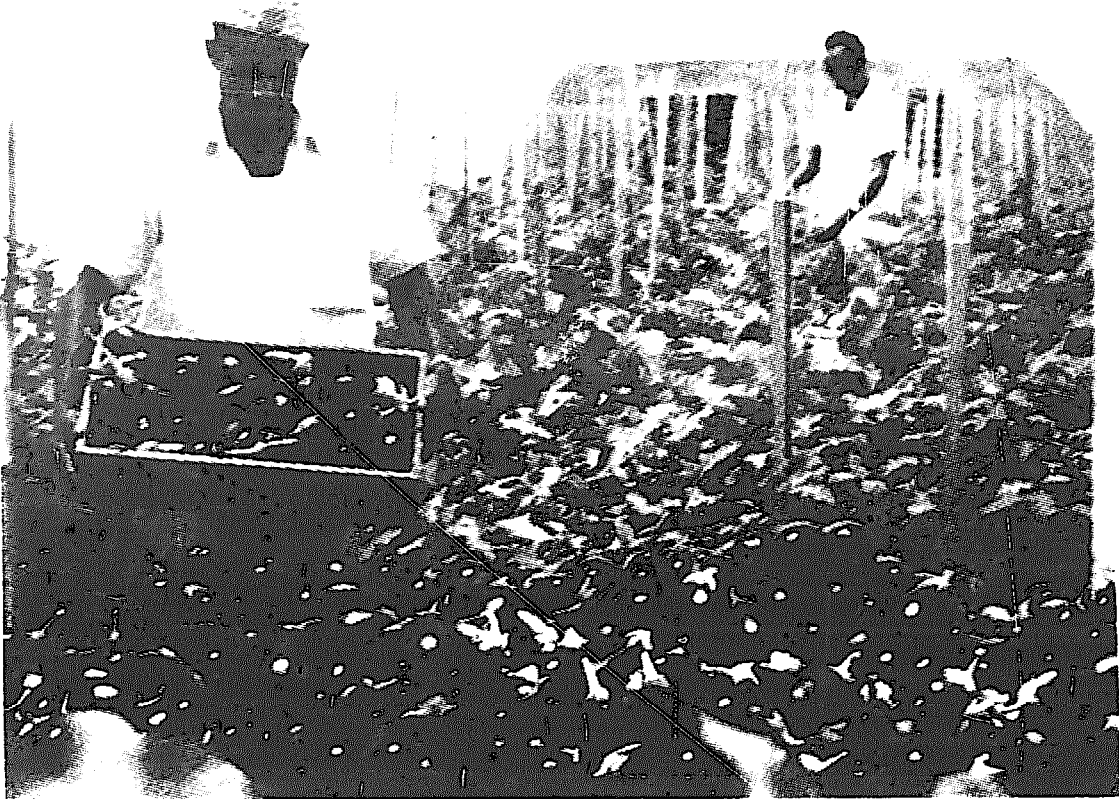

4 Aubergines or garden eggs thriving in Abu Dhabi hydroponic farm

## INTRODUCTION

**H**YDROPONICS is the art and science of growing plants without soil by feeding them on chemical solutions. Crops can be raised in the absence of organic matter simply by giving them in artificial form the nutrients which they usually draw from the earth through their roots. The basic principles of soilless culture are not new, in fact for over a century scientists have been producing plants for physiological experiments in their laboratories by the use of similar methods, but until comparatively recent years nobody ever thought of adapting or applying such ideas to practical or commercial food production. In fact the sole object of water culture experiments—that is, growing plants without soil by suspending their roots in containers full of solution—was to enable the farmer to make better use of his land. Horticulture by soilless methods was not even a dream. Then, suddenly, the world was startled by reports of amazing results obtained by Californian researchers who had managed to raise crops without any soil at all, by growing them out of doors in nutrient solutions or inert media moistened by cultural infusion. People began to talk about this new science which further investigation was eventually to develop into a tested and successful system.

### *Early experiments*

The study of crop nutrition began thousands of years ago, long before the time of Aristotle. Ancient history tells us that various experiments were undertaken by Theophrastus (372-287 B.C.), while several writings of



## HYDROPONICS—THE BENGAL SYSTEM

Dioscorides on botany and its allied subjects, dating from the first century A.D., are still extant. The earliest recorded scientific approach to the question, however, was that of Woodward (1699), who worked in England with water cultures to try to determine whether it was the water or the solid particles of soil that nourished the plants. Handicapped as they were by lack of equipment, investigators of that era could make little progress. But the modern theory of chemistry, built up during the seventeenth and eighteenth centuries, subsequently revolutionized scientific research. The experiments of

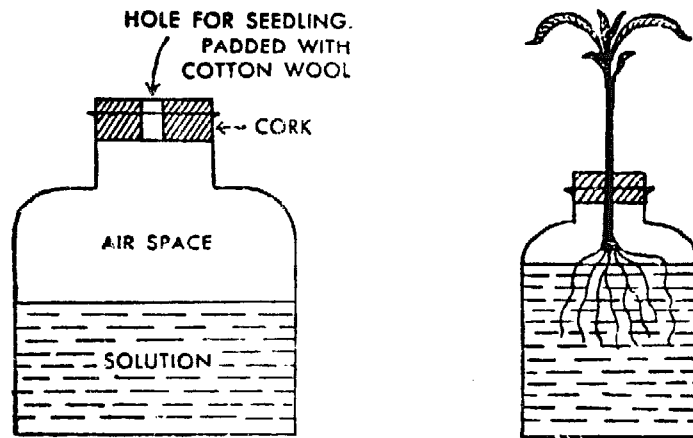

### WATER CULTURE

Experiment by Sachs and Knop in 1859-65.

Sir Humphrey Davy, inventor of the safety-lamp, had evolved a method of effecting chemical decomposition by means of an electric current. Several of the elements which go to make up matter were brought to light, and it was now possible for chemists to split up a compound into its constituent parts. By 1842 a list of nine elements believed to be essential to plant growth had been made out, and the discoveries of the German workers, Sachs<sup>1</sup> and Knop, in the years 1859-65, resulted in a develop-

<sup>1</sup> Julius Von Sachs (1832-97) Professor of Botany at the University of Wurzburg.

## INTRODUCTION

ment of the technique of soilless cultivation. The addition of chemicals to water was found to produce a nutrient solution which would support plant life, so that by 1920 the laboratory preparation of water cultures had been standardized and the methods for their use were well established.

### *The birth of hydroponics*

Until 1929, though the idea of producing plants artificially remained a laboratory technique, in fact the phrase 'crops grown without soil' was unknown. Scientists failed to realize the value of their discovery. In that year, however, a further step forward was taken when Professor W. F. Gericke, of the University of California, succeeded in growing tomato vines twenty-five feet in height. Even the most incredulous critics were astonished. A new factor had suddenly appeared and was making itself felt in the world of practical and scientific agriculture. Dr Gericke named his new discovery 'hydroponics', a word derived from the Greek, meaning literally 'water-working'. Such a novel technique was bound to attract great attention. The American press hailed it as the most colossal invention of the century, reporting with magnificent abandon that farmlands had become relics of the past. Banner headlines announced the feat, while numerous photographs were circulated showing the triumphant doctor picking his bumper crop with the aid of a step-ladder. Many extravagant and irresponsible claims were made for the new science, which could not at that time stand investigation.

### *Further research*

Although hydroponics had broken laboratory bounds and in one stride entered the world of practical horticulture, it was not initially regarded as an exact science. Because of this, and the fact that the different functions

## HYDROPONICS—THE BENGAL SYSTEM

of the various parts of the necessary apparatus were imperfectly understood, early sensational publicity threatened to destroy its future. Unscrupulous adventurers attempted to 'cash in' on the discovery by selling useless equipment at fantastic prices to the ignorant or credulous. But, fortunately, experienced research workers and scientific institutions throughout the United States began to give hydroponics considerable thought and attention. Dr Gericke had grown his first plants in large basins containing a nutrient solution, but slight changes had to be made to suit different regions, so the technique of sand and gravel culture was evolved in the Middle West. From America hydroponics spread to Europe. Another ten years' experimenting produced several practicable systems of soilless culture. Among the well-known institutions which have contributed so much to the

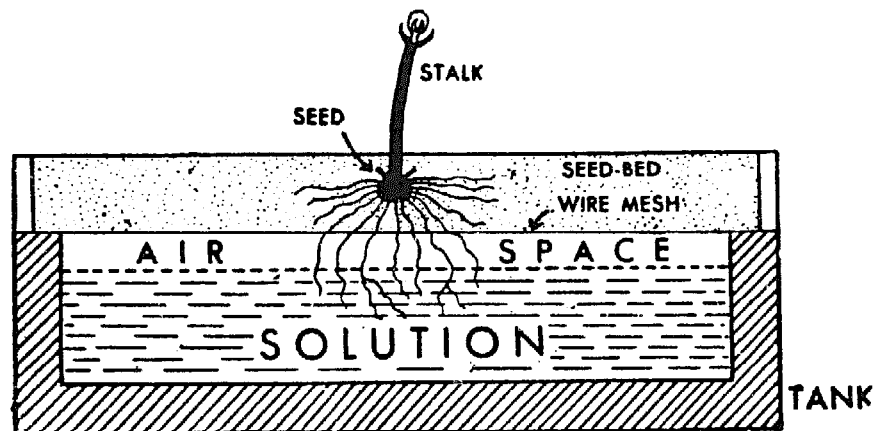

SOLUTION CULTURE

Dr Gericke's original method of soilless cultivation of plants.

establishment of the soilless cultivation of plants as a practical proposition are the Universities of Illinois, Ohio, Purdue, and California in the United States; Reading in Great Britain; Canada's Central Experimental Farm at Ottawa, and the internationally famous Imperial Chemical Industries Limited. Other pioneers of hydroponics

## INTRODUCTION

were the Boyce Thompson Institute for Plant Research, New York; the New Jersey Agriculture Experiment Station; the Alabama Polytechnic Institute; and the Horticultural Experiment Station, Naaldwijk, Netherlands. A list of some of the institutions connected with or engaged in soilless cultural research will be found in Appendix A of this book.

### *Advantages*

Today, hydroponics is an established branch of agronomical science. Progress has been rapid, and results obtained during the last thirty-five years in various countries, including the work conducted in Bengal, have proved it to be thoroughly practical and to have very definite advantages over conventional methods of horticulture. The two chief merits of the soilless cultivation of plants are, first, much higher crop yields, and secondly, the fact that hydroponics can be used in places where ordinary agriculture or gardening is impossible. Thus not only is it a profitable undertaking, but one which has proved of great benefit to humanity. People living in crowded city streets, without gardens, can grow fresh vegetables and fruits in window-boxes or on house tops. Town residents and workers in industrial settlements often have extensive verandas, backyards or pavements of which they can generally make little use. By means of hydroponics all such places can be made to yield a regular and abundant supply of clean, health-giving greenstuff. Other possibilities are factory roofs or disused roads. Not only town dwellers but also country residents have cause to be thankful to soilless culture. Deserts, rocky and stony land in mountainous districts or barren and sterile areas can be made productive at relatively low cost. It is difficult to exaggerate the importance of hydroponics for it has given a new lease of life to the landless worker.

## HYDROPONICS—THE BENGAL SYSTEM

We have already mentioned higher crop yields and adaptability to places unsuitable for conventional horticulture as characteristics of soilless culture, but there are also a few other advantages that will interest the reader, whether a commercially-minded businessman, or simply a housewife anxious to add to the family larder. Briefly these include quicker growth combined with relative freedom from soil diseases, and very consistent crops, the quality of the produce being excellent. There is also a considerable reduction in growing area, weeds are practically non-existent, while standard methods and automatic operations mean less labour, less cost, and no hard manual work. Some plants can be raised, out of season, better control of crops naturally results in addition to no dirt and no smells. Waterlogging never occurs, owing to good drainage. Nor does the use of hydroponics alter the accepted taste of a crop in any way, unless for the better. Many visitors to the author's hydroponica have remarked that the piquant savour of soilless cultured produce could not be found anywhere else in general horticulture. Chemically grown plants are not inferior to naturally reared ones in point of flavour, nor have analyses shown any deficiency in vitamin content. In fact, hydroponic fruits and vegetables are sweeter and more luscious than those grown in ordinary soil.

### *Higher yields*

A few statistics showing some of the individual hydroponic yields obtained in Bengal during 1946-74 contrasted with conventional Indian averages in soil, make interesting reading.<sup>1</sup>

As early as 1952 a crop of tomatoes in a hydroponicum yielded an average of over 24 lb. per plant, excluding

<sup>1</sup> See also pages 128-9 for additional results, recorded in part during work in various other regions of the world, from 1958-74.

## INTRODUCTION

'chats', picking having begun at 14½ weeks. Cauliflowers did extremely well, averaging 30,000 lb. per acre, while French beans yielded approximately 1 lb. per square foot

<i>Crop</i>	<i>Agricultural yield per acre</i>	<i>Hydroponic yield per acre</i>
Rice ...	1,000 lb.	12,000 lb.
Wheat ...	600 lb.	5,000 lb.
Potatoes ...	22,000 lb.	150,000 lb.
Maize ...	1,500 lb.	8,000 lb.
Soya-beans ...	600 lb.	1,500 lb.
Oats ...	850 lb.	3,000 lb.
Beetroot ...	9,000 lb.	20,000 lb.
Peas ...	2,000 lb.	14,000 lb.
Tomatoes ...	5-10 tons	200 tons

of trough space, the first pods being ready for consumption 5½ weeks after sowing. Potatoes and lettuces were very satisfactory crops, and work with flax proved valuable. Altogether sixty different crops were grown successfully in the experimental seasons of the period 1946-68, and another thirty kinds of useful plants have responded very favourably during further trials and extension work up to 1974.

Impressive though these results may appear they could be better, since the poor quality of the seeds, which were often the only ones available, sometimes spoiled much of the work. This is unfortunately a usual complaint in Bengal, and to obtain reliable seeds is still a matter of great difficulty. Some examples of overseas results are 30 lb. of tomatoes per plant in Britain, and 300 tons to the acre in Florida, California, and Southern Africa where the brilliant sunlight provides ideal climatic conditions. Dr Gericke grew potatoes at the rate of 2,500 bushels to the acre where the average soil production was only 116 bushels. His tomatoes produced fruit in 60 days, some giving 31 lb. per plant. In England, carnation growers

## HYDROPONICS—THE BENGAL SYSTEM

find their output of flowers can be greatly increased by hydroponic means, some plants in soilless beds coming into bloom four weeks earlier than similar ones in ordinary earth.

### *World development.*

The real romance of soilless cultivation began when, having broken laboratory bounds, it was taken up by administrative departments, businessmen and commercial organizations. Practical growers praised the science as it spread rapidly across the United States. The first triumph came when Pan American Airways decided to establish a hydroponicum on distant and barren Wake Island in the middle of the Pacific Ocean in order to provide the passengers and crews of the airliners with regular supplies of fresh vegetables. Then the British Ministry of Agriculture began to take an active interest in hydroponics, especially since its potential importance in the Grow-More-Food Campaign during the 1939-45 war was fully realized. In 1945 the Air Ministry in London took steps to commence soilless culture at the desert air base of Habbaniya in Iraq, and at the arid island of Bahrein in the Persian Gulf, where important oilfields are situated. In the case of Habbaniya, a vital link in Allied communications, all vegetables had had to be brought by air from Palestine to feed the troops stationed there—an expensive business. The United States Army has a special Hydroponics Branch, which grew over 8,000,000 lb. of fresh produce during 1952, a peak year for military demand. Some of the most successful installations have been those at isolated bases, notably in Guyana, Iwojima and Ascension Island. American Headquarters in the Far East has 80 acres devoted to vegetable units; while various oil companies in the West Indies, the Middle East, and the Sahara operating in barren areas, especially

## INTRODUCTION

off the Venezuelan coast at Aruba and Curacao, and in Kuwait have found soilless methods invaluable for ensuring that their employees get a regular ration of clean greenstuff. In the United States extensive commercial hydroponics exist, producing great quantities of food daily, especially in Illinois, Ohio, California, Arizona, Indiana and Florida, and there has been a noteworthy development of soilless culture in Mexico and neighbouring areas of Central America.

People in New York are taking increasingly to skyscraper gardening. Chinese residents of the city employ the technique for sprouting beans. Recent surveys have indicated that there are over 1,000,000 household soilless culture units operating in the United States. Russia, France, Canada, South Africa, Holland, Japan, Australia, and Germany are among other countries where hydroponics is receiving the attention it deserves. The English carnation-growing industry has partly switched over from soil to soilless methods. It is also of interest to note that a primitive form of hydroponics has been carried on in Kashmir for centuries. Visitors to that State will have observed light frameworks of branches, covered with rotten vegetation, floating on one or other of the numerous lakes. Excellent crops are raised by the local peasantry from these rafts which provide both water and nutrient to the growing plants. Similar 'floating gardens' were also used by the Aztecs of Mexico, before the Spanish Conquest in the sixteenth century A.D.

The soilless growth of plants is a great and growing world industry, and every day brings fresh word of some new development by olericulturists or hydroponicists.

### *The problem in India*

Hydroponics did not reach India until 1946. In the summer of that year the first research studies were com-



## HYDROPONICS—THE BENGAL SYSTEM

menced at the Government of Bengal's Experimental Farm at Kalimpong in the Darjeeling District. At the very beginning a number of problems peculiar to this sub-continent had to be faced. Even a cursory study of the various methods which were being practised in Britain and in America revealed how unsuited they were for general adoption by the public in India. Various physiological and practical reasons, in particular the elaborate and expensive apparatus required, were sufficient to prohibit them. A novel system, of which practicability and simplicity must be the keynotes, would have to be introduced if hydroponics was to succeed in Bengal, or in fact ever to prove of widespread value to the people of this part of Asia. One of the first problems to be faced was that of the Oriental monsoon or rainy season, which would obviously upset the controlled exactitude of all known methods. Techniques with impressive records of achievement in the United States had failed when tried under European conditions. Again, equipment readily obtainable in Western countries is often impossible to secure in India. Although large firms might conceivably afford expensive installations it was at once apparent that they would be generally out of the question in a land of great poverty, where the low individual standard of living implied an immediate lack of purchasing power. Another point that arose was the ignorance of the masses. What useful purpose could be served by speaking about nutrient mixtures to a person whose vocabulary contained no translation of the English word 'chemical'? It was subsequently discovered that the local inhabitants of the Darjeeling District did not even know of the existence of chemicals; indeed so primitive and superstitious was their outlook on life that their first reaction to the activity of soilless culturists was to denounce it as the work of devils! Not content with mere verbal attacks,

## INTRODUCTION

they endeavoured several times to smash the hydroponica by flinging large stones into them after dark.

Despite all these drawbacks, and various other forms of opposition, including the jealousy of unsympathetic and ignorant or petty-minded people, certain advantages presented themselves. Labour, so scarce in Britain and in America, is readily available in India. Furthermore, several indigenous materials exist which can be utilized quite satisfactorily in place of the highly-priced imported products of foreign industry. With very little ingenuity and a certain amount of improvisation, many such substitutes have, in fact, been profitably employed in the construction of apparatus. For these reasons, it was necessary from the beginning to reject complicated systems and to concentrate upon the development of a novel indigenous method. Elaborate appliances had to be eschewed. As a few hours' instruction would probably be all that any aspiring operator could hope to receive, a reliable code of rules and regulations must be devised. But hydroponics is both an art and a science. Just as in agriculture the better the farmer the better the crop, so also in the soilless growth of plants a tremendous amount depends upon local conditions and human skill. In addition to horticultural knowledge, some additional technical control is demanded of the soilless culturist. Careful appraisal of salient problems during 1946-7 resulted in the development of a Bengal system of hydroponics, which represented an effort to meet Indian requirements. Further research during 1948-74 has produced improvements in general technique, while, thanks to the zealous co-operation of enthusiasts in India and other parts of the world, it was possible to have parallel experiments conducted in many different regions, so that the methods could be adapted for all types of conditions.

## HYDROPONICS—THE BENGAL SYSTEM

### *Work in Bengal*

Tackling problems from the Indian angle, success was achieved in evolving a novel and original method of soilless culture of plants during 1946-8. Offered to the public as the Bengal system of hydroponics, it has the advantages of being inexpensive to instal, simple to maintain and economical to operate. Equipment has been reduced to a minimum, full use has been made of indigenous materials, while as far as possible simple rules have been framed to guide the gardener. Above all, the system is eminently practicable, and has proved successful during recent years at many places throughout India and in other countries. Work in Bengal was attended by many difficulties. Tremendous patience and painstaking effort were in demand. Official apathy was often discouraging; but on the other hand the enormous interest which members of the public all over India and in other lands have taken in the work has been most heartening. One object guided all the experiments carried out: to strip hydroponics of its complicated devices and to present it to the people of India and the world as a cheap, easy way of growing vegetables without soil. Numerous letters of appreciation from as far afield as the United Kingdom, France, the United States, Holland, Israel, Japan, Germany, Algeria, the Pacific, South and East Africa, Australia, New Zealand, Pakistan, South America, Burma, Sri Lanka, and even islands such as Malta, the Seychelles, Formosa, and those of the West Indies, have testified to what a large extent this object has been appreciated by the public, throughout the world.

### *Great possibilities*

India's chief problem today is food. Menaced as this country is by the constant threat of famine, urgent measures are necessary if disaster is to be avoided. Soilless

## INTRODUCTION

cultivation, conducted according to the Bengal method, could make Calcutta, Bombay and all large Indian cities self-supporting in all vegetables, including potatoes, and practically so in rice, wheat and other grains. Millions of tons of nourishing foodstuffs could be grown in hydroponics. Not only could immense barren lands be made productive, but crops might also be raised in desert areas or in sterile and arid regions. It is not claimed that hydroponics can entirely replace agriculture, but what has been proved beyond doubt is that waste land, rocks, even house-tops and back verandas—anywhere that sufficient sunshine and water are made available—can be made to bloom and bear as well, and often better, at much less cost and trouble. Heavy intercropping and closer sowing than horticulture permits has raised some hydroponic yields phenomenally. Rotation of crops is unnecessary, and the townsman can have year-round home produce in spite of little space to spare. Almost any discarded receptacle lying about the house can be used by the busy mother or overworked father to grow vegetables in, and there is no better, speedier, easier system than hydroponics.

Soilless culture was listed by an American Government investigating committee as one of the ten most important technical trends of the day. Hydroponics may eventually succeed in effecting profound social changes in the life of the world. Overpopulated nations, without dependencies and worried by an inadequacy of agricultural land, can easily use it to multiply their production of foodstuffs. Certainly the soilless cultivation of plants can give India—and indeed the world—all the extra food needed, and its introduction on a greater scale would afford lucrative employment to millions.

### *Some criticisms answered*

Many people wrongly imagine that hydroponics is a

## HYDROPONICS—THE BENGAL SYSTEM

complicated and expensive business. Nothing could be further from the truth—at any rate as far as the Bengal system is concerned, it is a really simple method by which crops can be grown economically without much expense. In poor countries like India not many people can afford to buy costly equipment. Hence the slogan of the Bengal method: 'Inexpensive to install, simple to maintain and economical to operate.' Suitable, with slight modifications, for any district, it has been tried out with success in Calcutta, South India, Bombay, Lucknow, and many other places. Good results have been obtained with the technique in Africa, England, Europe, North and South America, Australia, Sri Lanka, New Zealand, and various regions of contrasting climate. Appropriate adaptations were easy to make. Naturally research will have to go on, and new improvements can always be made; but it can be said definitely that the Bengal system is a practical proposition for both the amateur and the commercial grower. Two criticisms often heard are, first: Why use hydroponics when we have plenty of land if we would only develop, and by means of better cultural practices including manuring, improve it? And then the cry: But hydroponic yields are after all no better than those which could be obtained under ideal soil conditions! Both these comments call to mind a remark attributed to Charles II.<sup>1</sup> Emphasizing the difference between himself and his brother, the Duke of York (afterwards James II), Charles is reported to have said: 'Jamie would if he could, but I could if I would.' Critics of soilless culture fall into these categories. They generally overlook the fact that to improve the soil of India, or of any other country, so as to make it perfect, will take 50 to 100 years. Where, after all, can ideal soil conditions be obtained? Greenhouse culture, using earth beds, is at the best a wearisome

<sup>1</sup> King Charles II, British monarch (1660-85)

## INTRODUCTION

and expensive affair, involving periodic sterilization, and it is only under such conditions, employing glass, that anything approaching an ideal soil can be produced after a long period of time. Hydroponics, on the other hand, gives a return within three to six months, and maintains its efficiency indefinitely. Soilless units require less irrigation than conventional horticultural beds, and loss of nutrients seldom occurs in the Bengal system, since the growing medium is not flooded, but simply kept moist like a damp sponge.

No responsible worker has ever suggested that hydroponics should displace agriculture. For cereal production, soil will always be supreme. But intensive culture of vegetables and fruits by soilless methods has numerous advantages. Before leaving this subject, two words of warning are necessary. A hydroponicist, if he or she hopes to achieve success, must follow instructions with care and intelligence. A narrow safety margin makes it dangerous to ignore this caution. Anyone can operate the Bengal system with the aid of proper advice and reasonable intelligence. The thoughtful student who goes through this book with attention should experience few difficulties. Snags are bound to occur from time to time, but once the principles have been mastered the advantages of a method of gardening which is not dependent on Nature's whim, or the usual unforeseen disasters of soil culture such as erosion, drought, and other hazards, are too obvious to need recapitulation. Above all, it is clean and for the fastidious housewife this is a big consideration. All risk of contracting a disease transmitted through the animal excreta used in soil manuring is eliminated, while the food content of the fruits of plants grown in hydroponica is often of unique dietary value.

The reader will frequently be confronted by ill-informed disparagement of soilless culture from ignorant persons. This should not worry the aspiring hydroponicist.

## HYDROPONICS—THE BENGAL SYSTEM

Such criticisms are easily answered. Hydroponics does not depend on freak or sensational results: instead, its real merits are based on its value as a steady, controlled, and reliable method of intensive crop production, and the very stable and important advantages to be gained from its employment.



5. A close up of young summer vegetable seedlings, showing aggregate

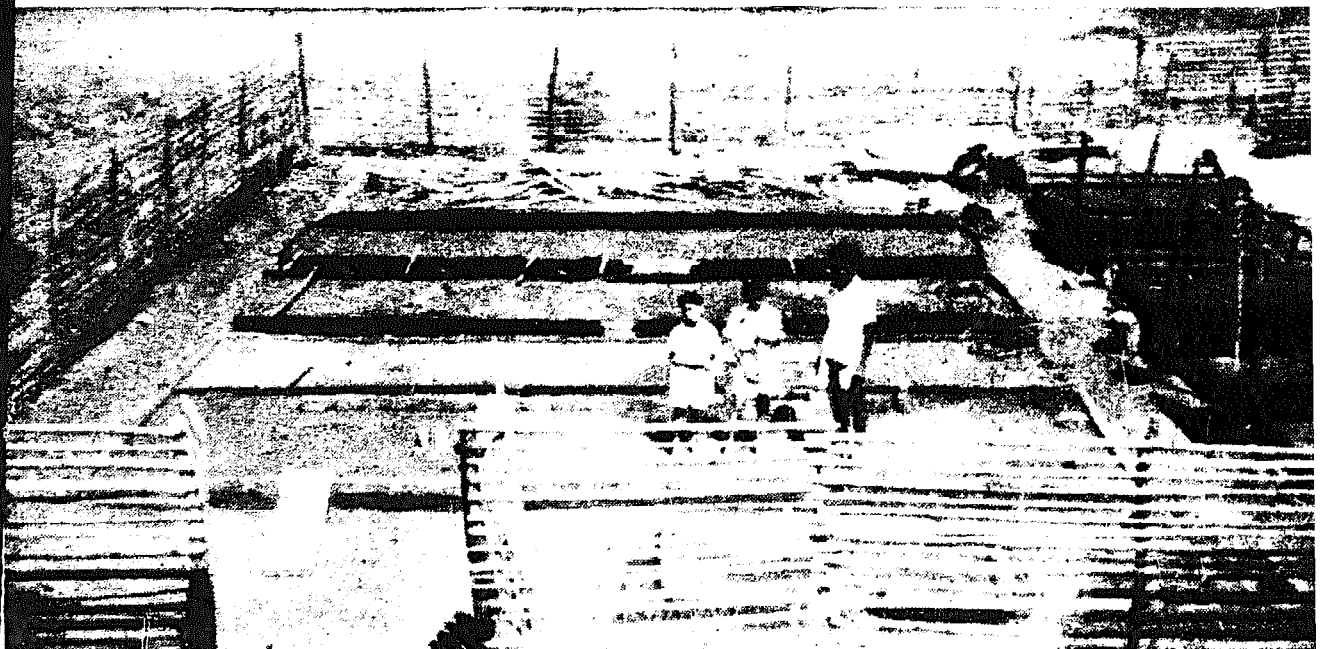

6. Work in progress on a hydroponic installation in Western India





7 Applying fertilizers to a hydroponic trough operated on the Bengal system

## HOW PLANTS GROW

**T**HE study of plant nutrition and growth is a vast and complex subject, and it is not possible in a short chapter to give much more than a brief outline in simple terms of certain salient points, so that the reader may obtain a general idea of the fundamentals of physiology.

In order to become familiar with the basic principles of soilless cultivation, some knowledge of the elementary processes which go on inside a plant is necessary. Most of us probably accept the existence of flowers and vegetables as a simple matter of fact. We no doubt know that soil and water are usually considered to be essentials by the gardener, and that some people are cleverer at raising seeds than others, but have we ever paused to consider what a wonderful and complex mechanism plant life really is? The involved physiological reactions which take place daily within the cell-wall of the most despised weed are, in fact, just as important and vital as the complicated processes by which life is sustained in the human body.

How plants grow, and why, is not only a subject of absorbing interest, but is also of real consequence to the student of hydroponics.

Growth is the natural result of certain chemical changes which take place regularly in all vital organisms. This gradual building up of living matter requires suitable surroundings and adequate nutrition to ensure continual healthy development, and in the case of green plants these essentials consist of water, air, light, mineral salts, and a support for the roots.

## HYDROPONICS—THE BENGAL SYSTEM

### *Life processes*

Although the cycle of plant life is intricate and ingenious, it can quite easily be explained in simple and non-technical terms. A plant is really a sort of natural workshop, each section of which is employed in the business of changing raw food material into living tissue. Stripped down to elemental terms, the tallest tree or the most beautiful flower will be found to consist of numberless masses of tiny units, called cells. These are often compared with individual bricks in a great building. The

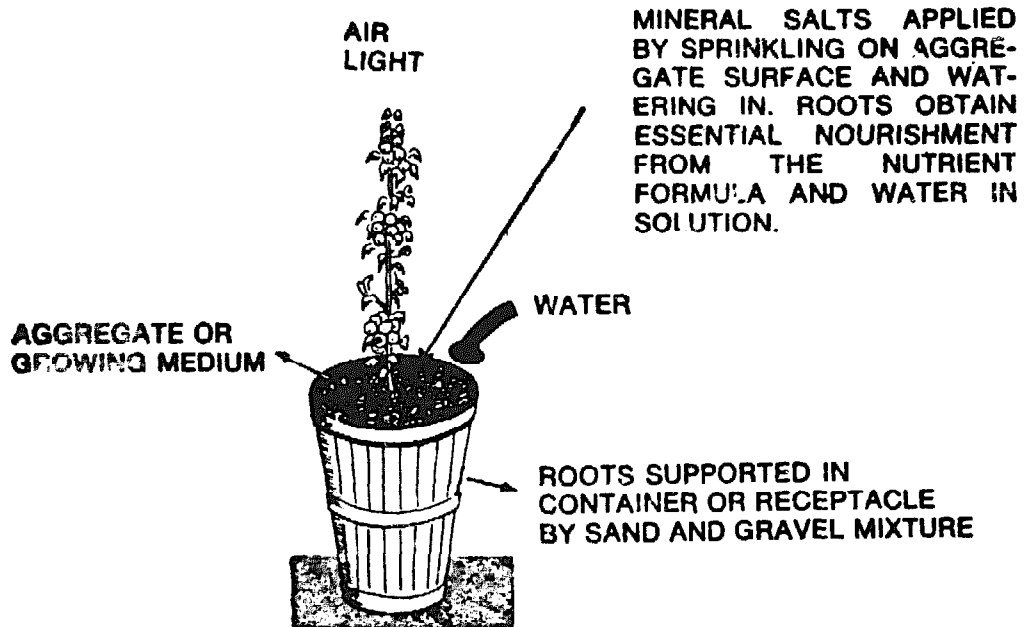

Essentials of Plant Growth and how these are supplied in the Bengal System of Hydroponics.

simplest forms of plant life are unicellular. Generally speaking, the cell consists of protoplasm, which is the actual vital substance, surrounded by a delicate membrane. Chloroplasts, containing the green pigment chlorophyll, are enclosed inside this cell-wall. If we observe such an organism carefully, we notice that it increases in size and multiplies.

## HOW PLANTS GROW

As green plants, unlike animals, cannot ingest solid or organic food material owing to the presence of the cell-wall, they are obliged to absorb part of their nourishment from the air, and part from solutions of inorganic salts or chemicals. These simple substances are built up by the various departments of the plants into living protoplasm through the expenditure of energy. How this energy is obtained is a subject of fascinating interest, for while the bulk of an animal's food, consisting as it does of fats, proteins and carbohydrates, contains a large store of potential energy, the simple, inorganic diet of a plant is virtually devoid of any such properties. The answer is, of course, that plants possess the ability to build up sugars and other carbohydrates from compounds such as water and carbon dioxide, using light as the source of energy. This process is known as carbon assimilation or photosynthesis, and can only be carried on when light acts upon chlorophyll in the presence of water. Chlorophyll, which is the green colouring matter in plants, enables the sun's radiant energy to bring about such an amazing transformation.

It is fairly generally known that a special relationship exists between plants and animals, called the 'carbon cycle'. A plant absorbs carbon dioxide from the air through a series of minute pores, or 'mouths', termed stomata, situated on the underside of the leaves, while, as a by-product of photosynthesis, oxygen is liberated. Animals, on the other hand, breathe in oxygen and exhale carbon dioxide. Plants do, however, need some oxygen since it forms the basis of important processes which form a part of normal growth. In addition to air, light and water, certain mineral salts are required for the production of chlorophyll, and the other functions preceding and following photosynthesis. These elements in conjunction with water are absorbed by tiny hairs on the roots of a green plant, by a force known as osmosis, while

## HYDROPONICS—THE BENGAL SYSTEM

the roots themselves are supported in nature by the firmness of the soil in which they rest.

### *Water*

The first of the five essentials for healthy plant growth which we shall now consider in greater detail is water. Chemically, pure water is a compound consisting of two parts of hydrogen to one of oxygen, but in actual practice it often contains traces of other elements. In many fruits water constitutes 90 per cent of the total weight, in green foliage leaves it is often as high as 80 per cent, while even in 'dry' seeds 10 to 12 per cent may frequently be found. If seeds of broad beans or peas are soaked in water for twenty-four hours their weight will probably be doubled, so high is the rate of absorption. In fact, germination cannot take place in the absence of sufficient moisture. Another phenomenon for which plants need ample water is transpiration. We all know how the cells in a leaf give up water in the form of a vapour to the atmosphere, when exposed to dry air. Unless this water is replaced the cells will lose their turgidity and the leaf wilts.

Of the elements necessary to plant life, all but carbon and to a lesser extent oxygen are derived from the water containing dissolved mineral substances or chemicals which is being continually absorbed by the roots. Even an appreciable amount of oxygen is obtained from this source. The force known as osmosis has already been mentioned. Osmosis is vital to plant life, since it is by this means that water containing chemical nutrients is taken in by the root hairs and circulated through the plant, where its presence is essential for the complicated and intricate process of carbon assimilation or photosynthesis.

## HOW PLANTS GROW

### *Light*

Sunshine consists of many different kinds of light rays, but experiments have shown that the green leaf synthesizes carbohydrates most actively in blue and red light. The importance of illumination is that it supplies the energy necessary for the conversion of carbon dioxide into organic compounds, while chlorophyll provides the mechanism by means of which this light energy is made available for the process. The rate of photosynthesis is affected by such factors as the intensity of illumination and the supply of carbon dioxide. Poor light results in little activity, while brilliant sunshine generally means rapid reaction.

### *Air*

Plants derive the greater part of their food requirement from the air, and over 40 per cent of their dry matter is accounted for by carbon obtained from the carbon dioxide in the atmosphere. This gas, together with oxygen, diffuses through the stomata into the foliage, where it is built up, as we already know, into sugars and other carbohydrates for the nourishment of the growing plant.

An important process for which air is essential is respiration, or the taking in of oxygen. Here again the gas enters the plant through the stomata, diffuses throughout the spaces between each cell and finally passes into solution. Together with the oxygen derived from the water absorbed by the roots, it meets the plant's requirements of this element. Respiration itself is an interesting function, being the exact reverse of photosynthesis.

### *Mineral salts*

Chemical analysis of plant material has revealed that about forty different mineral elements are concerned with the processes of growth and nutrition, but out of these

only fourteen are of vital concern to the non-technical student.

We have previously seen how carbon, hydrogen and oxygen are absorbed by the green plant, and incidentally learnt that all the other elements found present have been taken up in solution by the roots. These chemicals may be divided into two classes, namely the major elements and the trace elements. The former are required in relatively abundant proportions, while the latter are needed in very minute quantities only.

*Nitrogen* is extremely important for the production of proteins in plants. It promotes leaf and stem growth, makes for good foliage and healthy appearance, being in fact the foundation upon which the life-substance, or protoplasm, is built up.

*Phosphorus* stimulates the production of flowers and fruits, encourages healthy root growth, expedites the process of ripening and generally results in improved quality.

*Potassium* plays a vital part in the synthesis of sugars and starch within the plant. It hardens and strengthens the tissues and framework, while generally improving fructification.

*Calcium* seems to stimulate root growth and to strengthen the cell-walls. It also produces conditions in the nutrient solution that bring about absorption by the plant roots of ions, especially of potassium, which would otherwise remain insoluble.

*Magnesium* may be connected with the formation of vegetable oils. It is important for the movement of phosphorus within the plant, and enters into the composition of chlorophyll.

The reader will now be familiar with the names and functions of the eight major elements, namely carbon (C), hydrogen (H), oxygen (O), nitrogen (N), phosphorus (P), potassium (K), calcium (Ca) and magnesium (Mg).

## HOW PLANTS GROW

The references in brackets after each name are the chemical symbols which are usually assigned to the particular elements, and can be employed by the student of hydroponics as a useful and quick way of reference.

*Sulphur* (S) is an important plant food: it is associated with phosphorus, and is believed to promote the growth of beneficial bacteria, and assist the production of proteins.

*Iron* (Fe) is essential for chlorophyll formation, and plays an important role in biological processes.

*Manganese* (Mn) has certain rather complicated functions connected with nitrogen assimilation and reproduction. It is also said to improve the keeping quality of fruits and vegetables.

*Boron* (B) has been known to stimulate the cell to abnormal growth and division. It can in fact increase a plant's yield but its precise functions are not yet known.

*Zinc* (Zn) is one of the elements essential to plant growth, but its exact role in physiology is still undefined.

*Copper* (Cu) appears beneficial, and checks certain maladies. It is also believed to take part in chlorophyll production.

In addition to these six minor elements which, together with the others of major importance, comprise the list of those with which the student should familiarize himself, several others can, as a matter of interest, be mentioned briefly. *Silicon* (Si) is considered to play an important role in protecting plants from the attacks of various parasites by hardening the plant's tissues; *chlorine* (Cl) has been found to increase the water content of plant tissue; while *aluminium* (Al) in the form of a sulphate produces a beautiful, clear blue in *Hydrangea* flowers. *Sodium* (Na) can perform certain of the functions of potassium, and sometimes acts as an antidote against toxic salts; *iodine* (I), as is well known, prevents the disease of goitre in human beings if present in the vegetables



eaten by them. Many interesting functions of various other trace elements have been discovered from time to time by scientific investigators.

*Support for the roots*

The last essential for healthy plant growth is a suitable support for the roots. To stress such an obvious requirement may, at first glance, seem unnecessary, but unless the twofold function of the roots can be satisfactorily executed, proper development will be impossible. Under natural conditions, plants derive both food and support from the earth, but, as hydroponicists have pointed out, soil is in no way a perfect medium. Erosion, drought and flood are big drawbacks, while it also harbours weeds, pests and germs.

Roots require a firm support, plenty of moisture without excess saturation and plenty of aeration. Roots need to breathe just as much as leaves do. It is particularly important that their crowns should get plenty of oxygen from the air.

For these reasons any good support for the roots, whether in soil or in soilless culture, is not only porous but capable of retaining moisture for a reasonable period. It also provides a firm basis for the growth and development of the plant from the young seedling stage right up to maturity.

*Behaviour during growth*

Suppose we take a dry seed of, for example, the common broad bean (*Vicia faba*), and watch its behaviour and the different functions of the various parts during its development from a tiny seedling to an edible plant. The easiest way to study these processes is to bury the seed in a little moist sawdust. It is important that the sawdust be just damp and not flooded. Waterlogging will exclude

## HOW PLANTS GROW

air from the seed. Germination now takes place, and the seed will absorb enough water so that the outer skin bursts and the tiny embryo plant which is contained within the seed coat starts to develop. The young root, called the radicle, forces its way downwards to grip firmly the support—in this case the sawdust—while a small pointed structure called the plumule grows upwards towards the light, to become eventually the shoot and stem.

So far the young plant has developed by feeding on the food material stored within the seed, and by utilization of the basic essentials that we had provided for it—water, air and a support, all of which are contained in the little moist, porous heap of sawdust. Light, too, is present, and available for the seedling as soon as the plumule pushes its way up into the open air, since we have taken care to allow sunshine to reach it daily. But very soon the growing plant will have another demand to make, this time for the last essential—mineral salts. If these are not supplied the seedling will soon weaken and die. Consequently, we must feed our plant regularly with a nutrient mixture of some kind of manure containing all the important elements that we already know are necessary for growth and nutrition. If this is done, nothing, short of disease or accident, will prevent our seedling from developing into a healthy plant.

Flowers and vegetables require a certain amount of sleep, just as animals do. Plants generally rest at night and too much illumination can 'burn them up'—something which corresponds to a 'nervous breakdown' in human beings.

Vegetation is often very sensitive to toxic gases, and even to dust, which chokes the breathing pores or stomata. For this reason plants grown indoors need regular syringeing.

## HYDROPONICS—THE BENGAL SYSTEM

The reader will now have a fairly sound view of the basic ideas of plant physiology, and can confidently embark upon further study. Soilless cultivation is, in fact, nothing more than a practical exposition of the principles and functions that we have been discussing in this chapter. In hydroponics 'we learn as we go along', with the sure knowledge that we are proceeding on sound and scientific lines.

## APPARATUS

**D**ESIGNED particularly to meet the needs of the practical grower, the Bengal system of soilless culture of plants requires neither elaborate equipment nor expensive appliances. In fact, even if at the origination of the method it had been desired to employ such apparatus, the special conditions obtaining in India would have effectively prohibited its use. Hydroponicists in this

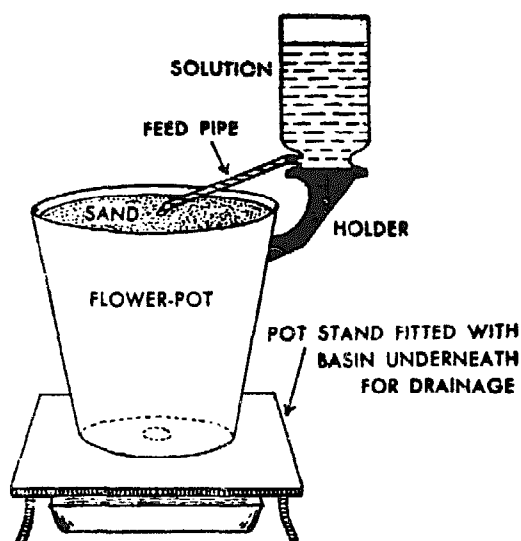

### SAND CULTURE

**A continuous flow unit designed in New Jersey for household use, 1934.**

subcontinent are faced with a variety of problems, including those of climate, meteorology, general non-availability of normal apparatus which cannot be satisfactorily or inexpensively produced in local factories and must be imported at high cost, as well as financial limitations which habitually decided most things in a land where

poverty is a permanent guest of the average household. These factors have already been discussed at length in a preceding chapter, and so do not require further recapitulation here.

A farm or garden devoted to soilless cultivation is usually called a hydroponicum. Units range from the small household pots and boxes to large commercial installations covering many acres. Local considerations will always play a big part in the design and construction of any hydroponicum, and with a little ingenuity an inexpensive unit can easily be fashioned from indigenous or substitute material. It will be simplest if we deal with each item of equipment in turn, but before doing this the question of location has to be considered briefly.

#### *The site*

The real utility of soilless growth lies in the fact that it can be carried on in places where ordinary methods of agriculture or horticulture are impracticable. Provided the five essentials for plant culture are present in some form or other, a hydroponicum may be laid down in any area. City dwellers will find an open roof-top, a sunny backyard or a window ledge ideal; for humble workers a few pots beside the cottage door ensures a supply of fresh vegetables. Factory owners, hotel proprietors or landlords usually have extensive roof space available which can be put to good use for food production by hydroponic means. Other probable town sites are the sides of pavements, strips down the middle of roads, public buildings or disused verandas. Mountainous regions offer a multitude of suitable spots, since in many places the hard rock surface gives a readymade foundation upon which the grower can position his unit. At desert air-stations excellent troughs could be built along runway edges. The possibilities are in fact inexhaustible.

## APPARATUS

American and European operators have gone in extensively for culture under glass, but in warm or tropical countries where heating is unnecessary most hydroponica will be located out of doors. Given sunlight and air any imaginable site may be utilized, supposing of course that water can be obtained nearby or conveyed to the place. The other two essentials—nutrient salts and a support for the roots—are, in the absence of soil, provided artificially, as the student has learnt already. The most unpromising site, where any form of conventional cultivation by normal horticultural methods would be unthinkable, can often be made to yield abundantly by hydroponic means. No trade secrets are involved: simply a careful study of the particular place, plus ingenuity, improvisation and sensible adaptation. One little point is always worth remembering: that is to make full use of any existing construction which can be fitted into the general scheme of the hydroponicum.

### *The trough*

A hydroponic trough is really nothing more than a bed or receptacle designed to hold in position whatever substance we intend to provide as support for the plant's roots. Troughs may be made from almost anything except galvanized iron, since the excess zinc in this material is often toxic. If galvanized sheeting has to be used it should first be given a protective coating of asphalt enamel. Wood, concrete, asphalt-impregnated mats or roofing felt, bricks and mortar, mud plaster. Plastic sheets, asbestos sheets and puddled alkali-treated clay have all been used with success. The housewife should not hesitate to press her discarded jars, tins and basins into service, while the gardener will find that his conventional flower-pots can be turned into admirable

## HYDROPONICS—THE BENGAL SYSTEM

hydroponic containers. Further research is continually resulting in the adaptation of an ever increasing number of cheap and easily obtained materials to the requirements of soilless culture.

Most growers of moderate means, especially in the country or the suburbs, will probably find that troughs made from non-erodible mud plaster or puddled clay suit their simple needs. Full instructions for mixing up these preparations are given in Chapter 10 of this book. One method of constructing hydroponic beds from this mud plaster is first to erect the base and framework, including the walls of the trough, in skeleton form.

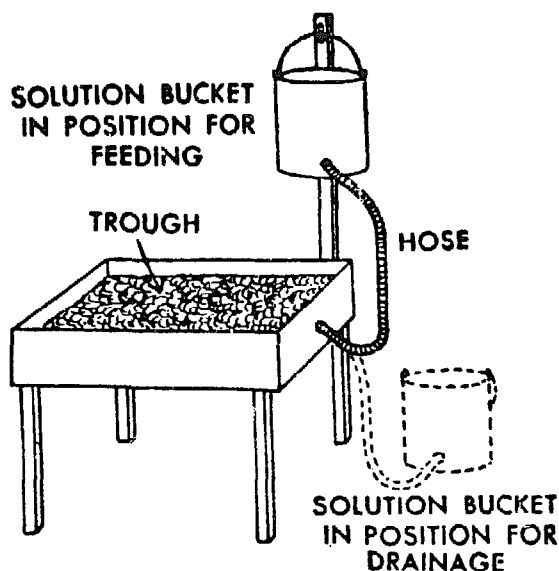

### AGGREGATE CULTURE

A small household trough.

These are built with large stones placed end to end, each having previously been shaped by hand. Successive coats of plaster are then applied to make a symmetrical and solid structure. Another cheap and quick way of making troughs is to use sheets of polythene or butyl synthetic rubber, laid flat in shallow boxes or depressions or else

APPARATUS

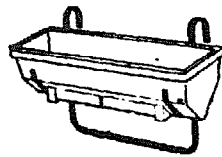
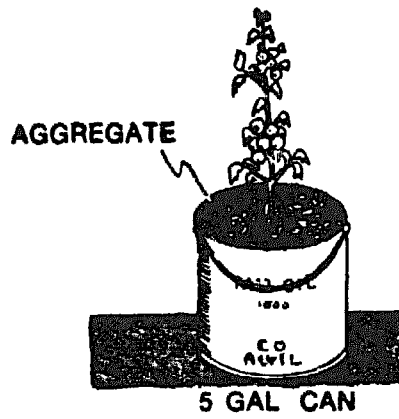
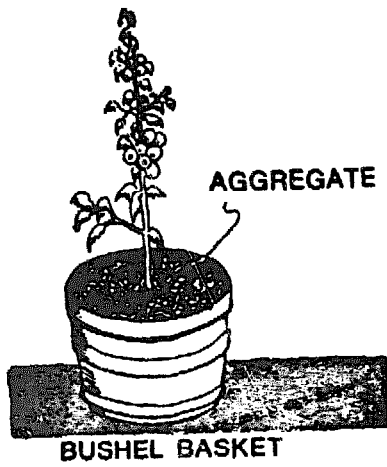

WINDOW BOX

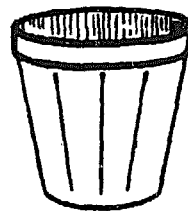

EARTHENWARE OR  
PLASTIC POT

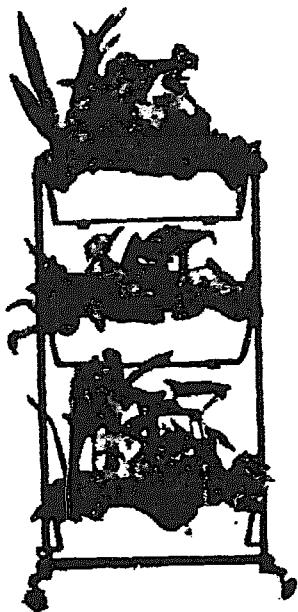

TROUGH FOR THE HOME  
IN TIERS

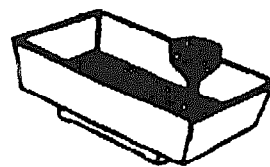

HOUSE TROUGH WITH FUNNEL  
FOR WATERING

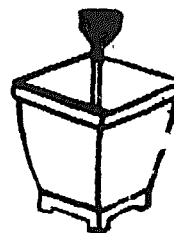

POT WITH WATER OR  
SOLUTION FUNNEL

Simple types of containers for the home.



## HYDROPONICS—THE BENGAL SYSTEM

supported on wire frames. Alternatively, the sides of beds may be of bricks or stones and the polythene draped over them. Care must be taken to secure the material firmly in place, pinning or fixing it into position along the tops of edges or sides of troughs. In all cases troughs should never be over five feet<sup>1</sup> wide, to allow easy access to the plants, but they can be of any convenient length. In some commercial installations beds are often several hundred feet long. The question of width is important, however, since there is nothing more aggravating than being obliged to stamp about on top of a trough in order to attend to the requirements of plants in the centre. Apart from other considerations this wastes valuable time. For general purposes, side walls six to eight inches high and up to one to three inches thick are satisfactory. Naturally, troughs made from wood, polythene, or asbestos sheets have thinner walls than those made from stones and plaster. It is a good thing to have the base slightly cambered, but this is not essential. The question of drainage varies according to the type of material used.

Practically all kinds of troughs except those made from mud plaster or clay rely entirely upon a sufficient number of outlet channels to prevent waterlogging and to ensure proper aeration. Small drainage holes fitted with plugs are always provided at regular intervals in the side walls of beds made from concrete, metal, plastics or other impermeable substances. With mud plaster, however, not only is an automatic supply of oxygen guaranteed by the steady percolation of excess moisture through the semi-porous walls (and consequent intake of air from above), but immoderate saturation of the trough is extremely unlikely to occur. Nevertheless, to guard against heavy monsoon rainfall, drainage pipes are often needed, even

<sup>1</sup> One foot = 30.48 centimetres.



8. Hydroponic oats. Excellent crops of this cereal can be easily raised in soilless cultures for emergency feeding purposes

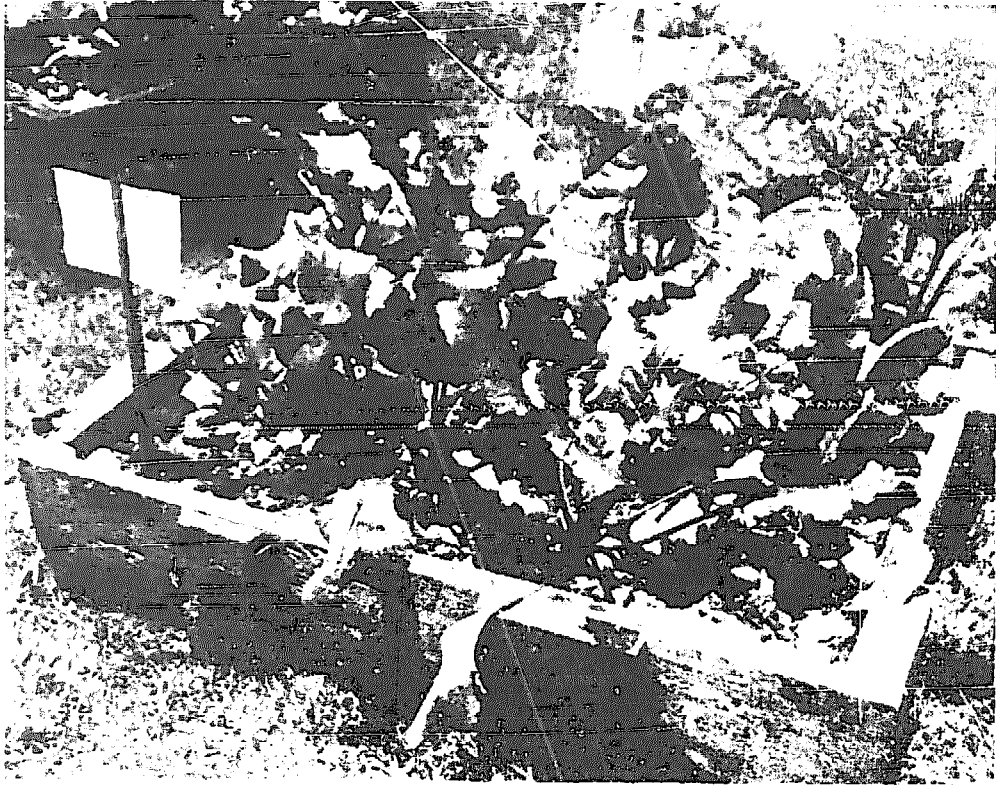

9. Young beetroots in an experimental trough at Kalimpung  
Stones used as aggregate are of  $\frac{1}{2}$ " grade



10. An excellent specimen of hydroponic lettuce

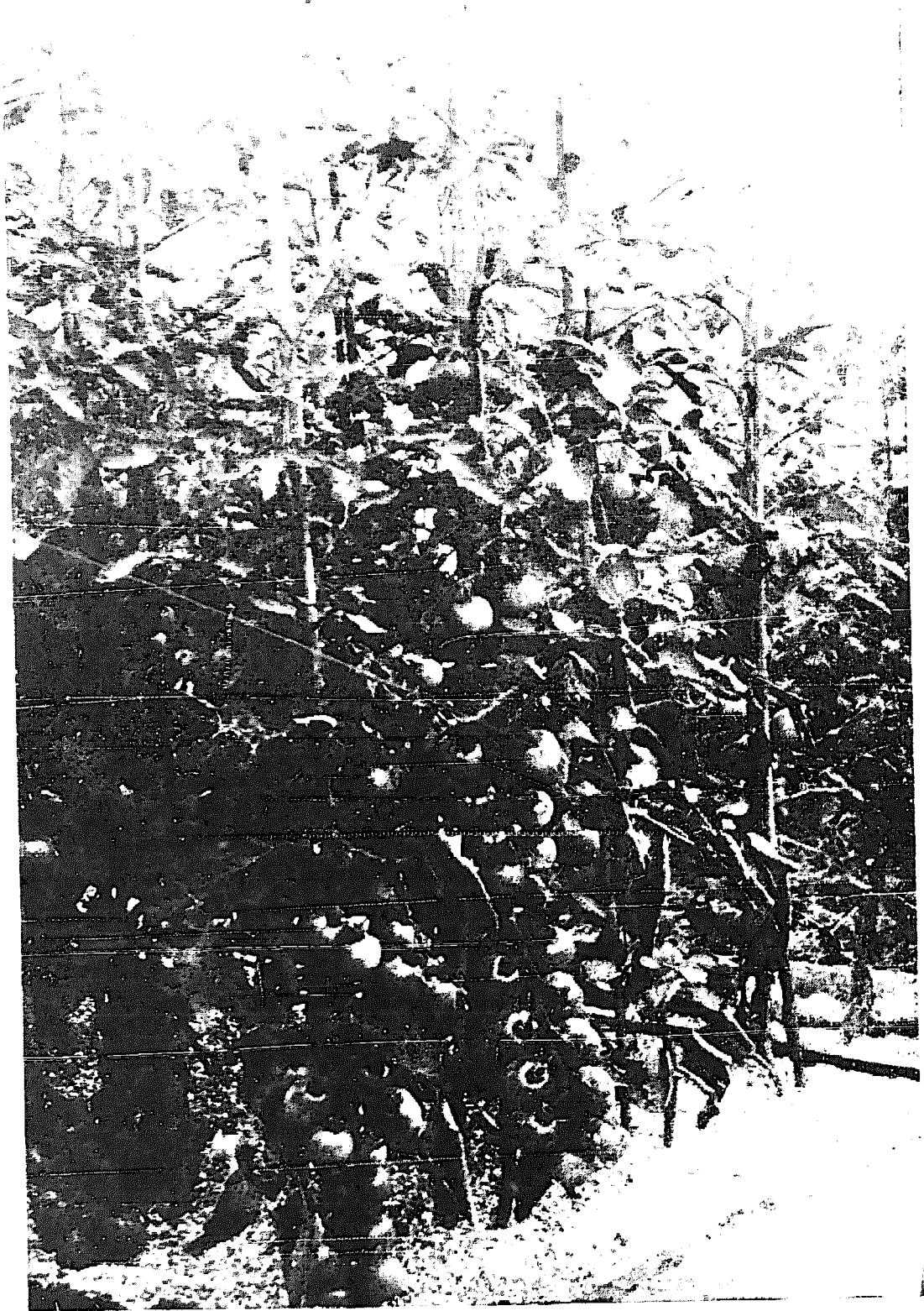

10. A fine crop of hydroponic tomatoes under glass

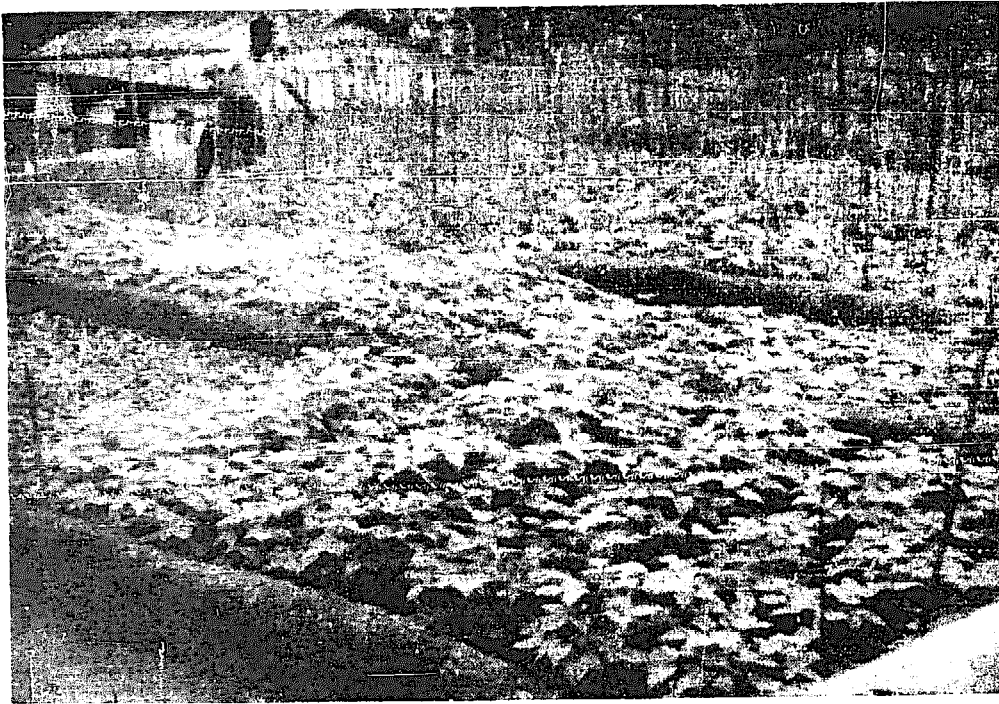

12. Hydroponic plants growing in troughs made from non-erodible mud plaster

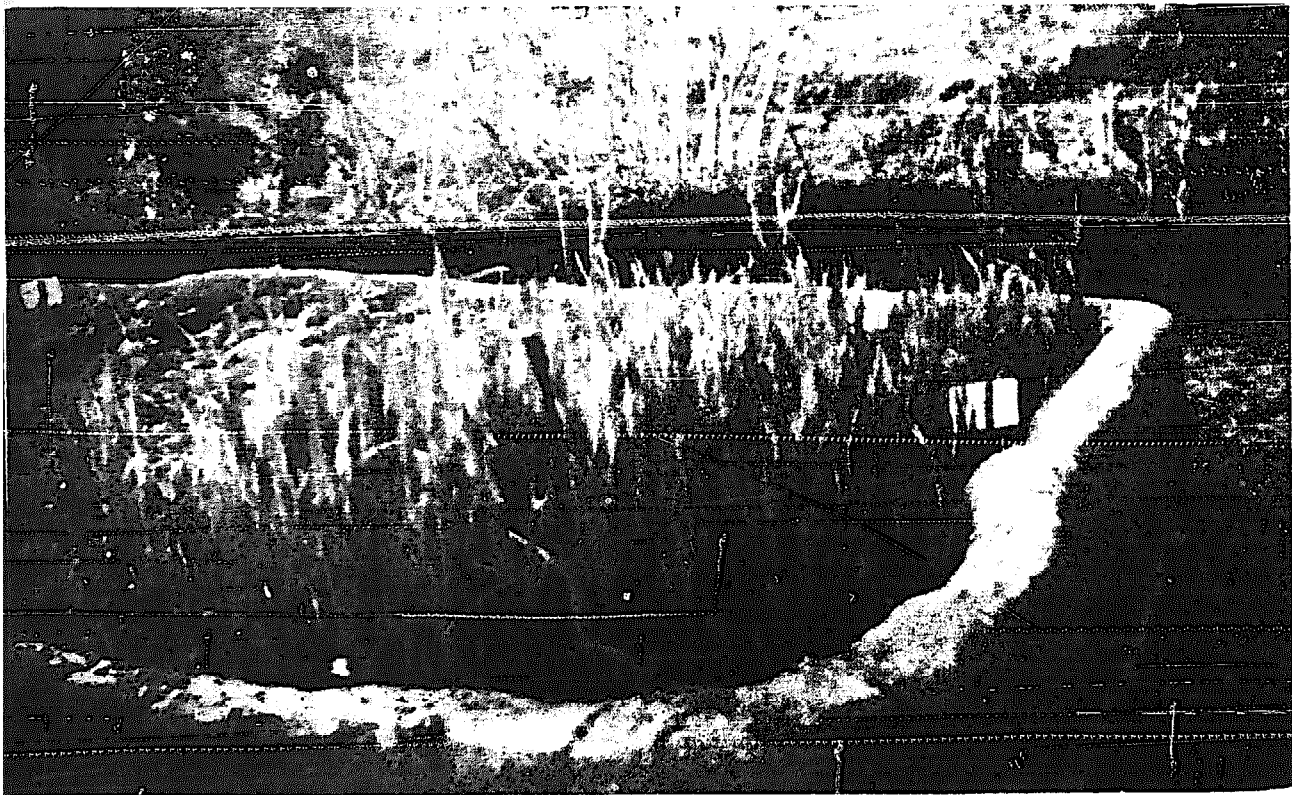

13. Wheat seedlings in an early experimental sector employing cinders

## APPARATUS

in plaster troughs, to run off superfluous water rapidly. A small gutter should always be built around the base of each wall to carry away any seepage. In a household hydroponicum, where jars or pots with holes punched in the bottom are in use, a basin or saucer placed under the receptacle will serve this purpose.

As the reader will already have realized, the Bengal method does not call for absolutely waterproof troughs. It is sufficient simply for the container to have a reasonably hard bottom or base and sides, so as to prevent undue escape of moisture by excess seepage or wasteful drainage. Of course, the more solid the walls and floor of the trough the less will be the total eventual requirement of water. In many cases a solid foundation upon which to site his troughs will be available to the grower. Roof-tops, roads and yards, especially if made of concrete, offer this, and it is merely necessary to construct a series of little side walls in order to prepare the beds. In hilly districts rock

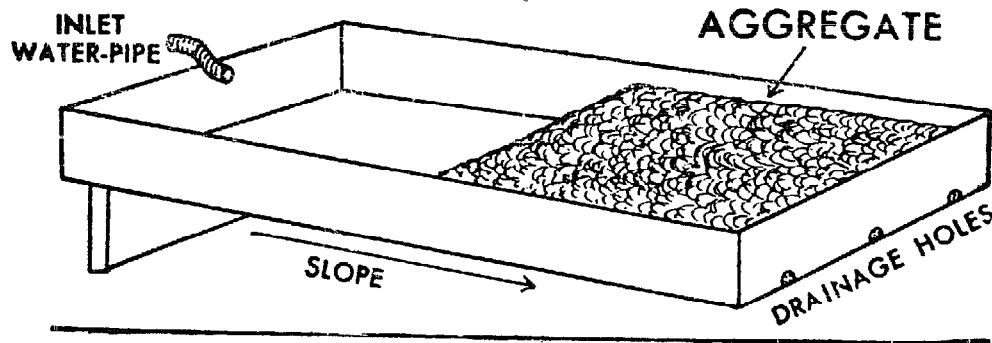

A HYDROPONIC TROUGH, BENGAL SYSTEM

5 feet wide and 20 feet long.

surfaces provide similar facilities. Large wooden containers must be strong, and require painting to prevent rot. Cement or bricks are particularly suitable for city use, while metal troughs, though expensive, would be permanent and more portable. If iron and steel apparatus

## HYDROPONICS—THE BENGAL SYSTEM

is to be exposed daily to the full glare of the tropical sun it is essential to insulate it by a thin encasement of plaster to prevent undue heat radiation. Asbestos sheeting has many advantages: it is strong and durable, and can be cut like wood; but in most cases local considerations will determine which particular substance is most suited to the requirements of the individual grower, and with a little ingenuity inexpensive troughs can easily be constructed from whatever building materials are available. The author has even seen beds, the base and side walls of which were made from ordinary mud, fortified, by an uneducated peasant, with chopped straw and glutinous cow manure, give excellent service. To prevent them from being washed away during the monsoon this resourceful cultivator had carefully covered each wall with a lattice-work support of thin bamboo.

### *The growing medium*

As soon as the troughs are completed they are filled up to a depth of six to eight inches with coarse inert aggregate, which may consist of gravel, crushed stone, cinders, leached coral rock, broken brick, or granite chips of between  $\frac{1}{4}$ " and  $\frac{5}{8}$ " grade, to which has been added a certain proportion of sand or residual dust. This mixture, which is one of the novel characteristics of the Bengal system, is the hydroponic substitute for soil's second function—that of providing a support for plant roots. Vermiculite, or treated peat mixed with small pebbles, may also be utilized. Actually, in soilless cultivation many different types of aggregates or growing mediums are employed, each varying a little according to the particular method to which it is adapted. Some systems in fact use no aggregate at all, and those readers interested in studying water or solution culture should, after reference to Chapter 7 of this book, obtain Dr Gericke's very interesting publication on the subject.

## APPARATUS

The most critical factor in the choice of a growing medium is to ensure, first, that it is not likely to suffocate the plants by preventing aeration of the roots, and secondly, that it will be capable of holding moisture. Too coarse an aggregate will dry out quickly. On the other hand a very fine medium, such as pure sand, may be liable to waterlogging during the wet season. If, however, a larger aggregate is unprocurable and sand alone has to be used, at least a layer of small blocks, two inches deep, should first be placed on the trough bottom. In mountain areas big boulders are plentiful and can be broken up with hammers to a suitable size. The grade of medium

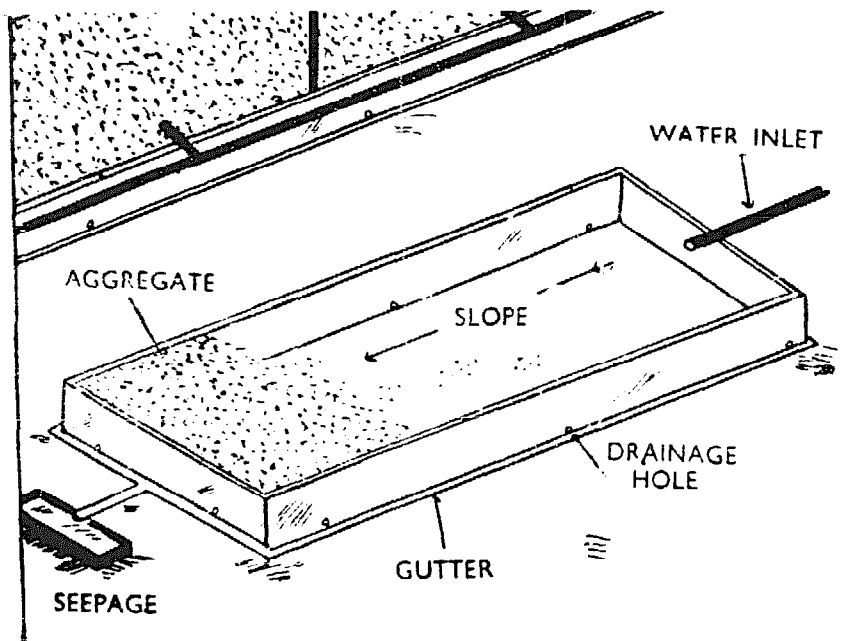

FEATURES OF A SOILLESS CULTURE TROUGH

resulting consists naturally of both rock chippings and dust or sand. Broken bricks have given very good results in the plains of North India. Here again they are smashed up into the right grade and care is taken to put both the chips and the dust or fine particles into the troughs. The best mixture for use with the Bengal method is, generally speaking, composed of a total quantity of about



## HYDROPONICS—THE BENGAL SYSTEM

five parts of coarse aggregate ( $\frac{1}{4}$ " to  $\frac{5}{8}$ " grade) to two or three of fine dust or sand. This ratio may be subject to variation or modification. For instance in a cold area, such as the Himalayan foothills where evaporation is not so great, the quantity of coarse aggregate in the growing medium can be increased to as much as six parts, whereas in a desert area or on the Indian plains during the hot season, when great dryness and a high temperature exhaust the moisture content in the troughs rapidly, as little as two parts of chippings to three of fine material can be used. Sand or stones alone will never prove successful with the Bengal method.

The best gravels are low in calcareous content. This means that they do not contain a large proportion of lime or calcium (Ca). Sometimes a hydroponicist may find that while he or she has an ample quantity of gravel, small stones or similar pebbles, no sand is available. The answer is, of course, to crush up some of the growing medium into a fine sandy dust and mix it up well with the larger aggregate. Cinders and coral need to be well leached with clean water before use, and here again some should afterwards be broken to powder and added in the desired proportions. Peat should be treated by pouring boiling water over it before mixing it with other aggregate in hydroponic beds, or else there will be some likelihood of local pockets or environments developing around plant roots, which could upset controlled growth.

Provided that the essential requirements of a growing medium, which we have already discussed, are borne in mind, and the needs of the system are complied with, practically any suitable material can be utilized as an aggregate for the soilless growth of plants. It is, however, necessary to qualify this statement by stressing that any material which would prove toxic to plants is obviously out of the question. As far as possible an inert medium,

## APPARATUS

such as the ones which we have recommended, should be employed. Very alkaline or acidic media are unsuitable, and require treatment before use, by leaching or soaking to remove objectionable substances.

### *The appliances*

In a large hydroponicum some apparatus has to be devised to convey water to the aggregate-filled trough, so that the growing medium can be kept moist without undue effort. A rubber hose can do this most easily and quickly, but if it is beyond the means of the grower, use may be made of some form of guttering for irrigation purposes. In country districts in India or other tropical countries, bamboos can be cut and split. When joined and fixed on level supports these make an ideal water channel. A stirrup pump or a garden can fitted with a rose is necessary for washing in the nutrient salts after application. A simple spreader has been produced by the author which speeds up the dry sprinkling of fertilizer salts. This consists of a slender cone made from thin sheet-metal. The apex is fitted with a series of holes similar to those of a pepper pot, while the base, which when in use is kept uppermost, is made to open.<sup>1</sup> The possession or use of a pair of scales or a balance is essential if the grower intends to apply his nutrients by weight, otherwise a spoon or some definite fixed measure of capacity will be required. Apart from these items no other equipment is necessary for the practical hydroponicist except certain tools which any gardener needs in his everyday work, though during very hot weather it is a good thing to have some screens or straw mats handy to provide overhead shade from the tropical midday sun, or perhaps polythene-plastic coverings to

<sup>1</sup> Ready-made spreaders of all sizes are now produced by seed and fertilizer firms.

## HYDROPONICS—THE BENGAL SYSTEM

give protection against excessive cold in regions where severe winters occur.

For advanced students, and large commercial growers who employ trained staffs, such items as pH testing outfits, heating apparatus, air-conditioning machines for out-of-season production of luxury crops, pumps, tablet machines, and various other appliances, as well as laboratory equipment, can be bought and used with profit. But for the ordinary amateur grower or small commercial operator such expensive things are absolutely unnecessary. In fact the housewife can manage with just a jug, a spoon, and a few tins filled with aggregate.

### *The water supply*

Hydroponics is simply another name for 'water-working', and the whole science of soilless cultivation has been built up around the fact that plants can absorb a certain portion of their nourishment from chemical solutions, thus dispensing with soil. Without water plants could not live, nor in fact could any life exist on our planet. This fact alone is sufficient to bring home to anyone its vital importance in everyday existence.

A regular and reasonably clean water supply is an essential part of the apparatus necessary for the soilless growth of plants. Pure water consists of two parts of hydrogen to one of oxygen, the chemical formula being  $H_2O$ . In practice, however, natural water generally contains various dissolved substances, called solutes, which means that its composition is often different according to the particular region or area from which it comes. For instance, we get 'hard' and 'soft' waters. Hardness is caused by the presence of excessive calcium and magnesium bicarbonates. To soften water we frequently add sodium carbonate to it. In hydroponics a water is judged by the various quantities of soluble inorganic substances

## APPARATUS

or mineral salts which it contains. Should salinity rise to too high a concentration it would prove toxic to the green plant.<sup>1</sup> It is always a good thing for a large-scale operator to know the chemical composition of his water supply, since on the basis of this a more satisfactory hydroponic formula can be made up. In nearly all large towns and cities a report on the local water can be obtained free from the Corporation or the Municipality, while in country districts the Agricultural Departments will probably undertake to supply an analysis. The progress of agronomic research has, generally speaking, made it quite easy to find out what sort of water may be found in particular districts, since a scientific survey of any region usually aims first at discovering the influence of the local water upon the area. One of the most important tasks of hydroponic investigators in the future will be to prepare maps marking off every country into various sections, each classified according to its type of water, so that growers can see at a glance what kind of supply they have.

The student is recommended to study as many examples of water analysis as he can obtain, but the average reader need not bother about such technical aspects. What may concern him is whether his water supply is alkaline or acidic. This he will find interesting to know, and if in doubt may ask any science graduate or chemist to test its pH. The reason for this will be explained in Chapter 4. But from the point of view of the housewife or the amateur grower questions such as these can safely be left in the hands of the expert. So long as their water supply comes from an approved source, whether it be municipal tap, spring, well or river they may rest assured that it will be quite suitable for practical hydroponics. Finally, when

<sup>1</sup> Nevertheless recent experiments carried out by the World Academy of Art and Science, Réhovot, indicate that in certain circumstances some crops will tolerate irrigation with sea water.

## HYDROPONICS—THE BENGAL SYSTEM

there is any doubt about the reliability of the local water it is quite easy to undertake a simple trial with some cut flowers in a vase. If these live for a satisfactory period, there is no reason why plants in a hydroponicum supplied with the same water should not do equally well.

During wet seasons the normal irrigation channels or pipes to the troughs generally have to be shut off, and reliance is then placed on the natural rainfall. If desired this can be assessed by a rain gauge, or checked by reading the weather reports in the daily Press. Rain water is usually neutral, being neither acidic nor alkaline. It is ideal for soilless cultivation.

### *The chemicals*

Fertilizer or commercial grade chemicals are the most satisfactory, as well as being less expensive than those purchased at a pharmacy, but trace elements which are only required in minute quantities by advanced culturists may be obtained from any chemist. With the increasing popularity of hydroponics certain manufacturers have started to prepare stock formulae or tablets for sale in particular districts as well as specially compounded slow-release mixtures. Here a few words of caution are necessary; buy only from reputable firms and never pay fancy prices. Various unscrupulous companies and individuals have at different times attempted to exploit the uninitiated by trying to sell valueless rubbish at exorbitant rates. When in doubt, always demand an analysis. All the fertilizers mentioned in this book are normally obtainable in most countries and if any difficulty is ever experienced in locating a supplier inquiry can easily be made at the offices of the local Agricultural Department.

The chemicals are a very important part of the apparatus of any system of soilless cultivation and a little extra attention expended on them will be amply repaid. They should always be stored in a dry shed or cupboard.

## APPARATUS

This is especially important during the monsoon season, or in wet weather when certain salts are liable to liquefy if exposed to damp. Detailed discussion of the best kinds of fertilizers for hydroponic use will be found in the chapter on Nutrient Mixtures, but generally speaking the types given in the list on pages 43-7 are available.

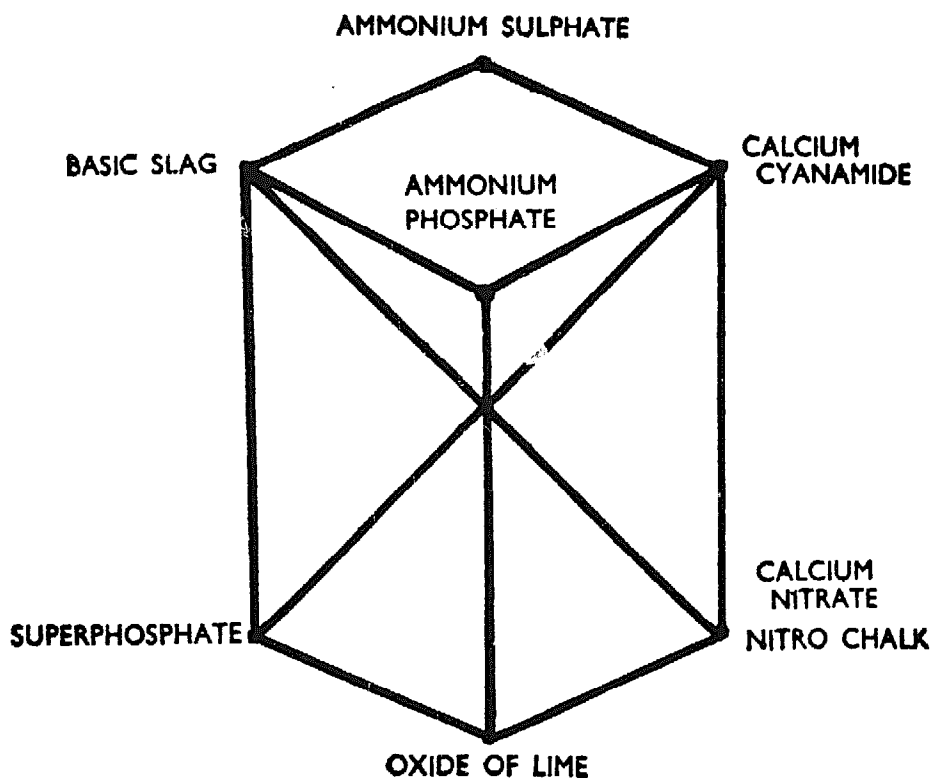

GEEHEN'S CHART

*Simplified for soilless culture.*

Fertilizers joined by thick lines should not be mixed. If one or more are being used in a formula, an alternative salt suitable for mixing should be substituted for the particular unsuitable chemical; for example nitrate of soda with basic slag; calcium sulphate with ammonium phosphate; and monopotassium phosphate or bonemeal with calcium cyanamide, using a 'filler'.

Even a casual study of the list—which is by no means exhaustive or fully detailed—will enable the reader to realize what a large number of various types of chemicals

## HYDROPONICS—THE BENGAL SYSTEM

there are from which to choose. Products manufactured in different areas often contain diverse percentages of a particular nutrient, so that the figures given are only approximate. Guaranteed analyses are, however, usually supplied by the distributors. Many salts contain two or three major elements. Should one kind of fertilizer be unavailable another can readily be substituted for it. Very often local or indigenous sources can be tapped and a satisfactory artificial inorganic or soluble organic nutrient obtained at little cost. The chief factors in making a selection should always be quality, availability and price.

The fertilizers listed in Table I should not normally be used together, since they may react chemically and render the formula valueless. A simplified form of Geehen's Chart illustrates this point (see page 41).

# APPARATUS

TABLE I  
LIST OF FERTILIZERS

NITROGENOUS	%N	OTHER SIGNIFICANT ELEMENTS/COMMENTS
Sodium nitrate ...	16	Sodium. Traces of potassium, boron, magnesium, iodine, calcium, chlorine, iron, and sulphur.
Ammonium sulphate ...	20	Sulphur 28%.
Ammonium nitrate ...	34	
Nitro-Chalk ... .. Cal-Nitro ... .. A-N-L ... ..	15.5-20.5	Calcium and magnesium oxides at about 9% and 7% respectively.
Calcium nitrate ...	15.5	Calcium oxide about 28%.
Calcium cyanamide ... Pulverized aero cyanamide Granular aero cyanamide	10-20 22 21	Calcium hydroxide about 70%. Traces of iron, aluminium, and silicon oxides.
Urea ... .. Uramon ... .. Calurea ... .. Uramite ... .. Ammonium sulphate nitrate ... ..	46 42 34 38 26	Calcium oxide 14%. Slow-release fertilizer.
Ammonium chloride ...	26	
Ammonium hydroxide ...	...	Added to irrigation water (nitrogation).
Ammonium bicarbonate	17	Not recommended, if others are available.



## HYDROPONICS—THE BENGAL SYSTEM

COMPOUNDS*	%N	%P <sub>2</sub> O <sub>5</sub>	%K <sub>2</sub> O	OTHER SIGNIFICANT ELEMENTS/ COMMENTS
Monammonium phosphate ...	12	61		
Diammonium phosphate ...	21	53		Loses ammonia in humid atmosphere.
Ammonium phosphate				
Ammo-Phos A ...	11	48		
Ammo-Phos B ...	16	20		
Ammoniated superphosphate ...	4	16		
Leunaphos ...	20	49		
Phosphazote ...	7	15		
Potazote ...	11-13		20-24	
Potassium nitrate ...	14		44	
Potassium ammonium nitrate ...	16		28	
Potassium orthophosphate ...		32-53	30-50	
Potassium metaphosphate ...		60	40	
Sodium potassium nitrate				
Nitropo ...	15		15	
Nitrophoska ...	10-16½	11-30	12-26½	
Ammo-Phos-ko				

\* A great many proprietary compounds are today being marketed, often under different trade names, by fertilizer manufacturers. These are now so numerous that it is not possible to list each one here. However, most brands have the analyses printed on the packets or bags, and care should be taken to read any such descriptions thoroughly before purchase, so as to be able to decide whether or not the ingredients or nutrient percentages are satisfactory.

## APPARATUS

PHOSPHATIC	%P <sub>2</sub> O <sub>5</sub>	OTHER SIGNIFICANT ELEMENTS/COMMENTS
Rock phosphate ... ..	20-30	Fluorine about 3%. Value depends on fineness of grinding. Only becomes available to plants after appreciable period. Contains varying amounts of lime.
Calcium phosphate ...		
Raw bonemeal ... ..	22-25	2-4% of nitrogen.
Steamed bonemeal ...	22-30	1-2% of nitrogen.
Precipitated bone ... ..	40	
Bone ash ... ..	30-40	Small amounts of magnesium and fluorine.
Bone char ... ..	30-35	1-2% nitrogen, and 10% carbon. A good conditioner.
Dissolved bone ... ..		All bonemeals are slow in action.
Bone superphosphate ...		
Vitriolated bone ... ..	15-20	
Basic slag ... ..	8-10	Also contains oxides of iron, calcium, and magnesium and trace of manganese. Slow acting.
Superphosphate		Up to 50% gypsum, plus iron, aluminium, silica, sulphur, and fluorine.
Single ... ..	15-20	
Concentrated ... ..	36-42	
Triple or Triple ...	45-50	
Calcium metaphosphate ...	65	Trace of fluorine.
Calcined phosphate ...	65	
Fused tricalcium phosphate ... ..	30-35	
Ephos phosphate ... ..	27	
Monocalcium phosphate ...	48-55	

Soluble organic phosphate compounds, including calcium glycol phosphate, calcium glucose-3-phosphate, calcium glycerophosphate, and calcium sorbitol-phosphate, potassium diphenylphosphate, and triethyl phosphate, are also suitable sources of the element.

Monosodium phosphate has been utilized with success.

NOTE: Rock phosphates, bonemeals, and basic slag, are slow-dissolving substances, and become available as nutrients only after some time has elapsed. Their use is not recommended unless other salts are unobtainable, and in any case only the most finely ground samples are really worthwhile.

## HYDROPONICS—THE BENGAL SYSTEM

POTASSIC	%K <sub>2</sub> O	OTHER SIGNIFICANT ELEMENTS/COMMENTS
Kainite ... ..	14-20	Also contains magnesium sulphate, magnesium and sodium chlorides, with up to 46% chlorine.
Carnallite ... ..	9-12	Also magnesium, sulphur, and common salt.
Sylvinite ... ..	20-42	Some calcium.
Hardsalz ... ..	16	
Potassium muriate ...	48-62	About 47% chlorine.
Potassium magnesium sulphate ... ..	48-53	Not less than 25% magnesium sulphate. Trace chlorine.
Potassium sulphate ...	42-48	Sulphur. Trace chlorine.
Potassium magnesium carbonate ... ..	20	Also 20% magnesia.
Potassium silicate ...	25	

In addition, use may be made of potassium phosphate, potassium dihydrogen phosphate, potassium hydroxide, and potassium carbonate. Potassium chloride is the same as muriate of potash.

### MAGNESIAN

Suitable fertilizers are: magnesium sulphate, anhydrous, and Epsom salts, tech., magnesium nitrate, magnesium phosphate, magnesium oxide, magnesium hydroxide, and magnesium carbonate.

### CALCIFEROUS

Sources of lime include: calcium chloride, calcium sulphate, calcium nitrate, calcium oxide, calcium hydroxide, calcium carbonate, calcium silicate, and tricalcium phosphate.

### FERRIFEROUS

Iron may be supplied through any of these salts: ferrous sulphate of iron, iron ammonium citrate, perchloride of iron, and ferrous phosphate.

### SULPHUREOUS

Sulphur is present in the majority of the major salts listed, and need not be given as a separate nutrient salt.

## APPARATUS

### TRACE

Manganese: both manganese sulphate and manganese chloride.

Copper: copper sulphate or blue vitriol.

Boron: sodium tetraborate (borax), potassium borate, boric acid powder, and finely ground borosilicates.

Zinc: zinc sulphate is generally used.

MISCELLANEOUS*	%N	%P <sub>2</sub> O <sub>5</sub>	%K <sub>2</sub> O	OTHER ELEMENTS
Nicifos ..	13-19	9-41		
Plantabbs ..	11	15	20	
Guano ..	10	9	6	
Manurin ..	11	12	15	Added calcium, magnesium, iron, and minor elements.
Commercial fertilizer ..	3-5	6-10	3-5	
Wood ashes ..			10-36	
FTE frits ..				Trace nutrients: iron, boron, copper, manganese, zinc, and molybdenum.
Sustanum (Temperate Zones)	6	4	7	2% MgO, 2% CaO and 1% trace elements.
(Tropical Zones)	7	5	5	"
Phostrogen ..	9.7	10	26.5	Magnesium, manganese, iron.
Vegerite ..	6	8	6	
Tomorite ..	4½	5	8	

\* Recently many new fertilizers with trade names have come on the market. Before using such nutrients it is essential to read the manufacturer's description of the contents or ask for an analysis. Never buy made-up fertilizers which are unaccompanied by a clear and definite statement of the ingredients and purpose of the mixtures in question.

The following have also been proposed as suitable fertilizers: ammonium formate, formamide, melamine nitrate, melamine phosphate, melamine sulphate, guanidine sulphate, phytin, diguanidine phosphate, triguanidine phosphate, and nucleic acid.

## NUTRIENT MIXTURES

**T**HE main elements which must be supplied to plants growing in a hydroponicum, and their individual functions, have already been briefly mentioned in Chapter 2 of this book. The reader will also now be familiar with the names of some of the chemicals or fertilizers which are generally used as vehicles for the application of the required mineral elements. Several hundred different mixtures have been proposed for hydroponic use, but it is clear that the actual choice of salts is of little consequence provided a proper concentration of the necessary elements is assured, and a satisfactory equilibrium maintained. In practice, however, availability and cost will be the chief factors in making a selection. Out of the large number of different chemicals listed on pages 43-7 only a few are in general use. Commercial grade fertilizers are the best to buy but trace elements, indicators and sulphuric acid will have to be in purer form. It is not at all necessary, though, for the hydroponicist to be obliged to make up these mixtures personally. Any reputable manufacturer, pharmacy, horticultural or agricultural firm can easily prepare any of the formulae given in this book, and supply it to the grower in ready-made form. In fact many companies do offer stock compounds, which are very often marketed as tablets, for sale in particular districts. The question of whether to mix up one's own nutrients, or to get them already prepared, depends both on knowledge and time. Should the student feel competent, after going through this book, to undertake the blending of his own fertilizers, he is strongly recommended to do so, since it is always cheaper in the



11. Broad beans are a useful soilless crop in backyard or roof top boxes

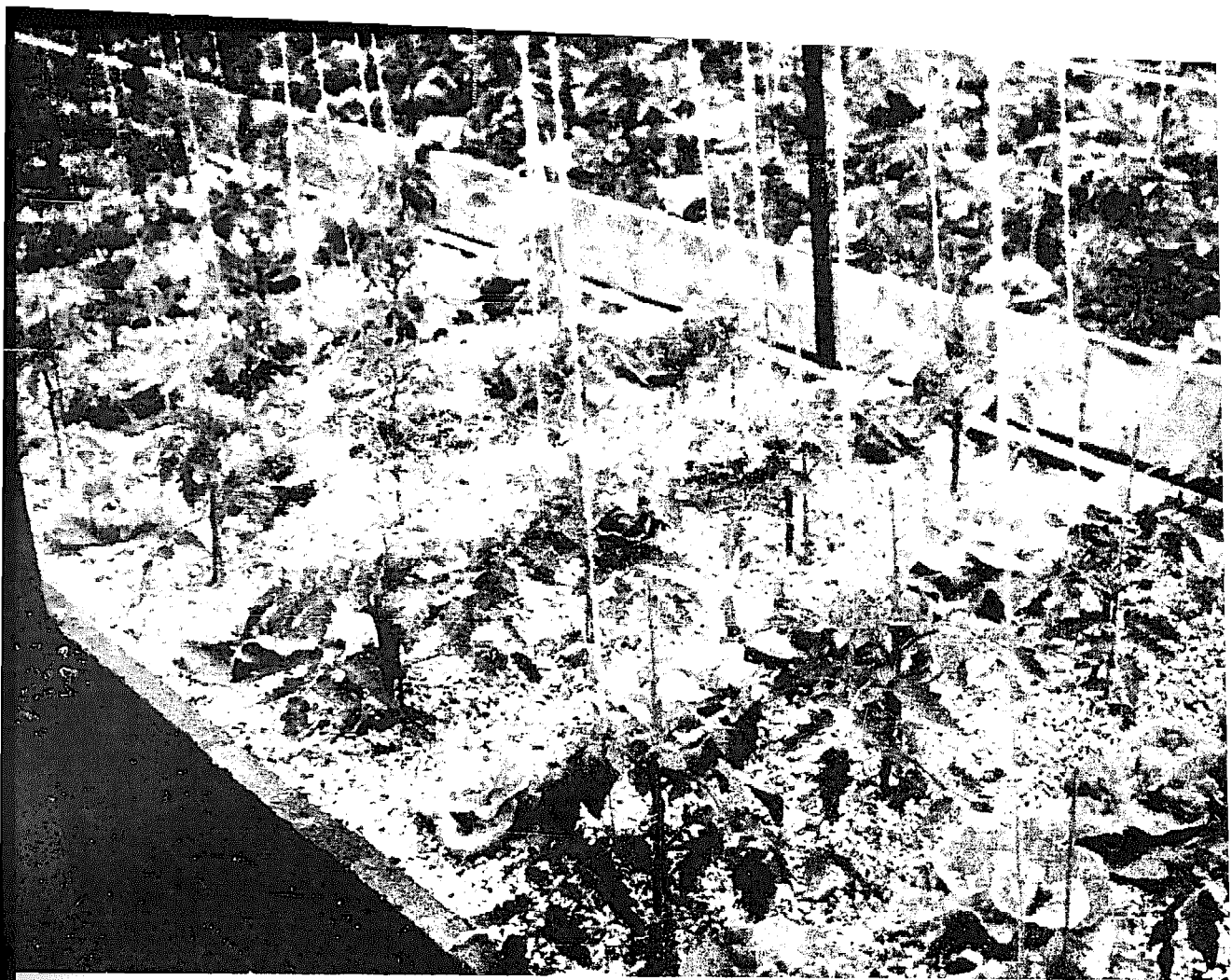

15 Young tomato and lettuce plants intercropped in the hydroponicum at Reading University. Note the method of supporting the vines on a series of upright strings

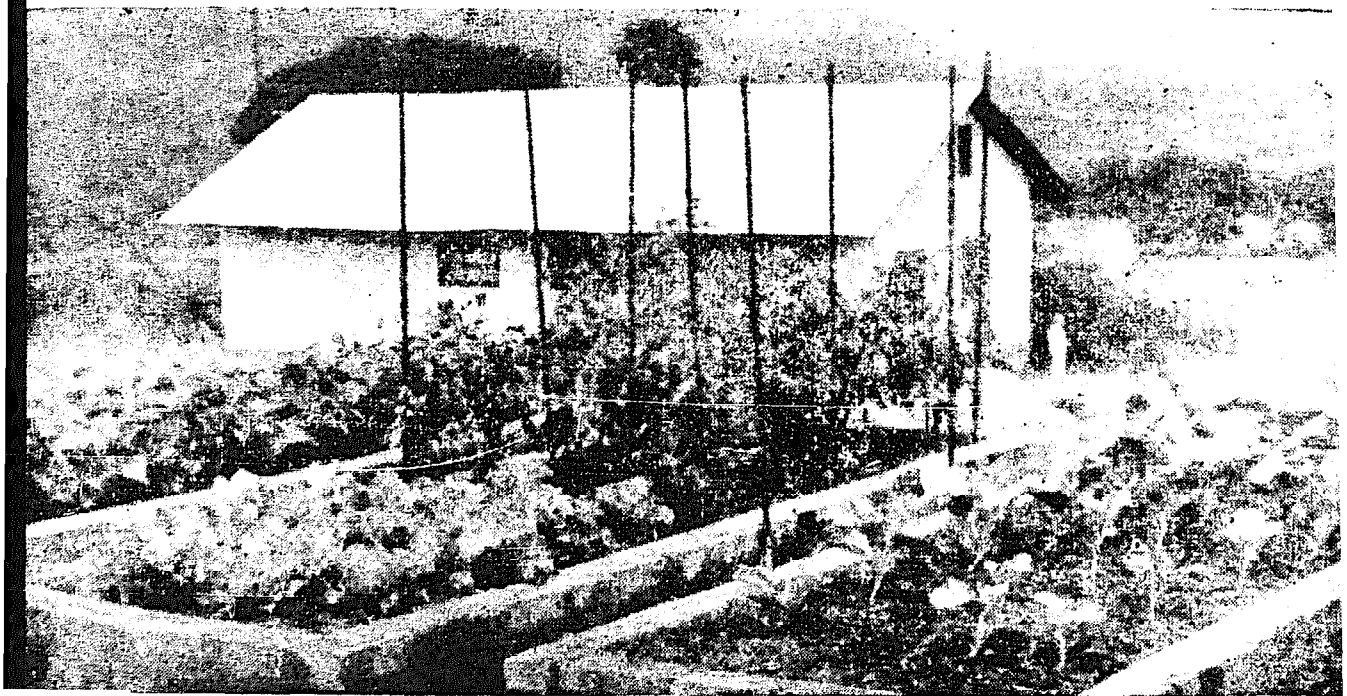

16 The Bengal system in Tanzania. A view of the soilless culture beds at Geta, near Lake Victoria

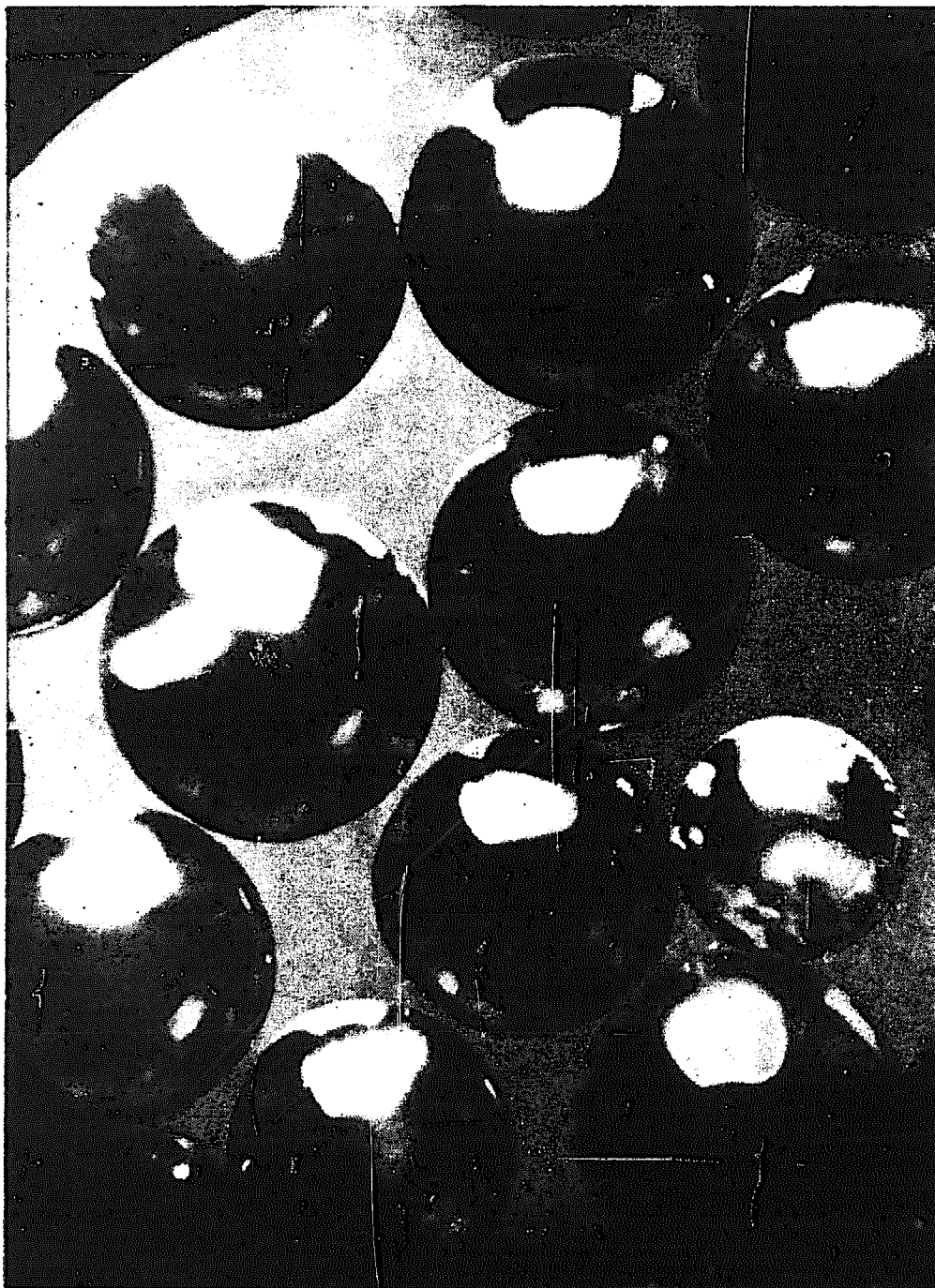

17. Photomicrograph of ion-exchange resin of 40-mesh size



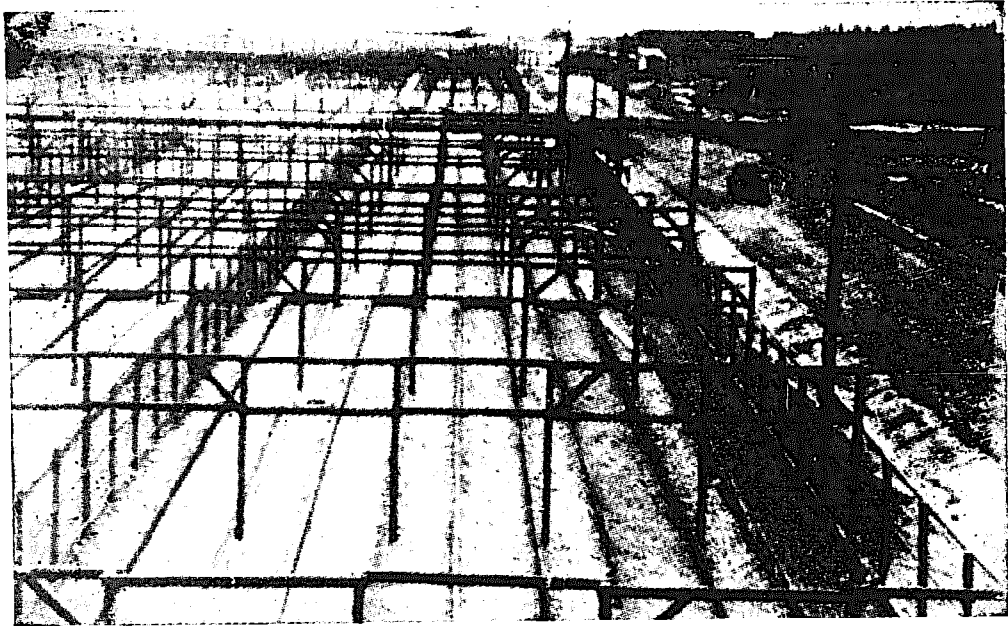

18. Construction of a five-acre soilless unit in Japan

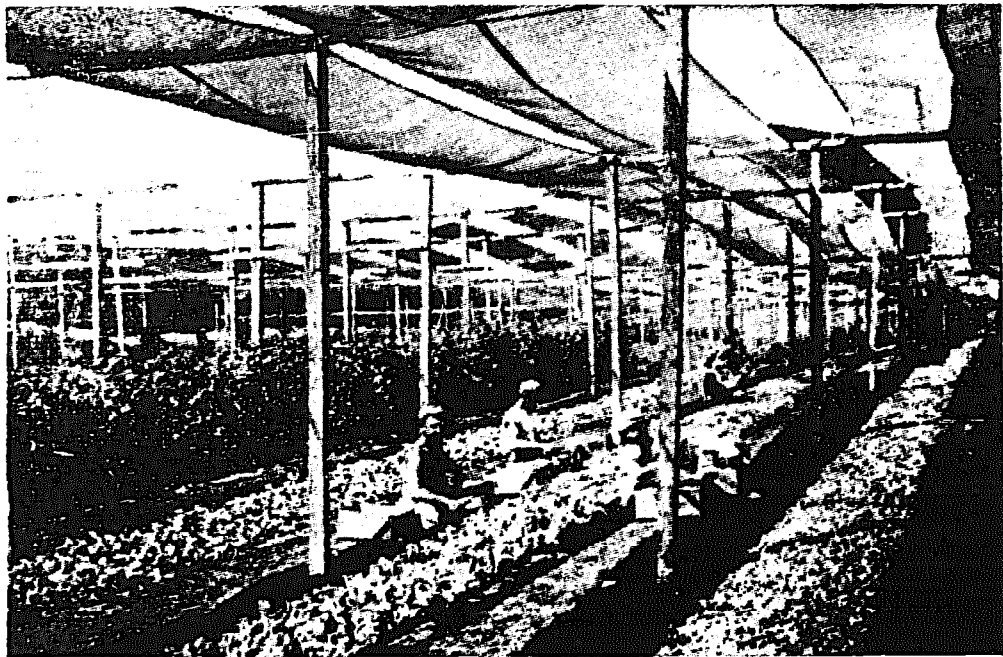

19. A hydroponicum with overhead shading in the tropics

## NUTRIENT MIXTURES

long run. Commercial installations should always prepare their own nutrients. But in the case of a busy housewife, or overworked office employee, probably the easiest course is to copy out a formula and hand it to the nearest chemist or reputable fertilizer salesman to be made up, just as if it were a doctor's prescription, or else select with discrimination a proprietary brand of tablets or stock mixture. But whatever the reader decides to do he must never forget to store the nutrients in a dry place.

### *The choice of a formula*

Experience only will tell what formula is best suited to a particular locality, the choice also depending upon the nature of the water supply. In a large commercial undertaking, where much is at stake, it is best to have this analysed. In addition to hydrogen and oxygen, certain other chemicals, including minor trace elements, are generally found in water. Some mineral salts may also precipitate from the selected aggregate. A correct fertilizer prescription will always take such factors into account, and suitable adjustments have to be made accordingly to the eventual mixture. An operator is not, of course, expected to work out these details alone: a careful study of this book or other hydroponic literature will usually put him right, but in cases of doubt it is merely necessary to submit all relevant particulars to the nearest research institution or other organization specializing in soilless cultivation. Any difficulties can then be speedily resolved, and expert advice obtained. The idea that there must be some 'best' mixtures for hydroponics has haunted investigators for many years. Up to now none has been discovered and it is unlikely that one will be, since the precise nutrient requirements of plants vary depending upon their habitat. Many 'good' formulae exist, but no 'best' one. The grower will usually be obliged to select

## HYDROPONICS—THE BENGAL SYSTEM

his formula according to whatever salts are locally obtainable.

Every effort has been made to keep the formulae as simple as possible. Many books of reference give rather complicated mixtures involving the use of an analytical balance, but experience has shown that a variation of a few grammes either way makes no difference in a large outdoor hydroponicum. Consideration must always be given to the particular grade or kind of fertilizer employed, because a difference in analysis or percentage content of a certain element naturally involves a slight adjustment in the quantities used. The normal fertilizer practice adopted for any special crop is often a useful guide, and the beginner can profitably consult some of the literature available on the subject. Many of the mixtures given in this book are based on observations made in India, where various nutrient elements are frequently present in the water supply. In areas where very pure and clean water has to be used, some increase in strength will often be advisable. In warm countries, the effects of climate render such high concentrations as those used in colder latitudes unnecessary. Brilliant sun and high light intensity during the dry season enable tropical hydroponicists to reduce the supply of potassium, in many cases up to fifty per cent. However, during the monsoon or dull weather it may have to be restored to nearly normal if outstanding results are required. This is only one of the special points that we have to consider when selecting formulae for use in various countries. Generally speaking, where plant growth appears slow, additional but not excessive quantities of nutrients should always be given. It must be borne in mind when drawing comparisons that one of the main features of the improved Bengal method of hydroponics is economy in cultural fertilizers, while the special technique em-

## NUTRIENT MIXTURES

ployed effectively ensures that no wastage of salts takes place.

### *Selection of salts*

The most important commercial grade and better type fertilizers recommended for the soilless cultivation of plants are listed below (Table II). These are the ones in commonest supply, and it is only in the unlikely event of these being unavailable that the grower will be driven to look for more expensive alternatives. Certain chemicals, as the reader will have already learnt, contain more than one nutrient.

### *The basic formula*

In dull and cloudy northern Europe and the eastern states of America an N : P<sub>2</sub>O<sub>5</sub> : K<sub>2</sub>O ratio of 2 : 1 : 4 has been concentrated on, but for hot and sunny India (and most other tropical countries as well) very suitable proportions have been found to be:

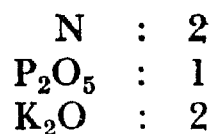

This assessment applies only during the drier time. Naturally, in deserts or hot arid regions where there is no rainy season this means all the year round, but in places which experience a true Asian monsoon the following ratio will be most applicable in cloudy or wet months:

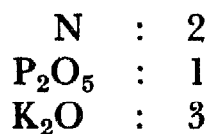

## HYDROPONICS—THE BENGAL SYSTEM

### TABLE II

NAME OF FERTILIZER SALT	ELEMENTS SUPPLIED
Sodium nitrate ... ..	N
Ammonium sulphate ... ..	N S
Potassium nitrate ... ..	N K
Calcium nitrate ... ..	N Ca
Superphosphate ... ..	P Ca
Ammonium phosphate ... ..	N P
Potassium sulphate ... ..	K S
Muriate <i>or</i> Chloride of Potash ...	K
Magnesium sulphate ... ..	Mg S
Calcium sulphate ... ..	Ca S
Epsom salts ... ..	Mg
Monocalcium phosphate ... ..	P Ca
Bonemeal ... ..	P N
Nicifos ... ..	N P
Manurin ... ..	N P K
Plantabbs ... ..	N P K
Sulphate of Iron ... ..	Fe
Manganese chloride <i>or</i> sulphate ...	Mn
Zinc sulphate ... ..	Zn
Copper sulphate ... ..	Cu
Boric acid powder ... ..	B

NUTRIENT MIXTURES

TABLE III

NAME OF FERTILIZER	MAIN ELEMENT(S) SUPPLIED	PARTS
Superphosphate Ammonium phosphate Monocalcium phosphate	P	4-7
Ammonium sulphate Ammonium nitrate Sodium nitrate	N	7½-10
Potassium nitrate	N K	
Calcium chloride Calcium sulphate	Ca	1½-2½
Muriate of potash Potassium sulphate	K	1½-3
Magnesium sulphate	Mg	2-3½
Ferric citrate Iron sulphate	Fe	Trace
Manganese chloride Manganese sulphate	Mn	Trace
Boric acid	B	Trace
Copper sulphate	Cu	Trace
Zinc sulphate	Zn	Trace

NOTE: Sulphur is already present in the sulphates of the main mixture.

## HYDROPONICS—THE BENGAL SYSTEM

In regions where a European type of climate prevails the ratio 2 : 1 : 4 should obviously be used, but such areas are very rare in South or East Asia. A suggestion for a general framework within which a basic formula may be built up is set out in Table III (page 53). The mixtures listed in this chapter are all intended for practical out-of-door or domestic and household hydroponics. Usually, for laboratory cultures where pure chemicals, distilled water and an absolutely inert aggregate are employed, more technically exact weights, shading down to minute fractions of a gramme, are necessary.

With these facts in mind the following practical formula base has been evolved, and utilized with success in India and many other countries.

### BASIC MIXTURE

FERTILIZER SALT	QUANTITY* IN OUNCES	ELEMENTS SUPPLIED
Sodium nitrate ...	12½	N
Superphosphate ...	7	P Ca
Potassium sulphate ...	4	K S
Magnesium sulphate ...	4	Mg S
Trace elements <sup>1</sup> ...	½ dram	
Zinc sulphate ...		Zn
Manganese sulphate ...		Mn
Boric Acid powder ...		B
Copper sulphate ...		Cu
Iron sulphate ...		Fe

<sup>1</sup> Details of individual quantities are given later in this chapter.  
NOTE: All superphosphates are single unless otherwise stated.

\* Formulae in this book have been given in ounces and pounds avoirdupois (Imperial system), because these are most familiar to the general public in English-speaking countries, or where English is employed as a second language, but for the convenience of those who wish to work with metric weights, the equivalents are:

- (oz.) One ounce = 28.35 grammes
- (lb.) One pound = 0.4536 kilogramme.

## NUTRIENT MIXTURES

Very often, after seeing this list of necessary chemicals, and half-heartedly attempting to purchase them locally, the budding hydroponicist has thrown up his hands in despair with the remark, 'It's impossible to obtain these in the market'. Generally this is not strictly correct, since a careful search will always uncover the desired nutrients, but as sometimes there may really be no local supply of a particular salt, we here stress that those listed above are by no means the only ones that can be used as constituents of the basic formula. To encourage the doubtful we hasten to add a—

### SECOND BASIC MIXTURE<sup>1</sup>

FERTILIZER SALT	QUANTITY IN OUNCES	ELEMENTS SUPPLIED
Ammonium sulphate ...	8	N S
Ammonium phosphate ...	5½	N P
Muriate of potash ...	3	K
Calcium sulphate ...	2	Ca S
Magnesium sulphate ...	4	Mg S
Trace elements (as in first basic mixture) ... ..	¼ dram	Zn Mn B Cu Fe

<sup>1</sup> Suggested as the most suitable for paddy. Rice plants can utilize considerable amounts of ammonium salts.

and a—

### THIRD BASIC MIXTURE

FERTILIZER SALT	QUANTITY IN OUNCES	ELEMENTS SUPPLIED
Ammonium sulphate ...	10	N S
Potassium sulphate ...	2½	K S
Superphosphate ...	6	P Ca
Magnesium sulphate ...	3	Mg S
Trace elements (as in first basic mixture) ... ..	¼ dram	Zn Mn B Cu Fe

and a fourth and fifth on page 56.



## HYDROPONICS—THE BENGAL SYSTEM

The reader should not imagine that the five basic formulae given here are the best that can be evolved: in fact, excellent though each may be, and satisfactory the results that should follow from its use, many improvements will undoubtedly still be possible when further research and scientific experiments have given us greater

### FOURTH BASIC MIXTURE

FERTILIZER SALT	QUANTITY IN OUNCES	ELEMENTS SUPPLIED
Potassium nitrate ...	19	N K
Superphosphate ...	$6\frac{1}{2}$	P Ca
Ammonium sulphate ...	5	N S
Magnesium sulphate ...	$5\frac{1}{2}$	Mg S
Trace elements (as in first basic mixture) ... ..	$\frac{2}{8}$ dram	Zn Mn B Cu Fe

### FIFTH BASIC MIXTURE

FERTILIZER SALT	QUANTITY IN OUNCES	ELEMENTS SUPPLIED
Ammonium phosphate ...	$2\frac{1}{2}$	N P
Nitrate of soda ...	8	N
<i>or</i>	<i>or</i>	
Nitrate of ammonia ...	4	N
Calcium nitrate ...	1	N Ca
Potassium sulphate ...	4	K S
Magnesium sulphate ...	4	Mg S
Trace elements (as in first basic mixture) ... ..	$\frac{1}{8}$ dram	Zn Mn B Cu Fe

knowledge of the local nutritional requirements of plants. But it is claimed that in all normal cases these basic mixtures will prove suitable as sound foundations for practical work. Great care has been taken to suggest only fertilizer salts which are normally available and

## NUTRIENT MIXTURES

easily obtainable. Possibly, mixtures in some ways superior might be made with other kinds of chemicals, but generally speaking they may be difficult to buy. For this reason, so far we have been obliged to list four or five salts formulae only. However, several more suggestions will be given later in this chapter and, should the grower be able to locate the necessary chemicals, he may find it worthwhile to try some of them out, especially the three salts ones which are quicker to prepare.

### *In case of difficulty*

Sometimes a hydroponicist may find that he has all the chemicals to hand which he requires to prepare, say, the third basic mixture, except Superphosphate. Should bonemeal be unavailable, as a substitute use can be made of Ammonium Phosphate, but since this contains a higher percentage of  $P_2O_5$  a reduction in the quantity employed should be made. Reference to the list (pages 43-7) will enable the reader to check up percentages at a glance, and, coupled with study and comparison of the different nutrient formulae in this chapter, will serve to show what variations are generally made when using alternative salts. It is not desirable in a popular non-technical book to go into complicated details about the scientific reasons for taking a particular course of action, but the student may bear in mind that the main object behind the preparation of any nutrient solution is to supply the growing plants with the proper amount of each element that they actually need. Proper equilibrium and balance must be maintained: in practice this means a mixture which, when it mingles with whatever water is being used to keep the troughs moist and goes into solution, will be neither too acidic nor too alkaline. An operator should never hesitate to switch his salts around: if one is unobtainable, simply substitute another. In any case of severe difficulty an expert may always be consulted.

## HYDROPONICS—THE BENGAL SYSTEM

### *Computation made easy*

An easy way of calculating the quantities of salts for a mixture is to proportion them out by measurement instead of by weight. It must be clearly understood, however, that this is only an approximate, not an exact method. Some chemicals are heavier than others. So the conversion of weight to capacity measure must be made separately for each salt. Fertilizers should be well crushed before measuring them out. For the convenience of the busy amateur a conversion table is given below.

TABLE IV

NAME OF CHEMICAL	APPROXIMATE NUMBER OF LEVEL TEASPOONFUL PER TWO OUNCES
Sodium nitrate ... ..	9
Ammonium sulphate ... ..	15
Calcium nitrate ... ..	11
Magnesium sulphate ... ..	14
Superphosphate ... ..	19
Muriate of potash ... ..	15
Potassium sulphate ... ..	10
Potassium nitrate ... ..	14
Calcium chloride ... ..	18
Monopotassium phosphate ... ..	15
Magnesium nitrate ... ..	14
Ammonium chloride ... ..	19

Teaspoons do vary a certain amount in different places, but not really seriously enough to affect cultural mixtures measured out by them for use with the Bengal system of hydroponics. The grower can easily make further conversions for any other salts, and jot the quantities down in his notebook. For a large-scale installation some big fixed measure of capacity, such as a bucket, may be used, and its weight value in terms of each fertilizer permanently

## NUTRIENT MIXTURES

assessed beforehand. This will often save a lot of valuable time.

### *Technique of preparation*

After being carefully weighed out or measured properly, the major nutrient salts should be well mixed together and any lumps broken up into a fine powder. This may be done in a bucket with a wooden spoon, mallet or other blunt-headed instrument. For small-scale household hydroponics it is unnecessary to bother about adding trace elements, since sufficient quantities of these occur as impurities in the main fertilizer chemicals. But when they are used it is best to weigh out a couple of ounces at a time, and after thorough mixing, which can be done with a pestle and mortar, to divide them up into small quantities of a dram each for convenience of application.<sup>1</sup>

Two ounces of trace element mixture<sup>2</sup> consists of:

Zinc sulphate	...	...	...	3 drams
Manganese sulphate	...	...	...	9 drams
Boric acid powder	...	...	...	7 drams
Copper sulphate	...	...	...	3 drams
Ferrous or iron sulphate	...	...	...	10 drams
Total	...	...	...	32 drams

(16 drams = one ounce avoirdupois)

Alternatively, the following more simply prepared mix can be used: Ferrous sulphate  $\frac{1}{2}$  oz, together with one level teaspoonful of boric acid powder, and half level teaspoonfuls of manganese sulphate, zinc sulphate, and copper sulphate.

<sup>1</sup> Prepared mixtures of fritted trace elements (FTE) are now available from Ferro Enamels Ltd, Agricultural Division, Wombourn, Wolverhampton, England, or local agents, which obviate this procedure, and it will be simpler to make use of these compounds.

<sup>2</sup> See also formula on page 69.

## HYDROPONICS—THE BENGAL SYSTEM

Nutrients should never be allowed to get damp or wet before application. For this reason a dry container to keep them in or a suitable store place is essential. This also applies to compound fertilizers, or tablets specially made for hydroponics. To prepare larger quantities simply multiply up all ingredients to the desired bulk, using a constant number (See note on page 69).

### *Rate of application*

Allow one ounce of nutrient mixture every week or ten days to each square yard<sup>1</sup> of growing medium in a trough. Sometimes quantities may be slightly increased or decreased,<sup>2</sup> and the reasons for this will be considered in a later chapter, but generally speaking this rate of application is the most satisfactory. If it is desired to add the compound to a water supply, thirty ounces dissolved in one hundred gallons should be given three or four times weekly as a solution. During the monsoon season, especially, it is often necessary to increase these quantities and the frequency of application too. When giving nutrients as a liquid feed, enough solution is allowed to adequately moisten the aggregate at any given time (see page 83).

### *Desirable variations*

Cloudy weather means that plants use more potassium, so during dull and wet seasons it is very advantageous if the grower increases the quantity of this element in his nutrient mixtures. In prolonged dull weather it can be safely doubled. This means, of course, adding a larger quantity of whatever potassium-containing salt is being employed. At the same time, for economy's sake, reduce

<sup>1</sup> One square yard = 0.836127 m<sup>2</sup>

<sup>2</sup> The maximum permissible, i.e. 2 oz. sq. yd. weekly in normal cases.

## NUTRIENT MIXTURES

the nitrogen slightly since crops only need nitrates in very large amounts on bright, sunny days.

Other useful modifications may be called for by the uncommon nature of a grower's water supply. Normally, all the formulæ given in this book will suit most average waters. Sometimes, however, local waters do contain certain mineral elements which make desirable an adjustment in the basic mixture. Two suggestions for the reader's consideration are given here, and should a spring, well, river or other source correspond to either of the two conditions mentioned, one of these formulæ could be profitably utilized.

### WHEN CALCIUM AND MAGNESIUM ARE ALREADY PRESENT IN THE WATER SUPPLY

Ammonium phosphate	...	...	...	...	7 oz
Potassium nitrate	...	...	...	...	34 oz
Ammonium sulphate	...	...	...	...	5 oz
Ammonium nitrate	...	...	...	...	5 oz
Trace elements	...	...	...	...	1 dram

### WHERE WATER CONTAINS INSUFFICIENT OR NO CALCIUM AND MAGNESIUM

Ammonium phosphate	...	...	...	...	7 oz
Potassium nitrate	...	...	...	...	33½ oz
Calcium nitrate	...	...	...	...	5 oz
Ammonium nitrate	...	...	...	...	5½ oz
Magnesium sulphate	...	...	...	...	19½ oz

Or

Superphosphate	...	...	...	...	18 oz
Potassium nitrate	...	...	...	...	34 oz
Calcium nitrate	...	...	...	...	27 oz
Magnesium sulphate	...	...	...	...	19½ oz

If a water is extremely alkaline, a little sulphuric acid may be added to it at the rate of not over  $\frac{1}{4}$  fluid ounce per 100 gallons. More than this will seldom be required. Similarly, an acidic water may be treated with dilute

## HYDROPONICS—THE BENGAL SYSTEM

alkali (lye). Remember *never* to pour water into sulphuric acid. To do this would cause a dangerous explosion. Always add the acid slowly to the water. Neglect of this precaution is merely foolhardy.

### *Acid balance*

When a nutrient mixture is sprinkled over the surface of the growing medium in a hydroponicum, and washed down into the aggregate with water, it dissolves, or goes into solution. Together with the water, it forms a mineralized film of moisture throughout the trough, from which the roots absorb nourishment. The reaction—that is the alkalinity or acidity—of this solution is most important. Most plants prefer a slightly acid reaction, and scientists gauge it by means of what is known as the pH scale. This refers to hydrogen-ion concentration. There is no need to go into technical details concerning pH values here : the advanced student can refer to some of the available literature on the subject. But it is vital to maintain the right degree of acidity in hydroponic beds, since no solution over pH 6.5 is really satisfactory for soilless growth. The reaction of a mixture is ascertained by the use of a coloured indicator. For the average operator, BDH Universal will be quite satisfactory. It may be purchased from any chemical stockist with full instructions for use. To test the value of any formula, it is simply necessary to add a little of it to the local water in correct proportions. Then when the mixture has quite dissolved, a few drops of the indicator are added to the resulting solution. Carefully watch the colour change. This will take place after about a minute : red is strongly acid and green too alkaline. A yellow colour, on the other hand, which shows a pH of between 5.5 and 6.5 means that the mixture is just right for plant

## NUTRIENT MIXTURES

culture. Periodic tests of the moisture contained in the growing medium are useful as a check. Most plants prefer an acidity of pH 6.0 and the hydroponicist is advised to concentrate on maintaining this figure.

Represented in simple diagrammatic form the pH scale, as it shows with a Universal Indicator, looks like this :

COLOUR CHANGE	pH	REACTION
Red	2	Very strongly acid
Orange	4	Strongly acid
Yellow	6	Weakly acid
Yellow-Green	7	Neutral
Green	8	Weakly alkaline
Greenish-Blue	10	Strongly alkaline

### *Tabloid nutrients*

The average reader will probably be most interested in the possibilities of hydroponics with tablet fertilizers, or readymade compounds which contain all or the majority of the elements essential for healthy plant growth. Many of these prepared nutrients are specially designed for soilless cultivation, and are based on the formulae given in this book. They may be either crushed into a powder and sprinkled between crop rows, or inserted just as they are deep down into the root zone. A good tablet will soon dissolve when pushed well into the moist aggregate of a trough. They can even be made into a solution. In any case the same general proportions by weight—about one ounce to each square yard of trough space per week or thirty ounces per hundred gallons of water three or four times weekly—as with ordinary nutrient mixtures, should be maintained.

Beware of tablet manufacturers who charge exorbitant prices ; there is no reason why compound nutrients should be very much more expensive than others which one



## HYDROPONICS—THE BENGAL SYSTEM

makes at home, or on the farm.<sup>1</sup> A tablet-making machine can be bought for as little as Rs 20.<sup>2</sup> This is quite an easy device to manipulate and will turn out 350 tablets per hour. For those who want to save money, while avoiding the necessity of regularly mixing up their own salts, a machine like this is a good investment, since by its aid anyone can prepare in a few hours enough tablets to last him for several months.

### *Other mixtures*

Some further useful mixtures for soilless culture, which have given successful results in many parts of the world, are added here for the benefit of hydroponicists. Only a comparatively small number of the multitude of possible formulae could for reasons of space be admitted, over 126 combinations being feasible with three salt mixtures alone.

	1			
Nitrate of soda	...	...	...	10 oz
Superphosphate	...	...	...	7 oz
Sulphate of ammonia	...	...	...	2½ oz
Sulphate of potash	...	...	...	3½ oz
Magnesium sulphate	...	...	...	4 oz
	2*			
Nitrate of soda	...	...	...	28 oz
Muriate of potash	...	...	...	2½ oz
Superphosphate	...	...	...	15 oz

<sup>1</sup> Prepared mixtures of fertilizer salts for hydroponics may be obtained in packets or bulk from certain reputable firms, including India Alkalies Ltd, 5 Garstin Place, Calcutta, West Bengal; Chas. C. Gilbert & Co., Ivy Street, San Diego 1, California, U.S.A.; Hydroponic Chemical Co., Inc., Box 97—C, Copley, Ohio, U.S.A.; or Phostrogen Ltd., Corwen, Merioneth, North Wales, U.K.

<sup>2</sup>From, for example, the Tablet Machine Works, Parade, Kanpur, U.P.

\* Similar to that recommended for carnation culture by Mullard, S. R. and Stoughton, R. H., in Bulletin No. 2 (Revised), issued by Imperial Chemical Industries Ltd (*The Culture of Plants in Sand and in Aggregate*).



20. Rice plants flourishing in a hydroponicum at 3,000 ft.



21. Hydroponic vegetables raised in Bengal for home food supplies

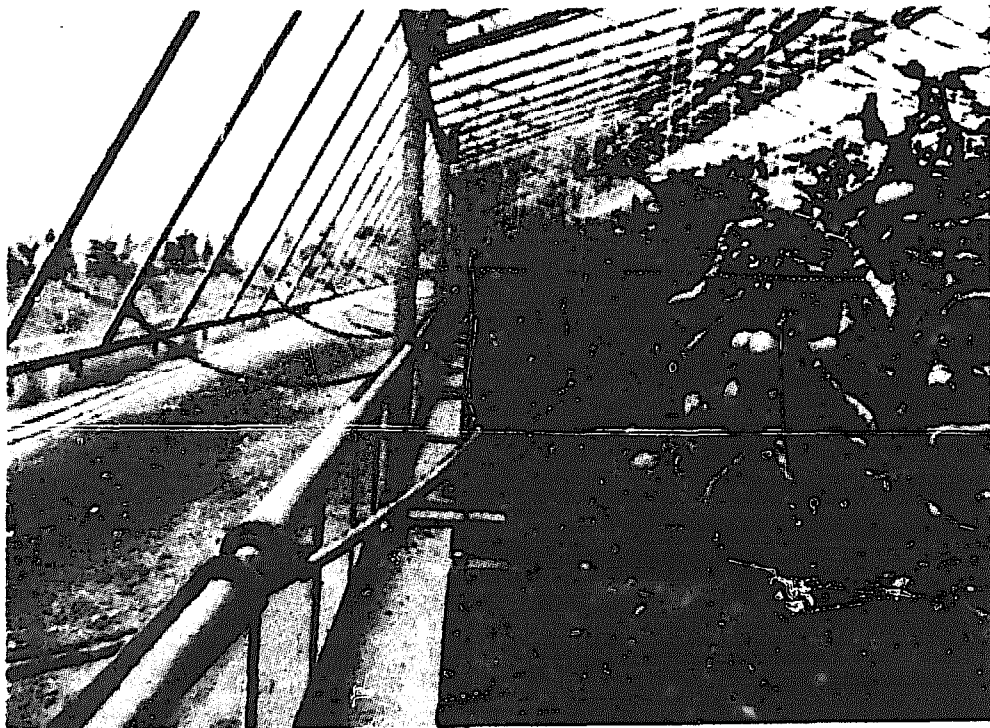

22. View of tomato crop in a commercial hydroponic unit, Sardinia

23. Rex Begonias in hydroponic unit. These flowers do very well in soilless gardening



24. Herbs for housewives in simple home soilless unit.  
*Left to Right* - Endive, Basil, Radish, Chives  
*Front* - Parsley - just sown; *Right Bottom* - Sage

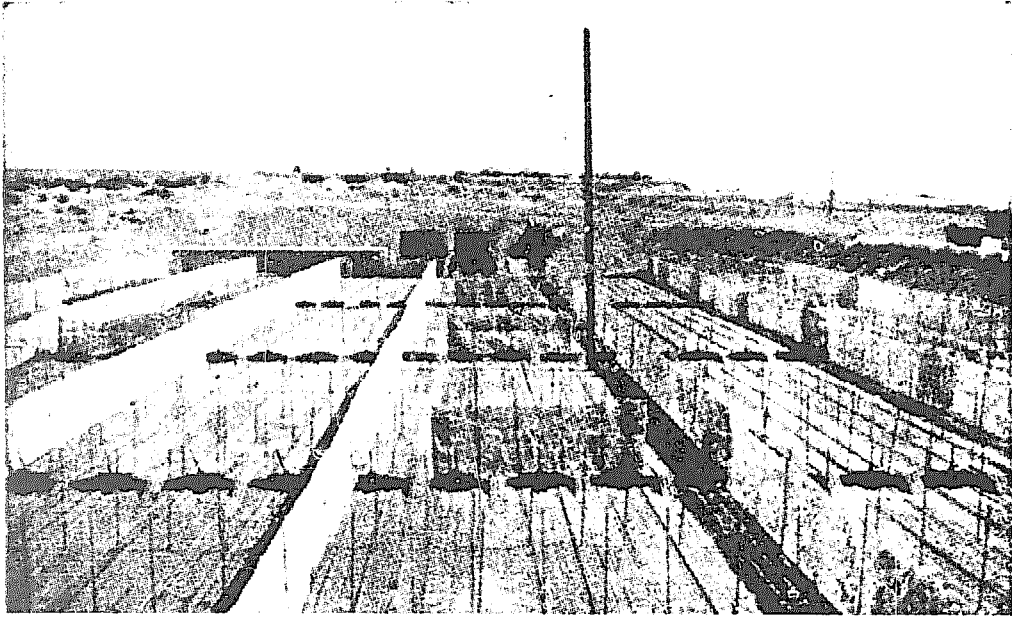

25, 26. Two views of large-scale soilless units

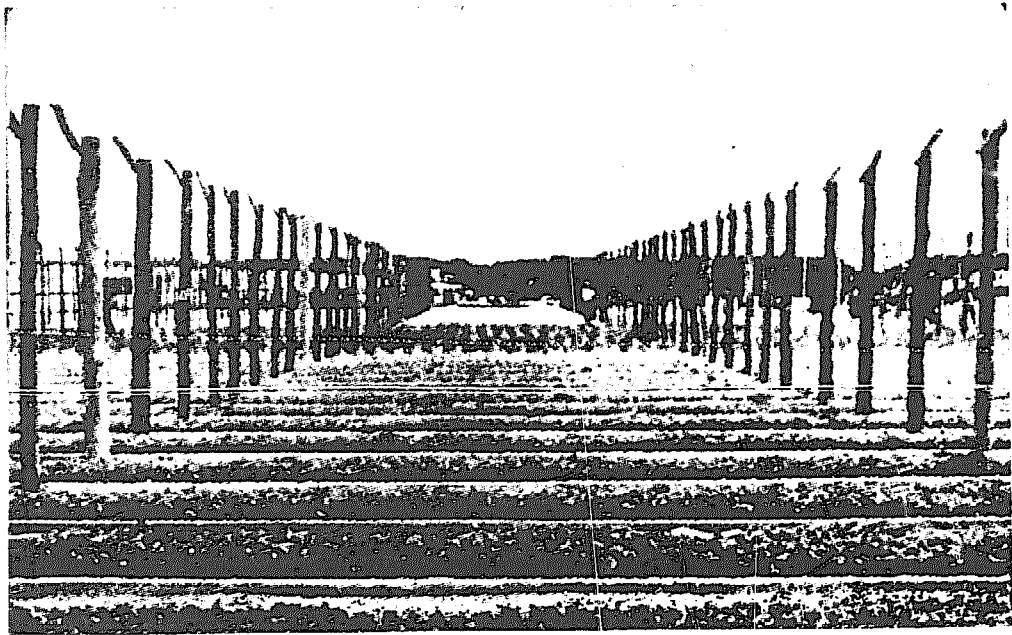

## NUTRIENT MIXTURES

Magnesium sulphate	...	...	...	...	8½ oz
Sulphate of ammonia	...	...	...	...	2 oz

*[During a cloudy or wet period the quantity of Muriate of Potash should be increased to 5 oz and the Sodium Nitrate reduced to 20 oz.]*

3					
Ammonium sulphate	...	...	...	...	3½ oz
Triple superphosphate	...	...	...	...	4 oz
Potassium sulphate	...	...	...	...	1½ oz
Calcium nitrate	...	...	...	...	1 oz
Magnesium sulphate	...	...	...	...	3 oz

4					
Monopotassium phosphate	...	...	...	...	9 oz
Calcium nitrate	...	...	...	...	2½ oz
Magnesium sulphate	...	...	...	...	7½ oz
Ammonium sulphate	...	...	...	...	1 oz

5					
Nitrate of soda	...	...	...	...	7½ oz
Monammonium phosphate	...	...	...	...	3 oz
Sulphate of potash	...	...	...	...	4 oz
Calcium nitrate	...	...	...	...	2 oz
Magnesium sulphate	...	...	...	...	3½ oz

6					
Potassium nitrate	...	...	...	...	27 oz
Calcium nitrate	...	...	...	...	5 oz
Treble or triple superphosphate	...	...	...	...	7½ oz
Epsom salts	...	...	...	...	6½ oz

7					
Sodium nitrate	...	...	...	...	6½ oz
Calcium chloride	...	...	...	...	3 oz
Monopotassium phosphate	...	...	...	...	1 oz
Magnesium sulphate	...	...	...	...	5½ oz

8					
Potassium nitrate	...	...	...	...	16 oz
Ammonium sulphate	...	...	...	...	6 oz
Superphosphate	...	...	...	...	6½ oz
Magnesium sulphate	...	...	...	...	5 oz

## HYDROPONICS—THE BENGAL SYSTEM

	9				
Potassium nitrate	...	...	...	...	2 oz
Magnesium nitrate	...	...	...	...	6 oz
Ammonium chloride	...	...	...	...	1½ oz
Calcium nitrate	...	...	...	...	19 oz
Monopotassium phosphate	...	...	...	...	5½ oz
Magnesium sulphate	...	...	...	...	1½ oz
	10				
Nitrate of soda	...	...	...	...	6½ oz
Superphosphate	...	...	...	...	3½ oz
Calcium sulphate	...	...	...	...	1 oz
Potassium sulphate	...	...	...	...	2 oz
Magnesium sulphate	...	...	...	...	2 oz
	11				
Ammonium sulphate	...	...	...	...	5½ oz
Superphosphate	...	...	...	...	5½ oz
Potassium nitrate	...	...	...	...	5 oz
Magnesium sulphate	...	...	...	...	3¾ oz
	12				
Calcium nitrate	...	...	...	...	4½ oz
Monopotassium phosphate	...	...	...	...	12 oz
Magnesium sulphate	...	...	...	...	9 oz
	13				
Ammonium nitrate	...	...	...	...	33½ oz
Potassium nitrate	...	...	...	...	15 oz
Monopotassium phosphate	...	...	...	...	7½ oz
Calcium chloride	...	...	...	...	13¾ oz
Magnesium sulphate	...	...	...	...	12 oz
	14				
Ammonium sulphate	...	...	...	...	2½ oz
Potassium nitrate	...	...	...	...	25 oz
Superphosphate or *Rock phosphate	...	...	...	...	9 oz
Calcium sulphate	...	...	...	...	30 oz
Magnesium sulphate	...	...	...	...	15 oz
Ammonium phosphate	...	...	...	...	3½ oz
*Must be very finely ground.					
	15				
Sodium nitrate	...	...	...	...	8 oz
Ammonium phosphate	...	...	...	...	1¾ oz
Potassium sulphate	...	...	...	...	4 oz
Calcium nitrate	...	...	...	...	1 oz
Magnesium sulphate	...	...	...	...	3½ oz

## NUTRIENT MIXTURES

<b>16</b>				
Potassium nitrate	...	...	...	10½ oz
Sodium chloride	...	...	...	4 oz
Calcium sulphate	...	...	...	3 oz
Magnesium phosphate	...	...	...	4 oz
Superphosphate	...	...	...	3½ oz
<b>17</b>				
Ammonium nitrate	...	...	...	3½ oz
Potassium nitrate	...	...	...	10 oz
Monopotassium phosphate	...	...	...	9½ oz
Magnesium sulphate	...	...	...	7 oz
Calcium sulphate	...	...	...	1 oz
<b>18</b>				
Calcium nitrate	...	...	...	4 oz
Monopotassium phosphate	...	...	...	10 oz
Potassium chloride	...	...	...	4 oz
Magnesium sulphate	...	...	...	5½ oz
<b>19</b>				
Potassium nitrate	...	...	...	10 oz
Superphosphate	...	...	...	8½ oz
Magnesium sulphate	...	...	...	6½ oz
<b>20</b>				
Magnesium nitrate	...	...	...	9 oz
Potassium sulphate	...	...	...	5 oz
Superphosphate	...	...	...	7½ oz
<b>21</b>				
Magnesium nitrate	...	...	...	10½ oz
Monopotassium phosphate	...	...	...	9½ oz
Calcium sulphate	...	...	...	2 oz
<b>22</b>				
Potassium nitrate	...	...	...	11 oz
Magnesium phosphate	...	...	...	10½ oz
Calcium sulphate	...	...	...	2¼ oz
<b>23</b>				
Calcium nitrate	...	...	...	7½ oz
Magnesium phosphate	...	...	...	8 oz
Potassium sulphate	...	...	...	6½ oz



## HYDROPONICS—THE BENGAL SYSTEM

24

Nicifos	...	...	...	...	20 oz
Potassium sulphate or Muriate of potash	...	...	...	...	6½ oz
Magnesium sulphate	...	...	...	...	6 oz

25

Ammonium sulphate	...	...	...	...	8 oz
Bonemeal	...	...	...	...	25 oz
Potassium sulphate	...	...	...	...	4½ oz
Calcium chloride	...	...	...	...	1¼ oz
Magnesium sulphate	...	...	...	...	4 oz

26

Calcium cyanamide*	...	...	...	...	7½ oz
Monopotassium phosphate	...	...	...	...	8 oz
Magnesium sulphate	...	...	...	...	3 oz

\* When using calcium cyanamide, care must be taken to keep it from direct contact with plants. It is best with a filler of dry silver sand, and should be well mixed with this and other salts of the formula.

27

Plantabbs or Manurin	...	...	...	...	20 oz
Magnesium sulphate	...	...	...	...	3½ oz

[Formula 27 could be further improved by the addition of 3 oz of Ammonium phosphate or sulphate, or 2 oz of Ammonium nitrate.]

28

Ammonium hydroxide	...	...	...	...	2½ oz
Phosphoric acid	...	...	...	...	3¾ oz
Potassium hydroxide	...	...	...	...	1½ oz
Calcium oxide	...	...	...	...	1¼ oz
Nitric acid	...	...	...	...	8½ oz
Sulphuric acid	...	...	...	...	1¾ oz
Magnesium oxide	...	...	...	...	1¾ oz

29

Potassium nitrate	...	...	...	...	7½ oz
Sulphate of ammonia	...	...	...	...	16½ oz
Magnesium sulphate	...	...	...	...	8½ oz
Superphosphate	...	...	...	...	14 oz

30

Sodium nitrate	...	...	...	...	7¾ oz
Ammonium sulphate	...	...	...	...	1¾ oz
Potassium sulphate	...	...	...	...	4 oz
Superphosphate	...	...	...	...	7½ oz
Magnesium sulphate	...	...	...	...	4¼ oz

## NUTRIENT MIXTURES

### 31\*

Potassium nitrate	...	...	...	9 lb. 3 oz
Ammonium sulphate	...	...	...	1 lb. 3 oz
Monocalcium phosphate	...	...	...	2 lb. 10 oz
Magnesium sulphate	...	...	...	4 lb. 6 oz
Calcium sulphate	...	...	...	6 lb. 6 oz

### 32\*

Potassium nitrate	...	...	...	5 lb. 13 oz
Ammonium sulphate	...	...	...	1 lb.
Monocalcium phosphate	...	...	...	2 lb. 8 oz
Magnesium sulphate	...	...	...	4 lb. 8 oz
Calcium sulphate	...	...	...	5 lb.

\* Recommended by the United States Department of Agriculture, Agricultural Research Service, Crops Research Division, Beltsville, Maryland.

### 33†

Potassium nitrate	...	...	...	4 lb.
Ammonium sulphate	...	...	...	1 lb.
Monocalcium phosphate	...	...	...	2 lb.
Magnesium sulphate (Epsom salts)	...	...	...	2 lb.
Calcium sulphate (agricultural gypsum)	...	...	...	13 lb.

† Formulated by the Agricultural Extension Service of the University of Florida.

## ANOTHER TRACE ELEMENT MIXTURE OF SIMPLE COMPOSITION

Iron sulphate	...	...	...	...	4 oz
Manganese sulphate	...	...	...	...	$\frac{1}{4}$ oz
Copper sulphate	...	...	...	...	$\frac{1}{8}$ oz
Sodium tetraborate (borax)	...	...	...	...	3 oz
Zinc sulphate	...	...	...	...	$\frac{1}{8}$ oz

NOTE: It will probably have been observed that the various formulae listed in this book contain only relatively small individual or total quantities of salts. This has been done so that mixing up will be simpler for beginners or those who may not wish to go in for large units. Major operators, or anyone wanting to prepare substantial amounts of nutrients at a time, can easily increase the bulk of any formula by multiplying individual quantities in it. Great care must, of course, be taken to employ a constant number for this, so that the proportions of the different fertilizers remain unaltered, otherwise a lack of balance would occur. For example, to

## HYDROPONICS—THE BENGAL SYSTEM

prepare a sizeable stock of formula No. 33, one could multiply each individual amount of the given salts by 100, resulting in the following quantities: potassium nitrate 400 lb., ammonium sulphate 100 lb., monocalcium phosphate 200 lb., magnesium sulphate 200 lb., and calcium sulphate 1300 lb., total 2200 lb., or nearly one long ton. Thus, though the amounts of the various nutrients are bigger, the ratios between them remain unchanged and the bulk stock corresponds exactly to the original specimen formula.

A perusal of these thirty-three formulae, together with those previously listed, will not only give the keen hydroponicist an opportunity of undertaking interesting experiments, but also of utilizing whatever chemicals may be obtainable in the neighbourhood. Several more mixtures can be proposed to include other alternative salts. There are very many formulae which can be used and all have their advocates. The guiding rule in preparing any formula is to ensure that the finished compound will maintain physiological balance, and exhibit proper antagonism. In practice this simply means a correct pH value showing alkalinity-acidity reaction of about 6.0 after mixing with the local water. Naturally, of course, all the various elements must be included in whatever solution may eventually be made up. For all the additional mixtures listed above, trace elements can be added at the rate of half a dram for every thirty ounces of major salt mixture, except in small domestic installations where it is not worthwhile to go to this trouble.

### *Slow-release fertilizers*

#### A. SYNTHETIC RESINS

Work has also been undertaken with synthetic carrier resins supplying plant nutrients in absorbed form. The advantages of using amberlites or permutits—as these ion-exchange materials<sup>1</sup> are often called—include the fact that sufficient nutrient may be incorporated in the media

<sup>1</sup> See photograph No. 17.

## NUTRIENT MIXTURES

at the beginning of the season to last all through the crop growth period, only water being necessary. This obviates the frequent use of fertilizers. Many of the complications of nutrient management are eliminated, there is a reduction of losses due to leaching during rainfall, and there is the possibility of varying single ion concentration with simultaneous variation in ions of opposite charge. Depending on the preparation, amberlites or permutits have either anion- or cation-exchange properties. The former is an amine-formaldehyde resin, while the latter are phenol-formaldehyde resins in which hydrogen of phenolic group is exchangeable for other cations.

The suggested amounts of synthetic resins for use in the simplified Bengal system are as follows :

SYNTHETIC RESIN	OZ
K + ...	72
Ca + + ...	37
Mg + + ...	18
NO <sub>3</sub> - ...	40
H <sub>2</sub> PO <sub>4</sub> - ...	2½-3
SO <sub>4</sub> = ...	5
H <sub>2</sub> BO <sub>4</sub> - ...	1
	<i>Drams</i>
Fe + + ...	1
Mn + + ...	½

Mix the above quantities in with each one square yard of the aggregate before planting or sowing. These are enough for a period of up to six months.

It has been found that the use of a potassium nitrate solution as the source of potash and nitrogen, with consequent omission of potassium- and nitrate- ion-exchangers from the beds, reduced any adverse contact effects. The beginner is therefore advised, should he or she find that growth is unsatisfactory, to leave out these synthetic resins from the mixture, and substitute instead

## HYDROPONICS—THE BENGAL SYSTEM

a watering of twenty ounces of potassium nitrate (salt-petre) in one hundred gallons of water, two or three times weekly, as required. (For irrigation needs see pages 84-7). Or if preferred, the salt may be applied dry at the rate of  $\frac{1}{2}$  to 1 oz per square yard of trough surface space every week or ten days, sprinkled evenly between crop rows and well watered in.

The use of synthetic resins is now well established and while further investigation continues at the research centres, the results obtained indicate that these carriers have a promising future in hydroponic culture.<sup>1</sup> Growers may try them, starting on a small scale. Supplies may be obtained for trial from the Rohm & Haas Company, Washington Square, Philadelphia 5, Pennsylvania, United States, or the Permutit Company Ltd, Gunnersbury Avenue, London W.4, England, and local agents. Pamphlets which give details of the conversion processes are also available from these firms.

### B. SUSTANUM

This consists of a porous carrier material manufactured from diatomaceous and siliceous substances, in which the nutrient elements are embedded. When incorporated in hydroponic troughs and properly watered, it supplies crops with adequate amounts of both the major and the trace elements over a considerable period of time. Successful results have been obtained in many parts of the world by using sustanum slow-release fertilizer in Bengal system soilless culture units. It is available in two formulae, one for tropical, and the other for temperate zone work, based upon the prescriptions contained in this book.

Sustanum combines most of the advantages of synthetic resins in hydroponics with the added value of being

<sup>1</sup> Recently, further work with synthetic resins in hydroponics has been undertaken at Istituto di Agronomia Generale e Coltivazioni Erbacee, Università degli Studi di Sassari, Sardinia, Italy.

## NUTRIENT MIXTURES

cheaper to buy. For general use, 1 lb. of this fertilizer mixed into each square yard of trough space will provide sufficient nourishment to last most crops for six months. Both large and small quantities of sustanum for hydroponics, together with full instructions for application, may be obtained from the manufacturers: Trace Element Fertilizers Ltd, 118 Ewell Road, Surbiton, Surrey, England, or through local horticultural stores. (See also page 83)

### C. OTHER COMPOUNDS

Urea-form fertilizers are often employed as sources of slowly soluble nitrogen in soilless cultivation. They are available under various trade names. In addition, it is now possible to obtain a range of different compounds which are being produced by certain firms and which are designed to give graduated nutrition to crops over fairly long periods. Such fertilizers can be employed to supply phosphorus, potash, magnesium, and other essential elements, as well as nitrogen. Often a single slow release compound may provide a combination of several plant foods in stated proportions. The sequestrene chemicals, like ferric potassium ethylenediamine tetra-acetate, have been used for supplying iron, in cases where there may be danger of this element reacting with other substances. For further details, more advanced literature should be consulted, as well as the publications of fertilizer manufacturers.

#### *Solution theory*

The dry fertilizer salts, or the nutrients in the synthetic carriers, which are used in hydroponics, go into solution with the water present in the beds of aggregate, forming there a liquid plant food. The formulae discussed in this chapter all have as their ultimate object the production

## HYDROPONICS—THE BENGAL SYSTEM

of a satisfactory nutrient solution for the crops to absorb. Differences between solutions are wide, but the basic requirements are assessed by approximating them to certain strengths. These are computed by reckoning the number of parts of any given element that should be present in a million parts of water in a solution. The subject would require a large volume to discuss it in full, but for those interested, the average desirable concentrations are:

ELEMENT	P.P.M.
Nitrogen ...	200-400
Potassium ...	100-200
Phosphorus ...	80-100
Magnesium ...	50-100
Calcium ...	300-500
Iron ...	2- 10
Manganese ...	0.5- 5
Boron ...	0.5- 5
Copper ...	0.5
Zinc ...	1.0

Variations of these concentrations have been used with success, and much depends on locality, climate, and light conditions. For example, as low as 31 p.p.m. of phosphorus is allowed at Purdue University, and as much as 390 p.p.m. of potassium is permitted in United States Army hydroponic formulae. Gericke in California employed 80 p.p.m. of calcium, while a Sussex nursery gives only 20 p.p.m. magnesium. Different crops have varying ideal requirements. Persons interested in making a further study of this subject, in particular of the relations of antagonism, are referred to more advanced texts.

More advanced readers may like to make use of the following conversion table in choosing a formula :

## NUTRIENT MIXTURES

### TABLE V

FERTILIZER	NUMBER OF OUNCES REQUIRED PER UNIT OF WATER TO GIVE CONCENTRATION OF 1 P.P.M. (STANDARD UNIT IS 100 GALLONS OF H <sub>2</sub> O)
Sodium nitrate ... ..	0.103 N
Calcium nitrate ... ..	0.135 N, also 1.4 Ca
Ammonium sulphate ... ..	0.076 N
Potassium nitrate (for N) ... ..	0.122 N, also 2.8 K
"                  (for K) ... ..	0.0044 K, also 0.36 N
Superphosphate (16% P <sub>2</sub> O <sub>5</sub> ) ... ..	0.268 P, also 3.8 Ca
Monocalcium phosphate ... ..	0.118 P, also 0.6 Ca
Monopotassium phosphate ... ..	0.071 P, also 0.056 K
Ammonium phosphate ... ..	0.160 N, also 0.072 P
Magnesium sulphate ... ..	0.172 Mg
Potassium sulphate ... ..	0.040 K
Potassium chloride or muriate ... ..	0.033 K
Calcium sulphate ... ..	0.076 Ca
Ferrous sulphate ... ..	0.089 Fe
Manganese sulphate ... ..	0.065 Mn
Boric acid powder ... ..	0.090 B
Ferric ammonium citrate ... ..	0.140 Fe
Copper sulphate ... ..	0.063 Cu
Zinc sulphate ... ..	0.071 Zn

NOTE: Although the computations are assessed by reference to the ratio of ounces/100 gallons, all mixtures used in the Bengal system of soilless cultivation are of course applied at rates of about one ounce of dry formula per one square yard of trough surface space every week or ten days, as needed.

To obtain the desired p.p.m. concentration, multiply the fraction by the p.p.m. required. Example, to obtain 300 p.p.m. of nitrogen in a mixture :

Using Sodium nitrate:  $0.103 \times 300 = 30.9$  oz.

Using Ammonium sulphate:  $0.076 \times 300 = 22.8$  oz.

We do, of course, know that ammonium sulphate averages 20 per cent N, against sodium nitrate's 16 per cent, hence less fertilizer will be needed.



## HYDROPONICS—THE BENGAL SYSTEM

In calculating the amounts of compound fertilizers needed to produce particular p.p.m., always work out first the element of which the salt contains most, otherwise a surplus of the second element may arise.

For the student who desires to experiment under controlled conditions, with a completely inert growing medium and distilled water, in the laboratory, this mixture is suggested :

LOOMIS AND SHULL'S STOCK SOLUTION FOR  
SHIVE'S R552 MIXTURE

SALT	GM. IN 1 LIT. H <sub>2</sub> O
KH <sub>2</sub> PO <sub>4</sub> ...     ...	49.01
Ca(NO <sub>3</sub> ) <sub>2</sub> .4H <sub>2</sub> O     ...     ...	24.56
MgSO <sub>4</sub> .7H <sub>2</sub> O     ...     ...	73.95

Fifty cubic centimetres of each of the three stock solutions, plus 4 or 5 mg. of ferric phosphate, made up to 1 litre form a full nutrient solution. Ten cubic centimetres of a stock solution consisting of 0.10 gm manganese chloride, 0.05 gm zinc chloride, 0.05 gm boric acid, 0.01 gm copper chloride in 1 litre H<sub>2</sub>O, are added at frequent intervals to the cultural solution or medium.

### *Points of interest*

As time goes on a great number of local and indigenous substitutes for employment as nutrients in soilless culture are being discovered by further research. Among such useful materials are processed oil cake, different waste substances or organic matter, and the dry ashes of burnt plants, which often contain up to twenty-five per cent K<sub>2</sub>O, and sea water which is sometimes quite rich in mineral elements. Investigations have also been made into the utility of adapting activated charcoal and

## NUTRIENT MIXTURES

effluents to hydroponic use, while the idea of hanging baskets in sludge tanks has been canvassed. Pine tree bark, impregnated with the essential nutrient ions, can be used to supply crops with the important elements. Mushrooms have been grown successfully in mixtures of sawdust and oatmeal. Pebble phosphate rock, as well as defluorinated phosphate rock, expanded vermiculite, straw, foam rubber, paper rolled in tight hard balls, plastics and other substances, have advantages as aggregates. Suitably treated peat may make a useful growing medium. Many further ingenious adaptations and modifications will, in fact, be evolved in the years ahead.

## THE SYSTEM IN PRACTICE

**T**HIS chapter is more or less a brief account in outline of practices adopted during studies carried out at Kalimpong and in Calcutta, with references to subsequent experiments and schemes in various parts of India and other countries with the Bengal system of hydroponics during the period 1946 to 1974.

### *The first hydroponicum*

In the early autumn of 1946 the first practical hydroponicum ever to be installed in India was constructed at Kalimpong. Three types of troughs were built—fairly small wooden containers made by sawing old packing cases in two; one large sector consisting of beds with non-erodible mud plaster side walls on a concrete base; and finally other tanks made entirely from mud plaster. Later, a considerable number of ordinary plant pots and a few metal containers were brought into use. All proved satisfactory, but types made from mud or clay required some additional support in the form of a thin lattice around the walls during the monsoon. This was simple to improvise from wickerwork or thin strips of cane. Irrigation was supplied both by a bamboo piping system and from rubber hose. Small containers could, however, be easily and quickly watered by hand with a jug or garden can. The reader will be already quite familiar with the general layout of the Bengal system of soilless cultivation, and the manner and method in which the apparatus for an installation is set up, after having gone through Chapter 3 of this book. The type of growing

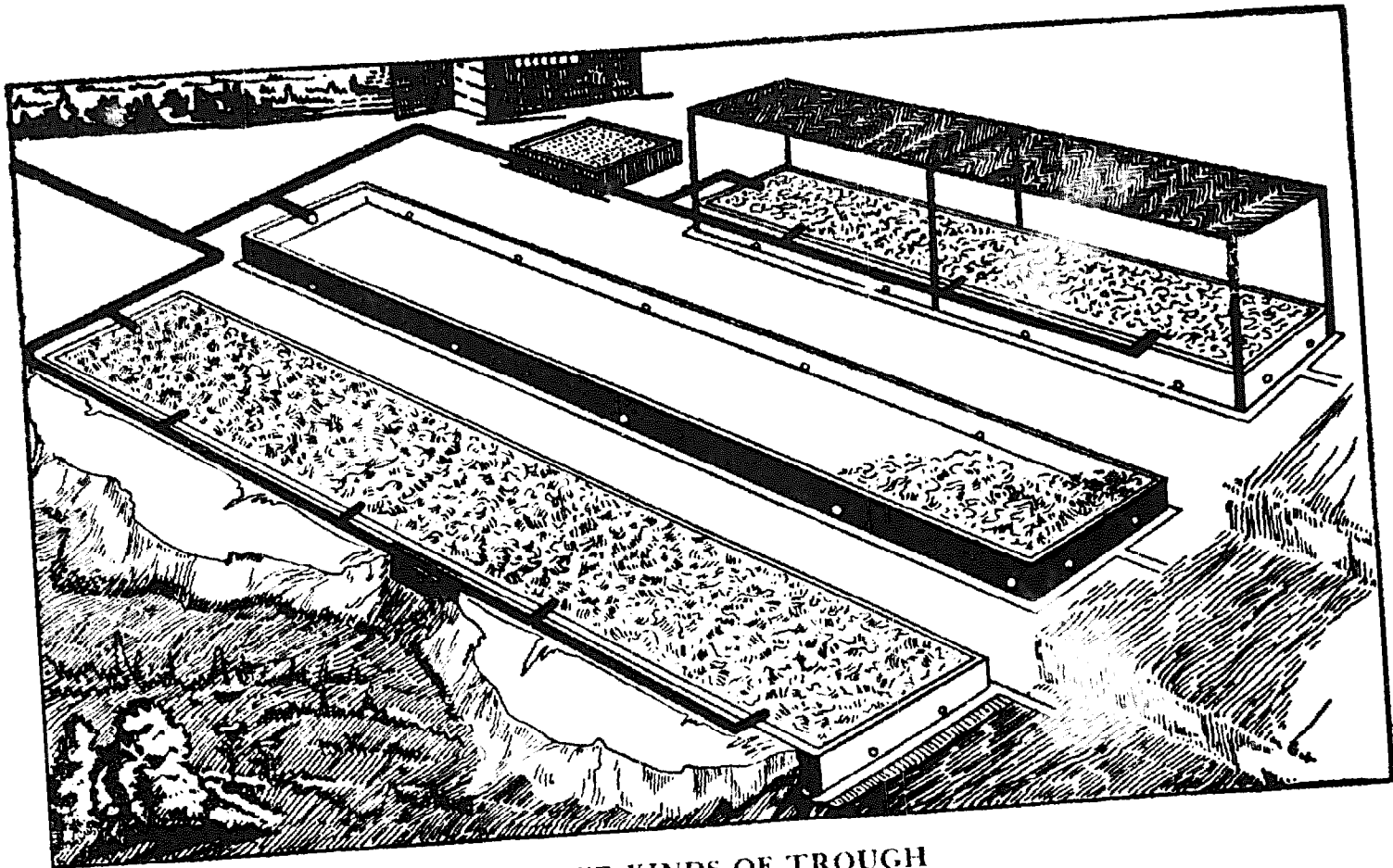

THE SYSTEM IN PRACTICE

THREE KINDS OF TROUGH

## HYDROPONICS—THE BENGAL SYSTEM

medium employed originally at Kalimpong consisted of a mixture of five parts of rock chippings ( $\frac{1}{4}$ " to  $\frac{5}{8}$ " grade) and one part of rock dust. Large mountain boulders, which are plentiful in the Darjeeling hills, were broken up with hammers to the required size. During this smashing process sufficient rock dust was obtained to provide the required percentage of sand-like material in the final mechanical analysis. There was therefore no need to add extra sand. Each trough or container, which had already been provided with small drainage holes at sides and ends, was filled to a depth of eight inches with aggregate, in which the chips and the sandy dust had been well mixed together.

### *Sowing of seed*

In some cases seeds were sown directly in the aggregate, but experience indicated that the best results could be obtained by germinating those with a diameter of under one-sixteenth of an inch, or very hard coated ones, in separate boxes, containing sand or some other extremely fine inert medium, and subsequently transplanting the seedlings when they had attained a height of three to four inches. Cereals and legumes were not transplanted, and had to be spaced out properly in the beginning. Before sowing, the aggregate was brought to the correct degree of saturation, dug over with a trowel or spade and raked smooth. As these were outdoor hydroponics, any refuse, dead leaves or weeds which had fallen on to the beds were removed. Weeds at no time proved a nuisance. Soilless culture is practically free from these pests.<sup>1</sup> No seeds of any variety were sown at a depth of more than

<sup>1</sup> In some other systems of hydroponics, weed growth has been reported to be troublesome in certain cases. The causes of this appear to be: too wide spacing of plants in troughs, lack of proper phytosanitary precautions, use of dirty or contaminated aggregates, or just poor management and inferior operational techniques.



27. Hydroponically produced maize presents an impressive sight against the soft cloud of a northern India sky

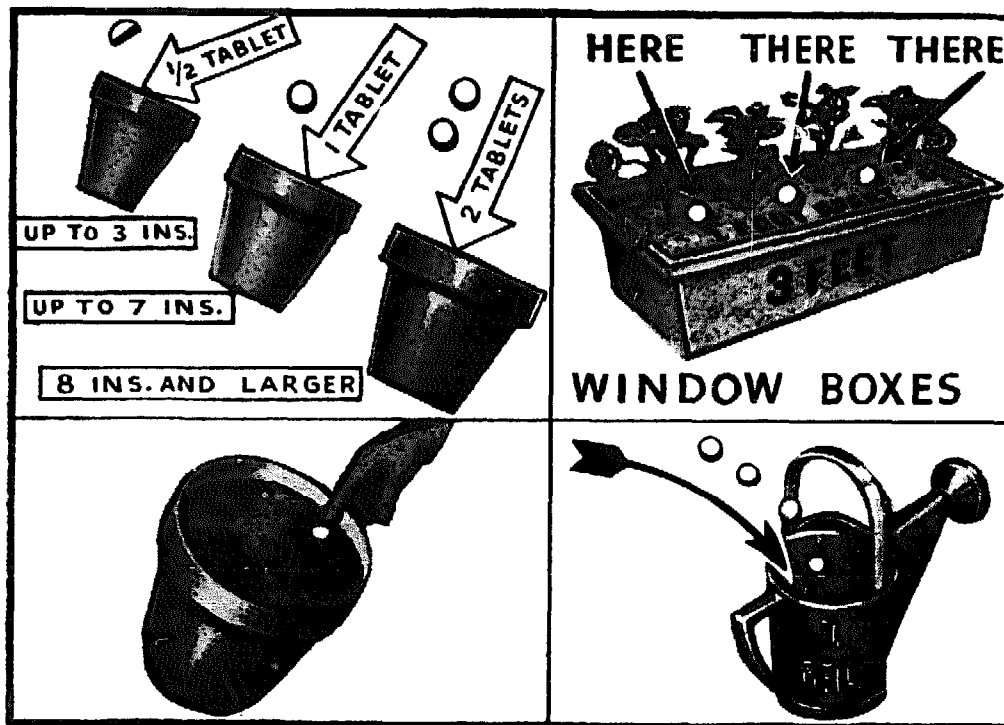

28. Using tablets in hydroponics

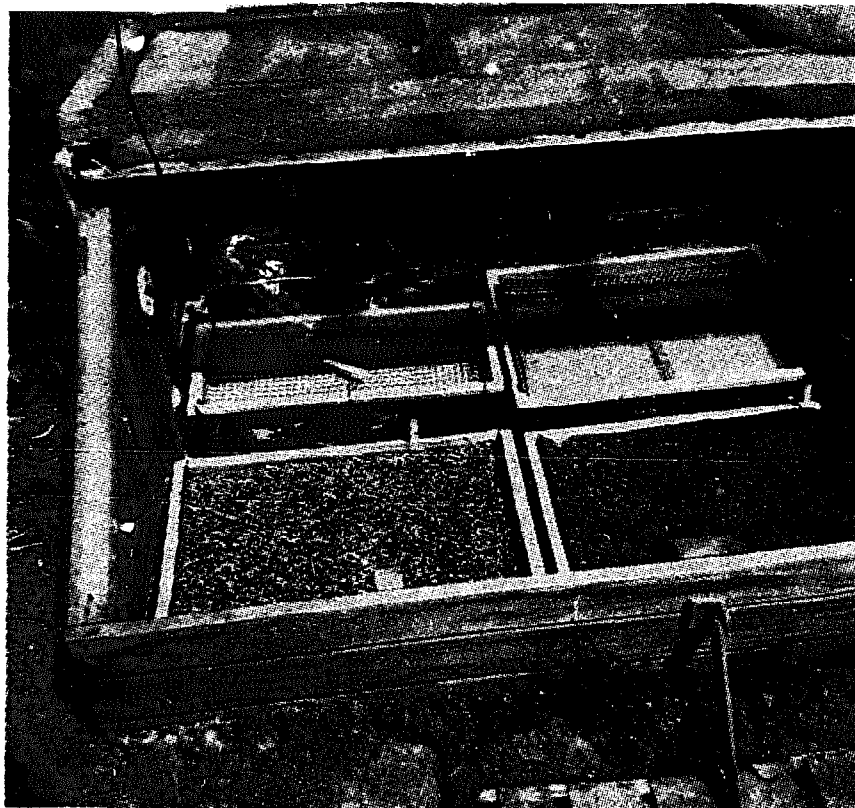

29. View of a small pilot grass production unit at IWOSC Pinner (U.K.) trials in 1968

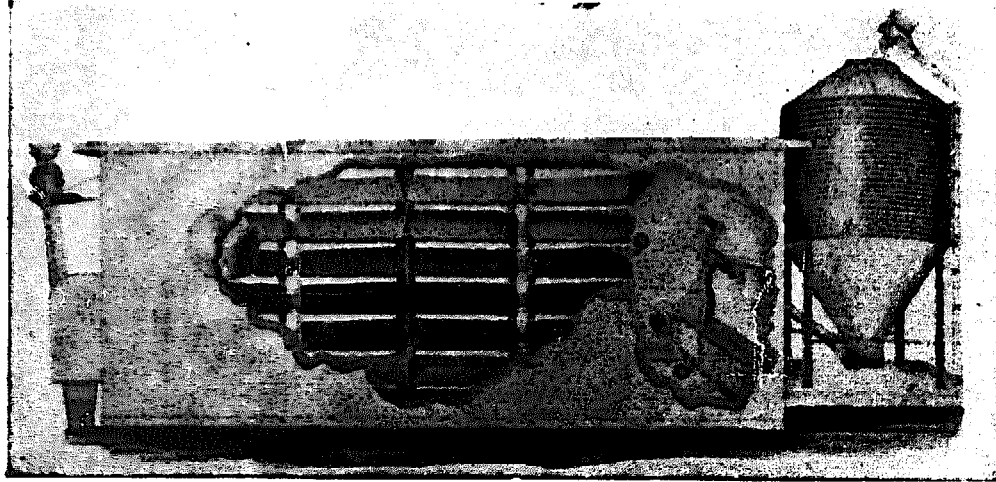

30. How an automatic hydroponic green forage unit looks inside. The cutaway section reveals the tiers of growing trays and the solution tanks. Such soilless 'grass factories' give immense yields

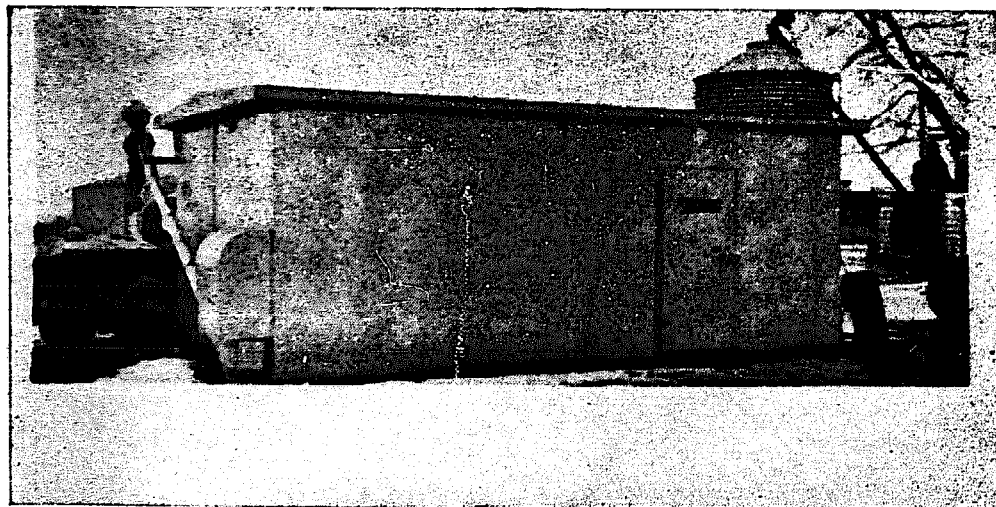

31. A factory-built installation for producing hydroponic grass and sprouted forage. Seed and grain is being poured into the hopper on the right, while on the left the auger device delivers the day's ration of greenfood. Normally, it takes under a week to turn the dry grain into palatable and succulent fodder for livestock



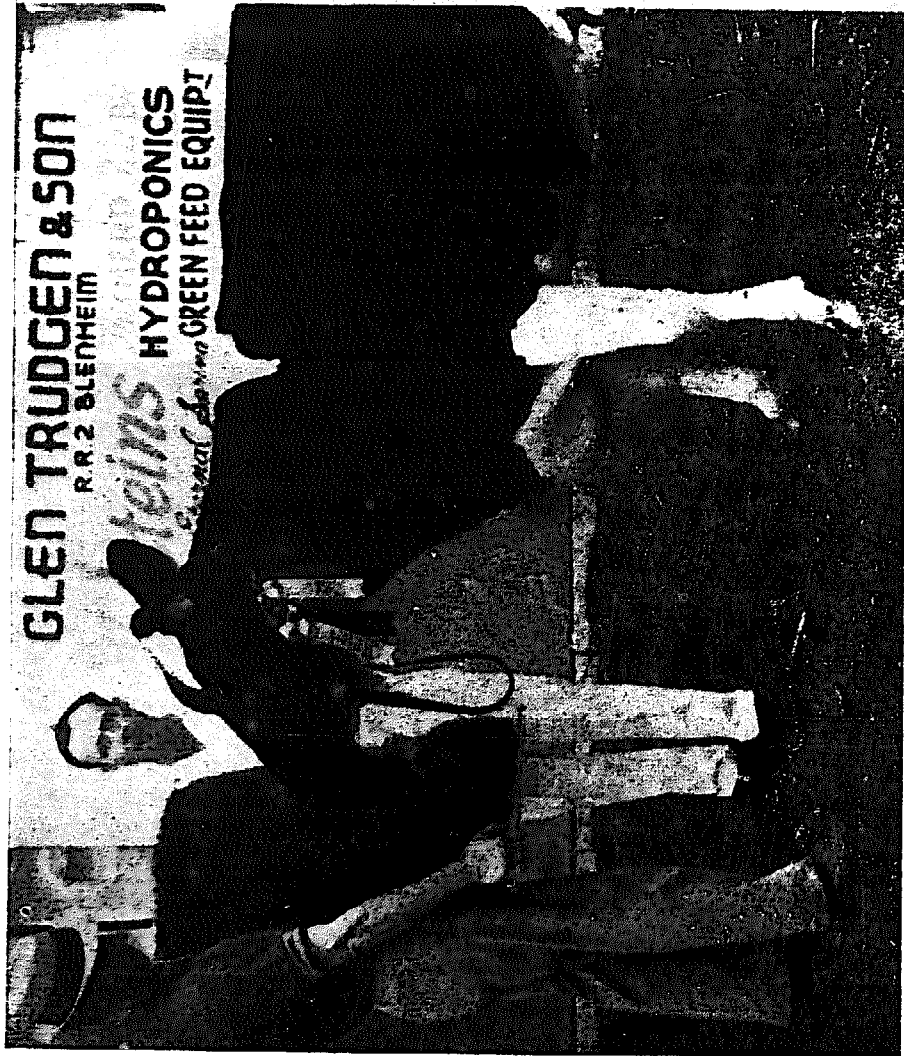

32. A prize-winning dairy cow enjoys her meal of hydroponic grass

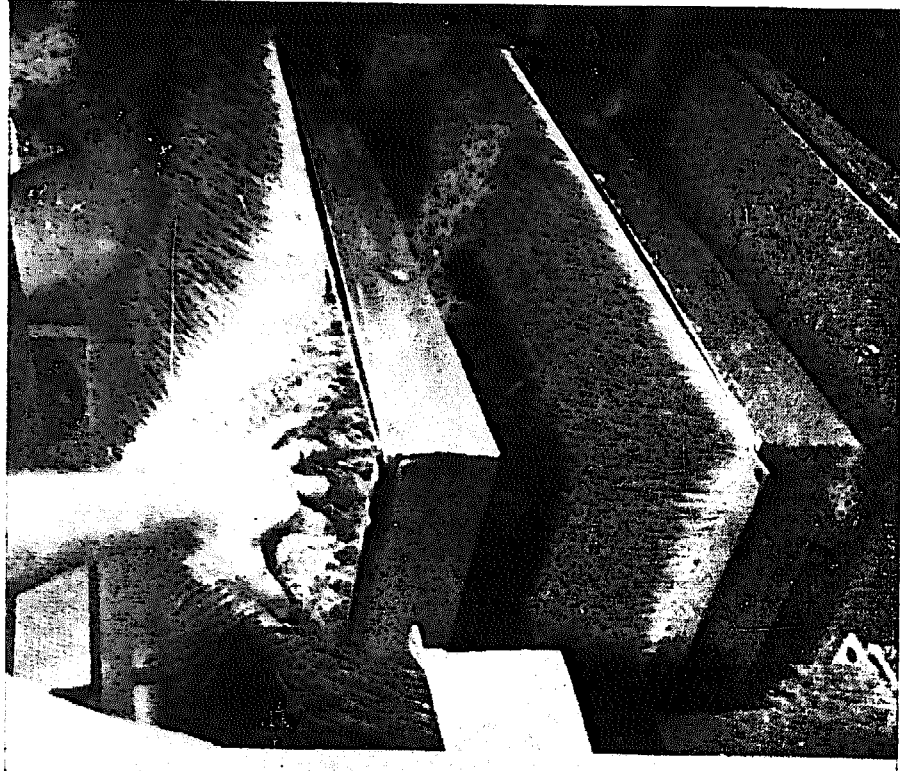

33. Fresh grass for farm animals. Roots, foliage and seed—all are edible, so there is no waste. Livestock love this feed

## THE SYSTEM IN PRACTICE

two inches. The smaller the seed the lighter has its covering of aggregate to be, and experiments soon showed that it was virtually impossible for a young shoot to force a way up from any greater depth than this in a hydroponic trough. In fact, for tomatoes and other small seeds it was found that a quarter to half an inch was ample. All crops were grown in straight rows parallel to the width of the bed so that nutrient salts might be applied without any difficulty.<sup>1</sup> Plants invariably established themselves immediately; there was no wilting. The operations of sowing and transplanting needed the same care and attention as in normal horticultural practice, and the skill of the operator was again called into question in determining the degree of saturation to be permitted in each trough. Care had also to be taken to protect young seedlings, especially maize and cabbage, from the depredations of mice, rats, and birds. Naphthalene balls placed on the surface of the aggregate at intervals were quite effective in repelling such pests.

### *Applying the nutrients*

No nutrient was applied to any crop until it had attained a height of about half an inch. Up to that time only water was given. In dry weather the chemical mixture was never applied more frequently than once every ten days. This period was even lengthened, but experience indicated that an inadequate supply of nutrient soon slowed up growth. Good results were also obtained by a weekly dosage of salts. As a normal rule it was found that the greater the quantity of chemicals the more rapid was development and the higher the yield, within of course the natural capacity of the particular species of plant,

<sup>1</sup>In large-scale units, operated with mechanical spreaders, crops may be sown or planted in rows parallel to the length of the beds, to facilitate movement of the distributing machinery, and allow uninterrupted passage of the drills. (See pp. 155-7.)

## HYDROPONICS—THE BENGAL SYSTEM

since too high a concentration would result in death or deformation. The actual formula which was at first employed corresponded to that numbered 10 in the chapter on Nutrient Mixtures (p. 66). The specified amounts of chemicals were weighed out, well mixed together, and applied dry either by hand or with a spreader. Considerable care was always taken to ensure that the salts were evenly sprinkled between the rows of crops and at no time was any chemical allowed to fall on plant stems or foliage. Periodic physiological observations were made and any deficiencies noted for correction by suitable adjustments. The heavy mountain rainfall exhausted a trough concentration of fertilizer salts fairly quickly, and it was then found necessary to increase the frequency of application to twice a week. The best way of fixing the amount of nutrient to be applied was to use as a basis the ratio of one ounce of mixed salts per square yard of bed surface, in which case intervals of up to ten days in the drier season, and five to seven days in the monsoon, gave satisfactory results. Immediately after the chemicals had been sprinkled over the troughs they were well watered in by a spray directed from a stirrup pump or by a garden can or pipe fitted with a rose. This carried them down to the root zone of the plants. There was no objection to dissolving the nutrient mixture in water and then applying it in liquid form. In fact, this procedure was frequently adopted.

### *What to do with tablets and slow-release mixtures*

Ready-made mixtures which come in tabloid form could either be applied whole if quickly soluble, crushed up to a powder and sprinkled over the growing medium, or else dissolved in an appropriate quantity of water and given in solution form. If the actual tablets themselves were applied straight from the packet it was necessary to push

## THE SYSTEM IN PRACTICE

them well down, at least four or five inches deep, into the growing medium near the roots of the plants. The quantities of any particular compound nutrients were also assessed by weight initially, but once the number of tablets to ounce or pound was known, computation could be more easily done by counting.

The slow-release fertilizers are a later development, although experiments have been going on for several years into the use of such materials for hydroponic cultivation. The main advantages of employing slow-release nutrients in soilless units have already been discussed on pages 70-73. As far as the amateur grower and the housewife are concerned, there is no doubt that these improved chemicals can be of help, since all mixing-up of different salts is eliminated. Commercial operators may also find that the labour saved when using slow-release fertilizers perhaps compensates for their extra cost. Nutrients of these types, including synthetic resins and sustanum, have been successfully employed at several centres where the Bengal system is installed, under varying conditions of climate.

It is best to weigh out the correct quantities of the various ion-exchange resins, or of the other carrier materials, just before the beds are prepared for sowing or planting. The procedure adopted at units in Europe, India, America and Africa, has been to mix the slow-release fertilizer thoroughly into the aggregate immediately prior to the initial irrigation. The rates of application will be found in Chapter 4. Both during experimental trials and in commercial production of market crops the plants were able to draw ample nourishment from the slow-release formulae for periods of up to six months. Only one dosage of the nutrient was necessary because the essential elements embedded in each carrier substance were made available to the roots

## HYDROPONICS—THE BENGAL SYSTEM

over lengthy intervals, and consequently no wastage or leaching occurred.

### *Watering*

The quantity of water to be provided daily was assessed by a simple calculation, based in the first place on normal horticultural practice. Water was allowed to run on to the dry aggregate in any particular bed until the medium had become sufficiently moist to support plant growth. The irrigation system was then shut off and notes made on such factors as evaporation and seepage. By careful observation over a few days, the exact number of gallons necessary for daily application to each individual sector in order to maintain it in perfect condition could be worked out. As the flow of water from the irrigation system was already known, all that remained was to open the pipes for a given period at desired intervals. The aggregate bed acted as a kind of sponge, through which the water spread evenly. Much depended on the climatic conditions—on very hot sunny days evaporation was quicker and some increase was necessary. Account was also taken of the natural rainfall.

The great thing was found to be to always keep the trough slightly moist, just like a damp sponge. It was best never to flood the aggregate to excess, or to allow water to stand on the surface. Should this occur the drainage holes required looking to. Nor, on the other hand, must the medium be allowed to get too dry or 'hard'.

Usually the water pipe was simply placed at one end of the trough, and the time noted. In the cold weather daily watering was unnecessary, twice or three times weekly being sufficient, but the very hot dry months of April, May, and the first part of June made two irrigations sometimes essential—early morning and evening.

## THE SYSTEM IN PRACTICE

To flood the troughs during the heat of noon was found to be a great mistake.

The rate of water consumption varies considerably in hydroponics, much depending on the local climatic conditions. At Kalimpong it was found that a trough of 1,000 square feet required 200 gallons per diem to keep it moist during the dry season, with daily temperatures of 80° Fahrenheit average. In Calcutta, although hot season temperatures are, on the whole, about 20° Fahrenheit higher, the climate is humid and water consumption is not appreciably greater, 1,000 square feet of trough space calling for about 300 gallons every day. Losses by evaporation can be checked by good shading. This compares favourably with soil requirements in India, where twice-daily waterings are needed in the hot dry times in horticultural work, averaging 1 gallon per square foot of soil surface.

In the colder areas, or at wet times, the rate of water used will be greatly reduced, either by lower evaporation losses, or by allowing some rain to fall on the troughs. On the average, the hydroponic grower will need to think in terms of a minimum of a quarter of a gallon daily for each one square foot of his trough surface space. Sometimes the requirement may be greater, and at other times it will be less, and at periods a bi-weekly application of water will suffice. The operator can easily judge what is called for, and the guiding rule in the Bengal system is to keep the aggregate constantly moist, just like a damp sponge that has been lightly wrung out. The beds should not be flooded (except at off-seasons to flush or sterilize them), nor should they be allowed to get too dry.

There are in all regions, no matter how arid the topography may be, underground supplies of water. These may be tapped by bore-holes, even sometimes at depths of several thousand feet. With soil cultures, it would not be economical to go to this trouble, but the yields and

## HYDROPONICS—THE BENGAL SYSTEM

returns from hydroponics are so good that it is a business proposition to utilize such sources of water. Furthermore, hydroponics conserves the available supply, since it is far more practicable to pipe whatever water may be obtainable into controlled soilless beds, than it is to dissipate it wastefully over the land, where much is soon lost in evaporation and seepage.

Portable sets which automatically distil fresh water from brine for use in hydroponic vegetable cultivation in desert or barren areas have also been evolved. A contraption like a dome, of glass or metal, acts as condenser. Under this the salt water is run into a series of trays surrounding a central column of paraffin wax or calcium chloride. The hot sun shining in the daytime evaporates

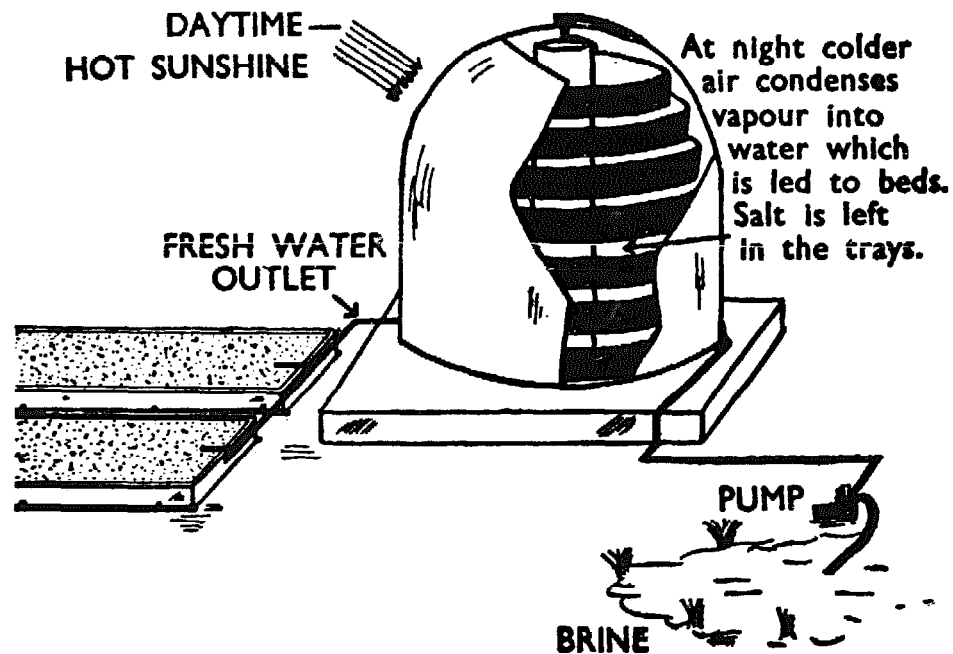

### FRESH WATER FROM BRINE

Portable device for producing fresh water from brine or saline ground-water in soilless units

the water as vapour, leaving the salt in the trays. At night the rapid cooling of the dome turns the trapped vapour

## THE SYSTEM IN PRACTICE

back into water, which then runs down the inside of the cover, and out into the beds through exit pipes. The trays are cleared and refilled periodically. By the use of this simple device, a constant supply of fresh water can be secured in the most unpromising sites, where a continental type of climate exists. Various other types of solar stills are available from manufacturers.

### *During wet weather*

The monsoon period which commenced in the third week of June took care of all watering for the next three or four months. The irrigation system was cut off. So was hand watering, reliance being placed entirely on the natural rainfall. During the month of July 1947, this averaged 1.55 inches per diem at Kalimpong (where the normal figure is a fairly high one of 95 inches annually). This meant a big excess in gallons, and all drainage holes had to be kept constantly open. However, the beds never became waterlogged, as local crops in soil did, and as quite often spells of a few days' dry weather intervened between downpours, the aggregate had a chance of aerating itself. A record of daily rainfall was kept.

### *Cropping area*

A reduction in the growing area compared with soil for a given crop, consequent upon the abundance of food available to each plant, was effected quite successfully. In some cases this economy amounted to nearly fifty per cent, and as a result of experience it may be safely said that the area of planting space required in hydroponics is often as little as half that needed in agriculture. Inter-cropping was at all times extensively practised.

### *Checking up*

The usual pH checks of moisture present in the growing medium were undertaken at weekly intervals. In



## HYDROPONICS--THE BENGAL SYSTEM

addition periodic tests were made of the irrigation water, and of the nutrient mixture, especially when alteration of the constituent chemicals of the latter was called for by variant climatic conditions. pH values were maintained between 6.0 and 6.5 although for certain crops some slight modification might be desirable.

### *Staking and spraying*

Normal techniques of staking and spraying were used and intercropping was extensively practised to save space. Garden or agricultural sprays proved very satisfactory for elimination of insect pests.

### *Reports from different localities*

During the years 1948-74 many interesting accounts of experiments done with the Bengal system came in from various parts of the world. From these several useful lessons were learnt, and as a result modifications could be effected for use in different areas. One experimenter in Uttar Pradesh found that during the hot early months of the year, shade was desirable. He fitted up his hydroponicum with overhead screens made of straw matting at a height of six feet. These satisfactorily excluded the strong, scorching, noonday rays from the troughs, while admitting both morning and evening sunshine. Excess evaporation was also prevented by the covers, which were removable. Broken-up bricks, with sand or brick dust added, proved excellent as a growing medium in several large towns, while cinders from the furnaces of a pottery factory near Calcutta were used with success in another instance. Drainage was always found to be most important: in one instance when a grower near Bombay neglected to provide it (he was utilizing old petrol and kerosene oil drums cut in half) the plants died from lack of aeration.

THE SYSTEM IN PRACTICE



WATER SUPPLY IN TERRACE CULTIVATION

## HYDROPONICS—THE BENGAL SYSTEM

Minor modifications or ingenious substitutions of a similar nature have enabled the Bengal system to give a good return in widely differing places. One Lucknow hydroponicist summed up his impressions of soilless culture in these words: 'I myself am thrilled at the results. The ease and simplicity of your Darjeeling method, the lack of labour and the way the plants have stood up to

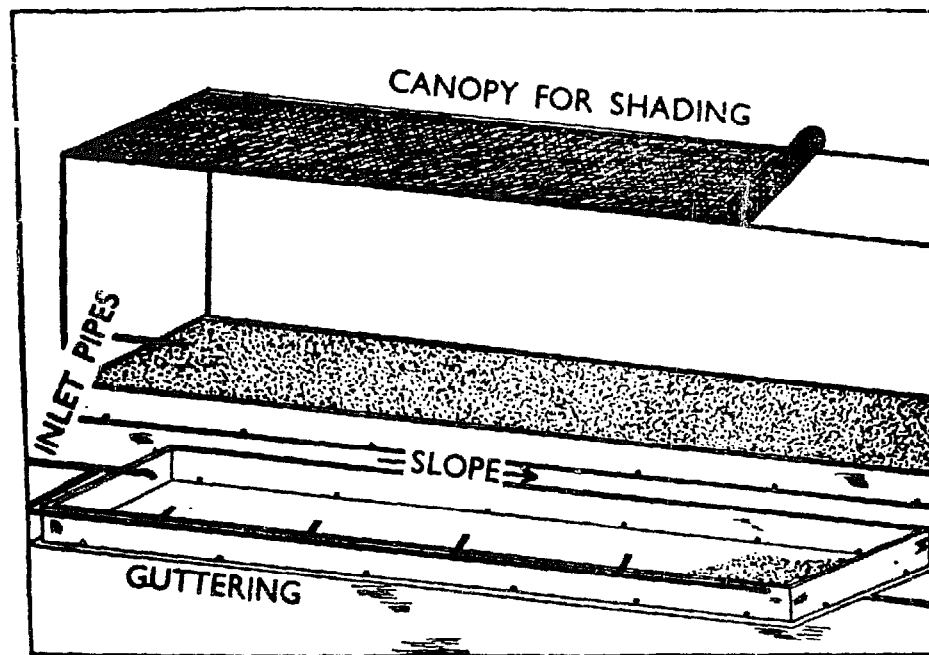

MATTING SHADES IN THE HYDROPONICUM

the harsh treatment of baring their roots periodically, just to satisfy my curiosity, have all truly amazed me. I have transplanted nine- to ten-inch tomato plants (now growing) into the trough with never a vestige of wilting; while much younger plants transplanted in soil have instantly drooped. Either by direct sowing or transplanting I have not lost a single plant in the trough. In all sincerity I can only repeat that I have been most pleasantly surprised.'

With the assistance of the local State Agricultural Department, experiments in growing tomatoes, kohlrabi,

## THE SYSTEM IN PRACTICE

cos lettuce, potatoes and onions, without using soil, were carried out in the garden of the Chief Minister of Uttar Pradesh during 1955-6. Commenting on the results, the Chief Minister said '... it does not require any complicated apparatus. Earthen pots or tin canisters can serve as containers, and the method can be applied successfully by any intelligent person. Without possessing a garden, he can grow fresh vegetables at home. I feel that steps should be taken by the Central and State Governments to popularize this method.' Subsequently, a demonstration unit was established in Lucknow, and was visited by the late Earl Attlee, who commented favourably upon the results, during his last tour of India.

In Bombay, a firm of chemical manufacturers operates a very efficient hydroponic installation, the produce from which is used to supply fresh green-food for the company's employees. The yield of vegetables and fruits is currently about two and a half pounds per square foot a season. Four or five successive crops are harvested annually. Extension of the unit is proceeding steadily.

Bengal methods have also given excellent results in East Africa, notably at Geita in Tanzania, where hydroponic gardens provided greenstuff for the staff and workers at a gold mine, and in Dar es Salaam, where a commercial installation was established near the city. In this latter case, existing groves of coconut trees supplied useful shade from the scorching equatorial sun, and troughs were made by excavating shallow depressions in the sandy ground and lining them with asphalt coated paper bags, formerly utilized for packing cement.

Other impressive work has been accomplished in the central Limpopo valley which forms the boundary between South Africa and Rhodesia. This is an arid barren region, with little surface water. By using underground supplies from boreholes, first class crops of horticultural

## HYDROPONICS—THE BENGAL SYSTEM

produce have been grown in what were formerly waste areas. Similar good returns have also been secured in other parts of the African continent, as well as in the Pacific and the Antipodes.

In Europe and the Americas, too, the Bengal system of hydroponics has been shown to be both practical and profitable under all kinds of conditions. Valuable trials have been conducted during the past ten years in cold places, where the operating techniques differ of necessity in minor details from those employed in hot lands, but apart from a few modifications, the method has remained basically the same throughout, producing fine yields under glass or out-of-doors.

The thousands of letters which continue to be received every year by the author give ample testimony of the efficiency and efficacy of these simplified soilless cropping techniques under the most varying circumstances and in all types of climates and regions. From these reports it has been possible to build up a mass of helpful information, which, supplemented by personal work and visits to numerous places, has greatly facilitated the extension and progressive improvement of the Bengal system, so that today there is hardly any major area in the world where there is not at least one hydroponic unit in operation, functioning efficiently and profitably thanks to the advice and guidance provided by the knowledge accumulated over the past twenty-five years.

## GENERAL TECHNIQUE

**T**HE beginner is strongly recommended to undertake a short preliminary period of experimental practice before launching out on a large scale. This will enable him to get the 'feel' of the method, and to ascertain if any local snags exist which will eventually necessitate the introduction of some desirable modification. Hydroponics is no fool's game, reasonable horticultural skill in watering, general cultural knowledge and some technical control being called for. But when reduced to practical terms, and especially when conducted by means of the Bengal method, soilless culture can be operated easily with the aid of proper advice and strict adherence to instructions.

### *Planting*

The reader is advised to germinate all small seeds, such as cauliflower or cabbage, tomato and lettuce in small boxes or pans full of sand or fine aggregate dust, afterwards transplanting the seedlings to their final positions in the growing medium of the main trough when a height of a few inches has been attained. Always take care not to damage the roots when lifting the plants. It is a good plan to keep a 'ball' of sand or dust around the base of each seedling during removal. This can be put intact with the young plant straight into the new situation in the permanent bed. If any difficulty is experienced in germinating tiny, delicate flower seeds like begonias or gloxinias the following scheme can be adopted: Place a large porous brick in a flat basin which

## HYDROPONICS—THE BENGAL SYSTEM

has been filled to a depth of two inches with water. On top of the brick place half an inch of fine sand, sloping this off along the edges at an angle of forty-five degrees so that it will not crumble away. The water in the pan below will keep the sand constantly and uniformly moist by capillary attraction. Lightly sprinkle the seeds on the surface of the sand, pressing them very gently down into it. Put the device in a shady spot, where the light is not too bright. Another simple method of propagation is to put the seeds between layers of damp blotting paper or muslin, in a covered bowl. Whatever medium is used for germination care must always be taken to see that it is kept at a proper degree of saturation. Too much water will kill the young plants, and encourage the fungoid disease known as 'damping off'. Undue dryness, on the other hand, will lead to burning and withering of delicate membranes, and for this reason a scorching sun, which causes excess evaporation, must be avoided. The reader will probably have observed how market gardeners always protect their seed beds by overhead shade, or some form of covering screens.

Cereals such as maize or oats, and leguminous crops like peas and beans, should not normally be transplanted. They are placed directly in the aggregate of the main trough. Rice can either be sown by broadcasting in rows, or else germinated in close planted batches and subsequently thinned out. In all cases of larger seeds the best technique is to make straight furrows about one or two inches deep in parallel lines across the width of each trough. Sow by dropping the seeds in, one by one, at the desired intervals apart, then rake back the displaced growing medium covering each row carefully and gently, pressing it down over each line. Very hard-shelled seeds can be first soaked in water for twenty-four hours. For a day or two after sowing, or when a seedling has just been transplanted, it is best to moisten the surrounding

## GENERAL TECHNIQUE

aggregate with a garden can or slow spray. Rough or injudicious watering must be refrained from: it is a frequent cause of failure, especially in the case of small seeds. A plentiful supply of air is required, and later light, but do not expose young plants to the midday tropical sun. Another point to watch is drainage; its importance cannot be overstressed. A wet, damp, cold aggregate or germination box will never give satisfactory results. Some seeds take much longer than others to germinate. Among flowers, larkspurs, clematis and anemones take from four to eight weeks. Celery, leeks, onions or potatoes sprout in about three to six weeks, but the majority of vegetables usually spring up within ten to fourteen days. Cuttings do well in sand. Bulbs have also

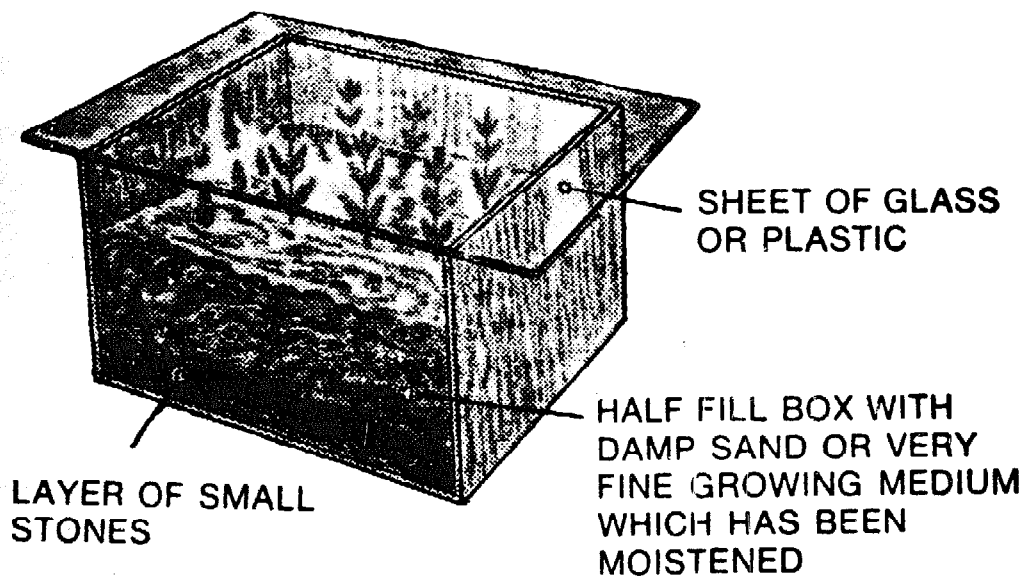

### ROOTING OF CUTTINGS IN HYDROPONICS

proved a success. Vegetables like beet or turnip need 'earthing-up' by putting a little extra aggregate around the roots as they grow to prevent them from becoming unduly exposed. When sowing seeds, or transplanting, and in doubt about the best distances apart to observe, it is easiest to take conventional soil rates as a guide,



## HYDROPONICS—THE BENGAL SYSTEM

reducing the gap between each seed or plant by as much as one half the normal space.

### *Intercropping*

Any well-planned hydroponicum will allow plenty of scope for careful intercropping. For instance several lots of radishes can be planted and interspersed with carrots. They would then be cleared before the carrots needed the room. An excellent technique of sowing quick-growing catch crops, like lettuces, sage, endive and similar species, amongst tomatoes, has been developed in Bengal. Other suggestions are potatoes and corn (maize), corn and pumpkins or cucumbers—a combination often adopted in the United States—lettuce and French beans, beans and sweet corn, or cabbages and celery. Many more combinations can be resorted to. A study of the time taken by various varieties to reach maturity will offer clues to the operator. In fact multiple cropping should always be resorted to in soilless culture. Never waste an inch of space or an hour of time in a hydroponicum. Sometimes the question of interspersing a catch crop like radish amongst tomatoes will arise. The operator does not wish to go to the bother of transplanting. How then to sow such small seeds direct into the coarser aggregate bed, between the existing plant rows? The easiest way is to mix the radish seed with a 'filler' of fine sand and scatter this straight on to the existing growing medium in the troughs between the tomatoes. Pelleted seeds and plastic seed strips are available for amateurs.

### *Seasonal variations*

In the majority of cases it is desirable to follow the normal seasonal crop changes. Any form of rotation is absolutely unnecessary, but generally speaking, in an outside hydroponicum, the question of temperature is pre-

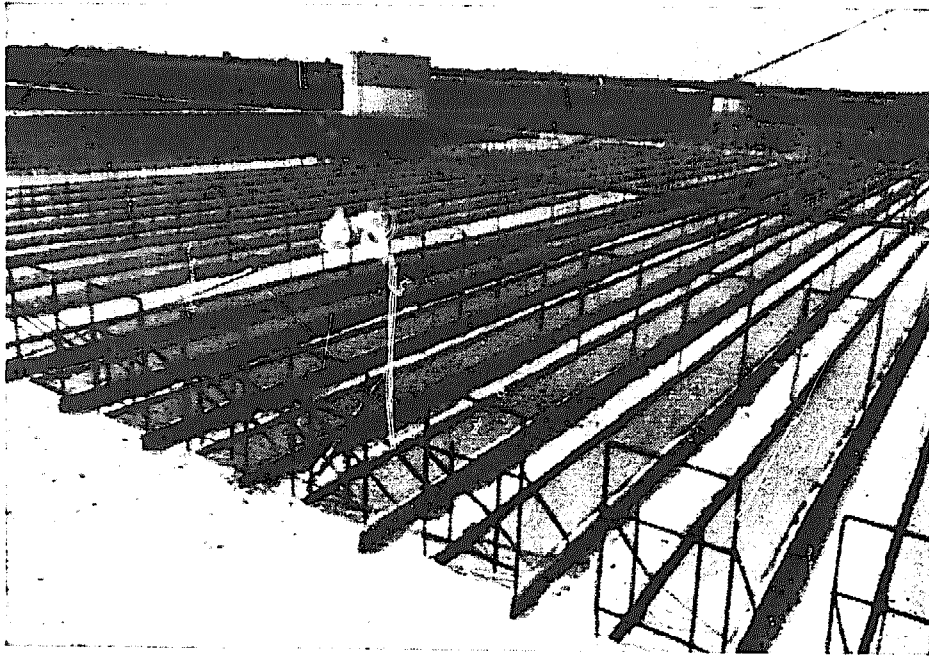

34. A newly-built soilless unit in Florida



35. Pineapples flourishing in hydroponic garden pots

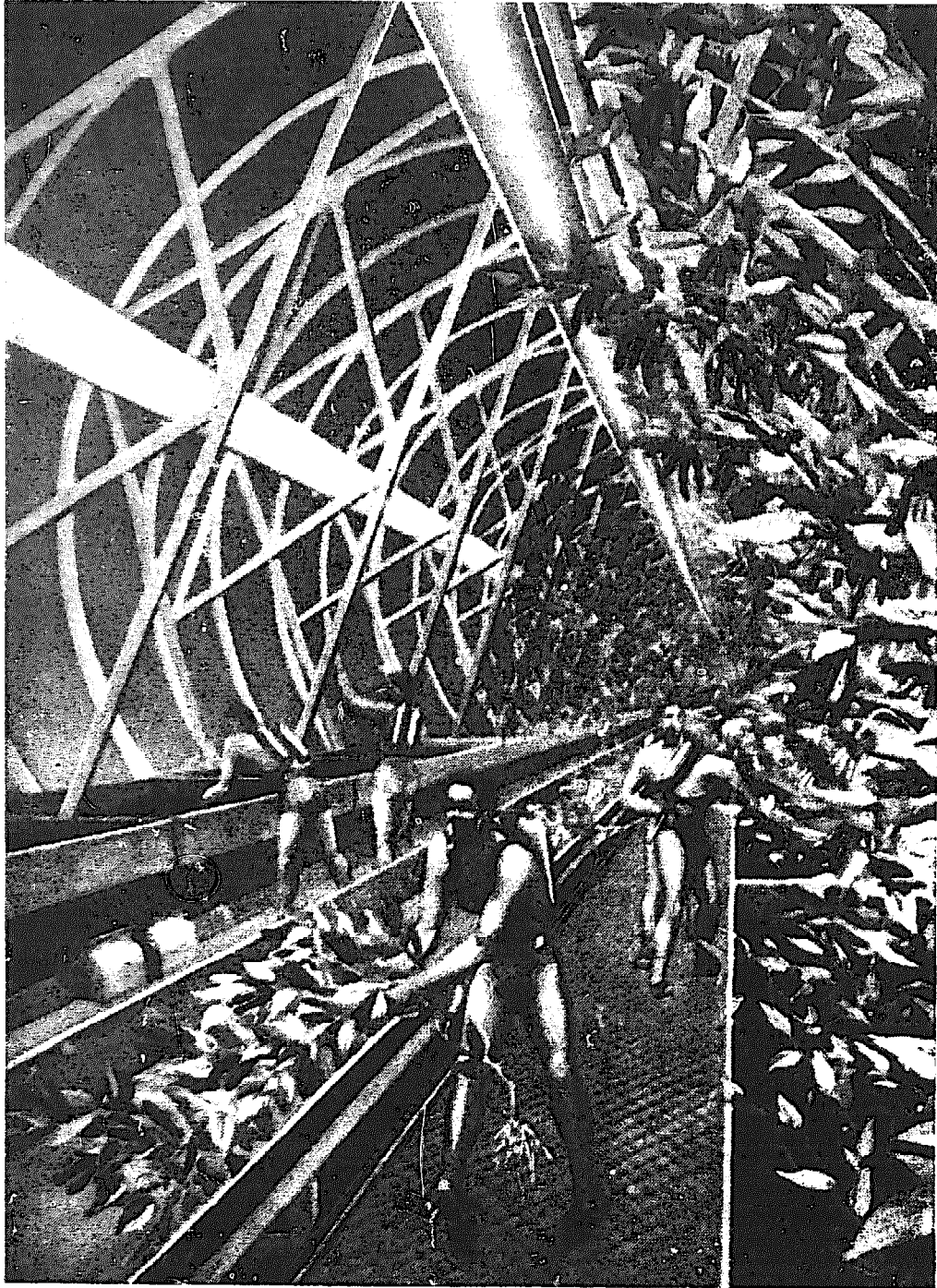

36. Giant Plants growing in CO<sub>2</sub> enriched atmosphere in a hydroponic space colony unit (Artist's impression).

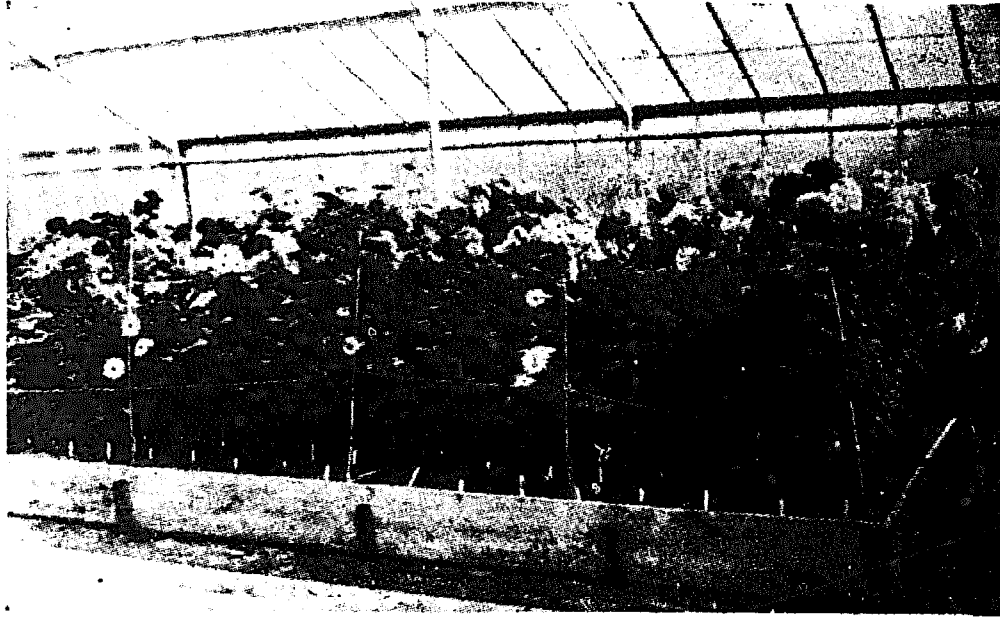

37. Hydroponic flowers



38. Chrysanthemums growing in a gravel aggregate



39 A fine tuchsia flourishing in a mixture of vermiculite and sand

## GENERAL TECHNIQUE

eminent. Certain plants cannot grow without enough warmth. Of course, if the gardener has a glasshouse, or an artificially heated or air-conditioned conservatory, he will be quite independent of any climatic condition, and can raise any crop just as and when he pleases. But for the person of slender means such an investment is often out of the question. Experiments have shown, however, that it is quite possible to grow certain vegetables in outdoor hydroponics irrespective of the time of the year, notably tomatoes during the monsoon, and some winter vegetables in the spring and early autumn, provided that shelter from a torrid sun is assured, or defoliation practised when the atmosphere is very humid. Varietal differences in each species are of considerable importance. One of the most urgent tasks confronting the Ministries of Agriculture in underdeveloped countries is to take steps to bring about an improvement in the quality of vegetable seeds available, and to introduce more satisfactory varieties to the public. Good seeds are difficult to obtain at present in many lands.

At first the hydroponicist should follow local soil practice fairly closely—for instance, cabbages and cauliflower in the cold months, and corn and various summer vegetables, like brinjals (egg-plant) and cucumbers during the monsoon—but as time goes on and experience perfects technique and knowledge, out-of-season crops may be attempted with confidence.

The growth and appearance of plants is a sure guide not only to the suitability of the nutrient mixture, but also to such factors as aeration, temperature and light. All these factors are important. Submersion of the root crown through waterlogging can cause complete collapse and death, although this never occurs with the Bengal method of soilless culture if the drainage system has been properly installed. Poor aeration starves young plants; they soon assume a peculiar appearance. Colour and

## HYDROPONICS—THE BENGAL SYSTEM

texture change, and a look of age prematurely imposed upon youth appears. Without light, formation of chlorophyll, which we have discussed in Chapter 2, will not take place, while low temperature means that certain species of plants just cannot grow at all. Again, excess heat prevents germination of some seeds such as lettuce, and fruiting of crops like cauliflower or broccoli. A good plan is to place lettuce seeds in the refrigerator for twenty-four hours before sowing in the hot weather. Mineral deficiencies and other common detriments are dealt with in Chapter 9, but brief mention may be made here of the practical technique of the nitrogen-potassium balance. Plants need less potassium in areas or times where or when there is brilliant sunlight than they do in cloudy, overcast places. It therefore follows that both for economy and best results the N-K ratio can be adjusted to correspond to climatic conditions. During dark winter days or dull monsoon months more potassium and less nitrogen salts should be given, but in bright daytimes when there is plenty of sunshine the converse applies—increase the nitrogen slightly and reduce the potash. Usually in India and neighbouring countries the winter and spring are sunny, and the rainy season is dull and cloudy. If plants grow slowly and are of an abnormally light green colour the concentration of nitrogen should in any case be increased. Again if development is very rapid, but weak, and tomatoes, for example, fail to flower or set fruit, the potassium supply should be stepped up. Changes should never be too small to produce marked effect.

### *Improving a growing medium*

An aggregate which has a high calcium content should be treated before use by leaching for a week with water containing sulphuric acid in the proportion of one quart to every hundred gallons. An excessively calcareous

## GENERAL TECHNIQUE

material can cause precipitation of phosphates from the nutrient salts which means that they are lost as plant food. Periodic disinfection of troughs, if required, can be accomplished by flushing them through with a solution of 1 per cent formaldehyde, followed by fresh water for several days. Or else the aggregate in the beds may be sterilized by using a solution of sodium trichlorophenate (Dowcide B) of 300 p.p.m., in water with 300 p.p.m. added of sodium hydroxide. Allow this mixture to remain in the troughs for twelve to twenty-four hours, then drain it off. Rinse through the growing medium with a second solution of 300 p.p.m., sodium hydroxide only in water, letting this run off too. Then flush well with two additional rinses of plain water to thoroughly cleanse the aggregate. Remember to wear rubber gloves during the work to protect the skin of the hands. Sodium hydroxide also has the merit of correcting over-acidity in growing media, and can be employed with good effect to bring cinders or other 'sour' materials into satisfactory condition for culture. SMDC sterilant is another suitable bed cleaning chemical. Use one gallon in 100 gallons of water. The incorporation of copper sulphate as a trace element, in the fertilizer mixtures, has been found to prevent the growth of algae or fungi in hydroponic beds. Should a very porous type of growing medium be employed, it is possible that a tendency will arise after some years for excessive quantities of nutrients to be absorbed by the aggregate. In such cases, a change of aggregate is recommended, but such an eventuality is unlikely before at least five years' continuous cropping has taken place.

### *Points to watch in household culture*

Plants grown in a room must be shielded from artificial light at night. Too much illumination besides being harmful deprives them of their rest period or 'sleep'. It



## HYDROPONICS—THE BENGAL SYSTEM

is also a good thing to gently spray the foliage of indoor plants with water now and then, so as to remove dust from the leaves, which would otherwise clog the pores and prevent proper breathing. Ventilation is another important item. Excess tobacco smoke, gas or oil fumes are toxic to crops. During the day, see that the containers receive their due share of early-morning and evening sun, but do not allow them to be exposed to the scorching glare of noon. Certain cold-climate species will be affected

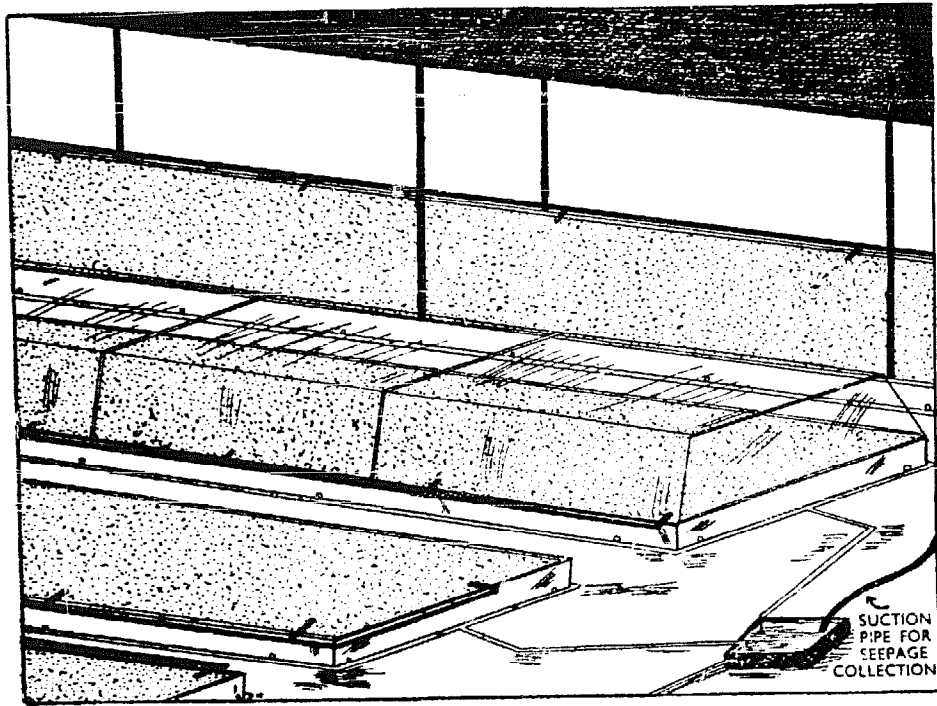

### PROTECTION OF HYDROPONIC TROUGHS AGAINST WEATHER

The centre bed is fitted with a glass cover, or cloche.  
Plastic perspex, or polythene, can also be used.

by great external temperatures while frost will speedily kill off tropical or warmth-loving plants. Indoor household or greenhouse crops may need artificial fertilizing, if they are situated where bees cannot visit the flowers.

## GENERAL TECHNIQUE

This can be done by very gently rubbing each bloom in turn with a very soft brush, rabbit's tail or cotton wool. If uncertain how to do this, ask a gardener to demonstrate. But, generally speaking, if bees and moths are encouraged to settle on the flowers—and this can be done by opening the windows day and night—artificial pollination is unnecessary.

### *Supports*

For commercial installations the most economical method of providing support for climbing crops or vines, like tomatoes, is to build a series of permanent posts into the framework of the troughs. Strong wire can be stretched between these and plants trained up them. The householder can easily utilize sticks, or canes. Normal horticultural practice should be followed.

### *Pests*

Insects may cause trouble to the soilless culturist. Suitable agricultural sprays such as pyrethrum and some others are the best preventives. Ground pests which live in soil, such as wire-worms and leather-jackets, do not frequent hydroponica, since they could not live in a chemically charged aggregate. Ants and termites can be checked with a powdered insecticide. Brief details of various methods of control for other pests and common troubles will be found in Chapters 9 and 10 of this book. Soilless culture is practically free from soil diseases, but insects must be guarded against, especially caterpillars, slugs, green and white flies, or red spider.

### *What to do if things go wrong*

The Bengal method of hydroponics is a tested and successful system. If the instructions given in this book are

carried out properly no fear need be entertained of serious trouble arising. Sometimes, however, difficulties and snags may come up owing to the inexperience of the operator or some special local condition. Novices with no gardening knowledge, whose only previous acquaintance with plants has been to buy them as ready-produced flowers or vegetables at shops or market stalls in towns, are warned to be on the watch for impediments. When faced with a dilemma, which is generally only petty trouble, easy of solution to any amateur or professional horticulturist, do not worry. Simply go carefully through this book, and if there is any friend or acquaintance who has any gardening or scientific knowledge, he or she should be called in to help.

The chapter on Common Deficiencies will often prove of help, but for those readers who may find it too advanced we give here a list of possible difficulties in question form. Should a grower, whether a commercial operator or just a housewife raising egg-plants and tomatoes for the family supper, run into trouble, a solution can often be found by mentally checking over these points. Remember that bad seed may often be at the root of the evil.

*Trouble*—Plants wilting and dying off.

*Possible Causes*—Growing medium too wet? Waterlogged? Are drainage holes functioning? Too dry? Excess salts? Lack of aeration? Presence of noxious fumes? Frost? Too hot? Toxic material in trough? Inattention to instructions? Careless mixing of nutrients? Insect pests? Bad ventilation? Rough transplanting, causing injury to roots? Fungoid disease? Atmospheric conditions too humid? Careless handling by child, or damage by animals? 'Damping-off'? Sown too thickly?

## GENERAL TECHNIQUE

*Trouble*—Slow growth.

*Possible Causes*—Lack of nitrogen? Insufficient nutrient salts? Poor light? Plants not getting the chemicals? Dirty foliage? Is the temperature insufficient? Insanitary conditions?

*Trouble*—No fruit.

*Possible Causes*—Are bees visiting the flowers? Has artificial fertilization been carried out if they are not? Is the potassium supply adequate? Is the place too wet? Too dry? Were the seeds buried too deep? Were the seeds bad or weak? Excessive acidity?

*Trouble*—Bad or no germination.

*Possible Causes*—Are the troughs or the sand boxes too wet? Too dry? Were the seeds buried too deep? Did ants steal them? Or birds, rats and mice eat them? Was the seed of poor quality? Excessive watering? Aggregate too cold? Season too hot?

*Trouble*—Yellowing.

*Possible Causes*—Too much shade? Iron deficiency? Lack of some mineral element?<sup>1</sup> Moisture dripping from overhead galvanized pipes? Aggregate too calcareous? Insufficient nutrient? Salts falling on foliage through careless application? (This generally follows from failure to sow plants in straight rows parallel to width of bed, as instructed.) Chlorosis?<sup>1</sup>

<sup>1</sup> See Chapter 9.

# HYDROPONICS—THE BENGAL SYSTEM

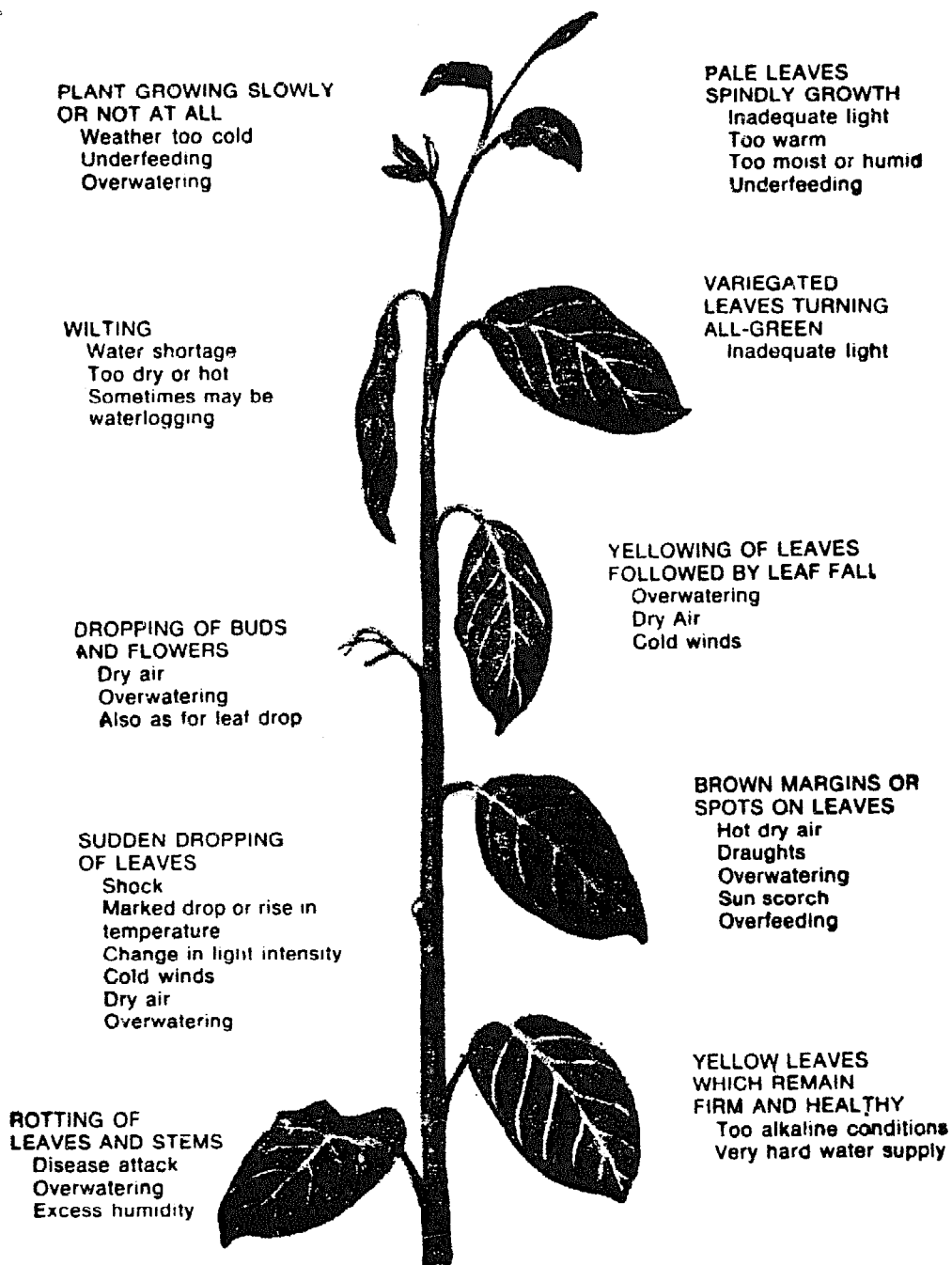

**PLANT GROWING SLOWLY  
OR NOT AT ALL**  
Weather too cold  
Underfeeding  
Overwatering

**PALE LEAVES  
SPINDLY GROWTH**  
Inadequate light  
Too warm  
Too moist or humid  
Underfeeding

**WILTING**  
Water shortage  
Too dry or hot  
Sometimes may be  
waterlogging

**VARIEGATED  
LEAVES TURNING  
ALL-GREEN**  
Inadequate light

**DROPPING OF BUDS  
AND FLOWERS**  
Dry air  
Overwatering  
Also as for leaf drop

**YELLOWING OF LEAVES  
FOLLOWED BY LEAF FALL**  
Overwatering  
Dry Air  
Cold winds

**SUDDEN DROPPING  
OF LEAVES**  
Shock  
Marked drop or rise in  
temperature  
Change in light intensity  
Cold winds  
Dry air  
Overwatering

**BROWN MARGINS OR  
SPOTS ON LEAVES**  
Hot dry air  
Draughts  
Overwatering  
Sun scorch  
Overfeeding

**ROTTING OF  
LEAVES AND STEMS**  
Disease attack  
Overwatering  
Excess humidity

**YELLOW LEAVES  
WHICH REMAIN  
FIRM AND HEALTHY**  
Too alkaline conditions  
Very hard water supply

## SOME TROUBLES AND THEIR POSSIBLE CAUSES

## NOTES ON OTHER METHODS

**A**LL the successful systems and methods of soilless culture which have been developed fall into one of five classes—solution culture, sand culture, aggregate culture, mixed aggregate culture, and miscellaneous culture devices. From a commercial point of view numerous different techniques are practicable, but normally the choice of any particular one will be governed by prevailing local conditions. Such factors as climate, meteorology, availability of apparatus and financial limitations must prove decisive. Amateur gardeners and householders will, generally speaking, prefer to use the simplest and most easily constructed growing units available.

### 1. SOLUTION CULTURE

With Dr Gericke's method waterproof troughs or benches of any suitable material are constructed. A wire grid fits closely over the top of each tank, which contains the nutrient solution. This grid serves as a support for the growing plants, whose roots descend through the mesh into the liquid below. A covering of wood wool (excelsior), peat or shavings, or some other inert material serves to exclude light from the solution, besides giving additional support and protection to the crop. Aeration of the root system is ensured by adjusting the level of the nutrient so as to leave an air space between its surface and the base of the wire grid.

Although excellent results have been obtained by the use of the Gericke method, it must be remembered that in

## HYDROPONICS—THE BENGAL SYSTEM

every case these experiments were conducted under the climatic conditions of California, where the strong sun and high light intensities are distinctly favourable to the liquid culture system. When tried out by growers of the Middle West, and later, on their introduction into Britain, hydroponica of this type proved partial failures due to lack of aeration of the root system. It is practically certain that this is due to the number of consecutive cloudy days in these areas.

Solution culture is expensive to instal, because it is essential to make the troughs waterproof, but there is a definite saving in chemicals and fertilizers, since none of the valuable salts are lost. It is, however, difficult to support the plant, and the cost of artificial aeration in localities where this is necessary would be high. The moist atmosphere of Bengal, together with the annual monsoon rainfall, as well as certain other factors, render the introduction of the Gericke method into eastern India difficult. Nevertheless there can be no doubt that this system, combined with a dry sunny climate, gives a good yield.

An adapted form of water culture is being employed with considerable success in Poland. The plants are placed in a layer of brown coal mixed with peat on a gauze of nylon and metallic wire, laid over the top of the solution tank. A space of about  $1\frac{1}{4}$  inches is left between the surface of the nutrient solution and the bottom of the gauze. This guarantees good aeration because it is kept in open contact with free air from outside by holes in the wall of the tank. The solution is non-circulating and is not renewed during the culture, and only replenished according to consumption by the plants. The tanks are disinfected for every new crop and a fresh solution made up. The Polish technique, which is known locally as the Wroclaw method, has been found to be cheaper to operate than gravel

## NOTES ON OTHER METHODS

culture. (See diagram on page 4: Dr Gericke's original method of soilless cultivation of plants).

### 2. SAND CULTURE

#### (a) *New Jersey Methods*

In the original New Jersey system the required nutrients were supplied by mixing the necessary chemicals in an elevated tank of water from which the solution flowed by gravity to impregnate the bench of sand in which crops were grown. Later this was abandoned in favour of waterproof troughs into which the liquid nutrient was forced several times a day by an electrically driven centrifugal pump.

The disadvantages of the New Jersey, or Withrow methods as they are known in the Middle West, are the initial outlay required and the fact that culture under glass is essential, because rain falling on a hydroponicum of this description would destroy the regulated balance of the entire system. On the other hand, completely automatic operation is ensured and labour charges are reduced to a minimum. (See diagram on page 27: Household sand culture.)

#### (b) *Surface Watering System*

The plants are grown in improvised beds or pots containing sand, the requisite nutrients and water being supplied in solution from a hosepipe or garden can to the surface of the medium. Free drainage is permitted, and watertight troughs are unnecessary. Considerable wastage of fertilizers, however, is bound to occur with the Surface Watering System. Heavy rainfall might lead to waterlogging of the troughs. In addition, labour may well become an expensive item as at least three or four applications of the nutrient solution are required weekly.



## HYDROPONICS—THE BENGAL SYSTEM

### (c) *Automatic Dilution Surface Watering System*

In order to reduce the amount of labour and space required for the storage of liquid nutrient, Jealott's Hill Research Station introduced a method of automatically diluting a concentrated solution, and of applying it by means of a system of sprays to the sand bed.

A low-pressure main water supply is needed, in addition to an Autominor injection pump and a ten gallon reservoir. Improved drainage is obtained by a layer of  $\frac{3}{4}$ " gravel on the bottom of the troughs underneath the sand.

### (d) *Drip Culture System*

By means of a feed line, diluted nutrient solution contained in an upper tank is allowed to drip continuously on to a bed of sand in which plants are grown. The solution percolates through the medium, is collected in a sump and pumped back to the reservoir at intervals. Waterproof troughs are necessary, and regular pH testing of the cultural mixture is essential.

### (e) *Dry Application System*

This is another modification of the sand culture method. Dry mixed nutrient salts are sprinkled periodically over the beds and immediately watered in. This is a very simple and economic practice; but the possibility of an outdoor hydroponicum worked on this principle becoming so saturated during a wet season that death may ensue owing to consequent submersion of the plants' root crowns should not be overlooked.

## 3. AGGREGATE CULTURE

### (a) *Sub-irrigation System*

A watertight trough, filled with  $\frac{1}{8}$ " to  $\frac{3}{8}$ " gravel or some other aggregate coarser than sand to a depth of 6", is periodically flooded with dilute solution from below,

## NOTES ON OTHER METHODS

and then allowed to drain. Each bed is built from precast concrete, jointed with asphalt or lined with polyethylene sheeting; other necessary apparatus consisting of a reservoir sunk below ground level, and a centrifugal pump. The entire system is automatic and by virtue of the ebb and flow of the liquid nutrients, the roots of the plants are well aerated. Periodic renewal of the solution is essential. A time clock is used to control irrigations.

Simpler units, which do not require pumps and are operated manually, can be installed for household use.

### (b) *The Flume*

This is a device for use with sub-irrigation, consisting of a curved artificial channel down which the liquid nutrients are directed, so that each trough may receive a correct

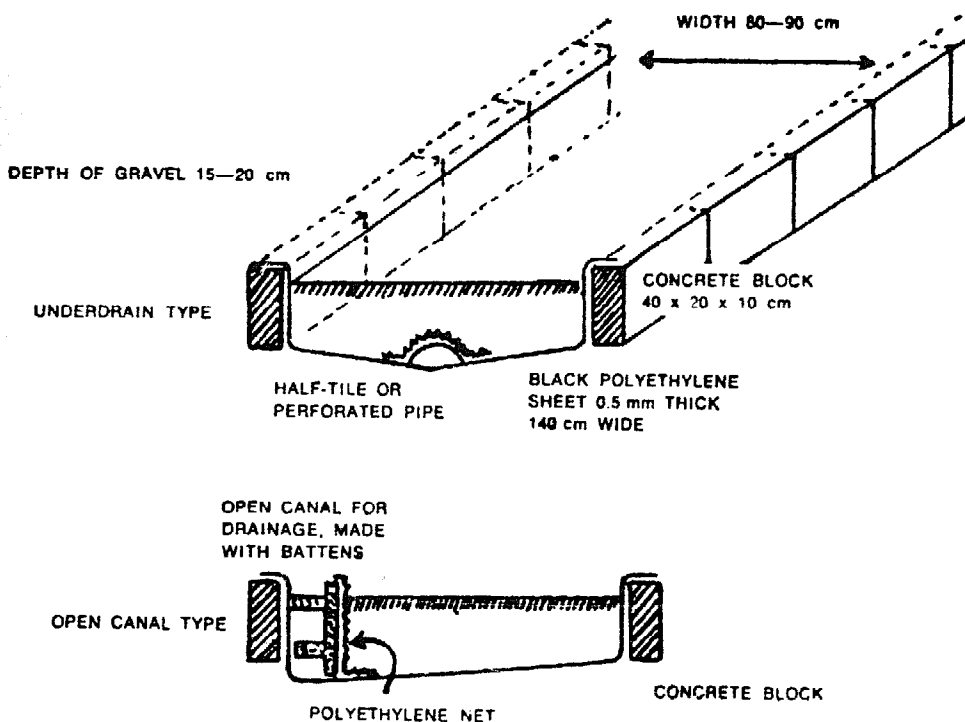

## SUB-IRRIGATION LAYOUT AND DESIGN

## HYDROPONICS—THE BENGAL SYSTEM

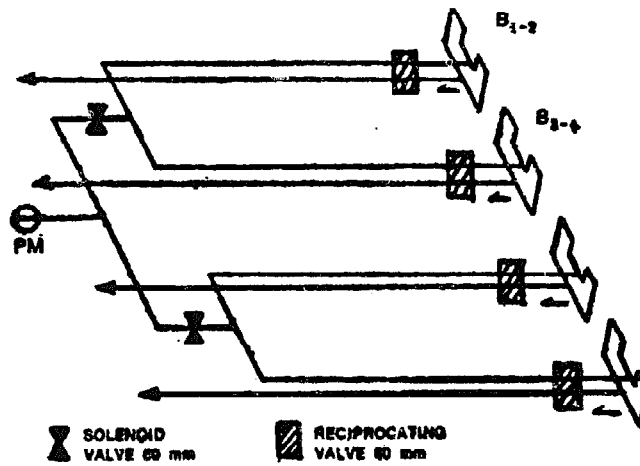
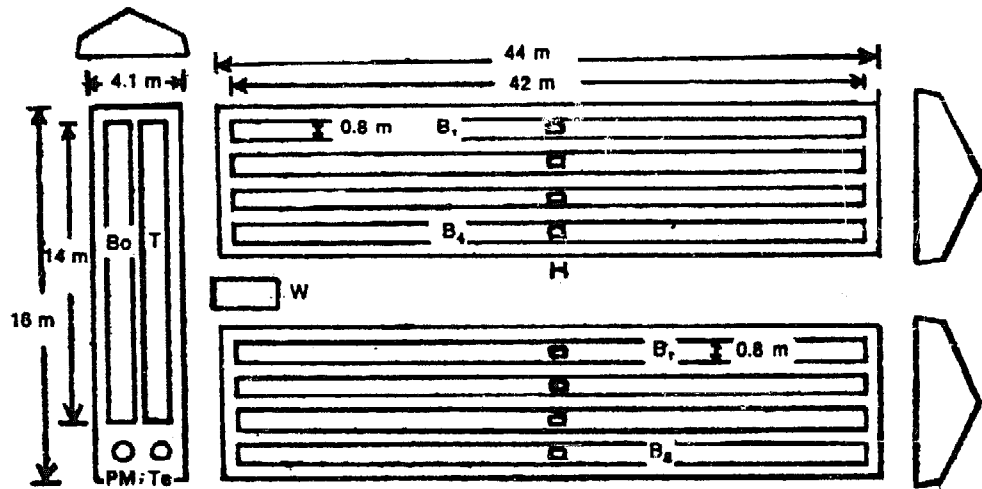

### TROUGH CONSTRUCTION

Unit installation in Japan. (Area 666 m<sup>2</sup>).

- Key: B<sub>0</sub> Propagation troughs, 1.2 m × 14 m, 2 rows  
 B<sub>1</sub> — B<sub>8</sub> Growing troughs 0.8 m × 42 m, 8 rows in sets of 2  
 T underground solution tank  
 Te tank entrance  
 PM feeding pump and motor 60 mm 15 HP  
 H end box for feeding and drainage  
 W boiler for heating

proportion as the solution passes it. Flumes have been employed successfully by growers in Florida.

### (c) *Ring Culture*

This is a modified form of aggregate culture, and has

NOTES ON OTHER METHODS

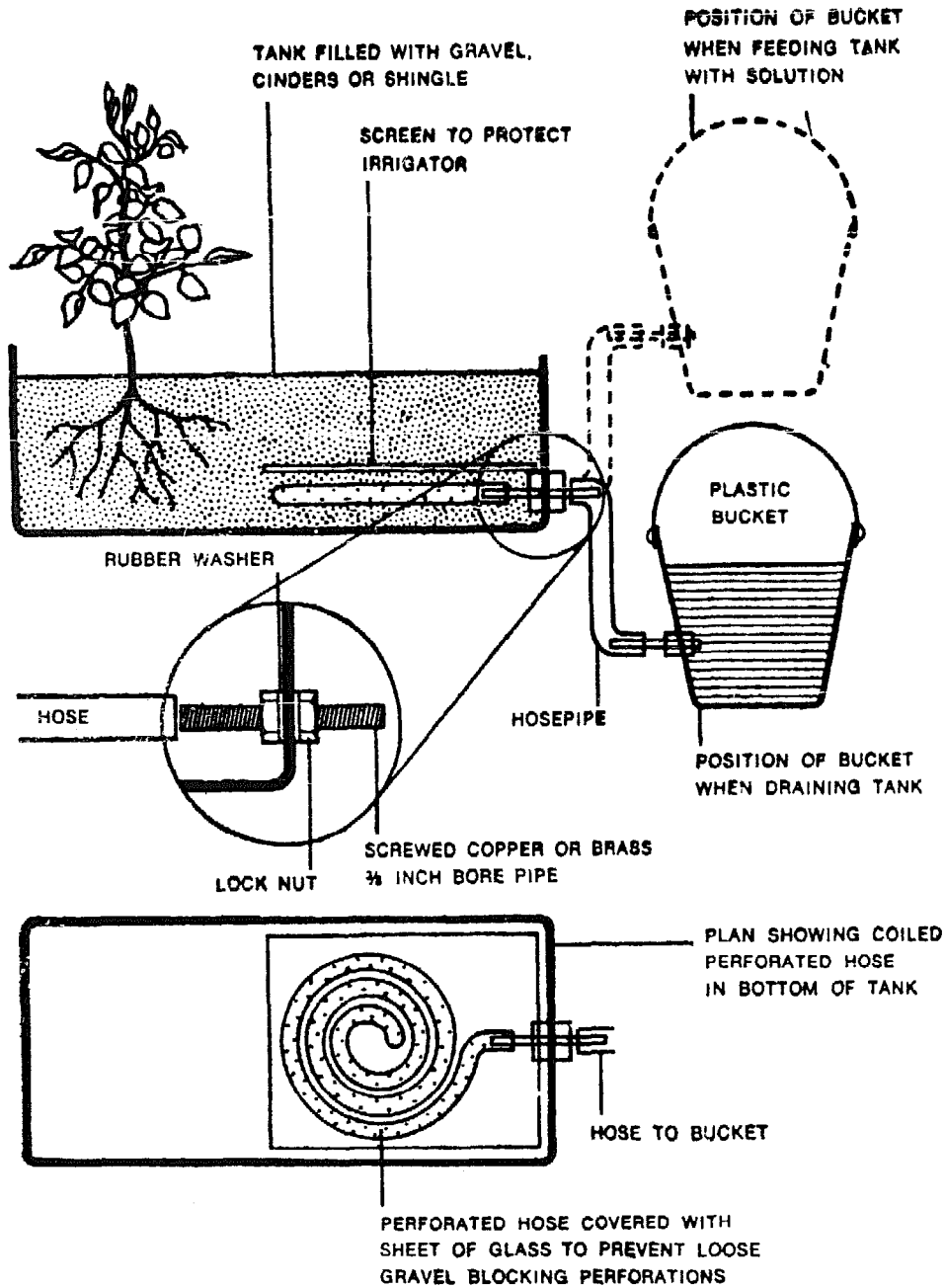

SIMPLE HOUSEHOLD AGGREGATE CULTURE

Design for manually operated unit

been found to be most efficient in damp areas or during periods of heavy rain. Plants are grown in pots or containers, filled with soilless compost—usually peat and sand

## HYDROPONICS—THE BENGAL SYSTEM

mixtures fortified with nutrients—and generally one to each individual receptacle. The pots are then stood upon beds of moderately coarse aggregate, such as cinders, stones, broken bricks, or pebbles. Any number of containers may be grouped together. The plants' roots descend from the pots into the aggregate below. When necessary, water is supplied to the sub-stratum and the soilless compost in the pots is kept moist. Other variations and modifications are often used.

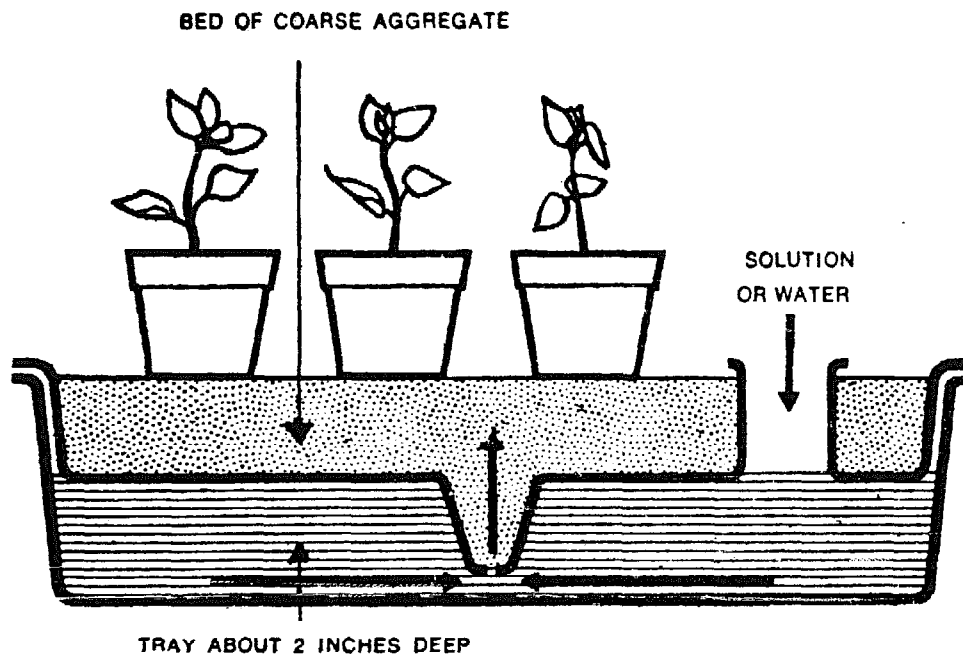

A TYPE OF RING CULTURE

### 4. MIXED AGGREGATE CULTURE

The Bengal system, and other similar techniques, fall under this heading. Mixed aggregates are used, generally composed of certain proportions of gravels and sand. Sometimes, vermiculite, leca—a product of cement-making, and other suitable substances are added to prepare satisfactory growing media.



10. A view of soilless beds, Calcutta.



11. A smiling housewife feeds her tomato plants with nutrient salts on the roof of her flat, with ease and comfort.

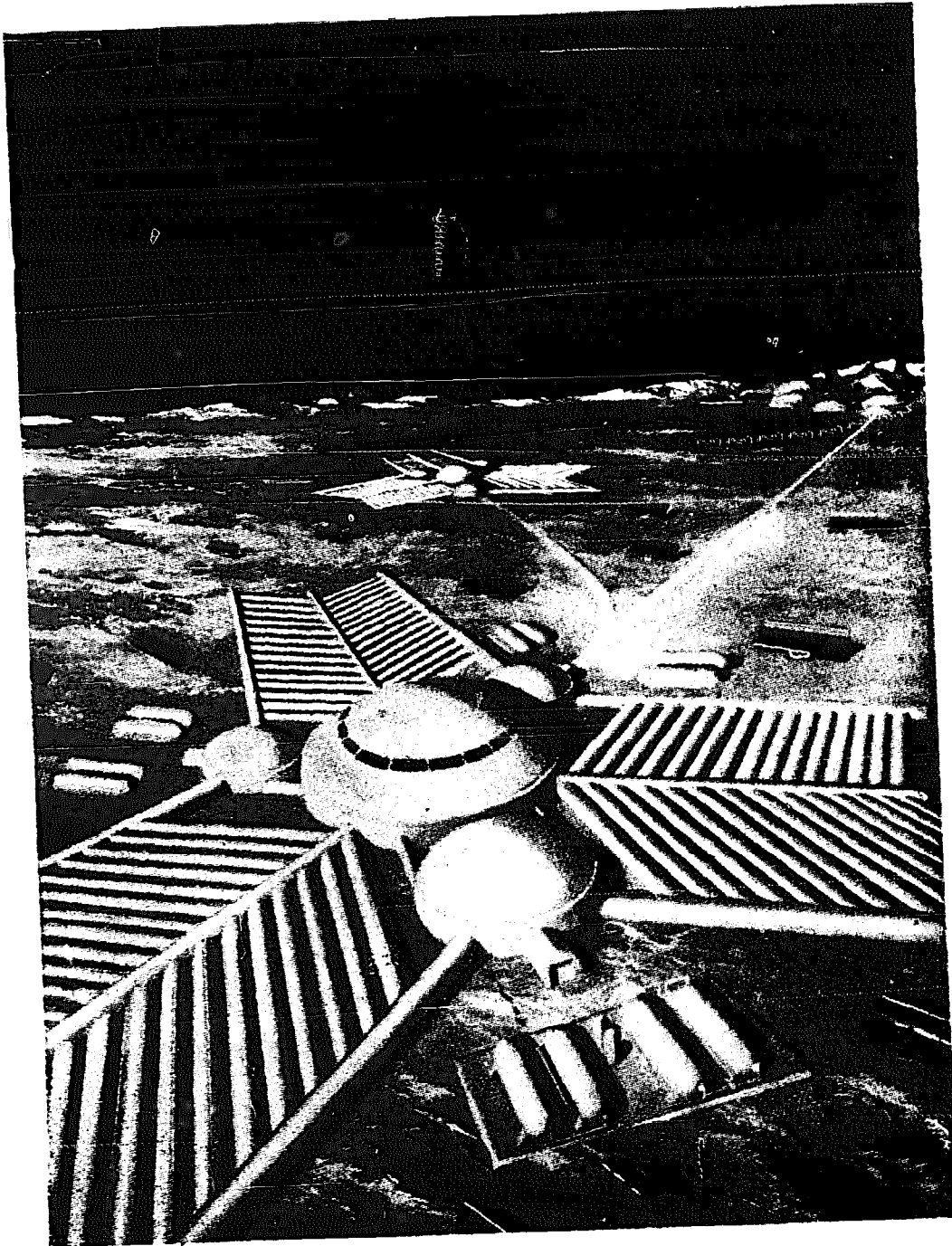

42. Design for a hydroponicum under lunar conditions prepared for the British Interplanetary Society. Soilless culture will be the only means of supplying space travellers with fresh greenstuff

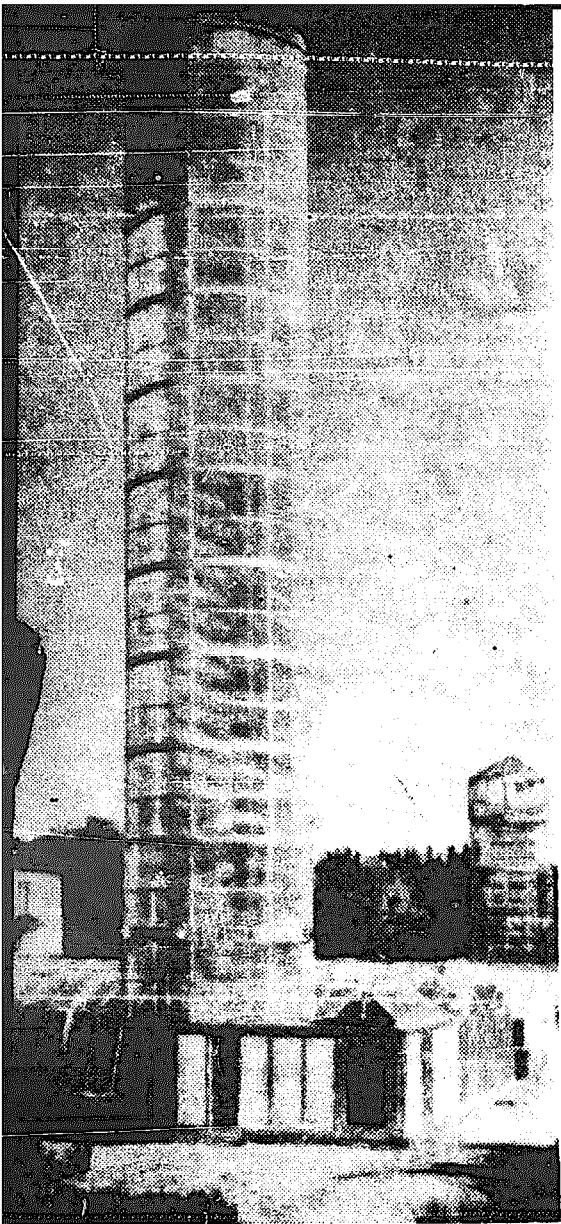

43. Tower hydroponics: A unit in Armenia

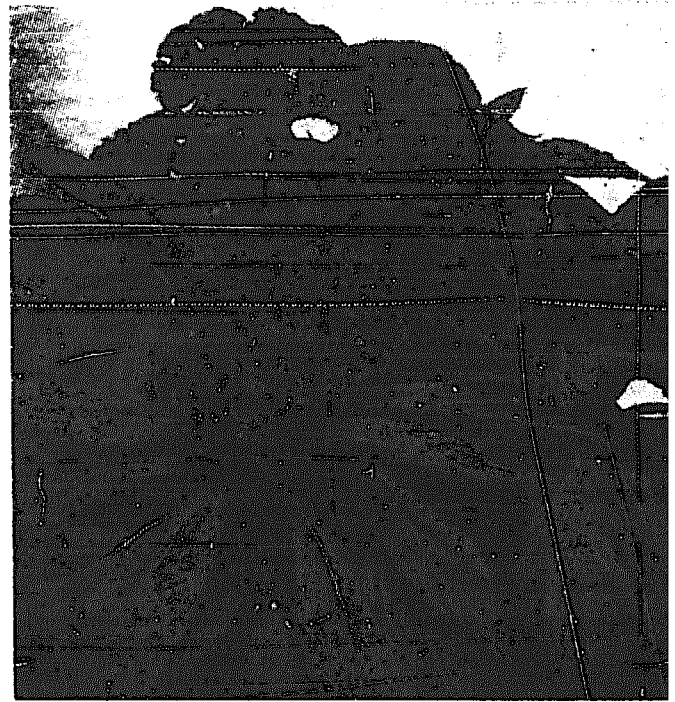

44. Flowers: Cockscombs grown without soil

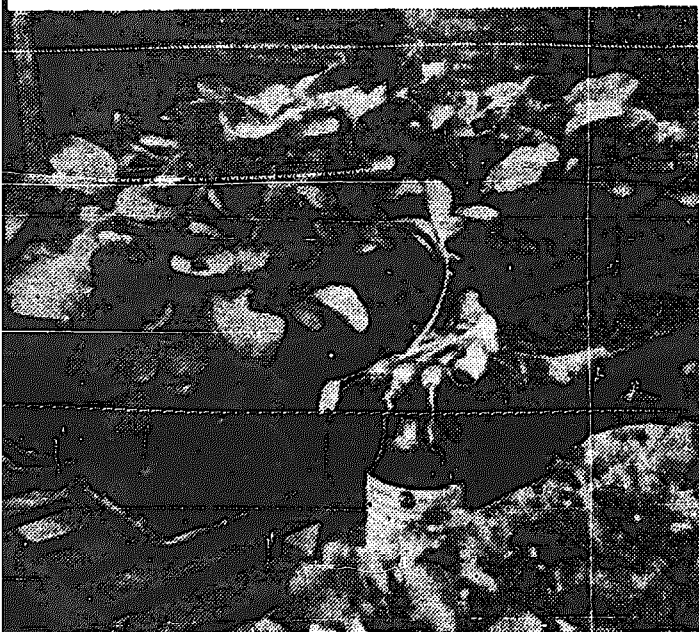

45. Radishes grown in home soilless unit. Note polythene lining to simple wooden boxes





46. Nutrient film layflats with lettuce crop



47. Small submersible electric pump for layflats

## NOTES ON OTHER METHODS

### 5. MISCELLANEOUS CULTURE DEVICES

A large number of different methods of soilless plant growing can be grouped under the category of miscellaneous devices. Many of these contrivances are efficient in operation and have given good service in different areas.

#### (a) *Nutrient Film Layflats*

Work on the development of different systems of soilless cultivation, utilizing various designs and equipment prepared from synthetic membranes, plastics and similar materials, after adaptation commonly called layflats (old Norse, *leggja*, to lay, and *flatr*, flat or floor), has been in progress for several years in a number of areas of the world. Original methods, devised by individual investigators, are stated to have yielded promising results. Certain commercially available layflat tubing installations are marketed by suppliers and manufacturers of horticultural apparatus.

Layflats constitute a flat 'floor', as the name implies, upon which crops may be grown hydroponically. They can be made with black or non-translucent polyethylene tubing or sheeting, butylite (butyl synthetic rubber) and substances of like properties.

The black plastic layflat tubing marketed under the name 'Solu-Ply' is punctured at regular intervals to give even distribution of solution. The rate of flow through the tubing can be adjusted readily by varying the pressure at source. When placed inside a length of butylite formed into a layflat tube of larger dimensions, the Solu-Ply will convey a slow current of nutrient solution past the roots of plants inserted into the butylite tube from above, through appropriate slits. Alternatively a system using only butylite, with or without flumes, consisting of two tubes—a smaller inside a larger—is equally effective. Two

## HYDROPONICS—THE BENGAL SYSTEM

such tubes are highly desirable to reduce any excessive heating of nutrient solution in hot climates.

Butylite layflats are now being made locally by cutting the sheeting into strips of 20 to 30 yards long with a width of from 16 to 20", according to the size of the plants to be grown. The cut edges of the strips are joined with plastic tape to form a tube. The material is folded over from the edges to the top centre, so that a gusset is effected at each side (See figure on page 116). The gussets are secured with plastic tape. This layflat is then rolled-out or placed on smooth sloping ground, with the sealed cut edge at the bottom. Slits at appropriate intervals are cut along the top in a straight line for inserting different species of seedlings, about  $\frac{1}{2}$  to  $\frac{3}{4}$ " long. The sealed edge at the base makes a slight V-form. A flume is not used, but a slight indentation is made in the ground surface to secure firm siting of the layflat. A hose or plastic pipe, perforated with 1 or 2 mm holes is now run right through inside the butylite layflat tube. This provides the flow line for the nutrient solution. The internal hose has a diameter of  $\frac{1}{2}$ ". The higher end of the layflat is sealed up, leaving the internal hose or pipe projecting about one foot. The lower end is sealed except for one aperture to permit egress of nutrient solution. The lower end of the internal hose is also sealed.

The projecting pipe or hose at the upper end of the device is connected to a header pipe with normal manifolds and valve arrangements for sub-irrigation. These ensure equalization of pressure when several devices are connected in units to the tank or reservoir. It has been found preferable to site the solution tank at the lower end of the layflat installation, so that it can serve the dual purpose of reservoir and sump. The aperture at the lower end of the device discharges through a short pipe into the reservoir-cum-sump.

The system operates as follows: The tank-cum-reservoir is filled with the desired nutrient solution and a small

## NOTES ON OTHER METHODS

diesel or submersible electric pump started. This pumps the solution up to the header pipe at the top end of the layflats, whence it enters each device through the internal perforated hose within the butylite deflated tubing. The solution is thrown out very gently through the apertures and falls around the plants' roots. It then trickles down slowly along the layflat towards the discharge end, re-enters the reservoir-cum-sump and can be re-circulated indefinitely with regular recharging and usual testing. The devices or layflats can be laid out in series. Provided the incline is smooth, very considerable gradients can be used for growing on by this method.

Overhead shading may be necessary in very hot times, but so far the double irrigation devices, with the internal hose, reduce heating of solution in the layflats. For taller crops wires with hanging twine will be placed above the devices to support stems. For small and short crops, these are not required, as the method supports them adequately and the butylite is quite stiff.

The advantages of such systems are that the installation capital costs are low, only a matter of the cost of the butylite and the plastic hose or Solu-Ply, plus ancillary piping, a small pump and very little labour. The method will operate almost automatically. In addition, all aggregates are obviated and no rigid troughs are needed. The units can be set out on bare ground in most areas and are long-lasting or movable.

Disadvantages may be extra crop support, need for the avoidance of rough handling by attendants and necessity for careful attention to detail. Because of the nature of the materials used, however, the roots do not entangle themselves within the devices and the whole plant can be pulled out easily at harvesting without disturbing or damaging layflat or internal hose. Root aeration is good, the plants receive a continuous supply of nutrients and it is thought that phytosanitary conditions will be better

## HYDROPONICS—THE BENGAL SYSTEM

than in standard hydroponic beds or troughs. Only a small tank is needed for large areas, and one pump.

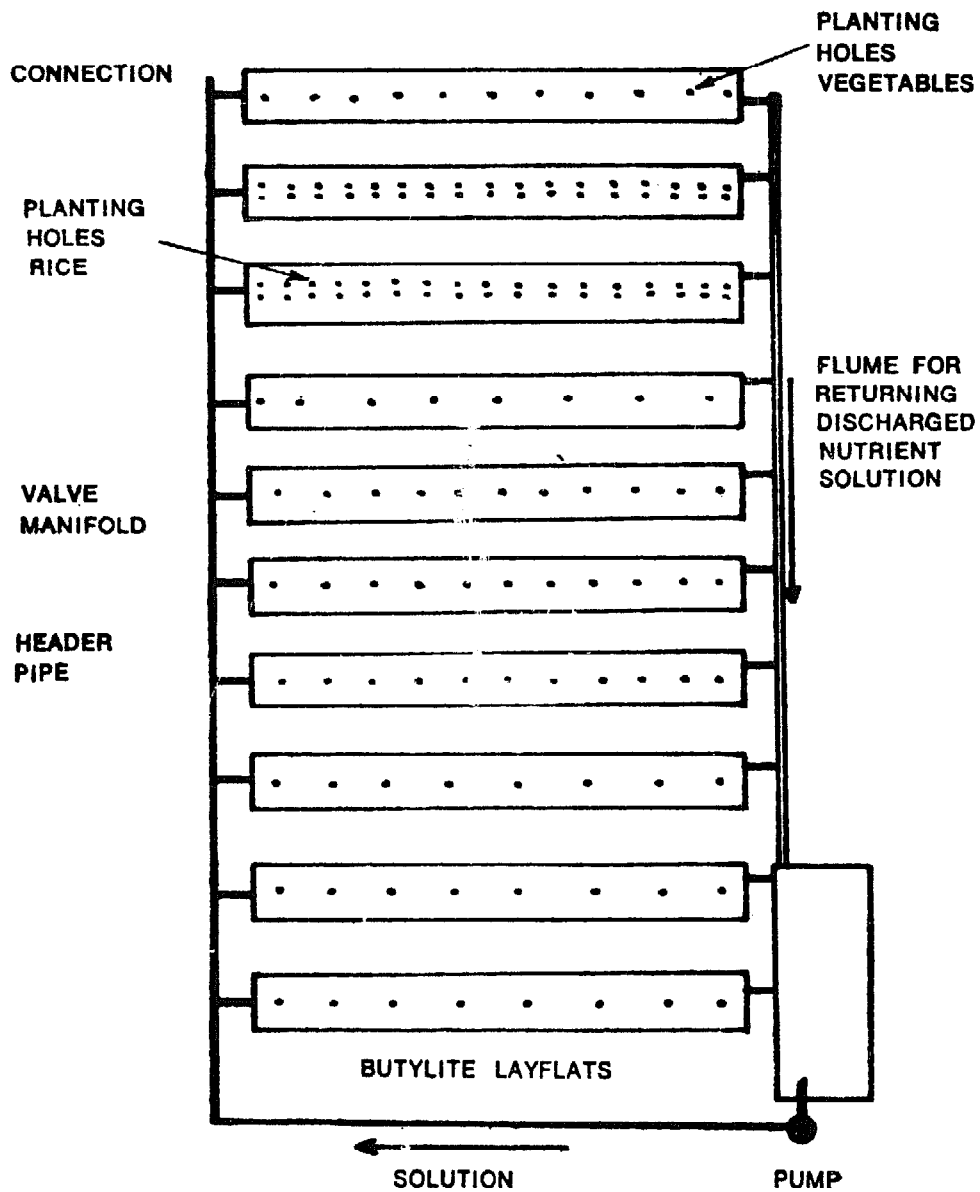

DESIGN FOR A NUTRIENT FILM LAYFLAT UNIT

Various modifications and adaptations of the technique have been employed successfully, with slightly different layflat folding. In cooler areas, the internal perforated hose may not be needed and the depressed tubes can be

## NOTES ON OTHER METHODS

### 1. FLUME-CUM-LAYFLAT

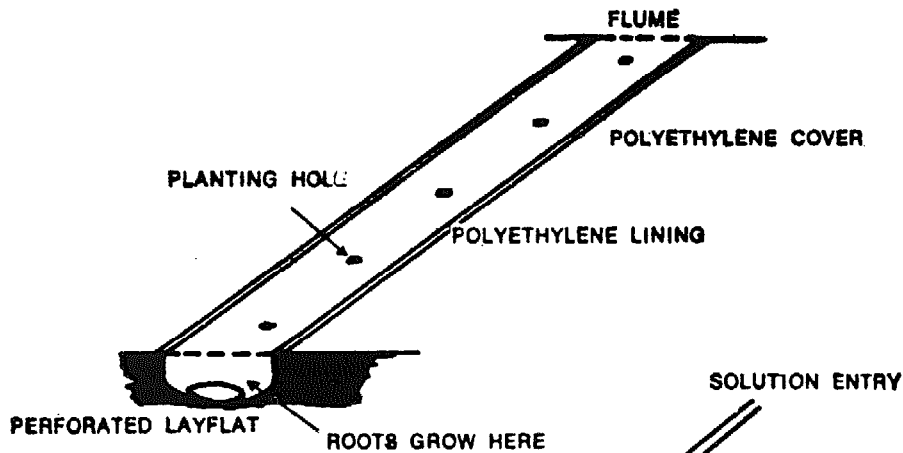

### 2. BUTYLITE LAYFLAT

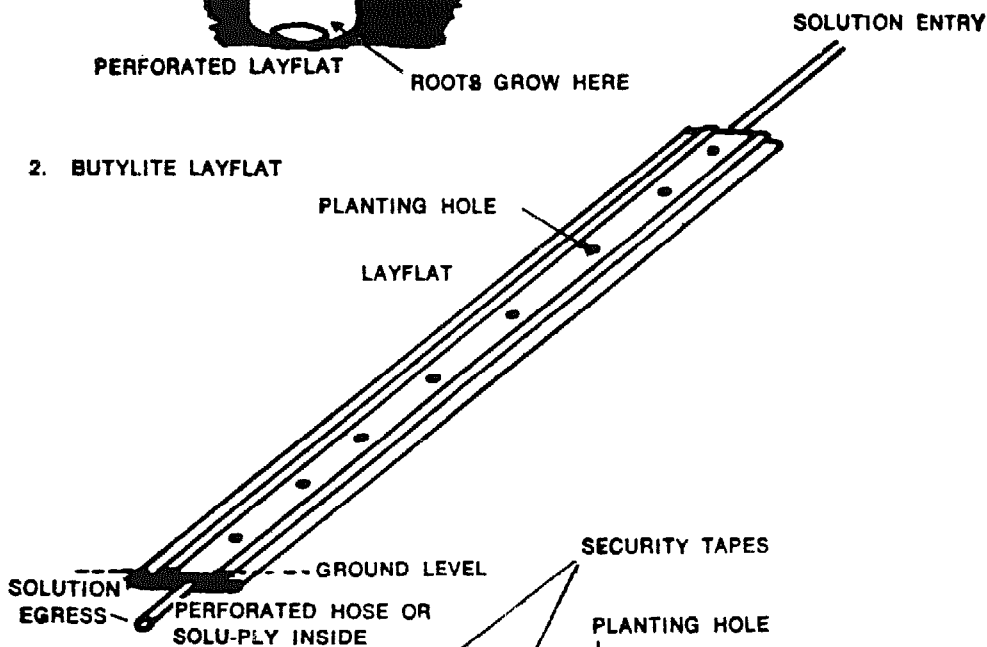

### 3. END VIEW OF BUTYLITE LAYFLAT FOLDING AND INTERNAL PERFORATED HOSE OR PLASTIC PIPE

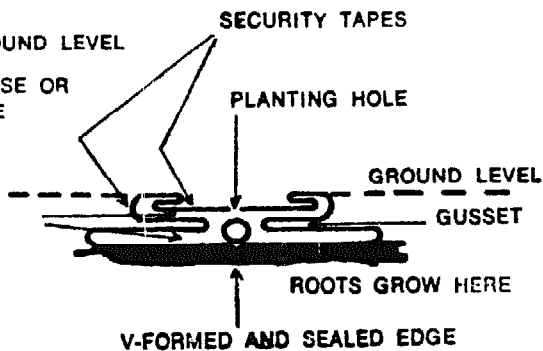

## NUTRIENT FILM METHOD

### Making and folding layflats

used alone or laid in flumes. Layflats can also be combined with flumes for growing root crops. This gives extra root space.

## HYDROPONICS—THE BENGAL SYSTEM

### (b) *Wicks*

Wicks have been used in hydroponics since the earliest days of soilless plant growth. For water cultures, cylindrical lamp wicks, as well as those made of glass wool, may be employed to irrigate the roots of crops growing on trays or grids placed above solution tanks. In such cases, the roots do not normally descend through the mesh into the liquid, but instead the nutrients pass up the wick to the roots and thus keep them moist and well nourished. In sand cultures, a double pot arrangement is frequently utilized. The inside or upper vessel is filled with sand and fitted with a glass wool wick, which passes through the bottom hole and draws in solution from the outer or upper container. The wick should be divided at the top and the branches spread out in the sand. Wick devices can prove effective in small aggregate cultures or for propagation work. Basins or tanks containing nutrient solution are located underneath the growing troughs or pots, the media in which are kept moist by the capillary attraction of the wicks. These run from the solution area up into the aggregate through holes in the bases of containers.

### (c) *Aeroponics*

In this system, the roots of plants are immersed, completely or partly, in suspensions or sprays of air and nutrient solution. In some ways, it resembles a mist culture. Crops may be grown in plastic trays, fitted with jets to discharge the suspension around their roots, or in vertical tubes through which circulates a similar nutrient spray. Considerable work has been done on this method at Istituto di Agronomia Generale e Coltivazioni Erbacee, Pisa, Italy.

### (d) *Tier arrangements*

It is practicable to grow plants hydroponically by using

## NOTES ON OTHER METHODS

arrangements of shelves or tiers, provided adequate light and air can be assured. The advantages of these devices are that householders can greatly increase their cropping area where space is limited, or the tiers can be erected inside rooms. For commercial producers of ornamental plants or shorter species, such as lettuces and radishes, the merits of such arrangements are considerable. Solution can be piped to the individual troughs, trays or pots, or they may be irrigated by hoses or cans. 40 watt daylight type fluorescent tubes are ideal for illuminating plants growing in tiers. This kind of device is generally utilized for growing hydroponic grass and forage and gives a very large yield from a small area, since cultivation is vertical in extent rather than horizontal or spread out.

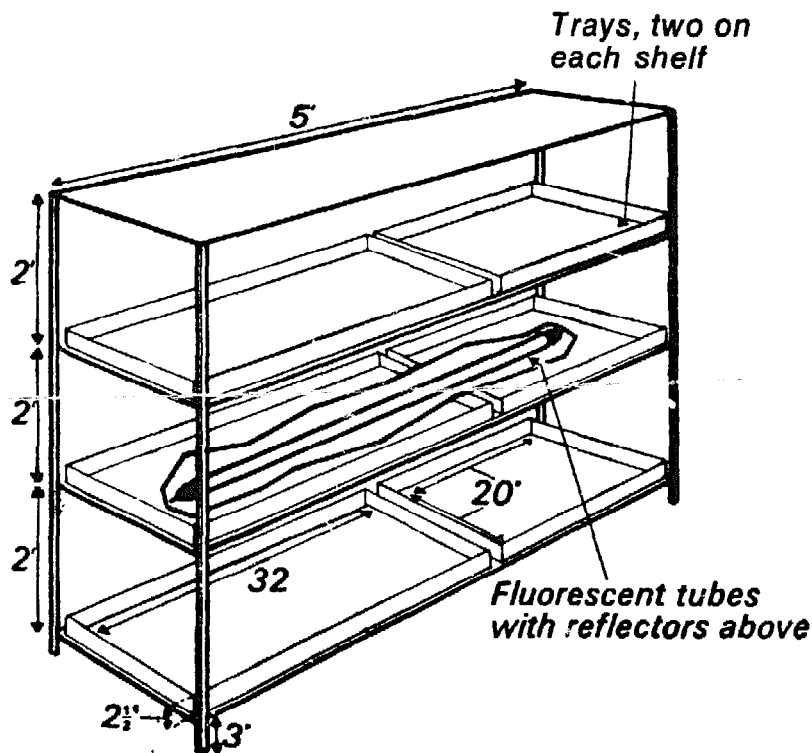

EXAMPLE OF TIER OF SHELVING AND LIGHTING STRIPS FOR INDOOR HYDROPONICS

Finally, it must be mentioned that it is quite practicable for soilless growers to adapt and modify most of the



## HYDROPONICS—THE BENGAL SYSTEM

different systems and methods mentioned in this chapter. Any hydroponic gardener, householder, or professional worker, with a mechanical or scientific turn of mind, can easily develop new techniques or arrangements to suit his or her convenience. There is ample opportunity for improvisation and ingenuity in soilless gardening and farming, provided you stick to the basic rules and use common-sense.

The Secretariat of the International Working-Group on Soilless Culture (IWOSC), P.O. Box 52, Wageningen, The Netherlands, has published two interesting Reports on the Proceedings of the Second and Third International Hydroponic Congresses, held at Las Palmas, Canary Islands, in 1969, and at Sassari, Sardinia, in 1973, respectively which contain detailed accounts of a wide variety of hydroponic methods used in many areas of the world. The author will be happy to reply to enquiries from readers for further advice on any aspect of growing plants without soil. Letters may be addressed to him c/o your nearest branch of the Oxford University Press.

## COMMERCIAL POSSIBILITIES

**M**ost of the ordinary advantages of soilless cultivation of plants over conventional agricultural or horticultural methods, which we have already briefly mentioned in Chapter 1, constitute very important points in favour of the large-scale adoption of hydroponics by commercial growers. Viewed from the business angle these can be readily estimated from the following list in which the benefits that may be hoped for have been enumerated in detail.

### *Chief benefits*

These include:

Higher crop yields than are obtainable in ordinary soil, relative freedom from soil diseases, quicker growth through plentiful supply of nutrients and reduction in growing area by means of closer planting. Crops are very consistent, while operating and maintenance costs are less than in horticulture because standard methods make work easy, with no hard manual labour. Better control of crops and planting is possible, weeds almost non-existent, excellent quality of fruits and flowers, with good drainage and no waterlogging. Economy of labour and lower wage bill as well as no smell and absolute cleanliness without any risk of catching diseases borne in the animal excreta used as soil manure are important considerations.

Some crops may be grown out of season, thus capturing luxury markets. Fruits of high mineral content or special dietary value can be produced at will. Supplies of organic manures are not necessary, and less fertilizers are needed

## HYDROPONICS—THE BENGAL SYSTEM

because there is no wastage. Water can be economized in, and the best use made of irrigation facilities; moreover crops can be grown in places where ordinary horticulture or agriculture is impossible.

Hydroponics gives an immediate return. There is no long period of waiting as there must always be with soil, and the efficiency of hydroponicum can be maintained indefinitely at negligible cost. It is simple to maintain, suitable with local modifications for any district and requires a minimum of equipment, in the construction of which full use can be made of indigenous materials and substitutes. Adherence to simple rules should ensure success. Finally, there is no risk of erosion or drought, and the grower is not dependent on the vagaries of Nature.

These very solid gains are all inherent in the hydroponic system. Interlinked, one with the other, they effectively demonstrate the real value. At the same time, it must be pointed out that in setting up any soilless culture installation certain essentials are called for. These are: a constant water supply and a strict adherence to instructions. Hydroponics has a narrow safety margin and it is dangerous to ignore this. Technical skill, horticultural knowledge and scientific control are required for commercial work.

### *Cheaper than soil*

American growers have always claimed that hydroponics is cheaper than soil. Experiments in Bengal and other areas have also shown this to be the case. Trials at the Colorado A. & M. College, Fort Collins, U.S.A., showed that expenses were 28 per cent less in hydroponics than in soil culture. It must be borne in mind when making any comparison that if fair contrasts are to be drawn the cost of building a hydroponicum of a certain size from scratch should be likened to the expense of bringing a similar area of *virgin* soil under cultivation.

## COMMERCIAL POSSIBILITIES

Secondly, once the troughs have been erected they will require little or no attention, especially if they are made of some non-erodible material, such as concrete or bricks, for many years. Soil, on the other hand, has to be cultivated regularly at considerable outlay. Economy in labour is another big point. Forty hours monthly is ample to allow for looking after one acre under hydroponics. Casual workers have, of course, to be engaged for extra operations such as plucking, picking and packaging of produce, but just the same applies to the ordinary market garden or farm. Again, far smaller quantities of fertilizers are required, since the whole of the nutrient supply is available to the plants without waste, whereas in normal soil cultivation much of the manure is used by micro-organisms in the soil, and quite a lot is leached out and lost by watering. In hydroponics wastage of nutrients is most unlikely to occur. There is much less water used, and in sterilizing gravel a smaller quantity of chemical is necessary for a given area than for soil. Aggregate gives up all its water to the crop growing in it, but in earth a very high percentage of the moisture present is not available to the plant. The amount of this non-available water which is never of any use at all, is often as high as 16 per cent in a clay soil where fine colloidal particles are abundant. Stone chips, sand, cinders, or gravel never wear out, but ordinary soil has to be renewed or renovated yearly. This is a very important consideration in intensive or greenhouse culture.

### *Smaller space requirements*

When plants are grown in hydroponic beds it is possible to set them closer together because the amount of nutrients is not restricted, as it is in soil culture. Light is, in fact, the only limiting factor. Multiple cropping, inter-spacing, better control and automatic operation

## HYDROPONICS—THE BENGAL SYSTEM

combined with standard methods all mean much larger yields. Close spacing also prevents weeds developing.

### *Growth speeded up*

The owner of a hydroponicum in Calcutta has stated that he finds the Bengal system of hydroponics at least twenty per cent quicker than ordinary soil cultivation. This is by no means an abnormal result. English carnation growers have obtained first class blooms from hydroponic plants four weeks earlier than from similar ones propagated in soil at the same time. Tomatoes in California produced fruit in two months. The British Ministry of Agriculture's Journal for June 1942 contained a report on hydroponics at Egham, from which the following extract will be of interest: 'The first crop grown was lettuce (variety, Cheshunt Early Giant), in April 1941. This responded exceptionally well, and produced sound, well-hearted plants ready for cutting about seven days earlier than similar plants in a soil bed alongside. The average weight of the plants was twenty-five per cent greater than that of those in soil, and fewer plants were lost from disease. The lettuces were followed by tomatoes (variety, E.S.I.), planted 10 April. Excellent growth was made, and by the time the first truss was ripening the plants were a foot taller than those in soil and in a correspondingly advanced stage of development. Picking commenced earlier on the plants in gravel, and by 30 August they had produced twenty per cent greater weight of fruit.'

### *No weeding*

Here again much time and expense can be saved. Large sums of money are habitually spent by the horticulturist in weeding, both on the extra labour and the purchase of killers. More consistent crops can consequently be grown, and as there is no ploughing, digging or hoeing,

## COMMERCIAL POSSIBILITIES

hard manual work is unknown in a hydroponicum. In fact it is gardening made easy. Aching backs and blistered hands become things of the past once the switch-over from soil to soilless culture has been made.

### *Freedom from diseases*

With reasonable precautions soil-borne diseases can be effectively eliminated from a hydroponicum. Future improvement in the knowledge of the exact nutritional needs of plants may also lead to the building up of greater resistance to aerial diseases and pests. Even during the height of the monsoon, no trouble was experienced in the Darjeeling hills with 'damping off' amongst tomatoes soillessly cultured at that time. Normally, the rainy period in India prohibits the raising of this vegetable by conventional methods. Agriculturists usually have to spend quite a lot of money on fungicides and similar compounds, and even then many of their plants die from various diseases owing to infected soil.

### *Improved quality*

Better control over plant nutrition provided by hydroponics enables a more uniform and higher quality of product to be marketed. Experiments conducted at the Department of Horticulture, Reading University, showed that on an average seventy-five per cent of first quality fruit was yielded by gravel-grown tomatoes, compared with approximately fifty per cent from soil-grown plants. Flavour and keeping qualities are generally better too. Carnation growers, operating on a commercial scale, have also remarked how well soilless produced flowers last. Highly mineralized fruits of great dietary value can be raised without much difficulty simply by manipulation of the nutrient mixture. In the United States, housewives prefer to buy hydroponic tomatoes, because of their good quality.

## HYDROPONICS—THE BENGAL SYSTEM

### *Out-of-season crops*

The production of vegetables at abnormal times is always a very profitable undertaking. Soilless cultivation enables this to be done in some cases at present, and further research will undoubtedly succeed in growing even more plants out of season. Air-conditioning of glass-houses during the hot weather would be of great help, while artificial heating of the aggregate will assist the raising of certain crops, normally produced during the warm summer, in the cold winter.

### *Some production statistics*

A short list of some of the main cropping averages obtained with hydroponica, both commercial and experimental, in different parts of the world, including soil controls, as well as some individual yields including results obtained in Bengal have been given on pp. 128-30 in the hope that they will prove of interest to the reader. As the *Calcutta Sunday Statesman* remarked in an editorial

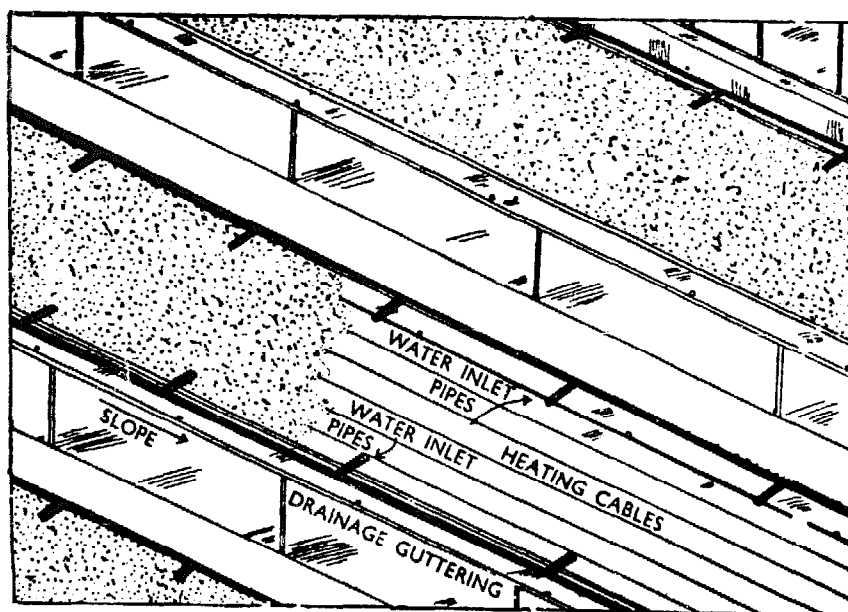

HYDROPONICS IN THE GREENHOUSE

## COMMERCIAL POSSIBILITIES

on 29 February 1948, '. . . if the result recorded can be largely reproduced something of outstanding importance to India will be achieved.'

### *Costs*

These vary from one country to another, but in India, the price of a ton of fertilizer grade chemical averages between Rs 200<sup>1</sup> and Rs 300 but individual costs range from Rs 50 to Rs 350. It is therefore necessary to exercise some care when purchasing nutrients in bulk, and to buy only from firms selling at controlled rates. Cheaper substitutes can often be located, or prepared by the grower himself. As a general rule the usual costs per mensem for sufficient salts to cover a one-acre hydroponic unit will be between Rs 35 and Rs 50 over the whole season. Slight variations will occur according to the time of the year, the period of growth of various crops or the formulae used. The permanent labour charge should not exceed Rs 1,500 per acre yearly at the most. As regards the cost of installation, this need not exceed fifty paise a square foot, if local materials are used, though where exceedingly elaborate troughs are required, it may rise to two rupees.

A copy of an interesting table has been reprinted on page 130 giving a list of a few of the costs and returns obtained in India during the period 1946-7.

The commercially minded reader will, no doubt, like to know what some individual plant yields have measured upto. These (Table VII) certainly show the system's potentialities. Hydroponic results in Bengal have in every case outdistanced the best foreign soil records, and with better seed there is no reason why they should not surpass even the Californian liquid cultures in the near future.

### *Estimated revenue*

A first-class hydroponicum in India growing high-value

<sup>1</sup> Refer to footnote on page 131.



TABLE VI. HYDROPONIC AVERAGES COMPARED WITH ORDINARY SOIL YIELDS

NAME OF CROP	BENGAL		UNITED STATES		WEST INDIES	
	<i>Hydroponic equivalent per acre</i>	<i>Agricultural average per acre</i>	<i>Hydroponic equivalent per acre</i>	<i>Agricultural average per acre</i>	<i>Hydroponic equivalent per acre</i>	<i>Agricultural average per acre</i>
Wheat ...	5,000 lb.	600 lb.				
Oats ...	3,000 lb.	850 lb.				
Rice ...	12,000 lb.	750-900 lb.				
Maize ...	8,000 lb.	1,500 lb.				
Soya beans ...	1,500 lb.	600 lb.				
Potatoes (earlyies) ...	70 tons	8 tons	62½ tons	6-10 tons		
Beetroot ...	20,000 lb.	9,000 lb.				
Cabbage ...	18,000 lb.	13,000 lb.				
Peas ...	14,000 lb.	2,000 lb.				
Tomatoes ...	180 tons	5-10 tons	300 tons in Florida	5-10 tons for unstaked field plants; 50 tons for greenhouse-cultured crops	178 tons per annum on a commercial field scale	
Cauliflowers ...	30,000 lb.	10-15,000 lb.				
French beans ...	42,000 lb. of pods for eating					
Lettuce ...	21,000 lb.	9,000 lb.				
Lady's finger ...	19,000 lb.	5-8,000 lb.				
Cucumber ...	28,000 lb.	7,000 lb.				

NOTE: With controlled cropping, increase in area brings no comparative decrease in yield. No matter how many times a hydroponic plot is multiplied in size, output will remain relatively constant.

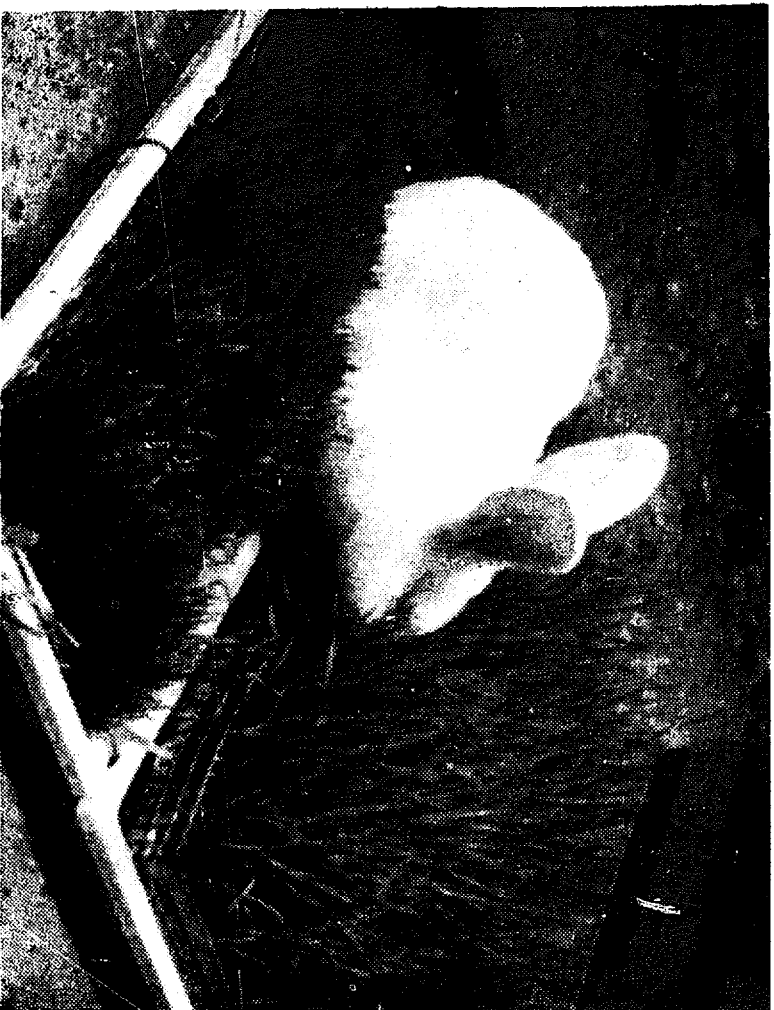

48. A pet rabbit enjoys a tasty meal of hydroponic grass

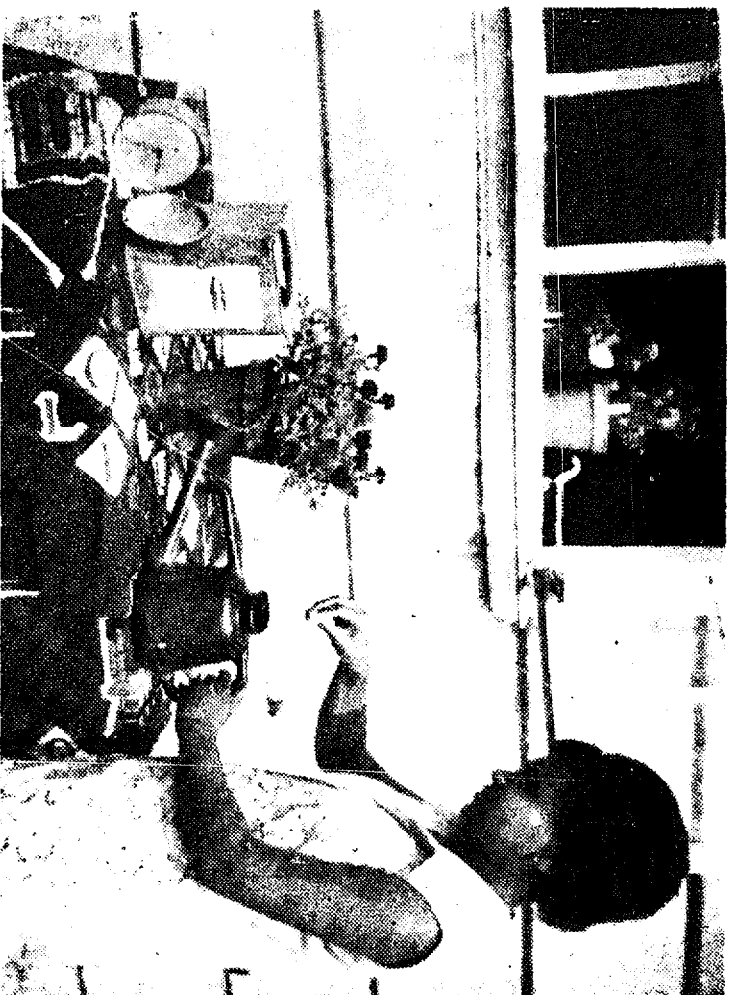

49. Ideal hobby for children. A young girl attends to her hydroponic plants

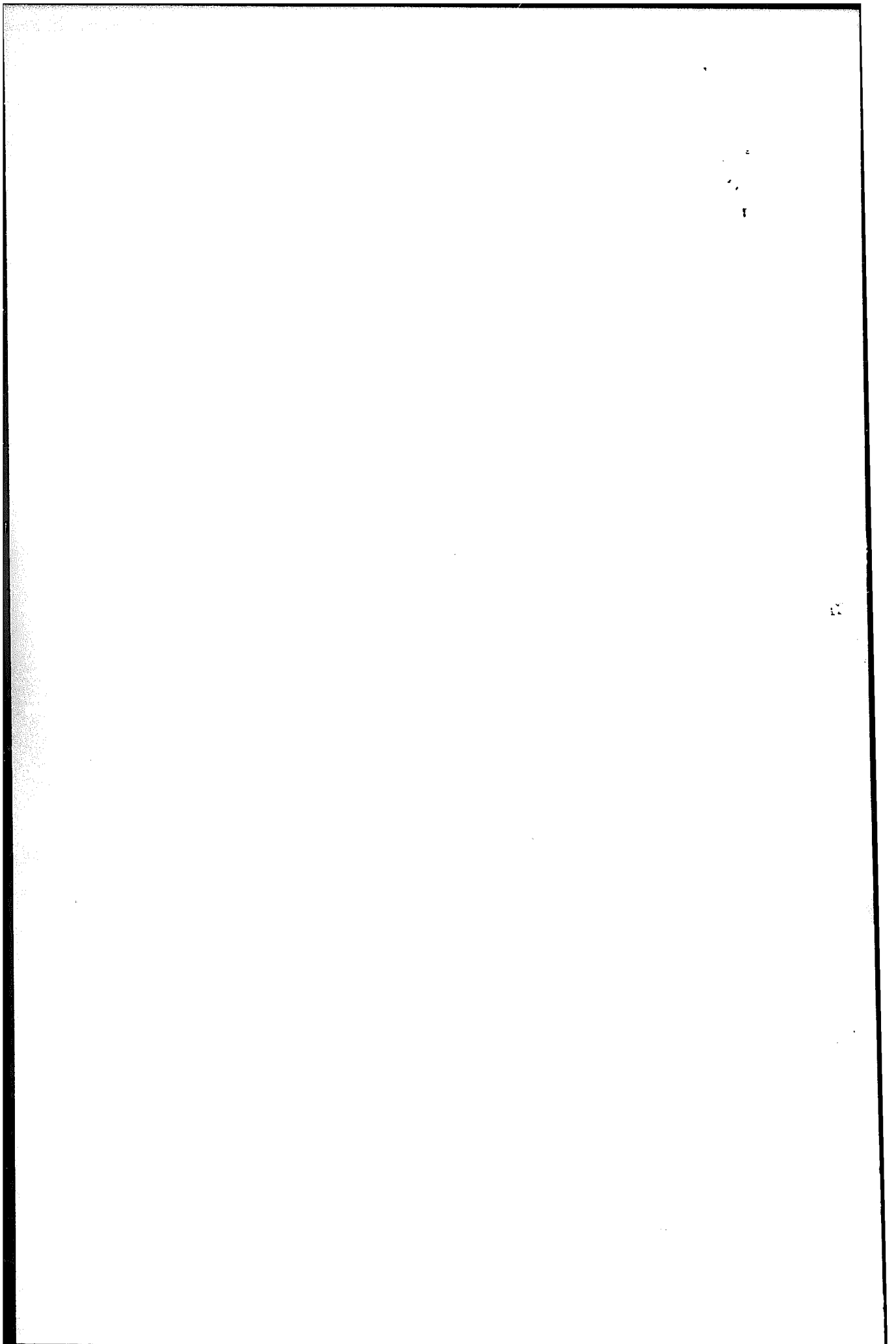

TABLE VII. ACTUAL TOMATO AVERAGES PER PLANT IN POUNDS

PRODUCED BY	HYDROPONIC YIELD <sup>1</sup>	SOIL CONTROL	VARIETY
Dr Gericke, University of California	31.0 27.4		Suttons' Majestic
I.W.O.S.C. Research and Demonstration Unit, Messina.	23.8	9.2	Market King
Hydroponic Research (East African experiments 1961-3)	18.0-24.2	8.0-10.0	Various Hybrids
F. Hicks Lymington, Hants	19.0		Ailsa Craig
Jealott's Hill Research Station	16.4		Stoner's M.P.
New Jersey Agricultural Experiment Station	Over 20.0		Marglobe
Hydroponic Research (West Bengal)	24.5	8.6	Suttons' Best of All
Hydroponic Research (U.K. Office)	30.0		Sunrise
Glenhazel Research Station, Boksburg, Transvaal.	22.5 (Highest individual plant yield)		Marglobe

<sup>1</sup> excluding 'chats'

COMMERCIAL POSSIBILITIES

TABLE VIII. COSTS AND RETURNS OBTAINED IN WEST BENGAL, 1946-7

CROP	AREA	COST OF NUTRIENT			LABOUR			INCIDENTAL CHARGES			LOCAL MARKET PRICES <sup>1</sup>	VALUE OF CROP		
		Rs.	A.	P.	Rs.	A.	P.	Rs.	A.	P.		Rs.	A.	P.
1. Tomatoes ...	1,000 sq. ft.	2	14	0	2	0	0	10	0	0	8 annas per seer <sup>2</sup>	1,375	8	0
2. Potatoes ...	1/50th acre	1	8	0	5	0	0	10	0	0	5 annas per seer	79	5	0
3. Oats ...	1,000 sq. ft.	2	4	0	1	0	0	2	0	0	Rs 10 per maund <sup>3</sup>	7	3	0
4. Maize ...	1/25th acre	3	6	0	2	0	0	6	0	0	Rs 20 per maund	68	4	0
5. Peas ...	1/100th acre	0	11	0	1	0	0	5	0	0	6 annas per seer	11	6	0

<sup>1</sup> Retail price prevailing in Spring of 1947.

<sup>2</sup> One seer = 2 lb avoirdupois.

<sup>3</sup> One maund = 82 lb avoirdupois.

One Indian rupee was equivalent to approximately 1s.6d. sterling (£1 = Rs 13/4 in 1946-7).

*Reprinted from Bulletin No. 1 of the Hydroponic Research Centre, Government of West Bengal, Experimental Farm, Kalimpong, Darjeeling, India.*

## COMMERCIAL POSSIBILITIES

crops, such as tomatoes, could be made to yield a gross revenue of Rs 50,000 per annum from each acre.<sup>1</sup> To attain this figure means, of course, careful application and study of problems, skilled technical control, well executed intercropping, and trained horticultural knowledge. Approximately one half of the above sum would be expended in maintenance, fertilizers, labour charges, seeds, insecticides, miscellaneous items of equipment, and transport costs, and casual engagement of extra workers for plucking and picking. So the grower is left with a net profit, at a conservative estimate, of Rs 20,000 yearly from each acre of his soilless culture installation. Few other local business can show such returns on an investment.<sup>2</sup>

### *High returns*

Figures prepared from actual operating returns by a Colorado firm of hydroponic manufacturers show that a soilless unit, producing just over sixty tons of tomatoes yearly in the United States, will bring in a total net profit of \$21,895 per annum at current rates. Maintenance would be carried out by two persons, including upkeep, mixing of nutrients, harvesting, packaging, and other tasks. In arriving at this figure, a gross income of \$44,000 is considered an average and typical one from an installation of the size in question, while the cash expenses and nominal depreciation amount to some \$22,000 a year.

Allowing for cost differences and income levels in separate countries, it is safe to say that generally speaking anyone investing in hydroponics may reasonably expect to receive in gross income about double what annual expenses and write down of equipment amount to. This means that the return on investment, after reckoning on

<sup>1</sup> Rs 19 = £1 sterling or 2.2 U.S. dollars approx. at 1974 exchange rates.

<sup>2</sup> As food prices increase, so profits may rise. The figures mentioned are simply intended to illustrate the system's potential.

## HYDROPONICS—THE BENGAL SYSTEM

normal amortization of capital, should be between 25 and 40 per cent. Confirmation of such figures has been obtained time and again from examination of the operational records and accounts of numerous commercial hydroponica in all parts of the world.

As already mentioned, construction costs will depend upon the materials employed and the place. Outdoor troughs in warm areas are naturally less expensive to set up and use than are those sited in cold regions, where protective coverings or enclosures are essential for winter time. If one of the new 'key factory' or ready-made units is bought, the capital outlay will be higher. A fair basis for starting would be to say that in Asia, Africa, and south or central America, building charges will be (in sterling) from one to five pence a square foot on the average; in Europe, the Antipodes, and north America from under five pence to as much as the equivalent of a United States dollar, depending upon the ingenuity and degree of improvisation of the grower, and in other areas somewhere between these figures according to the local cost levels and standards.

## COMMON DEFICIENCIES, PESTS AND DISEASES

**F**ROM time to time references have been made in this book to various deficiencies which may arise in plant culture. The reader will, in fact, already be familiar with some of the measures which should be taken to prevent such difficulties arising or to cure them if they actually do appear. The remedies for detriments like poor aeration, insect pests, toxic vapours or slow growth are too obvious to need recapitulation. An inadequate supply of any particular chemical will, however, cause certain symptoms to appear which need a little extra knowledge to recognize. Identification of these deficiencies is a matter of experience, and while in cases of doubt an expert should always be consulted, the table on page 134, compiled as a result of observations made in Bengal, may serve as a useful guide.

### *Learn to know each plant*

The experienced grower, whether a commercial operator or the owner of a household hydroponicum, must know his plants. There is no substitute for this old-fashioned but sound advice. Flowers and vegetables are living organisms, not machines, and that little bit of extra loving care will be amply repaid by the response obtained. The handy table which we have given on page 134 is not intended to do more than provide a guide in diagnosis—the rest depends upon experience, careful study of the plants, and above all strict adherence to instructions.



## HYDROPONICS—THE BENGAL SYSTEM

### TABLE IX. MINERAL DEFICIENCIES

SYMPTOMS	INDICATING A DEFICIENCY OF
1. Slow growth, poor development and light green or yellowish foliage ... ..	NITROGEN
2. Dull, abnormally dark green leaves, sometimes with grey or purple discolorations ...	PHOSPHORUS
3. Mottled lower leaves which later become brown and appear scorched ... ..	POTASSIUM
4. Stunted plants with dark and crinkled leaves ... ..	CALCIUM
5. Yellow leaves, delayed blooming, and slight spotting turning later to white and finally brown ... ..	MAGNESIUM
6. Leaves yellow between the veins followed by severe burning ...	IRON
7. Poor bloom and weak growth. Leaves appear checkered ...	MANGANESE
8. Veins turning yellow with dead areas of a purple colour forming at leaf bases ... ..	SULPHUR
9. Brittle stems ... ..	BORON
10. Stunted growth ... ..	ZINC

Excess quantities of any nutrient will frequently cause immediate death, generally preceded by severe burning and complete collapse of the plants.

## COMMON DEFICIENCIES, PESTS AND DISEASES

### *Chlorosis*

This is a form of yellowing in plants. Too much shade can cause it, but generally some nutritional deficiency is at the root of the trouble. If chlorosis develops in an otherwise healthy crop one usually suspects a lack of iron and the quantity of this element should be slightly increased. Sometimes a shortage of nitrogen leads to loss of colour, while deficiency of potassium or calcium can cause drying, yellowing and spotting of foliage.

### *Damping-off*

During the wet weather especially, this disease kills a great quantity of plants. Practically every gardener, at one time or another, has had the unfortunate experience of finding his seedlings dying in large numbers. Blank or bare patches appear and spread rapidly in the seed boxes. Damping-off disease is caused by a fungus, generally present in most soils. It is also carried on or in the seed, which accounts for its occasional appearance in hydroponica. Moist conditions or a humid atmosphere are conducive to its development. The most effective remedy is to allow plenty of fresh air to reach the crop. Bordeaux or Burgundy mixtures may also be applied, instructions for the preparation of which are given in the next chapter.

### *Leaf-curl*

This is an air-borne complaint, caused by a tiny insect known as the 'thrips'. Eggs are laid by the females inside the tissues of the leaves, and the young pests which hatch out in four or five days begin to feed on the tender foliage. The actual parasite cannot usually be located with the naked eye. Tobacco dust or decoction will kill the insects or grubs, thus effectively stopping the trouble. Prepare as instructed in Chapter 10.

## HYDROPONICS—THE BENGAL SYSTEM

### *Staggers*

Also known as foot-rot, this fungus attacks the base of the main stem. The tissues shrivel up and the plant falls over as though it were intoxicated. This parasite ceases its attention after the plants begin flowering. For a complete preventive the famous Cheshunt compound is hard to beat.

### *Nematodes*

Eelworms or nematodes have been reported as a source of trouble in some hydroponic units, though not so far in those operated under the Bengal system. These pests belong to many different species and strains, but those most likely to occur in intensive growth installations are the root-knot eelworms. In bad attacks, the whole root complex is affected, galls become apparent, the plant wilts and may even die. Another type causes stunting of crops, so that harvests are negligible. The minute white to brownish spherical bodies can be seen on roots or tubers. Nematode infestation would be a serious matter. Strict sanitary care is always necessary in soilless units, and usually this is effective in preventing infection, but as an added precaution it is desirable to keep a few African marigolds (*Tagetes spp.*) growing in beds, spaced out at intervals, in places where it is feared a nematode attack could occur. The powerful odour and secretions of these plants repel eelworms, but will not interfere with the regular cropping work or the stands of economic species. There are also certain chemical products on the market which are stated to kill nematodes should the pests be discovered in beds.

### *Other infections*

Strong and vigorous plants are far less likely to become infected or be attacked by pests and diseases than those

## COMMON DEFICIENCIES, PESTS AND DISEASES

which are unhappy in their surroundings. However, even the most healthy crops can be subjected to such common afflictions as aphides or greenfly, caterpillars, red spider, black or white flies, weavils and beetles, as well as mildews or moulds. To cure these and other different complaints, apply the standard treatments laid down in gardening manuals, using the appropriate insecticides or pesticides.

### *Beware of neglect*

Never neglect plants. So long as crops are not 'hungry', or in some way disabled, they can expend considerable energy in repelling insect pests and diseases. Hydroponics is singularly free from soil sicknesses, but this does not mean that inattention or rough handling can be tolerated. The importance of proper hygiene in soilless units cannot be over-emphasized. General tidiness does much to prevent trouble. It is highly inadvisable to leave refuse or rotting vegetation lying about. All rubbish should be disposed of promptly. Early removal of potential sources of infection can save large sums of money that would otherwise probably have to be expended in fighting outbreaks of disease caused originally by carelessness or neglect of elementary precautions. Real cleanliness and efficient phytosanitary methods are essential to successful growth without soil.

NOTE: It is suggested that readers should consider using 'safe' insecticides in hydroponics, rather than many poisonous modern chemical formulations. Pyrethrum is a good material, while the old-fashioned mixtures listed in this chapter have stood the test of time and can be made up cheaply at home. There is also much scope for simple biological controls in soilless cultivation.

# HYDROPONICS—THE BENGAL SYSTEM

## A. View of Unit

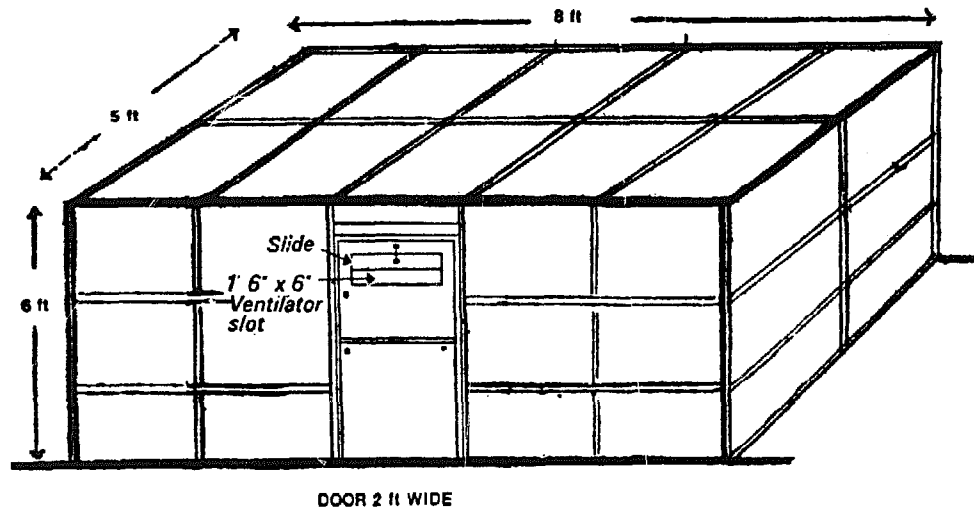

Construction: Timber or post frame and crosspieces, with covering of transparent plastic sheeting.

Size of unit: five feet  $\times$  eight feet  $\times$  six feet.

*Note:* There is another ventilator at the back, opposite to that in the top half of the doorway to give a through current of air.

## B. Arrangement of Door and ventilation

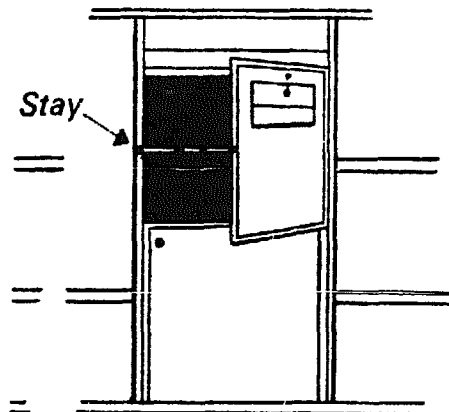

*Top half open in very hot weather to admit extra air*

A CHEAPLY MADE CONSERVATORY FOR HYDROPONICS

*Drawings by J. Sholto Douglas from his original designs*

## MISCELLANEOUS NOTES

**A** LARGE number of widely differing subjects, all connected with the soilless cultivation of plants, will be very briefly touched on in this chapter. For more detailed study of each question the student should refer to some of the published literature on the topic in question, or else to any reputable horticultural manual.

### *Heating*

The artificial heating of hydroponics is practised in Europe and America, but this is hardly necessary in the tropics. Growth has been found to be far more rapid when

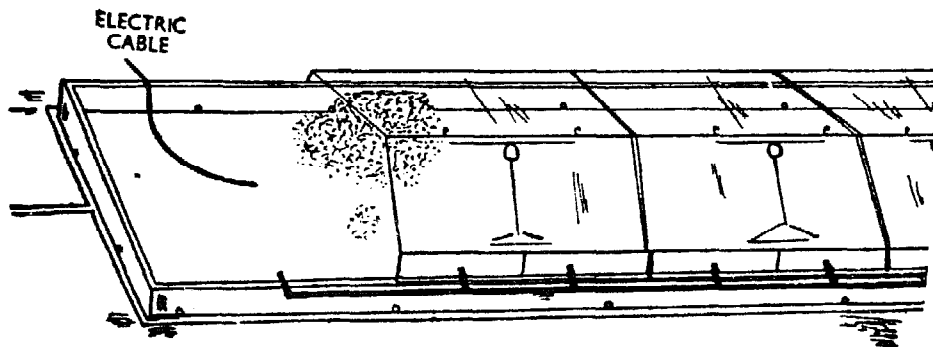

**ELECTRIC HEATING**

A heated hydroponic trough provided with cloche protection

reasonable temperatures are maintained at trough level. In winter, cloches may be put over out-of-door beds for protection against the cold. Electric cables, immersion heaters and radiators or pipes can all be utilized for maintaining warmth. More applicable to hot areas are the questions of shade and cooling down during the monsoon or summer. The possibilities of air-conditioning in

## HYDROPONICS—THE BENGAL SYSTEM

conservatories (See page 138) and greenhouses are great, while in outdoor installations good results have been obtained with overhead mats fixed on staging. Canopies should rest on supports seven to eight feet in height above the surface of the aggregate, so as to admit morning and evening light, but exclude the scorching noonday sun.

### *Weights and Measures*

#### AVOIRDUPOIS WEIGHTS

16 drams	...	...	...	=	1 ounce
16 ounces	...	...	...	=	1 pound
112 pounds	...	...	...	=	1 cwt.
20 cwt.	...	...	...	=	1 ton (2240 lb)
One short ton = 2000 lb					

#### INDIAN WEIGHTS

4 tolas	...	...	...	=	1 chhatak
4 chhataks	...	...	...	=	1 powah
4 powahs	...	...	...	=	1 seer
40 seers	...	...	...	=	1 maund

#### METRIC SYSTEM

10 grammes	...	..	=	1 decagramme
10 decagrammes	...	...	=	1 hectogramme
10 hectogrammes	...	...	=	1 kilogramme (kilo)
10 kilogrammes	...	...	=	1 myriagramme
100 myriagrammes	...	...	=	1 millier or tonne

#### SURFACE MEASURE

144 square inches	...	...	=	1 square foot
9 square feet	...	...	=	1 square yard
4840 square yards	...	...	=	1 acre
640 acres	...	...	=	1 square mile

One acre = 43,560 square feet.

#### EQUIVALENTS

1 ounce	...	...	=	28.35 grammes
1 maund	...	...	=	82 lb avoirdupois
1 tonne	...	...	=	0.984 ton
1 pound	...	...	=	0.4536 kilogramme
1 gallon	...	...	=	4.546 litres

## MISCELLANEOUS NOTES

1 dram	...	...	=	1.772 grammes
1 cwt.	...	...	=	50.80 kilogrammes
1 inch	...	...	=	2.54 centimetres
1 foot	...	..	=	30.48 centimetres
1 yard	...	...	=	0.914 metre
1 metre	...	...	=	3.280 feet or 1.094 yards
1 square foot	...	...	=	9.29 square decimetres
1 square yard	...	...	=	0.836 square metres (m <sup>2</sup> )
1 square metre	...	...	=	10.763 sq. feet or 1.196 sq. yards

The litre was abolished in 1964 as a scientific unit of volume, but is still in common use. One litre = 1000 cubic centimetres (c.c.)

### THERMOMETER COMPARISONS

Fahrenheit: Boiling 212°, Freezing 32°.

Celsius or Centigrade: Boiling 100°, Freezing 0°.

To reduce Fahrenheit to Celsius, subtract 32 degrees and multiply by 5/9; to reduce Celsius to Fahrenheit, multiply by 9/5 and add 32 degrees.

### MISCELLANEOUS DATA

One litre of water weighs 1 kilo. One gallon of water weighs 10 lb.

Wind Force: (Beaufort Scale)

No.	Wind	Speed (m.p.h.)
0	Calm	Less than 1
1	Light air	1 - 3
2	Light breeze	4 - 7
3	Gentle breeze	8 - 12
4	Moderate breeze	13 - 18
5	Fresh breeze	19 - 24
6	Strong breeze	25 - 31
7	Moderate gale	32 - 38
8 and above	Gales	39 upwards

(It is important to know wind force in exposed areas, so as to decide whether hydroponic crops need protection with screens or other shelter.)

Glasshouse Temperatures:	°F	
	Summer	Winter
HOT HOUSE		
Day	70 - 85	65 - 75
Night	65 - 75	60 - 70



## HYDROPONICS—THE BENGAL SYSTEM

### WARM HOUSE (Intermediate)

Day	65 — 75	60 — 70
Night	60 — 70	55 — 65

### COOL HOUSE

Day	60 — 65	55 — 65
Night	55 — 60	45 — 50

(These figures apply to temperate climates).

An inch deep of rain on an acre makes 22,622½ gallons, or 226,225 lb avoirdupois.

If plants are set 1 foot apart 43,560 are required per acre; if 1½ feet apart 19,360, if 2 feet apart 10,890; if 2½ feet apart 6,670 and if 3 feet apart 4,840 will be necessary.

### *Regeneration of seed*

Experiments were conducted in several areas in 1946-74 with seed collected from plants grown in various hydroponics. Even after a number of generations of complete separation from the soil, there was no evidence of any degeneracy or lack of vigour, and crops grown from soilless-cultured seed gave favourable results. In Italy special breeding work for hydroponics has been carried out.

### *Method of making non-erodible mud plaster*

The following quantities of material will be required to cover an area 1000 sq. ft. with a plaster 1" thick.<sup>1</sup>

75 cu. ft. of earth  
25 cu. ft. of sand  
4 bags of cement  
5-8 maunds of straw  
20 lb of sodium carbonate

Dissolve the sodium carbonate in sufficient water to soak 5-8 maunds of straw, add earth and work it up into a *gara*. Leave this mixture for a week, working it up every day and adding sufficient water to make up the loss

<sup>1</sup> Formula supplied by the Director of Irrigation Research, Punjab, Lahore.

## MISCELLANEOUS NOTES

due to evaporation. After a week the soil will have dispersed completely and the straw will be well rotted. Mix thoroughly 4 bags of cement with 25 cubic feet of sand and add to the *gara*, working up the entire mass to a suitable consistency and use as soon as possible.

Keeping the relative proportions of the various ingredients constant, the quantity of the mud plaster can be varied to suit individual requirements such as the area to be plastered and the thickness of the plaster. For ordinary plastering of side walls a layer of  $\frac{1}{2}$ " is quite sufficient. For plastering watercourses or trough bases a layer 1" thick is recommended.

The surface to which the plaster is to be applied should be thoroughly wetted immediately before applying the plaster. In summer, when the plaster is likely to dry up quickly, a gentle spray of water given occasionally improves the quality of the plaster by preventing rapid drying.

### *Alkali-puddled clay*

Clay, treated with alkali and puddled to render it impervious to water, forms a cheap method of building troughs. In this case the beds must, of course, be either sunk into the ground, or if above the surface the side walls will require some reinforcement. To the ordinary mixture of sand and clay used for puddling a little soda ash should be added.

Compounded mortar may also be used.<sup>1</sup> 100 cubic feet of unscreened coal cinders are mixed with 25 cubic feet of slaked lime. To these ingredients are added 40 gallons of molasses solution (specific gravity 1050), and 20 gallons of silicate of soda solution (specific gravity 1050). Mix the whole lot well, using a further quantity of plain water,

<sup>1</sup>Introduced at the Hydroponic and Fish Investigation Unit, West Bengal.

## HYDROPONICS—THE BENGAL SYSTEM

if necessary, to produce the right consistency for plastering or brick-making. Blocks of this material make good hydroponic beds. The specific gravity is determined by a Baume hydrometer. One pound avoirdupois of *chita* molasses in 4 gallons of water usually gives the required specific gravity. The more lime and molasses are used, the greater will be the eventual hardness of the cement or blocks.

### *Food values*

Various tests have been conducted in England to determine whether there are any significant variations between the fruits of plants grown in sand or aggregate and those raised in soil. Vitamin C content was found to be identical. Analyses of carbohydrate, protein and inorganic constituents which were carried out revealed no nutritional differences. All elements were found to be present in normal quantities. American experiments have shown that it is possible to produce crops of unique composition and dietary value by means of hydroponics. The mineral content of tomatoes has in fact been doubled, while flour made from soilless cultured wheat proved better for baking purposes.

### *Is hydroponics unnatural?*

Various rash and ignorant statements are made from time to time asserting that artificial methods of nourishing plants are unnatural and dangerous. Although it may be perfectly true to say that artificial fertilizers are often injurious in agriculture, no such charge can be sustained against hydroponics. The only legitimate criticism of chemicals is that they destroy the tilth and eventually cause erosion, consequently they should never be applied alone, but always together with substantial quantities of organic manures. But in soilless cultivation

## MISCELLANEOUS NOTES

there is no soil to destroy so this objection is in no way valid.

Plants derive the greater part of their food requirements from the air, but they cannot exist without supplies of water and various mineral elements which are absorbed through their roots. Normally these minerals are drawn up from the soil, some originating from the weathering of rock fragments; but nitrogen, the most important of all, is produced mainly from dead vegetation and animal remains. Such organic manures cannot, however, be directly absorbed by the roots of green plants, but must be first broken down by bacterial action, to ammonium compounds and finally to nitrates. Only then do they become of value to the crop. Thus when farmyard manure is applied to the soil it has to be converted gradually into an 'artificial' fertilizer before it can be made available for plant nourishment. Green plants can only take up inorganic mineral salts in solution; they cannot 'eat' anything organic.

In soilless culture the mineral salts are given direct, no process of change has to occur, and consequently the nutritive requirements of a crop are immediately met. There is nothing extraordinary about this—after all, chemical fertilizers are simply the products of normal organic substances, obtained by methods similar to what is occurring every day on any farm. Hydroponics is perfectly natural—it merely cuts out an unnecessary part of the life cycle, and obviates the laborious process necessary to change an organic substance into a mineral salt. Growth is also speeded up as each plant is assured of proper sustenance. Fundamentally, there is absolutely no difference between feeding crops on mineral salts and nourishing them on organic manures. One method is just better and quicker than the other, and a lot cleaner too.

## HYDROPONICS—THE BENGAL SYSTEM

### *Effluents*

The possibilities of adapting effluents to hydroponic use are great. Hanging baskets of aggregate, containing plants of economic value, may be suspended in channels of liquid solution from which the growing crops draw nourishment. Activated sludge tanks are another useful suggestion. An odourless powder produced from sewage has been evolved at the Albert Howard Foundation, Mayfield, Sussex, suitable for such cultures.

### *Algae culture*

Interest in algae as a possible source of food for both human beings and animals has been stimulated lately by the publication of various technical and scientific papers on this subject. Unicellular forms of algae are extremely nutritious since they contain a minimum of indigestible structures. In addition, when dried under favourable conditions, these microscopic plants average over 50 per cent protein. The growing of algae on a large scale has been accomplished with considerable success in special apparatus, such as plastic tubes, covered tanks or troughs, and similar devices. The solutions used for the cultures are essentially the same as those employed in ordinary hydroponics. Details of the various techniques in use are given in Publication 600, available from the Carnegie Institution of Washington, Washington, D.C., U.S.A.

Work is in progress at the Research Institute for Advanced Studies in Baltimore, Maryland, on the culture of hydrogen-oxidizing bacteria. It is felt that these might constitute the basis of an effective bio-regenerative life support system in space ships.

### *Root hormones and chromosome doubling*

Considerable research into the effects of hormones on plant growth has been carried out at the Boyce Thompson

## MISCELLANEOUS NOTES

Institute for Plant Research, New York. Auxins, as they are generally called, have produced amazing effects. The easy rooting of difficult cuttings is possible with their use. Many proprietary brands under different trade names can now be bought—most of them containing beta-indoleacetic or beta-indolebutyric acid. By the use of hormones hydroponics has also been found to be of value in the practice of forestry. Human urine is a prolific source of plant auxins. Soilless cultivation beds provide a controlled growing medium for such techniques.

Chromosomes are present in the nuclei of sexual cells, and are the bearers of the genes transporting hereditary characteristics. Sometimes doubling of chromosomes occurs accidentally in Nature, so producing much larger offspring, but it can also be artificially produced by means of colchicine, a chemical found in the roots of the meadow saffron, *Colchicum autumnale*. By this means fruits of greatly increased size have been grown. These experiments can be carried out more efficiently in hydroponics than in soil.

### *Effects of various other substances*

Ethylene gas is used in ripening certain fruits, while in combination with chlorohydrin it has been found to speed up potato sprouting. Thiourea improves germination of lettuce seed, and sodium thiocyanate is equally effective with dormant tubers. Dyes have been known to hasten growth. Deuterium oxide, or heavy water, however, appears to delay development. Treatment with gibberellic acid increases the height of plants, and sometimes results in greater dry weight. More startling disclosures will undoubtedly be made in the field of special chemicals during the next few years, and many others of benefit in crop culture, some of which can be safely used by the amateur, will probably be discovered.

## HYDROPONICS—THE BENGAL SYSTEM

### *Grass and sprouted forage*

These are highly nutritive foods, with important mineral and vitamin contents, for cattle and poultry. Small rations of sprouted fodder will restore general health and bloom very quickly. Racehorse trainers also find it of great value. Farmers can obtain far better results by using a nutrient solution, instead of just plain water, in their sprouting cabinets. In fact all livestock and pets thrive in hydroponically produced green forage.

Units for growing fresh grass and other seeds or grains, including common cereals like oats, maize, and rye or barley, may be large or small according to individual needs. It is quite simple to erect such installations on the farm or in the stables, but for those persons who cannot spare the time to undertake the task, several commercial firms are prepared to supply ready built outfits. Reliable hydroponic forage units can be bought from J. A. Gordon and Son Ltd., Stonehouse, near Stroud, Gloucestershire, England; Hydroponics Inc., 2039 S. Madison Ave., Indiana 46225, U.S.A., Hydroculture Inc., 10014 West Glendale Avenue, Glendale, Arizona 85311, U.S.A., or different suppliers, for delivery anywhere in the world.

Constructing a hydroponic forage unit, especially in limited space, calls for good planning and layout. The design should allow for multi-tier systems of trays or troughs, each being about six feet<sup>1</sup> long by two feet wide, with a depth of some three or four inches. These containers may be lined with hessian, paper of edible nature, or foam rubber, which can be soaked or sprayed with the nutrient solution. Alternatively, wire mesh or grids may

<sup>1</sup>Or shorter, if desired. Removable sections, each complete in itself, of 2 or 3 feet in length, can be fitted in both single trough and large automatic or manually operated multi-tiered installations, as necessary, to facilitate harvesting.

## MISCELLANEOUS NOTES

be used to support the germinating grains or seeds, with a small space underneath left for the liquid plant food to circulate. The crop to be sprouted is sprinkled evenly in the containers, and normally takes about six days to be ready for harvest. In cold areas, artificial heating and lighting are necessary, but in hot climates the work may be done out-of-doors. Suitable protective coverings to exclude frost or lessen sun scorch should be provided. Factory built soilless green forage units are supplied complete with solution tanks, piping, seed hoppers, and

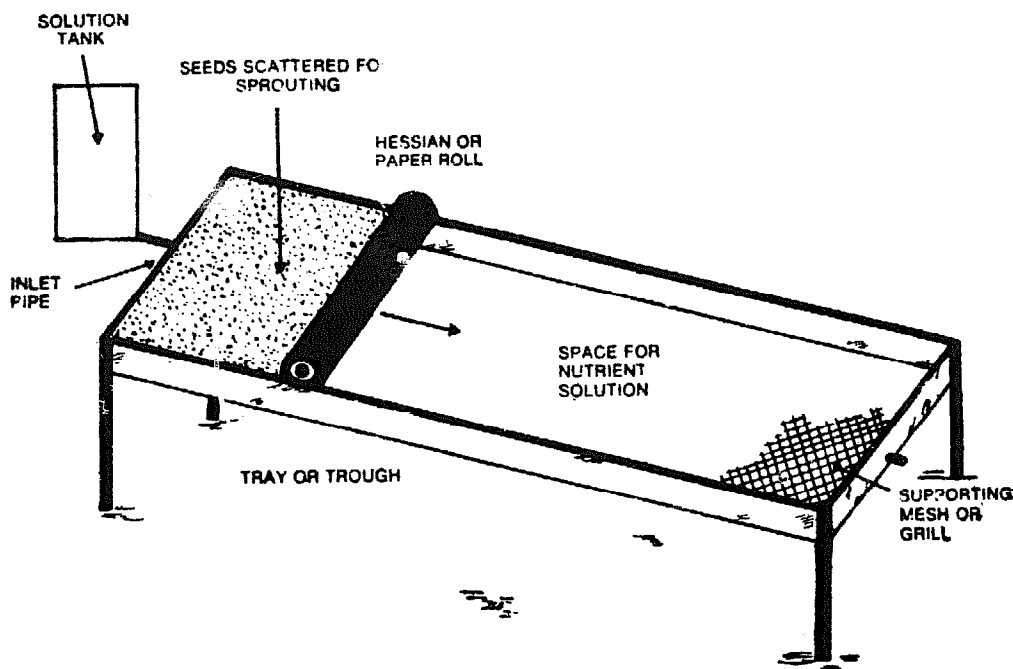

DESIGN FOR SIMPLE HYDROPONIC GREEN FEED OUTFIT

other accessories. Under proper management, a hydroponic grass or sprouted grain outfit can be expected to produce half a ton of fresh feed daily from an area twenty feet long by eight feet high, all the year round, independently of weather or local conditions. Usual formulae are employed for plant nutrition, but to secure the most speedy growth, it is desirable to use a urea fertilizer as the source of nitrogen, increasing the quantity of this



## HYDROPONICS—THE BENGAL SYSTEM

element in the mixture by up to fifty per cent. The rate of application of the whole prescription may, however, be reduced to about half an ounce to the square yard of trough surface space, or appropriately in liquid feeds.

Hydroponic green forage may be supplied entire to animals. Roots, foliage, and seeds—all are edible. Live-stock love this feed, and eat it with relish. Excellent results have been recorded by numerous farmers using soilless produced fresh grass and sprouted grains in many countries. The merits of the technique are especially noticeable in arid regions or in barren zones, and also in towns, urban districts, and in places where pasture land is in short supply. Ranchers, too, find the units invaluable, and more economical in practice than herding stock over large ranges, where grazing is frequently poor and of low nutritional worth.

This new application of simplified hydroponics has an important part to play in the feeding of farm animals. Literature is available from the firms mentioned above, and for the convenience of readers a selection of photographs and simple designs for layouts has been included in this book. (See pages 109-12, 116-7, 119, 126, 149, 151 and 161)

### *Artificial lighting*

Photosynthesis takes place just as well under artificial light as it does with sunshine. Ordinary incandescent lamps or fluorescent tubes will provide the required illumination. Irradiators have also been produced. Despite its higher cost, artificial lighting is undoubtedly playing a big part in indoor vegetable or flower production, especially of luxury crops, at the present time, and its use is likely to increase in the future.

### *Three useful compounds*

1. For checking damping-off.

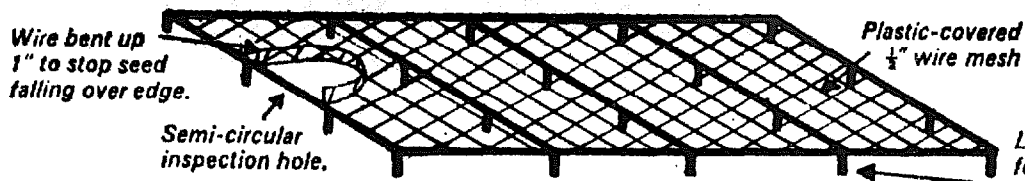

Lengths of fencing wire with ends bent to form  $\frac{1}{2}$ " legs are attached to the wire mesh to give it rigidity and keep it in position in trays. Paper is laid on top and unit stood in tray.

How a tray is arranged. The cutaway sections show the wire mesh grid with paper covering and space for solution underneath, and the inspection hole through which the nutrient liquid and water are added.

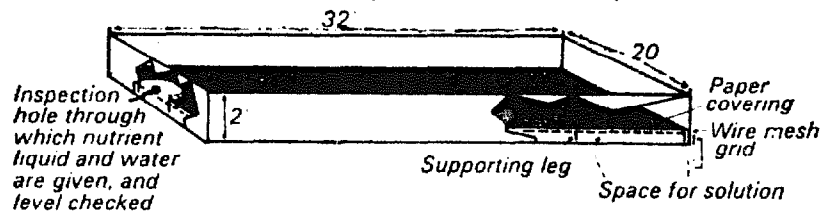

Section of tray giving detailed view of the placement of seed and how the solution feeds the growing crop.

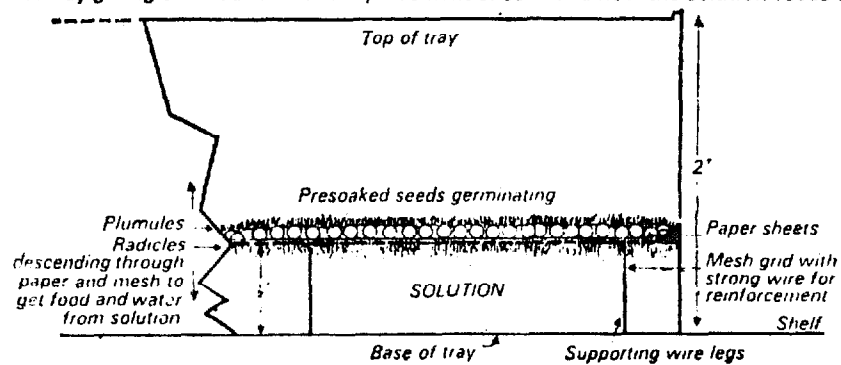

## HYDROPONICS — THE BENGAL SYSTEM

### BORDEAUX MIXTURE

Sulphate of copper	...	...	...	1 lb
Freshly burnt lime in lumps	...	...	...	1 lb
Water	...	...	...	12½ gallons

Put 2½ gallons of the water in a suitable vessel and dissolve in it the copper sulphate. This is best done by wrapping it in a piece of sacking, suspending it just beneath the surface of the water, and leaving it overnight. Place the lime in another container and slake it by adding water, a little at a time. If an earthenware vessel is used, care must be taken lest the heat generated by the slaking causes the pot to crack. When the lime is slaked, make up the water to 10 gallons and stir thoroughly. Then pour the sulphate solution into the milk of lime, mixing well. Strain and apply as soon as possible. If there is any doubt about the quality of the lime, the mixture may be tested by immersing in it a *clean* steel knife blade. If after a few seconds this shows a red deposit of metallic copper, more milk of lime must be added, and the test repeated. The deposit of copper indicates that unchanged sulphate of copper remains in the mixture, and if the latter were used in this condition, serious scorching of the foliage would follow.

### BURGUNDY MIXTURE

Sulphate of copper	...	...	...	1 lb
Washing soda crystals	...	...	...	1¼ lb
Water	...	...	...	10 gallons

Dissolve the copper sulphate in about 7 gallons of the water, and the soda crystals in the remaining 3 gallons. Add the soda solution to the sulphate solution and stir well.

## 2. For Staggers (Foot-rot) or Damping-off.

### CHESHUNT COMPOUND

Carbonate of ammonia	...	...	...	11 parts
Sulphate of copper	...	...	...	2 parts

## MISCELLANEOUS NOTES

Powder the copper sulphate, and mix thoroughly with the carbonate of ammonia. Place in a closely corked glass or stone jar for twenty-four hours, keeping away from any metal receptacle, in a cool cupboard. Dissolve one ounce of the compound in 2 gallons of water and apply at fortnightly intervals. It should be used without delay.

### 3. For Leaf-curl.

#### TOBACCO DECOCTION

Waste or country tobacco ...	...	...	1 lb
Ordinary bar soap ...	...	...	3 oz.
Water ...	...	...	6 gallons

Boil the tobacco in one gallon of water for half an hour, strain, then dissolve the soap in the resulting liquid. Dilute with the rest of the water (5 gallons) and spray on affected parts, at intervals of a few days.

#### *Treatment of seed*

Large increases in yield, as a result of soaking cereal seed in suitable liquid nutrients before sowing, have been obtained in Great Britain. A 21 per cent solution of potassium phosphate was employed. Manganese sulphate treatment was also successful. Research on this technique continues at several centres.

#### *Hydroponics helps forestry and plantation industries*

Workers at the Indian Tea Association's Experimental Station at Tocklai, Assam, favoured the application of hydroponics to tea for raising seedlings since the present method of using good soil means in effect a continual search for new nursery sites, because in removing *bheties* the top-soil is lost for good. The Kenya Coffee Board has shown considerable interest, while sisal, citrus, and tobacco growers find soilless beds better for production

## HYDROPONICS—THE BENGAL SYSTEM

of seedlings and cuttings of these plantation crops. Jute, flax, and cotton have responded favourably to hydroponic methods, and their use in forest nurseries for germinating tree species is quite common.

### *What actually constitutes hydroponics*

Soilless growth is an alternative name for hydroponics. The word 'hydroponics' means 'water-working'—raising crops by the agency of water, as opposed to by the use of soil. A controversy used to rage as to what actually constituted hydroponics. Californian operators claimed liquid culture alone merits the honour of being so described, while some British scientists maintained that only growth in aggregate or sand was really entitled to be known as hydroponics. Such attempts to drive a wedge between two parts of a new science were not only unfortunate, but unwise. Taking a stand strictly on the logical interpretation of the Greek word, it is considered that *all* systems of plant culture which depend on activated water, and not on soil, for crop nourishment and growth are entitled to be called 'hydroponic'. A simple term to remember, it is easy to pronounce in any language, and can be readily translated. A Calcutta newspaper has already suggested one such interpretation for India—*Panikheti*.

### *Mechanization*

By divorcing crop production from the soil, and opening up ways of making towns, urban areas, and barren or desert regions self-supporting in foodstuffs, soilless cultivation promises to bring about a number of alterations in growers' machinery demands, where large-scale hydroponic units exist. Many new types of equipment will, in the not-so-far-off future, be called for. Problems of town crop production, and installation of hydroponica

## MISCELLANEOUS NOTES

on high roof-tops or in barren places, will require solution. Water conservation, and distillation, will become more important than soil conservation. All this is, of course, of great interest to agricultural and horticultural engineers. A big opportunity for the extensive use of new types of implements and machinery, and in particular the development of suitable tractors to operate in the hydroponics, exists. Engineers in the United States are already taking active interest in the problems of mechanizing such units. The ordinary agricultural tractor is seldom suitable for soilless cultivation. In the first place, the ground clearance is inadequate, and the wheel base is often too narrow to span the beds. Again, the engine is usually incapable of running for a very long period at a

**A SPREADING MACHINE** for use in Soilless Cultivation. The hopper may be self-powered if a second pair of wheels is fitted, or it can be tractor-towed in the form shown.

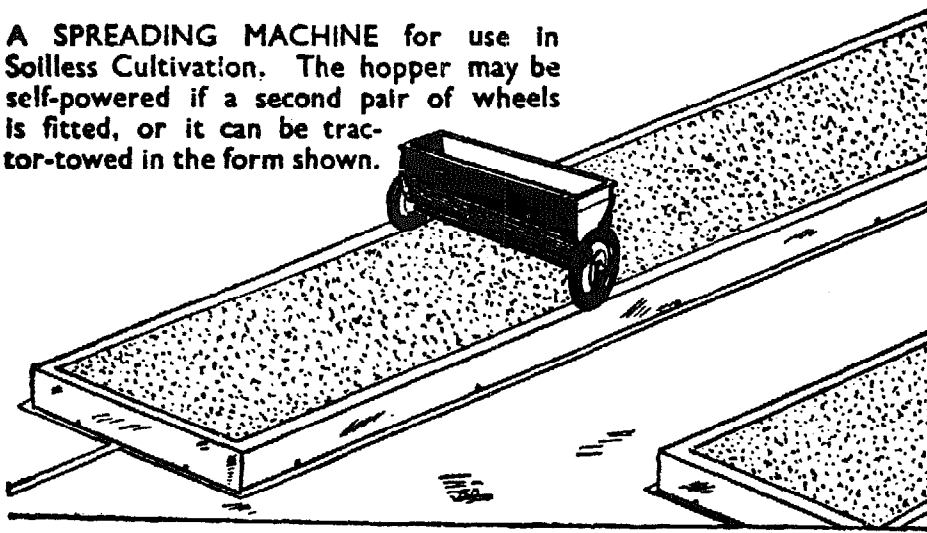

low enough speed for spreading dry nutrients on troughs. What is required is a machine with a low powered, very slow-running engine, coupled with extensible hydraulic elevators which will permit a ground clearance of the undercarriage of up to 12 feet if needed. The drawbar should be equipped to carry a tank of water fitted with jet spray nozzles and a series of 'drills' for delivering

## HYDROPONICS—THE BENGAL SYSTEM

nutrients. Such a tractor would be of great value in large-scale hydroponics.<sup>1</sup>

Several implements can be employed with advantage in soilless installations. Where tall crops are grown, a tank containing water and dry nutrients, mounted on a four-wheeled self-propelled chassis with adjustable elevator gear, may be used to distribute fertilizers and water to the beds. In the case of smaller units, the clearance at ground level is less. For hydroponics in general, a hopper fitted with an agitator force feed, which delivers fertilizers at a uniform rate, is ideal; and to avoid salts falling on the plants' foliage, rubber or metal delivery tubes can be run out from the bottom of the device to feed the nutrients straight down between the rows of the growing crops.

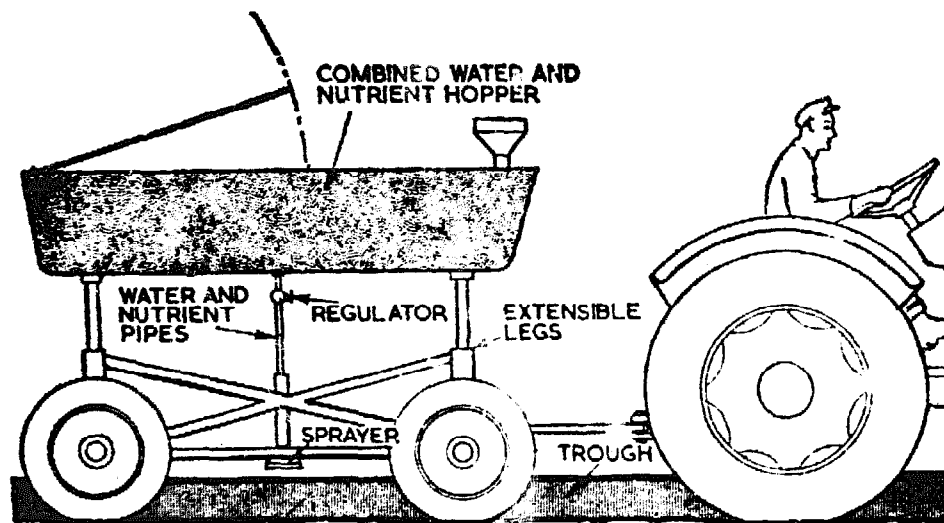

TRACTOR AND SPREADER FOR BENGAL SYSTEM

Hydroponics—the Bengal System. Tractor and spreader designed for applying nutrients in large hydroponic units. The machinery travels along the troughs quite quickly. The plant food is spread on the surface of the aggregate and is washed down to the roots with water from the tank or hopper. (Drawing: J. S. D.)

<sup>1</sup> Certain firms are now producing such tractors in limited numbers.

## MISCELLANEOUS NOTES

Attached to the back of each drill is a spray jet to wash the chemicals into solution.

With the rapid spread and increasing popularity of hydroponics, there is considerable scope for the introduction of machinery and other equipment to meet the needs of growers everywhere. It is hoped that the prototypes already referred to will be only the forerunners of many more implements and machines for use in soilless cultivation.

Amongst important developments in the field of intensive crop culture under controlled conditions, with the eventual goal of complete automation in mind, are such precision techniques as regulated ventilation in closed towers or plant factories, enrichment of the air with extra carbon dioxide to secure quicker maturation of crops, capillary irrigation with fibre-glass or polystyrene strips, use of photothermostats, vegetative growth retardants and inhibitors carried through the atmosphere, and computer systems. It is considered that logic units (the thinking part of computers) could measure and control light, air, aggregate temperature, humidity, and other connected effects. In addition, in growing media, they could sense and adjust nutrient ion concentration, salt tolerance, and oxygen content. In place of aggregate rooting medium, it may become practicable to surround roots with a nutrient fog. The sensing and selection of liquid nutrients by electrical conductivity methods will probably soon be standard practice in advanced hydroponic units. In short, soilless culture is currently progressing at ever increasing pace. New techniques are introduced in rapid succession, and the future holds out virtually unlimited possibilities.

### *Saucers in the parlour*

Certain bulbs like hyacinths and crocuses will grow well in saucers filled with pebbles, to which a little water,



## HYDROPONICS—THE BENGAL SYSTEM

with or without nutrients, has been added. The corm or bulb should be placed in the middle of this tiny heap of aggregate, and the water should reach nearly, but not quite, to its base. It is only necessary to keep the water (or solution) at this level, and flowering will be quite good for one season.

### *Keeping records*

The alert hydroponicist should regard a notebook as the first essential in his equipment. Nothing is of too petty a nature to be recorded. Such information as quantity and frequency of application of the nutrient mixture and the water; dates of sowing, planting, thinning out and harvesting; figures for yield of crops; notes on progress of growth; weather conditions; daily temperature; hours of sunshine; rainfall and a hundred and one other items will be of invaluable help in any future extension of hydroponic installation. Eventually a notebook maintained on these lines becomes a manual in itself, and a reliable guide for operational use. Some suggestions for preparing record sheets have been given on page 159.

**RECORD CHART I**

Key No. 53

SPECIES: Tomato			VARIETY: Best of All			AREA OF TROUGH: 500 square feet							
Date	Temperature		Rainfall in inches	Weather		Hours of sunshine	Condition of Crop			Fruits or flowers picked	Date sown or transplanted	Date picking commenced	Special remarks
	Max.	Min.		Sunny	Cloudy		Poor	Fair	Fine				
4/7	80°	67°	1.28		✓	Nil		✓		None	17/6		
5/7	81°	69°	0.30			4		✓		"			
6/7	85°	72°	Nil	✓		8			✓	"			D.D.T. insecticide applied

**RECORD CHART II**

Key No. 53

SPECIES: Tomato			VARIETY: Best of All			AREA OF TROUGH: 500 square feet			
Date	Formula used	Quantity	Nutrient variations	pH values if taken	Deficiency symptoms if any	NOTES Special remarks			
6/7	Second basic	60 oz.	20% increase K		None				
17/7	"	"							

## THE FUTURE OF HYDROPONICS

**S**OILLESS cultivation is still a new science. Thirty years ago few people knew of the existence of methods of raising crops without soil; today great and growing interest is being shown by all sections of the public in its possibilities and uses. Thousands of amateurs, and many commercial growers, have started hydroponics in numerous different regions.

### *What the Bengal System means*

The new method of soilless growth which originated in Bengal reduced hydroponics to basic essentials. It is now offered to the man-in-the-street as a steady, reliable, cheap, and very easy technique. 'Gardening without dirt', as one American magazine has described soilless culture, is at last a practical possibility for the amateur, and a profitable commercial undertaking for businessmen.

### *Need for demonstration centres*

If people throughout the world are to be given the opportunity of benefiting from the discoveries outlined in this book, immediate steps will have to be taken to open Government Demonstration Centres in all large towns and urban and rural areas, so that citizens may obtain free instruction and advice in the technique of practical hydroponics. Many wrongly imagine that the soilless cultivation of plants is a complicated and expensive business. This book should go a long way towards removing any such misconception, but to bring the true facts home to the average individual, especially if he or she is illite-

# THE FUTURE OF HYDROPONICS

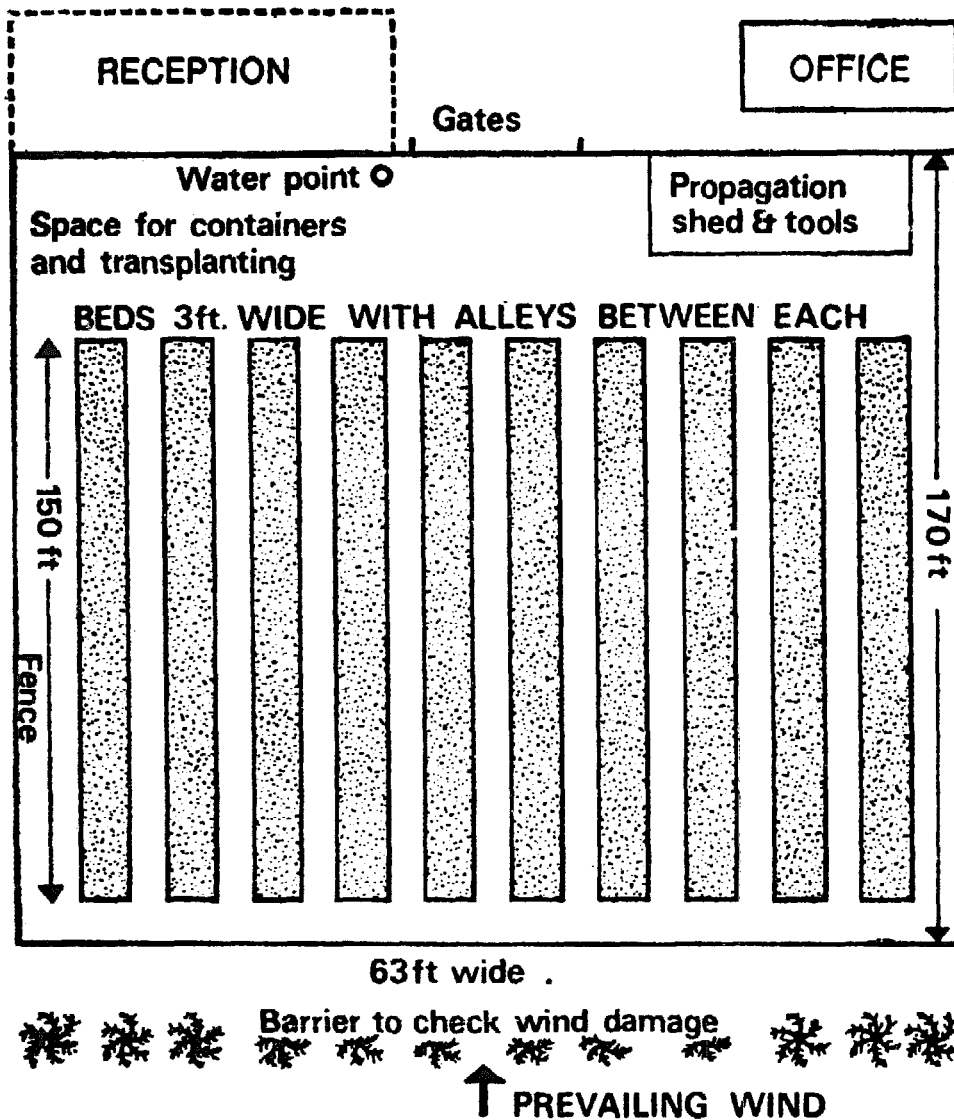

## LAYOUT FOR A HYDROPONIC DEMONSTRATION UNIT

Easily adapted to commercial use (Original drawing: J.S.D.)

rate, there can be nothing to compare with simple demonstrations. The last Commonwealth Trans-Antarctic Expedition decided to use Bengal system simplified hydroponics to produce fresh salads at the Base Camp for the members of the expeditions to eat. Several said on

## HYDROPONICS—THE BENGAL SYSTEM

behalf of the project that 'it was a valuable addition to our diet and morale'.

### *Social implications*

Multiple cropping and intensive culture by hydroponic means will effect profound changes in the social life of the world. An industrial worker may hope to regain some measure of that economic independence that his peasant ancestors possessed. With a permanent food supply at his back door, the fear of unemployment will be considerably lessened. Farmers or horticulturists could laugh at droughts, erosion or bad land. States lacking in soil resources would find soilless culture ideal. To city dwellers it is a heaven-sent benefaction. Unfortunately, the world food shortage shows no sign of abating at any time in the predictable future, and urgent steps are needed to save populations from semi- or total starvation. In Asia, Africa and South America, especially, millions are suffering from the bitter pangs of perpetual hunger. By bringing cheap and nourishing foodstuffs within the reach of all—even the poorest—hydroponics offers something of real value to humanity. As a Grow-More-Food device there can be few things more worthy of international recognition and official encouragement.

### *Still cheaper ways*

In order to help people living in areas where local conditions or standards may make it difficult to use inorganic nutrients for soilless crop growing, a cheaper way of getting quite good results with treated natural manures alone, or combined with a small proportion of fertilizer salts, has been developed at the Hydroponic and Fish Investigation Unit in Bengal. This is called the Sharder process. Results have been most encouraging. Normal beds of aggregate are employed for raising plants, but to

## THE FUTURE OF HYDROPONICS

supply essential nourishment to crops, manure shells or pots are placed at appropriate intervals along the troughs. These consist of earthenware vessels, lined with some kind of sieve or screen, and pierced by a number of tiny holes at the bottoms. The pots are filled with a nutrient sludge or semi-liquid manure, a typical formula for which would be:

Fresh or dried dung, one handful.  
Matured oilcakes, four teaspoonfuls.

Alternatively, such materials as hoof-and-horn meal, bonemeal, shoddy (wool waste), and similar plant food-stuffs can be utilized, the exact quantities depending upon their analyses (See pages 45 & 47). Dried wood ashes are also fairly good for the purpose. To prepare larger bulk amounts, simply multiply the quantities by a constant number.

The oilcake is matured by kneading it with a little water and adding ground bones together with some potash, afterwards keeping it in a closed container for about two months. This disposes of any smell that might occur if fresh cake was employed as a fertilizer.

When the manure shells are placed in the hydroponic troughs, and sunk down a few inches into the aggregate, with only the upper portions remaining exposed, they slowly release their nutrient contents into the growing medium. These then become available to the plants' roots as food. Covers should be placed over the vessels, and from time to time they may be refilled with nutrient sludge or topped up. Every three months, the beds should be flushed through with plain water to cleanse them, while for maintaining correct dampness of the aggregate normal irrigation is given in the same way that has already been described in this book. If available, small quantities of common inorganic fertilizers can also be added periodically to the shells or pots to boost growth.

## HYDROPONICS—THE BENGAL SYSTEM

The Sharder process may appeal as well to those persons who have conscientious objections to the use of inorganic manures. The following basic formula could easily be made up by town dwellers living in districts where dung is hard to obtain:

Item.	Ozs.
Hoof-and-horn meal ... ..	15
Bonemeal ... ..	8
Ground chalk ... ..	6
Ground magnesium limestone rock ... ..	18
Fresh wood ashes ... ..	20
Scrapings from a rusty iron nail (enough to cover half a teaspoon)	

Mix well together, and dilute to a thick sludge with water. Place in pots of about 2 lb capacity each, prepared as described above, and set them at intervals of up to one yard along the length of the hydroponic troughs, making sure the bottoms are sunk three or four inches into the aggregate. The sludge will slowly liberate its nutrients through the growing medium. Take care to see that it is not too thick, and that the liquid from it strains gradually out of the vessels into the beds, passing easily, but not too rapidly, across the linings or screens inside these shells. Top up with water and fresh supplies of the formula mixture monthly. Larger amounts may be made up at one time by increasing the total bulk as desired.

Those readers who wish to obtain further details of the Sharder process as used in Bengal type hydroponics are advised to consult Mr V. K. Chatterjee's interesting book *Practice of Soilless Cultivation (Sharder Process, Bengal System)*. See Appendix B. The technique has been recommended by Mr E. A. R. Banerjee, former Joint Director of Agriculture, Government of West Bengal, and now Special Adviser to the Indian Jute Association, as 'of great

## THE FUTURE OF HYDROPONICS

value to those who intend to take up hydroponics in the city of Calcutta and the towns of West Bengal'. The same comments would apply to any country where similar conditions or needs exist.

### *Floriculture*

A considerable amount of work with flowers has been carried out in Bengal and other areas, but for various critical reasons it was felt best to concentrate initially on raising economic plants. But those who are interested in growing flowers for the beautification of the home, or enjoyment, can rest assured that just as good results may be obtained with them as with vegetables. Commercial floriculturists, in fact, have been quick to realize the advantages of raising good blooms without soil. Several 'flower factories' are now in existence, notably in the United States, France, Italy and England, where many thousands of fine roses, chrysanthemums, carnations, fuchsias, and other plants are grown in hydroponica. For household use, one of the cleanest aggregates to employ is probably a mixture of equal parts of sand and vermiculite. This is light and it holds water well. The ordinary nutrient formulae are quite satisfactory for flowers, but amateurs may find it convenient to buy one of the slow-release fertilizers made up to an approved prescription containing all the essential elements, or else obtain a conventional proprietary hydroponic powder or tabloid mixture.

### *Plans for tomorrow*

Research is continuing into the problems of soilless culture, as they affect all countries. Many more questions and points of interest remain to be tackled. Certain problems still await solution. But, given proper support, the present writer feels that we may all confidently look forward to that not far-distant day when there will be a



## HYDROPONICS—THE BENGAL SYSTEM

hydroponicum in every home, banishing want, bringing economic independence, and ensuring that the children of the future may grow up amid healthy surroundings with clean, fresh food to eat. As world population rises, so the situation becomes more urgent. Today we have the technical knowledge and ability to provide, by means of simple hydroponic methods, all the basic nutritional requirements of any future increase in the number of the Earth's inhabitants. Not only would this imply the establishment of large cultural units in barren regions, but also the erection of hydroponic towers<sup>1</sup> and similar productive installations inside the great cities or megapoli of coming centuries. The only thing that is lacking is the energy and will on the part of some authorities to devote the necessary attention to these vital human needs. The progress of time, combined with the spread of full knowledge about soilless culture of crops, will, it is to be hoped, bring about an atmosphere of greater concern. Then, indeed, the races of mankind could enter upon an era of peace, prosperity, and plenty.

<sup>1</sup> See photograph 43.

## APPENDIX A

### *List of Institutions and Organizations engaged in or connected with soilless culture research*

#### *International*

International Working-Group on Soilless Culture (IWOSC).  
The secretariat is located at the Centre for Plant Physiological  
Research, P.O. Box 52, Wageningen, The Netherlands. (Presi-  
dent: Professor F. Penningsfeld; Secretary: Dr A. A. Steiner.)  
Centro International para la Hidroponia, (International Centre  
for Hydroponics) Caja Insular de Ahorros de Gran Canaria, Las  
Palmas, Canary Islands.

#### *Austria*

Akademische Wissenschaftl, Vienna.  
Hydroanlagen, Ort im Innkreis, Austria.  
Institut für Pflanzenbau und Pflanzenzüchtung, Vienna.

#### *Bahama Islands*

Hydroponics Ltd., Freeport, Grand Bahama.  
Institute for Hydroponics, West End, Grand Bahama.  
The Twenty-first Century Corporation Ltd., P.O. Box 1601,  
Nassau.

#### *Belgium*

Académie Royale.  
Ministère des Colonies, Direction de l'Agriculture.  
Research Station for Ornamental Plants, Melle.  
University of Brussels.  
University of Ghent.

#### *Brazil*

Centro Brasileiro de Pesquisas Hidroponicas, Sao Paulo.

#### *Canada*

Central Experimental Farm, Ottawa.  
Research Station, Saanichton, British Columbia.

## HYDROPONICS—THE BENGAL SYSTEM

### *Congo*

L'Institut National pour l'Etude Agronomique du Congo (INEAC),  
Yangambi.

### *Czechoslovakia*

Czechoslovakia Society of Botany, Prague.  
University of Prague.

### *Finland*

Research Institute, Hyrylä.  
Valio Laboratory, Helsinki.

### *France*

Académie Agricole Française.  
Académie des Sciences, Paris.  
Ecole Nationale Supérieure d'Horticulture, Versailles.  
Institut Pasteur.  
Station d'Agronomie, Route du Cap d'Antibes (AM).  
Station Centrale de Physiologie Végétale, Versailles.

### *Germany*

Institut für Bodenkunde und Pflanzenernährung, Weihenstephan.  
Institut für Gartenbau der Deutschen Akademie der Landwirtschaftswissenschaften zu Berlin in Grossbeeren.  
Institut für Nutzpflanzenforschung (Obstbau), Berlin.  
Institut für Obst- und Gemüsebau, Halle (Saale) Ludwig-Wuchererstrasse 2.  
Institut für Pflanzenernährung der Technischen Hochschule, Hanover.  
Landwirtschaftliche Versuchs-Station, Bonn.  
University of Berlin.  
University of Kiel.

### *Great Britain*

Bakeham Farm Nurseries, Surrey.  
British Carnation Society.  
Experimental and Research Station, Cheshunt (*now* Glasshouse Crops Research Station, Rustington, near Littlehampton, Sussex.)

## APPENDIX A

Hydroponic Advisory & Information Unit, Ickenham, Middx.  
Institute of Hydroponics, London Road, Corwen, Merioneth.  
J. A. Gordon & Son Ltd., Stonehouse, Glos.  
Jealott's Hill Research Station (Imperial Chemical Industries Ltd.)  
Long Ashton Research Station, University of Bristol.  
Richmond's Nurseries, Peel.  
Royal Horticultural Society.  
The Tintometer Ltd., Salisbury, Wiltshire.  
Trace Element Fertilisers Ltd., 118 Ewell Road, Surbiton, Surrey.  
University of Reading, Department of Horticulture.  
Whitehall Nurseries, Peel, near Blackpool.

### *Guernsey*

Castel School, Castel.

### *India*

Chief Minister's Secretariat, State of Uttar Pradesh, Lucknow.  
Excel Industries Ltd., Swami Vivekanand Road, Jogeshwari,  
Bombay 400 060.  
Field Research Centre, Mirik, Darjeeling, West Bengal.  
Hydroponic and Fish Investigation Unit, 45/4 Nil Kamal Kundu  
Lane (or 6 Jadu Mookherjee Lane), P.O. Sibpur, Howrah, West  
Bengal.

### *Israel*

Bar-Ilan University, Ramat-Gan.  
Kibbutz Yad Hanna.  
Kibuz-Chafez, Chaim.  
Negev Institute for Arid Zone Research.  
Volcani Institute of Agricultural Research, Bet Dagan.

### *Italy*

Institute of Botany, University of Pavia.  
Istituto de Orto Botanico, Perugia.  
Istituto di Agronomia Generale e Coltivazioni Erbacee, Pisa.  
Istituto di Agronomia Generale e Coltivazioni Erbacee, Sassari,  
Sardinia.

## HYDROPONICS—THE BENGAL SYSTEM

Istituto di Allevamento Vegetale, Perugia.

Istituto di Chimica Agraria, Università degli Studi S. Pietro,  
Perugia.

University of Naples.

### *Japan*

College of Agriculture, Imperial University of Tokyo.

Faculty of Agriculture, Tohoku University, Sendai

Faculty of Agronomy, Hokkaido Imperial University.

Headquarters, American Forces Far East (United States Army  
Hydroponics Corps).

Horticultural Research Station, Kanagawa.

### *Kuwait*

Hydroponic Section, Ministry of Public Works.

### *Mexico*

Hydroponic Unit, Apt. M-2181, Mexico, D.F.

### *Netherlands*

Centrum voor Plantenfysiologisch Onderzoek, Wageningen.

Department of Soilless Culture of the National Council for  
Agricultural Research, T.N.O., Koningskade 12, The Hague.

Horticultural Experiment Station, Naaldwijk.

Instituut voor Bodemvruchtbaarheid, Haren (Gr.)

Instituut voor Tuinbouwtechniek, S. L. Mansholtlaan 10, Wageningen.

Stichting Voedingsfysiologisch Onderzoek bij planten, Nonnensteeg  
3, Leiden.

### *New Zealand*

Department of Agriculture, Box 118, Nelson.

Department of Scientific and Industrial Research, Soil Bureau  
Experimental Station, Lower Hutt.

Industrial and Hydroponics Developments, Marlborough.

### *Philippines, The*

Linda-Mar Cooperation, Makati, Rizal.

## APPENDIX A

### *Poland*

Académie Polonaise des Sciences et Lettres.  
Institut für Gartenbau, Poznan.  
Institute of Horticulture, Warsaw.  
National Institute of Polish Rural Economy.  
Ogrod Botaniczny, University of Wrocław.  
Research Institute of Vegetable Crops, Skierniewice.

### *Russia (U.S.S.R.)*

Academy of Sciences, U.S.S.R.  
Agronomical Laboratory, Selskhoz Institute, Moscow.  
Institute of Agrochemical Problems and Hydrochemistry, Erevan,  
Armenia.  
Institute of Agronomy, Leningrad.  
K. A. Timiriazev Institute of Plant Physiology, Moscow.

### *Seychelles*

Department of Agriculture, Grand'Anse Experimental Station,  
Mahe.

### *South Africa*

J. Muller Laboratories, P.O. Box 2611, Cape Town.  
Smith Hydroponics Seedlings, P.O. Box 227, Westoriana, Transvaal.  
Transvaal Horticultural Society, P.O. Box 7616, Johannesburg.

### *Spain*

Catedrático de Fisiología Vegetal, Universidad de la Laguna,  
Tenerife.  
Consejo del Servicio Agrícola de Gran Canaria, Las Palmas,  
Canary Islands.  
Instituto Forestal de Investigaciones Experiencias, Madrid.  
Instituto Nacional de Investigaciones Agrarias, Madrid.  
Instituto Nacional de Investigaciones Agronomicas, Barcelona.  
Universidad de La Laguna, Tenerife.

### *Sweden*

Royal College of Forestry, Stockholm.  
Vegetable Division, State Horticultural Research Station, A. Karp.

## HYDROPONICS—THE BENGAL SYSTEM

### *Switzerland*

Versuchs-Station Wädenwil.

### *Tanzania*

Hydroponic Unit, Geita.

### *United States*

American Potash Institute.

American Society of Agronomy.

American Society of Horticultural Science.

Boyce Thompson Institute for Plant Research, New York.

Brookside Research Laboratories, New Knoxville, Ohio.

Chemical Garden Company, Evanston, Illinois.

Department of Agriculture, United States Government, Beltsville, Maryland.

Department of Horticulture, Colorado State University, Fort Collins.

Department of Horticulture, New Mexico State University Scientific Farms, San Antonio, Texas.

Department of Horticulture, Pennsylvania State University.

Hydroculture Inc., 1516 North 7th Avenue, Phoenix, 85007 Arizona.

Johns Hopkins University.

Kansas Agricultural Experiment Station.

New Jersey Experiment Station.

Ohio Agricultural Experimental Station.

Ohio State University, Division of Floriculture.

Pan-American Hydroponics Inc., Grapevine, Texas.

Purdue University Experiment Station.

Texas A. & M. University, College Station 77843, Texas.

University of Arizona.

University of California.

University of Florida, Agricultural Extension Service.

University of Illinois, Department of Agronomy.

University of Nebraska, Lincoln.

### *West Indies*

Yag Hydroponic Unit, P.O. Box 2644, Christiansted, St. Croix, U.S.V.I. 00820.

## APPENDIX A

### *Western Samoa*

South Pacific Regional College of Tropical Agriculture, Alafua,  
Apia.

**NOTE:** In addition to the institutions and organizations listed above, there are numerous scientists and investigators undertaking special studies on soilless culture in different countries as well as hundreds of thousands of commercial and amateur growers, from whom advice on hydroponics may be obtained. Working units are also located in southern Algeria in the Saharan region, in Aruba and Curacao (West Indies), in Abu Dhabi and other parts of Arabia, in the Pacific area, and in Australia, as well as in many more places. A Register of Consultants is maintained by the secretariat of IWOSC at Wageningen, Netherlands.



## APPENDIX B

### *Bibliography*

- An Experiment in Soilless Cultivation*. Publications Bureau, Information Directorate, Lucknow, Uttar Pradesh, India, 1956.
- BENTLEY, M., *Growing Plants Without Soil (Vermiculaponics)*. Hydro-Chemical Industries (Pty.) Ltd., Johannesburg, 1955.
- BEWLEY, W. F., *Commercial Glasshouse Crops*, Rev. Ed. (Section on Hydroponics) 1963, Country Life, London, 84/-
- BIEBEL, J. P., *Hydroponics—The Science of Growing Crops without Soil*. Bulletin No. 180, Florida Department of Agriculture, Tallahassee.
- CHATTERJEE, V. K., *Practice of Soilless Cultivation (Sharder Process)*. Alpha-Beta Publications, P.O. Box 2539 Calcutta 1, 1963, Rs 5.
- CHOUARD, P., *Cultures sans Sol*. La Maison Rustique, Paris, 1954, pp. 200, Frs 575.
- COLLINGS, GILBEART H., *Commercial Fertilizers, Their Sources and Use*. McGraw-Hill Publishing Co. Ltd., London, 5/c, 1955, 81s. 6d.
- CONNORS, C. H., & TIEDJENS, V. A., *Chemical Gardening for the Amateur*. Wm. H. Wise & Co., New York, 1939, out of print.
- DAVTYAN, G. S., *Hydroponics as an Industrial Achievement of Agrochemical Science*. Academy of Sciences of the Armenian S. S. R., Erevan, 1969.
- ELLIS, C., & SWANEY, M. W., *Soilless Growth of Plants*, Reinhold Publishing Corporation, New York, 1938, Second Ed. revised by Eastwood, T., and enlarged 1947, out of print.
- FAWCETT G. S., & STOUGHTON, R. H., *The Chemical Testing of Plant Nutrient Solutions*. The Tintometer Ltd, Salisbury, 1944, 8s. 6d.

## APPENDIX B

GERICKE, W. F., *The Complete Guide to Soilless Gardening*. Prentice-Hall Inc., New York, out of print.

HARRIS, D. A., *Hydroponics: Gardening Without Soil*. Purnell, Cape Town, 1966.

HEWITT, E. J., *Sand and Water Culture Methods used in the Study of Plant Nutrition*. (Technical Communication No. 22 (Revised) of the Commonwealth Bureau of Horticultural and Plantation Crops, East Malling, Maidstone, Kent, England.) Second Edition, 1966.

HOAGLAND, D. R., *Lectures on the Inorganic Nutrition of Plants*. Chronica Botanica Co., Waltham, Mass, U.S.A., 1944.

HOAGLAND, D. R., & ARNON, D. I., *The Water Culture Method of Growing Plants Without Soil*. University of California, 1950, out of print.

HOLLIS, H. F., *Profitable Growing Without Soil*. English Universities Press, London, 1964.

HOMES, M. V. L., ANSIAUX, J. R., & VAN SCHOOR, G., *L'aquiculture*. Service des Publications, Ministère des Colonies, Place Royale, Bruxelles, 1953.

*Hydroponics (Soilless Cultivation)*. Bulletin No. 1 (1946-7). Issued by the Hydroponic Research Centre, Government of West Bengal Experimental Farm, Kalimpong, Darjeeling, India, December 1947, out of print.

*Hydroponics as a hobby*. Circular 844, University of Illinois, College of Agriculture, Urbana.

*Land of Eternal Spring*. Hydroponic Green Forage. Hydroponics Inc., Indianapolis, Indiana.

LAURIE, A., *Soilless Culture Simplified*. W. Heffer & Sons, Cambridge, 1940, out of print.

LAURIE, A., & RIES, V. H., *Floriculture: Fundamentals and Practices* (ch. v). McGraw-Hill Book Co. Inc., New York, 2/e, 1950, \$9.95.

## HYDROPONICS—THE BENGAL SYSTEM

MATLIN, D. R., *Growing Plants Without Soil*. Chemical Publishing Corporation Inc., New York, 1939, out of print.

MILLER, C. M., *Plant Physiology* (chapters v and vi). McGraw-Hill Book Co. Inc., New York and London, 2/e, 1938, pp. 1202, \$18.50.

*Nutriculture*. Purdue University, 1948.

*Nutriculture*. United States War Department Technical Manual, 1946. Available from U.S. Army Adjutant-General Publications Center 1655, Woodson Road, Saint Louis, Missouri 63114.

PHILLIPS, A. H., *Gardening Without Soil*. C. A. Pearson Ltd., London, 1939, pp. 140, out of print.

PHILLIPS, A. H., *The Science of Soilless Culture*. (Advanced Sequel to *Gardening Without Soil*.) C. A. Pearson Ltd., London, 1943, pp. 118, out of print.

SAUNBY, T., *Soilless Culture*. Country Life Publications Ltd., London, 1953, 12s. 6d.

SCHWARZ, M., *Guide to Commercial Hydroponics*. Israel Universities Press, Jerusalem, 1968.

SHOLTO DOUGLAS, J., *The Possibilities of Soilless Cultivation*, vol. VI, no. 1. (Impact of Science on Society), United Nations Educational, Scientific & Cultural Organization, Paris, France, March 1955, 125 Frs.

SIMPSON, A. J., *Flowers and Vegetables Without Soil*. The London Gardens Society, October 1949, out of print.

STILES, W., *Trace Elements in Plants*. Cambridge University Press, 1946, out of print.

STOUT, J. G., and MARVEL, M. E., *Hydroponics—Culture of Vegetable Crops*. Circular 192, Florida Agricultural Extension Service, Gainesville.

SWARBRICK, T., *Harnessing the Hormone*, Grower Publications Ltd., London, 3s. 6d.

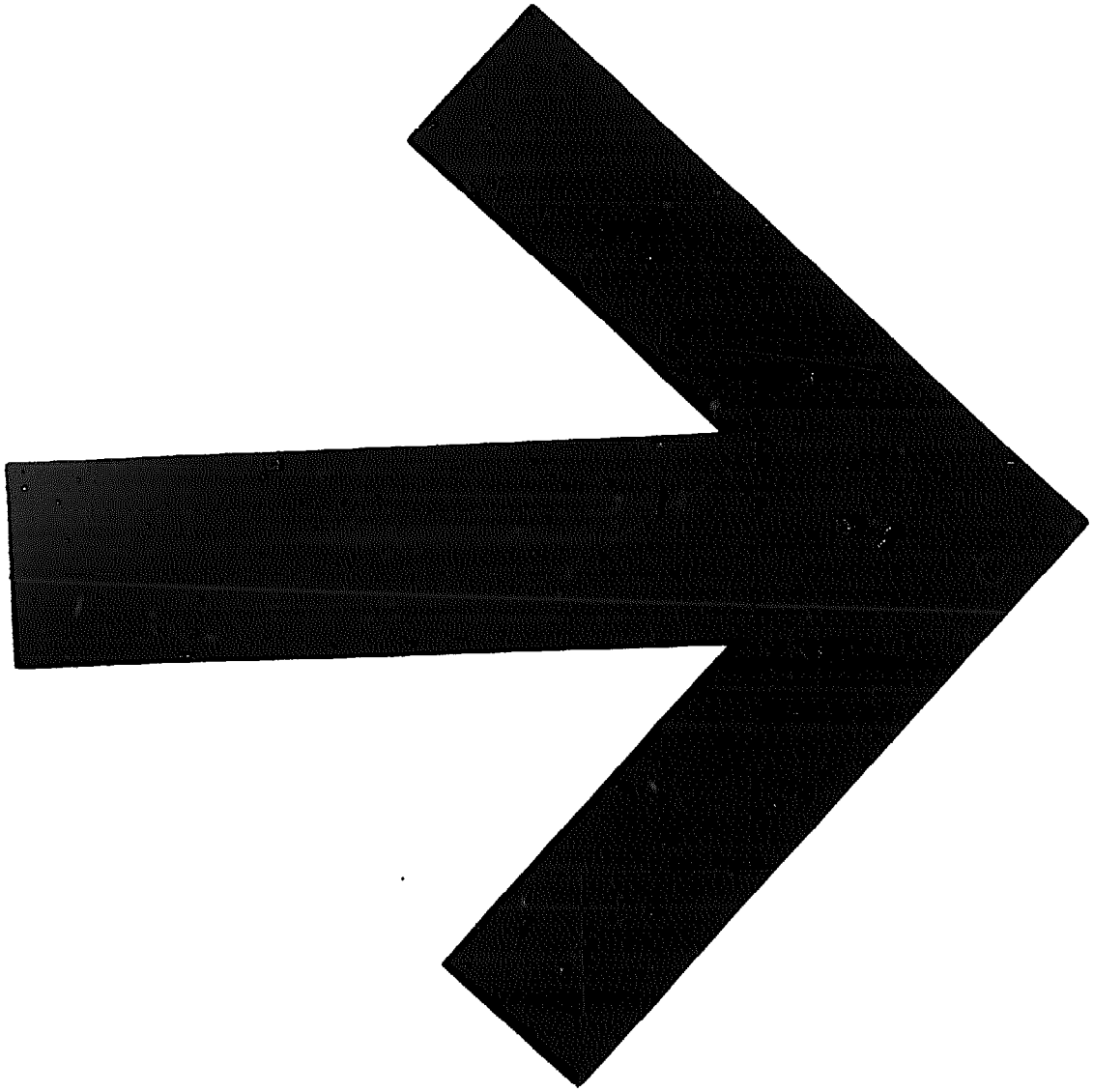

## APPENDIX B

BOUQUET, C. E., *Successful Gardening Without Soil*. C. Arthur Pearson Ltd., London, 1952, out of print.

BURNER, W. I., & HENRY, V. M., *Growing Plants in Nutrient Solutions, or Scientifically Controlled Growth*. John Wiley & Sons, New York, out of print.

NOTE: Unfortunately, many of the books listed above are today no longer in print. Readers wishing to consult such works could, however, perhaps be able to obtain them from public libraries or else might be able to borrow copies, in some instances, from agricultural and horticultural stations and institutions or from University faculties of agriculture and horticulture.

## INDEX

- acid, sulphuric, 48, 61, 68, 98;  
beta, indoleacetic and indo-  
lebutyric, 147
- acidity, excess in growing media,  
99
- aeration, 24, 35, 97, 102, 135
- aeroponics, 118
- Africa, southern, 7; East, 12, 91
- aggregate culture, 108-9
- aggregate, inert, 34-5, 54; too  
coarse, 35; mixture, 35-6;  
treatment of, 98-9
- Agriculture Ministry, British, 8,  
124
- ai. conditioning, 38, 97, 126, 139
- air liners, 8
- Air Ministry, British, 8
- Alabama, Polytechnic Institute, 5
- Albert Howard Foundation, 146
- algae, culture, 146; prevention  
of, 99
- Algeria, 12
- alkali, 61-2
- alkalinity, 62
- aluminium, 23
- amberlites, 70-1
- America, 4, 9, 10, 132
- American press, 3
- analysis, chemical, 6, 21, 40
- anemones, 95
- animals, diet for, 148
- Antipodes, 92
- ants, 101, 103
- aphides, 137
- Aristotle, 1
- Arizona, 9
- Aruba, 9
- asbestos sheets, 29, 34
- Ascension Island, 8
- Asia, 10; South or East, 54
- asphalt, 109; enamel, 29; im-  
pregnated mats, 29
- Attlee, Earl, 91
- Australia, 9, 12
- Austria, 167
- auxins, 147
- Aztecs, 9
- bacteria, 23
- bags, asphalt-coated, 91
- Bahama Islands, 167
- Bahrein, 8
- bamboo, 34, 78; guttering, 37
- bark, pine-tree, impregnated, 77
- barley, 148
- basic mixtures, 54-5
- basins, 4, 29, 33
- baskets, hanging, 77, 146; techni-  
que of, 77
- beans, broad, 24; French, 7, 96,  
128; sprouting, 9
- beetroot, 7, 95, 128
- begonias, 93
- Belgium, 167
- Bengal, 6, 7, 10, 12, 14, 50, 96,  
128, 129, 130, 162, 165, 167
- Bombay, 13, 14, 88, 91
- boreholes, depth of, 85
- boric acid, 59
- boron, 23, 74, 134

## INDEX

- Boyce Thompson Institute, 5, 146, 147  
 Brazil, 167  
 bricks, 29, 33, 123; broken, 34-5, 88  
 brinjals (egg-plant), 97, 102  
 Britain, 7, 10, 11, 153, 167, 168  
 broccoli, 98  
 bulbs, 95, 157  
 Burma, 12
- cabbage, 81, 93, 96, 97, 128  
 calcium, 22, 36, 61, 74, 134  
 Calcutta, 13, 14, 85, 88, 124  
 California, 7, 9, 124; University of, 3, 4, 129  
 Californian research, 1  
 Canada, 4, 9, 167  
 carbon, cycle, 19; dioxide, 19, 21  
 carnations, 9, 125, 165  
 Carnegie Institution of Washington, 146  
 carrier materials, 70-2, 83  
 carrots, 96  
 caterpillars, 101, 137  
 cauliflowers, 7, 93, 97-8, 128  
 cells, 95, 96  
 cels, 18, 20, 21, 22, 147  
 cement, 33, 143  
 charcoal, activated, 76  
 chats, 7  
 chemicals, types of (*see* fertilizers)  
 Cheshunt compound, 136, 152  
 Cheshunt Early Giant, lettuce, 124  
 chips, granite, 34, 80  
 chlorohydrin, 147  
 chlorophyll, 18, 19, 21, 23, 98  
 chloroplasts, 18  
 chlorosis, 103, 135  
 chromosomes, 147  
 chrysanthemums, 165  
 clay, puddled, 29, 143  
 clematis, 95  
 cloches, 100, 139  
 coffee (*see* Kenya Coffee Board)  
*Colchicum autumnale*, 147  
 cold area, 36  
 Colorado, 131  
 compounds, proprietary, 44; giving graduated nutrition, 73  
 concrete, 29, 32, 123  
 Congo, 168  
 containers, wooden, 33  
 copper, 23, 74; sulphate of, 59, 152  
 coral, leached, 36  
 corn, 96  
 costs, 6, 122, 127, 130  
 cotton, 154  
 crocuses, 157  
 crops, rotation of, unnecessary, 13; out of season, 6, 97, 126  
 cucumbers, 96, 128  
 Curaçao, 9  
 cuttings, 95, 147  
 Czechoslovakia, 168
- 'damping-off' 94, 102, 125, 135; cure for, 152  
 Dar es Salaam, '91  
 Darjeeling, 10, 80, 90, 125, 130  
 Davy, Sir H., 2  
 defluorinated phosphate, 77  
 defoliation, practice of, 97  
 desert air-stations, 8, 28  
 deserts, 5, 13, 36, 51

## INDEX

- deuterium oxide, 147  
 Discorides, 2  
 diseases, 6, 94, 121, 125  
 disinfection, 99  
 drainage, 6, 32, 35, 84, 88, 95, 97,  
     102, 107  
 drip culture system, 108  
 dry application system, 108  
 drought, 15, 24  
 dryness, excessive, 94, 103  
 dust, 100; choking by, 25  
 dyes, 147
- eelworms, 136  
 effluents, 77, 146  
 egg-plant, 97, 102  
 Egham, report from, 124  
 endive, 96'  
 England, 14, 165  
 erosion, 15, 24  
 ethylene gas, 147  
 Europe, 4, 83, 92  
 evaporation, 36, 84-5, 88, 94  
 Experimental Farm, Kalimpong,  
     10, 130; Ottawa, 4
- felt, roofing, 29  
 fertilization, artificial, 100-1, 103  
 fertilizers, application of, 81-2;  
     availability, 40-2, 55-7; new,  
     with trade names, 47; slow-  
     release, 72; storage, 40; sub-  
     stitute for, 76; trace, 47, 59;  
     various types, and analyses  
     of, 43-7, 52-3; urea-form, 73  
 'filler', 41, 96  
 Finland, 168  
 flax, 7, 154  
 floating gardens, 9
- flood, 24  
 Florida, 7, 9, 110; University of,  
     69  
 'flower factories', 165  
 flower-pots, 29  
 flowers, growing of, 23, 133, 165  
 flume, 109, 110  
 fly, green, pest, 101  
 foot-rot, 136; cure for, 152  
 forage, hydroponic, 148  
 forestry, 147  
 formaldehyde, 99  
 Formosa, 12  
 France, 9, 12, 165, 168  
 F. T. E., 47, 59  
 fumes, toxic, 100, 102  
 fungi, prevention of, 99
- gases, toxic, 25  
 Geita, 91  
 Gericke, Dr W. F., 3, 4, 7, 34, 74,  
     107, 129; method, 105  
 Germany, 9, 12, 168  
 germination, techniques for, 80,  
     93-6  
 gibberellic acid, 147  
 glass, use of, 15, 29, 126  
 gloxinias, 93  
 goitre, 23  
 grain, 148  
 grass, 148  
 gravel, 36, 125; culture in, 4, 108  
 Great Britain, 4, 7, 168  
 greenfly, 137  
 greenhouse culture, 14, 140  
 growing area, 6, 87; medium, 34-7  
 Grow-More-Food Campaign, 8,  
     162  
 Guernsey, 169



## INDEX

- gussets, 114  
 gutters, 33, 37  
 Guyana, 8
- Habbaniya, 8**  
 heat, excess of, 98, 103  
 heating, artificial, 139  
 Hicks, F., 129  
 Himalayan foothilis, 36  
 Holland, 9, 12  
 hormones, use of, 147  
 hose, rubber, 37  
 housewife, 6, 15, 29, 39, 102  
 hyacinth, 157  
 hydrangeas, 23  
 hydrogen, 20, 38  
 hydroponics, containers, 29-34;  
     definitions of, 1, 38, 160;  
     difficulties with, 102-3;  
     Bengal system, 11, 12, 14, 15,  
     27, 58, 75; merits of, 5, 13-14;  
     planting space, 96; public  
     interest in, 12; primitive  
     form of, 9; social effects of,  
     13; water test for, 39  
 hydroponicists, 9, 15, 37, 55, 63,  
     64, 158  
 hydroponicum, definition of, 28;  
     household, 29, 54; shade in  
     the, 88
- Illinois, 9; University of, 4**  
 illumination, 25, 99  
**Imperial Chemical Industries, 4,**  
     64  
**India, 9, 10, 11, 14, 51, 54, 83, 98,**  
     127, 169; soil of, 14  
**Indian Tea Association, 153**  
**Indiana, 9**
- indicators, 48, 62-3  
 indigenous materials, 11, 27, 34  
 infections, 136-7  
 intensive culture, 15  
 intercropping, 13, 88, 96, 131  
 iodine, 23  
 Iraq, 8  
 iron, 23, 74, 134, 135; galvanized,  
     29; apparatus, 33  
 irrigation, 15, 37, 84, 87  
 Israel, 12, 169  
 Italy, 165, 169  
 Iwojima, 8  
 I.W.O.S.C., 120, 129, 167
- Japan, 9, 12, 109, 170**  
 jars, 29, 33  
 Jealott's Hill Research Station,  
     108, 129  
 jute, 154
- Kalimpong, 10, 78, 80, 85, 87, 130**  
**Kashmir, 9**  
 keeping qualities, 125  
**Kenya Coffee Board, 153**  
 Knop, 2  
 kohlrabi, 90  
 Kuwait, 9, 170
- laboratory, experiments in, 76  
 labour, 6, 11, 90; economy of,  
     124-5; charge for, 131  
 lady's finger, 128  
 larkspurs, 95  
 leaf-curl, 135; cure for, 153  
 leather-jackets, pest, 101  
 leeks, 95  
 lettuce, 7, 96, 98, 128; seed, treat-

## INDEX

- ment of, 98, 147; cos lettuce, 91
- light, artificial, 99, 150
- lime (lye), 36, 62, 152
- Limpopo valley, 91
- London, 8
- Lucknow, 14, 90, 91
  
- magnesium, 22, 61, 74, 134
- maize, 7, 81, 94, 128, 130, 133
- Malta, 12
- manganese, 23, 74, 134; sulphate of, 153
- manure, cow, glutinous, 34
- marigolds, African, 136
- mats, overhead, 37, 140
- meadow saffron, 147
- mechanization, 154-7
- Mexico, 9, 170
- Middle East, 8
- Middle West, 4, 106, 107
- military bases, 8
- mixtures, fungicide, Bordeaux, 135, 152; Burgundy, 135, 152; Shive's (R 552), 76
- moisture, retention of, 25
- monsoon season, 10, 34, 40, 51, 60, 87, 125, 135
- mortar, 29; compounded, 143
- moths, 101
- multiple cropping, 96, 123, 162
- mushrooms, 77
  
- Naaldwijk, Horticulture Experiment Station, 5
- naphthalene, 81
- nematodes, pest, 136
- Netherlands, 5
  
- New Jersey, Agricultural Experiment Station, 129; methods, 107
- New York, 5, 9
- New Zealand, 12, 170
- nitrogen, 22, 61, 74, 98, 103, 134, 135, 145
- nitrogen-potassium balance, 60, 98
- North America, 14
- notes, keeping, 158
- nucleic acid, 47
- nutrient film layflats, 113-4
- nutrients, loss of, 15; p.p.m. limits, 74; spreader for, 37-8; storage of, 40, 60; application of, 81-2; tabloid, 63
  
- oatmeal, 77
- oats, 7, 94, 128, 130
- Ohio, 9; University of, 4
- oil cake, 163
- olericulturists, 9
- onions, 91, 95
- osmosis, 19, 20
- Ottawa, Central Experimental Farm, 4
- oxygen, 19, 20, 38; for root crowns, 24; supply of, 32
  
- Pacific Ocean, 8, 92
- Pakistan, 12
- Palestine, 8
- Pan American Airways, 8
- Panikheti*, 154
- paper, rolled balls, 77
- peas, 7, 94, 128, 130
- peat, 34, 77; treatment of, 36
- permutits, 70, 71

## I N D E X

- Persian Gulf, 8**  
**Philippines, 170**  
**pH testing, 38, 87; scale, 62-3;**  
     **values, 62, 70, 88**  
**phosphorus, 22, 74, 134**  
**photosynthesis, 19, 21**  
**phytosanitation, 80, 137**  
**plantation crops, 154**  
**plaster, mud, 30, 32; non-**  
     **erodible, 34, 142-3**  
**plastics, 32, 77**  
**plumule, 25**  
**Poland, 106**  
**pollination, technique of, 100**  
**polythene, 30, 32, 100**  
**potash, 71, 73**  
**potassium, 22, 51, 60, 74, 103, 134**  
**potatoes, 7, 13, 91, 96, 128, 130,**  
     **sprouting, 147**  
**pots, 28, 91**  
**protoplasm, 18, 22**  
**pumpkins, 96**  
**Purdue University, 4, 74**  
**pyrethrum, 101, 137**
- racehorses, diet for, 148**  
**radicle, 25**  
**radishes, 96**  
**rain, 40, 87, 107**  
**Reading, University of, 4, 125**  
**records, 158; chart for, 159**  
**Rehovot World Academy of Art**  
     **and Science, 39**  
**respiration, 21**  
**rice, 7, 13, 113, 128; sowing of,**  
     **94**  
**ring culture, 110-2**  
**rock, coral, 34; pebble phosphate,**  
     **77**
- roof-tops, 28, 33**  
**root crowns, 24, 97, 108**  
**rooting, 147**  
**roots, 24, 93, 95**  
**roses, 165**  
**rotation, unnecessary, 96**  
**rows, sowing in, 81, 94**  
**rubber, synthetic, 30; foam, 77**  
**Russia, 9, 171**  
**rye, 148**
- Sachs, 2**  
**safety margin, 15, 122**  
**sage, 96**  
**Sahara, 8**  
**salts, types of (see fertilizers)**  
**sand, 34, 35, 80, 95; culture in,**  
     **4, 107**  
**sawdust, 25, 77**  
**scales, use of, 37**  
**screens, overhead, 88, 94**  
**seedlings, transplanting of, 80,**  
     **93-6**  
**seeds, 20, 81, 93, 142, 153; regene-**  
     **ration of, 142; unreliability**  
     **of, 7, 97**  
**sequestrene chemicals, 73**  
**Seychelles, 12, 171**  
**shade, 37, 90**  
**Sharder process, 162-4**  
**silicon, 23**  
**sites, unpromising, 29**  
**skyscraper gardening, 9**  
**sleep, requirements of plants for,**  
     **25**  
**slow-release fertilizers, 83; mix-**  
     **tures, 47, 70-2**  
**slugs, 101**

## I N D E X

- sodium, 23; hydroxide, 99; tri-chlorophenate, 99  
 soil, 24; ideal condition of, 14-15  
 soilless cultivation, 3, 5, 13, 26, 36, 40, 93; mixtures for, 64-9  
 soilless units, 15, 72  
 Solu-Ply, 113, 115  
 solution culture, 105-6  
 South Africa, 9, 12, 91, 171  
 South America, 162  
 South India, 14  
 soya beans, 7, 128  
 Spain, 171  
 spider, red, 101, 137  
 sprays, agricultural, 88, 101  
 spreader, for fertilizers, 37, 156  
 Sri Lanka, 12, 14  
 staggers, pest, 136  
 steel apparatus, 33  
 sterilant, SMDC, 99  
 sterilization, 15, 99  
 stomata, 19, 21, 25  
 stone, crushed, 36  
 straw, 77; chopped, 34  
 sulphur, 23, 134  
 sunshine, 21, 61, 88, 95  
 surface watering system, 107  
 sustanum, 47, 72  
 Sweden, 171  
 sweet corn, 96  
 Switzerland, 172  
 synthetic resins, 70-2  
 syringing, 25
- tea, 153  
 temperatures; glasshouse, 139, 141-2  
 termites, 101  
 Theophrastus, 1  
 thiocyanate (*see* sodium)  
 thiourea, 147  
 thrips, 135  
 tins, 29  
 tobacco, dust, 135; decoction, 153; seedlings of, 154  
 Tocklai, Experimental Station, 153  
 tomatoes, 6, 7, 93, 96, 97, 102, 124, 125, 128, 130  
 trace elements, 48, 54-5  
 tractor and spreader, 156  
 Trans-Antarctic Expedition, 161  
 transpiration, 20  
 troughs, camber of, 32; framework, 29-32; kinds of, 32-3; for seeds, 93-4; metal, 33; outlets in, 32; width of, 32; for sprouted forage, 148; disinfection and sterilization, 99  
 tubers, dormant, 147  
 turnips, 95
- United Kingdom, 129  
 United States, 4, 8, 9, 10, 128, 165, 172  
 United States Army, 8  
 urea-form fertilizers, 73  
 Uttar Pradesh, 88
- vegetable raising, 8, 13  
 Venezuelan coast, 9

## INDEX

- ventilation, 100, 102
- vermiculite, 34, 77
- Wake Island, 8
- Washington, Carnegie Institution
  - of, 146
- water, composition of, 20, 38;
  - consumption of, 84-7; culture by, 1; device to produce fresh from brine, 86; hardness and softness of, 38; 'heavy', 147; salinity, 39; non-available, 123
- watering, damage by, 94
- waterlogging, 6, 35, 87, 97, 102
- weeds, 6, 80, 124
- weights and measures, 140-1
- Western Samoa, 173
- West Indies, 12, 128
- wheat, 7, 13, 128
- wicks, 118
- wire-worms, pest, 101
- Withrow methods, 107
- Woodward, 2
- Wroclaw method, 106
- yields, comparison of, 7, 91, 128
- zinc, 23, 29, 74, 134