

**AT** MICROFICHE  
REFERENCE  
LIBRARY  
A project of Volunteers in Asia

Illustrated Guide to Integrated Pest Management in Rice  
in Tropical Asia

By: W.H. Reissig, E.A. Heinrichs, J.A. Litsinger, K. Moody,  
L. Fiedler, T.W. Mew, and A.T. Barrion

Published by: The International Rice Research Institute  
P.O. Box 933  
Manila, Philippines

Available from: The International Rice Research Institute  
P.O. Box 933  
Manila, Philippines

Reproduced with permission.

Reproduction of this microfiche document in any form is subject to the same restrictions as those of the original document.

W. H. Reissig, E. A. Heinrichs, J. A. Litsinger,  
K. Moody, L. Fiedler, T. W. Mew, and A. T. Barrion

# ILLUSTRATED GUIDE TO INTEGRATED PEST MANAGEMENT IN RICE IN TROPICAL ASIA

The title text is overlaid with several detailed black and white line drawings. These include: a mosquito-like insect at the top right; a grasshopper on the left; a butterfly in the center; a mouse on the left; a rice plant with its roots and leaves in the center; a beetle on the right; a fly on the left; and a spotted beetle at the bottom center.

International Rice Research Institute

W. H. Reissig, E. A. Heinrichs, J. A. Litsinger,  
K. Moody, L. Fiedler, T. W. Mew, and A. T. Barrion

# **ILLUSTRATED GUIDE TO INTEGRATED PEST MANAGEMENT IN RICE IN TROPICAL ASIA**

**1986**

**International Rice Research Institute**

Los Baños, Laguna, Philippines

P.O. Box 933, Manila, Philippines

The International Rice Research Institute (IRRI) was established in 1960 by the Ford and Rockefeller Foundations with the help and approval of the Government of the Philippines. Today IRRI is one of the 13 nonprofit international research and training centers supported by the Consultative Group for International Agricultural Research (CGIAR). The CGIAR is sponsored by the Food and Agriculture Organization (FAO) of the United Nations, the International Bank for Reconstruction and Development (World Bank), and the United Nations Development Programme (UNDP). The CGIAR consists of 50 donor countries, international and regional organizations, and private foundations.

IRRI receives support, through the CGIAR, from a number of donors including: the Asian Development Bank, the European Economic Community, the Ford Foundation, the International Development Research Centre, the International Fund for Agricultural Development, the OPEC Special Fund, the Rockefeller Foundation, the United Nations Development Programme, the World Bank, and the international aid agencies of the following governments: Australia, Canada, China, Denmark, France, Federal Republic of Germany, India, Italy, Japan, Mexico, Netherlands, New Zealand, Norway, Philippines, Saudi Arabia, Spain, Sweden, Switzerland, United Kingdom, and United States.

The responsibility for this publication rests with the International Rice Research Institute.

Copyright © International Rice Research Institute 1986. Corrected edition reprinted 1986.

All rights reserved. Except for quotations of short passages for the purpose of criticism and review, no part of this publication may be reproduced, stored in retrieval systems, or transmitted in any form or by any means, electronic, mechanical, photocopying, recording, or otherwise, without prior permission of IRRI. This permission will not be unreasonably withheld for use for non-commercial purposes. IRRI does not require payment for the noncommercial use of its published works, and hopes that this copyright declaration will not diminish the bona fide use of its research findings in agricultural research and development.

The designations employed and the presentation of the material in this publication do not imply the expression of any opinion whatsoever on the part of IRRI concerning the legal status of any country, territory, city, or area, or of its authorities, or concerning the delimitation of its frontiers or boundaries.

### **Availability for translation and copublication**

The *Illustrated guide to integrated pest management in rice in tropical Asia* was designed for inexpensive copublication by national agricultural improvement programs and publishers. Its concept is similar to that of *A Farmer's Primer on Growing Rice*, which had been published in 30 languages by mid-1986. IRRI provides sets of the line drawings, with English text blocked off, to cooperators who then translate, typeset, and publish translations locally. IRRI does not ask for royalties or payment for translations of IRRI books published in developing nations. For details, contact the Communication and Publications Department, International Rice Research Institute, P.O. Box 933, Manila, Philippines.

1st printing, <i>English</i> 1985	2,000 copies
1st printing, <i>Bahasa Indonesia</i> 1985	3,000 copies
2d printing, <i>English</i> 1986	4,000 copies

ISBN 971-104-120-0

# CONTENTS

FOREWORD ix	
PREFACE xi	
INTRODUCTION 1	
<b>Introduction 3</b>	
STRUCTURE AND GROWTH STAGES 7	
<b>Rice Plant Structure and Growth Stages 9</b>	
Structure of the rice plant 10	
The tiller 10	
The rice leaf 10	
The rice stem 11	
The panicle 11	
Growth stages 11	
INSECT PESTS 17	
<b>Insect Pests of Rice 19</b>	
General characteristics of insects 19	
General life cycle 19	
Description of insect pests in this guide 22	
Soil pests 25	
Ants (Hymenoptera:Formicidae) 25	
Termites (Isoptera:Termitidae and Rhinotermitidae) 27	
White grubs (Coleoptera:Scarabaeidae) 29	
Mole cricket (Orthoptera:Gryllotalpidae) 35	
Rice root weevils (Coleoptera:Curculionidae) 40	
Root aphids (Homoptera:Aphididae) 45	
Pests at the vegetative stage 50	
Seedling maggots (Diptera:Muscidae) 50	
Rice whorl maggots (Diptera:Ephydriidae) 57	
Rice caseworm (Lepidoptera:Pyralidae) 65	
Rice green semilooper (Lepidoptera:Noctuidae) 73	
Rice green hairy caterpillar (Lepidoptera:Noctuidae) 79	
Rice leaf beetle (Coleoptera:Chrysomelidae) 83	
Rice thrips (Thysanoptera:Thripidae) 87	
Rice gall midge (Diptera:Cecidomyiidae) 92	
Armyworms and cutworms (Lepidoptera:Noctuidae) 99	
Grasshoppers, katydids, and field crickets (Orthoptera) 110	
Rice leafhoppers (Lepidoptera:Pyralidae) 119	
Rice stem borers (Lepidoptera) 128	
Striped stem borer 132	
Dark-headed and gold-fringed stem borers 133	
Yellow stem borer 135	
White stem borer 136	
Pink stem borer 137	
Damage 139	
Management 140	
Rice black bugs (Hemiptera:Pentatomidae) 147	
Rice hispa (Coleoptera:Chrysomelidae) 154	
Mealybug (Homoptera:Pseudococcidae) 159	
Pests at the reproductive stage 165	
Rice greenhorned caterpillar (Lepidoptera:Satyridae) 165	
Rice skippers (Lepidoptera:Hesperiidae) 170	
Rice brown planthopper (Homoptera:Delphacidae) 175	
Smaller brown planthopper (Homoptera:Delphacidae) 187	
Rice whitebacked planthopper (Homoptera:Delphacidae) 192	
Rice green leafhoppers (Homoptera:Cicadellidae) 200	
Rice zigzag leafhopper (Homoptera:Cicadellidae) 211	
Rice white leafhopper (Homoptera:Cicadellidae) 216	
Pests at the ripening stage 221	
Rice seed bugs (Hemiptera:Alydidae) 221	
Rice panicle mite (Acarina:Tarsonemidae) 228	
DISEASES 233	
<b>Rice Diseases 235</b>	
Rice blast 236	
Sheath blight 238	
Bakanae 240	
Brown spot 242	
Sheath rot 244	
Narrow brown leaf spot 245	
Stem rot 246	
False smut 248	

Bacterial blight 250  
Bacterial leaf streak 253  
Tungro virus 255  
Grassy stunt virus 257  
Rice ragged stunt 259  
Yellow dwarf disease 261  
Stem nematode 265  
White tip 267

#### WEEDS 271

##### **Weed Pests of Rice 273**

Severity of weeds in different types of rice culture 274

Integrated weed control 274

Types of weeds 275

Grasses 275

Sedges 275

Broadleaf weeds 276

Identification and ecology of common weeds in rice 276

*Commelina benghalensis* L. 276

*Cyperus difformis* L. 278

*Cyperus iria* L. 280

*Cyperus rotundus* L. 281

*Dactyloctenium aegyptium* (L.) Willd. 283

*Digitaria ciliaris* (Retz) Koel. 284

*Echinochloa colona* (L.) Link 285

*Echinochloa crus-galli* (L.) Beauv. 287

*Eleusine indica* (L.) Gaertn. 288

*Fimbristylis miliacea* (= *Littoralis*) (L.)

Vahl 291

*Monochoria vaginalis* (Burm.f.) Presl. 293

*Paspalum distichum* L. 295

*Portulaca oleracea* L. 296

*Scirpus maritimus* L. 298

*Sphenoclea zeylanica* Gaertn. 300

Methods of weed control 302

Weeding 302

Hand weeding 302

Mechanical weeding 304

Water management 304

Control of weeds by flooding 304

Problems in controlling weeds by flooding 305

Herbicides 306

Definition 306

Timing herbicide applications 307

Methods of herbicide action 308

Herbicide injury to rice 309

Symptoms of herbicide injury to rice 310

Management of weeds in different types of rice culture 310

Management of weeds in transplanted rice 311

Management of weeds in pregerminated rice sown on puddled soil 312

Management of weeds in dry-seeded wetland rice 314

Management of weeds in dryland rice 316

#### RICELAND RATS 319

##### **Biology and Management of Riceland Rats in Southeast Asia 321**

Biology of riceland rats 321

General life cycle 321

Relationship to damage 322

Damage 322

Management in Southeast Asia 324

Monitoring 324

Estimating crop loss 325

Control 326

Cultural control practices 326

Chemical control 328

Maintaining bait holders during the season 330

Pattern of bait consumption during the crop season 330

Advantages of cooperative rat control 331

Summary 331

#### CULTURAL CONTROL 333

##### **Cultural Control 335**

Practices effective at the farm level 336

Practices effective at the community level 339

Advantages of cultural control practices 340

Disadvantages of cultural control practices 340

#### RESISTANT VARIETIES 341

##### **Resistant Rice Varieties 343**

Definition of a resistant variety 343

Varietal resistance of rice to insect pests 344

Rice varietal resistance to diseases 345

Immunity 345

Hypersensitivity 345

Tolerance 346

Disease races and insect biotypes 346

Definition of "race" and "biotype" 346

Use of resistant varieties in the field 347

Factors influencing the chances and rate of development of new biotypes and races 348

BIOLOGICAL CONTROL OF INSECT PESTS 349  
**Biological Control of Rice Insect Pests 351**  
Effects of beneficials on insect pests 351  
Characteristics of parasites 351  
Characteristics of predators 352  
Parasites 353  
Parasites of leafhoppers and  
planthoppers 353  
Parasites of stem borers 358  
Parasites of other rice insect pests 363  
Predators 365  
Spiders 366  
Microvelia 367  
Cyrtorhinus 368  
Other predators 369  
Management and conservation of parasites  
and predators 369

PESTICIDES 371  
**Pesticides 373**  
Types of pesticides used in growing rice 373  
Pesticide toxicity 377  
Problems caused by pesticide misuse 380  
Selection of a pesticide 386  
Spray equipment 387  
Pesticide storage and disposal 390  
Pesticide calculations 390

INTEGRATION OF CONTROL MEASURES 393  
**Integration of Control Measures for All Rice  
Pests 395**  
Cultivars 396  
Pesticides 396  
Fertilizer 397  
Water management 397  
Planting method 397  
Planting time 397  
Cropping pattern 397  
Stubble management 397  
Weeding 397

INTEGRATED PEST MANAGEMENT 399  
**Implementation of Integrated Pest Management  
Strategies 401**  
Applied research phase 401  
Site selection 401  
Team formation 402  
Site description 402  
Research for design of pest management  
strategies 403  
Testing 404  
Evaluation 405  
Farmers' classes 405  
Extension phase 405  
Follow-up meetings 406

APPENDIX 408  
GLOSSARY 409

# FOREWORD

In the past, farmers in tropical Asia grew traditional rice cultivars and either relied primarily on cultural, mechanical, and physical methods of pest control or practiced no pest control. Pesticide application was limited because the yield potential of traditional varieties was too low to justify additional investments. Although pests destroyed part of each crop, severe outbreaks or epidemics were rare.

The widespread introduction of high-yielding rice cultivars in Asia in the last two decades and the associated changes in production practices have improved conditions for insects, diseases, weeds, and rodents. The higher yield potential of the new rices also made increased pesticide application economically attractive to farmers.

The replacement of traditional control methods by pesticides could increase hazards to nontarget organisms, however, and lead to the development of pesticide resistance and environmental contamination. To minimize such problems, Asian farmers must again diversify their pest control practices — a strategy that scientists now term integrated pest management (IPM).

Recently, scientists working in national rice production programs and at international agricultural research centers have written extensively about IPM for tropical rice. Many of the publications are research-oriented, fragmented, and too technical for nonscientists. Furthermore, much of the highly specialized information often focuses on a single species or a small group of pests.

This publication provides practical and comprehensive information to IPM workers in rice fields throughout tropical Asia. It briefly discusses rice plant structure and growth stages and stresses their relation to pest management. There are separate sections on cultural control of rice pests, resistant rice varieties, natural enemies of rice insect pests, and pesticides. The biology and management of the major groups of rice pests — insects, diseases, weeds, and rodents — are discussed in separate sections. Finally, integrated control measures for the entire rice pest complex and the

implementation of IPM strategies at the farmer level are described.

This volume represents the combined efforts of many persons. The style and first draft of the text were developed by W. H. Reissig of the New York Agricultural Experiment Station, Geneva, New York, USA, during a 1979-80 sabbatic leave at IRRI. Reissig's firsthand experience in developing IPM strategies for farmers gave him the necessary background to organize the information in a useful form. E. A. Heinrichs, IRRI entomologist, reviewed the technical material and worked with IRRI editors and artists after Reissig's departure.

J. A. Litsinger, IRRI cropping systems entomologist, provided technical information on the biology and management of many insect pests and composed the section on cultural control. K. Moody, IRRI agronomist, supplied technical information and reviewed the section on biology and control of weeds. L. A. Fiedler, a research biologist from the Denver Wildlife Research Center, stationed at the National Crop Protection Center, University of the Philippines at Los Baños, acted as technical consultant in the preparation of the section on Biology and Management of Riceland Rats in Southeast Asia. T. W. Mew, IRRI plant pathologist, provided technical information and reviewed the section on disease management. A. T. Barrion, IRRI entomology department senior research assistant, served as technical consultant and worked with artists in the preparation of the section on Natural Enemies of Rice Insect Pests.

This volume can be easily translated into the various languages of Southeast Asia and serve as a key source of information for IPM training programs. We hope that it will stimulate the implementation of IPM technology by rice farmers in tropical Asia as well as the development of similar publications for other rice-growing regions.

M. S. Swaminathan  
Director General



# PREFACE

During the past decade, scientists have developed the concept of integrated pest management (IPM) for rice. IPM technology has been generated by scientists working in national rice production programs and at international agricultural research centers, but only a limited amount of this technology has been tested in pilot IPM programs in tropical Asian countries.

The rate of adoption of IPM technology by farmers has been slow, perhaps because of these reasons: 1) some of the technology developed is either ineffective, economically unattractive to farmers, or difficult to implement; and 2) applied research scientists, extension officers, and farmers lack understanding of the principles and practices involved and the economic benefits from IPM.

There have been much interest and activity in IPM training from the international level to the level of farmers in tropical Asia. This manual was developed 1) to provide a source book for the training of extension officers who, in turn, will train farmers and implement rice IPM programs; and 2) to encourage applied research scientists to develop more effective IPM technology.

Among the topics are the principles of IPM and information on rice morphology and growth stages, which are necessary in the development of sampling methods and timing of control practices, and insects, weeds, diseases and rodents of major importance in tropical Asia. Details of the geographic distribution, life cycle of the pests, and damage they cause are described and illustrated. The integration of sampling methods, economic thresholds, pesticides, resistant varieties, and natural enemies in the management of pests is explained.

Numerous references were consulted in the writing of this manual. The sources of information and illustrations include the audiotutorial modules in pest control developed at IRRI and the following books: *The world's worst weeds, distribution and biology*, L. G. Holm, D. L. Plucknett, and J. V. Pancho,

*University Press, Hawaii, 1977; Rice virus diseases*, K. C. Ling, IRRI, 1972; *The virus diseases of the rice plant*, The Johns Hopkins Press, 1967; *Rice diseases*, S. H. Ou, Commonwealth Agricultural Bureaux, 1977; *A farmer's primer on growing rice*, B. S. Vergara, IRRI, 1981; *Principles and practices of rice production*, S. K. de Datta, John Wiley and Sons, 1981; *Monograph of insect pests and the natural enemies of rice*, Plant Protection Department, Hunan Agricultural Academy Institute, Changsha, China, 1978; *Insect pests of rice*, M. D. Pathak, IRRI, 1977; *The major insect pests of the rice plant*, The Johns Hopkins Press, 1967; and *Pests of rice*, D. H. Grist and R. J. W. Lever, Longmans. We acknowledge the individuals who contributed to the production of this manual. Danilo Amalin did the artwork on the insect pests, natural enemies, weeds, and diseases and Oscar Figuracion, Rebecca Brown, John Figarola, and Joseph Figarola, the illustrations. Rowena Dagang coordinated the movement of text and illustrative materials. Ram Cabrera, Fidelito Manto, and Patricio Mamon are responsible for the design and layout. The text was edited by T. R. Hargrove, head of the Communication and Publications Department, and G. S. Argosino, assistant editor. Individuals consulted during the writing and review of the text and figures were the late K. C. Ling, and F. Nuque of the Plant Pathology Department; V. A. Dyck of the Entomology Department; and R. Chavez, M. Mabbayad, and R. Lubigan of the Agronomy Department.

Our efforts in producing this manual will be richly rewarded if it serves as a catalyst in the implementation of IPM strategy in the rice fields of farmers in tropical Asia.

W. H. Reissig, E. A. Heinrichs,  
J. A. Litsinger, K. Moody, L. Fieldler,  
T. W. Mew, and A. T. Barrion

# INTRODUCTION

# Introduction

In Asia, losses from insects, diseases, weeds, and vertebrate pests that attack rice are difficult to quantify.

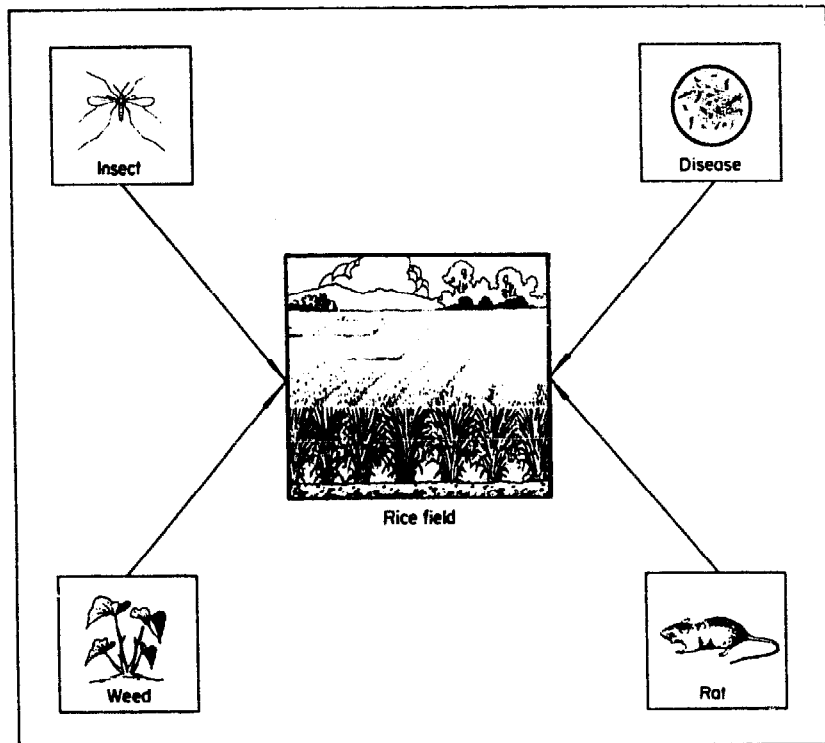

**Chronic pests** — weeds, most leaf-feeding insects, stem borers, most fungal diseases — annually reduce yields, but seldom cause epidemics. The pests are routinely controlled or are tolerated.

**Acute pests** — rats, blast, virus and bacterial diseases, leafhoppers and planthoppers — infrequently occur in epidemic proportions, but they cause great economic concern to the regions affected and their control is difficult.

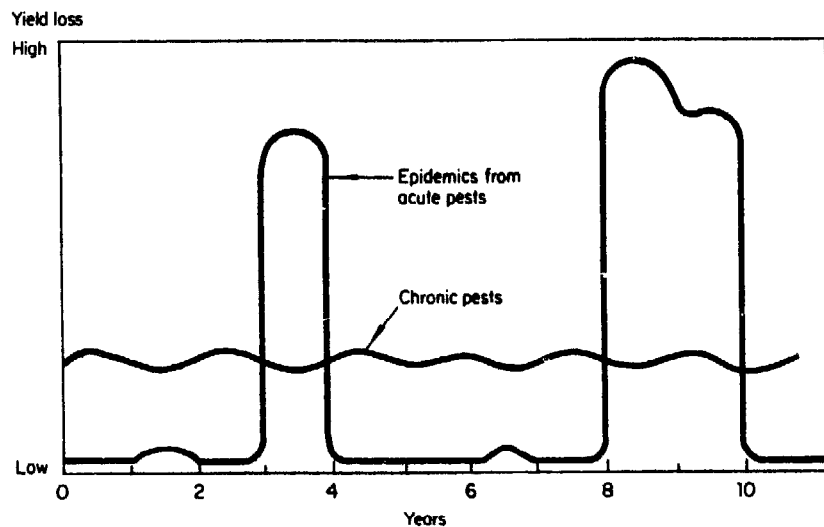

Pest epidemics have been recorded ever since rice was cultivated by man. Pests such as rats, rice blast, armyworms, locusts, and brown planthopper have historically challenged rice farmers who have responded with highly creative pest control measures such as control of the whitebacked planthopper by plugging the levees to raise the water level, pouring whale oil on the water surface and dislodging hoppers from the plants into the whale oil-treated water.

Historically, epidemics were associated with severe weather conditions such as extreme temperature fluctuations, drought, typhoons, or floods. Such weather conditions suppressed the natural enemies of rats and insects and allowed the entry of disease organisms into the plant.

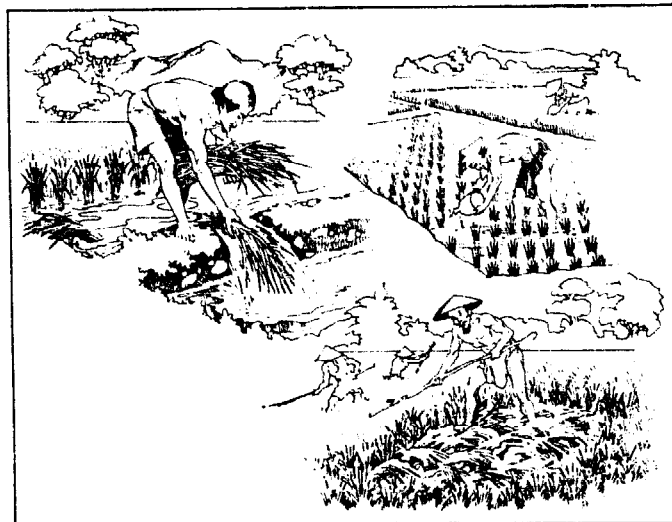

In recent years, the need to intensify rice production to feed a rapidly expanding population has brought about rapid changes in rice production technology. Many of these changes have created greater frequencies of pest epidemics.

- Expansion of farmland planted to rice has 1) aided pests whose greatly lowered populations during the dispersal phase of their life cycles was due to failure to find a suitable host, 2) allowed isolated pests to spread into new areas, and 3) increased the number of pest species, which transferred from wild hosts to rice when their natural habitats were destroyed.

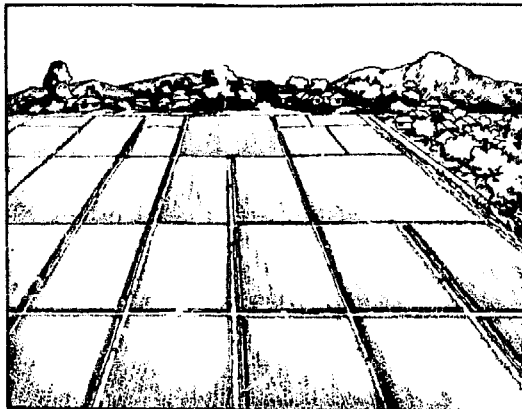

- New irrigation systems have 1) allowed dry season rice cropping to unleash pests whose numbers were annually depressed during a rice-free dry season, and 2) favored aquatic pests because of more stable water delivery to paddies.



- Development of new varieties has 1) led to replacement of traditional varieties — which had been selected by farmers for stable resistance, particularly to diseases — with modern varieties possessing narrower-based and less stable resistance, 2) increased pests favored by high tillering plant types, 3) allowed year-round cropping by introducing photoperiod insensitivity, and 4) increased the yield potential, making it more economical to attempt pest control measures that before would have been unprofitable.

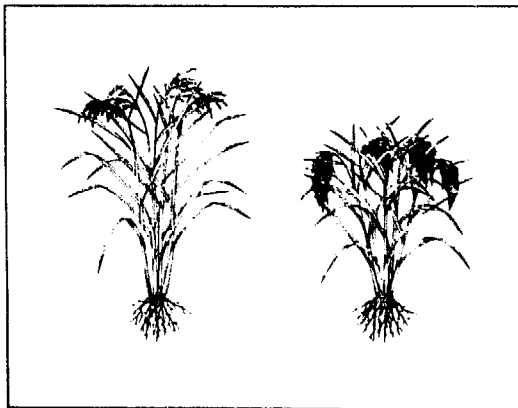

- Fertilizer usage increased with the development of fertilizer-responsive varieties which, in turn, have increased pest abundance. Weeds take up fertilizer and grow faster than rice. Insects multiply faster with better nutrition. Fertilizer increases the plant's susceptibility to diseases. Dense growing plants provide shelter for rats.



- Pesticide use has expanded in response to more pest problems and higher profits that could be realized from proper use. Farmers, however, often misuse pesticides by:
  1. choosing the wrong pesticide,
  2. applying on a calendar-based schedule without regard to pest numbers,
  3. using rates that are too low or too high, and
  4. not using enough water to thoroughly cover the plants.

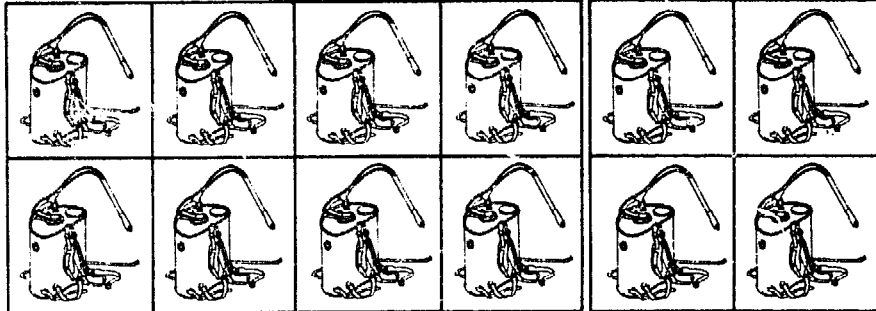
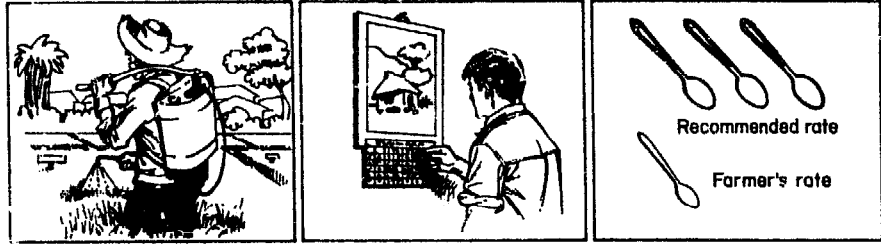

Recommended number of sprayer refills

Farmer's number of sprayer refills

Pesticide misuse may:

- 1) fail to kill the target pest and increase either its number (resurgence) or that of a formerly minor pest (secondary pest outbreak),
- 2) cause pesticide-resistant populations,
- 3) seriously harm the farmer during application or the nontarget organisms in the environment either directly or indirectly.



Hopperburn due to resurgence

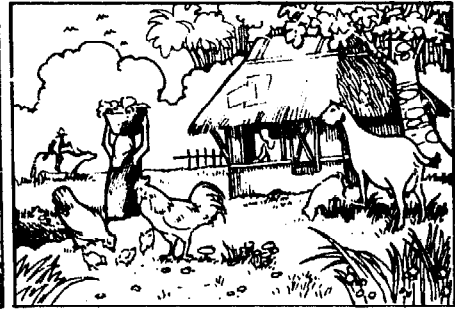

Nontarget organisms

The pest problems brought about by the new technology are by no means unique to rice. All too often, however, the immediate solution to a pest problem has meant repeated applications of pesticides.

The concept of pest control changed with the advent of modern synthetic pesticides which were inexpensive and easy to apply, and gave immediate results. During the pesticide era, the concept of control meant eradication, which sought total elimination of pests.

The concept of eradication has now been replaced with the concept of management, where the goal is to reduce pest populations to levels that are uneconomical to control. Low pest populations are tolerated.

1. Economic injury level: the pest population is large enough to cause crop losses costing more than the control.

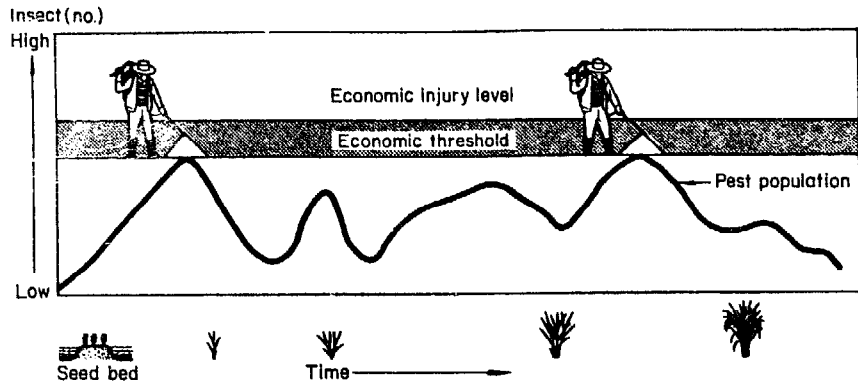

2. Economic threshold: the pest population at which control measures should be taken to prevent pest numbers from reaching the economic injury level.

Integrated pest management is a strategy or plan that utilizes various tactics or control methods — cultural, plant resistance, biological, and chemical — in a harmonious way. Control actions are based on frequent monitoring of pests.

Integrated pest management depends on multidisciplinary ecological strategies to weigh the effect of each tactic, as part of the agroecosystem, in producing the least disturbance and yield loss in the long run.

No pest control strategy increases potential yield. Such strategies can only ensure that the maximum yield physiologically obtainable in a particular field and season will not be significantly reduced by pests.

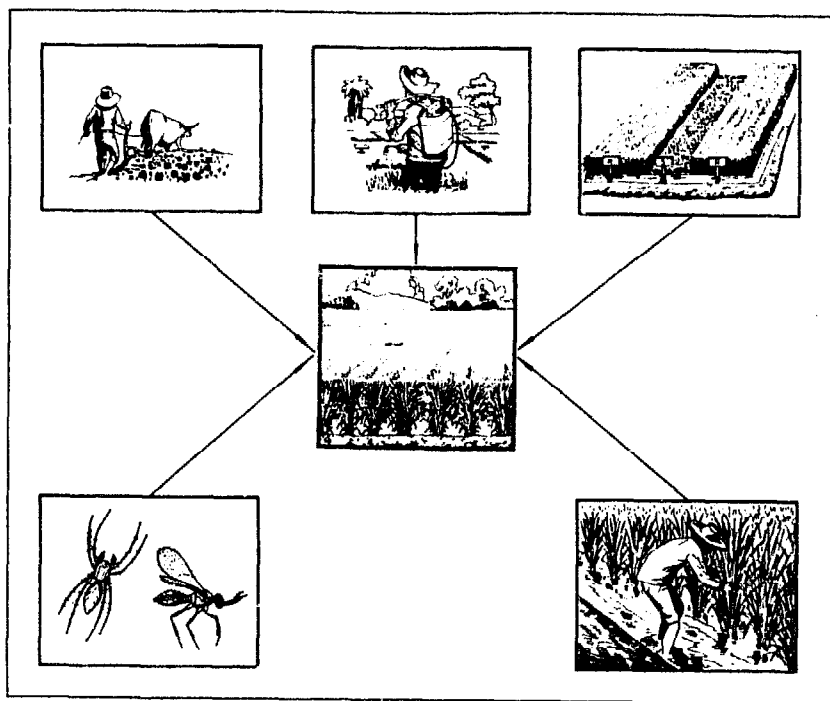

# STRUCTURE AND GROWTH STAGES

# Rice Plant Structure and Growth Stages

In a pest management program, familiarity with the different parts and growth stages of the rice plant is important.

Insects, diseases, and the damage they cause are found only on certain parts of the plant.

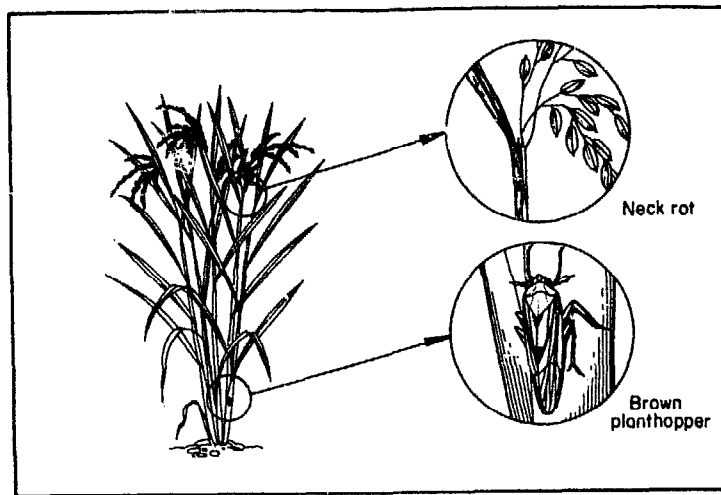

The life cycle of many pests is closely linked with the development of the rice plant.

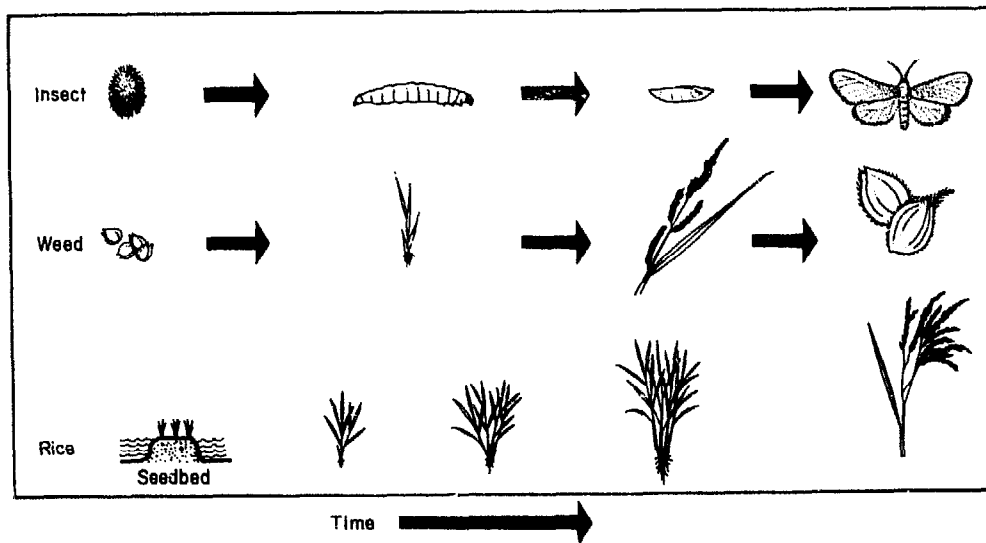

Many crop management practices must be applied only at certain rice growth stages.

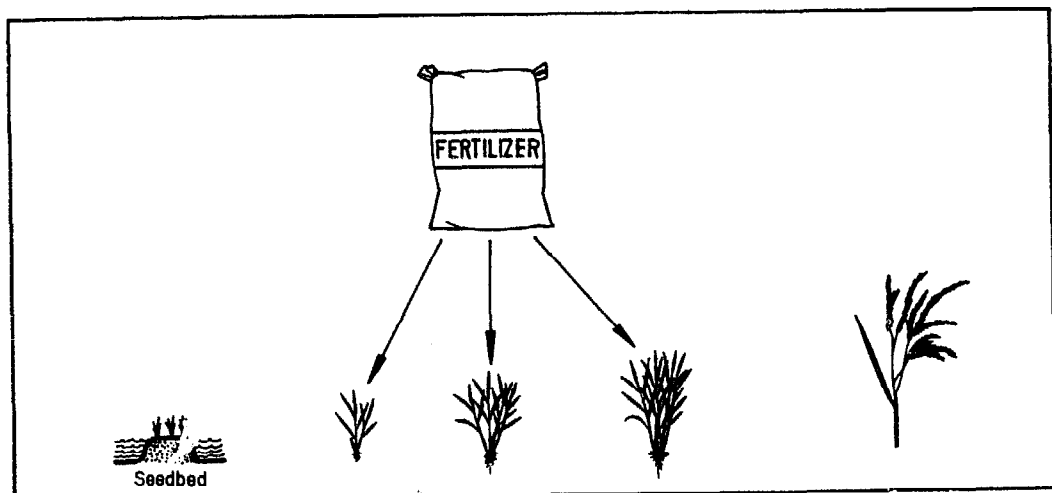



**STRUCTURE OF THE RICE PLANT**

**The tiller**

The tiller is a shoot that includes the roots, stem, and leaves. It may or may not have a panicle.

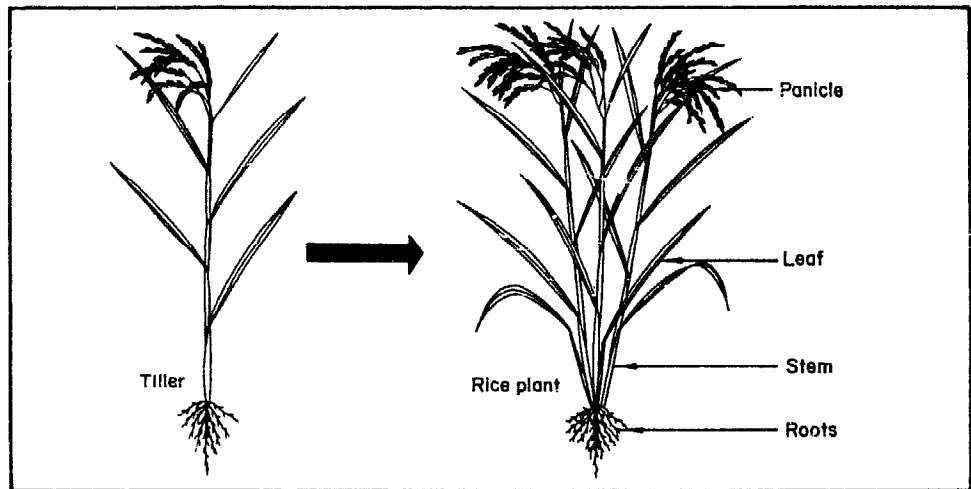

**The rice leaf**

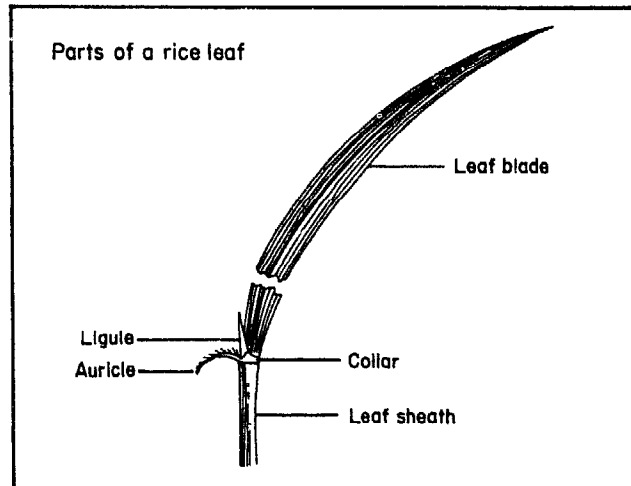

**Arrangement of leaves on a stem**

- The top leaf just below the panicle is called the flag leaf.
- The leaves grow alternately on the stem.

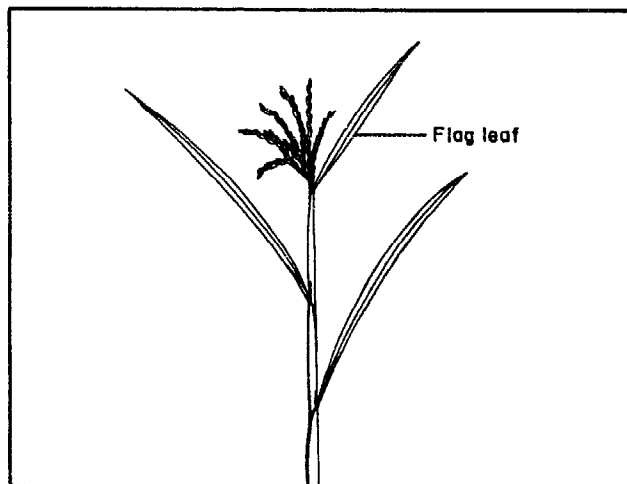

**The rice stem**

The culm, or jointed stem, of rice is made up of a series of nodes and internodes. The node is the solid part of the stem. The internode is the portion of the stem between the nodes.

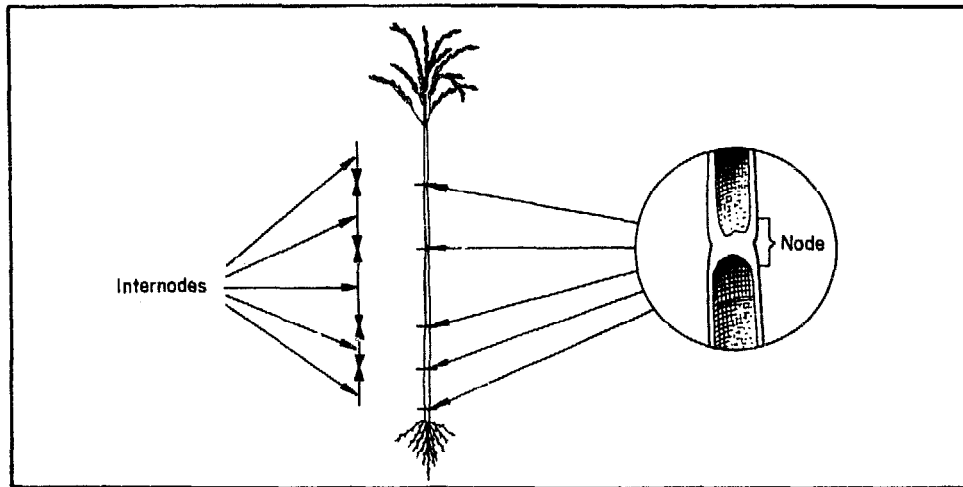
**The panicle**

The smallest unit of the panicle is the spikelet.

At flowering, the floral parts can be seen between the lemma and palea. The mature grain is covered by the rice hull (lemma and palea).

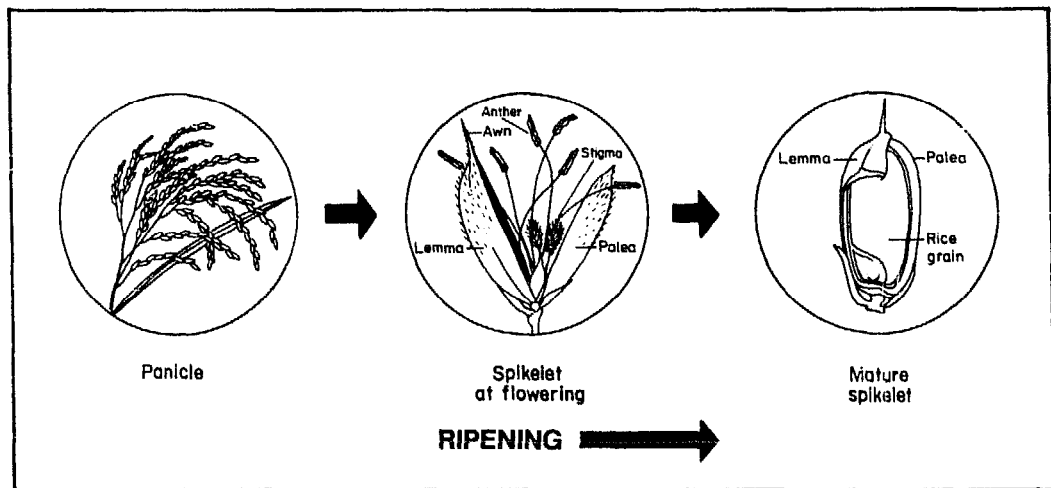
**GROWTH STAGES**

The growth cycle consists of steps of development called growth stages. Each stage has been assigned a number and a name.

**Stage 0 — germination to emergence**

The first stage covers the period from germination until the emergence of the first leaf.

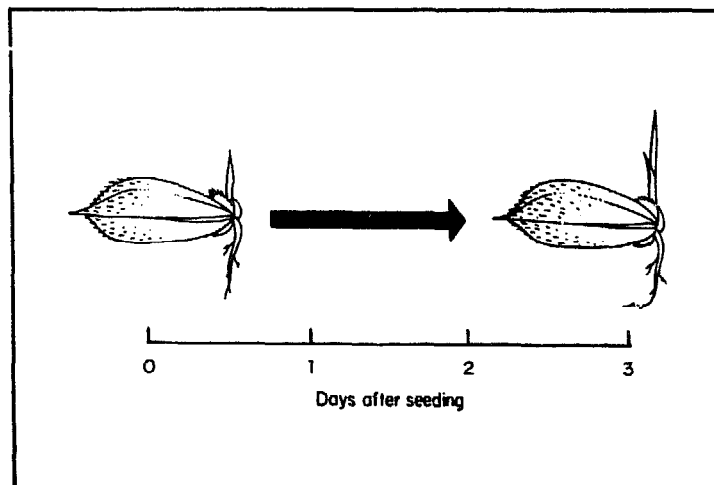

**Stage 1 — seedling stage**  
 The seedling stage covers the period after the emergence of the first leaf until just before the first tiller appears.

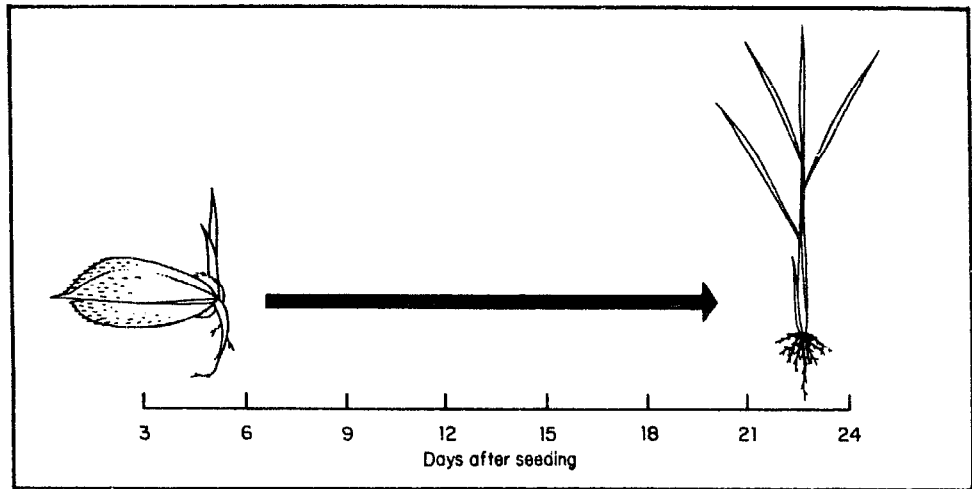

**Stage 2 — tillering stage**  
 The tillering stage extends from the appearance of the first tiller until the maximum number of tillers is reached.

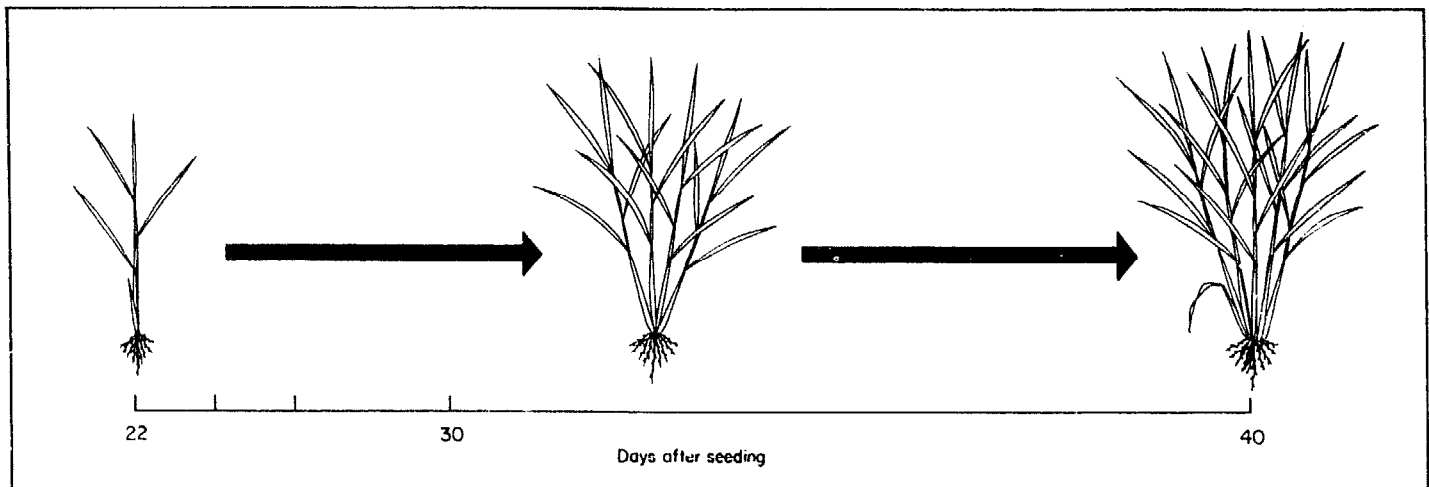

**Stage 3 — stem elongation**  
 Stem elongation begins late in the tillering stage and ends just before panicle initiation.

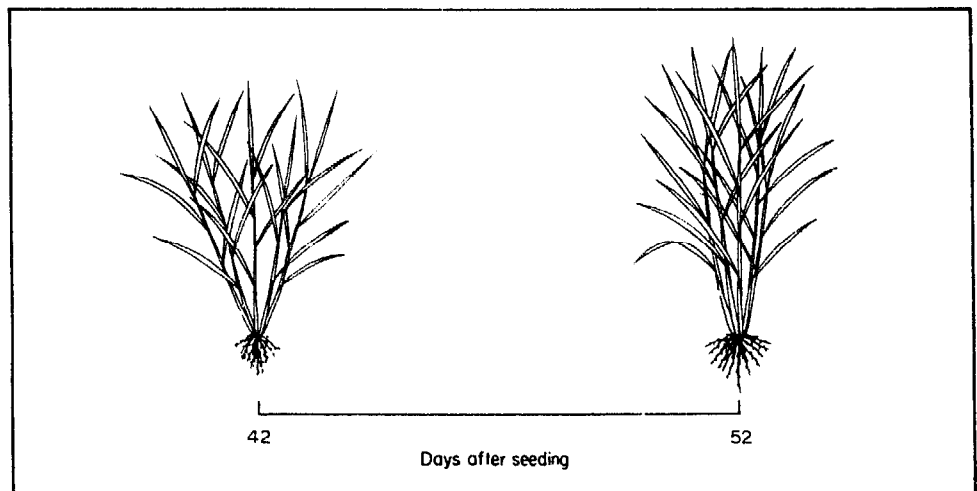

**Stage 4 — panicle initiation**  
 At the panicle initiation stage, the panicle develops and grows into a white feathery cone, creating a bulge at the base of the leaf sheath near the bottom of the tiller.

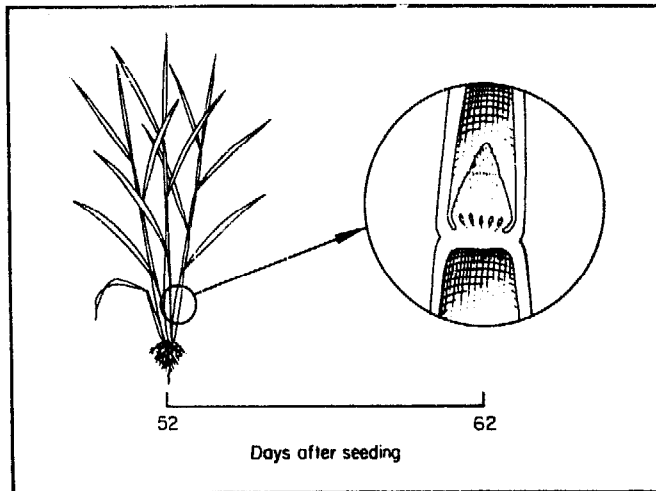

**Stage 5 — panicle development**  
 The panicle grows and extends upward inside the flag leaf sheath, and the spikelets develop. At the end of this stage, the panicle causes the flag leaf sheath to swell (booting).

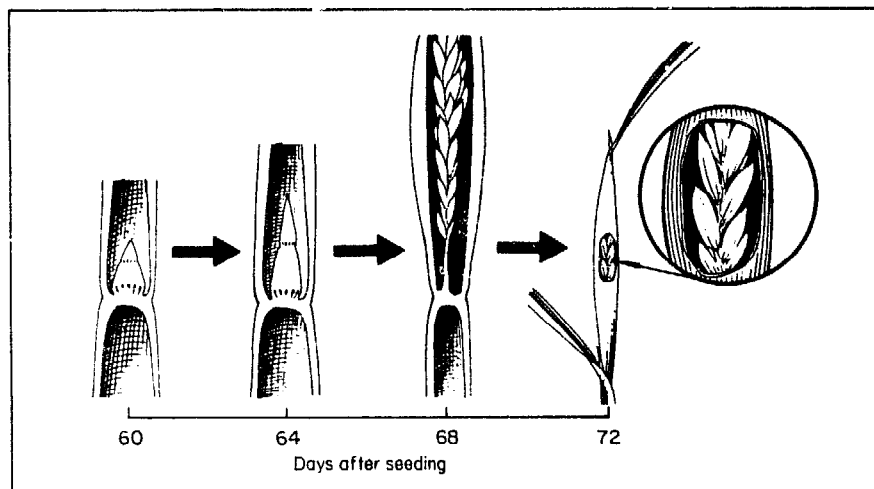

**Stage 6 — flowering**  
 The flowering stage begins when the panicles emerge from the leaf sheath (heading). It ends with pollination and fertilization.

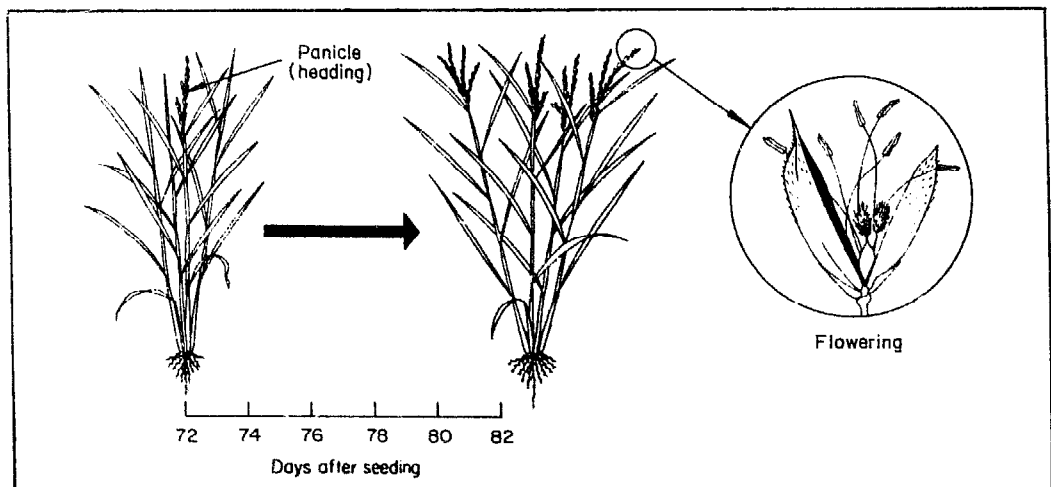

**Stage 7 — milk grain stage**  
 At the milk stage, the grain contains a white liquid that can be squeezed out with the fingers. The panicles are green and the flag leaves are green and erect.

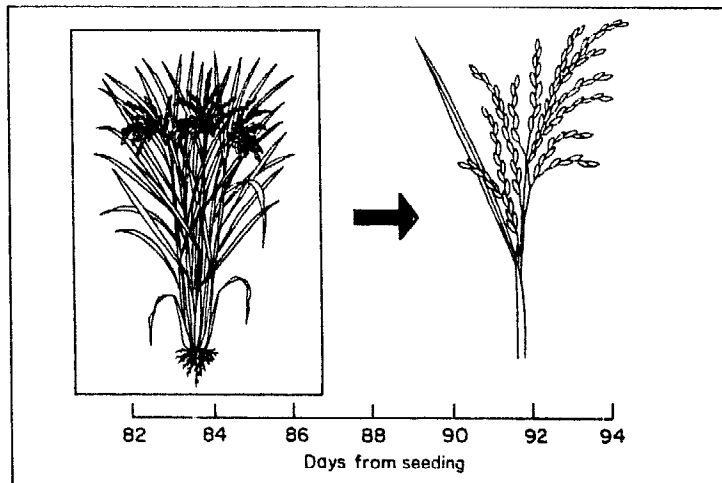

**Stage 8 — dough grain stage**  
 The milky portion of the grain turns into a soft and then a hard dough. The grain turns yellow and the whole field appears yellowish.

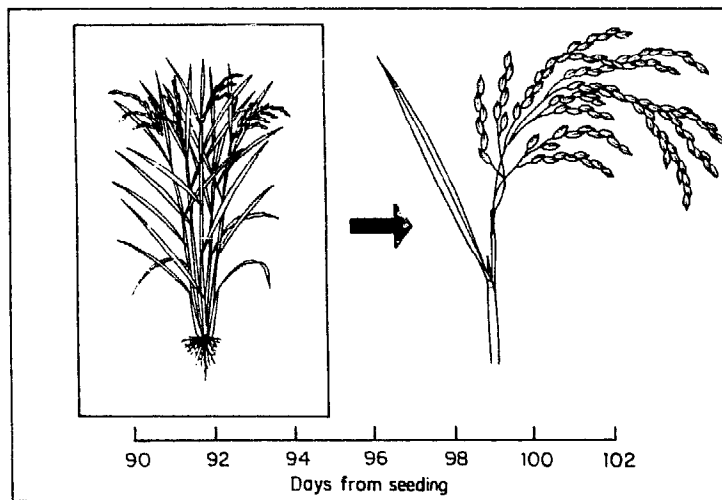

**Stage 9 — mature grain stage**  
 The grain is full-size, hard, and yellow. The upper leaves are dry and the panicles bend toward the ground.

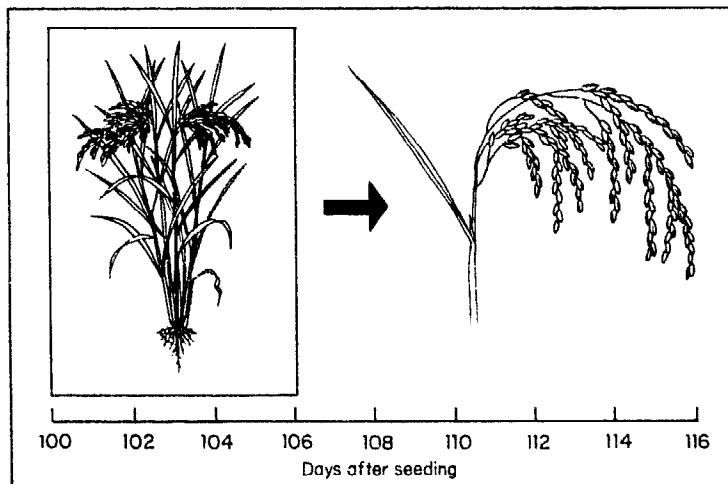

**General rice growth stages**

The nine individual growth stages combine into three general growth stages:

1. vegetative stage — from germination to panicle initiation
2. reproductive stage — from panicle initiation to flowering
3. ripening stage — from flowering to maturity.

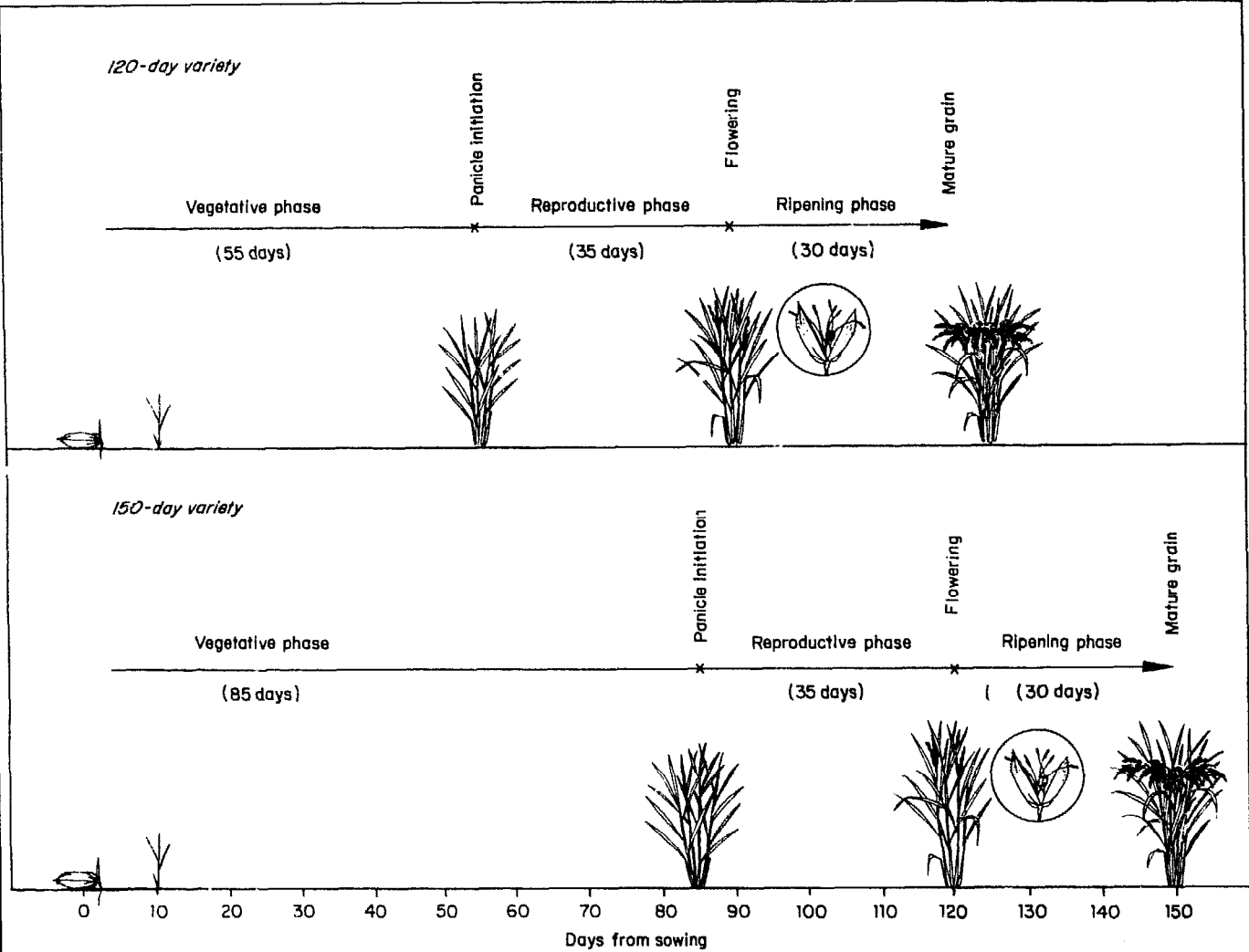

The number of days in the reproductive phase and that in the ripening phase are the same among most rice varieties.

The number of days in the vegetative phase varies in different varieties.

# INSECT PESTS

# Insect Pests of Rice

Insect pests are particularly abundant on rice grown in the tropics. About 30 different

species are of major importance in tropical Asia.

## General characteristics of insects

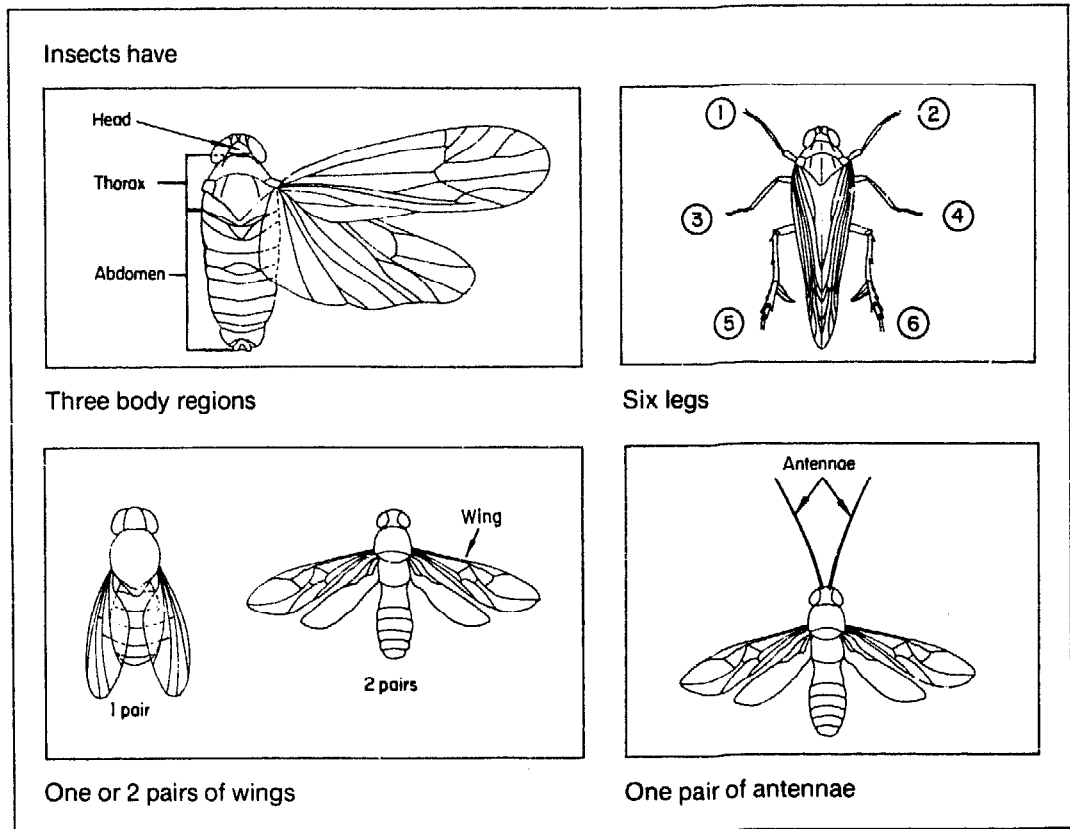

## General life cycle

Insects have two common general types of development or metamorphosis:

### Gradual metamorphosis

Insects with gradual metamorphosis go through the egg, nymphal, and adult stages.

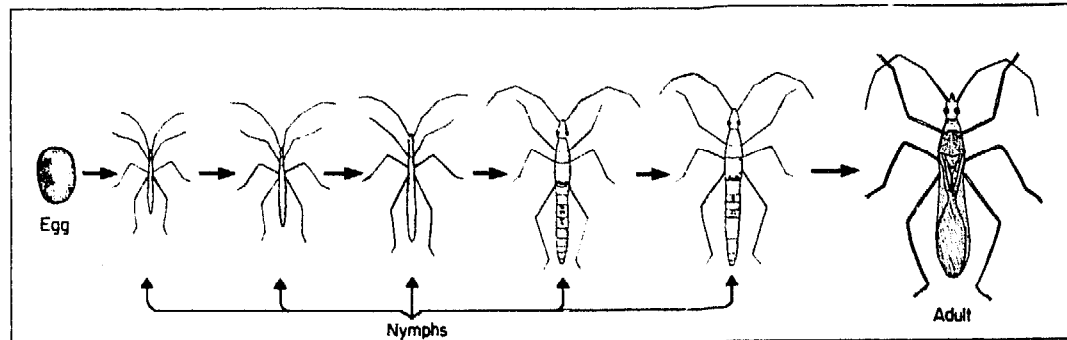

Nymphal stages may be similar to adults but lack completely developed wings and sexual organs.

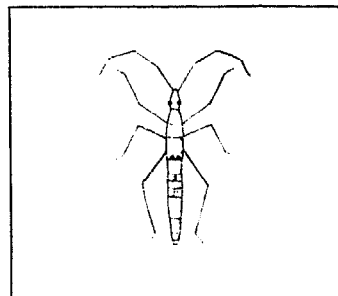

Adults and nymphs both feed on the plant and cause similar damage

Bugs, leafhoppers, and plant-hoppers are examples of insects with gradual metamorphosis.



**Complete metamorphosis**

Insects with complete metamorphosis go through the egg, larval, pupal, and adult stages.

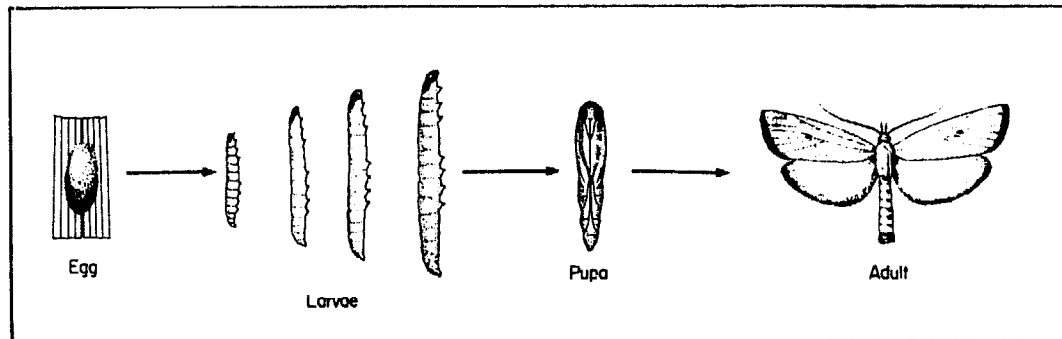

In some insects with complete metamorphosis (stem borers, armyworms, gall midge, whorl maggot) larvae feed on the plant and cause damage.

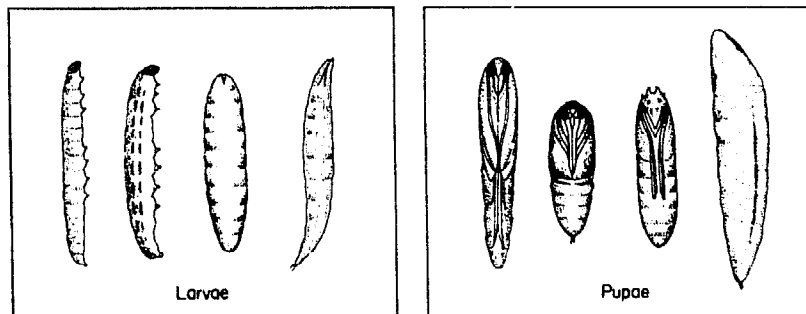

Adults do not feed upon or injure the plant.

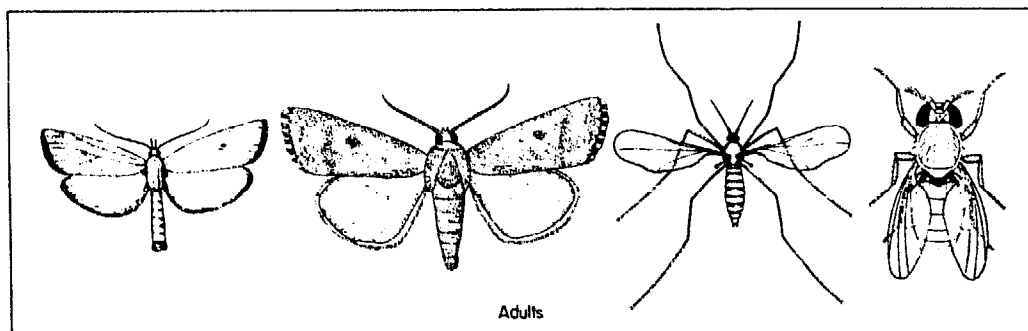

In other species (hispa) both the larva and adult feed upon and damage the plant.

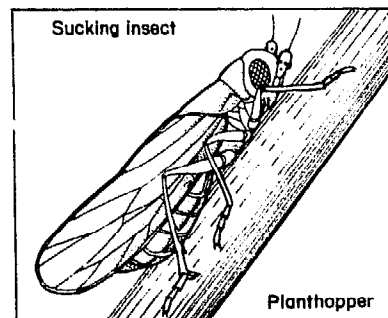
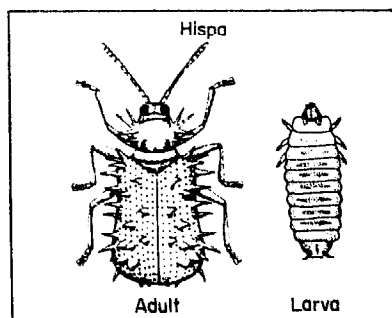

Most insect pests of rice can be divided into two groups on the basis of their mouthparts:

**Chewing insects** remove pieces of plant tissue. They may eat holes in the leaves or tunnel in the stem.

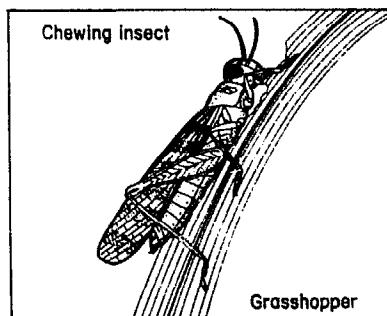

**Sucking insects** pierce the plant tissue and remove plant sap. Plants damaged by insects with sucking mouthparts may wilt or lose their green color. Sucking insects such as leafhoppers or planthoppers may also transmit virus diseases.

Rice insects can also be classified according to the plant parts upon which they feed:

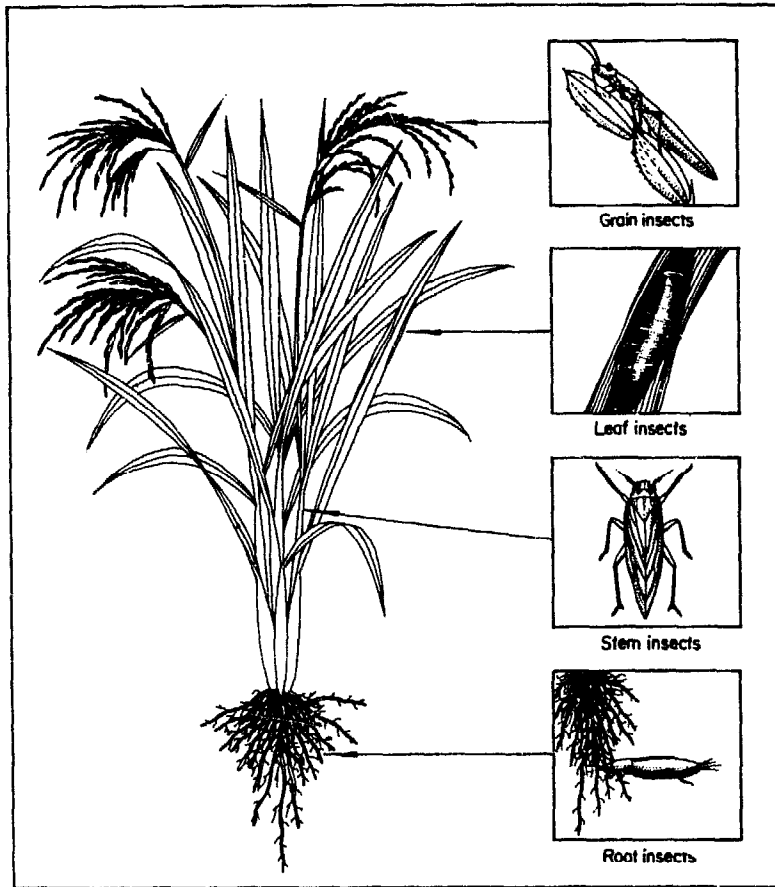

The biology and management of all insect pests attacking the various growth stages of rice are covered in this Guide. Insects attacking rice grain in storage were not included. The insect pests are presented and grouped in the chronological order in which they would attack a crop from sowing to harvest.

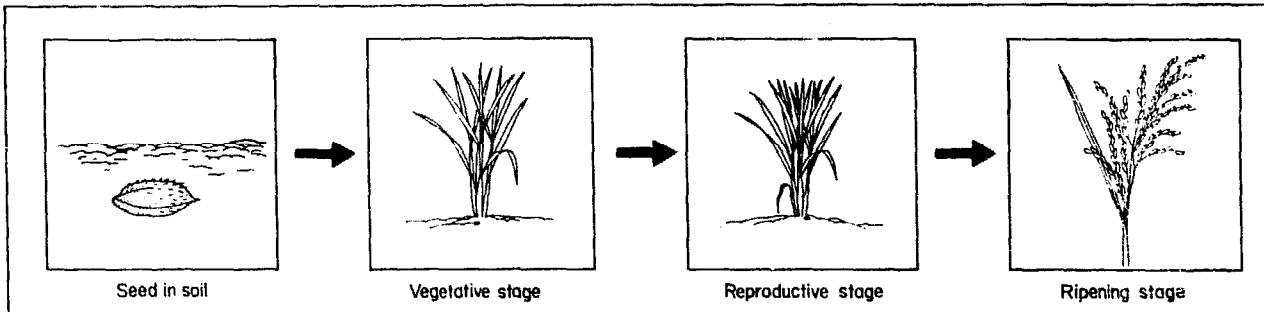

Scientific names are used to avoid confusion since common names of insects may vary among different countries.

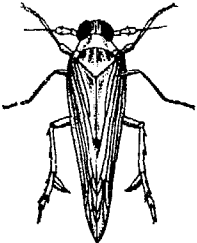

**Example of insect classification**

Common name — Rice brown planthopper  
 Order — Homoptera  
 Family — Delphacidae  
 Scientific name — *Nilaparvata lugens* (Stål)

↑ Genus

↑ Species

↑ Taxonomist originally describing species

↑ Parentheses indicate *N. lugens* was originally placed under another genus.

**Description of insect pests in this Guide**

Each insect pest or group of pests is described in a common format.

**Pest status**

Insects are designated as either major or minor pests based on a combination of three factors:

- Severity of economic loss (high, moderate, low)
- Frequency of occurrence and area affected within the insects' potential habitat.
- Ease of control (difficult, readily controlled).

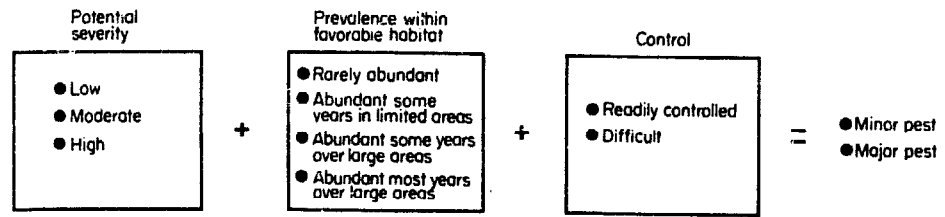

The pest status designation reflects only the general status of the insect species throughout Asia. The status

of any pest may vary considerably in localized areas and change through time.

• **Environment**

The preferred habitats or locations of insect pest

species were divided into three general categories:

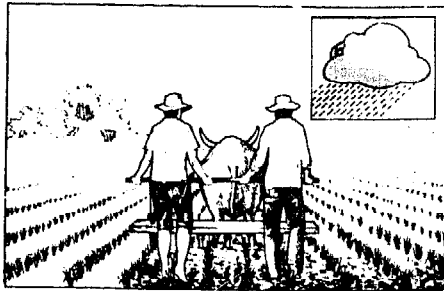

— rainfed upland rice fields (unpuddled, nonflooded)

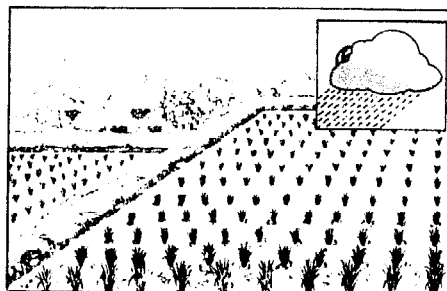

— rainfed wetland rice fields (puddled, flooded after rains)

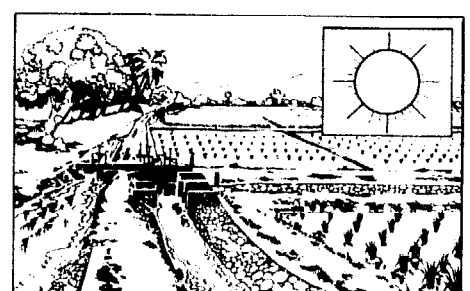

— irrigated wetland rice fields (puddled and flooded)

• **Distribution**

The distribution of major pest species throughout Asia is indicated. This distribution is only a general classification which may be incomplete in some areas and change with time.

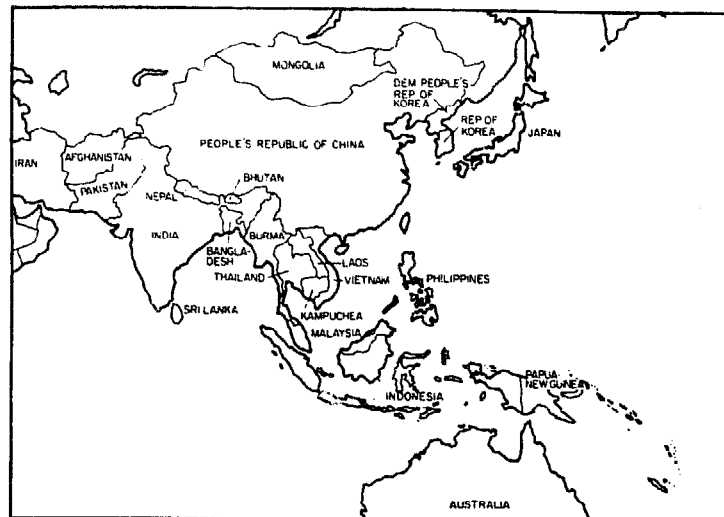

• Development and actual size

The actual size of the various life stages of the insect pests is presented along with detailed drawings and an indication of the duration of each stage under average conditions.

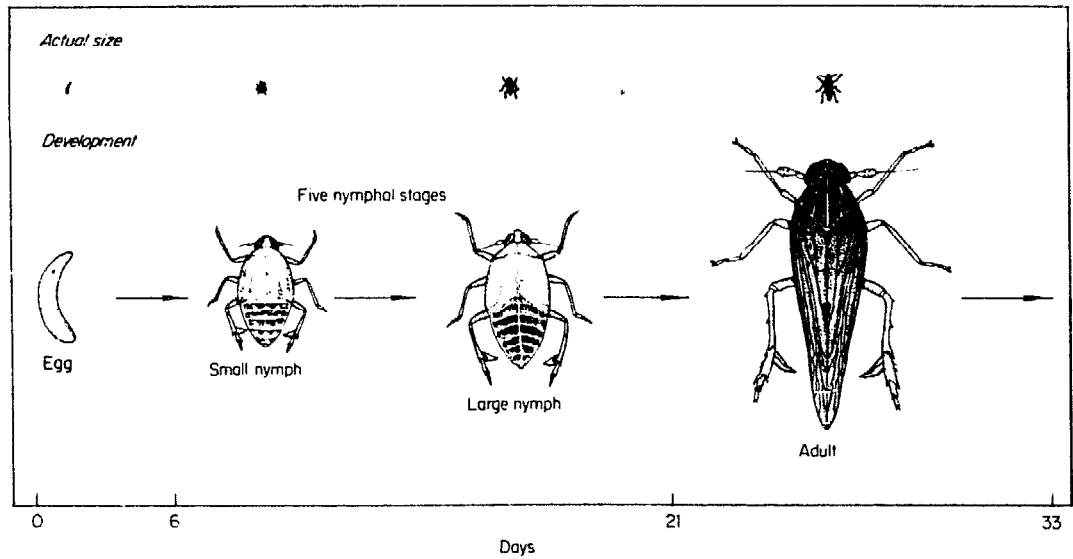

• Location and behavior

The location and behavior of various life stages of major insect pests are described.

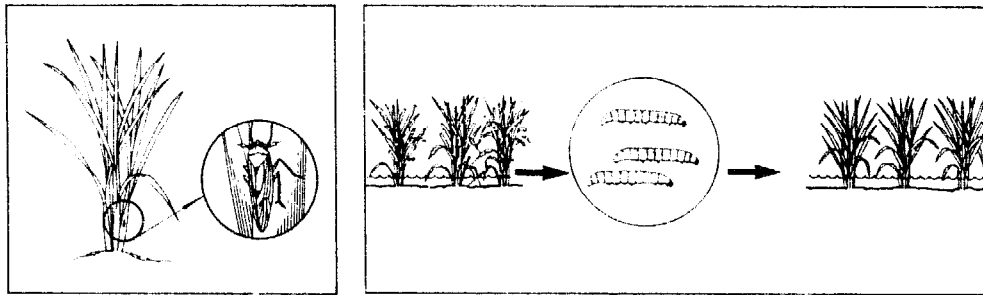

• Host range

The major species of host plants for each insect species are listed.

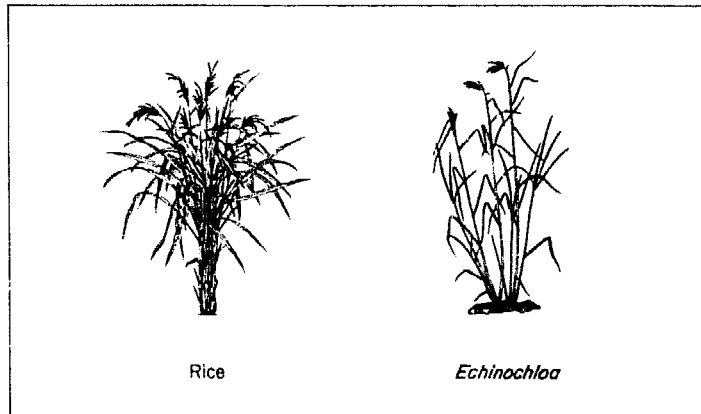

Damage

The type of damage caused by each insect pest is described and illustrated. Changes in rice plant color caused by insect injury are difficult to illustrate in line drawings.



**Management**

The section on management for each insect pest or group of species includes the following tactics arranged in the order in which they should be addressed in a pest management program:

**Control tactics**

**Cultural practices**

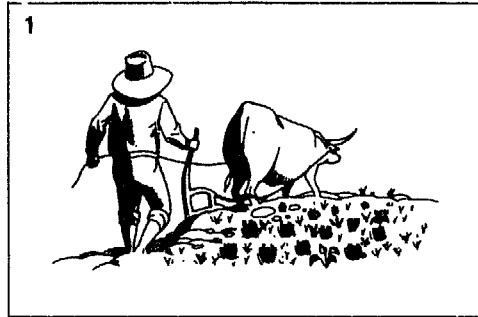

**Varietal resistance**

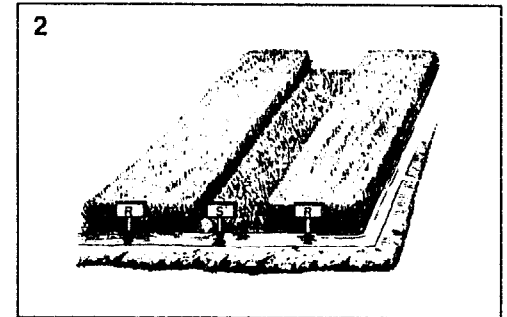

**Natural enemies**

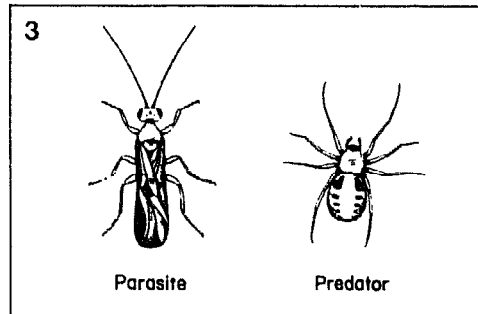

**Monitoring and sampling techniques**

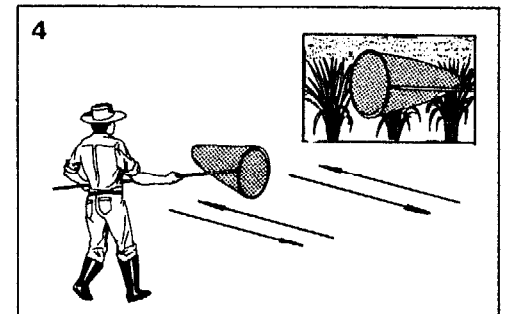

**Insecticides**



**Economic thresholds**

The economic thresholds presented in this publication are only general guidelines. Threshold values differ by location. The values may also be affected by crop age and simultaneous infestations of multiple pests.

Above the economic threshold, economic injury occurs, while below it no control is necessary.

Egg masses (no. / 20 hills)

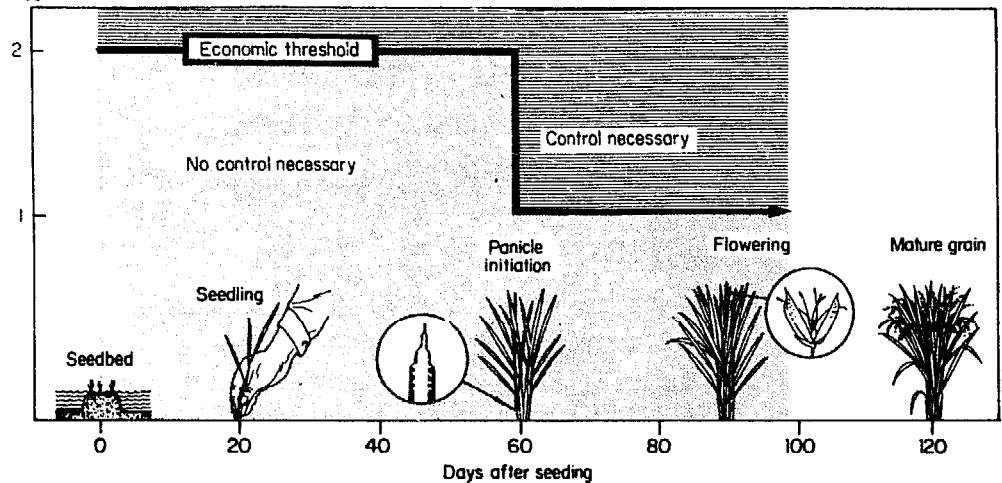

SOIL PESTS

ANTS (HYMENOPTERA: FORMICIDAE)

Several species of red or black soil-inhabiting ants — *Solenopsis*, *Monomorium*, *Pheidole*, and *Pheidologeton* — remove rice seed from newly sown fields in rainfed areas. Ants can be distinguished from other insects by the presence of the pedicel between the thorax and abdomen.

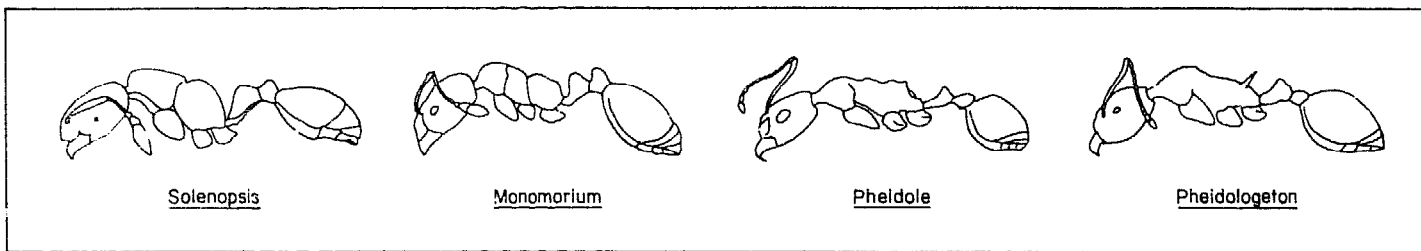
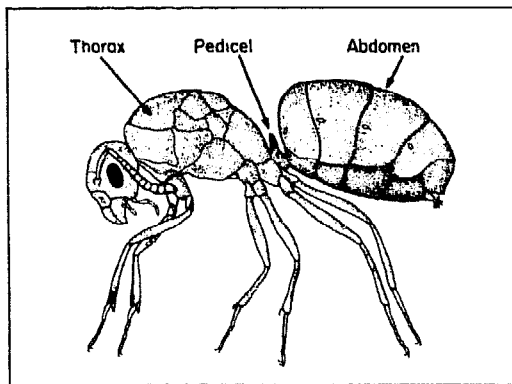

**Pest status**

Although ant populations in nonflooded rice fields are high, the greater tillering of the surviving plants normally compensates for loss of stand due to seed removal. Ants are readily controlled by insecticide.

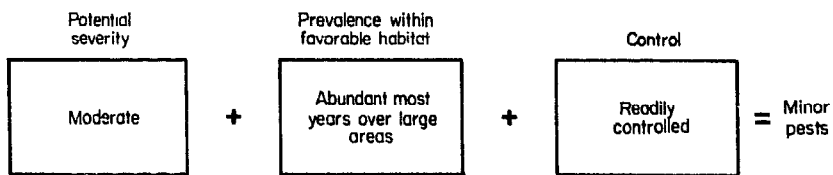

Ants are most prevalent in upland environments but also occur in dry-seeded rice

fields in rainfed wetlands. They are not a problem in puddled fields.

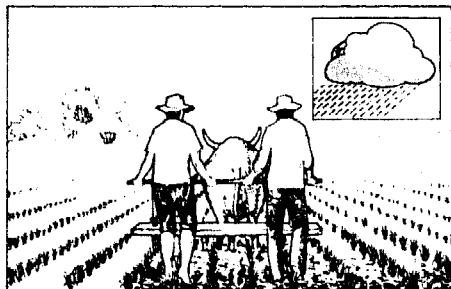

Upland

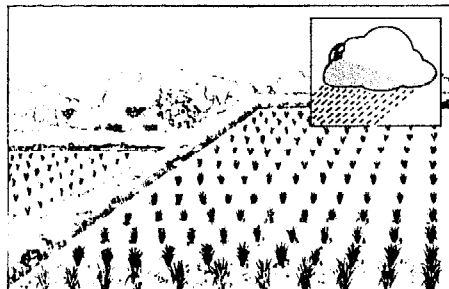

Rainfed wetland

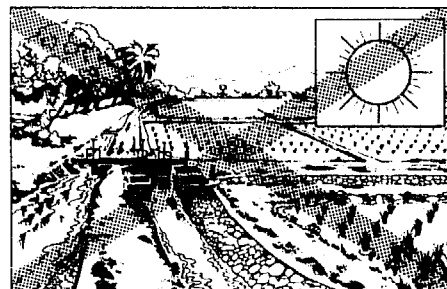

Irrigated wetland

Ants' nests are below the soil surface in upland fields, but are confined to rice levees in rainfed wetland fields.

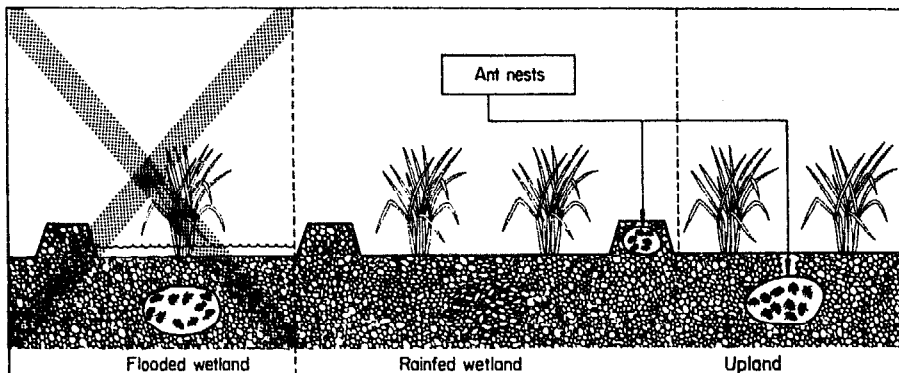

Whether ants forage day or night depends on the species. *Solenopsis* forages by day near the nest and prefers a dry habitat. *Pheidole*, *Pheidologeton*, and *Monomorium* forage long distances by night using chemical odor trails. These species prefer to nest in moist soils.

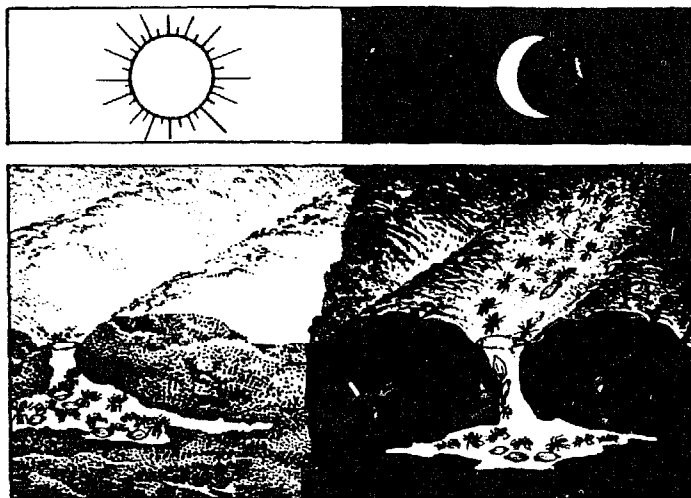

**Damage**

Ants store rice seed from the field in nests below ground. The result is loss of plant stand.



**Management**

*Cultural control.* Increasing the seeding rate compensates for ant-caused losses and may be less expensive than insecticides.

*Resistant varieties.* No variety is resistant to ants.

*Biological control.* Ants are hosts to various parasites — mermithid nematodes, ascomycete fungi (*Cordyceps* and *Laboulbenia*), phorid flies, strepsipterans, and eucharitine wasps; and are prey to a wide array of vertebrates — birds, snakes, ground lizards (*Dasia* and *Sphenomorphus*), bull frogs,



**Plant Resistance**

**Biological Control**

and ant-lions. The impact of natural enemies, however, has not been determined.

*Chemical control.* Treating seed with insecticide is the most effective way of controlling ants. Insecticide in powder form readily sticks to rice grains and makes it unnecessary to wet seeds or use a sticker.

There is no economic threshold for ants.

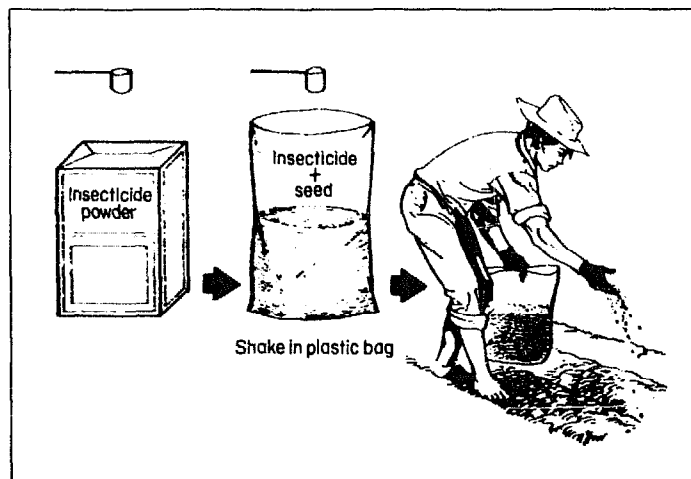

**Economic Threshold**

**TERMITES (ISOPTERA: TERMITIDAE AND RHINOTERMITIDAE)**

Termites are known as white ants because of the overall similarity to ants in body shape, wings, and the caste system of workers, soldiers, kings, and queens. Termites, however, lack a pedicel.

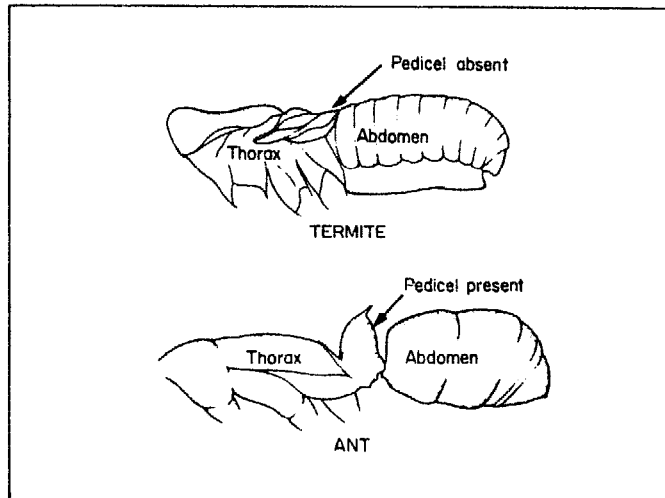

**Pest status**

Even though they are permanent residents of nonflooded environments, termites rarely attack rice and are readily controlled with insecticide.

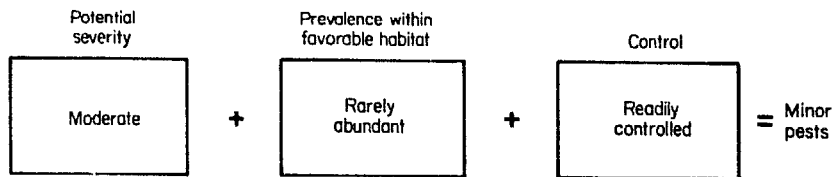

Termites can be a problem in upland environments, but also occur in light-textured

soils in rainfed wetland areas. Sustained flooding kills them.

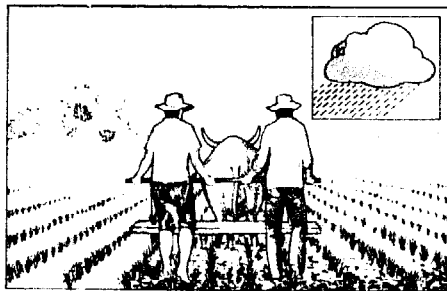

Upland

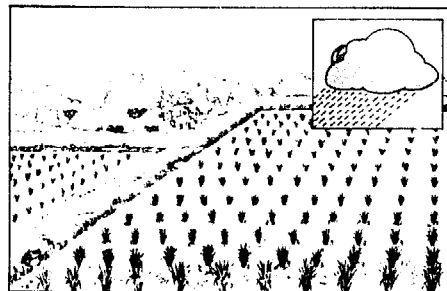

Rainfed wetland

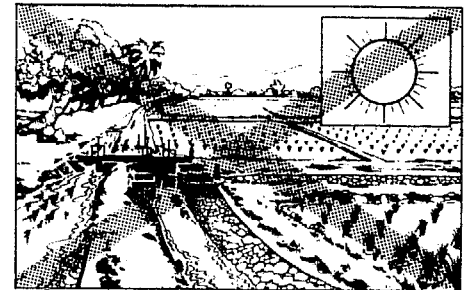

Irrigated wetland

Some grassland termites make permanent nests composed of many tunnels deep in the soil. Other species make nests as mounds above the ground. The tunnels are lined with body waste to seal the walls so that high humidity can be maintained.

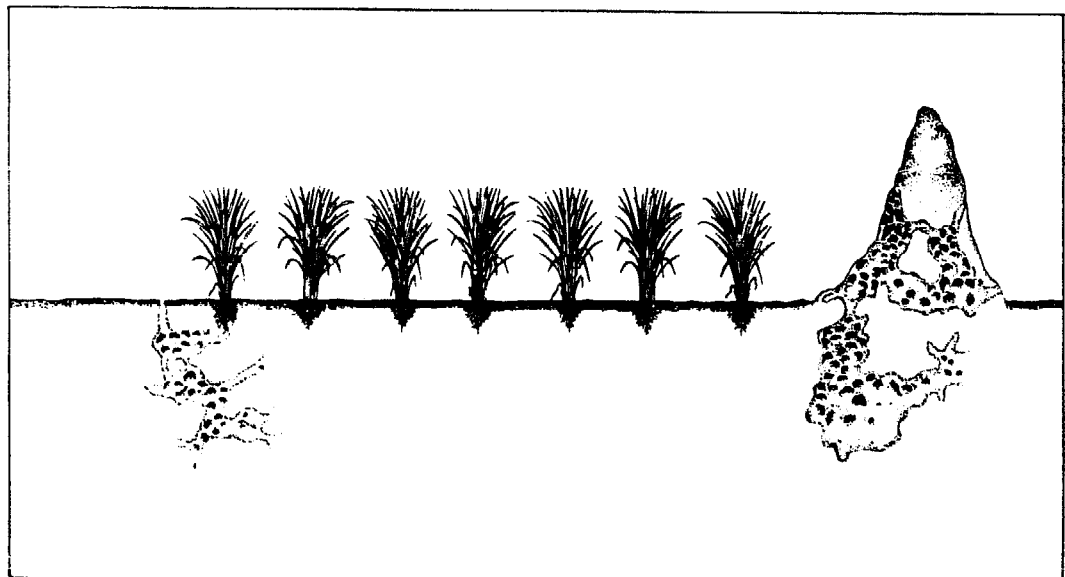



*Distribution in Asia.*

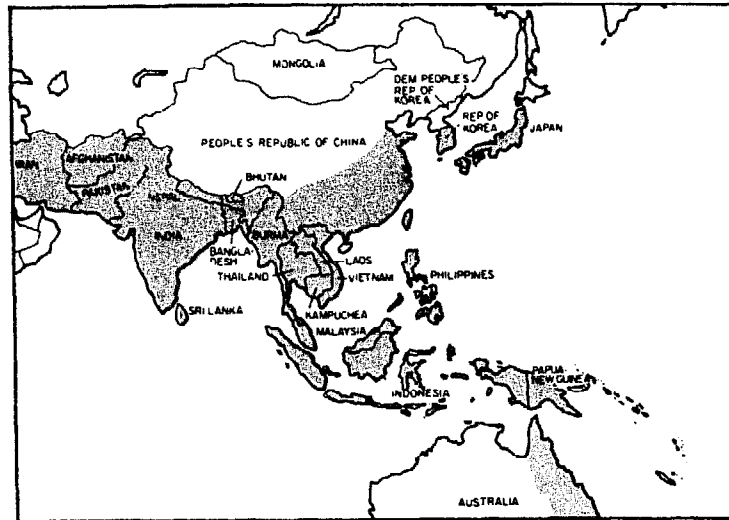

**Damage**

Most grassland termites lack symbiotic protozoa to digest cellulose. Instead they culture fungi in underground fungal combs. Fungal combs are made by termite workers of partly digested plant material. This plant material becomes inoculated with the fungi and the termites later eat the combs. Workers are constantly constructing and eating fungal combs in their nests.

Soldiers



Macrotermes gilvus (Hagen)  
(Termitidae)

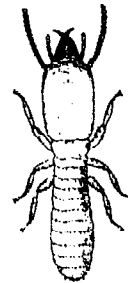

Heterotermes philippinensis (Light)  
(Rhinotermitidae)

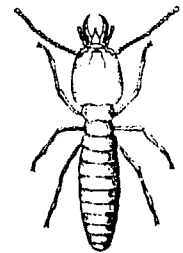

Coptotermes formosanus (Shiraki)  
(Rhinotermitidae)

Termites prefer dead to living plants but when their preferred food is gone, they feed on living roots. After land preparation, the termite workers feed on living plants. They tunnel through plant stems and eat roots, causing the plants to become stunted, then wilt. Damaged plants can easily be pulled by hand.

Droughts, when rice is not vigorously growing, encourage termites to attack a standing crop.



**Management**

**Cultural control.** To take advantage of termites' preference for dead plant material, farmers can divert the pest from the growing crop by putting crop residue in the field at planting.



**Chemical control.** Treating the seeds with insecticide at planting is usually effective against termites. If higher dosages are required, granules are applied in the seed furrows or hills.

Decision on insecticide use should be based on the history of damage in a particular field or perhaps portions of a field.

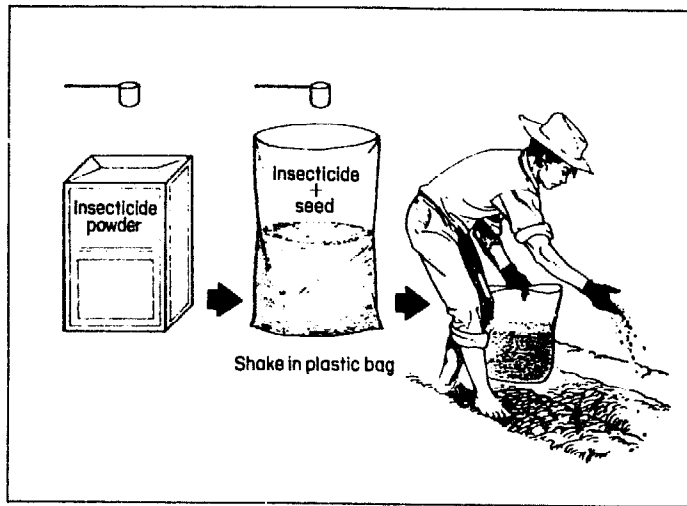

**WHITE GRUBS (COLEOPTERA: SCARABAEIDAE)**

The large larvae of scarab beetles are called white grubs. Grubs are larvae that live in soil. White grubs can be distinguished from other soil-inhabiting larvae by the swollen end of their abdomens, C-shaped body, and well-developed legs.

There are many species of white grubs, but none is widely distributed in Asia. White grubs as a group are common to all countries.

White grub species can be divided into two groups —

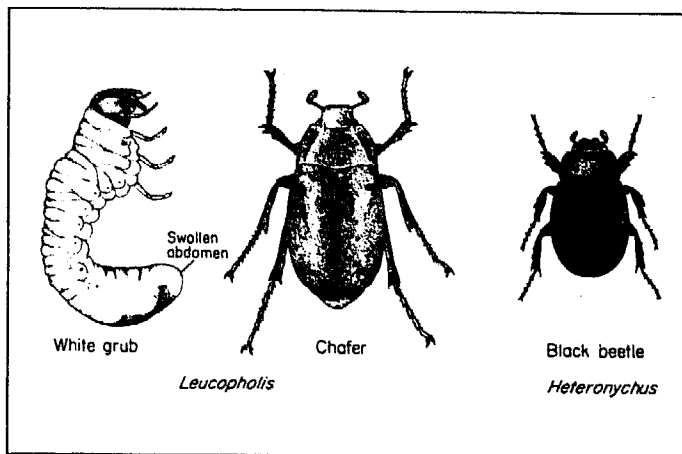

the chafers in which only the larvae feed on plant roots and the black beetles in which only the adults are root feeders.

**Pest status**

White grubs attack only portions of a field, but can recur annually. Mature larvae cannot be economically controlled with insecticide.

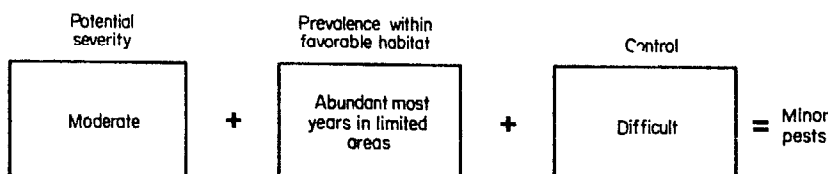

White grubs are restricted to nonflooded environments. They are most common in

upland rice but can occur in rainfed wetland areas with very light-textured soils.

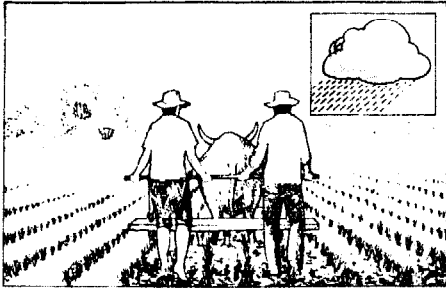

Upland

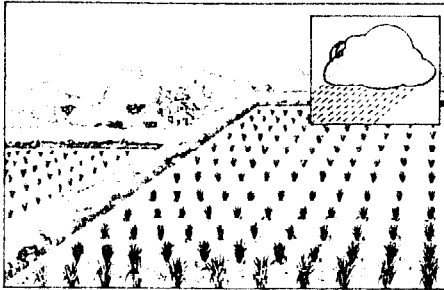

Rainfed wetland

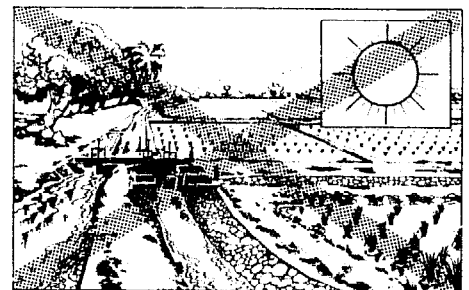

Irrigated wetland

*Distribution in Asia.*

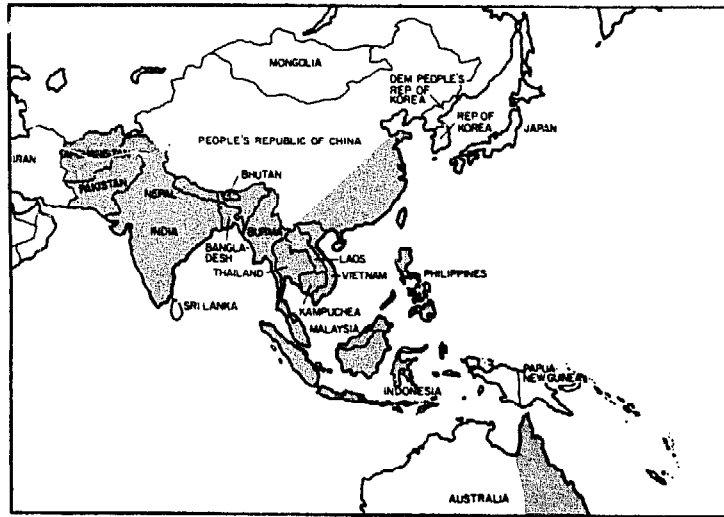

**Development and actual size**

White grubs typically have a 1-year life cycle in the tro-

pics. In temperate regions 2-year life cycles are common.

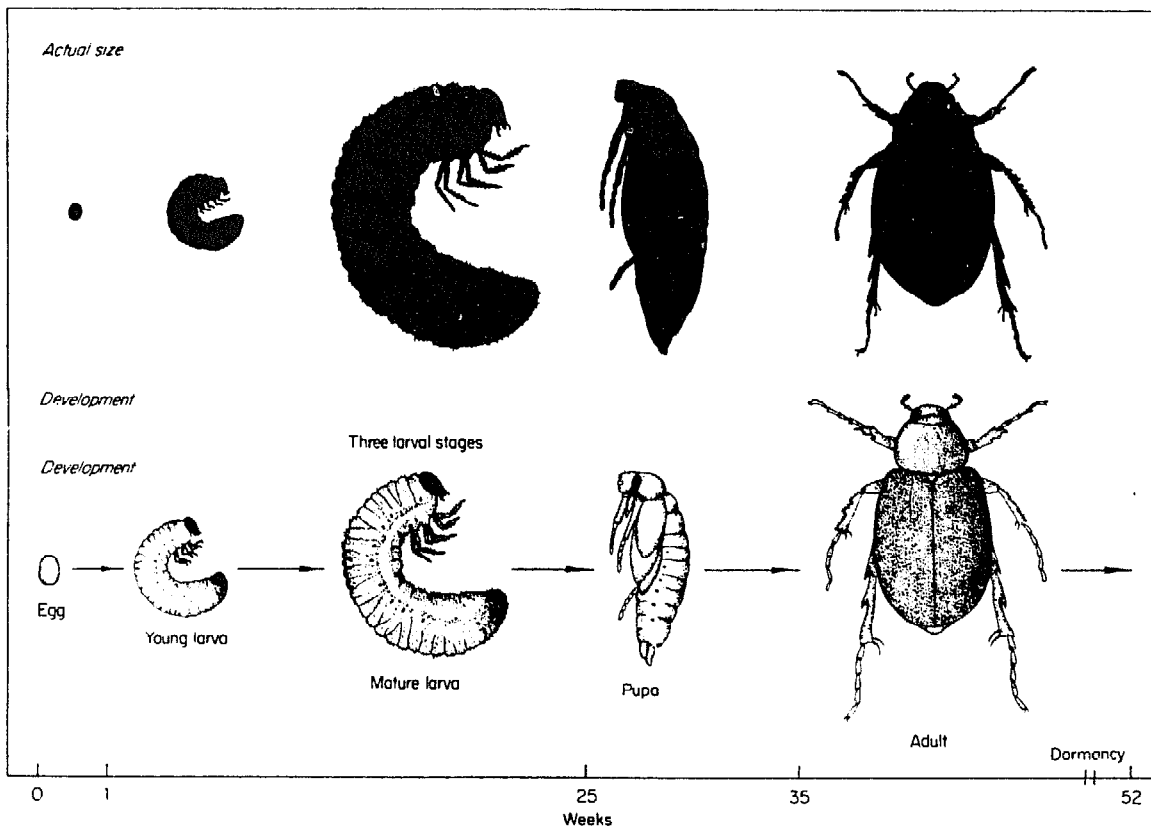

**Adult.** Beetles are grey, tan, dark-brown, or black. Adults develop in underground pupal cells where they rest as larvae in a dormant state during the unfavorable dry season. After the first soaking rains that mark the beginning of the rainy season, the larvae develop into pupae and the pupae into adults which emerge from the ground and fly to nearby trees.

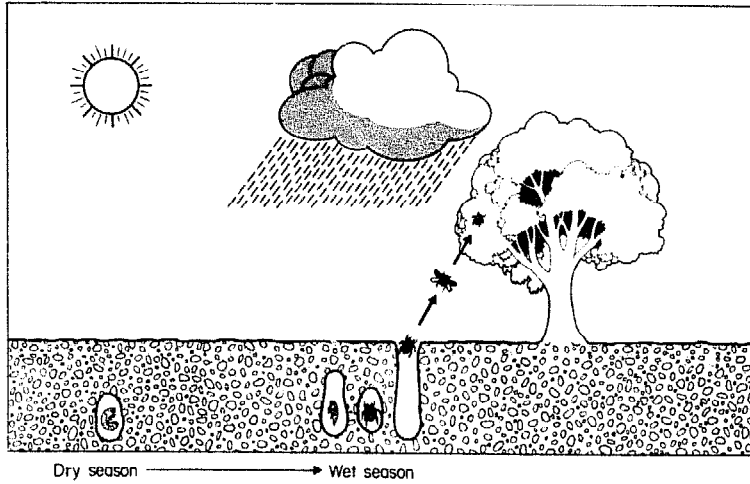

Adult beetles rest in the trees during the day and become active at night when they feed on tree foliage, mate, and fly to nearby fields to lay eggs.

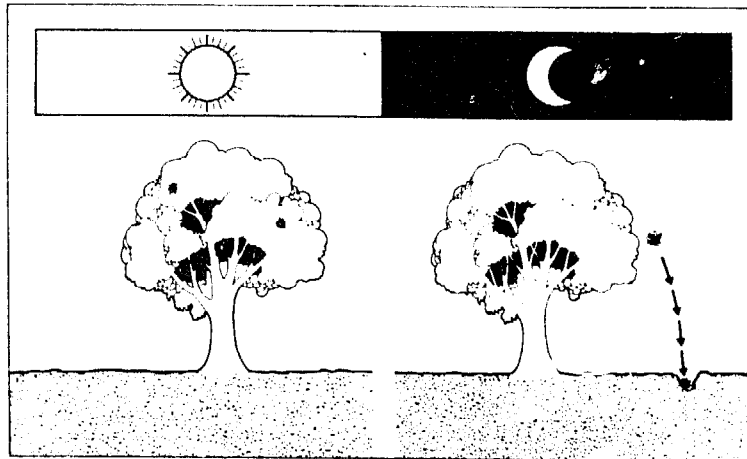

Adults are attracted to a light trap at night. Largest catches are during a new moon.

Eggs are laid singly in moist soil by the burrowing females. Tilled fields with soft texture are preferred sites for egg-laying.

Chafer females may lay 50 eggs in their lifetime of several weeks. Black beetle adults live about one year.

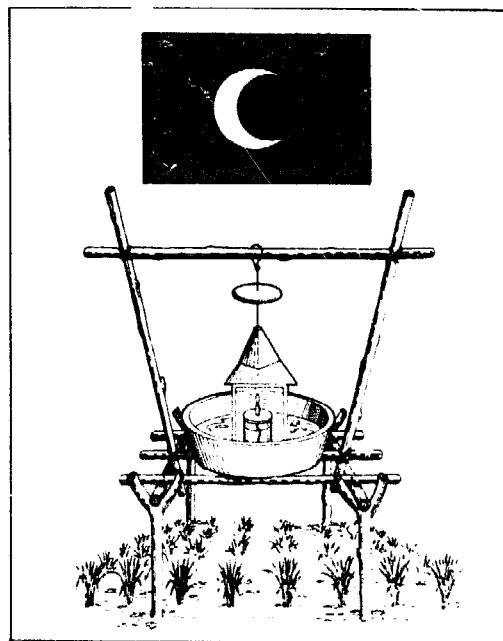

**Egg.** Eggs deposited singly are ovoid and creamy white with a leather-like shell.

The egg stage is highly susceptible to dry weather and must be in moist soil to hatch.

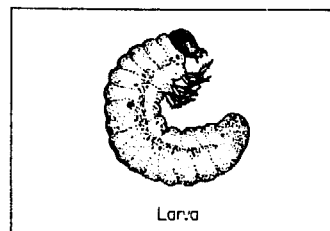
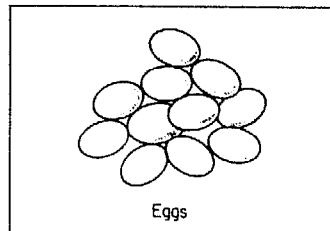

**Larva.** White grub larvae are difficult to classify into species without a microscope for examining body hairs, mouthparts, legs, and tarsal claws. They have a light to dark brown head and a white body.

The strict soil moisture requirements of white grub larvae help explain their uneven distribution. Larvae desiccate if the soil is dry, and they drown in heavy clay soils after a heavy rainfall.

White grub larvae can be found near the soil surface during rainy periods.

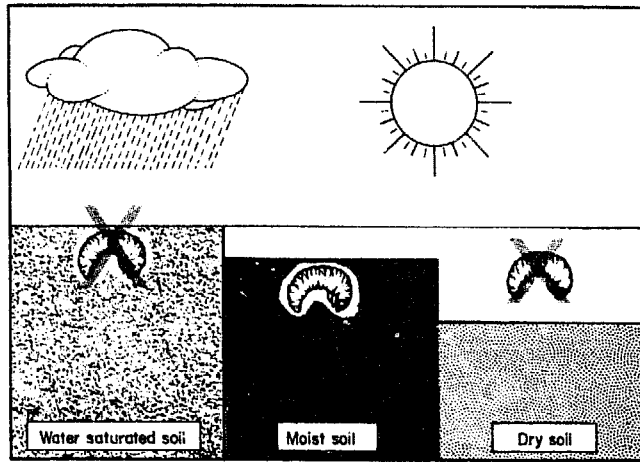

Larvae burrow down several meters in the soil during the dry season to form compact cells in which to pupate.

*Pupa.* The pupal cells protect the dark brown pupae from drying out.

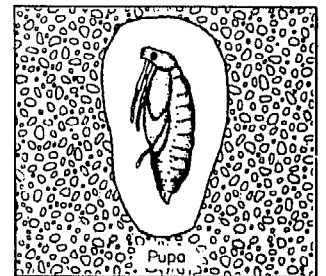
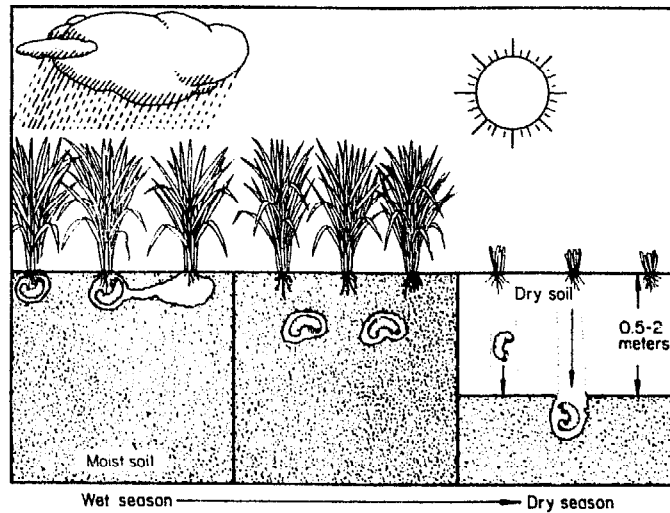

**Damage**

Black beetle adults burrow in the soil and feed on roots. The larvae feed entirely on organic matter and do not attack living roots.

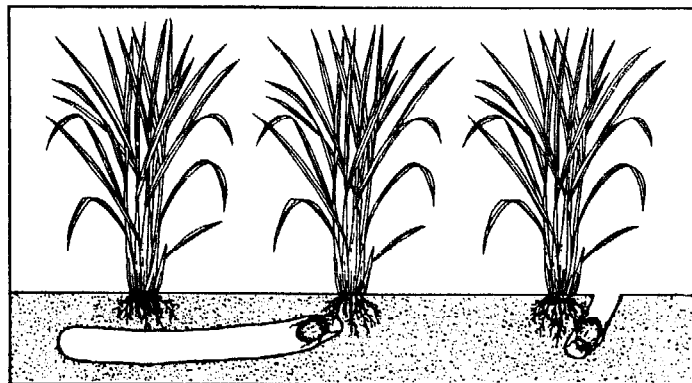

Chafer adults are foliage feeders on a wide variety of trees. Larvae feed on roots of living plants. They dig through the soil with their powerful legs and feed on their backs.

Rice is a preferred host because of its fibrous root system. Rice plants become stunted and wilt as a result of root loss. Damage to the crop under drought stress is higher because plants are less able to produce new roots.

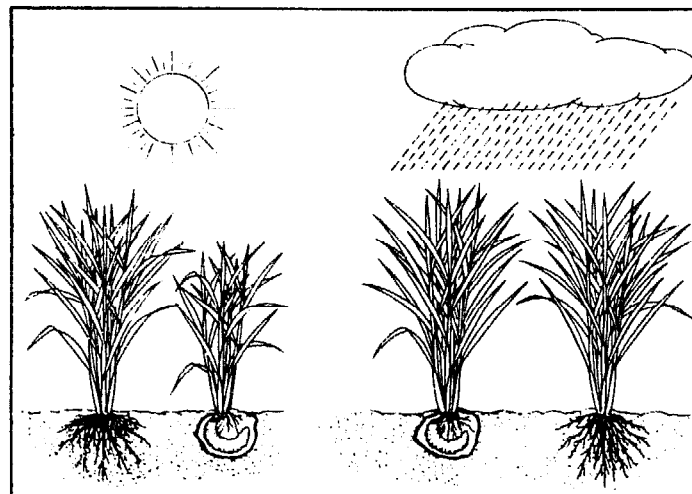

Most of the damage from chafers occurs from the last-stage larva.

Damage within a field is normally patchy because the chafer grubs and black beetles are not evenly distributed.

The same fields tend to be reinfested year after year.

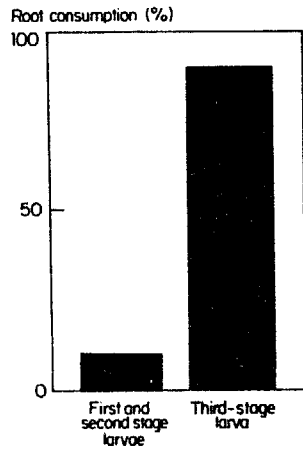

**Plant hosts.** Chafer larvae and black beetle adults feed on a wide variety of plant species but prefer plants with fibrous root systems.

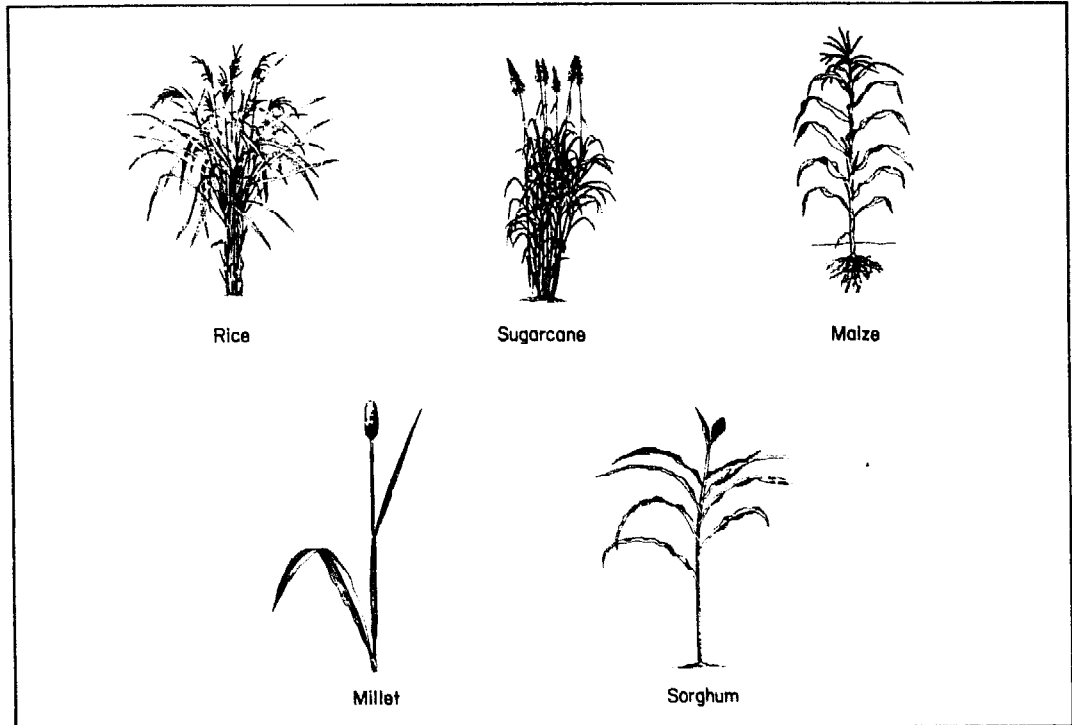
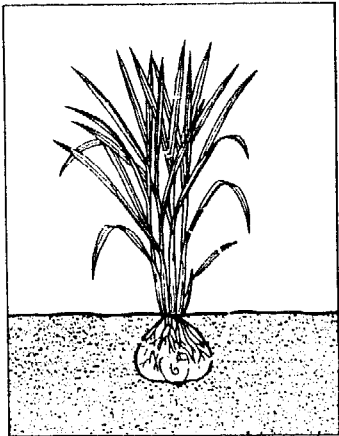

**Management**

**Cultural control.** Delaying land preparation until most chafer adults pass their egg-laying phase or die reduces the field population.

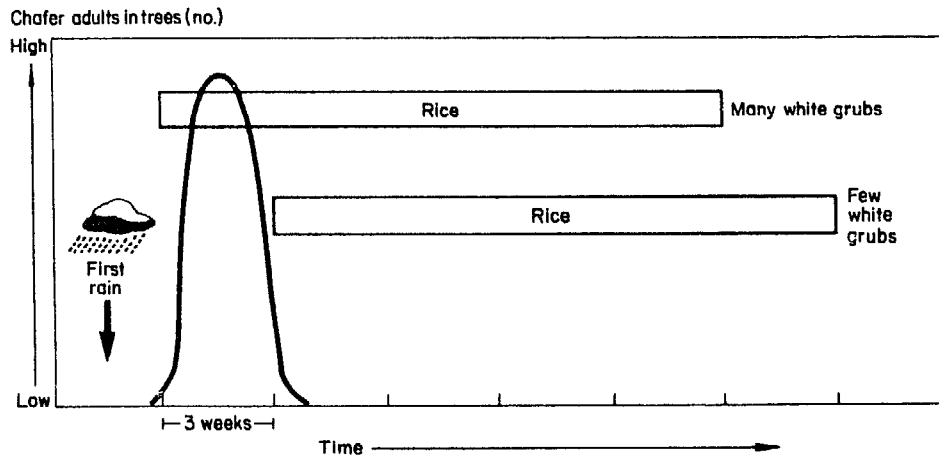

**Resistant varieties.** There are no varieties resistant to white grubs.

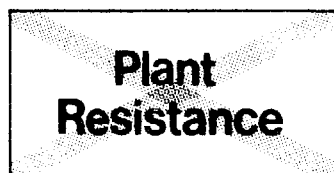

**Biological control.** Several specialized scoliid wasps can parasitize white grub larvae in the soil. Their control effect, however, is minimal.

Nematodes also parasitize white grubs.

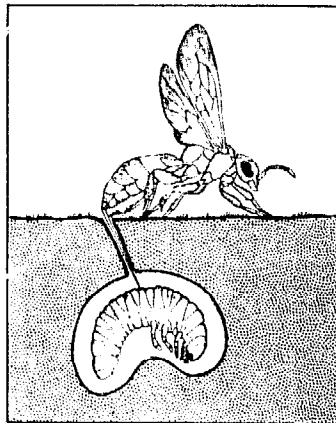

*Campsomeris marginella modesta* (Smith)  
(Scoliidae)

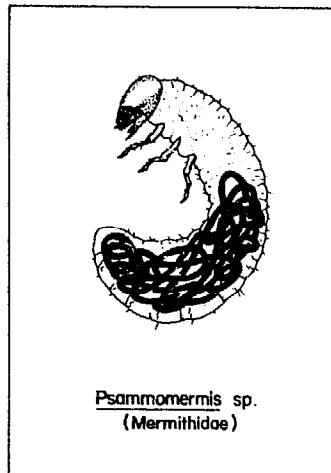

*Psammomermis* sp.  
(Mermithidae)

**Chemical control.**

- **Insecticide application.** Granular insecticides applied in crop furrows or hills at sowing are the only practical chemical control measure against white grubs. Granules covered by soil at planting remain active for several weeks.



Low insecticide dosages are effective against first- or second-stage chafer larvae, which are prevalent at the beginning of the rainy season when rice is sown. Insecticide control of third-stage white grubs is impractical after the damage is seen. Insecticide sprays on the soil are ineffective.

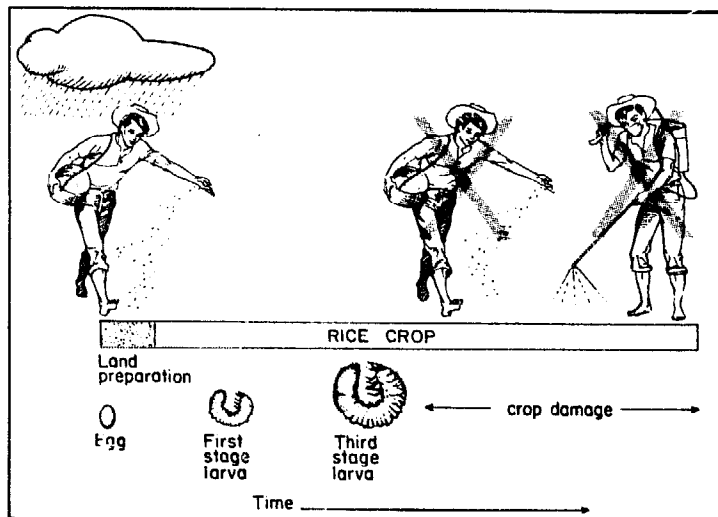

- **Scouting.** Because it is impractical to apply insecticide to the soil after the crop is planted, scouting and economic thresholds cannot be used.

**Economic Threshold**

If early planting is not practical or does not provide satisfactory control, insecticide should be applied at sowing time to fields which have a history of white grub damage.

**MOLE CRICKET (ORTHOPTERA: GRYLLOTALPIDAE)**

The mole cricket *Grylotalpa orientalis* (= *africana*) Burmeister is a soil-inhabiting insect. Adults and nymphs feed on roots. The insect is readily identifiable by its large size, enlarged front legs and prothorax, rudimentary hind wings, and anal cerci.

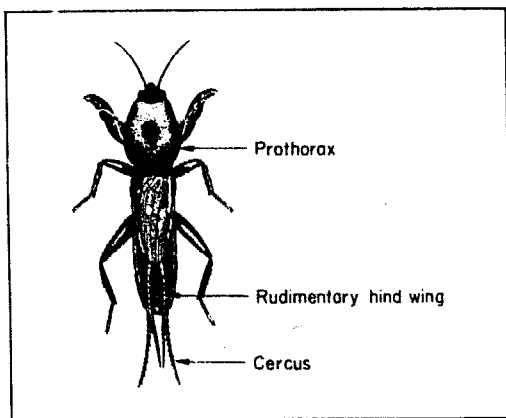

**Pest status**

Mole crickets only occasionally become sufficiently abundant to kill patches of young plants. They can be readily controlled with insecticide mixed with bait.

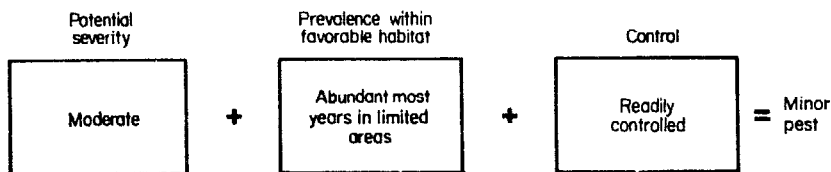

They occur in all rice environments but are more prevalent in nonflooded upland fields with moist soil that is easily tunneled. Adults

and nymphs forage for seed which they store either in permanent burrows or foraging-galleries in levees or field borders.

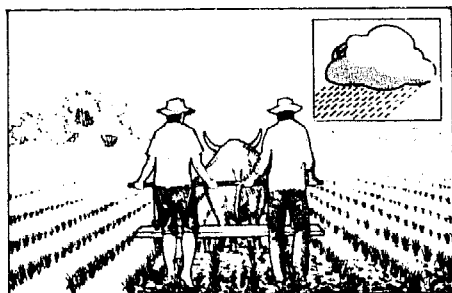

Upland

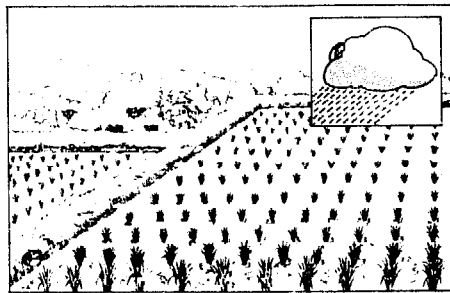

Rainfed wetland

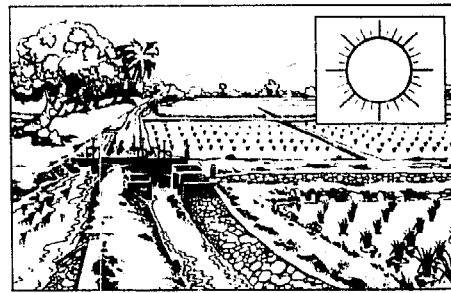

Irrigated wetland

*Distribution in Asia*

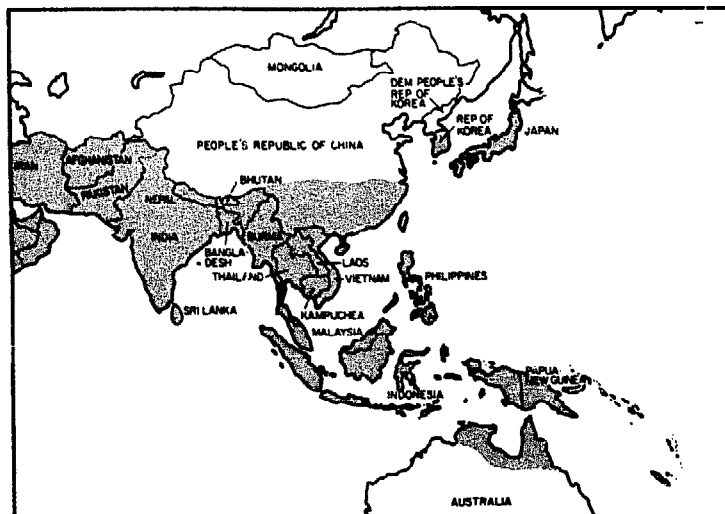



Development and actual size

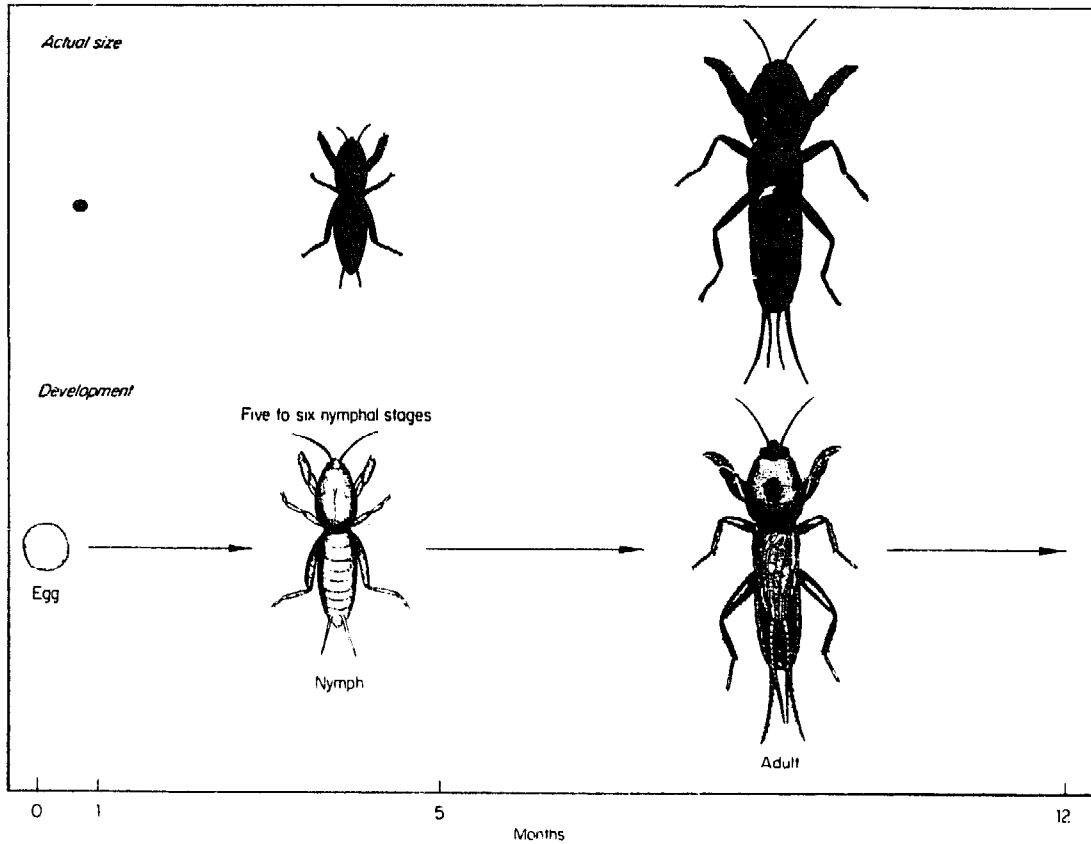

**Adult.** The tan to dark brown adults have enlarged front legs designed for digging tunnels in the soil. The first segment of the thorax is enlarged to help the insect push its way through the soil. During the night, adults actively dig branched burrows or search for food such as seeds or other insects aboveground. During the day, they are underground.

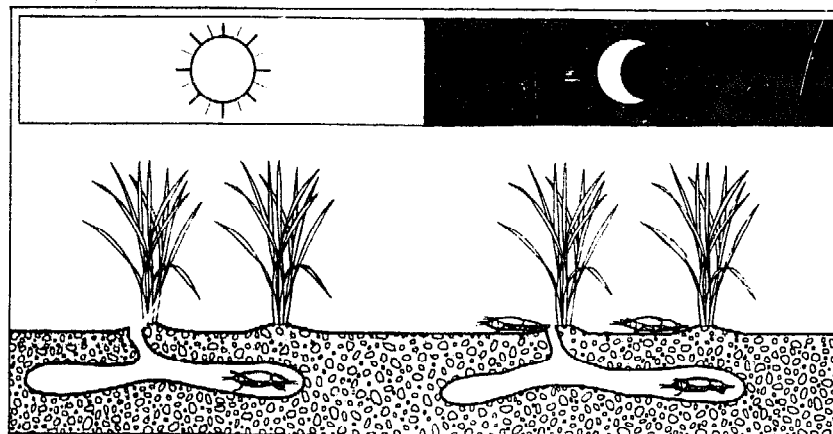

Adults are frequently seen swimming in flooded fields during puddling for wetland rice. Flooding causes them to leave their burrows.

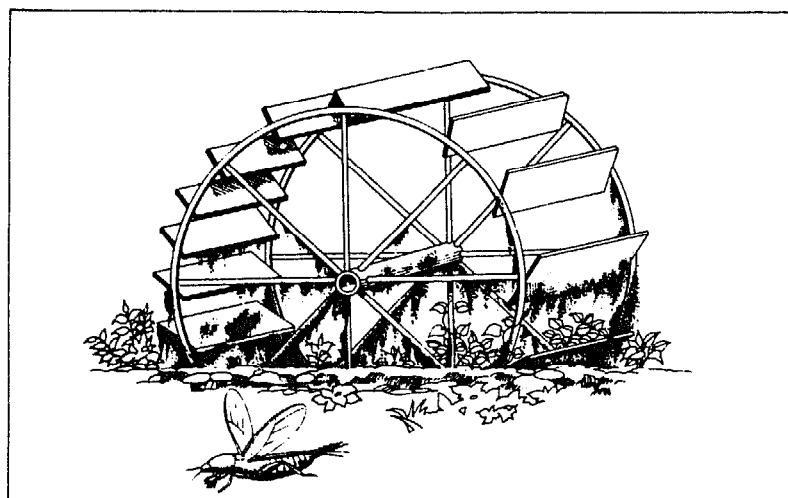

Because mole crickets cannot survive underwater, they make their burrows in rice bunds in flooded fields. Generally, they live in nonflooded fields.

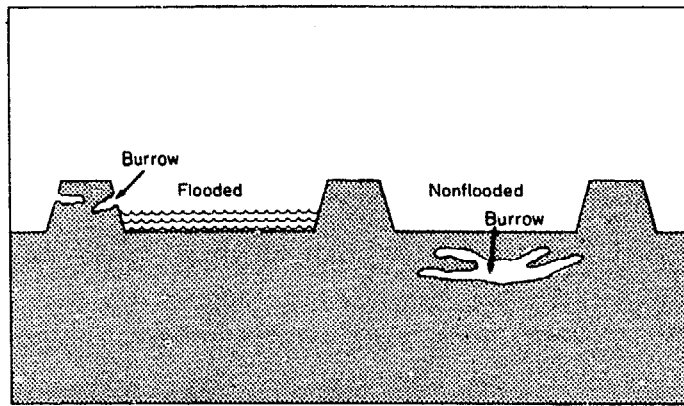

Adults are strong fliers despite their short wings, and are attracted to a light trap at night.

*Egg.* The white eggs are laid in masses of 30-50 in hardened cells beneath the soil surface. Each female may lay several hundred eggs during its lifetime of more than 6 months.

*Nymph.* The tan nymphs also burrow in the soil at night and feed on roots.

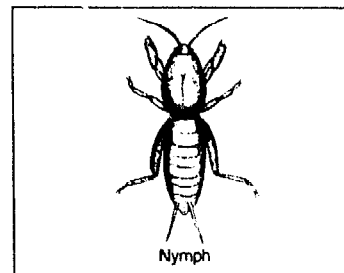
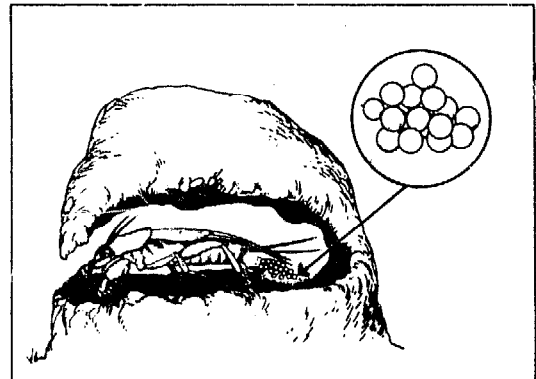
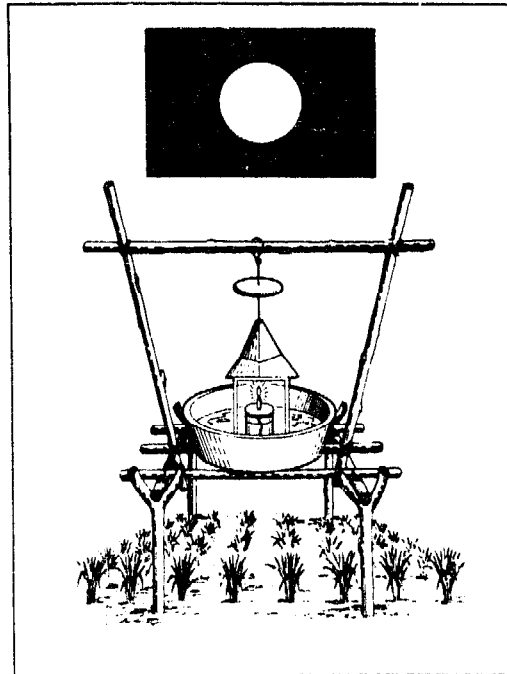

**Damage**

Foraging on seeds results in loss of plant stand in upland rice. Plants in a seedbed or during the early tillering period have small root systems and can be killed by mole crickets if the field is not flooded. Mole crickets cannot kill older plants because the root systems are large.

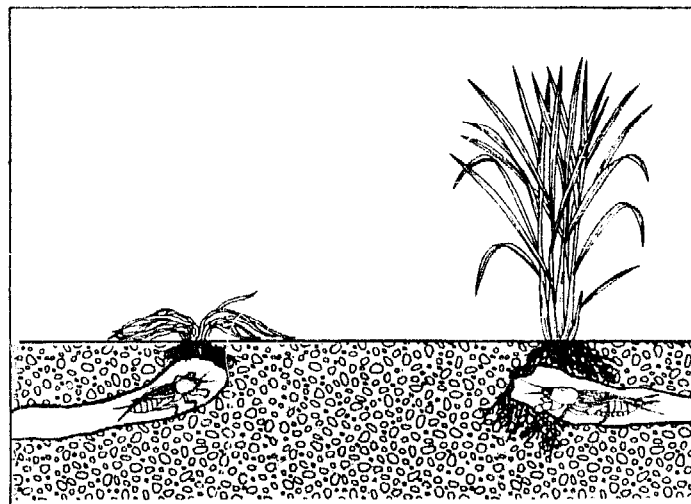

The pattern of damage in a field is not uniform. Damage is normally in patches. Normally damage is greater near the field borders.

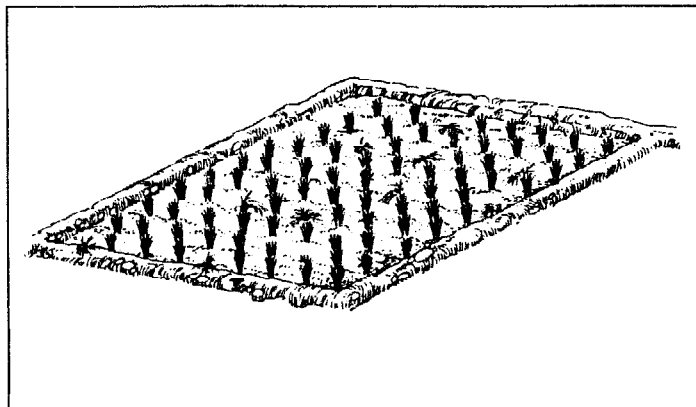

*Plant hosts.* Mole crickets feed on a wide range of plants with fibrous root systems.

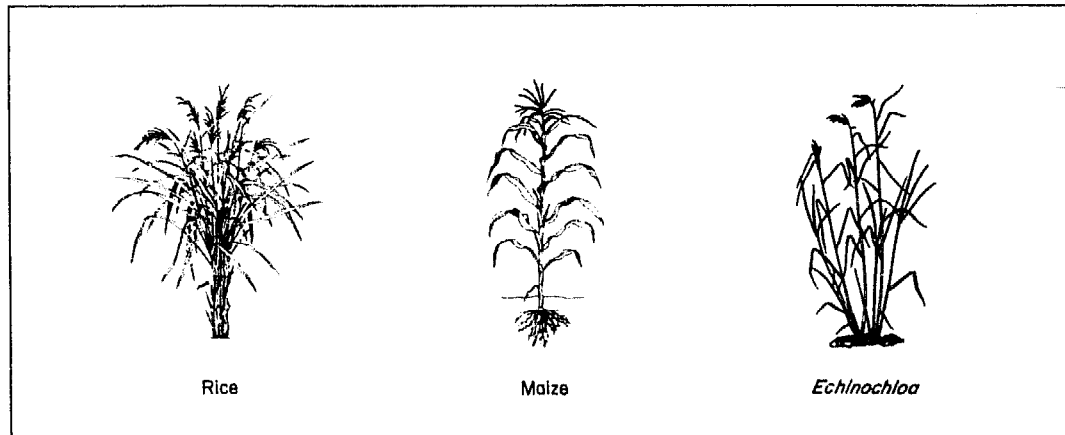

**Management**

*Cultural control.* Maintaining standing water in the field prevents mole crickets from tunneling in the soil and damaging the crop.

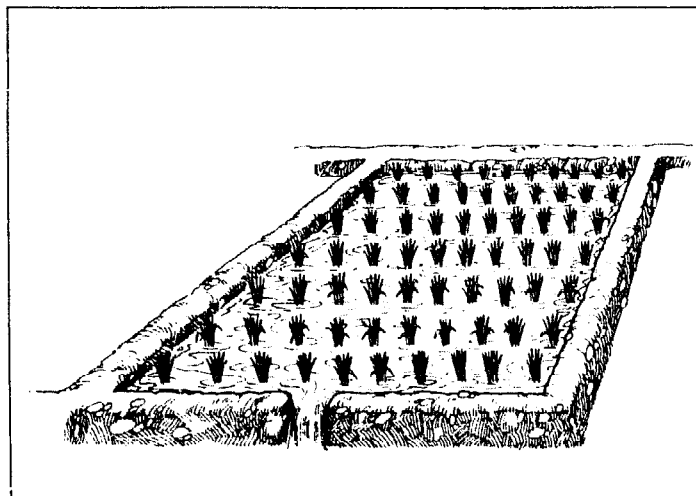

*Resistant varieties.* There are no varieties resistant to the mole cricket.

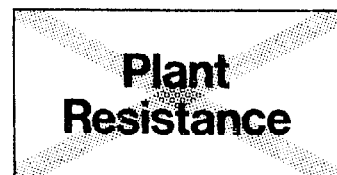

*Biological control.* Mole crickets are cannibalistic, thus regulating their own numbers. A sphecid wasp and nematodes parasitize nymphs and adults.

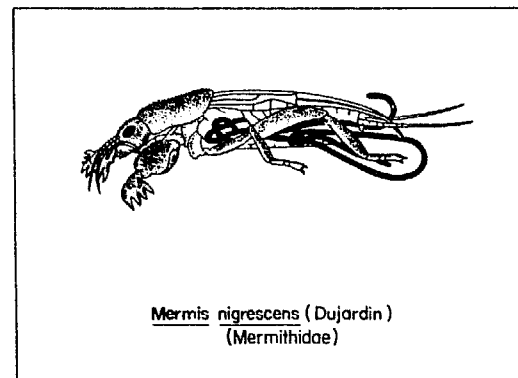
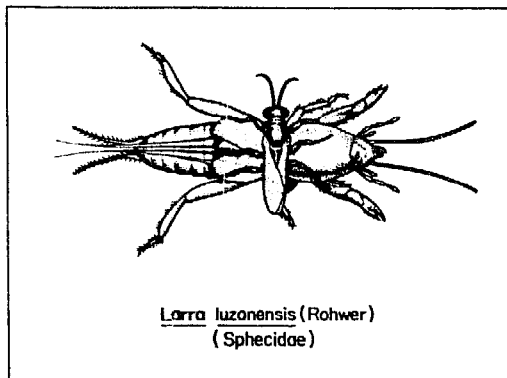

**Chemical control.**

• **Insecticide application.**

Poisoned bait made from moistened rice bran and liquid or powder insecticide can be placed in the field or on rice bunds to kill night-foraging mole crickets.

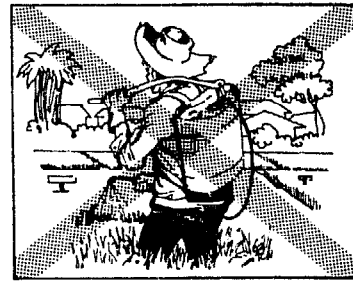
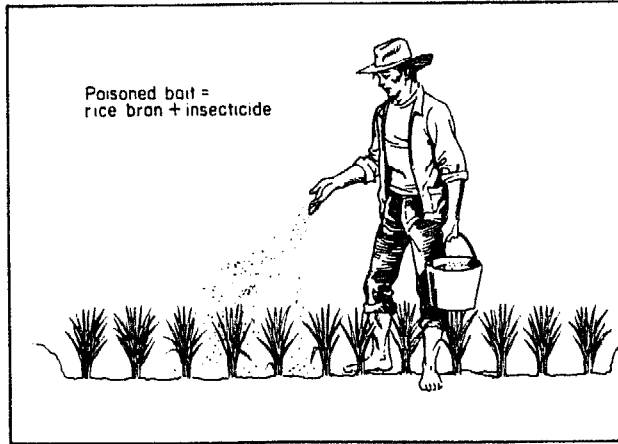

Foliar sprays are not effective.

Granular insecticides applied in the soil are effective but are costly.



• **Scouting.** Visit the field weekly from the seedbed stage through crop tillering. Look for dead plants throughout the field.

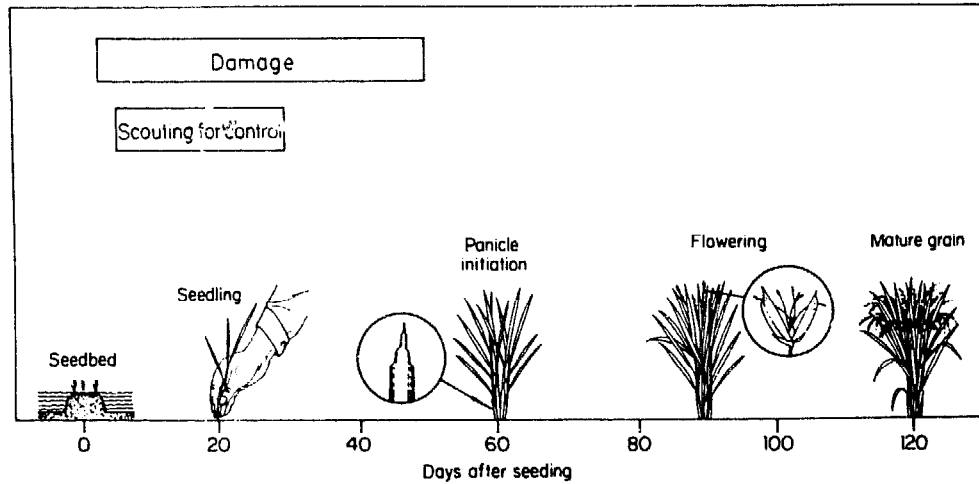

Apply poisoned bait when dead plants are found. No economic threshold has been established for mole crickets.

**Economic Threshold**

RICE ROOT WEEVILS (COLEOPTERA: CURCULIONIDAE)

Weevils can be distinguished from other beetles by their long snouts. The most widely known — the American rice water weevil *Lissorhoptrus oryzophilus* Kuschel — occurs in the Americas but recently entered Japan.

Several root weevils feed on rice in tropical and temperate Asia. The discussion focuses on three of the most widely distributed rice root weevils in Asia: *Echinocnemus squameus* Billberg of Japan, Korea, and China; *Echinocnemus oryzae* Marshall; and *Hydronomidius molitor* Faust of India.

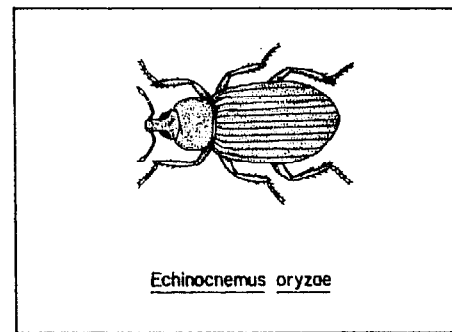
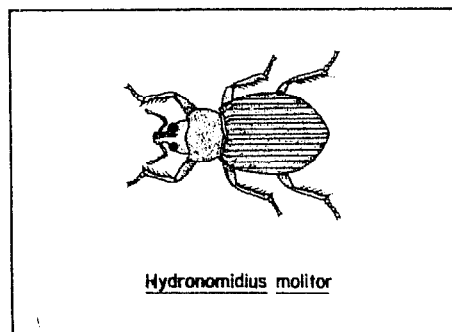
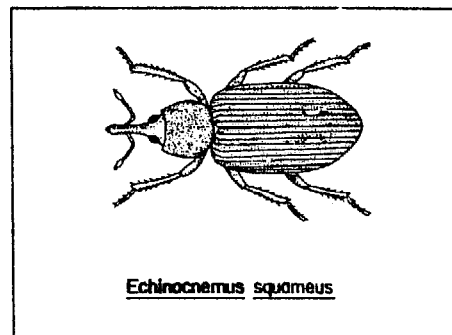
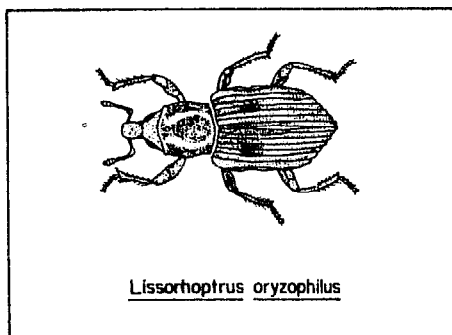

**Pest status**

Root weevils are readily controlled by insecticide. Much of the root damage they cause can be tolerated.

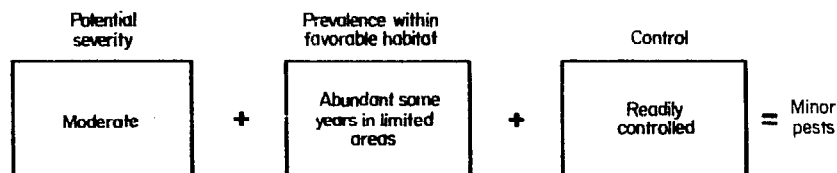

Root weevils are adapted to survive underwater and do

not occur in upland environments.

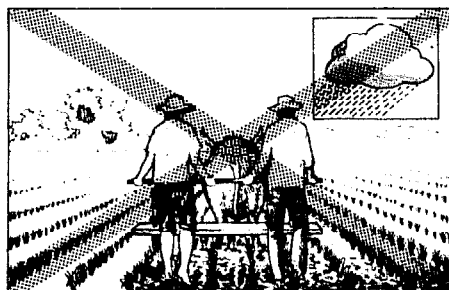

Upland

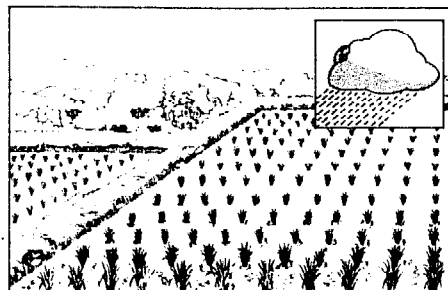

Rainfed wetland

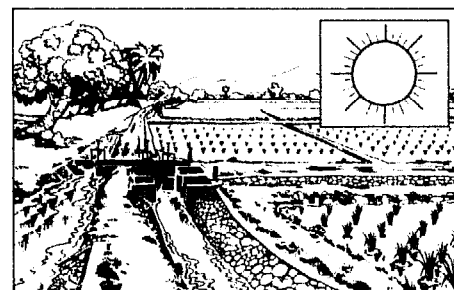

Irrigated wetland

*Distribution in Asia.*

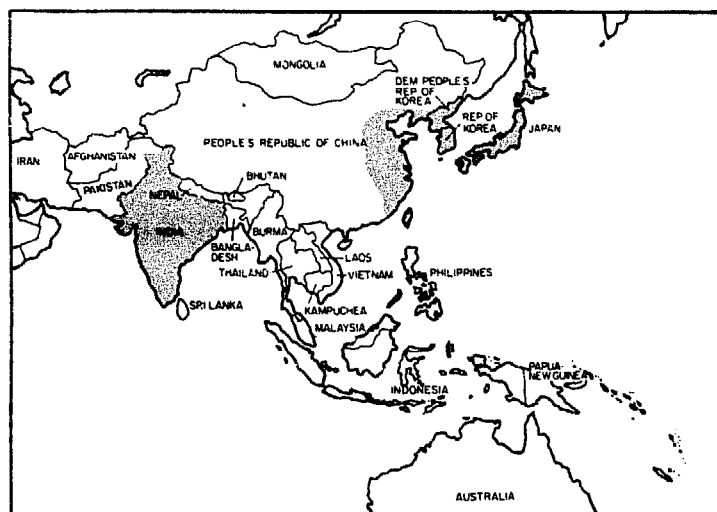

**Development and actual size**

The life cycles of the three species are similar and are discussed as one. Dormancy during the larval period extends the developmental period.

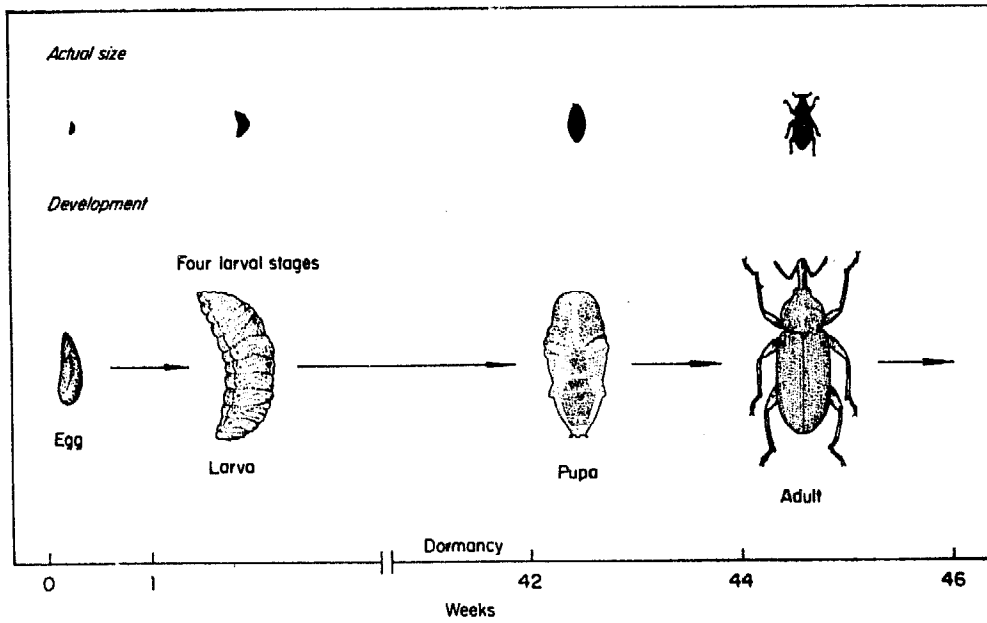

**Adult.** The grey black adults emerge from underground pupal cells after the onset of rains. Their behavior is similar to that of white grub beetles; however, they do not fly away from the fields.

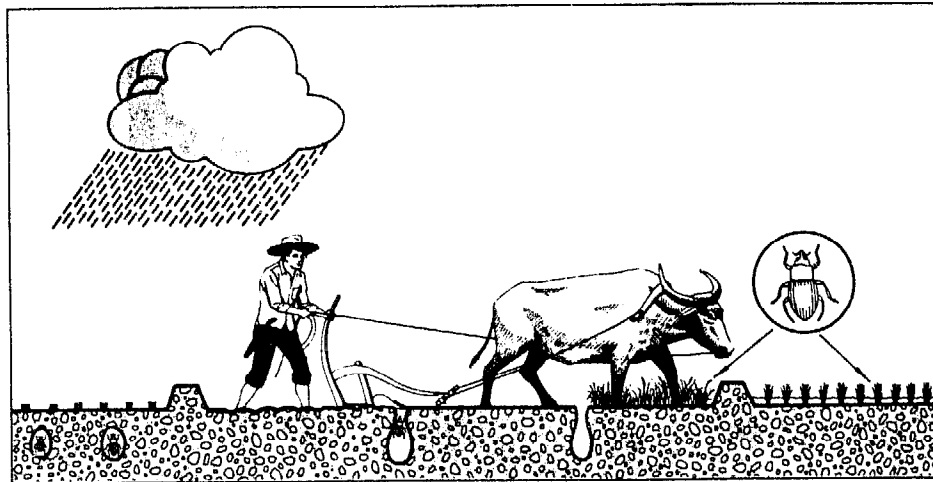

Adult weevils feed on leaves before going underwater to lay eggs at the base of plants.

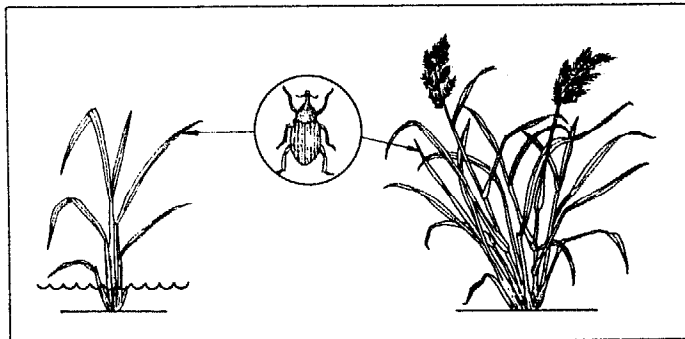

**Egg.** Oblong white eggs are laid singly under the soil, next to newly transplanted rice seedlings.

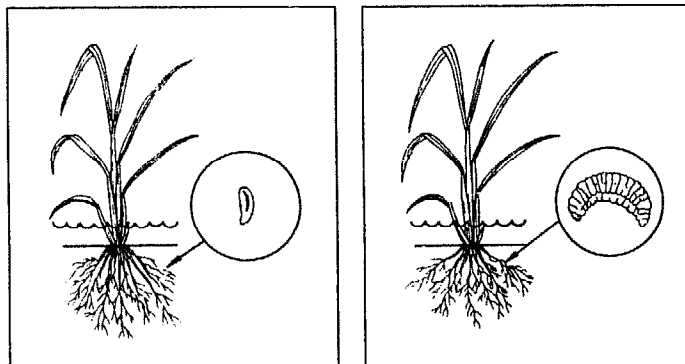

**Larva.** The larvae remain submerged underground, feeding on rice roots.

On their backs, larvae have special paired tubercles that take in oxygen from the roots.

With the onset of the dry season or winter, the larvae tunnel deeper into the soil to construct pupal chambers.

They remain underground through the dry season or winter, in dormancy.

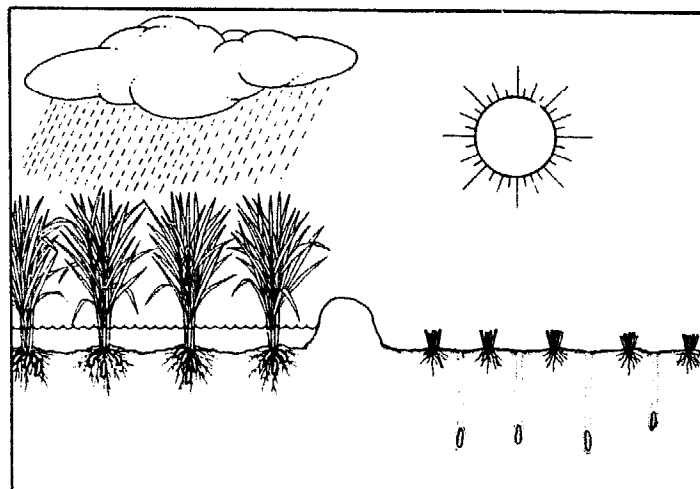
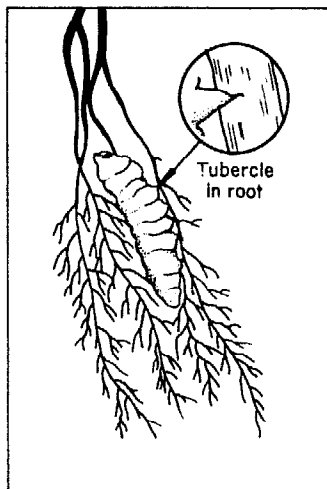

*Pupa.* The larvae pupate in the early monsoon or spring in underground cells.

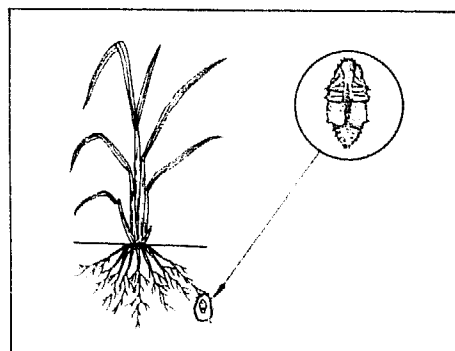

**Damage**

Adults feed on leaves of newly transplanted rice, but seldom cause economic damage.

Larvae feeding on roots during the wet season cause plants to become stunted and produce fewer tillers. Plants at tillering stage show more damage symptoms than plants after tillering.

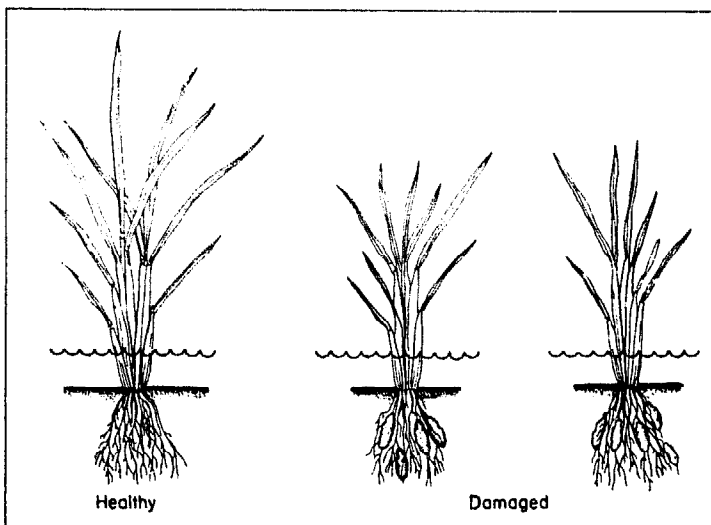
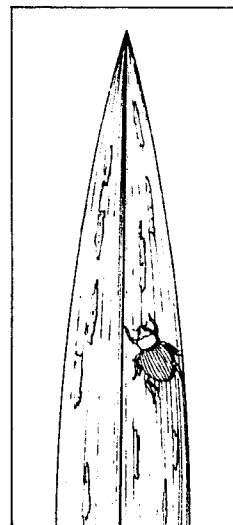

Root weevils are unevenly distributed. When abundant, they can kill young rice plants.



**Plant hosts.** Larvae feed on other grasses besides rice.

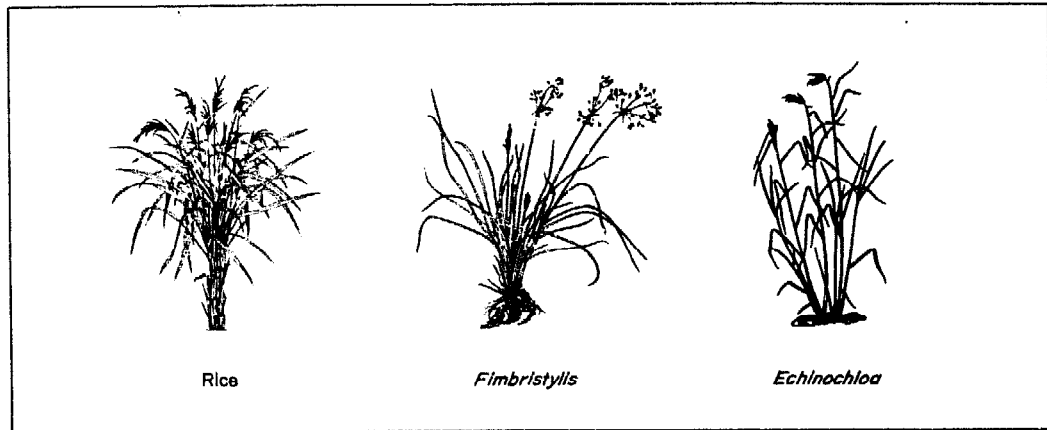

**Management**

**Cultural control.** Double-cropping flooded rice kills larvae in their pupal cells.

Crops whose planting is delayed escape the peak larval attack.

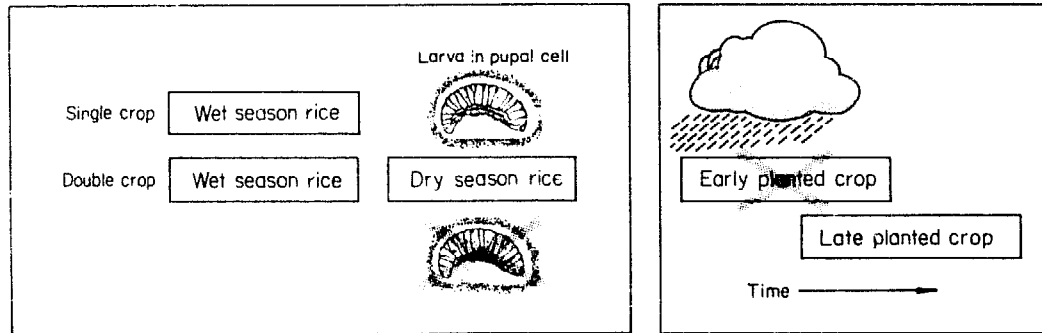

**Resistant varieties.** No resistant varieties are commercially available.

**Biological control.** The role of natural enemies has not been determined.

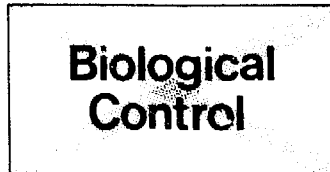
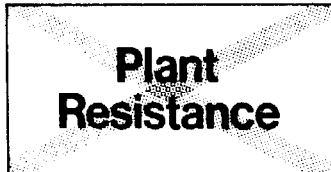

**Chemical control.**

- **Insecticide application.** Applying granular insecticide effectively controls larvae and is more efficient than applying foliar sprays to control the adults.



To control larvae in chronically infested areas, rice seedling roots should be soaked in insecticide for 6 hours before transplanting.

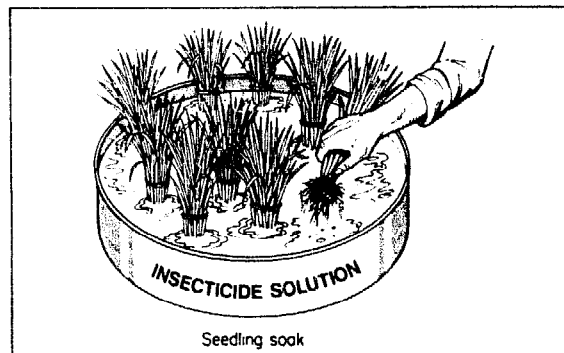



- **Scouting.** Visit the field each week during the vegetative stage and look for larvae or their damage symptoms.

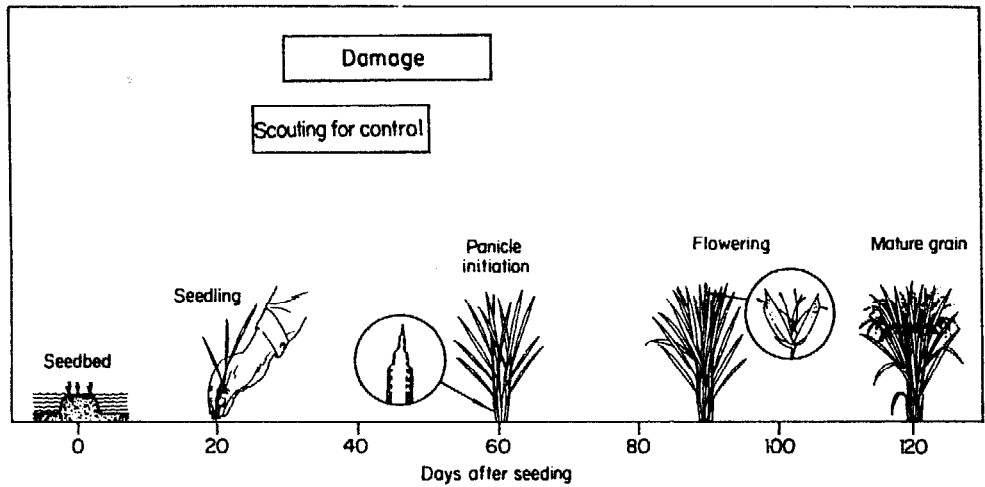

Pull up 20 plants at random within a field and record the percentage of infested hills.

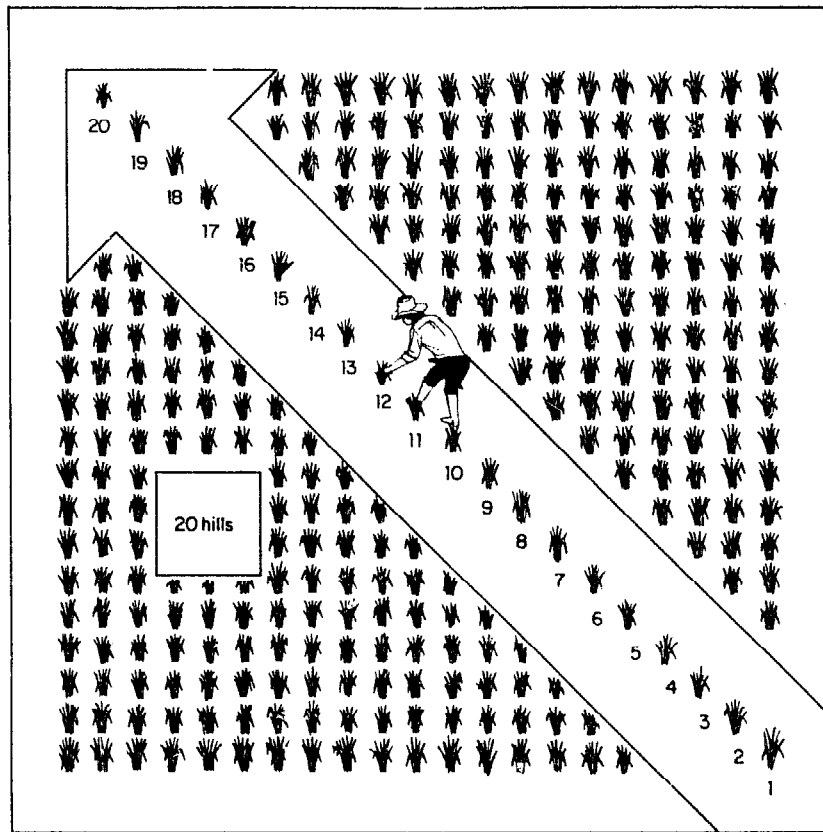

Broadcast granular insecticide when the economic threshold is reached.

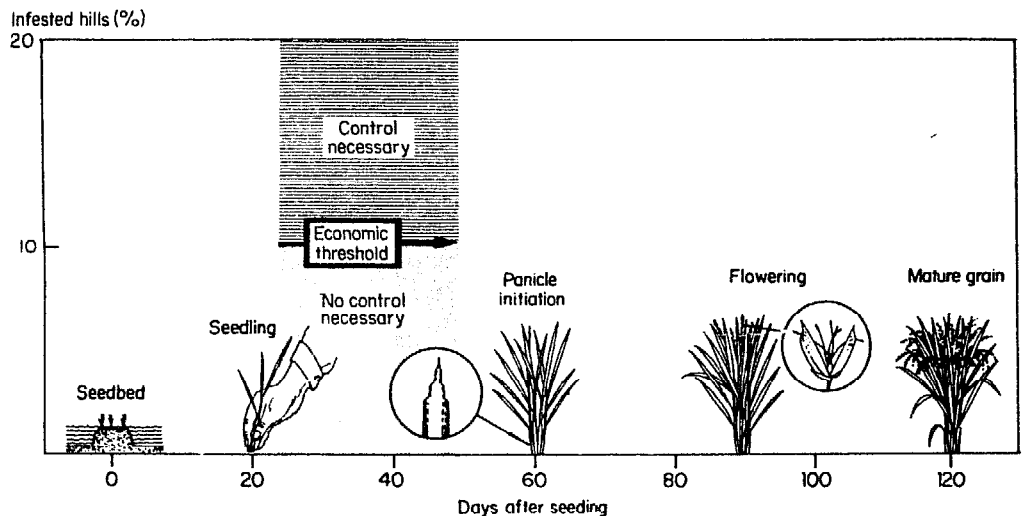

ROOT APHIDS (HOMOPTERA: APHIDIDAE)

Aphids are soft-bodied insects that live in colonies composed of nymphs and adults. Winged adults have transparent wings. Several species feed in colonies on rice roots just below the soil surface.

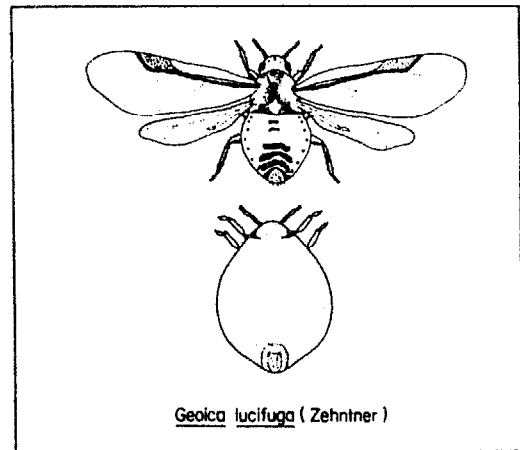
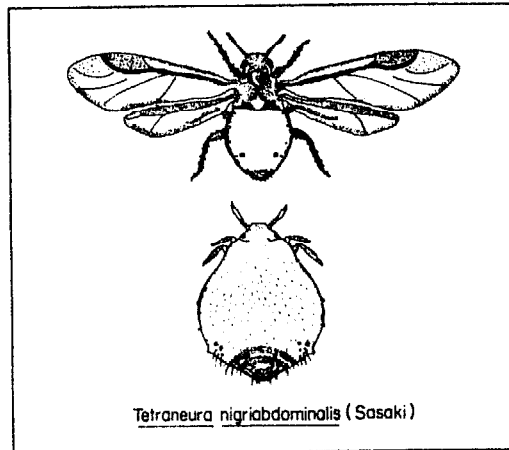

**Pest status**

Root aphids seldom are widespread, even within a field. Control by insecticides is difficult because the insects are located below the soil surface.

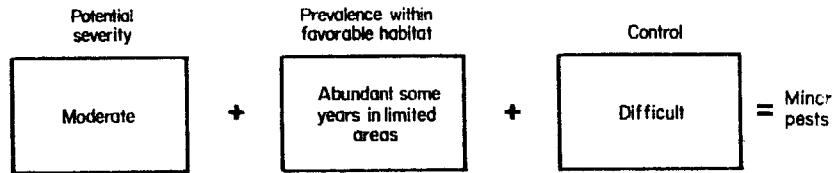

*Distribution in Asia.*

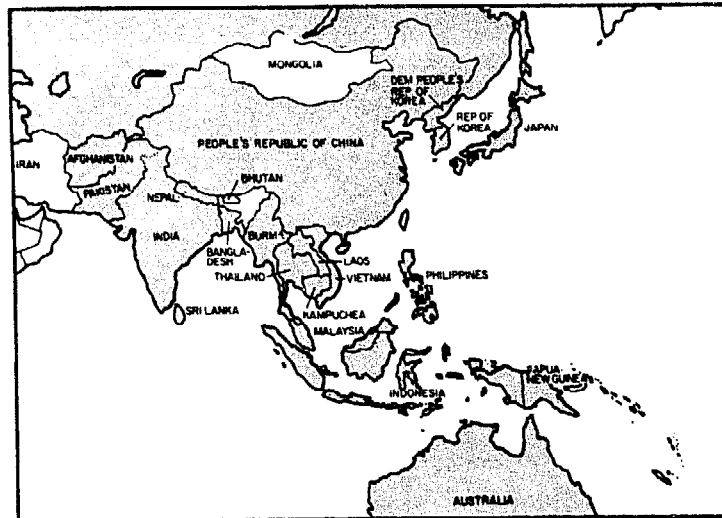

Root aphids occur only in well-drained soils in rainfed environments.

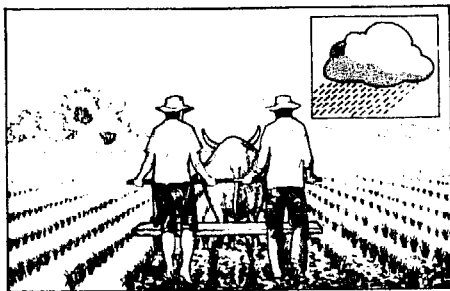

Upland

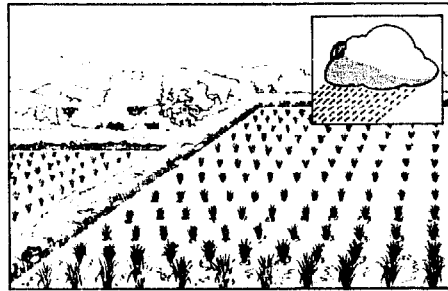

Rainfed wetland

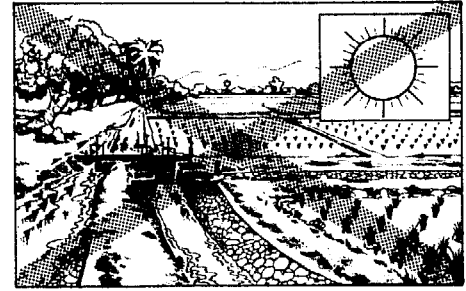

Irrigated wetland

**Development and actual size**  
Eggs develop and remain inside the female, which gives birth to nymphs.

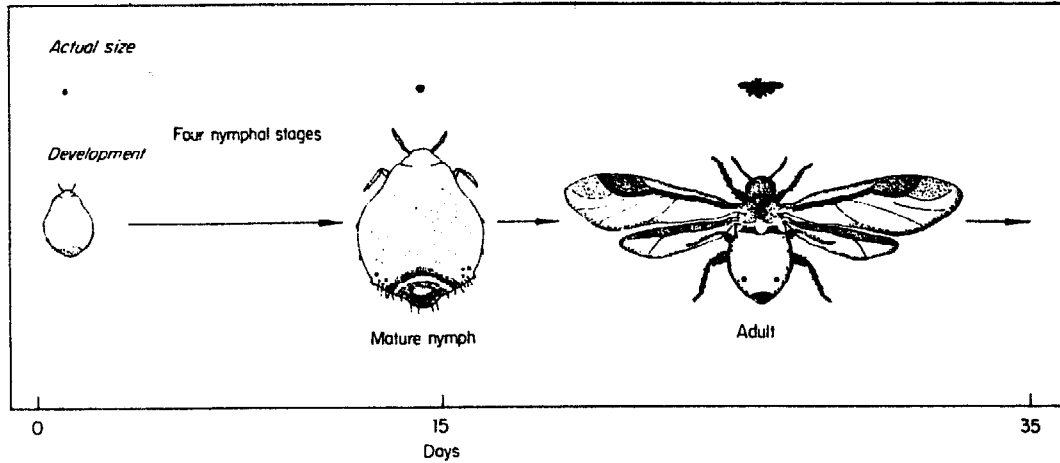

**Adult.** Root aphid species are composed entirely of females since no males occur. The yellow or dark orange females produce offspring without mating — a process called parthenogenesis.

Two adult forms occur — winged and nonwinged.

Winged adults fly into the rice field from their alternative plant hosts. They produce young, which become wingless adults.

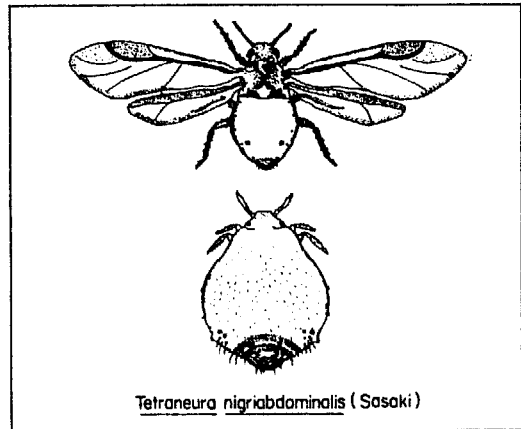
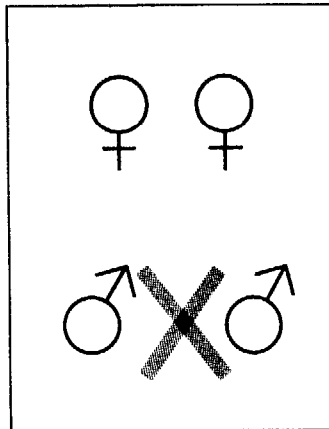

Several generations occur on rice. The winged adults produced when the crop is near maturity fly off to seek new plant hosts.

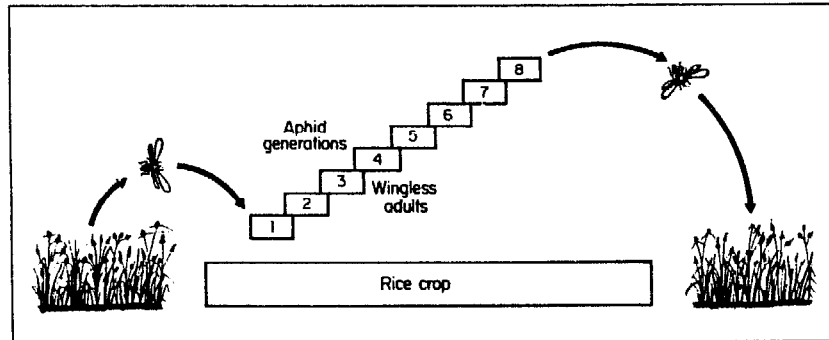

Adults occur on roots just below ground level, in cavities made by ants around the root system.

Each female produces 35-45 nymphs in a lifetime of 2-3 weeks.

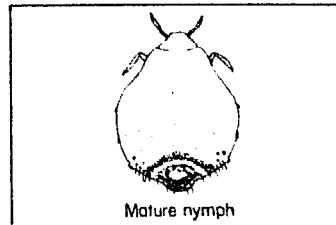
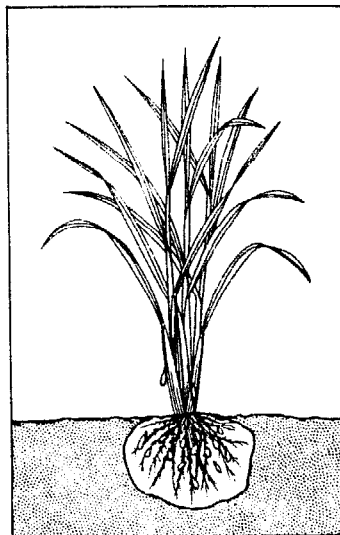

**Nymph.** Nymphs are transported from root to root by tending ants. Around the roots the ants construct spaces for nymphs to live in.

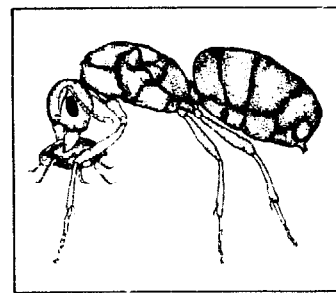

Tending ants feed on the honeydew produced by aphids.

**Damage**

Adults and nymphs remove plant fluids with their sucking mouthparts.

Removal of plant sap by a high number of aphids causes the leaves to turn yellow and become stunted.

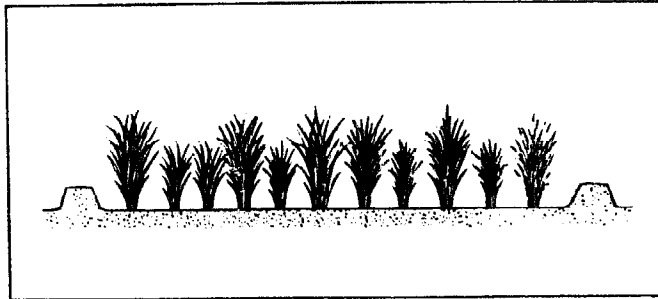

Aphid populations occur unevenly from hill to hill, and damage symptoms are not uniform across a field. Damage is greater during periods of drought stress.

**Plant hosts.** Rice root aphids have many hosts in the grass family.

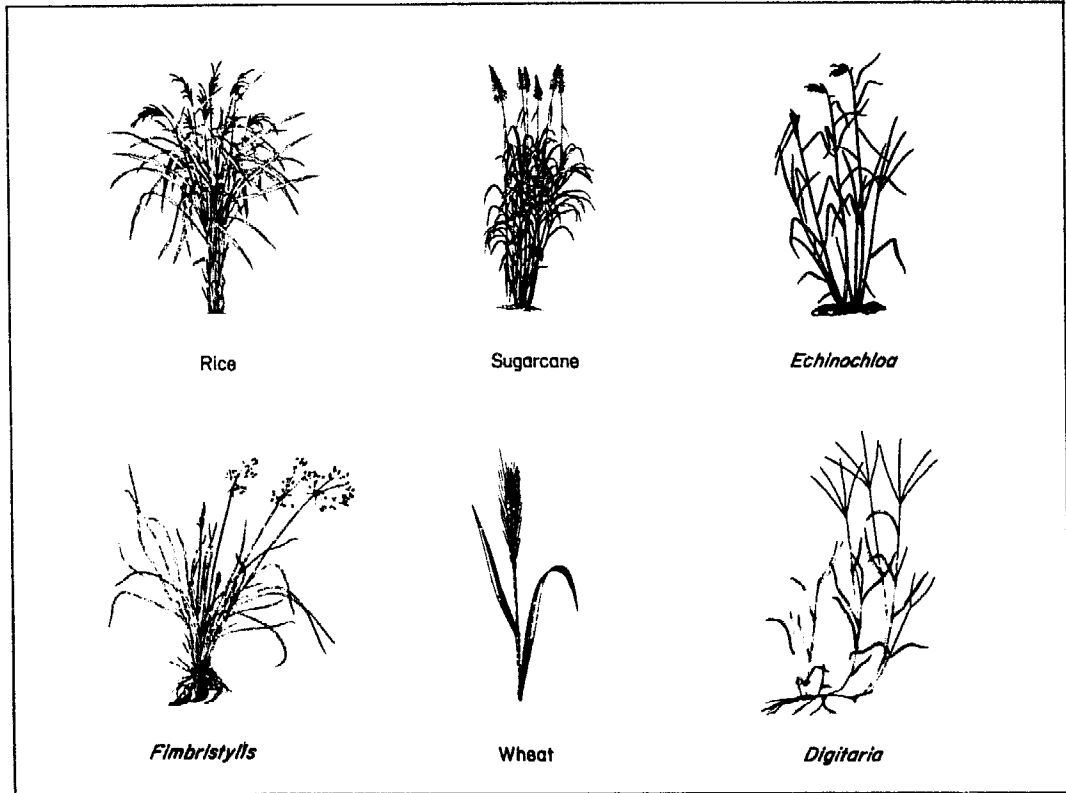

Rice

Sugarcane

*Echinochloa*

*Fimbristylis*

Wheat

*Digitaria*

**Management**

**Cultural control.** No practical cultural control methods are known.

**Resistant varieties.** No resistant varieties are known.

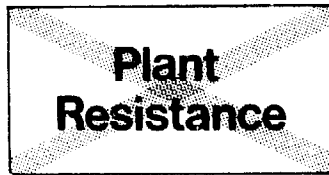

**Biological control.** Tending ants protect the aphids from many natural enemies, for example, lady beetles that

prey on nymphs and adults and nematodes that parasitize nymphs and adults.

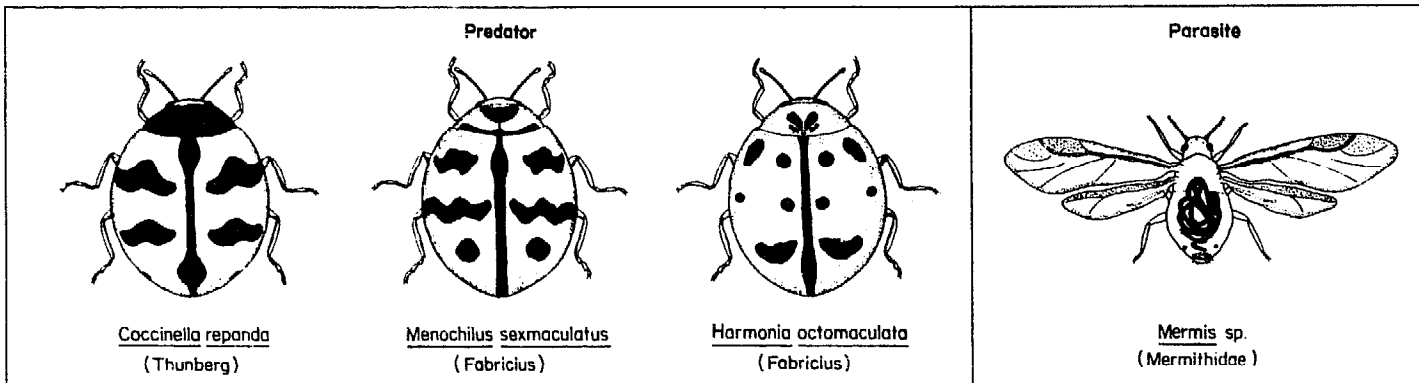

Predator

Parasite

Coccinella reponda  
(Thunberg)

Menochilus sexmaculatus  
(Fabricius)

Harmonia octomaculata  
(Fabricius)

Mermis sp.  
(Mermithidae)

**Chemical control.**

• **Insecticide application.**

Because aphids are found below the soil surface, control by foliar insecticides is effective only if spray nozzles are directed at the base of the plants and high volumes of water are used.

Seed treatment can also be effective.

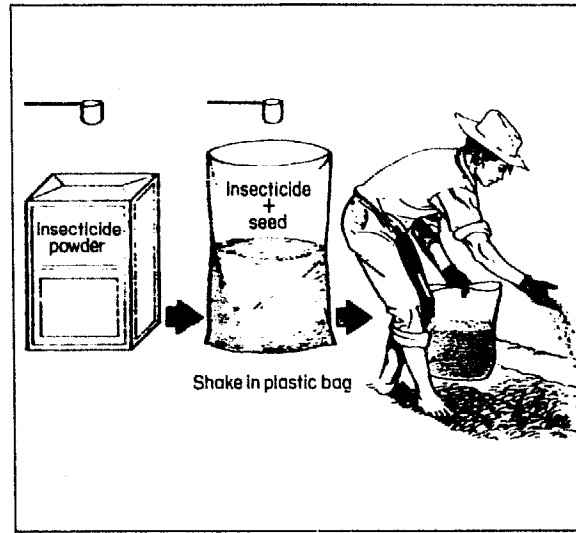

Granular insecticides must be placed at the base of each hill and covered by raking soil over the granules.



• **Scouting.** Visit the field each week beginning from the late tillering stage to flowering. Cross the field at each visit and look for signs of yellowing or stunting.

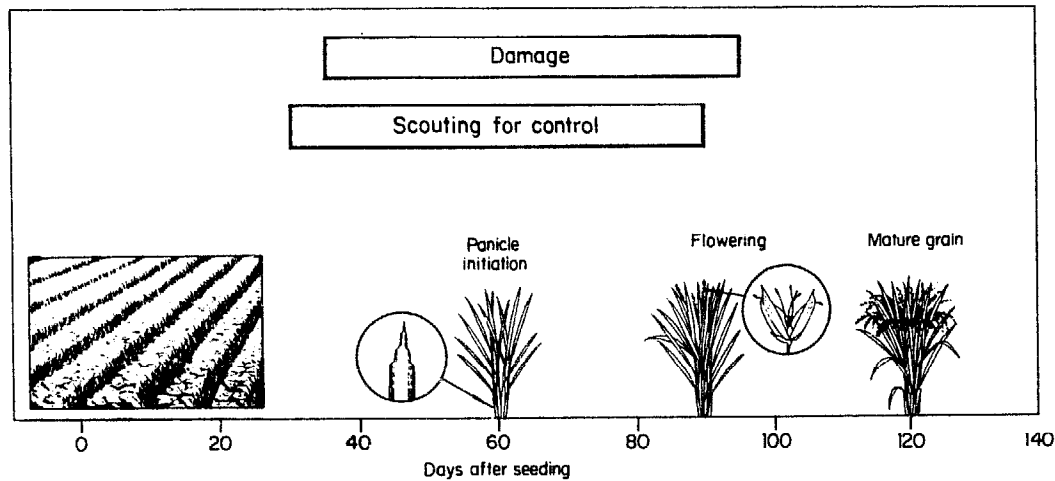

Dig at the base of plants showing symptoms of aphid attack and look for signs of aphids.  
 Determine percentage of infested hills.

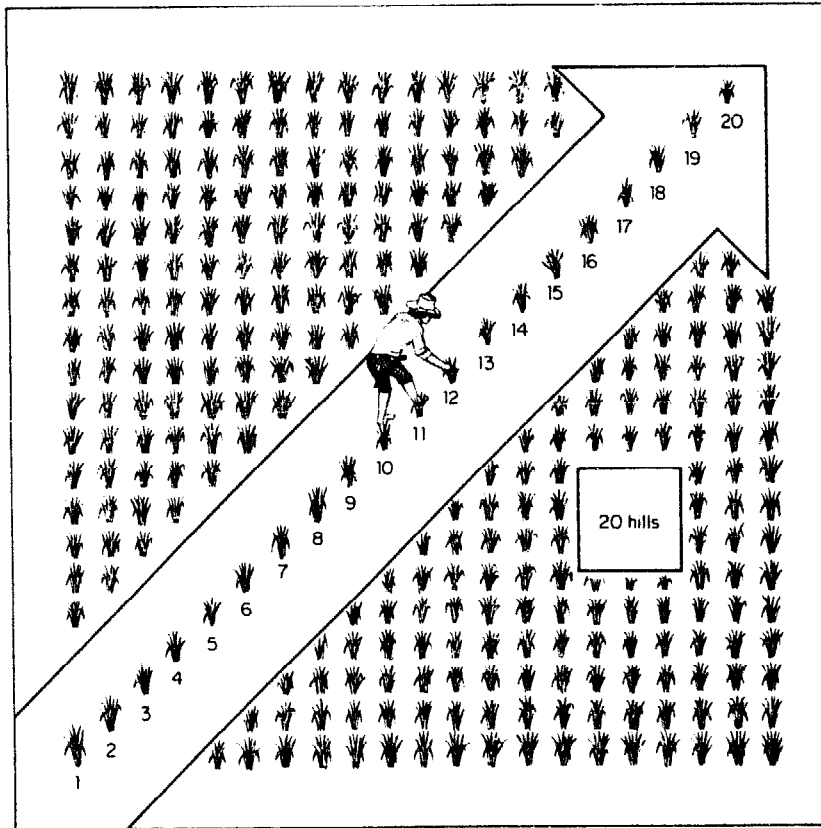

Apply insecticide when the economic threshold is reached.

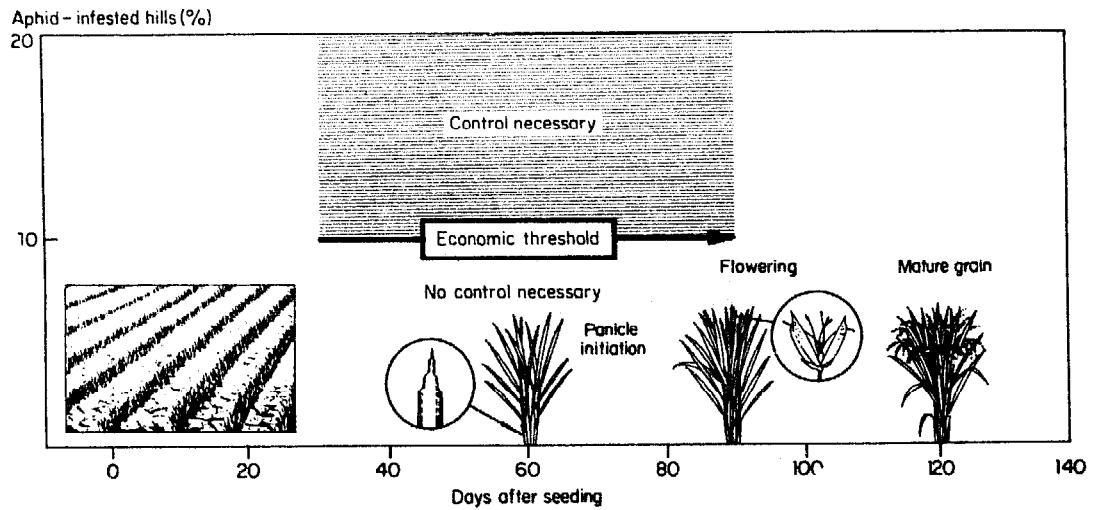

PESTS AT THE VEGETATIVE STAGE

SEEDLING MAGGOTS (DIPTERA: MUSCIDAE)

There are several species of small flies in the genus *Atherigona* which, as legless larvae (maggots), feed within developing rice tillers. The adult flies are similar in appearance to houseflies. They prefer to lay eggs only on seedling stage rice plants, hence the name seedling maggot.

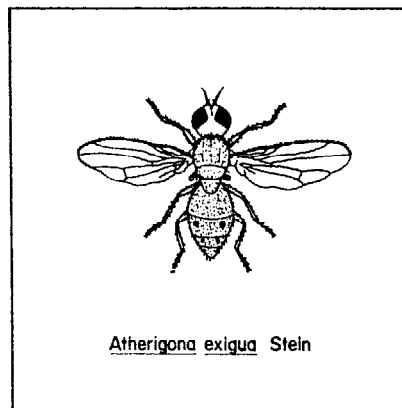
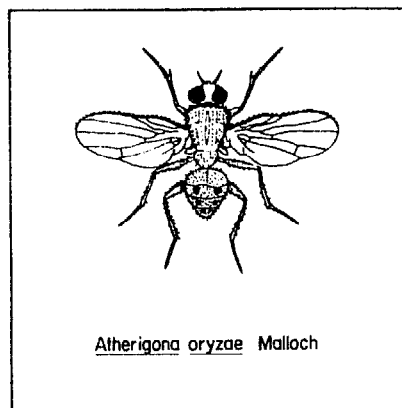

**Pest status**

Seedling maggots are highly seasonal in occurrence and can be readily controlled with insecticide. However use of economic thresholds in the field to be protected is difficult because the attack begins at crop emergence.

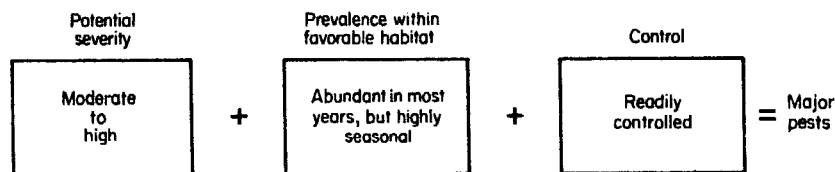

They are restricted to upland rice and do not occur in flooded wetlands.

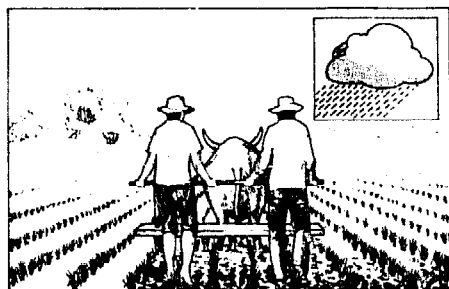

Upland

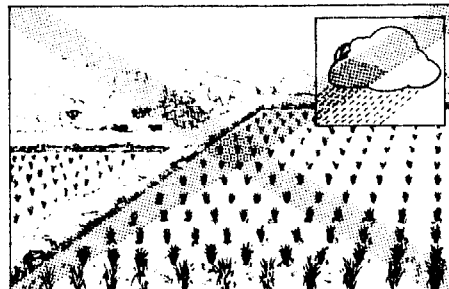

Rainfed wetland

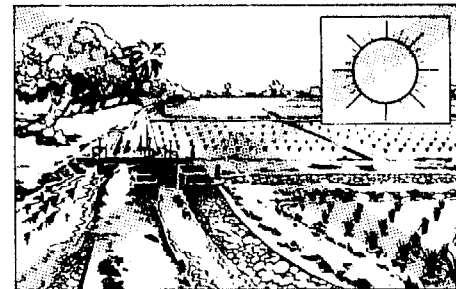

Irrigated wetland

*Distribution in Asia*

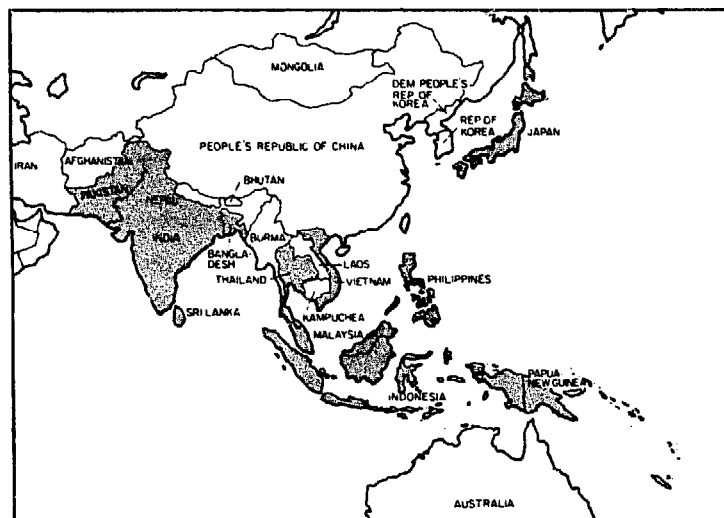

**Development and actual size**

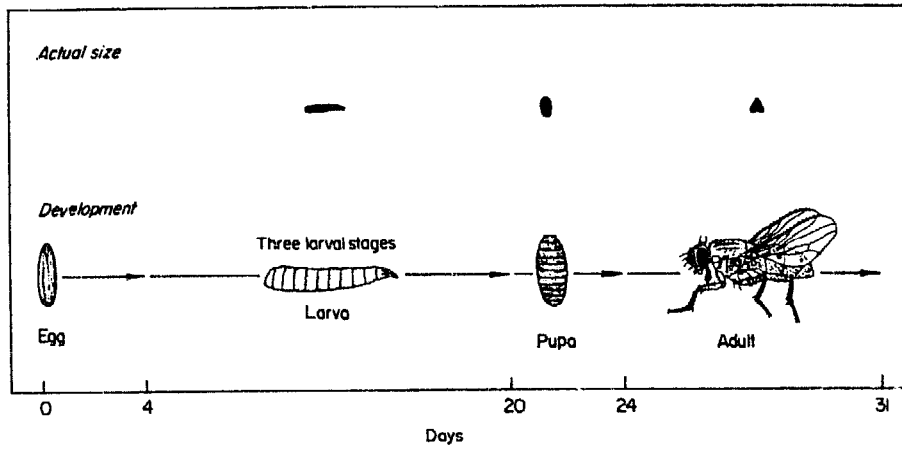

**Adult.** Adults are strong fliers but do not migrate. They are active only during the day.

Flies are highly attracted to plants less than one month old, and a female may lay 100 eggs during a lifetime of 3-7 days.

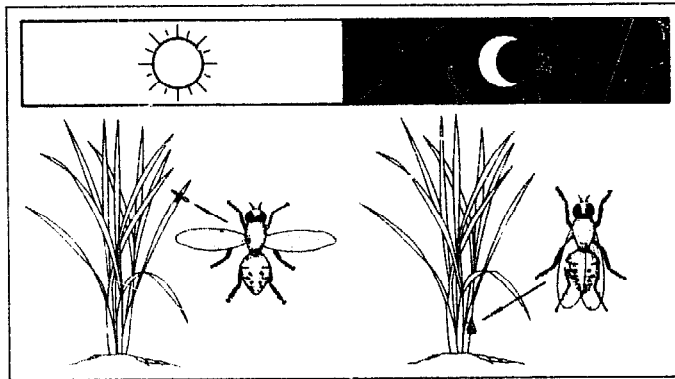

Adult occurrence is highly seasonal. Damaging infestation levels normally occur during a period of 2-3 months, beginning several months after the onset of the rainy season.

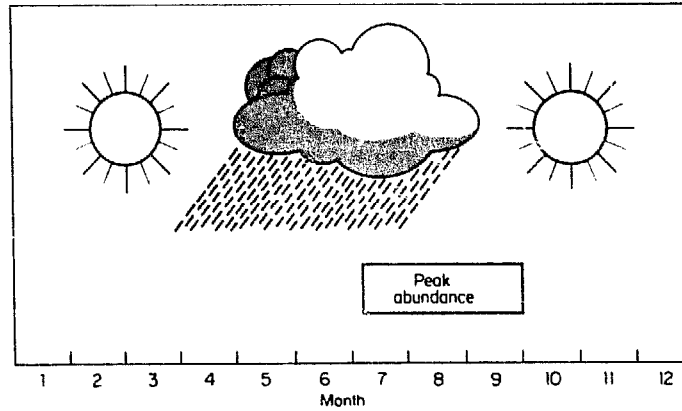

Adults are not attracted to a light trap.

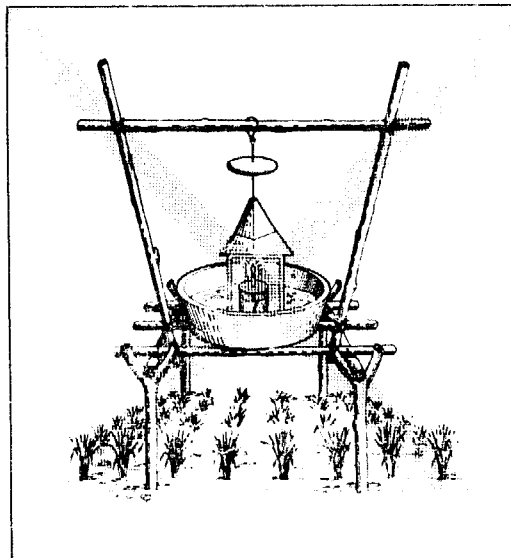



Adult flies are highly attracted to fish meal bait and can be captured in an inverted wire mesh cone trap set over seedling rice and the bait. Adult flies will always fly upward and after they enter the trap from below will be captured in the glass jar. The ground placement of the bait provides low fly catch.

More flies were captured with the shootfly trap made of a 6-inch plastic funnel and a 20-cm cylindrical polyvinyl chloride provided with fishmeal bait and killing agent underneath the fiber glass cover on top and a plastic collecting chamber at the bottom containing 80% alcohol.

The higher placement of fishmeal bait (1-2 m above the ground) facilitated the

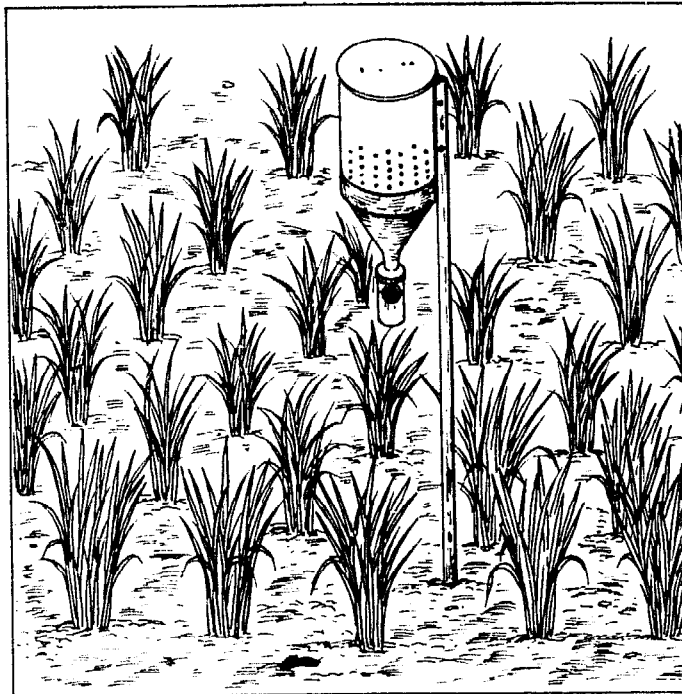

release of "bait smell" to a wider spectrum and attracted more flies. This method increased the catch in terms of the number of species and number of individuals.

**Egg.** The white elongate eggs are laid singly on the leaf blades of rice seedlings, and adhere to the plant by a sticky substance secreted by the female.

**Larva.** The maggot-like larva emerges from the egg and moves down the leaf blade on a film of dew in early morning. Each larva enters a tiller and feeds on internal tissue.

**Pupa.** The maggot passes three larval stages before it is ready to pupate in the soil or stems. Pupae are brown.

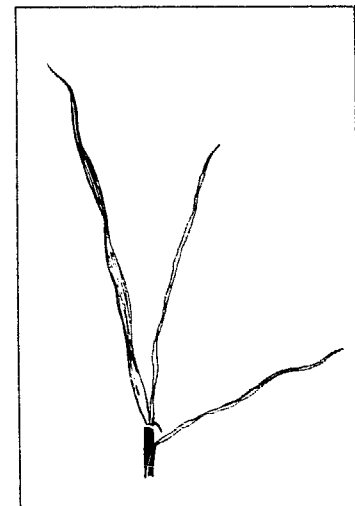
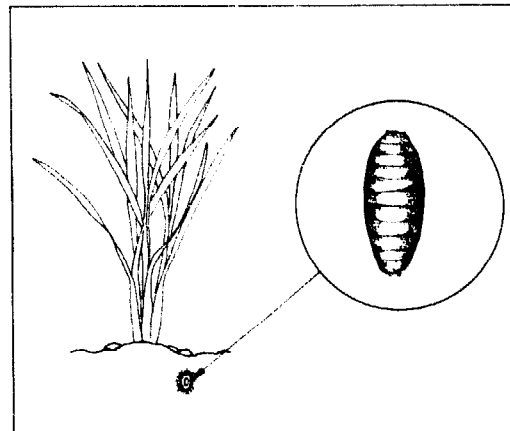
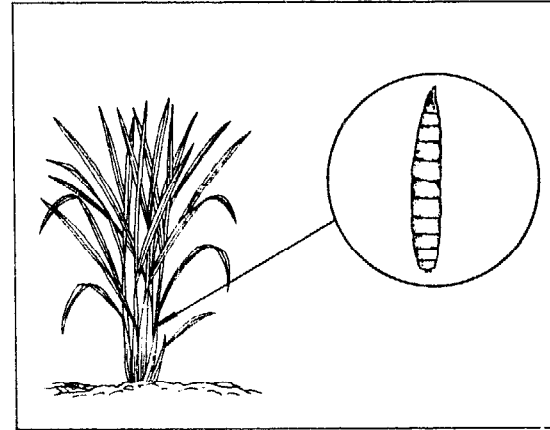
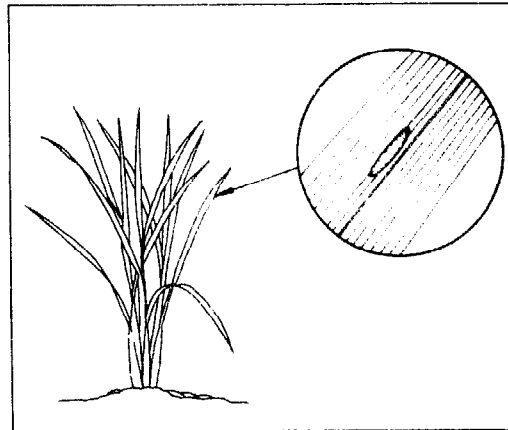

**Damage**

Larvae feed by moving their hardened mouth hook back and forth in a rasping motion. Larval feeding in the zone of new tiller development can kill tillers and form

deadhearts similar to those due to stem borers. Larvae feed on the decaying tissues. Tillers that survive exhibit discolored or transparent patches of damaged leaf

tissue along the margins and are readily torn by the wind. As a result the leaves become ragged and exhibit symptoms similar to whorl maggot damage.

During severe infestation, the field may have to be replanted.

Normally, the plants can recover, but maturity is delayed by 7-10 days.

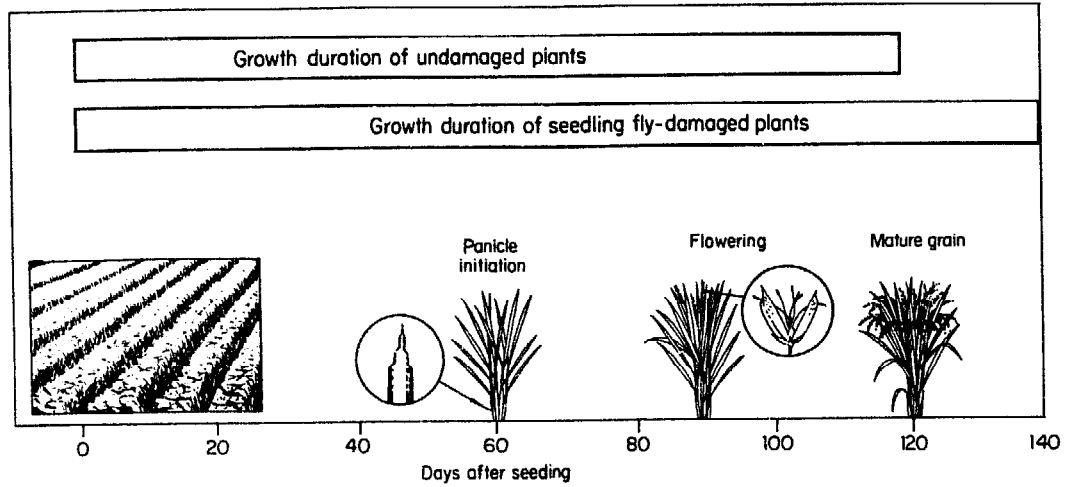

**Plant hosts.** The larvae develop equally well on rice and many plants of the grass family.

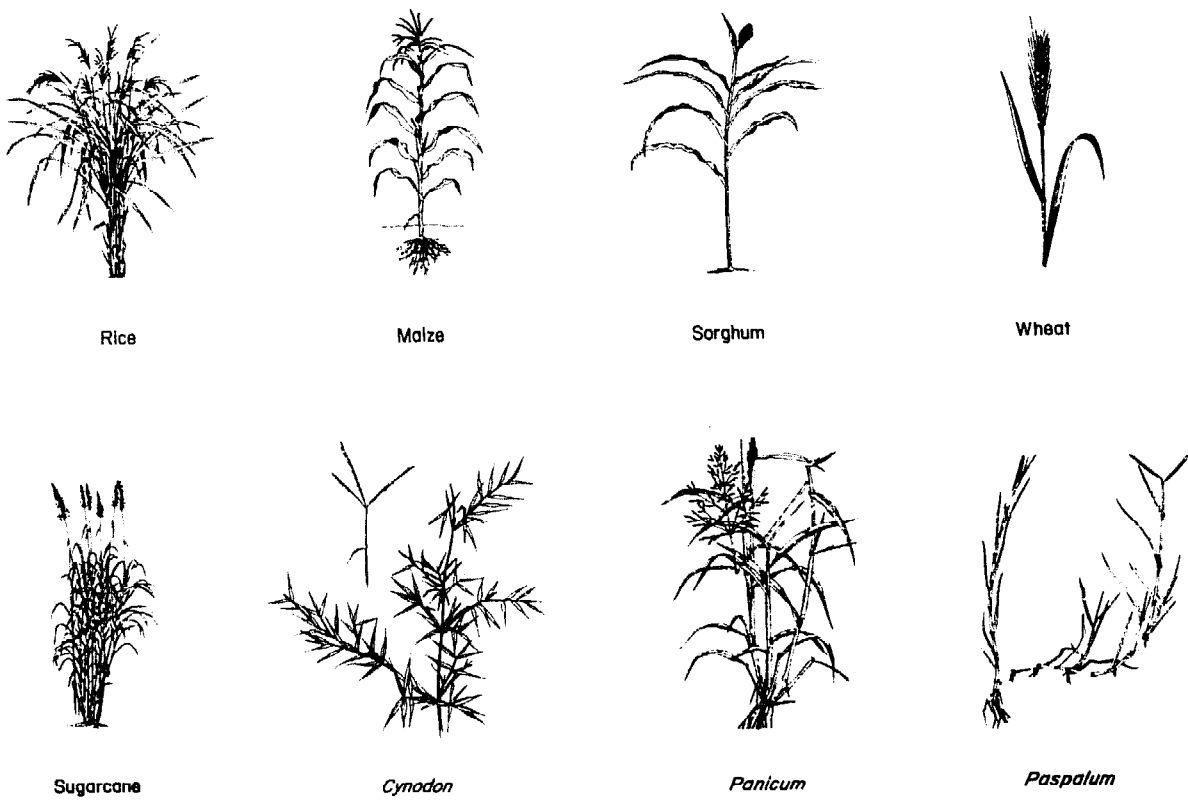

**Management**

**Cultural control.** The most practical control method is to avoid planting during peak seedling maggot abundance.

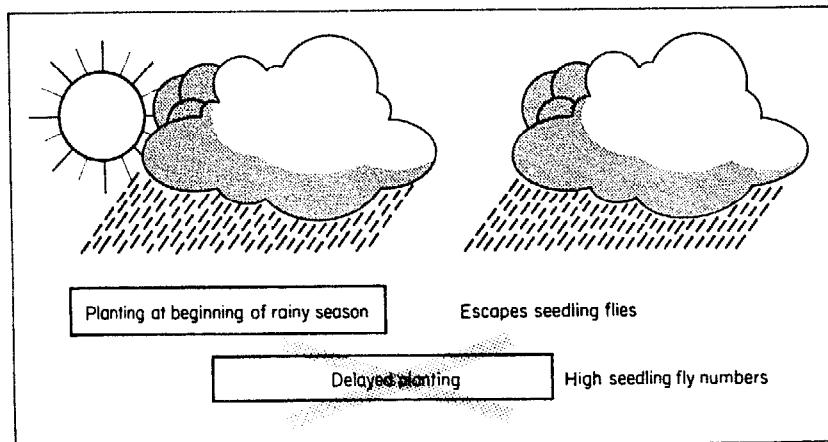

*Resistant varieties.* No resistant varieties are commercially available.

**Plant Resistance**

*Biological control.* Natural enemies attack all stages of seedling maggots. Trichogrammatid and eulophid wasps parasitize eggs.

Eulophid and braconid wasps parasitize the larval stage.

Spiders prey on adult flies.

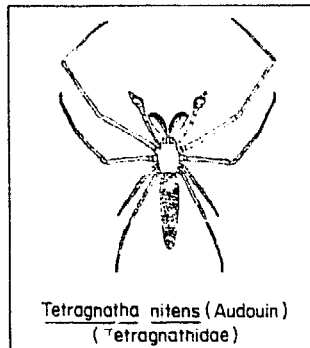
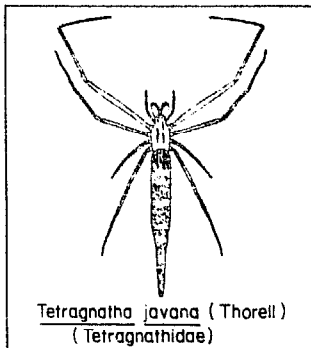
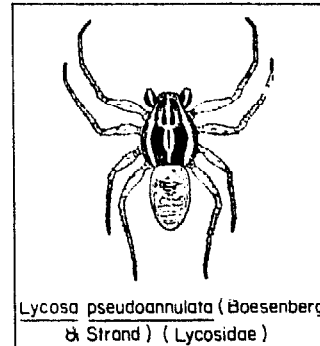
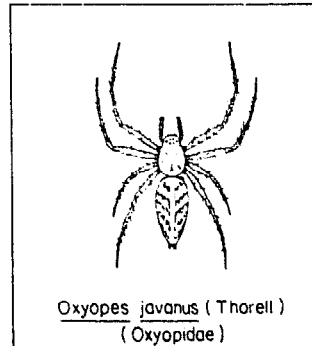
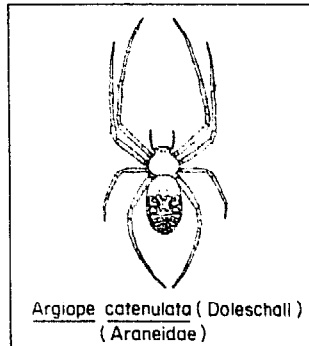
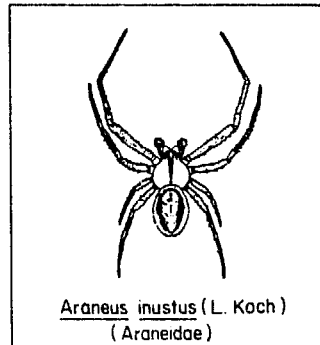
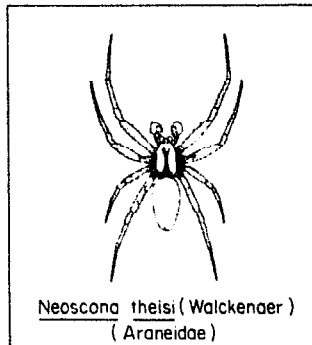
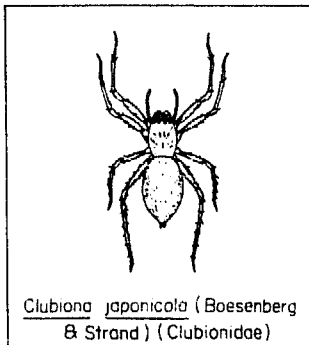
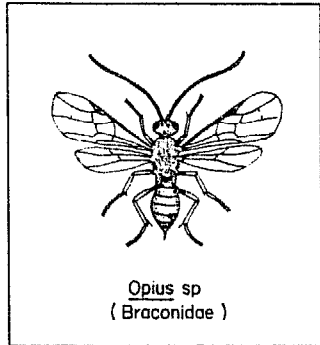
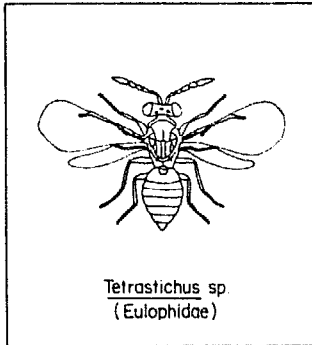
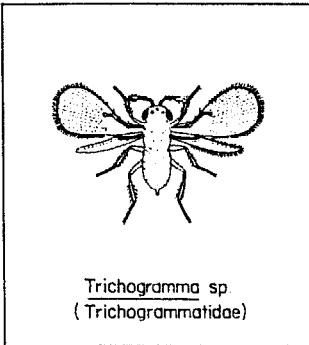

**Chemical control.**

- **Insecticide application.** If the crop will be planted during the period of peak infestation, insecticide is most efficient as seed treatment.

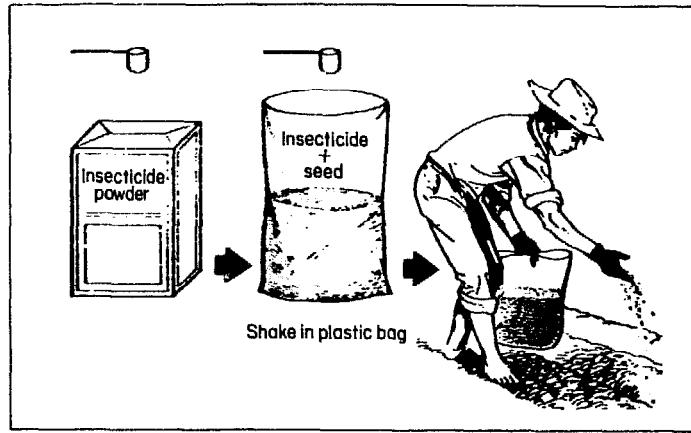

Granules are inefficient because of the high dosage necessary.



After the crop is planted, foliar sprays are the only practical control method but several applications may be necessary. The first application must be within one week after crop emergence.

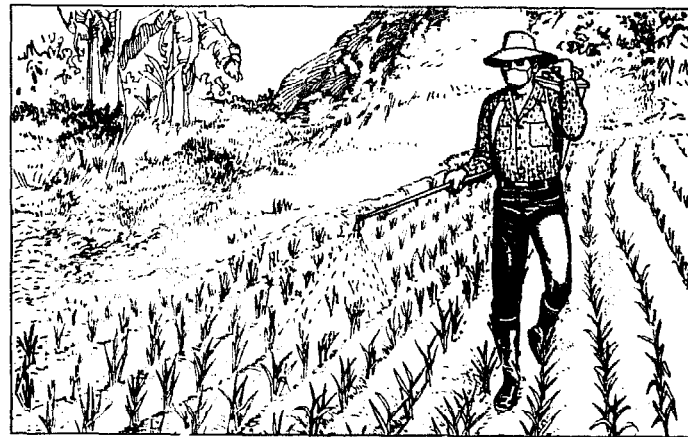

- **Scouting.** Sampling is based on damaged leaves. Because the damage symptoms appear after the critical control period, sample a neighbor's field planted 1-2 weeks ahead.

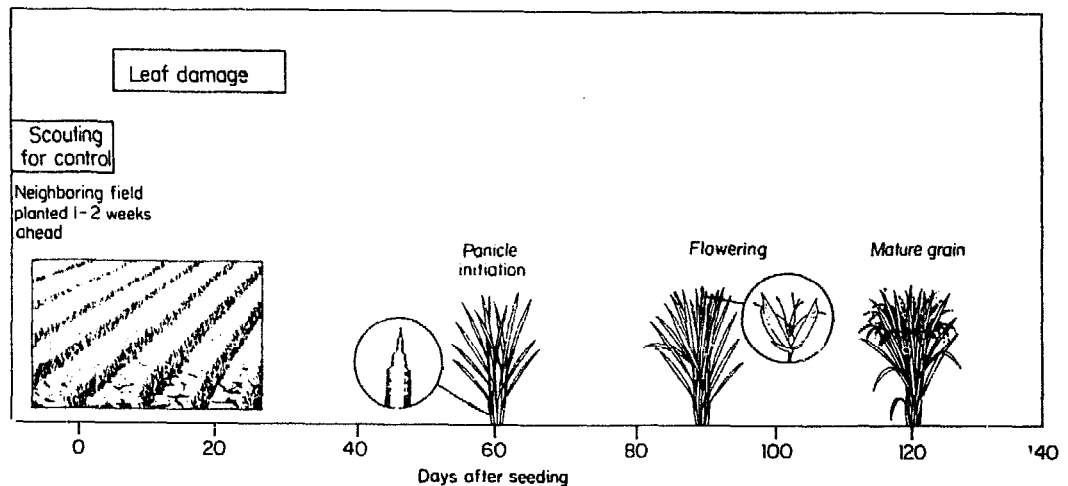

Cross that field and count the eggs from 20 plants or hills.

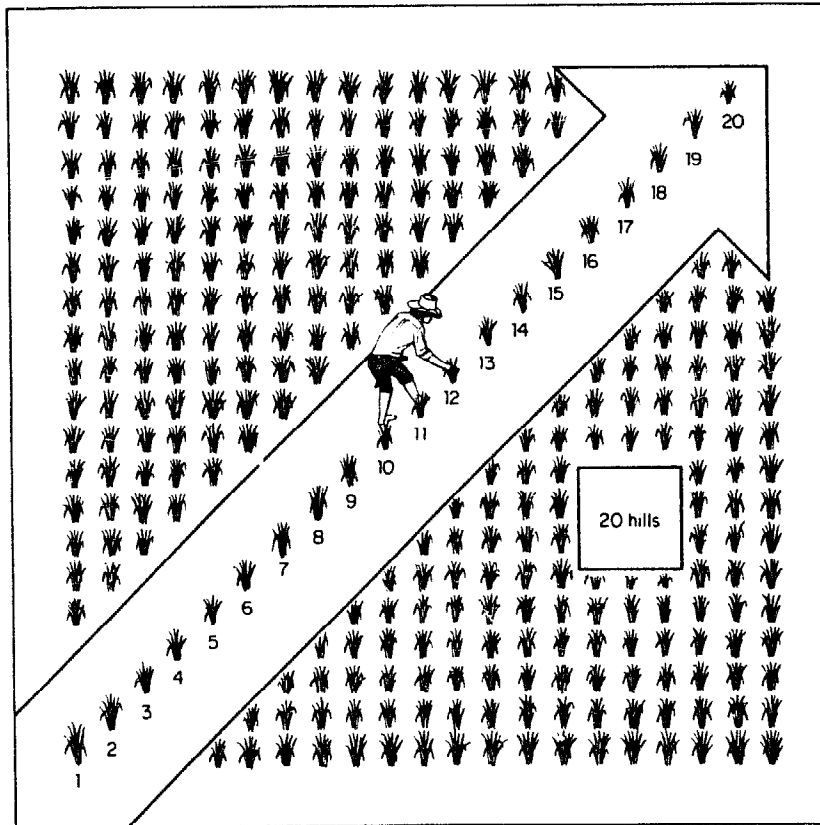

Use an insecticide if the economic threshold is reached.

Seedling maggot (no of eggs/plant or hill)

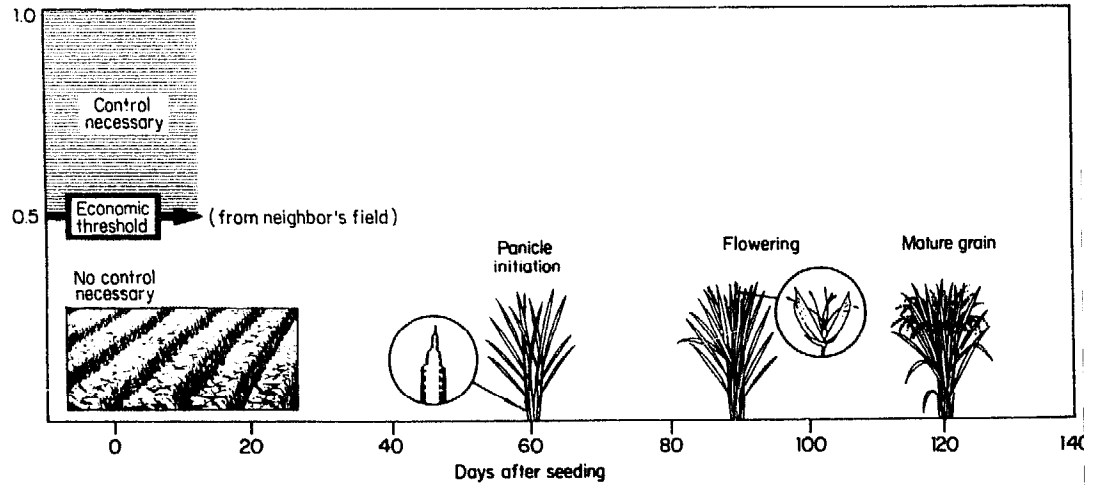

RICE WHORL MAGGOTS (DIPTERA: EPHYDRIDAE)

Rice whorl maggots of the genus *Hydrellia* are similar to seedling maggots, but occur in wetland environments. The adults are attracted to young transplanted rice fields with standing water. The larvae feed within developing leaf whorls. Three species occur in Asia.

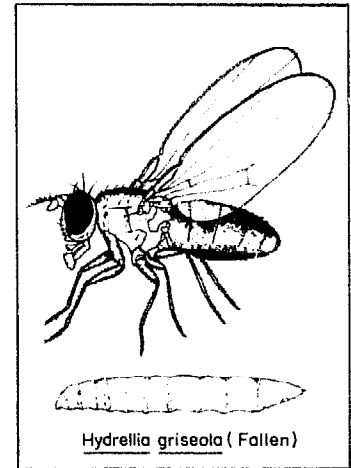
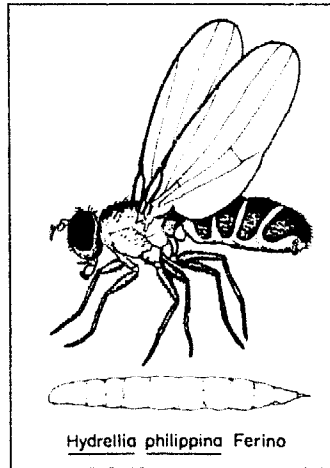
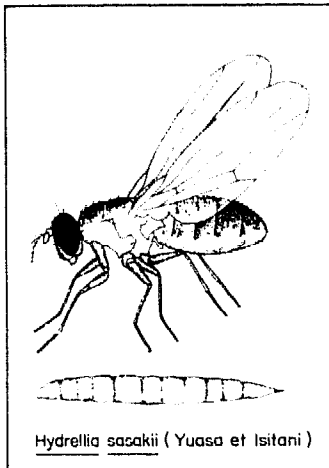

*Hydrellia griseola* is a leaf miner, not a true whorl maggot. Damage from it is similar to that caused by another fly, *Pseudonapomyza asiatica*, whose larvae tunnel within leaves, creating cleared trails or mines that become bigger as the larvae grow.

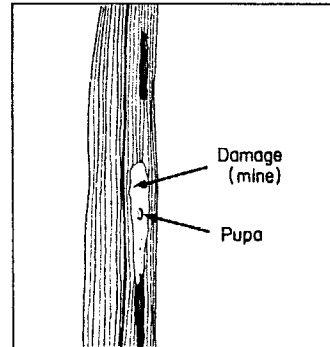
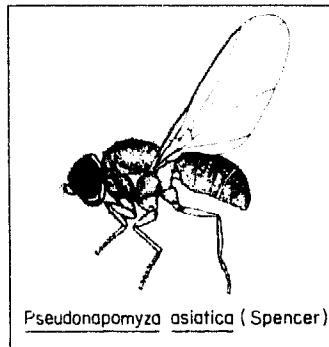

**Pest status**

Whorl maggots have increased in importance because of irrigation systems that 1) ensure standing water in paddies during the vegetative stage, 2) allow the presence of host plants year-round, and 3) favor the transplanting of young seedlings. Use of economic thresholds in the field to be

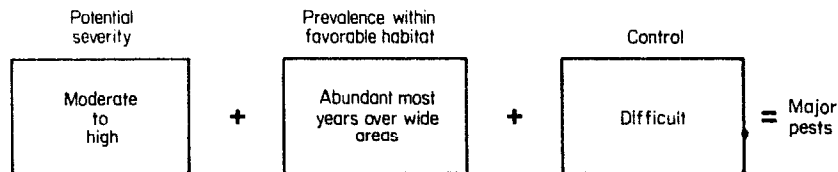

protected is difficult because the attack begins at transplanting.

Whorl maggots live in aquatic habitats and do not occur in upland rice.

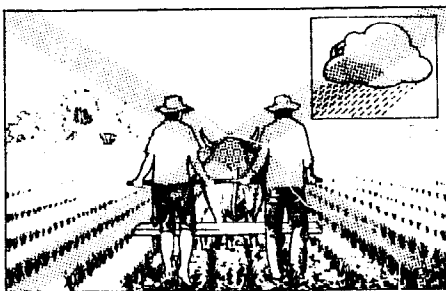

Upland

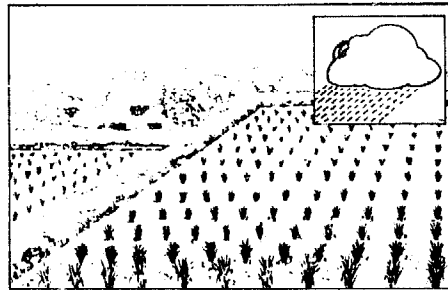

Rainfed wetland

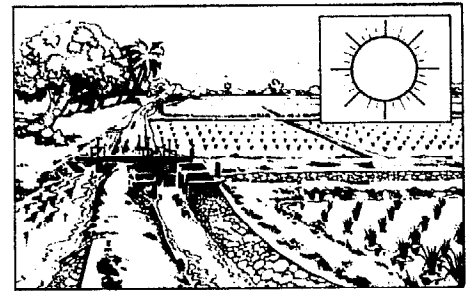

Irrigated wetland

Distribution in Asia.

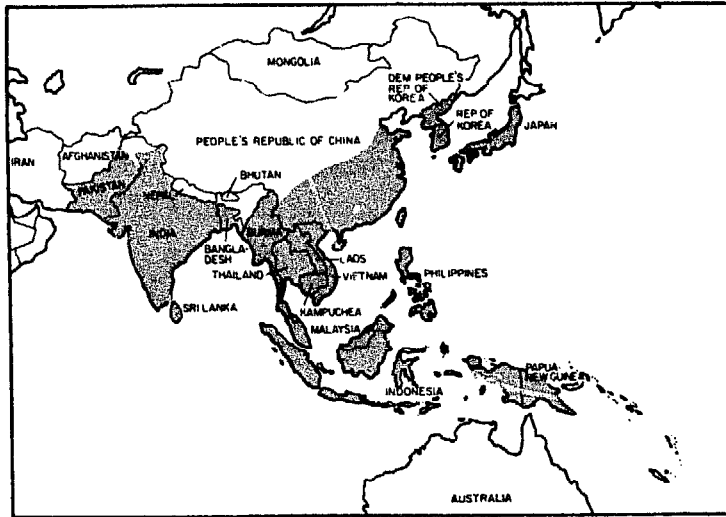

Development and actual size

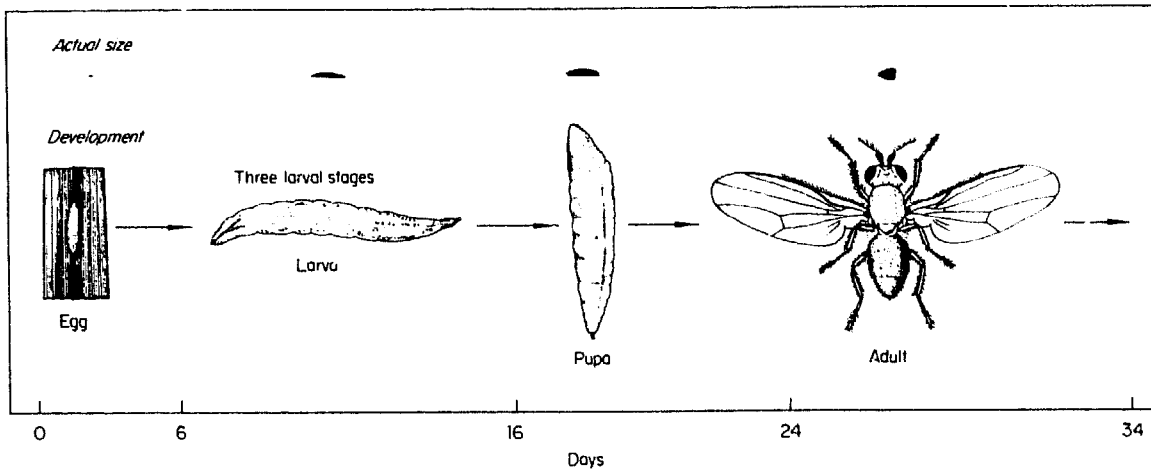

**Adult.** Adults are grey with transparent wings. The adult flies remain in lowland areas and do not migrate long distances after reaching adulthood. They are very difficult to identify in the field because they resemble other flies such as *Psilopa* and *Paralimna* whose larvae feed on rice and *Notiphila* spp. that live on decomposing organic matter in rice fields. *Notiphila* eggs are large and are laid in masses.

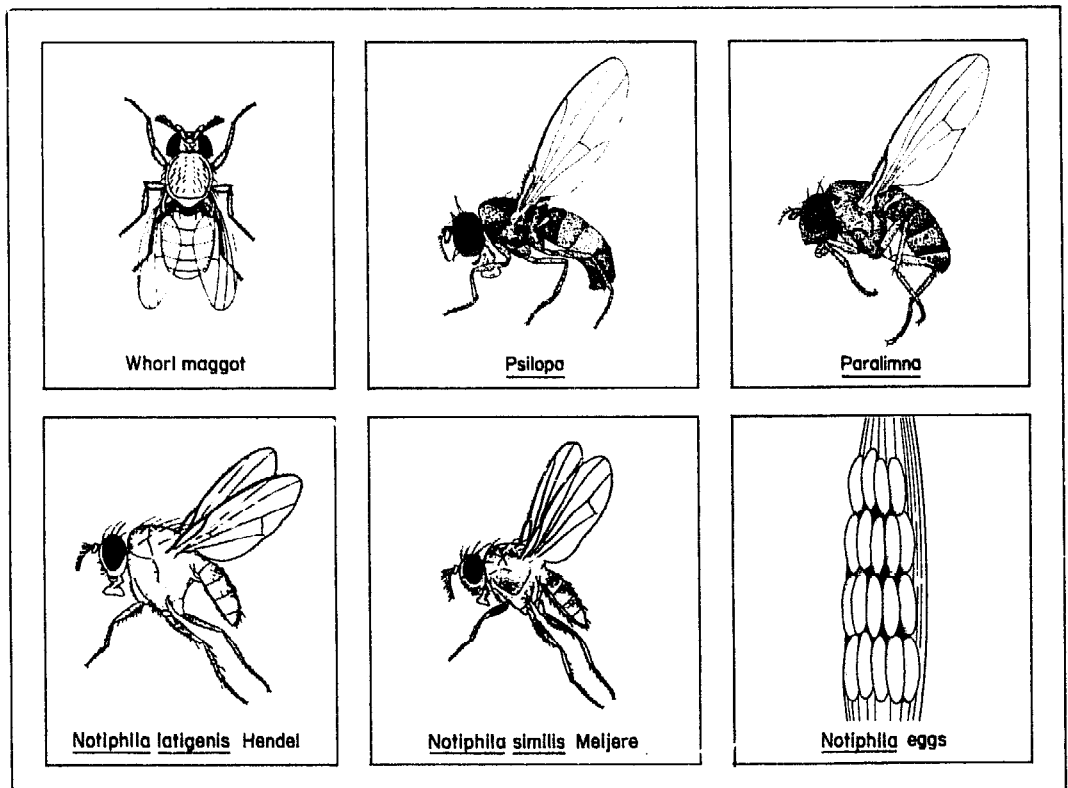

The adults are active during the day, locating rice fields by reflected sunlight from the water surface. They rest on rice leaves near the water.

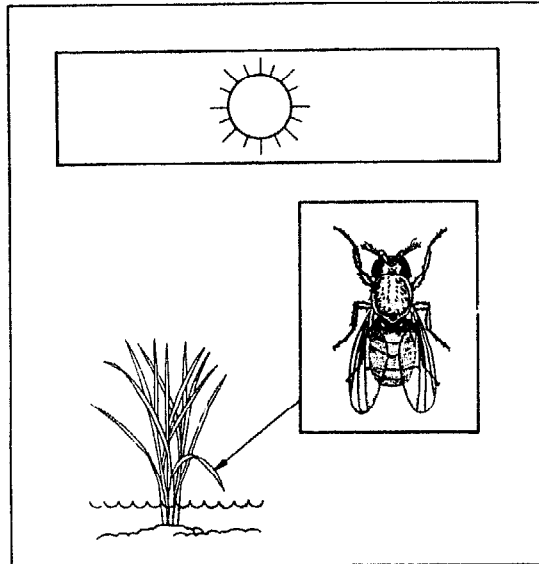

Adults no longer find rice once the crop canopy closes. Therefore, direct-seeded fields or seedbeds are not highly attractive to adults. Eggs are only found along the edges of flooded seedbeds.

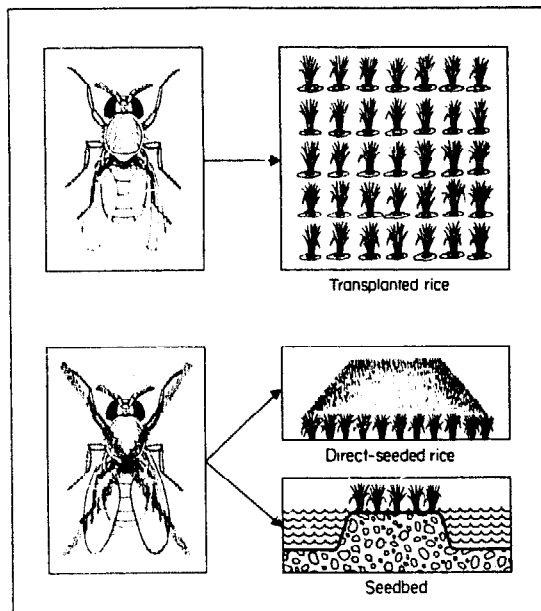

Each female lays an average of 100 eggs during its lifetime of 3-7 days.

Adults are not attracted to a light trap.

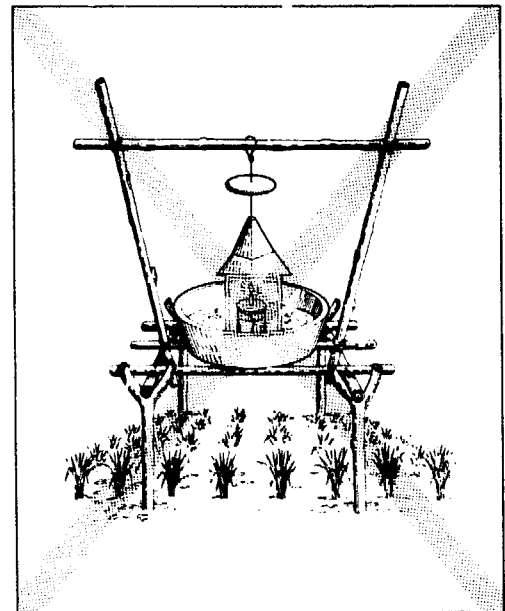

**Egg.** The female lays eggs singly on leaves during the first 30 days after transplanting. The elongate, white eggs are readily seen with the naked eye. A gluey substance secreted by the female causes the eggs to stick to leaves.

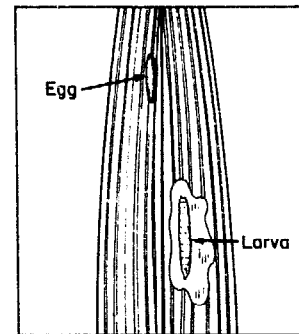
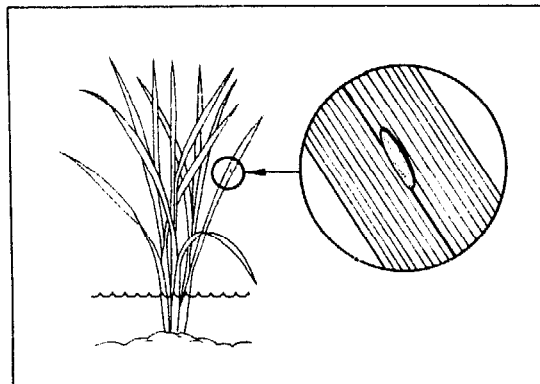

**Larva.** Upon hatching, the legless larvae are transparent to light cream in color. They wiggle down the leaf blade on a film of dew to the base of the tillers. Older larvae are yellow.



**Pupa.** The dark brown pupae are found inside older tillers.

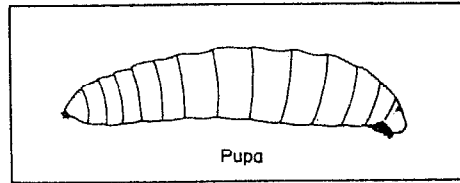

**Damage**

Larvae rasp plant tissues with their hardened mouth hooks. They eat the tissue of unopened leaves. When the leaves grow out, the damage becomes visible.

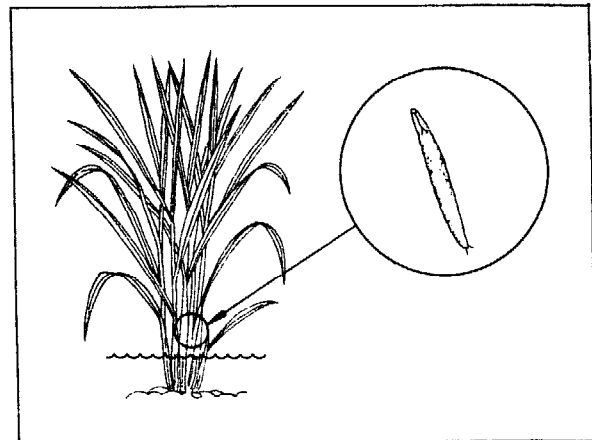
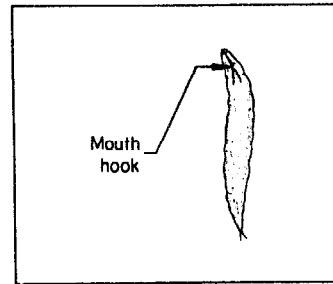

Older larvae feed on developing leaves at the base of rice plants in the zone of new developing tillers.

Damaged leaves have white or transparent patches near the edges after they unfold. No deadhearts are caused by whorl maggot feeding.

A lightly damaged leaf has only pinhole feeding areas.

The severely damaged leaves break from the wind.

Plants can recover from whorl maggot damage if no other pests are present, but maturation may be delayed 7-10 days.

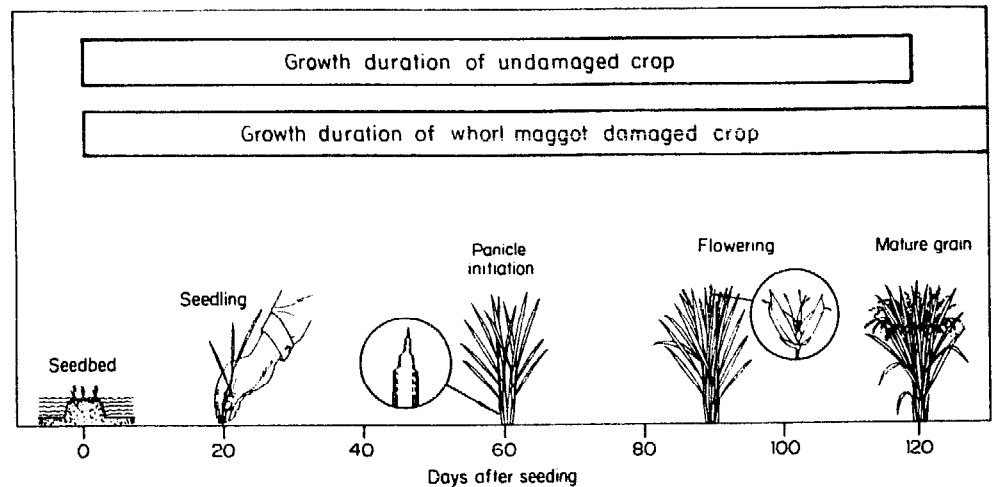
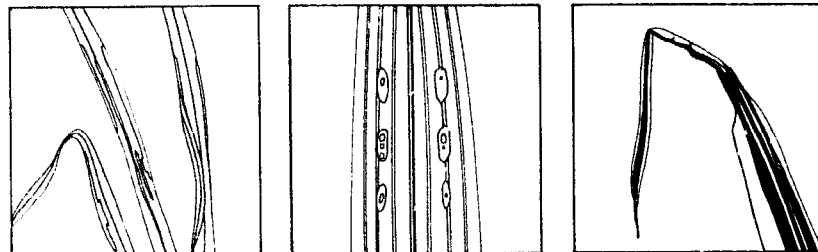

Damaged plants are stunted and set few tillers.

Yield loss occurs if other pests such as caseworm and stem borer infest the plants during the first 30 days after transplanting, and thus restrict the plants' ability to recover.

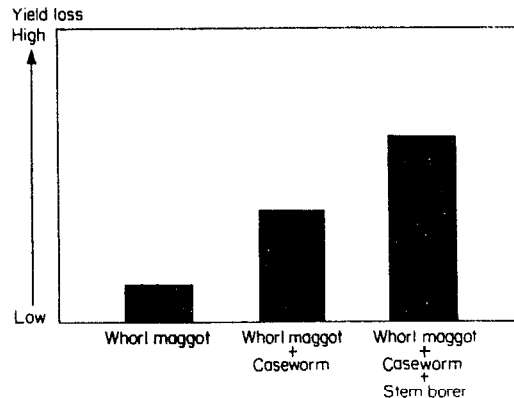

**Plant hosts.** Rice is the preferred host but whorl

maggots can develop on a number of grasses.

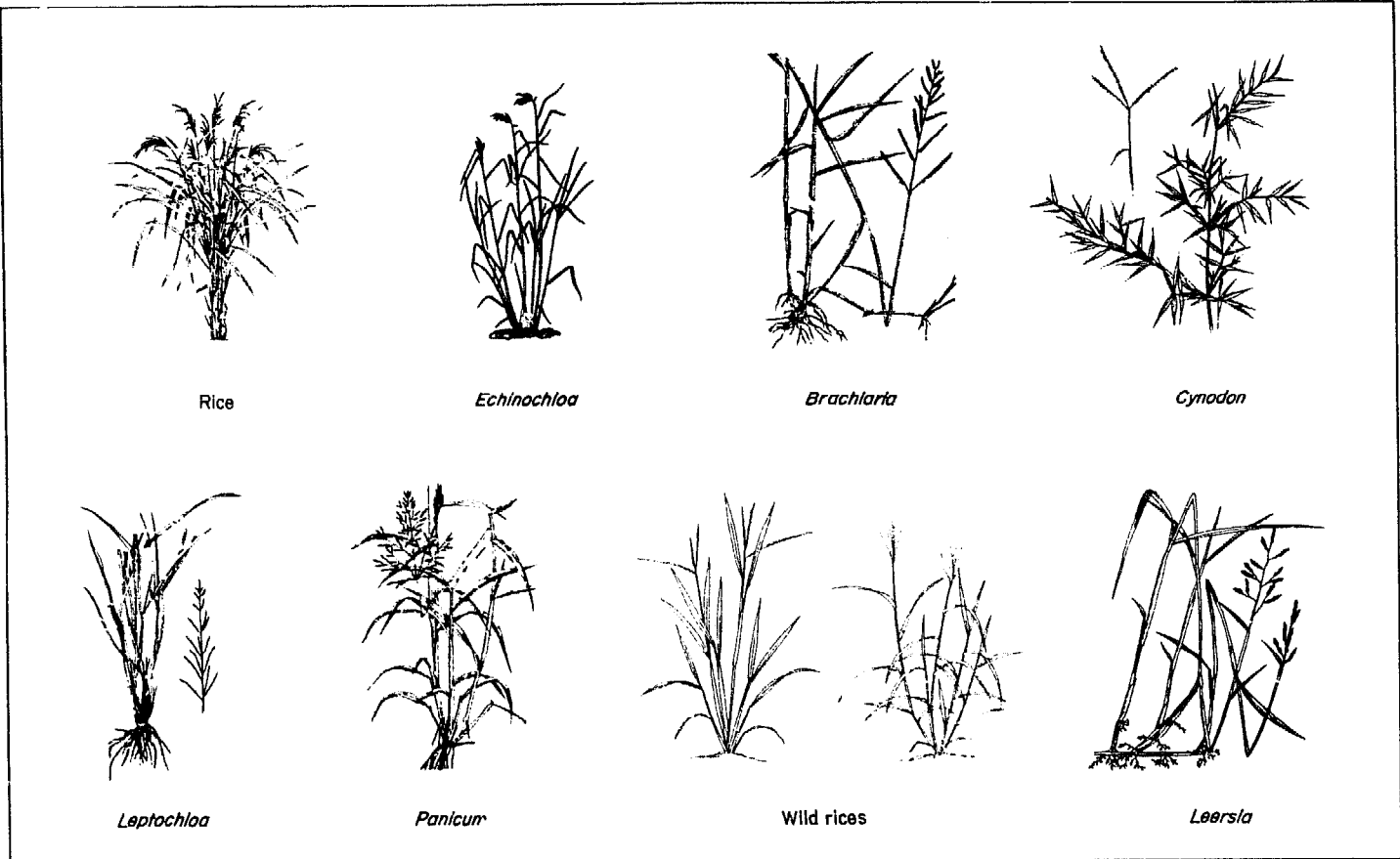

**Management**

**Cultural control.** Because adults are attracted to standing water, draining the paddy at intervals during the first 30 days after transplanting reduces egg laying. Drained fields, however, allow more weeds to grow.

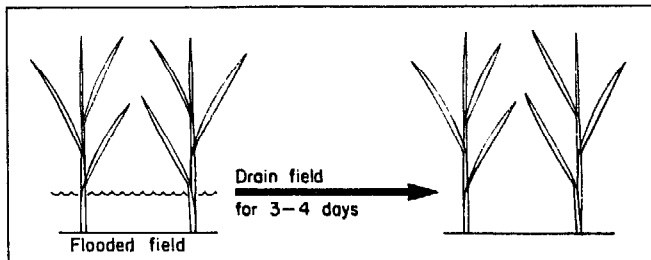

Crop establishment methods that enable the plants to cover the water surface most rapidly result in low and, often, insignificant damage from whorl maggot.

Direct seed rather than transplant.

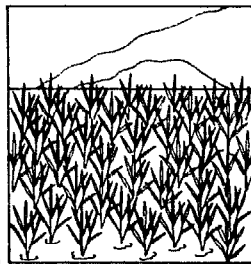
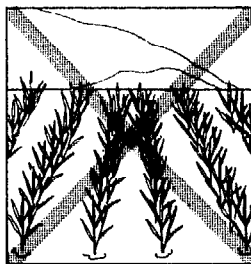

Azolla covering the water surface prevents an infestation from developing.

Transplant older seedlings.

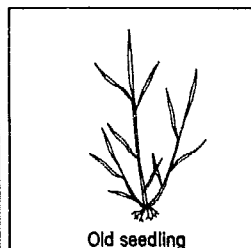
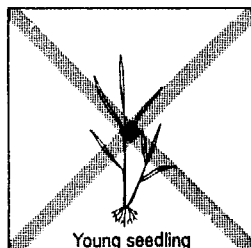

*Resistant varieties.* No resistant varieties are commercially available.

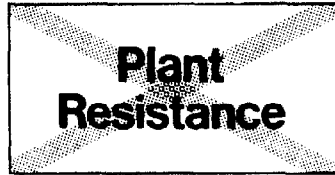

High tillering varieties can tolerate greater whorl maggot numbers than low tillering varieties can.

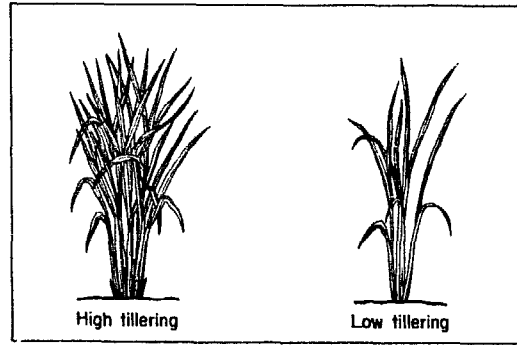

*Biological control.* Trichogrammatid wasps parasitize and dolichopodid flies prey upon the exposed eggs on leaves; eulophid and braconid wasps parasitize the larvae.

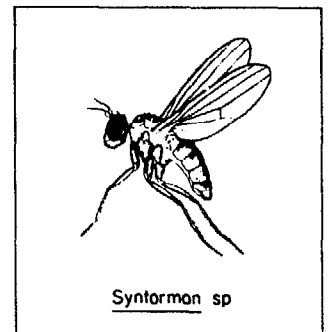
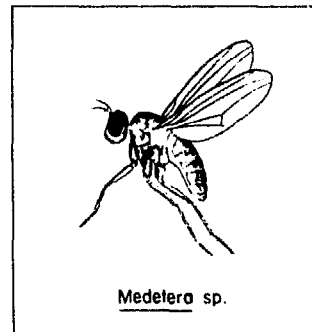
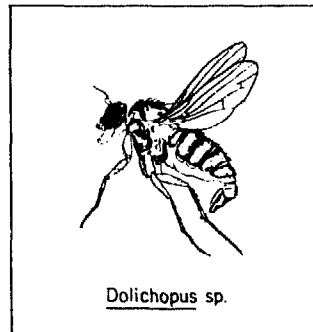
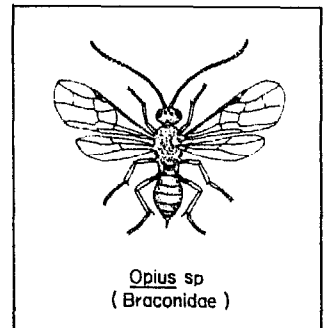
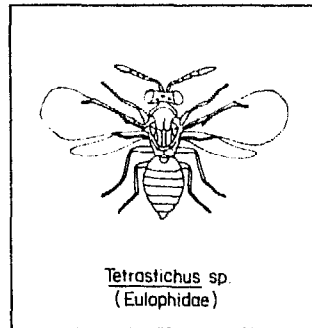
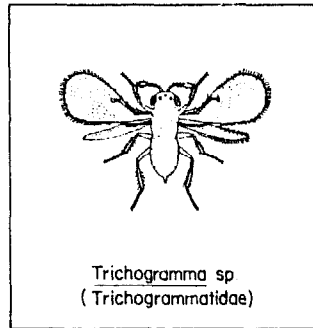

Whorl maggot adults are preyed upon by ephydrid flies and spiders.

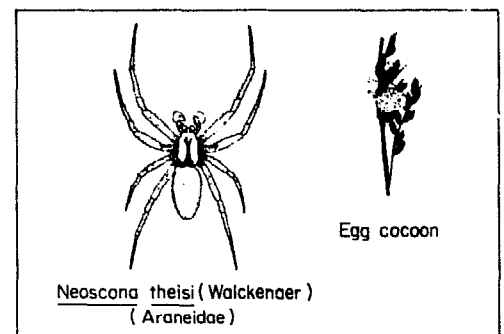
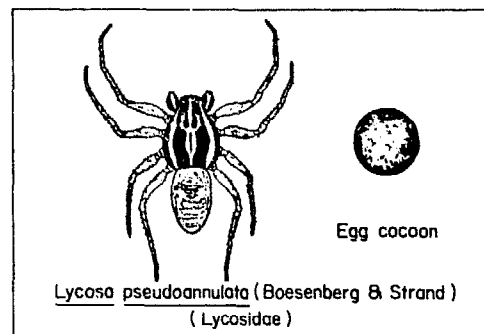
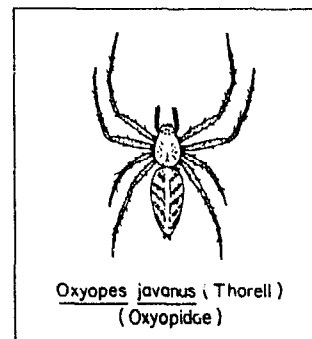
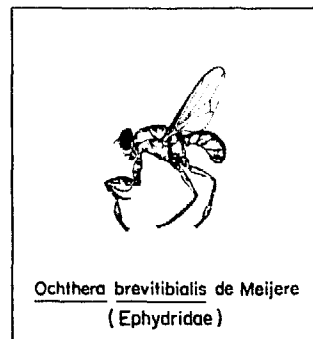

**Chemical control.**

- **Insecticide control.** There are four methods of insecticide application for whorl maggot control:
  1. Soil incorporation of systemic granules during last harrowing before transplanting,
  2. Soaking seedlings overnight in systemic insecticide solution,
  3. Coating the roots for 1 second in a runny mixture of paddy mud and insecticide, then drying overnight before transplanting.  $ZnO_2$  powder can be added to the slurry in zinc deficient areas,
  4. Paddy water broadcast of nonsystemic granules on standing water in field, or
  5. Foliar sprays — normally the least effective method — one and two weeks after transplanting.

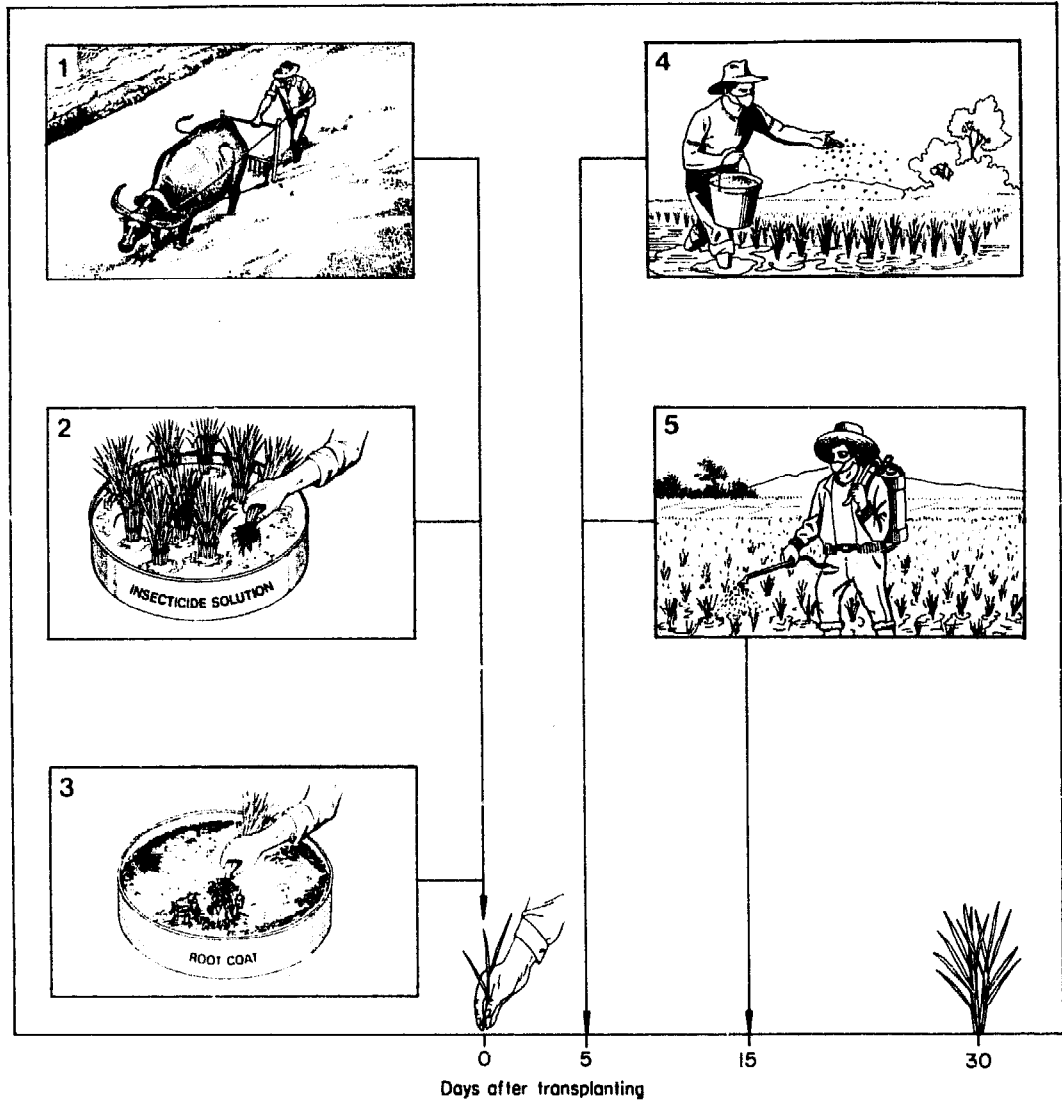

- **Scouting.** Sampling is based on number of eggs. Leaf damage symptoms are too delayed to be used as a timely unit of measurement. Scout a low-lying neighboring field planted 1-2 weeks earlier or the field itself up to 1 week after transplanting. There is no need to scout a densely planted seedbed. Direct seeded rice should be scouted within the first week.

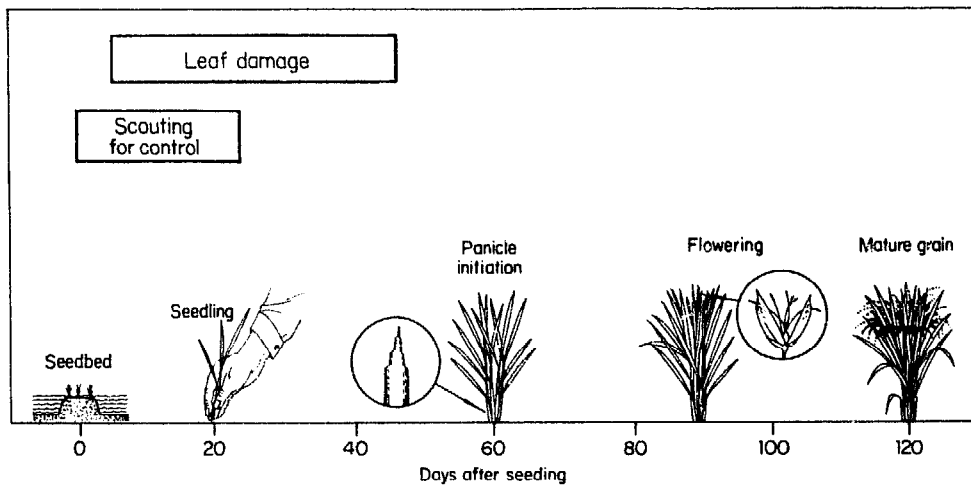

While crossing the paddy, randomly select 20 hills and record the number of eggs per hill. Select fields with standing water.

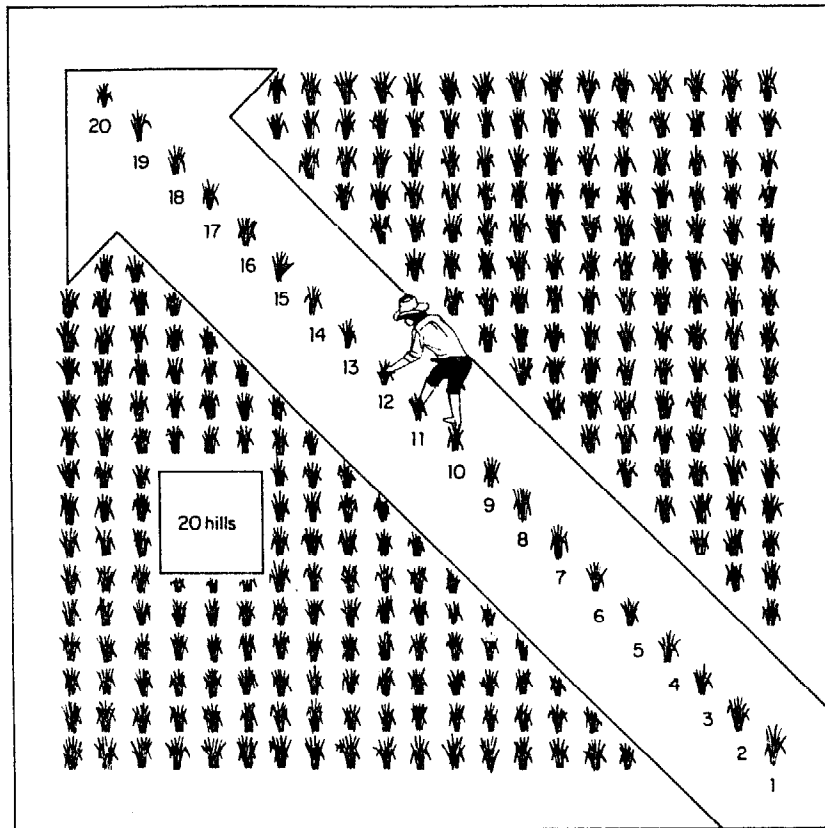

Insecticide application must be carried out no later than the first week after transplanting. Apply when the economic threshold is reached. If there is no standing water in the field, do not apply insecticide.

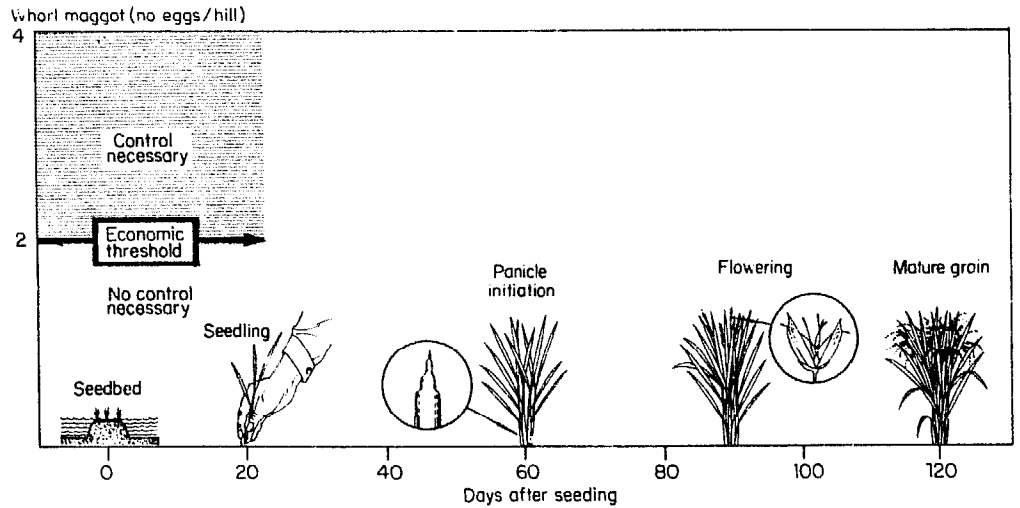

RICE CASEWORM (LEPIDOPTERA: PYRALIDAE)

The caseworm *Nymphula depunctalis* (Guenée) is an aquatic insect. The damaging stage is the larvae that live in sections of leaves cut from young rice plants and rolled into tubes called cases.

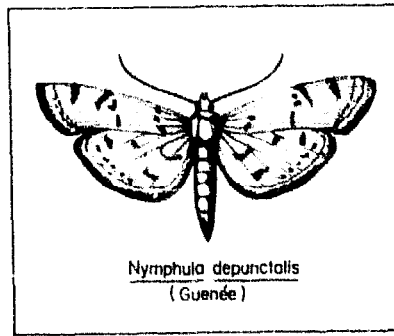
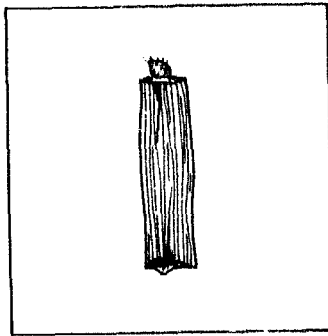

A number of related species occur in Asia, but *N. depunctalis* is the most widely distributed. *N. vittalis* and *N. fengwhanalis* occur in China.

Not all feed on rice. *Paraponyx diminutalis* and *P. fluctuosalis* feed on aquatic weed *Hydrilla* found in canals and rice fields.

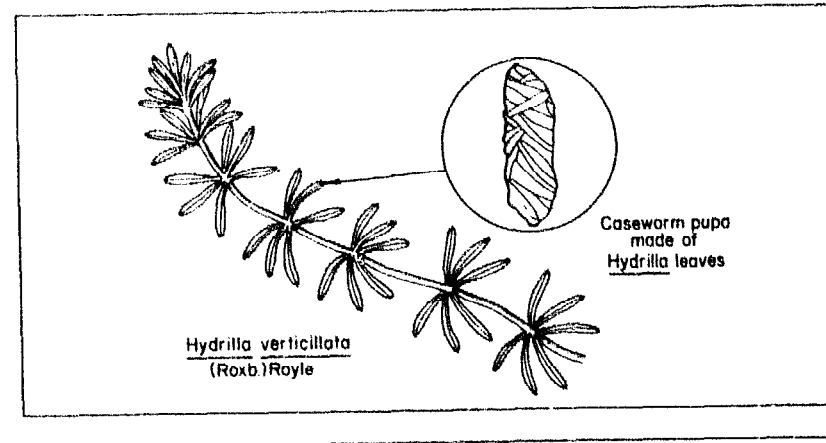
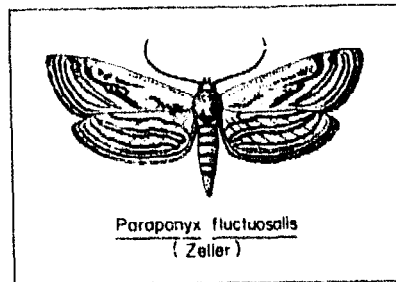
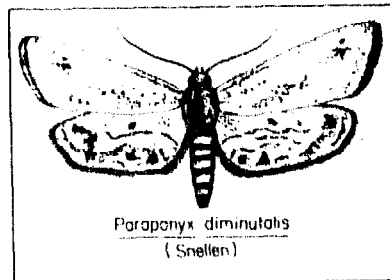
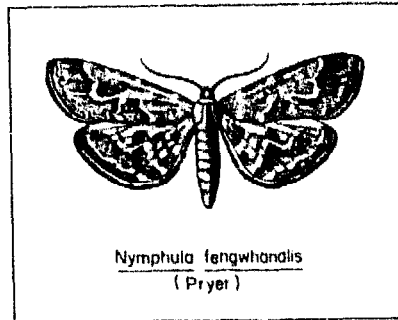
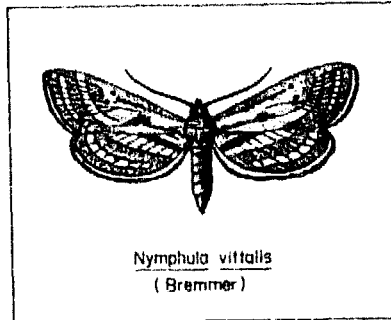

**Pest status**

In a field, damaged plants occur in patches. They normally recover from the effects of leaf removal in the early growth stages. Irrigation, which ensures prolonged standing water in the vegetative stage, increases the pest's

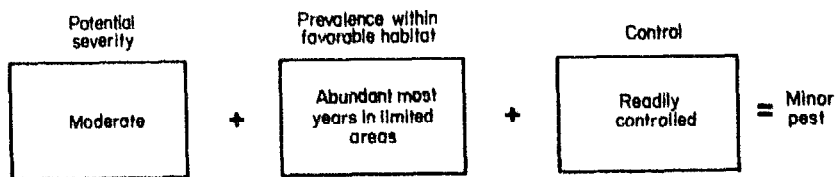

abundance. The larvae are very sensitive to insecticide.

The caseworm occurs only in rice fields with standing water. It is found in irrigated and rainfed wetland environments and is more prevalent in the rainy season.

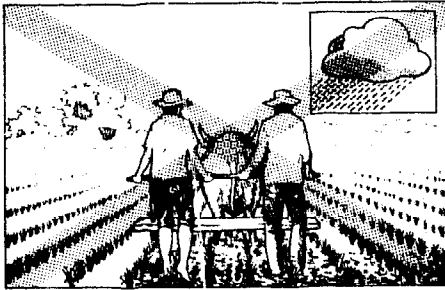

Upland

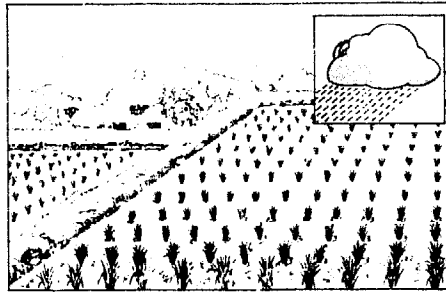

Rainfed wetland

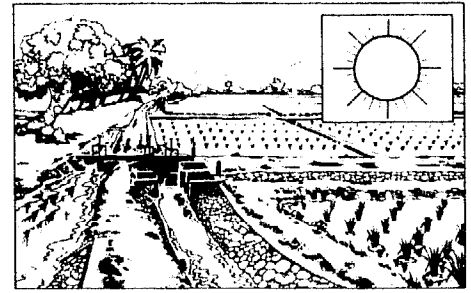

Irrigated wetland

*Distribution in Asia.*

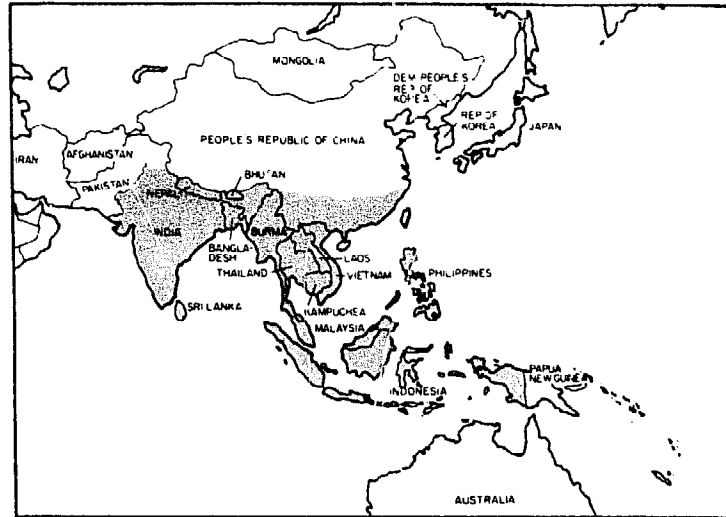

**Development and actual size**

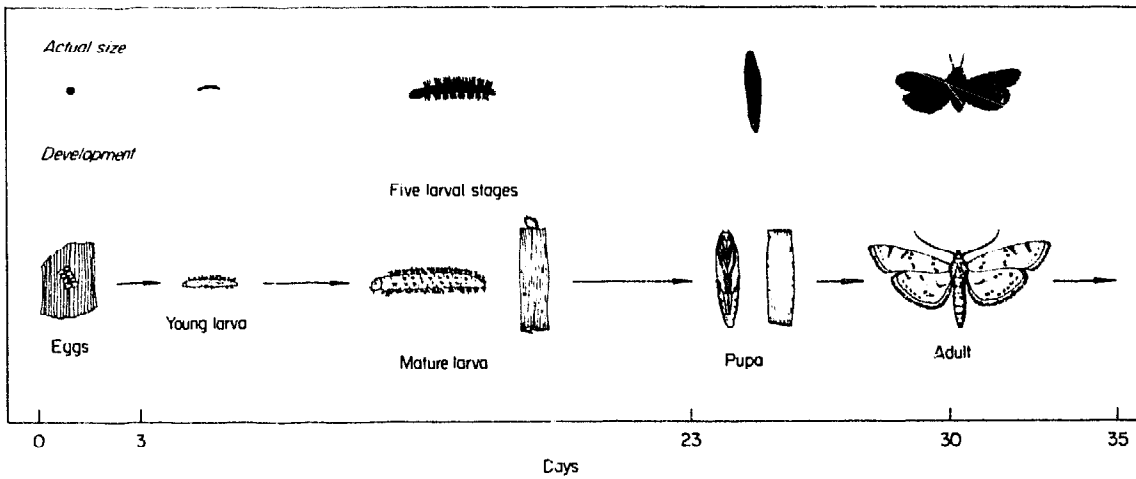

**Adult.** The adult moth is bright white with light brown and black spots. It can be distinguished from related species by its wing markings.

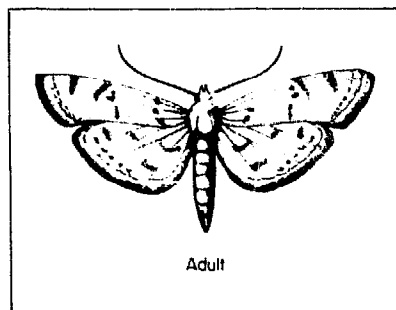

The caseworm moth hides in rice fields during the day and lays eggs at night.

Moths normally do not migrate further than one kilometer after becoming adults. Each female lays about 50 eggs during its lifetime of less than one week.

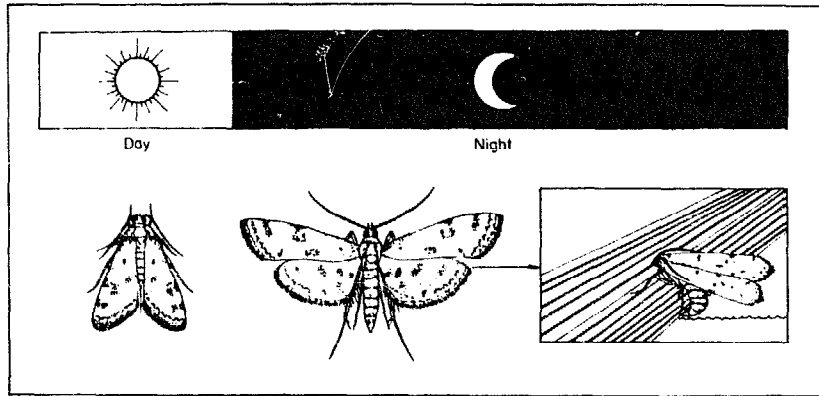

Moths are highly attracted to a light trap. Catches are highest during a new moon.

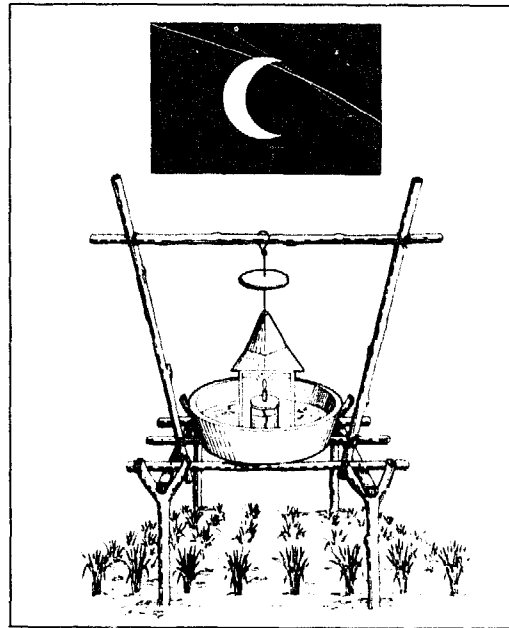

**Egg.** Eggs are pale yellow, disc-like, and irregular in shape. They are laid in batches of about 20 on the undersides of leaves floating on water. The eggs turn dark yellow as they mature.

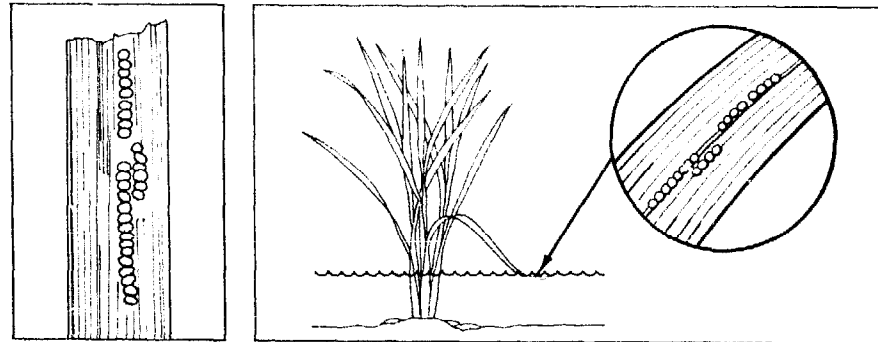

**Larva.** Newly hatched larvae remove the surface of young leaves. Older, pale green larvae have branched, thread-like gills along the sides of their bodies and can only take in oxygen from water.

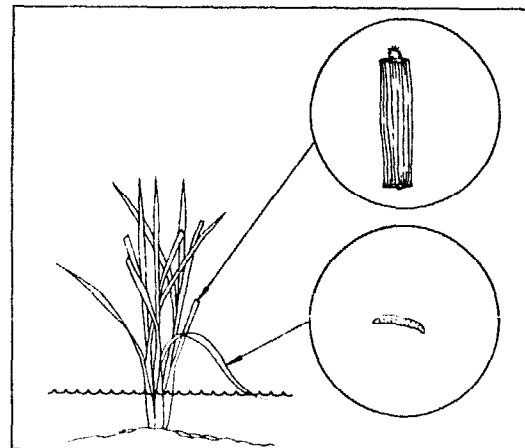



Larvae make their cases from leaf sections cut at right angles from leaf tips.

The larvae roll the leaf sections around their bodies and secure them with silk.

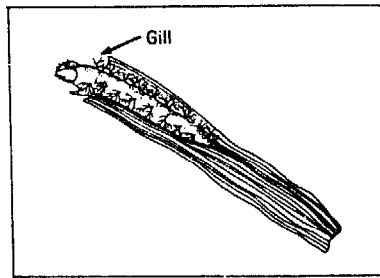

Water is trapped inside the leaf cases, which are open only at the head end. During the day, the larvae hide in their cases while floating on the water surface. At night they crawl up rice plants to feed, still within their cases. Cases are replaced with each molt.

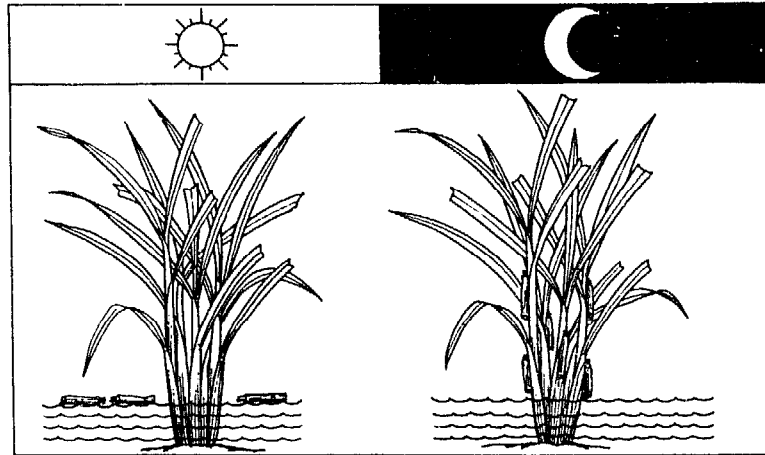

**Pupa.** When the larva is ready to pupate, it crawls on a plant and it attaches its case on a tiller above the water.

The larva spins a silk cocoon around its body inside the larval case where it pupates.

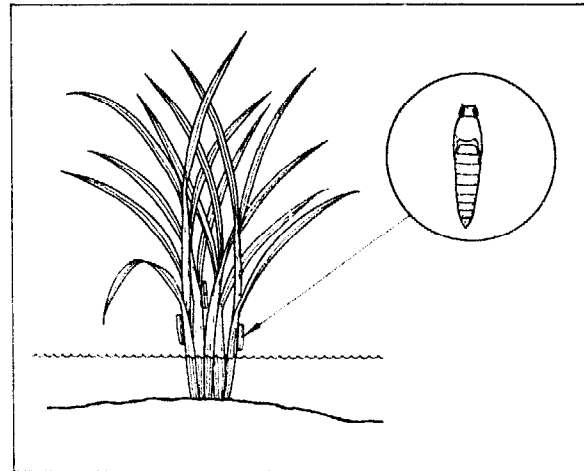

**Damage**

Damage can begin in a flooded seedbed, but does not occur after maximum tillering. The larvae feed by scraping patches of green tissue from young leaves, causing only the white epidermis to remain.

Caseworm damage can be distinguished from that of other pests in two ways:

- The ladder-like appearance of the removed leaf tissue, resulting from the back and forth motion of the head during feeding.

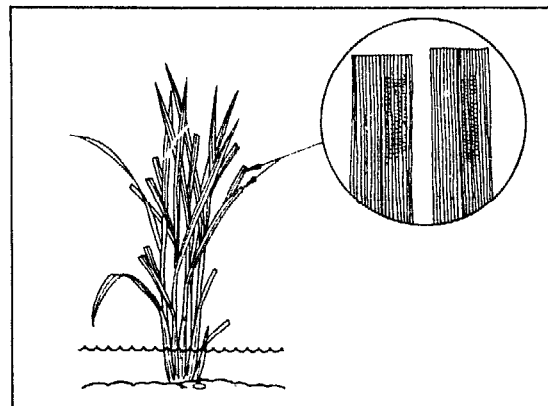
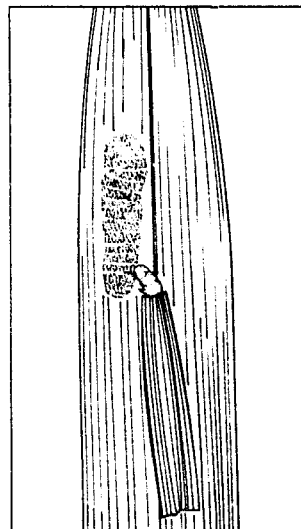

- Leaves cut at right angles as with a pair of scissors.

The pattern of damage is not uniform because the larvae floating in their cases are often carried to one side of the paddy by wind or water currents.

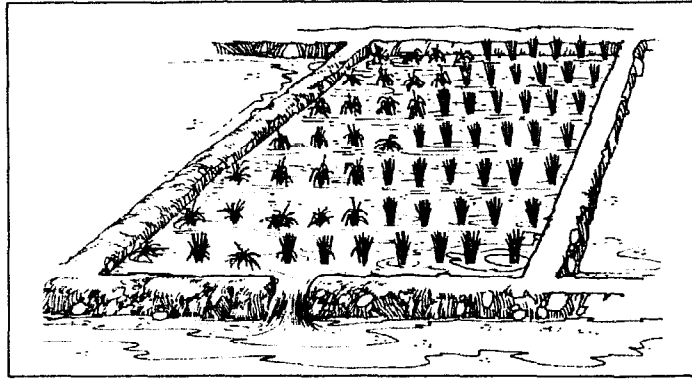

Along a slope, larvae in cases will be carried in runoff water to the lower-lying fields where damage will be more concentrated.

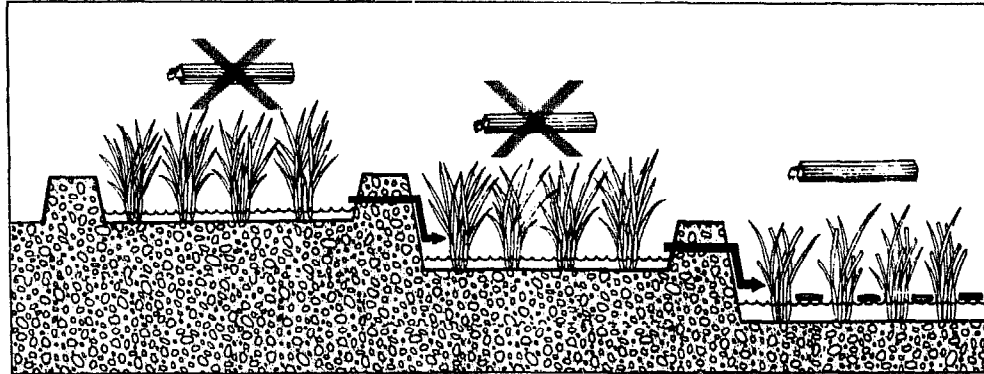

Damaged plants can recover if no other defoliating pests are present, but maturation may be delayed 7-10 days.

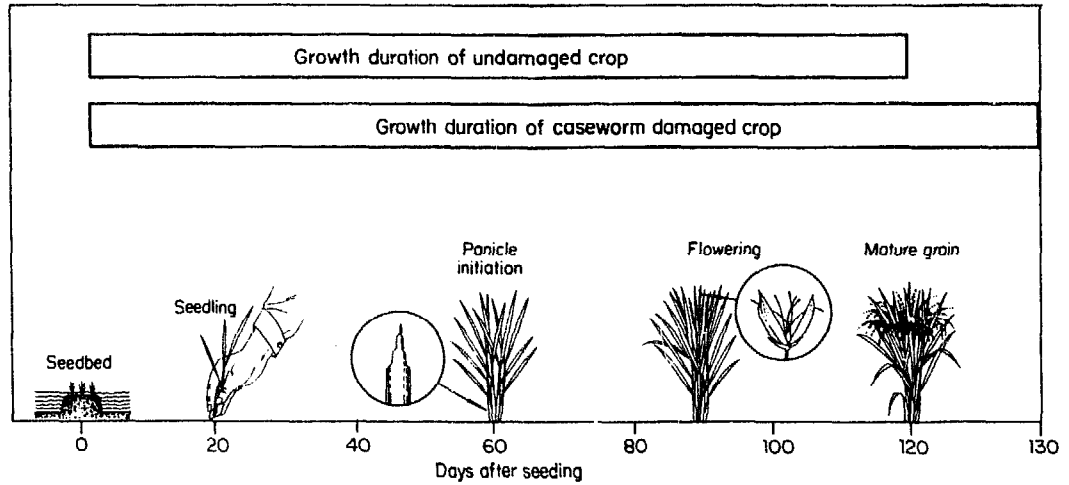

Yield loss occurs if other nondefoliating pests such as whorl maggot and stem borer infest the plants during the first 30 days after transplanting. Such pests restrict the plants' ability to recover. Damaged plants become stunted and produce fewer tillers.

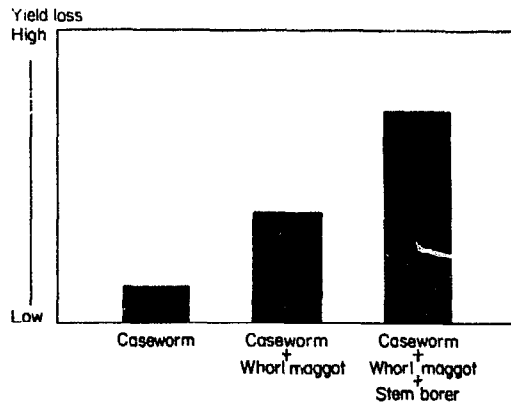

**Plant hosts.** Larvae prefer actively growing leaves and although they can survive on several grassy weed species, rice is their main host.

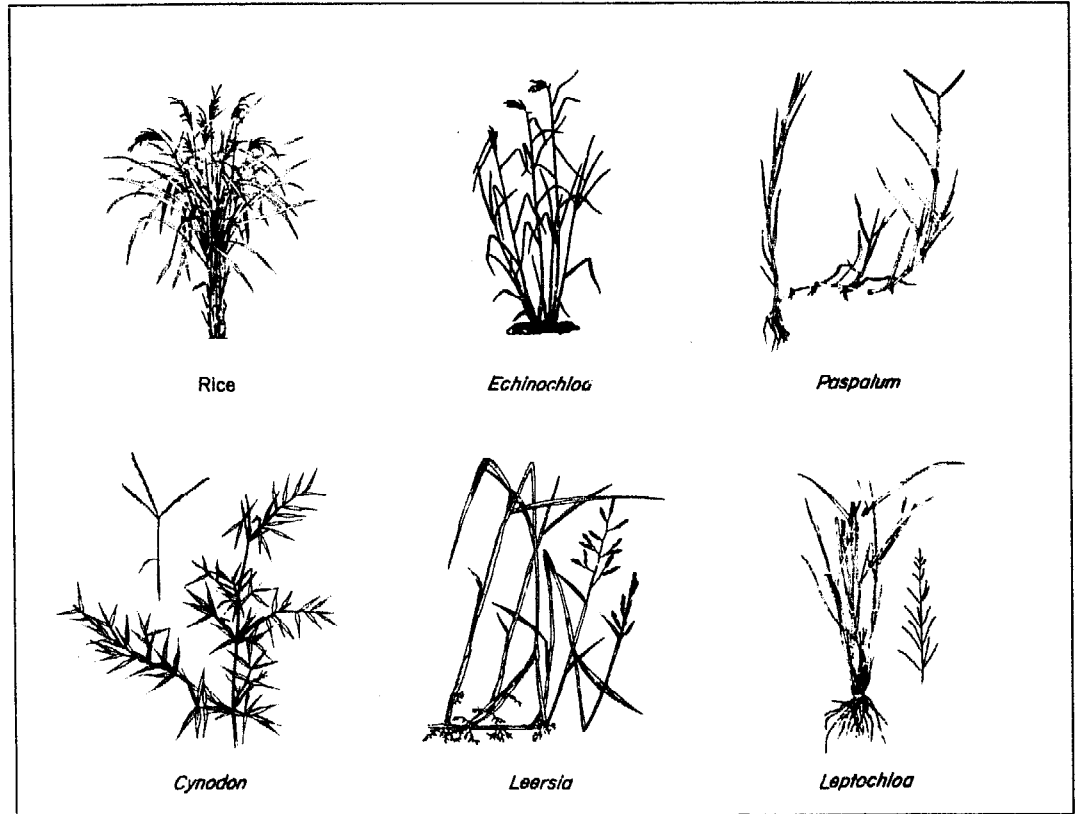

**Management**

**Cultural control.** A nonflooded seedbed is protected from caseworm attack.

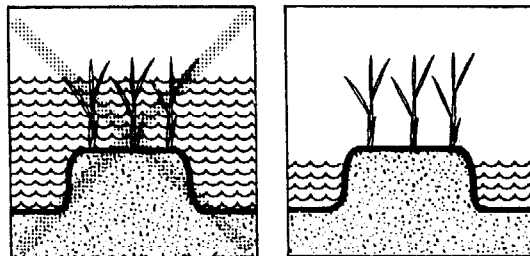

Transplanting older seedlings limits the period of larval attack.

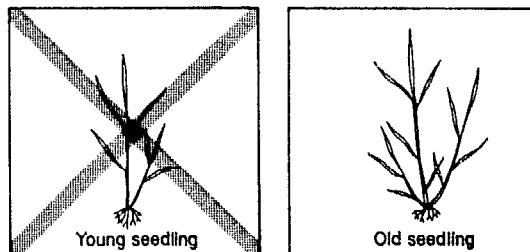

Draining the paddy for several days kills caseworm larvae, but weeds become a potential problem.

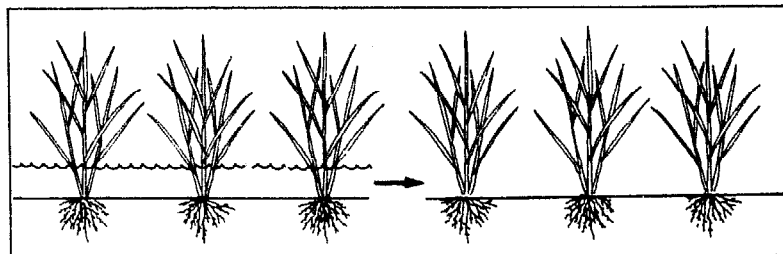

**Resistant varieties.** No resistant varieties are commercially available.

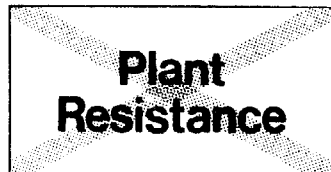

**Biological control. Snails**  
 — *Pila* and *Radix* =  
 (*Lymnaea*) — foraging for  
 algae inadvertently dislodge  
 eggs from rice leaves. A  
 braconid wasp parasitizes the  
 larval stage. The larvae of  
 hydrophilid and dytiscid  
 water beetles prey on the  
 caseworm larvae. Spiders  
 prey on adult moths.

Water beetle predators are  
 prevalent in more permanent  
 water sources. They are late  
 colonizers of rainfed lowland  
 rice fields, a fact which may  
 explain why the rice  
 caseworm is often abundant  
 in these more temporary  
 aquatic habitats.

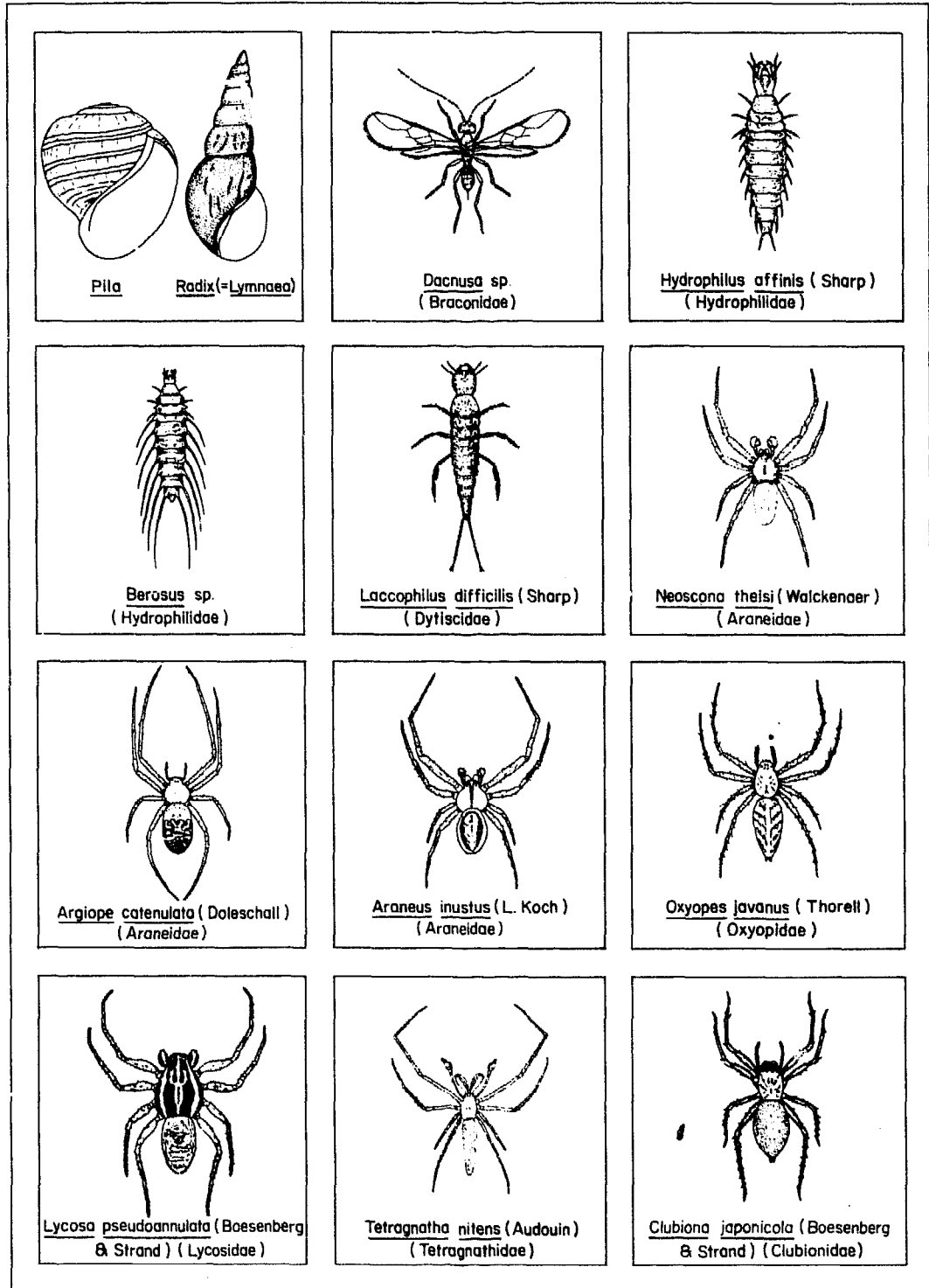

Caseworm eggs and larvae  
 are protected from the attack  
 of many parasites because  
 eggs are laid in water and the  
 larval stage remains in cases  
 floating on water.

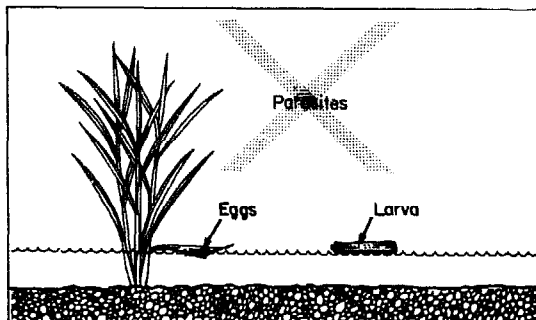

*Chemical control.*

- *Insecticide application.* Caseworm larvae are highly susceptible to insecticides and are readily controlled with foliar sprays or granules in the paddy water.
- *Scouting.* Sampling is based on plant damage. Scout seedbeds weekly for signs of larval feeding.



Direct-seeded and transplanter fields should be scouted weekly until maximum tillering. Damage symptoms appear at once on the crop; therefore, fields should be scouted even during rains.

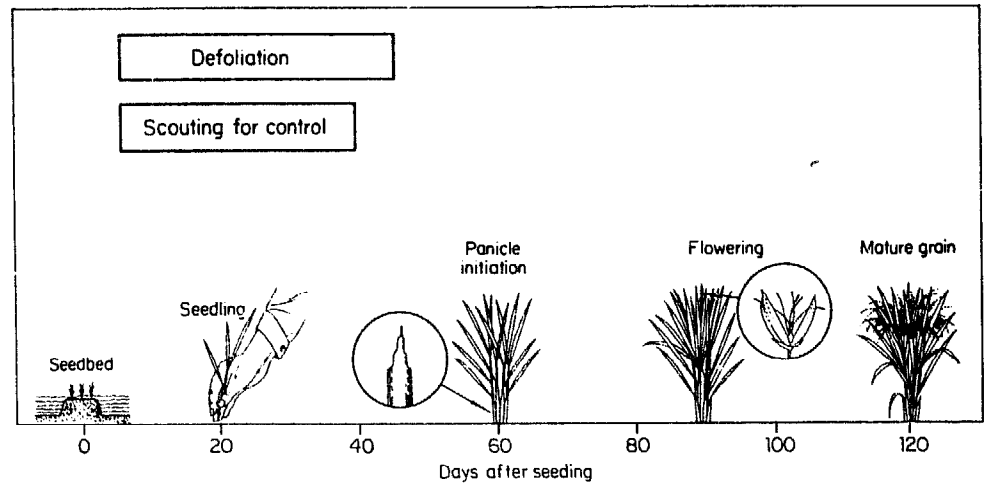

Look at the number of insect-damaged and undamaged leaves on 5 leaves from each of 20 hills chosen at random. Combine the damage caused by other leaf-feeding pests with that caused by caseworm.

Seeing caseworm moths while crossing the field is a warning to scout more frequently.

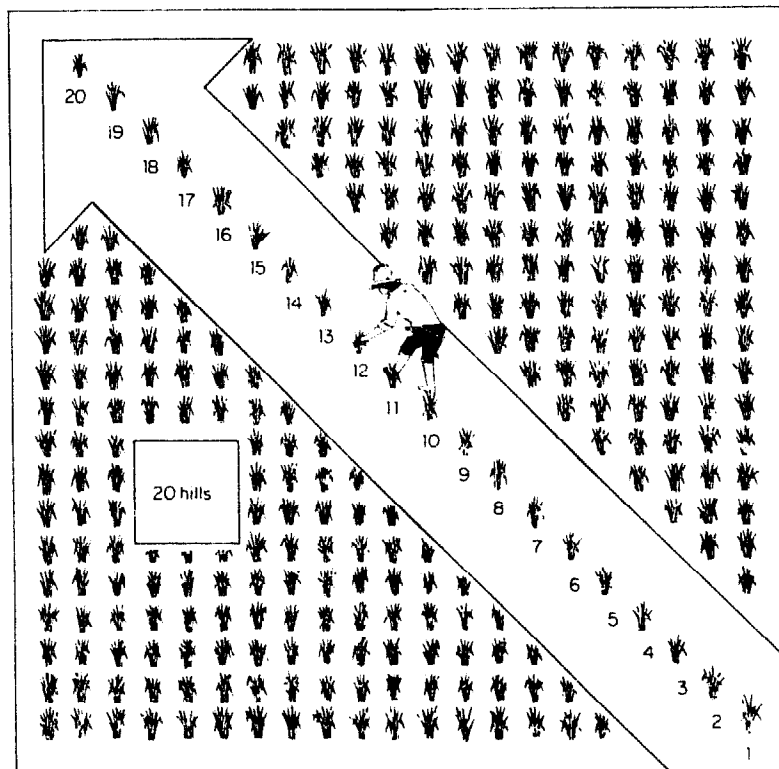

Determine the percentage of leaves showing signs of feeding from caseworm (cut leaves or leaves with tissue scraped away) and from other leaf-feeding pests.

The economic threshold is based on the percentage of leaves damaged by leaf-feeding insects. The rice plants' tolerance for defoliation decreases with age. Seedbed damage is readily compensated for by the plant.

Apply insecticides only to fields with standing water and only when live larvae are present.

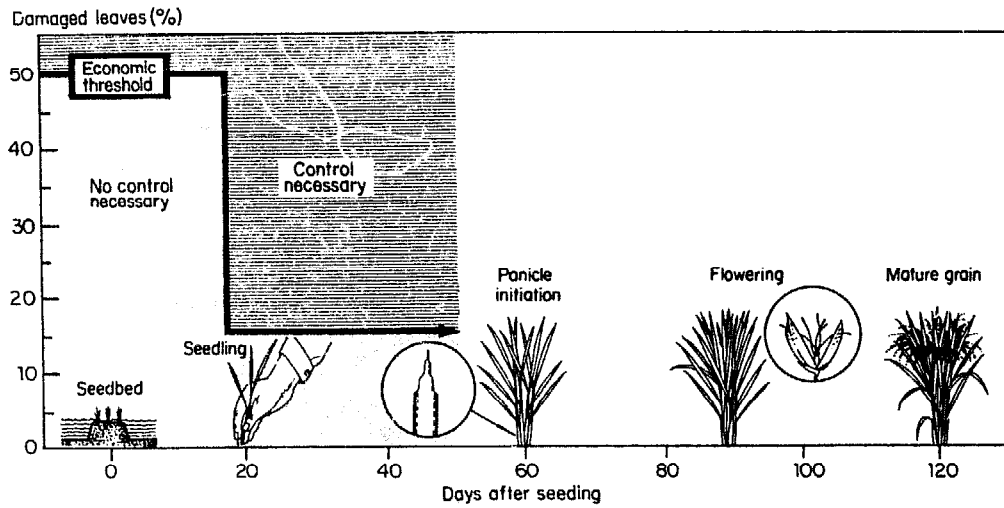

RICE GREEN SEMILOOPER (LEPIDOPTERA: NOCTUIDAE)

*Naranga aenescens* Moore is a moth whose green larvae feed on leaves. The larvae move by arching their backs in the shape of a loop. Semilooper means "half-looper" as the larva does not arch its back as completely as true loopers.

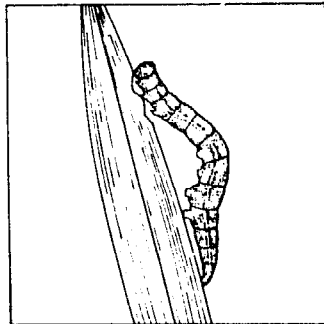

Pest status

Populations are normally held in check by parasites and pathogens but high numbers occasionally occur. Larvae are readily controlled by insecticide.

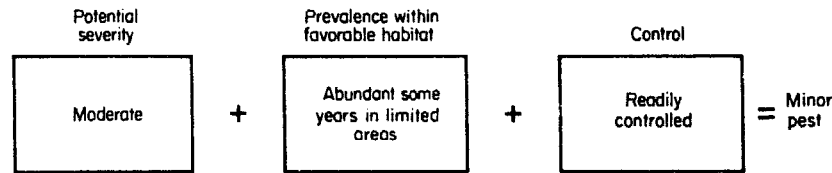

The green semilooper is found only in wetland environments and is abundant in the rainy season.



Upland

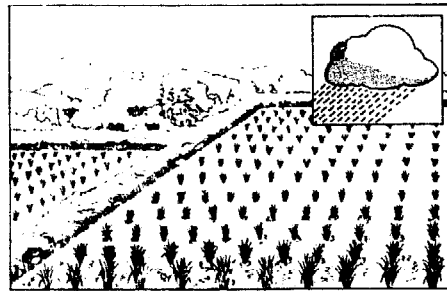

Rainfed wetland

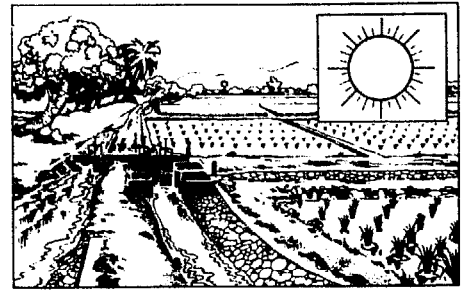

Irrigated wetland

*Distribution in Asia*

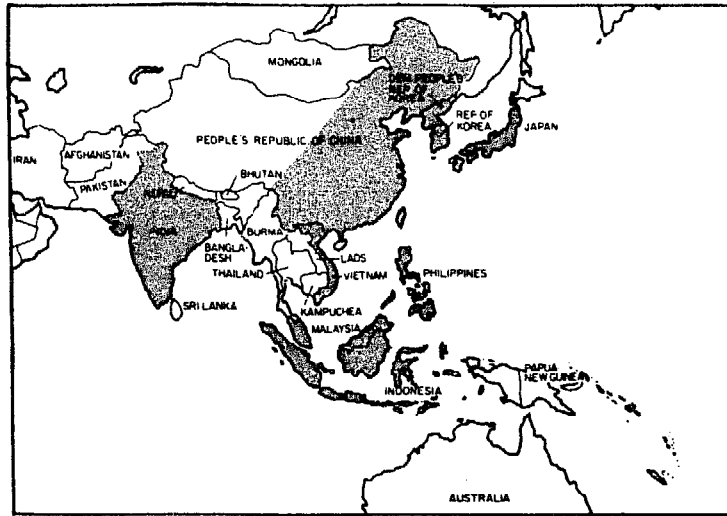

**Development and actual size**

*Adult.* Moths are yellow-orange with two diagonal, dark-red bands on each fore wing.

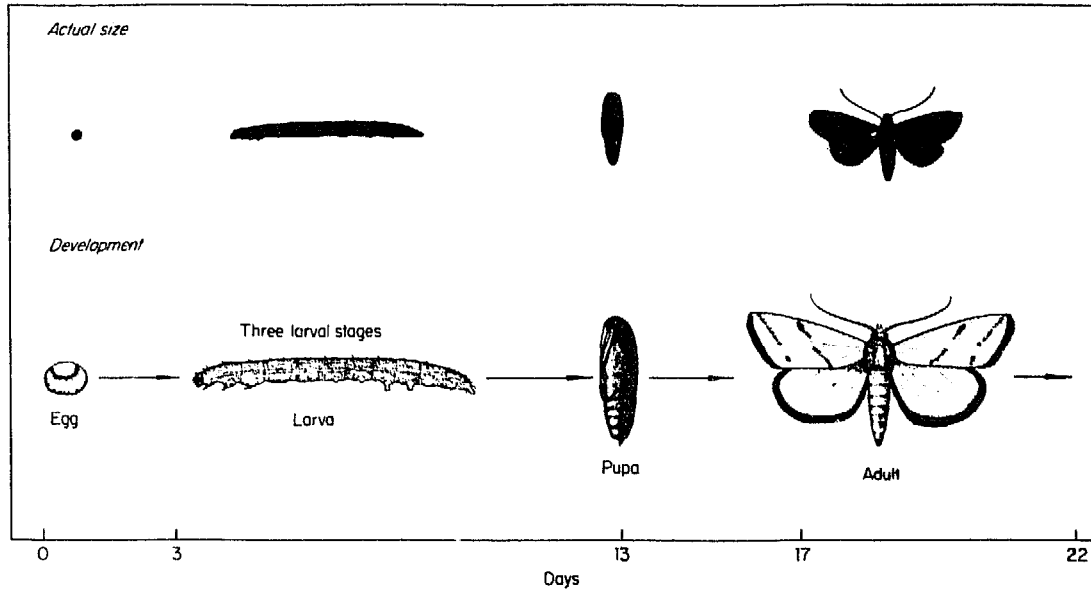
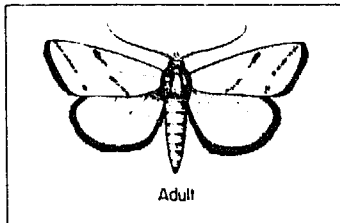

Adults hide in rice fields or in grassy areas at the base of plants during the day and become active at night.

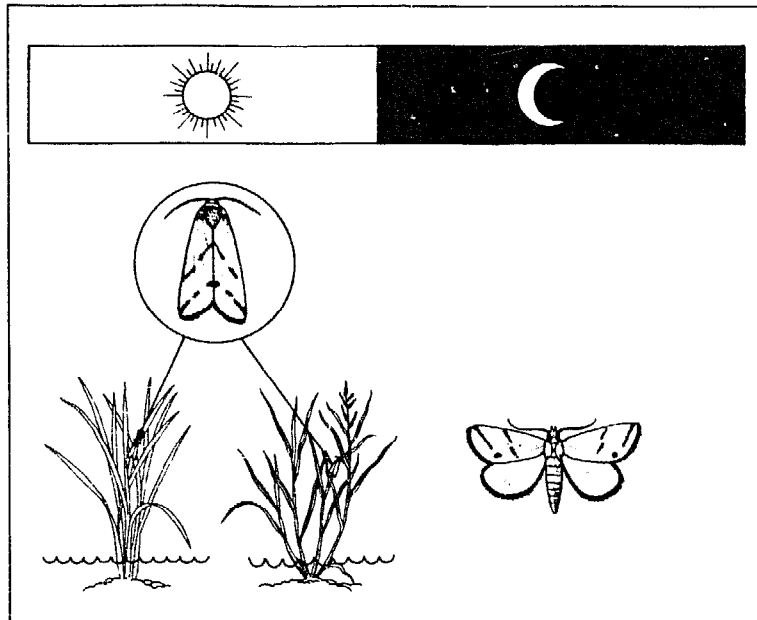

Each female lays 50-100 eggs during its lifetime of 3 to 5 days.

Moths are highly attracted to a light trap and catches are high during a new moon phase.

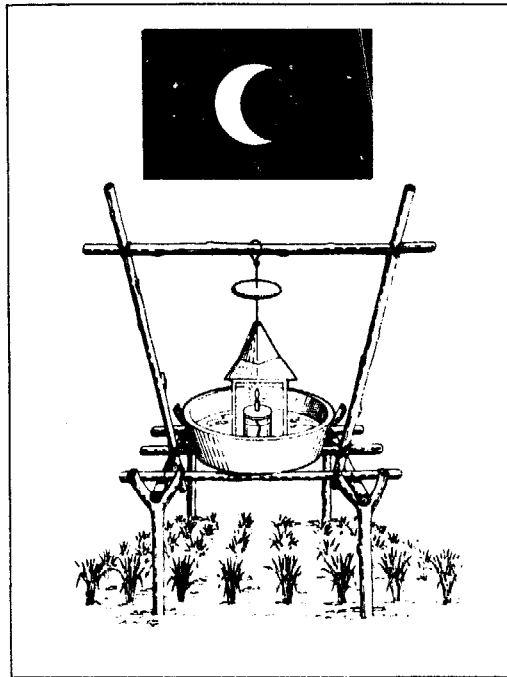

**Egg.** The spherical eggs are yellow when newly laid and develop purple markings when mature. They are laid on leaves in clusters up to 15 each.

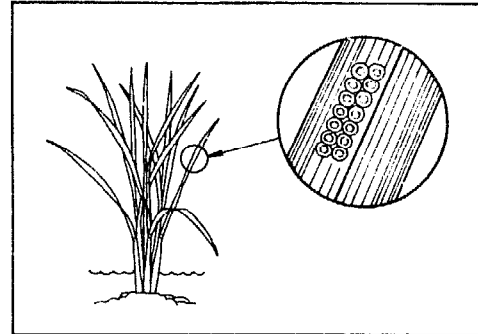

**Larva.** The head of the larva is yellow-green. Narrow white lines run along the light green body.

The larvae draw their hind legs forward, arching their backs when they move.

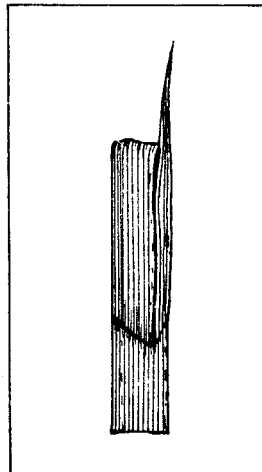
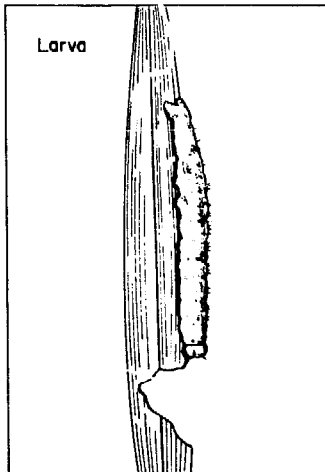

**Pupa.** When ready to pupate, the larva forms a pupal chamber by folding a rice leaf over and securing it with silk.

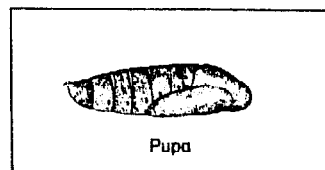

The pupa is light brown and smooth bodied. In temperate regions, it may lie dormant during periods of low temperature.

**Damage**

Larvae feed on leaf blades and prefer actively growing plants, from the seedbed through the tillering stage.

Young larvae scrape the leaf tissue from leaf blades.

Older larvae eat large areas on the edges of leaves to form notches.

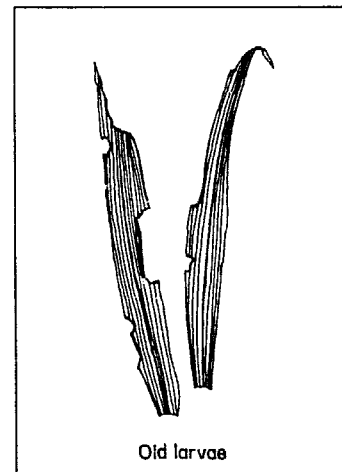
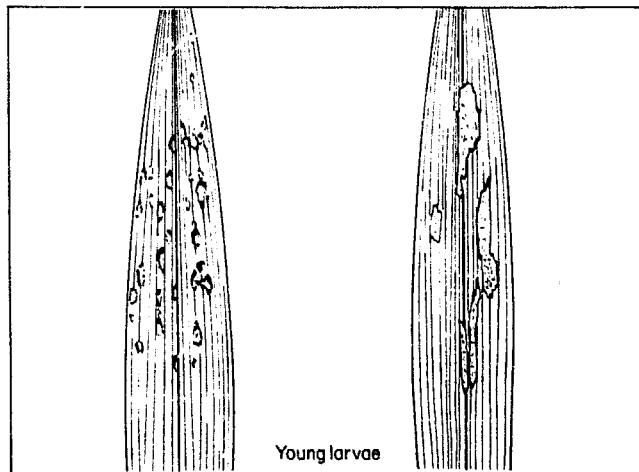



Young plants can normally recover from defoliation caused by the semilooper, but yield loss occurs if other nondefoliating pests such as whorl maggot and stem borer feed at the same time.

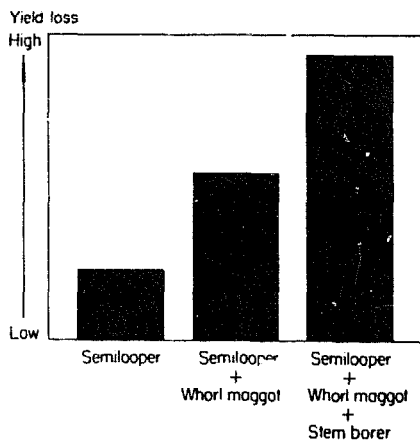

*Plant hosts.* The larvae also feed on grassy weeds.

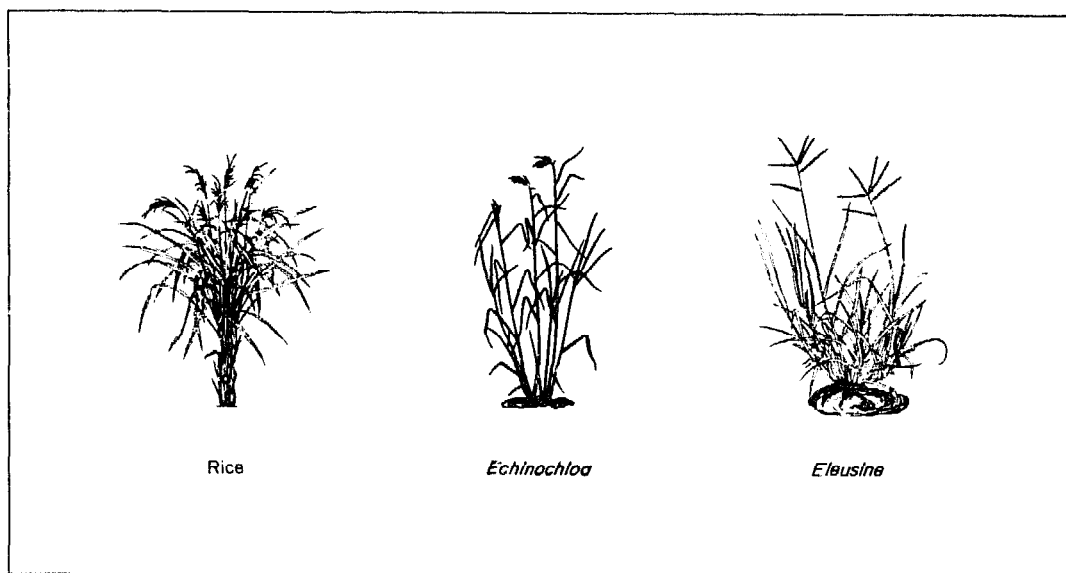

**Management**

*Cultural control.* Heavily fertilized crops result in high semilooper numbers.

Use only an optimal amount of fertilizer and split the applications.

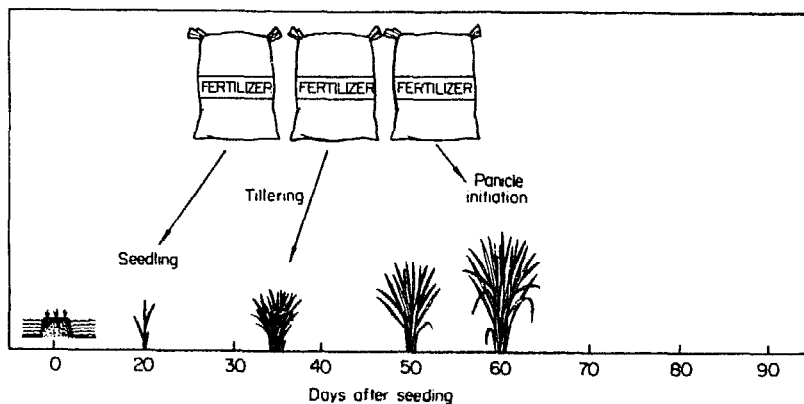

*Resistant varieties.* No resistant varieties have been developed for rice semilooper.

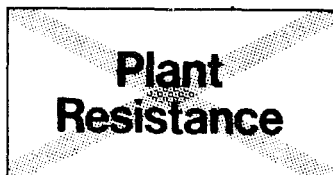

**Biological control.** Small trichogrammatid wasps parasitize eggs. Ichneumonid, braconid, elasmid, eulophid, and chalcid wasps parasitize the larvae and pupae.

Fungi also attack the larvae.

Spiders feed on adult moths in the crop canopy.



*Trichogramma nr. ostriniae* (Pang & Chen) (Trichogrammatidae)

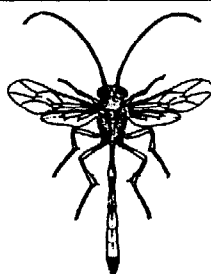

*Charops brachypterum* (Cameron) (Ichneumonidae)

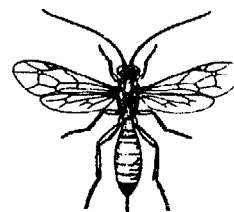

*Itoplectis narangae* (Ashmead) (Ichneumonidae)



*Cotesia flavipes* Cameron (Braconidae)

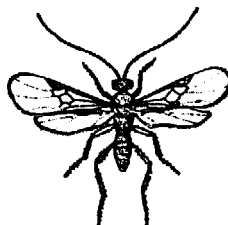

*Cotesia ruficrus* (Haliday) (Braconidae)

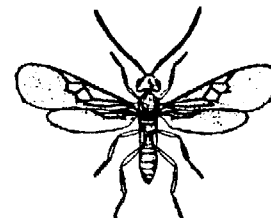

*Apanteles angustibasis* (Gahan) (Braconidae)



*Brachymeria lasus* (Walker) (Chalcididae)

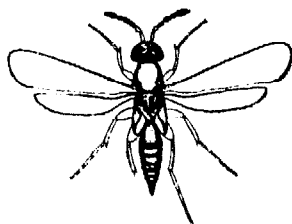

*Elas. s sp.* (Elasmidae)



*Euplectus chapadae* (Ashmead) (Eulophidae)



Pupal cocoon

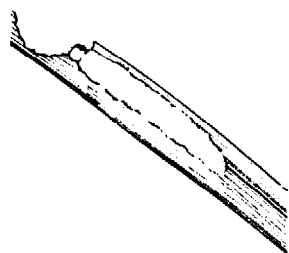

Diseased larva of *Naranga*



*Neoscona theisi* (Walckenaer) (Araneidae)

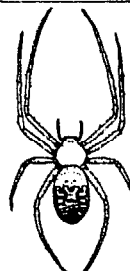

*Argiope catenulata* (Doleschall) (Araneidae)



*Araneus inustus* (L. Koch) (Araneidae)

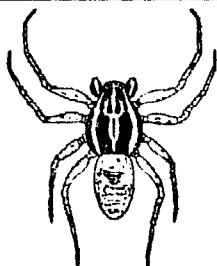

*Lycosa pseudoannulata* (Boesenberg & Strand) (Lycosidae)

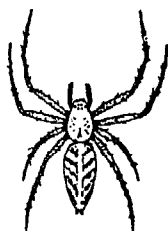

*Oxyopes javanus* (Thorell) (Oxyopidae)



*Clubiona japonicola* (Boesenberg & Strand) (Clubionidae)

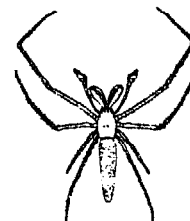

*Tetragnatho nitens* (Audouin) (Tetragnathidae)

*Chemical control.*

- *Insecticide application.* The green semilooper is readily controlled with insecticide. Foliar sprays or systemic granules are effective.



- *Scouting.* Visit the field weekly during early crop growth. A wet seedbed should be scouted.

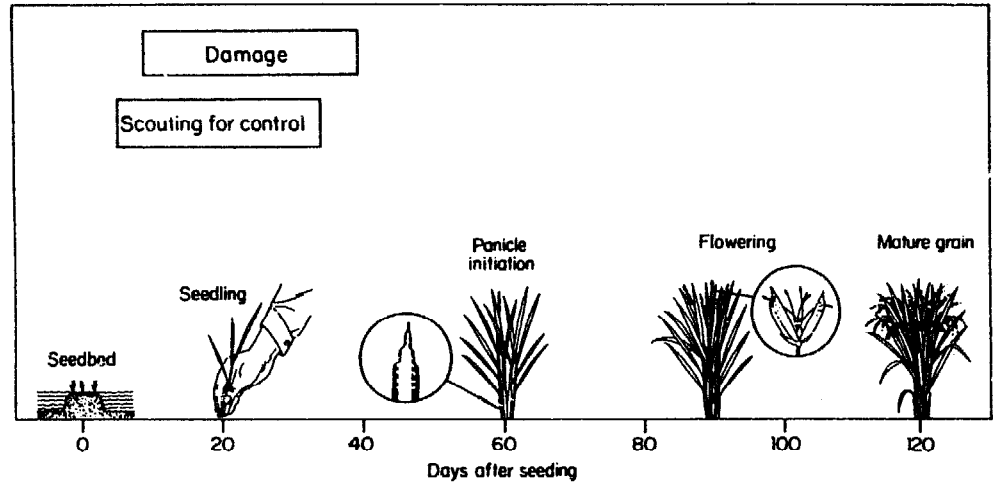

Select 5 leaves from each of 20 randomly selected hills across the field. Record the number of leaves damaged by all leaf-feeding insects combined. It is impractical to record early vegetative stage damage from each leaf-feeding pest separately.

Seeing semilooper moths while crossing the field is a warning to scout more frequently.

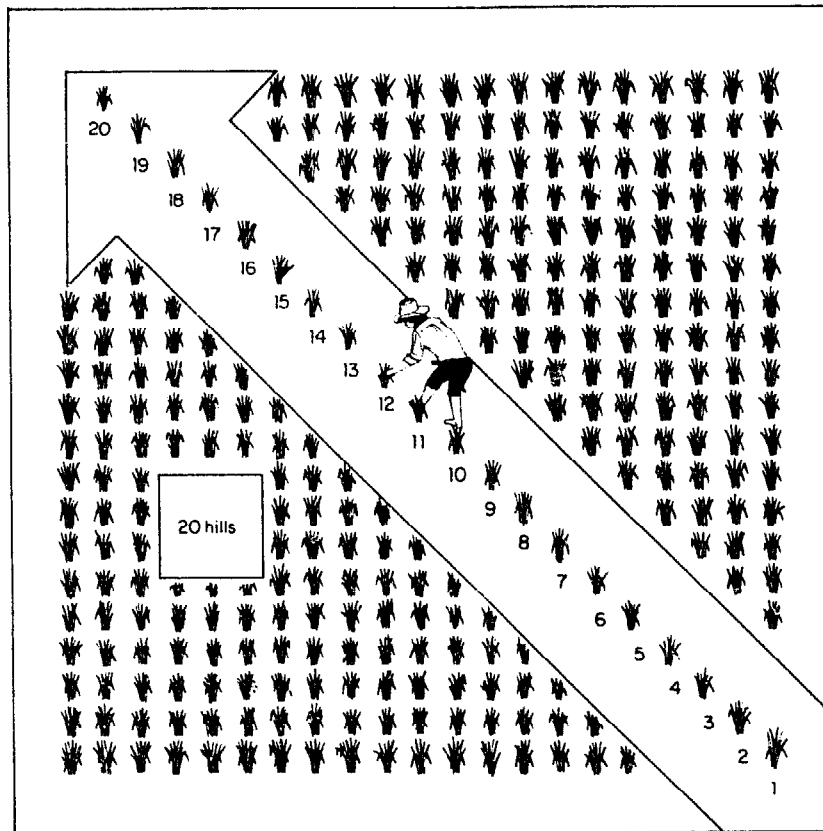

Apply insecticide when the economic threshold is reached. Rice at seedling stage can compensate more from leaf damage than older plants.

Apply insecticide only if live larvae are seen.

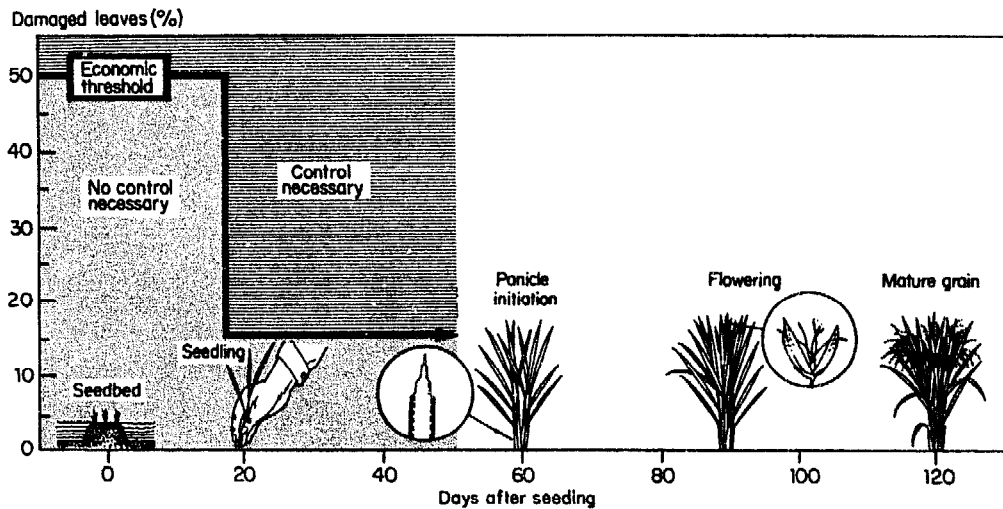

RICE GREEN HAIRY CATERPILLAR (LEPIDOPTERA: NOCTUIDAE)

The *Rivula atimeta* (Swinhoe) moth, whose green caterpillar feeds on the leaves of rice at the vegetative stage, produces damage similar to that from the rice green semilooper.

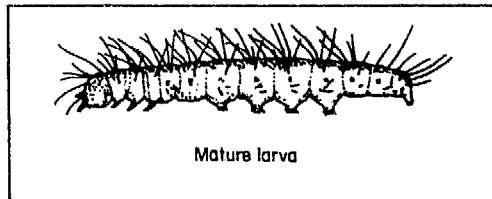

**Pest status**

Damage potential is moderate because the plants can, to a large extent, recover from defoliation at the vegetative stage.

Green hairy caterpillar incidence is normally low and can be readily controlled with insecticide.

The pest causes more damage to the rice crop when it occurs with other pest species that are not themselves defoliators.

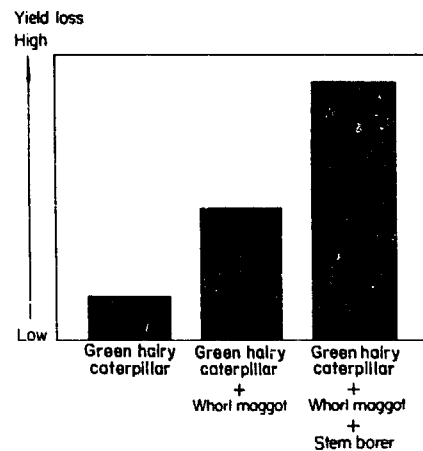
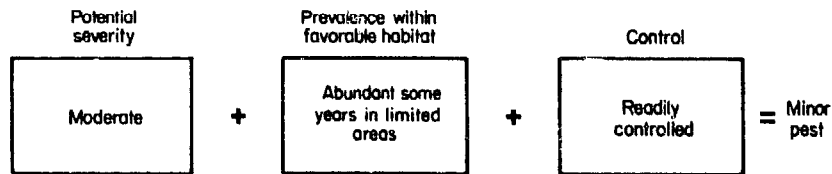

The green hairy caterpillar occurs in wetland environments where the fields have standing water.

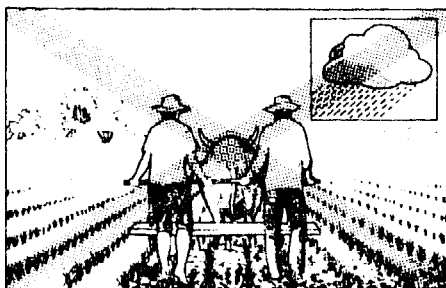

Upland

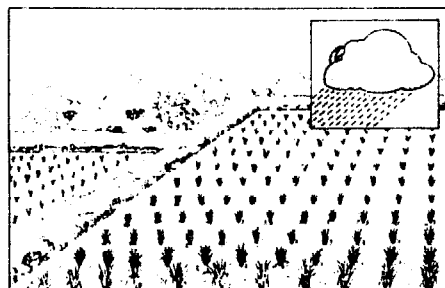

Rainfed wetland

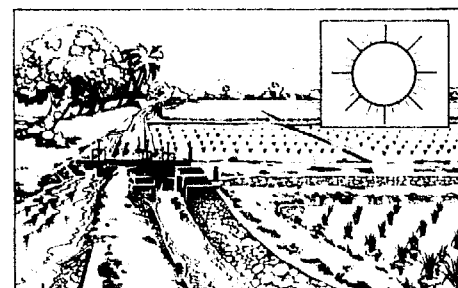

Irrigated wetland

*Distribution in Asia.*

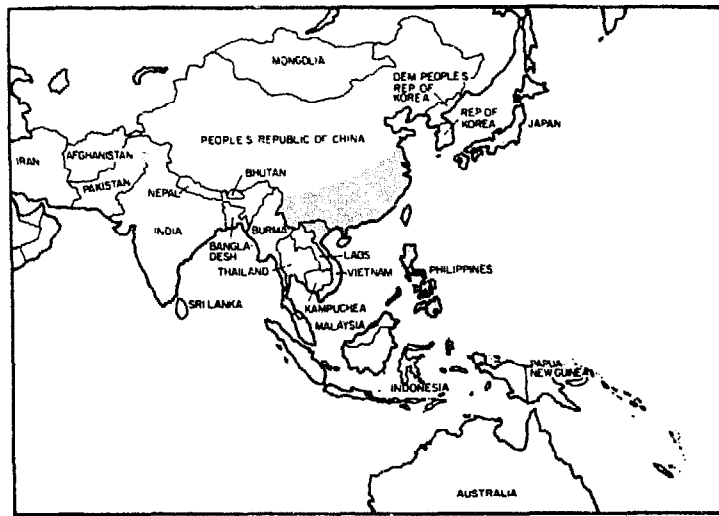

**Development and actual size**

*Adult.* The adult moth of either sex is white grey or light brown. Each female can lay 100-150 eggs in a lifetime of 6 days.

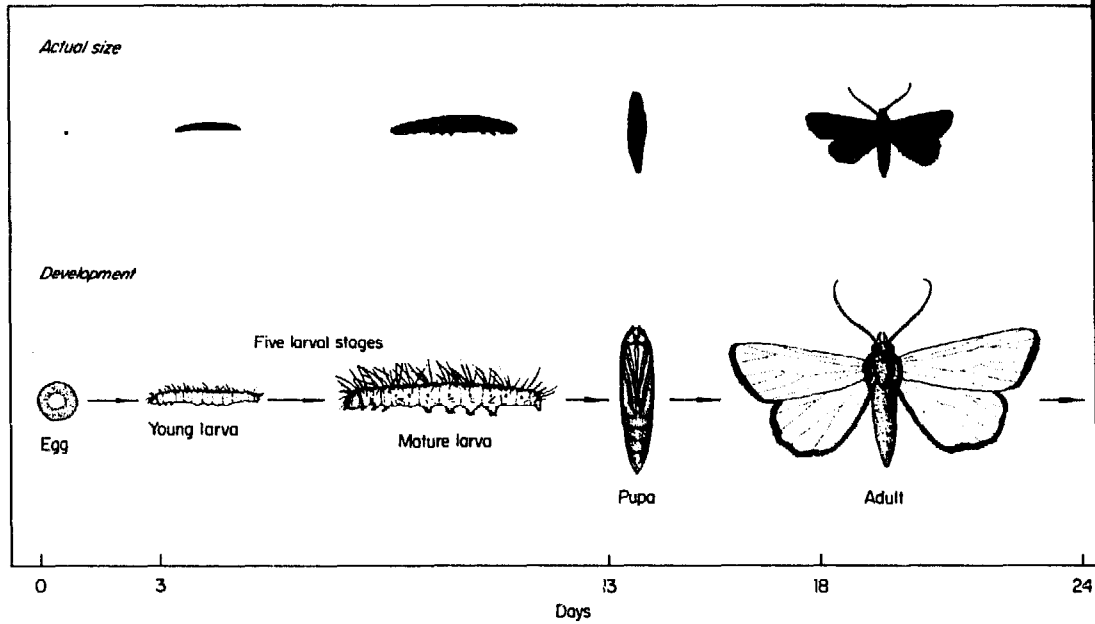
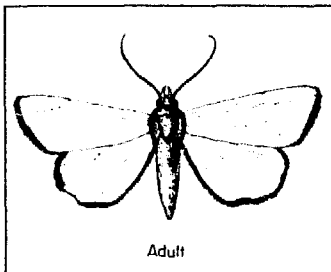

The adults are active at night and hide under the cover of vegetation during the day with their heads pointed down.

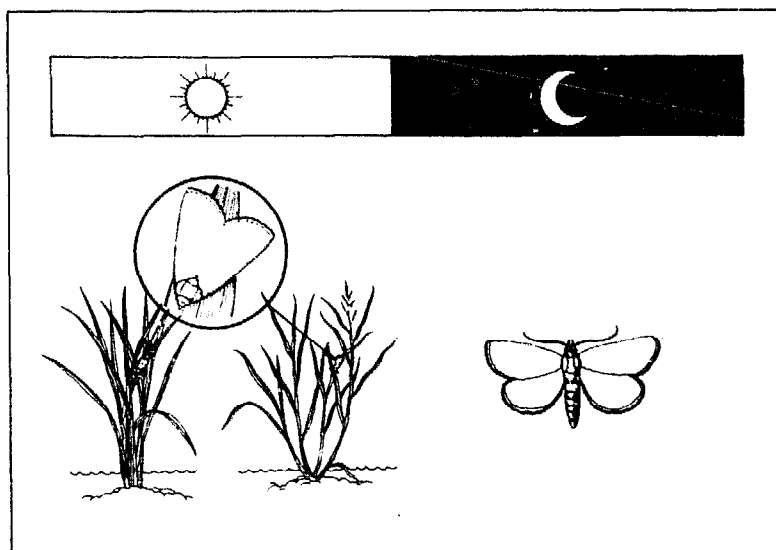

Adults are attracted to a light trap. Greatest numbers appear during a new moon.

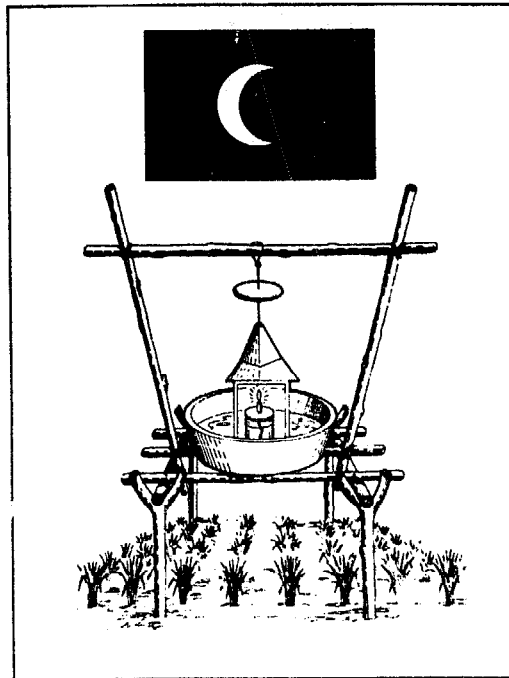

**Egg.** The spherical, pale-green eggs are laid singly on leaf blades.

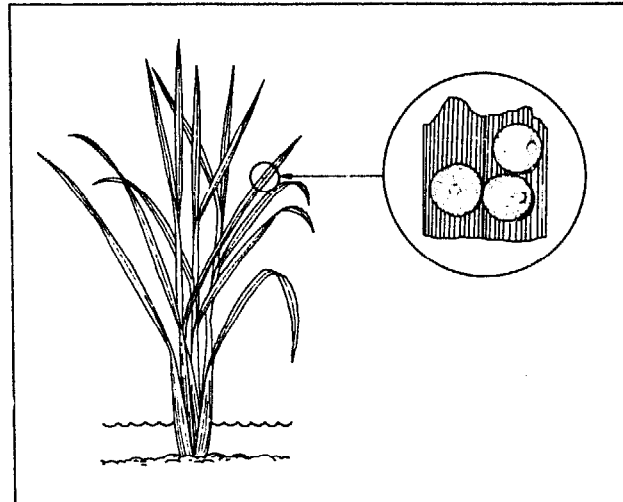

**Larva.** The pale-green larvae can be distinguished from similar species by the presence of the long thread-like hairs on their bodies, hence the name green hairy caterpillar.

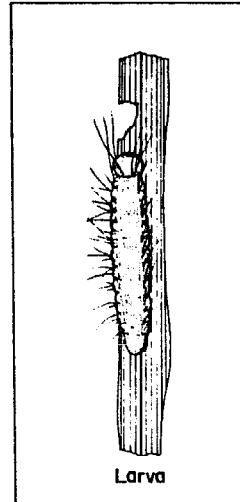

**Pupa.** When ready to pupate, the larvae spin a cocoon of silk on a leaf blade.

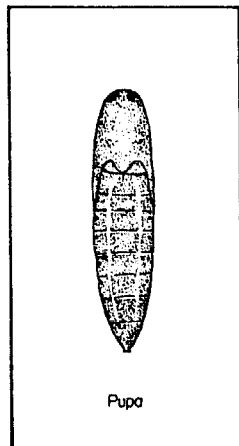

**Damage**  
Damage produced by the green hairy caterpillar is similar to that caused by the green semilooper.

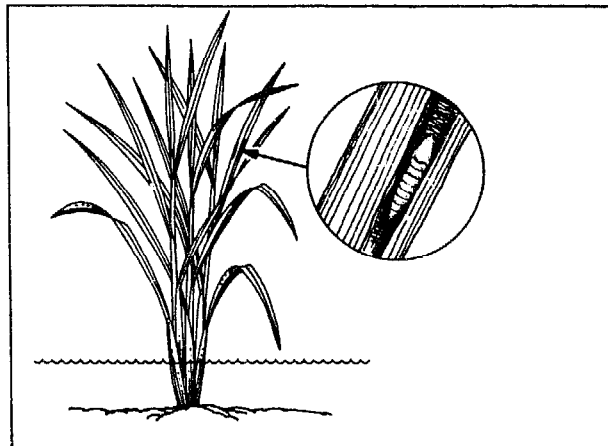

**Plant hosts.** The larvae also feed on grassy weeds.

**Management**

**Cultural control.** Heavily fertilized crops result in high numbers of this pest.

Use only an optimal amount of fertilizer.

**Resistant varieties.** There are no commercially available resistant varieties.

**Biological control.** Eggs are parasitized by trichogrammatid wasps.

Ichneumonid wasps parasitize the larval stage.

Larvae are attacked by fungi.

Adult moths are captured by spiders.



Rice

Echinochloa

Leersia

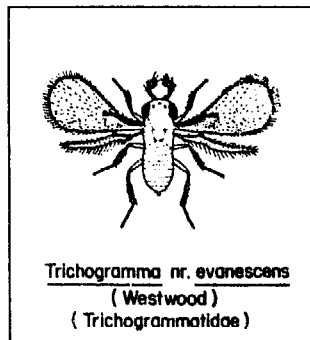
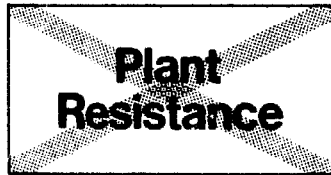

Trichogramma nr. evanescens  
(Westwood)  
(Trichogrammatidae)

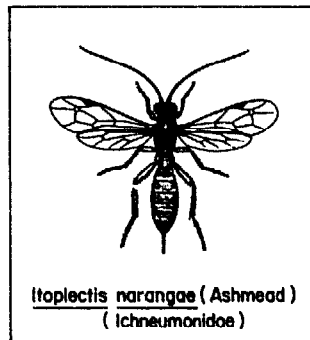

Itopectis narangae (Ashmead)  
(Ichneumonidae)

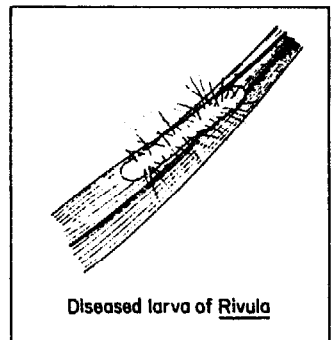

Diseased larva of Rivula

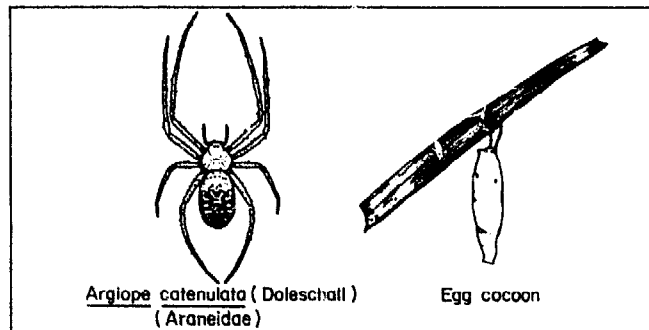

Argiope catenulata (Dolleschall)  
(Araneidae)

Egg cocoon

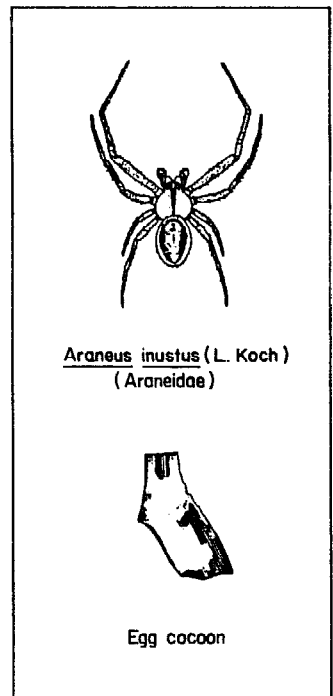

Araneus inustus (L. Koch)  
(Araneidae)

Egg cocoon

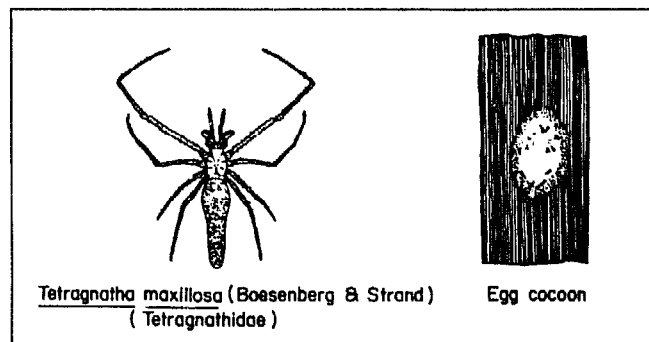

Tetragnatha maxillosa (Boesenberg & Strand)  
(Tetragnathidae)

Egg cocoon

**Chemical control.** Chemical control measures for the green hairy caterpillar are similar to those used for the green semilooper.

**RICE LEAF BEETLE (COLEOPTERA: CHRYSOMELIDAE)**

*Oulema (= Lema) oryzae* (Kuwayama) is a defoliator that is restricted to temperate rice growing regions of East Asia.

**Pest status**

The rice leaf beetle causes only moderate damage and can readily be controlled with insecticide.

It is found in upland and wetland environments.

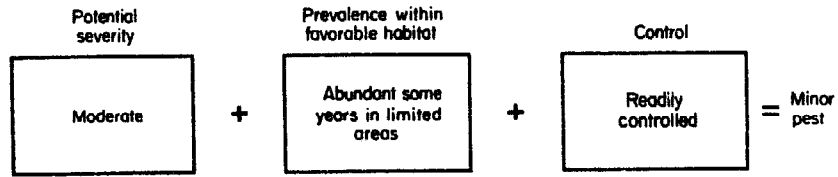

Upland

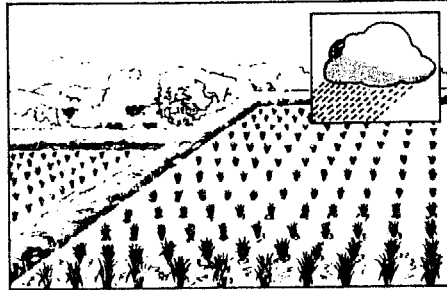

Rainfed wetland

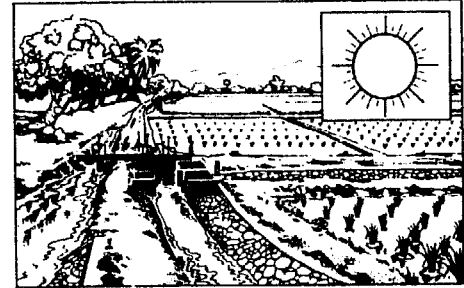

Irrigated wetland

**Distribution in Asia**

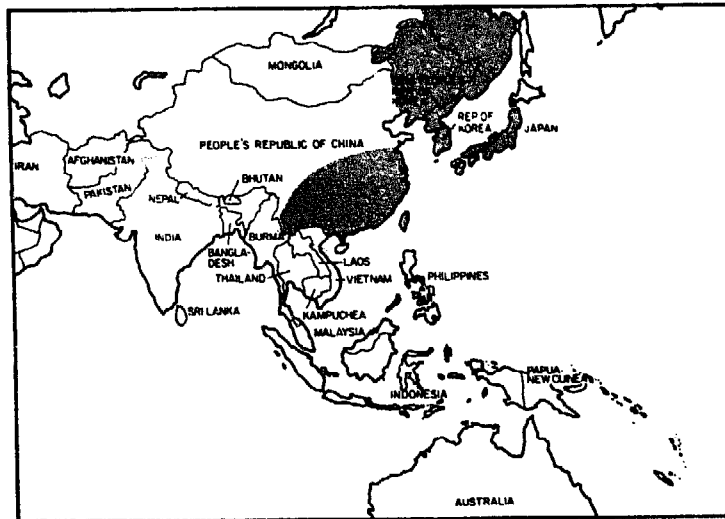

**Development and actual size**  
The rice leaf beetle has only one generation in a year.

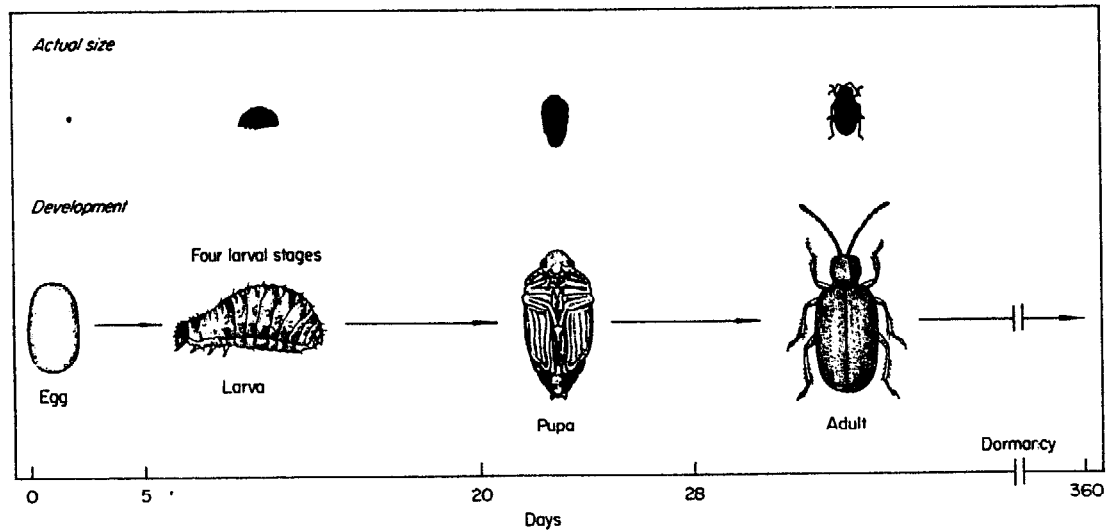



**Adult.** The adult beetle has shiny, dull black wing covers and a reddish-brown thorax.

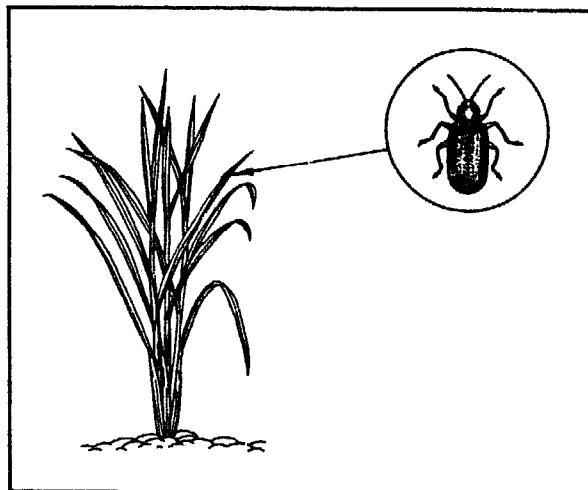

It feeds on leaves over a period of about 3 months and then hibernates in winter under plant litter and vegetation.

In spring, the previous year's adults emerge from overwintering sites to lay eggs.

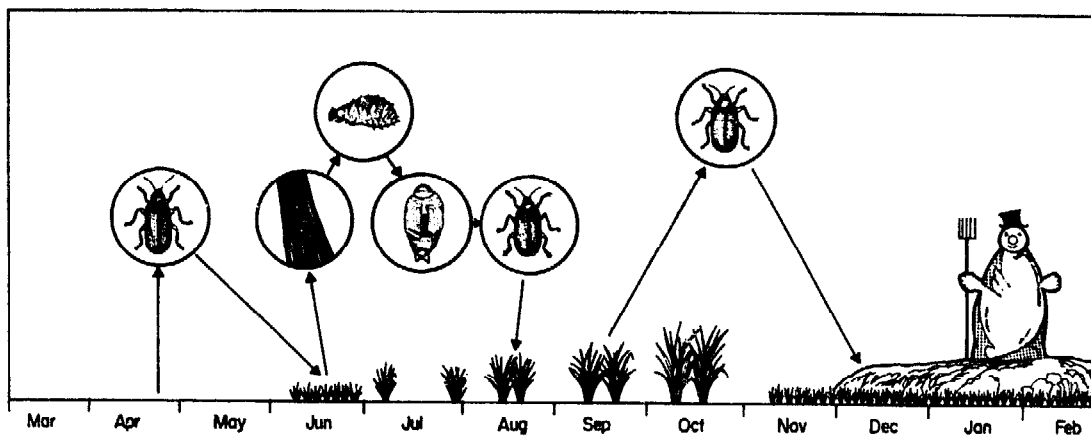

Adults are not attracted to a light trap.

**Egg.** The oval black eggs are laid in masses on the leaf blades.

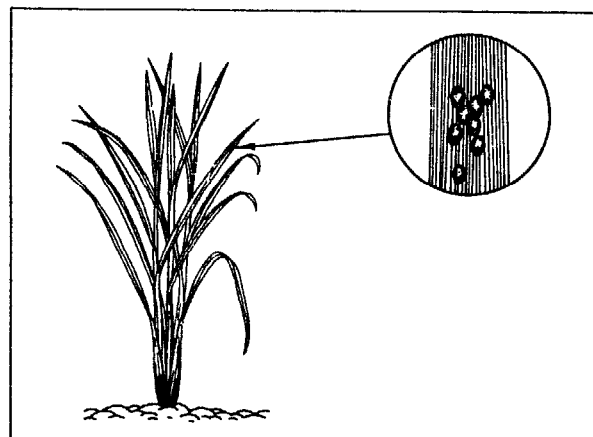
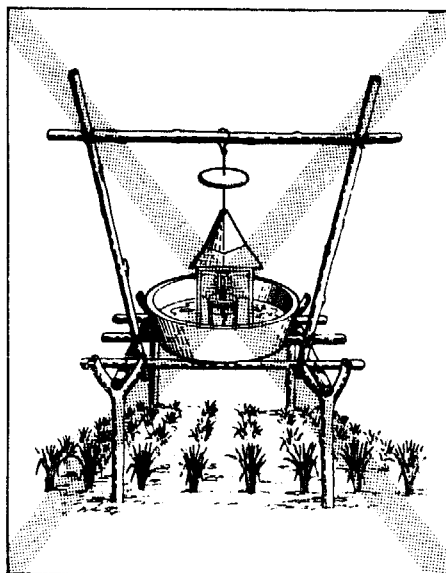

**Larva.** The brown larvae are globular in shape and are covered with their own excreta as camouflage.

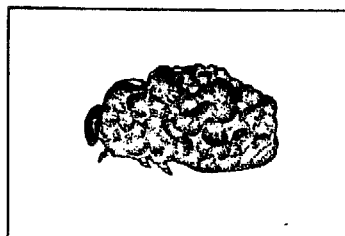
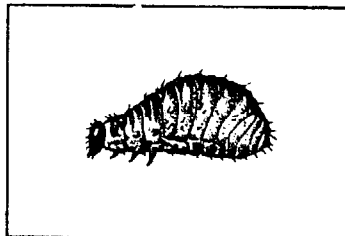

**Pupa.** The larvae spin a white cocoon for pupation. They pupate on the plant in wetland areas and in the soil in dryland areas. The naked pupa is yellow.

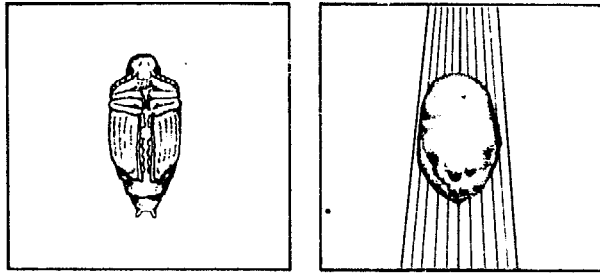

**Damage**

Both the larva and the adult beetle feed on leaves. The larvae skeletonize leaf blades in a linear fashion.

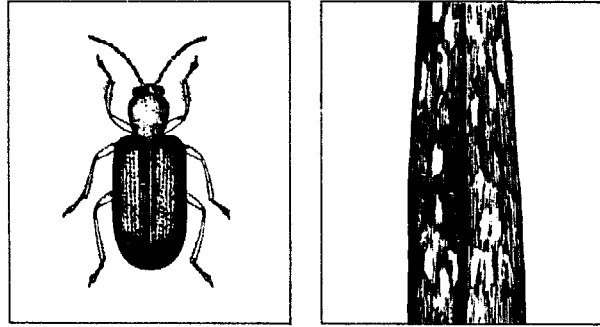

Heavy feeding causes the rice plant to become stunted and reduces tillering.

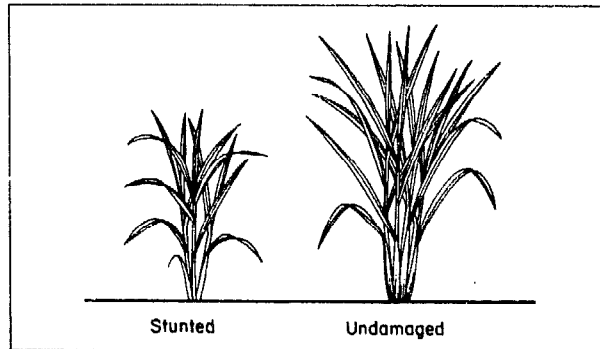

**Plant hosts.** The rice leaf beetle has many alternative hosts in the grass family.

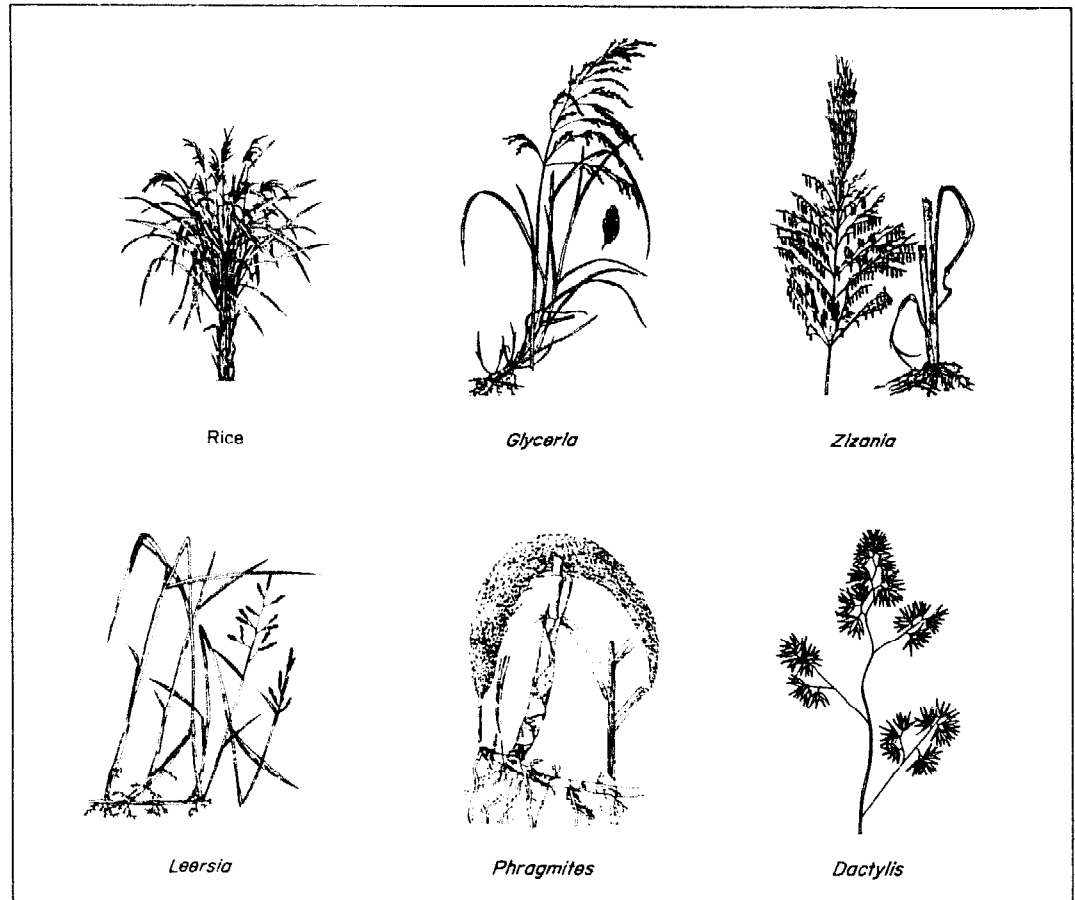

**Management**

*Cultural control.* No practical cultural control methods are known.

*Resistant varieties.* No resistant varieties are available commercially.

*Biological control.* A pteromalid wasp parasitizes the larva and a pentatomid bug preys on both adults and larvae.

**Cultural Control**

**Plant Resistance**

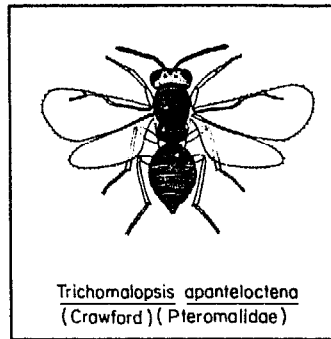

*Trichomalopsis apantelectena*  
(Crawford) (Pteromalidae)

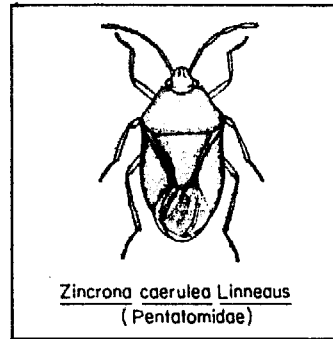

*Zincrona caerulea* Linneaus  
(Pentatomidae)



*Chemical control.*

- *Insecticide application.* Foliar sprays are the most practical chemical control method. Granules are not effective.

- *Scouting.* Fields should be monitored during the vegetative stage. Each week look for adults in the field.

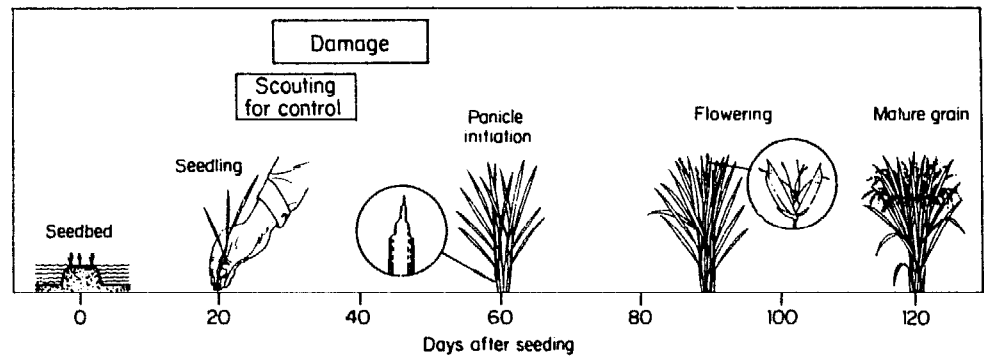

Randomly choose 20 hills to record the number of beetles.

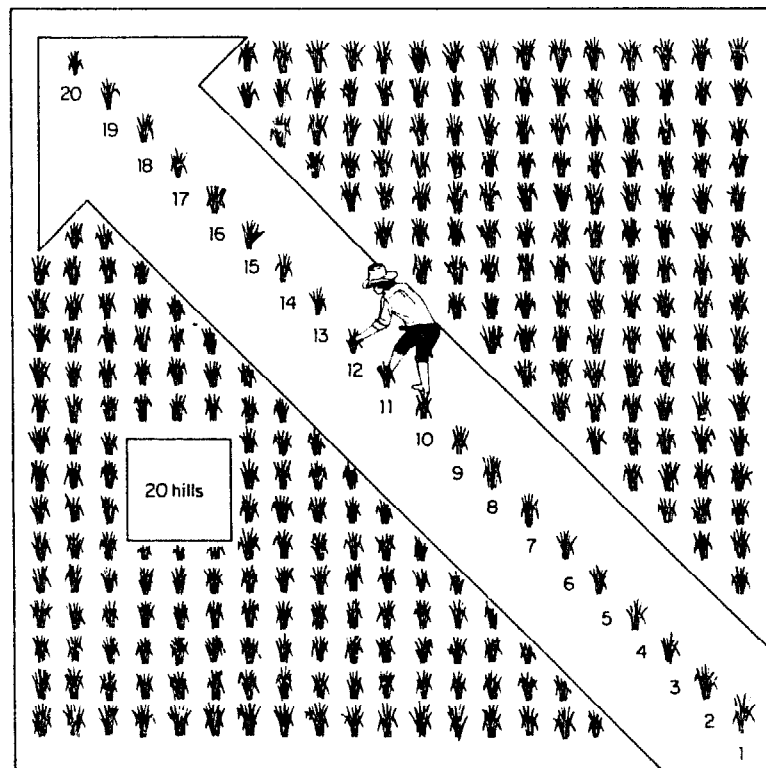

Apply insecticide when the economic threshold is reached.

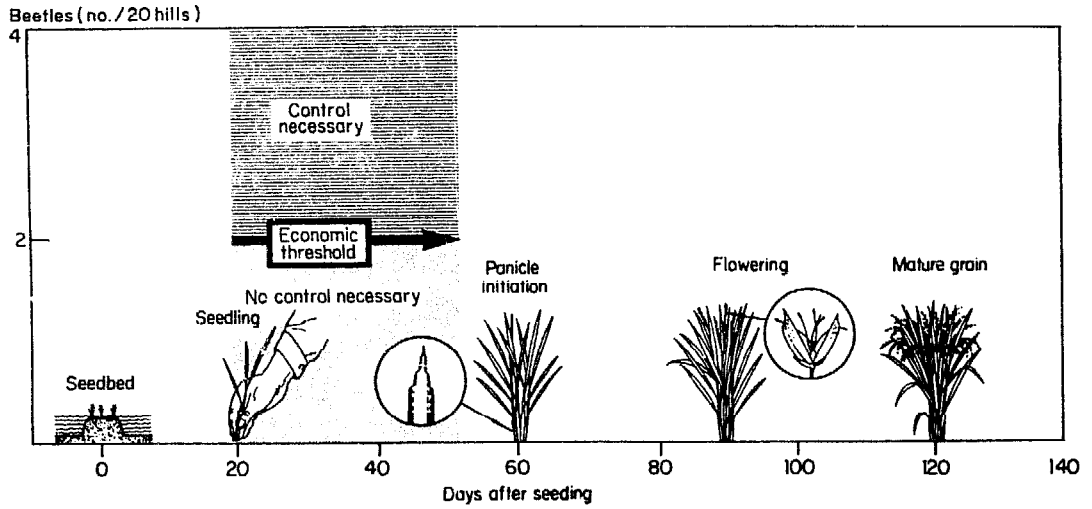

RICE THRIPS (THYSANOPTERA: THIRIPIDAE)

*Stenchaetothrips* (= *Baliothrips* = *Thrips*) *biformis* (= *oryzae*) (Bagnall) is a small insect barely visible to the naked eye. Feeding by adults and nymphs causes leaves to roll along the longitudinal axis to form a protected chamber. Adults are found inside rolled leaves on the upper parts of the plant.

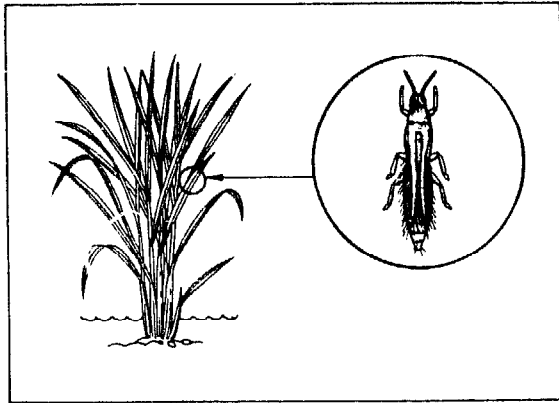

**Pest status**

Thrips outbreaks are normally small in scale and plants can recover from much of the damage. Thrips are controlled with insecticide.

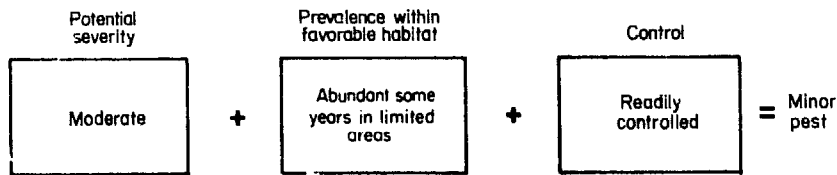

Thrips are present in all rice environments, but they are most abundant during

periods of dry weather. Heavy rainfall washes them off the plants.

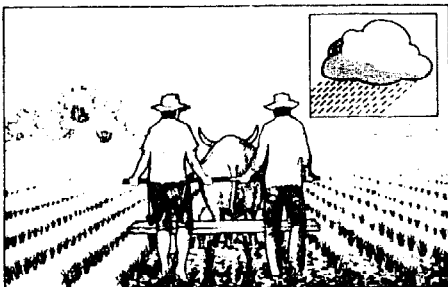

Upland

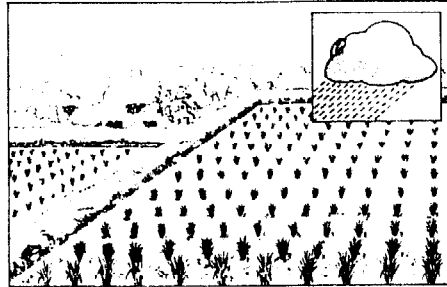

Rainfed wetland

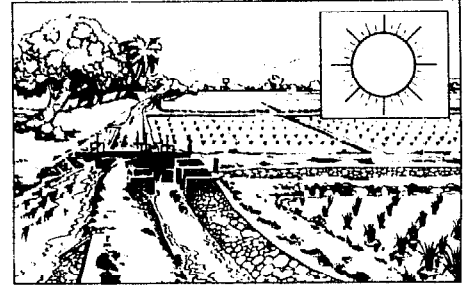

Irrigated wetland

*Distribution in Asia.*

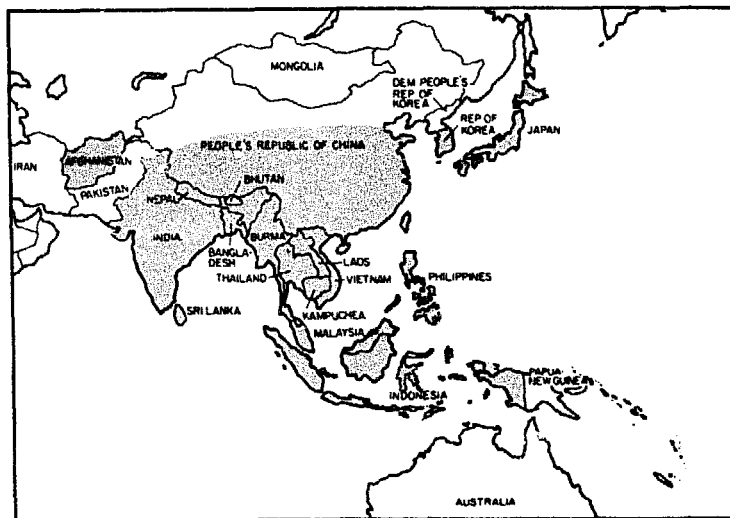

**Development and actual size**  
Thrips have a short life cycle and can multiply rapidly.

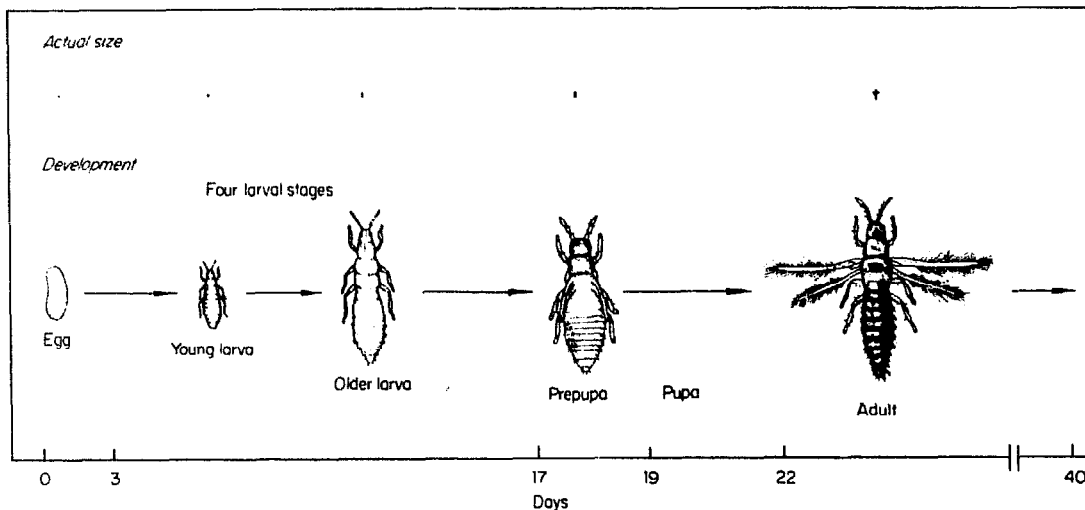

*Adult.* The dark brown adults have narrow, light brown fringed wings that lie along the insects' backs when they are at rest.

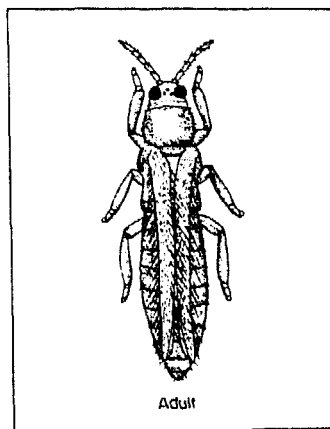

Adults are day-flying insects and are not attracted to a light trap.

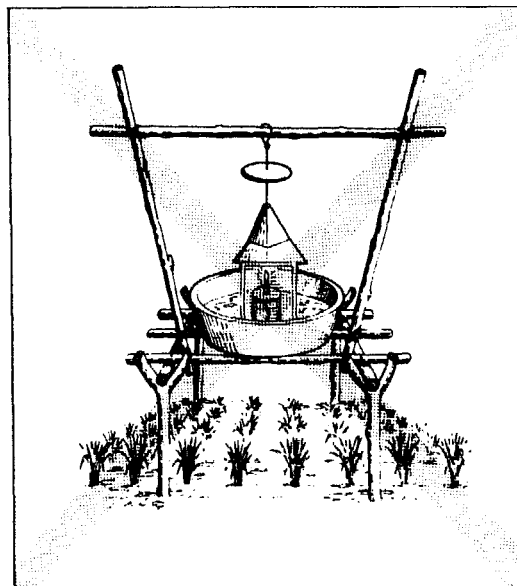

Despite their small size and fragile appearance, thrips can travel long distances. They migrate during the day and seek out newly planted rice fields or other grassy hosts.

**Egg.** Females sometimes produce fertile eggs without mating. A female lays about 25 eggs in a lifetime of 2 weeks.

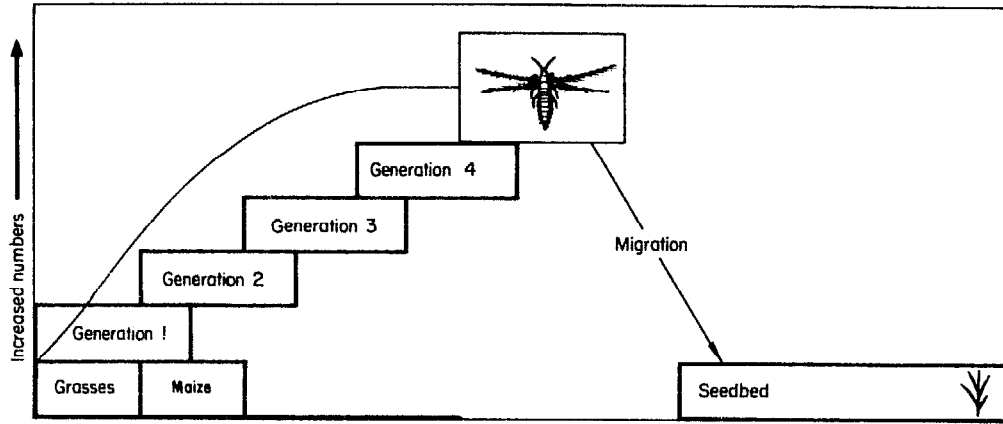

Eggs are laid on the youngest rice leaves on the surface facing the stem. The female cuts the leaf blade tissue with her ovipositor and lays cream-colored eggs singly into the leaf tissue. The upper half of the egg is exposed on the leaf surface.

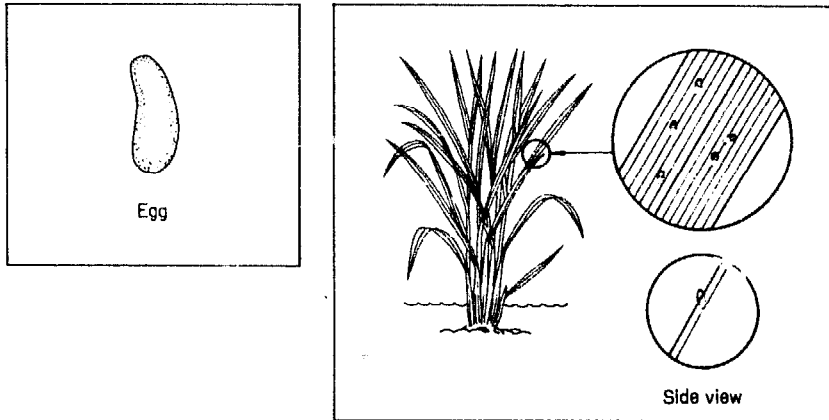

**Larva.** The yellow larvae feed on leaf tissue on the upper part of the plant.

They remain on the same plant in which they hatched.

**Pupa.** When the larva matures, it stops feeding and is transformed into a dark brown prepupa protected in a rolled leaf blade.

The prepupa is then transformed into a pupa, which has long wing pads.

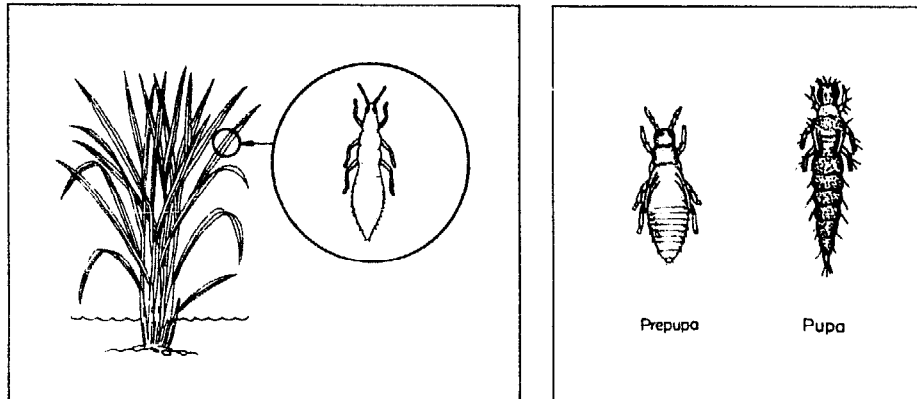

**Damage**

Larvae and adults have rasping mouthparts. They have only one mandible, which is used to puncture leaf tissue. The maxillae and mouth cone, which form a tube, are used to suck leaf sap.

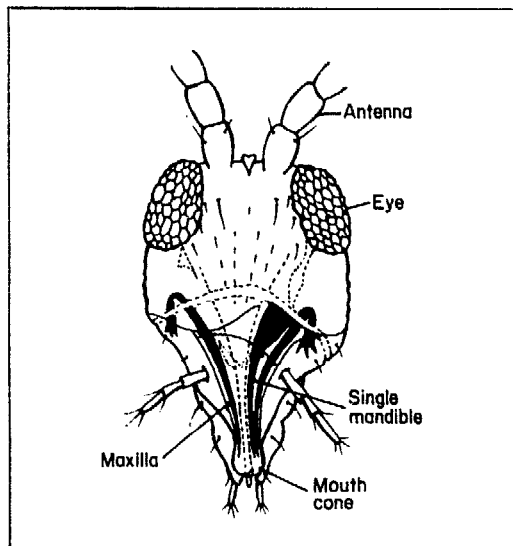

Larvae and adults feed on plant sap from wounds. Adults and nymphs feed extensively on leaf blades. Damaged leaves have silvery streaks; the extensive removal of green leaf tissue causes only a translucent epidermis to remain.

Damaged leaves curl inward longitudinally from the edges, forming a protective chamber for adults and nymphs.

Leaf tips then dry up, particularly when the crop is under drought stress.

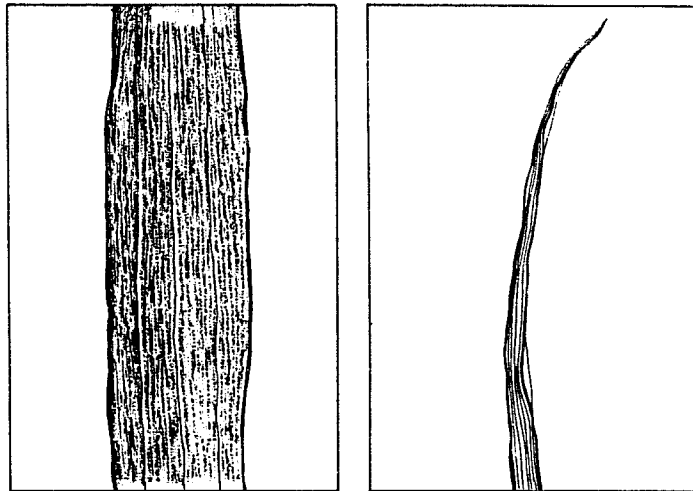

*Plant hosts.*

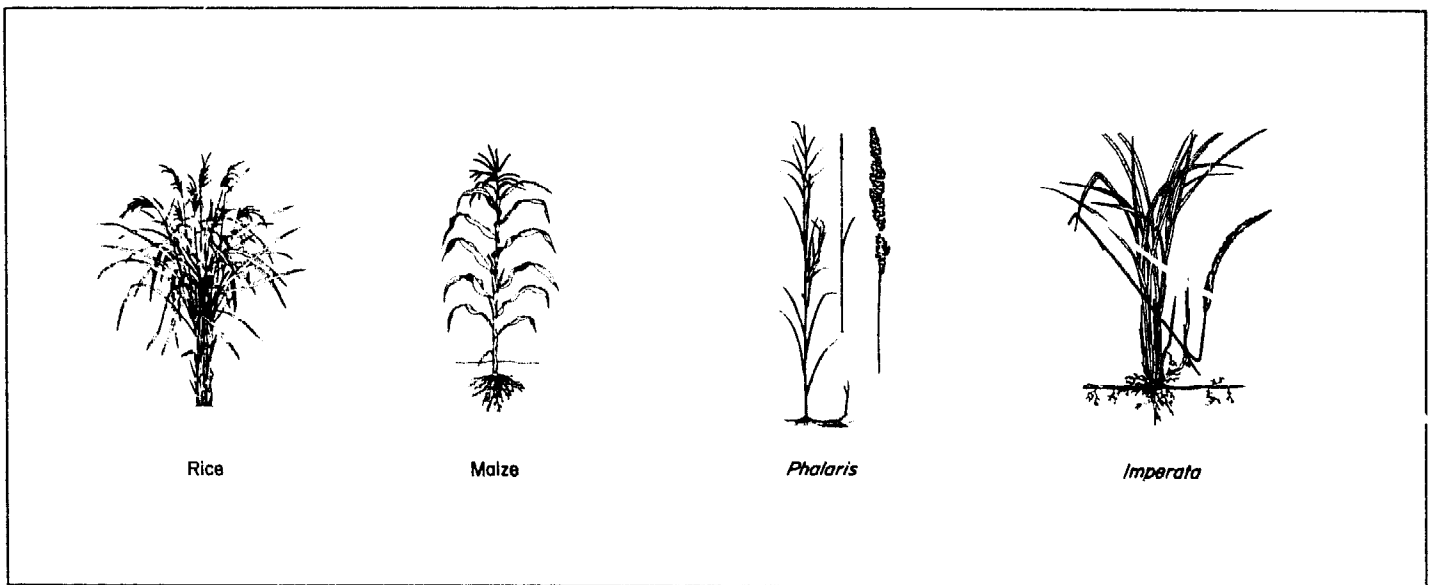

**Management**

*Cultural control.* Flooding the field to submerge plants for 2 days effectively controls thrips.

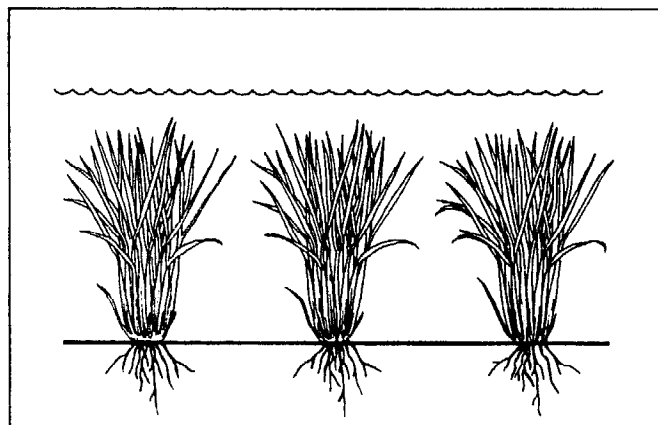

*Resistant varieties.* No resistant varieties are commercially available.

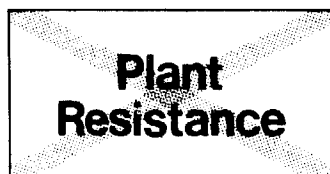

*Biological control.* The effectiveness of parasites, predators, and pathogens against thrips has not been determined.

**Chemical control.**

- **Insecticide application.** Thrips are readily controlled with insecticide. Apply insecticide sprays, dusts, or systemic granules.

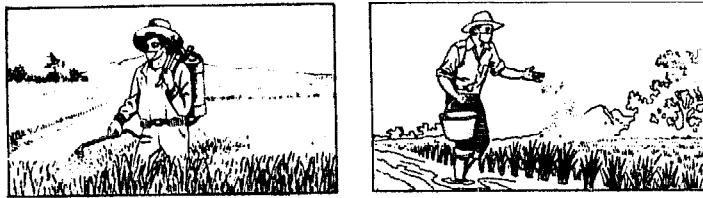

- **Scouting.** Sampling is based on the percentage of leaves showing thrips damage. Visit the field weekly, from the seedbed to panicle initiation.

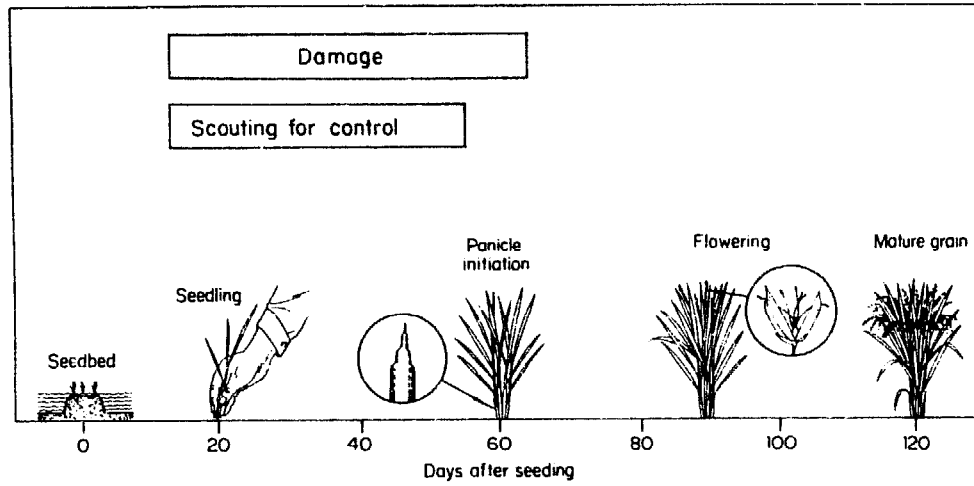

Pick 5 leaves from each of 20 randomly selected hills across the field and record the number of damaged leaves.

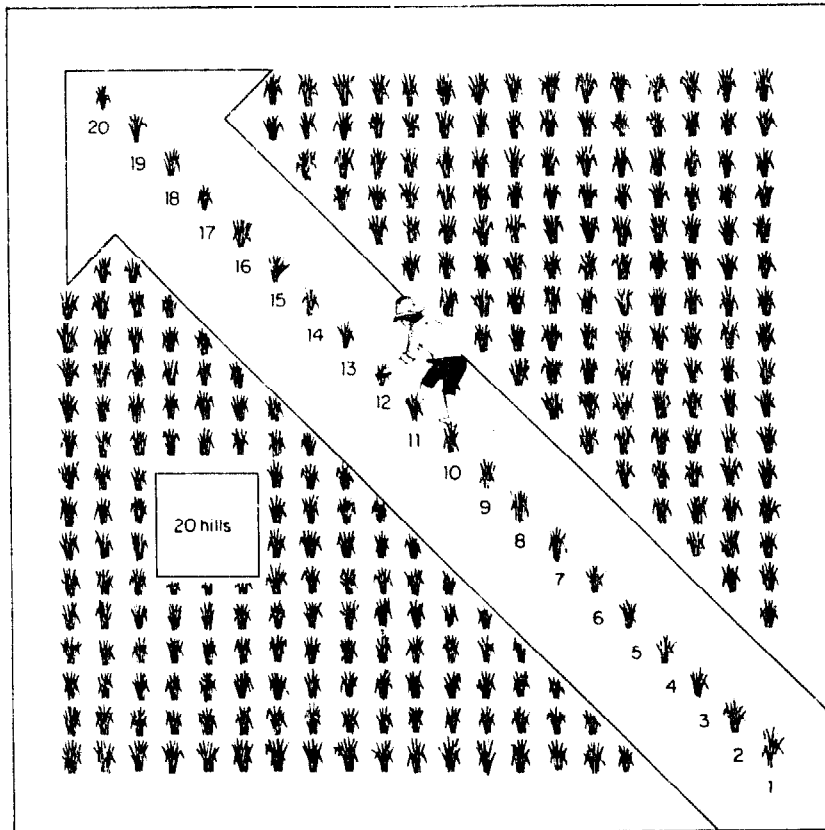



Apply insecticide when the economic threshold is reached.

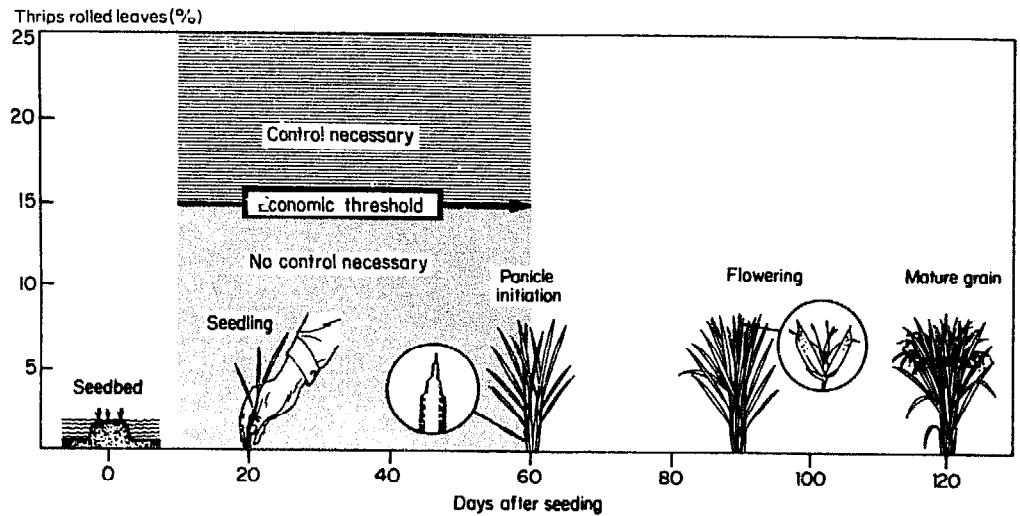

RICE GALL MIDGE (DIPTERA: CECIDOMYIIDAE)

*Orseolia* (= *Pachydiplosis*) *oryzae* (Wood-Mason) is a small fly similar in appearance and size to a gnat or mosquito. The maggot-like larva feeds inside developing tillers, causing their base to swell as galls.

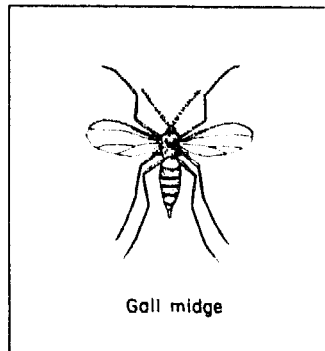

**Pest status**

The gall midge causes high economic loss almost every year in areas where it occurs. Resistant varieties are available, but they are highly location specific because of the many gall midge biotypes.

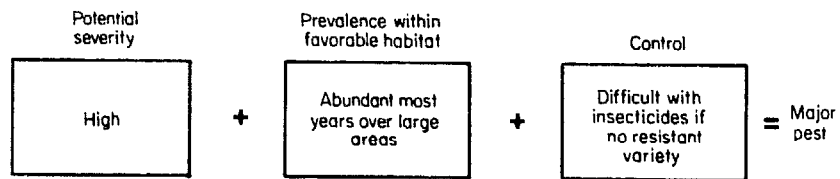

Gall midge becomes highly abundant during the rainy season in irrigated or rainfed wetland environments. It is not a pest in upland rice areas.

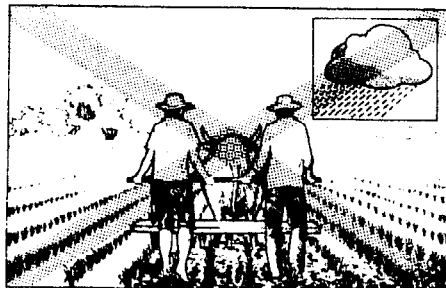

Upland

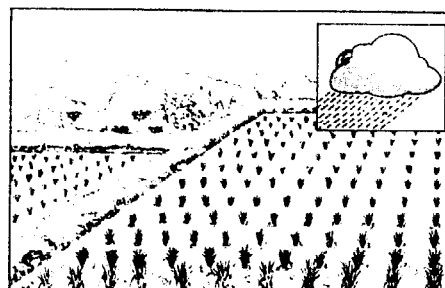

Rainfed wetland

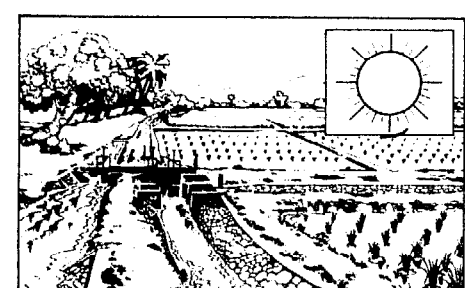

Irrigated wetland

It may also occur in relatively low numbers in the dry season in irrigated areas when fields are continuously flooded.

Gall midge abundance is favored by cloudy or rainy weather.

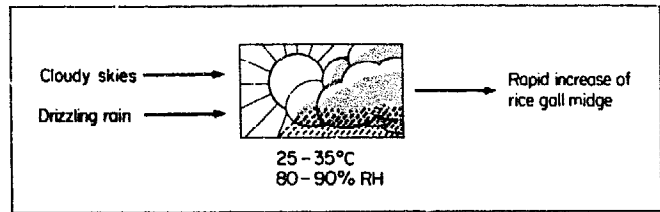
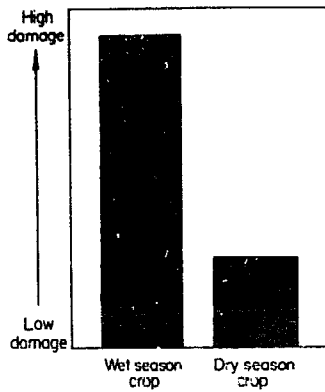

**Distribution in Asia.**

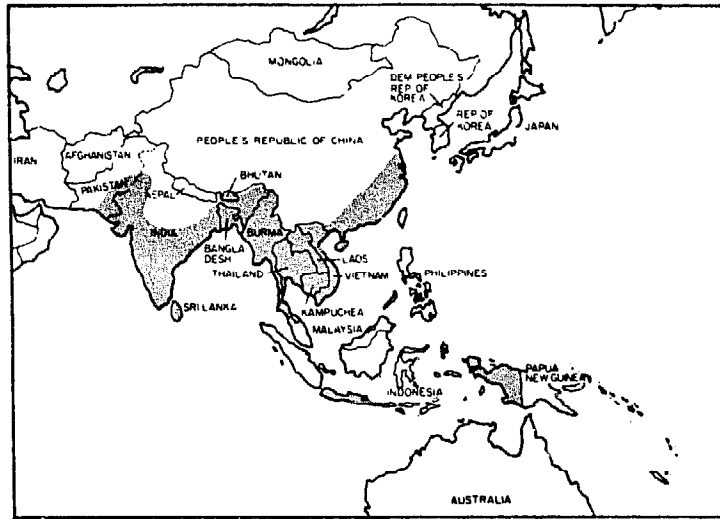

**Development and actual size**

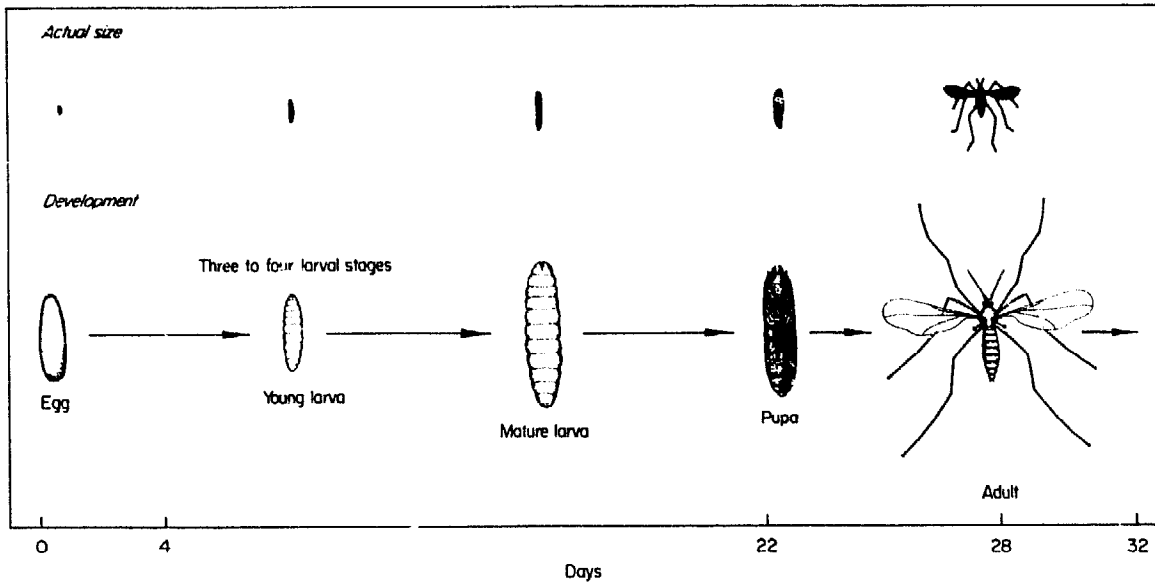

**Adult.** The male has a yellow-brown body and is smaller than the female which has a bright-red abdomen.

Adults are weak fliers and do not migrate, a fact which explains their localized distribution.

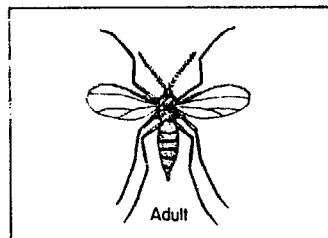

Gall midge adults emerge at the start of the monsoonal rains from wild rice and grass alternative hosts where they complete one to two generations until the rice crop is planted.

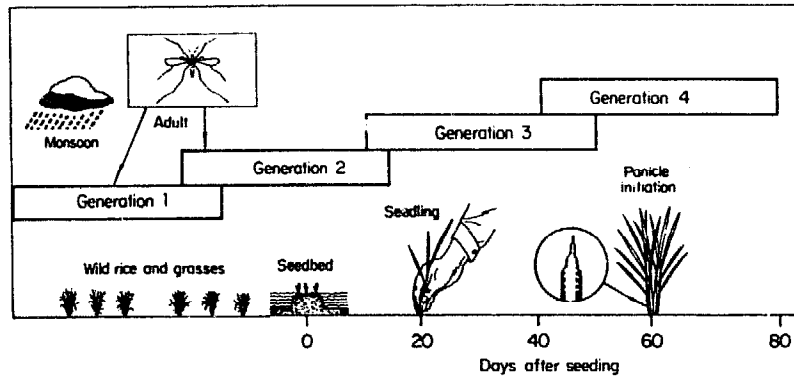

Adults are highly attracted to a light trap. Numbers are highest during a full moon.

Females lay eggs singly or in groups of three to four on the undersurface near the base of leaf blades.

Each female lays several hundred eggs in its lifetime of 4 days.

**Egg.** Newly laid eggs vary in color from white to pink, red, or yellow, but all become shiny amber before hatching.

Eggs require high relative humidity (80-90%) for development and hatching.

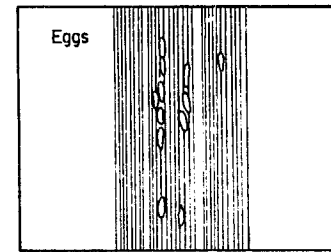
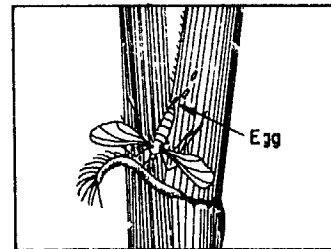
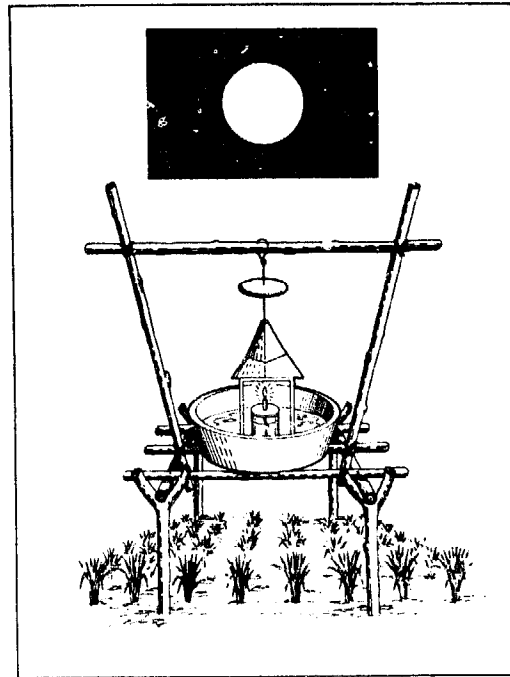

**Larva.** The maggot-like larvae are grey-white after hatching. It takes them about 6 hours to move down the leaf blade on a film of dew. Larvae die if humidity is low for more than 24 hours.

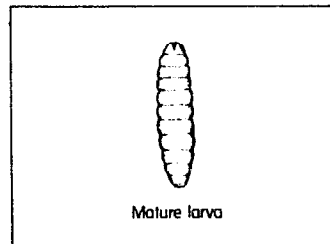

They move between the leaf sheath and the stem until they reach the growing point of the apical or side buds at a node.

The larvae feed inside the developing buds, the zone of differentiation of new tillers.

A hollow chamber, called a gall, forms around the developing larva. The tubular gall enlarges at the base as the larva feeds. It elongates and emerges as an abnormal tiller which is light green.

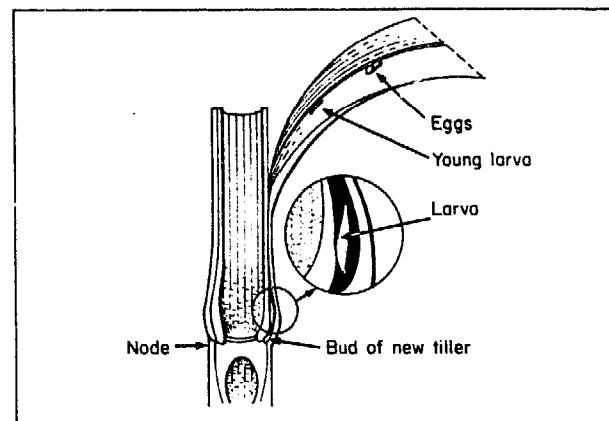

The tubular gall is capped by a solid plug of plant tissue at the base of the point where the leaf forms.

The larvae pupate at the base of the gall.

They remain dormant during the dry season in dormant buds of alternative hosts.

**Pupa.** The pupa is light pink and becomes red before emergence of the adult midge.

The pupa has abdominal spines which it uses to brace itself while wiggling to the top of the gall in preparation for emergence as an adult.

The pupa makes a hole at the top of the gall and

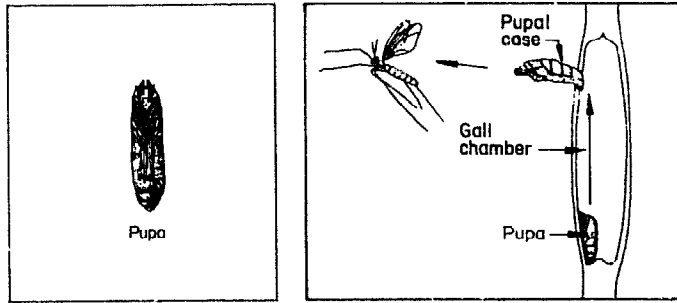

extends its body halfway through it, and the adult emerges.

Adult emergence usually takes place at night.

**Damage**

The gall midge turns the tillers into tubular galls that do not bear panicles.

By the time galls are observed (larger than 3 mm), the larvae have developed and pupated, and adults have emerged.

The galls continue to grow after adults have emerged.

A completely developed gall is a silvery-white hollow tube 1 cm wide and 10-30 cm long. The tubular galls are called onion leaves or silvershoots.

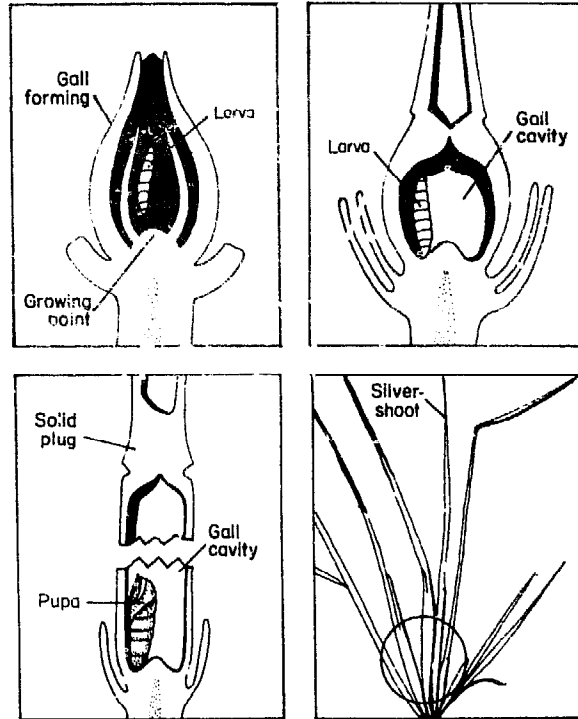

Early infestation causes excessive compensatory tillering, but these new tillers often become infested and few bear panicles.

Information on the mechanism of gall development is lacking. Either the direct feeding or a chemical secretion by the larva stimulates the leaf sheath to grow around the insect into an oval chamber which then develops into the gall.

Galls appear within a week after the larvae enter the growing point.

The gall midge damages rice from the seedbed to the end of the tillering stage.

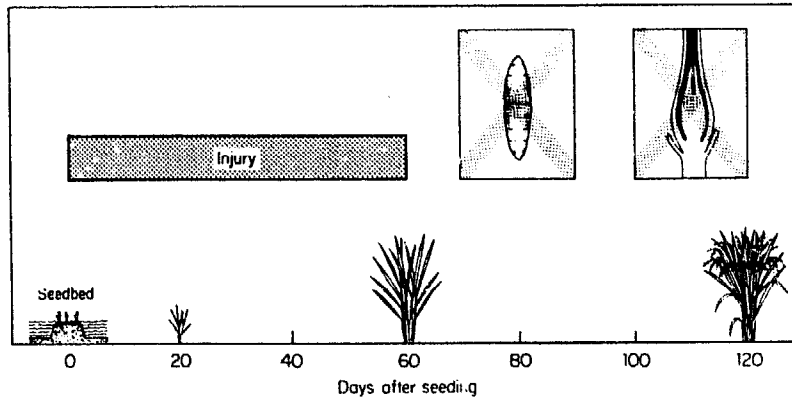

Young larvae cannot survive past the vegetative stage because there are no actively growing buds for them to attack.

Plant hosts. Some grassy weeds can serve as hosts but are less suitable than rice or wild rices.

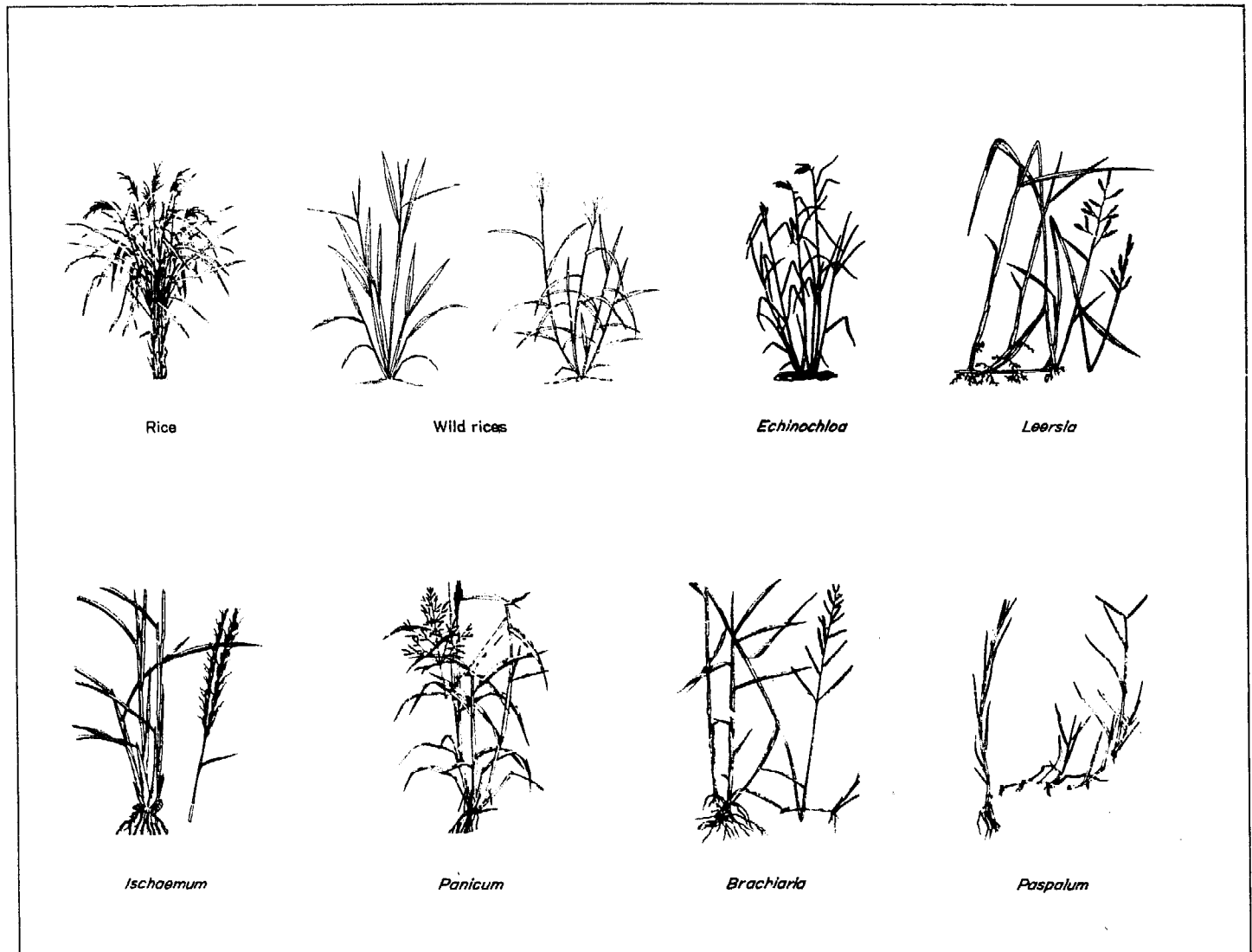

**Management**

**Cultural control.** Control or remove grassy weeds or wild rice alternative hosts from surrounding areas and rice fields.

Plow fields after harvest. Keep fallow land free of off-season plant hosts.

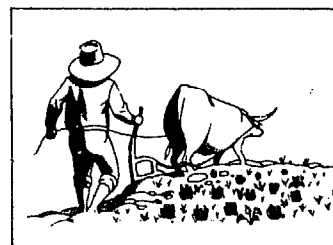

Plants at the vegetative stage are more susceptible to gall midge attack. Delay the wet season planting of photoperiod-sensitive varieties as long as possible after the monsoon begins to reduce the length of the vegetative period.

Plant photoperiod-insensitive varieties as early as possible at the beginning of the wet season to allow the crop to complete the

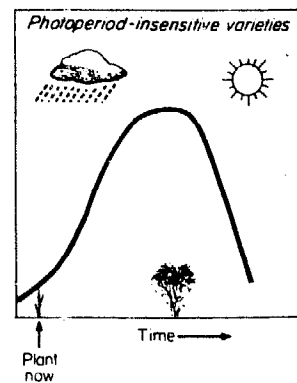
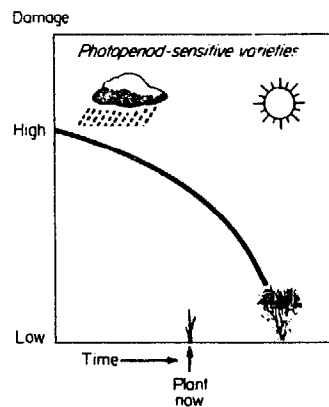

vegetative stage before gall midge populations transfer from alternative hosts.

Avoid staggered ages of fields by planting neighboring fields within 3 weeks in an area.

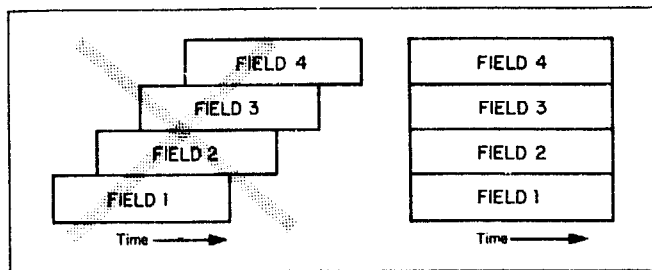

Use only moderate amounts of nitrogen fertilizer and split applications over three growth stages.

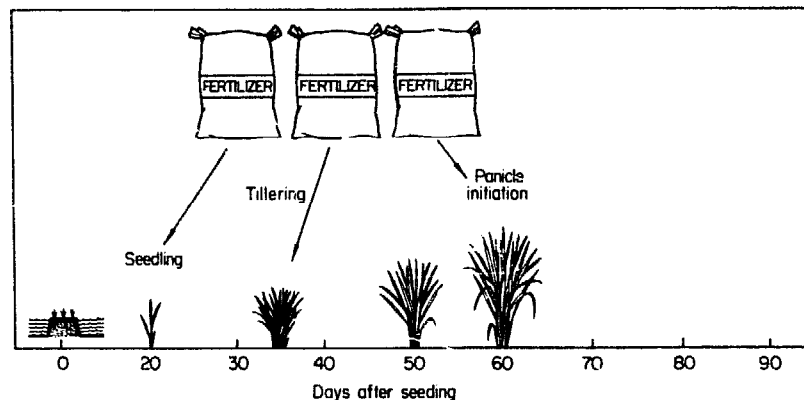

**Resistant varieties.** Planting a resistant variety is the most effective means of preventing gall midge damage.

The gall midge has several biotypes or local populations that damage certain resistant varieties. Therefore, a variety resistant in one country may not be resistant in another. Even within a country, such as India, a variety may be resistant in some areas but susceptible in others.

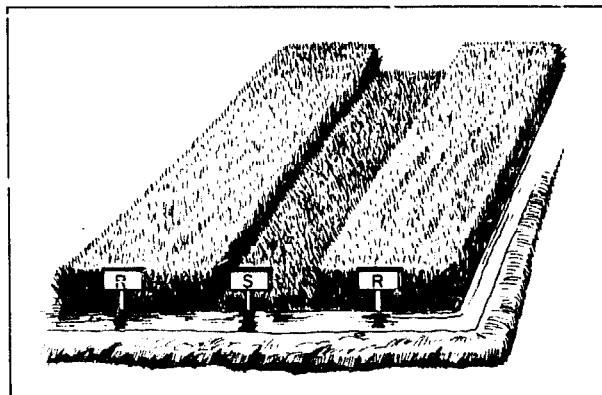

**Biological control.** A predatory phytoseiid mite attacks gall midge eggs. Several platygasterid, eupelmid, and pteromalid wasps parasitize the larvae.

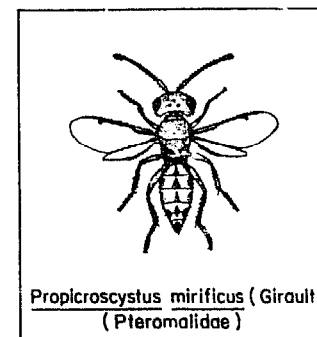
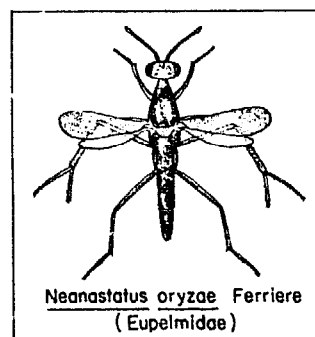
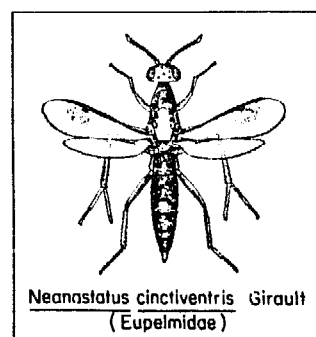
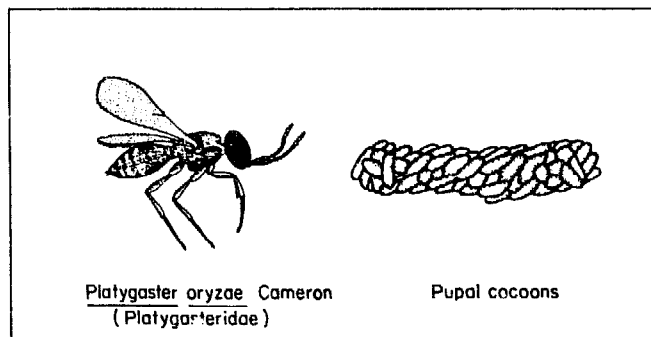
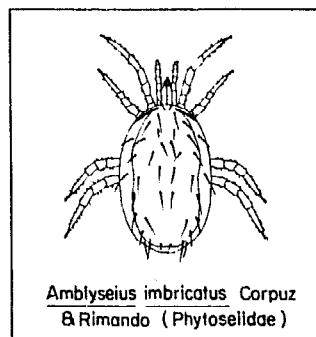

Spiders feed on the adult midges.

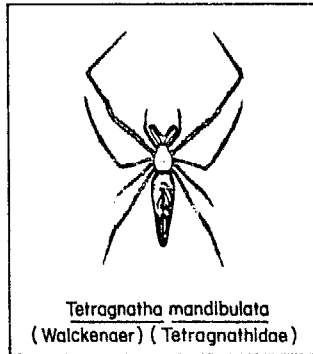

*Tetragnatha mandibulata*  
(Walckenaer) (Tetragnathidae)

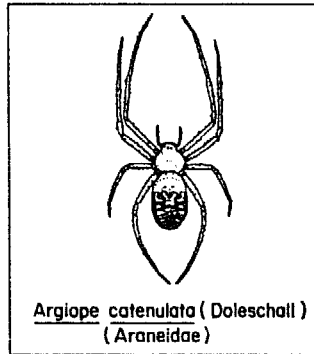

*Argiope catenulata* (Doleschall)  
(Araneidae)

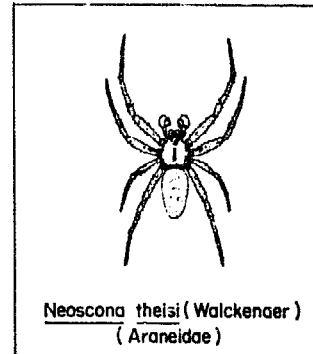

*Neoscona theisi* (Walckenaer)  
(Araneidae)

**Chemical control.**

- **Insecticide application.** It is difficult to control the gall midge with insecticide because the larvae are protected inside the plant or gall.

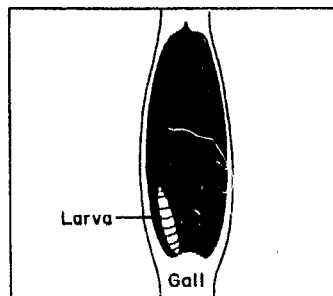

Larva  
Gall

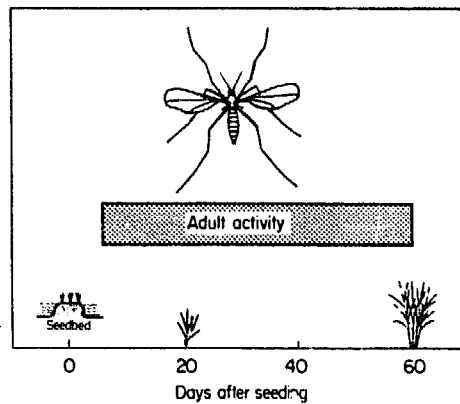

Furthermore, the adults remain active 2-4 months during crop growth.

Granules are usually more effective than sprays for gall midge control, but only if the fields have standing water.



- **Scouting.** Adult activity should be monitored from the seedbed to panicle initiation.

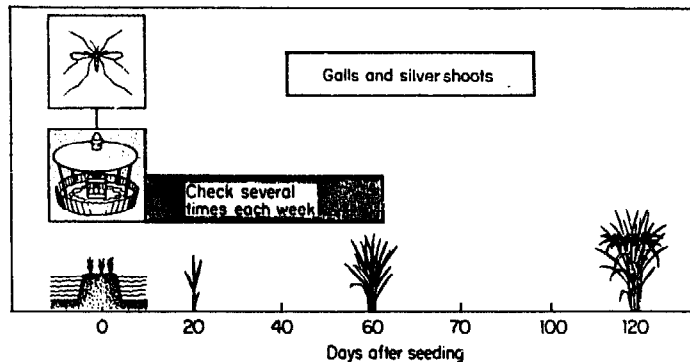

Apply insecticide after the peak periods of adult flight.

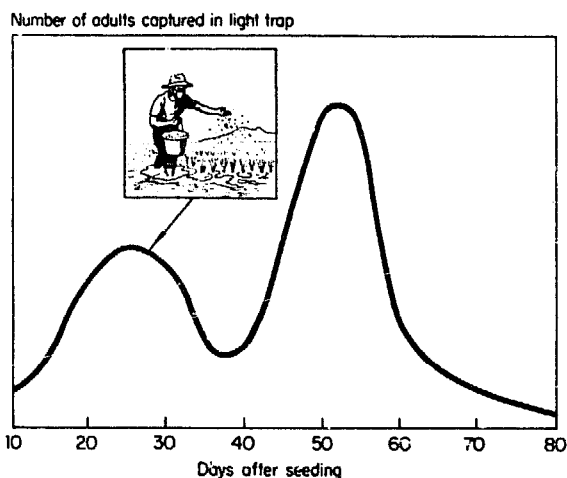

In areas of chronic and severe infestation, preventive applications of systemic granular insecticide in the seedbed or soaking seedlings before transplanting may be warranted.

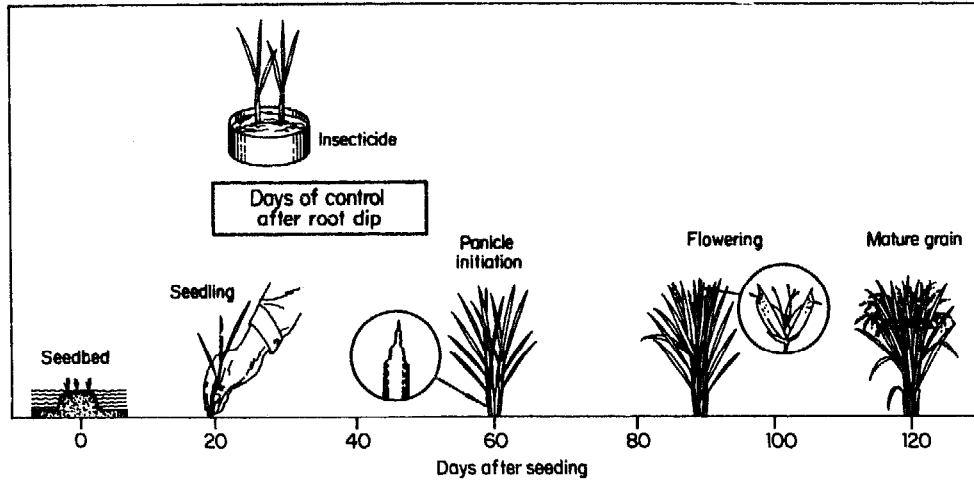

ARMYWORMS AND CUTWORMS (LEPIDOPTERA: NOCTUIDAE)

Many species of armyworms and cutworms attack rice. Their life cycles, damage, and management are similar.

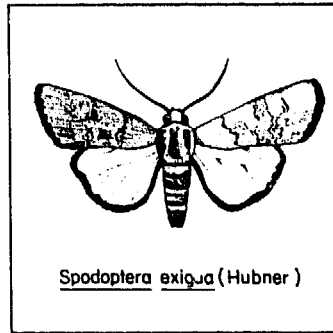
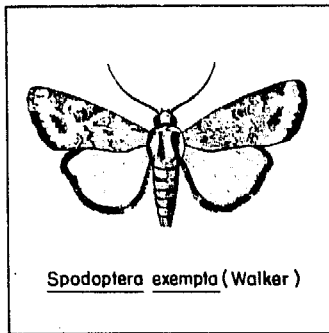

Armyworm larvae can become highly abundant and move in large groups, like an "army" from field to field.

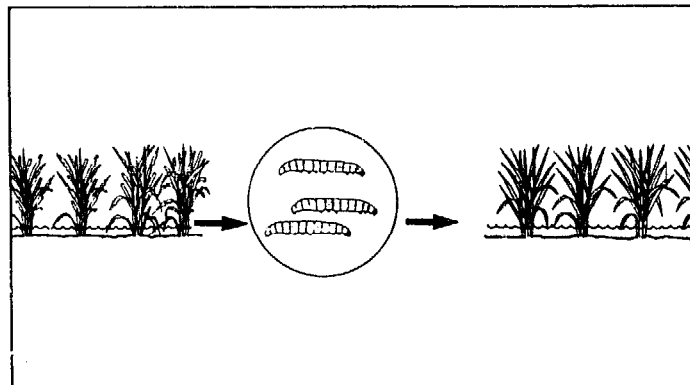

Armyworms and cutworms cut off seedlings at ground level. This behavior gives the cutworms their name.

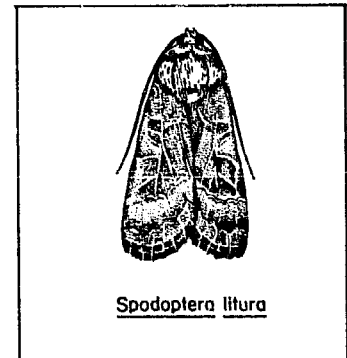
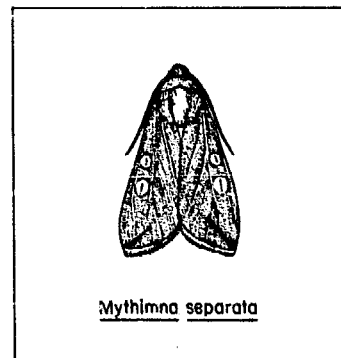

Discussion focuses on three of the most common species: rice ear-cutting caterpillar *Mythimna* (= *Pseudaleitia* = *Leucana* = *Cirphis*) *separata* (= *unipuncta*) (Walker), rice swarming caterpillar *Spodoptera mauritia* (Boisduval), and common cutworm *Spodoptera* (= *Prodenia*) *litura* (Fabricius).



**Pest status**

Amyworm and cutworm populations are highly localized and normally are held below threshold levels by parasites.

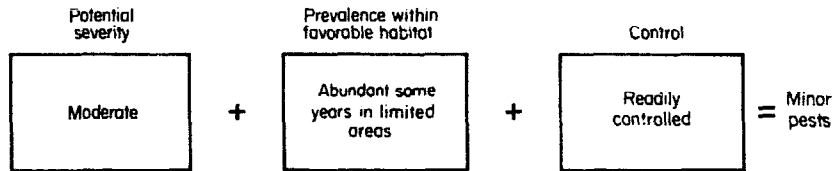

They occur in all rice environments, but are less prevalent in irrigated wetland rice. They are more abundant

in the rainy season because of the increased availability of their alternative hosts, the grassy weeds.

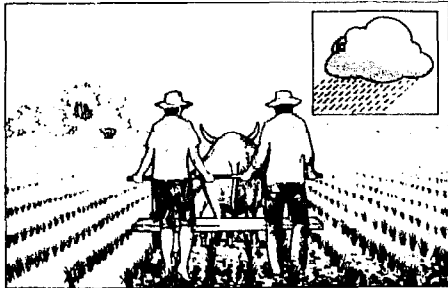

Upland

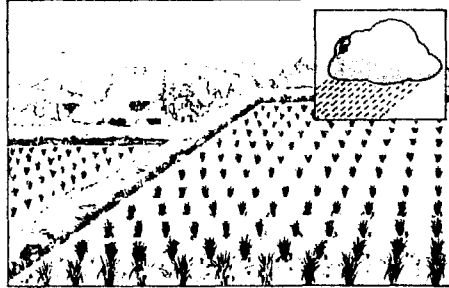

Rainfed wetland

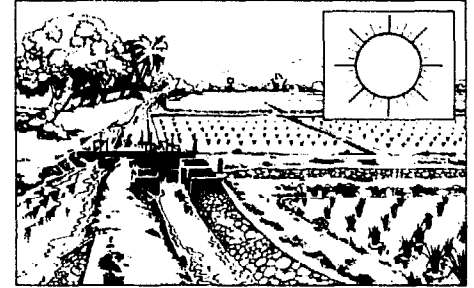

Irrigated wetland

*Distribution in Asia.*

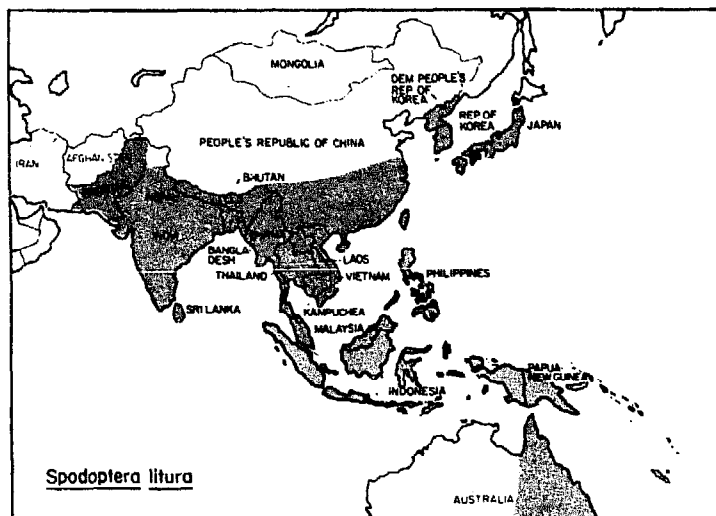
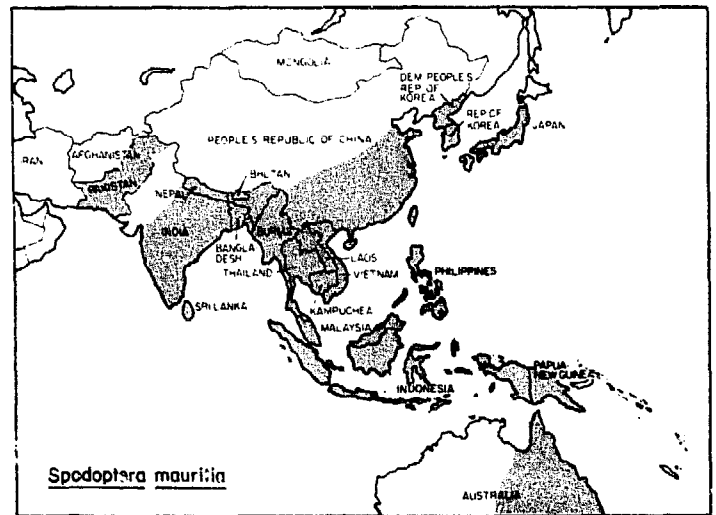
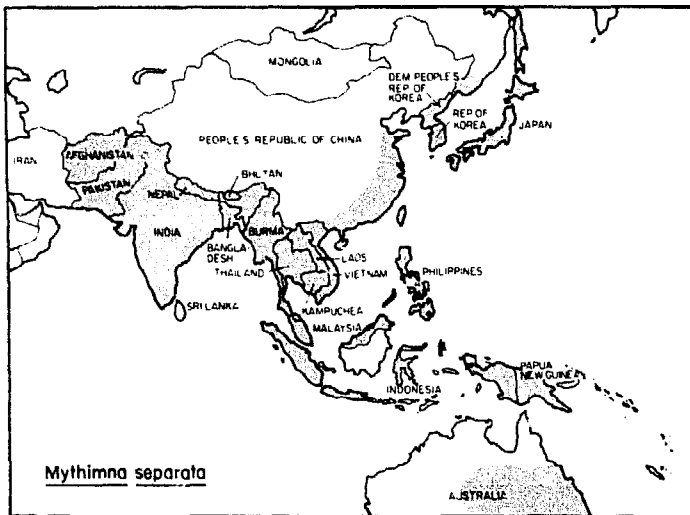

**Development and actual size**  
 The life cycles of armyworms and cutworms are similar.

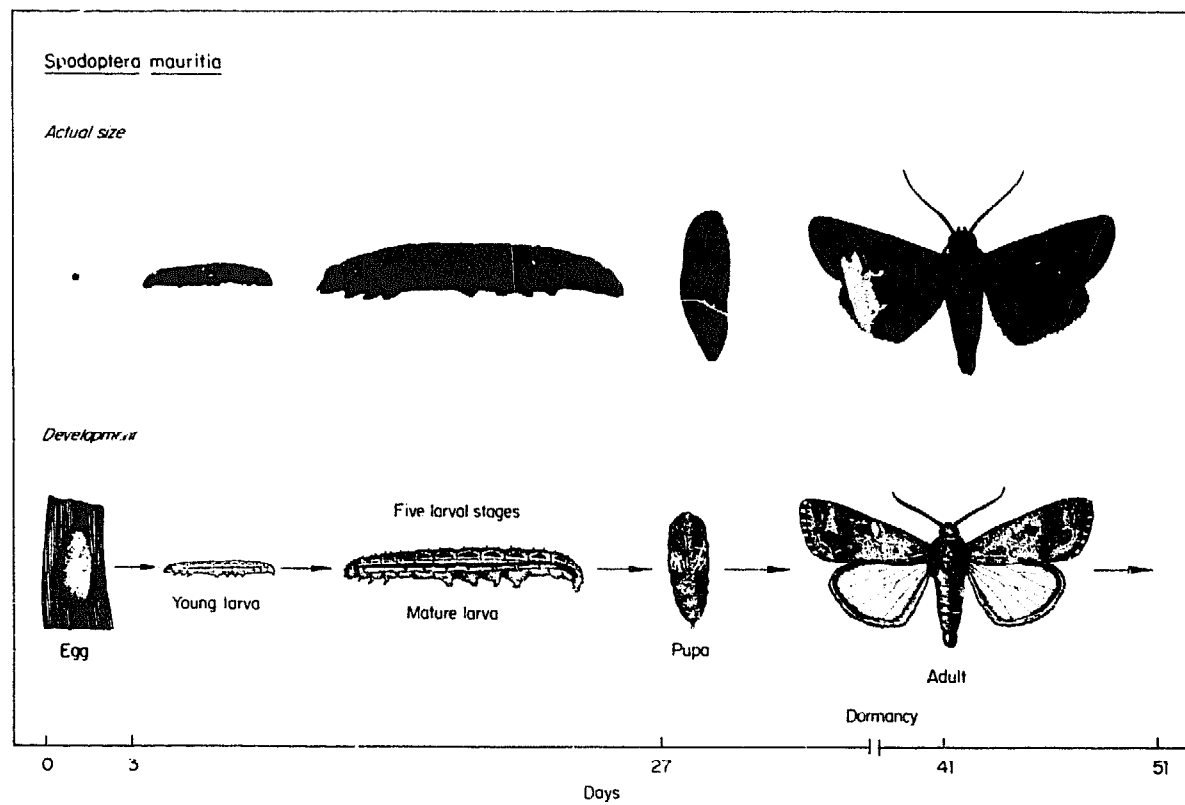
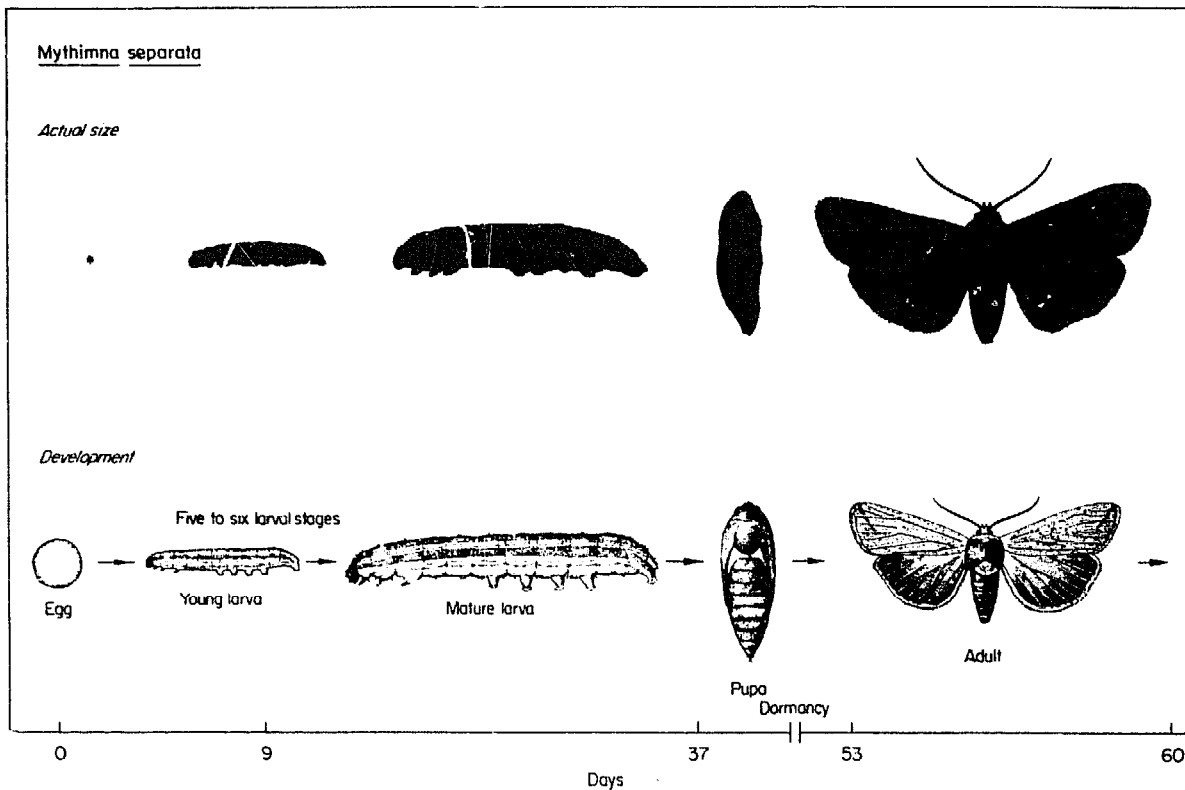

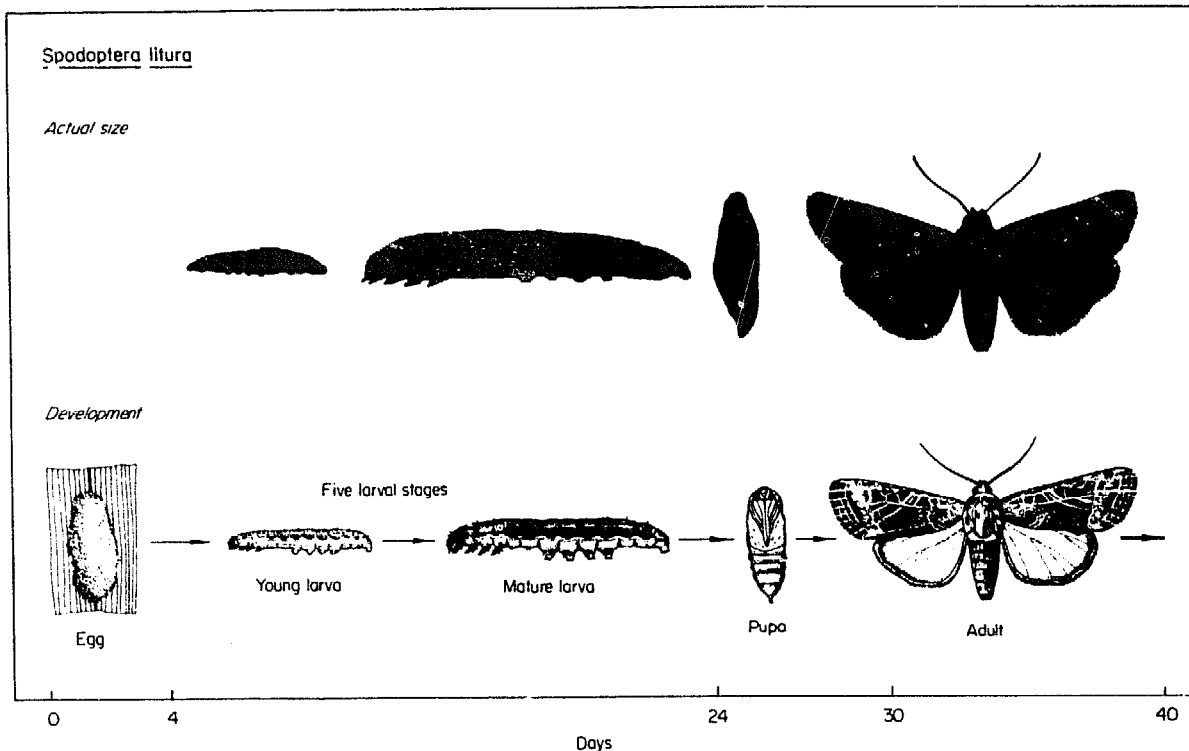

**Adult.** Rice ear-cutting caterpillar moths are pale red brown. The front wings have two pale round spots, and the hind wings are dark on top and white underneath.

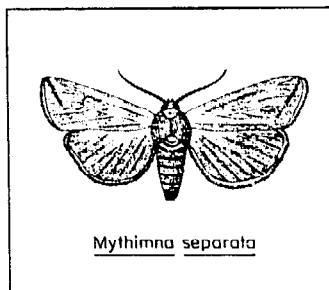

Rice-swarming caterpillar moths are dark brown. The front wings are brown or grey, with dark brown and dark yellow spots and one grey wavy line near the apical margin. The hind wings are white.

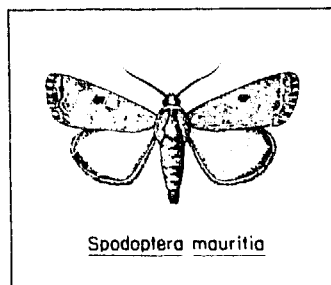

Moths of the common cutworm are dark purple brown. The front wings are a mixture of black spots and white and yellow wavy stripes. The hind wings are white.

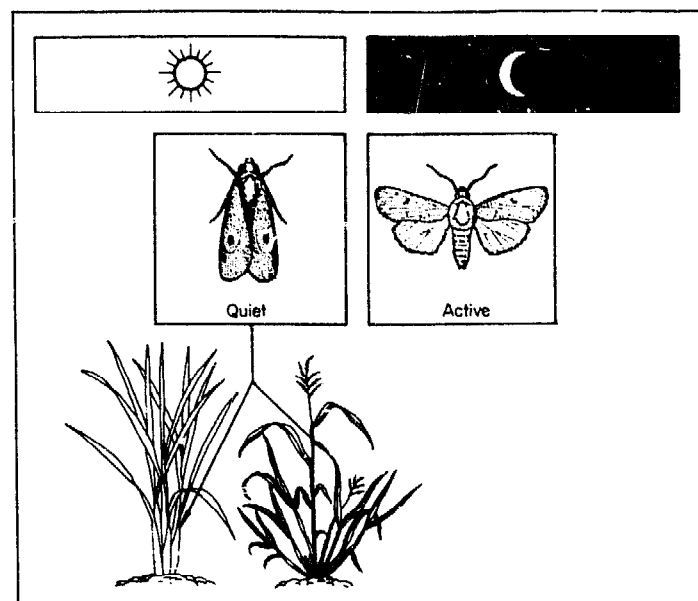
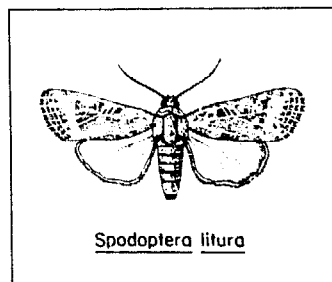

Adults are strong flyers and can migrate tens and even hundreds of kilometers.

They hide during the day at the base of rice plants and grassy weeds.

At night they fly, mate, or lay eggs.

Each female lays 800-1,000 eggs during its lifetime of about one week.

Armyworm and cutworm moths are highly attracted to light traps. Numbers are highest during a new moon.

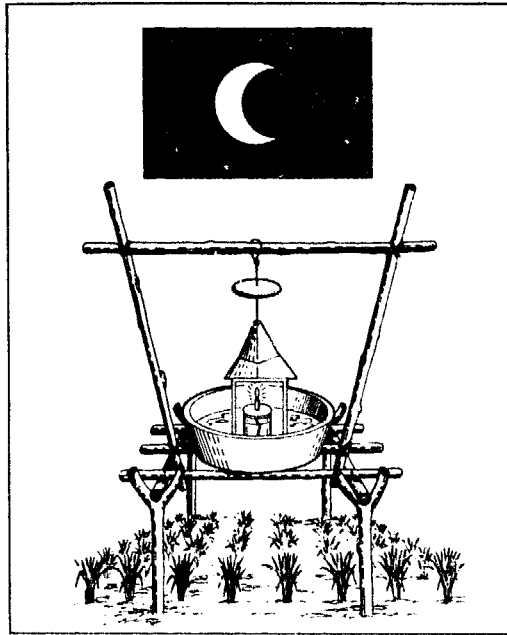

**Egg.** Eggs of armyworms and cutworms are laid in masses of about 100. They are spherical.

Rice ear-cutting caterpillar eggs are cemented between the base of the leaf sheath and stem and are not covered with hair. Eggs turn from green white to yellow as they mature.

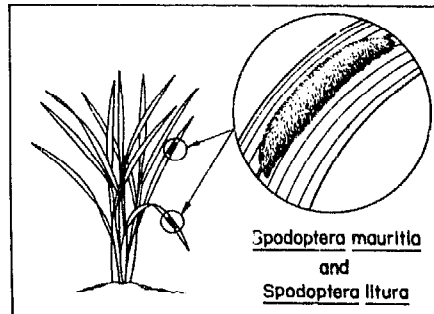
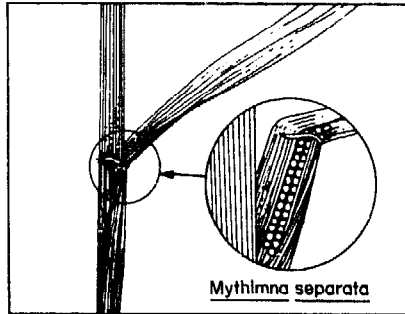

Rice swarming caterpillar and common cutworm eggs are laid on leaf blades and are covered by body hairs

from the female moth. Eggs change from white to yellow as they mature.

**Larva.** The head of the rice ear-cutting larva is orange or brown. Four longitudinal light grey to black stripes run along the green to pink body.

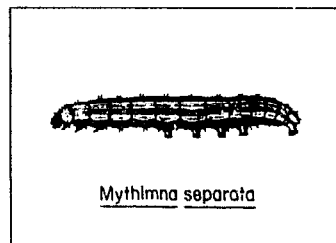

The head of the rice swarming caterpillar is a mottled light brown. Three longitudinal pale brown or red stripes and black crescent-shaped spots lie along the dark green body.

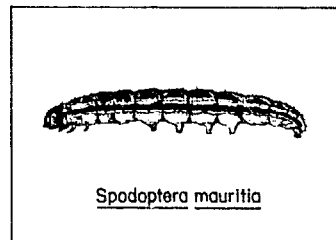

The common cutworm's head is black to dull brown, with a yellow V-shaped marking.

A bright yellow stripe running down the back has pale yellow stripes on each side. Black crescent spots lie next to the stripes.

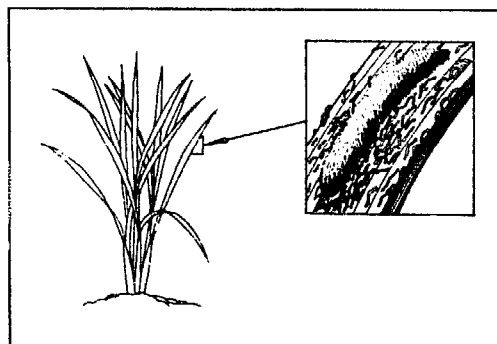
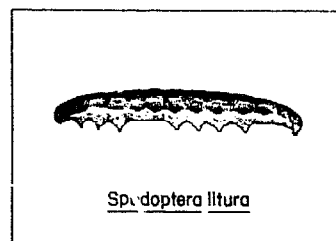

The body is grey to blackish green.

The larvae hatch during the early morning and feed together on the tips of leaves.

During the day the larvae hide on the ground under leaf litter in dryland fields and on plants above the water in wetland fields. The bodies of resting larvae assume the shape of the letter C.

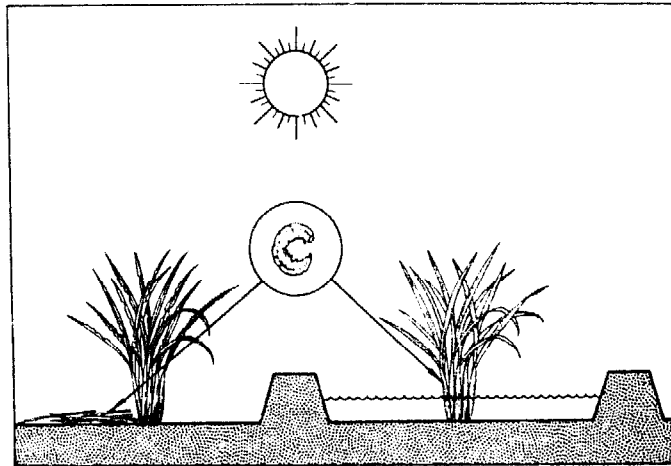

Larvae feed in the upper parts of the rice plant on cloudy days and during the night.

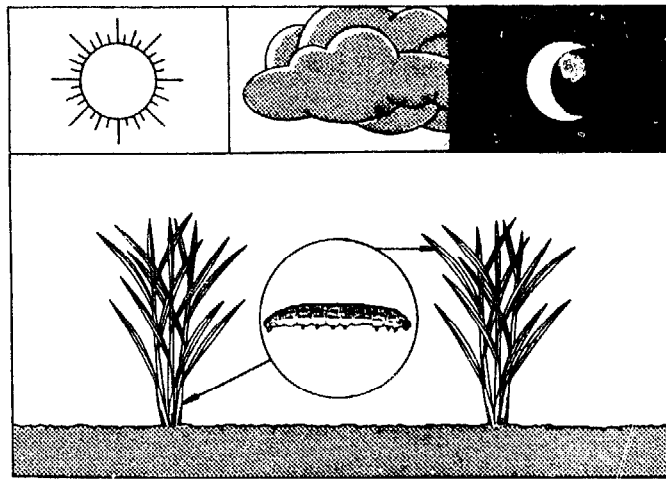

*Pupa.* Armyworms and cutworms prefer to pupate in the soil.

Larvae pupate at the base of the rice plants in dryland fields.

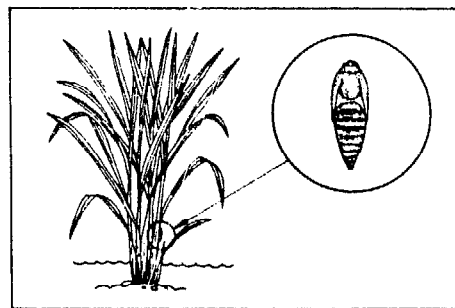
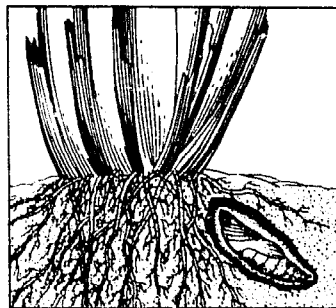

Larvae pupate on the plants in wetland fields or in grassy areas along field borders.

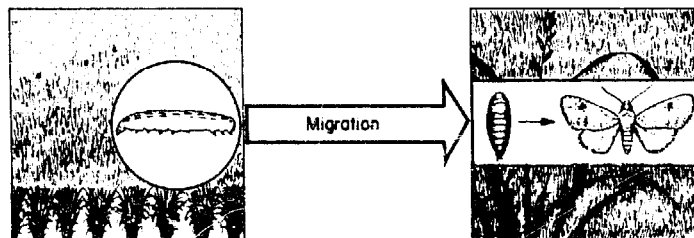
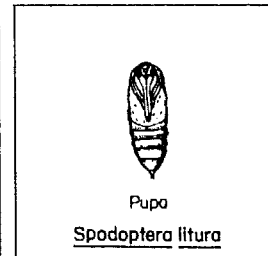
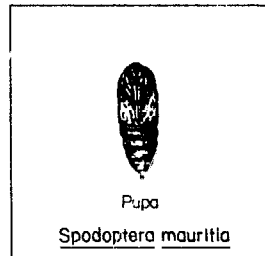

**Damage**

The larval stages of armyworm and cutworm moths feed mainly on leaves. Larvae feeding on leaf blades remove large areas either from leaf tips or along the margins.

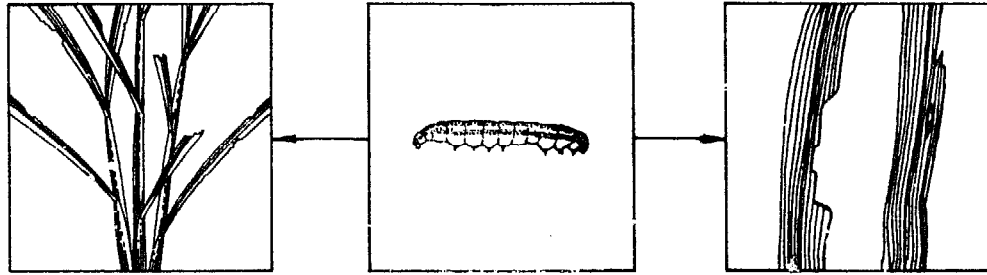

Older larvae can consume much more than younger larvae.

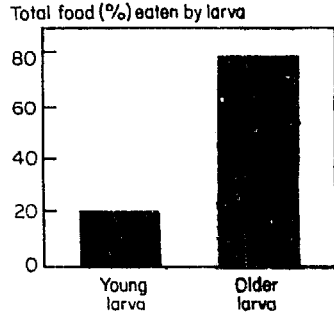

Armyworms and cutworms become active with the coming of monsoonal rains. They produce several generations on grassy weeds and then move to rice seedbeds and fields.

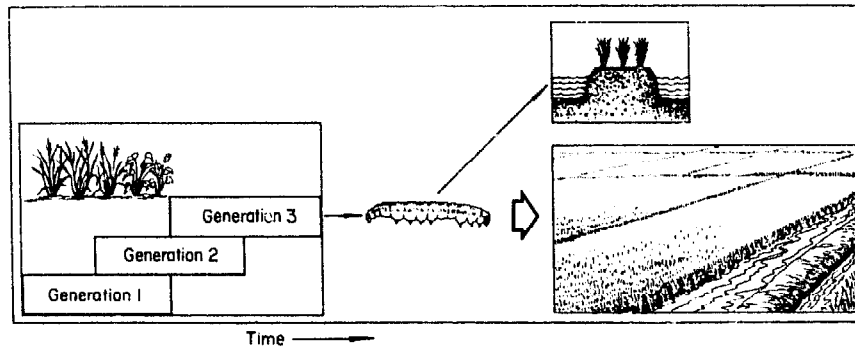

Larvae cut off young seedlings at the base. Rice panicles may be cut by larval feeding.

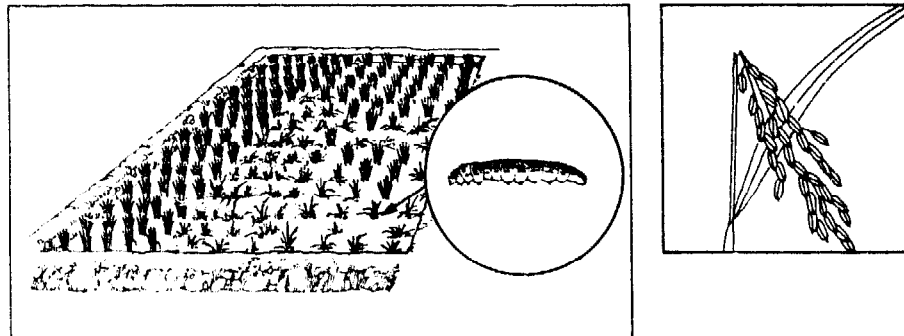

Outbreaks occur after periods of prolonged drought followed by heavy rain. The drought kills natural enemies and floods concentrate the armyworms and cutworms on rice plants.

Weeds and rice grow luxuriantly after a prolonged drought because of the nitrogen mineralization in the soil. Armyworms and cutworms feeding on the naturally fertilized plants produced more offspring. Most of the offspring survives because of the absence of natural enemies.

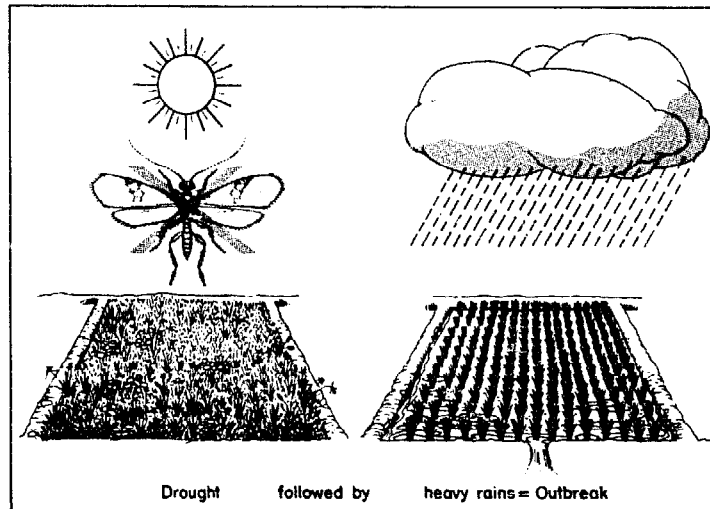

Plant hosts. Armyworms and cutworms have many alternative hosts. Not all are

grasses and no preference is shown for rice.



Rice



Wheat



Oats



Barley



Maize



Sugarcane



Sorghum



Mungbean



Tobacco



Jute



Castor



Sweet potato

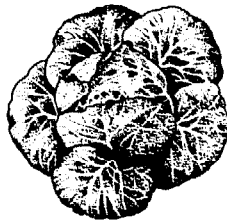

Cabbage



*Echinochloa*

**Management**

*Cultural control.* Establish seedbeds in sites far from large areas of weeds and grasses so that armyworms and cutworms cannot migrate from alternative hosts.

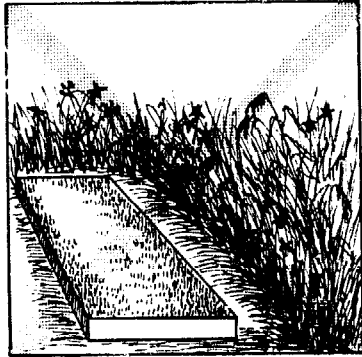

Remove weeds from areas outside of fields.  
Plow all fallow land.

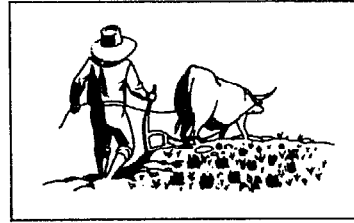
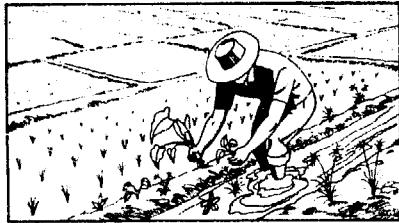

*Resistant varieties.* No resistant varieties are commercially available.

**Plant Resistance**

*Biological control.* Natural enemies play a key role in keeping armyworm and cutworm numbers below economic injury levels.

Eggs are parasitized by scelionid and trichogrammatid wasps.

Larvae are parasitized by braconid, eulophid, and chalcid wasps as well as by tachinid flies.

Ants and wasps also prey on eggs and larvae, and spiders prey on moths.

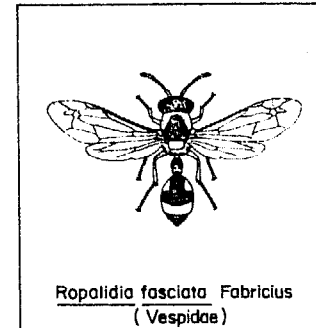
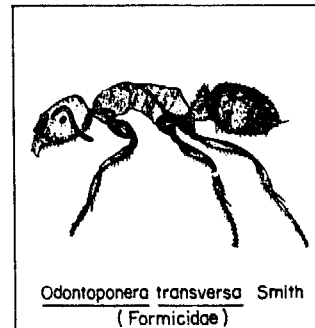
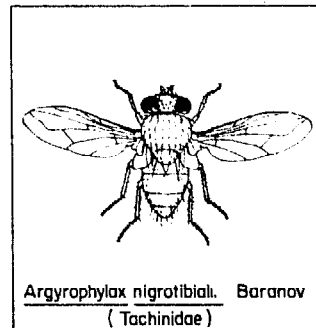
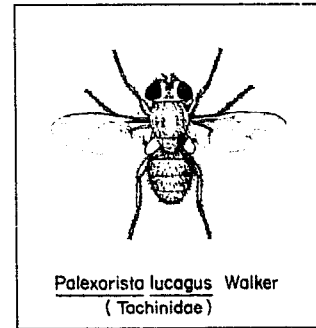
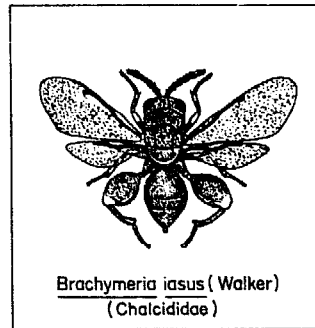
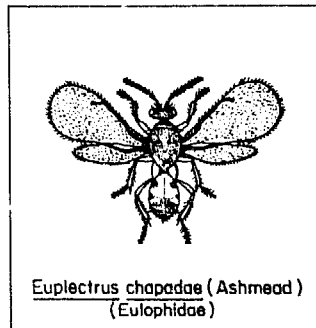
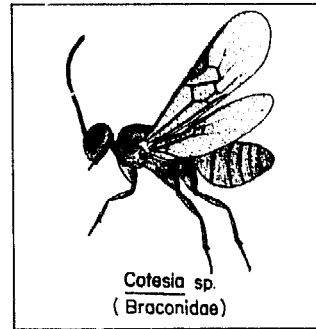
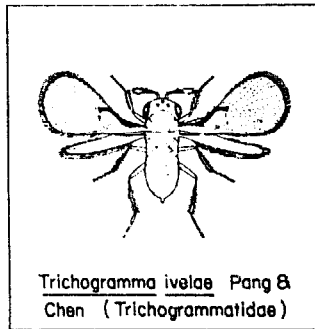
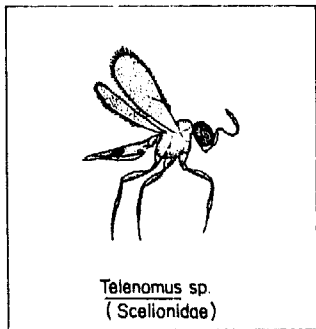



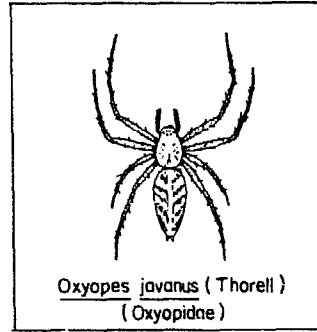
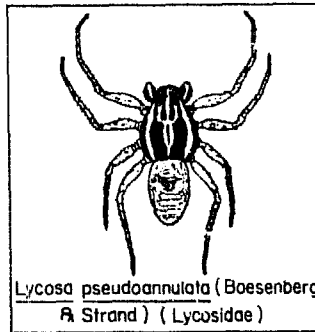

A polyhedrosis virus attacks the larval stage. Dead virus-infected larvae are black and hang limp from the plants.

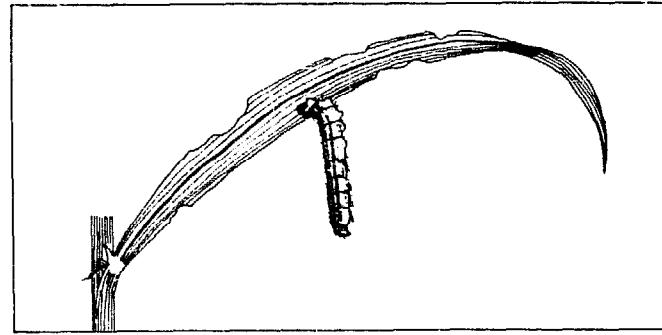

- Chemical control.*
- *Insecticide application.* Sprays are more effective than granules.

High dosages are required to kill large armyworm and cutworm larvae because insecticide toxicity is positively related to insect body weight.

Since insecticide breaks down rapidly in direct sunlight and high temperature, spray late in the afternoon before the



larvae leave their resting places to climb up the plants.

Spray only areas where damage occurs. Normally, damage is concentrated in certain areas of the field.

- *Scouting.* Scout the fields weekly from the seedbed to crop maturity.

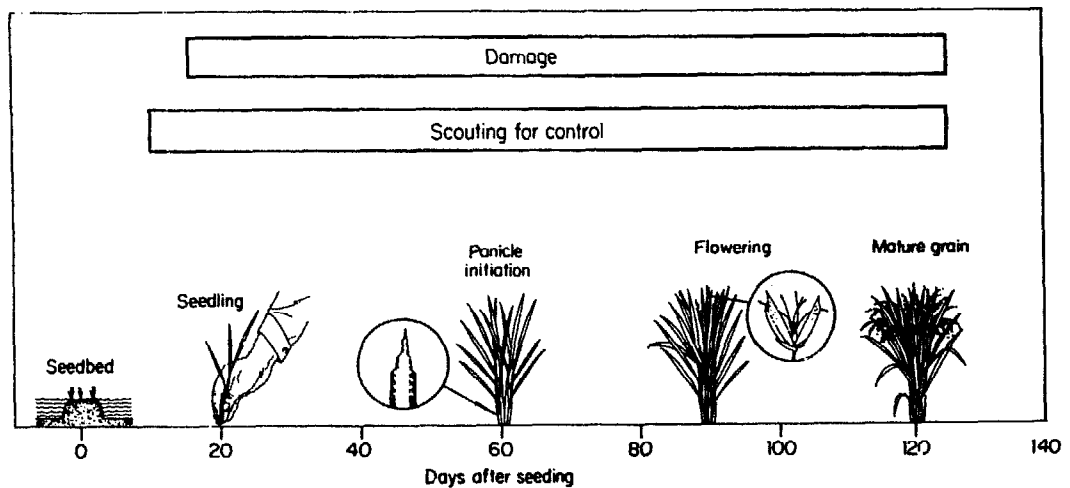

Field sampling is based on plant damage as a percentage of either damaged leaves or cut panicles. Randomly select 5 leaves or panicles in each of 20 hills across the field.

Seeing armyworm or cutworm moths while crossing the field is a warning to scout more frequently.

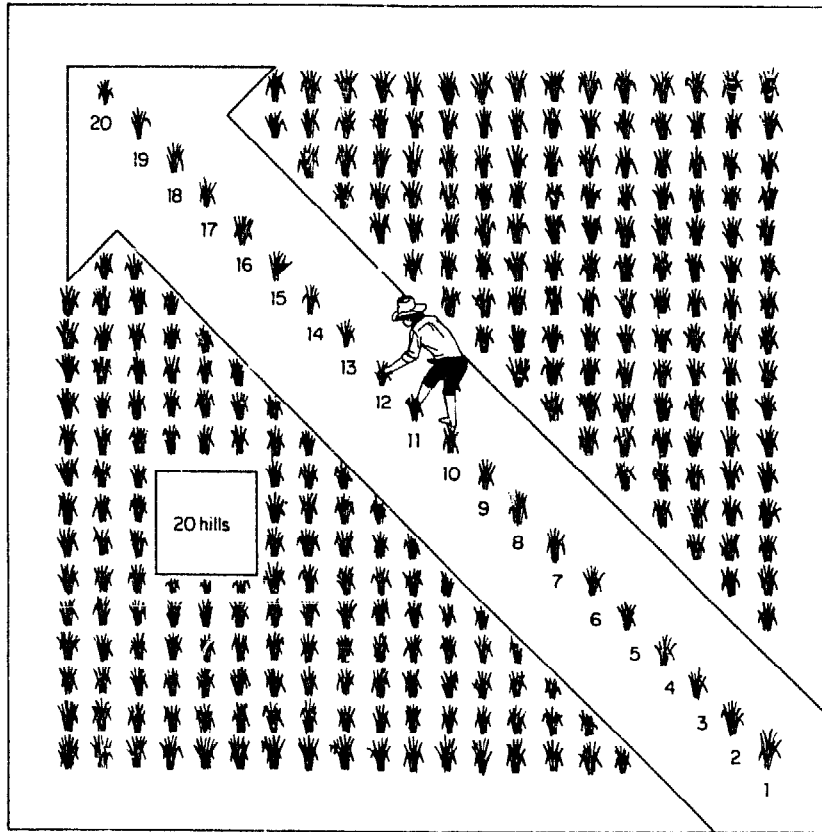

Determine percentage of damaged leaves or cut panicles from armyworm or cutworm feeding. Apply insecticide when the economic threshold is reached.

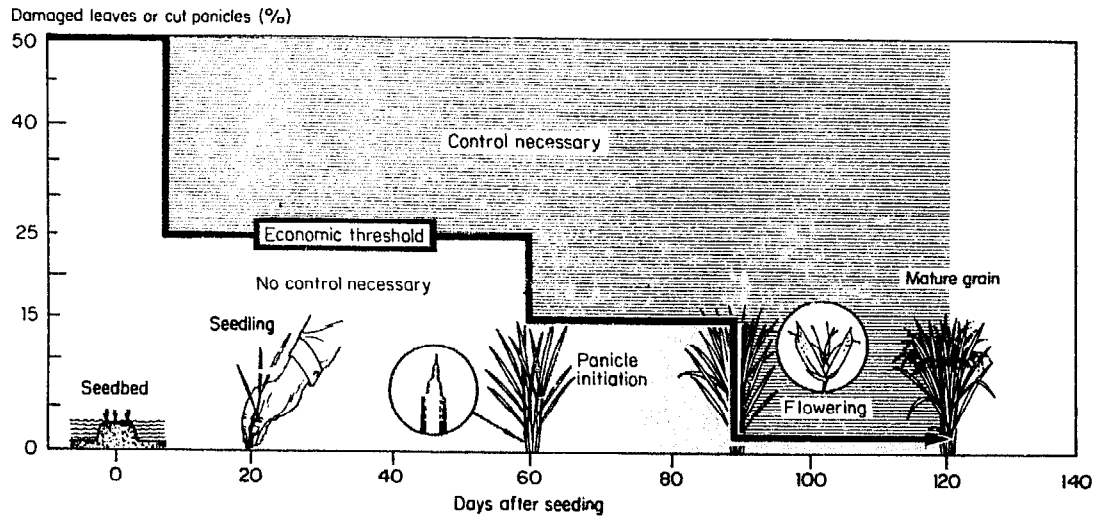

GRASSHOPPERS, KATYDIDS, AND FIELD CRICKETS (ORTHOPTERA)

Grasshoppers are adapted to grasslands because they feed on a wide array of grasses. Their hind legs are enlarged, giving the insects the ability to hop away for a quick escape.

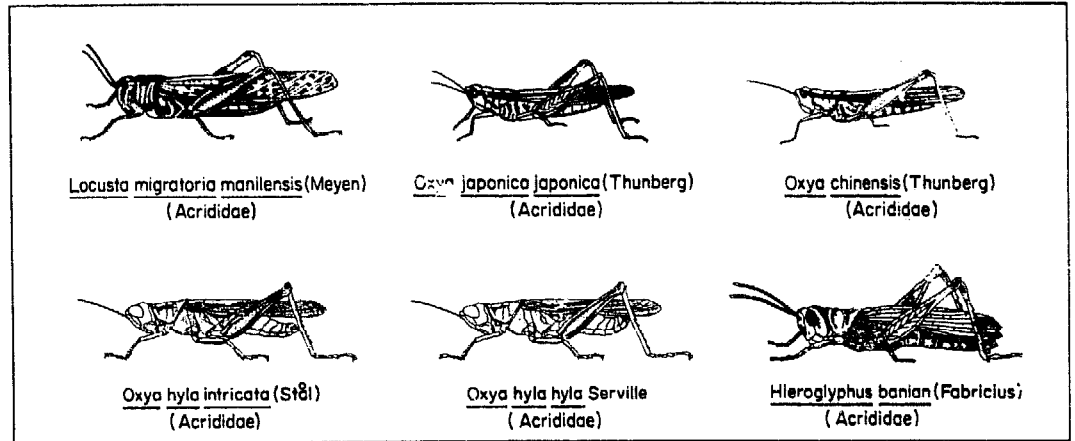

Some grasshopper species migrate in swarms and are called locusts.

Meadow grasshoppers (katydids) can be distinguished from other grasshoppers by the long thread-like antennae, elongated ovipositor of the female, and 4-segmented tarsi.

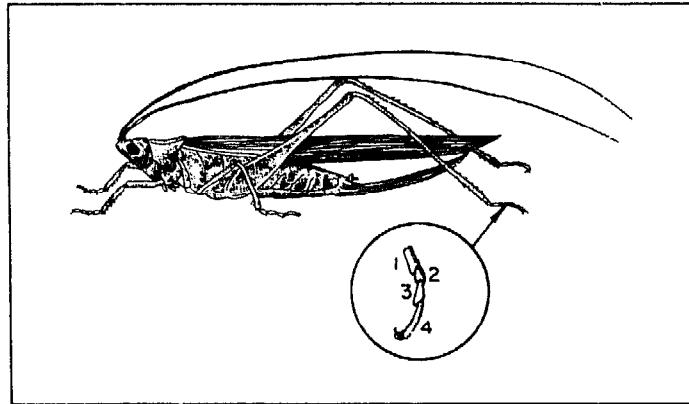

Acridid grasshoppers have antennae shorter than their body length.

Rice fields are habitats for many grasshopper species whose nymphs and adults defoliate plants.

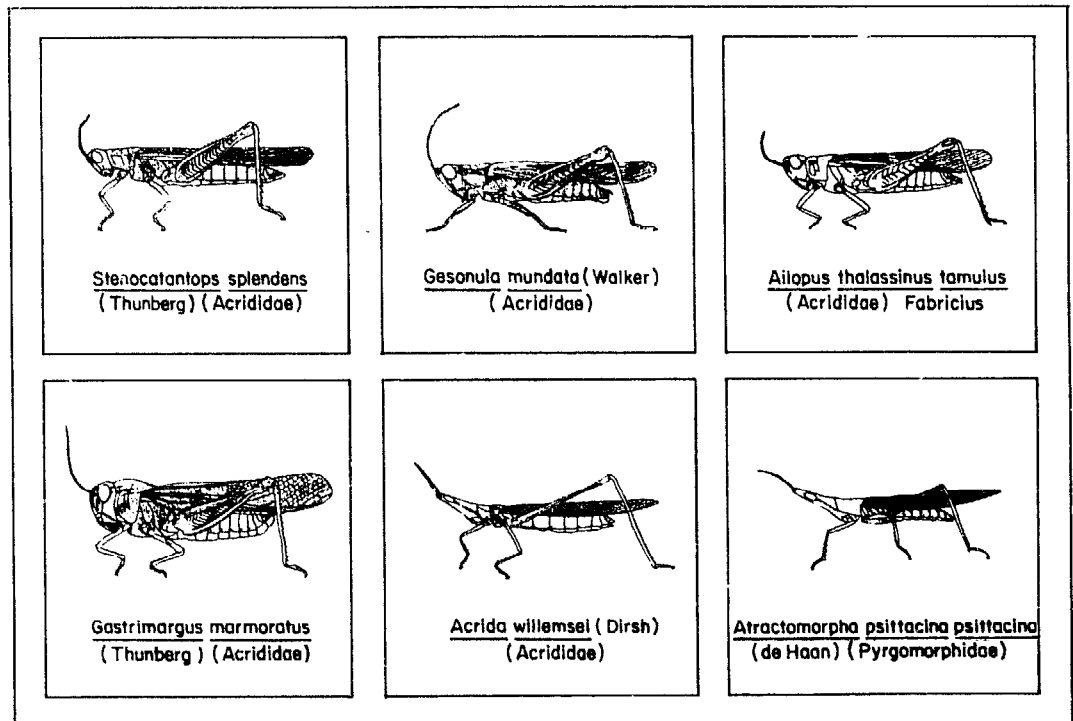

**Pest status**

Grasshoppers are localized in dry regions and can be readily controlled with insecticide. Locust outbreaks occur less frequently than in the past decades because more of their natural habitats have been cultivated.

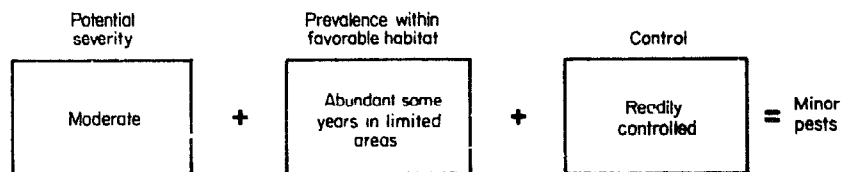

Most grasshopper species that occur in rice fields are nonswarming, and consequently cause minimal damage. When they become abundant, locusts can destroy a rice crop.

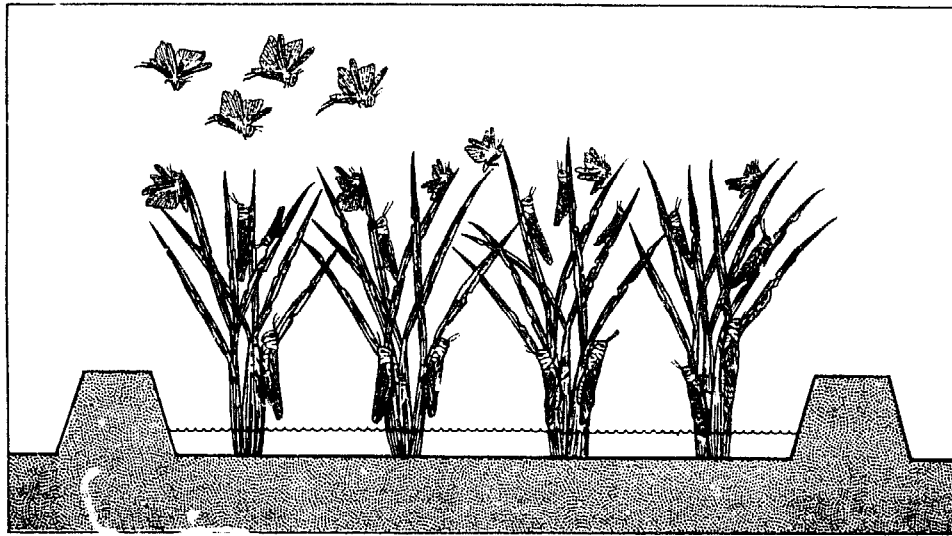

Distribution in Asia.

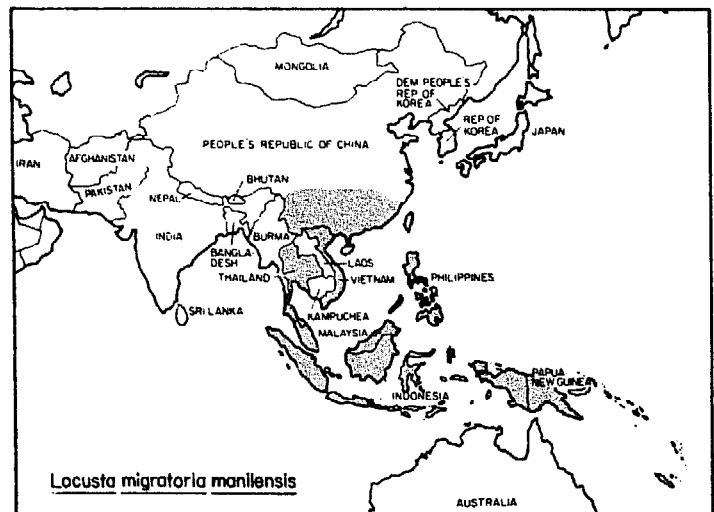
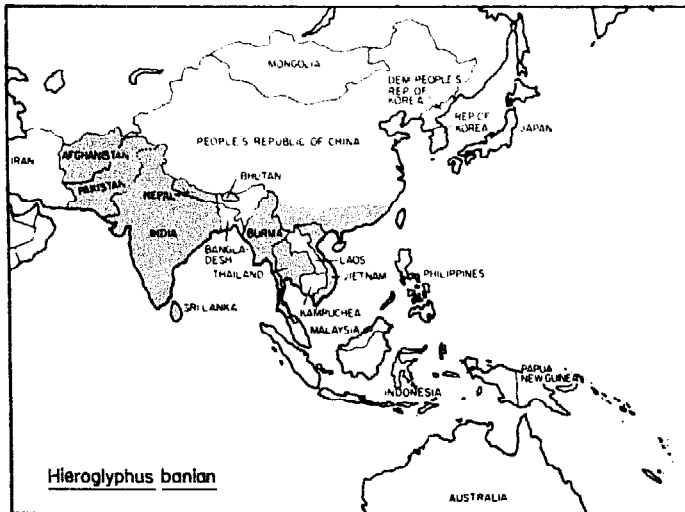
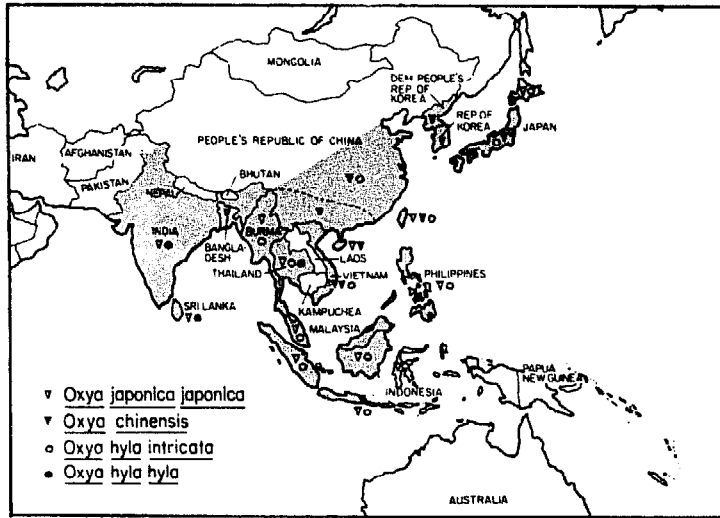

Locusts normally are in low numbers in favored grassland breeding areas typical of regions of low rainfall. Occasionally the breeding sites experience periods of high rainfall, and the resulting vigorous growth of host plants favors a rapid increase in locust numbers.

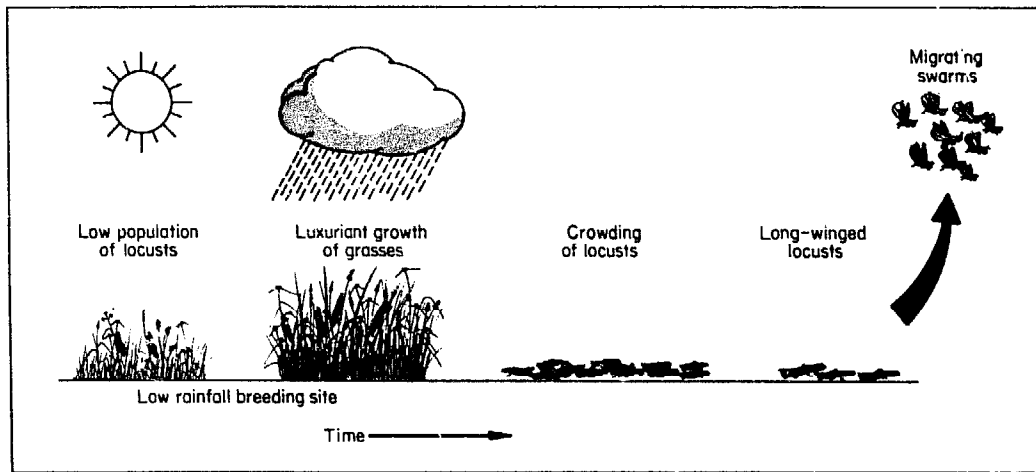

Crowding causes the succeeding generations of locusts to change into migratory forms, which are more robust and have well-developed wings. These migratory forms fly in swarms to infest new areas.

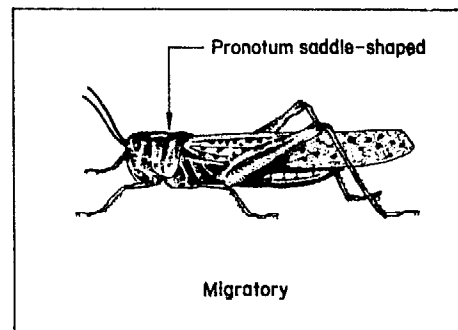
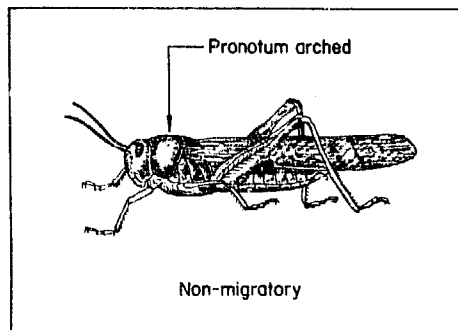

Grasshoppers and locusts are found in all rice environments, but are generally more prevalent in

rainfed areas. Grasshoppers occur in irrigated rice surrounded by grassland breeding grounds.

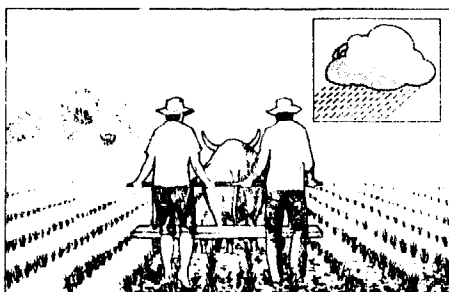

Upland

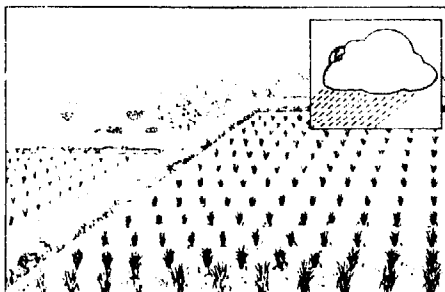

Rainfed wetland

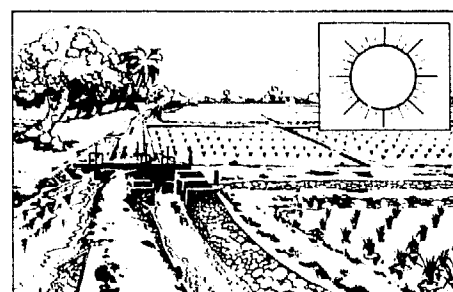

Irrigated wetland

**Development and actual size**

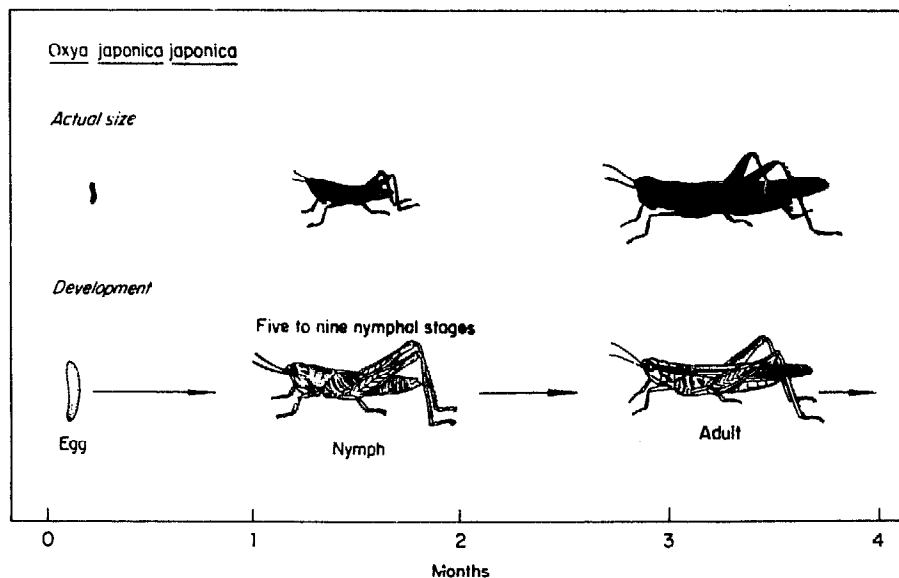

Hieroglyphus banian

Actual size



Development

Six to seven nymphal stages

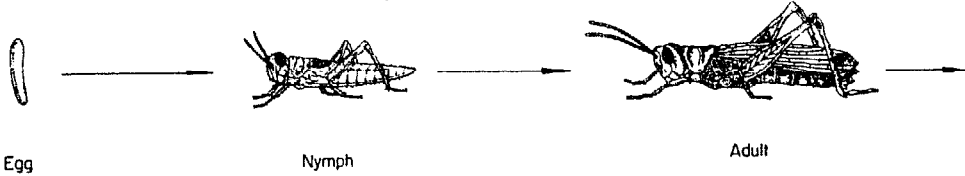

Egg

Nymph

Adult

0 3 7 11  
Months

Locusta migratoria manilensis

Actual size

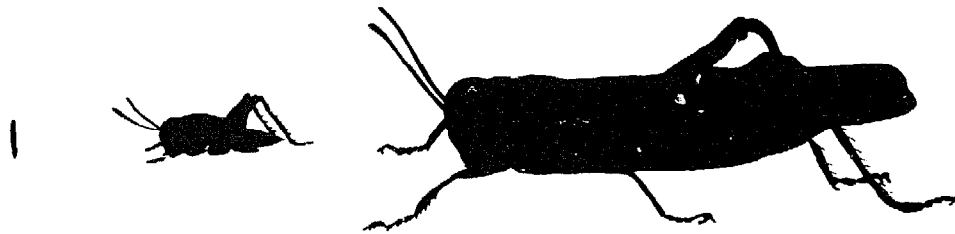

Development

Five to six nymphal stages

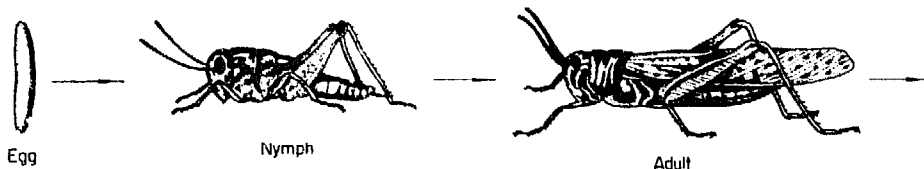

Egg

Nymph

Adult

0 1 4 7  
Months

Adult. The body of *Oxya japonica japonica* is bright green with a yellow-green stripe running from the head along the back. A black stripe runs along each side of the body.

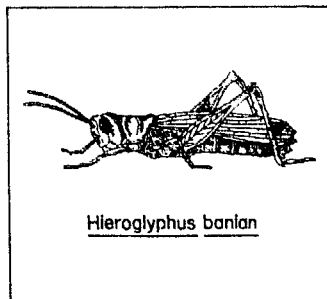
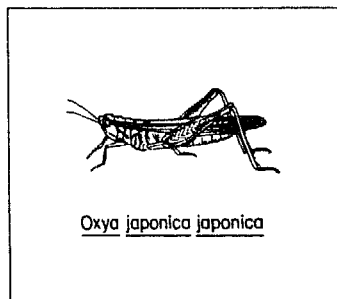

The body of *Hieroglyphus banian* is dull green or yellow-brown and has no stripes. The antennae are brown with yellow rings. The enlarged pair of legs is green.

The body of *Locusta migratoria manilensis* is brown with no stripes. The hind wings are dark yellow at the bases. The enlarged legs are brown.

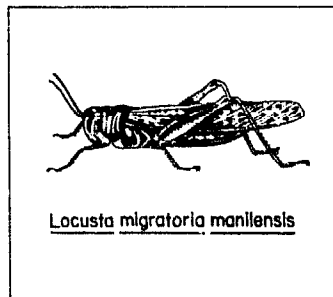

Adults feed on rice foliage with their chewing mouthparts. They are active at night; during the day they remain hidden at the base of plants.

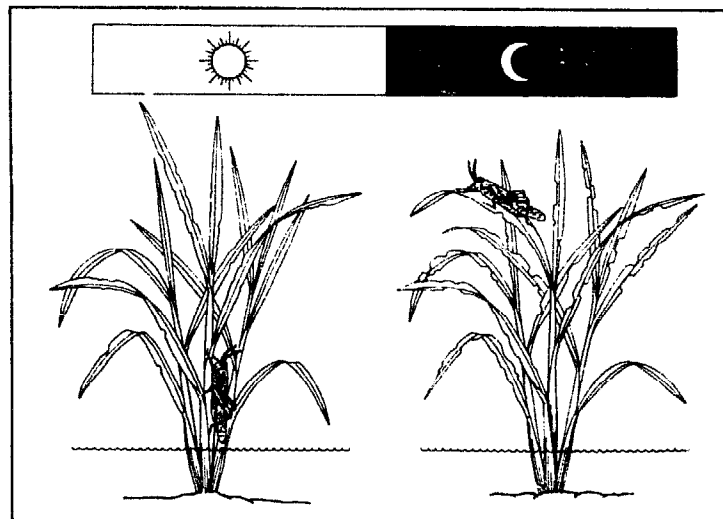

Each female lays 100-300 eggs in a lifetime of several months.

**Egg.** Eggs are laid in compact masses (or pods) of 35-100 eggs. They are covered with a frothy secretion to protect them from desiccation. Depending on the species, eggs are either white or yellow and the froth bubbles are either white or brown.

Egg pods are deposited in the soil in grasslands or dryland rice fields, or behind the leaf sheaths in wetland rice fields.

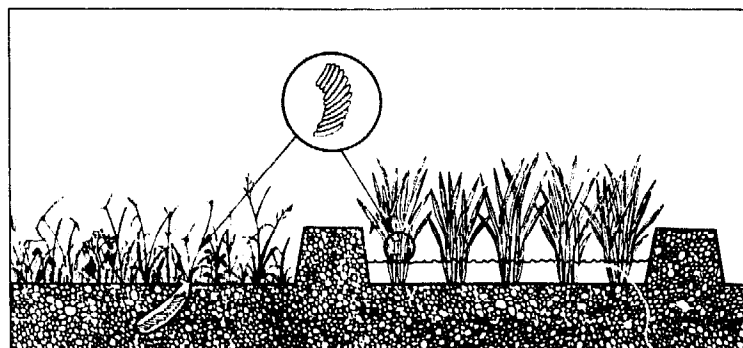
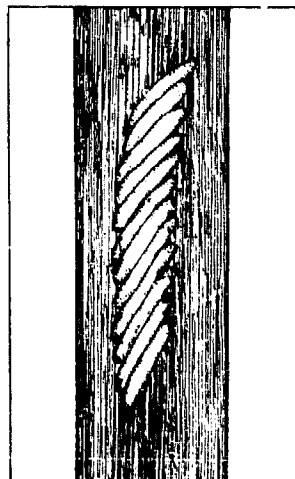

**Nymph.** The body of the *Oxya japonica japonica* nymph is green. Two narrow red-brown bands run down its back from the compound eyes to the bases of the wings.

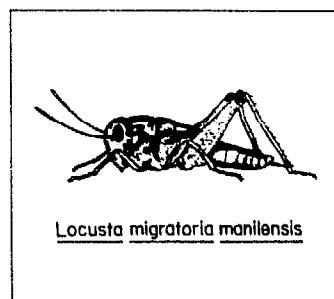
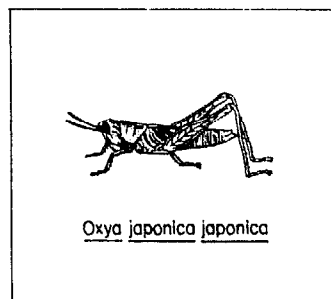

The body of the nymph of *Hieroglyphus banian* is red-brown, later becoming green. It has two broad stripes along the back.

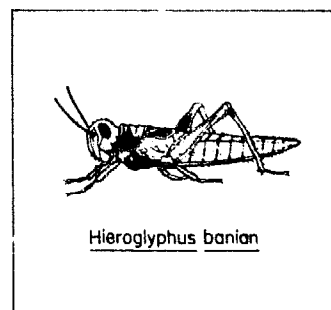

The body of the nymph of *Locusta migratoria manilensis* is brown-green to brown-orange. Two narrow black stripes lie behind the compound eyes and a much broader stripe is along the shoulders of the pronotum and wing buds.

Like the adults, the nymphs hide from birds at the base of plants during the day and feed on rice foliage at the night.

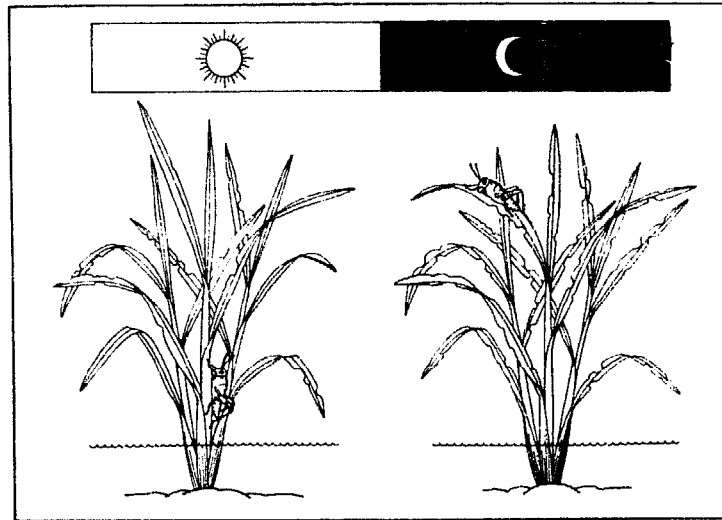

**Damage**

Grasshoppers can damage rice at all stages of crop growth. The damage caused by meadow grasshoppers to rice grains is partially outweighed by their role as predators. *Conocephalus* is an important stem borer egg predator.

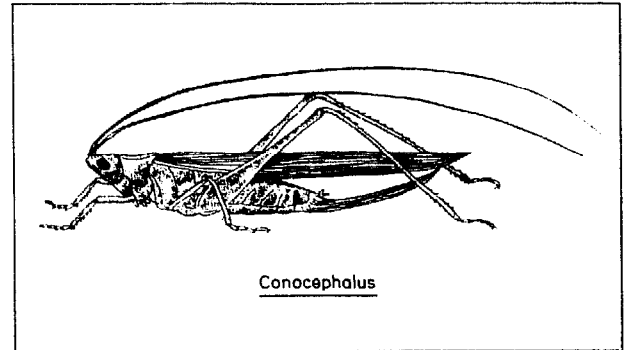
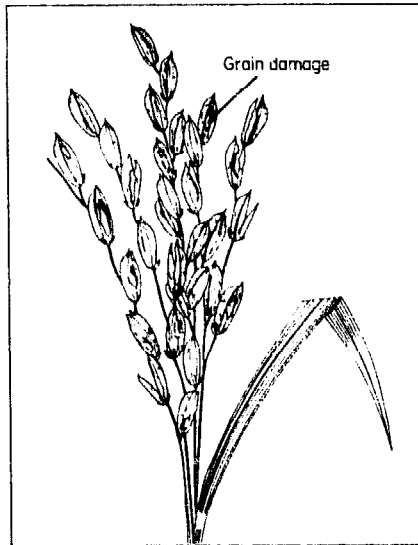

Field crickets (gryllids) normally feed on seeds, roots, or leaves of young seedlings.

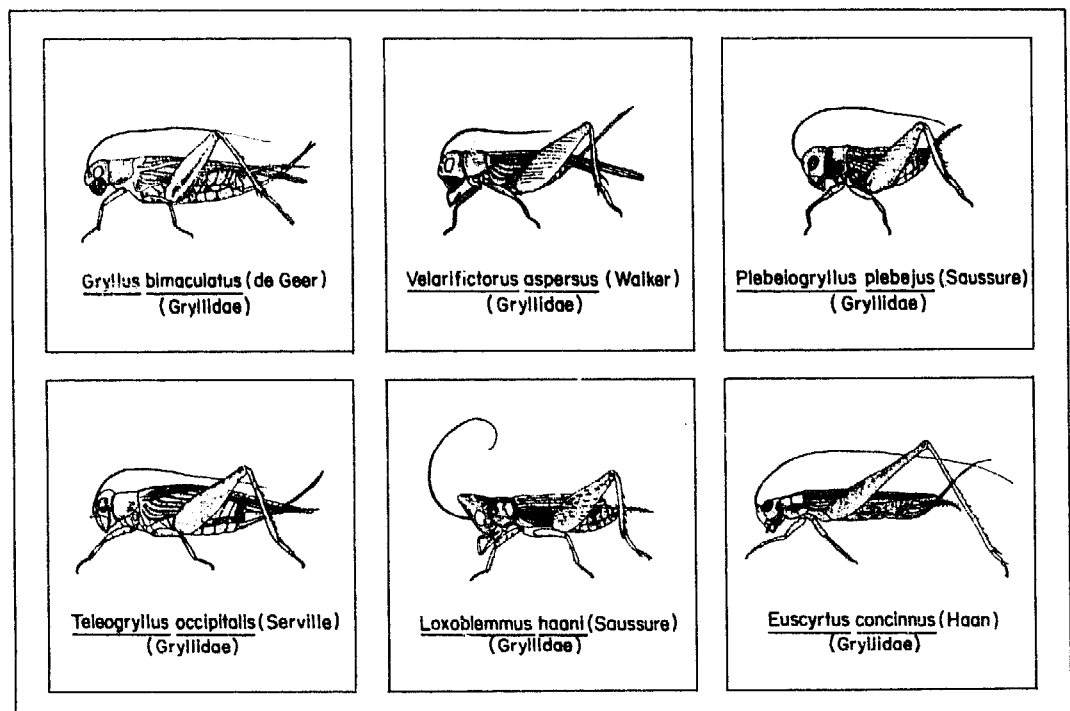



Some species of field crickets defoliate rice plants by removing the central portions of leaves. In contrast, grasshoppers feed on the leaf margins.

Field crickets have long antennae as do katydids but have 3-segmented tarsi. They resemble mole crickets but lack enlarged front legs.

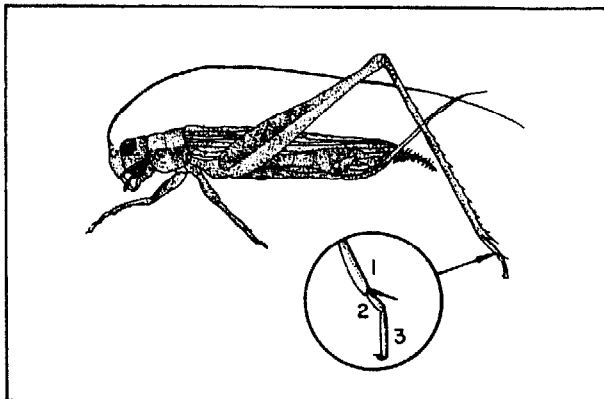
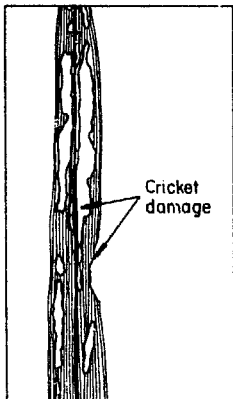

Adults and nymphs feed on rice leaves from the margins of leaf blades, creating cutout areas. Grasshoppers are large enough to feed even on the midrib. They also can cut rice panicles as armyworms do.

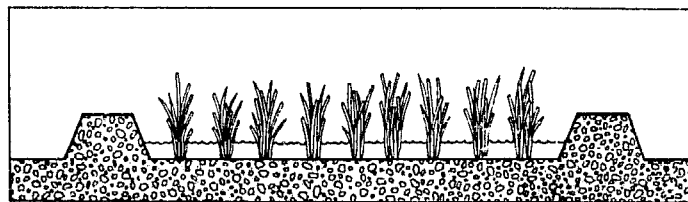
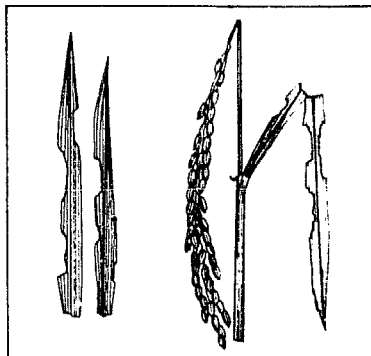

Swarming locusts can remove most of the foliage in a rice field leaving only the bases of tillers.

*Plant hosts.* Grasshoppers have an extremely wide host range and show no distinct preference for rice.

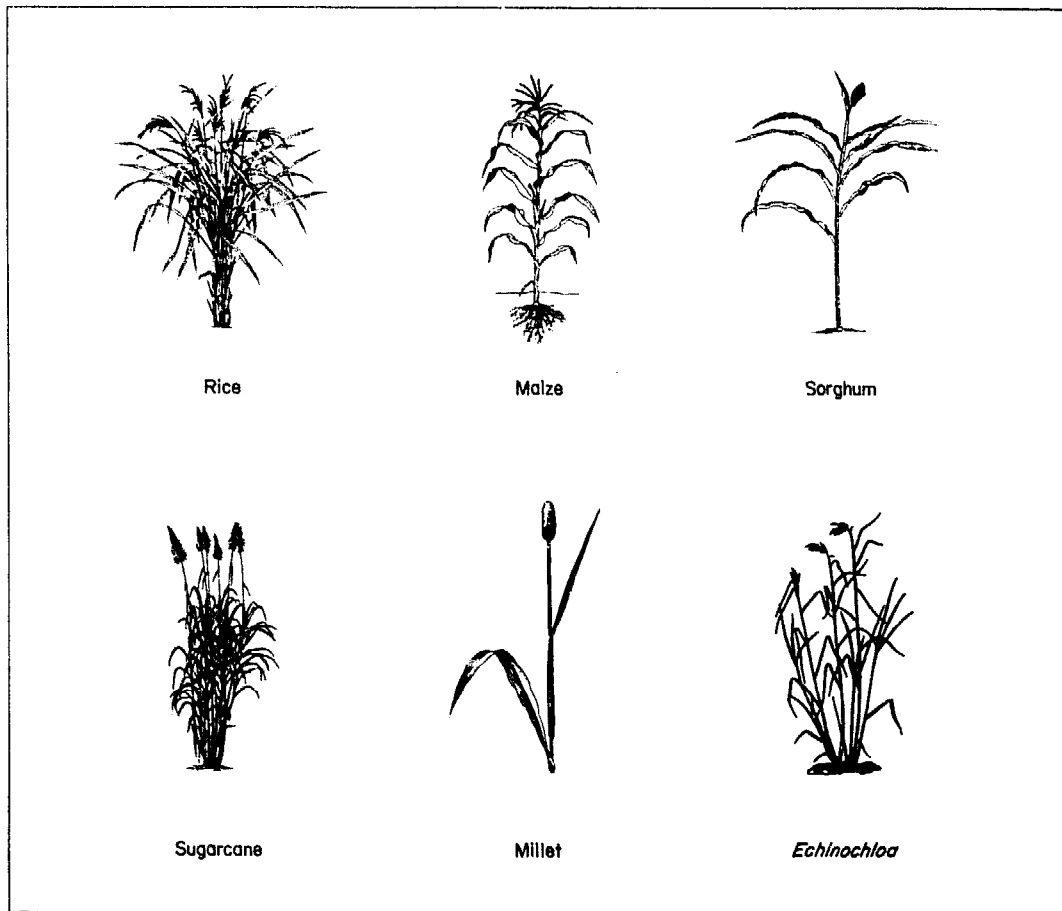

Rice

Malze

Sorghum

Sugarcane

Millet

*Echinochloa*

**Management**

**Cultural control.** No effective cultural control methods are known.

**Resistant varieties.** No variety is resistant to grasshoppers or locusts.

**Biological control.** Different scelionid parasitic wasps can locate grasshopper eggs in the soil or on plants. Those adapted to locating eggs in the soil have elongated abdomens.

Nymphs and adults are killed by parasitic flies, nematodes, and fungal pathogens.

Birds, frogs, and web-spinning spiders, and sphecid wasps are the major predators.

**Cultural Control**

**Plant Resistance**

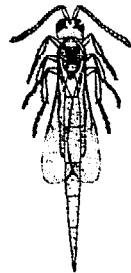

*Macroteleia nr. indica* (Sharma)  
(Scellionidae)

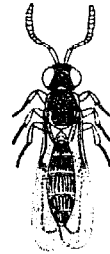

*Scelio sp.*  
(Scellionidae)



*Paratheresia sp.*  
(Tachinidae)

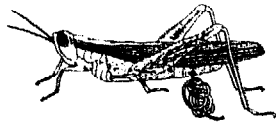

*Hexameris sp.*  
(Mermithidae)



*Entomophthora nr. grylli* Fresenius  
(Entomophthoraceae)



*Ploceus philippinus* (Linnaeus)  
(Ploceidae)

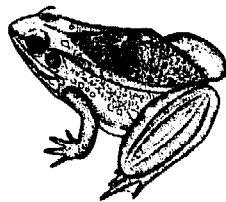

*Rana sp.*  
(Ranidae)

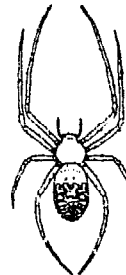

*Arcione catenulata* (Doleschall)  
(Araneidae)

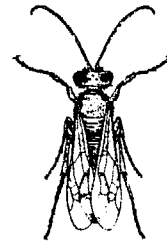

Sphecid wasp

**Chemical control.**

- **Insecticide application.** Poisoned baits are used to control locusts in their grassland breeding grounds.

Locusts are attracted to salty rice bran. Bait is made by moistening rice bran with salt water.

Insecticide is then added and the dried poisoned bait is spread on the ground among swarms of nymphs.



Grasshoppers in rice fields are controlled by foliar sprays.

Granules are not effective against grasshoppers.



- **Scouting.** Locust breeding areas are well-known and are continually monitored for the development of migratory forms. Once migratory forms are sighted, a campaign to control them is initiated before swarms develop and leave the area.

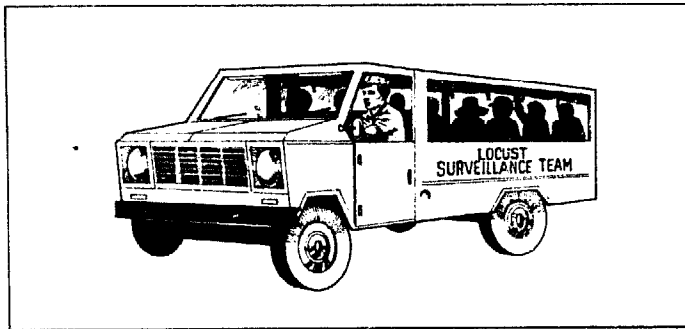

Grasshoppers can damage rice fields throughout rice growth.

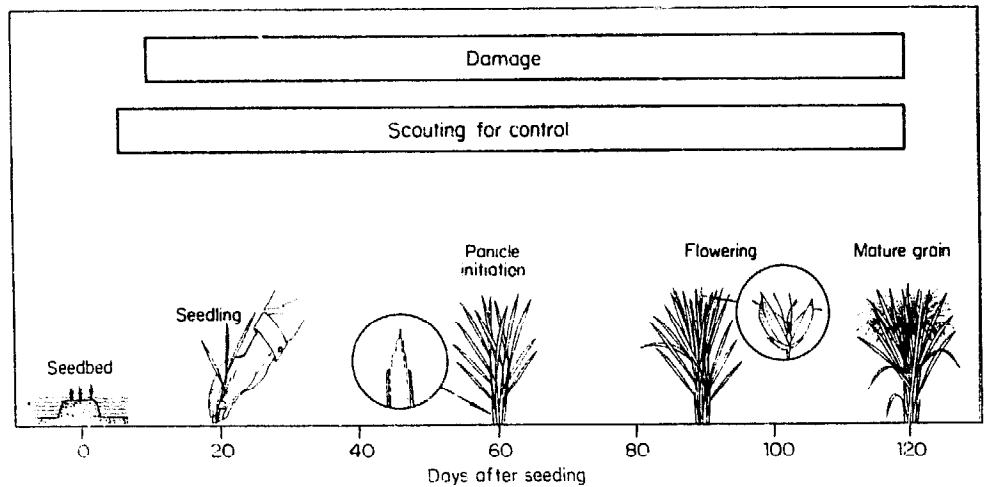

Visit the field each week, picking 5 leaves from each of 20 randomly selected hills, across the field.

Determine the percentage of damaged leaves or panicles. Leaf damage from grasshoppers and other defoliating insect pests should be combined to form the threshold value.

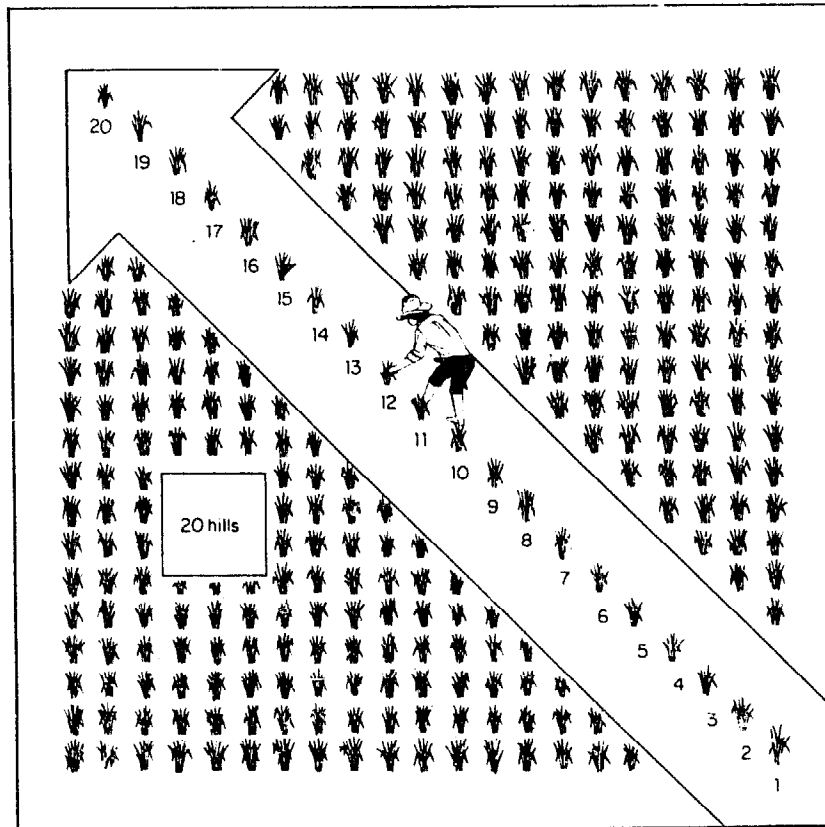

Spray insecticide when the economic threshold is reached.

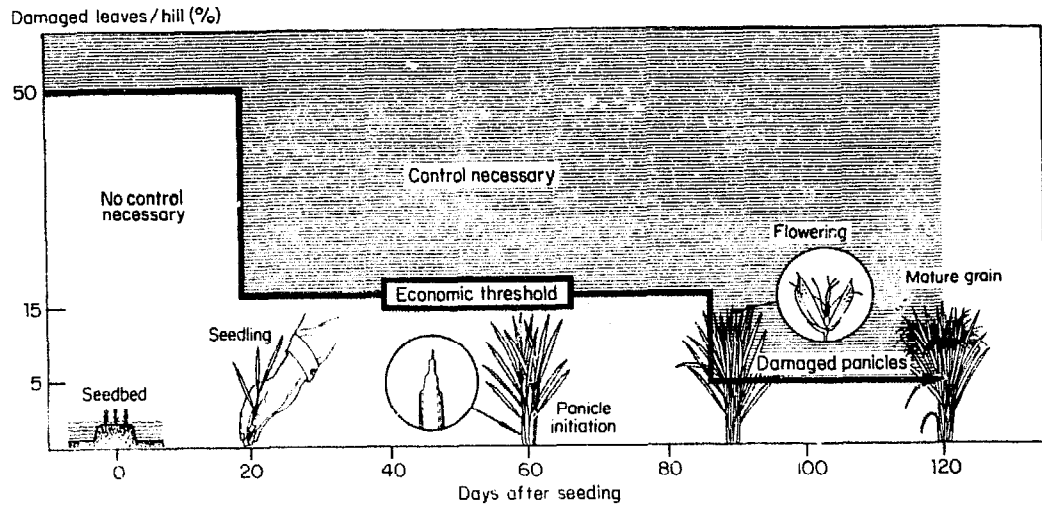

RICE LEAFFOLDERS (LEPIDOPTERA: PYRALIDAE)

Four species of leaffolders occur in Asia. *Cnaphalocrocis medinalis*, *Marasmia* (= *Susumia*) *exigua*, and *Marasmia patnalis* are more common than *Marasmia ruralis*.

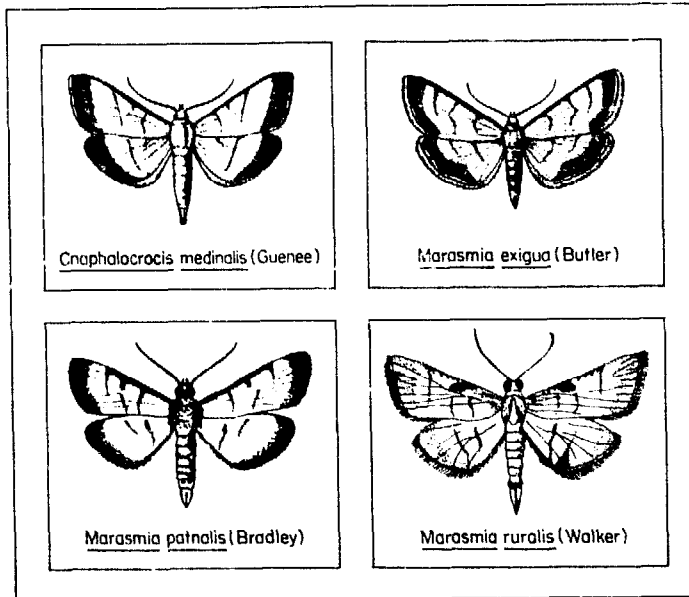

The four are closely related moths and can be distinguished by wing markings.

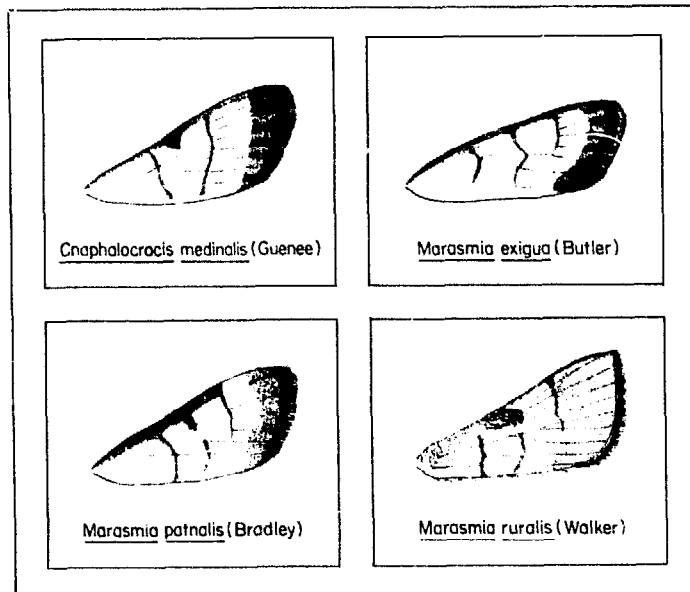

To form a protective feeding chamber, the larva folds a leaf blade together by attaching to the leaf margins silk strands that shrink upon drying.

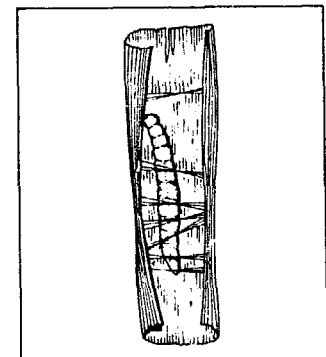

**Pest status**

Rice leafhoppers are widespread and often cause significant yield loss. They have increased in importance in areas where rice is heavily fertilized and is cropped in both the wet and dry seasons. Outbreaks occur

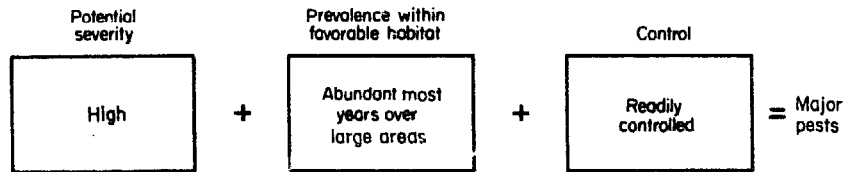

after prolonged drought or heavy use of insecticide.

Leafhoppers occur in all environments and are more abundant in the rainy season.

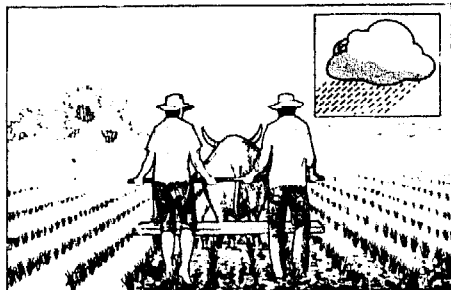

Upland

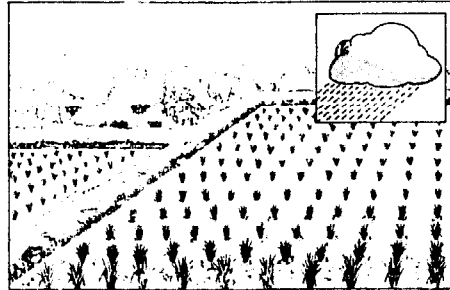

Rainfed wetland

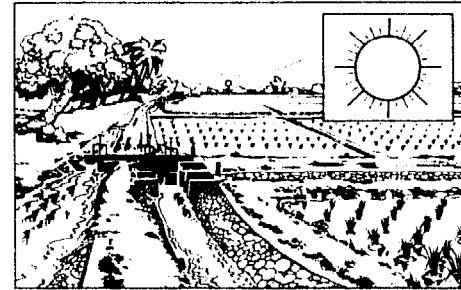

Irrigated wetland

*Distribution in Asia.*

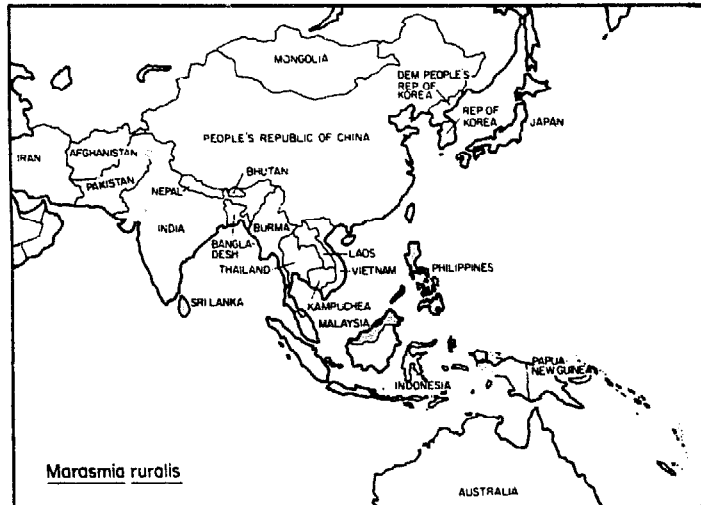
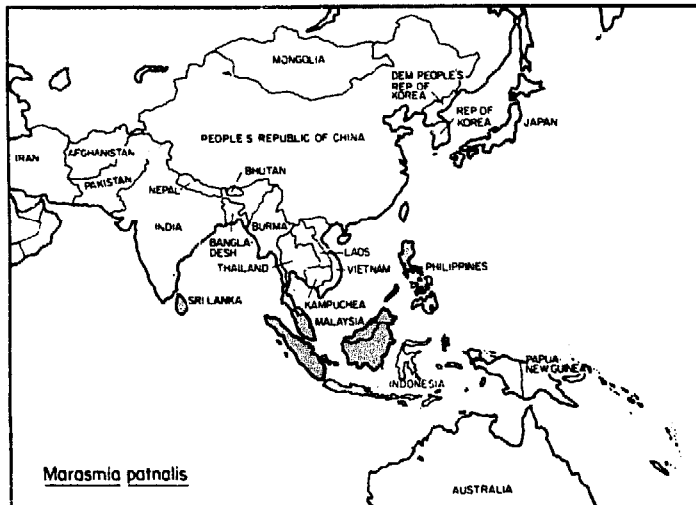
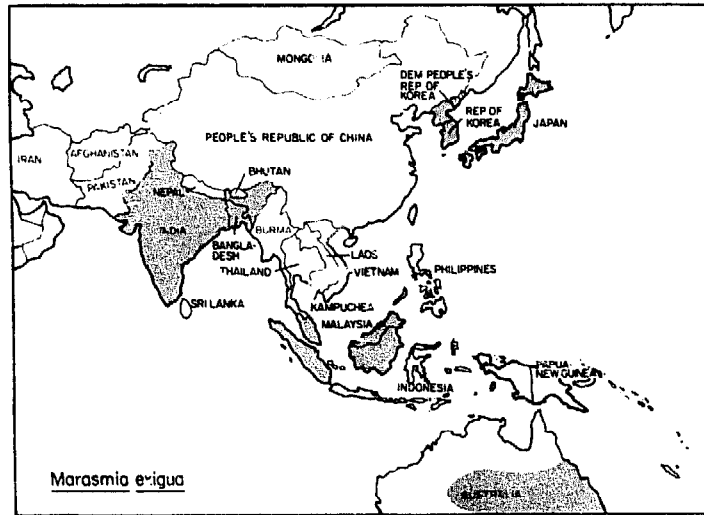
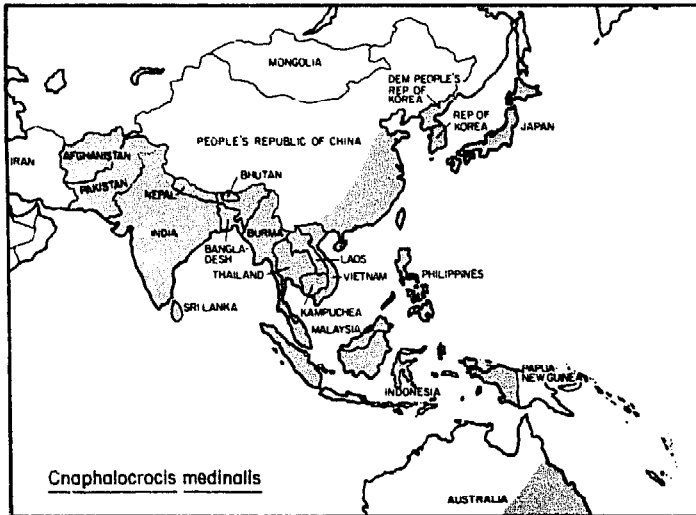

**Development and actual size**  
 Because *Cnaphalocrocis* is more commonly known than *Marasmia*, its biology, damage, and management will be described.

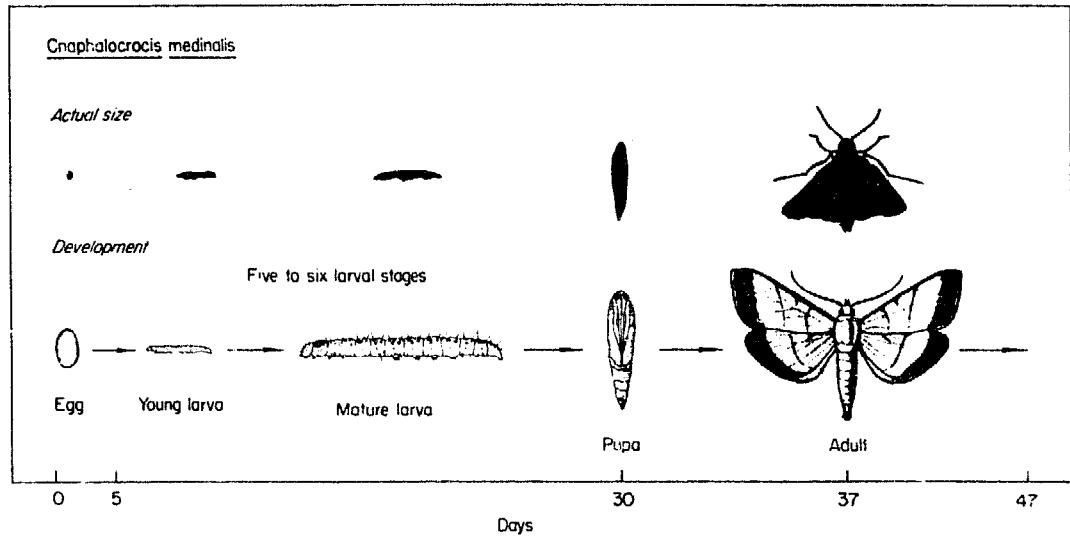

**Adult.** The adult moth is yellow brown. When at rest, it is in the shape of an equal-sided triangle. As in most species, the male is slightly smaller than the female. It has a tuft of thick black hairs in the mid-costa.

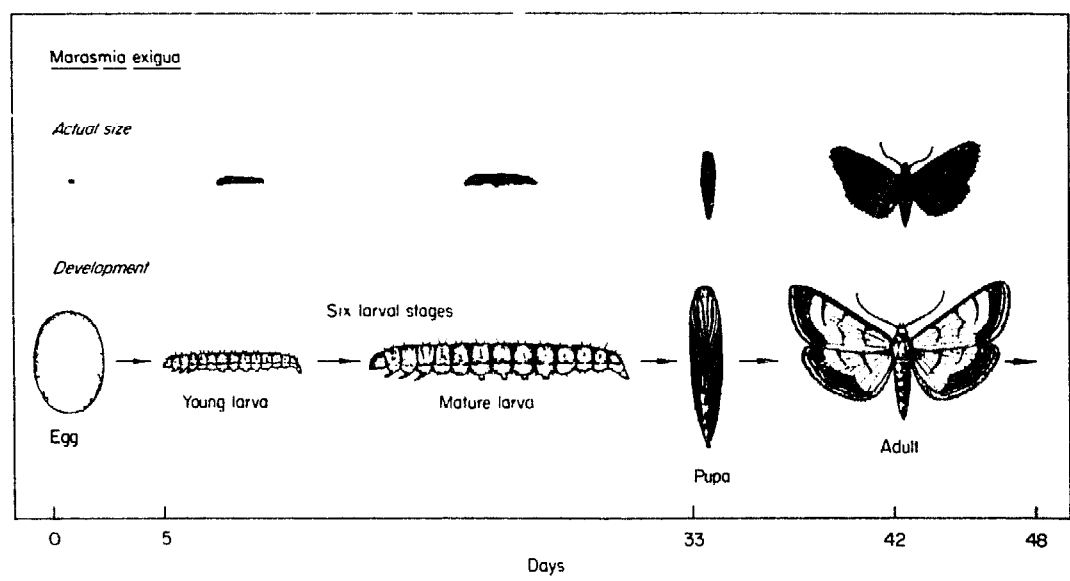
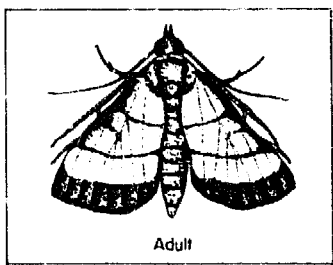

Moths may migrate up to several kilometers after reaching adulthood.

The female attracts its mate by giving off a chemical called a pheromone. Mating and egg laying occur at night. *Cnaphalocrocis* females lay more eggs (300) than *Marasmia* spp. (120) during their lifetime of 3-10 days.

Adults hide on rice and grassy weeds during the day to escape predation by birds and only take short flights when disturbed.

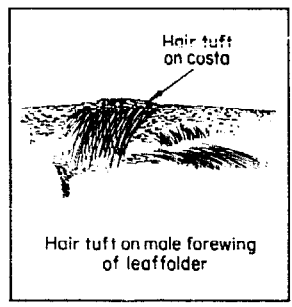
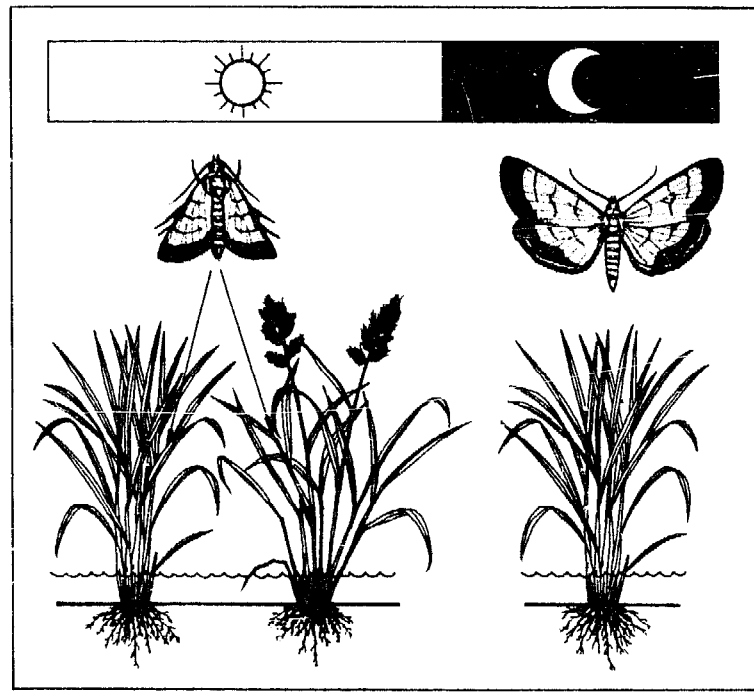

Adults are attracted to light at night but are seldom caught in light traps.

**Egg.** The disc-shaped, ovoid eggs are laid singly in batches of 10-12 in *Cnaphalocrocis* and 2-9 in *Marasmia* spp. in a line parallel to the midrib. More eggs are laid on the upper than the lower leaf surfaces.

The eggs are visible to the naked eye. Eggs turn from transparent to a cream color as they mature.

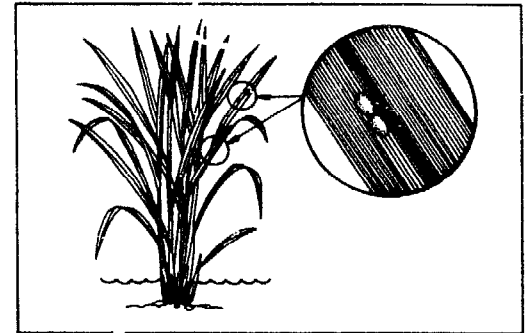
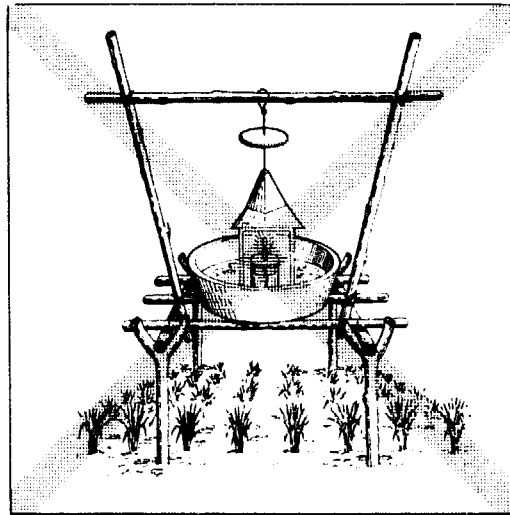

**Larva.** After hatching, the young larvae crawl to the base of the youngest unopened leaves and begin to feed.

They migrate to older leaves from the second larval stage onward.

Only one larva feeds within a tubular feeding chamber in *C. medinalis* and usually two larvae in *Marasmia* spp. Some feeding chambers are made from leaves bent tip down.

The larva remains within the folded leaf, feeding by scraping the leaf surface tissue. Each larva may feed in three to four leaves during its lifetime.

Mature larvae are yellowish green with dark-brown heads. They jump or wiggle rapidly when touched.

**Prepupa.** A resting stage of 1-2 days occurs in *Marasmia* but not in *Cnaphalocrocis*.

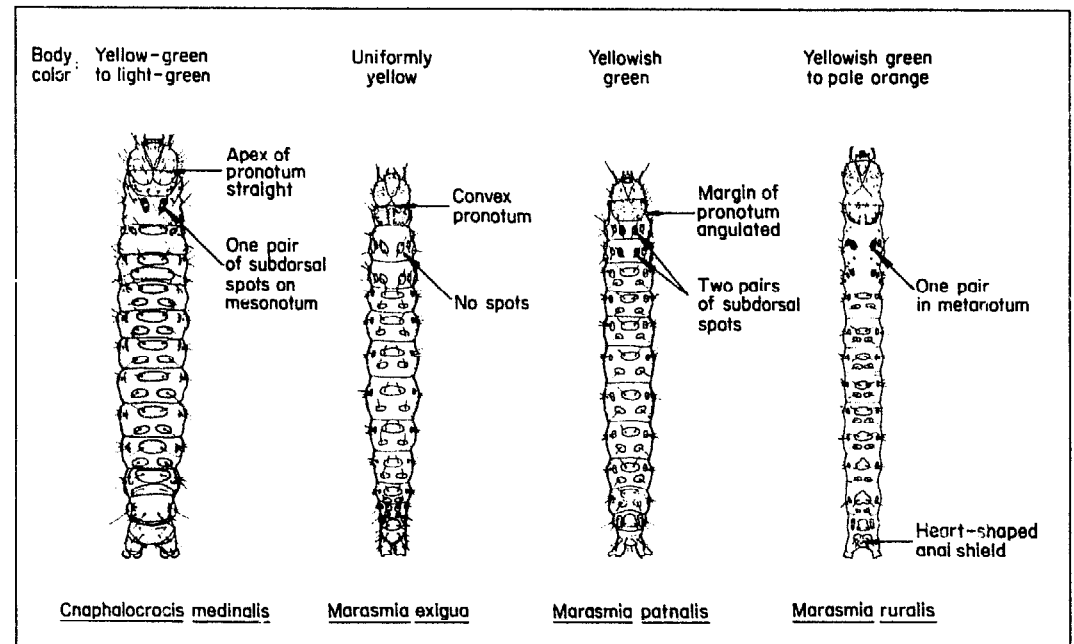
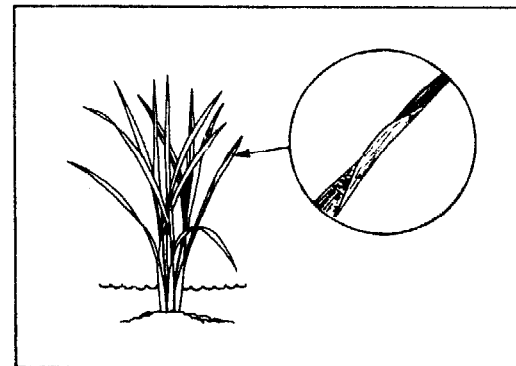
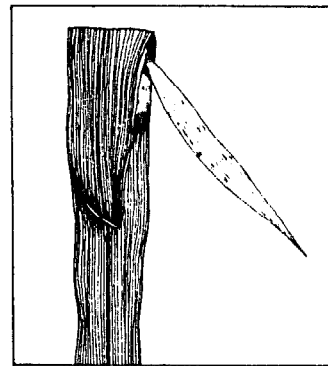

**Pupa.** The larvae pupate in loosely woven strands of silk threads on leaf blades and rice stubble.

The pupa turns from bright yellow to brown as it develops.

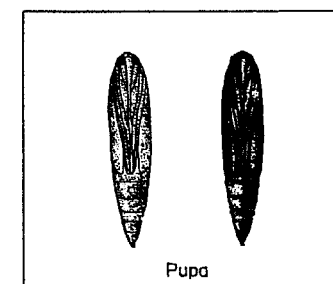
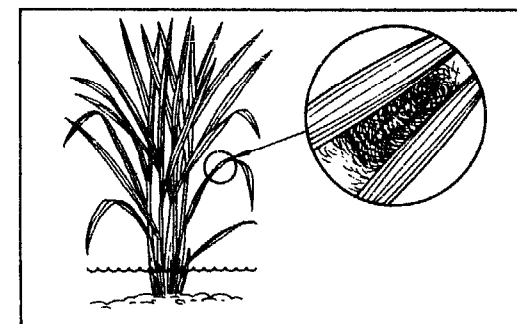

**Damage**

The removal of leaf tissue by a larva within a feeding chamber causes longitudinal white and transparent streaks on the leaf blade.

Each leaf blade may contain several feeding streaks.

When infestation is high, each plant may contain many folded leaves. Heavily damaged leaves become dry and highly infested fields appear scorched.

Yield loss is high when the flag leaf is damaged.

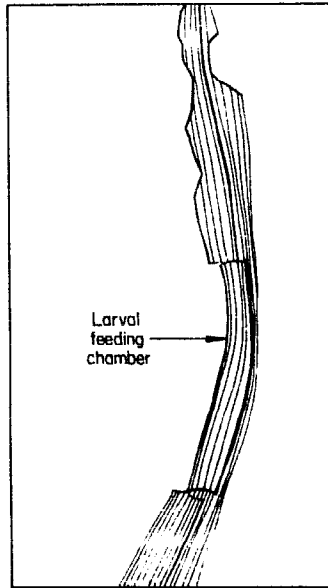

*Plant hosts.* The larvae feed on rice, weeds, and crops within the grass family.

Maize, sorghum, and sugarcane are minor hosts.



Rice



*Echinochloa*



*Eleusine*



*Leersia*



*Panicum*

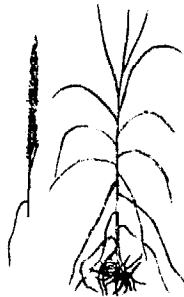

*Pennisetum*



*Isachne*



*Bracharia*





*Paspalum*



*Dichanthium*



*Imperata*

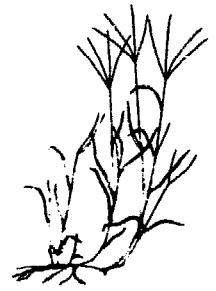

*Digitaria*



Maize



Sorghum



Sugarcane

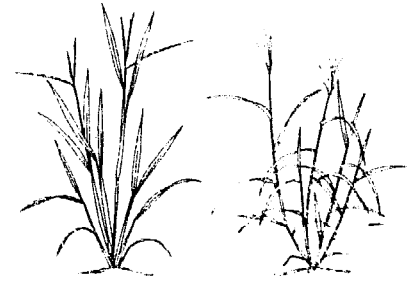

Wild rices

**Management**

*Cultural control.* High infestation occurs from high use of nitrogenous fertilizer. Split fertilizer application during the growing season and reduce the amount.

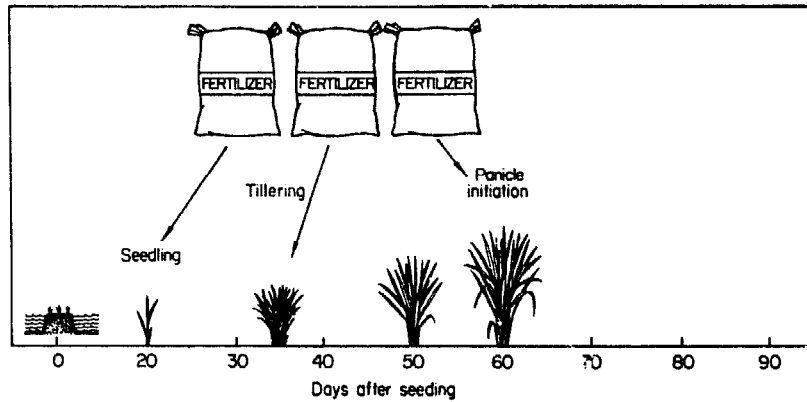

Higher infestation occurs in areas where the rice crop is shaded by trees.

Remove grassy weeds from rice fields and surrounding borders to prevent the buildup of rice leafhoppers on alternative hosts.

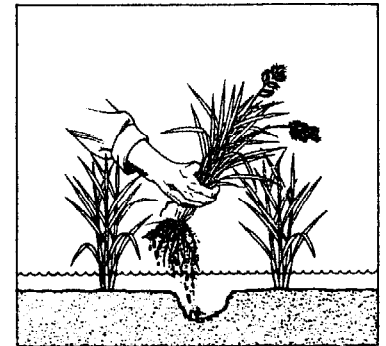
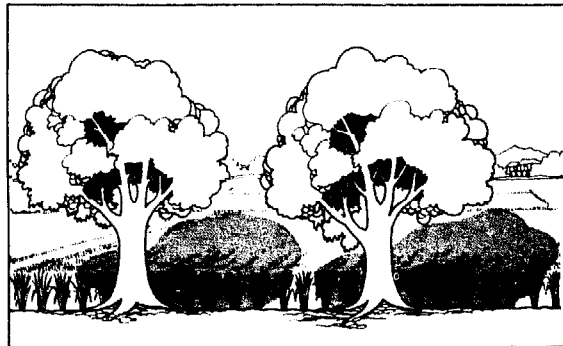

*Resistant varieties.* No resistant varieties are commercially available.

**Plant Resistance**

**Biological control.** High natural mortality occurs from the activity of beneficial arthropods, which attack leaf-folders at every growth stage.

Tiny trichogrammatid wasps develop, one each inside an egg, killing the leaf folder larva before it hatches.

Many species of wasps -- braconids, ichneumonids, chalcids, elasmids, and encyrtids -- parasitize the larval and pupal stages. Dead larvae infected with fungi are flattened and stick to the leaves while those killed by viruses turn black and hang from leaves.

Crickets prey on eggs and damselflies, ants and beetles prey on the larvae.

Spiders capture adult moths.

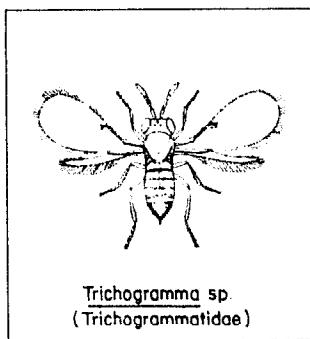

Trichogramma sp.  
(Trichogrammatidae)

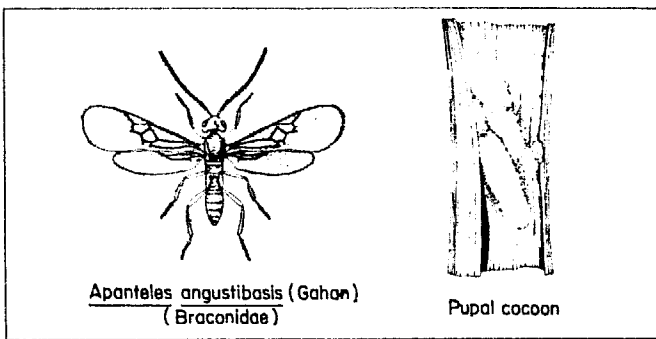

Apanteles angustibasis (Gahan)  
(Braconidae)

Pupal cocoon

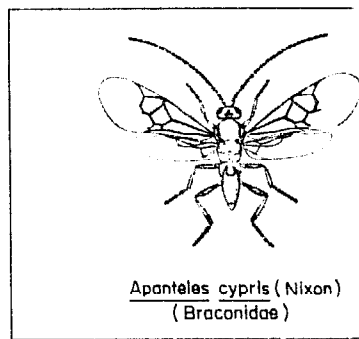

Apanteles cypris (Nixon)  
(Braconidae)

Pupal cocoon

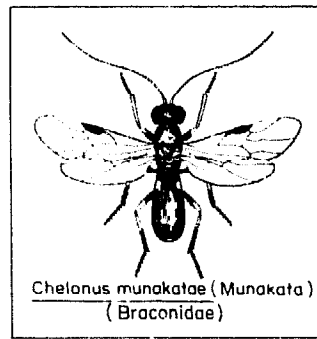

Chelonus munakatae (Munakata)  
(Braconidae)

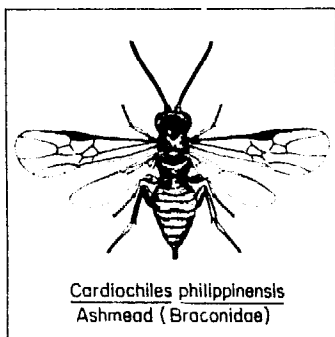

Cardiochiles philippinensis  
Ashmead (Braconidae)

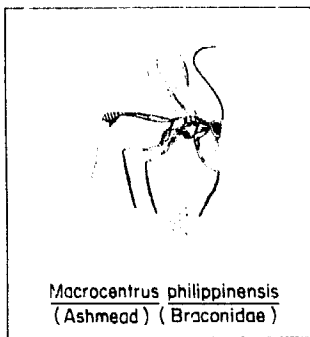

Macrocentrus philippinensis  
(Ashmead) (Braconidae)

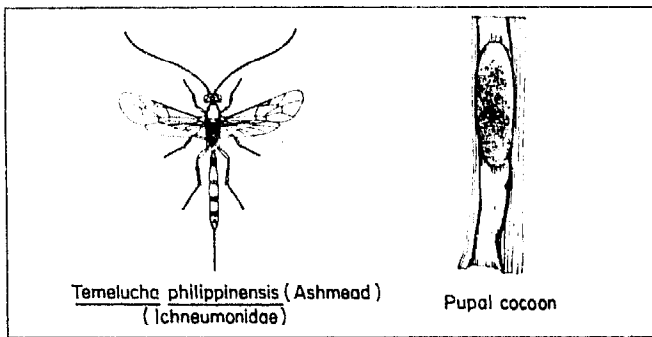

Temelucha philippinensis (Ashmead)  
(Ichneumonidae)

Pupal cocoon

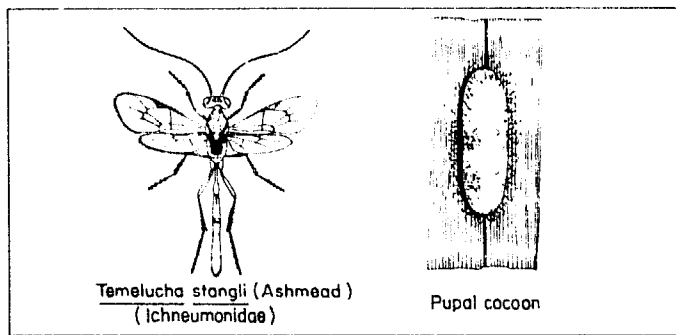

Temelucha stangli (Ashmead)  
(Ichneumonidae)

Pupal cocoon

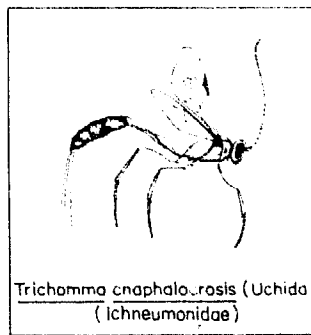

Trichomma cnaphalorosis (Uchida)  
(Ichneumonidae)

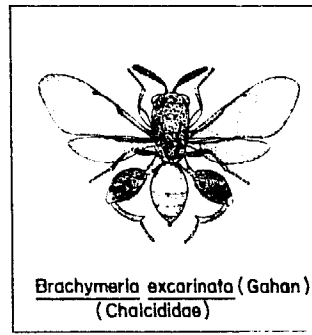

Brachymeria excarinata (Gahan)  
(Chalcididae)

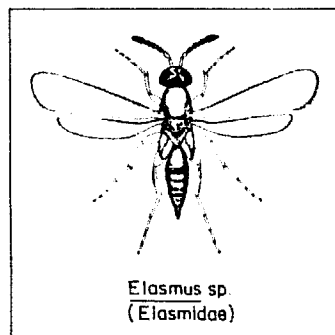

Elasmus sp.  
(Elasmidae)

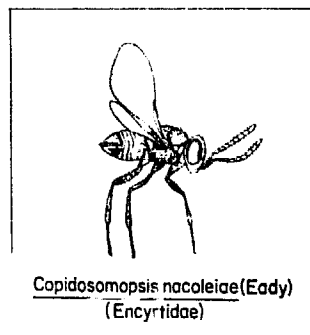

Copidosomopsis nacoletiae (Eady)  
(Encyrtidae)

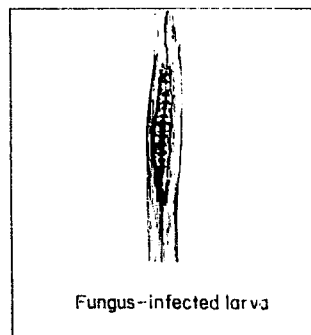

Fungus-infected larva

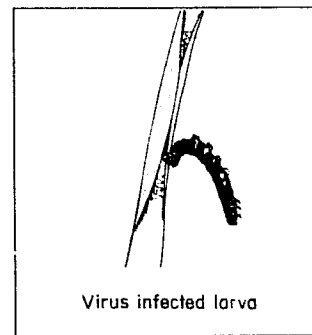

Virus infected larva

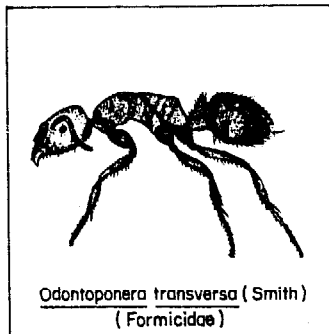

*Odontoponera transversa* (Smith)  
(Formicidae)

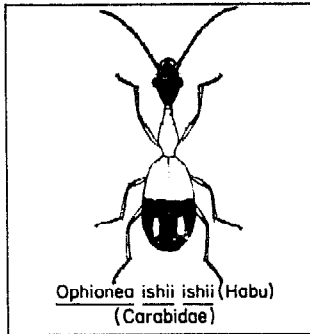

*Ophionea ishii ishii* (Habu)  
(Carabidae)

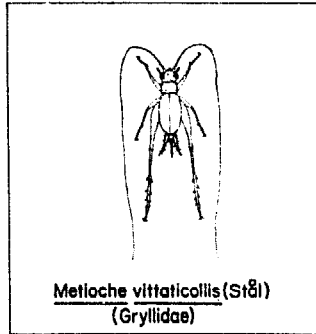

*Metloche vittaticollis* (Stål)  
(Gryllidae)

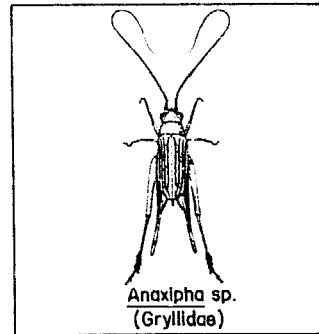

*Anaxipha* sp.  
(Gryllidae)

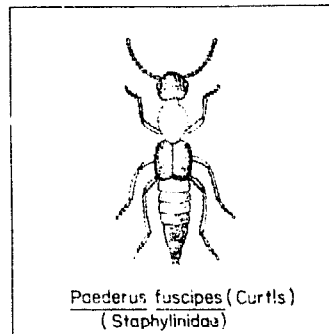

*Paederus fuscipes* (Curtis)  
(Staphylinidae)

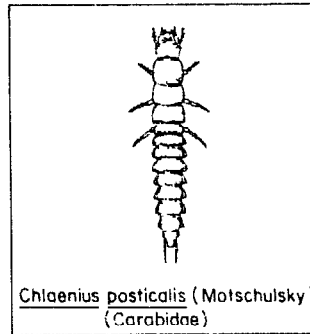

*Chlaenius posticalis* (Motschulsky)  
(Carabidae)

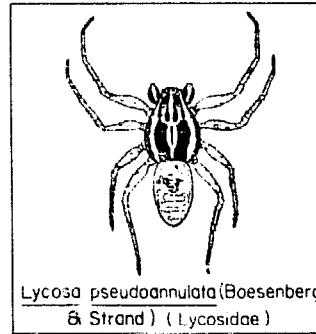

*Lycosa pseudoannulata* (Boesenberg  
& Strand) (Lycosidae)

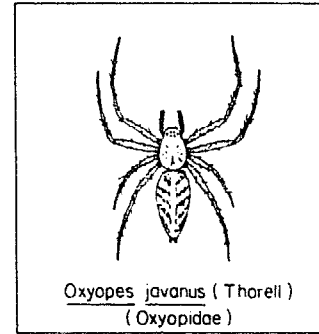

*Oxyopes javanus* (Thorell)  
(Oxyopidae)

**Chemical control.**

- **Insecticide application.** Granular insecticides broadcast into paddy water are not effective against the leaf folder. Spray formulations are preferred.



- **Scouting.** Populations can be monitored with a pheromone-baited water trap. This method uses a synthetic female sex attractant held in a slow-release dispenser over a pan of soapy water to lure and trap males. Economic threshold values for moth catches need to be developed locally.

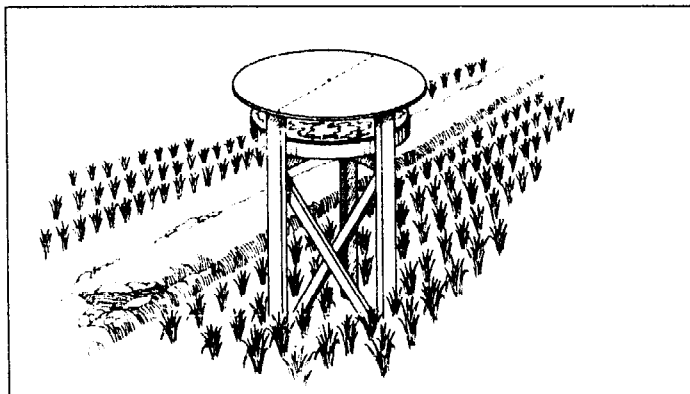

Field sampling is based on plant damage. Begin scouting the fields weekly for damage 2 weeks after transplanting until the flag leaf appears.

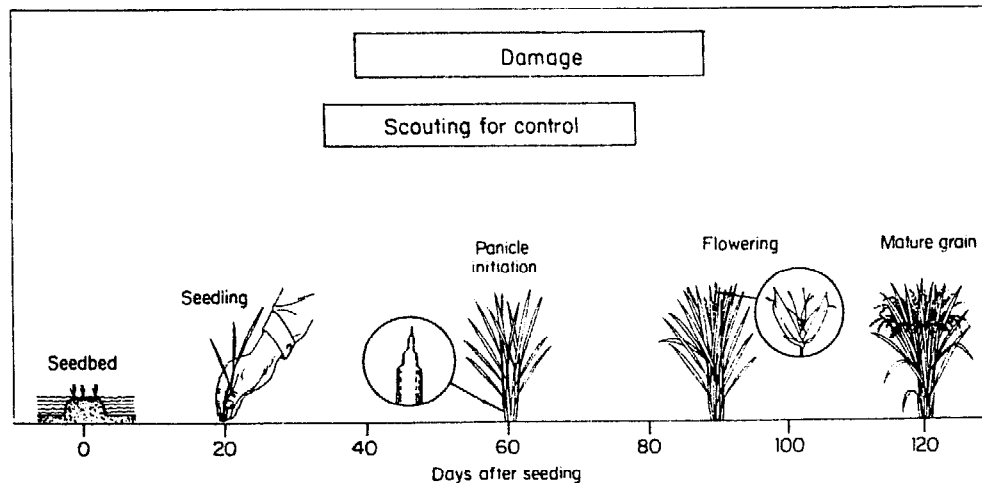

Randomly pick 5 leaves from each of 2 hills across the field. Take note of leaf folder moths while walking across the field.

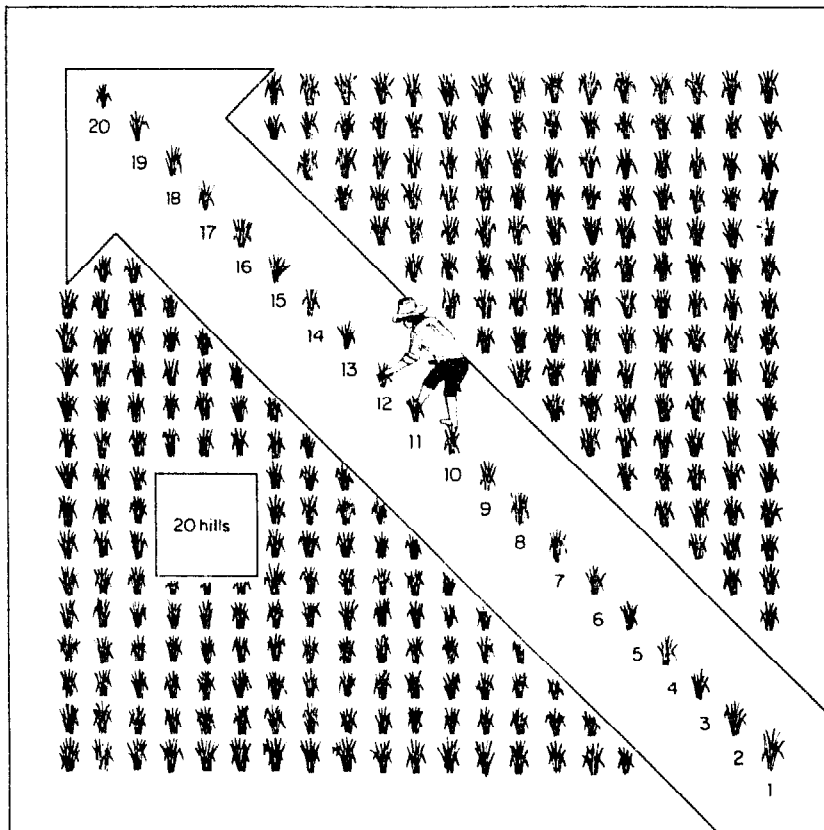

Increase sampling frequency to twice a week when moths are found while walking in the field or in pheromone traps.

Apply insecticide when the economic threshold is reached. The economic threshold is lower when the flag leaves are present.

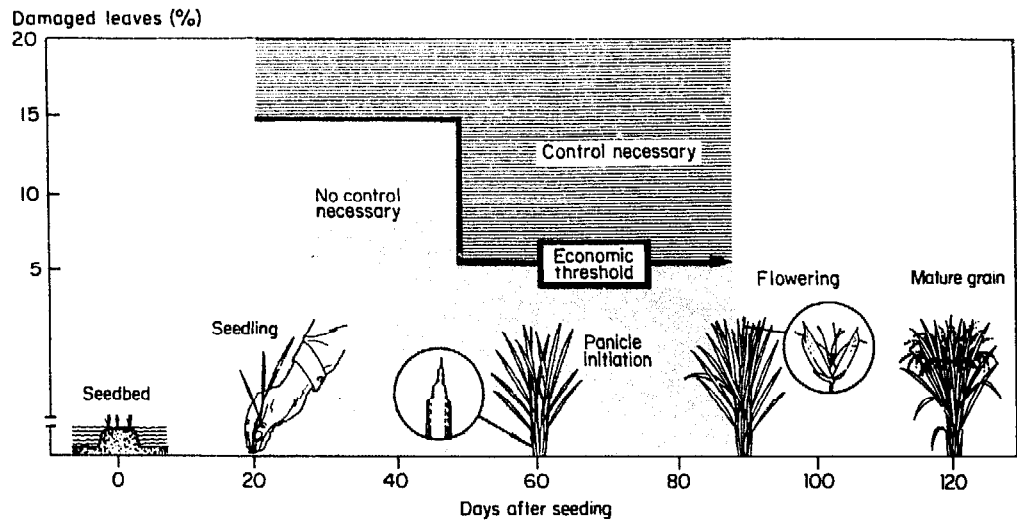

RICE STEM BORERS (LEPIDOPTERA)

Six stem borer species are important pests of rice in Asia. They are rice striped borer *Chilo suppressalis* (= *simplex*), dark-headed stem borer *Chilo* (= *Chilotraea*) *polychrysus* (= *polychrysa*), gold-fringed stem borer *Chilo auricilius* (= *auricilia*), rice yellow stem borer *Scirpophaga* (= *Tryporyza*= *Schoenobius*) *incertulas* (= *incertellus*= *bipunctifer*), rice white stem borer *Scirpophaga* (= *Tryporyza*= *Schoenobius*) *innatata*, and pink stem borer *Sesamia inferens*.

The life cycle, habits, and management of the different species and the crop injury they cause are similar and are described together. Identification, distribution, host range, and distinguishing characteristics of each species are described separately.

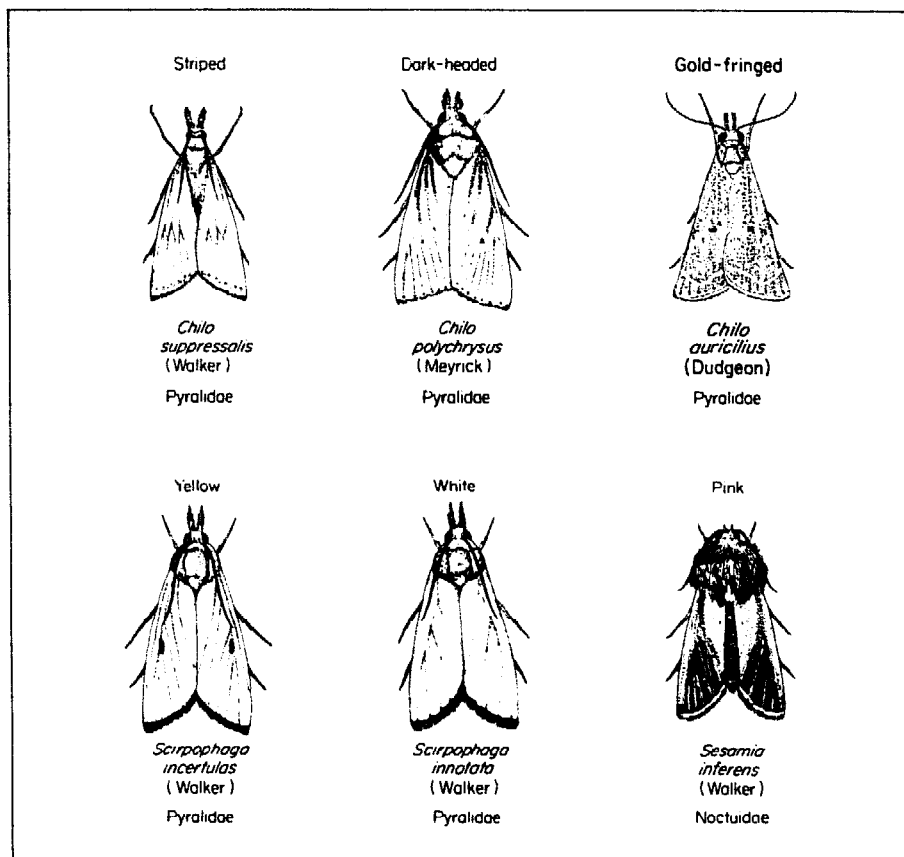

**Pest status**

Stem borers are widespread in occurrence. They cause significant damage by reducing tiller number even on resistant varieties and are difficult to control with insecticide.

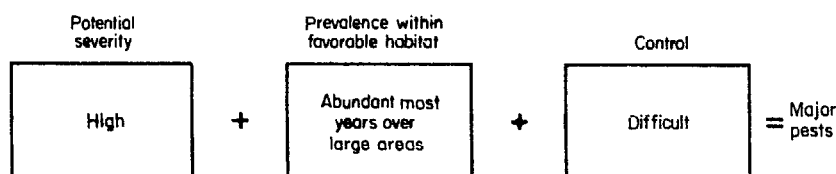

Stem borers occur in all rice environments and are generally most abundant toward the end of the rainy season. Species with wide host ranges are prevalent in upland rice.

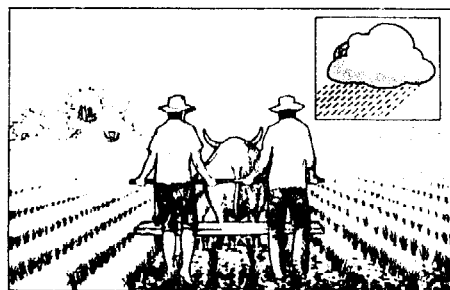

Upland

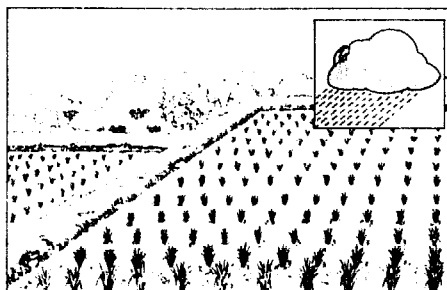

Rainfed wetland

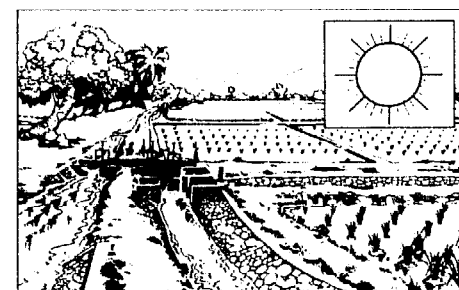

Irrigated wetland

**Development and actual size**  
 All six species have a similar life cycle.

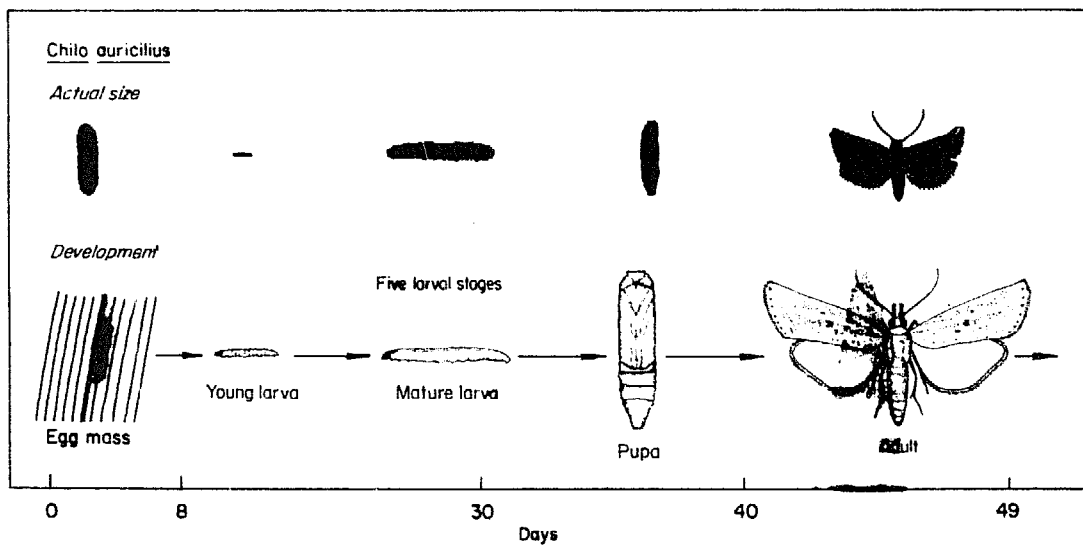
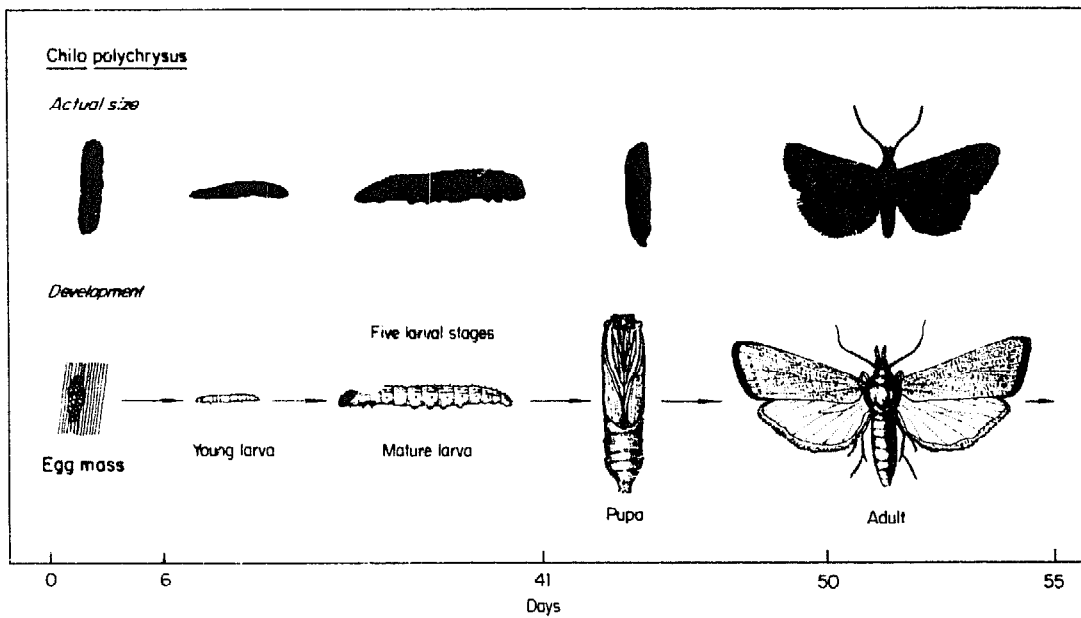
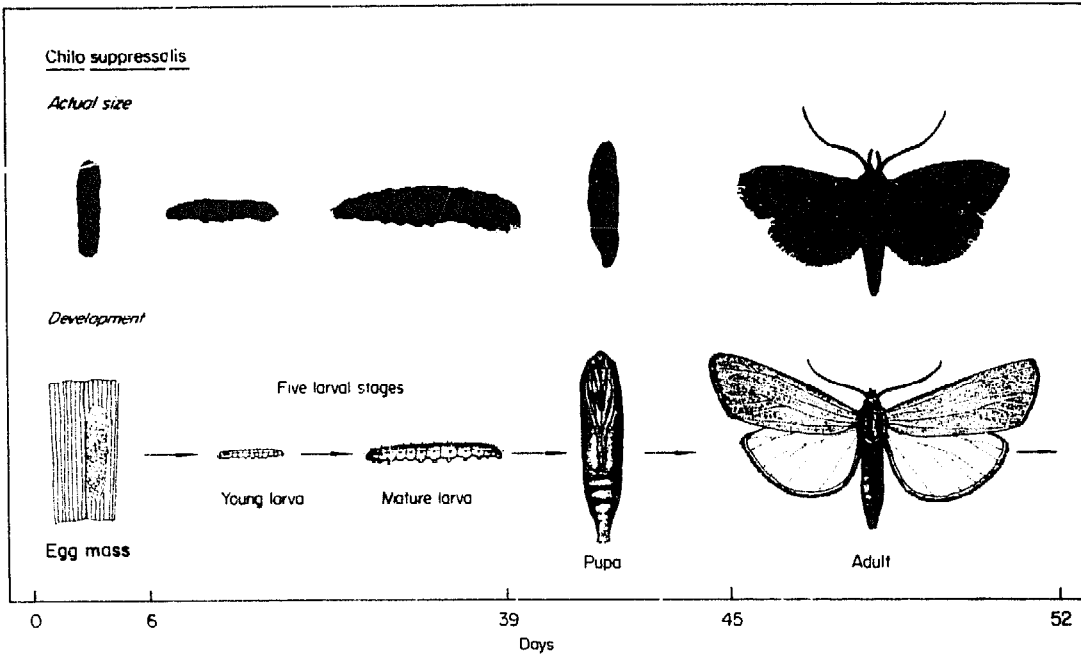

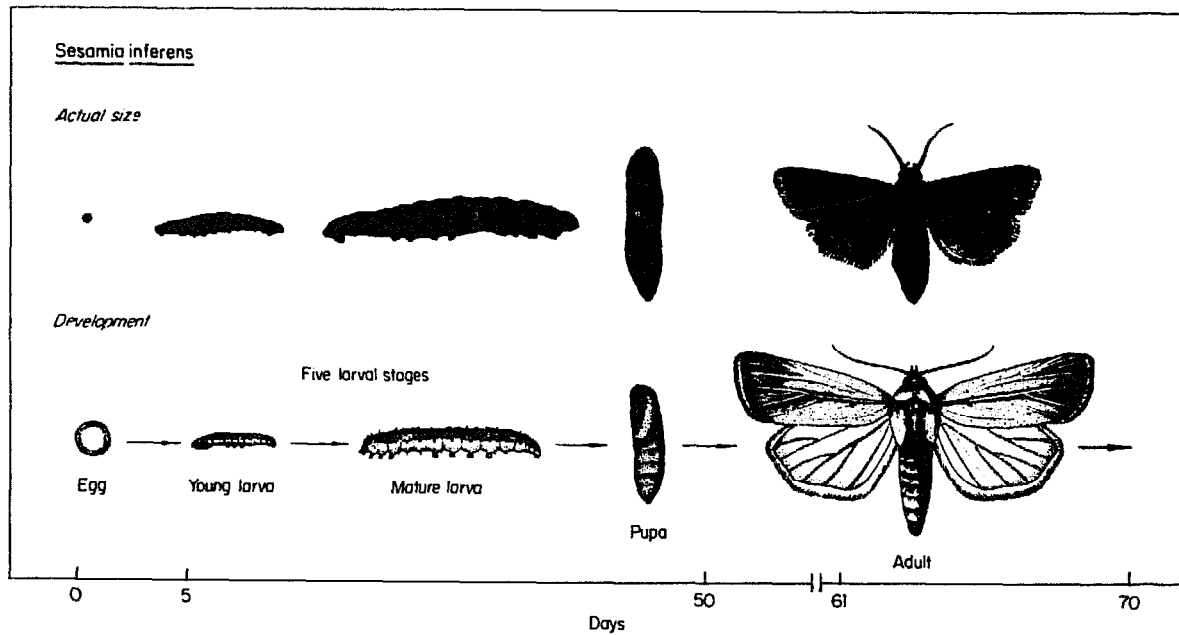
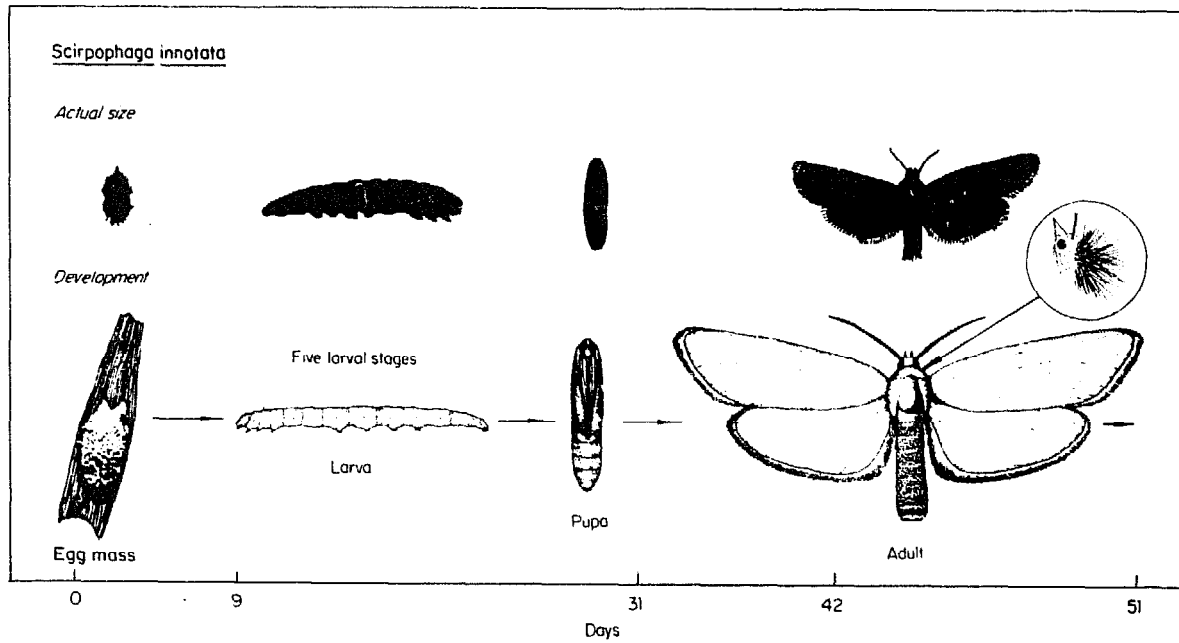
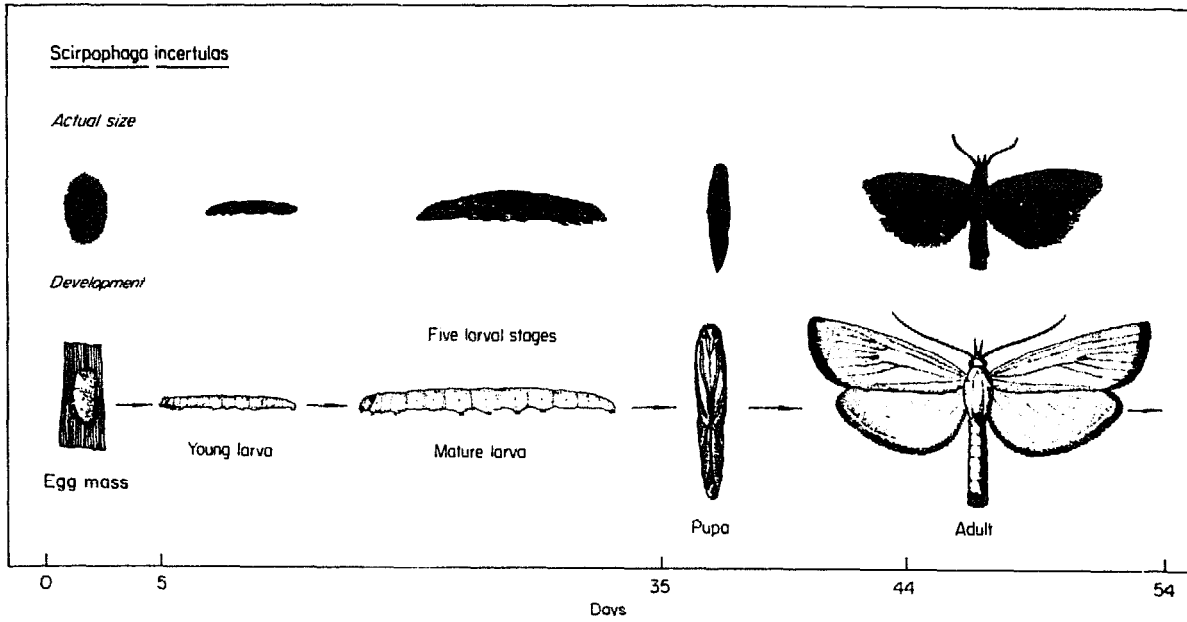

**Adult.** Adults are quiet during the day, hiding among the rice plants or weeds near the field. When disturbed they fly only a few meters. The moths are active at night and fly to rice fields to lay eggs.

Stem borer moths are strong fliers, but normally range within 2 km from their origin.

Each female lays 200-300 eggs during a lifetime of 4 days.

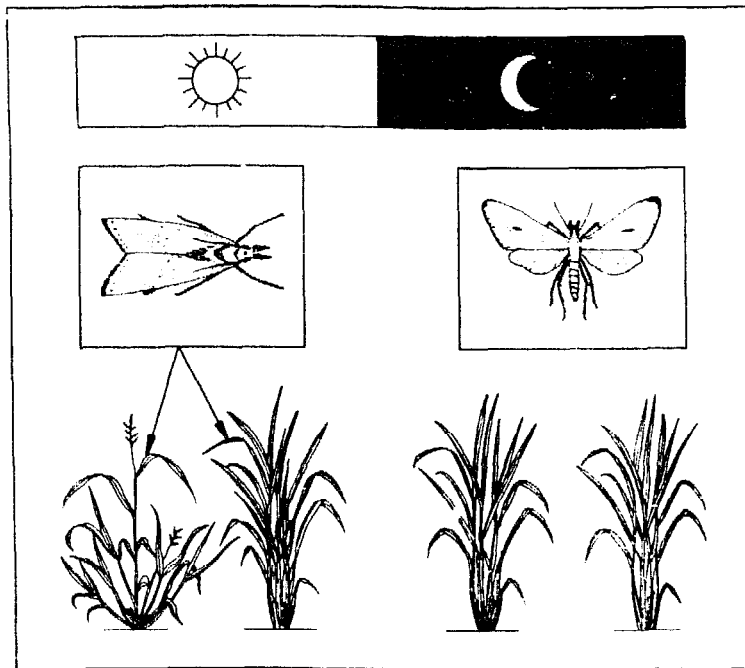

Adults are attracted to a light trap. The greatest numbers are caught during a new moon.

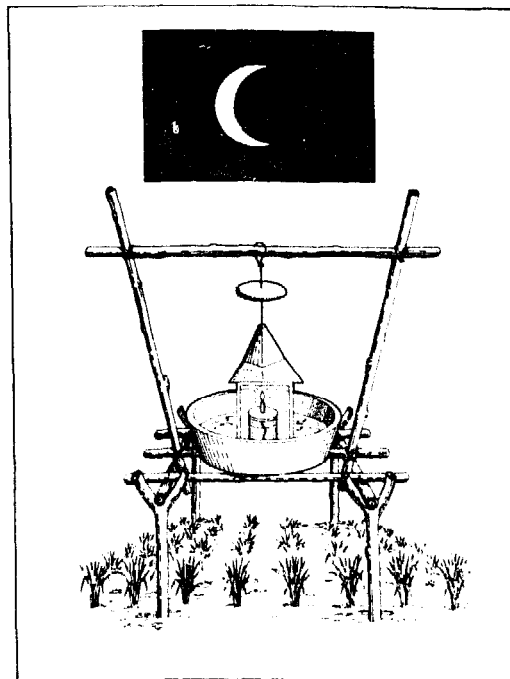

**Egg.** Eggs are laid in masses of 5-200 on rice leaves or leaf sheaths. Egg shape, appearance of the egg mass, and location on the plant are specific characteristics that vary among species.

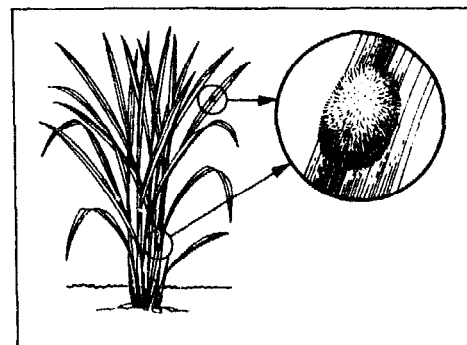

**Larva.** Newly hatched larvae often suspend themselves from leaves by a silken thread and are blown to other plants. Others make a tube from cut leaves, and swim or drift to nearby plants. Young larvae feed on leaves and leaf sheaths.

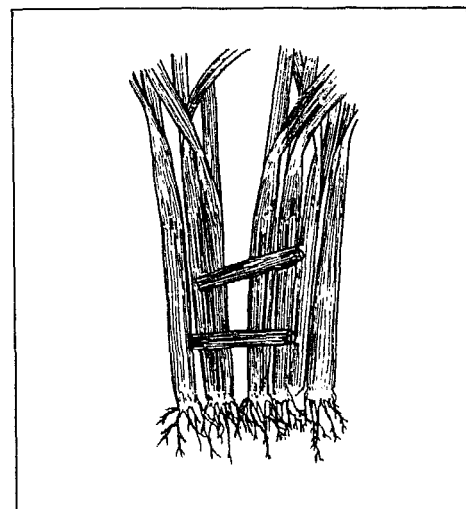
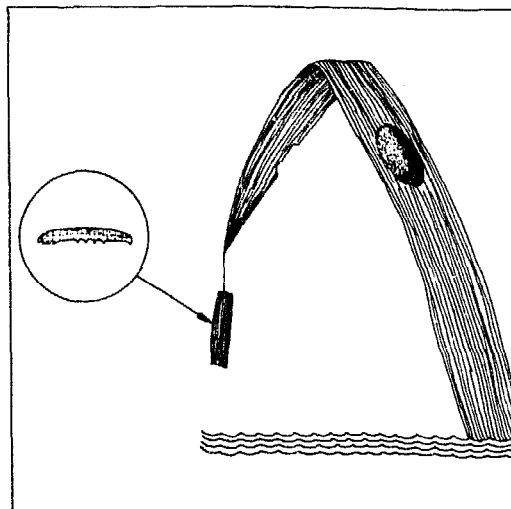



Medium-aged larvae penetrate the leaf sheath and feed between the sheath and tiller for several days before entering the stem. Older larvae feed inside the stem near the base of the plant. Mature larvae inside the stem may move below the soil surface and hibernate when conditions are unfavorable.

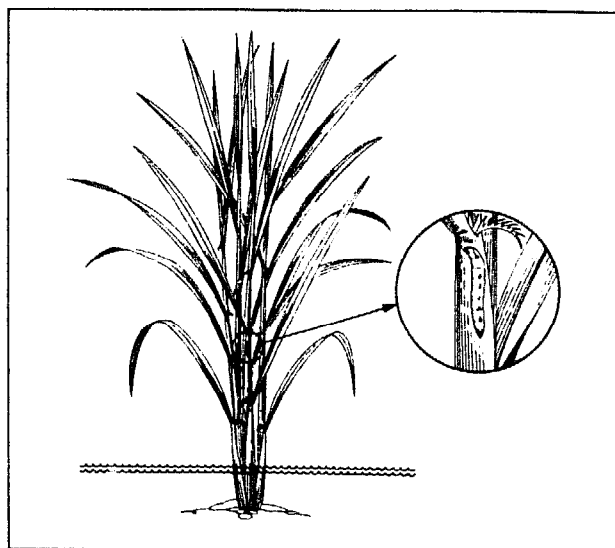

**Pupa.** Larvae pupate inside the stems near the ground or several centimeters below the soil surface.

Adults emerge from the pupal case and crawl out of the rice stem through the exit hole cut previously by the mature larvae.

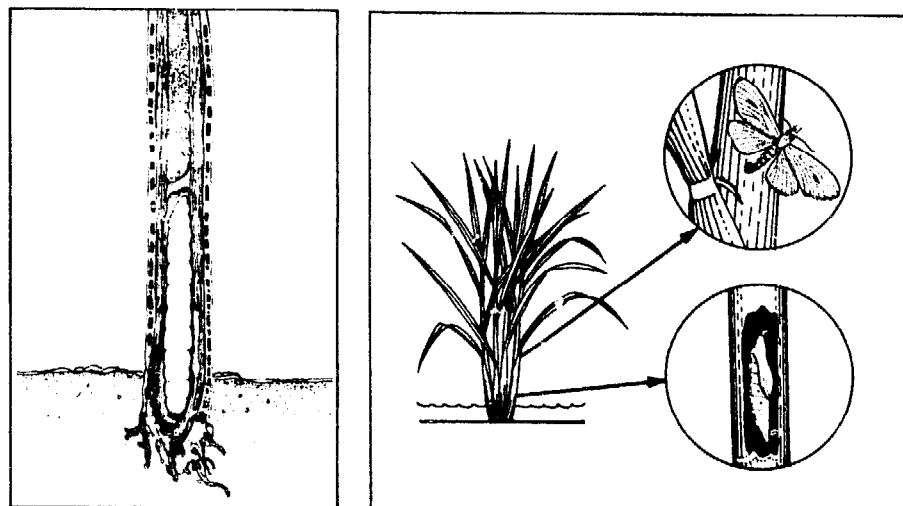

**Striped stem borer**

*Distribution in Asia.*

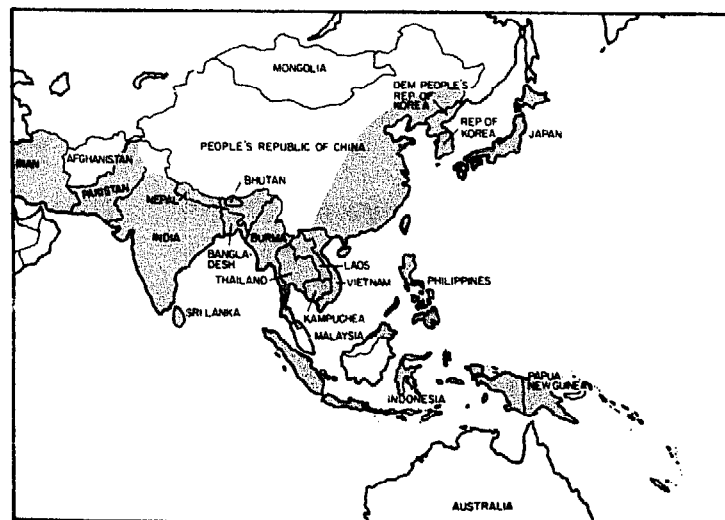

The striped stem borer moth is straw to light brown with silvery scales and a row of black dots at the tip of the fore wing; the hind wing is yellow-white.

The eggs are disc-like, pale yellow, and overlap in the egg mass.

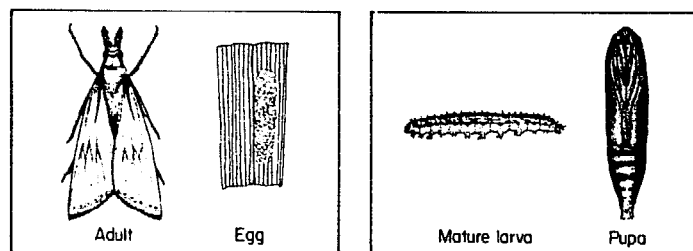

The larva has a yellow-brown head. It gets its name from three dorsal and two lateral brown stripes along its body.

In temperate regions the larvae overwinter in rice straw or rice stubble.

The pupa is dark brown.

**Plant hosts.** The larvae can develop on maize or grassy weeds, but prefer rice.

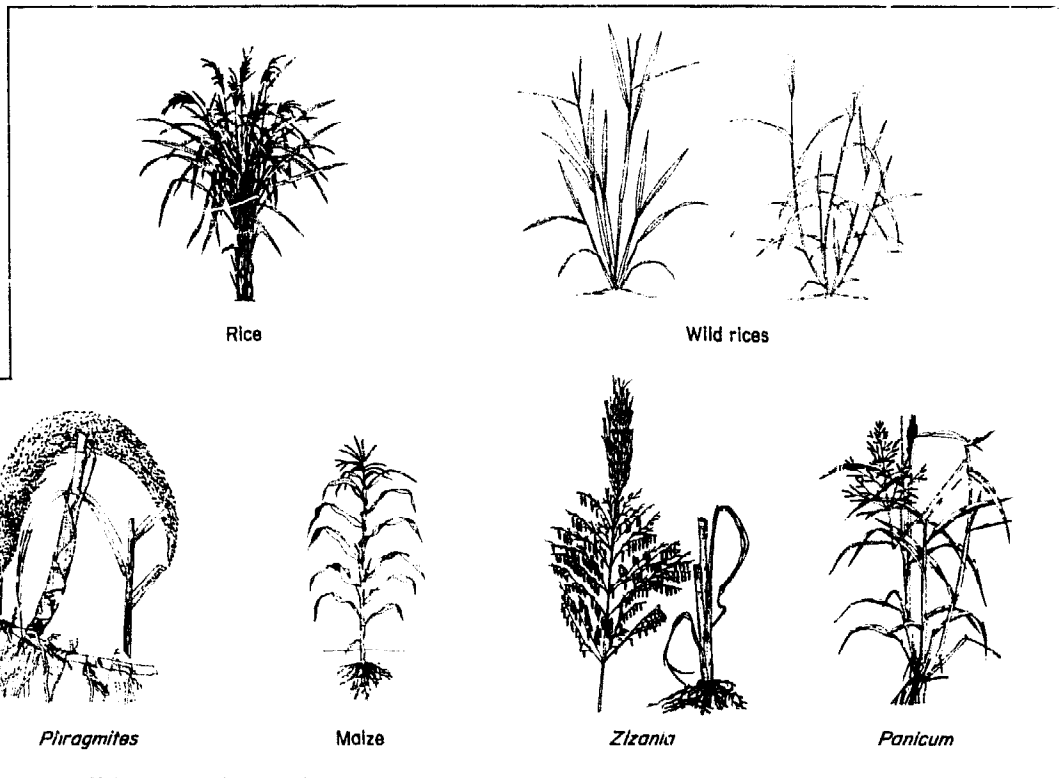

**Distinguishing characteristics**

- Egg masses are deposited near the base of leaves or leaf sheaths and are not covered with hair.
- Larval body with five longitudinal rows of purplish brown stripes.
- Many larvae may be found in one rice stem.
- Second generation larvae: about 3-16 aggregate inside the leaf sheath of the flag leaf and feed on the panicles.

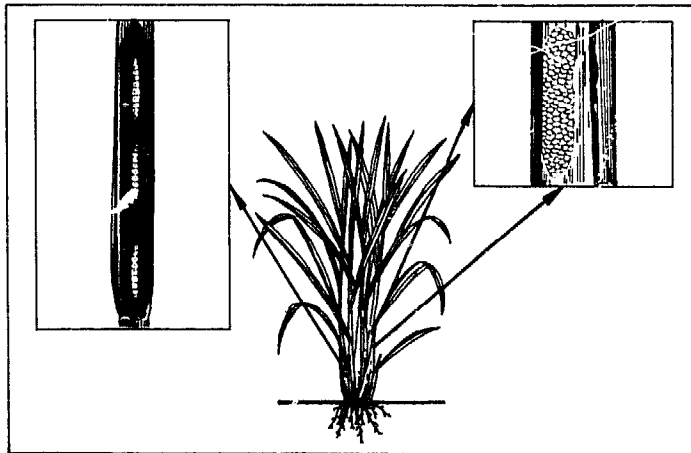

- The striped stem borer is most abundant in temperate regions and in areas that do not flood.

**Dark-headed and gold-fringed stem borers**

**Distribution in Asia**

The range of dark-headed stem borer *C. polychrysus* overlaps that of the gold-fringed stem borer *C. auricilius*. Their moths and immature stages viz. eggs, larvae, and pupae are morphologically similar and in many instances externally indistinguishable. The adult moth is straw to light brown with silver scales at the center of the fore wing in *C. polychrysus*, silver lines near the apical one-fifth in *C. auricilius*, and several black dots at the tip of their fore

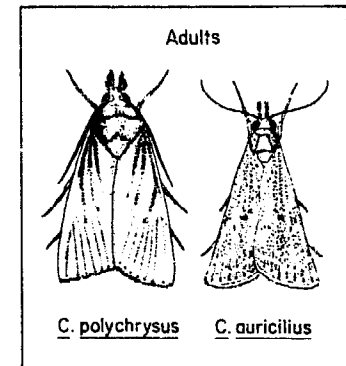
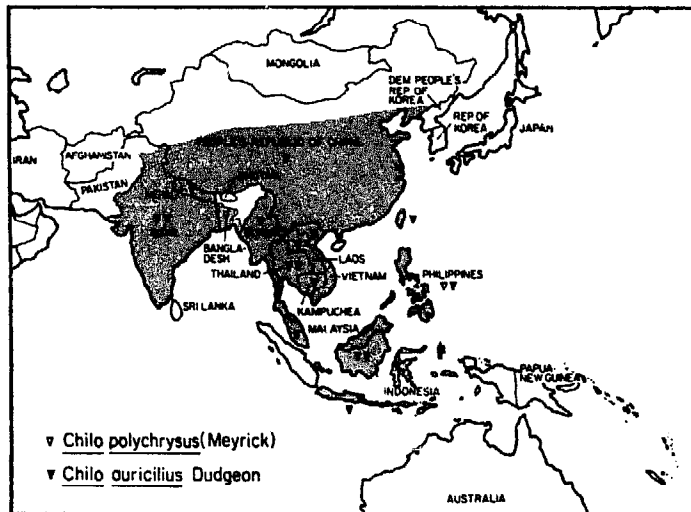

wings. The hind wings are yellow-white.

The scale-like pale-yellow eggs overlap in the egg mass.

The larva has a black head and black connecting thoracic plate.

On the abdomen, three dorsal and two lateral brown stripes are distinct.

The pupa is yellow-brown with two distinct bumps at the front of the head.

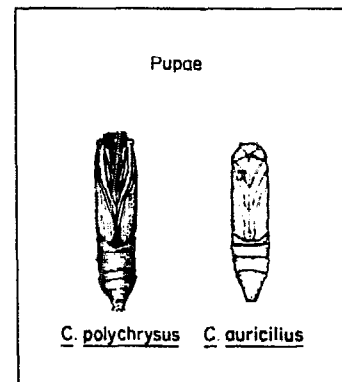
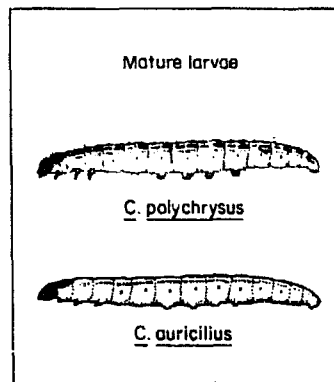
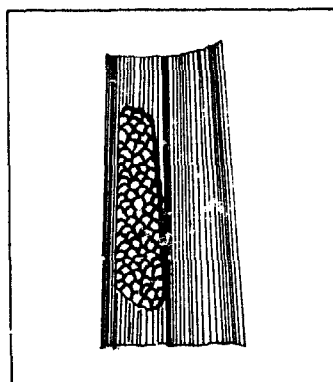

*Plant hosts.* Rice is not the only preferred host.

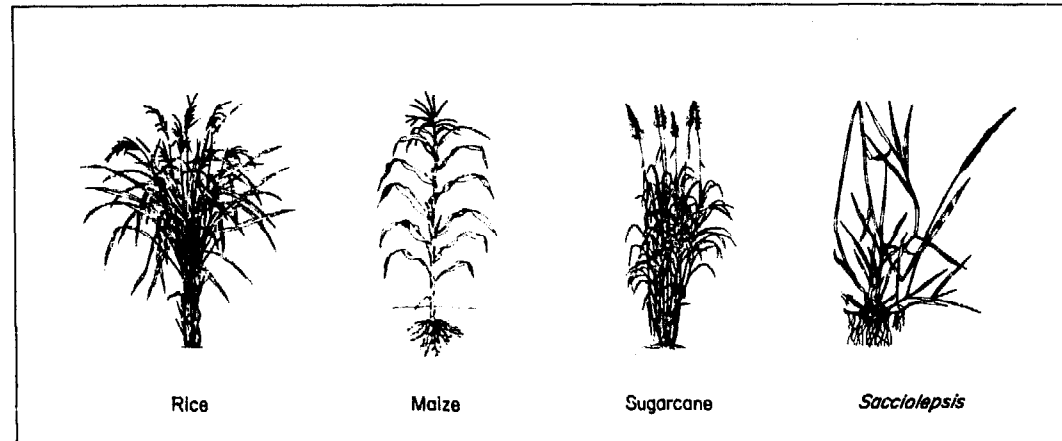

*Distinguishing characteristics*

- Eggs are laid in rows near the base of the leaves and on leaf sheaths, and are not covered with hair.
- The heads of the dark-headed and gold-fringed stem borer larvae are darker than the head of the striped stem borer larva.
- Second generation larvae, about 8-16, aggregate inside the leaf sheath of the flag leaf and feed on the panicles.
- The dark-headed stem borer is normally not abundant in rice, except in

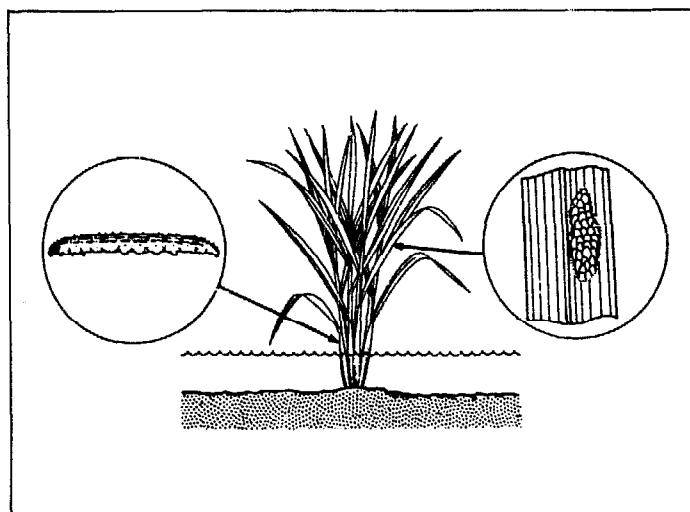

Malaysia. The gold-fringed stem borer is common in upland rice in the Philippines.

**Yellow stem borer**

*Distribution in Asia*

The male and female yellow stem borer moths differ in appearance. The male is small-sized and is light brown with numerous small brownish dots, five along the subterminal area and eight or nine near the tip of the fore wing. The female is medium-sized and straw-colored, becoming darker toward the tip, and has a very distinct black spot in the center of each fore wing. The hind wings are pale and straw-colored.

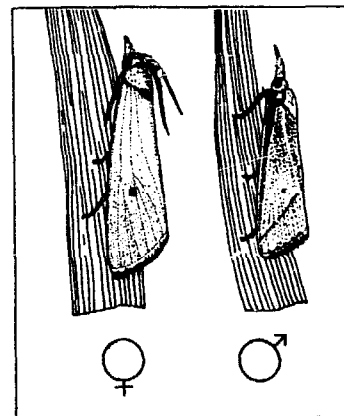
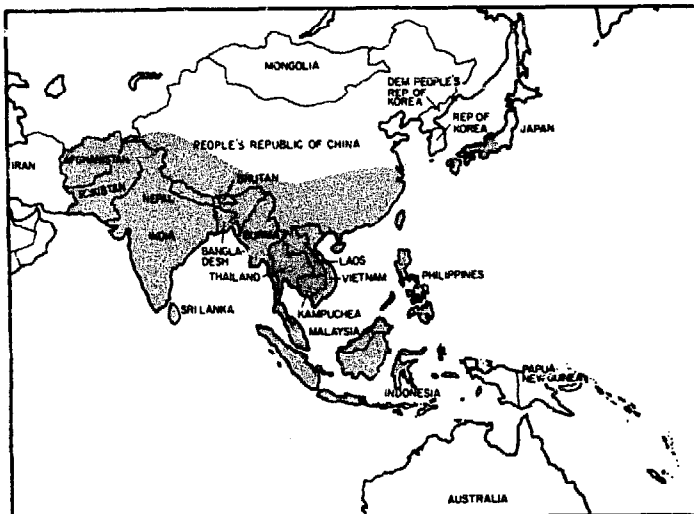

The disc-like eggs are laid in oval batches and are covered with a mat of tan anal hairs from the female moth.

The larvae have small orange heads. This stem borer gets its name from its pale, hairless yellow body. The larva is the overwintering

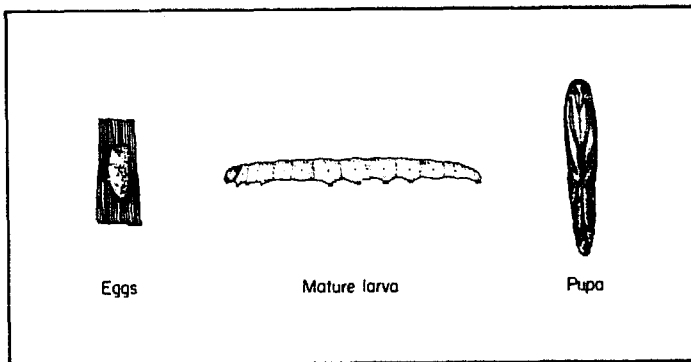

stage in temperate regions. The pupae are elongated and yellow-white.

*Plant host.* The larva feeds only on rice and related wild rices.

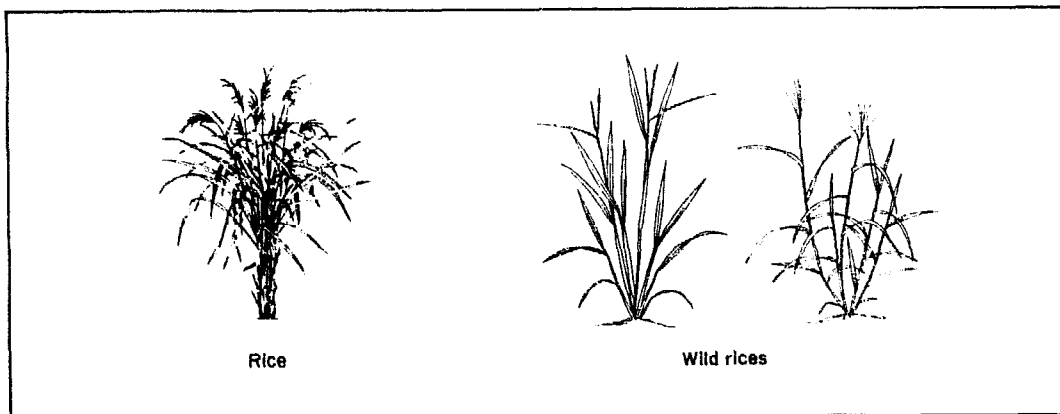

*Distinguishing characteristics*

- Egg masses are laid near leaf tips and are covered with hair.
- Only one larva occurs in a stem.
- The pupae are found at the extreme base of the plant, often below the soil.
- The yellow stem borer is most abundant in aquatic habitats where flooding occurs and in places where multiple rice crops are grown annually. Larvae seal entrance holes with silk to make stems watertight.

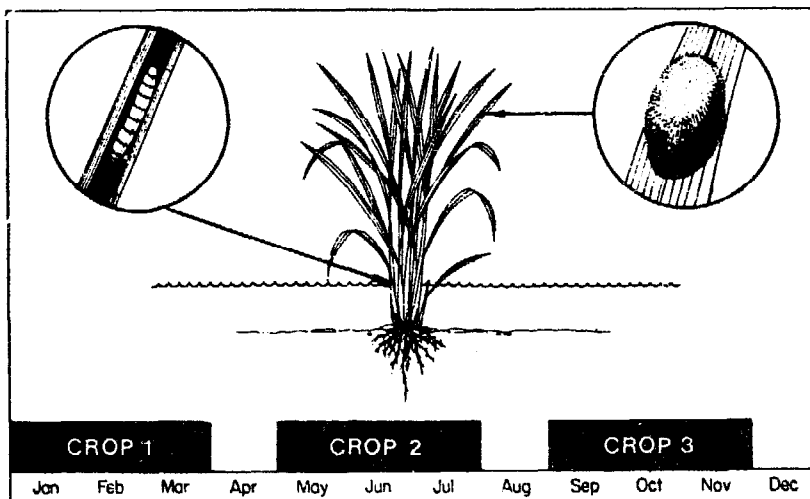

**White stem borer**

*Distribution in Asia*

The adult white stem borer is similar to the yellow stem borer in appearance. The male is smaller than the female. Moths of white stem borer have longer hairs on the prothorax.

The egg masses are identical to those of the yellow stem borer.

The larvae appear like those of the yellow stem borer. The white stem borer pupae tend to be more white-colored than those of the yellow stem borer. These two stem borers can only be clearly differentiated as female adults. The yellow stem borer female has a

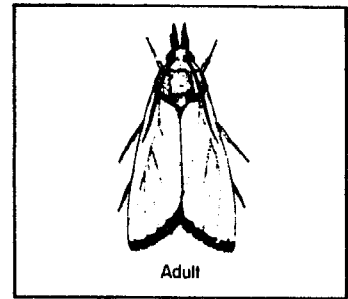
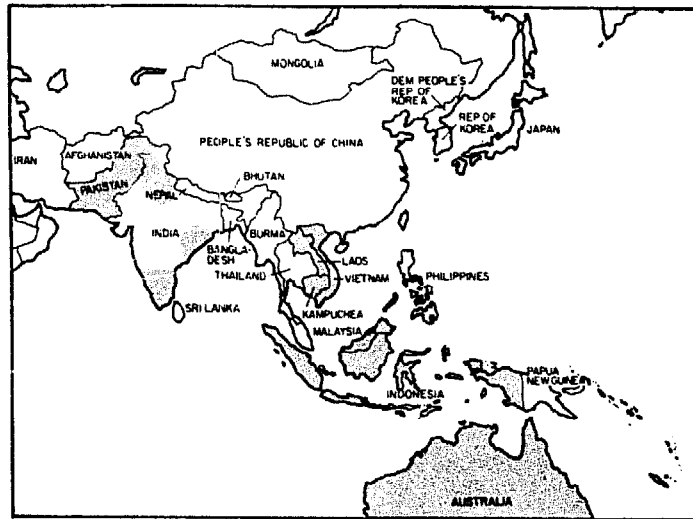

Adult

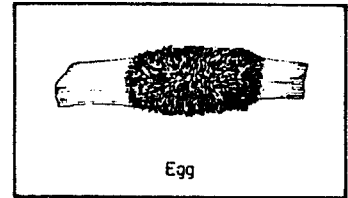

Egg

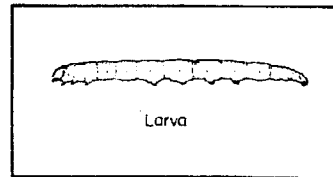

Larva

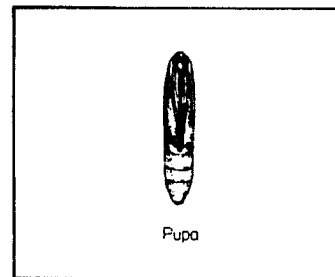

Pupa

black spot on each front wing whereas the white stem borer female has no spot.

*Plant hosts.* Larvae are reported to have a wide host range.

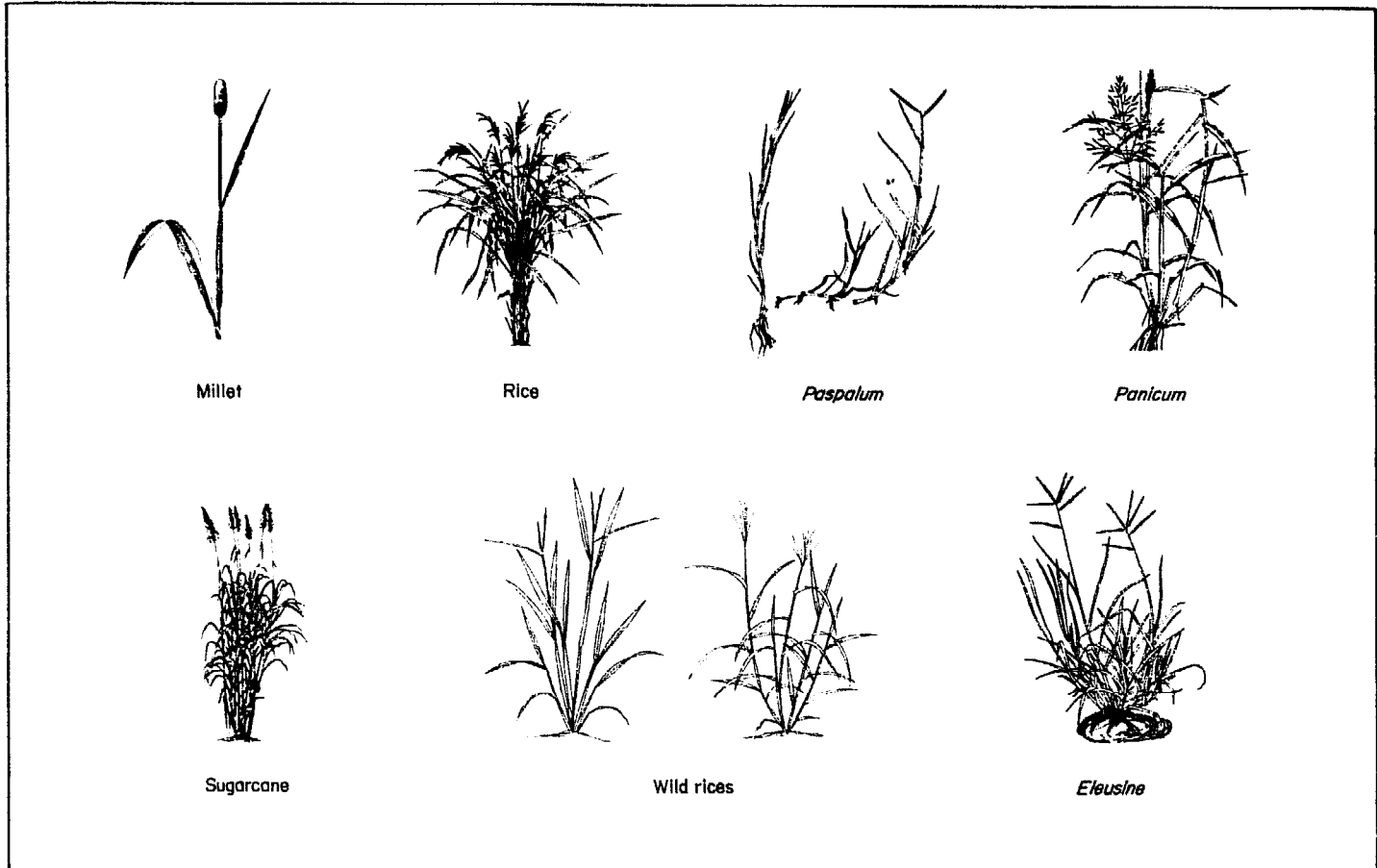

Millet

Rice

*Paspalum*

*Panicum*

Sugarcane

Wild rices

*Eleusine*

**Distinguishing characteristics.** The egg mass, larva, and pupa of the white stem borer are similar to those of the yellow stem borer.

- The white stem borer occurs predominantly in areas where there is only one wet season rice crop a year and the stubble is left undisturbed during the dry season.

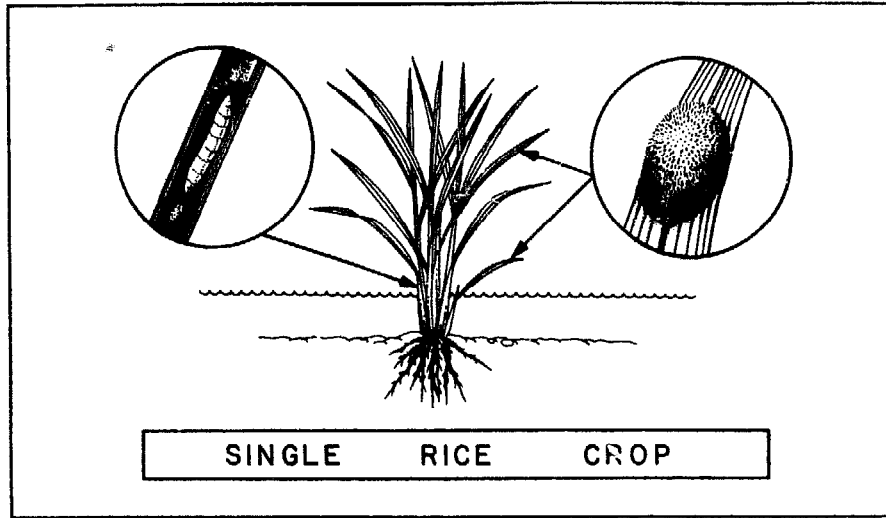

- The larvae remain dormant at the base of the plants during the dry season.

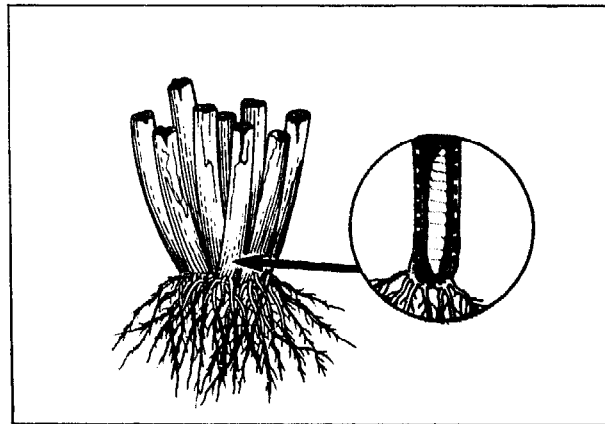

**Pink stem borer**

*Distribution in Asia*

The pink stem borer belongs to a family different from that of the other stem borers. It is related to cutworms and armyworms.

The adult is robust and tan with dark brown markings. From a central point in the fore wing, a typical radiation of grey-black lines spreads toward the wing tips, ending in a thin terminal line of dark spots. The hind wings are white.

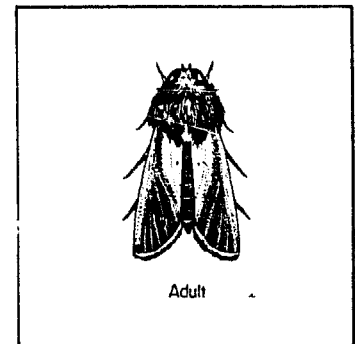
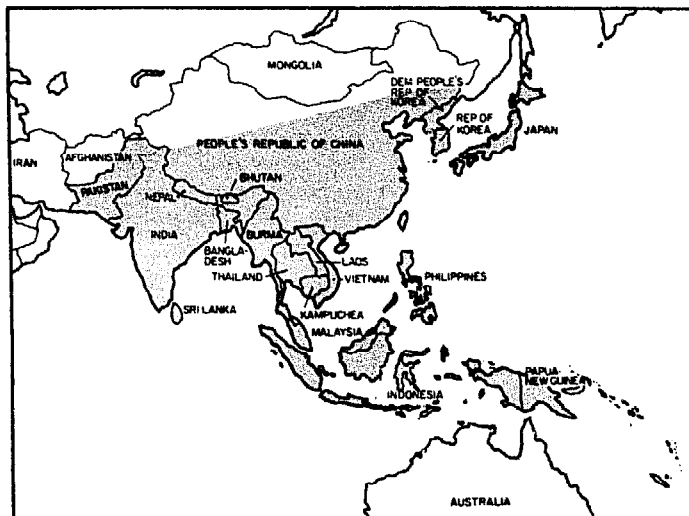

The bead-like eggs are laid in rows between the leaf sheath and stem and are not covered with hair.

The larva has an orange-red head. Its body is purple-pink on top and white below.

The pupa is dark brown and robust.

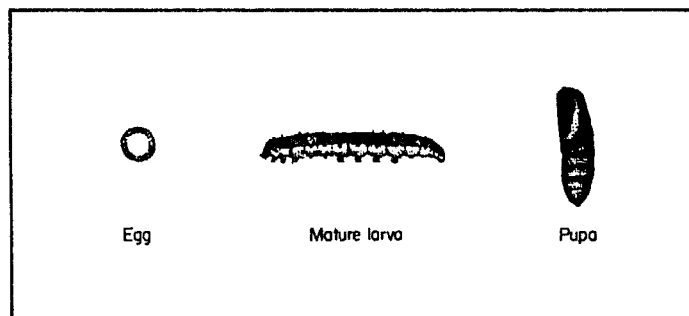

*Plant hosts.* The larvae have a wide host range.

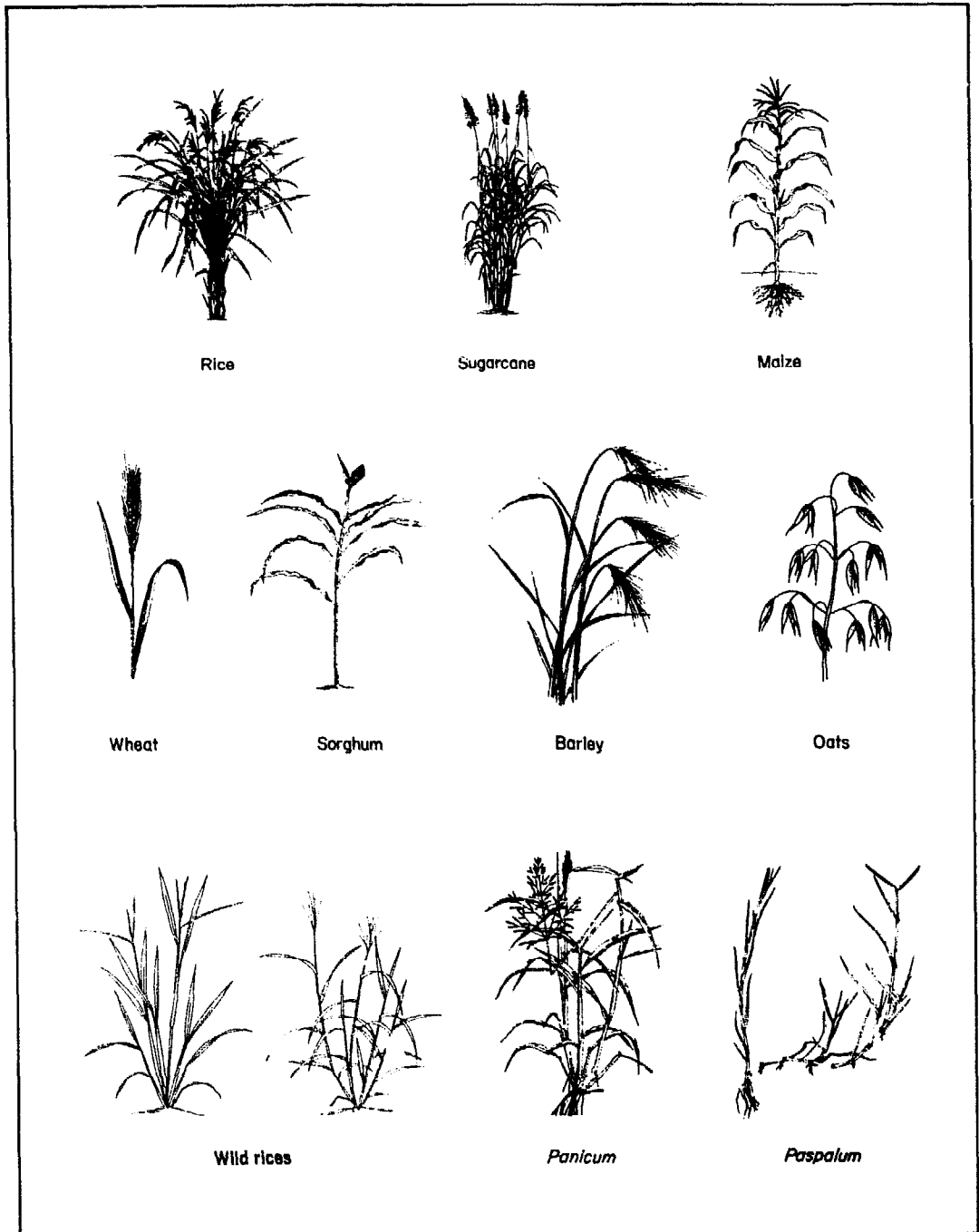

*Distinguishing characteristics*

- The eggs are laid between the leaf sheath and the stem and are not covered with hair.
- Larvae may pupate between the leaf sheath and the stem, instead of inside the stem.

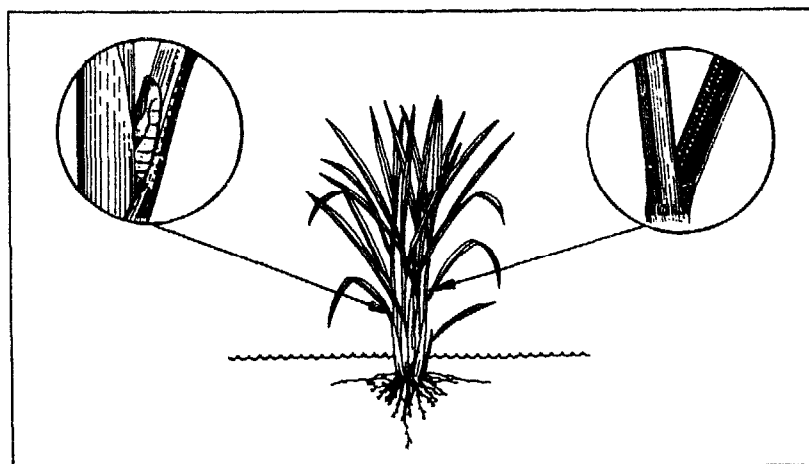

**Damage**

The larvae that have penetrated a tiller feed on the inner surface of the stem walls and thus interrupt the movement of water and nutrients.

Tunneling by the larvae weakens rice stems, which then break easily.

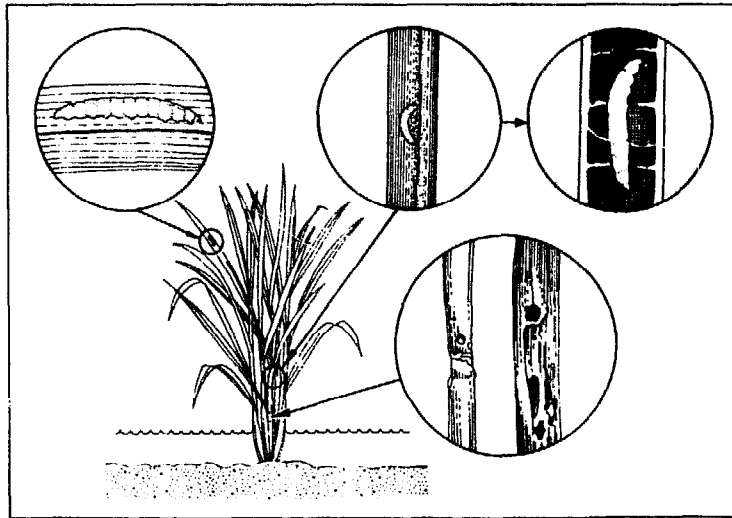

Damage depends on the age of the plant when it is attacked.

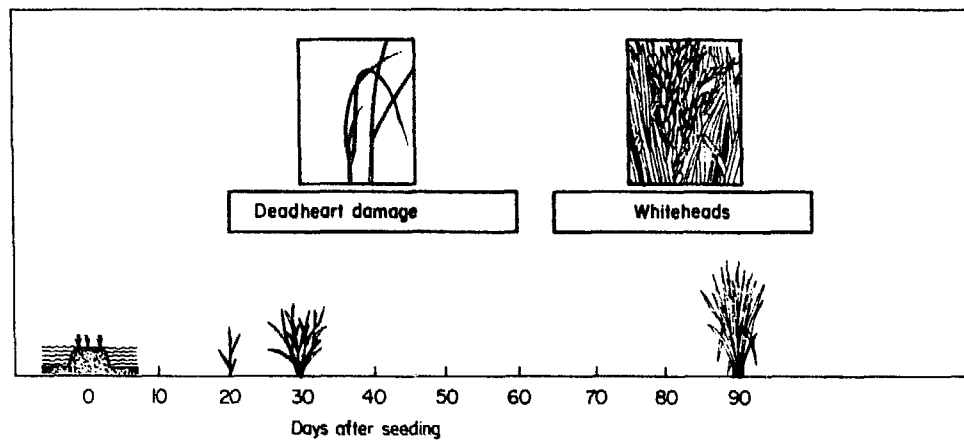

If damage occurs when the plants are young, the central leaves of the damaged tillers turn brown. This damage is called deadhearts.

If the damage occurs after the spikelets form, panicles turn white and no grain filling occurs. The damaged panicles are called whiteheads.

Tiller damage from diseases such as kresek resembles deadhearts. Drought and neck blast can also cause whiteheads.

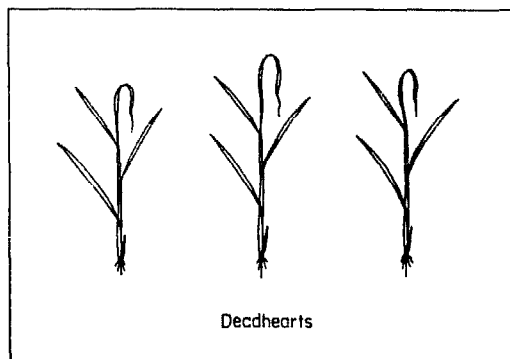

Panicles damaged by stem borers can easily be pulled out by hand and may show insect feeding near the base.



Stem borer damaged tillers are filled with frass (waste from the digestive tract) and have larval entrance and exit holes.



**Management**

*Cultural control.*

- Plant an early-maturing rice variety.

The stem borer completes fewer generations in an early-maturing variety. Populations on such a variety are lower and damage is reduced.

- Plant fields in an area within 3 to 4 weeks, which is less than the time for one stem borer generation.

Stem borers complete fewer generations when fields are planted synchronously.

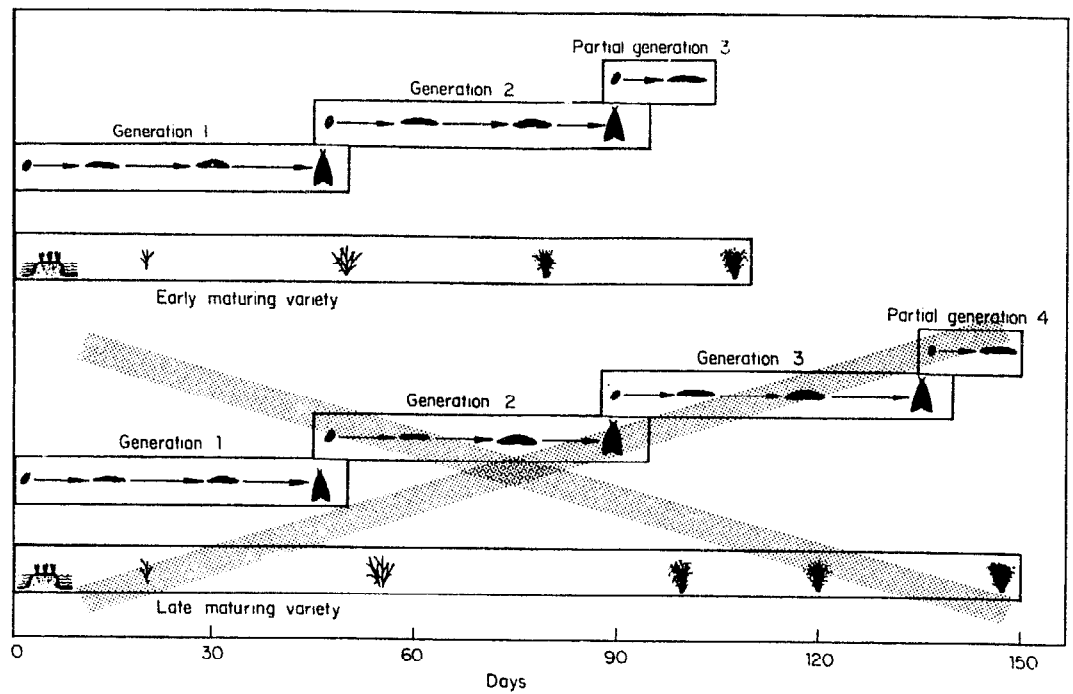

Fields planted later may be severely damaged by stem borers that have built up in fields planted earlier.

Stem borers in late planted crops may be carried over to attack a second rice crop.

Stem borers on the first crop will not be carried over to the second crop if the stubble is plowed under after the first crop is harvested, and the ground is left fallow for at least 3 to 4 weeks between crops.

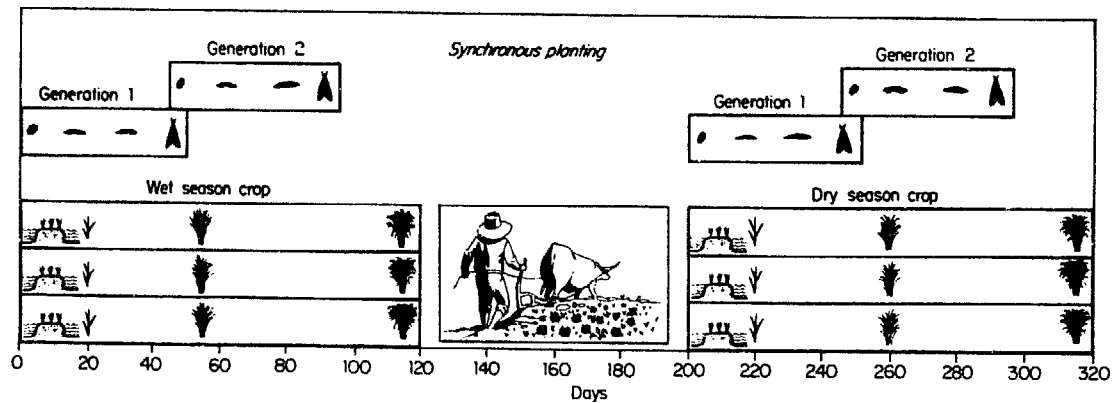
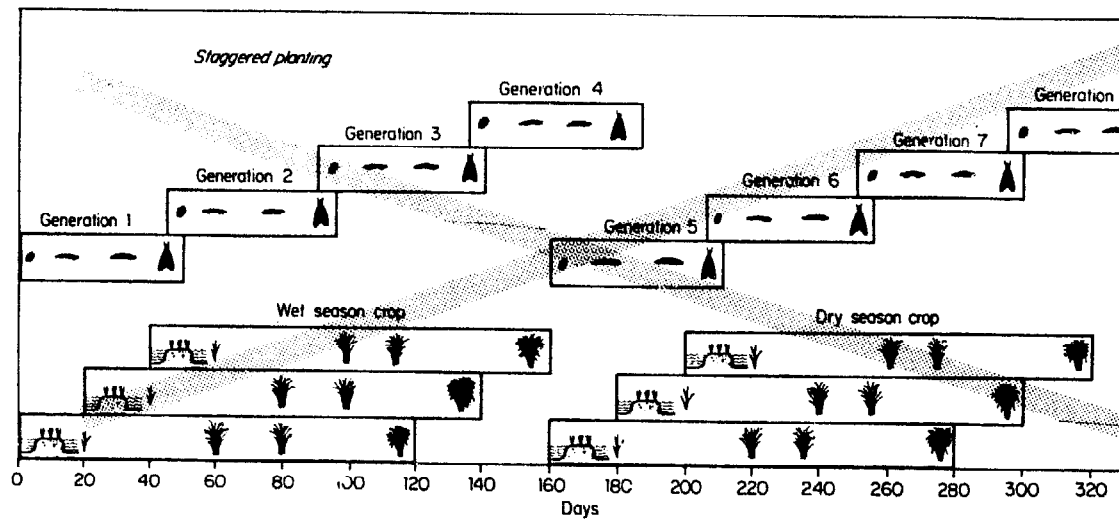

- Remove rice stubble and straw.

Plow stubble immediately after harvest to destroy yellow and white stem borer larvae and pupae.

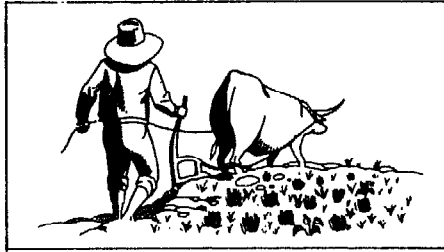

Cut stubble close to the ground so that many of the remaining striped, dark-headed, and pink stem borer larvae are removed with the straw.

Burn or sun-dry straw after threshing to destroy stem borer larvae.

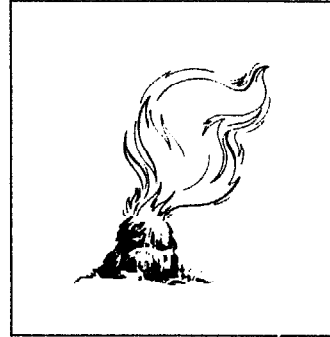
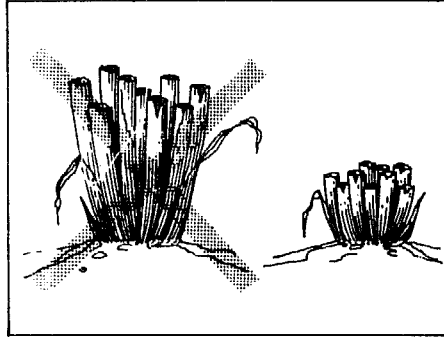

- Avoid excessive nitrogen fertilizer by splitting fertilizer applications.

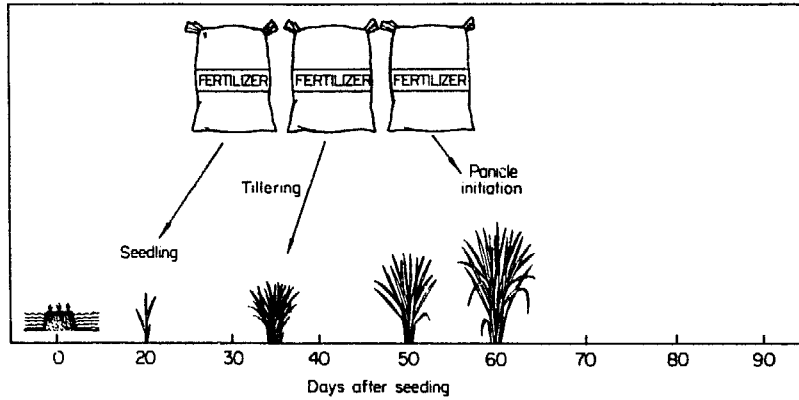

- Remove seedlings with stem borer egg masses before transplanting.
- Flooding a field will not control all stem borers. The yellow stem borer is in fact a major pest of deepwater rice and the larvae can complete their development.

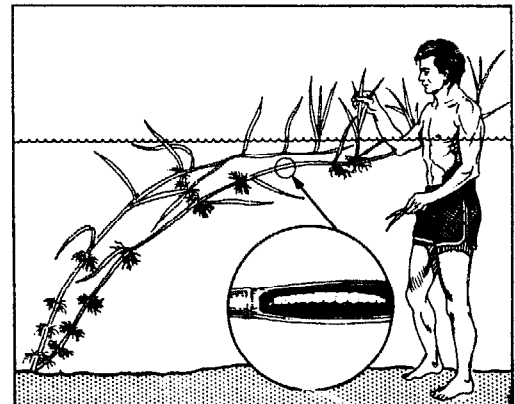
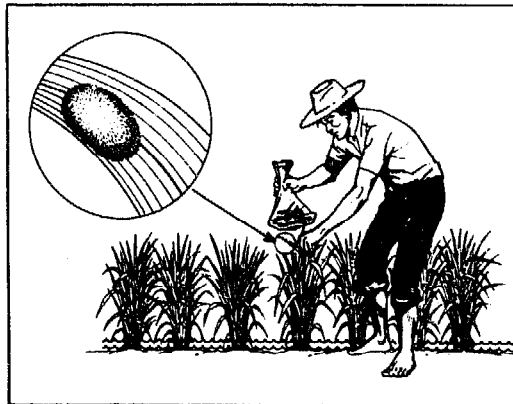

*Resistant varieties.* Many improved varieties have moderate resistance to stem borers.

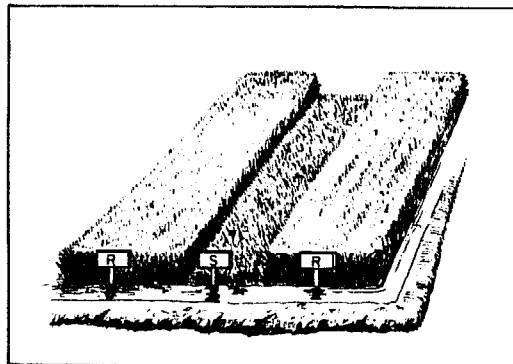

Because some chemicals in the rice plant affect the moth, the plant becomes less attractive for egg laying and larvae that emerge have a lower rate of survival, are small, and take a longer time to mature.

High tillering varieties can compensate more for deadhearts during the tillering stage than low tillering varieties can.

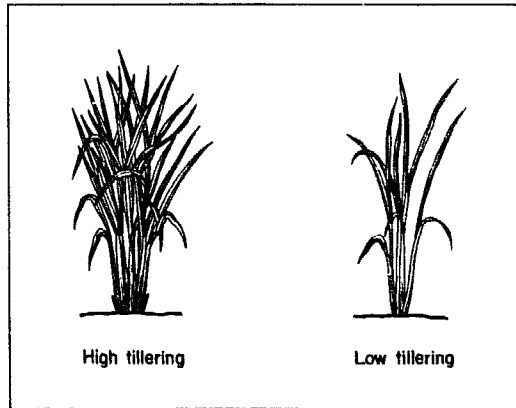

**Biological control.** Stem borer eggs are parasitized by small trichogrammatid, scellionid, and eulophid

wasps. The parasite preferences for stem borer species differ. Parasitization rates are normally very high.

<p>1</p> <p>Striped</p>	<p>2</p> <p>Dark headed</p>	<p>3</p> <p>Yellow</p>	<p>4</p> <p>White</p>	<p>5</p> <p>Pink</p>
<p>D E F G H</p>	<p>D E F G</p>	<p>A B C D F G</p>	<p>A B F G</p>	<p>B D G</p>
<p>A</p> <p><i>Telenomus rowani</i> (Gahan) (Scellionidae)</p>	<p>B</p> <p><i>Tetrastichus schoenobii</i> (Ferriere) (Eulophidae)</p>	<p>C</p> <p><i>Telenomus dignoides</i> (Nixon) (Scellionidae)</p>	<p>D</p> <p><i>Tetrastichus ayyari</i> (Rohwer) (Eulophidae)</p>	<p>E</p> <p><i>Telenomus dignus</i> (Gahan) (Scellionidae)</p>
<p>F</p> <p><i>Trichogramma japonicum</i> (Ashmead) (Trichogrammatidae)</p>	<p>G</p> <p><i>Trichogramma australicum</i> (Girault) (Trichogrammatidae)</p>	<p>H</p> <p><i>Trichogramma chilonis</i> (Ishii) (Trichogrammatidae)</p>		

Eulophid wasps have elongated ovipositors and can lay their eggs in stem borer eggs, even if the latter are covered with a mat of hair. Scelionid wasps, however, parasitize stem borer eggs while the moth is in the act of oviposition — before the eggs are covered with hair. The wasp locates the female moths, possibly by the windborne chemical sex pheromone given off by the female moth to attract a mate. The wasp attaches itself to the tuft of anal hair near the female moth's ovipositor and waits for the moth to lay eggs.

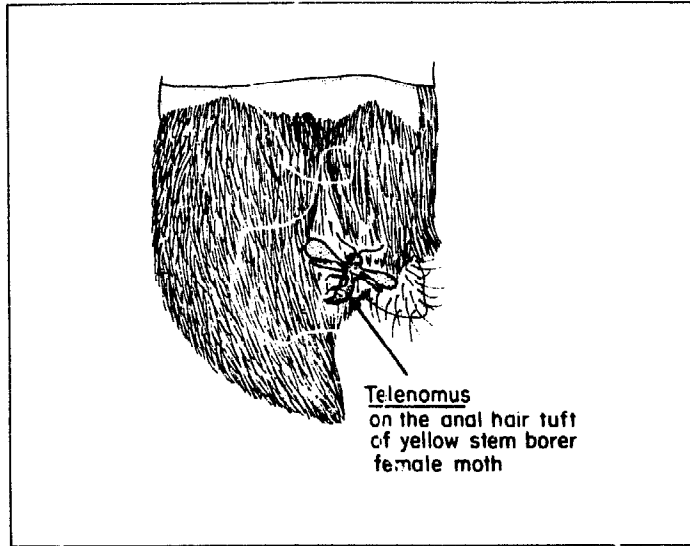

Egg masses are also the food of several predators. Tettigoniid and gryllid predators prefer yellow and white stem borer egg masses and consume the hair mat covering the eggs as well as the underlying eggs.

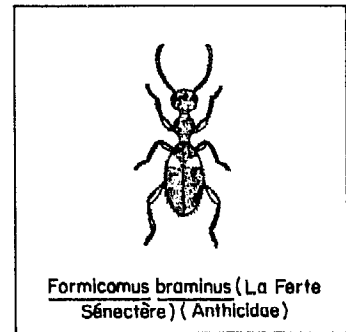
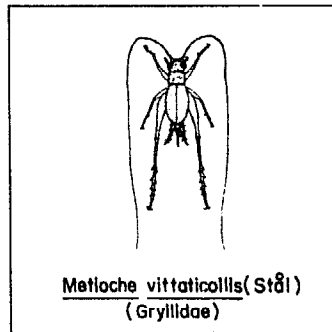
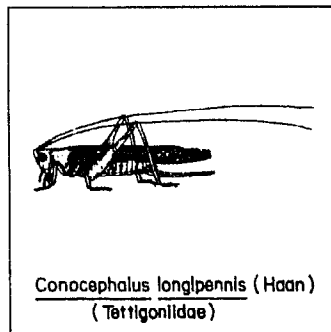

The larval and pupal stages are attacked by a large number of parasites,

but parasitization rates are often very low.

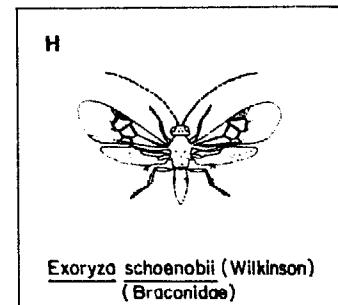
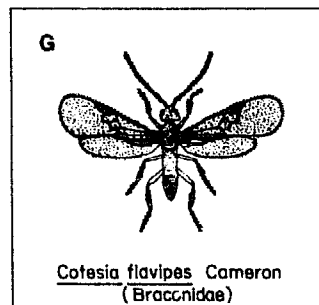
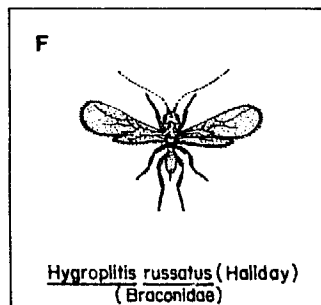
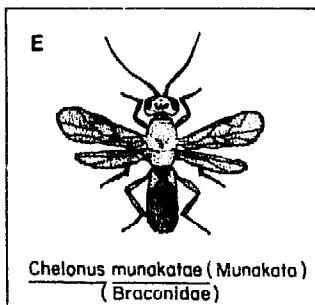
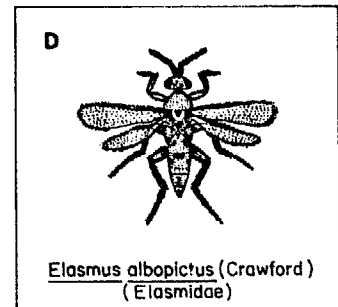
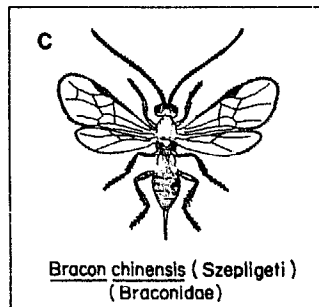
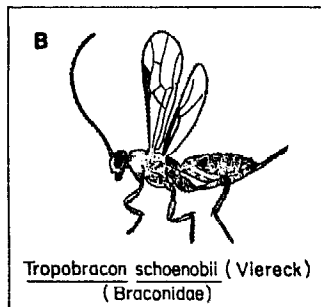
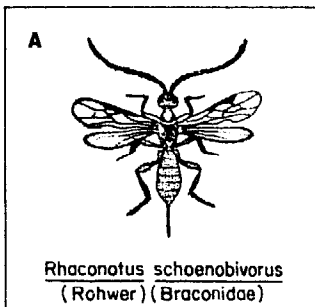
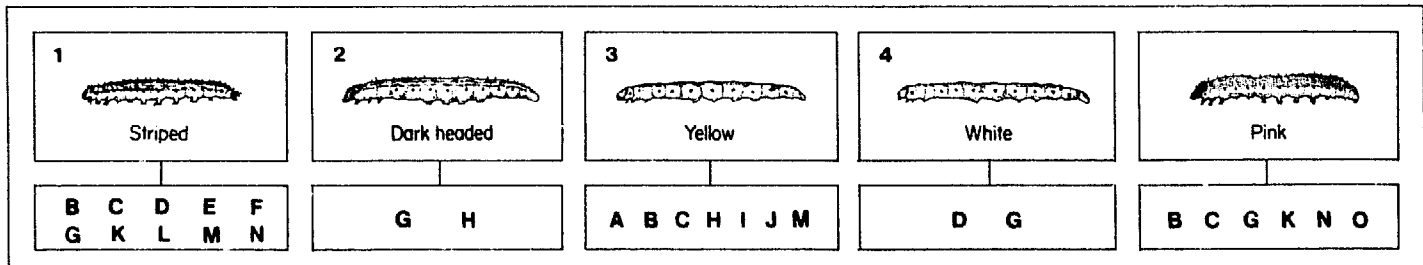

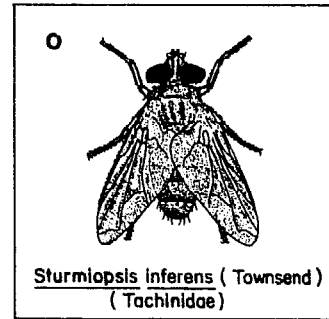
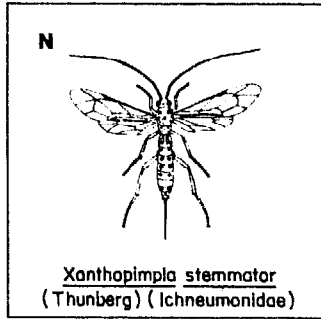
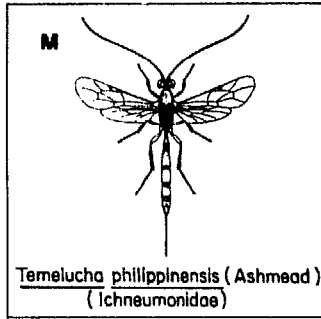
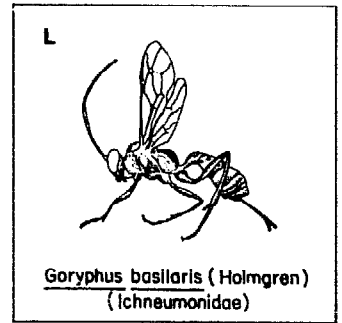
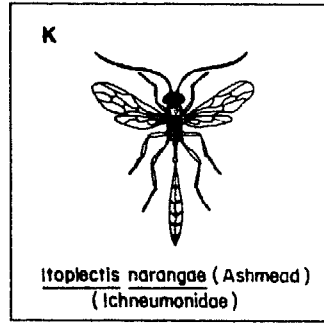
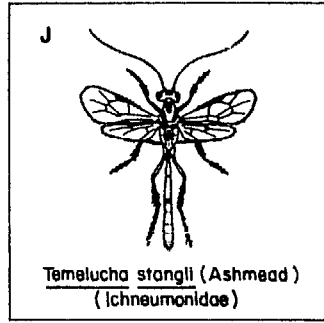
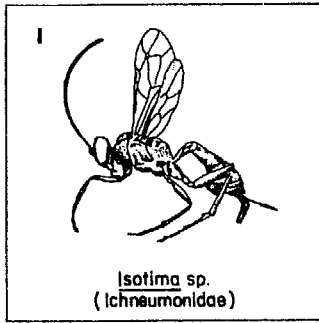

Carabid ground beetles prey on larvae, and spiders prey on adult moths.

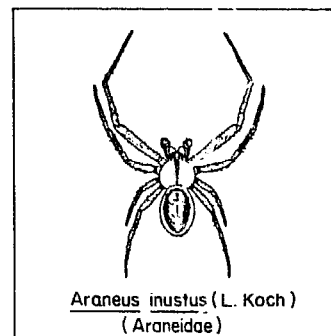
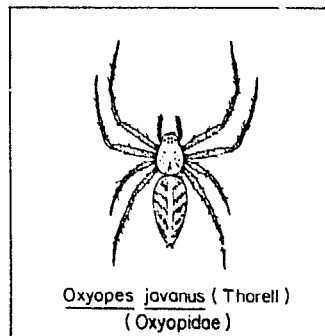
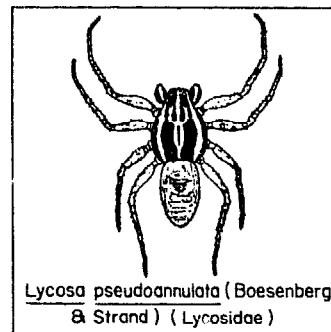
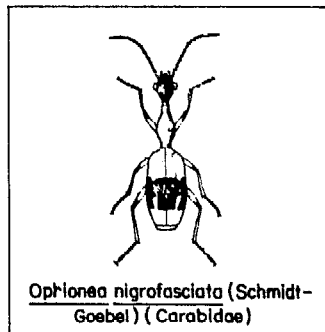

Several species of fungi can infect the larval stage and consume the stem borer at the base of stems when it is about to pupate. The *Cordyceps* fungus grows long, noodelike arms from the stem borer's body.

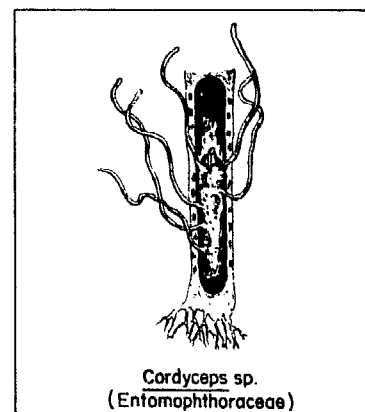

**Chemical control.**

• **Insecticide application.**

Because stem borer larvae enter tillers, controlling them with insecticide is often difficult.

1. **Tillering stage.** If fields are flooded during the tillering stage, sprays and granules are equally effective.

If the paddy water depth is less than 5 cm, sprays can be used.

2. **Panicle initiation to flowering.** After the crop reaches maximum tillering, granules are not effective and only spray formulations should be used.

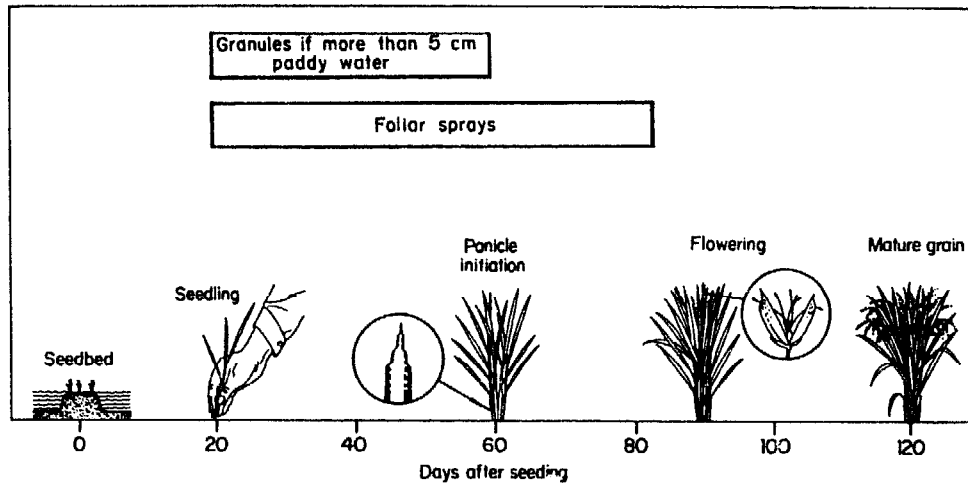

Larvae entering tiller (%)

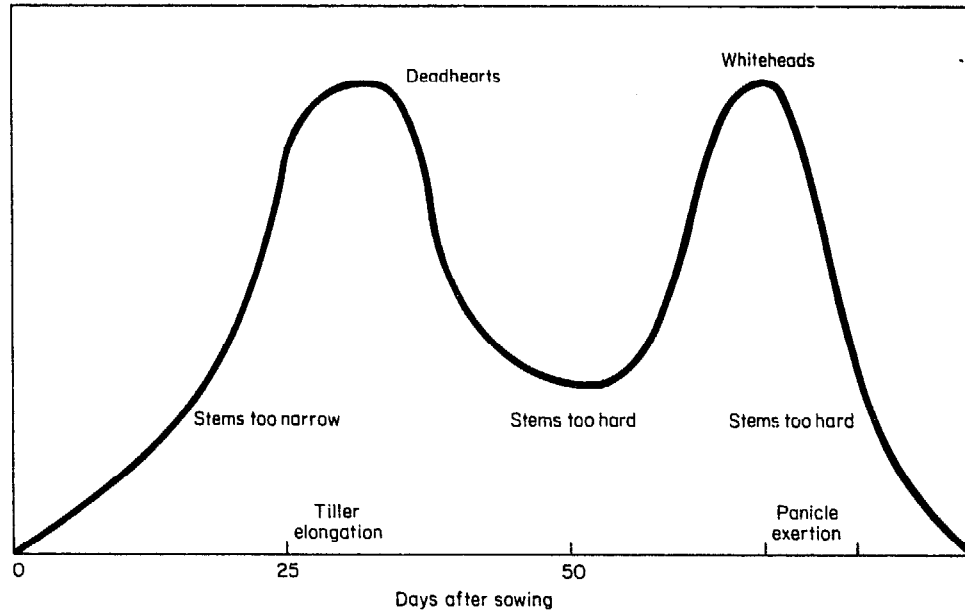

• **Scouting.** The key to the establishment of stem borers in a crop is the survival of eggs — mostly the net result of parasite activity — and the ability of the first-instar larvae to quickly bore into tillers, seeking shelter from predators and insecticide.

Most first-instar larvae succumb to predators because the tillers of seedling rice are too thin to be entered. But small-mandibled first instars can readily enter wider diametered, older tillers which are actively elongating, particularly under heavy fertilization. After the elongation phase, tissues become more densely packed and

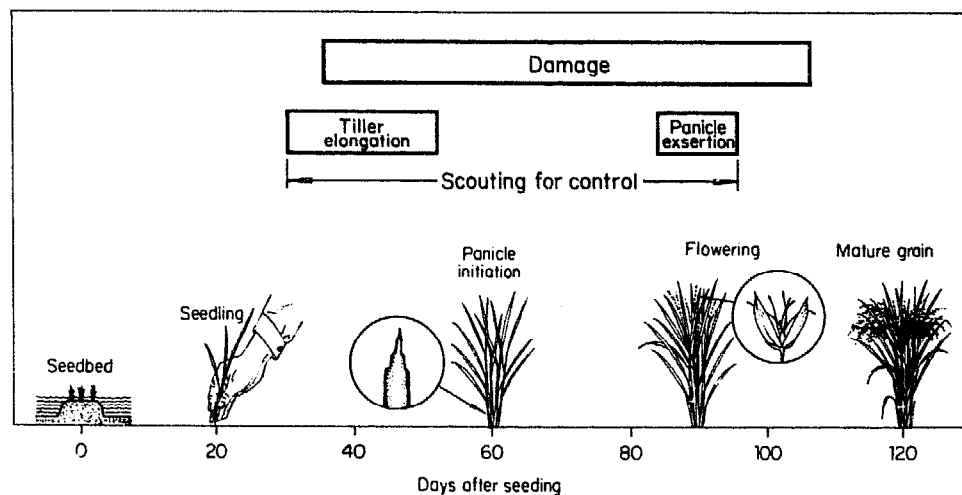

hardened, prohibiting entry to most first-instar larvae. Larval penetration again becomes easier into the soft tissues of the bases of

elongating panicles. Successful entry during panicle exertion leads to whiteheads. Fields should only be

scouted during the two most vulnerable growth stages: tiller elongation and panicle exertion.

Record the number of egg masses from 20 randomly chosen hills across each field. Results are better if more hills are sampled; therefore, adjacent fields can be combined.

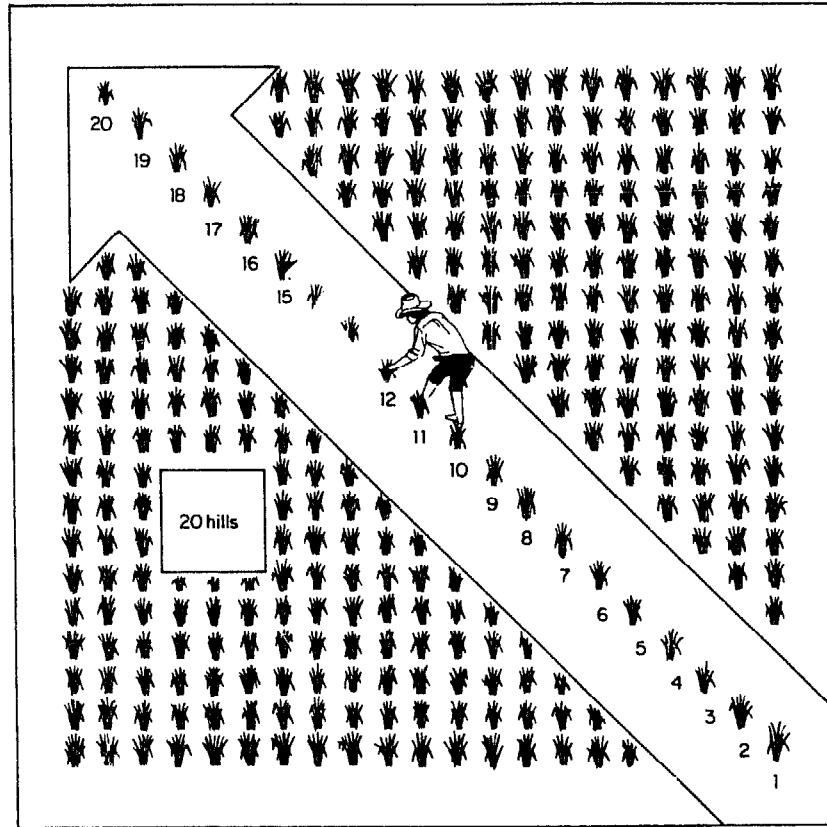

Insecticides should not be applied when the threshold is reached because the eggs may be highly parasitized.

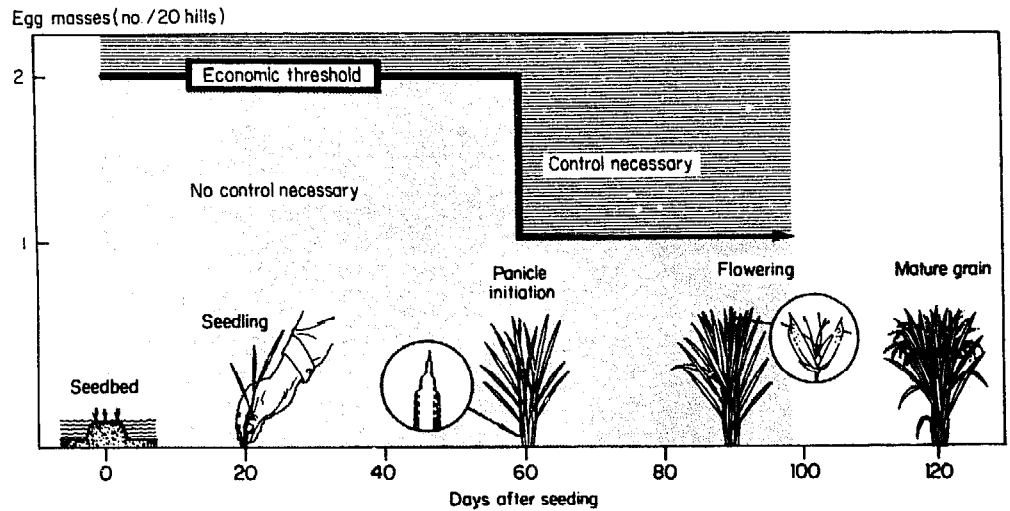

When the threshold is reached, collect egg masses and hold them in sealed jars until the larvae and parasites emerge. If more larvae than parasites emerge, then apply insecticide right away before those in the field enter the plants. If more parasites emerge, there is no need to apply insecticide.

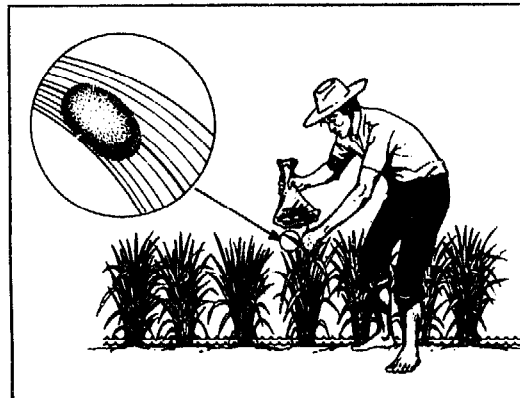

RICE BLACK BUGS (HEMIPTERA: PENTATOMIDAE)

Two species of rice black bugs are important in Asia: the Malayan rice black bug *Scotinophara* (= *Podops*) *coarctata* (Fabricius) and the Japanese rice black bug *Scotinophara* (= *Podops*) *lurida* (Burmeister).

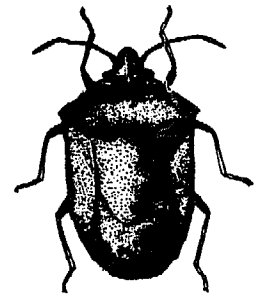
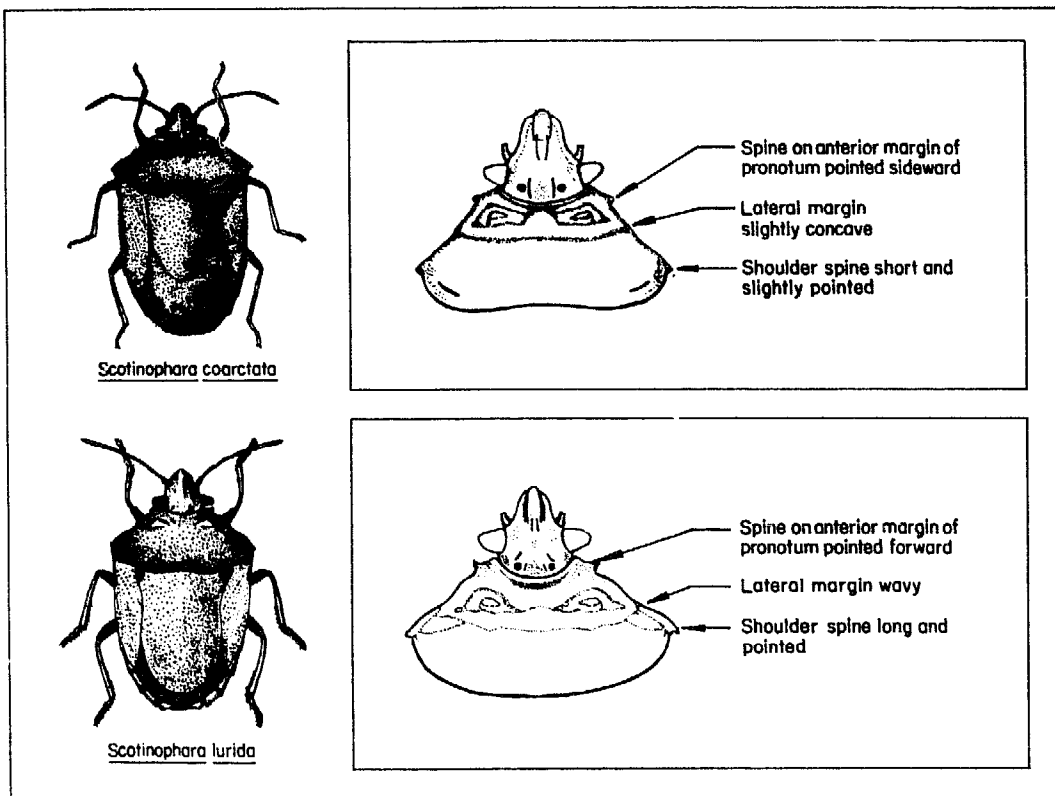

*Scotinophara coarctata*

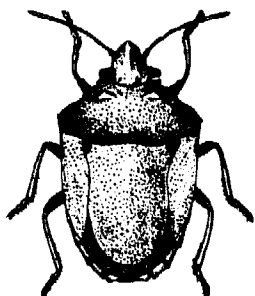

*Scotinophara lurida*

There are many other species of similar-looking bugs in rice fields, but they are rarely abundant.

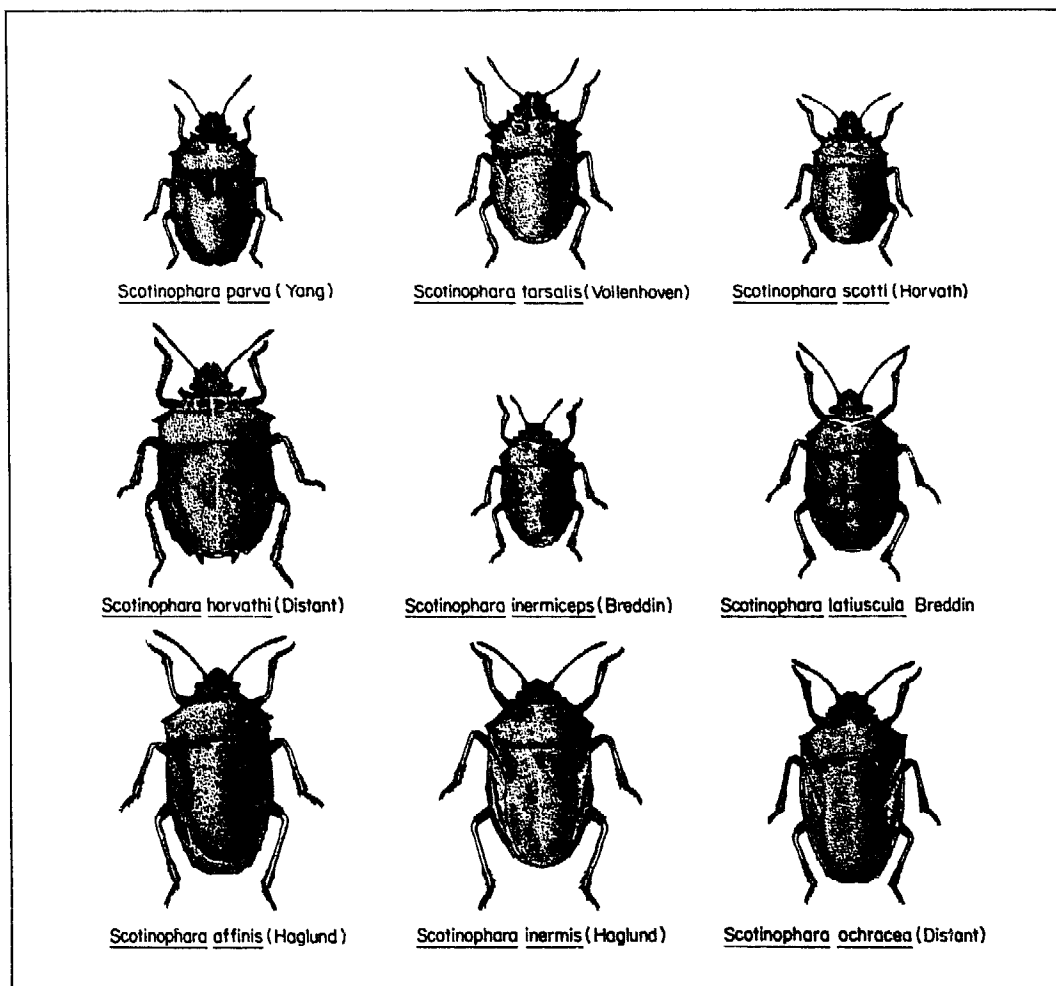

*Scotinophara parva* (Yang)



*Scotinophara tarsalis* (Vollenhoven)



*Scotinophara scotti* (Horvath)

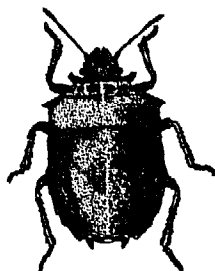

*Scotinophara horvathi* (Distant)



*Scotinophara inermiceps* (Breddin)

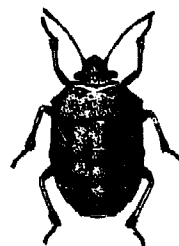

*Scotinophara latiuscula* Breddin

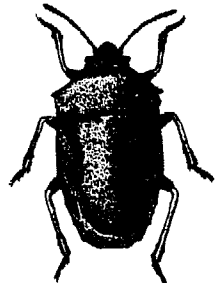

*Scotinophara affinis* (Haglund)

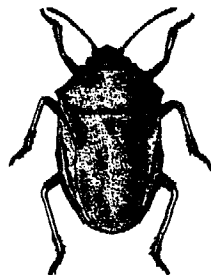

*Scotinophara inermis* (Haglund)

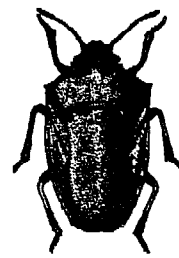

*Scotinophara ochracea* (Distant)



**Pest status**

The Malayan and Japanese black bugs often are abundant in their preferred habitats. Because chemical control is difficult, yield losses are often high.

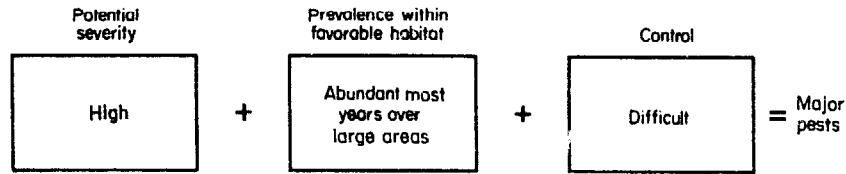

Both species occur in wetland environments but *S. coarctata* prefers swampy areas.

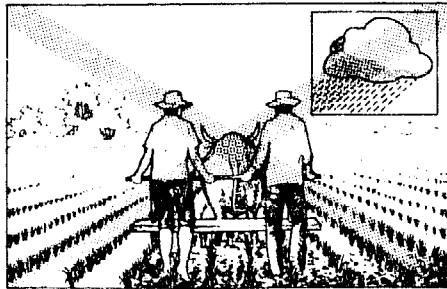

Upland

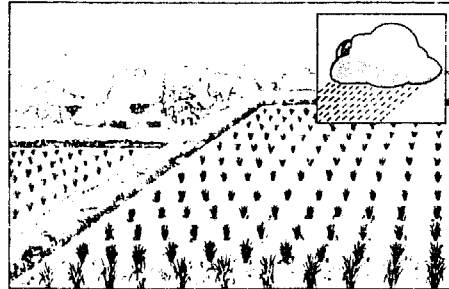

Rainfed wetland

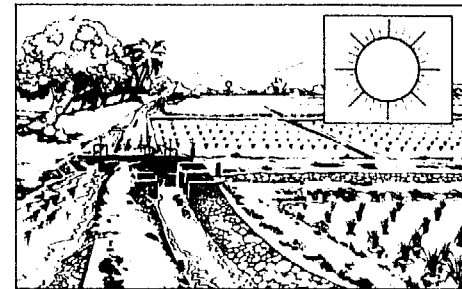

Irrigated wetland

*Distribution in Asia.*

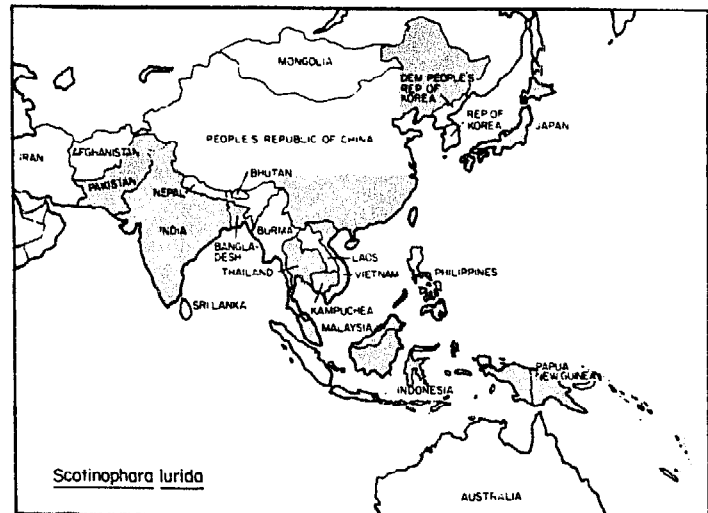
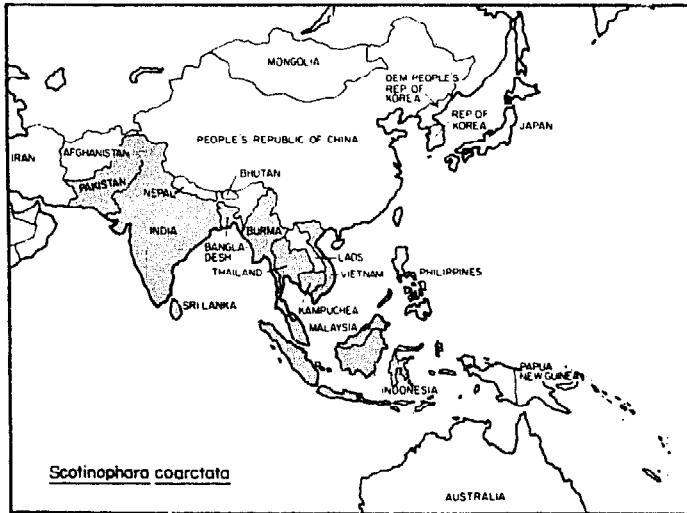

**Development and actual size**

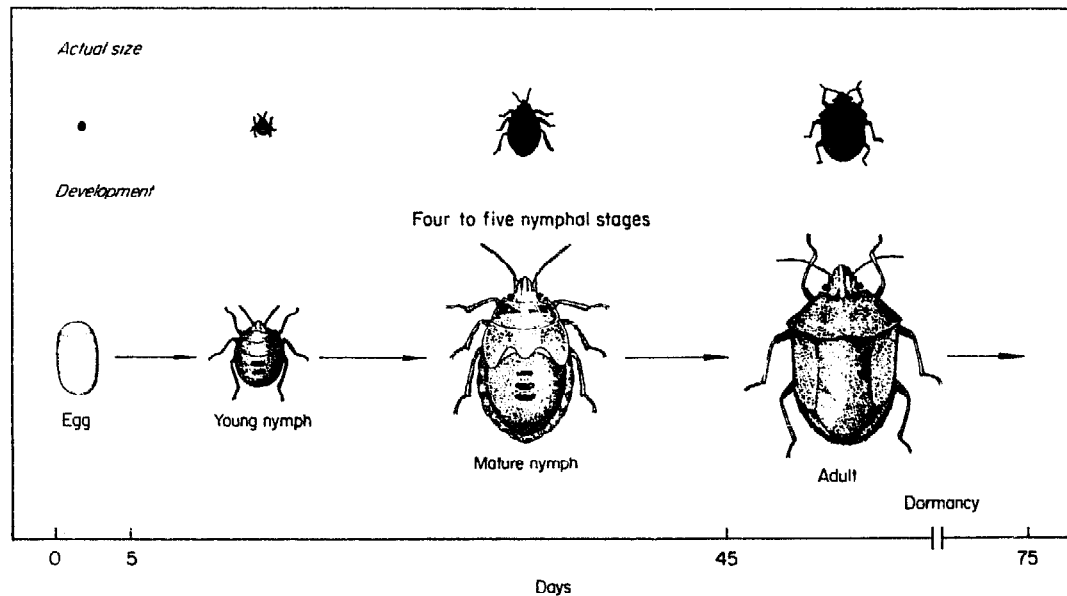

**Adult.** The shiny dark brown or black adults aggregate at the base of rice plants immediately above the water level during the day. They move up the rice plants at night and use their sucking mouthparts to remove plant sap from tillers.

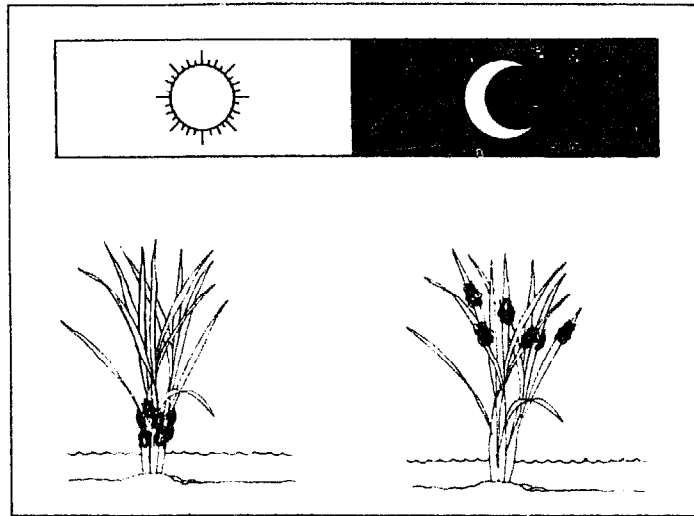

The long-living adults pass the winter or dry season in a dormant state in cracks in the soil in grassy areas. With favorable weather they fly to the rice crop and reproduce over several generations. They return to their resting sites after rice harvest. Adults are capable of migrating long distances.

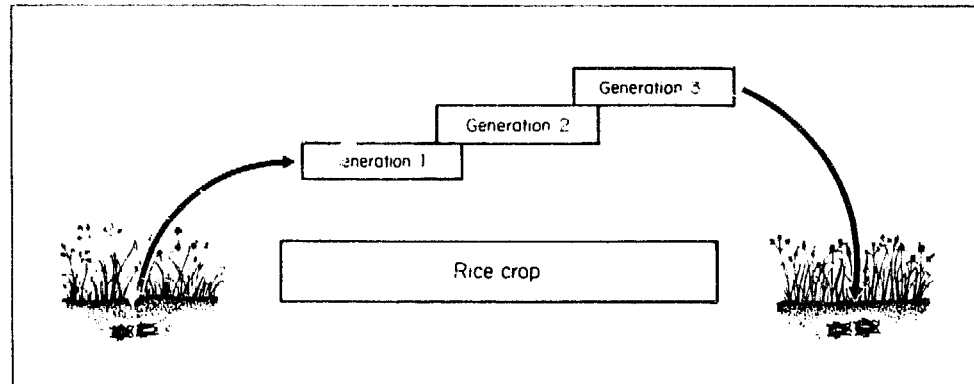

Adults are highly attracted to a high intensity light trap, and catches are highest during a full moon.

Kerosene light traps are not bright enough to attract black bugs.

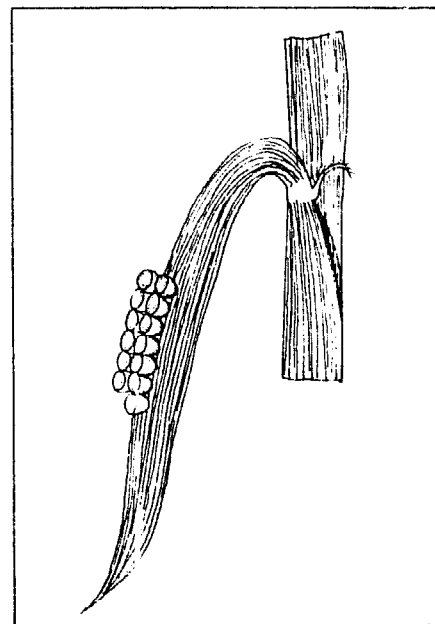
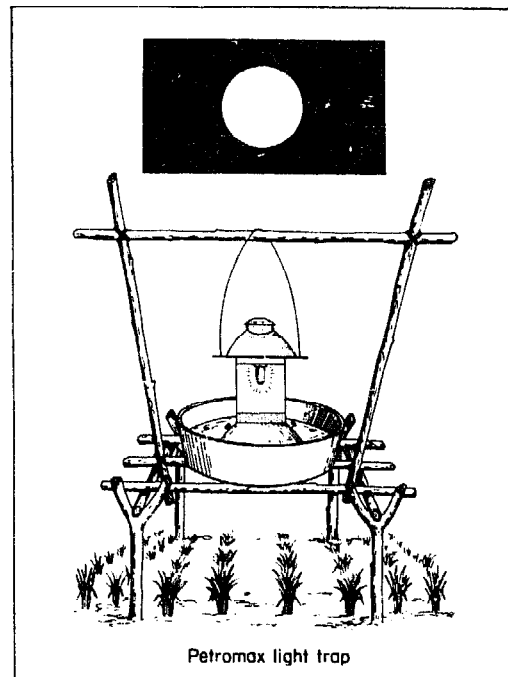

Adults give off an offensive odor when disturbed.

A female lays about 200 eggs during her lifetime.

**Egg.** The greenish pink eggs are laid in masses of up to 15 in several parallel rows on lower leaves near the water level.

*Nymph*. The nymphs are brown and yellow with black spots.

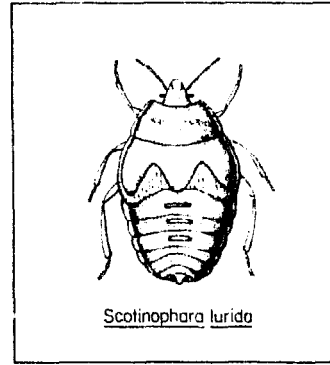
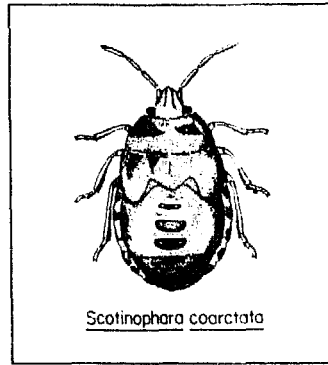

Like the adults, they remain at the base of the plants or in cracks in the soil during the day and feed at night.

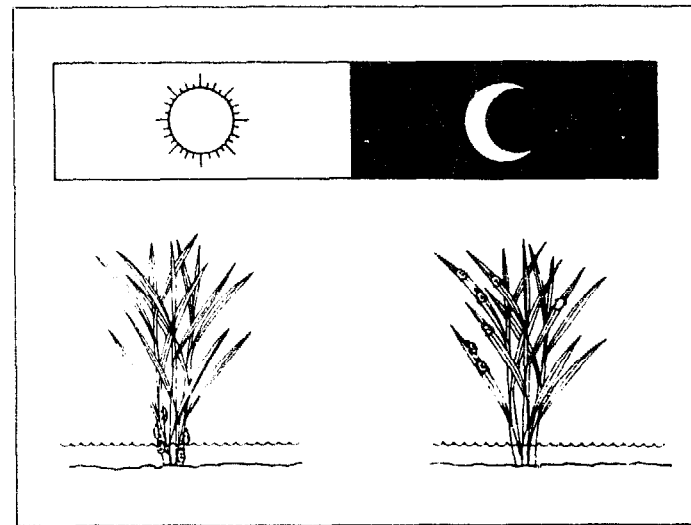

**Damage**

Sap removal by adults and nymphs causes plants to turn reddish brown or yellow. Stem nodes are preferred feeding sites because large sap reservoirs occur there which meet the high feeding requirements of these relatively large insects.

During the tillering stage, black bug feeding causes stunted growth and reduced tiller number.

After the booting stage, attacked plants have stunted panicles, incomplete panicle exertion, and panicles with empty grains (whiteheads).

Plants can wilt and die from the feeding of high numbers of black bugs or suffer bugburn much like that caused by planthoppers.

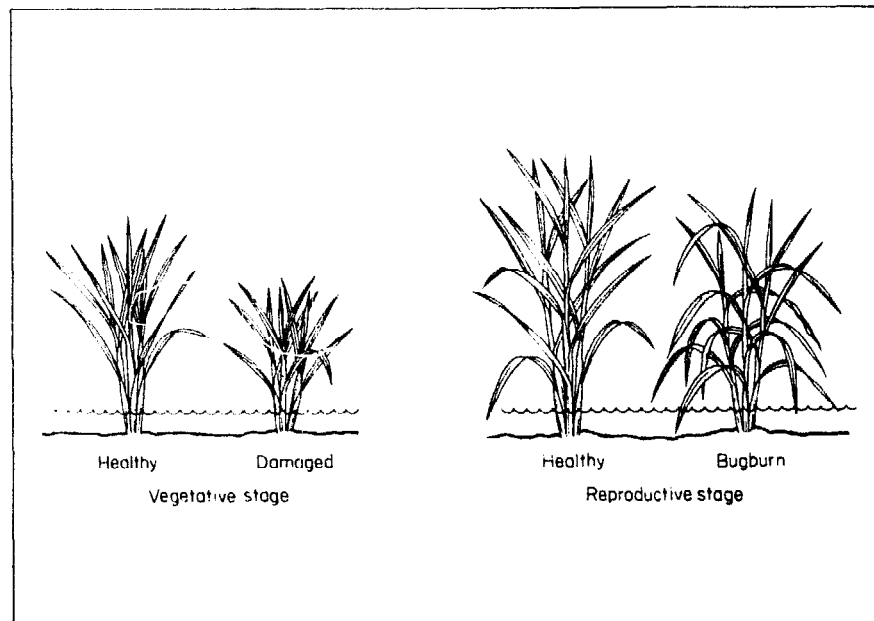

*Plant hosts.* Nymphs and adults have a wide range of alternative hosts.

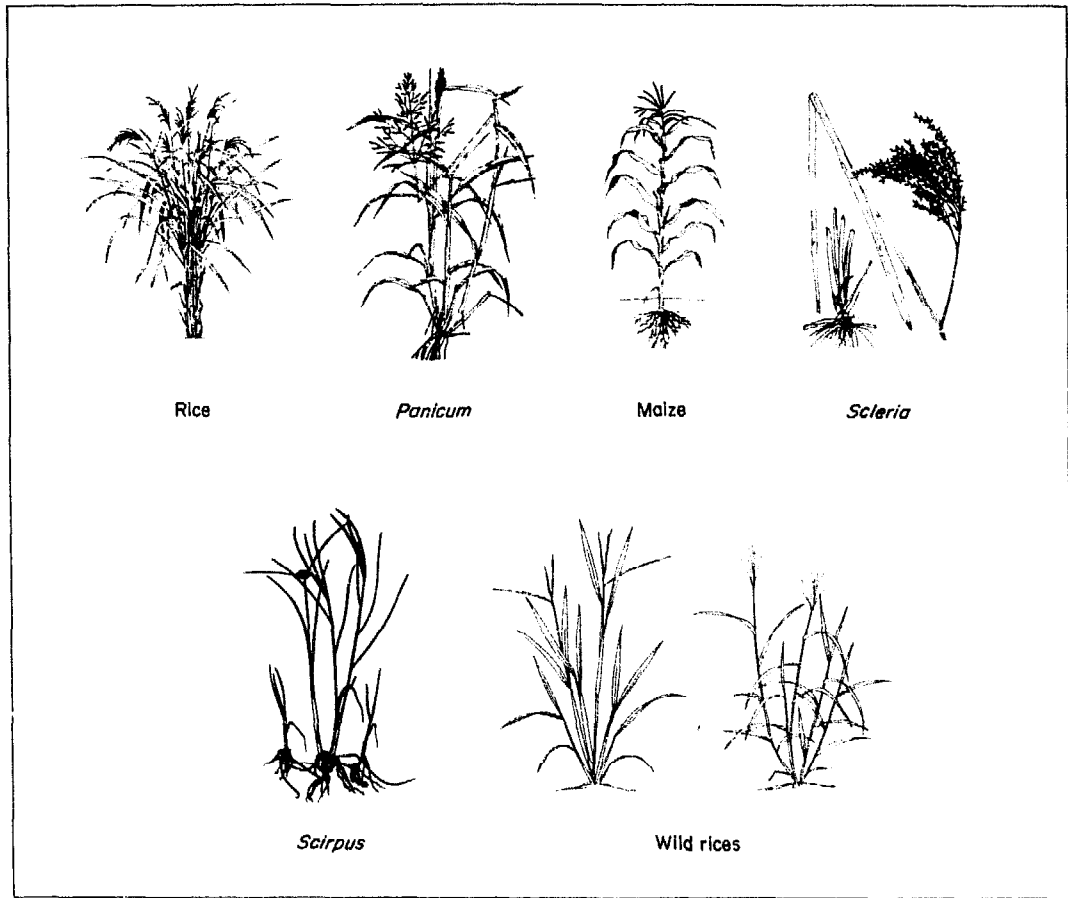

**Management**

*Cultural control.* Remove weeds from the field to allow more sunlight to reach the base of rice plants.



Plant an early-maturing variety to reduce population buildup of black bugs.

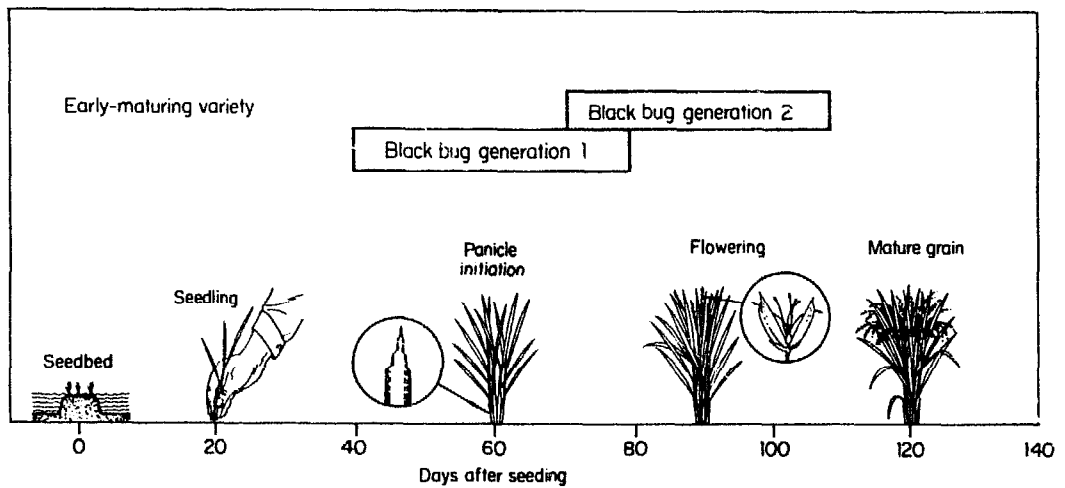

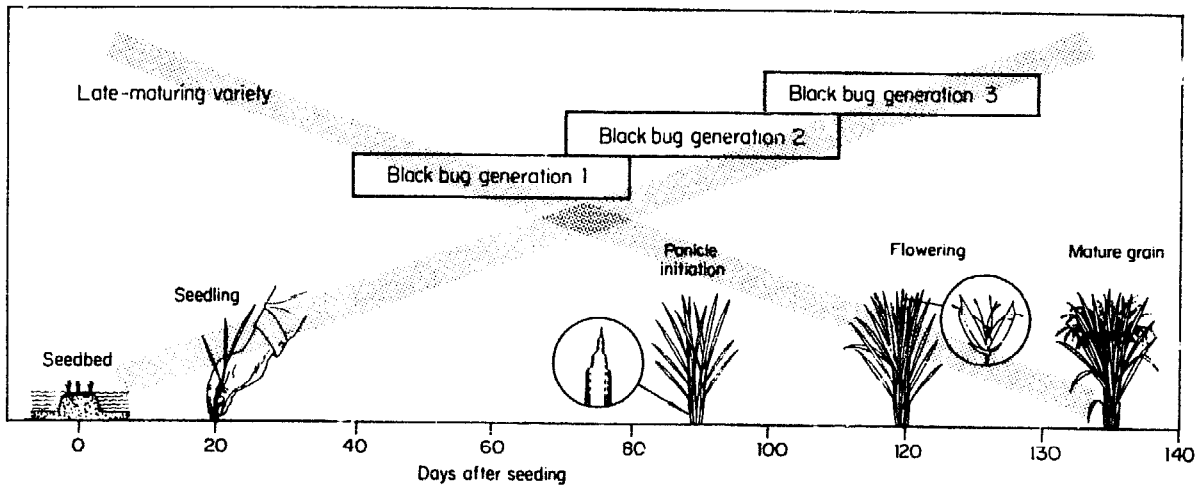

**Resistant varieties.** No resistant varieties are commercially available.

## Plant Resistance

**Biological control.** Natural enemies attack all life stages of black bugs.

Small scelionid wasps parasitize eggs.

Frogs and ground lizards prey on nymphs and adults.

A fungal disease affects both nymphs and adults. White fungal growth emerges from the dead bodies. Larvae and adults of carabid ground beetles feed on black bug eggs, nymphs, and adults. Nabid bugs prey on eggs and nymphs.

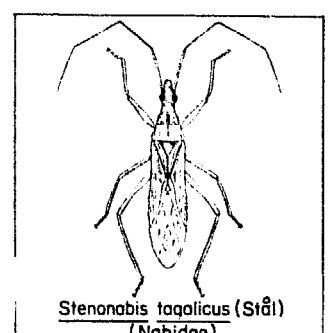
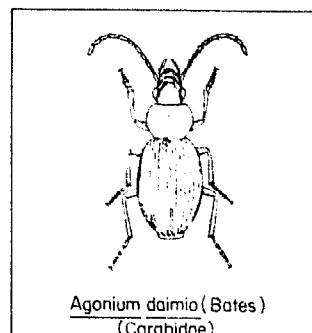
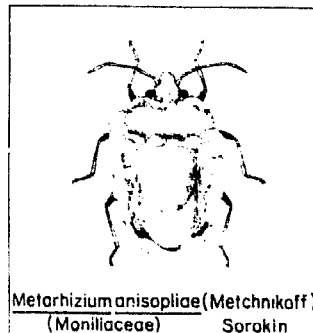
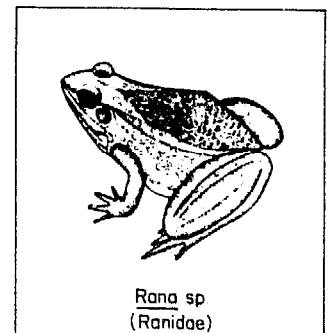
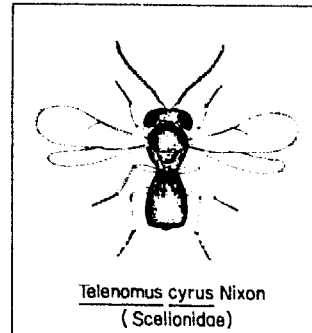
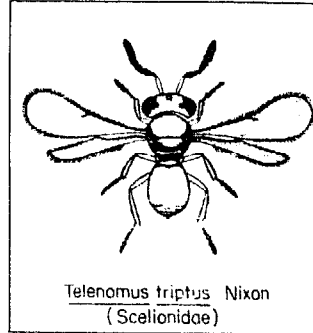

**Chemical control.**

- **Insecticide application.** Foliar sprays are more effective than granules.

Direct spray to the base of plants where the black bugs stay.

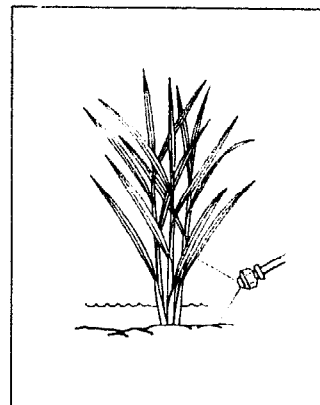

• **Scouting.** Visit the field weekly during the entire rice crop period to record black bug numbers.

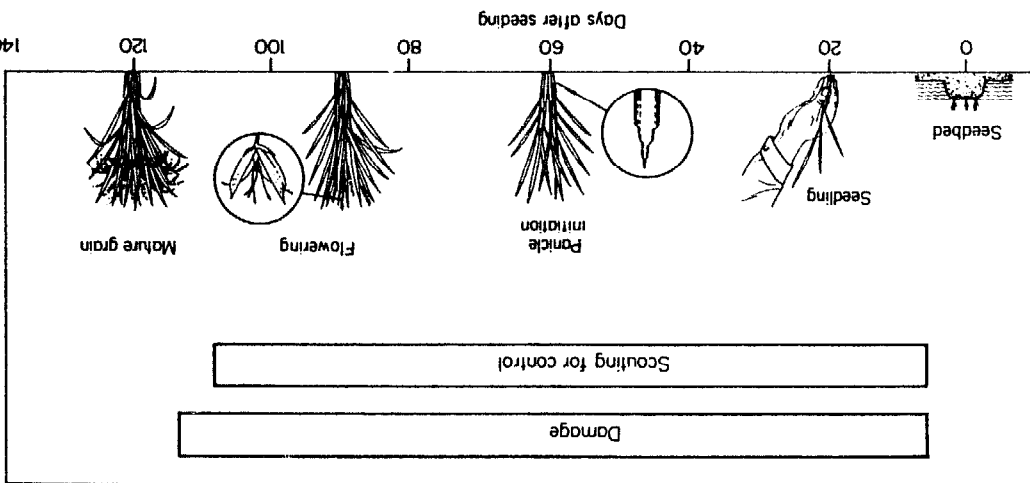

Randomly select 20 hills across the field and count the number of adults and nymphs.

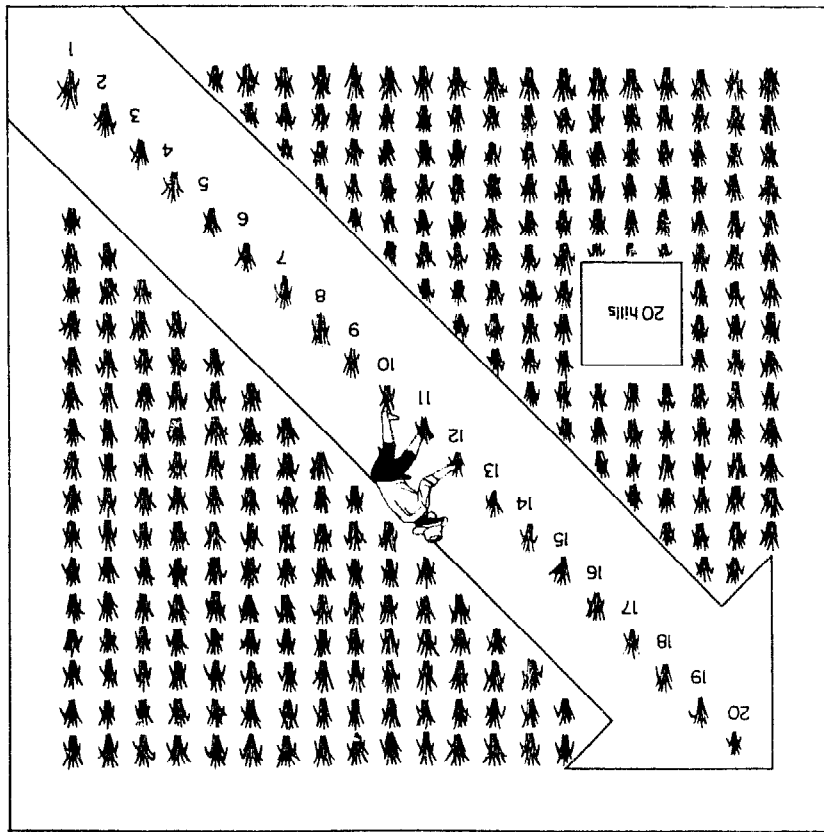

Use insecticide when the black bug population reaches the economic threshold.

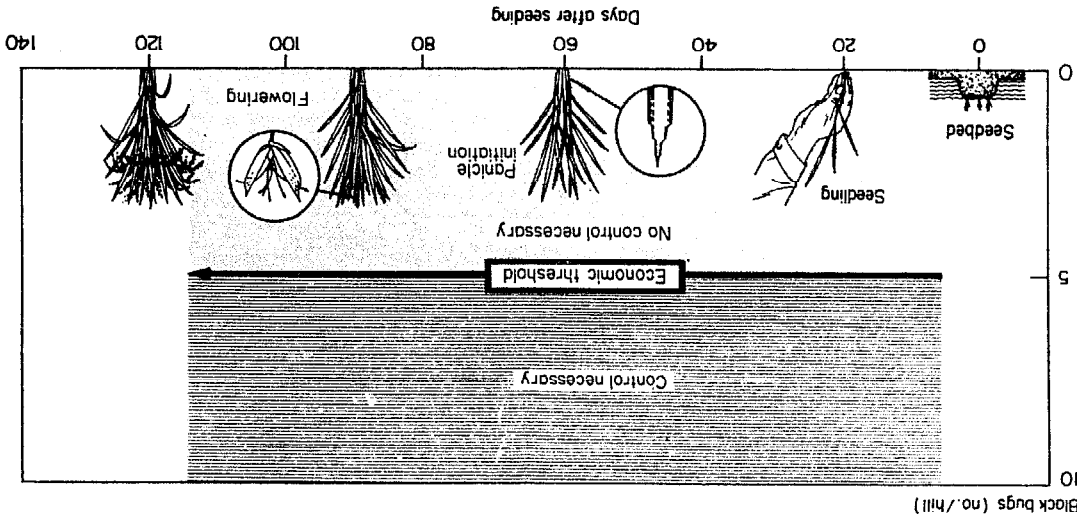

RICE HISPA (COLEOPTERA: CHRYSOMELIDAE)

Hispa means spiny. *Dicladispa (= Hispa) armigera* (Olivier) is a beetle covered with many short spines. Both the larva and adult damage rice leaves.

A related hispa species, *Leptispa pygmoea* Baly, causes the same type of damage as the rice hispa.

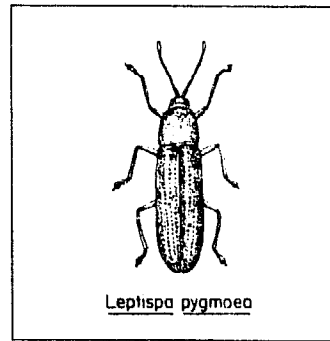

**Pest status**

Although hispa reaches outbreak proportions from time to time, the areas affected are limited and the insect can readily be controlled with insecticide.

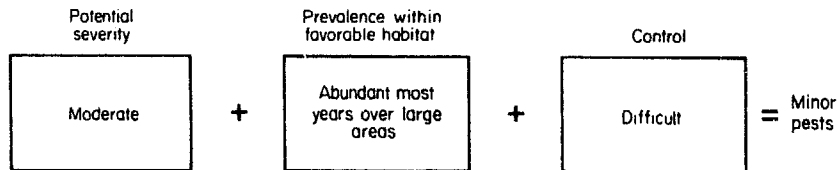

Hispa is prevalent in wetland rice environments, particularly irrigated areas

where rice grows throughout the year. It is more abundant in the rainy season.

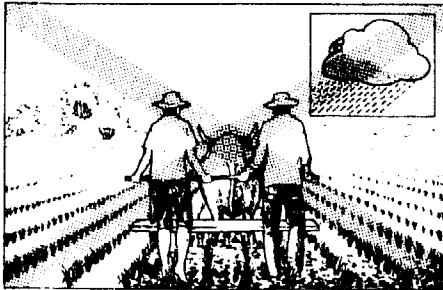

Upland

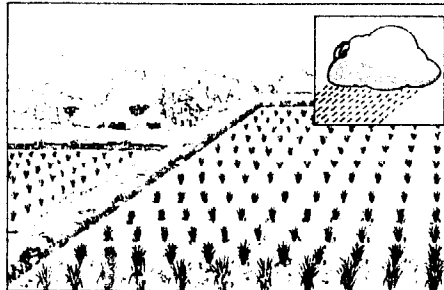

Rainfed wetland

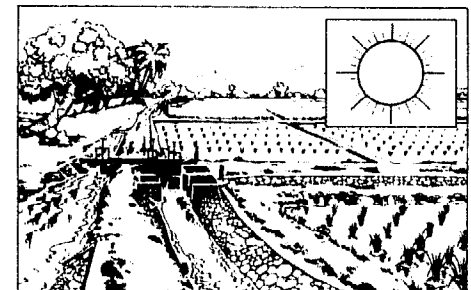

Irrigated wetland

*Distribution in Asia.*

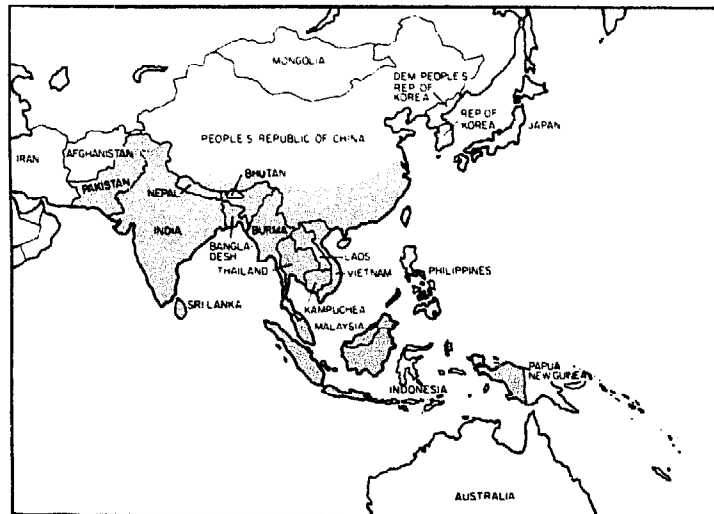

**Development and actual size**

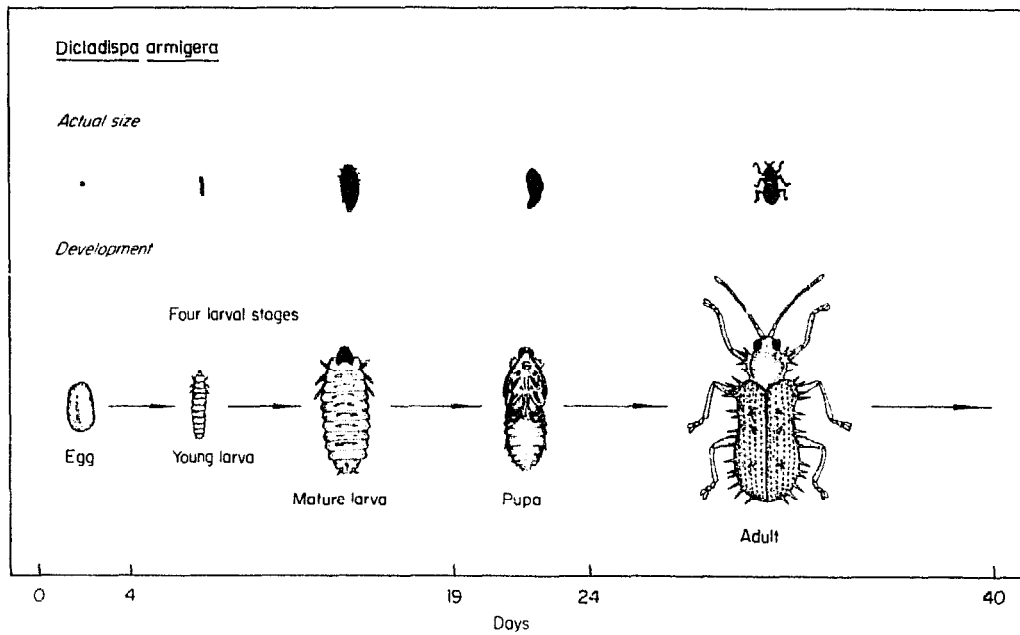

**Adult.** The adult is blue-black and shiny. Its wing covers have many spines.

Adults are not attracted to a light trap.

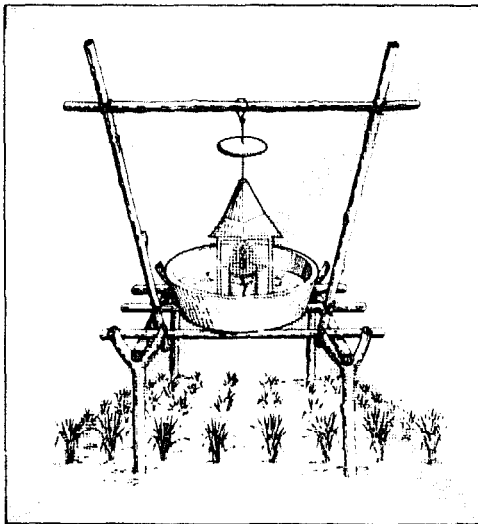

They are active during the day when they feed and disperse.

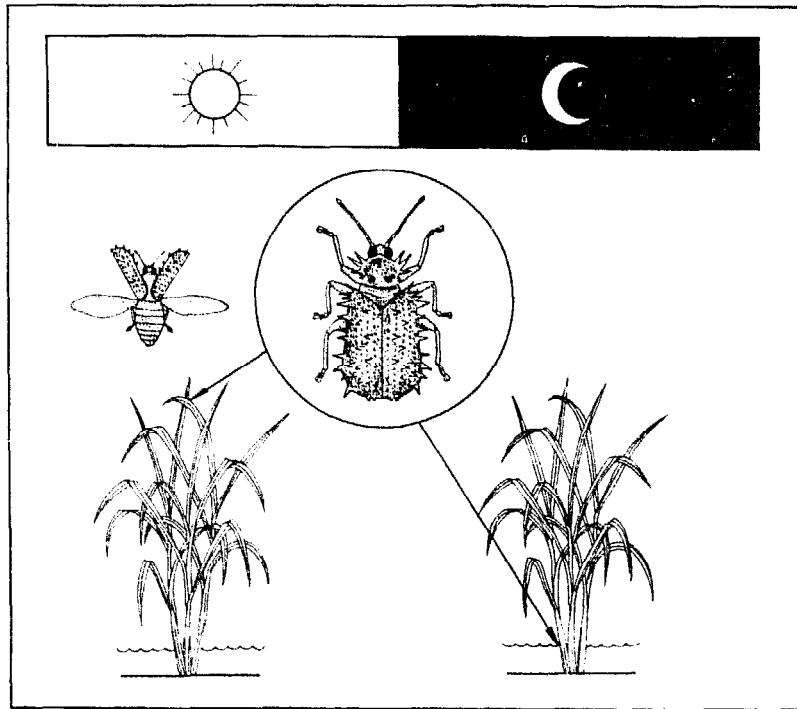

Each female lays about 50 eggs during its lifetime of 1-2 months. During the dry season, adult numbers in rainfed areas decline when the area of host plants is reduced.

**Egg.** The white, oval eggs are laid singly near the tips of young leaves. They are partially inserted into the lower leaf surfaces, and are partially covered with a dark secretion from the female.

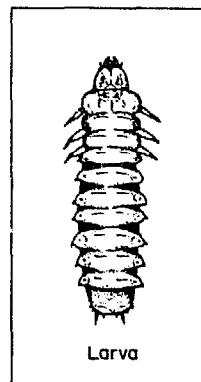
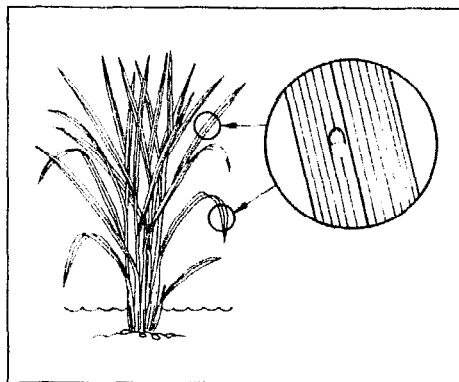

**Larva.** After hatching, the flat white larvae tunnel inside the leaves as leafminers.

The larvae eat the center leaf tissue, leaving only a transparent skin on the top and bottom of the leaves.

A larva completes its development inside a leaf.



*Pupa.* The brown pupa develops inside the leaf mine.

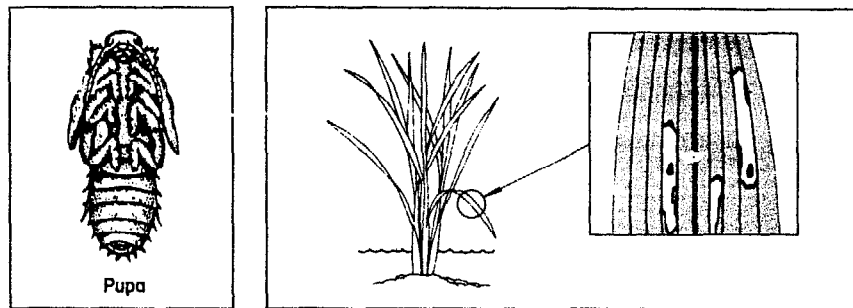

**Damage**

Both the adults and larvae feed on rice leaves, preferring plants at the vegetative stage. Adults scrape the upper leaf surface tissue and leave white streaks of uneaten lower epidermis between the parallel leaf veins.

Larval mines are irregular, semitransparent patches that run parallel to the leaf veins.

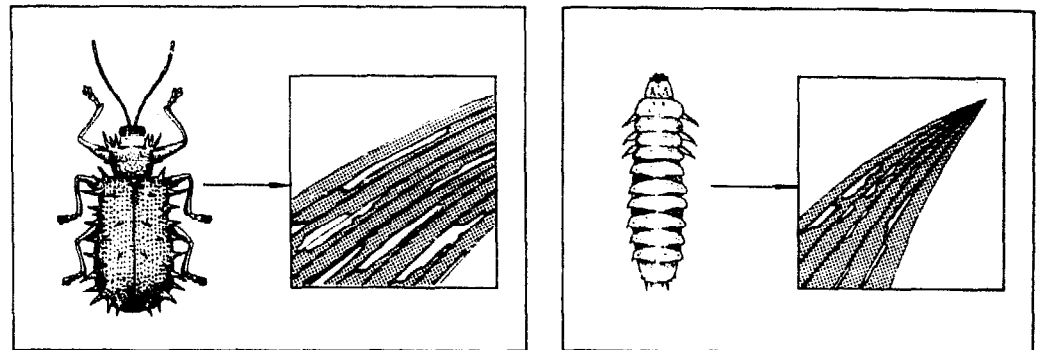

In severe infestations, the leaves dry and turn brown so that the damaged field has a burned appearance.

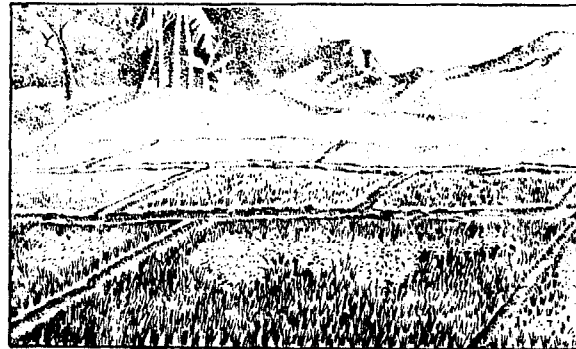

*Plant hosts.* The rice hispa feeds mainly on rice, but also survives on grassy weeds.

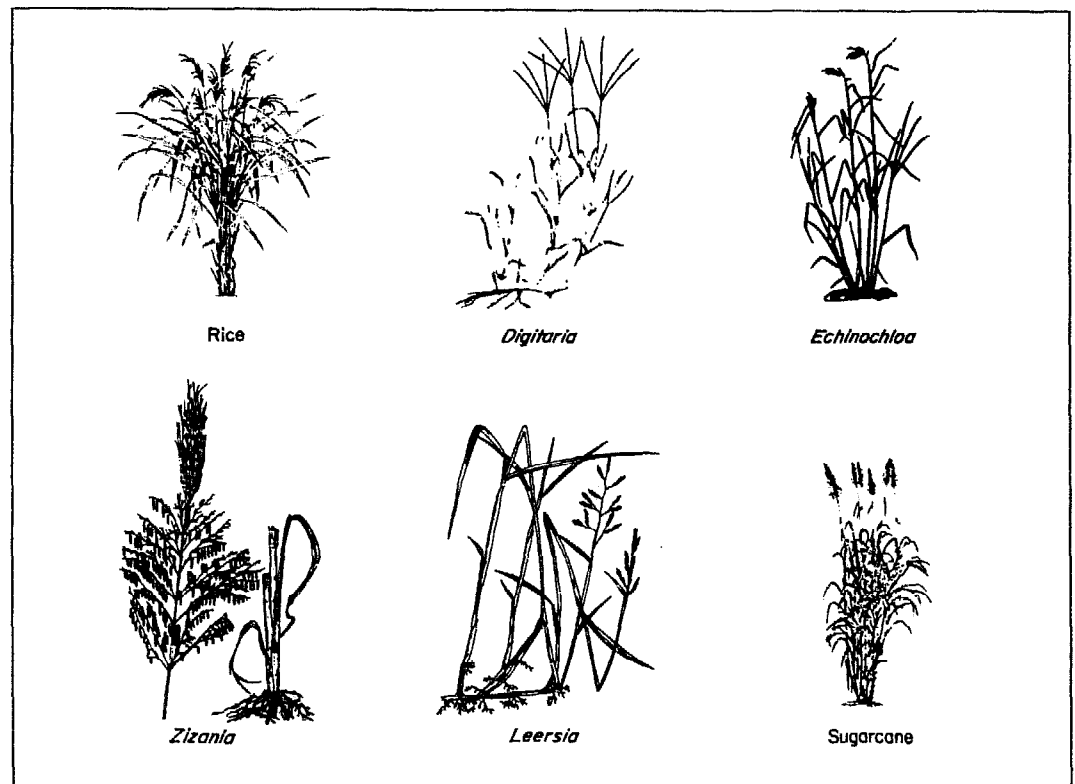

**Management**

*Cultural control.* Close spacing results in greater leaf densities that can tolerate higher hispa numbers.

Removing grassy weeds in and near rice fields removes alternative hosts.

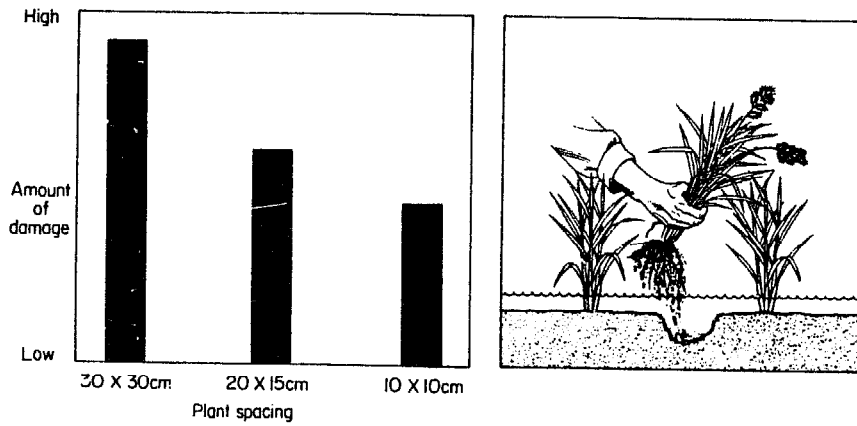

Planting early at the beginning of the monsoon rains is a method that allows a field to escape hispa build-up on alternative hosts or other rice fields.

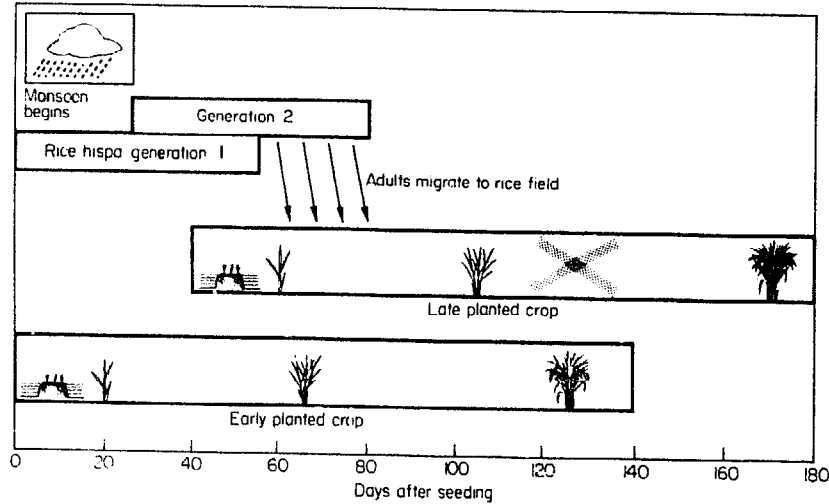

Hand picking damaged leaves removes larvae from the field and prevents hispa buildup. Damaged leaves can be removed until booting.

A piece of rope soaked in a mixture of 1 part kerosene and 1 part water can be pulled through the leaf canopy.

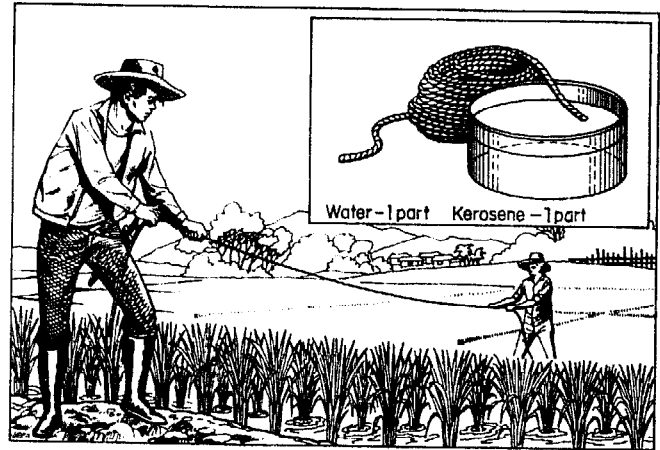
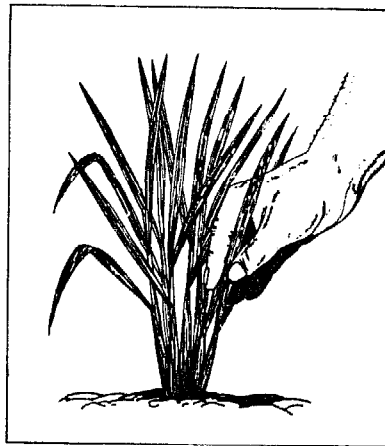

*Resistant varieties.* No resistant varieties are commercially available.

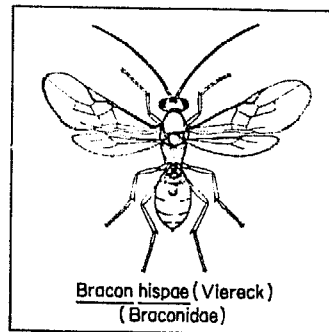
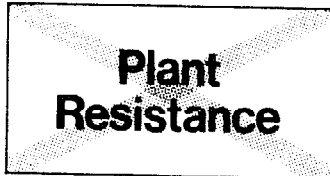

*Biological control.* The role of natural enemies has not been fully assessed. However, several braconid wasps parasitize the larvae.

**Chemical control.**

- **Insecticide application.** Chemicals play an important role in rice hispa control.

Adults are more exposed and susceptible to insecticide than are the larvae, which are protected in leaf mines.

Sprays and dusts are usually more effective than granular formulations.

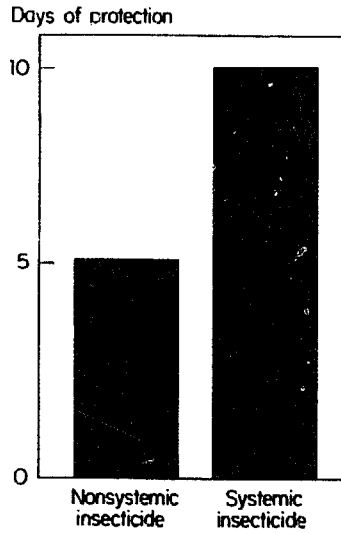

Systemic insecticides give longer residual protection and are more effective against larvae than are nonsystemic chemicals.

- **Scouting.** Starting with the seedbed, check for the presence of adults.

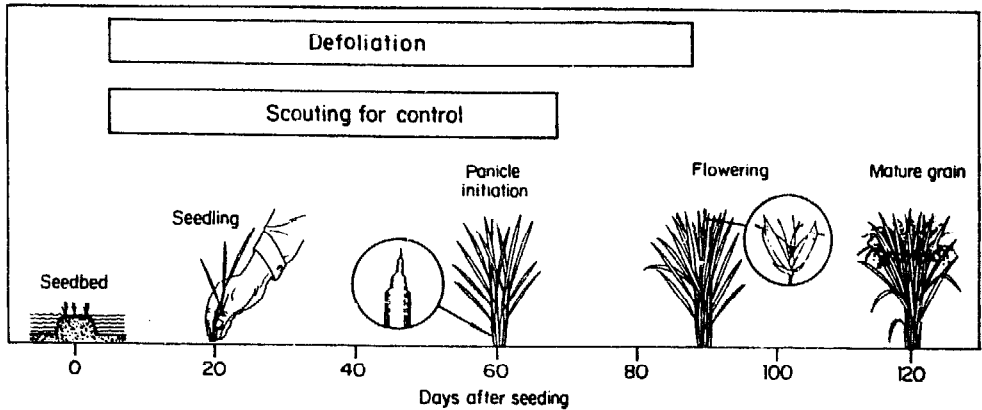

Weekly from transplanting to panicle initiation, count the number of adults and larval mines on 5 leaves in each of 20 randomly chosen hills across the paddy.

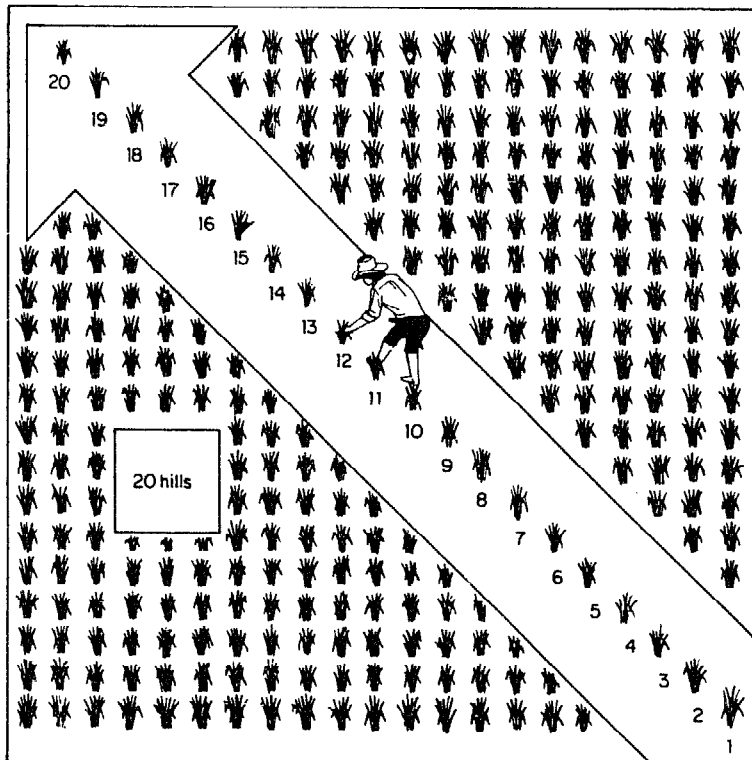

Apply insecticide when the economic threshold is reached for either adults or larval mines.

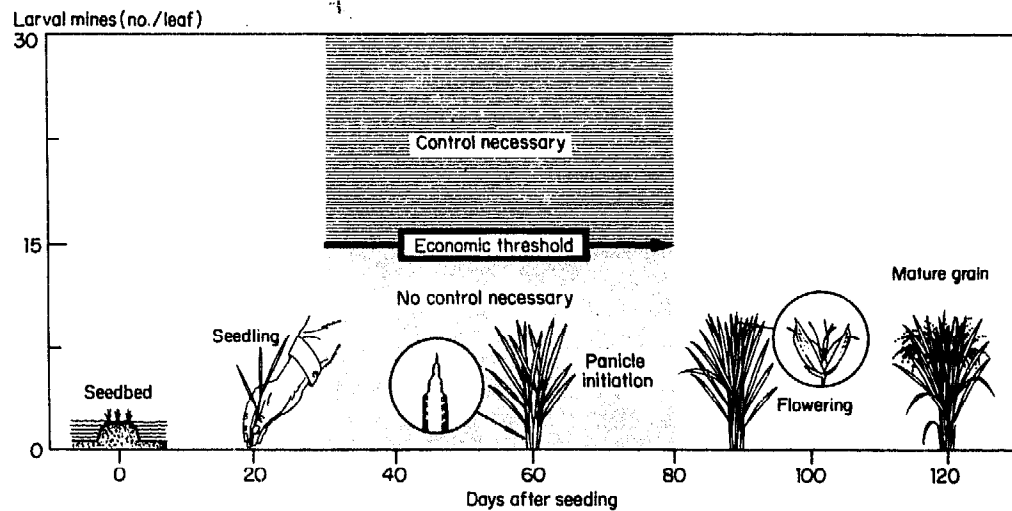
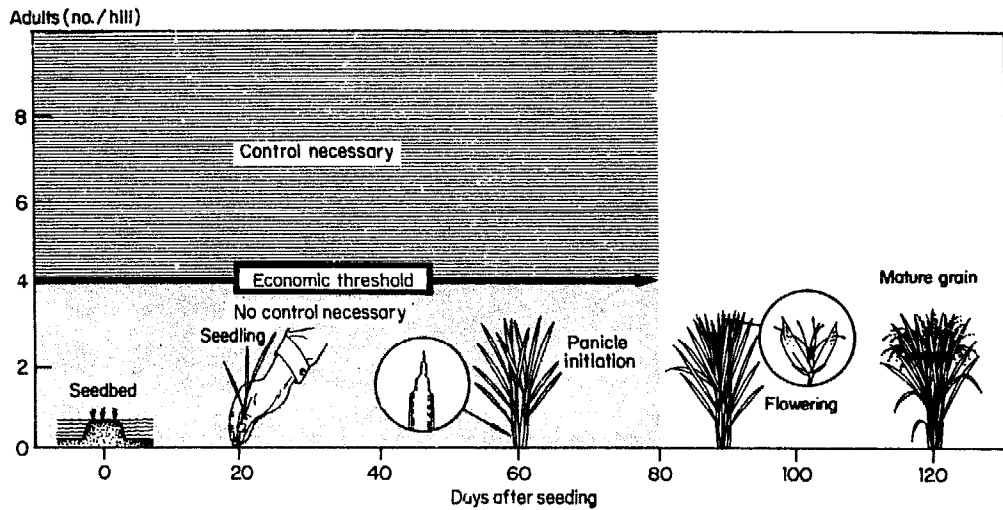

MEALYBUG (HOMOPTERA: PSEUDOCOCCIDAE)

Mealybugs are plant-sucking, relatively immobile insects related to scales. They secrete white filaments of wax to cover themselves. *Brevinnia* (= *Heterococcus*, = *Ripersia*) *rehi* (= *oryzae*) (Lindinger) is the main mealybug pest of rice in Asia.

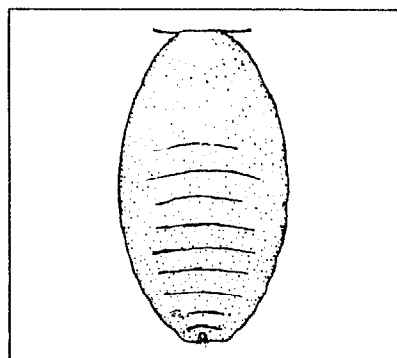

Pest status

Mealybugs are abundant during droughts when rice plants can least tolerate removal of plant sap. But large populations are infrequent. Control by insecticide is difficult because mealybugs are

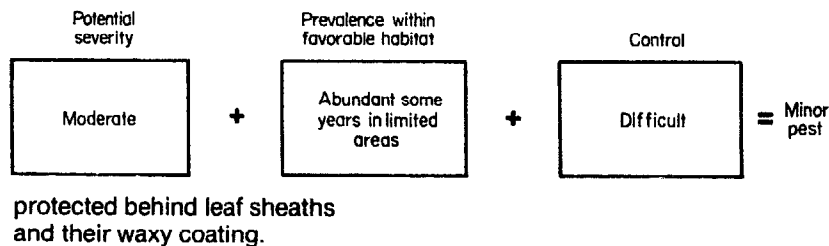

The mealybug is found in  
rainfed rice environments

and is not prevalent in  
irrigated rice.

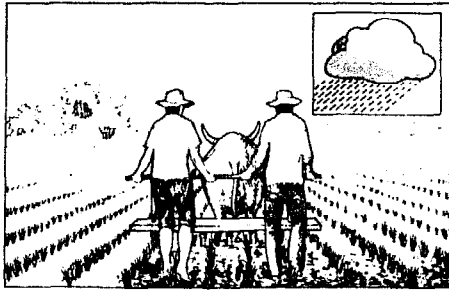

Upland

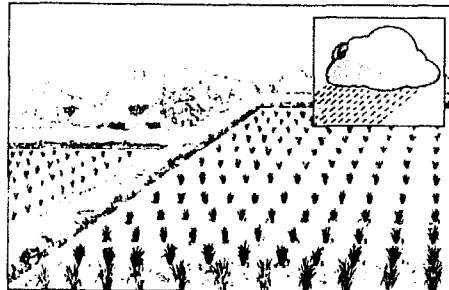

Rainfed wetland

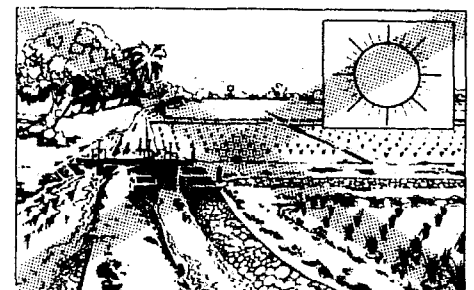

Irrigated wetland

*Distribution in Asia.*

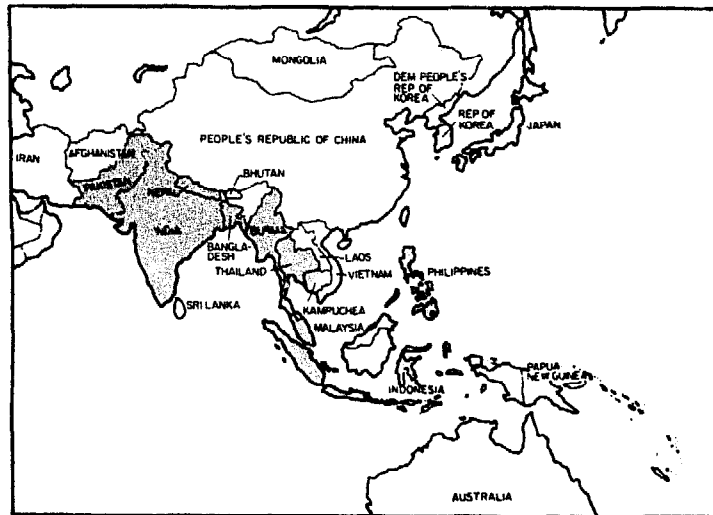

**Development and actual size**

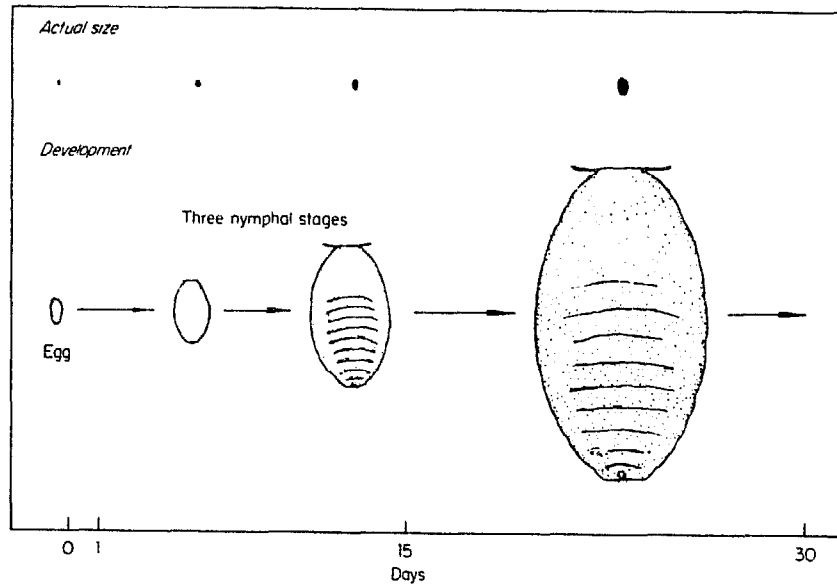

**Adult.** The males and females do not look alike.

The females are wingless, soft-bodied, pink, and covered with waxy threads.

The males which are smaller have wings and are pale yellow.

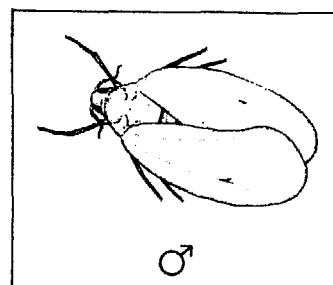
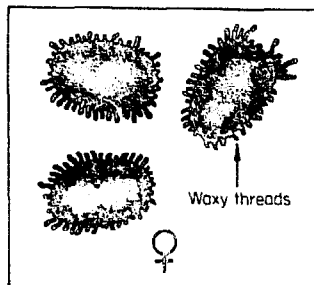

The females remain stationary on the stems behind leaf sheaths at the base of plants.

Each female lays about 100 eggs during her 2-week lifetime.

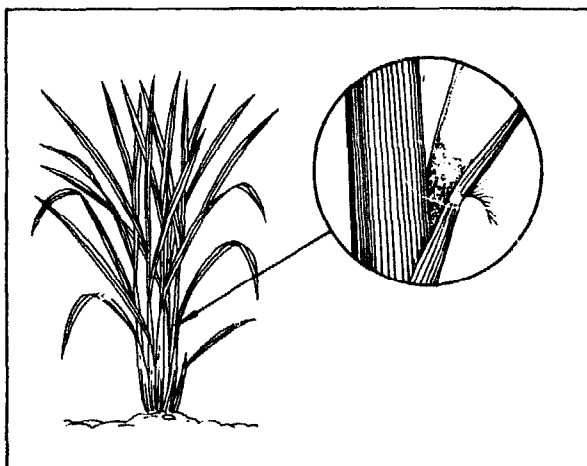

**Egg.** The yellow-white eggs are laid in chains on waxy threads.

The eggs hatch within 6 hours.

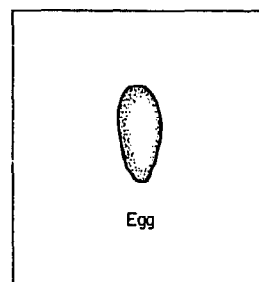
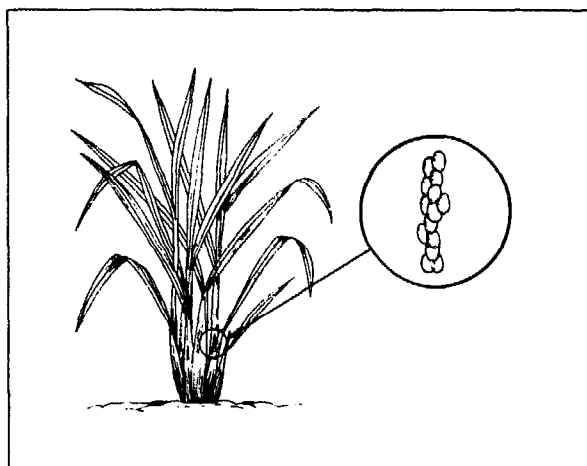

**Nymph.** The young nymphs are white and become pale yellow and later pale pink. At first they take shelter under the body of the female; later they move from plant to plant by crawling (crawler stage), or may be dispersed in the wind.

After the dispersal period, the nymphs settle down on a rice tiller behind a leaf sheath and feed. They tend to feed in groups.

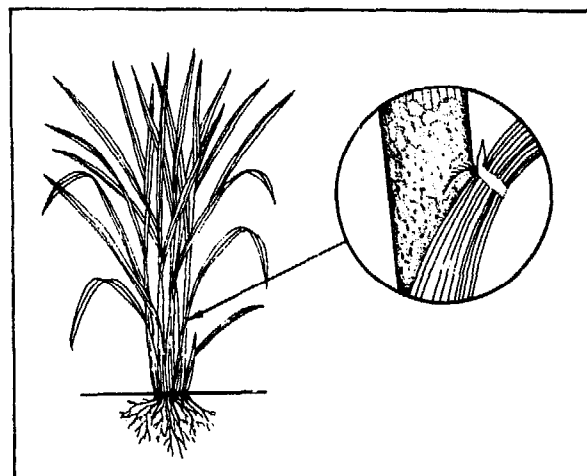

#### Damage

Nymphs and adults remove plant sap. Under conditions that favor high populations, mealybug feeding causes the leaves to turn yellow. The plants become stunted.

The pattern of damaged plants is not uniform because mealybug numbers vary greatly between hills.

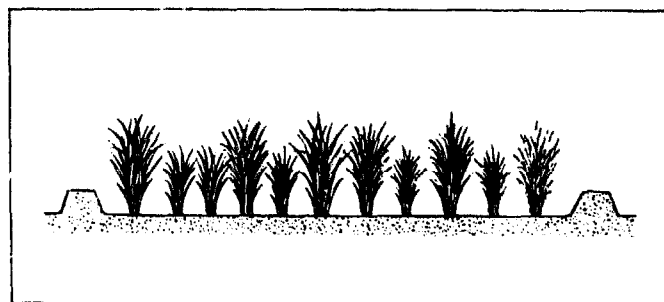

Dry spells result in a large population buildup of mealybugs and damage to drought-stressed plants can be high.

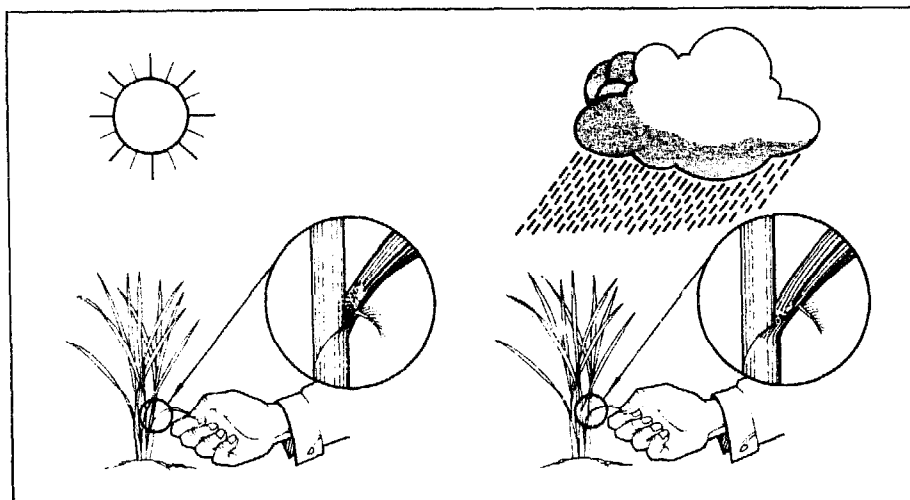

*Plant hosts.* The mealybug can develop on grassy weeds. It shows no distinct preference for rice.

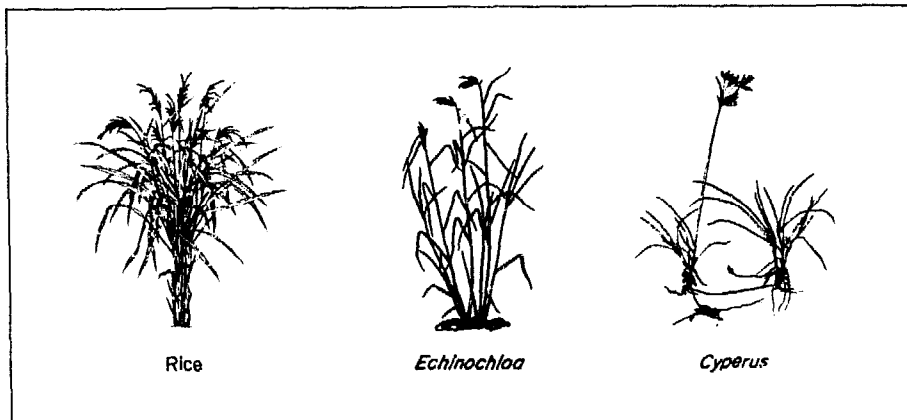

**Management**

*Cultural control.* Remove and destroy infested plants at the first sign of mealybug damage.



*Resistant varieties.* No resistant varieties are commercially available.

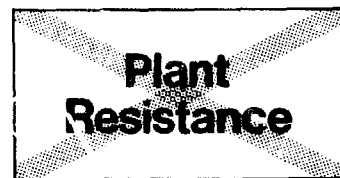

*Biological control.* Mealybugs give off honeydew and are tended by ants which protect them from most predators and parasites.

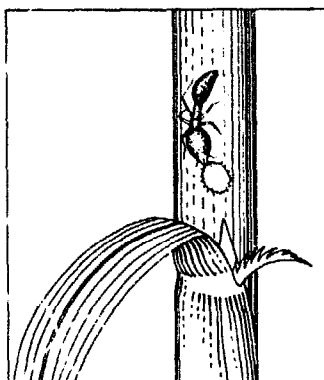

Lady beetles are the main natural enemies of mealybug.

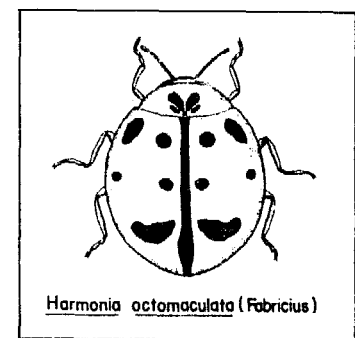
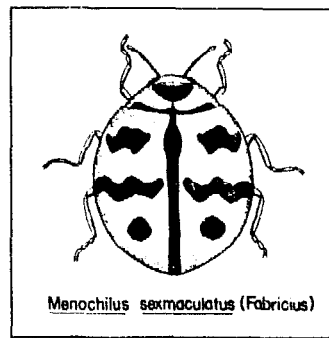
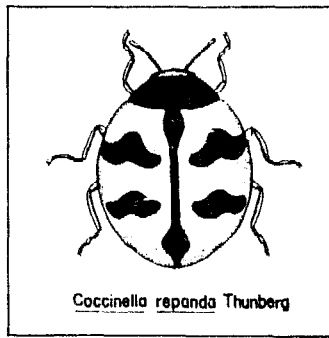

- Chemical control.**
- **Insecticide application.** The waxy secretions covering the mealybugs and their habit of living behind leaf sheaths protect them from insecticide.

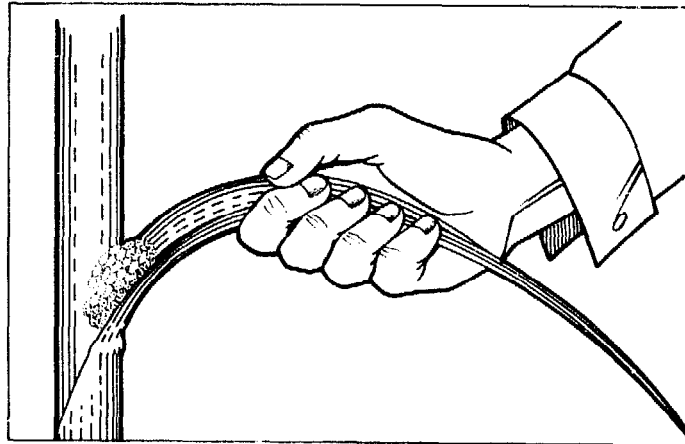

As damaged fields have no standing water, broadcasting of granules is impractical. Foliar sprays are effective if the nozzle is directed to the base of plants.

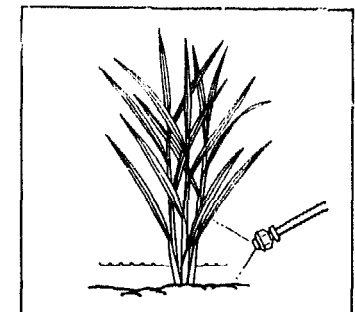

- **Scouting.** Mealybugs can infest the rice crop from tillering to harvest. Mealybug abundance is recorded as percentage of plants infested with colonies.

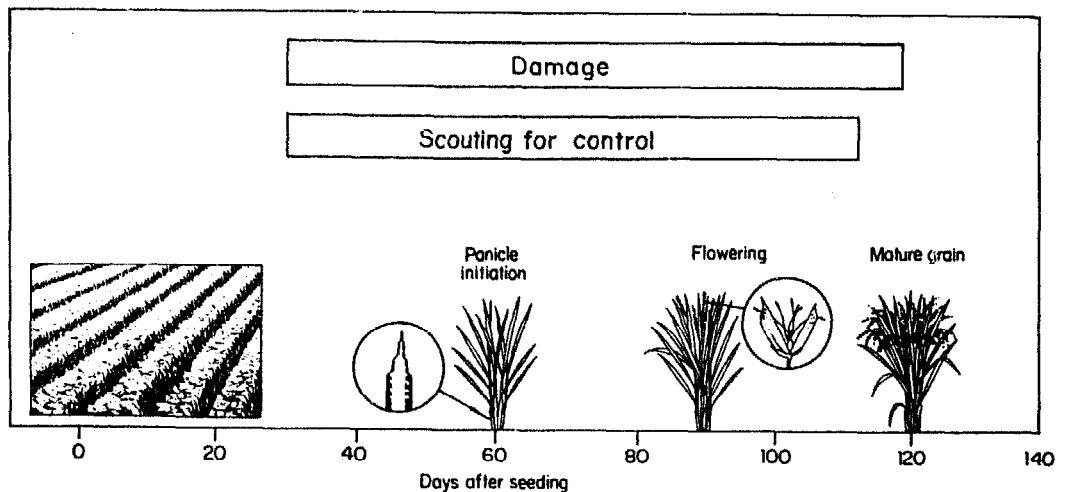



Visit the field each week and look at the base of 20 hills across the field.

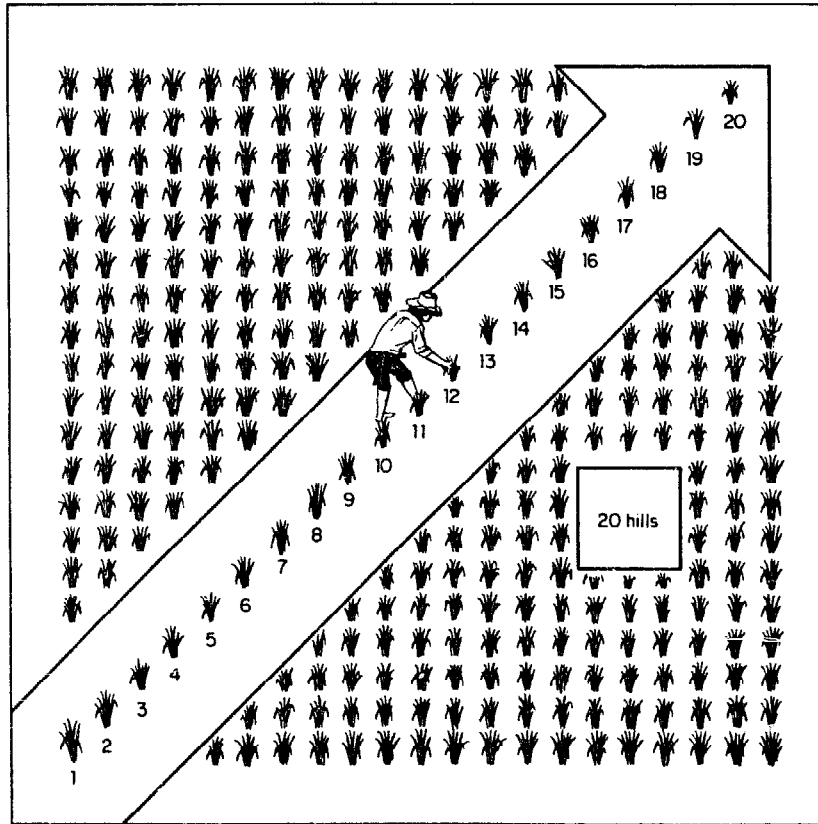

Apply insecticide when the economic threshold is reached.

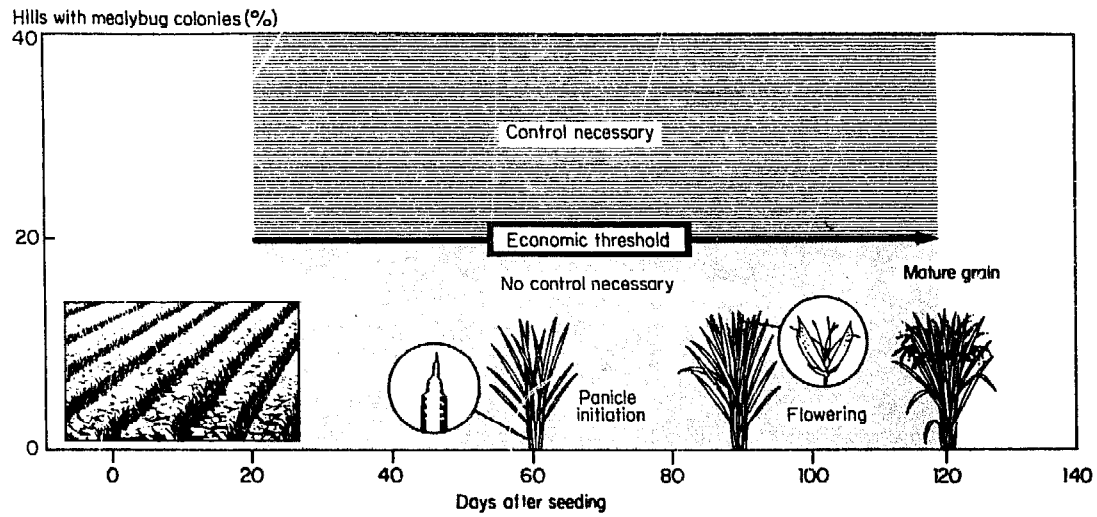

PESTS AT THE REPRODUCTIVE STAGE

RICE GREENHORNED CATERPILLAR (LEPIDOPTERA: SATYRIDAE)

*Melanitis leda ismene* (Cramer) and *Mycalesis* sp. are large butterflies. Their greenhorned caterpillars have two prominent horns (tubercles) on the head and two at the end of the abdomen.

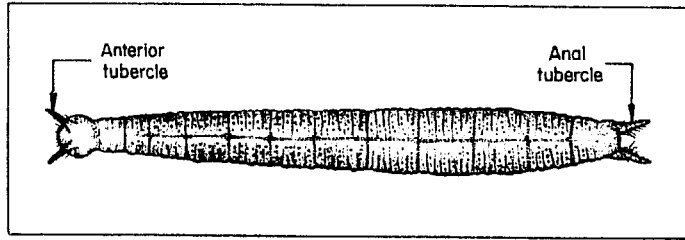

**Pest status**

Due to the low reproductive potential of the pest and the activity of its natural enemies, greenhorned caterpillar numbers are usually too low to cause economic loss.

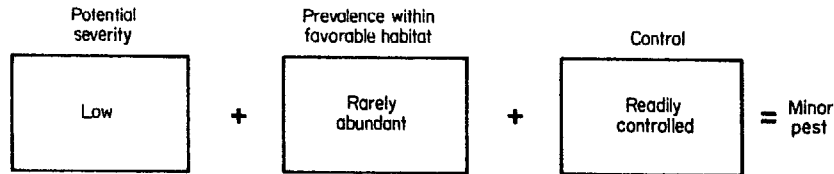

The pest occurs in all rice environments, but is more prevalent in rainfed areas.

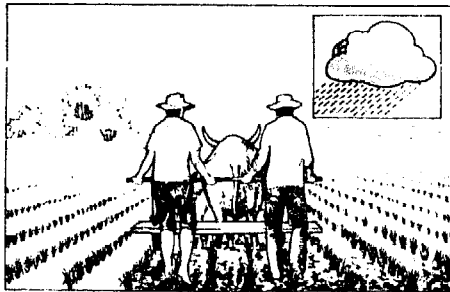

Upland

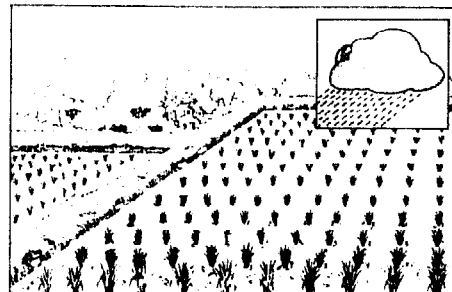

Irrigated wetland

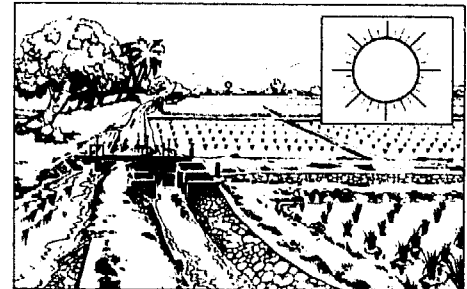

Rainfed wetland

*Distribution in Asia*

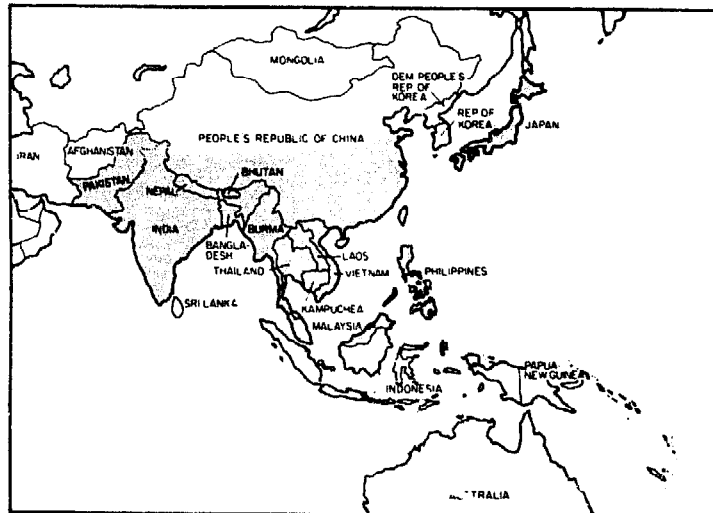

Development and actual size

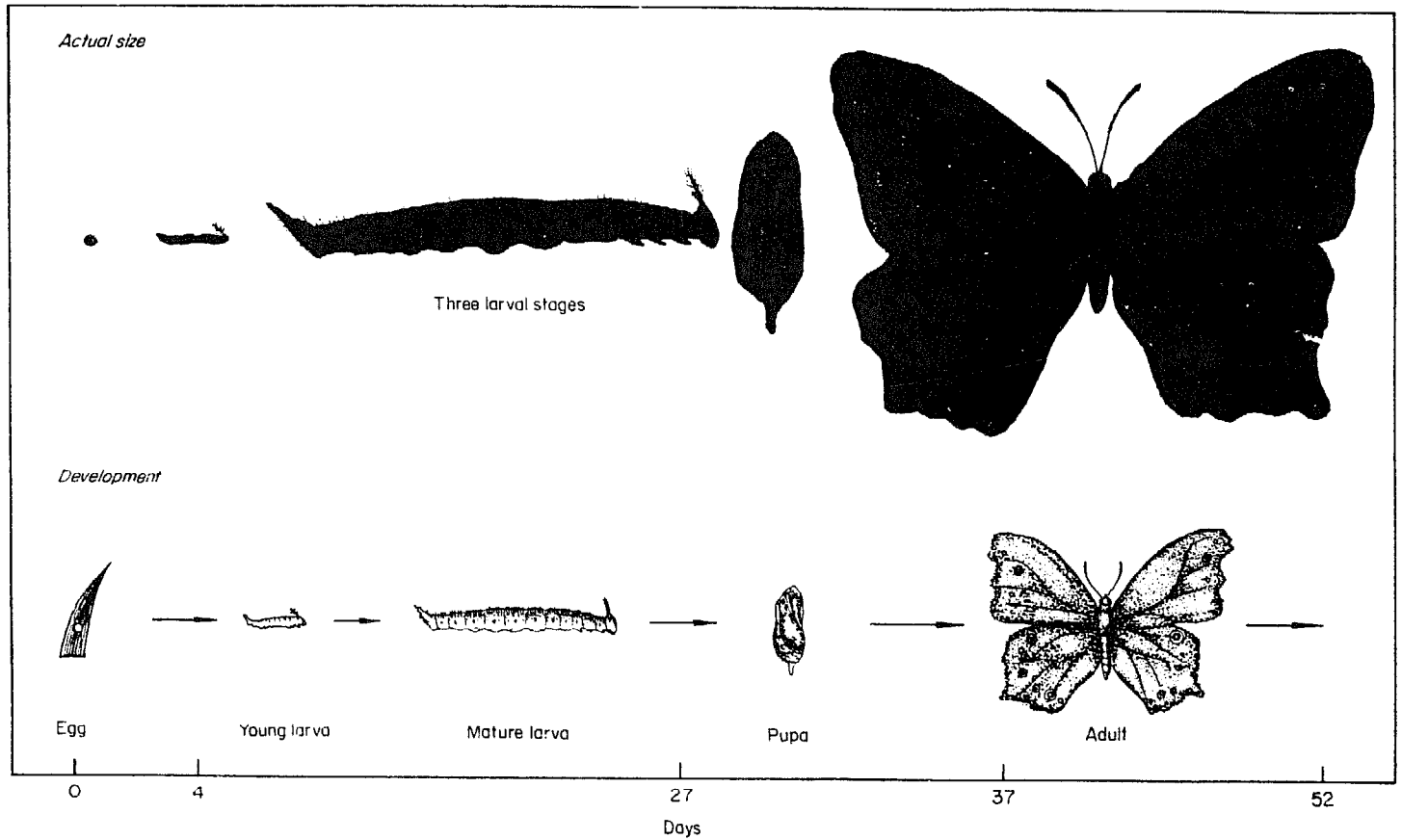

**Adult.** The dull, dark brown butterfly has a pair of large, spherical, white and brown spots on each fore wing and target-like spots on the underwings. The wings are folded above the body when the insect is at rest. It flies at dusk, making darting movements among the rice plants.

Each female lays 50-100 eggs in its lifetime of about 2 weeks.

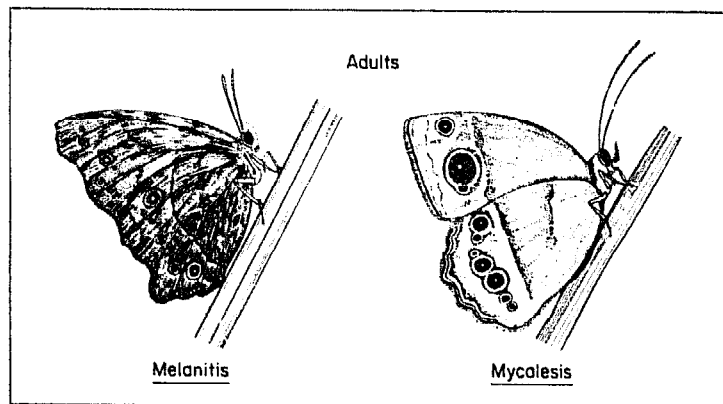

Adults are not attracted to a light trap.

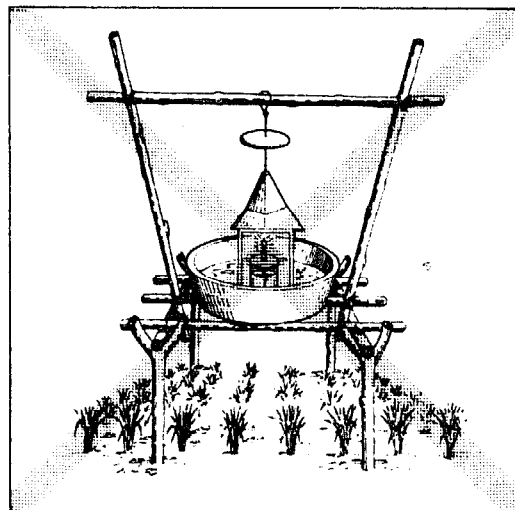

**Egg.** The pearl-like eggs are laid singly or in rows on rice leaves, and are difficult to see.

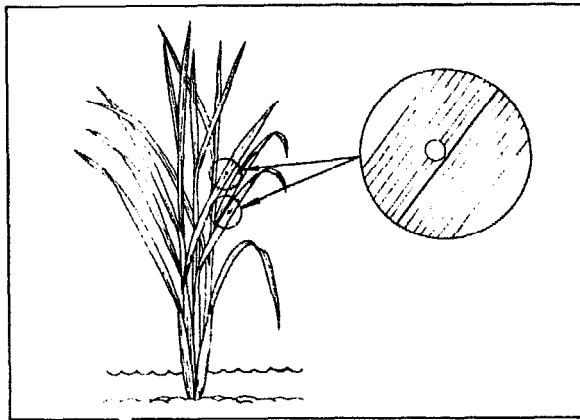

**Larva.** The yellow-green larva blends into the rice foliage and, in spite of its large size, may be overlooked.

The body is covered with small, yellow, bead-like hairs.

The head is flat and square.

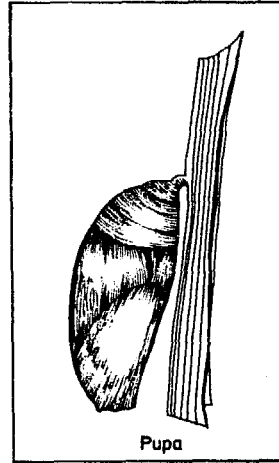
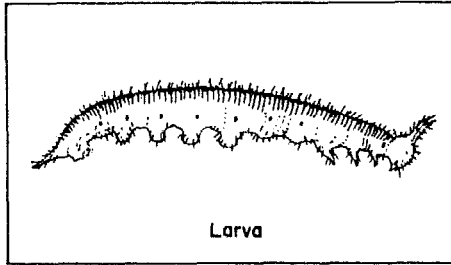

**Pupa.** The chrysalis containing the pupa is green and smooth. It is suspended from the leaves.

**Damage**

The large larvae feed on the margins and tips of leaf blades and remove leaf tissue and veins.

Damage symptoms are similar to those from other large defoliating insects, such as armyworms and grasshoppers that feed on rice.

Yield loss occurs because of removal of leaf tissue.

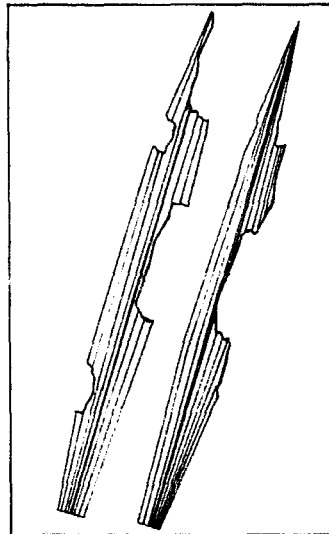
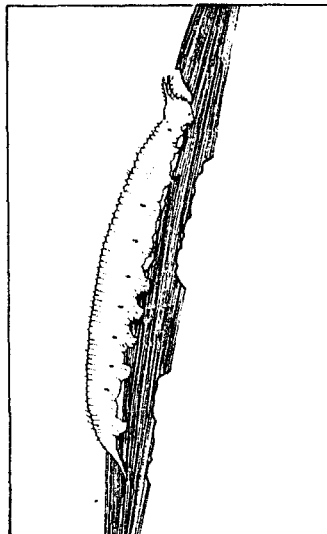

**Plant hosts.** The larvae feed on the leaves of rice and wild grasses.

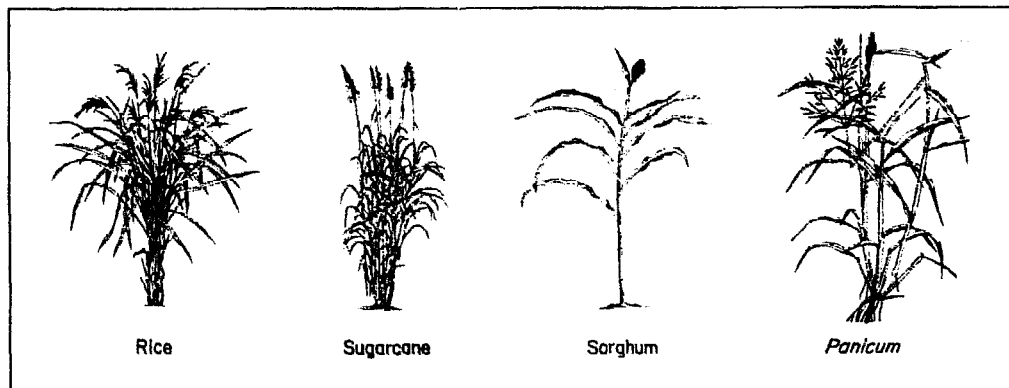

**Management**

**Cultural control.** No effective cultural control practices have been developed.

**Resistant varieties.** No resistant varieties have been developed.

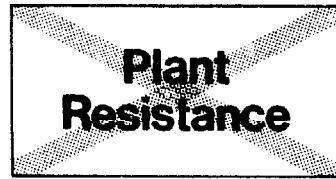

**Biological control.** Eggs are parasitized by trichogrammatid wasps. The larvae are parasitized by chalcid wasps and tachinid flies, and are preyed upon by vespid wasps.

Adult butterflies are prey to spiders.

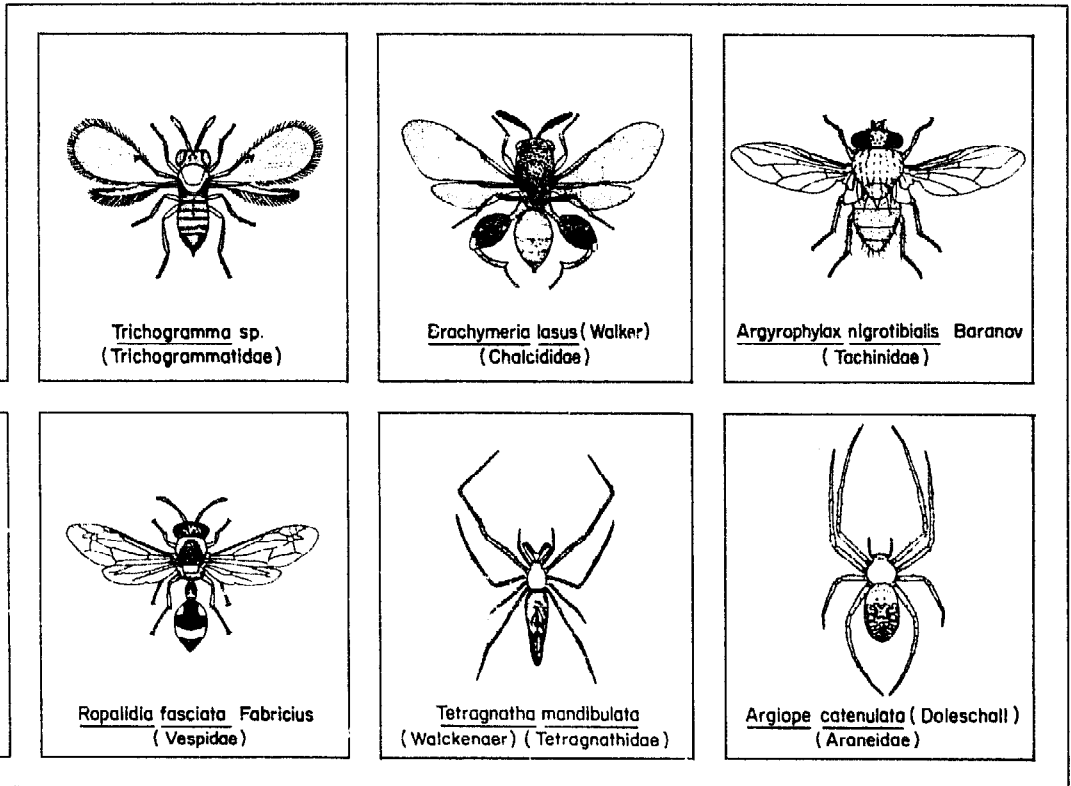

**Chemical control.**

- **Insecticide application.** The larvae of the greenhorned caterpillar can readily be controlled by sprayable insecticides.



Granules are not highly effective when applied to older plants because of the greater plant mass.

- **Scouting.** Sampling is based on plant damage. Scout the fields weekly for damage, from 30 days after seeding until flowering.

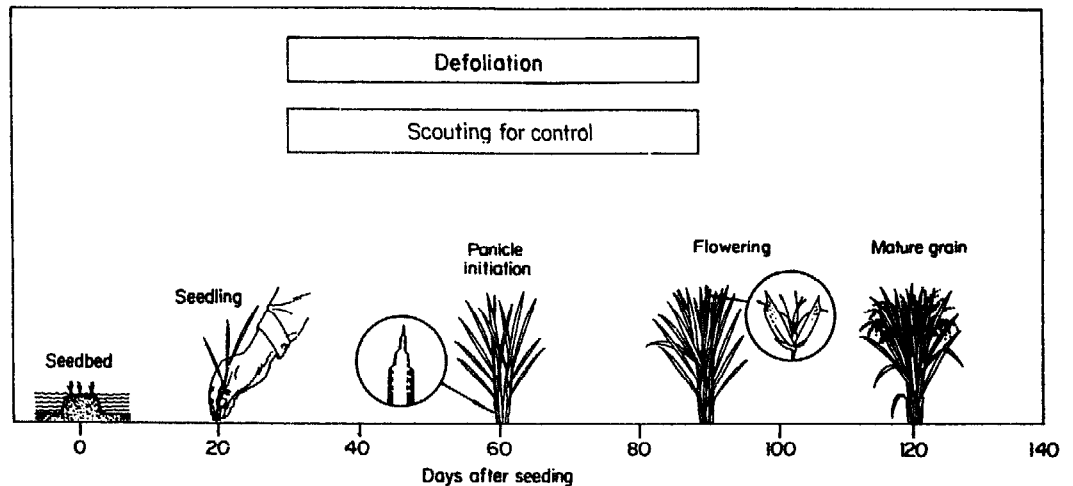

Randomly pick 5 leaves from each of 20 hills across the paddy.

Yield loss is related to the degree of defoliation; therefore, there is no need to distinguish leaves damaged by the greenhorned caterpillar from leaves damaged by other pests such as armyworms, cutworms, grasshoppers, and rice skippers.

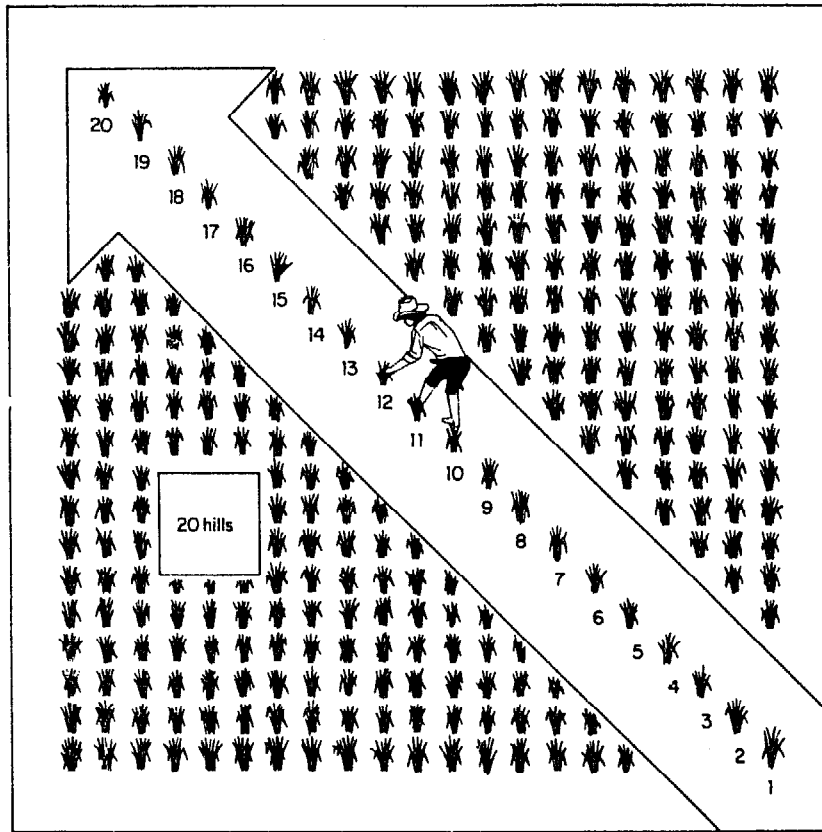

The economic threshold is based on percentage of damaged leaves due to all pests that remove leaf tissue.

Apply insecticide when the economic threshold is reached.

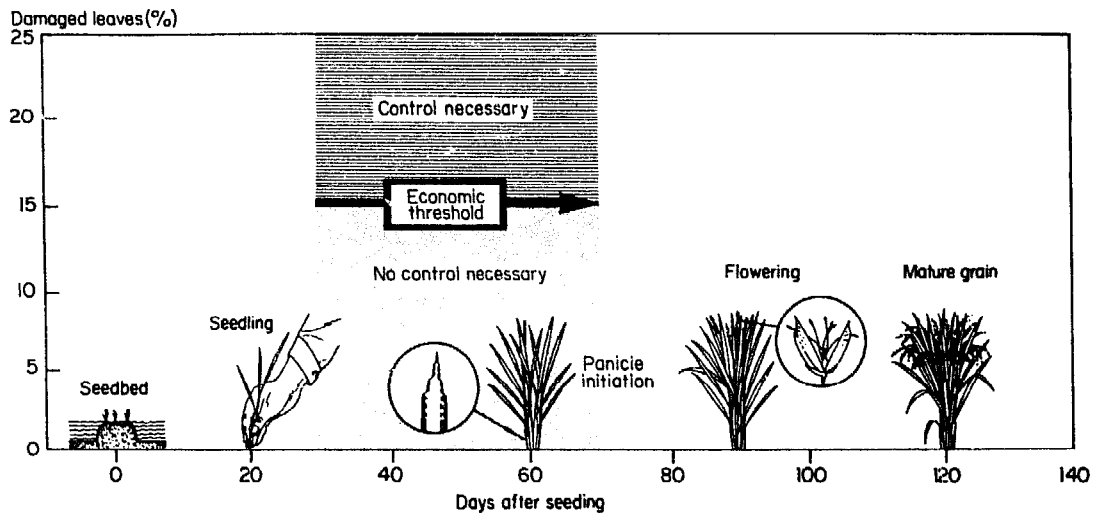

RICE SKIPPERS (LEPIDOPTERA: HESPERIIDAE)

*Pelopidas mathias* (Fabricius) and *Parnara guttata* (Bremer and Grey) are the most widespread rice field species of these day-flying skipper butterflies. Skippers are so named because of their fast and erratic flight behavior — they skip from plant to plant.

The two species can be separated in the adult stage by the pattern of spots on the wings and spines on the second pair of legs. The distinguishing larval characteristic is banding on the head.

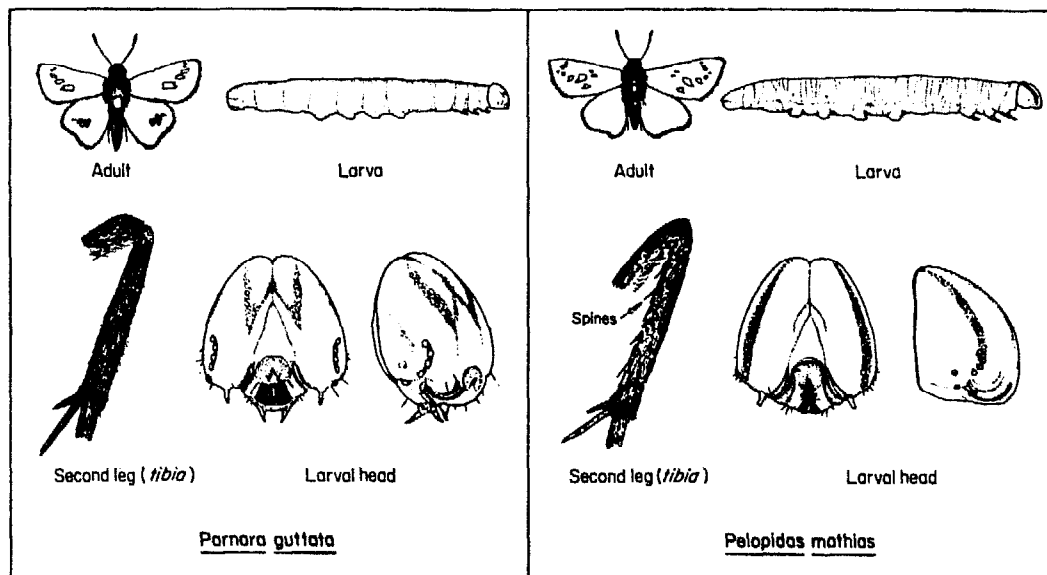

**Pest status**

The larvae rarely abound in rice fields and occasions of yield loss from skippers are rare.

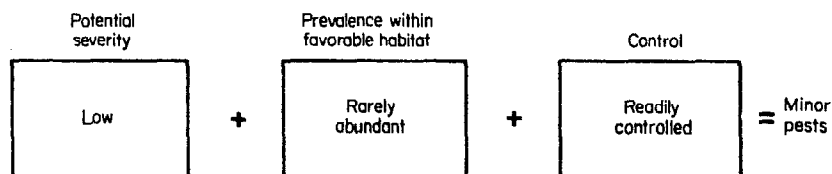

Skippers occur in all rice environments, but are more prevalent in rainfed rice.

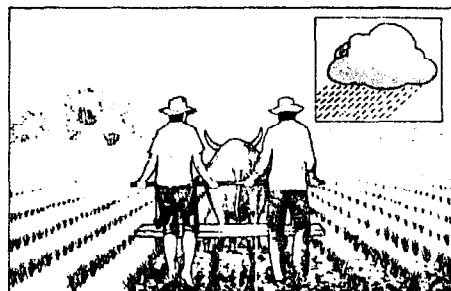

Upland

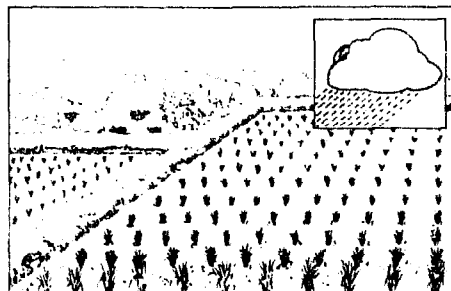

Rainfed wetland

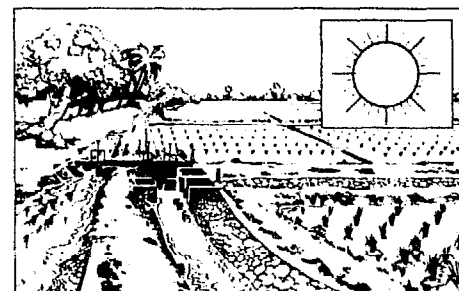

Irrigated wetland

*Distribution in Asia*

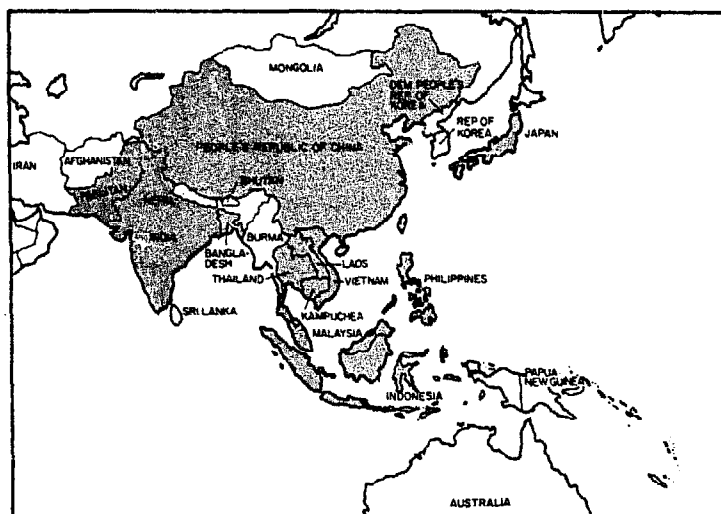

**Development and actual size**

*Adult.* Adults are light brown with orange markings and white spots.

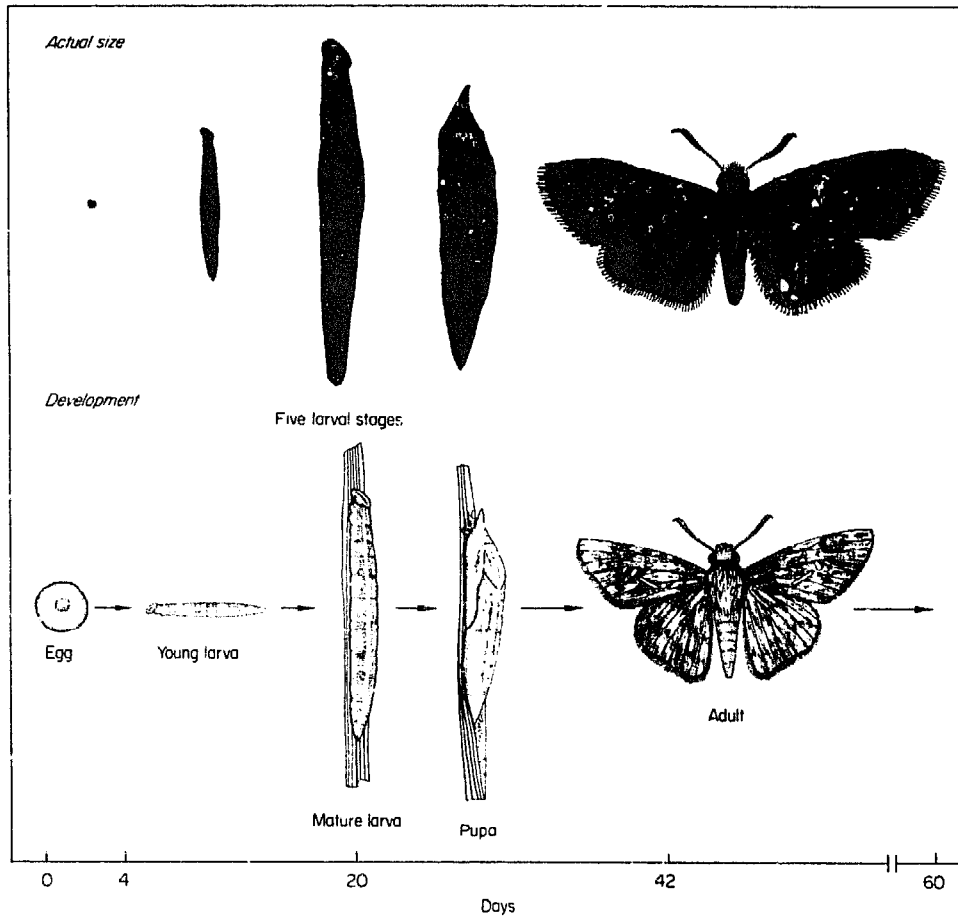
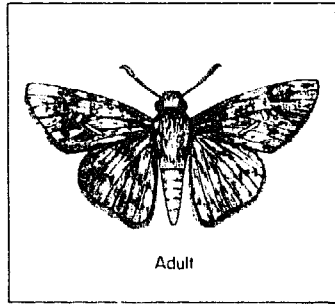

Skipper butterflies are active during the day and rest at night.

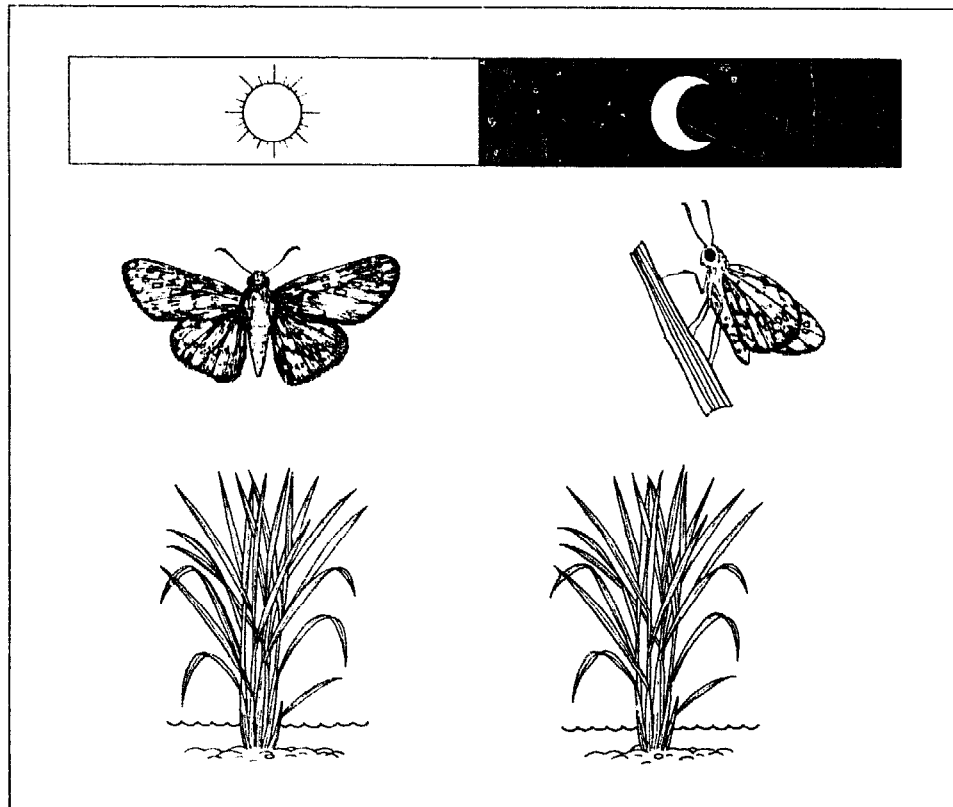



**Egg.** The white spherical eggs are laid singly. They are glued on leaf blades by the female.

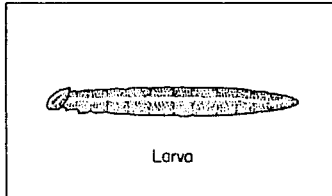
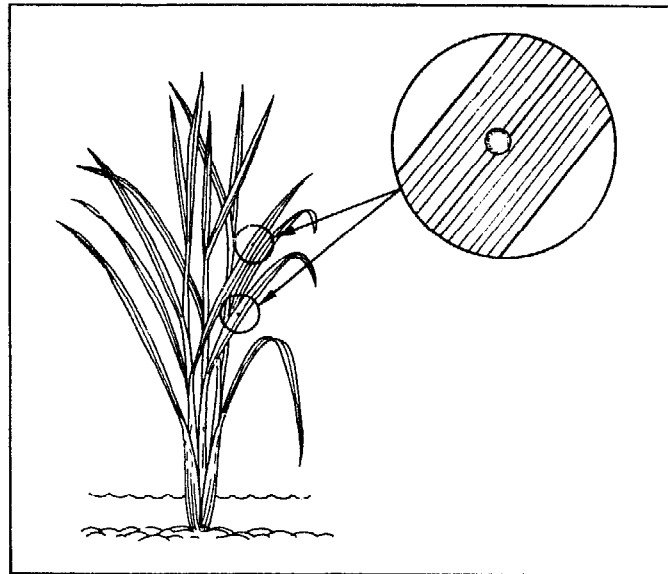

**Larva.** Skipper larvae are similar in size and coloration to those of the greenhorned caterpillar, but have no horns.

Skipper larvae rest at the base of plants during the day and feed on leaf blades at night.

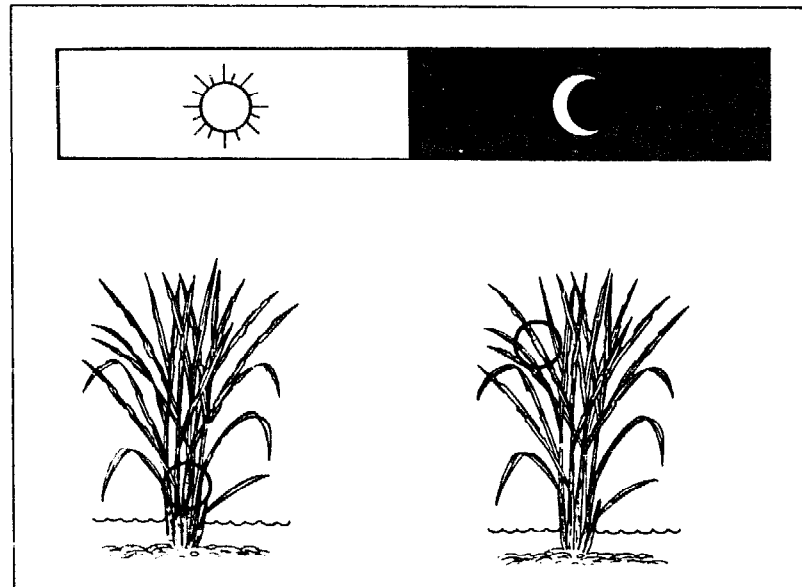

Young larvae roll portions of the leaf blade to make a protected chamber where they rest during the day.

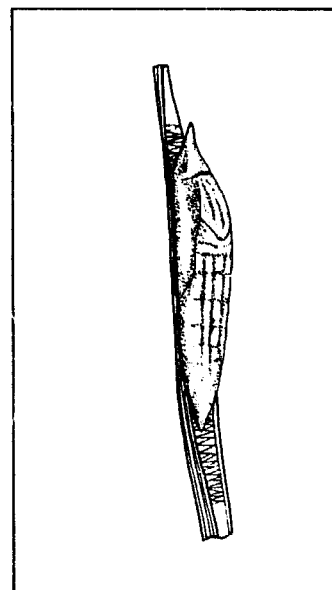
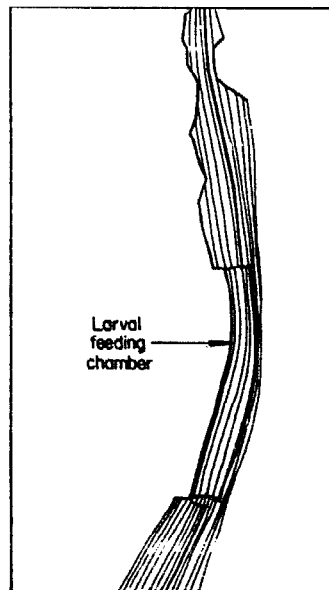

**Pupa.** The larva ties a leaf or leaves together with silken threads to form a tube where it will pupate. The light brown or light green pupa rests in a bed of silk and has a pointed end which is attached to the folded leaf.

**Damage**

Rice skippers produce damage similar to that caused by the greenhorned caterpillar.

The larvae feed on rice foliage.

*Plant hosts.* Skipper larvae feed on many plants of the grass family.

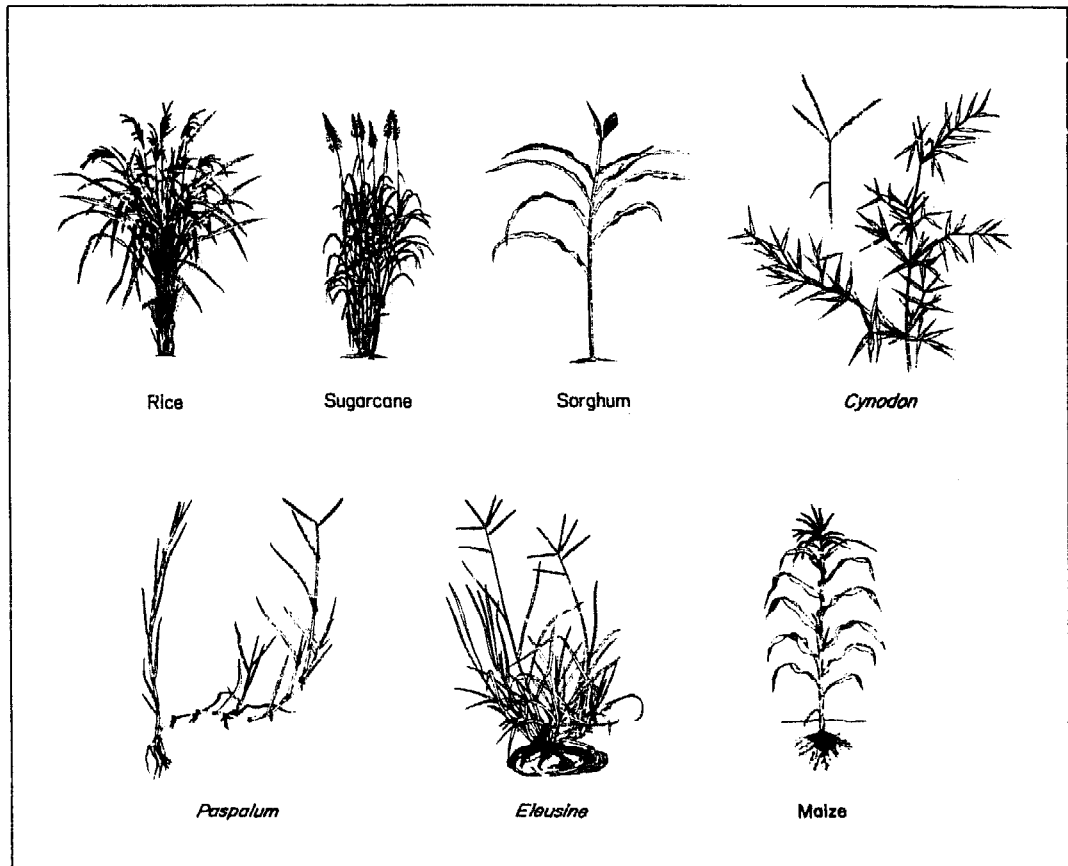

**Management**

*Cultural control.* No effective cultural control methods have been developed.

*Resistant varieties.* There are no commercially available resistant varieties.

*Biological control.* Rice skipper populations are regulated by a wide variety of natural enemies.

Eggs are parasitized by trichogrammatid wasps.

Many species of ichneumonid, braconid, chalcid, and eulophid wasps and tachinid flies parasitize the larvae.

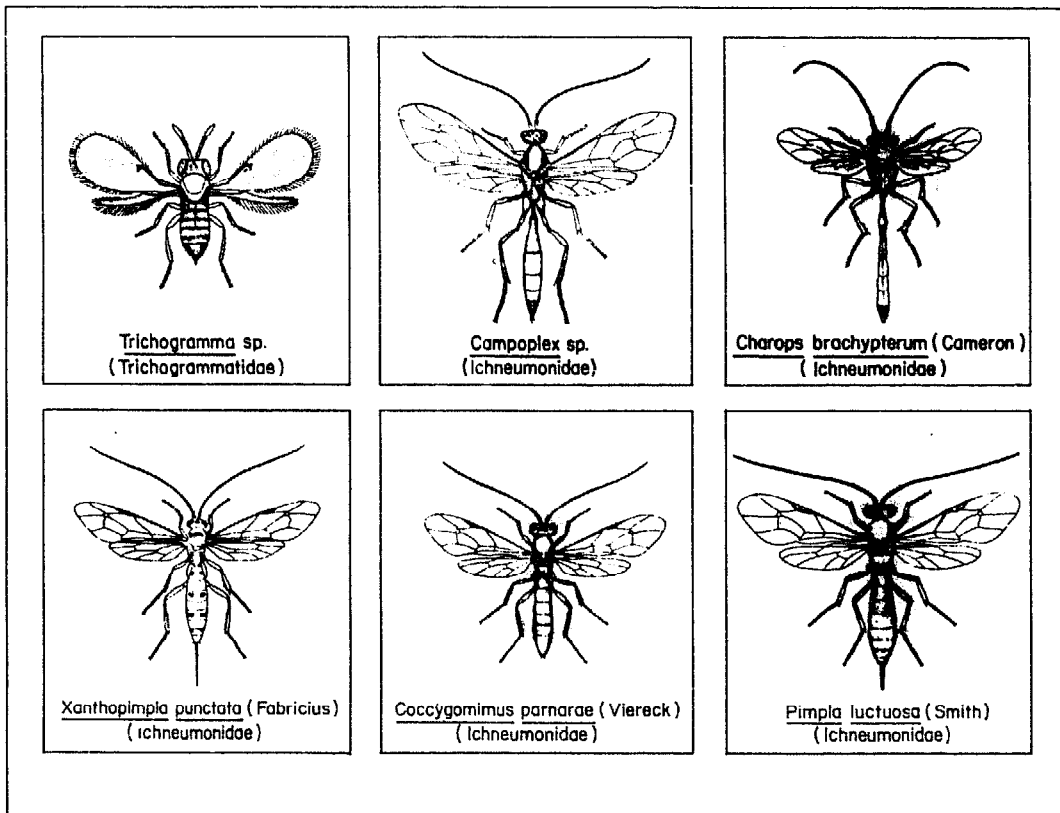
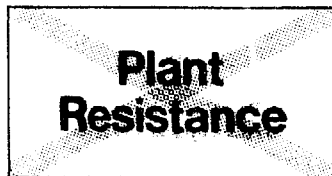

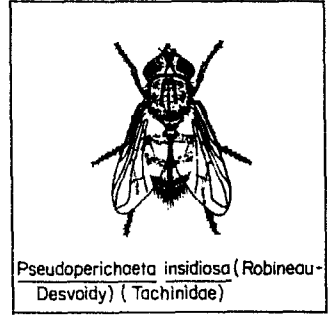
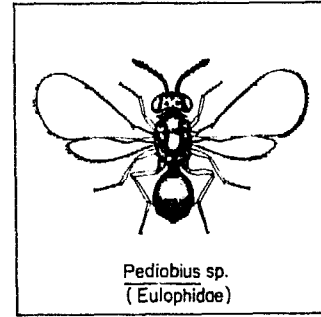
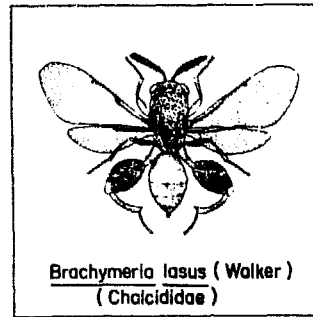
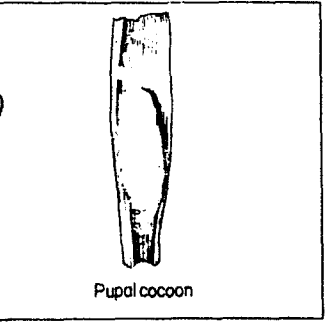
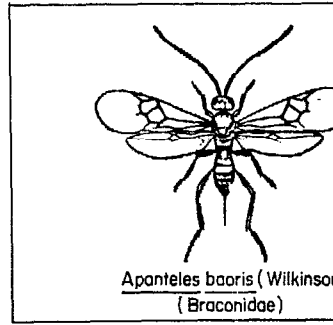
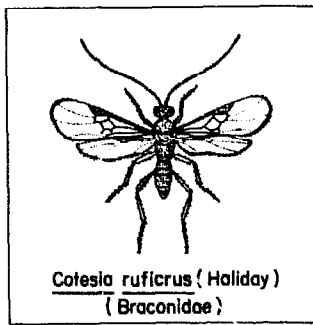

Larvae are preyed upon by earwigs and reduviid bugs.

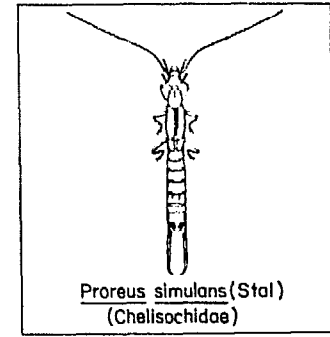
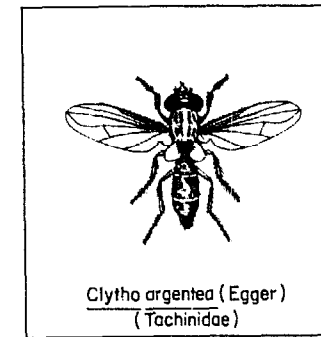
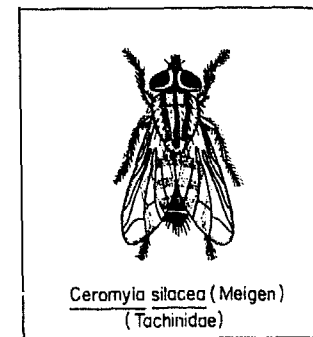
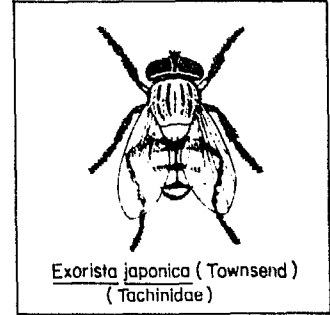
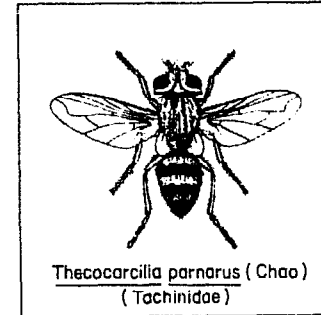
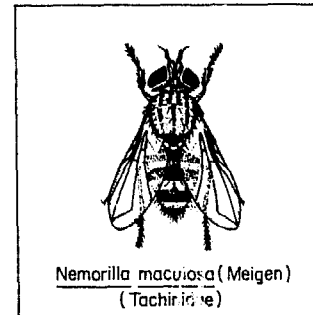

Large orb-web spinning spiders capture skipper adults in flight.

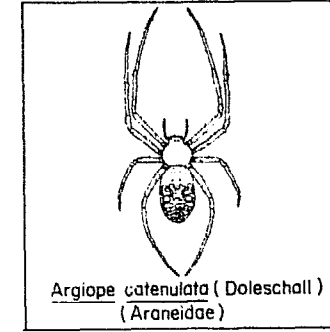
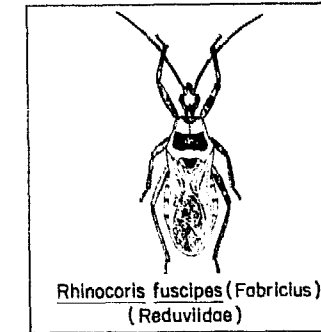
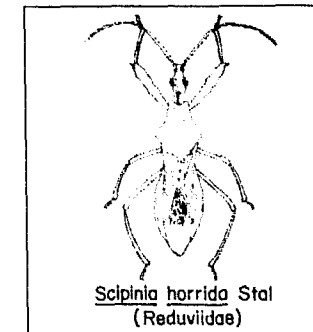

**Chemical control.**  
Chemical control, scouting, sampling, and economic threshold level for the rice

skipper are similar to those for the greenhorned caterpillar.

RICE BROWN PLANTHOPPER (HOMOPTERA: DELPHACIDAE)

*Nilaparvata lugens* (Stål) (= *Delphax oryzae*) is probably the most serious insect pest of rice in Asia. Its feeding causes plants to wilt and causes a symptom called hopperburn. It also transmits grassy stunt and ragged stunt virus diseases.

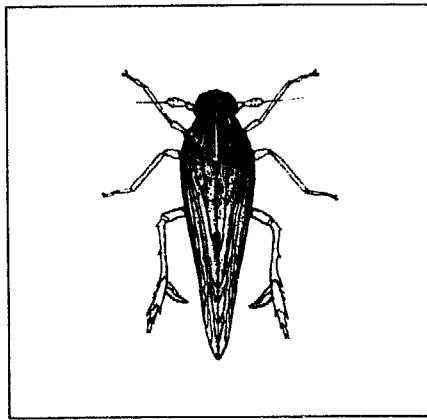

**Pest status**

The rice brown planthopper has a high capacity to reproduce. Frequently, farmers' misuse of insecticide causes outbreaks of hopperburn and/or virus diseases over large areas. The development of biotypes often reduces the life-span of resistant rice varieties. The effectiveness of control by

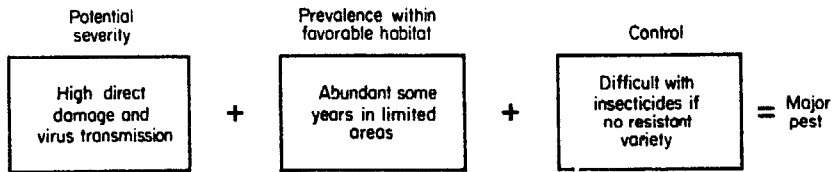

insecticide is lessened because the hoppers are found at the base of plants and the crop canopy acts as

an umbrella to protect the insects from the spray droplets.

The brown planthopper is mainly a pest of irrigated wetland rice, but it can also

become abundant in rainfed wetland environments. It is rare in upland rice.



Upland

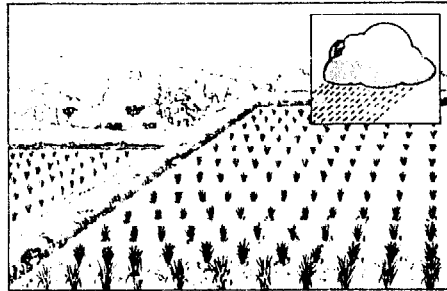

Rainfed wetland

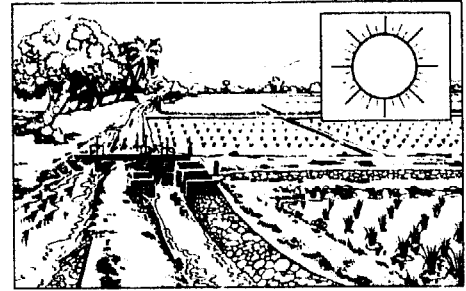

Irrigated wetland

*Distribution in Asia.*

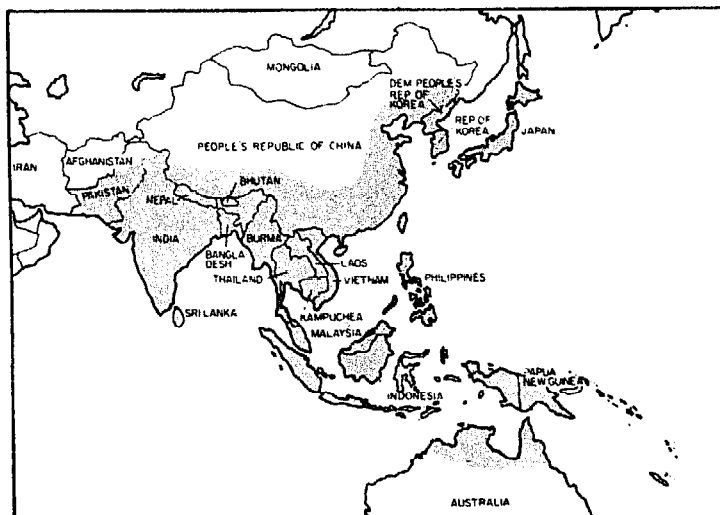

**Development and actual size**

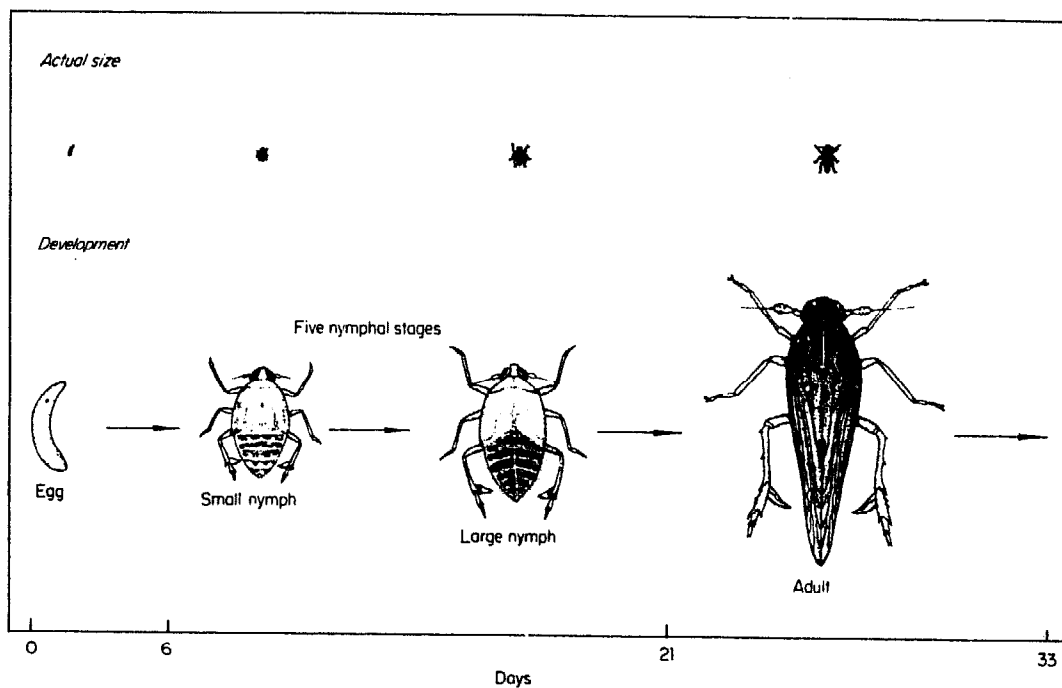

**Adult. Short-winged (brachypterous) and long-winged (macropterous) adults occur in both sexes. Short-winged forms cannot fly but remain in the field to feed and reproduce. Long-winged form disperse.**

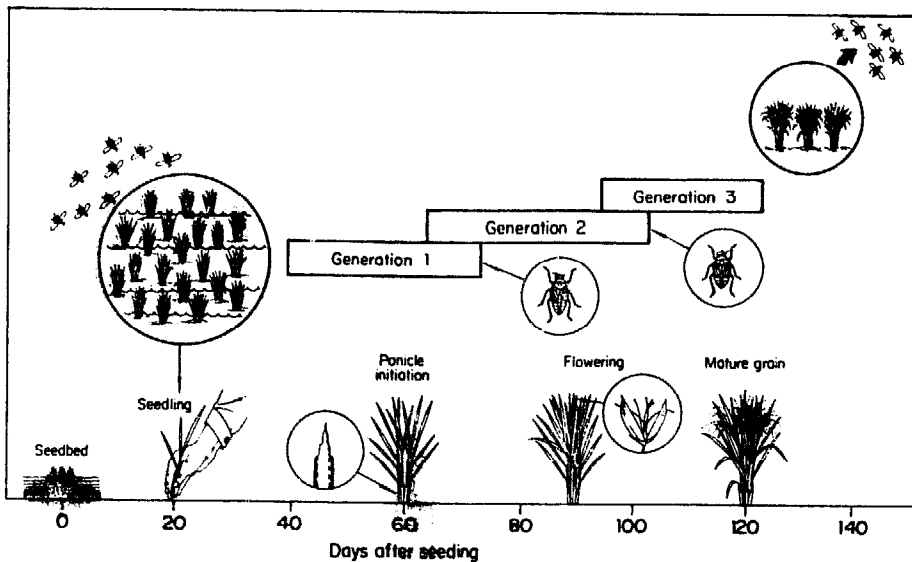
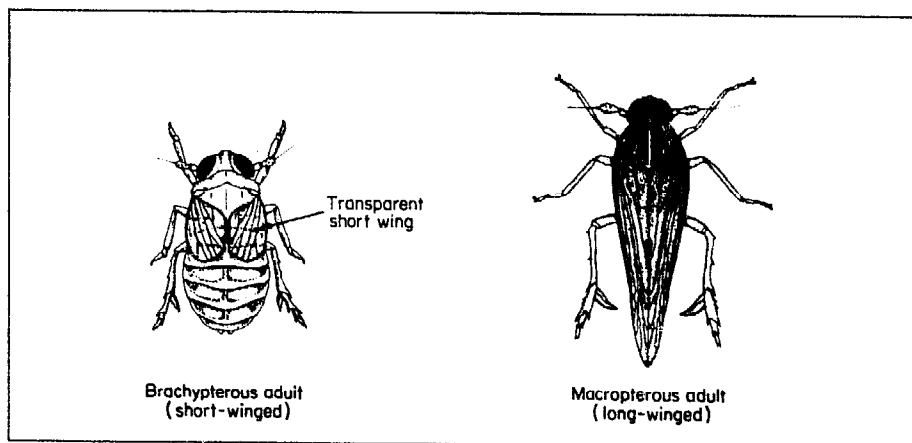

Macropterous females lay about 100 eggs and brachypterous females 300 eggs during a lifetime of about 2 weeks. Openings for eggs are made in the tillers by the saw-like ovipositor.

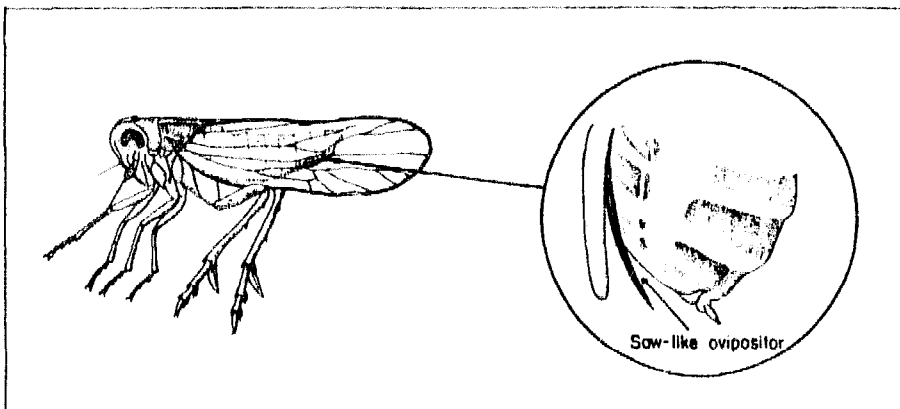

Adults suck the plant sap from the base of plants where they stay day and night.

Long-winged adults are highly attracted to a light trap. Highest catches occur during a full moon.

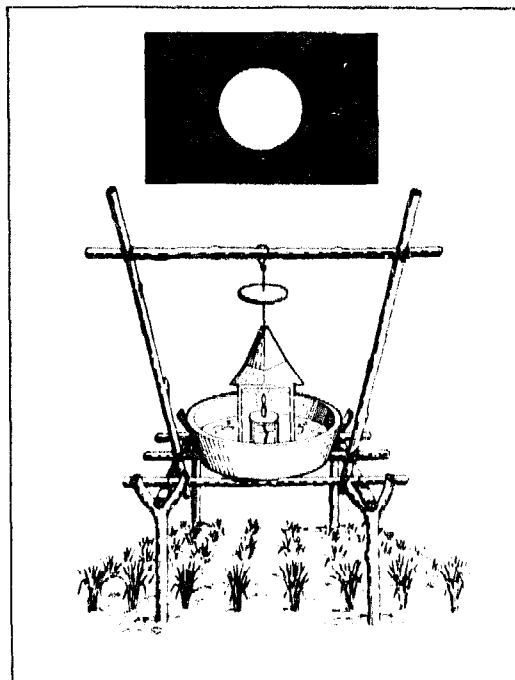
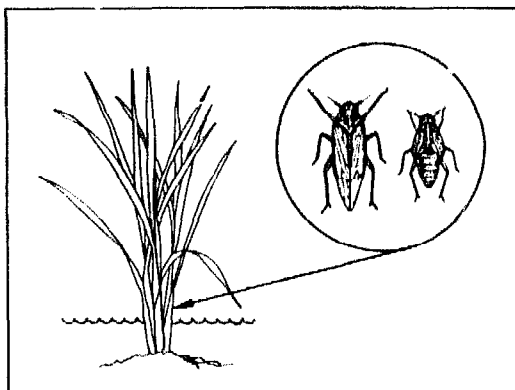

A related species, *Nilaparvata bakeri* (Muir), often confused with the brown plant-

hopper, is found in light trap collections but is not a pest of rice.

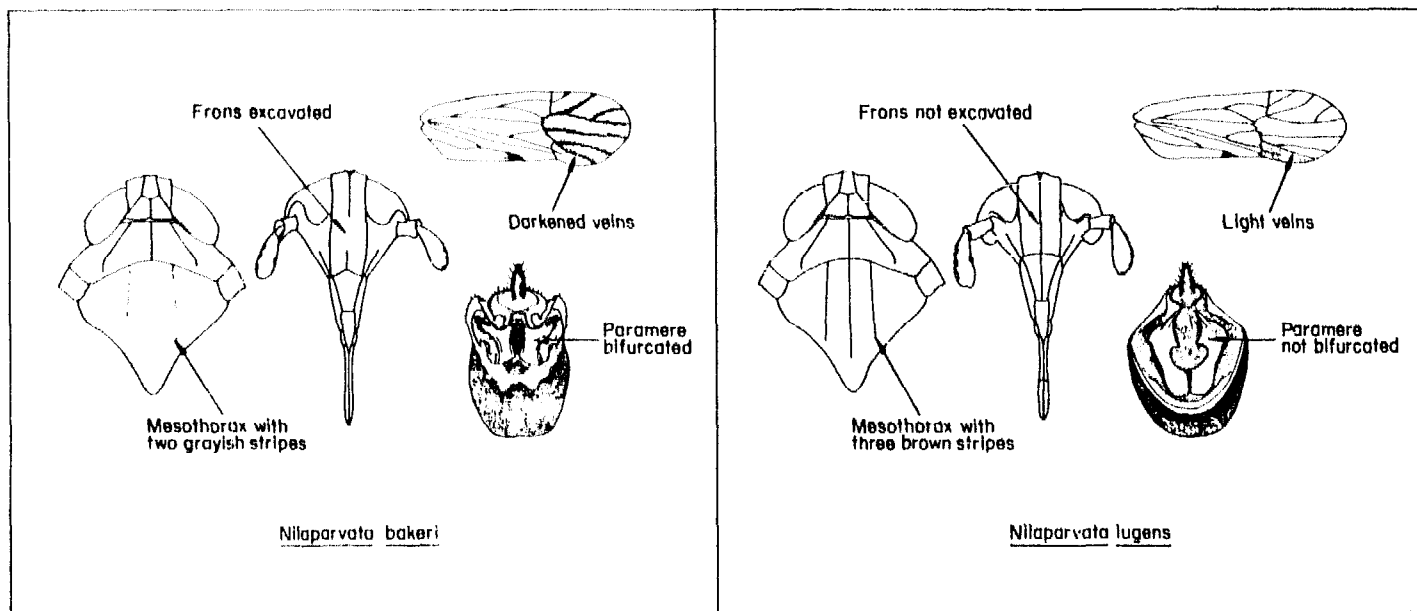

**Egg.** The white eggs are inserted into the midrib or leaf sheath in masses of 8-16.

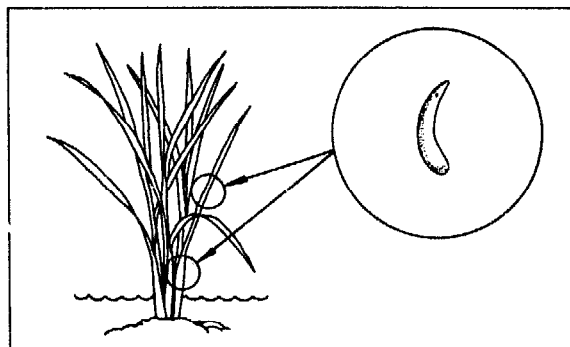

Eggs are covered by a dome-shaped egg plug secreted by the female. Red eye spots develop at the head end before the eggs hatch.

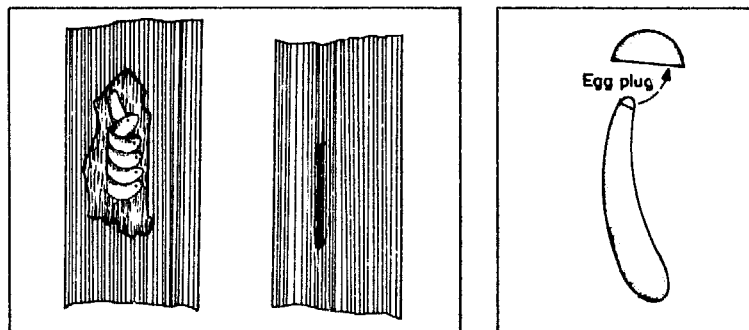

**Nymph.** Nymphs are found near the base of tillers where it is shady and humidity is high. Young nymphs are white, turning brown as they mature.

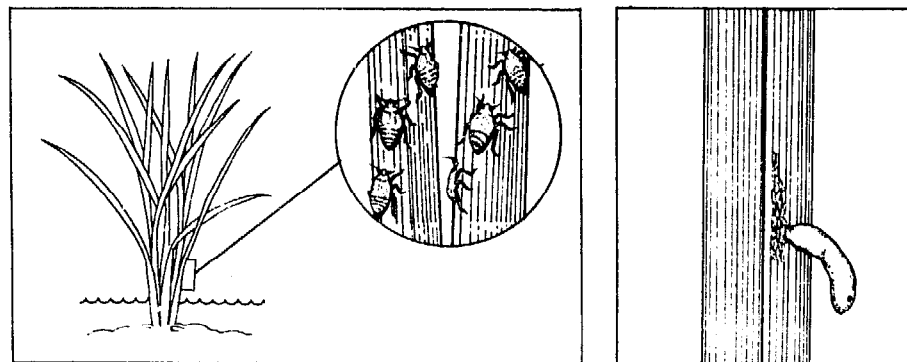

As with all leafhoppers and planthoppers, nymphs and adults move laterally like crabs to the opposite side of tillers when disturbed. Nymphs feed on the same tillers in which they hatched and, unlike those of other hopper species, can become highly aggregated.

The wing pads of mature nymphs are light brown and opaque; short-winged adults have transparent wings.

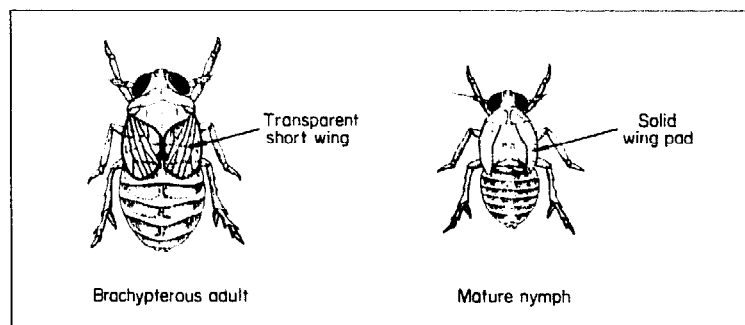

**Damage**

Nymphs and adults insert their sucking mouthparts into the plant tissue and remove plant sap from phloem cells. The brown planthopper removes more plant sap than it can digest. The excess plant sap, which is high in sugars, is expelled from the body as honeydew. The honeydew drops fall on the base of plants and in time turn black from infection by a sooty mold fungus.

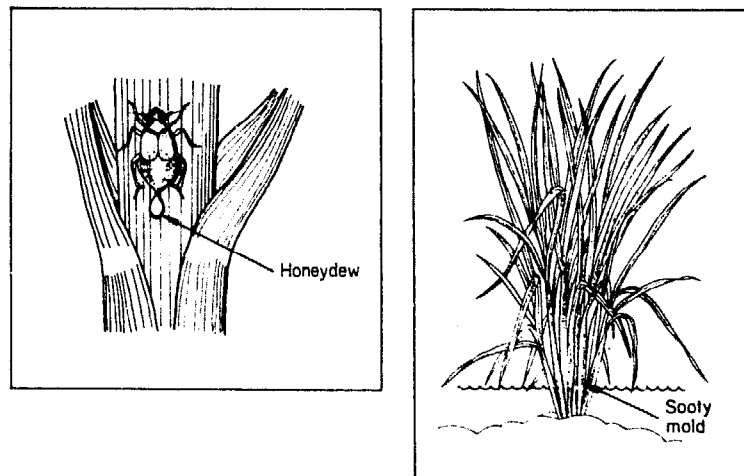

During the act of feeding, the brown planthoppers secrete solid feeding sheaths into the plant tissue to form a feeding tube. The feeding sheaths block the flow of plant sap.

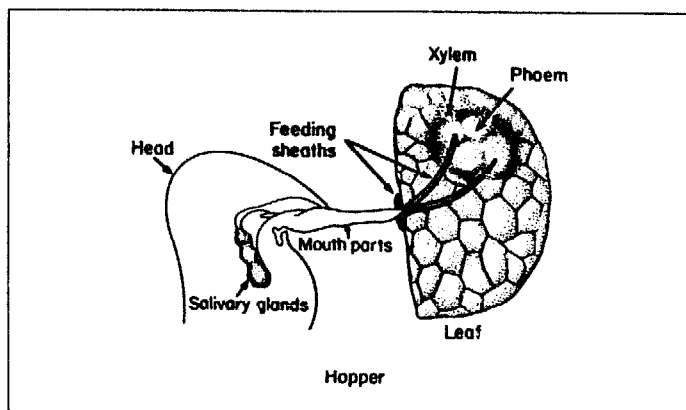

The brown planthopper may remove enough sap or block its flow to cause the tillers to dry and turn brown, producing hopperburn during later growth stages. Hopperburn occurs more rapidly during cloudy weather. Photosynthesis during sunny days allows the plant to recover from sap removal by hoppers.

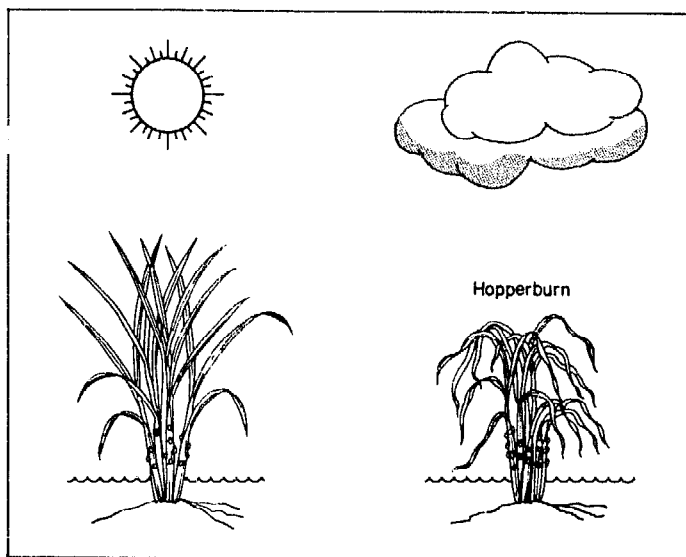

The brown planthopper also transmits ragged stunt and grassy stunt viruses.

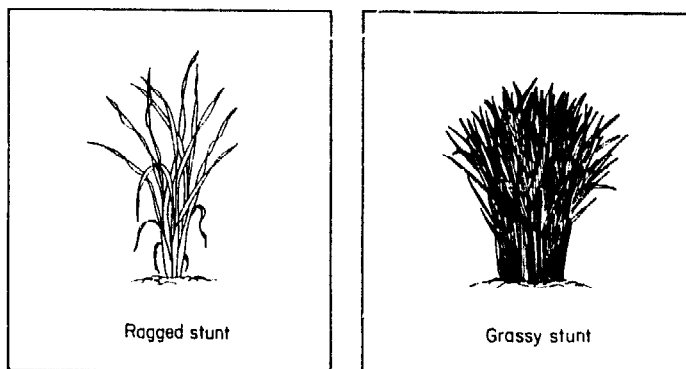

Brown planthopper outbreaks are associated with development of irrigation systems to allow year-round rice cropping (thus continuous planthopper buildup), excessive fertilizer usage that results in higher planthopper populations, and the use of insecticides that kill natural enemies.

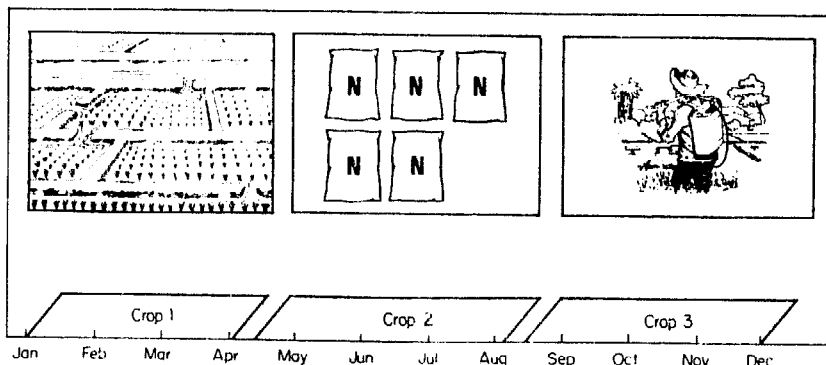



**Plant hosts.** The brown planthopper is restricted to rice and wild rices, but reproduction can occur on *Leersia hexandra*.

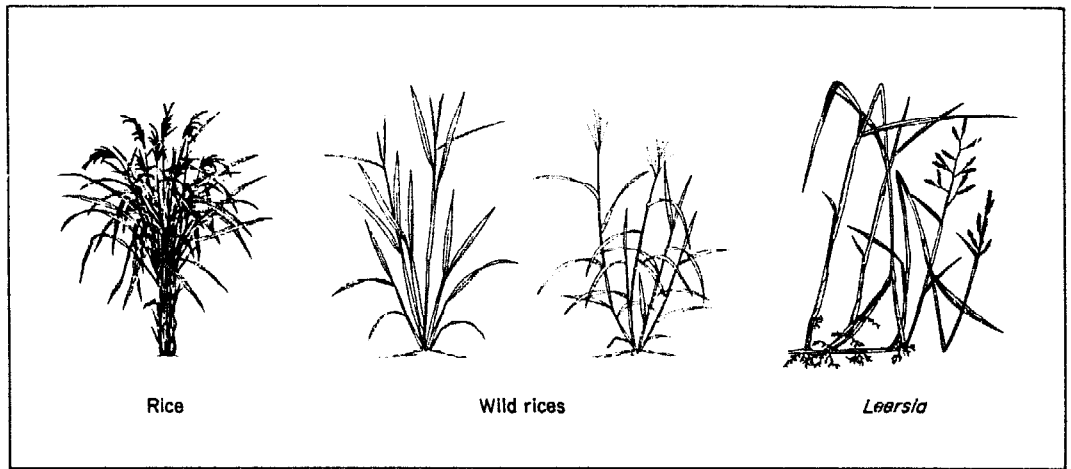

**Management**

**Cultural control.** Grow no more than two rice crops per year. Create a rice-free period during the year with early-maturing varieties, plant neighboring fields within 3 weeks of each other, and plow down volunteer ratoon after harvest.

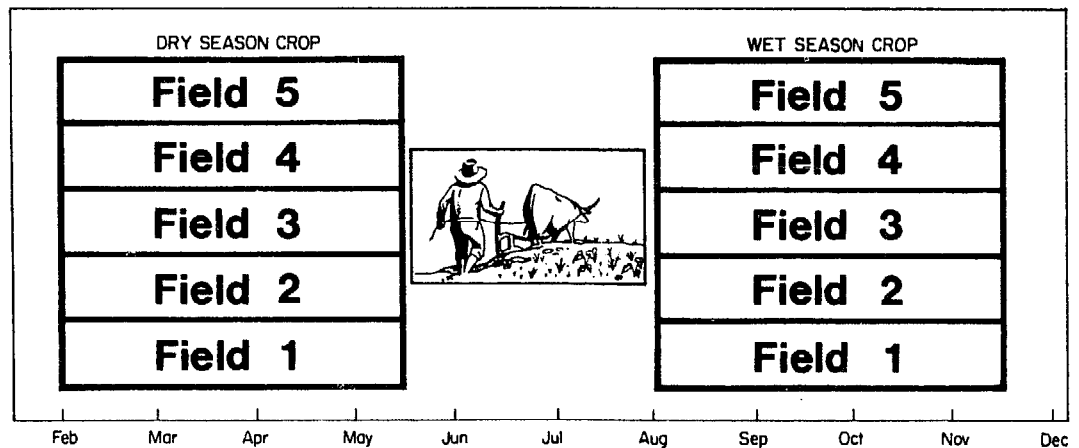

Use fertilizer judiciously. Split nitrogen applications three times during crop growth.

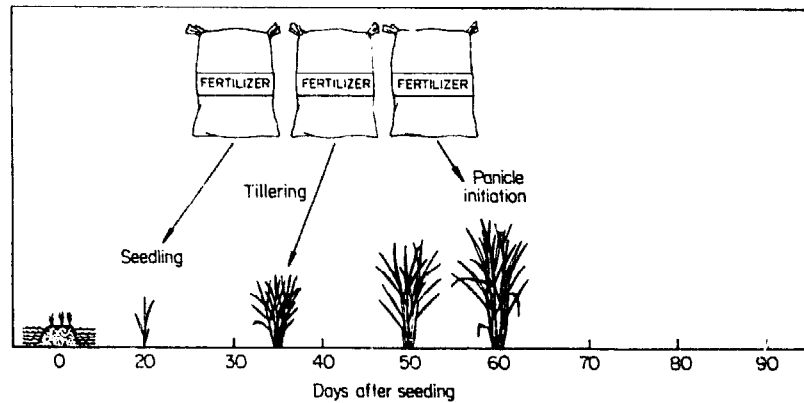

To reduce brown planthopper populations, drain the field for 3 or 4 days during infestations.

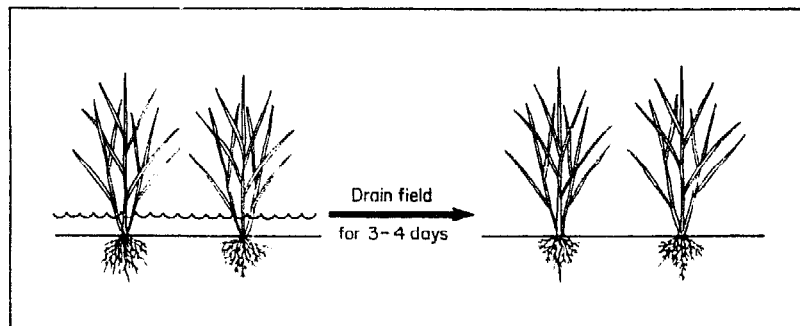

Eliminate virus sources in rice and weeds by plowing down rice stubble and ratoon.

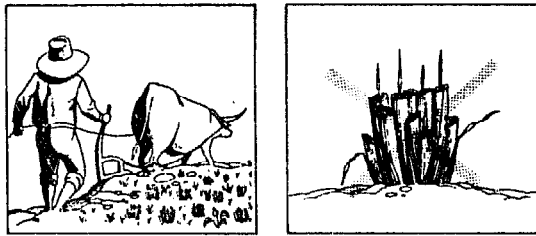

Plant seedbed in areas as far as possible from lights and sources of virus infection. Lights attract virus-infected hoppers, and weeds are alternative hosts of virus and virus-carrying hoppers.



**Resistant varieties.** Planting a resistant variety is an effective way of controlling brown planthopper.

Brown planthopper numbers decrease on resistant varieties because of the presence of toxic chemicals produced by the plants.

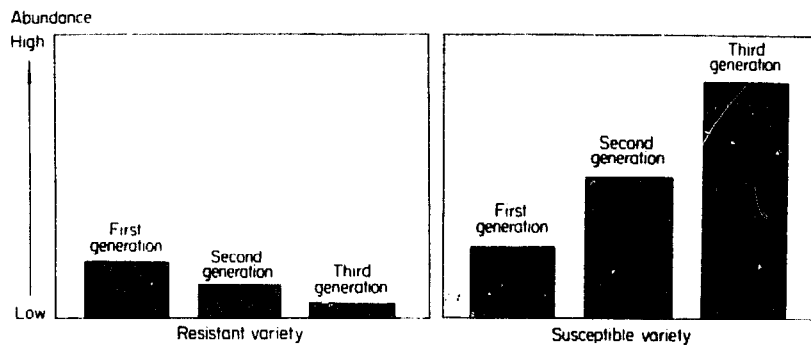

If varieties with the same genes for high levels of resistance are widely planted, however, new biotypes or field populations capable of attacking the resistant varieties can develop through natural selection.

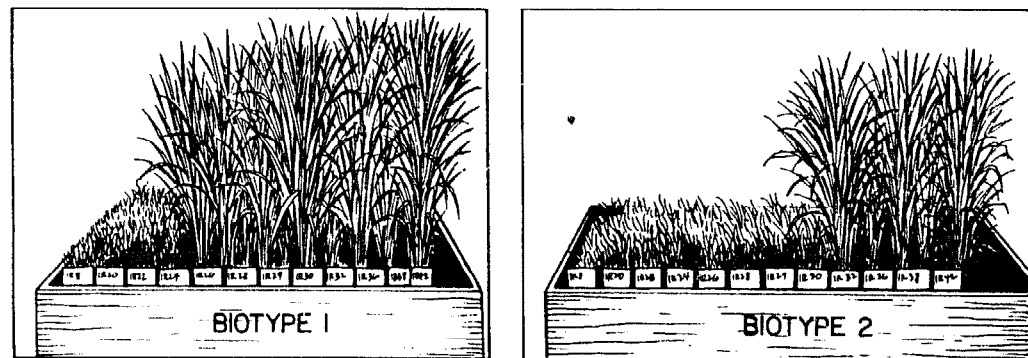

Early-maturing varieties act to reduce brown planthopper population development.

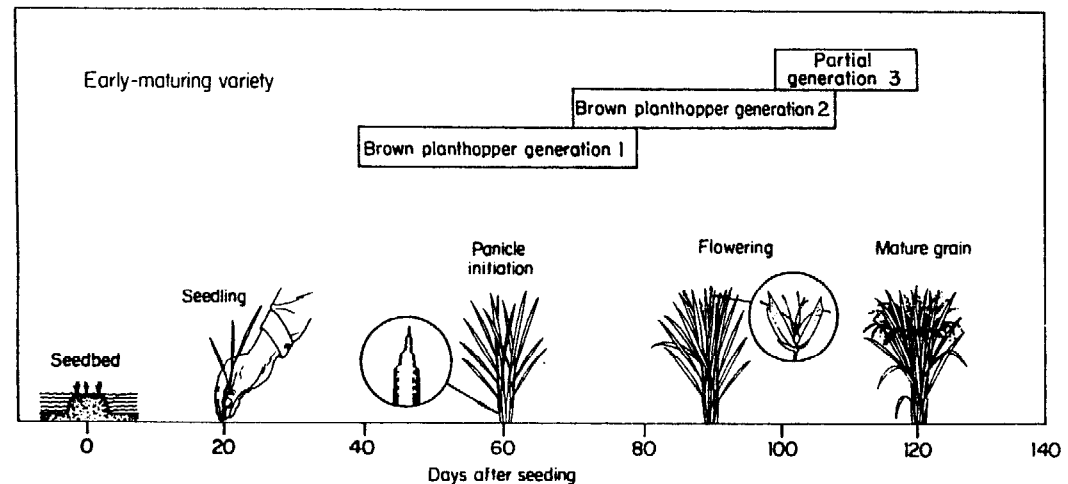

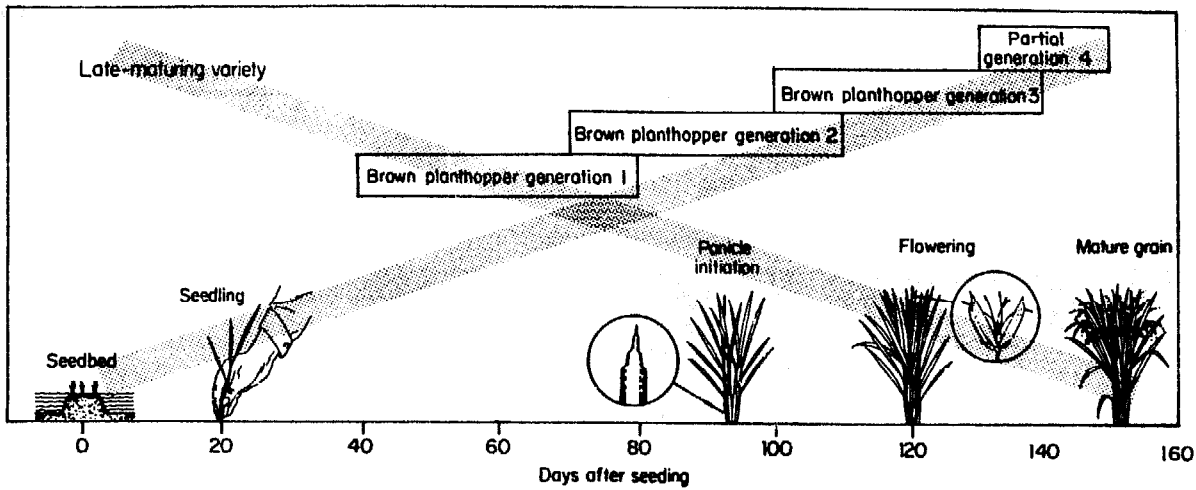

Higher planthopper populations per area occur on high tillering varieties because of the increased plant surface on which to feed.

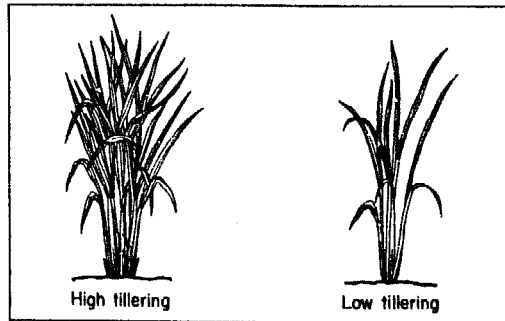

**Biological control.** Many parasites, predators, and pathogens attack all stages of the brown planthopper and effectively control this pest under most situations. Improper use of insecticide, however, can kill the natural enemies and thus lead to dramatic brown planthopper outbreaks.

Eggs are parasitized by mymarid, trichogrammatid, and eulophid wasps.

Mirid bugs and phytoseiid mites prey on eggs.

Elenchid strepsipterans, dryinid wasps, and nematodes parasitize nymphs and adults.

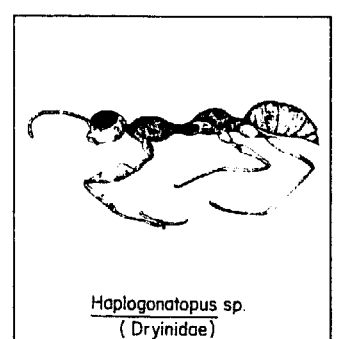
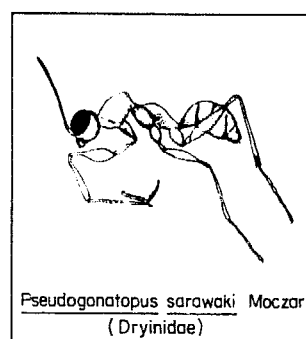
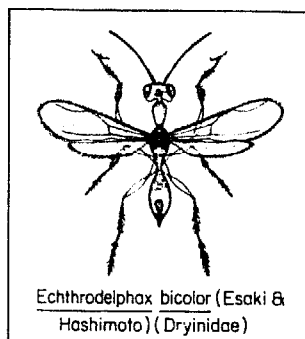
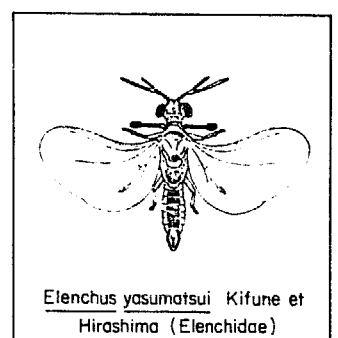
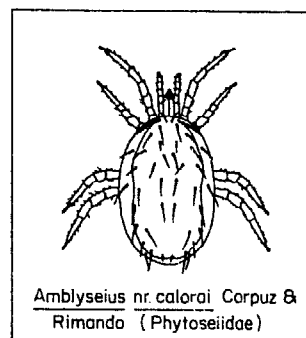
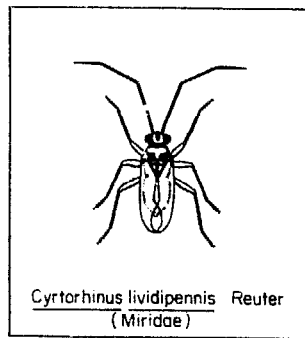
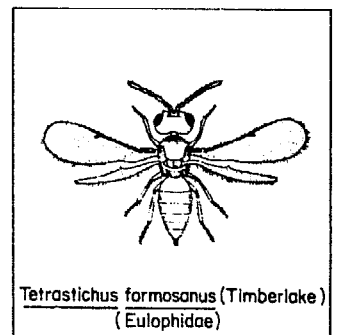
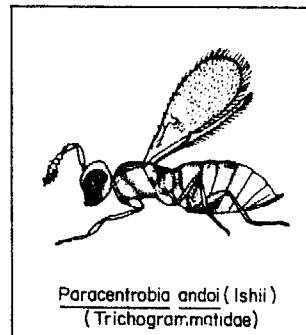
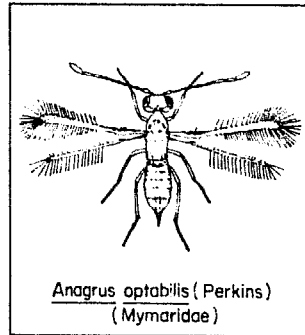

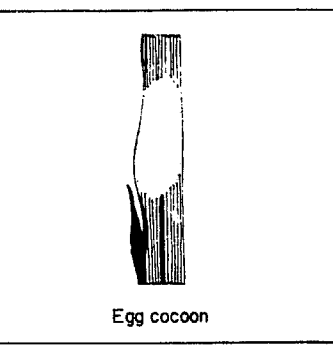
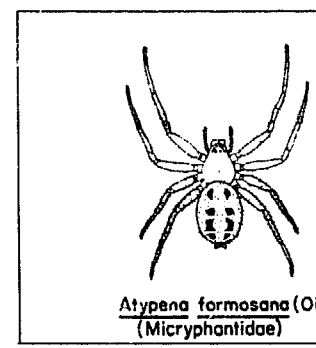
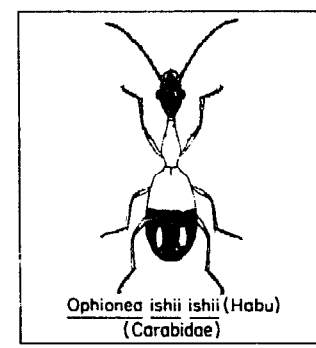
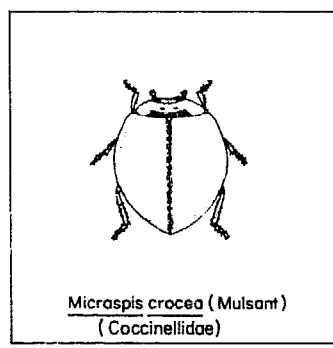
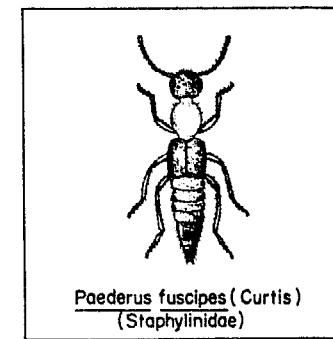
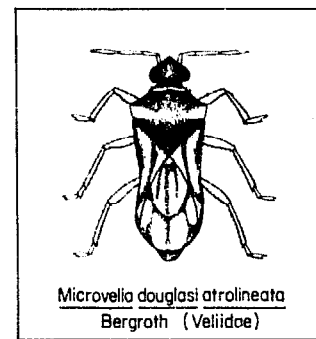
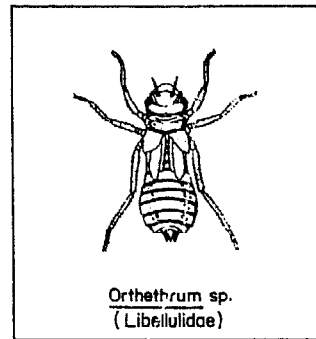
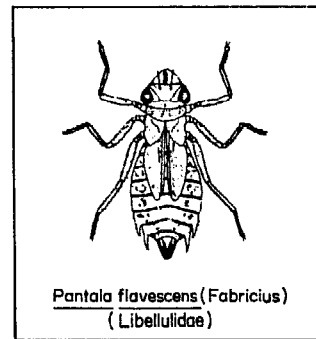
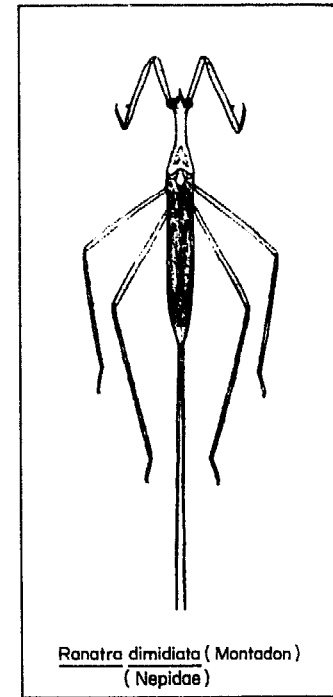
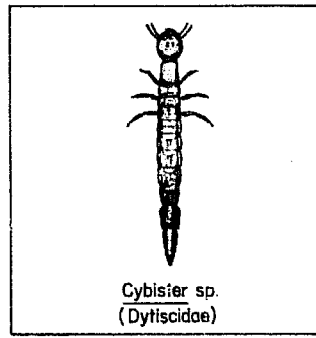
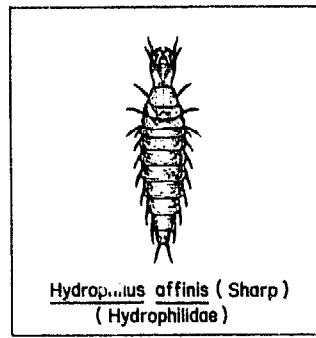
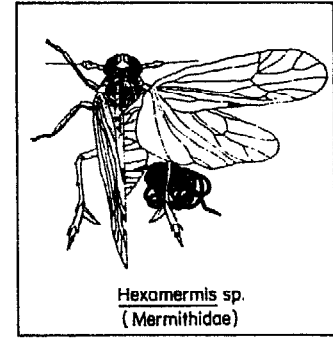
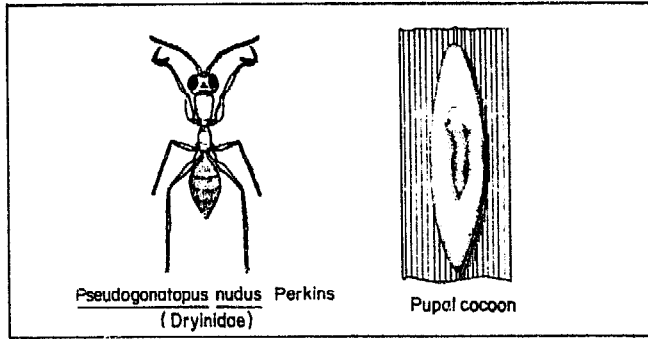

Aquatic predators under the water surface (hydrophilid and dytiscid beetles and damselfly and dragonfly immatures) and those that swim on the surface (nepid, microveliid, and mesoveliid bugs) prey on hoppers that feed near the water or fall into the water.

Beetles and spiders actively search the foliage for brown planthopper nymphs and adults. Dragonflies and damselflies prey on moving adults and nymphs.

Fungal pathogens infect brown planthopper nymphs and adults. After the death of the hoppers, the fungi grow out of the corpses.

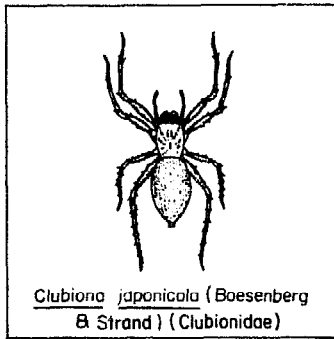

*Clubiona japonicola* (Boesenberg & Strand) (Clubionidae)

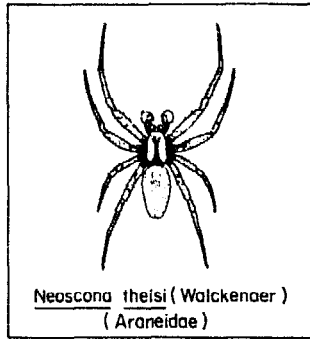

*Neoscona theisi* (Walckenaer) (Araneidae)

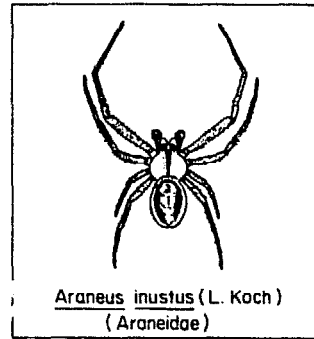

*Araneus inustus* (L. Koch) (Araneidae)

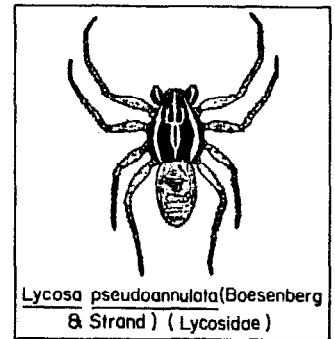

*Lycosa pseudoannulata* (Boesenberg & Strand) (Lycosidae)

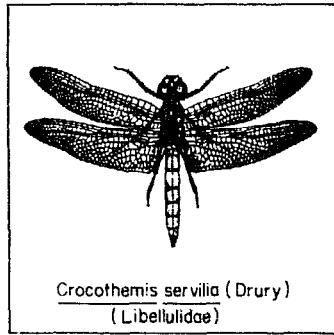

*Crocothemis servilia* (Drury) (Libellulidae)

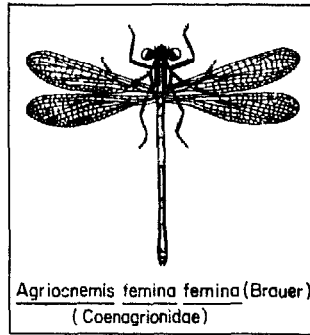

*Agrionemis femina femina* (Brauer) (Coenagrionidae)



*Beauveria bassiana* (Balsamo) Vuillemin (Moniliaceae)

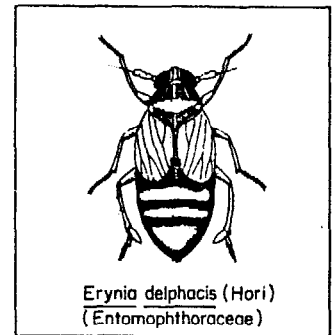

*Erynia delphacis* (Hori) (Entomophthoraceae)

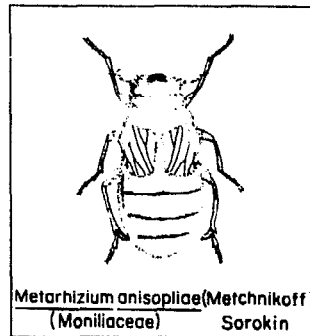

*Metarhizium anisopliae* (Metchnikoff) Sorokin (Moniliaceae)

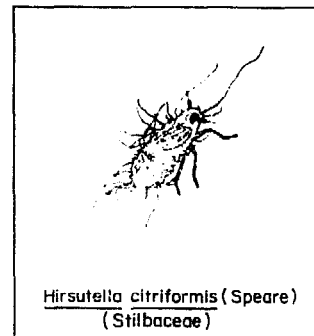

*Hirsutella citrifomis* (Spear) (Stilbaceae)

**Chemical control.**

- **Insecticide application.** Insecticide to control brown planthopper usually is not necessary in fields planted to a resistant variety. Apply an effective insecticide on susceptible varieties whenever the brown planthopper population reaches the economic threshold.



Granules are less effective than sprays or dusts, particularly when applied to older plants with a greater biomass.

Applying insecticide when long-winged adults are numerous will kill natural enemies and not the eggs. When the eggs hatch, most nymphs will survive.

Applying insecticide when the population is mostly young nymphs is wasteful. Predators normally will lower their numbers and young nymphs cannot damage the crop.

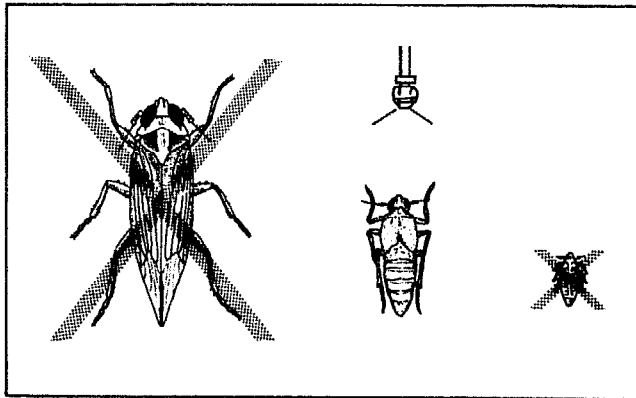

Insecticide applied to the tops of plants will not reach the brown planthopper below.

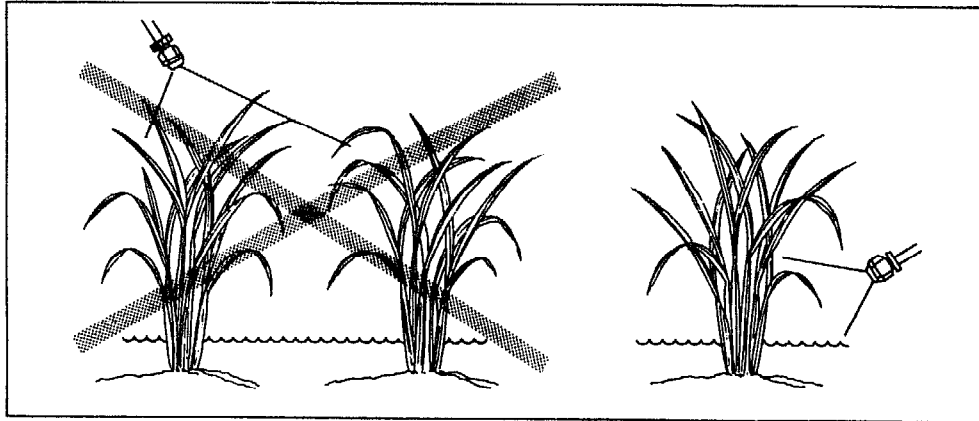

Applying insecticide to fields of rice varieties susceptible to the brown planthopper may cause the number of brown planthoppers to be higher than when no insecticide is applied. This dramatic contradiction of the expected outcome is called resurgence.

Do not apply an insecticide that causes resurgence.

Brown planthopper (no.)

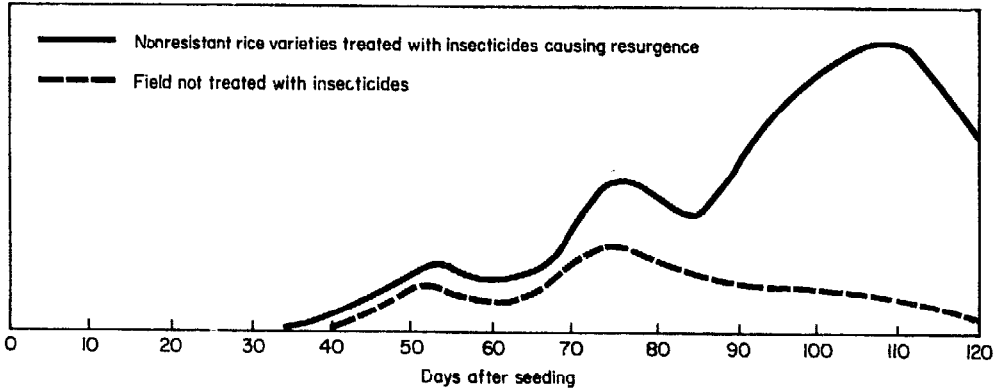

- **Scouting.** Visit the fields weekly from the seedbed to dough grain stage.

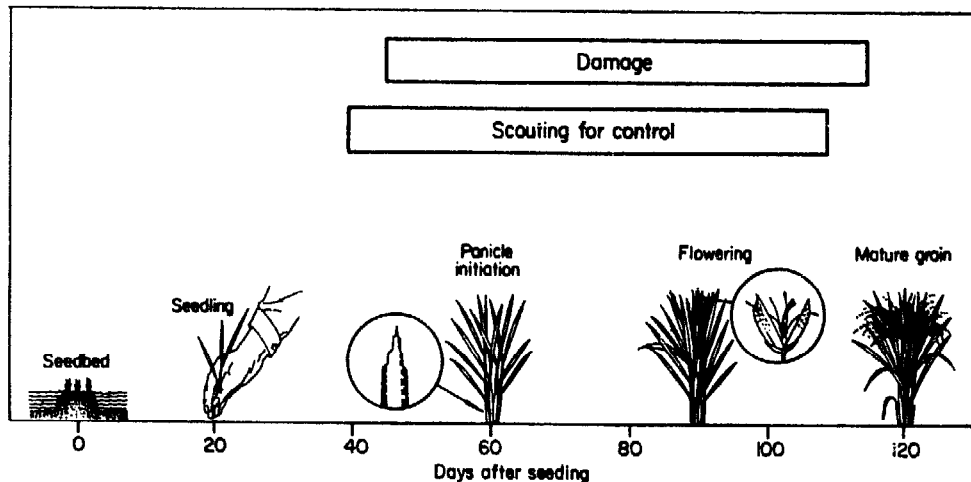

Pick 20 hills at random across the paddy. Hit each hill several times with the hand and count the number of mature nymphs that fall on the water. Mature nymphs are brown and immature nymphs are white.

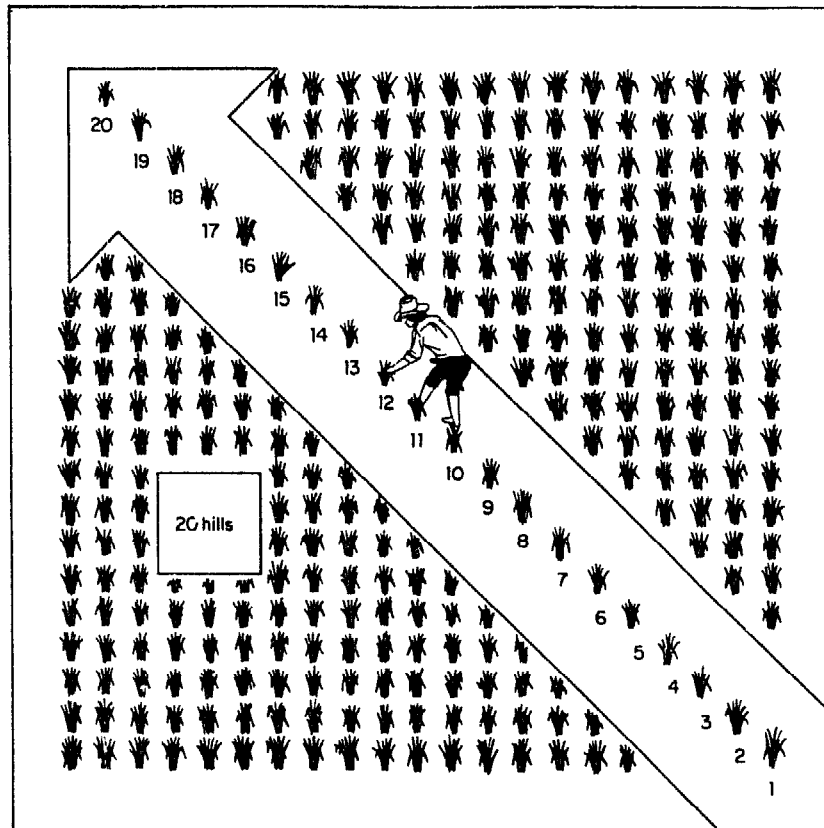

Determine the average number of tillers per hill. No action is required until the number of mature nymphs reaches one per tiller. When that occurs, visit the field every 3 to 4 days thereafter. If the population of mature nymphs increases beyond one per tiller, spray the base of the plants.

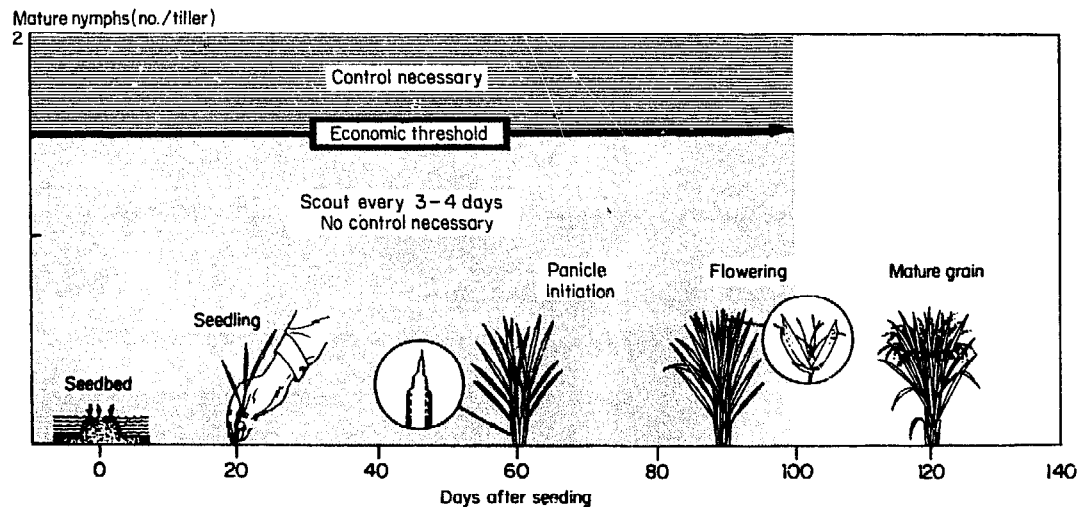

**SMALLER BROWN PLANTHOPPER (HOMOPTERA: DELPHACIDAE)**

*Laodelphax striatellus* (Fallen) (*Delphax* = *Liburnia* = *Delphacodes striatella*) appears like the brown planthopper but is smaller.

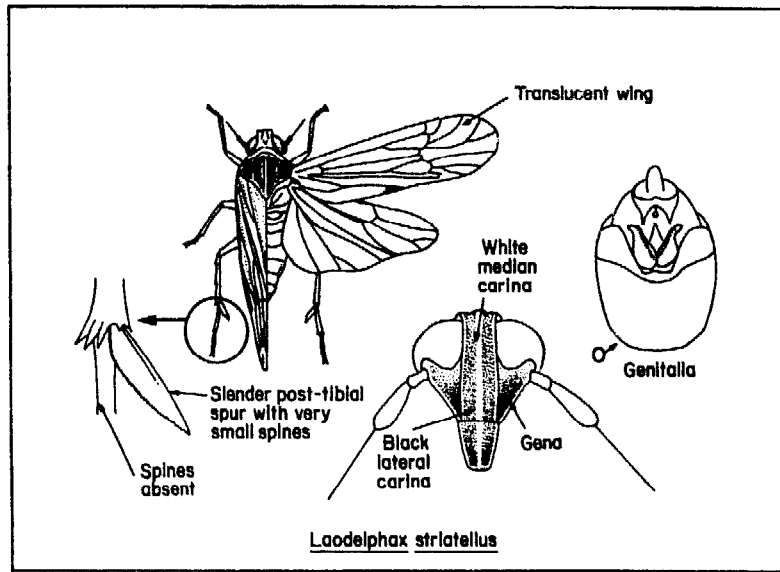

**Pest status**

The smaller brown planthopper transmits black-streaked dwarf and stripe virus diseases and remains as a vector throughout its life after feeding on one virus-infected plant. However, it can be readily controlled with insecticide.

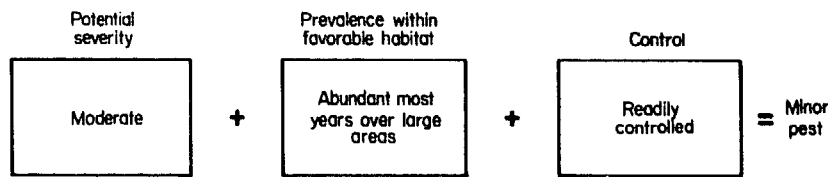

It is found in all rice environments but is restricted to temperate climates.

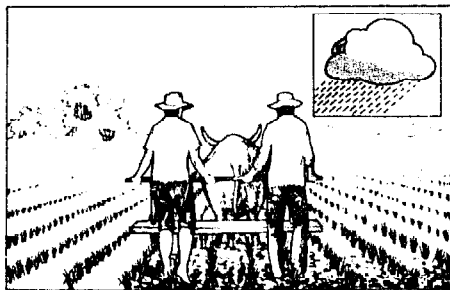

Upland

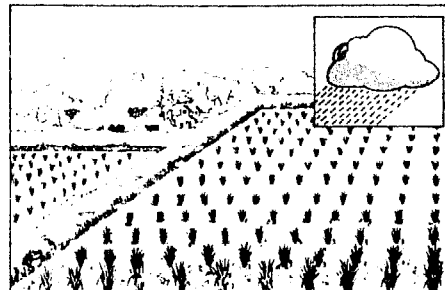

Rainfed wetland

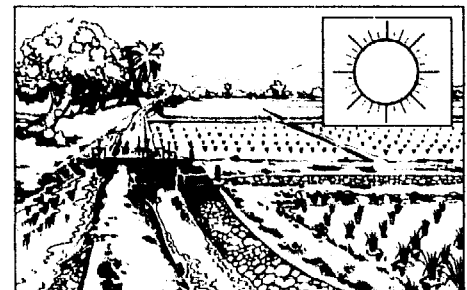

Irrigated wetland

*Distribution in Asia.*

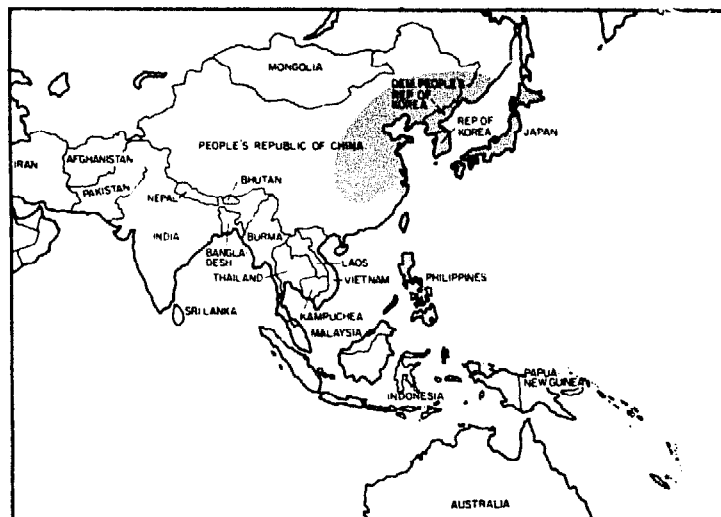



**Development and actual size**

The life cycle of the smaller brown planthopper is longer than that of other planthoppers because of the cooler climates in which it lives.

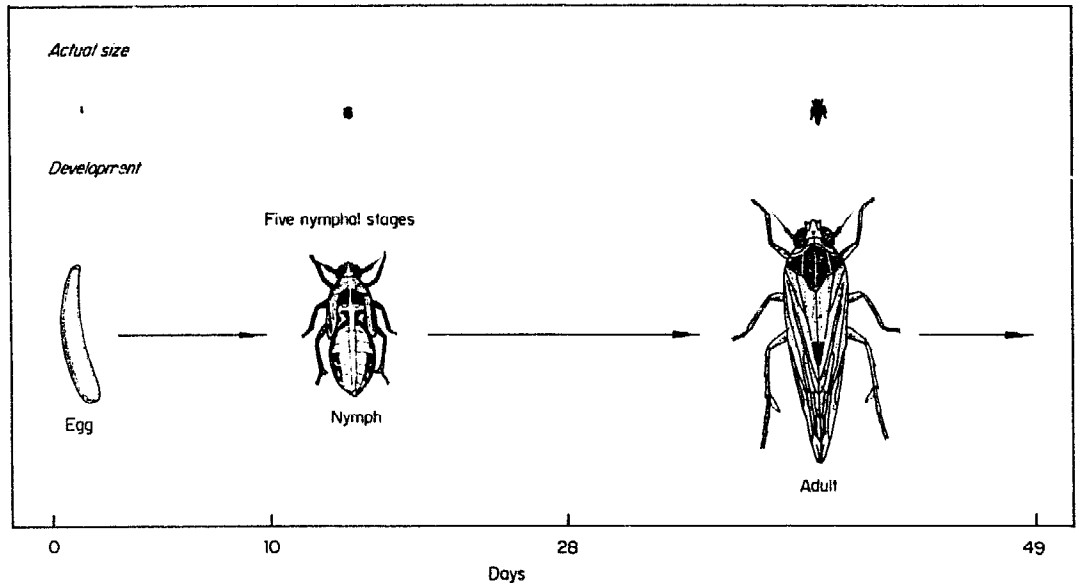

**Adult.** The adults are smaller than those of the brown or whitebacked planthoppers. The head is pale yellow. The thorax at the juncture of the wings of the male is black, and that of the female is pale yellow medially and black along the lateral margins. There are black dots between the wings at the end of the body.

Long- and short-winged forms occur. Long-winged adults fly to rice nurseries and newly transplanted fields in the spring from winter wheat, barley, or grasses.

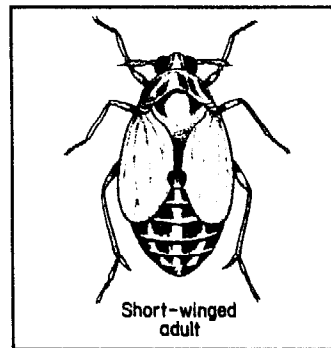
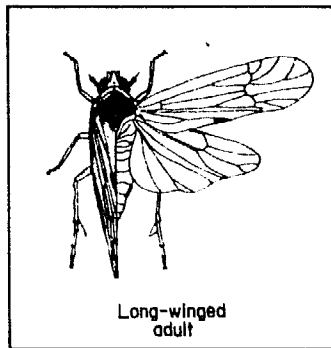

The adults suck plant sap from the base of the plants.

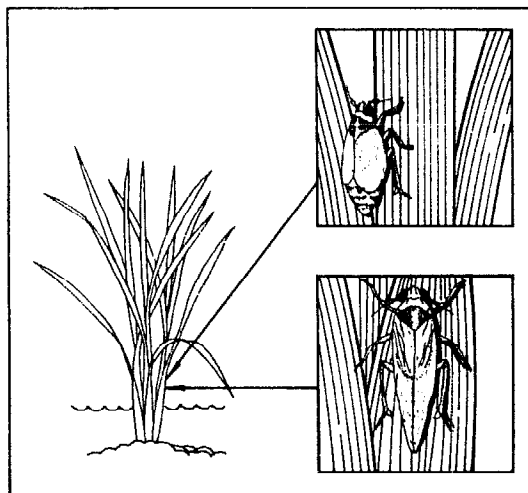

Adults are highly attracted to a light trap. Highest catches are during full moon.

To deposit eggs, the female cuts openings in the tillers with its saw-like ovipositor.

Each female lays 50-200 eggs during its lifetime of about 3 weeks.

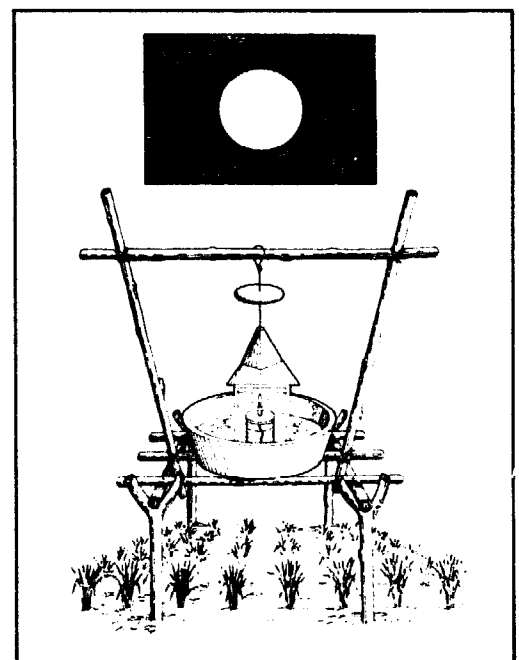

**Egg.** The white eggs are laid in masses in the leaf midrib or leaf sheath near the base of the plant. Each egg is capped with a small egg plug.

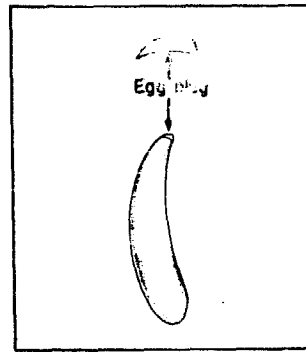
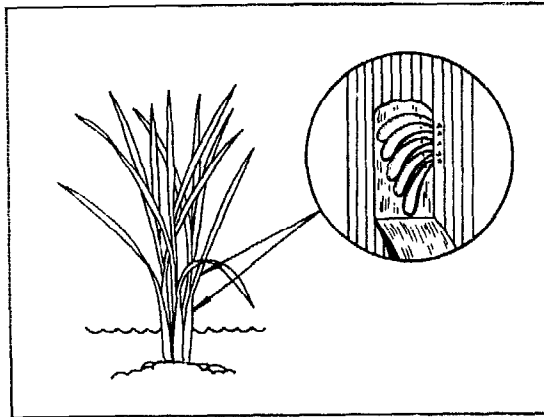

**Nymph.** The nymphs are light to dark brown and feed at the base of the plant by removing plant sap. In winter, the fourth-stage nymph lies dormant on alternative hosts.

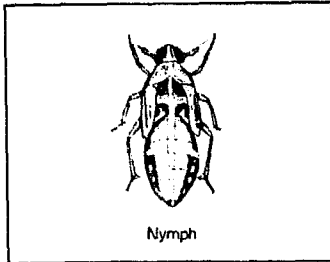

**Damage**

The smaller brown plant-hopper does not usually damage rice by direct feeding; however, it is an important transmitter of two virus diseases: black-streaked dwarf and stripe.

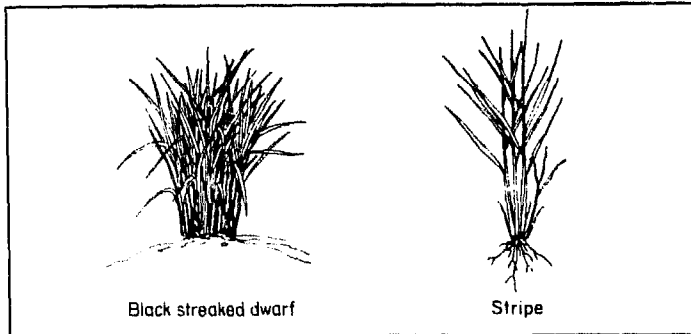

**Plant hosts.** The smaller brown planthopper utilizes a number of alternative hosts especially in winter.

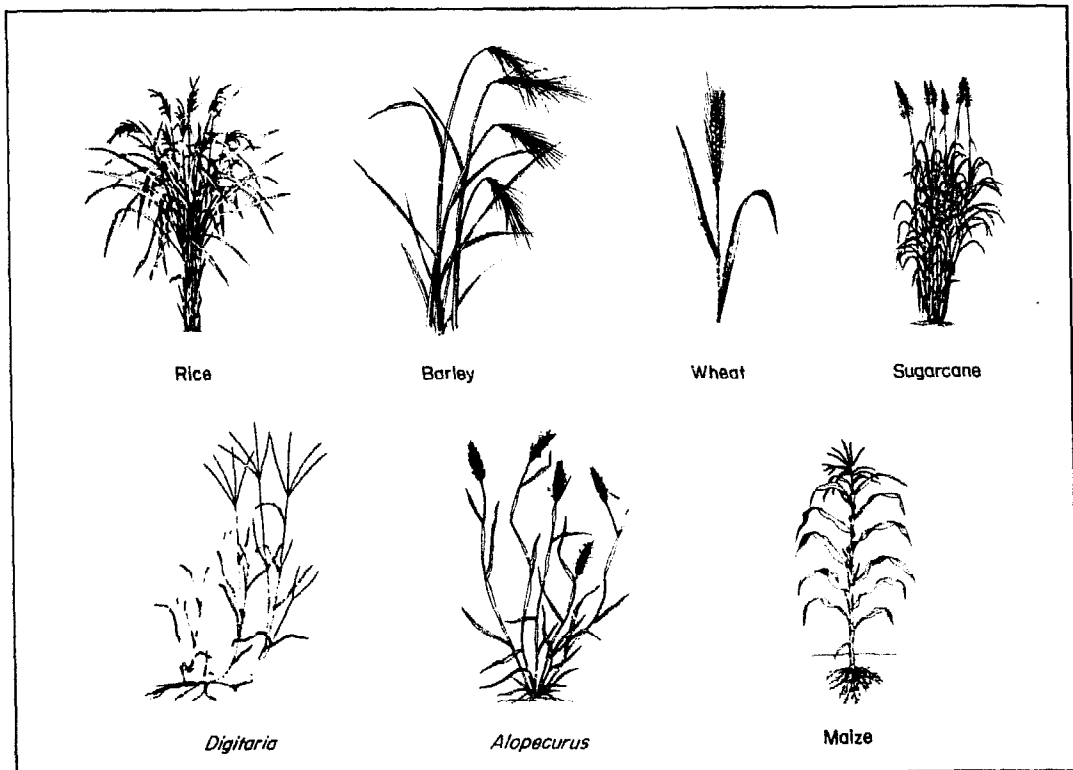

**Management**

*Cultural control.* Keep fallow fields free of weeds during winter to remove overwintering sites.

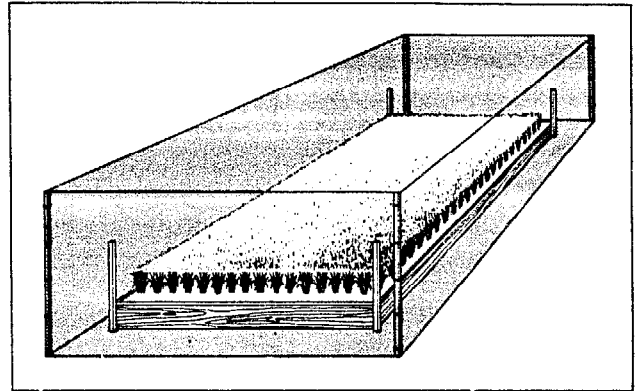
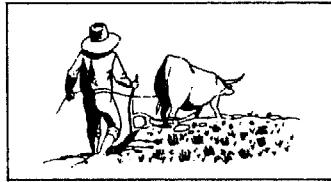

In the early spring, protect seedling nurseries from migrating adults by covering them with netting.

*Resistant varieties.* Some varieties are resistant to black-streaked dwarf and stripe virus disease and to the smaller brown planthopper itself.

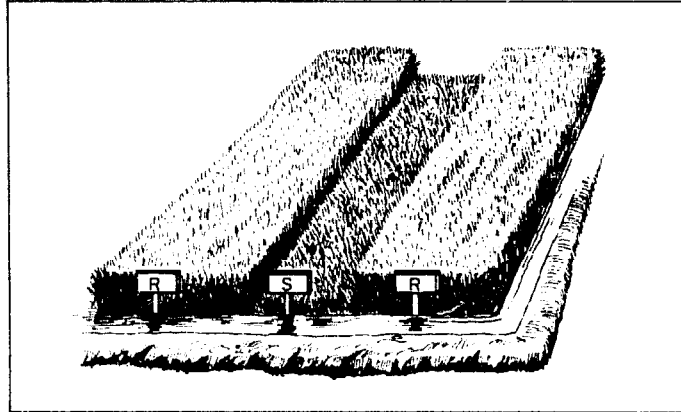

*Biological control.* Natural enemies attack all stages of the smaller brown planthopper. In temperate climates, however, natural enemy populations are lower than in the tropics.

The eggs are parasitized by small trichogrammatid wasps and preyed upon by mirid bugs.

Nymphs and adults are parasitized by dryinid wasps and fungal diseases.

Predators of nymphs and adults include aquatic underwater beetles and immature dragonflies, as well as water surface-dwelling microveliid and mesoveliid bugs, and spiders.

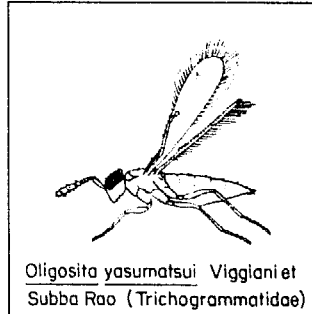

*Oligosita yasumatsui* Viggiani et Subba Rao (Trichogrammatidae)

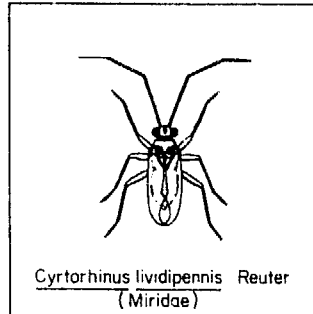

*Cyrtorhinus lividipennis* Reuter (Miridae)

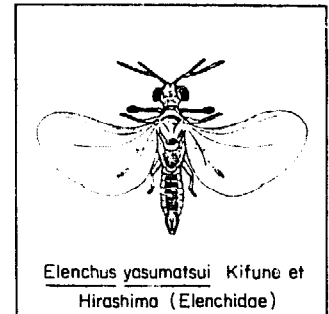

*Elenchus yasumatsui* Kifune et Hirashima (Elenchidae)

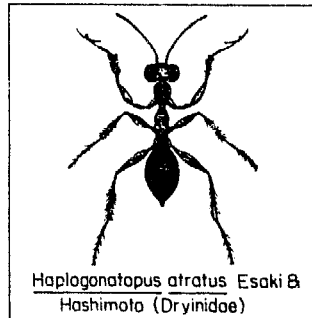

*Haplogonatopus atratus* Esaki & Hashimoto (Dryinidae)

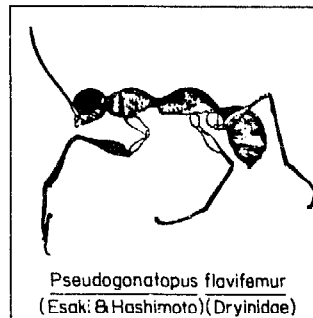

*Pseudogonatopus flavifemur* (Esaki & Hashimoto) (Dryinidae)

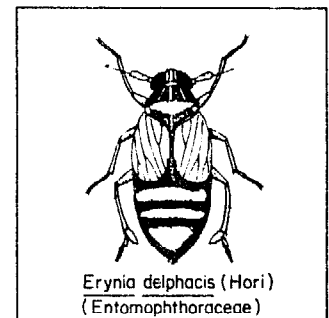

*Erynia delphacis* (Hori) (Entomophthoraceae)

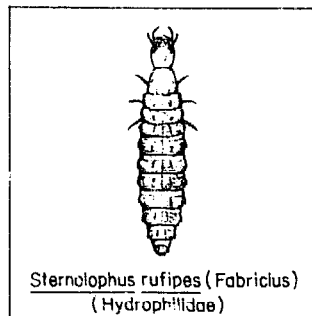

*Sternolophus rufipes* (Fabricius) (Hydrophilidae)

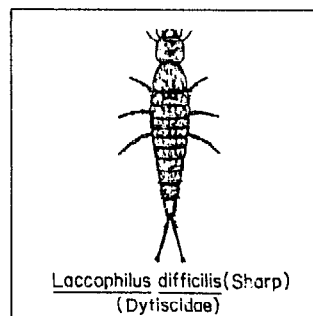

*Laccophilus difficilis* (Sharp) (Dytiscidae)

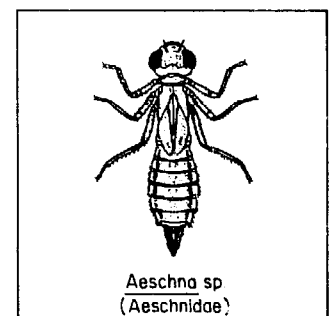

*Aeschna* sp (Aeschnidae)

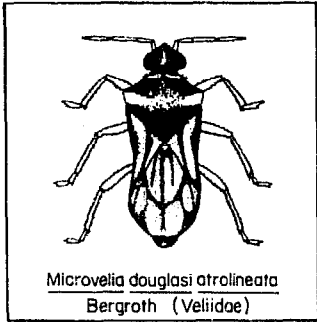

*Microvelia douglasi atrolineata*  
Bergröth (Veliidae)

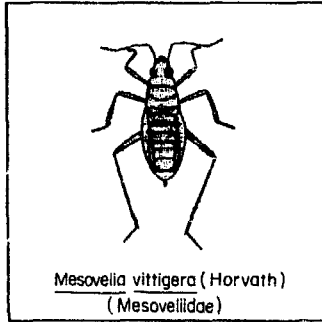

*Mesovelia vittigera* (Horvath)  
(Mesoveliidae)

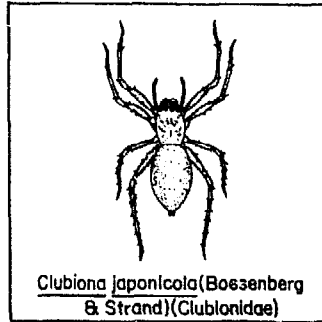

*Clubiona japonicola* (Boesenberg  
& Strand) (Clubionidae)

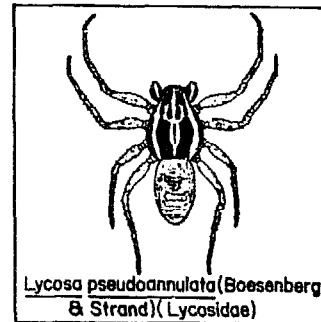

*Lycosa pseudoannulata* (Boesenberg  
& Strand) (Lycosidae)

**Chemical control.**

- **Insecticide application.** Calendar-based applications of insecticide to the smaller brown planthopper during the early growth stages of rice



prevent virus infection.  
Repeated foliar sprays  
are necessary to protect the  
crop.

- **Scouting.** Nationwide forecasting systems on virus diseases transmitted by the smaller brown planthopper make control efforts more efficient.

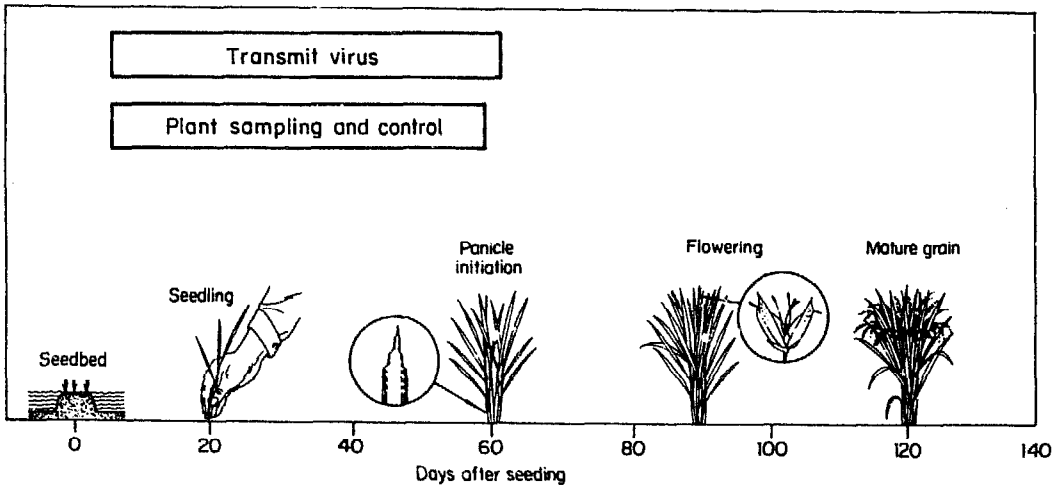

There is no economic  
threshold for the smaller  
brown planthopper.

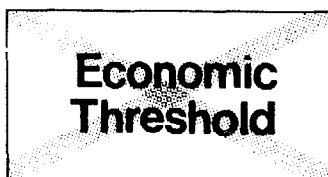

RICE WHITEBACKED PLANTHOPPER (HOMOPTERA: DELPHACIDAE)

Despite its common name, *Sogatella* (= *Sogata*) *furcifera* cannot be distinguished from other planthoppers in the adult stage by the white band along the back (thorax) between the wing bases.

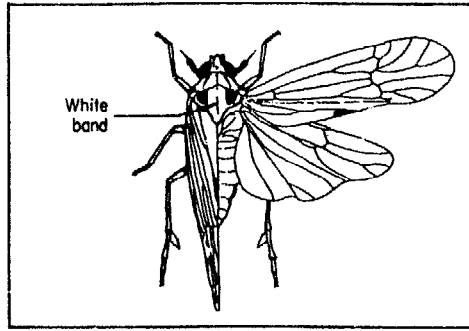

Several related species occur in rice fields although rice is not their principal host. Each can be distinguished by wing, head, and male genitalia characters except for females of *S. panicicola* and *S. longifurcifera*.

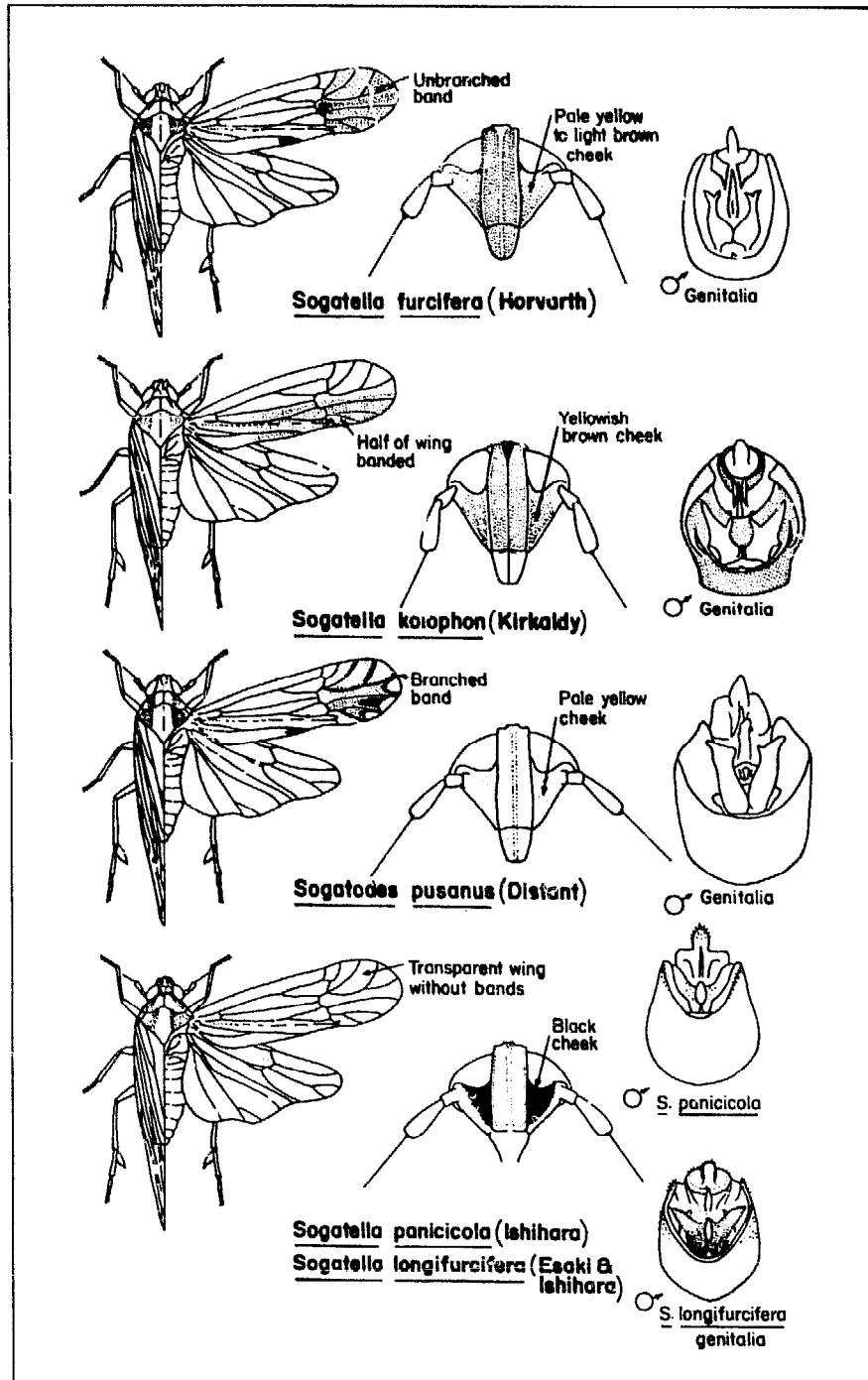

**Pest status**

Even though it does not transmit virus diseases, the whitebacked planthopper occurs widely and can become sufficiently numerous to kill plants by hopperburn. If detected in time, it can be readily controlled with insecticide.

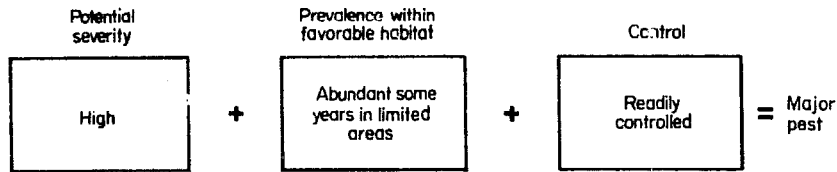

The whitebacked plant-hopper occurs in all rice environments.

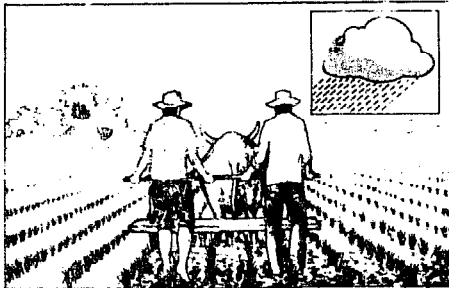

Upland

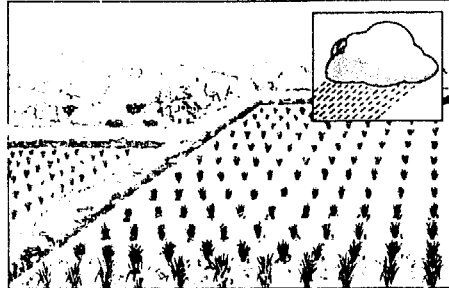

Rainfed wetland

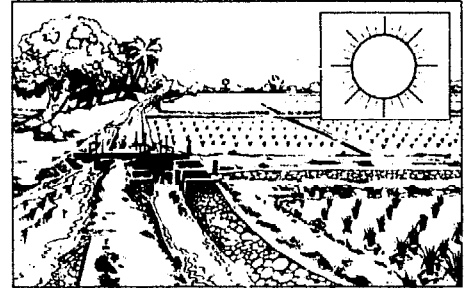

Irrigated wetland

*Distribution in Asia*

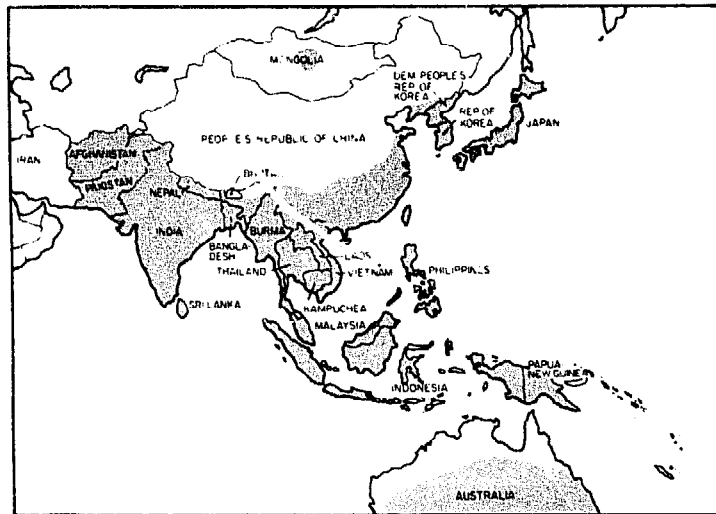

**Development and actual size**

*Adult.* The adults are brown to black with a yellow body and a conspicuous dorsal white band between the junctures of the wings.

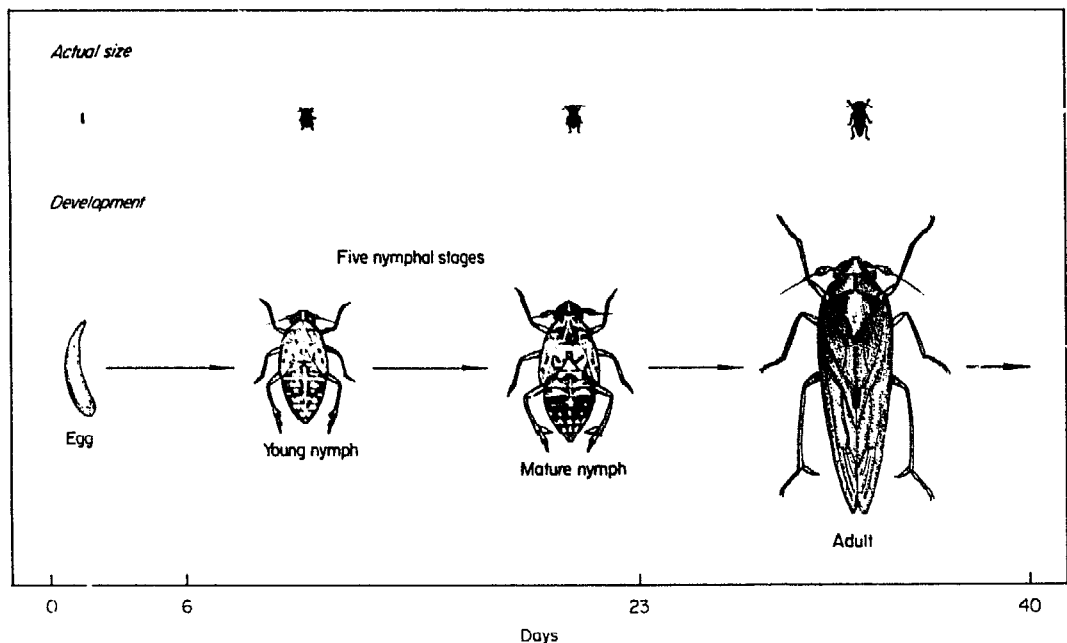

Both long- and short-winged forms occur only in the female. Males are all long-winged.

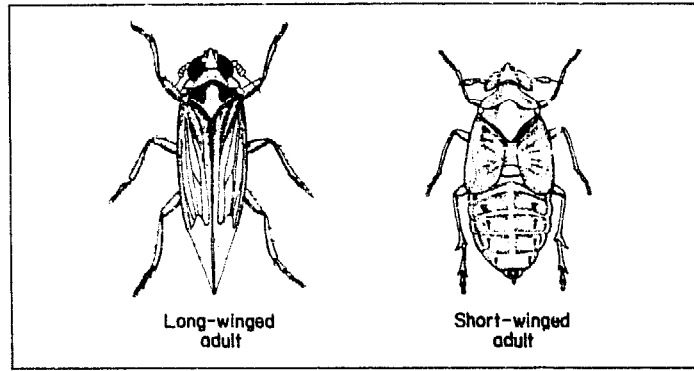

The whitebacked plant-hoppers feed at the base of the rice plant.

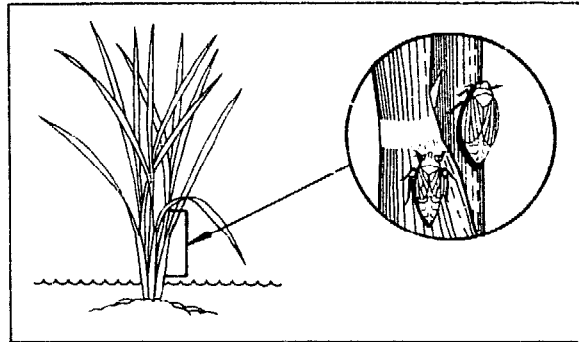

Long-winged adults enter the field during the first 30 days after seeding.

Generations that are completed on the rice crop are fewer than those of the brown planthopper. The whitebacked planthopper prefers a younger crop and produces long-winged migratory forms before the plants flower.

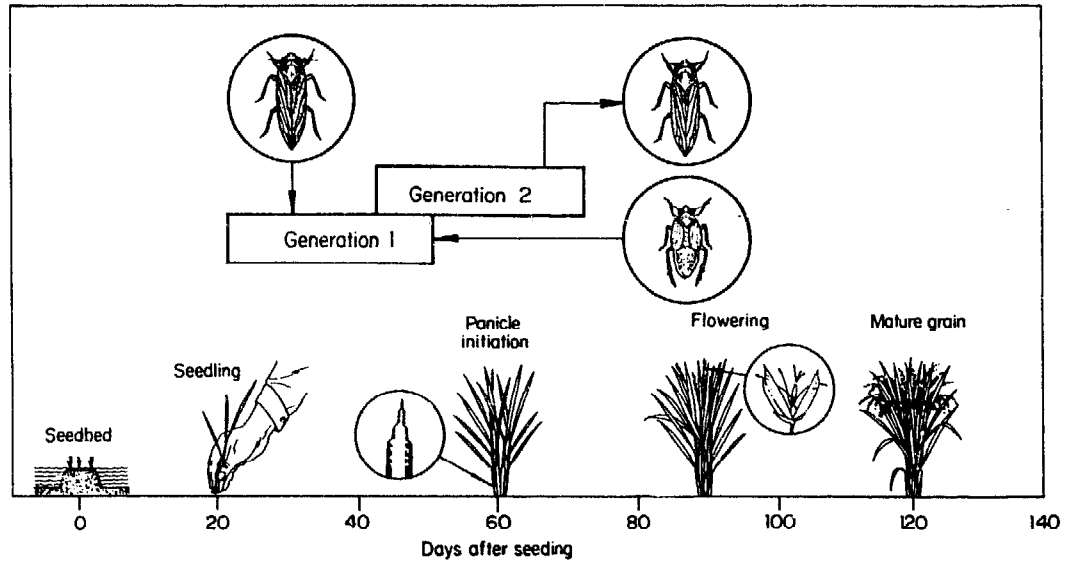

Adults are highly attracted to a light trap. Catches are highest during full moon.

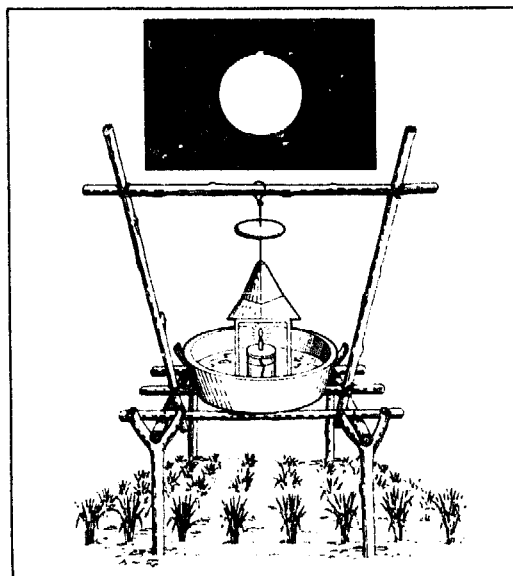

Each female lays 300-500 eggs during a lifetime of about 2 weeks.

**Egg.** The eggs are similar in size and shape to those of the brown planthopper, but the egg plug is longer.

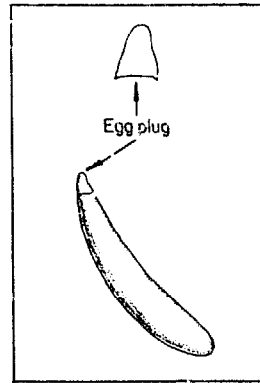
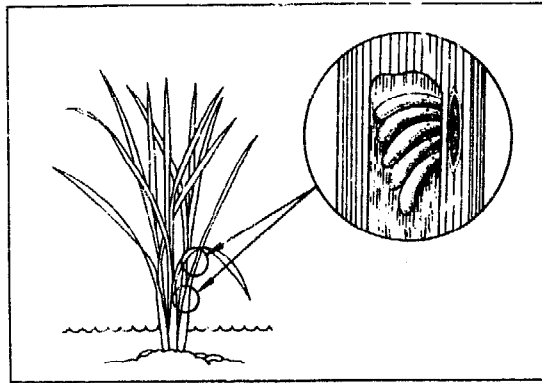

**Nymph.** Young nymphs of all planthoppers appear white and cannot be differentiated by species in the field.

Older nymphs of the whitebacked planthopper have distinctive black and white spots on the top of their abdomen.

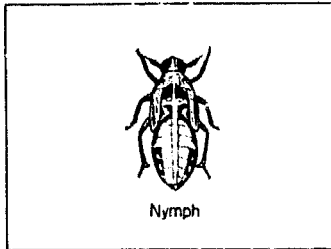

**Damage**

Nymphs and adults suck sap from the base of the tillers. Honeydew production is less than in the brown planthopper; consequently, sooty-mold on plants is less of a symptom of damage.

High populations remove enough sap to cause the plants to turn orange-yellow. Later, the leaves dry and turn brown.



Hopperburned plants initially occur in small patches in the field. The patches coalesce if the population continues to increase. Damage is most common during the early reproductive stage.

The whitebacked planthopper does not transmit virus diseases.

**Plant hosts.** The whitebacked planthopper has a wide host range.

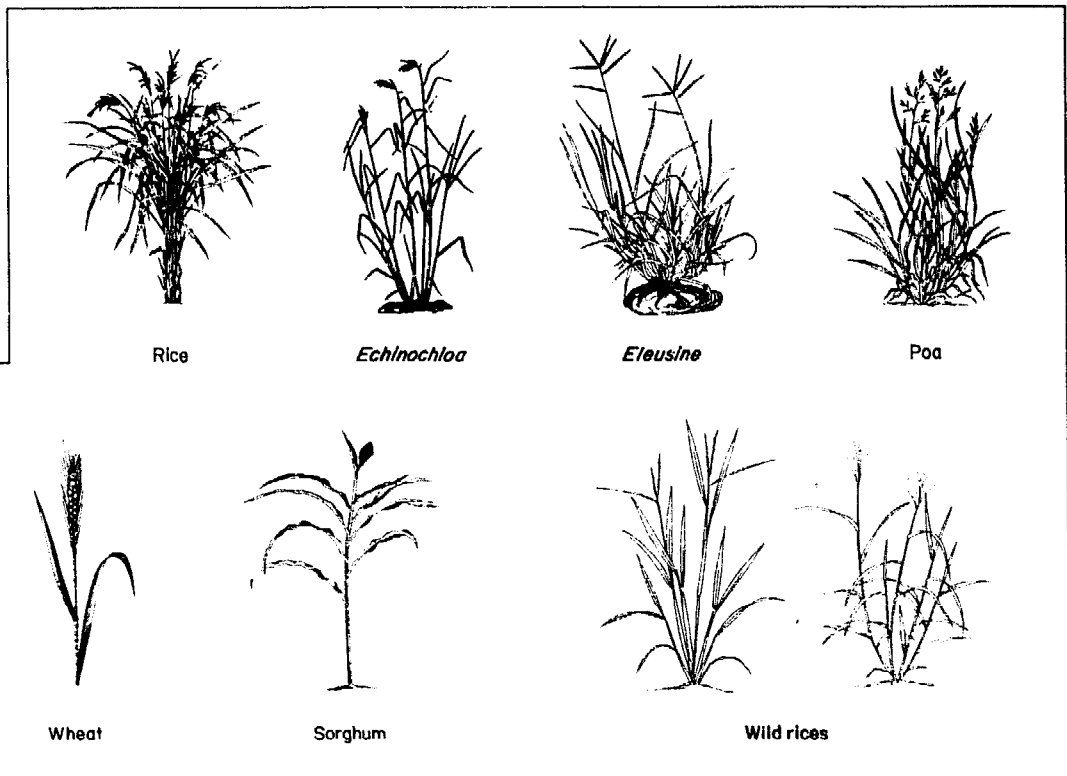



**Management**

*Cultural control.* The cultural control methods effective against the brown planthopper also control the whitebacked planthopper.

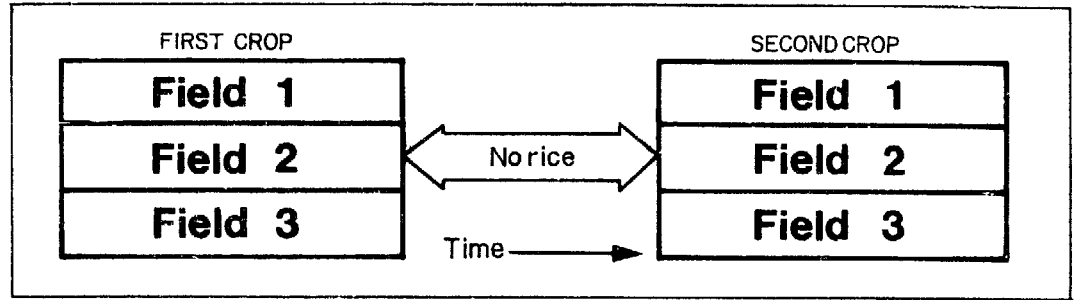

*Resistant varieties.* No resistant varieties are commercially available for whitebacked planthopper.

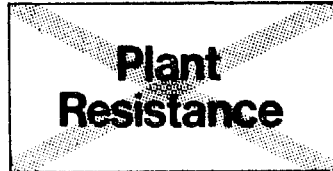

Because the whitebacked planthopper disperses from the crop between booting and flowering, early-maturing varieties can reduce the number of whitebacked planthopper generations.

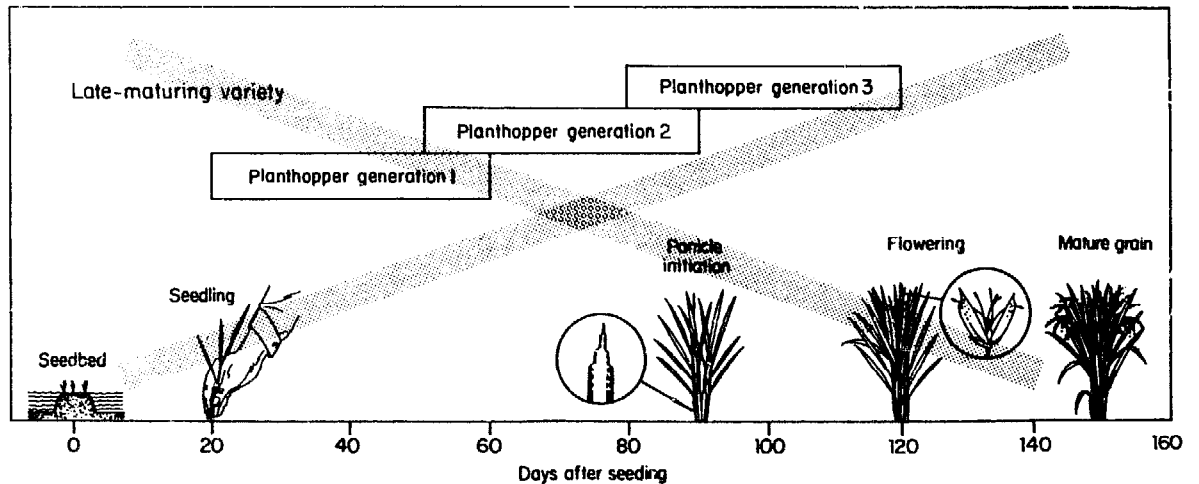
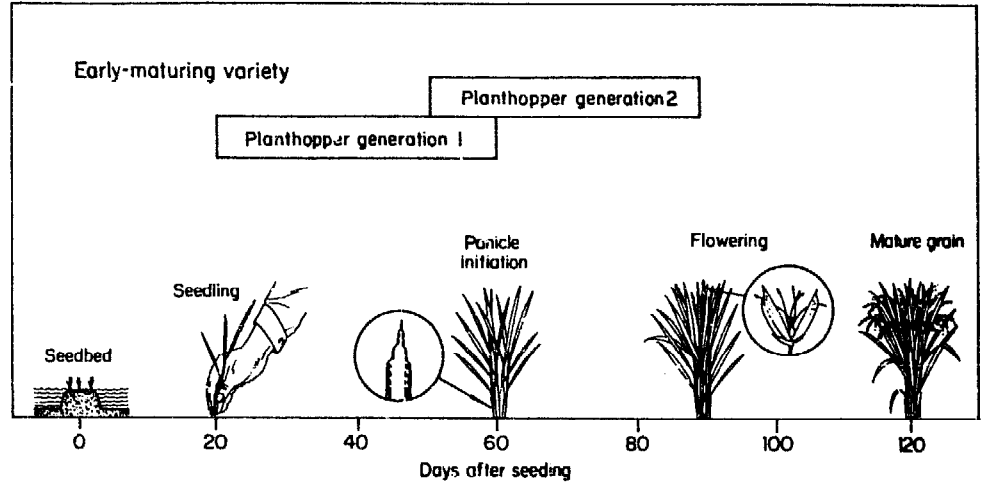

High-tillering varieties allow higher numbers of adults and nymphs on a per-area basis than low-tillering varieties.

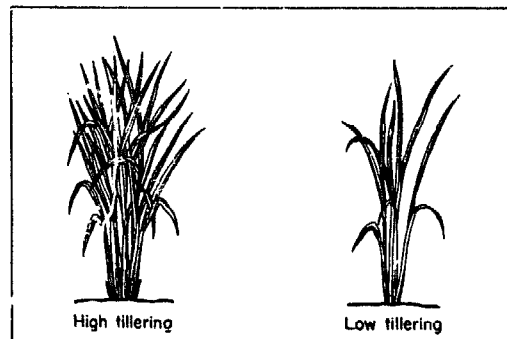

**Biological control.** Natural enemies attack all stages of the whitebacked planthopper and generally maintain its population at low levels. Indiscriminate insecticide usage may kill proportionately more natural enemies than whitebacked planthopper and lead to population outbreaks.

Whitebacked planthopper eggs are parasitized by small parasitic wasps or are preyed upon by mirid bugs or phytoseiid mites.

Nymphs and adults are parasitized by dryinid wasps or fungi.

Predators of nymphs and adults include underwater hydrophilid and dytiscid beetles as well as immature forms of coenagrionid damselflies and libellulid dragonflies.

Water-surface dwelling veliid and mesoveliid bugs are also important predators. These aquatic predators prey mainly on planthoppers that fall on the water surface, but can also capture hoppers from foliage near the water level.

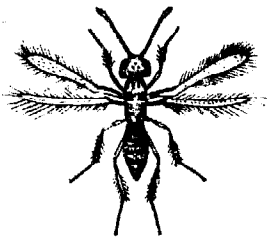

*Anagrus flaveolus* Waterhouse  
(Mymaridae)



*Oligosita aesopi* (Girault)  
(Trichogrammatidae)



*Cyrtorhinus lividipennis* Reuter  
(Miridae)

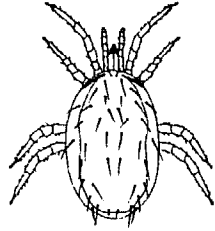

*Amblyseius imbricatus* Corpuz &  
Rimando (Phytoseiidae)

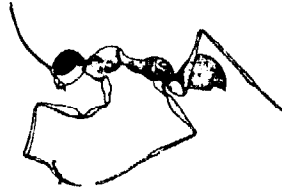

*Pseudogonatopus nudus* (Perkins)  
(Dryinidae)

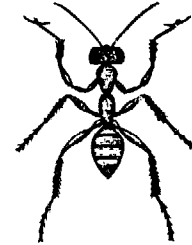

*Haplogonatopus apicalis*  
Perkins (Dryinidae)



*Pseudogonatopus ponomarenkoi*  
(Moczar) (Dryinidae)

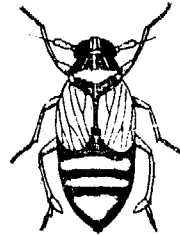

*Erynia delphacis* (Hori)  
(Entomophthoraceae)



*Berosus* sp.  
(Hydrophilidae)



*Agabus* nr. *conspicuus* (Sharp)  
(Dytiscidae)

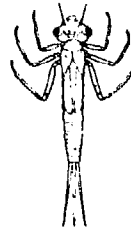

*Ischnura senegalensis* (Rambur)  
(Coenagrionidae)



*Crocothemis servilia* (Drury)  
(Libellulidae)

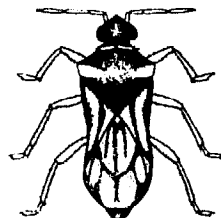

*Microvelia douglasi atrilineata*  
Bergroth (Veliidae)



*Mesovelia vittigera* (Horvath)  
(Mesoveliidae)

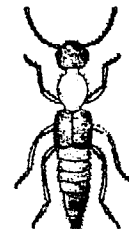

*Paederus fuscipes* (Curtis)  
(Staphylinidae)

Staphylinid and carabid beetles and lygaeid bugs as well as spiders search rice foliage for planthopper nymphs and adults.

Coenagrionid damselfly adults prey on hoppers resting on the foliage, but libellulid dragonfly adults capture only hoppers in flight.

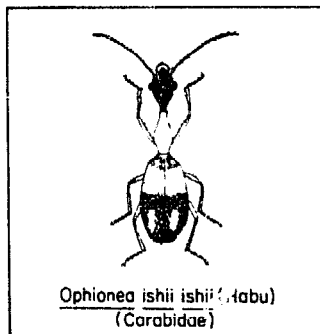

*Ophionea ishii ishii* (Tabu)  
(Carabidae)

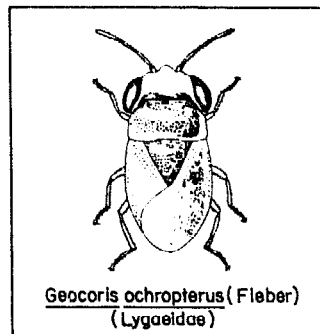

*Geocoris ochropterus* (Fleber)  
(Lygaeidae)

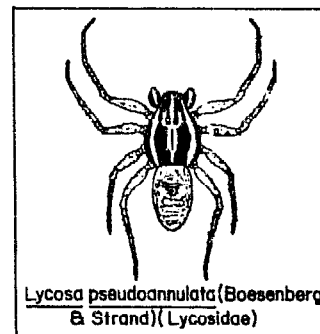

*Lycosa pseudoannulata* (Boesenberg & Strand)  
(Lycosidae)

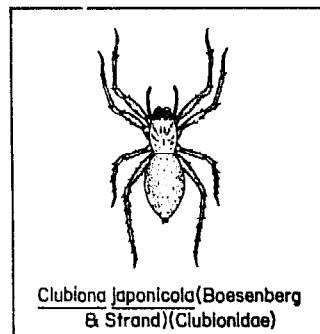

*Clubiona japonicola* (Boesenberg & Strand)  
(Clubionidae)

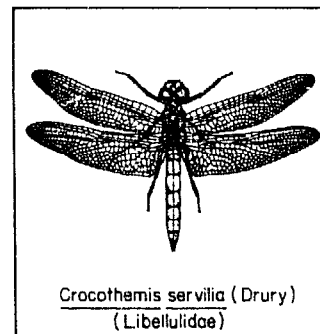

*Crocothemis servilia* (Drury)  
(Libellulidae)

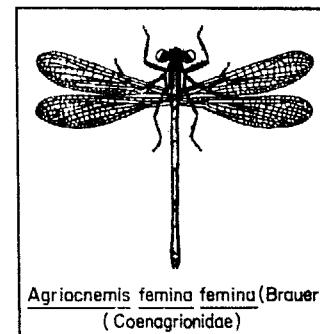

*Agriacnemis femina femina* (Brauer)  
(Coenagrionidae)

**Chemical control.**

- **Insecticide application.** Insecticide application methods for whitebacked planthopper are the same as those described for the brown planthopper.

Sprays or dust are more effective than granules.

Do not apply an insecticide which causes resurgence.

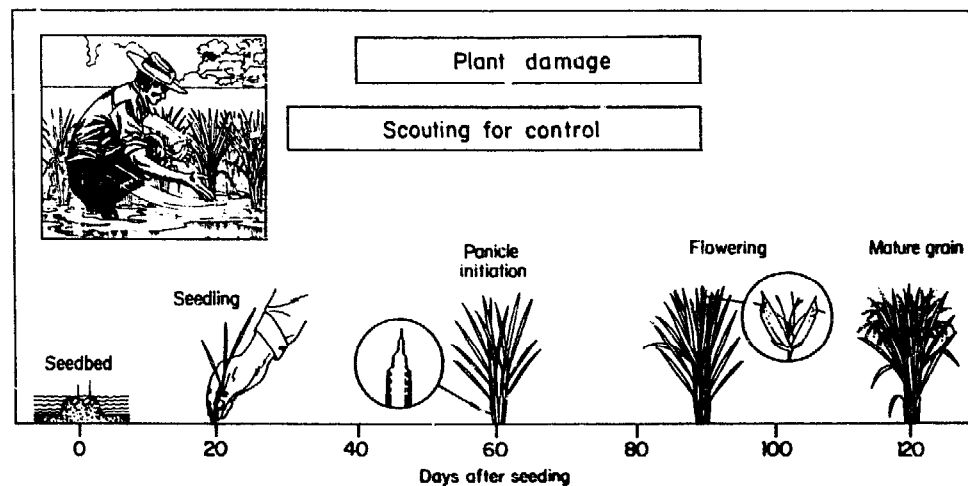

- **Scouting.** Visit the fields weekly from 30 days after seeding to flowering. Slap the plants to remove

hoppers from 20 randomly selected hills or points across the field.

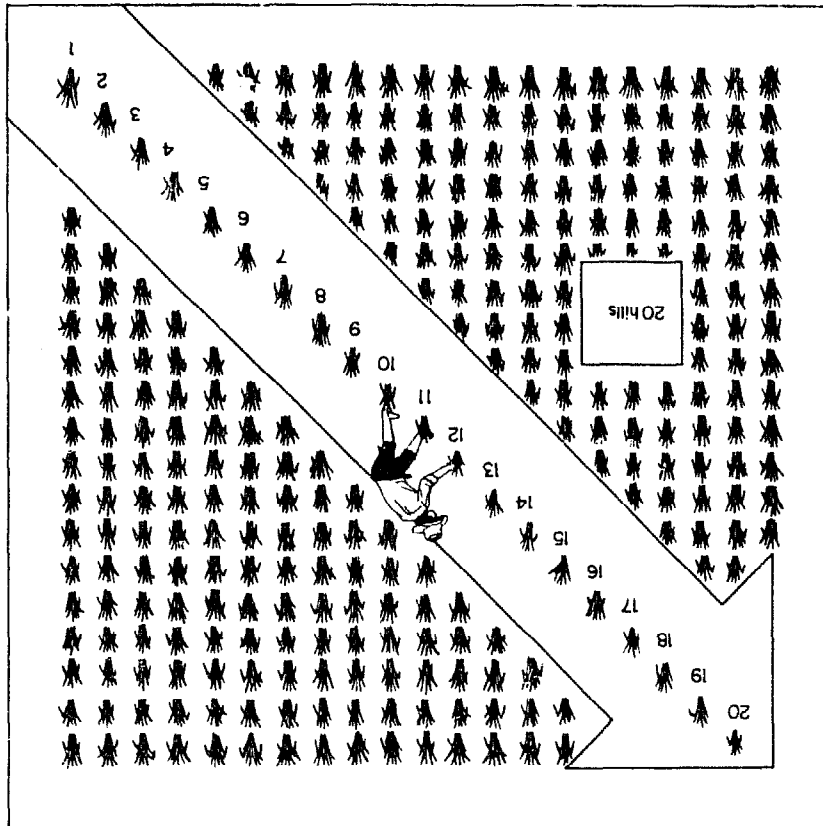

Determine the average number of hoppers per tiller. When the population reaches one whitebacked planthopper per tiller, scout twice a week. Apply insecticide to the base of the plant when the population of mature nymphs exceeds one per tiller.

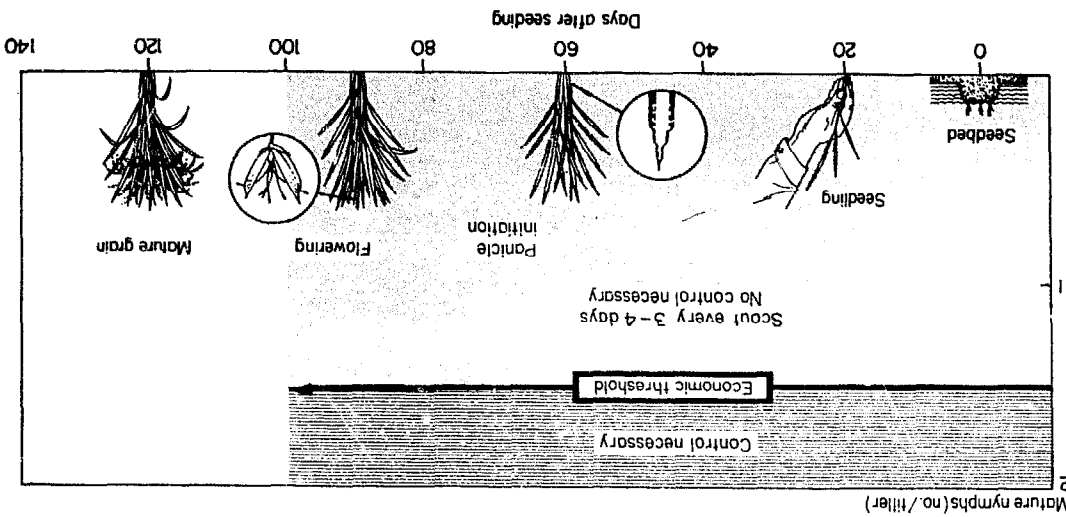

Mature nymphs (no./tiller)

RICE GREEN LEAFHOPPERS (HOMOPTERA: CICADELLIDAE)

Four species of rice green leafhoppers in the genus *Nephotettix* are commonly found in Asia. They are *N. virescens* (= *bipunctata* (*tus*) = *impicticeps*), *N. nigropictus* (= *apicalis* = *nigromaculatus* = *nigropicta* = *bipunctatus apicalis* = *apicalis apicalis*), *N. malayanus*, and *N. cincticeps* (= *bipunctatus cincticeps* = *apicalis cincticeps*).

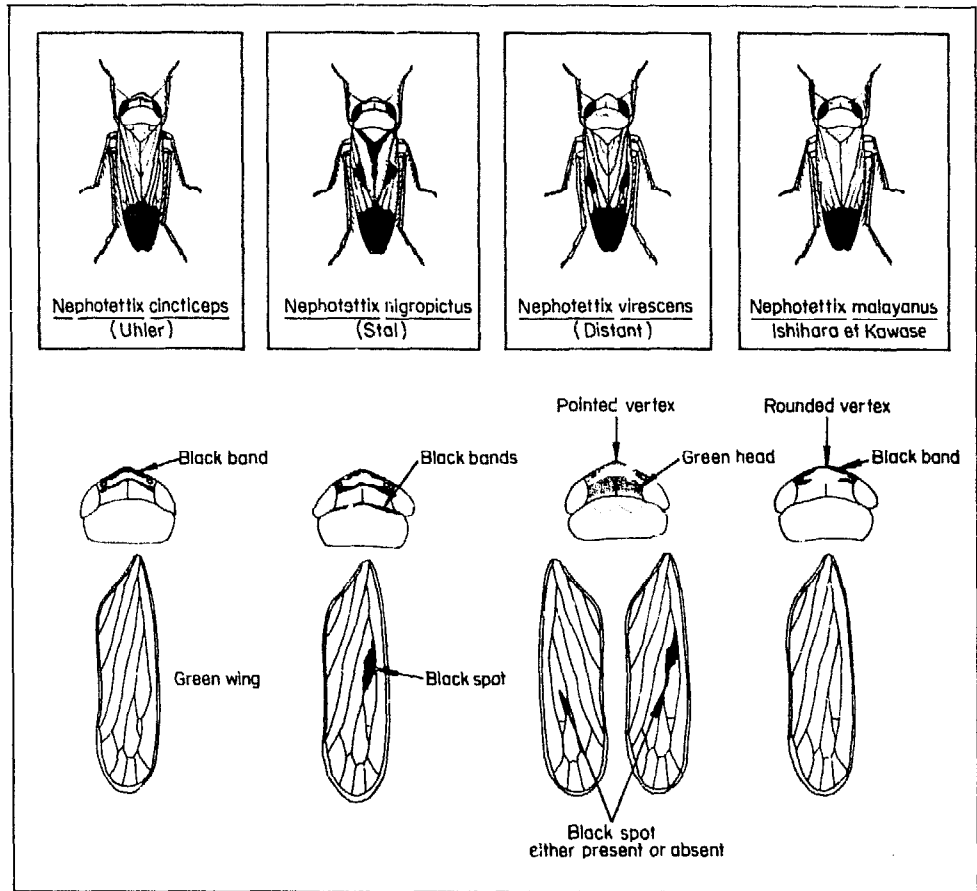

**Pest status**

Adults and nymphs transmit several serious virus diseases. When their populations are high, they directly damage rice plants. Green leafhopper populations can be readily controlled with resistant varieties or insecticides, but

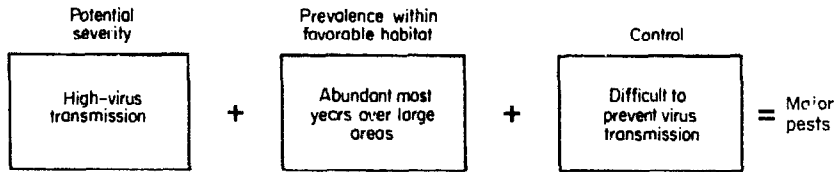

prevention of virus infection is difficult when insect numbers are high.

By allowing year-round rice cropping, irrigation has increased the importance of these pests. They are generally not prevalent in

upland rice. Green leafhoppers are more abundant in the rainy season and on vigorously growing rice crops.

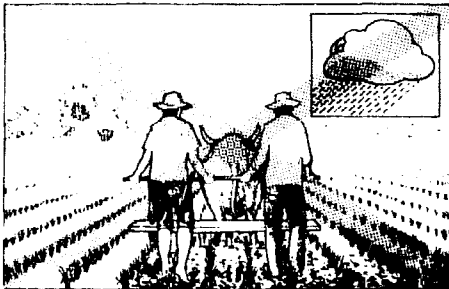

Upland

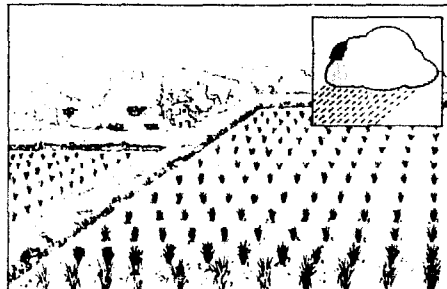

Rainfed wetland

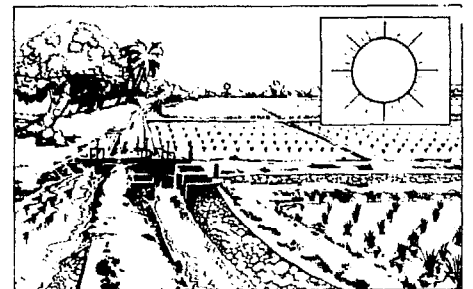

Irrigated wetland

Distribution in Asia. *N. cincticeps* is confined to temperate regions whereas

*N. virescens*, *N. nigropictus*, and *N. malayanus* are tropical species.

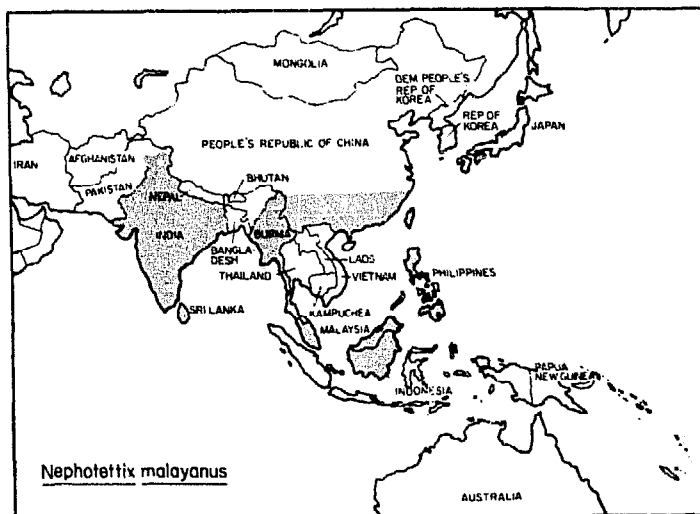
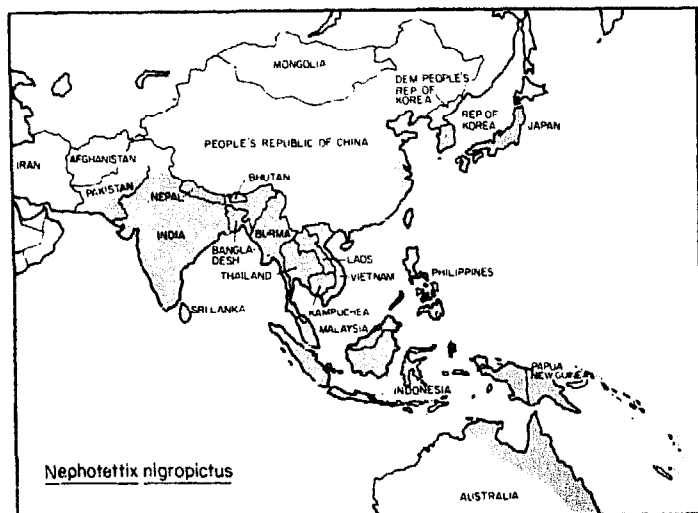
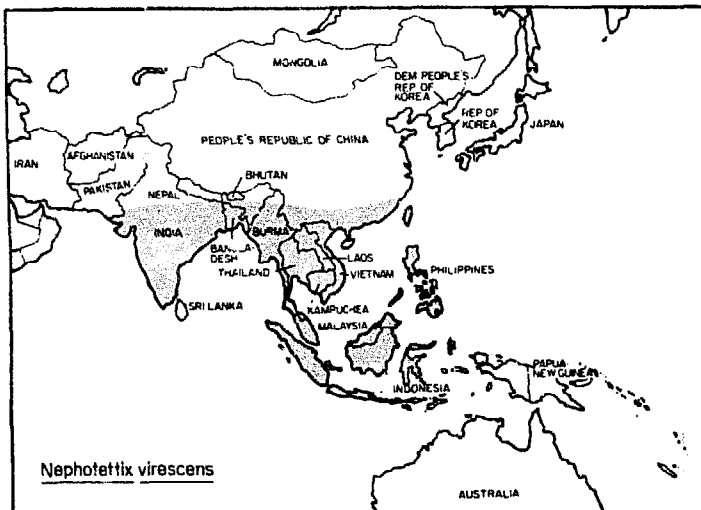
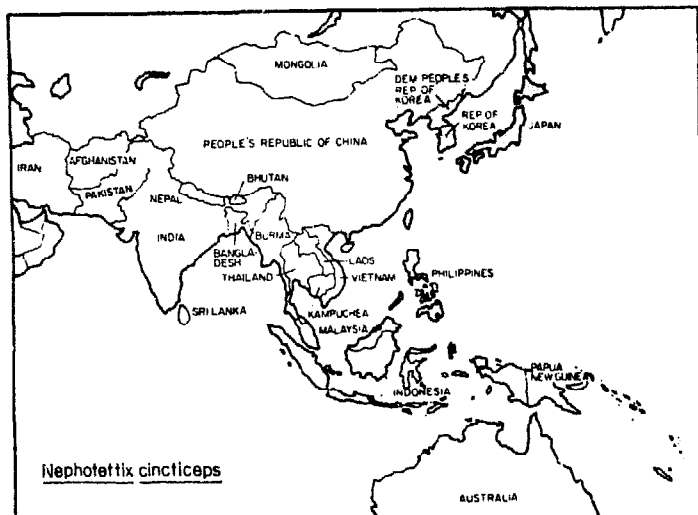

**Development and actual size**

Development time for all species is the same under similar temperature regimes.

The duration of the life cycles for the tropics is given here. It is longer for temperate climates.

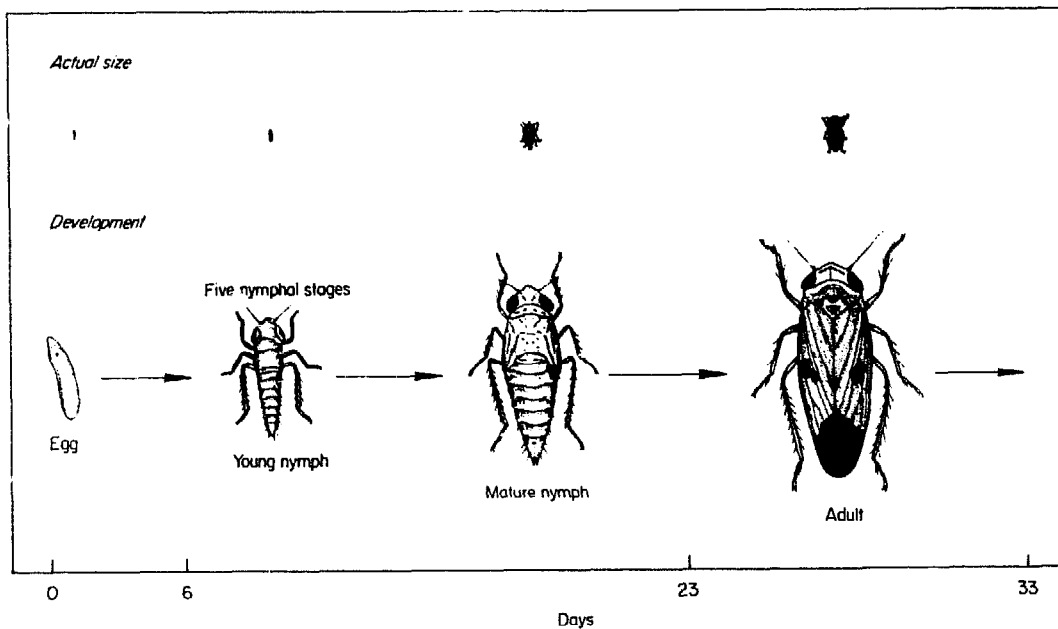

**Adult.** Adults are pale green and may have black markings on the head or wings. They are highly mobile and fly when disturbed in the field.

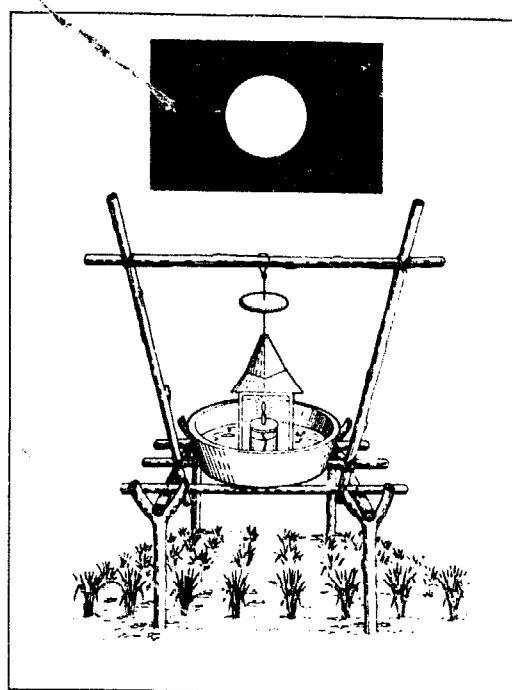
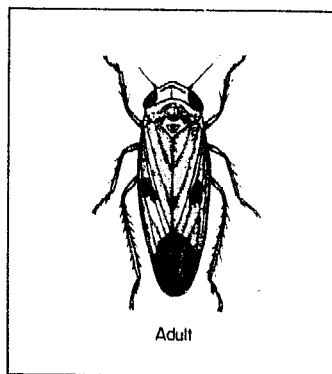

Adults are highly attracted to a light trap. Catches are highest during full moon.

Adults can fly long distances, but movement is normally confined to several kilometers.

The leafhoppers migrate into the field soon after the seedlings emerge and are most numerous during the vegetative stage. Adults feed and rest on the upper portions of the rice plant.

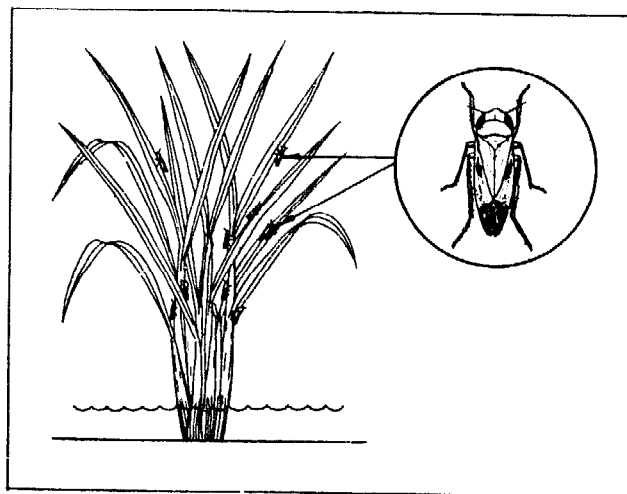

There are no short-winged forms in leafhoppers. Each female lays several hundred eggs in an average life-span of 3 weeks. Females make openings in the tillers with their saw-like ovipositors.

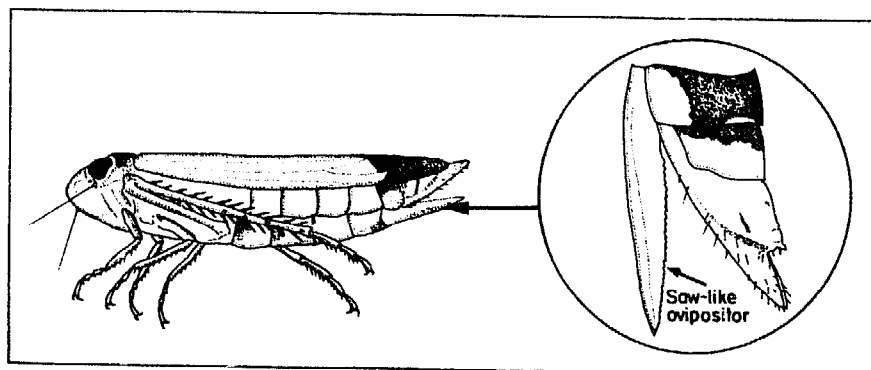

**Egg.** Freshly laid eggs are white or pale yellow, but later turn brown and develop red eyespots.

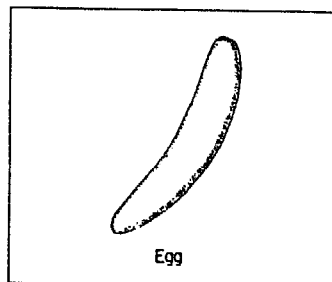

Young plants are preferred for egg laying. Eggs are deposited in leaf sheaths or midribs near the base of the plant in batches of 8-16.

*Nymph.* The yellow or pale green nymphs are most numerous during the tillering stage.

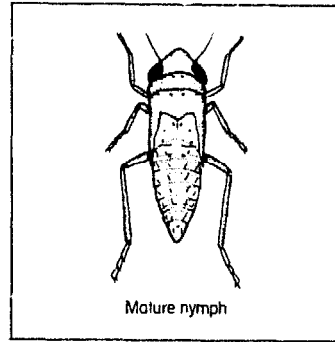
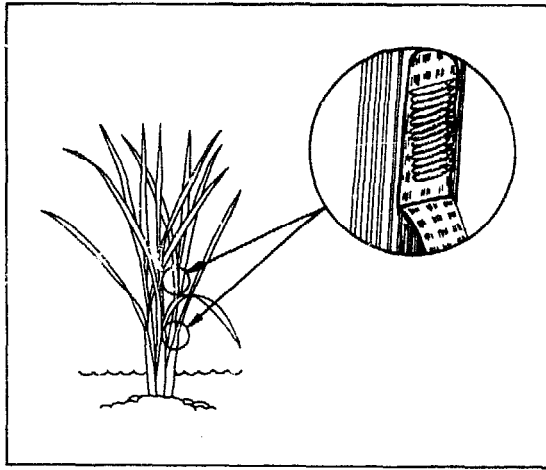

They are usually in the upper parts of the plant in the morning and move to the lower parts in the afternoon.

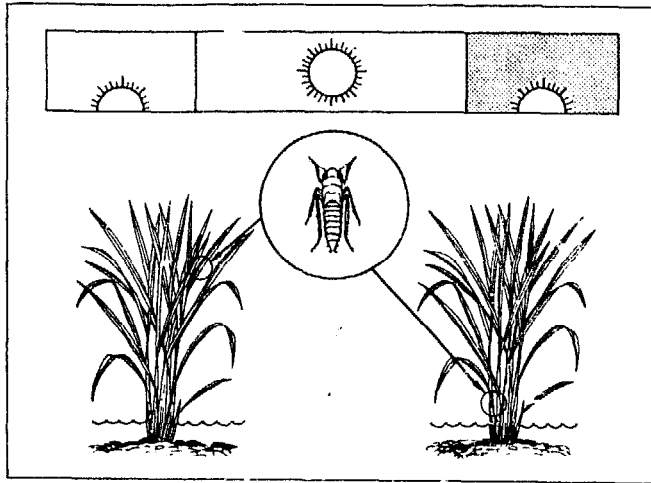

**Damage**

Green leafhopper adults and nymphs disperse in response to crowding and rarely reach the high densities necessary to cause hopperburn.

Nymphs and adults suck the sap from the leaves and tillers with their sucking mouthparts. Their feeding can stunt plant growth.

More serious than direct feeding injury are the virus diseases transmitted by both the adults and nymphs.

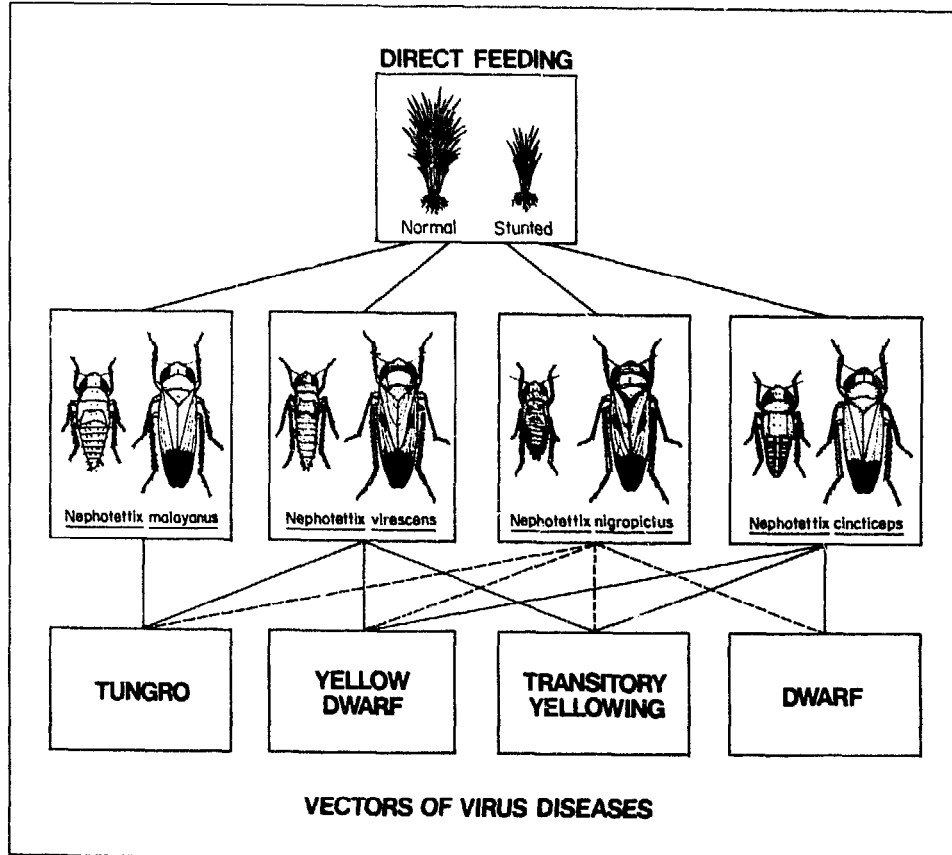





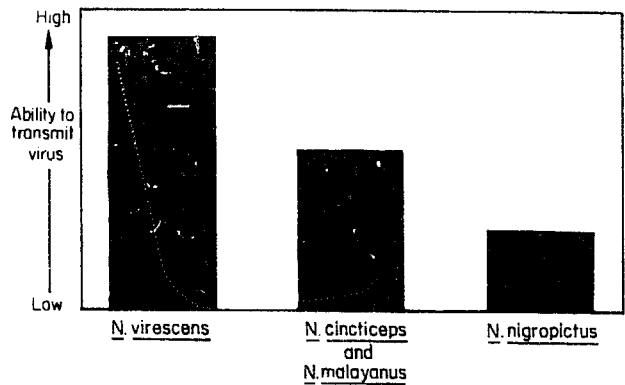



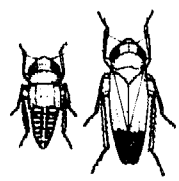







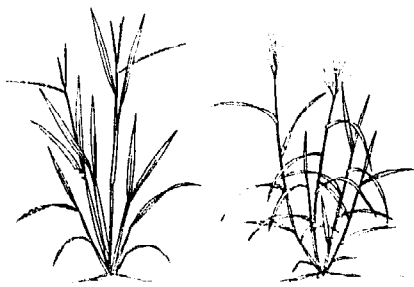



*N. nigropictus* is less effective than the three other species in virus disease transmission.

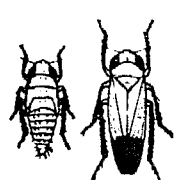

Plant hosts. *N. cincticeps* and *N. virescens* are more specific to rice than *N. nigropictus* or *N. malayanus*.

 <p><i>Nephotettix cincticeps</i></p>	 <p>Rice</p>	 <p><i>Echinochloa</i></p>	 <p>Poa</p>	 <p><i>Alopecurus</i></p>
 <p><i>Nephotettix virescens</i></p>	 <p>Rice</p>	 <p><i>Echinochloa</i></p>	 <p>Wild rices</p>	
 <p><i>Nephotettix nigropictus</i></p>	 <p>Rice</p>	 <p><i>Echinochloa</i></p>	 <p><i>Leersia</i></p>	 <p>Wild rices</p>
 <p><i>Nephotettix malayanus</i></p>	 <p>Rice</p>	 <p><i>Echinochloa</i></p>	 <p><i>Leersia</i></p>	

**Management**

*Cultural control.* Grow no more than two rice crops per year. Create rice-free periods by synchronous planting, using early-maturing varieties, and plowing down stubble after harvest to minimize green leafhopper populations and remove virus sources from the field.

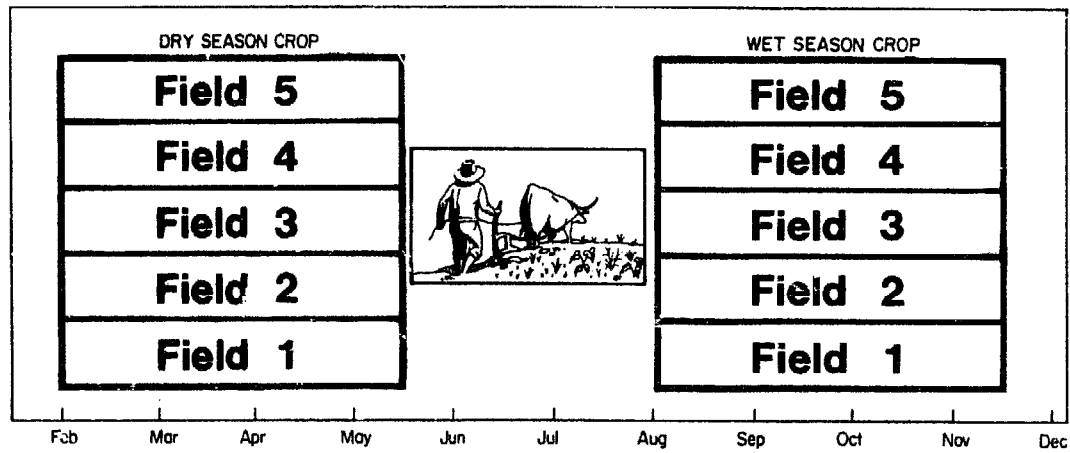

Covering a seedbed with mesh cloth prevents hoppers from transmitting viruses at a time when the crop can be most severely infected.

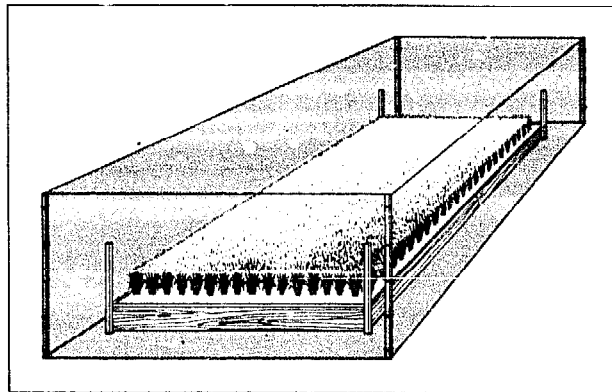

Place seedbeds away from lights so as not to attract virus-infected hoppers.

Virus-infected hoppers also breed in weedy areas; therefore, set seedbeds away from weeds.

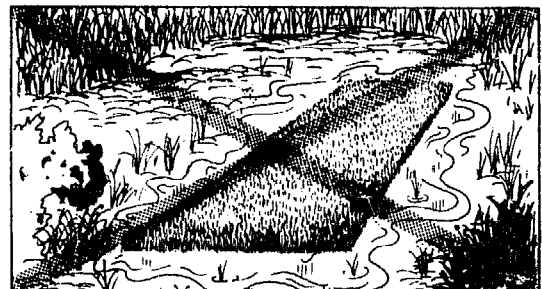
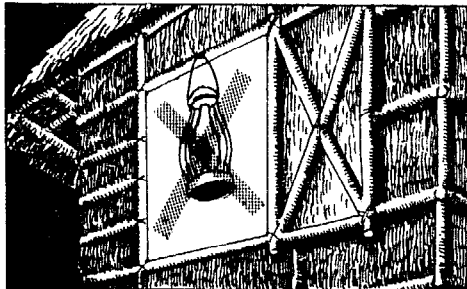

*Resistant varieties.* Many varieties resistant to green leafhoppers are commercially available.

Few varieties are resistant to the virus diseases, but widespread planting of green leafhopper-resistant varieties is normally effective in minimizing virus incidence.

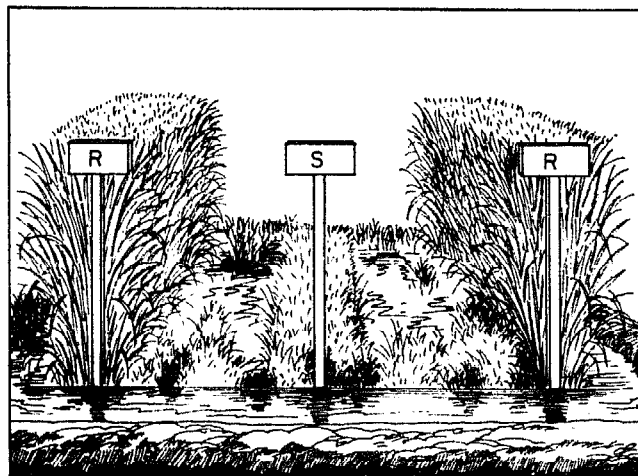

The decision to select a tungro-resistant variety can be made after scouting the ratoon of the previous crop in the vicinity of the field. Tungro readily shows up in a ratoon. If tungro is prevalent in the ratoon, use of a resistant variety is recommended.

Early-maturing varieties reduce the period for green leafhopper population increase, but will not directly prevent virus infection.

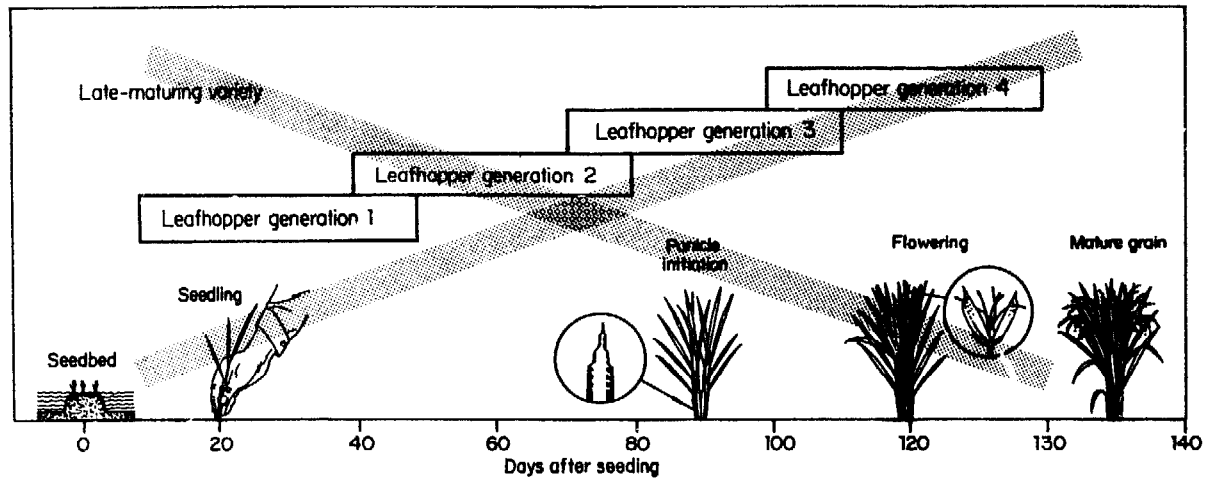
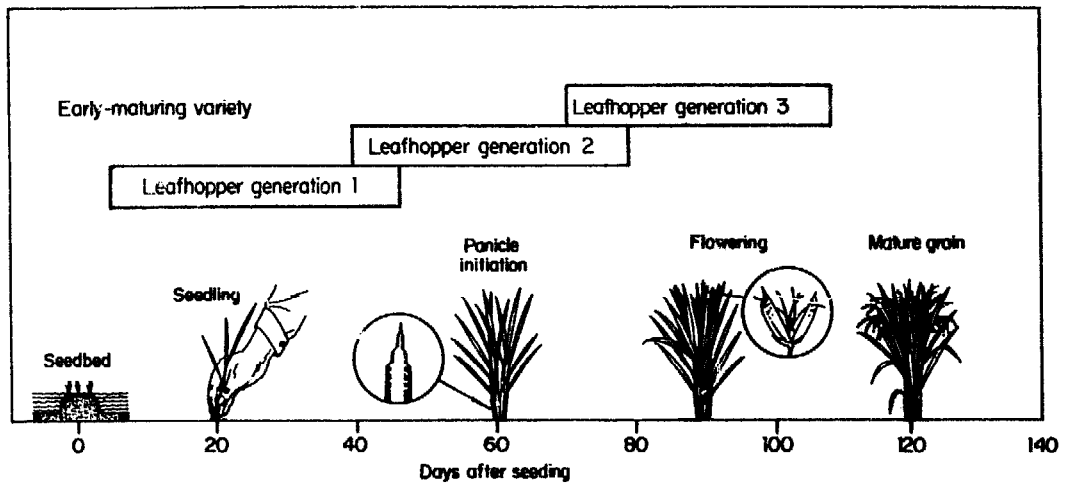

**Biological control.** Green leafhoppers are normally held in check by the activities of parasites, predators, and pathogens.

Eggs are parasitized by trichogrammatid and mymarid wasps and preyed upon by mirid bugs.

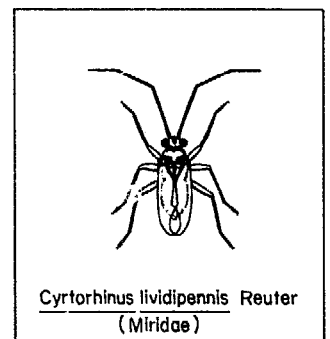
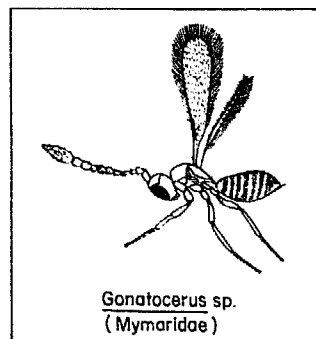
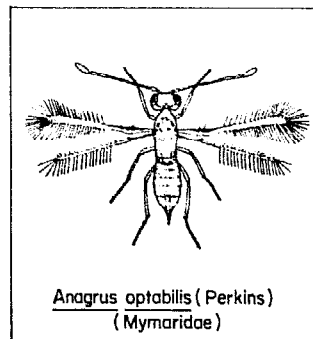
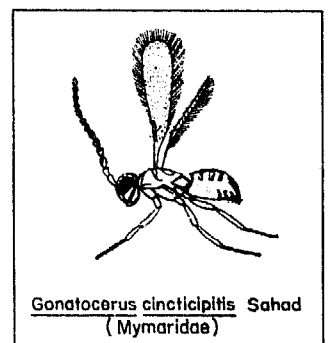
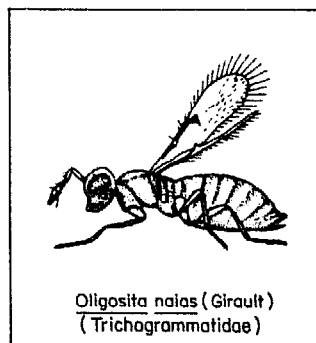
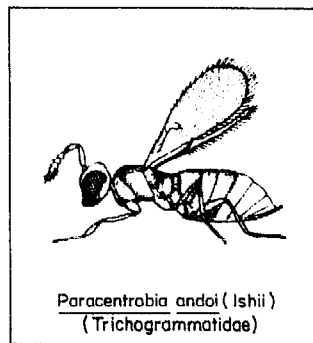

Nymphs and adults are parasitized by pipunculid flies, dryinid wasps, halictophagid strepsipterans, and nematodes.

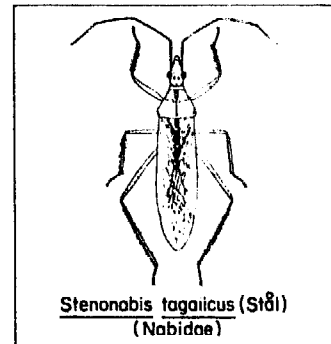
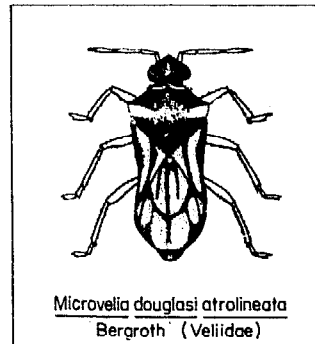
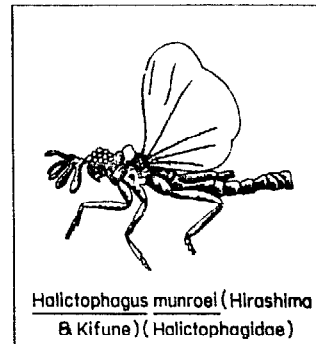
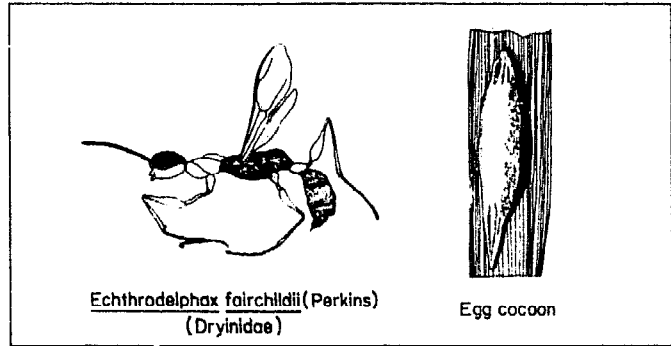
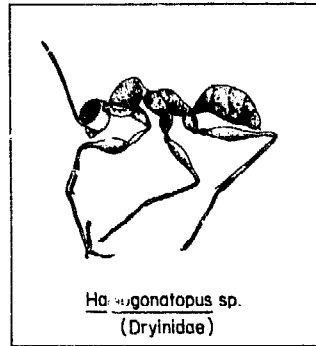
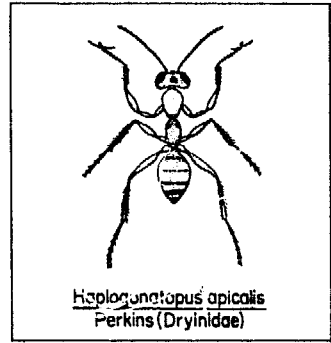
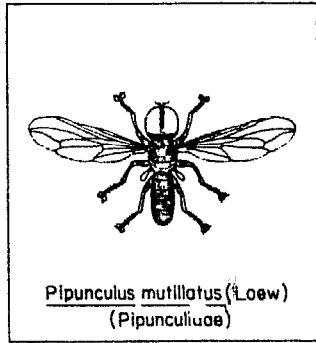

An array of predators also attack nymphs and adults: aquatic veliid bugs, nabid bugs, empid flies, damselflies, dragonflies, and spiders.

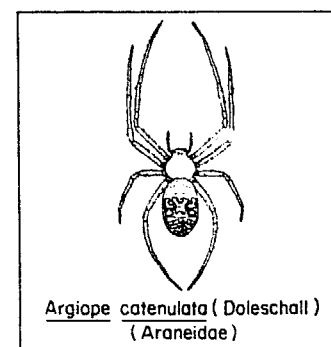
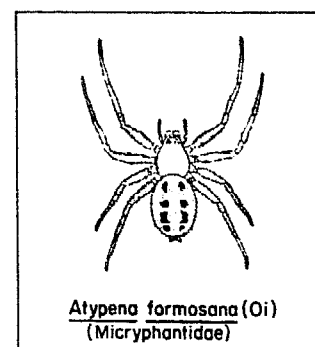
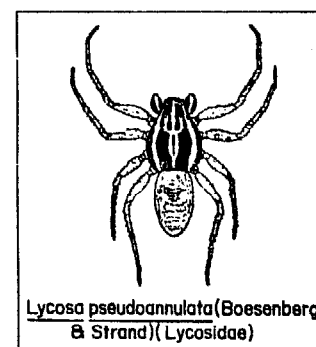
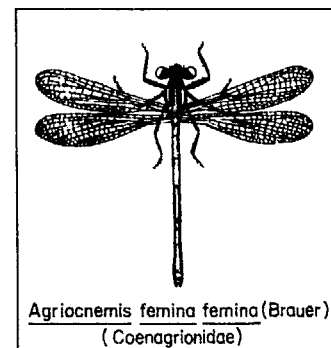
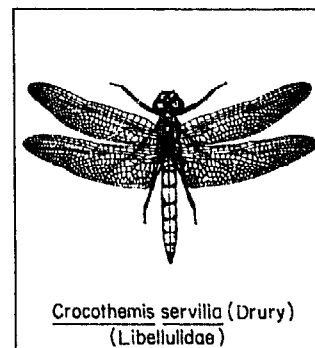
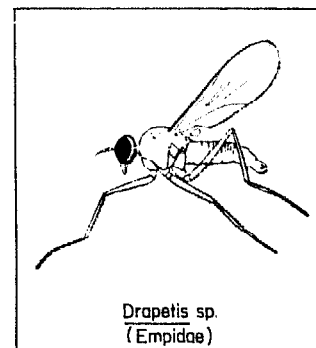

Nematodes and fungal pathogens also infect nymphs and adults. A white fungal mat grows from the inside and covers the body of dead leafhoppers.

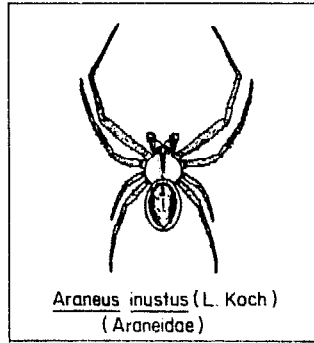

*Araneus inustus* (L. Koch)  
(Araneidae)

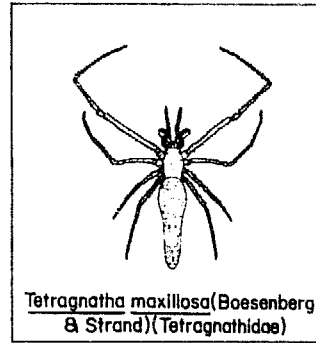

*Tetragnatha maxillosa* (Boesenberg & Strand)  
(Tetragnathidae)

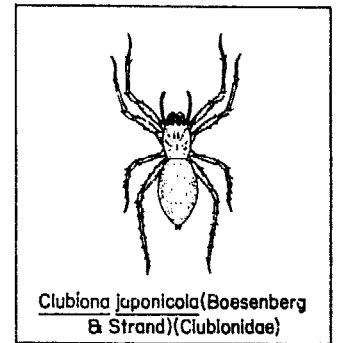

*Clubiona japonicola* (Boesenberg & Strand)  
(Clubionidae)

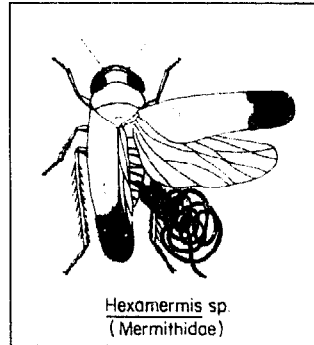

*Hexameris* sp.  
(Mermithidae)

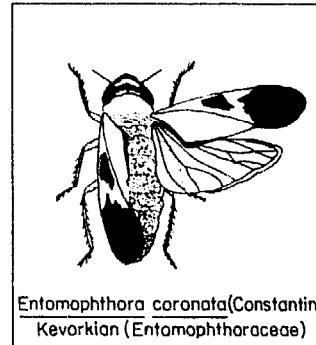

*Entomophthora coronata* (Constantin)  
Kevorkian (Entomophthoraceae)

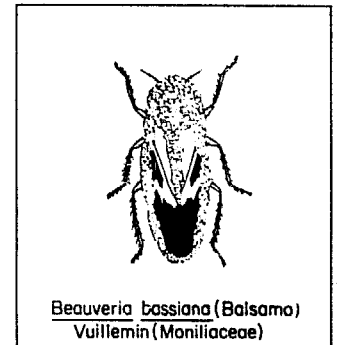

*Beauveria bassiana* (Balsamo)  
Vuillemin (Moniliaceae)

**Chemical control.**

- **Insecticide application.** If virus diseases transmitted by green leafhoppers are prevalent in an area and a susceptible variety is used, the rice crop must be protected with insecticide from the seedbed unless the seedbed is covered. A systemic insecticide is preferred. Systemic granules should be incorporated into the soil before sowing the seedbed. Soil-incorporated granules are more efficient than broadcast granules or sprays in the seedbed.

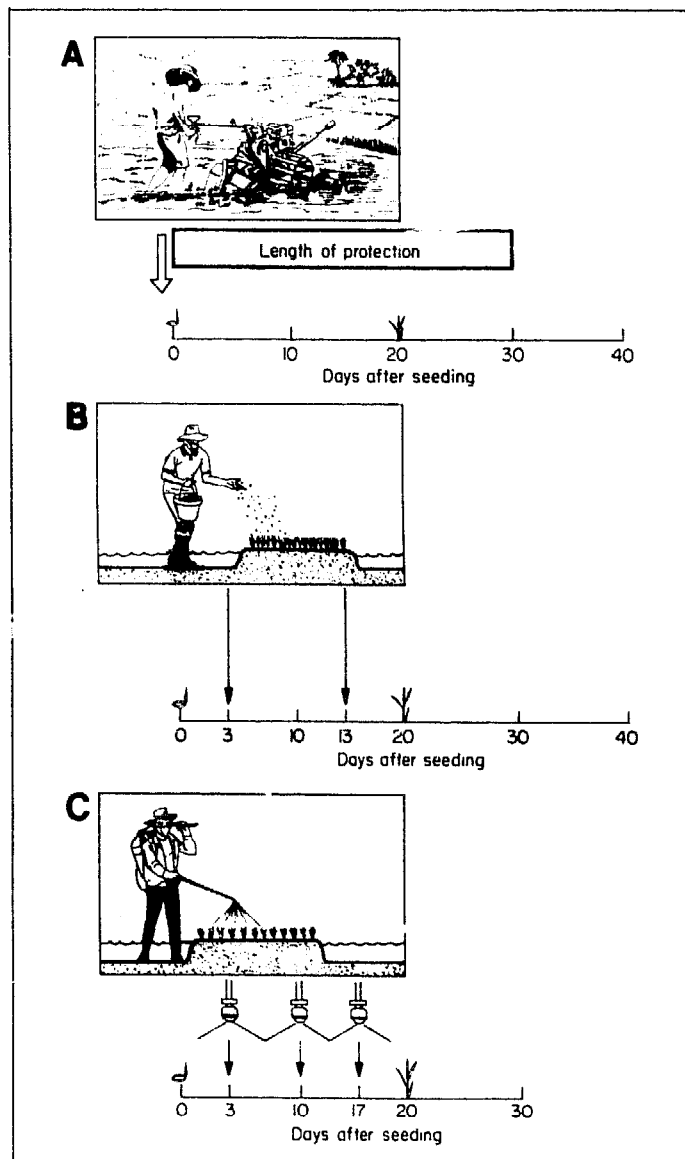

A similar choice of protection should be sought immediately before transplanting. Soaking seedlings in insecticide solution for 6-12 hours before transplanting gives protection for 20 days, whereas soil incorporation or broadcasting of systemic granules protects the crop for 40 days.

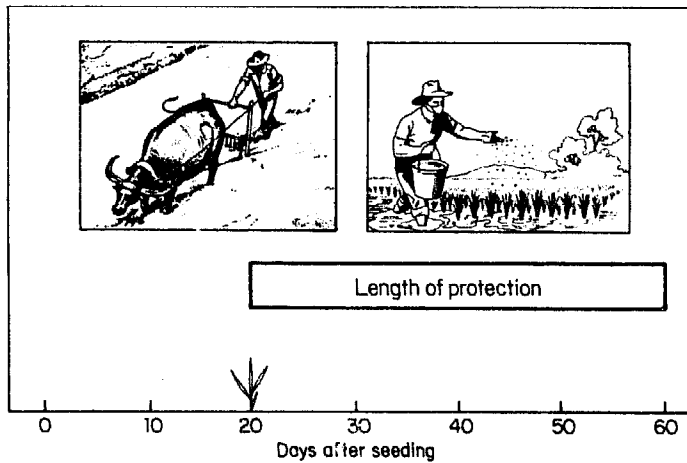
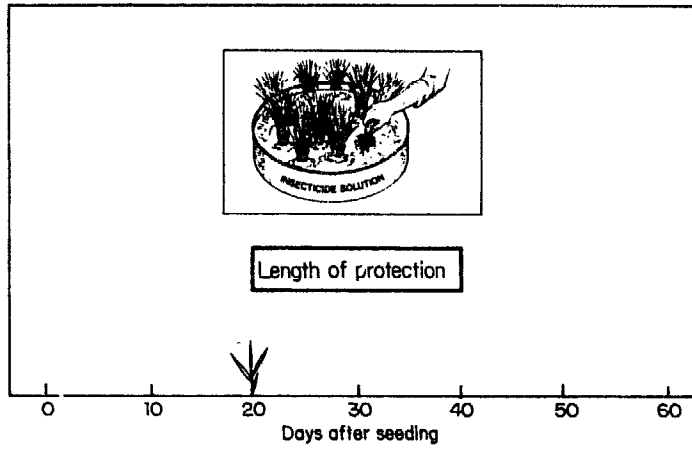

- **Scouting.** If a susceptible variety is used and preventive insecticide applications are not carried out, the crop should be monitored for green leafhopper activity.

Green leafhoppers should be monitored in the crop from the seedbed to panicle initiation.

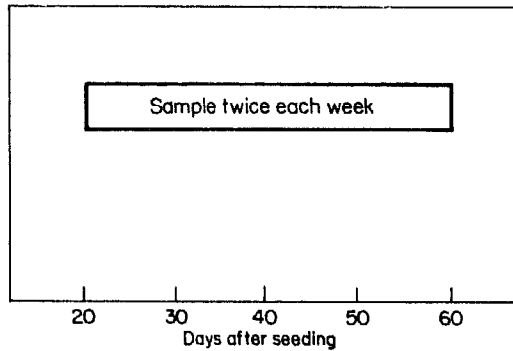

Individual seedbeds and fields can be sampled with a sweep net to determine if chemical control is necessary. Sampling should be done in the morning.

A sweep net is particularly effective in catching green leafhoppers because they feed on the upper portions of the rice plant.

Swing the net in a "brush stroke" (following the arc of a pendulum) for each sweep.

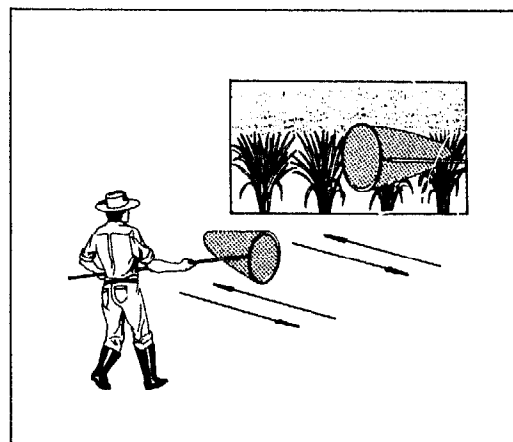

The bottom of the net should penetrate the rice canopy during a sweep.

Make 10 sweeps (a sweep is one pass of the net across the plants, either to or fro) while following a diagonal line across the paddy.

Take sweep net samples twice a week, from the seedling stage to panicle initiation.

Count both nymphs and adults.

If a sweep net is not available, plant tapping can be used. Each week randomly pick 20 hills across the paddy. Slap the plants with force several times with the palm of the hand. Count both adults and nymphs that fall on the water.

Calculate the average green leafhopper number per hill.

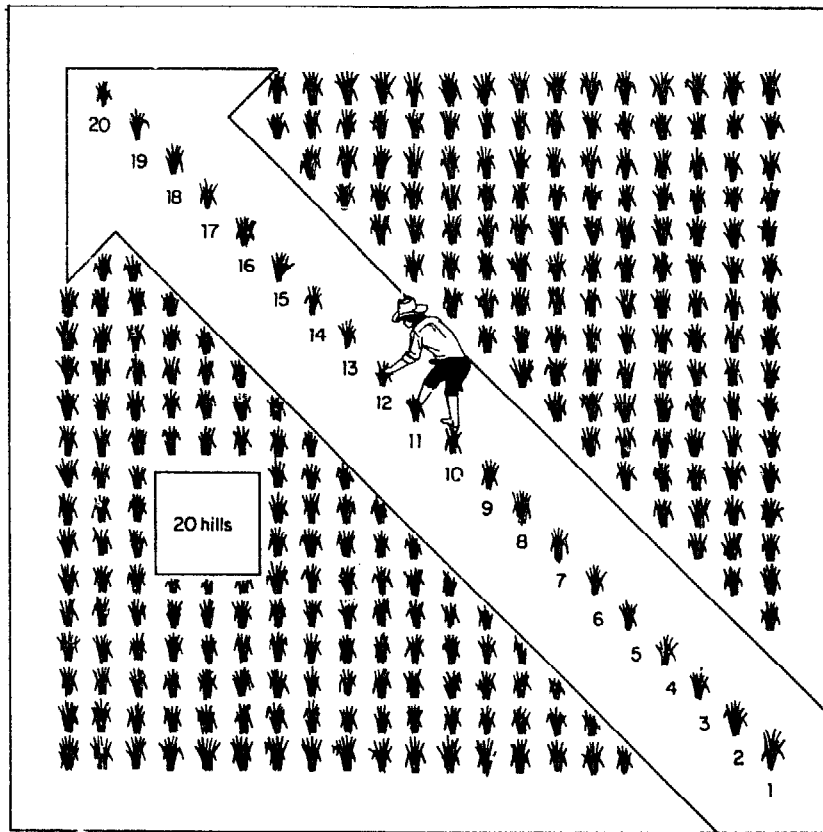

Spray a systemic insecticide when the economic threshold is reached.

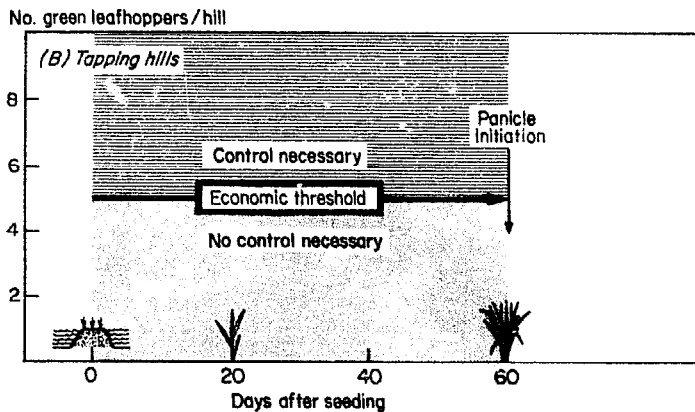
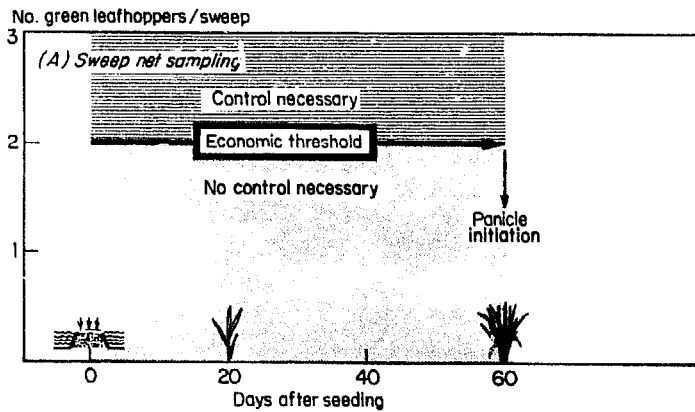

RICE ZIGZAG LEAFHOPPER (HOMOPTERA: CICADELLIDAE)

*Recilia* (= *Inazuma*) *dorsalis* (Motschulsky) (= *Deltocephalus dorsalis*) is a pest mainly because it transmits virus diseases. The adult has dark zigzag markings on the wings. Other leafhoppers having zigzag wing patterns such as *Scaphoideus*, *Deltocephalus*, and *Eutettix* are found in light trap collections but do not feed on rice. The zigzag patterns are more obvious on these species when they are wet.

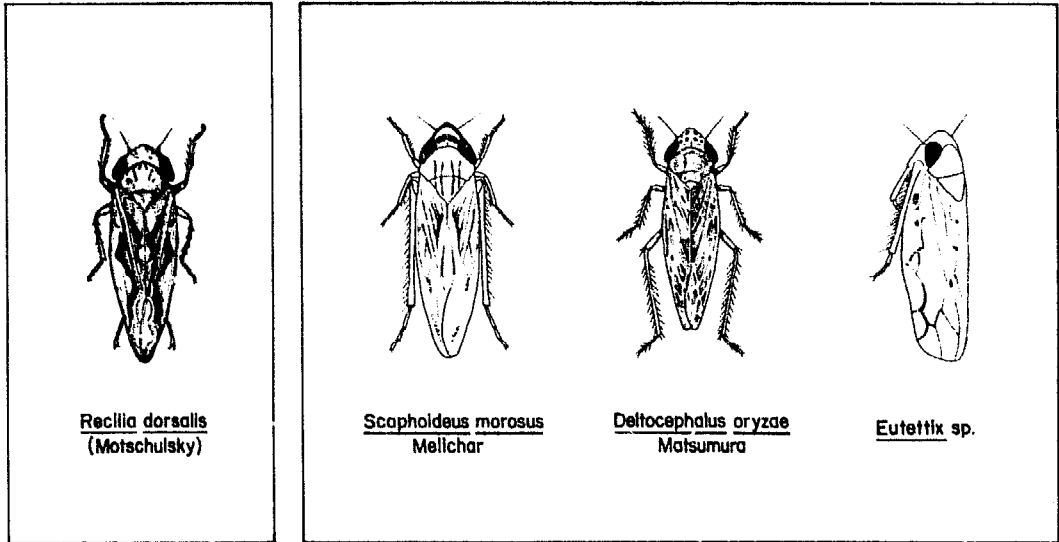

**Pest status**

Zigzag leafhopper can transmit tungro, dwarf, and orange leaf virus diseases. It plays a minor role as a pest because its population is generally low.

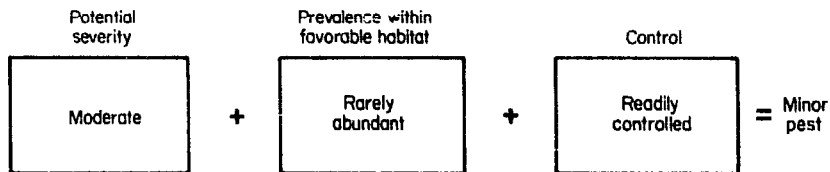

It occurs in all rice environments but transmits the virus diseases only to wetland rice.

The zigzag leafhopper is particularly abundant in the early rainy season.

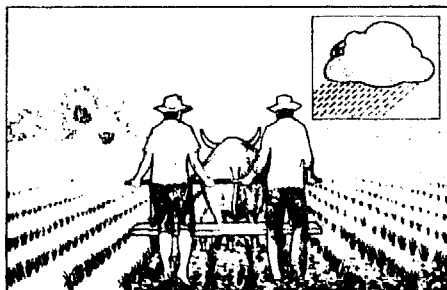

Upland

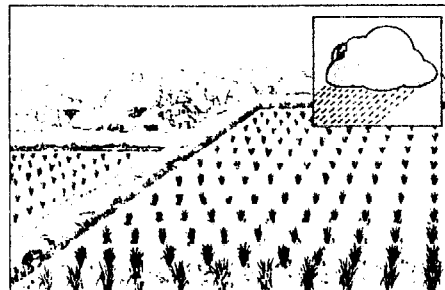

Rainfed wetland

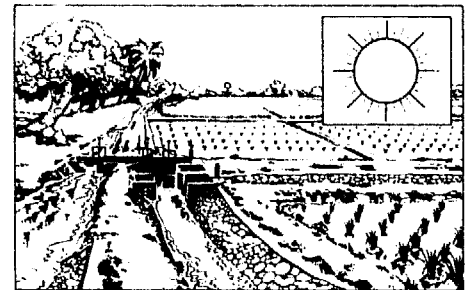

Irrigated wetland

*Distribution in Asia*

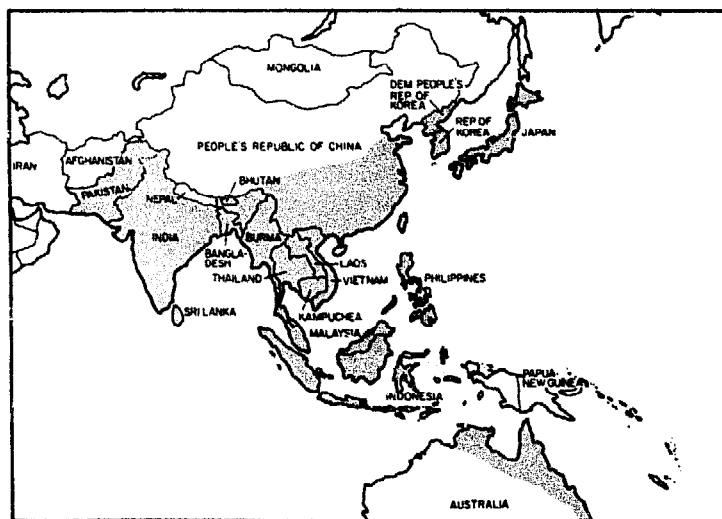



**Development and actual size**

**Adult.** The adult is readily recognized by the characteristic zigzag white and brown pattern on the front wings.

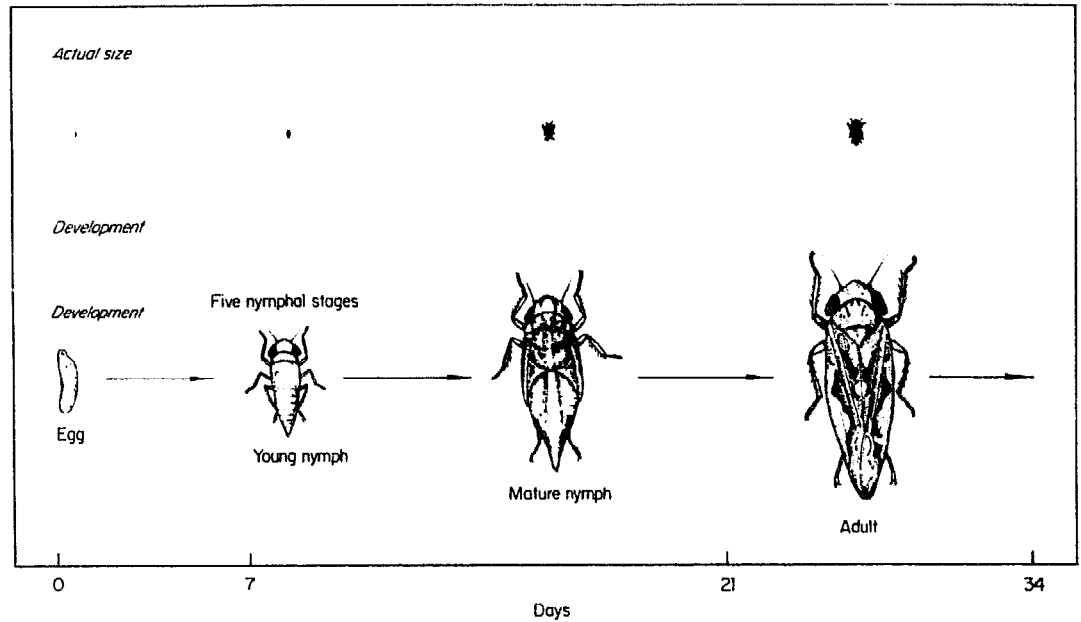
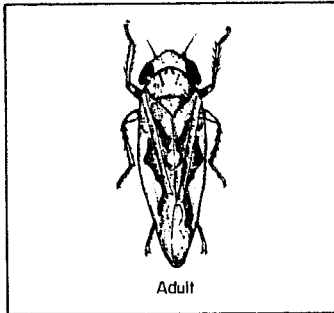

The adults are highly mobile and enter rice fields in the early growth stages.

The zigzag leafhopper is highly attracted to a light trap and catches are high during a full moon.

Each female may deposit 100-200 eggs in its lifetime of 10-14 days. To lay eggs, she cuts openings in tillers with her saw-like ovipositor.

**Egg.** The white eggs are laid individually in the leaf sheaths.

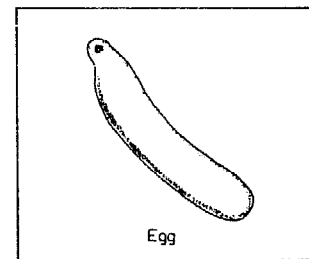
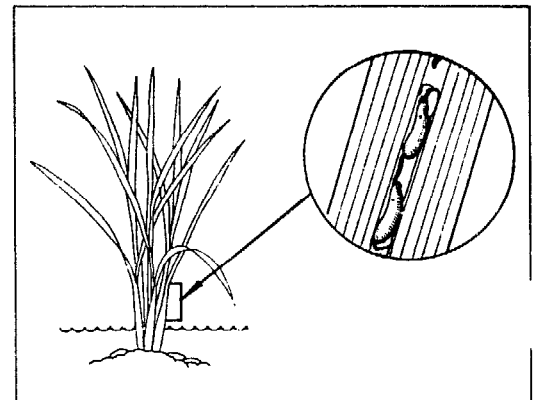
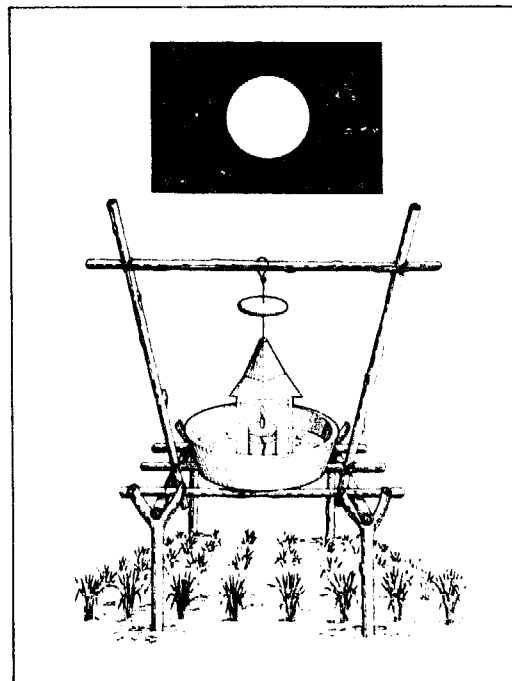

**Nymph.** The yellowish brown nymphs are found both on leaves in the upper parts of the plant and on tillers near the base of the plant.

Nymphs are usually more numerous during the vegetative stage of rice.

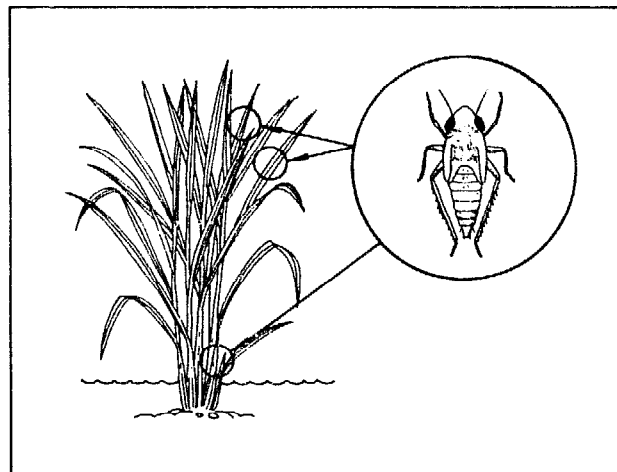

**Damage**

Nymphs and adults damage the plant by sucking sap from the leaves and leaf sheaths.

Damaged plants have dried leaf tips and leaf margins show orange discoloration.

Later, the whole leaf becomes orange and the leaf margins curl.

Damage symptoms appear first on older leaves.

Young seedlings wilt and die when the hopper attacks in large numbers.

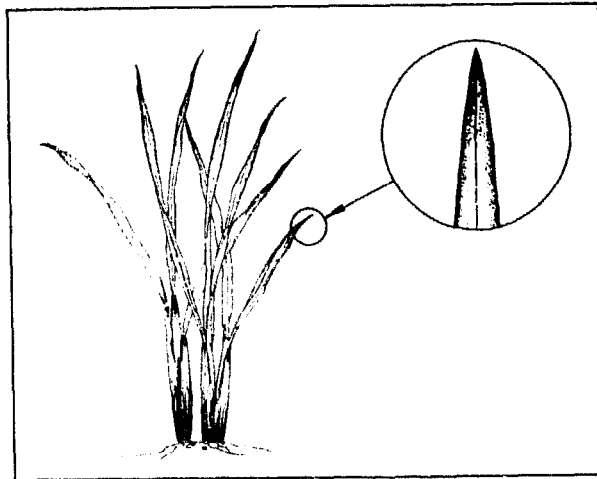

The zigzag leafhopper transmits rice tungro, dwarf, and orange leaf viruses.

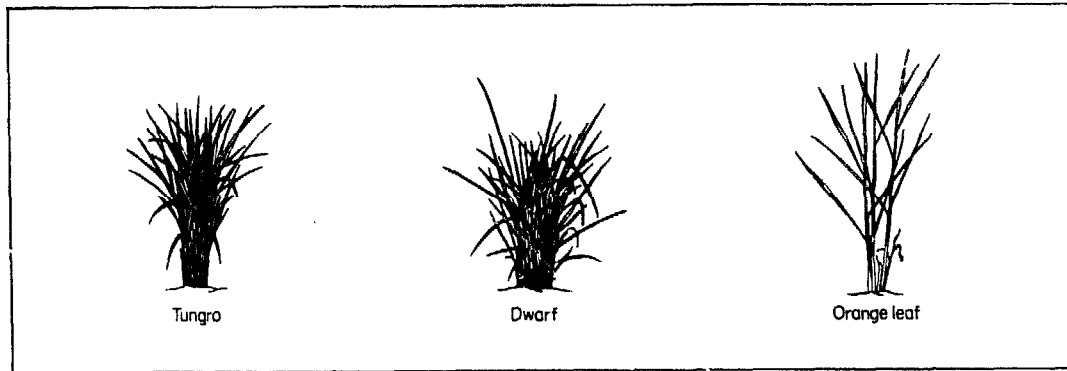

*Plant hosts.* Alternative hosts are in the grass family.

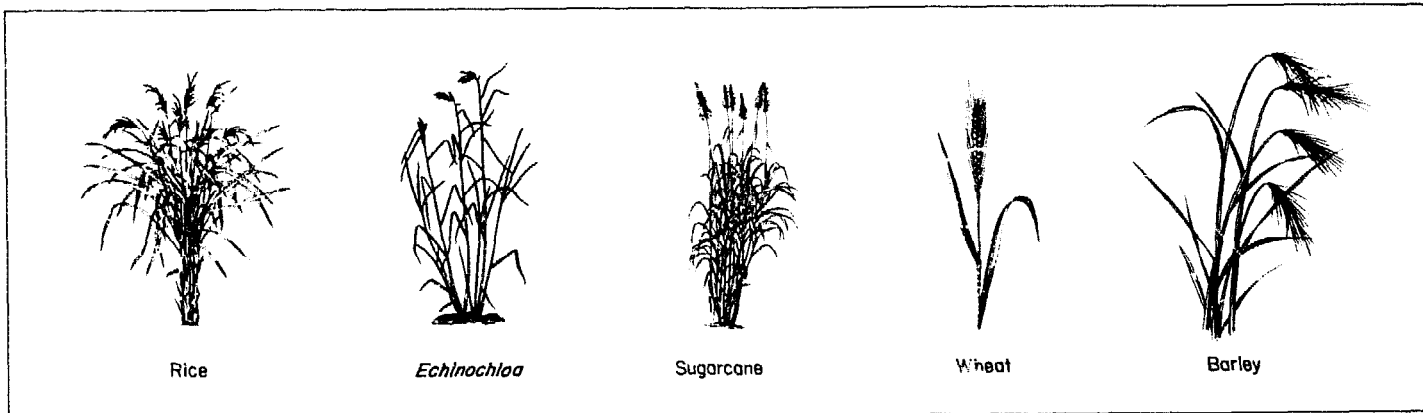

**Management**

*Cultural control.* Grassy weeds and volunteer rice in fallow fields allow the zigzag leafhopper and the viruses they transmit to exist between rice crops.

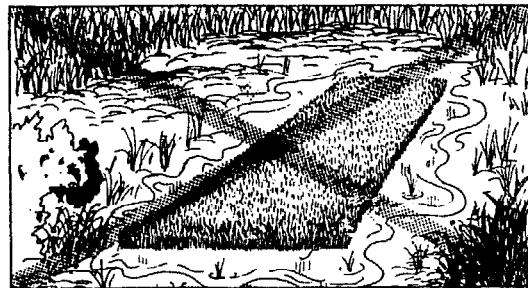
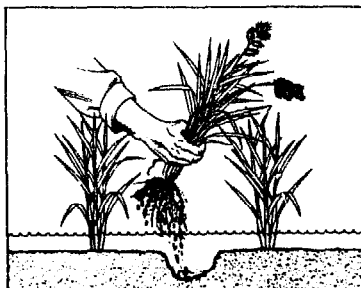

Keep fallow fields free of vegetation between rice crops.

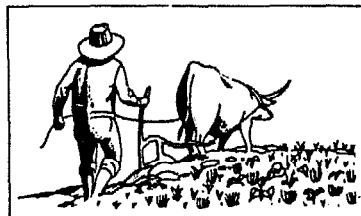

Establish seedbeds away from weedy areas or lights.

**Resistant varieties.** No resistant varieties are commercially available for either the zigzag leafhopper or orange leaf or dwarf viruses.

## Plant Resistance

**Biological control.** Parasites and predators normally regulate zigzag leafhopper numbers.

Mymarid parasites and the mirid bug attack the egg stage.

Dryinid wasps and pipunculid flies parasitize nymphs and adults.

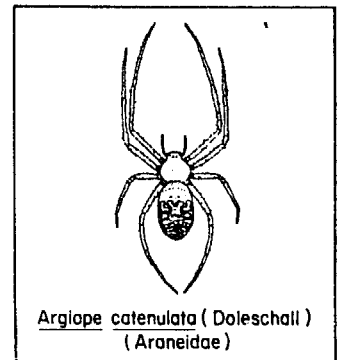
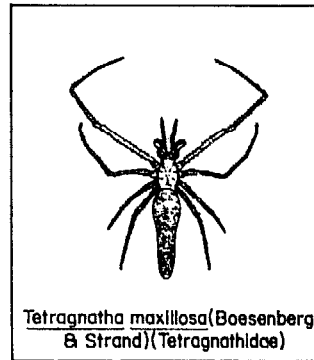
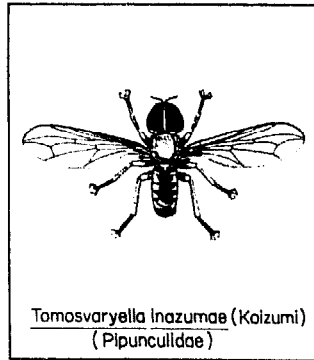
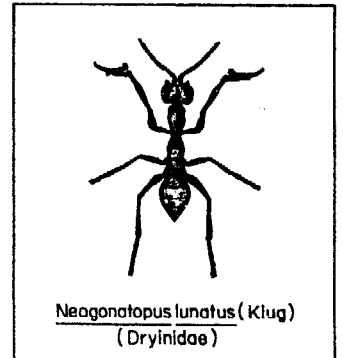
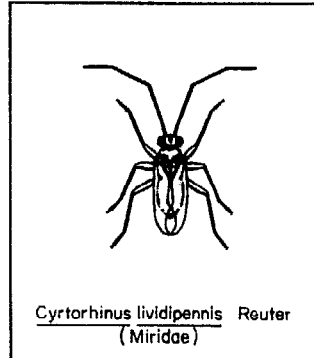
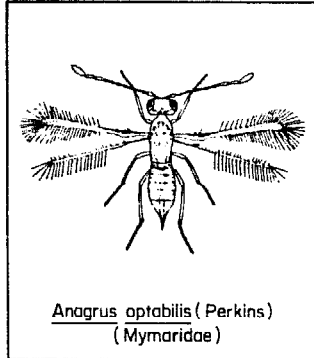

Spiders that inhabit the leaf canopy prey on adults.

- Chemical control.**
- **Insecticide application.** Foliar sprays are more effective than granular insecticides.



- **Scouting.** Visit the field weekly from the seedbed to panicle initiation.

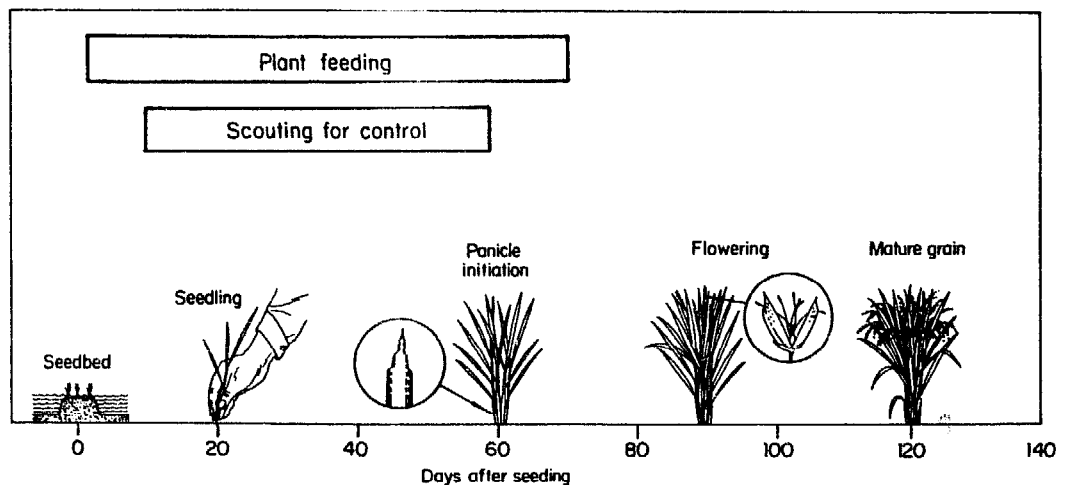

Record the number of zigzag leafhoppers from 20 randomly selected hills across the field.

Calculate the number of zigzag leafhoppers per tiller.

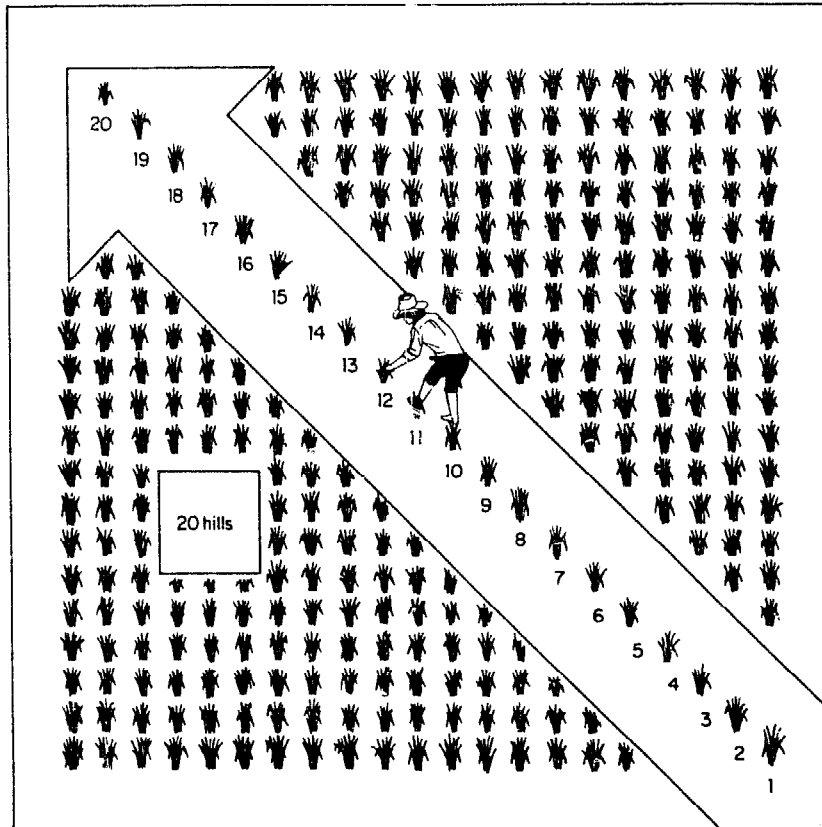

Spray insecticide when the economic threshold is reached.

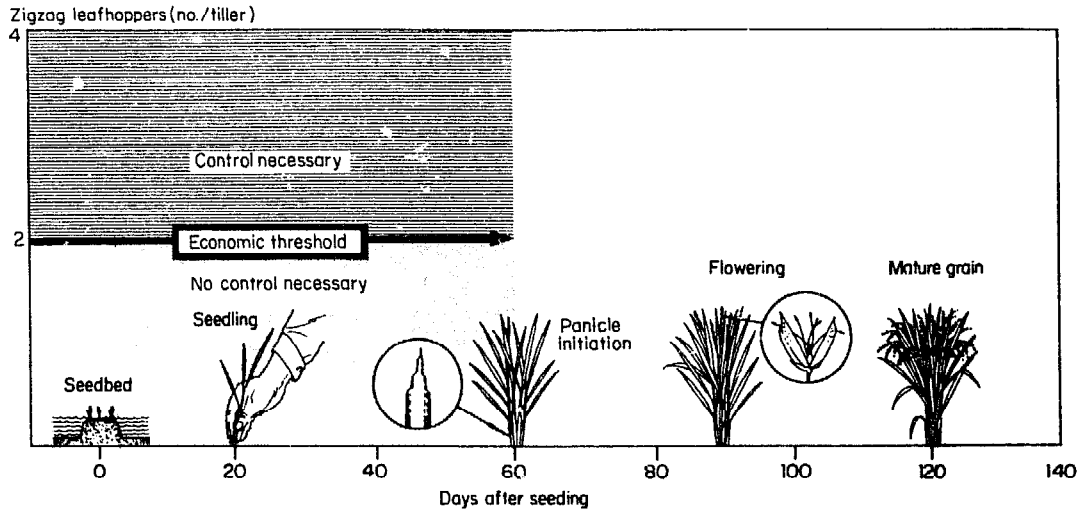

RICE WHITE LEAFHOPPER (HOMOPTERA: CICADELLIDAE)

*Cofana* (= *Tettigella* = *Cicadella*) *spectra* (Distant) is the largest of the rice leafhoppers and is entirely white. Other leafhoppers of minor importance include the rice orange leafhopper *Thaia oryzivora* Ghauri and the rice blue leafhopper *Zygina maculifrons* (Motschulsky).

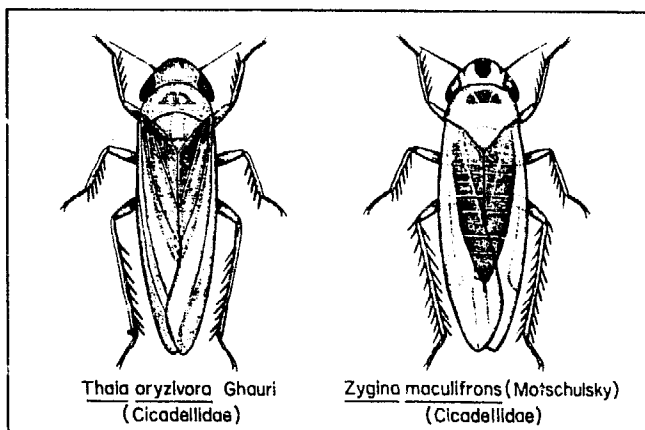

*Nisia atrovonosa*, which resembles white leafhopper in appearance, also occurs in rice fields. It is neither a delphacid planthopper nor a cicadellid leafhopper and feeds on grasses and sedges.

Leafhoppers have tibial spines and planthoppers have a tarsal spur. *Nisia atrovonosa* has neither of these characters and belongs to the family Meenoplidae. The biology, damage, and management of only the rice white leafhopper will be discussed.

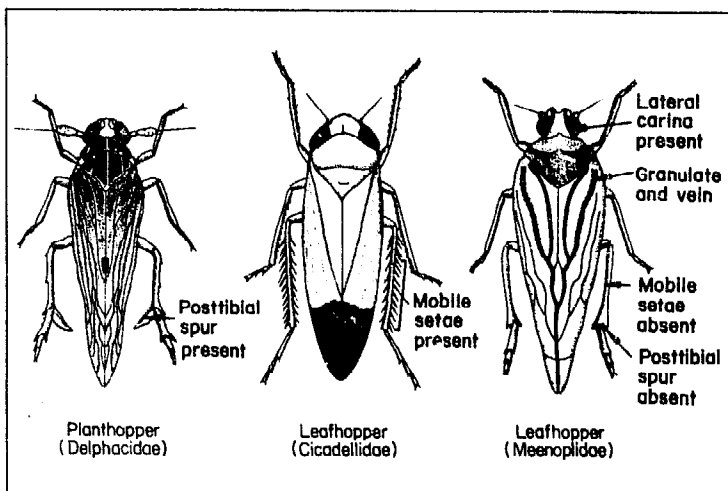
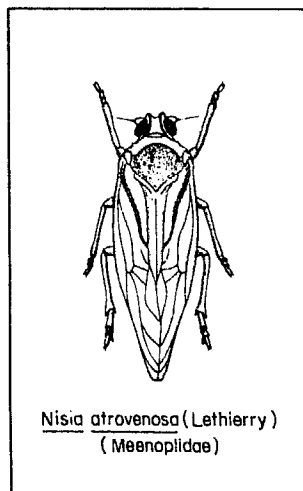

**Pest status**

The rice white leafhopper rarely occurs at population levels that cause yield loss and does not transmit any virus diseases.

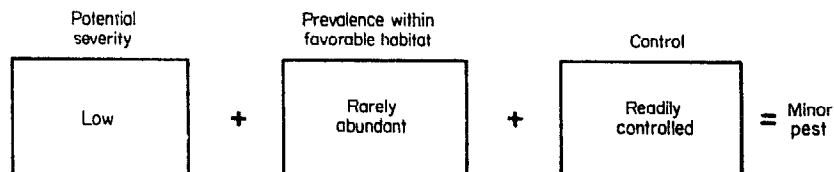

The white leafhopper occurs in all rice environments, but is particularly associated with

rainfed wetland rice and is more abundant at the end of the rainy season.

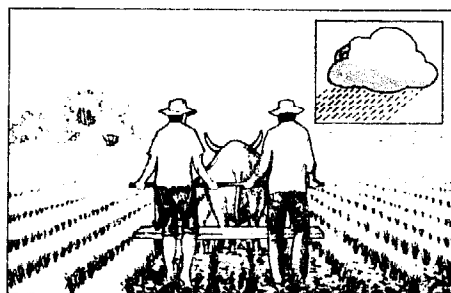

Upland

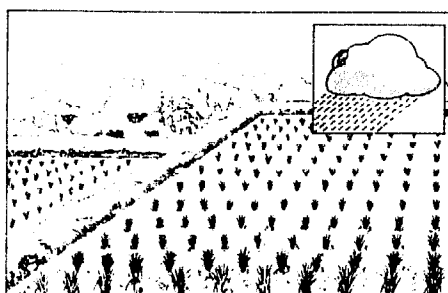

Rainfed wetland

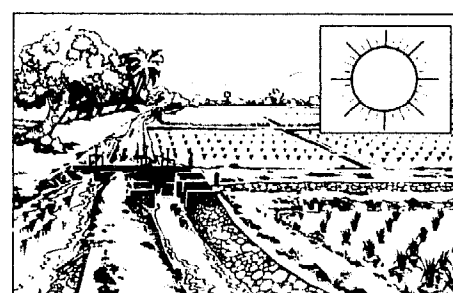

Irrigated wetland

**Distribution in Asia.**

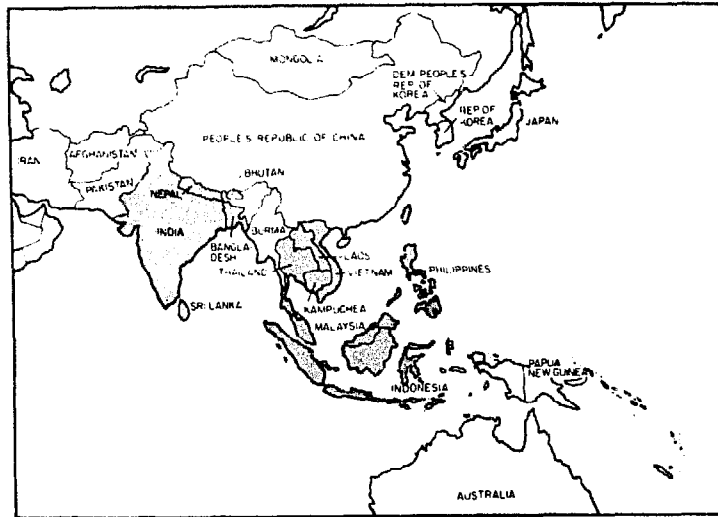

**Development and actual size**

**Adult.** The large adults are grey-white with prominent wing veins.

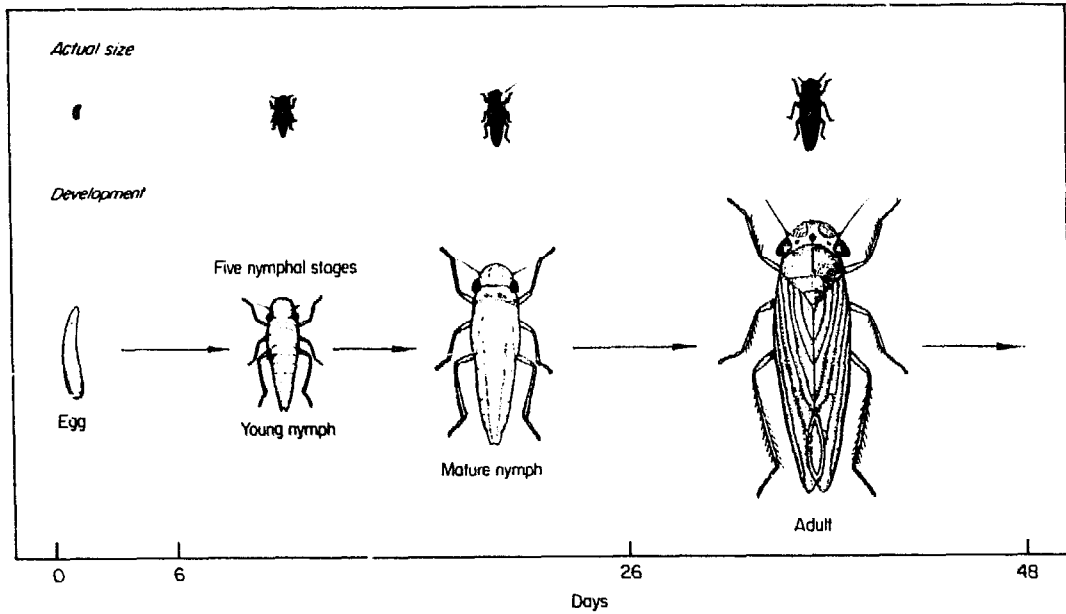
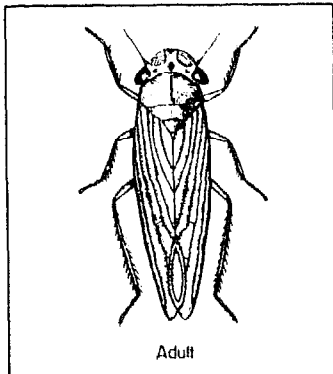

Adults rest on the lower surfaces of leaf blades or on tillers near the base of plants. They are agile insects and hop away when disturbed. Adults are highly attracted to a light trap at night. Catches are abundant during a full moon.

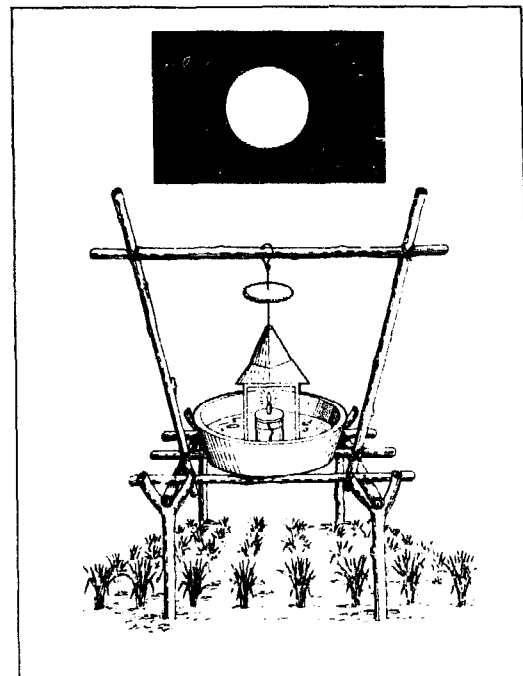
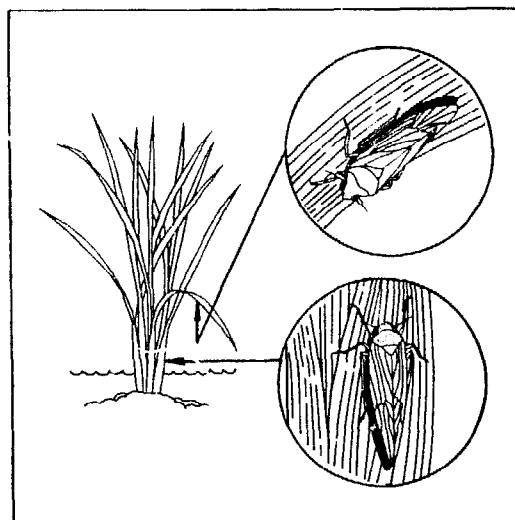

Each female may lay 100-200 eggs during its lifetime of 3 weeks.

The female cuts into rice tillers with her saw-like ovipositor to create an opening in which to lay eggs.

**Egg.** The elongate white eggs are laid in leaf sheaths in rows of 10-15 at the base of plants above the paddy water.

The female covers the egg masses with a chalky substance.

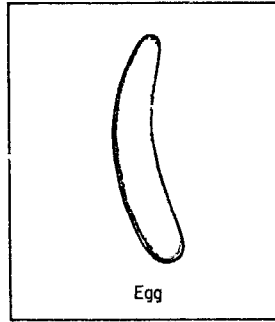

Egg

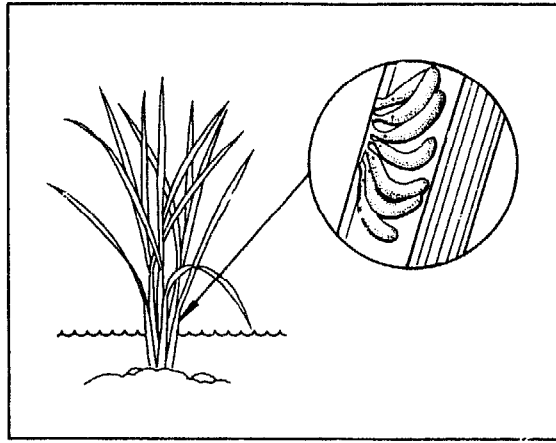

**Nymph.** The pale orange nymphs feed on tillers just above the water line.

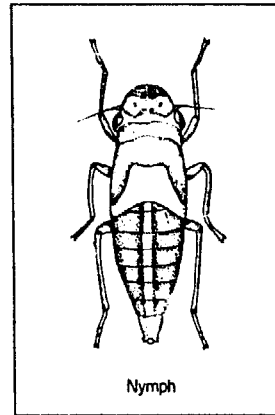

Nymph

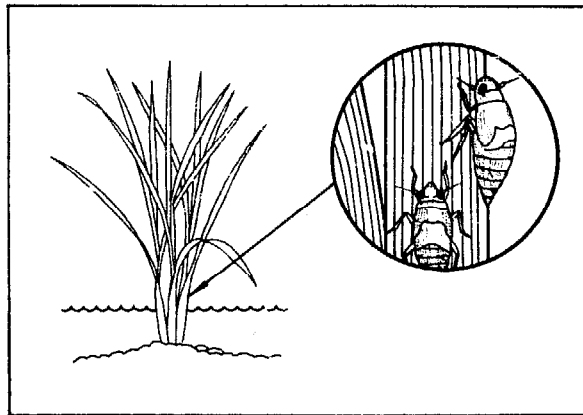

**Damage**

Adults and nymphs suck sap from the plants, causing the tips of leaves to dry up. Later the whole leaf turns orange and curls. Plant growth becomes stunted.

The white leafhopper does not transmit any plant viruses.

Nymph populations usually build up during late tillering and reproductive stages of rice growth.

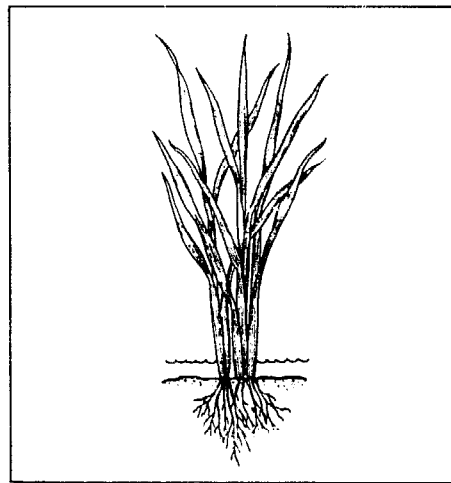

**Plant hosts.** The white leafhopper breeds on an array of plants in the grass family.

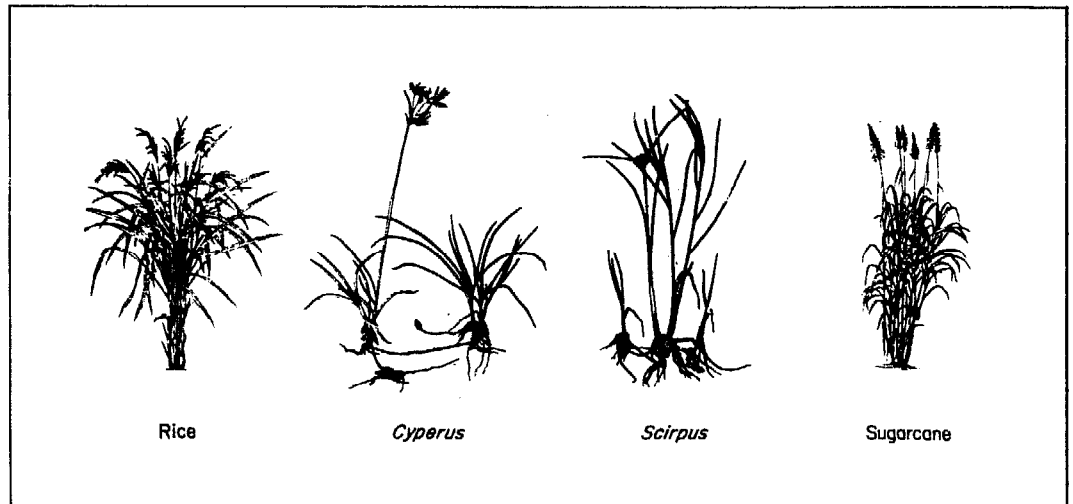

Rice

Cyperus

Scirpus

Sugarcane

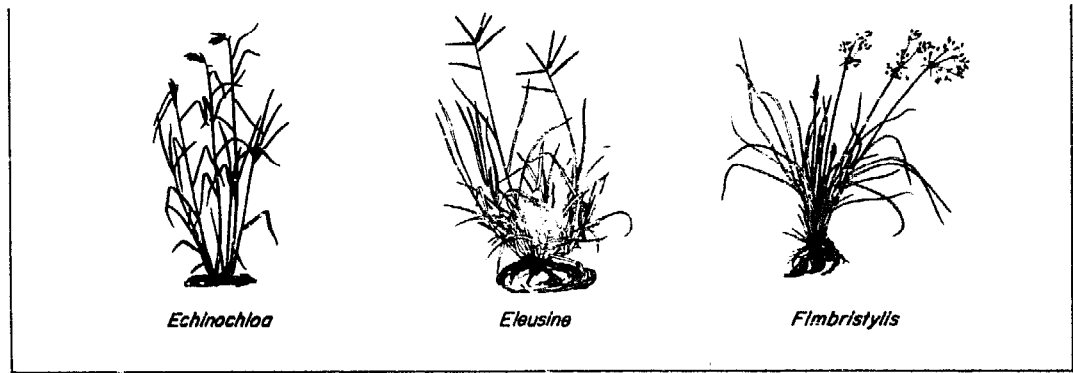

**Management**

**Cultural control.** Practice clean culture by removing weeds from fields during the rice crop and from rice fields during fallow periods.

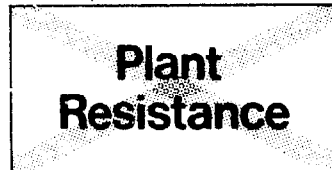
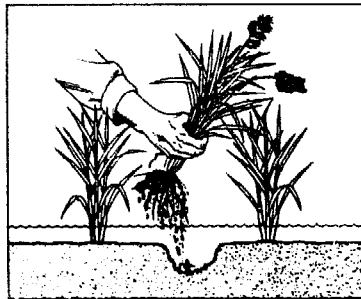

*Resistant varieties.* No resistant varieties are commercially available.

**Biological control.** The action of a wide array of natural enemies attacking all growth stages normally keeps the white leafhopper populations below economic threshold levels.

Eggs are parasitized by tiny mymarid wasps and are preyed upon by mirid bugs. Young nymphs fall prey to aquatic veliid and mesoveliid bugs. Strepsiptera are commonly found as internal parasites of older nymphs or adults. Web-building and hunting spiders capture many flying adults.

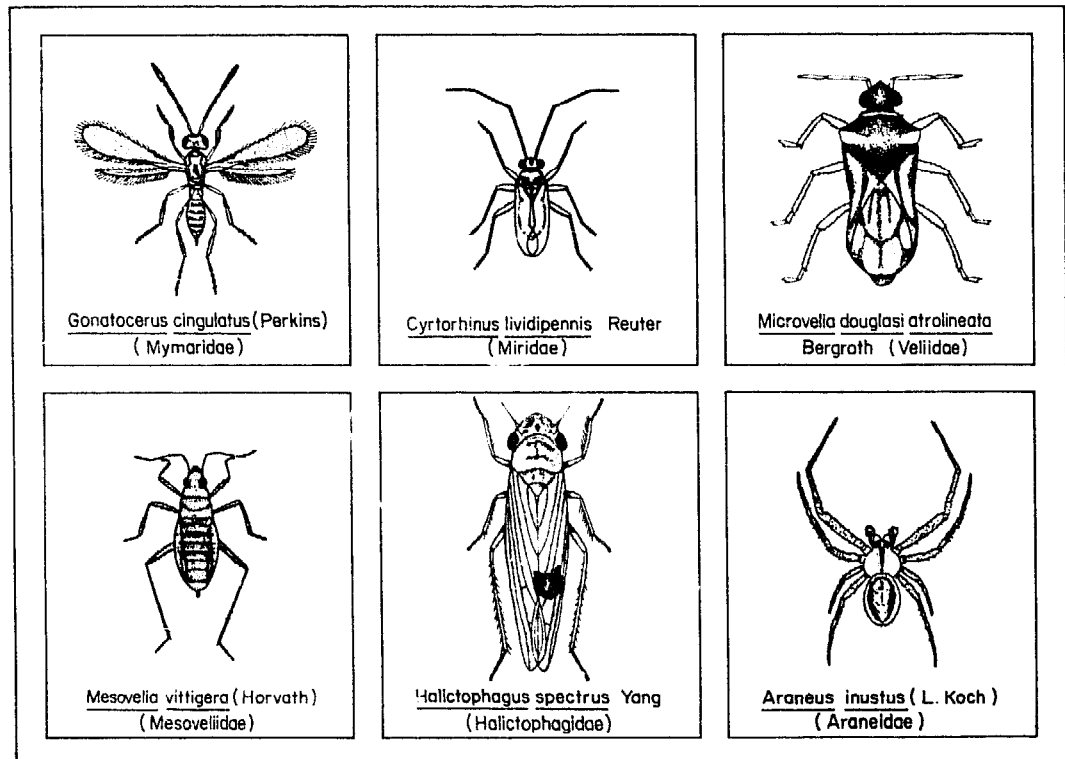

**Chemical control.**

• **Insecticide application.** Insecticide spray or dust formulations are preferred.

Granules are not effective because the white leafhopper is abundant when the plants are fully grown and are too large.





- **Scouting.** Begin scouting weekly from the midvegetative period until after flowering.

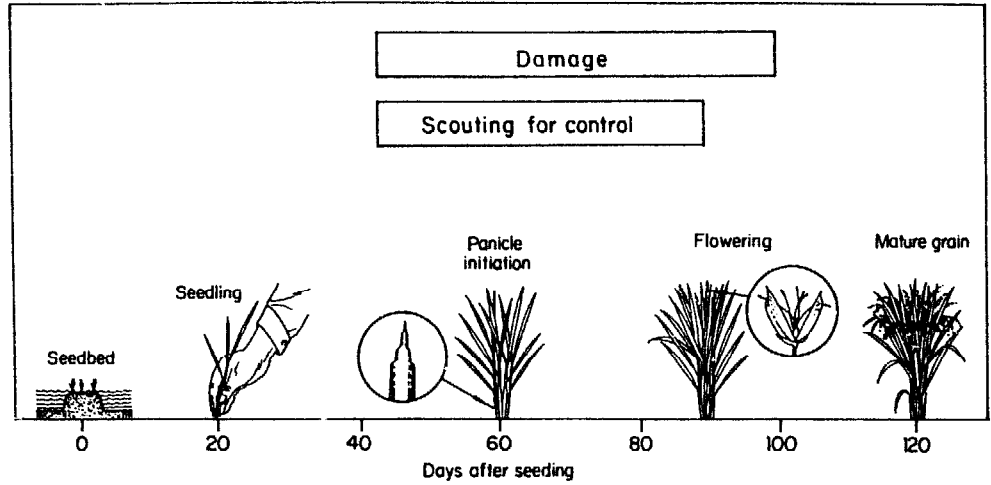

Record the number of leafhoppers on 20 randomly selected hills across the field.

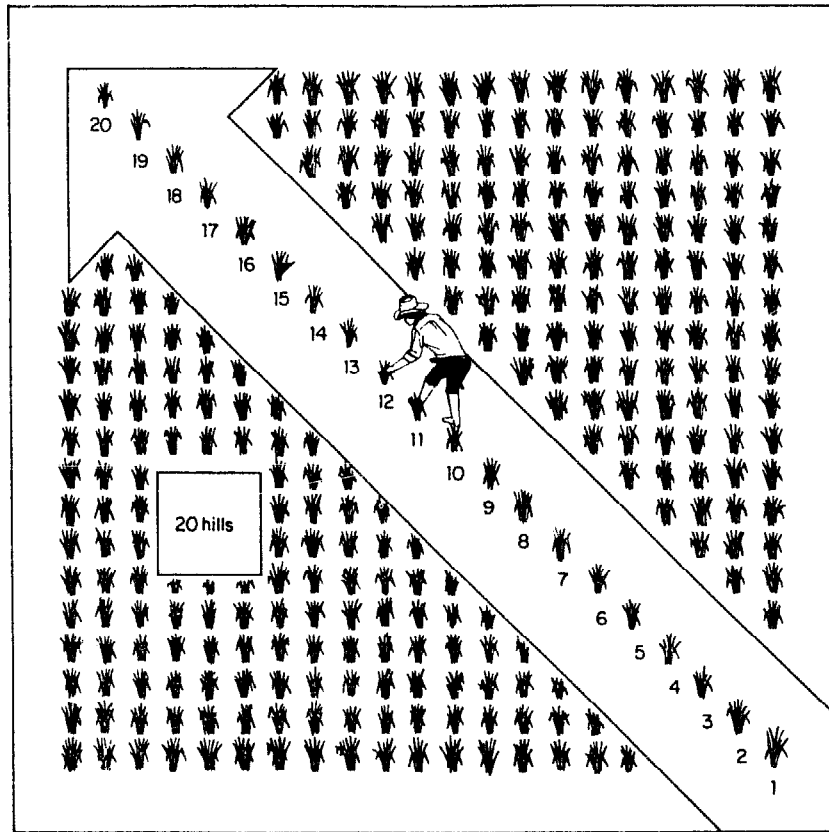

Determine the average number of white leafhoppers per hill. Apply insecticide when the economic threshold is reached.

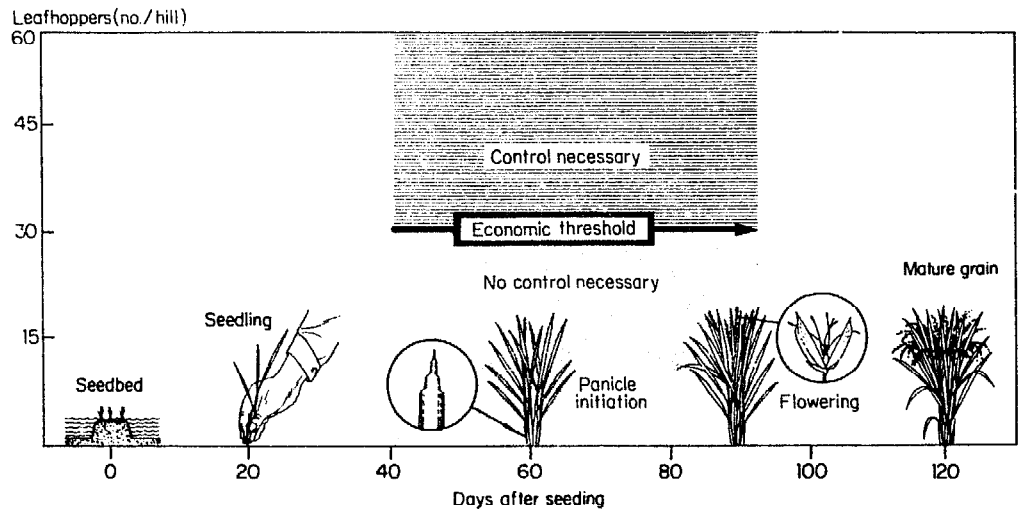

PESTS AT THE RIPENING STAGE

Rice pollen is a nutritious food source. It attracts many insects to rice panicles during flowering.

Insects, however, do not cause sterility or unfilled grains when they feed on pollen. Generally, the rice plant produces more pollen than is needed for fertilization.

Many insects that feed on pollen are beneficial species. One example is the lady beetle which is not a pest.

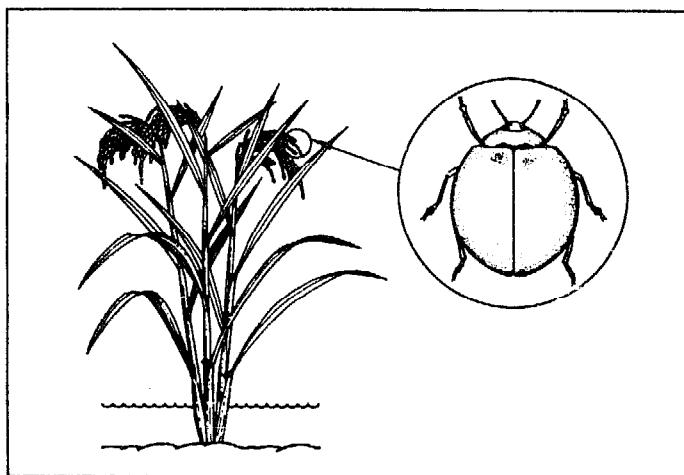

RICE SEED BUGS (HEMIPTERA: ALYDIDAE)

Several species of true bugs of the genus *Leptocoris* are commonly called rice bugs. These species are discussed together because their appearance, biology, and the damage they cause are similar.

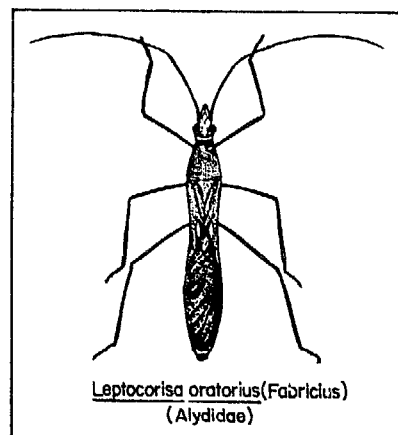
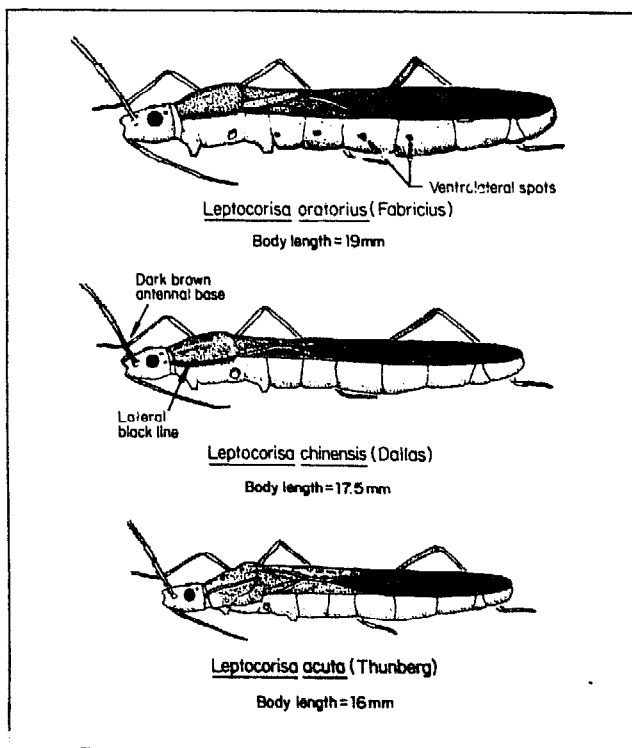

A number of other true bugs that damage rice seed are not discussed.

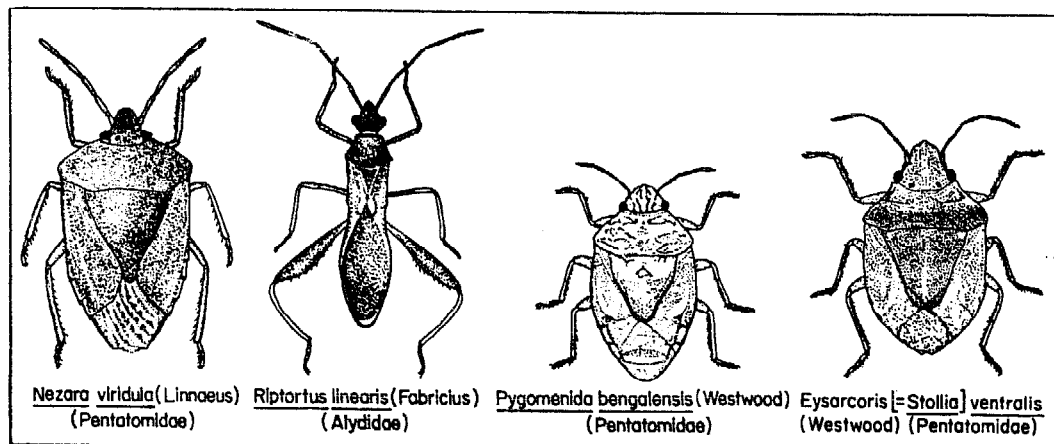

**Pest status**

Yield loss from rice bugs that feed on grains normally is minimal because their populations are highly variable, and damage occurs only during a short segment of crop growth. Rice bugs are found in all rice environments, but are more

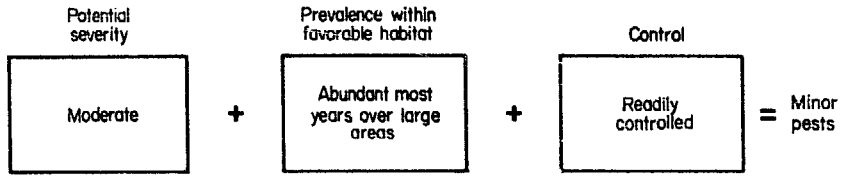

prevalent in rainfed wetland or upland rice.

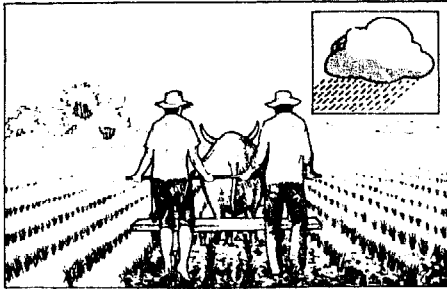

Upland

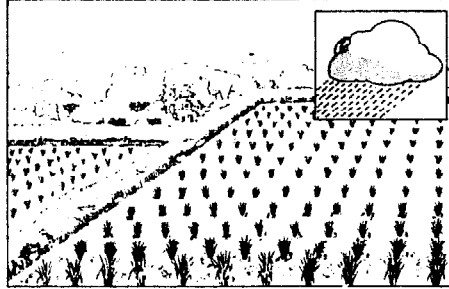

Rainfed wetland

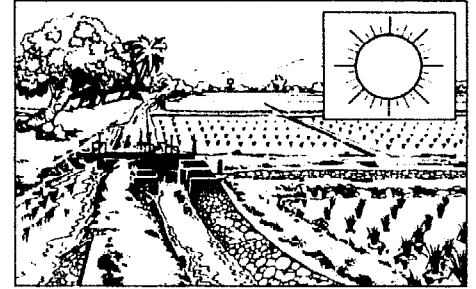

Irrigated wetland

Factors that cause high rice bug populations are nearby woodlands, extensive weedy areas near rice fields, and staggered rice planting.

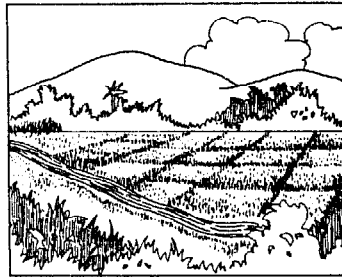

*Distribution in Asia*

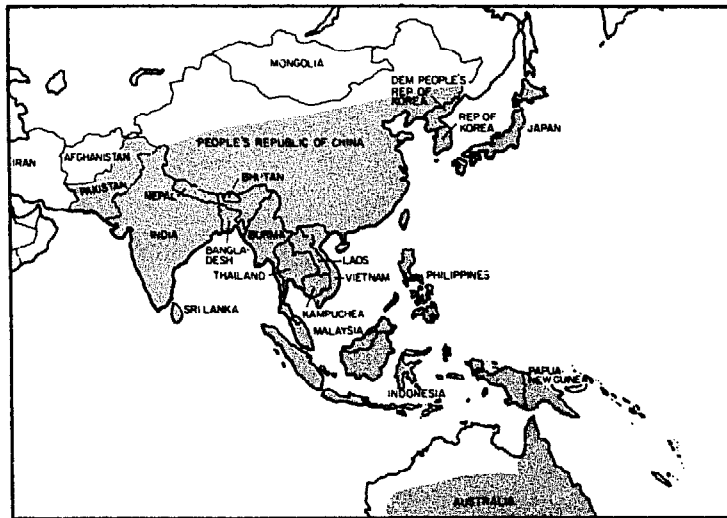

**Development and actual size**

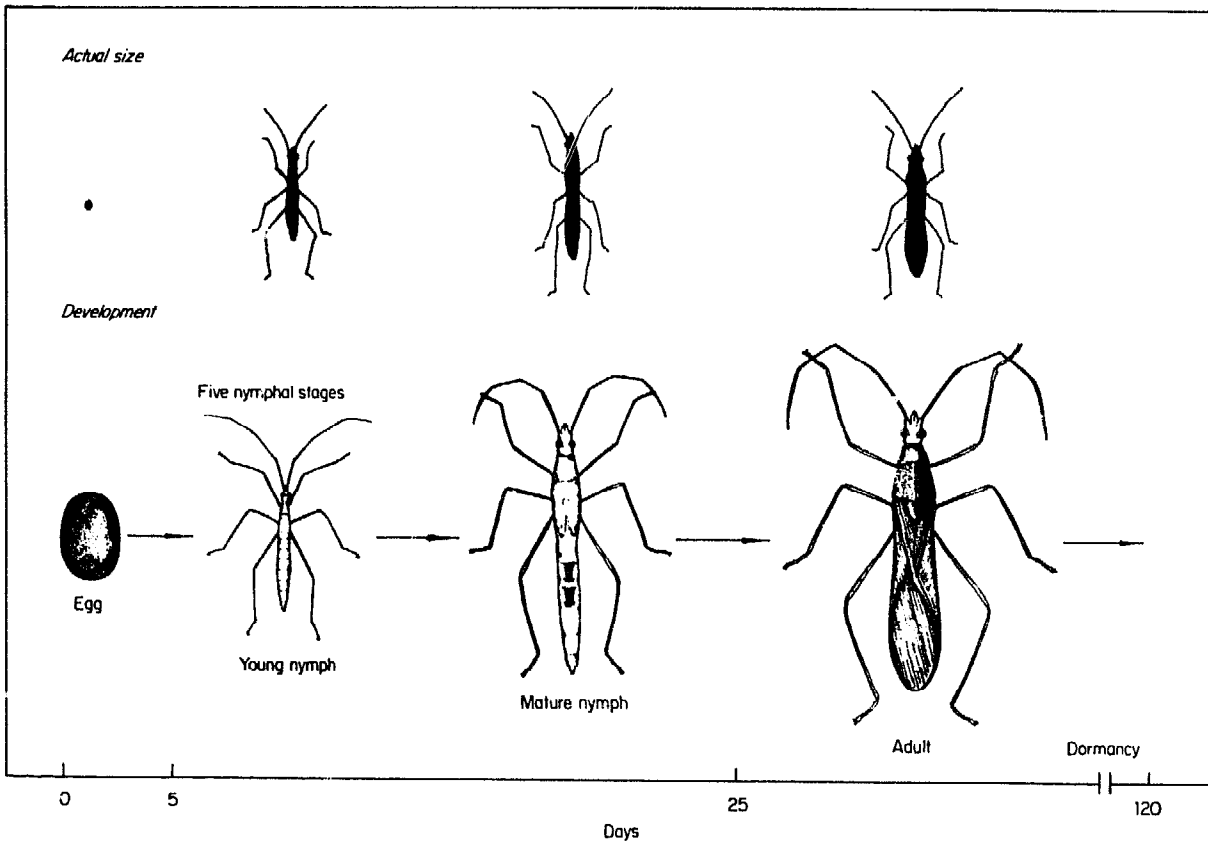

**Adult.** Adults are slender, have long legs and antennae, and brown-green bodies.

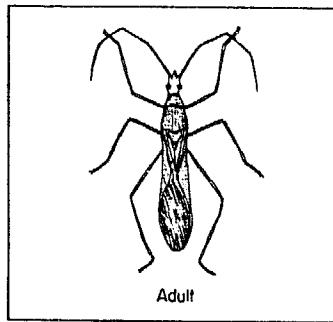

Rice bugs become active when the monsoonal rains begin.

They complete 1-2

generations on alternative grassy weed hosts before migrating to rice fields during the flowering stage.

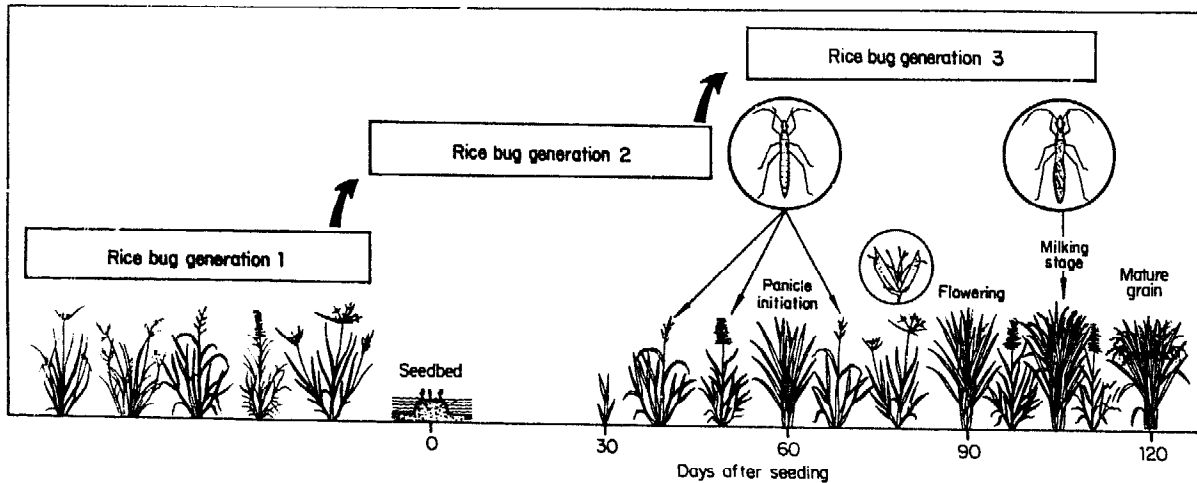

When disturbed, adults fly and give off an offensive odor from scent glands on their abdomens.

Adults are active in the late afternoon and early morning. They rest in grassy areas during periods of bright sunshine.

During the dry season, adults move to wooded areas where they remain dormant.

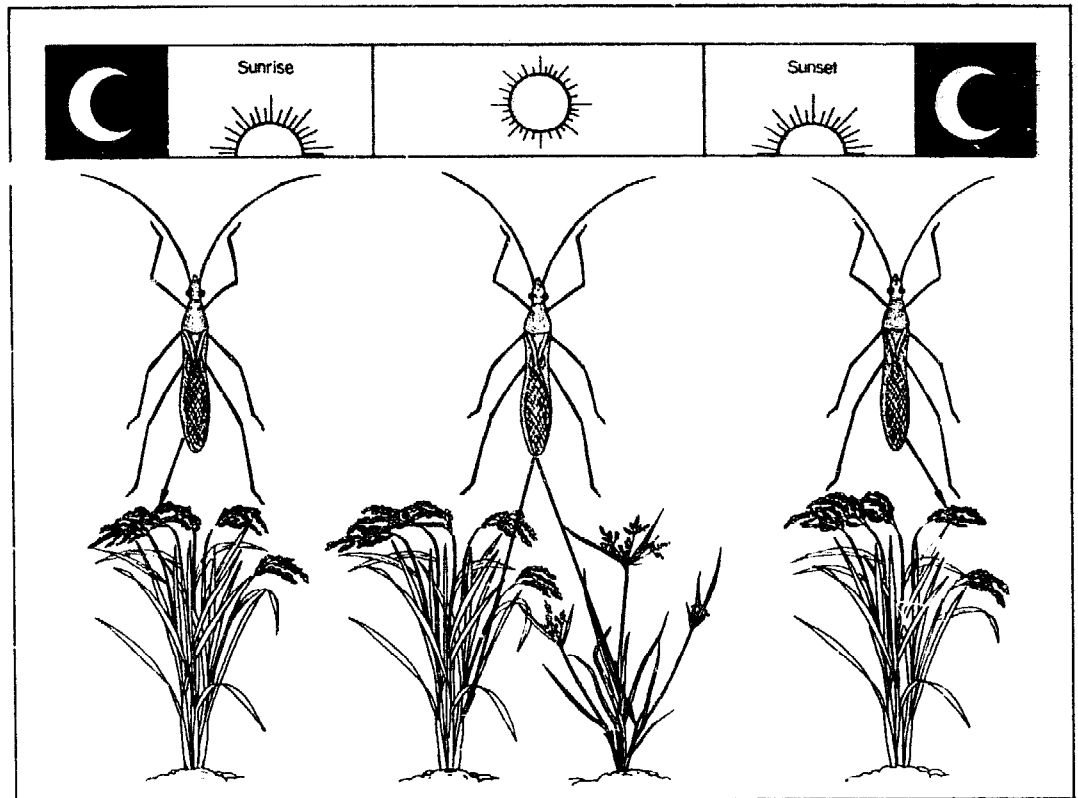

They are not readily collected in a light trap at night.

Each female may lay several hundred eggs during a lifetime of 2-3 months.

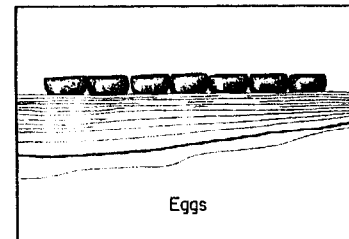
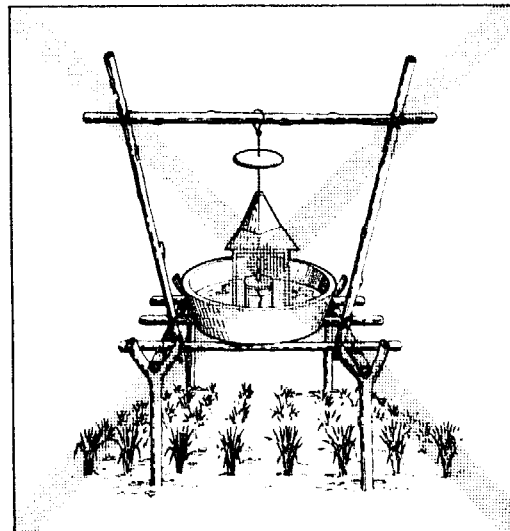

Eggs

**Egg.** The dark red-brown, disc-shaped eggs are laid in batches of 10-20 in 2 or 3 straight rows along the midrib on the upper surface of a leaf.

During hatching, the upper half of the egg breaks away, leaving a distinct hole.

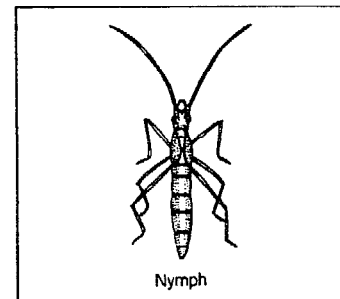
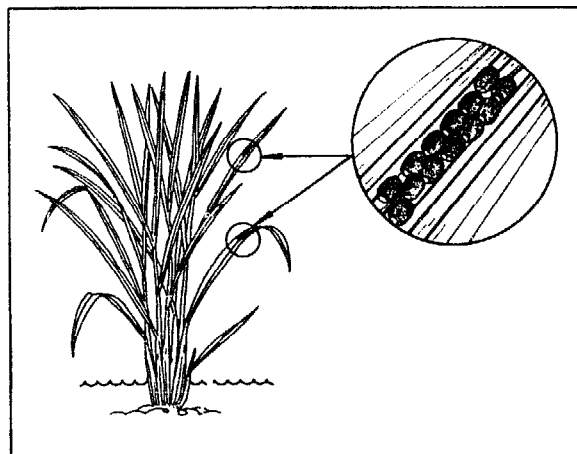

Nymph

**Nymph.** The brown-green nymphs aggregate on rice plants. They blend with the foliage and often are undetected.

**Damage**

Nymphs and adults prefer to feed on the endosperm of rice grains but also suck plant sap.

They have sucking mouthparts. To feed, they secrete a liquid to form a stylet sheath that hardens around the point of feeding and holds the mouthparts in place. Stylet sheaths are white and can be seen with the naked eye.

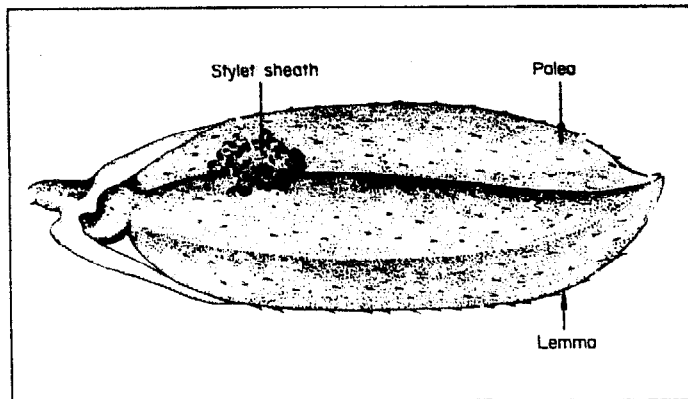

Rice bugs do not bore a hole through rice hulls as do other rice seed bugs. They enter the rice grain through the space between the lemma and the palea.

Stylet sheaths left after feeding can be found in that section of rice grains.

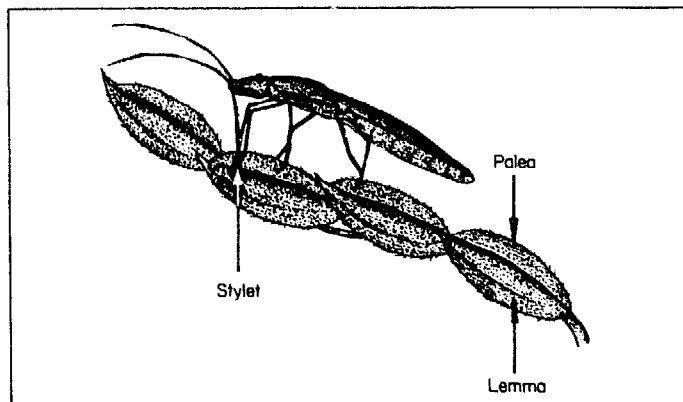

Both nymphs and adults feed on rice grains. They prefer rice at milk stage but will also feed on soft and hard dough rice grains. Growing nymphs are more active feeders than adults, but adults cause more total damage because they feed over a longer period of time. Removal of the liquid milky white endosperm results in a smaller grain.

Rice bugs do not directly cause unfilled grains because they cannot remove all the liquid endosperm from a developing grain.

When rice bugs feed on soft or hard dough endosperm in a solid state, they inject enzymes to predigest

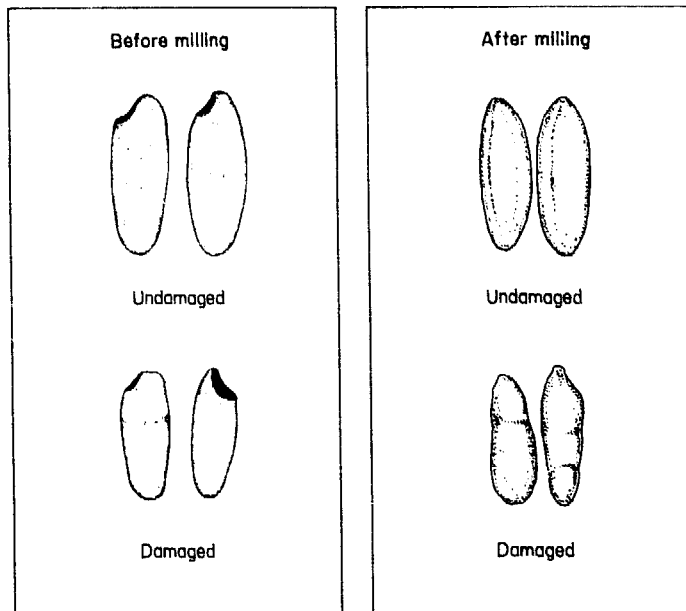

the carbohydrate. In the process they contaminate the grain with microorganisms that cause grain discoloration or pecky rice.

Damage from feeding at this stage impairs grain quality rather than reduces grain weight.

Pecky rice grains are more liable to break during milling and form broken rice.

Farmers in most countries do not realize monetary loss from pecky rice as this aspect of grain quality is usually not checked when the crop is sold.

*Plant hosts.* Many grasses act as alternative hosts, but rice and *Echinochloa* are the most important.

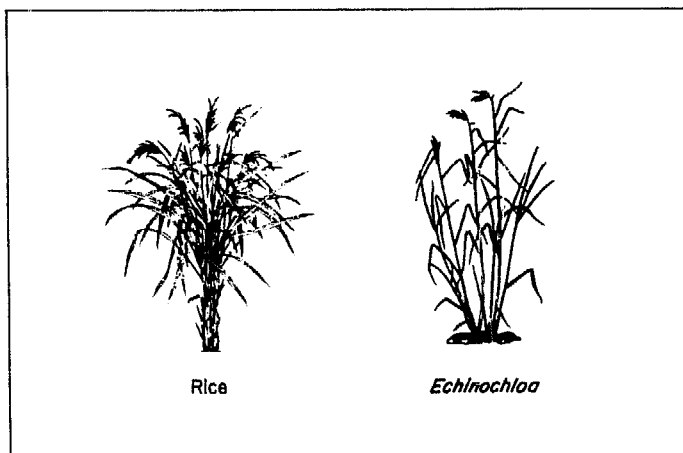

**Management**

*Cultural control.* Eliminate grassy weeds from the rice field, levees, and surrounding areas.

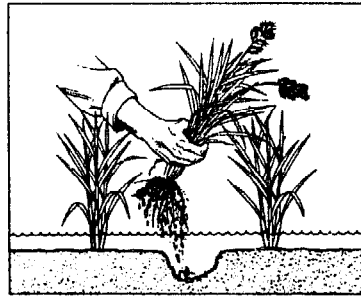

Avoid staggered planting of fields in an area.

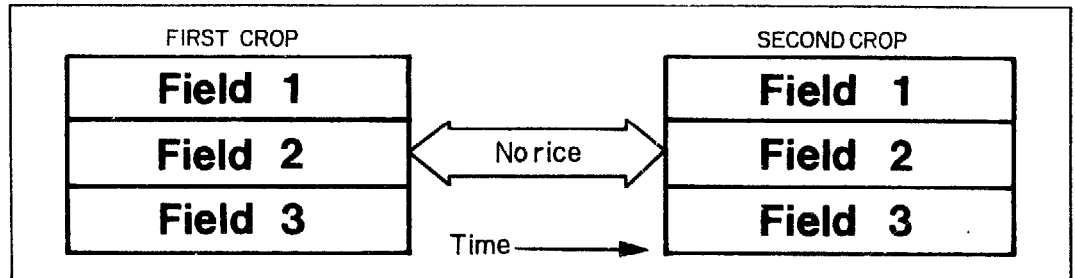

*Resistant varieties.* No resistant varieties are commercially available. Awned varieties are not resistant to rice bugs.

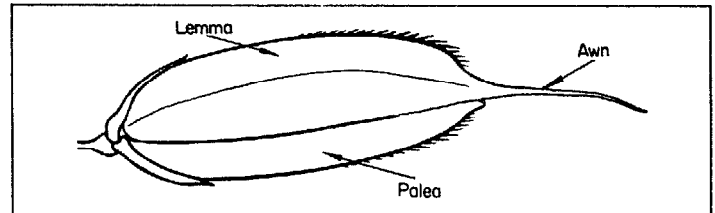
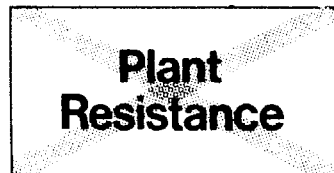

*Biological control.* Small scelionid wasps parasitize the eggs.  
 A parasitized egg shows a distinct hole where the wasp has emerged.  
 The meadow grasshopper preys on rice bug eggs.  
 Spiders prey on nymphs and adults.  
 Fungi infect both nymphs and adults.

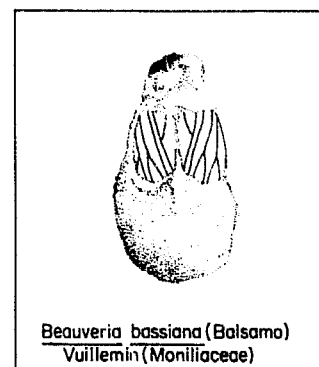
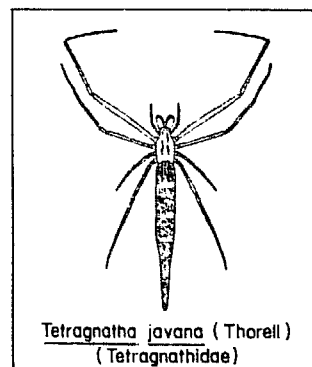
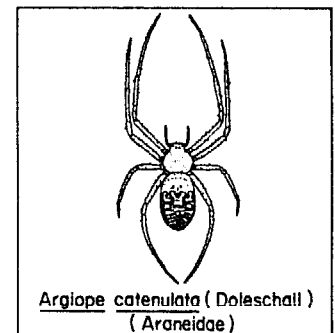
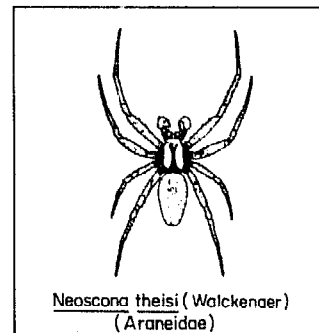
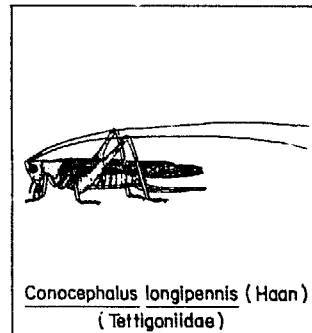
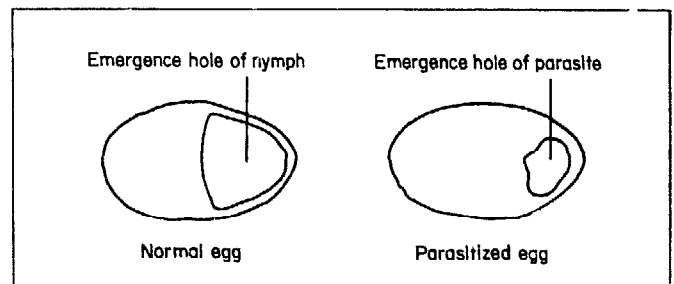
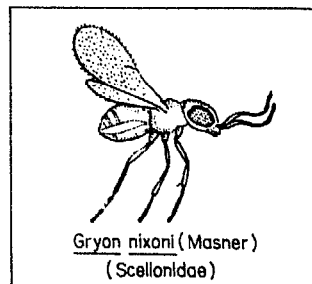

**Chemical control.**

- **Insecticide application.** The rice bug is readily controlled with spray or dust formulations.

Granular insecticides are ineffective.



- **Scouting.** Scout the fields beginning a week before the milk stage and continue twice weekly until hard dough stage.

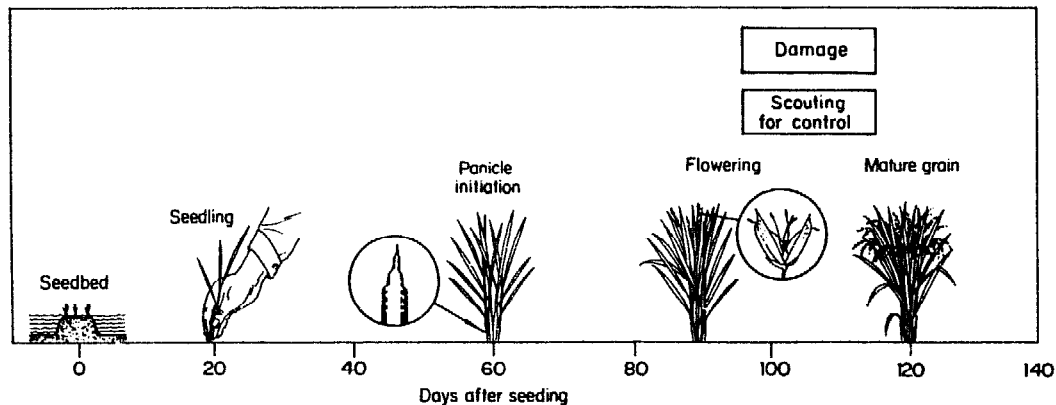

Sample early in the morning or late in the afternoon from 20 randomly chosen hills across the field.

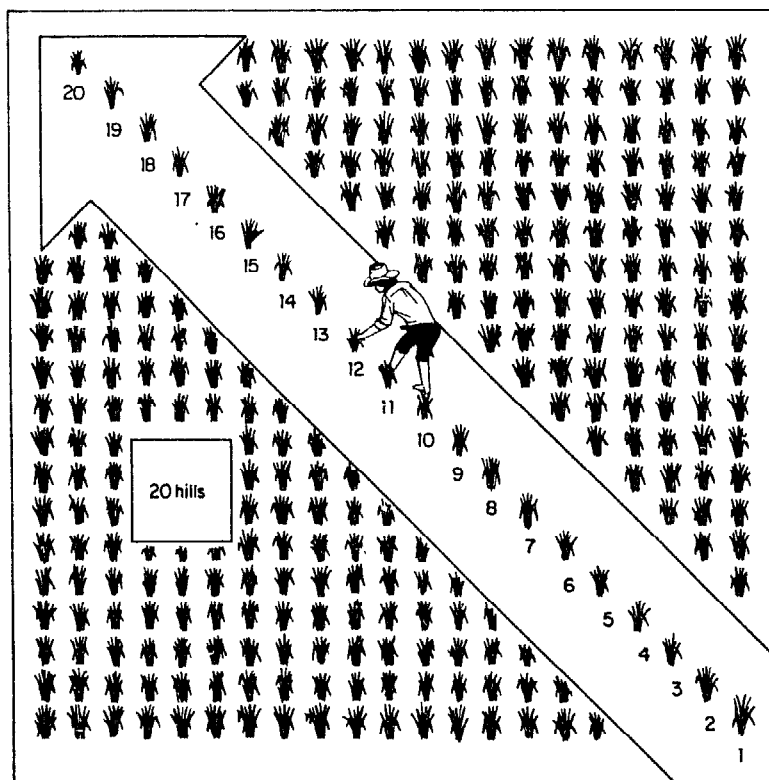

Record the number of rice bugs per hill and apply insecticide when the economic threshold is reached.

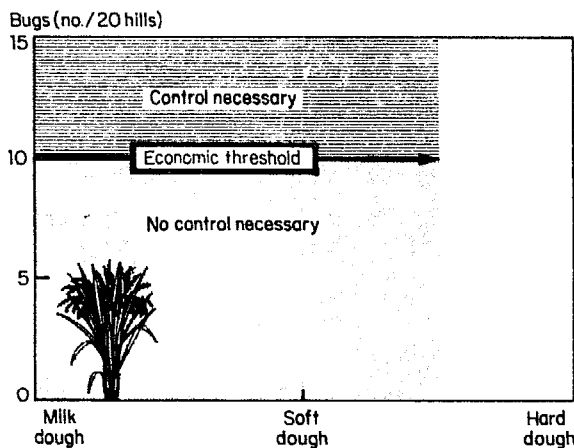



RICE PANICLE MITE (ACARINA: TARSONEMIDAE)

*Steneotarsonemus spinki* Smiley is a mite that is more closely related to ticks and spiders than to insects. It has four pairs of legs and an unsegmented body. Mites are extremely small and only someone with a trained eye can recognize them in the field. Because of their size, they are often overlooked as

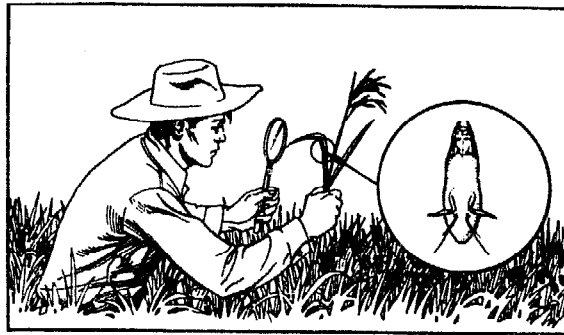

the cause of sterile panicles. Other tarsonemid mites such as *Caloglyphus* and *Tarsonemus* are also found in rice.

The most commonly known mite pests on rice are the red spider mite *Oligonychus oryzae*. As their name implies, these mites are red and spin silk webs. They are most commonly encountered in greenhouse cultures of rice, but are rarely pests in the field.

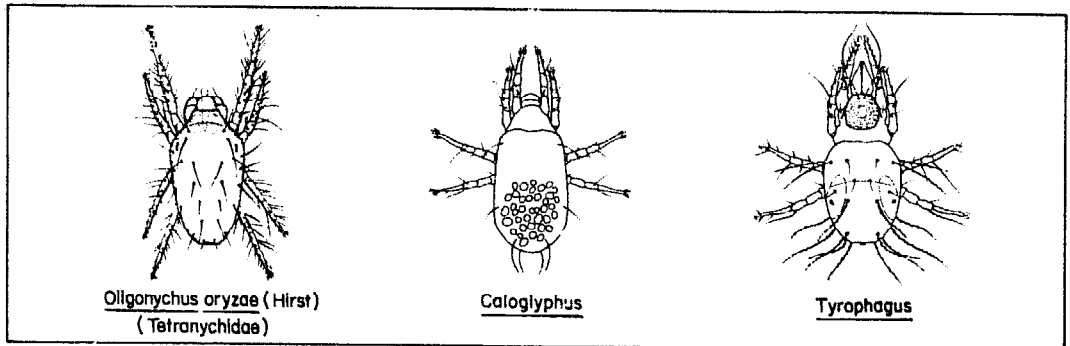

**Pest status**

The panicle mite causes unfilled grains and carries sheath rot fungus. Its population is normally held in check by natural enemies. Control by chemicals is difficult. In fact, the mite's emergence as a pest has been associated with heavy usage of insecticide.

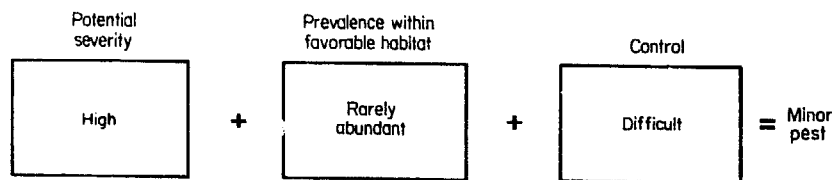

The mite is most abundant on the second crop of rice or on a ratoon. As a pest, it is associated with irrigated rice.

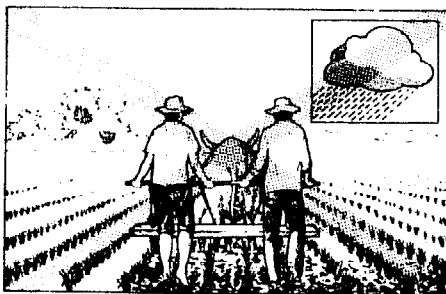

Upland

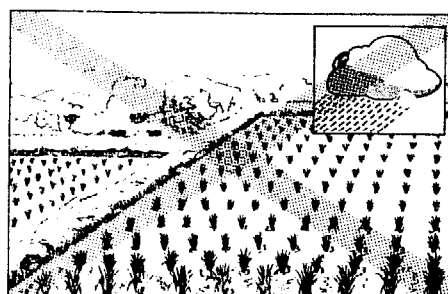

Rainfed wetland

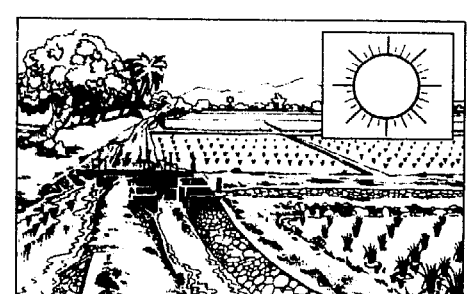

Irrigated wetland

**Distribution in Asia.** The panicle mite is probably more widespread than the records indicate.

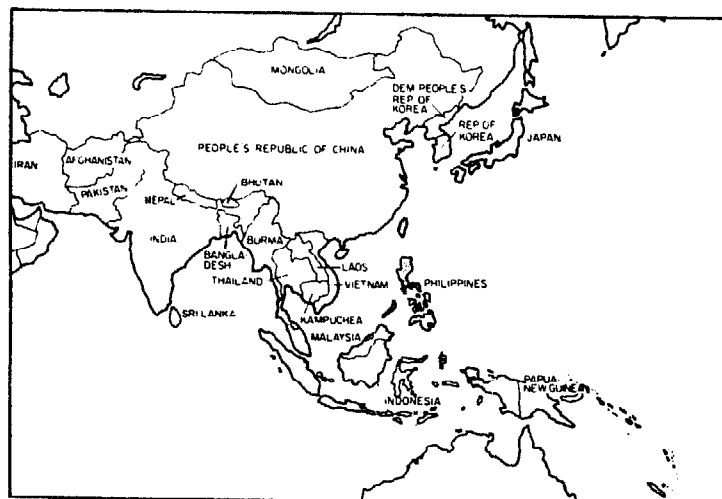

**Development and actual size**  
The life cycle is longer in temperate environments.

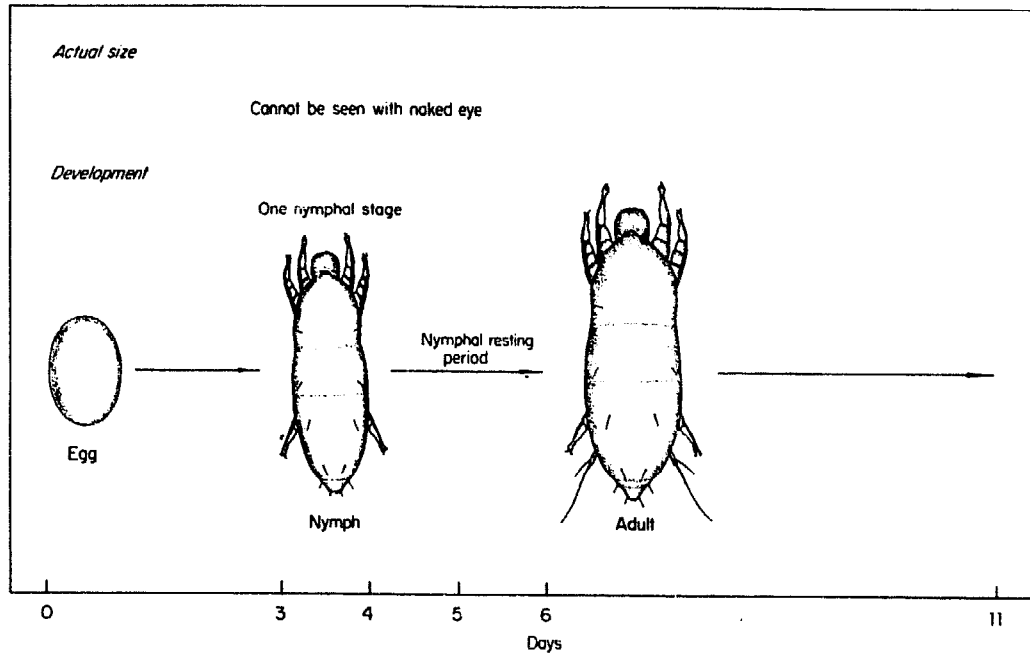

**Adult.** The tarsonemid mites are transparent and slightly brownish. The male and female distinctly differ in body shape, but each has four pairs of legs. The hind pair in the male are used as pinchers for defense; those in the female are reduced in size.

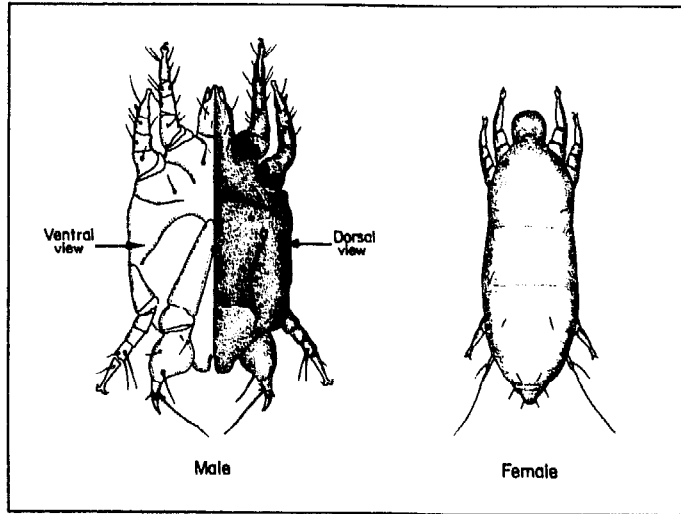

Adults are most common in the air spaces within the upper parts of leaf sheaths. Only when their numbers are high do they go to the panicles.

A female will lay about 50 eggs in its lifetime of 5 days. Nonfertilized eggs become male mites.

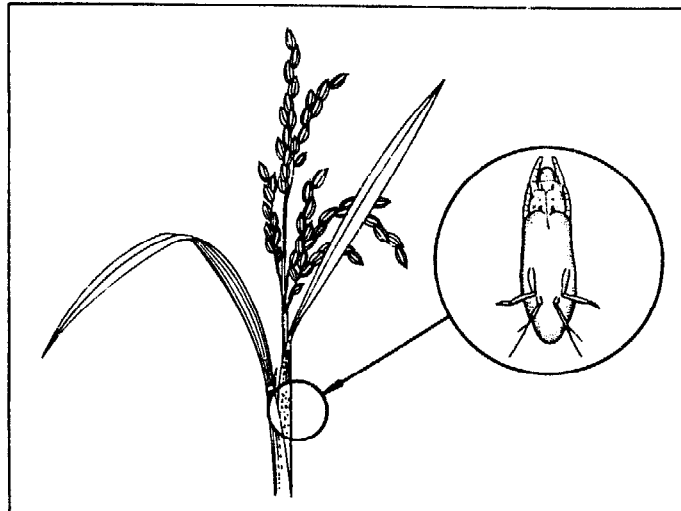

**Egg.** The ovoid eggs are white or opaque and are deposited singly in the air spaces of leaf sheaths, within a colony of mites.

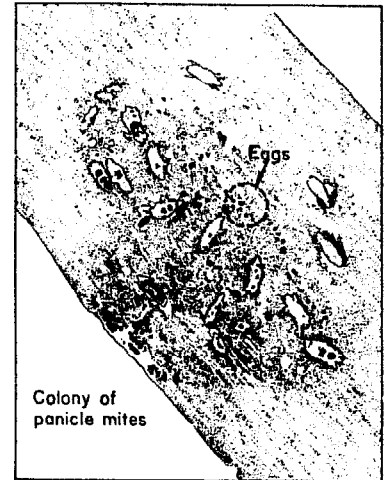
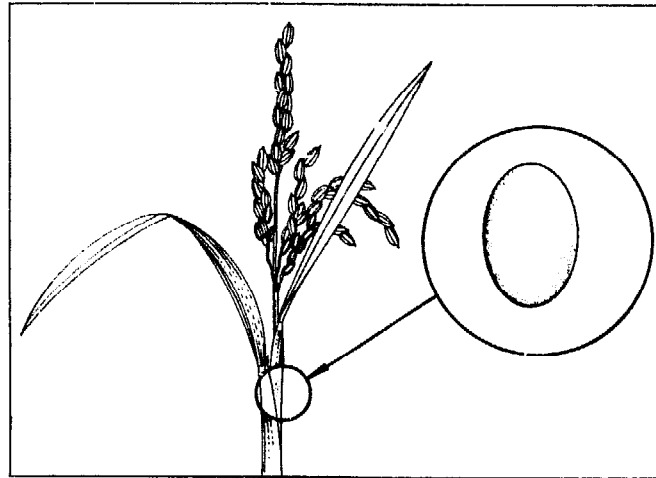

**Nymph.** Unlike the adult female, the elongate nymph has only three pairs of legs. Nymphs are transported by male adults. The nymph enters a one-day resting period before becoming an adult.

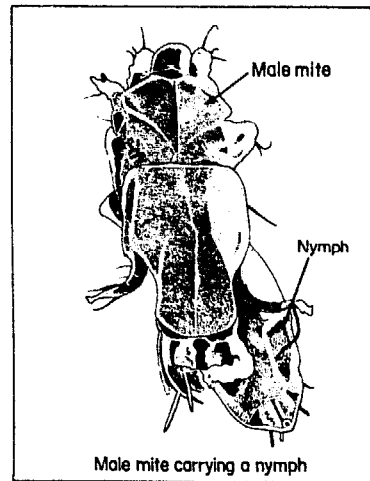
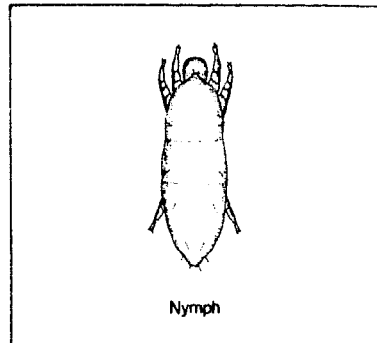

**Damage** With their needle-like mouthparts, the mites remove plant sap from within leaf sheaths. The result is elongated dark necrotic streaks that can be seen on the outer surface.

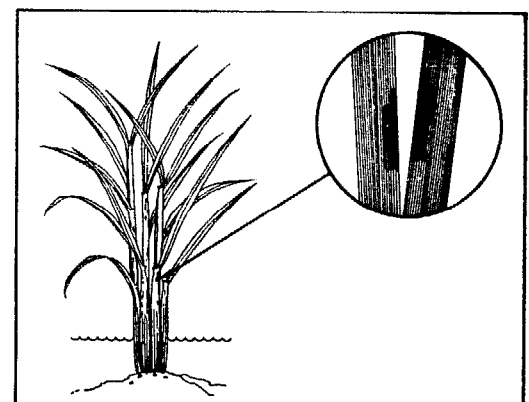
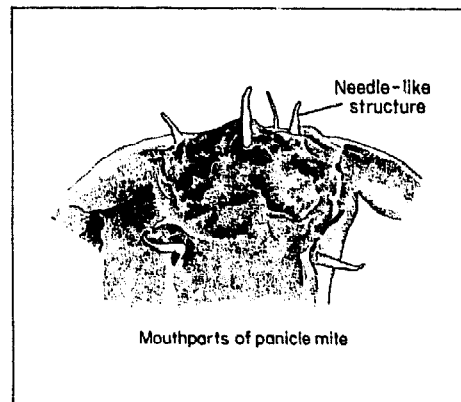

When their numbers are high, the mites crawl up to the panicle and feed on developing rice spikelets, thus causing empty grains. Panicles with many unfilled grains remain erect in the field while undamaged panicles bend because of their weight.

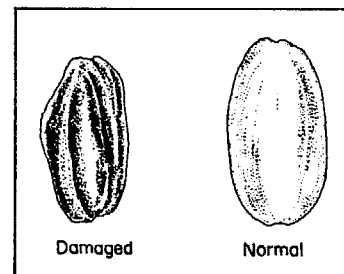
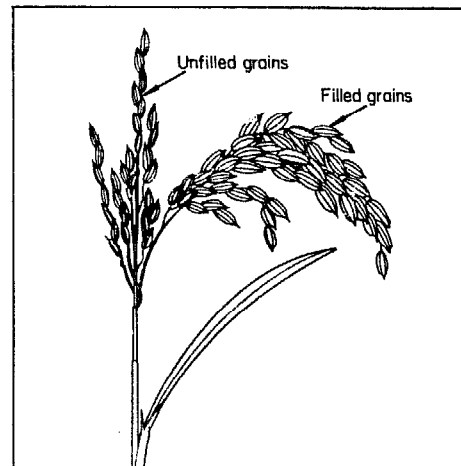

Feeding causes distortion, shrinkage, and discoloration of filled grains.

The panicle mite carries the resting stage (conidia) of the sheath rot fungus.

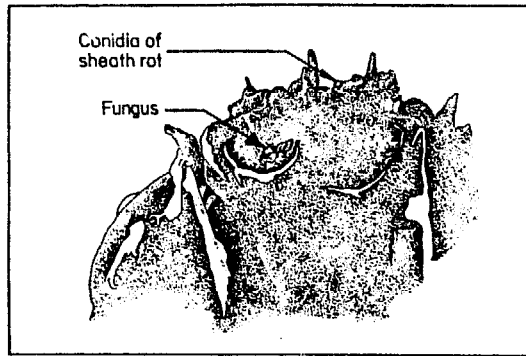

**Management**

*Cultural control.* Create a rice-free period by plowing down rice stubble between crops and planting neighboring fields within 3 weeks of each other.

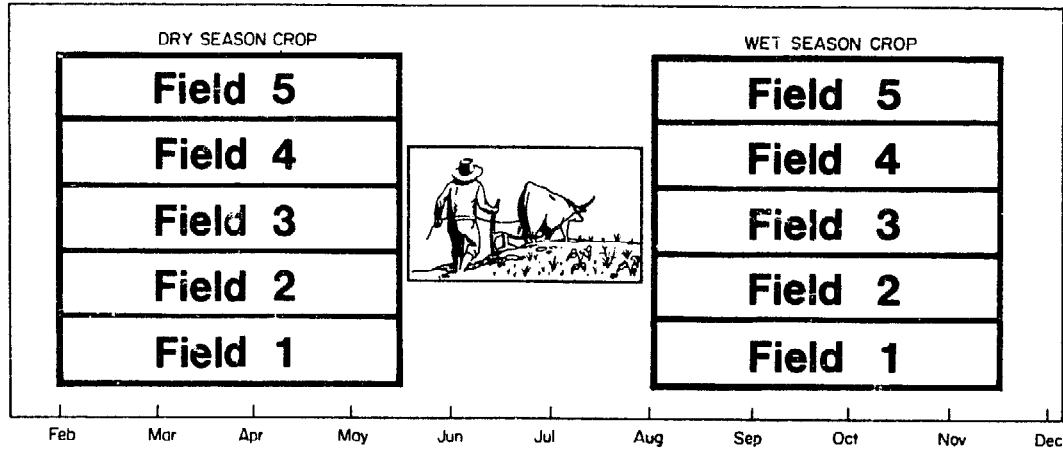

*Resistant varieties.* No resistant varieties are commercially available.

**Plant Resistance**

*Biological control.* Several species of predatory mites normally maintain the panicle mite at subeconomic numbers.

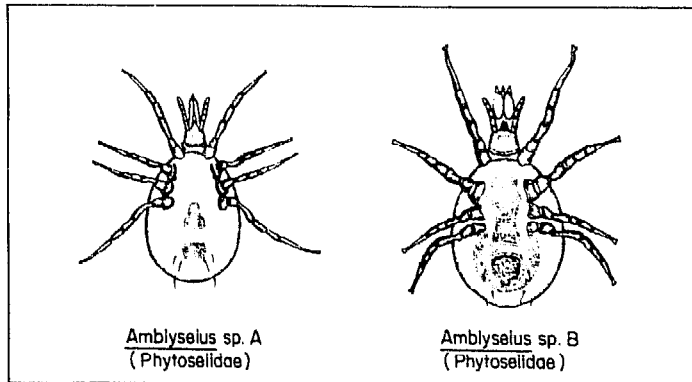

An internal parasitic protozoan also reduces panicle mite numbers.

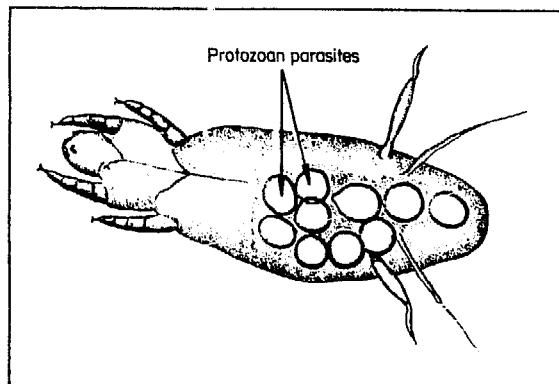

**Chemical control.**

• **Acaricide application.**

Foliar spraying is the only proven method of applying acaricides (pesticides that kill mites).

Minimize acaricide usage to conserve the number of beneficial predatory mites.



- **Scouting.** No economic thresholds have been developed for the panicle mite, but monitoring leaf sheath damage may indicate whether a problem is developing on the second crop or ratoon.

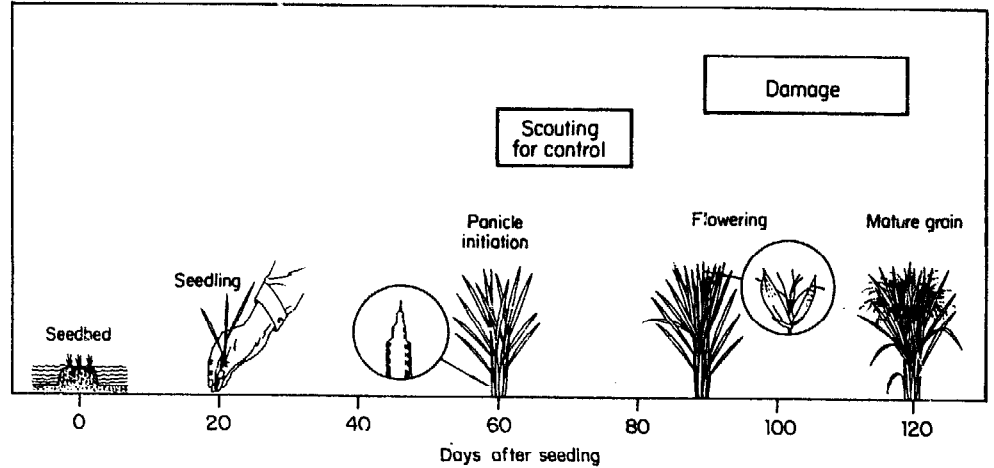

# DISEASES

## Rice Diseases

A disease is an abnormal condition that injures the plant or causes it to function improperly. Diseases are readily recognized by their symptoms — associated visible changes in the plant.

Various agents, acting either singly or in combination, cause diseases. The agents can be biotic (living) or abiotic (nonliving). Living, disease-inciting organisms are called *pathogens*.

The pathogens of rice diseases are bacteria, fungi, nematodes, viruses, and mycoplasma-like organisms.

These pathogens cause visible disease symptoms on the entire plant, or on individual plant parts such as leaves, stems, leaf sheaths, panicles, or grains.

Rice disease symptoms can be categorized in several groups:

1. Overall dwarfing or stunting of the plant,
2. Changes in color, such as yellowing or chlorosis,

3. Necrosis or death of the tissues (leaf spot, streak, scald, etc.),
4. Wilting due to interference in water movement within the plant,
5. Unusual development or transformation of organs (false smut, kernel smut, etc.).

A disease is the result of the interactions between a pathogen and a host in a favorable environment. A disease generally occurs because the host cultivar is susceptible, the pathogen strain is virulent, and the environment is favorable. An understanding of the disease "triangular relationship" helps control the disease.

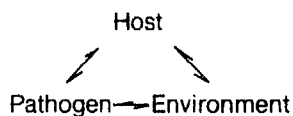

An *epidemic* or serious outbreak of a disease occurs when a disease increases

over time in a crop population.

Cultural conditions and cultural practices may influence disease incidence and severity. Blast disease is more severe in upland than in lowland growing conditions. Nitrogen fertilizer affects blast development. The greater the rate of nitrogen application, the more severe the disease.

The biotic environment may influence disease. Tungro incidence and spread increase with an increase in number of its vector, the viruliferous green leafhopper. As vectors, the adult insects are three times more efficient than nymphs. The incidence and spread of rice virus diseases in the tropics are determined by the dispersal, movement, and migration of viruliferous vector insects.

Host-plant resistance can control plant diseases. But certain pathogens such as those that cause blast dis-

ease are extremely variable; thus, they can shift rapidly and shorten the effective life of a resistant cultivar.

Varietal resistance is essential as the base of effective disease control, but other control measures such as chemicals are sometimes necessary. Varietal resistance to bacterial blight and grassy stunt lasts longer than resistance to blast.

A high level of resistance to certain rice diseases such as sheath blight and stem rot has not been identified in modern rice cultivars. Cultural practices and chemicals are presently the most important methods for controlling those diseases.

Diseases that progress slowly are generally managed more easily than those that progress rapidly. The management of rapid-spreading diseases is difficult.

## RICE BLAST

Rice blast is caused by the fungus *Pyricularia oryzae*. It is one of the most destructive diseases of rice, causing as much as 50% crop loss in areas where severe outbreaks occur.

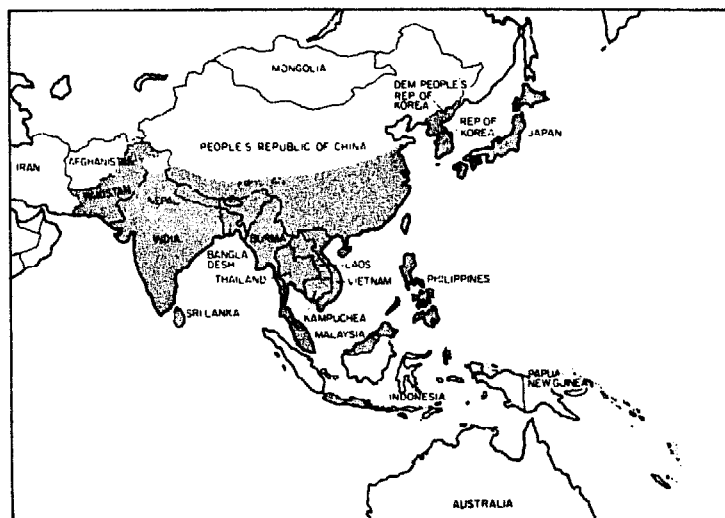

## Symptoms

- The fungus produces spots or lesions on leaves, nodes, and parts of the panicles and grains. The spots are elongated and pointed at each end.
- Severely infected leaves are killed.

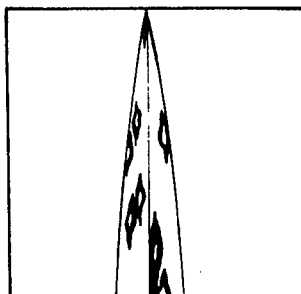

- The size and shape of the spots vary on different rice varieties.

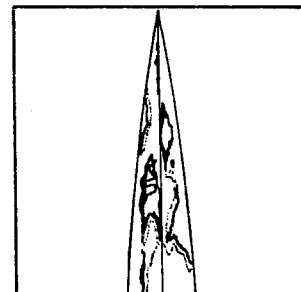
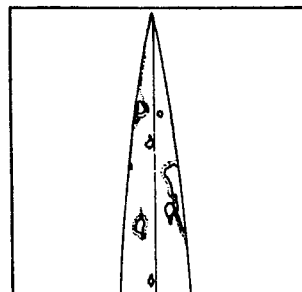
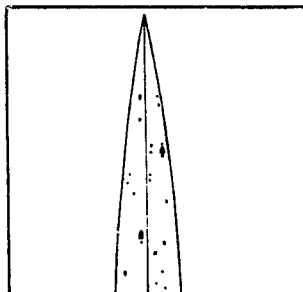

- Infected nodes turn blackish and break easily.
- Any part of the panicle may also be infected.
- When the base of the panicle is attacked, it turns brown and the stem usually breaks just below the panicle.

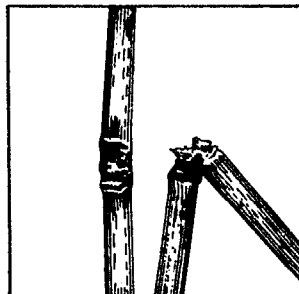



**Disease cycle**

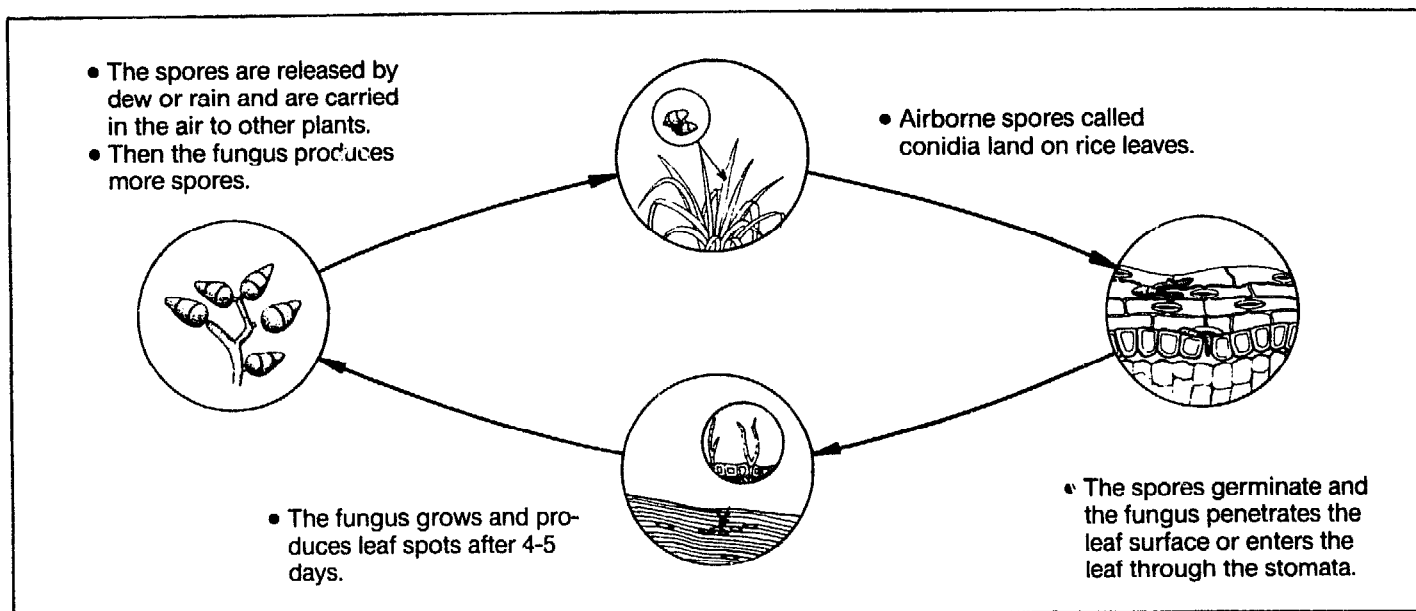

**Factors favoring the development and severity of rice blast**

- A high amount of quick-acting fertilizer, such as ammonium sulfate.
- Cloudy skies, frequent rain, and drizzles.
- A relative humidity of 90% and higher. Long periods when leaves are covered with dew.
- Blast spores are present in the air throughout the year in the tropics, and the disease develops continuously.
- Seedlings in the tropics are often severely damaged, but severe infection after transplanting is rare.
- Blast damages dryland rice more severely than it does wetland rice.

Days after seeding

**Control**

*Resistant varieties*

- Planting resistant varieties is the most practical and economical way of controlling rice blast.

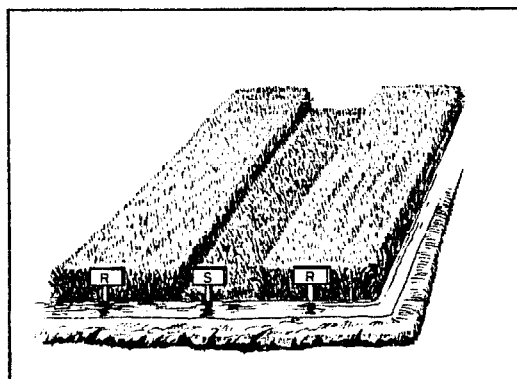

*Chemical control*

- Several fungicides will control rice blast on leaves and panicles. For technical and economic reasons, chemicals are not widely used for blast control in the tropics.

**Cultural control**

- Raise seedlings in wetland conditions.
- Avoid excess nitrogen fertilizer.
- Split fertilizer applications.

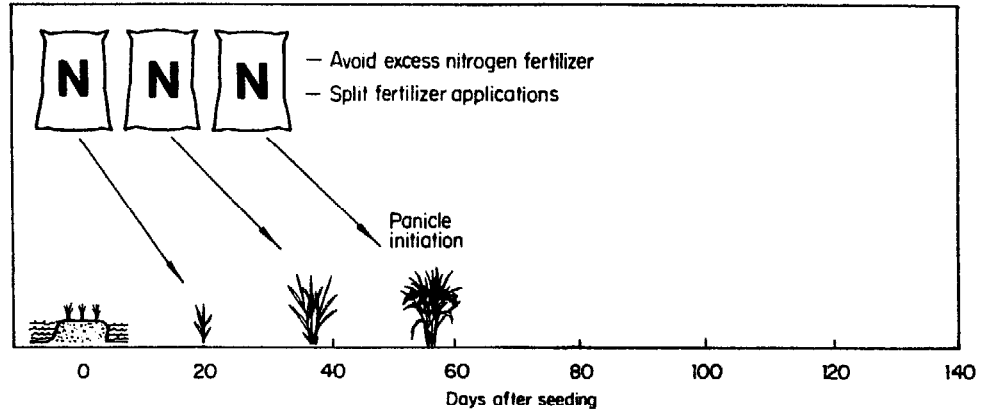
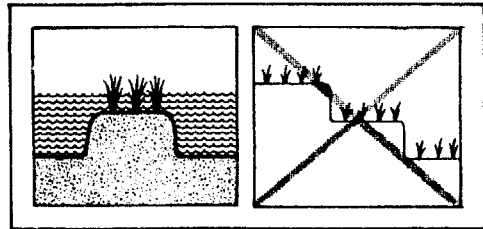

**SHEATH BLIGHT**

Sheath blight is caused by the aerial form of the fungus *Rhizoctonia solani*. It occurs both in the tropics and in the temperate areas. Severity of the disease depends on cultivation, land preparation, varieties, crop management, etc.

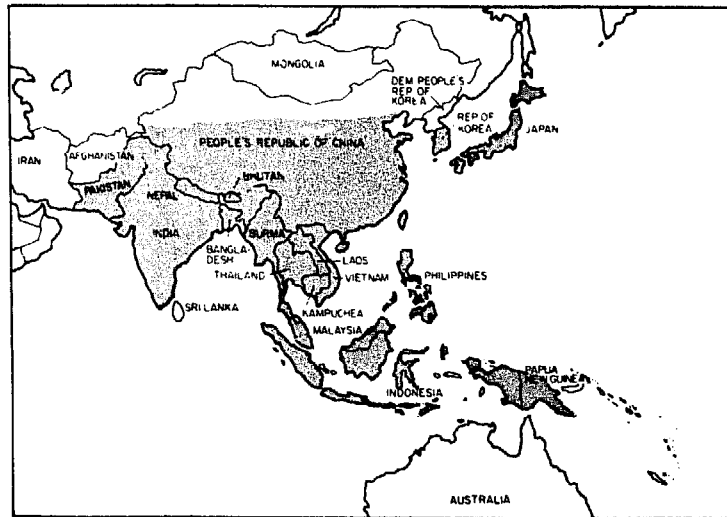

**Symptoms**

- Sheath blight causes spots mostly on the leaf sheath, but spots may also occur on the leaf blades if conditions are favorable.
- Infection bodies called sclerotia form on the spots.
- Many of the plant's leaves are killed during severe infections and yields may be reduced 20-25% if the disease develops at booting stage.

**Disease cycle**

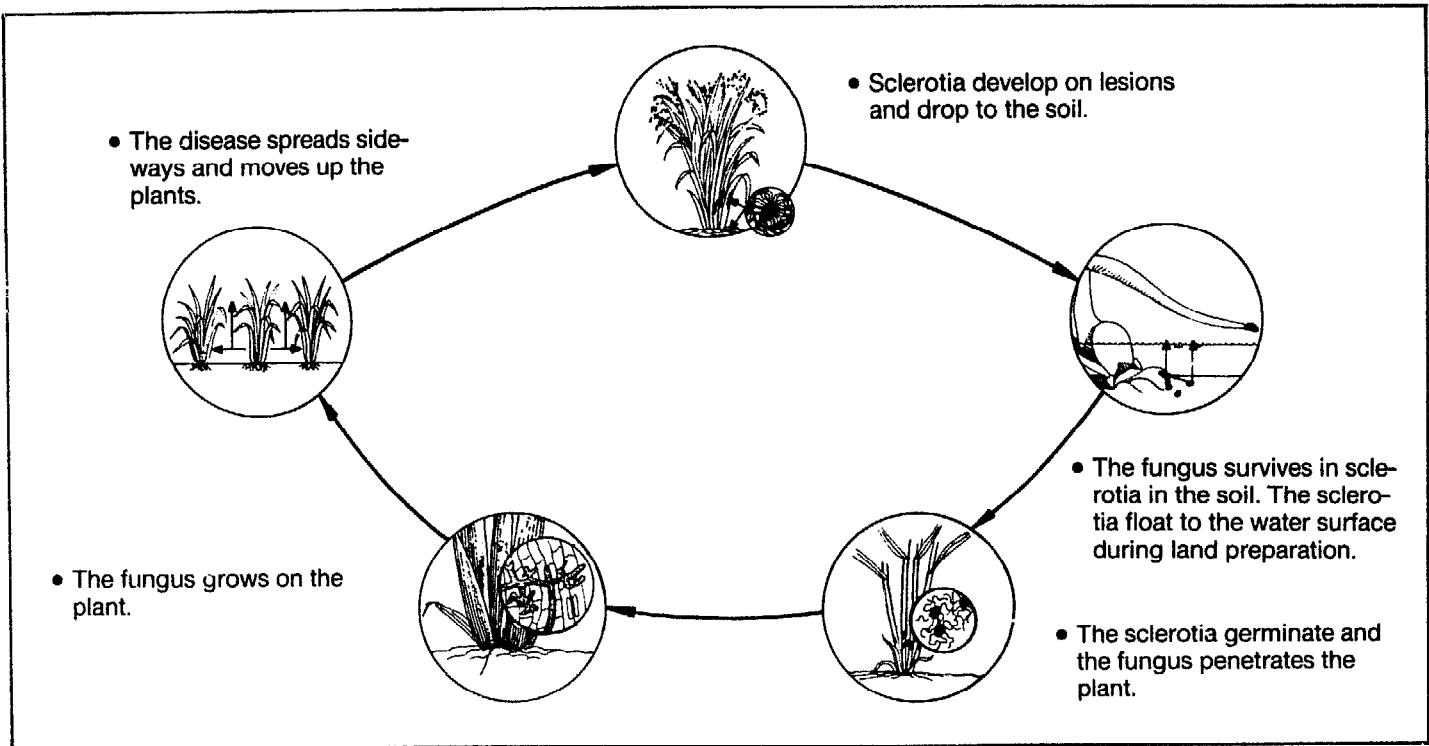

**Factors increasing the severity of sheath blight in the field**

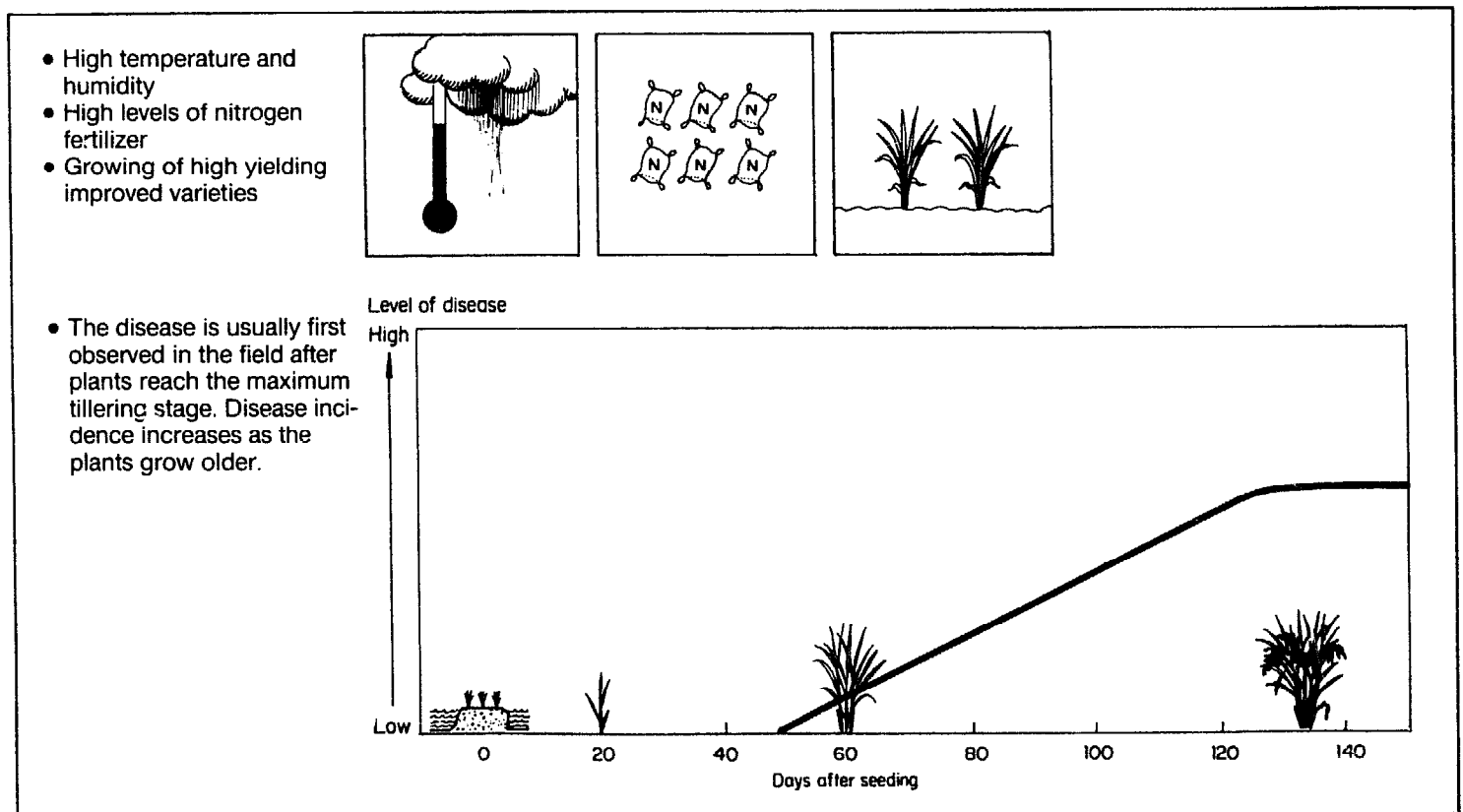

**Control**

**Resistant varieties**

- No variety has a high level of resistance to the disease, but some moderately resistant varieties have been selected.

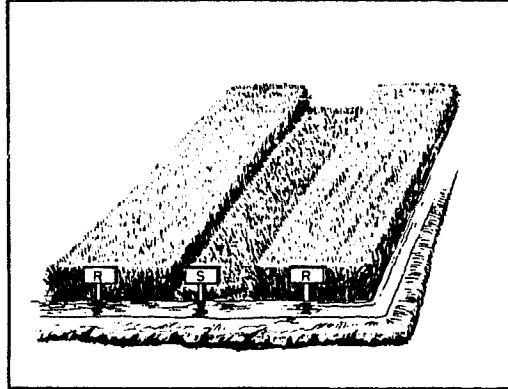

**Chemicals**

- There are fungicides efficacious in controlling the disease.
- Sprays should be applied on the leaf sheath when infection is at the maximum tillering stage, and again at the booting stage.

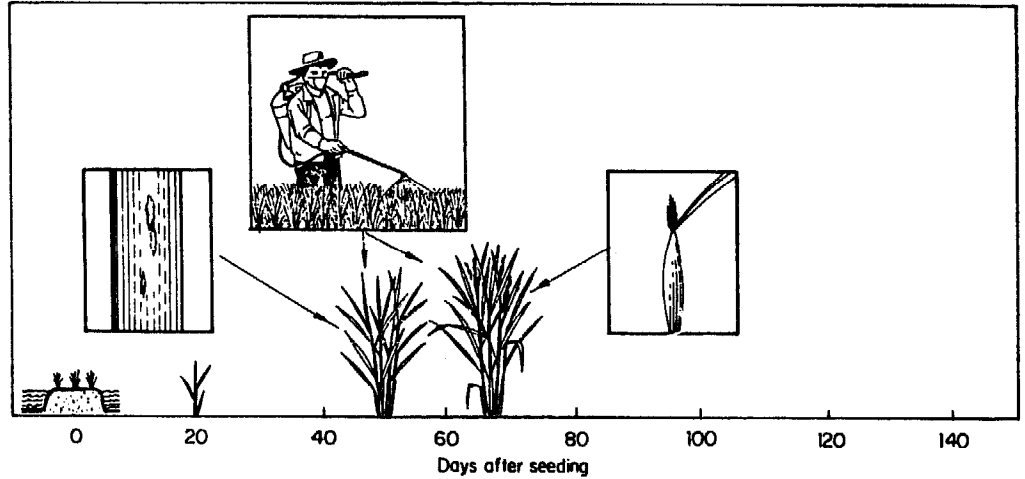

**BAKANAE**

Bakanae is caused by the fungus *Gibberella fujikuroi*. Severe damage from the disease is rare, but crop losses up to 20% may occur in outbreak areas.

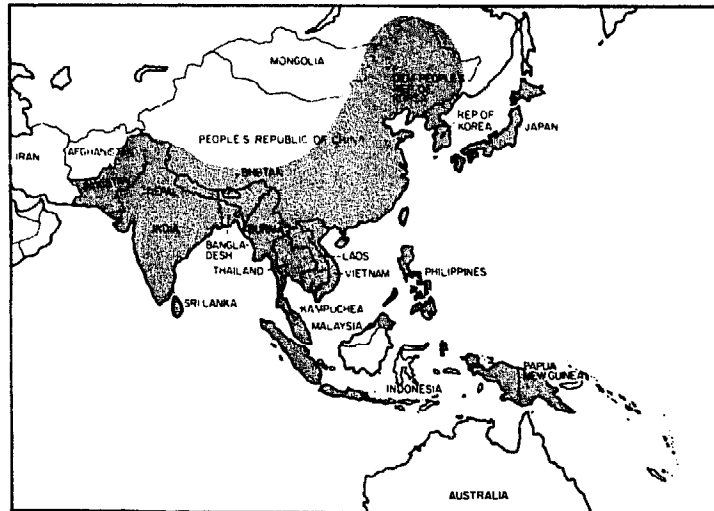

Symptoms

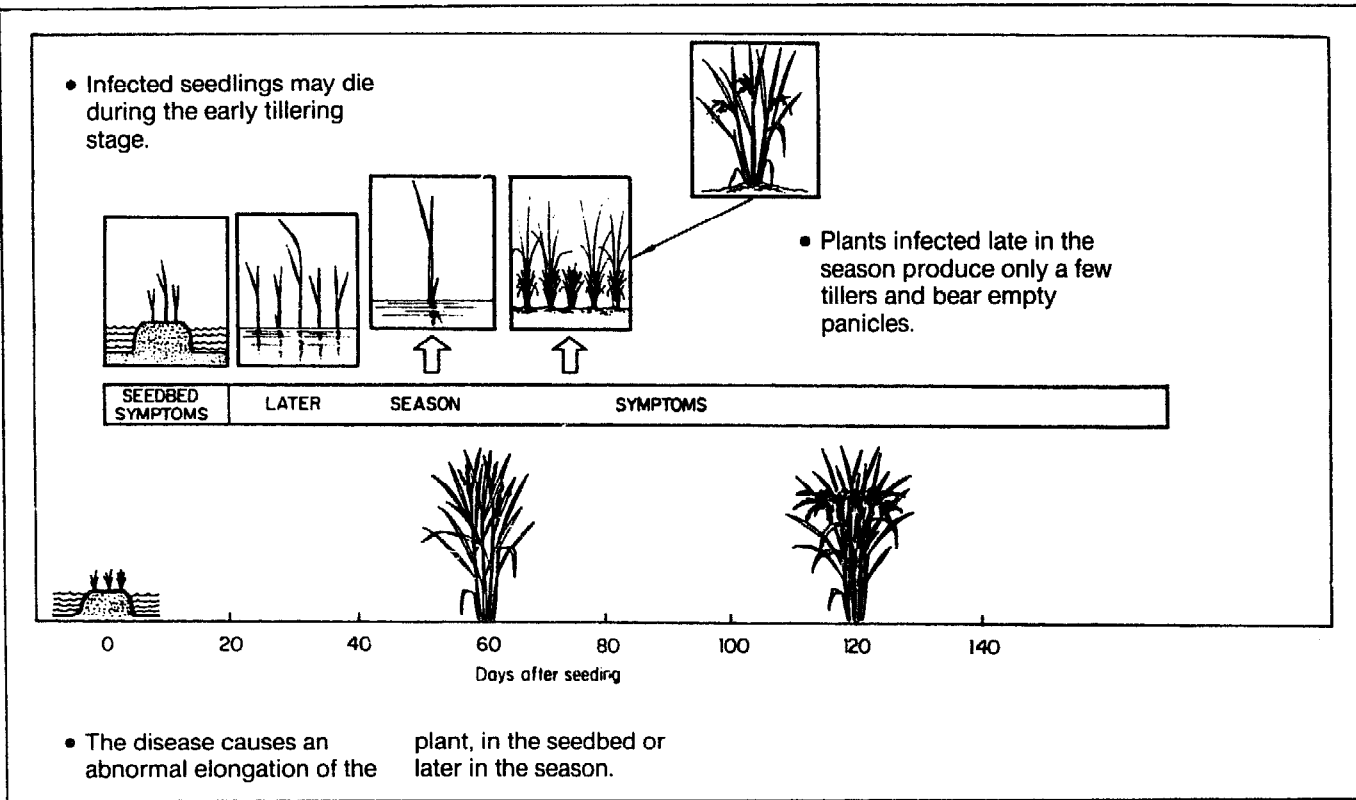

Disease cycle

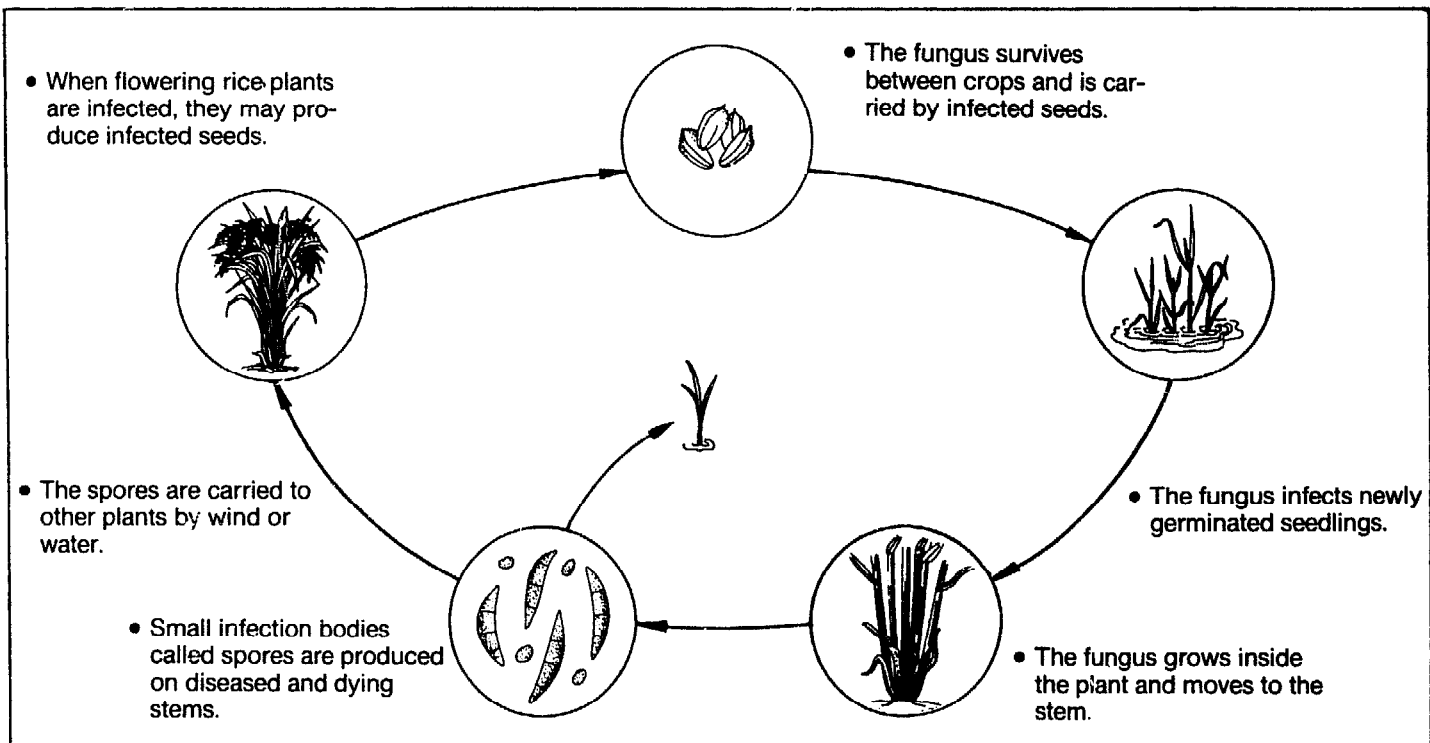

- The development of bakanae is favored by high temperatures and high levels of nitrogenous fertilizer.

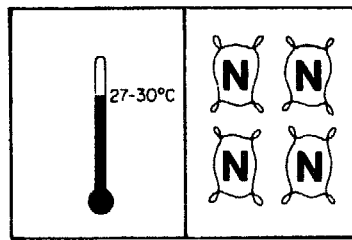

**Control**

*Resistant varieties*

- Some varieties are more susceptible to bakanae than others. Do not plant a susceptible variety in areas where the disease is severe and do not use seeds from infected fields.

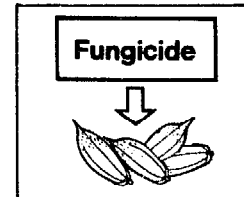
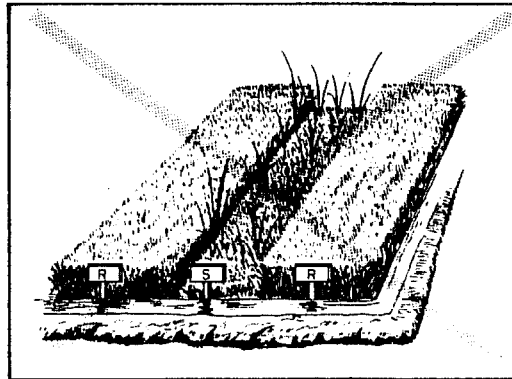

*Chemical control*

- The disease can be effectively controlled by treating the seeds with fungicides before planting.

**BROWN SPOT**

The brown spot disease of rice is caused by the fungus *Helminthosporium oryzae*.

The disease is common in soils that are poorly drained or deficient in nutrients. It is often difficult to separate the losses caused by brown spot from those caused by soil deficiencies.

The disease is rare in rice crops grown on fertile soil.

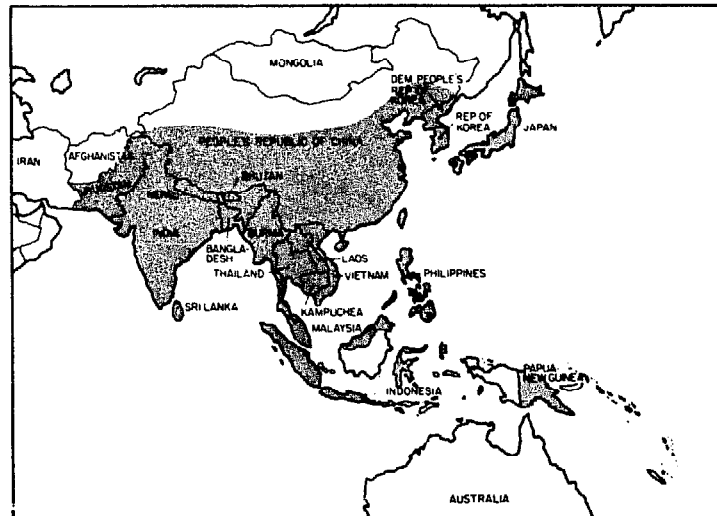

**Symptoms**

- The most common symptoms are spots on the leaf and glumes or grains in the panicle. A fully developed spot has the size and shape of a sesame seed.
- Seedling blight may occur in seedlings grown from heavily infected seeds.

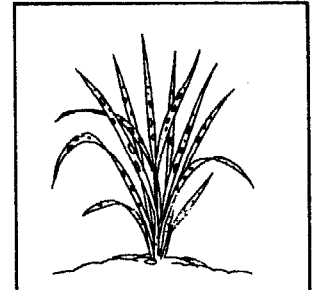
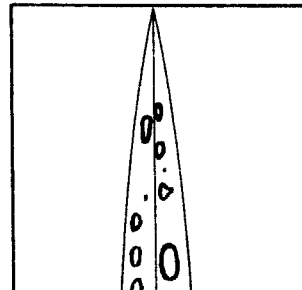
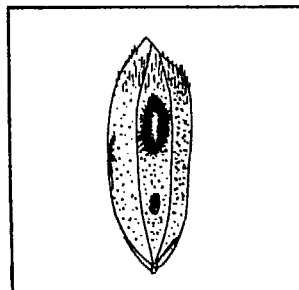

**Disease cycle**

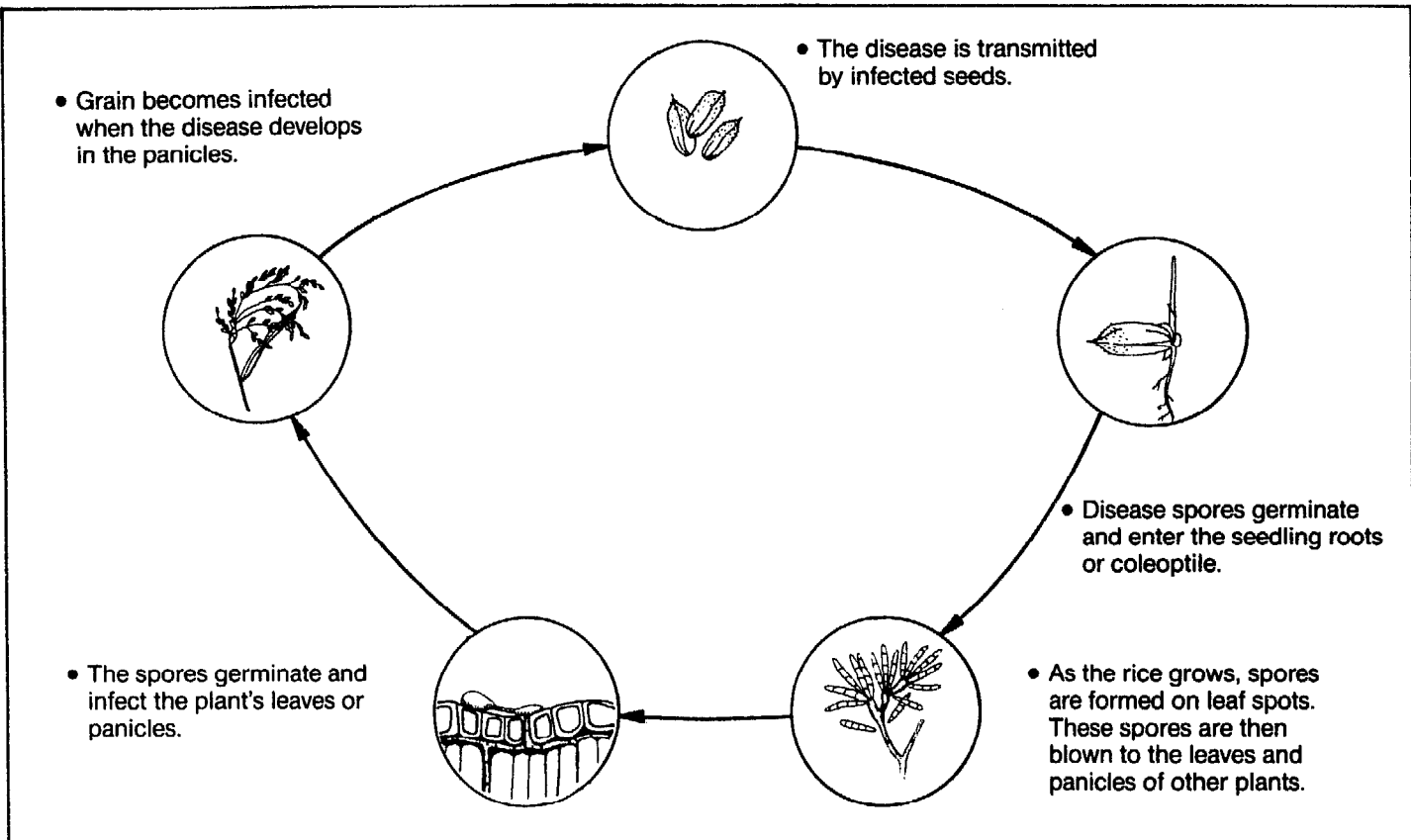

- The condition of the soil is important in regulating the severity of brown spot.

- Plants grown in poorly drained soils lacking silica, potassium, nitrogen, man-

- ganese, or magnesium are easily attacked by the fungus.

**Type of damage**

- Brown spot may kill up to 50% of seedlings.
- It lowers grain quality and weight.

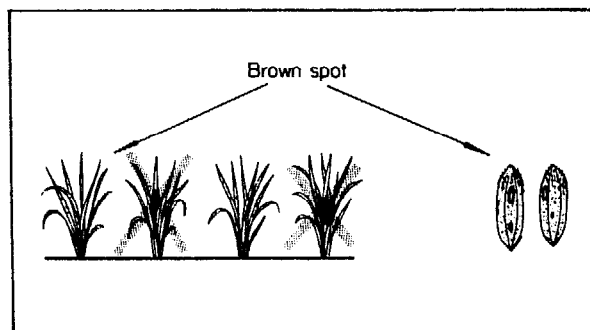

**Control**

**Resistant variety**

- Planting a resistant variety is the most practical way of controlling brown spot in areas where the disease is common and serious.

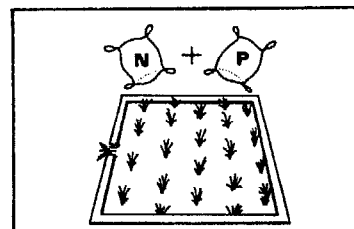
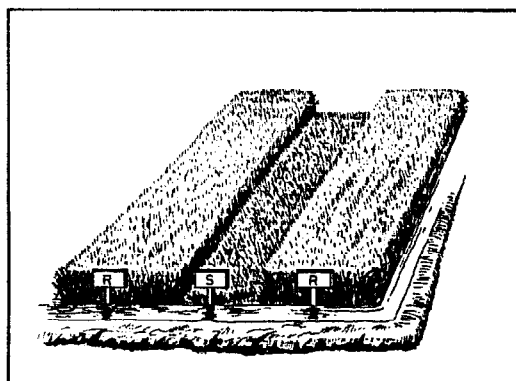

**Cultural control**

- The most effective way of controlling brown spot is to grow plants in good soil and provide adequate fertilizer.

**Chemical control**

- Treating the seeds with fungicides or hot water will also help control the disease.

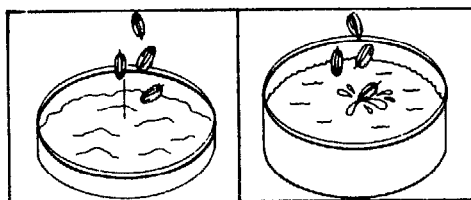

**SHEATH ROT**

Sheath rot is caused by the fungus *Acrocyndrium oryzae*.

Little is known about crop losses caused by sheath rot, but it is not uncommon for 10-30% of the tillers to be infected in fields where the disease occurs.

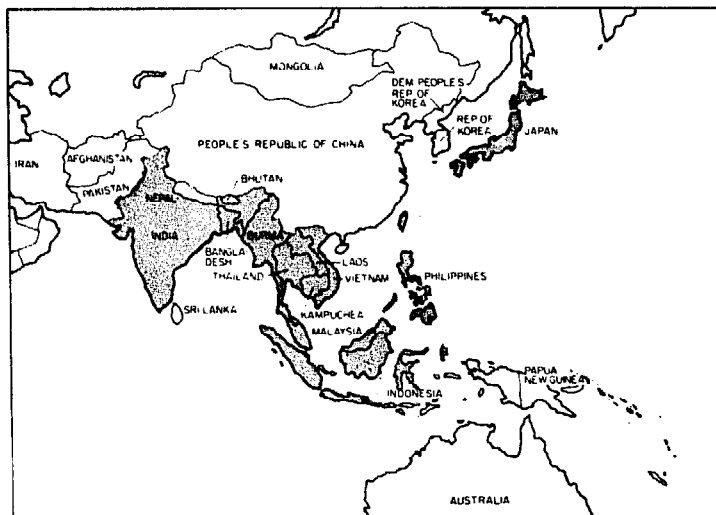

**Symptoms**

- Spots develop on the uppermost leaf sheaths enclosing the panicles.

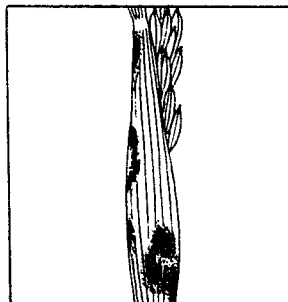
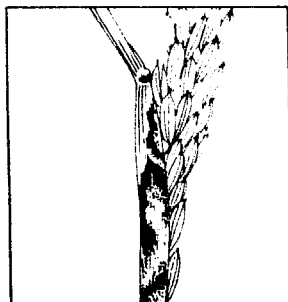

- The young panicles remain in the leaf sheath or emerge only partially. Grains remain unfilled or are discolored.
- A whitish, powdery fungal growth occurs on the panicle inside the sheath.
- Eventually, the panicle may rot.

**Disease cycle**

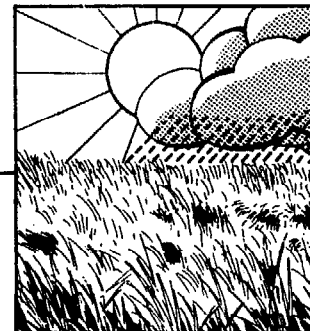
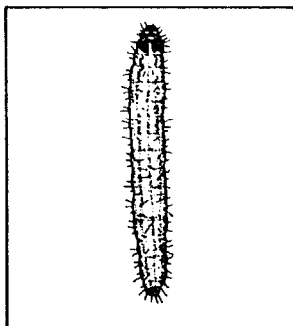

- Little is known about the life cycle of the fungus.
- The disease is usually found in plants injured by

insects or diseases, particularly stem borer and viruses.

- Hot humid weather favors sheath rot development.



**Control**

- Little is known about control of the disease, but some varieties are more susceptible than others.

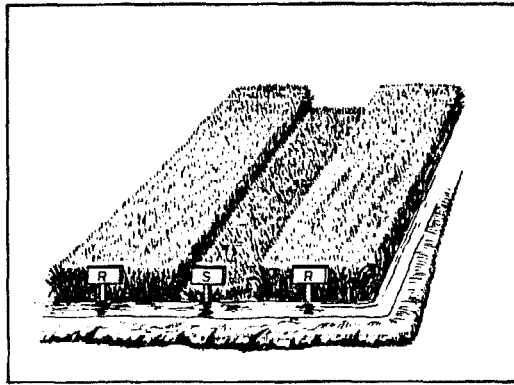
**NARROW BROWN LEAF SPOT**

The narrow brown leaf spot disease is caused by the fungus *Cercospora oryzae*.

The disease causes serious losses only on very susceptible varieties.

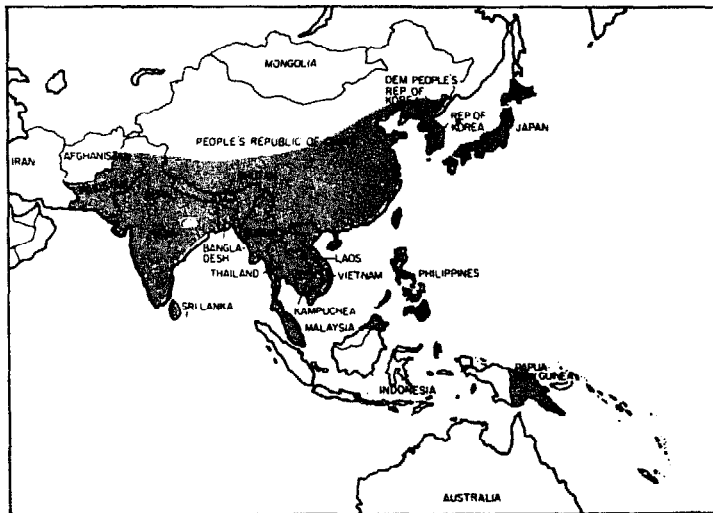
**Symptoms**

- The disease produces linear spots, mostly on the leaf blades. Spots may also occur on the leaf sheath and rice hulls.
- Symptoms usually appear first on the flag leaf during later growth stages.

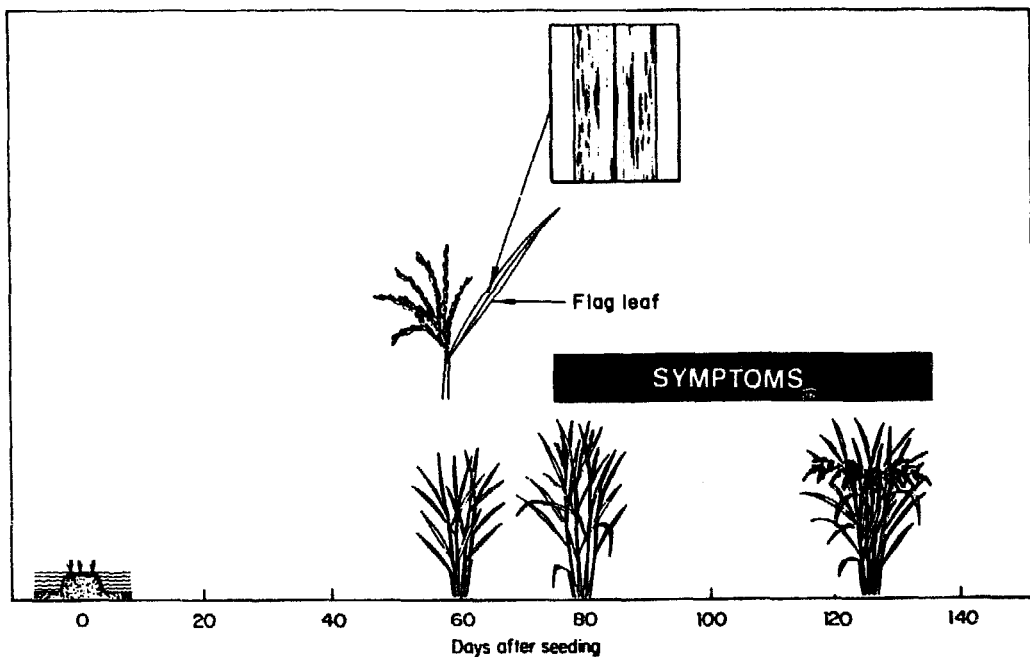

**Disease cycle**

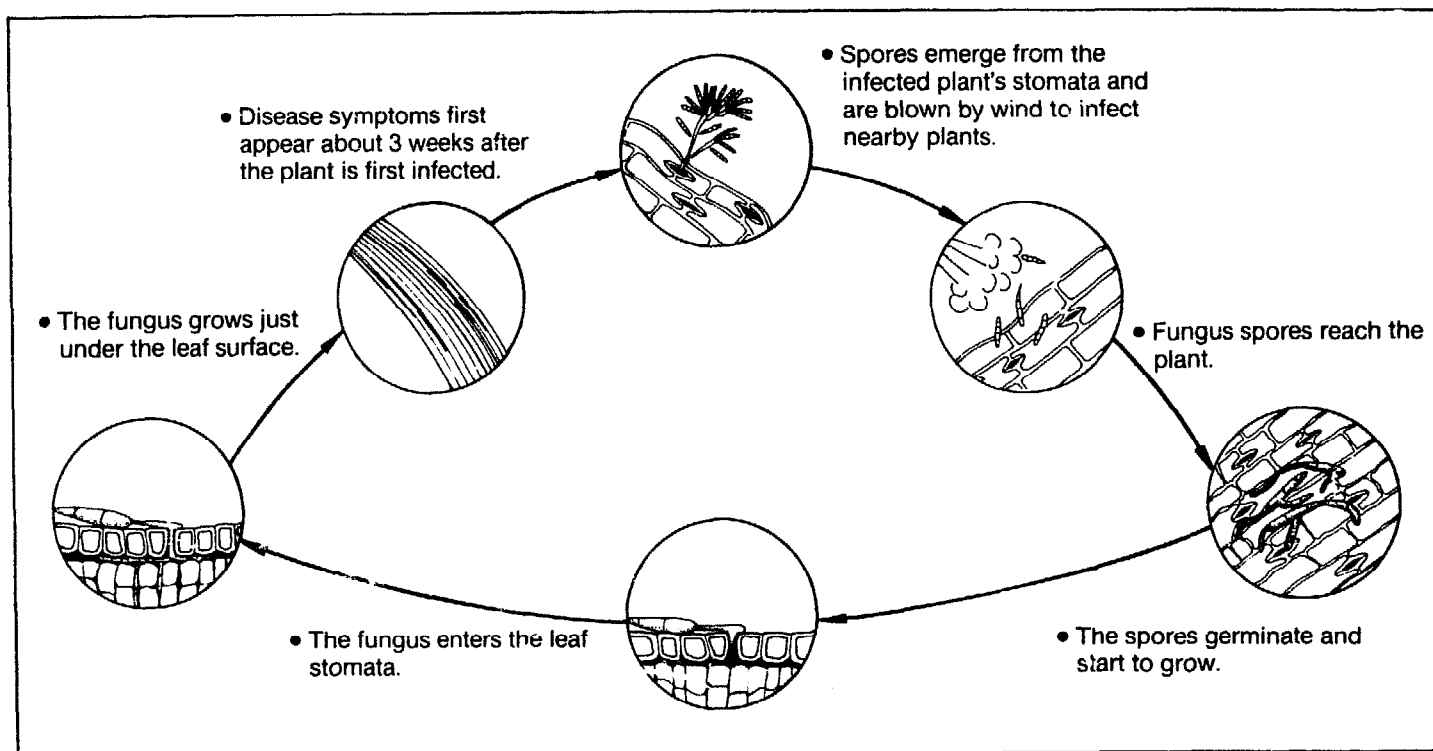

**Control**

*Resistant varieties*

- Plant a variety that is less susceptible to the disease. No resistant varieties are currently available.

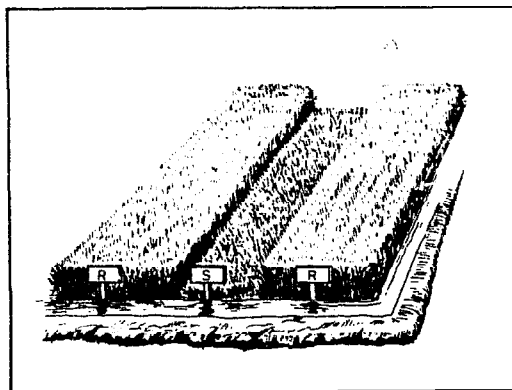

- Chemical control*
- Apply fungicides.

**STEM ROT**

Stem rot, which is caused by the fungus *Helminthosporium sigmoideum*, occurs in almost every field where rice has been grown for many years.

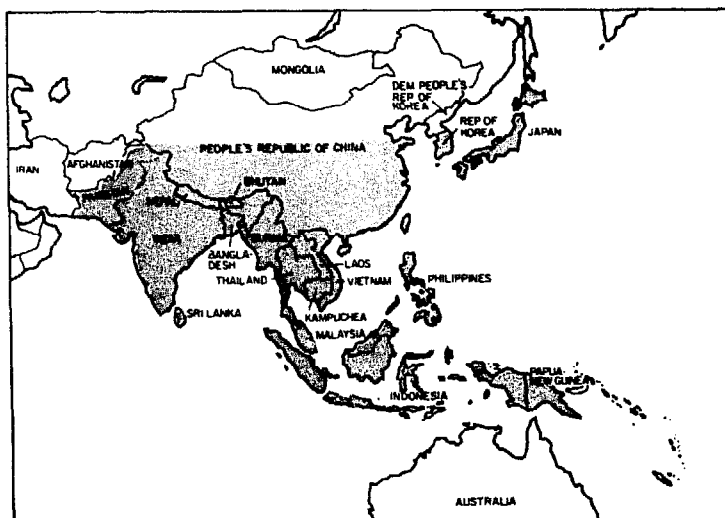

**Symptoms**

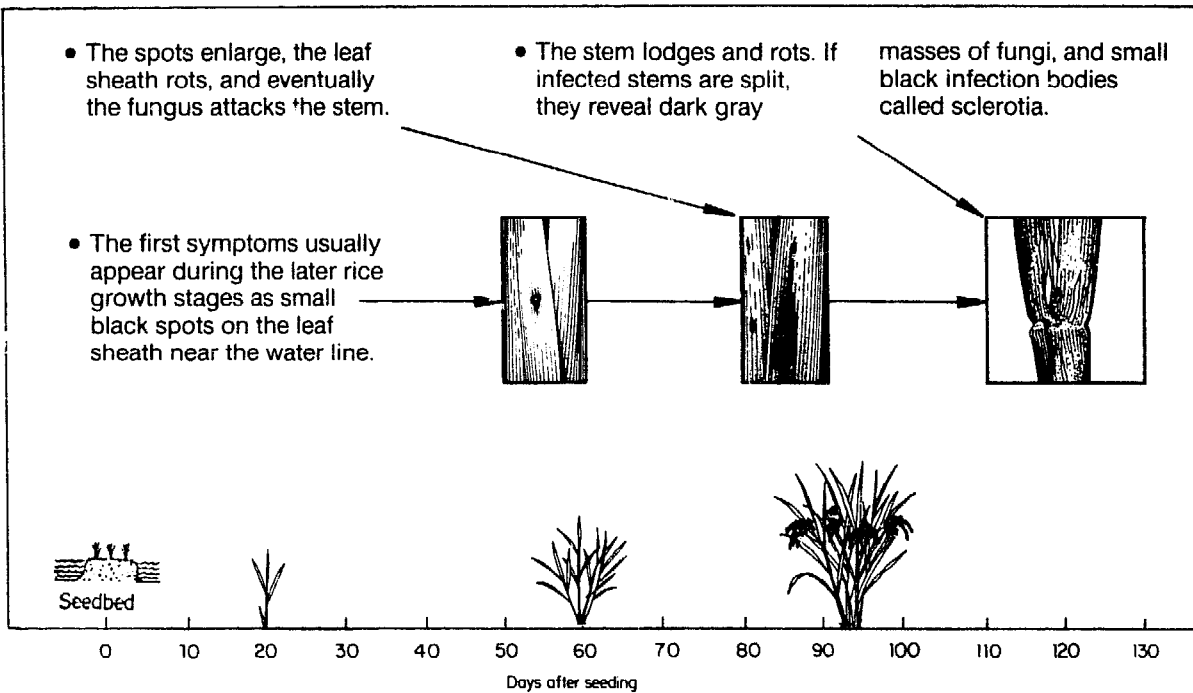

**Disease cycle**

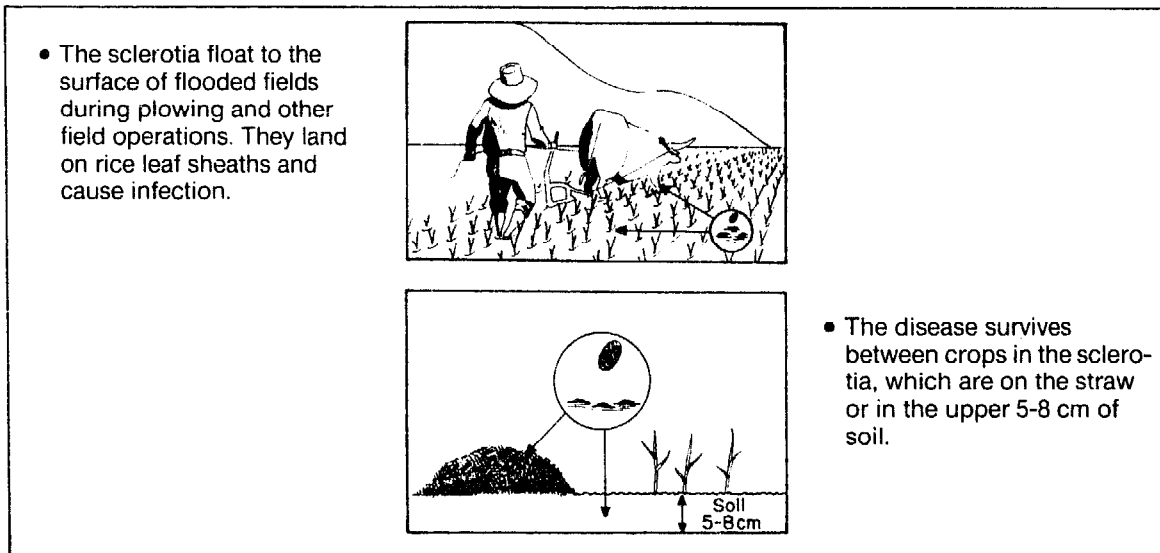

**Factors causing high levels of stem rot**

- The percentage of infection is low on normal plants and high on plants with wounds from lodging or insect attack.
- High levels of nitrogen and phosphorus in the soil also increase the severity of stem rot.
- Yields of susceptible varieties are reduced. Usually, damage from stem rot reaches its peak at harvest.

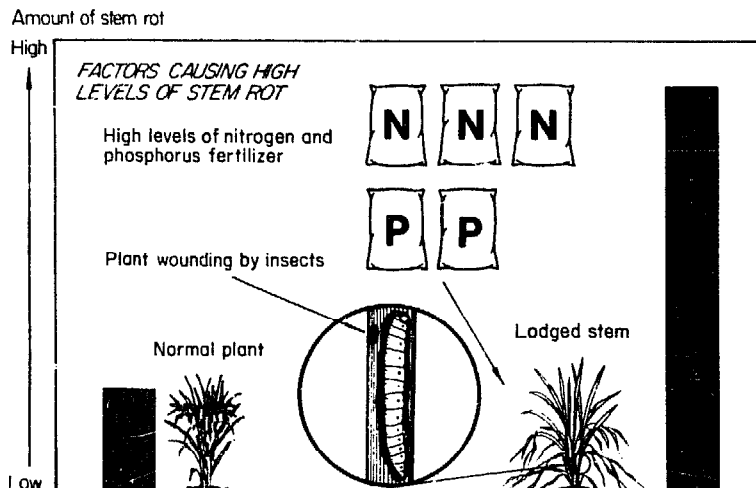

**Control**

- Burn straw and stubble after harvest or let straw be decomposed.

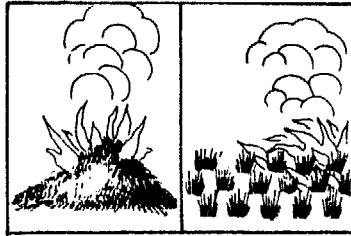

- Chemical control can be efficacious but spray on the stem at or before maximum tillering.

- Drain the field after harvest and allow the soil to dry and crack before irrigating again.



- Avoid excessive nitrogen and phosphorus fertilizer.
- Add potash and sodium silicate to the soil to decrease the severity of the disease.

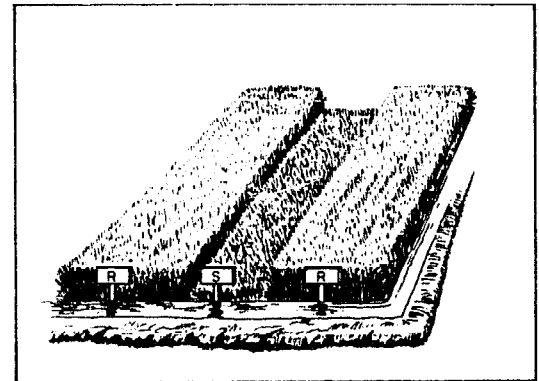
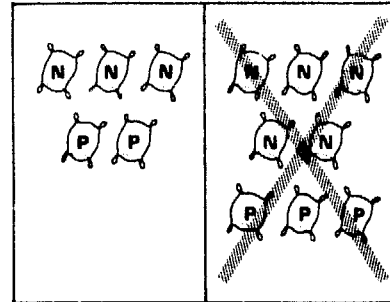

- Plant resistant varieties with sturdy stem that does not lodge and break.

**FALSE SMUT**

False smut is caused by the fungus *Ustilaginoidea virens*. The occurrence of the disease is believed to indicate a good year because weather favorable to the development of false smut also favors good crop production. The disease usually causes severe damage only in small areas.

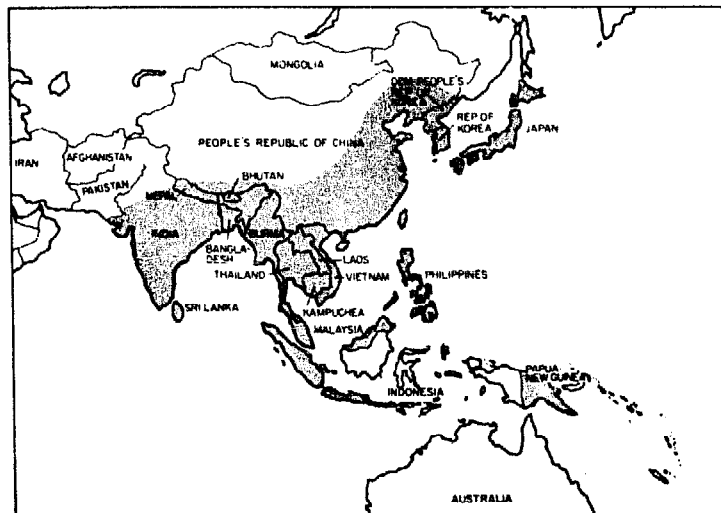

**Symptoms**

- The fungus changes single grains of the panicle into velvety balls, which may grow to a diameter of 1 cm or more.

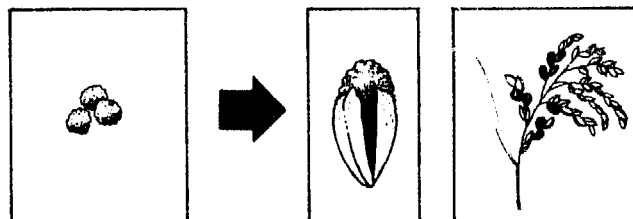

- Usually, only a few grains in a panicle are infected and the rest are normal.

**Disease cycle**

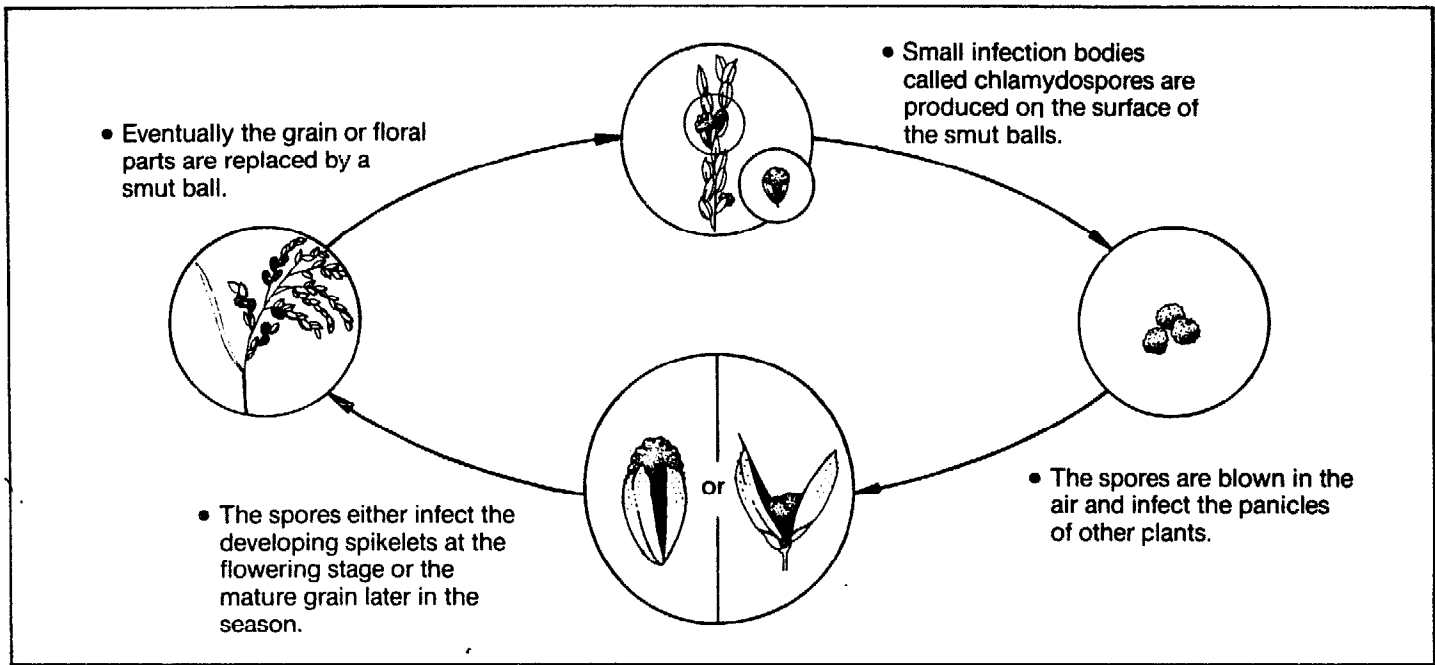

**Timing of disease development**

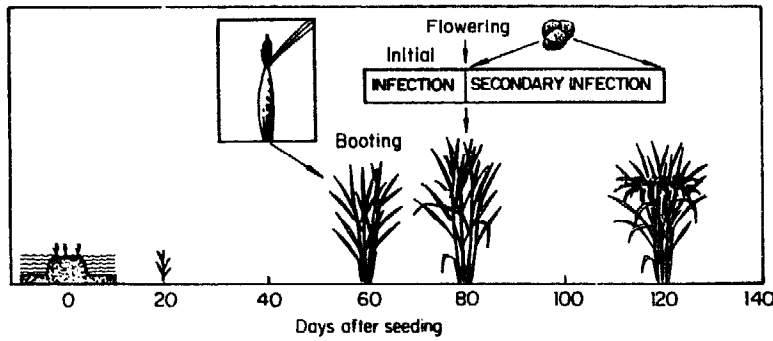

**Control**

Usually, no special control measures are necessary.

**Resistant varieties**

- Rice varieties that are less susceptible to the disease can be planted.

**Chemical control**

- In areas where the disease may cause economic loss, spraying or dusting with a fungicide just before flowering will provide some control.

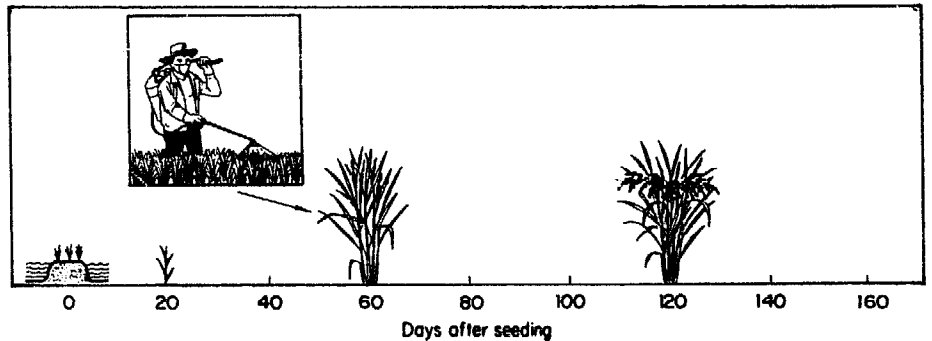
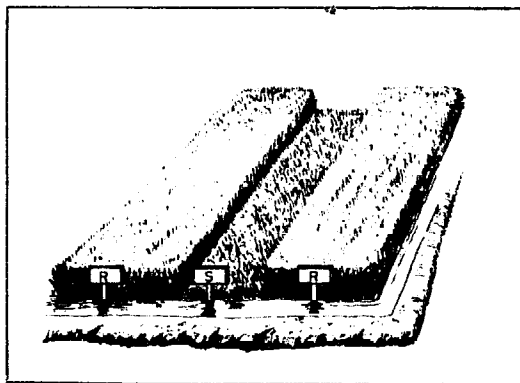

**BACTERIAL BLIGHT**

Bacterial blight is reported to have reduced Asia's annual rice production by as much as 60%.

Bacterial blight is caused by *Xanthomonas campestris* pv. *oryzae*, an organism closely related to the bacteria causing bacterial leaf streak.

The bacterium has races that differ in their ability to infect different resistant rice varieties.

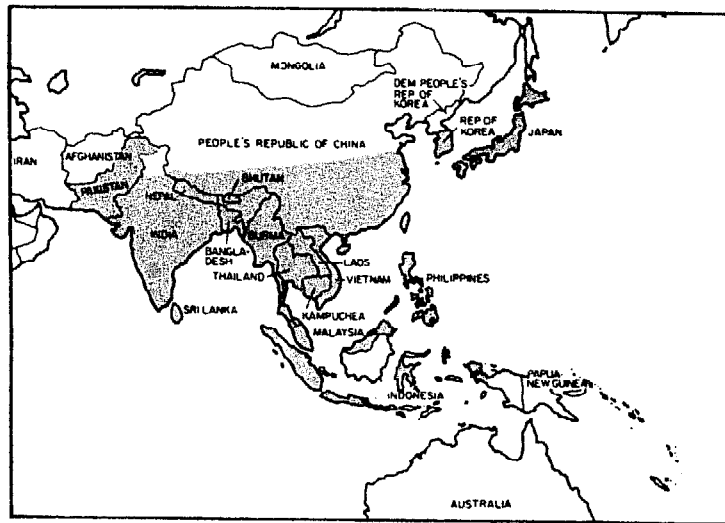

**Symptoms**

The disease has several forms of symptoms.

*Leaf blight symptoms*

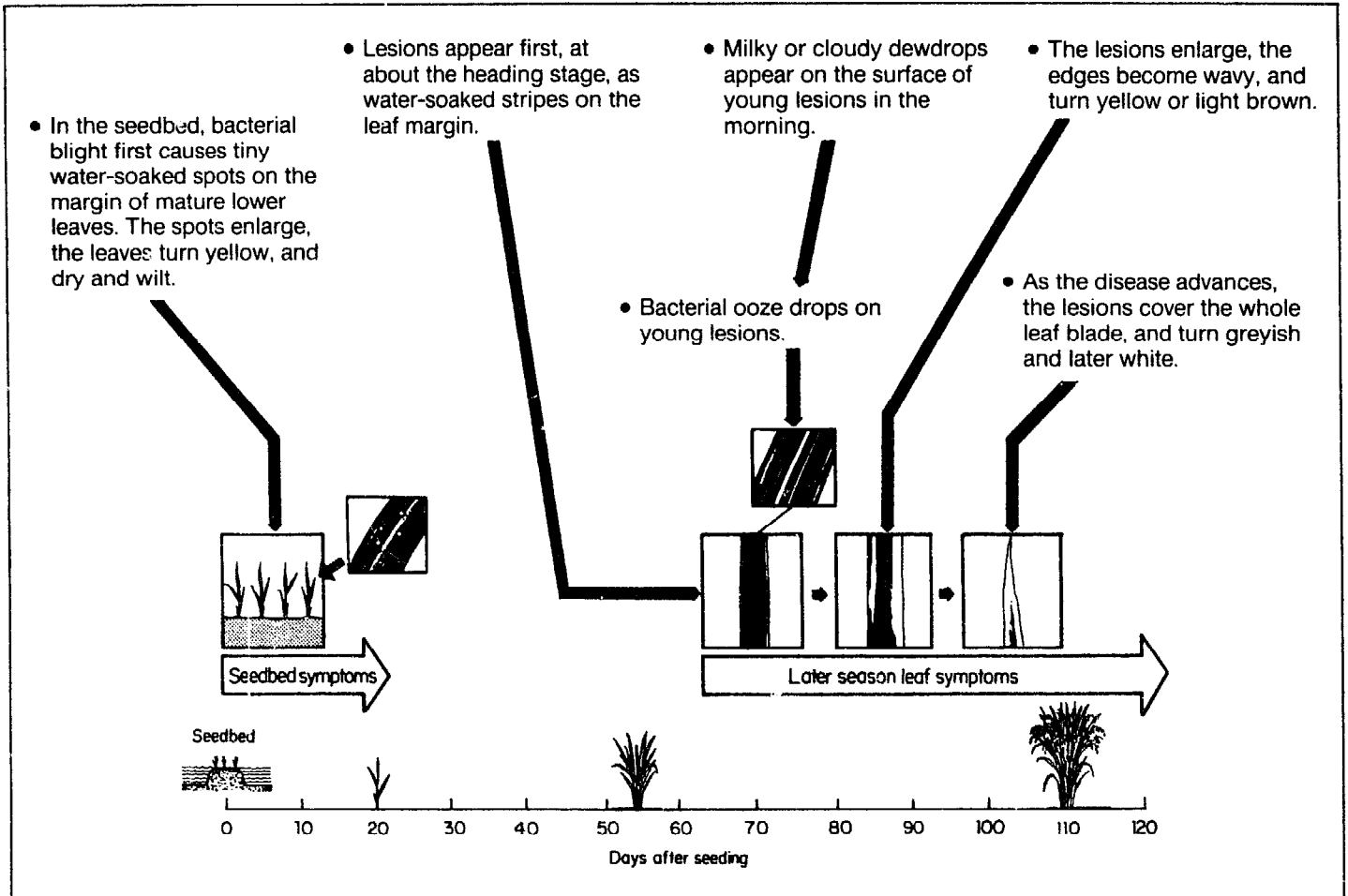

**Kresek symptoms**

- Kresek symptoms usually occur 2-6 weeks after the seedling stage.
- Kresek symptoms sometimes resemble rice stem borer damage.

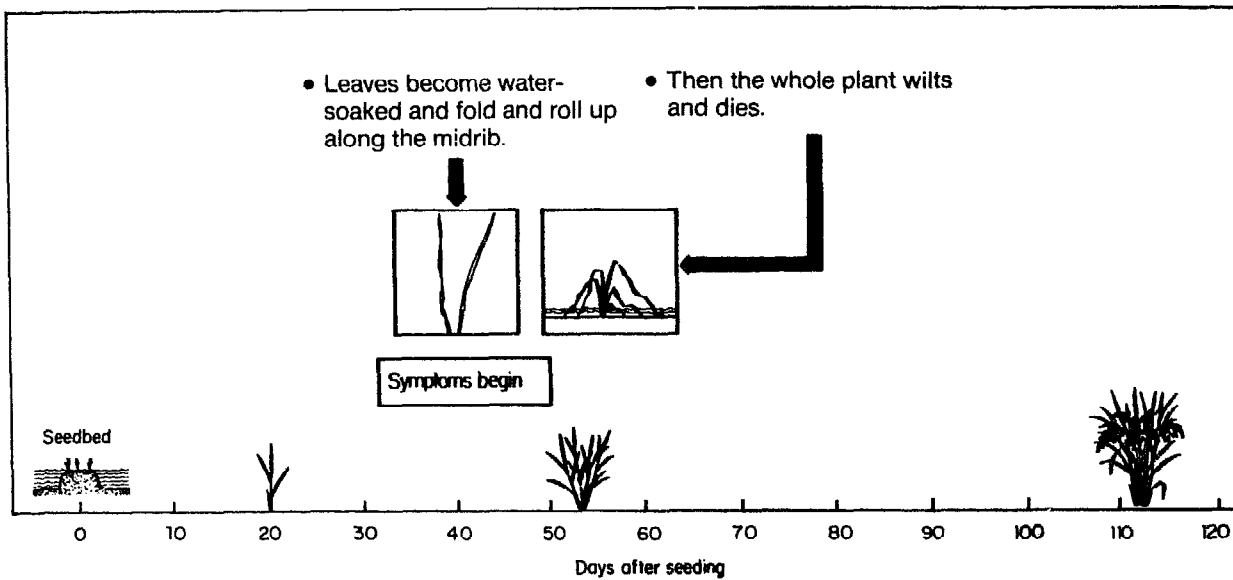
**Separating kresek damage from stem borer injury**

To distinguish kresek symptoms from rice stem borer damage, cut off the lower part of the plant and squeeze it between the fingers. A yellowish bacterial ooze will appear at the cut ends if kresek is present.

**Pale yellow symptoms**

- Pale yellow occurs in the tropics, but is not common.
- Older leaves of infected plants are a normal green, but the youngest leaves are yellow or have a yellow stripe.



**Disease cycle**

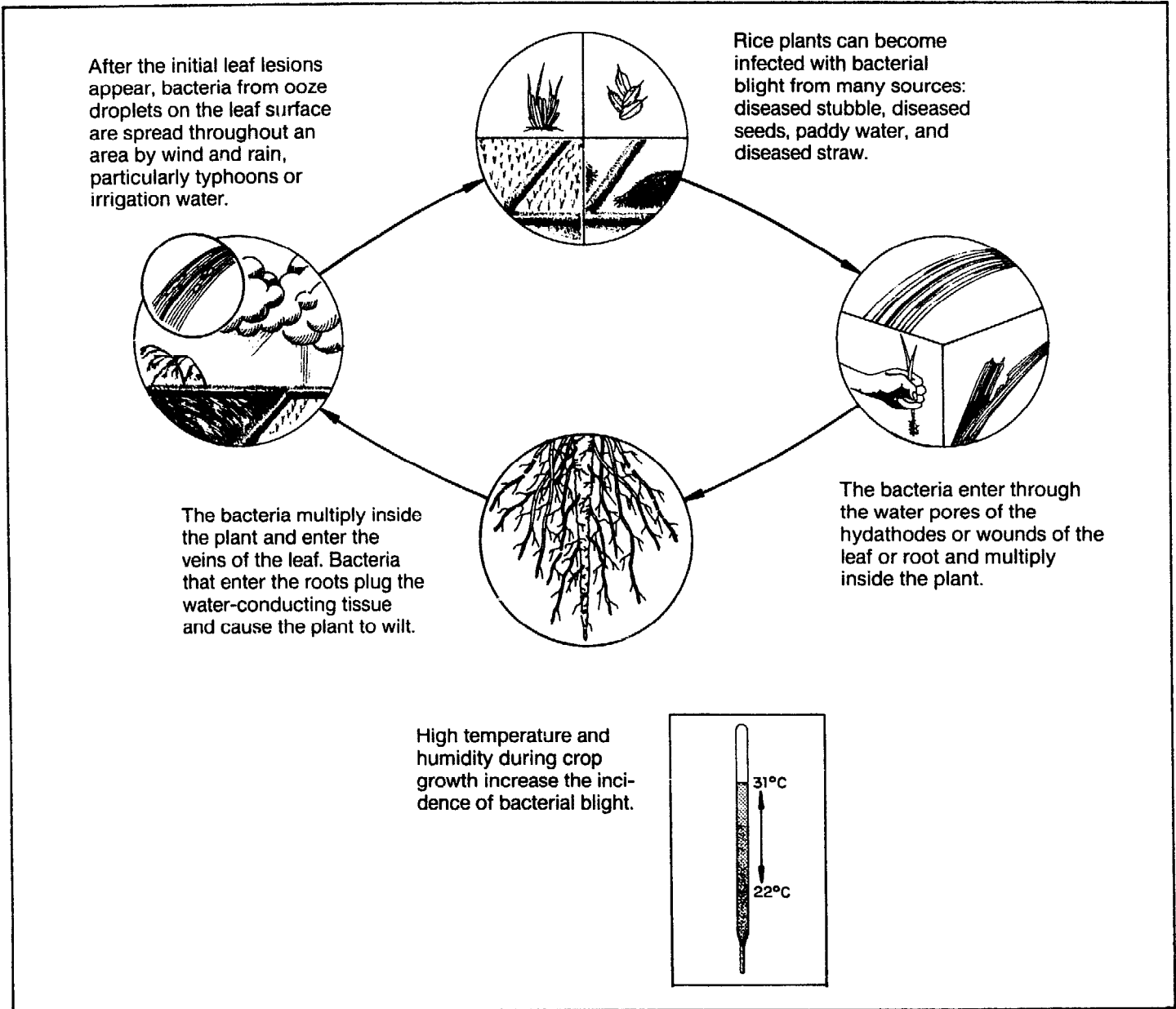

**Hosts**

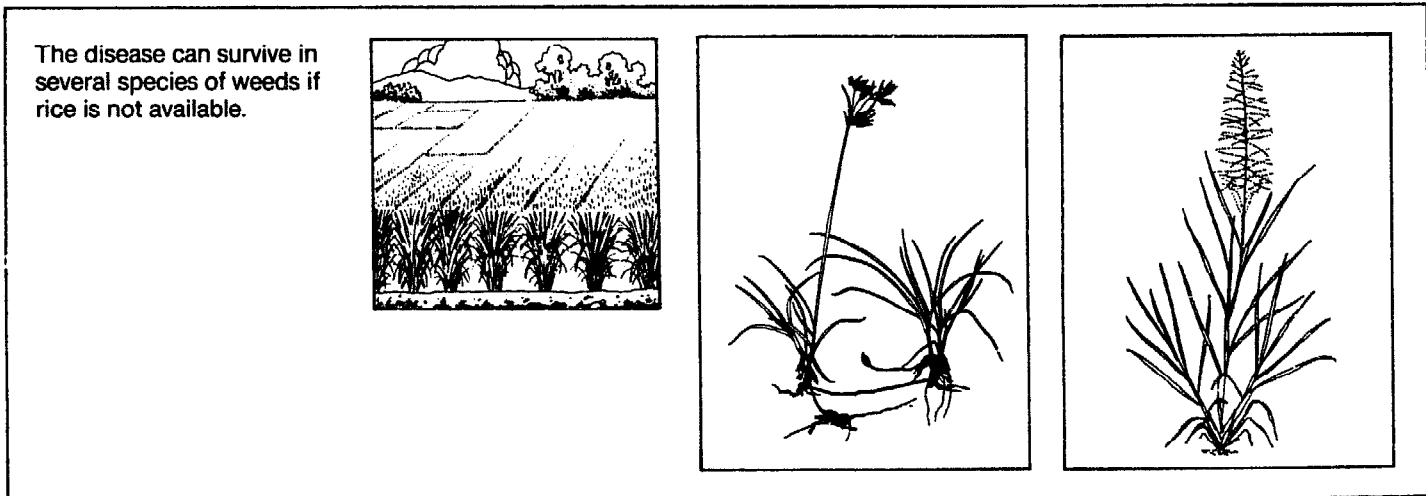



## Control

In the tropics, planting of resistant varieties is currently the only practical way of controlling bacterial blight.

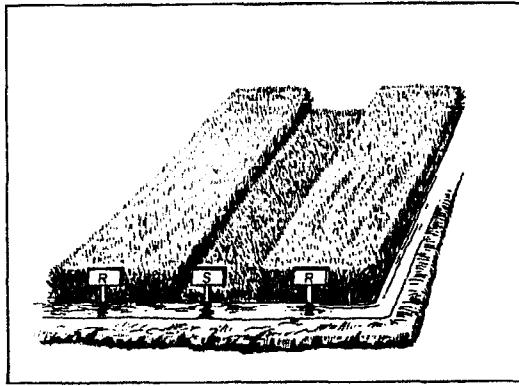

## BACTERIAL LEAF STREAK

The bacteria causing the disease *Xanthomonas campestris* pv. *oryzicola* is closely related to the bacteria causing bacterial blight, but it infects different species of plants and attacks the rice plant in a different way.

Under favorable weather conditions, losses from bacterial leaf streak may be as serious as those from bacterial blight.

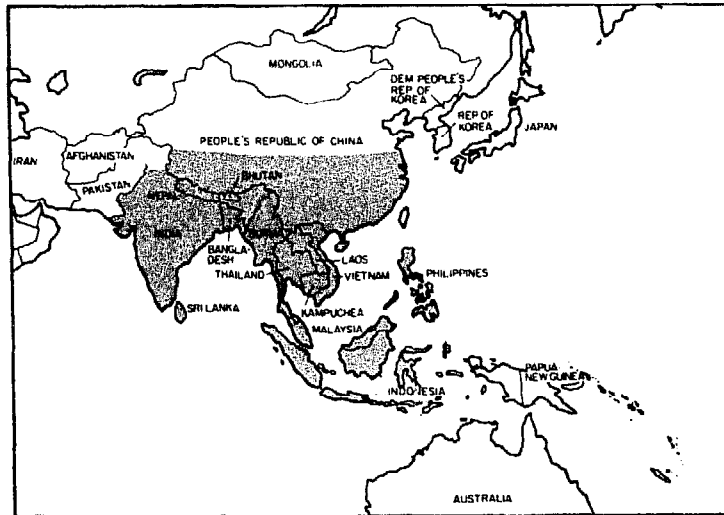

## Symptoms

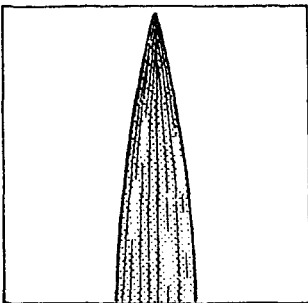

- The first symptoms are transparent, linear lesions between the veins. Many tiny oozes can be observed on the lesions.

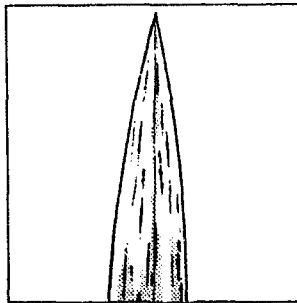

- Later, the lesions turn brown, become longer, and cover the larger veins.

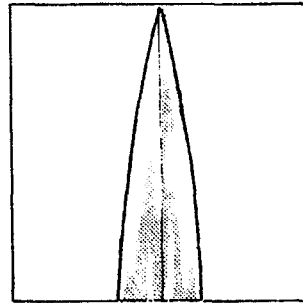

- The whole leaves of susceptible varieties may turn brown and die during the later stages of disease development. At this point the disease symptoms look the same as those of bacterial blight.

Disease cycle

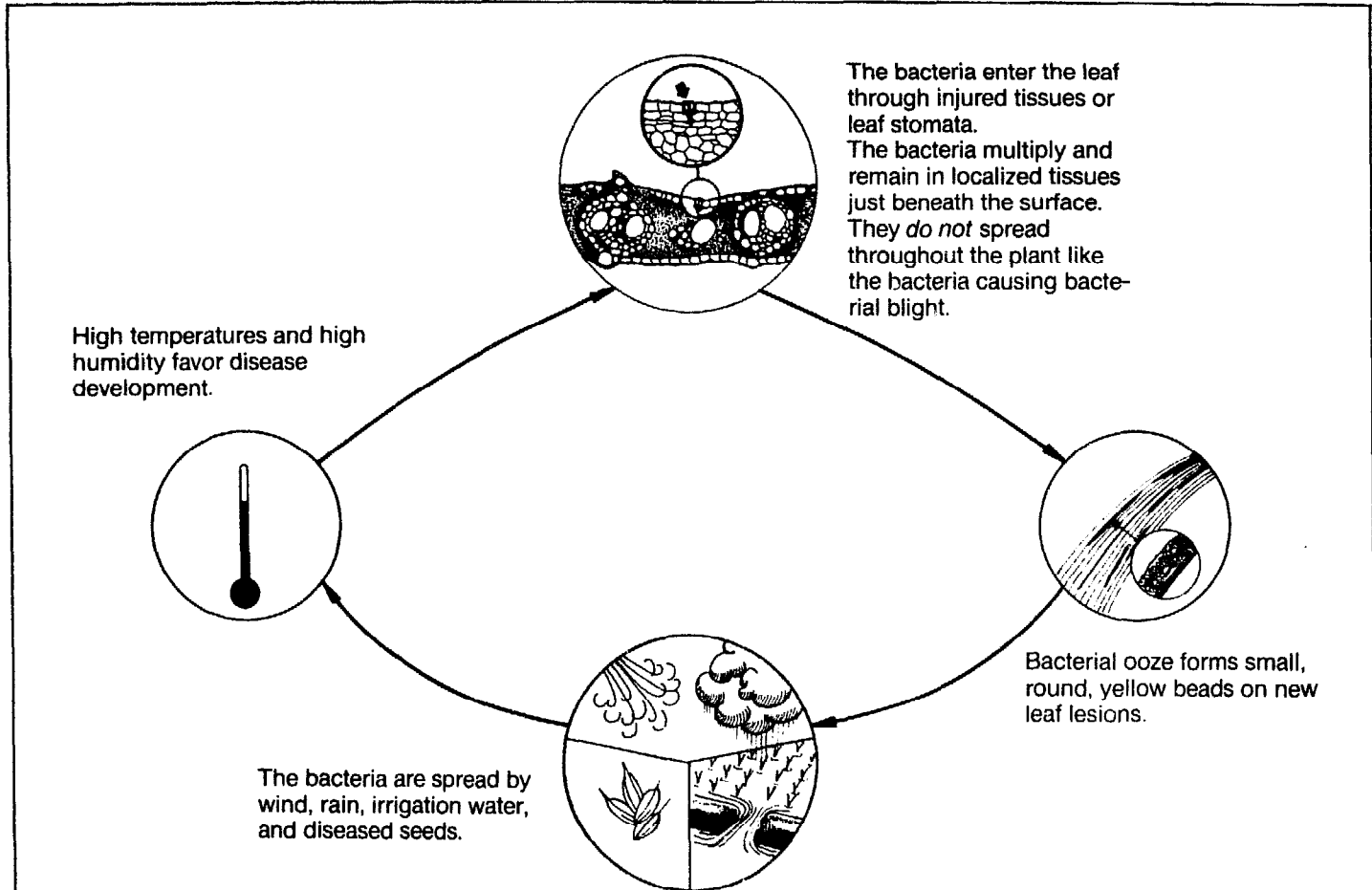

- Bacteria are probably present throughout the year in the tropics on cultivated and wild rice or weeds.

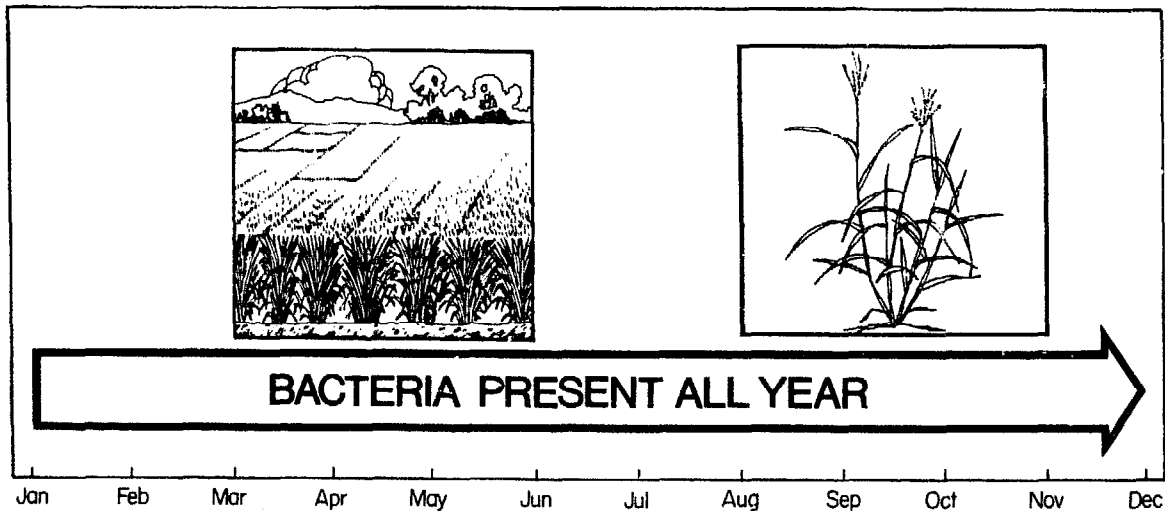

**Control**

The only practical method for controlling bacterial leaf streak in the tropics is planting of resistant varieties.

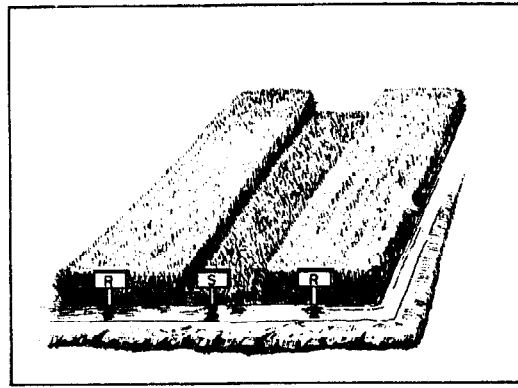

**TUNGRO VIRUS**

Tungro is one of the most damaging virus diseases of rice in Southeast Asia.

Periodic outbreaks have affected thousands of hectares in many countries.

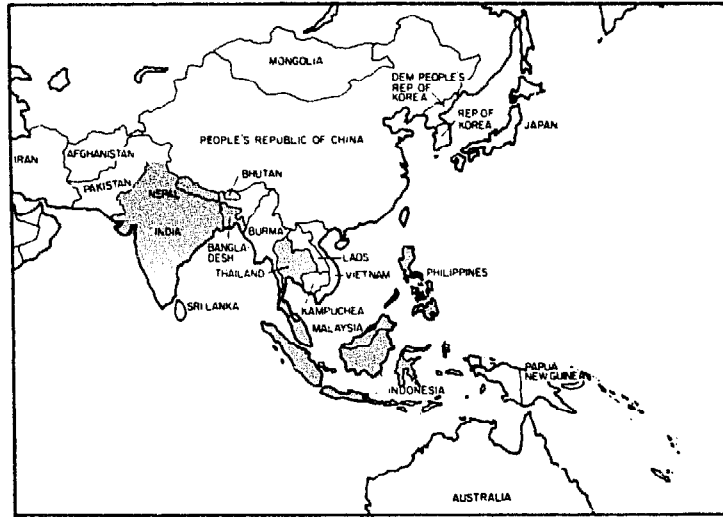

**Symptoms**

Tungro stunts rice plants and turns the leaves to different shades of yellow or orange.

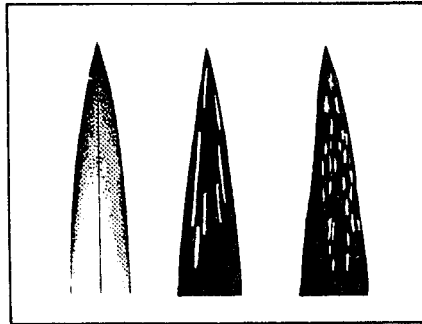

- Yellowing begins at the leaf tip and may extend down the blade.
- Infected leaves may also be mottled or striped.
- Plants infected during the early stages of growth are more severely damaged than those that are attacked later.

Stunting of rice plants infected at different growth stages with tungro virus.

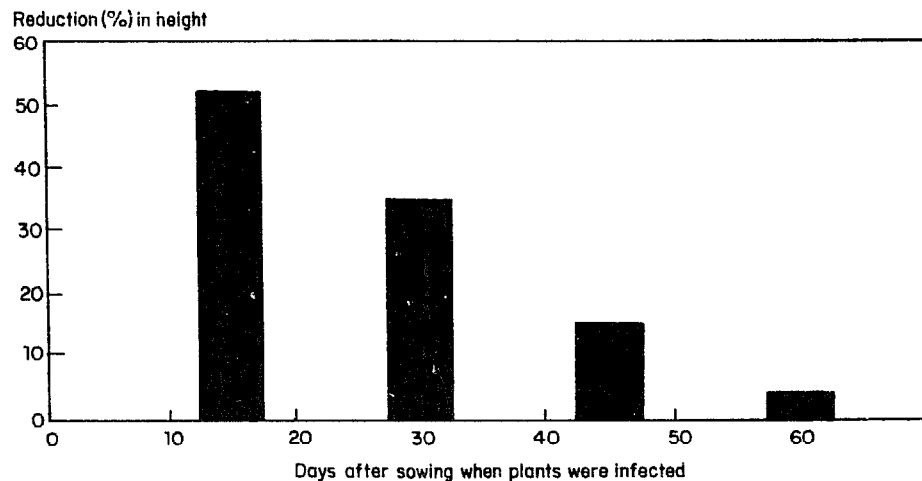

Yield reduction in rice plants infected at different growth stages with tungro virus.

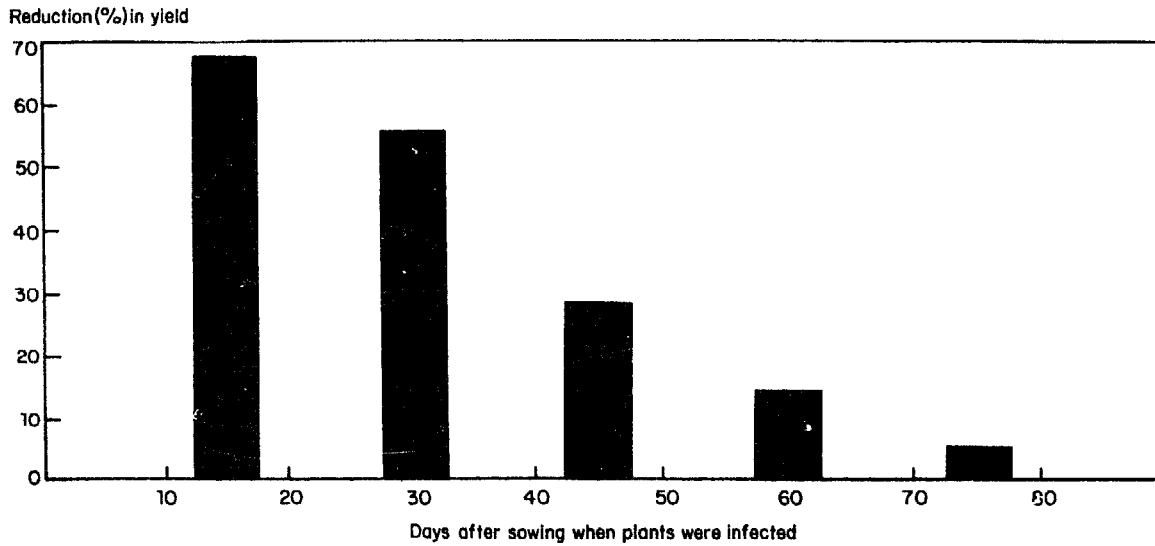

**Vectors and transmission**

- Tungro virus is transmitted by several leafhopper species.
- Adults and nymphs are about equally effective in transmitting the disease.
- *N. virescens* is the most effective transmitter of the virus (see page 204).

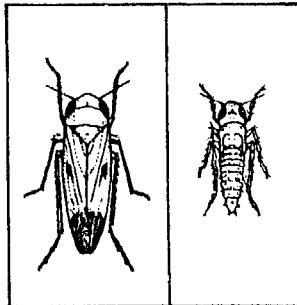

*N. virescens*

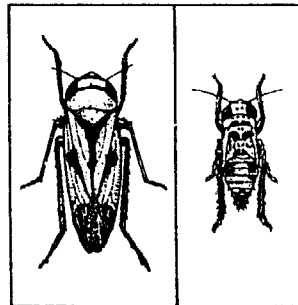

*N. nigropictus*

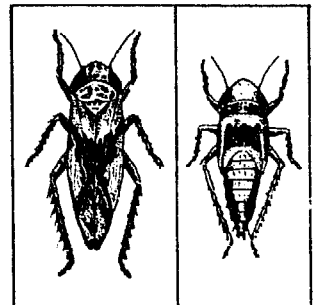

*R. dorsalis*

- The insects can pick up the virus by feeding on the plant for only a short time (about 30 minutes) and can transmit the virus almost immediately after feeding.
- The virus does not persist in the insect's body. After each feeding the insect can

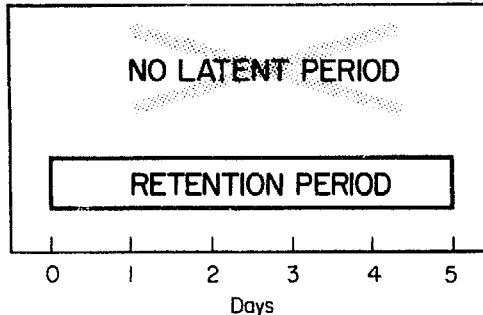

only transmit the virus for about 5 days. The longest period is less than a week.

- Although the virus does not persist in the insect, leafhoppers can feed and become re-infective many times after acquisition feeding.

- Nymphs lose their infectivity after each molt.

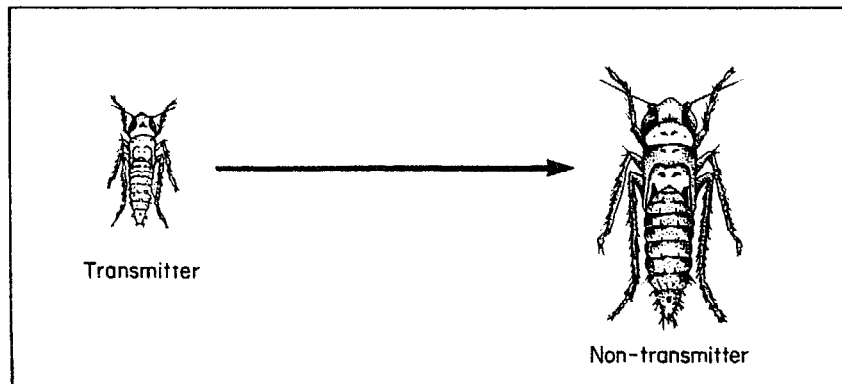

## Disease cycle

- The availability of infected host plants determines the severity of tungro because the insects must feed repeatedly on diseased plants to be continuously infective.
- Wild rice, ratooning stubble, and grassy weeds may all serve as sources of virus between rice crops.

## Sources of tungro virus

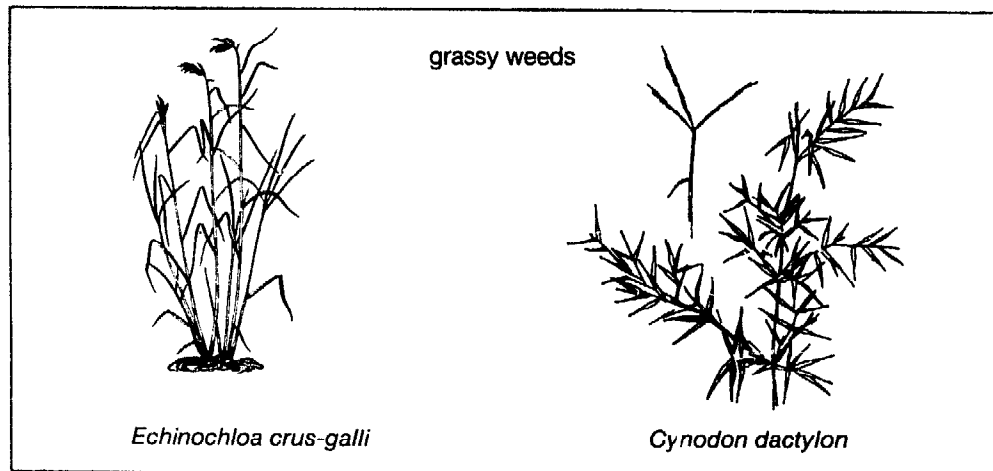
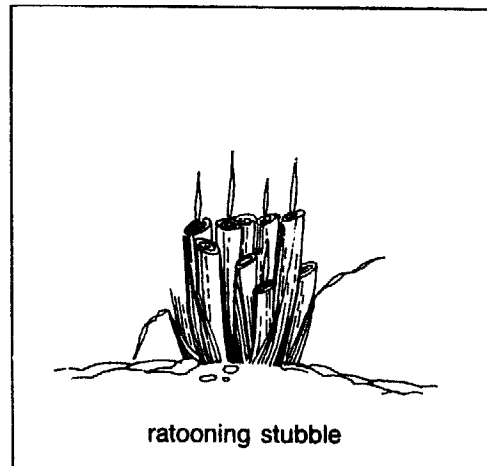
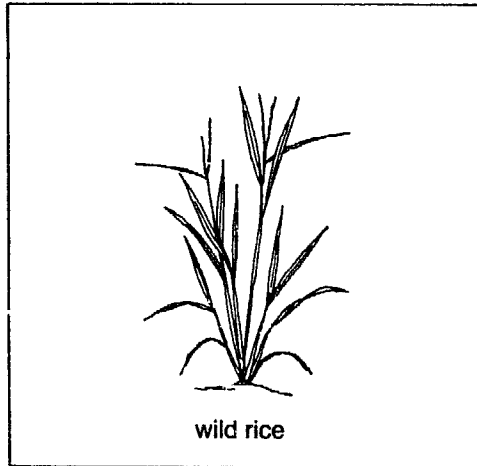

## GRASSY STUNT VIRUS

The grassy stunt virus has caused serious damage in sporadic outbreaks in limited areas, but is generally not a widespread problem.

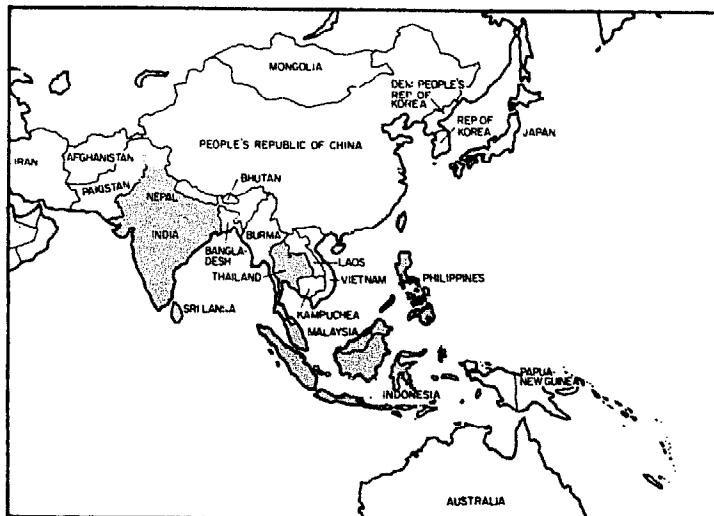



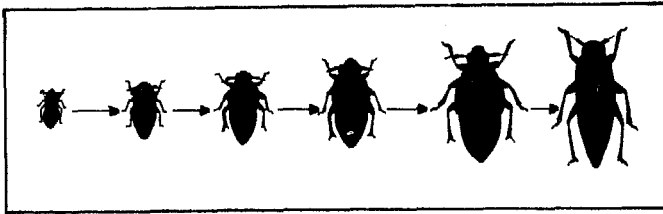

- Nymphs do not lose their infectivity after molting.

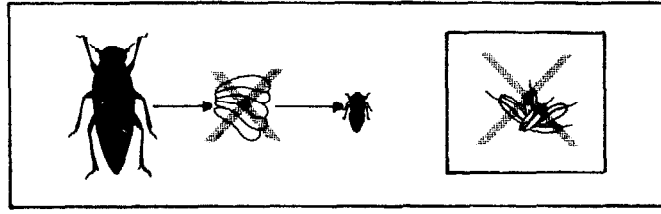

- The disease is not transmitted through planthopper eggs or by the rice seed.

**Hosts of the virus**

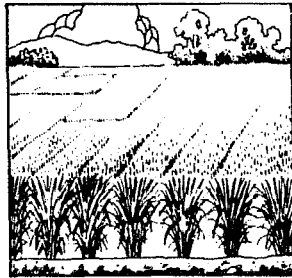

Cultivated rice

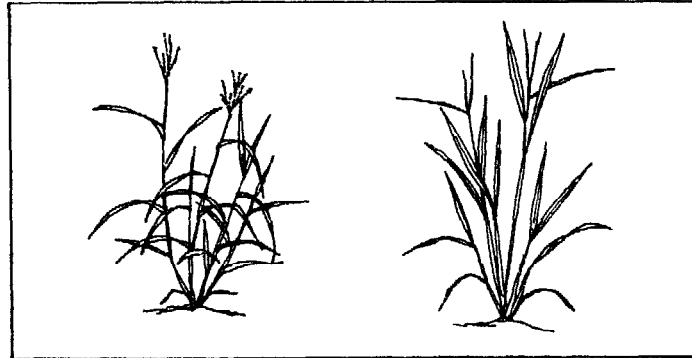

Many species of wild rices

**Disease cycle**

- The development of grassy stunt virus depends upon both the presence of the brown planthopper and the availability of infected host plants.
- Under favorable conditions, the brown planthopper multiplies rapidly and the disease may increase rapidly.

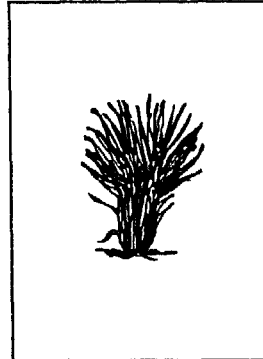
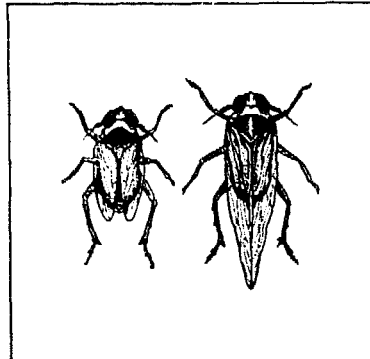

- Long-winged adults are more important in spreading the disease than the short-winged forms that cannot fly.

**RICE RAGGED STUNT**

Ragged stunt is a recently discovered virus disease that may greatly reduce yields in rice varieties susceptible to the virus and its vector, the brown planthopper.

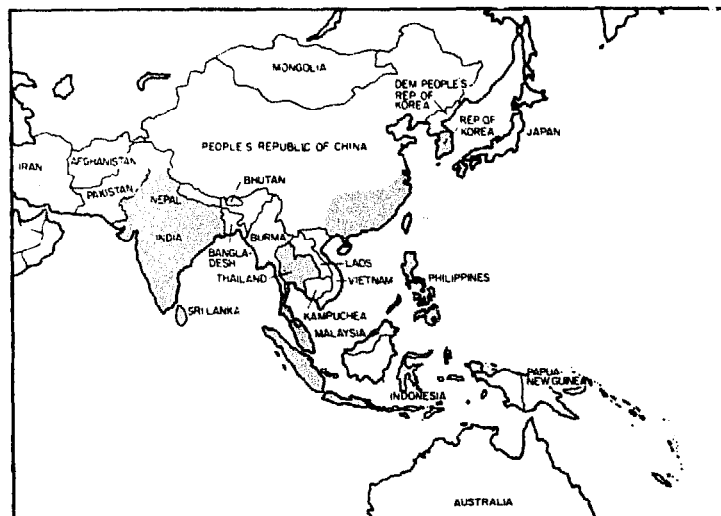

**Symptoms**

*Symptoms during early growth stages*

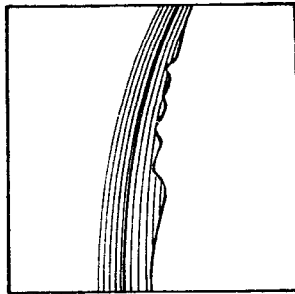
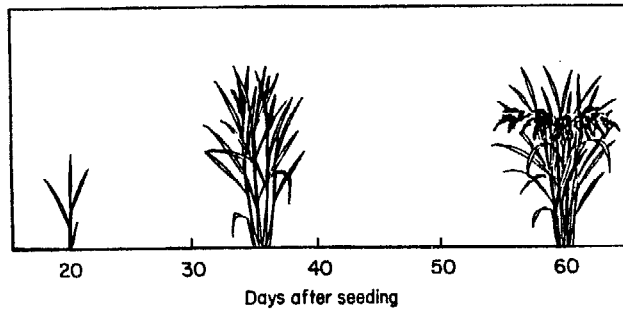

• Ragged leaves

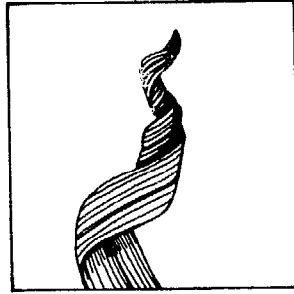

• Twisted leaves

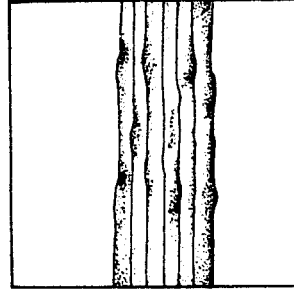

• Swelling along veins

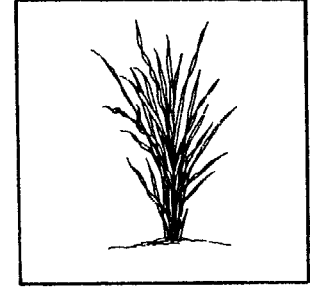

• Plants infected during early growth stages are often severely stunted.

*Symptoms during later growth stages*

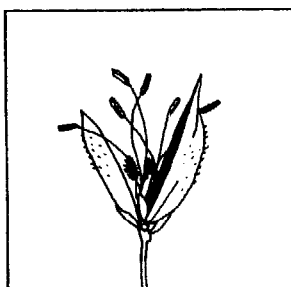
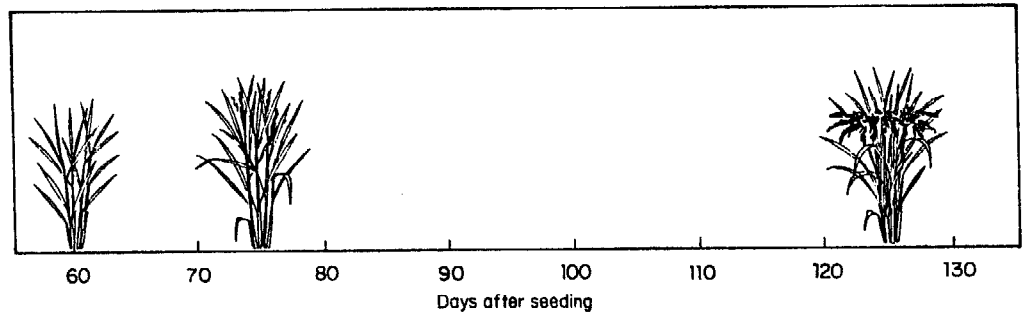

• Delayed flowering

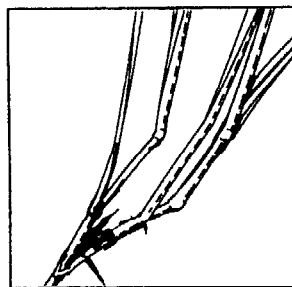

• Nodal branches

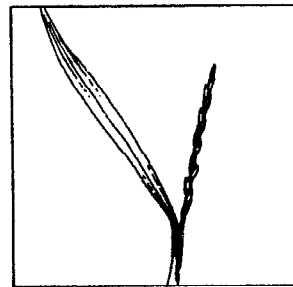

• Incomplete panicle emergence

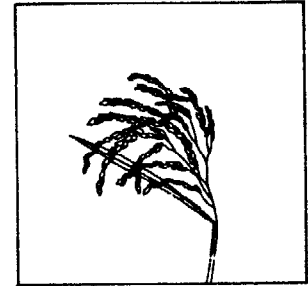

• Unfilled grains

**Vectors and transmission**

- Ragged stunt is transmitted by brown planthopper nymphs and adults.

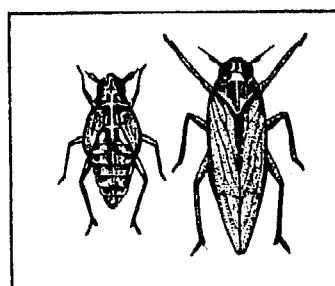

- In areas where the virus occurs, about 40% of the brown planthoppers can transmit the disease.



- Brown planthopper nymphs can still transmit the disease after they molt.

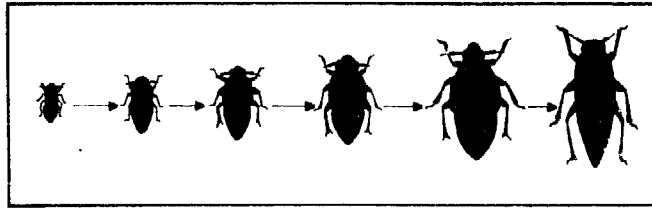

- The virus is not transmitted through brown planthopper eggs, the soil, or rice seed.

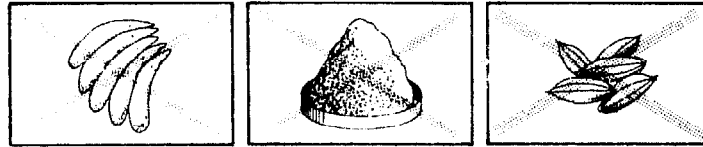

- The brown planthopper cannot transmit the disease until about 9 days after the insect has fed on an infected plant (average latent period).
- After the insects acquire the disease, they can retain the virus for 3-35 days. The average retention time is about 2 weeks.

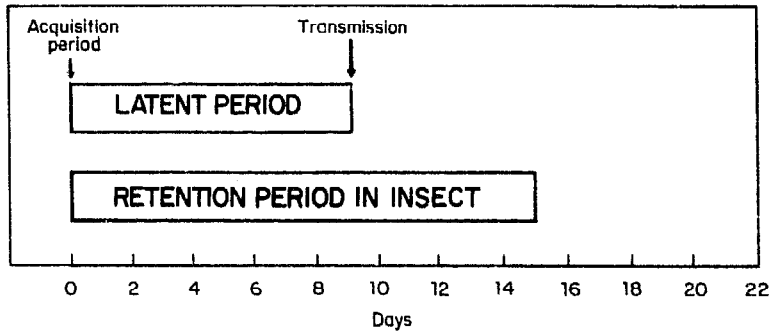

**Hosts of the virus**

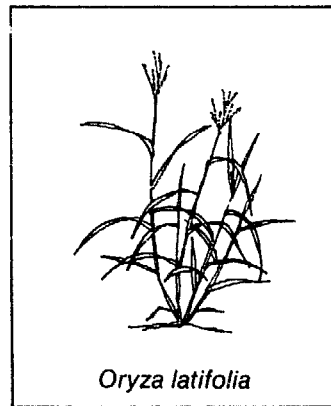

**YELLOW DWARF DISEASE**

The yellow dwarf disease is widely distributed in Asia, but occurs only occasionally. The disease is most serious in Japan and Taiwan. It causes little yield loss in the tropics because the plants are infected during the later growth stages.

Yellow dwarf is caused by a virus-like disease agent called a mycoplasma.

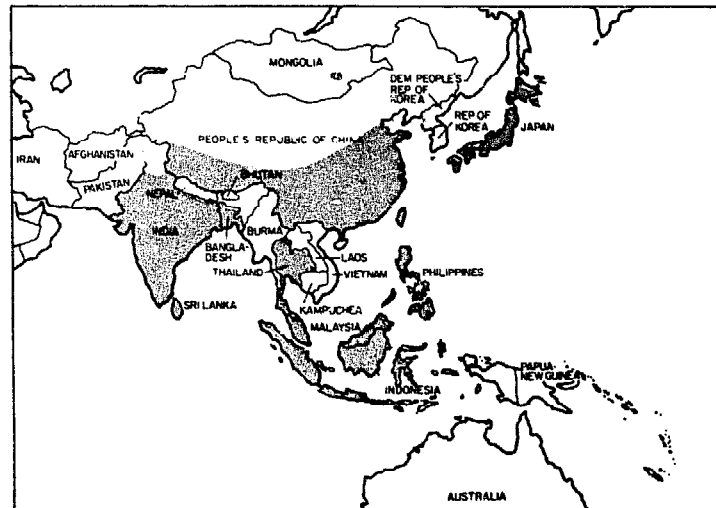

**Symptoms**

- Plants are stunted and yellowish, and have an increased number of tillers.
- Stunting is more severe when plants are infected at the early growth stage.

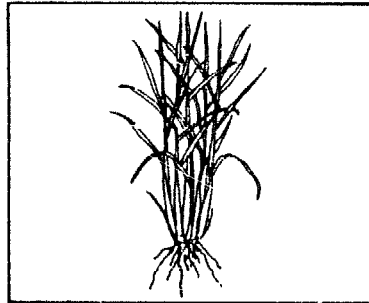

- Infected plants usually produce either no panicles or unfilled grains.
- Plants affected during the later growth stages may not develop symptoms before harvest.

**Differences between symptoms of yellow dwarf and grassy stunt.**

**Yellow dwarf**

- Leaves are light yellow, soft, and slightly droopy.

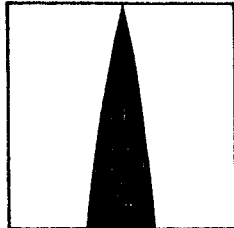

Yellow dwarf

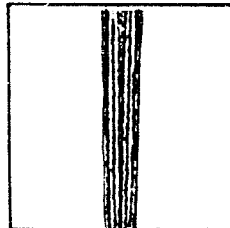

Grassy stunt

**Grassy stunt**

- Leaves are narrower and their green color is darker. They may have many rusty spots.

**Vectors and transmission**

- A high percentage (70-95%) of these leafhoppers are able to transmit the virus.
- Leafhoppers transmit yellow dwarf

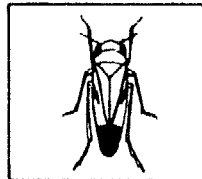

*N. cincticeps*

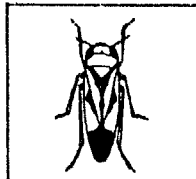

*N. nigropictus*



*N. virescens*

- Leafhoppers can become infected after feeding on a diseased plant.
- The insects cannot transmit the disease until 20 days after becoming infected (latent period). They remain infected until they die.

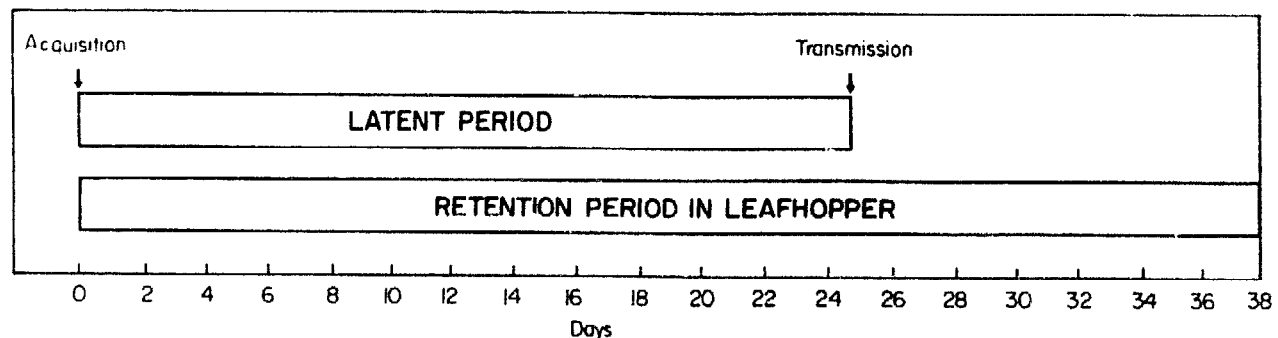

- Nymphs remain infective after molts, but the disease is not transmitted through leafhopper eggs.
- The virus is not transmitted through rice seed.

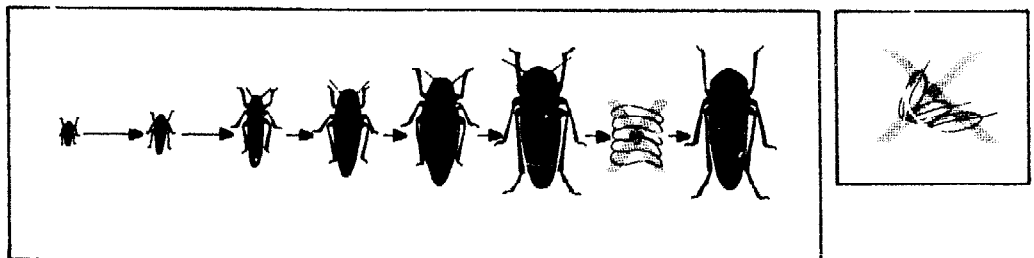

**Disease cycle**

- The disease overwinters in leafhoppers and in several species of wild grasses.
- The buildup of yellow dwarf

is very slow because of the long latent period, i.e. from acquisition to transmission, in the leafhopper vector and

the slow development of the disease in the plant.

*Development of the yellow dwarf disease in the rice plant.*

- Under conditions of high temperature disease symptoms appear about 30 days after infection.
- Under low temperature disease symptoms appear up to 90 days after infection.

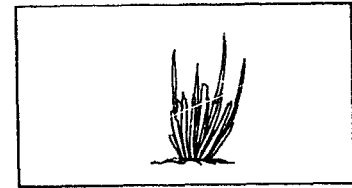
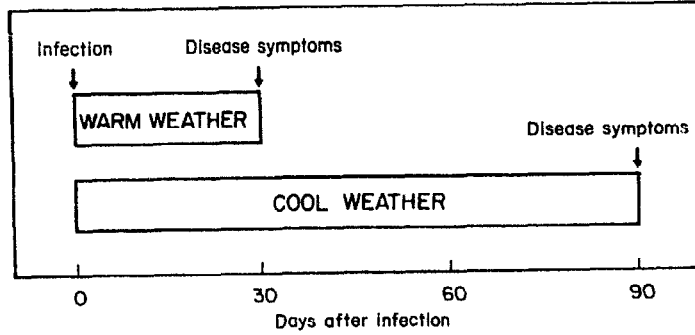

- In the tropics, ratoon plants growing from stubbles may be diseased and act as virus sources for later infections.

**Control of virus diseases**

The development and spread of virus depends upon several factors:

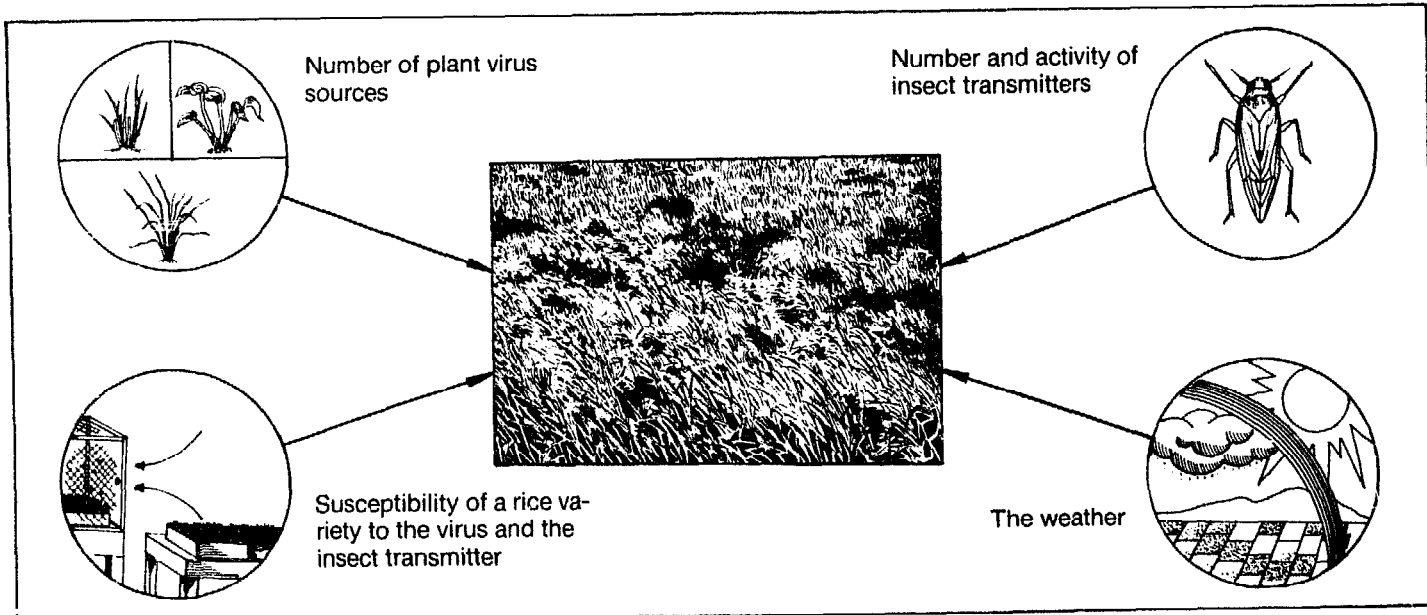

The only way to control virus diseases is to prevent the plant from becoming infected.

Currently, there are no practical ways of curing a plant after it becomes infected.

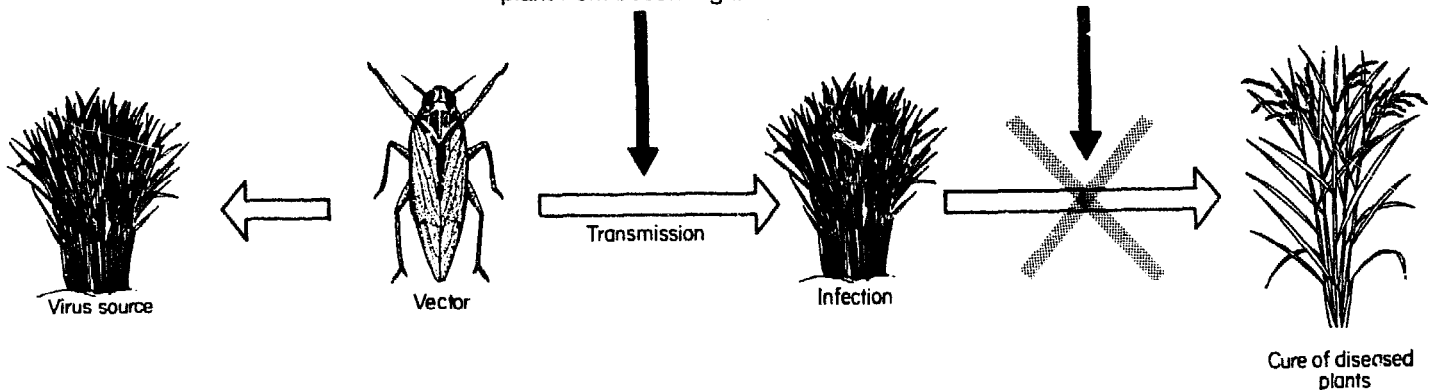

- Virus control programs should concentrate on preventing disease during the early stages of plant growth. Infection at that stage causes the most damage.

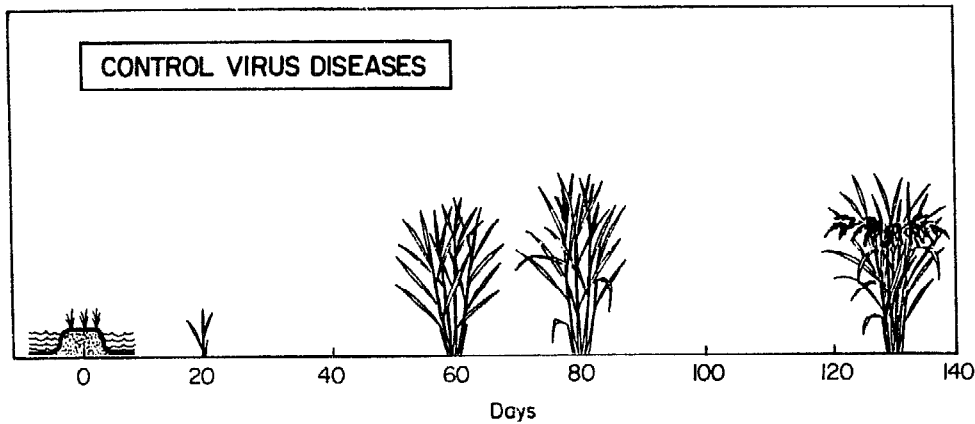

**Control methods**

*Resistant varieties*

- Planting resistant rice varieties is the simplest, cheapest, and most effective way of controlling both virus diseases and vector insects.

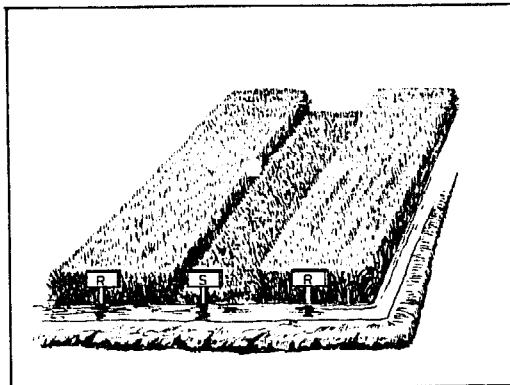

- A variety may be
- resistant to the feeding and development of the insect transmitter or
  - resistant to the infection and development of a virus disease.



*Control of vectors*

- It is very difficult to control virus vectors (leafhoppers and planthoppers) with insecticides.

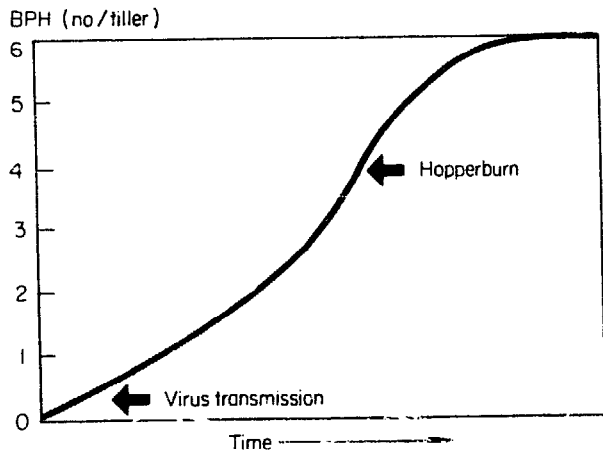

ive insecticide treatments should be applied during the early growth stages instead of waiting until insect transmitters reach the economic threshold.

- High populations of leafhoppers and planthoppers must build up to directly damage the crop and cause hopperburn.
- Low insect populations can cause high rates of virus infection.

- Only one insect is enough to infect a plant. High populations are not necessary to cause high tungro infection rates.
- It is sometimes difficult to kill insects quickly enough to prevent them from feeding on plants and transmitting the virus. In areas where virus outbreaks have recently occurred, protec-



Controlling vectors in areas where virus outbreaks have occurred.

- Protective insecticide applications

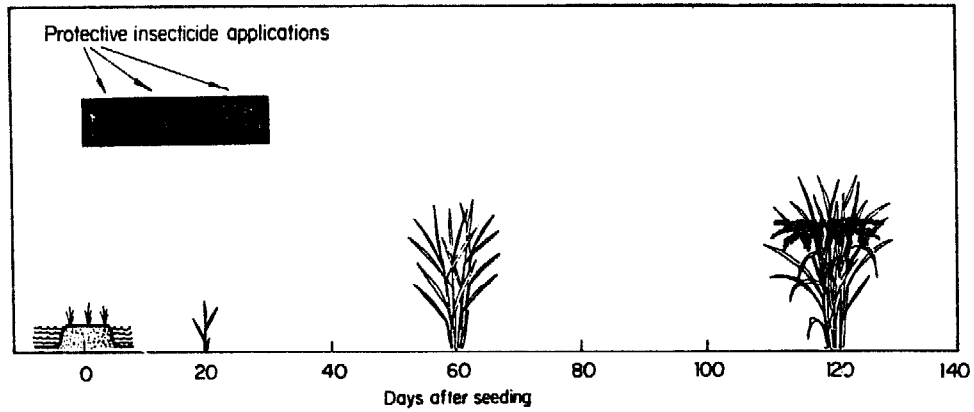

- Eliminating sources of virus diseases by eliminating infected plants that serve as sources of disease.

- Rogue (remove) diseased rice plants and weeds from the rice field. Roguing is successful when only a



small percentage of plants are infected, or when it is done frequently.

- Control or destroy weeds in rice fields, levees, and surrounding areas.



- Plow under the rice stubble immediately after harvest to prevent ratoon growth, which is a disease source and breeding place for insect transmitters.

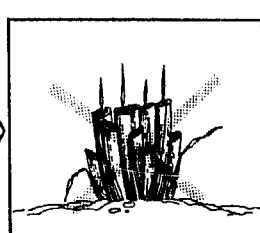

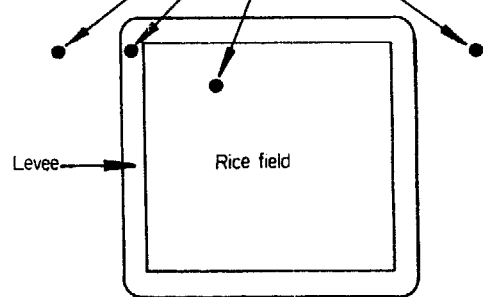



### STEM NEMATODE

Damage from the stem nematode *Ditylenchus angustus* is restricted to certain areas where the climate and cultural conditions are suitable for the pest's development.

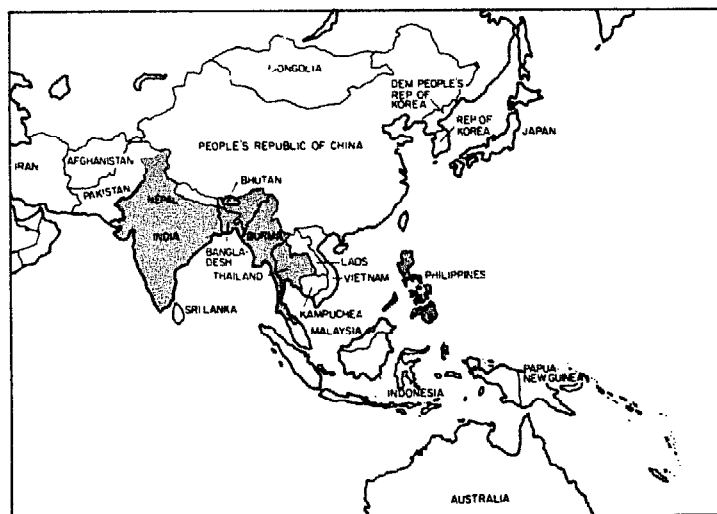
Rice crops in infected areas may suffer yield losses ranging from 20 to 90%.



**Symptoms**

- The most noticeable symptoms are stunting, twisted stems, and damaged panicles.

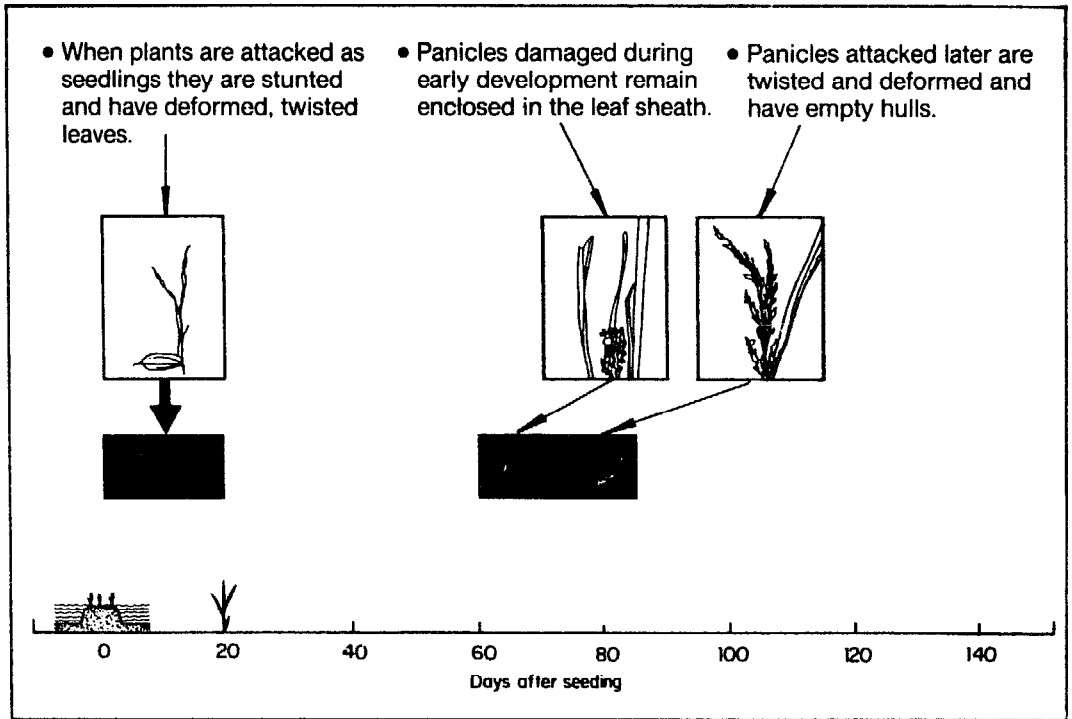

**Disease cycle**

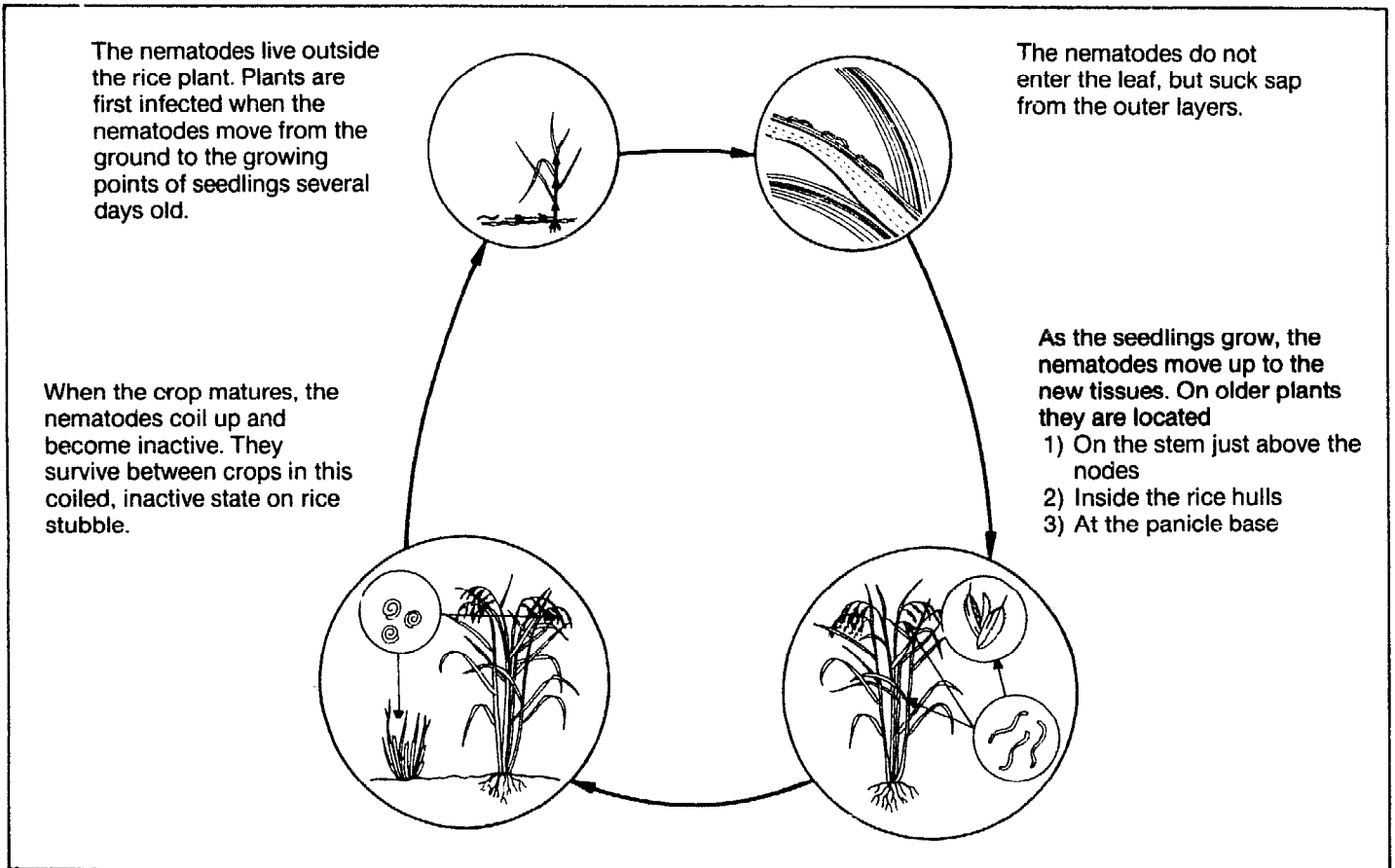

## Factors causing serious infestations of the stem nematodes

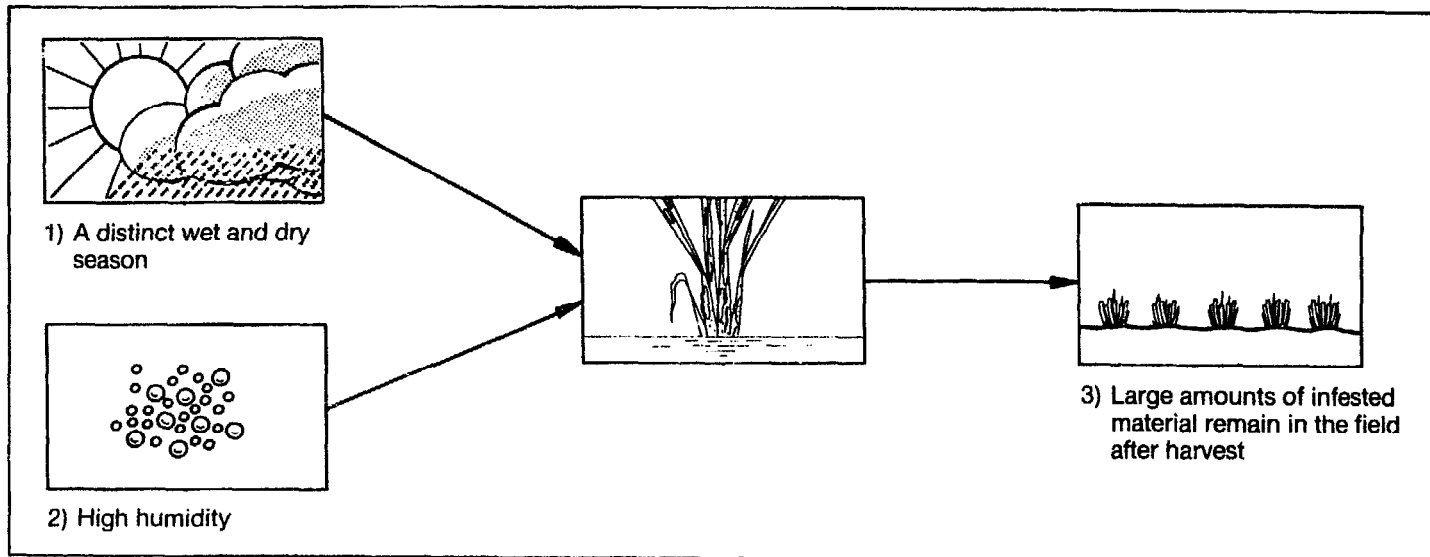

## Control

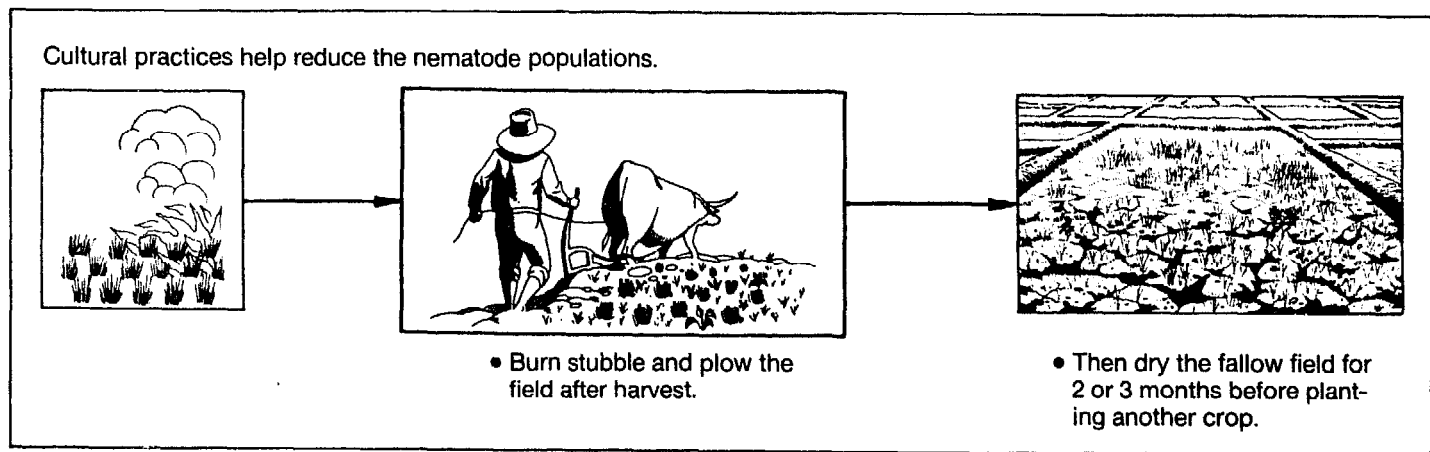

## WHITE TIP

White tip is caused by a nematode or a small eelworm called *Aphelenchoides besseyi*.

Crop losses from white tip are variable, ranging from 10 to 50%. The disease is usually more serious in temperate regions than in the tropics.

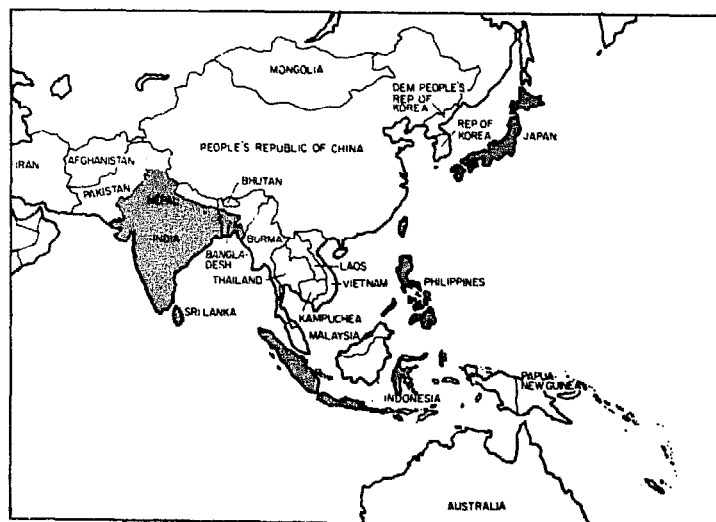

**Symptoms**

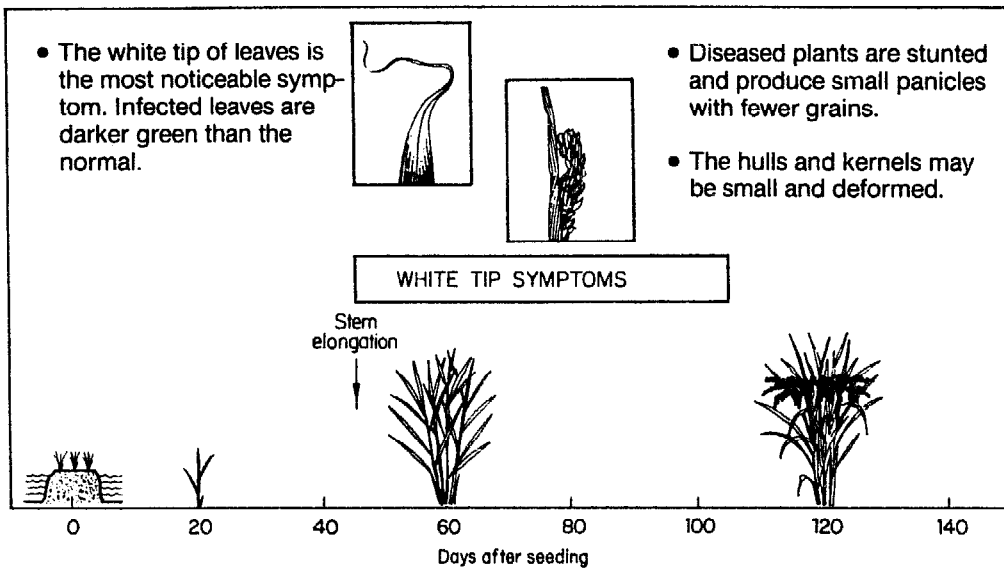

**Disease cycle**

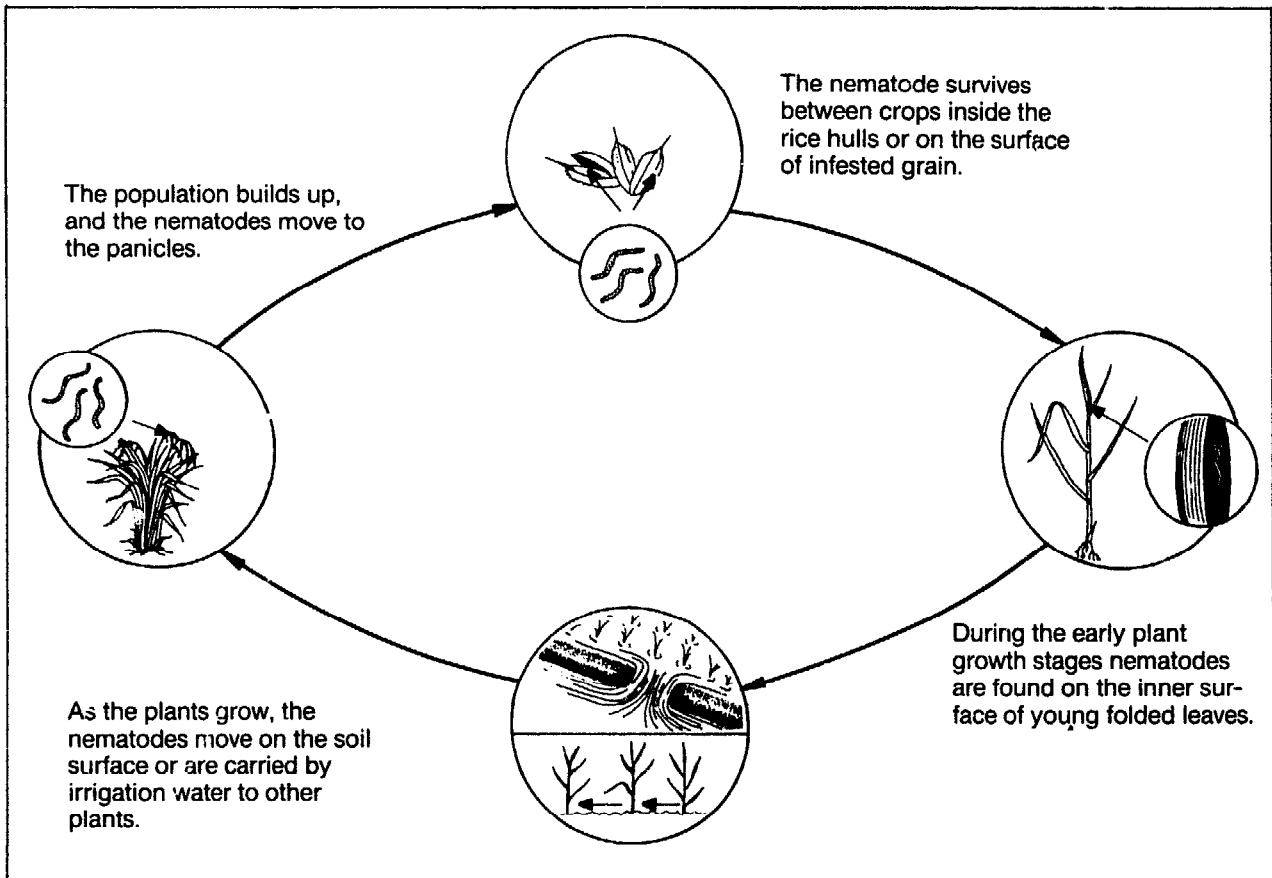



**Control**

*Resistant varieties*

- Some varieties are more susceptible to white tip than others.

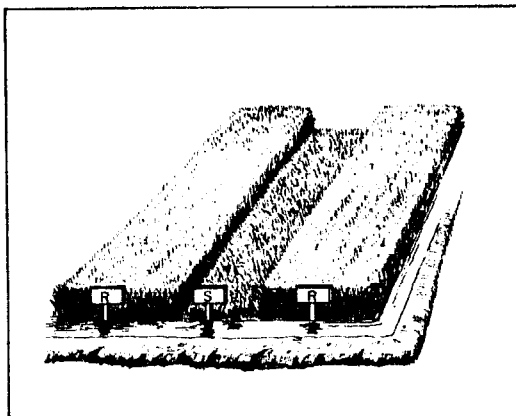

*Cultural control*

- Treating seeds with hot water will reduce infection.

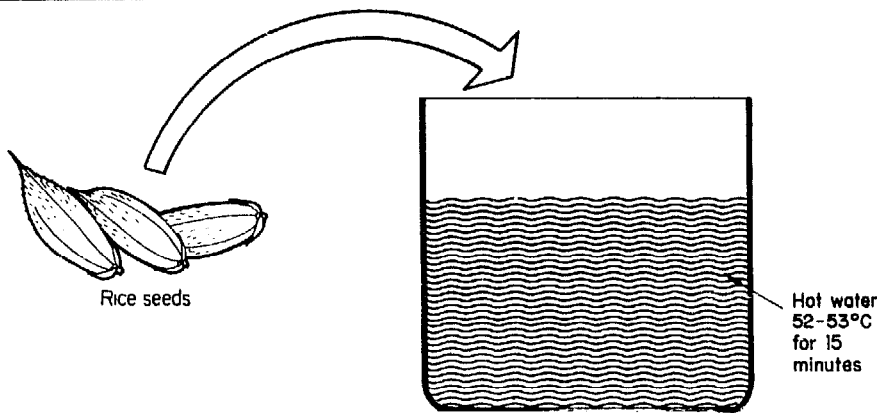

- Planting earlier than usual may reduce infection in areas commonly affected by the nematode.

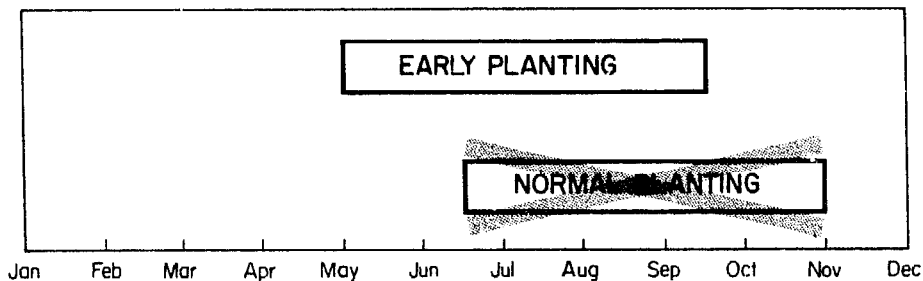

# WEEDS

## Weed Pests of Rice

Weeds reduce rice yields by competing with the rice plants for sunlight, moisture, and soil nutrients.

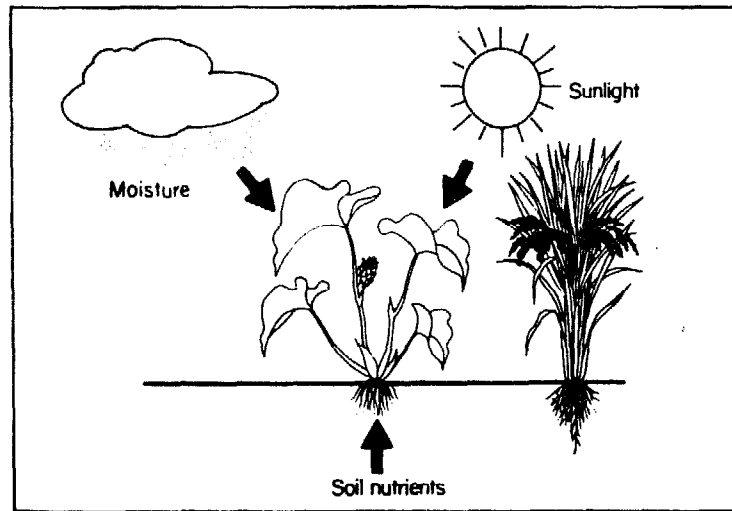

Fertilizer application may not increase yields in weedy fields because weeds absorb nitrogen more effectively than the rice plants.

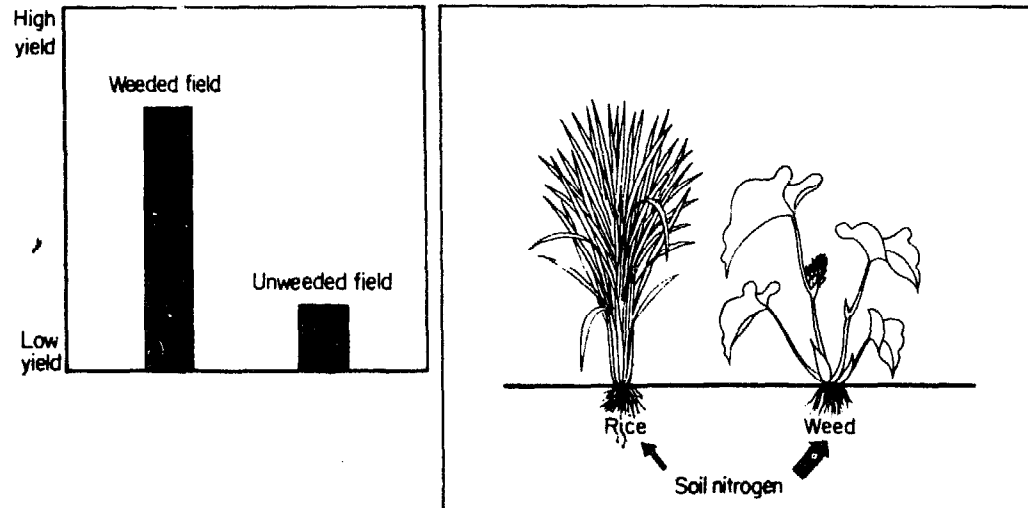

Weeds are also harmful because they may be alternate hosts for insect and disease pests of rice, and provide shelter for rats.

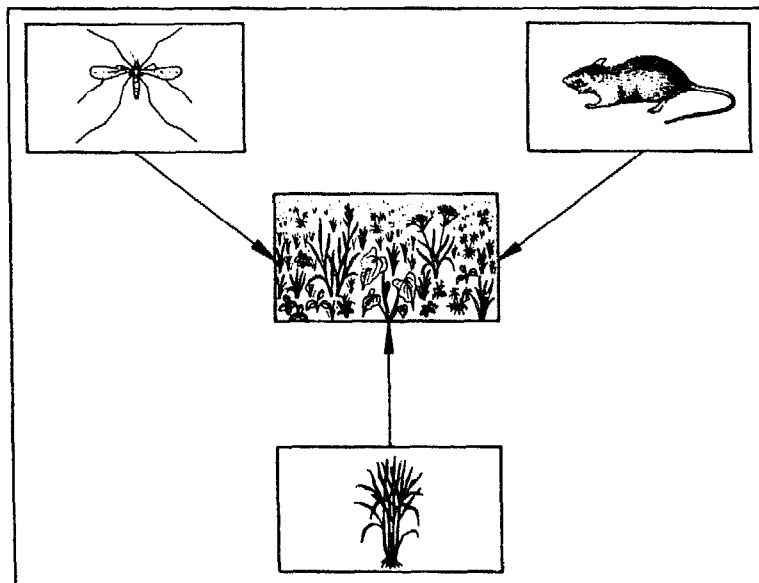

**SEVERITY OF WEEDS IN DIFFERENT TYPES OF RICE CULTURE**

- Weeds are usually most serious in dryland and dry-seeded rainfed rice and may destroy the entire crop if they are not adequately controlled.
- Weeds are usually least serious in irrigated transplanted fields but may still reduce yields, particularly when large amounts of fertilizer are applied to modern cultivars.

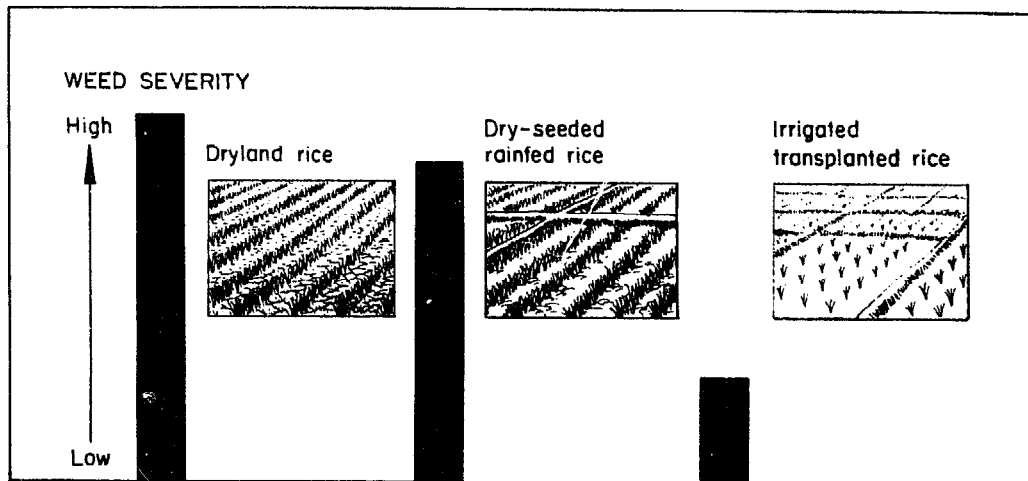

**INTEGRATED WEED CONTROL.**

- Weeds are most effectively controlled over a long period of time by an integrated program combining different control methods.

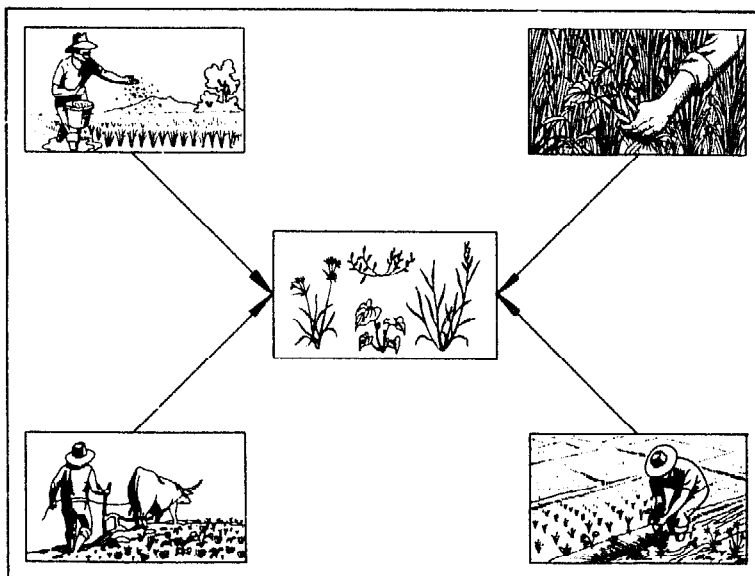

- If a single control method is used for a long time, weed species resistant to that method will build up, and eventually the control measure will fail.

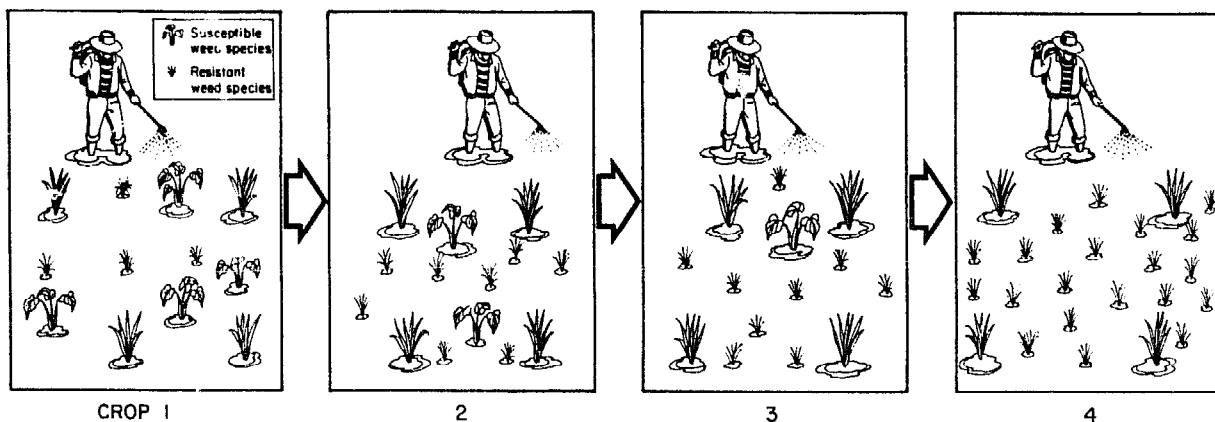

**TYPES OF WEEDS**

Weeds can be divided into three general types, based on their appearance:

**Grasses**

General characteristics of grasses

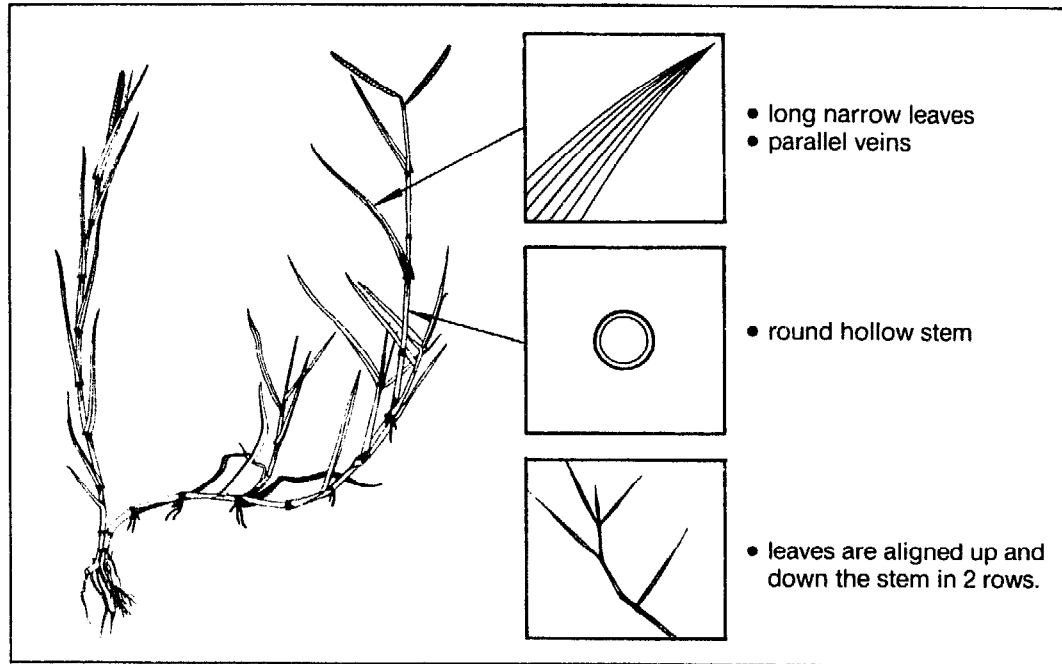

**Sedges**

Sedges are similar to grasses but:

- leaves are aligned up and down the stem in 3 rows;
- stems are usually solid and triangular.

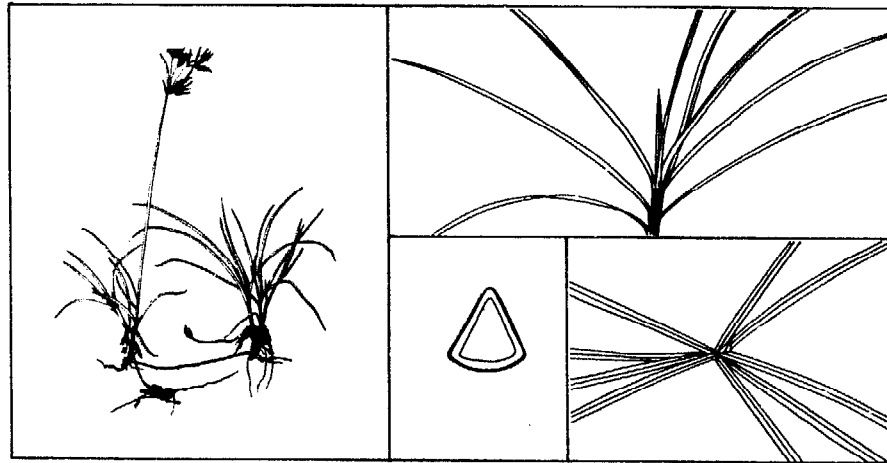

**Broadleaf weeds**

Leaves may have various shapes and arrangements of veins.

The leaves are usually wider than those of grasses and sedges.

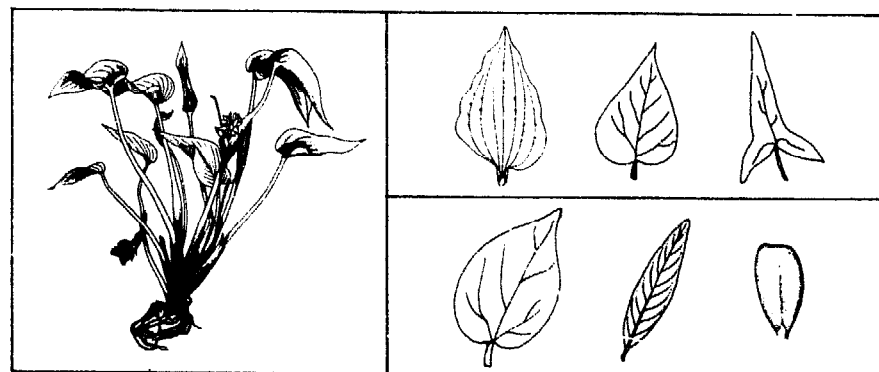

Weeds are also sometimes grouped according to the length of their life cycle:

- Perennials require more than 1 year to complete their life cycle.
- Annuals complete their life cycle in 1 year or less.

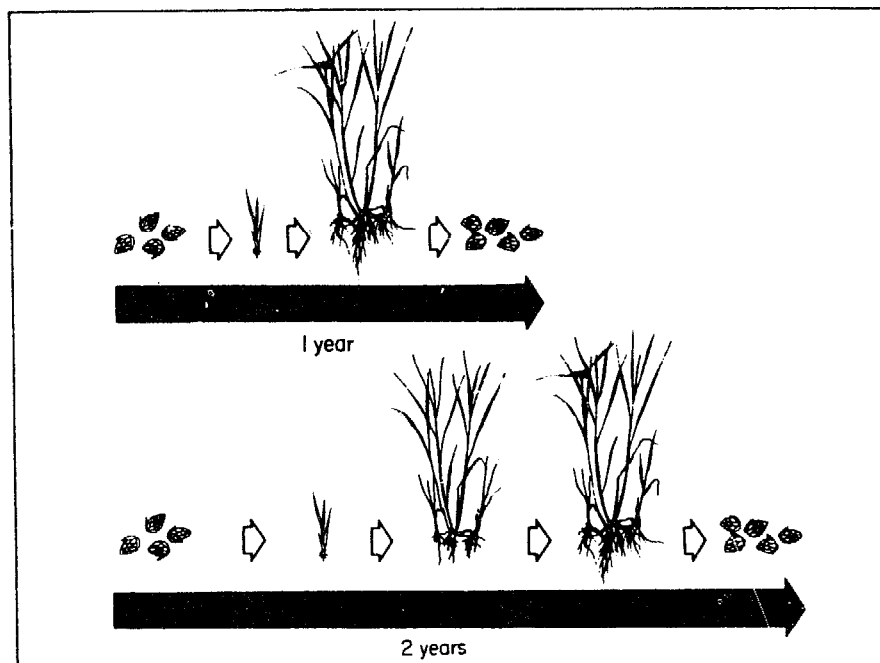



IDENTIFICATION AND ECOLOGY OF COMMON WEEDS IN RICE

*COMMELINA BENGHALENSIS* L.

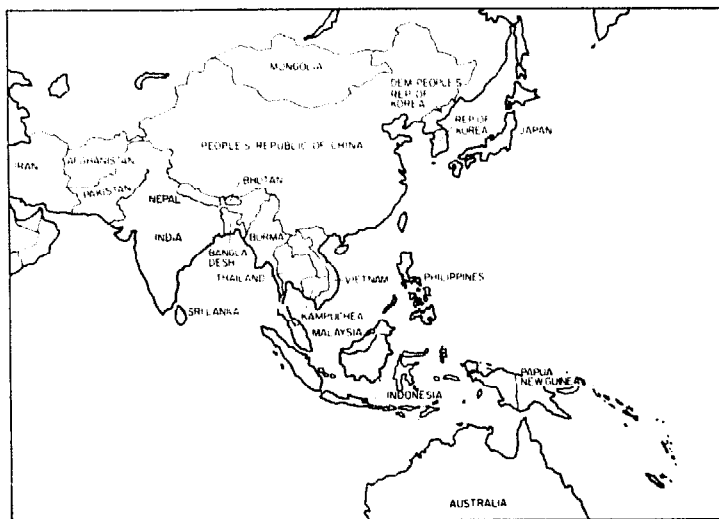
Countries in which *C. benghalensis* is most serious

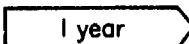

Type

	Broadleaf weed
	Annual (temperate areas)
	 Perennial (tropics)

Found in:

- dryland rice

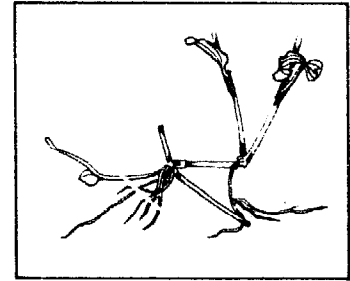
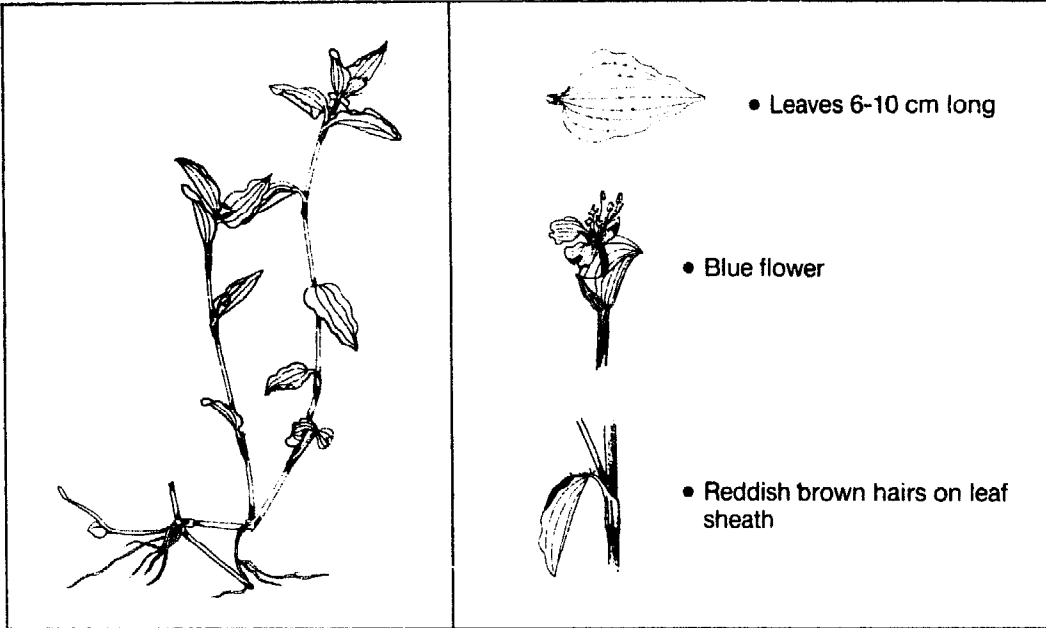

**Identification****Distinguishing characteristics****Reproduction and dissemination**

This weed reproduces mainly by seed.

Creeping stems if cut during cultivation, root and grow.

**Habitat:** dryland rice fields; along dikes; field borders; roadside, banks of irrigation ditches

- The plants root in water-saturated soils, but can survive after the soil dries.
- *C. benghalensis* grows best when soils are moist and fertile, but can persist in sandy or rocky soils.

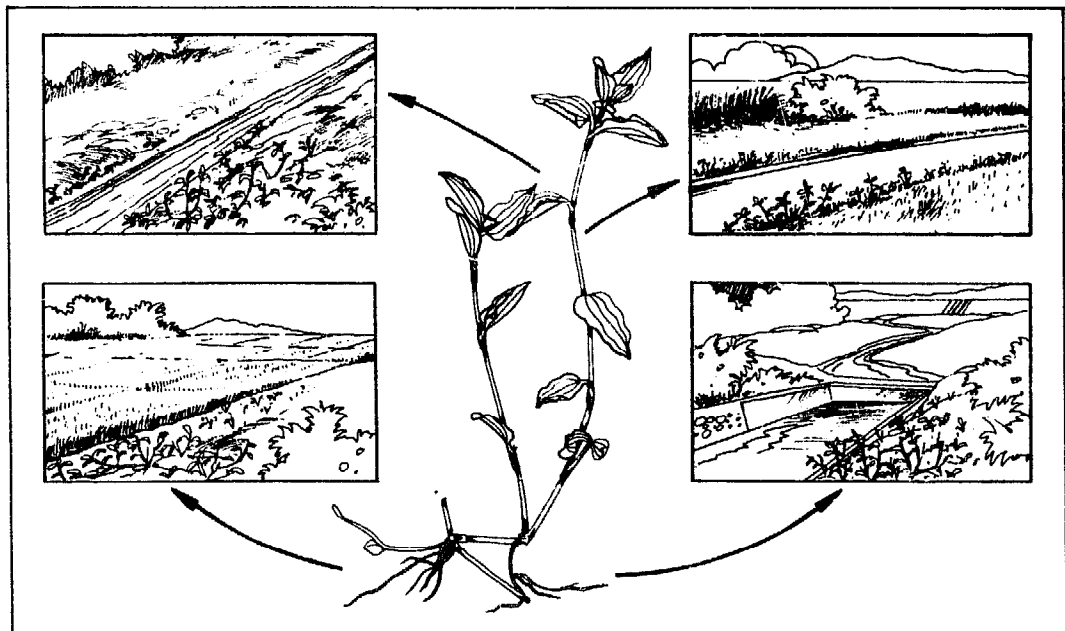
**Ecology**

- The plants may be injured by cultivation, but stem cuttings survive on the soil surface and root again.
- The plants form dense pure stands, smothering low-growing crops.

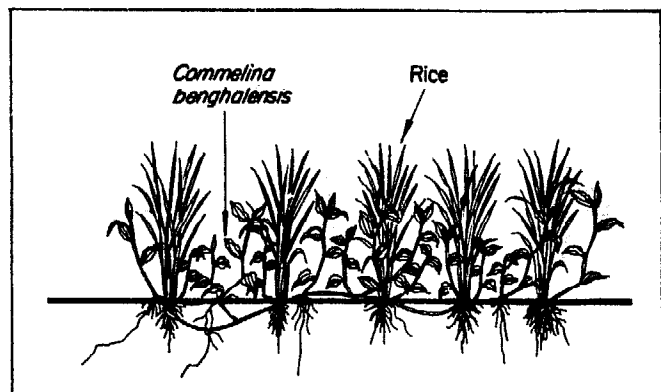

**CYPERUS DIFFORMIS L.**

Countries in which *C. difformis* is most serious

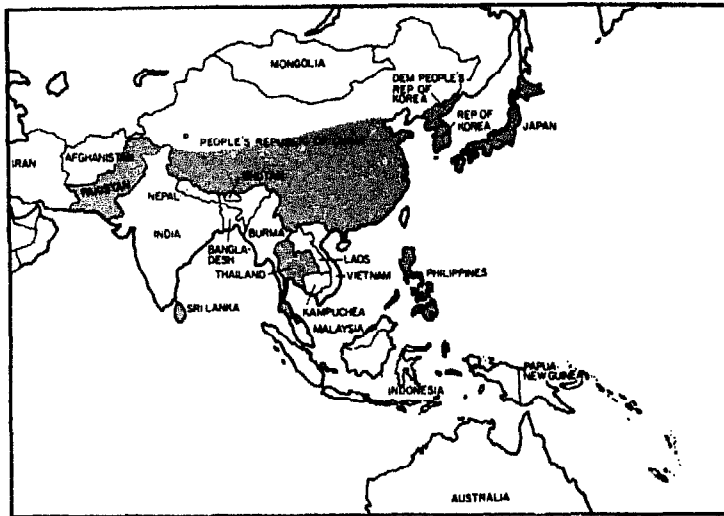

**Type**

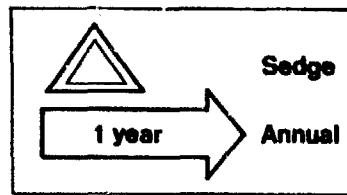

**Found in:**

- Wetland rice



**Identification**

**Distinguishing characteristic**

Flowers yellowish, very numerous, and crowded in ovoid masses.

**Reproduction and dissemination**

- *C. difformis* reproduces from seeds.

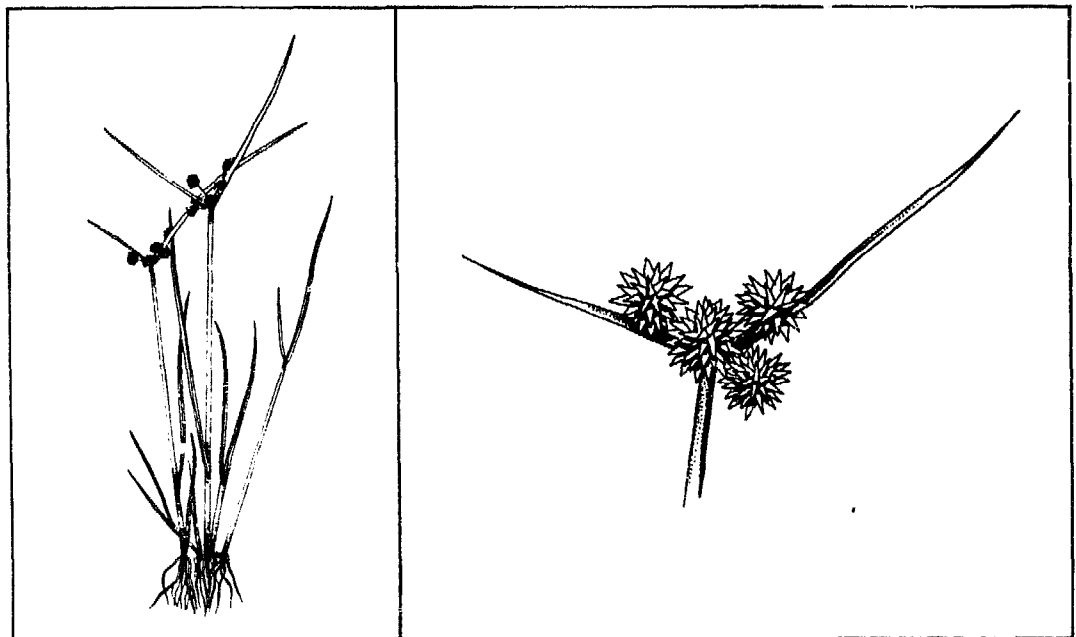

**Habitat:** grassy swamps, wetland rice fields, along rivers or streams, open wet areas

- *C. difformis* grows best in rich, fertile soils that are flooded or very moist.

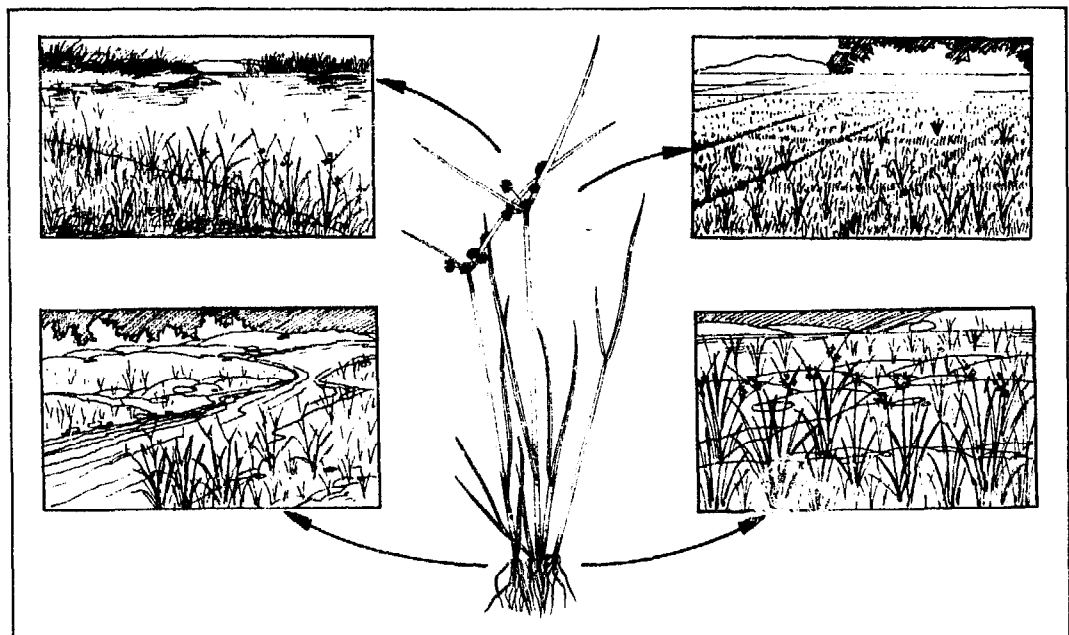



**Ecology**

- The plant may rapidly cover the ground because of its short life cycle and abundant seed production.

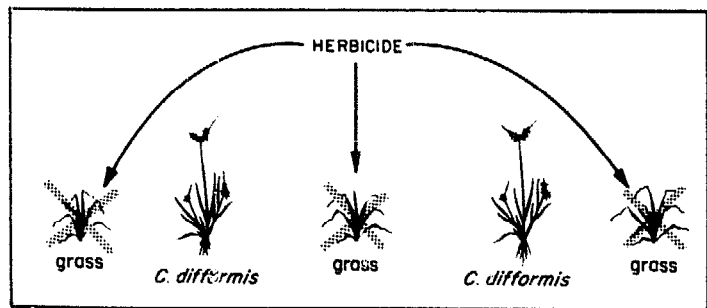
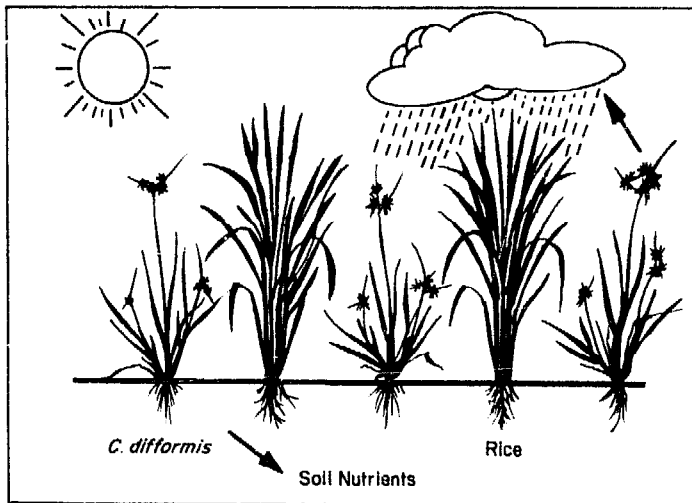
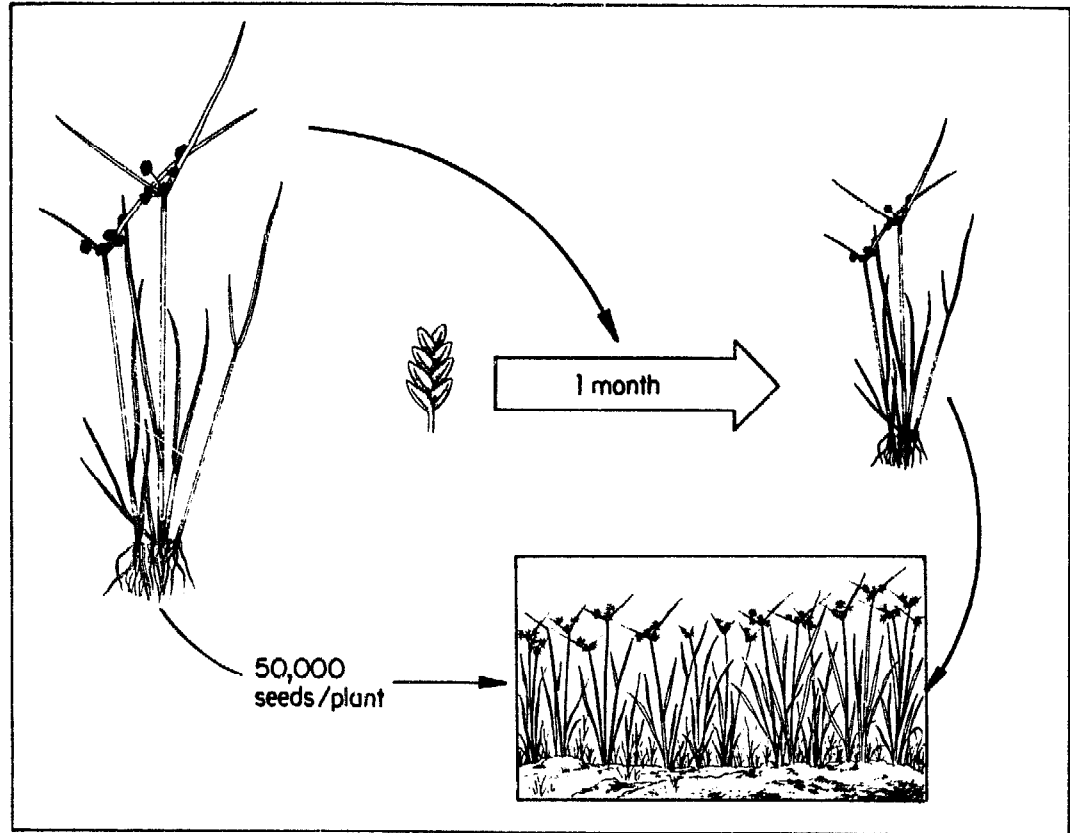

- *C. difformis* may become the dominant weed in rice fields when the herbicides used are effective against grasses but do not kill sedges.

- The weeds do not shade rice plants, but may compete for water and nutrients.

- This weed cannot tolerate deep flooding, and may be controlled by water management.

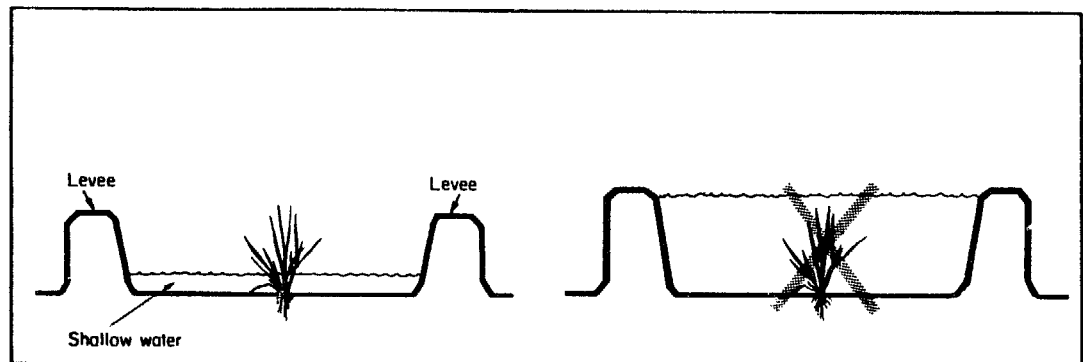

**CYPERUS IRIA L.**

Countries in which *C. iria* is most serious.

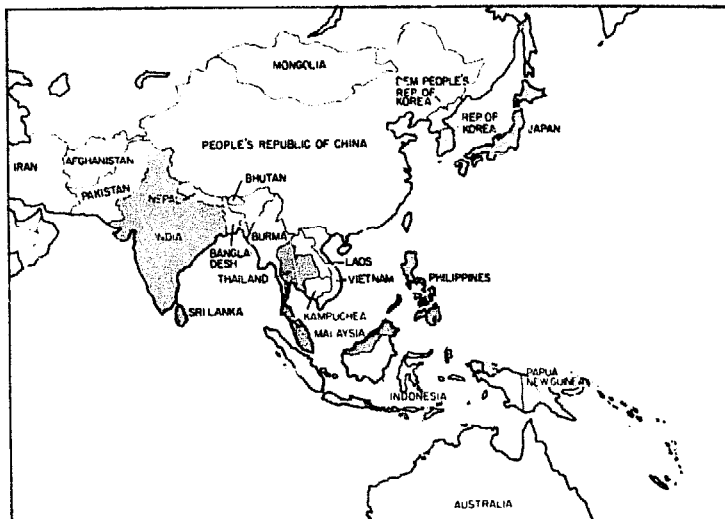

**Type**

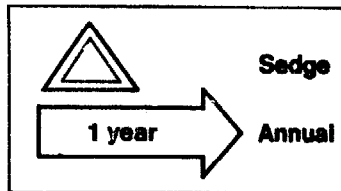

**Found in:**

- Wetland rice.

- Dryland and dry-seeded wetland rice.



**Identification**

**Distinguishing characteristics**

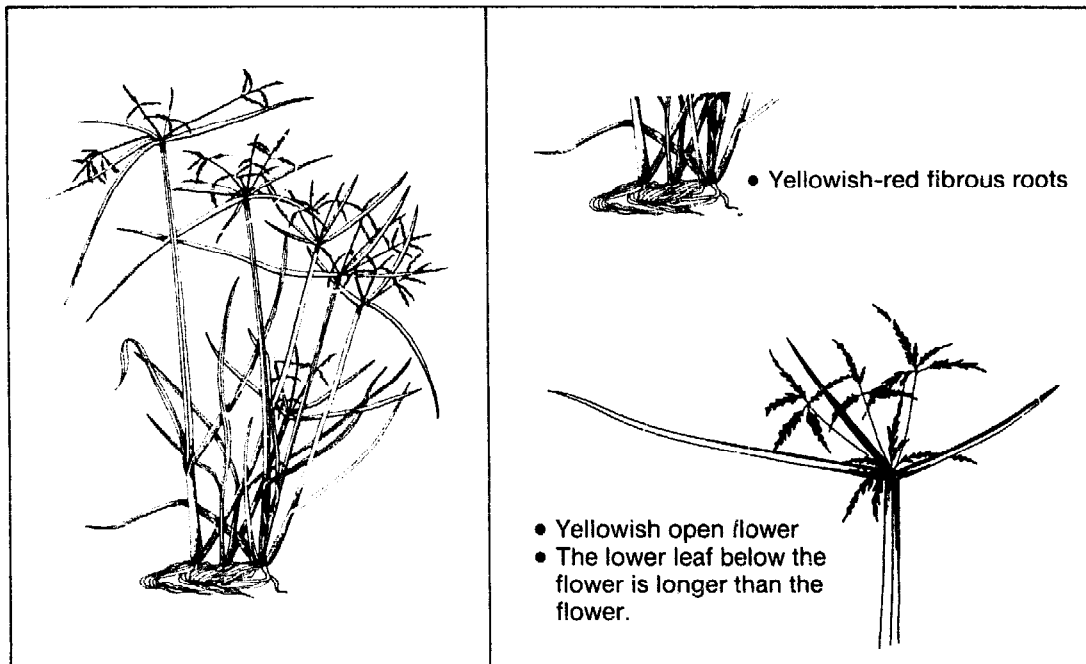

**Reproduction and dissemination**

- *C. iria* reproduces from seeds. Each plant may produce up to 5,000 seeds.



**Habitat:** *C. iria* is found in wet open areas and in wetland, dryland, and dry-seeded rice fields.



**CYPERUS ROTUNDUS L.**

Countries in which *C. rotundus* is most serious.

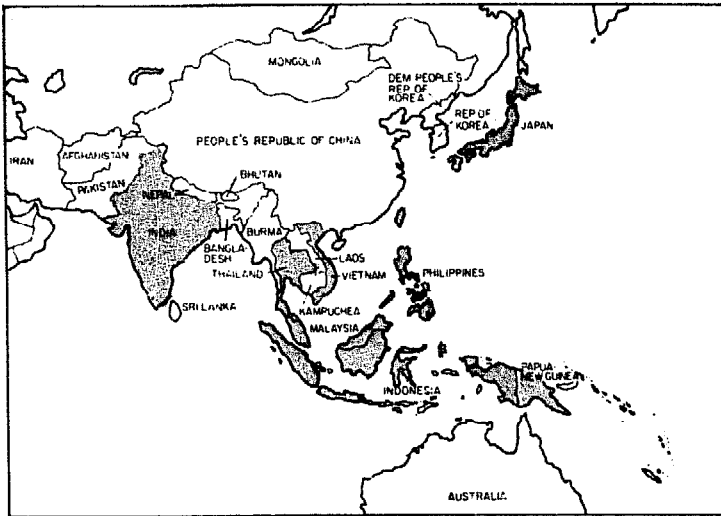

**Type**

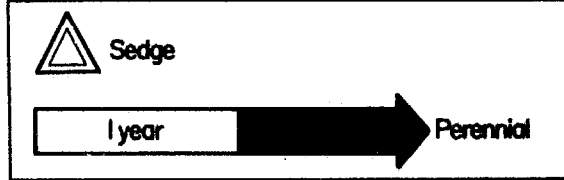

**Found in:**  
• Dryland rice



**Identification**  
Distinguishing characteristics

- Red or purplish-brown seed head
- Underground stems and tubers
- 3 rows of leaves near the plant base

**Reproduction and dissemination**

- The plant occasionally produces seeds.
- The plant usually reproduces from underground stems and tubers.

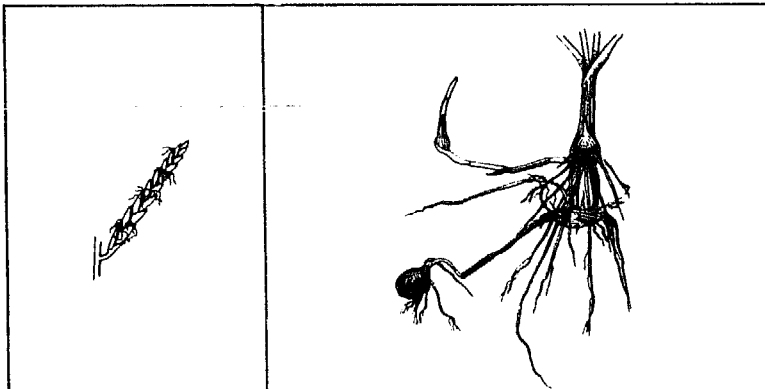

**Habitat:** fields, roadsides, edges of woods, banks of irrigation canals, streams

- The distribution of *C. rotundus* is limited mainly by cool temperatures.
- The weed grows well in almost every soil type, elevation, humidity, soil moisture, and pH. It is tolerant of high temperature.



**Ecology**

- *C. rotundus* is most serious in dryland fields where annual weeds are controlled efficiently, thus leaving *C. rotundus* uncontrolled.



- This weed is highly competitive with rice for both moisture and soil nutrients.
- Tubers have a deep root system and can survive long periods of drought or flooding.

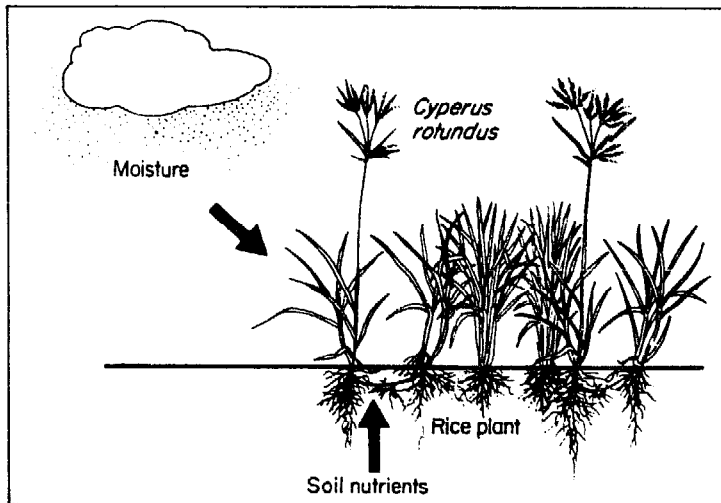

***DACTYLOCTENIUM AEGYPTIUM* (L.) WILLD.**  
 Countries in which *D. aegyptium* is most serious.

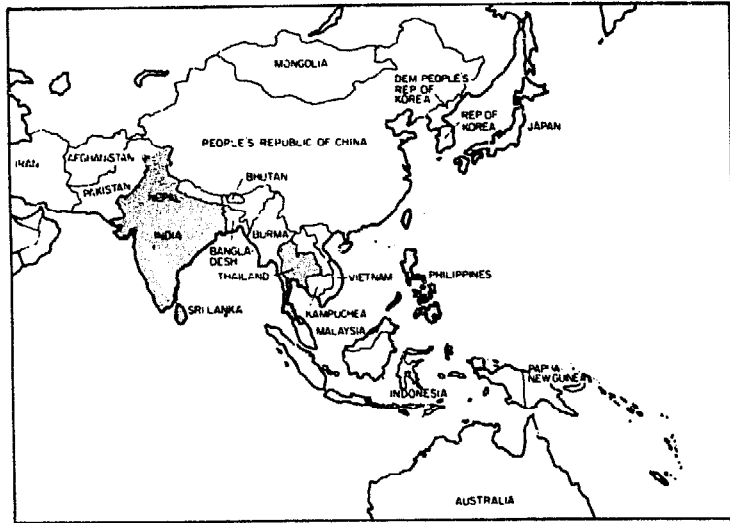

**Type**

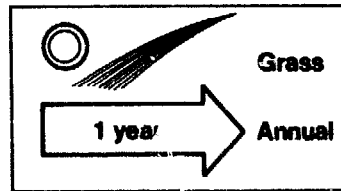

**Found in:**  
 • Dryland rice



**Identification**

**Distinguishing characteristics**

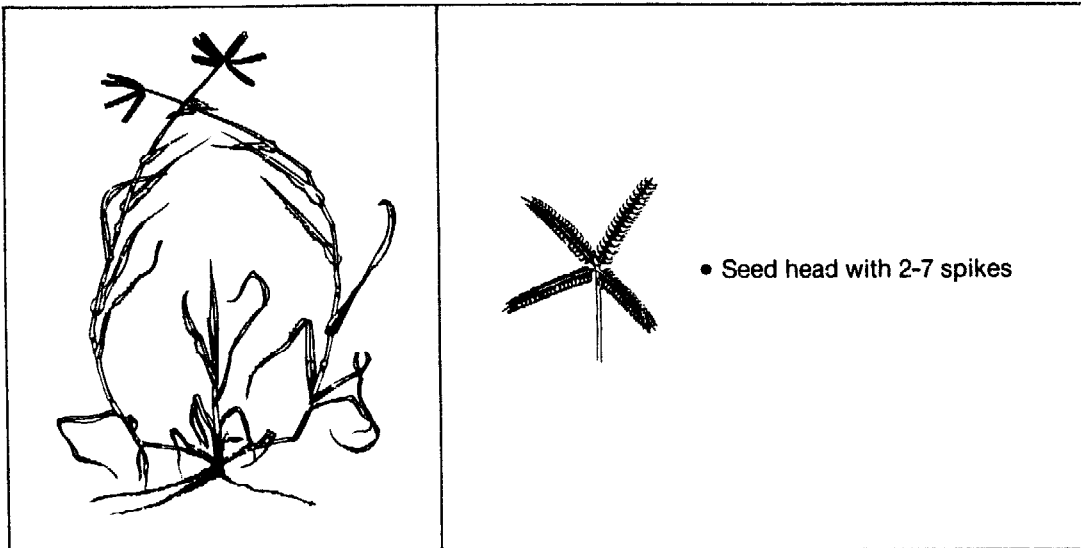

**Reproduction and dissemination**

- Each plant may produce up to 60,000 seeds.
- Creeping stems root at lower nodes.

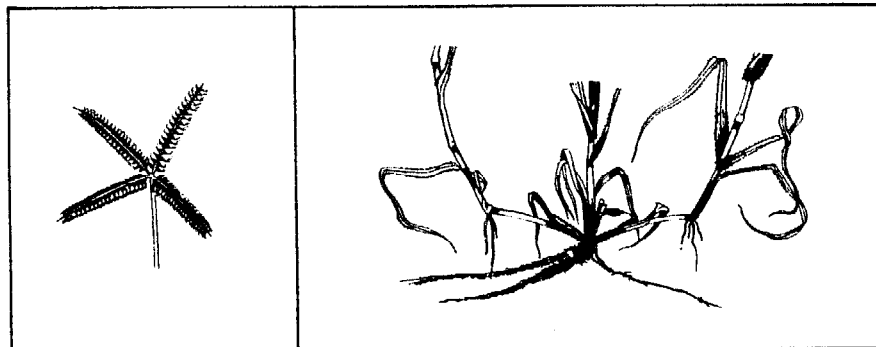

**Habitat**

The weed is common in both cultivated land and waste areas. It grows well in sandy soils with low moisture.

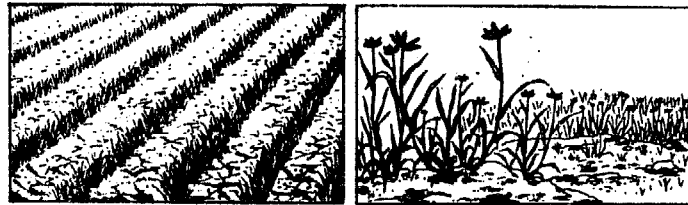

**Ecology**

*D. aegyptium* flowers all year in the tropics.

***DIGITARIA CILIARIS* (RETZ) KOEL.**

Countries in which *D. ciliaris* is most serious.

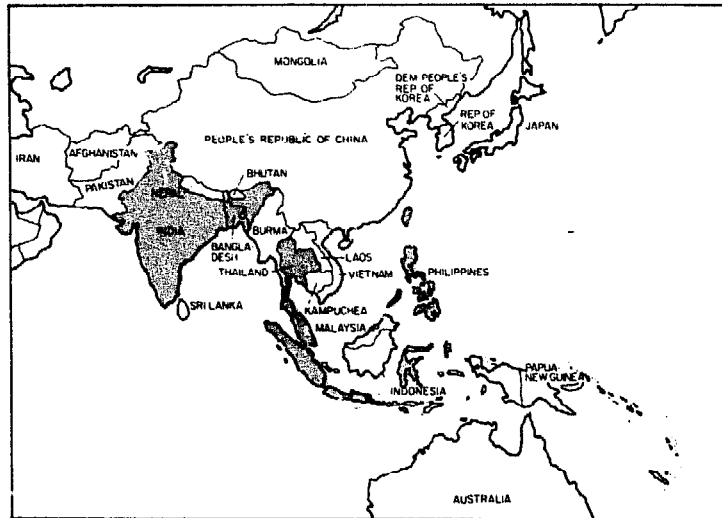

**Type**

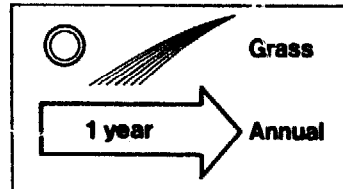

**Found in:**

- Dryland rice.



**Identification**

**Distinguishing characteristics**

Seed head has 3-13 narrow finger-like projections.

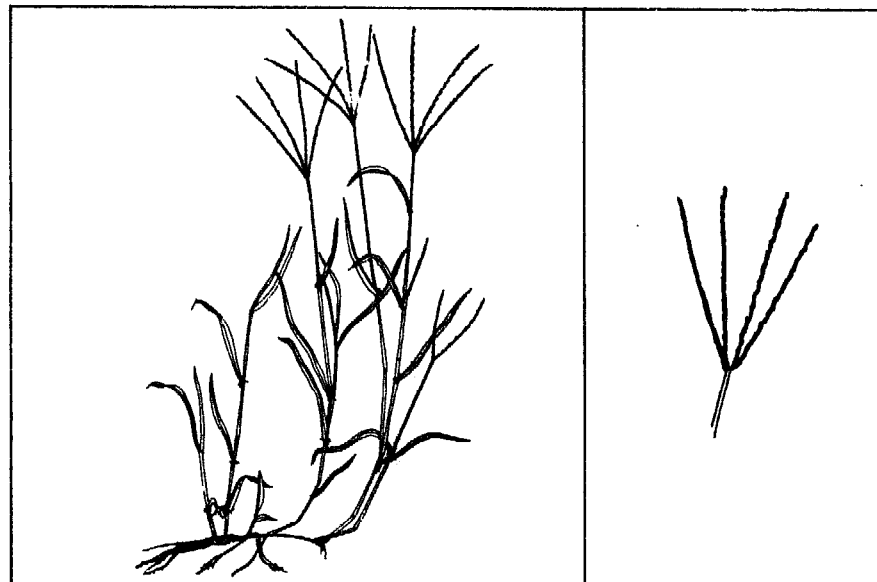

**Reproduction and dissemination**

- Each plant may produce thousands of seeds.
- The weed sometimes spreads by rooting of the nodes of stems on the ground.

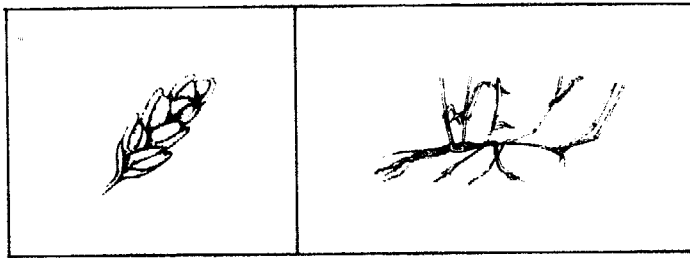

**Ecology**

- *D. ciliaris* is tolerant of high temperatures and may show maximum growth when other plants are under stress due to hot, dry weather.
- The weed is very competitive because it can root and spread along the ground surface. A single plant may cover 2-3 m<sup>2</sup>.

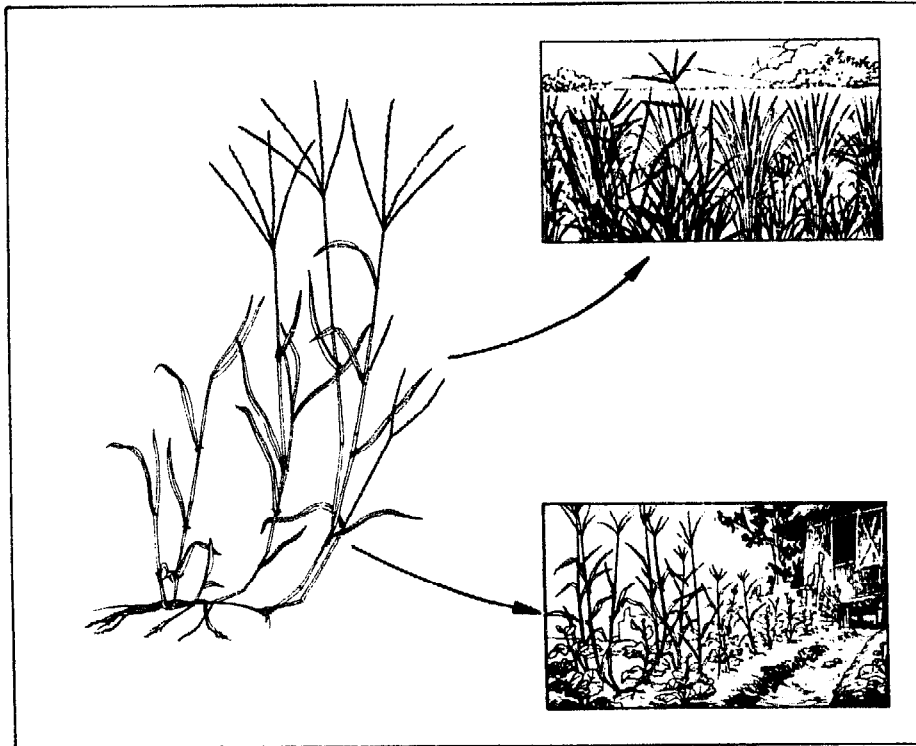

**ECHINOCHLOA COLONA (L.) LINK**

Countries in which *E. colona* is most serious.

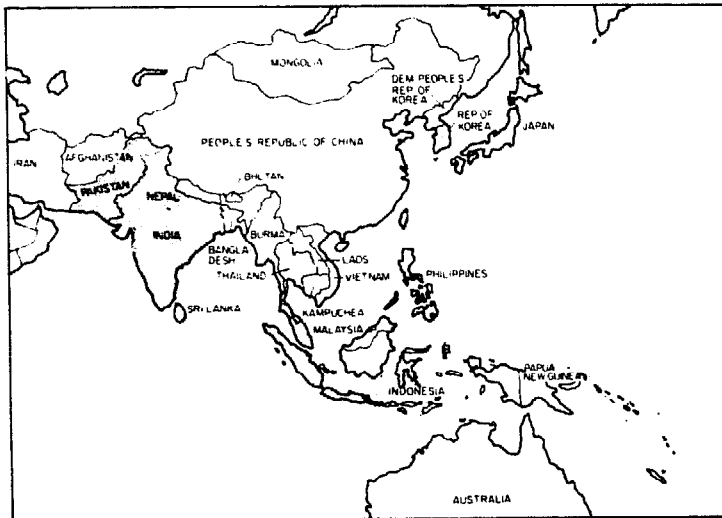

**Type**

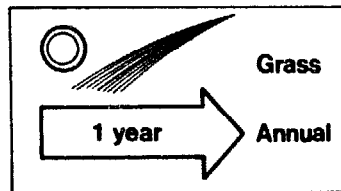

**Found in:**

- Dryland rice and wetland rice



**Identification**

**Distinguishing characteristics**

- Slightly spreading growth habit. Less than 1 m high.

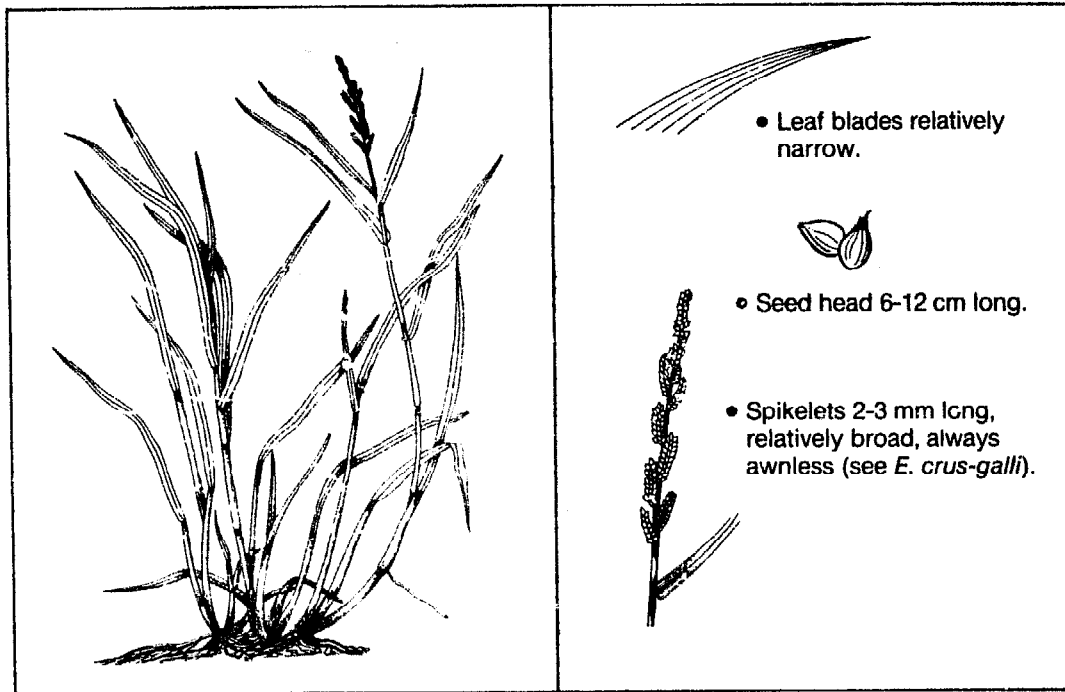

**Reproduction and dissemination**

- Each plant may produce thousands of seeds.
- Seeds are transported from field to field by irrigation water and farm machinery.

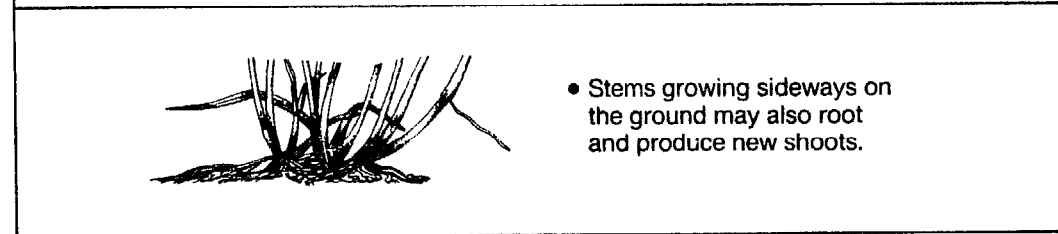
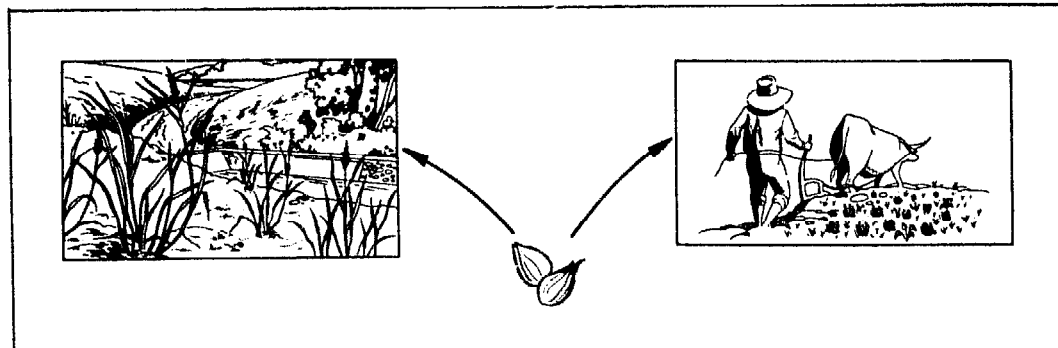

**Ecology**

- Young seedlings resemble rice plants. By the time they can be recognized and removed, the crop has already been damaged.
- *E. colona* grows rapidly during the rainy season or when irrigation water is abundant.

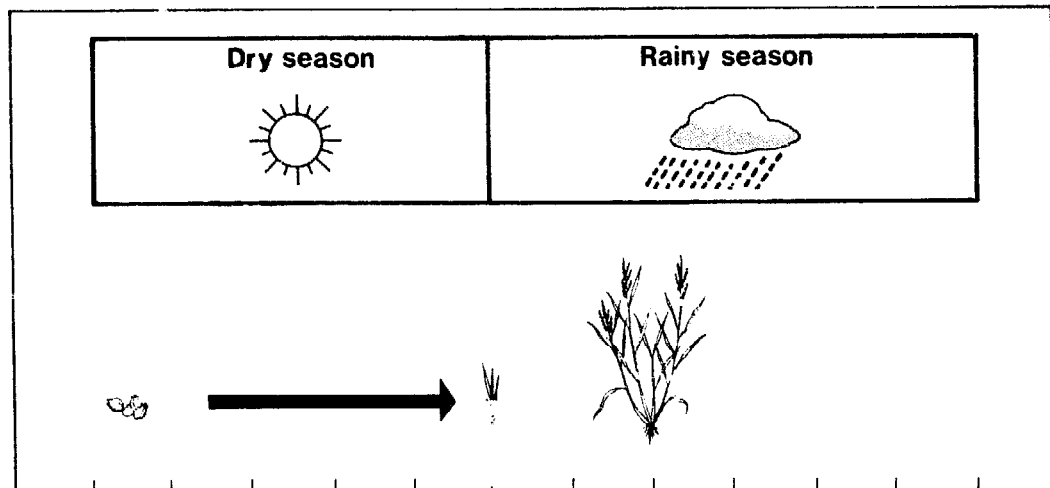



- This weed is an excellent competitor and may completely crowd out a rice crop if fields are poorly managed. Its effects on yields are similar to those described for *E. crus-galli*.

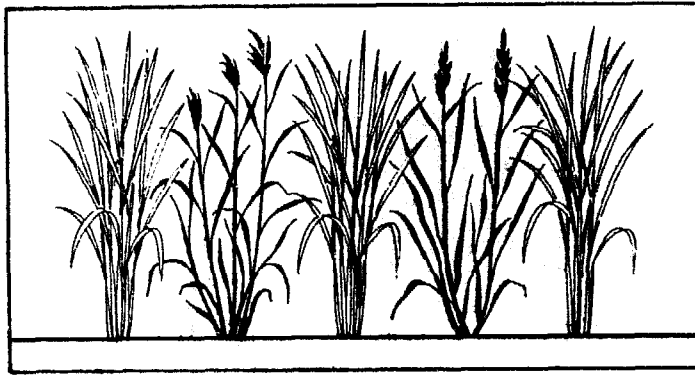

*ECHINOCHLOA CRUS-GALLI* (L.) BEAUV.  
Countries in which *E. crus-galli* is most serious.

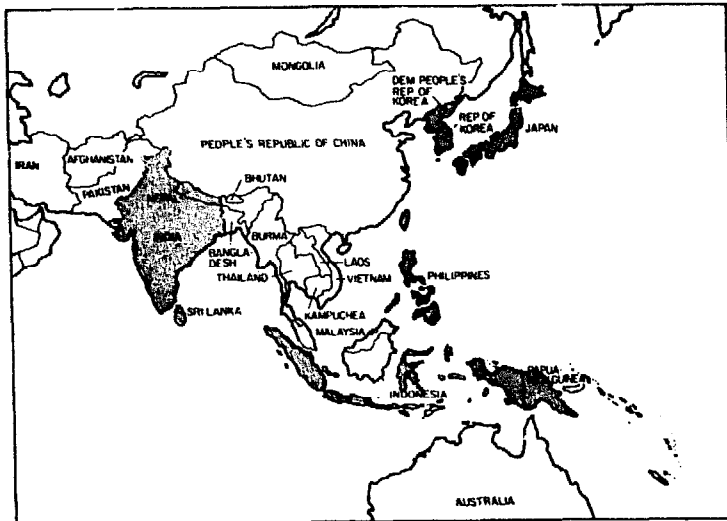

#### Type

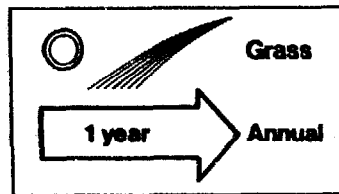

#### Found in:

- Wetland rice.



#### Identification

Distinguishing characteristics



- Upright growth habit, 1-3 m high.



- Leaf blades relatively wide, 1-2 cm wide, 40 cm long.



- Seed head 6-20 cm long.



- Spikelets usually have 2 awns. Sometimes spikelets are awnless.
- Spikelets 3-3.5 mm long, relatively narrow (see *E. colona*).

**Reproduction and dissemination**

- *E. crus-galli* reproduces by seeds.

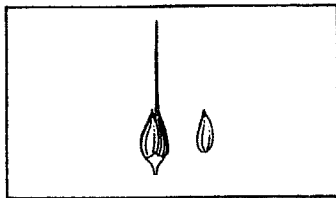

**Habitat**

- *E. crus-galli* prefers wet soils and will grow when partially submerged.
- It grows best in heavy soils with a high nitrogen content.

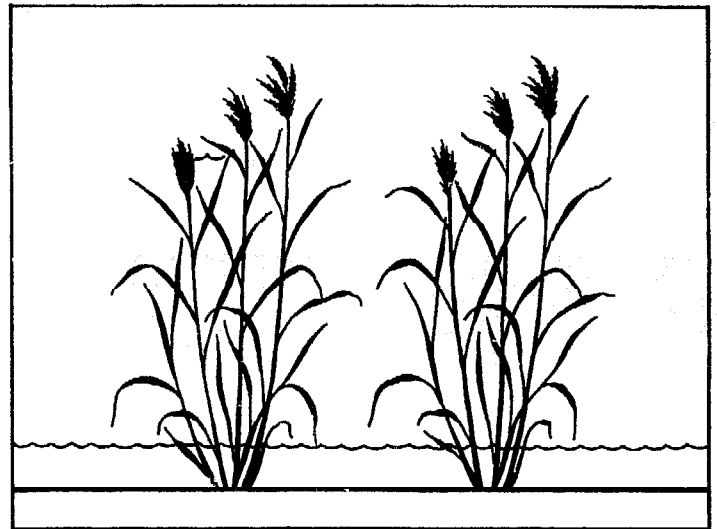

**Ecology**

- *E. crus-galli* grows well under conditions favorable to the growth of rice.
- The young weed looks like a rice seedling and is often transplanted by mistake.
- Rice yield reductions are most serious when the weed grows during the first 60 days after rice germinates.

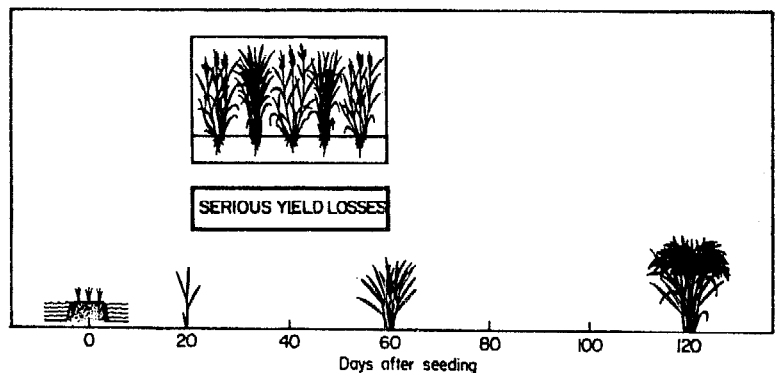
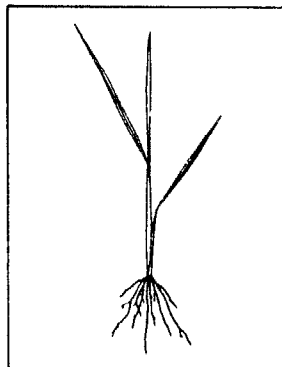

**ELEUSINE INDICA (L.) GAERTN.**

Countries in which *E. indica* is most serious.

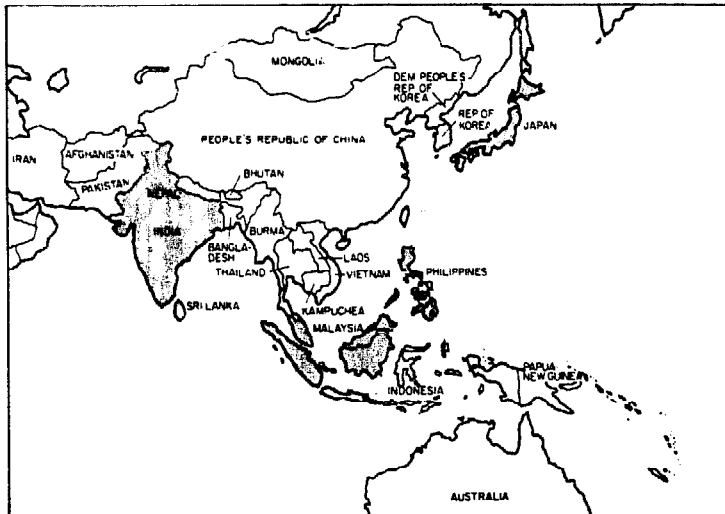

**Type**

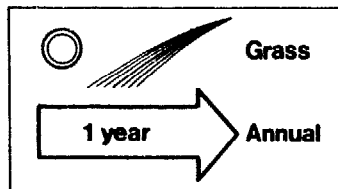

**Found in:**

- Dryland rice.



**Identification**

**Distinguishing characteristic**

- windmill-shaped seed head

**Reproduction and dissemination**

- *E. indica* reproduces from seed. Each plant may produce as many as 50,000 seeds.

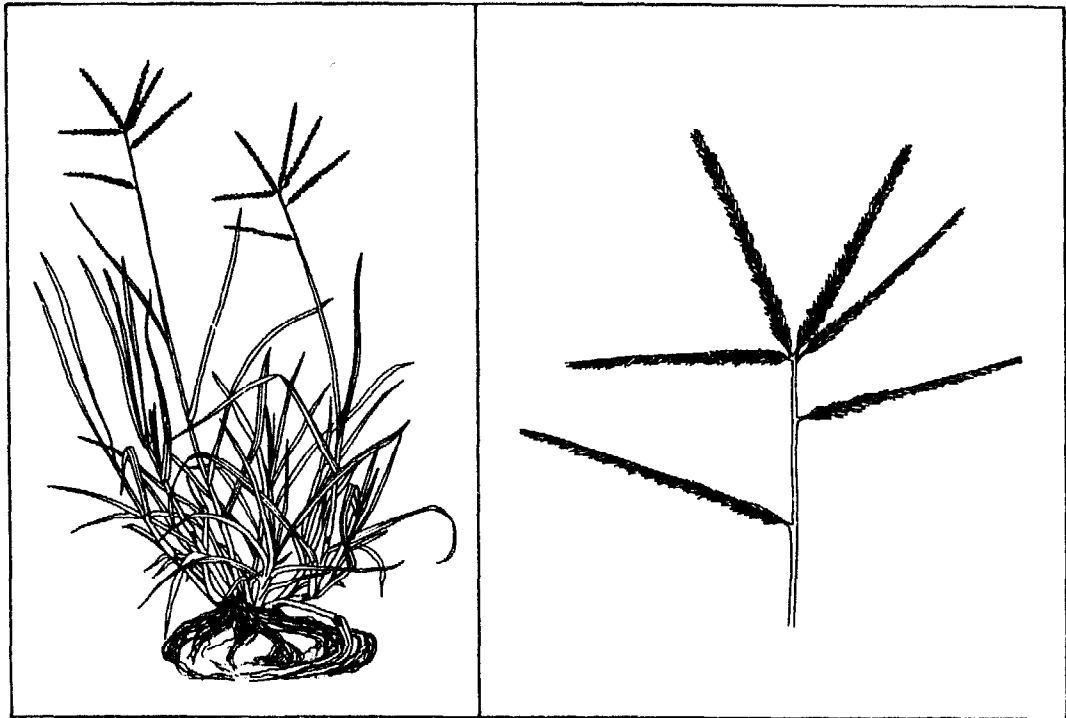
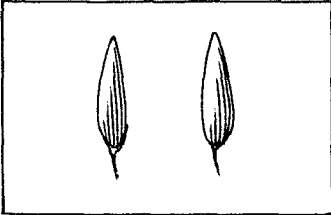

**Habitat** — along irrigation canals, cultivated fields and damp, marshy areas.

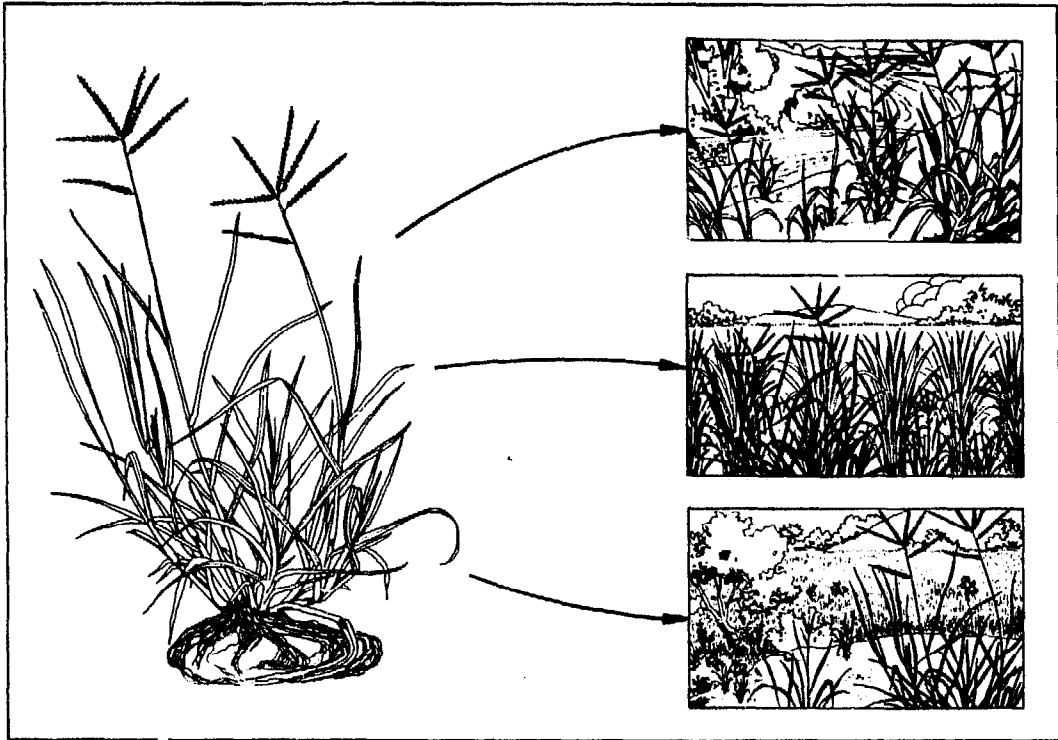

**Ecology**

- *E. indica* does not grow well in the tropics during the dry season or when the soil is not moist.

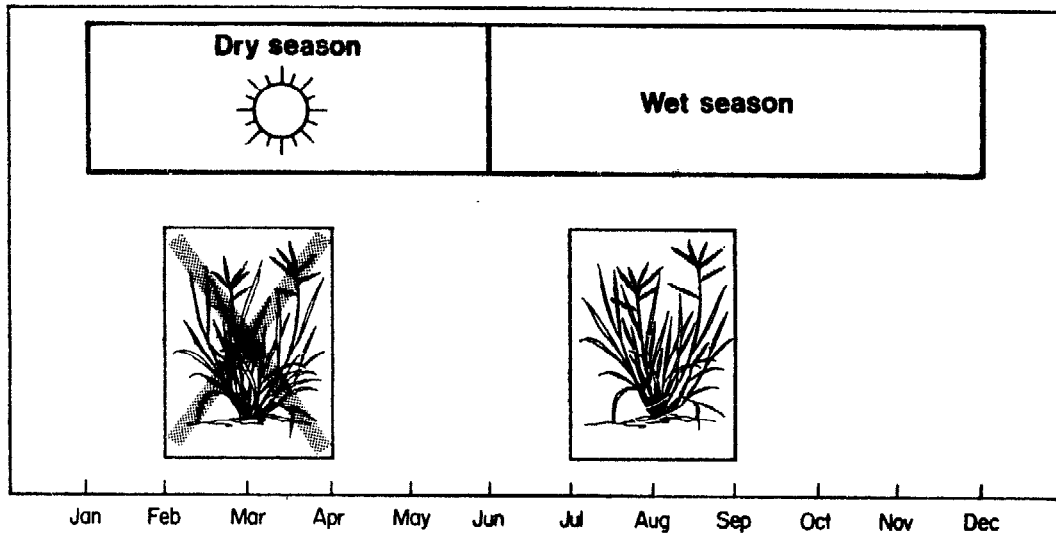

- The weed flowers at day lengths between 6 and 16 hours.

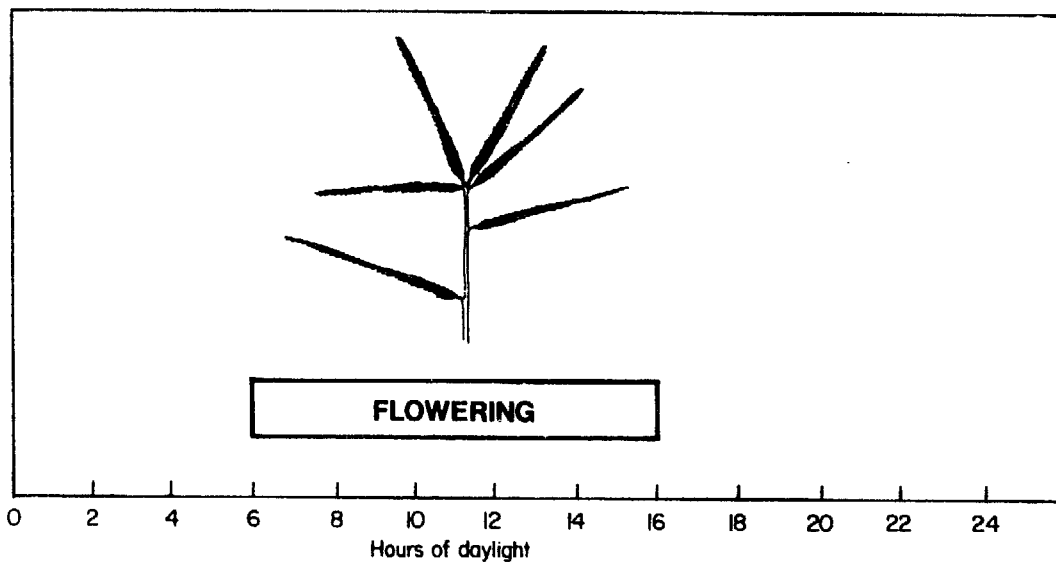

- In the tropics, *E. indica* completes a reproductive cycle in about 5 weeks.

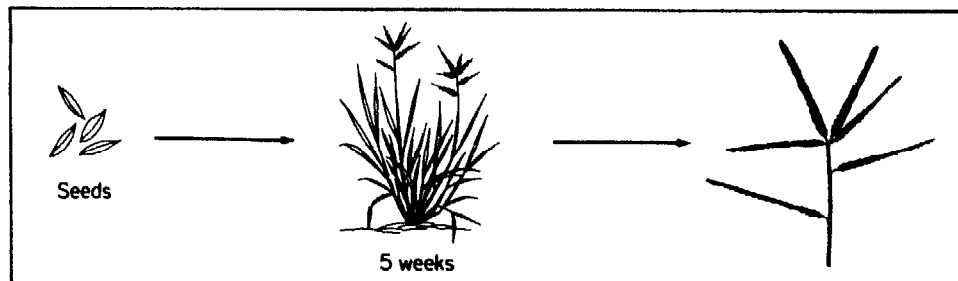

**FIMBRISTYLIS MILIACEA (= LITTORALIS) (L.) VAHL**  
 Countries in which *F. miliacea* is most serious.

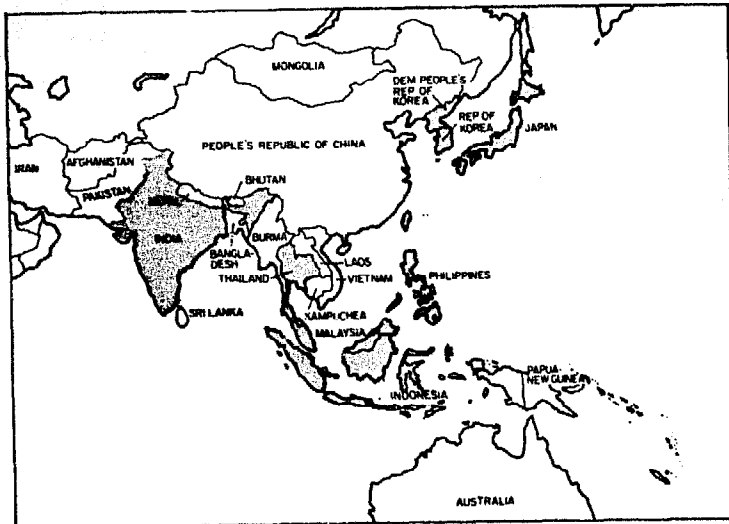

**Type**

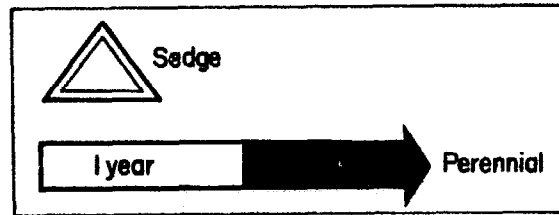

**Found in:**

- Wetland rice.



**Identification**

**Distinguishing characteristics**

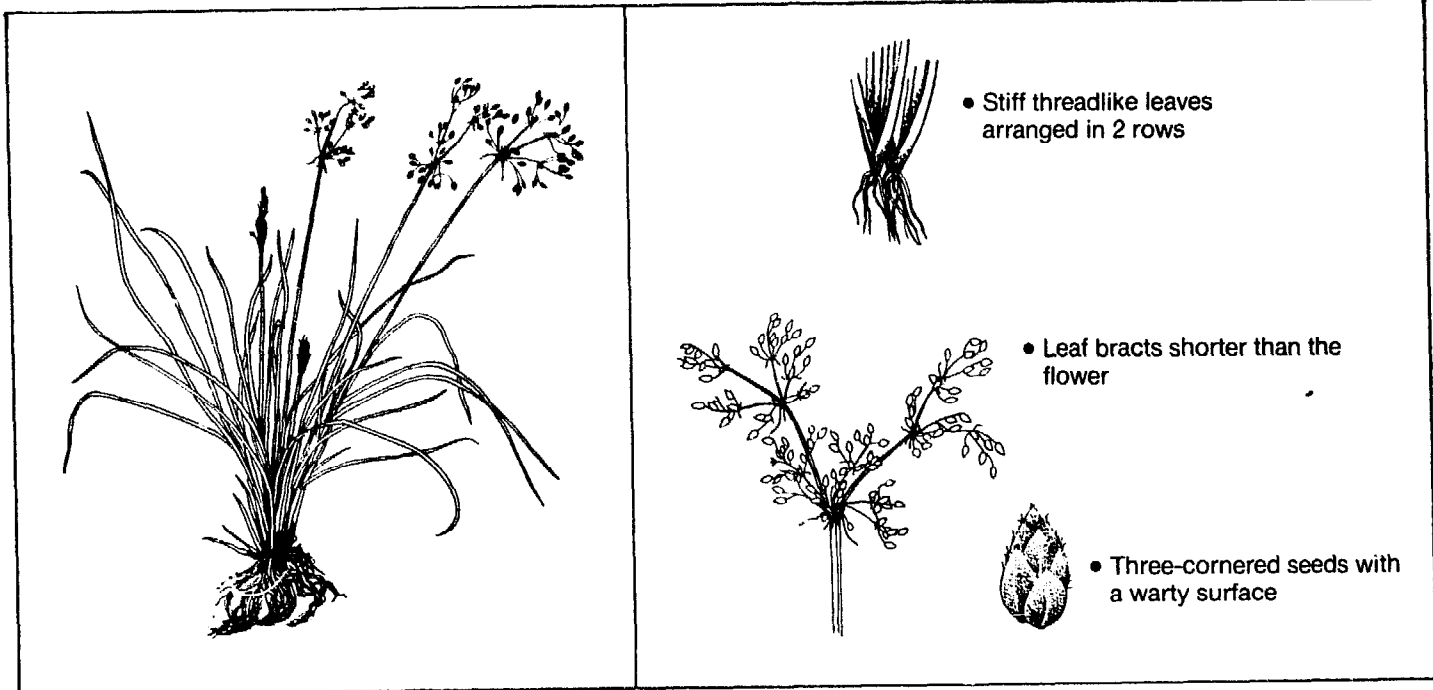

**Reproduction and dissemination**

- *F. miliacea* reproduces from seed. Each plant may produce as many as 10,000 seeds.



**Habitat:** fields uncultivated during the dry season; submerged rice field; damp, open waste areas.

- *F. miliacea* grows well in damp soil, but may not become established in submerged areas.

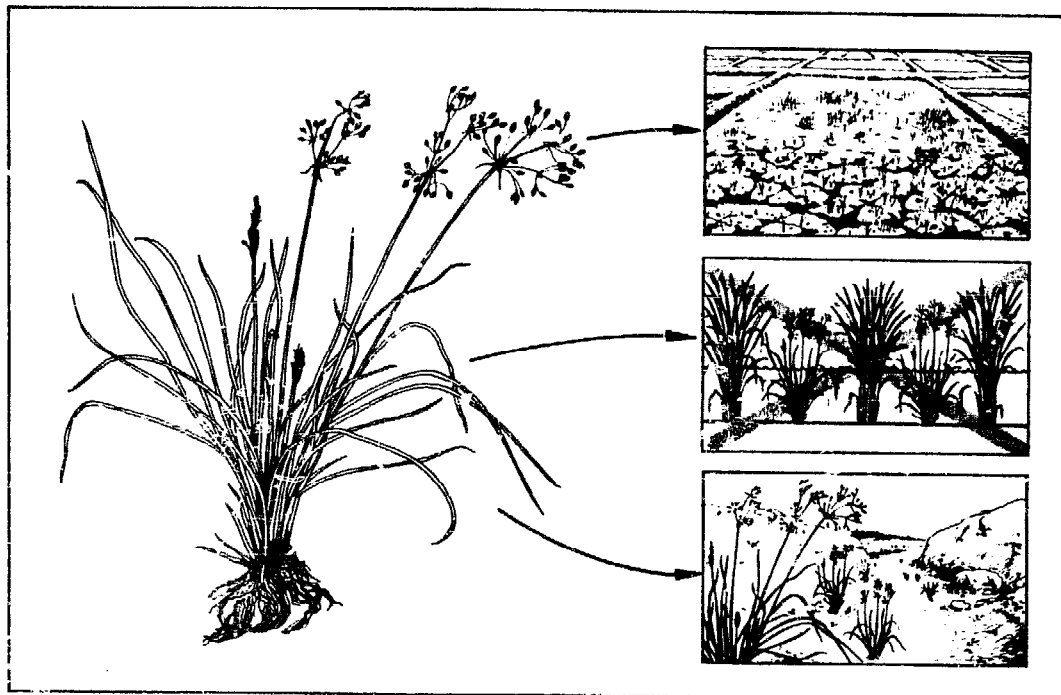

**Ecology**

- *F. miliacea* is becoming increasingly serious in wetland rice throughout Asia.
- Many seeds germinate during the early stages of rice growth, but some germination continues throughout crop development. This continuous seed germination makes it difficult to control the weed with a single herbicide application because seedlings from later germinating seeds may escape.

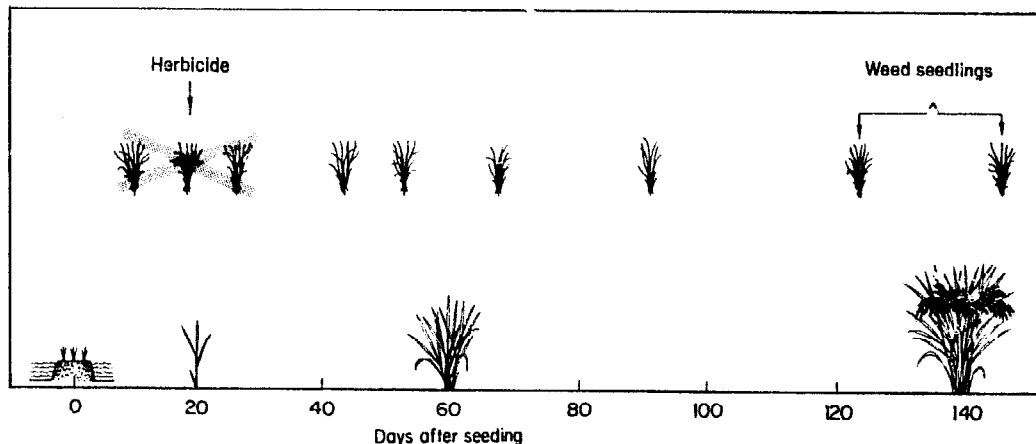

- *F. miliacea* is very competitive for soil nutrients because its roots spread more rapidly than rice roots do.

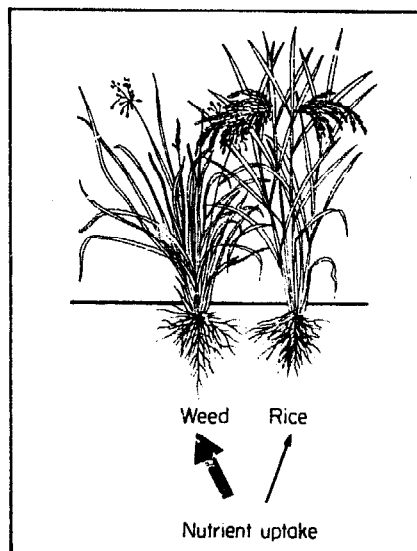

**MONOCHORIA VAGINALIS (BURM. F.) PRESL.**  
**Countries in which *M. vaginalis* is most serious.**

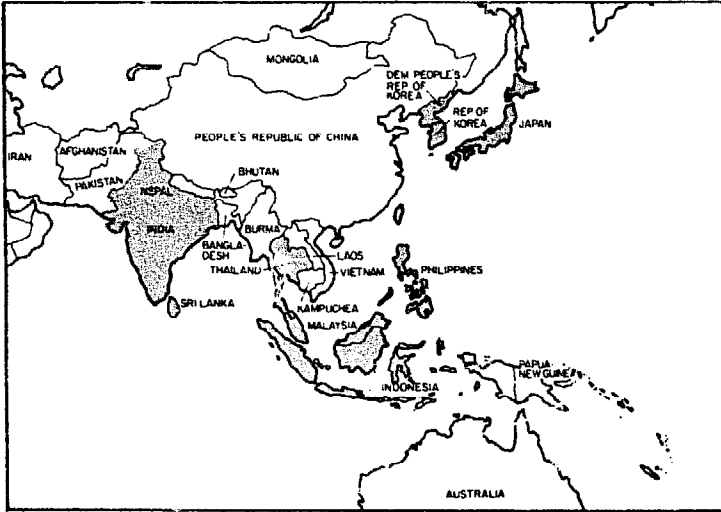

**Type**

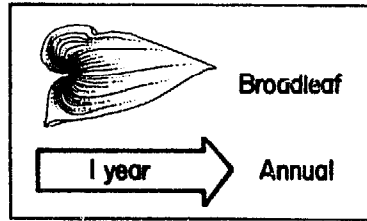

**Found in:**

- Wetland rice.



**Identification**

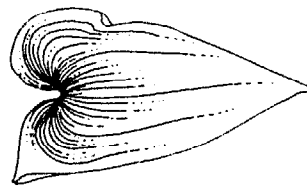

- Shiny heart-shaped leaves



- Blue flower on the opposite side of the stem from the leaf.



- Curved stigma.

**Reproduction and dissemination**

- *M. vaginalis* reproduces from seeds.

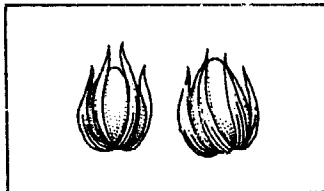

**Habitat** — freshwater pools, mud flats in rivers, flooded rice fields, along canals and ditches

- The plant roots in mud and its upper portion grows above the water.

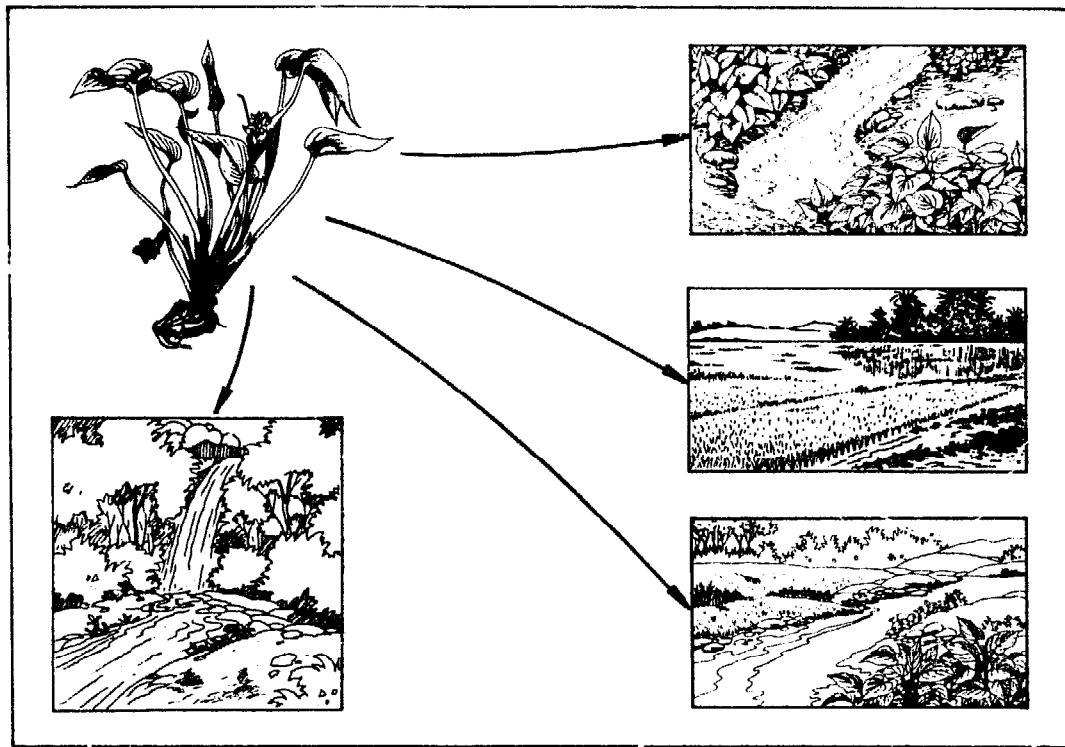

**Ecology**

- *M. vaginalis* often produces higher fresh-weight yields in rice fields than any other weed species.
- However, it is relatively short and shallow rooted, and may not compete as successfully for sunlight and soil nutrients as some other weeds.

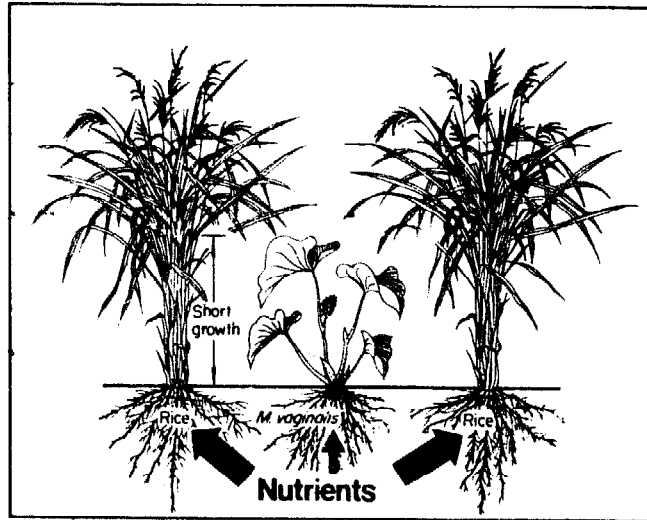



***PASPALUM DISTICHUM* L.**

Countries in which *P. distichum* is most serious.

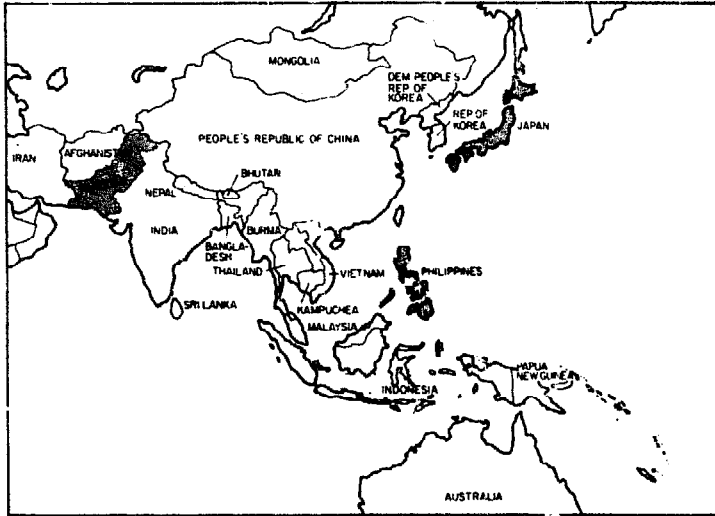
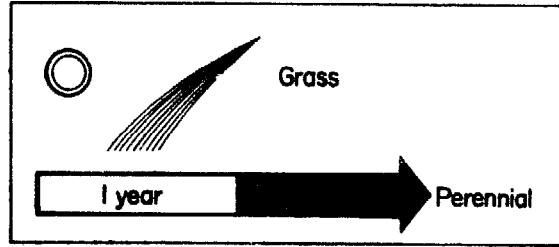
**Type****Found In:**

- Wetland rice.

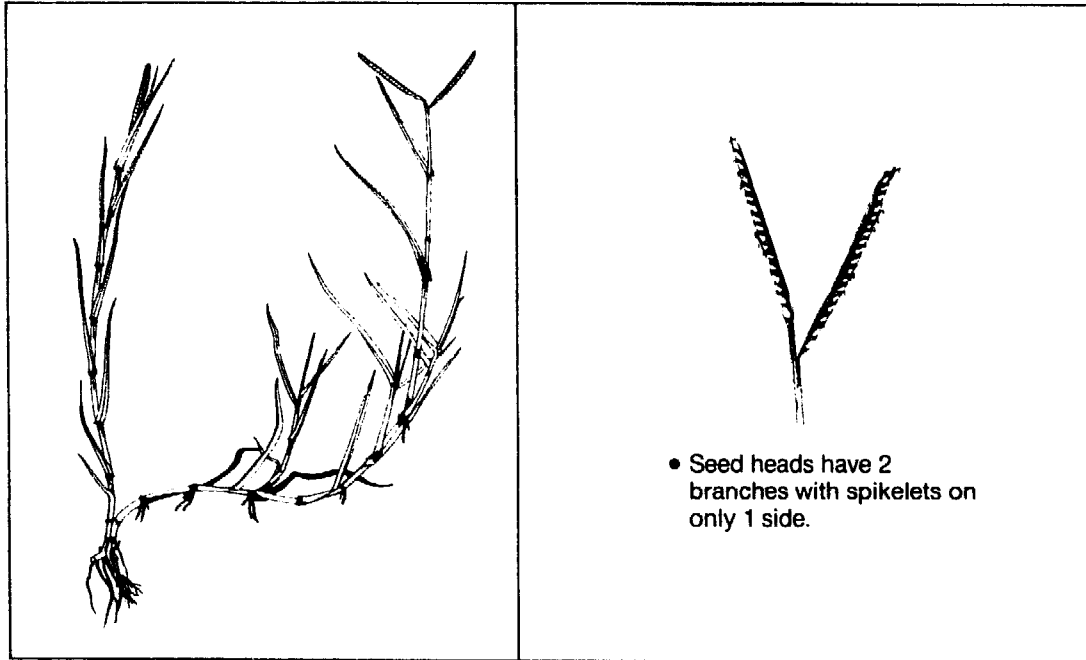
**Identification****Distinguishing characteristic**

- Seed heads have 2 branches with spikelets on only 1 side.

**Reproduction and dissemination**

- *P. distichum* reproduces from pieces of creeping underground stems.

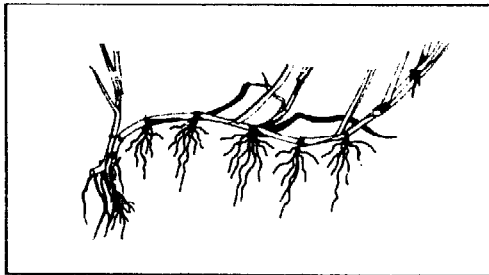

**Habitat**

- Flooded fields
- Open fields
- Along irrigation ditches

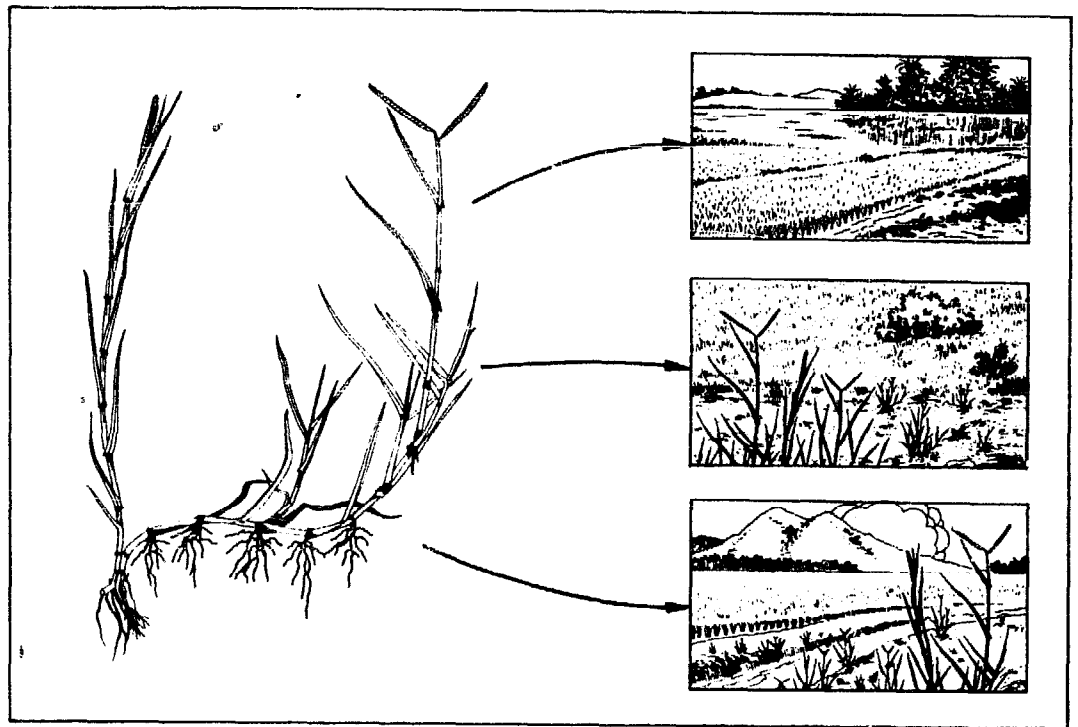

**Ecology**

- *P. distichum* can survive in flooded fields, poorly drained soils, and even in well-drained fields.

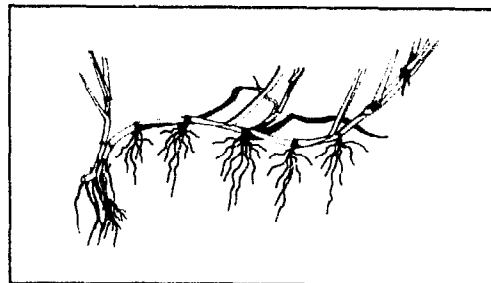

- The plants produce a thick mat of roots just below the surface, which may limit the flow of irrigation water when the weeds grow beside irrigation canals.

**PORTULACA OLERACEA L.**

Countries in which *P. oleracea* is most serious.

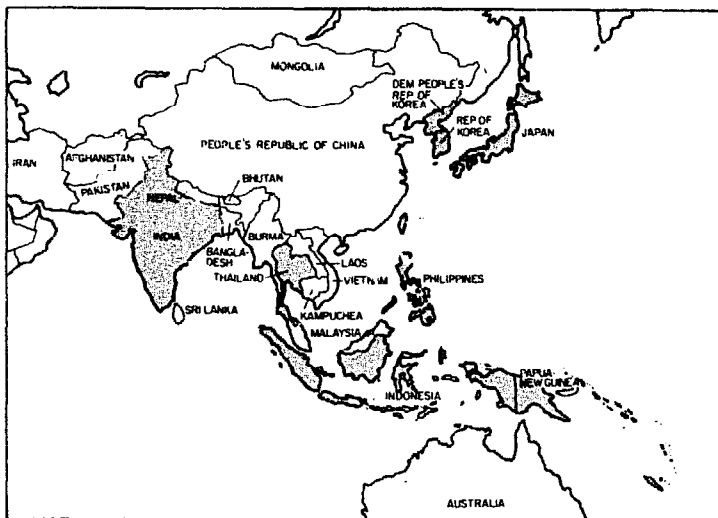

**Type**

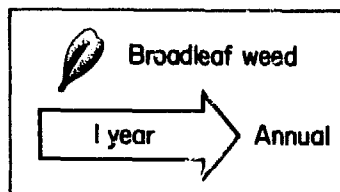

**Found in:**

- Dryland rice.

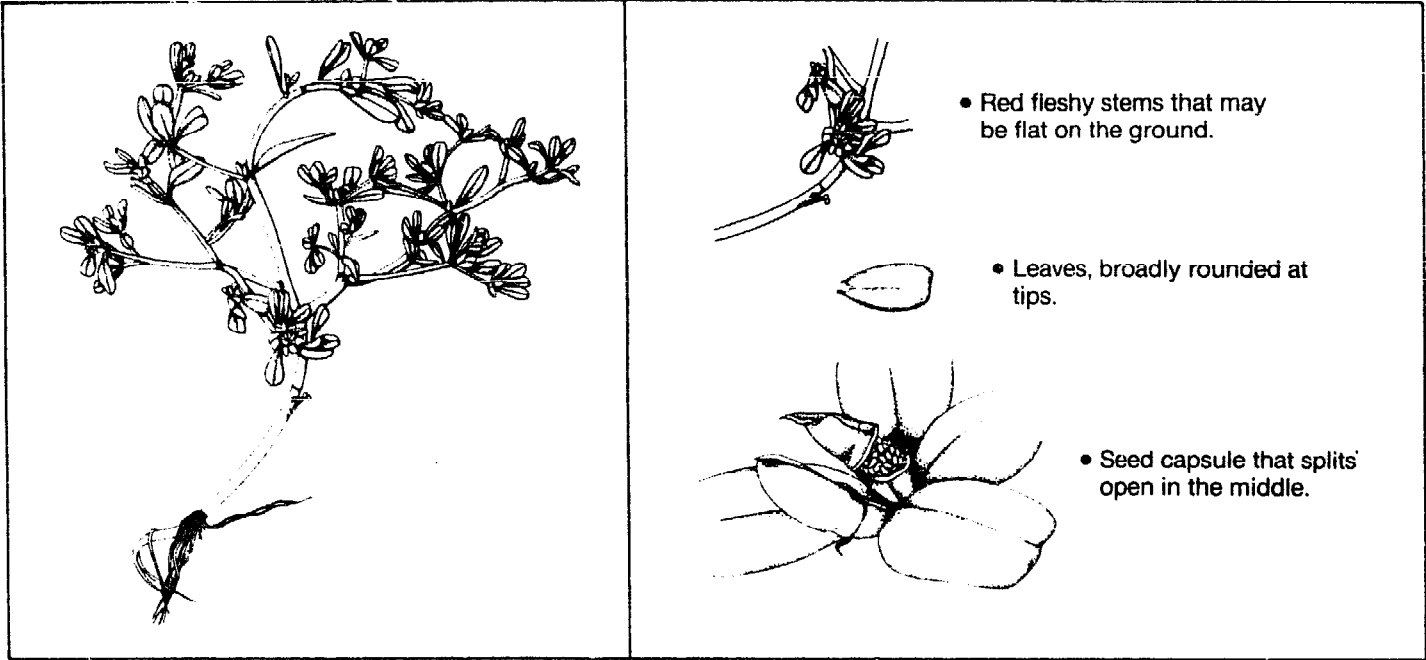

**Identification****Distinguishing characteristics****Reproduction and dissemination**

- Seeds are spread by water.
- Pieces of the stem may be spread by tools or cultivation. These stem pieces root on contacting the soil.

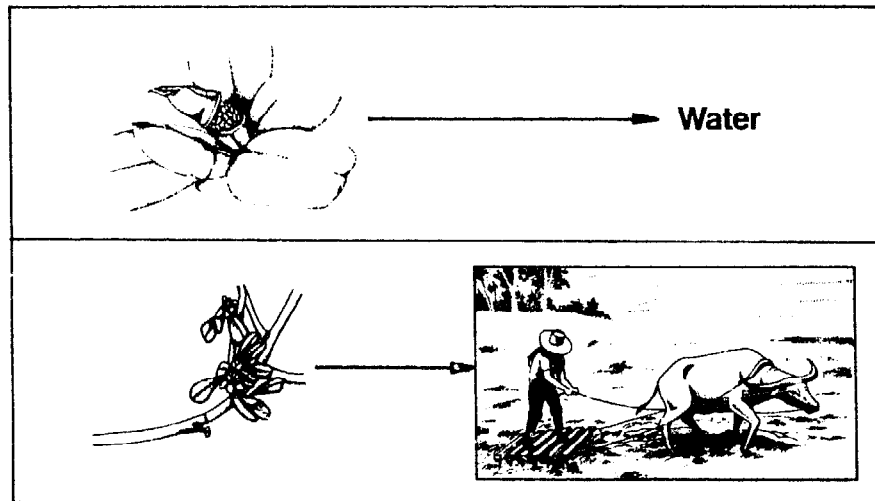
**Habitat** — cultivated fields, eroded slopes and cliffs

- *P. oleracea* grows well in open areas and prefers rich, moist soil.

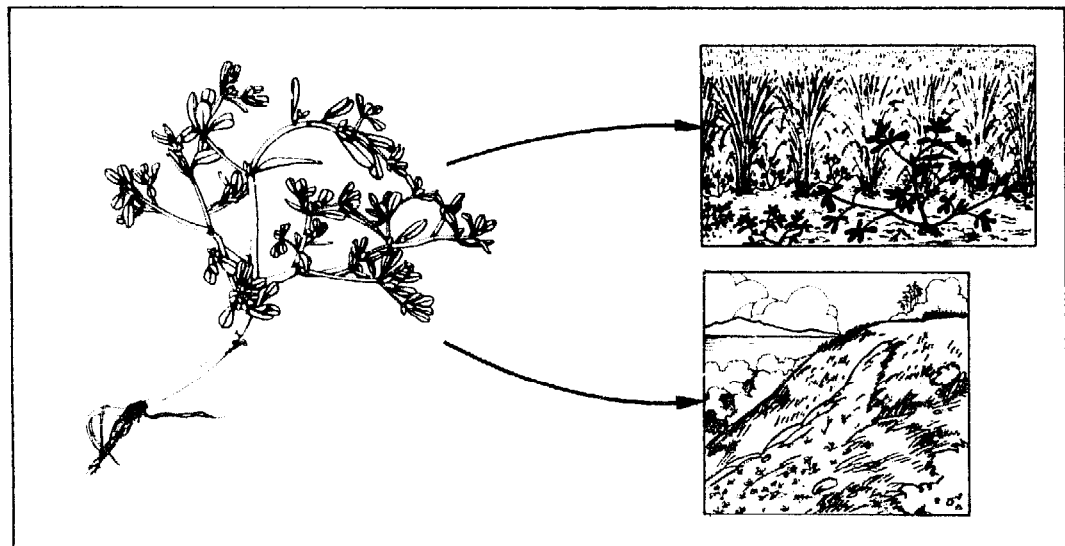

**Ecology**

- A reproductive cycle is completed every month in the tropics.
- The weed grows well in a wide temperature range.

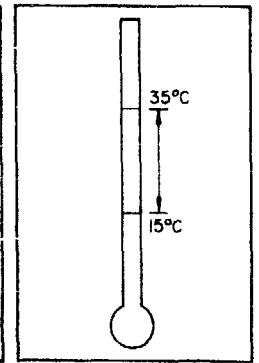
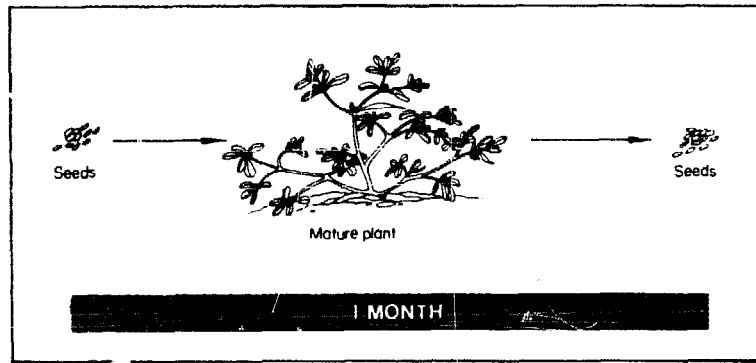

**SCIRPUS MARITIMUS L.**

Countries in which *S. maritimus* is most serious

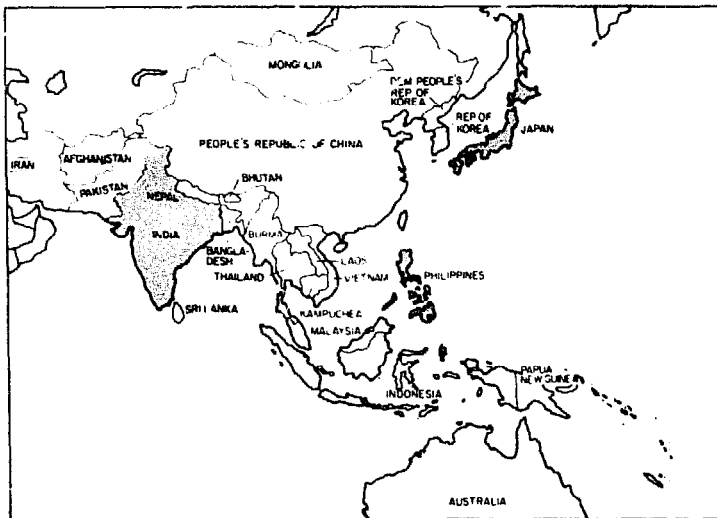

**Type**

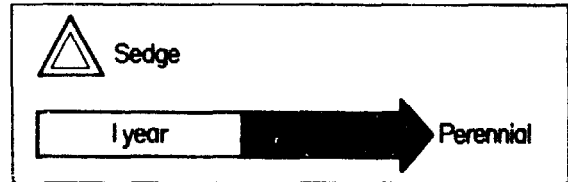

**Found in:**

- Wetland rice.



**Identification**

**Distinguishing characteristics**

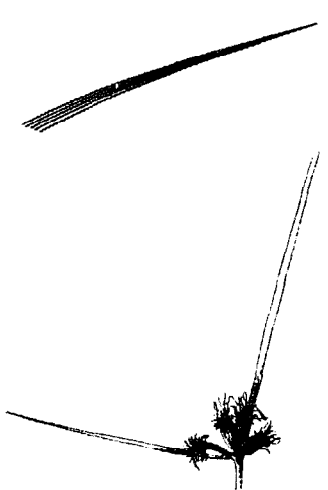

- The leaves are narrow and often as long as the stems.
- The spikelets are grouped in a dense cluster.
- A narrow leaf (bract) 10-25 cm long is found just below the seed head.

### Reproduction and dissemination

- *S. maritimus* reproduces mainly from tubers and rhizomes (underground stems).
- Tubers in the soil produce new stems when the top growth is killed or pulled by hand.

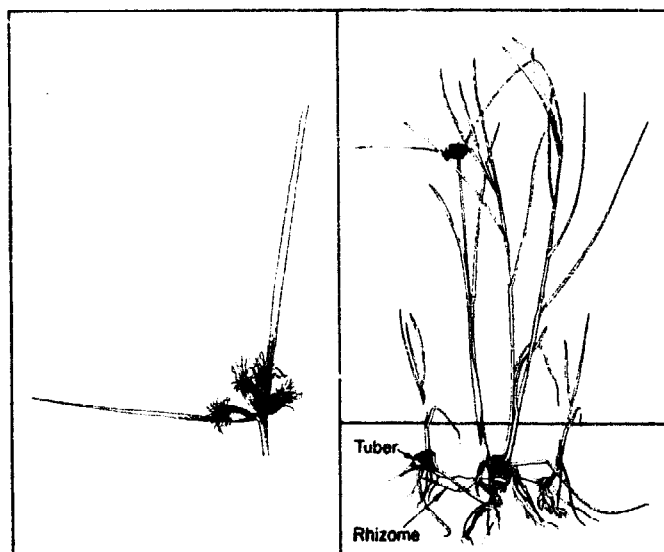

**Habitat** — along riverbanks, swamps

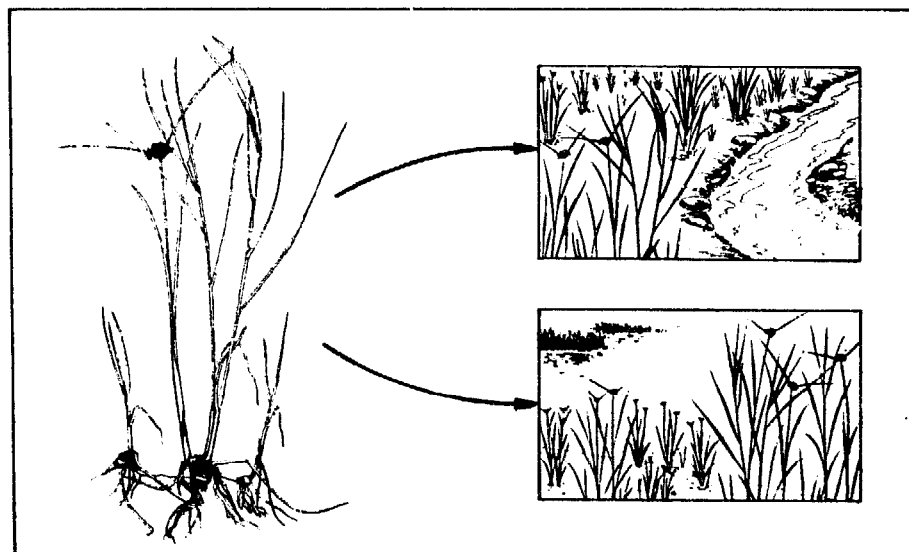

### Ecology

- *S. maritimus* grows over a wide range of temperatures and photoperiods.
- The weed's stems grow rapidly (several centimeters a day) during early rice growth, and may severely shade semidwarf rice cultivars during the first 40 days after seeding or transplanting.
- The weed also competes effectively with rice for nitrogen up to 60 days after seeding.

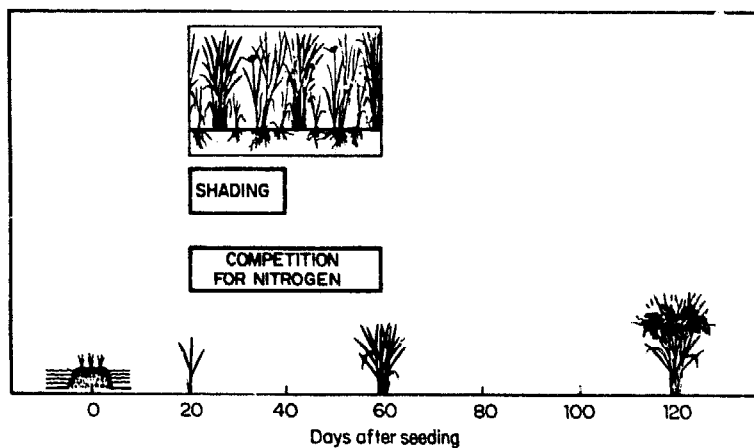

- Most herbicides effective against annuals do not control *S. maritimus*.

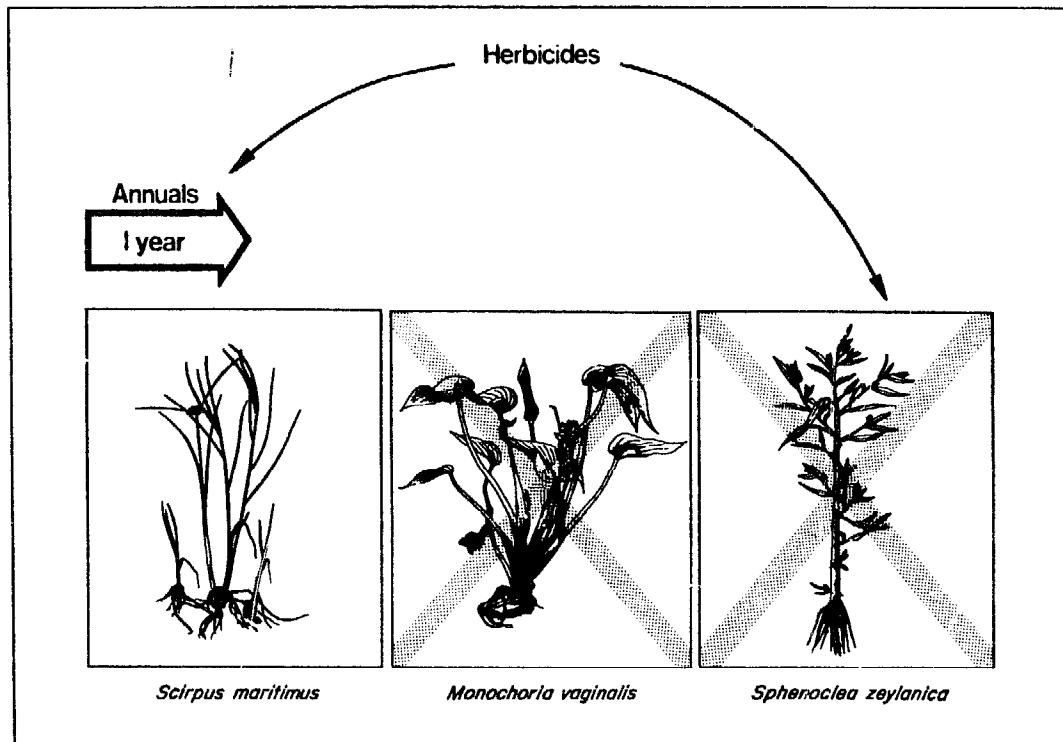

**SPHENOCLEA ZEYLANICA GAERTN.**

Countries in which *S. zeylanica* is most serious

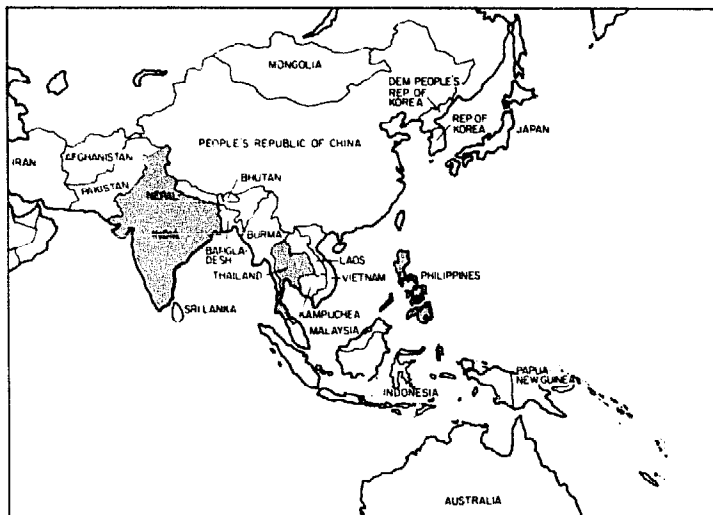

**Type**

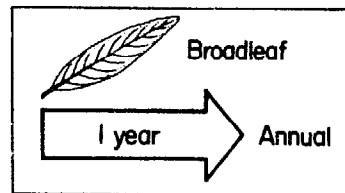

**Found in:**  
• Wetland rice.

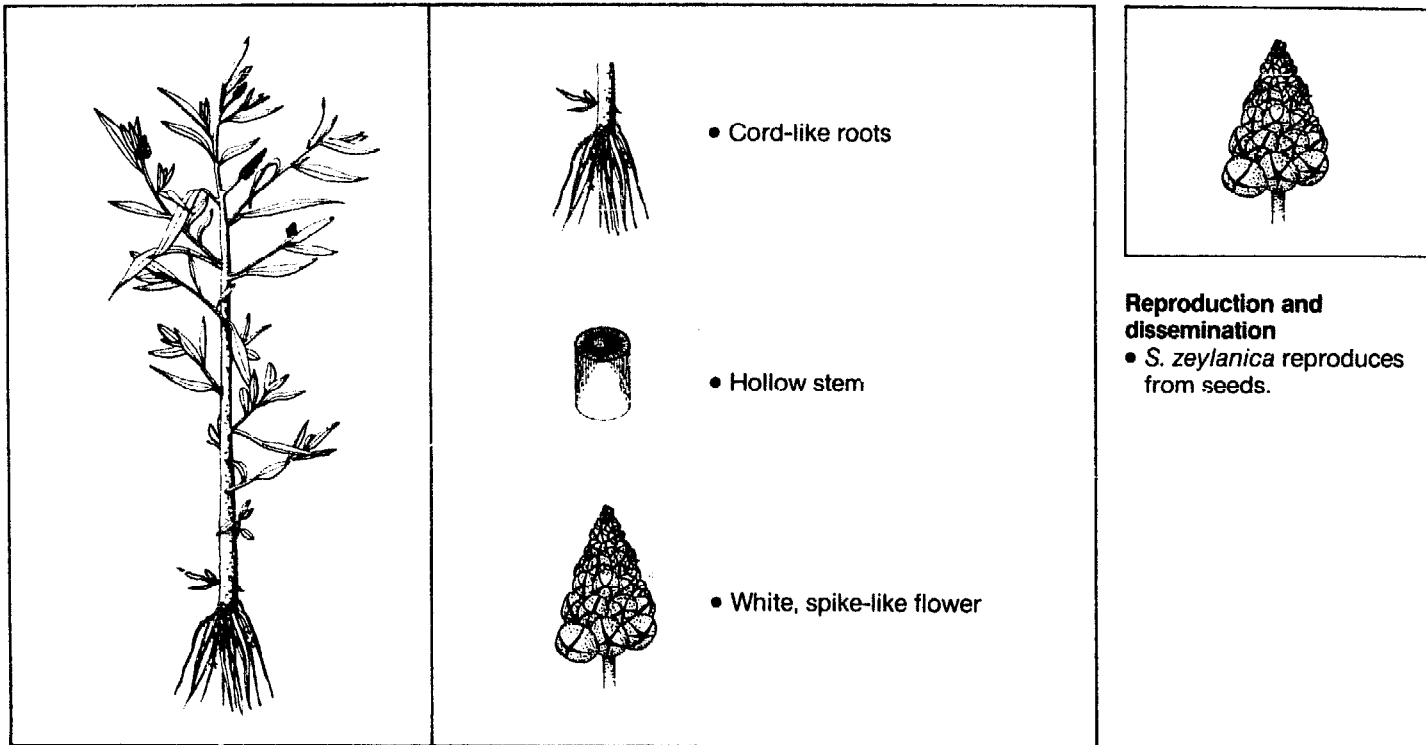

**Identification****Distinguishing characteristics**

**Habitat** — Prolonged flooded wetland rice fields and swamps.

- *S. zeylanica* grows in almost any kind of wet ground at low altitudes.
- It is most common and serious in wetland rice fields, and may occasionally be a problem in other crops such as taro.

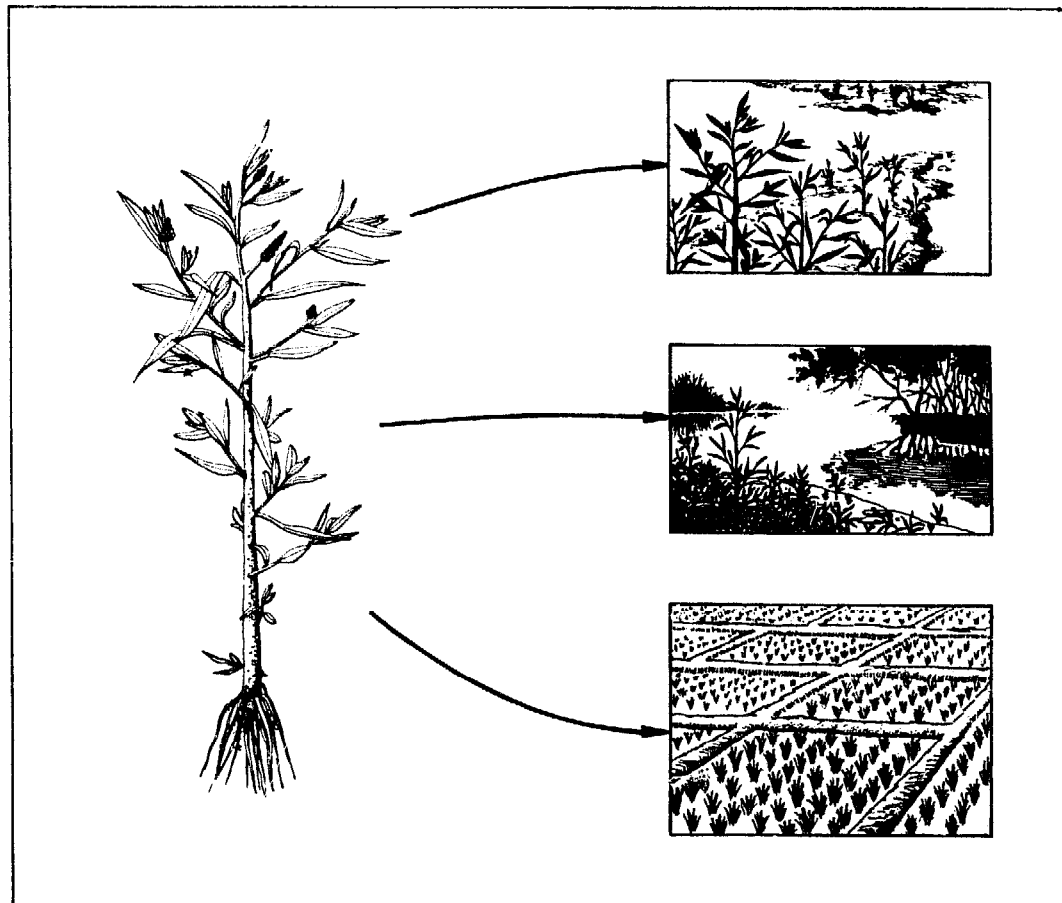

Methods of weed control

WEEDING

**Hand weeding**

Hand weeding is the oldest, simplest, and most direct way of controlling weeds in rice fields.

*Advantages of hand weeding*



- Effective against young weeds

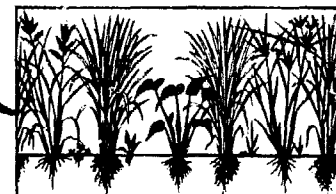

- Weeds growing within hills and between rows of rice can be removed without damaging the rice plants.

*Disadvantages of hand weeding*

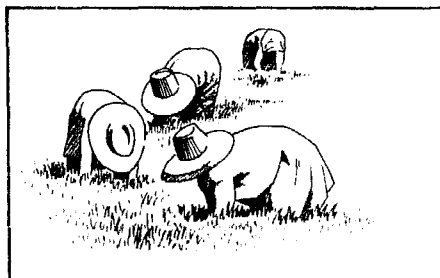

- It is laborious and time-consuming

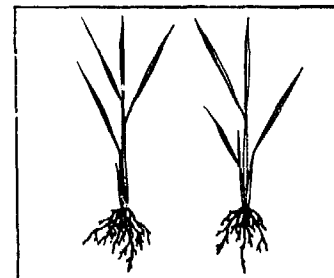

- Young weed seedlings cannot be distinguished from rice plants early in the season, when hand weeding is most effective.

*Timing hand weeding*

- Hand weeding should be done early in crop growth. The exact time depends on the rice culture.

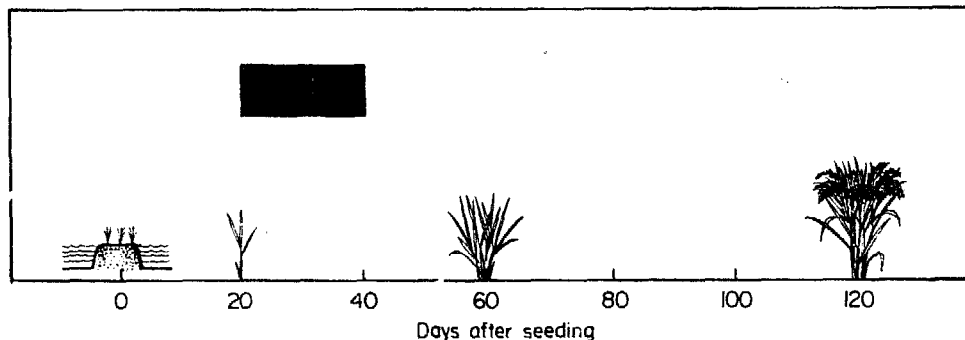



**Techniques**

- Perennial weeds, which regrow from underground structures and are difficult to control by a single hand weeding, can be controlled by repeated hand weedings.

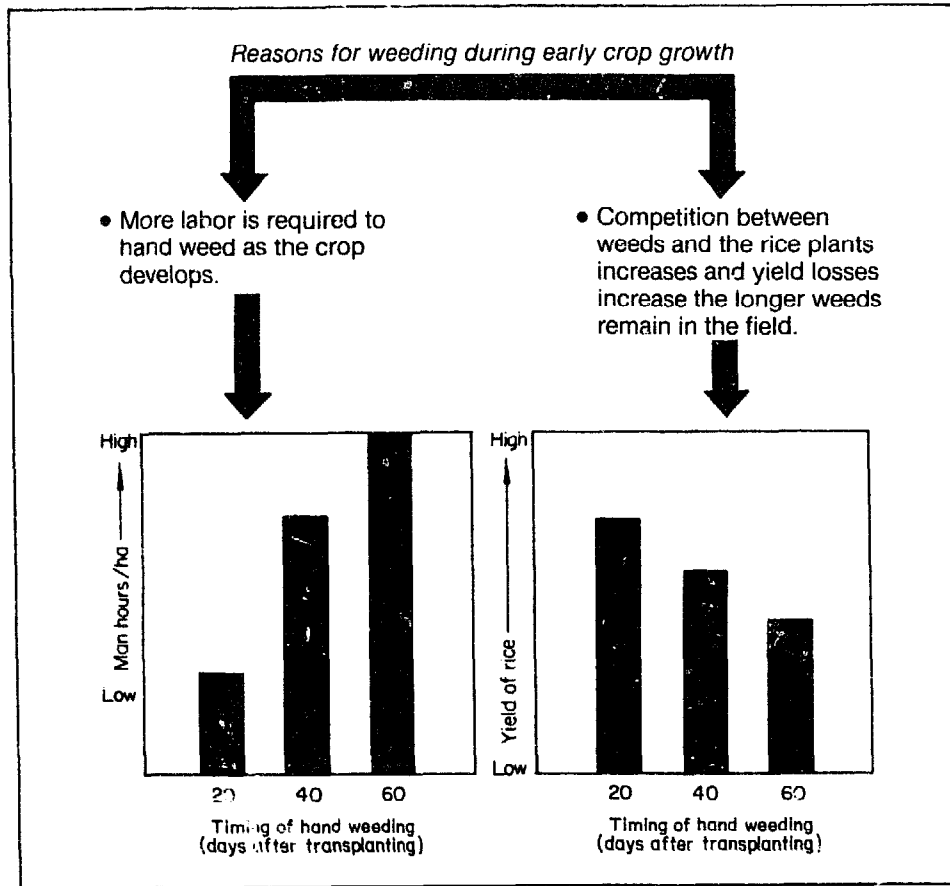

- Young weeds are difficult to grasp and can be uprooted by stirring the soil with the fingers held apart.



- Larger weeds should be pulled and removed from the field, or buried in the mud in wetland rice, or left between rows of dryland rice to dry.

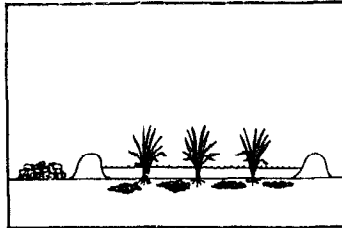

Pile of weeds outside field

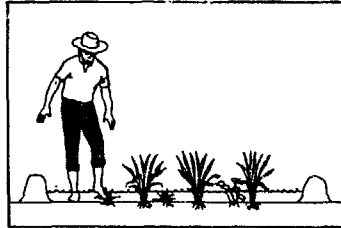

Man stepping on weed to bury it

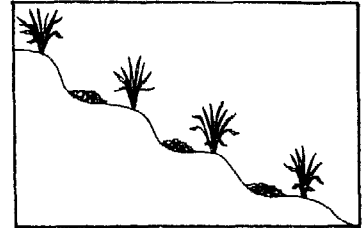

Pile of weeds between rows of dryland rice

- Hand tools increase the efficiency of hand weeding in drier upland soil.

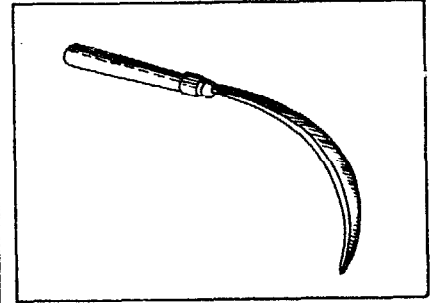
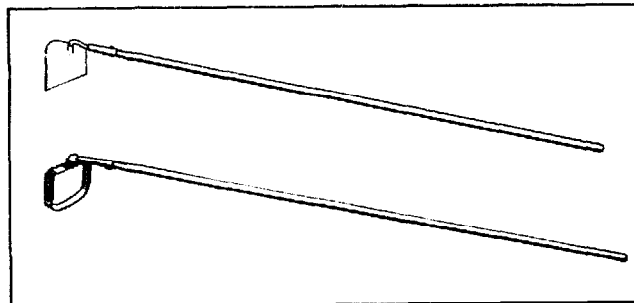

**Mechanical weeding**

The push-type rotary weeder is the most effective mechanical weeder for wetland rice.

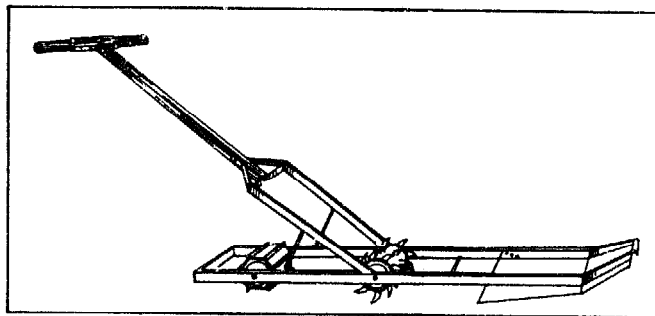

*Using the mechanical weeder*

- The rice must be planted in straight rows in not closer than 20- × 20-cm spacing.
- The soil must be soft and saturated.

- If soil is too dry, the weeder rolls over the soil surface and the weeds.
- The weeder cannot work weeds into the soil in flooded fields. Weeds float to the water surface and may grow again.
- A rotary weeder cannot pass close enough to the rice plants to remove all weeds, so some additional hand weeding may be necessary.

**WATER MANAGEMENT**

**Control of weeds by flooding**

- Flooding is an important management practice in controlling weeds
- Rice grows and yields just as well in saturated soil as in standing water.



- A major benefit from standing water is better weed control.

### Problems in controlling weeds by flooding

Flooding will not control weeds if:

- The water level drops too low.
- The field is not level and some areas dry out.

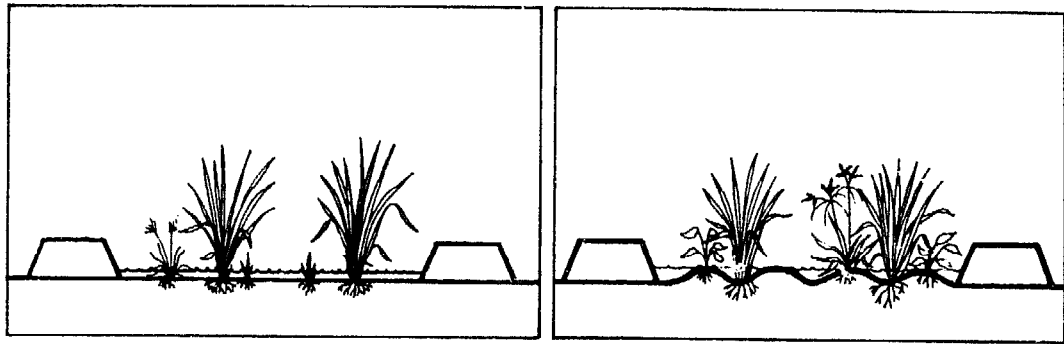

- The field occasionally dries out, allowing weed seeds to germinate.

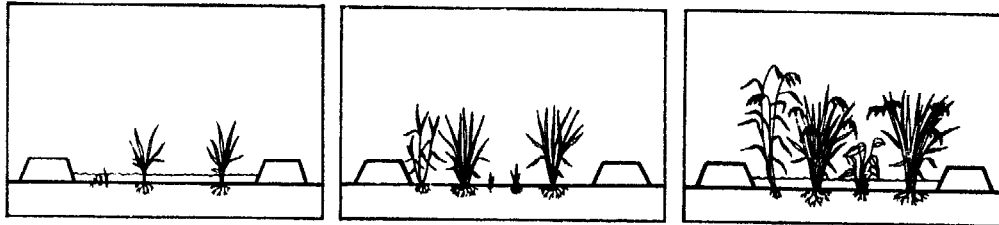

### Effect of water depth on weeds

- With 1-2 cm water, grasses are reduced, but some broadleaf weeds and sedges remain.
- With 5-10 cm water, grasses are almost eliminated but a few broadleaf weeds and sedges may remain.

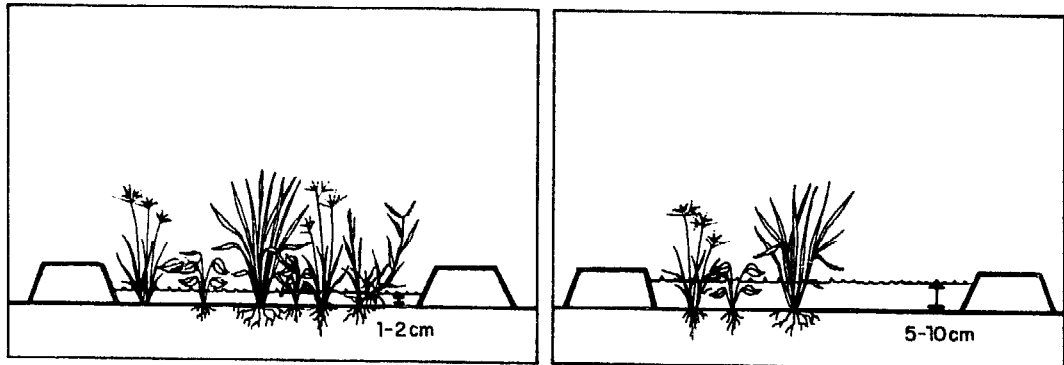

### Time of flooding

- Transplanted rice should be flooded 3-4 days after transplanting. As the plants grow the water level can be raised up to 5-10 cm.

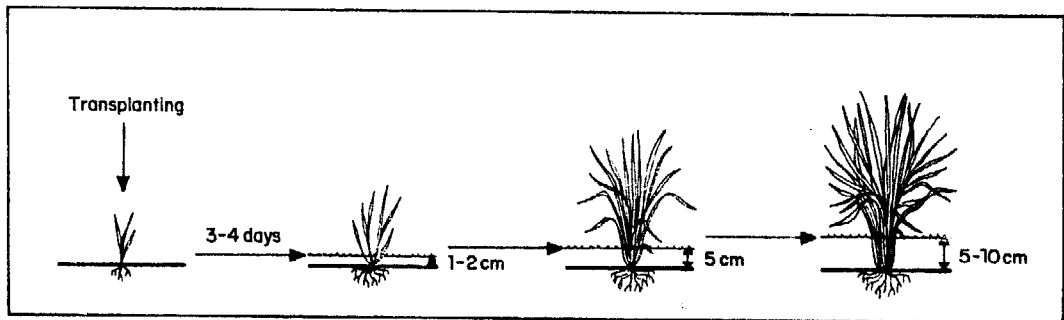

- Direct-seeded rice can be flooded after the seeds germinate and the crop becomes established. Flooding is not completely effective with this planting system because some weeds become established with the young rice plants.

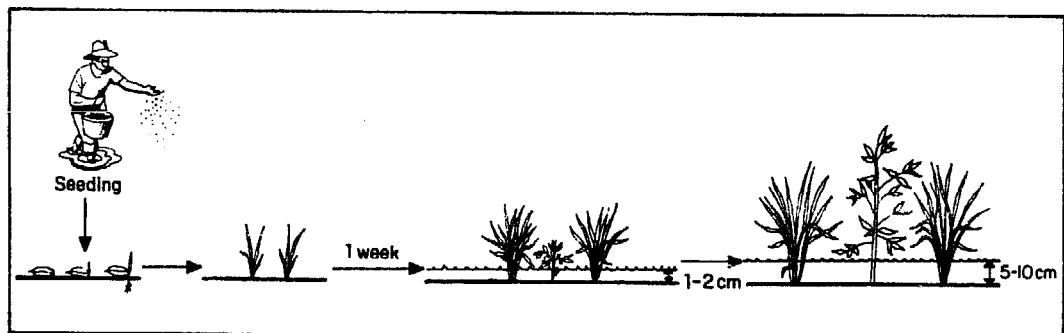

**HERBICIDES**

**Definition**

A herbicide is a chemical (pesticide) used to kill or prevent the growth of weeds. Herbicides are most effective when used in combination with other control methods.

**Herbicide** →



**Advantages of herbicides**



- Applying herbicides saves labor.



- Herbicides can be used in all rice environments.



**Disadvantage of herbicides**

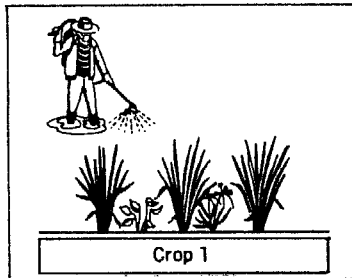

- The continued use of the same herbicide leads to a buildup of weeds, particularly perennials, which are difficult to control with herbicides.

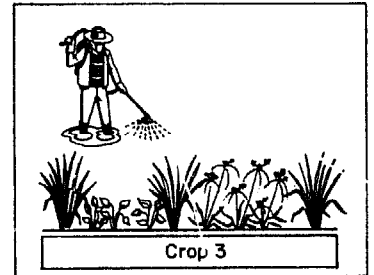
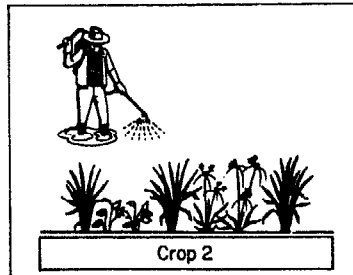

To prevent this buildup:

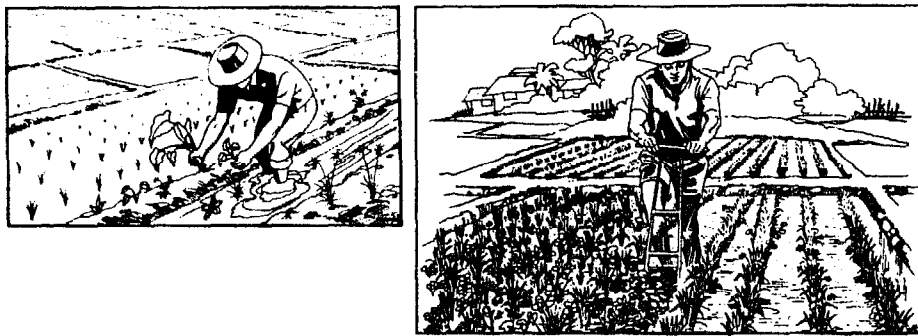
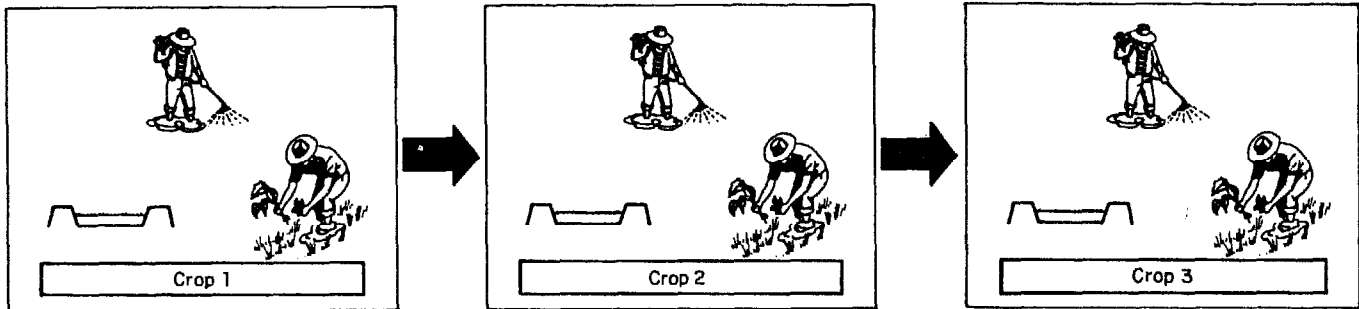
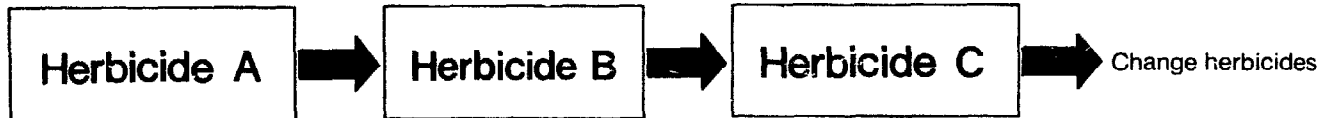
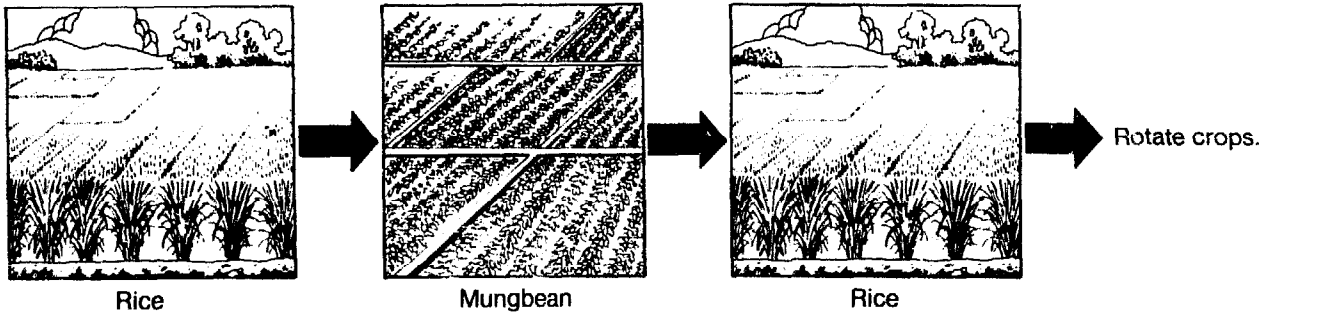

Use several control methods together.

The best way of preventing the buildup of weeds tolerant of herbicides is to periodically remove them by hand or by mechanical weeding.

**Timing herbicide applications**

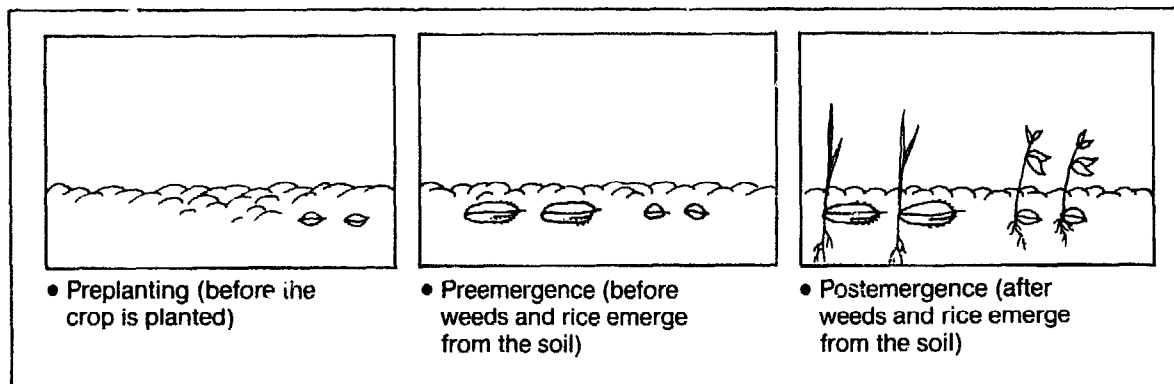

Methods of herbicide action

**Contact herbicides**

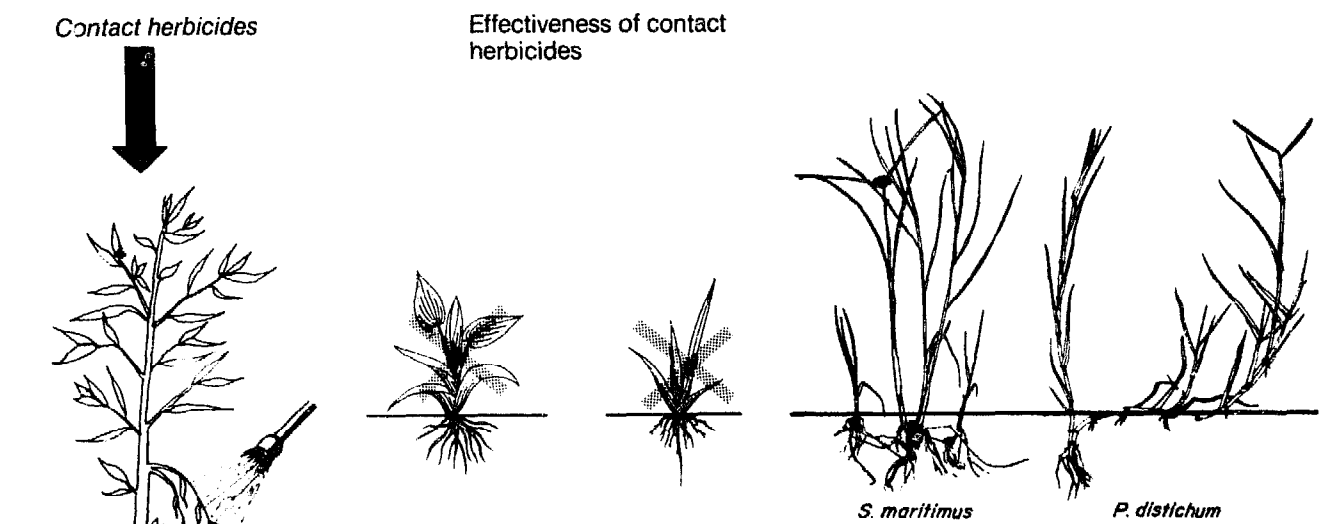

**Effectiveness of contact herbicides**

- Contact herbicides kill only the plant parts that are sprayed.
- Contact herbicides are generally most effective against broadleaf weeds and seedlings of perennials.
- They will not kill established perennial weeds.

*S. maritimus*      *P. distichum*

**Systemic or translocated herbicides**

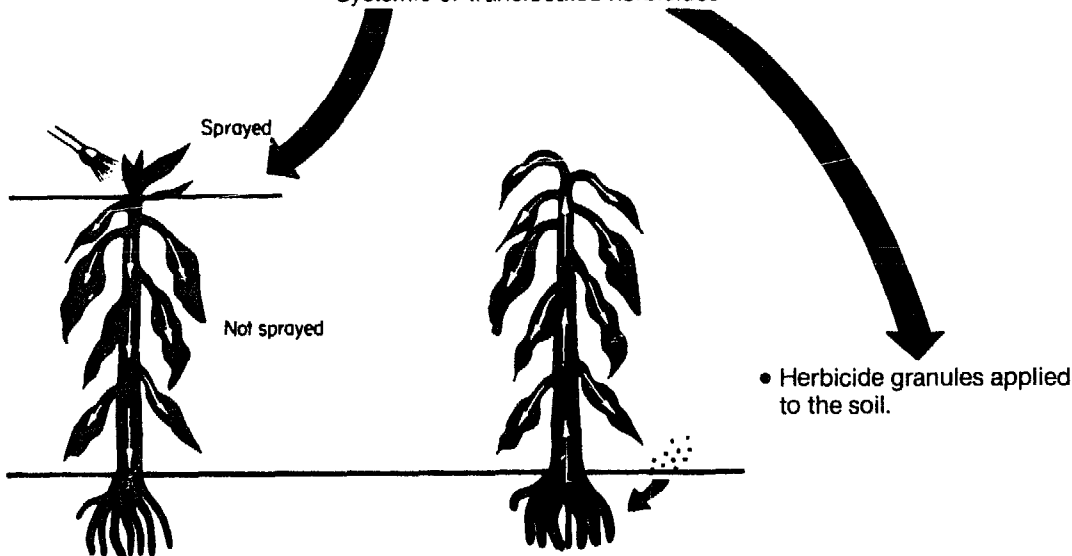

- Systemic herbicides move within the plant to kill portions that were not treated.
- Systemic herbicides can be sprayed on the foliage or applied to the soil and absorbed by the plant's roots.

• Herbicide granules applied to the soil.

Selective and nonselective herbicides

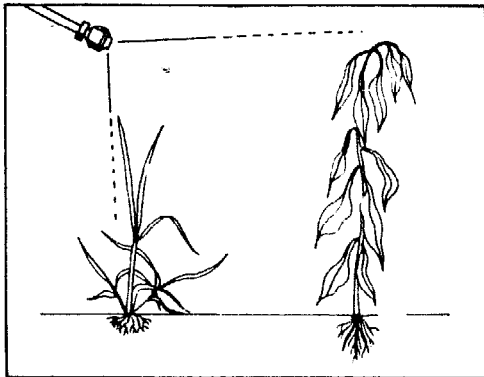

- Selective herbicides kill some plant species, but do not damage others.

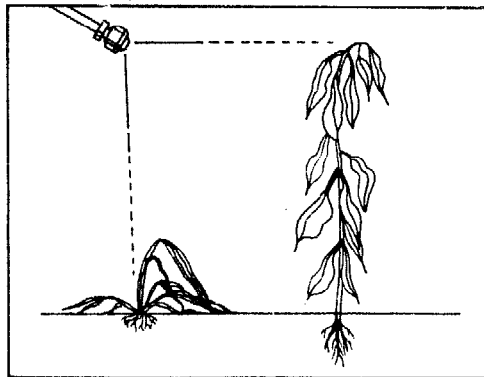

- Nonselective herbicides will kill all plants.

Herbicide injury to rice

Improper herbicide use will injure rice plants:



- Using the wrong herbicide (nonselective herbicide)

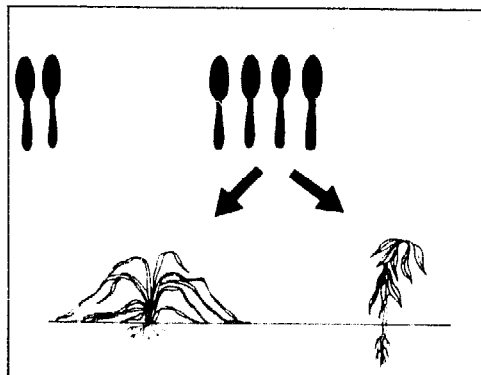

- Applying too much herbicide — high rate

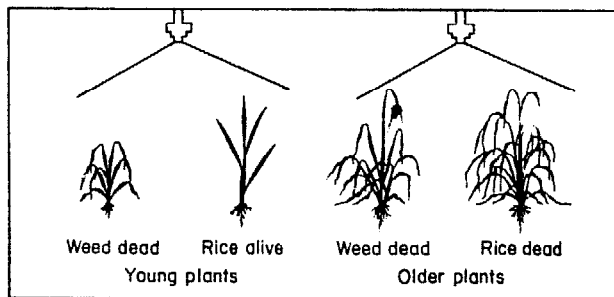

- Applying herbicide at the wrong time — postemergence herbicide

**Symptoms of herbicide injury to rice**

Herbicide damage to rice may be confused with injury caused by insects or diseases.

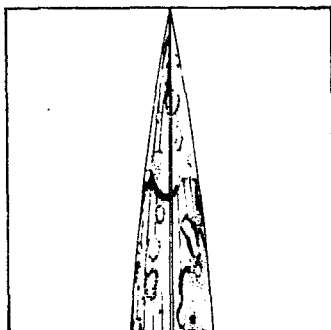

• Leaf spots caused by herbicides are more circular than those caused by diseases.

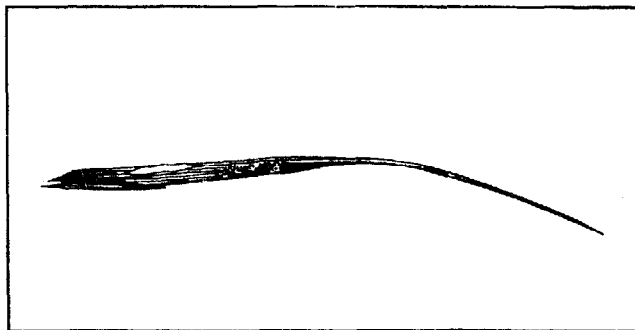

• Herbicide may cause rice to produce onion-like leaves.

• Herbicides may also cause

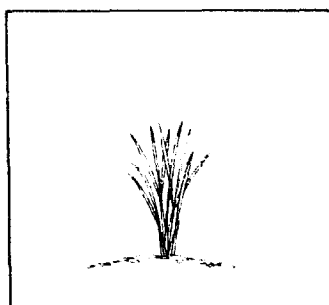

stunting

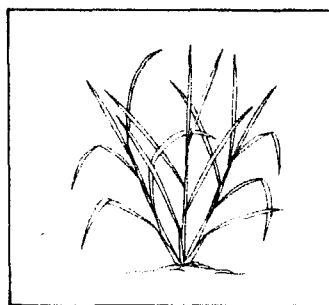

plants with spread tillers

**MANAGEMENT OF WEEDS IN DIFFERENT TYPES OF RICE CULTURE**

**Preventive weed control**

Preventive weed control measures should be used on all types of rice culture to prevent the introduction and spread of weeds.

This will increase the effectiveness of all direct control methods.

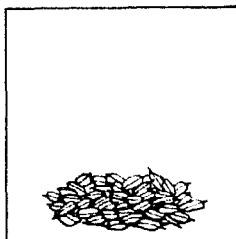

• Use weed-free rice seed.

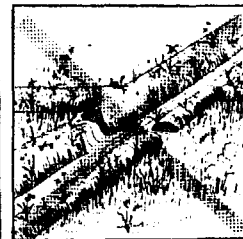
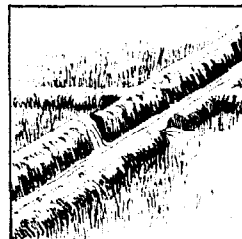
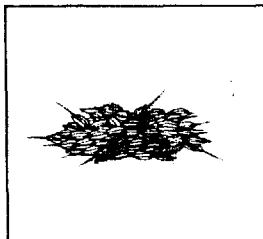

• Keep levees and irrigation canals free of weeds.

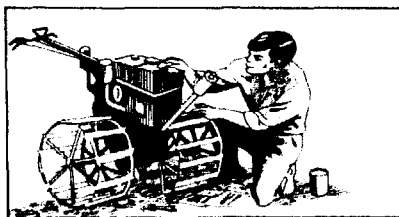

• Keep tools and machinery clean.



• Keep animals out of fields as much as possible.

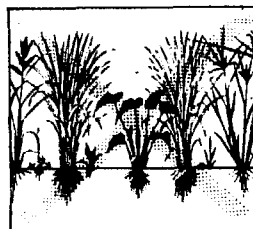

• Do not allow weeds to produce seed or reproduce vegetatively.



**MANAGEMENT OF WEEDS IN TRANSPLANTED RICE**

Weed control is less difficult in transplanted rice because the normal cropping practices reduce the number of weeds.



**Land preparation**

- Plow the field to incorporate weeds left from the previous crop or fallow period into the soil.
- Puddle the soil, and harrow 2-4 times to destroy weeds not killed by plowing.
- Level the field so that uniform flooding and water depth can be maintained.

**Transplanting**

*Cultivar selection*

- A taller cultivar producing a large number of tillers will compete better with weeds than a shorter (semidwarf) cultivar with fewer tillers.

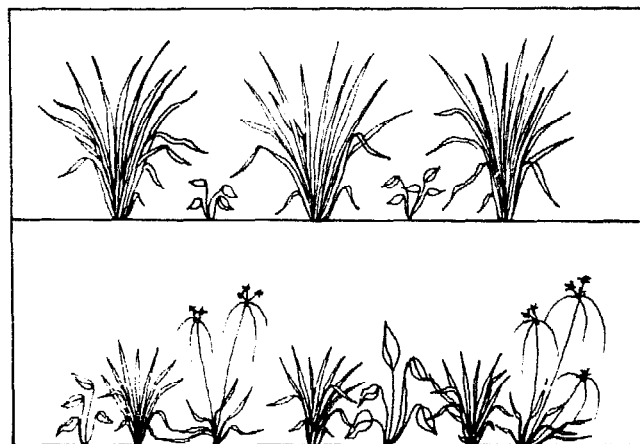

*Plant spacing*

- Closer spaced plants compete more effectively against weeds. Spacing transplanted rice hills 15 x 15 cm apart should minimize weed competition.

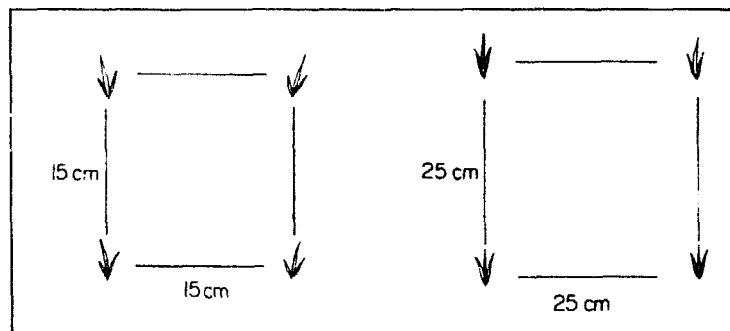

**Flooding**

- Flood the fields 2-3 days after transplanting.
- Maintain 5-10 cm of standing water continuously throughout the season.

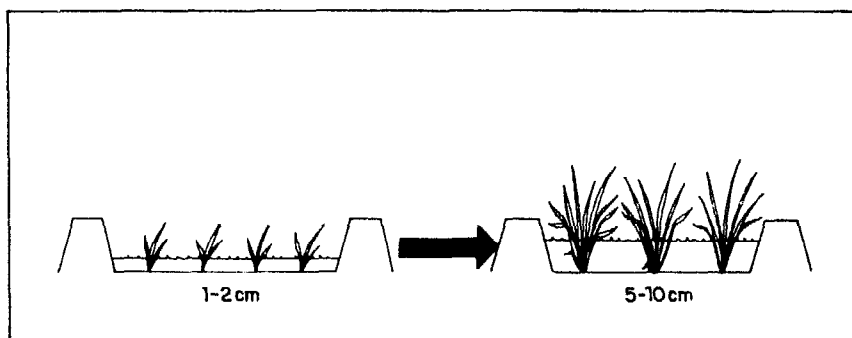

In areas where weed problems are severe or land preparation and the water supply are inadequate, additional weed control may be necessary.

The illustration shows a person wearing a hat and a long-sleeved shirt, bent over and weeding a rice field. The field is filled with rice plants and some weeds.

- Weed the crop once by hand or with a mechanical weeder about 21 days after transplanting or
- If labor is scarce or expensive, apply a herbicide before weeds emerge.

The diagram shows a sequence of events: on the left, two small rice seedlings are shown. An arrow points to the right, where a downward arrow labeled 'Herbicide' points to a cluster of 'Weed seeds' on the ground. A second arrow points to the right, showing two larger, healthy rice plants, indicating that the herbicide successfully prevented weed growth.

**Fertilizer application**

- In transplanted rice, control weeds before topdressing fertilizer so that the fertilizer will benefit the crop, and not stimulate weed growth.

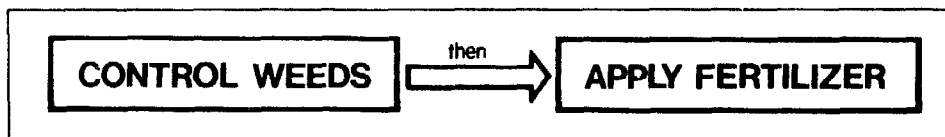

**MANAGEMENT OF WEEDS IN PREGERMINATED RICE SOWN ON PUDDLED SOIL**

**Land preparation**

- Operations for land preparation are almost the same as those described for transplanted rice (see page 311).

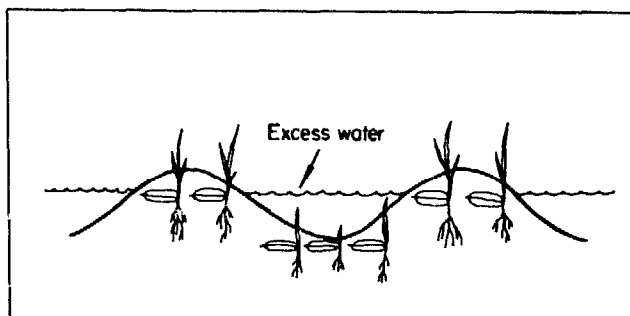

- Leveling of the field is very important for direct-seeded rice because the developing seedlings can be killed or their growth can be slowed when water accumulates in low areas.

**Planting**

- Sowing pregerminated seed allows rice to become established before weed seeds germinate.
- Increased seed rates also reduce weed competition.

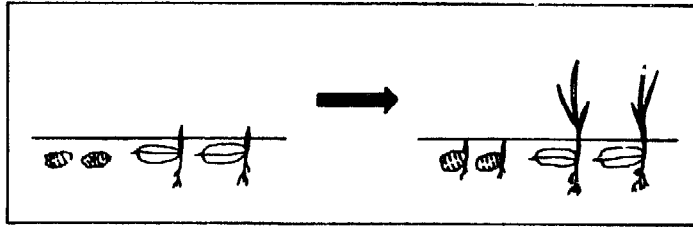

- Planting seed in rows rather than broadcasting makes weeding easier during crop growth.

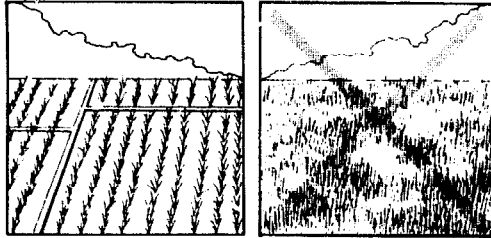

**Flooding**

- Direct-seeded rice cannot be flooded until the seedlings are established.
- Some weed seeds will germinate and the weeds will become established along with the rice before they can be controlled by standing water.

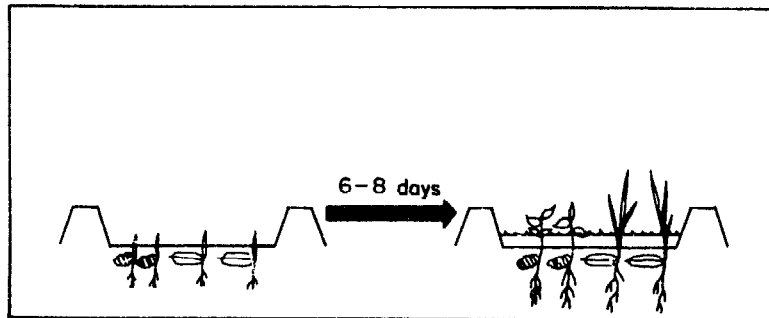

**Weeding**

- Broadcast direct-seeded rice cannot easily be weeded by hand because young plants are damaged in the weeding operations.

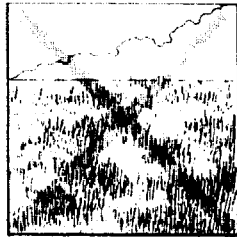

**Weeding rice sown in rows**

- If rice is sown in rows, 1-2 weedings should be adequate.

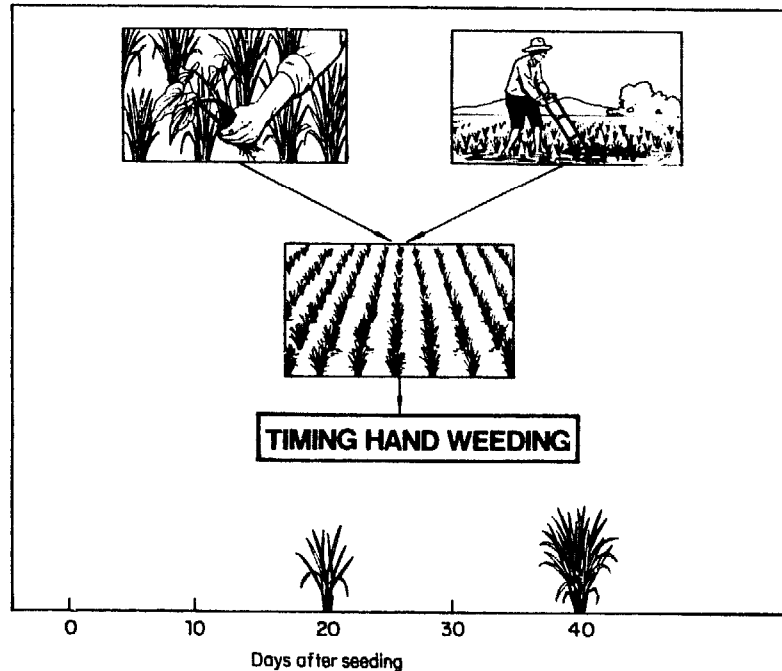

*Application of fertilizer and herbicide*

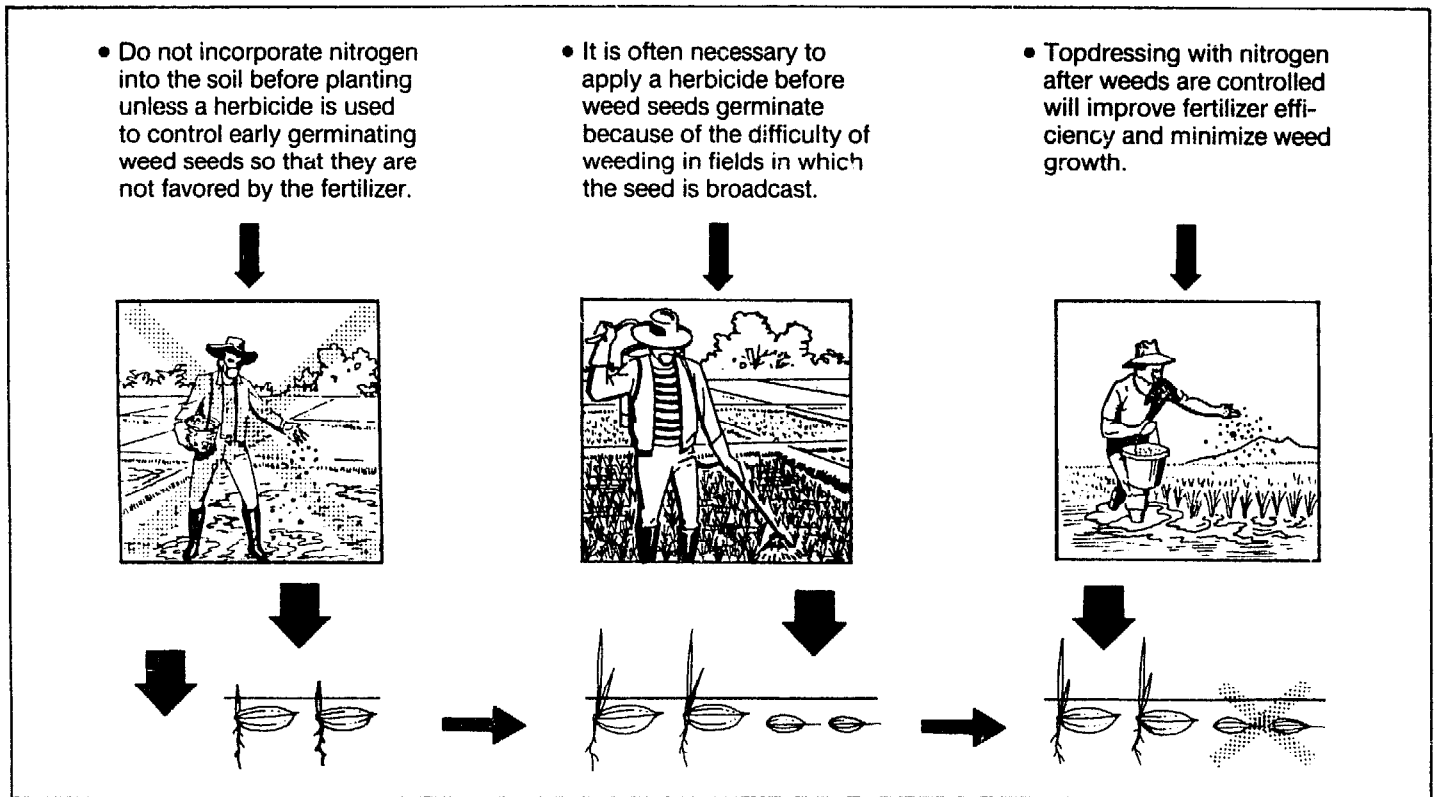

**MANAGEMENT OF WEEDS IN DRY-SEEDED WETLAND RICE**

Weeds are a more serious problem in dry-seeded rice than in wetland rice culture.

- More weeds and different species occur when rice is



planted in dry soil than on puddled soil.

- Weeds and rice germinate at about the same time; therefore, competition between them increases.

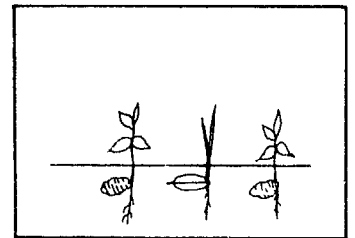

**Land preparation**

- If possible land should be plowed immediately after the previous crop is harvested and the fallow land kept weed-free by tillage during the dry season.

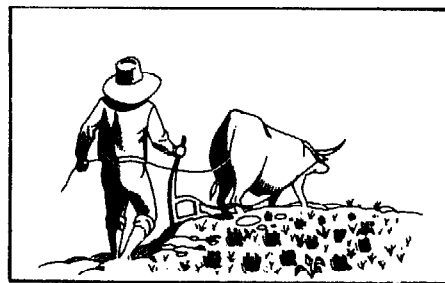

- Clods should be broken down by harrowing so that they do not interfere with seeding or the emergence of the crop.

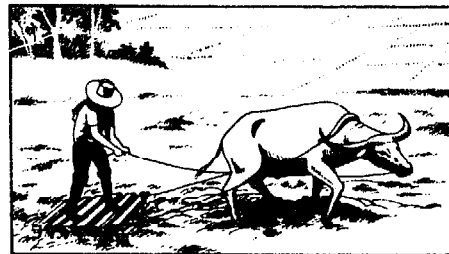

- The seedbed should not be too fine because a smooth surface is favorable for weed growth.

**Planting**

- Broadcasting is the most common method of planting dry-seeded rice.
- Planting in rows makes the crop easier to weed.



**Flooding**

- Often not enough water is available to control weeds in dry-seeded rice by flooding early in the season.
- The weeds become established and compete with the crop for the limited amount of water when rice is most susceptible to yield reductions.

**Weeding**

- 2-3 weedings may be needed during the first 8 weeks of growth.

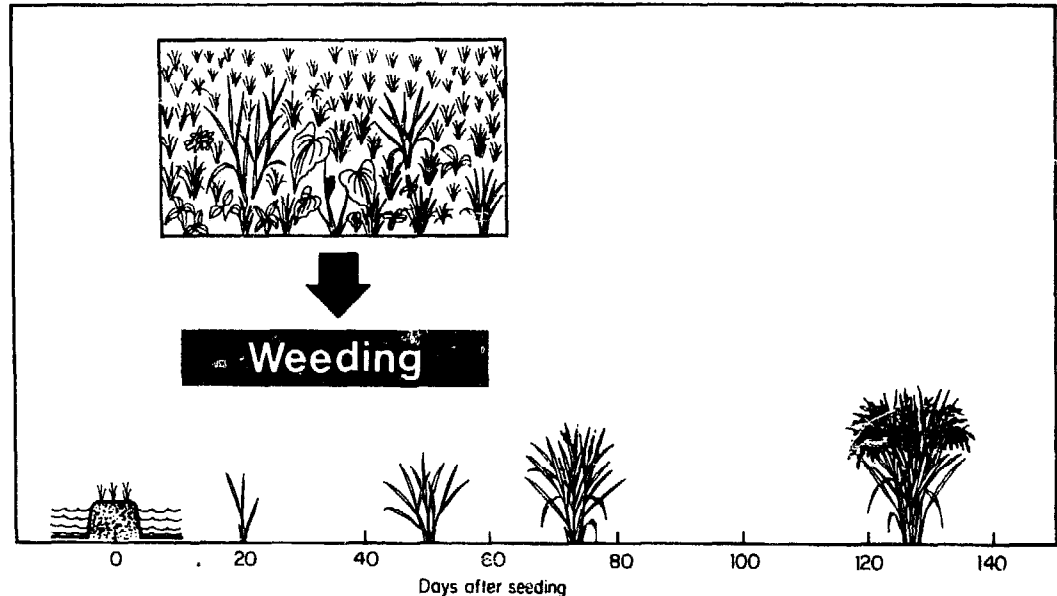

**Herbicides**

- Herbicides are very important in controlling weeds in dry-seeded rice because weeds are usually abundant and other control methods are not very effective or are very laborious.

*Timing herbicide application in dry-seeded rice*

- Do not apply the herbicide to dry soil immediately after seeding because the material may break down before it is activated and moved into the soil by subsequent rains.
- Apply the herbicide after rains have moistened the soil and before weed seeds germinate.

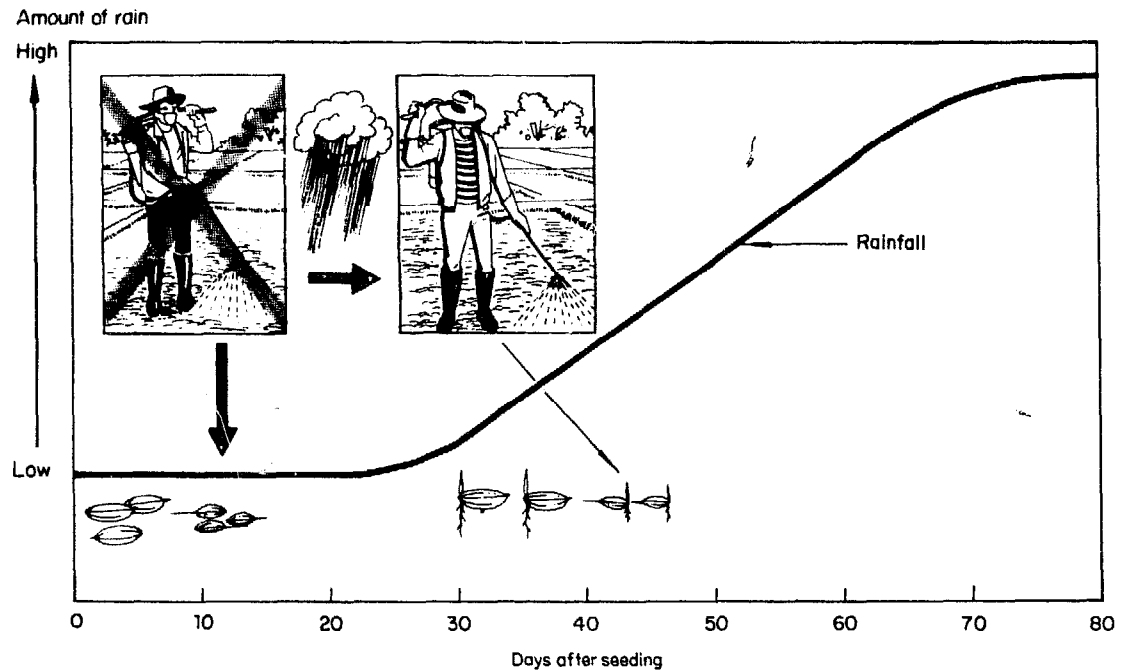

- The rice stand may be reduced if heavy rains cause water ponding on the field for several days right after the herbicides are applied.

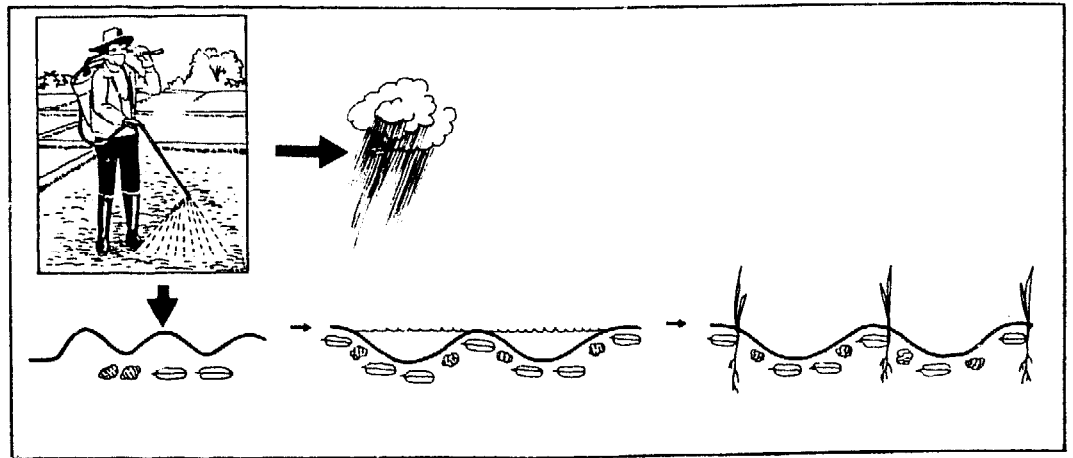

**MANAGEMENT OF WEEDS IN DRYLAND RICE**

Weed control is one of the most serious problems limiting dryland rice production.

In severe cases the entire crop may be destroyed by weeds.

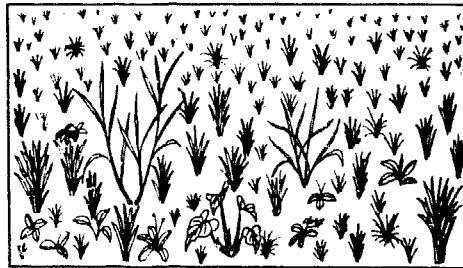

**Land preparation**

- Land preparation is similar to that described for dry-seeded wetland rice (see page 314).
- The seedbed does not need to be leveled because the fields are not flooded.



- A rough seedbed is desirable to reduce weed seed germination and prevent soil erosion from heavy rainfall.

**Planting**

- The traditional rice cultivars usually planted in upland fields are taller and more competitive against weeds than many improved cultivars.
- The rice should be planted in rows to make weeding easier.
- The rows should be spaced so that interrow cultivation can be carried out.

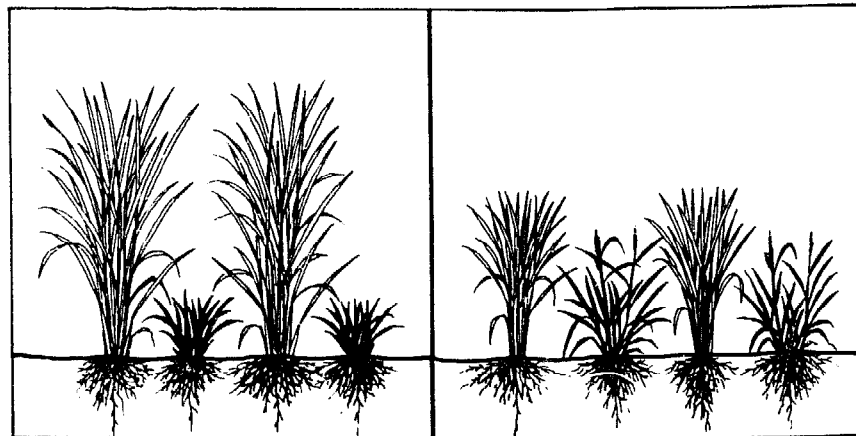

Traditional cultivar

Improved cultivar

**Flooding**

- Standing water to control weeds is not available in dryland fields.



**Weeding**

- Up to 3 weeding may be necessary in dryland rice.
- Weeds between rows can be removed mechanically, but to obtain maximum yields, weeds within rows must be removed by hand.

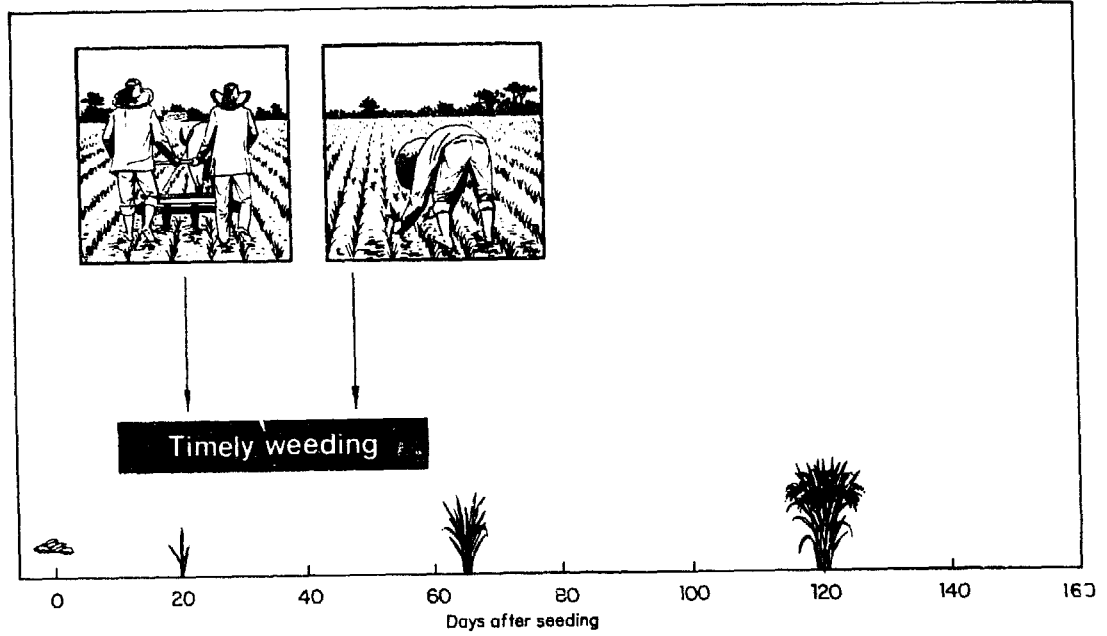

**Herbicides**

- Herbicides cannot be used profitably to control weeds in dryland rice unless labor and cultivation costs are high.

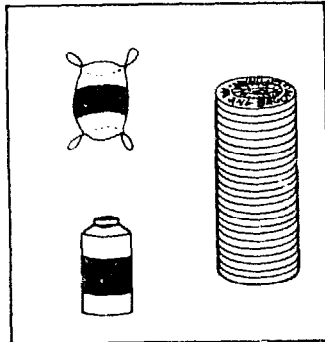

- If it is culturally and economically feasible to use herbicides, they should be applied as previously described for dry-seeded wetland rice (see page 314).

# RICELAND RATS



# Biology and Management of Riceland Rats in Southeast Asia

Rats occur in almost all rice fields in Southeast Asia and frequently cause estimated yield losses ranging from 5 to 80%.

The most common and serious species in Southeast Asia are *Rattus argentiventer*, *Rattus r. mindanensis*, and *Rattus exulans*.

These three rat species are called "riceland rats." The habits, damage, and control techniques are similar and so it is not necessary to separately identify them.

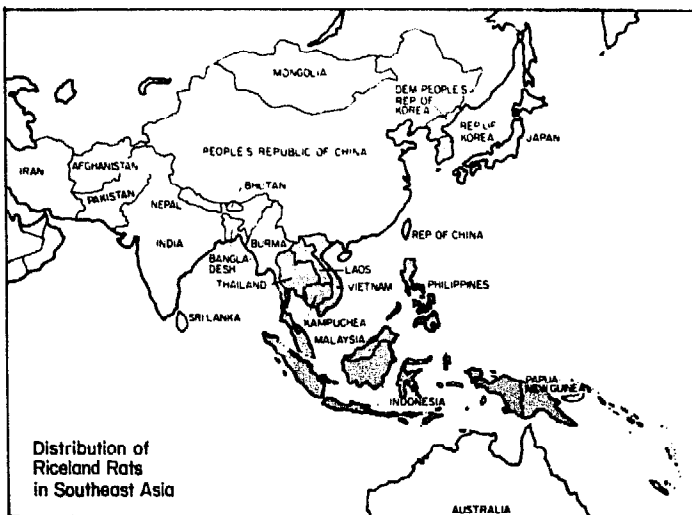

Other species of rats present in South Asia and parts of Southeast Asia are *Bandicota bengalensis* and *B. indica*.

These species differ from riceland rats in biology, habits, and the crop damage they cause. Management techniques for control of these two species are still being developed.

The following sections on biology and control apply only to riceland rat species.

## BIOLOGY OF RICELAND RATS

### General life cycle

- Rats can live for one year or longer.
- Females may reproduce up to 4 times a year, averaging 6 rats/litter.

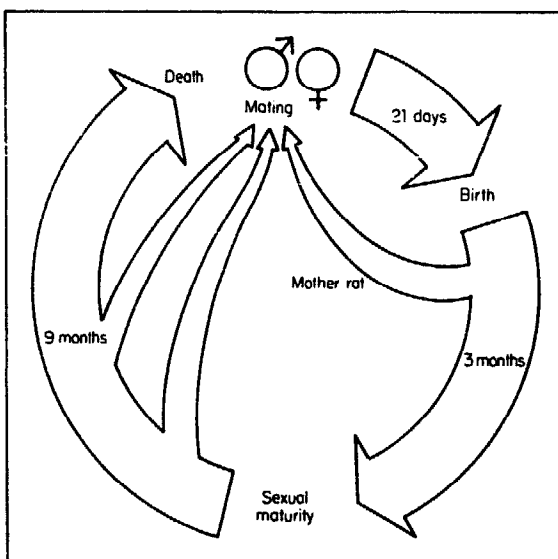

### Reproductive potential

- The potential number of offspring produced and weaned by one female rat in one year is 24.
- The potential number of rats produced by one pair and their offspring in one year is more than 500.
- Disease, predation, competition, and availability of food and water limit the actual number of offspring that reach maturity. The net reproductive potential is therefore much less.

Month		Subtotal	Accumulated total
1	3 ♀ + 3 ♂	6	6
4	12 ♀ + 12 ♂	24	30
7	48 ♀ + 48 ♂	96	126
10	192 ♀ + 192 ♂	384	510
13	768 ♀ + 768 ♂	1536	2046

**Relationship to damage**

• The reproductive cycle of riceland rats and the relative amount of damage are closely associated with crop growth and development.

Both rat reproduction and crop damage:

1. Occur at all stages of rice growth but reach their peak while grain is maturing.
2. Are greater during the wet season than during the dry.

More food, water, and shelter provide optimal breeding conditions.

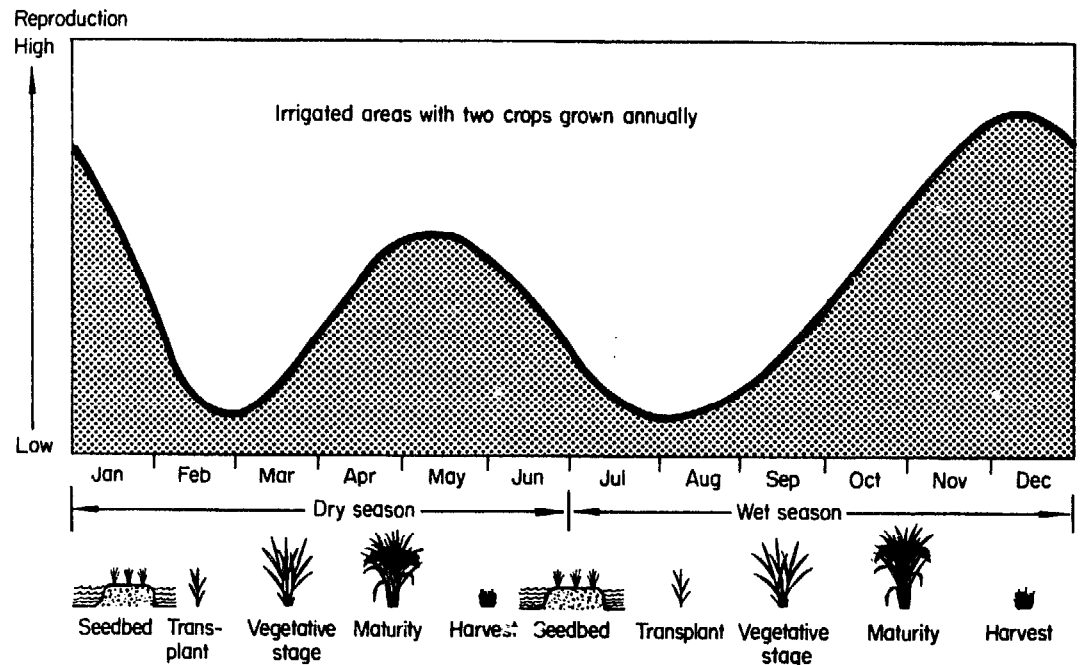
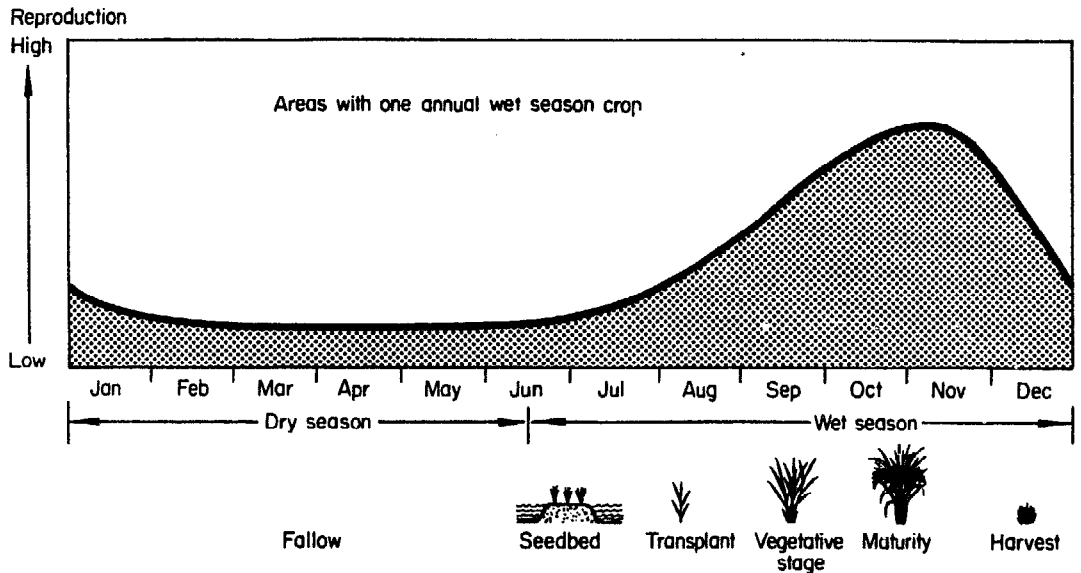

**Damage**

Damage in the seedbed can be due to rats consuming seeds directly or pulling up germinating seeds later on.

- Rats cut or pull up recently transplanted seedlings. The result is missing hills.
- The rats cut or bend older tillers to reach the developing panicles. The eaten or chewed area on the stem may resemble insect damage.

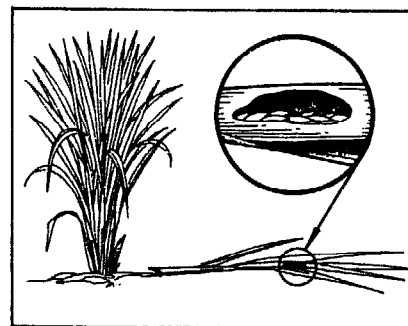
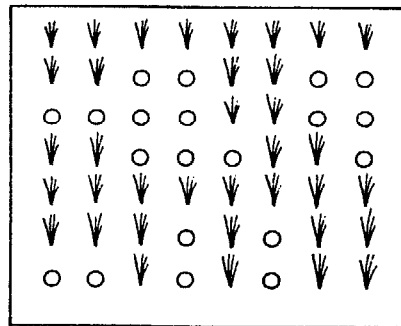

- As the crop matures, rats cut or bend tillers to eat the ripening grain.
- Damaged tillers are cut near the base at a 45° angle.

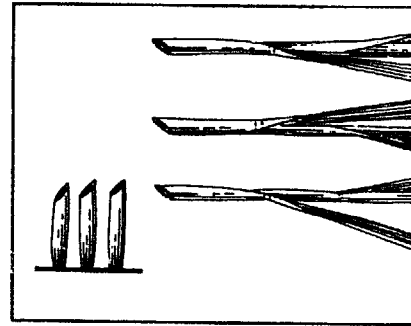
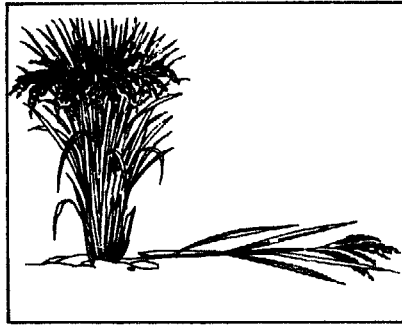

- The rate or number of tillers cut per rat per night is dependent on the season and crop stage. Generally it is high in the wet season and the vegetative stage, lower in the dry season and ripening stage.

Season, stage	Relative tiller cutting rates per rat per night	
	Higher	Lower
Wet season	X	
Dry season		X
Vegetative stage	X	
Ripening stage		X

- Damage is usually low during the vegetative stage, increasing rapidly after the flowering stage. The increased damage results from the greater number of rats due to increased cover (rice plants, weeds, etc.) and food (rice).

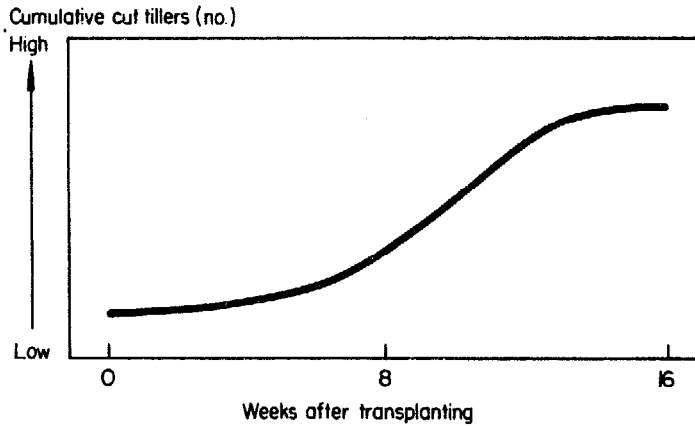

- A low or moderate population of rats will cut tillers randomly throughout a field. Damage will not be visible from a distance until more than 15% of the tillers are cut.

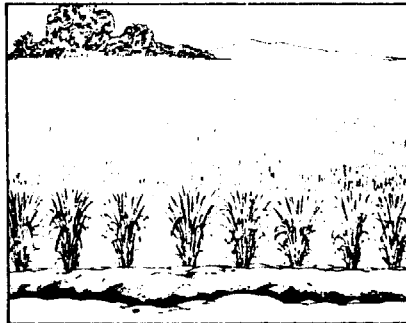

- When high rat populations occur, damage may be concentrated near the center of the paddy. From a distance the damage will be visible. Retillering of cut stems will produce a younger stage area that is surrounded by more mature rice.



- Rats feed at night.

MANAGEMENT IN SOUTHEAST ASIA

It is not always helpful to monitor rat populations or activity when crop protection is the primary objective. Whether rat activity is high or

low will not change the following recommended management techniques. However, monitoring may be desirable to provide

additional information in special situations such as for research or for a demonstration of management techniques.

**Monitoring**

• Riceland rats spend the daytime in vegetation, weeds, or maturing rice fields. They are not readily

seen; only their runways and footprints in muddy areas are visible.  
 • The general level of rat

activity in a rice field can be observed by inspecting the area for signs of activity.



• Active burrow



• Footprints in mud.



• Runways in grassy areas

Using tracking tiles

• A more exact way of measuring rat activity is the use of tracking tiles to record footprints.  
 • Tracking tiles are 15- × 15-cm square of white

linoleum or vinyl, one-half coated with printers ink.  
 • During the dry season a small amount of vegetable oil is added to the ink to prevent drying.  
 • If a tracking tile is not

available, the paddy mud can be raised immediately adjacent to the dikes to form platforms with smooth tops capable of recording footprints.

Arrangement of tracking tiles in the field

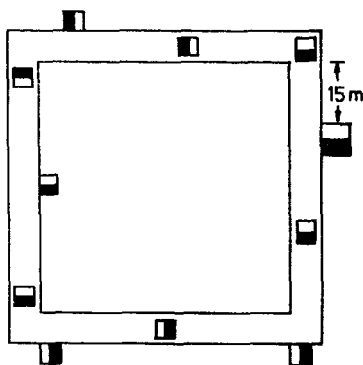

• Tiles may be placed on or against the edge of levees in flooded paddies and spaced 15 m apart.



• Tiles along the edges of levees can be placed on top of a pile of mud to raise them above the water level.

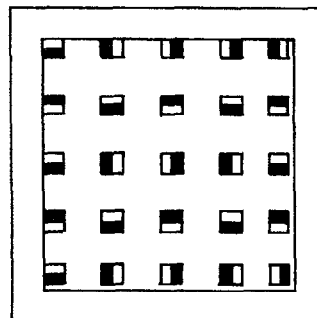

• In a dry field, space tiles evenly at the rate of 50/ha.

- Examine the tiles each morning and record the number of those with rat footprints. Clean the non-inked half with acetone and

- recoat the inked side with fresh ink before the tiles are returned to the field.
- Set the tiles out for 3 consecutive nights.

$$\text{Rat activity} = \% \text{ positive tiles} = \frac{\text{total tiles marked}}{\text{total tiles set}} \times 100$$

- 10% or less = low rat activity
- 30% or more = high rat activity

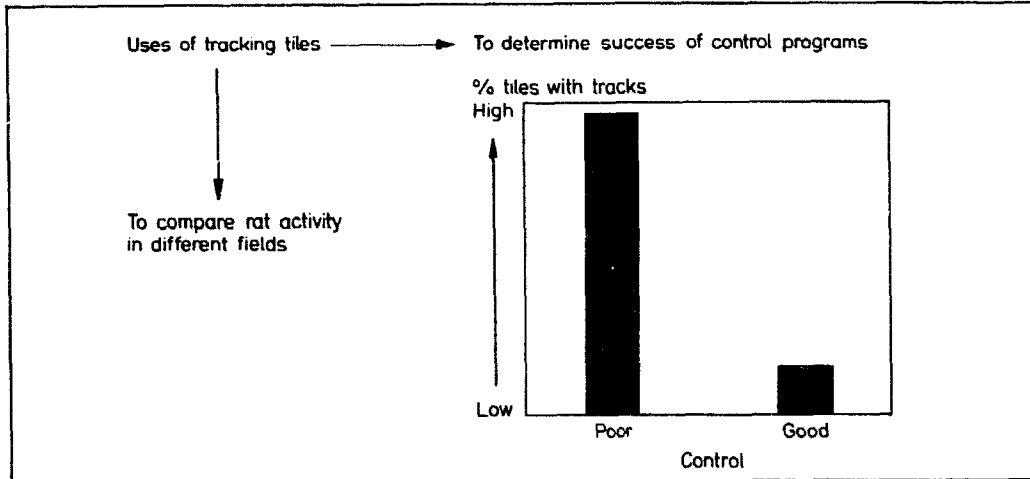

- Other visible signs such as runways, burrows, or damaged tillers will usually confirm tracking tile results.

**Estimating crop loss**

The sampling period for estimating damage should be within 2 weeks of harvest. Sampling may be done earlier, but additional damage would occur and the results would not reflect damage at harvest.

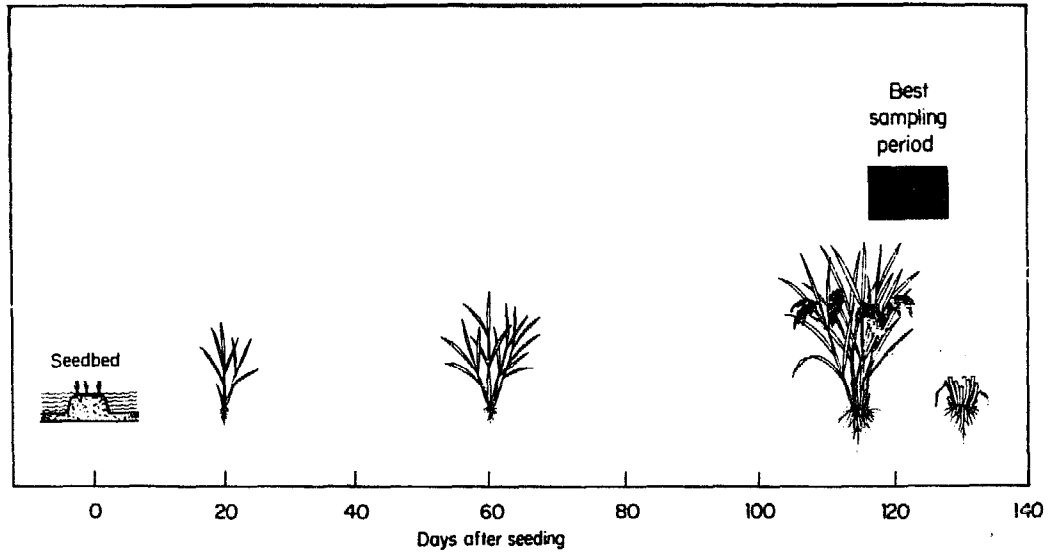

*Sampling method.* The percentage of cut tillers in a paddy can give an estimate of crop damage due to rats. This information can be used to determine if rat control was adequate during crop growth.

For transplanted rice that is grown in rows the following method can be used.

Examine every tiller in each of the 100 selected hills and record the number of cut tillers and the number of uncut tillers.

Calculate:

$$\% \text{ cut tillers} = \frac{\text{total cut tillers}}{\text{total tillers examined}} \times 100$$

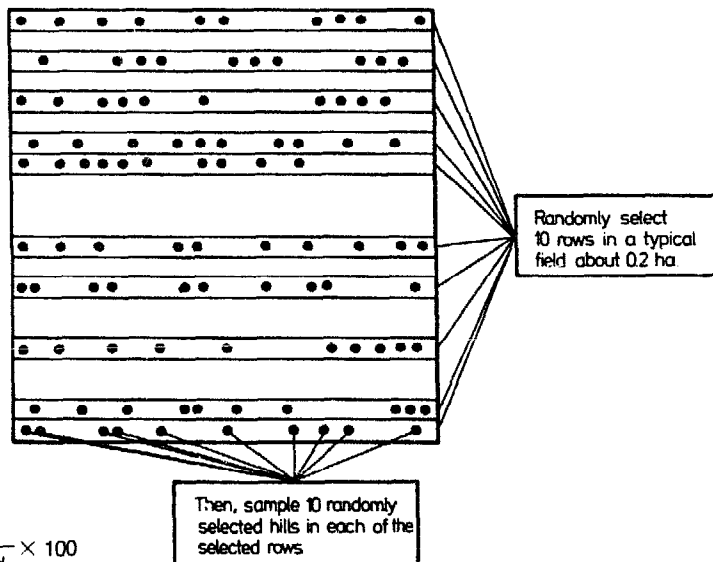

**Control**

The effectiveness of a rat control program is judged by the amount of crop damage caused by rats as observed at harvest.

- The number of dead rats observed is not important.

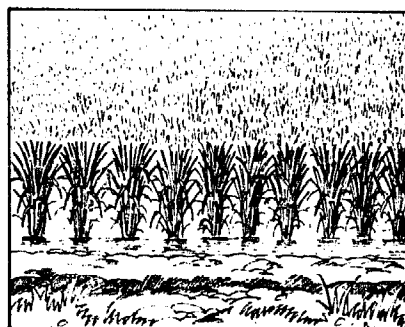
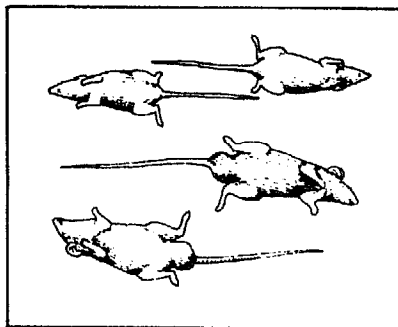

- Reinvasion or immigration of rats can occur quickly; therefore, a continuous or sustained baiting program is necessary.



- When rats are gradually controlled over the entire cropping season, large numbers of dead rats are not seen. However, this method is more effective than other control strategies in preventing crop damage.

*Timing control programs*

- Rat control efforts must begin within 2 weeks after transplanting and continue until the grain matures.
- Do not wait until the grain matures to begin control. By then the rat population could already be high and difficult to control, with severe crop damage occurring.
- Rat control is most effective when all farms use sustained baiting and cultural control practices.

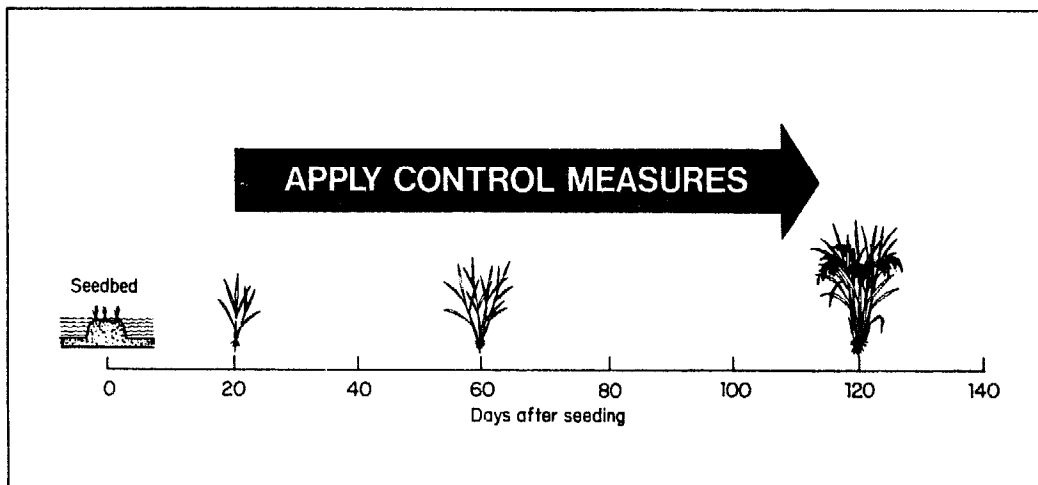

**Cultural control practices**

Rat control can best be achieved by being aware of the rats' basic needs such as food and shelter and then limiting those factors which favor rats. There are several cultural practices that can be used to limit rat population growth.

It is difficult to control all these factors in a rice-growing area.

- With some cultural control measures, however, we can limit food and shelter, which are the most important factors that determine rat population levels.

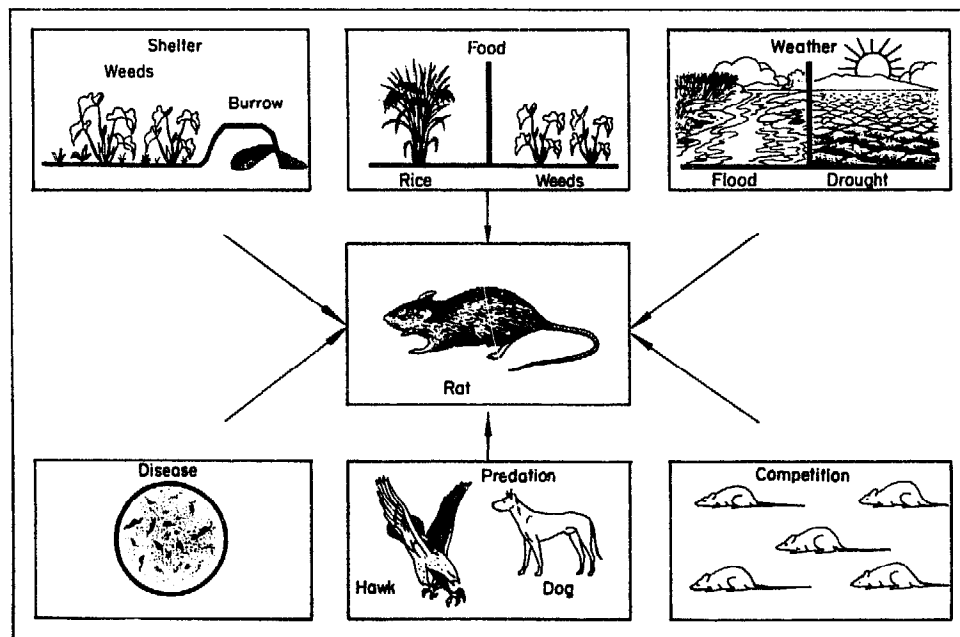

- Cut down or remove weeds on dikes and surrounding areas. This will reduce shelter or daytime resting areas.
- A weed-free rice field will provide less shelter and therefore a less favored rat habitat.

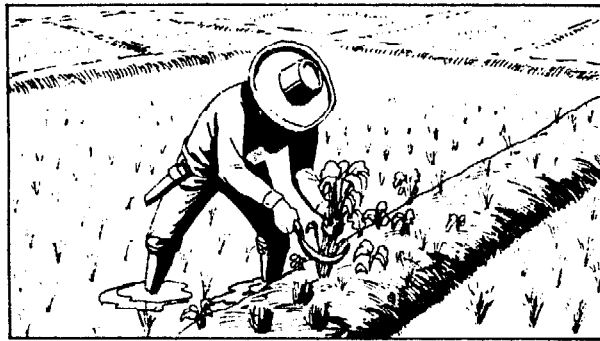

- Paddies flooded to just below dike level will fill rat burrows with water and eliminate nesting sites. Because rats are excellent swimmers, temporary flooding will not destroy them, but will force them to higher ground.

- Completely remove or destroy rice straw piles after harvest. They provide a place for rats to burrow, nest, and produce young rats.
- Reduce the size and number of dikes to limit burrowing sites and places for weeds to grow.

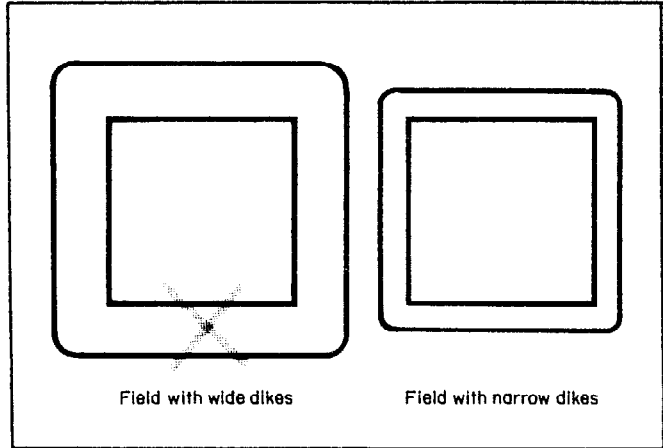

- Plant fields in the same area at the same time. Large areas transplanted at the same time will sustain less damage than areas with staggered planting times.

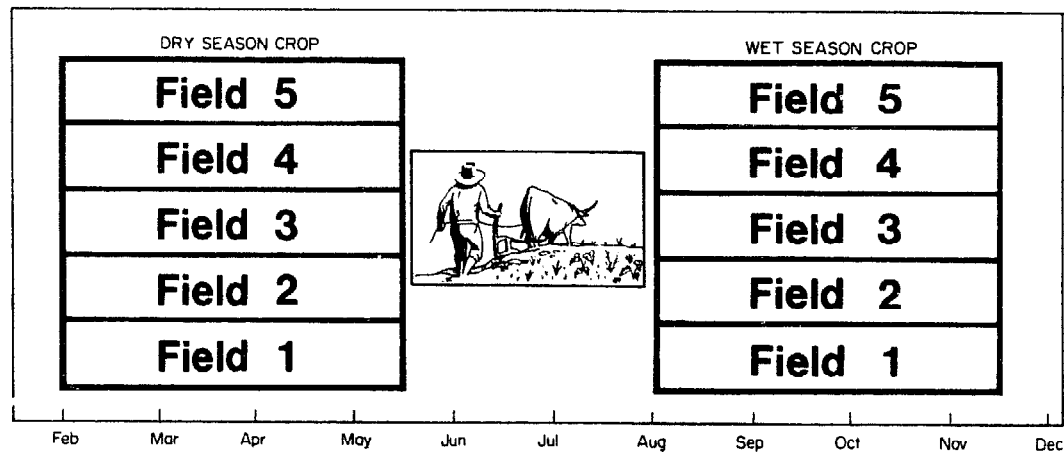

- In areas where planting is staggered, rats may concentrate and severely damage early and late planted fields during the ripening stage.

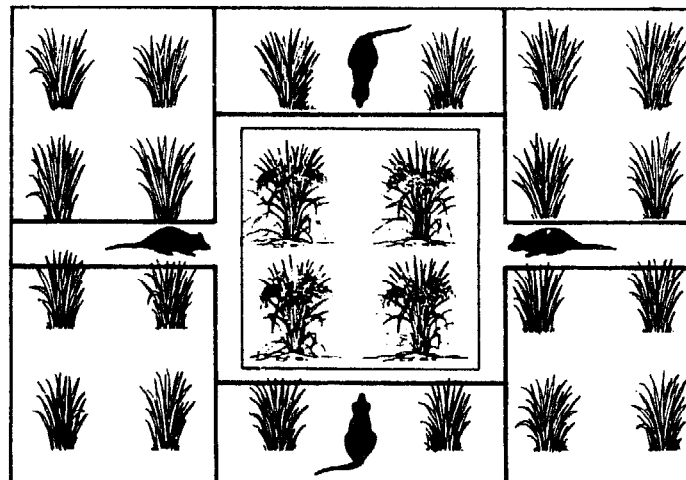

Early planted field

- Rats in harvested fields move to the remaining unharvested fields because food and shelter are abundant.

In many cases a farmer's rice field is surrounded by others in which rats are not controlled. Under these circumstances, the rice farmer using these recommendations can still protect his crop from high rat damage.

When all farmers in a given area control rats the individual costs are reduced

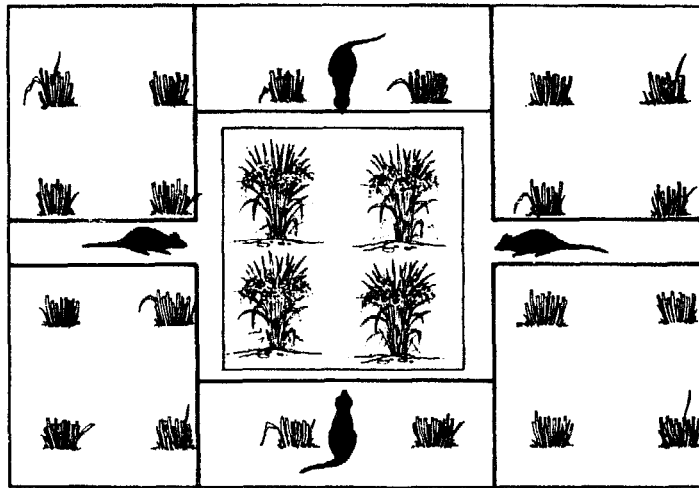

Late planted field

and effectiveness increased. Large-scale programs can rapidly increase yields and extend management techniques over a wide area.

**Chemical control**

Cultural control often will not adequately control rats. If these cultural practices are used in combination with chemical baiting, the effectiveness of an integrated rat control program will be increased.

Many kinds of rodenticides are available. They can be

separated into two basic groups: acute (quick kill) and chronic (slow kill). The older or traditional acute rodenticides are cheaper and more readily available but are not preferred for rat control in rice. The chronic or anticoagulant rodenticides are effective only with several

feedings. This is because they cause internal bleeding which occurs over several days. Some anticoagulants now being introduced require only a single feeding, but they are not as yet readily available to the small farmer.

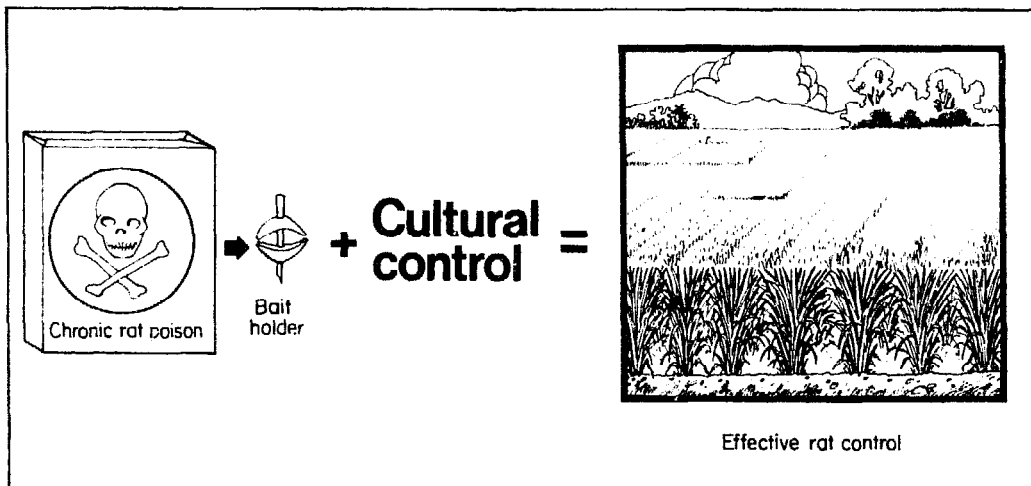

Compared with traditional acute rodenticides the chronic anticoagulant rodenticides are less hazardous to humans and beneficial animals.

Traditional acute rodenticides become less effective with time because many rats survive after eating small amounts of bait, and learn to associate their illness with the bait (bait shyness).

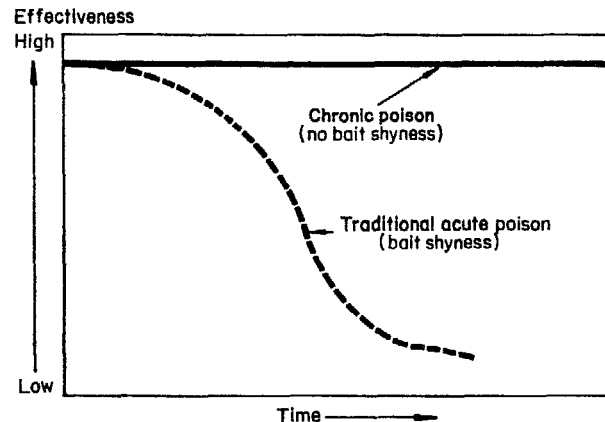
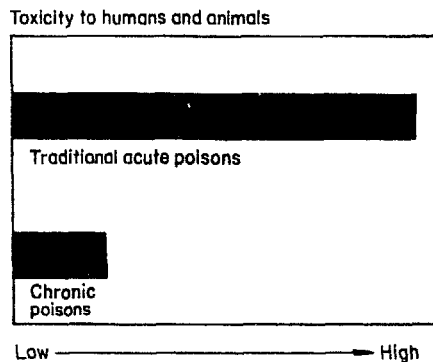



*Materials used in a baiting program.* Chronic anticoagulant baiting programs require a rodenticide, a bait material readily accepted by rats, a suitable bait holder, and frequent visits to the field.

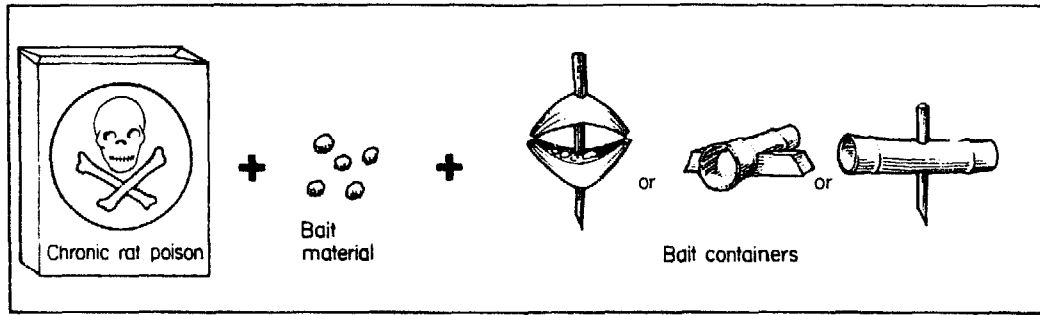

When chronic anticoagulant rodenticides are used, rats must feed two or three times before death will occur. After 3 days rats stop feeding and become sick. Six to 10 days after initial feeding they die.

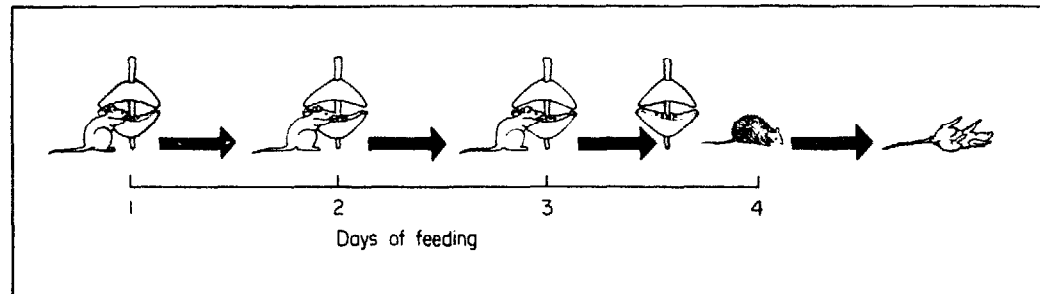

- Since chronic poisons kill slowly, rats may die in burrows or in other areas where dead bodies are not visible.

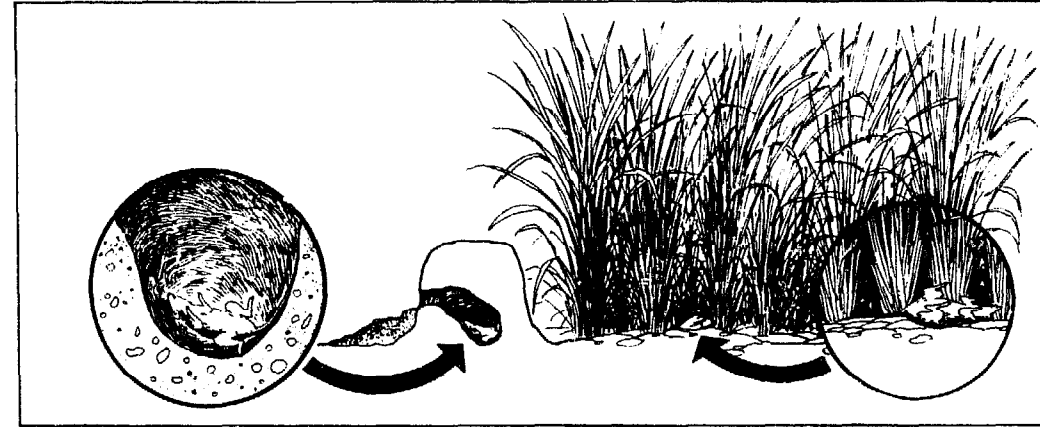

- General procedures for sustained baiting*
- Read the directions on the container carefully before mixing the poison with the bait material.
  - Any low-cost available material such as low-grade

- milled rice or broken rice can be used as bait. However, rats must like it.
- Local materials such as bamboo, oil cans, or coconut husks can be used as bait holders.
- Begin baiting soon after

- transplanting and continue through the ripening stage.
- Establish five baiting points in each hectare.
- Check baiting points twice a week.

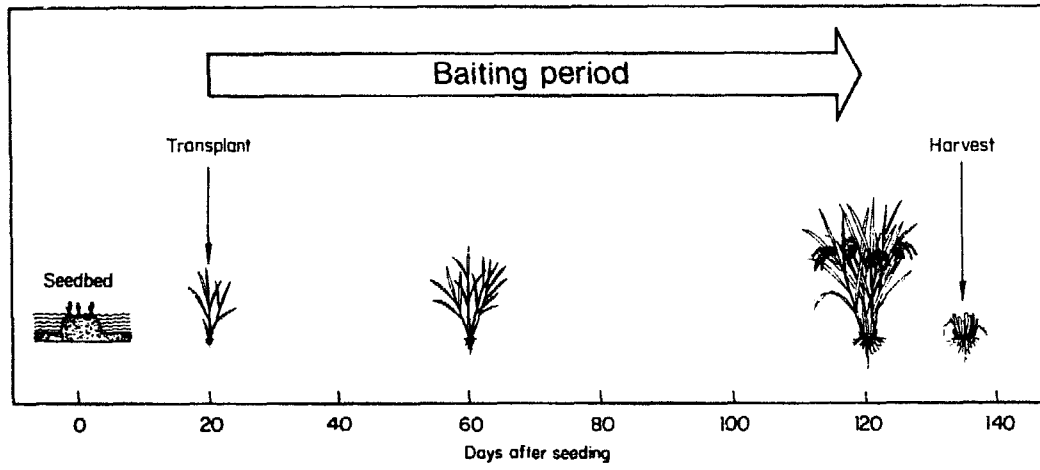

**Density and spacing of baiting points (location of bait holders)**

- Use five baiting points for each hectare of rice field.
- Baiting points should be about 50 m apart.
- The best location for the baiting point is within the paddy, at least one meter from the dike.

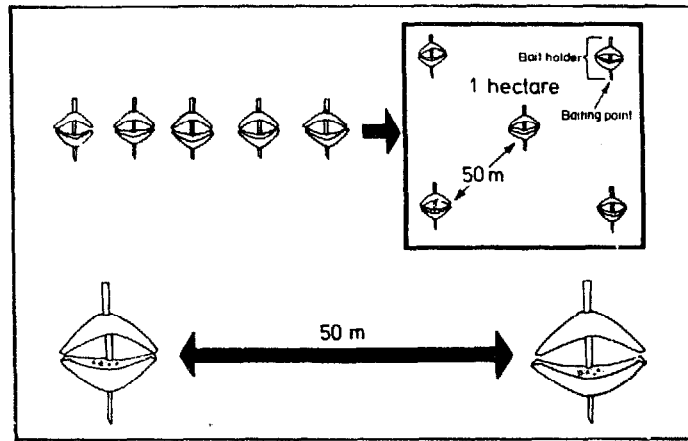

- Put 6 tablespoons of poisoned bait in each holder.
- Check holder after 3 days.
- If one-half of the bait is gone at any holder, set out 2 more holders 1 m from the first in a cluster.
- Put poisoned bait in each holder.

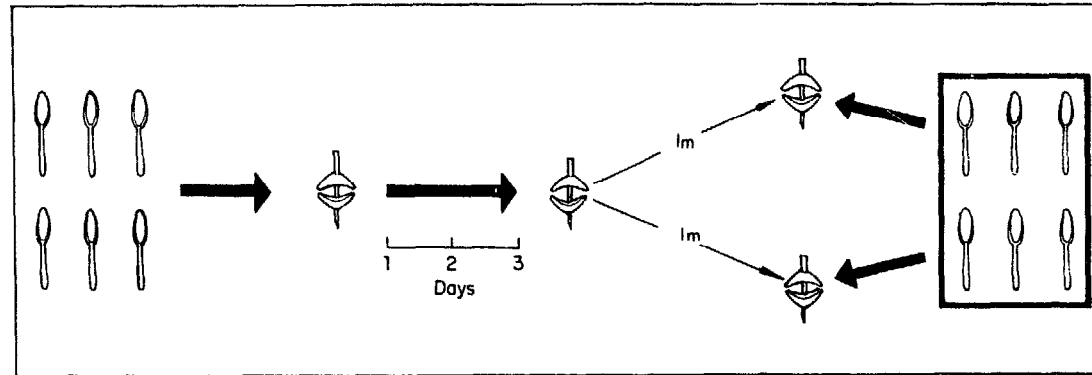

**Maintaining bait holders during the season**

- Check holders at the 5 baiting points twice a week throughout the season and add bait holders and bait when necessary.
- Always add enough bait so that holders never become empty.

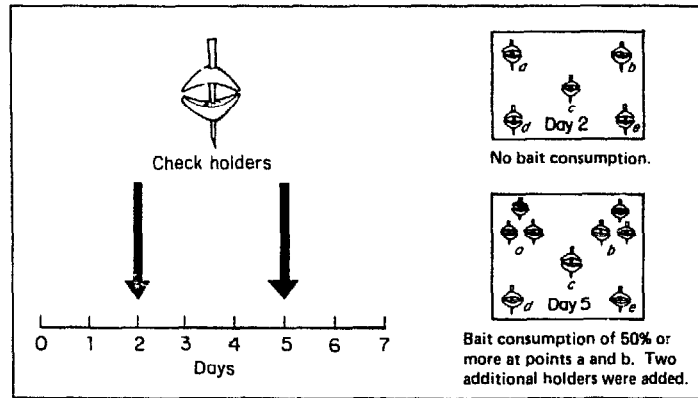

- Remove and replace wet or moldy bait.
- If rats do not eat any bait at any point, reduce the number of holders.
- Always leave at least one bait holder at each of the 5 original baiting points to monitor rat activity.

**Pattern of bait consumption during the crop season**

More bait is eaten as rats move into the field and consume bait from the added holders.

When rice heads mature, less bait is eaten because most rats have already been killed, bait holders have been reduced, and any remaining rats would prefer to feed on the rice rather than the poisoned bait.

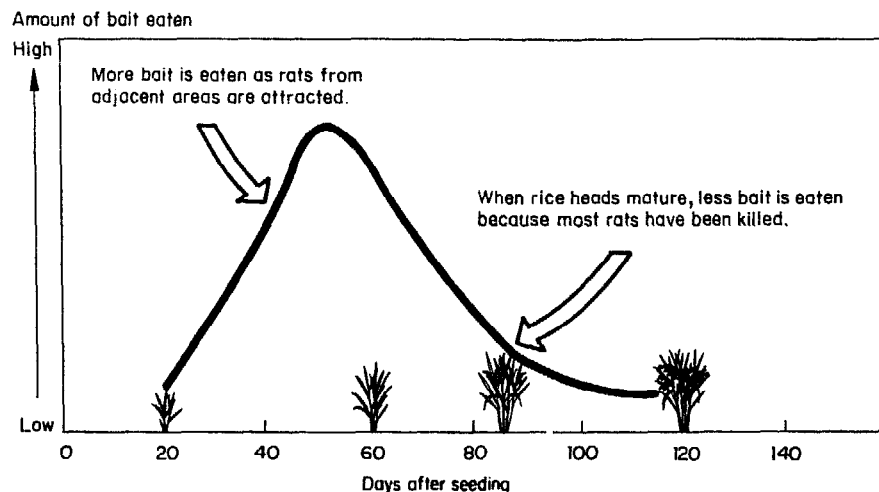

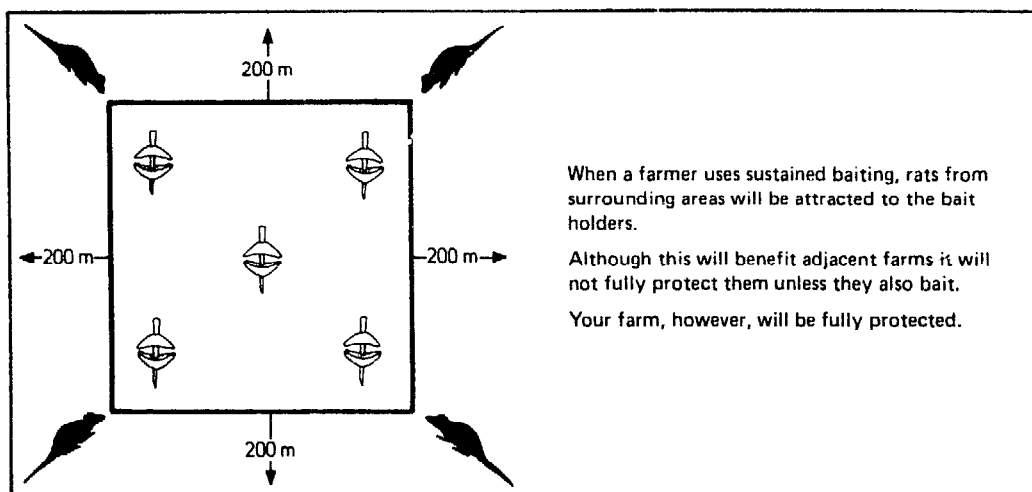

**Advantages of cooperative rat control**

When one farmer uses sustained baiting, the protective benefits may extend outside his farm for 200 m in all directions.

Rat control is more effective if a farmer and all of his neighbors in an area use sustained baiting and cultural control practices.

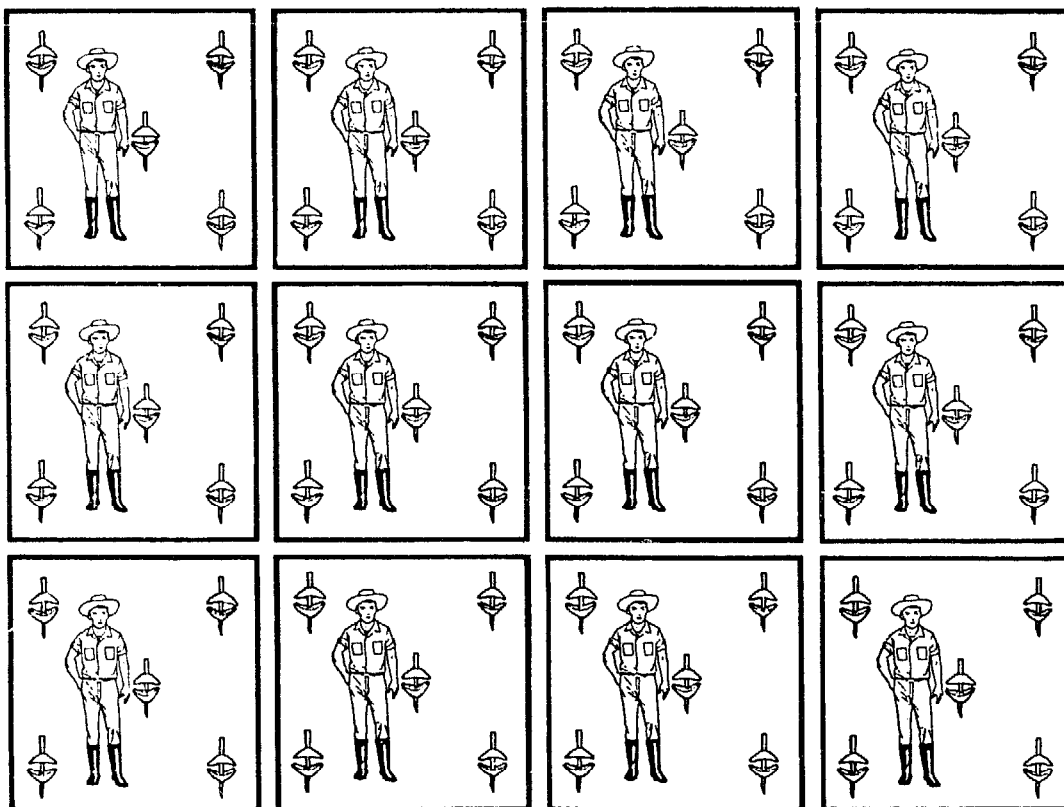

**SUMMARY**

These recommendations have been developed, tested, and shown to be effective in the Philippines. They were designed for the individual small farmer, with the assumption that adjacent farms may not control rats. These recommendations may be modified to account for

local conditions in other countries.

When these recommendations are followed and rat damage still occurs, the reason can usually be traced to a failure to follow all the steps. For example,

1. Weeds were allowed to grow tall on dikes and

adjacent areas.

2. Planting time was too early or too late, not in synchrony with most of the other fields in the area.

3. Bait holders were not checked twice a week.

4. Bait holders were not increased when consump-

tion of bait increased.

5. Rodenticide was not mixed according to label directions.

6. Bait material used was not accepted by rats.

7. Traditional acute rodenticide was used and bait shyness developed.

# CULTURAL CONTROL

# Cultural Control

Cultural control of rice pests covers crop production methods — used consciously or unconsciously by farmers — that improve yield by reducing pest numbers.

The term *cultural* is derived from *crop culture*, meaning the technology of growing a crop. The term culture also fits the anthropological definition of patterns of behavior (crop production practices) that are passed from farmer to son and have achieved greatest yield stability over time.

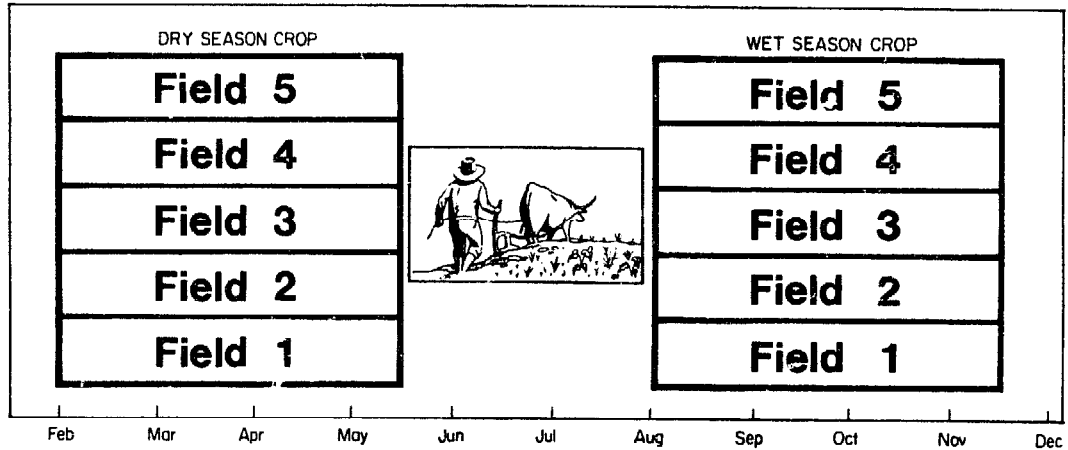

- Cultural control is
- the use of crop husbandry practices,
  - patterns of behavior transferred from generation to generation,
  - farmer-based technology with little dependence on outside resources, and
  - reapplication of resources not originally intended for pest control.

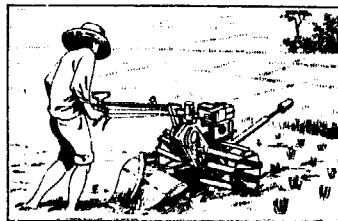

It is often difficult to measure the effectiveness of cultural practices because the same practice may decrease one pest but increase another. Another practice may control a pest but reduce yield. Therefore the farmer must decide which cultural practices are best for each location.

Examples of decisions to make are

- The choice to direct-seed or transplant in a wetland environment:
  - Transplanting controls most weeds.
  - Direct seeding controls kresek and whorl maggots.
- The choice to use nitrogen fertilizer or not:
  - Nitrogen increases not only yield but also most pest populations.

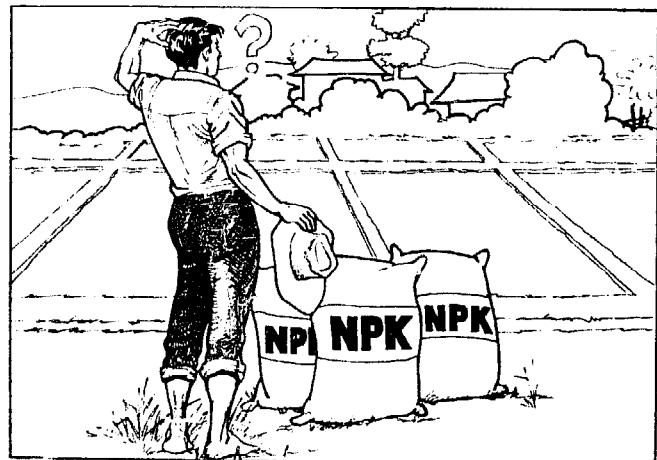
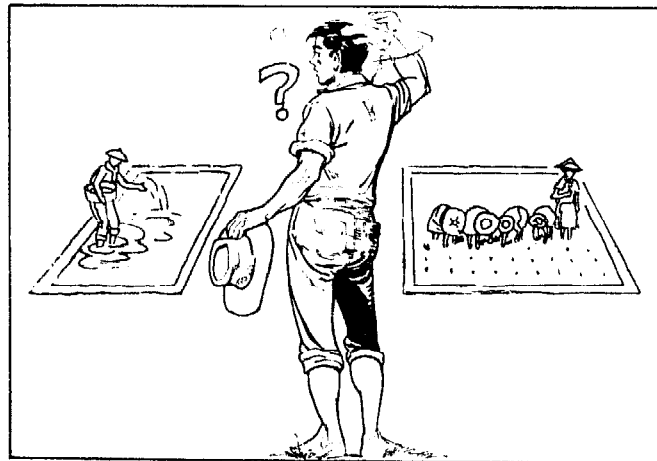

Cultural practices can be divided into those that directly benefit the farmer if he carries them out at the farm level, and those which require community action to be effective.

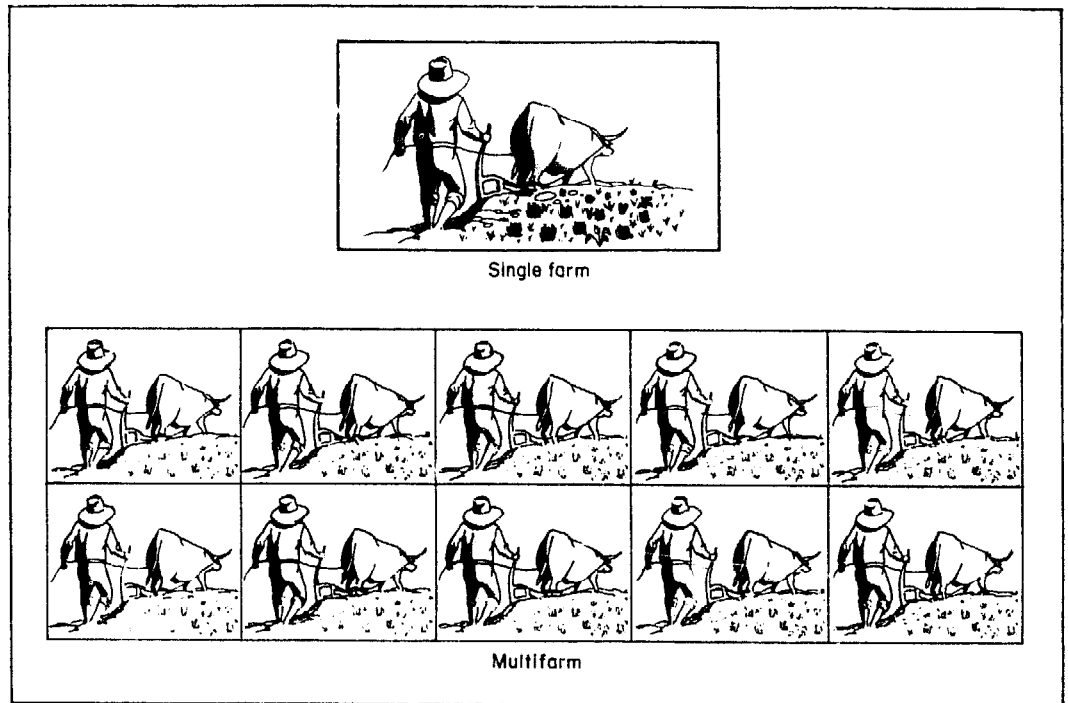

**Practices effective at the farm level**

Cultural control practices include farmer-developed indigenous methods:

- Local plants with pesticide properties
- Household remedies — salt, kerosene, oil, sand, ashes, sugar, or baits
- Traditional beliefs — planting by phases of the moon (possibly to avoid insect pests such as stem borers)
- Magical or superstitious practices — food offerings to rats in return for sparing the standing crop, unlucky days for farm operations, bad omens, or hex signs to repel pests and protect the crop

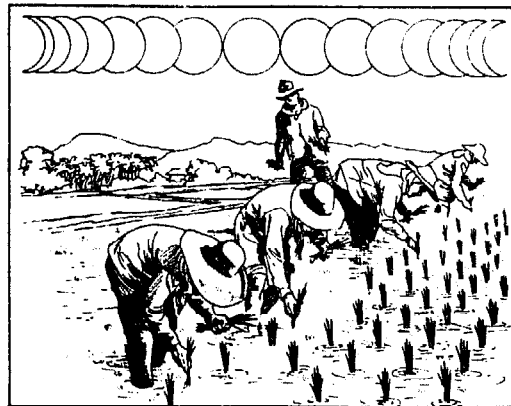
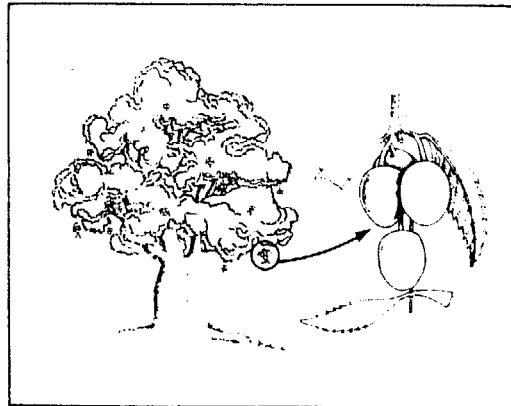

Conventional crop husbandry consists of the following practices:

- Puddling the soil probably evolved as a weed control practice. Most weed seeds or rhizomes cannot germinate or grow without air several centimeters under the surface of puddled soil.
- Repeated tillage in dryland rice fields exposes weed rhizomes to high temperatures and buries weed seeds deep in the soil where they cannot germinate.

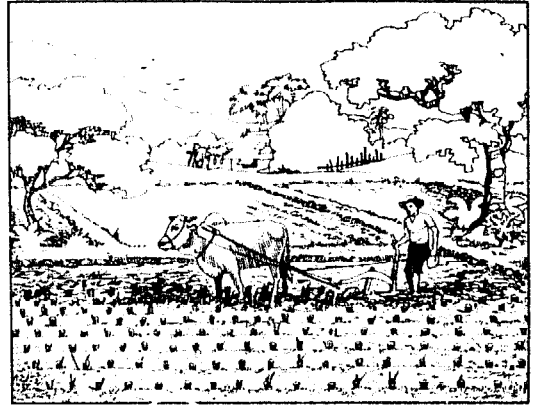
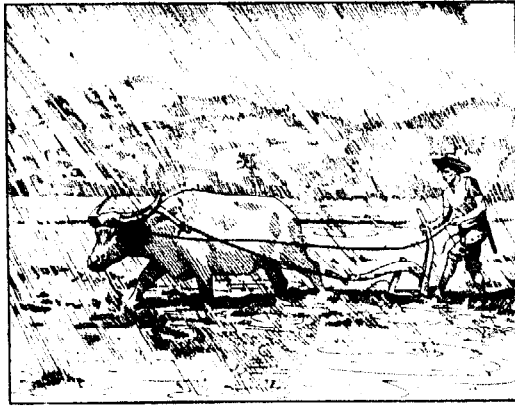

- Planting in rows allows labor-saving interrow weed cultivation.
- Direct seeding reduces kresek disease that enters through root wounds made when seedlings are pulled from seedbeds.



- Use of a seedbed confines the crop to a small area where weeds and insects can be removed by hand. Seedbeds can also be covered with plastic or cloth to prevent vector insects, birds, and rats from reaching the crop.
- A dry seedbed does not attract rice caseworm, whorl maggots, or some aquatic insects.



- Transplanting older seedlings shortens field time and therefore population buildup from pests that attack only during the vegetative stage. Older seedlings are more competitive with weeds; however, yields are lower when older seedlings are planted.
- Leveling a wetland field before planting results in more efficient weed control with standing water.

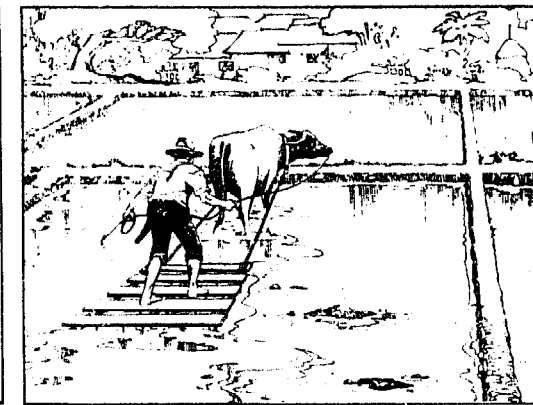

- Dense plantings give a high tiller number per unit area and
  1. protect rice from whorl maggots, which use light reflection from a water surface in locating rice plants,
  2. provide better canopy
- Maintaining standing water in the paddy controls most weeds and minimizes rice blast incidence, but encourages whorl maggot, caseworm, and brown planthopper.

cover to shade out weeds, and  
 3. give higher yields.  
 However, they increase brown planthopper oviposition sites and lead to higher populations and greater damage.

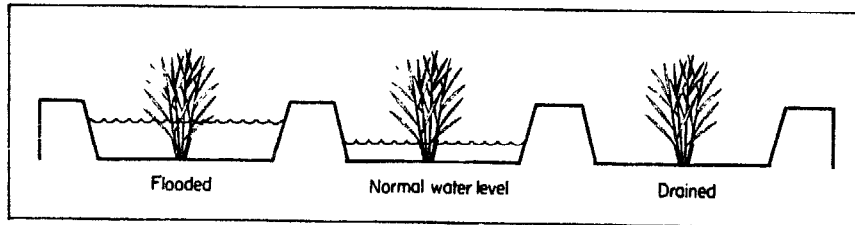

- Flooding the fields to higher than normal depths drives planthoppers and other insects higher on the rice plants where they are more readily controlled by chemicals. Flooding does not drown insect eggs or stem borer larvae within the plants. The yellow stem borer can survive one meter below the water in deepwater rice where it is a major pest. Deeper flooding also controls weeds more effectively.
- Early-maturing varieties minimize the number of pest generations per crop, thereby lowering pest damage. Such varieties are highly effective against insects that have short life cycles and attack all stages of rice growth. Insect abundance increases exponentially rather than arithmetically in time.

chemicals. Flooding does not drown insect eggs or stem borer larvae within the plants. The yellow stem borer can survive one

meter below the water in deepwater rice where it is a major pest. Deeper flooding also controls weeds more effectively.

- Periodic draining of rice fields reduces brown planthopper, whorl maggot, and caseworm, but encourages weed growth.

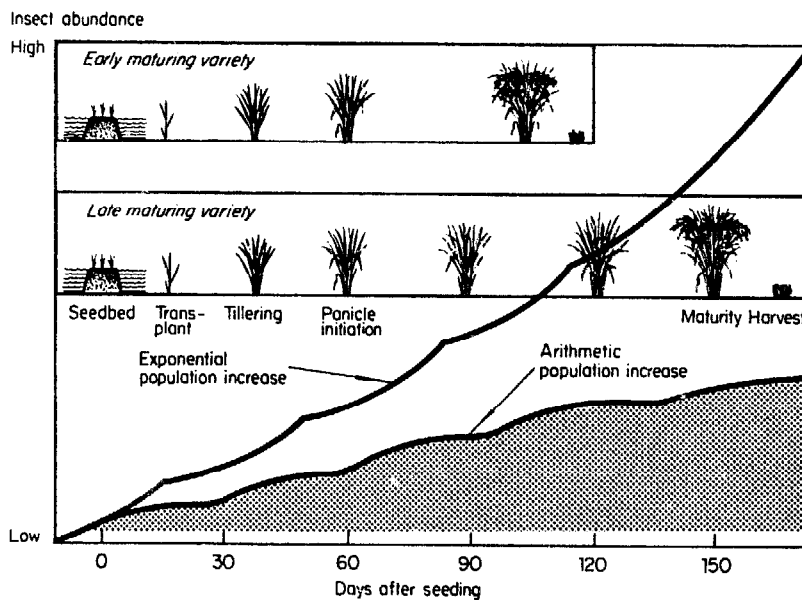

- In areas where there are seasons without rice, fields planted at the beginning of the growing season are usually less severely damaged by insects and diseases, but infestation of birds and rodents may be great unless most farmers plant early.

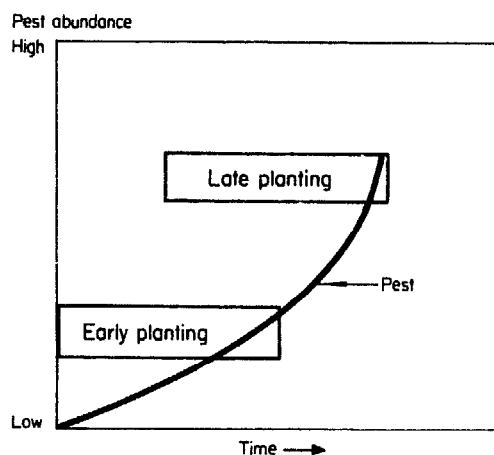



• High rates of nitrogen fertilizer provide greater plant nutrition and higher yield. However, they also:

1. increase weed populations in the current and subsequent crops,
2. increase the incidence of fungal and bacterial diseases by increasing tissue susceptibility and tiller density that favors dew formation, and

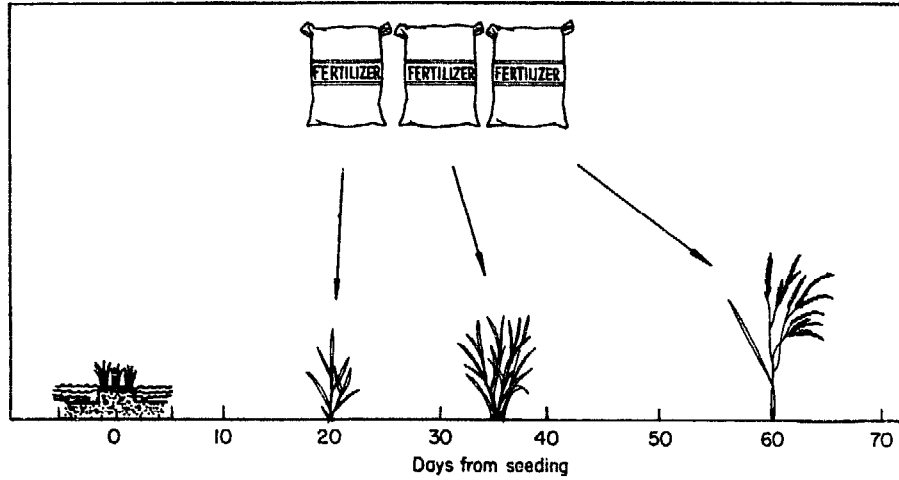

3. encourage the multiplication of brown planthopper and leaf folder (in general

insects grow larger, cause more damage, produce more offspring, and complete more

generations per crop on plants treated with high levels of nitrogen).

Reduced nitrogen rates and split applications minimize pest problems and increase profit.

**Practices effective at the community level**

• Crop rotation — rotating rice with a nonhost crop will remove a pest's food and reverse its population

buildup. This method is effective against pests for which rice is the preferred host.

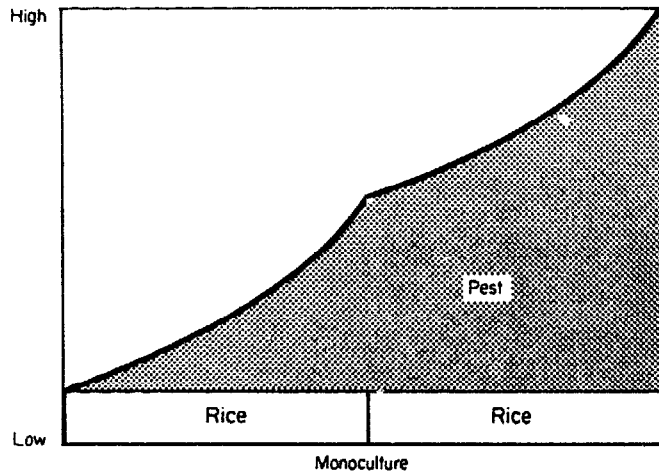
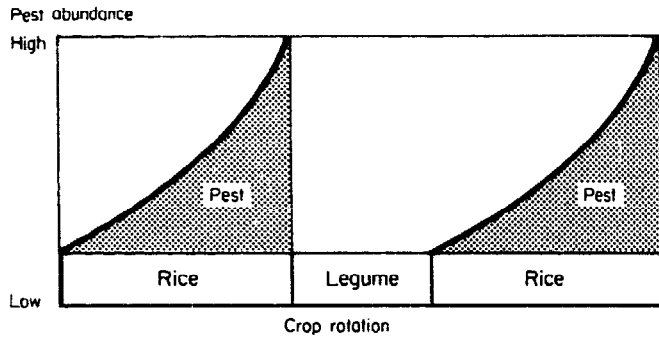

• Weeding — cutting weeds from areas bordering paddies and removing weeds from rice fields reduce nesting sites and shelter for rats and alternative hosts of insects.

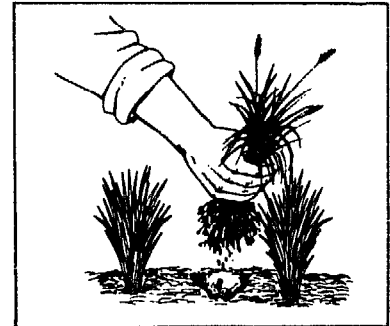

• Stubble management — at harvest, cutting the crop close to the ground and spreading the plants to expose them to the sun kill stem borers inside the stems.

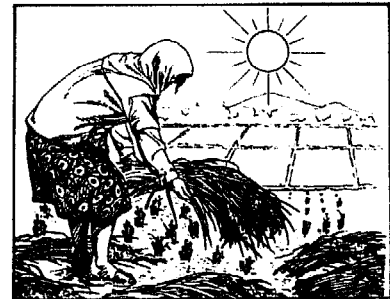

• Burning straw — stem borers that could emerge and infest neighboring fields are killed. But burning stubble left in the field has little effect on pest reduction.



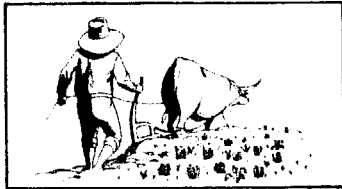

- Cultivation — plowing under the rice stubble after harvest to prevent a volunteer ratoon crop and subsequent weed buildup is particularly important in curbing the spread of virus diseases in the community and in removing food and shelter for most pests.

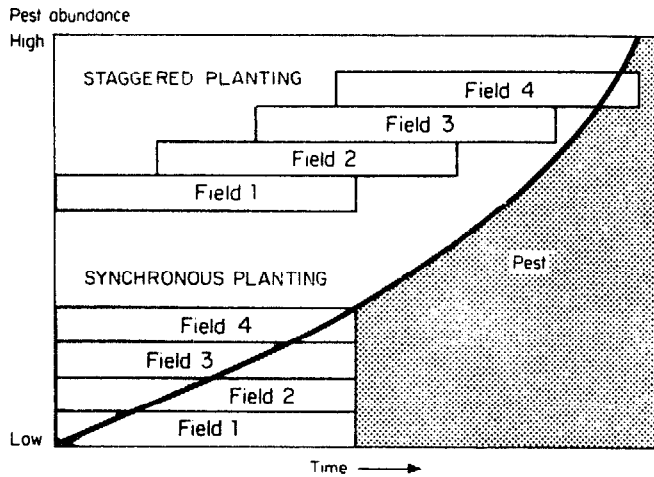

- Synchronous planting — insects, diseases, and rats readily disperse from field to field. They can maintain high population levels and cause great yield losses in farm communities where planting times of neighboring fields are staggered beyond an interval of 3 to 4 weeks (the generation time of most pests). Synchronous planting and the creation of a rice-free period of at least one month between successive rice crops greatly reduce pest abundance.

Because synchronous planting is impractical for fields in a large rice-growing area, the whole area can be divided into blocks, each 3 to 5 kilometers in diameter (beyond the effective dispersal range of most pests). Adjacent blocks should be out of phase with each other by no more than 3 to 4 weeks.

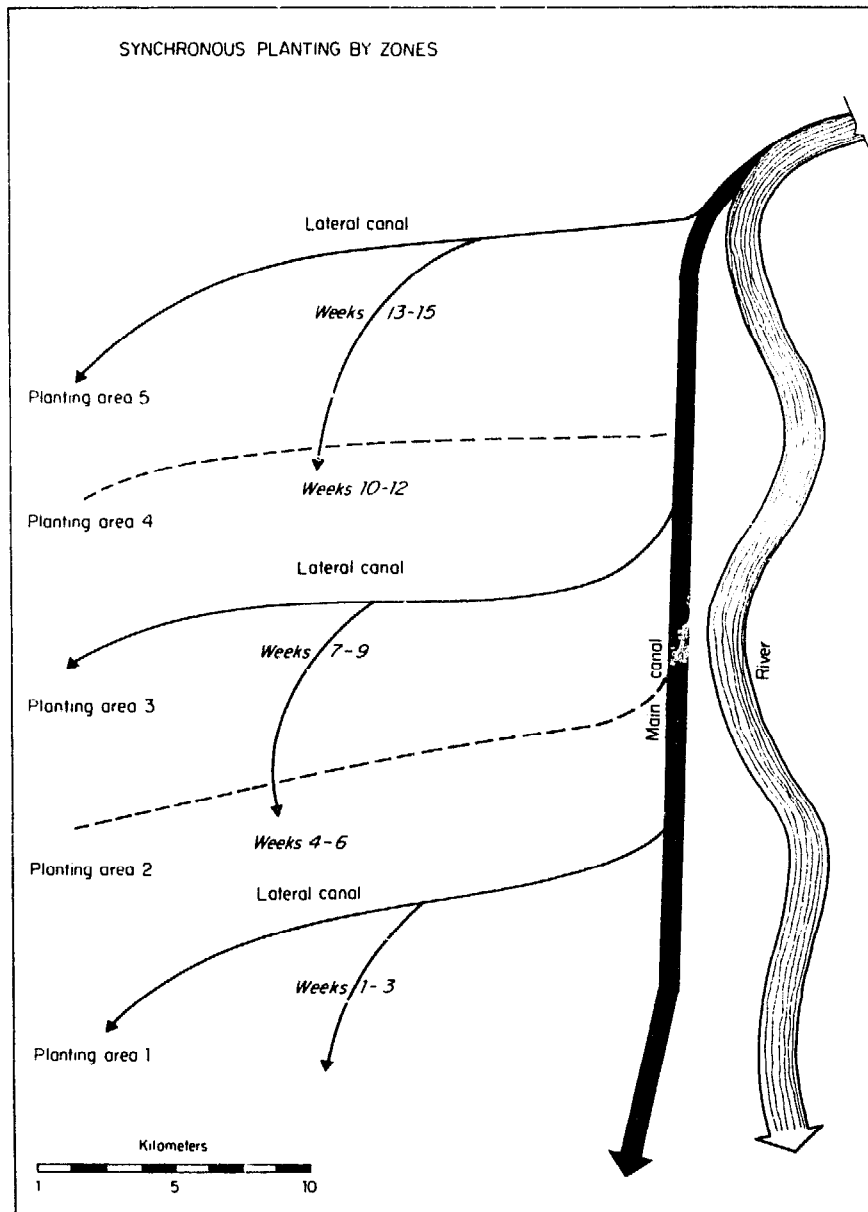

**Advantages of cultural control practices**

- Pests have not shown that they can overcome the suppressive effect of cultural control practices through the development of biotypes.
- Most practices are inexpensive or utilize resources available to farmers such as labor or indigenous materials.
- Most practices are compatible with other control tactics.

**Disadvantages of cultural control practices**

- Most methods reduce some pests but increase others.
- Some practices decrease pests but also decrease yield.
- Communitywide practices requiring organization of farmers and institutions may be difficult to achieve.

# RESISTANT VARIETIES

# Resistant Rice Varieties

For as long as crops have been grown, farmers have noticed that some varieties suffered more damage from insects and diseases than other varieties. Recently rice

breeding programs were initiated in many countries to select and develop good quality, high yielding rice varieties that are resistant to insects and diseases.

## Definition of a resistant variety

The term *resistance* has been defined in many ways. For practical purposes a variety is considered resistant if it produces a larger amount of a good quality crop than other varieties grown under the same conditions and exposed to similar populations of insects and diseases.

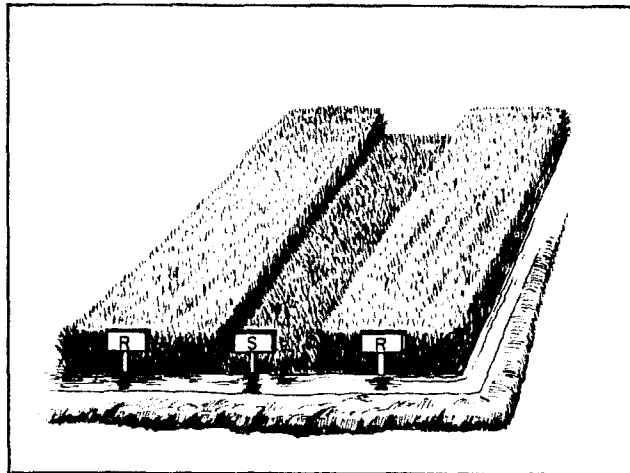

Resistance is an inherited characteristic that is due to one or many different genes.

Resistant varieties are one important part of an integrated pest management program for rice for several reasons:

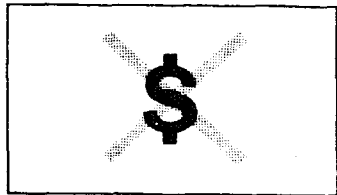

- They do not increase farmers' costs.

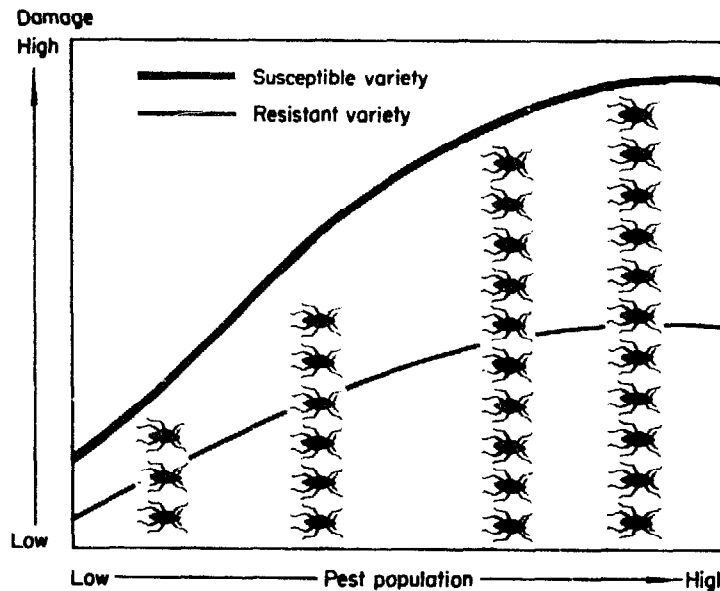

- They limit damage at all levels of pest population throughout the season.

- They require less pesticide than susceptible varieties do.

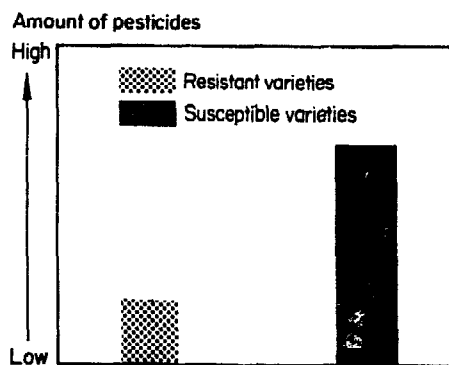

- They can be integrated effectively with other control methods in a pest management program.

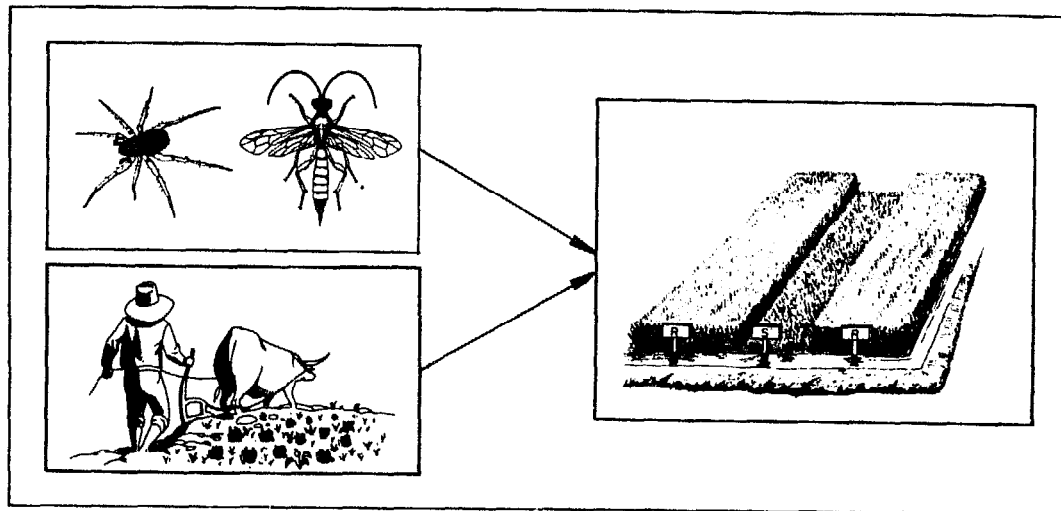

Resistant varieties are particularly well suited for use in a rice pest management program in Asia because the value of production per hectare is lower for rice than for other crops, farms are small, and farmers lack money and knowledge to properly apply pesticides.



**VARIETAL RESISTANCE OF RICE TO INSECT PESTS**

The resistance of rice to insects can be divided into three basic categories:

1. Tolerance — the host plant can survive heavy infestations without a significant yield loss. Pest numbers on a tolerant variety are equal to those on a susceptible variety.
2. Nonpreference -- insects do not feed upon, oviposit in, or use a resistant variety for shelter.
3. Antibiosis — insects do not grow, survive, or reproduce well on the host plant.

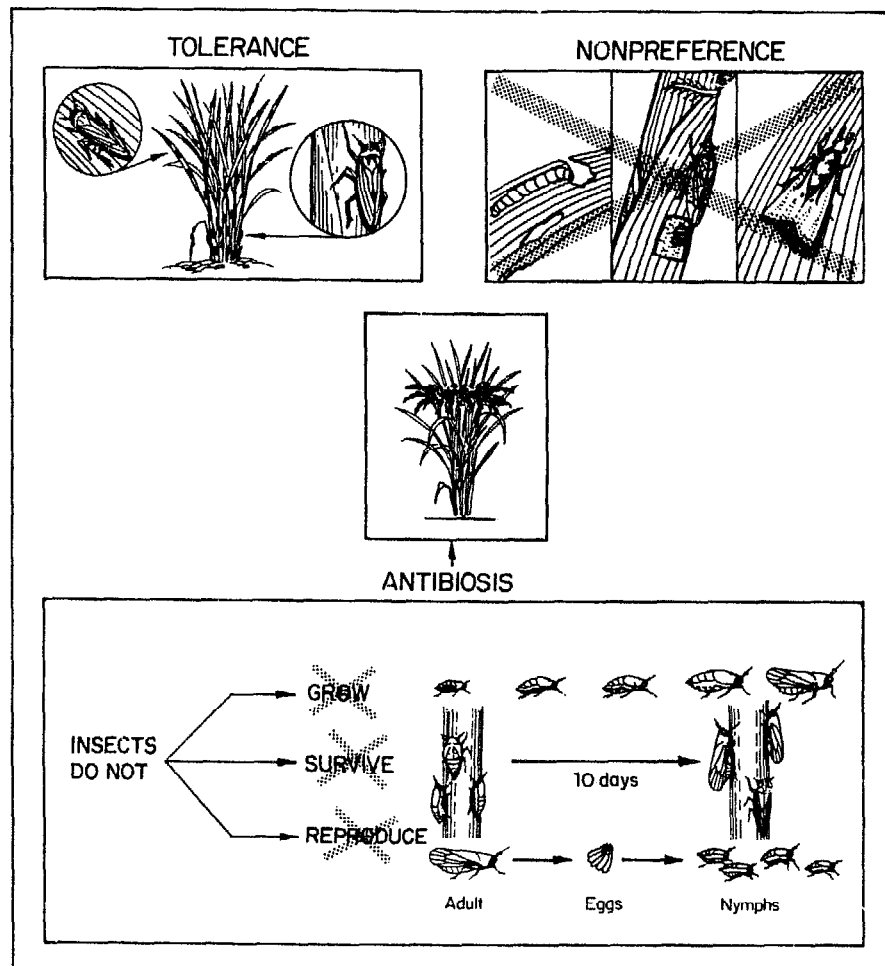

It is sometimes difficult to identify the type of resistance of a given rice variety to an insect pest. Some varieties may have only one type of resistance, but others may have a combination of the three kinds.

For example, rice varietal resistance to the yellow stem borer is primarily

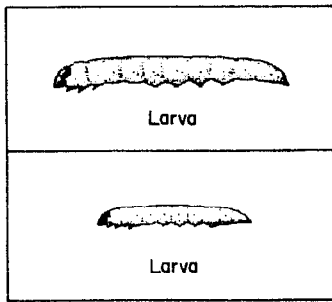

antibiosis. Larvae feeding on the resistant rice are smaller and survival is reduced.

However, resistance to the striped stem borer is due to both nonpreference and antibiosis.

**Nonpreference**

Moths deposit fewer egg masses on resistant varieties.

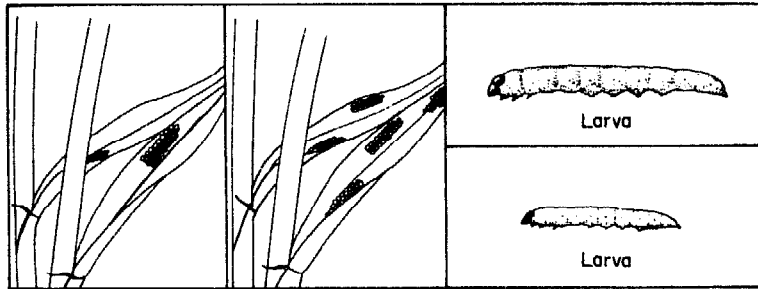

**Antibiosis**

Larvae are small and survival is reduced.

The level of resistance to different insects may vary greatly among varieties. Even highly resistant varieties may be damaged by a heavy infestation.

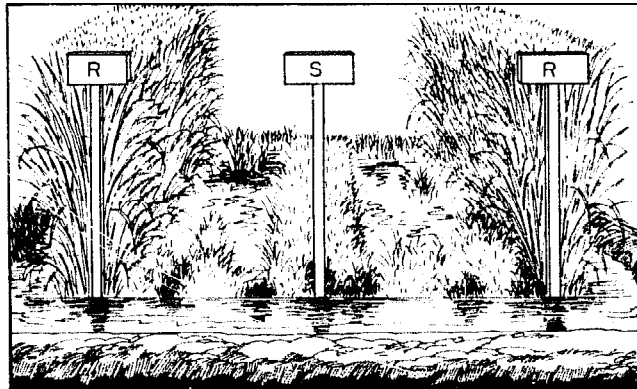

Varieties that are highly resistant to the brown planthopper have been developed.



Varieties with only moderate levels of stem borer resistance have been developed.

**RICE VARIETAL RESISTANCE TO DISEASES**

The reactions of rice varieties to plant diseases can be divided into three categories:

**Immunity**

- The rice plant is not attacked by a disease under any conditions.

Rice varieties are rarely immune to rice diseases. Usually if a disease has different races, a resistant variety is immune to some races but is attacked by others.

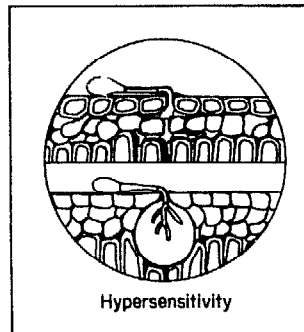
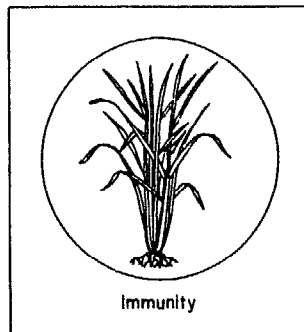

**Hypersensitivity**

- Invaded cells are killed so quickly that the disease remains localized and cannot spread throughout the plant. Often the disease is completely suppressed as part of the "hypersensitive" reaction. Infected plants are largely undamaged.

**Tolerance**

- Tolerance is the most common kind of disease resistance. The rice variety infected by the disease may develop symptoms, but the crop yield is greater than that of susceptible varieties. In tolerant varieties, the appearance, amount and type of symptoms, and the severity of the disease vary greatly. Tolerant varieties still serve as sources of inoculum which can infect susceptible varieties nearby.

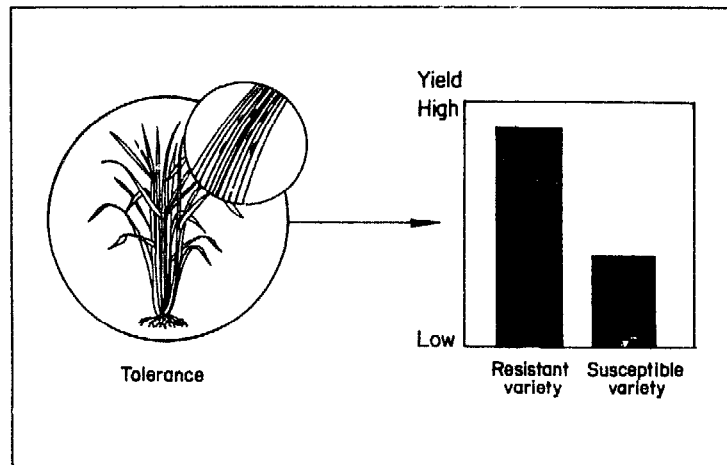

- Symptoms of rice blast on varieties with different levels of tolerance: resistant, moderately resistant, susceptible.

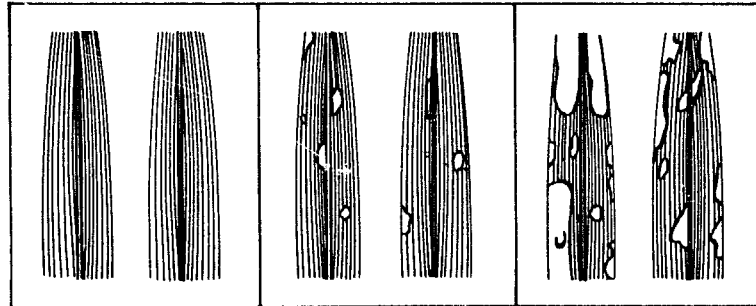

**DISEASE RACES AND INSECT BIOTYPES**

**Definition of "race" and "biotype"**

Insect biotypes or disease races consist of forms that are capable of surviving on and damaging varieties that are resistant to other populations of the same pest species.

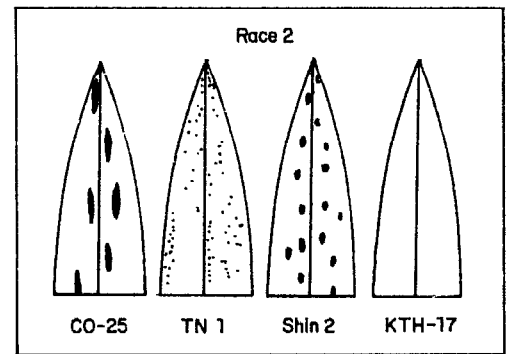
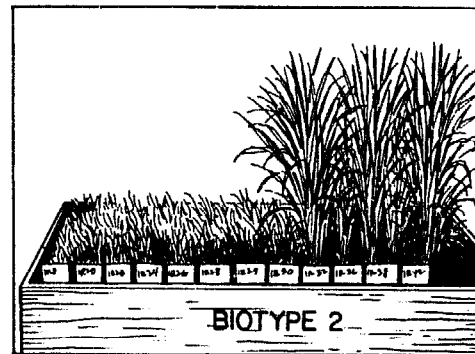
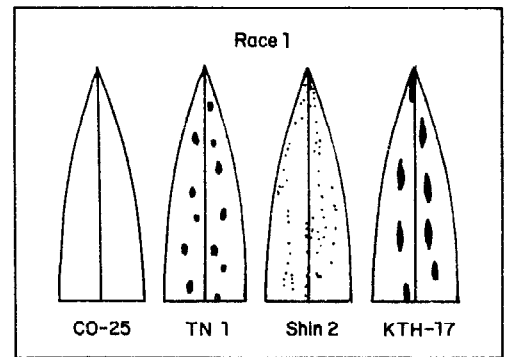
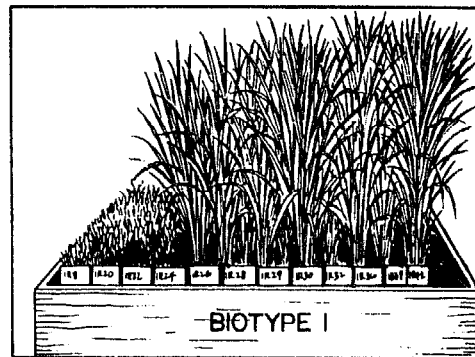

Reaction of rice varieties to different biotypes of the brown planthopper. IR26, IR28, IR29, and IR30 are resistant to biotype 1 but susceptible to biotype 2.

Reaction of rice varieties to two races of rice blast.

- Several important rice insect pest species, particularly the leafhoppers and planthoppers, have different biotypes; disease agents are even more variable. Most

important rice diseases have many different races and the capability to form new races in a relatively short period of time.

On the basis of their reaction to pest races or biotypes, resistant varieties can be divided into two general groups: those with horizontal resistance and those with vertical resistance.

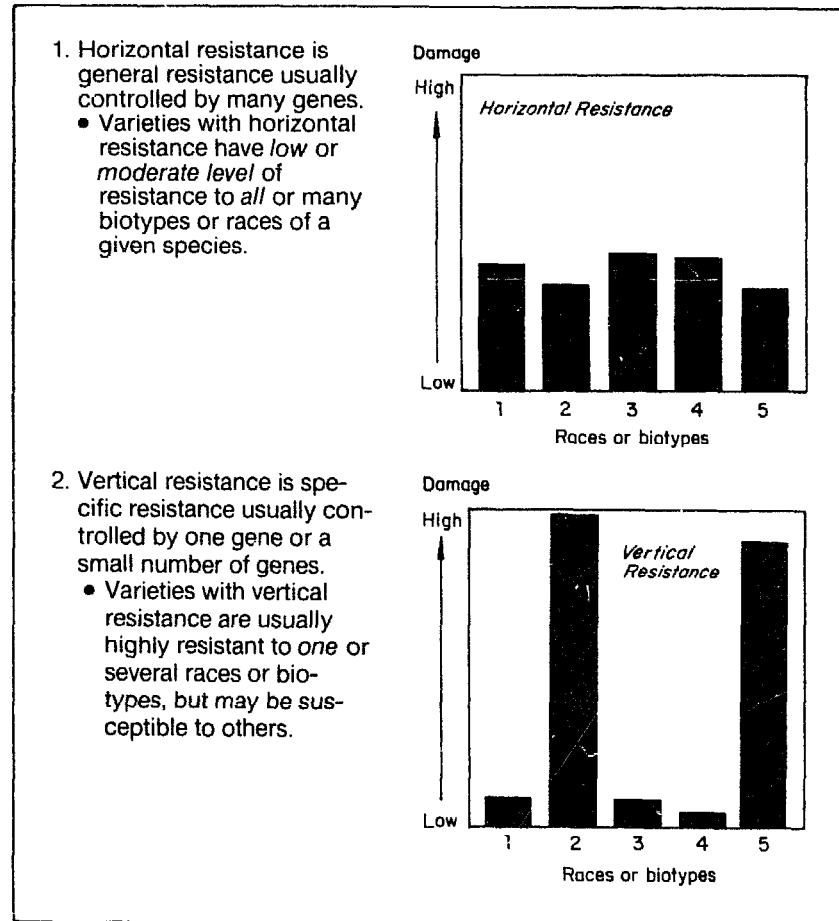

**Use of resistant varieties in the field**

1. Whenever a resistant variety is planted in the field, the number of pests and their damage will decrease rapidly.
2. Usually, not all of the pests will die. During successive generations, the survivors produce offspring that gradually become capable of surviving, damaging, and reproducing on the formerly resistant variety.
3. Eventually, a new pest race or biotype that can overcome the varietal resistance is selected.

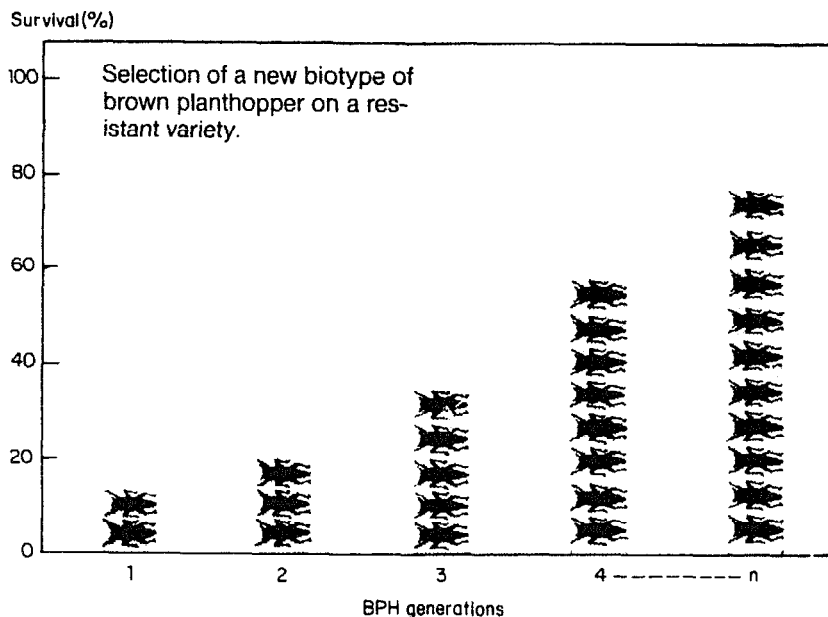



**Factors influencing the chances and rate of development of new biotypes and races**

1. The genetic makeup of the insect or disease pest.  
 Within a population of pests a minority of individuals are unaffected by a resistant variety. These individuals are selected to survive in the presence of the resistant variety and in time become the

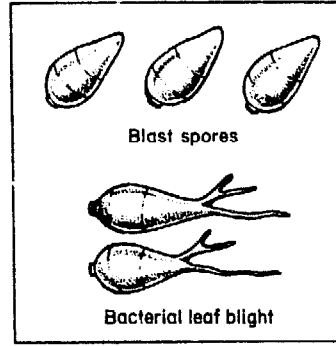

majority form in the pest population. When a variety "breaks down" it is the pest population — not the variety — that has changed.  
 2. Pesticide applications may destroy insect natural enemies and allow faster population growth of the newly selected biotype.

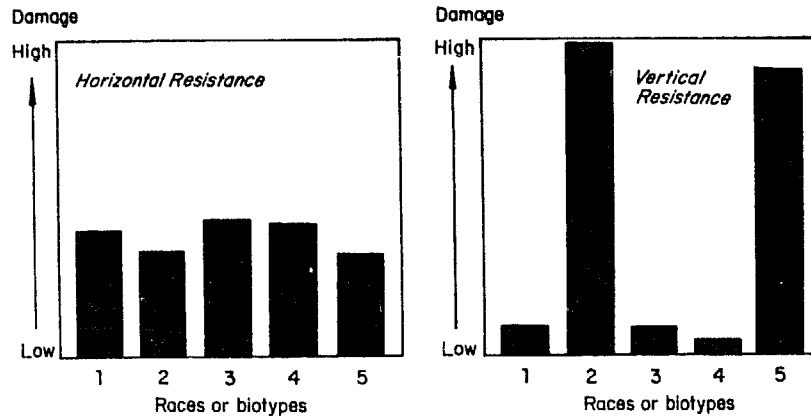
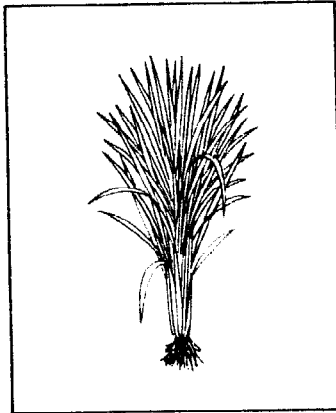

3. The genetic makeup of the resistant variety.

4. The type and level of resistance to the pest.

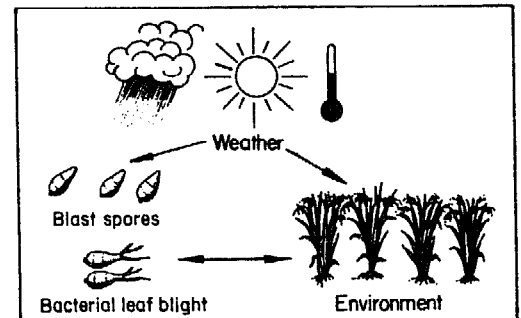
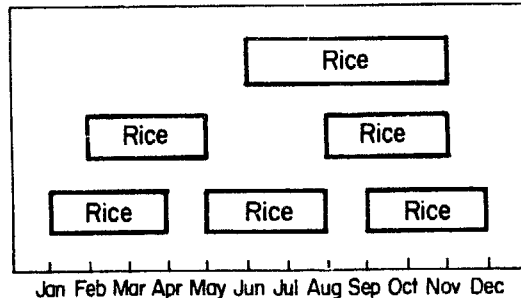

5. The hectareage planted to a resistant variety.

6. Cropping patterns in an area.

7. Weather and other factors influencing population levels of pests in the field.

It is difficult to predict when, or if, the resistance of a variety will break down in the field because of all the variables affecting the development of races and biotypes. Because of the possibility that resistance will fail, all varieties, not just the resistant ones, should be observed. Traditional varieties may show signs of horizontal resistance that could be used



Hopperburn caused by a new biotype

in national programs. Any severe damage should be reported to the proper research organization or government authority. Scientists can determine if the resistance has been overcome, and either release a new resistant variety or develop appropriate management recommendations to protect older varieties.

# BIOLOGICAL CONTROL OF RICE INSECT PESTS

# Biological Control of Rice Insect Pests

All insect pests of rice are affected by natural controls that limit their reproduction and population buildup.

- Diseases and pathogens
- Amount of food and shelter
- Weather
- Predators
- Parasites

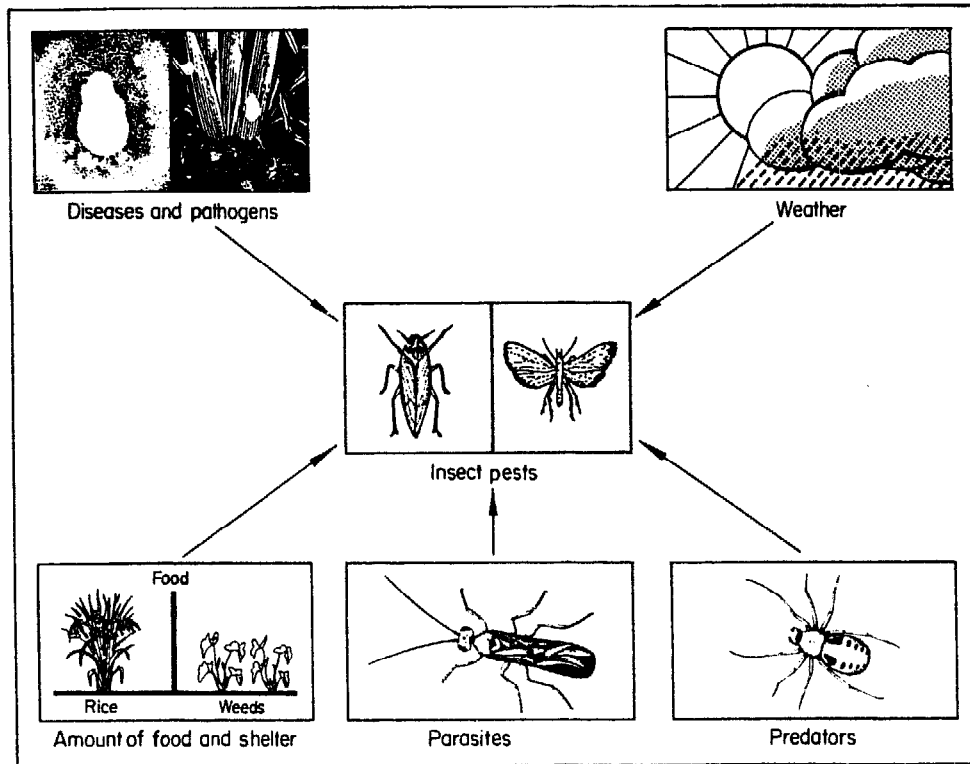

## Effects of beneficials on insect pests

- Parasites and predators are called *beneficials* because they help control insect pests.
- Beneficials alone will not always prevent damaging buildups of insect pests, but they reduce the severity of damage and the frequency of outbreaks.
- Some insect pests are more effectively controlled by beneficials than are others.

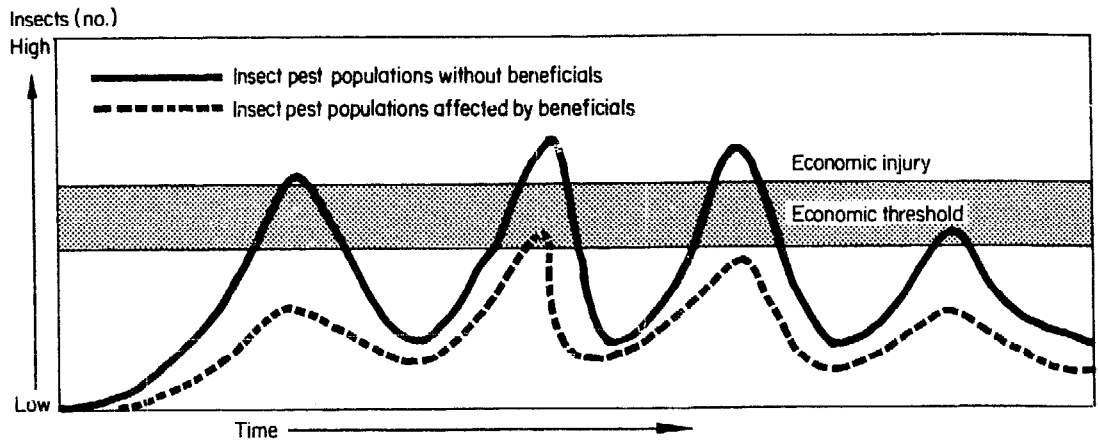

## Characteristics of parasites

- Parasites attack only one prey species or a few closely related species.
- Only the larvae are parasitic. Each parasite usually feeds on only a single host and gradually destroys it.

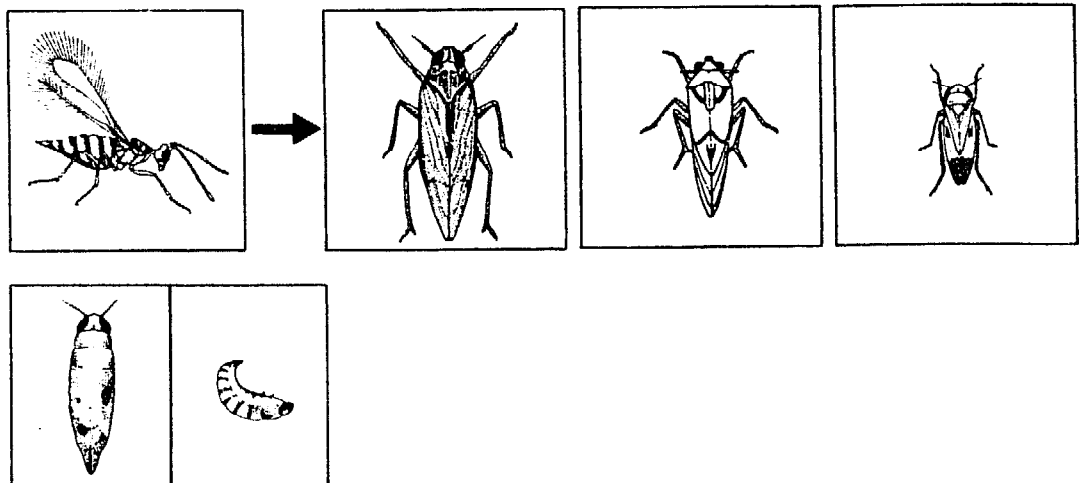

- Parasites of rice pests are other insects, commonly flies or wasps.

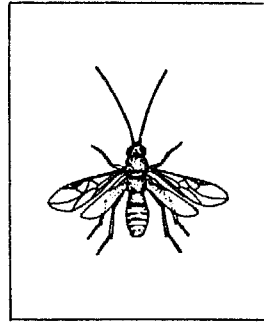
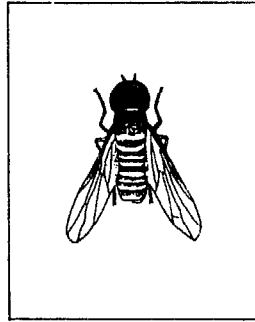

- Adults are free living, feeding on nectar, honeydew, or host body fluids.

**Characteristics of predators**

- Most common predators of rice insect pests are other insects and spiders.

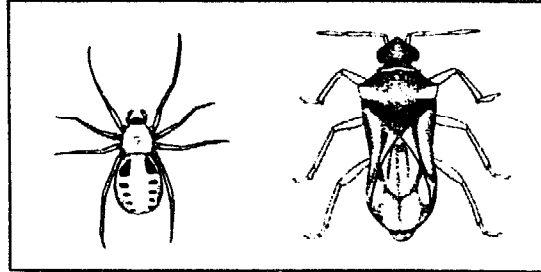

- A predator may feed on many different species of insects.

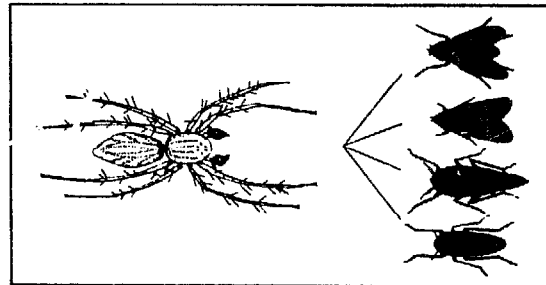

- A single predator may attack a number of insect prey.
- Predators kill their prey quickly by eating them or sucking their body fluids.

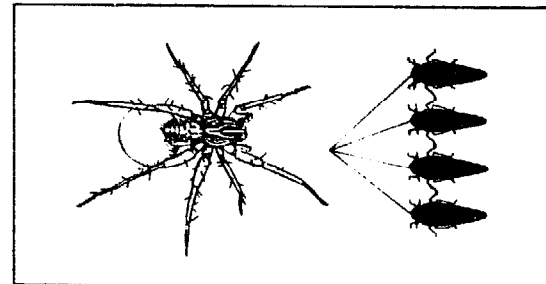

- Usually both the immature and adult stages attack prey.

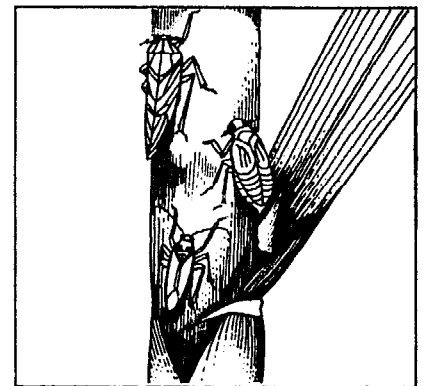
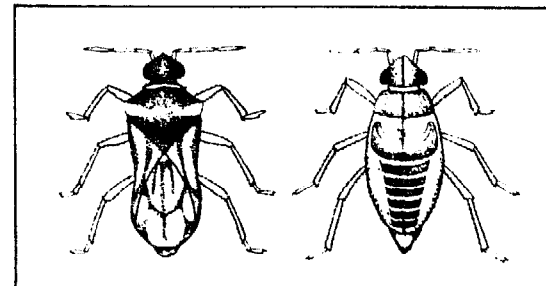

- Predators develop separately from their prey but live in the same area.

**PARASITES**

**Parasites of leafhoppers and planthoppers**  
**Parasites of eggs**

— Leafhopper and planthopper eggs are generally more heavily parasitized than adults and nymphs.

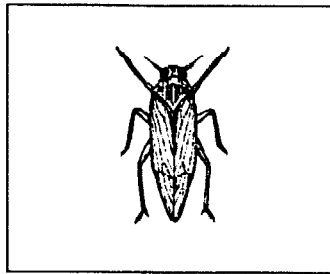
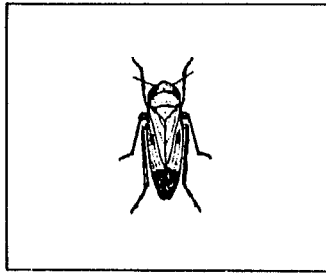

— Egg parasitization varies considerably among hopper species. It fluctuates during the season, but usually averages about 30%.

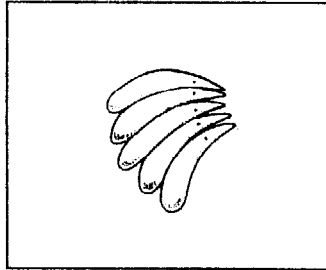

• **Estimating egg parasitization**

- Remove a piece of the leaf sheath containing an egg mass.
- Place egg masses in a closed container on filter paper moistened with an antifungal agent.
- Hopper nymphs emerge first.
- Adult egg parasites emerge several days after unparasitized eggs hatch.

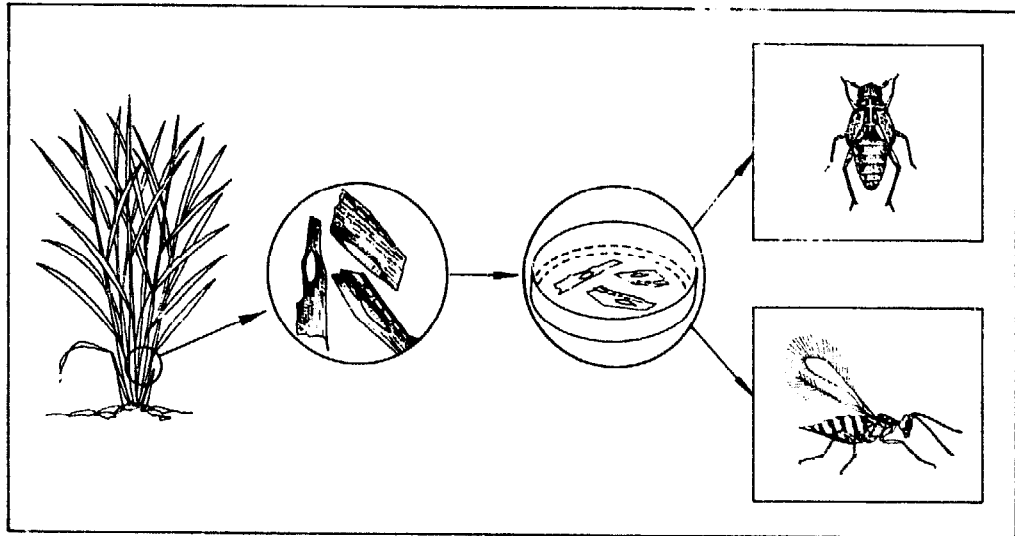

To estimate egg parasitization

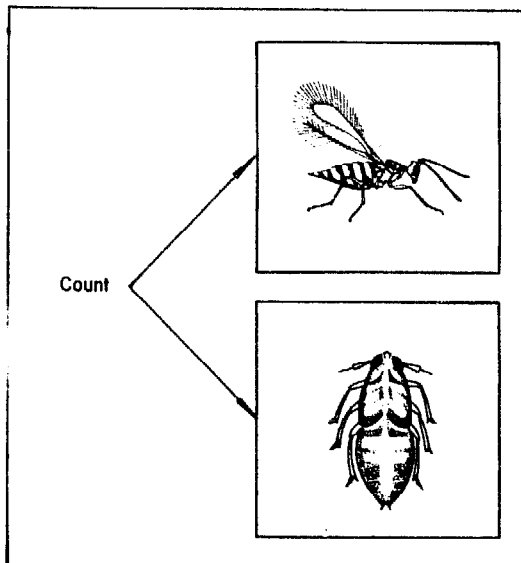

$$\% \text{ egg parasitization} = \frac{\text{no. of parasite adults}}{\text{no. of hopper nymphs} + \text{no. of parasite adults}} \times 100$$

General life cycle of parasites of hopper eggs

- The adult female parasite lays most of its eggs the first day after it emerges from the pupal stage. It searches with its antennae until it finds a hopper egg mass and then lays its eggs inside the hopper eggs.
- The parasite larva develops and pupates inside the hopper egg.

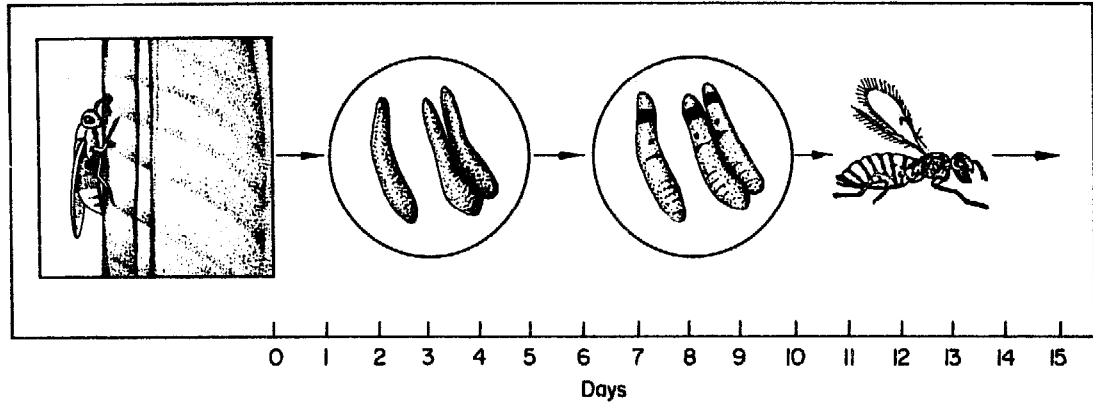

- The *Anagrus*, *Oligosita*, and *Gonatocerus* spp. are the common parasites of hopper eggs.

*Anagrus* species

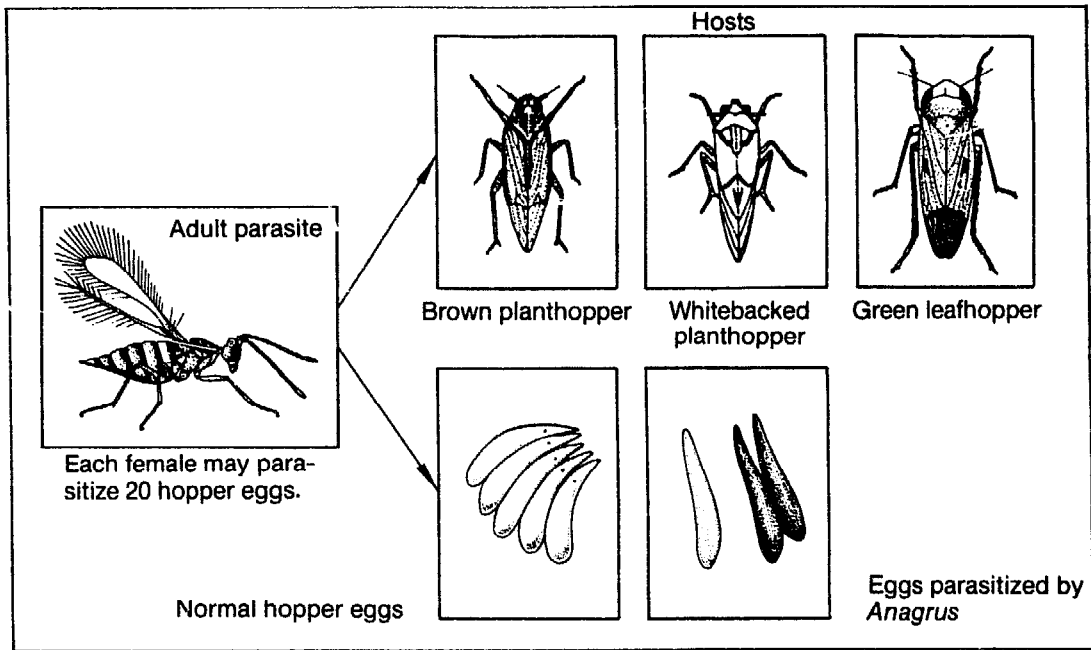

*Oligosita* species

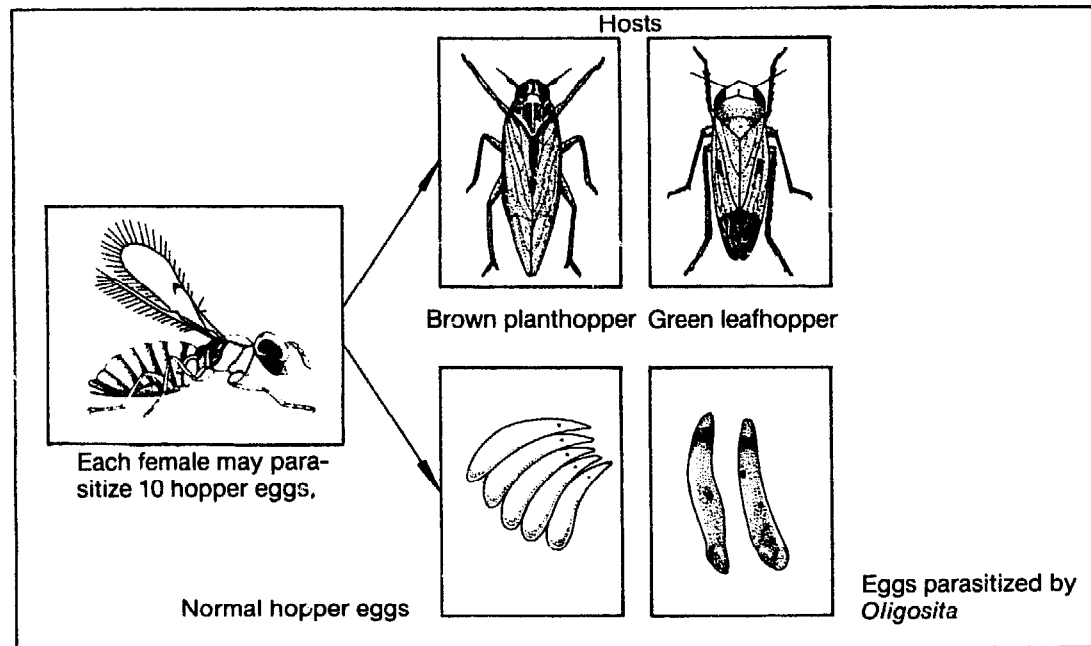

*Gonatocerus* species

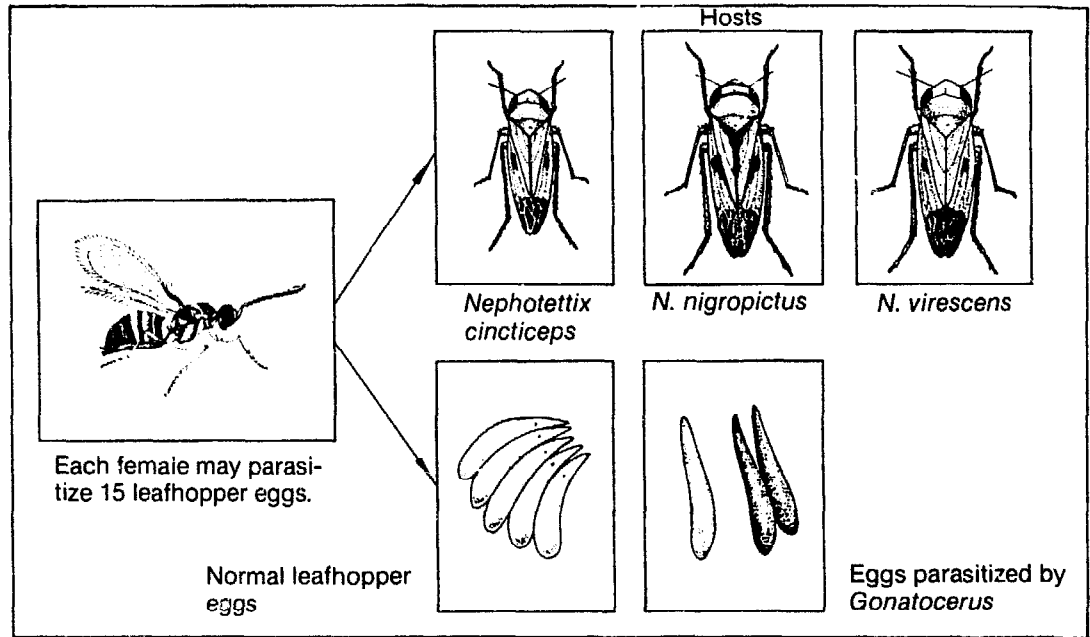

Parasites of nymphs and adults

- Hopper nymphs and adults are attacked by several species of parasites, but the percentage of parasitization of these life stages is not as high as that of eggs.

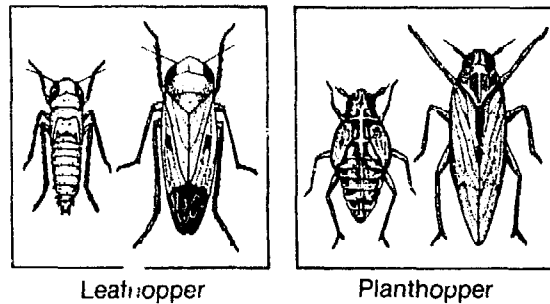

• Estimating parasitization of nymphs and adults

- Cage hoppers collected from the field on rice plants in small cages.
- Collect the emerging adult parasites.

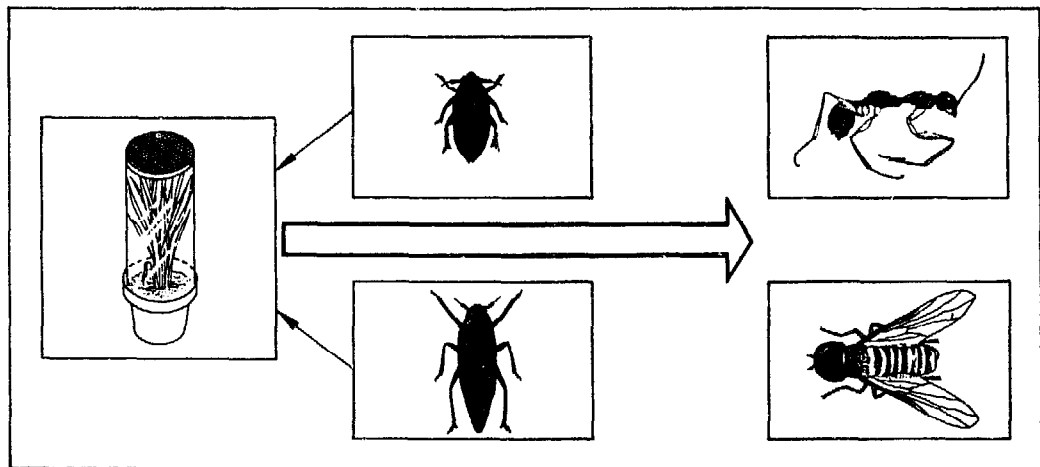

To estimate % parasitization

Record the hoppers placed in the cage.

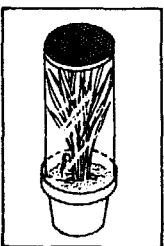

Count the adult parasites which emerge from the caged hoppers.

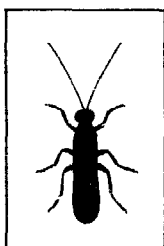

$$\% \text{ parasitization} = \frac{\text{no. of emerged parasite adults}}{\text{no. of hoppers placed in cage}} \times 100$$

- The dryinids, strepsipterans, and pipunculids parasitize hopper nymphs and adults.

*Dryinidae*

- Life stages  
A group of 5 wasp species of the Dryinidae family are common parasites of hopper nymphs and adults.

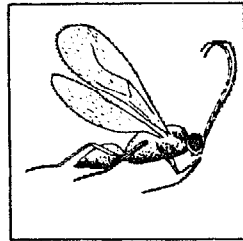

Adult male

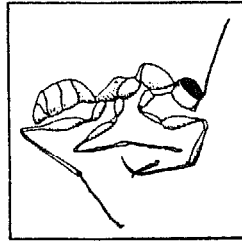

Adult female

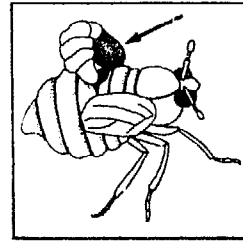

Larva

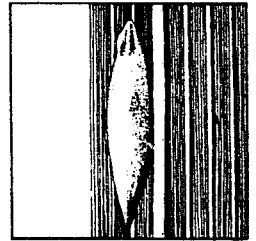

Pupa

- General life cycle

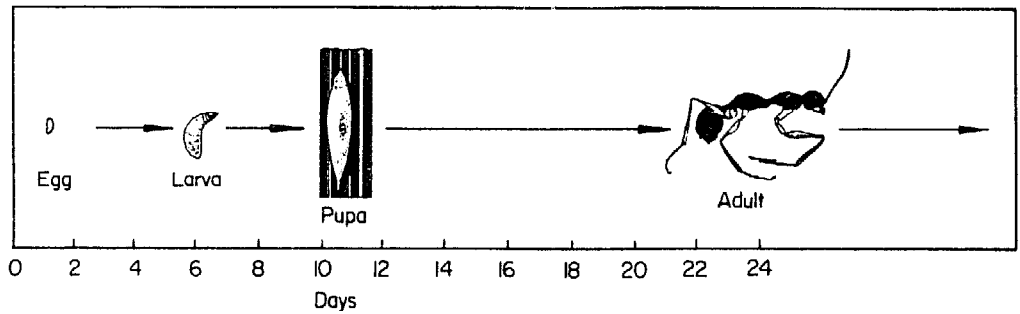

- Biology of adults

- Adults have front legs adapted for grasping hopper nymphs and adults.
- Each dryinid may eat several leafhoppers a day.
- Females lay eggs inside hopper nymphs.
- Each female may parasitize up to 10 nymphs/day.

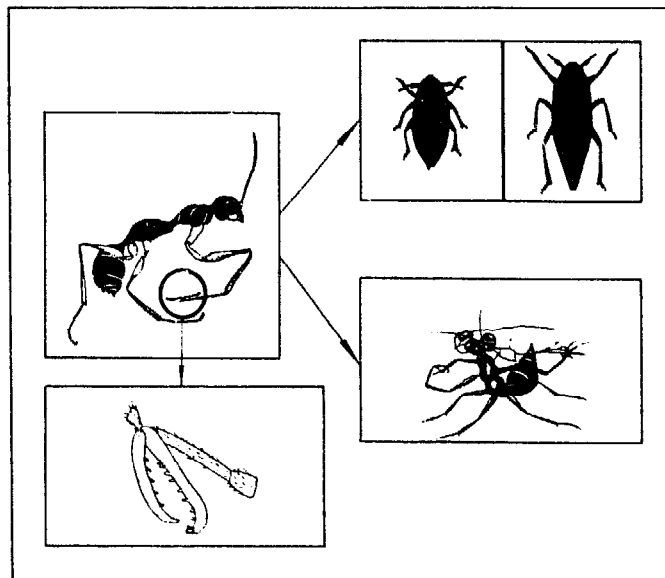

- Biology of larvae

The larvae gradually consume the body contents of the host. Then they wiggle out of the sac on the hopper's abdomen, and pupate in a white cocoon on a rice leaf.

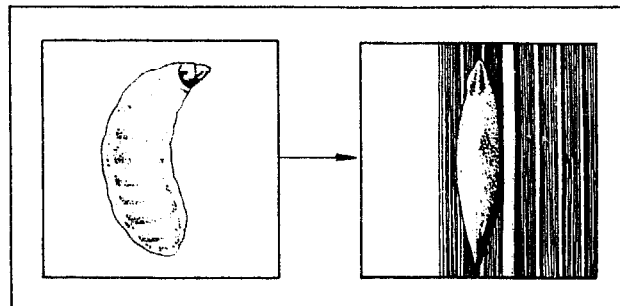



- Migration of dryinids to rice fields  
Most dryinids enter rice fields as larvae on migrating parasitized hoppers. A few adults also move into rice fields.

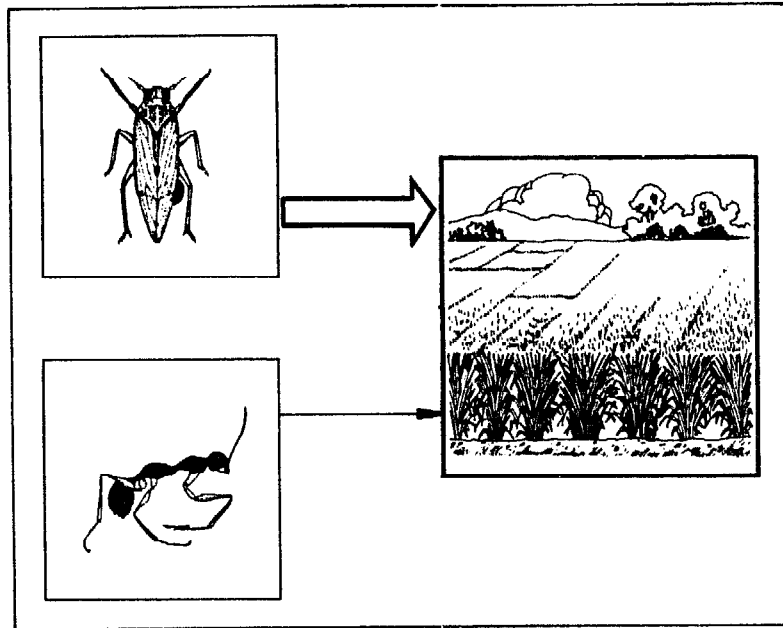

*Strepsiptera*

- Insects of the order Strepsiptera also parasitize leafhoppers and planthoppers.
- Each adult female bears thousands of living larvae called triungulins.

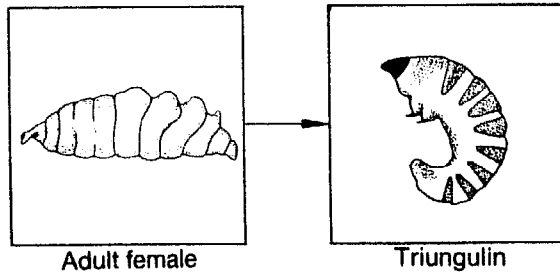

- The triungulins crawl to a hopper nymph or adult and bore inside.
- They do not survive for more than several hours unless they locate a host.

- Development of larvae.

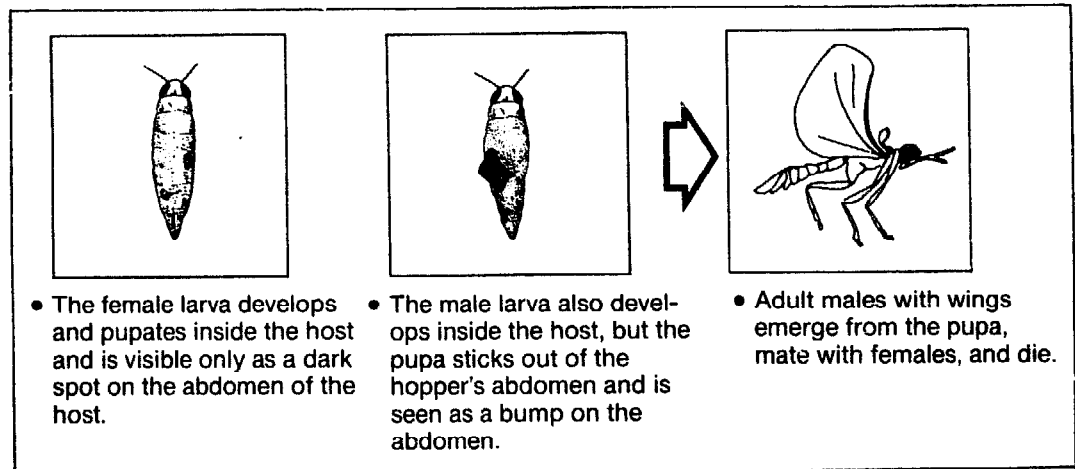

Characteristics of hoppers parasitized by Strepsiptera

- Parasitized hoppers may survive for a long time before they die.
- Parasitized hoppers do not reproduce, but may feed and damage plants before they die.

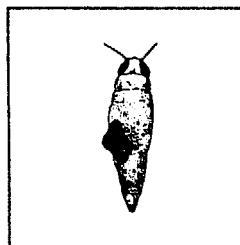

- Strepsipterans always disperse through parasitized hoppers.
- Strepsipterans usually parasitize less than 10% of hopper nymphs and adults.

**Pipunculidae**

Several species of flies of the family Pipunculidae parasitize only green leafhopper nymphs and adults.

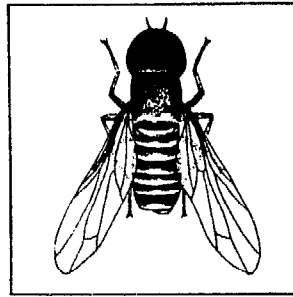

- The adult females lay their eggs inside the body of a leafhopper nymph.

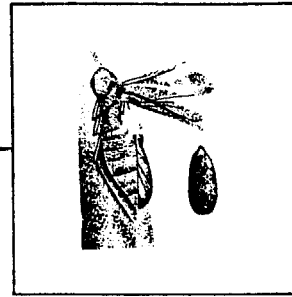

- Parasitized nymphs develop normally for awhile, but are killed when the mature parasite larvae emerge from the host's body.

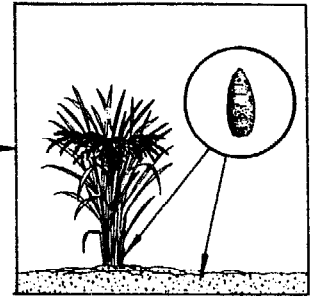

- The larvae pupate in the soil or near the base of the rice tillers.

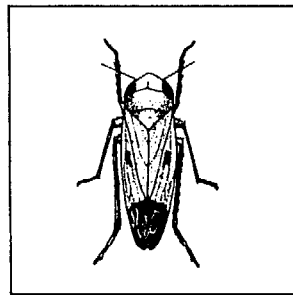

- Pipunculids are the most important parasites of green leafhoppers, often attacking 25% of the nymphs and the adults in the field.

**Parasites of stem borers**

Parasites of eggs

- Eggs of the stem borer are more heavily parasitized than other life stages, probably because they are accessible on rice leaves.
- The levels of egg parasitization vary widely, ranging from 0 to 100%.

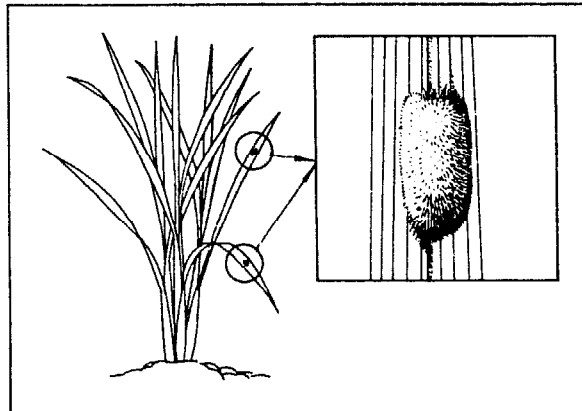

**Estimating parasitization of stem borer eggs**

- It is difficult to visually determine in the field if

stem borer eggs are parasitized.

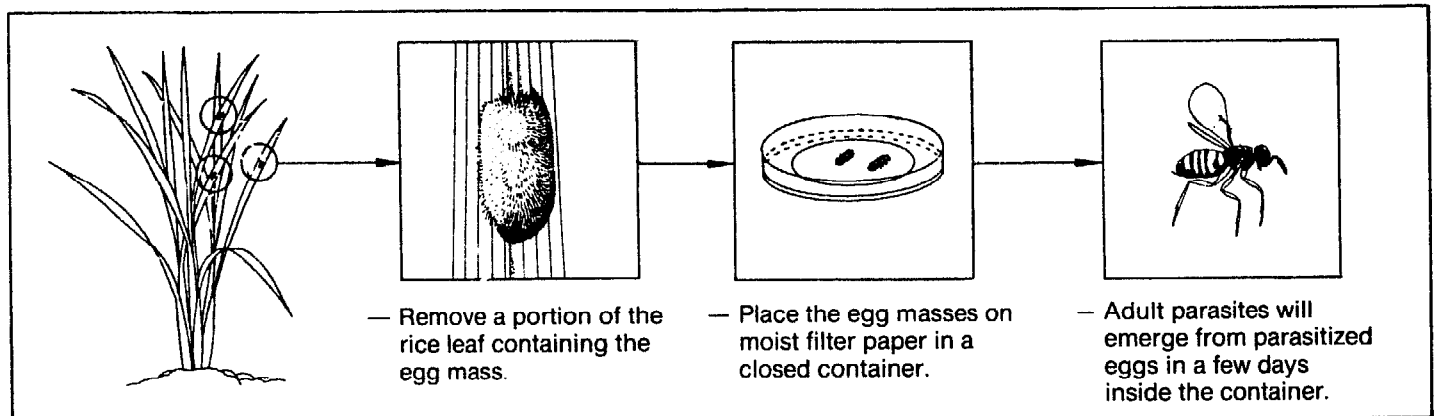

- About 17 insect species parasitize rice stem borer eggs in Asia.
- The most common and widely distributed groups are *Trichogramma*, *Telenomus*, and *Tetrastichus*.

*Trichogramma* species

- General characteristics
  - short antennae
  - small body
  - hairs on wings
  - 3-segmented tarsi

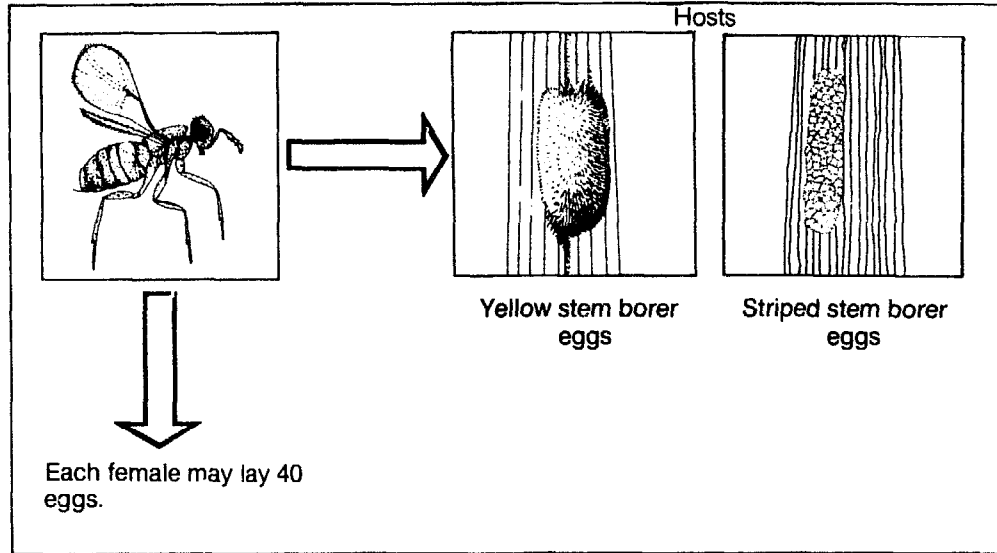

• Life cycle

- *Trichogramma* reproduces best at temperatures of 20°-25° C with an average relative humidity greater than 70%.
- Adults live 7 days.

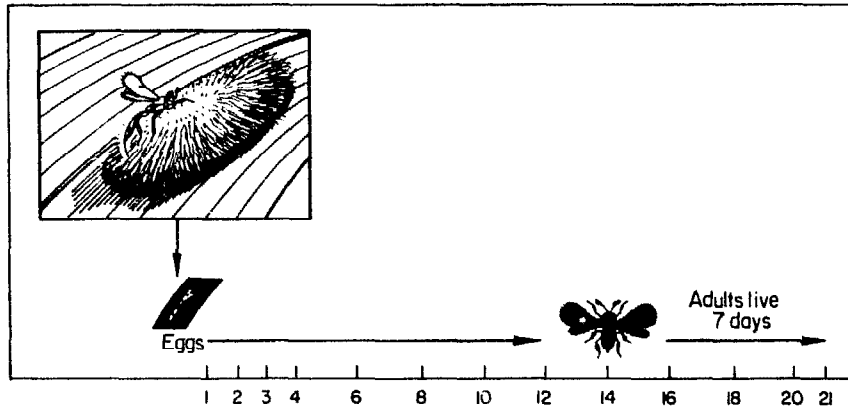

*Telenomus* species

- General characteristics
  - 11 to 12 segmented antenna
  - pointed abdomen
  - thin 3rd abdominal segment

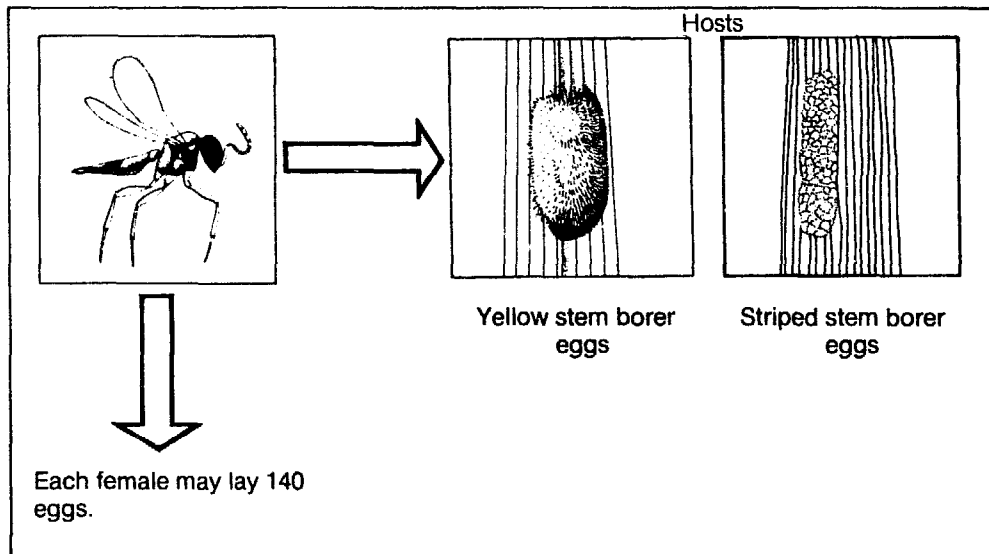

• Life cycle

- Adults survive for 14 days.
- *Telenomus* may be more effective than *Trichogramma* as a parasite of stem borer eggs because the adults live longer and females have a greater reproductive capacity.

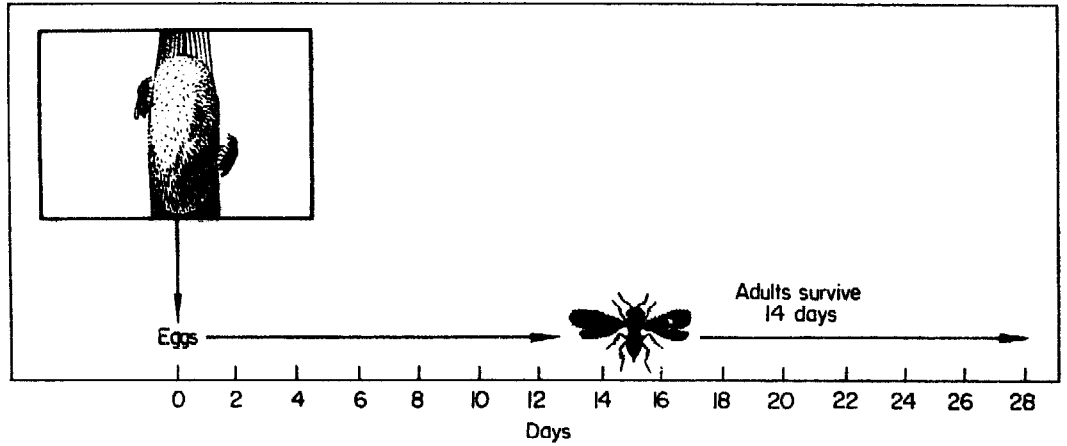

*Tetrastichus* species

- *Tetrastichus* species are primarily parasites of eggs of the yellow stem borer.
- They occasionally attack eggs of the striped stem borer.
- *Tetrastichus* species — sometimes considered more effective than *Telenomus* — attack all eggs in a mass as well as hatching stem borer larvae.

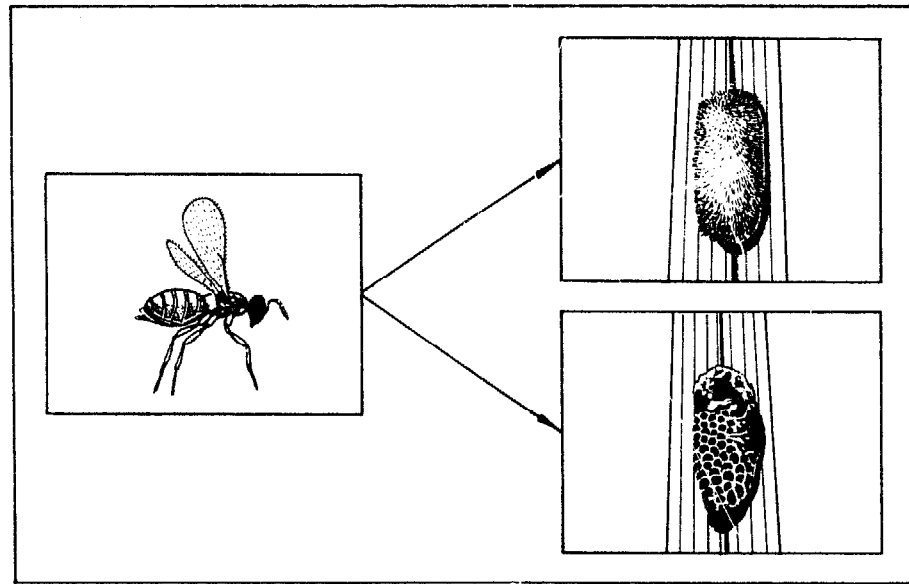

Parasites of stem borer larvae and pupae

- Many insect species parasitize rice stem borer larvae and pupae, but the percentage of parasitization is usually low, about 5-10%.
- These larvae and pupae are somewhat protected from natural enemies because they develop mainly inside rice stems.
- Parasitized stem borer larvae and pupae cannot be distinguished from normal ones at the early stages of parasitization. Parasitized pupae eventually turn dark.

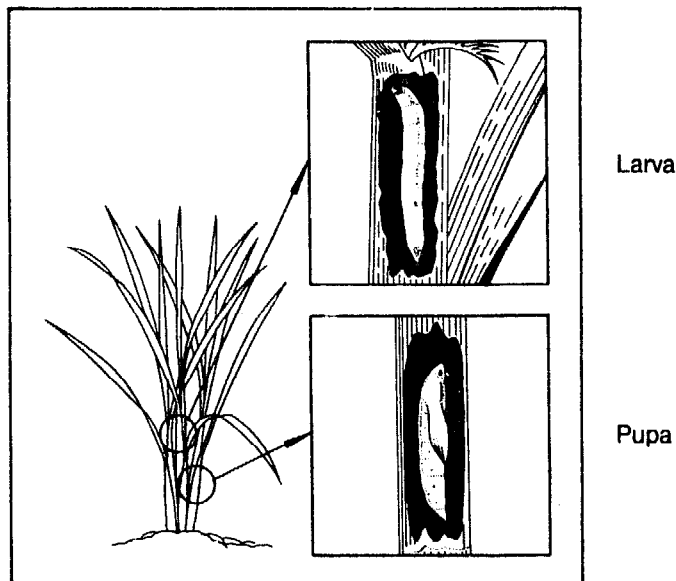

**Estimating parasitization of stem borer larvae and pupae**

- Remove a portion of the stem containing a larva or pupa and place in a closed, transparent vial.
- Some parasite larvae such as *Cotesia* (= *Apanteles*) emerge and pupate in silver cocoons outside the host. Other parasite species develop in the host larvae and parasite adults emerge from the host pupae.

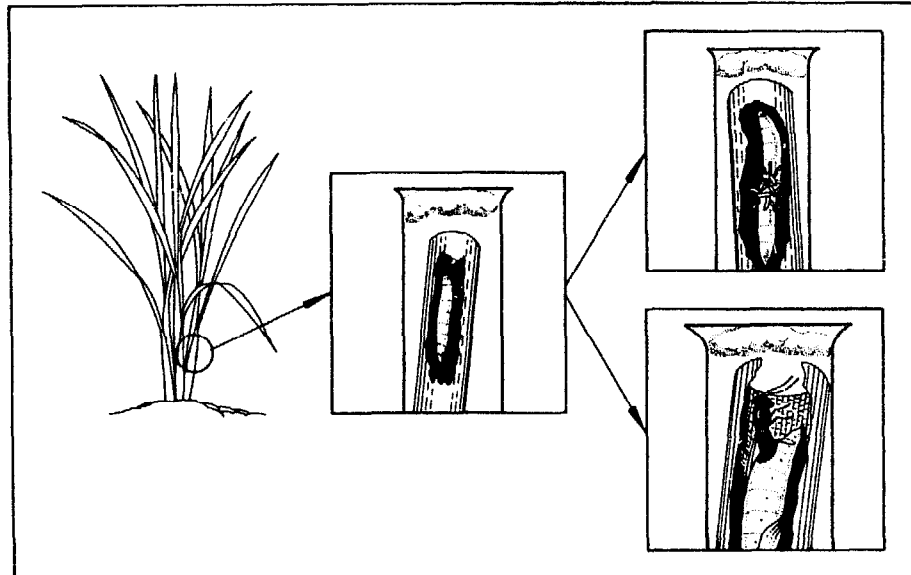

*Cotesia* (= *Apanteles*), *Tropobracon schoenobii*, *Sturmiopsis inferens* are common parasites of stem borer larvae.

- General characteristics of *Cotesia* (= *Apanteles*)

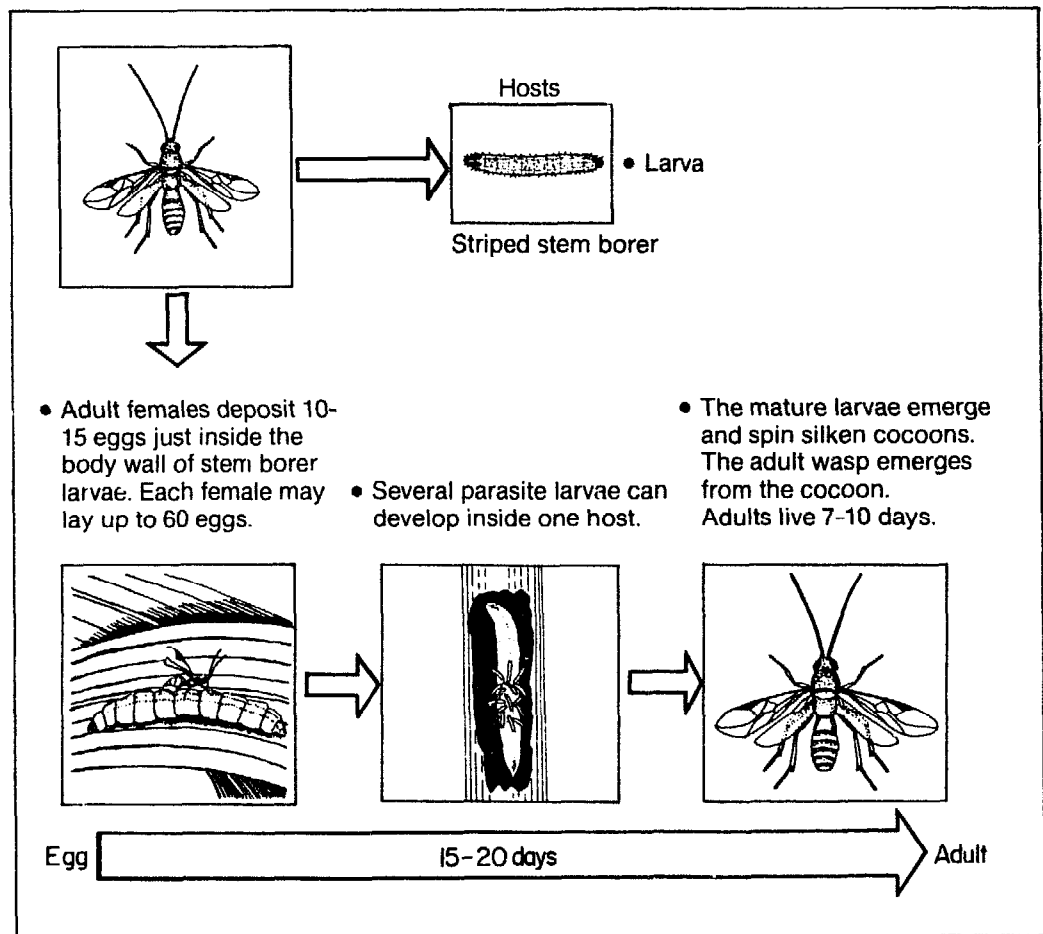

• General characteristics of *Tropobracon schoenobii*

— The level of larval parasitization by *T. schoenobii* varies widely — from 0 to 90%.

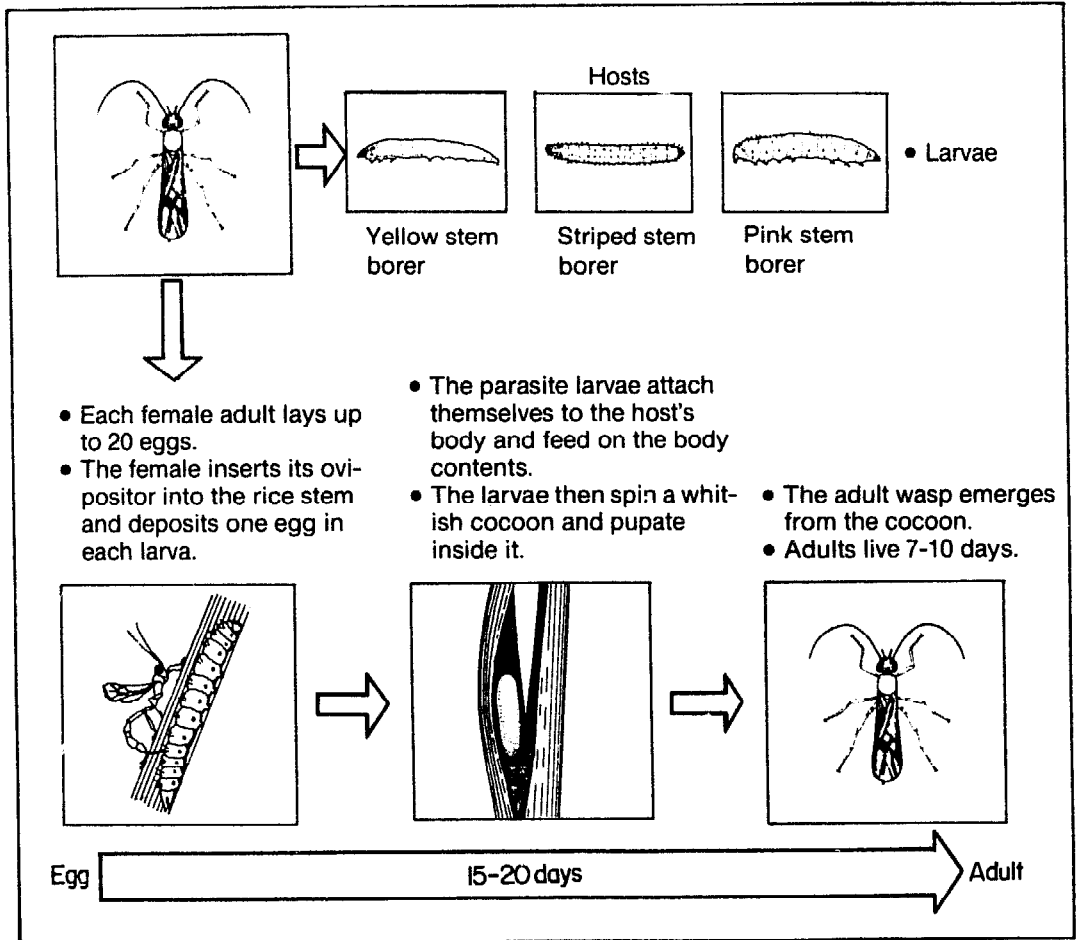

• General characteristics of *Sturmiopsis inferens*

— *S. inferens* is one of the more effective parasites, sometimes attacking up to 80% of the stem borer larvae.

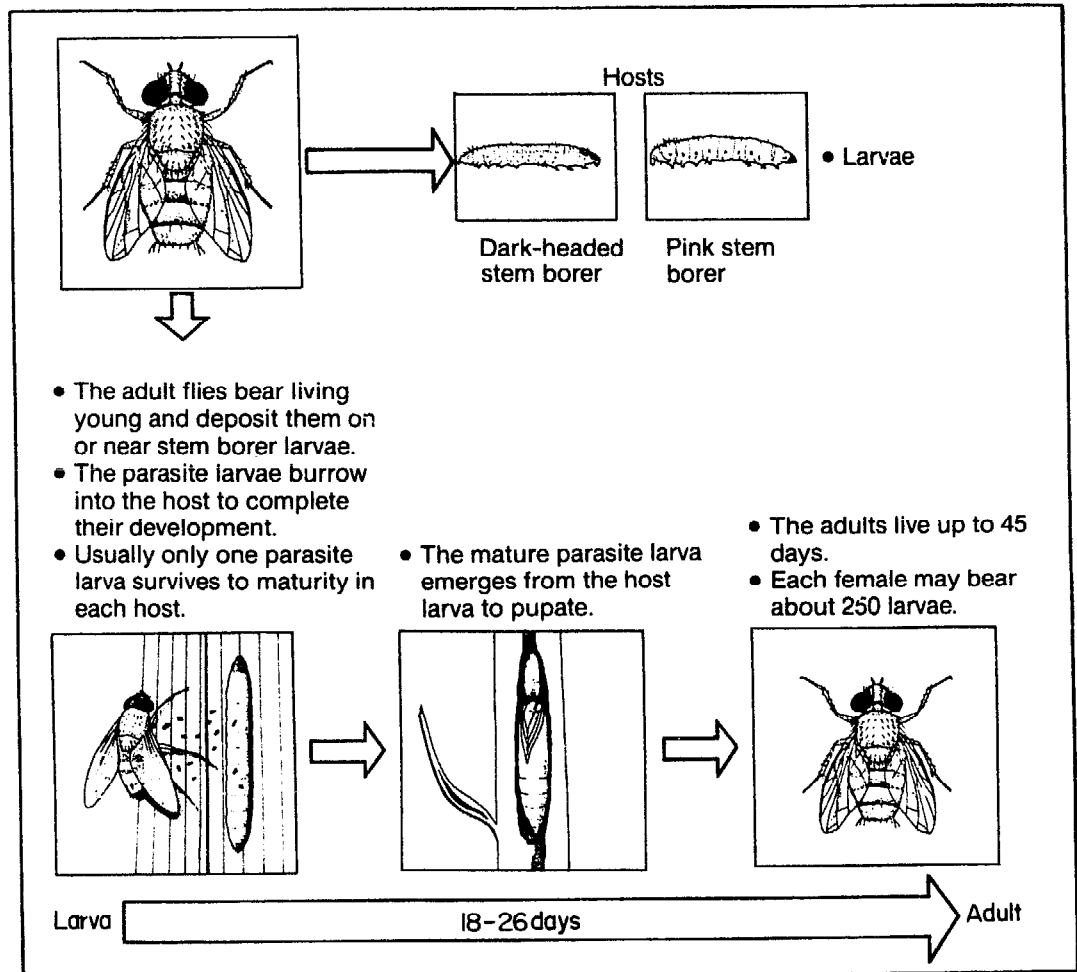

**Other parasites of larvae**

- Only one parasite emerges from each host parasitized by *Bracon chinensis*.

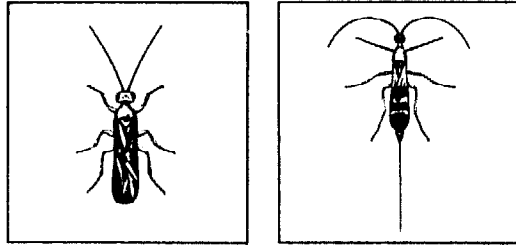

- Adults of *Stenobracon nicevillei* have very long ovipositors.

**Parasites of stem borer pupae**

- Parasites of stem borer pupae include *Itoplectis* and *Xanthopimpla*.

• General characteristics of *Itoplectis*

- The adults may survive for 4-6 weeks.
- Females may lay 300 eggs over a long period of time.

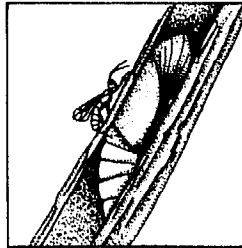
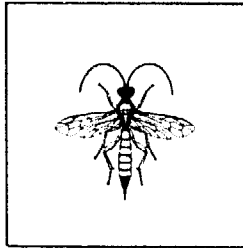

- The adult females search with their antennae for borer pupae inside the rice stem.
- A female may deposit several eggs in each pupa, but usually only one larva survives to maturity.

• General characteristics of *Xanthopimpla*

- Females survive for 4-9 weeks; each may lay 5-14 eggs.

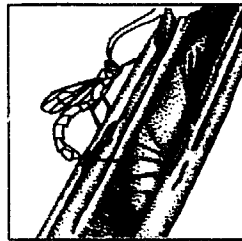

- The female searches with its antennae for stem borer pupae in rice stems.
- Then with its ovipositor, the female penetrates the stem and lays a single egg in each pupa.
- The parasite larva completes its development and pupates inside the host pupal case. The adult parasite emerges from the stem borer pupal case.

• Life cycle

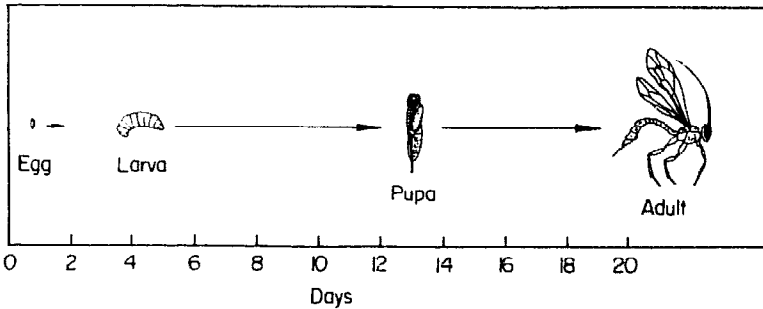

**Parasites of other rice insect pests**

Parasites of rice insect pests other than stem borers and

hoppers are less well known, although they are also important in reducing pest population levels.

**Rice bug**

- Eggs of the rice bug (*Leptocoris*) are attacked by a parasite of the genus *Gryon*.

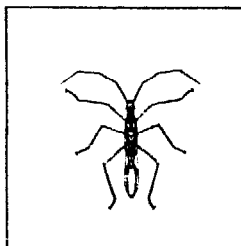

Rice bug

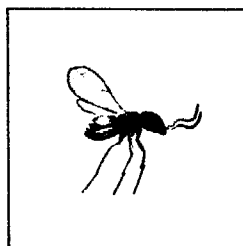

Gryon

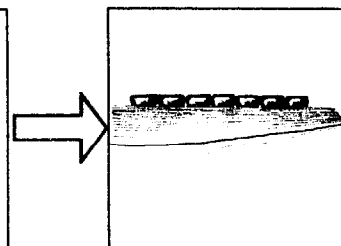

Rice bug eggs

**Whorl maggot**

- Larvae of the whorl maggot (*Hydrellia*) are parasitized by a small wasp, *Opius*, emerging from the host pupae.

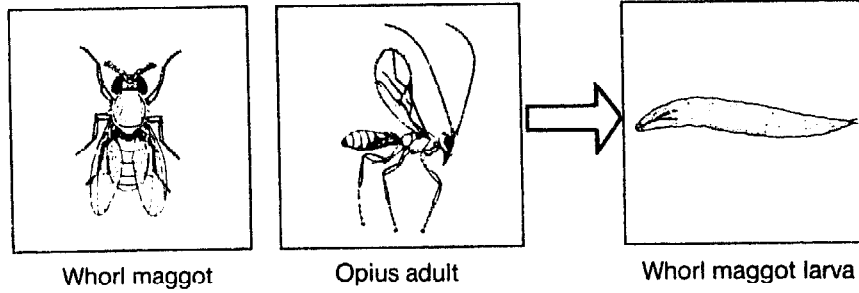

**Gall midge**

- *Platygaster oryzae* is the most important and widely distributed parasite of the gall midge.

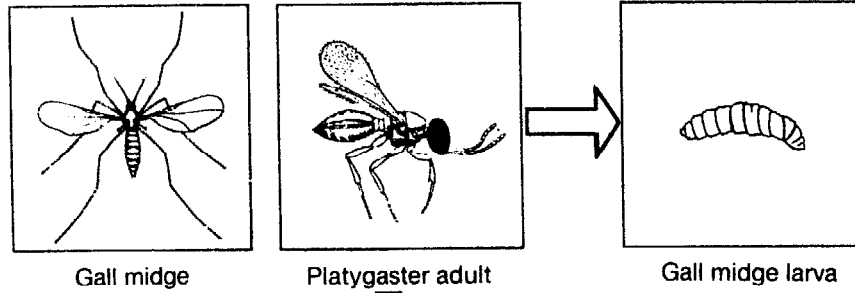

Each female may lay 600 eggs.

- The female adult wasp lays eggs inside newly hatched gall midge larvae.

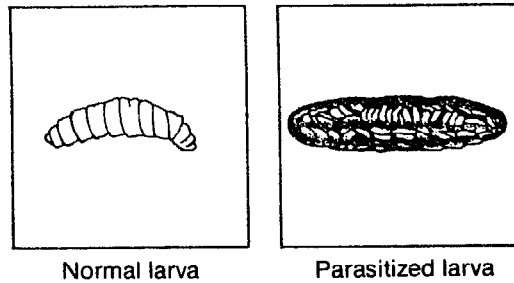

- Parasitized larvae are filled with parasite cocoons and are much larger than normal larvae.

**Life cycle of *Platygaster oryzae***

The level of parasitization from *P. oryzae* sometimes reaches 80%. This parasite may suppress gall midge populations if parasitization reaches 50% before the peak of gall midge damage occurs.

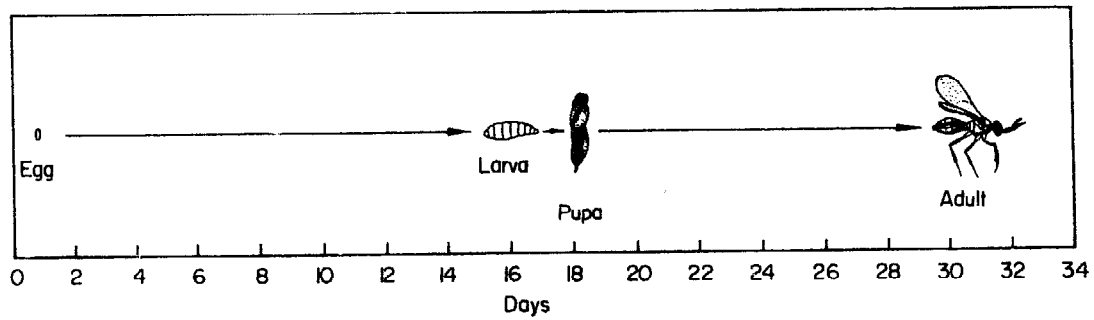

**Rice hispa**

- A *Bracon* sp. of wasp is the most common parasite of hispa.
- Usually, larval parasitization is less than 10%.

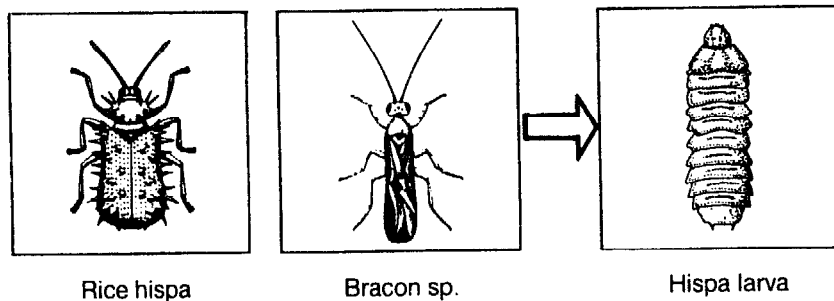



**Leaffolders**

- Female parasites of the genus *Copidosomopsis* lay their eggs inside the leaffolder eggs. Numerous parasite larvae develop from a single egg and pupate inside the host larvae.

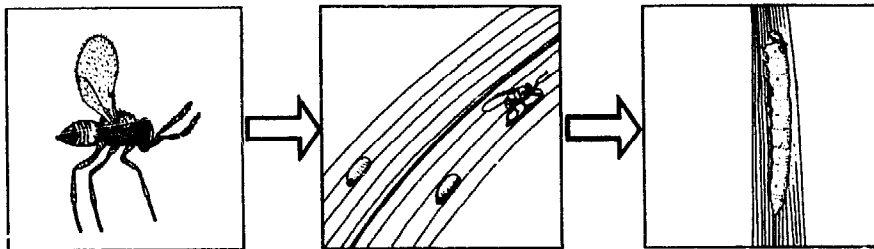

- Leaf folder larvae are attacked by the parasites *Macrocentrus* and *Temelucha*.

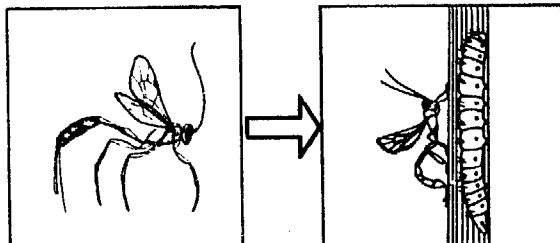

- With their long ovipositors, *Temelucha* females can penetrate the leaf to find a larva.

- The *Trichomma* wasp also parasitizes leaf folder larvae.
  - The female lays eggs in the leaf folder larva.
  - The parasite adult emerges from the leaf folder pupa.

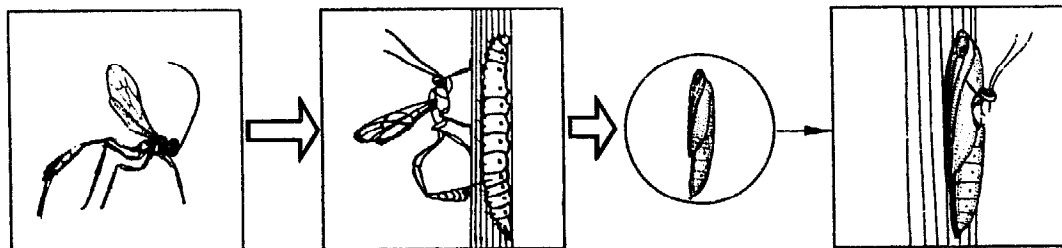

- *Brachymeria* parasitizes leaf folder pupae.
- Distinguishing characteristics
  - black body
  - enlarged hind leg

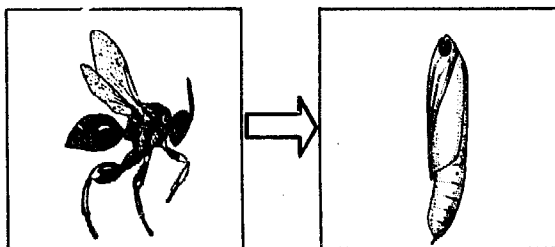

**PREDATORS**

It is often difficult to determine which insect species are attacked by a predator and how many prey are killed.

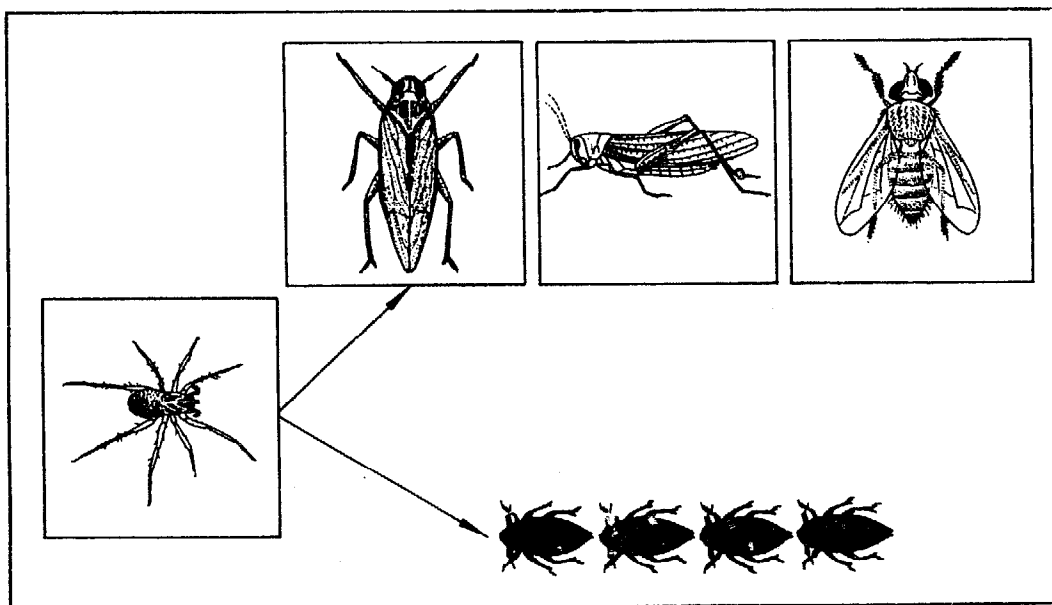

To observe and measure predation:

- Cage together a known number of predators and prey on an insect-free rice plant in the field or greenhouse.
- Count the remaining predators and prey daily.

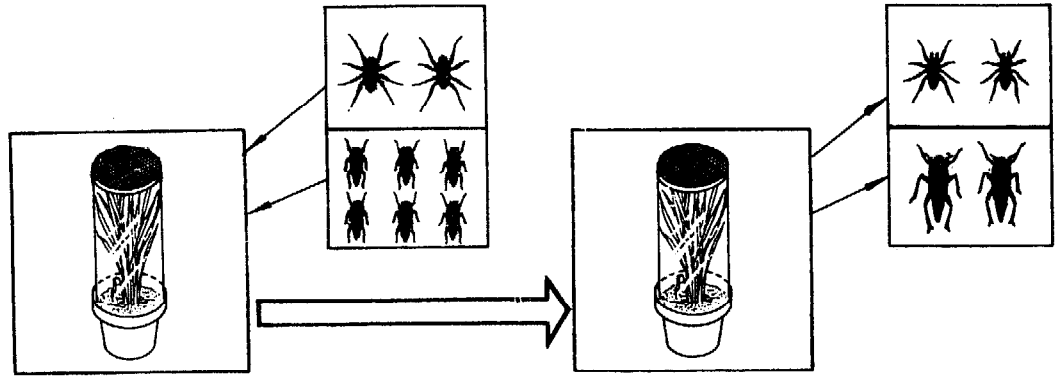

**Spiders**

*Lycosa*

Life cycle

- Newly hatched spiderlings remain attached to the mother for several days.
- During its lifetime, each female may produce several egg sacs, each containing 60 eggs.

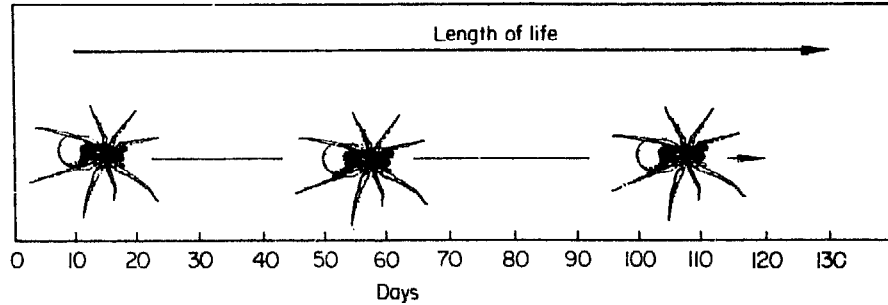

Identification of sexes

- Distinguishing characteristics
  - Male has large pedipalpi.
  - Female carries an egg sac.

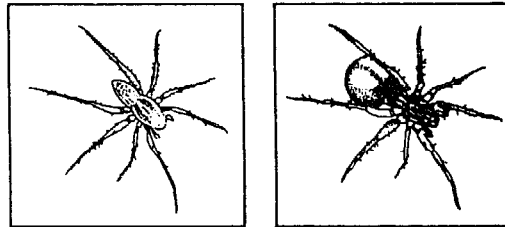

- *Lycosa* spiders are probably the most important predators in rice fields.
  - These spiders do not make webs, but hunt their prey.

Habits and prey — leafhopper, planthopper

- Adults are commonly found near the base of rice plants.
- The diet of *Lycosa* depends upon the types of insects available, but leafhoppers and planthoppers are the major prey. *Lycosa* eat both nymphs and adults.
- Spiders also eat each other at high population densities.

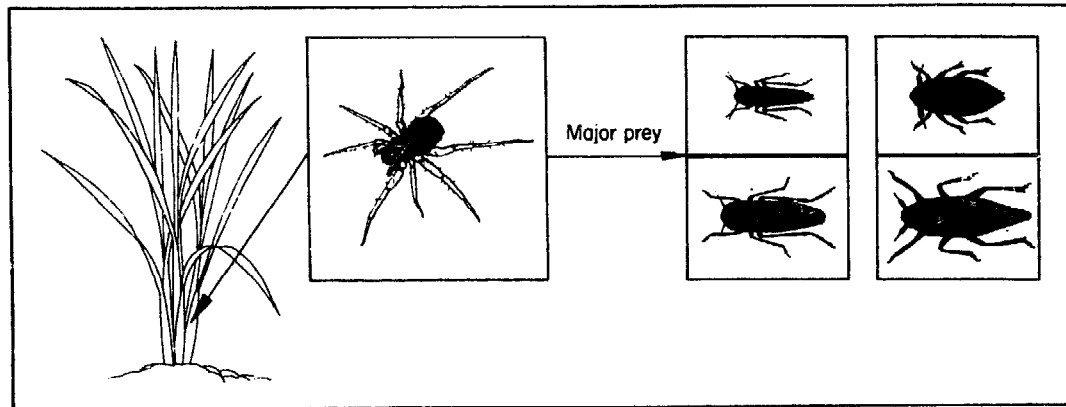

- Other hunting spiders common in rice fields

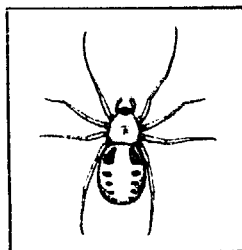

Atypena

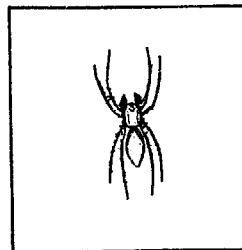

Oxyopes

*Argiope* and *Tetragnatha* are web-spinning spiders. They are probably not major predators of rice insects, although some flying pests are trapped in their web.

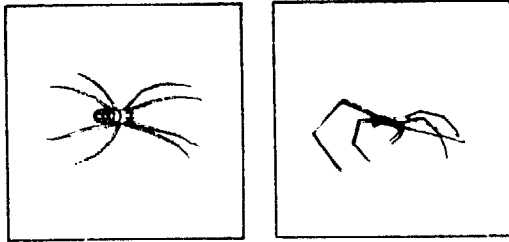

**Microvelia**  
Life stages

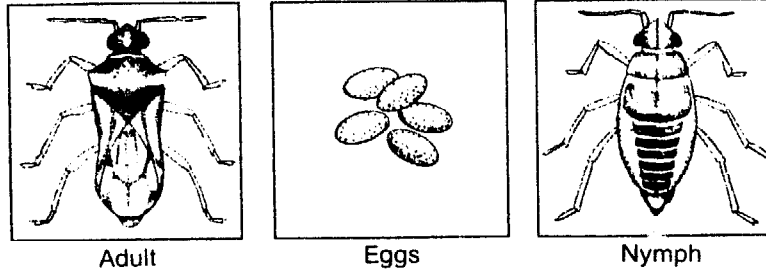

Adult

Eggs

Nymph

Life cycle

- Adults live about 30 days.
- Females may lay 4-5 eggs/day.

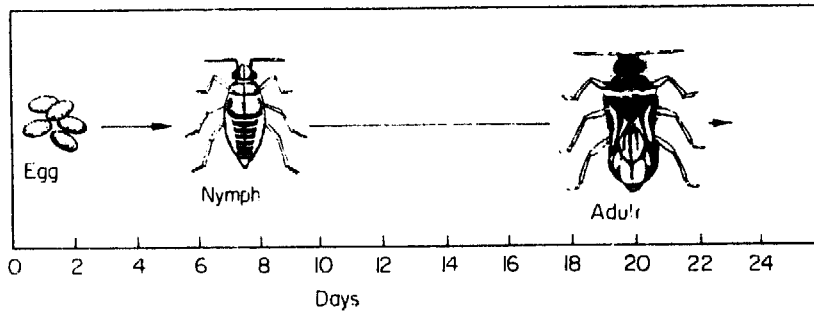

Hab its

- Nymphs and adults live on the water surface, attacking insects that fall into the water.
- Eggs are laid on the plant near the water surface.

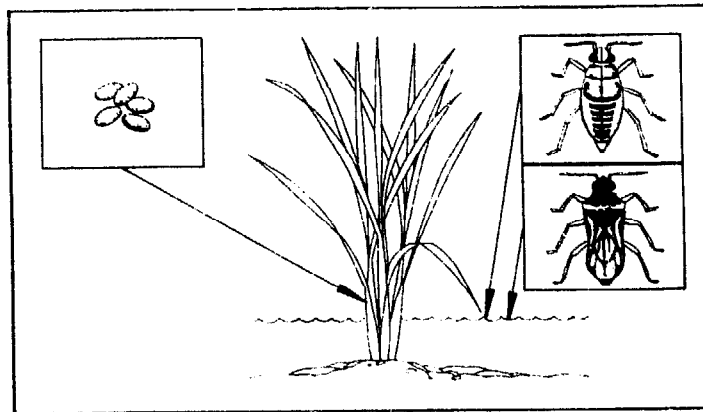

Feeding

- *Microvelia* prey primarily on small hopper nymphs.
- One microvelioid will attack a very small insect that falls into the water and groups of the bugs attack larger prey.

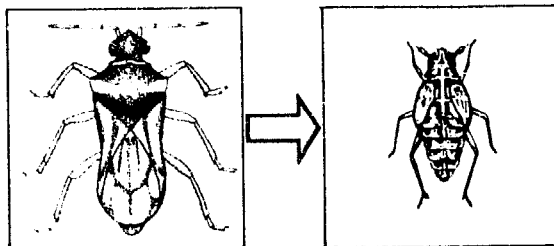

- The bugs paralyze their prey by injecting a toxic solution with their mouthparts.
- Groups of these predators will congregate around rice hills heavily infested with planthoppers.

- *Microvelia* can survive for long periods without food, but rice fields must be flooded or saturated for the bugs to survive.

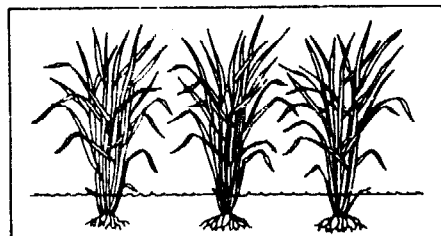

**Cyrtorhinus**  
Life stages

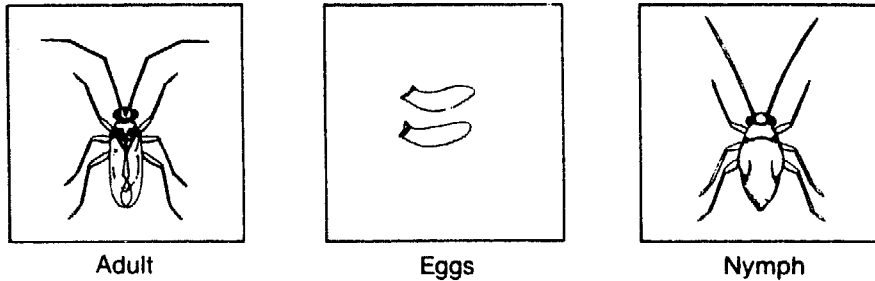

Adult

Eggs

Nymph

**Life cycle**

- Each female may lay 10-13 eggs.

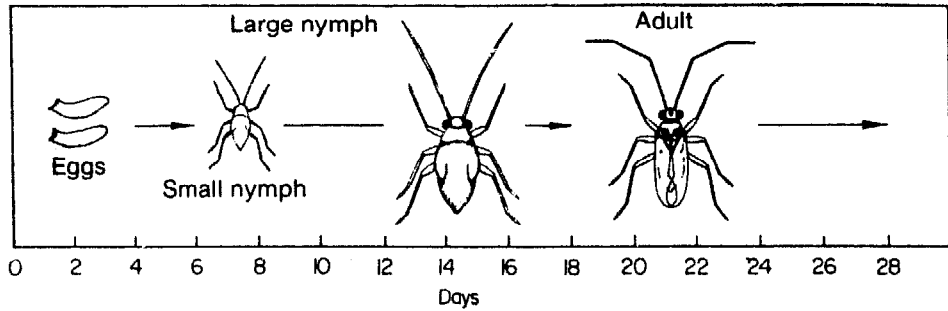

**Prey**

- Both nymphs and adults of *Cyrtorhinus* are important predators of hopper eggs.

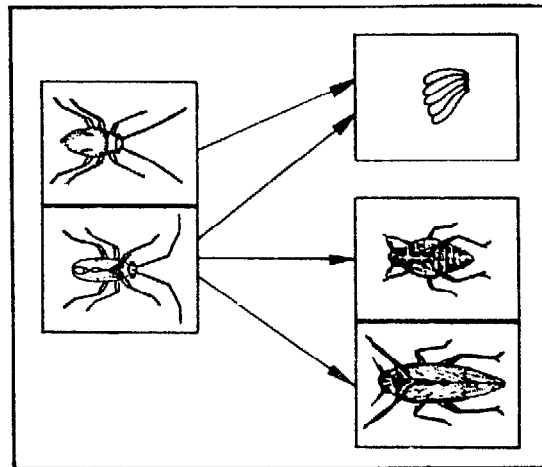

- The adult *Cyrtorhinus* also attack hopper nymphs and adults.

**Habits**

- Nymphs and adults are found on rice leaves and near the base of tillers where hoppers are abundant.
- The eggs are laid singly or in groups in the leaf sheath.

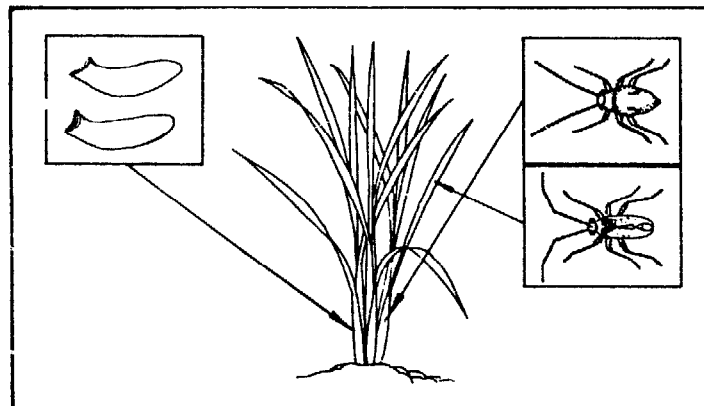

- *Cyrtorhinus* nymphs and adults insert their mouth-parts into hopper eggs and suck out the liquid, causing the eggs to collapse.

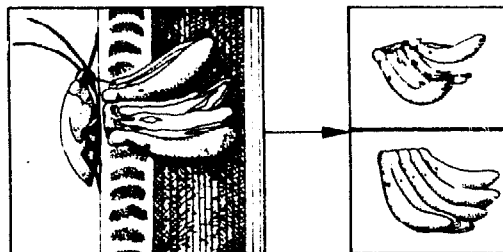

Damaged eggs

Normal eggs

**Other predators**

**Coccinellidae**

- Adults and larvae of coccinellid (or ladybird beetles) attack several rice pests including leafhoppers and planthoppers.

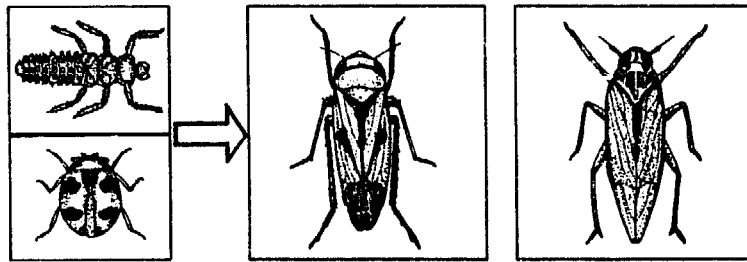

Predator

Prey

**Beetles**

- Ground beetles and rove beetles prey on rice pests in some areas.

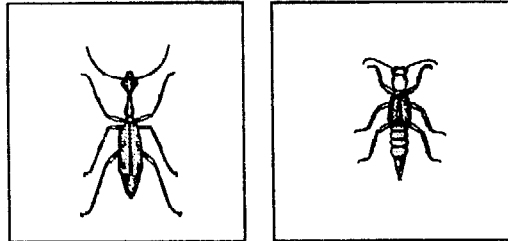

*Ophionea* ground beetle    *Paederus* rove beetle

**Damselflies**

- Damselflies of the genus *Agriocnemis* hunt inside the rice canopy and may eat hoppers, midges, and other insects.

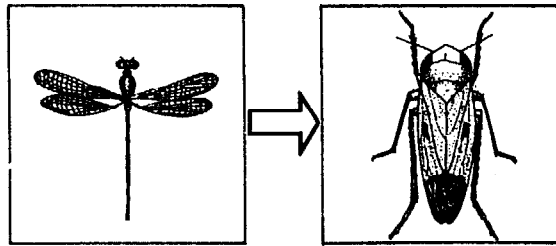

Predator

Prey

**Management and conservation of parasites and predators**

Approaches to increase the effectiveness of parasites and predators in rice fields:

- Mass rearing of parasites in the laboratory and releasing mass-reared parasites in the field.

This approach, such as the mass rearing of *Trichogramma* for leaffolder control, has been useful in some countries, such as China, but is not currently economically feasible on a large scale throughout Asia.

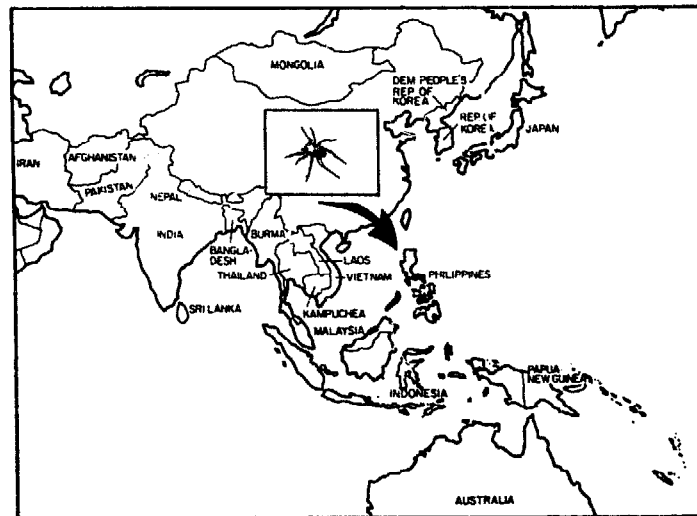

- Importing beneficials from other countries and establishing them to help supplement native parasites and predators. This method has not been successful for control of rice pests in the past. More effort is needed to improve the chances of establishing imported beneficials in rice fields.

- Conserving native parasites and predators.

Currently the most practical method of obtaining maximum benefits from beneficials is to conserve native species of parasites and predators and create favorable conditions so their populations will increase.

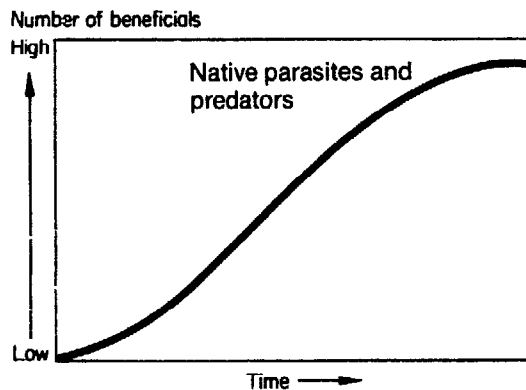

- Reducing the harmful effects of chemicals on beneficials. Pesticides, particularly insecticides, may kill many parasites and predators in rice fields. To reduce the harmful effects of these chemicals on beneficials:
  1. If possible, apply a selective insecticide. Some insecticides are more poisonous to parasites and predators than others. Apply the minimum dosage of an insecticide that is toxic to the pest and least harmful to beneficials.

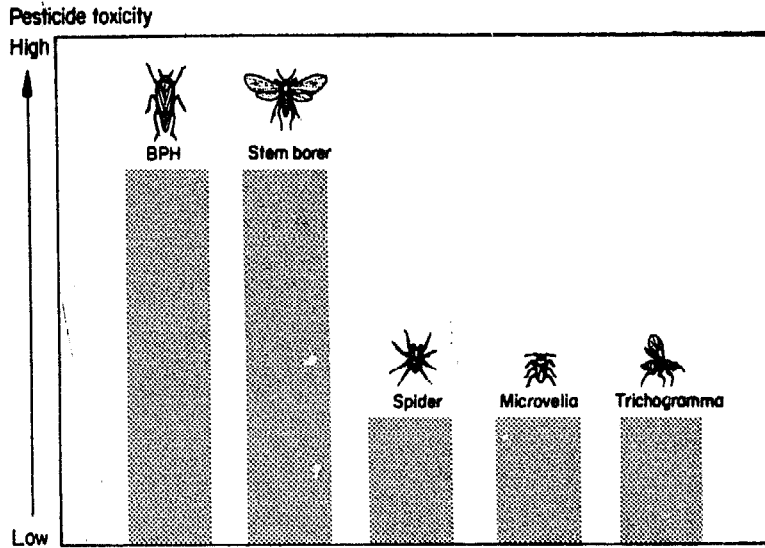

2. Apply insecticides only when necessary. Do not apply insecticides on a regular, calendar-based schedule. Apply insecticides only when pest populations reach the economic threshold. This will ensure that some prey are available to stimulate increases of parasites and predators.

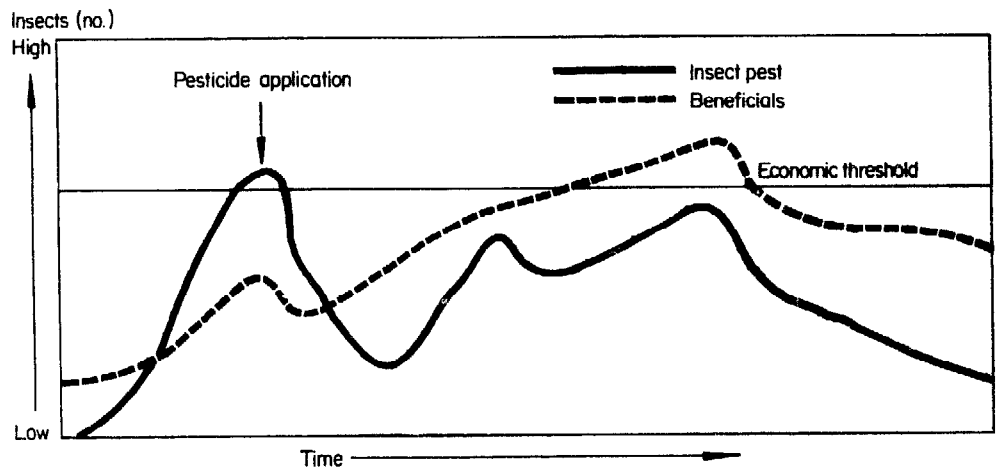

3. Use selective formulations and application methods. If possible, use a formulation and application technique that is least harmful to beneficials. For example, either applying granules or incorporating insecticides into the soil is usually less harmful to beneficials than foliar sprays.

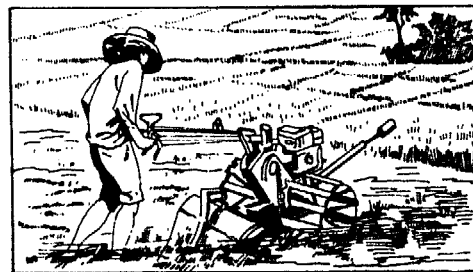

# PESTICIDES

# Pesticides

A pesticide is any chemical used to control pests.

## Types of pesticides used in growing rice

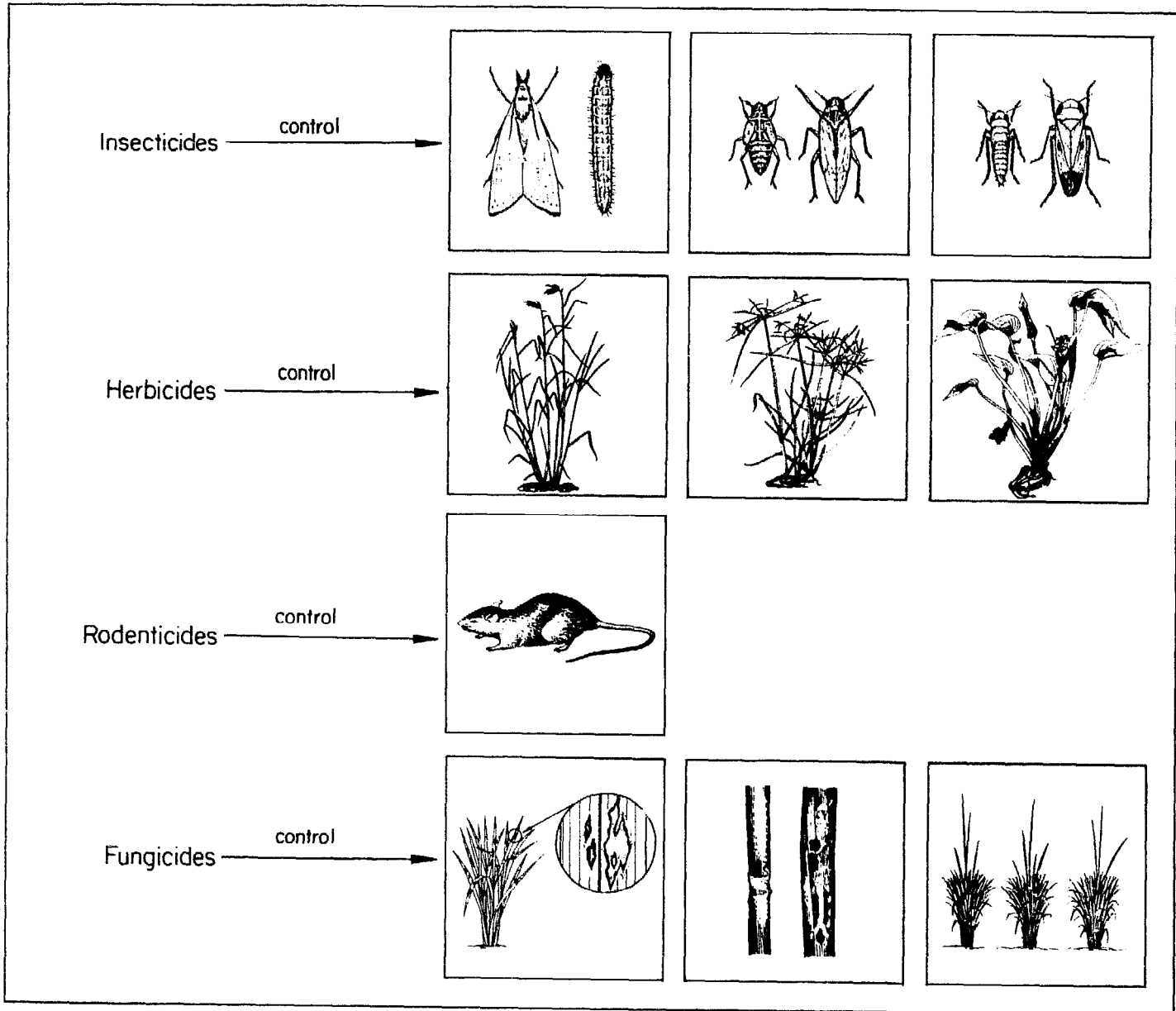

### Formulations

A pesticide is usually not applied in a pure form. It must be diluted with water, oil, or an inactive solid so it is less toxic to humans and can be spread evenly over a large area. The final product is called a pesticide formulation.

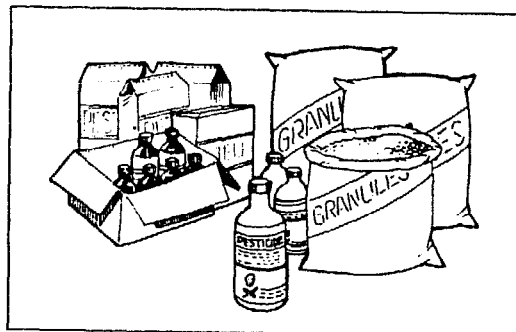



Types of formulations

Dusts

Dusts = pesticide + a finely ground dry particle such as clay, talc, or volcanic ash

- Advantage  
Dusts require no mixing and can be applied directly to the rice plant

Advantage

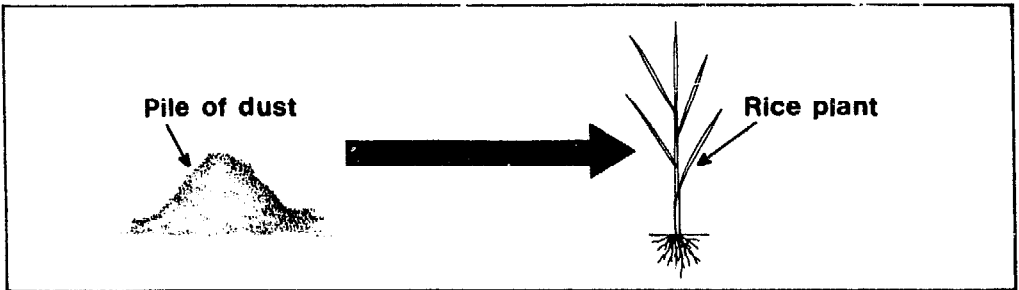

- Disadvantage  
Dusts may drift long distances from where they were applied and contaminate areas where humans and livestock are present.

Disadvantage

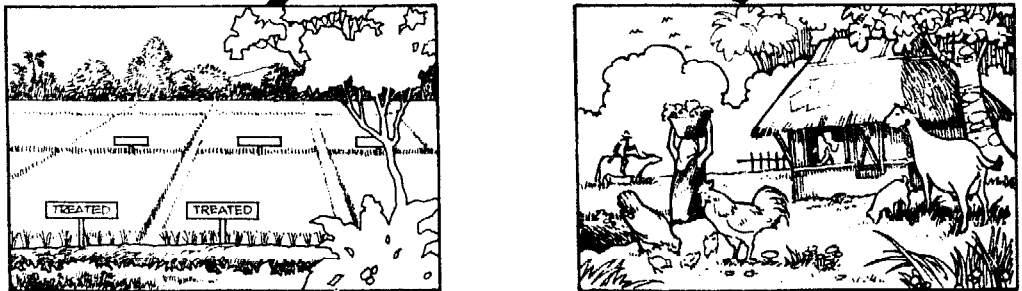

Granules

Granules = pesticide + dry particles of clay or sand which are larger than those used in a dust

- Advantages  
Granules as purchased can be applied with simple equipment and require no additional mixing. Granules are relatively non-toxic to applicators and do not drift from the target area.

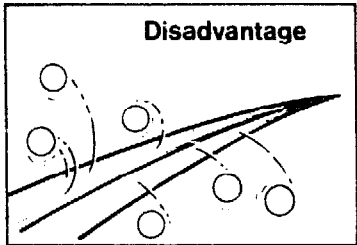
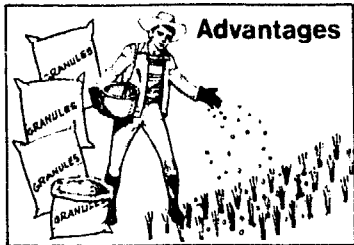

- Disadvantage  
Granules cannot be used to treat foliage because they will not stick to it.

**Liquid formulations**

Liquid formulations, called emulsifiable concentrates, are mixed with water and sprayed.

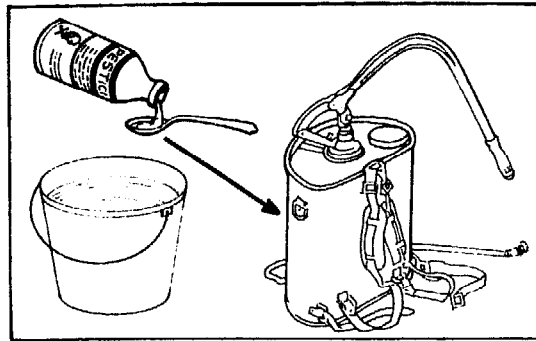

A liquid formulation may contain all or some of the agents listed below:

Pesticide in liquid form	+ organic solvent (to dissolve pesticide)	+ emulsifier (to help pesticide mix with water)	+ spreaders and stickers (to help pesticide cover and stick to target area better)
--------------------------	---	---	--

**Advantages**

Liquid formulations contain a high concentration of pesticide so the price per unit of pesticide is low. They are easy to transport and store. They are effective for treating foliage. They require little agitation in the tank to keep them mixed.

**Disadvantages**

It is easy to underdose or overdose if they are not carefully mixed. They are dangerous to humans because of their liquid form, which allows the pesticide to be absorbed through the skin.

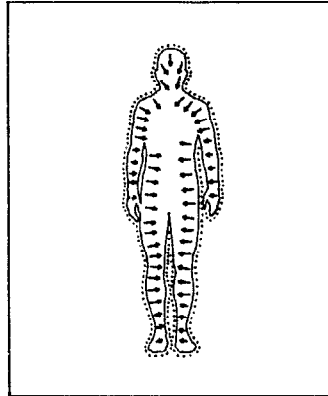

**Flowables**

Flowables are a special kind of liquid formulation in which finely ground solid particles of pesticide are suspended in a liquid. They are applied and used in the same way as other liquid formulations.

Flowables = finely ground solid particles of pesticide + a liquid

**Advantage**

They do not clog nozzles and require only moderate agitation.

**Disadvantages**

Similar to those for liquid formulations.

**Wettable powders**

Wettable powders have the same materials as emulsifiable concentrates, except that the insecticide is distributed in small, dry, powder-like particles. The amount of pesticide in these formulations ranges from 15 to 95%.

Wettable powders are mixed with water to form suspensions. The suspended particles settle out if not agitated.

Wettable powders = pesticide in powder form + wetting agent (increases spreading of droplets and helps pesticide cover target area better)

**Advantages**

Wettable powder is relatively cheap per unit. Wettable powders are easy to carry and store. They are easily measured and mixed and are not absorbed easily through the skin. They can be used effectively to treat foliage.

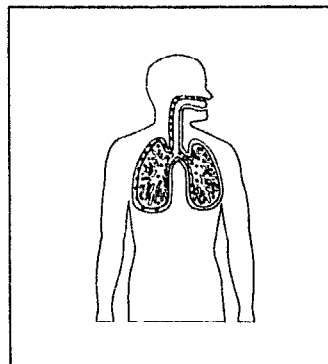

**Disadvantages**

They may be toxic to the applicator if he inhales the concentrated dust during mixing.

They must be agitated periodically in the spray tank or they will settle out.



**Soluble powders**

Soluble powders have the same materials as wettable powders but dissolve in water to form solutions. Thus, they do not settle out like wettable powders.

- **Advantages**  
The same as for wettable powders. In addition, soluble powders need not be agitated in the spray tank as they will not settle out.

- **Disadvantage**  
They may be toxic to the applicator if he inhales the concentrated powder during mixing.

**Poisonous baits**

A poisonous bait is food or other substances mixed with a pesticide. Baits are eaten by pests and cause their death.

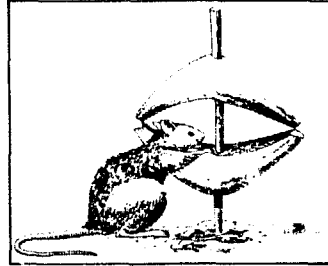

- **Advantages**  
Baits are useful for pests such as rats and birds that range over a large area. With baits, low amounts of pesticide are used in small areas and environmental pollution is minimized.

- **Disadvantages**  
Baits are often attractive and dangerous to children and livestock. Baits may be ineffective when the pest prefers the crop rather than the baits.

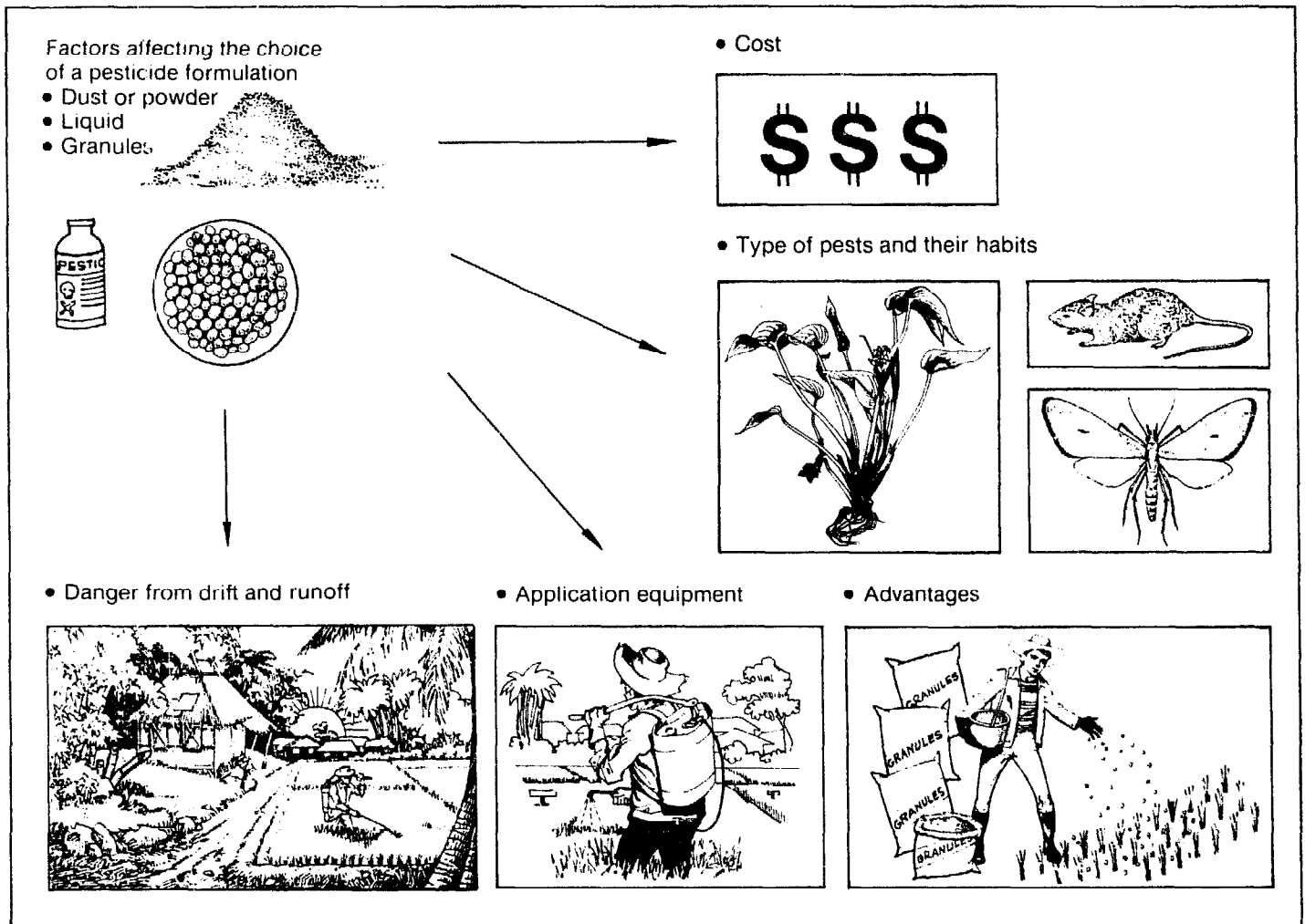

**Pesticide toxicity**

Most pesticides control the pest by poisoning it. Many pesticides are also poisonous to humans. Some may kill or seriously injure people, and others can irritate the skin, eyes, nose, or mouth.



**Ways in which pesticides enter the body**

- Oral  
Pesticide may enter the body through the mouth
  - Eating
  - Smoking
  - Storage in food containers

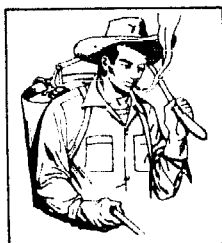
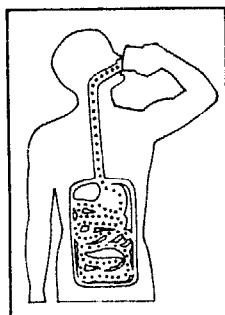

- Dermal  
Pesticide can also be taken in through the skin. Wearing clothes that are wet from a pesticide solution, or letting pesticide liquids or powders and dusts touch your skin during mixing or application of the materials is dangerous.



Areas of the body where pesticides are absorbed most easily are the

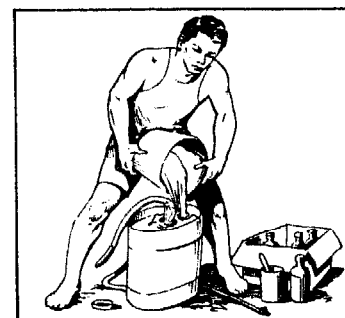
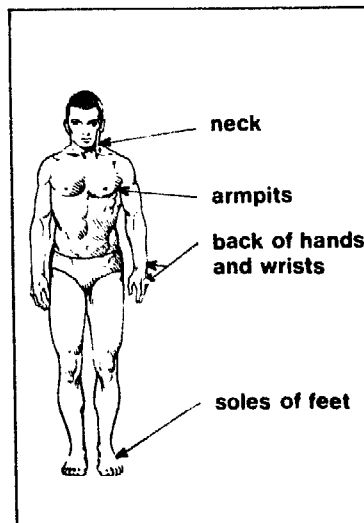

- Inhalation  
You can breathe in pesticides too. Pesticide dusts, fumes, or spray mists can be inhaled. This route of entry is most important when dusts, wettable powders, or granules are applied.

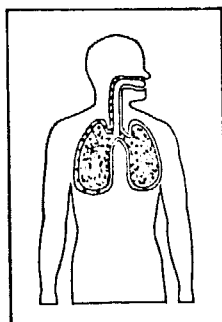

Which methods of entry are most important?

- Inhalation
- Dermal
- Oral

The dermal and inhalation routes of pesticide entry are more important to the applicator than the oral route.

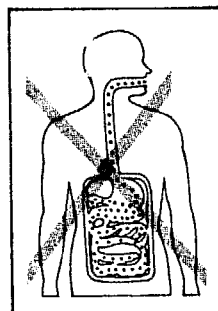
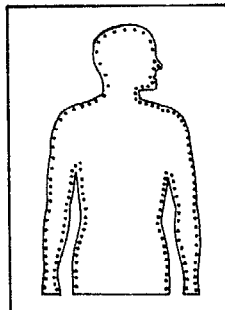
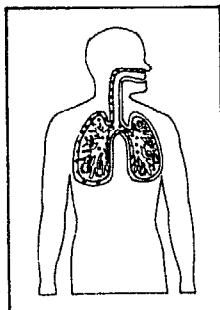

You may breathe in pesticides or splash them on the body during applications, but you do not purposely eat or drink the chemicals you are using. You can be poisoned no matter how the pesticide enters your body. It may poison you in all 3 ways.

Definition of toxicity – Toxicity means “how poisonous.” The toxicity of a pesticide may be measured in more than one way.

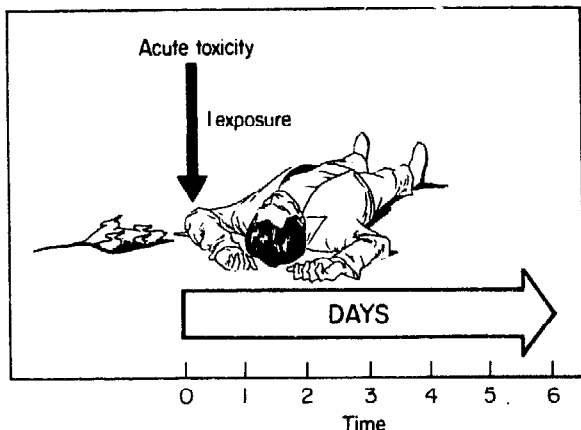

**Acute toxicity**  
Acute toxicity is the poisonous effect of a pesticide on animals or humans after a single exposure. Acute toxicity may be measured in terms of oral, dermal, and inhalation toxicity.

measured in LD<sub>50</sub> amounts ranging from 0 up. LD means lethal dose (deadly amount) required to kill 50% of test animals in a given time period. Usually LD<sub>50</sub> values are measured in milligrams of insecticide per kilogram body weight of humans (1 mg/kg = 1 part/million).

Measuring acute toxicity – Oral and dermal toxicity are

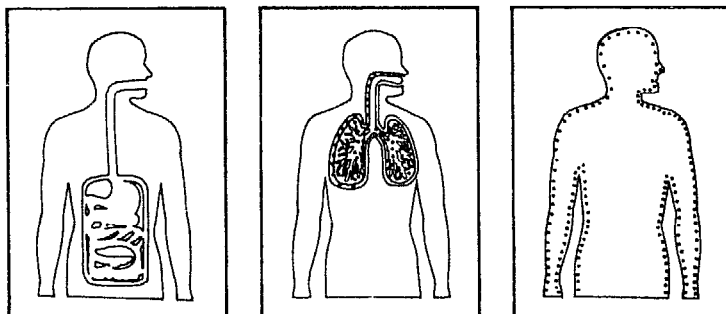

• Oral toxicity • Inhalation toxicity • Dermal toxicity

- Pesticides with low LD<sub>50</sub> values are more toxic than pesticides with high LD<sub>50</sub> values. For example, a pesticide with an LD<sub>50</sub> of 10 mg/kg is *more* toxic than one with an LD<sub>50</sub> of 100 mg/kg.

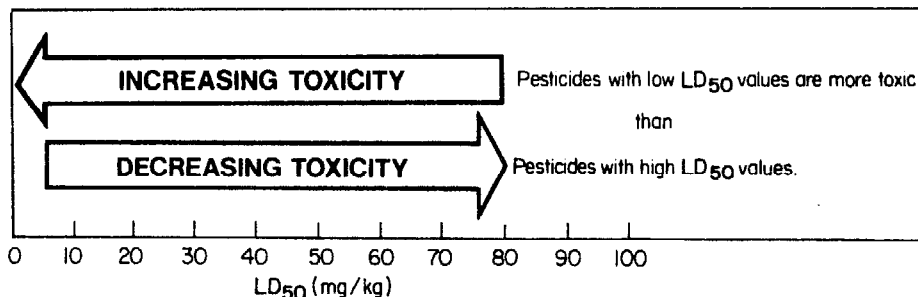

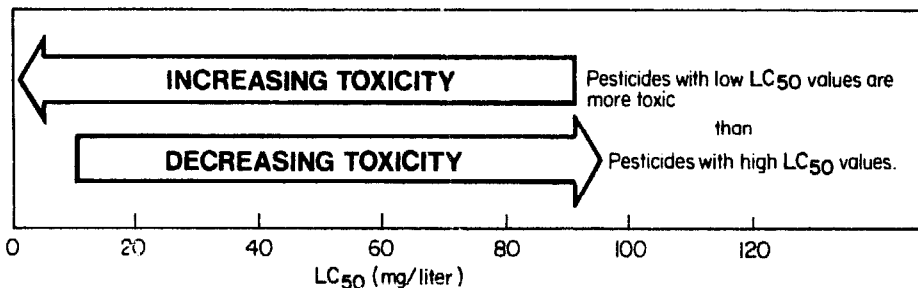

Acute inhalation toxicity is measured by LC<sub>50</sub>. LC means lethal concentration. LC<sub>50</sub> values are measured in milligrams per liter.

- Pesticides with low LC<sub>50</sub> values are more toxic than pesticides with high LC<sub>50</sub> values.



Acute toxicity is the basis for the warning statements on the pesticide label (see page 379).

Category	Signal words on label	Acute toxicity			Probable oral lethal dose for a 70-kg man
		LD <sub>50</sub> (mg/kg)		LC <sub>50</sub> (mg liter)	
		Oral	Dermal	Inhalation	
Highly toxic	Danger poison 	0-50	0-200	0-2,000	A few drops to 1 teaspoon 
Moderately toxic	Warning	51 to 500	201 to 2,000	2,001 to 20,000	Over one teaspoon to 30 g 
Slightly toxic	Caution	501 to 5,000	2,001 to 20,000		Over 31 g to 480 g
Relatively nontoxic	None	More than 5,000	More than 20,000		More than 480 g

**Chronic toxicity**

Chronic toxicity is the poisonous effect of a pesticide on animal or man after small, repeated doses over a period of time.

Chronic toxicity is important because some pesticides can remain in the body for a long time.

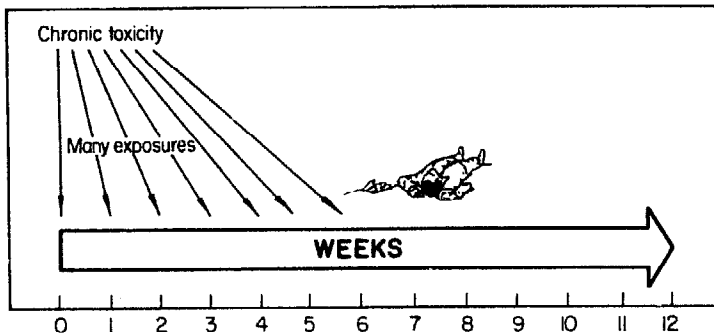

If you are often exposed to these pesticides, they may build up in your body. You can be poisoned even without getting a large dose of pesticide.

**Information on a pesticide label**

- Type of pesticide: insecticide, herbicide, etc.
- Trade names: A single pesticide is sometimes sold by different chemical companies under different trade names.
- Net contents
- Directions for use: What pests are controlled? What crops it can be used on? How much should be applied? Other ideas and suggestions.

**NET CONTENTS: 1 quart**

# Kill'em

## INSECTICIDE

**CAUTION:**  
Harmful if swallowed. Avoid breathing dust or spray mist. Avoid contact with skin. Wash thoroughly after handling. Wash contaminated clothing before use. Avoid contamination of food and foodstuffs.

**NOTICE:**  
No warranty of any kind, expressed or implied, is made concerning the use of this product. User assumes all risk and liability resulting from handling, use or application.

**DIRECTIONS FOR USE**

Crops	Pests	Rate/5-gal. water
Rice	leafhoppers, planthoppers, leafhoppers, ricebugs, armyworms.	2-4 table-spoonsful or 650 grams to 1 kilo/ha.
Vegetable	cucumber beetles, flea beetles, leafhoppers, fruit worms, squash bugs, army worms, stink bugs	2-4 table-spoonsful or 1/2 to 3/4 kilo/ha.
Corn	comborars, earworms, silkbeetles aphids	2-4 table-spoonsful or 1/2 to 3/4 kilo/ha.

Active Ingredients  
2-Isopropylphenyl-N-methyl carbamate ..... 50%

Inert Ingredients:  
(wetting agent, spreading agent, etc.) ..... 50%

100%

Makati, Metro Manila, Philippines

**Keep Out of Reach of Children!**

• The common name or chemical name for the actual poison and the percentage of the material in the formulation.

• Name and address of the chemical company.

• Hazard statement: Pesticides are grouped according to their toxicity, which is described by signal words on the label.

Reading the pesticide label

Read the label before you buy the chemical to determine:

- If this is the chemical you need for the job.
- If the material is too toxic to use under your conditions.
- The concentration of active ingredient.
- If the formulation is suitable for your equipment and conditions.

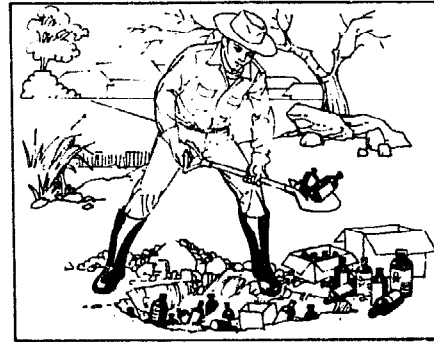
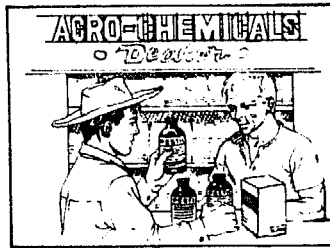

Read the label before storing and disposing of pesticides or pesticide containers to determine:

- Where and how to store the material.
- How to decontaminate and dispose of the container or leftover pesticides.

Read the label before you mix and apply the chemical to determine:

- Warnings and antidotes if necessary.
- Protective equipment necessary for application.
- How much to use.
- When and how to apply.

**Problems caused by pesticide misuse**

Pesticides are a useful and necessary part of integrated

pest management in rice, but they must be applied properly and used only when necessary.

Improper use or overuse of pesticides may cause undesirable side effects:

Pesticide resistance



• resistant planthopper

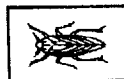

• insecticide - susceptible planthopper



Generation 1



Generation 2

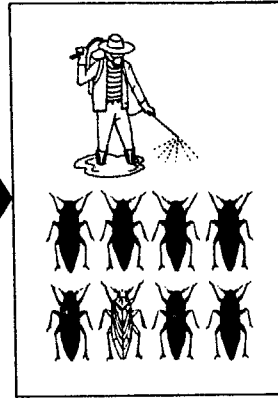

Generation 3

Several species of rice insect pests have already become resistant to certain insecticides. If in the future more pesticides are used on rice in Asia, resistance problems will probably increase. To reduce the likelihood of the development of pesticide resistance, apply chemicals only when pest levels reach the economic threshold, and use the minimum effective rate.

**Environmental pollution**

● **Non-accumulative pesticides**  
Some pesticides break down quickly into harmless materials after they are applied. Although these materials may be initially toxic to animals and humans, they do not have a

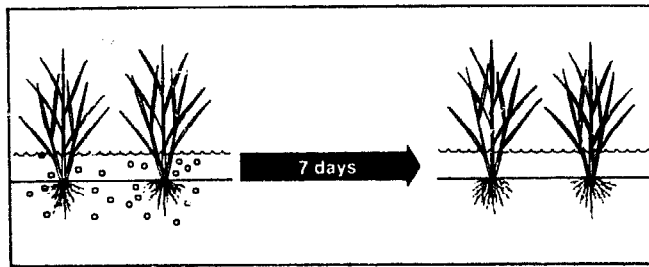

long-lasting harmful effect on the environment.

● **Persistent pesticides**  
Other pesticides may remain unchanged in the environment for long periods. These materials are not necessarily harmful unless they are taken up and accumulate in living organisms.

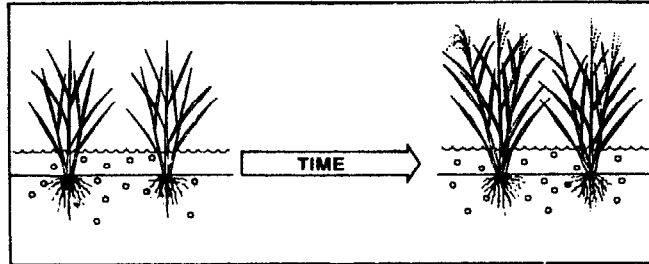

● **Accumulative pesticides**  
Some pesticides may be taken up from the environment and accumulate in animals and plants. Wildlife and people that eat animals contaminated with pesticide may be poisoned without directly contacting

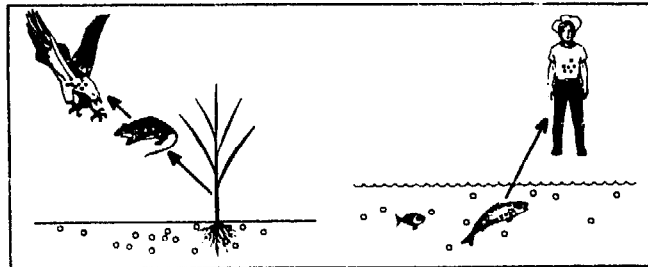

a pesticide. This type of pesticide is very harmful in the environment and causes long-lasting damage.

**Phytotoxicity**

The active ingredient or materials in pesticide formulations may damage crop plants. Phytotoxicity, or toxicity to plants, may be caused by:

- a. using the wrong pesticide,
- b. applying an improper pesticide mixture,
- c. incorrect timing of application,
- d. using too much pesticide,
- e. selecting the wrong pesticide formulation.

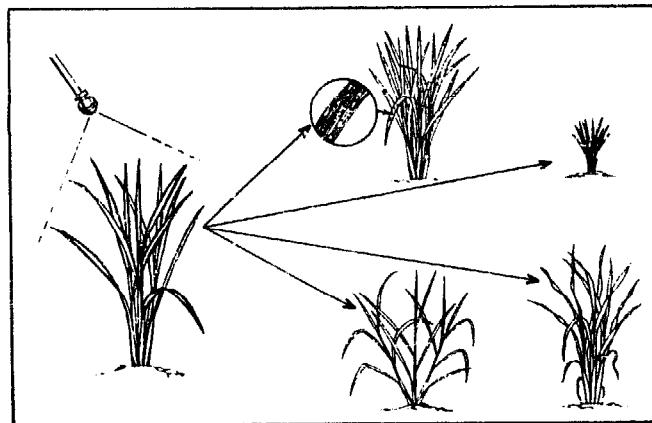

Common symptoms of phytotoxicity are

- spots on leaves
- stunting
- twisting of leaves
- tillers spread out

**Damage to nontarget organisms through:**

- wind
  - irrigation water
- If pesticides are carried by wind, water, or other means from the area where they were applied, they may be harmful to humans, livestock, wildlife, and other crops.

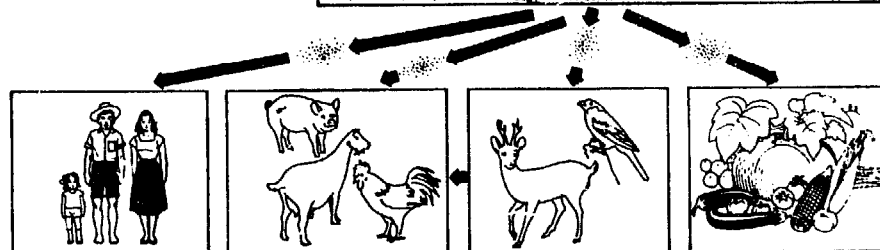



Precautions in handling pesticides



*Before application:*

- Read the label to determine:
  - a. rates,
  - b. timing,
  - c. need for protective clothing and equipment,
  - d. antidotes and other precautionary measures,
  - e. field reentry intervals after treatment, and
  - f. other safety measures.

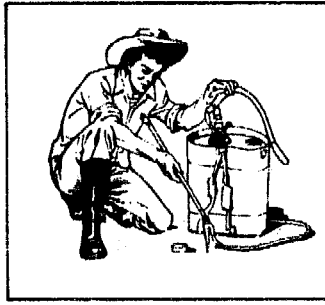

Check the sprayer

- a. Fill the tank with plain water and test the sprayer to be sure there are no leaks or loose connections and the equipment is working properly.
- b. Repair or replace any worn or faulty parts.



Mixing and filling

Extra caution is necessary when mixing and filling sprayers because the pesticide is concentrated:

- a. Wear protective clothing.
- b. Open pesticide containers carefully to avoid splashes, spills, or drift.
- c. Stand upwind when adding material to the sprayer to avoid drift of pesticide fumes or particles.



d. Keep your head away from the opening of the sprayer.

- e. If concentrated pesticide is spilled on clothing, wash and change clothes immediately.
- f. Do not mix pesticides with your hand or allow the concentrated materials to touch bare skin.

*During application*

- Wear protective clothing when applying highly toxic pesticides.
- Avoid exposure.
- Do not eat, drink, smoke, or blow clogged nozzles with your mouth while applying pesticides.

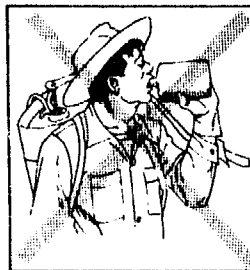
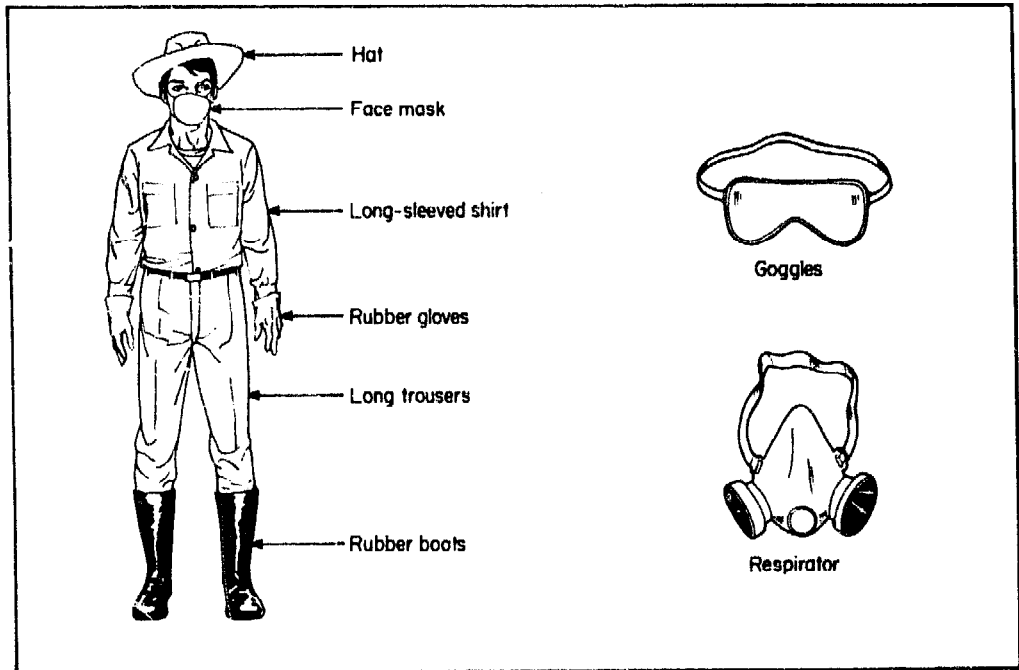

- Spray with the wind to avoid contact with pesticide drift.

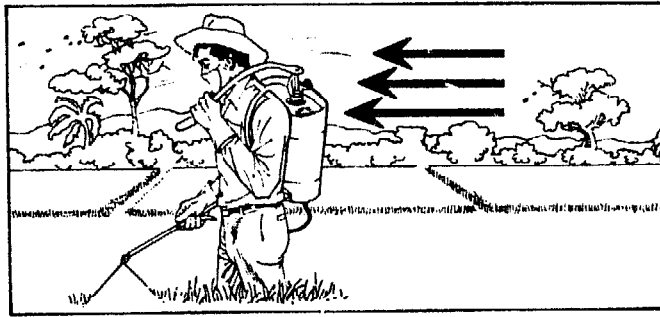

- Avoid contamination of nontarget areas.
- Do not spray during high winds to prevent drift.
- Do not spray near or in ponds, lakes, or streams.



- Spray areas near homes in early morning or evening when humans, pets, and livestock are less likely to be exposed.



*After application*

- Make sure the sprayer is empty. If necessary, spray remaining material on another field. Clean and rinse the inside and outside of sprayer and return to storage area.
- Dispose of empty pesticide containers properly.
- Store remaining pesticide properly.

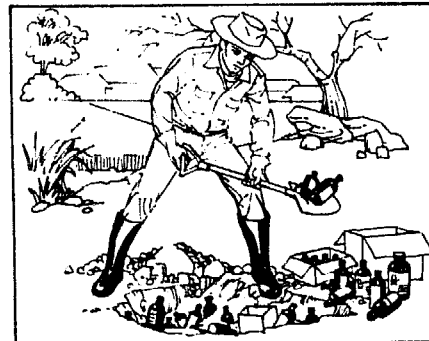
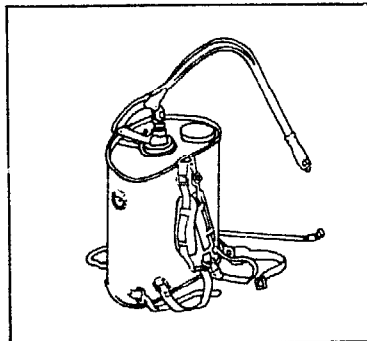

- Bathe and change clothing.
- Stay away from treated fields for 1-2 days. This prevents poisoning from contact with treated plants or water and inhalation of pesticide fumes.

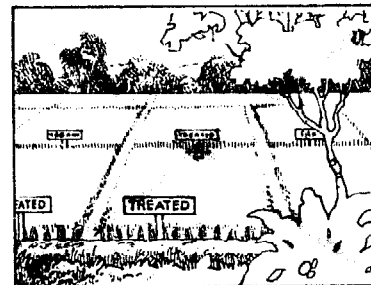

*Symptoms of pesticide poisoning*

The symptoms of pesticide poisoning are similar to those of other types of poisoning and diseases.

Pesticide poisoning may be confused with:

• Heat exhaustion



• Food poisoning



• Asthma or other illnesses

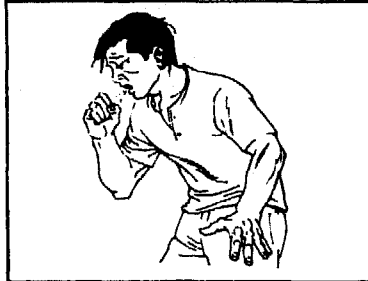

Just because a person becomes ill after using or being around pesticides is not proof that he is poisoned.

**Kinds of poisoning**

• **Acute poisoning**  
Acute poisoning occurs after exposure to a single dose of pesticide. Symptoms may occur immediately or be slightly delayed.

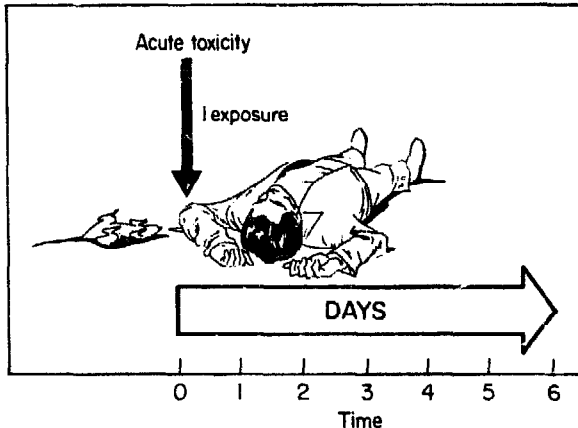

• **Chronic poisoning**  
Chronic poisoning occurs after repeated exposures over long time periods. Symptoms include nervousness, slowed reflexes, irritability, and a general decline of health.

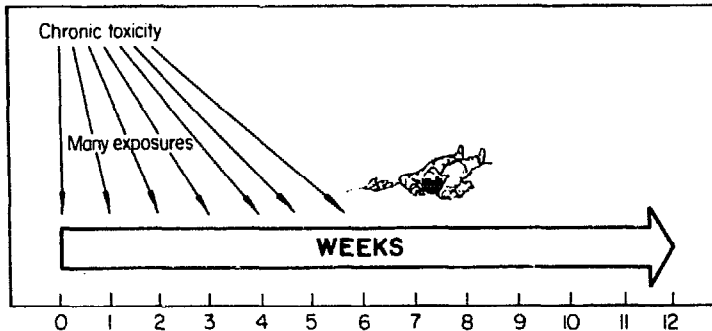

**General symptoms**

- Mild poisoning or early symptoms of acute poisoning:
  - irritation of eyes, nose, or throat
  - headache
  - dizziness
  - fatigue
  - diarrhea

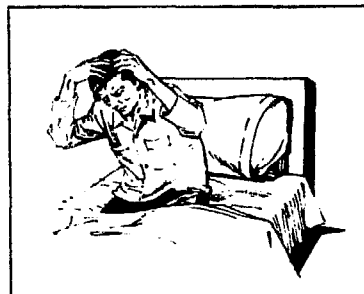

• Moderate poisoning or early symptoms of acute poisoning.

- upset stomach
- blurred vision
- extreme weakness
- excessive perspiration
- muscle twitches
- rapid heartbeat

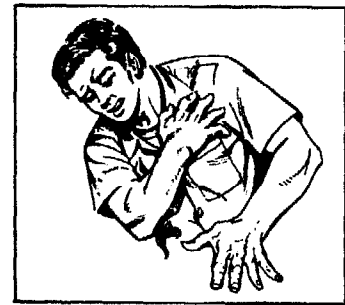

• Severe or acute poisoning

- vomiting and convulsions

- pinpoint pupils

- difficulty in breathing

- unconsciousness

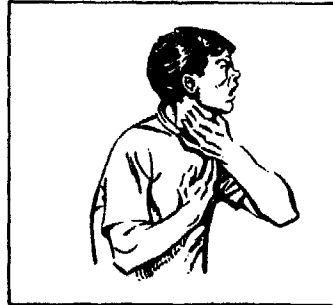
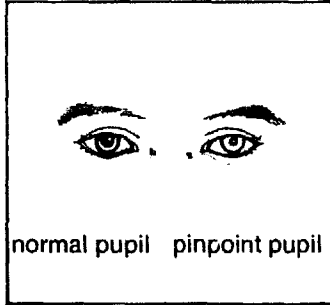
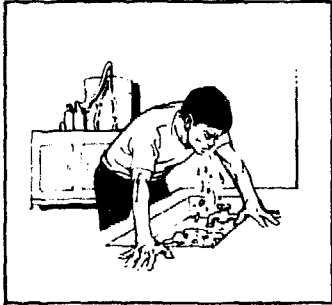

First aid for pesticide poisoning

Call a doctor or get the patient to a hospital. Always save the pesticide and the label for the doctor.

While waiting for medical help or transporting the victim to the hospital, apply the following first aid measures:

- If the patient has poison on the skin, the faster it is washed off, the less the injury will be.
- Remove clothing.
  - Drench skin and body with water from a hose, faucet, ditch, or pond.
  - Dry patient, and wrap in a clean blanket.



If the patient has poison in the eye, wash the eye as quickly and gently as possible.

- Hold eyelids open and wash eyes with a gentle stream of running water for 15 or more minutes.
- Do not use chemicals in the wash water.

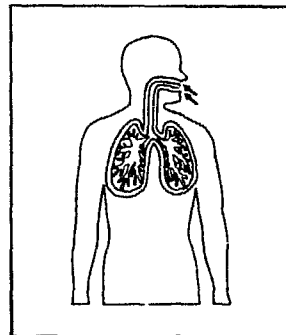

If the patient has inhaled poison, immediately move him to fresh air.

- Loosen all tight clothing.
- Prevent chilling.
- Apply artificial respiration if breathing has stopped or is irregular.
- Do not give alcohol in any form.

**Selection of a pesticide**

Before choosing and applying any pesticide several factors must be considered:

- Identify the pest
  - Carefully check the field to identify both symptoms of damage and species of pests.
  - Sometimes, very conspicuous insects or diseases do not cause serious crop loss.
  - Often damage from unfavorable weather, soil, or growing conditions may be confused with pest injury.

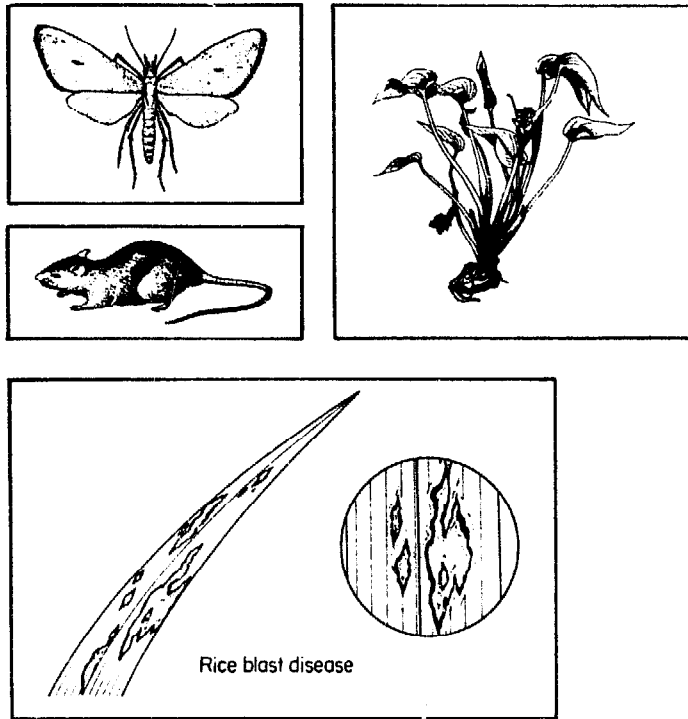

- Determine if control is necessary
  - Use the sampling techniques and economic threshold levels described in this manual to decide if pest populations or damage is large enough to require control.

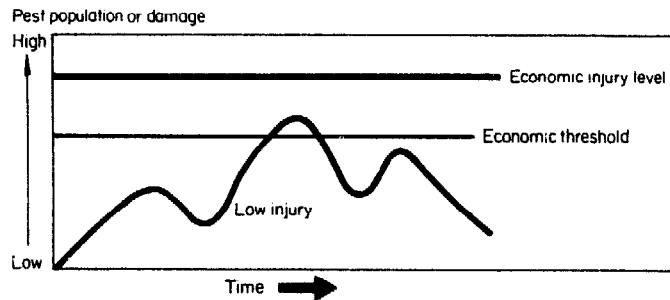

— Make sure that the pest is in the proper stage of development to be controlled by pesticides, and that it is not too early or late in crop growth for control to be economically beneficial.

**Alternative pest control methods**

- Consider other control methods
  - The integration of various types of nonchemical control measures has been discussed for most rice pests in this manual.
  - Pesticides should be applied only when these alternative control

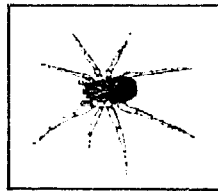

beneficials

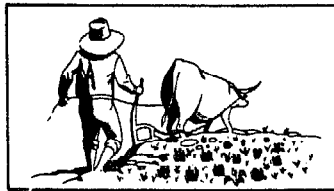

cultural control

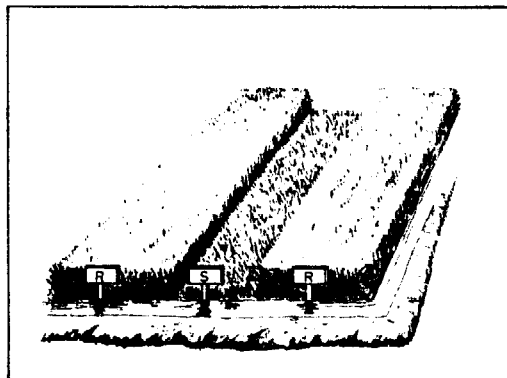

resistant varieties

methods do not reduce or maintain the pest population below the economic threshold.

- After you have identified the pest, determined if control is necessary, and considered other control measures, a pesticide application may be the most practical control method.

• Choose a pesticide that:

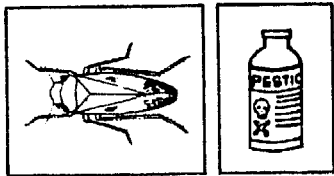
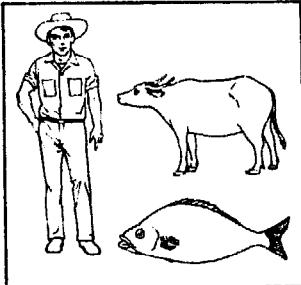
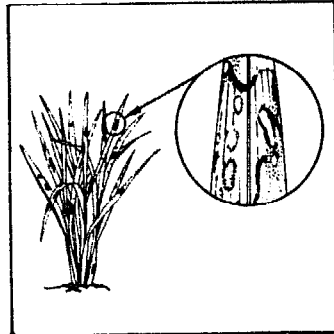
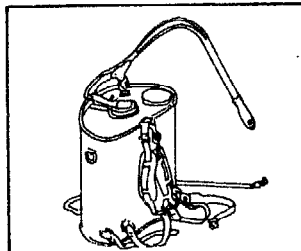
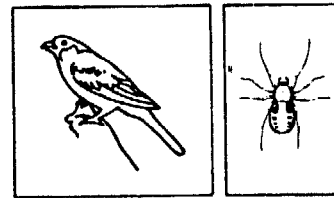
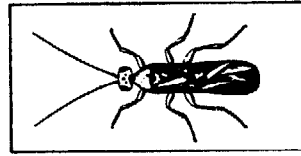
<ul style="list-style-type: none"> <li>- Is effective against the target pest.</li> <li>- Has directions on the label for the intended use.</li> </ul>			<ul style="list-style-type: none"> <li>- Will not move off the treated area, to persist in the environment to harm humans, livestock, or fish.</li> </ul>
<ul style="list-style-type: none"> <li>- Will not cause injury (phytotoxicity) to the crop.</li> </ul>			<ul style="list-style-type: none"> <li>- Is the right formulation to work in the equipment the applicator will use.</li> </ul>
<ul style="list-style-type: none"> <li>- Will cause the least damage to beneficial organisms (birds, parasites, and predators).</li> </ul>			

**Spray equipment**

**Knapsack sprayers**

Knapsack sprayers are the most common and widely used sprayers for rice throughout Asia. They have a capacity of 8-20 liters, are carried on the operator's back, and are operated by continuous hand pumping.

Knapsack sprayers are operated by continuous hand pumping. The pump inside the tank, which is operated by moving an outside lever, may be either a plunger type or a diaphragm pump with an air chamber. Some sprayers also have an agitator inside the tank to keep spray solutions thoroughly mixed. If the sprayer does not have an agitator, the operator may have to periodically stop and slosh

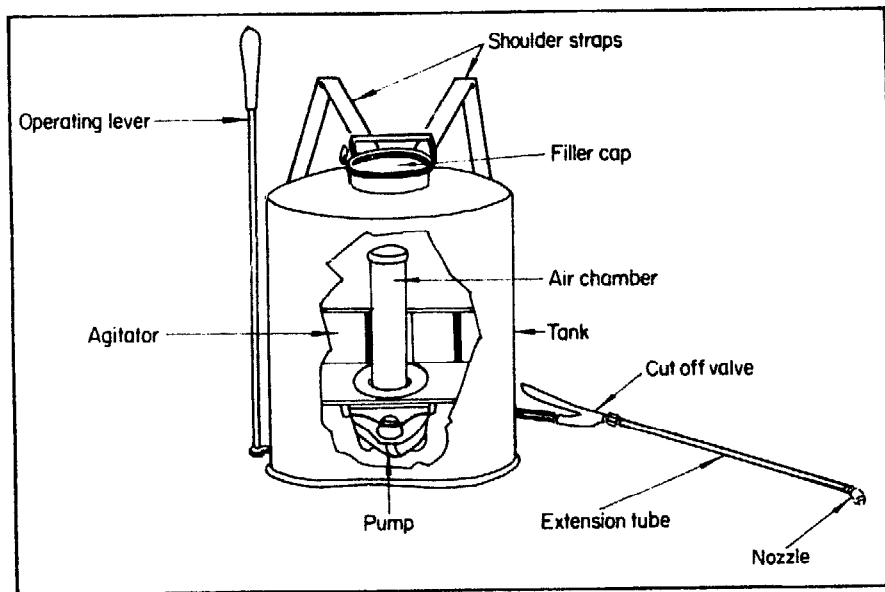

Parts of a Knapsack sprayer

around the tank contents to keep sprays from setting (particularly wettable powders). The cut-off valve controls the flow of spray to the nozzle.

Cleaning the sprayer

1. Empty the tank of remaining pesticide. Either drain the tank on wasteland where the pesticide will not contaminate irrigation canals, streams, or cropland or spray the remaining pesticide on a crop for which the pesticide is appropriate.

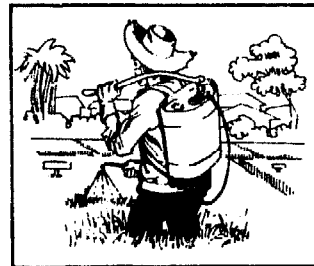

2. Fill the tank 1/3 full with detergent solution, shake vigorously, then operate the pump 10 times while spraying the rinse solution. Pour out the remaining rinse solution.  
 3. Repeat step 2 two times using clean water.  
 4. Drain the sprayer.

Spray nozzles

The spray nozzle breaks up liquids into droplets and disperses these droplets in a

particular pattern. Different types of nozzles produce different droplet patterns.

Types of sprayer nozzles

• Fan nozzles

Fan nozzles are used mainly for applying herbicides. They may also be used for directed insecticide applications.

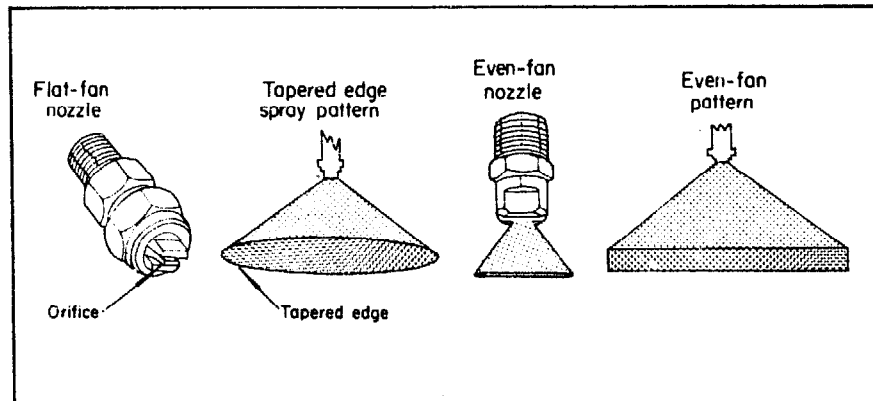

• Cone nozzles

Cone nozzles give good coverage of plant leaf and stem surfaces for control of insects and diseases.

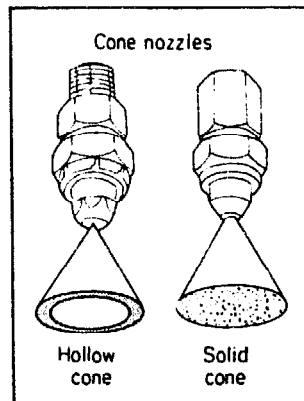

## Calibration of knapsack sprayers

1. Check the sprayer to make sure there are no leaks, the nozzle is clear, and the parts are in good condition.



2. Stake out a test area in the field.

3. Place a known amount of water into the sprayer tank.



4. Establish the spray swath.

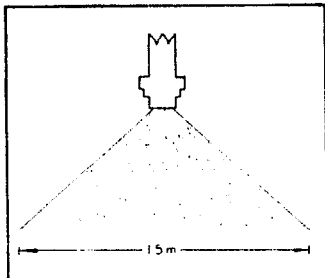

5. Enter the test area and make the test run, spraying the area at the recommended pressure and speed.



6. After spraying the test area measure the length of the test area sprayed.

7. Calculate the application rate in liters/ha:

$$\text{Area sprayed (ha)} = \frac{\text{swath established (m)} \times \text{distance traveled (m)}}{10,000}$$

$$\text{Application rate} = \frac{\text{volume sprayed}}{\text{area sprayed}}$$

Example:

spray swath = 4 m

distance traveled = 40 m

volume sprayed = 5.0 liters

$$\text{Area sprayed} = \frac{4 \times 40 \text{ m}}{10,000 \text{ m}^2} = 0.016 \text{ ha}$$

$$\text{Application rate} = \frac{5.0 \text{ liters}}{0.016} = 313 \text{ liters/ha}$$

8. Next calculate the amount of the formulated pesticide needed in each sprayerload.

Example:

You have a 10-liter sprayer and you want to apply 313 liters of spray solution/ha.

You want to apply 0.5 kg ai of pesticide/ha and the formulated pesticide is 25 EC (25% ai emulsifiable concentrate).

- a. First, calculate no. of sprayerloads/ha:

$$= \frac{\text{liters of spray solution/ha}}{\text{sprayer capacity in liters}} = \frac{313}{10} = 31$$

- b. Next, calculate the amount of commercial formulation to be applied/ha:

$$= \frac{\text{rate in kg ai/ha}}{\% \text{ ai in the formulation}} = \frac{0.5}{0.25} = 2.0$$

- c. Divide the amount of commercial formulation to be applied/ha by the no. of sprayerloads/ha:

$$= \frac{2.0}{31} = 0.065 \text{ kg of the commercial pesticide formulation}$$

Proper calibration of sprayers will ensure that pesticides are uniformly distributed and the crop is covered adequately. This will improve pest control and save money.



**Pesticide storage and disposal**

**Storage**

Store pesticides in original containers in a safe, dry, locked, and well-ventilated area.

They should be sealed, correctly labeled, and kept out of the reach of animals and children.

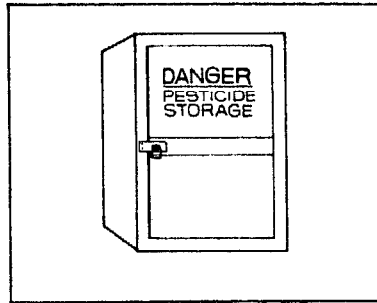

**Disposal of pesticide containers**

Rinse all empty containers 3 times with clean water, and dump rinse water into the sprayer.

Separate the used containers that will burn and those that will not.

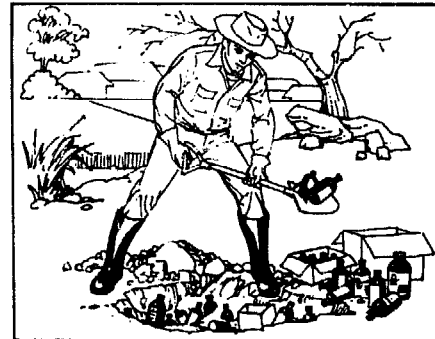
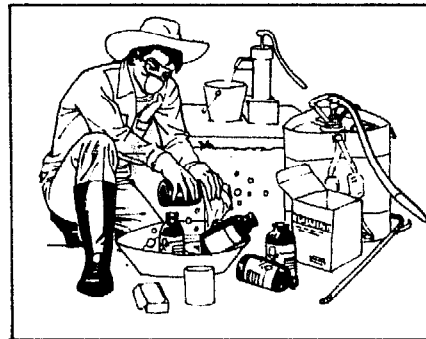

Where burning is not unlawful, small amounts of cardboard or paper containers may be burned in areas far from humans and livestock. Bury the leftover ashes. Do not burn empty containers that contained mercury, lead, cadmium, arsenic, or inorganic pesticides.

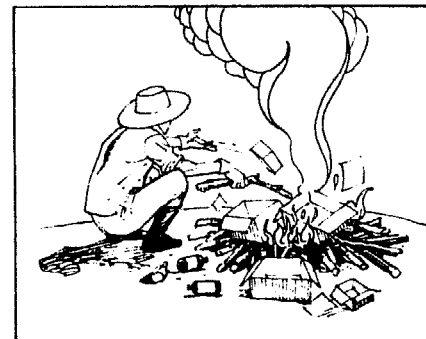

Crush and bury non-burnable containers in a land area where humans, livestock, and groundwater will not be contaminated. Containers should be buried at least 0.5 m beneath the soil.

**Pesticide calculations**

Simple conversion factors  
 Area: 1 hectare (ha) = 10,000 square meters (m<sup>2</sup>)  
 Weight: 1 kilogram (kg) = 1,000 grams (g)

Volume: 1 liter = 1,000 milliliters (ml)  
 1 gallon (gal) = 3.8 liters  
 1 tablespoon = 10 ml

To convert g/liter to % divide by 10  
 To convert lb/US gallon to % multiply by 12  
 To convert lb/Imperial gallon to % multiply by 10

**Foliar sprays**

It is important to apply the correct volume of spray per hectare when treating a field. If the spray volume is too low, the rice plants are not properly covered. If too much spray is applied, the insecticides will run off the foliage and be wasted.

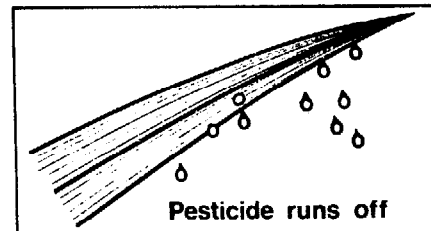
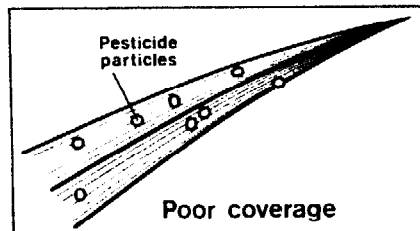

To provide adequate coverage, a knapsack sprayer should be calibrated (see page 389) to deliver at least 300 liters spray/ha. Information needed to calculate spray volume in liters per hectare:

- size of sprayer (liters)
- area of field (ha)
- number of sprayerloads

$$\text{liters of spray/ha} = \frac{\text{size of sprayer (liters)} \times \text{no. of loads}}{\text{area of field (ha)}}$$

**Example:**

You have a 10-liter sprayer and you apply 6 loads to a 0.2-ha field. What is your spray volume (liters/ha) in the field?

**Solution:**

$$\text{liter of spray/ha} = \frac{10 \text{ liters (size of sprayer)} \times 6 \text{ loads}}{0.2 \text{ ha}} = \frac{60}{0.2} = 300$$

To determine how many sprayerloads are necessary to achieve a certain spray volume (liters/ha), use the equation:

$$\text{No. of loads} = \frac{\text{desired spray volume (liters/ha)} \times \text{area of field (ha)}}{\text{size of sprayer (liters)}}$$

**Example:**

You have a 10-liter sprayer, and wish to apply a spray at a rate of 250 liters/ha in a 0.4-ha field. How many sprayerloads do you need to apply?

**Solution:**

$$\begin{aligned} \text{No. of loads} &= \frac{250 \text{ (desired spray volume in liters/ha)} \times 0.4 \text{ ha (area of field)}}{10 \text{ liters (size of sprayer)}} \\ &= \frac{250 \times 0.4}{10} \\ &= 10 \text{ loads} \end{aligned}$$

To calculate dosages needed for foliar sprays, convert rate recommendations to:

- percent concentration in the solution
- kg ai/ha

**Calculations of % concentration in recommended solution**  
Rate recommendations on pesticide labels are often given in weight or volume of formulated product to be added to a certain weight or volume of water.

$$\% \text{ concentration} = \frac{\text{volume (ml) or weight (g) of recommended formulation}}{\text{recommended volume (ml) or weight of water (g)}} \times \text{\% active ingredient}$$

**Example:**

Product	Label recommendation	Calculation	Concentration of the solution (%)
50% EC	Add 20 ml of product/20 liters of water	$\frac{20 \text{ ml} \times 50\%}{20 \text{ liters} \times 1,000 \text{ ml/liter}}$	= .05
50% WP	Add 15 grams of product/5 gallons of water	$\frac{15 \text{ g} \times 50\%}{5 \text{ gal} \times 3,800 \text{ g/gal}}$	= .04
30% EC	Add 3 tablespoons to 5 gallons of water	$\frac{3 \text{ tablespoons} \times 10 \text{ g/tbsp} \times 30\%}{5 \text{ gal} \times 3,800 \text{ g/gal}}$	= .05

**Calculation of rate when % concentration is known**

Necessary information:

- recommended rate (% concentration ai)
- volume (liters of spray desired/treated area)
- % ai in commercial formulation
- area (ha) to be treated

**Example:**

You wish to apply 320 liters of spray solution/ha to a 0.5-ha area. The recommended spray concentration of the 45% EC pesticide is 0.04%. How many liters of the commercial formulation are required for the treatment?

**Solution:**

$$1. \text{ Spray volume needed for the treated area} = 320 \text{ liters} \times 0.5 \text{ ha} = 160 \text{ liters}$$

$$\begin{aligned} 2. \text{ Liters of commercial formulation} &= \frac{\text{volume of spray required} \times \text{\% recommended spray concentration}}{\text{\% active ingredient in formulation}} \\ &= \frac{160 \times .04}{45} = 0.142 \text{ liter} \end{aligned}$$

$$3. \text{ Amount of commercial material per sprayerload} = \frac{\text{liters of commercial formulation} \times \text{capacity of sprayer (liters)}}{\text{amount spray required (liters)}}$$

If you have an 8-liter sprayer:

$$\begin{aligned} \text{Amount of material per sprayerload (kg)} &= \frac{0.142 \times 8}{160} \\ &= .007 \end{aligned}$$

Calculation of rate when recommendations are based on kg ai/ha.

Necessary information:

- a. recommended rate (kg ai/ha)
- b. percent ai in the formulation
- c. area (ha) to be treated

Example:

You wish to apply 320 liters/ha of spray solution to a 0.5-ha area. The recommended rate of the 70% wettable powder pesticide is 0.75 kg ai/ha. How many kilograms of the commercial formulation are required to treat the 0.5-ha area?

Solution:

$$1. \text{ Commercial formulation (kg)} = \frac{\text{recommended rate (kg ai/ha)} \times \text{area to be treated (ha)}}{\% \text{ ai in commercial formulation}} \times 100$$

$$= \frac{0.75 \times 0.5}{70} \times 100 = 0.536$$

$$2. \text{ Volume of spray needed for the treated area} = 320 \text{ liters/ha} \times 0.5 \text{ ha}$$

$$= 160 \text{ liters}$$

$$3. \text{ Amount of materials/sprayerload (kg)} = \frac{\text{kg of commercial formulation} \times \text{capacity of sprayer (liters)}}{\text{amount of spray required (liters)}}$$

If you have an 8-liter sprayer:

$$= \frac{0.536 \times 8}{160}$$

$$= 0.27 \text{ kg} = 27 \text{ g/sprayerload}$$

Use the same equation for liquid formulations. Amounts will be in liters and milliliters and not kg and g.

*Applying pesticide granules*

Necessary information:

- a. recommended rate (kg ai/ha)
- b. area to be treated (ha)
- c. percent ai in the granular formulation

Example:

You wish to apply pesticide granules at a rate of 0.6 kg ai/ha to a 2-ha field. The granules contain 3% ai. How many kilograms of commercial formulation are needed to treat this area?

Solution:

$$\text{Commercial formulation (kg)} = \frac{\text{recommended rate (kg ai/ha)} \times \text{area to be treated (ha)}}{\% \text{ ai in commercial formulation}} \times 100$$

$$= \frac{0.6 \times 2}{3} \times 100 = 40$$

# INTEGRATION OF CONTROL MEASURES

# Integration of Control Measures for All Rice Pests

In this manual, the different rice pests — insects, weeds, diseases, and rats — are discussed separately and the biology and management of each pest presented individually.

In the field, the different pests, the weather, agricultural practices, and the rice plant are interdependent and are all linked together in a unit called the agroecosystem.

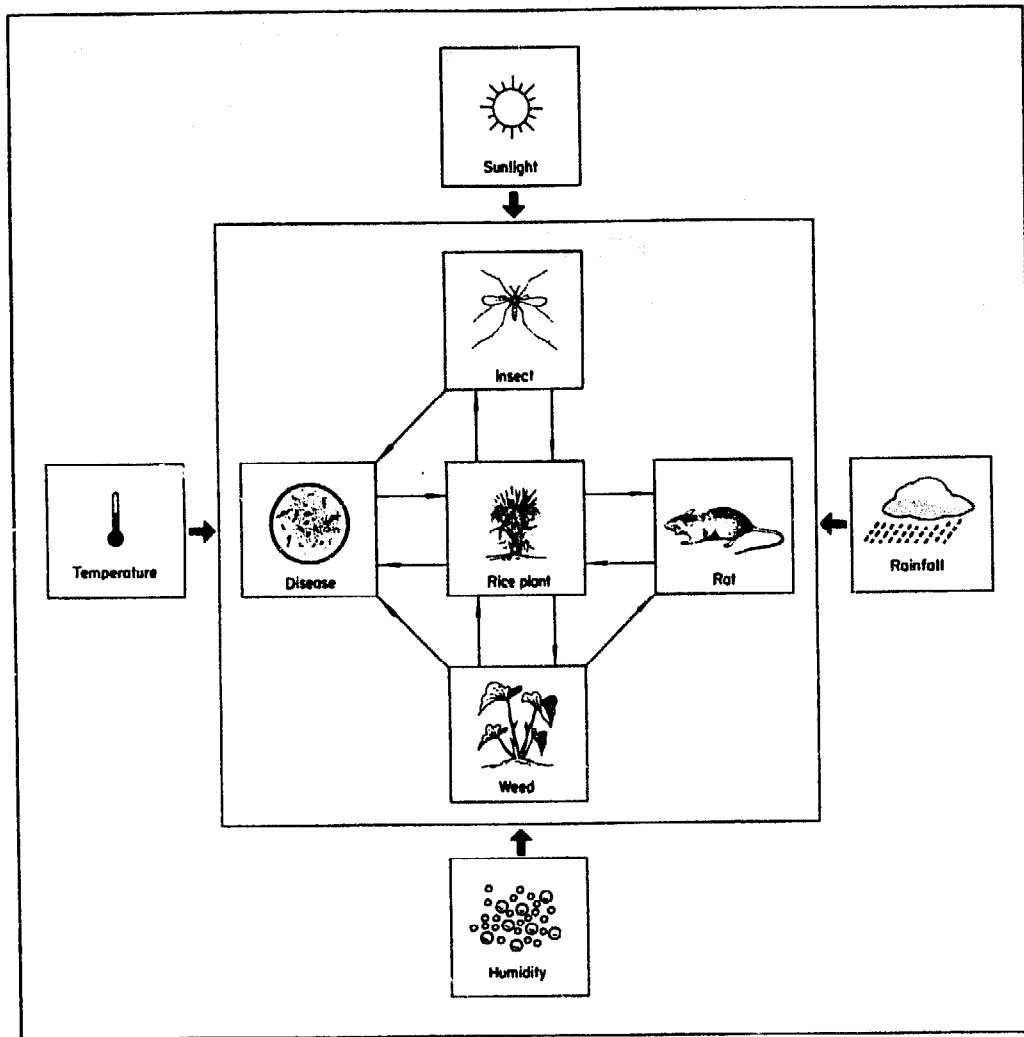

Because of this interrelationship, control measures directed against one pest or group of pests may affect other pests.

For an effective pest management program for rice, the effects of individual control and management practices on the entire pest complex must be considered and integrated so that as many pests as possible are maintained at nondamaging levels.

Sometimes complete integration of agronomic practices and control measures for all individual pest species is not possible. The farmer must

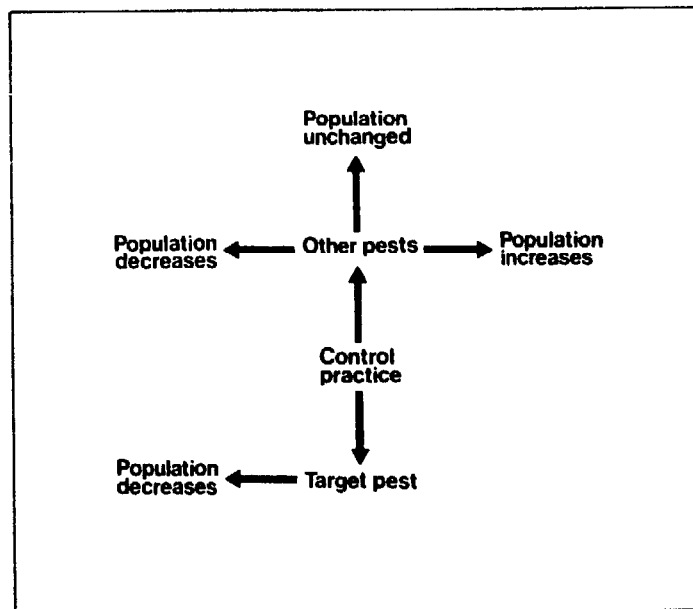

then decide which pests are most serious. He must manage them as effectively as possible while seeking maximum profit, although this may cause some minor pests to become more abundant.

The following information about some of the general relationships among management practices and different groups of pests and bio-control agents (predators and parasites of insects) as described in the table will help in designing more effective integrated management programs.

General relationship among management practices, pest population, and biological agents.<sup>a</sup>

Management practice	Rats	Weeds	Bacterial diseases	Fungal diseases	Virus diseases	Nematodes	Leafhoppers and planthoppers	Stem borers	Biocontrol agents
<b>Cultivars</b>									
Short duration	—	+	?	?	N	N	—	N	N
Insect resistance	?	—	—	—	—	N	—	—	—
Disease resistance	?	—	—	—	—	—	+	+	N
<b>Pesticides</b>									
Rodenticides	—	—	N	N	N	N	N	N	N
Insecticides	—	—	—	—	—	—	±	—	—
Fungicides	N	—	N	—	N	N	±	N	—
Herbicides	—	—	—	—	—	N	N	N	—
Nematicides	N	±	N	N	N	—	N	N	—
<b>Fertilizer</b>									
High N	+	+	+	+	+	+	+	+	+
High P and K	+	+	—	N	N	?	?	N	N
Split N application	—	—	N	—	N	N	—	—	N
<b>Water management</b>									
Periodic draining	+	+	N	N	—	N	—	N	N
Upland cultivation	—	+	—	+	—	+	—	N	N
Flooded	—	—	+	—	+	—	+	N	N
<b>Planting method</b>									
Transplanting	—	—	N	N	N	N	N	N	N
Direct seeding	+	+	N	N	+	N	+	N	N
Close spacing	+	—	+	N	+	N	+	N	N
<b>Planting time</b>									
Early planting	+	N	—	—	—	—	—	—	N
Late planting	+	N	+	+	+	+	+	+	N
Wet season	+	+	+	+	+	N	+	+	+
<b>Cropping pattern</b>									
Staggered planting	+	N	+	+	+	N	+	+	+
Synchronous planting	—	N	—	—	—	N	—	—	—
Multiple rice crops	+	+	+	+	+	+	+	+	+
<b>Crop residue management</b>									
Plowing stubbles	—	—	—	—	—	N	—	—	N
Burning straw	—	N	—	—	N	N	N	—	N
Weeding	—	—	—	—	—	N	N	N	—

<sup>a</sup>+ = increases pest populations or damage, or both. — = decreases pest populations or damage, or both. N = no effect on pest populations or damage, or both. ? = effect unknown. ± = pests may increase or decrease.

## CULTIVARS

- Short-duration cultivars decrease rat and planthopper populations. The planthoppers are unable to complete as many generations as on long-duration cultivars; thus populations may not reach damaging levels. Weed damage is more severe because of the shorter time for crop recovery after weeds senesce.
- Insect resistance has a negative effect on pests and biocontrol agents. When insect populations are low, the crop grows faster. The canopy closes sooner and thus shades the weeds. Bacterial and fungal diseases decrease because feeding damage on the leaves and stems, which allows entrance of pathogens, is less in insect-

resistant varieties. Resistant varieties control the leafhopper and planthopper vectors of rice viruses. Because of fewer prey, biocontrol agents decrease, but the ratio of insect pests to predator is lower, and thus more favorable, on resistant than on susceptible cultivars.

- Disease resistance decreases weeds because healthy plants are more competitive. But healthy and lush growing plants are also more attractive to colonization by insects.

## PESTICIDES

- Weeds grow where rats damage rice. Rodenticides help rice to compete with weeds.
- Insecticides reduce all the pests. Rat damage is less because there are few stem

borer-infected plants, to which rats are attracted. Control of insects allows plants to grow better and be more competitive with weeds. Any management option which increases crop growth decreases weeds. Bacterial and fungal diseases are less because pathogens invade insect-damaged tissue. Virus vectors — the hoppers — are generally controlled by insecticides. However, certain insecticides, if improperly applied, will cause increases of planthoppers, a condition referred to as *resurgence*.

- Fungicides increase crop growth and thus decrease weeds. Because some fungicides have antifeedant action and ovicidal effects, they may decrease hoppers. However, they may increase hopper popu-

lations if they control fungal pathogens attacking hoppers.

- Herbicides reduce rat populations that are attracted to weedy fields. Herbicide use reduces disease incidence because weeds are alternate hosts for some diseases. A decrease in weeds decreases species diversity and populations of insect predators and parasites.
- Nematicides may increase or decrease weeds. They kill nematodes that attack weeds. On the other hand, control of nematodes that attack rice results in a better rice crop that is more competitive with weeds. Nematodes which parasitize insect pests may be partially controlled with nematicides but other biocontrol agents would probably not be affected.

## FERTILIZER

- High nitrogen rates generally favor rice pests, and as the population increases the biocontrol agents also increase. Rats prefer to attack lush growing plants, and insects and diseases grow well on healthy, lush growing plants.
- High phosphorus and potassium make plants grow well and attractive to rats.
- The crop cannot use all of the nitrogen if it is applied at one time; the weeds also benefit. Split nitrogen application decreases weed growth because the majority of the amount applied is used by the rice crop; very little or none is left for the weeds. The crop should be weeded before nitrogen is topdressed. Fungal diseases and insects are decreased because rice vegetative growth is less rapid with split applications at transplanting and panicle initiation. Highly fertilized, rapidly growing plants are more susceptible to fungal diseases and are highly nutritious to insects. Moreover, the closed canopy provides environmental conditions suitable for hoppers.

## WATER MANAGEMENT

- Periodic draining of fields increases rat and weed problems but decreases virus vectors and, consequently, virus disease infection. Rats increase because draining increases weed

populations and exposes rat burrowing space on the levees.

- Upland fields have higher populations of weeds, nematodes, and a higher degree of fungal disease infection, especially blast. Blast is favored by upland conditions because there is much dew on the plants. Bacterial disease incidence is low because moisture to disperse the pathogen from one plant to another is insufficient. Hopper populations are low because of the dry ecological conditions and thus virus carried by hoppers is also low.
- Flooding helps to control rats, weeds, fungal diseases, and soil-inhabiting nematodes. Bacterial diseases increase because the pathogen disperses rapidly by water and enters the plant where it is in contact with water. Vectors of viruses, the hoppers, increase under the humid conditions in flooded fields.

## PLANTING METHOD

- Transplanting has no effects on most pests and biological agents, but it reduces weed problems because of the competitive advantage of transplanted seedlings which are almost a month old by the time weed seeds germinate.
- Direct seeding increases weed populations because it makes hand weeding difficult. Moreover, there are no herbicides that are highly effective against the various weed species. They

close spacing between plants under direct seeding provides favorable conditions for the hopper vectors of viruses.

- Close spacing increases rat populations by providing more cover. It produces suitable ecological conditions for the growth of bacteria and the virus vectors, the hoppers. Weeds decrease because of the competition from rice plants.

## PLANTING TIME

- Early planting is a cultural method that effectively controls most pests. But when a farmer plants earlier than his neighbors, rats from the surrounding areas move to his planted field near harvest time. Diseases and insects are low because there has not been sufficient time to build up disease inoculum levels and insect populations.
- Late planting increases most pests. Rats increase because they move from the harvested neighboring fields to the late planted field which still provides a source of food and cover.
- Wet season planting favors most pests because of the large area planted to rice and the abundance of alternate hosts.

## CROPPING PATTERN

- Staggered planting of neighboring fields favors all pests except weeds and nematodes. It also favors biocontrol agents, espe-

cially in the latest planted fields. Pests which build up in one field move to younger adjacent fields when they mature.

- Synchronous planting has the opposite effect of staggered planting and is an effective cultural control method.
- Multiple rice cropping increases the incidence of all pests and the populations of biocontrol agents. Proper pesticide management practices must be followed to conserve the biocontrol agents necessary for the increased pest population when 2-3 crops a year are grown.

## STUBBLE MANAGEMENT

- Plowing is an excellent management practice that controls most pests because it removes the stubbles which serve as their habitat.
- Burning straw also controls stem borers hibernating in the stems and rats hiding in the straw. However, it has no detrimental effect on weeds as temperatures reached in burning straw generally are insufficient to kill weed seeds.

## WEEDING

- Weeding destroys habitat in which rats hide and destroys alternate hosts of pathogens and insects. Biocontrol agents are most abundant in weedy fields and species diversity is greater. Thus weeding has a negative effect on biocontrol agents.

# INTEGRATED PEST MANAGEMENT



# Implementation of Integrated Pest Management Strategies

Implementation of integrated pest management strategies' design begins with farmers in their communities. It is community development because through the process, farmers learn to recognize and deal with their own problems. By designing their own strategies, farmers learn how to gather information, make decisions, and execute them.



At the same time, those who are implementors learn how to listen, obtain information from outside sources, and communicate that information to farmers in a usable form.

This process requires a continuous commitment, beginning with an applied research phase of about 2-3 years' duration followed by a perpetual extension phase — only the frequency and



intensity of interactions decline with time.

Once technology for a region has been approximated, integrated pest management implementation can jump to the extension phase in nearby villages without duplicating the applied research phase.

## APPLIED RESEARCH PHASE

### Site selection

Integrated pest management reverses the concept of developing national recommendations derived from research results in a limited number of sites. Rather the regional sites become the focal points.

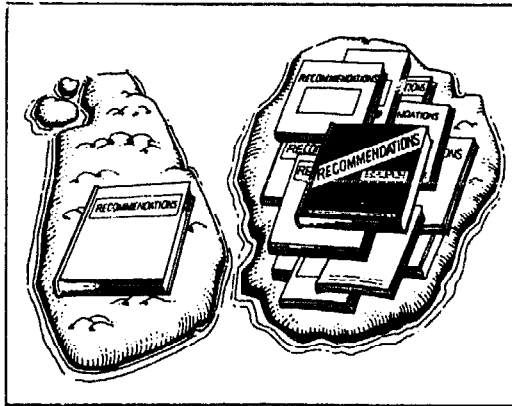

One or several neighboring villages with a history of pest problems and heavy pesticide use should be selected because farmers there will be more receptive.

Focusing on one or several villages allows concentration on the social processes of strategy building, not on the recommended tactics themselves. Farmers must own and control the technology if they are to feel comfortable using it.



**Team formation**

Teams to be formed at the regional and national levels should involve research, surveillance, extension organizations, and farmers.

The national team acts as a coordinating body and supports the regional teams financially, logistically, and technically.

At least one formal meeting should be held each year, where the regional teams report their results to the national team.

The regional team should at the minimum have strong pest control research, surveillance, and extension components. The extension service should have a history of working with the farmers in the site area. Nonpest-control research team mem-

bers can be an economist and an agronomist.

The regional team is directly involved in data

gathering and interacts with farmers. One person is selected as a coordinator who should live as close as

possible to the target villages. The site coordinator serves as a communication bridge between the various agencies and personnel working at the site and makes decisions involving use of shared resources.

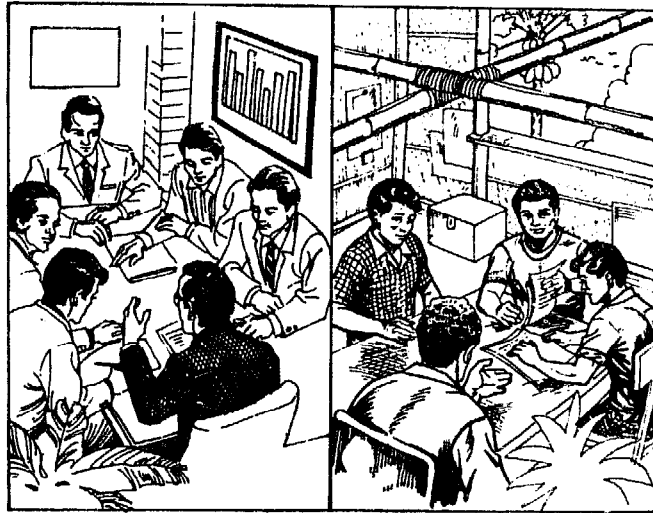

Once the regional team is formed, a meeting should be held in each of the villages to describe the purpose of the program to the farmers and their leaders. If the farmers are receptive, several of their leaders should become part of the regional team. If they do not voice support for the program, select another site.

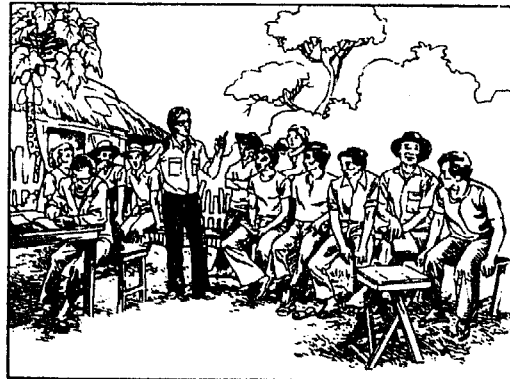

**Site description**

Information on the biological, physical, sociological, and economic aspects of the target area will be needed to develop pest strategies.

• Extension workers and researchers who have worked at the site and farmers should be consulted about soil, weather, and agronomic features as well as pest problems. It is important that the team learn how to grow rice crops that achieve the agronomic potential for the site. An agronomist team member can provide this information and may undertake on-site agronomic trials to confirm the technology.

• The economist should perform a baseline survey to determine farmers' crop production practices,

tenure status, labor arrangements, varieties used, cost of credit, labor, and agrochemical usage to

calculate costs and returns from rice production. This information helps researchers to decide what technology to test in field trials and gives them price structures with which to evaluate technology performance.

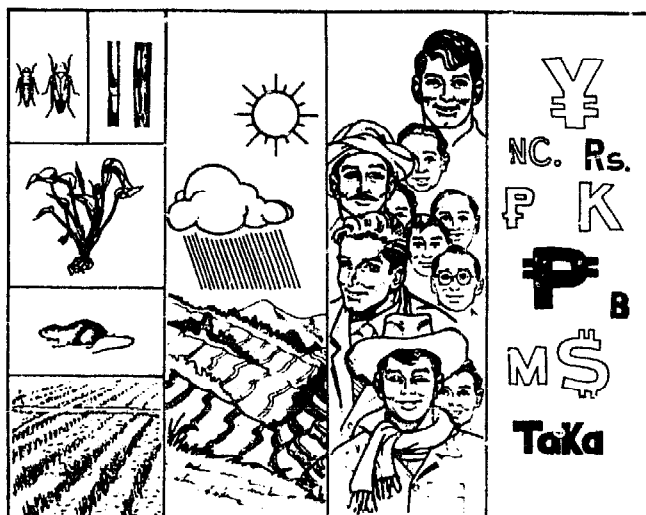

- Through interviews, researchers in each discipline should determine the key pests as perceived by farmers and the control measures used. Farmers' pest control methods should be evaluated for their suitability along with newer technology.

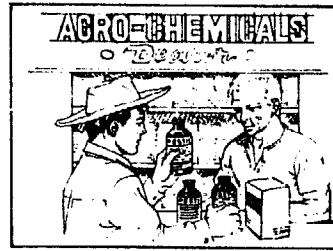

- Prices for agrochemicals should be obtained from local outlets.

- Trials conducted at the site should quantify yield losses and identify the key pests responsible for those losses so that control strategies can focus on actual problems.

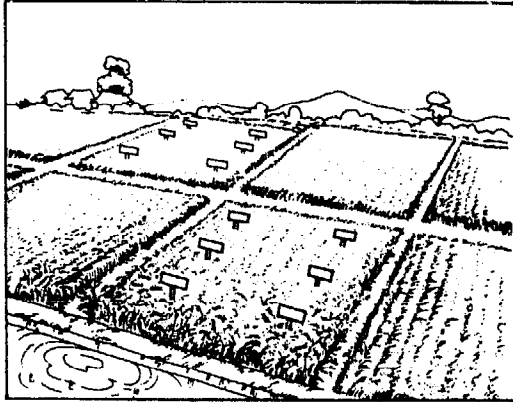

**Research for design of pest management strategies**

The basic philosophy is to start with an understanding of the farmers' crop production and pest control practices. Field trials, farmer surveys, and other on-site data gathering activities will pinpoint key pests and quantify economic losses.

The known technology for combating the key pests should be assessed.



Features of the farmers' production and pest control practices that might economically be changed to produce profitable and stable yields should be determined.

Cultural control methods should be assessed. Can any be fitted into the farmers' system? Such ideas should be discussed in farmer meetings. Such meetings may lead to a field trial to test potential practices or to communitywide adoption of synchronous planting.

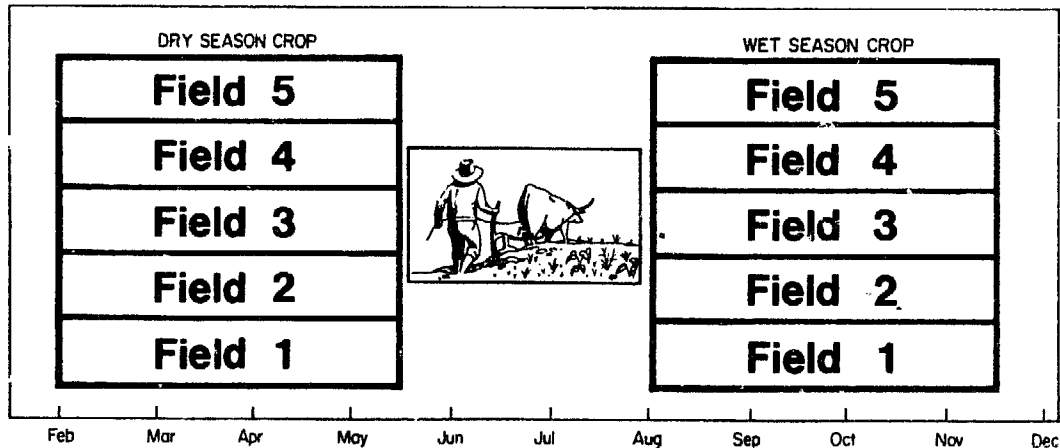

Any pest-resistant varieties not being grown can be discussed with the farmers as they may have very good reasons for not growing them. A field trial designed to test the yield of and pest reaction to resistant varieties may be undertaken.

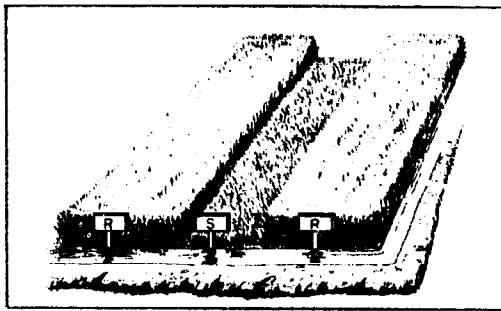

Measures to conserve natural enemies of pests should also be assessed with farmers, for example, pointing out that certain pesticides cause pest resurgence and indiscriminate use of pesticides may cause more harm than good.

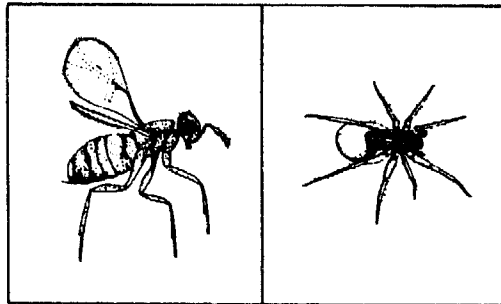

The efficacy and profitability of pesticides (fungicides, herbicides, rodenticides, insecticides) should be verified at the site. Economic threshold values for insect pests should be refined and verified by on-site field trials.

**Testing**

Separate trials should be carried out by weed, disease, insect, and vertebrate pest control disciplines. The results, however, will be examined and analyzed with researchers from other disciplines. The farmers should agree to help with the trials. Land should not be rented, but the cost of inputs for growing the crop can be given to farmer cooperators who, in turn, will grow and maintain the crop, except for operations involving the pest discipline. The farmer retains the yield and bears the risks from crop damage from sources outside of the management of the trial, e.g. stray livestock, drought, and floods.

Treatments are replicated on different farms to expose the technology to the realistic range of variation existing among farms.

The trials are conducted at the time the crop is grown by the farmers. The farmer cooperators should plant the trials over the existing range of planting dates at the site.

Verification trials differ from experiment station trials in that only proven

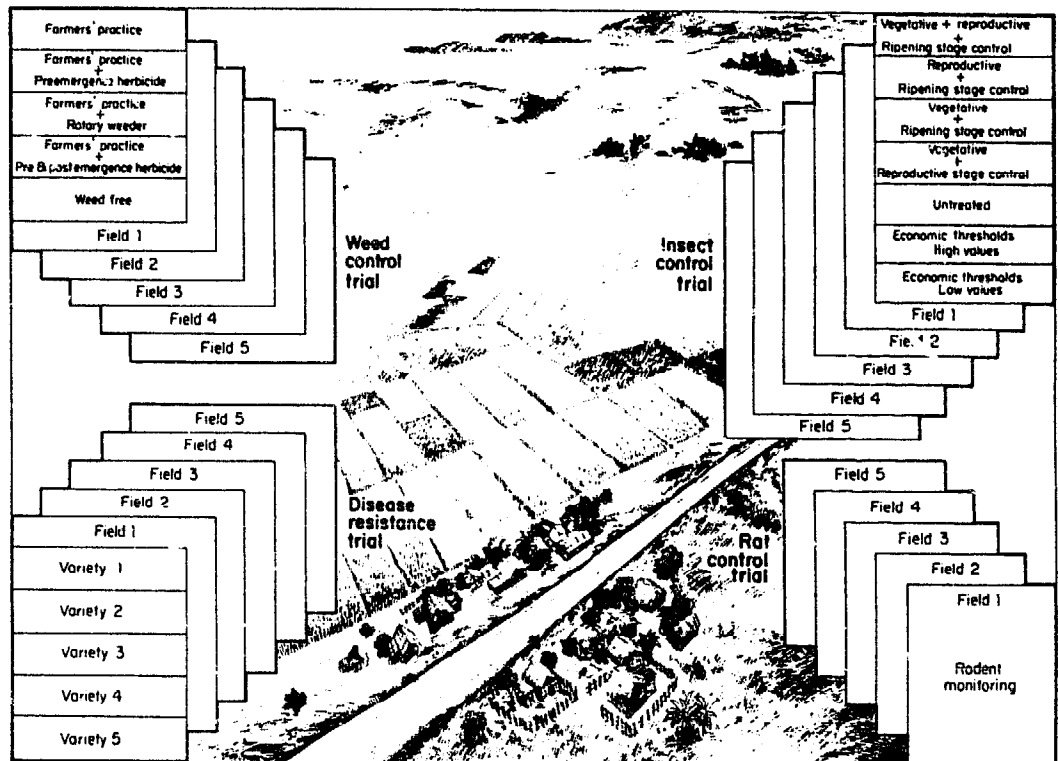

technology is tested. Verification trials such as the following are conducted:

- variety trial to evaluate pest resistance (particularly diseases) and yield potential;
- insect control trial to

measure yield loss at each growth stage and refine and verify economic thresholds. Information on yield loss helps in the interpretation of treatments that will establish economic threshold values.

- weed control trial to measure yield loss and test weed control practices
- rodent control trial to measure population levels and test the suitability of baits and bait holders and other control practices

### Evaluation

Each of the trials should be conducted over at least 2 years for each season until the research team is satisfied that the technology is suitable.

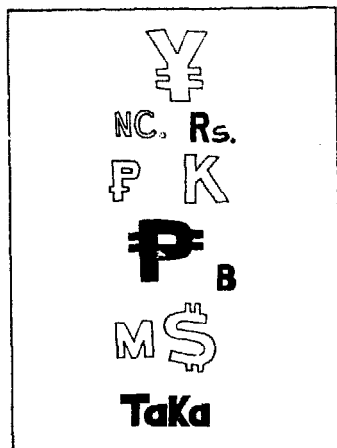

Economic analyses of the pest control technology should include costs-and-returns and benefit-cost ratios.

Returns (profit) should exceed the levels farmers receive from their current pest control practices.

The benefit-cost ratios for material inputs should be higher than two, meaning that there should be at least a two-to-one rate of return from investment costs.

The economist member of the team can evaluate the technology.

### EXTENSION PHASE

After the regional and national integrated pest management teams have tested and formulated an integrated pest management strategy, the information is extended to farmers throughout the target area.

The farmers themselves must be given technological information to be able to diagnose field problems and make management decisions. The functions of a national pest surveillance network are to predict epidemics from

acute pests, monitor the development of biotypes and races resulting from new pest-resistant varieties, participate in the introduction of exotic natural enemies into the country, handle mass rearing and release of indigenous natural enemies, and monitor the development of pesticide-resistant pest populations.

### Farmers' classes

The first step is to hold weekly farmers' classes in several villages (or village units in more populated locations) for an entire crop season. The technical information is explained in the weekly subject matter sessions lasting one to two hours each. Each session involves a short lecture, with demonstrations if possible, followed by question and answer periods and then a field exercise.

Before classes begin, the regional team should invite all farmers in the village to a general meeting to explain the purpose of the classes. The farmers then decide where and when the classes will be held and what subjects to cover first. The subjects should include all aspects of crop production, as the extension officer's responsibilities are broader than simply pest



management. After this meeting the research members of the team no longer are directly involved at the site other than to diagnose problems and prescribe solutions to field problems that trouble the extension officer. However, researchers are accountable for the performance of the technology and must respond if the technology fails in any way.

The extension officer will organize each weekly class and present the information to the farmers. The attitude of the extension officer toward the farmers and the manner in which the classes are conducted are critical to the success of the implementation process.

Classes are only an initial step in the farmers' learning process. Through the classes the farmers should become

exposed to new knowledge that could evoke their curiosity and create in them a desire to attend weekly meetings over succeeding crop seasons to learn more. If farmers' attendance at meetings declines, the extension officer must visit the farmers in their homes more frequently to establish social bonds with them.

Farmers will not be able to assimilate sufficient information over a period of only one crop season no matter how well the information is presented. Therefore, there is no need for elaborate training aids such as movies, colorslides, or handouts. A blackboard is helpful, however. Written quizzes or examinations where farmers are tested should be avoided. The extension officer conducting

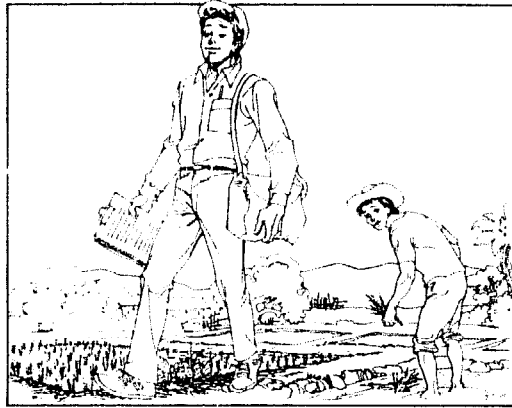

the classes should have sufficient social and technical skills to develop a solid rapport with farmers and gain their respect.

The farmers' opinions and ideas should always be respected, and the extension officer should have no air of superiority. The officer should always come to class on time, as frequent absences will lower farmer attendance at meetings.

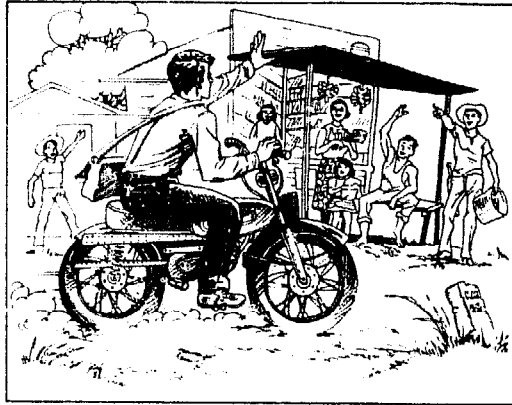

**Follow-up meetings**

Farmers learn to diagnose pest problems and make control decisions through experiences where they are not told what to do but rather have to think on their own. Because the extension officer cannot meet with each farmer in the village regularly — it is important that existing farmers' organizations be utilized. Organizations such as irrigation associations where farmer groupings are based on field location are ideal.

After the farmer classes are over, the extension officer should meet with farmer leaders during succeeding crop seasons. Each farmer leader should represent no more than 20 farmers. These follow-up meetings, again held weekly at a predesignated time, could rotate among the homes of the farmer leaders.

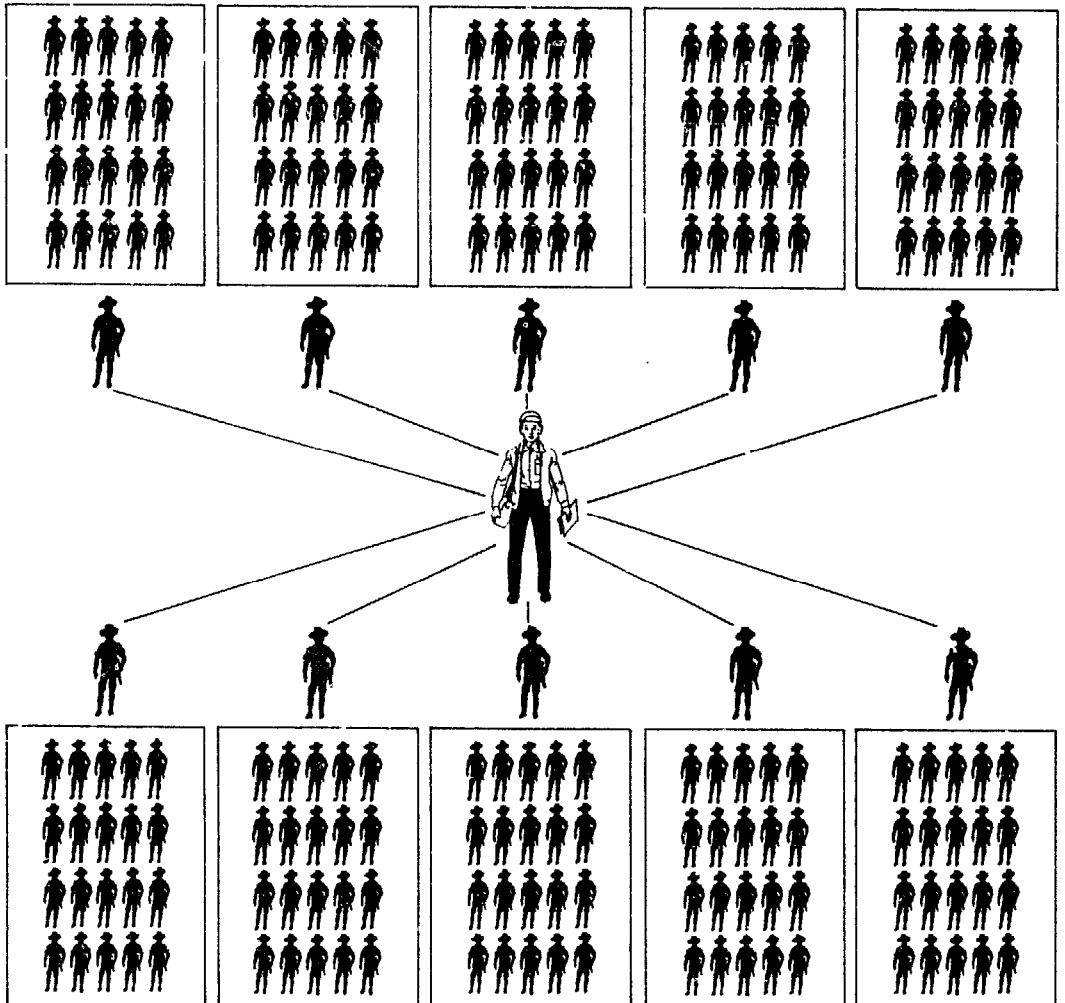

Group decision making is an important aspect of the learning process. Before each weekly meeting each farmer leader needs to meet with his members either in groups or individually and together they will scout their fields to diagnose problems and arrive at solutions. However, the farmers will not carry out any field operations such as pesticide application until after the weekly follow-up meeting with the extension officer.



Each follow-up meeting may last one to two hours. Half of the time is spent on discussions at the home of one of the farmer leaders and the other half in a short verification tour in the field.

The farmer group leaders report to the extension officer the problems they diagnosed and the action that they believe should be taken. The extension officer notes down the problems and the farmers' solutions but does not make a decision until they are in the fields. There

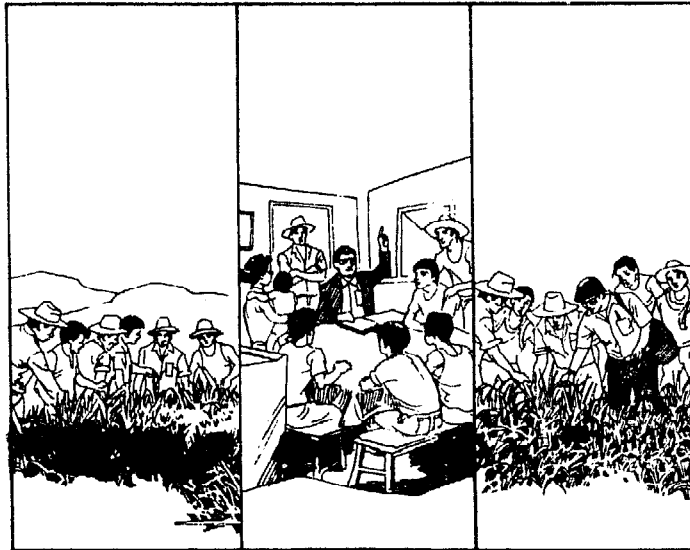

the problems are shown to the extension officer who confirms or rejects the farmers' diagnoses and solutions. During the field tour the extension officer can point out problems overlooked by the farmers.

The farmers can learn a little more from the discussion in the field. The problems brought out in the follow-up meetings may deal not only with pests, but all crop production problems. These small lessons learned each week, however, must focus on problems as they naturally develop in the field.

The extension officer should be responsible only for technology. Direct involvement in a credit program will lessen his or her effectiveness.

The extension officer needs the support of the regional and national integrated pest management teams in confirming problem diagnoses and in presenting latest technologies.

As the farmers' capabilities in problem diagnosis and decision making progress over several crop seasons, the frequency of follow-up meetings may be reduced to twice a month and, eventually, to only two or three meetings per crop season.

Farmers not only can begin to monitor field problems for themselves but also can extend these skills to other farmers.

Because pest problems and solutions change with time, there will be a continual need for the extension officer to maintain scheduled visits to each village. Each extension officer can readily cover 6 to 10 villages or village units.

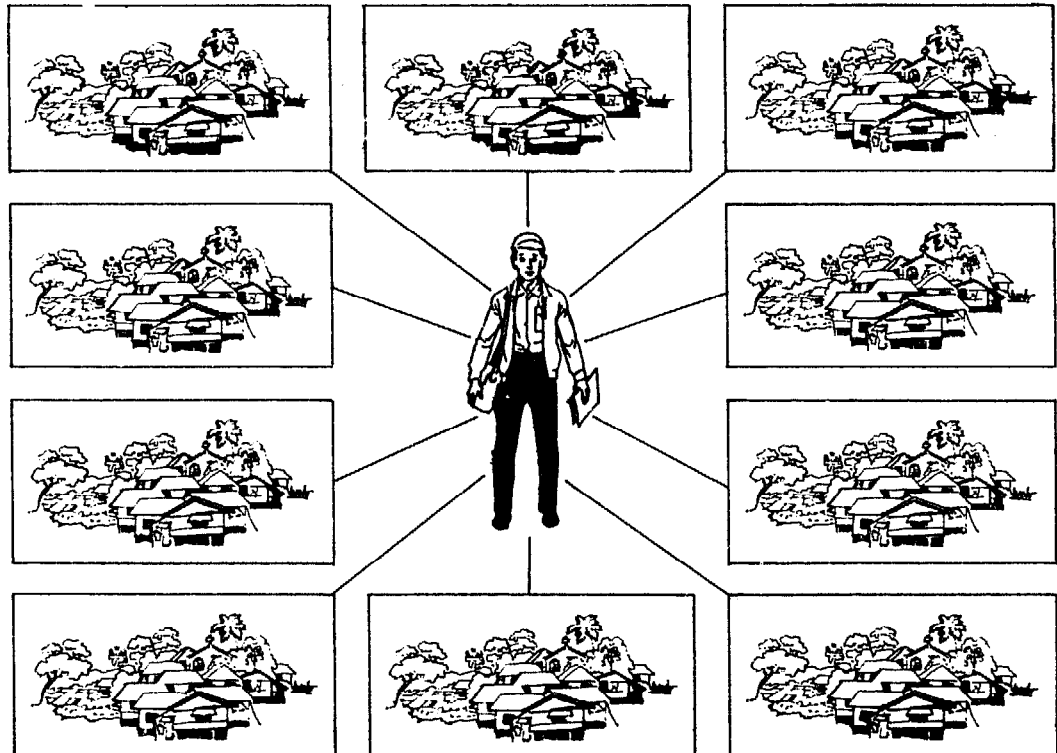

# APPENDIX

## Arthropod Identification Service

### Guidelines for preparing specimens

- Immature (soft-bodied) specimens
  - Kill by immersing in hot (not boiling) water for 10 minutes.
  - Transfer to 1) vials containing a mixture of 80 parts 85% alcohol, 5 parts glacial acetic acid, 5 parts glycerine, and 10 parts clean water, or 2) vials containing 80% alcohol.
  - Fill each vial to overflowing (no air bubbles) before capping.
  - Dip the capped end of the vial in molten candle wax or paraffin to seal.
- Adult (hard-bodied) specimens
  - Specimens larger than 5 mm*
    - Pin or wrap in soft tissue paper (do not wrap in cotton, which is very difficult to untangle from specimens).
    - Dry specimens after pinning and before wrapping.
  - Specimens smaller than 5 mm*
    - Preserve in vials filled to overflowing with 80% alcohol.
    - Dip the capped end of the vial in molten candle wax or paraffin to seal.
- Information label for each specimen, either pinned/wrapped or preserved in alcohol, should contain
  - Type of rice culture and environment,
  - Stage of the host — egg, larva, pupa, or adult — if specimen is a parasite.
  - Name of collection area and distance to nearest town that can be found on a popular road map, and
  - Collection date and name of collector.
- Prepare 5 male and 5 female, and 10 immature specimens of each arthropod to be identified.

### Shipping specimens

- Pinned or wrapped specimens
  - Remove all preservative crystals from boxes of dried, pinned, or wrapped specimens before shipping.
  - Pin specimens in a strong box that is provided with a strong pinning bottom such as cork to hold pins (Fig. 1).
  - Place additional pins on each side of every pinned insect to prevent movement.
  - Place a layer of cardboard on top of the pins.
  - To hold specimens snugly, place a layer of cotton between the cardboard and the top of the box.
- Specimens in liquid
  - Wrap with cotton each vial containing specimens preserved in liquid.
- Packing for shipment
  - Pack vials or the pinning box in a larger container (Fig. 2).
  - If you are shipping specimens in vials and specimens in a pinning box, keep the two containers separate from each other in the large shipping container.
  - The shipping container should be large enough to permit surrounding the specimen boxes with at least 5 cm of packing material on all sides and on the top and bottom.
  - Include your name and address in the shipping box.

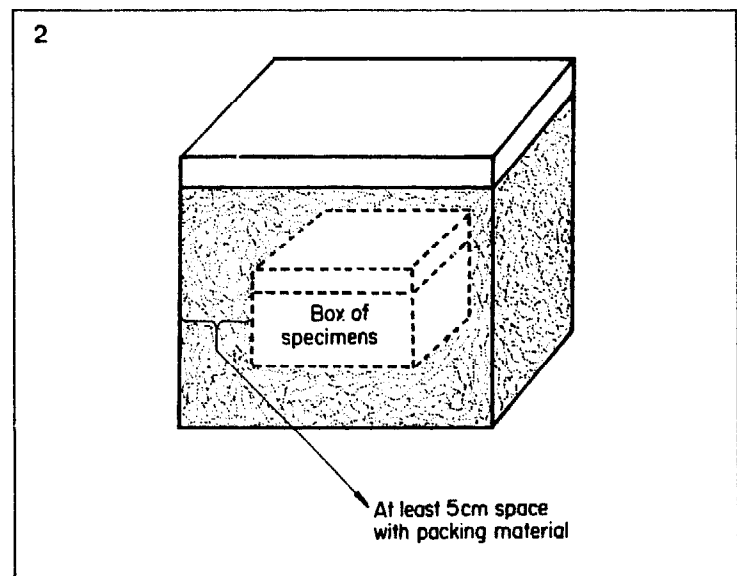
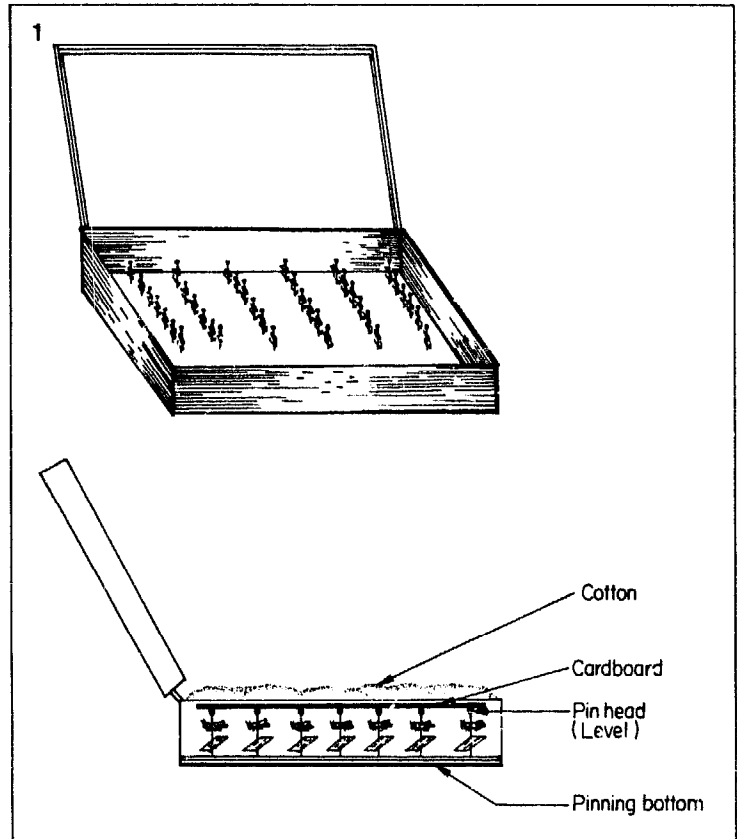

- Enclose in the box copies of any letters sent separately.
- Send specimens to:

Entomology Department  
IRRI, P. O. Box 933  
Manila, Philippines



# GLOSSARY

- Accumulative pesticide.** A pesticide which tends to build up in the tissues of animals, plants, or the environment.
- Acute toxicity.** How poisonous a pesticide is to an animal or man after a single exposure.
- Adult.** The mature stage of an insect which occurs after the nymphal or pupal stages. Adults have mature sexual organs and usually have wings.
- Adult activity.** Abundance of adult insects as indicated by light trap catches.
- Alternate host.** One of the two or more kinds of plants on which an insect or disease may complete its life cycle.
- Annual.** A plant which completes its life cycle in one year or less. The plant dies after flowering or maturity.
- Antibiosis.** A type of varietal resistance in which insects do not grow, survive, or reproduce well on the plant.
- Anticoagulant.** A chemical used for rodent control which when eaten prevents blood clotting by interfering with vitamin K. It causes the rat to bleed to death.
- Antidote.** A remedy to counteract the toxic effects of a pesticide such as atropine sulfate for carbamate and phosphate poisoning.
- Ascospore.** The spore produced by fungi in a sac-like body called the ascus.
- Awn (syn.: arista, beard).** A bristle-like extension of varying length originating from the lemma of the rice grain.
- Bacterium (pl., bacteria).** Primitive, one-celled, microscopic organisms which reproduce by fission. Some bacteria infect rice and produce disease symptoms.
- Bait.** A food substance, mixed with a pesticide, which attracts a pest to eat the pesticide.
- Bait shyness.** Occurs when rats learn to associate their illness with poison bait upon which they have fed and stop feeding on it.
- Beneficials.** Parasites and predators which kill insect pests and therefore help reduce insect pest populations.
- Biological control.** The man-directed control of insect pests by employing natural means such as predators, parasites, or pathogens.
- Biotype.** A population of insects that is capable of surviving on and damaging varieties that are resistant to other populations of the same insect species.
- BPH.** Abbreviation for brown planthopper.
- Bract.** A leaf from the axis of which a flower arises.
- Broadcast application.** To spread pesticide granules by hand or machine randomly over a surface area.
- Chlamydospore.** A thick-walled, resting fungal spore; also used for smut spores.
- Chronic toxicity.** How poisonous a pesticide is to an animal or man after small, repeated doses over a period of time.
- Clod.** A mass or lump of aggregated soil, usually clay soil.
- Cocoon.** A silken case made by the larva and inside which an insect pupa develops.
- Coleoptile.** Appearing at seed germination, the cylinder-like, protective covering that encloses the young plumule.
- Common name.** A universally accepted name given a pesticide by an appropriate professional organization.
- Condensation.** The reduction of water vapor to a liquid on the leaf surface.
- Conidium (pl., conidia).** Any asexual fungal spore except sporangiospore, or chlamydospore.
- Contact herbicide.** A herbicide which affects only those plant parts with which it comes in contact.
- Cultural control.** The use of agronomic practices such as soil tillage, varying planting time, fertility levels, sanitation, water management, and short-duration cultivars to reduce pest populations.
- Damage (plant).** Destruction, injury, or loss in value caused by the feeding activity of insects and rats or by disease infection or by weed infestation.
- Deadheart.** Dead rice tiller caused by a stem borer which girdles its base.
- Defoliation.** Removal of leaves or portions of leaves from a plant.
- Dermal toxicity.** How poisonous a pesticide is to man or animal when absorbed through the skin.
- Dew.** Moisture condensed from the atmosphere which forms small drops on the surface of plants. Hot days and cold nights produce condensation.
- Direct damage.** Plant damage caused by the feeding of an insect through the removal of plant sap or plant parts as compared with indirect damage caused by a disease transmitted by an insect which causes delayed symptoms.
- Direct seeding.** A rice planting system in which seeds (either pregerminated or dry) are sown directly in the field.
- Disease.** A condition in which use or structure of any part of the living organism is not normal.
- Drift.** Movement by the wind or air currents of a pesticide in small droplets or as dust particles from the target area to an area not intended to be treated.
- Drizzle.** A light rain falling in small drops.
- Dryland (syn., upland).** Level areas without levees and sloping areas which are not terraced where rice is grown during the rainy season without retaining water in the field.
- Dust.** A finely ground dry mixture containing a small amount of pesticide and a carrier such as clay, talc, or volcanic ash. The dust is carried to the rice plants by the wind.
- Ecology.** In weed science it is the study of the effect of climatic, soil, topographic, and biotic factors on weed populations.
- Economic injury level.** The pest population density where the loss caused by the pest is greater than the cost to control the pest. The pest density at which artificial control measures are economically justified.
- Economic threshold.** The pest density at which artificial control measures should be applied to prevent an increasing pest population from reaching the economic injury level. It is a control action threshold which tells the farmer when he must take action to prevent a pest outbreak.
- Egg.** In insects, the reproductive body in which the embryo develops and from which the nymph or larva hatches.
- Egg mass.** A group of eggs deposited by the female insect which are adjacent to each other as in the rice bug or overlapping such as in the yellow stem borer as opposed to eggs laid singly.
- Emergence (insect).** Act of an adult insect leaving the pupal case or last nymphal skin.
- Emigrate.** Movement of animals such as insects or rats away from a particular area.
- Emulsifiable concentrate.** A pesticide formulation with a large amount of active ingredient dissolved in a liquid, plus an emulsifying agent. When water is added an emulsion or opaque liquid is formed.
- Eyespots.** Eyes of an insect embryo within an egg which appear as spots through the egg shell.
- Fallow.** Land that is ordinarily used for crops but allowed to lie idle.
- Flag leaf.** The uppermost rice leaf originating just below the panicle base.
- Flowable.** A liquid chemical formulation in which finely ground, solid particles of pesticide are suspended in a small amount of liquid.
- Footprint.** An impression of an animal's (such as a rat) foot in a soft or wet soil or on a tracking tile.
- Formulation.** The form in which a pesticide is sold for use, e.g. dust, granule, wettable powder, emulsifiable concentrate, etc.
- Fungus (pl., fungi).** An organism with no chlorophyll, reproducing by sexual or asexual spores, usually with mycelium with well marked nuclei.
- Gall.** An abnormal plant growth, swelling, or tumor induced by another organism such as an insect.
- Generation.** The time between birth and reproduction of an individual.
- GLH.** Abbreviation for green leafhopper.

- Granule.** Pesticide impregnated on dry particles, larger than those used as a dust which allows it to be spread by hand.
- Growing point.** Mass of meristematic tissue at the stem tip where growth in length of the stem occurs.
- Habitat.** In weed science, a location or site where a weed commonly grows, as in ricefields, levees, and irrigation canals.
- Hatching.** The emergence of a nymph or larval insect from the egg.
- Herbicide.** Chemical used to kill or prevent growth of weeds.
- Hibernation.** A period of arrested development usually due to cold temperatures.
- Hill.** A group of rice plants directly adjacent to each other because the seeds or seedlings were planted together. A hill may also consist of only one plant.
- Hopperburn.** Drying up of rice plants caused by the feeding of leaf and planthoppers which remove plant sap.
- Horizontal resistance.** A general resistance, controlled by many minor genes, which provides resistance (usually moderate) to all disease races or insect biotypes of a given species.
- Host.** The organism on which a parasite lives; the plant on which a pest feeds.
- Host plant.** A plant species which serves as a source of food, shelter, or as an oviposition site for various organisms.
- Humidity.** The amount of water vapor in the air.
- Hypersusceptibility.** A type of resistance to a disease in which invaded cells are killed so quickly that the disease remains localized and cannot spread throughout the plant.
- Immigrate.** Movement of animals such as insects or rats into a particular area.
- Immunity.** A type of resistance to disease in which the rice plant is not attacked under any conditions. Rice cultivars are rarely immune to rice diseases.
- Inhalation toxicity.** How poisonous a pesticide is to man or animal when it is breathed in.
- Insect.** Members of phylum Arthropoda ("jointed legs") with unique characteristics of six legs, division of the body into three distinct body regions (head, thorax, and abdomen), and wings.
- Integrated rice pest management.** Management of rice pests including diseases, insects, weeds, and rodents at populations below the economic injury level through the use of combinations of two or more control methods such as biological and chemical control.
- Label.** Information attached to the pesticide container which should include the name of the pesticide, manufacturer's name, net content, ingredient statement, warning statement, directions for use and antidotes for accidental poisoning.
- Larva.** An immature stage of an insect occurring between the egg and pupal stage in insects having complete metamorphosis.
- Latent period.** Incubation period of a virus in an insect. The time between acquisition of the virus and the time when the insect becomes infective.
- LC (lethal concentration).**  $LC_{50}$  refers to the concentration required to kill 50% of test animals in a given time period.  $LC_{50}$  values are expressed in mg pesticide/liter of air or liquid.
- LD (lethal dose).**  $LD_{50}$  refers to the dose of pesticide required to kill 50% of test animals in a given time period.  $LD_{50}$  values are usually expressed in  $\mu$ g pesticide/g or mg pesticide/kg body weight of the test animal.
- Leafhopper.** Insect of the order Homoptera, family Cicadellidae, which feeds by removing sap from veins in leaves of the rice plant. More slender and quick moving than planthoppers.
- Leaf sheath.** The lower part of the leaf originating from a node and enclosing the stem (culm) above the node.
- Leaf veins.** Vascular bundles of the leaf seen, externally in monocotyledonous plants such as rice, as longitudinal ridges.
- Lemma (syn., outer glume).** The hardened 5-nerved bract of the floret partly enclosing the palea.
- Lesion.** Localized spot of diseased tissue on a plant part.
- Levee.** Dike made of soil to retain water in rice fields.
- Life cycle.** The stages in the growth and development of an organism that occur between the appearance of the individual and its death or reproduction.
- Light trap.** A device used to collect insects, consisting of a light source which attracts insects at night and a mechanism which traps the insects.
- Liquid formulation.** Pesticide formulations which are applied as sprays, for example, emulsifiable concentrates and flowable formulations.
- Lodging.** To fall down. Characteristic of rice cultivars with weak stems to fall over when under the influence of strong winds. Lodging is most common near harvest when the upper portion of the plant is heavy because of the weight of the grain. High nitrogen, high plant populations, and weed competition contribute to lodging.
- Management (pest).** Management of pest populations through the use of monitoring methods and the employment of control measures based on economic thresholds.
- Midrib.** Central vein of the leaf.
- Milk stage.** Stage occurring during the ripening phase of rice growth and development when the inside of the grain is at first watery but later turns milky in consistency.
- Mine.** A cavity between the upper and lower surface of a leaf caused by the removal of plant tissue by the feeding of an insect larva.
- Modern varieties.** Dwarf, stiff-stemmed, high-tillering, nitrogen-responsive, photoperiod-insensitive high yielding varieties in contrast to traditional varieties (cultivars).
- Molt.** In insects, the process of shedding the skin.
- Monitor.** To make regular observations to determine the density or feeding activity of a pest population.
- Multiple crops.** Two or more crops in the same field in a year.
- Mycoplasma.** Virus-like agents.
- Natural enemies.** Pathogens, parasites, and predators which regulate populations of insect pests.
- Node.** The solid portion of the jointed stem. Leaves, tillers, and adventitious roots arise from nodes on the stem.
- Nonpreference.** A type of resistance in which insects do not feed upon, oviposit in, or use a plant for shelter.
- Nontarget organisms.** Organisms such as beneficial insects against which pesticides are not directed.
- Nymph.** In certain insects, the stage of development immediately after hatching; resembling the adult but lacking fully developed wings and sexual organs.
- Oral toxicity.** Toxicity of a pesticide which enters the body through the mouth.
- Outbreak.** A sudden increase in a pest population resulting in economic damage to the rice crop.
- Oviposition.** The act of laying or depositing eggs.
- Palea.** The hardened 3-nerved bract of the floret which fits closely to the lemma. It is narrower than the lemma.
- Panicle.** The terminal shoot of the rice plant that produces grain.
- Parasite.** An insect (commonly a wasp or fly) whose larvae develop within the body of its host and usually feed on a single host and destroy it.
- Perennial.** Plants which require more than one year to complete their life cycle.
- Perithecium (pl., perithecia).** In fungi, a globular to flask-shaped body having a hole through which ascospores are released.
- Persistent pesticides.** Pesticides which remain unchanged in the environment for long periods. They are not readily broken down into single components by microorganisms, enzymes, heat, or ultraviolet light.
- Pest.** An unwanted organism which competes with people for food and shelter, or threatens their health, comfort, or welfare.
- Pesticide.** Any substance used to control pests including insecticide, herbicide, fungicide, bactericide, rodenticide, or nematocide.
- Photoperiod-sensitive cultivars.** Cultivars which will not flower unless exposed to certain day lengths.
- Phytotoxicity.** Plant injury caused by chemicals or some other agent. Common symptoms are spotting, wilting, stunting, tiller spreading, and twisting of leaves.
- Planthopper.** Insect of the order Homoptera, family Delphacidae, which feeds by removing sap from leaf veins along the lower portion of the rice plant. Usually more stout and slow moving than leafhoppers.
- Predator.** An animal that attacks or feeds on other animals.
- Prey.** The animal on which a predator feeds.
- Pupa.** A nonfeeding and usually inactive stage which occurs between the larval and adult stages of insect development.

- Race.** Population of a disease organism that is capable of surviving on and damaging cultivars (varieties) that are resistant to other populations of the same pest species. Same as biotype in insects.
- Rate.** The amount of active ingredient of a pesticide applied to a unit area.
- Ratoon.** New tillers which grow from the stubble of harvested plants. These new tillers constitute the ratoon crop.
- Rats.** Rodents of the genus *Rattus* and other allied genera distinguished from mice by their larger size and difference in teeth and other structures.
- Reproductive stage.** From panicle initiation to flowering; a stage when the plant matures sexually.
- Resistance to pesticides.** The ability of populations of pests to survive doses of a pesticide which are normally lethal.
- Resistant variety.** A variety which produces a larger amount of a good quality crop than other varieties when grown under the same conditions and exposed to similar populations of insects or diseases.
- Resurgence.** Significantly more damage or more insects in an insecticide-treated crop after insecticide application than in an untreated crop.
- Retention period.** In insect disease transmission, the period after acquisition feeding during which an insect is able to transmit a virus disease.
- Ripening stage.** From flowering to reproductive maturity.
- Root dip.** Placing the roots of rice plants in a solution of insecticide for a period of less than 12 hours. After that it becomes a root soak.
- Rotale.** To plant a different crop species each season, such as rice in the wet season and cowpea in the dry season.
- Runway.** Area regularly walked on by rodents resulting in a path.
- SBPH.** Abbreviation for small brown planthopper.
- Sclerotium (pl., sclerotia).** Resting mass of fungus tissue often more or less spherical, normally having no spores.
- Secondary pests.** Pests which because of natural control agents normally have low populations and do not require chemical applications.
- Seedbed.** The bed on which rice seeds are sown consisting of soil (wet-bed method) or banana leaves and plastic sheets ("dapog method").
- Seedling.** From rice seed germination to tillering during which the plants grow to the five-leaf stage.
- Selective pesticide.** A pesticide that kills a certain pest or group of pests but not natural enemies.
- Soil incorporation.** Mixing or working a broadcast granular insecticide into the top several centimeters of the soil before transplanting.
- Soluble powder.** A finely ground, solid pesticide that will dissolve in water to form a solution.
- Spikelet.** A unit on the rice panicle consisting of one or more flowers and their bracts.
- Spore.** A single- to many-celled reproductive body in the fungi.
- Spray.** To apply minute particles of liquids containing a pesticide.
- Staggered planting.** Planting different fields in a community or a farm over a period of several weeks in contrast to simultaneous planting where planting of all fields is done over a period of a week or less.
- Stamen.** Male part of the flower consisting of the pollen-bearing anther and the filament.
- Stem (syn., culm).** For rice, a round, smooth surfaced, upright portion of the plant consisting of hollow internodes joined by solid nodes.
- Stomata.** A small opening, controlled by the guard cells, in the epidermis of the leaf or other plant parts.
- Stubble.** The lower portion of the stem remaining in the field after the rice has been harvested.
- Sustained baiting.** A type of rat control in which poisoned bait is continuously available in bait holders from shortly after transplanting until 2 weeks before harvest or until bait consumption stops.
- Sweep net.** A device for collecting insects from plants, consisting of a cone-shaped net attached to a handle that is moved in a 180° sweeping motion across plants.
- Systemic pesticide.** A pesticide that is absorbed through the roots or upper plant parts and is translocated within the plant.
- Tapping hills.** To strike hills of rice with the hand to dislodge insects.
- Target pest.** Pest against which control measures are directed.
- Tiller.** A stem and its leaves.
- Tolerance.** A tolerant rice variety is infested by insects and diseases and may show damage or develop symptoms, but the crop yield is greater than that of susceptible varieties.
- Toxicity.** How poisonous a pesticide is to a living organism.
- Tracking tile.** White linoleum or vinyl flooring square, one-half coated with printer's ink, and used to detect rat activity by recording their footprints.
- Trade name (proprietary or brand name).** Name given a pesticide by its manufacturer or formulator. One pesticide may have many trade names.
- Traditional cultivars.** Tall, weak-stemmed, low-yielding cultivars grown by farmers for many years and which lodge under high fertilizer rates, in contrast to modern cultivars (varieties).
- Transplant.** To remove seedlings from the nursery (seedbed) and plant in the field either by hand or mechanically.
- Tuber.** Enlarged, fleshy, underground stem.
- Vector.** An insect which transmits a disease.
- Vegetative stage.** From germination to panicle initiation.
- Vertical resistance.** Varieties with this type of resistance, which is controlled by one or a few major genes, are usually highly resistant to one or several disease races or insect biotypes of a given species but are susceptible to others.
- Viruliferous.** Virus-carrying; an insect that has been given access to a virus source.
- Virus.** A submicroscopic infectious agent consisting of particles made up of DNA or RNA which are usually covered by protein and reproduce only in living cells.
- Virus transmission.** Transmission of a virus to a plant by insect vectors.
- WBPH.** Abbreviation for whitebacked planthopper.
- Weed.** Any unwanted plant that is injurious to the rice crop.
- Wetland (syn., lowland).** Level areas with levees prepared wet or dry that are flooded by water from either irrigation (irrigated) or rainfall (rainfed).
- Wettable powder.** A pesticide formulation in the form of a powder that is mixed with water to be applied. It does not dissolve in water, but forms a suspension.
- Whitehead.** White, empty panicle resulting from the attack of a stem borer which cuts the lower portion of the stem.
- Wild rice.** Species of *Oryza* other than *O. sativa*; usually a noncultivated species.