

AT MICROFICHE
REFERENCE
LIBRARY

A project of Volunteers in Asia

The Employment of Draught Animals in Agriculture

by: Research & Experimental Centre for Tropical
Mechanical Agricultural Equipment

Published by:

Food and Agriculture Organization of the
United Nations
Via delle Terme di Caracalla
00100 Rome
Italy

Paper copies are \$16.75.

Available from:

UNIPUB
P.O. Box 433
Murray Hill Station
New York, NY 10157 USA

Reproduced by permission of the Food and
Agriculture Organization of the United Nations.

Reproduction of this microfiche document in any
form is subject to the same restrictions as those
of the original document.

*THE EMPLOYMENT OF DRAUGHT ANIMALS
IN AGRICULTURE*



Issued by arrangement with
CENTRE D'ÉTUDES ET D'EXPÉRIMENTATION DU MACHINISME AGRICOLE TROPICAL
by the
FOOD AND AGRICULTURE ORGANIZATION OF THE UNITED NATIONS

While the benefits of power mechanization in agriculture have long been widely acclaimed, the offsetting difficulties and disadvantages of the use of mechanical traction in certain circumstances and areas have been recognized only more recently.

The authors do not claim that the farmer must make use of draught animals and the related cultivation equipment in addition to his traditional or imported hand tools. But there are many examples which confirm that in tropical regions he should employ animal traction whenever possible and power mechanized equipment when justified or essential.

The text considers the draught animals generally employed, the implements involved, the rural skills required so that the animals and the implements may be used to best advantage, and the economic considerations having a major influence upon the rational use of animal traction.

The manual was originally issued in French by the *Centre d'études et d'expérimentation du machinisme agricole tropical* as No. 13 in the series *Techniques rurales en Afrique*.

MANUAL ON THE EMPLOYMENT OF DRAUGHT ANIMALS
IN AGRICULTURE

Issued by arrangement with the CENTRE D'ETUDES ET D'EXPERIMENTATION
DU MACHINISME AGRICOLE TROPICAL

by

THE FOOD AND AGRICULTURE ORGANIZATION OF THE UNITED NATIONS

Rome 1972

**Unipub is the exclusive
United States distributor of
this publication.**

Kindly indicate in any review or
listing that the publication is
available from:

unipub

Box 433 Murray Hill Station
New York, NY 10016

Please send us two copies of your
review or listing.

Price:

unipub

Box 433 Murray Hill Station
New York, NY 10016

© Centre d'études et d'expérimentation du machinisme
agricole tropical, 1968

© English translation: Food and Agriculture Organization of the
United Nations, 1972

Printed by FAO at its Headquarters in Rome, Italy

FOREWORD

The original version of this manual on the Employment of Draught Animals in Agriculture was published in French in 1968 at the request, and with the assistance, of the Secretariat of State for Foreign Affairs of the French Republic. Its preparation was entrusted to the Research and Experimental Centre for Tropical Mechanical Agricultural Equipment (C.E.E.M.A.T.), in cooperation with the Institute of Stock-raising and Veterinary Medicine in Tropical Countries (I.E.M.V.T.).

Its purpose was to provide the officers and technicians of the agricultural services of the French-speaking African states with a manual to be used in the preparation and conduct of animal draught mechanization operations. This aim was fully justified since this method of draught is extensively used in the agriculture of many countries where the great majority of the farmers work small areas on a family basis and do not have sufficient income to change over quickly to power mechanization. Animal draught cultivation, wherever it is possible, enables the farmer to improve his working conditions and his productivity. Its use, however, must in no way imply condemnation of power mechanization, appropriate standards for which are now being worked out for tropical Africa.

The manual, including more than 250 pages with illustrations, has achieved a well-deserved success and a second French edition is now in course of distribution.

FAO felt that a manual of this kind met a real requirement, not only for French-speaking tropical Africa, but also for many other regions or countries where the level of rural development and general conditions are such as to encourage animal draught cultivation. This is why FAO offers a translation of this manual for use by English-speaking agricultural officers and technicians. We feel sure that they will appreciate its practical value for field operations.

The authors have provided technical details of a very wide range of equipment, manufactured mainly in France and in 17 other countries. This English edition does not give the names of the individual manufacturers.

FAO is most grateful to the Secretariat of State for Foreign Affairs of the French Republic for permitting this translation; and to the Swedish International Development Authority (SIDA) which granted the funds required for the translation, editing and printing of the present version. This publication is a happy indication of the identity of views and the valuable cooperation which can be established between multilateral cooperation and bilateral aid organizations.

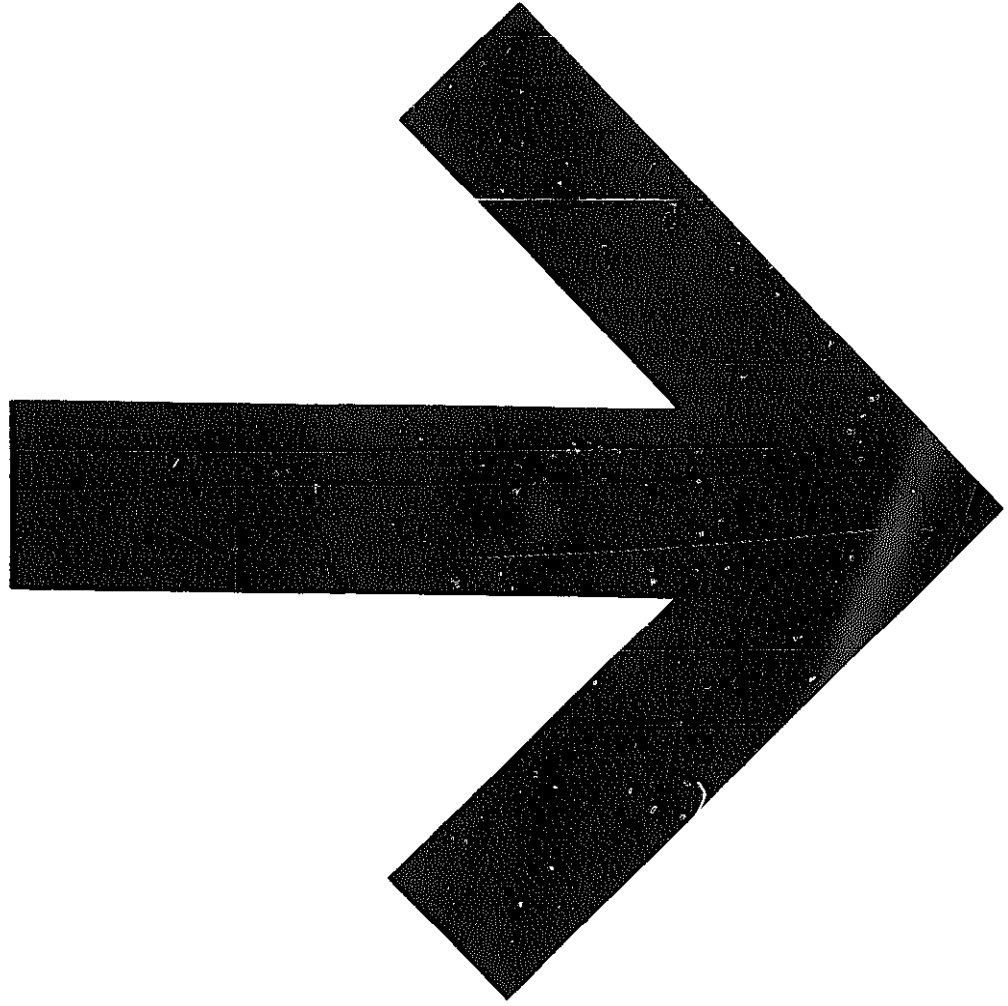

C O N T E N T S

	<u>Pages</u>
FOREWORD	i
INTRODUCTION	iv
PART I	
- Draught Animals Available in Africa	
I Species and Breeds	2
II Choice of Animals	11
III Health Control when Buying	14
IV Care of Animals and Hygiene	17
V Weight and Power of Draught Animals	23
VI Training of Bovines	32
VII Housing of the Animals	40
VIII Feeding - Production and Conservation of Feed	45
IX Production of Manure, Litter	59
X Harnessing Methods according to Species and Breed	60
PART II	
I Animal Draught Agricultural Implements	73
II Soil Preparation in Rainfed Farming	79
III Implements for Working the Soil when Dry	82
IV Equipment for the Soil Preparation of Irrigated Rice Fields	125
V Precision Sowing Transplanting - Broadcast Sowing	156
VII Harvesting Equipment	174
VIII Transport: Ox, Horse and Donkey Carts	184
PART III	
Draught Animals - A Source of Energy for Raising Water and other Tasks	200
PART IV	
- Rural Handicrafts	203
I Present Status of Rural Handicrafts	204
II Improvement of Rural Handicrafts	207
III From Rural Artisan to Dealer Repairer	215

	<u>Pages</u>
PART V	
- Economic Consideration	219
I Mechanization and Progress in Tropical Agriculture	219
II Amount of Capital to be Invested, Maintenance and Amortization	221
III Comparison of Time and Cost of Cultivation by Hand, with Draught Animals and with Power Equipment	226
IV Combination of the Three Cultivation Methods	235
ANNEX : Simple Method of Calculating the Cost of Using Draught Animals in Tropical Countries	238
Bibliography	246

INTRODUCTION

This manual is mainly concerned with the application of animal draught equipment, a form of agricultural mechanization predominant in the tropical regions of Africa including Madagascar.

This does not mean that we only mention what is already in existence in these regions. On the contrary, all sources of information have been used, both those which are at present used in the other developing countries and those which have more or less been given up in countries which have progressed beyond this stage.

The mechanization of agriculture may be understood in various ways.

This manual deals with the use of implements operated, directly or indirectly, by domesticated animals, with particular reference to those pulled by the animals which may be available to certain farmers.

Animal draught cultivation methods in Africa have developed fairly recently and usually sporadically and very unevenly. This stems from historical factors, primarily the human element, as well as from agronomic considerations and from the animals themselves.

There is, however, considerable interest in animal draught cultivation. Indeed, by making use of it, the farmer reduces his heavy physical work and increases the productivity of his work and his crop production and thus improves his lot. In the countries in which we are interested, this form of mechanization is applicable in many regions and concerns numerous populations which, at present, generally only use hand tools for their own food crops or for cash crops.

It may be wondered why the farmers should not be encouraged to benefit from the advantages of another form of agricultural mechanization, i.e. power mechanization. In this introduction, we set out the reasons which we consider are against the immediate and general introduction of "power equipment" into the normal cultivation operations in the countries concerned.

BACKGROUND AND PRESENT STATUS OF ANIMAL DRAUGHT EQUIPMENT

The use of the power of domestic animals has had a profound effect on the history of civilizations. In South-East Asia, in the Middle East and in certain countries bordering on the Mediterranean, the use of draught animals continues to be predominant for the cultivation of the soil. Similar methods have been in use for a thousand years or so. The situation, however, is quite different in the countries in which we are interested. While the buffalo pulling a plough in a rice-field may be an integral part of the South-East Asian country scene, the pair of oxen harnessed to a hoe is still an extremely rare sight in the cotton-fields of Tropical Africa.

In regions where the ecological conditions permit large domestic animals to live, it may be wondered why man has not always made use of this source of energy.

The reason is that, in most cases, crop cultivation and animal husbandry are traditionally carried on by two separate categories of the rural population, on the one hand those who cultivate crops and, on the other, the stock-raisers. Furthermore, the

fields are usually cultivated on a shifting cultivation basis while the stock-raiser is more the shepherd type. Although he is accustomed to animals, he does not know how to train them nor how to operate agricultural implements.

With rare exceptions, it was only between the two world wars that equipment was introduced in regions where there were large herds in an attempt to popularize the use of draught animals for cultivation. It was thought that this would be the easiest way to introduce animal draught equipment.

In most cases, operations started with the use of oxen (in Guinea, Mali, Nigeria and certain areas of East Africa and Madagascar about 50 years ago). In some cases (in Senegal for example), to provide the relatively small effort needed for pulling ground-nut planters, equines were initially used, first donkeys and then, quite soon after, horses.

Gradually, and despite all sorts of difficulties and prejudices which had to be overcome, the use of animals has become normal to the farmer, even in areas where, only a few years ago, it would have been unthinkable to consider the introduction of animal draught cultivation.

The first implements imported varied according to region and type of cultivation. In the first instance, their aim was to reduce particular difficulties with certain types of cultivation, such as insufficient speed of sowing for ground-nuts in Senegal and excessive manual effort for hoeing in the rice-fields of Mali and Guinea. Initially, it was not a question of introducing a new method of cultivation but of applying more power, by means of draught animals, to certain cultivation operations. At the same time, however, that certain implements were being popularised in rural areas, the research and experimental Centres and Stations were working with a full range of tillage implements in various crops, using as wide as possible a range of implements, at the same time making use of animal manure as fertilizer. Near these Centres, similar experiments were carried out, generally on a village scale.

The first implements introduced were selected from among those still in use in temperate regions. Fairly quickly, however, various manufacturers made available tools which were better adapted to the working conditions, to the requirements and capabilities of the farmers as well as to the available tractive power. The countries which were the last to be reached by animal draught mechanization thus had the good fortune to be provided with equipment better suited to their local conditions.

The main incentive for the development of animal draught cultivation was often the hope of increasing the production of agricultural produce for export.

Rice, however, also benefited, for example in Guinea and Madagascar, from the introduction of animal traction. As well as assisting farmers in the production of subsistence crops, it also permitted regional and even international trade (Madagascar for luxury quality rice). The implements used were, almost exclusively, various types of ploughs and cultivators. The same applied, and still does, in East Africa, despite the relatively large number of implements in use.

A variety of implements were used for ground-nut cultivation. In Senegal, despite initial efforts at diversification, the planter was, until recently, the only implement accepted by the farmers, whereas in the north of Nigeria, the ridging plough, which has allowed ground-nut cultivation to be extended so that exports have been increased, remains the only draught implement used.

Cotton, on the other hand, had hardly been affected by any extension of mechanization until the end of the last world war. Since then, and particularly in the last few years, in various French-speaking tropical countries, there is a tendency,

within the framework of "integrated operations", to mechanize cotton cultivation. A range of draught cultivation equipment has been used varying from area to area. This has included primary and secondary tillage equipment and transport equipment.

The extension of equipment for advanced cultivation methods has led, and is still leading, to a progressive increase in the number of implements in these countries, an increase which has become considerable in recent years.

Furthermore, small scale experiments have been carried out over a long period with the object of enabling the farmers to take advantage of all the benefits of draught cultivation. It was hoped in this way to transform the farms and the way of life of the farmer. These experiments have resulted either in technical and economic successes (such as the village of M'PESOKA and the BOUNDIALI region in Mali) or more frequently in failures (such as "pilot-farms" in Upper Volta and "deep-litter sheds" in Dahomey).

Finally, both animal draught cultivation and power mechanization (with collectively owned equipment) have sometimes been used for the agricultural development of certain areas. Thanks to the intelligent sharing out of tasks, they have achieved valuable and lasting results for the farmers, as has been the case at Sakay (Madagascar), Terres Neuves de Boulel (Senegal) and Sodaica (also Senegal).

In general, a twofold trend may at present be observed:

- general extension of suitably-designed equipment over large areas in which some implements are already in use, thus permitting mechanization of the major part of the more important cultivation work (in Mali and Senegal),
- intensive training and the systematic mechanization of certain operations assisted by outside Agencies who may or may not have specialized experience in tropical crop production.

The whole range of previous experiments, including successes and failures, has provided a useful knowledge of the problems connected with draught cultivation with the equipment at present available, appropriately adapted to local conditions.

Generally speaking, and with the exception of some difficulties in certain countries, it may be said that the experimental phase is over and that the orientation is now towards effective and economically viable action.

THE VALUE OF ANIMAL DRAUGHT EQUIPMENT IN AGRICULTURE

It seems obvious that the farmer should, wherever possible, make use of domestic animals to help in his cultivation work.

Their use reduces his labour in the preparation of the soil, in tending his crops and, sometimes, in harvesting the produce. With a pair of oxen harnessed to a plough, provided that he masters the use of both, he will naturally require less effort than when he works with an "angady" or a hand hoe to prepare a piece of land for sowing or planting. The same applies if he uses a ridging-plough enabling him to make the ridges in which he will, for example, plant his cassava cuttings. He can even use the animals by themselves, with much less effort than with his traditional methods, to prepare the mud in which he will plant out his rice seedlings, by making them tread the flooded rice-field; even though this method has certain disadvantages, it being better to make use of a "puddling" roller.

For tilling his crops the use of animals to pull, for example, a hoe with various interchangeable tines will, even under the worst conditions, only require him to hoe and

weed by hand the unworked strip close to where the ground-nuts are growing.

Although there are relatively few animal draught harvesting implements, it is only necessary to observe the interest shown by farmers during demonstrations of ground-nut lifting to be convinced of the success of suitable lifting implements.

Even though the physical effort involved is not very different in the two cases of cultivation by hand and with draught animals, the productivity of human labour is increased by the use of the latter, as also is crop production.

On the other hand, the use of animal traction implies obligations and, directly or indirectly, leads to an increase in the farmer's work; there are, however, compensating factors if the new method is introduced rationally.

The farmer must become accustomed to the animals, despite lack of tradition in their use. He must learn both how to work with them and how to carry out the tasks involved in keeping them in good physical condition so that they are able to perform the work he can expect of them. He must accept the fact that he will, to a certain extent, have to spend time with his animals.

He will also, sometimes, have to undertake work for which he has no special aptitude, such as making certain bits of harness, since qualified artisans are often lacking.

The larger area cultivated will have the immediate effect of increasing certain manual tasks, such as weeding the increased area under cultivation. Harvesting also will be more exacting, particularly as the yield per unit area will have been improved.

Furthermore, the ploughs and other soil preparation implements can only be used really satisfactorily and without damage to the implements themselves if the soil is properly cleared, particularly of tree stumps. Animal draught implements cannot unfortunately carry out this task. It is also necessary to sow in rows so that mechanical tilling may be applied and this means having to change established customs.

The collection of straw and haulms, the manufacture of manure, its transport to the field and its spreading, are all major items of work, even if its digging in results in appreciably increased yields.

Finally, the introduction of farm implements and animals involves buying them and providing for their replacement.

These obligations and this extra work must, however, lead to the application of better techniques in both agriculture and stock-breeding. The latter directly provides the farmer with milk and meat while he, producing better crops, prepares himself for the use of more complex machines. These will enable him, without too much difficulty, eventually to use power mechanized equipment. And this brings us to a last question of principle.

WHY NOT CHANGE OVER DIRECTLY FROM MANUAL TO POWER MECHANIZED CULTIVATION?

In view of the obligations involved in the development of animal traction, it may be wondered why the farmer cannot immediately be allowed the benefits of power mechanization. These are, indeed, much more extensive than those offered by animal traction. So that rational use may be made of animals, arrangements must be made to change the farmer's way of life and habits as well as the whole structure of his operations; all this to achieve satisfactory results, even though they are far below those which can be expected of power mechanization which has, in temperate regions,

made such rapid strides that yields are now achieved which would have been thought quite impossible twenty years ago.

Against these possible advantages of power mechanization could be set the long series of failures in this field recorded in Africa since the last world war, whether it be in the case of collective use of power equipment (by large para-national enterprises, public services, etc.) or in the case of individual use by African farmers. These adverse experiences should not be taken as a reason for condemning mechanization, but rather as useful experience for defining the conditions under which its use is possible.

It is thus known - with general hindsight - that power mechanization can only be considered to be economically viable if the necessary funds are available, if the users are sufficiently competent and if the necessary infrastructure exists.

The acquisition of certain multi-purpose animal draught implements or power agricultural equipment is usually of no interest to the individual farmer who does not have the necessary funds available. It is obvious that, in most countries in Africa, the farmer is unable to buy a tractor. The rational use of mechanized equipment presupposes, in addition to a minimum mechanical competence he is far from having, a knowledge of intensive cultivation methods which he almost never practises.

In addition to these difficulties, the technical support services, without which a tractor quickly becomes unserviceable, particularly for lack of appropriate maintenance, is generally lacking.

Distances are long and roads are often difficult and the servicing facilities are seldom near the area of use. The farmer would have to store fuel and nearby artisans are not sufficiently skilled to carry out emergency repairs.

Various suggestions have been made - and some have been applied - to overcome these difficulties. Credit facilities can be made available either on a national basis, with due regard to the normal budget difficulties of the countries concerned, or on an individual basis.

In this latter case the question automatically arises as to the guarantees the farmer is able to give. Unfortunately he can hardly ever give any. It becomes necessary to study the economic viability and application of the tractor for the types of cultivation practised.

Indeed, the lender, whoever he may be, has to take risks and it is rare for a private concern to agree to do so.

As regards the acquisition of agronomic and mechanical skills, no solution has yet been found other than providing training courses run by competent technicians over a fairly long period until the farmers attending the courses are sufficiently trained to be able to work under less intense and less continuous control. Although this type of training gives the farmers a good insight into the agronomic techniques involved in the application of mechanization, it has the disadvantage of not including the tractor driver, who, moreover, is not himself a mechanic. Furthermore, a certain amount of infrastructure is essential to support power mechanization.

We have set out above three conditions necessary for the development of power mechanization. They can very rarely be met in the countries in which we are interested and can only be achieved more or less artificially in the pursuit of a particular aim in a specified area.

Assuming that these conditions are met, they are still only preliminaries: the

profitability of the mechanized operations still has to be ensured; i.e. production costs, accurately and fully calculated, have to be balanced against the value of the product. Experience shows that this is rarely possible, bearing in mind, on the one hand, the cost of agricultural produce for sale on internal markets (particularly for local consumption) which, in the final analysis, depends on the general standard of living and, on the other, on the prices obtained for exported tropical agricultural products. In most cases yields have to be considerably increased - a state of affairs which can only partly be achieved by mechanization on its own - before mechanization starts to show a profit. This takes into account only internal prices and not the balance of payments of foreign currency.

Finally, in present circumstances, the actual choice of basic equipment for mechanization is not easy since the ordinary modern tractor requires advanced technical knowledge by whoever wants to get full value from it. Furthermore, the two-wheel motor cultivator is relatively costly, less robust and fairly difficult and tiring to drive and the "simplified small tractor" is still, in various forms, at the prototype stages and does not seem very hopeful from the cost and traction capability points of view.

We propose to consider now the following :

- draught animals
- the implements, using direct traction or involving an intermediate machine
- rural skills, which must play their part so that the animals and the implements may be properly used
- some economic considerations having a major influence on the rational use of animal traction.

Before proceeding further, it seems worthwhile pointing out that the issue of this manual does not imply the adoption of any exclusive position on the subject.

Indeed, we do not claim that, at present, the farmer must make use of animal draught cultivation implements in addition to his traditional or newly imported hand tools. There are many examples which confirm the succinct statement that he should make use of animal traction whenever possible and power mechanized cultivation equipment when justified or essential.

Finally, in the application of mechanization there must be practical proof of its effectiveness in order to assess the relative economic viability of power mechanized equipment and draught animal cultivation with respect to each specific cultivation operation or, better, for all the work of a farm unit. This requires the ready availability of extension workers to advise the farmer. Advice will be given here about the use of animal traction.

PART ONE

DRAUGHT ANIMALS AVAILABLE IN TROPICAL AFRICASPECIES AND BREEDS

The animals which can be used for traction belong to the following species: bovines, equines, asinines, camels and mules.

A) BOVINES

These are divided into: zebus and taurines.

The first are usually of local origin (with the exception of some breeds imported into East Africa and Madagascar: the Indian Sahiwal and the America Brahma), the second are either of local origin or imported. As regards working bovines, they are nearly all of local breeds; indeed, animals are only imported for specially profitable purposes such as milk or meat. We shall now describe some important working breeds.

1) Bovines in West Africa (including Chad and Cameroon)

- The PEUL ZEBU, with short horns, is rather a group of breeds which go under the names of "White Peul Zebu", "Sudanese Peul Zebu", "Nigerian Peul Zebu" and "Cameroon Peul Zebu".

They are rectilinear*, medioliner, eumetric: the horns, of medium length, are usually lyre-shaped.

These zebus are put to work at 3 or 4 years of age. Although slow, they work hard and are even-tempered.

- The GOBRA ZEBU: a lean animal, subconvexilinear, longilinear, hypermetric, with long horns, lives in Senegal. Its hump is very well developed and it has long legs.

It is one of the most used and best suited breeds of West Africa. When crossed with N'Dama taurines it produces a massive stocky animal perfectly suited to draught work.

- The M'BORORO ZEBU: Convexilinear, longilinear, hypermetric, with long horns, mahogany-coloured coat and very widely dispersed throughout the Sahelian area. The method of breeding gives it a fierce nature making it difficult to train. This can be done, however and good results have been achieved in the Central African Republic.

- The SHORT-HORNED SAHELIAN ZEBU: lives in the Sahelian regions south of the Sahara from Mauritania to Chad. It is rectilinear, medioliner, eumetric, thickset and well-covered. It has short and slender legs, generally short horns and the hindquarters are slightly inclined.

* In order to avoid long explanations we have used the conventional shortened forms of animal classification. The first of the three successive adjectives relates to the head profile (and, incidentally, the whole body), which may be rectilinear (flat forehead, eye-sockets not protruding, horns extending the line of the neck), convex (rounded and prominent neck, sunken eye-sockets), or concave; the second adjective refers to the proportions of the body, i.e. to the relation between length, breadth and depth - the terms medioliner, brevilinear and longilinear are self-explanatory; the third adjective refers to size, i.e. the weight of the animal which may be average or "eumetric", heavy - "hypermetric" or light - "ellipometric".

Used in Nigeria, it is put to work when 3 years old.
It is active, a good worker and has an equable temperament.
It is an excellent beast of burden and can carry 80 to 100 kg.

- The N'DAMA TAURINE originated at Fouta-Djallon (Guinea). It is found in Guinea, Casamance, Ivory Coast and Mali and has been exported to the Congo and the Central African Republic.

It is rectilinear, mediolinar, eumetric, has lyre-shaped horns and a fawn or black coat with white patches on the sloping parts of the body.

It is excellently shaped for draught work: short-legged and broad-backed.

The short-horned Taurine: (Baoulé) is a little light but is nevertheless used in the Central African Republic.

N'Dama Zebu crosses are found where their living areas are adjacent. They are widely used in Senegal and Mali.

2) Bovines in Central Africa

We shall mention the following from among the many breeds in this area:

- The ANKOLE, a large, long-horned, lean zebu. Its coat is generally deep red-brown, though variations are possible. It is found in Uganda, Tanzania, Congo (Kinshasa), Ruanda and Burundi.

The oxen are used as draught animals. They are put to work at about 2½ years, when their average weight is 300 kg. They are active and docile.

- The BAROTSE, a breed which lives in Zambia.

It is used as a draught animal and is put to work at 2 or 3 years of age. It is even tempered but its suitability is limited by the weakness of its hooves.

- The NILOTIC ZEBUS, a huge heterogenous group living in the Upper Nile basin.

The oxen can be trained as draught animals and are docile but slow.

They are put to work at 6 years of age and can go on working for about 8 years.

- The ANGONI, a zebu originating in Zambia and mainly bred for meat. It is not normally used as a draught animal but, whenever tests have been made, it has proved active and even tempered.

3) Bovines in East Africa

- The BUKEDI belongs to the big group of "East African short-horned zebus".

It is a small stocky animal with big muscles. Some working oxen weigh as much as 450 kg.

Used as a draught animal, the Bukedi is even tempered and works regularly although slowly. It is put to work at 2 or 3 years of age.



PEUL ZEBU



SUDANESE ZEBU

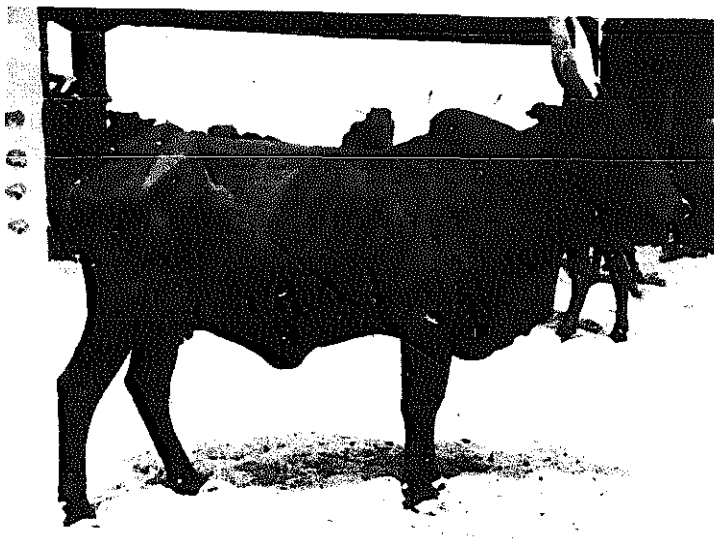

M'BORORO ZEBU



MADAGASCAR ZEBU

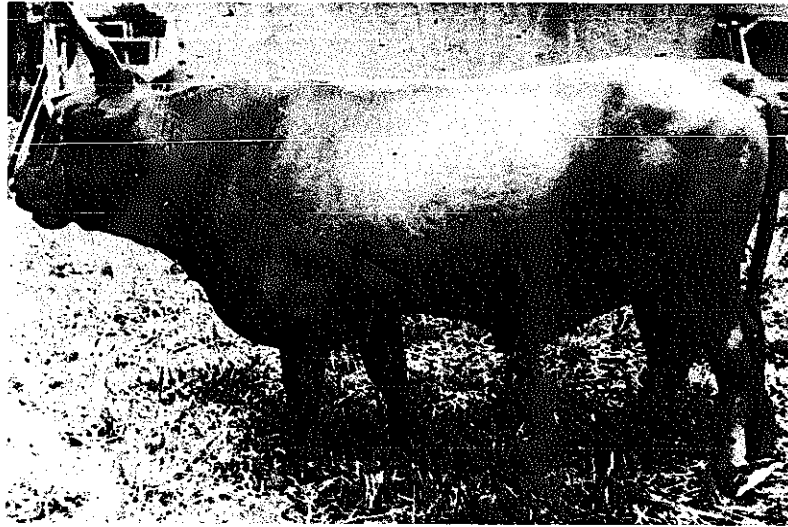

N'DAMA BULL



N'DAMA BOVINES

- The NGANDA appears to result from a cross between the Ankolé and the Bukedi. It is a massive medium-sized animal sometimes without horns. Its hooves are tough.

The oxen are used as draught animals.

4) Bovines in Madagascar

- The MADAGASCAR ZEBU, rectilinear, medioliner, eumetric is stocky and of medium size. Its horns are lyre- or crescent-shaped. Its coat is vari-coloured.

Although bred mainly for meat, this docile zebu is extensively used as a working animal, for such work as the preparation of rice-fields, ploughing and pulling carts.

It is put to work at 4 years of age when it reaches a weight of about 300 kg.

B) HORSES

1) Horses in West Africa

Three types of horse are found: arab, barbary, dongolaw.

Only the latter two are of interest to us.

- The BARBARY HORSE

The finest specimens are to be found in Mauritania, but there are many derivatives. They are rectilinear, medioliner, eumetric with powerful legs and a light coat.

- The DONGOLAW HORSE

This breed is to be found in the eastern part of West Africa. The purest strains are in Nigeria. It is convexilinear, longilinear, eumetric. It is very long-necked and slender-legged. It has a dark coat with white points.

When crossed with the barbary it is the basis of many breeds, such as the Haoussa, Songhai, Mossi, etc.

- The PONY

This type exists in Senegal and Chad. It is improved by arab blood.

The horse, of any of these three types is an excellent draught animal, both for pulling carts and for light work. It is fast and easy to handle. It is much used in Senegal.

2) Horses in East Africa

The horses found in East Africa stem from the arab type. Generally speaking they are little used as draught animals.

3) Horses in Madagascar

Little horse-breeding is carried on, this animal being considered a luxury. It is hardly used at all, with the exception of a few carriage horses in the capital.

C) DONKEYS

The donkey is to be found throughout Africa, but its living area is limited towards the south because of its susceptibility to trypanosomiasis.

Its coat is short and gray with a cross-shaped black band.

It is a good carrier, capable of bearing loads of 50 to 100 kg.

It is fairly frequently used as a draught animal in Senegal and Upper Volta and this use is developing slowly elsewhere.

D) DROMEDARIES

As with the donkey, it would be deceptive to try to describe breeds. The dromedary is mainly used in the Sahara regions as a pack or saddle animal. It is seldom harnessed, except for drawing water (in Mauritania and Niger).

E) MULES

Mules are very rarely used, even though very successful trials of crossing with Poitou and Moroccan he-asses were carried out in Mali between 1930 and 1944.

TABLE OF SIZES AND WEIGHTS OF DRAUGHT ANIMALS

SPECIES	Breed	SIZE (height at withers) adult, (cm.)		ADULT WEIGHT (kg.)	
		Male	Female	Male	Female
TAURINES	N'Dama	105 - 115	105 - 110	250 - 280 max : 325	245 - 280
ZEBUS	Peul	130	120	300 - 350 max : 475	250 - 300
	Gobra	125 - 140	125 - 135	300 - 400 max : 525	250 - 350
	Bororo	130 - 145	130 - 140	350 - 450 max : 500	360 - 450
	Sahelian	130	123	300 - 400	250 - 300
	Madagascar	125 - 135	120	400	300
	Ankole	145	120	500	345
	Baroke	130	126	490	345
	Nilotic	122	108	350	255
	Angoni	125	120	560	480
	Bukedi	-	-	365	261
Nganda	-	-	280	270	

TABLE OF SIZES AND WEIGHTS OF DRAUGHT ANIMALS (cont'd.)

SPECIES	Breed	SIZE (height at withers) adult, (cm.)		ADULT WEIGHT (kg.)	
		Male	Female	Male	Female
HORSES	Barbary	140 - 148		300 - 450	
	Dongolaw	140 - 145		300 - 350	
	Pony	125 - 135			
-----		-----		-----	
DONKEYS		0,70 - 1		80 - 100	
-----		-----		-----	
MULES		1,20 - 1,30		200 - 250	
-----		-----		-----	
DROMEDARIES		1,90 - 2,10		500	

NOTE: The measurements, particularly the weights, given here, apply to properly fed animals.

II

CHOICE OF ANIMALSA) CHOICE BY SPECIES

The choice is, in fact, often limited in each region by non-technical considerations. We have, however, felt it worthwhile collecting together the arguments for and against each species.

1) The Horsea) ADVANTAGES

- It is a friendly animal which becomes attached to its owner.
- It enjoys a certain prestige in Africa, so that the farmer is inclined to give it greater care than he would to an ox.
- It is easy to train for all kinds of work.
- When working, it is fast, easy to handle, docile and can be simply, easily and accurately controlled.

b) DISADVANTAGES

- It is often too light in Africa, where its weight may be 250 to 280 kg. under average maintenance conditions.
- It has a fairly weak constitution and needs special care and attention. It is costly to maintain.
- It is susceptible to trypanosomiasis.
- It tires fairly quickly when working.
- It is expensive to buy.
- Its harness is costly.

2) The Oxa) ADVANTAGES

- It works slowly but unflaggingly.
- It is hardy and strong and easy to feed.
- Its harnessing is simple and the yoke can be made locally at low cost.
- Its purchase price is attractive (in some countries 1 pair of oxen = 1 horse).
- At the end of its working life, it may be sold for meat, after fattening if possible.

b) DISADVANTAGES

- It is not a friendly animal, at least as far as many African farmers are concerned who are totally lacking in "farming sense". The farmer considers the ox solely from the point of view of its working value.

- The ox needs relatively large grazing areas.
- It appears to be more difficult to train than the horse. It needs more manpower to control it.
- When working, it is slow.

3) The Donkey

a) ADVANTAGES

- It is a friendly, hardy and quiet animal.
- It is economical to buy and can be maintained with farm produce.
- It is easy to train and is intelligent.
- It is patient when working (light draught work and carrying).

b) DISADVANTAGES

- Very light and limited in strength.
- It tires easily if driven too fast.
- It is susceptible to trypanosomiasis and harness sores.

4) The Dromedary

This animal is patient and hardy but difficult to train and sometimes has an awkward temperament.

B) CHOICE OF BREED

In the preceding chapter we listed the main breeds suitable for work.

Let us stress that, in most cases and whenever possible, use should be made of local breeds, to be found on the spot and to avoid transfers or imports of animals, the disadvantages of which will be described in Chapter IV.

C) CHOICE OF INDIVIDUAL

Within a particular species or breed, what are the qualities to be looked for when choosing a draught animal?

1) Build

As regards the ox, as a draught animal, it must be powerful, compact, sturdy, with well-developed muscles, particularly those of the back and the hindquarters.

Its legs must be strong and as short as possible ("low on the ground"). Its chest must be ample and deep.

It must have strong hooves.

With the draught horse, in addition to the same power characteristics as the ox, the following will be looked for: short and straight shoulders, as long forelegs and as strong muscles as possible (starting leverage), sloping hindquarters and short hindlegs.

2) Character

Whatever the species, a calm and docile animal will be sought, without vices (tendency to kick or to butt).

3) Age

With the ox, training starts at about 2 or 3 years of age. With the horse, a little later (3 years).

4) Sex

Gelded males are usually used.

The mare, the she-ass and the cow can, however, be used.

5) Utilization and work to be donea) The Ox

The ox is particularly suitable on fairly heavy soil, for fairly deep work (15 cm.), for lifting ground-nuts, digging in green manure, pulling loaded carts, drawing water from wells.

b) The Horse

The horse will mainly be used on light soil for shallow row-crop work (such as ground-nuts, sorghum and millet), and for pulling the seeder or the light hoe.

It is without peer for pulling light shafted carts or cabs.

On the other hand, it is not strong enough for ploughing or pulling the ground-nut lifter.

c) The Donkey

The donkey is suitable for :

- light draught work and carrying
- light work, such as weeding, hoeing, sowing or single row planter.

d) The Dromedary

It is used mainly as a beast of burden and, in near-desert regions, for drawing water.

III

HEALTH CONTROL WHEN BUYING

At the time of buying it is necessary to check, with the assistance of a veterinary surgeon:

- A) By means of a clinical examination, that the animal is not ill.
- B) If it comes from another region, that it is not liable to transmit diseases.
- C) Take steps to ensure that it is as far as possible protected against disease.

A) CHECKING THAT THE ANIMAL IS NOT ILL

Taking into account the local incidence of disease or that of the region from which the animal comes, it should be examined by a veterinary surgeon and be subjected to various tests showing that it is free of disease.

With the ox

- a) A tuberculin test to detect tuberculosis.
- b) A blood test for freedom from brucellosis.
- c) A blood smear to look for blood parasites (piroplasma, trypanosomes).
- d) An examination of droppings to look for digestive parasites and possible infection with Johne's disease.

With the horse, donkey and dromedary

- a) A blood smear.
- b) An examination of droppings.

B) CHECKING THAT IT CANNOT TRANSMIT A CONTAGIOUS DISEASE

In order to do this, the animal must be quarantined, i.e. isolated in a shed, park or enclosure for a fortnight to a month. It must have adequate food and water.

C) TAKING STEPS TO PREVENT ILLNESS

During the quarantine period the animal must be vaccinated against the main diseases rife in the area, or it must be given chemical preventive treatment.

VACCINATIONS

- for the ox
 - rinderpest
 - contagious bovine pleuropneumonia
 - Anthrax
 - Blackquarter
 - Pasteurellosis.
- for the horse and donkey
 - African horse sickness
 - Tetanus

PROPHYLACTIC TREATMENT

- For the ox, horse, donkey and dromedary

- De-worm periodically using modern anthelmintics. In each case the manufacturer's instructions must be carefully followed.

If the animal comes from an area where trypanosomiasis occurs, it may be advisable to have it treated. A veterinary surgeon will decide which drug to use according to the species of animal and trypanosome involved, and whether curative or protective treatment is needed.

IV

CARE OF ANIMALS AND HYGIENEA) EFFECT OF DRAUGHT CULTIVATION ON ANIMAL PHYSIOLOGY1) Fatigue

Fatigue caused by too much work results in a lowering of physical resistance, making the animal more susceptible to disease. In this way, for example, trypanotolerant bovines living in an area infested by trypanosomiasis can be affected by the disease when subject to fatigue and overwork.

Fatigue also has a direct effect on the animal: loss of weight and weakness which may lead to death from exhaustion.

2) Transfers of animals

Animal draught cultivation involves transfers of animals from breeding areas to agricultural areas: there are many examples: N'damas in Senegal, N'damas from Mali to Ivory Coast, animals from Ivory Coast and Guinea to the Central African Republic, etc.

These movements may have the following consequences:

- A change in the animal's way of life, such as the change from the traditional extensive breeding ground to the semi-enclosed conditions of the working ox. During this period of adaptation, it may happen that the animals will not eat and will lose weight and become apprehensive, etc.

- From the health point of view, as we have seen, these animals may transmit diseases, like, for example, the zebu cattle from Sahel which introduced contagious bovine pleuropneumonia into the Guinea area. Changes in environment may expose animals to new diseases and parasites to which they have no immunity, and may be the cause of severe outbreaks of disease. These are the reasons why animals available on the spot should be used whenever possible.

3) Accidents at work

These are mainly due to bad handling of the harnessed animals or to defective harness.

Many injuries are caused by ill-treatment (blows), bruises, sores, insect bites, etc. Harness sores are particularly frequent on the withers, at the base of the horns, on the ears and under girths. Restraint injuries are caused by pulling too hard on the nose-ring during work or the use of rope to hobble the animals when resting.

B) HYGIENE

Certain elementary principles of hygiene must be observed with draught animals.

In Africa, generally speaking, the horse is well looked after. On the other hand, the areas where the farmers have become accustomed to looking after their oxen well are still too rare.

1) Work and rest

The animal must be allowed adequate time to feed, and in the case of ruminants to chew the cud.

The draught ox works an average of 4 to 5 hours a day. The unduly hot hours must be avoided. During the remainder of the time, for rest and feeding, the animal must be put in the shade, either in a shed or under a tree. It is not recommended that an animal be tethered in a pasture in the full sun.

2) Feed

This must be of good quality and the animals must be watered regularly at fixed times.

We shall return to this subject at greater length in a special chapter.

3) Body carea) Grooming

This can be done dry (particularly with horses) with a stiff brush and a curry-comb and then finished off with a soft brush.

In tropical countries, particularly with bovines, the animals may be washed and brushed with soap and water, rinsed thoroughly, left to dry and then brushed. Grooming must be carried out at least once a week.

b) Care of the hooves

Avoid stones and earth getting stuck between the parts of the cloven hoof (ox) or in the hoof (horse). Clear with a special tool or a piece of wood. Avoid pointed hooks or sharp knives.

In certain cases (animals working on hard land or animals with soft or brittle horn) the animal must be shod.

c) Care of the mane (horse)

Comb or crop the mane.

4) Harness hygiene

When the parts of a harness are manufactured, care must be taken to avoid sharp angles, protruding nails or screws, too heavy stitching, in short, anything which might hurt or interfere with the animal.

The harness must be kept clean by periodical cleaning or washing and, at the same time, disinfection with a phenol or cresol solution.

5) Housing hygiene

It is while housed that animals are most likely to spread infection from one to another.

Overcrowding must be avoided and the stables must be kept clean by:

- periodic cleaning and disinfection,
- renewal of litter

- drainage of liquid manure
- action against insects.

This latter action is accomplished by means of long-lasting insecticide sprays.

C) PREVENTION OF DISEASE

1) Contagious diseases

It is recommended that vaccination be carried out without waiting for a disease to break out.

Action must be taken in good time, since treatment is costly and rarely fully effective.

- RINDERPEST

Cattle must be vaccinated as calves and then once again after they are 12 months old. If Tissue Culture vaccine is used there is no obvious reaction, so that animals can be injected at any time of the year. The immunity will be life long.

- PERIPNEUMONIA

If you suspect that this disease is present, call in your veterinary surgeon as soon as possible, so that any infected animal may be got rid of immediately. Treatment may cure the animals of their symptoms, but many of them remain as carriers and can infect other healthy animals. This is therefore a very serious disease, and breeders and owners must be aware of the risks in areas where it is enzootic. Healthy animals must be protected by vaccination.

- ANTHRAX AND BLACKQUARTER

Vaccination is carried out every 6 to 12 months in areas where the diseases occur.

2) Parasitic diseases

- TRYPANOSOMIASIS

In suitable areas a co-ordinated attack on the tsetse fly may give good results in the control of this disease. The methods used, which may include bush clearance and the large scale spraying of insecticides, are obviously not the responsibility of the animal husbandry extension worker.

It must be appreciated that in some areas and with certain species of trypanosomes the disease is spread by biting flies such as Tabanus and Stomoxys, and can be a major problem even though no tsetse flies are present.

In addition protection of the animals by the injection of drugs may be necessary, a point which can only be decided by your veterinary surgeon.

HELMINTHIASIS

The animals must be periodically de-wormed at intervals depending on their age and the season of the year. In general more frequent treatments are required for young animals, and for all animals during and just after the rainy season.

For stomach and intestinal worms phenothiazine has largely been replaced by modern drugs which are much more efficient. These must be used strictly in accordance with the manufacturer's instructions.

Where animals graze on marshy ground, liver fluke infection may be a serious problem in cattle. Carbon tetrachloride may be used for treatment in some areas, but in others leads to severe toxic symptoms. Much safer and more effective medicines are now available—consult your veterinary surgeon regarding which one you should use and the best times of the year to give it.

EXTERNAL PARASITES

Lice, which breed on the animals, are the easiest to control, and are susceptible to almost all insecticides. Two applications are required — one to kill the lice present on the animal at the time and the second 10-14 days later to kill lice which have hatched from the eggs attached to the animal's hair.

Fleas breed on the ground and thus repeated treatments are necessary in order to keep the infestation under control. Some insecticides do not have a persistent action and so the animal can become re-infested almost immediately, others are persistent and will keep the animal free for days or even weeks. The intervals between treatments must be decided by observation in each case.

Ticks are perhaps the biggest problem, and in many parts of the world have developed resistance to some of the dips used against them. In areas of heavy infestation treatment every 5-7 days may be required, where infection is light the intervals can be longer, except in areas where the ticks are transmitting important diseases such as East Coast Fever and Heartwater, when continued regular dipping at short intervals may be essential.

Animals may be sprayed using hand or motor operated pumps, or in the simplest way washed with a bucket and cloth or sponge. It is important that the animals are thoroughly soaked to the skin all over, paying particular attention to the ears and the end of the tail.

It must be emphasized that most of the chemicals used are very poisonous, especially in their concentrated forms. They must therefore be handled very carefully, and diluted before use exactly as directed by the manufacturers.

MINOR INDIVIDUAL ATTENTION

There are a number of non contagious diseases and conditions, often quite minor, which may affect the animals. Many of these result from the nature of the work performed.

While awaiting the veterinary surgeon's advice the man in charge of the animal may well have to render first aid treatment.

1) Wounds

These may be the result of fighting or accidents, but are commonly due to badly made or badly fitting harness. In the latter case it is important to change or adjust the harness so that pressure or friction is removed from the injured area, otherwise the wound will have no chance to get better. The animal must also be rested until the injury has healed.

Fresh wounds: If the wound is fresh and clean your veterinary surgeon may decide to stitch it. Therefore do not touch the exposed surfaces if you can help it, a light dusting with a sulphonamide powder may be useful. If the wound is dirty - say contaminated with soil or manure - it should be washed gently with a non-irritating antiseptic such as a 0.1% quaternary ammonium solution or a 0.1% potassium permanganate solution, or best of all with hydrogen peroxide (10 volumes strength 1 part, plus warm water 2 parts). When clean dust lightly with sulphonamide powder.

Never use alcohol of any strength on a fresh wound - it is not very efficient against bacteria and will do a lot of damage to the tissues. Tincture of iodine will also do more harm than good.

Old infected wounds: As considerable tissue damage has already occurred, rather stronger antiseptics may be used. Hydrogen peroxide is again very useful to clean up the area, or one may use quaternary ammonium compounds 0.5%, potassium permanganate 1%, gentian violet solution 0.1% or weak tincture of iodine.

Sulphonamides are not very effective if there is much pus or dead tissue about, so an antibiotic powder, spray or cream should be used.

In the case of deep or contaminated wounds in horses, it may be advisable for your veterinary surgeon to give an injection of antitetanus serum, but this will not be necessary if the animal is protected against tetanus by regular vaccination.

2) Strains

These result from undue effort in a joint, often caused by excessive work on bad ground. They give rise to pain, swelling and lameness.

- TREATMENT

The animal must be given complete rest until the condition is cured, and then put back to work very gradually.

While the part is hot and painful it should be douched with cold water as often as possible.

If the swelling and lameness continue it may be helpful to rub the part with a rubefacient or mildly irritating medicine such as vinegar or a paste made by mixing mustard with water. If anything stronger than this is needed it should be prescribed and applied by a veterinary surgeon.

3) Tenosynovitis

This is straining or stretching of a tendon followed by inflammation of the synovial sheath which surrounds it. It is most likely to be seen in horses.

Treatment is exactly the same as for the strain of a joint.

4) Bursitis or hygroma

A bursa is a synovial sac, the ones most likely to be affected are those lying between a bony prominence and the skin, or between a tendon and a bone. The condition is commonest in horses. The cause is always injury, for example rubbing from badly fitting harness, or lying on concrete floors without adequate bedding. The symptom is a local fluid filled swelling which may be painful enough to prevent the animal from working.

While the swelling is hot and painful cold douches are helpful. If the condition becomes chronic your veterinary surgeon should be called in - he may decide to apply a strong counter-irritant or to drain and inject the swelling.

Never try to open one of these swellings yourself, as it is sure to become infected and then takes a very long time to recover.

5) Mange

A common disease in animals kept under intensive conditions. There are several different types of the disease, all are easily spread by direct contact or the use of brushes, harness, blankets etc. first on a diseased animal and then on a healthy one. The symptoms in general are itching, the formation of scabs and crusts, loss of hair and marked thickening of the skin.

- TREATMENT

Always try to treat the disease in its early stages, if it has spread over much of the body treatment may be very difficult.

Soften the scabs by applying vegetable oil, then scrub gently with soap and water.

Apply with a soft brush or by spraying a solution to kill the mites:

γ = gamma - γ BHC (Lindane) 0.06%

- organo-phosphorus acaricides at strengths specified by the manufacturers.

Repeat every 5 to 7 days until cured.

6) Ringworm

A fungus disease of the skin which may be seen in all species of animals. It is commonest in young cattle particularly on the head and neck. The symptoms are almost round lesions with loss of hair, scab formation, and in cattle very marked thickening of the skin. In neglected cases the lesions may join together to involve large areas.

- TREATMENT

Dilute tincture of iodine }
glycerine } equal parts

Paint on the lesions daily.

In severe or stubborn cases call in your veterinary surgeon.

WEIGHT AND POWER OF DRAUGHT ANIMALSA) GENERAL REMARKS

In addition to knowing the average tractive effort which draught animals can produce, it is also useful to assess the amount of work that can be expected in a day and the conditions under which it can be obtained. In short, how the animals work must be understood.

Unfortunately, the tractive effort that can be obtained from a draught animal depends, more than anything else, on its individual characteristics, i.e. its breed, its sex, its age, its weight, its size, the quality of its feed, its training for the work, its health, etc. This is why it is impossible to give useful information, i.e. precise figures, which are applicable everywhere. The tractive power of draught animals has been measured, at different times, particularly in Europe, the United States and South America, by, amongst others, Ringelmann, Vitali, Böhle, Maschek, but the figures obtained are in no way applicable in Tropical Africa.

In these latter regions, accurate and systematic measurements have only recently been made and still only in a few areas. Research work has been applied much more frequently to horses than to oxen, since the former were almost solely used in Europe and America, until the development of internal combustion engines, for road transport and this seemed to justify these studies more than those related to the agricultural work of the regions further South.

On the other hand, the general relationships established by this research, and particularly the principles used and checked, are applicable everywhere. We shall, therefore, first summarise what we consider the most interesting of these general data, thus enabling us to set the general scene for the practical results which can be taken into account for certain regions of Tropical Africa which we will then describe in detail. This latter description will be mainly based on measurements taken recently in these regions by the C.E.E.M.A.T. in cooperation with the I.E.M.V.T. The purpose of these trials was to try to find the sustained effort achievable by the draught animals of these regions under normal conditions of agricultural work or, in the case of intermittent work, the maximum effort possible, and the power they make available for the various kinds of agricultural work. In particular cases, they have permitted assessment of the maximum tractive effort which the agricultural implements can stand.

The general studies on the output of draught animals have shown that what is called their "total output" (the energy furnished by the animal and available for work divided by the energy contained in its rations) over a long working period is of the order of 0.12 for man, 0.10 to 0.12 for the horse family and 0.09 to 0.10 for bovines.

It is known that the output of relatively powerful mechanical engines, calculated in the same way, can at present reach 0.25 and even 0.30.

This idea of output, which can be accurately expressed, emphasizes the fact that working animals can only be used efficiently if they receive sufficient food. Details on this are given in Chapter VIII of this same Part.

It seems, moreover, that each animal, under a given set of living and working conditions, is capable of carrying out a certain amount of work daily which cannot be exceeded and which has been assessed at 3600 times the weight of the animal moving at

1 metre a second (this applies particularly to the mule and the horse in Brazil). This means that the animal, working for 10 hours a day, can provide a tractive force equal to 1/10th of its weight (at a speed of 1 m/s if a horse is concerned).

Whatever the exact value of this figure, it is certain that a greater force can only be produced for a shorter time and also that a greater tractive force can only be developed at a lower speed (by reducing the pace length). For each species, breed and even individual, it appears that there is a natural average speed of movement which the animal tends to adopt, to the extent to which the effort demanded permits. As an example, when harnessed to a cart of a weight corresponding to their size and on suitable ground, the Peul Zebu moves at 3 km/h, the Ankole at 3.5 km/h and the Sahelian Zebu at between 5 and 6 km/h.

Working animals can, however, over a very short period of time, develop much higher power than that produced during "normal" work. The bovines are capable of this to some extent like the horse, which is not alone in being able to produce a sudden effort. Thus, in trials in Italy, pairs of strong well-fed oxen have been able to develop 20 to 30 horsepower over a distance of 100 metres and, in the United States, a good pair of draught horses have been able to develop 20 to 25 horsepower for 10 seconds, while in Brazil, single 550 kg oxen have developed 2 to 3.75 horsepower over a hundred metres.

The normal work under these conditions and which is, in part, explained by a strong acceleration of the draught animals, is obviously produced to the detriment of the total time the average effort can be maintained; the animals tire quickly when performing tasks involving numerous peaks of effort.

Excessive overloading may, moreover, seriously affect the health of the animals.

Here, we shall only consider one of the possible uses of working animals: traction. It must, however, be remembered that they can carry loads which may, for example, be as much as 50 to 65% of the weight of the animal in the case of donkeys, well suited to this kind of work. Animals can also be used in a third way by lifting their own weight up an inclined plane (or a wheel) - but this method of use, which was previously to be found in Europe and the United States, has been completely abandoned. It involved, moreover, the use of complicated machines.

As regards the mechanics of animal traction, various observations have been made and measurements taken. It must be remembered that the greater part of the weight of quadrupeds is distributed over the front legs (nearly 60% in the case of the ox) and that the hindlegs do little more than provide movement during normal traction, i.e. other than when exceptional momentary resistance has to be overcome. The weight bearing on these hind legs is therefore of great importance to the animal's grip.

Furthermore, the animal's effort is applied on the ground at hoof level in a more or less horizontal direction so that the compactness and texture of the soil also have an important influence on the available tractive effort. On loose ground, without any consistency, this effort is much reduced. For a different reason, on an uphill or downhill slope, because of the reduction in the proportion of its weight perpendicular to the ground, the animal's grip is lessened. In addition, when going downhill, the animal has to brake its advance with its front legs, resulting in extra fatigue.

Finally, the tension in the hind legs of the animal varies alternately with each step so that there are corresponding variations in the tractive effort which is never constant.

Using two or more animals harnessed together results in a relative loss of efficiency of each of them, at least with the yokes and harnesses at present used.

According to Bockelberg, who made a special study of the relationship between the number of animals used together and the resulting loss of efficiency, this amounts, with relation to the tractive effort of a single animal, to 7.5% for two animals, 15% for three, 22% for four, 30% for five and 37% for six.

Accordingly, when using a pair of oxen of the same strength, the tractive effort of a single ox working on its own would be multiplied by 1.9. If two pairs of identical oxen were used, the tractive effort of one pair would be multiplied by 1.7 and, with three pairs by only 2.

B) POWER OF DRAUGHT ANIMALS

Strength is not the characteristic which permits assessment of whether draught animals can carry out specific agricultural work; it is rather the tractive effort available, whatever its speed, which gives information on the capabilities of the unit for the work to be carried out.

When draught animals are used outside certain normal limits of speed of movement, either above or below, it is easier to induce the animals to develop their maximum power by requiring a relatively low tractive effort at a relatively high speed. This can be seen from an examination of the data set out in tables II and III.

The maximum power of a pair of Renitelo oxen (table II) was obtained with an average force of 150 kg and at 2.9 km/h whereas Demi-Brahma oxen (table III) developed 20 kg m/s less with a practically identical average force.

The idea of power is involved in the calculation of the output although the agriculturist usually relates work achieved to the area worked.

Nevertheless, power may serve as a comparative parameter and enables the behaviour of the various draught animals to be interpreted under very different working conditions such as, for example, ploughing at 2.2 km/h with a 150 kg tractive load and mowing grass at 3.5 km/h with a tractive load of only 90 kg.

The tiredness of the oxen is fairly similar in both cases, even though the tractive effort required by the mower is much less than that by the plough. The power developed by the draught animals, of the order of 90 kg m/s explains this comparable state of tiredness with, nevertheless, more pronounced shortness of breath at the end of the day for the unit with the mower, its speed being greater.

- Level of sustained effort developed by different draught animals:

Table III shows that there is a wide variation in average traction capabilities with relation to the weight of the draught animal, particularly between the donkey and the various bovines subjected to these tests.

These capabilities are as follows:

- for the donkey: better than 1/4 of its weight
- for a pair of N'Dama oxen (Defa): about 1/7th of their weight
- for a pair of N'Dama oxen (Minankro): about 1/10th of their weight
- for a pair of Madagascar Zebu oxen: about 1/8th of their weight
- for a pair of Demi-Brahma oxen: about 1/7th of their weight.

These different levels of tractive effort, obtained with certain types of draught animals under conditions peculiar to different countries, provide reference points from which can be estimated the average working output of the most widely used animals in

tropical climates. Scientists of temperate climates have been able to assess the work furnished by the animals in an 8 hour working day (by the most recent authors) or a 10 hour day (for certain earlier authors). However conditions are different in a tropical climate and the length of time the animals can be kept working each day without exhausting them is very unlikely to exceed 3 to 6 hours (oxen are sometimes used for light work for 8 hours on alternate days). Under light working conditions, with animals in good health, and in view of the general law discussed above, higher performances relative to the weight of the animals can certainly be expected.

DONKEYS: The capabilities of the donkey are thus shown to be better than those accepted by certain authors in Europe (Ringelmann: 1/8th of the weight). It must, nevertheless, be borne in mind that the farmer often has considerable difficulty in feeding his animals, particularly towards the end of the dry season. These animals, particularly donkeys, are liable to start the season of agricultural work in relatively poor condition.

It may therefore be accepted that a donkey can produce a continuous effort of between 1/5th and 1/6th of its weight at a speed of the order of 2.5 to 2.8 km/h for 3 to 3½ hours a day.

Experience shows that it is difficult to keep a donkey working for more than 3½ hours, or 4 at most, however long rest periods are allowed. A normal day's work should be organized along the following lines: two sessions of an hour and a half to two hours each with a rest period in between of a half to three quarters of an hour.

The performance of horses has not been studied, since this animal is not particularly suitable for such arduous work as ploughing used for carrying out tests of effort and power.

BOVINES: Only oxen have been subjected to trials, although it must be recognized that cows also have a certain value.

It is found that the variations in output of different oxen depends more on the type of soil being worked than on the type of oxen.

The output will be a maximum on regularly worked agricultural land, i.e. the effort will reach about 1/7th the weight of the draught animals, whereas it will not be more than 1/10th on land not properly worked and containing a fair number of obstacles such as stones, tufts of couch grass or the roots of small shrubs. The latter is fairly common and applies in practice to the ploughing of land left fallow with fresh growth of shrubs which, despite prior clearance, have retained a certain number of creeping roots.

These roots, and possibly other obstacles, cause jolts and, therefore, peaks in the tractive effort which, as mentioned above, quickly tire the draught animals, whatever the average effort.

Because of these unduly severe irregularities, it is sometimes necessary to reduce the width or depth worked by the implement.

Thus, draught animals which can develop an average force of 100 kg when there are peaks of 150 to 200 kg, can produce an average of no more than 80 kg if the peaks reach 250-275 kg. The intense fatigue caused by such high peaks must be compensated for by a reduction in the sustained effort so that the animals may recover, which is only possible if the sustained effort is very low; hence the need to reduce the width or depth of the work.

The working day of draught oxen is about 5 to 6 hours, either in a single session broken by a reasonable rest period or else half in the morning and half at the end of

the day. It appears that the most widely used timetable is to work from 5 or 6 in the morning until 11 or mid-day, the farmer then spending the afternoon on other tasks.

By reducing the duration of work, the intensity of effort demanded can be increased to some extent, provided that it is sufficiently regular not to strain the animals unduly. In actual fact, an appreciable increase in the area worked often involves such an increase in total effort that a unit consisting of a single pair of oxen can no longer cope with the work.

Conversely, by reducing the intensity of effort demanded, it should be possible to increase the daily working hours a little. The problem then is to choose a timetable which avoids the hottest part of the day; it is particularly this requirement which limits working hours when the animals have to produce a big effort.

In some countries with fairly heavy land, the farmers habitually work with units of two or even three pairs of oxen. In Madagascar, in particular, ploughing to a depth of 10 or 12 cm. needs at least two pairs of oxen most of the time. Three pairs are generally used in Tanzania.

TO SUM UP, the trials carried out and the experience of the extension workers show that there is a level of work which should be required of draught oxen which depends on the state of the ground, the speed of working and the daily hours worked.

Working at a rate which suits the animals and adopting a timetable similar to that described earlier, the average effort will be about 1/10th of the weight of the animals when ploughing in ground containing obstacles and 1/8th when already well-worked agricultural land is involved.

When 2 or 3 pairs of oxen are used - a fairly infrequent occurrence in tropical African countries - it is particularly the standard of training which determines the traction capability; using several animals together, even if they are well driven, results in losses of effort. The average losses indicated earlier have not been checked under tropical conditions. On the assumption that they are generally valid, on well cultivated land and with a pair of oxen weighing 750 kg, an effort of 1/8th of the total weight would be achieved, i.e. about 90 kg; with two pairs of similar weight in harness the possible effort would be 90 x 1.7 or about 150 kg and, with three pairs: 90 x 2, or 180 kg.

For work such as scarifying, hoeing and weeding, during which the farmer has a tendency to speed up the pace, it is preferable to adjust the implements so that the average tractive effort is limited to 1/10th of the weight of the animals, the power absorbed during this kind of work being often of the same order as when ploughing.

C) PRACTICAL CONDITIONS FOR THE UTILIZATION OF DRAUGHT ANIMALS

Based on the estimate of the traction capabilities of draught animals as a function of their weight and the characteristics of the ground to be worked, how should the area to be worked be adjusted to the level of effort available?

This is where advice from the Extension Agencies is needed. If they advocate the development of draught cultivation and recommend the use of certain implements, they must also warn the farmer against using the animals in a way that is harmful to them.

In order to do this, it is absolutely essential to carry out various dynamometric tests on each type of soil, in order to determine the width and depth of work corresponding to the various levels of effort calculated for the main types of draught animals likely to be used by the farmer.

The National Agriculture Institutes or Agricultural Engineering Services of the various countries, or any other competent Body, could include these studies in their programmes. The Services, Institutes or Agencies responsible for the extension of draught cultivation should take part in the studies so that the farmers may quickly become aware of the limits of the work which can reasonably be expected of draught animals in the area.

In actual fact, the farmer is too often left to his own ideas of how much work his animals can do, on the pretext that, knowing his animals, he knows very well how to estimate how tired they are.

Practical experience shows that tiredness is often fairly difficult to assess and, in the absence of accurate criteria, the threshold is often overstepped beyond which the animals have great difficulty in regaining their strength - if they are given the opportunity, which is by no means always the case.

It is sometimes found that aiming at high output or utilization at whatever cost in draught cultivation, with too arduous work, results in working conditions which compromise the length of life of the animals thus abnormally increasing the death rate.

The optimum output from draught animals can only be obtained by using adult animals which have not had their growth impeded by being put to work too early.

The age at which training starts is often about $2\frac{1}{2}$ to 3 years, the cost of purchase then being lower than that of adult animals. Care must be taken not to include arduous work among the tasks carried out by the young animals and on no account must they be harnessed with adult animals doing deep ploughing.

Furthermore, harnessed units should only be made up of animals of the same breed, or at very least of animals whose reaction is similar in dealing with work loads.

It thus appears rather illogical to harness together two pairs of Zebus and one pair of Renitelos, as is sometimes done in Madagascar under the pretext that the latter heavier animals increase the capability of the unit. As the average speed of advance of Renitelos is generally higher than that of the Zebus, they are obliged to adopt an abnormal pace; furthermore, they try to overcome obstacles whereas the Zebus have a tendency rather to stop. There is certainly an increase in output but, producing more effort than the Zebus, the Renitelos tire quicker so that an apparently false conclusion may be reached that the Renitelo is not as strong as the Zebu.

D) THE IDEA OF MAXIMUM INSTANTANEOUS EFFORT

Study of the power of draught animals, and of the continuous effort available, determines the average effort which will be applied to various agricultural implements.

The maximum effort reached when ploughing with a pair of oxen weighing a total of 700 to 800 kg. will, depending on ground conditions, generally be between 250 and 400 kg.

It sometimes happens that implements are subjected to much greater efforts, mainly when the implement comes up against an unexpected obstacle such as a stump, big root, block of stone, etc.

An acceleration by the animals may further increase the strain on the implement, which often happens on badly prepared land when the animals, having been slowed down by variations in the effort required, are suddenly urged forward by the driver.

The maximum efforts which can be developed by various types of draught units are set out in Table IV. With a donkey or a horse, the maximum instantaneous effort is as much as, or even exceeds, twice the weight of the animal. With a pair of oxen the maximum is about the same as their weight.

In the case of bovines, the extreme values are all obtained at speeds appreciably higher than normal for these animals.

The mean of the maximum values recorded which varies from a half to 2/3rds of the weight of the animals corresponds to trials carried out at a speed nearer that of actual working conditions.

Accordingly, it appears essential for the mechanical characteristics of a plough to be calculated on the basis of the weight of the draught animals most widely used so that the maximum effort applied, even accidentally, cannot damage the implement.

TABLE II

Trials of Maximum Power in a Day's Work

TYPE OF DRAUGHT ANIMALS	Weight kg	Age Years	Mean effort kg	Mean of maximum efforts kg	Speed km/h	Power kg m/s	Duration of day's work	
							Hours worked	Effective hours
1 pair of White Peul Zebu bullocks (Saria)	790	11	110	188	2,3	69	5.20	4.05
1 pair of N'Dama bullocks (Farako-Ba)	720	11 & 13	100	255	2,7	75	5	4.25
1 pair of Renitelo bullocks (Kianjasoa)	1110	5½	150	360	2,9	120	3.40	3.40

TABLE III

Power of draught animals over long periods: (ploughing and tillage work)

TYPE & NO. OF ANIMALS	Weight kg	Age years	Average effort kg	Mean of maximum efforts(4) kg	Speed km/	Power kg m/s	Daily working hours		Duration of trial(1) days
							Hours worked	Effective hours	
1 donkey	160	-	46	88			6	3 to 3½	14 - 10
1 pair of oxen N'Dama (Sefa)	657	6 & 8	90	170	2,2	54	5½	5½ (2)	4 - 4
1 pair of oxen N'Dama (Mirankro)	800	9 & 10	80	215	2,0	44	5	4	11 - 10
1 pair of Madagascar Zebu bullocks (3) (Kianjasoa)	650	4 & 5	80	150	2,5	56	4.3/4	4.3/4 (2)	3 - 3
2 pairs of Madagascar Zebu bullocks	1300	4 & 5	160	400	1,8	80	5.3/4	5.3/4 (2)	2 - 2
3 pairs of Madagascar Zebu bullocks	1945	4 & 5	200	435	1,6	88	5	5 (2)	2 - 2
1 pair of oxen 1/2 Brahma (Hiadana)	1060	6	147	310	2,4	97	5.10	4.40	11 - 10

- 1) The first figure indicates the period covered by the trial and the second the number of days worked.
- 2) The effective hours worked are identical with the hours worked since the animals were used morning and evening for 2 to 3 hours; it was not necessary to break these half-sessions with rest periods.
- 3) 3 pairs of Madagascar Zebu bullocks worked: first with 2 pairs in harness, then 3 pairs made up by adding a third pair, ploughing an unprepared field; subsequently a single pair of the original unit did harrowing.
- 4) The values shown in this column are the mean of the maximum efforts recorded after each furrow.

TABLE IV

Maximum instantaneous effort

No. and type of animals	Number of tests	Weight kg	Age years	Instant- aneous Efforts	Mean Speed	Instant- aneous Efforts	Speed
				Mean kg	km/h	Maxima kg	km/h
1 donkey	4	155	-	215	3.8	355	4.5
1 pair of donkeys	4	310	-	355	4.1	480	4.5
1 horse	7	265	-	425	4.7	550	4.8
1 pair of Djokhore bullocks	13	730	7 to 10	500	3.4	780	4.5
1 pair of Djokhore cows	6	635	-	375	2.8	570	4.0
1 pair of White Peul Zebu bullocks	2	770	9 - 11	565	-	800	-
1 pair of Madagascar Zebu bullocks	2	650	4 - 5	345	3.1	750	4.5
2 pairs of Madagascar Zebu bullocks	1	1300	4 - 5	650	3.1	more than 1000	3.8
1 pair of Remitelo bullocks	1	1110	5½	590	3.9	more than 1000	4.5

NOTE: The harnesses used were as follows:

- collar and then breast-harness for the donkeys (no significant difference)
- breast-harness for the horses
- head yoke for the Djokhore bullocks and cows
- withers yoke for the Peul Zebus, the Madagascar Zebus and the Remitelos.

VI

TRAINING OF BOVINESA) CHOICE OF DRAUGHT ANIMAL FOR TRAINING1) Desirable characteristics

To the extent possible, the animals chosen should be stocky, thick-set, strong muscled (particularly thigh, hindquarters and loins), short-legged, powerful and strong-jointed; with large feet with solid hollow-soled hooves (preferably black); broad and deep chested.

The use of the withers yoke requires solid shoulders, not too sloping and the presence of a hump to help keep the yoke in place.

The use of a head yoke requires a powerful, short neck, a thick nape, a wide head and solid wide-based horns of medium length and angled forwards.

- With a young animal the following must be stressed:
 - . the size and firmness of the bone structure and joints,
 - . the presence of muscles under a fine, short-haired glossy coat.
- The yoke should be fitted to bovines of the same size, age and build.
- Generally speaking, the following should be avoided:
 - . unduly bulky, narrow-chested, long-headed animals on thin legs,
 - . vicious or lifeless oxen.

2) Sex

Bulls are not very docile and are difficult to train.

Cows need a lot of feed to cover their maintenance and lactation and gestation periods which may, moreover, be considered ill-suited to the rudimentary breeding conditions in Africa.

They cannot work continuously and must stop for 1 to 2 months each year (end of gestation period, beginning of lactation).

Bullocks are the bovines best suited to draught work.

- AGE OF CASTRATION

This must be done between 10 months and 2 years, the best time being between 18 months and 2 years. Too early (at 7 or 8 months) results in a slowing down of body development.

Too late (after 5 years), castration does no more than reduce the male characteristics.

- TIME OF YEAR FOR CASTRATION

This is of little importance if the dry season is not very marked or if additional feed is available on the farm.

In countries with marked dry seasons it is very important to carry out this operation shortly before the rainy season (hence the choice of animals born before or at the beginning of the rainy season).

B) AGE FOR TRAINING

The suitable age is, on average, between $3\frac{1}{2}$ and 4 years, though training can be undertaken at $2\frac{1}{2}$ years provided that sufficient feed can be provided when working.

The best time of year is at the end of the dry season (this allows the training to be completed with the first ploughings and sowings and adequate feed to be provided).

It can be done at any time of year if the animals are being trained to pull carts. Otherwise additional training before ploughing is essential.

C) TRAINING METHODS

1) Duration of training

This depends on many factors, the more important of which are :

- The age of the animals. They learn quicker the younger they are.
- Their character. A lively animal, which will later be able to give better service than an initially more docile one, will be more difficult to handle and will require longer training.
- Their state of health. More can obviously be demanded of a healthier animal.
- The trainer. The skill, experience and character of the trainer may all influence the duration of training.

The training of a pair of oxen for the various types of agricultural work takes an average of a month. The time required for the various exercises provided for in the following programme may vary widely.

2) Training programme

This applies to a programme proposed for a pair of oxen.

a) PUTTING ON AND ACCEPTING THE YOKE

b) TRAINING FOR WALKING

- Start - walk - stop
- Development of tractive effort
- Straight line
- Turns

- Walking backwards

(These different exercises can be conducted with and without reins).

c) ADAPTATION TO SPECIFIC TASKS

- Ploughing
- Spring time cultivating
- Pulling a cart.

d) WORK WITH A SINGLE ANIMAL

GENERAL REMARKS

The technique of training can be acquired, but the trainer must have the personal qualities of patience, firmness and sympathy towards animals. The training atmosphere is well understood by such people. As any brutality is out of the question, moderate blows which do not hurt the animal can be delivered at the beginning of training to enforce obedience. The normal methods of command (voice, gestures, reins) must always accompany the blows and then replace them completely after the results have been achieved.

An ordinary goad which pierces the skin and reduces the value of the leather should never be used. The electric goad however is very effective and is not dangerous.

Finally, there is no point in obstinately continuing the training of an animal which has shown itself to be vicious. It is better to get rid of it quickly, because of the accident risk it represents.

The training period upsets animals because of the unusual routine. As a result they expend more energy than during normal work. They must therefore be fed on a generously calculated scale (see chapter VIII).

Working sessions must not be long (for example not more than three periods of $1\frac{1}{2}$ hours in a day). The hottest hours must be avoided and so must stops during working sessions.

1) Putting on and accepting the yoke

The first aim is to restrain the animals to force them to accept the yoke. Depending on their character this operation may be easy or very difficult.

A wary bovine, not wearing a nostril rope, is caught by trying to approach it in the middle of the herd so that its movements are restricted. If it is by itself, it must be caught by surprise, or by surrounding it with several men. The first job is to get a rope round its horns. If the animal panics it must be given time to calm down.

In inter-tropical Africa, restraint by means of a light cord passed through a hole in the nostril partition is common practice. Accidents are rare, but brutal use of the cord may result in tearing the partition. The metal nose ring is preferable in all cases. It is smooth and does not hurt and cannot break (fig. 1).

With violent and nervous cases, it is helpful to tie a rope round the base of the horns or to the legs.

Putting the yoke on very restive animals may be achieved by using an already trained animal together with the one to be trained. Whenever it can be used, this method is the best.



Fig. 1 -

Screwed ring

La Guerche ring

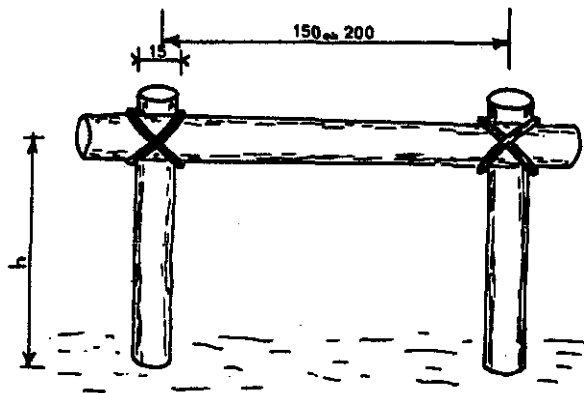
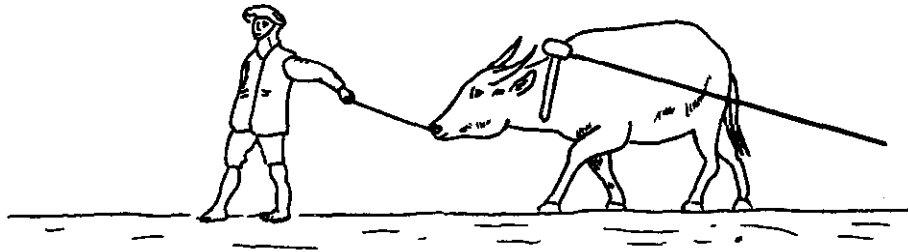
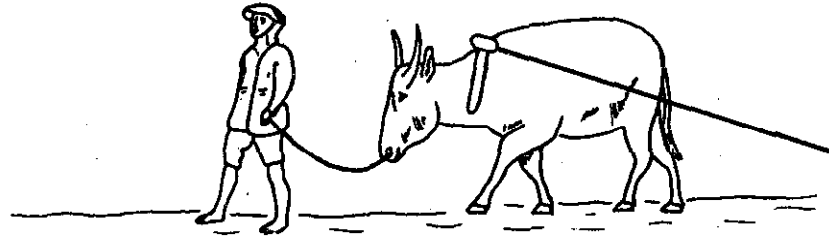

Fig. 1a - Simplified "stock": height depends on the size of the oxen

Fig. 2 : LEADING



I - To be avoided: the man is pulling on the nose rope, the animal stretches its muzzle forward



II - Normal attitude: the nose rope is slack, the ox carries its head normally

Another method also to be recommended is that of the "stock". This consists of a frame made of two strong wooden posts of about 10 cm. diameter which are sunk vertically into the ground to a depth of 1 m. The height above the ground must be suited to the size of the oxen (on average 1.50 m.). They are set about 2 m. apart. A horizontal crosspiece of the same diameter joins the two posts at the head height of the oxen. It is held in position by ropes which can be cut quickly if necessary. The heads of the animals are attached to the horizontal bar by the horns (fig. 1a).

The stock not only allows the yoke to be put on but enables the animals to be restrained for such other operations as trimming the horns, marking, care of the feet, etc.

The oxen must be left tied under the yoke until they are perfectly calm. They should be trained to accept putting on and removal of the yoke without violent reactions. Usually, one day is enough, but several days may be necessary.

2) Training to walk

As soon as a pair of oxen accept the yoke, their training in walking starts. Efforts are made to encourage them to move together, while individual movements are discouraged. If needs be, the trainer puts himself in front of the animals and facing them.

He holds the nose-ropes while his assistant (who is essential) or assistants (if the beasts are difficult) keeps close to the flanks of the animals which they may control by means of ropes attached to their legs.

The animals must not be dragged by their nose-ropes (which would result in lifting their heads with the nose held forward). These ropes are used to control the spacing and height of the heads (fig. 2).

A fault, difficult to correct, becomes apparent when the oxen tend to lean against each other or, on the contrary, to separate. It is then necessary to make them walk by themselves with a single yoke while training them for draught work.

Very quick progress to the development of tractive effort is necessary. Very often, the first two exercises (walking under the yoke and tractive effort) can be undertaken together, the animals being easier to handle when they have an effort to make, provided that it is not in excess of their capabilities.

The thing to be dragged may merely be a tree trunk attached to the yoke by a chain. A sledge, loaded progressively and in accordance with the strength of the animals, might perhaps be the best device.

Sowing the weeding work require that the trained oxen can be guided accurately. This result is generally achieved in Africa by making a cowherd (often a child) walk at the head of the oxen.

It is useful, during training, to introduce the use of reins which are more effective in allowing accurate guidance of the harnessed animals by the person at the implement (fig. 2a).

The reins, usually 8 mm. ropes, are attached to the ears or the nostrils. A simple system consists of a single rope attached by a loop to the right horn of the left hand ox with a turn round the left ear of the same animal, through the hands of the driver behind the animals and returning to make a turn round the right ear of the right hand ox before being attached by a loop to its left horn. The left hand animal is thus pulled solely to the left and the right one to the right. The same arrangement

is used with nose rings when fitted (without attachment to the horns) with the two nose rings also joined by a rope.

A more sophisticated system is that of double reins, similar to those used with a pair of horses harnessed abreast. The left rein (which runs along the left flank of the left animal) is divided into two parts attached to the two left ears of the animals or to the two nose rings and the right rein is similarly fixed on the other side.

Bovines quickly become accustomed to guidance by reins, starting with leading them from in front. Once the reins are in place and held normally by the trainer, the cowherd first continues to lead the oxen, close to but without touching them. He then gradually moves further away as the exercise develops, finally leaving the oxen guided solely by the reins. This exercise requires particularly good coordination between the two operators.

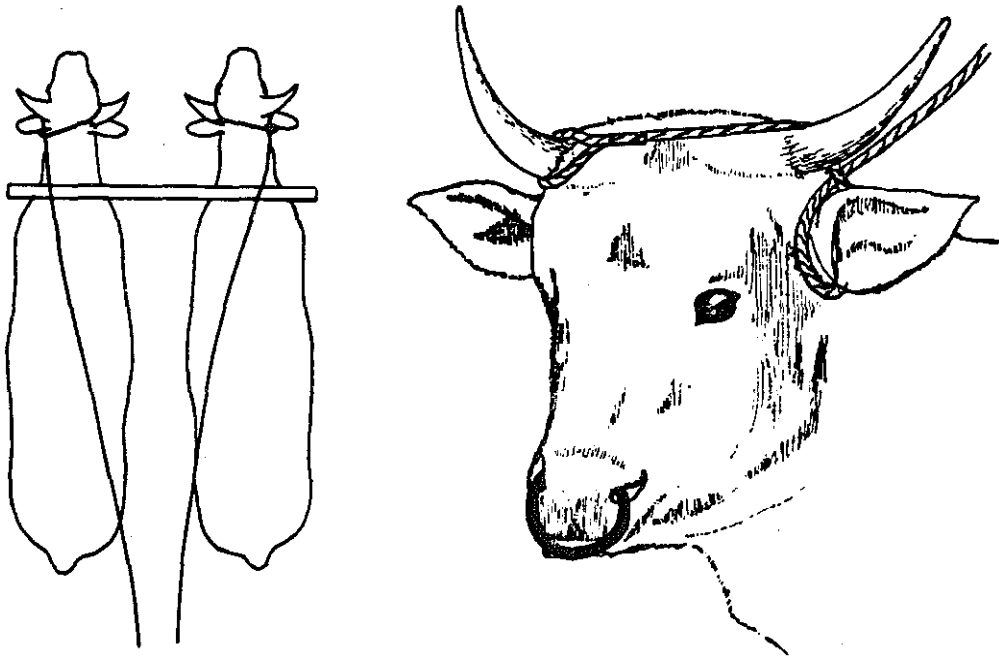

Fig. 2a

Pair of oxen with reins
on their outer ears

Detail of the rein
round the ear

Turns, both wide and sharp, must be taught by making the animals carry out figures of eight so that they get into the habit of turning both ways.

Starting up must be taught from behind (combining voice and gestures) and not from in front. To teach stopping, the cowherd stops in front of the animals at the same time as the trainer pulls back on the reins.

Walking backwards is taught as soon as the oxen obey the reins properly, but first by pushing on their muzzles with both hands from in front. At the very beginning, blows

on their nostrils may be necessary. Walking backwards must be achieved over a relatively long distance when working with carts. The difficulty is to prevent the hindquarters from going in different directions. During the training period the use of straps to keep them parallel may possibly be used.

3) Adaptation to specific work

Oxen which know how to walk properly must still be trained for the various tasks, for which they cannot be used straight away.

For ploughing, they must be taught to walk one in the furrow (which hinders its movement) and the other on the land and to continue straight on after the end of the furrow until the implement itself reaches the end.

Training for work with spike tooth and spring tooth harrows is easy, but the animals must get used to walking on loose ground.

Changing over to the cart, whose resistance to movement is less constant than that of an earth-moving implement, may give rise to accidents as the animals may bolt. This changeover must not, therefore, be undertaken too early and it is wise, to begin with, to keep an assistant in front of the oxen.

4) Work with a single animal

When the pair of oxen works calmly and obediently, it becomes easy to uncouple them and make them work separately. It will thus be possible to use the oxen alternately for weeding between lines or together with different implements. Only a few hours are generally needed for this training.

5) After training

Although training may seem to be complete after a few weeks, the various habits have still only been learnt very superficially. During a long period of inaction after training the animals will tend to lose the habit of daily contact with their master and the equipment with which they work. This may make it necessary to start the training again almost completely. The oxen must therefore be put to regular work as soon as they are trained and the value of the cart cannot be over-emphasised since in this way the draught animals can continue to be kept at work.

The method of guiding the animals must be exactly the same as that used in training. It is therefore very important that the training should take place in the presence of, and even with the assistance of, the owner of the animals.

It is desirable for the animals always to be driven by the same cowherd, or at least by a limited number of people, since the animals become accustomed to the people with whom they work.*

Finally, the way of life of the draught animals must be as regular as possible, since habit is a basic factor in effective employment of them.

* In the cattle shed, the two oxen of the same pair must be tethered side by side.

VII

HOUSING OF THE ANIMALS

In African rural areas, very simple housing must be envisaged for the animals used for cultivation, constructed of local materials such as clay and earthen blocks, wood and straw.

A) THE CATTLE SHED

This must:

- shelter the animal from sun and rain,
- be adequately hygienic (good drainage, cleanliness) and well ventilated,
- make it possible for all the fodder to be eaten,
- permit complete utilization of the manure.

1) Dimensions

Each animal needs a rectangular space of about 1.50 m. wide and length according to size of the animal (from the muzzle to the rear of the hind quarters) + 0.10 m; i.e. an average of 2 m. to 2.50 m.

2) Floor

This must be impervious and hard and preferably sloping to facilitate the run-off of liquid manure.

It must not be slippery.

As far as possible, a slightly raised site should be chosen.

3) Construction

Let us take the example of a cattle shed for 2 animals: 9 vertical posts, 6 of which 2 m. high support roofing made of woven vegetable material or of thatch. The posts mark out two 1.50 m. x 2.50 m. spaces for the animals and a corridor 1.50 m. wide and 3 m. long.

The walls and stall sides should be made of horizontal wooden cross-members acting as barriers and capable of being padded with straw (figs. 3 and 4).

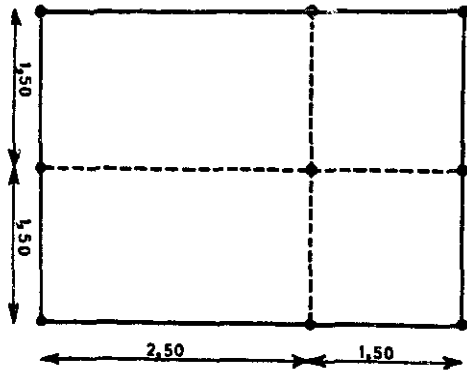

Fig. 3 - Plan of a cattleshed for two animals

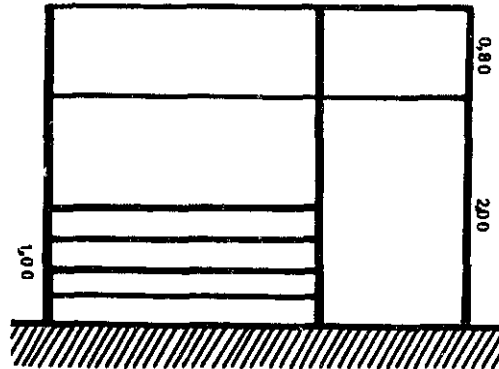

Fig. 4 - Cross section (for two or more pairs of animals, the ridge pole should be perpendicular to the line shown here, i.e. parallel to the corridor).

The height of these walls should be 1 m. or 1.20 m. The whole shed is thus amply ventilated.

If it is to house several pairs of oxen, the animals of each pair must be tethered alongside each other.

If possible, the manger should be made of brick. 200 litre casks cut in two can also be used.

The manger must be able to hold 100 litres per animal and should be 0.60 m. wide with its rim 0.50 m. above the ground (fig. 5).

B) DEEP LITTER CATTLE SHED

In the deep litter cattle shed, the manure stays put; it is covered over every day with a layer of litter and the manure is cleared out once or twice a year.

No droppings are lost, the manure is well packed and maintenance work is reduced to a minimum.

A: exercise area
 E: covered area for the animals
 a: drinking trough
 d: door
 f: 1.50m high round posts supporting
 the enclosure
 g: sheet metal guttering
 m: manger
 p: posts made of tree trunks driven
 into the ground.

Fig. 5 - Free shelter
 (3 pair of oxen)

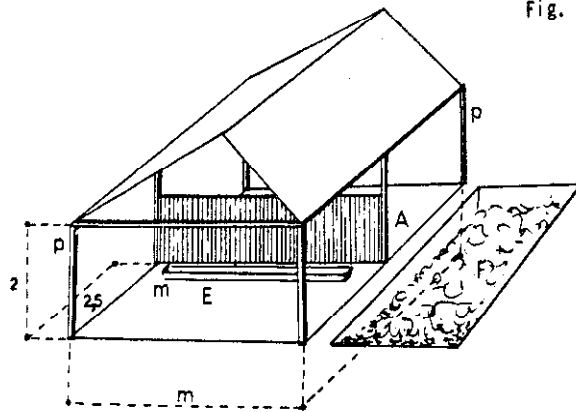
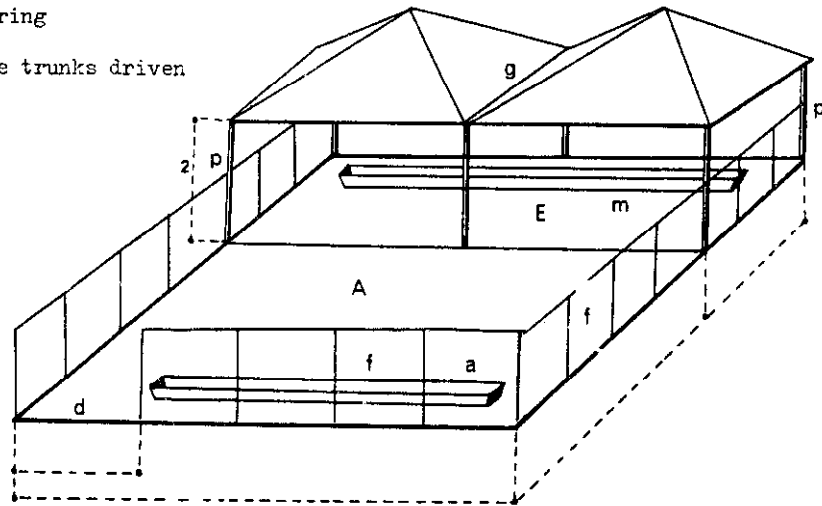

Fig. 6 - Cattle shed with manure trench
 (1 pair of oxen)

A: feeding area
 E: Space for the animals
 F: manure trench
 c: enclosure with round posts
 m: manger
 p: posts made of tree trunks
 driven into the ground

- 1) In its simplest form, the cattle shed will consist of a shelter under which the animals will be regularly tethered with a little straw as litter so that their manure can be collected. The roof of this shelter may serve as a reserve of straw or of forage.
- 2) A more sophisticated type of deep litter cattle shed will include a 2.50 m. wide trench (to facilitate covering over a length proportional to the number of oxen, counting 2 m. per pair of oxen).

Here are its main details: (figs. 6 - 7 - 8 - 9)

- Depth 1 m, with excavated earth thrown up onto the edges forming a slope.
- Inclined plane at one end to facilitate entry and exit of the animals.
- Thorn-bushes planted on the rear excavated earth or a movable barrier of round posts.
- At the bottom of the trench, the addition of 5 to 7 cm. of packed laterite to prevent too much infiltration of liquid manure (which should be absorbed by good litter). Depending on the type of soil, the side walls may also be rendered with laterite.
- Roofing supported by wooden posts and framework and covered with vegetable matter tiling or thatch.
- A well sunk nearby and equipped with pail and rope.

C) THE STABLE

In Tropical Africa, the stable often consists of straw roofing under which the horse is tethered. It is wide open and amply ventilated. If the necessary materials are available, housing may be built similar to a cattle shed and enclosed by earth walls. Its dimensions should be as follows:

For 1 horse: width 1.70 m.
 total length 4.00 m.

In addition to the manger, a rack must be constructed.

For 1 donkey: width 1.00 m.
 total length 2.50 m.

PERSPECTIVE

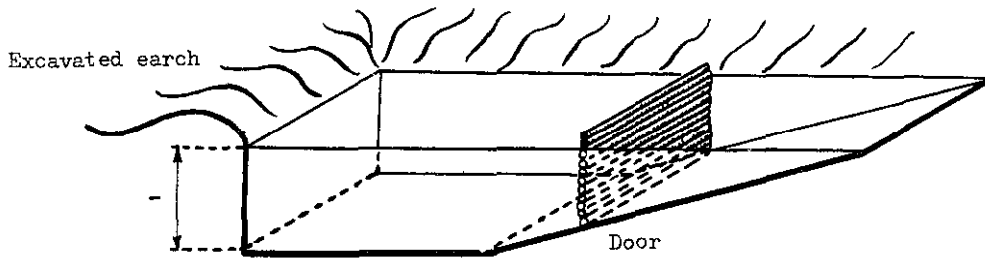

Fig. 7

PLAN

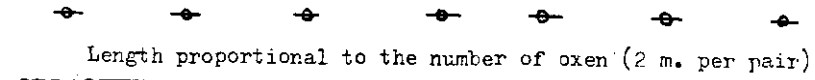
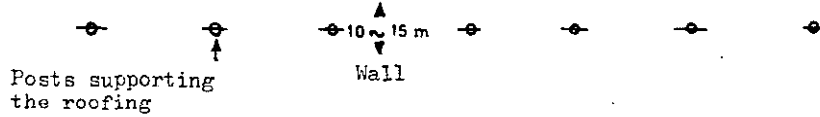

Fig. 8



SECTION

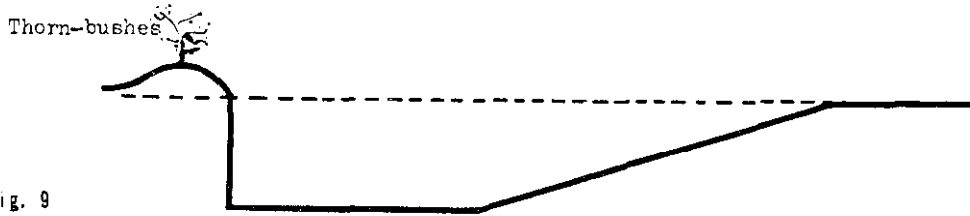

Fig. 9

VIII

FEEDING - PRODUCTION AND CONSERVATION OF FEED

The correct feeding of the draught animals is one of the essential conditions in the success of animal draft cultivation. In Africa, whereas the horse is generally well cared for and properly nourished, it is much more difficult to make the farmer understand that he must pay just as much attention to feeding his oxen as he would do for a horse.

The difficulties in feeding draught animals stem from the fact that the adoption of animal draft cultivation straight away commits the farmer, who is rarely a stock-breeder, to a more developed aspect of stock management than is the case with the stock-raiser. Indeed, the agricultural areas are very different to the pasture areas and, since the use of the animals in situ avoids seasonal transfers, the farmer has to take the ox to the fallow land, prepare reserves of feed, distribute additional rations and provide drinking water.

A) THEORETICAL REQUIREMENTS

Estimates of the theoretical requirements of bovine draught animals vary from author to author. The following figures for a 300 kg bullock may however be taken as representative:

	Maintenance	2.60 U.F. per day (1)
In addition:		
	light work	1.40 U.F.
	medium work	2.60 U.F.
	sustained work	4.00 U.F.

(1) U.F. : abbreviation for forage unit.

Here are some figures for the maintenance rations of oxen of various weights:

200 kg	:	1.95 U.F.
250	:	2.30
300	:	2.60
350	:	2.95
400	:	3.25
450	:	3.55
500	:	3.85

Furthermore, the following formulae apply within fairly wide limits: with E as the maintenance ration, the total ration for light work may be taken as $\frac{3}{2} E$; for medium work: $2 E$; and for heavy work: $\frac{5}{2} E$.

As regards the qualitative composition of the ration, the digestible protein requirement, for both maintenance and work, amounts to 250 g.

The bulk coefficient (dry matter per forage unit) must be about:

2	for a resting ox
1.5	for a working ox

Maintenance ration for a horse:

resting	2.5 U.F. per day
working	5 U.F.

and 325 g. of nitrogenous digestible matter (maintenance and work)

Maintenance ration for a donkey:

maintenance	1.5 U.F. per day
light work	2.5 U.F.
continuous work	4 U.F.

The working donkey must be properly fed and not left to its own devices.

At the end of this chapter will be found a table of food values of the animal feeds normally found in Africa.

B) SEASONAL TRANSFERS

Some farmers, particularly in the Sahel-Sudan regions, make their animals work during the rainy season and, in the dry season, entrust them to Peul pastoral people who move north with the herds. This system should be abandoned and draught animals must remain where they are.

C) FEEDING OF ANIMALS ON FALLOW LAND

The use of fallow land for grazing remains the main source of supply of feed for working animals. Fallow land, often 3 to 5 years old, is needed since the African farmer has not yet become accustomed to the regular use of soil improvement methods and fertilizers.

The use of fallow land is only possible in those areas of the Sudanian-Guinean zones where there is sufficient rainfall.

On tropical fallow land, as well as on natural pastures, graminaceae are predominant and are sometimes the only greenstuffs present. If the land is left fallow for a long time, saplings and shrubs may also begin to grow in addition to herbaceous plants.

The nutritional value to be got from fallow land is generally fairly low: 5 to 6 hectares of fallow are needed to feed one ox weighing about 300 kg. To assess the area needed to feed a bovine, use is sometimes made of the following empirical formula: to feed an adult 300 kg. ox at least as many hectares are needed as there are months in the dry season.

IMPROVEMENT OF NATURAL FALLOW LAND

The following may be used to improve the pasture:
Either graminaceae: Pennisetum purpureum (elephant grass), a hybrid P., known as red neck, or leguminous plants: Stylosanthes gracilis for example.

The following improvement methods are recommended:

- First put the herd out to pasture on land with the improved species and then put it on the fallow land for a few days: the seeds absorbed are eliminated in the droppings thus assisting the soil improvement.

- It is, however, particularly by means of enclosed areas that appreciable progress can be made in the production of feed on natural pastures and in their effective use.

The fencing will preferably consist of live hedges (cotton-trees, spurge, mesquite, etc.). These fences enable the animals to be penned in, as a result of which the hard stalks will be trampled, broken down and converted into humus, the soil will be manured by their droppings and the cropped grass will sprout again. Care must, however, be taken not to put too many animals in the enclosure.

- Mowing of pasture land achieves similar results. In addition it enables forage reserves to be stored.

D) FORAGE CULTIVATION

With the agricultural progress associated with stock-breeding, it will be necessary to cultivate plants in the area for cropping, as well as temporary grassland for feeding the animals.

The principle of forage cultivation is to incorporate it into the crop rotation system. The following crop rotation may, for example, be grown:

- a - ground-nuts - millet - ground-nuts - forage over 3 years
- b - cotton - sorghum and beans, ground-nuts - sorghum and andropogon or again
- c - sorghum - ground-nuts (or cotton) - sorghum - Bengal hemp⁽¹⁾

The plants cultivated in tropical countries for forage production belong almost exclusively to the Gramineaceous and Leguminous families, particularly the former.

Here are the main species which may be used:

1) Graminaceae

a) Thick stalked

- Maize, an excellent forage plant for its stalk and its grain. Needs rich soil and heavy manuring.

- Forage millet. Broadcast sown, it is an excellent high yield (up to 30 tons per hectare) forage crop.

- Sorghum. Same advantage as millet. Disadvantage: the stalks rapidly harden. When eaten green there are risks of digestive ill effects for the animals.

- Coix-lacryma - Jobi grows in a variety of soils. It gives high yields with 3 to 5 crops a year in a humid climate.

- Some varieties of sugar cane with relatively fine stalks may be used as forage.

(1) The first rotation is recommended by the Rural Agriculture Centre at Bambey, the second by BOUDET for countries with a Sudanian-type climate and the third by DUMONT, for countries with an annual rainfall of less than 1 m.

b) Medium or fine stalks

Depending on their main use, these may be classified as follows:

b-1) HAY GRASSES: these are generally annual Gramineae with upright stalks.

- Teff (*Eragrostis abyssinica*). Grows very quickly and produces excellent hay.
- Sudan-grass (*Andropogon sorghum*). Very resistant to drought; may be cultivated in a dry climate with a short rainy season. Makes good silage.
- Various graminaceae of the Panicum, Paspalum and Digitaria types (Finger grass: *Digitaria exilis* is cultivated for its seed and has a stalk which makes excellent forage).

b-2) INTERMEDIATE GRASSES: they may be used for hay and may also be eaten green. Here are some examples:

- Guinea grass (*Panicum maximum*)
 - Elephant grass (*Pennisetum purpureum*). Needs a lot of water and prefers rich soil. Its yield may reach 90 tons per hectare.
 - Brachiaria and Digitaria Umfoluzi. Excellent species for cultivated grass-land for use as pasture, for hay or silage cropping. Yields are about 20 tons per hectare. The best, in humid areas, is *B. ruziziensis* and, for humid low-lying land, *B. mutica*.
 - Phalaris bulbosa. Fairly demanding. Much sought after by the animals.
 - Rhode-grass (*Chloris gayana*). Good both for hay and for grazing.
- B-3) PASTURE GRASSES: These are perennial graminaceae which, generally speaking, produce hay which is of poor quality or difficult to keep.

We may mention:

- Paspalum dilatatum, in humid soils.
- Brachiaria mutica (or Para-grass) also in humid soils.
- Pennisetum longistylum (or Kikuyu-grass) of high forage value.

2) Leguminous plants

These should preferably be mixed with the graminaceae.

- Stylosanthes gracilis is particularly successful where the annual rainfall exceeds 1,000 mm. Its yield with two crops may reach 10 tons per hectare.
- Beans (*Dolichos Lablab*) may be sown between lines of sorghum; it makes good pasture in the dry season. Its yield is 6 to 10 tons of forage per hectare.

- Bengal-hemp gives good forage provided that it is cut before the stalks become woody. It can be used for silage.

E) PRESERVATION OF FEED

1) Hay

In tropical countries it must be mown before it flowers because the grass then rapidly becomes hard and of low mineral content.

Haymaking is generally difficult in hot countries, except in the Sahelian region where it can be dried easily.

The forage must be exposed to the sun as little as possible.

Big stacks should be made as soon as the hay is sufficiently dry.

The hay of tropical pastures is generally one third less nutritive than that of temperate climates. During drying it loses, in particular, a lot of carotene, a principle source of vitamin A.

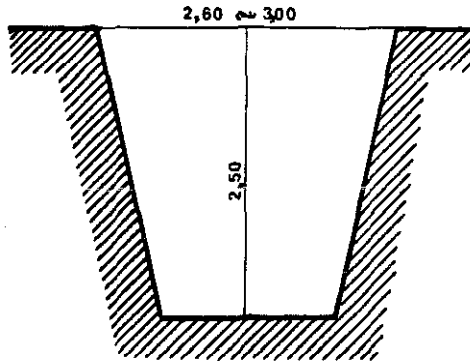

Fig. 10 Section of a silage trench

2) Ensilage

This is a procedure for the airtight preservation of feed, and in bulk. It enables moist nourishment to be fed to the animals during the dry season.

Silage pits should be dug in permeable soil (fig. 10).

Plants with thick stalks must be broken up.

Filling is done in successive layers of 30 to 40 cm. with packing down as the work progresses.

Fermentations occur (particularly lactic). The last layer is covered with a little straw and with earth which is packed down. Care must be taken to avoid any air entering the silage pit or clamp.

Ensilage enables reserve of feed to be stored so that it can be fed to the animals at any time of the year.

It will keep for up to 1 year.

F) ADDITIONAL FEEDING

1) The use of crop by-products *

In Africa, these by-products are all too often left unused and are wasted.

* See the following publications:

- . Tropical products usable as animal feeds in French-speaking West Africa. Mongodin (B.) and Van den Berg (X.). I.E.M.V.T. - B.D.P.A.
- . The food values of 150 foodstuffs in West Africa. Mongodin (B.) and Rivière (R.). I.E.M.V.T. - (1965).

- Ground-nut haulm, which is rich in nitrogenous matter, has a forage value of 0.5 U.F. per kg.

Harvested and dried under the best conditions the haulm from a 4 hectare ground-nut field (in Senegal) can feed a pair of oxen for at least 200 days.

The animals are each given 8 to 10 kg. morning and evening.

- Cowpea haulm is harvested and preserved like that of ground-nuts. Storage must be sufficiently ventilated to avoid mould.

- Rice straw can be used as a source of additional nourishment to ensure carry over during the dry season, particularly for adult ruminants.

- Rice and millet bran, mostly fed to poultry, can provide an additional source of energy for working oxen and horses.

- Ground-nut cattle-cake can be given at a rate of 300 to 500 g. per day per animal to young growing beasts.

- Roots and tubers: yams and, particularly, cassava are excellent for oxen in providing for immediate energy requirements.

2) Mineral additives

a) REQUIREMENTS

These are summarised in the following table:

		MAINTENANCE	GROWTH	GESTATION	LACTATION	WORK
BOVINES	Ca	5 gr/100 kg of weight	15 g/kg of gain	6 g/100 kg of weight	2.5 to 3 g/kg of milk	-
	P	5 gr/100 kg of weight	6 g/kg of gain	5.5g/100 kg of weight	2 to 2.5g/kg of milk	-
	NaCl	5 gr/100 kg of weight	2 g/kg of gain			-
EQUINES 300 kg animal	Ca	15 gr	7.9g/kg of growth			-
	P	9 g	7.3g/kg of growth		16.7 g 15.2 g	

b) PRACTICAL ADMINISTRATION

The best method of giving animals mineral salts is to make a "mineral lick" available to them. There are many different formulae available in the trade. Here is one recommended in Senegal (Boulel Agricultural Research Station).

demensions 17 x 9 x 5 cm

weight 2 kg

composition:

bicalcium phosphate 2%

sodium chloride 82%

calcium carbonate 4%

g) WATER AND WATERING

Here are some practical figures.

- For bovines:

In extensive cattle raising with night pasturage in the Sudanian area:

- in the rainy season:

Zebus: 16 litres (extremes 10 l. to 23 l.)

Taurines: 12.5 litres (extremes 7 l. to 19 l.)

- in the dry season:

Zebus: 21 litres (extremes 12 l. to 29 l.)

Taurines: 20.5 litres (extremes 13 l. to 25 l.)

In extensive cattle raising grounds without night pasturing: 30 to 40 litres per day.

For working animals: 40 to 50 litres per day in the dry season.

- For horses: 30 to 50 litres per day.

- For donkeys and mules: 15 to 30 litres per day.

- For dromedaries: 50 to 60 litres every 2 days.

h) TYPES OF RATIONS RECOMMENDED FOR WORKING OXEN

BAMBEY Agricultural Research Centre (Senegal)

- Ground-nut haulm 12 kg

- Bush hay 4 kg

- Bush silage 4 kg

- Crushed sorghum 2 kg

SARIA (Upper Volta)

- Hay or straw 8 - 10 kg per day
(tricalcium phosphate 3 kg
- 1 kg mixture of (sea salt 5 kg
(sorghum seed 100 kg
- 1 kg of ground-nut cattle-cake

C.F.D.T. Centre (Niger)

- 7 to 10 kg of hay
- 1 to 2.5 kg of sorghum or ground-nut cattle-cake.

IVORY COAST (according to BOUDET)

- Medium work
 - 20 kg of young grass
 - 5 kg of grass ready for cutting
 - 3 kg of ground-nut haulm
 - 1 kg of millet
- (U.F. 4.3
i.e. (MAD(1) : 416 kg
(Bulk : 1.7
- Light work in drier area
 - Hay or rice straw 5 kg
 - ground-nut haulm 8 kg
 - ground-nut cattle-cake 0.5 kg
 - low quality ground rice 0.5 kg
 - sorghum 1 kg

(1) (Matières azotées digestibles)
Digestible nitrogenous matter

FORAGE - GRAMINACEAE

DESCRIPTION	M.S.	M.P.B.	Cell. M.G.	ENA	Ca	P	M.P.D.	ENERGY	
			% of dry matter				Ruminants	Ruminants	
<u>Digitaria Umfolozi</u>									
Green forage	(15.3	13.5	33.7	1.3	38.4	0.49	0.23	9.4	0.60
	20.7	8.7	35.4	1.8	43.3	0.60	0.38	4.8	0.57
	32.7	5.0	36.3	1.5	45.8	0.64	0.33	2.5	0.54
Fresh growth	16.2	11.8	32.4	1.0	43.4	0.58	0.31	7.7	0.66
Mali hay	79.0	2.5	38.3	0.8	45.0	0.40	0.22	0.4	0.36
Ivory Coast hay	87.0	7.8	37.6	2.1	44.2	0.42	0.24	3.1	0.44
<u>Millet forage</u>									
(Sorghum Almun)	7.4	21.5	25.5	1.2	34.6	0.62	0.54	16.9	0.70
	8.9	15.9	34.4	1.3	35.1	0.59	0.56	11.6	0.57
	15.0	8.6	40.4	1.1	39.2	0.30	0.35	4.7	0.41
	25.3	8.3	40.5	1.1	41.0	0.23	0.28	4.4	0.45
	30.9	5.4	41.1	1.0	43.6	0.23	0.28	2.7	0.42
<u>Maize forage</u>									
Green	21.9	8.7	23.7	2.7	59.4	0.34	0.20	4.8	0.89
Cob forming stage	48.2	8.8	28.0	0.9	54.8	0.69	0.25	4.9	0.75
Straw	93.6	5.0	34.7	1.1	52.5	-	-	0.8	0.53
<u>Pennisetum Merkeri</u>									
Green forage	13.1	13.4	32.7	2.4	36.2	0.34	0.26	9.3	0.60
" "	17.0	9.8	35.7	1.6	41.5	0.41	0.19	5.9	0.56
" "	25.1	7.7	37.2	1.9	42.0	0.44	0.14	3.8	0.51
" "	39.9	6.2	38.0	1.8	42.5	0.45	0.18	3.1	0.48
<u>Pennisetum clandestinum</u>									
	19.5	15.7	32.7	1.8	43.5	0.44	0.50	11.4	0.70
	91.6	10.5	35.1	1.8	46.3	0.31	0.32	6.5	0.52
<u>Pennisetum polystachion</u>									
Green forage	18.8	8.3	36.8	1.4	41.5	0.26	0.22	4.4	0.54
Hay	92.0	4.1	43.2	1.0	45.0	0.21	0.25	2.0	0.34
<u>Pennisetum purpureum</u>									
(Elephant grass)	20.6	10.6	34.9	2.7	39.3	0.40	0.20	6.6	0.57
<u>Andropogon Gayanus</u>									
	18.0	10.2	35.0	1.4	45.1	0.35	0.20	6.2	0.66
	22.4	9.0	34.8	1.5	45.7	0.36	0.17	5.1	0.63
Hay	27.6	8.0	35.5	1.5	47.5	0.36	0.15	4.1	0.62
	34.6	7.4	35.8	1.7	48.8	0.39	0.15	3.5	0.63
	44.0	5.3	37.6	1.6	49.3	0.39	0.13	2.5	0.58
	93.2	2.8	39.7	1.2	49.8	0.39	0.06	0.5	0.41

FORAGE - GRAMINACEAE (cont'd.)

DESCRIPTION	M.S.	M.P.B.	Cell. % of dry matter	M.G.	ENA	Ca	P	M.P.D. Ruminants	ENERGY Ruminants
<u>Paspalum virgatum</u>									
Green forage	22.5	9.9	35.1	1.2	43.0	0.35	0.17	6.0	0.59
" "	29.2	6.4	36.9	1.4	47.9	0.26	0.15	3.0	0.58
Hay	91.8	5.7	38.0	1.3	48.2	0.43	0.14	1.4	0.45

<u>Panicum maximum</u>									
Green forage	16.6	10.7	34.3	1.2	41.1	0.45	0.27	6.7	0.57
" "	25.8	9.2	34.7	1.5	43.3	0.44	0.25	5.3	0.58
" "	34.7	7.5	35.9	1.7	45.5	0.54	0.22	3.6	0.57
Hay	92.5	7.1	36.9	1.7	45.4	0.69	0.26	2.6	0.45

<u>Panicum antidotale</u>									
	18.3	15.1	33.0	1.4	37.1	0.75	0.24	10.7	0.61
	25.3	12.4	35.0	1.7	39.9	0.59	0.23	8.3	0.58
	34.3	10.6	36.5	1.9	43.3	0.54	0.22	6.6	0.59

<u>Cenchrus ciliaris</u>									
	25.2	8.4	34.9	1.5	38.3	0.59	0.18	4.5	0.50
	34.3	6.4	41.8	1.7	40.2	0.33	0.17	3.0	0.37
	45.7	5.3	43.5	1.5	41.1	0.29	0.17	2.5	0.36

<u>Cenchrus setigerus</u>									
	25.9	7.1	35.9	1.2	41.5	0.44	0.20	3.5	0.48
	33.7	6.4	36.2	1.2	45.1	0.39	0.19	3.0	0.55

<u>Aristida mutabilis</u>									
	52.1	3.9	40.2	1.1	48.6	0.25	0.11	2.0	0.51
	83.4	2.8	41.5	1.0	48.5	0.31	0.09	0.5	0.39
	94.0	2.1	42.8	0.8	48.4	0.23	0.07	0.3	0.36

<u>NATURAL PASTURES</u>									
% of dry matter									
<u>Natural green pastures</u>									
Fresh shoots	17.7	22.8	23.9	2.0	34.3	0.29	0.45	18.2	0.77
Young forage:									
good quality	24.8	9.7	33.9	2.1	44.0	0.31	0.24	5.8	0.61
average quality	21.7	7.2	35.7	1.5	45.8	0.31	0.24	3.5	0.50
Older forage:									
average quality	30.8	6.8	36.7	1.6	47.3	0.30	0.18	3.2	0.48
Young forage:									
poor quality	23.0	4.1	36.9	1.4	46.6	0.42	0.15	2.1	0.43
Older forage:									
poor quality	39.6	4.9	40.3	1.6	48.6	0.48	0.10	2.0	0.35

NATURAL PASTURES (cont'd.)

DESCRIPTION	M.S.	M.P.B.	Cell.	M.G.	ENA	Ca	P	M.P.D. Ruminants	ENERGY Ruminants
% of dry matter									
<u>Graminaceous hay (natural)</u>									
(average quality)	64.0	6.5	37.4	1.8	47.7	0.69	0.09	2.6	0.46
	92.0	3.7	42.3	1.0	45.7	0.45	0.05	0.5	0.37
Graminaceous straw	96.4	3.1	44.7	0.7	46.9	0.40	0.10	0.4	0.30
<u>Natural green forage</u>									
Graminaceae and Leguminous plants	25.6	11.5	31.0	2.2	46.9	0.87	0.10	7.5	0.72
<u>FORAGE - LEGUMINOUS PLANTS</u>									
<u>Pure strains</u>									
% of dry matter									
<u>Stylosanthes gracilis</u>									
Green forage	21.0	16.5	27.5	2.1	42.6	1.65	0.23	12.4	0.73
" "	30.0	12.6	29.7	2.0	46.8	1.44	0.21	8.5	0.71
" "	44.0	10.0	30.5	2.1	49.9	1.22	0.18	5.9	0.72
Hay	92.8	9.9	32.5	1.1	49.6	0.85	0.17	6.1	0.54
<u>Centrosema pubescens</u>									
Green forage	21.8	19.6	30.9	2.1	39.3	1.04	0.21	15.5	0.70
" "	29.4	18.8	32.2	1.9	41.4	1.15	0.18	14.7	0.68
Hay	87.0	17.2	32.6	2.1	42.4	1.88	0.27	12.5	0.54
<u>Phascelus atropurpureus</u>									
	23.0	20.9	23.5	2.0	47.0	1.25	0.28	16.8	0.83
	95.0	14.6	28.7	2.3	48.6	1.74	0.30	10.1	0.60
<u>Fueraria javanica</u>	91.5	17.9	29.0	2.0	42.1	1.20	0.18	13.2	0.58
<u>Desmodium asperum</u>	25.2	21.1	20.6	2.5	46.3	1.66	0.22	17.0	0.85
	37.6	20.2	21.5	2.8	47.9	1.35	0.19	16.1	0.84
<u>Desmodium tortuosum</u>	23.8	24.1	25.0	2.1	38.0	1.64	0.23	20.0	0.77
<u>CEREAL GRAINS</u>									
Small millet (West African)	89.31	10.04	1.52	4.95	70.91	0.022	0.262	6.22	0.98
Sorghum (West African)	89.97	10.42	2.62	3.23	71.66	0.026	0.291	5.94	0.92

CEREAL GRAINS (cont'd.)

DESCRIPTION	M.S.	M.P.B.	% of dry matter				Ca	P	M.P.D.		ENERGY
			Cell.	M.G.	EMA				Ruminants	Ruminants	
Maize (dry countries)											
(West African)	92.6	10.95	2.15	4.15	74.03	0.022	0.339	7.73	1.08		
Maize (coastal countries)											
(West African)	87.07	8.82	1.83	2.96	71.93	0.032	0.340	6.61	1.05		
Finger grass											
(West African)	88.0	6.30	8.1	3.8	65.3	0.06	0.26	2.64	0.76		
Eleusine (Far											
East & Africa)	89.2	6.8	2.9	2.3	74.3	0.34	0.37	2.85	0.80		

Rice (Far East)											
Paddy	87.0	6.7	8.8	2.1	64.0	0.08	0.26	5.09	0.87		
Cargo rice	86.1	7.9	1.0	2.0	74.0	0.04	0.30	6.00	1.03		
Milled rice	86.2	7.4	0.2	0.5	77.7	0.01	0.13	4.88	1.05		

Rice (Africa)											
Paddy	89.5	7.4	8.4	2.13	64.1	0.05	0.28	5.62	0.87		
Cargo rice	89.5	7.6	0.4	1.6	78.9	0.10	0.22	5.77	1.08		
Milled rice	88.2	6.6	0.2	0.18	80.7	0.09	0.09	4.35	1.07		
Oats (Madagascar)	86.7	12.40	11.6	4.5	55.5	0.10	0.40	9.30	0.73		
Barley	86.4	13.2	3.5	1.9	65.3	0.05	0.40	9.50	0.89		
Coix Lacrima Jobi											
(whole grain)	86.0	11.0	11.9	2.2	55.6	0.06	0.25	-	-		

<u>SEEDS OF LEGUMINOUS PLANTS</u>											
Angola peas											
(Cajanus Cajan)	87.5	19.3	7.4	1.3	55.4	0.16	0.28	-	-		
Beans (Dolichos											
lablab)	89.6	23.9	7.75	2.75	52.2	0.26	0.29	19.59	1.01		
Haricot beans											
(phaseolus)	89.4	19.8	4.6	1.8	60.1	0.23	0.33	10.69	0.76		
Cow peas (Vigna)	90.4	23.35	3.92	1.8	57.65	0.17	0.42	19.14	1.06		
Earth peas (Voandzeia											
Sub-terranea)	90.83	17.10	4.9	7.63	58.04	0.12	0.29	14.02	1.11		
Gum Arabic tree											
(Acacia nilotica)	92.5	15.4	21.2	2.8	47.5	0.59	0.22	-	-		
Carob beans	85.2	12.8	8.9	1.6	58.6	-	-	6.5	0.87		

GRAIN BY-PRODUCTS

DESCRIPTION	M.S.	M.P.B.	Cell.	M.G.	ENA	Ca	P	M.P.D.	ENERGY
								Ruminants	Ruminants
Coarse wheat bran (West African)	88.78	11.39	14.64	2.63	54.62	0.131	1.069	8.98	0.74
Fine wheat bran (West African)	87.97	15.33	8.96	3.45	55.43	0.11	1.02	11.34	0.74
Milled wheat bran (West African)	87.14	15.66	8.06	3.59	55.28	0.100	0.924	12.79	0.88
Small maize bran - Traditional milling Rhodesia	92.0	12.1	7.5	10.7	57.0	0.05	0.58	7.86	0.80
Sorghum bran - Traditional milling Niger	90.2	13.3	4.3	8.4	61.2	0.05	0.46	10.4	0.87
Sorghum bran - Industrial milling	88.2	15.4	9.3	4.7	55.7	-	-	12.01	0.78
Maize bran - Traditional milling Africa	86.00	10.75	5.9	8.5	56.1	0.06	0.72	6.23	0.92
Maize bran - Industrial milling Dakar	86.6	10.9	12.0	7.2	53.5	0.03	0.51	6.30	0.92
Rice bran - Africa and Madagascar	88.65	6.40	20.55	4.15	46.75	0.09	0.41	4.16	0.42
Rice bran flour	89.59	11.01	6.22	12.69	52.51	0.048	1.269	7.18	1.02
<u>STRAW, HUSKS AND HULL</u>									
Rice straw	92.5	3.9	33.5	1.4	39.6	0.19	0.07	0.35	0.29
Rice husks	92.0	3.0	40.7	0.8	28.4	0.08	0.08	0.12	0.29
Cocoa pods	92.1	15.3	17.9	4.8	46.7	0.20	0.15	4.13	0.46
Vigna Sinensis hull Madagascar	39.3	7.9	40.1	0.8	37.1	0.44	-	5.60	0.85
Whole maize head (grain + cob)	93.96	7.49	12.44	2.8	63.31	0.015	0.221	5.45	0.84
Maize cobs (West African)	88.3	1.6	40.1	0.2	44.2	0.01	0.03	0	0.40
<u>HAULM AND LEAVES</u>									
Bean leaves (Dolichos Lablab)	93.9	18.3	16.0	3.2	40.7	1.2	0.15	14.27	0.56
Ground-nut haulm - Maradi & Madagascar	92.1	11.8	21.2	1.7	45.7	1.19	0.13	6.37	0.40
Dried baobab leaves (West African)	91.0	9.6	14.4	1.8	58.4	1.08	0.40	5.76	0.41
Angola pea leaves	85.3	16.4	25.5	2.3	34.0	-	-	12.79	0.57
Sahel acacia leaves	60.8	19.43	13.01	4.98	55.90	3.05	1.90	10.10	0.46

HAUL AND LEAVES (cont'd.)

DESCRIPTION	M.S.	M.P.B.	Cell	M.G.	ENA	Ca	P	M.P.D.	ENERGY
Leaves of Balanites								Ruminants	Ruminants
Egyptiaca	91.10	23.20	16.60	2.40	37.30	1.53	0.12	13.45	0.51
Sweet potato (haulm)	18.1	1.31	5.9	0.3	9.1	0.01	0.03	0.35	0.10
Banana leaves -									
Madagascar and									
Tanganyika	16.2	2.3	4.5	0.73	8.33	0.17	0.03	1.26	0.14
Haulm of Niebe									
Vignas sinensis	89.0	12.5	31.0	2.5	36.0	0.57	0.26	7.62	0.61
Leucaena glauca	25.0	4.9	5.0	0.6	12.8	0.7	0.03	3.18	0.15
<u>ROOTS AND TUBERS</u>									
Fresh cassava	34.25	1.24	0.74	0.25	31.07	0.044	0.043	0	0.34
Dried cassava	88.06	2.10	2.70	0.67	80.33	0.099	0.088	0	0.98
Fresh potatoes	27.93	1.06	1.13	0.26	24.33	0.025	0.070	0.68	0.22
Dried potatoes -									
Africa & Madagascar	86.73	2.80	3.56	0.66	75.30	0.20	0.18	0.39	0.90
Yams									
Fresh yam	36.85	2.00	1.05	0.10	32.54	0.116	0.052	0	0.39
Dried yam	89.65	8.85	2.70	0.25	73.95	0.19	0.120	5.04	0.59
Dried taro									
(Golocasia									
Esculenta)	83.5	6.80	2.40	0.30	71.15	0.018	0.20	0.95	0.84
<u>MISCELLANEOUS FRUITS AND GRAINS</u>									
Whole banana	24.10	1.25	0.95	0.28	22.00	0.015	0.023	0.68	0.26
Banana pulp	24.12	1.00	0.47	0.09	22.00	0.024	0.020	0.55	0.25
Cottonseed (Africa)	92.8	19.8	24.1	19.5	25.1	0.17	0.57	12.47	1.03
Green Mangoes (pulp)	14.5	0.3	0.6	0.8	14.0	0.02	0.01	0.16	0.18
Breadfruit									
(Artocarpus									
communis)	30.0	1.3	1.8	0.4	25.5	0.02	0.04	0	0.31

NOTE: For graminaceous and leguminous forages, the composition is given in percentage of dry matter; the energy value is that contained in one kilogramme of dry matter.

For the other products, the data relate to the basic product as it can be eaten.

IX

PRODUCTION OF MANURE. LITTER

Apart from a few rare exceptions when the animals used for cultivation in the wet season are sent away with the herds in the dry season, draught oxen are tending more and more to remain settled in the same area. On days when they are not working they are put out to graze in the morning by a cowherd and brought back to the village in the evening where they spend the night in an enclosure made of thorns or, more rarely, in rudimentary deep litter cattle-sheds.

As soon as the animals remain settled, manure can be collected. At present, only the progressive farmers make and use manure.

See the "housing" chapter for descriptions of the manure-shelter and the deep litter shed.

As regards litter, millet straw is often used; it decomposes properly. The production of manure can be increased by making semi-artificial manure, although this involves extra work. The litter is then removed regularly and put on successive layers of straw which are then watered.

Just before the rainy season, the manure is put out in the fields in piles and then spread before ploughing; mineral fertiliser is usually spread just after ploughing.

The quality of the manure varies with the species of animal producing it. Bovine droppings have a higher fertilising power than those of horses or donkeys and, for equal weight, produce a greater quantity of manure.

Horse and donkey manure is, however, very good for market-gardening.

Draught animals provide the opportunity for the production of manure.

The quantity of manure produced by an ox stabled at night may amount to 3.2 tons a year.

Trials with permanent stabling have enabled 10 tons to be produced.

A 300 kg. horse gives about 300 kg of manure a month. A donkey 100 kg.

X

HARNESSING METHODS ACCORDING TO SPECIES AND BREEDA) CHOICE OF HARNESS TYPE ACCORDING TO SPECIES AND BREED

Horses are harnessed by breast-strap, saddle and back-strap (Senegal). Donkeys have either a breast-strap with saddle and back-strap (Senegal) or a collar (SATEC). The latter must be properly adjusted.

With oxen, the animals are usually harnessed in pairs. The single yoke is rarely seen.

Zebus, with their narrow, long poorly muscled shoulders and long, thin and heavy heads (often with excessive horns), pull better with the shoulder than with the head; hence the use of the shoulder yoke (except in Senegal).

Taurines, particularly N'Damas, with powerful short shoulders, thick necks and wide heads with short forward-turning horns, can pull with the head. The neck-yoke or fore-head yoke may be used.

B) TYPES OF HARNESS

The reader should refer to the diagrams which explain the brief descriptions given below.

1) Horses

The horse is generally used individually with a fairly rudimentary harness. This includes:

- a collar, usually wooden, in one piece or in two parts, bound together with or without padding and, more often than not, replaced by a leather breast-strap;
- a saddle, often made of wood and sheet metal with jute sack padding, set behind the withers;

In most cases, there is neither back-strap nor breeching-strap except when pulling a cart.

2) Donkeys

The normal harness consists of neck-strap, saddle and back-strap (Senegal) - Fig. 11.

The SATEC in Upper Volta recommends harnessing by collar (fig. 12).

This consists of cloth and horsehair padding on pieces of baobab wood and the traces are made of sisal rope.

A stronger type is used in Dahomey (the first type easily gets out of shape) (Fig. 13 and 14).

In Niger a simple breast-strap with shoulder-strap is used which is much more comfortable and is simpler (Fig. 15).

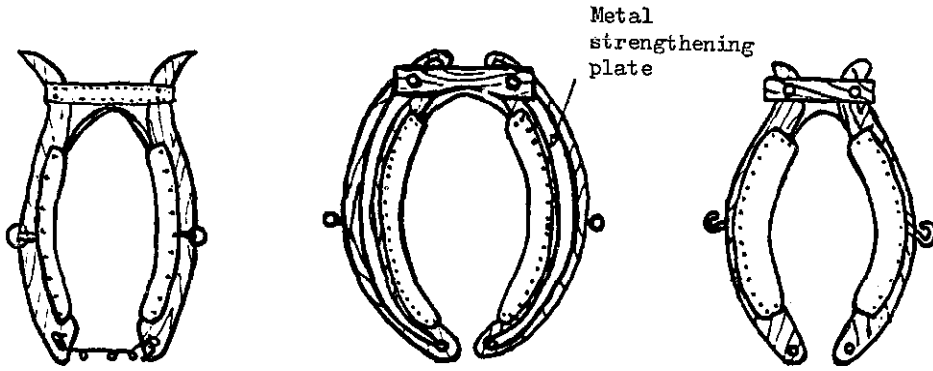

Fig. 12 - S.A.T.E.C. COLLAR
Upper Volta

Fig. 13 - SEKOU TYPE
Dahomey

Fig. 14 - DOSSAZOUME TYPE
Dahomey (S.A.T.E.C.)

Fig. 11

Fig. 15 - Donkey breast-strap

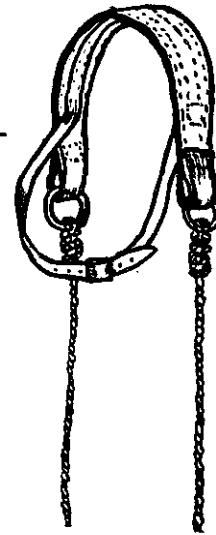
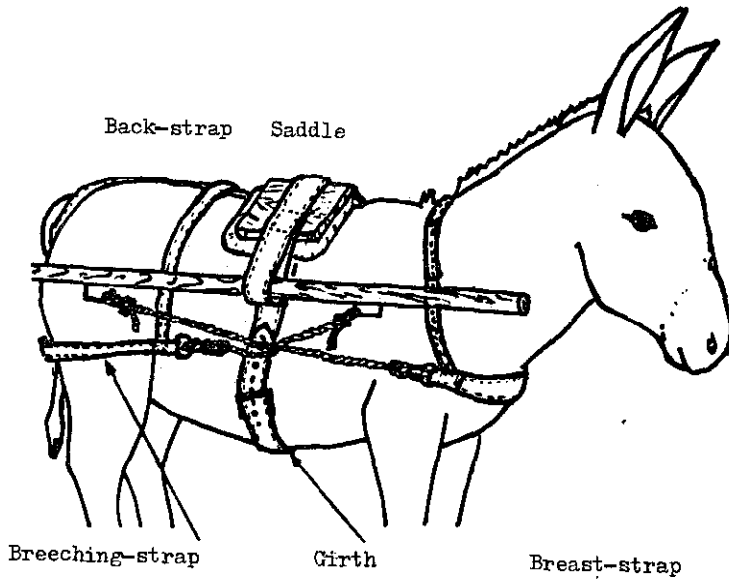
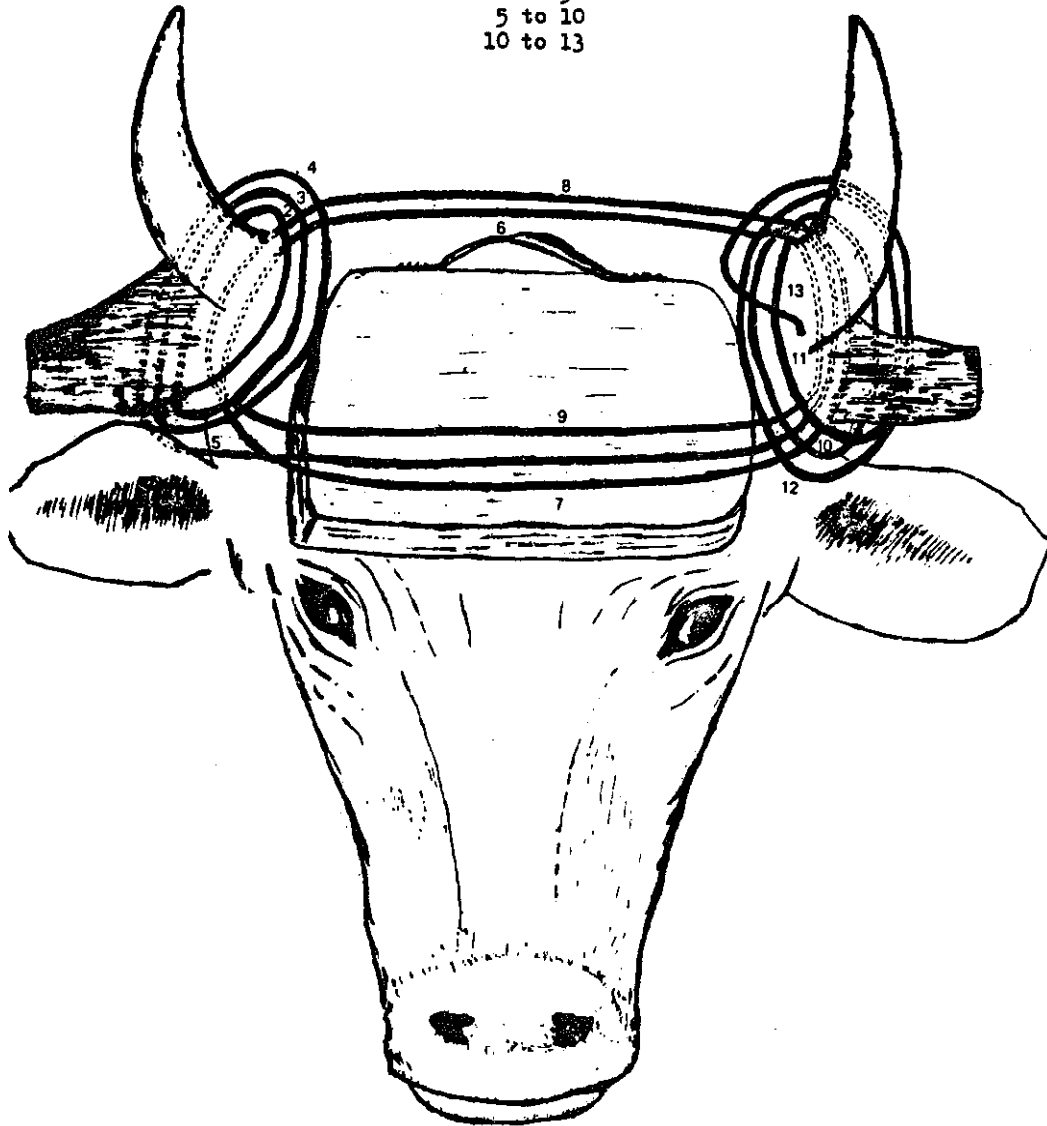

Fig. 16 -

HEAD YOKE

Method of attaching straps

- 1 to 5
- 5 to 10
- 10 to 13



3) Oxena) THE DOUBLE NECK-YOKE

This is a single piece of wood hollowed out over the neck and grooved on the upper surface over the hollows and the base of the horns to take the attachment straps. Hooks are fitted to take these straps.

It is attached to the head and the horns by means of straps made of leather thongs 2.5 to 3 cm wide, or of cords laced 3 times round each horn and crossing between them. No padding between wood and head. Care must be taken to ensure that the hollows fit the neck perfectly (Fig. 16).

ADVANTAGES - This yoke permits:

- good control over the animal
- the animal to be directed better from behind by means of reins attached to its horns or ears or to a nose rope (Madagascar)
- sudden efforts and easy movement backwards.

DISADVANTAGES -

- It prevents swinging the head (impossibility of shaking off flies)
- the shoulders are subjected to lateral pressures which hinders movement
- when turning, it causes crabwise walking
- it needs careful fitting to the neck, possibly by using jute pads (sores on the neck are frequent)
- it is difficult to attach
- it requires animals of the same size

MAIN TYPES

BAMBEY (Senegal). This type has been imitated in Ivory Coast and Togo (Fig. 17-18). Padding is provided between the yoke and the neck and between the forehead straps. The straps are made of thongs or 8 mm rope.

Characteristics

	LENGTH	WEIGHT
N'Dama	1.06 to 1.10 m	3.5 to 4 kg
Zebus	1.20 to 1.40 1.35 m	

BOUAKE (Ivory Coast). There is an opening for a shaft (Fig. 19).

BOUAKE-MINANKRO (Ivory Coast). This is a simplified form of the Bambey (Fig. 20).

TOGO. This is a very simple type with the hollowed curve often too wide (Fig. 21).

UPPER VOLTA. This is the type used in the Farako-Ba region (Figs. 22-23).

Fig. 17 - SENEGAL
(Bambey)

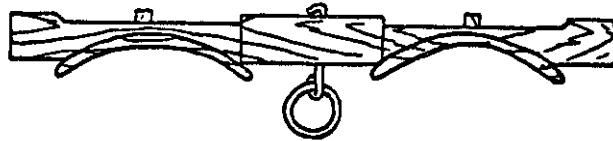

Fig. 18 - SENEGAL
(Boulell)

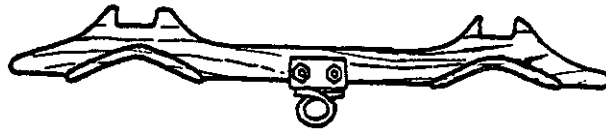

Fig. 19 - IVORY COAST
(Bouaké)

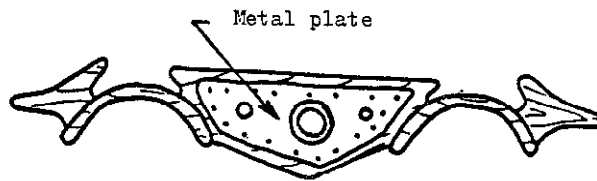

Fig. 20 - IVORY COAST
(Bouaké, Minankro)

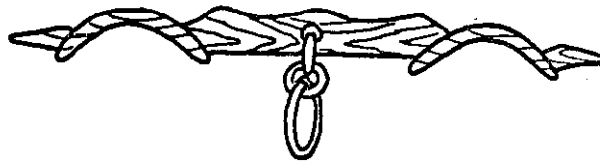

Fig. 21 - TOGO
(Dapango)

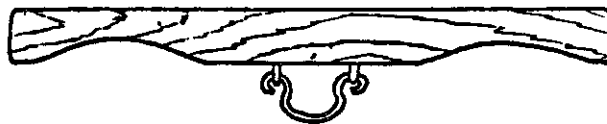

Fig. 22 - UPPER VOLTA

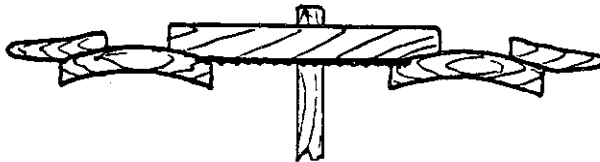
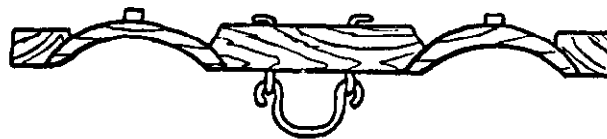

Fig. 23 - UPPER VOLTA
(Farako)



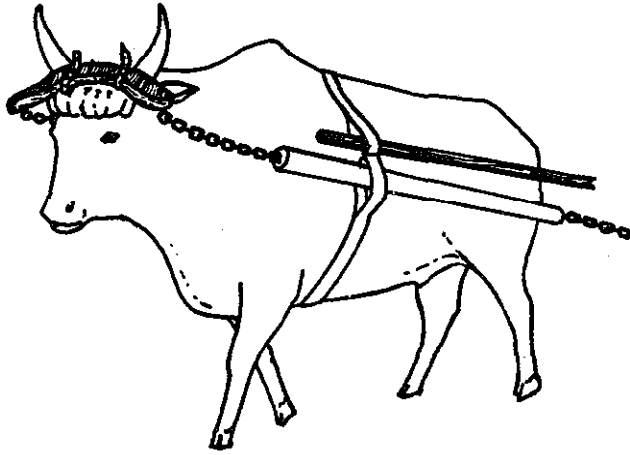

Fig. 26 - Harness with forehead yoke (Zaire)

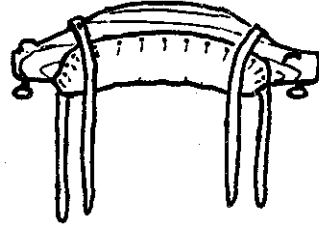

Fig. 24 - Forehead yoke



Fig. 25 - Neck Yoke

Fig. 27 - Central African Republic

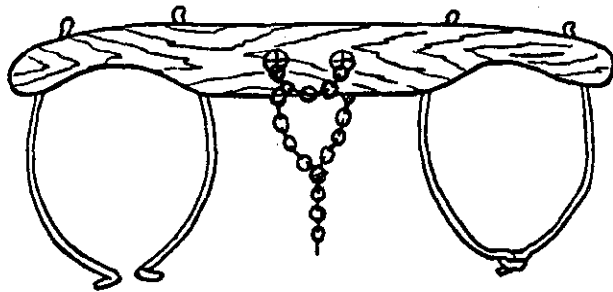
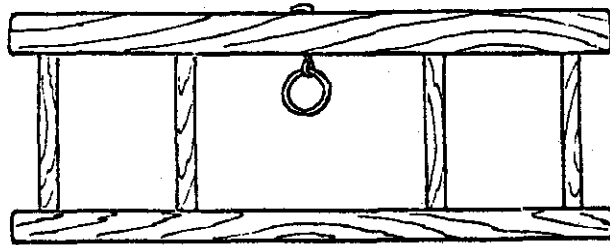

Fig. 28 - Upper Volta (Saria)

b) THE SINGLE NECK-YOKE

Rarely used in Africa, it has been successfully tried in Zaïre (Figs. 24--25--26).

c) THE DOUBLE SHOULDER-YOKE

This is made of a piece of wood of varying shapes - roughly rounded in contact with the neck and hollowed out on its rear lower side, to ensure a good fit over the shoulders. It varies in length according to whether it is a ploughing yoke, a harrowing yoke or 2-notched yoke for ploughing and harrowing (Niger, SATEC Madagascar).

There is a wide variety of attachment systems:

- Loop of rope, iron bar bent into a U or a double cross and attached to the lower part
- wooden frame (C.A.R.) (Fig. 27)

For traction, the chain is attached directly or via an iron hook through the wooden part, or again, to a ring attached to the wood. The shaft passes either inside a ring attached to the wood or, more rarely, inside the wooden part itself.

ADVANTAGES of the shoulder yokes:

- It is simple in shape and easy to make
- it quickly adjusts to the animal
- it leaves the animal's movements free
- traction is applied at shoulder height: hence more direct use of the strength of the back
- it is light and does not need a pair of oxen of exactly the same size
- it can be fitted to hornless oxen

DISADVANTAGES

- it compresses the trachea and the blood vessels where they enter the chest
- shoulder sores are frequent, particularly at the shoulder blades, if the attachment is by means of iron rods
- the applied tractive force is diagonally upwards, hence a tendency for the yoke to slip back
- driving is more difficult

DESCRIPTION OF VARIOUS TYPES

UPPER VOLTA (Saria Station) (Fig. 28). Consists of a wooden piece 1.35 m long with iron rod attachments.

The traction chain passes through two holes made in the yoke.

In addition, spacers are used between the oxen's nostrils.

Fig. 29 - NIGER

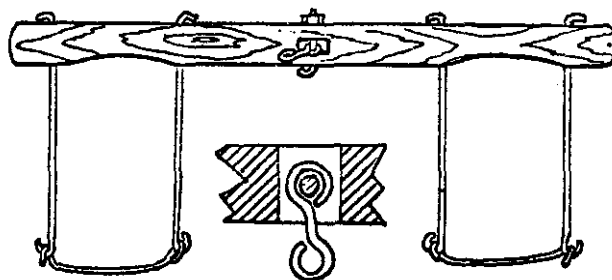

Fig. 30 - NIGER
(C.F.J.A. Maradi)

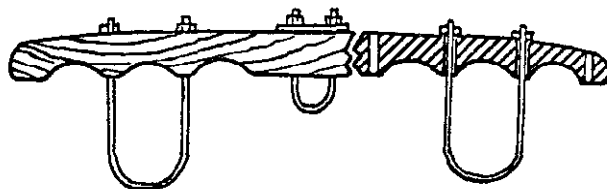

Fig. 31 - MALI
(C.R.Z. Sotuba)

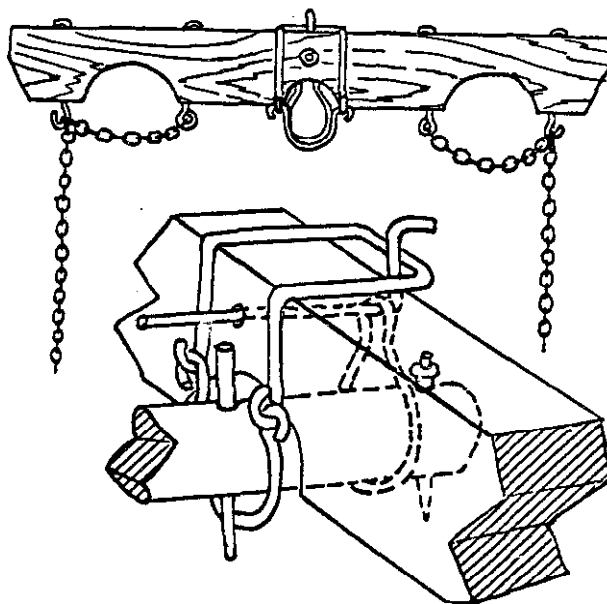

Fig. 32 - MALI

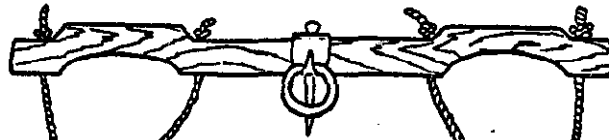

Fig. 33

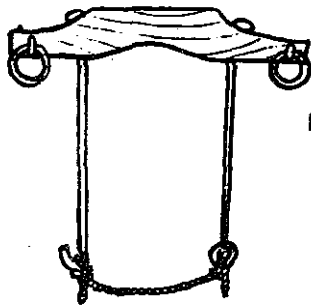
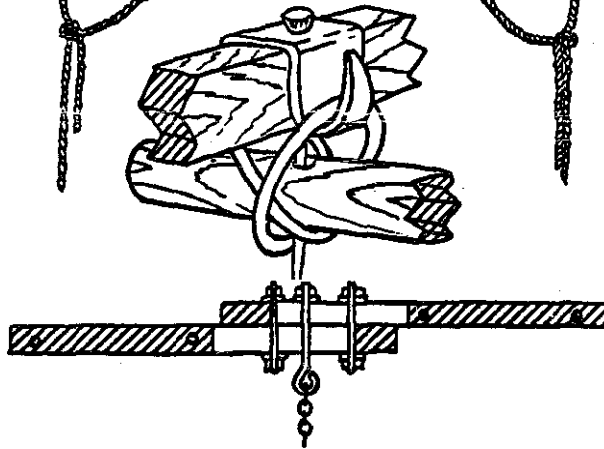

Fig. 35 - Shoulder yoke
(Niger)

Fig. 36 - Shoulder yoke
(C.F.J.A. Niger)

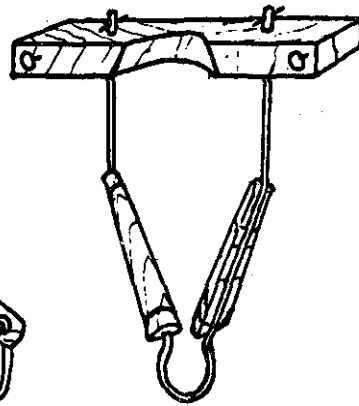
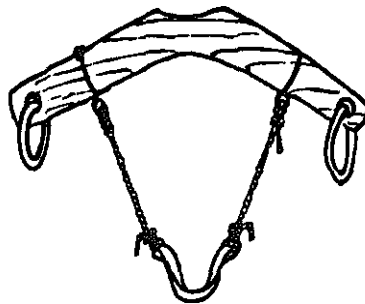

Fig. 37 - Shoulder yoke



NIGER. A rudimentary yoke is attached by ropes of 2 lengths (2 m to 2.10 m) for hoeing, with shoulder to shoulder spacing: 80 cm.

The variable-spacing Maradi yoke is attached by U-shaped iron rods for which various positions are provided (Fig. 29-30).

The shaft attachment varies: hooks or hole in the yoke.

MALI. A more complex type of yoke with a special method of attaching the shaft (fig. 31-32).

THE SPECIAL VARIABLE SPACING YOKE (CFDT Yoke) is worthy of note. It is made of two pieces of wood sliding over each other. In the Ségou region, a heavy and fairly complicated yoke is used (Fig. 33).

d) THE SINGLE SHOULDER YOKE

Trials have been carried out, particularly in Niger (Figs. 35-36-37).

Here is a list, which is not exhaustive, of the kinds of trees or shrubs currently used in Africa for making yokes:

- Cordia africana* ("Dimbou" in Senegal)
- Pterocarpus erinaceus*
- Tamarindus indica* (Tamarind tree)
- Balanites aegyptiaca*
- Mitragyna ciliata* or *inermis* ("Diou" in Mali)
- Khaya senegalensis* (Eastard mahogany)
- Tectona grandis* (Teak in Ivory Coast)
- Hyphaene thebaica* (Dum in Niger)
- Butyrospermum parkii* (Karité in Senegal, "SE" in Mali)
- Parkia biglobosa* (Nere in Upper Volta, Nette in Dahomey)
- "Gaboug" and "Dong" (Togo)

NOTE: Figure 38 gives examples of dimensions of yokes in Niger.

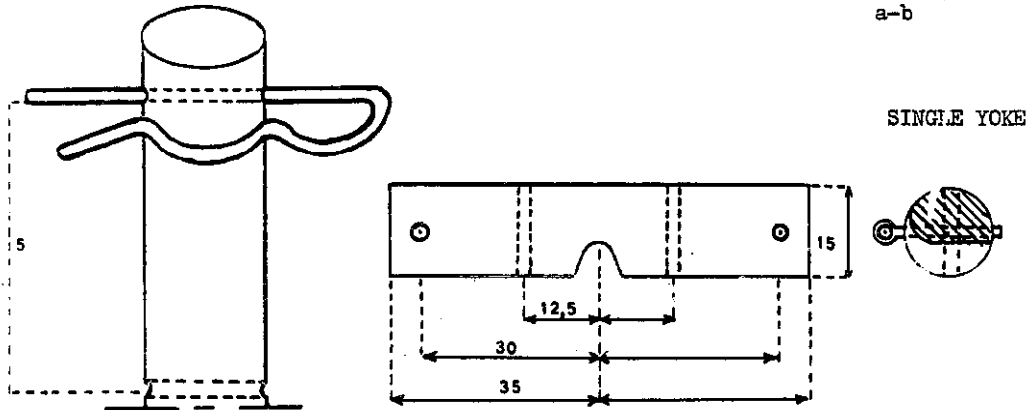
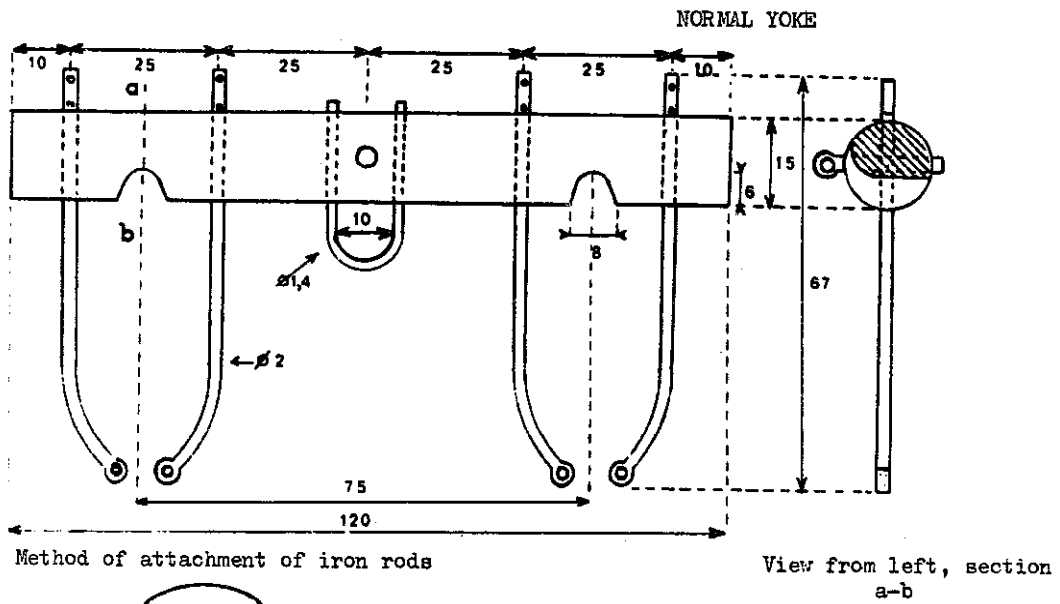
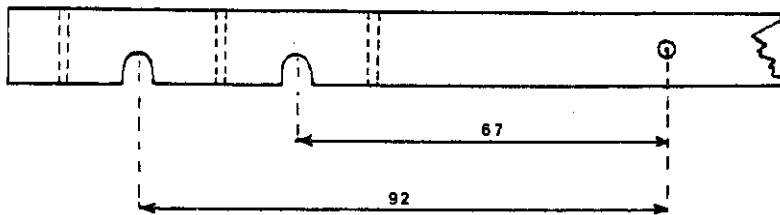

Fig. 38 - LONG YOKE



dimensions in cm.

P A R T T W O

I

ANIMAL DRAUGHT AGRICULTURAL IMPLEMENTSGENERAL REMARKS

Part one of this handbook has been devoted mainly to the animals called upon very occasionally to carry loads or more often to pull agricultural implements.

These agricultural implements - which may be either field equipment or on the farm crop handling and processing equipment - will be described at length and commented on in the succeeding pages. Before starting on the subject in detail, however, it seems worthwhile collecting together some general ideas in order better to understand the wide variety of difficulties encountered when supplying individual peasant farms with equipment in the tropical regions of Africa and in Madagascar.

Strangely enough, although we are dealing with animal draught agricultural implements it must be said that the agriculture of the countries concerned is distinguished by the fact that it mainly makes use of human energy.

It must, indeed, be borne in mind that most of the farmers possess absolutely nothing but hand tools and that the draught animal, although no longer the exception, is still not common and is reserved for certain specific operations.

Nevertheless, despite this gap, which we would like to see filled, agricultural machines are slowly penetrating into the bush. There are economic and technical reasons for this slowness.

A) ECONOMIC DIFFICULTIES

It is well known how under-equipped the countries concerned are, in the industrial as well as in the rural field. As regards the latter, with a few exceptions, there is no existing infrastructure, such as a sales/repair network for agricultural machinery. Now, when the vast size of such a system in Europe is considered, together with the essential part it plays in rural life, it can well be understood why it is difficult to distribute and maintain even simple equipment in Africa and Madagascar.

In the same context, the economic climate is hardly favourable to the mechanization of agriculture. There is little or no encouragement towards increased production and modernization of farming enterprises (furthermore it is doubtful whether the expression "farm enterprise" can properly be applied to the groups of family huts and the shifting cultivation methods mainly carried on with the elementary purpose of feeding the family, problems of income and trading being of relatively secondary importance).

In some cases the State has intervened, for example by setting up state marketing organizations - this is the case with cotton and sometimes with ground-nuts - the improved economic conditions then quickly result in an increase in production and therefore in the farmer's income. Only then can the vicious circle of economic underdevelopment be broken: output remains restricted while there is a lack of production inputs, and conversely there is a lack of production inputs because output is so small.

B) TECHNICAL DIFFICULTIES

Whereas in Europe the farmer is now an experienced technician who has to be able to deal with problems which daily become more complex, the African farmer has remained technically at the hand tool stage.

Generally speaking, he does not know that anything else exists or, if he knows that certain more technical means are used, his distrust of them is explained by a lack of accurate knowledge. This is where the need for technical training of the farmer shows up, in order to overcome the many obstacles opposing, for example, his giving up his hand hoe for a plough.

Technical training at the suitable level for the farmer must enable him:

- to know what implements appropriate to his use are available,
- to know the capabilities and limitations of these implements,
- to use and maintain them properly.

It must, however, be recognized that, in addition to this lack of technical knowledge on the part of the farmer, there are many other difficulties arising from the implements themselves which are not always technically suited to the local agricultural conditions. They must be suited:

- To the soil, i.e. suited agronomically, without causing violent and harmful changes or upsetting the often precarious ecological balance;
- to the draught animals: too heavy a machine or one demanding too much effort will be unusable;
- to the users themselves, a delicate implement, difficult to adjust and maintain cannot be widely distributed among the farming masses. This does not mean that this same implement may not have a place in the hands of a limited, but technically more advanced, élite.

To sum up, agricultural implements must, according to the criteria outlined above, be:

- light, to be suited to the capabilities of the draught animals,
- simple, to correspond to the technical level of the farmer,
- robust, in order:- to withstand accidental stresses caused by the ground, the men or the animals;
to be usable, even in the absence of any after-sales service organization;
- finally, of low cost, to correspond to the limited means of the users.

Naturally, these characteristics are only partially compatible and it is very rare that a particular implement will have all of them to the same degree, which comes to the same as saying that an implement is practically never ideal.

*
* * *

The mechanisation of agriculture by means of draught animals cannot be complete and uniform. Some operations must be given priority for mechanization others, on the contrary, can wait for the farmer to reach a higher state of technical skill or of purchasing power.

The following order of priorities to be respected in mechanization, based on technical and economic criteria, is mainly taken from R. Tourte's work.

1. Rainfed cultivation

PRIOR CONDITIONS - Clearance - Removal of tree stumps:

This operation is an essential preliminary to any rational mechanisation, even animal draught. Unfortunately, it can only be mentioned here as a reminder, since no animal draught implement for the purpose can be honestly recommended. The solution must lie in clearance by hand (the most frequent), by machine or by chemical methods.

Priority No. 1.

- Preparation of the soil at the beginning of the rainy season.

The performance of this operation is the target of continuous effort on the part of the extension workers. Its advisability is not always apparent to the inexperienced farmer and, furthermore, the time generally available for this work is short, about a month. The mouldboard plough is practically the only implement to be recommended.

- Preparation of the soil (in the dry season)

When the time available for ploughing at the beginning of the rainy season is too short, it is necessary to recommend a method of preparation of the soil which can be applied earlier in the calendar. In this case, however, the effort needed is such that ploughing is usually impossible, which means that other methods must be used which may be pseudo-ploughing or superficial methods using implements other than ploughs, some of which are also used for secondary tillage operations. These methods are often the only ones possible but their agronomic value is sometimes questioned.

- Sowing

In the Sahelian-Sudanian area, where the agricultural season is short and where - in consequence - sowing must be done as early as possible, the mechanical planter is considered an implement of great economic importance.

The planters at present available are of the single grain and often single row type; they are satisfactory for ground-nuts, maize and some secondary plants (such as haricot beans) and suitable for millet and sorghum. Generally speaking, therefore, they are adequate for the cultivation work carried on in the area in question.

In the Sudan area, cotton is grown in addition to the crops already mentioned; however, the planters available generally sow cotton badly unless the cotton seeds have been previously delinted. This disadvantage is, however, to some extent limited by the fact that the longer rainy season allows some staggering of the sowing so that the crops can be sown by hand without undue problem. In this area, therefore, the planter is of less importance.

In the Guinean area, or in the forest areas, the value of the planter becomes still less, on the one hand because the crops grown do not lend themselves to its use and, on the other, because rather more time is available for preparing the ground and sowing.

- Weeding

This is undoubtedly the operation which gains most from mechanization, since it involves a veritable race against the weeds, a race which is often lost by the farmer with hand tools only.

For broadcast sown crops, the use of animal draught implements which pass over the crop at the beginning of the growing cycle may be recommended, such as flexible weeders, spike-tooth harrows and rotary hoes.

For row crop cultivation, other implements may be used at a later stage, such as hoes and inter-row cultivators.

- Harvesting

Mechanization of harvesting is at present only possible in the case of ground-nuts.

The mechanization of harvesting, or rather lifting, is very beneficial, both because it leaves very little behind in the ground and because it allows the crop to be harvested at optimum maturity.

The available lifters are satisfactory, provided that sufficient tractive power is available.

- Transport

Transport accounts for a high proportion of farming activities. This is why the cart, drawn by a donkey, one or two oxen or more rarely by a horse, plays an important role everywhere in the development of animal traction. Sometimes, the cart must even have absolute priority over other implements, when it is desired to demonstrate the economic aspect of its use. Indeed, it sometimes happens that the owners of carts enjoy relatively high incomes as a result of the jobbing work they do for other farmers without means of transport.

PRIORITY No. 2

- Harvesting of forage

There is no implement available at present for harvesting forage that is appropriate to the economic and technical levels of its possible users. It is the more regrettable since the extension of animal traction is everywhere hindered by the problems of feeding the livestock.

PRIORITY No. 3

- Fertiliser spreading

Mechanization of this operation is not justified by the area involved which is still relatively small. Accurate placement of fertilizer can be important and is worth having. This is why planters with fertilizer attachments are of interest if they place the fertilizer accurately, if they are neither too heavy nor too costly and to the extent to which planters are already used.

- Crop Protection

With certain commercial crops such as cotton, this is an operation of very great importance, although less so with food crops. In all cases, however, there are very few suitable draught implements and these would in fact only be desirable when justified by intensification of farming in the case of closely grouped cultivated areas of sufficient size to amortize the equipment.

2. Irrigated farming

It is only in the case of rice that the problem differs from the previous one and the desirable order of priority for mechanization may then be:

PRIORITY No. 1

- Levelling, building permanent bunds

This is not strictly agricultural work but is rather land improvement work for which animal draught equipment may be used, such as: levellers, diggers, ridgers, etc.

- Ploughing or puddling

If the ploughing is done "dry", the implements are the same as the conventional European or Asiatic ploughs used for dry cultivation and discussed elsewhere in this manual.

If the preparation of the rice-field takes place or continues after flooding, more specific implements must be used, for example puddling rollers.

PRIORITY No. 2

- Sowing

There are practically no multi-row seeders which can be generally used, since those available are much too costly. As regards single-row seeders, they can be used provided that amortization is possible by using them for other crops.

- Transplanting

Chinese types, more or less prototypes, are said to be under continuous trial but it seems unlikely that their use can be quickly extended.

Some hand types are at present on trial in Madagascar and Mali.

- Crop maintenance

Animal draught rotary hoes do exist but so far their use has been very restricted.

- Harvesting

It seems that nothing in this field is likely to be available for a long time; the European type harvesters, reapers, binders or swathers, cannot be used because they are too heavy, too costly and ill-suited to rice.

Before itemising the various categories of implements whose use may be advised for:

- soil preparation: dry or under water,
- sowing,
- weeding and crop protection,
- harvesting,
- miscellaneous transport

we shall, in broad outline, discuss the complex question of soil preparation work with or without soil inversion.

II

SOIL PREPARATION IN RAINFED FARMING

with and without soil inversion

EROSION, MAINTENANCE OF FERTILITYPLOUGHING-IN OF ORGANIC MATTER

In addition to using draught animals as a source of energy for raising water or for carrying out certain work connected with the processing of products, which will be the subject of a special chapter, the main purpose of animal draught is to carry out the work involved in soil preparation, sowing, weeding, crop protection and harvesting as well as transport. In the tropical regions of Africa, animal draught cultivation is of interest, mainly to the Sahelian-Sudanian region, to a lesser degree to the Guinean region and hardly at all to the forest area. This means that, in most cases, the cultivation season is limited by the duration of the single rainy season. Ploughing during the dry season is not possible, because the ploughs could have difficulty in penetrating the soil. In low rainfall areas, where the annual rainfall is less than 800 mm., soil preparation which may take up a lot of time may not be feasible at the beginning of the rainy season. For example, ploughing immediately before sowing if it takes up much time could be harmful to the normal progress of the growing cycle of the crops. This is a particular problem in the ground-nut growing area of Senegal.

The question therefore arises: how is the soil to be prepared when there is insufficient time available for ploughing?

Even when ploughing is possible, it is not always advisable if it increases the risks of damage to the soil as a result of erosion by wind or water. This latter risk is a big one in many countries when ploughing is done too early at the end of the rainy season, i.e. at a time when the ground is still sufficiently moist to be worked easily. Being exposed to several heavy rains at the end of the rainy season, the soil may be seriously eroded if fresh growth does not quickly protect it. Furthermore, it must also be protected against wind erosion during the ensuing long dry season.

Another question then arises: is ploughing always desirable and, if not, what system can be used in preference?

Finally, it may happen that there is sufficient time available for the initial preparation of the soil, that ploughing is agronomically desirable and, nevertheless, that it cannot be carried out for lack of adequate power. This is the case in certain regions where there are no trained draught oxen and where the tractive power furnished by donkeys does not allow normal ploughing. We are thus faced with the first question again: what method can then be used in place of ploughing?

It is hardly possible to give precise and definite answers to these questions, since each region has its own peculiar characteristics (from the points of view of soil, cultivation, climate and draught animals). However, from past and present trials in many countries, it would appear that ploughing is very often essential for obtaining proper yields and, in consequence, as far as possible, the obstacles to ploughing have to be overcome. Thus, erosion can be prevented, or at least reduced to an acceptable level, when the ploughing is done at the beginning of the rainy season, or better still, when the cultivated area lies within a larger area where erosion control measures, such as contour ploughing are in force, which is, unfortunately, very rarely the case.

When the main difficulty with ploughing is the resistance of the ground to the forward movement of the plough, the solution must be sought in two ways.

On the one hand, the strength of the draught animals may be increased by, for example, changing over from one donkey to two donkeys, from two oxen to four oxen (which may be possible, under certain conditions, in Africa, as is the case in certain regions of Madagascar).

On the other hand, the depth of ploughing may be reduced.

If, generally speaking, ploughing is desirable from the agronomic point of view, this is probably mainly for three reasons: loosening the soil, ploughing in of organic matter and the weed control.

Seed bed preparation achieved by ploughing, even to a very limited depth (less than 10 cm) is generally better than that achieved by hand working of the soil on flat ground (ridge cultivation is very different) using hoe type implements. It is also better than the loosening resulting from the use of animal draught implements with points or tines which do not turn the soil over. This results in better penetration of the first rains, which are often irregular in frequency and intensity, and in the more certain germination of the seed sown. Moreover, deep working of the soil helps the development of the plant.

Ploughing in of organic matter, whether it be farmyard manure or compost (in all their forms) or green manures or - more generally - grass growing naturally at the time the soil is being prepared, can really only be done by ploughing, and this is very important. Unfortunately, in the general run of cases, the ploughing in of prepared organic matter is still only at the trial stage in most of the regions with which we are concerned. The same applies to ploughing in of green manures.

In Senegal, where very little ploughing is done, it is used mainly for ploughing in of green manures. Indeed, the crop rotation recommended by the Agronomic Research Centre includes either a field sown with millet or sorghum (as green manure for ploughing in before ripening at the end of the rainy season), or else fallow, either mown or not, ploughed in under the same conditions. It is only in some agricultural sectors with experienced leadership that certain farmers seem to have understood the need for ploughing in of green manures and have been putting it into practice relatively regularly for several seasons.

The weed control ensured by ploughing at the beginning of the cycle is probably an advantage which is relatively little understood but which, however, is a major one when compared with non-inversion soil preparation methods. Indeed, normal ploughing leaves the soil relatively clean on the surface and, if sowing follows quickly, as is frequently the case, the cultivated plant has an initial advantage over the weeds. A very important consequence: there will be a relatively long time between the sowing and the optimum date for the first weeding, an important operation for the future of the crop in African cultivation. If, on the contrary, in the absence of ploughing, the soil has been prepared superficially, the first weeds are not properly throttled and the farmer is overwhelmed by the growth of grass; the first weeding then involves considerable work in relation to the manpower available on the farm, bearing in mind the extension method of cultivation usually adopted and the consequence on yields can be disastrous.

In short, it really seems that ploughing, as a method of starting cultivation operations, is desirable everywhere, except in arid regions and sandy soils lacking in body, where it is still, however, useful but must be done only at the end of the rainy season to plough in green manure.

It is only in these latter regions, therefore, that non-inversion working of the soil is to be recommended at the beginning of the agricultural cycle; this applies particularly when the ground is covered with very limited or practically no vegetation. The implements to be used should be those designed for non-inversion ploughing operations (with tines or discs).

In practice, because of the low power provided by the draught animals available, it is mainly the use of mechanical crop weeding implements which must be considered. Indeed, it is mainly "hoes" that are beginning to be used in these regions. Their working parts, which are inter-changeable and of various shapes, are similar to those of the non-inversion ploughing implements (cultivators and others) including the "sweeps" of medium dimensions hitherto reserved for ground-nut lifting.

As regards disc implements, their partial digging in capability should be taken into consideration but their use in animal draught cultivation is very difficult, for various reasons to which we shall return, and examples of use are very rare.

The work which can be carried out with hoes, or with multi-purpose frames similarly equipped, encounter many difficulties which also militate in favour of ploughing whenever possible.

In Senegal, more widespread preparation of the soil "dry", i.e. before the rainy season, would be desirable, in order to make the soil better able to accept and, particularly, to retain the first rains. This would have a beneficial effect on the initial growth of the crops that are grown and, in consequence, on yields. Fairly deep working should be carried out in order to penetrate the crust which forms at the end of the rainy season. To replace ploughing, which is not very suitable and is difficult with a pair of oxen, the Bambey CRA has had to use a rigid tine which can be drawn by a pair of oxen, and is capable of breaking up the soil into clods without inverting it. This tine appears to have the advantage of loosening the soil without exposing it to erosion and of making it suitable for absorbing the first rains.

The value of this tillage, which is unquestionable from the agronomic point of view, is however much reduced by the difficulty in implementing it, since the effort needed to pull a single tine at sufficient depth, even in light soil, is at the extreme limit of the draught capability of a single pair of oxen.

Preparation of the soil without turning over by means of animal draught therefore comes up against three obstacles. The very superficial "scratching" resulting from tines of various shapes, such as those of the scarifier, is very difficult to achieve and is of little agronomic advantage. It can, therefore, be dropped without any very serious harm to yields. Or else the desirable sub-soil work cannot, in practice, be carried out with the means available to the average farmer with his pair of oxen. Or finally, disc implements can only be used in exceptional cases.

III

IMPLEMENTS FOR WORKING THE SOIL WHEN DRYA) GENERAL REMARKS

Of all the equipment designed for working the soil "dry" before sowing, the plough is, as we have seen, the essential implement, not only because of the work it does, but also because certain other implements can only be used after ploughing; such is the case with surface working implements (harrows and rollers) and with other secondary tillage implements.

It is also, and by far, the most complicated implement to use for working the soil. Operators therefore must be fully conversant with it in order to make best use of it. They have to know how to adjust it and maintain it properly. Furthermore, there is not just one plough; there are many types which differ more or less from each other and sometimes considerably, as regards their design, their adjustments, their weight and the materials used in their construction. Even limiting ourselves to the implements most commonly used, the choice is huge and the list and description of them will necessarily be long.

The Ridgers, which should really be included under the term ridging ploughs, constitute a category of implements it is difficult to classify. If they are used directly to prepare ridges, as is the case in the North of Nigeria, they must be likened to a plough and even a heavy plough; if, on the contrary, they are used during the growing season, they will be classified among the weed control implements (even though the same implement may be concerned). Similarly, the plough may be used during cultivation to build up and raise the ridges or even they may possibly make the ridges in the first place which helps the weeds to be buried.

With the secondary tillage implements, often with teeth (or tines) and rarely with discs, it will be a question of a fairly wide variety of implements, the only common characteristic of which is that, unlike the ploughs, they do not turn over the soil. Just as much care must be taken in the study of the traditional plough or "ards" as of the cultivators, weeders, scarifiers, disc-harrows and stubble-ploughs.

The surface-working implements consist of various types of harrows and rollers. The latter may be packers (smooth or grooved) or clod-crushers (frames) simple or complex (culti-packers). It is convenient to classify the "rotary hoes" separately since these, despite their name, come in a category lying between harrows and rollers. Although all these instruments are available, they are still very rarely used since their value is sometimes open to question in tropical regions because agriculture has not advanced much and, probably, because of their high cost.

Finally, there is a particular category of implements, designed specially for use in the tropics which has only recently appeared and which may be classified under the general term of "multi-purpose frames" or as polycultivators. For technical or - sometimes - economic reasons, they have, over the past few years, achieved some popularity with extension workers and advisory bodies and with farmers, provided that the latter have been able to acquire sufficient technical knowledge to enable them to carry out the necessary relatively complex assembly and adjustment operations.

B) PLOUGHS

Here we shall mainly discuss ploughs of the "conventional" type, i.e. the European type with separate share and mould-board, throwing the earth to one side and turning it over. These are, in fact, practically the only types now used in animal draught cultivation *. It would only unnecessarily complicate an already far from simple subject to mention here the many types of traditional ards made locally since, normally, their replacement by manufactured implements is always desirable. The modern Chinese or Japanese types of plough will, however, also be mentioned and described since, although they are fairly similar to the ard, they do more or less turn the soil over and appear to require less tractive effort. They are listed among the ploughs of the "open-up and turn-over" type.

Before, however, starting on the description of a typical plough and then mentioning examples of the other main types available, we should first discuss the purpose of ploughing.

1) Ploughing

a) PURPOSE OF PLOUGHING

Ploughing is a method of cultivation whose main purpose is to loosen the surface layer of the soil in which seed will be sown or seedlings will be planted out later.

This loosening is achieved by turning over the furrow slice, thus exposing a certain quantity of soil to atmospheric action (by air, rain and solar radiation). The soil is thus made ready to store the water of the first rains so that it can be available later to the growing plant, so that the necessary oxygen can be supplied, etc.

* It should be remembered that the true ard is considered a secondary tillage type implement.

Fig. 39 - Turning over the furrow slice

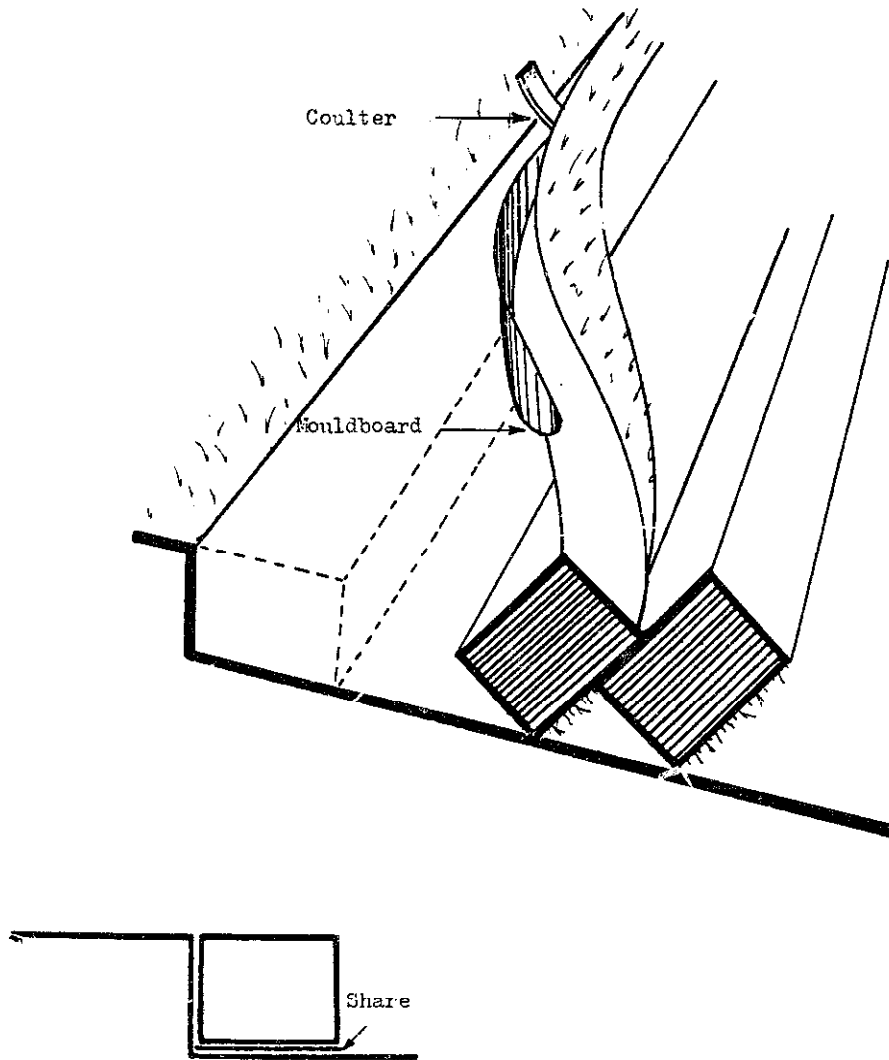

Ploughing is also carried out for the following reasons:

- ploughing in of grass, vegetable waste, fertilizer and soil improvers (mineral and organic farmyard manure, green manure)
- uprooting certain weeds (couch-grass, imperata, red rice) whose roots or rhizomes are destroyed on the surface by drying out.

b) CHARACTERISTICS OF PLOUGHING

Ploughing consists of turning over of a continuous furrow slice cut by two working parts. The width and depth of this slice are chosen by the ploughman to suit the type of crop grown, the dimensions of the plough and the strength of the draught animals (fig. 39).

The width depends on the width of the ploughshare. With donkey draught, this width is about 15 cm; with heavy oxen it may be as much as 30 cm.

The depth also depends on the plough's characteristics but may also be adjusted by the ploughman. With donkey draught it rarely exceeds 10 cm. In exceptional cases with oxen, it may be as much as 25 cm.

Generally speaking ploughing is classified as follows:

- light if less than 15 cm deep
- medium up to 25 cm
- deep up to 35 cm
- very deep up to 1 m.

With animal draught, however, only the first two can usually be achieved.

Let us recall the meanings of certain terms which we shall use later on to describe plough settings (fig 40):

- the area not yet worked is the unploughed land
- the area already worked is the ploughed land
- the vertical edge separating the fallow land from the ploughed land is the furrow wall cut by the coulter
- the horizontal surface between the ploughed and unploughed land is the bottom of the trench or the furrow cut by the share
- the first furrow made by the plough is the lead furrow
- the last furrow, the finishing furrow.

There are three main types of ploughing which are used depending on the plough available, the nature of the soil or the intended crop. In conventional ploughing the plough always turns the earth to the same side (left or right) relative to its direction of movement. The direction in which the soil is turned thus changes each time an about turn is made at the end of the furrow.

For conventional ploughing it is advisable to divide up the area to be ploughed into lands so as to reduce walking at the ends of the furrows to a minimum.

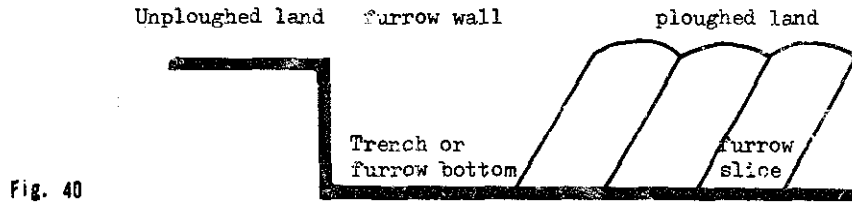

Fig. 40



Fig. 41 - Field lay out "in lands"

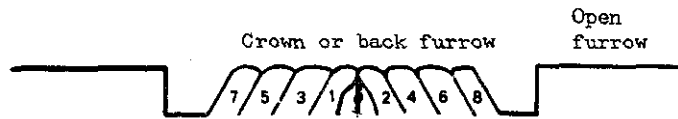

Fig. 42 - Opening up gathering

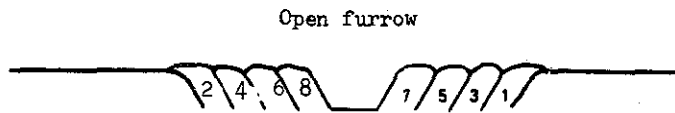

Fig. 43 - Finished off

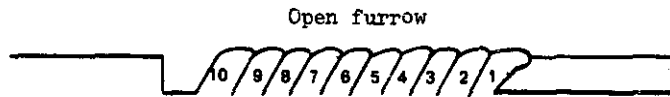

Fig. 44 - One way or reversible ploughing

Normally one should first mark out the lands to be ploughed. Then when starting to plough, a shallow first cut is taken down the middle throwing the soil outwards. Then a return cut is taken in the opposite direction again throwing the soil outwards. This has the effect of leaving a shallow trench in the middle. Next one ploughs back the unploughed soil lying underneath the first shallow furrow slice, throwing the whole back to cover the shallow trench in the middle. Then repeat the same, ploughing back the unploughed soil under the other shallow furrow slice. This then forms a crown or small ridge in the middle, and ensures that all the soil is cut. From there one carries on ploughing up one side and back the other, throwing all the ploughed furrow slices in towards the centre (Fig. 42). Finally, when the ploughing of the adjacent lands has been completed, one is left with an open furrow between the lands (Fig. 43).

The strip of land in the middle is a ridge or a crown resulting from two cuts back to back. Each half of each furrow will lean in opposite directions (Fig. 41).

Ploughing is one way when the earth is always turned in the same direction with relation to the field; i.e. the plough must be capable of turning alternately right and left on consecutive out and return runs. The resulting ploughed land has a lead furrow, a finishing open furrow and no central crown (fig. 44).

Concentric or Felleberg ploughing consists in working continuously round the field either starting on one side or in the middle. This is the only method which results in work similar to one way ploughing, using a conventional plough (Fig. 45).

2) Description and details of a typical mouldboard plough

In order to describe, with a fair degree of accuracy, the component parts, the features and the adjustments of ploughs, we shall use a concrete example, that of a conventional two-wheeled plough (Fig. 46). This type always turns the earth to the right and is therefore a plough for ploughing in lands.

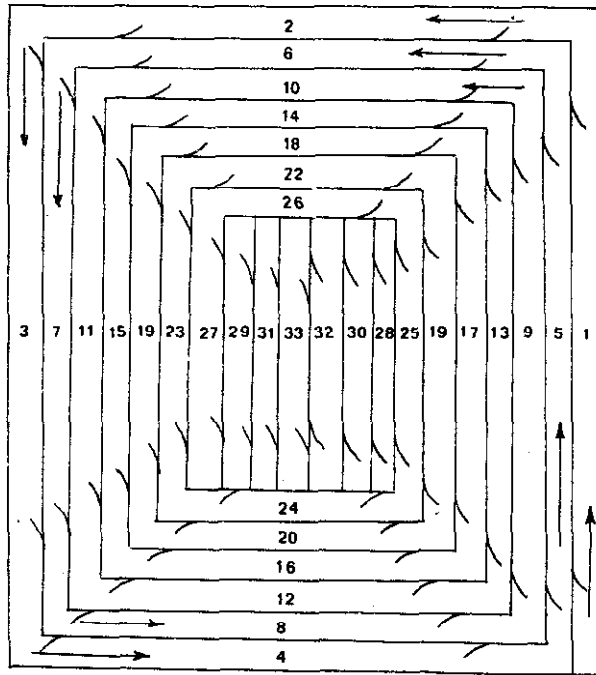

Fig. 45 - Ploughing continuously round and round the field

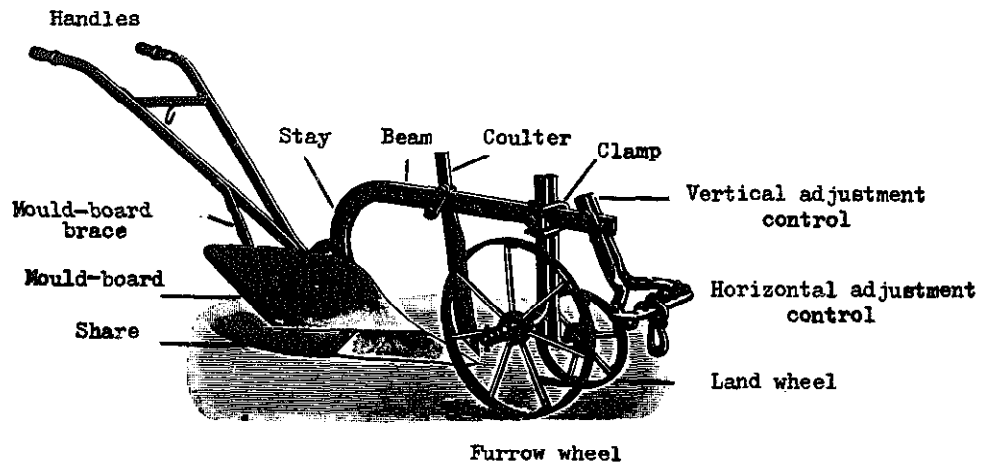

Fig. 46

a) DESCRIPTION

The working parts (Fig. 47):

- The coulter (9, fig. 47). This is a steel cutting blade with a triangular section which cuts the soil vertically along the furrow wall. The shaft of the coulter is attached to the beam by the coulter-bracket so that its cutting edge leans forward (the lower tip ahead of the shaft). For good ploughing, the tip of the coulter must be positioned a few centimetres ahead of and above the tip of the share.

The cutting edge of the coulter is not exactly on the axis of the forward movement of the plough. It is turned slightly towards the furrow wall thus helping to keep the plough in the furrow.

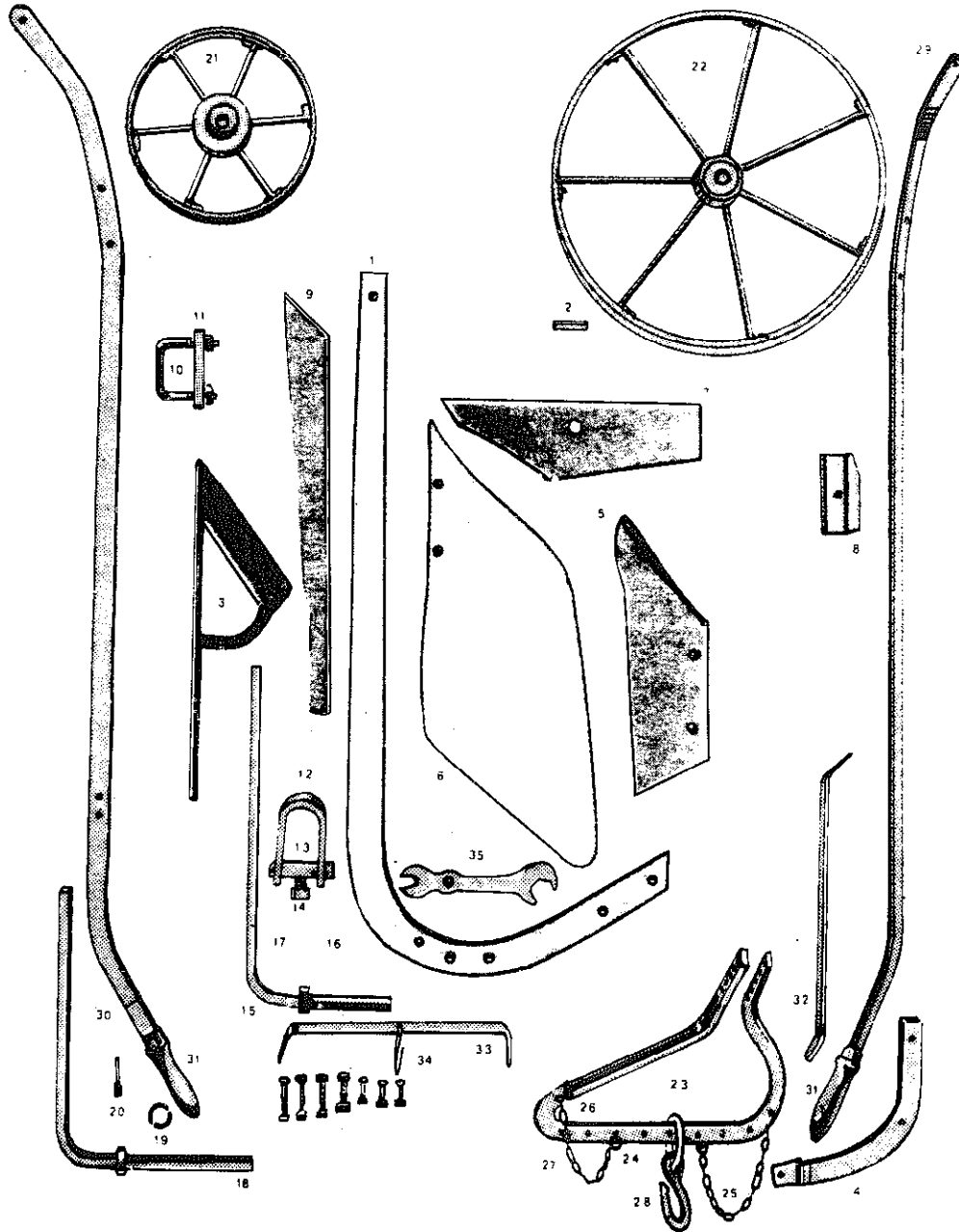

Fig. 47 - The parts of a plough

The coulter must be maintained in good condition which means that it must be rebeaten or resharpened when worn.

For shallow ploughing, particularly in light soil, it may be an advantage to remove the coulter. This is why some ploughs are available without coulters. *

- The share (5, Fig. 47). This is one of the two main parts of all ploughs; it cuts the slice of earth horizontally and starts turning it over (Fig. 49).

The share may be trapezoidal, or triangular. It is attached by two bolts (countersunk and pinned) to the sole-plate or frog (3, Fig. 47). On some ploughs, a share with a bar point is fitted. This is in the form of a "bar" which takes most of the wear and can be moved forward as its point wears back.

The parts of the share have special names and they form pre-determined angles which must be known.

The cutting edge (fig. 48) cuts the slice of earth in a slanting direction.

The cutting angle (or angle of attack) is the angle formed by the cutting edge, the tip of the share and the furrow wall (Fig. 48).

The angle of penetration is that made by the slope of the upper surface of the share.

The digging angle (or pitch of share) (Fig. 48) prevents the whole lower surface of the share rubbing along the bottom of the furrow. Only at two points is there contact with the soil: at the cutting edge and at the heel piece.

The purpose of the lead angle of the share is to prevent rubbing against the furrow wall. The only parts which remain in contact with the soil are the side of the share and the heel piece, as well as the landside.

The share is made of carbon steel which may be hardened. When wear has blunted the cutting edge and the point, the share must be dismantled and reforged (and rehardened).

- The mouldboard (6, Fig. 47) is the other main part of the plough which turns over the earth previously cut by the coulter and the share. It is an extension of the share to the rear. It may vary in length. According to its form the mouldboard may be "general purpose, digger or semi-digger". It is made of semi-hard steel, or of soft centre steel. It is attached in front to the sole-plate or frog by two countersunk bolts and at the rear to the mouldboard brace the other end of which is attached to lower end of the handles thus providing a solid anchoring. (This method of attachment is not found on all ploughs, particularly when a second brace is fitted) (Fig. 50).

The following non-working parts do not play a direct part in ploughing but are part of the frame or have the function of support brackets or braces.

The beam (see Fig. 46 and No. 1 of Fig. 47) is the main frame of the plough to which all the other parts are attached, directly or indirectly.

Originally made of wood, it is now often of forged or drop-forged steel and, more rarely, in tubular or hollow section form, of square or rectangular section.

* In certain cases a disc coulter may be used; it costs more than the knife coulter but is effective for ploughing leys.

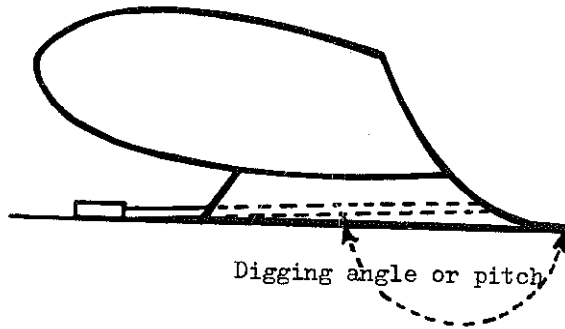
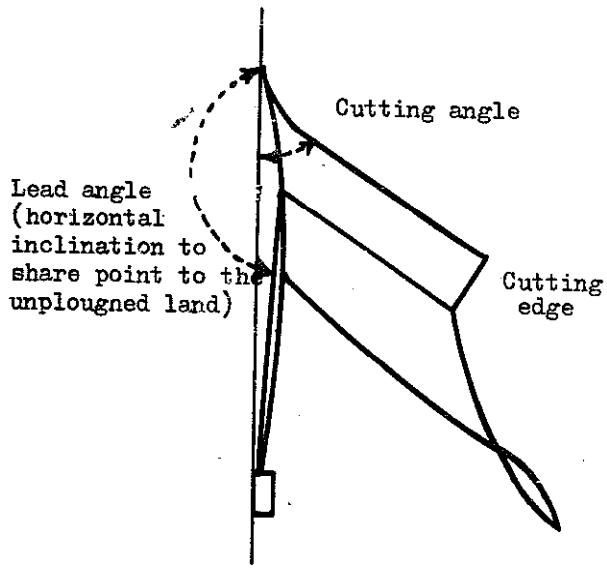

The angles of the plough Fig. 48

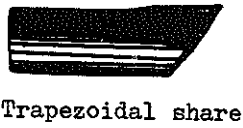
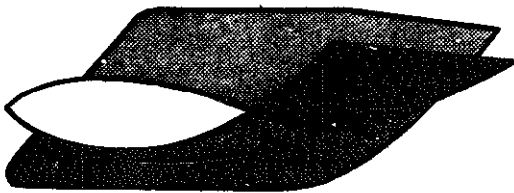

Fig. 49

General purpose mouldboard

Fig. 50



Digger mouldboard

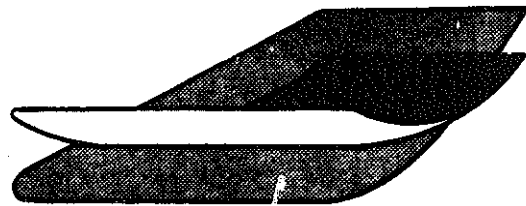

Semi digger mouldboard

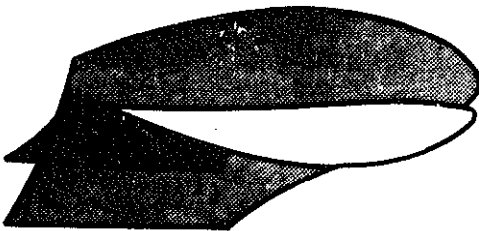

The "standard or stay" is a part at the rear of the beam and to which are attached the main parts of every plough. It may be considered an extension to the beam, but may also be a separate part made of steel or cast iron and bolted to the beam. On certain ploughs there are two stays in order to make the attachment of the other parts more rigid.

The frog (3, Fig. 47) is the part attached to the lower part of the stay or stays. Its front part is called the sole-plate. It is to the frog that the mouldboard and the share are attached. At its rear is the heel piece (8, Fig. 47) which is, nearly always, detachable. During ploughing, the heel bears in the angle formed by the bottom of the furrow and the furrow wall; it is therefore a wearing part.

The landside (7, Fig. 47) is another wearing part consisting of a metal plate bolted to the frog. Its purpose is to prevent wear of the frog and of the stay as a result of friction along the furrow wall.

The handles (29-31, Fig. 47) enable the ploughman to control the plough when working. They are often attached to the base of the stay, as well as to a strengthening piece (4, Fig. 47). On some ploughs, the height of the handles can be adjusted to the height of the ploughman.

Finally, let us examine various means for making adjustments:

- The wheels (21-22, Fig. 47) are, in the example chosen, two in number: a big furrow wheel and a smaller land wheel.

The standards which carry the two wheels are attached to the beam by a single clamp. Each wheel may be adjusted for height to achieve the settings necessary for good ploughing.

- The adjustable drawbar (23, Fig. 47). In our example, there are two adjustments, each for a different purpose. The height is adjustable where the two arms at the upper rear end of the drawbar are attached to the beam. The lateral adjustments are made at the forward lower end of the drawbar to which the harnessing hook is attached (28, Fig. 47).

The term "plough body" covers the assembly consisting of the following parts: share, mouldboard, frog, landside and heel.

b) WORKING ADJUSTMENTS

With nearly all mouldboard ploughs (whether animal draught or tractor) it is essential that the pitch adjustment is correct to ensure good ploughing. This requires that the rear heel piece of the landside should run along the bottom of the furrow at the same level as the point of the share (in the same horizontal plane) (Fig. 53).

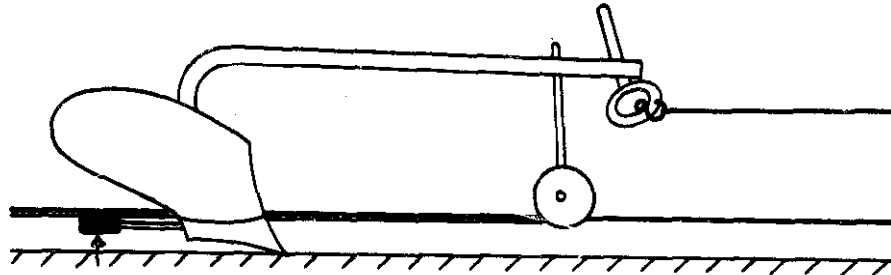

Fig. 51 Incorrect pitch adjustment:
The wheel presses too heavily on the ground and the heel piece is up in the air

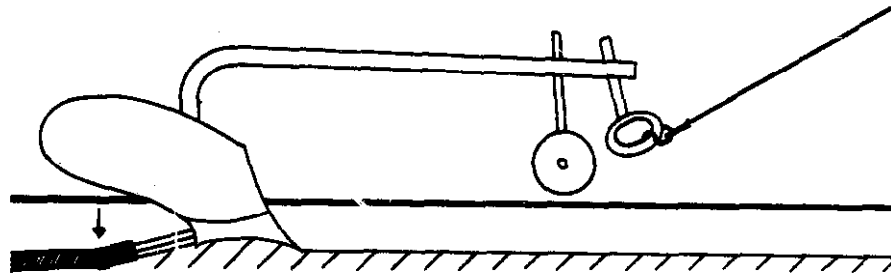

Fig. 52 Incorrect pitch adjustment:
The wheel lifts off the ground and the heel piece presses too hard into the furrow bottom

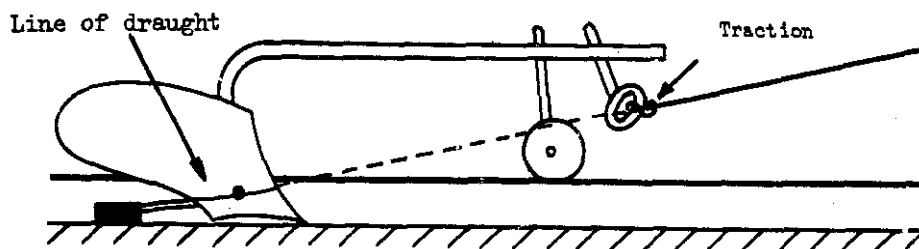

Fig. 53 Correct pitch adjustment:
Heel piece sits on furrow bottom at the same level as the point of the share

In order to achieve correct pitch, i.e. good ploughing, the use of the vertical regulator must be properly understood. In practice, the pitch is correct when the centre of resistance to forward movement, the harnessing attachment point and the line of draught (attachment to the yoke, for example) are all in the same straight line. Experience has shown that all the forces to which a plough is subject when in use, have a resultant whose line of draught is roughly at the centre of the line where the share and mouldboard join, (see Fig. 53). It can then be understood how careful adjustment of the vertical regulator can enable this alignment to be achieved.

ADJUSTMENT OF PLOUGHING DEPTH

To simplify matters, we shall consider only the land wheel.

Let us assume that it is raised to its top position. Since we want the wheel always to bear on the land and so that the heel-piece bears on the soil, the share has to dig deep into the ground in order to bring the heel-share line back to the horizontal. On the contrary, if the land wheel is lowered to the position shown in Fig. 52, the heel-piece bears too heavily on the soil when the plough is at rest on the ground; the depth of ploughing is thus nil.

Depth of ploughing therefore follows this rule:

- ploughing is deeper as the front of the beam is closer to the ground, i.e. as the supporting wheel is raised higher.

ADJUSTMENT OF PLOUGHING WIDTH (Fig. 54)

The width of the furrow ploughed depends on how far the ploughman keeps the land wheel from the wall of the previous furrow.

In practice, ploughing width is adjusted by changing the position of the harnessing hook on the lateral regulator: if the hook is moved towards the unploughed land, the ploughing width is reduced; if it is moved towards the furrow, the ploughing width is increased. Like the adjustment of the pitch, that of width depends on the alignment of the following three points: centre of resistance on the plough, position of the harness on the lateral regulator and the attachment point on the yoke (see Fig. 54).

SECONDARY ADJUSTMENT OF PITCH AND PERPENDICULARITY

The foregoing rules apply to the main adjustments, but a secondary adjustment must be carried out during ploughing to ensure a correct line of draught. This secondary adjustment is made by the vertical regulator.

a) Let us assume that the regulator is in the low position, that the harnessing chain is short and that the harnessed animals are big (Fig. 52). The land wheel then has a tendency to rise and the plough rests on its heel, resulting in incorrect pitch and bad ploughing. The remedy is to raise the regulator until the wheel bears on the ground without undue force.

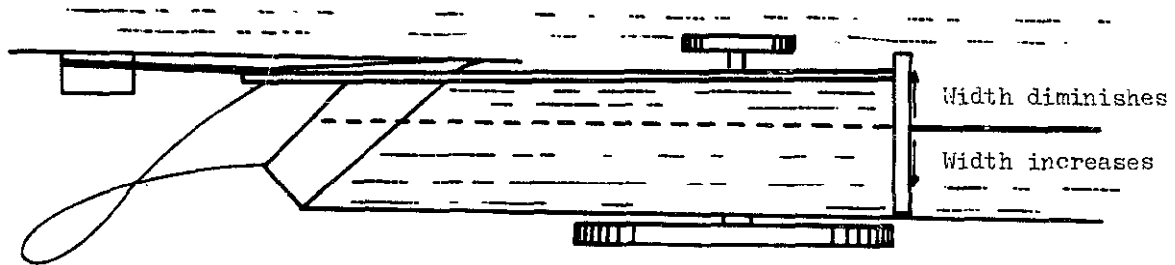

Fig. 54 - Adjustment of ploughing width

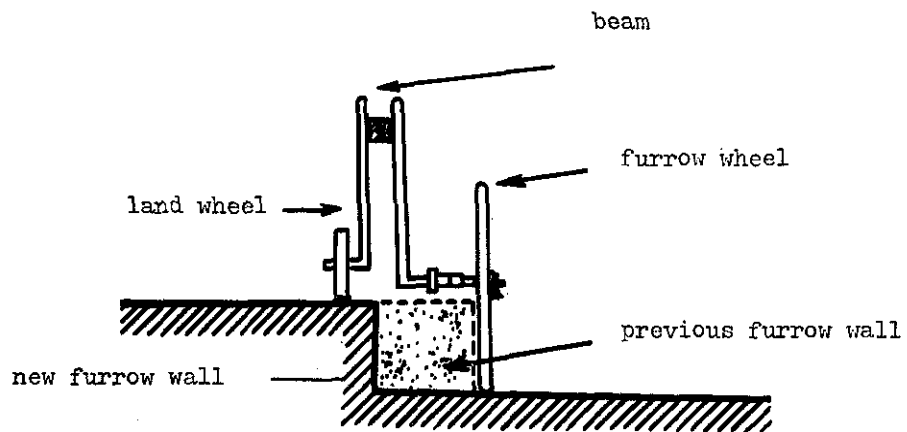

Fig. 55 - Positions of the supporting wheels during ploughing
(plough viewed from behind)

b) Let us assume the opposite fault: regulator too high, long harnessing chain, small oxen. The land wheel bears too heavily on the ground (leaving a visible trace, or even making the rim of the land wheel collapse) and the heel has a tendency to lift, pivoting round the wheel (the handles follow this movement). There is no longer a proper line of draught and, in order to keep the plough at the desired depth, the ploughman has to keep his weight continuously on the handles, which is always very tiring and rarely effective.

To correct this fault, the regulator must be lowered until the land wheel no longer bears too heavily on the ground.

c) Finally, the vertical setting of the plough requires the stay to be held in the vertical plane. This is necessary to achieve a thoroughly horizontal bottom of the furrow and is achieved by the ploughman with the handles. These must be kept properly level, which is easy if the other adjustments have been made correctly. In practice one refers to the perpendicularity (uprightness) of the stay.

CONCLUSION

A badly adjusted plough can never plough well: it causes ploughing which is irregular in depth and width, it imposes heavy and irregular loads on the draught animals, tiring them quickly and it also tires and discourages the ploughman. If he has not learnt how to make the necessary adjustments, he comes to the wrong conclusion that the plough works badly because it is badly designed and he quickly gives up ploughing.

OTHER ADJUSTMENTS - THE FURROW WHEEL (Fig. 55)

As its name implies, this wheel travels in the bottom of the previous furrow. The main purpose of the furrow wheel is that it makes it easier to control the uprightness and thus the performance, and handling of the implement. The height setting of the furrow wheel controls the uprightness of the plough and the horizontal setting controls the width of the furrow, in conjunction with the position of the harnessing hook on the lateral regulator. In some cases the track width is adjustable by packing washers which allow the wheel to be moved along its axle.

Removal of the furrow wheel should not affect the other adjustments (except the uprightness). If, after removal, the ploughing width increases, it means that the track width was insufficient.

The furrow wheel is said to be "toeing in" when the rim of the wheel, while travelling in the furrow, rubs against the furrow wall. If it rubs too hard, an adjustment must be made since this exaggerated "toe" increases the draught effort required and thus tires the draught animals.

ONE WAY PLOUGHING

We have described above a plough for conventional ploughing in lands. Ploughs for one way ploughing have the same main characteristics described above but, in addition, they have:

- either two opposite and symmetrical plough bodies one or the other of which is put in the working position for ploughing in one direction and the other for the opposite direction; these are known as reversible ploughs;

- or two bodies displaced not 180° but only 90°: known as "quarter turn";
- or against a single double body with two ordinary shares extended by a single mouldboard of special shape, known as turn wrest.

These different types are described in detail later.

3) Classification of the principal animal draught ploughs

Among the possible different methods of classification, that are used here applies mainly to the method of stabilizing and supports of the ploughs; and, incidentally, since we shall progress from the simple to the complex, the ploughs will be listed in order of increasing weight, at least from one category to the next.

a) CONVENTIONAL MOULDBOARD TYPE PLOUGHS

a-1) Ploughs with no stability

These are sometimes wrongly called ards, whereas they are indeed ploughs, albeit simplified. They should rather be called "ploughs without supports" or "without wheels" (Fig. 56). They differ from the typical plough already described in that they have no furrow wheel (or land wheel) and, in nearly all cases, no coulter either. In addition, they are always light ploughs with a share 6 to 8 inches wide (15 or 20 cm) and whose weight rarely exceeds 25 kg. These light weight ploughs are comparatively cheap since the price of simple agricultural implements is generally proportional to their weight. Furthermore, the plough must be light because the ploughman is often inexperienced and has to compensate with physical power applied through the handles for the lack of support wheels, particularly when the adjustments through the hitch point have not been properly made (which is unfortunately often the case).

Theoretically, however, handling the plough to keep it upright and in line is similar to a plough with wheels, except that the vertical regulator will enable both the pitch and depth of ploughing to be adjusted together. Nor is anything changed as regards width adjustment which still involves the lateral regulator. Difficulties arise, however, due to different soil consistencies and uneven soil resistance causing continuous variations in depth (and therefore of width) which, without the help of a supporting wheel, puts a considerable load on the ploughman. During ploughing, he has to apply physical effort through the handles to keep the depth and width as constant as possible. He raises the handles, if the plough is not biting deep enough and he tilts them momentarily towards the land if it is not biting wide enough and vice versa.

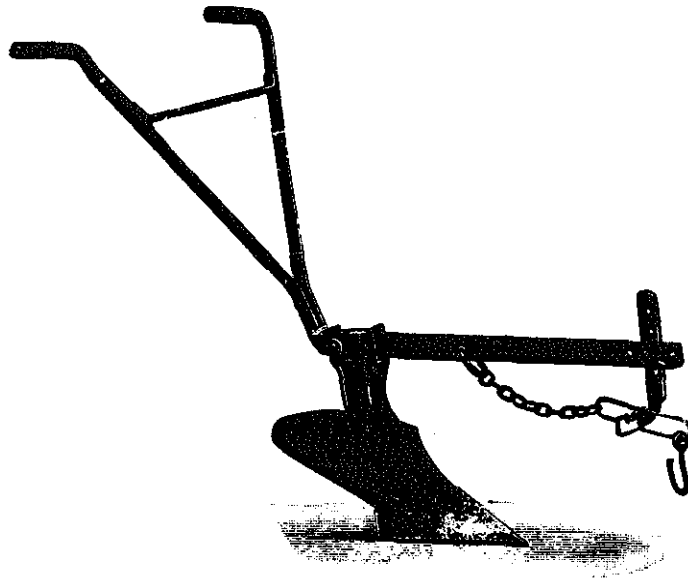

Fig. 58 - Plough with no stability - without support wheels

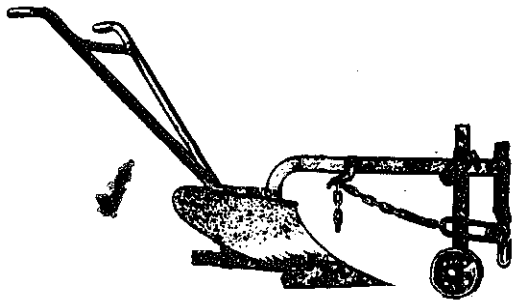

Fig. 57 - Plough with longitudinal stability - with support wheels

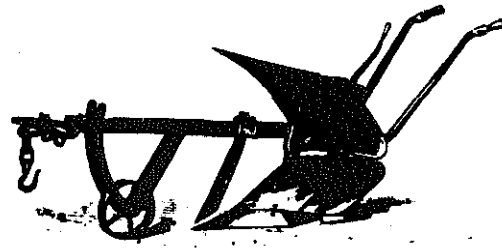

Fig. 58

In practice, very few manufacturers make ploughs of this type since they are technically out-dated and find little favour with extension workers *. When they exist already, it is always possible, at extra charge, to add a land wheel, thus considerably improving their performance.

a-2) Ploughs with longitudinal stability

These are the ploughs with land wheels often called "small wheel ploughs". They are by far the most widespread, since they combine simplicity of manufacture with relative ease of adjustment and of operation (Fig. 57).

In the same category may be included the "skid"ploughs, the skid acting in the same way as the small wheel while being less costly and stronger. Indeed the short distance between the beam and the ground means using a very small diameter wheel whose axle quickly gets smothered in dust, mud or grass, leading to jamming and rapid wear. Under these circumstances, it would seem that preference should be given to the skid in ground which is wet and sticky where a skid works better and absorbs less energy than a badly running wheel. The same would seem to apply to stony ground where a narrow skid (or shoe) easily makes a way for itself, whereas a small wheel would have difficulty.

a-21) For draught by donkey or light bovine

These ploughs have 6 inch (15 cm) and sometimes 8 inch (20 cm) shares. Most of them plough conventionally in lands and some of them do one-way ploughing. They are always light (less than 30 kg) and usually have no coulter; the depth of ploughing rarely exceeds 10 cm even in the lightest soils.

a-22) For draught by medium and heavy bovines

These are, by far, the most widely used ploughs wherever bovine draught is possible. Most of them are suitable for ploughing in lands with a single body. Some types, however, are designed for one-way ploughing. They either have two separate bodies carried by two stays with the axis of rotation near the axis of the beam (these are known as "reversible ploughs"), or the two bodies are linked by a single mouldboard, these are then turn-wrest ploughs like those previously mentioned.

The nominal width of the shares is always between 8 and 11 inches (15 and 28 cm), most of them being 10 inches (25 cm.). This detail is important because, more so than the weight, on it depends the draught effort required.

a-3) Ploughs with longitudinal and lateral stability

There is no plough of this type which is suitable for donkey draught, since they are always relatively heavy.

A distinction must be made here between the two-wheel ploughs in which the beam is fixed, with the wheels adjustable up and down and laterally and those in which the wheels carry the front part of the beam where the beam is free to rotate, thus changing the degree of uprightness of the chassis. Lateral stability is therefore relative.

* Except in some special cases, such as in the Cameroons and Upper Volta.

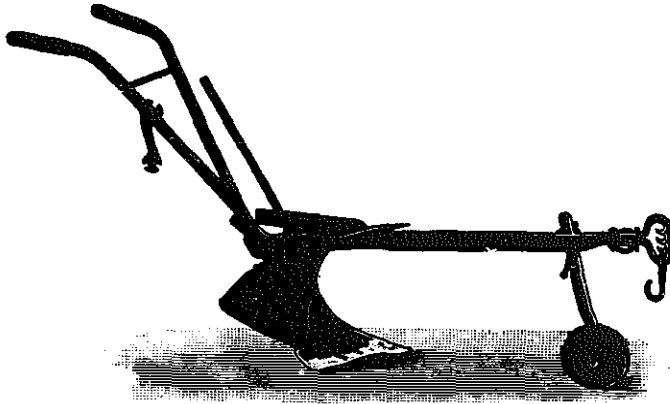
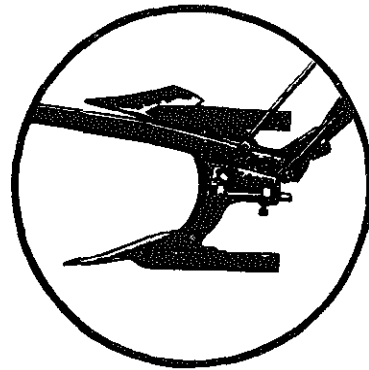

Fig. 59 Turn-wrest plough



Detail of the pivoting system and locking by lever

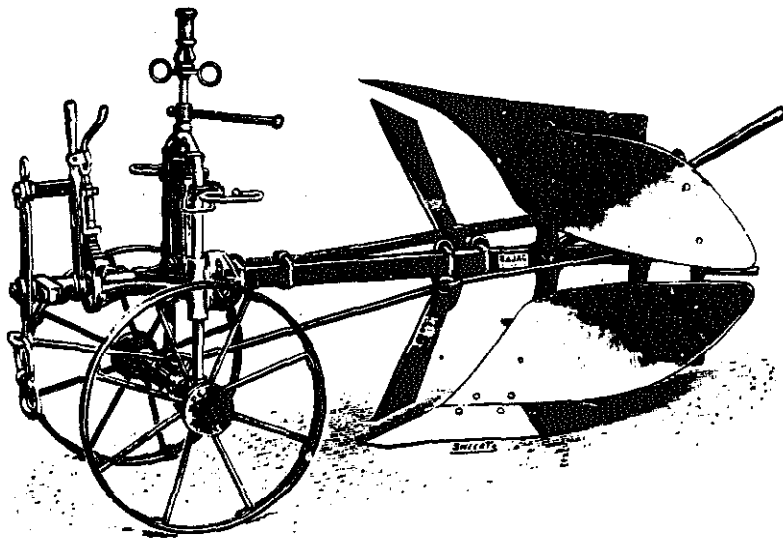

Fig. 60 - Reversible plough for one way ploughing: on wheels

a-31) Conventional ploughs with wheels for ploughing in lands

These are simple small ploughs with a land wheel to which a larger diameter furrow wheel has been added (like that described as the typical plough under 2). Lateral stability makes a considerable contribution to regular ploughing and to reduction of fatigue for the ploughman, without however increasing the draught effort required. Unfortunately, they are slightly more expensive than the previous types and prudence must be exercised in their distribution for the following reasons:

- the adjustments are more difficult, since the track width must be appropriate to the width of the furrow and to the position of the lateral regulator,
- and above all, good ploughing is only possible on well cleared land since the 2 wheels give the plough stability but as a result it is impossible to make the plough swerve or tilt as would be possible with single wheel support, to get round a stump or other obstacle. These ploughs should only, therefore, be recommended to experienced farmers who already have well cleared land.

a-32) Forecarriage ploughs for ploughing in lands (Fig. 60a)

Very few ploughs of this type are being made.

a-33) Ploughs on wheels for one-way ploughing (Fig. 60)

These are the reversible ploughs. The "Brabant" is the basic type in this category, of which there are many different types available. Most of them weigh over 80 kg or even more than 100 kg and are therefore used only for heavy bovine draught, particularly in Madagascar. In the Lake Alaotra region two to four pairs of oxen are used with a Brabant for ploughing fairly wet rice-fields. There are also certain lighter types, including some new models, which can be used with light bovine draught.

a-34) Forecarriage plough for one-way ploughing (Fig. 60a)

There are a few models available, but they are hardly used at all in Africa and are of little interest because they are technically inferior and the price is about the same.

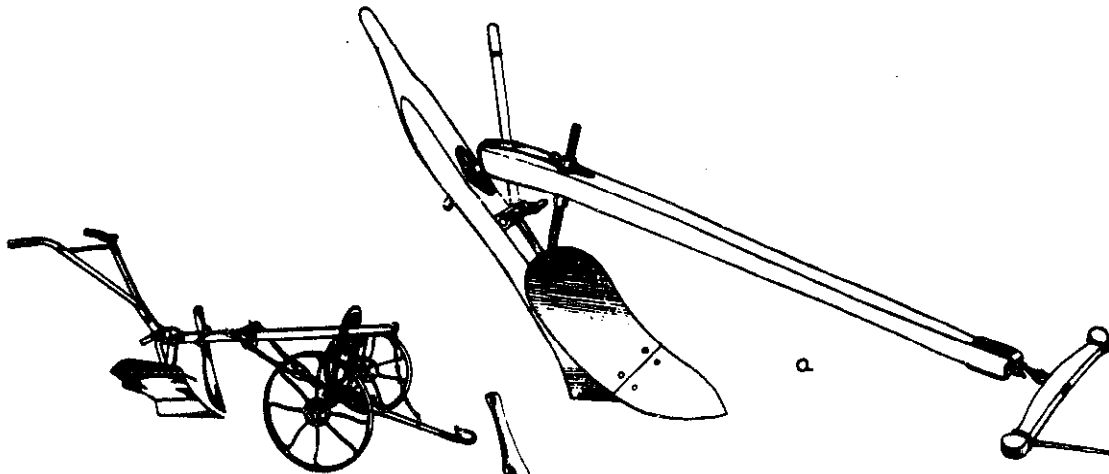

Fig. 60a - Forecarriage plough
for conventional
ploughing in lands

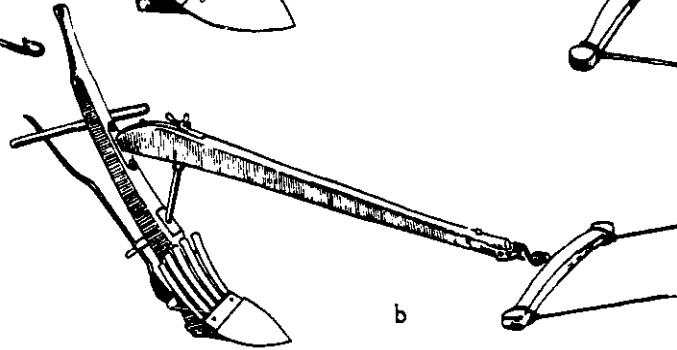

Fig. 61 - Japanese plough
a) current type
b) reversible turn-wrest type

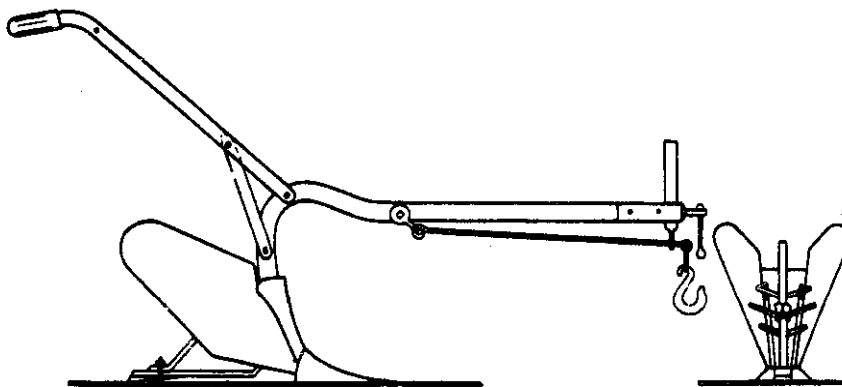

Fig. 62 - Ridging-plough

b) CHINESE OR JAPANESE "OPENER-INVERSION" TYPE PLOUGHS

These are of extremely ancient origin but, in their modern form, are still sufficiently simple and effective to be of interest to users in the tropics.

They differ from the European type ploughs mainly in the shape of their working parts - share and mouldboard - putting them midway between the true ard which does not turn the soil over and the soil inversion type of plough (Fig. 61).

The share is asymmetrical, shaped like a spear-tip, fairly steep-sloping and extended by a mouldboard which is usually symmetrical and concave in shape and does very little in helping to turn over the earth.

To reduce friction as much as possible, the mouldboard is often slatted. Sometimes the steel blades making up the slats are hinged on a shaft at their lower ends (at the joint with the share) so that they can move separately in contact with the earth and still further reduce resistance to forward movement. This type of slatted mouldboard is especially useful in wet or even flooded clay soils.

The stay, sometimes made of wood, is extended along its upper part to provide a single handle, to which a detachable second handle is sometimes added.

The beam may also be wooden and its front part, which has no support, is fairly close to the ground. The height of the front of the beam can be adjusted by altering the angle between the beam and the stay by means of a threaded rod. It is, moreover, this adjustment which is used to alter the depth of ploughing.

The construction of the plough is such that the draught effort of the draught animals is transmitted along an ideal straight line running from the yoke to the centre of the share, passing through the point where it is attached to the beam of the plough, thus ensuring the efficiency and good balance of the implement when working.

These ploughs, which are very light: 14 to 20 kg, are mostly pulled by one or two draught animals and controlled by one man who keeps the main handle slightly inclined to the side towards which the soil is to be turned. The soil is opened up without its being really cut and without being compacted.

Provided that they are sufficiently strongly-built, which is not always the case with the few models to be seen in Africa, these ploughs would seem to be suitable for small farmers because of their very low cost and because they would appear to need a relatively small applied effort.

A very wide variety of models of this plough is available in Japan and Taiwan (and in Continental China). These, always without small wheel or any other support, may be of the "reversible-turn-under beam" type. A type working on a similar principle but with a small supporting wheel is made by a North African manufacturer; it was designed for Algerian peasant farmers to replace the traditional wooden ard. The share plough with symmetrical mouldboard was part of a universal frame and was also of the turn-under beam type.

C) RIDGERS

In certain regions of tropical Africa the plough is practically unknown and the ridger is used instead. This is the case in the north of Nigeria where some 40000 farmers use ridging ploughs as their only animal draught cultivation implement.

It may well be wondered what reasons have led the farmers to ridge their land. It is rarely possible to claim erosion as a justification; either by wind or because of unduly violent downpours since the ridges are not always made along the same lines, some following the natural slope of the ground and others crossing it.

It would be more logical to admit that, having to turn over a certain quantity of earth, the farmer has preferred to use the quickest and least tiring method.

The ridge is never destroyed. It is re-made, first before sowing and then again during growth. This concern for keeping the ridges in good condition results in rectangular and perfectly maintained fields.

Not destroying the ridges means growing the crops in rows which are always the same distance apart. The ridges are set at a standard distance apart of 3 feet (91 cm) which is suitable for the main crops (millet and sorghum); they are also used for cotton for which they are suitable, and for ground-nuts, haricot beans and earth peas (for which they are much too far apart).

There are not many models of ridgers because the draught effort required for direct ridging is always greater than that with a plough.

This is because a ridger is, in effect, a double plough, simultaneously cutting and turning the earth to right and left by means of two symmetrical shares and mouldboards (see Fig. 62). It makes two half-ridges simultaneously. When the ridger is fitted with a heel piece (which is not always the case), its adjustment is the same as that of a plough but, in this case, a lateral adjustment would serve no purpose since the opposing lateral forces cancel each other out.

The distance from ridge-top to ridge-top depends on the width of the ridger, but also on the working depth and the adjustment of the wings, i.e. the mouldboards which may, on certain types, be set at various angles and, in consequence, raise the earth to a lesser or greater extent. This adjustment may be made by loosening of nuts and bolts, in which case it is a lengthy operation, or by a screw or lever system when it can, in practice, be done without stopping the draught animals.

All the sufficiently sturdy ridging ploughs may be used for direct ridging provided that the draught animals are able to transmit the necessary tractive effort (bovine draught will always be used).

If needs be, by means of the wing adjustments it is possible to build ridges in two runs (a shallow run followed by a second deeper run) but this involves very complicated adjustment.

D) SOIL WORKING IMPLEMENTS WITH TINES AND DISCS

The purpose of these is to complete the work done by the ploughs, such as secondary tillage, destruction of weeds and, sometimes to substitute for ploughing.

1) Ards - Fig. 63

1) Ards

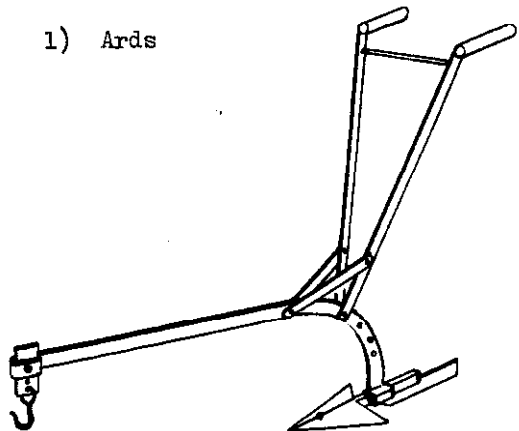

Fig. 63 - Ard

These should have been mentioned first among the soil-working implements since they are of far earlier origin. They do not, however, turn the soil over and can only make a furrow with slightly raised edges. Their working parts, essentially a share and, sometimes, a rudimentary mouldboard are symmetrical in the vertical plane through the draught axis. As in the case with the ridgers, there are, therefore, no lateral forces which make both adjustment and control simpler (Fig. 63).

The few ards available nowadays in modern form are used solely in arid areas for soil preparation without soil inversion. This is the case with an ard which was developed as the result of an FAO study based on the traditional Lybian ard, with a view to its improvement. Starting with this ard made of wood, with the exception of the share, a metal unit was developed with interchangeable working parts. A true ard made entirely of steel is also made in Italy.

2) Cultivators

These are implements with rigid or flexible tines which can be fitted with shares of various shapes. They are difficult to classify and this can be done with reference either to the share or to the tines.

a) CLASSIFICATION ACCORDING TO SHARE SHAPE

- The scarifying share is usually formed by the lower part of the tine (strengthened and shaped). It is concave and has a reinforced tip; it is fairly narrow (50 to 55 mm.); it penetrates the ground at an angle of entry of 30° to 60° . The scarifier does aeration and deep loosening work (Fig. 64).

- The cultivator share is narrow and elongated and always attached to the front of the tine. It is nearly always reversible (Fig. 65).

- The weeder share is triangular with two lateral wings which are sharply concave. This share penetrates the ground to a shallow depth at a small entry angle. It carries out weeding, cleaning (bringing debris of all kinds to the surface) and soil loosening work (Fig. 66-67).

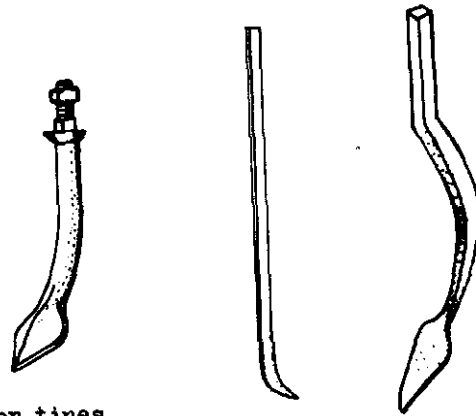

Fig. 64 - Scarifier tines

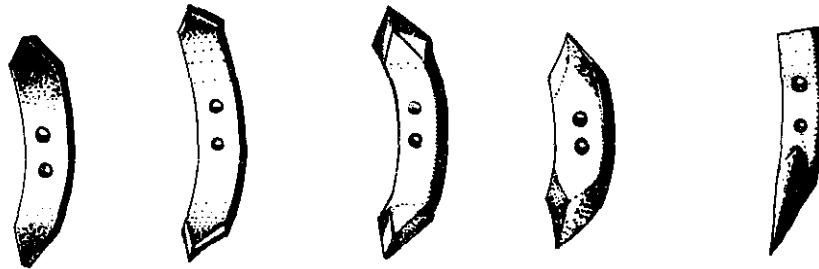

Fig. 65

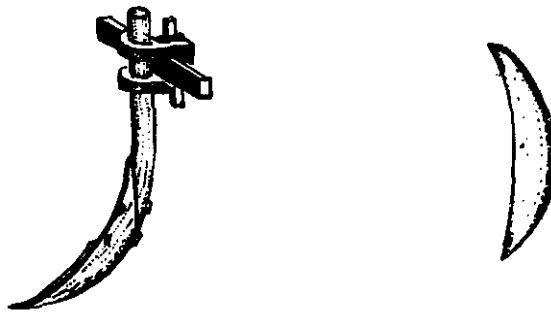

Fig. 66

b) CLASSIFICATION ACCORDING TO THE TINES

- The rigid tine is used less and less. It is mounted vertically. With animal draught implements, no safety system is generally provided (Fig. 68).
- The rigid hinged tine (of the tiller type) is held in the vertical position by a spring. The spring absorbs shocks and the tine vibrates as it moves along. The entry angle remains the same, as long as the spring works properly (Fig. 69).
- The flexible tine may be flexible to varying degrees:
 - the flat tine, consisting of a curved steel blade, whose upper part is sometimes reinforced ("shouldered") (Fig. 70),
 - the coiled tine, of square section, which is hardly ever available for animal draught implements (Fig. 71).

The body is a rigid frame, usually on wheels, with, in all cases, a depth adjustment system.

Among the types of cultivator mentioned, that which is by far the most used for animal draught work in the tropics is the flexible flat toothed cultivator, commonly known as a spring tine harrow. It is available either as a simple cultivator with its teeth attached to a body without supporting wheels and hinged on a shaft to adjust working depth, or, more frequently, as an attachment to a multicultivator or multi-purpose frame, an implement which will be discussed later.

3) Disc harrows

There is now a big market for these implements as a result of the mechanization of agriculture. With animal draught cultivation, however, their value is much more open to question, not for technical reasons, even though the disc implements work better at the high speeds achievable by tractors, but for economic reasons. They are, indeed, relatively costly. They are usually heavy implements requiring considerable draught effort (Fig. 72).

In view of the weight limit imposed by the animal draught method under consideration in this manual, only simple disc harrows can be discussed. These consist of two shafts each fitted with a row of concave discs with spherical caps. The two shafts carrying the discs are arranged in a wide V open to the front.

Disc harrow - Fig. 72

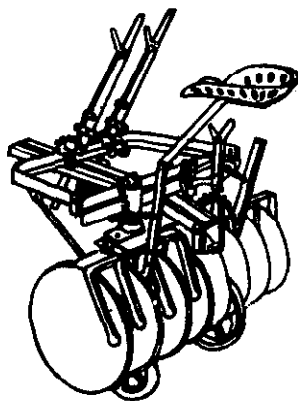

Each shaft carries 3 to 6 discs mounted vertically which can rotate on roller or ball bearings or on shell or wooden bearings. The discs, with internal levelling, have a maximum diameter of 50 cm and are set 15 to 20 cm apart.

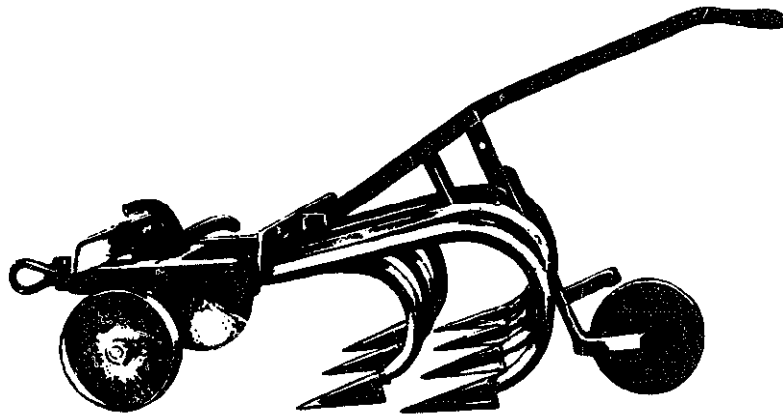

Fig. 67 - Animal draught weeder or scarifier

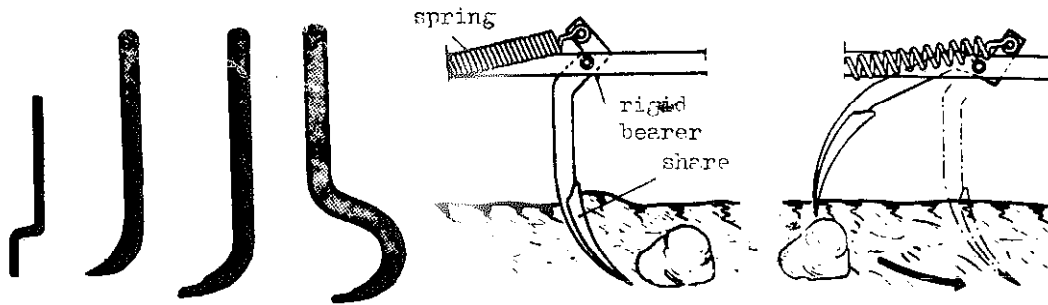

Fig. 68 - Rigid tines

Fig. 69 - Retractable rigid tine-spring loaded



Flat tine



Fig. 70

Reinforced flat tine



Fig. 71 -

Coiled tine

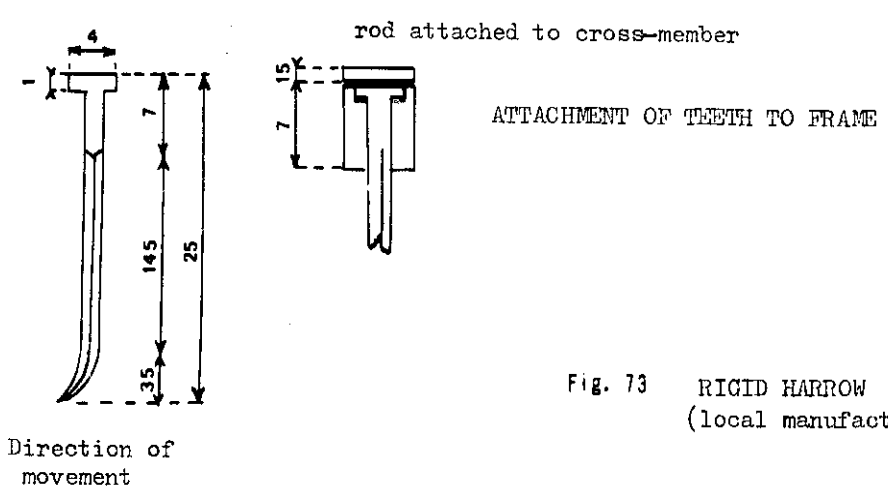
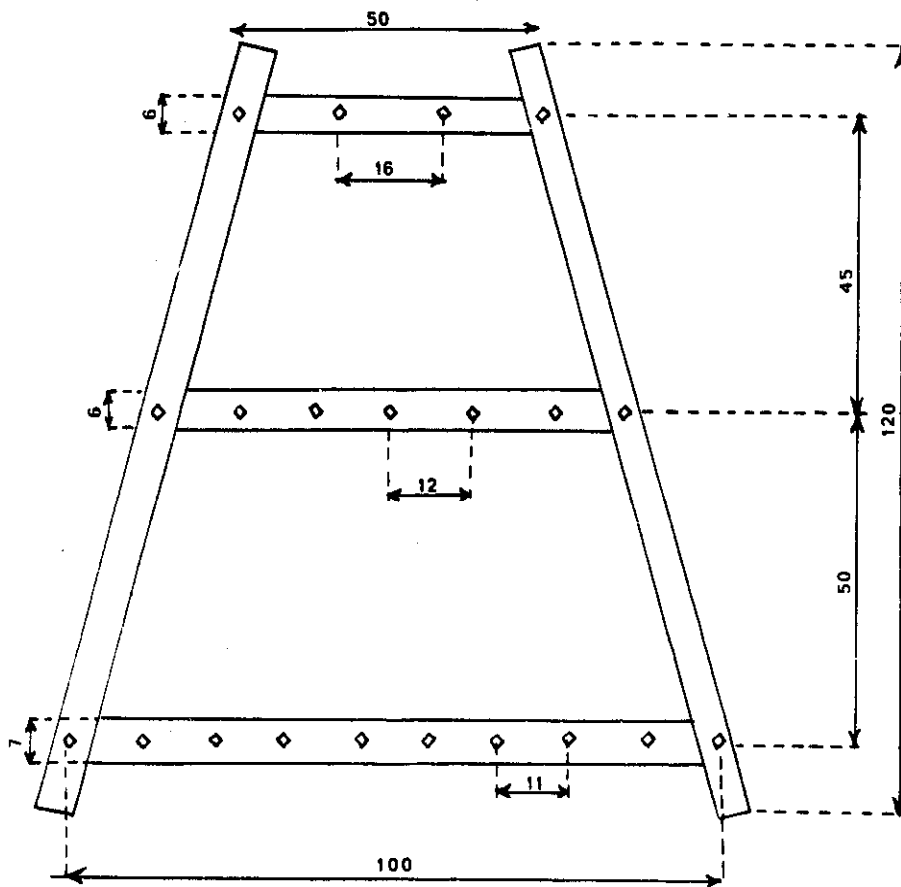

The harrow works the ground thoroughly as its discs are set more obliquely to the direction of movement, i.e. as their angle of attack is increased. Conversely, it does practically no effective work when the shafts of the two sets of discs are in a straight line; in this case, the harrow rolls over the ground and this is, moreover, the only way in which the most simple implements can be transported.

Except in Madagascar, where there are a few, disc harrows are only very rarely used.

Such harrows are sometimes provided in the range of implements for attachment to multi-purpose bodies. These are usually as described above, but in some cases they may be offset harrow; i.e. two sets of discs one behind the other but not parallel.

The share or disc stubble-ploughs are only mentioned in passing since, they are never used in tropical agriculture with draught animals.

E) SURFACE TILLAGE IMPLEMENTS

The main purpose of these is to prepare the seedbed for good germination of the seed.

1) Harrows

These implements are far too little known in Africa, despite the fact that they are almost essential for seedbed preparation where mechanical planters are used. When seed is sown by hand, harrowing can be dispensed without much harm, although there is always the risk of a downpour breaking the big clods left by the plough which will then bury the seeds too deep. If, however, it is desired to use a mechanical planter after ploughing, the harrow becomes not only useful but essential. Indeed, the animal draught planter used (which is always light) must be able to roll over the seedbed without too much bumping if satisfactory sowing is to be achieved. However, this is never the case on land which has only been ploughed.

Harrows are implements which work at shallow depth with simple teeth without shares. There are several different types.

- Rigid spike tooth harrows, harrows consisting of a rigid wood or metal frame to which are attached pointed teeth which are chamfered and arranged vertically so as to work the soil (Fig. 73).
- Linked spike tooth harrows, consisting of several rigid frames or sections joined together. The most rational arrangement is that in which each unit has several longitudinal members arranged in zig-zag fashion and fitted with teeth, hence their name of Zig-Zag harrows (Fig. 74).

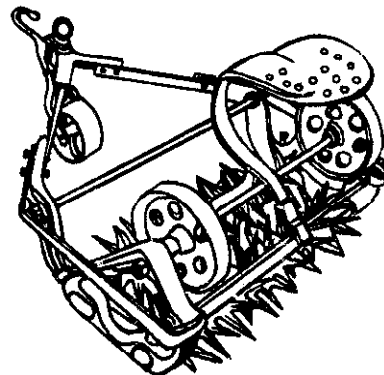

Fig. 77 - Rolling harrow

- Unlike the linked harrows which only have transverse flexibility, the flexible harrows have also longitudinal flexibility. They consist of small frames or sections carrying the teeth linked together by flexible links (Fig. 75-76).
- Rolling harrows with a frame with two or three cross shafts on bearings. Fitted to the shafts are discs with radial pointed helical teeth which interact in such a way as to avoid clogging and are self-cleaning (Fig. 77). A very special type of rolling harrow is made in Asia, either by local artisans or industrially. It has wooden or metal teeth attached to a roller (Fig. 77a).

2) Rollers

Rollers could, at a pinch, be left out since they are extremely rarely used and, in the regions in which we are concerned, are reserved solely for work at a few experimental stations and farms. Their agronomic value is not questioned but, in the order of priority of equipment for the African farmer and bearing in mind his purchasing power, rollers are only of very minor interest. To this should be added the considerable draught effort they need which is often too much for the capabilities of the animals available.

The roller is used to pack the earth, to break up clods and for levelling. They are sometimes listed under two separate categories:

- compaction rollers which crush clods and bury them,
 - clod-crushers which crush and pulverize, producing a powdery soil and compacting the sub-soil.
- a) The compaction roller consists of one or more cylindrical units on a single shaft (Fig. 78). The corrugated roller is only a variant of the compaction roller.
 - b) The Cambridge or ring roller, composed of independent parts or discs on a single shaft, is a clod-crushing roller which is more effective than the smooth surfaced roller (Fig. 79).
 - c) The ring roller is also available as a two row model. It has two parallel shafts one behind the other. Each set of roller is made up of adjacent cast iron discs. The arrangement is such that a disc of the rear roller passes between two discs of the front roller. This roller is particularly effective in powdering the soil.
 - d) The "crosskill" roller is a typical clod-crusher; it has two series of independent discs with alternately two different diameters on a single shaft, with a big disc between two small ones. One of the two series of discs has a hub of diameter greater than that of the shaft so that all the units can roll on the ground despite their different sizes. As their angular speed is not the same, they unclog themselves automatically. Furthermore, the rims of the discs are notched (Fig. 80).
 - e) The "crosskilette", often confused with the crosskill, is made up of units consisting of small diameter discs, all of the same diameter with teeth on their rims. There are about ten of these discs on one shaft. A crosskilette generally has two parallel shafts one behind the other.
 - f) The toothed clod-crushing roller has a double row of stars whose points are oblique and arranged spirally so that they do not get clogged. It differs from a rotary harrow only in its greater weight.

The frame of the rollers is always very simple and consists of a frame attached to the shaft or shafts of the rollers.

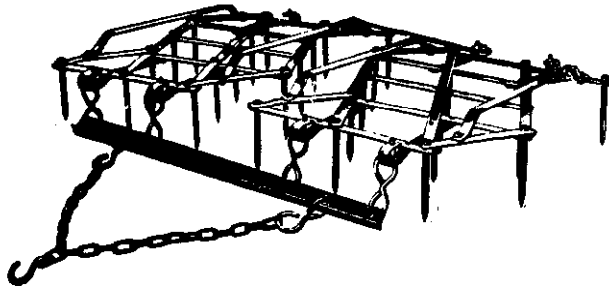

Fig. 74 - Two section harrow (zig-zag)

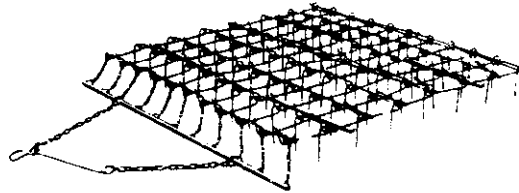

Fig. 75 - Chain harrow

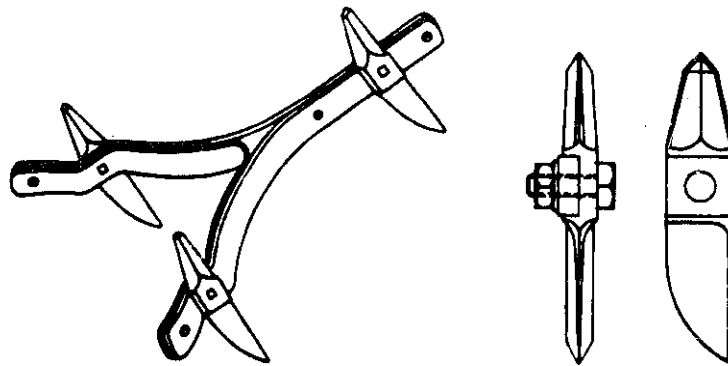

Fig. 76 - Reversible teeth for spike tooth harrows

Fig. 77a - Rotary harrows or clod crushers

Upper: Malaysian wooden type

Lower: Japanese metal type

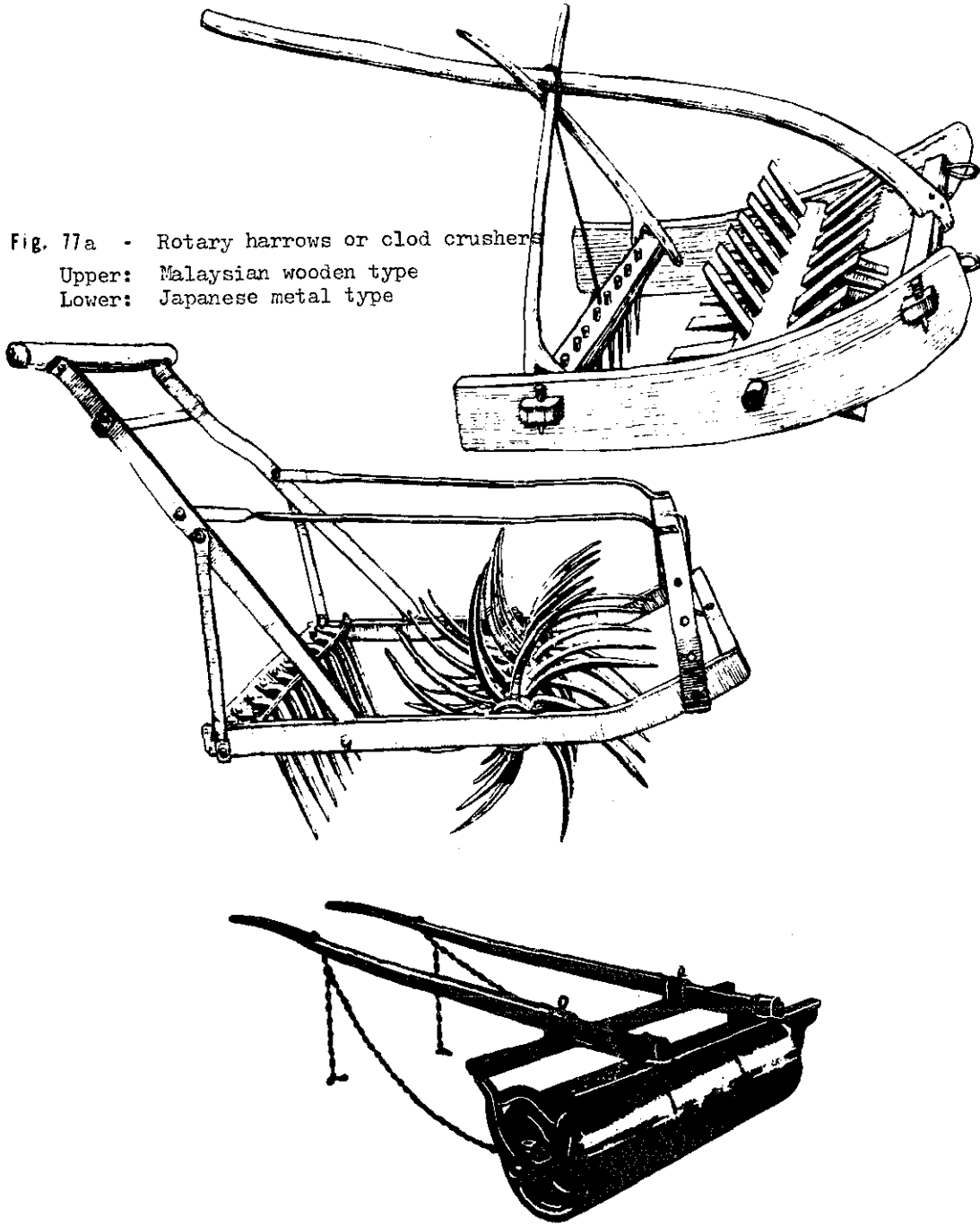

Fig. 78 - Compaction roller

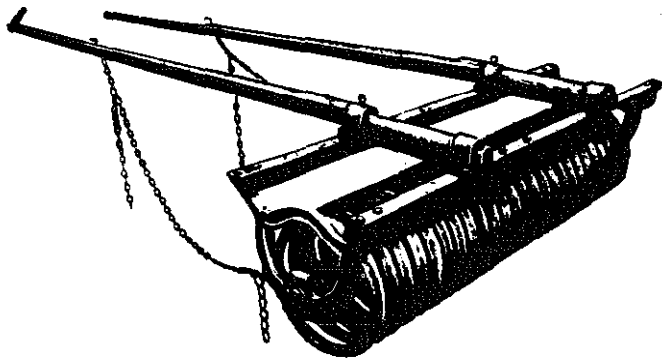
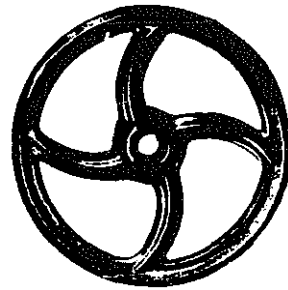

Fig. 79 Cambridge or ring roller



Disc of Cambridge roller

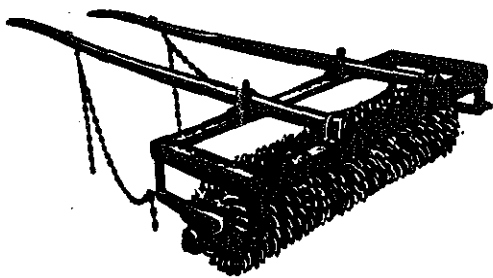
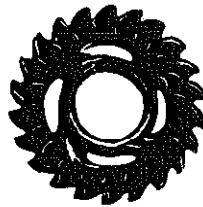

Fig. 80 Crosskill roller



Big hub



Small hub

Crosskill roller discs

F) MULTIPURPOSE TOOL CARRIERS

As previously mentioned, simple implements which have been used in Europe with the large animals normally found there, often proved unsuccessful in Africa because the strength of the animals available was much less than that of the equivalent of European horses or oxen.

The problem was therefore re-examined by some manufacturers for African conditions and it was mainly light ploughs which started being made some 20 to 30 years ago. Since the last World War, the failure of various power mechanization experiments has led to a return to animal draught cultivation. In a concern for economy in the face of low income users, design engineers have, as far as possible, grouped together into a single unit various implements whose individual development and limited sales would have been very costly.

Thus, alongside the "simple implements" each for a single operation (ploughing, sowing, etc.) the multipurpose machine has appeared which can be used for several different operations in succession.

Such a machine is made up of two parts:

- one, which is the same for all purposes, is the tool-carrier, body or frame,
- the other, which can be changed for each particular use, is the working part or tool.

Here, we shall mainly discuss the frame.

The tillage implement has to be teamed up with the animals, i.e. what it can do depends on the power of animals and there are, therefore, different implements for different draught animals.

Generally speaking, the range of tillage implements is divided into those which can be used for:

- donkey cultivation
- horse cultivation *
- light ox draught
- medium ox draught
- European type heavy horse or ox draught.

A number of French manufacturers have made special efforts to meet the various requirements listed above, and are producing models for tool-carrier assemblies, for ox draught and for donkey or light ox draught.

* We should point out that horse drawn implements are less and less considered by the manufacturers of multipurpose implements in view of the general unsuitability of the horse in tropical Africa for prolonged effort.

The British, at the National Institute of Agricultural Engineering, have developed a multipurpose tool carrier similar to the French implements. A polycultivator is also made in India. Finally, in Madagascar, an Italian engineer has developed equipment with polycultivator features which has, in particular, an adjustable track width, a variable height of tool-carrier arm and no shaft.

The multipurpose tool-carriers would appear to mark an important step forward in the development of mechanization in African countries with Sudanian/Sahelian climatic conditions.

Among the numerous different types available, there are a few with excellent features. There is a wide range of tools available for them, capable of doing good work, particularly as a result of adaptation work carried out locally by, or in cooperation with, research bodies (such as the Bambeby C.R.A.). The development of suitable tools has been carried on for many years in Europe by certain manufacturers and helped by engineers and mechanics working on the farms using their equipment. This work has not been possible in Africa, with exception of a few research stations with competent personnel. This is why the greatest caution must be exercised, particularly in interpreting the assessments of the tool users. A user may complain that "the" plough body of a certain multipurpose implement is ridiculously narrow for the ground he has to till whereas, in fact, he may only possess the smallest of the three plough bodies offered by the manufacturer.

There is a clear distinction between the use of multipurpose frames, without wheels and tool-carrier frames with support wheels. The frame without wheels can be relatively easily lifted and carried by the driver on foot to avoid an obstacle. The tool frames with supporting wheels, particularly if they are designed for a seated operator, require ground which is completely free of obstacles, i.e. which has been tilled relatively intensely over a long period. The multipurpose frames without supporting wheels (but possibly with small secondary wheels) are pulled with a chain, whereas the tool frames with large supporting wheels can be used for transport and have a pole for pulling to which the animals are harnessed.

For the equipment on a farm, the choice between a set of implements consisting of a plough and, at least, a weeder/hoe and that represented by a good multipurpose frame is, above all, based on economic considerations. On certain African peasant farms, however, the plough must be used at the same time as the crop weeding implement. In this connection it must be stressed that some plough frames can be fitted with a ridging body or a scarifying tine instead of the plough body, so that a set of equipment could be envisaged consisting of two frames with limited interchangeability.

As regards the relatively high price of the multipurpose frames, it must be emphasized that their cost must in theory be amortised over all the very varied work they permit, or at least over a major proportion of this work. Their use is therefore only economically justified if they are used for a variety of different crops making up the crop rotation system of a farm and not just for a single crop, even if this crop offers a high commercial return. This extensive use of the multi-purpose frames assumes either fairly advanced agricultural development or effective extension work, so that the means are available to extend the methods to all branches of peasant farming.

MAIN MULTIPURPOSE FRAMES1) Donkey draught

To begin with, in this category, there are the hand-operated implements which can, however, be harnessed to an animal, then come implements specially designed for donkey draught and, finally, others designed normally for light ox draught but whose light weight and the small width and depth of soil worked make them suitable for draught by one or two donkeys. These implements should normally be able to be pulled fairly easily by a single small bullock or cow.

a) HAND HOE

The oldest of the implements at present available commercially consists essentially of a simple hoe with a single non-adjustable wheel at the front. It can also be used for weeding (which can be done by hand), light scarifying, ridging and even ploughing by means of a small plough body.

It is a transitional implement between hand cultivation and draught animal cultivation.

b) MULTIPURPOSE TOOL

Another type of tool can be used for a limited variety of purposes. It may be equipped with a small ridger, with a plough body, with a more or less narrow scarifying tine which can be used for crop-lifting, or with five hoeing teeth. Like the light hoe described above, it would appear to lie at the lower limit of animal draught cultivation.

c) Another donkey draught type hoe is derived from the "griffon", a form of horse-drawn hoe used by the vine-growers of southern France.

The hoe has been reduced in weight (it weighs 26 kg) for use in Upper Volta and has, to a large extent, contributed to the success of animal draught cultivation in that country by enabling a large herd of previously unemployed donkeys to be made use of.

It is an angular expansion hoe fitted with five flexible stays to which may be attached cultivating teeth or tines. The fact that the stays can be fitted quickly means that their number can be adapted to the work in hand, as well as to the draught effort available. In addition, one or two ridging bodies can be fitted so that the implement can almost be called multipurpose.

d) Another light unit recently developed in France is a multipurpose implement specially designed for donkey draught. The rectangular, steel bar frame only weighs 11.5 kg and can be fitted with the following implements:

- 6 inch (15 cm) plough;
- two to five flexible cultivator stays;
- ground-nut lifter;
- ridgers;
- lister type furrow opener.

e) There is also a relatively heavy implement (the chassis alone weighs 16 kg) which may be more suitable to light ox draught. Once again, it is an implement which lies between donkey draught and ox draught

The basic unit has a 40 x 14 mm flat steel bar chassis and two handles with a single supporting wheel at the front. A cross-member is welded to the rear part of the frame, to which the various implements may be attached: plough, ridger, hoe using spring tines, rigid tines or shovel points and even a fertilizer spreader.

2) Light and medium ox draught

In tropical agriculture, light ox draught means the use of fairly small animals with generally insufficient feed (particularly during tillage work at the beginning of the rainy season). As a result, the average draught effort is low and is usually not more than 80 kg with a pair of oxen.

A model made in France weighs 21 kg for the chassis without tools. Its increased variety of uses, which makes it into a real "multicultivator".

Among its attachments may be mentioned:

- 6, 8 or 10 inch (15, 20 or 25 cm) ploughs,
- ridgers of various dimensions with adjustable or fixed wings,
- ridging unit consisting of a ridger with mouldboard or two angle discs,
- shovel points on rigid tines,
- wheels with sweeps or skimmers, mounted on flexible or rigid stays,
- harrow with rigid teeth or flexible teeth (weeder),
- ground-nut lifting blade,
- fertilizer spreader.

A multipurpose chassis has recently been developed in France and is only just being put on the market. Trials are at present in progress. Despite lack of experience of its capabilities it can be classified among those implements suitable for light ox draught.

It consists of a rectangular beam with a single front supporting wheel; it has to be kept upright by means of two handles. Ten different implements may be mounted on this basic assembly: plough, rigid and flexible toothed cultivators, hoe, tool for earthing up and splitting back, ridger-digger, lister, lifter, planters (2), (Fig.81).

Fig. 81 - Example of MULTICULTIVATORS

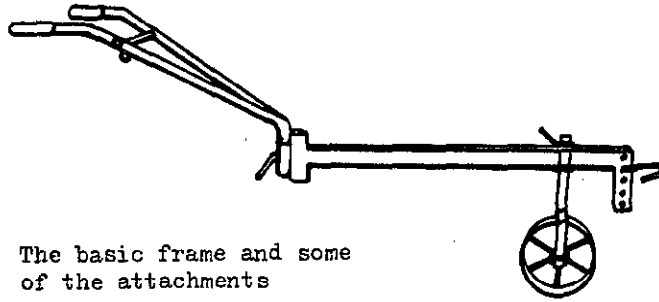

The basic frame and some of the attachments

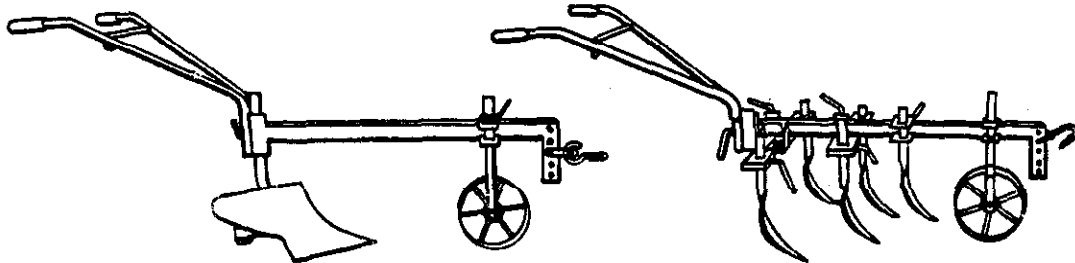

Plough

Cultivator

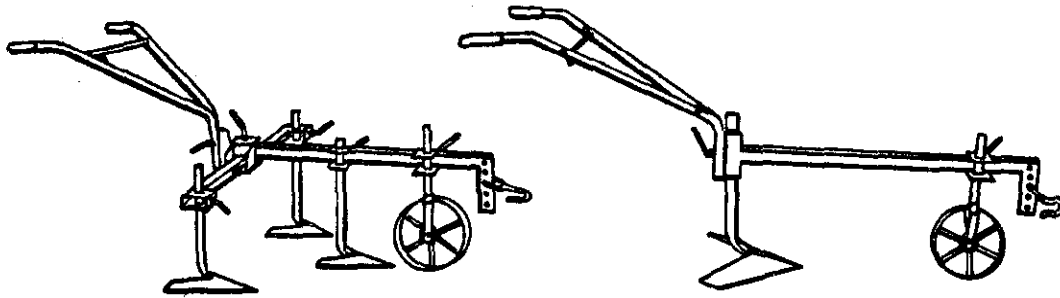

Hoe

Lifter

c) A medium weight "multipurpose agricultural implement" based on the same principle as those already described consists of a beam with supporting wheel, on which various tools can be fitted. It does, however, have a particularly light and strong main beam. It can be equipped as a plough (three different bodies), spring tine cultivator, hoe, weeder, ridger, ground-nut lifter, etc. In this case also, the number of working parts can be changed to match the available draught effort (Fig. 82).

d) With another implement a step is made towards better control of the tools, because the frame (which is rectangular) is supported at the front by two small wheels. These give the unit adequate transverse stability at the price, it is true, of a very slight loss in draught effort.

e) An improvement version of the above has sufficient under frame clearance for cultivation on ridges.

The stability of the chassis is also provided by two supporting wheels, at a maximum distance apart of 60 cm. It has the same range of implements, but a plough body for one way ploughing of the $\frac{1}{4}$ turn reversible type has been specially designed for this model. In addition, it can be used for offset work such as the maintenance of row cultivation.

3) Heavy ox draught

This equipment is distinguished by the fact that the multipurpose implements under this category are heavier, loosen a greater quantity of earth and have a wider range of uses. An important additional advantage is that it can be used for transport. This is made possible by the fitting of large metal, or more often pneumatic, wheels.

Incidentally, but important also, these implements are not pulled by a chain but by a pole - or shafts.

Finally, the frame for carrying the various tools is a support which is really stable laterally (the track width may be more than 1 m) and longitudinally, since pulling by pole makes the whole assembly more rigid.

Under these conditions, there is nothing to stop the fitting of mounted or partially mounted tools which are attached in a similar manner to tractor mounted equipment.

It is almost as if oxen were being used in place of a tractor, with a seat on the implement, but without a mechanical or hydraulic lifting arrangement for the implements.

a) "POLYCULTIVATOR" (Fig. 83)

The chassis with straight shaft and pole may be equipped with: a wagon platform, a broadcast seeder, spring tine harrow, a cultivator weeder, a plough body, 2 row planter, a ground-nut lifter, a mower, etc. The straight shaft makes the polycultivator only suitable for level cultivation work.

Fig. 82 - Examples of a MULTICULTIVATOR

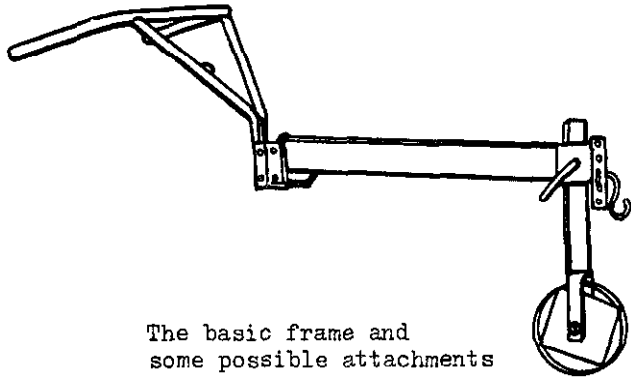

The basic frame and some possible attachments

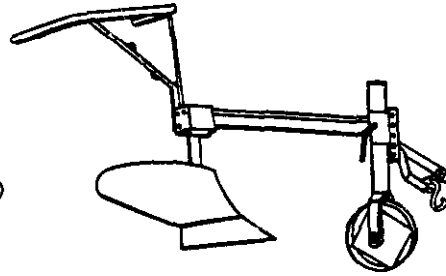

Plough

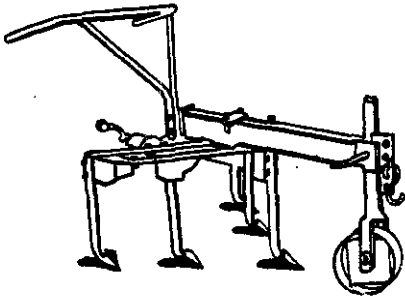

Hoe - harrow - weeder

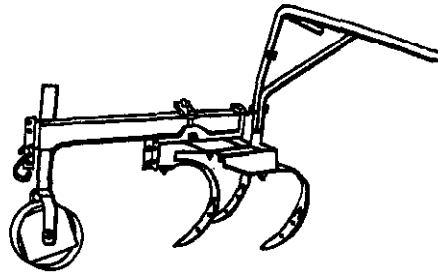

Springtime cultivator

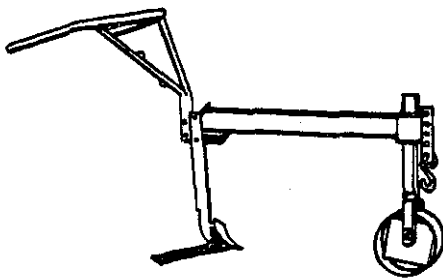

Ground-nut lifter

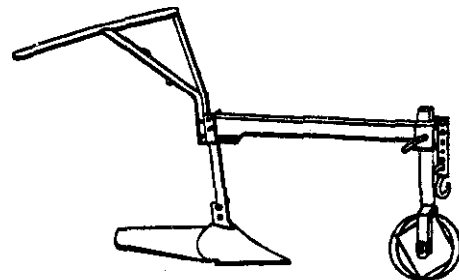

Ridger with adjustable wings

Fig. 83 - A POLYCULTIVATOR

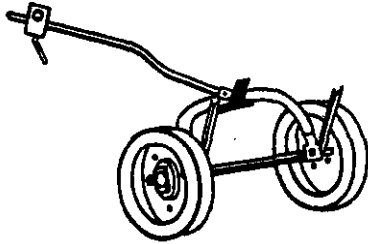

The basic chassis and some of the possible attachments

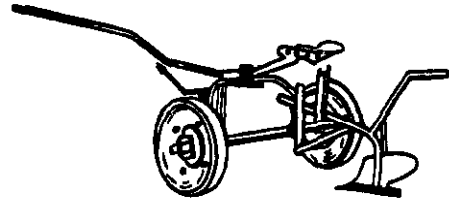

Plough

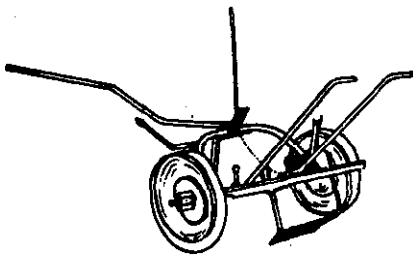

Lifter

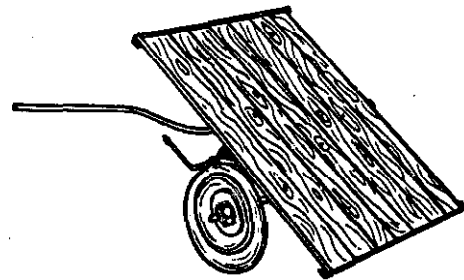

Wagon

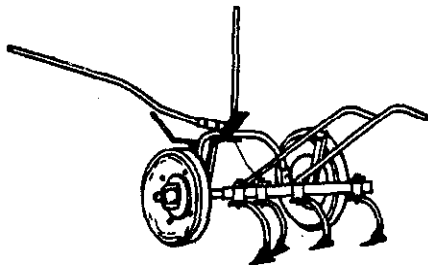

Hoe

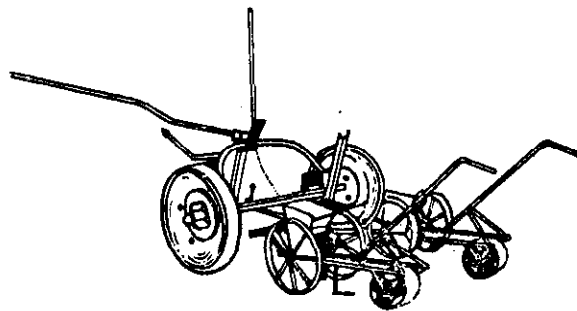

Row-crop planter

b) "UNIVERSAL" CHASSIS MADE IN INDIA

This equipment has been manufactured for several years and it would appear that it came out at about the same time as the French polycultivator. It consists of a chassis with no shaft and with a seat. In addition to the normal versions, it can also be fitted with a levelling blade carried at the rear, as well as a "Tonga" - a fitting for carrying people.

c) MULTIPURPOSE IMPLEMENT

Another multipurpose chassis made in India has 2 metal supporting wheels and the driver may be seated. The shaft is straight but, even so, the large wheels give it considerable ground clearance. The track width cannot be adjusted, but the tools are controlled by a mechanical lifting system.

The following may be fitted:

- a plough with 46 cm diameter discs (this is rare in animal draught cultivation)
- a disc harrow of the offset type with 40 cm diameter discs,
- a rigid toothed cultivator,
- a ridger with fixed wings,
- a rear levelling blade.

d) N.I.A.E. MULTIPURPOSE IMPLEMENT

The assembly was designed by the National Institute of Agricultural Engineering. Lengthy development work was necessary which seems to be continuing at the same time as commercial production. Its characteristics are very similar to those of the French polycultivator already mentioned.

e) TROPICULTIVATOR

This is the version of the French polycultivator for cultivation on ridges. The bridge type chassis, without shaft, gives a clearance of 0.80 m under the chassis. The track width may be varied from 0.60 m to 2 m. The rear tool bar is lifted by a 3 point system.

f) POLY CULTIVATOR

There is another model of a multipurpose chassis without shaft and with good clearance (70 cm). The track width is variable (0.56 m to 2 m). The various versions are similar to those of the Tropicultivator.

IV

EQUIPMENT FOR THE SOIL PREPARATION OF IRRIGATED RICE-FIELDS,DRY OR UNDER WATER

The preparation of the soil of rice-fields mainly depends on the method of cultivation, this depending on the rainfall and the possibility of bringing in additional water. The rice may be cultivated:

- either dry, or
- with additional irrigation, whose effectiveness depends on the degree of water control achieved.

Where dry cultivation is concerned, the rice is cultivated like any other cereal and, in theory, the soil is prepared by using methods and equipment similar to those used for other annual crops. We shall not repeat the descriptions of these implements which have already been discussed in a previous chapter; the aim is to achieve clean and loosened earth so that good sowing may be carried out in conditions favourable for the future development of the plant. This is subject to the hazards of climate and the yields obtained vary widely, sometimes being insignificant; nevertheless, under certain conditions, satisfactory results are possible; average yields of 15 quintals per hectare have been reported, particularly in Ivory Coast.

Rice cultivation under water is, however, the general rule and it is with irrigated cultivation that the best yields are obtained, these, moreover, depending on the degree of water control. It is obvious that rice-fields which rely on rainfall or floods (uncertain water reserves) will give less reliable results than those produced with good well-controlled irrigation. The methods and implements used for the soil preparation of rice-fields depend, to a large extent, on the amount of water available when the work is carried out.

There are two possible cultivation methods:

- direct sowing, dry;
- direct sowing or transplanting in soil under water.

In the first case, it is, in fact, a question of conventional soil preparation for dry cultivation, contingent on maintaining the original level surface as well as the means for making bunds, drainage etc.; the implements used are mostly those applicable to other crops (such as ards, ploughs, disc harrows), whereas, in the second case, it is often necessary to make use of implements specially designed for specific tasks, such as for puddling and seedbed preparation under water (in particular, rotary hoes).

Some of these implements can be used either dry or under water (ards, some ploughs, rotary hoes, etc.).

Generally speaking, preparation of irrigated rice-fields takes place at the beginning of the rainy season, except in particular cases where, as a result of sufficient control of the water in the dry season, rice can be grown out of season. At the beginning of the rainy season, however, the animals are often in bad condition, so that a very great effort can not be demanded of them, even though preparation of the rice-fields is very exacting in energy.

This is why, in the following descriptions, we shall have to limit ourselves to equipment and implements not exceeding a certain weight, above which any use in tropical countries becomes impossible. When we mention European-designed equipment which is too large for logical use in Africa, this must be borne in mind if its use is planned as it must, in most cases, be pulled by a pair of oxen.

Despite the appearance of a certain form of power mechanization over the past few years, particularly in Japan, animal draught cultivation for rice-growing still plays a very important role in Asia; it could also play this role in Africa since, with some exceptions, the African rice-grower mainly uses hand methods for rice cultivation.

The soil has to be prepared so that the seed (sown dry or in wet mud, broadcast or in rows), or the plant (transplanted) may find the best conditions for its development through to harvesting. Efforts must therefore be made to ensure as perfect as possible a soil preparation (but this often fails to be achieved, rice-growers can frequently be seen, in the Sudanian-Sahelian area, for example, sowing rice on very badly prepared ground). The wide range of animal draught cultivation implements at present in use for rice-growing enables the ground to be properly prepared, provided that the appropriate equipment is used. The methods used must result in periodical oxidation of the soil of the rice-fields while retaining its proper physical structure.

There are three phases to be examined in succession:

- ploughing proper, primary tillage;
- seedbed preparation, secondary tillage;
- forming a layer of wet mud on top of a relatively waterproof layer.

This schematic description of the work is not always exactly followed, sometimes the ploughing may be omitted (direct-treading or puddling in rice-fields under water), in other cases dry seedbed preparation does not take place because the wet mud is formed directly on the ploughed land after it has been submerged, finally, seed may be sown dry, even though the rice-field is subsequently irrigated.

Rice-fields under water can only be managed properly if the necessary infrastructure has been established to ensure good utilization and good distribution of the water. This mainly involves good levelling and making of bunds. We shall, therefore, take a quick look at the equipment used for this purpose, before going on to the equipment used for soil preparation.

A) LEVELLING AND MAKING BUNDS

With irrigated rice-growing it is absolutely essential to achieve good water control. This can only be achieved by correct levelling and careful construction of bunds to keep the water in.

1. Levelling

There are two phases in the levelling of a rice-field: general levelling and fine levelling.

General levelling. In areas where irrigated rice-growing is not traditional, this involves the use of major power operated earth moving equipment. Extreme caution must be exercised in order to prevent excessive removal of the top-soil.

Animal draught can obviously only be used to a very limited extent for this levelling work, which usually involves moving tens or hundreds of cubic metres of earth per hectare, depending on the relative size of individual plots. Except in particularly favourable cases, therefore, animal draught can only provide limited additional help.

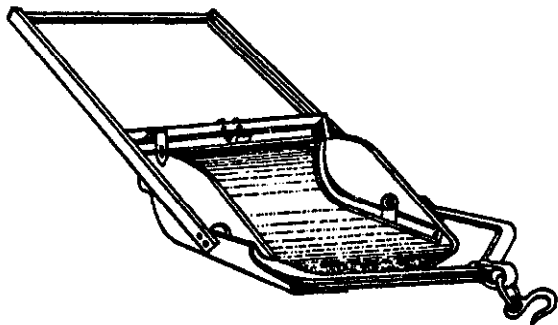

Fig. 84 - Earth Scoop

Fig. 84 - Earth scoop. Among the animal draught levelling implements which can help with general levelling, we may mention the earth scoop, formerly frequently used in Europe, although now they are manufactured much less frequently. They are used on dry ground which is sufficiently loose for the loading effort not to be unduly heavy. They hold 50 to 150 litres. Loading is automatic and unloading is done by tipping over where desired by means of a simple device (stop or catch). The distance to be covered must be fairly short (a few dozen metres). A very simple scoop, weight empty 60 kg., has been developed in Madagascar and should cost about 10,000 francs CFA.

Fine levelling has to be done before seeding, since the soil preparation work, particularly the ploughing if it is done in lands, produces surface unevenness which must be removed. The implements used for this purpose are generally very simple and can, therefore, if needs be, be made locally; some are used on dry and others on flooded ground. Most of them are multi-purpose and can also help with the paddy (wet mud) preparation which we shall discuss later. They are different types of harrow such as the conventional wooden-framed harrow with teeth and the various "Spanish" and "Italian" harrows.

The levelling board consists of a heavy plank 1 or 2 metres long which is drawn by one or two animals. Handles are used to make it dig into the mud or, on the contrary, to lift out by controlling the tilt of the loading edge of the board. Sometimes, two planks can be used together, they are then flexibly linked by, for example, rubber bands.

The heavy plank may be replaced by a simple log with a pole at the front for attachment to the yoke or the log may have rings for attaching chains.

The upright levelling scraper works best in water, or at least on very wet ground, but it can also be used on dry ground. It consists of two planks and a handle. One of the planks may be about 1.80 m long and 0.30 m wide. It is moved forward in a vertical position, perpendicular to the draught line and works along its lower edge. It is made stable by a second plank which is attached at the centre of the first plank by a flexible joint (hinges or other method), this second plank, which is perpendicular to the first, and is about 1 metre long, carries the operator who, by means of handles solidly attached to the first plank, adjusts the degree of "bite" of this levelling board and thus ensure that the final smoothing off is done properly. The working edge of the levelling board is reinforced with a metal blade (fig. 85).

The float, or levelling sled, is usually a wooden implement, except for the reinforcing shoes and the attachment points. Its effectiveness depends on its length; it is therefore, by definition, a bulky implement which cannot be used on small plots. In addition, the draught effort needed is relatively too great for the animals usually available.

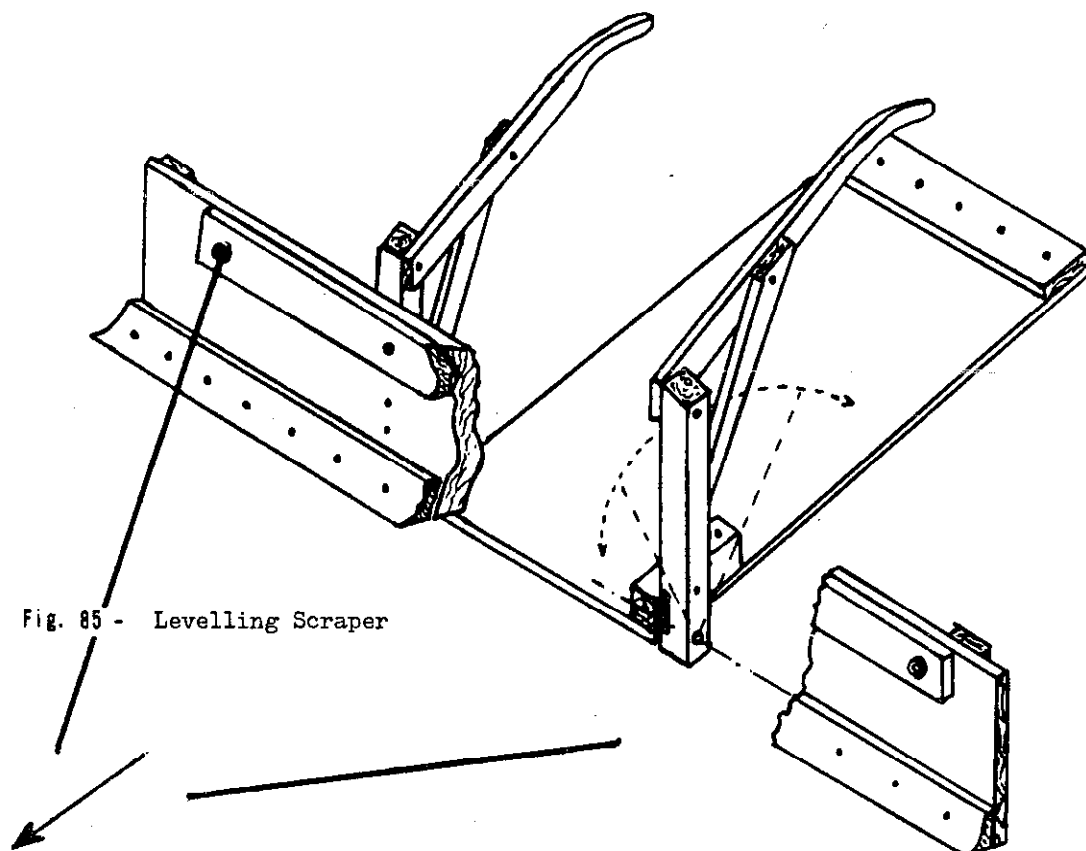

Fig. 85 - Levelling Scraper

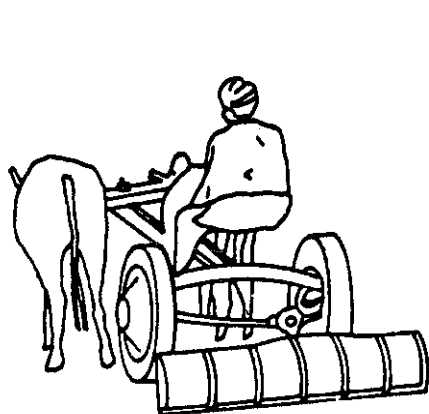

Fig. 86 - Polycultivator with levelling blade

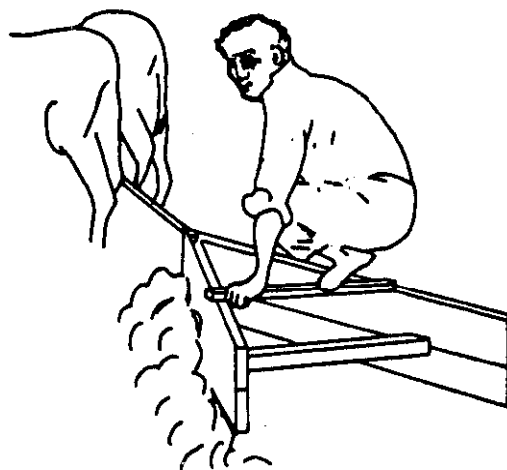

Fig. 87 - Indian type Ridger

Swivelling levelling blades are available, some as wheeled models of the polycultivator or multicultivator type: Fig. 86.

2. Making bunds

The bunds must, to the maximum extent possible, be permanent. They should be well anchored and watertight. Bunds are generally built by hand, unless power is available permitting the use of big implements.

Few bund making implements have been designed for animal draught. There is, however, an implement which is locally made and is fairly widespread in Asia, and is used in India, also for making banks and terracing against erosion. It consists of two planks about two metres long and 30 to 40 cm wide put together in a V, with the point forwards (Fig. 87). The operator gets onto the V and roughly regulates its working depth by shifting his weight forwards or backwards. Before this implement is used, start making the bund by cutting a furrow with a mouldboard plough.

In this connection we should mention that an out and return run with a mouldboard plough quickly produces a small bund which only needs packing down with a shovel to be effective.

Fig. 88 - Bund former

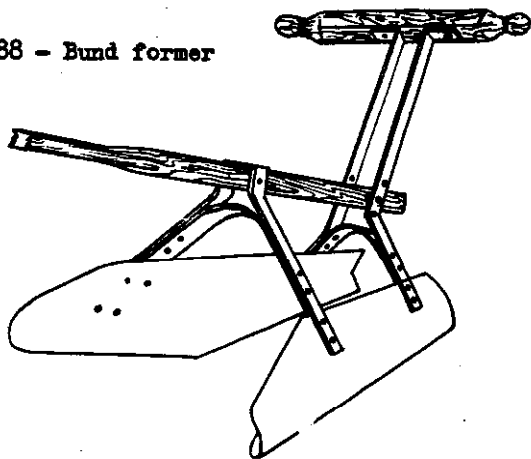

A variant of the preceding implement may also be used, either for making ditches or as a bund former. It also consists of two planks, one of which, the biggest, (about 2 m) is set on the draught axis, whereas the other, hinged at the top some distance from the front, can be displaced more or less by moving the attachment point by means of a cross-member. A handle is provided for the operator to steady himself on the implement and also helps him to control it.

Various types of animal draught ridgers with shares or discs may also be used to rough out bunds.

A very simple bund former is used in India. It consists of two wooden or metal planks, forming an open V with the wide opening facing forward. The earth, which must be well loosened beforehand, therefore builds up to the rear as the implement moves forward. The walls are concave and thus help to form the bund. Steering is by a handle. An implement of this kind is used in Spain where it is called an "acaballonadora" (ridger) and has been adapted for tractor use (Fig. 88).

Very few animal draught implements have been designed for the maintenance of drainage ditches or irrigation canals. An implement exists in Spain which is based on the principle mentioned later for the "draga de talles", but, including in addition, at each end a second disc 10 to 15 cm from the outside discs of the roller; these two additional discs whose purpose is to cut the edge of the ditch and the weeds growing on it, are of different diameter to that of the two other original discs; the implement is 50 to 70 cm wide.

B) EQUIPMENT FOR THE PREPARATION OF IRRIGATED RICE-FIELDS

The soil should normally be tilled for rice to a depth of about 10 to 15 cm. At any lesser depth, weed destruction is inadequate, whereas with a depth of more than 20 cm there may be a reduction in yields, probably because the organic matter is buried too deeply for the root system to be able to reach the nutritive elements resulting from its

decomposition. In any case, the working depth must remain constant over the years so that the hard sole of plough pan, lying as it does some 15 cm from the surface of the soil, is not destroyed. There is thus a layer of impermeable earth which helps reduce losses of water and nutritive elements during flooding which lasts throughout the period of growth of the rice.

1. Ploughing

We shall group together here actual ploughing and the work done by other tillage implements, since, with rice-growing - particularly flooded cultivation - there is not such a strict division between the two categories of work as is the case with dry cultivation.

The main purposes of ploughing in rice-fields are:

- loosening of the soil, usually to be followed by puddling,
- aeration of the ground and the germination of weeds which can then be destroyed by other tillage operations,
- digging in of vegetable or organic matter, with a view to achieving a granular structure allowing the right degree of permeability favourable to oxidation.

To achieve these results, the ploughing must meet two main conditions;

- the optimum depth seems to be between 10 and 15 cm.
- it must be done 4 to 6 weeks before sowing or transplanting.

a) PLOUGHING EQUIPMENT

Ards and ploughs with forecarriages are used almost everywhere for dry ploughing, but a distinction must be made: whereas in the Far East it has been traditional over a long period mainly to use ards without mouldboards, working without turning the soil, in Africa and Madagascar, only ploughs with mouldboards have been recommended; these are heavier and therefore more expensive. This is explained by the fact that, unlike Asia where animal draught cultivation is traditional, in Tropical Africa the use of draught animals is relatively recent and the ploughs have usually been imported from Europe. But turning over the soil, which has many advantages (aeration, digging in weeds) requires a relatively high draught effort which explains why Western type mouldboard ploughs can only be used after the first rains have fallen, so that there is a delay which may be harmful to the subsequent cultivation operations.

The Chinese and Japanese ploughs which are a compromise between the ard without mouldboard and the plough, do not turn the soil over completely, and they have the advantage of being very light. Some are, as previously mentioned, reversible, which is an appreciable advantage for maintaining the previously established levelling and to avoid the boundary furrows of ploughing in lands.

The use of a slatted mouldboard may be advantageous in heavy soils, particularly those of rice-fields, since the draught effort necessary is reduced by a reduction in friction. As already mentioned, this type of mouldboard is fitted mainly to the ploughs made in Asia.

One way ploughing is normally to be recommended for rice. Several manufacturers have available reversible ploughs weighing from about 30 kg up to 120 and even 150 kg., for reversible ploughs on two wheels.

These ploughs were described in the preceding chapter. Practically no changes have been designed specially for rice-growing, with the exception of the adoption, in certain cases, of slatted mouldboards, which are as yet little used in Africa. In some very exceptional cases it is even possible to use them on flooded land.

Generally speaking, one or two ploughings are sufficient to ensure the first preparation of the rice-field properly, but that depends on the equipment used. Thus, in India, the use of very simple ards sometimes makes it necessary to cover the ground at least 5 times. On average, for a ploughing width of 15 to 20 cm and a depth of 10 to 15 cm., 25 to 30 hours per hectare of continuous work must be reckoned, representing 5 to 10 days' work for one or two men and a pair of oxen.

b) SECONDARY TILLAGE EQUIPMENT

In actual fact, in rice-growing, turning the soil over does not appear essential in all cases. Ards without mouldboards which are still extensively used in Asia are more like cultivators than ploughs. ~~The secondary tillage equipment discussed in the following paragraph can mostly be used for this work: disc harrows, cultivators, expanding hoes etc.~~ On the other hand, the disc stubble-ploughs which require too much tractive effort, are not used with draught animals.

2. Final Seed Bed Preparation.

Primary tillage operations by ploughing leaves a lumpy soil which must be further prepared carefully so that the sowing (or transplanting) may be carried out under good conditions; this final seed bed preparation, can be performed by a variety of implements, some of which are specially designed for work under water, whereas others can be used dry or under water, or only dry.

a) SECONDARY TILLAGE EQUIPMENT USED IN PLACE OF PLOUGHS

Disc harrows drawn by animals can, in some cases, be used for seed bed preparation of the soil although they are implements which are designed to be worked at a relatively high speed. They must be used under clearly defined conditions of ground humidity and must often be weighted which aggravates the draught problem. In addition, disc harrows have the disadvantage of being relatively expensive. Details of these implements have been given in an earlier chapter.

Secondary tillage can be carried out with tined or toothed tillage implements provided that the vegetation is not too dense and that the soil has been cleared of stumps and roots. This technique, which has certain advantages (lower draught effort), could, in rice-growing, probably take the place of turning over the soil with the conventional plough, when dry tillage has to be followed by other types of tillage on flooded ground.

Expanding hoes, as well as the multicultivators and polycultivators already mentioned in an earlier chapter, are also suitable for the dry preparation of rice-fields which will subsequently be flooded.

b) SURFACE TILLAGE EQUIPMENT

All-metal zig-zag type harrows are sometimes used for final seed bed preparation of rice-fields, either dry or under water. The frame is often made of wood and the teeth are sometimes made locally; this is the case, in particular, in Madagascar. This design of harrow can be turned over and used for smoothing.

Rollers (weighted, clod-crushers etc.) can also be used for seed bed preparation on dry ground but it must be recognised that their general application has so far been hindered by their high cost.

3. Puddling

The operation of "puddling" must comply with certain conditions:

- it must be carried out on very wet or submerged soil, shortly before sowing or transplanting
- it must cause a hardening of the plough pan.

Puddling is usually carried out with implements specially made for the purpose.

Nevertheless, some of the implements already mentioned can be used on soil under water even though they were not originally designed for this purpose. It is mainly in Asia that implements specially designed for the purpose are found, but adaptations or new developments have been studied in other countries.

In this category of implements, we may mention:

a) IMPLEMENTS WITH FIXED WORKING PARTS

- The peg-tooth or comb-harrow, used throughout Asia, is pulled by one or two buffaloes. The Malaysian type is 1.10 m wide and has 12 teeth 30 cm long. A steering handle enables the implement to be lowered or raised as it is pulled along, to combine kneading and levelling. The tractive effort demanded is fairly high. The teeth are generally round, of 3 to 4 cm diameter and made of wood; but they can also be metal. They are then set closer together (Fig. 89).

The Burmese harrow, a variant of the former type, has a better designed draught line which makes for easier handling and thus reduces the tractive effort required. By removing the teeth, this implement is converted into a levelling board (Fig. 90).

These harrows have the advantage of being relatively inexpensive and light (about 20 kg for a width of 1 metre) and therefore easily transportable across country.

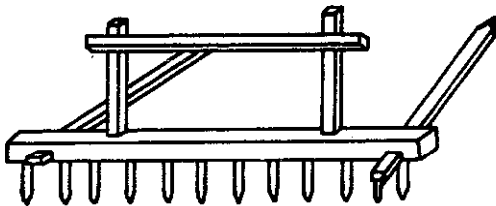

Fig. 89 - Comb-harrow

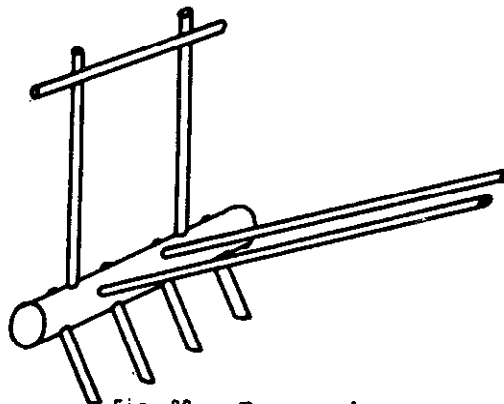

Fig. 90 - Burmese harrow, convertible into levelling board by removal of teeth

- The "Spanish harrow" or Spanish board", also suitable for power mechanization. This consists of a float to which are attached a number of blades like miniature mould-boards which loosen the earth, to knead it and produce the desired consistency known as "mastic". The Spanish board also helps, by reason of its shape, to level the soil.

Several variants of it are to be found.

- The "rastrilla" ("Spanish harrow") is made up of a 1.50 to 2 m long and 25 to 30 cm wide float, under which are attached, by set screws, a single row of triangular metal blades (apex forward). The blades are 6 to 7 cm deep with a maximum length of 25 to 30 cm. When used for levelling, this implement is turned upside down.

Another type of harrow consists of 3 rows of curved metal blades. The rear row are well clear of the edge of the float. These blades are permanently fixed to the platform and are not bolted. The two outer blades of the rear row are turned inwards so that they are practically at right angles to all the other blades.

The Acme harrow (an animal draught implement of American origin and traditionally much used in Italy and in Spain) is entirely made of metal. The frame is made of three intersecting bars; 2 rows of curved blades, a total of 12 or 13, are welded to the front and rear iron bars (Fig. 92-93).

Another type of Spanish harrow consists of a wooden float about 2 m long and 30 to 35 cm wide. Spiral-shaped knives, 5 to 8 cm wide and 35 cm long, are bolted to the rear of the float 20 to 25 cm apart. Smaller knives are interspersed with the big knives and bolted about 5 cm from them and forming an angle with them open to the rear. The big knives turn to the right on the right half of the float and to the left on the other half. This implement is therefore similar to the Italian wooden float harrow. On one version of the harrow, vertical discs rigidly attached to a horizontal bar are substituted for the small knives. A board may be on top of the working parts so that the operator can ride on the implement.

In Italy, the "float-harrow" has a working width of 2 to 3 m (in its horse-drawn version). It has 2 rows of working parts which clear the rear of the float by a few centimetres. The working parts are small shares of various shapes suited to the soil conditions of the rice-fields and are made by local artisans. These implements are used for puddling and are, therefore, used under water, but also on dry ground for final seed bed preparation and for levelling. These harrows sometimes consist of two linked parts which enable the operator, who rides on one part, to control the work via handles (Fig. 94-95).

In the Camargue, harrows known as "Italian boards" have sometimes been used for animal draught cultivation and subsequently have been adapted for use with tractors. These implements are derived from the float harrow used in Italy. They consist of a wooden plank to which are fitted spiral working parts 15 to 25 cm long and 5 to 12 cm high. This plank may be 2 to 3 metres in length; it is sometimes linked to another plank in front of it to which are attached the draught chains. Improvements have been made to these "Italian floats". Some are now made entirely of metal and are designed so that the mud cannot collect on top. In the Camargue (with tractor cultivation), these implements are practically only used for puddling where rice is transplanted, whereas, in other countries, they are used more generally.

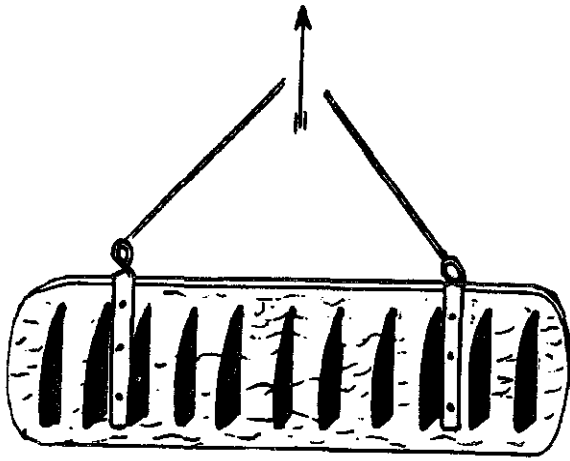

Fig. 91 - "Rastrilla" Spanish harrow
(seen from below)

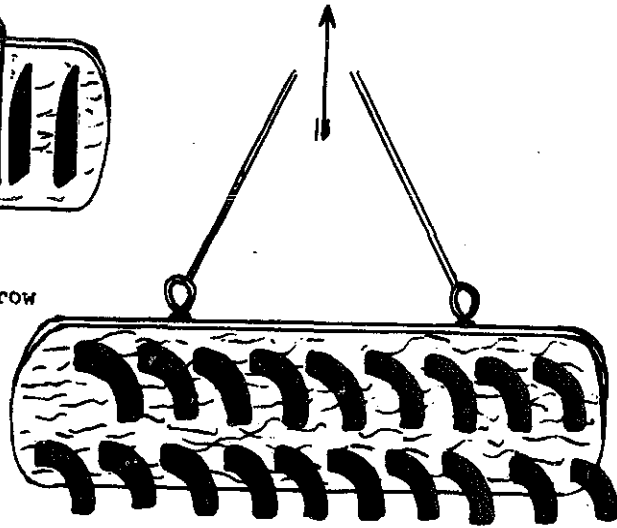

Fig. 92 - "Acme" Spanish harrow

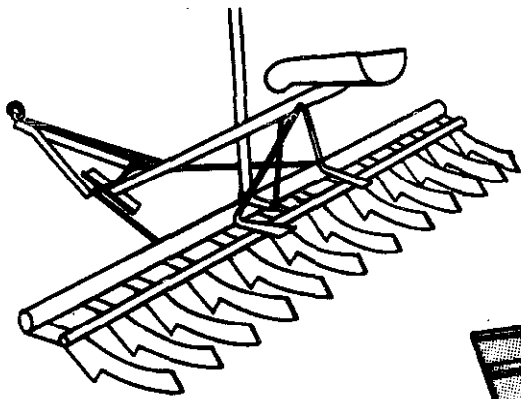

Fig. 93 - Acme type harrow

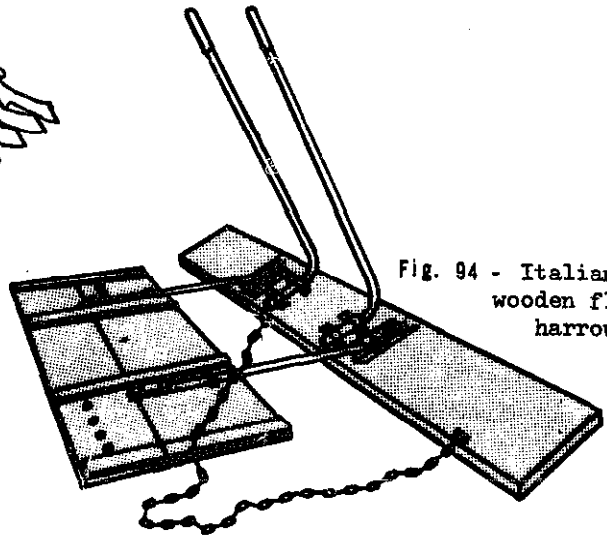

Fig. 94 - Italian wooden float-harrow

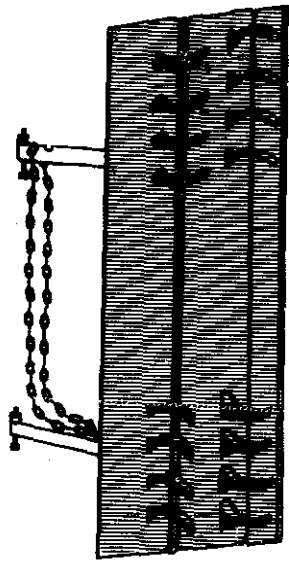

Fig. 95 - Italian Wooden float-harrow

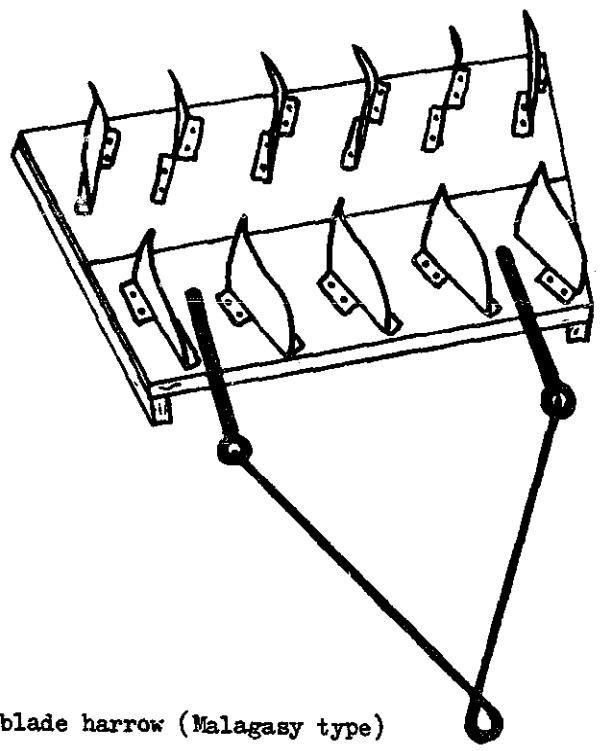

Fig. 96 - 2-row blade harrow (Malagasy type)

The blade harrow, developed in Madagascar, is similar to the Spanish harrows. It has 2 or 3 rows of 5 to 7 blades, attached to a wooden float which can be taken apart, and so arranged that the cut earth is kneaded; it may be fitted with a levelling board at the rear. This harrow weighs between 31 and 52 kg depending on the type of blades used (Fig. 96).

b) ROTARY IMPLEMENTS

These have to work in a sufficient depth of water to prevent mud building up between the working parts. The implements are either puddling rollers or rotary harrows.

Special puddling rollers of different types are used in Asia.

- Blade rollers, with metal or wooden frames to which are attached 10 to 15 cm blades, which are fitted at the centre of a frame for working in paddy fields.

- Traditional wooden rollers with 6 longitudinal 10 cm deep grooves. They are about 1.80 m wide and can be drawn by an ox or a buffalo.

- Harrow-rollers are used in Formosa. They consist of a 60 cm diameter, 1.60 to 2.70 m long roller with 8 to 10 cm wide paddles on its circumference. The action of the paddles kneads the soil, as well as burying any weeds which may have escaped earlier ploughing.

- "Puddling" rollers have been developed in Madagascar since 1962. They are mainly based on the operating principle of the cage-wheels fitted to certain tractors. In certain cases, they enable puddling operations to be carried out in rice-fields without ploughing before-hand. These implements were initially designed to replace the traditional puddling of the rice-fields by oxen. They are simple but effective requiring only a single pair of oxen and capable of working in small rice-fields of any shape. The implement has a working width of about 0.80 m and weighs about 160 kg. The working parts are 50 mm angle iron cleats (a total of 88 on one version) 15 cm long welded to 16 35 mm angle iron cross members at right angles to the direction of advance and themselves welded to 3 metal wheels (Fig. 97).

This type of roller gives good results in relatively light soil. Unploughed ground needs to be worked over 7 to 10 times which means 14 to 20 ox-days' work per hectare instead of 60 to 80 with traditional puddling. In Spain, specially designed rotary instruments have only been in use for a few years.

- One type of puddling machine made in Spain, consists of a 1.50 m long by 30 cm wide wooden plate carrying a platform 40 to 45 cm above it for the driver. To this assembly, towards the rear, is fitted, via adjustable linked metal parts, a hollow roller similar, in fact, to a cage-wheel. This roller consists of 4 or 5 metal blades 5 cm in width welded at each end to two thin discs and held inside by two or three welded rings. The blades are inclined in the direction of rotation. In certain cases, this implement may be used back to front, i.e. with the roller in front. A simple adjustment enables the working depth to be varied. The draught effort is applied via two rings attached to the lower plate (Fig. 98).

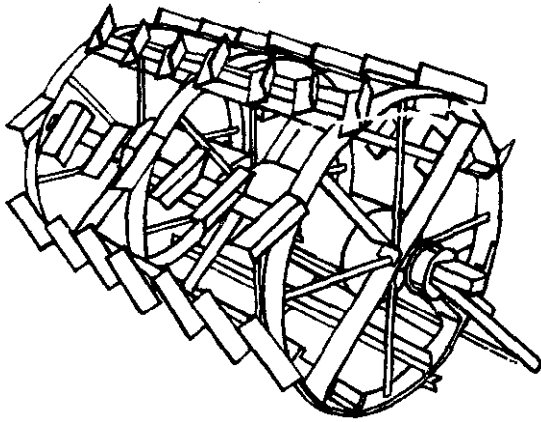

Fig. 97 - Puddling roller (with concrete ballast), Madagascar

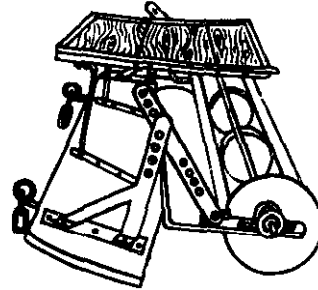

Fig. 98 - Type of puddling machine made in Spain

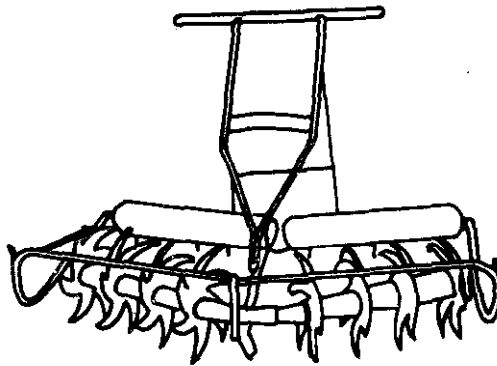

Fig. 99 - Disc harrow

- Another wider type has 2 co-axial rollers 90 cm wide and 35 cm in diameter. At the ends, the two discs are replaced by two adjustable wooden shoes by which the working depth can be controlled.

Rotary harrows (or rotary hoes) of various types are also used for the puddling of rice-fields.

- The type most generally used in the Far East consists of: at the rear, a row of fixed teeth and, at the front, several rows of straight or curved teeth attached to the circumference of a rotating hub. The teeth are either metal or wooden.

- A rotary disc harrow has been developed in Japan (CECOCO) for animal draught. It has 6 or 8 curved cut away discs, of 30 to 40 cm diameter and spaced at intervals of about 20 centimetres on two shafts arranged in a V. A 90 cm wide harrow (6 discs) only weighs 25 kg and can be pulled by a single animal. This type of implement is particularly useful for very grassy rice-fields since the discs cut up the vegetable matter and mix it effectively with the earth. Two or three runs are usually sufficient for proper puddling. They are said to be capable of carrying out one run covering 1 to 1.5 hectares per day (Fig. 99).

- The toothed roller harrows (which we have already mentioned) have curved metal teeth attached to a solid metal hub; a series of these hubs at 15 cm intervals rotates on a single shaft. These implements are widely used as clod-breakers in dry cultivation, but it would appear that they are also suitable for puddling.

- A type of rotary harrow has been developed in Madagascar made entirely of metal, 1.30 m wide and weighing 80 kg, without concrete ballast; it has 45 teeth made of 45 mm angle iron with 5 teeth per hub. Each tooth is 32 cm long and its tip is forked and curved so as to increase the puddling effect. The 9 hubs are mounted on a single shaft; the teeth of two successive hubs are staggered.

Fig. 100 - "Carret del favo" - Spanish disc harrow

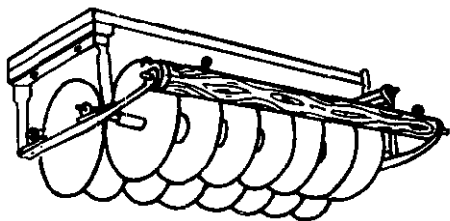

Fig. 100 "Carret del favo"
Spanish disc harrow

A type of disc harrow which cannot be classified among the rollers or harrows, appears to be very widespread in Spain. This is known as the "carret del favo". It is 1.5 to 2 m wide and has two parallel metal shafts about 30 cm apart. Each shaft carries 7 to 8 discs, or 6 to 7, flat discs, 35 to 40 cm in diameter set 20 cm apart and exactly at right angles to the shaft carrying them. The discs of the two rows are staggered. A platform on which the driver rides is fitted over the top of the discs.

This implement may be used in dry conditions or in water, particularly for "discing" in green manure which has preferably been flattened or mown beforehand (Fig. 100).

The rotary implements for use with animal draught and therefore not power-driven, are worthy of special attention. They are suitable for the puddling of rice-fields since, without breaking the plough pan, they chop up and bury the vegetable matter satisfactorily. In addition, they have the advantage of being simple (local manufacture possible), relatively inexpensive and only need relatively limited draught effort. Co-ordinated research and trials are needed in this field in order to develop implements suitable for various types of soil and for types of animals.

PRECISION SOWING - TRANSPLANTING - BROADCAST SOWING

Logically, this chapter should start with broadcast sowing. Unfortunately the various types of broadcasters are, for a variety of reasons, hardly used at all in the countries in which we are interested. Of the various types of sowing and planting equipment, only the single row planters are used in appreciable numbers in Africa.

A) SOWING IMPLEMENTS

Sowing is the most important agricultural work after soil preparation. Indeed, the correct timing and the way in which it is carried out have a profound influence on germination and on the growth of the seedlings and the possibility of being able to do the weeding at the appropriate time, and in consequence, on the yield.

There are various types of implements for sowing or making sowing easier: furrow openers, dibbling wheels, broadcast sowers, multi-row seed drills for large scale cultivation, and single row precision planters.

1) Sowing preparation implements

a) THE FURROW OPENERS OR MARKERS

The purpose of the furrow opener is, on the one hand to mark out the rows along which the seed will be sown and, on the other, to form a shallow furrow, of variable depth, in which the seeds are sown by hand.

The main interest of this implement is that it facilitates sowing in parallel lines, thus permitting subsequent crop maintenance with animal draught implements.

Furrow openers or markers can be made of local materials (a baulk of timber with "wedges" at the desired intervals, two handles at the rear and a harnessing attachment at the front). They can also be one of the unit attachments for fitting to multipurpose tool carriers; in this latter case, the tines can be set at various spacings by means of sliding clamps or U bolts (Fig. 101-102). To achieve satisfactory results, these implements require a very carefully prepared seed bed, particularly in clay soils.

b) THE MARKER WHEEL FOR DIBBLING

Like the furrow opener, the marker wheel is used to mark out sowing lines along the ground. But, in this case, the lines are not continuous and the holes made are used for sowing in clusters.

It consists of a series of metal wheels (wheelbarrow type), a varying number of which are mounted on a shaft. Flat iron lugs are welded to the rims of the wheels at predetermined intervals. Row spacing can be fixed or variable. The implement is completed by a clevis at the front and, possibly, a box for ballast weights (Fig. 103).

2) Sowing implementsa) THE BROADCAST SOWER

Particularly intended for sowing forage crop seeds, this is hardly used at all in Africa. Broadcast sowing of cereals is not recommended here. It could however be considered for sowing rice in nursery plots, but, in this case, the seed is usually sown by means of a hand broadcasting tool, because of the small areas to be covered and of working conditions (sowing in wet mud), or else for sowing cover crops (Fig. 104).

b) SEED DRILLS

Seed drills place the seeds in small parallel furrows opened in the seed-bed, and then covering them with earth 1*.

Sowing in rows has the following advantages over broadcast sowing:

- the depth at which the seed is buried can be regulated
- even distribution of seed
- economy of seed (about 30%)
- better root development
- aeration and insolation of the base of the stems
- subsequent use of weed control implements is possible.

Sowing in parallel rows can be achieved by means of multirow seed drills or single row planters.

b-1) MULTI-ROW SEED DRILLS

These usually need a draught effort which is too great for local draught animals and are therefore hardly used at all, with the exception of the narrowest versions which are sometimes used in rice growing.

We may mention, in passing, the most rudimentary of the Chinese rice seeders, whose use goes back for over 2,000 years and is still in use now. It is made entirely of wood and its system of operation is as follows: an agitator consisting of a bamboo rod, vibrated by a pendulum (a stone on a cord) passes through a shutter at the bottom of the hopper, and by means of this vibratory movement, causes the paddy to flow into the seed tubes.

Multi-row seed drills have three main parts: the hopper, the distribution components and the burying components (Fig. 105).

- The hopper, preferably metal because of climatic and parasitic action, has an agitator at the bottom (which is funnel-shaped).

- The distribution components are fitted to the bottom of the hopper.

* Exceptionally, when sowing rice in paddies, covering the seeds is not recommended, they should simply be spread on the surface of the soil. We should also note that cereal seed drills are only suitable for sowing on dry ground.

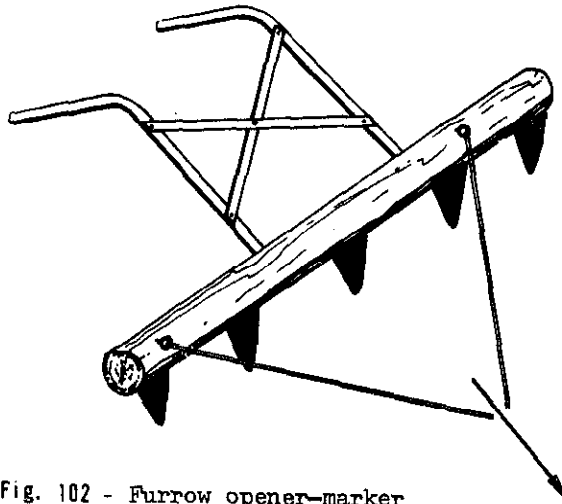

Fig. 102 - Furrow opener-marker

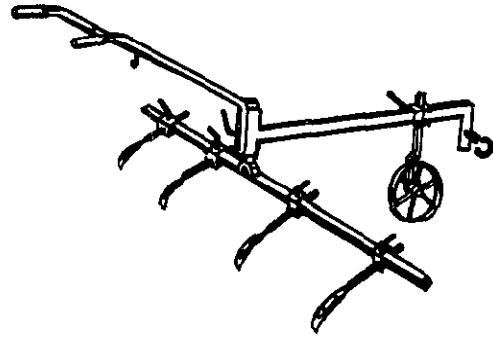

Fig. 101 - Furrow opener attachment fitted to multi purpose tool carrier

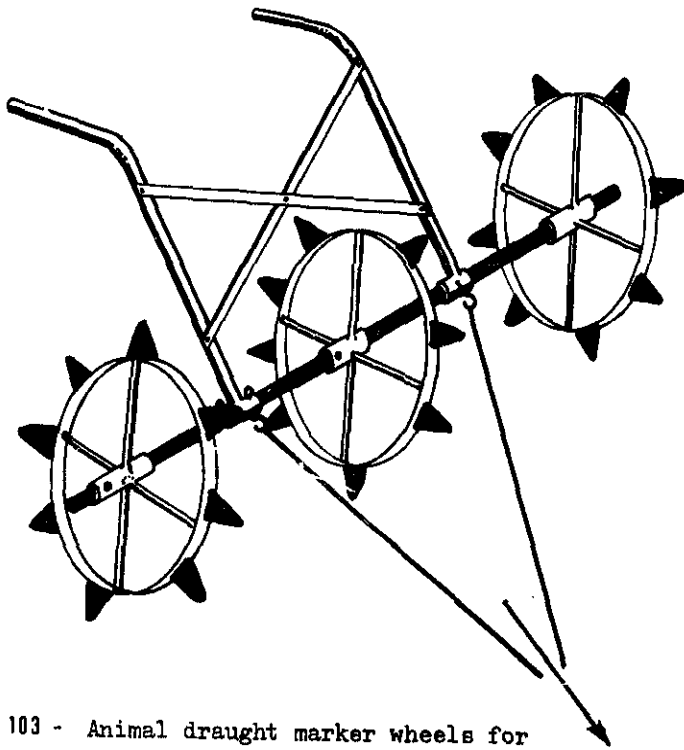

Fig. 103 - Animal draught marker wheels for dibbling

Many types of feed mechanism are available on the market. In tropical Africa, the few types most generally used are fluted roller seed metering devices. Studded roller or spur type seed metering devices may also be found *.

With fluted roller distribution, either straight or spiral, each unit is contained in a housing connected to the lower part of the hopper and to the seed tube. The seeds go from the hopper to the tube or spout via the grooves of the fluted roller: this is known as forcefeed distribution. To regulate the flow, it is sufficient to vary the groove's length by sliding the cylinder in its housing, or again, to alter the speed of rotation of the roller by means of a 2 or 3 speed gear-box or by interchangeable pinions or sprockets (Fig. 106).

Studded roller distribution (Fig.107) is done by rollers with a double row of studs. The seeds are pushed through without being enclosed in a restricted space, as in the preceding case, so that there is no risk of the seeds being broken; the flow is regulated by varying the speed of rotation of the studded roller by means of a gear-box with up to 80 combinations. The fairly high cost price of this gear-box has so far prevented the use of this distribution system for animal draught seed drills used in Africa. It is sometimes possible to change the sprocket cylinder shaft.

- The seed placement components known as coulters or "shoes", consisting primarily of hoe coulters or discs, are used to open a small furrow, at the bottom of which the seed is deposited and, possibly, covered over by means of a variety of devices (small chain dragged along the ground, small light harrow tines or teeth, small press wheel) (Fig. 108).

Discs are recommended in stony or rough ground; they need less draught effort but are more difficult to maintain than hoe coulters (daily greasing necessary) (Fig. 109).

USE OF MULTI-ROW SEED DRILLS

- Adjustment of seed placement components

The distance between rows is adjusted either by closing off a certain number of seed distribution units or by moving the coulters or disc arms attached to a cross-member of the chassis by sliding sleeves, or the two methods together.

Adjustment of depth of sowing is done by putting different weights on the lever arm or by adjusting the variable pressure coil springs.

- Adjustment of rate of seeding

The sowing charts supplied by the manufacturers only give very approximate information on the choice of precise settings. It is recommended that the rate of sowing be checked using the actual seeds to be sown.

The recommended checking method is as follows:

- Adjust the seed distribution in accordance with the information provided by the manufacturer.

* As also may cup feed mechanisms, which are simple and accurate (Fig. 105a)

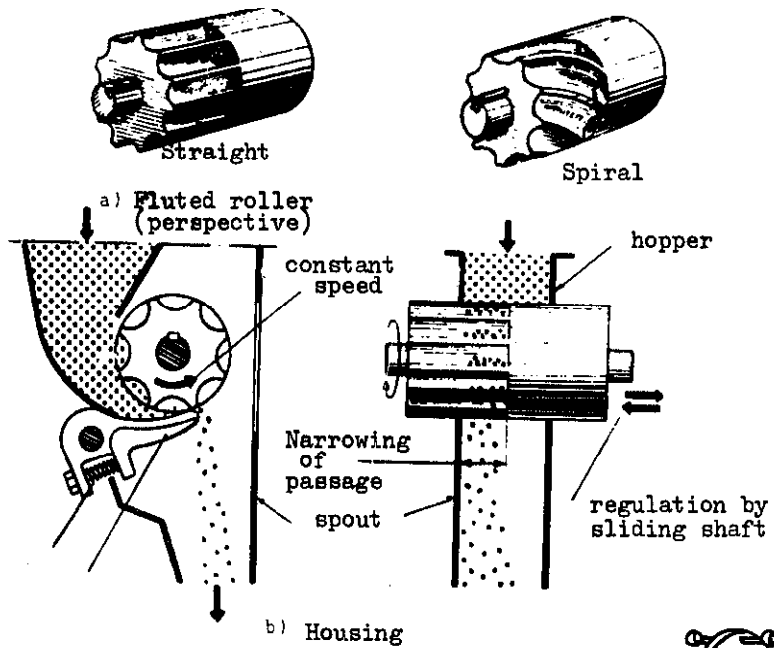

Fig. 106 - Fluted roller feed system

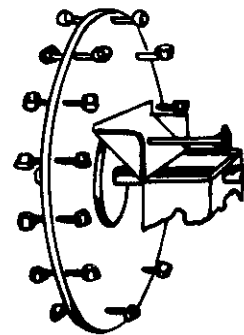

Fig. 105 bis
Cup feed system

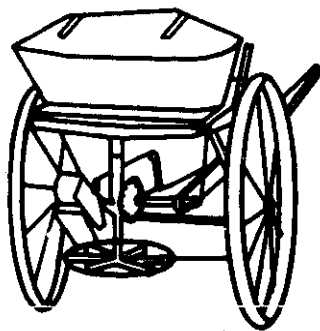

Fig. 104 - "Broadcast seeder"
(spinner broadcaster)

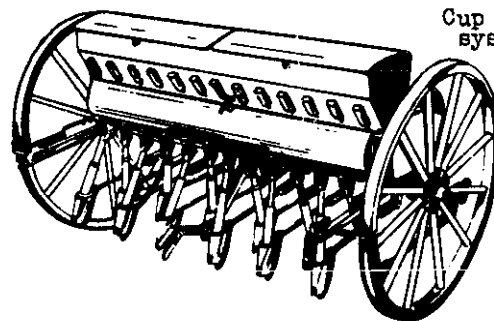

Fig. 105 - Cereal seed drill

- Jack up the chassis so that the main driving wheel through which the seed distribution system is actuated may be turned by hand.
- Set the special feed through to the emptying position so that the seeds may be collected as they pass through the feed mechanism (if there is no trough, put a container or a sheet to catch the seeds under the seed tubes and coulters).
- Measure the circumference of the wheel, e.g. C metres.

If the working width is L metres, the area sown in square metres for one turn of the wheel is: C x L. The number of wheel turns for one hectare (NT_{Ha}) is therefore:

$$NT_{Ha} = \frac{10,000}{C \times L}$$

- To obtain the actual flow carry out the trial with say 100 turns. Weigh the seed collected. The rate of sowing will then be $\frac{NT_{Ha}}{100}$ or $\frac{10,000}{C \times L} / 100$
- If the actual flow is not the same as the desired flow, start the trial again with a different flow adjustment.
- When working, seed drill must be driven absolutely straight. It is advisable to watch the contents of the hopper and the functioning of each distributing mechanism and also the seed coulters.

b-2) Single row precision seed-planters

Unlike the ordinary seed drills which sow relatively irregularly and not seed by seed, the precision seed planters are designed to let the seeds fall regularly, one by one, at fairly constant intervals. Furthermore, the height from which the seeds fall is very small (a few centimetres) to prevent them bouncing or rolling along the bottom of the furrow (Fig. 110-111).

The distribution system is chain driven either by the main wheels or by the planter's press wheel.

These seed planters have, in addition, other components attached to the frame: a coulter at the front, fingers to cover over the seed, a seed coulter (shoe or blade) and a marker, hinged to the rear frame, whose purpose is to mark the next row.

Among the many types of seed planters, the most widespread in tropical Africa are the inclined plane distribution planters, the horizontal plate planters and (particularly in English-speaking Africa) the vertical drum planters, also known as wheel-feed planters.

b-21) Inclined plane planters

These are mainly used for delicate seeds, particularly ground-nuts. A distribution disc inclined at about 60° rotates on one of the inner sides of the hopper. This disc has slots in it corresponding to the size of the seeds to be sown. The disc is sometimes replaced by a star wheel with cups (for sowing millet) (fig. 112).

Each slot catches a seed as it passes the bottom of the hopper and releases it at the top of its travel. The seed then falls freely into a seed tube. The spacing of the seeds is adjusted by altering the speed of rotation of the disc (by means of interchangeable pinions or sprockets), or by changing discs (with varying numbers of slots), or by the two methods together. The free fall of the seeds down the tube is about 25 to 30 cm.

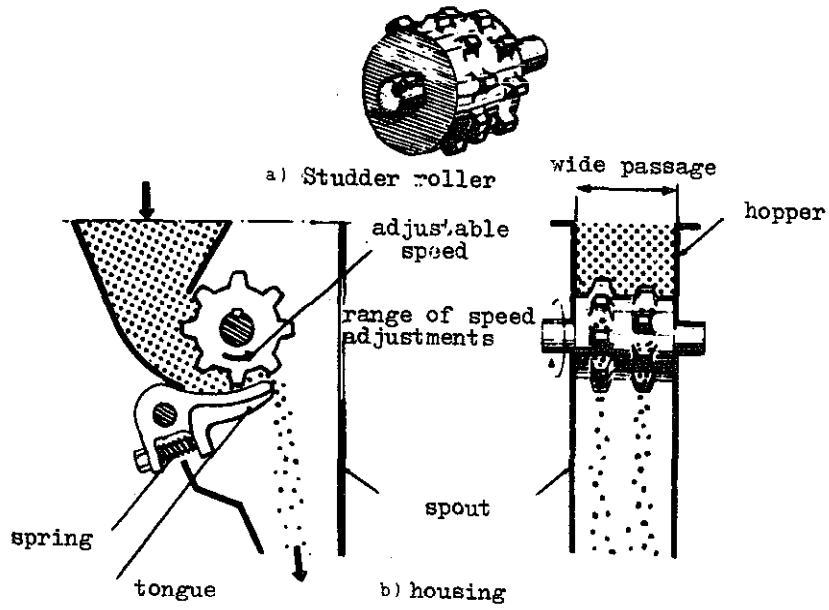
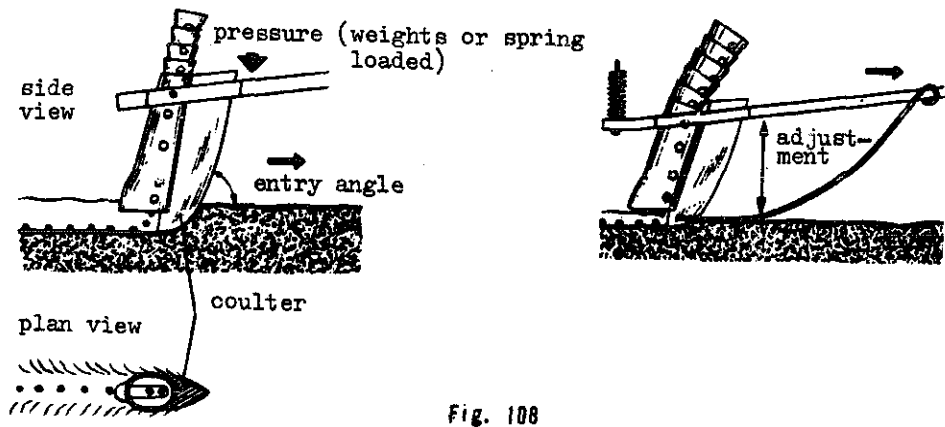

Fig. 107 - Studder roller feed system



Hoe coulter

Fig. 108

Limitation of depth of coulter by means of a slide

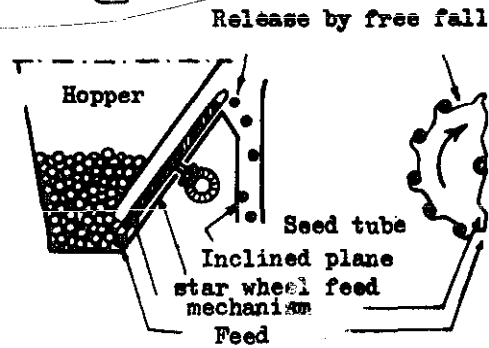
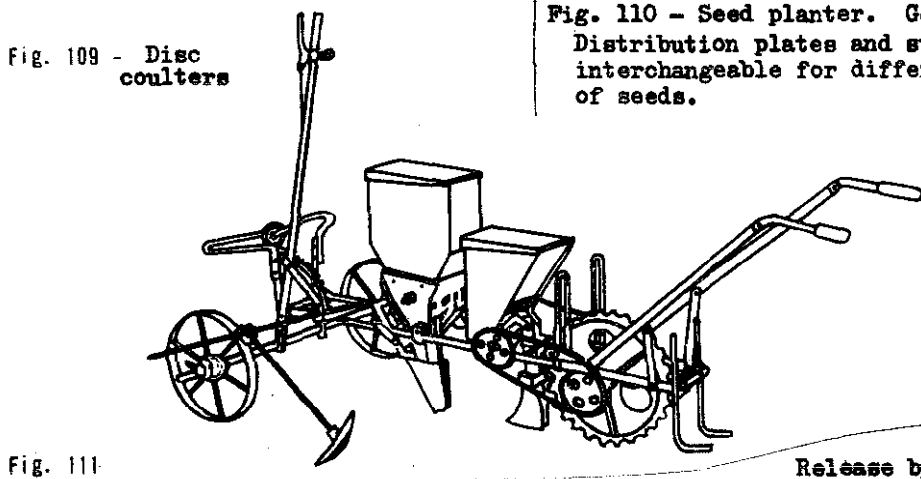
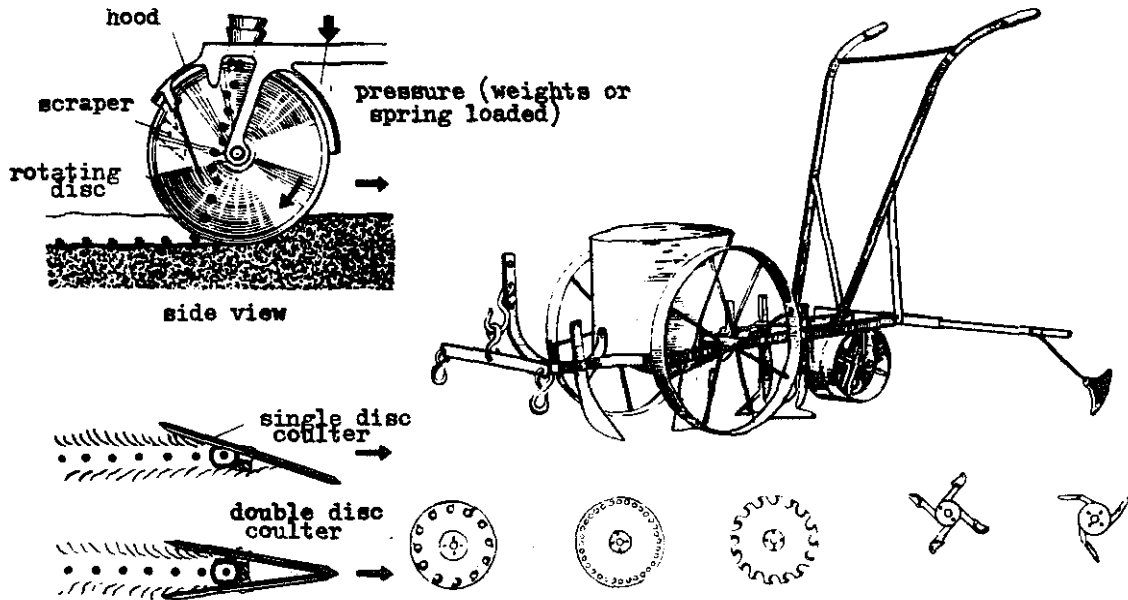

b-22) Horizontal plate seed planter

A horizontal plate, with spaces or slots round its rim, rotates at the bottom of a cylindrical hopper. The seeds fall into these spaces and are carried round by the plate to the mouth of the seed tube, near which is an ejection device which discards excess seeds (Fig. 113).

Seed spacing is again achieved by adjusting the speed of the plate or by using plates with different numbers of slots.

The risk of crushing delicate and uneven size seeds is greater than with the previous type.

b-23) Vertical drum planters or wheel feed planters

A drum rolling on the ground acts as the source of supply; the seeds escape through calibrated holes on its circumference. A furrow opener and seed coverer move forward with the drum. The spacing between the seeds, or clusters, cannot be altered (Fig. 114).

A disadvantage of this type of seed planter is the small size of the hopper and gaps in the rows resulting from the drum not turning properly.

COMMENT - Various arrangements are possible with each type of planter; conventional (2 wheels and handles); simplified planter units for fitting to a multipurpose tool bar; arched type for sowing on ridges; etc.

USE OF SEED PLANTERS

Two planters can be hitched together by means of a hitch-bar, or two or more units can be fitted on a multipurpose frame, in order to make better use of the power of the animals available.

The normal adjustments of planters are as follows:

- sowing depth, by adjusting the seed coulter or shoe;
- row width by adjusting the marker.

While working, keep a watch on hopper contents, the good functioning of the seed distribution system and driving in a straight line.

B) TRANSPLANTING IMPLEMENTS

This category of implement covers equipment for planting tubers and for transplanting seedlings. The former are at present practically unknown in Africa; while the use of the second type is still very little developed.

TRANSPLANTING IMPLEMENTS

These could be used for planting sisal seedlings and for transplanting cassava cuttings (power machines are already used for these purposes). Their use could also be justified on some big tobacco plantations.

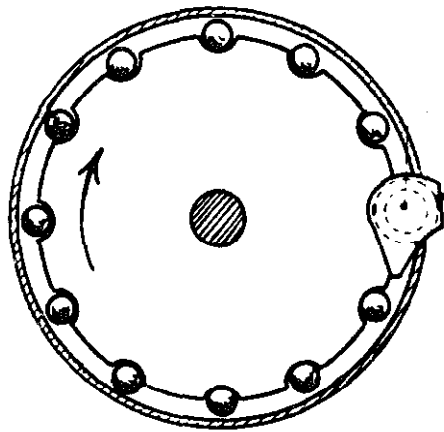
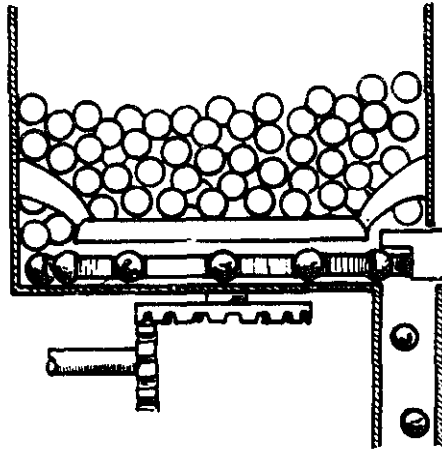

Fig. 113 - Horizontal plate seed distribution system

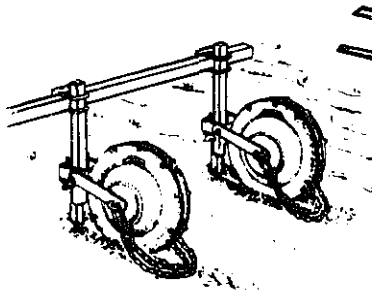

Fig. 114 - Rotating drum planter units fitted to a multipurpose bar

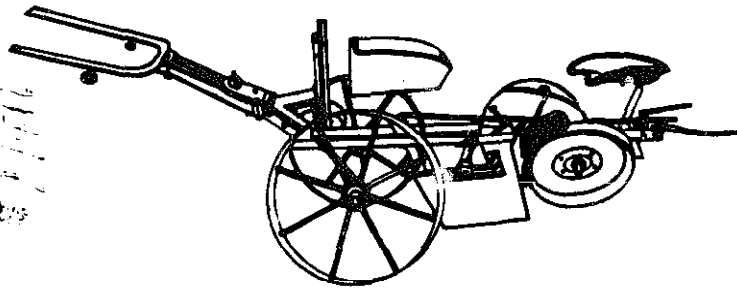

Fig. 115 - Transplanting implements

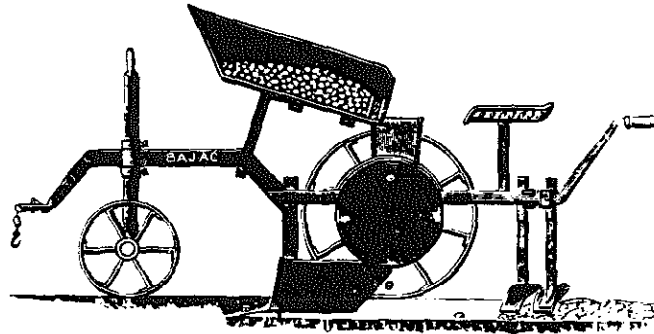

Fig. 115 a - Planter for tubers

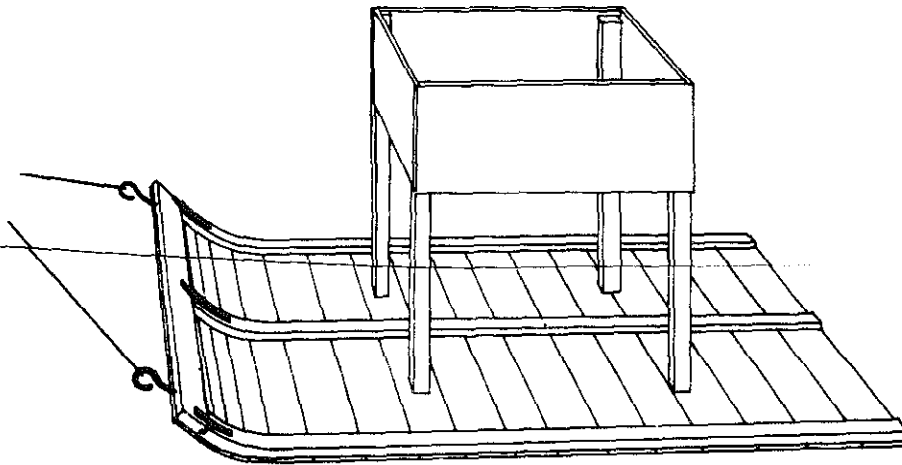

Fig. 116 - Spreading fertilizer by sled

The main components of the simplest transplanting implements are two discs which grip the seedlings fed to them simply by a person carried by the implement. These discs are either both made of thin sheet steel, or one of steel and the other of rubber. The seedlings are freed, after about half a turn, in a furrow usually made by ridging tools and immediately closed and pressed by the appropriate components (press wheels). Correct spacing is achieved either by an indicator on the disc or by the ringing of a bell (Fig. 115).

In another system, the discs are replaced by wheels fitted with grips round the circumference which close automatically at the top and open as they reach the bottom by means of a cam.

Most of the transplanters are multipurpose implements. Simply by changing a few parts, they can be turned into tuber planters etc. (Fig. 115a).

As regards rice, research has been carried on for some years into animal draught transplanting implements for working in water both in Europe (Italy) and in Asia (China, Japan). Until recently, none has given really satisfactory results, except in China, where it is understood, from the little information available, that the use of this type of machine may have gone beyond the experimental stage.

The simplest transplanting implement pulled by draught animals consists of a sled, carrying both operators and seedlings (runners under the sled make the rows). Trials with this latter type of implement, pulled by oxen, were carried out in Italy between 1928 and 1930. It was found to be of limited technical and economic value.

C) FERTILISER SPREADING IMPLEMENTS

There is a very wide range of animal draught equipment for spreading fertilizer, because the material to be spread is very varied and because the quantities to be applied may be very different. The following distinctions are made, depending on the kind of material to be spread:

- Distributors for spreading chemical fertiliser;
- Distributors of liquid fertilisers, in particular liquid manure;
- Distributors of soil improvers;
- Farm-yard manure spreaders.

The last three types are hardly used at all in tropical Africa. As regards distributors of chemical fertilisers, the following simplified classification may be made:

- | | |
|-------------------------|---|
| By distribution system: | - distributors with openings: augers, slotted plates, chains; |
| | - movable floor distributors: moving floor, plate type; |
| | - centrifugal distributors. |

By spreading method: - broadcast;
 - fertilizer "placement".

We shall only discuss those types of distributors which are used to some extent in tropical Africa, i.e. sugar distributors, plate type distributors, centrifugal spreaders, and fertilizer placement distributors.

We should however also mention a locally made Spanish implement, designed to facilitate hand spreading of fertilizer in rice-fields, whose use could possibly be extended in Africa. It consists of a special sled with a fertilizer container pulled by draught animals. The operator stands at the rear of the sled and spreads the fertilizer by hand, driving the animals at the same time. The curved front of the sled enables bunds to be crossed (Fig. 116).

1) Auger type spreaders

These are fitted with a cast iron or plastic auger attached to a square shaft. Rotation of the auger placed on the bottom of the fertilizer hopper, forces the product towards a series of openings or slits. An agitator is generally fitted in the hopper (Fig. 117).

Rate of flow is regulated either by the speed of rotation of the auger shaft or by the size of the openings which are controlled by an adjustable shutter.

2) Plate type spreaders

A series of horizontal dished plates is fitted at the base of the distributor and are rotated at uniform speed. The fertilizer carried round by the plates is discharged by flicker type fingers fed by a deflector (Fig. 118-119).

Flow is regulated by changing the speed of rotation of the plates and by altering by means of a shutter the amount of fertilizer fed onto the plates.



Fig. 117 - Auger type distributor

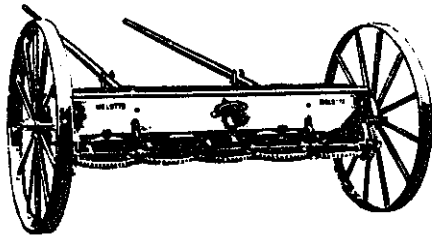
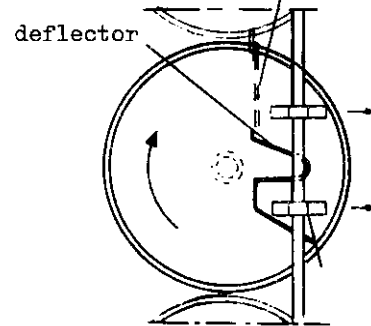
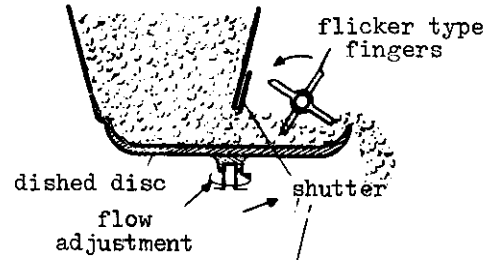

Fig. 119 - Plate type distributor

Fig. 118 - Plate distributor

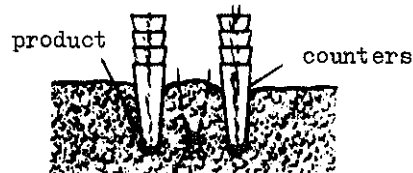
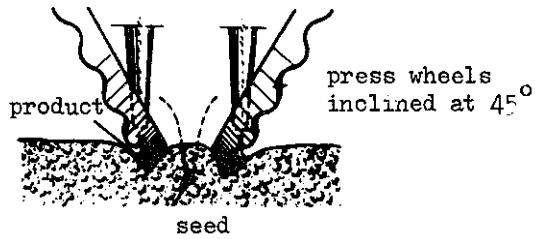
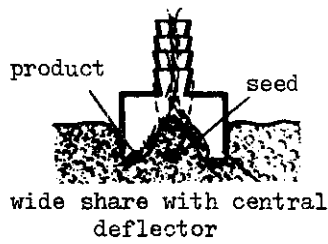

Fig. 120 - Different depth placement components fitted to planters

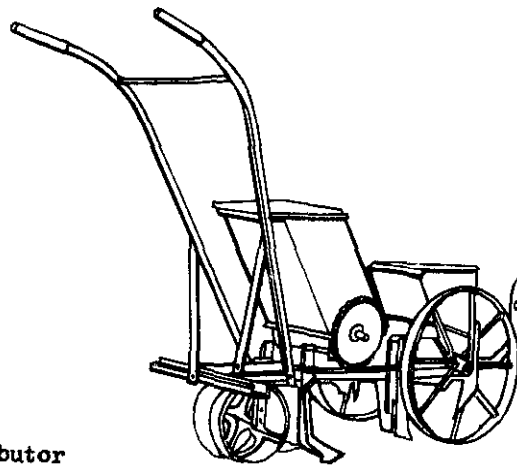

Fig. 121 -- Placement type distributor
for fertilizer and insecticides

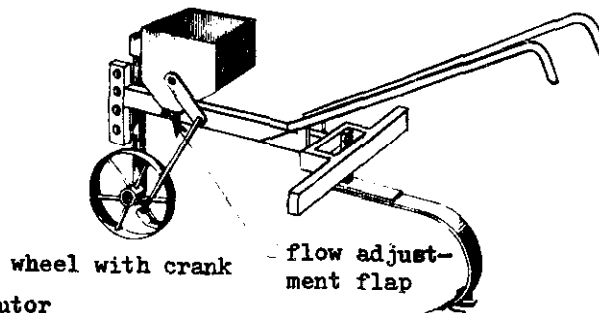

Fig. 122 - Fertilizer Distributor
fitted to a hoe: granulated
fertilizer only

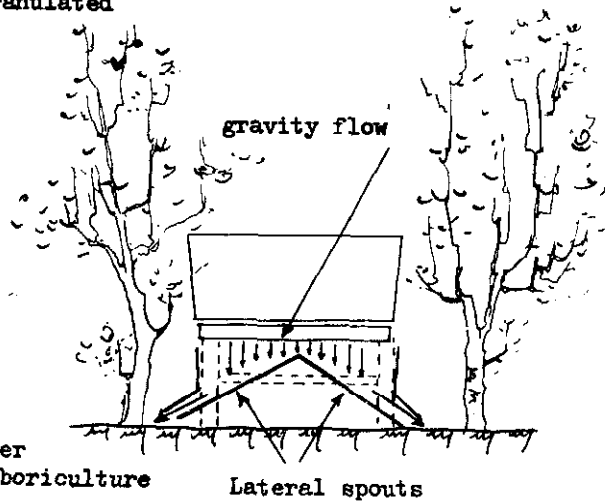

Fig. 123 - Placement fertilizer
distributor for arboriculture

Lateral spouts

3) Centrifugal distributors

The fertilizer is contained in a hopper, which is generally cone or pyramid shaped, and flows out of the bottom whence it is scattered over a width of several metres by means of a device consisting usually of one or two horizontal discs fitted with paddles and rotated at high speed (500 to 600 rpm) (Fig. 104).

The delivery per hectare depends on the setting of the feed opening (graduated indicator) and the consistency of the fertilizer (density, grain size, degree of humidity).

These centrifugal distributors are sometimes used for the broadcast sowing of cereals or seed for forage.

4) Placement fertilizer distributors

We shall only deal here with placement of solid chemical fertilizers. Placement may also be of value for liquid fertilizers, insecticides and fungicides and, finally, herbicides (solid or liquid) and that it can be done either on the surface or at a certain depth.

The placement of fertilizers consists in putting them close to the roots of the plants, with the dual purpose of providing the cultivated plants with an immediate reserve of food (without encouraging the weeds) and of making savings both in the amount of fertilizer added to the soil and in manpower, since this placement is often associated with another cultivation operation (Fig. 120).

Fertilizer placement at the same time as sowing is beginning to be applied with ground-nuts and, to some extent, with cotton. Two main types of seed planter with fertilizer placement attachment are now sometimes found in tropical Africa; for surface placement and for shallow depth placement.

The first consists of a metal hopper whose trough-shaped bottom has two openings. The fertilizer is forced, by paddles on a shaft, towards calibrated openings (inter-changeable plates with openings of different sizes enable the delivery of the fertilizer to be adjusted at will). The fertilizer falls either side of the row of seeds and is incorporated into the soil by means of two small shares carried on the planter frame (Fig. 121).

The second type is fitted with a studded roller type distribution system and burying components ahead of the seed coulter, consisting of two small and very narrow shares whose depth can be adjusted as desired (Fig. 111).

There are also fertilizer placement attachments fitted to a hoe, solely for granulated fertilizers (Fig. 122).

5) Fertilizer placement in arboriculture

The normal placement at depth with this kind of cultivation cannot be done with animal draught implements. In view of the considerable draught power required, the only remaining possibility is surface placement of fertilizer.

The example of coffee plantations, with cover plants sown between the rows, shown the value of this type of distributor which enables the fertilizer to be placed either side of the cover plants thus only benefiting the coffee-shrubs.

These placement distributors, with a variety of feed systems, are distinguished by their small working width and by one or two inter-changeable sheet metal spouts for directing the fertilizer towards the shrubs (fig. 123).

6) Maintenance of fertilizer distributors

Fertiliser distributors need careful maintenance, Being corrosive to a greater or lesser degree, the fertilisers attack all the metal parts.

It is therefore essential to wash the hopper and the distributor copiously with water as soon as spreading is finished. If the distributor is to remain unused for a fairly long time it is advisable, after washing and scraping, to oil all the metal parts.

VI

EQUIPMENT FOR WEED CONTROL AND CROP PROTECTION

A. GENERAL REMARKS

Removal of weeds hindering the growth of sown crops has a vital effect on yields. With annual rainfed tropical crops, competition from weeds reaches a degree of intensity quite unknown in temperate countries. The reasons for this are quite simple.

With rainfed tropical crops, the farmers can rarely work the soil sufficiently before sowing to have much effect on the growth of weeds and thus limit their density in comparison with the sown crop. On the one hand, the tillage equipment available is generally very rudimentary. On the other, even with adequate equipment for primary tillage of the soil, the hardness of the ground at the end of the dry season often prevents ploughing sufficiently early before sowing for it to be possible to plough a second time or even to follow up with effective seedbed preparation operations. Particularly with the heaviest African clay soils, the possibility of ploughing after the harvest, at the end of the rainy season, or at the beginning of the dry season, is very limited, certainly if only animal draught ploughs are available, which is still nearly always the case.

The second very important factor concerning the invasion of crops by weeds is that these develop at an alarming rate, the climatic conditions being very favourable to them as soon as the rainy season starts.

Thirdly, African farmers everywhere have a tendency to sow the maximum possible area, allowing the minimum possible time per unit area for ploughing, secondary tillage and sowing; this is because they have not yet generally advanced beyond the concept of extensive agriculture, characterised, in particular, by the low density of sowing. As a result their crops always tend to be smothered by heavy weed growth; the more so because they try to take maximum advantage of the favourable sowing period before undertaking hand weeding of the earliest plots sown.

Like rainy season crops, rice irrigated by flooding is extremely sensitive to weed control. Despite the powerful destructive effect of flooding on certain kinds of weeds, particularly when there is full water control, the rice yield may, in certain cases, be reduced by 40% through lack of weeding.

Weeding operations using draught animals should, under certain conditions, be able to prevent the usual heavy crop losses. Weeding operations, however, are really just one of a whole series of intensive cultivation techniques which may effect the use of draught animals, as well as crop yields.

Among these techniques, chemical crop protection is especially important and may, on occasion, be carried out with equipment pulled by draught animals.

Weeds need to be controlled at various stages in the cropping cycle, namely: at the primary ploughing stage; during the secondary tillage and seedbed preparation stage; and after sowing during the various stages of crop growth.

THE SOIL

The physical composition of the soil gives it a particular structure, which is influenced by previous cultivation operations and by the season of the year. Mechanical weed control is considerably affected by the specific resistance of the soil to the working parts of the implements. In flooded rice cultivation, this resistance is normally fairly low since the work is being carried out in mud or under water and particularly because the soil of the rice-field has been carefully surface-worked before transplanting.

In any case, the effect of tillage operations before sowing is of vital importance. It will not always be possible to carry out mechanical weed control with animal draught implements where the soil preparation has consisted only of very rough clearance work.

The soil to be tilled may be flat, in ridges or in mounds. Land which is in mounds is quite unsuited to draught cultivation because the mounds are liable to be irregularly distributed and much too big (for example, the mounds of yams may be 50 to 60 cm high).

Sowing on "flat" ground is the normal practice in Africa. Ridges made before sowing are only found in limited areas where making them may be the only cultivation work carried out before sowing.

The ridges may, for example, be 90 cm apart and 25 to 30 cm high (ground-nuts, cotton, etc.). Growing crops on ridges has an important advantage after sowing in that it makes it easy for the draught animals to follow the rows of plants, which, with flat cultivation, are hidden by the weeds. Animal draught weed control operations may thus be carried out as soon as the crop appears above ground.

On flat ground, on the contrary, the crops sown in rows have an appearance much the same as broadcast sown crops, in that the rows cannot be seen being hidden by weeds.

Transplanted rice has a considerable start over the weeds but the first weeding should not be too much delayed. The rows are easy to see if the seedlings are planted out in rows.

THE CROPS

Generally speaking, annual crops can be broadcast or sown in rows. It must be remembered that sowing in rows does not necessarily involve the use of a planter, as for instance cotton for which no planter was, until recently, used in Africa and similarly ground-nuts and millet in Niger. We mentioned, earlier, markers and marker wheels for animal draught. They can also be designed for use by hand. This is the case of the multi-wheel markers of the Far East which permit rice to be transplanted in square plots.

Sowing in rows is not, however, an absolutely essential preliminary to any mechanized weeding operation. There are special "harrows" (weeders, chain-harrows and rotary hoes) which can be used "in all directions", shortly after the sown crops show above ground. These will uproot many of the weeds - provided that the sowing was done on clean ground, in which the weeds have been prevented from getting a start over the sown crop. This tillage, which applies equally to broadcast sown and certain row planted crops, quickly becomes impossible as the crops develop. For any later weeding, it is essential to sow in rows. In practice, this means using a marker when a single row seeder is used.

Similarly, direct sown submerged rice is sometimes treated against weeds (in Ceylon) by means of a levelling board or a harrow frame under water shortly after the seeds sprout. At three or four weeks the rice may also be weeded and thinned by means of a harrow.

At present, in French-speaking Africa, draught animals for weed control are used for relatively few crops. Such mechanised weeding could undoubtedly be advantageous for the following crops, at least during the early stages of their growth: ground-nuts, cotton, millet, sorghum, cassava, sesame, beans, earth peas and rainfed rice. Furthermore, the weeding of irrigated rice transplanted in rows is sometimes, in certain parts of Asia, done with animal draught implements. There are certain implements which could usefully be introduced for this purpose in Africa.

The spacing between rows is obviously very important for maintenance work. It would be desirable, as far as possible, for the same spacing to be used for all the main crops, in order to simplify the design of the equipment used for weeding, provided that the system of twin rows for high density sowing is adopted.

Furthermore, in Africa two crops are often sown together, particularly ground-nuts and other leguminous crops, with millet. Generally speaking these combined crops are very difficult to weed mechanically because of the narrow space between rows, except in cases where this has been taken into account during sowing - which does not so far seem to be the case in any country.

Weeding operations become less necessary as the cultivated plants cover the ground, but, in all cases, several runs are essential to ensure proper weed control during the whole growth period. Spacing between rows is an important factor in this.

METHODS OF WEED CONTROL

Harrowing, mentioned above, uproots young weeds by pushing them along parallel to the ground.

Other methods include hewing, scarifying and earthing up. In addition, animal draught "rotary weeders" for rice growing in water do an uprooting and reburying job under very different conditions. Bladed roller "bush breakers" can help to keep weeds under control in arboriculture (cover crops and natural regrowth plants).

Some types of hoe have wide and flat cutting blades. These, in theory, attack weeds only and only disturb the soil a little. In addition to their action against weeds, they destroy the capillary canals.

Other types of hoes are aimed at tillage of the surface layer of the soil. Its purpose is to give this section of the soil a particular consistency to allow rain to penetrate easily (possibly by breaking the crust).

It therefore reduces the risks of erosion by run-off and favours root growth in the surface soil, at the same time as it aerates it. The working depth of the soil engaging parts is relatively shallow in order to avoid loosening the soil to such an extent that it is attacked by rainwater thus causing erosion. This type of hoe is fitted with narrow and more or less vertical working parts.

Flat weeder blades are often combined together with narrow tines or points. Rarely is it attempted to destroy the weeds without disturbing the soil at all. Indeed, propagation by cuttings and regrowth from roots occurs very quickly in the rainy season if the weeds are not uprooted.

In relation to the width worked, flat working parts offer very little resistance to forward movement, so that speedy work can be carried out with little draught effort. Weeding with these implements can be very effective under good conditions. On the other hand, it is often difficult to keep the working parts at a steady depth - as also applies to ground-nut lifters, and they sometimes also have a tendency to drift sideways because of differences in the hardness of the soil and because of obstacles. They are difficult to use in soil which has not been properly worked to provide a good seedbed. In addition, the frames used for animal draught cultivation do not always remain perfectly horizontal while working and it appears that, generally speaking, the working parts have a tendency to dig in too much, thus working at excessive depth (5 to 6 cm instead of 2 to 3 cm). A surface slice of earth is thus cut off.

Tined working parts, with their steep angle of entry naturally offer greater resistance. They are easier to keep to the correct depth and are generally more stable; in certain cases, ground which has not been prepared before seeding can be worked with hoes fitted with tines.

Mechanized weeding and hoeing always leave unweeded strips of varying width either side of the plant which must be weeded or hoed by hand. These operations leave the cut or uprooted weeds on the surface. This may be an advantage from the point of view of protecting the soil against water run-off (formation of crust and run-off) but the vegetable waste not dug in has little chance of decomposing usefully for the cultivated plants.

Surface hoeing and weeding must be done when conditions are favourable, i.e. after rain and on partially re-dried ground (at most, two days after the rain, i.e. at the moment when weeds are starting to germinate).

The crumbling of the soil produced by surface working parts is generally such that the next rain produces a glazing effect which hinders water absorption and causes violent run-off in the furrows left by the working parts. The resulting erosion may be serious.

Furthermore, in certain cases, it has been found that weeding in a clay soil, necessarily done in very wet ground, produces an impervious hard pan.

It may be possible to overcome this problem by combining flat weeding with relatively deep hoeing, using rigid tined working parts.

This scarifying with narrow teeth, is similar in principle though less deep than work carried out with a sub-soiler. It is one way of working the soil during crop growth which does not disperse the soil particles nor form a plough pan as would the wide deep-penetrating share of a hoe.

Finally, earthing up can be carried out when the crop has been sown on flat ground and the ridges made before sowing can be raised again during growth of the crop.

Earthing up during growth from flat soil is generally easier, as a result of the dampness of the ground, than doing so before sowing, particularly as it is not generally done until the growing plants have developed appreciably. We have already dealt with earthing up in an earlier section.

Building up the ridges, and at the same time deepening the furrow, will put more earth on the sides of the ridges. In order to be effective, this requires a wider working implement than that used just for ridging. Without a wider set body, the ridge would be widened but its top surface would not be covered with fresh earth and the weeds there would not be stifled or destroyed. Ridging or ridge building can be followed by tillage with an animal draught hoe (weeding, hoeing) in the row gaps, together with hand hoeing of the ridges. Some animal draught hoes or multipurpose frames, fitted with appropriate multiple working parts, should in theory be capable of ridge maintenance at the same time as intercultivation.

Earthing up helps to bury the weeds, whether uprooted or not, and their incorporation in the ridge. Under certain conditions, if the ridges are intelligently built on the contour, it may also help the fight against water erosion and provide good drainage to the soil where the roots are growing. On the other hand, whatever the consistency of the soil, earthing up demands much more energy than that required by other types of weed control work, meaning either more powerful draught animals or more repeat runs.

Rotary weed control implements, such as Japanese type weeders and rotary hoes, combine weeding by uprooting with surface hoeing (particularly the rotary hoes). In addition, the rotary weeders bury the weeds to some extent in the surface layer of liquid mud in which they work.

As regards the rotary shrub-clearers, consisting of rollers with radial or tangential blades, these are capable of cutting back vegetation which is not too woody by crushing the stalks and cutting them at regular intervals. They also scarify the soil to some extent, at the same time as partially incorporating the vegetation, if it is not too dense.

CROP PROTECTION

Implements designed for animal draught can be used for spraying (by pressure or pneumatic) or dusting of low or bushy annual crops, or shrubs. Those which work solely by animal draught (the moving parts being driven by the main wheels) are designed for a fairly high speed of travel, at the pace of strong horses. When ox draught is intended, an auxiliary engine for the pump or fan is probably preferable.

Some of these implements are particularly simple and relatively inexpensive. Generally speaking, however, they can only be used economically on big enough areas covering several family farms.

Dusting does not at present appear to be of interest for low crops in most tropical regions. It may with advantage be replaced by spraying which results in more lasting deposits of the active component, and thus more resistant to rain. Dusting is, however, used on cotton plants in certain dry areas of Central and South America.

Spraying can be used for treatment with insecticides, fungicides and herbicides, and possibly, also, for spreading liquid fertilizer. The implements for use with animal draught are designed for the treatment either of low crops or of shrubs.

METHOD OF HITCHING WEEDING HOE BEHIND DRAUGHT ANIMALS

There are three different methods of hitching up implements for inter-row weeding operations. Using one animal only, a hoe is hitched directly behind the animal as it walks down the row between 2 rows of growing plants. The height of the growing plant presents no problem.

If two animals are used with a centrally attached weeding hoe (short yoke) then the implement has to bridge one row of the growing crop. This type of implement can be used only as long as the height of the growing crop is below the height of the frame of the implement that bridges the growing crop. Alternatively the hoe can be hitched to a pair of animals, with the hoe following directly behind one animal. Or the hoe may be hitched to follow in an inbetween row, with the animals walking on either side (long yoke).

It is rare to find animal draught implements for the simultaneous tillage of more than one row. Some multipurpose frames, however, make it possible to weed/hoe two rows, with cotton for example at 0.80 m spacing or even millet with 1 m spacing. In this case, it is essential that successive rows be parallel and it would be inadequate merely for this to apply to two adjacent rows (as might be the case with a 2-row seeder without marker).

The use, in paddy rice-growing, of a multi-wheel marker in two directions at right angles to each other, permits such accurate transplanting that animal draught tillage implements can be used in both these directions, thus considerably reducing the work left to be done by hand.

B. SOME TECHNICAL DETAILS ON EQUIPMENT

WORKING PARTS

Weed control is carried out by means of working parts attached to tines or to stays. These may be multipurpose frames which we have already discussed, or "hoe" frames. For chemical crop protection, special frames, which may have to bridge the growing crop are needed, or else ordinary carts with special equipment.

A very wide variety of working parts is produced by specialised manufacturers but parts may also be adapted from equipment supplied by the major manufacturers of agricultural equipment.

There are a number of similar types of weeding hoes with often only slight variations in the working parts used for the different types of inter-row cultivating operations.

For weeding, use is made either of blades or sweeps parallel to the ground, or "angle blades" or sweeps or else triangular parts (fig. 124) (duckfoot or shovel points on blades).

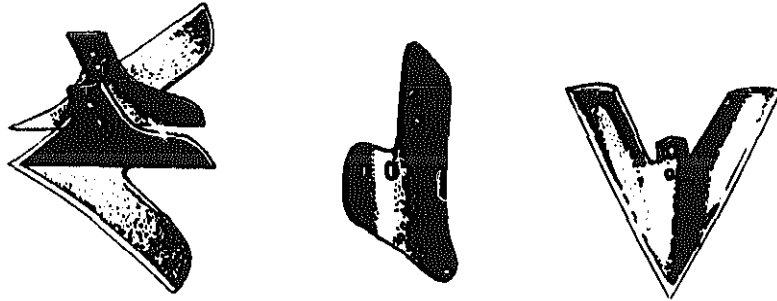

Fig. 124

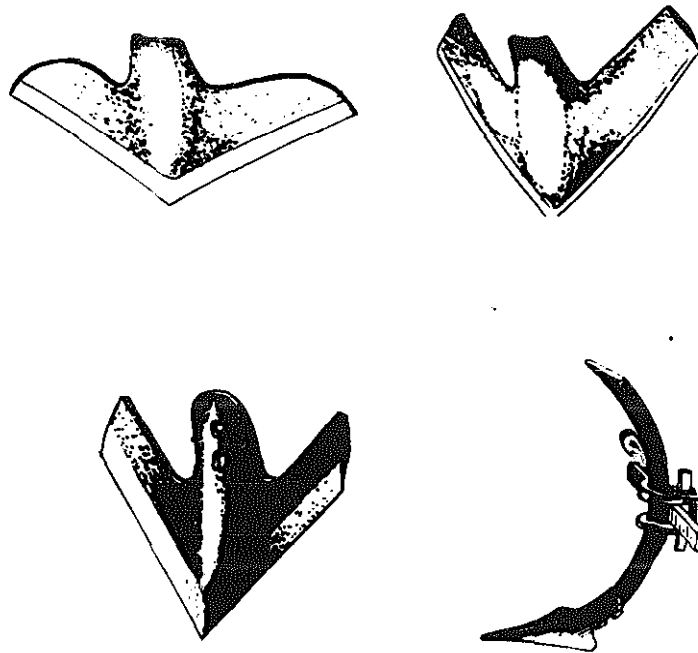

Fig. 125

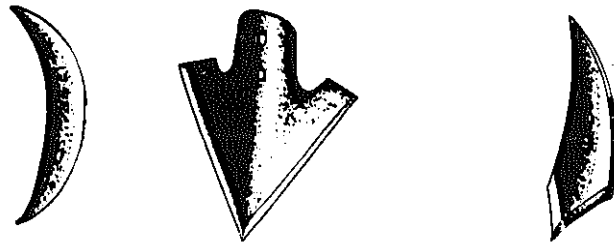

Fig. 126

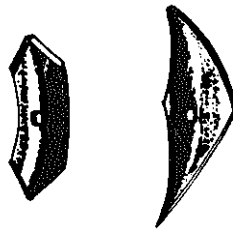

Fig. 127



Fig. 128

The angle blades are essentially assymetrical and work on only one side of the tine or stay to which they are attached. They vary in length (e.g. 12 to 40 cm) and in width. In addition, the angle of work in relation to the line of forward movement is variable with different models. Some have a back piece of varying size, consisting of a vertical part attached to the tine or stay which may serve to push the weeded vegetation to one side.

The triangular shares are also known as duckfoot or shovel blades (shovel points if they are narrow) and may be "straight-shouldered," i.e. forming an equilateral triangle, or else they may have one half blade longer than the other. They are then called "sweeps". Their working width may, for example, reach 15 to 50 cm (or more). They can be completely flat or, which is more usual, the two halves of the share, of equal size, form a very wide angle (so that the passage of the share lifts the earth) (fig. 125).

For hoeing, relatively narrow points (e.g. 5 to 10 cm wide) are used which are pointed at the tips and more or less rounded around the tine and also curved from front to rear. These tines may be reversible, i.e. they can be reversed after one tip is worn. They may have parallel sides coming to a more or less sharp point at one or both ends ("cultivator shares") or with curved sides coming to a point ("up-rooting shares") (fig. 126).

Scarifying is carried out with much narrower working parts, often no wider than their tines or stays (rigid). They may be of square section, working on a diagonal, with the tip slightly curved forwards. Another typical shape of scarifier points is that of "grassland rejuvenating tines" which are fairly deep from front to rear, of very elongated triangular section, like a matchet blade. They may be up to 25 cm in length (fig. 127).

Harrowing, considered as a method of weed control, includes the use of flexible weeders, chain-harrows and rotary hoes.

The working parts or "teeth" of flexible weeders are thin and elongated and are attached directly to the frame. They are either narrow, flat, spring steel blades attached at one end to the frame of the weeder with the other end folded back on itself, or else they are made of small diameter steel rods acting as both tine and working part (fig. 128).

The length of the teeth varies according to type, from 25 to 50 cm. Designed in this way, the teeth are relatively flexible so that, when the implement is moving along, they vibrate at high frequency which is extremely beneficial in causing very shallow loosening of the soil which is sufficient to uproot weeds in their early stages of growth but insufficient to damage the cultivated plants at a more advanced growth stage. Working depth is from a few millimetres to about a centimetre. The weeder, however, only works well at a speed above 4 kph.

Trials with this type of implement, carried out mainly at the Bambey Agricultural Research Centre, have led to the conclusion that, with a tractor, a single passage with a flexible weeder is sufficient during the rainy season, provided that the soil is worked at the right moment, i.e. that it has partially dried out - up to two days after rainfall; under these conditions, two runs at right angles to each other should prevent the development of weeds for about six days. With ox draught, the flexible weeder is ineffective, although it works reasonably well when pulled by a horse (though inferior to being pulled behind a tractor) provided that runs at right angles to each other are made.

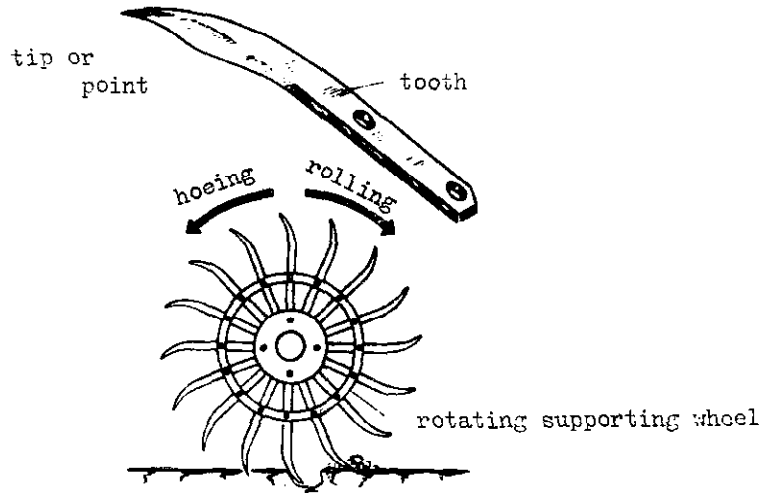

Fig. 129 - Tip and supporting wheel of pull type rotary hoe.

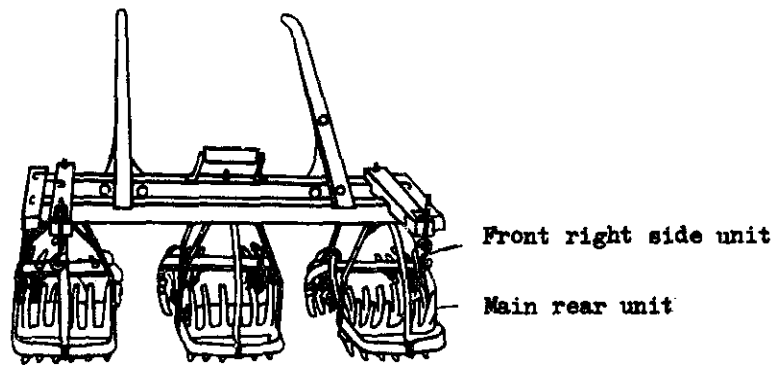

Fig. 130 - Rotary hoe (Japan)



Fig. 131

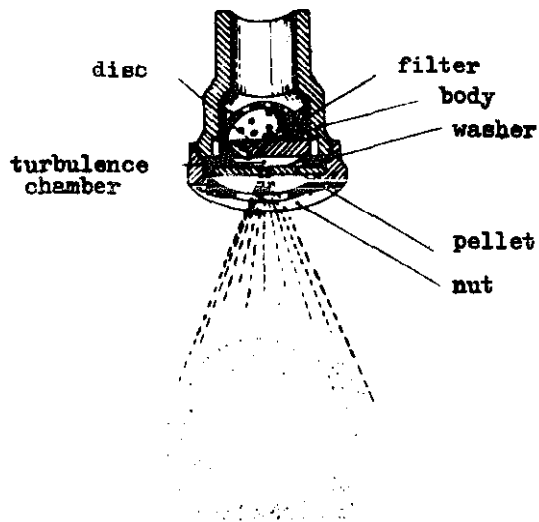

Fig. 132 - Section of plain turbulence chamber nozzle

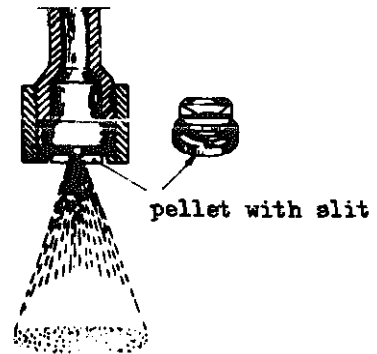

Fig. 133 - Section of a flat jet nozzle

The flexible weeder can also be used immediately before the cultivated plants start to appear above ground. This method of tillage replaces the traditional tillage operation.

The "chain-harrow" works in much the same way as the flexible weeder, using the surface action of a large number of flexible teeth. These are very short and are attached directly to a flexible frame which closely follows the unevenness of the ground (fig. 75).

Rotary hoes have long-toothed wheels rotating side by side on a common shaft. These teeth may be mounted on narrow discs and consist of flat blades at right angles to the rotation axis (and therefore cutting as they advance), or they may be widened at the tip, parallel to the rotation axis in the form of an elongated spoon. These blades are curved, either at their tips or throughout their length; they are not, therefore, simple "spokes" and are different from the teeth of the clod-crushing rollers we have already described (fig. 129).

They can be moved forwards or backwards, since the teeth are all curved in the same direction on a single shaft. These implements have a tendency to break up the soil finely and more or less deeply, at the same time as they uproot the weeds, when moved in a direction such that the teeth attack the soil with their tips. They can then stir up the soil to a depth of 2 to 8 cm. Moved in the opposite direction, they pack the soil by breaking up the surface clods but also (according to information from America) by removing air pockets. It has been found that they do not work satisfactorily on wet ground.

The Bambeay Agricultural Research Centre has recently taken an interest in the use of these rotary hoes (of the spoon type) for animal draught. The conclusion of the first trials has been that weeds could be destroyed, even at low speed, by single runs at calculated time intervals or by two runs on the same day. It was found that the type of hoe used in the trials was not effective against *Cyperus*. It does not cause the formation of a pan (there appears to be a period when the use of such an implement would not be recommended: when the seedlings of the cultivated plant are just showing).

Rotary weeders of the Japanese type for rice-fields, in which the rice is transplanted or sown in rows, have drums as their working parts (two successive drums) fitted with flat curved teeth like those of the rotary hoes. These drums can be mounted on their shafts with plain or needle bearings. The teeth may also be made of piano wire (fig. 130).

We shall not discuss further the ridging bodies used for making relatively big ridges. For weed control, use may be made of small fixed wing ridging shares (shovel blades) 25 cm wide for example, and mouldboards which are either "double mouldboards" similar to the shovel blades but narrower (15 to 20 cm) or "single mouldboards" (turning to right or left), making up, in a single part, a small plough body with its mouldboard (width 12 to 20 cm). They can be used for earthing up and for splitting-back (fig. 131).

As regards animal draught chemical crop protection equipment, those which have proved most suitable for use in tropical agriculture are pressure sprayers. With these, the chemical liquids are atomized by passing, under pressure, through a special device called a nozzle. The implements have a horizontal boom with nozzles "for low crops", and a vertical boom for orchards. These booms consist either of a metal frame carrying the nozzles with a flexible pipe taking the pressurized liquid to each nozzle or, more simply, lengths of metal piping containing the liquid under pressure with the nozzles screwed directly into them. These pipes are joined together by flexible piping and are fed from the pump in the same way.

The nozzles may be of the centrifugal type. In this case they usually contain a thin outlet spray disc with a calibrated hole (usually of a diameter between 0.7 and 1.5 mm), and a swirl nozzle which may be a swirl plate with 2 or 4 spiral passages on its inner surface, or a set of two thin cylinders, the first of which has two spiral passages and the second, a series of holes so arranged as to direct the pressurized liquid solely into the spiral passages (fig. 132).

Between the swirl nozzle and the spray disc is a space which forms the swirl chamber, which is cylindrical, or rather, on "precision" nozzles, conical.

When it reaches the swirl chamber after passing through the passages, the liquid is given a rapid whirling motion and forms a head on the edges of the exit hole from which the droplets of liquid fly off, partly under centrifugal action. The centrifugal action may be more or less violent, depending on nozzle form. With an alternative action, which applies only in the case of fan nozzles, the droplets tend to be thrown directly in the axis of the nozzle. The stronger the centrifugal action, the finer the droplets and, for equal pressure, the less range they have.

The fan nozzles, without centrifugal action, have only one calibrated outlet hole in the middle of the U-shaped slot for flattening the jet. In this case, the droplets are formed as a result of the very considerable change in speed of the liquid in the very short time it takes to pass through the nozzle (the flow of the "system" is the same at all points and the diameter suddenly falls from that of the supply pipe to that of the exit hole, i.e. by a factor of 10, so that the speed becomes 100 times greater) (fig. 133).

Finally, with deflector nozzles, the liquid breaks up into droplets against a flat surface at right angles to the direction in which it comes out.

Centrifugal nozzles are used for fungicides and insecticides, whereas fan and deflector nozzles, which produce much less fine droplets, are used for spreading herbicides and fertilizers.

The pumps are either: diaphragm spray pumps, usually hand operated, or piston pumps (often double action) operated by hand or by a crank on a main wheel; or 2-piston hub-pumps; or 2- or 3-piston pumps driven by an auxiliary engine (figs. 135, 136, 137).

In the case of wheel driven pumps or hand operated pumps, the pressures obtained are relatively low (of the order of 4 to 7 kg). This applies even with the mobile wheel-driven pumping units where the speed of travel can be fairly high. However, the pressure at the nozzle obviously depends on the total flow from the nozzles which is a function of the fineness of their outlet holes.

STAYS AND FRAMES

The various working parts we have described (other than for rotary hoes) for mechanical weed control may be fitted to frames with rigid or flexible stays. Generally speaking, light implements, such as animal draught implements are more stable, do a better job and are easier to adjust and handle when they are fitted with rigid stays rather than flexible ones. With the latter, the unevenness of soil resistance is smoothed out by movement of the working parts so that a relatively large width may be worked with low draught effort. However, the regularity and quality (depth) of the work suffer considerably.

Rigid stays are generally vertical and may be fitted, partially in certain cases on their forward facing sides, with a rounded shield which prevents or reduces blockages.



inlet valve

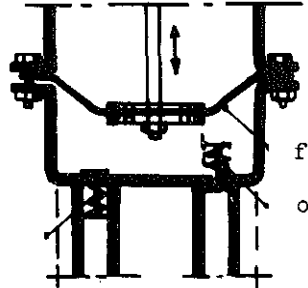

flexible membrane
outlet valve

Fig. 134 - Deflector

Fig. 135 Layout of a single membrane pump

Hub-pump in section

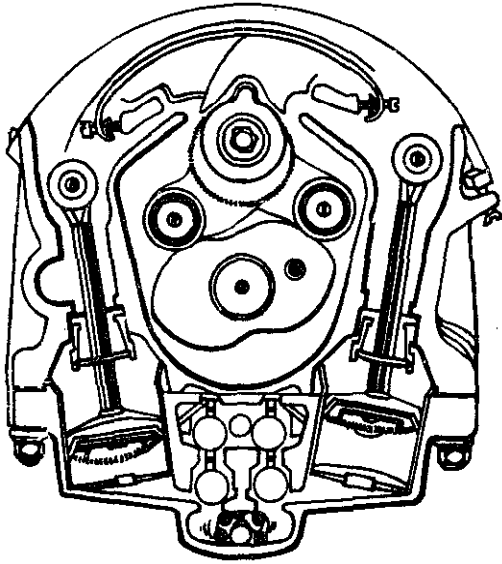

Hub-pump fitted in its wheel

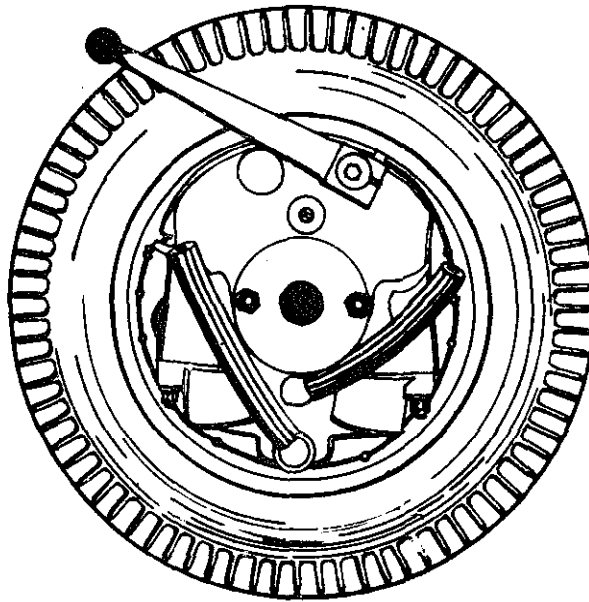

Fig. 136 -

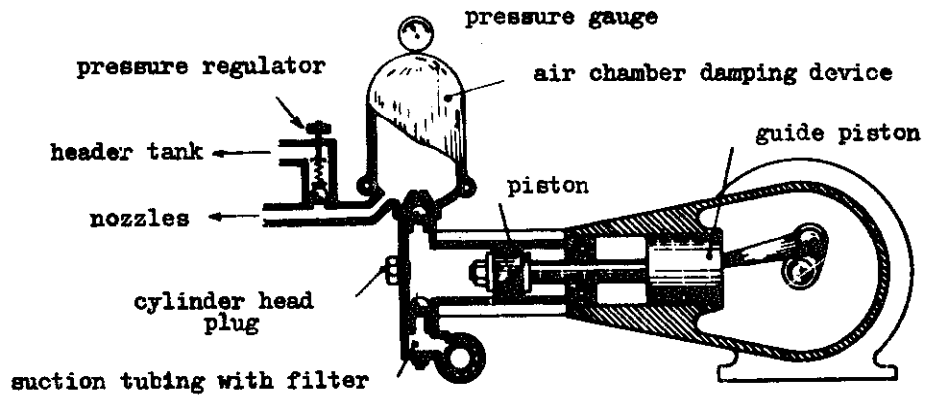

Fig. 137 - Layout of a piston pump with pressure regulator

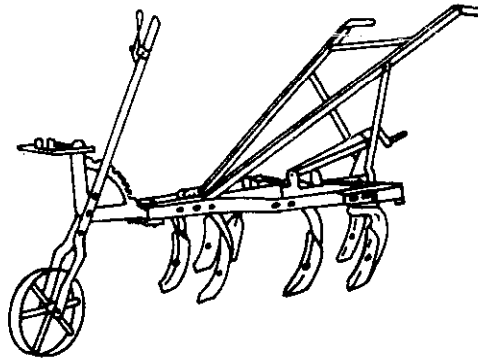

Fig. 138 - Angular expansion weeding hoe or scuffler

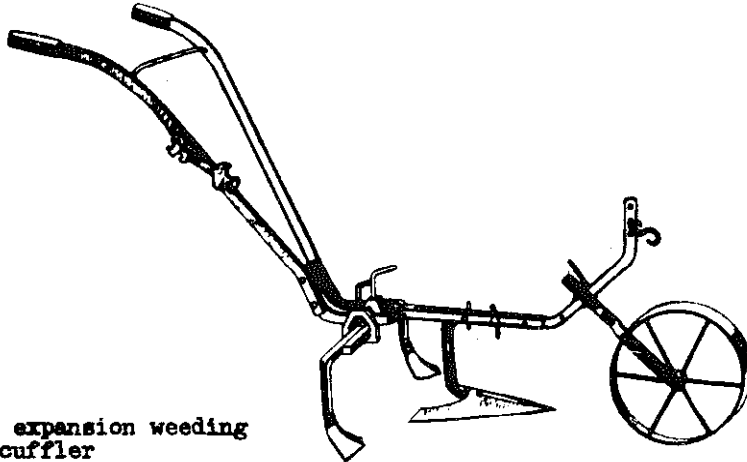

Fig. 139 - Parallel expansion weeding hoe or scuffler

With animal draught implements, the flexible stays usually consist of more or less closed C-shaped single blade flat springs. There are also S-shaped flat springs which can be stiffened up by means of one or two short blades at their upper ends. Square section springs, with one or two coils or without coils, seem to be little used in animal draught cultivation.

We have previously described multipurpose frames, multicultivators and polycultivators, which can be fitted with a wide variety of working parts for weed control.

There are also tools designed specially for weed control operations (weeding, hoeing and ridging, but usually excluding scarifying for reasons of strength). These are known as scufflers or weeding hoes.

Hoes can be classified, according to their weight, as donkey hoes (maximum draught effort 30 kg), designed specially for the limited draught capabilities available to the African farmer and as ox hoes, of which there are more types and which are really the European type horse hoes widely used in Europe until recently. These are much heavier.

The hoe, being a weed control tool, must be adjustable for width for different row spacings. There are two main types of working width adjustment, i.e. the method of expanding the frame of the hoe:

a) ANGULAR EXPANDING HOES

The frame consists of:

- a central beam with the depth adjustment wheel at the front. The handles are attached to the rear of the frame.
- two side beams which are attached to the front of the central beam, from where they can pivot inwards and outwards. The side beams are normally linked at the rear by means of a crank or a lever sliding along the central beam. The working width is adjusted either by a screw adjustment or by a ratchet lever or by a lever bolted to a quadrant or by a rack or finally by two flat steel quadrants, each welded to the middle or end of one of the cross-members, which slide over each other and are locked in the desired position by a butterfly nut or by a cam lever.

These hoes have the advantage of being easily adjustable without need for dismantling; adjustment is even possible during work without bringing the draught animals to a halt. The control system is, however, relatively complicated and therefore costly and the angle of attack of the working parts on the cross-members changes as the working width is changed. In extreme cases, a long and tedious adjustment must be carried out on each stay attached to the cross-members by rotating them in their brackets. In normal use, however, this secondary but nevertheless important adjustment is very rarely made, with the result that the quality of the work is often impaired.

Angular expansion hoes are usually fitted with a toothed quadrant lifting lever, a forked joint system, or a screw lever acting on a metal wheel at the front, to allow adjustment in depth of the working parts.

With some models it is possible to make both horizontal and vertical adjustments, an important advantage with offset draught. Their stays are nearly always rigid.

b) PARALLEL EXPANDING HOES (fig. 139)

Depending on type, the frame has one or more beams and, when there are more than one, their distance apart is fixed. Horizontal holes are made in them through which pass the cross-members carrying the tool-stays; the working width is adjusted by sliding these cross-members laterally. With the types in general use, the width can only be altered when stationary and involves the fairly lengthy work of loosening several bolts and tightening them up again.

With the lightest hoes, the single central beam does not have holes for the sliding cross-members, these being attached by clamps whose tightening is easier than that of bolts.

As with the angle hoes, the parallel hoes have a front wheel whose bracket can be set to various positions relative to the chassis by means of a lever and toothed quadrant or by an adjustable clamp.

- SPECIAL FRAMES

Some of the soil working parts we have described earlier are only used to make up special implements and cannot be attached indiscriminately to any frame.

This applies to weeder teeth, which are fitted side by side on a special frame bar. This can have a pole or shafts attached to it, or it can be fitted to the tool-carrying member of a multipurpose frame.

It also applies to the teeth of a chain-harrow, which are, in fact, no more than extensions of the frame of the harrow, itself consisting of small steel wire units linked together.

Similarly, implements with rotating working parts, rotary hoes, rice-field rotary weeders and undergrowth clearers with blade rollers, all have special frame with draught attachments.

In the case of rotary hoes, the toothed discs available for power-driven cultivation are usually fitted in "sections" of 6 or 7 with two parallel shafts on the frame one in front and the other behind. These sections are grouped together in varying numbers to build up a complete assembly. Their axes of rotation are all perpendicular to the direction of travel. However, units with only a few discs on a single shaft are sometimes fitted by certain American manufacturers in hoeing units for working on or very close to the row.

The implements of this type available for animal draught cultivation have two sets of these discs side by side, with their shafts forming an angle between them (as is the case with the "skew-treaders" of mulch-farming). Others with toothed discs inclined in relation to the spokes but not curved, have four sets of discs on a rectangular chassis.

Animal draught rotary weeders for rice fields are made mainly in Japan.

CROP PROTECTION EQUIPMENT

A pneumatic knapsack sprayer is available. It has a 3 hp 2-stroke petrol engine and can also be used for dusting.

A pulled duster, on an arched chassis, is being produced with the fan driven by the main wheel (fig. 140).

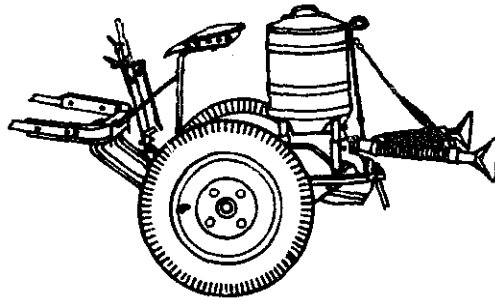

Fig. 140 - Animal draught

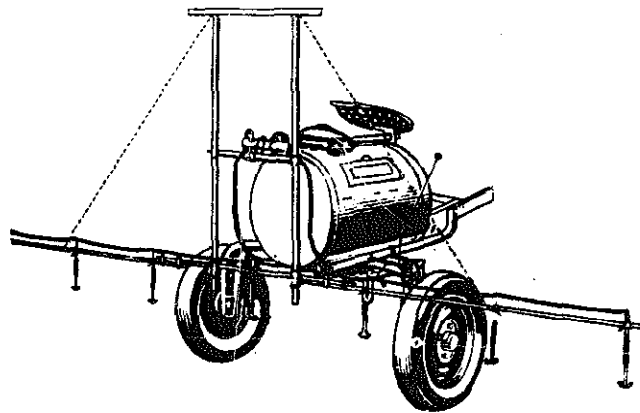

Fig. 141 - Animal draught sprayer

The other implements of this type are pressure sprayers. Some have a beam, whose total length may be as much as 6 m, attached to the rear of a cart and a hand pump (double action piston or diaphragm) which the operator controls standing in the cart. The liquid to be sprayed is pumped from a suitable container (fig. 141).

The special frame to which are attached tanks containing at least 150 litres are often of the arched type, with under-frame clearance of up to 1.60 m.

The horizontal beams may be set at different heights.

Most types can be fitted with an auxiliary engine to replace the main wheel drive.

VII

HARVESTING EQUIPMENT

As a result of the use of the implements mentioned earlier, crop yields have increased and this aggravates harvesting problems. Unfortunately there is little suitable animal draught harvesting equipment available. Whether it is a question of harvesting grain, forage or fibre crops, or fruit above or below ground, etc., equipment must be appropriate to the product to be separated from the rest of the plant and thus it must be specific to its purpose.

For animal draught, there are at present only very few implements available which are suitable for the crops grown in the areas we are considering. In certain cases, existing equipment could be adapted, such as tuber lifters for cassava or yams, but the draught efforts needed would be too much for the local animals. It is difficult to use implements, such as reapers or binders, which get bogged down in the rice field and may cause considerable losses through shedding of the paddy. Also their use would necessitate unduly exacting work such as special preparation of rough fields to make them suitable for harvesting by mowing machine. Finally, there may be no suitable equipment for harvesting, as is the case, for example, with millet or sorghum.

In consequence, a few years ago, there would have been nothing to say in this connection. Happily, animal draught ground-nut lifting equipment has recently made its appearance. The use of animal draught equipment can still be recommended for other crops, provided certain conditions are met.

A. HARVESTING OF FORAGE CROPS

In addition to the cost of acquiring certain specialised equipment, which really means only buying it for multi-farm use, its use implies the fulfilment of two conditions. First, since it can only be a question of mowing natural pastures, these must be reasonably free of shrubs. There are, in most cases, too many shrubs and the only equipment capable of dealing with these woody plants is unfortunately power-driven.

Accepting that a pasture consists mainly of grass either naturally or as a result of improvement, the grass is often in tufts which are much bigger and tougher than the graminaceae or leguminous plants of temperate regions. We do not intend here to go into the methods to be followed to encourage plants suitable for mowing and their proper distribution.

Under certain conditions, mowing machines can be used and perhaps rakes, after tedders.

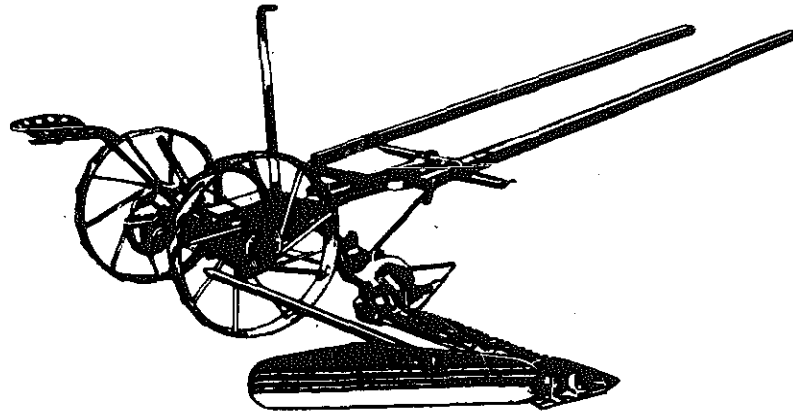

Fig. 142
Cutter bar mower for animal draught.

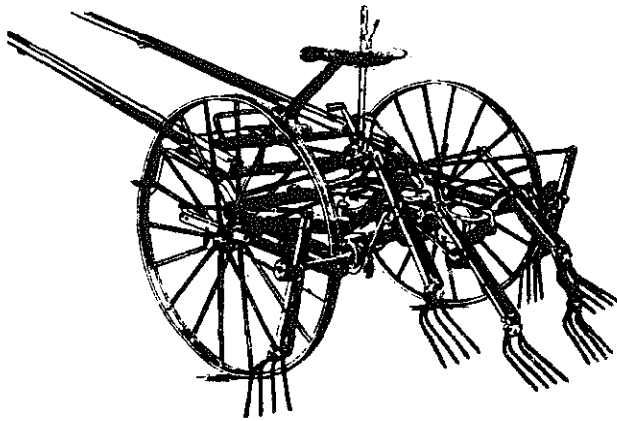

Fig. 143 Tedder

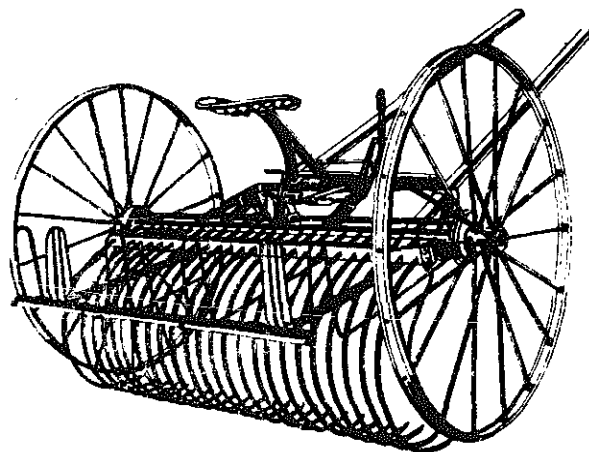

FIG. 144 - Dump-rake

These implements, and particularly the tedders, were originally designed for horse draught, but certain types could be used with European oxen, which are slower than horses.

They were then adapted to the tractor and were then superseded by power-driven machines specially designed for power mechanization. In view of the small number of horses to be found in the regions we are considering and since their draught effort is fairly low, the only machines which can be used are those specially designed for ox draught, since, otherwise, the cutter bar speed would be too low ... unless the mowing machine were fitted with an auxiliary engine. The oxen chosen must obviously be powerful and not over-worked. There are very few manufacturers who still make ordinary cutter bar mowers for animal draught (fig. 142).

For haymaking work, other than mowing, we would briefly mention tedders. For animal draught very few forked implements (fig. 143) are still available. Furthermore, the implements are complicated and must move fairly quickly to be effective.

As regards "dump-rakes", or side-rakes, here again, very few types are now available. The types designed for animal draught or intended for power mechanization and adapted for draught animals are ill-suited to African requirements. The rough terrain and the weight of the implements (dump-rakes or side rakes) make their use difficult, with rare exceptions (fig. 144).

There are, nevertheless, small types of dump-rake designed for motor cultivators, some of which are made in France. They could be adapted to multipurpose frames, preferably those of polycultivators.

B. GRAIN HARVESTING

The harvesting of wheat, barley, oats, and rye, can be carried out with conventional equipment such as reapers, binders, or mowing machines fitted with bunching attachments. These cereals are, however, very little grown in inter-tropical Africa and sorghum and millet which are the more common cereals are not suitable for these machines. Manufacturers making them can still be found in Europe. Strong horses are needed for pulling them.

For harvesting rain fed rice, of the varieties currently grown, these machines have, in addition, the disadvantage of serious losses due to shedding even with reapers which do not bind the sheaves. In the case of binders, a relatively light machine with a single canvas conveyor would be preferable. Where the harvesting of irrigated rice is concerned, the risks of bogging down are added to the other disadvantages, particularly since some of these harvesters weigh more than a ton. Transplanted rice, like the grass of permanent pastures, has the disadvantage of forming tufts which are very difficult to mow.

To sum up, there are few intermediate alternatives between the sickle and the conventional combine harvester for harvesting rice. However animals, with or without equipment can help with threshing. The paddy is stacked on a threshing floor and the animals tread it with their feet. It must be stacked sufficiently thickly for their hooves not to crush the grain. The straw is then shaken and removed, while the paddy, chaff, etc., are collected for winnowing. The output with rice, using a pair of oxen, is about 140 kg of grain per hour.

This method, used in Asia and in the countries surrounding the Mediterranean (where buckets are sometimes used to stop animal droppings from getting mixed with the grain) is worth introducing more extensively in inter-tropical Africa and Madagascar.

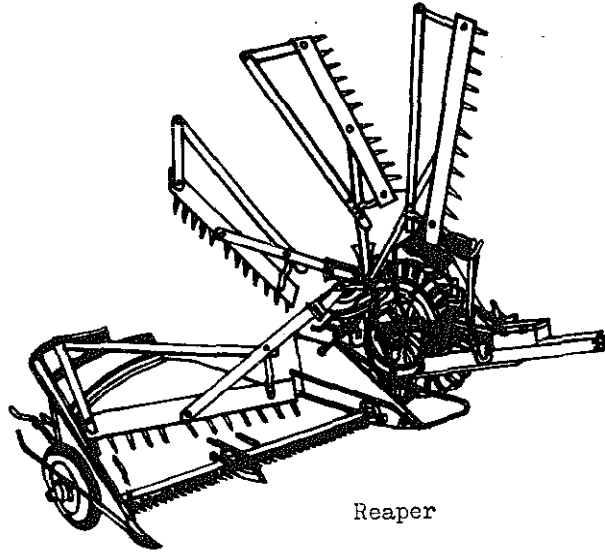

Reaper

Fig. 145

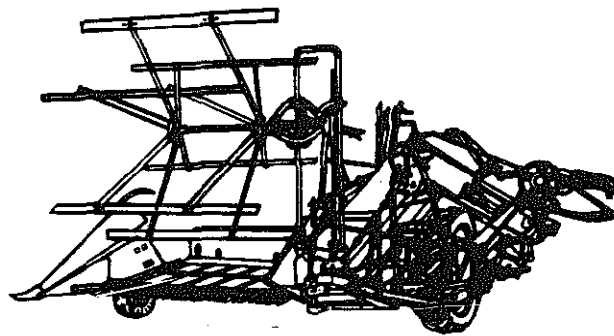

Binder

It should be pointed out that the threshing floor must be cleared of weeds and levelled and then coated with a mud mixture, consisting of clay and animal droppings, which is left to dry before the treading out.

Sometimes a sled, a roller or a kind of disc harrow with flat discs is pulled by the animals on the threshing floor in order to speed up the operation (Middle East). Such a device with three rows of discs (fig. 146) is made in India.

C. HARVESTING OF GROUND-NUTS

As already mentioned, draught animals are beginning to be used for the lifting of ground-nuts, mainly with simple and light equipment. For additional tasks, other equipment may be considered.

1. Lifting

Animal draught equipment for lifting ground-nuts and thus facilitating extraction of the pods from the earth has only recently come into use in Africa. For example, in Senegal, the number of lifters in use amounted to only 1,000 in 1963. These are however simple blades attached to a rudimentary frame (originally special equipment but subsequently attached to a multicultivator frame, etc.). Working at a depth of 5 to 10 cm and therefore below the ground-nuts, these implements cut the roots below the level of the pods and the gynophores joining them to the stalks and, at the same time, break up the soil. This soil is difficult to penetrate by the blades, particularly since the harvesting in the Sahelian area must be done as late as possible at the end of the rainy season when the soil is getting harder and harder. If the harvesting is done earlier, the yield falls by about 1 or 2% per day early. If, however, the soil is allowed to get too hard, the crop has to be abandoned.

The effort demanded is as much as or more than a pair of African oxen can provide. This is why it is impossible to consider the use of real diggers which would raise all vegetable matter out of the ground and deposit it on the surface. Although such diggers used to exist in the United States where the draught mules are more powerful, they are no longer manufactured there.

The efficient capacity of lifters depends mainly on the condition of the ground when the harvesting is done. This depends primarily on the composition of the soil, its humidity and its consistency, and also on any soil improvers incorporated in it or special tillage work which may have been done, such as ridging and possibly irrigation before the harvest, etc.

In practice, what can be achieved by lifters depends primarily on the humidity of the soil, which varies from region to region, from year to year, etc. Drought is often a serious constraint in the Sudanian-Sahelian region, particularly when the rainy season stops early.

There is a wide variety of lifter blades. The simplest are flat rectangular blades with straight or curved or V-shaped cutting edges. They may have extension fingers fitted forming a simplified grid. They are attached to one or two stays. Most countries have their own type or types of blade which are appropriate to their particular ecology (figs. 147, 148, 149, 149a).

The flat straight-edged blades, although simple and strong, are not usually very satisfactory as soon as conditions become difficult, i.e. fields covered in weeds, hard ground, etc.

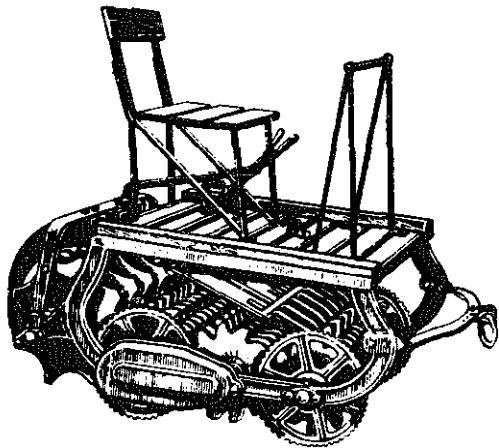

Fig. 146 - Animal draught disc-treader type thresher



Skimmer type blade (US)



Curved blade (India)



Shovel point (Senegal)



V Blade (Florida)

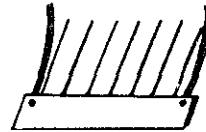

Flat blade (Universal)

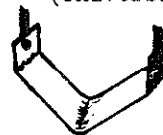

"V" blade (Rhodesia)



Arched (Senegal)

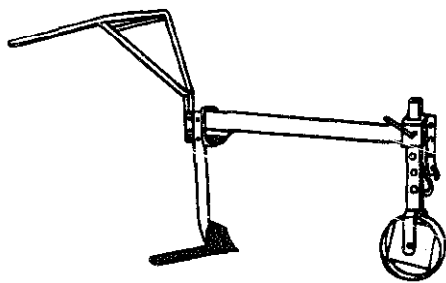

Fig. 149 - Lifter with swept block "V" Blade

Fig. 147 - Sketches of various types of ground-nut lifter blades

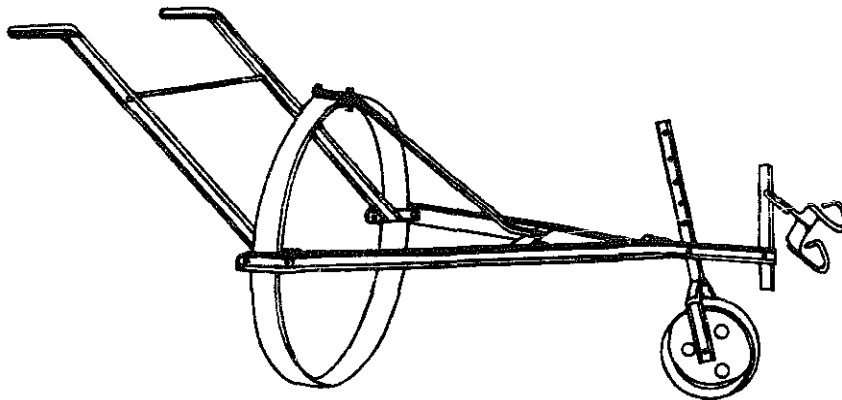

Fig. 148 - Hoop type lifter

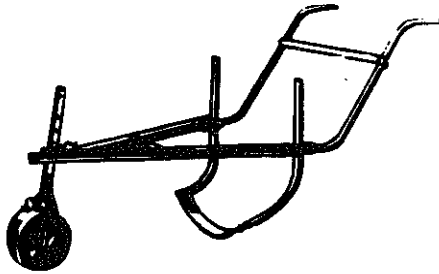

Fig. 149 a. Curved blade lifter.

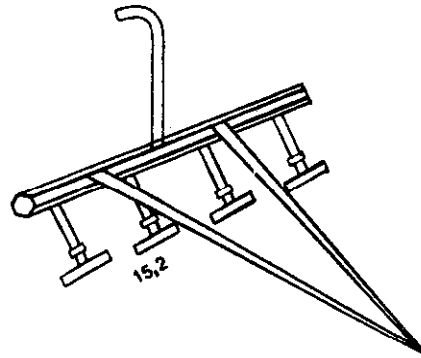

Fig. 150 - Popular "Guntaka" used in India

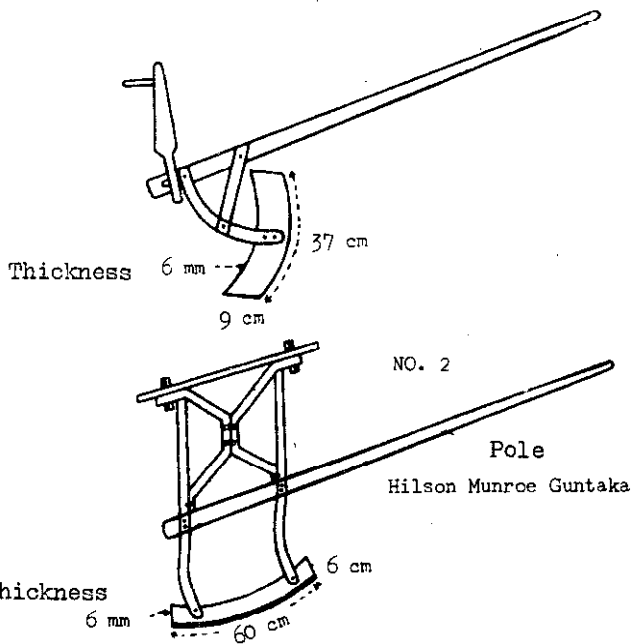

Fig. 151 - Improved "Guntakas" used in India

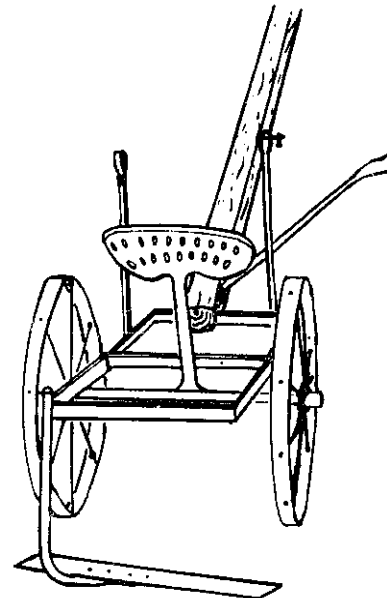

Fig. 152 - Lifter on frame with wheels

In the Sudanian-Sahelian areas of Africa, blades in the form of a hoop were popular at one time. Now, however, swept back V-shaped blades are preferred; these are similar to a wide weeder share and are attached to a stay which is curved on its leading edge in an attempt to stop clogging. It is important to be able to vary the entry angle of the share considerably, depending on the hardness of the ground. The first models of these lifters were designed and made in France. In Senegal, their use is already widespread. In Niger they are beginning to become popular. These blades are proving satisfactory, in both hard and loose soil ("deck" or "dior" in Senegal), with creeping and bush varieties of ground-nuts, whether or not planted in rows, on condition, however, that the blade of an appropriate width is selected. Indeed, the manufacturers usually have available several widths, between 20 and 50 cm and even up to 60 cm (for the sand-dune soils of Niger).

For example, a wide blade is recommended for "creeping varieties", whether in rows or not, in loose soil, and a narrow blade for bush varieties in hard ground.

Lifters with swept back V blades usually need less than 100 kg of draught effort. This may sometimes be as low as 40 kg. The narrow blades could, if need be, be pulled by a horse in very loose soil (free running sand).

Twelve hours will be needed for lifting one hectare (in loose, clean and still fresh soil).

Swept back V blades are made by several multicultivator manufacturers for fitting to their frames. In Senegal "Polyculteur" is made with a harnessing attachment enabling a "medium unit" lifter to be fitted and, for the lightest soils, two lifters may be fitted to this polycultivator.

Furthermore, village blacksmiths sometimes fabricate lifter blades copied from imported ones and these are often quite satisfactory. They are fitted to a variety of frames.

The swept back V blade lifters seem to be less suitable for the soils in which ground-nuts are grown in Madagascar; although it may be that the latest, stronger types have not yet been tried. Malagasy farmers have also been using hoop, or curved type lifters. Most often, however, it has been found that suitably adapted plough bodies are the most satisfactory. Sometimes only the share remains, the mouldboard being completely removed. In other cases, the mouldboard is cut down, only the base being left; or again, latticed mouldboards may be used. Flat blades with straight cutting edges have also been tried but do not appear very effective, even though more powerful draught animals are available in Madagascar than in Senegal. Arched polycultivators fitted with such lifters are an advantage for straddling the rows.

A ridger, with the wings removed, is commonly used for ground-nut lifting in Nigeria. In Argentina, in the Province of Tucuman, the ground-nuts "are lifted with a pointed ard without mouldboard".

In India it appears that, of the methods and equipment used or tried, only two are reasonably satisfactory: the scoop type potato lifter and, especially, the "guntakas". The latter are particularly suitable for creeping ground-nuts.

The guntakas are lifters with straight or concave blades of variable width. It is the only type of implement in this country which gives an acceptable output: 0.6 hectares per day (8 hours). However, it often needs 3 people to work it properly; one man on the guntaka to give weight to bury it 6 or 10 cm and, usually, a woman walking each side to stop the stays from getting clogged (fig. 150).

These implements have the advantage of being well-known and are made and repaired locally; they need, however, a pair of strong animals to pull them.

As an improvement on the straight blades of the guntaka, the Indians seem to prefer blades with a concave cutting edge to those with an angular edge. The working part may be chamfered (fig. 151).

In the State of Bombay, they use lifter blades fitted to a frame with two big wheels, and which can be adjusted for height by a lever and quadrant. This adjustment is easy while moving, whereas the guntakas have to be adjusted before harnessing. A straight blade for creeping ground-nuts is attached laterally, by means of a single stout stay, to the rear of the chassis. Despite its advantages, this equipment is not widely used. Its output is said to be similar to that of a guntaka (fig. 152).

The Japanese use curiously shaped lifter blades, sometimes similar to sweep blades. These are fitted either to an animal draught frame or, more usually, to a motor cultivator.

The best kinds of lifting blade, like some of those described above, generally leave less than 10% of the nuts in the ground. This figure is comparable with the average results obtained with hand lifting. Some blades, however, may under the same conditions leave a higher proportion of pods in the ground.

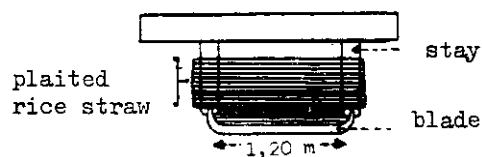

In order to glean the pods left in the ground after lifting, Indian farmers tie fairly tightly plaited rice straw between the stays of their guntakas and run through the field again. In this way they bring up any detached pods which escaped the first passage (fig. 153).

Fig. 153 - Gleaner for ground-nut pods

Fig. 153 - Gleaner for ground-nut pods

The special shape of some lifter blades fitted to anti-clogging stays enables them to bring the ground-nut plants partly above ground.

2. Raking and gathering

After lifting, the ground-nuts must be collected for haulm removal. Before gathering them into piles or putting them on drying frames, it is helpful to gather several rows of ground-nuts together. There are two possible ways of doing this:

The Use of Side Rakes (see above)

Conventional side rakes are often ill-suited to ground-nuts, whose foliage is liable to get caught up in the raking tines. This could be overcome by fitting them with radial anti-clogging bars.

Finger wheel side rakes may be suitable although they make poorly ventilated windrows, which is a disadvantage for haulm removal. The reservations made earlier about the use of this type of equipment with slow draught animals would still apply.

Dump rakes would be better. Unfortunately, as we said earlier, very few are still being manufactured. It seems that a rake of this type has been adapted in India to a wooden chassis for raking ground-nuts. It would, however, have to be fitted with wheels to avoid damaging the crop.

D. HARVESTING OF TUBERS AND ROOTS

Animal draught implements are very little used for harvesting yams, tar s, sweet potatoes, cassava, potatoes, etc.

On the one hand, the implements which could be adapted for such work are heavy and costly consequently the animals available would not be able to pull them properly even if the farmer was financially able to buy them. Additionally, the shape of the roots and tubers, even if they are not too deeply rooted, make the use of mechanical devices difficult. Furthermore, the surface covering - or the presence of stalks - is a further obstacle to their use. It is, therefore, only for potatoes that animal draught lifters can be envisaged, since the reasons quoted above for not using true diggers for ground-nuts, also apply here. It should be noted that, in the regions with which we are concerned, even at altitude, it is unusual to grow potatoes.

Potato lifters consist of a share, usually concave, which has to penetrate the ridge where the tubers are clustered. It is attached by a stay to a frame with a small front wheel. Provided that appropriate tillage operations have kept the soil sufficiently loose, these implements can be harnessed to one, or better, two pairs of fairly powerful oxen. Fairly simple ridger bodies are often used for this task (fig. 154).

If the special lifter share is fitted with extension fingers, or if the ridger's mouldboards are replaced by slats on fingers, the result is a simplified digger which needs about the same draught effort as a ridger, i.e. at the top limit of the capabilities of the animals available.

There can be no question of apron or drum type diggers, which put the tubers on top of the soil from which they have been separated, because the draught effort involved becomes much too great.

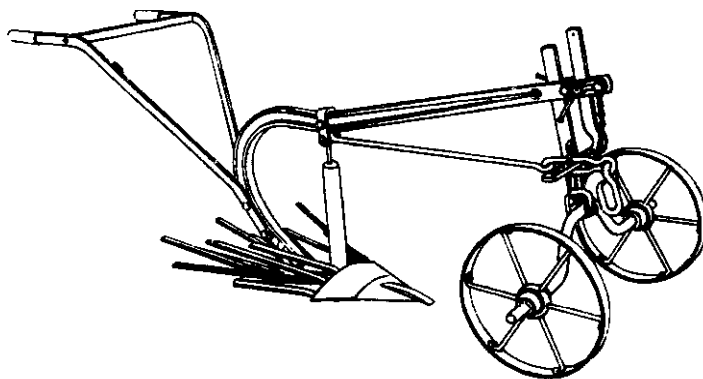

Fig. 154 · Potato lifter

VIII

TRANSPORT: OX, HORSE AND DONKEY CARTS

Transport by domestic animal is certainly much older than what has become known as animal draught cultivation. Whether it be in Mediterranean Asia or in tropical Africa, animal transport has been, and still is, an important means of transporting goods or even people. In these countries, it is quite commonplace to meet a donkey on the road, heavily laden with its owner and, possibly, an additional load.

It is less common, though by no means rare, to see a pack-ox carrying a man or a load, particularly in the arid regions of Africa. In Mauretania and Mali for example, this particular work is done by zebus.

As regards the horse, it is not in the least surprising that it should be an extremely common means of transport, as used to be the case in Europe.

The actual carrying of loads is hardly rational from the point of view of work done. However it only involves a very small investment. With donkeys, the finest pack animals (after the camel), the fastening of the load is often rudimentary and consists merely of a few cord lashings. Some carriers have made or bought bags or wicker baskets for the loads and in order to ensure better balancing on the animal's back (fig. 155-156).

It must, however, be said that pack transport is not really advisable and should be reserved for mountainous areas which are impracticable for wheeled vehicles. Everywhere else, the cart should be used because its efficiency is far greater.

In addition to the pack and the cart, we must briefly mention the sled. Sleds are certainly not advisable for transport on roads, but they are useful for short distance transport on very wet ground. On an ill-drained rice-field during harvesting, even a rudimentary sled can often be extremely useful for carrying paddy in sheaves. It is, moreover, on wet or even flooded ground that a sled's traction coefficient will be best (1).

Neither pack transport, nor sled transport is the real answer for the rural population. The real answer is wheeled transport by cart.

It should be pointed out that it is of interest not only to the farmer, but also to the rural population in general and even to the townsman. Indeed, the owner of a cart is not necessarily a farmer; he may be a trader, an artisan, a coal merchant, etc., which explains why, in certain regions of Africa, many donkey or horse-drawn carts are seen in the towns and very few or none at all out in the country.

The farmer has only recently become interested in the cart. The majority of locally manufactured or imported vehicles have been used for non-agricultural transport, particularly with draught donkeys and horses. Carts first came into use in the ports for urban transport purposes.

It has always been difficult to amortise the cost of an agricultural cart, which is a considerable investment, indeed one of the biggest of all the range of equipment the farmer may require. Without quoting precise figures, a cart costs about three

(1) The traction coefficient is the ratio between the effort provided by the draught animals to move the load and the load itself.

to five times as much as a medium-sized plough. This is why it is not always possible to equip farmers with them, particularly because, on the farm, they do not directly contribute to increasing crop yields, whereas the relationship between the plough and an increase in crop yield is much more obvious.

Nevertheless, since the farmer is above all a carrier, the importance of the cart is self evident and this is well proven by the success of the many efforts made, wherever draught animals are available, to make them available at a reasonable price.

Certainly, some of these efforts were made a long time ago; Malagasy artisans have been making carts for over sixty years and, in that country, professional cartwrights make wooden spoked wheels with metal rims, of a type very similar to those which, until a short time ago, were made in all countries of Europe and still are in some of them.

In other countries, such as the Central African Republic, less skilled artisans with more limited tools make solid wheels sawn from previously assembled blocks of timber. For nearly twenty years, however, the basic raw materials for making carts have been scrap car chassis or even just front axles with the steering system blocked. These axles with their original pneumatic tyred wheels, together with a simple platform attached above the axle by two angle irons or iron bars, with a wooden pole or shafts, make up a cart which is sturdy and relatively inexpensive. Unfortunately for the cartwrights, car accidents are still too rare and old cars are seldom discarded. Furthermore, wheels without axles and thus without any form of suspension are ill adapted for conversion into carts.

At the present time, carts available locally in Africa may originate from:

1. Importers of complete carts. This is a simple enough way to provide for local requirements but it is a costly way of doing it because, in addition to importing the mechanical parts, the wooden platform and pole are also imported.
2. Importers of carts without flooring or pole.
3. Local artisanal or semi-industrial manufacturers who import axles and wheels and make the platform and brackets, the pole or shafts, the rails, etc.

Local manufacture of carts by the third method is the most reasonable way to do it; primarily because it reduces the import cost while still providing sufficient technical guarantees; secondly because it gives the local artisans work within their capabilities and, finally, because it may lead to the creation of a small industry which will not necessarily always be limited to the partial manufacture of carts.

It is, however, necessary to know what type to manufacture, and past and present trial and error show that it is indeed difficult to define the ideal cart; one which would please everybody, need no maintenance, be cheap to buy and be well suited to all possible transport requirements and to the draught animals. Before going into technical details, we shall try to define a few general principles.

A. DRAUGHT METHOD

1. Donkey-cart (fig. 157)

This must naturally be light, i.e. weigh about 100 to 140 kg empty and be able to carry a load of at least 500 kg across country without distortion or breaking.

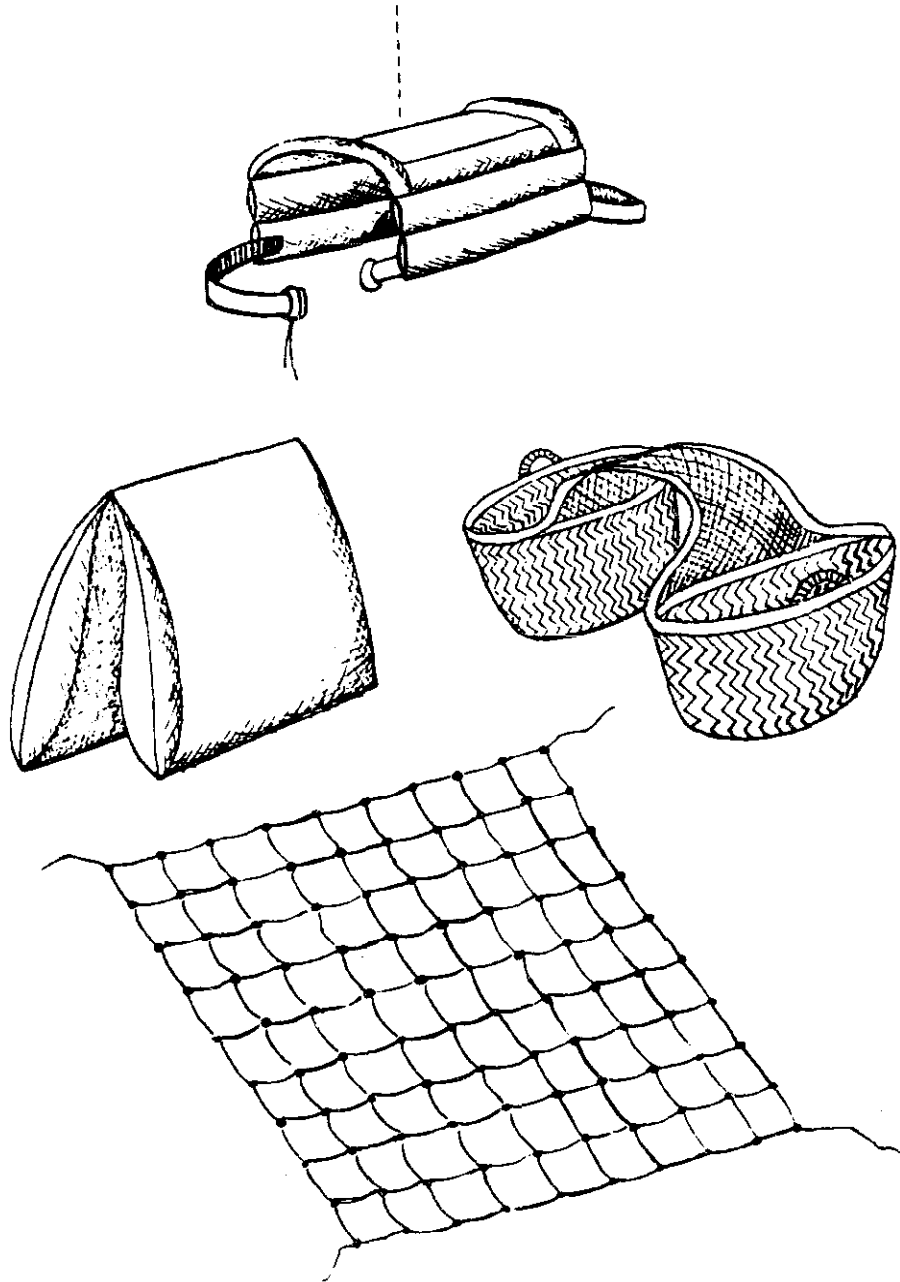
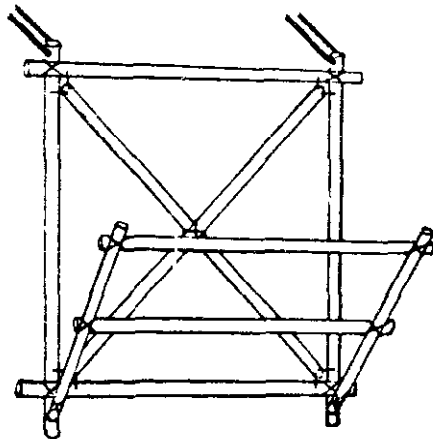
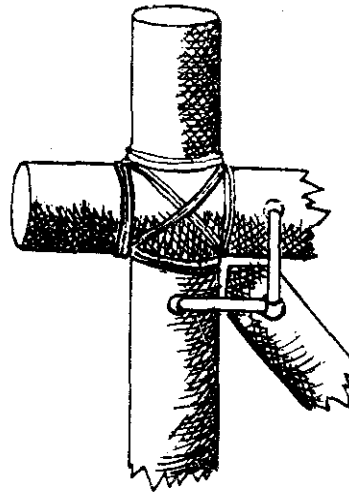

Fig. 155 Sketches of Moroccan type pack harnessing for carrying various loads



Sketch of cradle fitting



Detail of assembly

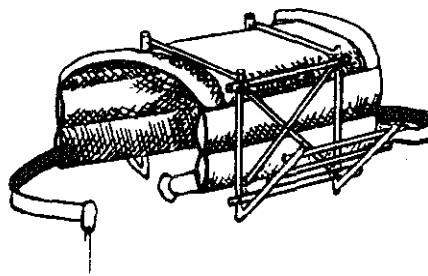

Cradle fitted to a Moroccan
type barda

Fig. 156 - Sketches of Moroccan type pack harnessing for carrying various loads

The floor area must never be less than 2 square metres. The ground clearance of the axle, if possible, should be more than 0.25 m so that it can clear obstacles and avoid accidents by catching on a stump, etc. The ideal is to do away with the axle, the wheels then being carried by arms, but this raises problems of solidity and ease of manufacture.

The spacing of the shafts, preferably made of metal, is about 0.50 m at the tips, their length in front of the platform being 1.40 m.

With the box-cart style, its capacity must be about 0.50 cubic metres.

2. Single ox-cart

The possibility of single ox draught is too often overlooked although it can be very useful, for example, in all cases where it is desired to substitute the ox for the donkey and where the farmer may, to begin with, have only one animal (e.g. Upper Volta). The interest in using a single ox is partly because of the draught capability of an ox harnessed to a cart (this will be examined later) and also because the donkey-cart previously described can be used without major modifications. It is only necessary to provide longer (2 m) and wider spaced (0.65 m) shafts. The harness will consist of a neck or withers yoke, depending on local custom, but the yoke can be permanently attached to the shafts of the cart. More complicated harness can also be used with a collar, if maximum use is to be made of the ox's draught power.

3. Ox-cart using a pair of oxen

For many years this is the system which has been most widely advocated. A great number of designs are available, of which the following are the general principles: the empty weight must not be much more than 200 kg, while the useful load must be able to reach 1,000 kg without distortion or breakage. The floor area may vary from 2.5 m² to 4 m² with a maximum width of 1.50 m. A minimum ground clearance of 0.30 m must be provided. The pole may be made of wood, never less than two metres in length, provided that the essential (and sometimes forgotten) condition is met that the farmer can cut a spare pole of acceptable dimensions from the local woodland. If this condition cannot be met, a metal tube is preferable, provided that it is very solid, even if it is more expensive. Many are the carts in good condition which remain permanently unused following breakage of the pole, simply because the owner cannot find a pole of the right dimensions near his farm.

4. Horse-cart

This is practically only used in Senegal and is little different from the donkey-carts.

B. DETAILS

1. Choice of wheels

Among the many questions concerning the design of carts, that concerning the type of wheel is certainly the most prominent. The choice relates both to size and type of wheel.

a) LARGE DIAMETER METAL WHEELS (fig. 159)

These have certainly been in use the longest, since GALLIENI introduced them in Madagascar at the end of the 19th century and they probably appeared in Africa at about the same time.

They may have a diameter of 1 to 1.20 m and the rim width may vary from 10 to 15 cm.

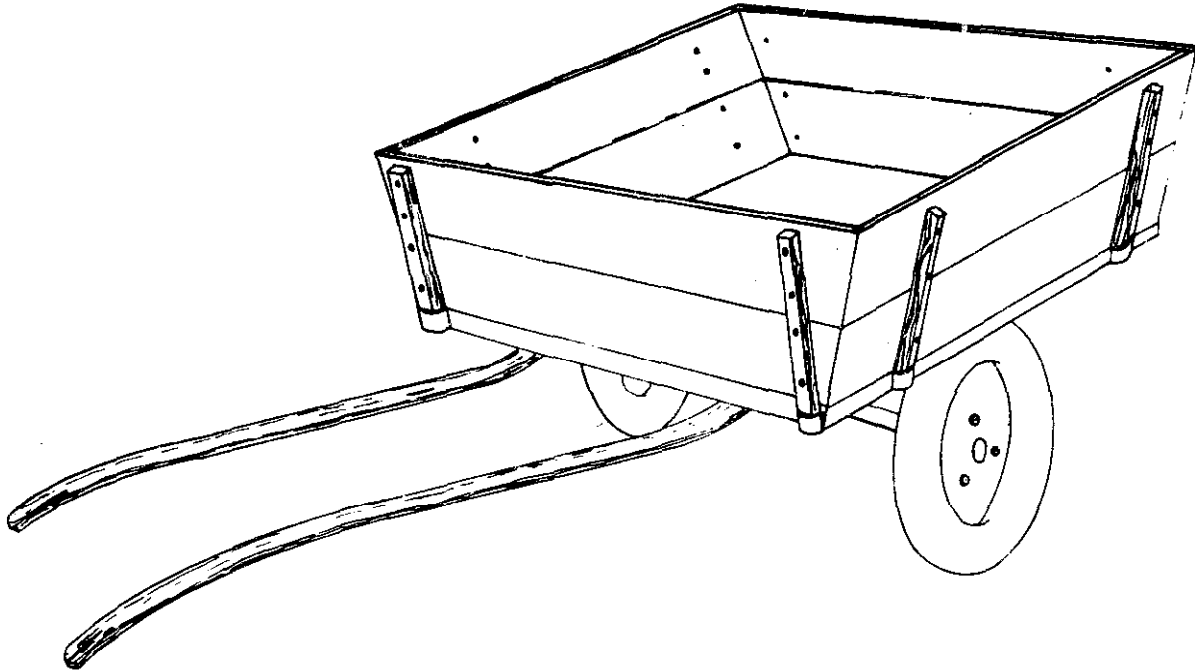

Fig. 157 - Donkey-cart with shafts
(useful load 400 kg)

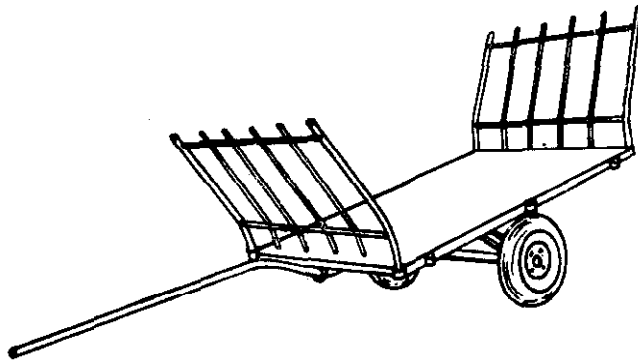

Fig. 158 - 1,000 kg farm wagon "AFRICA No.2 type", with
pole for ox draught.

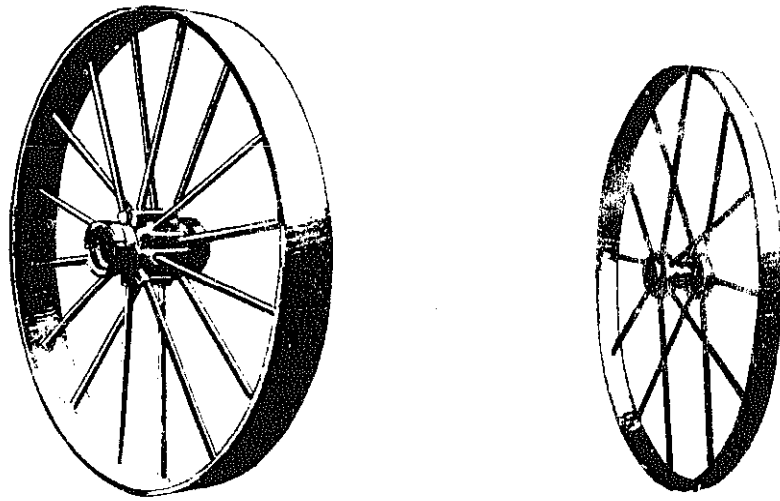

Fig. 159 - Some types of cart wheels

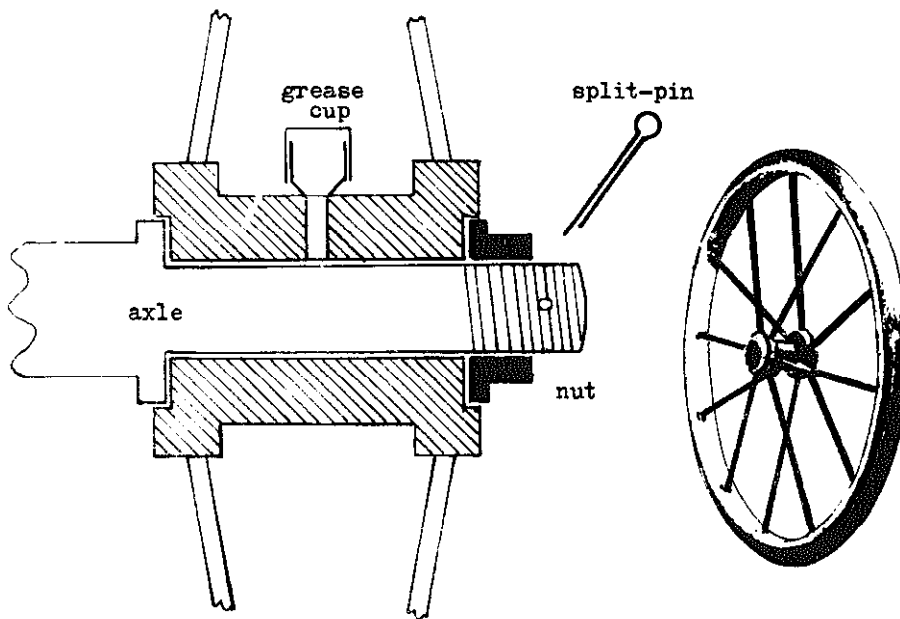

Fig. 160

Fig. 161

In all cases plain bearings are used, either cylindrical or conical. Sometimes the manufacturer inserts, between the axle neck and the wheel hub, a pair of split bronze bushes whose friction coefficient is lower than that of cast iron against steel. This design was introduced following unduly rapid wear of the hub, which was really caused by lack of lubrication, but which resulted in both wheels and axles being scrapped. The bushes are a definite advance, their replacement being cheap and easy, provided that the necessary spares are available.

As regards lubrication, here again there are two solutions, neither of them perfect. The first is a grease-chamber relatively well sealed against mud and dust, but which needs removal of the wheel to be refilled, which is rarely done. The other solution is to fit a grease cup screwed into a hole tapped through the hub into the grease chamber. Although, technically, this second solution may seem preferable, it is not so in practice since, in addition to the fact that the existence of a grease-cup does not necessarily mean that the owner will use it, it very often happens that the cup gets unscrewed or breaks and then mud, sand and dust can freely enter the grease chamber and cause very rapid wear (fig. 160).

The large diameter wheels are heavy and relatively costly. This means that the platform has to be unduly high, if it is desired to fit it above the axle by means of simple brackets. As a result stability may be endangered and loading is always difficult. If the platform is set between the wheels, directly on the axle, it is certainly lowered to a reasonable height (the radius of the wheel plus the diameter of the axle) but, at the same time, its width is limited since it must always be appreciably less than the wheel track.

b) SMALL DIAMETER METAL WHEELS

The characteristics of these are much the same as above with a diameter 50 to 80 cm and a rim width usually of 8 to 12 cm.

The lubrication problems are the same or if anything less favourable since the bearings are nearer the sand or mud and the wheels rotate faster.

The rolling coefficient is always less good and the ground clearance is reduced. These disadvantages are, however, compensated for by lower cost and weight and by its being easy to extend the cart body above the wheels, without unduly raising the load above ground.

c) METAL DISC WHEELS WITH SOLID OR SPONGE RUBBER TYRES

These wheels are universally unpopular. They are heavy, costly and fragile in that the solid rubber tyres, and even more so the sponge rubber, are easily gashed by rough road surfaces and stumps. While the solid tyres may last a reasonably long time, the others quickly wear out; this at least seems to be the result of isolated experiences, since sponge rubber tyres are very rarely found.

d) METAL DISC WHEELS WITH PNEUMATIC TYRES

This is obviously the ideal modern solution, particularly if, as is often the case, they are fitted with ball or roller bearings.

Under their advantages may be listed: lower draught effort (see later), relative flexibility of suspension with good effect on chassis life, ability to move without making deep ruts, lightness, etc.

Among the disadvantages, cost is a very relative one, since the metal rims are cheap and 145 x 15 car tyres for ox-carts or 135 x 13 for donkey-carts are available from obsolete stock and are also sold at reasonable price. The only serious disadvantage is the risk of punctures and it is this risk which, for a long time, was the reason why metal wheels were the only ones to be recommended. It is indeed a fact that carts are too often seen permanently abandoned because their tyres are punctured or merely deflated and that their owners have neither the tools, nor the necessary technical knowledge to carry out the simple repair needed.

This however is not a valid reason for condemning the pneumatic tyre; initially extension workers should take on the repairs and pressure checking themselves. They must check that a cart's tyres are always correctly inflated and, in particular, they must make the users understand that they must stop at once if they get a puncture.

A second stage, particularly in thorny areas where punctures are liable to be relatively frequent, may be to equip each user with a set of tyre-changing tools and a puncture repair outfit.

Pneumatic tyred wheels are automatically associated with ball or roller bearings. This need not be so since there are also carts with plain bearings on which pneumatic tyred wheels are fitted.

2. Choice of bearings and axles

This brings us to the advantages of the various types of bearing, plain or ball.

We have already mentioned that plain bearings wear out quickly and that this defect is to some extent remedied by split bronze bushes. It was thought for a long time that ball bearings wore out even quicker and that they should not be used. There were even attempts to introduce axles rotating in wooden bearings! Now, provided that the ball bearing is properly greased when fitted, is reasonably protected, or better still, sealed, one can be reasonably sure that it will last a very long time without attention. The contrary would, indeed, be surprising; it would be extraordinary for a cart wheel bearing to fail when a similar bearing on a car has to withstand at least as heavy loads at far higher speeds without necessarily being better greased. Despite their slightly higher cost, the present tendency towards the use of ball or roller bearings with pneumatic tyred wheels seems well justified (fig. 162).

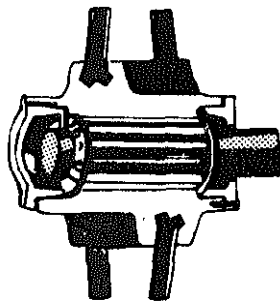

roller bearings

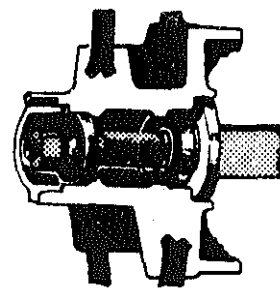

ball or tapered roller bearings

Fig. 162 - Bearings

As regards the axles, various manufacturers provide 35 mm square section steel axles for carts with a useful load of 500 kg and 40 mm for ox-carts with 1,000 kg useful load. This is the most usual type but it does not exclude others. Thus, in Dahomey, some locally made carts have Citroen rear suspension arms with their bearings, resulting in new style carts without axles and therefore with considerable ground clearance. Donkey-carts use the parts from the Citroen "2 CV" and ox-carts the arms of the "ID". These arms are welded to a tubular cross-member on which the platform is laid. This is just one example among others but is worthy of mention because of its originality.

3. Details of the loading platform

When the transport of bulky but not heavy products is involved, a platform with detachable side members is advisable. The cart may then be supplied with or without the side members. The platform in all cases should be provided with the means to attach the sides. It is a good idea to have the sides sloping outwards in order to increase the useful capacity to some extent. It seems unnecessary to deliver the side members complete and it should be sufficient to supply the metal mountings already drilled and with bolts. The user can then complete the work with local materials, provided that he is given the necessary instructions.

The platform may be made of metal (with a single piece of sheet iron) or of hard wood. This is a question of local cost price and of weight. One of the recognized advantages of the platforms of some imported carts is precisely the saving in dead weight resulting from the use of metal; a thin iron sheet welded to a light frame results in both strength and low weight. The simplest arrangement, consisting of an angle iron frame to which planks can be fitted, sometimes results in a very heavy platform.

4. Arrangements other than platform and side members

Few box-carts are seen in use. Nevertheless, simple home-made arrangements can produce a tip-up box-cart which can be very useful for transporting manure, stones and all bulky materials. However, with such arrangements, the dead weight is very high, sometimes as much as the useful load, so that efficiency is much reduced (fig. 163).

Water-carts are more numerous, but they are nearly all to be found at research stations and agricultural institutes. In view of their high price, the best thing for the peasant farmer who already owns a cart is to buy one or two 200 litre casks which he can carry temporarily on his cart as and when required. The height and weight of the casks, however, does not make them particularly easy to fill and empty (fig. 164).

Four-wheel wagons are not in general use, probably because of their high cost and the draught effort required. The simplest consist of two sets of wheels connected together by a central beam or pole also known as a "perch". The front set of wheels pivots in a turn-table, resulting in an excellent steering lock. The few examples in use at the research stations are satisfactory since, with good draught animals, they can carry big loads without the need of adjusting the weight distribution. A wagon could probably be used on a collective basis by a group of several peasant farmers (fig. 165).

5. Various manufacturers

In addition to local manufacture, which will certainly go on developing, at least on the basis of imported wheels and axles (e.g. in Senegal), several manufacturers still make types of cart suited to the requirements of the countries in question.

C. PRACTICAL TRANSPORT POSSIBILITIES

Trials are at present in progress to assess, on the one hand the characteristics of the ideal cart and, on the other, their practical possibilities with various draught animals.

In fact, the type of terrain and, particularly, its hilliness, will have a considerable influence on the useful load of a cart, depending on the capabilities of the animals. A specific example will serve to illustrate this concept, though a reminder of certain definitions will first be given.

A rolling coefficient may be established for any vehicle travelling on ground of a particular type; it is the ratio between (a) the force needed to move the vehicle, and (b) the load carried including the dead weight. This coefficient will be lower as the bearings turn more freely. It will be affected by the dimensions and type of wheels, etc. It is found that this coefficient will vary from 0.01, on, for example, a concrete surface, to 0.1, on damp agricultural soil, to reach and even exceed 0.25 in marshy ground.

On an absolutely smooth, level, concrete surface, the movement of an ox-cart weighing 1,250 kg (1,000 kg useful load plus 250 kg dead weight) will require a force of:

$$1,250 \times 0.01 = 12.5 \text{ kg}$$

This is within the capability of any draught animal, although a much greater instantaneous starting force will be required to overcome the inertia of the load.

On damp agricultural soil, however, the force to be developed becomes:

$$1,250 \times 0.1 = 125 \text{ kg}$$

This is a full load for a pair of oxen and this will also apply on sandy soil.

Let us now consider what happens when going up slopes of known steepness.

The formula for calculating the theoretical force is:

$$T = k P + P i$$

where P is the total weight of the loaded vehicle, k the rolling coefficient, i the steepness in metres per metre length of slope and T the draught effort required to move the vehicle.

Let us take a concrete surface slope of steepness 0.10 m per metre:

$$T = 0.01 \times 1,250 + 1,250 \times 0.10 = 137.5 \text{ kg.}$$

It is thus seen that, much more than the rolling coefficient, it is the type of ground and, particularly, the steepness of the slopes which determine the useful load.

All other things being equal, pneumatic tyred wheels have better rolling qualities than iron wheels and this seems particularly true on muddy or sandy ground. A pneumatic tyre manufacturer claims that, compared with an iron-rimmed cart wheel, a pneumatic tyred wheel reduces the rolling coefficient by the following percentages:

35% on the road and 64% on muddy ground.

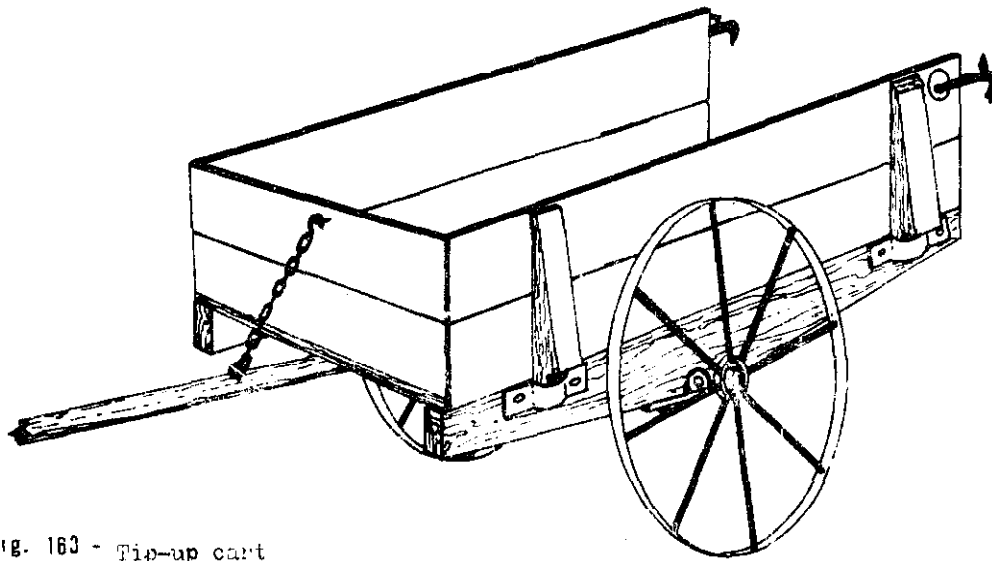
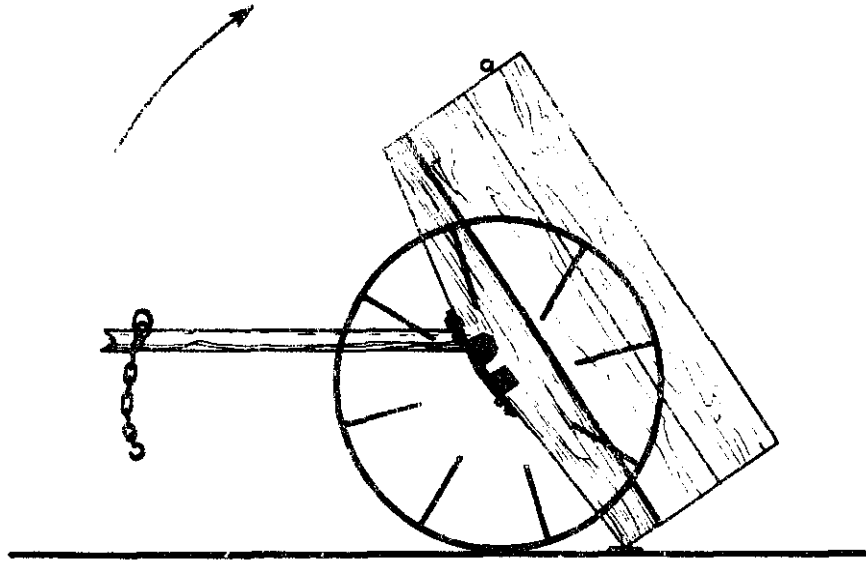

Fig. 163 - Tip-up cart

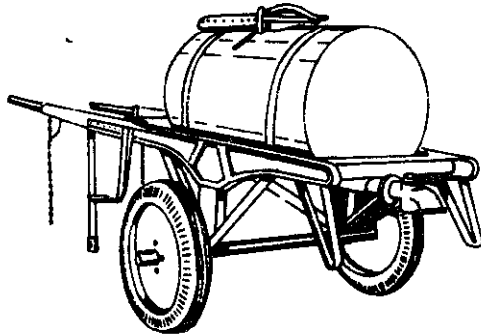

Fig. 164 - Water cart

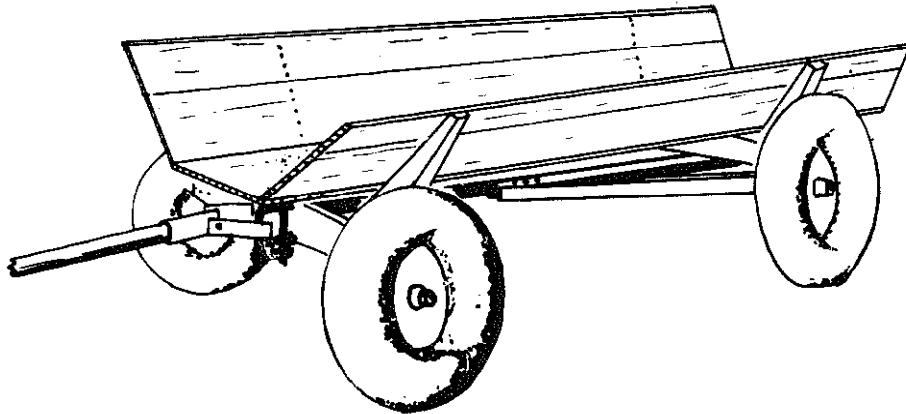

Fig. 165 - 4-wheeled wagon (pneumatic tyres)

It would be interesting to know the percentage for sandy ground.

The effort to be developed when going uphill may cause the draught animals to stop, which is not very serious. It must not, however, be forgotten that slopes are downhill just as often as they are uphill and that a pair of oxen with a withers yoke finds it very tiring holding back a load, if only because the yoke slips forward and tends to strangle them, not to mention the braking effort we have discussed. In the worst case, an accident may occur because of involuntary running away of the draught animals. The remedy would be to fit a braking system (a mechanical device), but this solution is often impossible, although one manufacturer has made available a brake controlled by a lever for Madagascar. Usually, the load has to be limited to an acceptable weight for both downhill and uphill work. Going up or down hill alters the longitudinal balance of the cart to the detriment of the efficiency of the draught animals. This is why four-wheeled wagons are more often used than carts in mountainous countries.

Whether the wheels are metal or not, however, the maximum forces will really depend on the steepness of the slopes. Thus, although choice of wheels is certainly important, it may be less so for the success of cart work than other factors, of which price is probably the most vital.

Practical experience proves that, on relatively flat and firm ground a reasonable useful load for a pair of oxen is 800 kg and up to 400 kg for a donkey, with the essential provision that the load must be properly balanced.

Recent experience in Madagascar has shown that some locally manufactured carts were completely out of balance, even when empty, because of the position of the axle. With one of these carts, empty, the downward load of the pole (bearing on the necks or withers of the oxen through the yoke) was checked; it amounted to 75 kg. With a driver sitting at the front of the cart on the special shelf for the purpose, the vertical load went up to 125 kg. To bring the vertical load down to a still high but more reasonable figure of 35 kg, the rear of the platform had to be loaded with a weight of 250 kg!

A well made cart must be correctly balanced when empty. This is one of the important characteristics to check. Care must be taken not to upset this balance unduly by ensuring that carts are loaded evenly and correctly. In no case must the downward load at the end of the pole or the shafts exceed about 20 kg.

In conclusion, let us say a few words about harnesses. Those needed for a cart with a pole and pulled by a pair of oxen are the same as for a plough, but the pole, which takes the place of the chain, is attached to a central ring on the yoke. In other cases, the yoke is simply lashed permanently to the pole for quick harnessing up, which implies at least one spare yoke for other work.

In the all too rare case of a single ox-cart, we have already mentioned the value of the single neck or withers yoke, but a collar may also be used.

With donkeys and horses, the collar or the lightest breast-harness must be used. This has already been discussed in the first part of this manual.

In conclusion, it is very important to note that, even in regions where the animals can do other work, it is often with the cart that animal draught is first used and, to begin with, for taking people and produce to market. Later, the owner uses his cart for transporting seed, implements, etc., between the village and his fields and does the same for his neighbours. Finally, and unfortunately all too rarely, the cart is used for carrying manure. What must be stressed is the fact that, because he needs his animals at various times of the year, the farmer must provide shelter and a reserve of forage for them near their shed or rudimentary stable - their work brings him in money.

When they are well treated and well fed, the animals work better. When the cultivation season arrives, having not been put out with a stock breeder's herd during the dry season, they can immediately start working in good condition in the fields.

One can not over emphasize the importance of the cart as a vital factor in agricultural development.

PART THREE

DRAUGHT ANIMALSA SOURCE OF ENERGY FOR RAISING WATER AND OTHER TASKS

I

SOME GENERAL REMARKS

In the preceding part of this handbook, we have dealt extensively with equipment powered directly by draught animals without mechanical intervention. As soon as we leave the field or the road, however, matters become more complicated when we want to apply this animal energy to "farmstead" work. It was quickly found that, here, "animal draught" could not be used directly like it was for pulling an ard, since it was necessary to develop a circular or to and fro movement. In other words, it was therefore necessary to design a complicated system of animal power gears to convert the animal's effort and adapt it to the particular task to be performed.

The use of animal power gears was steadily increasing in temperate zones until some 50 - 60 years ago. The peak of its use, in Europe and North America, was reached at the beginning of the 20th Century when the applicable transmission systems were technically well developed (perfectly machined gears, high quality cast iron and steels, etc.). At that time as yet little use was being made of inanimate sources of energy (the steam engine was still expensive and electricity was out of reach, while internal combustion engines were hardly in existence).

More than twenty manufacturers of animal power gears were marketing their products in France alone, for driving such implements as threshing machines and for pumping, or more precisely for raising water by means of bucket conveyors, chain pumps, etc. This steady progress towards the improvement of and the general use of animal power gears continued in Europe and North America until the appearance of petrol and paraffin and subsequently diesel internal combustion engines which really started spreading from about 1920. Since that time the use of animal power gears has declined rapidly in these countries. Nevertheless some of the traditional rudimentary animal power gears, often of wooden construction, are still being used for lifting water, mainly in North Africa, the Near and the Far East. In South East Asia they are also being used for sugar cane crushers.

Animal power gears could still perform a useful function in certain parts of Africa, particularly for lifting water in remote villages. This would apply particularly in cattle rearing areas or where draught animals are used. A water lifting device can be worked with one or two draught animals. On the other hand it would not be practicable to use animal power gears for operating farmstead equipment, such as thrashers, shellers or grinders because they have too high a power requirement. There is only limited power available from an animal power gear. The continuous power output with an ox for instance is on average equivalent to $1/8$ of the weight of the animal.

The average working speed of draught animals on a circular track is 0.60 M for oxen or donkeys, and 0.70 M for horses. Thus the power available from a power gear worked by a single animal is something like 0.16 HP for a donkey, 0.25 HP for a horse or light ox and

0.32 HP for an ox of 400 Kg. In practice one may expect with a pair of animals an output of between 0.30 and 0.60 HP for a period of 45 minutes. Account has to be taken of resting time and that the maximum number of hours worked per day may not exceed 4 hours.

There are still a few manufacturers in Europe, notably in France, Poland, Portugal and Spain who can deliver animal power water lifting devices. Such devices are presently being used in the Cameroons, Niger, Senegal and Upper Volta.

In addition to various types of water lifting devices, animal power gears are also being used for sugar cane crushing machines with vertical cylinders. These are used by rural artisans in India and several countries of South East Asia. This type of cane crusher is still being manufactured mainly in India and in Britain.

In all those tropical regions where draught animals are helping in the development of the country, the use of animal power gears can provide a definite improvement over human power whilst awaiting the introduction of the internal combustion engine. However, it is advisable to use animal power gears only where the power required can be adjusted to match the available power of the animals. Thus the input of a sugar cane crusher can be so controlled that it matches the available power. And a cup type water lifter can be powered by a donkey in good condition to lift 1/2 cu.m. of water from a 20 m. deep well per working day.

An argument against animal power gears is that they are relatively expensive in comparison with internal combustion or electric motors. However they are not intended to be used where electric power is available. Moreover, they are more reliable, they do not require maintenance and furthermore they make use of a type of power that is all too often underemployed and the running costs are very moderate.

PART FOUR

RURAL HANDICRAFTS

In the previous chapters we have discussed draught animals and the equipment operated by them. In the next part we shall deal with the economic aspect of the use of draught animals. In this part, however, we shall consider how the maintenance, repair and even manufacture of certain equipment or harnesses can be done at user level, in other words to what extent these tasks can be done by rural artisans.

Although at present for the most part, only hand tools for agricultural requirements are made by rural artisans, their activities should, in the future, expand vigorously as a result of the provision of new agricultural implements.

Indeed, the after-sales service needed to keep this equipment in good condition hardly exists at all in tropical Africa. While there has usually been a rather casual approach to the maintenance of the equipment and the replacement of worn out parts, it must also be admitted that some firms which have competed in providing this equipment, would encounter financial difficulties in providing a proper after-sales service, in their area of coverage, for all the wide range of different implements of different makes which they represent. This would very often mean, solely for spare parts, keeping stocks worth more than the equipment sold.

As a direct result of the lack of an after-sales service, the user could give the impression of being wealthy, because he often abandons his implements(1). It is probably quite normal to accept that the small scale sales agents in the bush are not in a position to provide an after-sales service for the equipment distributed in relatively small numbers; particularly if this is meant to include not only the supply of spares but also their fitting and possibly, also, general overhaul of the implement. Nevertheless, the work has to be done somehow.

Straightaway, it seems logical that this service should be provided by the blacksmiths already in the villages who should thus develop into farriers or rural mechanics. This implies adequate training and the provision of the appropriate equipment for their work.

BUT WHAT IS AN AFTER-SALES SERVICE?

It consists in ensuring, at all times, the speedy repair of agricultural implements which develop faults or which break down after supply.

Indeed, it is important that the equipment is always kept in perfect running order and that, when necessary, the results of accidents or breakdowns can be remedied in the shortest possible time, regardless of the geographical dispersion of the farms.

Since, generally speaking, the manufacturer, or importer, is not at present in a position to provide an after-sales service for his equipment and that, in most cases, the individual farmer has no training to enable him to carry out the smallest repair, only the rural artisans could (and must) become the cornerstones of the proper maintenance of animal draft implements, and, in consequence, of the satisfactory development of its extension.

As regards development of the use of animal draught implements, several other activities will come within the scope of rural handicrafts. We may mention saddlery (at least one of its aspects, harness-making, is of interest to animal draught cultivation), woodworking or carpentry (making yokes) and sometimes basket-making. These are the activities we shall now examine.

(1) From the commercial point of view, it may seem better to replace the whole implement rather than a part but, from the economic point of view such action is undesirable both for the farmer and for the administrative authorities and indeed, in the long run, for the supplier too.

To begin with, we should briefly recall how the after-sales service for agricultural implements is organized in countries where agriculture is sufficiently modernized, in Europe for example.

Various professions are involved in the maintenance of agricultural equipment; starting from the manufacturer or importer, these are:-

- the regional concessionaire;
- the dealer-repairer;
- the rural artisan.

The first, on a regional scale, is rather like a "wholesaler" who distributes the equipment and supplies the spare parts. He may also undertake major overhauls in his repair shop.

The second, on a more limited scale, sells and repairs agricultural equipment; his conventional and material links with the concessionaire may vary widely.

Finally, the rural artisan deals with breakdowns on a village or group of villages scale. In addition, he often has a close relationship with the dealer-repairer for whom he acts as local feeler, particularly in reporting his clients' needs.

In Africa, these various intermediaries (who are useful if not essential) do not yet exist because of the small numbers and wide variety of implements at present in use.

I. PRESENT STATUS OF RURAL HANDICRAFTS

At the present time, as regards agricultural equipment, rural handicrafts are limited mainly to the manufacture of local design of implement, sometimes copied from extremely ancient types. We may mention, as an example, the hand hoes and the carts of Madagascar, the traditional hand hoes in Africa, and more or less rudimentary harnesses (fig. 174).

Little maintenance work is undertaken by the artisan. This is because the farmer waits till the last possible moment when parts are worn out or have failed completely before going to see the artisan, whose main activities consist in sharpening a tool, replacing a cartwheel spoke and, sometimes, welding a broken part.

When it is a question of improvements or repairs, the work is usually expensive (prices are based on import prices or on those of repairs carried out in a city workshop) and badly done because of lack of technical skill and equipment as well as bad choice of raw materials.

These features apply fairly generally. A distinction must, however, be made between Malagasy rural handicrafts and those of mainland Africa. The Malagasy artisan is appreciably more capable of maintaining-repairing animal draught implements, one reason being that he uses more advanced methods and is better equipped.

A difference should also be made in rural handicrafts between the professions of blacksmith and saddler. The first should be capable of maintaining and repairing agricultural equipment while the second should be able to make various types of harness used locally, which sometimes implies that he knows the rudiments of woodworking.

Under what conditions, however, do these artisans usually work?

A. THE BLACKSMITH

The equipment, tools and working methods briefly described hereafter represent what is generally found in French-speaking Africa.

The workshop and tools are extremely rudimentary (fig. 175).

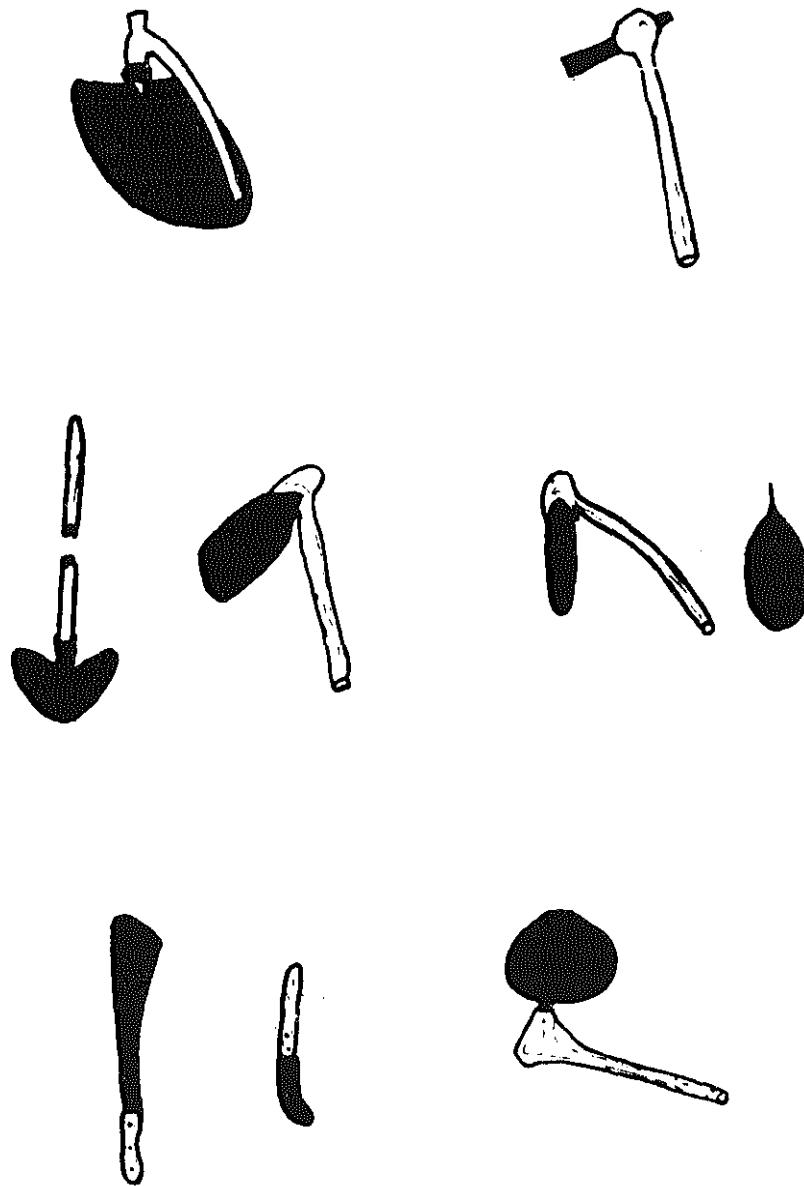
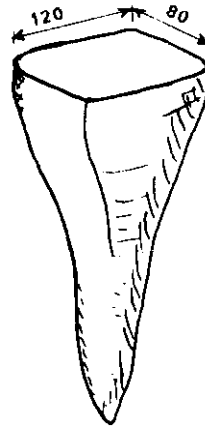
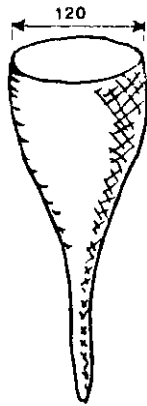
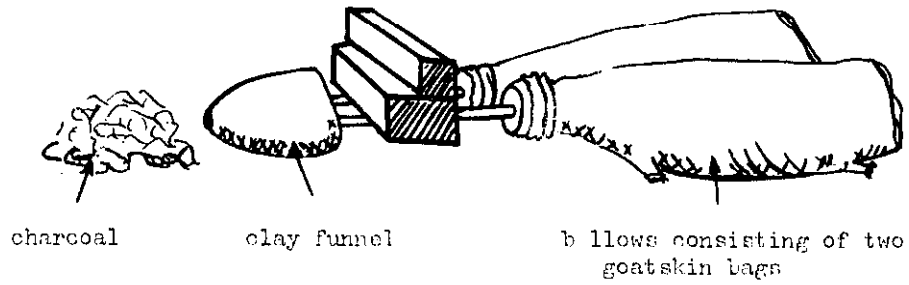

Fig. 174 - Some traditional tools made by artisans

Fig. 175 - Sketch of a Nigerian artisan's traditional forge



Anvils

Sketches of blacksmith's tools

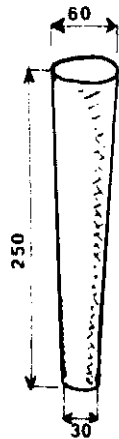

sledge-hammer head

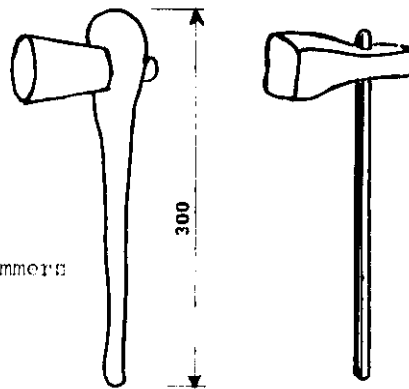

hammers

The workshop is generally set up under a round shelter, of average diameter 3.50 m, made of posts driven into the ground on which is laid a framework of branches over which may be added a matting covering.

The forge, made locally, is directly on the ground. It should be noted that some blacksmiths using portable bellows have dismantled them and set them on the ground so that they can work sitting down.

The anvil is a simple block, generally of truncated cone shape, and whose striking face is 12 to 15 cm in diameter. It is driven into a tree-trunk buried in the ground.

The vice is hardly used at all and very often the artisan uses his feet instead.

The tools usually consist of: sledge-hammers and claw hammers, pincers and tongs, cold-chisels, files, etc.

A very few artisans have hack-saws and light anvils.

Working methods are extremely simple. The workman rarely takes measurements. The use of gauges, the square, the mould, etc. is unknown. The fuel used is wood or charcoal (often of low quality). The raw materials no longer come from the extraction and treatment on the spot of iron ore, but usually consist of scrap iron.

B) THE LEATHER WORKER

This artisan traditionally works in leather and skins to make fancy leather goods and articles for shoe-making and, sometimes, saddlery. So far, he has not had occasion to make harnesses for animals.

He has a small workshop and works at home.

His equipment, mostly locally made is extremely limited: paring-knife, polisher, bradawls, scissors, hammer, etc.

He either buys his raw materials (leather, fabric, thread) or makes them himself (tanned skins, fine strips of leather instead of thread).

As regards working methods, it may be said that his skill is some compensation for his lack of technical knowledge.

So that rural handicrafts may play the important part they are capable of in the development of animal draught cultivation they must either be trained or their skills improved, but this involves qualified experts. The artisans should also be given the necessary equipment for dealing with new requirements.

II. IMPROVEMENT OF RURAL HANDICRAFTS

What part can the rural artisan play in the development of animal draught cultivation, how can his equipment, training and working methods be improved? These are various questions we shall briefly examine below.

A) THE ROLE OF RURAL HANDICRAFTS

Development should enable:-

- the blacksmiths to be in a position to maintain and repair (and possibly adapt) locally or regionally distributed agricultural implements; their main concern will be to help the farmer, whose requirements they should be able to meet completely, as regards both animal draught implements (maintenance and repair)

and the traditional agricultural tools (hoe, axe, sickle, knives, etc.) whose quality will have to be improved;

- the harness-makers to be in a position to make the various types of harnesses recommended by the qualified Services (Yokes, collars, saddles, traces, draught poles, etc.) and to maintain and repair them.

B) IMPROVEMENT OF EQUIPMENT AND WORKING METHODS

1) The blacksmith (fig. 176-177)

He must be taught how to improve his present methods, to know how to use better tools and how to make use of new methods.

The main requirements for improving methods and traditional tools are as follows:

- the use of better fuel with a higher calorific value;
- general practice of working standing up;
- adaptation of the traditional equipment to this new method of working, involving raising the roof of the workshop but also the forge and the anvil. It will then be necessary to have a bench for the tools and these latter might need longer handles;
- the use of measuring and marking instruments: rules, square, compasses, scribes, gauges;
- the use of ancillary forge methods: hot and cold cutting, stamping, punching and splitting, welding and brazing; forging of steel (shares, hoe and harrow teeth), tempering;
- the use of various assembly methods: hot rivetting, oxyacetylene welding, the use of screws, bolts and washers;
- improvement in finishing: the use of files, a mould, a polisher;
- the routine maintenance of and simple repairs to mechanical farming implements.

2) The harness-maker-saddler

The harness-maker, whose skills are generally considered to be good, must however be given additional training so that he may improve his traditional methods and, in particular, he must be able to do a limited amount of wood-work.

He should, therefore:-

- be taught the use of a wider range of tools (pedal operated knife, curved bradawl, compasses, punching tool, etc.);
- learn new working methods (two needle sewing, leather thong sewing, maximum use of local raw materials, etc.);
- be shown how to make the new articles expected of him (yokes, collars, traces, etc.).

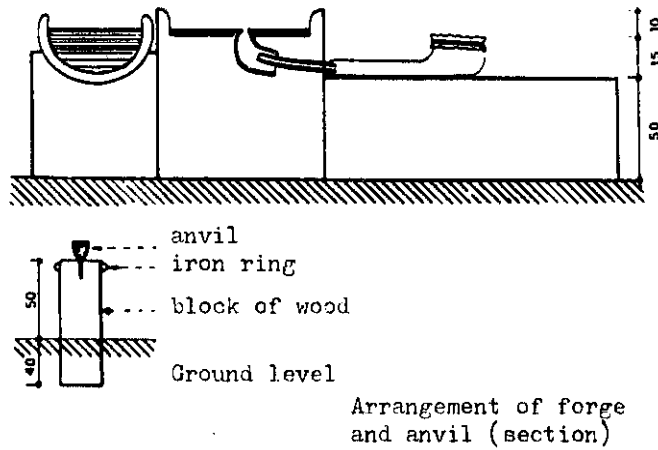
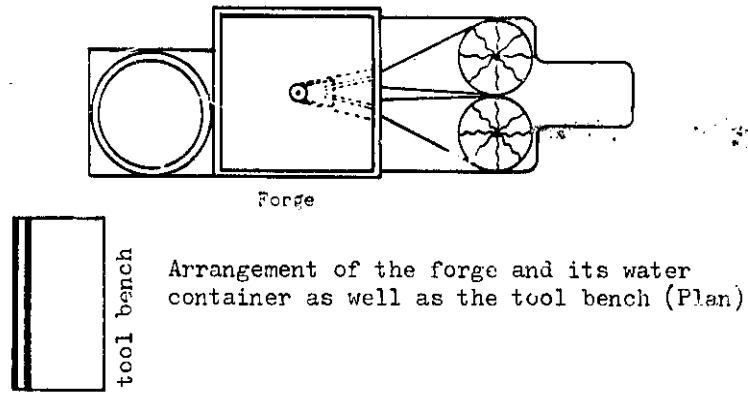

Fig. 176 - Sketch of adaptation of blacksmith's equipment for working standing up

Suggested diameter of workshop: about 3.50 m

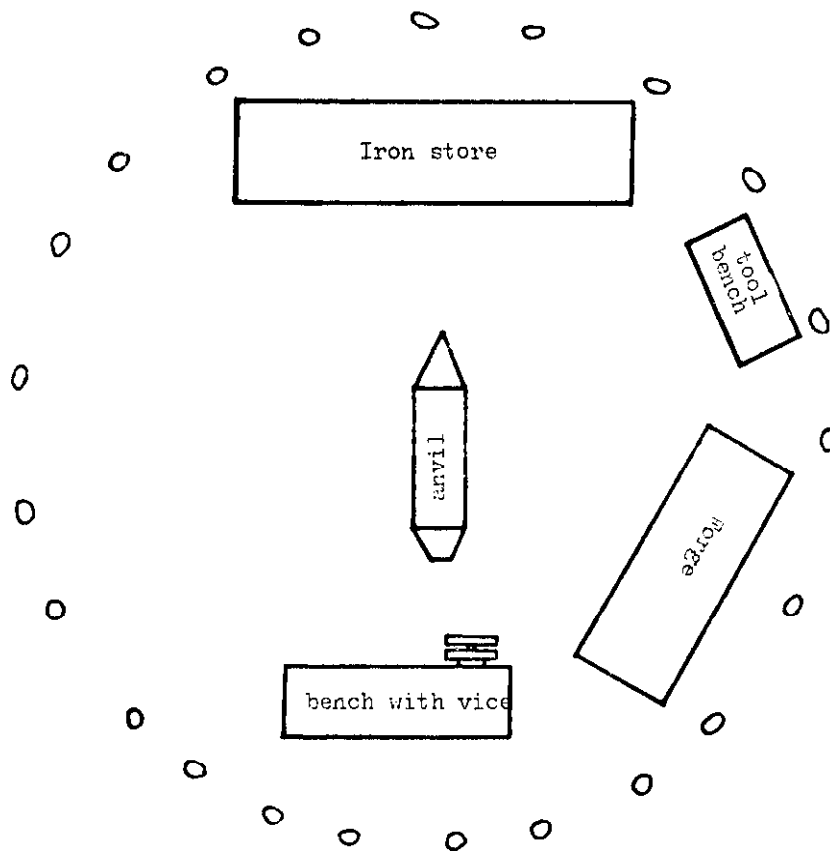

Fig. 177 - Sketch of modified traditional workshop

C) IMPROVEMENT OR TRAINING OF RURAL ARTISANS

The rural artisan blacksmith, as described above, will be an important link, if not an essential one, between the Manufacturer or Importer and the User of agricultural machines. It is, however, only gradually that the rural artisan will be able to play this part. He must first be trained.

It is the responsibility of the appropriate public services to undertake or promote the establishment of the necessary basic tools and equipment.

We cannot list here all the requirements for training the rural artisan. After mentioning some of the steps taken in certain countries for improving the professional qualifications of the rural artisans, we shall give two examples of such training, at different levels.

In Madagascar, the Minister of State for Rural Economy has created a Technical Aid Company (the S.A.T.E.C.) responsible for working out and then implementing a programme for improving rural handicrafts. The aim is "to teach the rural artisans the simple techniques of mechanics, forge work, welding and brazing, so that they can repair agricultural implements and make various simple agricultural tools or machines."

In Senegal, a factory making agricultural equipment (SISCOMA), considered it vital to set up, within the factory itself, a professional training center. This trains the members of the distribution network and the agricultural extension workers and also runs a series of courses for rural artisans "who can thus improve their rudimentary methods and acquire an extensive knowledge of the implements they may sometimes be called on to repair".

It is to be hoped that other local factories making or assembling agricultural equipment (ABI in Ivory Coast, TROPIC in Cameroon, SIDEMA in Madagascar) will adopt a similar attitude towards the training of rural artisans.

In Upper Volta, a harness-making workshop has been set up at the instance of the local SATEC agency and trains harness-makers to make the various types of harness used locally.

In Niger, the U.N.C.C. is concerned about the rural handicrafts problem and is planning to organize a mobile workshop (temporarily the best solution) pending the training of the village blacksmiths to maintain and repair agricultural equipment. In order, at least partially, to alleviate present difficulties in this field, the C.E.E.M.A.T. Engineer responsible for the practical training courses in agricultural mechanics is adjusting his subject matter to include a large amount of simple mechanical work and is making particular efforts to provide specialist training for certain rural artisans.

In Mali, the local authorities, faced with the general distribution of agricultural equipment and with the fact that, for the moment, the local artisans are unable to carry out maintenance or repair work, have made special arrangements. As an integral part of an experiment they are financing, these authorities have called on the C.E.E.M.A.T. and the B.D.P.A., jointly, to train qualified technicians and to equip the service vans, which are used on a roving basis for extension work, for the repair of agricultural machinery. These vans carry the necessary tools and sets of spares for the maintenance and repair of locally distributed implements. (fig. 178-179).

- 1st example: The training of rural artisans in Chad (Pala and Fort Archambault)

The aim here is to train general purpose rural artisans to work on their own account in the villages of Southern Chad, where animal draught cultivation is developing.

The instruction is essentially practical and is given by the I.L.O.; it is designed to train pupils to become cartwright-blacksmiths (working in wood and in iron).

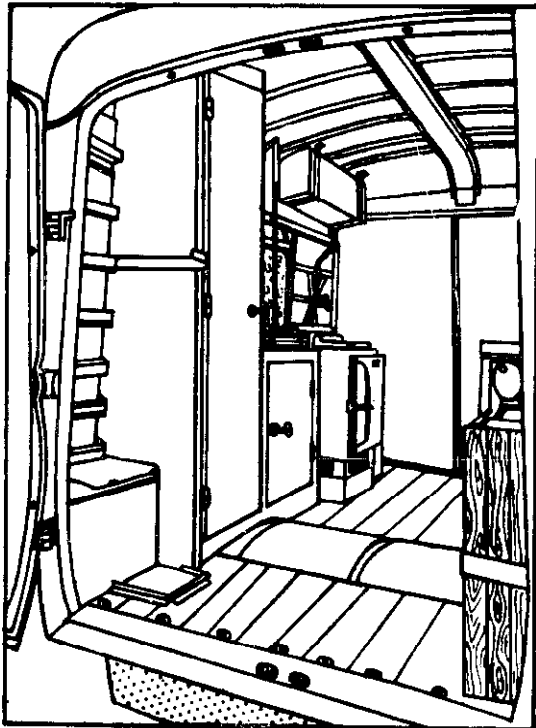

Fig. 178 - MALI service van
accommodation section

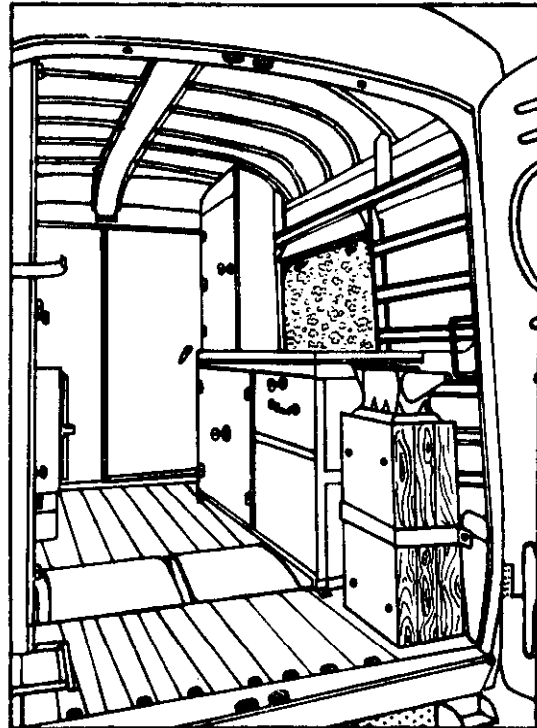

Fig. 179 - MALI service van
work-bench and forge

SOURCE AND STANDARD OF PUPILS

These are young adult Chad citizens, 18 to 30 years old, from the up-country villages where they want to work.

Their level of education is generally limited to 2 or 3 years at a rural school. In most cases, they have already lost the benefit of this schooling, dimmed by time and the lack of opportunity to make use of the knowledge gained. Candidates are however required to know how to count and be able to speak either French or Arabic in addition to their mother tongue.

SOURCE AND STANDARD OF INSTRUCTORS

Other than two International Labour Office experts who are specialists, one in iron-work and the other in woodwork, three Chad instructors help with the training. The latter are young men from the south of the country whose scholastic knowledge is at about primary school certificate level, with additional technical training to professional competence certificate level; they must be able to speak one or more local dialects.

LENGTH OF TRAINING

The total duration of the training course is about 9 months and includes:-

- basic training: 120 working days, made up of 60 days on wood work and 60 on iron work
- practical in-service training: 70 working days.

TRAINING METHODS

Two workshops, one for wood and one for iron, enable the pupils to work as apprentices using very simple tools, without any motive power, similar to those they will have to use in the villages where they will be working. The details of the training programme have been worked out on the basis of the following criteria:

- local manufacture by traditional artisans;
- new requirements resulting from the recent introduction of animal draught cultivation.

During their time at the Training Centre, the pupils make some of their tools themselves (forge tools, bellows, various gauges, etc.). The others are made available to them, thanks to a loan from the Chad Development Bank (B.D.T.) of about 90,000 F CFA, repayable in 3 years.

They are also given instruction in basic business methods which is essential since these artisans are granted a loan by a State bank to set themselves up, solely on the guarantee of the future success of their business.

A roving mobile workshop assists with the practical in-service training. This is carried out in the home villages of the pupils, and enables them to be helped in setting themselves up.

COST OF TRAINING

The premises used are old disused Army buildings on the outskirts of Fort Archambault.

The cost of training (operating expenses) has been estimated at 200,000 F CFA per pupil.

- 2nd example: Training of rural artisans in Madagascar

The Rural Development Commission considers that the artisan should be trained where he normally works, or under as nearly similar conditions as possible.

In order to do this, a mobile workshop has been used to set up demonstration centres. The artisans taking part in the demonstrations are then visited individually, each case being considered separately.

Training of the artisans varies with their level of development. They may be grouped into two main categories:

LEVEL 1: These are artisans working in the most traditional way with bad tools and who usually have very little money. Their monthly income is estimated at about 4,000 Malagasy francs to feed a usually large family including children too young to help.

LEVEL 2: These are artisans using better tools and more rational methods. Their monthly income may be assessed at about 10,000 F. Their training must be specifically orientated. Greater emphasis must be laid on organization and management.

The technical training of the first group (Level 1) covers:

- plough repair and maintenance operations: how to repair a wheel, beat out a share, straighten a mouldboard, beat out or remake a bar point share, and adjust the plough;
- improvements to tools (tongs) and the introduction of new tools (die stamps, taps and dies);
- the manufacture of items in general use, in order to make use of slack periods (yoke rings, wheelbarrows, forks, small hand tools).

The technical training of the second group (Level 2) involves:

- maintenance and repair operations on a variety of implements;
- modernization of equipment (drill, hand-press, sheet metal roller, bending machine for wheel rims, etc.);
- oxyacetylene or electric-arc welding (1); it is, indeed, essential to introduce welding to the artisans; nothing really constructive can be done without the assistance of this new technique (some advanced artisans already possess oxyacetylene welding equipment, often with an acetylene generator, and one of them even has electric welding equipment);
- the manufacture of small items;
- the production of agricultural implements (rotary rice weeder, cart).

The technical training of the two groups is completed by commercial training appropriate to their level.

(1) In view of the cost of a new acetylene generator (45,000 Malagasy francs), it is difficult to insist on its purchase when it is desired to popularise welding. The use of bottled acetylene seems more economical. A definite opinion can, however, only be given when the efficiency of locally made generators is known.

III. FROM RURAL ARTISAN TO DEALER-REPAIRER

Although it may seem to be asking too much to want, straightaway, to establish a network of dealer-repairers similar to that found in countries where agriculture is highly mechanized, there is no question but that the matter must be examined in the years to come with a view to progressive training towards this profession. It will, indeed, have a major part to play and that sooner than might generally be expected.

A) THE ROLE OF THE DEALER-REPAIRER

He will be responsible for selling agricultural equipment, which means that he must be capable of assembling the equipment made by the factory, adjusting it and demonstrating it to the farmers.

He must be able to maintain it and repair it, like the rural artisan, but at a more advanced level. In order to do this, he must know how to use the implements, be capable of using modern working methods and have the necessary tools.

He will be able to manufacture certain simple agricultural implements and to adapt other more complicated implements to local conditions. In this role of manufacturer, he must be organized to meet demand and be encouraged towards production of work of impeccable quality.

As a manager, he will have to learn how to keep accounts, complying with current social and financial regulations, how to assess hours worked and their value and thus establish prices for his work.

He must be capable of diversifying his activities in order to ensure full employment for himself.

COMMENT:

There are now in Madagascar, as a result of encouragement from the Handicrafts Economic and Technical Centre (CETA), a certain number of highly qualified rural artisans who are undertaking, under adequate supervision, the manufacture of various sub-assemblies for simple agricultural implements, such as parts of rotary weeders or puddling harrows.

These artisans get their raw materials from the CETA and deliver the manufactured sub-assemblies to it. The main advantages of this system are the quality of the raw materials used and that of ensuring a market for the parts made.

B) HOW CAN TODAY'S RURAL ARTISAN BECOME TOMORROW'S DEALER-REPAIRER?

The most highly technically qualified rural artisan will never become a first class dealer-repairer without a basic knowledge of the accounting and management appropriate to his profession. In addition he must become familiar with the implements he has to sell or repair and have adequate equipment. Finally, his responsibilities must be clearly defined.

1. Commercial training

This must be applied particularly to the establishment of cost prices, repair charges and book-keeping.

- COST PRICES

The method of calculating cost prices must be very simple, so that it may be understood and applied by everybody. To begin with, a simple method of weighting the

price on the basis of all ancillary expenses should be used.

Payment for time worked must also be taken into account.

When several workmen are employed, labour costs must be calculated.

The problem of amortization must be examined as soon as implements are acquired. In this connection, a parallel may be established between payments spread over a period by means of bank loans and the progressive building up of a reserve for buying new equipment.

- ESTABLISHMENT OF A SCALE OF CHARGES

It must be possible to work out a scale of charges on the basis of the cost of the work or of the items produced in large quantities. For particular work, the concept of an estimate must be understood.

The agricultural extension workers must be informed of the scale of charges so that they can in turn advise the farmers. It should show the cost of the commonest repairs and that of items made by the artisans.

- BOOK-KEEPING

It is absolutely essential to keep a daily accounts book and an invoice ledger, prepare invoices, make inventories etc.

Finally, the dealer-repairer must be able to go through a spares catalogue and write out an order.

2. Knowledge of equipment

It is up to the manufacturer or his local representatives to advise future dealer-repairers concerning all the manufactured items they will be responsible for distributing and maintaining.

This may be done at training courses during slack periods for the dealer-repairers.

3. Working equipment

When a rural artisan has to sell new equipment, repair it and supply spares to the users, in short, do what is expected of him, it is clear that the workshop, as described earlier, will no longer be adequate.

It will no longer suffice to use a space open to the four winds, nor a scanty set of tools. On the contrary, in addition to the workshop itself, there must be space for the storage of new equipment and spare parts. In addition to the conventional tools, there must be a certain number of special tools and gauges appropriate to the equipment distributed. These tools may be furnished by the manufacturer.

4. Area to be serviced

The area to be serviced will depend on the number of implements distributed, their complexity and the drive of the dealer-repairer and also of the professional skill of the farmers (who may themselves be able to carry out various minor mechanical tasks).

A priori, it seems that an area of up to 20 km radius round the workshop will be the best suited for the distribution of animal draught cultivation equipment in that, on the one hand, it will provide sufficient work for the dealer-repairer, and, on the other, a speedy repair service for the farmers concerned.

This will mean that the dealer-repairer will have to provide himself with a means of transport, possibly a van, so that he can take care of his incoming stocks, deliveries and field service.

5. Investment needed

The adaptation of existing buildings or, more often, the construction of new ones, the acquisition of the necessary set of tools and of a vehicle will constitute a very heavy expenditure - even the best rural artisan will rarely have the necessary capital available.

Buying on credit will therefore be essential. The necessary loans may be granted by a National Development Bank or an Agricultural Credit Bank, or again by the local manufacturers or importers, in whose interest it is to set up the dealer-repairers. In some cases, the manufacturers may themselves assume the responsibility for the buildings and the working tools and equipment and the setting up in business of the dealer-repairers they have trained; the latter then become managers of the local businesses thus created.

C) MAINTENANCE AND REPAIRS ON THE FARM

In the same way as the better rural artisans must be capable of becoming dealer-repairers, the better farmers must gradually take on the maintenance of, as well as the necessary minor repairs to, their agricultural implements.

The maintenance of, and certain minor repairs to, agricultural implements needs an essential minimum of tools, the details of which are too varied to be listed here. The tools must be for working with both metal and wood.

As the tools are to be used to keep the agricultural equipment in good running order, they must themselves be properly looked after.

o

o o

The rural artisans have a very important part to play in keeping animal draught cultivation equipment in good running order. Any operation aimed at the extension of animal draught implements must therefore take into account the presence and the qualifications of the rural artisans in the area concerned. Their absence may temporarily be made up for by state controlled agencies. Some authorities establish such agencies, or use those already in existence, for distribution and provide them with maintenance-repair equipment (which necessitates management of stocks of equipment and spare parts). This solution should only be a temporary one pending the establishment of local artisans.

It seems essential to train and increase the competence of the rural artisans, in the same way as for agricultural supervisors, and extension workers concerned with agricultural implements.

The best of these rural artisans will be able to become tomorrow's dealer-repairers, with all the competence normally expected of such a profession, while, at the same time, the farmers will gradually become more capable of carrying out day-to-day maintenance of their implements themselves, even doing minor repairs.

PART FIVE

ECONOMIC CONSIDERATIONS

Measures aimed at improving the agriculture of the developing tropical countries must be undertaken on a large scale to achieve the best results. This means that measures must be taken simultaneously on all factors affecting production, working methods, use of good seed and seedlings, fertilizer application, crop protection, crop production and stock-raising together when possible, with increased mechanization and improvement of methods of management and organization; all these factors are interconnected. Among them, mechanization is particularly important.

I. MECHANIZATION AND PROGRESS IN TROPICAL AGRICULTURE

The provision of mechanical agricultural equipment results in an increase in output both from the land and from labour. In addition, it is one of the essential conditions of any human and social progress for the majority of the agricultural population of all countries, whether developing or wealthy and industrialized.

A) MECHANIZATION OF AGRICULTURE - ACHIEVING INCREASED PRODUCTIVITY OF LABOUR

Agricultural productivity is the ratio of production to the amount of work needed to achieve it.

Some examples, taken at random from the many C.E.E.M.A.T. references on the subject, may give us an awareness of man's limited working capacity unless he is helped by appropriate equipment, however rudimentary.

- in Madagascar, in the Basse Ikopa region, cassava-growing involves 143 or 87 days' work per hectare, depending on whether the work is done wholly with hand tools or with the aid of animal draught cultivation implements;
- In Senegal, with ground-nut growing, these figures are respectively 480 and 311 hours' work per hectare.

In the first case, the productivity of the work done is approximately doubled, simply by using animal draught cultivation implements. In the second case, the increase is again considerable.

B) MECHANIZATION OF AGRICULTURE - ACHIEVING INCREASED PRODUCTIVITY OF THE LAND

This is a much less tangible aspect of the value of the mechanization of agriculture. Although it is less well-known and is also difficult to measure, it should, nevertheless, certainly not be over-looked.

1. Increase in unit yields

Various operations, made possible by increased working capacity and speed of execution, are proof of the technical advantages of mechanization.

- Cultivation operations carried out at the appropriate time.

Example: an IRCT trial, carried out at BOSSANGO (Central African Republic) in 1962-63, confirmed the best date for sowing cotton (15th June) and demonstrated the fall in production of 1% for each day's delay in sowing. The use of a planter is therefore well worthwhile.

- Work made possible by the use of additional power.

Example: land difficult to plough before the rainy season.

- Improved quality of work.

Example: in the Cameroons, in the Diamaré Department, the CFDT observed that the mere fact of ploughing the earth increased cotton yields by 10 to 20% compared with manual preparation with a hoe.

- Speedy harvesting, limiting losses.

Example: some varieties of ground-nuts, with a short dormant period, germinate in the ground if they are not harvested as soon as they are ready; hence the value of lifters.

2. Intensification of cultivation

Additional cultivation activities, multi-cropping rotation of crops (cash crops and subsistence crops), growing inter-season crops, growing green fertilizer, etc. are all new activities made possible by mechanization.

3. Improvement in the quality of the produce

The improvement realized as a consequence of crop protection treatment, of harvesting at the best time and of good preservation as a result of transport of the produce to sheltered storage and, possibly, better processing, all lead to an increase in the value of harvested crops.

C) MECHANIZATION OF AGRICULTURE - A FACTOR OF SOCIAL IMPROVEMENT

Improvements in the productivity of the labour and of the land lead to an increase in the standard of living of the farmers who find their incomes increased. The nutritional standards of the farmer and, more generally, of all the inhabitants of the country are also raised.

By facilitating heavy work, replacing most of the arduous tasks by animals or other sources of power, the mechanization of agriculture relieves man of much physical effort.

On no account, however, must the obligations involved in the use of animal draught cultivation be glossed over: training of the animals daily care (feed, grooming), maintenance of equipment, construction and maintenance of a cattle-shed, transport of straw for litter, transport of manure, etc. are some of the additional tasks that the farmer must face. All this work is, however, very well compensated for by the advantages he gets from his equipment (faster and less arduous work, and, in particular, the production of manure).

From a more general point of view, we should remember that the provision of agricultural equipment is of interest to the majority of the population in countries which are still mainly agricultural. It therefore seems capable of being a great step forward towards equitable income distribution in countries with a mixed economy.

Finally, the mechanization of agriculture is also likely to have very favourable consequences on the general economy of the country, which we cannot, unfortunately, go into in this manual. We shall merely make a few comments, in the next section, on rural economics as applied to the mechanization of agriculture.

II. AMOUNT OF CAPITAL TO BE INVESTED, MAINTENANCE AND AMORTIZATION

There is practically no information available on this economic aspect of animal draught cultivation. Some Authors have tackled this particular aspect incidentally, sometimes making a distinction between studies on the matter at individual farm level and those made at a national level.

The information available about the relatively old animal draught cultivation methods is too scattered and their large scale extension is too recent for it to be possible to make a valid economic assessment.

The main items to be examined in such a study will however now be indicated, so that the technical experts concerned may make a preliminary approach to these questions.

A) INVESTMENT

Investing in equipment means increasing the means of production. The farm must, however, be in a position to accept the suggested new equipment. In other words, it is essential that this equipment should fit in with the organization of the farm, as it is at present, or as it is likely to become. The introduction of any new equipment on a farm must, if it is to be economically viable, be accompanied by some reorganization.

It is therefore difficult to be specific about the amount of capital to invest, without basic data on the organization of the farms, or data enabling an assessment to be made of the implements needed to equip the farms rationally. Furthermore, each case must be treated on its particular merits.

Knowing the details of a particular farm, what then would be the various appropriate categories of investment?

1) The draught animals

Depending on climate, the countries concerned, the animals available and traditional customs, units of draught bullocks, cows, horses, donkeys and even camels may be found.

Whichever of these draught animals is involved, the sum invested applies either to the purchase price of trained animals or - which is more difficult to assess - to the cost of raising the animals by the farmer himself, to which must be added the cost of training them (1).

On some state run farms the value of draught animals acquired by a farmer may include incidental expenses such as: maintenance of the animals before distribution, transport, insurance, vaccinations, etc.

2) The cultivation implements

When the equipment appropriate to the farm has been decided on (some factors in assessing this "appropriateness" are given in the next section), calculation of the cost of their purchase does not present any difficulty.

3) Incidental expenses

Under this category of expenses may be included, on the one hand, the building of a deep-litter cattle-shed for housing the draught animals and, on the other, the provision

(1) In order to simplify matters and for areas where animal draught cultivation is already sufficiently developed for there to be markets dealing in draught animals, it would seem more appropriate to keep to the rates found in these markets.

of a shelter for the implements.

In addition, to complete the picture, one could also mention human investment; for example, when a member of the family goes to a Centre to learn how to train animals and how to use animal draught implements.

SOME EXAMPLES OF INVESTMENTS NECESSARY ON THE INTRODUCTION OF ANIMAL DRAUGHT CULTIVATION ON SENEGALESE FARMS(2)

The crop rotation system used is as follows: ground-nuts, millet, green manure.

- 1st case

The equipment (medium sized unit) consists of:

- a tool frame, fitted with two small metal wheels, with attachable tools (multicultivator),
- a cart,
- a pair of oxen.

The cultivated area is 6.40 hectares (3.20 ground-nuts; 1.60 millet; 1.60 green manure).

The family consists of father, mother, young brother, a paid employee, a 10-year old child and an infant.

The investments are as follows:-

- 2-row planter	34,130 F
- 2-wheel forecarriage	3,600 F
- chain harrow	5,325 F
- spring tine cultivator for weeding	4,800 F
- lifter	8,332 F
- plough	4,750 F
- cart	27,000 F
- a pair of trained oxen	25,000 F
TOTAL	112,937 F CFA

- 2nd case

The equipment (large unit) consists of:

- an axle fitted with pneumatic-tyred wheels carrying a chassis on which may be mounted a cart platform or a tool-bar (polycultivator), with the attachable tools appropriate to the working conditions;
- a pair of oxen.

The cultivated area is 8.80 hectares (4.40 ground-nuts; 2.20 millet; 2.20 green manure).

The family is the same as in the previous case.

The investments are as follows:-

(2) From J. Monnier's "Contribution to the study of ox draught in Senegal"; *Machinisme Agricole Tropical* No.10 and 11.

- chassis plus pole	30,605 F
- iron frame platform	5,325 F
- wooden flooring	2,500 F
- tool-bar	6,680 F
- lever	1,875 F
- spring tine weeder	6,645 F
- chain harrow	5,325 F
- 2-row planter	34,130 F
- 2 lifters	16,664 F
- arms for attaching the lifters	1,328 F
- plough	8,900 F
- a pair of trained oxen	25,000 F

TOTAL 144,977 F CFA

(The Author has not taken into account the cost of building a deep-litter cattle-shed or an equipment shelter).

AN EXAMPLE OF THE INVESTMENT NECESSARY FOR THE INTRODUCTION OF ANIMAL DRAUGHT CULTIVATION ON A FARM IN THE CENTRAL AFRICAN REPUBLIC(1)

The crop rotation system used is as follows:

- cotton in the first year;
- ground-nuts and maize in the 2nd year with rice and sesame at the tail-end of the season;
- in the 3rd year, planting of cassava cuttings among the traditional food crops;
- in the 4th year, harvesting of the cassava and start of fallow (2 years).

Unlike the preceding case, the standard cultivation sequence consists solely of independent items.

The cultivated area is 2.10 hectares (0.70 cotton; 0.50 groundnuts; 0.20 maize; 0.50 rice; 0.20 sesame; 0.70 cassava and traditional food crops); 2.80 hectares are however worked if the end of season crops are taken into account.

The composition of the family is not stated.

The investments are as follows:-

- plough	8,945 F
- cart	27,000 F
- harrow	5,500 F
- hoe	11,000 F
- 2 yokes (of different lengths)	2,000 F
- 2 harness chains	1,900 F
- a pair of trained oxen	33,000 F

TOTAL 89,345 F CFA

(The cost of making a deep-litter cattle-shed and an equipment shelter has not been taken into account).

(1) From R. Morel's "A rural development technique; animal draught in the OUAKA Province of the Central African Republic"; *Machinisme Agricole Tropical* No.13 - January-March 1966.

COMMENT:

If the total investments are related to the area under cultivation, the following amounts in round figures are obtained:-

- For Senegal:

1st case (6.40 ha cultivated)	17,650 F per hectare
2nd case (8.80 ha cultivated)	16,450 F per hectare

- For the C.A.R. (2.80 ha cultivated) 31,900 F per hectare

These figures show how important is the farm's organization and, even more so, the area cultivated, as a factor in assessing the equipment needed.

It is for this reason, there being no possibility of increasing the area cultivated per farm, that the organizers of the operation carried out in the C.A.R. had to organize the standard cultivation sequence to cover 2 and even 3 farms grouped together into an "Association". This solution involves, however, various difficulties which it would take too long to go into now (the individualism of the farmers, difficulties which can be foreseen at peak working periods, bad maintenance of the draught animals and the equipment, etc.).

B) MAINTENANCE

Maintaining means keeping in good condition. The length of time the equipment owned can be kept in use depends on good maintenance.

This is an oft-neglected aspect of plans for the introduction of animal draught cultivation. Like the equipment and the shelters, the draught animals must be given constant attention, the cost of which must be taken into account.

1) The draught animals

While everybody knows that an animal has to be fed, it is quite common to find that animals doing a considerable amount of work are not given the additional feed necessary for keeping them in good condition.

In addition, the work involved in looking after the animals (feeding, grooming) and the veterinary charges they are liable to incur are all items which must be taken into account. (In the annex on the calculation of the cost of using draught animals, there is some useful information on how to make such calculations.)

2) The equipment

The equipment wears as it is used and this is quite normal, but it also wears quicker the less well it is maintained.

Ploughshares and the hoeing blades of a hoe must be replaced after they have been worn by work. However, when a planter becomes unserviceable because it has been left out in the open or when a cart axle wears because it has not been lubricated, this is due to lack of proper care which should not have occurred.

The replacement of parts which wear normally and such necessary items for maintenance as paint, oil and grease are expenses which are easily calculated.

3) Shelters for animals, feed and equipment

These are generally made of odd bits and pieces and often need no more than minor maintenance, which, other than a few days' work, does not involve any real expenses.

C) AMORTIZATION

Amortization consists in progressively rebuilding the capital sum used to acquire the means of production on a farm; this rebuilt capital allows the means of production to be renewed when they are no longer fit for use.

It is thus easy to understand that the longer the means of production can be kept in use, the smaller will be the annual amortization instalments. Accordingly, it is most important to try to prolong (within reasonable limits) the life of the equipment by means of good maintenance.

1) The draught animals

In this case the amount to be amortized is the purchase price, less the resale value. The latter may be practically nil (in the case of horses or donkeys) or considerable (oxen resold for slaughter).

The length of time animals can be used for draught work varies in the different countries and the average figures which may be taken are shown in the annex.

It should be noted that, in view of the frailty of animals, it is advisable to insure them.

2) The equipment

There is not yet, in the French-speaking tropical countries, a secondhand market for agricultural equipment. The amount to be amortized is therefore the purchase price.

Detailed observations have not yet been made on the subject of amortization periods for animal draught cultivation equipment.

It is usual to base calculations on an average of 5 years, the figure normally used by the Agencies making loans to the farmer. There is, however, no question but that certain categories of well maintained equipment can be used much longer, for example for 10 years; this applies, in particular, to ploughs and carts.

Naturally, when estimating possible life (in years), account must be taken of annual utilization or, in other words, of the area over which the implement is required to work.

3) The shelters

Being made of odd bits and pieces, it is generally considered that these should be amortized over 5 years.

o

o o

Other economic aspects could also be examined, in particular, the concept of interest on the capital invested (an example with figures, taking this additional item into account, will be found in the annex.)

III. COMPARISON OF TIME AND COST OF CULTIVATION BY HAND, WITH DRAUGHT ANIMALS AND WITH POWER EQUIPMENT

It is more advantageous to extend a new method which reduces the use of manpower when time is precious, when the work is urgent or when the optimum period is short, rather than to introduce a new method which reduces work in the off-season or during slack periods.

The problem of peaks of work when the farmer is snowed under with urgent agricultural work is well known in farming. It is a major bottleneck in agricultural development, since it is a factor which limits the area worked and, to some extent, also limits yields.

The other aspect of the problem is under-employment. This appears in various forms: almost permanent under-employment in some cases, very marked seasonal under-employment in others and, in many cases, concealed under-employment.

Assessment of the financial value of working time has, however, two advantages (although this assessment is difficult in an economy which still includes a considerable proportion of subsistence level living): on the one hand, it enables all the data to be reduced to a more general efficiency unit and, on the other, it enables production costs to be examined.

Whatever the apparent advantages of a particular working method as shown below in an example, it is advisable, before introducing new methods (e.g. the substitution of draught animals for manual labour or power-operated equipment for animal draught cultivation) to take account of the existing farming system. This is necessary in order to see whether new methods can reasonably be applied without introducing any unduly advanced innovations which might give rise to unfavourable consequences.

A) WORKING TIME

To illustrate the considerable differences there may be in working time, depending on the source of power used, we shall take the example of ground-nut growing.

1) Entirely manual cultivation

<u>CULTIVATION TASK</u>	<u>HOURS/HECTARE</u>
- Ground preparation (cleaning with the hand hoe stacking and burning weeds)	30
- Shelling the seed nuts	70
- Sowing	60
- Hoeing immediately after sowing	35
- Other hoeings:	
. first	50
. second	50
. third (rarely carried out but recommended)	35
- Manual weeding (large weeds)	20
- Lifting (creeping varieties of ground-nuts)	60
- Gathering and stacking	20
- Threshing, winnowing	50
TOTAL	480 hours

2) Animal draught cultivation

Work carried out with a polycultivator and the following attachable implements: plough, 2-row planter with fertilizer attachment, weeder, spring tine cultivator, and lifters.

<u>CULTIVATION TASK</u>	<u>HOURS/HECTARE</u>	
	Man	Animals (pair of oxen)
- cleaning the ground	20	-
- surface soil preparation	16	8
- shelling of seed nuts	70	-
- sowing and fertilizer application	14	7
- light surface tillage	5	5
- hoeings (three)	48	24
- manual weeding along the rows	50	-
- lifting	18	9
- gathering and stacking	20	-
- threshing, winnowing	50	-
TOTAL	311	53

3) Partial power-operated equipment

(In order to retain the similarity with the working conditions set out above, the work of ploughing in green manures is omitted here.)

Work carried out by means of track tractors (45 hp) for soil preparation and four-wheel tractors (35 hp) for the other cultivation tasks.

<u>CULTIVATION TASK</u>	<u>HOURS/HECTARE</u>	
	Man	Tractor
- soil preparation		
. stubble-ploughing	2	2
. disc-harrowing	1	-
- shelling seed nuts	70	-
- sowing (4-row planter with fertilizer attachment)	2	1
- harrowing	1.5	1.5
- Hoeing (semi-portable hoe)	2	2
- weeding by hand along the rows	50	-
- lifting, putting into rows	2	2
- gathering and stacking	20	-
- mechanical threshing	12	2
- handling of stacks and sacks	15	1
TOTAL	177.5	12.5

4) Full power-operated cultivation

This method of growing ground-nuts is not carried on in tropical Africa but is regularly used in the United States.

<u>CULTIVATION TASK</u>	<u>HOURS/HECTARE</u>	
	Man	Tractor
- Soil preparation:		
. ploughing	2	2
. secondary tillage	1	1
- shelling, chemical dressing of seeds and mechanical grading of seeds	0.5	-
- sowing	2	1
- weeding/hoeing		
. weeder (2 runs)	1.5	1.5
. hoe (2 runs)	4	2
- lifting 2 rows at a time, shaking, putting in small piles or rows	4	2
- threshing, miscellaneous handling	15	2
TOTAL	30	11.5

5) Comments

Summary of the hours worked per hectare

	MAN	ANIMALS	TRACTOR
- Entirely manual cultivation	480	-	-
- Animal draught cultivation	311	53	-
- Partial power-operated equipment	177.5	-	12.5
- Full power-operated cultivation	30	-	11.5

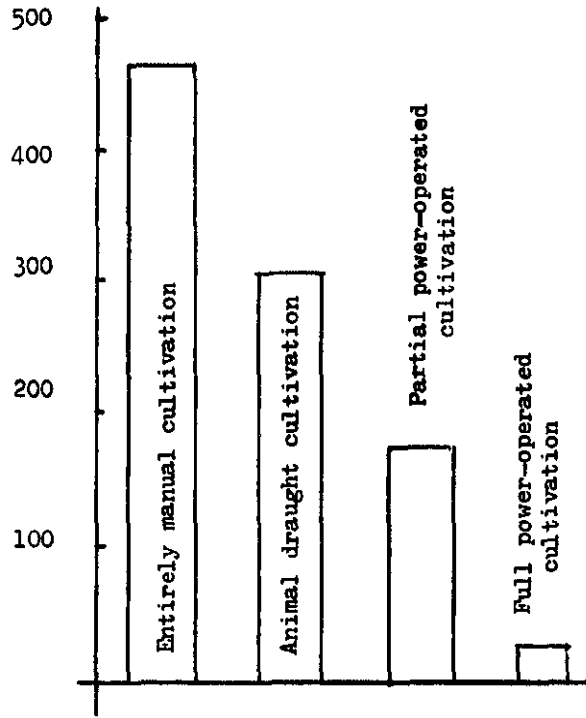

COMPARATIVE WORKING TIMES
(hours/hectare)

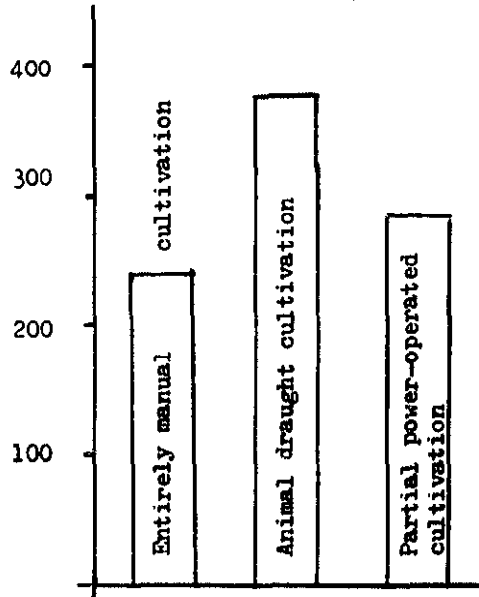

COSTING OF DAY'S WORK
(in F. CFA)

What do these figures tell us? At first sight, it might be considered that the third type of farming with power-operated cultivation is the most desirable. Indeed, in this case, the cultivation of a hectare of ground-nuts only requires 4 days' work.

Is this possible, however, technically, agronomically, economically and psychologically?

Before trying to answer this question, it seems appropriate to compare the costs of the first three farming methods (since the third method, full power-operated cultivation, actually does not, at present, apply in countries which are inadequately equipped generally and have abundant manpower).

B) PROFITABILITIES COMPARED

We do not at present have the basic data for calculating the cost of a particular method of cultivation and, even less so, the overall expenses of a particular farm. It is, therefore, more appropriate to assess the value of the manpower used for different farming methods, and this, naturally, for each different crop grown, if necessary. This is what is usually called the "value of a day's manpower".

Taking the foregoing example again, that of ground-nuts, and despite the many approximations needed for such calculations not based on a particular farm or equipment, it is still possible to provide the very simple guide lines for making such an assessment.

It is merely necessary to subtract from the market value of the harvest all the expenses other than manpower and to divide the result by the number of man days devoted to work on the particular cultivation. Although this may sound simple, its practical application needs fairly numerous estimates, as the following examples show.

1) Entirely manual cultivation

MARKET VALUE OF THE CROP

The average ground-nut yield in Senegal is about 800 kg per hectare and, for convenience of calculation, the selling price is estimated as 20 F CFA.

The market value is therefore $20 \times 80 = 16,000$ F

CULTIVATION EXPENSES

- seed: 70 kg at 20 F = 1,400 F
- amortization of hand tools per hectare: 100 F

The cultivation expenses are therefore 1,500 F/ha.

VALUE OF DAY'S MANPOWER

With 8 hour working days, manual cultivation needs $\frac{480}{8} = 60$ days work per ha.

The value of a day's manpower on manual cultivation of ground-nuts is therefore

$$\frac{16,000 - 1,500}{60} = \text{about } 240 \text{ F.}$$

2) Animal draught cultivationMARKET VALUE OF THE CROP

With the cultivation done better, particularly better working of the soil, tasks done at the right time and the use of fertilizer, the yield easily reaches 1,200 kg per ha., i.e. at 20 F the kilo, a market value of 24,000 F.

CULTIVATION EXPENSES

- seed: 70 kg at 20 F = 1,400 F
- The equipment used is, in this case, a polycultivator with the implements already mentioned. The cost of this outfit is estimated as 150,000 F CFA. it enables about 10 hectares to be cultivated a year.

Amortized over 5 years (which is probably low) the annual expenditure is

$$\frac{150,000}{5 \times 10} = 3,000 \text{ F}$$

- The draught animals worked for 53 hours, i.e. at an hourly cost of 50 F (see annex on the calculation of the cost of using draught animals), a cost of 2,650 F
- 100 kg of fertilizer was used at an average cost of 20 F a kg, i.e. 2,000 F.

The cultivation expenses thus amount to 1,400 + 3,000 + 2,650 + 2,000 = 9,050 F.

VALUE OF DAY'S MANPOWER

311 hours' work represent about 39 days.

therefore: The value of a day's manpower on animal draught cultivation of ground-nuts is

$$\frac{24,000 - 9,050}{39} = \text{about } 380 \text{ F}$$

3) Partial power-operated cultivationMARKET VALUE OF CROP

Identical with the previous case, i.e. 24,000 F.

CULTIVATION COSTS

- Seed: 70 kg at 20 F 1,400 F
- Fertilizer: 100 kg at 20 F 2,000 F
- The equipment expenses are difficult to calculate.

One hour's work by a tractor and the necessary ancillary equipment will be estimated at an average of 1,250 F CFA(1); i.e. an expenditure per hectare of 1,250 x 11.5 = 14,375 F

(1) Bearing in mind that the tractor driver's work has already been counted in the number of manpower days worked.

The cultivation costs thus amount to: $1,400 + 2,000 + 14,375 = 17,775$ F.

VALUE OF DAY'S MANPOWER

177.5 hours' work represent about 22 days.

The unit value of a day's manpower on power-operated cultivation of ground-nuts is therefore: $\frac{24,000 - 17,775}{22} = \text{about } 280$ F

4) Summary

With entirely manual cultivation	240 F
With animal draught cultivation	380 F
With partial power-operated cultivation	280 F

These figures call for some comments.

They are based on theoretical data. For example, with animal draught cultivation, it is only necessary for the polycultivator not to be made full use of (5 hectares instead of 10) to show a considerable increase in the amortization charges, and, in consequence, a reduction in the value of a day's manpower. Similarly, in the case of power-operated cultivation, a higher average tractor-hour cost (which might be the consequence of under-employment) would also result in a lower day's manpower value.

How much importance should be attached to these figures?

To the extent to which they were established on a particular farm, where exact measurements were taken of the time spent working and where the cultivation expenses were calculated thoroughly and accurately, it seems that the figures may be taken as correct.

The example given here is based on a single crop, ground, nuts. The same calculations can be made for a single cultivation operation. Thus, a study carried out in Madagascar resulted in an assessment of the value of a day's manpower spent on weeding rice-fields. Under certain conditions (weeding with a Japanese rotary weeder on rice-fields with transplants at 30×30) it was established that this value was more than 1,300 F CFA.

What precisely do these figures signify?

On the one hand, that, in the example given, it is more profitable to cultivate ground-nuts using draught animals and power-operated equipment than using manual labour alone.

On the other, to use a particular example, assuming that all the manual cultivation work was done by one man, that it is preferable to be self-employed, with a value of a day's manpower of 240 F, than an agricultural labourer on a farm if the standard daily wage is less than that amount.

Finally, and particularly, on the basis of a specific farm, these figures can be used to assess the value to a farmer of the introduction of a new item of equipment.

They are only applicable, however, if they are related to the farm in question. An example will serve to illustrate this restriction.

Let us assume that, in each case, the area put down to ground-nuts ha. The annual income under each method of cultivation would then be:-

- Entirely manual: 240 F x 60 (days) x 5 (ha) = 72,000 F
- Animal draught cultivation: 380 F x 39 (days) x 5 (ha) = 74,100 F
- Partial power-operated cultivation: 280 x 22 (days) x 5 (ha) = 30,800 F

There is practically no difference between manual and animal draught cultivation, while power-operated cultivation produces an income markedly lower than that of the other two cases.

In the second case, the only advantage of animal draught cultivation will be a reduction in the annual time spent working on the farm and, in the third case, in addition to an even shorter annual duration of work, there is also a considerable fall in income.

This example demonstrates the importance which must be attached to the area cultivated or cultivable on the farm when it is desired to introduce new equipment. In other words, and this has been an accepted fact for a very long time in countries with modern agriculture, any introduction of new equipment on a farm must be accompanied either by an increase in area cultivated or by a reduction in manpower or, by increased yields; if not there will inevitably be increased under-employment of the available manpower(1).

These various factors are closely connected with those set out earlier concerning the criteria for selecting new equipment with the best chances of success.

C) HOW TO JUDGE THE OPPORTUNENESS OF INTRODUCING NEW EQUIPMENT

The study of this economic aspect of agricultural mechanization is long and complex because, on the one hand, of the existence of many different implements and, on the other, of the extreme diversity of the farms to be equipped.

Within the limited scope of this manual, we can only hope to touch on the main principles involved in equipping the farmer. It is appropriate to leave, to the technical experts responsible for training and extension, the practical application of the various factors which depend on the requirements and characteristics of the farms where they are doing their work.

Indeed, it will, as a rule, be their responsibility to study the most appropriate methods to be adopted in each particular case.

Generally speaking, an implement is appropriate when it allows the necessary agricultural work to be carried out under satisfactory conditions from a technical, agronomic, economic and functional point of view.

1) Technical considerations

The mechanization of agriculture must be aimed at increasing the area that can be cultivated or substituting machines or implements for manual labour. The equipment should be able to achieve the same output or, preferably, a higher output.

Each technical expert may, of course, have his personal opinion about which machine he considers suitable for doing the required work properly. No single individual can, however, know everything. Accurate guidance on the subject must come from pooling the ideas of a country's various technical experts, together with the results of trials

(1) There are some exceptions to this statement, particularly when it is a question of equipment needed to perform a cultivation operation within a short and clearly defined time (e.g. sowing), or else when there is the possibility of sub-contract work on other farms.

carried out by an Agricultural Mechanization Trials Station(1).

The standard of the after-sales service, whether it is provided by the manufacturer, the dealer or the local artisan is also a factor which must not be over-looked (see Part Four).

2) Agronomic considerations

The problem is more complex: as a result of frequent local experiments, tropical agronomists have learnt to be cautious. It may seem surprising that, generally speaking, it is not possible formally to advise for or against the use of the plough for tropical dry agriculture.

In no case must the proposed implement lead to deterioration of the structure of cultivated soils (particularly through erosion). Agricultural technical experts should be capable of proposing suitable methods to take care of the specifically agronomic problems which may arise.

3) Economic considerations

Mechanization of a farm always means heavy investment when compared with the farmer's income. The purchase of a 10,000 F CFA plough is just as much a problem to the Malagasy or African farmer as is the purchase of a combine harvester to the European farmer.

It has already been shown how to make a simple assessment of the economic consequences of any change in the equipment of a farm. Let us repeat that none of the aspects of the problem must be overlooked:

- the possibility of increasing the area cultivated;
- increasing the productivity per hectare;
- reducing the manpower needed;
- the possibility of carrying out other work on the farm, such as changing over to other crops (replacing "subsistence" by "cash crops"), of catch-crops (made possible by speedier lifting of the previous harvest, e.g. onions in certain Malagasy rice-fields), artisanal work (e.g. basket-making or pottery) or, finally, external work (contract work for neighbouring farmers).

The financing of mechanization raises problems which are difficult to solve.

In view of the present limited financial resources of the farmers, the purchase of equipment means, that most of them, have to apply to a national credit agency (of the Agricultural Credit type). This agency must not exact a high rate of interest on the capital loaned and must only demand modest guarantees from its borrowers.

The creation of Associations or Cooperatives for purchasing fairly expensive equipment or which is intended for use on several small farms whose area cannot be increased, does not solve the problem. Although they may allow more rational use of the implements purchased, such groupings have, to begin with, restricted financial means (a cooperative is only rich when its members are). Here again, therefore, requests have to be made for loans or subsidies.

(1) We have purposely not mentioned, here, imported implements which have sometimes been made available to farmers following bilateral trade agreements and without prior technical study of the precise requirements.

4) Functional considerations

The farmer must show interest in acquiring the implement and he must be capable of using it, at least with advice from competent technical instructors and extension workers.

This aspect, which has already been discussed in Part Two (General Remarks) will not be further developed here.

To sum up, before considering the introduction of any new equipment on a farm, it is advisable to weigh up all the possible agronomic and economic consequences of this introduction on the existing farming systems.

IV. COMBINATION OF THE THREE CULTIVATION METHODS

As we have been able to establish from the examples of the growing of ground-nuts in Senegal, when work is done by draught animals, some work still remains to be done with hand tools.

Indeed, since at the present time, it is impossible to conceive of power-operated equipment which can carry out all cultivation operations without human intervention - if nothing else the equipment has to be driven by man - animal draught cultivation cannot be considered a method which eliminates all manual labour.

A combination of these three cultivation methods may be arranged in various ways:-

- animal draught cultivation with manual assistance;
- power-operated and animal draught cultivation;
- power-operated and animal draught cultivation with manual assistance.

A) ANIMAL DRAUGHT CULTIVATION WITH MANUAL ASSISTANCE

This is the type of combination most usually found in Africa in areas where action has been taken to extend animal draught cultivation.

On the basis of the reasoning which prompted the technical experts to recommend the purchase of equipment, the implements purchased were usually only suitable for a single cultivation operation, at least in the early stages of the introduction of animal draught cultivation. It was a question of removing or alleviating bottlenecks, for example, sowing within the vital time limits (resulting in a considerable increase in the number of mechanical planters in Senegal), or of allowing larger areas of land to be properly prepared (ploughs for rice-growing in Mali and Guinea), etc.

Later, it became apparent that the removal of one bottleneck was likely quickly to result in another. For example, the feasibility of quicker sowing (leading to an increase in the areas cultivated) no longer allowed the farmer to carry out proper hoeing of the larger areas sown.

Thus, in certain areas where the farmers were ready to accept new ideas, it became possible in time to carry out many different cultivation operations with draught animals for a particular crop. For example:-

- with ground nuts: soil preparation, sowing, fertilizer-spreading, inter-row weed control, lifting and transport of the harvested crop;
- with cotton: soil preparation, sowing, fertilizer-spreading, inter-row weed control, transport of the harvested crop;
- with rice: soil preparation, sowing (dry cultivation) transport of the harvested crop.

B) POWER-OPERATED CULTIVATION WITH MANUAL ASSISTANCE

Certain cultivation and prior-to-cultivation (land preparation) operations are difficult, and even impossible, by hand or with the assistance of animal draught; indeed, in some cases these operations need implements driven through a power take-off (present tendency in countries with modern agriculture where the use of rotary implements is steadily developing).

Depending on the operations involved, the use of a tractor may become more and more essential. With some, such as power operated cultivation of rice at Richard Toll (Senegal), the tractor, or the power-operated implement, carries out all the operations which can be mechanized.

Elsewhere, with other operations, mechanical power is of interest only for soil conservation (for example, the GUMA at Grimari and the old SCAERS in Guinea), or for bringing new land into cultivation (power-operated land clearance for coffee-shrubs at DALOA in Ivory Coast and deep ploughing of very heavy soils for cotton at SEMNORD in the Camerouns. There are many areas in tropical Africa where there has been the maximum possible application of mechanical power for all operations. In very few cases, however, have economically viable results been achieved to date, for the various reasons set out in the Introduction to this manual.

To use power only for soil preparation (necessitated by difficult soil conditions, the lack of draught animals, etc.) can, together with good management, give satisfactory results. This is the case, for example, with the cotton-growing in "Association" carried out by the CFDT in Senegal, with rice-growing by the SCAERS in Guinea (at least during the last few years of the operation), with the CUMAs of GRIMARI and with rice-growing in North Cameroon (SEMARY).

A combination of working methods, tractor power and manual labour, may be justified economically when the necessary prior studies have been carried out and good management organized, contrary to what may have been written elsewhere, i.e. that such a combination was only a "hybrid compromise" which could not have lasting good results.

A combination of mechanical power and manual labour has also been criticized for causing a reduction in the amount of work done by the farmers concerned who "sit under a mango-tree watching the tractor work for them". Against this statement, which may indeed be true in certain cases, the example may be quoted of the old SCAER at DRAGUEDA (Guinea) where, on average, the farmers, with their animal draught cultivation equipment, work twice the area tilled by the Power Cultivation Section. The example may also be quoted for certain modern peasant farms such as that at MWEA in Kenya.

This confirms, moreover, that any introduction of new equipment (whether bought or hired) cannot be successful without changing the organization of the farm.

Indeed, the introduction of any new technique, is only valid when it has been thoroughly prepared from all points of view including, and most important of all, psychological preparation of the farmers concerned.

C) POWER-OPERATED AND ANIMAL-DRAUGHT CULTIVATION WORK WITH MANUAL ASSISTANCE

Such combinations of working methods have so far only rarely been directly applied. There are however some "reconversions" of power-operated systems to a combination of power-operated and animal draught cultivation work, such as that in which the SEMA at BOULEL (Senegal) is taking an interest. From the beginning, however, these reconversions are burdened with a very heavy infrastructure and implements which are not always very suitable, thus considerably hindering efficient management.

Nevertheless, two cases may be mentioned where a combination of these various working methods has been organized with satisfactory results. These are the operation started by the B.D.P.A. in 1952 at the SAKAY, in Madagascar and the "CUMA de GRIMARI" operation in the Central African Republic, for which was recommended the use of animal draught cultivation for the various operations following on preparation of the soil by tractors.

Certain other operations may also be reported where land improvement (clearance, levelling, drainage or irrigation works) has been done with power-operated equipment and on which the subsequent cultivation is done with animal draught equipment.

It appears that the reason why practically no operations of this kind have been organized, is that the agricultural technical experts have a tendency to feel, when draught animals are available in a region, that it is out of the question to recommend the introduction of tractors. Such an opinion is partially justified at present, while the resources of the developing countries still do not permit the widescale introduction of imported power-operated equipment.

The agriculture of these countries must not, however, be considered to have reached its final stage. As a country develops, so will the proportion of its population working in agriculture decrease, while the desire to work with new techniques will increase; all reasons which will inevitably lead, over a period of time - to which it is still almost impossible to set a definite limit - to the general use of power-operated cultivation equipment.

Whenever possible, the combination of the three working methods discussed here (power-operated, animal draught and manual labour) will have the following advantages: first, of allowing increased areas to be cultivated and, second, of causing an increase in productivity and production (this, naturally, on the assumption that all the necessary precautions are taken to ensure the viability of the actions taken) and, finally, of progressively putting the farmer in contact with the equipment he will sooner or later need to use.

It is this final point which deserves attention in those countries where such operations are already possible.

A N N E XSIMPLE METHOD OF CALCULATING THE COST OF
USING DRAUGHT ANIMALS IN TROPICAL COUNTRIES

This is a working method enabling a calculation to be made, with reasonable accuracy, of what the cost may be of using draught animals in the various cultivation operations now being developed.

The study of the profitability of animal draught cultivation itself, a much broader and more complex problem, will not be examined here for lack of sound information on the subject. It is one which needs a knowledge of many specific and detailed factors, particularly the size of the farms with relation to the equipment and, naturally, to the kinds of crop grown.

The hourly cost of utilization depends on how the animals live (whether sheltered or kept in the open air), how intensely they are made to work (annual duration of use) and what species is being considered (ox, donkey or horse).

Generally speaking, tropical Africa oxen are mainly used, horses sometimes (chiefly in Senegal) and donkeys rarely (Upper Volta) with grazing for feed and, frequently, very low utilization rates.

There are, with draught animals as with tractors a certain number of items to be examined in turn, which, although they are often identical, are for convenience's sake, listed in a different order.

The main calculation items to be studied are as follows:

- capital costs, with amortization and interest;
- expenses for feed, in which a distinction may be made between normal feed (maintenance ration) and high quality feed (working ration);
- maintenance expenses including grooming and other care, harness, shoes and veterinary charges;
- operating expenses;
- overheads, including housing and insurance of the animals.

Like the assessment of the hourly cost of operating tractors, that of operating draught animals has various characteristics which are peculiar to the African countries and Madagascar. In particular, we may mention :

- feed, at least as far as natural pastures are concerned: very often, the latter do not involve any expenditure;
- shoes: the animals are very rarely shod;
- veterinary attention: often provided free by the responsible Services;
- housing for the animals: unfortunately, very rarely provided.

Nevertheless, so that the Reader may be aware of all the factors involved (if only on a research Station or a big farm, where the various restrictions listed above do not apply), all the items which should enter into the calculation will be examined. Two examples with figures, one concerning a family farm and the other, work on a research Station or big farm, will serve to show both the simplicity of the calculation to be carried out and the considerable difference in the cost of the draught animals in the two cases considered.

o

o o

THE DIFFERENT ITEMS IN THE CALCULATION OF THE COSTS

1) CAPITAL EXPENSES

a) Amortization

In calculating the amortization, account is taken of the market value of the animals and not the capitalized breeding expenses. Indeed, if the animals were raised on the farm itself, which is, moreover, often the case, these expenses may well be above or below the market value(1).

The amount to be amortized will therefore be the purchase price or the market value (2) less the resale value (or slaughter value).

The value to be amortized may, in certain cases, be nil or even negative; for example, when the resale value, after use, is higher than the purchase price(3).

It should also be noted that the resale value may be practically nil. This is the case with donkeys and, in certain countries, with horses, where horse-meat is not eaten.

-
- (1) In agricultural book-keeping the increase or decrease in value found will rather be shown in the profits and losses account under the stock-breeding section.
 - (2) The purchase price includes the cost of training the oxen. This cost may be considered negligible if the training is done by the farmer himself. On the other hand, as part of the operation of extending animal draught cultivation, it may account for a relatively large part of the selling price of the animals. This is the case, in particular, in Senegal, where trainers are paid on a flat rate basis. of 2,500 F CFA per pair of oxen.
 - (3) In Senegal, a pair of oxen is cited which, weighing 280 kg a head when purchased, are resold after use as draught animals for 5 years, at a higher price; this because of a gain in weight of the order of 100 to 120 kg a head.

The time the animals are kept in use for draught work varies from country to country; the average values may be taken as follows:-

- oxen : 6 years (1)
- horses : 7 to 8 years (2)
- donkeys: 8 to 10 years.

b) Interest

This should theoretically be calculated, like any capital asset, on the real value of the stock. In order to simplify matters, it will be calculated at 6% (3) and applying this to 75% (4) of the purchase price of the animals (trained and ready for work).

2) FEED COSTS

Here, a distinction must be made between high quality feed and coarse feed. The latter is generally, particularly on family farms, considered to cost nothing(5).

Although, with developed agriculture, when deciding on the animals' rations, account is taken of the energy value of the feed, the quantity of digestible nitrogenous matter it contains, its bulk and its cellulose content(6), etc., in our case and as a first approach to the question, only the energy requirements of the animals will be considered.

-
- (1) In Senegal: responsible farmers usually keep their draught animals for five years and resell them in good condition. This figure of 5 years may be considered an acceptable average. Some speculators make their oxen work for one or two years and then resell them. On the other hand, cases are quoted of animals having worked for 8 to 9 years and which are then resold at a profit for slaughter. In the Boulé region, the oxen (Gobra-N'Dama crosses) are trained when 3-4 years old. They are used until they are 7,8 and sometimes even 12 years old which means 3 to 8 years' continuous use for cultivation work and for various transport tasks (water, wood, feed reserves, harvesting, etc.). In Ivory Coast: a partial census of draught oxen (in the Korhogo region) showed 8 3-year olds, 22 4-year olds, 10 5-year olds and one 6-year old. In Mali: according to an inquiry carried out in 1960, 30,000 oxen were in use for cultivation work, their ages lying between 4 and 12 years. In this country there is a tendency to make young oxen (3-year olds) work and to keep them in service for a long time (up to 12 years in extreme cases); they are frequently used for 8 years.
- (2) Nevertheless, it is frequently found, in the towns, that horses are still pulling carts when they are 15 years old.
- (3) Mean rate of "medium term" loans granted by local Agricultural Loan Funds.
- (4) Although we take 50% in the case of agricultural implements, we allow 75% here; this to take into account the fact that the value of the draught animals increases during the first few years of use and, generally speaking, then falls off very slowly; with equipment, the value starts falling immediately after purchase.
- (5) Nevertheless, in countries where agriculture is highly modernized, account is taken of the fact that the consumption of feed by draught animals results in a loss of income as compared with its possible consumption by animals in milk.
- (6) Trials have proved that the animals of tropical countries assimilate high cellulose content feed better than those of temperate countries.

a) Daily energy requirements

These requirements were given in detail in Part One, Section VIII of this manual.

b) Forage values of local feed sources

A table of references was given in the same section of the manual.

c) The estimation of feed costs, with particular reference to high quality feed (millet, sorghum and maize; cassava roots, etc.), must be based on selling prices on the local market and not on their cost price to the farmer (a figure moreover which it is usually quite impossible to calculate).3) MAINTENANCE COSTSa) Grooming and other care costs

When this work is done by the family it is usually not taken into account. On big farms the basis for calculation will be 125 hours' work per animal per year (i.e. about 1/2 an hour a day). This figure, moreover, may vary widely, depending on the amount of care given to the animals (for example the need to bring water to them or to take them to a drinking place).

b) Harness

Depending on the type of harness (various yokes, collar, breast-strap, etc.) and the quality of the materials used in making them, harnesses may be amortized over 1 to 5 years.

With a specific type of harness, this amortization time will itself depend on the annual utilization of the draught animals.

c) Shoes

Animals are very rarely shod in Africa.

d) Veterinary charges and medicaments

This group of expenses is, in some African countries, covered by a "Veterinary Assistance" scheme under which the farmers can, on request, get the necessary prophylactic treatment for their animals free of charge.

In other countries, or with large private and even sometimes state farms, this has to be paid for. Although not many references are available, it appears that the average annual expenditure may be assessed at 8% of the value of the animals.

In Section IV of Part One of the manual, will be found a list of the main prophylactic treatments to be given to the animals.

4) WAGES OF THE DRIVER

Even if the work is done by a member of the family, the hourly or daily wage, depending on how the animals are used, must be taken into account. In any case, in assessing the amount to be entered under this item, the possible incidence of social charges

and paid holidays must not be over-looked.(1)

5) OVERHEADS

a) Housing

An animal needs an enclosed space of about 30 m³ for its shelter. This idea of size is given for information: in the French-speaking tropical countries the animals are usually housed in traditional type partly open shelters. These constructions will be amortized over 2 to 4 years, depending on the quality of the materials used.

b) Insurance

When a farmer uses his own animals, this expenditure is very often nil, but it is one which must not be over-looked when the draught animals are bought on credit. In this case, insurance is even compulsory in some countries such as Madagascar (Mutuelles de l'Alaoatra) and Senegal where the animals are marked(2).

o

o

o

(1) As an example, in the Republic of Congo Brazzaville, the employers' social charge contribution amounts to more than 25% of the wage paid to the employee (Marchés Tropicaux No. 944 of 28/11/64, page 2872).

(2) In Senegal, only 8/10ths of the animal's value is insured, the hide being estimated as worth 2/10ths; it is understood that the annual rate is 8% for an animal sold on credit extending over 5 years.

EXAMPLES WITH FIGURES

The following examples relate to the hourly cost of using draught oxen (the most frequent case) on a family farm and also on a large farm (with paid labour).

1) ITEMIZED DETAILS OF COSTS

- Purchase price of a pair of trained oxen (each weighing 350 kg)	32,000 F CFA
- Resale value (for slaughter)	20,000 F CFA
- Value to be amortized	12,000 F CFA
- Amortization time: 6 years	
- Cost per FU ⁽¹⁾ of high quality feed (e.g. millet)	15 F CFA
- Cost per FU of coarse feed	5 F CFA
- Cost of a withers yoke (to be amortized in 2 years with annual utilization of less than 750 hours)	1,500 F CFA
- Hourly wage of manpower (including miscellaneous charges)	
. family farms	30 F CFA
. large farm	35 F CFA
- Annual cost of housing (on large farms)	5,000 F CFA

2) COST OF UTILIZATION (F CFA)

EXPENDITURE ITEM	HOURS' WORK PER YEAR				
	250	500	750	1,000	1,250
<u>FAMILY FARM</u>					
- Amortization: 12,000/6	2,000	2,000	2,000	2,000	2,000
- Interest: 32,000 x 3/4 x 6/100	1,440	1,440	1,440	1,440	1,440
- Maintenance feed or coarse feedstuffs	p.m.	p.m.	p.m.	p.m.	p.m.
- Working feed or high quality feed-stuffs (see Annexes to table on next page)	3,780	7,470	11,250	14,940	18,000
- Grooming and other care	p.m.	p.m.	p.m.	p.m.	p.m.
- Harness	750	750	750	1,500	1,500
- Veterinary charges	p.m.	p.m.	p.m.	p.m.	p.m.
- Housing	p.m.	p.m.	p.m.	p.m.	p.m.
- Insurance 32,000 x 8/10 x 8/100 = 2,048	2,050	2,050	2,050	2,050	2,050
- Driver	7,500	15,000	22,500	30,000	37,500
Annual Total	17,520	28,710	39,990	51,930	62,490
Hourly Cost	70	57.40	53.30	51.90	50
<u>LARGE FARM</u>					
- Expenditures itemized above	17,520	28,710	39,990	51,930	62,490
- Coarse feed (see Annexes to table on next page)	10,950)				
- Grooming and other care	8,750)	i	d	e	m
- Veterinary charges 32,000 x 8/100	2,560)				
- Housing	5,000)				

(1) FU = Feed Units

EXPENDITURE ITEM	HOURS' WORK PER YEAR				
	250	500	750	1,000	1,250
LARGE FARM (cont.d)					
- Driver (5 F per hour more than in previous case)	1,250	2,500	3,750	5,000	6,250
Annual Total	46,330	58,470	71,000	84,190	96,000
Hourly Cost	185.30	116.90	94.70	84.20	76.80

3) ANNEX TO THE TABLEa) Working feed

The animals work for 6 hours doing "average" work.

With 350 kg oxen, the working ration in this case is 2.95 FU i.e. about 3 FU per animal; and it has been assumed that high quality feed was needed.

- Number of hours worked per year i.e. in 6-hour days, about	250 42	500 83	750 125	1 000 166	1 250 200
- FU needed per animal	126	249	375	498	600
- Cost of this feed (at 15 F per FU)	1,890	3,735	5,625	7,470	9,000
- i.e. for 2 animals	3,780	7,470	11,250	14,940	18,000

b) Maintenance feed

Throughout the year, regardless of work: at a rate of 3 FU per day per animal, the annual requirements will be $365 \times 3 \times 2 = 2,190$ FU, consisting of coarse feed.

The FU, corresponding, for example, to about 4 kg of hay, may be estimated to cost 5 F CFA. The annual expenditure is therefore 10,950 F.

c) The Number of Hours Worked Annually by Draught Animals given at the head of the table and repeated on the graph, correspond, as far as the first three are concerned (250, 500 and 750 hours) to those most frequently found on family farms; the other two (1,000 and 1,250) are those recorded on large farms or experimental stations and farms.

As an example, at Bambey, it is estimated that the average number of hours worked annually by draught oxen in Senegal is 500 hours. In Madagascar in the Highlands and in the Lake Alaotra region, where animal draught cultivation has become normal practice, the annual number of hours is understood to be about 750 hours.

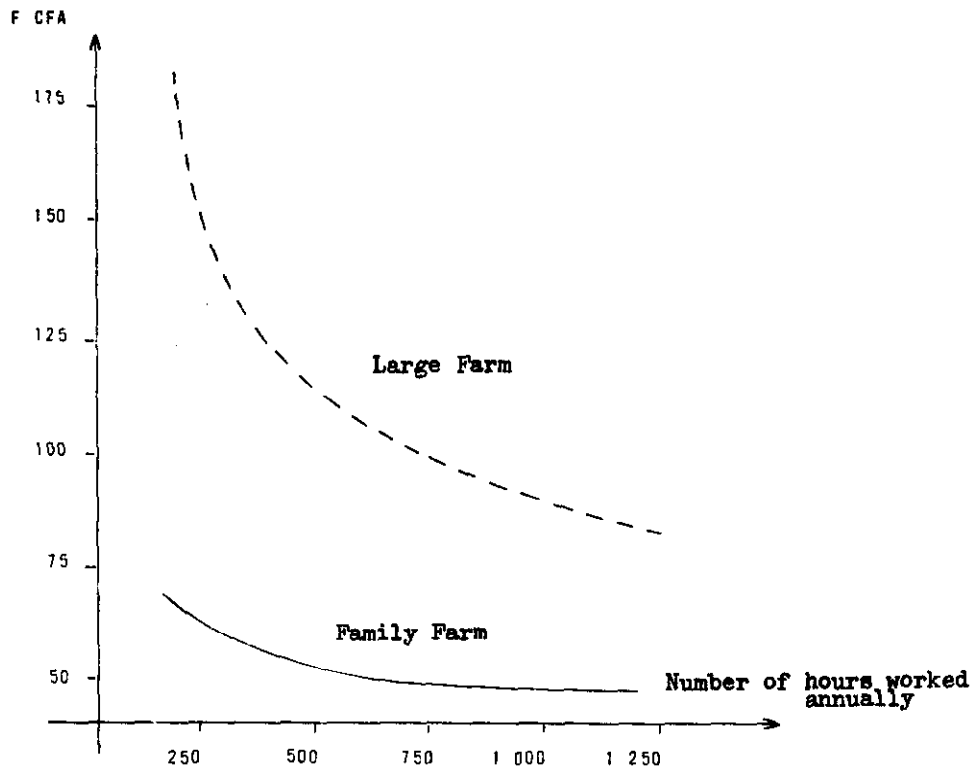

COMPARISON OF HOURLY UTILIZATION COSTS ON A LARGE FARM AND ON A FAMILY FARM

CONCLUSION

We hope that this annex, despite its provisional character because certain assumptions have had to be made (for lack of detailed information), will help anybody interested in animal draught cultivation to calculate, at least with reasonable accuracy, the cost of using draught animals in the French-speaking tropical countries.

The example with figures and its graphic representation demonstrate, on the one hand, the important effect of annual utilization on the hourly cost and, on the other, the very considerable difference between costs on a family farm and on a large farm.

It is worth noting that, as the family farms are gradually incorporated into a developed agricultural system, this difference will decrease; the additional expenses at present incurred by the large farm will gradually and progressively apply also to the family farms.

Nevertheless, bearing in mind the present state of development of animal draught cultivation, which varies so widely from one country to another, we have thought it worthwhile to make a distinction between these two cases.

BIBLIOGRAPHY

(Text and Illustrations)

- BONLIEU (A) Appareils à traction animale, traitement des récoltes au Sénégal - C.C.T.A. - Agricultural Mechanization Bulletin - Vol 2 - No. 1 - 1961
- BRASSE-BROSSARD (L) Le manuel de bon charretier - Maison Rustique - 1945
- CASSE, DUMAS, GARIN Bilan des expériences de culture attelée en Afrique Occidentale d'expression française, Guinée exceptée - Ministère de la Coopération - B.D.P.A. - I.E.M.V.T. - 1965
- C.E.E.M.A.T. Le rouleau piétineur à traction animale dans la préparation des rizières, à Madagascar - Machinisme Agricole Tropical - No. 8 - 1964
- CHAI (B.S.) Status of labour and effective methods of animal power mechanization of rice growing in Korea - F.A.O. - Ref. ICR/54/SP/8 - 1954
- DEMAIN (H.M.) Etude sur certains artisanats ruraux voltaïques - Ministère de la Coopération - SATEC - 1964
- DEMAIN (H.M.) et LUGASSY (J) Etude sur certains artisanats ruraux nigériens - Ministère de la Coopération - SATEC - 1964
- DUFFOUR (A) Une condition indispensable du développement du machinisme: le dressage des boeufs - Bulletin de Madagascar - No. 219 - 1964
- HOPFEN (H.J.) Small Farm Implements - FAO Development Paper No. 32 - 1953
- HOPFEN (H.J.) Farm Implements for Arid and Tropical Regions - FAO Development Paper No. 67 - 1960
- ISMAN Matériels utilisés en Algérie dans l'agriculture traditionnelle et leur amélioration - Congrès international technique du machinisme agricole. Comptes-rendus - D - 12/11 - 1961
- JANNAUD (G) Un semoir à traction animale de construction locale, le "Semoir Cheminault" I.R.A.M. - Division des Techniques Culturelles - Section Machinisme Agricole - Madagascar - 1962
- JANNAUD (G) Quelques considérations sur l'emploi de la traction bovine à Madagascar - I.R.A.M., Division des Techniques culturelles, Section Machinisme Agricole - 1962
- KULKARNI (R.V.) Replace your wooden plow with this new device - Indian Farming - No. 12 - 1964

- LABROUSSE (G) Conditions générales du développement de la mécanisation agricole dans les pays tropicaux d'expression française - Congrès international technique du machinisme agricole, Comptes-rendus D - 14/11 - 1961
- LABROUSSE (G) et GODRON (E) Mécanisation de la culture de l'arachide - Machinisme Agricole Tropical - No. 11 bis - 1965
- LABROUSSE (G) et UZUREAU (C) Méthodes et matériels susceptibles d'être utilisés pour l'amélioration de la production rizicole - Agronomie Tropicale - No. 6 - 1962
- LAKSHMIPATHY (B.M.) No backbreaking with these improved implements - Indian Farming - 1958
- LE LOUS et ZELTNER l'artisanat de mécanique agricole - République Malgache - Centre Economique et Technique de l'artisanat - SATEC - 1964
- LE QUINIO (A) Compte-rendu de mission en Italie, matériels de riziculture - C.E.E.M.A.T. - 1963
- LE QUINIO (A) Compte-rendu de mission en Espagne, matériels de riziculture - C.E.E.M.A.T. - 1963
- LE QUINIO (A) Rapport de mission au Niger - C.E.E.M.A.T. - 1965
- LE QUINIO (A) Rapport de mission en Afrique Orientale - C.E.E.M.A.T. - 1966
- LEROY (A.M.) Le boeuf - Encyclopédie des Connaissances Agricoles, Hachette - 1942
- MALLARAJ ARS (V.M.) A seed drill that suits all soils - Indian Farming - 1964
- MARIE-SAINTE (Y) La culture attelée au Sénégal - République du Sénégal: Aménagement du Territoire - Université de Dakar - 1963
- MARSDEN (R.H.) Ox-drawn toolbar equipment, Report of field trials, 1960-61, in Tanganyika and Uganda - N.I.A.E.
- MATHIEU (P) La traction bovine - I.N.E.A.C. - Vol. 8 - No. 4 - 1959
- MOHAMAD (N.D.) Improvements to the Malayan plough in rice cultivation - C.I.R. Kuala Lumpur - 1962
- MOLENAAR (A) Machines à élever l'eau pour l'irrigation - F.A.O. - Progrès et mise en valeur - Agriculture - Cahier No. 60 - 1956
- MONNIER (J) Contribution à l'étude de la traction bovine au Sénégal - Machinisme Agricole Tropical - No. 10 et 11 - 1965
- MOREL (R) Une méthode de développement rural: la traction animale dans la Préfecture de la Ouaka (République Centrafricaine) - Machinisme Agricole Tropical - No. 13 - 1966

- NERLI (N) Meccanica agraria - Riccardo Patron - Bologna - 1961
- NOLLE (J) La polyvalence des machines agricoles, facteur d'évolution - Congrès international technique du Machinisme Agricole - Comptes-rendus - B3 - 2/I - 1961
- OFFICE DU NIGER Archives
- PANTULU (S.L.N.) et KRISHNARAO (B) The Andhara farmer calls it the Guntaka - Indian Farming - No. 3 - 1958
- PATEL (S.M.) The Anand hoe is a better hoe - Indian Farming - 1959
- RINGELMANN (M) Génie Rural appliqué aux colonies - A. Challamel - 1908
- RINGUELET (R) Le petit outillage à traction animale en culture irriguée - C.R.E.G.R. du Maroc - Cahier No. 6 - 1958
- SCHERRER (J) Compte-rendu de missions en Afrique (Haute-Volta, Sénégal, Côte d'Ivoire) et à Madagascar - Mesure de la puissance des attelages - C.E.E.M.A.T. - 1965 et 1966
- SHAH (N.C.) Bombay's many improved farm implements - Indian Farming - No. 3 - 1958
- STOKES (A.R.) Mechanization and the peasant farmer - World Crops - Dec. 1963
- STOUT (B.A.) Equipment for Rice Production - FAO Development Paper No. 84 - 1966
- TOLAINE (O) et ROSTON (P.J.) Les animaux et l'effort de traction - Boletim da Divisao de Mecanização Agricola - Secrétariat de l'Agriculture, Etat de Sao Paulo, Brésil - 1957-58
- TOURTE (R) Les instruments de désherbage à traction animale - Note Technique du C R A de Bamby, Sénégal - Direction agronomique - 1961
- TOURTE (R) Quelques machines adaptées à l'agriculture de la zone arachidière d'Afrique Tropicale - Congrès international technique du machinisme agricole - Comptes-rendus D - 10/II - 1961
- TOURTE (R) L'équipement mécanique de l'agriculture traditionnelle africaine facteur fondamental d'évolution - Congrès international technique du machinisme agricole - Comptes-rendus - D 2/II - 1961
- UZUREAU (C) Rapport de mission en Afrique de l'Ouest: Dahomey, Togo, Haute-Volta, Nigéria - C.E.E.M.A.T. - 1966
- FAO Planning and Organization of Projects for the Improvement of Hand and Animal operated Implements - FAO Informal Working Bulletin No. 12 - 1960

- Guide sommaire d'utilisation du petit matériel agricole mis au point par le Centre des Expérimentations - Génie Rural, Maroc - 1962
- L'action du C.E.T.A. en matière d'artisanat rural, 1964-65 - Centre d'Etudes Techniques Agricoles - Madagascar - 1965
- (Service Technique, C.F.D.T.) - La culture attelée dans la zone cotonnière du Nord Cameroun - Machinisme Agricole Tropical - No. 11 - 1965
- La traction bovine - Compte-rendu des Journées de la Recherche au CRA Bambeï 5-6 Avril 1960 - C R A Bambeï, Division d'Agronomie - 1960
- Macchine e attrezzi per vivai - Il Riso - No. 5 - 1958
- Etude d'une machine élévatoire pour l'eau (Tchad) - B.D.P.A. - No. 64/10/X - 1964.