

**AT** MICROFICHE  
REFERENCE  
LIBRARY

A project of Volunteers in Asia

Animal Traction

Manual No. M-12

by: Peter R. Watson

Published by:  
Peace Corps  
Information Collection and Exchange  
806 Connecticut Avenue, N.W.  
Washington, DC 20525 USA

Available from:  
Peace Corps  
Information Collection and Exchange  
806 Connecticut Avenue, N.W.  
Washington, DC 20525 USA

Reproduction of this microfiche document in any form is subject to the same restrictions as those of the original document.

APPROPRIATE TECHNOLOGIES FOR DEVELOPMENT

# **Animal Traction**

**Peace Corps**

INFORMATION COLLECTION & EXCHANGE

MANUAL M-12

# **Animal Traction**

Written by:

**Peter R. Watson**

Edited by:

**Richard Davis**

**Marilyn S. Chakroff**

Illustrated by:

**Marilyn Kaufman**

**Mary Conn**

This publication was produced  
for Peace Corps by the TransCentury  
Corporation, Washington, D.C.

Peace Corps  
Information Collection & Exchange  
Appropriate Technologies for Development  
Manual Number M-12  
August 1981

**ANIMAL TRACTION**  
August 1981

Prepared for Peace Corps by  
the TransCentury Corporation  
under Contract No. 79-043-0129

Available through  
Peace Corps, ICE  
806 Connecticut Avenue, N.W.  
Washington, D.C. 20525



## About this Manual

This manual is a practical guide to the use of draft animals and animal-powered farm equipment. It is written primarily for use by Peace Corps Volunteers and agricultural extension personnel working in animal traction development programs, but it can be used by farmers who are teaching themselves to use these techniques.

While some of the information contained in the manual is specific to the extension of animal-powered agriculture in Africa, the principles explained and illustrated are fundamental: they are generally applicable wherever the method is being used or introduced.

In writing the manual, priority has been given to information which the author, reviewers, and editors feel will be valuable to a majority of Volunteers working in animal traction programs. A

resource guide is included to help readers find information specific to areas of interest or need. It should be further noted that authorities do not always agree on the importance of given techniques or the effectiveness of certain methods. In some cases it has been necessary for the author to make recommendations based on his experience as an animal traction Volunteer and as a Volunteer trainer.

## About the Author

Peter R. Watson has five years of experience working with draft animals, primarily in West Africa. From 1972 to 1976 Mr. Watson supervised 25 farmers and seven agricultural extension agents in a program to popularize the use of animals for power in Benin. He operated a small farm using animal-drawn equipment in the cultivation of a variety of traditional food and cash crops. In 1979 Mr. Watson was hired by the Peace Corps as an instructor for their animal traction Volunteers. Mr. Watson's previous writing experience included articles about the culture of the Bariba people of Benin and Nigeria, and an extensive report on the evolution and potential of animal traction technology in a traditional rural farming community in West Africa.

## Acknowledgments

So many people have contributed to this manual that it would be impossible to thank them all individually. However, I do want to give my thanks to those reviewers who read and corrected previous drafts of the manual and to the people who gave special help during the research phase. I am especially grateful to Kelly Morris and Steve Joyce at Peace Corps and to Buckley Lye and Rob Shulman, who gave careful review of the manual and made valuable suggestions. At TransCentury I want to thank Paul Chakroff, Project Manager, for his continued support throughout the project, and Michael Costa for his review of the sections on animal health and nutrition. A very warm special thanks goes to Ben, Marcia, and Junior Ellingson for their help in giving me first-hand experience with catching bulls. Finally, I would like to thank the following people for their help in providing information for this manual: Carol and Fred Watson, Pat Wetmore, Helen Davidson, Andre

Lona, Pierre Huet, Ted Bermingham, Paul Schmidt, and Mrs. Thorsnes.

And a special thanks to Cade Ware for his excellent typing and layout work.

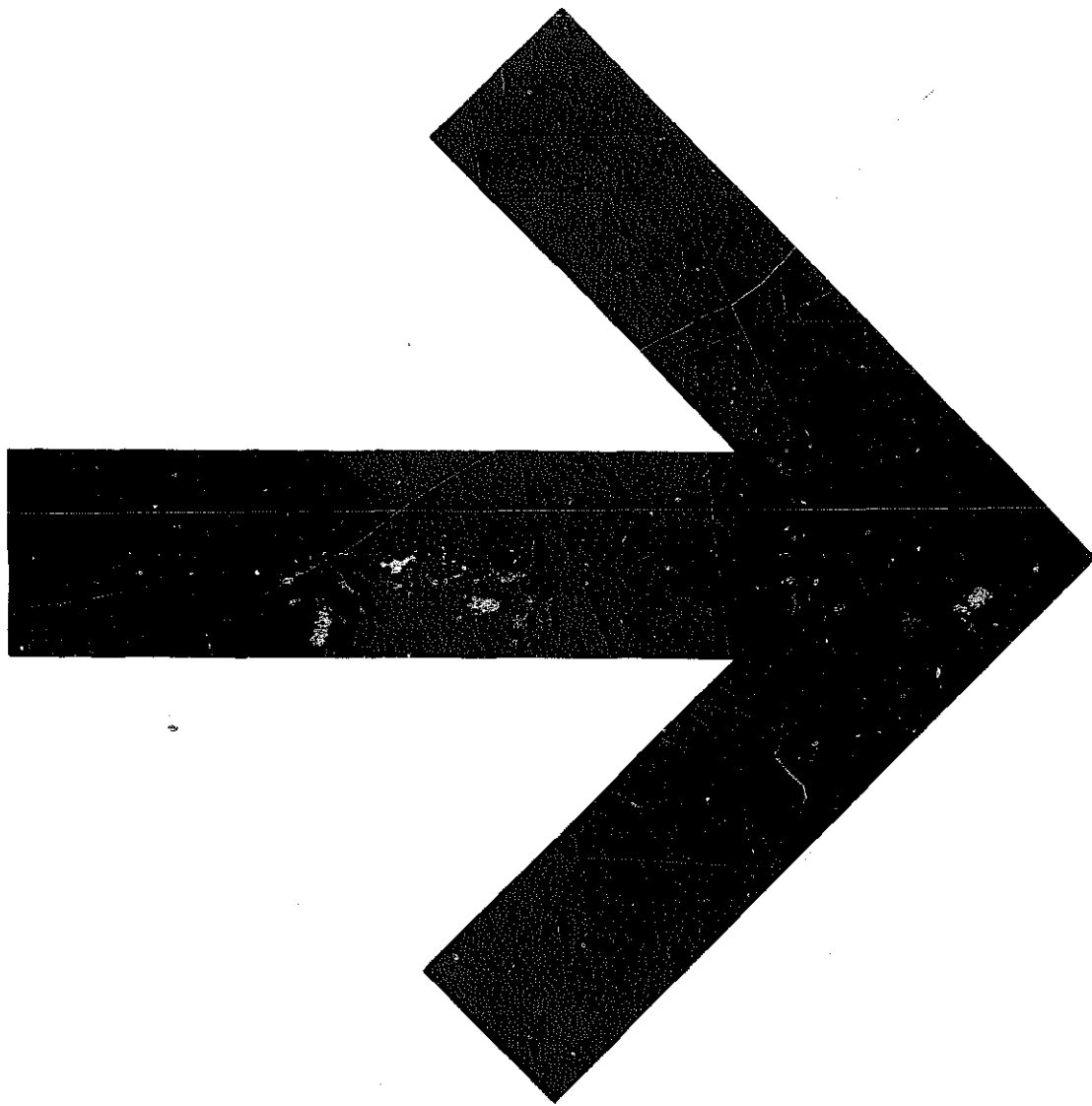

# Animal Traction

## Table of Contents

	<u>Page</u>
About This Manual	i
About the Author	ii
Acknowledgments	iii
1. Introduction	1
2. Draft Animal Selection	9
3. Animal Husbandry	31
4. Training Draft Animals	49
5. Yokes and Harnesses	75
6. Hitches	97
7. Field Operations and Implements	115
8. Economic and Technical Assistance	153
9. Animal Traction Extension	161
<u>Appendices</u>	
A. Animal Power	173
B. Animal Nutrition	175
C. Disease Recognition and Control	201

D. Workshop and Spare Parts Inventory	209
E. Animal Traction Instruction Forms	211
F. Draft Animals Used in Africa	217
Bibliography	223
Resources	231
Glossary	237
Index	241

# 1. Introduction

## What is Animal Traction?

In many parts of the world, farmers have adapted hoes and cultivating tools so they can be pulled by people, animals or engines. This is called mechanized agriculture; the type of power used is called traction, or pulling power.

Animal traction, animal-powered mechanization, and animal draft are terms which describe the use of animals to pull farm equipment, vehicles, and other loads. The most common draft animals are cattle, horses and mules, but donkeys, camels, domestic water buffalo, yaks, dogs, reindeer and even elephants are used for traction in some parts of the world. The kind of animals used and the kind of

work performed depend largely on people's resourcefulness in raising and training animals and devising hitches that allow them to pull.

## History of Animal Traction

Illustrations on the walls of Egyptian tombs show farmers using animal traction from as early as 1400 B.C. In these hieroglyphics the handle of a hand-held hoe was extended and lashed to the horns of oxen with rope. These illustrations

also show humans pulling plows.

The first plows, pulled by people or animals, probably were not used to break the soil but to stir soil which had already been loosened by hand-held hoes. Animals were used to pull branches across a seedbed in order to cover the scattered seed.

In the transition from manual hoeing to human or animal traction, the basic "elbow" or "checkmark" design of the hoe did not change. What changed was the method of pulling. Instead of being pulled in a series of short, individual strokes or chops, the hoe was pulled continuously. It was this continuous motion which transformed the hoe into the "plow".

## Why Use Animal Traction?

Agricultural mechanization has become a high priority in devel-

oping nations. This innovation is important because farmers using traditional techniques are unable to produce sufficient food for increasing populations. Mechanization can expand the area under cultivation and provide better soil preparation, leading to greater harvests. Government extension services therefore strive to give farmers tools, information and advice to enable them to increase productivity.

Benefits of mechanization to farmers include lightened workloads, better and more regular yields, or an easing of problems caused by short growing seasons or insufficient labor. Mechanization also can help to produce income with which farmers can acquire goods and services.

Yet mechanization is not practical or economical for every farmer. New tools are expensive. Acceptance of new techniques increases dependency on outside technical assistance. Thus the farmer who already produces enough food for his family may be reluctant to risk a known harvest (traditional yield) for an uncertain gain in productivity.



can double or triple the area cultivated, thereby increasing crop yields.

- It is affordable technology. Animals and equipment are low in cost compared to tractors. With careful planning and application, the investment can pay for itself in a few years. Low-interest loans are often available through government or sponsoring agencies.
- Animals and equipment can be supplied locally, creating less dependence on external resources than tractors and other machinery. Tractors need fossil fuels, spare parts, and maintenance know-how which may not be available to farmers.
- Used on a small scale, it does not require radical changes in cropping patterns or the role of family or hired labor. Although it does reduce manpower needs in some field operations, the reduction is not drastic and labor can shift to other activities like planting, spraying, harvesting and caring for animals and harness.
- It creates work opportunities. The use of animal traction can stimulate the development of artisan resources, increasing jobs for local blacksmiths, carpenters, and leathermakers who produce needed equipment. It also creates work in the areas of transport, water-pulling, and till-

age on a contract basis. (Farmers can hire out their teams and equipment.) Often new opportunities arise in marketing and agro-industry.

- It encourages livestock production and development of meat, leather and byproduct markets.

## Some Considerations

While there are advantages to using animal traction, there are possible disadvantages. Changes in one part of the total agricultural system may affect other parts of that system; without planning, the change from handhoe to animal traction may have negative effects on farming families. National agricultural goals like increased production, market growth, and agro-industrial development may be offset by disruption of important traditions and values. Here are some reasons why farmers may prefer traditional techniques:

- New techniques can disrupt established labor patterns and family organization. Farmers who use animals to plow extra land, for example, also must use animals to weed it. However, inexperience, animal or equipment loss, or poor advice from extension agents could leave farmers unable to perform mechanical weeding. The burden would then fall on their families.
- Surplus cropping may complicate traditional patterns of wealth-sharing among family and friends. Farmers may be wary of jealousy, criticism, or demands that may result from increased production and selling of surpluses for individual gain.
- New technology can increase farmer reliance on outside technical assistance. Sometimes limited supplies, ineffective delivery chains, and absence of skilled agricultural and veterinary extension personnel have made it difficult for farmers to use animal traction successfully.

## How Can Animal Traction Be Used?

Animal traction farm technology can be adapted to meet the requirements of individual farmers. Nearly all manual tillage operations, such as hauling (by wagon), water-lifting, skidding (logging), and threshing, can employ animal power.

Animal traction can be used to complement ongoing manual operations or replace them entirely. Usually, mechanization of one operation requires mechanization of some others. In parts of Africa, for example, farmers plowing additional land using animals also have to mechanize weeding, because manual laborers don't have time to weed the extra crops. Harvesting and threshing, however, are done by hand because dry weather preserves crops, giving farmers time to complete these operations by hand.

As farmers increase producti-

vity and earn capital, they are able to purchase more animals and equipment. Eventually, they may replace animal power with engine power.

But animal traction is not just for farmers who want to expand production. It is also for those who could or would farm if they did not have to do it by hand. While the logistics of financing equipment and technical assistance forces programs to concentrate on farmers who expand operations and stimulate markets, it should be clear that farmers who support themselves and their families contribute to the overall stability of national economies. The importance of this very fundamental view of animal traction economics becomes clearer as growing numbers of young people leave farms seeking an easier way of life in the cities. Animal traction technology can reverse this process by giving farmers tools that make their occupation secure and productive.

## **Before Beginning: What Do You Need to Know?**

This manual is a practical guide to the selection, care, and training of draft animals, and to the equipment and field techniques used in animal-powered farming systems.

It is also a guide to animal traction extension, describing how instructors can teach these skills to farmers and other agents. Many animal traction programs offer special incentives and services to farmers willing to try new methods. These may include farm planning, financial assistance programs, veterinary and artisan support systems, marketing systems, and equipment supply and distribution procedures. Instructors must be familiar with these services and able to explain them to farmers.

Successful animal traction begins with farmers who understand and appreciate the value of draft

animals and who treat them with care and kindness. Instructors can help new farmers most, perhaps, by showing them what to expect from their animals, and what the animals need in return.

## 2. Draft Animal Selection

Farmers must be able to select the animal or animals most appropriate for their needs. The animals they choose must be culturally acceptable, trainable, maintainable, and profitable within the overall farm plan. It is also important that the animal be available locally, since these animals are already adapted to local feeds and climate and are likely to be resistant to diseases in the region. Of course, farmers should choose healthy animals from strong stock. In some areas, farmers must consider social or religious traditions which restrict the ownership or use of animals.

In this chapter the word "bovine" applies to cattle (or cows) and the word "equine" refers to

horses and horse-like animals (donkeys and mules).

### Popular Draft Animals

#### Oxen

The most commonly-used draft animals are cattle. Among cattle oxen are often preferred, because they are well-muscled and have good temperaments. An ox is a bull which has been castrated and trained to pull loads, but the term is sometimes used to describe a working

cow. In this manual, "ox" will refer to animals of either sex. Some stockmen define oxen by age as well, distinguishing them from younger "bullocks" by their full mouths (present at four years of age.) Oxen are well-adapted to savanna and forest-savanna lands. Their use in rain forest zones has been restricted by disease, most notably trypanosomiasis, or bovine sleeping sickness.

### Donkeys

In arid areas, the cost of maintaining cattle is often too great to make oxen a feasible source of farm power. Donkeys are better suited to these climates and often supply sufficient power for the kind of agriculture practiced. Donkeys are popular draft animals because they are inexpensive (often less than half the price of oxen on the live market), easy to train, and effective where shallow breaking rather than overturning of the soil is all that is needed before plant-

ing begins. The use of light equipment and the improvement of husbandry techniques has made it increasingly clear that donkeys are an important source of farm power.

### Horses

Horses, by contrast, have not been popular draft animals in some areas of the world, notably West Africa. Horses can be more expensive to feed than bulls because they are not ruminant animals and therefore use roughage less efficiently. While they theoretically provide more power than bulls, horses do not deliver a sustained tractive, or pulling, effort under difficult conditions. However, horses are much faster than oxen.

### Mules

Mules found in Africa are rarely used for draft purposes. Like horses, mules are expensive to feed. But where they are culturally acceptable (because they are a cross-breed, they are considered unclean

by some Muslims), they have great potential. They have the intelligence and sure-footedness of the donkey and the strength of the horse, and are easily harnessed. A mule is a cross between a male donkey (jack) and a female horse (mare). The male offspring of this cross, called a horse mule, is always sterile, while the female offspring, or mare mule, is usually infertile. The female donkey, known as a jennet or jenny, is rarely bred with the male horse, or stallion. However, their offspring, the macho (male) and hinny (female), are basically indistinguishable from mules, and are good work animals.

### Camels

Camels are used as pack animals through much of the Sahara. In Mauritania, Niger, Chad, Mali and Senegal they are used to supply power for drawing water; occasionally they are used to draw plows or light weeding implements. For information on husbandry and use of camels as draft animals, see page 234.

### Buffalo

The domestic buffalo is used extensively as a draft animal in Asia; less commonly in Egypt and the Near East. Attempts have been made to cross Asian domestic and African wild breeds, but in each instance the resulting population succumbed to disease. Some researchers feel that further experiments will prove the value of importing and breeding the animal in Africa, as its milk, meat, and labor potentials are high. Today experimental herds are maintained in Mozambique and Tanzania. Buffalo work at a slower rate than oxen, but are generally considered to be stronger and better adapted to wet terrain.

Except for camels, any of the animals mentioned above can be trained and harnessed using the methods described in the chapter on training.

# Determining Power Requirements

Before attempting to determine the kind and number of animals required for any particular farm, animal owners should be familiar with the concepts of pulling (draft) capacity and power. They should also consider the work characteristics of draft animals.

## Draft

In order to move any object, an animal must exert a force equal to the weight or resistance of that object. For example, it takes 50 kilograms (kg) of force to move a 50-kg log. If the movement is accomplished by pulling, rather than by lifting, or carrying, the force is called draft.

The draft capacity of an animal increases with its weight. A generally accepted rule is that an animal can exert a constant pull on

a load which equals approximately one-tenth of its body weight. The rule applies when the animal is allowed to assume a natural pace and expected to produce an extended rather than a concentrated effort. A 300-kg bull, for example, can pull a 30-kg log all day, but if it is made to pull 130 kg, it will work only three or four hours before it tires. If it is made to pull at a faster pace, it also will tire sooner.

A draft animal must be able to produce bursts of extra force as well as work at a steady pace. Under normal conditions, 30 kg of force may be required to pull a log, but if it must be dragged up a hill, or if the log catches in a gully, the force needed (draft requirement) increases. Horses, mules and oxen are preferred draft animals because they can pull loads over long distances at reasonable speeds and, when necessary, provide extra pulling capacity.



## Power

Power is the combination of pulling capacity and speed, or pace. Under normal conditions, a large horse will pull a 150-pound (1b) load at a steady rate of 2-1/2 miles per hour (mph). This rate of work is defined as one horsepower (hp). A bull of the same weight, pulling the same load, will assume a normal pace of 1-1/2 mph. At the end of an eight-hour day, the horse will have moved the load further, or produced more work than the bull, and is thus said to be more powerful than the bull.

Tests have shown that light horses, bulls, buffalo, mules and camels all provide about three-quarters horsepower, cows about one-half horsepower, and donkeys one-third horsepower. But it must be remembered that these are the rates at which the animals normally deliver force, not the maximum force they can produce in a given instant. In pulling tests, horses have, for several seconds, exerted pulls up to twice their weight and bulls have

pulled up to their actual weight. But the intensity of such efforts uses up the animal's strength and reduces the total time it is able to work.

## Work Characteristics

Animals vary not only in their ability to pull loads, but also in the number of hours they will work. In the tropics, breeds of oxen will pull between one-seventh and one-tenth of their weight for four to five hours per day. Donkeys will pull about one-fifth of their weight for three to four hours. In tests performed in Africa, bulls worked longer when the load was decreased slightly and the work done in two sessions, two to three hours in the morning and two to three hours in late afternoon. Donkeys refused to work beyond three or four hours regardless of how the work was distributed and in spite of a reduction in the size of the load.

(Source: CEEMAT, Manuel de Culture avec Traction Animale. 1968.)

# General Rules Concerning Power Requirements

The above information, qualified by the following rules, makes it possible to determine the kind and number of draft animals needed to power various field operations:

- Given the soil conditions of a region, the weight of the implement to be used and the average depth at which the implement will work, the animal(s) must be able to deliver, for an extended period of time, a force equal to and preferably more than the total resistance, or draft requirement of the work. Tables 1 and 2 gives the draft requirements of various field implements.
- Work that requires frequent "peak efforts" (pulling a plow through rooted or rocky soil; pulling a cart over hilly terrain) tires animals quickly. The operator must compensate by reducing the length of the work day, reducing the intensity of the work (for example, taking smaller cuts with the plow), or providing frequent rests. The alternative is to increase the number of animals used.
- Individual animals do not pull to capacity when hitched in pairs or multiple arrangements. Tests have shown that the individual is 7.5 percent less efficient when it works within a pair. The percentage increases to 15, 22, 30 and 37 percent when the animal works in a team of three, four, five and six animals, respectively.
- As the line of pull is lowered (or as the angle between the line of pull and the ground becomes more acute), less power is needed to move the load. Donkeys and short-legged cattle can produce more power than their weight would indicate because they are closer to the ground.
- Animals deliver maximum performance only when the harness (yoke, collar or breastband) is properly fitted and provides a broad, smooth surface against which to push. Test evidence suggests that bovine animals can deliver 25-50 percent more horsepower when harnessed in a breastband or collar rather than a yoke. The difference is explained in the lower point of draft, the increased comfort of the harness, and in the fact that the animal pushes against a much larger surface area.
- Animals must be in good health and properly trained.

# Method for Determining Size of the Hitch

A basic approach to determining the kind and number of animals required is to estimate the maximum power the farmer will need and then calculate the size of the animal or team of animals that could supply it. The combination of animals that will satisfy the farmer's power needs is called a hitch. The size of the hitch can be determined by using the tables below, or by making the calculations found in Appendix A.

Table 2 gives the draft requirements of various field operations. Remember that the draft requirement is the amount of power needed to pull an implement through the soil.

Tables 3 and 4 give the amount of power donkeys and bulls, respectively, can deliver in relation to their body weight and number of individuals in the hitch.

To determine the kind of hitch

needed, first find the draft requirement of the most difficult operation to be performed (Tables 1 and 2). Use Tables 3 and 4 to find which size animal or combination of animals will deliver this amount of power. Then determine the weights of the available animals to match animal power to draft requirements.

For example:

Difficulty of work--The most difficult field operation will be plowing fairly light soils during the rainy season with a single moldboard plow. The farmer's fields are old (have been cultivated the previous season) and plowing depth will not exceed 15 centimeters (cm).

Draft requirements--According to Table 1 about 70 kg of pulling power are needed to do this kind of work.

Hitch options--Tables 3 and 4 can be used to determine two hitches that would satisfy the draft requirement:

- 1) two 300-kg bulls (69.5 kg of power or draft)
- 2) four 110-kg donkeys (69 kg of power or draft).

Table 1--Requirements of Some Farm Implements  
for Operations on Medium Loam Soils\*

Operation	Draft Requirement	
	lbs	kg
Plowing fallow land with single moldboard plow		
11.4 cm wide, 12.7 cm deep	196	89
14.0 cm wide, 12.7 cm deep	207	94
16.5 cm wide, 15.2 cm deep	267	121
25.0 cm wide, 18.0 cm deep	375	170
Plowing fallow land with double moldboard plow		
30.0 cm wide, 5.5 cm deep	256	116
Harrowing plowed soil		
18-tine peg tooth harrow, 6.3 cm deep	101	46
5 spring tines, 11.4 cm deep	260	118
heavy harrowing 165-320 cm wide	176-220	80-100
light harrowing 320 cm wide	198	90
Leveling plowed soil with a 180-cm-long board ridden by a person of 53 kg weight	198	90
Rolling	212	96
Cultivating, 3-tine cultivator, 9 cm deep	117	53
Seed drilling, 175-299 cm wide, 11-13 openers	198	90
Wheeled transport of loads up to one metric ton, on average farm roads	198-265	90-120

Source: Hopfen, H. J. 1969. Farm Implements for Arid and Tropical Regions. Food and Agriculture Organization of the United Nations, Rome, Italy.

\*See Chapter 7 for a description of these operations and implements.

Table 3--Power of Donkeys (in breastband or collar)

Weight of donkey (kg)	Power of animal working alone (kg)	In team of 2		In team of 3		In team of 4	
		Single animal	TEAM TOTAL	Single animal	TEAM TOTAL	Single animal	TEAM TOTAL
80	16	14.8	29.5	13.6	41	12.5	50
90	18	16.5	33	15.3	46	14	56
100	20	18.5	37	17	51	15.6	62
110	22	20.4	41	18.7	56	17.2	69
120	24	22.2	44.5	20.4	61	18.7	75
130	26	24	48	22.1	66	20.3	81
140	28	25.9	52	23.8	71.5	21.8	87
150	30	27.8	55.5	25.5	76.5	23.4	94

If animals to be used are of the same size, match draft requirement to figure in TOTAL columns. For example, an animal owner could meet a requirement of 56 kg of power by using two 150-kg donkeys, three 110-kg donkeys, or four small animals of 90 kg apiece.

If animals are of different sizes, use single animal column for any size hitch, and add individual power together to get hitch total.

power when working in these types of harnesses.

## Determining Weights of Animals

To determine an animal's weight, first measure the length of the animal from point of shoulder to point of rump (A-B) and the circumference of its torso at point of

Table 4--Power of Bulls (in yoke)

Weight of bull (kg)	Power of animal working alone (kg)	In team of 2		In team of 3		In team of 4	
		Single animal	TEAM TOTAL	Single animal	TEAM TOTAL	Single animal	TEAM TOTAL
200	25.0	23.1	46.2	21.3	64	19.5	78
225	28.1	26	52	23.9	71.5	21.9	87.5
250	31.3	29	58	26.6	80	24.4	97.5
275	34.4	31.8	63.5	29.2	87.5	26.8	107
300	37.5	34.7	69.5	31.9	95.5	29.3	117
325	40.6	37.6	75	34.5	103.5	31.7	126.5
350	44	40.5	81	37.2	111.5	34.1	136.5
375	47	43.3	86.5	39.8	119.5	36.5	146
400	50	46.2	92.5	42.5	127.5	39	156

NOTE: For a method of calculating draft power in hitches up to six animals, see Appendix A.

heart (C) with a tape or rope. (See the drawing on page 20.)

When taking the torso or girth measurement, observe these rules:

- o Measure in the morning before the animal drinks. Don't give it hay the night before.
- o Have the animal stand squarely with its head in a normal position.
- o Pull the tape snugly around the torso, at the smallest circumference behind the shoulders.

Next, follow these formulas:

For bovine animals

Substitute measurements A-B (length) and C (circumference of torso at point of heart, or girth) into this formula:

$$\frac{\text{girth} \times \text{girth} \times \text{length}}{300} = \text{weight}$$

For this formula, measurements must be taken in inches. If a metric tape or rope/rule is used to measure the animal, centimeters must be converted to inches before the formula can be used. One inch = 2.54 cm.

Example:

Girth of bull measures 152 cm, length measures 135 cm.

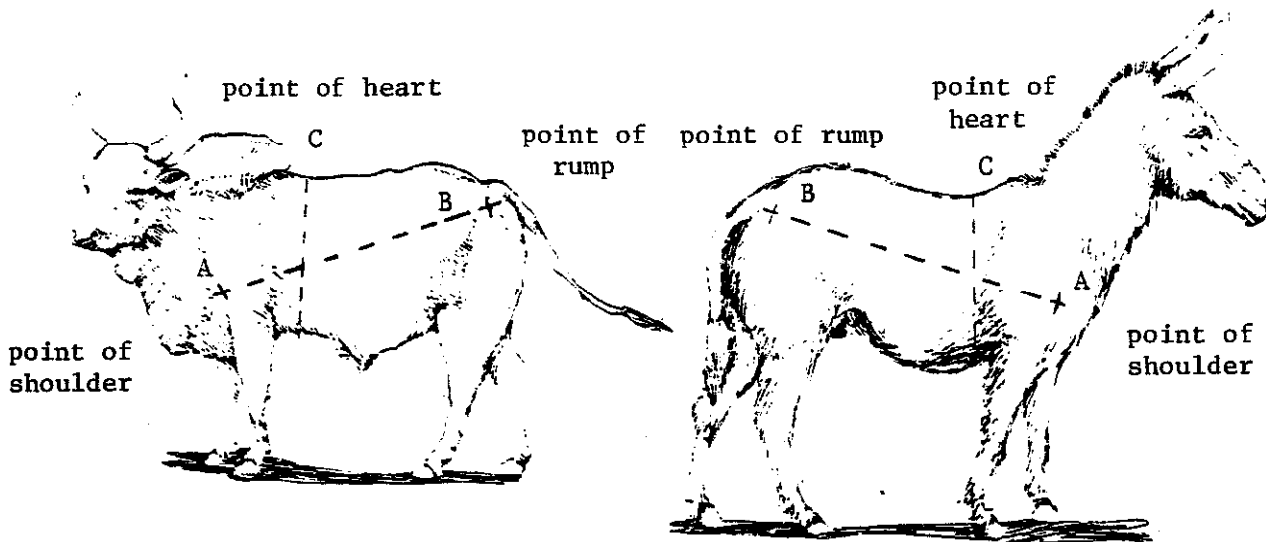

$$\frac{152}{2.54} = 60 \text{ inches (girth)}$$

$$\frac{135}{2.54} = 53 \text{ inches (length)}$$

$$\frac{60 \times 60 \times 53}{300} = 636 \text{ lbs}$$

Since one kg = 2.2 lbs, the weight of the animal in kg is obtained by dividing 2.2 into the answer above (636 lbs).

$$\frac{636}{2.2} = 289 \text{ kg}$$

The bull weighs 636 lbs or 289 kg.

An alternate method for estimating the weight of a steer (castrated bull):

$$\text{Live weight} = 1.04 [27.5758 \times \text{heart girth}] - 1.04967]$$

#### For equine animals

Substitute measurements A-B (length) and C (girth) into this formula:

$$\frac{\text{girth} \times \text{girth} \times \text{length}}{300} + 50 \text{ lbs} = \text{weight}$$

Measurements must be taken in inches, or converted into inches, before the formula is used.

Example:

Donkey's girth measures 37 inches, donkey's length measures 35 inches.

$$\frac{37 \times 37 \times 35}{300} + 50 = \text{weight of donkey}$$

$$160 + 50 = 210 \text{ lbs}$$

If the animal's weight is to be expressed in kg,

$$\frac{210}{2.2} = 95 \text{ kg}$$

The donkey weighs 210 lbs or 95 kg.

## Selection of Individual Draft Animals

Once farmers decide what kind of draft animal will be used, they must be able to choose individual animals which are sound and trainable and have a considerable work expectancy and resale value. Selecting a good draft animal is a matter of evaluating both physical and behavioral attributes. Age, sex, conformation (shape), and temperament are helpful criteria for judging a draft animal's value. The farmer's total animal needs must be noted when judging an individual animal. If it is to be used as a pair, it should be roughly the same age and size as its work mate, and should be the same sex.

## Age of Bovine Animals

Ideally, farmers should raise their own draft cattle or purchase them when they are very young. This allows the farmers to provide proper nutrition during the critical growth stage as well as to observe and shape the animal's behavior long before it is put to work.

Oxen are normally put to work between the ages of three and four years. They may be trained at two to three years of age and given light work for a season. However, before the age of three, oxen have little power, and hard work can stunt their growth or cause abnormal development of bone and muscle. After the age of four, animals may be difficult to handle and train; they must be broken of old habits before their power can be used.

Although oxen can work until they are 12 or older, many farmers prefer to sell them as soon as their work capacity tapers off. A common practice is to work oxen hard until age seven or eight, use



them as a reserve or alternate animal (or pair) for a season or two, and then sell them for butchering.

When buying an ox, the purchaser can determine the animal's age by counting its teeth. Because the approach of an unfamiliar person may cause the animal to shy or to struggle, it is best to have the owner open the animal's mouth. Otherwise restrain the animal and pry open the mouth by pulling up on the nostrils and down on the lower jaw.

Cattle have front teeth only in the lower jaw. Temporary teeth appear at one month. The first permanent teeth appear at age two. By age five, the animal has a full set of permanent teeth. The age of older animals can be determined by observing the wear patterns of the teeth and matching them to the patterns shown in the illustration on the next page. An alternate method is to count the number of rings on the animal's horns; each ring corresponds to one year of growth, the first ring appearing at age two.

## Age of Equine Animals

Recommended ages for training and working equine animals are very similar to those outlined for cattle. However, in practice, these animals are worked until they are older because their meat is less valuable. The age of a horse, donkey or mule can be determined by comparing the animal's mouth to the diagrams on the following page.

As the animal grows older, the enamel wears off the tooth, giving it a smooth, white grinding surface (the dark center disappears). The teeth grow longer and begin to slant; the entire mouth elongates. Compare the side views of the four- and thirty-year-old horse and note the increased pointing of the jaw.

The correct method for opening the animal's mouth is as follows:

- Place the palm of one hand under the animal's jaw;
- Insert the thumb and middle finger into the animal's mouth on either side of the lower jaw, at a point behind the teeth;

Determining the Age of Cattle

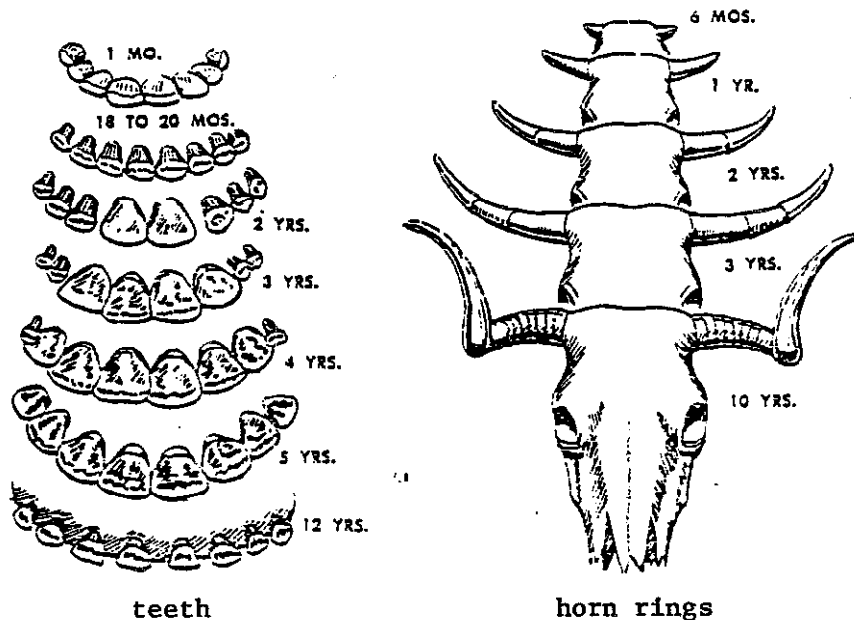

Source: Ward, Fay E. 1958. The Cowboy at Work. Hastings House, New York. (Reprinted by permission of the publishers.)

Determining the Age of Equine Animals

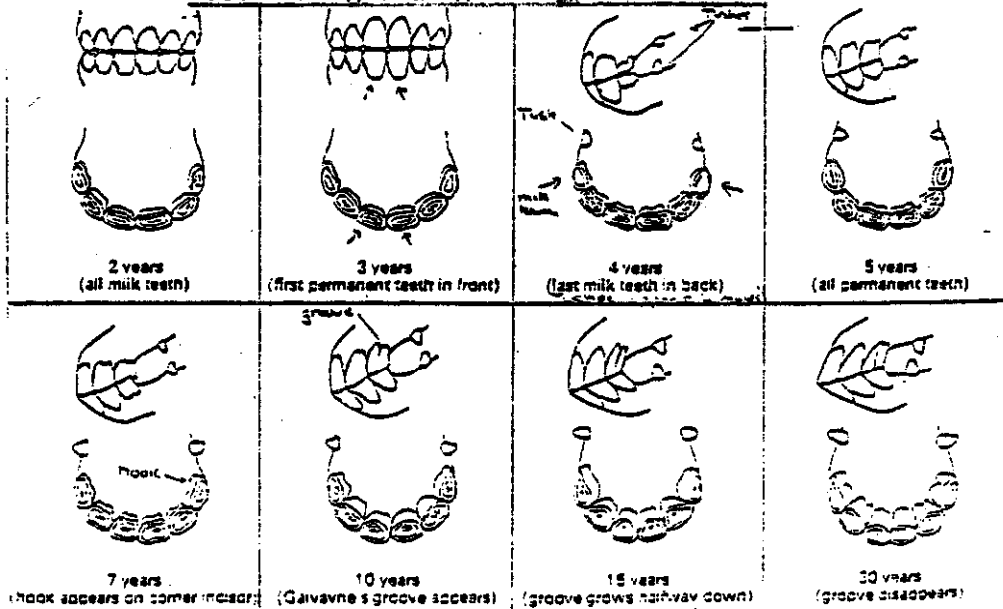

Source: Edwards, Elwyn Hartley, and Geddes, Candita, eds. 1973. Complete Book of the Horse. Arco Publishing Co., New York. (Reprinted by permission of the publishers.)

- Rub or press the gums with these fingers; this will cause the animal to open its mouth;
- Grasp the tongue with the other hand, pull the tongue out, and hold it to one side so that teeth can be seen.

#### Opening Animal's Mouth

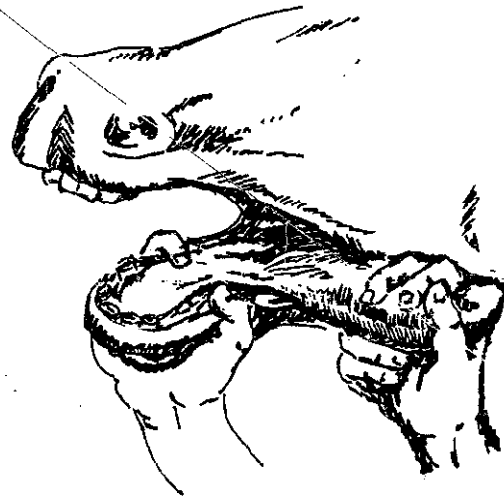

#### Sex of Bovine Animals

Sex has a bearing on the power and temperament of draft animals. As a rule males tend to be bigger, more powerful, and more difficult to train than females. Females have less endurance and, of course, cannot be used when they are carrying or nursing young.

Studies of African cattle have shown that within the same breed and age bracket, males tend to be 50-100 kg heavier than females and can work twice as long during a given day (bulls, five to six hours; cows, two to three hours). Studies from temperate zones show more pronounced differences in size and power.

Such evidence makes it clear that there is an advantage to using

male animals. However, the males of some breeds of cattle and buffalo have proven particularly difficult to train. In these circumstances, the animals are castrated at the age of one and a half years in order to make them more docile. There is disagreement about the value of castration, however. Some farmers feel that this makes the animals lazy or interferes with their physical development. Tests have substantiated that castrating eight-month-old calves retards their growth. Other tests, comparing two-year-old cas-

trated and entire male buffaloes, showed that the animals performed equally well. Castration also limits a small farmer's ability to raise his own stock, especially if he owns only a few animals.

### Sex of Equine Animals

Castrated horses or donkeys (geldings) are preferred over stallions because they are even-tempered and manageable in the presence of females. Female horses, mules and donkeys are nearly as powerful as males and geldings, but are known for their stubbornness and unpredictable moods.

## Conformation

Conformation refers to the form or shape of an animal. An animal with good conformation has a shape which shows the normal characteristics of its species and breed.

An animal used for draft must have a build well suited for pulling. It should be low to the ground, have powerful shoulders and legs, and have a broad frontal dimension that will accommodate the placement of a harness. It must be big enough to deliver, alone or in a pair, the power needed to pull equipment for an extended period of time. It must also be able to exert the concentrated or "instantaneous" effort needed to overcome temporary increases in the draft requirement caused by roots, rocks, hard soil, or inclines.

While some animals are bred to produce good draft abilities, within any breed individual animals vary greatly in these qualities, and care must be taken to choose those with the most potential. A thin but well-balanced animal can be strengthened with a good diet, health care, and work. However, an animal with a swayback, bad legs or impaired vision will be a constant source of trouble.

Selection is a process of matching ideal qualities against

those seen or latent in a given animal. Good draft animals, regardless of species or breed, will have the following qualities:

- head well proportioned; squarish, sculptured look
- balanced vision and hearing; head carriage high and straight
- normal mouth; good teeth and jaw structure
- body should have depth and width; short, full neck, full shoulders, broad chest, and straight, broad back
- wide, thick hindquarters, low-set and evenly-fleshed
- short legs, straight and square to the body; ample bone
- clean, well-developed joints; no swelling or unusual boniness; no turning in or out of knees or hoofs; free movement of limbs
- feet straight, hard; normal angulation of hoof.

### Ideal Conformation in Bulls

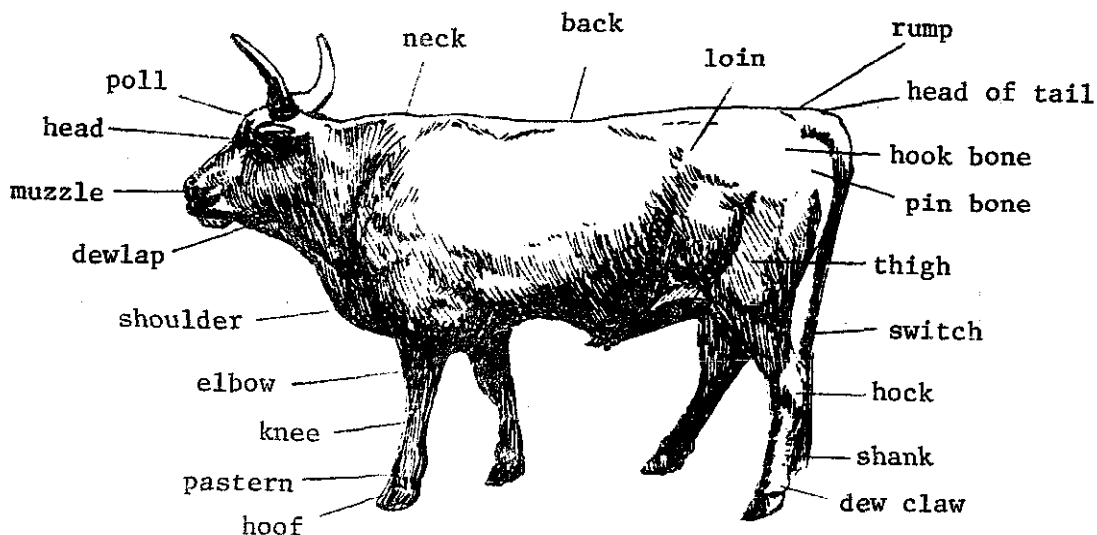

A N'Dama Bull (see also page 217)

Ideal Conformation in Horses

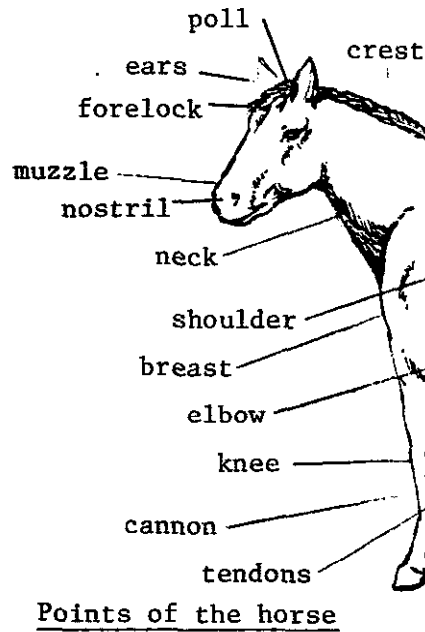

The illustrations below can serve as general guidelines for identifying qualities in donkeys and mules as well as horses.

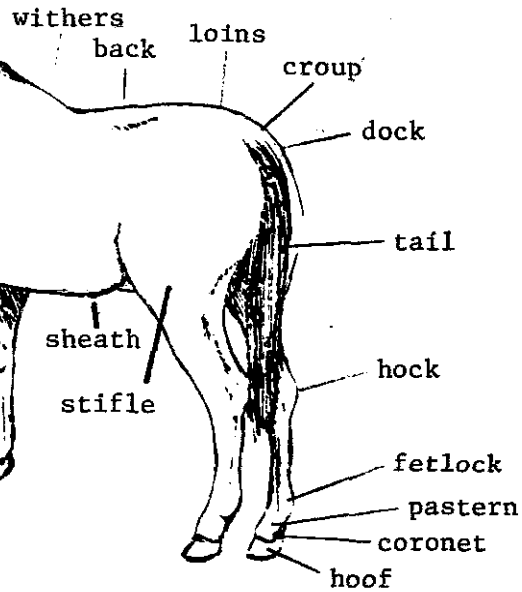

Conformation Faults of the Horse

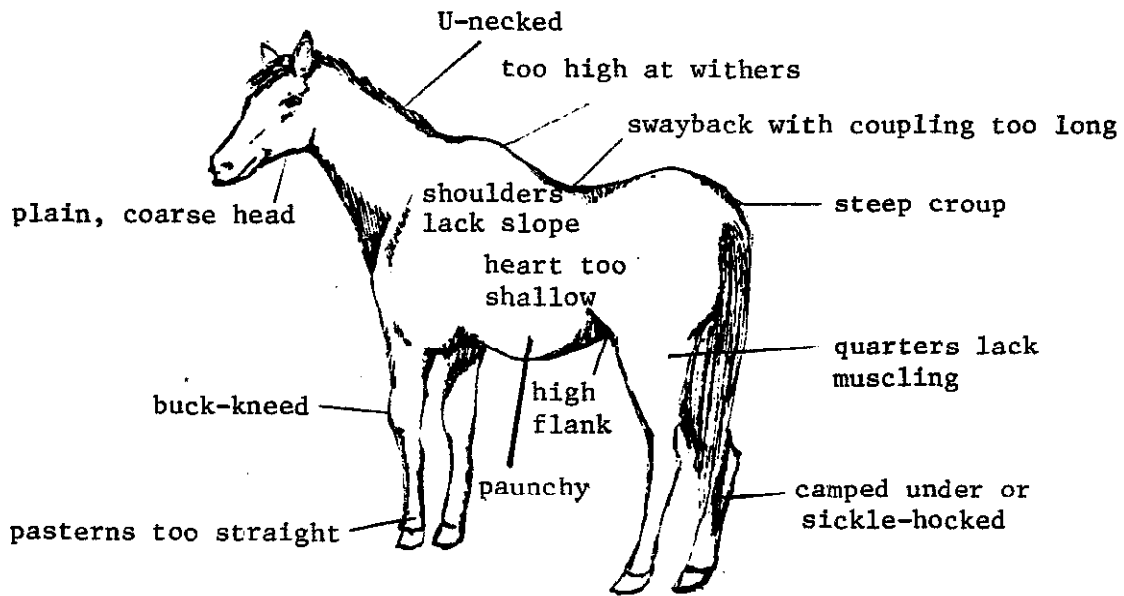

Equine Leg Conformation

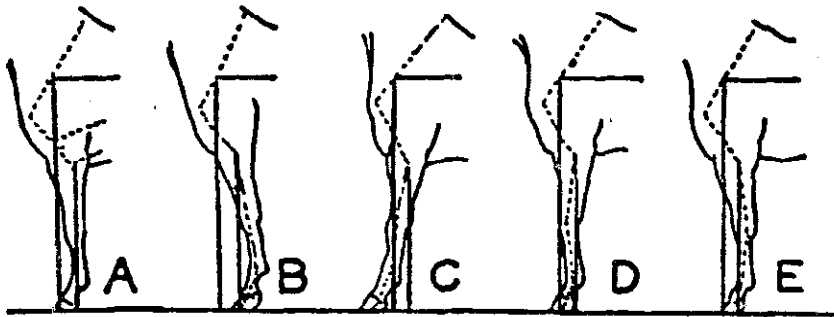

The proper and faulty conformation of the forelegs when viewed from the side:

- A - correct conformation
- B - forelegs too far under body
- C - forelegs too far advanced
- D - buck-kneed
- E - calf-kneed--standing with knees too far back.

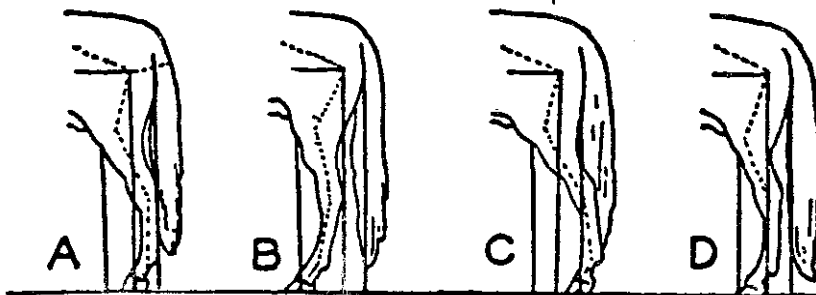

The proper and faulty conformation of the hind legs when viewed from the side:

- A - correct conformation
- B - sickle-hocked--hind legs too far under body
- C - legs set too far back
- D - hock joint too straight.

The proper and faulty conformation of the forelegs (top) when viewed from the front, and the hind legs (bottom) when viewed from the rear. The forelegs:

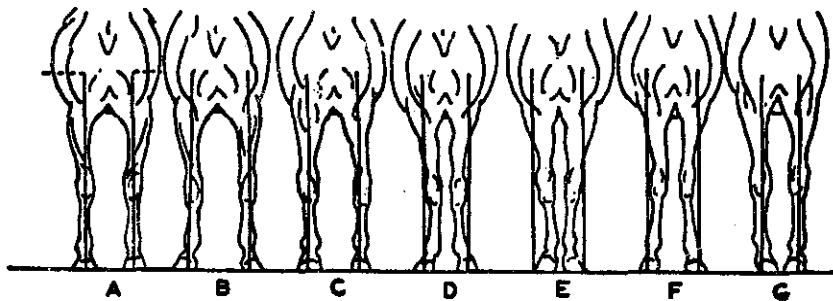

- A - correct conformation
- B - splay-footed or base-narrow forefeet, toe cut out, heels in
- C - bowed legs
- D - knock-kneed, set close together with toes pointing outward
- E - conformation predisposing to interfering
- F - knees set close together
- G - pigeon-toed or toe narrow--a conformation which will cause the animal to wing or throw out the feet as they are elevated.

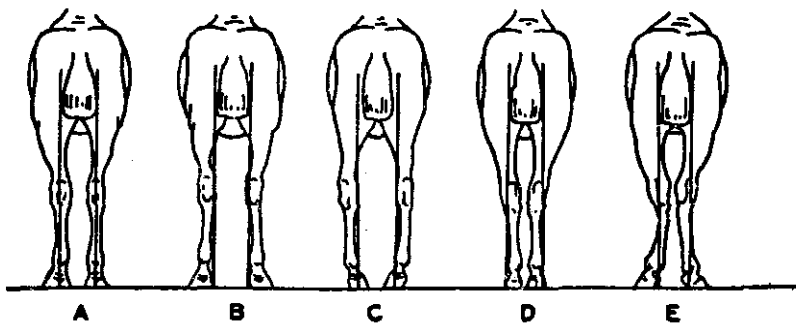

The hind legs:

- A - correct conformation
- B - hind legs set too far apart
- C - bandy-legged--wide at the hocks and hind feet toe-in
- D - hind legs set too close together
- E - cow-hocked.

Source: U.S. Department of Agriculture

## Temperament

Temperament refers to the nature or disposition of an animal. Part of its temperament is determined genetically, both by breed and parentage; some of it is learned-- a response to the treatment it receives from other animals or the people who raise and handle it.

Temperament is reflected in an animal's behavior, the way it moves and acts, and the way it

reacts to the things around it. It is difficult to know much about temperament from the quick evaluation that usually precedes the purchase of a draft animal. The buyer must guess, from what is observable, whether or not an animal will accept new routines or maintenance and training, behave well in a pair, and prove to be a spirited yet steady-paced and manageable worker. Sometimes, what is observable is not typical of the animal's behavior. A basically lethargic bull, for example, may become very alert or



nervous at the approach of a stranger, exhibiting a fierceness that could be misinterpreted as a strong yet controllable spirit. A donkey that is mishandled and mismanaged might kick or butt at its owner, or at any adult, but be led away quite easily by a child. The buyer must be aware of such possibilities and at the same time draw some basic conclusions about the animal's temperament.

The following are signs of good temperament:

- Good overall conformation and health. The animal has no physical handicaps that require it to compensate with aggressive or stubborn behavior. An animal with bad vision or hearing, an unsound leg or joint, or with a chronic respiratory or muscular weakness, protects itself by balking, spooking, shying, refusing to be harnessed or lying down during work. Its temperament is affected or shaped by its physical condition.
- The animal accepts the handling of the owner. The owner can pick up the animal's foot, open its mouth, lead it with a rope without having to use force or harsh measures.
- It does not shy or kick at other animals. The buyer should try to be present when it is being turned out with a herd or put into a corral with other animals. If an animal is unusually aggressive or cowardly, it may not work well in a pair. Aggressive animals force their work-mates to shy or lean out of the yoke or harness, while cowardly animals may refuse to step evenly with their mates, lagging behind.

When an animal is taken from its herd or original owner and staked out or corralled in a new place, it may experience shock. The animal may show signs of aggression, withdrawal, stubbornness, fear, or general anxiety. None of these reactions is unnatural during the adjustment period, and should not be taken as a sign of an unsuitable disposition.

An animal's character becomes clear later, during training and pre-season work. At that time the farmer can judge the ability of the animal to work as part of a pair or team. Buying an animal early in the off-season allows the owner time to seek a replacement should a problem arise.

# 3. Animal Husbandry

A draft animal's value is based on the special training and care that enables it to pull. The time, money, and effort that goes into raising and maintaining an animal makes it costly and hard to replace. At some seasons of the year, the loss or inefficient performance of a draft animal can result in production setbacks or crop failures that are very costly to the farmer.

In order to protect their investment, farmers must keep their animals strong, healthy, and even-tempered through proper handling, a good feeding program, and prompt medical attention when necessary.

## Shelter

It is important to give work animals a place where they can eat and rest unbothered by weather, insects, other animals, and uncomfortable restraints such as hobbles, short ties, and narrow stalls. In the tropics, animals do not need elaborate shelters, but stabling them in dry, comfortable surroundings contributes to their overall soundness and work value.

A lean-to with a straw roof provides shelter from heat, rain, and wind. A simple lean-to is a wall four or five meters long and two and a half meters high, with a canopy on one side. It is built on

high ground so water drains away. The wall is situated so it blocks prevailing winds, and the roof made on the side opposite the wind. An earthen floor is adequate, but straw or sand should be kept in the area where the animal sleeps, or "beds down." Horses often prefer standing to lying on a hard, cold, or wet surface, so owners should make special efforts to ensure that bedding is ample.

Manure and urine-soaked straw should be collected regularly to reduce fly populations and hoof

infections. It makes excellent compost, but should not be piled or stored near the stable area.

A smokefire made from a green log or slow-burning stump helps keep the shelter area free of mosquitoes and flies.

A manger, trough, or rack can be built into the wall of the lean-to to hold hay, grain, salt licks or water buckets.

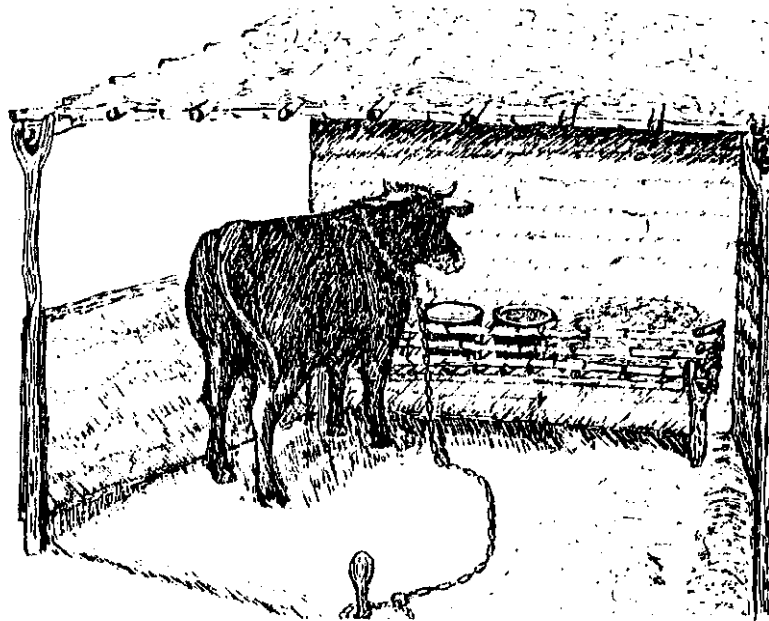

## Stalls and Corrals

A lean-to can be made into a stall, or "box stall", by closing off the three open sides with a wood fence or mud walls. The sides should be sturdy and high enough so animals cannot jump out. A stall for one horse or bull should be approximately 25 square meters.

A stall may be expanded into a pen or small corral where two or more animals are kept. Usually, animals can be left at liberty in this area, but if they compete for food or fight, they must be tied, or kept in separate pens within the larger area. If they are tied, they must be able to reach individual feed and bedding areas without getting tangled in their ropes (see below).

Horses are more active than either donkeys or bulls and so it is advisable to let them move freely in a stall or corral. Tying them or keeping them in narrow stalls can cause them to develop nervous habits such as weaving, kicking, pawing, cribbing (locking the lower

jaw against a stallboard or feed trough and sucking air), halter pulling or refusing to lie down.

## Tethering

There are many instances, both in the stable and field, when owners must tie, hold, or immobilize their animals. Controlling their movements without hurting them requires proper use of ropes and basic harness equipment. Improperly tied, animals may suffer from fatigue, rope burns, limb injuries, poor posture, or nervousness due to boredom or fear. Serious injuries or strangulation can result from use of slip knots or very short ties.

Animals tied in a lean-to or stall should be fastened on a line long enough to permit movement and access to feed and bedding areas. The line is attached to the base of a support pole or to a stake, using a fixed loop. A fixed loop is one that does not "slip," or close around the stake; the animal should be able to circle the stake without "winding itself up." The top of the stake should be broader than

the diameter of the loop so the loop cannot be pulled off.

The free end of the stake rope is attached to the animal's halter. A halter is a piece of rope which fits over an animal's head and muzzle and allows the owner to lead, tie, or control it. The halter's design makes it strong, safe, comfortable and easy to use on cattle, horses, and donkeys.

A simple halter can be made of strong soft rope.

The halter is especially useful during training because it allows the trainer to control an animal's head from three points. It is superior to single-point attachments such as the hornrope or nosering for this reason.

#### Improved Halter

##### For Cattle

##### Or Equines

Each draft animal should have a permanent halter so it can be led or tied easily. The halter also can be used like a bridle. Reins or "lines" are attached to the side

rings so the head can be pulled right or left for turns, and straight back toward the chest for stopping and backing-up.

Local craftsmen can make strong, comfortable halters from leather, heavy canvas, or flat-wound rope. Rings and buckles are made or bought.

#### How to Put on a Halter

- Make friends with the animal. Talk to it, touch it, feed and water it, clean its stall, occasionally give it a tidbit or hand-feed it salt. Let it get used to you. If you can pat it on the neck and touch its nose and ear, you can probably slip the halter on.

In the case of cattle, especially horned varieties, it is safest to catch and tie the animal before attempting to place the halter. Use the method shown on page 54. If the animal is obviously very docile and used to handling and you want to do it without ties, be alert to circumstances which may cause it to toss its head and injure you: fast movements, flies, sudden noise, approach of another person or animal.

- Stand next to the animal's left side, facing the side of its head. Hold the free end, or poll piece, in your right hand, and the noose-like nose-band in your left. Let the rest of the halter hang free.

## Making a Simple Halter

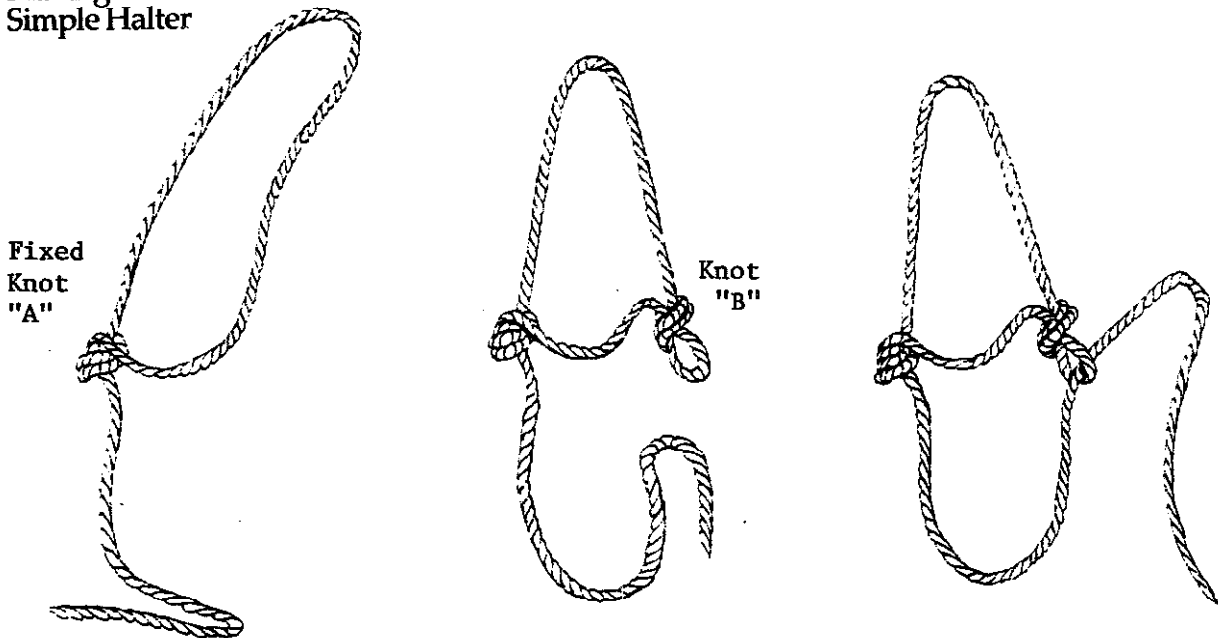

- Make a large loop 1 m in diameter at the end of a rope 3 meters long. Use a fixed knot for Knot A; do not use a slip knot.
- Make a small fixed loop about one-third of the way down one side of the large loop. This is Knot B.
- Pass the free end of the rope through the small loop made in the second step.
- Place the halter over the animal's head so that the non-slipping portion (the headband) fits behind its ears. The slipping section (noseband) fits over the muzzle.

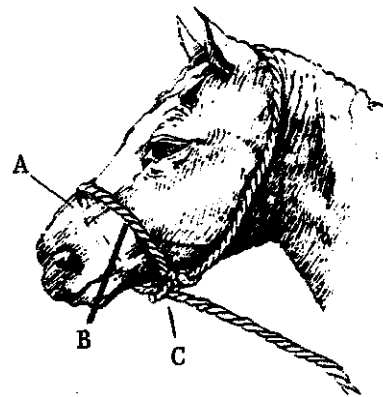

Halter showing where additional ropes may be tied to give maximum control of the head during turning or stopping (A,B,C).

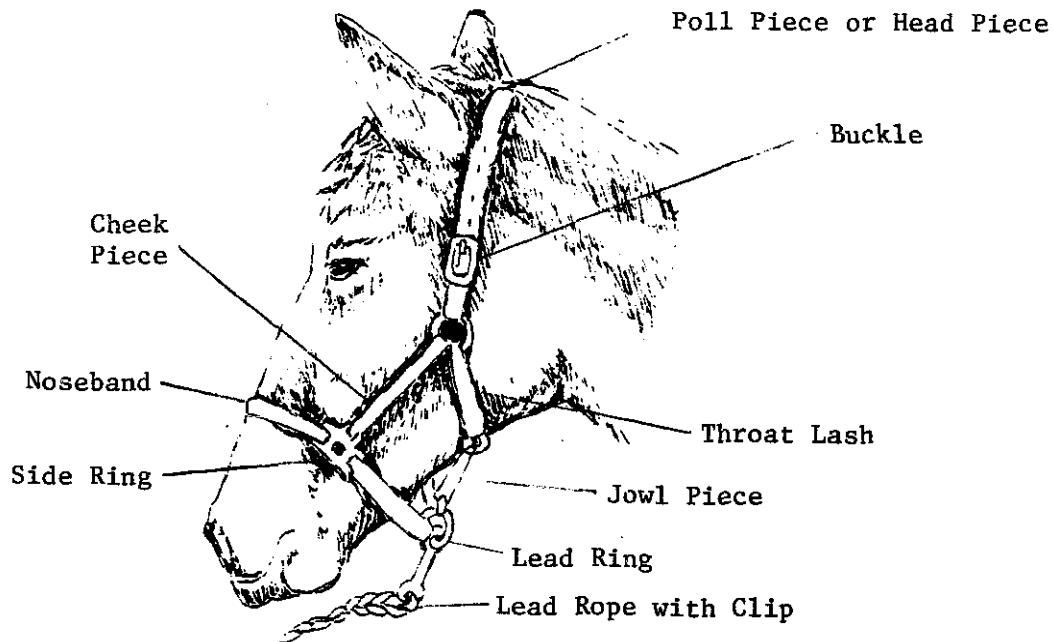

Leather Halter for Horses, Donkeys, Mules, or Cattle

How to Put on a Halter (cont.)

- Pass the free end under the animal's jaw and up toward the right ear. At the same time, begin to slip the noseband over the muzzle. If it tosses its head, try to move with it; speak to it in a low, soft tone.
- Flip the end of the poll piece so it passes behind the ears and drops down toward you. This is done with the right hand. The right hand remains against the right cheek, still holding the middle of the poll piece.
- If your right hand is high

enough on the cheek, there will be enough tension on the noseband to keep it in place while you use your left hand to grab the tip of the poll piece.

- Feed the end of the poll piece through the ring or buckle of the cheekpiece. The more you tighten it, the higher the noseband rides on the muzzle. You want the noseband to circle the muzzle—not squeeze it. You should be able to slide your hand (flat) between the band and the muzzle.

### Alternative Method for Tethering a Bull

- Have a local blacksmith take a one-meter piece of iron and bend it into an open, spiraling screw. Hang it from the bull's neck on a piece of strong cord and feed the last link of a chain onto the spiral.
- Tie the other end of the chain to the stake rope (a short length of strong rope which is permanently attached to the stake with a fixed loop so that the rope will not wind itself up).
- The stake may be made of a broken milling pestle or any strong, tapered stick.

Tying animals by the legs or horns on a regular basis is a poor

practice. Constant rubbing produces burns, soreness, and infection. In some cases the animal tries to protect the tender area by kicking out, refusing to be handled, or shying away.

Cattle wearing noserings should not have heavy chain attached to the ring, as this discourages normal carriage of the head.

#### Noserings

While noserings can be helpful for controlling very temperamental, headstrong animals, their use can often lead owners into the bad habit

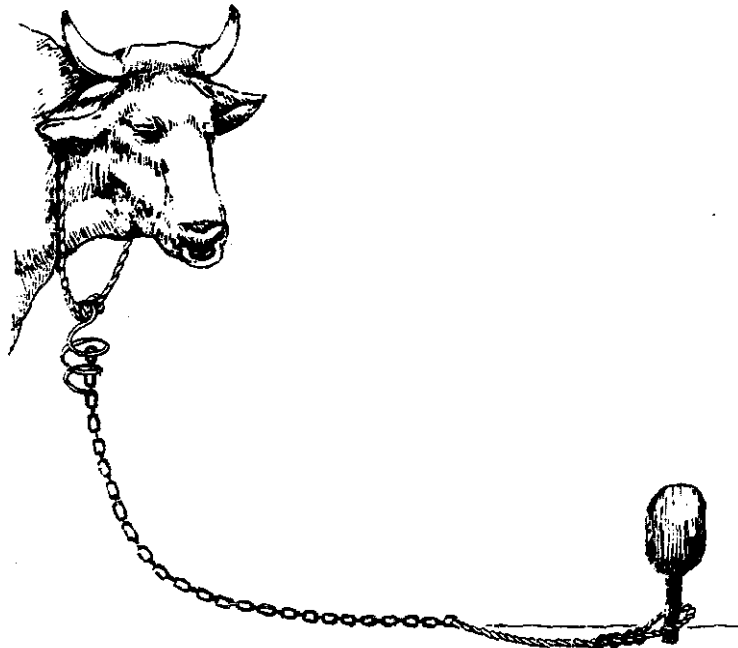



of "dragging" them from the front instead of driving (guiding) them from behind. Some stockmen feel that immediate "ringing" (placement of the ring) sets the stage for training by showing the animal "who's boss." But in most cases animals selected for work purposes can be handled and controlled with halters. Causing them pain or fright, especially during the adjustment period, may make them too nervous to eat, drink, or rest.

## Nutrition

A good feeding program is essential in maintaining the strength and health of draft animals. Food is the fuel which an animal converts to energy and pulling power. Animals that are not fed enough of the right foods can show chronic fatigue, will lose the ability to work, and are more susceptible to disease. Excess calories are

stored as fat, causing animals to become inefficient workers, lazy, stubborn, and ill-tempered.

A basic knowledge of the dietary needs of draft animals and of the nutritional content of available feeds will enable owners to plan a feeding program that will help their animals to work to their full potential.

### Why Draft Animals Need Special Diets

Grazing draft animals need supplemental feeding for two reasons:

- to increase energy intake and prevent protein, vitamin and mineral deficiencies
- because of limited grazing time or limited forage availability.

Pulling loads is hard work.

Animals burn many more calories when working than when idle or grazing. This means that the energy requirements of an animal will increase with the work load. Experience and research in tropical areas have

shown that animals need about twice their normal energy maintenance requirement when they are used for medium-intensity draft work.

Without this additional food, draft animals grow thin and weak, because they must burn body tissue in order to produce the energy needed to perform work. Not only do these animals lose strength, they become increasingly susceptible to injury and disease. An adequate diet is especially important to young draft animals because their growth may be stunted or their conformation affected if food normally used to build bone and muscle must be converted into work energy during the critical early years.

Work animals have limited time to eat, since they work during the time they would normally be grazing or foraging for food. In the time remaining after work, they may not be able to find and eat enough grass to replace the calories lost during work.

## General Rules for Feeding

- 1) Feed the animal so that it gains weight and maintains strength but does not become fat or lazy. Never let it lose weight.
- 2) Feed large quantities of grass, straw, and other bulky, fibrous foods. These foods are called roughages. If they are of good quality, they supply all the nutrients that a grazing (non-working) animal needs for body maintenance. Protein, phosphorous and Vitamin A may be deficient in forage growing on arid land.
- 3) If only poor quality roughage diet is available, supplement the roughage diet with grain and other concentrate feeds such as beans, seeds, and mill by-products. These feeds give the animal additional energy for work.
- 4) Give the animals salt and mineral supplements.
- 5) Worm the animals regularly if parasites are present. This ensures that parasites do not interfere with digestion and that animals get the full value of food.
- 6) Use quality feeds:
  - Do not let animals graze in pastures where herds of other animals graze, or eat grain

or hay from the ground or stable floor. These may be contaminated with parasites.

- Never feed moldy or dusty feeds. These cause serious digestive problems.
- Improve the nutritional value of insect-infested grain by mixing good grains, mill by-products, or peanut or cottonseed cake into the daily ration.
- Never give animals free access to lush, young grass or leaves of young corn or peanut plants. These can cause serious conditions like bloat, colic, or dehydration due to diarrhea.

Recommended rations and feeding products are discussed in detail in Appendix B.

#### Water Requirements

During the rainy season, grazing animals get considerable amounts of water from the grasses and other succulent forages they consume. Under these circumstances, drinking water consumption is not an accurate indication of water requirements. Actual water needs are determined by size, species, environment, and intensity of work. Larger animals drink more because they have a greater body mass to cool. Muscular activity (work) generates additional

heat. Working animals lose water from sweating and therefore need to increase their water intake.

#### Water Requirements of Draft Animals

Animal	Liters per day
Oxen	10-30 rainy season 15-40 dry season
Horse	30-50
Donkey	10-20
Mule	15-30

Working animals should have access to water at least three times per day--morning, noon, and night. Horses and some cattle engaged in heavy work may need a short drink every two or three hours. Zebu, cattle, donkeys and mules can work for longer periods without a drink, but still should be offered water during the mid-day resting/grazing period. A heated animal should never be allowed free access to water.

Some animals will drink too much water in the evening. This may prevent them from eating their

concentrate feeds. They should not be allowed to drink freely until after feeding. A small drink may be given before food is offered.

## Grooming

Grooming refers to the process of cleaning animals so that their coats are free of dust, dirt, manure and sweat.

### Importance of Animal Grooming:

- 1) At night, animals may lie in manure, water or urine-soaked ground. When this material hardens on the coat (hair), it attracts flies and other insects which are a nuisance to the animal and which may carry disease. Sometimes this material contains parasites such as hookworm, which can enter the skin and seriously affect the animal's health.
- 2) When sweat evaporates, it leaves a mat of stiff hair. A harness or yoke rubbing against this mat will pull some of the hair loose and harder clumps of hair will rub against the exposed skin. This results in

a burn or raw spot which becomes increasingly tender and finally an open wound. These wounds are called girth sores or yoke galls. They can cause pain which makes animals extremely irritable and hard to handle.

- 3) Daily grooming results in closer physical contact between owner and animal. This association develops trust between them. The owner learns about the animal's moods, sensitivities, and reactions. The animal becomes familiar with the owner's voice, movements, and commands, and becomes easier to handle.
- 4) Daily grooming lets the owner take a close look at the animal each day. Minor problems like ticks, scratches, muscle strains, harness sores, and stones in the hoof can be detected and treated before they become serious problems.

To groom animals, a person needs two tools--a curry comb and a brush. A curry comb is an oval-shaped plastic or metal brushing device which is used to loosen sweat, manure and other materials from the animal's coat. The brush is used to remove the materials loosened during currying.

How to Groom an Animal:

- 1) Cross-tie the animal (see page 64 for method).
- 2) Put the curry comb in the right hand and the brush in the left. Starting high on the animal's neck, apply the curry using gentle, circular motions. When the neck is curried, use the brush to remove the loosened materials. Use firm strokes and brush in the direction of the natural lay of the coat.
- 3) Clean one section of the coat at a time. Work front to back, using first the curry, then the brush to clean each section. When the entire first side (including the legs) is finished, go to the opposite side and repeat the process starting high on the neck.
- 4) Pay special attention to areas where harness touches the animal. Remove all hardened sweat.
- 5) When currying the legs, be very gentle. Use the edge of the curry to clean the bony structures around the knees, hocks, elbows, and fetlocks.
- 6) Leave the head until last. Brush it gently. Be sure to loosen the halter and remove any sweat or loose hair caked under it (especially behind the ears and on the muzzle).
- 7) If the animal moves, kicks, or attempts to reach back and bite, immobilize it by tight-

ening the crossties and lifting one of the legs in the manner described on page 65.

- 8) Use water to loosen material that is sticky or very hard.
- 9) Pick up each hoof and check for stones. Remove stones or caked manure with a hoof pick or blunt instrument.
- 10) Clean the harness. If the harness is caked with sweat and loose hair, it will dig into the animal and cause a sore. Clean the leather with a scraper; then use a sponge and warm water to remove the finer residue. Keep the leather supple by applying vegetable oil or petroleum once a week.

The best time to groom an ani-

mal is before the working period.

This ensures that it will be clean when harnessed and that sores will not occur. It also helps to prepare the animal for harnessing and work by making it attentive to the owner's voice and commands.

# Minor Medical Problems and First Aid

Farmers and extension agents should be able to handle minor medical problems and common first aid measures. This section reviews the diagnosis and treatment of common problems. For information on diagnosis and treatment of other illnesses, see Appendix C.

## Abscess

This is a pus-filled swelling caused by the presence of foreign material under the skin. The material may be a thorn or broken needle, dirt introduced by a puncture, or blood from a ruptured vessel (result of a blow or bruise). The swelling will come to a head, break, and

drain naturally. If the animal is in pain, the process should be hastened by applying hot soaks (one or two per day). The abscess is then cut open with a sterile, sharp knife and flushed out with a solution of salt water or mild antiseptic. Massage improves the drainage. Sulfa powder can be applied inside the abscess. The cleaned cavity is then plugged with sterile gauze or antiseptic cloth. The area must be drained daily until the discharge ceases.

## Bloat

Bloat is a condition that affects ruminants. The intake of lush, early-growth pasture, immature grain, or any feed to which the animal is unaccustomed causes unusual amounts of foam to build up in the stomach. This prevents normal belching. A gas forms, the animal's left side distends. Breathing becomes difficult and death may be the result. Serious cases are treated by piercing the animal's side with

a special device; this should be performed only by a veterinarian or trained veterinary medic.

Bloat often can be alleviated through administration of a drench. A pint of vegetable oil (or peanut oil) is put in a bottle and the animal is made to drink (see below). It is preferable to have a veterinarian do this, but in emergency situations, the farmer or extension agent can do it by following these steps:

- 1) Raise the animal's head just enough to allow liquid to flow down its throat. Hold the animal by the nostrils.
- 2) Insert the bottle into the side of the mouth between the front teeth and the rear molars so the animal cannot bite or break it. The mouth of the bottle should rest on the animal's tongue.
- 3) Tilt the bottle so the liquid flows slowly and the animal can swallow it. If the animal coughs, or appears not to be swallowing, the liquid may be passing into the windpipe (and lungs) instead of the gullet. This can cause pneumonia and kill the animal.

## Colic

Colic is pain of the digestive tract. Colic affects equine animals which have eaten too much grain, indigestible roughage, or lush forage. Animals with poor teeth are especially prone to the condition because they cannot break down foods in the mouth before swallowing them. Ground-fed animals may ingest sand with their food and suffer from sand colic. A chronic form of colic is due to the migration of strongyles (worms) in the digestive tract. In all cases, the animal suffers pain from the gas which builds up in the stomach. The pain may become so intense that the animal injures itself by kicking or rolling.

Symptoms include pawing, kicking up at the stomach, rolling (this causes leg and spine injuries), biting the flank, sweating, constipation, increased heartbeat, and shock. Keep the horse warm and quiet and administer drench.

## Constipation

Constipation should be treated by administering a mineral oil drench (1-4 quarts, depending on the size of the animal). A veterinarian may administer liquid paraffin or magnesium sulfate through a tube inserted into the stomach via the nostrils; this should not be attempted by inexperienced persons, since it might pass into the lungs. In emergency situations, an agent or farmer should give a drench made of 1-1/2 pints warm beer, 1/2 glass whiskey or rum and 1-1/2 pints water, or 1-1/2 pints warm milk and 2 tablespoons ginger.

## Diarrhea

Diarrhea may develop from the excessive consumption of lush green pasture. It can cause dehydration of an animal. Regulation of the intake of lush pasture will prevent this problem.

## Founder

This condition affects equine animals, particularly horses; it causes lameness and eventually cripples the animal. It is due to poor circulation in the hoof (too much blood) caused by an overly rich diet, concussion of the hoof, overwork, or colds. The animal stands on its heels; its feet are hot (the hoof and the flesh directly above it feel warm to the touch); it limps or may refuse to move. Eventually, rings develop around the hoof wall and the toe portion of the hoof begins to grow outward, curling back on itself.

An animal with founder must be made to walk even though it refuses at first. The activity forces the hoof to perform its natural function, which is to pump blood up out of the foot. Cold soaks are used to relieve swelling and pain. This is done easily by having the animal stand in mud, a stream, or a filled irrigation ditch; otherwise, it is kept standing in buckets of cold water.



## Hoof Problems (Equines)

**STONE IN HOOF:** Carefully remove the stone by prying it out with a hoofpick, screwdriver, or non-pointed instrument.

**THORN IN HOOF:** Tap the suspected area with a wrench or bolt until the animal flinches. Trim surface area if possible and pull the thorn out. Soak the hoof in warm salty water to draw out infection. Then apply a poultice composed of a hot paste of bran and epsom salts that have been pre-mixed in boiling water and partially cooled. Pack this around the hoof and wrap it in burlap. After 10-12 hours, remove the poultice, flush the wound with antiseptic, and then pack it with pine tar. If swelling and heat indicate that the infection is still present, repeat the procedure.

**SANDCRACK:** This is one of several conditions caused by drying out of the hoof and improper diet, including insufficient oil intake. Cracks appear during the dry season when the animal lacks the green forage necessary for production of horn, which forms the hard outer wall of the hoof. The crack descends from the coronary band down into the hoof wall. It is painful and causes lameness; sometimes

infection results. Cracks are sometimes the result of a direct blow, such as a kick by another animal. Sometimes cracks are related to a conformation fault, as when an animal's natural gait causes it to hit one foot with the other. The blow damages the horn-producing mechanism in the coronary band.

Treatment consists of inserting a wooden wedge into the crack and wrapping it with a bandage so the crack cannot open and close when the animal walks. Workload should be decreased and diet corrected by feeding concentrates to provide additional oil.

## Snakebite

Animals are usually bitten on the leg or head. Symptoms include intense local swelling, lameness, swelling of the head, lips and gums, shock, lowered body temperature, and impaired vision.

Treatment is as follows:

- 1) Apply wide tourniquet five cm above the bite, not so tight that it cuts circulation. Loosen it every 15-20 minutes for a two-hour period following detection of the bite.
- 2) Clip the hair around the bite.

Enlarge the wounds (fang marks) by making incisions parallel to the blood vessels. Apply a non-oral suction to the wound for a period of 30 minutes.

- 3) A large bull should be injected with 50 milliliters (ml) of polyvalent antivenin; smaller animals receive larger dosages.

## Sprains

A sprain results from damage to a muscle, tendon, ligament, or joint. The tissue is stretched or torn when the animal steps in a hole, twists its foot, or pulls too great a load. Swelling and temperature increase may occur in the affected area, but some sprains are hard to detect, being related to chronic conformation faults in the legs. In these instances soreness begins after several hours of work and disappears with a night's rest.

Application of cold packs relieves the swelling and pain. The affected limb is wrapped in loose cotton or cloth and then wound with a strip bandage. Rest is the best treatment for lameness.

## A NOTE ON DETECTING LAMENESS:

When the animal is lame in the front legs, its head will go up when the lame foot hits the ground. Lead the animal toward the observer, first at a walk, then at a trot. Lameness is more easily seen when the animal trots.

When the animal is lame in the hind legs, its head will drop when the lame foot hits the ground. Lead the animal away from the observer, first at a walk, then at a trot.

These are the most common kinds of lameness. Other lameness is related to the abnormal growth of bone or the accumulation of fluids in the joint. A veterinarian should be consulted when these more serious problems are suspected.

## Wounds and Burns

Minor flesh wounds are washed with soap and sterile (boiled) water, or with hydrogen peroxide or a one percent solution of potassium permanganate. Alcohol, iodine, and creos-

sote are stronger antiseptics that can damage tissues and delay healing if applied too liberally. After the wound is clean, dust it with antibiotic powder and cover it.

An untreated or improperly cleaned wound may become infected. Soreness, inflammation, and pus are common symptoms of infection.

Rope or harness burns should be washed with soap and water and covered with petroleum jelly or antibiotic ointment. The application of wood ash will cause a scar to form quickly and will also help keep flies off the wound. The harness and pads should be cleaned and adjusted.

## 4. Training Draft Animals

Some animal traction extension programs sell trained animals to farmers or encourage systems of custom or contract training, where the farmer pays a professional to do the training. However, these options are often not available, and many, if not most, farmers are involved in the training of their own animals.

Those who instruct these farmers in animal traction should keep in mind that many of them are already familiar with basic care and handling of animals, though the animals may not be used for traction purposes. In fact, farmers may be more knowledgeable about particularities of a local breed or individual animal than the instructor; in many cases the teaching can go both ways. Also, instructors who become

involved in animal training should always remember that their goal is to include farmers in every operation and make them do the training. Farmers quickly become confident trainers when they are shown tools and techniques that give them sure controls over the animals.

This chapter describes one program for training cattle, and another for horses, donkeys, and mules. The programs described are not the only ones possible, but are accepted as standard by many experienced trainers. They are direct, effective, and pose minimal threat of injury to trainers and animals.

An important step in training animals is getting them used to harness. Sometimes it may be helpful or necessary for the reader to refer to Chapter 5, Harnessing,

before reading this chapter.

## Before Training Begins

Before formal training sessions begin, an animal should have time to adjust to its new owner and surroundings. Separated from its familiar environment and handled by someone whose touch, voice, and movements may be new, it may refuse to eat or drink, appear abnormally quiet or nervous, or try to run away.

New owners can help their animals adjust by:

- handling them in a calm, confident way. People who use hesitant motions, speak in excited voices or misuse ropes and whips can cause animals to react defensively. Cattle kick, butt, toss their heads, or simply refuse to move. Horses, donkeys, and mules may kick, bite, rear, or try to squeeze a person against a fence or wall;
- avoiding frightening the animal with procedures that cause it pain or discomfort. Inexperienced owners are sometimes anxious to make their animals more docile or trainable through castration, use of drugs, or restraints such as noserings or hobbles. While such measures may be needed or advisable under some circumstances, it is generally poor practice to use them before an animal has had time to adjust and reveal its natural disposition.

## General Comments on Training Procedure

Training draft animals is the process of teaching them to obey commands, accept harnesses and yokes, and pull loads. The person who gives the commands and controls their speed and direction is called the driver. The goal of training is to teach animals to obey the driver's signals so he/she can steer the load (plow, wagon, etc.) and regulate the power of the animal(s) at the same

time.

Before an animal is trained, it is "broke" or "broken" and made to recognize the authority of the trainer. Breaking an animal is a matter of introducing it to new schedules, procedures and expectations--and teaching it to obey. The word also describes the process of getting an animal used to new behavior or equipment. A bull is broken of aggressive behavior, but broken to harness.

Animals learn at different rates. An animal is considered trained when it responds consistently to commands. This may take as little as two weeks, or as long as two months. Many factors influence the rate of learning: species and breed, individual temperament, health and condition, type of harness equipment used, and skill, patience, and persistence of the trainer.

Animals learn faster, and new owners acquire training skills, when training advances in small, clear steps. Generally speaking, one-and-a-half-hour sessions are

used. Two of these sessions are given per animal per day. Training is done in the same location and during the same hours each day. Early morning and late afternoon are good times, as this gives animals time to rest and graze between sessions.

Before any draft animal is harnessed as part of a team, it must individually recognize and obey the voice commands stand, walk, stop, left, right, and back. Commands are given in the language the driver will use. The importance of teaching voice commands cannot be overemphasized. Drivers who must rely on an assistant to control their animals with pulls of a rope or constant whipping get limited performance and results.

Sometimes it is possible to train an animal by putting it in a yoke or harness with a veteran animal. This is a good technique, but it does not eliminate the need for individual training. The driver must be able to control each animal within the team if the team is to pull evenly. This is especially

important during turns, or when one animal lags or acts up.

Finally, it should be understood that handling and training methods for cattle differ from those used for equines. This is because these classes of animals have different strengths and temperaments. With horses, donkeys and mules, the overall approach is to use the least severe methods possible, resorting to greater force if needed. With cattle, and particularly bulls, it is important to break the animal of its independence quickly and with carefully applied force. Forceful handling is rarely needed once a bull recognizes your strength and your ability to make it obey.

## Training Cattle

This section will deal first with methods of catching and

restraining, and then with actual training procedures. Information on harnesses and types of hitches (ways of connecting individuals or teams to loads) is given in Chapter 5, Harnessing.

### Catching and Restraining

Owners must be able to catch, restrain, and immobilize their animals for examination, treatment, or harnessing. Young animals and older ones which haven't been handled much may be very unmanageable at first. Catching and controlling them without hurting them, or oneself, is a matter of establishing and maintaining physical advantage through use of mechanical force. The techniques detailed below are recommended because they are safe and easy to learn, and require minimum equipment.

An experienced stock handler can catch an animal by throwing a noosed rope, or lasso, around its head or feet. Learning to do this takes much time and practice, so beginners will want to use other

techniques.

Choosing the right technique is important because animals that repeatedly outsmart or overpower their trainers become headstrong, inattentive, and increasingly hard to handle. Before trying to catch an animal, watch its movements, judge its disposition, and decide which measures are most likely to work.

The methods described are used for catching an animal which is loose in a corral.

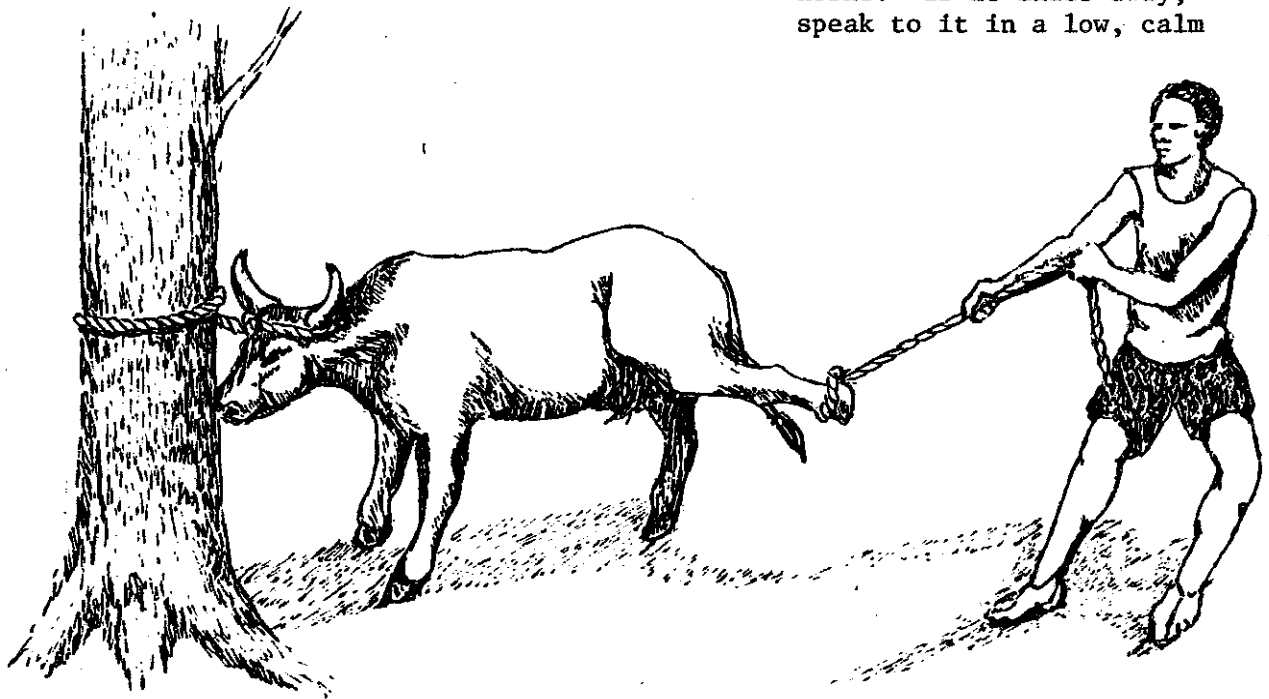

#### Lead Rope Method

(for quieter animals who have been raised in domestic situations and handled frequently)

- 1) Make a running noose at the end of a 3- or 4-meter rope. This is done by tying a fixed loop, or honda, at one end of the rope and then threading the opposite end through it.

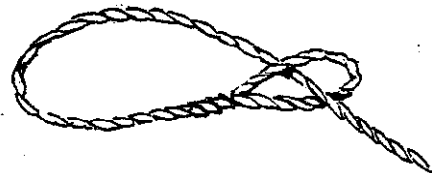

- 2) Approach the animal slowly and slip the noose around its horns. If it shies away, speak to it in a low, calm



voice and approach it from another angle. Once the rope is on the horns (or tied to the halter if the animal has one), lead it to a post or hitching rail and tie it so its forehead is close, but not against, the wood. This is called "tying the animal on a short lead."

- 3) If the animal is frightened or unruly, lock its horns and head securely against the wood by carefully shortening the rope.
- 4) If the animal kicks or swings its hindquarters while being yoked or harnessed, attach a rope to a rear leg.

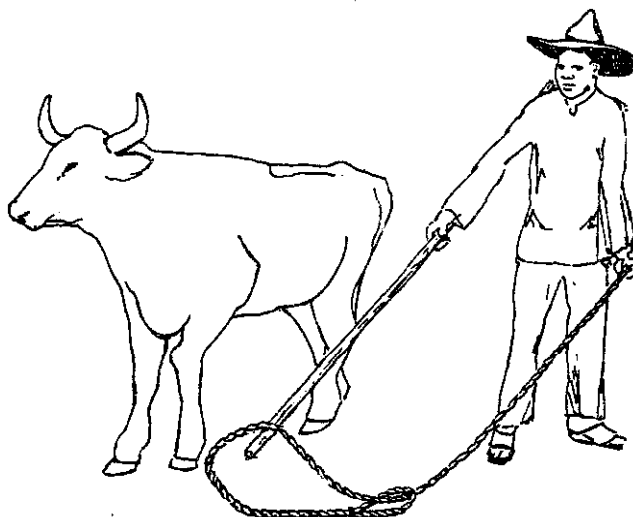

#### Pole and Noose Method

(for animals accustomed to some handling, but which shy, balk, or butt at the approach of the trainer)

- 1) Hang a running noose on the end of a 3-meter pole. Holding the pole in one hand and the free end, or shank, of the rope in the other, approach the animal slowly and position the noose in front of its hind leg.
- 2) Use your voice and body position to make the animal step toward the loop. Be prepared to drop the pole and pull on the rope as soon as the foot is inside the loop. Pull up and back; if you simply pull back, the noose will slide out under the hoof and you will have to try again.

- 3) Pull the animal backward to the centerpost of the corral and hold it secure while a second person approaches from the front and slips a rope around its horns. Avoid using a post which is part of the fence; animals are often injured when they kick out and catch a foot between the rails.

#### Open Noose Method

(for animals brought in from the range; animals which are large and aggressive; animals which cannot be caught with a pole and noose)

- 1) Put a sturdy post inside a corral. The post should be chest-high, smooth, and very firmly set. It should be 2-1/2 to 3 meters from the fence. Refer to this post as the "centerpost".

- 2) On a fencepost opposite this post, put a nail or peg at a height of 6 or 7 cm (3-4 inches) above ground level.
- 3) Make a running noose at one end of a 5-meter rope. Arrange the rope on the ground between the peg and the centerpost so it forms the letter "P". The top of the "P", or loop, should be near the fence. The bottom of the "P", or shank, is stretched back toward the centerpost.  
Hang the upper-left-hand portion of the loop over the peg. The rest of the loop should be on the ground.
- 4) Stand near the centerpost and

hold the shank of the rope with one hand. Have a second person drive the animal around the corral from the right. When the animal's midsection is passing over the loop, raise your arm quickly and without bending the elbow. A properly-timed motion will throw the entire lefthand portion of the loop into the air, and across the path of the oncoming hind legs. The noose will close as your arm rises.

The technique works because the natural tendency of the animal is to run along the fence. Hanging the rope on the peg makes it easier for the trainer to start the noose

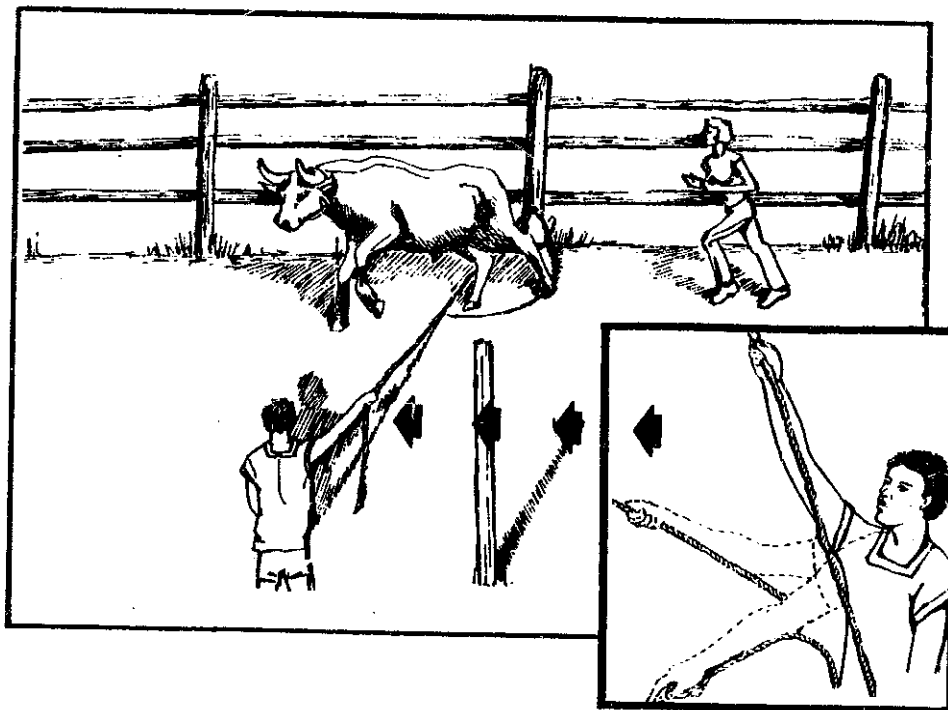

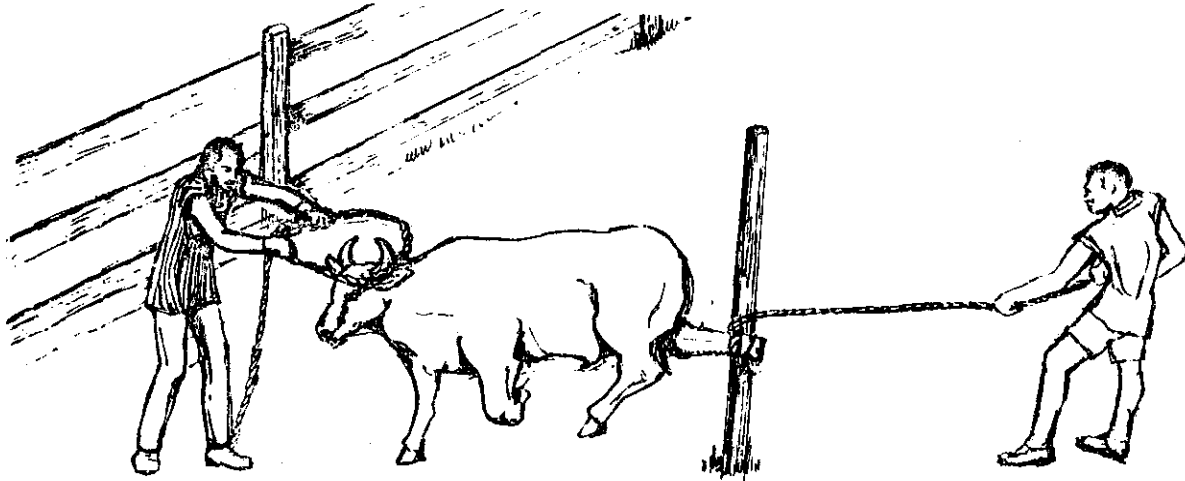

moving in an upward direction  
--or, to give it "lift".

- 5) Draw the animal back until you are in a position to wind the rope once around the post. Then get behind the post and continue to draw the animal in until its leg is snug against the wood.
- 6) With the animal secured by this first rope, someone can safely approach from the front and slip a second rope over its horns.

If the animal has been caught by a foreleg, it will be necessary to attach ropes to both the horns and a hind leg.

### Casting a Bull

Sometimes an animal must be immobilized completely before it can be treated or harnessed. This is done by casting it--pulling it to the ground and tying its legs. To do this, tighten a noose around its horns. Bring the free rope back to the withers and cinch it loosely around the animal's girth. Then pass the rope back and cinch it again around the loins. Pulling the free end exerts pressure on the loin area, and the animal sinks down.

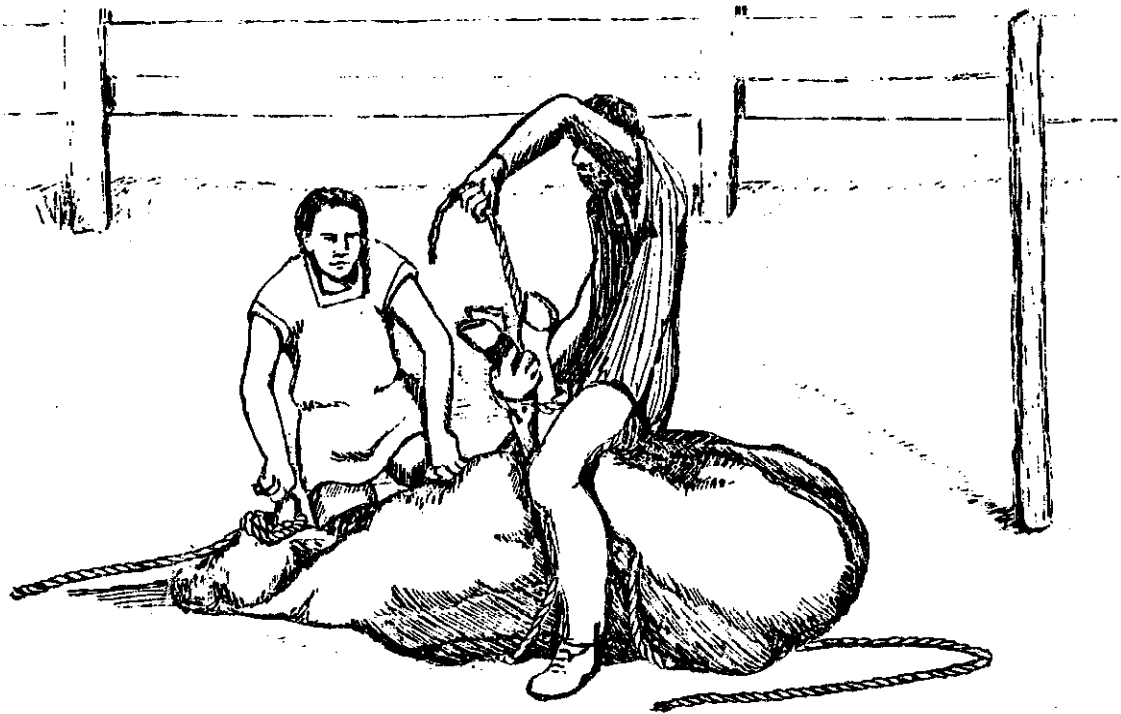
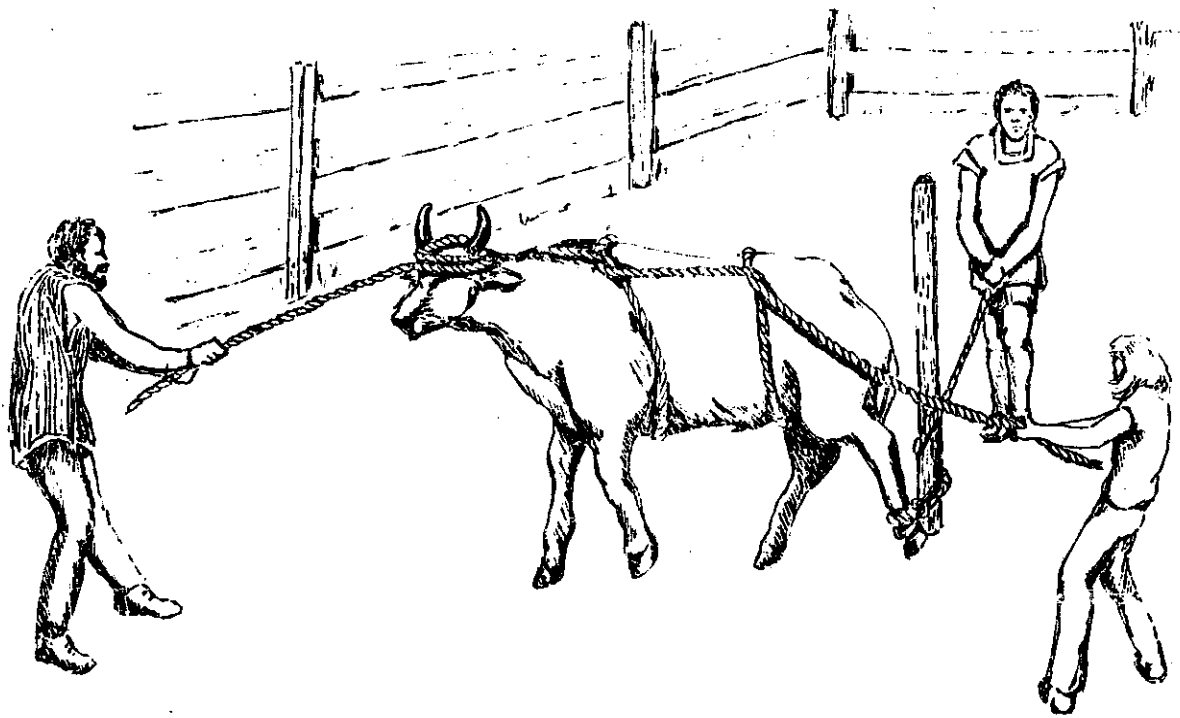

Once the animal is down, the rear legs can be bound with rope at the fetlocks. To further immobilize the animal, one person can hold its head, while another puts his or her knee on the animal's front shoulder.

## Program for Training Cattle

The program consists of four phases. During the first two phases, the animals are taught to obey voice commands individually. In the last two, the individuals are yoked as a team, redrilled on all voice commands, and then made to pull a log (skidding).

### Breaking an Animal Using a Running-W Harness

Cattle can be difficult to control during the first few days of

training, so the first step is to break them of their independence. This is done by using a running-W harness. This is a mechanical teaching aid which lets the trainer stop the animal instantly by making it trip and fall. The purpose of the drill is to make the animal recognize the strength and authority of the trainer, and pay attention to his/her voice.

- a) Make, or have local craftsmen make, the parts of the harness:

surcingle--an adjustable belt, approximately 3 meters long, which circles the animal's torso. It has a ring or fixed loop on each side called a side ring, and one underneath called a chest ring.

anklet--an adjustable bracelet which fits around the foot just above the hoof. It has one ring or fixed loop.

All parts can be made of rope, but leather straps fitted with metal rings are easier to use and less likely to cause sores or burns. The surcingle later is used to help support the lines (reins), and so it is recommended that one be made for each animal.

- b) Chose soft terrain for break-

### Running-W Harness

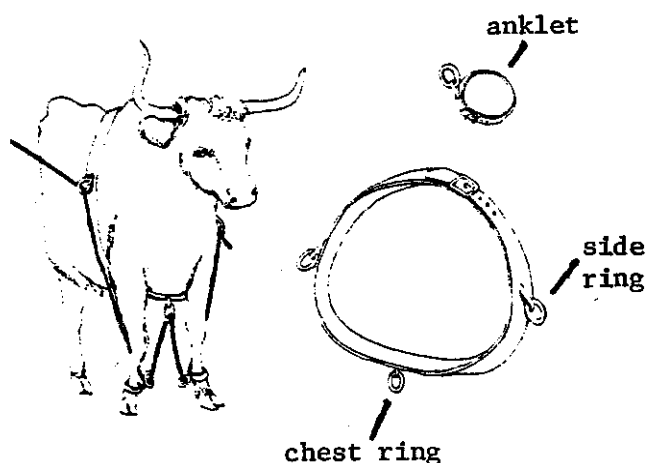

ing, preferably a sandy corral.

- c) Place the harness. First, immobilize the animal and buckle or tie the surcingle around its torso just behind the front legs. Make it snug. Then buckle on the anklets.

Feed one end of a 10-meter rope through one of the side rings, down to the ring on the nearest foot, and up through the chest ring. Make sure the rope goes behind the knee, not in front of it. Draw the rope through the chest ring, down to the other anklet ring, and up to the other side ring. Tie it to this ring. Seen from the front, the rope should form a "W" pattern.

The free end should be long enough to let the trainer stand several meters behind the animal's rear quarters.

- d) Stand behind the rear quarters holding the free end of the rope. The rope is called a "trip rope". Have an assistant remove all other ropes.

Make the animal walk forward. Urge the bull forward by raising your free arm and stepping toward the tail. At the same time, tell it to walk. Use a clear, controlled voice. If necessary, tap the bull with a stick. Try to avoid making it bolt or run. The goal is to make it walk ahead of you at a fixed distance.

- e) Stop. When the animal is moving, give the command to stop two or three times and then pull the trip rope so the front legs buckle and the bull drops to its knees. Keep tension on the rope so the animal can't get up right away. Then give the command for walk, releasing the tension and walking toward the tail. Use voice and body position to get the bull up and moving, tapping it with a stick if necessary.

- f) Repeat the process of making it walk and stop five or six times. The purpose of the drill is to:

- teach the animal to pay attention to the trainer; listen.

- show it the trainer is stronger and not afraid.
- begin to teach it that the command stop is related to the action stop.

g) Evaluate progress. Most animals learn to obey the commands walk and stop after two or three days. Breaking sessions are kept short--30-45 minutes in the morning, and again in the afternoon. Harness is left on between sessions so the animal gets used to it, but the surcingle is loosened.

While it may seem that an animal has learned to obey the commands during a given session, be sure to check its memory: begin each new lesson with a review of the old.

Some animals may not learn so quickly. Be patient and persistent. If an animal doesn't respond after five or six days, try putting it in a yoke with a trained animal and repeat the drills; use the W-harness on the untrained animal. When the session is over, turn the pair loose in a corral with the yoke still on. Later, repeat drills.

Some animals have physical or behavioral problems that make them aggressive or extremely stubborn and unmanageable. Castration may help

if the animal is still under 18 months of age. The safest and easiest solution is to find a replacement animal.

## Ground Driving

This is the process of controlling an animal's movements from behind using voice commands and lines. Lines are long reins attached to the animal's halter (or nosering).

- Place the W-harness.
- If the animal isn't wearing a halter or nosering, make a halter and put it on (see page 35).
- Attach lines from either side of the halter or nosering and run them through the side rings of the surcingle. They should be long enough to reach a driver standing several meters behind the animal. The driver holds a line in each hand.
- Have an assistant control the trip rope. Continue to use the trip rope as a teaching aid/safety device throughout training. Once the trainer can manage the lines with one hand, he/she can take the trip rope in the other.
- Now follow the steps b, c, d and e described on page 71.

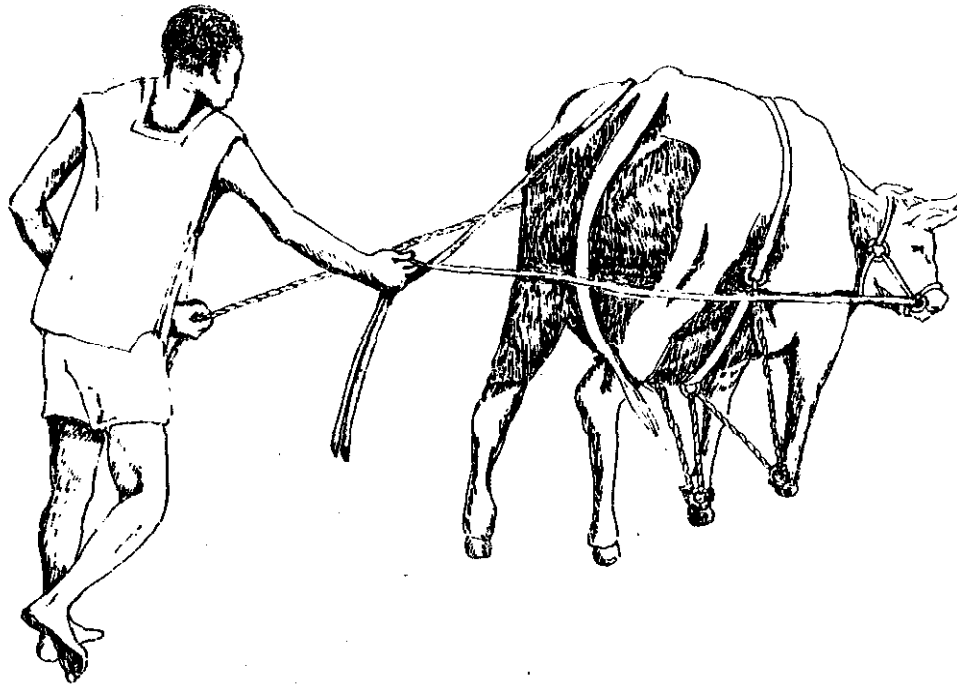

These steps are for ground driving horses, but they do not differ when applied to cattle. The leverage offered through a halter or nosering is sufficient to turn a bull's head; a bridle and bit is not needed.

Important Note: During this stage of training, each command is preceded by the animal's name. Later, when in a team, it can be singled out and made to respond.

### Yoke-Breaking the Team

Before the team is yoked, the trainer must decide which animal belongs on the right-hand side. This is the animal which walks in the furrow during plowing. The taller of the pair is usually put in the furrow, as this makes the yoke ride parallel to the uncut ground and square to each animal's neck. The team pulls more evenly, and is less likely to develop sores or yoke galls. When speaking about pairs of



animals, it is customary to refer to the right-hand animal as the "off" animal and the left-hand one as the "near" animal.

- a) Tie the animals to a rail, side by side. They should be wearing W-harness and halters (or noserings). The lines should not yet be attached.
- b) Place the yoke. Stand on one side holding the yoke. Pass one end over the team's back to an assistant on the opposite side. If the team shies or refuses, try passing it from the other side. Shying is often caused by imperfect vision or the sudden appearance of a strange object near the head.

- c) Adjust the bows by sliding them up or down in the yoke stock so they rest against the animals' chests without touching the base of the neck (windpipe).

Note: The best yoke for training purposes is the kind shown below. Each bow is made of two J-shaped bars which can be turned so they lock and unlock under the animal's neck. If the team falls, or gets the yoke caught, the bows are unlocked and the yoke lifted off. A single piece bow can be extremely difficult to remove in these situations; the danger of strangulation is great.

When single piece bows are

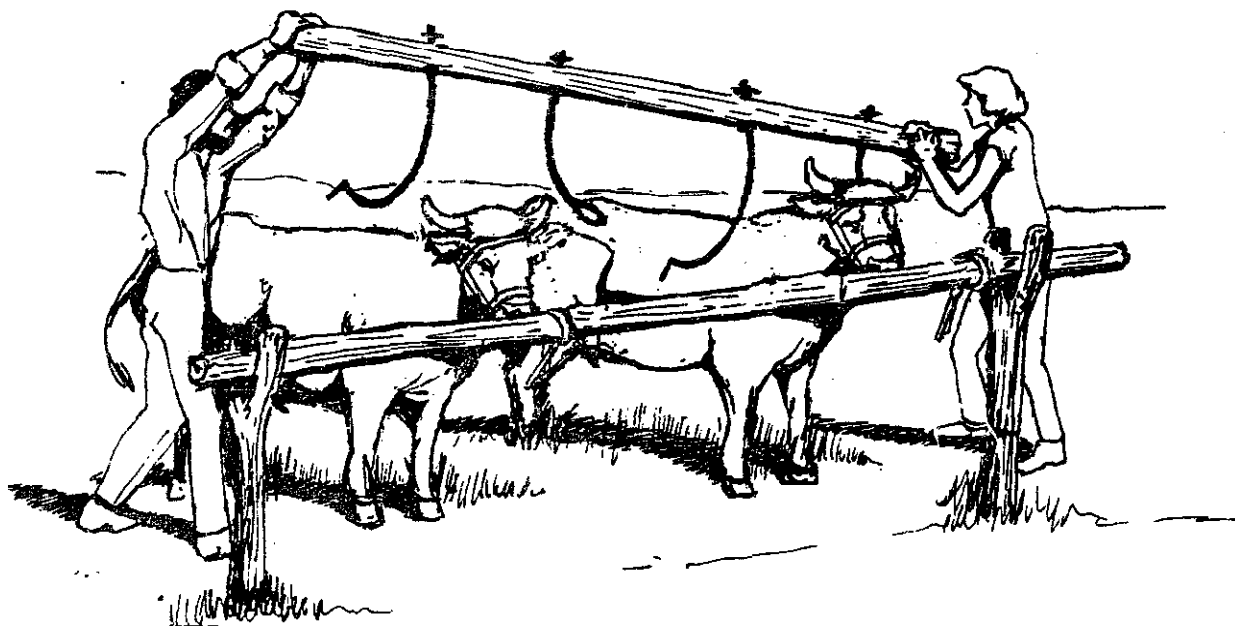

- used: First lay the stock across the animals' necks, then slip the bows up and into the stock from underneath.
- d) Place the lines. (Use the system illustrated on page \_\_, and see page \_\_, lead pair.)
  - e) Drive the team from behind, drilling it on the commands walk, stop, right, and left.
  - f) Teach the animals to distinguish between individual and general commands.

Slow one animal down by pulling its lines. Then get it to speed up by calling its name and giving the command for walk in a sharp voice.

Example: "Walk" means both animals walk; the team moves forward or speeds up. It is a general command. "Red! Walk!" means you want Red to pick up his pace so he is walking even with the other. He was lagging behind.

- g) Teach the team to back up. The command is given and the driver pulls back on the lines evenly. At the same time, an assistant standing in front of the team urges it back by tapping the animals' knees with a stick and raising his hand so they shy. Pushing against the yoke helps if they don't shy back. Pulling the yoke with a chain also helps.

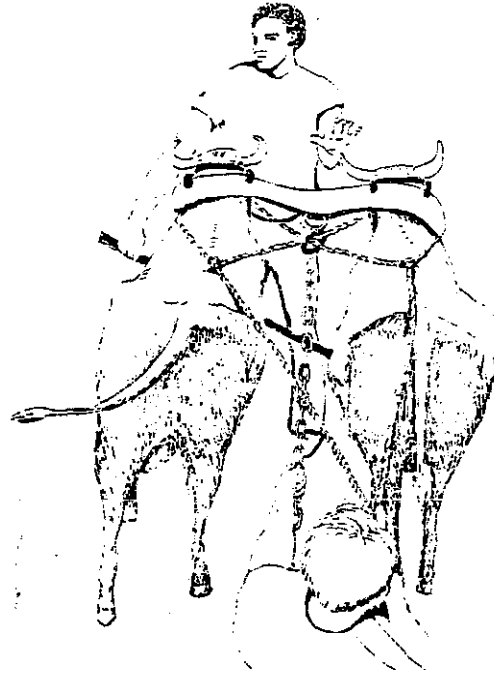

### Breaking the Team to Pull (Skidding)

- a) Yoke the team. Use lines and trip ropes.
- b) Skid a log. Wrap a chain around the butt (broadest) end of a log. Extend the chain so it forms a straight line with the log. The chain should be 3-4 meters long and have a hook on the end. The log should be very light and easy to drag. Drive the team over the log and toward an assistant who stands at the end of the chain. Have the assistant hook the chain to the clevis which is at the midpoint of the yoke stock. An alternative

method is to attach the chain to the clevis and let the team drag it so the free end is close to the end of the log. If this method is used, be sure the team is used to dragging the chain.

Drive the team, practicing all commands. Have the assistant control one or both of the trip ropes. Rest the team for a minute or so after every 5-10 minutes of work. Don't let them get out of breath or overheated. Make sure the yoke doesn't cause bruises or sores.

- c) Increase the size of the load. Attach a short rope to the back of the log and when practicing turns, bring it around as though it were a plow or cultivator. Pull the log back as you would if the plow snagged on a root.
- d) Hitch your team to a field implement or load or repeat drills.

#### A Note on Breaking Cattle to Collar Harness:

Animals that have pulled in yokes usually will pull in a collar with very little additional training. The section on training horses in collars will be helpful to those who are training cattle in collars. However, it is important to break cattle with a running-W harness first.

## Training Horses, Donkeys and Mules

### Catching

Whether staked out or corralled, these animals are generally caught using very simple methods. Approached slowly and spoken to softly, or offered a handful of grain, they rarely refuse to be taken by the halter and led. They are easily cornered in a corral and grabbed by the halter, or by the nose and ear; in some cases, a rope may be slipped over the animal's head.

### Cross-tying

Cross ties are ropes which used to immobilize a horse or donkey in a standing position. To make cross ties, fasten two pieces of

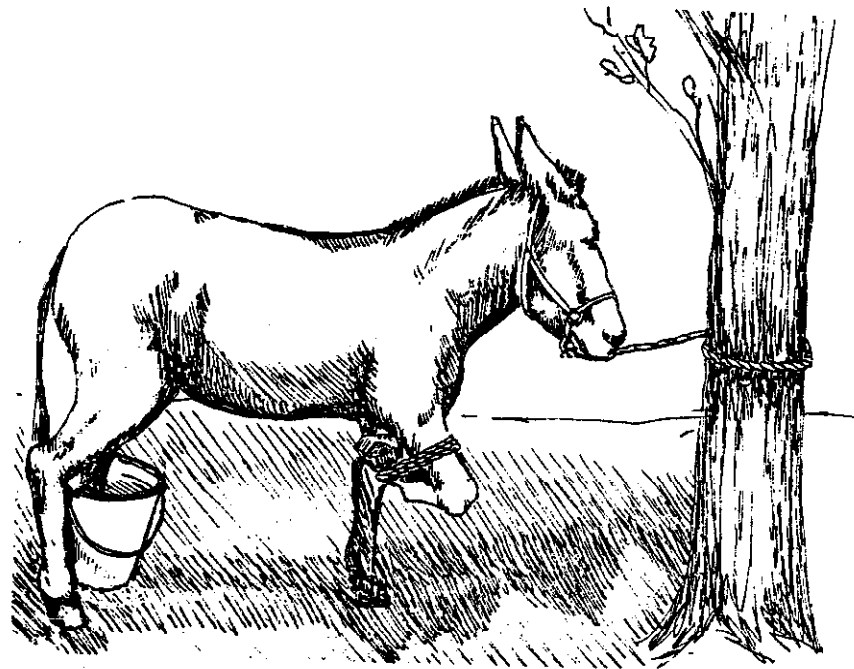
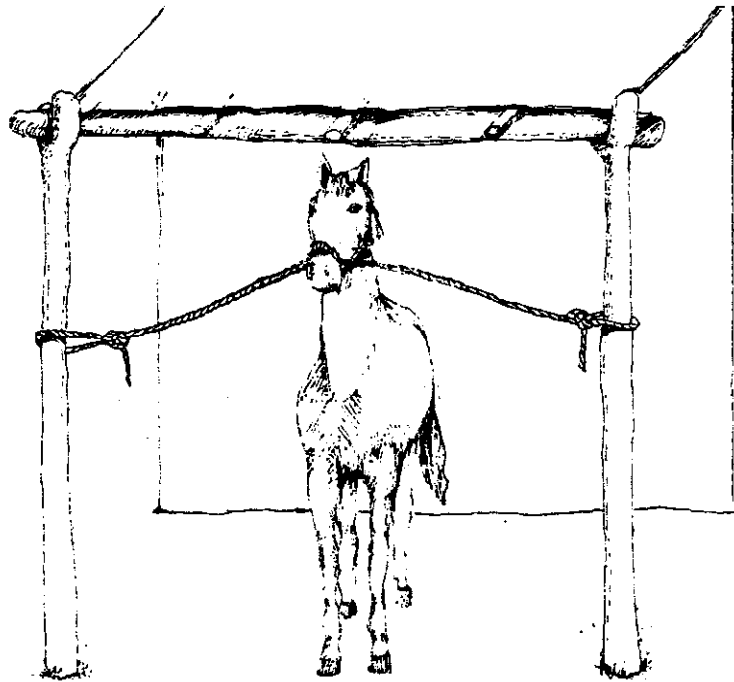

rope one meter long to each of two posts or trees which are spaced two meters apart. Fasten the ropes to the halter, one at each side, drawing them tight so the animal cannot move its head.

To immobilize the animal, lift one of its legs, squeeze the tendon above the fetlock and pull the leg upward. Thus forced to stand on three legs, the animal cannot move.

If working alone, the trainer can use a belt or rope to hold one of the front feet. The animal will not fall and will remain still while being treated for ticks or wounds. It is especially useful if one of the animal's feet must be kept in a bucket of water.

### Casting an Equine

Casting a horse or donkey by pulling the hind legs out from under it is best accomplished in the following manner:

- Choose soft terrain.
- Hold the animal in front with cross-ties, or by a strong lead rope or "twitch", which

is a loop attached to a short handle.

- To apply the switch, put the loop over the muzzle and twist until very secure.
- Tie a fixed loop in the center of a long rope, and fit the loop around the animal's neck like a collar. The knot rests on the withers and the two ends are parted over the back, one on each side, and brought along the flanks and down between the hind legs. The right-hand rope circles behind the right pastern and is brought forward along the animal's right side. The

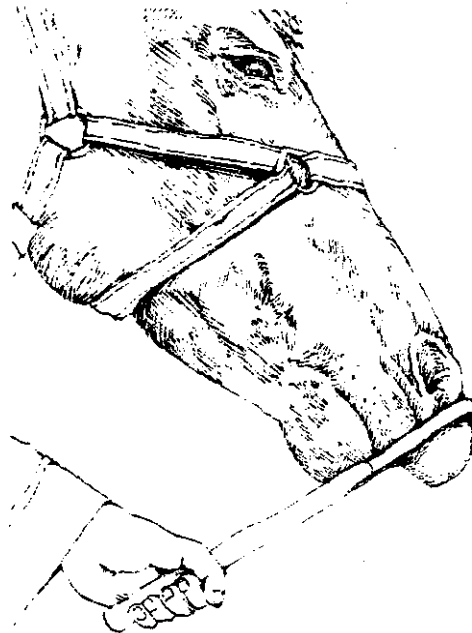

Using a Twitch

### Casting a Horse

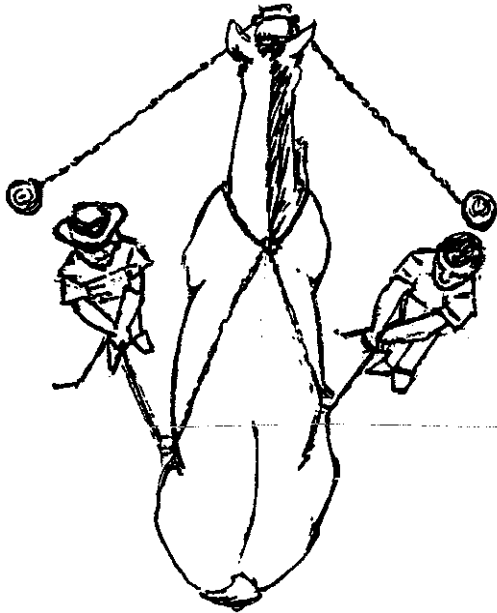

left-hand rope is used in a similar fashion on the left side.

- People on either side of the animal pull ropes, "walking" the rear legs forward until the animal sinks gently into a sitting position.

Rope burns caused by the casting method can be reduced by running the ropes through anklets attached to the animal's feet. Further advantage can be established by placing a surcingle around the girth of the animal and feeding the ends of the draw-ropes through the support rings.

Once the animal is cast, spe-

cial care should be taken to ensure that its head is kept low and outstretched; serious neck and back injuries may result when a horse or donkey is allowed to raise its head once it is on its side.

Proper control of the legs will ensure that the animal does not injure itself or the people around it. Immobilize the hind leg by attaching a rope above the pastern, bringing it around the neck and chest and then locking it behind the hock and drawing it up. Control a foreleg by pulling it up into the

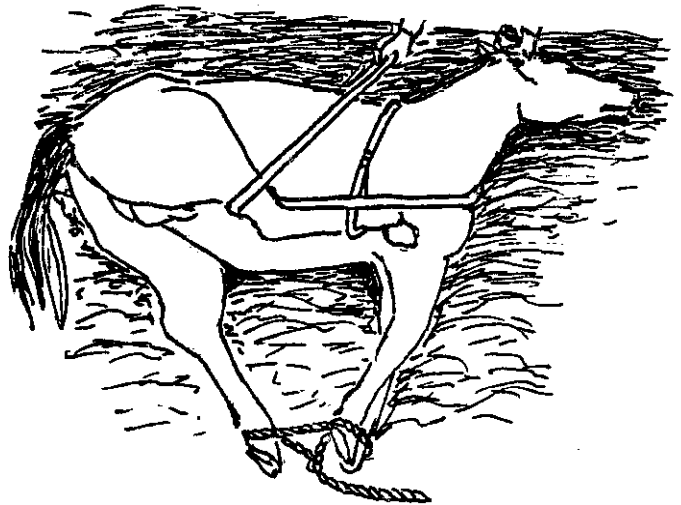

Tying the Legs

chest either by hand or with rope. Limbs not drawn up should be bound together at the fetlock with soft rope. In no case should a leg be pinned by having someone sit on it.

## Program for Training Horses, Donkeys and Mules

The program consists of six phases. On the average, it will take 3-4 weeks of training before the animal is able to pull a cart or field implement.

Note: In the United States, it is standard procedure to approach, lead, harness, mount, and dismount from the animal's left side (sometimes called the "near" side). In countries where a right-hand standard is used, proceed from the right, reversing hand positions described below.

### Halter Breaking

- a) Place a halter on the animal. Fasten a one-meter rope to the chin ring of the halter. This is called a lead rope or lead shank.
- b) Stand on the left side of the animal close to its head. Hold the excess rope in the left hand. You are facing forward. The command given is the animal's name and the word "stand". Use a firm, unexcited voice.
- c) Walk forward, pulling with your right hand and giving the command for walk. If the animal won't move, you can get it started by pulling its head toward you. This throws it off balance and forces it to take a step (be careful not to let it step on you). Keep pulling the animal around you in a tight circle, forcing it to take successive steps. Gradually straighten out the line of movement. Don't look at the animal: look forward.

#### If the animal refuses to lead:

- Have a second person encourage it from behind by tapping it with a stick or whip. The voice command, however, comes from the trainer--the person leading it. Use whips sparingly.

- Practice next to an animal that already is trained. When breaking a colt, walk it next to its mother.

- Use a "come-along".

If two assistants are available, have them stand behind the animal and hold opposite ends of a 2-meter rope or strap. When you give the command for walk, have them move up and push the animal forward with the rope.

If you are alone, circle the rear quarters with a large, fixed noose and bring the free end of the rope forward and through the chin ring of the halter. Pull on the free end of the rope to lead the animal (see illustration below).

- d) Teach the animal to stop by pulling the lead rope back and down so pressure is exerted on the front of the noseband. Give the command and pull back without turning and looking at the animal. For extra leverage, lock your right elbow into its chest as you tug back on the halter.

- e) Practice turns. Walking on the left, the trainer uses the lead rope to turn the head.

For a left turn, pull the rope toward you and begin to circle leftward as you give the command. The pull is perpendicular to the head--not up or down. The animal feels pressure from the right side of the halter. For a right turn,

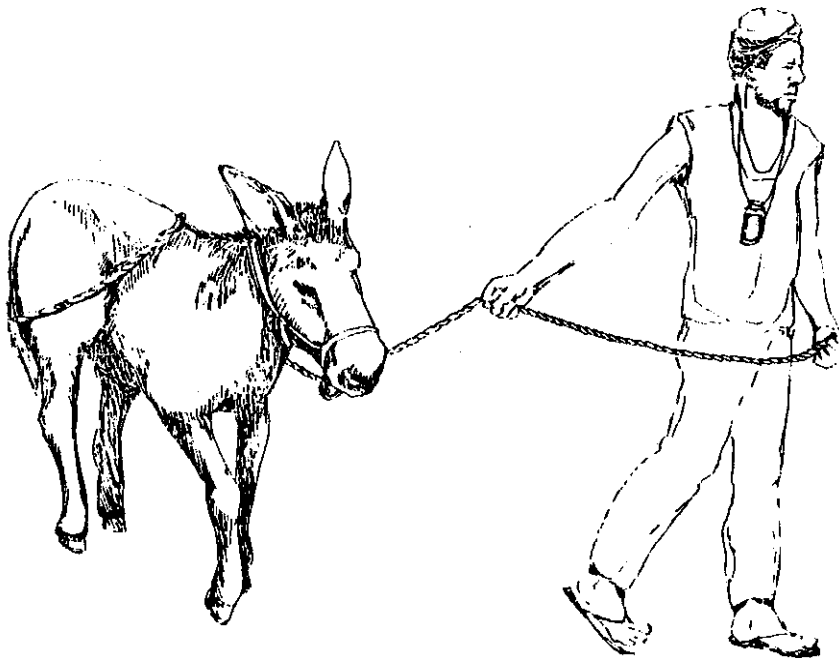



walk as close to the animal as you can and then begin to extend your arm under the chin and then out to the right. The animal feels pressure from the left side of the halter.

- f) To back up, stand in the usual position, but face the rear of the animal. Hold the lead rope in the left hand and push back and up gently while giving the command.
- g) During the first few sessions, use the same area for training, avoiding potential distractions. Later, lead the animal to other areas. See if it will lead into a stall, stream, woods, over a bridge. How does it behave around other animals and people?

Breaking to a halter may take 1-2 weeks of two one-and-a-half-hour sessions each day. Be patient and persistent. Do not be discouraged if the animal refuses to lead, or fails to recognize commands as quickly as you think it should. Never abuse it. Try to outsmart it: show it you can make it do what you want without hurting it.

It is extremely important to reward correct behavior. This is done with a pat on the neck and a word of praise. Do not reward with food.

## Lunging (Longeing)

Once an animal begins to associate voice commands with the movements expected by the trainer, the lead rope is extended and commands are given while the animal circles the trainer. This process is called lunging. Its purpose is to get the animal to listen and obey from a greater distance. This phase should take only 3-4 days.

- a) Attach a 5-meter rope to the halter. This is the "lunge line".
- b) Stand one or two meters back from the animal holding the line in the left hand and a long switch or whip in the right.
- c) Have the animal circle you to the left, obeying the commands for walk, stop, and stand. Use the switch to drive the animal forward as needed.  
If it refuses to move forward, have an assistant stand behind it and use the switch. If it moves in toward you, force it to keep its distance by having the assistant walk inside the circle between you and it.
- d) Reverse the direction and repeat all drills.

- e) Gradually extend the lunge line until the animal will respond to commands given at a distance of five meters.

### Harness-Breaking

This is the process of getting the animal used to the harness it will wear when pulling a cart, plow, or other field implement. Basically, it involves repeating lunging drills while the animal is wearing its harness.

Do not try to put the harness

on all at once. This can frighten it, or distract it so much that it won't listen to you. A good approach is to lunge it first with its bridle, then with bridle and surcingle, then bridle, collar and surcingle, and finally in full harness. This should take 2-3 days.

Note: Description of the actual harnessing procedure is found on page 86, How to Harness a Horse, Donkey or Mule.

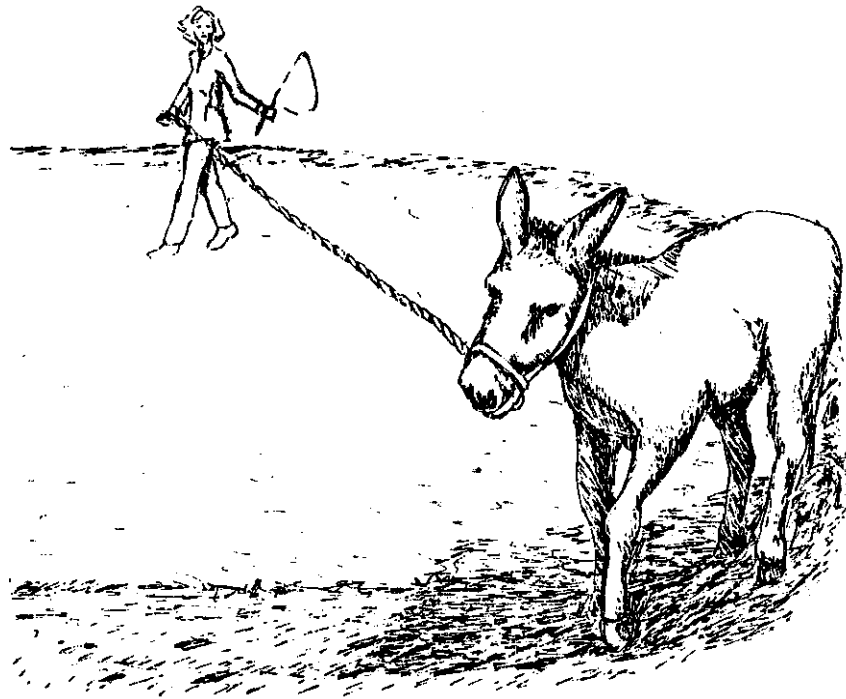

## Ground Driving

This is the process of teaching the animal to obey commands given from behind--the place where the driver or plow operator will be when actual work is done.

- a) Put the harness on, making these checks:

Traces should be fastened to the britching so they do not drag on the ground.

Lines go from their starting point on the bit, pass through rings on both the hames and the jack saddle, and then back to the driver.

- b) Stand approximately two meters behind the animal holding the lines. Keep your hands high, about level with the animal's mouth. Keep them shoulder-width (your shoulders). Try to establish enough tension on the lines so you can feel the bit without actually pulling the animal back toward you. The tension on the lines makes the animal pay attention. It should be alert to your control even though you are not moving.
- c) Release the tension slightly, and give the animal's name and the command for walk. If it doesn't move, snap one line so it slaps the top of rear quarters. Repeat the command using a louder voice.

- d) Practice turns by using the lines to pull the head right or left. Remember that if you pull one line, you must slacken the other.

To turn right, draw your right arm back and to the outside of your shoulder without jerking or changing the height of the line. At the same time, extend your left arm straight forward so there is no tension on the left side of the animal's mouth.

Reverse the procedure for a left turn.

- e) Make the animal back up. Begin in the position described in step b. Give the animal's name and the command "back" while pulling back with both lines. Don't change the height of your hands. Pull gently, but firmly. Use a low voice and draw out the word so it lasts for several seconds at a time.

Ground driving may take 3-4 days of two one-and-a-half-hour sessions per day.

## Skidding

Skidding is the process of dragging logs or fallen trees using animal power. It is used primarily during logging or field-clearing operations, but it is extremely

useful as a training procedure for draft animals. Teaching an animal to skid should take 2-3 days.

- a) Put the harness on the animal and unhook the left trace from the britching ring.
- b) Hook the trace to one end of a swingtree or "tree".
- c) Stand behind the animal and ground drive it, making a very large circle to the left. This lets the animal get used to the noise and vibration without having the trace rub against its flank.
- d) Hook both traces to the tree and ground drive the animal. Tie a safety rope to the middle of the tree so if the animal spooks and runs, you can run with it and keep the tree from hitting the back legs. Hold the lines in your right hand, the safety rope in your left.

Add resistance by having an assistant pull back on the safety rope. The tree is now off the ground, as it would be when attached to a cart or implement. The assistant stands directly behind the animal, the driver slightly to his right.

- e) Skid a log. Wrap a chain around the butt end of a log. Drive the animal over the log and forward so its swingtree can be fastened to the chain. The swingtree can be fastened

to the chain. The swingtree must have a ring in the center. Stop and hold the animal steady with the lines as an assistant hooks the chain to the ring.

- f) Drill on all commands (except back).

### Training the Team

When individual animals are well trained, they are harnessed as a team, ground-driven, skidded, and finally hitched to a cart or implement. The commands practiced in each stage are stand, walk, stop, turns, and backing up. Training the team, the last phase, should take one week.

## 5. Yokes and Harnesses

Yokes and harnesses are kinds of gear worn by draft animals when they work. Most of the gear is designed for pulling; it fits around or over the animal's front, providing a broad, comfortable surface to push against. The "push" is turned into pull through use of rope, chain or leather lines which connect the yoke or harness to the load.

Yokes are normally used with oxen because these animals drive forward with their heads and necks low, and have both strength and protection there. The yoke is a bar or frame of wood which locks two animals together, one at either end of a bar carried on the withers or strapped to the horns. In some instances, equine teams are fitted with padding that allows them to pull from this type of yoke. Other

types of yoke are for single animals, and still others are for special use with harnessed wagon teams.

Harnesses are networks of adjustable leather straps and pads used primarily for horses, donkeys, and mules. These animals have broad chests and strong shoulders, and so their harnesses are made to fit against these areas. The use of harness can increase the power of oxen, but the expense of leather and difficulty of ensuring fit have limited acceptance of this practice.

Major types of yoke and pulling harness are discussed in this section. Steering, braking, and backing-up gear is discussed also, because it is used along with pulling gear. A full set of harness consists of a collar or breastband harness, a bridle and lines (reins),

and a breeching harness. A yoke is not normally considered a harness; when it is used along with other gear, the set is identified as a "yoke with lines," or a "yoke with lines and breeching".

## Yokes and Harnesses for Cattle

### Bow Yoke

The bow yoke is an inexpensive and efficient device for harnessing the power of cattle. When the team pulls, the wooden crosspiece or stock presses back against the muscle and cartilage which forms the front of the animals' withers. This area, very pronounced on some breeds, is called the boss or hump. It provides a natural seat for a yoke.

The yoke is held in place by bows, U-shaped pieces of wood or metal which fit into the stock from

underneath. Broad wooden bows provide more surface area than most peg thong or round-iron varieties, and give the animal extra surface to push against with its shoulder. However, there is great advantage in a bow that locks and unlocks under the neck; these bows are easy to remove if a team has fallen and can't or won't get up.

#### To make a yoke:

- 1) Cut a piece of green (live) wood one meter long. The piece should be thick enough so that once the bark has been peeled off, the pole is 12 cm thick. This pole is called a yoke stock. It should be a variety of wood that will be strong and light and provide a smooth surface for the team to push against.
- 2) Mark the center of the pole with a piece of charcoal. On either side of this mark make a set of marks. The first mark in the set is 30 cm from the center; the second is 50 cm.
- 3) Have a carpenter drill a hole through each mark, or have a blacksmith make the holes by burning through the wood with a hot metal point (an awl). The holes must be big enough to let the bows slide in and out freely. They must also be big enough to allow for some

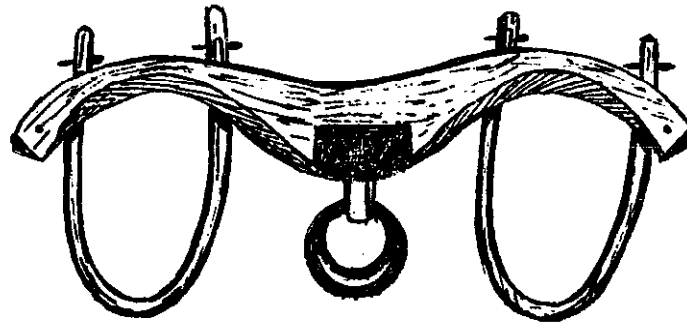

Wooden Bow Yoke with Carved Stock, Solid Bows, Draw Ring and Pole Ring.

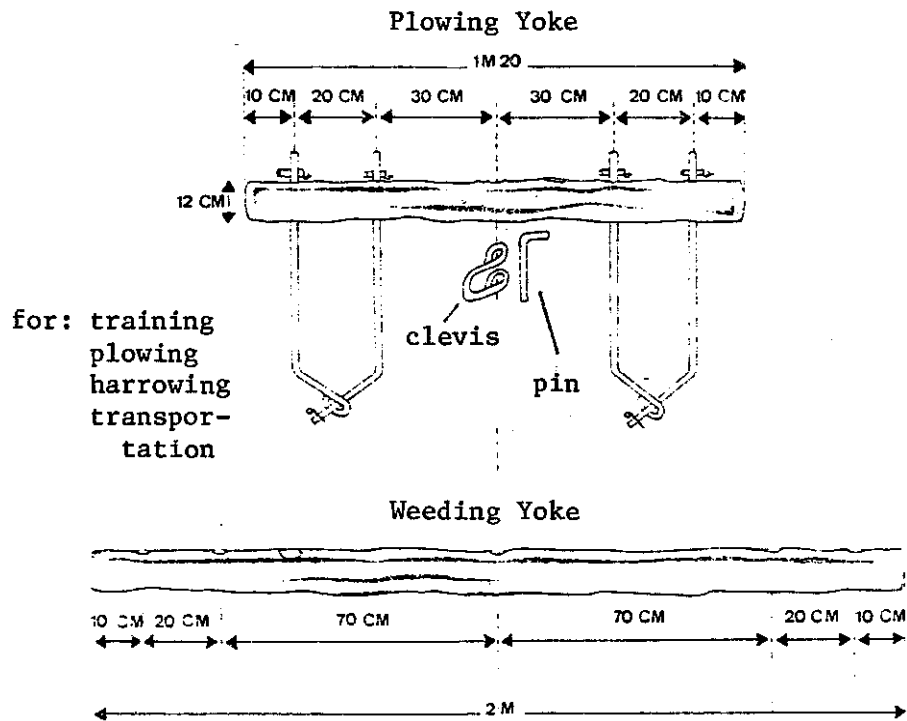

for: training  
plowing  
harrowing  
transportation

for ridging and weeding/ridging operations where crops are planted in rows 80 centimeters apart

Source: Dineur, Bruno, Georges Moriers and Pierre Canard. 1976. Guide pratique de la culture atelée au Bénin. Food and Agriculture Organization of the United Nations, Rome.

shrinkage of the wood. Remember that green wood shrinks as it dries.

- 4) Make the bows of round iron 12 mm thick. Have the blacksmith cut four pieces of round iron one meter long and shape them so they fit into the yoke stock as shown in the illustration. The bows lock together so that cotter pins can be passed through to keep the bow from slipping down out of the stock holes. For an explanation of the procedure for putting the yoke on a team, see page 62.

## Head Yoke

Most head yokes lock behind the horns and are tied to the forehead and horns with straps. The stock is carved out to accommodate the backs of the horns, and so once the yoke is on, the team becomes an extremely tight unit. They are especially useful for cart work because they keep the shaft (tongue of the cart) from driving the stock forward or back during respective backing and braking situations.

Single animal yokes fit either

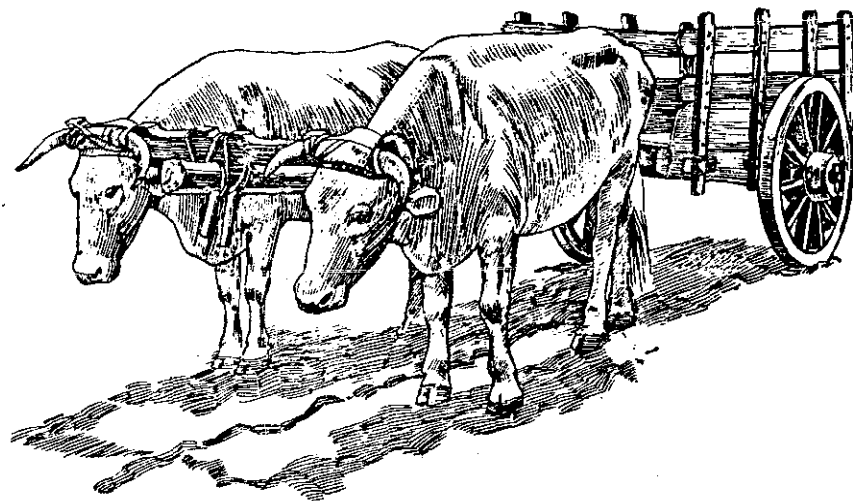

Head Yoke

Source: Hopfen, H.J. 1969. Farm Implements for Arid and Tropical Regions. Food and Agriculture Organization of the United Nations, Rome.



behind or in front of the horns.  
Lengths of rope, chain or leather  
(called traces) connect the ends of  
the yoke to the load.

### Sling Yokes and Sling Harnesses

This equipment is for single  
animals performing light work such  
as weeding or peanut ridging. Many  
variations are possible, but all are  
seated over the hump or withers and

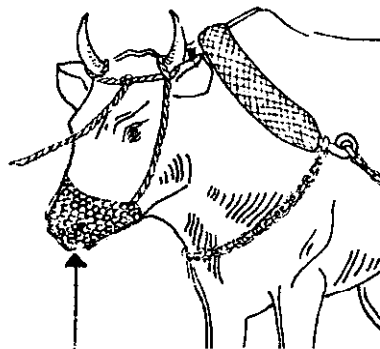

Muzzle Used  
During Weeding

West Africa--Sling Made of  
Padded Steel Bar (Round Iron)

Source: Dineur, Op. cit.

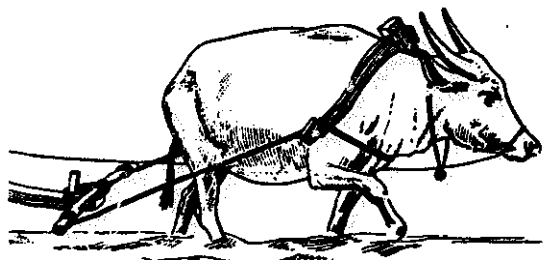

China--Wooden  
Sling (Unpadded)

Source: Hopfen, Op. Cit.

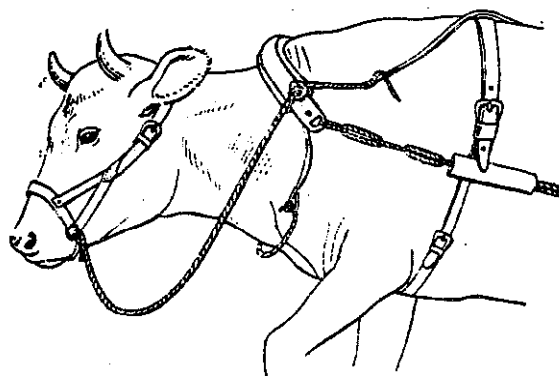

Switzerland--  
Flexible Sling

Source: Hopfen, Op. Cit.

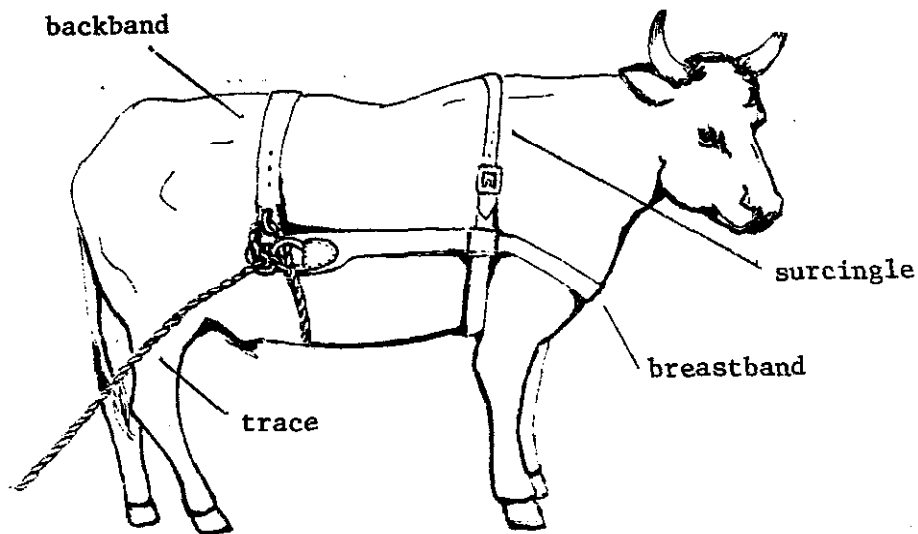

Breastband Harness for Bull

connected to the load with traces. Use of a surcingle or neck strap gives stability to the traces and prevents the sling from rocking on the animals' neck.

#### Breastband Harness

This type of harness is a broad band of leather which circles the animal's chest and sides, and which is supported by a surcingle and backband. The trace is attached where the breastband and backband

meet.

The breastband must be high enough on the chest so it does not interfere with movement of the shoulder. Correct position is shown above.

The harness shown was tested on domestic water buffalo in Thailand and shown to be more efficient than commonly-used wooden slings.

#### Collar Harness

Properly fitted, the collar

Collar Harness

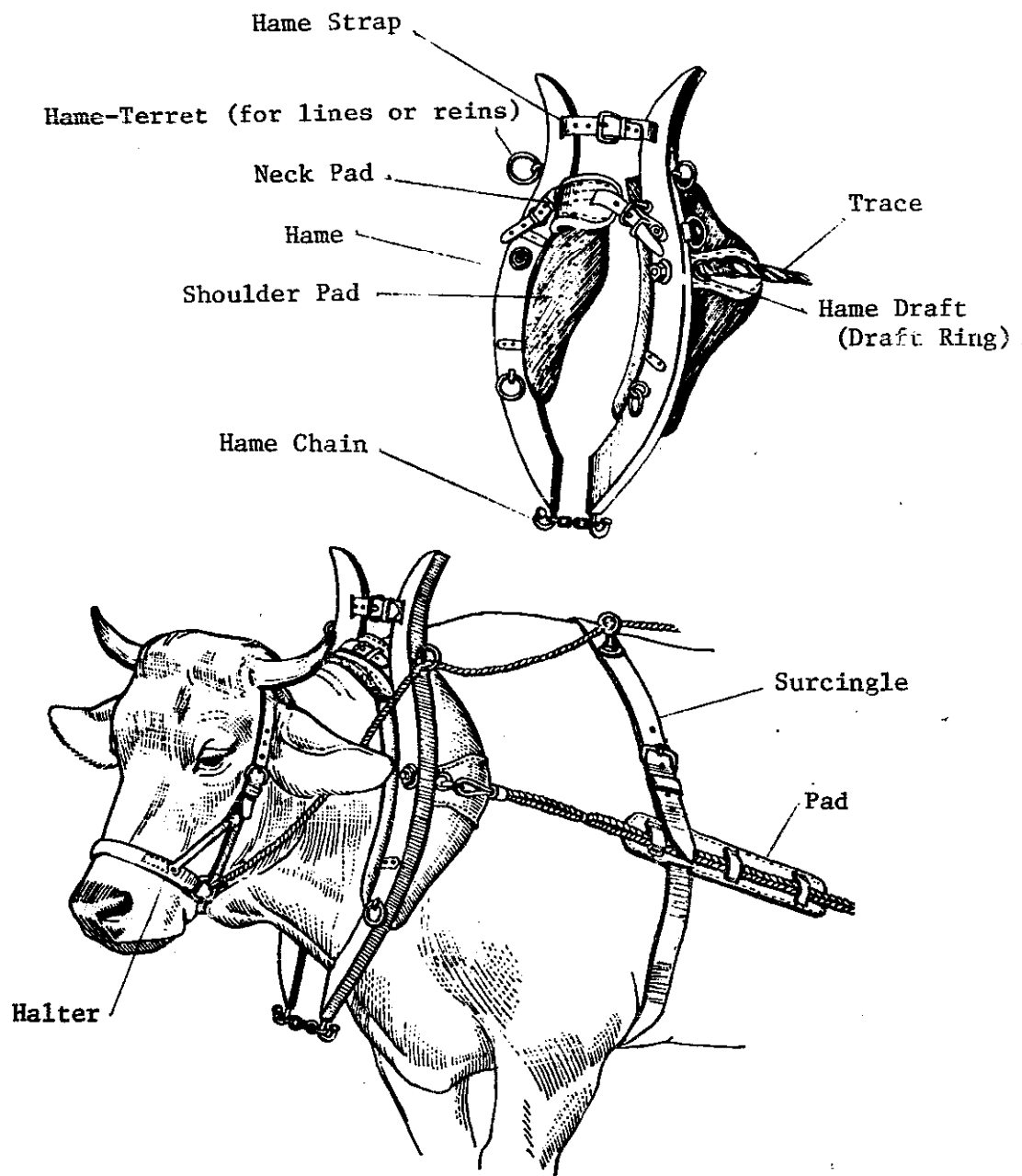

Source: Hopfen, Op. Cit.

harness provides excellent draft for cattle and buffalo. These animals have relatively narrow chests and the collar must be shaped so it does not interfere with movement of the shoulder. The collars have been used with success in Germany, the United States, and more recently Thailand.

In traction tests performed with domestic buffalo in Thailand, breastband and collar harnesses were shown to be about equal in performance, both types showing a 25 percent increase in draft efficiency over wooden slings. The increase was explained by 1) the greater surface area against which the animal pushes and 2) the increased comfort and related longer working capacity of the animal.

## Yokes and Harnesses for Horses, Donkeys and Mules

### Breastband Harness (Dutch Collar)

This is the simplest type of equine harness. The breastband is a broad band of leather which circles the animal's chest and connects to traces which in turn connect to a swingtree and the load. The band is held in place by straps. The forward strap, the neck strap, adjusts so that the breastband can be raised or lowered for correct position on the chest. The backstrap holds up the ends of the breastband where the traces attach.

This type of harness is not as efficient as the collar harness because the animal's push is concentrated on a comparatively small band of leather. However, it is quite adequate for light or medium tillage,

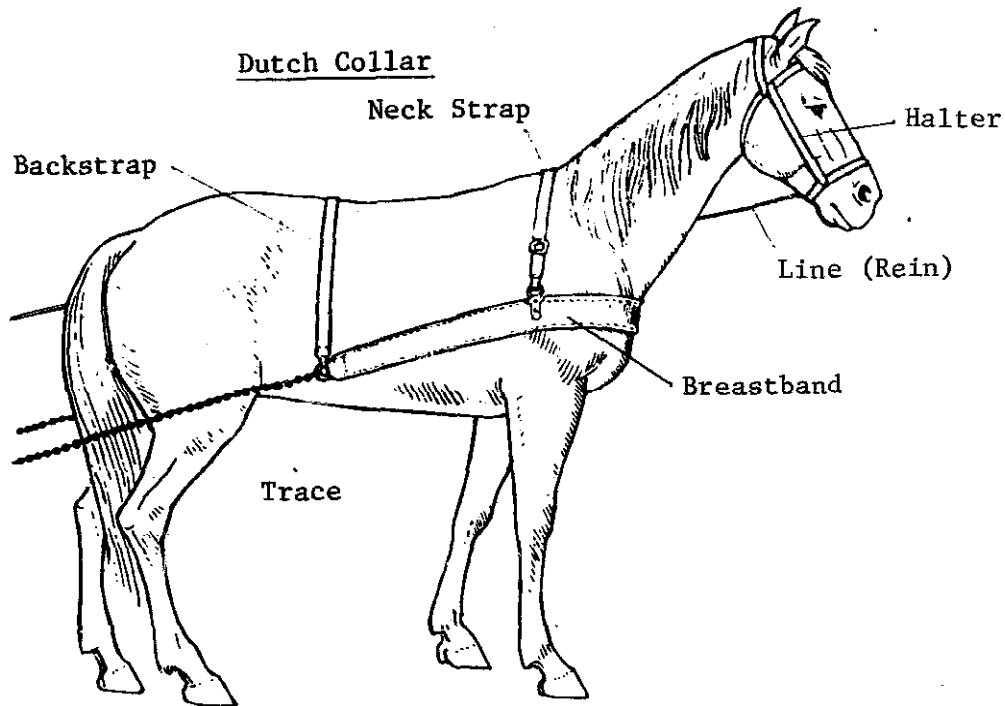

Breastband Harness, or Dutch Collar, Showing Correct Position of Straps

or cart work. It is inexpensive and easy to make and fit.

### Bow Yoke

Equine animals are sometimes yoked like cattle, but they must first be fitted with pads and collars that protect their withers and give them a point to push from.

Generally speaking, yokes do not permit efficient use of equine power.

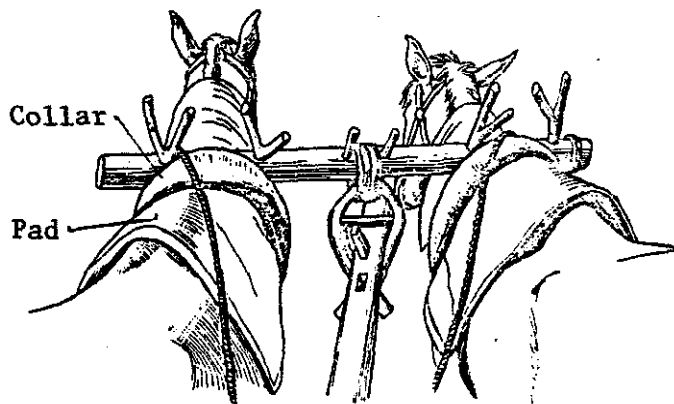

Yoke Adapted for Equine Use

Source: Hopfen, Op. Cit.

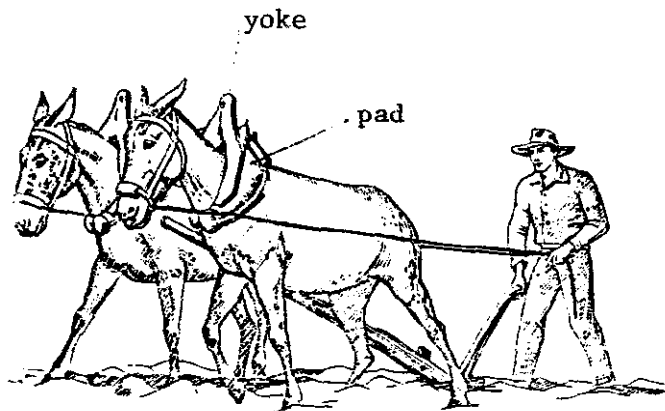

Wooden-Sling Type Yoke Used with Collar. The sling is similar to a set of hames.

Source: Hopfen, Op. Cit.

### Collar Harness

Horses, donkeys and mules have no natural padding to absorb the pressure of a yoke. For this reason, a pad is provided before the yoke is applied. The pad is called a collar. The "yoke" is made of pieces of wood or metal called hames. The hames, which are joined at the top with a strap, are placed over the withers and seated into grooves in the collar. When the animal pulls, the collar presses

against the chest and shoulders and transmits the power to the load through the traces (straps or chains connecting the hame to the swingtree behind).

The point where the trace meets the hame is called the point of draft. The attachment is made by trying or hooking the end of the trace to a ring on the hame called the hame-draft.

The dark area in the drawing shows the correct position of the collar. The white circle is the point of draft. The dotted lines

### Point of Draft

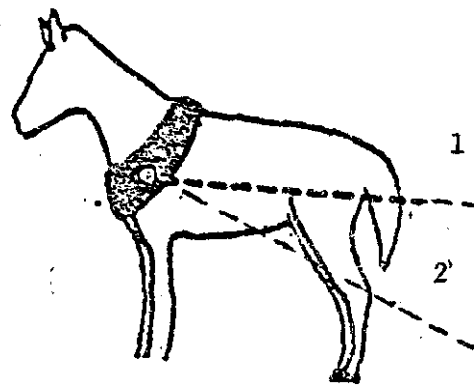

Source: Needham, Joseph. Science and Civilization in China, Vol. 4. Cambridge University Press, New York.

### Collar

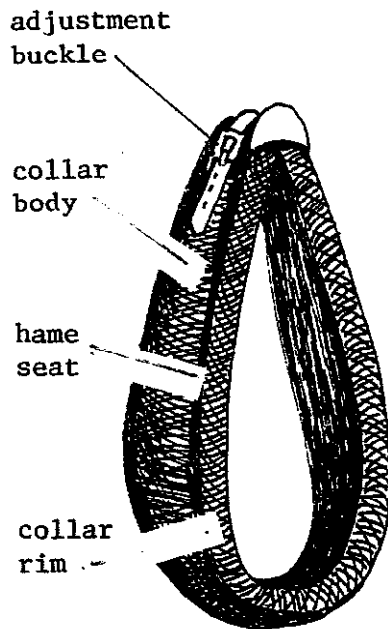

### Collar with Hames and Trace

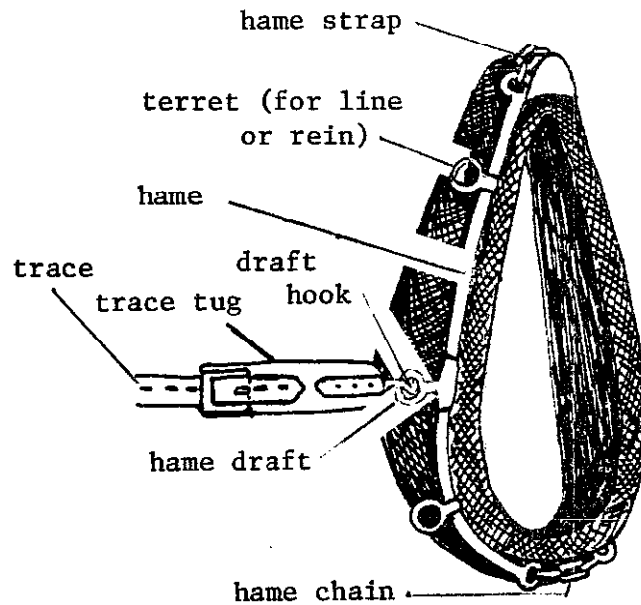

show the correct line of draft for  
(1) a cart with two shafts, and  
(2) an implement or swingtree.

Besides collar, hames, and traces, collar harness has a surcingle which fits around the animal's girth and helps carry the traces and lines. The strap may be used to hold up the shafts of a cart, and in this case it is furnished with a pad to protect the back. The strap with the pad attached is called a jack saddle.

The last part of the collar

harness is the bridle. It is similar to a halter, but instead of controlling the muzzle or nose, it controls the mouth. It is a system of straps designed to hold a metal bar or bit in the animal's mouth. A line is attached to either end of the bit, allowing the driver to turn the head. An even pull on both lines brings the head down and toward the chest, stopping the animal. The lines usually pass through supporting rings on the hames; the rings are called terrets.

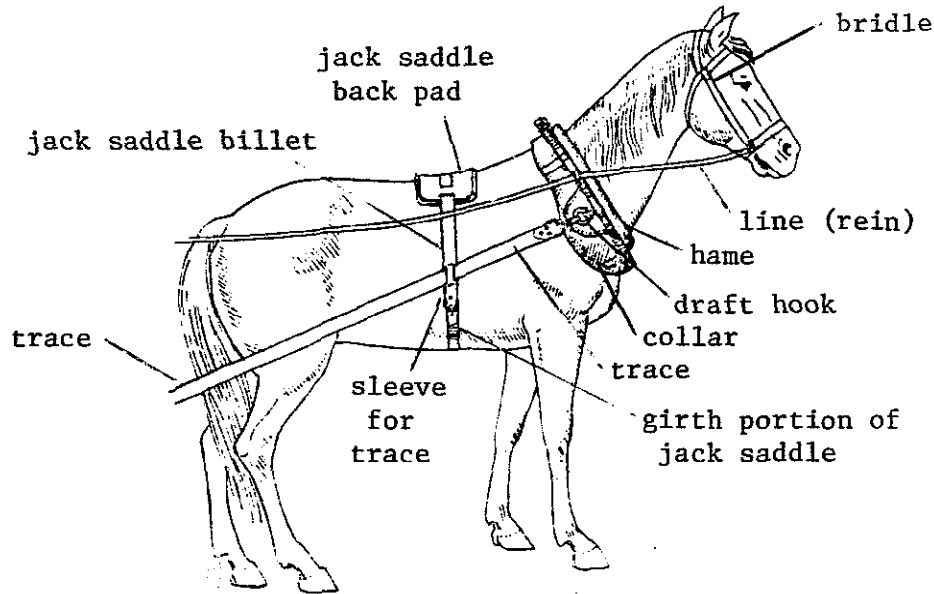

Collar Harness Consisting of Collar and Hames, Jack Saddle, Traces, and Bridle with Lines

## How to Harness a Horse, Donkey or Mule

Step 1 - Cross-tie the animal.  
Refer to page 64.

Step 2 - Place and secure collar.  
Stand on the left, next to the animal's head and open the buckle at the top of the collar. Slide the collar up and under the neck and buckle so it fits snugly and back against the shoulders. If you can't slide your hand (flat) between the collar and the neck, loosen it one notch.

Some collars, like the one

shown on page 81, have the hames built in. These adjust at the bottom, and so they are put on from above.

Once an animal is used to being harnessed, it is easier and faster to slip the collar over the head without rebuckling. Almost all collars are slightly wider at the bottom and at the top, so hold the collar upside-down and push it over the head. Once it has cleared the brow and ears, turn and seat it.

Step 3 - Place the hames, jack saddle and britching (breeching; see page 92 for description). These parts are linked together by interconnecting straps (side straps and traces), and so



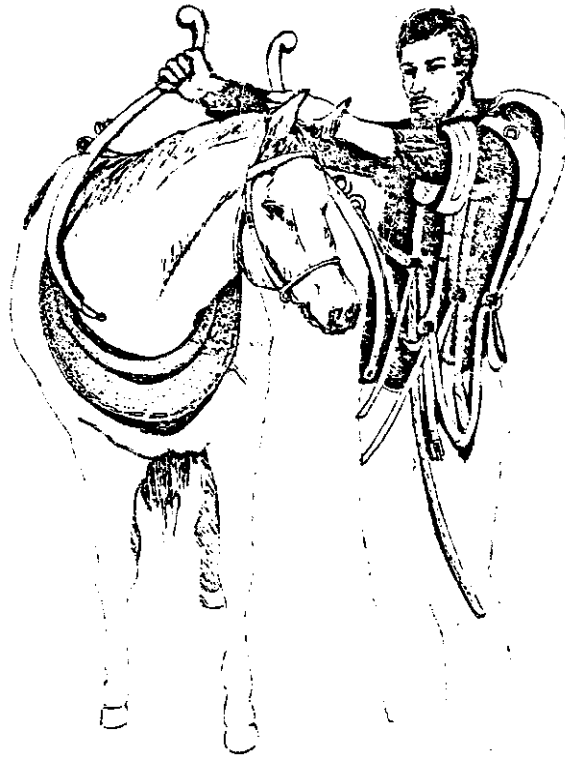

and so they are treated as a single unit.

Usually, harness is stored on two pegs. The hames, which are joined at the top by the hame strap, hang on one peg. The jack saddle and britching hang on the other with the britching on the outer end of the peg. This arrangement is used so the harness can be picked up and put on the animal without getting tangled or out of order.

First, put your left arm through the britching and sling both parts (seat and hip strap) up onto your shoulder. Second, bring the jack saddle onto your forearm and let it

hang. Third, pick up the hames, one in each hand. The right hame must be in the right hand.

Holding the harness like this, stand just to the left of the collar and lift the hames high enough so you can get the right hame over the top of the collar. Let both hames down into the grooves in the collar. This is called "seating the hames". Do not buckle them yet.

Next, lay the rest of the harness over the animal's back. The jack saddle should be behind the withers, the britching further back. They are not positioned and

secured until you go back and buckle the hames.

Buckle the hames at the base of the collar. Then pull the britching over the rear quarters. The britching seat is brought down over the tail as far as it will go, and then the tail is pulled up and over it, and allowed to drop.

Reach under the animal and grab the free end of the jack saddle. This is called the girth or belly band. Bring it toward you and up to the ring or buckle on the left side of the jack saddle. Fasten it, allowing enough room for your hand to slide between it and the animal.

Step 4--Place the bridle. The bridle is worn over the halter. The halter is not in the way, and you need it when you remove the bridle, or when you lead or tie the bridled animal.

Put the lines over the head and lay them on the withers or back.

Hold the top of the bridle (cavesson) in your right hand and the bit in your left. Stand to the side of the head and bring your arm over it so your wrist is between the ears and your fingertips on the forehead.

Work the bridle upwards so the noseband circles the muzzle and the bit comes into contact with the teeth. Work the bit

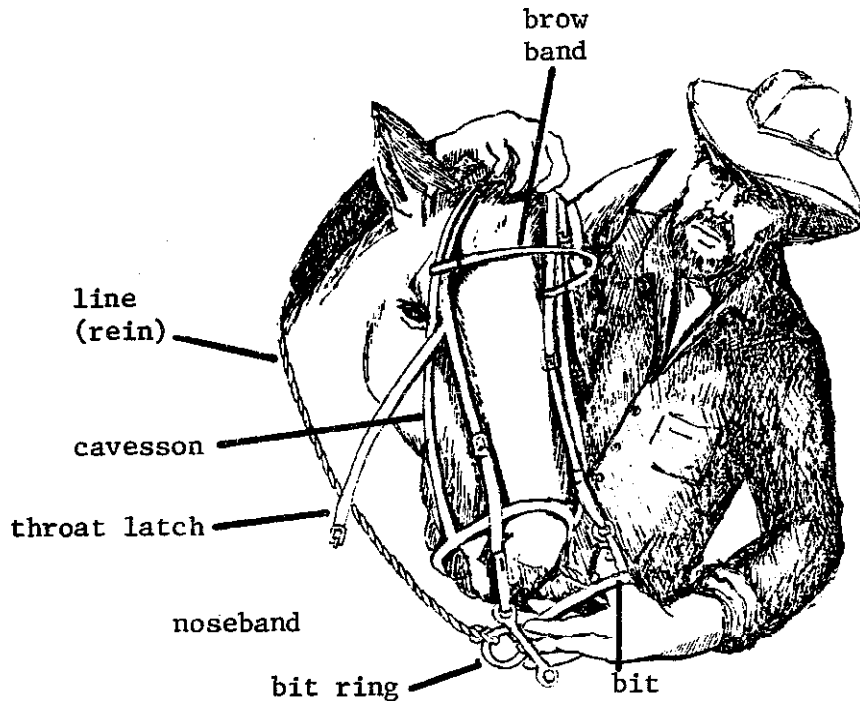

Placing the Bridle

into the mouth by massaging the gums with your fingers. If the bit is held as shown, your thumb and middle finger will be in position to do this.

Once the bit has cleared the front teeth, pull up with your right hand until you are able to work the top of the cavesson over the right ear, and then the left.

Fasten the throat latch, bringing it under the jaw and up to its buckle.

Step 5--Fasten the traces to the singletree (except during harness-breaking because no load will be pulled). The trace (one on either side) hooks to the draft ring on the hame, and runs back to the load. As it passes back, it goes through a supporting sleeve on the jack saddle. When britching is used, the trace passes through an additional support which hangs down from the britching ring. The support is called a trace-holder or lazy strap, and it keeps slack in the trace from getting underfoot when the animal backs up or turns.

Note: Normally traces are left on the harness when it is taken off the animal. When unharnessing, unhook the trace from the load and fasten it to the britching ring.

## Steering Systems

Few animals are so well trained that they turn and stop when the driver gives a voice command. Turns, partial turns, stops and changes in speed are accomplished by a combination of voice commands and signals made through the lines. Lines are long ropes or leather straps that reach from the driver to the animal's head. The lines attach to the sides of a bridle, halter, or nosering, all gear designed to transfer pressure from the lines to the sides of the nose or mouth.

Lines have two functions: they help the driver regulate the degree of turning and the amount of speed, and they act as a safety control in cases where an animal spooks or refuses to obey. It is important to arrange lines so they perform both functions.

Some farmers avoid using lines by having an assistant lead the animal or team from the front. This is not a bad practice if extra labor is

into the mouth by massaging the gums with your fingers: If the bit is held as shown, your thumb and middle finger will be in position to do this.

Once the bit has cleared the front teeth, pull up with your right hand until you are able to work the top of the cavesson over the right ear, and then the left.

Fasten the throat latch, bringing it under the jaw and up to its buckle.

Step 5--Fasten the traces to the singletree (except during harness-breaking because no load will be pulled). The trace (one on either side) hooks to the draft ring on the hame, and runs back to the load. As it passes back, it goes through a supporting sleeve on the jack saddle. When britching is used, the trace passes through an additional support which hangs down from the britching ring. The support is called a trace-holder or lazy strap, and it keeps slack in the trace from getting underfoot when the animal backs up or turns.

Note: Normally traces are left on the harness when it is taken off the animal. When unharnessing, unhook the trace from the load and fasten it to the britching ring.

## Steering Systems

Few animals are so well trained that they turn and stop when the driver gives a voice command. Turns, partial turns, stops and changes in speed are accomplished by a combination of voice commands and signals made through the lines. Lines are long ropes or leather straps that reach from the driver to the animal's head. The lines attach to the sides of a bridle, halter, or nosering, all gear designed to transfer pressure from the lines to the sides of the nose or mouth.

Lines have two functions: they help the driver regulate the degree of turning and the amount of speed, and they act as a safety control in cases where an animal spooks or refuses to obey. It is important to arrange lines so they perform both functions.

Some farmers avoid using lines by having an assistant lead the animal or team from the front. This is not a bad practice if extra labor is

available, and if the animal is never to be used to pull a cart or wagon. It is dangerous to drive a vehicle using animals unaccustomed to lines, or using a steering/stop-ping system that provides little or no leverage.

### Single Animal Systems

Halter and lines (for cattle, or easily controlled horses, donkeys or mules). The driver controls the speed and direction of the animal by pulling lines attached to side rings of the halter.

A right hand turn is made by pulling the right line out and to the side. The line of pull should be level and at the same height as the point of leverage (the side ring of the halter). The movement tightens the halter against the left side of the animal's head and begins to bring the nose around to the right. You must slacken the left line as you pull back to the right.

A left turn is made by doing the reverse. A stop is made by pulling both lines at once, drawing the muzzle into the chest. A hard snap of the lines will usually stop

an animal that won't respond to even pressure.

If the halter is made of rope, pad the noseband with cloth so it doesn't rub the nose and cause burns or sores.

It is a good practice to support the lines by running them through rings on the hames, surcingle, or backpad. This takes the weight of the lines off the nose and encourages the animal to carry its head normally. It also keeps the lines from slackening and getting underfoot during turns or rest periods.

Bridle and lines (for horses, donkeys and mules). This is the same system as halter/lines but instead of attaching to the siderings of the halter, the lines attach to the bit rings of the bridle.

Some bridles are bitless and work by exerting pressures on the nose like a halter.

Noserings (cattle only). Both lines attach to the ring and then split back to the sides and to the driver. Use a surcingle with siderings to support the lines as they pass back.

### Team Systems

Team lines with coupling. A long line called a team line is fastened to the outside of

Team  
Lines  
With  
Coupling

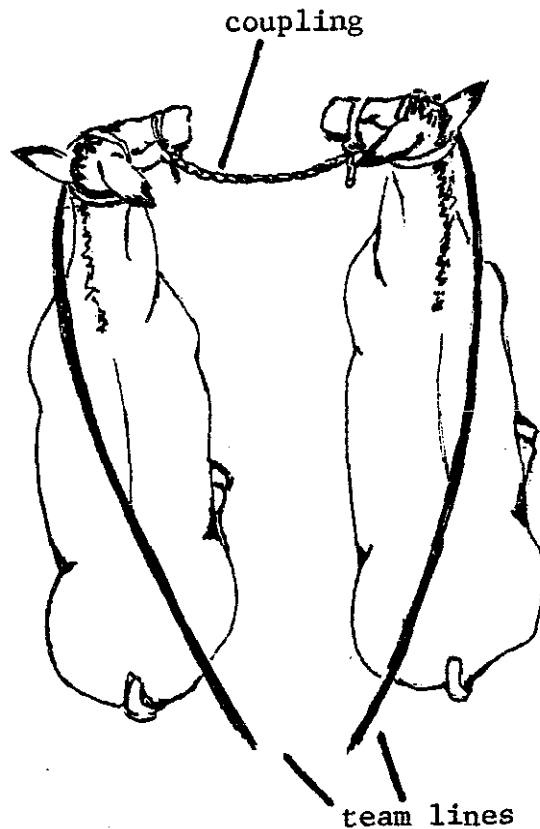

each animal's headgear (bridle, halter, or nosering). The insides of the headgear are then linked together with a short piece of rope or chain. This is called a coupling.

When the driver pulls the left team line, the left animal turns to the outside (left). As it turns, the coupling tightens and pulls the right-hand animal to the left. A right turn is accomplished by the opposite process.

This system works well with animals in a yoke, or well-trained animals in harness. It is not recommended for cart or wagon work because the dri-

ver has no leverage for stopping.

Team lines without coupling. When a team is working in a weeding yoke, the distance between the animals is so great that the driver may want to attach team lines to the insides of the headgear. This gives him/her shorter, lighter lines to work with.

To make a right turn, the driver pulls the left line. This pulls the left animal's head to the inside (right). As it turns, it puts sideward pressure on its bow and the whole yoke is pushed to the right. This signals the right-hand animal to turn right.

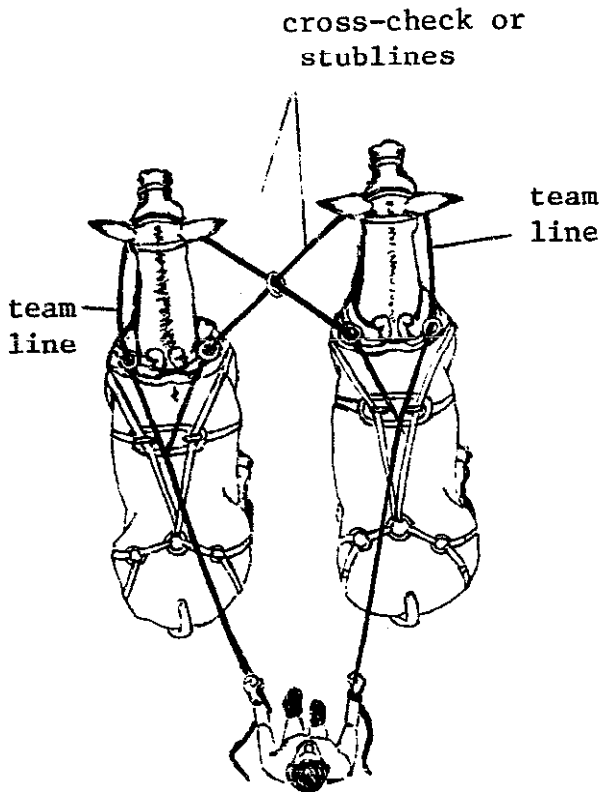

Team Lines with Cross-Check

Team lines with cross-check.

A complete steering system lets the driver turn both animals--not just one. Each outside line (see above) is equipped with a second, shorter line that branches off and crosses over to the headgear of the other animal. When the driver pulls the left line, for example, he/she is pulling the end of a Y-shaped line that connects to the left side of each animal's headgear.

A set of Y-shaped lines is called team lines. Each line is made up of a long outside line called a team line and a short cross-over line called a cross-over check line or stub-line.

Cross-checks are supported as they cross over. If the team is in a yoke, the yoke stock can serve as a support. If the team is in collar harness, the lines go through rings on or attached to the inside hames of the opposite animal.

It is important that the cross-checks are the same length and connect to the team lines equal distances back from the headgear. They must also connect at the right distance.

Adjustment of the cross-checks is made by trial and error. Pull back on both lines evenly. If the team backs up straight, the lines are adjusted correctly. If the animals crowd together as they back up, the checks are connected to the team lines too far back. If the animals split apart, the checks are connected too far forward.

## Breeching Harness

Breeching (britching) harness is a kind of harness that enables a team to exert backward pressure on the shaft of a wagon or cart, causing it to brake or back up. It can be used with all types of yoke and harness.

Breeching harness looks like a breastband collar worn around the rear quarters. Its main part, called the breeching seat, is a wide band of leather that circles an animal's buttocks. It is held in place by a band which passes over the top of the rump. The band is called a hip strap. The breeching is connected to the yoke or harness by a pair of straps (or ropes) called sidestraps, hold-back straps, or pole straps.

Sidestraps are adjusted so they are slightly slack when a vehi-

cle is being pulled forward on flat terrain. When the load begins to move downhill, the shaft (of wagon or cart) drives forward against the yoke or harness, the sidestraps tighten, and the breeching seat closes against the buttocks. The animal brakes by resisting the pressure of the breeching seat.

Used for backing up, the breeching works like a breastband collar in reverse. The sidestraps tighten and pull against the yoke or harness the same way traces tighten and pull against a singletree. The

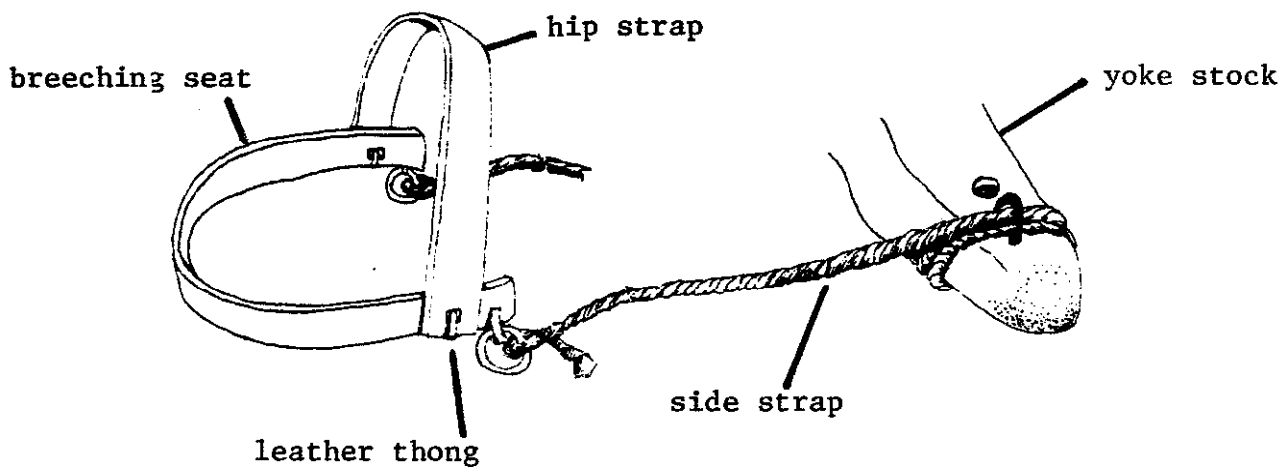



yoke or harness pulls back on the front of the wagon shaft and the vehicle backs up.

### How Breeching Works as a Brake

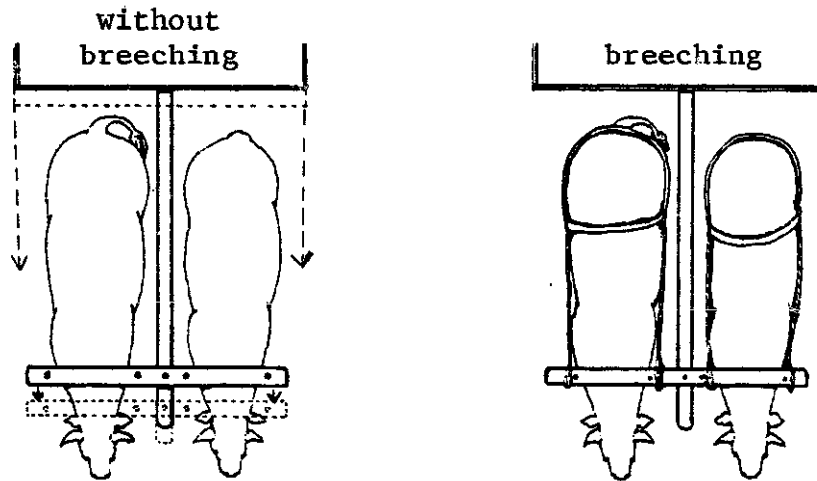

Yoke driven forward by shaft when load is moved downhill. The animal brakes with its head and neck.

The yoke is held in place with breeching. The animal brakes with its rear quarters.

The illustration on page 95 shows the breeching in dark lines. The breeching is not in use, so the pole strap is clipped or tied to the hame. When the animal is hitched to a wagon, the strap is connected to a jockey yoke, which works like a singletree.

Correctly positioned, the breeching seat crosses the base of

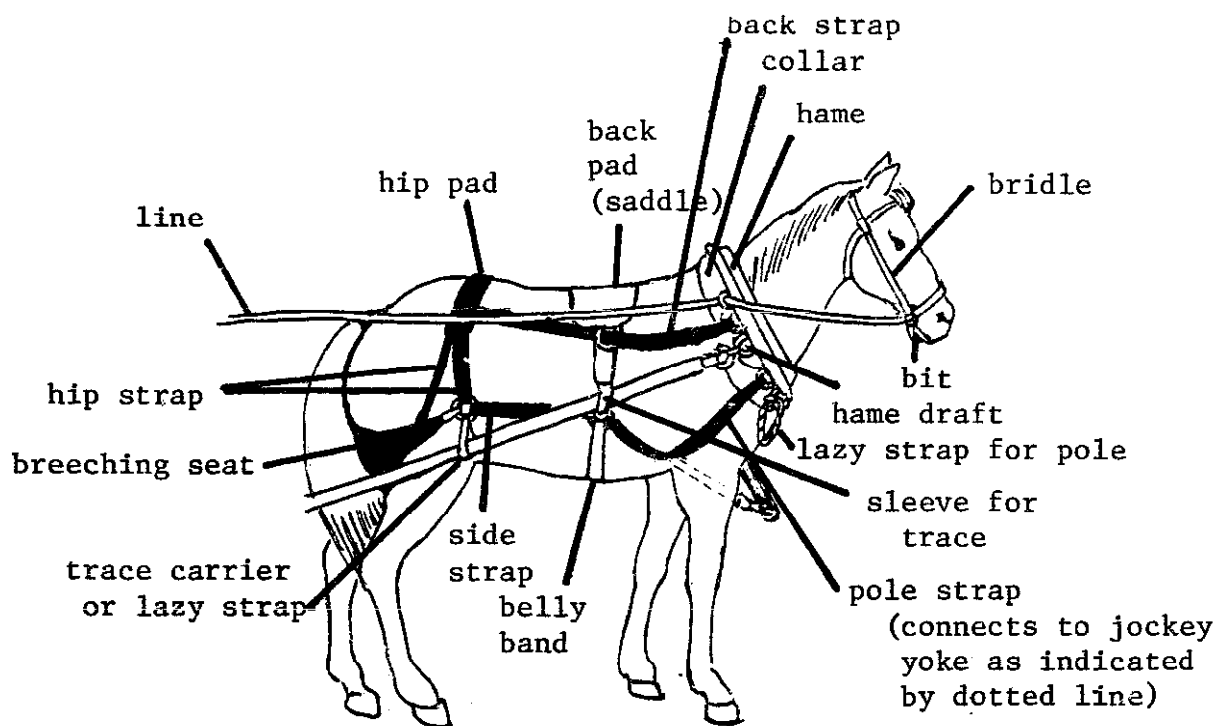

Full Collar Harness with Breeching Parts Highlighted

the buttocks. The height is adjusted by the hip strap.

Back straps are needed when breeching is used. These connect the hip strap to the collar and help stabilize the entire harness.

# 6. Hitches

A hitch is the connection between the power and the load. Hitches to field implements are made by hooking a chain from a yoke or swingtree to a ring or hole on the implement. Hitches to vehicles are made the same way, but involve connection of steering systems (wagon shaft and lines) and braking systems (britching) as well, so that the "hitch" is really a combination of hitches.

In a broad sense, a hitch is an arrangement of equipment and animals that will supply adequate, efficient power for a particular job. A four-horse plow hitch is a unit designed for pulling a large plow through very heavy soil. A four-horse wagon hitch is a unit designed for pulling a wagon, but if the wagon has no brakes, the hitch necessarily includes gear which performs this important function.

Both implement and vehicle hitches are discussed in this chapter, with attention given to common types within each group. Types are identified according to the system used to transfer and connect power to the load, and by the number of animals in the hitch.

## Safety Rules

Hitching is a procedure that exposes owners and animals to a certain amount of danger. Animals are injured when they back into equipment, get hung-up in chains, swingtrees, or over the shaft of a wagon, or when they bolt forward half-hitched. People are injured when animals kick or step unexpectedly, or more seriously, when a team pulls the load forward before they can get out of the way.

Attention to these rules will

minimize danger to all involved:

- Watch the animals; look for nervousness or potential causes for movement or spooking--noise, insects, sudden appearance of persons, vehicles or other animals.
- Never hook a chain or traces to the load before:
  - the hook or harness is fully secured and all buckles are checked
  - the lines (reins) are connected to bridles and are within easy reach
  - the wagon shaft has been lifted so the neckyoke connects it to the collar.
- When you are ready to make the hitch, have someone stand in front and steady the animal or team.
- When making the actual hitch, position yourself so you can get out of the way if the animals spook. Take these precautions:
  - Don't stand over the chain or wagon shaft; don't cross over it. Walk out and around if you need to get to the opposite side.
  - Don't stand between a swing-tree and the shaft of a wagon.

## Implement Hitches

An animal or team pulling a log (skidding) or a field implement needs only a forward pulling system, because the load can't roll forward and hit it from behind. The digging or dragging action of the load acts like a brake and eliminates the need for breeching. Backing up is usually accomplished by the manual effort of the equipment operator, or, if the equipment is too heavy, wide turns are used to reverse the direction.

### Yoke to Implement (two animals)

This type of hitch is made by connecting a chain from a yoke to a ring or hole on the front of the implement being pulled. The team pushes against the yoke and its power is transferred back to the load through the chain. The chain is called a draw chain.

The chain is hooked to a

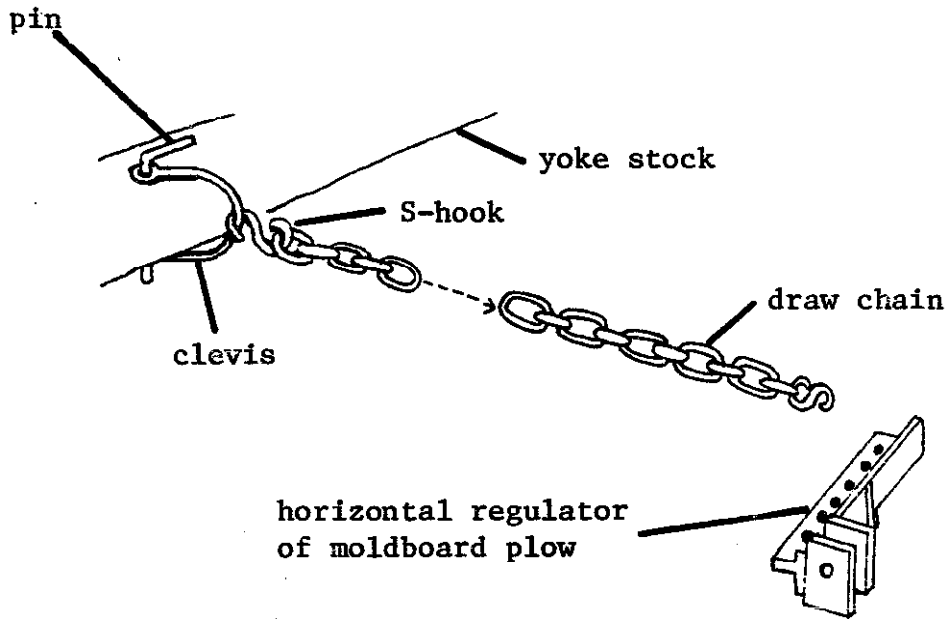

clevis located in the center of the yoke stock. The clevis is held in place by an L-shaped pin which should be easily removable. A three-meter chain is normally used for plowing; if the chain does not have built-in hooks, locally made S-hooks can be used.

Most implements are drawn directly off the buckhead, the front end of the tool-carrying beam. A moldboard plow, however, is offset on a horizontal regulator, a perforated plate that allows the operator to move the line of draft to the right

of the beam. The adjustment is discussed on page 125. Sometimes an adjustment must be made on the yoke stock itself. Normally, the stronger animal is placed on the right or "off" side of the chain; during plowing, it walks in the furrow where footing is soft and greater effort is needed. If this animal is very short and the other (left side) tall, the added difference of the furrow-depth will pitch the stock down to the right and may give both animals yoke galls. In this and other instances, the weaker animal should be placed

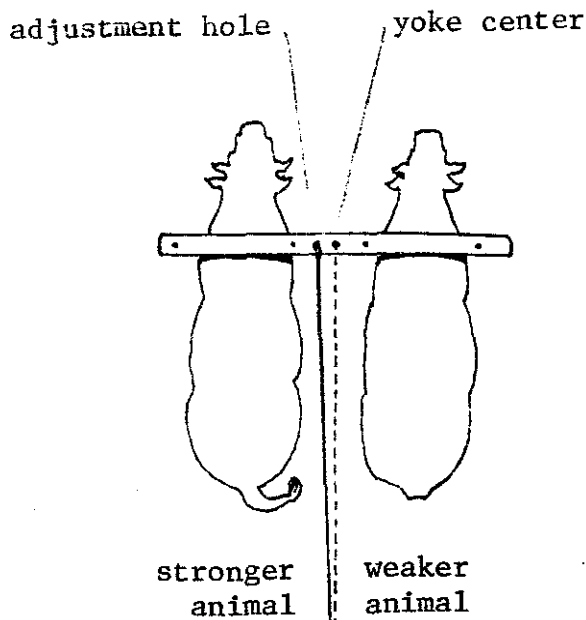

Evening a Pair  
by Yoke Stock Adjustment

in the furrow. To equalize the pull and ensure that the animals work as a unit, the chain is moved to the left of the yoke center. This will give the weaker animal a longer lever to push against and allow it to step up and maintain the pace of the stronger. The process is called "evening" the pair: the stouter animal is given the short end of the yoke.

If the yoke stock is of very strong wood, two holes can be bored, one in the center, one just left of center. When the operator substi-

tutes or replaces one of the animals, he can adjust the yoke as needed.

#### Tandem Yokes to Implement (four animals)

Two teams of oxen can be yoked to an implement where heavy soils (argilous, black cotton land, paddy land) are being plowed, or where a heavy harrow, roller, or ridger is being used. (See page 102.)

The weaker pair is used as the front or level team. The stouter

pair is put behind; it is called the wheel team. Because the lines are attached to the lead team for steering, cross-checks are used (see page 92). The lines may be attached to halters or noserings, but an alternate horn-to-ear method can be used (see page 107). With a little practice, the driver can learn to snap the lines across the back of a lagging animal. Lines pass through the clevis of the rear (wheel) yoke; this gives them support.

The chain leaves the clevis of the lead yoke, passes under the clevis of the second, passes over a support rope, or strap tied between the backbands of the wheel team (called chain support) and then to the implement. The wheel team is connected to the main draft (chain) with a short piece of chain (extension chain) attached to its clevis. This avoids the problem that results when the lead team is tied into the wheelers' yoke proper (the stock would be yanked forward onto the team's horns whenever the leaders pulled).

The backband traverse is needed to support the lengthy chain.

### Singletree to Implement (one animal)

An animal wearing a collar or breastband harness, or a sling or single head yoke, needs a special system to convey its power back to the load. Ropes or chains are attached to sides of the harness or yoke and connected to a bar located behind the animal. The bar is a

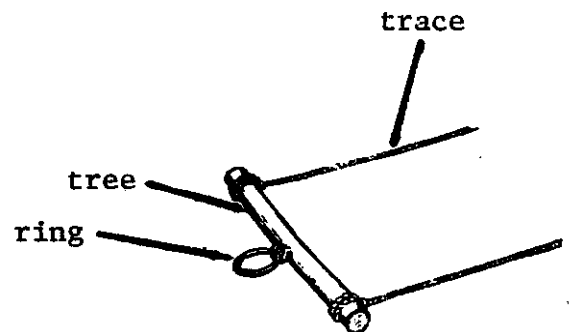

Source: Hopfen, Op. Cit.

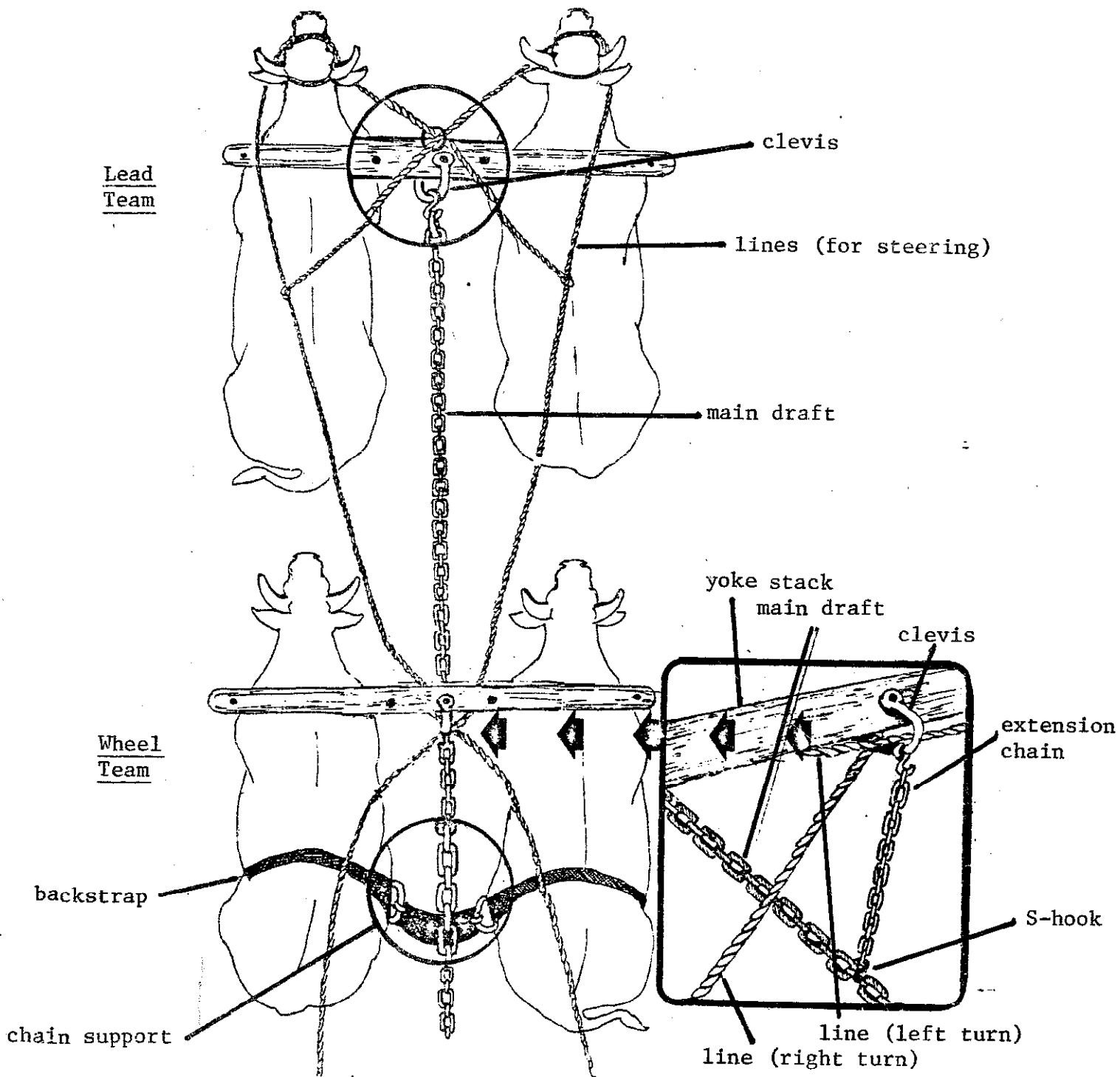

Tandem Yokes to Implement  
 (with magnifications of hitchpoints)



piece of wood furnished with rings or grooves that hold the ropes. The bar is called a singletree, or swingtree (other names include swingletree, whippetree, tree). The lines that attach to it are called traces.

The singletree has a ring in the center which is connected to the load with a hook and short piece of chain.

### Doubletree to Implement (two animals)

A team in collar or breastband harness can have its traces attached to a longer bar called a doubletree. A short chain connects the doubletree to the load. As with the yoke, advantage can be given to the weaker animal by moving the chain off center and toward the other.

An improvement over this arrangement is achieved by giving each animal an individual tree, or singletree. The two singletrees are then connected to the doubletree. The implement is connected to the

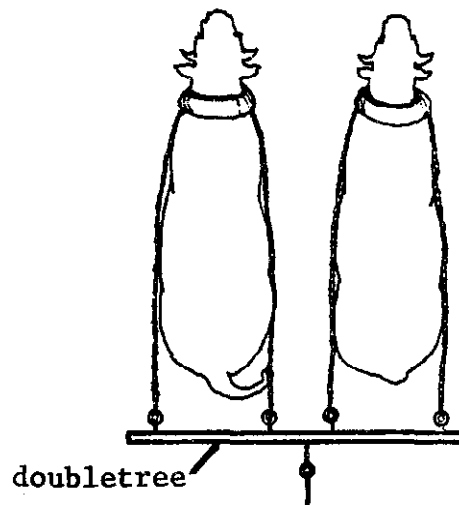

Doubletree

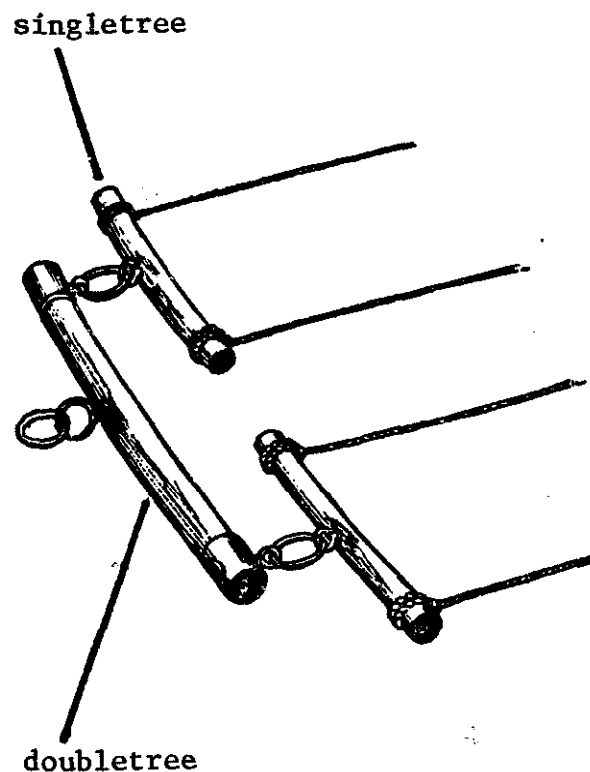

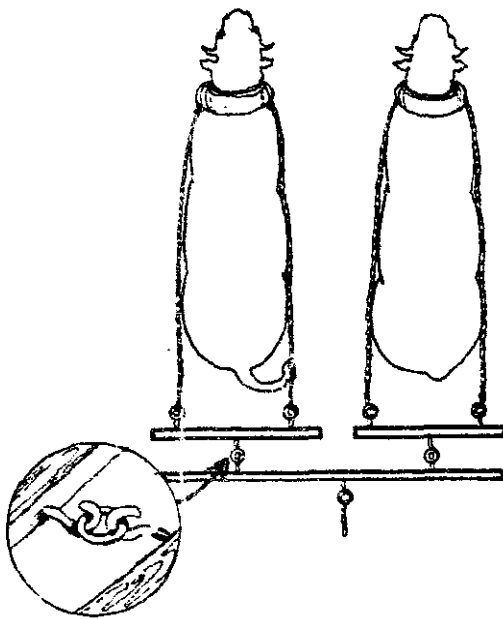

Doubletree to Implement Hitch (Standard)

doubletree.

Use of singletrees and doubletrees lets the driver make very fine adjustments in the amount of pull delivered by each animal. When one of the animals begins to lag, he shortens its traces or the chain connecting its singletree to the main tree. This lets the animal meet the point of resistance sooner: it no longer has to catch up with the other animal in order to meet the load. An adjustment of a link or two, coupled with some gentle prodding, will "even" the pair and the pull.

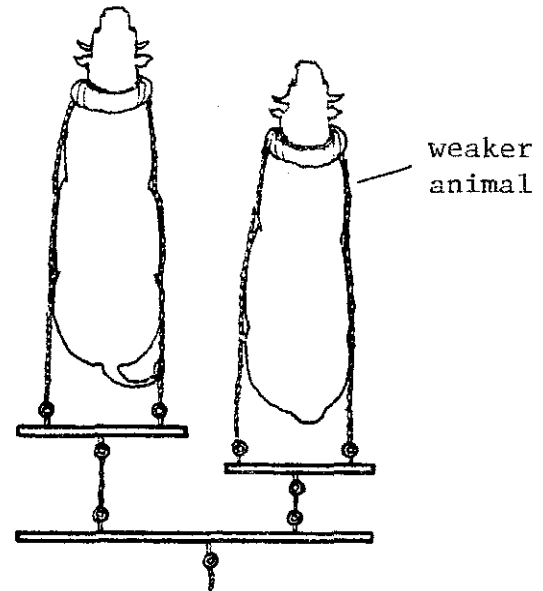

Evening the Pair with a Swingtree Adjustment

### Doubletree to Implement: Multiple Hitches

Multiple hitches are easy to arrange and can be extremely valuable to farmers owning lighter draft animals. Donkeys or young cattle (two or three years old) can be worked in tandem pairs, three abreast, or in a one-two pattern. Collars or breastbands must be used with equines, but single head or sling yokes can be used for cattle.

In a tandem pair hitch, the

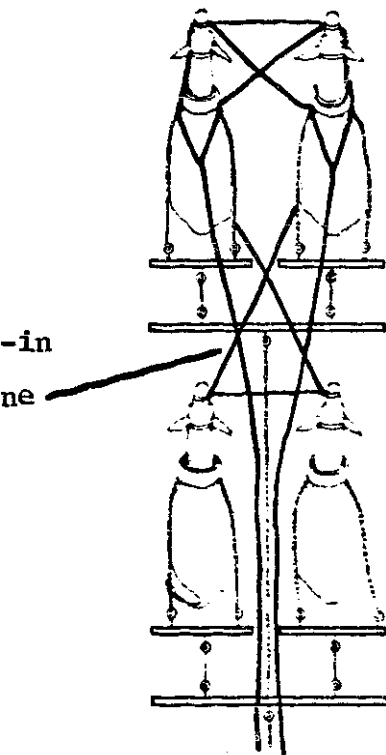

Tandem Pair Hitch

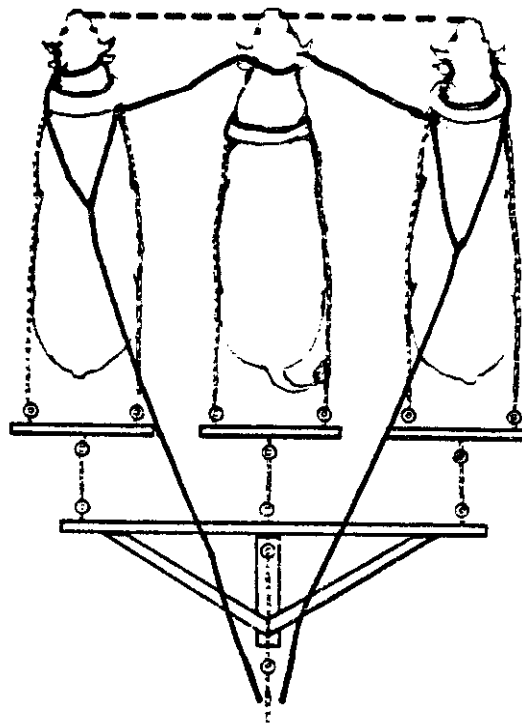

Three-Abreast Hitch

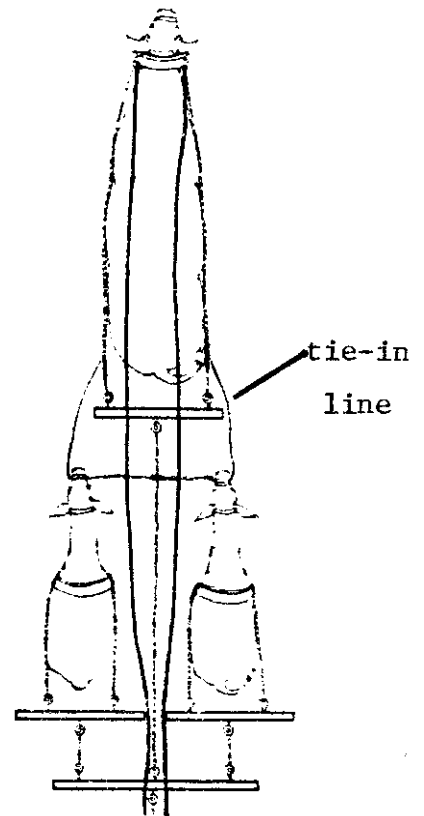

Wedge-Shaped Hitch

leaders are driven with team lines and cross-checks. The wheelers are connected to the leaders with tie-in lines--short ropes which connect their halters to the traces of the leaders. Couplings are used on both teams for additional control.

In a three-abreast hitch, the outside animals are driven with team lines and the middle animal controlled with couplings. Additional steering control can be obtained by adding cross-checks.

In a wedge-shaped hitch the

lead animal is driven with lines and wheelers controlled with tie-in lines and a coupling.

Note: If the wheelers walk too fast and tend to close up on the leaders, they can be held back with bucking straps. Bucking straps are lines arranged just like team lines with cross-checks. However, the free ends are not held by the driver, but attached to the draw chain. Attach them to the chain where it passes between the wheeler's single-trees. For more on multiple hitches, see page 234.

# Vehicle Hitches

Most hitches to vehicles are designed and made so the animal or team can brake and back the load up as well as pull it forward.

Teams in yokes can get some leverage for breaking by lifting their heads and resisting the pressure created when the shaft of the wagon pushes against the back of the yoke. Horned cattle can back a load up by pushing back against the yoke stock with their horns. The stock is connected to the wagon shaft and when it goes back, the shaft and the wagon go back.

These controls are effective only with very light carts or wagons, or when the vehicle has an independent braking system (mechanical brakes). They are not adequate if the load is heavy or if the terrain is hilly. In the latter instances, animals should be fitted with breeching harness before being hitched to the load.

Animals or teams in sling or breastband harnesses have no braking or backing power at all. Those in collar harnesses have very limited ability. A general rule is that animals in harness should wear breeching when pulling vehicles.

Basic types of vehicle hitches are discussed below. Some involve yokes, others harnesses.

Yoke to Wagon

## Yoke to Wagon (Two Animals)

There are many ways to connect the shaft or tongue of a wagon to a yoke. The method shown here is recommended because it minimizes strain on animals and vehicle and because the component parts are easily made in a local forge and can be mounted or removed, without wrenches, as needed.

The hitch is made by attaching a draw chain to the centerpoint of the stock by means of a pin and clevis. Two rings are kept on the clevis, a small draw-ring for the chain and a larger pole ring for the shaft of a cart or wagon. A field imple-

Yoke-to-Wagon Hitch

Top View

lope circles  
opposite ear  
before going  
back.

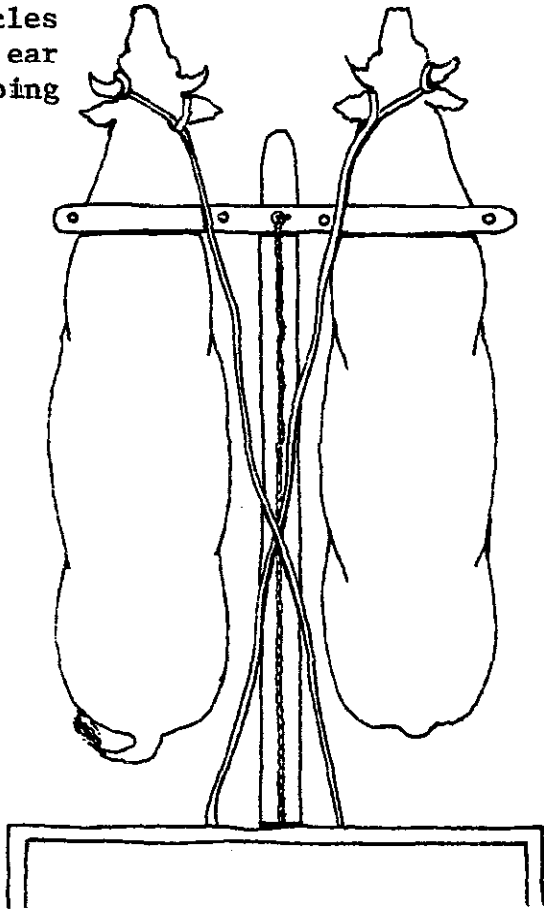

Detail of connection  
between yoke and  
wagonshaft.

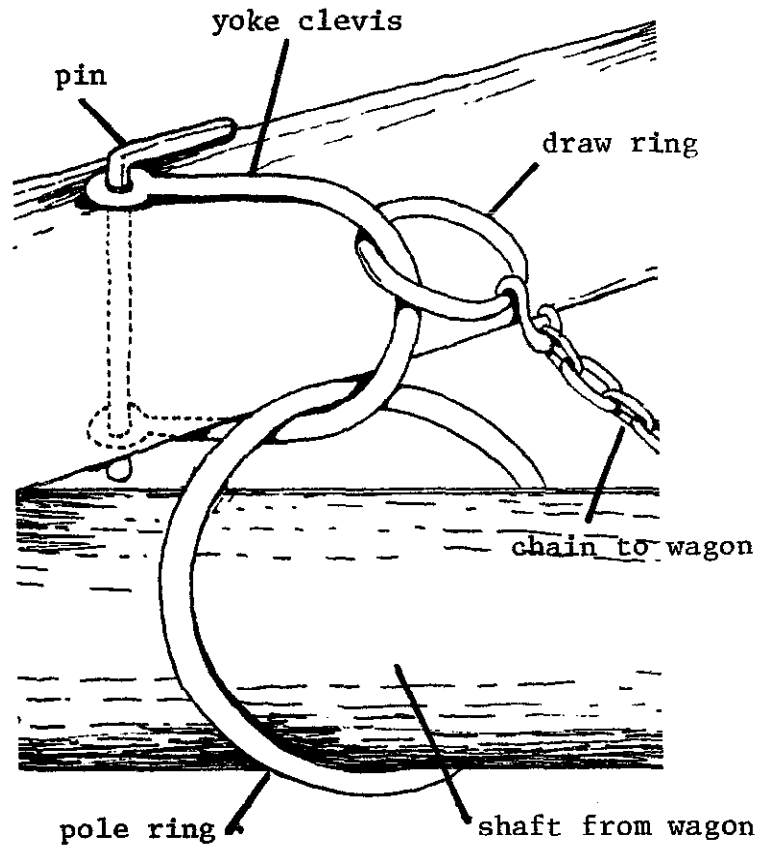

Side View

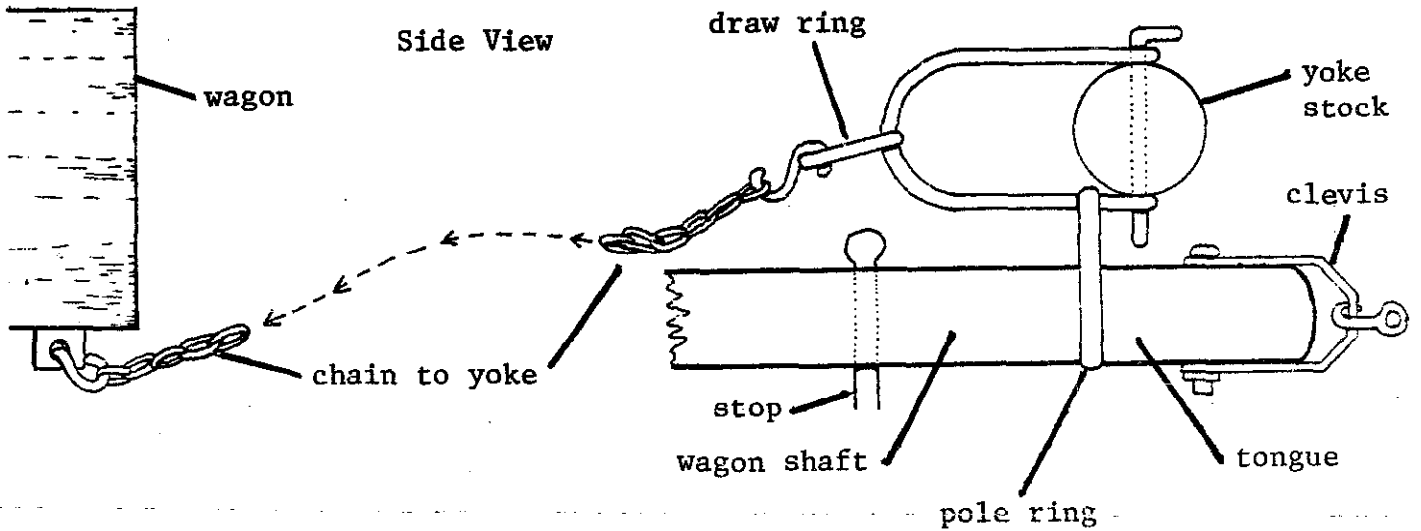

ment can be attached, by chain and hook, to the clevis, or to either of the two rings; however, when a wagon is pulled, the chain should be attached to the draw-ring and the wagon shaft passed through the pole ring. The load is pulled by the chain, not the shaft. This lets the shaft slide forward and back through the ring, eliminating much of the jarring produced by a "hard" or fixed connection. The shaft is furnished with a stop that prevents it from sliding too far forward. The chain keeps it from sliding too far back.

Chain Adjustment--When the chain is fully extended, it must be shorter than the length of the wagon shaft. If it is equal or longer, the team will "walk off the tongue" --the shaft will slide out of the pole ring before the chain tightens and begins to pull the wagon. In this case, the tongue will be banging on the ground as the load moves forward. This can frighten the team and cause a serious accident.

To make the proper adjustment, measure the length of the shaft and

subtract 20 cm. This figure should equal the length of the fully-extended chain.

The shaft, correctly used, is for turning, braking, and balancing the load; it is used as a hitchpoint only if a second team is used in front.

### Tandem Yokes to Wagon (four animals)

More power can be supplied to the yoke-wagon hitch (above) by hooking a second team to the metal clevis located on the tongue of the wagon (the tongue is the end of the shaft). The front team (lead team) pulls the shaft. The back team (wheel team) pulls by the chain connecting its draw-ring to the wagon. Use the more obedient, well-trained team as the lead, the stronger as the wheel team.

## Doubletree to Wagon (two animals)

### ● Preparation

Connect the doubletree and singletree to the back of the wagon shaft and connect the neckyoke and jockey yokes to front of the wagon shaft (tongue).

The tongue of the wagon (end of the wagon shaft) must be fitted with equipment that can be connected to the team's harness. The equipment lets the team hold up the shaft and brake and back the load. The

neckyoke is a wooden crossbar the same length as the doubletree, but made of lighter wood. It has a ring in the center and one on each side. The center ring is large enough so the tongue can slide through it. The side rings are smaller; they connect the neckyoke to the harness via shorter yokes called jockey yokes. A jockey yoke has a ring in the center and one at each end.

To prepare the tongue for hitching, lay the neckyoke on the ground just in front of the tongue. It should be at right angles to the tongue. Then fasten the jockey yokes to the neckyoke. The center ring of the jockey yoke hooks to the

### Top View of Wagon Before Team Is Hitched

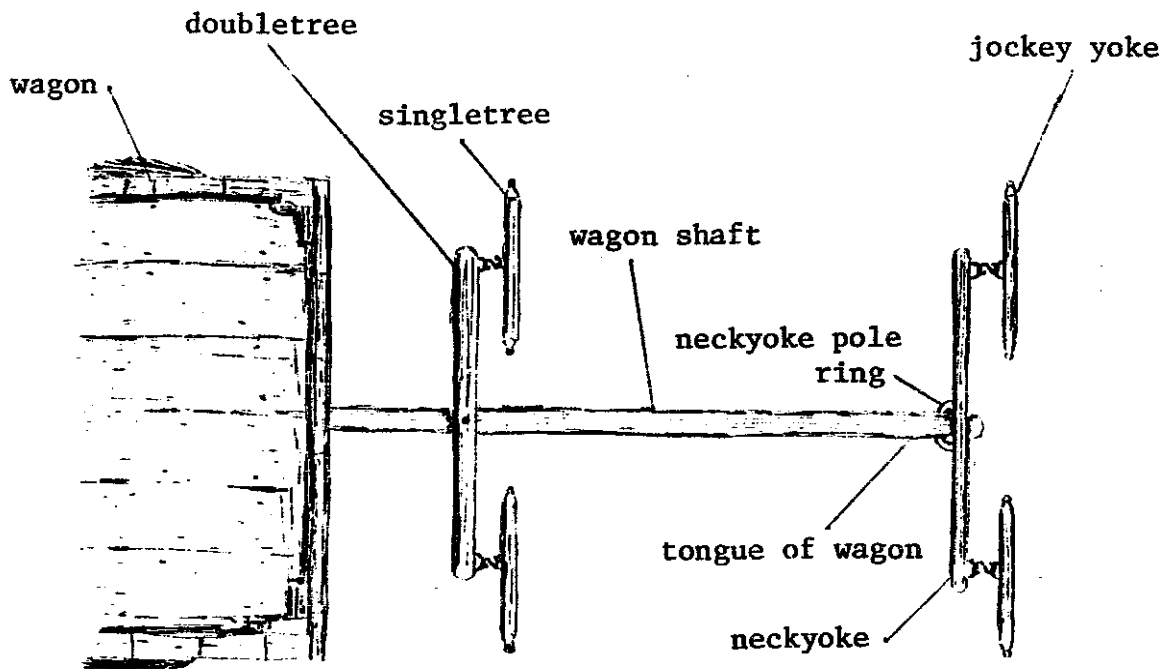

end ring of the neckyoke.

Now slide the center ring of the neckyoke over the tongue.

Check the alignment of the equipment at either end of the shaft. A straight line drawn through the midpoint of each jockey yoke should intersect the midpoint of each single-tree and be parallel to the wagon shaft.

Harness the animals. Use the harness shown on page 95 .

- Position the team and hitch the lines.

Position the animals on either side of the shaft so their collars are roughly over the neckyoke. Do this by leading each animal to the correct position or by driving them into position as a unit.

To place the team as a unit, fasten their lines and drive them toward the shaft.

Approach it from the side and behind. Let one animal step over it and then straighten the team and ease it up toward the neckyoke. Once they're in a position and steady, tuck the lines in the britching, or somewhere they can be reached easily, and go forward to place the neckyoke. (Don't walk between them--go around.)

If the animals were led into position individually, fasten the lines before proceeding.

- Hitch the neckyoke.

Stand in front of the team and

pick up the neckyoke (jockey yokes attached). In doing this, you will have also lifted the wagonshaft. Next, you want to free your hands so you can connect the jockey yokes to the lazy straps on the collars. To do this, bend your knees and use them to hold up the neckyoke.

Now fasten the inside ring of each jockey yoke to the inside lazy strap on each collar. With this done, the shaft is now held up by the collar, and so you can stand up and finish the job by connecting the outside lazy straps to the outside rings of the jockey yokes.

- Hitch the braking/backing up system.

At this point, the shaft is being held up by the collars. The tops of the collars are bearing down on the tops of the animals' necks. This is hard on the team, and it is better to transfer this weight to the backpad at the top of the jack saddle. This is done by connecting the pole straps to the jockey yokes.

When not being used, pole straps come forward out of the jack saddle, side rings and fasten to the hames (see page 95). Take them off the hames and connect them to the ends of the jockey yokes. Tighten them until tension on the lazy straps is relieved, and



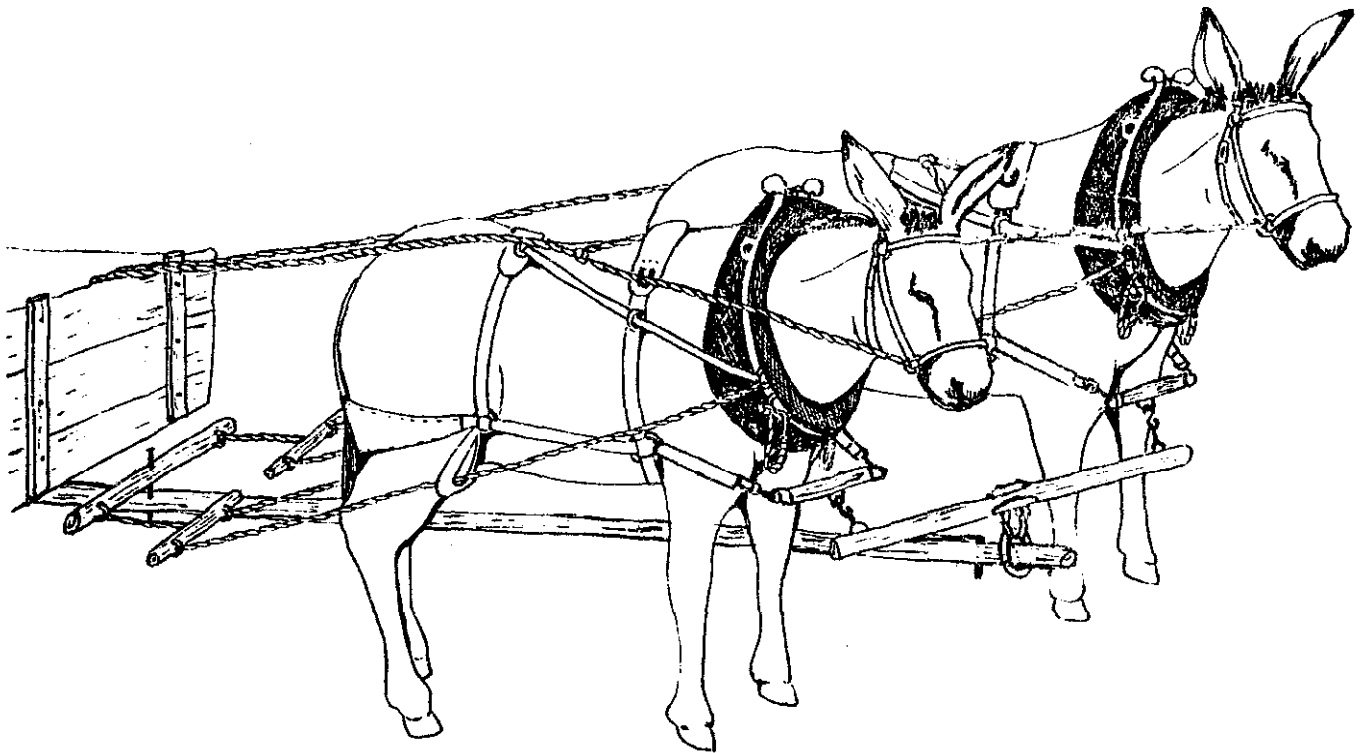

Doubletree to Wagon Hitch

then unhook the lazy straps and hook them back up on the hames.

Connection of the pole straps puts the weight of the shaft on the animals' backs, but it also links the breeching to wagon tongue. When the animal backs up, the breeching closes against the buttocks and pulls the side straps, pole straps, and jockey yoke. The jockey yokes then act like singletrees, pulling the longer neckyoke (equivalent of doubletree) which in turn pulls on the tongue of the wagon. The wagon is backed up.

When the wagon is driven downhill, the shaft drives forward, pulling the neckyoke

forward. Jockey yokes, pole straps and side straps are all pulled forward until the breeching seat closes against the buttocks. The animal resists the pressure by leaning back into its breeching. In this instance, breeching works like a brake.

The pole straps are adjusted by trial and error.

If the straps are too short, the breeching will interfere with the animal's normal gait. It will squeeze or tighten against the buttocks when the animal is walking on level ground.

If the straps are too long, the shaft will drive too far

forward before the breeching has a chance to work. This can cause two problems: a) the breeching slams into the animal's rear quarters instead of meeting them; there is strain on both the animal and the harness; b) the singletrees come forward with the shaft and bang the animal's heels.

- Hitch the pulling system.

The pulling system is connected by fastening the ends of the traces to the singletrees. Connect the inside traces first, walking out and around the team to reach the other side. Make sure the traces are the same length, and that they pull the load before the team walks so far forward that

the neckyoke slips off the tongue.

### Double-shafted Cart Hitch (one animal)

One-animal carts are double-shafted. Shafts are supported by loops hung from a saddle. The saddle is a thick pad or backpad which distributes weight and pressure from the shafts across the animal's back.

The cart is pulled forward by short traces which connect the col-

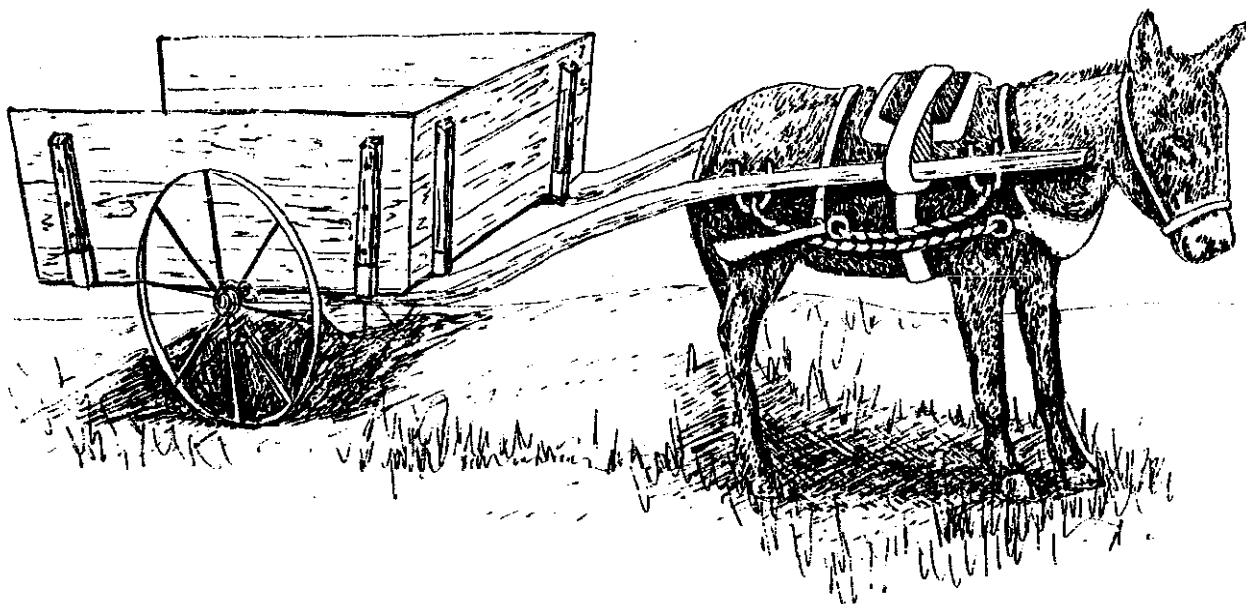

lar or breastband to the middle of each shaft. In the illustration below, the trace is shown as a rope tied to a ring on the end of the breastband. It connects to an iron U-bolt located halfway back on the shaft.

Backing and braking are accomplished through use of breeching and hold-back straps. In the illustration, the hold-back strap (or side-strap) ties to a ring on the end of the britching seat and runs forward to a U-bolt located toward the front of the shaft. When the cart goes downhill, the shaft slides forward in the loop, and the hold-back strap tightens and pulls the britching seat up against the donkey's rear quarters. The donkey brakes the cart by resisting the pressure of the britching seat.

The cart is backed up when the driver backs the animal into its britching. The hold-back straps then act like traces, pulling back on the front ends of the shafts.

# 7. Field Operations and Implements

Animal traction can be used to accomplish a variety of operations related to crop production. Operations which loosen and improve the soil where crops are grown are called tillage operations; plows, harrows, weeders, cultivators and ridgers are tillage implements. Other field operations include skidding (clearing fields of logs and brush), planting, and harvesting.

Tilling is any process that loosens the soil where crops are grown. The work may be done by hand, using hoes, or with animal or engine-powered equipment. Tilling improves soil structure and helps crops root and grow.

Primary tillage refers to operations which loosen very com-

pact soil. Hilling (mounding) or ridging by hand, plowing with a moldboard plow, or breaking land with an ard or discing plow are examples of primary tillage operations. They are used on virgin land (never cultivated), fallow land (used, but since overgrown with grass or forest), or on fields which have hardened during winter or off-season months.

Later operations, such as harrowing, clod crushing, weeding (cultivating), and ridging are forms of secondary tillage. These operations are used to prepare the seedbed or improve the soil where crops are maturing.

## Clearing Fields With Animal Power

Animals can be used to clear fields of fallen trees or other debris that will interfere with plowing. Skidding is the process of dragging a log on the ground. Bob-sledding is similar, but one end of the log is lifted onto a sled to reduce friction and make pulling easier.

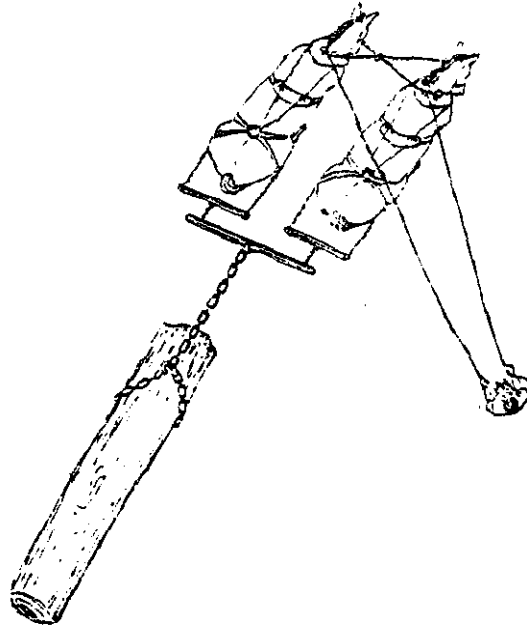

Skidding a Log

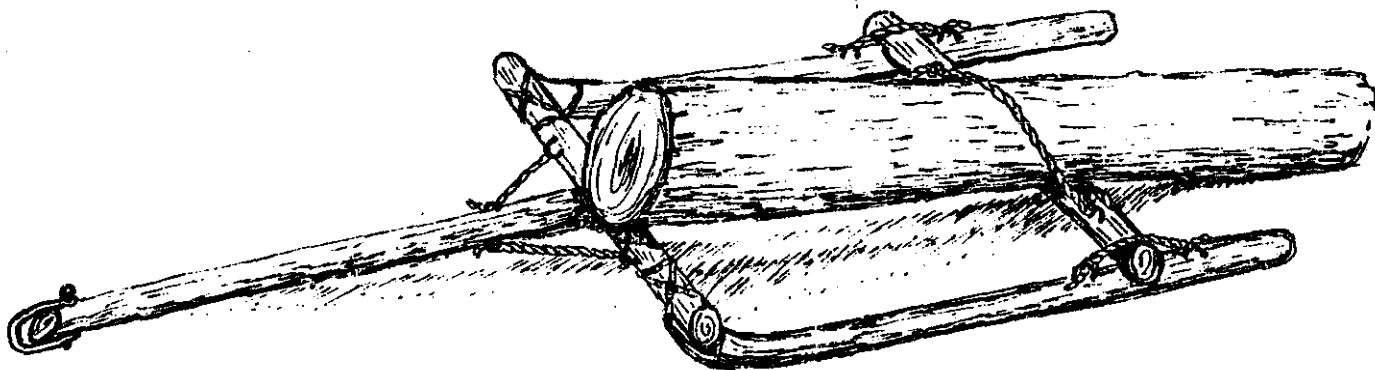

Bobsled

Standard procedure is to attach the chain to the log or sled and then drive the team into a position where the chain can be hitched to its doubletree, or to a drawchain dragged from a yoke. When moving the load, the driver should stand to the side of the log or sled and watch out for stones, debris, or variations in slope that can throw or roll the end of the log toward him/her, causing injury.

## Plowing

Plowing is most often done with a moldboard plow. This is a tool that loosens earth by cutting a slice and turning it partially over so that air and water reach the area where plants root, often referred to as the root zone. The soil is cut by a blade, called a share. The soil is lifted and turned by a moldboard. The cut made by a plow is called a furrow and the soil thrown is called a furrow slice. When the moisture

### Moldboard Plow

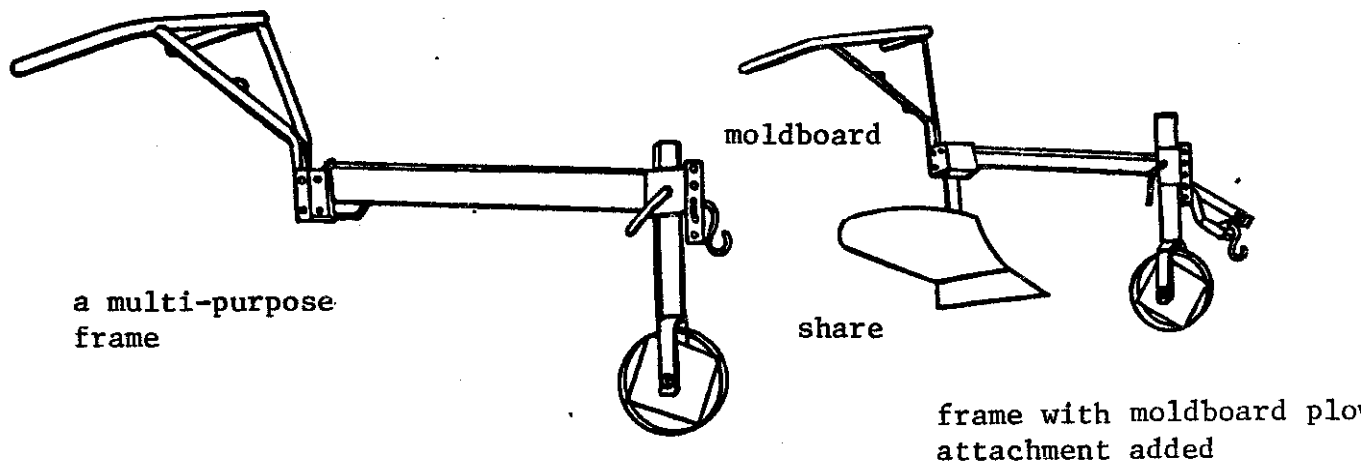

Source: Centre d'études et d'expérimentation du machinisme agriculture tropical (CEEMAT). Manuel de Culture avec Traction Animale. 1968. CEEMAT, Parc de Tourvoie, 92160 Antony, France.

## Turning Over the Furrow Slice

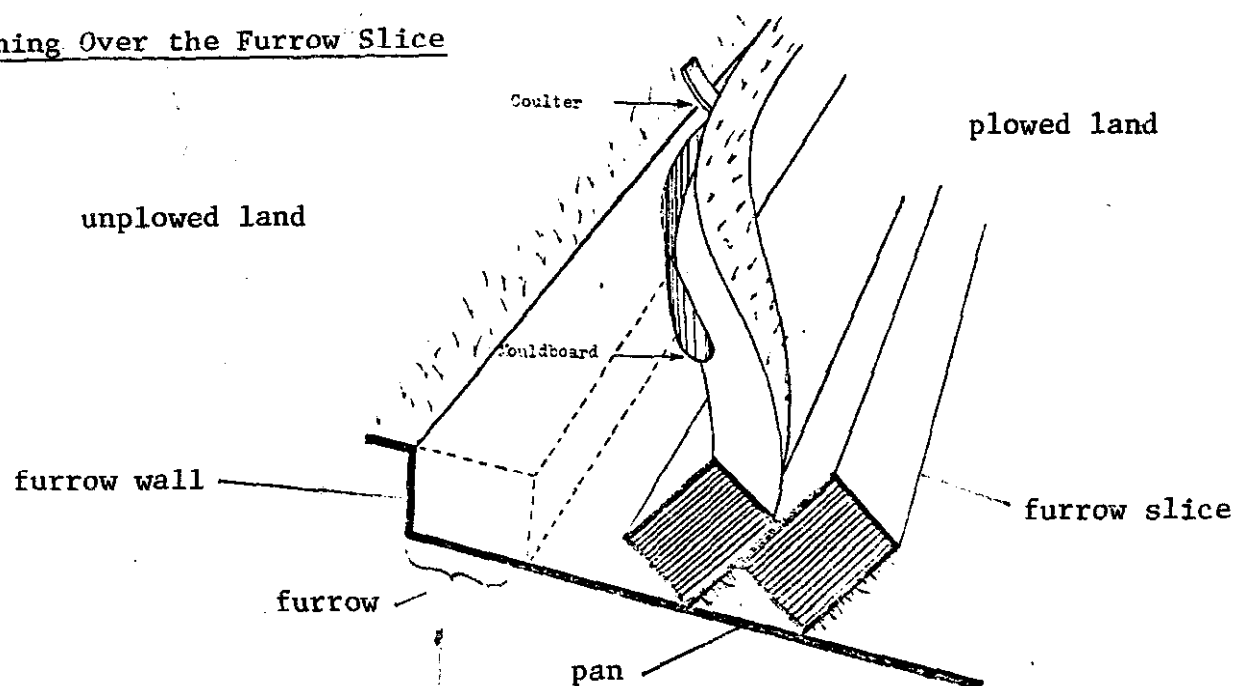

Source: CEEMAT, Op. Cit.

level of the soil is right (damp, not sticky), the furrow slice curls off the upper portion of the plow moldboard and is thrown into the side of the adjacent slice.

The furrow slice loses its internal tightness as it is tumbled, jarred, and then squeezed between the moldboard's tail and the adjacent slice. Although the slice appears to hold its form, separations between soil particles permit entrance of air and water, and later make it easy for seedling roots to branch out. Clumps and clods may

remain after plowing, but these can be broken afterwards with harrows or other equipment.

Width of the slice varies with the length of the share. Depth is controlled by setting the wheel or by the length of the chain between the yoke and the implement; an average depth is 10-20 cm.

## of Plowing

Good plowing stimulates plant growth by opening the compact upper surface of the soil so roots can develop quickly, taking nutrients, water, and oxygen from the soil. Moisture is absorbed easily, seeping down to deeper areas where it can act as a reserve during dry periods.

Plowing also serves to turn under weeds and organic surface material that becomes valuable ferti-

lizer. Good plowing tilts the furrow slice so decaying material is spread evenly through the loose soil. As oxygen and water penetrate and as sun dries exposed roots, the material decays and provides nutrients for the crop.

Plowing done after a crop is harvested is called backplowing. Stubble and surface debris is turned back into the soil where it decomposes and returns nutrients to the soil. If the plowing was deep, it is followed in the spring with light backplowing or scarification. Back-

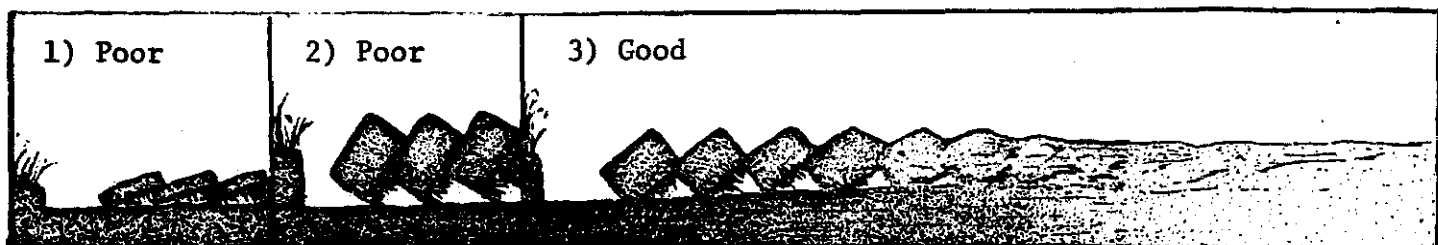

Effects of depth of plowing relative to width of furrow on the final position of the furrow slice:

- 1) Unbroken layer of sod between the seedbed and pan. Bonding is slow.
- 2) Too much contact between furrow slices. The bed stays rigid longer. It does not settle.
- 3) Upper edge of furrow slices can be readily worked down to a seedbed without the interference of sod. Later packing and preparation should break down the lower edge of the furrow slice and bring topsoil into contact with subsoil.

Correct angulation of the plow slice can be achieved when the depth of plowing is about one-half the width of the furrow.



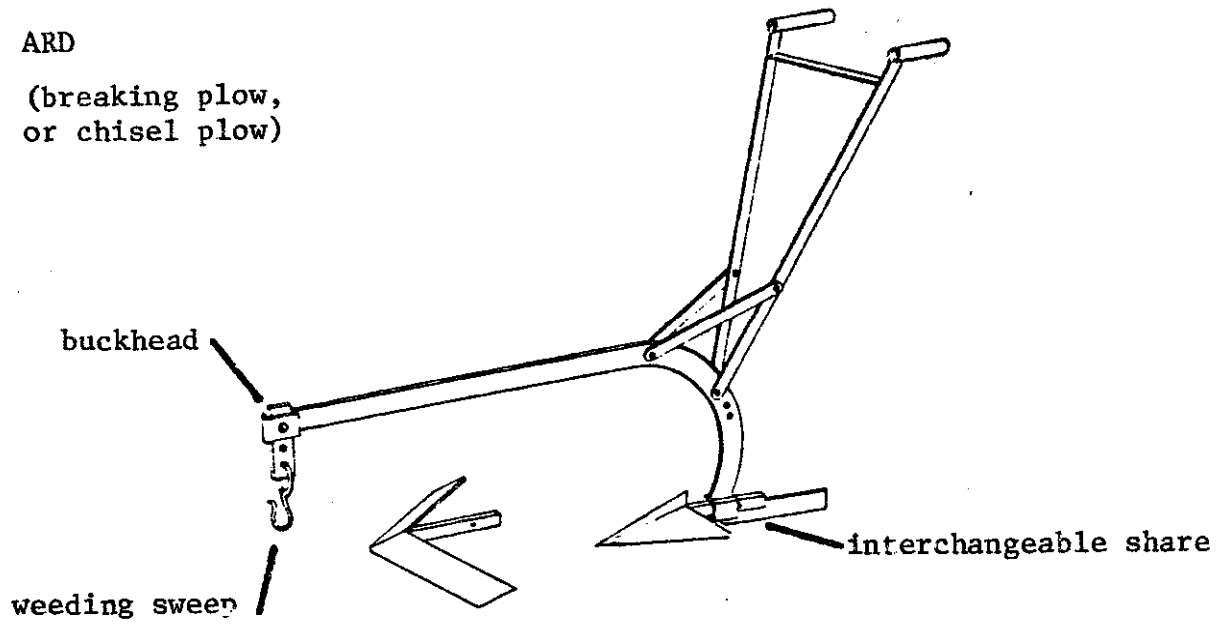

Source: Hopfen, Op. Cit.

plowing to a depth different from initial plowing prevents fixation of the pan ("hard pan") and aids maintenance of a healthy soil profile.

Shallow tillage plows, which break the soil surface but do not turn it under, are called breaking plows, chisel plows, or ards. They are used where short growing seasons and dry soil conditions make shallow plowing a desirable technique (typically in Africa's Sahelian and sub-Saharan zones). A breaking plow has no moldboard and hence no side draft; as a result it will hold a

straight line when pulled by a single animal.

### Adjusting the Plow

Draft tools can be adjusted to deliver the kind and quality of tillage farmers want, and minimize the effort required by the operator. Plow adjustment features include the adjustable wheel, the horizontal regulator, and the vertical regulator. In addition, handles on some plows can be adjusted according to

Multi-Purpose Tool Frame (Arara brand)

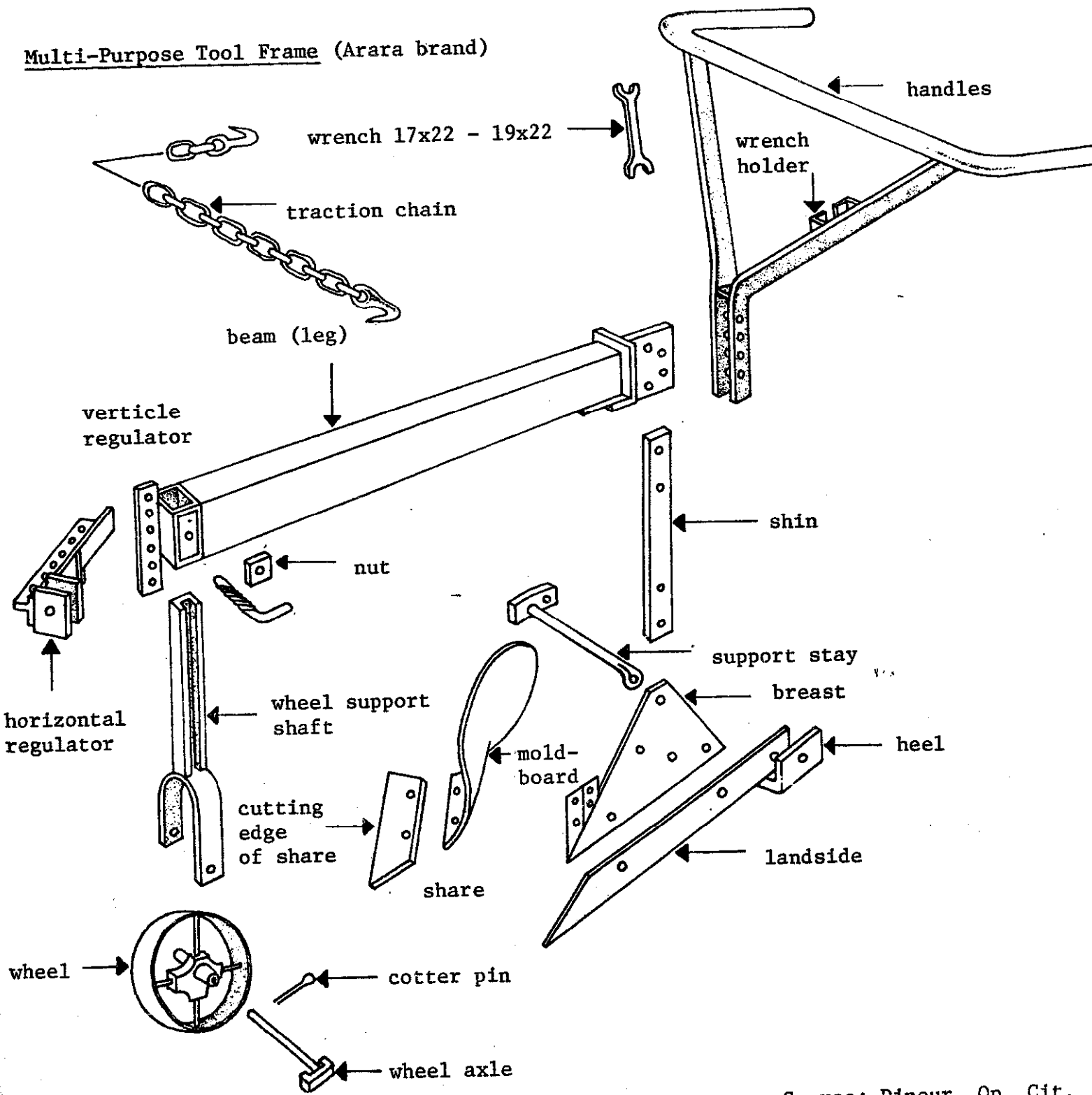

Source: Dineur, Op. Cit.

the height of the operator.

Adjustments are better understood with experience as the operator learns the "feel" of the tool, how land is supposed to break over a ridger, or curl off a moldboard. Until then, an animal traction instructor can point out adjustments which minimize operator effort while maximizing tillage objectives. An instructor can adjust the equipment, demonstrate its use, and then let the farmer use it. Later, adjustments can be made that change the blade action and produce different results. In this way, the farmer learns about the performance range of the equipment through supervised, hands-on experience.

## Depth of Plowing

Plow without wheel: Some plows have no wheel in front, and in these cases the depth of plowing depends on the length of the hitch, that is, the connection between the animal(s) and the load. Lengthening the hitch increases the depth of the plowcut. Shortening the hitch reduces the depth of the cut.

Adjustments are made by trial and error. If the objective is to plow a furrow 15 cm deep and the plow is working at 12 cm, lengthen the hitch by adding a few links to the drawchain where it connects to the front of the plow. If the cut is too deep, drop a few links.

If the team is pulling in harness rather than a yoke, regulate the length of the hitch by adding or dropping links on the short drawchain connecting the doubletree to the front of the plow. The adjustment can also be made on the traces, but each of four traces will have to be adjusted.

Plow with wheel: Plows with wheels are adjusted by raising or lowering the wheel in relation to the beam. If the wheel is high, or close to the beam, plowing will be deep. If it is low, far from the beam, plowing will be shallow.

The wheel is mounted on a shaft that slides up and down through a hole in the beam. To set the plowing depth, the operator slides the shaft up or down and locks it into place with a bolt (see plow diagram, page 117.)

When the bottom of the wheel is even with the bottom of the plow, there is zero depth of tillage; the plow, if pulled, will ride on the surface. In order for the plow to descend, the shaft/wheel assembly must be raised so the wheel is closer to the beam.

Adjustments are usually made by trial and error, but a very precise

adjustment can be made in this manner:

- put the plow on flat ground and steady it so the plow bottom is level and the beam parallel to the ground.
- loosen the bolt holding the shaft/wheel assembly to the beam and let the shaft slide down until the wheel hits the ground.
- decide how deep you want to plow and raise the wheel the same distance off the ground. If you want your furrows 12 cm deep, raise the shaft until the bottom of the wheel is 12 cm above the ground, and then lock the shaft in place.

### Correct Line of Traction: Vertical Regulation

When a plow is cutting correctly, it works flat on the furrow bottom: the point of the share and the bottom of the heelpiece are level. This does not happen automatically. The operator usually has to make an adjustment called vertical regulation. The adjustment is made by raising or lowering the point where the drawchain meets the front of the plow.

On some plows, the drawchain hooks to a pin that slides through the beam and locks at various heights. On others, it hooks to a perforated bar welded to the front of the beam. These devices, and others like them, are called vertical regulators.

The adjustment is made by trial and error. After the wheel is set, the operator begins to cut a furrow. If the wheel presses hard into the ground leaving a deep trace-mark, and/or if the plow snags and bounces, even when there are no roots, the chain is too high. If the wheel lifts off the ground and the plow tends to ride up to the surface, the chain is hitched too low.

Vertical regulation is correct when the plow bottom works flat. The plow glides smoothly, maintaining its depth. The wheel rolls easily and the beam is parallel to the ground. The operator doesn't have to help the plow maintain its digging plane by exerting pressure on the handles.

When this is happening, the drawchain will be riding on the line

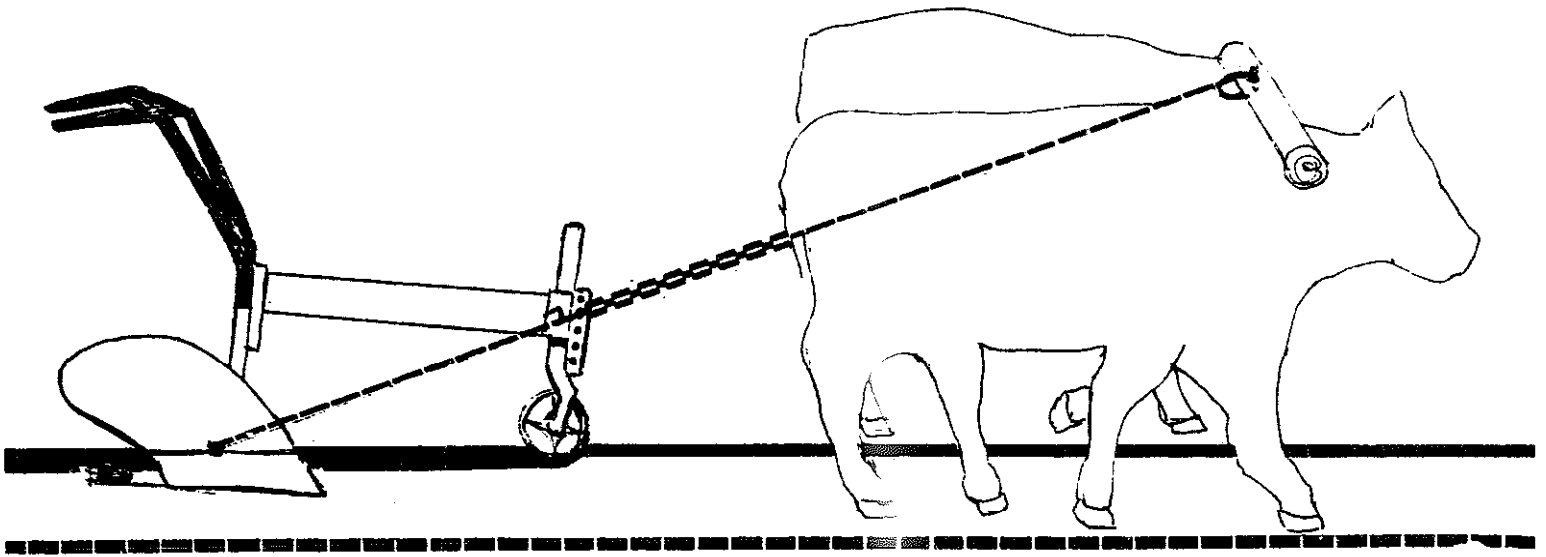

INCORRECT vertical adjustment: The plowpoint angles down, the heelpiece lifts up, the entire plowbottom pitches down, causing snagging and wheel pressure. The operator has to keep pulling up or lifting the plow handles.

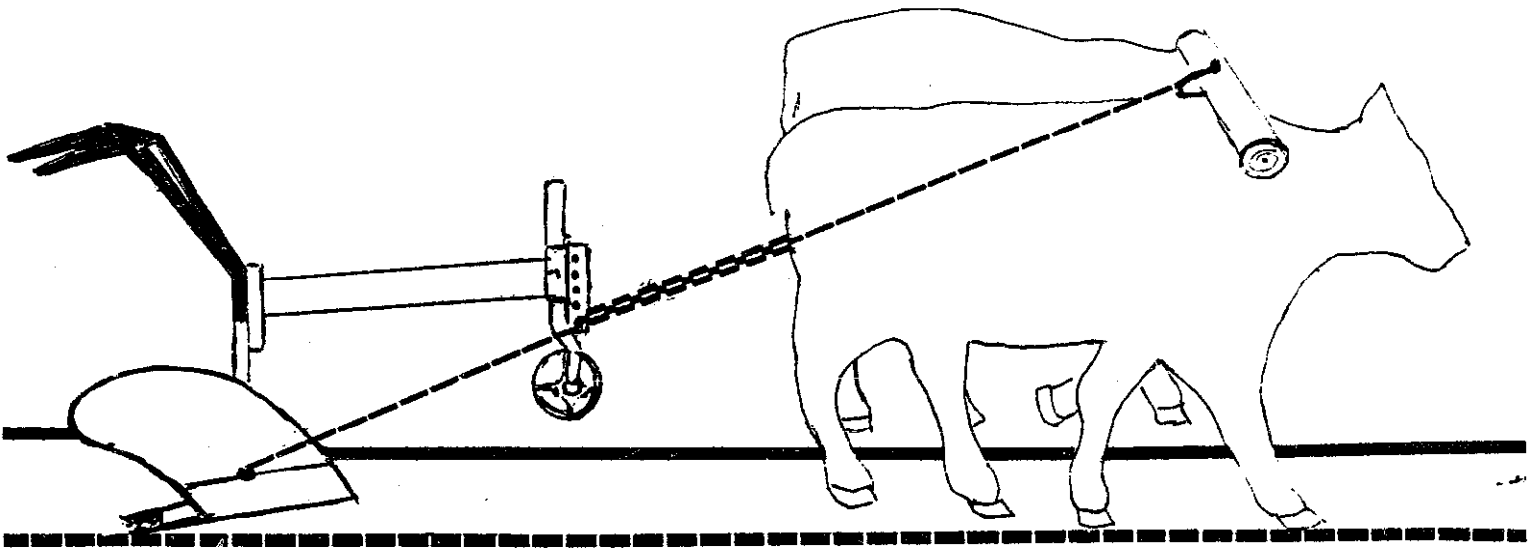

INCORRECT vertical adjustment: The plowpoint angles up, the heelpiece presses down, the plowbottom pitches up, causing the plow to ride to the surface. The operator has to keep pushing down on the plow handles.

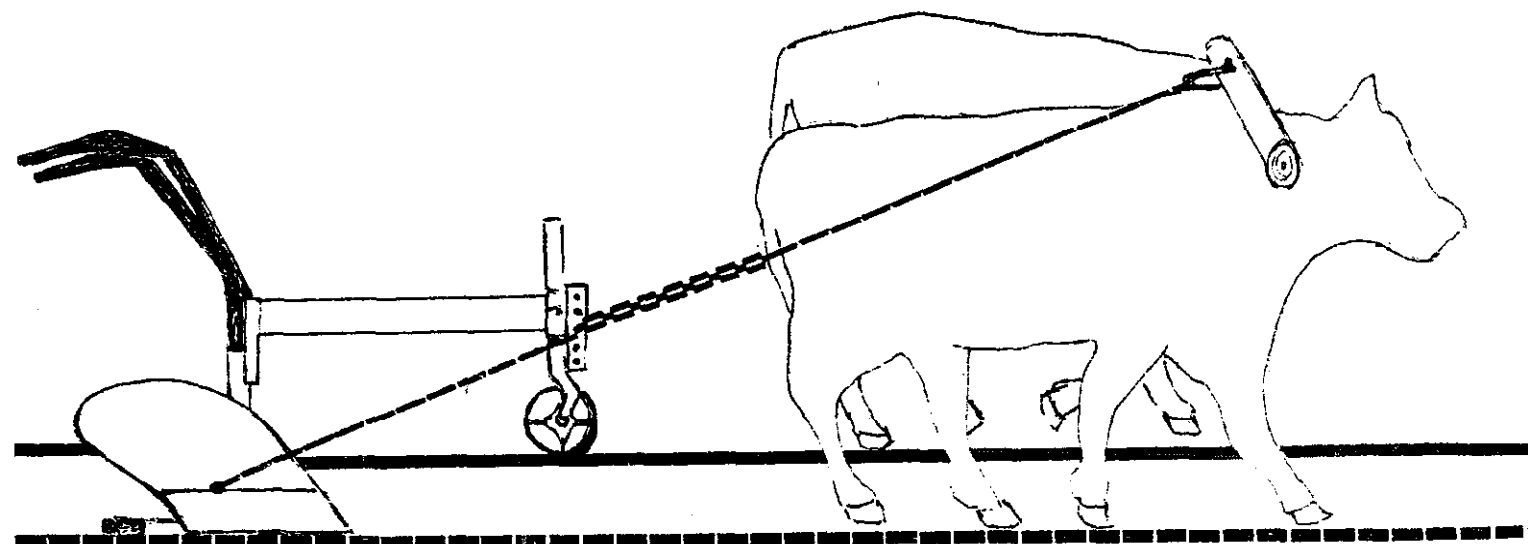

CORRECT vertical adjustment: The plowpoint and the heelpieces are on the same level. The plowbottom works flat.

of draft, or line of traction--an imaginary straight line that connects the point of draft (yoke clevis or hame draft) to the point of resistance. The point of resistance is located near the midpoint of the share/moldboard joint; it is the point where the plow meets the most resistance from the soil.

#### Width of Plowing: Horizontal Regulation

Width of plowing is established by positioning the drawchain

on the horizontal regulator--a notched or perforated bar fixed to the vertical regulator. As the chain is moved toward the right end of the bar, the plow cuts a broader furrow. As it is moved to the left, it cuts a narrower furrow.

The plow is easiest to control when the chain is hooked to the hole in the center of the bar, or to the hole just right of center. When this hitch is made, the beam runs parallel to the furrow cut. The forces on the moldboard are very uniform and the plowman does nothing

Width of Plowing:  
Horizontal  
Regulation

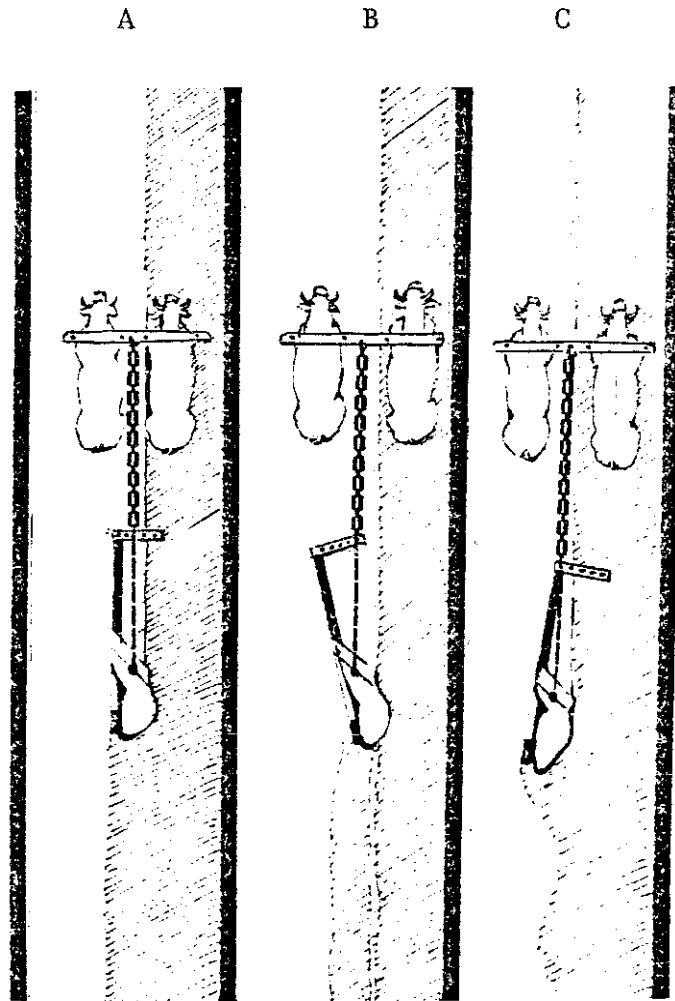

but balance the plow and help it around roots and stones. (Fig. A)

When broader or narrower cuts are made, the plowman must use more control. If the chain is hitched to the right, the plow will angle toward the unplowed land. The operator keeps it going straight by tipping it to the left, and the plow is bearing down slightly on the left handle. But if it's hitched all the way to the right, the share may not have a long enough edge to cut all of the furrow slice. In this case, the operator must develop enough

speed and thrust to knock the whole slice over. A strong, steady-pulling team is needed and the operator must keep constant pressure on the left plow handle. (Fig. B)

If the chain is hitched to the left of the regulator midpoint, the plow will cut a narrower furrow. The operator uses slight pressure on the right handle to keep the furrow uniform. If the chain is hitched all the way to the left, the plow will angle into the open furrow unless the operator compensates with manual effort. (Fig. C)

## Aids for Plowing Heavy Vegetation

Some plows are equipped with a coulter, a knife-like blade which is fixed to the beam in front of the moldboard. It extends downward so it pre-cuts roots and sod and makes it easier for the moldboard to turn the furrow slice.

If grass is very tall or vegetation heavy, it may stick up between the turned furrow slices and continue to grow. In these cases, pre-flatten it by attaching a heavy chain to the outermost hole of the horizontal regulator (or to the right-hand end of a singletree) and loop it back to the beam.

An alternative method is to stretch a heavy-gauge wire from the horizontal regulator to a point on the ground behind the moldboard. When plowing begins, the weight of the turning furrow slice puts tension on the wire and keeps it in position to flatten the oncoming grass. At the beginning of each

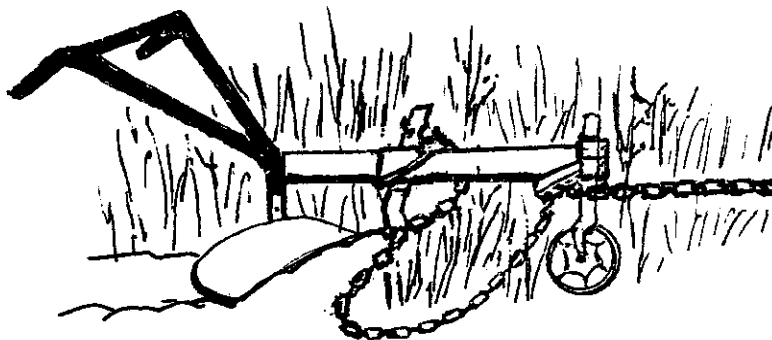

### Use of Coulter and Aid Chain

furrow, the plow operator must stand on the end of the wire until the slice begins to turn over on top of it.

### Field Layout

A sturdy, well-trained pair of bulls can plow a hectare (ha) of clear, root-free land in four days. Farmers who learn to break the hectare into standard-size strips or parcels will know how much work their bulls can produce per day,



and this knowledge will help them plan the labor effort of the family.

A practical work strip is 12 m wide and 50 m long. With this field layout animals will not tire and the driver will waste no time or energy turning the plow at the end of the row. If a plowteam turns four of these strips a day, it will have completed one-fourth hectare.

The recommended layout for plowing a one-hectare field is

illustrated below. If no measuring ropes or chains are available, work-strips are laid out approximately 60 paces long (a pace = a normal walking step) and 15 paces across. At least four meters (5-6 paces) of unplowed land, or headland, must be left at the top and bottom of each strip to allow room for turns. Two meters of clear land should be left along the side of the first strip if the field is bordered by a forest; this space will be needed when the

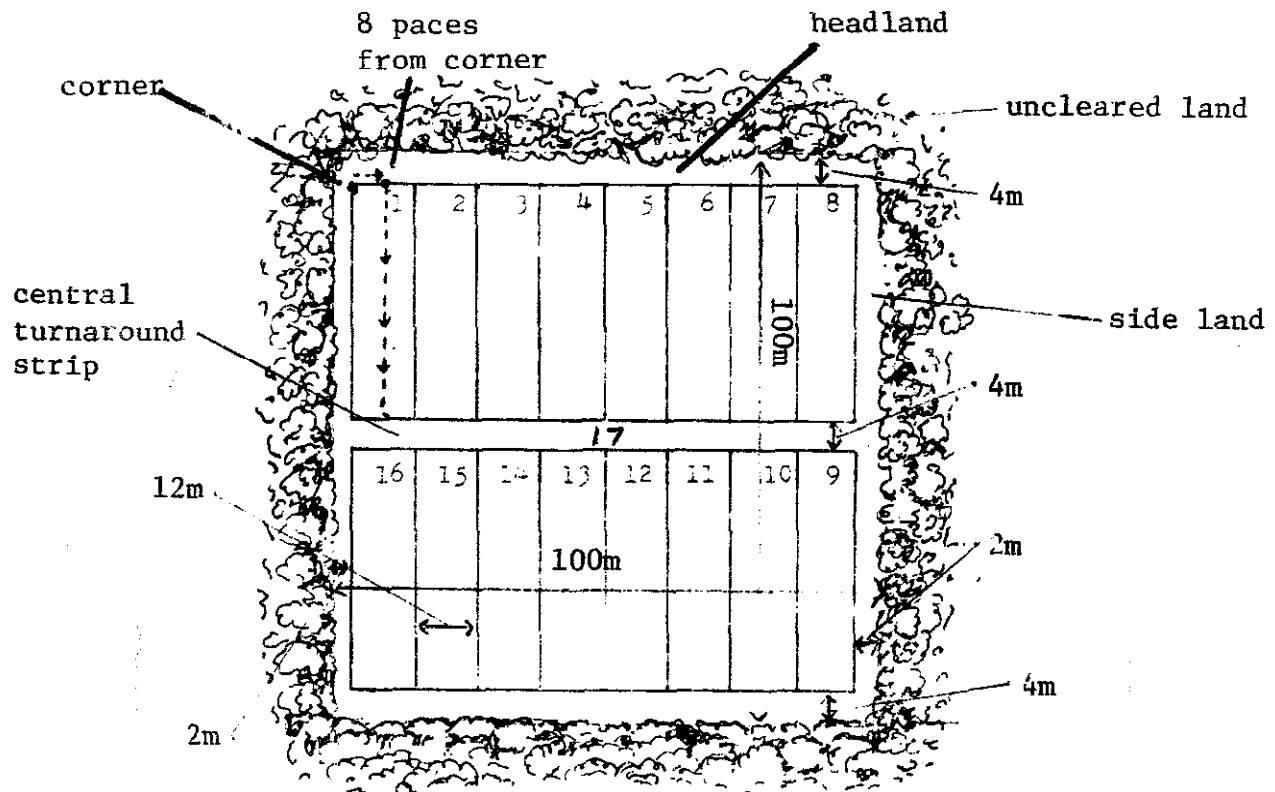

Well-planned field showing use of central turnaround strip. The turnaround strip is plowed last.

## Setting the Crown

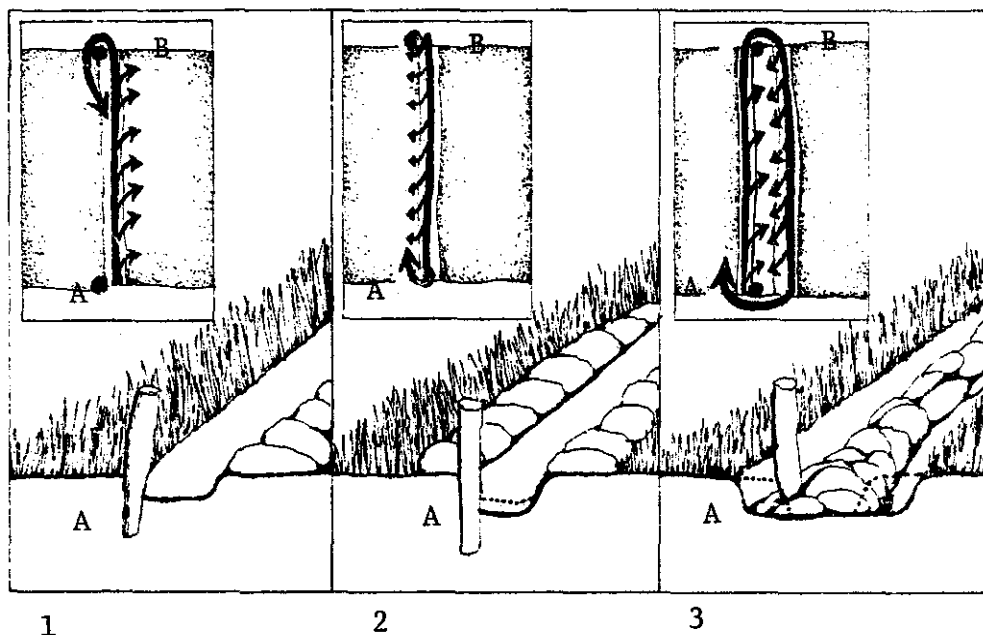

team weeds the outermost row. A central turnaround strip is used so that the team and driver do not have to make turns on already-plowed land. This strip is plowed last.

Before plowing the first workstrip, mark the corners of the headlands, sidelands, and central turnaround strip. Then take eight paces along the inside of the headland and place a stake there. Put another stake opposite the first, and on the border of the turnaround strip.

The workstrip is plowed by making a series of clockwise passes (right-hand turns) around a ridge made between the two stakes. The ridge is

called a crown. Plowing begins by setting the crown.

Steps to set crown:

- Place the plow just to the right of the first stake (A) and cut a shallow furrow to the opposite stake (B) (Fig. 1).
- Reverse the team and put the plow back into the furrow just made. Return to Point A, cutting the furrow a little deeper. The result is that you have made a well-defined trench whose sides are banked with loose soil (Fig. 2).
- Turn to the right and put the plowpoint next to the loose soil.

Return to the opposite end of the field, throwing this soil back into the trench. Then turn to the right and come back along the other side of the trench, throwing the rest of the loose soil in (Figure 3).

- Readjust the plow, setting the wheel so the moldboard will work at the full, desired depth. Then cut a furrow in the land just to the left of the filled trench. The new furrow slice will fold against the soil in the trench and partially cover it. On the return trip, more dirt will be thrown against it, and on top of it. The result will be a ridge of earth that will be slightly higher than the rest of the plowed field. This is the "crown".
- Correctly made, the crown is made of loosened, turned earth. Some plowmen make the crown simply by throwing a set of furrow slices over a center of hard, unplowed land. The result is that later, the plants in the rows either side of the crown do not have access to well-tilled soil.

Once the crown is set, plowing proceeds in a clockwise manner until the plowed strip is approximately 15 paces wide. Then stakes A and B are pulled out and placed eight paces to the right of the edge of the plowed land. The stakes mark the line where the plowman

sets a new crown and begins the next workstrip.

## Concentric Plowing

A concentric pattern may be effective if plowing is expanded around a block made of two or three completed workstrips. However, a pattern that works inward toward an increasingly smaller square of unplowed land is not practical. Land is trampled with each turn, and when the central workstrips are plowed, there is no headland for turning.

### Notes on Using the Plow

The following suggestions will be helpful to instructors teaching farmers to use the plow.

- Choose "easy" ground--an old field free of roots, rocks and trees. Plow one or two days after rain. During the dry season, farmers can practice on sandy or pebbly soils; however, these soils may be too loose or powdery to be plowed into uniform furrow slices.
- Make sure the plow is adjusted correctly. Set it to cut a shallow but well-defined furrow. Lower the handles if

possible. Do not teach farmers about adjustments until they have the "feel" of a correctly working plow.

- In the beginning, walk beside the farmers and drive the bulls for them so they can concentrate on using the plow. When starting new strips, lead the bulls from the front so they do not veer. Remember that once the guide cuts are made, the bulls follow them quite easily.
- Do not let farmers push the plow or bear down on the handles, since this drives the plowshare into the ground and makes the animals' work harder. Advise them to stand erect; show them that their job is simply to balance and steer the plow. They can cut a broader slice by dipping the handles slightly to the right; they narrow the slice by dipping them to the left. Eventually the farmers will learn to feel roots and rocks as they come across the share and help the plow around them with these same dipping motions.
- Teach them to walk in the furrow and lean to the landside. If they walk on the high ground, they will tend to push their plow to the right and make unnecessarily narrow cuts. If they straddle the cut, they will tire from constantly stepping up and down.

- During a turn, farmers should lift the handles and wheel the plow like a wheelbarrow. If the plow is not equipped with a wheel, they lean it on its right and let it drag. They should not cut the headland (turning area) because it is time-consuming and makes footing difficult.
- If the team is working poorly, as may be the case with a new pair, let the farmer practice using a pair that pulls well and obeys commands. The demonstration pair is ideal for hands-on learning.

## Harrowing

Harrowing is the process of smoothing and leveling a plowed field. The harrow breaks clods and works the tops of furrow slices into a fine, moisture-retaining bed where seeds germinate easily. Higher germination rates resulting from harrowing are explained by improved structure of the seedbed:

- it is better aerated
- it is moisture-retaining
- there is more contact between the seed and soil particles; large air pockets and clods are eliminated and

- seeds are easily covered
- some weeds are killed.

A further advantage of harrowing is that it breaks down the tubes or coils of earth which are the remnant of furrow slices, making it easier to use line tracers or mechanical seeders.

There are several major types of harrows. Spike-tooth harrows are wooden or metal frames studded with rows of pegs or teeth (tines). Spring-tooth harrows are much like cultivators, but they have more teeth and can work to greater

depths. They are especially useful for pulling up vines, roots and stones; they require greater draft than spike-tooth harrows. Disc harrows work the soil to an even greater degree, slicing and partially turning the bed; they are highly effective in soil that is heavy, sticky, or broken into large, hard clods.

Spike-tooth harrows are useful in granular, lateritic soils or in sandy soils that have been plowed when slightly wet and then left to settle; they are pulled perpendicu-

#### Spike-Tooth Harrows

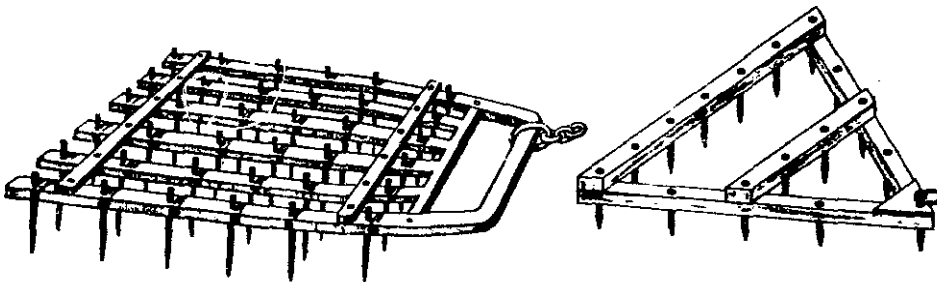

Source: Hopfen, Op. Cit.

## Planker

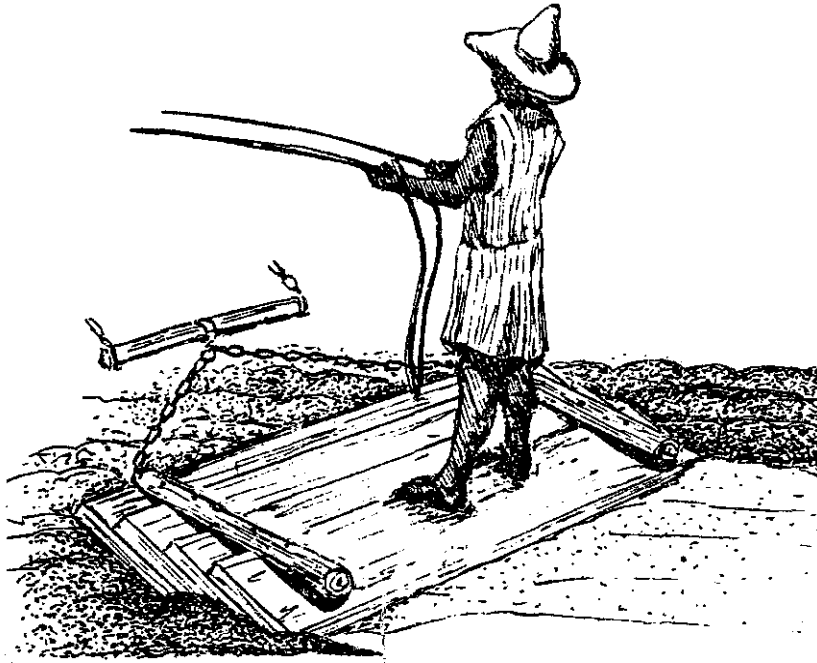

lar to rows. In heavier soils it may be necessary to harrow parallel to the furrows and afterwards at angles to them.

Spike-tooth harrows can be made locally and at little cost. The frame must be sturdy and able to carry weights such as logs or rocks; the weights help hold the harrow down, preventing bouncing, jarring and poor penetration of teeth. In fields where stumps and protruding rocks can cause interference, wedge-shaped frames are used, or the operator guides the harrow

using a rope or set of handles. Teeth should be long enough to work the top several inches of soil. They should have a pointed tip, and the shafts should be made and fitted so the leading edge cuts into the soil (teeth made from round iron should be hammered into a triangular or diamond shape).

An affordable, easily-made alternative to the disc harrow is the planker, or plank drag. Used in combination with a spike-tooth harrow, it works heavy soil into an excellent seedbed.

## Line Tracing for Parallel Rows

Since animal traction can reduce the labor needed for primary tillage, farmers can increase the size of their fields. However, they run the risk of insufficient labor for hand-weeding the extra area, so mechanical weed cultivation of parallel rows becomes a necessity.

Parallel rows are established by scoring the seedbed with a marking device called a line tracer, and then planting along the scoremarks. As plants mature, farmers can weed (cultivate), fertilize, ridge, and in some cases harvest them using animal power. This would not be possible if inter-row widths varied, as is often the case when sowers line up shoulder to shoulder and advance across the field planting the seeds. Variations as little as 10-15 cm would make mechanical maintenance of the crop impossible; animals would step on plants and blades or cultivator tines would sever roots each time the

rows got closer.

A line tracer is a frame made of a handle and a crossbar and pulled by hand or animal power. The crossbar is equipped with moveable teeth. The teeth are set at intervals that correspond to the recommended row spacing for a particular crop. The operator makes a set of marks the length of the field, turns, sets the outermost tooth on the outermost line made during the previous pass, and then draws the tracer back across the field. This gives the sowers a visible mark by exposing the darker, moist soil just under the surface; if the operator gets too far ahead of the sowers, the lines will dry and be harder to see.

A tracer can be made of light, sturdy wood or bamboo and fitted with hardwood or metal teeth. The pole used for the crossbar must be of straight, uniform stock because a tapered pole is heavier on one end and will throw the tracer off balance when it is pulled. Teeth must be long enough to pass through the crossbar and accommodate con-

Relationship of parallel line-tracing  
to later weeding operation

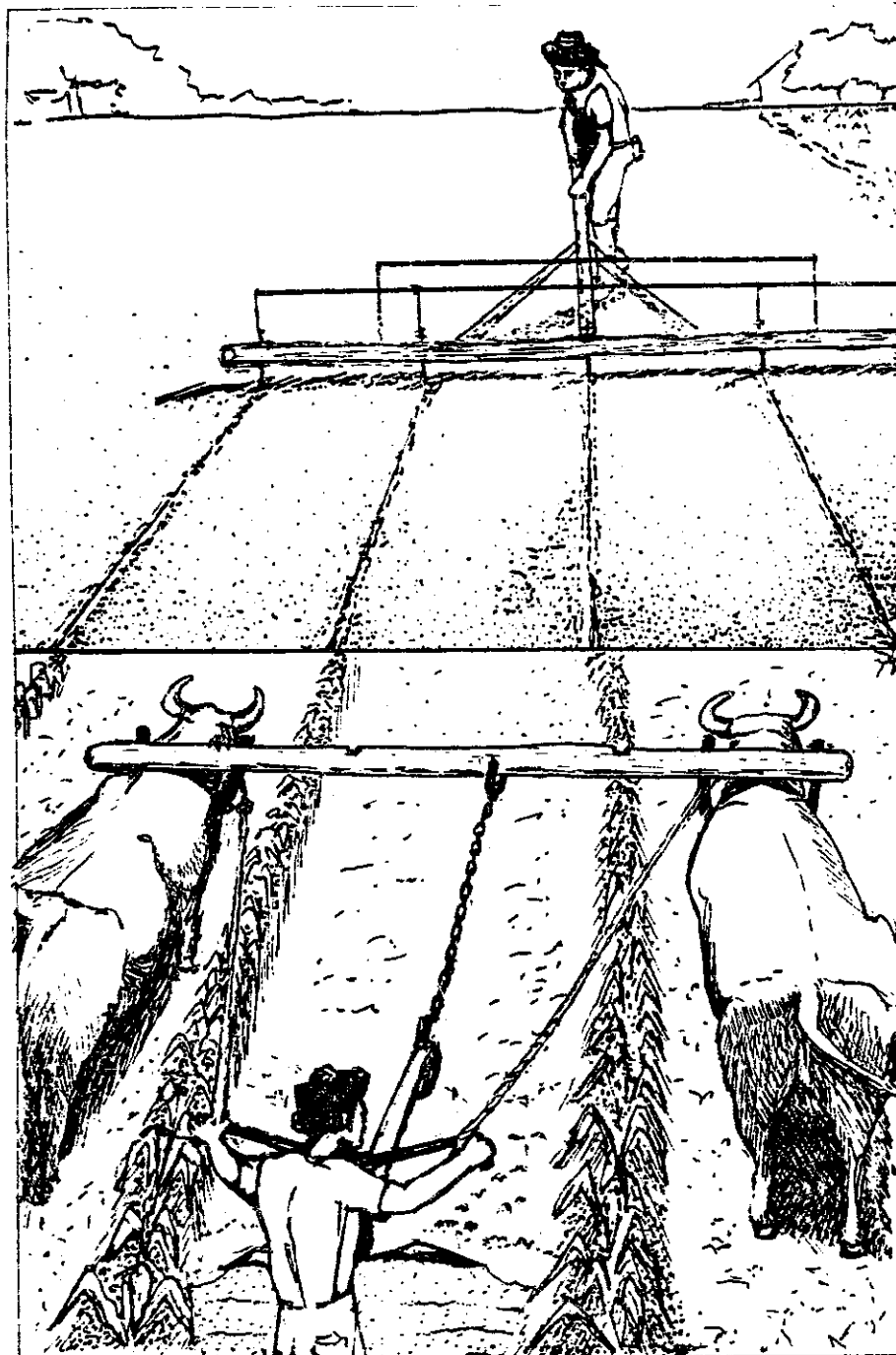



# Line Tracer

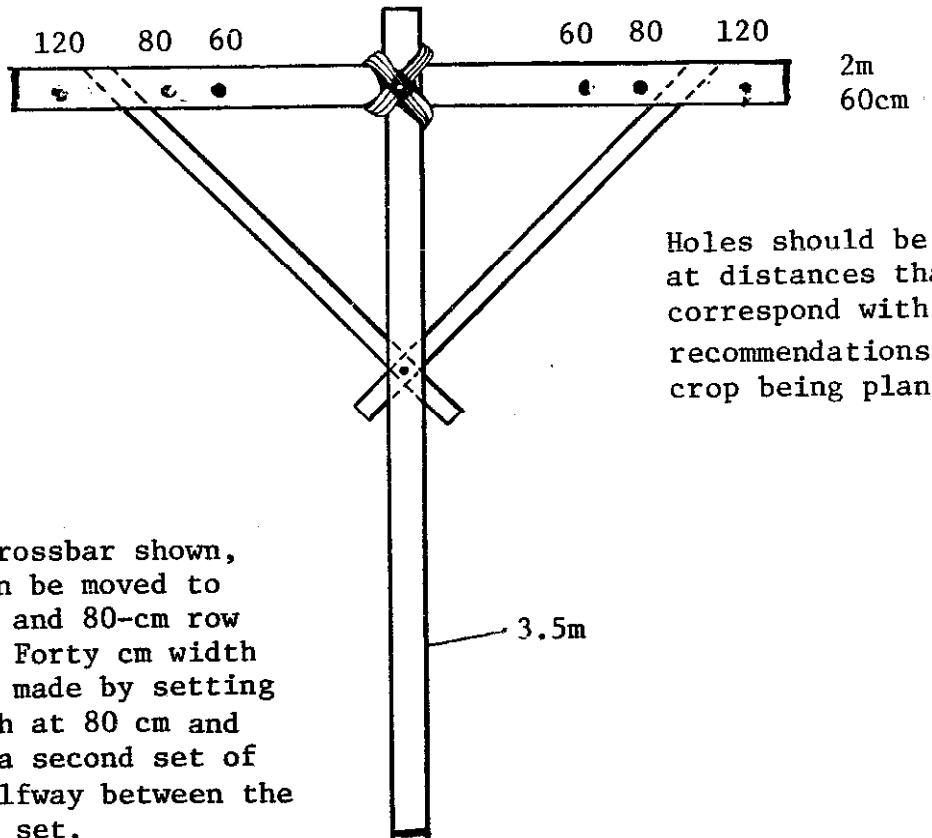

Holes should be made at distances that correspond with recommendations for crop being planted.

In the crossbar shown, teeth can be moved to make 60- and 80-cm row widths. Forty cm width would be made by setting the teeth at 80 cm and tracing a second set of lines halfway between the original set.

siderable irregularity in the surface of the field. The center tooth must be long enough to pass through the crossbar and the handle; it is not removeable. Other teeth can be moved into various holes in the crossbar.

The bar and handle should be joined so the teeth travel perpendicular to the ground when the marker is used. To do this, fit the bar with teeth and have an assistant hold the bar on the ground in a working position. Then lay one end of the handle over the bar mid-

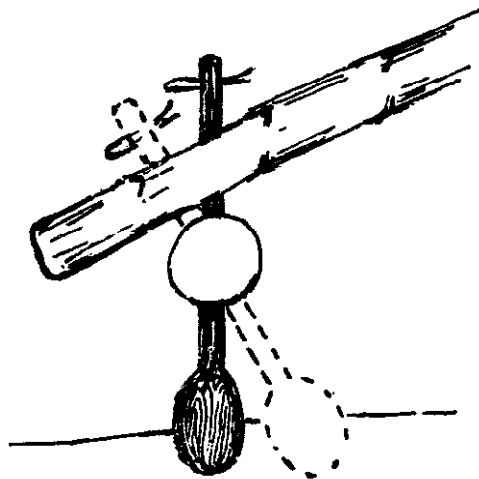

Side view of handle crossbar joint showing how joint affects tooth penetration angle.

point and lift the free end so it is hip high (pulling position). Mark and join the two pieces so they fit at this angle.

Line tracing for parallel rows has other advantages besides those already mentioned:

- It makes it easier to calculate densities and yields, and determine fertilizer requirements
- Drawing two sets of parallel lines perpendicular to each other provides intersects where seeds can be planted; later, cross-cultivation is possible for both inter-row and intra-row weeds.

Parallel rows can also be made by planting along a stretched rope or string, or by using a mechanical seeder.

### Mechanical Seeders

A mechanical seeder is a hand- or animal-drawn machine that cuts a shallow furrow in the seedbed and then deposits and covers seed. The advantage of seeders is that they drill seed at uniform depth and at regular intervals along the row,

Seed Drill or Seed Planter

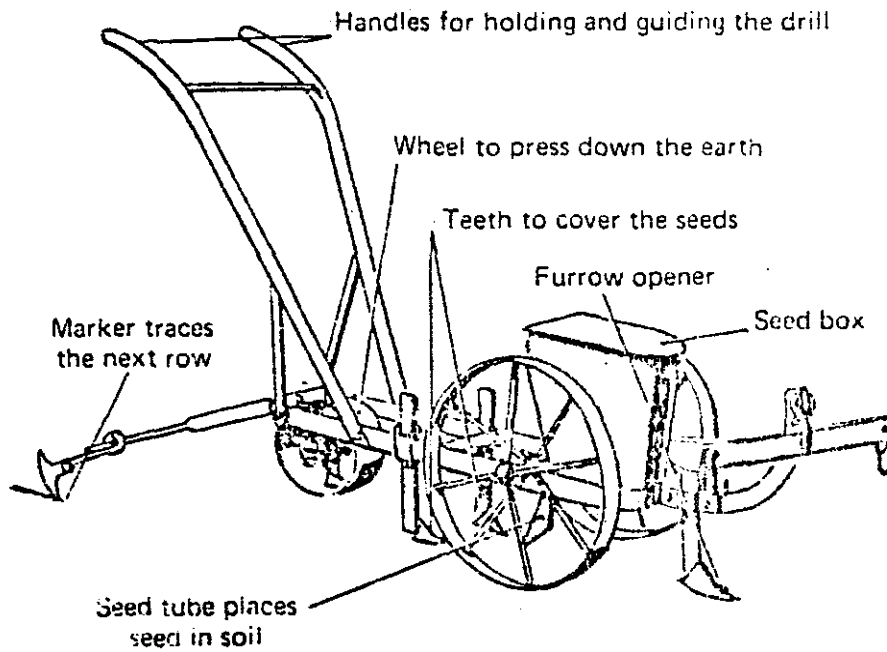

- Seed planter with interchangeable seed plates and stars for different seeds.

Source: Food and Agriculture Organization of the United Nations

reducing seed loss and ensuring proper density. They are useful also because at planting time, manual labor may be involved in late soil preparation and early weeding operations as well as planting. With the help of mechanical seeders farmers can achieve desired seed densities without placing strains on labor. The main drawback of seeders is their relatively high cost.

## Mechanical Weed Control

In most cases, the farmer who uses animal power will plow and plant more ground than can be weeded by hand. Plants are no longer tended individually, but by the row. The weeding operation can be accompanied with a weeding sweep or with a cultivator.

Sweeps work at shallow depths, uprooting weeds and loosening soil between row crops. They come in various widths to accommodate var-

### Sweeps

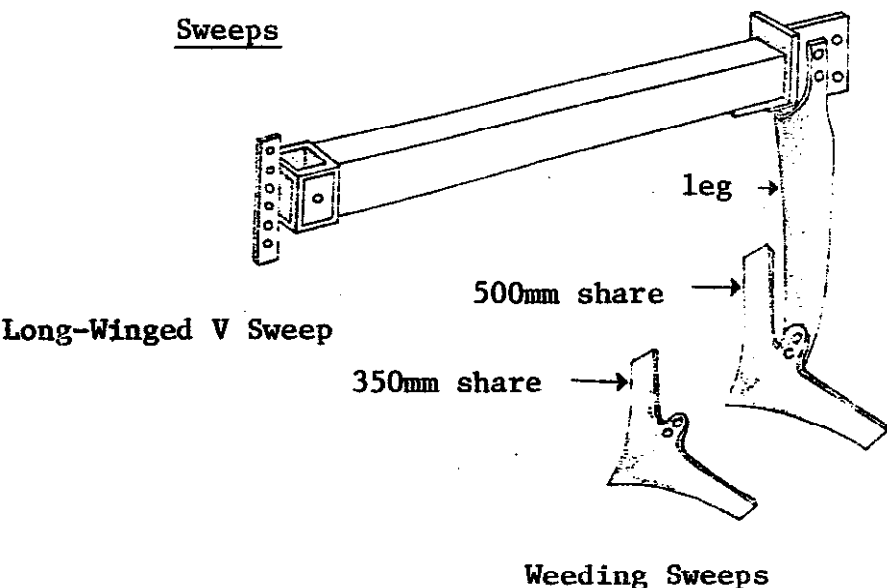

Sweep for Ridging Potatoes

Source: Dineur, Op. Cit.

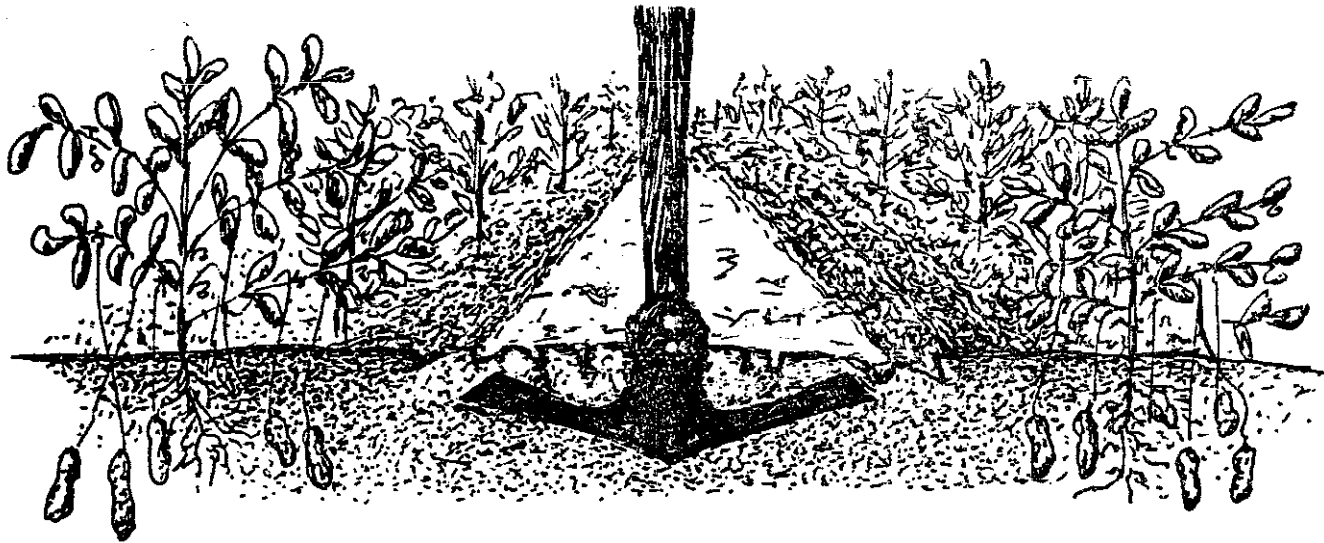

Weeding peanuts with a sweep. Cross-section showing proximity of blade to peanuts.

ious inter-row distances. Correct choice of blade and depth of work ensures that pruning of crop roots does not occur. Generally speaking, a 35-cm blade (350 mm) is suitable for rows spaced 60 cm apart, a 50-cm blade (500 mm) for rows 80 cm apart.

The sweep has several functions:

- It scrapes a shallow furrow between rows, cutting or uprooting weeds in its path. In addition, it pushes some soil to the sides, covering weed seedlings growing between plants on the row.

- It builds a light bank of soil against the row. The soil helps shade and support roots of the plants, and also covers fertilizer distributed at the base of the plants.
- It loosens soil, improving aeration and moisture retention.

Timing is very important.

Weeds must be killed before they compete with crops for soil nutrients and water reserves. The first weeding is performed as soon as weed seedlings appear between the crops. It is delicate work because crops are young and easily knocked over if

too much soil is pushed to the sides.

Two adjustments are made to concentrate blade action on weeds:

- Bottom depth of work is determined by height of the wheel. Depth increases as the shaft/wheel is raised.

#### Wheel Adjustment

Adjust wheel so that blade undercuts weed.

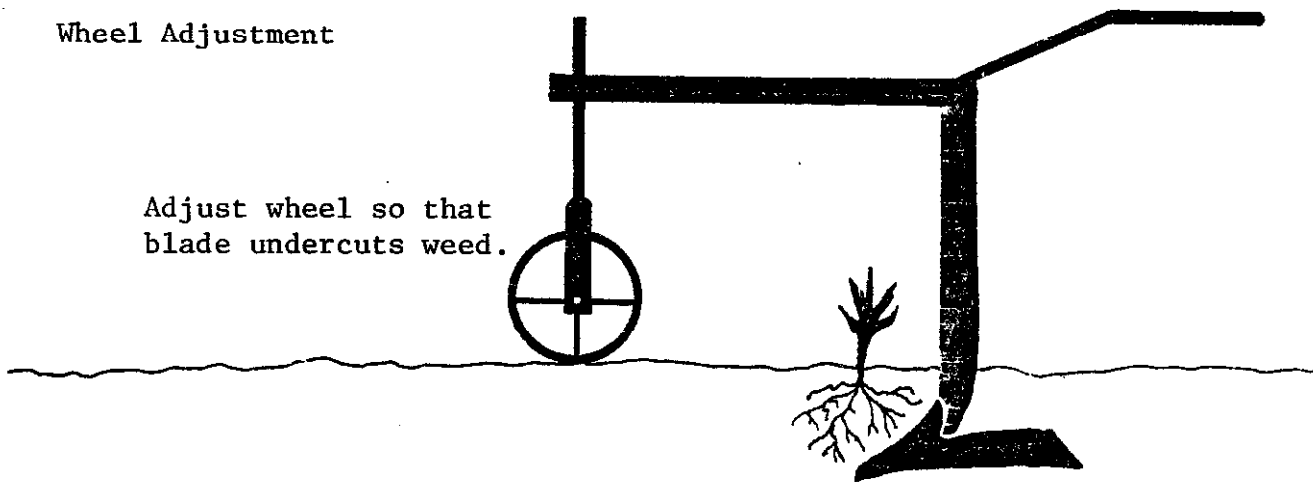

- Intensity of work is determined by the position of the blade up or down in the slots at the base of the leg.

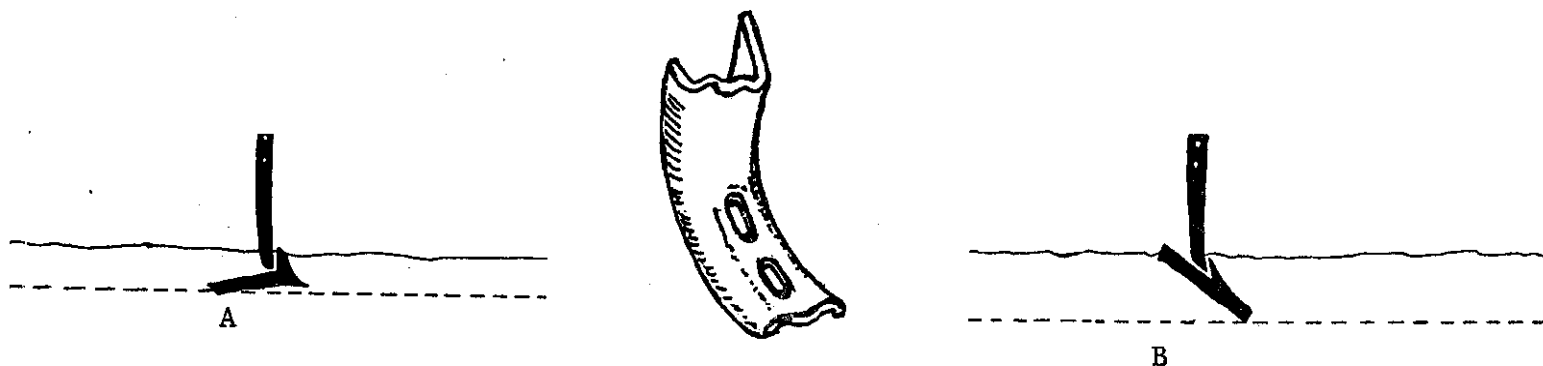

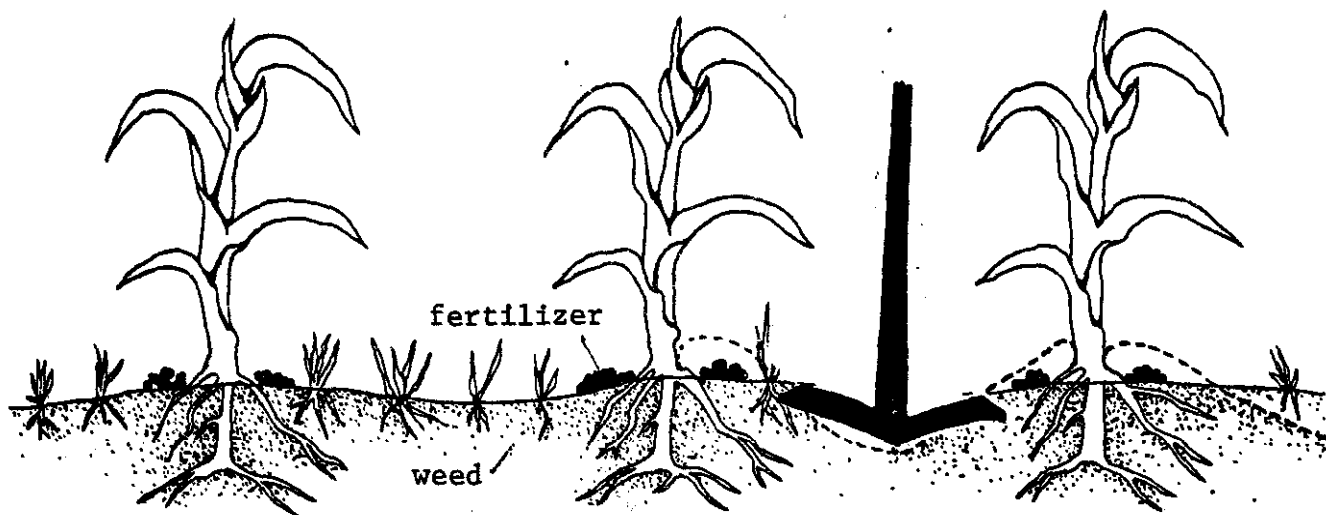

Weeding/Banking Operation

For early weeding (weeds at one- or two-leaf stage; crops young): set the blade in the lowest position in the slots. The blade will slice under weeds, dislodging their roots; weeds wilt and die. In this position, the blades will not push soil out of the furrow toward the crop (A).

For late weeding/light banking (large or creeping weeds; crops older with stronger stems): set the blade in the highest position in the slots. The blade face is then more vertical resulting in greater contact between the blade and the soil. Weeds are

knocked over and soil is pushed to the sides where it can cover weeds growing near plant stems (B).

No horizontal regulation of the drawchain is necessary with sweeps because the blades are symmetrical and have no side draft (page 143).

Weeding with a sweep can be done by one animal if soil conditions do not create too high a traction effort. In heavy, wet, or very weedy soils, two animals may be needed. In this case, the height of the plants will determine the type of hitch used. A doubletree

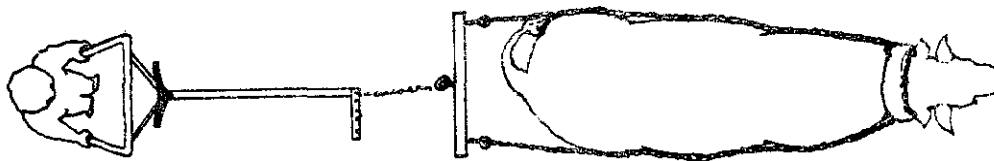

can be used if plants are very low, but if it hits the tops of the plants, the animals will have to wear a yoke. Donkeys can be placed in a yoke if the withers are protected with pads and collars (see page 85).

### **Weeding Muzzle**

In some instances, it is necessary to muzzle an animal to keep it from eating the crop during the weeding operation. A muzzle can be made of rope or woven rafia (palm leaves). It is worn over the muzzle

and fastened behind the horns (page 79). Equine animals wearing halters or bridles can usually be controlled by tugging on the rein opposite the direction of head movement.

### **Cultivators**

Cultivating is the process of scratching, mixing or stirring the uppermost layer of earth. A cultivator can be used as a plow or weeding device or to break ridges and mounds left from the previous season. A typical, animal-drawn



cultivating tool is a set of five flexible tines mounted on a tool-frame; duckfoot shovels or chisel points are attached to the ends of the tines. Smaller cultivators have three tines, while larger ones may have up to 15 tines.

The cultivator, with its capacity to carry multiple tines with sweeps of varying widths, has several important uses:

As a plow--Cultivating is an alternative to plowing when time or soil conditions do not permit use of a moldboard plow. This is often

the case in semi-arid regions where crops must be planted soon after the first rains in order to mature. The cultivator's wide track allows quick tillage; its shallow stirring action provides a seedbed without pulverizing soil and creating the danger of erosion. Repeated cultivations, however, can lead to erosion.

Cultivators also are used for preparation of rice lands. The topsoil is stirred and later, the field is banked and flooded. Rice planted in 40-cm rows can be weeded

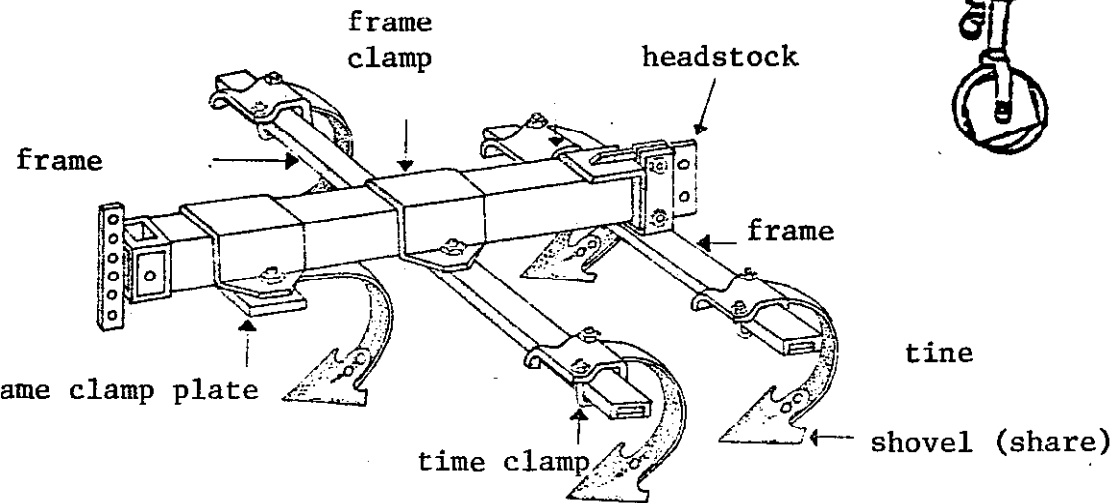

Five-Tooth Cultivator

Source: Dineur, Op. Cit.

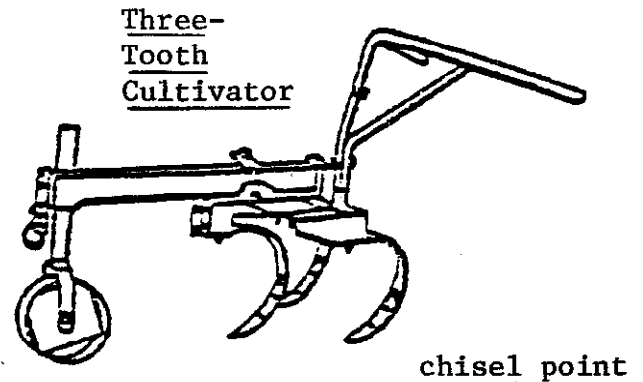

Source: CEFMAT, Op. Cit.

with a single 25-cm shovel mounted on the cultivator frame, or with two shovels (a double shovel) spaced on either side of the row.

As a harrow--When used for harrowing, the cultivator is equipped with the maximum number of tines which are spaced and arranged so that clods are broken and soil worked into a finer seedbed. The operation is performed soon after plowing, when soil is moist and clods break apart easily; dry clods glance off the tines. Very heavy or root-bound clods catch between the tines and cause it to drag or float to the surface.

As a weeding device--Cultivators can be used as general purpose weeding tools. Though new antrac farmers may find this tool expensive and complicated, its versatility is an important feature. Agents should be able to demonstrate its potential.

Cultivators work at fairly shallow depths with a limited range of adjustment. If the wheel is too high (too close to the beam), the front tines work at a greater depth than the rear shovels which will

assume a vertical pitch; the cultivator will skip, catch, and veer. When the wheel is too low, the shovel points will not penetrate and the operator will have to press very hard on the handles. Correct traction is achieved when all shovels run at the same depth.

As a leveler--The cultivator's considerable weight allows for the leveling of old ridges or mounds. In rain forest zones, hoe farmers plant a second crop soon after the harvest of the first. They weed the field, reshape the worn ridges by hand, and then plant a new crop in the stubble of the old. A cultivator can break up the ridges and stir in organic material simultaneously; when the new crop is established, the cultivator can perform a combined weeding/ridging operation.

In drier areas, mounds and ridges can be broken directly after the harvest or at the beginning of the new season. In the latter case, the soil may be loose enough after cultivating to permit effective pre-plant ridging. Otherwise,

### Ridger with Adjustable Wings

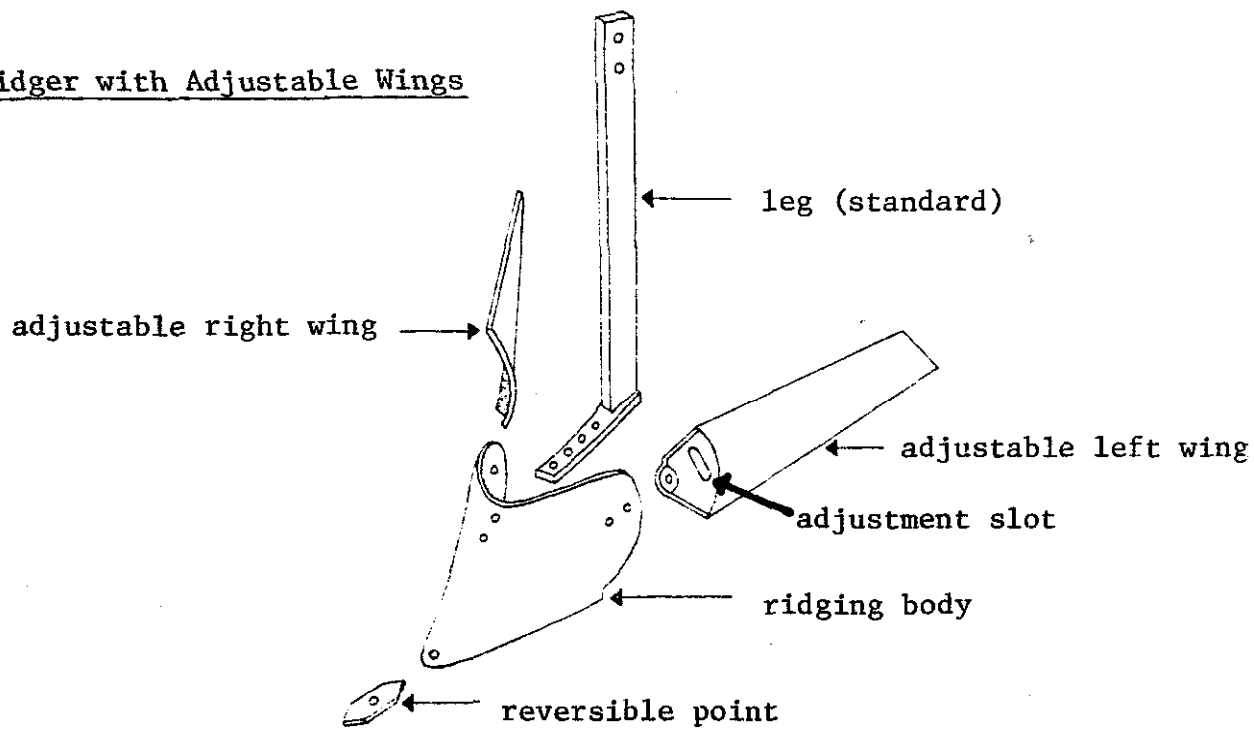

Source: Dineur, Op. Cit.

a moldboard plow and harrow would be used to level the field, crops would be planted on a flat seedbed and ridging would be done later, after the plants were growing.

weeding/ridging operation required for most grain crops. Like the moldboard bottom, it is mounted on a special leg that bolts to the toolframe.

### Ridging

A ridger is a wedge-shaped shovel that throws equal amounts of dirt to the right and left of a central furrow. It is a popular tool because it is easy to use and because it quickly accomplishes the

A ridger cuts a furrow between row crops, uprooting weeds and throwing soil right and left against the crops. The soil buries weeds growing at the base of the crop, and at the same time stabilizes the crop stem and helps it support the maturing fruit. It also covers organic or chemical fertilizer distributed along the row.

Ridging can be performed any time after the crop is established and won't be knocked over by the soil pushed against it. In many instances, early weeding is done with a sweep or cultivator and later weeding/ridging operations done with a ridger. Once the crop has developed a leafy canopy, the shade greatly reduces weed competition and further weeding becomes unnecessary.

Adjustments: To increase the amount of soil thrown, raise the shaft/wheel assembly or lengthen

the drawchain. Width of operation is controlled by position of the adjustable wings in relation to the ridger body; as the wings are lowered, soil is pushed further to the side.

No horizontal regulation is needed.

### Ridging Tall Crops

In corn and sorghum that has grown too tall to allow clearance of a yoke, a single strong animal

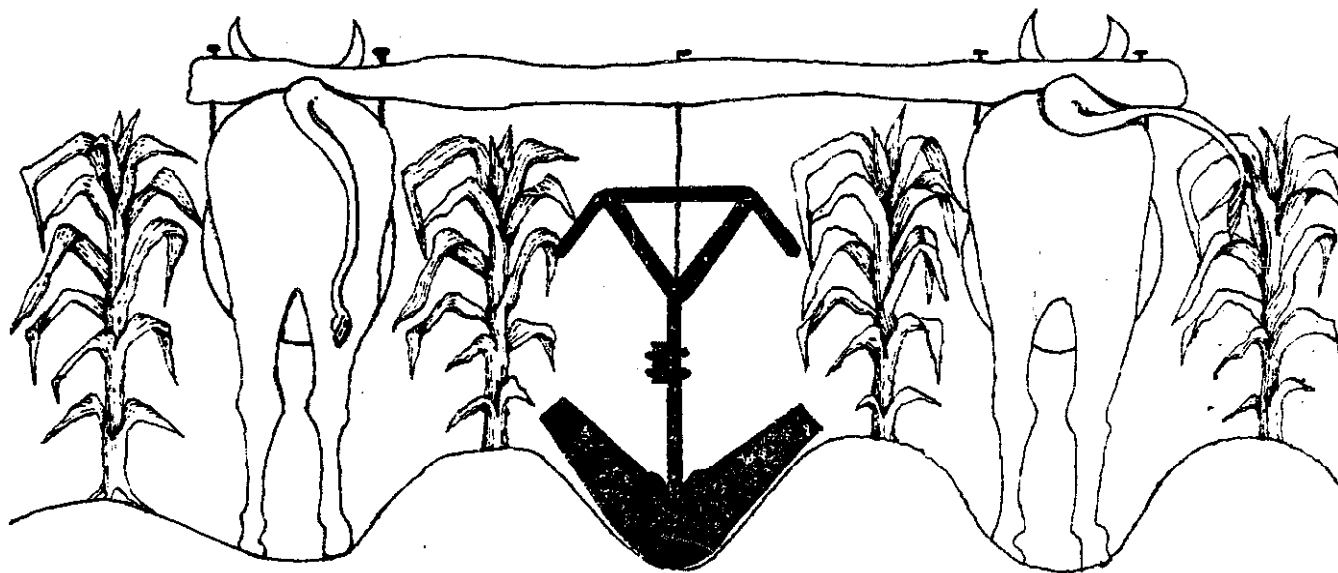

Ridging an Established Crop

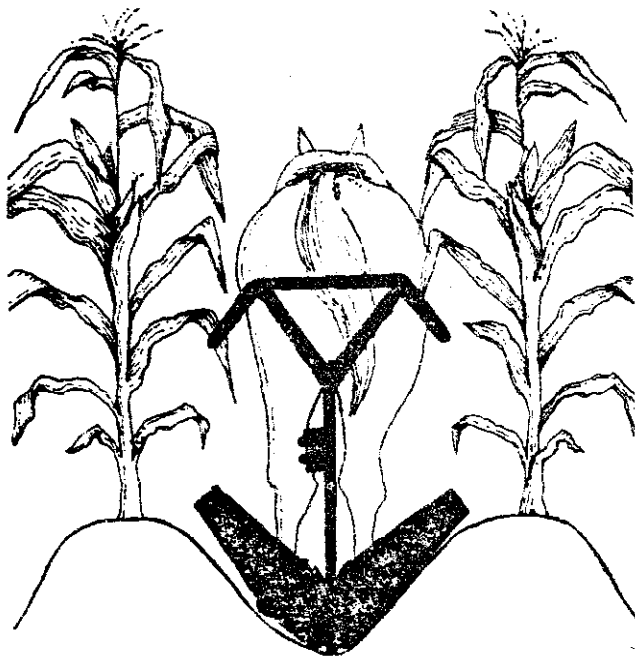

Single Animal Ridging Maturing Corn

can be used to make ridges. The animal is harnessed in a collar or breastband, traces are fastened to a singletree, and the singletree hitched to a ridger.

Primary Tillage With a Ridger

The ridger may be used for primary tillage where the land was plowed the preceding season. Farmers make ridges directly in unplowed soil and then plant. The

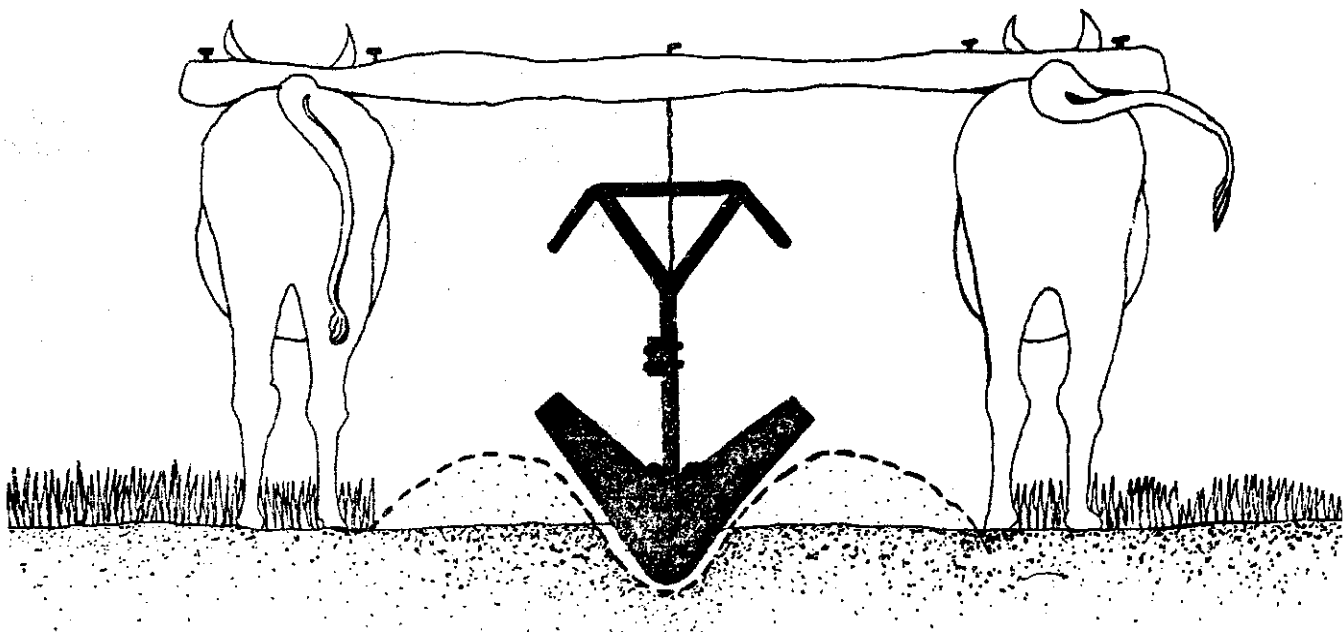

operation is less time-consuming than plowing with a moldboard, but it has the disadvantage of burying hard soil under a relatively narrow crown of loose soil. The hard soil has less water storage potential than plowed soil; also, it interferes with fast rooting.

### Ridging and Fertilizer

Chemical fertilizer can be spread along evenly-spaced trace lines made on a flat field and then

buried as the ridge is formed. The procedure is called pre-plant banding. The ridger can also be used to cover fertilizer applied to the top of an already-formed ridge.

### Smaller Ridges

Small, closely-spaced ridges can be made by removing the ridger wings and using the ridger body alone. Used this way, the ridger is an effective tool for banking soil against peanut plants. A sin-

### Pre-Plant Banding

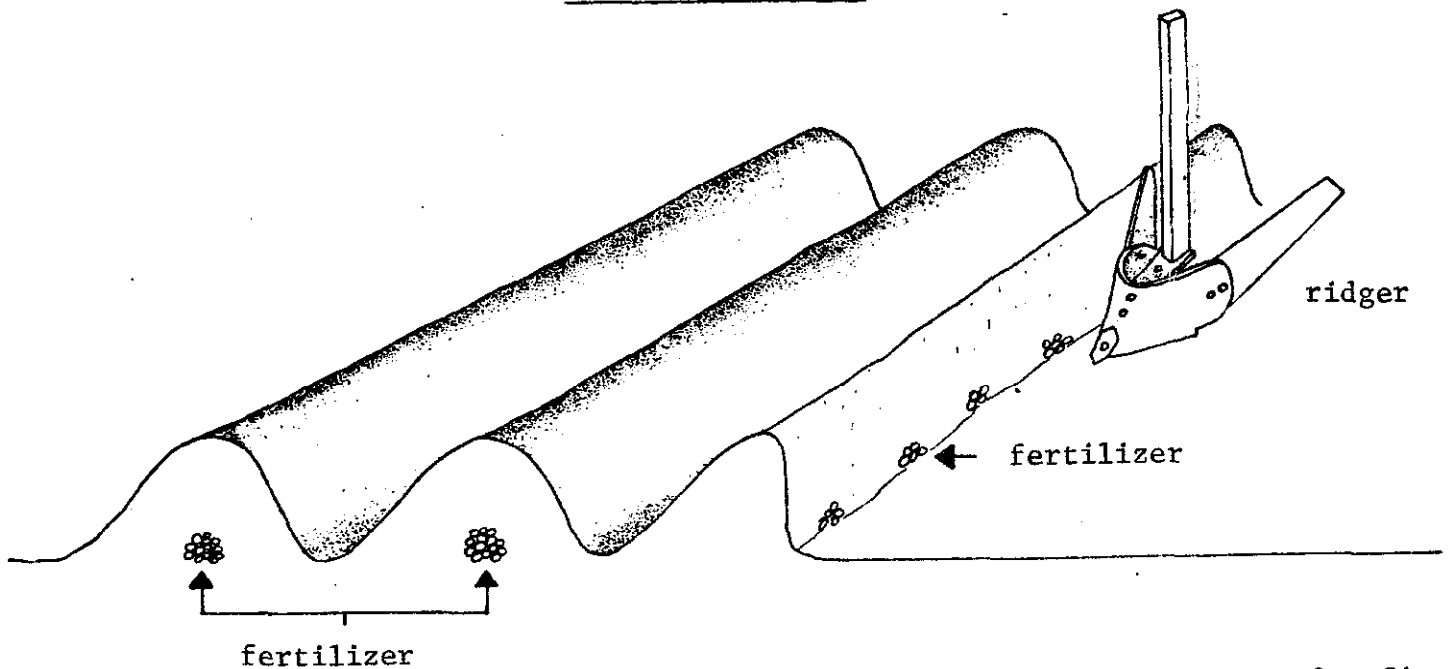

Source: Dineur, Op. Cit.

### Banking Peanuts

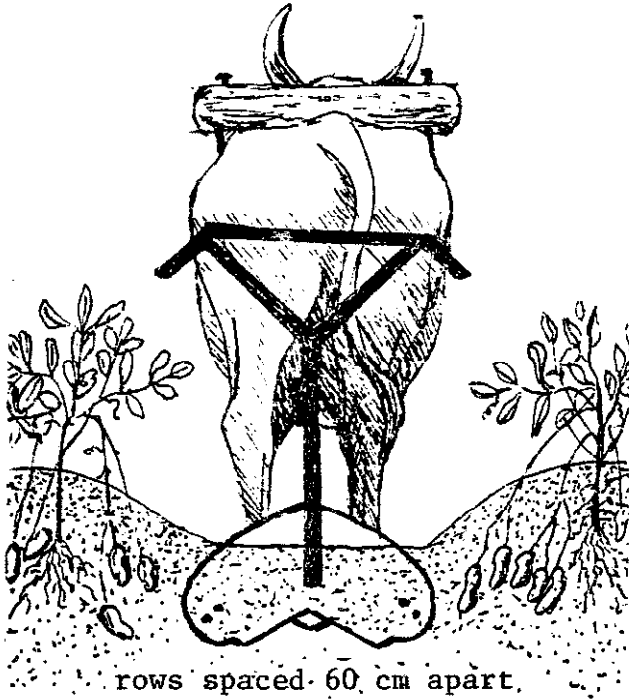

gle animal usually can supply the power needed for this operation.

### Lifting Peanuts with a Sweep

Because peanuts grow underground, a carefully adjusted weeding sweep can be an effective harvesting device. A sweep adjusted to uproot peanuts is called a lifter. In theory, peanuts are planted early enough so that the soil still has humidity when the crop is harvested,

since once the ground hardens, the stems holding the pods become brittle. They break when the soil is loosened and many peanuts are lost.

In practice, the ground is often hard or hardening by harvest time. As a result it is extremely important to adjust the lifter correctly. The operator sets it to slice under the root zone. The entire horizon of soil containing the peanuts is "lifted". As it is lifted, the soil is broken apart by the leg arm of the sweep. The peanuts will remain attached to the plant, but will have been freed from the hardening crust of earth.

Afterwards, it is easy for workers to pull out the plants and pile them, upside-down, so the pods dry in the sun.

A 30-40-cm V-sweep is well suited for the work; it is long enough to cut under the plant and stiff enough to remain level. Longer blades are more flexible, and in hard soil, set the blade in a slicing rather than a pushing position by fixing it in the lowest part of the slot on the leg (page 141).

Depth of work increases as the shaft/wheel assembly is raised and decreases as it is lowered. The blade must cut below the peanuts, but not so deep that it creates extra work for the team. Depth varies according to the variety of peanut and soil conditions, but generally falls within an 8-12 cm range. The nose of the blade should pass 2-3 cm under the plant; establish the proper depth of the cut by trial and error. To find out if the cut is too shallow, use a hoe to dig under an area where the lifter has been used. If there are peanuts, the cut was too shallow, and the wheel must be raised.

No horizontal regulation is necessary.

A strong team is needed for lifting because the work is at a deep level and the ground may be hard. When the lifting is done with oxen, the standard plow yoke is used. If the longer weeding yoke is used, the team veers when the blade hits a very hard pocket of earth. This occurs toward the top of hills and in

### Lifting Peanuts with a Sweep

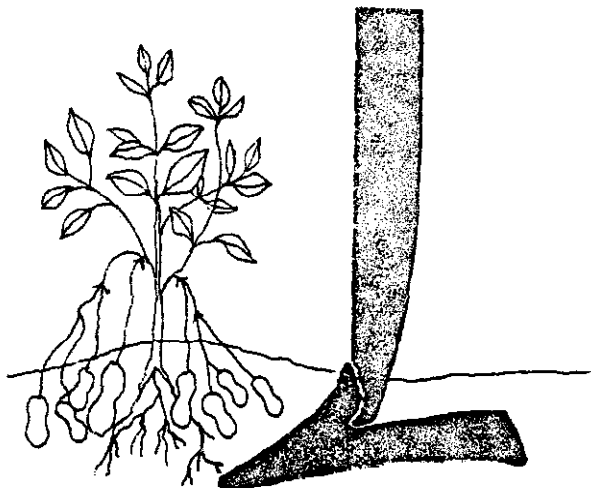

Nose of blade cuts just underneath entire plant.

portions of the field where the ground is raised or contains a high clay content.

The wedge-shaped three-animal hitch should be used if donkeys do the lifting. If four donkeys are used, the strongest pair is put in the back.

If the soil is not too hard, a cultivator can be used. The teeth are arranged in a tight wedge and the wheel is set close to the beam. The method is useful where peanuts have been sown on traditional wide ridges, since these



ridges tend to be soft underneath and break apart easily. Where the crust is very hard, the flexible quality of the tines makes penetration difficult; once below the crust, the ends of the teeth (shovels) catch in hard pockets, jump, and drive the machine upward, making cutting depth difficult to maintain.

# 8. Economic and Technical Assistance

Farm planning assistance, equipment options, and financial help are basic elements of many animal traction programs. The programs are designed so farmers can choose a combination of animals and equipment that will meet their individual needs. The combination is called a technical package. It includes animals and materials, as well as the advice, information, and instruction of extension agents.

Increasingly, the approach of extension services is to offer a number of standard technical packages which allow agents to accommodate individual needs and preferences and at the same time supply growing numbers of farmers with basic organ-

ized support.

## Farm Planning Assistance

Farmers thinking about using animal traction probably have considered its advantages already. Of equal importance is an understanding of how animal traction will affect the overall farm operation. This is where an animal traction instructor can be especially helpful.

Instructors should visit the

fields which the farmer intends to plant during the forthcoming season, and the fields left fallow. Only after understanding the existing pattern of land and labor use, and how the farmer calculates yearly needs, can an advisor begin to see where and if animal traction can be used to advantage.

Understanding how and why a farmer uses traditional cropping methods takes both time and great effort. This effort is required in order to match plans and needs; quick judgments concerning the use of animal traction easily can lead to failure.

After studying each situation, an instructor can offer advice concerning the purchase of equipment, how much must be produced to cover the cost of expanded operations, whether donkeys would be more efficient than bulls, and how the use of animals would affect the distribution of labor. It is extremely important, for example, to point out that animal traction increases the amount of manual labor needed for land preparation

(clearing), planting, and harvesting, and decreases the amount needed for primary tillage and weeding. Other points concerning labor include:

- Traditional fields can be plowed before laborers hoe them into the mounds or ridges where crops will be planted. The labor saved in this operation can be used to plant additional lands plowed with the animals.
- In mid-season, laborers might be busy weeding traditional fields and unable to help weed fields plowed by animal traction. These fields, therefore, could be arranged so the farmer and the draft team can weed them alone. If crops are grown in regularly-spaced rows, the animals will be able to walk between them and pull a weeding device. This concept can be demonstrated by laying a weeding yoke across four lines or ridges representing a planted field. The farmers can then see where the animals will walk and where the weeding plow goes. The line tracer, used to mark the rows before seeding, can also be demonstrated.
- Additional lands planted would not exceed the maximum number of hectares the family labor force could effectively harvest.

# Equipment Options

A number of factors must be considered when choosing equipment: type of crop, area cropped, climate and soil conditions, availability and type of animal power, potential of local artisans to repair and manufacture parts. Equipment must be durable, affordable, and easy to transport, use and maintain.

Many farmers have recognized the economy and versatility of the multi-purpose breakdown toolframe and purchase it as the core of an equipment package which includes a number of standard attachments. Frame-based equipment is popular because it is easy to move and can be fitted with an assortment of relatively inexpensive blades that achieve various tillage objectives.

For many African farmers, the concept of a toolframe is not new. A handhoe which can be fit-

ted with a mounding blade, a ridging blade, and a weeding blade is especially designed for options. In programs where toolframes are used or available, agents can help farmers understand the versatility of animal-drawn equipment by showing them toolframe options--moldboard plows, ridgers, weeders, cultivators, and peanut lifters.

A one-piece, one-purpose tool appears less complicated and less expensive to beginning farmers, but can cause them trouble later. A non-adaptable moldboard plow lets them turn many hectares of land, but unless they hire extra laborers to ridge and/or weed it, the crops suffer and the yield is poor. They may solve the problem later, by purchasing a ridging plow or a cultivator, or they may decide that animal traction is too expensive and simply return to traditional methods.

Ultimately, it is less expensive to purchase a multi-purpose toolframe with attachments than to buy a set of single-purpose tools, unless those specialty tools are

locally made and are cheaper than an imported toolframe. Although toolframes look complicated, attachments are easily changed.

### Locally-Made Equipment

Many of the tools used by farmers can be manufactured locally. Yokes, harnesses, harrows, line tracers, plowshares, ridger points, and many toolframe parts can be made by village artisans who are given a model, prototype, or picture to work from. The equipment is often less expensive than imported goods, and it is more readily supplied to farmers.

In some programs, instructors encourage village blacksmiths, carpenters and leathermakers to attend clinics or workshops where they can learn additional skills and techniques. Credit to purchase new tools or materials may be extended to those who attend.

Quality control and tool standardization should be major objectives of training programs, so

that artisans can produce replacement parts for local or imported equipment. Individuals, equipment centers, or farmer associations can purchase, stock, or sell them as needed.

Skilled artisans also can supply custom-made equipment such as yokes, harness, sweeps, and sleds. Some artisans work at regional or national manufacturing centers, where wagons, toolframes, and other types of equipment are produced on a large scale.

## Credit for Equipment

Without financial help, many traditional farmers would not be able or willing to buy animals and animal-drawn equipment. Those with few or no cash reserves could not risk precious food or animal stores for the potential benefits of new methods. Those who could afford

the materials might consider it too great a risk if the program were new and the quality of related technical assistance unproven. As a result, many programs offer farmers credit or loans.

Two approaches have been used to extend credit to farmers; either the animal traction instructor and/or local extension agent handles applications, contracts, equipment distribution, and payments, or the agricultural supervisor or a special credit supervisor handles these functions. Administrators increasingly favor the second approach because instructional agents feel that their image and effectiveness as teachers is hampered when they are forced to collect loan payments.

Whatever the arrangement, the ability and willingness to repay a loan is based on the ability and willingness of extension services to deliver proper tools, skills, and support. From the farmer's viewpoint, the continued presence, interest and guidance of a qualified field instructor is a prerequisite for repayment of the loan; without

this support, a return to traditional methods is the only logical and economical choice.

The experience gained in past projects has led to the development of credit systems based on low-interest, medium-term loans. The project may be financed through grants or national banks, or it may operate with its own earnings.

In some credit systems, the farmer pays 5-10 percent simple interest on a 2-5 year loan. The loan usually is reimbursed in a series of equal or increasing annual payments which may begin after a one-year grace period. Rebates may be offered to farmers who make full, early repayment. Because cash down payments are thought to discourage new farmers, most projects accept the purchase of animals, yoke and chain, or harness equipment as ample sign of commitment.

As part of the loan agreement, farmers may be required to do some or all of the following:

- Produce a minimum of one or two hectares of a government-marketed cash crop and concur with extension-recommended

cropping procedures, including use of hybrid seed, fertilizer, pesticides, planting and weeding procedures.

- Comply with an animal health care plan including construction of shelter, designation of compost area, prepayment of one-year vaccination and deworming treatments, growing and storing forage for dry-season feeding, and obtaining animal insurance or maintaining substitute animals.
- Participate in an extension-organized clinic on equipment assembly, adjustment, repair, and maintenance.
- Agree to pay penalty on overdue payments, or in case of foreclosures and repossession, to pay outstanding debt and/or depreciation costs.
- Become a member of a group or association of animal traction farmers which stocks supplies, organizes instruction, and maintains a common fund. In some cases, the group is chartered and lends money to members who are unable to make annual payments.

(Examples of equipment title and payment records are found in Appendix E.)

## Credit for Animals

In some areas animals may be available only through project-run holding stations or permanent ranches. Animals are bred, castrated, raised, and trained by project personnel, and then sold to farmers. Or animals may simply be imported, medically screened, and then sold, either by themselves or as part of a larger animal/equipment technical package.

Farmers requesting loans for the purchase of animals may have to meet the following preconditions:

- Provide an animal care plan (see above).
- Purchase a "Health Card". This is a prepaid form or ticket which lists both scheduled and actual treatments or checks performed by veterinary personnel. The card is purchased each year; it may be a standard feature of an animal insurance policy.
- Enroll in an animal insurance policy program. An increas-

ingly popular idea with programmers and farmers alike, the policy covers credit-bought animals lost to disease or accident. Premiums are paid annually.

- Become a member of an animal clinic. In some programs, farmer associations purchase and stock veterinary supplies to ensure against national shortages; animals are then grouped and treated by trained veterinary personnel. Vaccination days, or organizational meetings of the association, may be used as forums where preventive medicine, disease control, or animal nutrition are discussed.

## Procedures and Controls

The credit officers or supervisors cooperating with animal traction personnel may perform these duties:

- Identify credit candidates and fill out application forms. The application includes information on the size and status of the farmer's operation and his or her ability to meet pre-

conditions of the loan.

- Write the contract. The farmer, credit officer (or extension agent acting as credit officer) and national project organization each receive a copy. The animal traction agent may serve as witness to signing of the contract.
- Visit farms and ensure that preconditions of the loan are met and maintained through the life of the contract; that is, that animal shelter, vaccination schedule, equipment care, and the clinic and meeting attendance requirements are met.
- Collect annual payments on loan and insurance premiums; write yearly report/summary.
- Handle all defaults, foreclosures, repossessions, deferrals, rebates, and late payments.

In addition, the officers may order and deliver equipment; help organize training clinics for farmers, artisans, agricultural and veterinary personnel; and establish credit for animal traction farmer associations. Associations with common funds may be awarded credit to buy material stocks; in some cases the size of the common fund may determine the amount or terms of



individual credit extended to members. Credit officers may report or review the effectiveness of agents or agencies supporting borrowers.

### When Credit Is Not Available

Animal traction can be economically feasible even when credit is not available. For example, some farmers may be able to use their equipment to do contract work. A person who owns just a moldboard plow or a ridgeplow can use it to maintain rather than expand present operations, and then rent out services to other farmers. A farmer who can purchase a locally-made wagon can begin to pay for other equipment by selling transportation. Such possibilities can and should be pointed out to people with limited interest in animal traction and to those who do not qualify for a credit package, but who can afford a wagon or a simple plow.

# 9. Animal Traction Extension

Many countries have agricultural extension services of some kind in which locally-based extension workers or agents visit farmers and advise them on new plant species, pests and diseases of crops, and the use of fertilizers and pesticides. Extension agents understand the need for farmers to produce more for the national economy and are expected to help farmers increase their production to meet both the family's needs and those of the national government.

People who work small farms, however, may not view changes in methods of production as beneficial, for several reasons. Farmers whose needs have been met traditionally at the family and village level may

be satisfied with their current agricultural production level and feel no need to increase production.

Social or cultural practices and traditions may dictate the types and number of crops grown, the cropping method, and even when crops are planted or harvested. Farmers using traditional tools and techniques for many years know how much work is required for a certain harvest. Changing to animal traction or to a new type of crop involves taking a risk; farmers may, as a result, be reluctant to try it.

Extension agents provide the support necessary to encourage the farmers and reduce risks of failure from improper use of new systems. Extension programs can provide edu-

cation and equipment, and health care for the animals. The success of an animal traction program may depend upon the availability of these services to farmers.

## Extension Education

Extension education is a way of supplying new ideas, information, and technology to people who are far from schools or who have no time to attend classes. The teacher, or extension agent, is a trained specialist who lives in a small town or village and circulates to outlying communities where people have shown interest in improving traditional skills or developing new ones.

The extension agent's classroom may be a cornfield, forge, family kitchen, shop or marketplace, or dispensary; the student is usually a successful, long-practicing professional farmer; the method of teaching is informal discussion, demonstration, and application.

While it is ultimately

the village extension agent who becomes the farmer's key resource on animal traction, it is often a special instructor who has the job of popularizing the method in a given region. The instructor may be an outside technical assistant such as a Volunteer, missionary or private consultant, or a trained agent of the country's agricultural service.

### Animal Traction Instructors

The animal traction instructor shows farmers the advantages of the method and helps them acquire animals, tools and practical skills. Instructors also help local artisans learn to make and repair animal traction equipment.

The instructor must ensure that farmers will continue to receive local support after that agent has left the village. This is accomplished by transferring instructional skills to local extension personnel. In the field, animal traction specialists transfer

skills to veteran agents at work-shops and clinics, during coordinated farm visits and often through informal contact. In some instances, the instructor may be assigned a counterpart who is his or her assistant, and finally, replacement. This assistant may be the local general agent, the agent supervisor, or a member of a cadre of national animal traction instructors. In older, well-developed programs, the village agent has become the "specialist".

### Instructional Settings

Animal traction instructors may be assigned to work at a regional center, where group instruction is the central activity, or in a centrally located village, where field visits constitute the bulk of the work.

When instructors are assigned to a central village, they may be expected to visit and work in the surrounding villages. The

village of residence is selected for its accessibility by road and for its staff of supportive government personnel, such as medics, veterinary nurses, agricultural supervisors or general agents, primary school teachers, or other administrative staff. Sometimes called a pilot village or village center, it is a natural location for supply distribution, demonstrations and meetings because it is a hub of traditional market and social activities. Thus travel between the central village and those surrounding it is part of the normal, established pattern of the villagers.

Instructors may be given sets of demonstration equipment and funds to buy and maintain teams of draft animals. They live and work in the village and visit the surrounding areas on a regular basis. As farmer interest grows, instructors may become involved in systems of local and national support, such as:

- farmer associations or cooperatives which supply parts, equipment and veterinary supplies.
- workshops where artisans build

and repair animal traction equipment.

- training sessions for agricultural and veterinary personnel who already work or intend to work with farmers who use animal traction.

Regional centers are usually located on the outskirts of a town or area administrative center and serve a broad geographical zone. These stations are often composed of residences, barns, workshops, storehouses, trucks and a staff of animal trainers, herders, fieldworkers and extension service trainees. These centers may serve as administrative points for pilot villages. The instructor is responsible for coordinating a number of programs, including courses for both farmers and agents in animal husbandry and training, and equipment maintenance. There might also be programs in stock breeding, artisan training, and crop trials. During the cropping season, group training is suspended and the instructor makes regular visits to villages, fields, and workshops where techniques are being put into practice.

Assignments may vary because farmer reaction to instructional settings varies. Some farmers will not use technology that requires them to seek training, equipment or services outside the village. Farmers also may object to being organized in non-traditional groups while at the center. Farmers who are willing to try new methods expect the attention and interest of an instructor who is nearby and who has time to listen, visit fields and give personal assistance.

#### Guidelines for Field Visits

The instructor must be present the first time farmers use a new tool, and until they show that they can adjust and handle it. In practice, this means finding out when and where the farmer is going to plant each crop, recommending which fields can be plowed, maintained, and harvested with draft equipment, and being there when it is done.

Agents should listen and

observe, respect standards of social courtesy and obligation, and explain and demonstrate useful techniques in order to earn the confidence and trust of farmers.

Although relatively short assignments make it difficult, the instructor must be able to speak the farmer's language. This effort, however limited, is a sign of interest and commitment. It allows the instructor to establish the social relationship which often precedes a business relationship.

A fundamental approach to instruction requires the agent to adjust the tool and demonstrate the technique before the farmer begins. Until the farmer gets the feel of the tool--sees what it does, and what it is supposed to do--he or she cannot be expected to understand how an adjustment affects the performance of that tool. This learning process and the fact that a given tool, used under different conditions (soil; power of animals) must be custom-adjusted, make it obvious and critical that the instructor establish a program of

initial and follow-up visits for each farmer.

A sample visitation and instruction form is given in Appendix E.

### Cooperation Between Extension Agents and Instructors

Many of the small villages within the animal traction instructor's reach are served by a resident general agricultural extension agent who knows each farmer and who visits those who are using techniques promoted by the national extension organization. The village agent's knowledge of local language, customs, and existing farm practice makes him/her a valuable colleague and resource for the animal traction instructor. The agent's knowledge of individual farmers' abilities and interests makes him/her a natural, informal counterpart.

Working with village agents by accompanying them on their rotational field visits is the easiest yet most frequently overlooked

method of reaching the farmer. The agent is often in the field or spends the night or several days at a family farm or village. Field visits should be arranged beforehand at the monthly meeting of the agricultural supervisor, at a market, or by leaving messages.

It is important to visit both traditional and agent-supervised fields. The latter may be grouped into sections or "blocks", where the same crop (usually a cash or hybrid variety) is sown by individual families. Agents want instructors to meet these farmers because they have already shown interest in new technology. The more traditional farmers may be harder to visit. Their fields may be widely scattered, they may have shown little interest in new crops and techniques, and agents may not have had the time or interest to visit them. Meeting these farmers is often a matter of instructor initiative.

The tendency of instructors and extension agents to work independently of each other has been observed in many projects. Unde-

fining official relationships, conflicting work schedules, cultural and even occupational differences are cited as causes of the problem. The fact remains, however, that instructors who spend all of their time with farmers not only deprive themselves of the valuable experience of the extension agent, they also deprive the agent of valuable animal traction skills. Veteran agents who ignore newer methods because it means more study or work or exposure to the authority of an outsider are soon unable to supply farmers with the information they need.

The instructor can take several steps to expose village agents to animal traction and prepare them to assume responsibility:

- Express interest and participate in meetings held by the agent supervisor. Because animal traction is part of a growing package of technology offered to the farmer through extension services, instructors who are isolated from the information and problems discussed at these meetings cannot do their jobs. Meetings usually are held monthly, or as necessary, and all village

agents within the supervisor's area must attend.

- Coordinate field visits. Touring fields with the local agent is a good way of meeting farmers and learning about their techniques. Once farmers have begun to use animal traction, the instructor should continue to work through and with the local agent. Agents should be encouraged to assist in demonstrations and field instruction; they should be notified well in advance and briefed on the operation to be performed. It is helpful for the instructor to chart the skills of each agent; efforts should be made to expose him or her to all techniques. For an example of a chart used in the field, see Appendix E.
- Organize clinics/workshops. Agent supervisors and area supervisors are often receptive to the idea of organizing demonstrations for village agents. During the off-season it is easy to arrange two- or three-day sessions in animal training and/or equipment maintenance. When the cropping season begins and ground is cultivable, short demonstrations can be scheduled on market or meeting days when all or some agents will be in the same village. Because they will have come from considerable distances and must return the

same day, it is extremely important to have animals and equipment ready to go and to keep demonstrations short and to the point.

- Encourage agents to use animal traction. Many agents hire laborers and farm several hectares of crops for personal consumption and sale, or as part of a subsidized trial or demonstration program. The animal traction agent can encourage the agricultural agent to buy or rent a draft unit, or obtain a program-funded demonstration unit to effect this operation.

## Demonstrations

In some areas where animal traction is being introduced for the first time, the instructor may promote interest by demonstrating techniques in the fields which belong to the village agent, school, youth club, or farmer association.

Open demonstrations are generally well received, but must be scheduled when the ground is workable--the time when farmers are busiest and may not attend. Individual demonstrations are effective but



inadvisable if they involve labor output that may be seen as a gift, or if they indicate favoritism. The most effective demonstration is an indirect one.

One way to provide an indirect demonstration is to maintain a small field or fields using a combination of traditional and animal-powered labor. One problem with instructor-maintained fields, however, is that some farmers may attribute success to the instructor's special resources or abilities.

Ideally, the land under cultivation should be located along roads or major paths where farmers can see the work being done. Permission to use the land is given by the village chief, mayor, or whatever person or council controls land use. Compensation for use of the land may be given in the form of labor (the instructor helps the landowner plow, weed or transport some of his crops), or in cash or credit supplied by the project. The field could be located in the block managed by the local extension agent.

While instructors could plow, weed and transport their crops alone, or with the aid of a counterpart or village agent, they could not clear, plant, or harvest without hired help. These operations require intensive use of hand labor and traditional farmers depend on spouses, children, and often hired labor to accomplish them. By hiring labor, instructors not only generate interest in their work, they demonstrate that what they teach is an integrated system, combining manual and animal-powered techniques.

The advantage of practicing agriculture in the village is twofold: it lets farmers see what agents are talking about, and it lets the agents see what the farmers are talking about. By personally using established local technology, the agents begin to see the impact of proposed changes from the farmers' viewpoint. The agents become sensitive to the limitations and potential of tools, particularly the ones they are selling. All too often, equipment tested at agricultural stations fails to perform in

the less-than-optimal conditions of the field. Techniques recommended for their cash-producing potential may upset delicate labor balances that farmers have learned over centuries to respect.

Once farmers have begun to show interest and to use animal traction, instructors should concentrate all of their efforts in the fields. The success or failure of these first few animal traction farmers often determines the extent of subsequent interest. At this point, the instructor may want to loan his or her animals and equipment to a school or youth club, to a village cooperative or farmer association, or to a local extension agent.

### Schools and Youth Clubs

Many village primary schools and youth clubs grow cash crops and use the profits to buy room furnishings, sports equipment, musical instruments, or other supplies. They often get organizational, finan-

cial or instructional assistance through government channels.

By cooperating with local teachers, club officers, agricultural personnel, and regional youth club supervisors, the animal traction instructor can familiarize these groups with draft agriculture. This cooperation might include:

- A visit to the group's field.
- A pre-arranged visit to a classroom or club meeting.
- An invitation extended to the group to attend a demonstration and participate in "hands-on" activity. The demonstration could be in the instructor's field, or in the school or club field. The student or farmer is allowed to lead or drive the team, or handle equipment. Beginners find it easy to harrow.
- Labor-sharing. The group helps the instructor plant or harvest his or her fields (manual assistance); the instructor, in turn, helps plow, weed, or harvest the group's fields (animal assistance).

### Invitational Competitions

The use of animal traction has been successfully promoted by hold-

ing competitions among farmers.

For example, in Benin from 1970 to 1976, competitions were organized by cooperating local extension personnel and funded by a joint United Nations-Beninese Agricultural Ministry animal traction project.

Arrangements were made with the help of local animal traction farmer associations. The focal point of each competition was an hour-long contest where farmers used their oxen to plow adjacent strips of cleared land. Points were awarded for depth and regularity of plowing, obedience of animals, appearance of animals, and speed of work. Prizes were given to all contestants; a typical first prize was a sum equal to the yearly payment on an equipment/credit package. Other prizes included replacement ploughshares, traction chains, salt licks, and tubes for cart tires. No entry fees were required. All bulls were given free preventive treatment for trypanosomiasis.

Animal traction agents who would like to try such a demonstration should keep these points in mind:

- Ideally, the event should be scheduled toward the end of the cropping season (between weeding and harvesting operations) when farmers have time to attend. Though preparations may be made through the local animal traction farmer association or by farmers in the instructor's village, all animal traction farmers within the area covered by the instructor should be invited. Planning should begin 6-8 months beforehand. The event should fall on a market day.
- The event should be public. In Benin, it took the appearance of a festival. The village chief, family heads, and market vendors were notified well in advance. Interest spread primarily through word of mouth. Farmers, village agents, instructors, and supervisors from distant areas came to watch; the event became an occasion for numerous social activities.
- It should be organized through established channels; participation and cooperation of agricultural personnel--national, regional, local, and animal traction--is one of the goals of the competition. Invitations should be extended to appropriate officials and arrangements made for their comfort.
- The competition should be preceded by a morning-long veter-

inary clinic. A team of regional veterinary medics could treat the animals, assess their health and physical appearance, discuss feeding requirements, disease control and prevention, and organize schedules for prophylactic treatment.

- The field should be cleared by the local animal traction association or by participating farmers, then divided and staked into plow strips 50 m long and 12 m wide, measured by the village agent. After the contest, the field could be used to grow a seed crop of forage grass for participating farmers.
- Judges should be agricultural agents, supervisors, and veterinary medics from outside the immediate area.
- A project-funded, instructor-hosted reception should be given after the competition for all participants, village officials, visiting officials, and organizers.

# Appendix A

## Animal Power

The formulas below can be used to approximate the size of the hitch (animal or animals) which will supply the desired amount of power. "W" is the weight of a single animal, "d" is the draft requirement (this is taken from the chart on page 17), and "c" is the animal's power coefficient. For a bull, "c" is 8 or 1/8 of W); for a donkey, it is five (or 1/5 of W). If animals will be working new or hilly land, or will be harnessed in yokes rather than collars or breastbands, coefficients should be increased to 9 or 10 for bulls, 6 or 7 for donkeys.

The first two formulas (below, A and B) are used to calculate the weight of animals that will be used alone; the other formulas allow for the losses of efficiency that result when multiple hitches are used.

Assuming a farmer needed a draft unit that supplied a total of 57 kg of force, the following calculations would be made.

$$W = \frac{57 \times 8}{1.85} \text{ or } W = 246$$

or, each of two bulls would have to weigh 246 kg. (Note that, used alone, this animal will supply 1/8 x 246, or 30.8 kg draft. In a

---

A	One bull	$W = 1/8 d$
B	One donkey	$W = 1/5 d$
C	Pair of animals	$W = dc/1.85$
D	Team of three animals	$W = dc/2.55$
E	Team of four (tandem pairs)	$W = dc/3.12$
F	Team of five	$W = dc/3.5$
G	Team of six	$W = dc/3.78$

---

team of two, it is 7.5% less efficient, supplying only 28.5 kg draft--or half of the 57 kg needed.

$$W = \frac{57 \times 5}{1.85} \text{ or } W = 154$$

If the farmer could not buy or obtain a pair of bulls, the donkeys might be a practical alternative. However, donkeys work only 3-4 hours per day, so the farmer might consider buying two pair and working them in separate morning/

afternoon shifts. If the donkeys in the area were of a small breed, it might take three or four animals to deliver the necessary power:

$$W = \frac{57 \times 5}{2.55} \text{ or } W = 112$$

or each of three donkeys would have to weight approximately 112 kg. Or

$$W = \frac{57 \times 5}{3.12} \text{ or } W = 91$$

or each of four donkeys would have to weight about 90 kg if the draft requirement of 57 kg were to be met.

# Appendix B

## Animal Nutrition

Several systems have been devised which make it possible to express the nutritional requirements of work animals and formulate diets based on corresponding nutrient and energy values of feeds. A simple and practical method used in many parts of Africa is based on a standard called the forage unit. A forage unit is defined as the net energy value of one kilogram of barley. It is the energy contained in the proteins, carbohydrates (starches), and fats which compose the barley and which the animal does not lose through elimination of feces, urine or gas, or in heat (work) produced by digestive organs. Net energy is defined as the energy available for maintenance of body functions --heartbeat, respiration, heat, motion. Energy intake above maintenance level is stored as fat or used for production or work. The abbreviation U.F. (Unité Fourragère)

designates one (1) forage unit.

### Energy Needs: Bovine Animals

Oxen are ruminant. This means that they swallow large amounts of unchewed food as they graze and eat. Later, they regurgitate this feed in small portions (boluses) and chews it thoroughly. The micro-organisms (bacteria and protozoa) in the animal's forestomach (rumen) break down fibrous feeds (including the cellulose) and use them as a substance for growth. These micro-organisms and their products then become digestible nutrients for the animal. For this reason, ruminants can derive many nutrients from roughage whereas other animals cannot.

Deficiencies in energy, protein, phosphorous and Vitamin A are likely to occur in animals grazing forage on arid land. If the land has very poor forage, the animals may use up more energy obtaining feed than they can get from feed. This creates a net loss of energy to the animal. An energy supplement must be given daily to the animal, but protein, phosphorus and Vitamin A supplements may be effective if provided only once a week. Daily hand feeding of a supplement is the best method for updating the amount consumed.

The following energy requirements for ruminant draft animals have been established at agricultural research centers in Africa:

#### Bovine Animals

- The maintenance energy requirement--the amount of feed energy needed to keep a non-working animal from gaining or losing weight--is represented as "E". Tests show that a 300-kg idle bull needs the equivalent of the energy contained in 2.6

kg of dry barley grain--or 2.6 U.F.--to sustain its weight. The bull's maintenance requirement is expressed as  $E = 2.6$  U.F. (CEEMAT, Manuel de Culture avec Traction Animale, 1971).

- The size of the animal affects its maintenance requirement:

Daily maintenance requirements of oxen (idle).  
(Taken from two tests; figures are approximate values.)

Weight of Animal	Maintenance Requirement ("E")
Kg	U.F.
100	1.2
150	1.6
200	2.0
250	2.3-2.5
300	2.6
350	2.9
400	3.2
450	3.5
500	3.8

- The total daily energy requirement is the sum of the maintenance ration--the food energy needed to keep a non-working animal from gaining or losing weight--and a quantity which can be called the work ration. CEEMAT suggests that for an oxen doing light work, the total energy required is "E" (maintenance) + 1/2 E. This can be easily expressed as  $T = 3/2 E$ . CEEMAT further suggests



for oxen doing medium work  $T = 2 E$ , and for heavy work  $T = 5/2 E$ .

Using this information in conjunction with tables which give the energy values of various feeds, the farmer and/or extension person can formulate or "compound" a ration of roughages and concentrates which can be expressed as a specific number of forage units. For example, if a 300-kg ox is going to be used for plowing (heavy work), it needs about 6.5 U.F. ( $T = 5/2 E$ ; or  $T = 2.6 \times 5/2 = 6.5$ ) to maintain its weight. Later in the season, when lighter weeding and cultivating operations are performed, the diet would be reduced to about 5 forage units ( $2.6 \times 2$ ). If the animal were used for occasional cart work, as might be the case during harvest operations, or if it were being trained, the energy requirement would range between 3 and 4 units (light work).

## Energy Needs: Equine Animals

Horses, donkeys, and mules are non-ruminant animals. They do not store food and later chew it, as oxen do. In addition to their molars, they have a set of upper and lower front teeth suitable for grinding roughages. (Bovines have no upper front teeth: they pull the grass loose, swallow it, and later bring it up and chew it with their rear molars.) With equines, digestion begins in the mouth, continues in the stomach, and is completed by various intestinal organs.

Equine animals must be fed with respect to their particular digestive functions and abilities. Where an ox can be fed its entire ration at the end of the day, a working horse, because of its smaller stomach and faster rate of metabolism, should be given its feed in small quantities. This facilitates complete, regular digestion of nutrients and ensures that the animal will be comfortable when working.

A common plan is to feed the grain (concentrate) ration in three equal parts, morning, noon, and night; the roughage ration 1/2-3/4 at night, the remainder being given in the morning and at noon.

Body weight being equal, horses have somewhat higher maintenance energy needs than oxen because they are naturally more active. Their activity is related to their more nervous disposition and higher rate of metabolism (rate of using digested nutrients to build and repair body tissue and to produce heat and work). But horses can store more energy in their muscles than oxen and this explains their ability to produce greater bursts of power and work at a faster rate.

Research in both tropical and temperate climates shows that equine animals need about twice their maintenance requirements when doing medium-to-hard work. The following guidelines are suggested by CEEMAT for equines:

Idle horse: 2.5 U.F. per day  
(Assume 250-kg horse.)

Working horse: 5.0 U.F. per day  
(Assume 4-5 hrs. pulling cultivator, medium soil.)

Idle donkey: 1.5 U.F. per day  
(Assume 100-kg donkey.)

Light work donkey: 2.5 U.F. per day  
(Assume 3 hrs., cultivator, light soil.)

Continuous work donkey: 4.0 U.F. per day  
(Assume 5 hrs., cultivator, light-medium soil.)

Unfortunately, very little data is available on the value of feeds as they apply to equine animals in the tropics. Thus it is necessary to use the tables adapted for bovines when formulating diets. Experience indicates that the values are generally applicable with the exception of straws. Bacteria in the ruminant's stomach enables it to digest straw and low-grade roughages effectively. Equines can derive very little energy from coarse fiber, so care must be taken to supply them with better hays and fodders.

# Nutrient Needs of Draft Animals: Protein, Minerals, Vitamins

It can be assumed, generally, that a ration formulated from high-quality pasture grasses and grains will supply, in addition to an animal's energy needs, the proteins, vitamins, and minerals necessary for overall health. However, imbalances can result from seasonal unavailability of feeds or conditions which affect the quality of feed. As pasture grows older, for example, the minerals tend to move from the leaves and stems downward into the roots where the grazing animal does not get them; or, if soils are low in phosphorus (as is often the case on tropical range), the grass which derives its nutrients from the soil also will be low in phosphorus. Such considerations make it advantageous for the stockowner to have some know-

ledge of the classes of feeds and their nutritional composition.

The protein and mineral needs of draft animals are summarized in the table below. While nutrition lists have shown that these needs--with the exception of salt, which is lost in sweat--do not increase as the animal performs more work, serious problems can result from deficiencies. Without protein, the body cannot renew cells that form muscles and other tissues. Minerals are important in the growth and maintenance of skeletal structure as well as in metabolic and digestive function. Calcium and phosphorous values are given in most feed composition tables; if they are absent in natural feeds, they must be given as an additive in the concentrate mix (grains or meal) or in a block lick with salt.

A standard mineral supplement is made of two parts calcium, one part phosphorus and one part salt. Bone meal is prepared by boiling or steaming fresh bones and then pulverizing and drying them. This

## DAILY PROTEIN AND MINERAL REQUIREMENTS FOR DRAFT ANIMALS

Animal	Digestible Protein	Calcium	Phosphorus	Salt
Bull	80-130 grams per forage unit (U.F.)	5 g per 100 kg live weight	3-5 g per 100 kg live weight	5 g per 100 kg live weight
Horse (250 kg)	325 g	15 g	9 g	free access system (salt block)

feed contains about 20% calcium and 10% phosphorus, a good ratio of these important minerals.

Requirements may be adjusted depending on the elements available in the pasture where the animal grazes. A mineral-starved animal should not be given free access to a lick or loose mixture. Instead, mix the correct dose in with its concentrate.

A ration is a combination of feeds which provides the daily

requirements for energy, protein, vitamins and minerals. Since the chemical composition or nutritional value of grain or pasture is determined by soil, weather, and other environmental factors, rations should be formulated using data obtained from regional testing centers. When this is not possible, other tables may be used, but with attention to the system of measuring as well as basic principles of feeding.

# Feeds and Feed Composition

The feed given to draft animals is called forage. Forage sometimes refers to the leafy, fibrous, or tuberous portion of plants consumed by animals, but it may also refer to any edible portion of the plant. Forage may be wild or domestic, fresh or dry, standing (as in the field or forest) or harvested and stored. When green forage is fermented in a pit or silo, it is called silage.

It is important to distinguish the various types of forage materials, know their basic nutritive properties, and understand how they are analyzed before using feed composition tables. (Feed Composition Tables are found on page 188.)

Forages are divided into roughages and concentrates. Roughages include green pasture (pasture grass), hays, legumes, and fodders. They are classified together because of the fiber content. When

a feed analysis is made on roughages, all of the moisture is removed and composition is given on a "100% dry matter basis". That is, only the plant solids are analyzed.

Concentrates include low fiber, highly digestible feeds like grain, grain by-products, and high protein meals. They are analyzed on an "as-fed basis", which means the feed is analyzed as it is normally fed to the animal.

## Pasture

Pasture refers to any grass or legumes, usually green, which are fed to animals. Pasture may also refer to the land area where the plants grow and where the animals graze. Pasture is highest in nutritional value when it is young and succulent (high in moisture).

## Green Chop or Soiling Crop

Normally, work animals are allowed to graze. At times, however, plants are cut and brought to

them. Cut pasture is called green chop or soiling crop. The rainy season work schedule may limit daytime grazing and the farmer may want to feed fresh-cut pasture in the stable or paddock area rather than send animals out at night.

A maturing pasture loses moisture. Feed composition tables reflect water loss by the increasing percentage of dry matter and decreasing amounts of digestible protein, minerals, and digestible energy (forage value). Most grasses with a dry matter content between 20 and 30% have greater than maintenance nutrient content. Grass with a dry matter range of 20-40% is sometimes classified as "standing hay".

## Hay

Hay is any grass or legume which is cut (or mown), dried, and preserved as a winter or dry season forage. The dry matter content of hay ranges from 40-85%. Hay has a high nutrient quality when it is

cut before it goes to seed. Cut grass is allowed to dry, or "cure," in the field. Because the grass contains moisture, it must be turned to expose the underside to sunlight; otherwise, it will mold. The hay is cured when it snaps without releasing juice or moisture (this usually takes 1-3 days in the tropics). Hay is stored in an enclosed compartment (an old house or hut is suitable if not termite-infested) where light and wind cannot enter and cause further drying. In the humid tropics where molding is highly likely, air circulation (wind) is an advantage, and storage should allow for this. If late season rains make it difficult to cure hay, grass can be preserved by making it into silage (see below).

Good quality hay is green in color, slightly brittle, has a clean, fragrant smell, and is free of dirt, stones, and woody stems. If hay is offered from a rack or trough, it does not pick up dust; dusty hay should be sprinkled with water before it is fed to keep animals from developing heaves

(coughing condition) which can lead to pneumonia.

Most kinds of grass hay (except legume hay) of the same quality or grade have about equal nutritional value. The definition of "hay" varies. Some tables, especially those based on arid area

research, list hay under grasses having very high percentages of dry matter. In the table below, which is adapted from some of these studies, roughages are grouped according to the following general characteristics:

Roughage	% dry matter	% digestible protein*	digestible energy (U.F.)
Green pasture	under 20	over 6	over 0.6
Standing hay	20-40	2-5	0.5-0.6
Cured hay	40-85	1-5	0.4-0.5
Grass straw	85	under 1	under 0.4

\*Values based on 100% dry matter.

## Straw

Straw is dead or dying grass. It contains very little moisture, is high in coarse fiber and low in nutritional value. Bovine animals, because of unique digestive abilities, are able to derive more nutrients from the fibers than horses or donkeys. Straw is especially useful

when animals are kept on low-energy diets (during the off season); then it should be fed with protein and mineral supplements. Straw contains few vitamins; these are supplied in the high quality hays and silages which should comprise the greater part of the roughage diet.

## Legumes

Legumes include nitrogen-fixing plants like clover, alfalfa or beans which are much higher in protein, calcium, and Vitamin A and D content than grasses. Legumes can be offered fresh, as silage or as hay. Their ability to "fix" or put nitrogen into the soil makes them an important part of crop rotation schemes. Planted in association with grass crops, legumes improve both the soil and the crop, adding fertilizer (nitrogen) to the pasture mix. The leaves (and stems) of cowpeas, soybeans and peanuts can be dried as hay or wilted and preserved as silage after the seed is harvested. These feeds, when mixed with drier, coarser forages, improve the nutritional value of the ration, and also have a mild laxative effect that helps the animal eliminate the indigestible fibers. However, fast-growing lush young legumes in the pre-flowering stages may cause bloat or colic when offered to cattle or equine animals, and therefore should be

avoided or restricted.

## Fodder

Fodder is the combination of leaves, stems, husks, hulls (peanut shells), cobs, or grain which is chopped, mixed, and usually fed in a dry state. Corn (or sorghum) grown specifically for animal feed and cut before the grain matures is called corn fodder. Corn fodder may be cured, ensiled, or fed fresh. Shock corn is similar to fodder but the grain has been allowed to mature before the plant is cut and chopped. Corn stover is a mixture made of dried stalks, leaves, and husks; the ear (cob and grain) has been removed. Tree fodder is a term applied to the leafy tree branches which graziers (herders) cut for their animals. In Africa, many species of Acacia are used as tree fodder. The leaves and stems are green during the dry season; they are high in calcium and phosphorous.



## Grain

Grain is the seed portion of cereal plants--corn, sorghum, millet, and rice. Grains are low in the bulky fibers that constitute the plants which produce them; as a result, they are classified as "concentrates". They are high in starch value (carbohydrates) and therefore an important source of energy to work animals that have limited time to graze. They are not low in protein, but the proteins found in grain are not as easily digested as those found in legumes. Animals not accustomed to eating grain may find it unpalatable; in these cases the grain should be partially crushed and a small quantity of salt or brewers' wet meal added (see below). The feeding of shock corn or fodder/grain mixes is an effective means of introducing grain into the diets of animals raised on pasture. Some tests made in West Africa approximate the total nutritional value of grains as compared to quantities of mixed natural pasture:

1 kg of crushed millet = 7 kg of  
pasture  
1 kg of crushed corn = 9 kg of  
pasture  
1 kg of cotton seed = 6 kg of  
pasture.

Some grains have a U.F. value greater than one (1) because of high fat content. Fat has 2.25 times more energy per unit than carbohydrates.

Overfeeding of grains results in serious digestive problems. Generally speaking, an animal should not be fed more than 2 kg of grain per day. Horses may "bolt" grain by swallowing it whole or only partially chewed. This can be prevented by mixing grasses or legumes in with the grain or by placing several large, round stones in the feed.

## Grain By-products

These include the hulls, brans, polishings and germs (centers) of the grain kernel. They are separated from the meaty, starchy portion of the kernel during the milling process. The hull is the hard, outer shell of the seed. Softer

layers called bran may be found between the hull and the meat, or in the outermost coating (wheat has no hull but rather bran layers). Polishings are powdery residues that are separated from the finer flour when rice grain is milled. Brewers' wet meal is the residue of sprouted millet, corn or sorghum which is boiled to make beer. In Africa brewers' meal is sometimes mixed with water and offered as a mash to horses. Grain by-products (except for hulls) are generally high in fiber, protein and minerals and are less expensive to feed than whole kernels.

### Seeds and Seed Cake

The seeds and seed cake of cotton plants (oil seed) and bean, pea, and peanut plants (legume seed) are high in energy and fat and may be fed whole or in a processed form. When the hulls (shells) of peanuts or cotton are removed and the oil extracted from the raw meat, the

or cake. Sometimes the meal contains some hull material; it almost always contains some oil. Meal and cake have the same composition, but meal is loose and finely ground whereas cake consists of large chunks.

### Silage

Silage is succulent forage material which has been cut, chopped and preserved in an air-tight compartment. It is a palatable, inexpensive feed which is higher in moisture and nutrient content than either hay or dry fodder. It is extremely useful in areas where seasonal dryness limits natural grazing. Green forage, preferably corn or sorghum fodder, young grass, and legumes are wilted in the field to a moisture level of 60-70%. This takes from 2 to 24 hours depending upon the humidity. The forage is dropped when stems can be twisted without breaking, but before leaves show any signs of dryness. The chopped plants then are layered and

compacted in a 2mx2mx2m earth-walled pit (or longer trench of equal depth, slightly pitched to allow for drainage). The pit is covered with earth and a natural fermentation process occurs. If the plant material has been tightly compressed without air pockets or leaks, no molding or rotting should occur. Hay, dry fodder, or partially-wilted legume tops (such as the leaves of the harvested peanut plant) also may be ensiled, but in drier regions, some water may have to be sprinkled in with the forage as it is trampled down to ensure that fermentation occurs. (For further information on silage, see ICE Reprint No. 15a, Utilization and Construction of Pit Silos.)

## Calculating A Ration

Ration calculation can be demonstrated by the following

examples using Table A (see page 168).

Example 1. To calculate the amount of Sudan Grass #1 needed to meet the U.F. maintenance requirement of a 300-kg bull. The value in Table A for digestible protein, phosphorous, calcium and U.F. are based on 100% dry matter. However, one kg of fresh roughage has less than 100% dry matter. Therefore, the first step is to adjust the amount of dry matter per kg of fresh roughage to 100% dry matter. For Sudan Grass #1, the percentage of dry matter per kg is 29.7%. One kg of fresh Sudan Grass #1 is adjusted to a 100% dry matter basis by the following calculation:

$$\frac{1}{29.7\%} = 3.36 \text{ kg (100\% dry matter basis)}$$

This means that 3.36 kg of fresh Sudan Grass #1 contains one kg of dry matter. Step two is to locate the U.F. maintenance requirement of a 300-kg bull. The daily maintenance requirements of oxen chart (see page 176) shows the U.F. value of a 300-kg bull as 2.6. Step three is to calculate the amount of fresh Sudan Grass #1 needed for a 2.6 U.F.

TABLE A: COMPOSITION OF SOME AFRICAN FEEDS

	% Dry Matter	% Digestible protein	% Phosphorous	% Calcium	U.F. (Forage units) for ruminants
	----- (100 % dry matter basis) -----				
<b>GREEN PASTURE GRASSES</b>					
Sudan ( <i>Andropogon gavanus</i> )	18.0	6.2	0.02	0.35	0.66
Guinea ( <i>Panicum maximum</i> )	16.6	6.7	0.27	0.45	0.57
Elephant ( <i>Pennisetum purpureum</i> )	18.5	6.9	0.26	0.60	0.58 *
Digitaria	15.3	9.4	0.23	0.49	0.60
mixed fresh shoots	17.7	18.2	0.45	0.29	0.77
mixed young pasture	24.8	5.8	0.24	0.31	0.61
same w/some legumes mixed in	25.6	7.5	0.10	0.87	0.72
<b>DRIER PASTURE (standing hay)</b>					
Sudan #1	29.7	4.2	0.12	0.34	0.57 *
Sudan #2	34.6	3.5	0.15	0.39	0.63
Guinea	34.7	3.6	0.22	0.54	0.57
Digitaria	32.7	2.5	0.33	0.64	0.54
mixed - average quality	30.8	3.2	0.18	0.30	0.48
mixed - poor quality	39.6	2.0	0.10	0.48	0.35
Para grass ( <i>Brachiaria</i> )	28.6		0.08	0.22	0.58 *
CURED HAY - average quality	64.0	2.6	0.09	0.69	0.46
<b>STRAW</b>					
Sudan	93.2	0.5	0.06	0.39	0.49
Guinea	95.7	0	0.08	0.48	0.49
Elephant	93.2	0	0.04	0.17	0.15 *
"Ivory Coast hay"	87.0	3.1	0.24	0.42	0.44
Brachiaria	94.1	0.1	0.06	0.62	0.37 *
mixed (standing or cut)	96.4	0.4	0.10	0.40	0.30
<b>GREEN LEGUMES</b>					
<i>Stylosanthes gracilis</i>	21.0	12.4	0.23	1.65	0.73
same-older	44.0	5.9	0.18	1.22	0.72
<i>Centrosema pubescens</i>	21.8	15.5	0.21	1.04	0.70
same-older	29.4	14.7	0.18	1.15	0.68
<b>LEGUME HAY</b>					
<i>Stylosanthes</i>	92.8	6.1	0.17	0.85	0.54
<i>Centrosema</i>	87.0	12.5	0.27	1.88	0.54
Peanut hay (as-fed basis)	92.1	6.3	0.13	1.19	0.40
Bean hay ( <i>Dolichos lablab</i> ) as-fed basis)	93.9	14.2	1.2	0.15	0.56
Cowpea hay ( <i>Vignas sinensis</i> ) (as-fed)	89.0	7.62	0.26	0.57	0.61
<b>FODDERS</b>					
Corn-whole young plant	21.9	4.8	0.20	0.34	0.89
Corn-same with cob forming	48.2	4.9	0.25	0.69	0.75
Corn-dry leaves+stalk+husk	93.6	0.8	---	---	0.53
Millet ( <i>sorghum alnum</i> )whole	27.4	16.9	0.54	0.62	0.70
Millet-whole plant-older	15.0	4.7	0.35	0.30	0.41
Millet-same-older	30.9	2.7	0.28	0.23	0.42
Millet-leaves+stalks dry	85.00	1.9	0.14	0.55	0.36

\* (asterisk) indicates foodstuff analyzed by Essai Rural, Upper Volta, 1978. All others analyzed by CEEMAT, Africa, 1971.

TABLE B: COMPOSITION OF SOME AFRICAN FEEDS - AS-FED BASIS

	% Dry Matter	% Digestible protein	% Phosphorous	% Calcium	U.F. (ruminants)
<b>GRAINS</b>					
Corn (coastal-West Africa)	87.0	6.61	0.34	0.03	1.05
Corn (Savanna-West Africa)	92.6	7.73	0.33	0.02	1.08
Corn (Upper Volta)	88.5	8.7	0.36	0.07	1.23 *
Millet (Upper Volta)	91.8	7.3	0.37	0.40	0.97 *
Paddy rice	87.3	4.7	0.26	0.06	0.82
Sorghum	89.9	5.9	0.29	0.02	0.92
Fonio	88.4	3.6	0.06	0.07	0.86 *
<b>BRANS</b>					
Corn (traditional milling)	86.0	6.23	0.72	0.06	0.92
Millet	92.3	9.0	0.61	0.09	0.86 *
Rice	88.6	4.16	0.41	0.09	0.42
Sorghum	90.7	6.8	0.64	0.09	0.78
<b>CAKES AND MEALS</b>					
Peanut cake	92.7	47.3	0.65	0.11	1.13 *
Cottonseed meal (industrial)	-----	21.2	1.2	0.15	TDN .56
<b>SEEDS</b>					
Cottonseed (whole)	94.4	9.6	0.49	0.11	1.05 *
Peanuts	90.8	14.0	0.29	0.12	1.11
Cow peas (Vigna)	90.4	19.1	0.42	0.17	1.06
Beans (Dolichos lablab)	89.6	19.9	0.29	0.26	-----
<b>SILAGE-wilted Sudan grass</b>					
	95.0	5.5	0.16	0.33	0.41 **
<b>LEAVES</b>					
Banana (Tanganika)	16.2	1.26	0.05	0.17	0.14
Manioc (Cassava)	27.3	9.4	0.51	0.92	0.64
Sahel acacia	60.8	10.1	1.9	3.05	0.46
Acacia albida (dry leaves)	92.8	7.2	0.15	0.23	0.69
Baobab (dry) W. Africa	91.0	5.7	0.40	1.08	0.41
<b>MISCELLANEOUS</b>					
Brewers wet meal (local)	30.7	17.6	0.41	0.26	0.80
Brewers meal dried (local)	92.3	21.6	0.33	0.03	0.87 *
Breadfruit (Artocarpus com.)	30.0	0	0.04	0.02	0.31
Mango (green/pulp) (munis)	14.5	0.16	0.01	0.02	0.18
Yam - fresh	36.8	0	0.05	0.11	0.39
Yam - dried	89.6	3.04	0.12	0.19	0.59
Cassava (manioc) - fresh	34.2	0	0.04	0.04	0.34
Cassava-dried	88.0	0	0.08	0.09	0.98
Rice husks (chaff)	92.0	0.12	0.08	0.08	0.29
Bean hulls (Vigna sinensis)	39.3	5.60	-----	0.44	0.85
Cocoa pods	92.1	4.13	0.15	0.20	0.46
Corn cobs	88.3	0	0.03	0.01	0.40
Corn-mature cob + grain chop	93.3	5.4	0.01	0.22	0.84
Whole banana	24.10	0.68	0.02	0.01	0.26
Banana pulp	24.12	0.55	0.02	0.02	0.25
Sugar cane molasses	83.3	0.9	0.03	1.49	1.04 *
Nere powder (Mali)	-----	-----	-----	-----	1.00
Rice straw	92.5	0.35	0.07	0.19	0.29

\*\*National Zootechnical Research Center, Bamako, Mali, 1974; Ensilage research project by James Lajoie, Peace Corps Volunteer Energy value is in TDN.

value. If 3.36 kg of fresh Sudan Grass #1 yields 0.57 U.F., then the needed calculation is:

$$3.36 \times \frac{2.6}{0.57} = 13.3 \text{ kg.}$$

Therefore, the bull requires 13.3 kg of green Sudan Grass #1 per day.

Example 2. To calculate the amount of Sudan cured hay to meet the U.F. maintenance requirement of a 300-kg bull, follow the same steps:

Step 1)

$$\frac{100}{93.2} = 1.07$$

Step 2)

$$1.07 \times \frac{2.6}{0.41} = 6.78 \text{ kg (U.F. value 1 kg dry matter)}$$

Therefore the bull requires 6.78 kg of hay to meet its maintenance requirements. Calculation of protein and mineral contents of Sudan grass indicates that the fresh material meets nearly all of the animals' needs, but that the hay is deficient in every category. During the dry season, then, the stockowner would give the bull a grain supplement or mix a legume hay (high nutrient value) with

the Sudan hay in order to balance the ration.

Feeds presented on an "as-fed" basis do not need adjustment for dry matter content.

To formulate a ration for a 300-kg bull:

- 1) Determine the animal's weight. Here, the weight is given as 300 kg.
- 2) Determine the maintenance requirements (per day basis).

U.F. (forage units) = 2.6 for a 300-kg bull

D.P. (digestible protein, or, in some charts "M.A.D." --matière azoté digestible) = 80-130 g per U.F., or assuming a 300-kg bull needs and average 105 g/U.F.,  $2.5 \times 105 = 273 \text{ g.}$

P (phosphorous) = 3-5 g per 100 kg live weight, or using an average of 4 g:

$$\frac{300 \text{ kg weight}}{100} \times 4 = 12 \text{ g}$$

Ca (calcium) = 5 g per 100 kg live weight, or

$$\frac{300}{100} \times 5 = 15 \text{ g}$$

NaCl (sodium chloride; salt) = 5 g/100 kg live weight or

$$\frac{300}{100} \times 5 = 15 \text{ g.}$$

3) Determine the energy value of the roughages the animal would normally consume. If left to graze freely, a bovine animal will consume between 10 and 20 kg of pasture (grass) per day. Since its digestive organs must process regular amounts of bulky material in order to function properly, it is reasonable to base the maintenance ration on roughages and the work or production ration on concentrate-supplements (grains and other low-fiber, high-energy feeds). It has already been established that 13.3 kg of green Sudan grass will furnish a 300-kg bull with its maintenance energy needs; in this example, this represents the average quality of mixed pasture grass that would be found early in the rainy season.

4) Determine the protein content of the roughage (maintenance) diet. Recall that for a work animal, protein, mineral and vitamin intake need not increase with production; only energy needs increase.

The following steps would be taken to find the number of grams of digestible protein contained in 13.3 kg of green Sudan grass:

a) One kg of 100% dry Sudan grass contains 4.2% protein, or 42 g of digestible protein per kg of dry matter.

b) In 13.3 kg of green Sudan grass there are 3.9 kg of dry matter:

$\frac{13.3 \text{ kg green Sudan grass}^*}{3.36 \text{ kg green Sudan \#1 giving 1 kg D.M.}}$

= 3.9 kg D.M.

\*Ration consumed by bull

c) In 3.9 D.M., there are 164 g of digestible protein; in the 13.3 kg of fresh grass consumed by the bull, there are 164 g protein.

$42 \text{ g} \times 3.9 \text{ kg} = 164 \text{ g digestible protein}$

This ration is deficient in protein, since the requirement is 273 g (established earlier). However, in a wet season, free-grazing situation, the animal would find a mixture of grasses that would meet all of its needs. The feeding of a protein supplement would be extremely important when the grasses begin to dry out, or if grazing time was limited to less than eight hours per day.

5) Determine the phosphorous value of the roughage.

a) One kg of 100% dry Sudan grass contains 0.12% phosphorous; or, 0.12% of 1000 g = 1.2 phosphorous per kg D.M.

b) 13.3 kg of green Sudan grass contains 3.9 kg D.M.; or,  $3.9 \times 1.2 = 4.7 \text{ g of phosphorous.}$

This ration is deficient in phosphorous, the requirement being 4 g per 100 kg live weight, or 12 g. The difference would probably be made up in the pasture mixture as long as grasses remained lush, but the stockman would be wise to furnish the animal with a mineral lick containing phosphorous year-round.

- 6) Determine the calcium value of the roughage.
- a) One kg of 100% dry Sudan grass contains 0.34% Ca or  $0.0034 \times 1000 = 3.4$  Ca per kg D.M.
  - b) 13.3 kg of green Sudan grass contains  $3.9 \times 3.4$  g of Ca = 13.2 total Ca

The bull's Ca requirement is 5 g per 100 kg live weight, or 15 g total. Again, by providing them with a mineral lick, the owner ensures the animals' health regardless of fluctuations in grazing conditions.

- 7) Salt needs. While CEEMAT suggests that 5 g/100 kg live weight is sufficient for a working animal, it may be found that a bull consumes more if given free access to a block--especially during heavy work when salt is lost in sweat. Except in the case of salt-starved animals, the free-access system works well because animals will not normally consume more than they need. Phosphorous, Vitamin A

and limited amounts of protein can be fed in a salt mix or block. The intake can be regulated by the feed formulation or texture of the block.

- 8) Calculate the work needs of the animal and determine the supplemental ration that will be fed.

A bull doing heavy work (plowing) needs  $5/2$  E, or  $5/2$  of its maintenance requirement. A 300-kg bull needs  $5/2 \times 2.6$ , or 6.5 U.F. per day.

In the example used, the bulky portion of the full ration consists of 13.3 kg of green Sudan grass; the grass has a U.F. value of 2.6. The supplemental work ration must provide about 4 additional U.F. if the animal is to get the required 6.5 U.F. These units can be supplied from any of the feeds listed in the table, but consideration would be given to these points:

- a) Cost of feed. Grain is very expensive compared to grain by-products and other concentrate feeds. It is also in short supply during the work season; most of it has been used during the dry months.
- b) Some feeds, particularly lush young pasture, legumes, and brans, have a laxative effect. Too much dry grain can also cause digestive trouble. It is generally advisable to



feed a supplement made of a combination of various feeds.

c) Animals have individual preferences and may refuse to eat the supplemental ration as given. Pre-cracking grains or adding salt, brewers' meal or bone meal to a ration may make it more palatable. The owner should make an effort to discover what the animal likes, what it digests easily, and when it will eat. Normally, an ox is fed its concentrate ration in the evening after it has grazed. However, a small portion of the ration may be given in the morning, or at noon if the animal has been allowed to graze and drink first. Animals do not work well when overly full and so it is preferable to have them eat at the end of the day.

d) Time of year determines the availability of certain feeds. Green corn or sorghum fodders are not available during the plowing season when they would be most useful. The farmer should store silage, hay and grain reserves for this heavy work period.

Suggested daily rations for a 300-kg bull doing heavy work (plowing) are given below. A 13 kg por-

tion of mixed green pasture (early wet season grasses) has an approximate forage value of 2.5 U.F. and this quantity will be consumed if the bull is allowed 6-7 hours grazing time. In practice, 2-3 hours (grazing) would be given at mid-day (after the morning work session) and the remainder would be given in late afternoon/early evening.

Examples of Daily Rations for a 300-kg Bull:

I.	(approximately equal to)
13 kg mixed green pasture	2.5 U.F.
2 kg mixed cracked corn and sorghum	2.0
1 kg peanut cake	1.0
2 kg legume hay (night-fed at stable)	1.0
Total:	6.5 U.F.

II.	
a.m.--1 kg brewers' meal mixed in 4 liters water	1.0 U.F.
13 kg mixed green pasture	2.5
4 kg mixed green chop (night-fed cut pasture)	1.0
2 kg cottonseed	2.0
Total:	6.5 U.F.

III.	
a.m.--1 kg peanut cake	1.0 U.F.
13 kg mixed green pasture	2.5
2 kg legume hay	1.0

2 kg mix wet brewers' meal	
and cracked corn	2.0
	<hr/>
Total:	6.5 U.F.

## Recommended Rations and Feeding Practices

The rations given below are intended to serve as general guidelines for establishing a successful feeding program. When formulating rations, consider the factors which may lower the benefits of the ration, including:

- Environmental factors which affect the composition and hence, nutritional value of food: soil, climate, seasonal changes, insect damage, mold.
- Animals will adapt to a wide variety of feeds, but the change must be gradual to prevent the animal from going off feed.
- Digestibility: Individual digestive ability can be affected by age, teeth, condition of digestive organs and functions, presence of

parasites, quality of food. In feeding ruminants, changes in diets from high roughage to low roughage (high concentrate) affect the population of microbes in the rumen. Rapid changes can result in serious upsets in the animals' physiology. Any major changes should be made gradually over a two-week period.

Rations should be altered as experience and observation suggest.

In addition to the recommended guidelines, some specific suggestions follow on how and when to feed animals.

Note: Research and practical experience have demonstrated that the nutritional needs of animals and the nutrient values of various diets can be calculated quite accurately.

### Oxen

Oxen need pasture, grain, and may need additional protein and mineral supplements in order to meet nutritional requirements. Supplements are expensive but may be practical and necessary (especially if mineral deficiencies are present).

Here is an example of a feeding

schedule for a working ox kept on pasture:

5:30 am 1/2 kg cracked corn +  
1/2 kg peanut cake  
(mixture)  
(7-12 noon) (plowing)  
12-4 pm short drink followed by  
free grazing (super-  
vised); Let the ani-  
mals graze toward a  
stream or well and  
give it free  
access to water.  
(4-6) (plowing)  
6 pm short drink  
7 pm mixture containing 1-1/2  
kg crushed grain sor-  
ghum + 1/2 kg peanut  
cake or cottonseed  
meal  
8 pm free access to water and  
mineral block; stall-

feeding of 2 kg of  
legume hay. Water,  
hay and mineral block  
are left where the  
animal can reach them  
during the night.

#### Roughages

Bovine animals need roughage  
(pasture grass, hay) in order to  
maintain basic nutritional and  
energy needs. Most oxen grazing on  
young pasture can consume enough  
feed and nutrients to maintain a  
healthy status in six to eight hours.  
Oxen that do not have sufficient  
time to graze must be fed cut pas-  
ture in the stall at night.

CHART A RECOMMENDED PASTURE ALLOWANCES FOR OXEN (idle or working)\*

Weight of ox (in kg)	Type of Pasture (in kg per day)					
	Mixed Green Grass (Early- Mid Rainy Season)	(approximate number of grazing hours needed)**	or	Mixed Green Grass--Drier (Mid- late Rainy Sseason)	or	Mixed Cured Hay (Stall-fed)
200	16.5	(5 hr)	or	11	or	6.5
250	20	(6 )	or	13	or	8
300	22.5	(6.5 )	or	15	or	9
350	25	(7.5 )	or	16.5	or	10
400	30	(8.5 )	or	20	or	12

\*based on the maintenance needs of ruminant animals as found on page 176 and on energy values of African pasture grasses as recorded by CEEMAT and Essai Rural.

\*\*based on study by Lander (1949); testing was done during the rainy season.

Chart A approximates the amount of roughage an ox needs daily.

Other types of roughage which oxen eat include fresh legumes, grasses, hay, straw, corn or sorghum fodder, and tree fodder. These products should be included in the diet whenever possible.

When work schedules do not permit adequate grazing time, oxen should be stall-fed hay or cut green pasture at night. Estimate the amount of pasture to feed at night by using the following method:

- 1) Estimate the amount of pasture consumed daily by the animal. For example, assume an ox eats 3 kg of pasture per hour (rainy season; grass in abundance). Multiply the number of hours the animal grazed by three.

$$\begin{array}{r} 5 \text{ (number of hours grazed} \\ \text{during day)} \\ \times 3 \text{ (kg of grass eaten per} \\ \text{hour during rainy season)} \\ \hline = 15 \text{ (kg grass eaten while} \\ \text{grazing during the day)} \end{array}$$

- 2) Subtract the amount of pasture eaten during free grazing from the total amount it needs. This gives the approximate kg of pasture to cut and feed at night.

$$\begin{array}{r} 22.5 \text{ (kg pasture needed by} \\ \text{300-kg bull--obtained} \\ \text{from Chart A).} \\ - 15.0 \text{ (kg pasture eaten during} \\ \text{free grazing)} \end{array}$$

$$\begin{array}{r} \hline = 7.5 \text{ (kg roughage to feed at} \\ \text{night)} \end{array}$$

- 3) Establish a suitable standard of measure by using a bucket or container. Pack the bucket with grass, weigh it, and then subtract the weight of the bucket. Check the weight of the measure every few weeks, adjusting the amount to allow for changes in moisture content of the grass.

#### Grain and Other Concentrates

Grain is the seed portion of cereal plants such as corn, sorghum, millet and rice. Grains are low in fiber and thus are called "concentrates". Grains have a high starch content (carbohydrates) which is an important source of energy to work animals that have limited time to graze. Other concentrates include beans and mill by-products, such as peanut cake, cottonseed meal, and brewers' meal (described on page 185).

#### Amount of Concentrate to Feed

For working animals, use the table below (Chart B) to determine

the amount of concentrates to feed. This should provide sufficient energy needed by working animals. Feed intake varies with the weight of the animal and the work load. The terms "light," "medium" and "heavy" are used to define the work load.

The concentrates may be decreased by 1 kg if the roughage intake includes 2 kg of legume hay or 5 kg of green legumes.

For non-working (idle) oxen, feed the following amounts of concentrates:

- Off-day during the work season--light work ration (see Chart B).
- Off-season or dry season--one-half light work ration (each day).

	<u>Hours of Work</u>		
	<u>LIGHT</u>	<u>MEDIUM</u>	<u>HARD</u>
Ox pulling 1/8 its weight	2-3	3-5	5-7
Donkey pulling 1/5 its weight	1-2	2-4	4-5
Horse pulling 1/7 its weight	2-3	3-5	5-8

<u>CHART B CONCENTRATE NEEDED FOR WORKING OXEN</u>			
Weight of ox (in kg)	Amount of Grain to Feed per Day (in kg)		
	At Light Work	At Med. Work	At Heavy Work
200	1.00	2.00	3.00
250	1.25	2.50	3.75
300	1.30	2.60	3.90
350	1.45	2.90	4.35
400	1.60	3.20	4.80

The figures are based on maintenance needs of ruminant animals (see page 176) and the assumption that one kg of grain (corn, sorghum, millet, and/or barley) has a forage value equal to one (one kg of 100% dry grain = 1 U.F.; see explanation of forage value on page 175).

### When to Feed Concentrates

- Working oxen: Feed 1/4-1/3 of the ration in the morning, the rest in the evening. Do not feed when the animal is hot (i.e., immediately after work) or after it has had large quantities of water.
- Non-working oxen: Feed the entire ration in the evening when the animal returns from pasture.

### How to Feed Concentrates

Feed concentrates in a container that cannot be knocked over. Stake or corral oxen so each has access to a separate container. This way you can see how much and what each animal eats. Also, it keeps more aggressive individuals from taking other animals' food.

Experiment with grains to find out which ones an animal likes. If an ox refuses to eat grain, crush it and add a little salt. Leave it near the ox throughout the night. A little water added to cottonseed will make it a little more palatable.

Give the animal fresh rations every day. Keep the feeding container clean.

### Feed Supplements

A diet consisting of high quality grass, hay, and grain should supply protein, vitamins, and miner-

als necessary for overall health.

However, nutrition deficiencies can result from unavailability of feeds or conditions which affect the quality or digestibility of feed. The following supplements should be fed to provide balanced diets:

- Protein: Mature oxen should be provided with concentrates that supply additional protein. Examples of this would include feeding a daily allowance of one of the following: 1/3 kg peanut cake, 3/4 cottonseed meal, 1 kg wet brewers' meal, or 1-1/2 kg sorghum bran.
- Minerals and salt: Animals should have free access to a salt block lick which contains two parts calcium, one part phosphorous and one part salt. If a lick is not obtainable, mix bone meal (or other source of calcium and phosphorous) and salt in the feed. (For quantities, see Appendix B, page 192.)

### Equines

Equine animals must be fed with regard to their particular needs and digestive capabilities. While an ox can be fed once at the

end of the day, a working horse should be given feed in small quantities. This practice facilitates complete, regular digestion of nutrients and ensures that the animal will be comfortable while working.

#### Horses and Mules

- 1) Feed the right amount. Total daily consumption of roughages and concentrates combined should be between 0.8 and 1.0 kg for every 40 kg of live body weight. A 320-kg horse, for example, should get between 6.4 and 8 kg of feed per day.
- 2) Idle horses are fed chiefly on grass and hay. One-third to one-half of the roughage should be grass or legume hay. (Straw should not be fed to horses, for they do not have the ability to digest it.)
- 3) For working horses, about half of the total ration should consist of roughage, half grain and other concentrates.
- 4) Working horses should be fed ration in three equal parts at morning, noon and night. Idle horses may be given the entire ration in the evening, or half in the morning and half in the evening.
- 5) Grain should be partially crushed to aid digestion.
- 6) A few handfuls of chopped

straw or dry corn leaves can be offered along with the grain. These feeds encourage the animal to chew more thoroughly.

- 7) Both idle and working horses need one-third of a high protein supplement like bran, brewers' meal or cottonseed meal mixed with the grain. Brewers' meal can be mixed in water and given as a drink.
- 8) Allow animals free access to a mineral/salt block lick, or add bone meal and salt to the concentrate ration as recommended in Appendix B, page 192.

#### Recommended Rations

For a 300-kg horse the recommendations are:

Idle: 3-1/2 kg cured grass hay + 2 kg legume hay + 1/2 kg grain mixed with several handfuls of wet brewers' meal with the grain;

or

4 kg green pasture containing legumes + 1 kg grain + 1/2 kg cottonseed meal;

or

3 kg dried pasture grass (standing hay) + 2 kg legume hay + 1/2 kg grain + 1/2 kg sorghum bran.

Medium work: 2 kg green pasture + 2 kg legume hay + 3 kg grain + 1/2 kg brewers' meal;

or

2 kg green pasture (legumes + grass) + 2 kg cured grass hay + 3 kg grain + 1/2 kg cotton-

seed meal (or cowpea meal or peanut cake).

As workload increases:

- Replace cured grass hay or green pasture with legume hay.
- Increase the concentrate meal portion by 1/2 kg and decrease the grain portion by 1/2 kg.

As workload decreases:

- Decrease the grain portion and increase the roughage portion.
- Adjust the ration according to the weight of the animal using the rules given above (1-3). Use the rations given for the 300-kg horse as a guide for establishing the proportions of various feeds.

Donkeys

Generally speaking, donkeys are fed like horses. However, donkeys can subsist on very coarse forages like straw, crop stubble, and leaves and stems of desert plants. Unlike horses, they will not overeat when given free access to pasture or grain. They prefer to nibble throughout the day.

Donkeys can be fed according to the following rules:

- 1) Allow free access to pasture whenever possible. Otherwise, supply the donkey with fresh hay and straw.

- 2) Provide a 1/3-kg mixture of grain plus oilcake daily.
- 3) Provide a 90-110 kg working donkey with additional grain along with the above rations, according to the following guidelines:

light work: 1 kg additional grain

medium work: 1-1/2 kg additional grain

hard work: 2 kg additional grain

(Larger donkeys should be given grain in proportionate amounts.)

- 4) Provide free access to mineral/salt lick and water as with horses.



# Appendix C

## Disease Recognition and Control

### Anthrax (Bacillus anthracis)

The disease is caused by a spore which can live in the soil for many years. It is ingested in pasture, feed, or water. It may also be transmitted into a wound from brush, fertilizer or contact with another animal (rubbing; wound to wound contact), or through fly or mosquito bites. Incubation is 1-5 days. All warm-blooded animals and humans are susceptible.

Symptoms: High fever, prostration, colic, diarrhea, increased heartbeat and respiration, swellings around the throat, blood in milk, urine or mucus; upon death, lack of rigor mortis, enlarged spleen, liver, and kidneys.

Treatment: Early administration of massive doses of penicillin

sometimes effective.

Prevention: Rotate pastures; spray animals with fly repellents. Nine types of serums, bacterins and vaccines are now available. There may be veterinary intervention according to the area. Quarantine infected herds.

Remarks: Carcasses and contaminated materials should be buried at a minimum depth of two meters. A disease of lower animals that is transmissible to humans.

### Brucellosis (Bang's disease, undulant fever)

An infectious disease which causes pregnant heifers and cows to abort the fetus, retain afterbirth, or develop uterine infections. The bacteria are transmitted through ingestion of feed or bedding, or through licking of wounds, vaginal discharge

or aborted fetus. Also affects sheep, goats, swine, horses and humans with varying symptoms and results.

Symptoms (in cattle): Aborted fetus (7-8 months); relaxed placenta, enlargement of joints and testicles, sterility, uterine infection, reduced conception rate.

Treatment: French vaccines are in experimental stage.

Prevention: Vaccinate calves 2-10 months old in areas where disease is present. Slaughter infected animals.

Remarks: The meat of slaughtered animals may be consumed if cooked. Pasteurization kills the bacteria in contaminated milk.

#### Blackleg (Blackquarter)

A highly infectious and fatal disease affecting cattle and sheep. Young animals are particularly susceptible; older animals develop some natural immunity. The disease often occurs regularly in the same herds and localities. The bacteria lives in the soil; it is ingested or enters the body through a wound and then spreads through the herd by way of contaminated feed (saliva or other secretions from the infected

animal carry the bacteria). Incubation 1-5 days.

Symptoms: Lameness, swellings in joints, back, loin, and hind-quarters (these are gas-filled lumps which crackle when pressed). Also: fever, loss of appetite, rapid breathing, depression. Death in two days after onset of symptoms.

Treatment: Massive doses of antibiotics in early stages of disease.

Prevention: Immunization of calves 1-4 months old. Afterwards, these animals are vaccinated every 6-12 months until three years of age.

Remarks: Burn and bury carcasses; the disease does not affect humans, but the meat should not be consumed.

#### Contagious Bovine Pleuropneumonia

This is a chronic respiratory disease which causes the lungs of the infected animal to fill with liquid.

Symptoms: Chronic cough, diminished appetite evidenced by irregular grazing habits. Affected animal may be too weak to move with the herd. Elevated temperature. Discharges may contain pus, blood, or be of unusually strong odor. Pinching of nostrils will induce a short, dry cough.

Treatment: No known treatment.

Prevention: Annual vaccination.

Remarks: Cured animals which have been infected with this disease do not make good draft animals. Lesions in the lungs (damaged tissues) make the animal short-winded.

Pasteurellosis (Shipping fever; sometimes called "Hemorrhagic Septicemia", but this is considered a misnomer.

The disease is caused by viruses and/or bacteria commonly present in the lungs or mucous membranes of cattle, horses and other animals. Strains vary in their ability to cause disease, but animals under stressful conditions (shipping, transfer to new environment) are particularly susceptible. Exposure, overcrowding, physical tension, improper feeding lower the resistance of the infected animal and increase the presence and strength of the micro-organism.

Incubation 2-10 days.

Symptoms: Diarrhea, loss of appetite, variable high temperature, difficult breathing, prostration, discharge from eyes and nose, swelling in neck region. Can kill in 2-3 days.

Treatment: Isolation of infected

animal; use of antibiotics and/or sulfonamides.

Prevention: Annual vaccination; good management and feeding.

Remarks: Newly acquired draft animals should not be trained, castrated, or dehorned in the days following transfer. Use of animals which have been infected and recovered from the disease may be uneconomical to use due to lesions on the lungs.

Rinderpest (Cattle plague)

A highly contagious virus affecting cattle. Three forms are known, two of which result in very rapid death and one which is chronic. Transmission of the disease is primarily through ingestion of contaminated food or water. Incubation 3-6 days.

Symptoms: Fever, poor appetite (slow emaciation of chronically affected animals), dehydration due to diarrhea, discharge from nose and eyes, salivation, swelling and closing of eyes. Lips, muzzle, vaginal membranes bear white spots inside a raw ring 1/2 cm wide.

Treatment: No known treatment.

Prevention: Annual vaccination; life-long effective vaccine now available.

## Tetanus (Lockjaw)

This is a highly fatal disease which is usually the result of an infected wound. Bacterial infection causes the release of powerful poisons into the bloodstream. Horses and donkeys are particularly susceptible, but ruminants, swine, and humans also are affected. Incubation: one week to several months.

Symptoms: Increasing stiffness of the head and neck with accompanying difficulty during chewing and swallowing. The inner eyelid draws over the eye. After 24 hours, the animal shows extreme sensitivity to noise, becoming excitable and frightened. Spasms occur in the neck and back, the head and neck extend. The animal will not lie down, remaining standing until close to death.

Treatment: Tetanus antitoxin administered immediately after appearance of first symptoms.

Prevention: Immunization with antitoxin and annual booster. Proper disinfection of all wounds.

# Parasites and Parasitic Disease

Parasites are organisms that live at the expense of another organism or "host". Internal parasites live inside the host in blood, muscle, or other body tissue which provides a favorable environment for growth and reproduction. External parasites live on or under the skin, or pierce the skin and feed on the animal's blood. In general, parasites do not kill the host, but cause a chronic state of ill-health which is reflected in low productivity and high susceptibility to other diseases. Young, pregnant, lactating, or malnourished animals are those most seriously affected by parasites.

## Helminthiasis

This is a general name for any one of a number of conditions related to the presence of worms in the digestive system. While inside the host animal, they absorb food,

interfere with digestion, or reduce the efficiency of blood-forming tissue. Sometimes the worms migrate to other parts of the body. The life cycle is completed when the female lays eggs which are passed out in the feces and which continue to incubate in pasture, manure, bedding, water, or intermediate host. Except in the case of hookworm (see below), the eggs are ingested by the new host (the draft animal) and hatch inside its digestive tract.

**Symptoms:** Chronic weight loss, variable diarrhea and constipation, weakness, lowering productivity. Other symptoms are specific to the type of worm.

**Treatment:** Numerous products are available and should be used as recommended by local veterinary or sanitary officials. Commonly used anti-worm treatments (anthelmintics) are phenothiazine, thibenzole, and Vadephen. Administration varies from 2-4 times per year according to size and type of animal, and climatic conditions which affect the presence of the particular organism.

**Prevention:** Rotation of pastures and use of sanitary watering troughs reduces the likelihood that an animal will ingest par-

asite eggs; good feeding and management coupled with regular administration of anthelmintics (as prescribed).

**Remarks:** Worms may be classified in three major groups:

#### ROUNDWORMS

Ascarids affect pigs, cattle, poultry, and especially horses; they are intestinal worms which can impair growth or cause death in young animals. Worms may migrate to lungs and cause damage.

Hookworms are blood-sucking worms which are ingested or which enter the skin and migrate to the intestine, causing gastro-enteritis and anemia in ruminants and pigs.

Strongyles affect horses and mules, causing anemia, emaciation, colic, and sometimes death. Some species of the worm appear in the feces.

**FLUKES** are found in all animals, especially those which graze in wet or marshy areas. The liver is damaged and fluids leak into the body cavity, giving the animal a "pot-bellied" appearance. Ruminants are especially susceptible. The disease is called Distomatosis.

**TAPEWORMS** primarily affect sheep and goats, but may be present in horses or cattle.

Worms in the digestive tract can be very long and rob the animal of nutrients. Worm larvae may live in the bladder or muscle tissue and cause general weakness and lowered productivity.

### Mange (Scabies)

Highly contagious skin disease transmitted by mites which burrow under the skin and breed in large numbers. The itching causes the animal to rub, depositing the organism on trees or fences where other animals then contract the disease.

Symptoms: Hair falls out, grey scabs appear, skin thickens and develops folds. Itching is intense and may cause animal to bite or rub itself, causing open lesions. With demodectic mange (present in West Africa), small bumps appear on the shoulder, neck, and trunk.

Treatment: Cut the hair; apply iodine, creosote or mixture of two parts oil, one part kerosene.

Prevention: Isolate infected animals; keep harness, bedding and stable area clean. Spray animal with solution of 0.66% lindane. Burn hair clippings of treated animals.

Remarks: Mange is sometimes classified along with scabies because both are transmitted

by mites and are similar in other respects. It may be noted that Chorioptic Scabies or leg mange is present in West Africa, especially in equine animals.

### Ringworm

This fungus grows on the outer layer of skin, causing itching, and, in severe cases, secondary infection due to rubbing. Ringworm is contagious, affecting all animals and humans.

Symptoms: Raised, quarter-sized patches of hair with crusty edge, especially on the ear, nose, eyes, lips, or any area that tends to be moist or humid. The patch becomes raw when the animal rubs or bites it in an attempt to relieve the itching.

Treatment: Cut the hair, remove the scabs with a brush or curry comb; wash with soap and boiled water and apply full strength iodine, creosote, or fungus ointment every 2-3 days.

Prevention: Isolate infected animals; clean and disinfect brushes and tack (harness) regularly; ensure that stable is well-ventilated and sanitary.

Remarks: Fungus diseases are most common during humid seasons, with animals recovering during the dry months.

## Ticks

Ticks attach themselves to the skin, burrow, and feed off the animal's blood. They also spread fevers: piroplasmosis, brucellosis, typhus, East Coast Fever, heartwater. Grazing animals are most likely to be affected because ticks cling to tall grass and attach themselves to the passing host (especially during summer months).

**Symptoms:** Ticks are visible on the underside of the animal and around the ears. The animal kicks up at its belly shakes its head. Eventually it becomes anemic and starts to lose weight.

**Treatment:** Dab on kerosene, turpentine, or parafin.

**Prevention:** Regular application of insecticides as recommended by local veterinary service. Sprays or dips can be very effective if done every 5-7 days; commonly used products include Tigal liquid (mix one part tigel in 800 parts water), Tox (2.5 parts in 1,000 parts water), Gamatox (1 kg in 500 liters water). For ear ticks, use Lindane, Gamatox (mix 1 kg in 500 liters of water), Tox (2.5 parts/1,000 parts water).

## Trypanosomiasis

This is a disease caused by

parasites called trypanosomes which live in the blood and which are carried by the tsetse fly (glossina), or other biting insects. The disease affects the nervous system, making the animal lethargic and chronically thin; sometimes death results. All animals and humans are affected. Zebu cattle and horses are particularly susceptible.

N'dama cattle and some donkeys have a high resistance. The disease is especially prevalent in a band or "vector" which crosses the African continent just north and south of the equator.

**Symptoms:** Intermittent fever, poor appetite, chronic thinness (especially seen in sunken flanks), swelling of lymph glands, eye mucus and watering, accelerated respiration.

**Treatment:** No known treatment.

**Prevention:** For cattle--Vaccination with Ethedium three times yearly, or with Prothedium or Berenil as prescribed.  
For horses--Vaccination with Trypadine as prescribed.

# Appendix D

## Workshop and Spare Parts Inventory

It is important for animal traction workers to keep an inventory of tools and parts which can be used to show farmers, local craftsmen and agricultural extension agents how to maintain, repair, and in some cases build essential equipment. Once farmers have seen the need for these tools and parts, workers should encourage them to cooperatively purchase and manage the inventory. They should also help artisans learn to build yokes, line tracers, and basic harness equipment that farmers cannot make alone. In some instances, animal traction workers may be able to help the artisans acquire tools or special training through the projects.

### A. Basic Tool List

metric tape measure  
hammer  
saws: one wood (crosscut saw);  
one metal (hacksaw w/spare  
blades)  
files: one coarse wood; one  
medium metal; one triangular  
file for sharpening  
saw  
wood chisel  
draw knife  
Exacto knife and spare blades  
adjustable wrenches (2)  
pliers (with wire cutter)  
leather punch or awl  
machete  
crow bar  
large clamps (2)  
one bit brace (ratchet type  
hand drill 2/assorted bits)

### B. Supplementary Tools and Supplies

oilstone (for sharpening  
knives, chisel)  
rope  
wire  
nails (assorted)  
glue (wood)  
cotter pins  
12 mm round iron (for making  
yoke bows and clevises,  
hooks, line tracer and/or



harrow teeth)  
hoof pick  
curry comb  
hard brush  
first aid kit containing:  
  disinfectant  
  sterile gauze and cotton  
  tape  
  antibiotic powder  
  antibiotic cream  
  razor blades  
  snakebite kit  
syringe and needles  
antibiotics

C. Plowframe-Related Equipment and  
Spare Parts

  nuts and bolts (sizes stocked  
    according to plowframe speci-  
    fications)  
  wrenches  
  plowframe wheels  
  plowframe wheel axles  
  tempered plowshares  
  tempered sweeps (various sizes)  
  ridger points  
  landside heels  
  plow handles  
  chain

If rubber-tired carts or wagons  
are used, the following addi-  
tional equipment should be  
stocked:

  tires  
  tire rims  
  tubes  
  valves  
  grease (for repacking wheel  
    bearings)  
  patch and glue kits  
  tire irons

Demonstration Equipment

Animal traction workers loca-  
ted in villages or areas where ani-  
mal traction has not been previously  
introduced may need animals, harness,  
and field equipment for demonstra-  
tions.

Basic Demonstration Unit

one pair of three-year-old  
  oxen  
halters (2)  
running W-harness (2)  
plow yoke (double)  
weeding yoke (double)  
weeding yoke for single ani-  
  mal  
line tracer  
plowframe  
plowframe attachments includ-  
  ing:  
  moldboard plow  
  weeding sweep or 5-tine cul-  
    tivator  
  ridger

# **Appendix E**

## **Animal Traction**

### **Instruction Forms**

Record of Instruction

Field Techniques

Construction of weeding yoke--60 cm & 80 cm options

Construction of line tracer

Construction of standard plowing yoke

Train bulls

Plowing

Weeding peanuts with 350-mm blade--single yoke

Weeding peanuts with 350-mm blade--60-cm yoke (2 bulls)

Ridging peanuts with ridger body--single yoke (1 bull)

Lifting peanuts with 350-mm blade; 2 bulls (60-cm yoke)

Combined operation--applying fertilizer and weeding cotton--500-mm blade--2 bulls, 80-cm yoke

Weeding/ridging cotton--2 bulls--80-cm yoke

	Enc. Issa	Enc. Yerima	Enc. N'Dvie	Enc. Gunou	Chef S.S. Ezzo
Construction of weeding yoke--60 cm & 80 cm options	XE	-	-	XE	-
Construction of line tracer	XE	-	-	XE	-
Construction of standard plowing yoke	X	-	-	-	-
Train bulls	DXE	-	-	XE	D
Plowing	DXE	DX	-	DXE	DXE
Weeding peanuts with 350-mm blade--single yoke	DX	-	D	D	DX
Weeding peanuts with 350-mm blade--60-cm yoke (2 bulls)	DX	D	-	D	DXE
Ridging peanuts with ridger body--single yoke (1 bull)	-	-	D	-	-
Lifting peanuts with 350-mm blade; 2 bulls (60-cm yoke)	DX	-	-	D	DX
Combined operation--applying fertilizer and weeding cotton--500-mm blade--2 bulls, 80-cm yoke	X	-	-	-	X
Weeding/ridging cotton--2 bulls--80-cm yoke	DX	D	-	DX	D

Record of Instruction (cont.)

Field Techniques	Enc. Issa	Enc. Yerima	Enc. N'Dvie	Enc. Gunou	Chef S.S. Esso
Weeding/ridging corn/ sorghum--2 bulls--80- cm yoke	D	D	—	DX	DX
Weeding/ridging corn/ sorghum--1 bull--single yoke	—	—	—	—	—
Weeding corn/sorghum-- 500-mm sweep--2 bulls --80-cm yoke	D	—	D	DX	D
Weeding corn/sorghum-- 500-mm sweep--1 bull-- single yoke	—	—	—	—	—

Code: "D" indicates that the agent attended a pre-season demonstration of the technique.  
 "X" indicates that the agent performed the operation in a farmer's field during the season with the Volunteer present.  
 "E" indicates that the agent can demonstrate the technique to a farmer without the assistance of the Volunteer.

Animal traction instructors can keep track of individual farmer's progress using a similar form.

Equipment Title and Payment Record

Buyer _____		Village _____	
<u>CASH PURCHASES</u>			
Item	Price (in CFA)	Selling Agent	Date
Wagon assembly	2500	Keros Equipment Center	6-12-72
Manure wheel (seed)	300	↓	
Weeding muggle	75		
Ridger point	150		
Harrow	1950		
Line tracer	300		
Yoke + cotter pins	800		
2 3-meter draw chains	1050		
Animal training fee	1000		

Equipment Title and Payment Record (cont.)

CREDIT PURCHASES - 5 years/5% fixed interest

Item	Cash Price	Credit Price	Annual Payment	Rebate	Date	Comment
Tool frame	5.700	7.125	1.425	285	25-12-72	A rebate is made if more than one annual payment is made at a time.
Plow	5.500	6.875	1.375	275	"	
Ridger	2.600	3.250	650	130	"	
Wearing sweep w/ 500mm blade	1.800	2.250	450	90	"	
300mm blade	.900	1.125	225	45	"	
Wagon	19.500	24.375	4.875	975	"	
	36.000	45.000	9.000	1.800		

PAYMENTS

Sector Chief	Witness	Amount	Rebate	Date	Comment
Monitor	Extension agent/volunteer			Jan. 74	
"	"			" 75	
"	"			" 76	
"	"			" 77	
"	"			" 78	

Example of equipment title and payment record used in Benin. Copies go to the buyer, the selling agent, and the project administrator.

# Appendix F

## Animal Breeds

### Used for Power

#### Characteristics of African Cattle Breeds Suitable for Animal Traction

N'Dama. This breed of cattle originated in Guinea but is found in Senegal, Mali, the Ivory Coast, Ghana, Nigeria, and the Central African Republic. Translated, the name means "small cattle". The animal has square, compact features that are highly desirable in a draft animal. The following characteristics are typical of the breed: short, broad head; lyre-shaped horns; short legs; small dewlap; broad back; undefined withers. Coat is short and usually fawn-colored (also can be white, yellowish, black, brown or red). Animals are 95-120 cm high at the withers (ground to withers); males weigh 300-400 kg, females 230-350 kg. Approximately 45-55% of the carcass is usable meat.

The breed is small and in some tests, animals did not work efficiently for more than three or four hours per day. It is, however, resistant to trypanosomiasis and therefore

a practical animal in wetter, coastal zones where the disease is prevalent. (In these respects, it is similar to the Lagunae breed of Togo and Benin.) Excellent draft animals are produced when N'Dama and Zebu breeds are crossed. (See illustration page 26.)

White Peul Zebu. This breed is one of a group of breeds herded by the nomadic Peul or Fulani people of West Africa. The animals are usually white with black eyes, ears, muzzles, tail switches, hoofs and horn tips. Faces are squarish with flat foreheads and eye sockets flush (as opposed to protruding). They are long-legged, long-necked and heavy. Bulls average 550 kg, 135 cm high at the withers; cows, 350 kg and 125 cm.

The large hump makes the animal suitable for work in a yoke; however, the overall high carriage elevates the line of draft and makes pulling

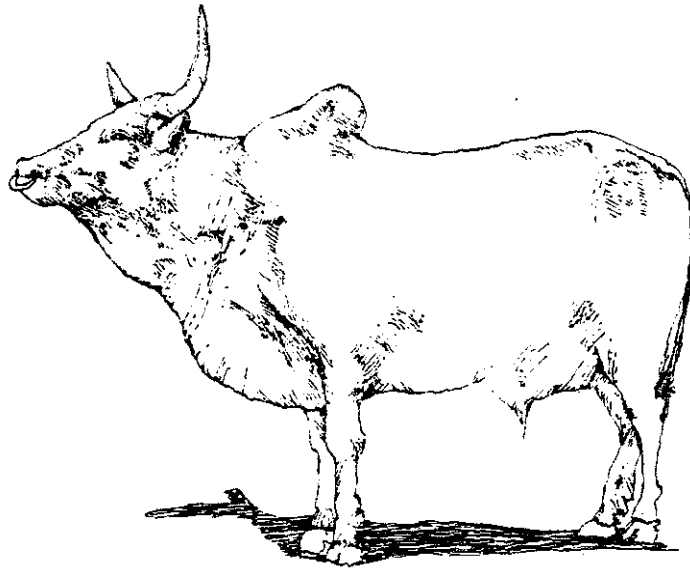

White Peul Zebu with Good Conformation

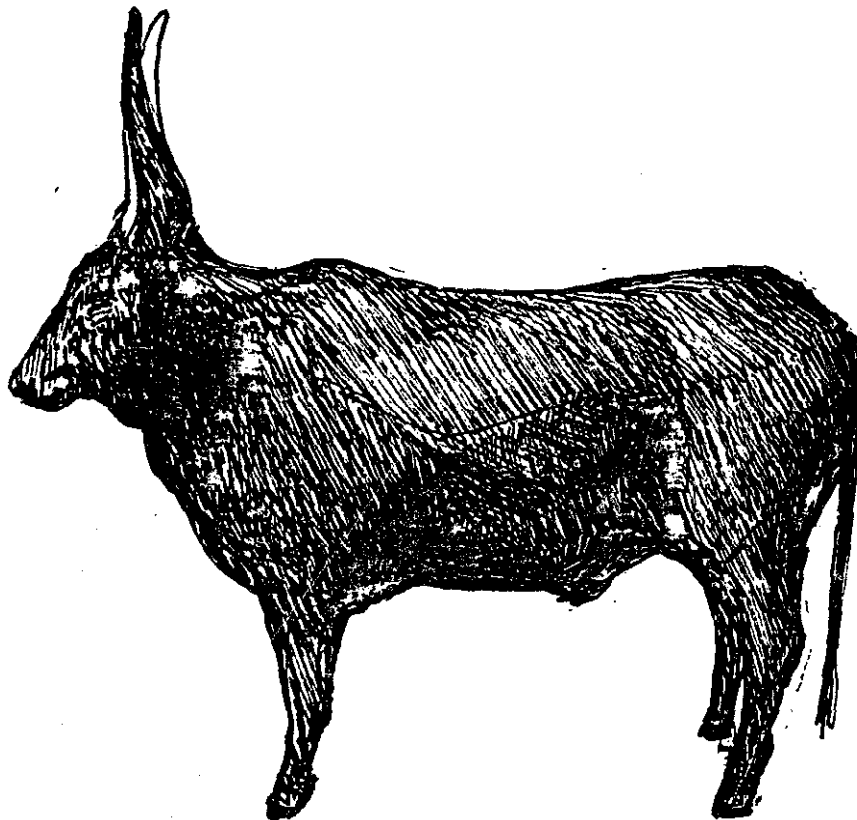

Bahima Zebu with Good Conformation



more difficult. The animals work slowly, sustain an effort for five to six hours per day, and can exert great force when momentary resistance must be overcome. They are noted for their even temper.

Bahima Zebu. This breed is of the Ankole cattle group of central Africa. Like the White Peul Zebu, it is a large animal with a long body and long legs. At two and a half years (work age), it may weigh as much as 300 kg, later attaining a weight of 500 kg and a height of 145 cm. Adult cows weigh 350 kg and are 120 cm high at the withers. Horns are long, high and graceful; common color is deep red.

A more practical draft animal within the Ankole group is the Bashi Zebu of Zaire. It is a smaller breed, with bulls averaging 300 kg and cows 250 kg. It can work five hours per day in hard dry soil (plow). A cross between the Bashi and the Bukedi--a short-horned East African Zebu--gives a very muscular, medium-sized animal excellent for draft (Nganda).

Characteristics of African Donkey Breeds Suitable for Animal Traction:

Female Masai ass (Kenya, Tanzania, Malawi). The average adult is 100 cm high at the withers, 110 cm long, and has a girth of 115 cm (circumference). Note the well-fleshed rear quarters and flank, the muscular shoulder, and straight, well-set legs. However, the slightly swayed back is typical of older animals and mares in foal (carrying young). Note the attentive face and overall strong appearance of the animal.

Female Libyan ass. The animal has a number of readily visible conformation faults: a roach back (rather than being perfectly straight), forelegs too far under (compare to the animal above, whose legs are straighter and whose hoofs are in line with the shoulder). Note the square, well-proportioned head and thick neck. The shoulder stripe is typical of the breed and is common in the wild breeds from which the animal descends.

West African ass, showing qualities of the Minianka breed of southern Mali. Note the overall small, delicate appearance of the animal, the shoulder stripe, the white underside and leg markings, the high croup, the size of the head in proportion to the body. The thick-set, full-looking torso and shoulder are also typical

(The sketches are based on actual subjects; discussion includes comments on individual conformation.)

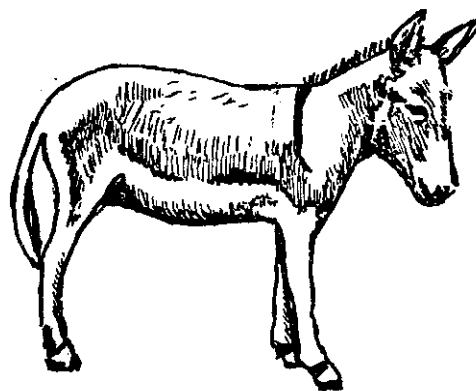
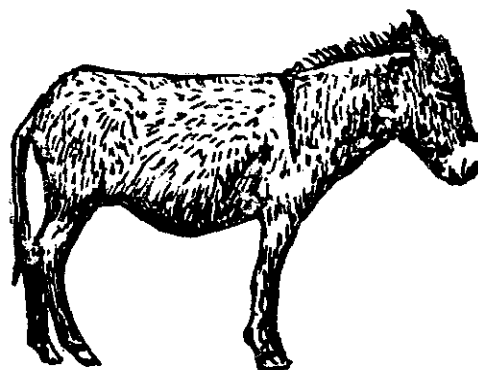
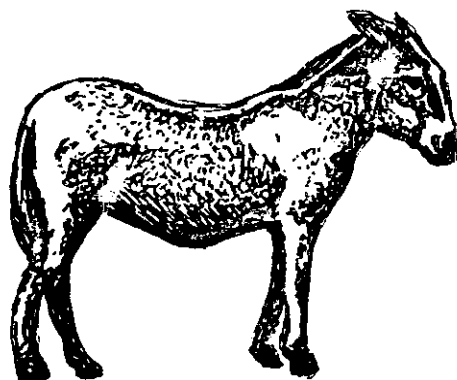

of the breed. However, the poor angulation of the hoof to the pastern relate to the individual animal. Such problems are generally caused by a combination of genetic weakness (individual), poor nutrition, and exposure to improper work conditions (poorly balanced loads, overwork).

Sahel ass. This is a large, heavy-set animal well suited for draft. The breed is typically grey, 105-115 cm high at the withers, and has a large, long head and face. Shoulder stripe is usually present. The back is long and straight, the croup fairly short (as with most African breeds), the heart and barrel girths deep, the neck full and strong. The individual pictured shows all of these qualities with one exception: the back is swayed, possible the result of heavy cart work.

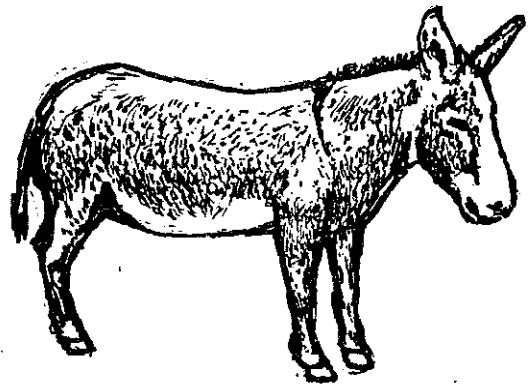

Gourma ass. Note the overall thickness of the individual shown. The back is straight, the flanks full, the girth deep, and the legs heavy-set with ample bone and strong-looking joints. The front hoofs need trimming, as indicated by the long toe and short heel. The animal has good conformation from the standpoint of draft efficiency as well as breed. Average height of the breed is 105-110 cm; color is grey to whitish; distribution ranges throughout the Sahel area with high concentrations near the Niger River bend.

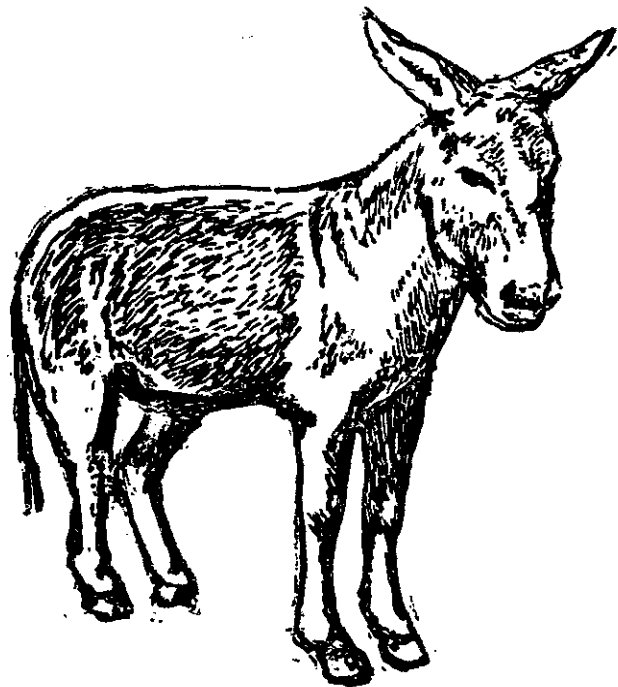

# Bibliography

- Anthony, Kenneth R.M., et al. 1979. Agricultural Change in Tropical Africa. Cornell University Press, Ithaca, NY, and London.
- Aten, A., Innes, R.F., and Knew, E. 1954. Flaying and Curing of Hides and Skins as a Rural Industry. Food and Agricultural Organization of the United Nations, Rome.
- Bamtey, C.R.A. de. 1967. A propos d'un matériel de traction bovine. Institut de Recherches Agronomiques Tropicales et des Cultures Vivrières, Paris.
- Benor, Daniel, and Harrison, J.Q. 1977. Agricultural Extension: The Training and Visit System. World Bank, 1818 H St., N.W., Washington, D.C.
- Berg, Liv, Krisno Nimpuno, and Roger Van Zeanenberg. Towards Village Industry. Intermediate Technology Publications, Ltd., Forest Grove, OR, USA.
- Blood, D.C., and Henderson, J.A., Veterinary Medicine. William and Wilkins Company, Baltimore.
- Boyd, John. 1976. Tools for Agriculture. McGraw-Hill Book Company, New York.
- Campbell, John R., and Lasley, John F. 1969. The Science of Animals that Serve Mankind. McGraw-Hill Book Company, New York.
- Centre d'études et d'expérimentation du mécanisme agricole tropical (CEEMAT). 1968. Manuel de Culture avec Traction Animale (The Employment of Draft Animals in Agriculture). English translation 1972. Food and Agriculture Organization of the United Nations, Rome. Available from Editions Eyrolles, 61 Boulevard St. Germain, 75005 Paris, France. Price 69.50 fr.
- This comprehensive manual on animal traction was prepared by a French organization specializing in research and development in tropical agriculture. It discusses the animals, tools, and techniques used in various parts of Africa and contains sections on the development of rural handicrafts (artisan support; village industry) and the economics of mechanization. Information on selection and use of equipment will be of special interest to Volunteers working in dry or irrigated

regions or in programs where animal-powered sowing, harvesting, and transportation is practiced.

----- . 1974. Aide-Memoire du Moniteur de Culture Attelée (Schemas). CEEMAT, Parc de Tourvoie, 92160 Antony, France. Available from Editions Eyrolles, 61 Boulevard St. Germain, 75005 Paris, France.

Handbook for animal traction extension agents. This is the written complement to CEEMAT's course in animal traction. It was originally published for use by extension agents in Niger, serving as both a course guide (during formal training) and a field handbook. It was then expanded for use in other countries, particularly those in tropical Africa.

It consists of a 130-page text and a separate 65-page book of sketches, drawings, and diagrams. Subjects include animal power, husbandry, harness, plowing, plow adjustments, cultivating, seeding, weeding, ridging, crop protection, harvesting, transportation (grain) and water-lifting, equipment assembly and maintenance, re-hammering of plowshares, and a section on teaching these techniques to farmers and other extension personnel.

Highly recommended. Available in French only.

Cockrill, Ross W., ed. 1974. The Husbandry and Health of the Domestic Buffalo. Food and Agriculture Organization of the United Nations, Rome.

de Wilde, John C., et al. 1974. Experiences with Agriculture Development in Tropical Africa. John Hopkins Press, Baltimore.

Case studies of animal traction in Upper Volta and other countries.

Dineur, Bruno, Georges Morieres and Pierre Canard. 1976. Guide pratique de la culture atelée au Bénin. Food and Agriculture Organization of the United Nations, Rome. 84 pages.

The manual explains and illustrates the fundamentals of animal traction technology as was being introduced in Benin, West Africa. It is intended as a guide for Beninese extension agents who are working with farmers using draft animals and equipment for the first time. It is very clearly written and illustrated and will be of interest and value to French-speaking Volunteers.

Drew, James. 1943. Blacksmithing. Modern Energy and Technology Alternatives, P.O. Box 128, Marble Mouth, WA 98268, USA.

Ensminger, M.E. 1978. The Stockman's Handbook. Animal Agri-Series. The Interstate Printers & Publishers, Inc., Dan-

ville, Illinois, USA. 1192 pages.

The textbook deals with fundamental and more technical aspects of animal science as they may be applied to management of beef cattle, dairy cattle, sheep, swine, and horses. Subject breakdown (partial): animal behavior; breeding; feeding (nutrition and feed value charts); production of pasture and range forages, hay and crop residues, silages, hay, and grain; conformation; animal health and disease; marketing animal products. Also contains comprehensive list of agricultural magazines and helpful agricultural resources (with addresses).

----- Animal Science, 7th edition. The Interstate Printers & Publishers, Inc., Danville, Illinois, USA.

Epstein, H. The Origin of Domestic Animals of Africa. Africana Publishing Corporation, New York.

Farnham, A.B. Home Tanning and Leather-Making Guide. Modern Energy and Technology Alternatives, P.O. Box 128, Marble Mount, WA 98268, USA.

Food and Agriculture Organization of the United Nations. 1974. Rural Tanning Techniques. FAO Development Paper #68. Available from Distribution and Sales Section, Food and Agriculture Organization of the

United Nations, Via delle Terme de Caracalla, 00100 Rome; or from UNIPUB, Box 433, Murray Hill Station, New York 10016. Price \$8.50.

----- 1977. Better Farming Series. FAO, Rome.

Twenty-six titles have been published in this series, designed as handbooks for a two-year intermediate-level agricultural education and training course. They may be purchased as a set or as individual documents.

#### First Year

1. The plant: the living plant, the root
2. The plant: the stem, the buds, the leaves
3. The plant: the flower
4. The soil: how the soil is made up
5. The soil: how to conserve the soil
6. The soil: how to improve the soil
7. Crop farming
8. Animal husbandry; feeding and care of animals
9. Animal husbandry: animal diseases: how animals reproduce

#### Second Year

10. The farm business survey
11. Cattle breeding
12. Sheep and goat breeding
13. Keeping chickens
14. Farming with animal power
15. Cereals
16. Roots and tubers

articles on the design and application of tools. For example, the section titled "The Continuing Role of Draft Animals" includes (1) catalogued subsections on plows, harrows, ridgers, cultivators; (2) address lists of North American harness-makers, wagon-makers and wheelwrights, blacksmith equipment suppliers, draft horse publications, draft horse workshops; (3) articles titled: "Farming with Horse Power," "Power for Field Work," "Thoughts of a Designer of Animal-Drawn Equipment," "The Efficient Use of Animal Power." Major sections are as follows: Tools for Cultivating, Continuing Role of Draft Animals, Tractors, Equipment for Seeding and Planting, Harvesting Equipment, Cleaning Grains and Seeds, Processing Equipment, Tools for Adding Organic Materials to the Soil, Woodlot and Orchard Management, Livestock Equipment, Tools for Fishfarming.

Johnson, Paul G. 1976. Farm Implements in the Making of America. Wallace-Homestead Book Co., Des Moines, Iowa, USA.

King, J.O.L. 1978. An Introduction to Animal Husbandry. John Wiley & Sons, New York.

Kline, C.K., et al. Agricultural Mechanization in Equatorial Africa. Institute of International Agriculture Research Report No. 6. Michigan State University, 118 Agriculture

Hall, East Lansing, MI 48824, USA. 465 pages.

This is a documented field study of the hand-, animal- and engine-powered farm technology used in Africa today. The concept of mechanization and the impact of agricultural change is viewed through case studies made in 19 African countries. The studies become the basis for an index of recommendations and guidelines which could help extension Volunteers identify problems and develop solutions related to animal traction technology. The bibliography is extremely thorough. It cites the major references on agricultural mechanization in equatorial Africa and uses a "key word" annotation system to specify subject material.

Leese, A.A. A Treatise on the One-Humped Camel in Health and in Disease. Haynes and Son, Lincolnshire, England.

Macpherson, George A. 1975. First Steps in Village Mechanisation. Tanzania Publishing House, Dar Es Salaam. 235 pages.

Mansfield, Toots, 1961. Calf Roping. Western Horseman, Inc. Colorado Springs, Colorado, USA. 56 pages. Available from The Western Horseman, 3850 North Nevada Avenue, Colorado Springs, Colorado, USA.

McDowell, R.E. Ruminant Products: More than Meat and Milk. Winrock Report, Winrock Inter-

national Livestock Research and Training Center, Petit Jean Mountain, Morrilton, Arkansas, USA.

Michael, A.M., S.C. Knierim, and R.M. Reeser. 1964. Simple Bullock-Drawn Implements for Efficient Irrigation. University of Udaipur, India.

Miller, W.C., and R.D.S. Robertson. 1943. Practical Animal Husbandry. Oliver & Boyd, Edinburgh, Scotland.

Morrison, Frank B. 1948. Feeds and Feeding: A Handbook for the Student and Stockman. Morrison Publishing Company, Ithaca, NY, USA.

Morss, Elliott R. 1975. Strategies for Small Farmer Development. Development Alternatives, Washington, DC.

This is a study funded by the U.S. Agency for International Development to improve the design and implementation of projects to assist subsistence agriculture farmers.

Muller, J. 1977. Promotion of Rural Implement Manufacture in Tanzania. Production of Tools for Food Production in East Africa. Centre for Development Research, Copenhagen.

Needham, Joseph. Science and Civilization in China, Vol. 4. Cambridge University Press, New York.

Organization of African Unity. Bulletin of Animal Health and

Production in Africa. Inter-African Bureau of Animal Resources, Nairobi, Kenya. Available from Eleza Services, Scientific Publications Division, Box 14925, Nairobi, Kenya. (\$10.00/year)

Partridge, Michael. 1973. Farm Tools. Promontory Press, Boston, MA, USA.

Rao, S. 1965. A New Bullock Harness for More Bullock Power. Allahabad Agricultural Institute, Allahabad, India. Available from Allahabad Agricultural Institute, Inc., M.O. Center, Stony Point, New York, NY.

Sargent, Merritt W. 1979. Recommendations to National Government and International Donors for the Design and Implementation of Animal Traction Programs. Michigan State University, East Lansing, MI 48823, USA.

----- 1979. A provincial planning and implementation guide for the Introduction and Maintenance of Animal Traction. Michigan State University, East Lansing, MI 48823, USA.

----- 1979. A Village Level Extension Guide for the Introduction and Maintenance of Animal Traction. Michigan State University, East Lansing, MI 48823, USA.

Shulman, Robert. 1979. Strategy for the Advancement of Animal Traction in Mali. U.S. Agency



for International Development,  
B.P. 34, Bamako, Mali.

- Seigmund, O.H., ed. 1973. The Merck Veterinary Manual. Merck & Co., Inc., Rahway, NJ, USA.
- Spaulding, C.E. 1976. Veterinary Guide for Animal Owners. Rodale Press, Emmaus, PA, USA.
- Stamm, Gustave W. 1963. Veterinary Guide for Farmers. Hawthorne Books, Baltimore.
- Steinmetz, H. 1976. Farm Implement and Machinery: Multilingual illustrated dictionary. 524 Betzdorf/Seig, Western Germany.
- Stout, B.A. 1966. Equipment for Rice Production. FAO Development Paper #84, FAO, Rome.
- Telleen, Maurice. 1977. The Draft Horse Primer. Rodale Press, Emmaus, PA, USA. 380 pages. Available from Rodale Press, 33 E. Minor St., Emmaus, PA 18049, USA. Price \$10.95.
- This is a guide to the care and use of work horses and mules. The author notes that the work "is made up largely of materials from booklets published by U.S. land grant schools during the twenties and thirties when they had an active interest in heavy horses as a major source of agricultural power." The author has included reprints of articles he has written for The Draft Horse Journal, Western Horseman Magazine, and Organic Gardening and

Farming, as well as newer material developed specifically for this book. Subject breakdown: return of draft horse, conformation and breeds, buying a team, feeding and care, shoeing and foot care, harness and hitching, breeding, machinery for horsepowered farm.

- UNIDO. 1975. Animal-Drawn Agricultural Implements, Hand-Operated Machines and Simple Power Equipment in the Least Developed and Other Developing Countries. Publication ID/148. Free to serious groups, from United Nations Industrial Development Organization, P.O. Box 707, A-1011, Vienna.
- Volunteers in Technical Assistance. 1979 Directory of Development Resources: Africa. VITA, 3706 Rhode Island Avenue, Mt. Rainier, Md. 20822, USA. Price \$9.95 plus 5 percent service charge.
- Wakeman, D.L., and T.J. Cunha. 1967. Light Horse Production in Florida. Bulletin No. 188. Department of Agriculture, State of Florida.
- Ward, Fay E. 1958. The Cowboy at Work. Hastings House Publishers, New York.
- Wijewardene, R. 1977. "Small-Farm Vehicle." Proceedings of ITDG Seminar: Simple Vehicles for Developing Countries. Information Paper 3. Intermediate Technology Development Group, Transport Panel, London.

Williamson, G., and Payne, W.J.A.  
1959. An Introduction to Animal Husbandry in the Tropics.  
Longmans, London. 435 pages.

The author presents very specific information on the most important classes of production livestock. This is a key reference for Volunteers managing or raising livestock in tropical areas. Major sections include climate (effects of), health maintenance, nutrition, breeding, animal products; husbandry: traditional (cattle), beef cattle, dairy cattle, oxen, buffalo, camels, sheep, goats, swine, poultry.

World Bank. 1978. Appropriate technology in rural development: vehicles designed for on- and off-farm operations.  
Regional Development Unit,  
Transportation Department,  
Washington, DC.

A literature review of the work output of animals with particular reference to their use in civil construction.  
Washington, DC, IBRD, 1976.  
(Technical Memorandum No. 21)  
Study of the Substitution of Labor and Equipment in Civil Construction.

# Resources

## Agricultural Research Organizations and Institutions

Agricultural Tools Research Center, Suruchi Vesahat, P.O. Box 4, Bardoliz, 394-601 Dist. Surat, Gujarat, India.

Applied Scientific Research Corporation of Thailand (ASRCT), 196 Phabronyothin Road, Bangkok, Bangkok-9. Publishes monthly newsletter, "ASRCT Research News."

Bureau pour le Développement de la Production Agricole, 202 Rue de la Croix-Nivert, 75738 Paris CEDEX 15. Information on camels in animal traction.

Centre d'Etude et de'Expérimentation du Machinisme Agricole Topicale (CEEMAT), Parc de Tourvoie, 92160 Antony, France. Adaptions of agricultural machinery to tropical conditions. Three-times-a-year review "Machinisme Agricole Tropicale," and a newsletter "Lettre d'information."

Center for Tropical Agriculture, University of Florida, Institute of Food and Agricultural Sciences, 2001 McCarty Hall, Gainesville, FL 32601, USA. International agriculture development, training of foreign

students in new methods, and U.S. students in tropical needs.

Department of Agricultural Economics and Rural Sociology, Institute of Agricultural Research, Samaiu, Ahmadu Bello University, P.M.B. 1044, Zaria, Nigeria. On request, mails information on agriculture extension and research.

Food and Agriculture Organization (FAO) of the United Nations, Via delle Terme de Caracalla, 00100 Rome. Publishes FAO "Books in Print," which lists all annual publications, and booklets in the Better Farming Series. Also available are filmstrips on animal traction using a horse and a camel. Publications available through UNIPUB, 650 First Avenue, P.O. Box 433, Murray Hill Station, New York 10116.

Fundacao Gaucha de Trabalho, Porto Alegre, Rio Grande do Sul, Brazil. Has published 12 field manuals for agricultural extension workers.

Institut de Recherches Agronomiques Tropicales et des Cultures Vivrières (IRAT), 110 Rue de l'Université, 75340 Paris CEDEX 07. Institute of Agricultural Research

- (IAR), P.O. Box 2003, Addis Abba, Ethiopia.
- Intermediate Technology Development Group (ITDG), 9 King Street, London WC2 E8HN. All ITDG publications can be ordered from International Scholarly Book Service, Inc., Box 555, Forest Grove, OR 97116, USA.
- International Center for Arid & Semi-Arid Land Studies, Texas Tech University, Lubbock, Texas 49409, USA. Studies on new plants, animals bred for arid lands; also solar energy, soil sciences, waste disposal, desert ecology, salinity, etc.
- International Crops Research Institute for the Semi-Arid Tropics (ICRISAT), 1-11-256, Begumset, Hyderabad 500 016 U.P., India.
- International Institute of Tropical Agriculture (IITA), P.M.B. 5320, Ibadan, Nigeria. Publishes "IITA Newsletter," quarterly (free).
- International Office of Epizootics, 12 Rue de Prony, Paris XVII.
- International Rice Research Institute (IRRI), P.O. Box 933, Manila. Publishes "IRRI Reporter," quarterly (free).
- Koninklijk Instituut voor de Tropen (Royal Tropical Institute), Department of Agricultural Research, Mauritskade 63, 1092 AD Amsterdam.
- National Research Council, 2101 Constitution Avenue, N.W., Washington, D.C. Publishes bulletins on the nutrient requirements of domestic animals.
- National Technical Information Service (NTIS), 5285 Port Royal Road, Springfield, VA 22161, USA. Write for publications list.
- Société d'Aide Technique et de Coopération (SATEC), 110 Rue de l'Université, 75340 Paris CEDEX 07.
- Société d'Etudes et de Développement Agricoles Associés (SEDAGRI), 202 Rue de la Croix-Nivert, Paris XV.
- Stichting Tool (TOOL), (Foundation for Technical Development in Developing Countries) Mauritskade 61a, Amsterdam. Write for publications lists.
- Technical Assistance Information Clearing House (TAICH), 200 Park Avenue South, New York 10003. Write for list of titles available.
- Tillers Research International, c/o Richard Rosenberg, 1402 Hillcrest Avenue, Kalamazoo, MI 49008, USA.
- U.S. Agency for International Development (USAID), U.S. State Department, 320 21st Street, N.W., Washington, D.C. Write for list of reports to AID R&D Report Distribution, P.O. Box 353, Norfolk, VA 23501, USA.
- U.S. Department of Agriculture, Washington, D.C., USA. A list of U.S. Department of Agriculture publications can be obtained by directing a request to the Office of Information, U.S. Department of Agriculture, Washington, D.C. 20250, or write to the Foreign Develop-

ment Division.

U.S. Peace Corps/Information Collection & Exchange, Room M-700, 806 Connecticut Avenue, N.W., Washington, D.C. 20525. Peace Corps ICE makes available a wide range of publications on agriculture and agricultural extension. Lists of these publications are available at local Peace Corps offices or can be obtained by writing directly to Peace Corps.

Volunteers in Asia (VIA), Inc., Box 4543, Stanford, CA 94305, USA. Write for publications list.

Volunteers in Technical Assistance, Inc. (VITA), 3706 Rhode Island Avenue, Mt. Rainier, MD. 20822 USA. This organization answers technical questions from the field and has a publications list that includes Peace Corps and ITDG manuals and pamphlets. Write to ICE for publications lists or with specific questions to be referred.

#### Draft Animal Workshops

Draft Horse Institute, c/o  
Ted Bermingham  
Indian Summer Farm  
Cabot, UT 05647, USA.

Offers five-day intensive course in care and use of draft horses with emphasis on development of student skills. Subjects: selection of horses; selection and use of harness; animal husbandry and health.

Draft Horse Workshop  
Clarksburg, MA 01247, USA.

Hillcraft School of Horse-shoeing  
10890 Deer Creek Canyon Road  
Littleton, CO 80120, USA.

Office of Continuing Education  
North Adams State College  
North Adams, MA 01247, USA.

Offers courses in draft animal use (horses).

#### Equipment Manufacturers and Suppliers

Agro-Util, Inc.  
404 Broadway, Box 271  
South Haven, MI 4909, USA.

Simple, low-cost tools to help small farmers.

Cumberland General Store  
Rt. 3, Box 479  
Crossville, TN 38555, USA.

Has a catalogue for ordering equipment.

Detweiler's Harness Shop  
Rt. 1, Box 228  
Hazleton, IA 50641, USA.

Has a catalogue for ordering equipment.

Freeport Harness Shop  
Freeport, ME 04032, USA.

Hamburg Plow Works, Inc.  
1021 S. Fourth Street  
Hamburg, PA 19526, USA.

H. B. Harness Mfg. Co.  
75 Bathurst St.  
Toronto, Ontario, Canada

Holt, John, Agricultural Engineers, Ltd.  
P.O. Box 352, Zaria, Nigeria

Siscoma  
B.P. 3214  
Dakar, Senegal

Société des Forges Tropicales  
B.P. 706  
Douala, Cameroun

Tanzanian Agricultural Machinery,  
Testing Unit (TAMTU)  
Box 1839  
Arusha, Tanzania

Wengend's Manufacturing  
R.R. 2, Box 267  
Dalton, OH 44618, USA

Small moldboard plows.

Wheat State Harness Company  
406 West Adams  
Pittsburg, KA 66762, USA.

#### Periodicals

Evener, The  
Putney, VT 05346, USA.  
11 issues annually, \$6.00/year.

Draft Horse Journal  
Rt. 3  
Waverly, IA 50677, USA.  
4 issues annually, \$6.00/year.

Mr. Longears  
Rt. 5, Box 65  
Denton, Texas 76201, USA.  
Publication of American Donkey  
and Mule Association.

Small Farmer's Journal  
Box 197  
Junction City, OR 97448, USA.  
4 issues annually, \$8.50/year.

#### Special Applications (for camels, mules, and multiple hitches)

Camels: Fort, J., "Mécanisation des  
Pratiques Agricoles Transition-  
nelles en Zone Sahélienne du

Nord." From: Machinisme Agri-  
cole Tropical, Centre d'Etudes  
et d'Expérimentation du Mach-  
inisme Agricole Tropical (CEE-  
MAT), No. 41 (January-March  
1975).

Further information may be  
obtained by writing:

Bureau pour le Développement  
de la Production Agricole  
202 Rue de la Croix-Nivert  
75738 Paris CEDEX 15.

Mules: Wiggins, L.L., and C.L. Evans.  
Mule Power in Ethiopian Agri-  
culture, Bulletin 15. Dire  
Dawa: Imperial Ethiopian Col-  
lege of Agriculture and Mechan-  
ical Arts, Experimental Station.

CEEMAT may be able to furnish  
information on breeding trials  
carried out in Mali between  
1930 and 1944 (crossing with  
Poitou and Moroccan he-asses).

or, request information from:

Division of Machinism Agricole  
B.P. 155  
Bamako, Mali.

Multiple hitches: The hitching  
techniques shown in these arti-  
cles and booklets are still  
applicable and will be of  
great help to persons using  
multiple hitches.

American Society of Agricul-  
tural Engineers. "The Effi-  
cient Use of Animal Power."  
February 1922 issue of their  
publication Agricultural Engi-  
neering. For photocopy,  
write:

American Society of Agricultural Engineers  
St. Joseph, MI, USA.  
Send \$2.00 and letter of inquiry.

Horse and Mule Association of America, The Hitch Booklet, 1926. Three-, four-, five- and six-horse hitches; text and illustrations.

Horses-Mules, Power-Profit, 1934. Three-sixteen horse hitches. Photocopies available through USDA Library, Beltsville, MD, USA.

# Glossary

- animal traction--use of draft animals to power farm equipment.
- bovine--of the ox family (Bovidae); includes cattle, domestic water buffalo, carabao, zebu, yak.
- breeching (britching)--a kind of harness which circles an animal's rear quarters, permitting it to brake or back-up a wheeled implement or vehicle.
- cast--1. to immobilize an animal by forcing it to the ground and tying it.  
2. to be on the ground and in a position where movement is impossible; as, "a horse cast in its stall."
- clevis--a piece of U-shaped metal which fits onto the tongue of a wagon, the midpoint of a yoke, or the front of a plow, and serves as a hitch point for a chain or hook. The clevis is held in place by a pin which passes through the two ends and the bar or beam between them.
- conformation--the overall form or shape of an animal, including both its individual characteristics and those of its species and breed.
- cultivate--the process of loosening the earth around plants, primarily to kill weeds and let air and water penetrate.
- draft (draught)--1. pull; pulling  
2. the thickest, widest part of a collar, fitting against the shoulder where pressure will be greatest when the animal pulls.
- drawchain--the chain connecting the power source to implement or vehicle being pulled.
- driver--person guiding a team of draft animals from behind, using use of lines (reins) and/or voice commands. The driver often steers or operates equipment at the same time.
- equine--of the horse family (equidae), including horses, asses (donkeys), and mules.
- fixed loop--a small permanent loop knotted or spliced at the end of the rope. A lasso or running noose is made by passing the free end of the rope through the loop.
- forage--any plant material, fresh or dry, used as feed for domestic animals. Commonly refers to vegetation, but also includes grain.
- furrow--a narrow trench made by a plow or other farm implement. The land thrown out or to the



- side of the trench is called a furrow slice.
- hames--a set of wooden or metal bars which are seated against the collar of a pulling harness, one either side, to which traces and other straps attach.
- hitch--1. the connection between power and the load  
2. the combination of animals and equipment used to supply power and connect it to the load  
3. action of connecting the power to the load.
- hitchpoint--the point where the draw-chain hooks, or connects to the load.
- harness--a combination of leather straps, worn by a draft animal, permitting it to pull, or pull, brake, and back up a load. Bridle and lines are also part of the harness.
- jack saddle--1. a harness part which circles an animal's torso and distributes pressure from the wagonshaft or cart shafts onto the back  
2. any padded surcingle which helps stabilize the harness and carry lines and traces.
- lines--a set of long ropes or leathers which fasten to an animal's halter or bridle and pass back to the driver, letting him steer and stop.
- line of traction (line of draft)--the line between the point of draft and the point of resistance.
- load--the field implement (plow, cultivator, etc.) or vehicle (cart or wagon) which is being pulled.
- moldboard--a curved piece of metal which turns the furrow slice on its side after it has been cut by the plowblade, or share.
- neckyoke--wooden bar worn under the necks of animals in harness, permitting them to hold up the tongue of a wagon, and brake and back up the wagon.
- point of draft--the point where the drawchain or trace connects to the power. On a yoke, this is the clevis located at the midpoint of the stock (crossbar). It is called the yoke draft. On a collar harness, it is the point where the trace connects to the hame. It is called the hame draft.
- point of resistance--point where there is greatest opposition to pulling. The centerpoint of the load. On a plow, this is roughly the midpoint of the share/moldboard joint.
- power--rate at which an animal can transform its energy into pull work.
- ration--a fixed allowance of feed and water.
- skidding--1. a process of dragging logs or fallen trees, usually as part of logging or field-clearing operations.  
2. a training procedure which teaches the animals to pull by having them draft light logs.
- swingtree--any bar used to transfer pull from the traces to the load. One-animal swingtrees are called singletrees. Longer bars are called doubletrees. When two animals are used,

each of the two singletrees is connected to the doubletree, which is in turn connected to the load.

surcingle--strap which encircles an animal's torso and helps stabilize other parts of the harness, or helps keep lines, ropes, or traces from dragging on the ground.

tandem--positioned one behind the other.

traces--a set of ropes or leather straps which transfer draft from an animal's harness back to the load. Traces attach to rings on the hames, or to the ends of a breastband, sling, or singleyoke. Behind the animal they attach to a singletree.

traction--1. drawing or pulling  
2. kind of power used to draw or pull loads.

vehicle--a cart or wagon.

yoke--1. a wooden bar carried across the neck or horns of oxen, permitting them to pull  
2. a pair of oxen fastened in a yoke.

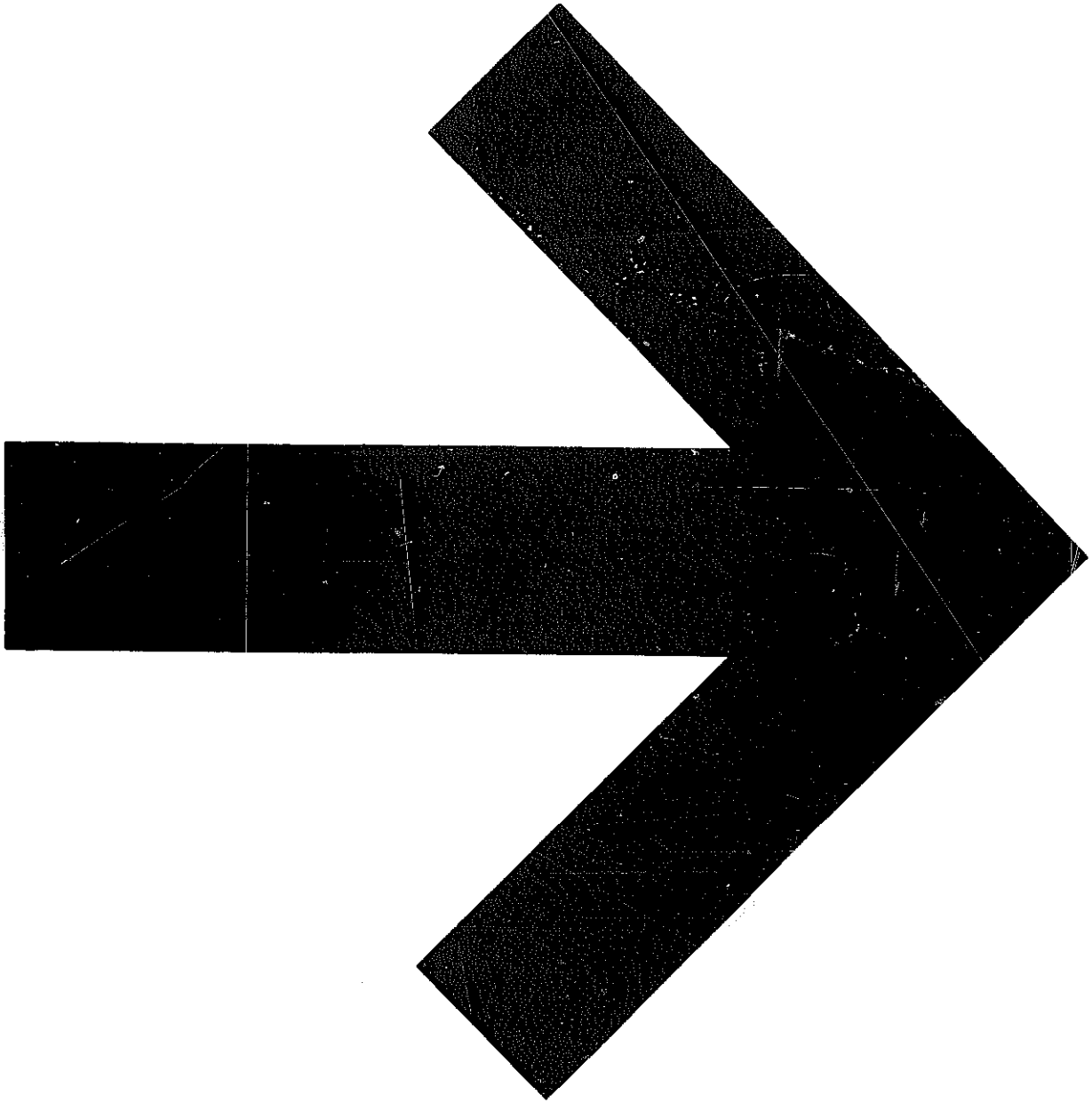

# Index

- Abscess 43
- Agricultural Extension 6,153,161,231
  - Demonstrations 167-169
  - Extension Agents 153,162-167
  - Instructors 6-7,153,159,162,212
  - Invitational Competitions 169-171
  - School and Youth Clubs 169
- Ard 120
- Bloat 43-44
- Breaking 51
  - Cattle 58-64
  - Equine Animals 68-73
- Breastband Harness 80,82-83
- Breeching Harness 92-15,110-112,113
- Buffalo 11
- Burns 47-48
- Camels 11,234
- Casting
  - Cattle 56-58
  - Equine 66-68
- Cattle 9
  - Breeds of African 217-219
  - Catching and Restraining 52
  - Feed 38-40,194-198
  - Harness 76-82
  - Power 19
  - Selection 21-22,217-219
  - Shelter 13,31
  - Training 58-64
  - Water Requirements 40,194
- Castration 24,50,60
- Catching 52-58,64
- Collar Harness 81-82,84-85,111
- Colic 44
- Conformation 25-28,217-221
- Corral 33
- Coulters 118,127
- Credit 156-160
  - For Animals 158
  - For Equipment 156-158,214-215
- Cross Ties 64-66
- Cultivators 143-146
- Diarrhea 45
- Diseases
  - Bacterial and Viral
    - Anthrax 201
    - Brucellosis 201-202
    - Blackleg 202
    - Contagious Bovine
      - Pleuropneumonia 202-203
    - Pasteurelloses 203
    - Rinderpest 203
    - Tetanus 204
  - Parasitic
    - Helminthiasis (worms) 39,204
    - Mange 206
    - Ringworm 206
    - Ticks 207
    - Trypanosomiasis 207
- Donkeys (see also Horses) 10,178,200,220
- Draft Animals
  - Importance of 1,5-6,161
  - Power of 12-14,172-173
  - Types of 9-11,217-221
- Draft, Line of 123-125
- Draft, Point of 84
- Draft Requirements (tables) 12,14-17
- Doubletree 103-104,109-112
- Dutch Collar 83-84

- Energy Needs 38-39
  - Cattle 175-177
  - Equine 177-178
- Equipment (see also Field Equipment) 155-156
  - Credit for 156-158
  - Spare Parts 209-210
  - Suppliers 156,233-234
- Equine Animals (see Horses, Donkeys, Mules)
- Evening, Evener 99-100,104
- Extension (see Agriculture)
- Feed
  - Composition of (tables) 188
  - Concentrates 181,196-198
  - Feeding Practices 193,194
  - General Rules for 39-40,194
  - Roughages 39,191-192,195-196
  - Types of 181-187,188-189
- Feeding Schedules
  - Cattle 194-198
  - Equine 198-200
- Field Operations 115
  - Clearing 116-117
  - Cultivating 143-146
  - Harrowing 131-133,145
  - Line Tracing for Parallel Rows 134-137 (Seeding) 134
  - Peanut Lifting 150-152
  - Plowing 117-131
  - Ridging 146-150
  - Weeding 139-143,145
- First Aid 43-48
- Fixed Loop 33-37,53
- Fodder 184
- Founder (Laminitis) 45
- Forage 181
- Grain 185
- Green Chop 181-182
- Grooming 41-42
- Ground Driving
  - Cattle 60-61
  - Equine 72
- Halter
  - Halter Breaking 68-70
  - How to Make 33-35
  - How to Place 34,36
  - Types 34-36
- Harness 75-76
  - Breaking to 71
  - How to Place 86-89,109-112
  - Parts of 86,95
  - Types of
    - Breastband
      - Cattle 80
      - Equine 82-83
    - Breeching Harness 92-95,110
    - Collar Harness 81-82,84-85,109
    - Sling Harness 79
- Harrowing 131-133,145
- Hay 182-183,189-190,195
- Hitches 97-98
  - Size of 15,104-105
  - Types of
    - To Implements 98-105, 122
    - To Vehicles 106-113
- Hoof Problems 46
- Horses (Donkeys and Mules) 10,20-28
  - Feed 38-40,117-178,198-201
  - Harness 82-89
  - Power 10,12-13,18-19
  - Restraint 69-68
  - Shelter 32-33
  - Training 68-73
  - Tying 34-36,64-66
- Information and Restraints 233-235
  - Lameness 45,46,47
  - Lead Rope 36,53-54,68
  - Lean-to 31-32,65
  - Legumes 184
  - Lifter, Peanut 153-152
  - Line of Traction 123-125
  - Line Tracer (for Planting in Parallel Rows) 134-137
    - Relationship to Yoke 77,135,139
- Lines (Reins)

Types of 90-92,102,105,107  
 Use of 89-90  
 Lunging (Longeing) 70-71  
 Maintenance of Equipment 42,209  
 Maintenance Requirements  
     Cattle 176,190,192  
     Equine 178  
 Mechanization 1-3  
 Mineral Supplements 179,191,198  
 Moldboard Plow 117-118  
 Mules 10,199-200,234  
     Importance in Africa 10  
     (see also Horses, Donkeys)  
 Neckstall (illustration of) 37  
 Neckyoke 119,110  
 Noserings 37-38  
 Nutrition (see also Feed) 38,175  
     Energy Needs  
         Cattle 175-176,191,193  
         Equine 171-178  
     Feed Composition Charts 188-189  
     Feed, Types of 181-187,188-189  
     Forage Unit 175,176-178,188,192  
     General Rules for Feeding  
     Grain and Concentrates 181,185,196  
     Importance of 38-39  
     Minerals 179-180,191,198  
     Protein 179-180,191  
     Rations  
         How to Calculate 187-194  
         Recommended Rations  
             Cattle 194-198  
             Equines 198-200  
     Vitamins 176,179-180,198  
     Water Requirements 40  
 Pasture 181,195  
 Planting (Parallel Rows) 134,138,139  
 Plowing  
     Effects of 119-120  
     Field Layout 127-130  
     Instructional Techniques 130-131  
 Plows (Adjustments) 120,122  
     Depth 118,119,122-123  
     Line of Traction 123,125  
     Parts of 121,127  
     Width 99,118,119,125-126  
 Power 12-20,173-174  
     Amount Needed for Imple-  
         ments (tables) 16-17  
     Of Animals 14,18,19  
     Relationship to Harness 14,17-18,  
         99-100,104,173  
 Rations  
     How to Calculate 187,190-194  
     Recommended for Cattle 194-198  
     Recommended for Equines 198-200  
 Restraints  
     Cattle 33,52-58  
     Equine 33,64-68  
 Ridging  
     Corn and Sorghum 147-148  
     Placement of Fertilizers 149  
     Peanuts 149-150  
     Ridger 146  
 Roughages 39,181,183,191-193,195-196  
 Running Noose 53  
 Running-W Harness 53-60  
 Selection of Individual Draft  
     Animals 21-25  
 Sex (Influence on Power/Perfor-  
     mance of Draft Animals) 24,25  
 Shelter 31-33  
 Silage 186  
 Singletree 101,103-104  
 Size of Hitch 15,97,173  
 Skidding 63-64,72-73,116,117  
 Snakebite 46  
 Spiral 37  
 Sprains 47  
 Stalls 33  
 Steering System (see Lines)  
 Straw 183  
 Supplements 176,192-193,198  
 Swingtrees 101,103-105,109-112  
 Technical Assistance (see also  
     Agricultural Extension) 6-7,153

Credit 156-159,161-162  
 Equipment Options 155-156  
 Farm Planning Assistance 153-155  
 Temperament of Draft Animals 28-29  
 Tillage  
   Primary 115,148  
   Secondary 115  
 Toolframe 121,155-156  
 Traction  
   Definition of 1  
   Line of 123-125  
   Point of Resistance 125  
   Tests 13,14  
 Training 49-52  
   Cattle 52-64  
     Breaking Single Animal 58-60  
     Ground-Driving Single  
       Animal 60-61  
     Yoke-Breaking Team 61-63  
     Breaking Team to Pull 63-64  
   Horses, Donkeys, Mules 68-73  
     Halter Breaking 68-70  
     Lunging 70  
     Harness Breaking 71  
     Ground-Driving 72  
     Skidding 71-72  
     Training in Team 73  
 Trypanosomiasis 10,207  
 Tying  
   Cattle 33-37  
   Equine 33-36  
 Vehicles  
   Braking and Backing with  
     Harness 92-95,106-113  
   Cart 112  
   Hitches to 106-113  
   Wagon 106-112  
 Wagon, Hitches to 106-113  
 Water Requirements 40,194,200  
 Weed Control 139-145  
   Sweeps 120,139-143  
   Weeding and Banking 142  
   Weed Muzzle 79,143  
   With Cultivator 145  
 Weight of Animals 18-21  
 Workshop Inventory 209-210  
 Wounds 47-48  
 Yokes  
   Breaking to 61-63  
   Hitches with  
     Yoke to Implement Hitch 98-102  
     Yoke to Vehicle Hitches 106-108  
   How to Make 76-78  
   How to Place 62  
   Types of  
     Bow 76,83,147  
     Head 78-79  
     Jockey 109  
     Neck 109  
     Safety 76  
     Single Animal 78,79,150  
     Sling 79,84  
   Yoke for Equines (Pulling) 83,84  
   Yokes for Backing Up and Braking  
     Vehicles 78,109-112

23

Since 1961 when the Peace Corps was created, more than 80,000 U.S. citizens have served as Volunteers in developing countries, living and working among the people of the Third World as colleagues and co-workers. Today 6000 PCVs are involved in programs designed to help strengthen local capacity to address such fundamental concerns as food production, water supply, energy development, nutrition and health education and reforestation.

Peace Corps overseas offices:

<u>BELIZE</u> P.O. Box 487 Belize City	<u>FIJI</u> P.O. Box 1094 Suva	<u>MALAYSIA</u> 177 Jalan Raja Muda Kuala Lumpur	<u>SEYCHELLES</u> Box 564 Victoria
<u>BENIN</u> BP 971 Cotonou	<u>GABON</u> BP 2098 Libreville	<u>MALI</u> BP 85 Bamako	<u>SIERRA LEONE</u> Private Mail Bag Freetown
<u>BOTSWANA</u> P.O. Box 93 Gaborone	<u>GAMBIA, The</u> P.O. Box 582 Banjul	<u>MAURITANIA</u> BP 222 Nouakchott	<u>SOLOMON ISLANDS</u> P.O. Box 547 Honiara
<u>CAMEROON</u> BP 817 Yaounde	<u>GHANA</u> P.O. Box 5796 Accra (North)	<u>MICRONESIA</u> P.O. Box 336 Saipan, Mariana Islands	<u>SWAZILAND</u> P.O. Box 362 Mbabane
<u>CENTRAL AFRICAN REPUBLIC</u> BP 1080 Bangui	<u>GUATEMALA</u> 6a Avenida 1-46 Zona 2 Guatemala	<u>MOROCCO</u> 1, Rue Benzerte Rabat	<u>TANZANIA</u> Box 9123 Dar es Salaam
<u>CHILE</u> Casilla 27-D Santiago	<u>HONDURAS</u> Apartado Postal C-51 Tegucigalpa	<u>NEPAL</u> P.O. Box 613 Kathmandu	<u>THAILAND</u> 42 Soi Somprasong 2 Petchburi Road Bangkok 4
<u>COLOMBIA</u> Carrera 9 #86-26 Bogota	<u>IVORY COAST</u> BP 1127 Abidjan	<u>NIGER</u> BP 10537 Niamey	<u>TOGO</u> BP 3194 Lome
<u>COSTA RICA</u> Apartado Postal 1266 San Jose	<u>JAMAICA</u> 9 Musgrove Avenue Kingston 10	<u>OMAN</u> P.O. Box 966 Muscat	<u>TONGA</u> BP 147 Nuku'Alofa
<u>DOMINICAN REPUBLIC</u> Apartado Postal 1414 Santo Domingo	<u>KENYA</u> P.O. Box 30518 Nairobi	<u>PAPUA NEW GUINEA</u> c/o American Embassy Port Moresby	<u>TUNISIA</u> 8, Ave. Louis Braille Tunis
<u>EASTERN CARRIBBEAN</u> Including: Antigua Barbados, Grenada, Montserrat, St. Kitts-Nevis, St. Lucia, St. Vincent, Dominica "Erin Court" Bishops Court Hill P.O. Box 696-C Bridgetown, Barbados	<u>KOREA</u> Gwang Wha Moon P.O. Box 521 Seoul	<u>PARAGUAY</u> c/o American Embassy Asuncion	<u>UPPER VOLTA</u> BP 537-Samandin Ouagadougou
<u>ECUADOR</u> Casilla 635-A Quito	<u>LESOTHO</u> P.O. Box 554 Maseru	<u>PHILIPPINES</u> P.O. Box 7013 Manila	<u>WESTERN SAMOA</u> P.O. Box 880 Apia
	<u>LIBERIA</u> Box 707 Monrovia	<u>RWANDA</u> c/o American Embassy Kigali	<u>YEMEN</u> P.O. Box 1151 Sana'a
	<u>MALAWI</u> Box 208 Lilongwe	<u>SENEGAL</u> BP 254 Dakar	<u>ZAIRE</u> BP 697 Kinshasa