

AT MICROFICHE
REFERENCE
LIBRARY

A project of Volunteers in Asia

Food Drying, Publication IDRC-195e

edited by Gordon Yaciuk

Published by:

IDRC
Box 8500
Ottawa
CANADA K1G 3H9

Available from:

same as above

Reproduced by permission.

Reproduction of this microfiche document in any form is subject to the same restrictions as those of the original document.



**FOOD
DRYING**

Proceedings of a Workshop
Held at Edmonton, Alberta, 6-9 July 1981

The International Development Research Centre is a public corporation created by the Parliament of Canada in 1970 to support research designed to adapt science and technology to the needs of developing countries. The Centre's activity is concentrated in five sectors: agriculture, food and nutrition sciences; health sciences; information sciences; social sciences, and communications. IDRC is financed solely by the Parliament of Canada; its policies, however, are set by an international Board of Governors. The Centre's headquarters are in Ottawa, Canada. Regional offices are located in Africa, Asia, Latin America, and the Middle East.

© 1982 International Development Research Centre
Postal Address: Box 8500, Ottawa, Canada K1G 3H9
Head Office: 60 Queen Street, Ottawa
Reprinted 1984

Yaciuk, G.

IDRC-195e

Food drying : proceedings of a workshop held at Edmonton, Alberta,
6-9 July 1981. Ottawa, Ont., IDRC, 1982, 104 p. : ill.

/Drying/, /dried food/, /dehydrated food/, /nutritional value/ —
/dried fruit/, /fish preservation/, /grains/, /coffee/, /vegetables/,
/marketing/, /consumer demand/, /solar energy/, /dehydration/,
/technical aspects/.

UDC: 664.8.047

ISBN: 0-88936-333-1

Microfiche edition available

Il existe également une édition française de cette publication

Food Drying

**Proceedings of a workshop held at Edmonton
Alberta, 6-9 July 1981**

Editor: Gordon Yaciuk

Sponsored by
**International Development Research Centre,
Ottawa, Canada**

in collaboration with
**Alberta Department of Agriculture,
Edmonton, Canada**

Abstract/Résumé/Resumen

The authors of this volume include researchers and scientists from many countries that encompass diverse climatic, geographic, and socioeconomic conditions. Their disciplines were also numerous: home economics, food science, nutrition, physics, and engineering.

The workshop covered the most important areas in the design and operation of a drying system. These are: drying requirements, consumer acceptance, heat and mass transfer, and heat sources. Within drying requirements, the need for drying the product is discussed as well as drying times and rates, sample preparation, quality changes during drying, rehydration problems, and problems with storage of the dried product. The section on consumer acceptance includes the effects of drying on the nutritive value of food, the introduction of a dried food to the consumer market, and how consumers provide valuable information to scientists to help in improving a process or product. The theory and design of a drying chamber and process control are explained under heat and mass transfer and an operational, full-scale drying system is examined. Finally, under heat sources, a number of examples are given in the use of the sun, petroleum products, agriculture wastes, and wood as heat sources for a drying process. A final concluding commentary is made on the overall recommendations derived from the workshop and proposals for future work are given.

Les auteurs de ce volume sont des chercheurs et des techniciens venus de pays très différents les uns des autres du point de vue climat, géographie et conditions socio-économiques. Les disciplines représentées étaient aussi très diverses: économie domestique, alimentation, nutrition, physique, génie mécanique.

Le colloque a examiné les questions les plus importantes en ce qui concerne la conception et l'utilisation d'une installation de séchage: besoins en matière de séchage, l'accueil du consommateur, transmission de la chaleur et évacuation de l'humidité, sources de chaleur. Le chapitre sur les besoins en matière de séchage traite de la nécessité et de la durée de cette opération, de la préparation des échantillons, de l'action du séchage sur la qualité du produit, des problèmes de réhydratation et des problèmes de stockage du produit sec. Le chapitre sur l'accueil du consommateur traite des effets du séchage sur la valeur nutritive du produit, de la commercialisation d'un produit sec et de l'aide que peuvent apporter les consommateurs à l'amélioration d'un procédé ou d'un produit. Le chapitre sur la transmission de la chaleur et l'évacuation de l'humidité traite de la théorie et de la conception d'un séchoir, des modes de réglage et décrit une installation en service. Enfin, le chapitre sur les sources de chaleur donne des exemples l'utilisation du soleil, des produits pétroliers, des déchets agricoles et du bois. Un exposé des conclusions dégagées par le colloque et de ses recommandations est présenté à la fin de l'ouvrage.

Los autores de este volumen comprenden investigadores y científicos de varios países que, en conjunto, abarcan diversas condiciones climáticas, geográficas y socio-económicas. Sus disciplinas respectivas también son numerosas: economía del hogar, ciencias de alimentación, nutrición, física e ingeniería.

El cursillo abarcó los aspectos más importantes en el diseño y operación de un sistema de deshidratación. Estos son: requisitos de la deshidratación, aceptación por el consumidor, transferencia de calor y masa y fuentes de calor. Entre los requisitos se examina la necesidad de deshidratar el producto así como los tiempos e índices del proceso, preparación de muestras, cambios en calidad durante la deshidratación, problemas que presenta la rehidratación y problemas resultantes del almacenamiento del producto deshidratado. La sección de aceptación por el consumidor comprende los efectos de la deshidratación sobre el valor nutritivo del alimento, la introducción de un alimento deshidratado en el mercado del consumidor, y como éstos a su vez proveen información valiosa a los científicos ayudándoles a mejorar un proceso o producto. Se explican la teoría y diseño de la cámara de deshidratación y el proceso de control bajo transferencia de calor y masa, examinándose un sistema operativo de deshidratación a escala comercial. Finalmente, y bajo el concepto de fuentes de calor, se citan varios ejemplos relacionados con el uso del sol, de productos petrolíferos, y desechos agrícolas, así como el de la madera como fuentes de calor para procesos de deshidratación. Se efectúa un comentario final sobre recomendaciones generales derivadas del cursillo al tiempo que se efectúan propuestas para el trabajo futuro.

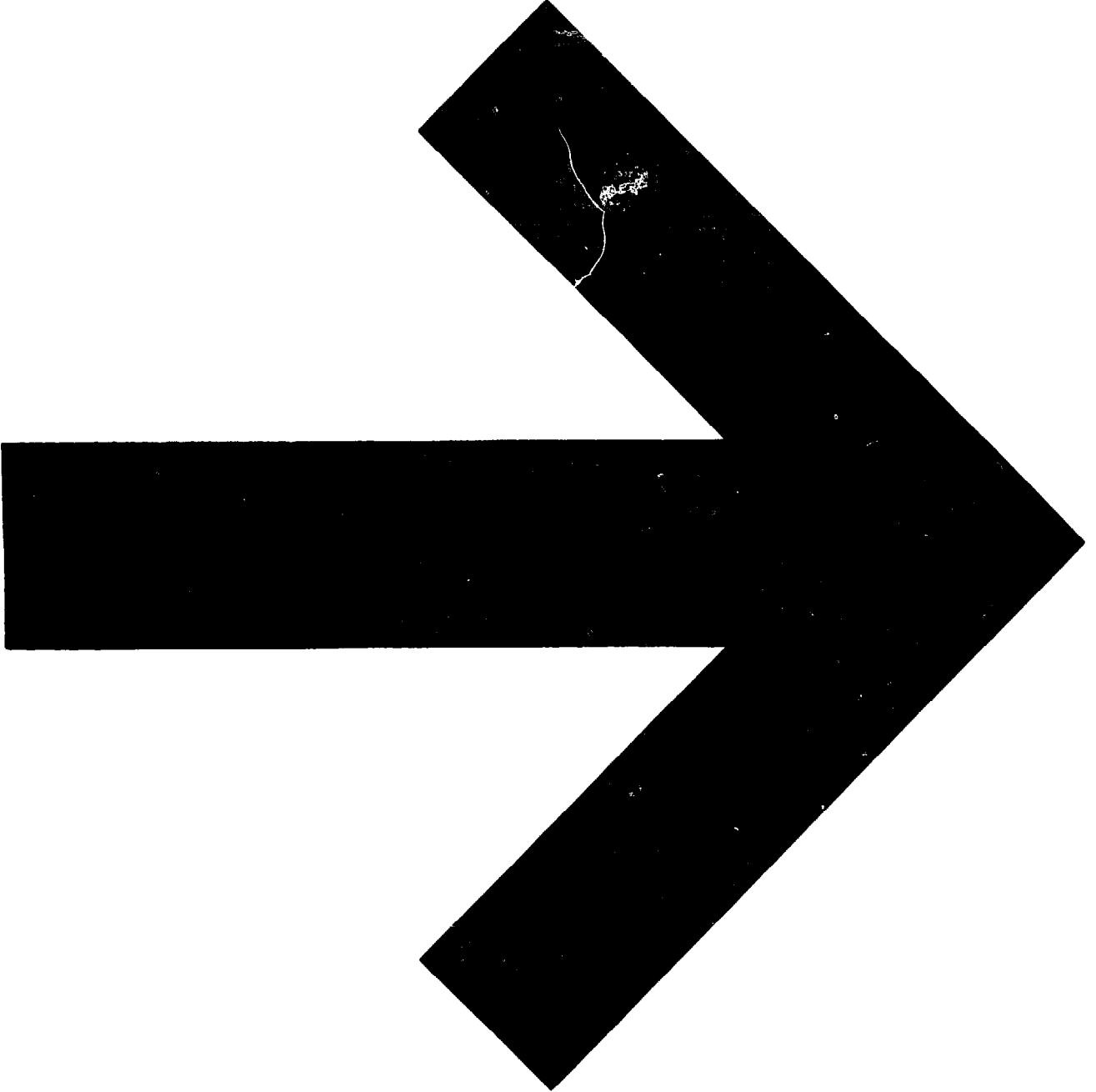

Contents

Foreword	5
Participants	6
Introduction	
Theme and objectives of the workshop G. Yaciuk	9
Drying Requirements	
Drying of fish in India P.V. Prabhu and K.K. Balachandran	11
Drying of vegetables in Egypt H.M. Ali and I.A. Sakr	15
Drying of potatoes (<i>papa seca</i>) in Peru C. Lescano	20
Drying of paddy in Indonesia Suahyadi	27
Consumer Acceptance	
Effect of drying on the nutritive value of foods in Kenya	
M.I. Gomez	31
Designing cowpea products for Northeastern Thailand	
T. Ngarmsak, M.D. Earle, and A.M. Anderson	36
Consumer acceptance of dehydrated banana weaning food in	
Costa Rica Celsa Lastreto G., Rodney Cooke, and	
Armando Campos S.	40
Marketing dried fish in East Java, Indonesia	
J.A. Sumardi, H. Purnomo, W.H. Susanto, Putiati, Darius,	
and I. Suryo	47
Heat and Mass Transfer	
Drying of cereal grains in the Philippines S.C. Andales	51
Drying onions in Niger A. Ba, Ch. Banzet, and J.M. Degbe	61
Drying fish in the Philippines Ernesto V. Carpio	63
Drying grapes in northern Chile J.M. Olhagaray	71
Heat Sources	
Solar energy as a heat source in crop drying in Sierra Leone	
Michael W. Bassey	73
Solar and natural air drying of rough rice in Korea	
Hak Kyun Koh and Chang Joo Chung	81
Farm grain dryer — Thailand Sriwai Singhagajen	89
Economic evaluation of alternative energy sources for coffee bean	
drying R. García, C. Porres, J.F. Calzada, J.F. Menchú, and	
C. Rolz	94
Dryers for cooperatives for food production in Indonesia	
Sjachputra	99
Conclusions	
Commentary G. Yaciuk	103

Foreword

For as long as we have historical record, the heat of the sun has been used to dry cereal grains, vegetables, fruit, fish, and meat. Solar radiation is widely used as a direct source of energy by which to dry and dehydrate foods of many kinds in many countries. As fossil fuel costs continue to rise, direct and indirect solar drying will gain increasing importance as a method of food preservation throughout the world.

The International Development Research Centre (IDRC) is supporting several research projects in which solar radiation alone or together with combusted agricultural wastes is used to dry crops and other food materials, in several of which the influence of variable drying conditions upon nutrient retention is being studied.

Because the food dehydration and crop drying projects financed by IDRC are located in countries with widely different environmental conditions and the spectrum of research activities calls for a variety of scientific disciplines, it appeared desirable to bring together research workers representative of the geographic and scientific diversity involved.

A workshop was, therefore, organized from 6 to 9 July 1981, at the University of Alberta and in collaboration with the Alberta Department of Agriculture (ADA), which included 2 days of formal sessions; a 1-day tour organized by the ADA of a grain dryer manufacturing plant, a local farm, and a primary elevator; and 1 day of informal visits to various university departments and commercial organizations by individual participants. Those attending the workshop came from Bangladesh, Chile, Egypt, Guatemala, India, Indonesia, Kenya, Korea, Malaysia, Mali, Niger, Costa Rica, Peru, the Philippines, Sierra Leone, Singapore, Thailand, and Zambia, encompassing immensely diverse climatic, geographic, and socioeconomic conditions and with experience that embraced home economics, food science, nutrition, physics, and engineering. The main topics covered included drying requirements, consumer acceptance, heat and mass transfer, and heat sources. This publication comprises the papers presented and discussed, together with a commentary by the technical coordinator of the meeting.

It is the belief of my colleagues in the Agriculture, Food and Nutrition Sciences (AFNS) Division that, thanks to the contributions by those who took part, this publication may prove of lasting value to others in developing countries who share similar interests and concerns.

J.H. Hulse
Director
Agriculture, Food and Nutrition Sciences Division

Participants

A. Alam, Post-Harvest Technical Scheme Project Co-ordinator, Central Institute of Agricultural Engineering, Shri Guru Tegh Bahadur Complex, T.T. Nagar, Bhopal 462 003, India.

Hatem Mohamed Ali, Head, Laboratory on Animal and Poultry Nutrition, National Research Centre, Dokki, Cairo, Egypt.

Silvestre C. Andales, Assistant Professor and Project Leader, UPLB/IDRC Postharvest Project, Department of Agricultural Process Engineering, University of the Philippines at Los Baños, College, Laguna 3720, Philippines.

M. Zohadie Bardaie, Department of Agricultural Engineering, Universiti Pertanian Malaysia, Serdang, Selangor, Malaysia.

Michael W. Bassey, Department of Mechanical Engineering, Fourah Bay College, University of Sierra Leone, Freetown, Sierra Leone.

Ernesto V. Carpio, Project Engineer, Department of Food Science and Technology, University of the Philippines at Los Baños, College, Laguna 3720, Philippines.

Teoh Inn Chek, Lembaga Padi Dan Beras Negara, Tingkat 20-21, Bangunan UMBC, 4, Jalan Sulaiman, Kuala Lumpur, Peti Surat 108, Malaysia.

Chong Thean Chhong, Chemical and Food Process Section, Singapore Institute of Standards and Industrial Research, Maxwell P.O. Box 2611, Singapore 9046, Republic of Singapore.

J.M. Degbe, Office national de l'énergie solaire, B.P. 621, Niamey, Niger.

Dante B. de Padua, Technical Team Leader, Southeast Asia Cooperative Post-Harvest Research and Development Programme, c/o SEARCA, College, Laguna 3720, Philippines.

W. Edwardson, Senior Program Officer, Agriculture, Food and Nutrition Sciences Division, International Development Research Centre, 10454 Whyte Avenue, Suite 304, Edmonton, Alberta, Canada.

R.S. Forrest, Associate Director, Engineering and Home Design Sector, Alberta Department of Agriculture, Agriculture Building, 9718 107 Street, Edmonton, Alberta, Canada.

Ricardo García, Engineer, Applied Research Division, Instituto Centroamericano de Investigación y Tecnología Industrial, Avenida La Reforma 4-47 Zone 10, Apartado Postal 1552, Guatemala, C.A.

Celsa Lastreto Gomez, Centro de Investigaciones on Tecnología de Alimentos, Universidad de Costa Rica, San Jose, Costa Rica.

M.I. Gomez, Lecturer, Department of Food Science and Technology, Faculty of Agriculture, University of Nairobi, P.O. Box 29053, Kabete, Nairobi, Kenya.

H.K. Koh, Associate Professor, Division of Agricultural Machinery and Process Engineering, Department of Agricultural Engineering, College of Agriculture, Seoul National University, Suweon, Korea 170.

Carlos Lescano, Jefe, Departamento de Tecnologia de Alimentos y Productos Agropecuarios, Universidad Nacional Agraria La Molina, Apartado 456, Lima, Peru.

J. Lorenzana, Agricultural Engineering Department, Isabela State University, Echaque, Isabela, Philippines.

Joseph M. Mwale, Senior Scientific Officer, Food Technology Research Unit, National Council for Scientific Research, P.O. Box CH-158, Chelston, Lusaka, Zambia.

Candido Joven Miguel, Pasig Distributors Corporation, 114 Plaza Rizal, Pasig, Metro Manila, Philippines.

Tipvanna Ngarmsak, Department of Agricultural Products, Faculty of Agriculture, Khon Kaen University, Khon Kaen, Thailand.

J.M. Olhagaray, Institute of Technological Research (INTEC/CHILE), Casilla 667, Santiago de Chile, Chile.

P.V. Prabhu, Scientist, Central Institute of Fisheries Technology, CIFT/IDRC Fish Processing Project, Willingdon Island, Matsyapuri P.O., Cochin 682 029, India.

Abdus Satter, Senior Scientific Officer, Agricultural Engineering, Bangladesh Agricultural Research Institute, Joydebpur, Dacca, Bangladesh.

O.G.A. Schmidt, Program Officer, Agriculture, Food and Nutrition Sciences Division, International Development Research Centre, 10454 Whyte Avenue, Suite 304, Edmonton, Alberta, Canada.

Sriwai Singhagajen, Chief, Storage and Processing Section, Agricultural Engineering Division, Department of Agriculture, Ministry of Agriculture and Cooperatives, Bangkok, Bangkok 9, Thailand.

Wenceslao M. Sison, Agricultural Plans and Programs Supervisor/Project Leader, Technical Research and Services Directorate, National Food Authority, 101 E. Rodriguez Sr. Avenue, Matimyas Building, Quezon City, Philippines.

Sjachputra, c/o Haji Muslimin Nasution, Ministry of Co-operatives, Departemen Perdagangan Dan Koperasi, Sekretariat Menteri Muda Urusan Koperasi, P.O. Box 384, Jakarta, Indonesia.

Suahyadi, Project Leader, National Logistics Agency (BULOG), BULOG/IDRC Postharvest Rice Technology Project, P.O. Box 2345, Jakarta, Indonesia.

J.A. Sumardi, Departemen Pendidikan Dan Kebudayaan, Universitas Brawijaya, Proyek Kerjasama Unibraw/IDRC, Jalan Mayjen Haryono 169, Malang, Jatim, Indonesia.

Salomon Chavez Tapia, Departamento de Tecnologia Pesquera, Universidad Nacional Agraria La Molina, Apartado 456, Lima, Peru.

Cheick Oumar Traoré, Laboratoire de l'énergie solaire, B.P. 134, Bamako, Mali.

S. Vogel, Program Officer, Agriculture, Food and Nutrition Sciences Division, International Development Research Centre, 10454 Whyte Avenue, Suite 304, Edmonton, Alberta, Canada.

G. Yaciuk, Program Officer, Agriculture, Food and Nutrition Sciences Division, International Development Research Centre, 10454 Whyte Avenue, Suite 304, Edmonton, Alberta, Canada.

IDRC Staff

M.C. Beaussart, Administrative Assistant, Agriculture, Food and Nutrition Sciences Division, IDRC, 10454 Whyte Avenue, Suite 304, Edmonton, Alberta, Canada.

A. Chouinard, Technical Editor, Communications Division, IDRC, Box 8500, Ottawa, Ontario, Canada K1G 3H9.

K. Kealey-Vallière, Assistant Technical Editor, Communications Division, IDRC, Box 8500, Ottawa, Ontario, Canada K1G 3H9.

Theme and Objectives of the Workshop

G. Yaciuk¹

Through previous experience, it was felt that the workshop should cover the four topics most important in the design and operation of a drying system, namely: drying requirements, consumer acceptance, heat and mass transfer, and heat sources. The majority of the papers deal with the scientist's particular research and, therefore, do not appear to follow a particular format. They do, however, respond to the type of information normally considered within one of the four topics.

Section I examines drying requirements of four different commodity types. In terms of heat transfer, fish can usually be considered as a slab, paddy as a porous bed, and potatoes as cubes or strips. Each paper looks at the need for drying the product, drying times and rates, sample preparation, quality changes during drying, rehydration problems, and problems with storage of the dried product.

Section II contains four papers related to consumer acceptability. The first paper discusses effects of drying on the nutritive value of food, in particular, drying effects on carotene and vitamin C retention in a number of Kenyan vegetables. Although the second paper discusses the design of new cowpea-based foods in Thailand, some of the ideas may be of value in the introduction of a

dried food. The third paper examines how consumers may work together with a scientist to improve a process or a product. Often an improved process yields more product than can be used by the processor (often the farmer or fisherman). The fourth paper examines fish marketing in East Java.

No dryer is designed efficiently without some theoretical consideration of heat and mass transfer rates. The first three papers in section III discuss theory, design of a drying chamber, and process control. The fourth paper examines drying of grapes on a large commercial scale and as such is the only report at the workshop on an operational full-scale drying system.

Section IV examines a number of examples in the use of the sun, petroleum products, and agriculture wastes and wood as heat sources for a drying process.

Special thanks are extended for the editorial support received from Amy Chouinard and Kathy Kealey-Vallière of IDRC's Communications Division and to R.S. Forrest, W. Edwardson, and S.M. Vogel for chairing the sessions; to M.C. Beaussart for handling logistical aspects; and to IDRC and the Alberta Department of Agriculture for funding the workshop.

¹Technical coordinator for meeting, Program Officer, Agriculture, Food and Nutrition Sciences Division, International Development Research Centre, 10454 Whyte Avenue, Suite 304, Edmonton, Alberta, Canada.

Drying of Fish in India

P.V. Prabhu and K.K. Balachandran¹

Abstract. Among the several methods of long-term preservation of fish, drying is perhaps the simplest method that does not require sophisticated equipment or highly skilled workers. Traditional drying in the sun, although practiced widely, poses some problems such as slow drying and contamination with sand, insects, and pathogenic bacteria. It is, therefore, necessary to consider mechanical drying of fish. The influence of temperature of drying, relative humidity in the dryer, and the air velocity as well as salting before drying are discussed in this paper. General defects observed in the course of storage of fish and some methods for minimizing them are also given.

Fish spoil quickly because of bacteria, enzymes, and chemical reactions, but bacterial and enzyme actions can be minimized or arrested by controlling the storage temperature of the fish. Chilling, freezing, and canning are some of the processes; however, these are techniques that require sophisticated equipment for the processing, storage, and distribution of the processed products.

Water is essential for bacterial growth as well as for the activity of enzymes. The removal of water from fish reduces the chances for the action of spoilage bacteria. Drying, either without or after salting and with or without smoking, is a widely accepted traditional practice of preserving fish. Salting, smoking, and drying are processes that can be employed with the minimum of equipment and operated by semi- or unskilled workers. Normally, drying is done in combination with either salting or smoking or both. Salting slows down or even prevents the bacterial spoilage of fish. Some chemicals present in smoke also destroy spoilage bacteria. The removal of water by drying can halt the growth of bacteria and moulds. Drying is, therefore, a simple method of preserving fish that does not require complicated equipment, can be handled by unskilled workers, turns out a product with good storage properties, and provides a highly concentrated food.

Because drying involves the removal of water to stop the action of bacteria or enzymes, attention must be given to what amount of water can be removed before the quality and flavour of the product are affected. Most of the spoilage bacteria do not grow in foods that have less than 25% moisture content (MC). Similarly, moulds also cease to grow when the moisture content is 15% or less. However, if the fish is salted before being dried the permissible amount of water can be higher. Depending upon the amount of salt used, 35–40% MC can be considered safe enough to inhibit the action of bacteria or moulds.

In this paper, the discussions on drying will be limited to sun or mechanical drying of fish, fresh or salted. The principal method of drying practiced in India is sun drying, which is mainly used for the by-catch from shrimp trawling. Fish is dried fresh or salted depending upon the species. The most common practice is to spread the fish on sandy beaches, bamboo mats, or raised cement platforms where they are allowed to dry for 2–3 days. Fish like anchovies (*Engraulis indica*) are dried without salt; however, larger fish are generally salted whole or after having been split. Even larger fish like shark are split; deep scores are made in the open flesh to allow the salt to penetrate, and the fish are left heavily salted overnight and then dried. Fish like Bombay duck (*Harpodon nehereus*), which contain 90–92% water, are hung from scaffolds erected in the open and then dried. In most cases after a day's drying the fish are usually heaped together overnight and spread out and dried again the next day. This facilitates the diffusion

¹Central Institute of Fisheries Technology (CIFT), Willingdon Island, Matsyapuri P.O., Cochin 682 029, India.

of water from the relatively moist interior to the surface from where it can be more easily evaporated during the subsequent drying operation.

Drying of Unsalted Fish

The type of fish that are usually dried unsalted includes anchovies, small silver bellies, and Bombay duck, for example, which are all used for human consumption, as well as several other varieties of small fish that are converted into fish meal. The facilities available at landing sites determine whether these fish are dried either by being spread on sand on the beach or on mats or, less often, on cement platforms erected for this purpose with the exception of Bombay duck, which, as discussed earlier, is often dried by hanging on scaffolds.

Bombay duck is a typical fish of the Gujarat coast in India where a huge quantity of fish (about 80000 t) is landed within a period of 4 months. Only a small proportion is consumed in fresh form, the rest is sun dried and used for local consumption and export. The drying practice presently used is to wash the fish in creek water and to hang them by pairs joined jaw-to-jaw on horizontal ropes. Ten to twelve of these ropes are then tied horizontally, one above the other, leaving a space of about 30 cm between them. Normally, 80–100 fish are hung per metre. A systematic study covering various aspects of drying Bombay duck on scaffolds has shown that optimum water loss occurs when 50–60 fish are hung on a 1-m length of rope. This permits adequate circulation of air over individual fish and yields a final product that is satisfactory both in physical and in organoleptic characteristics. With this method water loss of 87% of fresh fish has been achieved. Decreasing the number of fish per metre of rope did not improve the drying time, whereas increasing the number of fish resulted in a slower drying rate and excessive spoilage.

Normally, in cases where the fish is dried without salting, the process is continued until about 10% MC. Although Bombay duck and anchovies dried in this manner are exported, other fish are used locally, some being converted into fish meal.

Salted Sun-Dried Fish

A number of species of fish, large and small, fatty and lean, are salted and sun dried in India.

Mackerel, jew fish, sole, lactarius, cat fish, and shark, among others, are most commonly preserved by this method. The fish are normally split open from the dorsal side, mixed with common salt (marine salt) in the ratio of 5:1, kept overnight, and dried the following day. The fish are then dried for 2 or 3 days in the sun until about 35% MC. Salted and dried fish are generally marketed within the country.

Generally, the fish that are used for drying are not very fresh. Often, only fish that cannot be sold in the fresh fish market are dried. Ice is either not used at all or used only sparingly. Proper handling is also not observed, and drying is done, with very limited exceptions, in the open, which increases the risk of contamination. Flies often lay eggs that, although not detected immediately, become a problem during storage. Occasionally, contaminated fish present a significant public health concern.

Drying of Fish in Mechanical Dryers

Because of the problems connected with sun drying, consideration is now being given to the mechanical dehydration of fish. In mechanical dehydration, the drying process is carried out under controlled conditions. The temperature of drying, air velocity, as well as the relative humidity (RH) in the drying atmosphere should be strictly controlled to ensure that the final product is of satisfactory quality.

Drying Temperature

In mechanical dryers, hot air is employed as the carrier of heat to the fish as well as water vapour from the fish. At the initial stages, when the fish flesh is saturated with water, the temperature of drying should not exceed 40–50°C depending upon the fish used. At temperatures above 40–50°C most of the fish flesh gets cooked, which makes the final dry product brittle.

Air Velocity

In mechanical hot-air dryers, it has been observed that the higher the velocity of air passing over the fish the greater will be the rate of evaporation of water. However, if the air velocity is increased beyond a certain limit, a small whirlpool of air will occur between the fish and this will result in nonuniform drying. Experiments have shown that an air velocity of 1.5–2 m/sec is ideal for drying most of the fish.

Relative Humidity

The rate of evaporation of water depends on the partial pressure of water vapour in the air surrounding the fish and the partial pressure of water vapour on the surface of the fish. Therefore, at a constant air velocity, the drier the air the faster is the rate of evaporation of water.

Water in fish is not present as pure water. It contains dissolved salts and protein, etc. When water leaves the fish at the surface these residues are left and if the air is very dry a crust will form on the surface. This phenomenon is called case-hardening. Case-hardening also occurs when the temperature of the air is raised and, therefore, diffusion of water from deeper layers to the surface becomes difficult. This will result in an increase in the temperature of fish flesh, which will affect the quality. Also, if the relative humidity of the air at the inlet point of the dryer is too high, the drying process will be prolonged, and the fish will spoil before the drying process is over. Relative humidity between 50 and 60% is recommended for drying in hot-air dryers.

Constant- and Falling-Rate Periods

There are two distinct stages when fish are air-dried: the constant-rate period and the falling-rate period. In the first stage, the rate of evaporation of water per unit area per unit time remains a constant and this is similar to evaporation from a saturated surface. Once the surface water is evaporated, further evaporation can take place only as fast as it diffuses to the surface from within. The rate of diffusion slows down as the drying process progresses and consequently the rate of evaporation also falls. This is the falling-rate period.

Even in mechanical dehydration, 18–22 hours are required so that the end product will be sufficiently low in moisture to ensure safe storage. Although mechanical dehydration takes less time than sun drying, it is still considered to be too long a process, and, naturally, the cost of producing dried fish using mechanical dryers is high compared to the sun-drying process. Dried fish is an inexpensive commodity for the common people, therefore, an increase in the price of mechanically dried fish over that of sun-dried fish is likely to be unacceptable to consumers even though the increase in price would be justified by the improved quality. Consideration should, therefore, be given to

determine ways to cut down the drying time, without sacrificing quality, in an effort to reduce production costs. One method suggested for accelerating the drying process is to subject the fish to successively higher temperatures during the falling-rate period. This method has since been applied in the case of tropical fishes and has resulted in great success.

At the Central Institute of Fisheries Technology (CIFT) in India, freshly split fish (average weight 90–110 g) are dried under a phased temperature program, initially at 45°C until the period during which drying is constant is complete. Then drying is done at progressively increasing temperatures of up to 60°C, with 50% RH. Fish are dried to a final moisture content below 20% in 12–14 hours.

Salted fish do not exhibit any constant-rate period. In the case of salted fish, the initial high rate of drying suddenly falls; however, this fall in rate can be compensated to a large extent by a slow increase in temperature. In the case of salted fish like mackerel, jew fish, etc., it took 10–12 hours to bring the moisture content below 30%.

A tunnel dryer employing this principle with appropriate controls for temperature, humidity, and air velocity has been designed at CIFT.

Rehydration

In India, dry fish is consumed in different styles; after frying in oil, as chutney, or prepared just like fresh fish after reconstitution in water. Denaturation of the proteins takes place during the process of dehydration, particularly when the fish is dried at high temperatures as in mechanical dryers thereby affecting the rehydration capacity. However, if the drying conditions are carefully controlled, case-hardening as well as too high an increase in the temperature of the flesh can be avoided, and a final product that rehydrates to give a fair texture can be produced.

Packaging and Storage

The main causes of spoilage of dry fish are moulds, bacteria, discoloration, rancidity, attack by insects, and changes in texture. Mould growth is relatively low at 65% RH, but mould grows rapidly at 75% RH or higher, a condition generally obtained in the coastal areas. However, in the monsoon season, the relative humidity is 90% or higher and provides an atmosphere quite

conducive for all types of spoilage to progress. Salted and dried lizard fish (*Saurida* sp.) kept outside had the following changes in moisture content during 4 months' storage: initial moisture content (MC_i), 28%; after storage at 55-60% RH for 3 months, 19% MC; and after a month's storage at 90% RH, 45% MC.

At 90% RH, because of the attack of bacteria and moulds, the fish flesh becomes slimy, soft, and severely discoloured. Although bacterial spoilage is controlled in salted fish, spoilage caused by moulds occurs whether the fish is salted or unsalted. Sorbic acid or sodium propionate treatments are effective barriers against moulds; however, the problem of providing an effective barrier against the moisture loss or uptake remains. In the former case, weight loss and toughening of the texture are the main problems, whereas in the latter case incidental spoilage and attack by mould and bacteria are important.

Another important sign of spoilage in salted fish is the "pink," the colour developed because of the growth of halophylic bacteria of the *Serratia* sp. Curing salt is the main source of these microorganisms. Solar salt (marine salt) is known to contain these microorganisms in relatively large numbers and hence the problem's incidence is more widespread where solar salt is used for curing.

Dried fish in general, and dried fatty fish in particular, become discoloured during storage. They also develop rancid odours and flavours. The additional cost of providing an air-tight package for dried fish would not be economically acceptable to the common people and has, therefore, not been attempted.

Although there have been sporadic reports on the effectiveness of various antioxidants like butylated-hydroxyanisole (BHA), butylated-hydroxytoluene (BHT), etc., on the prevention of rancidity in fish, no information is available on their commercial utilization.

Insect infestation has not been a serious problem in the storage of salted fish, but it is common in unsalted fish. Fumigation is one method used to prevent this.

Commercially dried fish in India, particularly on the east coast, are packed in palmyrah (palm) leaf mats and tied securely with ropes, covered with hessian cloth, and sewed at the joints to provide a safe package. At present there are no consumer packs of dry fish available, although mechanically dried fish are packed in polyethylene bags for the retail market. However, polyethylene is not strong enough to withstand any physical damage from fins and other sharp contours of dry fish. Studies on low- and high-density polyethylenes, polyvinylchloride films, etc., are under way on the most suitable packaging for consumer packs of dry fish.

Drying of Vegetables in Egypt

H.M. Ali and I.A. Sakr¹

Abstract. A solar dryer was used to dry Jew's mallow (*Corchorus olitorius* L.) and okra (*Hibiscus esculentus* L.). The drying procedure depends on using heated air of 60°C on average. The results revealed that the rate of drying was high in the first 3 hours and then slowed down during the remainder of the drying time. The duration of drying for both Jew's mallow and okra was on average 22.5 hours and 40 hours respectively, and the moisture removed during that period was about 72–75%. The quality of the dried product was acceptable to the consumer and was considered to be nutritionally satisfactory. The storage of dried products for 32 weeks at room temperature showed no adverse effect on quality or change in chemical composition.

Because of the high market potential for the two dried products, a technofeasibility study was carried out to determine the economic possibility of using this dryer in rural areas.

The economical growing of fruits and vegetables is limited in many countries to certain seasons and localities, and to meet the demand during the entire year in all areas, the commodities are preserved using different techniques. The causes of loss are linked in many complex ways to beliefs and attitudes that underlie traditional ways of managing the postharvest system and complicate change. These factors must be carefully examined and understood before new conservation technologies and practices can be successfully introduced.

Drying technologies, as a process for food conservation, seem to be an adequate method under most conditions in developing economies. Therefore, the International Development Research Centre (IDRC) of Canada, together with the National Research Centre (NRC) of Egypt, financed a project to develop a community solar dryer capable of drying commodities without affecting the nutritive quality.

Methodology

Baseline data about prevailing climatic conditions, including solar-radiation intensities, wind speeds, rainfall, ambient air temperature, and relative humidity (RH) were collected. (Meteorological data should be studied for at

¹Laboratory on Animal and Poultry Nutrition, National Research Centre (NRC), Dokki, Cairo, Egypt.

least 10 years to obtain a good average.) Data were collected on harvesting time, total production, amounts processed, and chemical composition of the fresh product. Existing drying operations were surveyed at the government level and in rural societies, and an evaluation of the chemical composition of the products was made. Samples of vegetables were dried artificially using an electrically heated oven and sunlight to determine the nutritive value of the product and to make an economic evaluation of the whole operation. The solar dryer was designed according to: climatic conditions, availability of daily solar energy, crop type, and size of operation.

A questionnaire was designed to determine the type of commodities needing drying, the level of acceptability of dried products, potential market for dried products, consumer preference, the total amount of crop harvested daily and the portion that would be preserved, and the storing facilities.

In the experimental procedure for test drying, specified amounts of green agricultural commodities were brought in from the field in plastic bags. They were loaded on the trays and placed in the drying chamber on three levels. A fan was used to force hot air into the drying chamber. Hourly temperatures for ambient air and heated air were recorded by means of thermocouples installed at strategic locations and connected to a 17-point recording potentiometer. Relative humidity was recorded with a hygrothermograph

for air entering and leaving the chamber. The airflow rate was measured as a product of air velocity and cross-sectional area. Moisture content (MC), ash, fibre, nitrogen-free extract, protein, and total carbohydrates of the fresh commodities and dried commodities were determined using methods of the Association of Official Agriculture Chemists (AOAC 1968).

Dried products were stored at room temperature in sealed plastic bags and jute bags tied with ropes. Bimonthly samples were checked to detect moulds and to determine the nutrient content of the products. A technoeconomic evaluation was also made on the community dryer taking into consideration the cost differential between the fresh and the manufactured product.

Crops to be Dried

The results revealed that two main vegetable crops are likely to be dried in the rural communities; Jew's mallow (*Corchorus olitorius* L.) and okra (*Hibiscus esculentus* L.). There is also a potential market for the two products in the urban societies.

Okra and Jew's mallow are cultivated in February and March. They are first harvested in June and the harvesting season can last until September or October. The first harvests are consumed fresh, and the late harvests are used for drying. Jew's mallow gives 6 harvests and okra gives about 4-5 harvests. The average production in one harvest is about 1.5 t (total annual production of Jew's mallow is 73000 t and for okra it is 65000 t). The average period between each harvest is 20-25 days.

The freshly harvested vegetables are packed in jute bags, sprayed with water, and loaded on trucks to be transported for marketing. Jew's mallow begins to deteriorate 12 hours after harvesting, however, okra begins to deteriorate only after 2-4 days. The rate of deterioration differs considerably from one crop to another. Deterioration is also a result of improper handling and storage conditions prior to marketing, especially when the market is a long distance from the farm. Because of the size of land ownership in Egypt, and the market mechanism, the farmers have a choice between accepting any price offered to them or selling their first-class products in the city market and dehydrating the rest to be sold in the off-season. However, the farmers are taking a risk by keeping the dehydrated product, because if it is not properly dried it usually becomes infected by fungi.

Dried produce compared to fresh produce amounts to about 4.5% of the total production, but production is growing rapidly, therefore, precise data about the annual rate of growth is not available.

Survey of Existing Drying Operations

The main vegetable-producing governorates lie in the Delta of the River Nile. A sample of 42 villages, representing 1% of the total Egyptian villages, were visited to study the traditional drying practices used in rural communities.

In all areas visited, sun drying was the main drying procedure. No artificial drying was used in any of the governorates visited. If the market price of the produce drops significantly the farmers will harvest the crop and begin the simple drying operation by first washing the produce to remove surface dirt and then spreading it on mats or any other available surface. At the village level, the drying process involves the whole family.

In the governorates located near large cities like Cairo and Alexandria, there is a vegetable-drying system designed to supply the markets in these cities. The system consists of a series of drying mats on the ground. The size of the drying area ranges from 200 to 2000 m². Young children begin harvesting in the early morning and leave the crop on the ground for wilting for 2 hours. It is then collected and returned to the drying area for cleaning where it is spread on mats and left to partially dry in the sun. When it is half dried it is transported to another drying area in the shade, the idea being to preserve the green colour as much as possible so that it will retain an attractive appearance for the consumer.

Most of the produce is packed in 50-kg jute bags and sent to the city market. The average drying times for sun-dried Jew's mallow and okra in rural areas are 3-4 days and 5-7 days, respectively.

The chemical analysis of fresh samples and dehydrated samples taken from the visited areas is shown in Table 1. The results represent the average of 210 samples collected from different operations in the different localities. There was a great variation in the moisture content among samples and accordingly other nutrients were affected.

From the questionnaire it was found that one family produces an average of 10 kg of okra and 10 kg of Jew's mallow. The most important observation about the products was the high

Table 1. Chemical analysis of fresh and sun-dried commodities.

Commodity	Moisture content (%)	Crude protein (%)	Fibre (%)	Ether extract (%)	Soluble carbohydrates (%)	Ash (%)
Jew's mallow						
Fresh	83.26	3.83	1.71	0.41	8.03	2.76
Sun dried	7.45	23.62	10.59	3.50	38.72	16.12
Okra						
Fresh	86.72	2.54	0.93	0.25	8.38	1.18
Sun dried	11.35	16.78	12.74	2.70	46.47	9.96

percentage of impurities. It seems that sun drying was not enough to inactivate enzymes and reduce the fungal load. The questionnaire also indicated a difference in opinion concerning the number of drying units needed as farmers preferred to have their own individual dryers, but government agencies preferred huge drying units capable of serving an entire community in the production of a variety of commodities.

Development of the Solar Dehydrator

Based on the previous findings, the solar energy laboratory developed the community-size solar dehydrator to help in the drying of a variety of commodities containing a high moisture content (> 75%). The facility consisted of a solar air heater with 24 m² of absorber surface to supply heat for the air coming from a

1.4 kW centrifugal fan capable of moving 800 m³ of air per hour through a duct. The heated air enters the drying chamber with a pressure rise of 10–15 cm of water. The drying chamber has a volume of 10 m³ and a chimney is provided to equalize the air pressure to prevent the commodities from being blown around inside the chamber. Trays of stainless steel wire mesh are fixed along the walls of the drying chamber on three levels. The design of the solar collector is illustrated in Fig. 1.

We carried out some experimental work to measure the rate of drying vegetables using air drying, and we found that the highest rate of drying took place during the first 3 hours. The duration of drying depends upon: initial water content, properties of the commodity, thickness of the commodity on the tray, air velocity, and ambient air temperature and relative humidity.

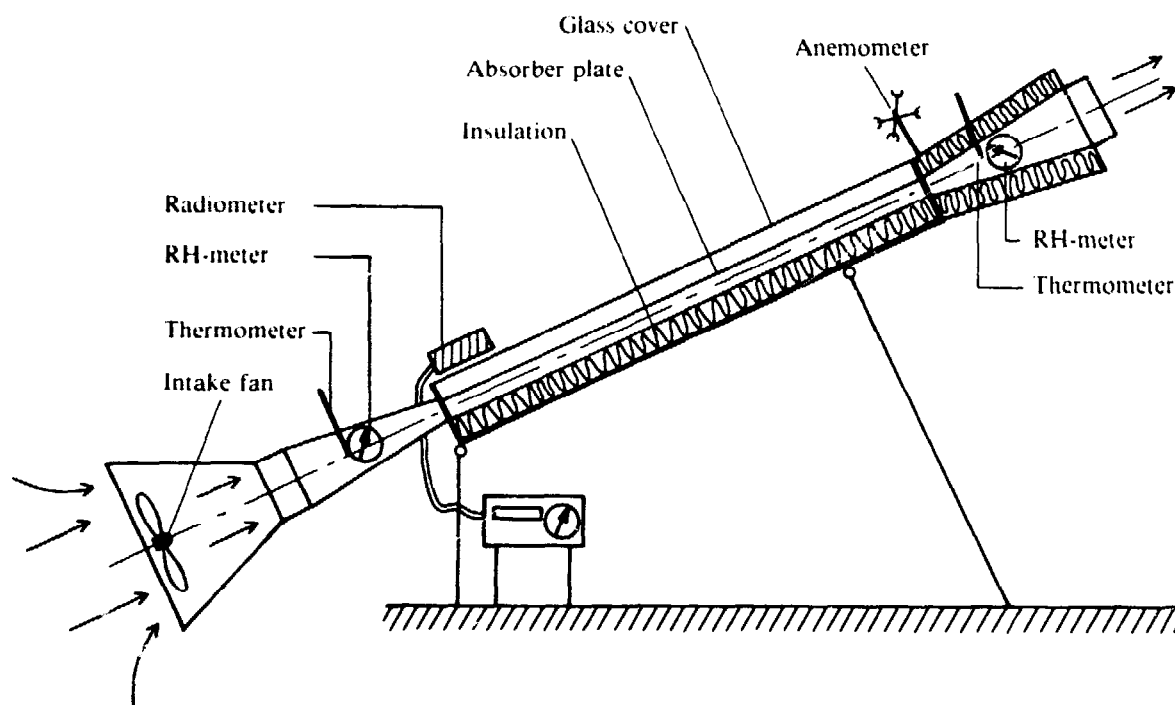

Fig. 1. Cross section of the solar collector.

Drying Process

Drying tests carried out by our research team commenced in the late summer when vegetable commodities are in abundance and their prices are lower. Jew's mallow and okra were brought in from the field in plastic bags directly after harvesting. They were washed and blanched in water and then loaded on the trays in thin layers of 6 mm. Trays were placed in the drying chamber when the air temperature inside reached 60°C. The commodities were turned twice daily. Hourly temperature and relative humidity for both the ambient air entering and leaving the drying chamber were recorded. When the relative humidity values for ambient air both entering and leaving the chamber showed similar values, drying was continued for another 2 hours to ensure that the moisture content of the product was about 10–13%, which is the value required to ensure safe storage. After completion of the drying, the products were left for 1 hour to cool and were then packed in nylon or jute bags. Samples from both the fresh products and dried products were taken to the laboratory to determine moisture content, crude protein, crude fibre, ether extract, and total carbohydrates and ash content (AOAC 1968).

Table 2 summarizes the results of the drying experiments on Jew's mallow and okra. Two drying experiments were carried out for each commodity. Jew's mallow and okra were dried once in August and once in October. There was no appreciable difference in the weight of the commodities used in the two different tests. Within each drying experiment the fan was only on during the drying period and provided 800 m³/hour of air.

The initial moisture content (MC) of the fresh commodities was not less than 80% and the target moisture content was 10–15%. The drying time in the October experiments was longer because of the higher relative humidity recorded in this period and fewer hours of sunshine.

Drying Problems

In the drying experiments carried out over the last 2 years, it was found that if the drying rate, due to the high air velocity, is too great, the product tends to dry mainly from the surface layers and, after being removed from the dryer, the surface becomes moist again. Overdrying of the vegetables is pointless, because the storage of the dried commodity in air of high relative humidity will result in the absorption of moisture from the atmosphere until it reaches an equilibrium moisture content. Overdrying caused remarkable losses in the leaves of some vegetables.

Effect of Drying on the Quality of Vegetables

Dehydrated commodities can lose some of their nutrients during the dehydration process. Oxidation is a primary cause of loss, particularly in the case of ascorbic acid, but nonoxidative losses also occur. There is evidence that non-enzymatic browning reduces the value of the protein (Hendel 1960).

Lewis et al. (1949) observed that glucose reacts with acetic, citric, or lactic acid in a model system to produce brown pigments and carbon dioxide. Oxygen accelerates the process. Heat is also considered as a main factor responsible for protein damage. Heat damage is due to a time-temperature relationship. There is evidence that heat damage is much more likely to occur when the initial moisture content is high. Based on the results of the Regional Research Laboratory of the United States Department of Agriculture that metal grid trays reduce losses during drying of riced potatoes, we used stainless steel trays to hasten drying and reduce the length of drying time.

It is very important when drying green vegetables to have a final product that meets with consumer acceptance. Good colour, and consequently carotene content, can be retained

Table 2. Summary of drying experiments on Jew's mallow and okra.

Commodity	Harvesting date	Amount of material (kg)		Drying period (hours)	Average drying temperature (°C)	Average temperature rise (°C)	Average moisture removed (%)	Moisture content of final product (%)
		In	Out					
Jew's mallow	21/08/79	37.5	5.87	20	58.5	32	72.91	10.35
	03/10/79	20.5	3.10	25	53.5	29	72.90	10.36
Okra	25/08/79	37.9	7.58	36	55.5	30	75.47	11.25
	10/10/79	36.0	7.00	44	54.0	28	76.17	10.55

by ~~fin~~ching. Appropriate storage conditions can help to retain the desired qualities as well.

Storage Problems of Dried Vegetables

High moisture content will contribute to quality deterioration and indirectly to a decrease in quantity. Even under the most controlled conditions, the stored produce cannot be guaranteed as mould free. The infestation of moulds in the presence of moisture, increases the respiration rate of moulds. The production of 14.7 g of CO₂ is accompanied by 1% dry-matter loss (Sinha 1971). In the process of respiration there is a liberation of heat and water and, therefore, the moisture content of the produce increases, which in turn increases the reaction until the produce spoils.

In our experiments, we found that storage in nylon bags had no adverse effect on the chemical composition of the stored commodity. The chemical analysis showed no serious changes. Moisture content, protein, ether extract, fibre, carbohydrate, and ash content were almost the same. The fungal load did not exceed 100000 spores/g in the examined samples. However, further tests are needed to be conclusive. Some of these include enzymatic activity, aflatoxin determination, and carotene and vitamin deterioration.

Future Work

The technoeconomic evaluation of three solar dryers installed at different locations in Egypt indicated that we overestimated the requirements for steel (65% of total costs) necessary to build the dryer, which in turn increased the initial cost and subsequently decreased the profit (cost-benefit ratio of 1.23:1 and a pay-back period of

4.7 years). Another design now is taking this factor into consideration.

In the final analysis, it should be stated that, once a decision is taken by policymakers to reduce postharvest losses of food commodities, drying should be given serious consideration as this can save about 20% of the losses experienced in production. Early harvesting of crops reduces losses in the field and increases the land available for other crops and better production due to the early planting of the next crop. The postharvest losses of vegetables due to the long distance from production sites to the market can be reduced together with the cost of transportation. The economic benefits are so great that drying should be considered as a standard practice in reducing postharvest losses.

Acknowledgments

Mr M. Shokry and Mr A.H. Abdel Gawad gave valuable assistance in preparing the data. Mrs Fatma M. Salman is thanked for preparing the figures in this article. The valuable advice of Mr C. MacCormac in evaluating the technofeasibility of dryers is also appreciated.

-
- AOAC (Association of Official Agriculture Chemists). 1968. Official methods of analysis (10th ed.). Washington, DC, USA, AOAC.
- Hendel, C.E. 1960. Effects of drying and dehydration on food nutrients. In: Harris, R.F. and Loesecke, H. von, eds., Nutritional evaluation of food processing, pp. 148-157. 1st ed.
- Lewis, V.H., Esselen, W.B., Jr., and Fellers, C.R. 1949. Nonenzymatic browning of foodstuffs. Production of carbon dioxide. *Industrial and Engineering Chemistry*, 41, 2587-2591.
- Sinha, R.N. 1971. Interrelationship of physical, chemical and biological variables in the deterioration of stored grains. In: Sinha, R.N. and Muir, W.E., *Grain storage: part of a system*. Connecticut, USA, AVI Publishing Co., Inc.

Drying of Potatoes (*Papa Seca*) in Peru

C. Lescano¹

Abstract. A laboratory-level process for obtaining two grades of *papa seca* of improved quality was developed: extra (> 8 cm diameter) and first grade (6.5–8 cm diameter). The process includes: grading, mechanical washing, abrasive peeling, cutting into strips (1 × 1 cm), steam cooking (1.7 kg/cm² absolute pressure), heated air drying (50°C dry-bulb temperature), grinding, and packaging.

Experiments on drying of cooked potatoes, using a laboratory cabinet dryer, demonstrated that: potato varieties with low-solid contents (Yungay, Ticahuasi, and Revolucion) provided better quality products than high-solid varieties; gelatinization of starch affected the water-sorption isotherms and slowed down the drying rate, as compared with uncooked potatoes; and the absence of the constant-rate period of drying and the presence of more than three falling-rate periods of drying for strips (1 × 1 × 4 cm) and slices (1 × 5 cm diameter).

Many developing countries are located in tropical zones where the potato grows well. However, only in the Andean region of South America, where the cultivated potato originated as a wild plant, does the potato play an important role in feeding the population. In Peru, the consumption per capita is 142 kg/year, rising to 288 kg in the Peruvian Altiplano (Christiansen 1977).

It is well known that the potato produces a higher yield of calories, protein, and many essential vitamins and minerals per unit area per unit time than the major cereal crops and other root crops. The production and utilization of fresh potatoes as a low-cost food in developing countries is held back because of problems encountered in the storage, transportation, and marketing of this bulky, high-moisture, and highly perishable product and by the wide-ranging seasonal fluctuations in price.

Traditional Preservation Methods

Improved means of preservation are required to avoid these problems. In South America, traditional methods for the preservation of

potatoes have evolved over centuries. Today, they still involve primitive techniques to produce dehydrated products. Generally, potatoes chosen to be processed by these methods cannot be consumed in fresh form. The bitter varieties, which are the only ones grown in the highest valleys (more than 3600 m above sea level), are processed into *chuño*. Common, nonbitter varieties grown throughout the lower regions of the highlands are processed into *papa seca* and, in smaller amounts, into starch.

Individual families make *papa seca* by boiling, peeling, chopping, and sun-drying spoiled or damaged potatoes. Once dried, the *papa seca* is often ground. The final product is brown in colour, of mixed particle size, and often adulterated with dirt and small stones.

Papa seca is very popular throughout Peru. It is mainly used in one dish, *carapulca*, which is made by first toasting the *papa seca*, then boiling it in water with pork, tomatoes, onions, and garlic. Many families supplement their income by producing *papa seca* in excess of their own needs and selling it in the rural and urban markets.

Development of an Improved Method

Under a 2-year grant provided by the International Development Research Centre (IDRC), the Universidad Nacional Agraria (UNA) La

¹Departamento de Tecnología de Alimentos y Productos Agropecuarios, Universidad Nacional Agraria La Molina, Apartado 456, Lima, Peru.

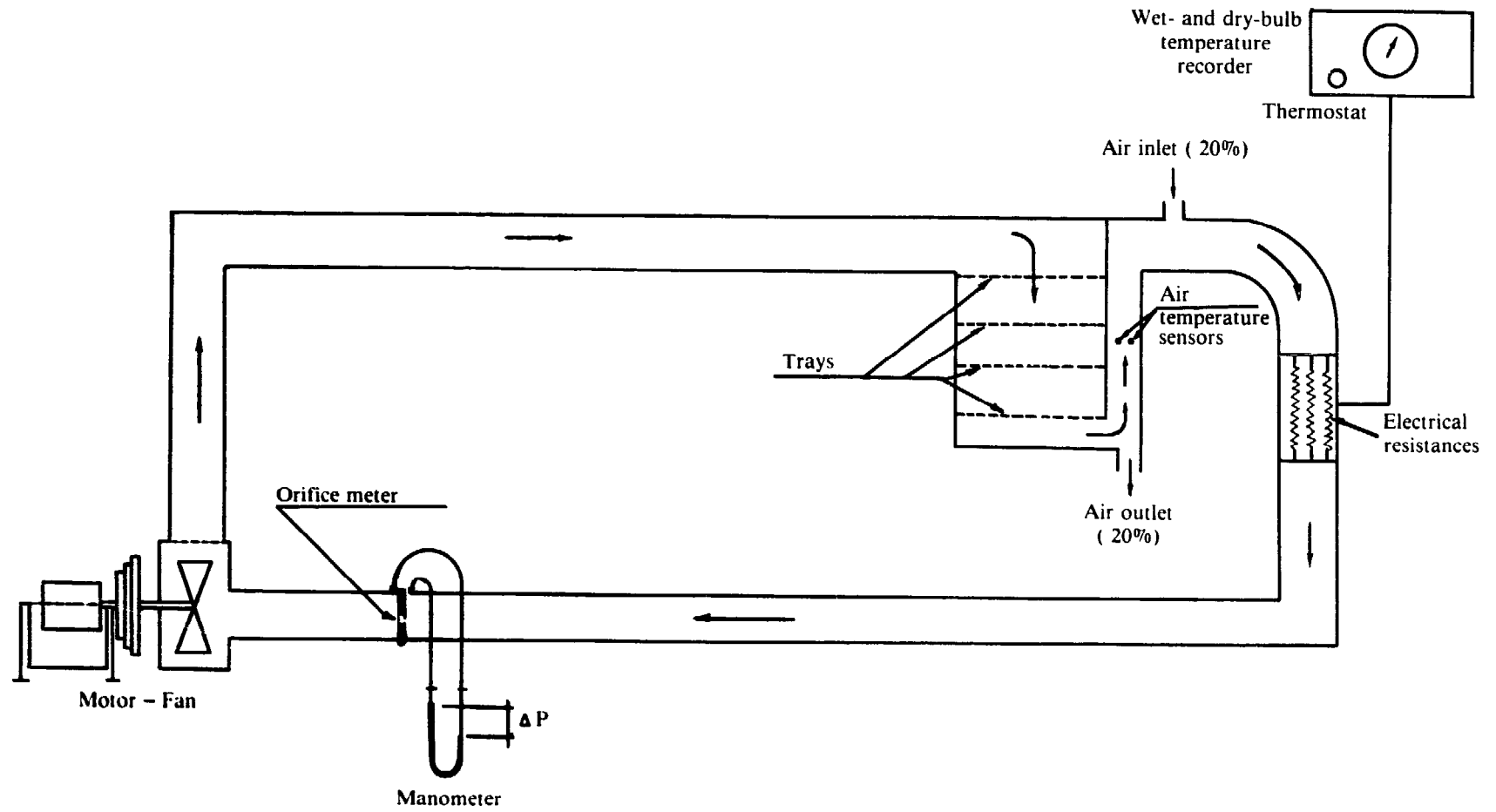

Fig. 1. Diagram of the tray laboratory dryer.

Molina, Lima, Peru, in subcontract with the International Potato Centre (CIP), a village-level or cooperative method is being developed for processing potatoes as *papa seca* for marketing in urban and rural centres. This paper focuses on the unit operation of drying within the laboratory process developed to produce *papa seca*, under the general and specific objectives of the IDRC-UNA-CIP project.

A laboratory-level process to obtain *papa seca* has been developed for extra (> 8 cm diameter) and first-grade (6.5-8 cm diameter) potatoes. This process includes: grading, mechanical washing, abrasive peeling, cutting in strips, steam cooking, hot-air drying, grinding, and packaging. (Dried *papa seca* can be stored for 3-4 years when packed in polyethylene bags.)

Results of experimental work presented in this paper will point out the influence of product characteristics on the drying process. Correlation of temperature, humidity, and velocity of

air over the material to be dried has been discussed in detail by Van Arsdel (Van Arsdel et al. 1973).

Technical information is available on drying of potatoes (Ede and Hales 1948; Van Arsdel 1951; Gorling 1958; Saravocos and Charm 1962). However, all the results reported have been on blanched or scalded potatoes, not on the drying of cooked potatoes, where the gelatinization of starch granules and the behaviour of starch seems to be important. When the end purpose is to produce flour, freezing the product beforehand is useful, but yellow is the desired colour for *papa seca* and freezing turns it white.

The experimental laboratory dryer is shown in Fig. 1. Dry- and wet-bulb temperatures can be registered during the entire drying. A thermostat controls air temperature. It is possible to obtain four air velocities: 6, 4, 2.8, and 1.32 m/sec. (The capacity of the indirect solar dryer at the pilot stage is 2 kg/2 days.)

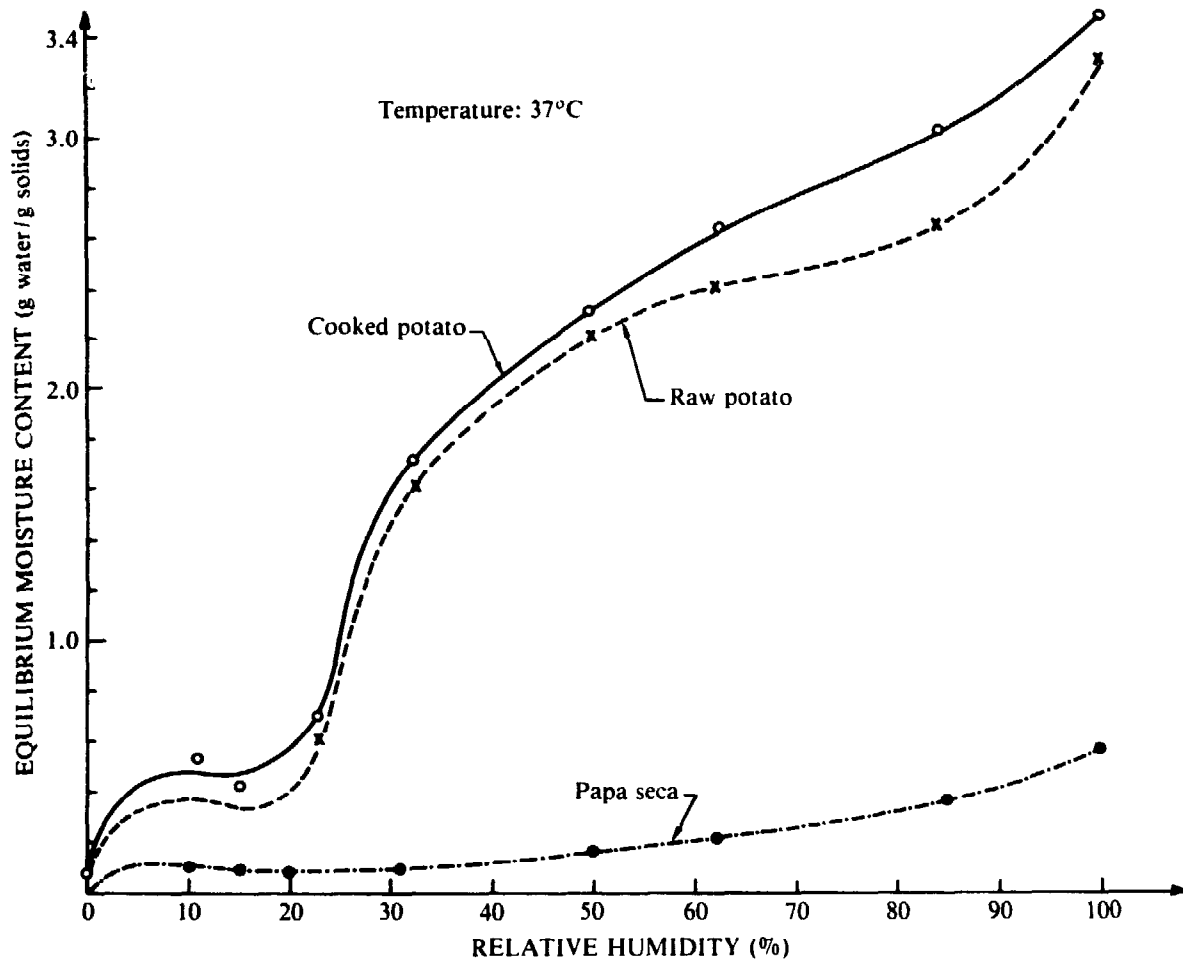

Fig. 2. Water sorption isotherms of the Yungay variety of potato (raw, cooked, and *papa seca*).

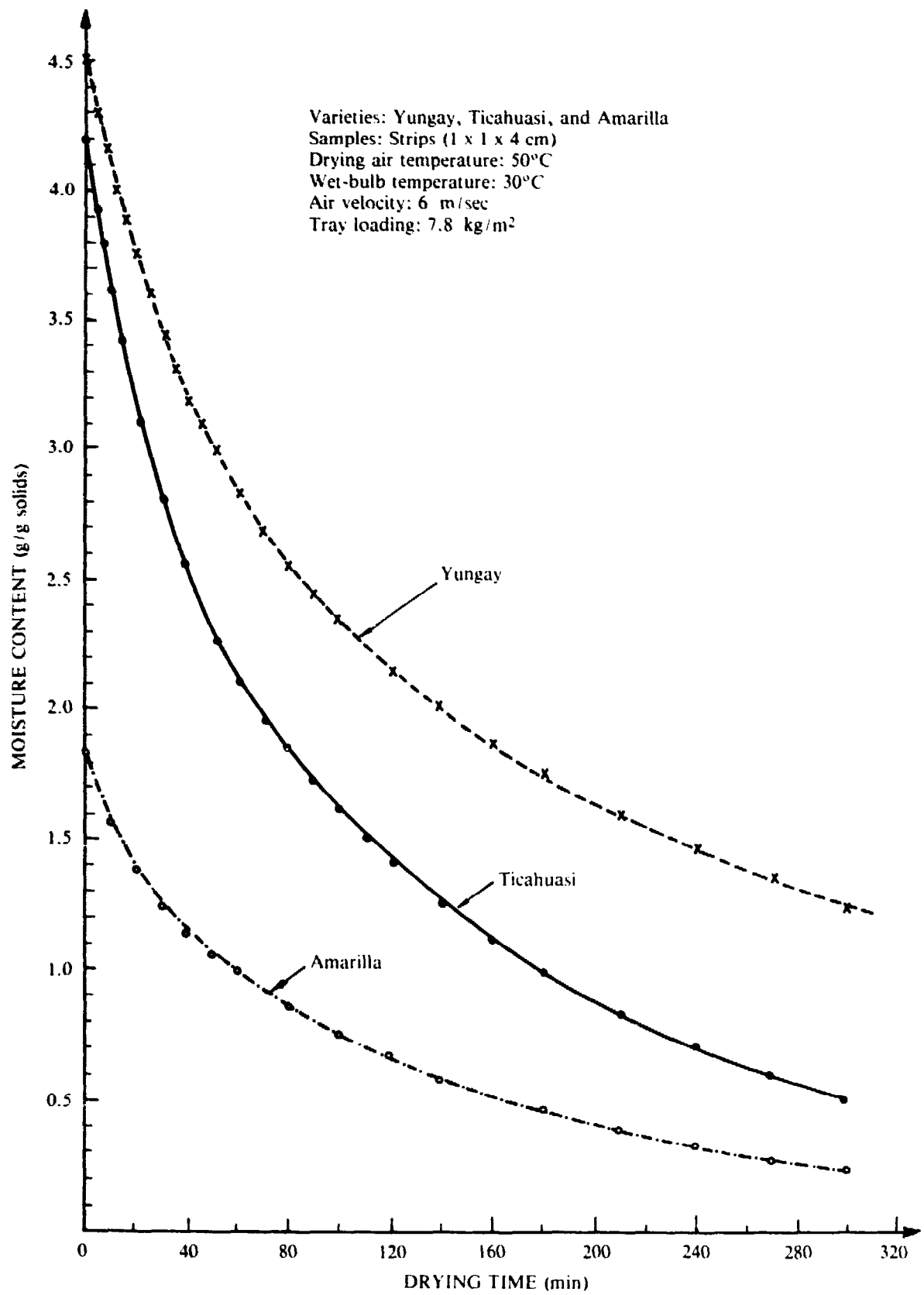

Fig. 3. *Papa seca* processing showing the influence of potato variety on drying.

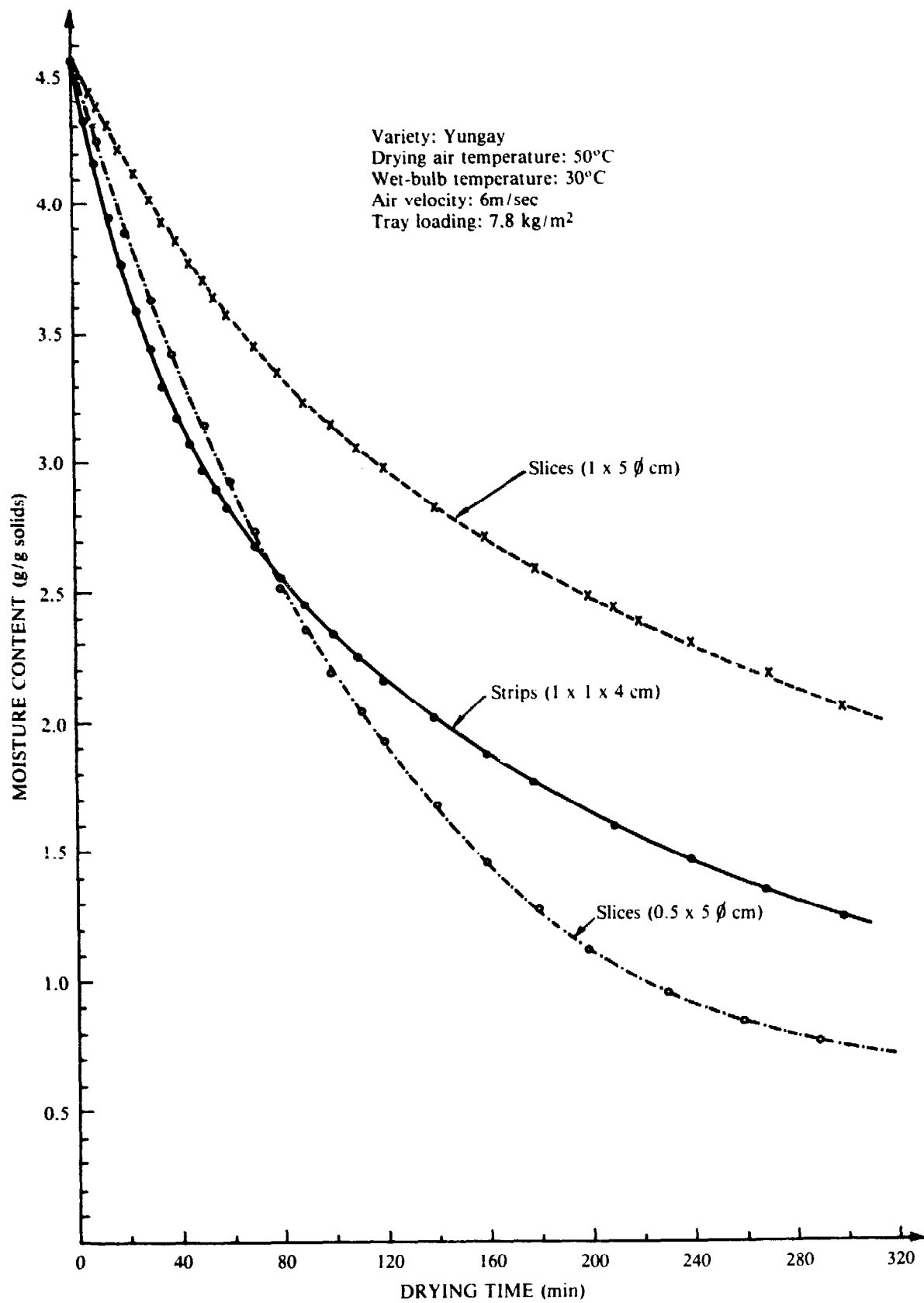

Fig. 4. *Papa seca* processing showing the influence of shape (strips and slices) and dimension of samples on drying.

Samples used in the drying tests were: Ticahuasi, Yungay, Revolucion, and Amarilla varieties; extra- and first-grade sizes; mechanically peeled by abrasion; and steam-cooked at 1.7 kg/cm² of absolute pressure for 10 min for the Amarilla variety and 12 min for Ticahuasi, Revolucion, and Yungay varieties.

Results

An important feature is that cooked potatoes are used in making *papa seca*. Figure 2 presents sorption isotherms for raw and cooked potatoes and also for *papa seca* (Yungay variety). A marked difference is shown for the dried and undried products. The difference between cooked (steamed) and raw potatoes can be explained by the gelatinization of starch granules and changes in physical structure caused by cooking. Physical and chemical changes caused by cooking also affect rates of drying, for example, steam-cooked potatoes dry at a slower rate than raw potatoes.

The variety of potato used has proven to be an important variable in the processing of *papa seca*.

The quality of the final product is superior for potatoes with a higher moisture content (MC). The varieties with a high content of solids (native varieties) affect the structure of the final product, even though they dry faster and with less energy consumption. However, they will crumble easily, resulting in too small particle size after grinding. After rehydration, the appearance is like a puree, without preserving the individual particle size and shape, which is a characteristic of *papa seca* of good quality. Yungay and Ticahuasi varieties have a low solids content (22.7 and 21.36%, respectively) but the Amarilla variety (29.51%) is a high solids content potato. Drying curves for three varieties of potato are shown in Fig. 3. The Amarilla variety, with a high solids content, will dry faster than the Yungay and Ticahuasi varieties. However, only the two varieties with high moisture content will produce *papa seca* of acceptable quality.

Shape and size of the product to be dried affect the drying process. Figures 4 and 5 show that strips (1 × 1 × 4 cm) will dry faster than slices of 1 cm thick and 5 cm diameter. If slices are only 0.5 cm thick they will dry faster. Figure 5 also shows that under the drying conditions of

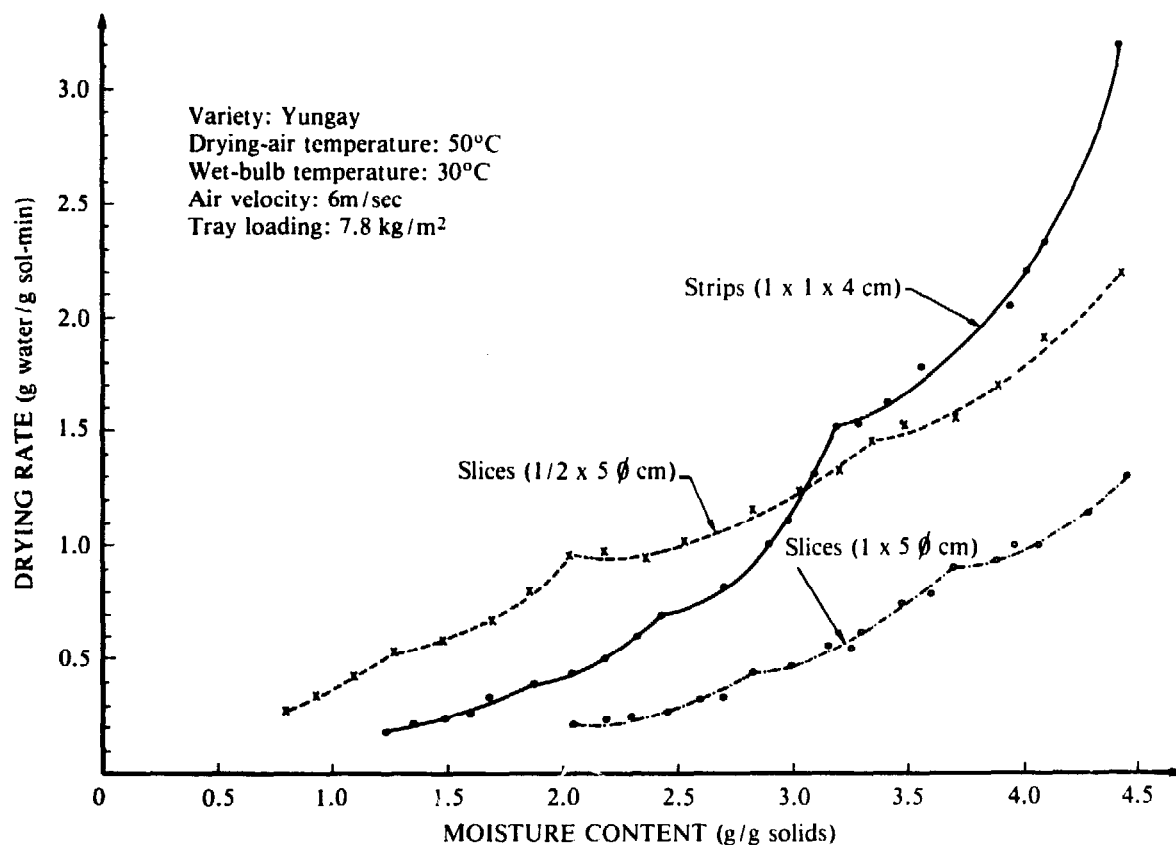

Fig. 5. *Papa seca* processing showing the influence of shape (strips and slices) and dimensions of samples on drying rates.

the test, boiled potato strips and slices present only falling-rate periods of drying, with shapes similar to the ones obtained by Gorling (1958).

Christiansen, J.A. 1977. The utilization of bitter potatoes to improve food production in the high altitudes of the tropics. Connecticut, USA, Cornell University, unpublished Ph.D. thesis.

Ede, A.J. and Hales, K.C. 1948. The physics of drying in heated air, with special reference to fruit and vegetables. Great Britain, Department of Scientific and Industrial Research, Food Investigation Board, Special Report 53.

Gorling, P. 1958. Physical phenomena during the drying of foodstuffs. In: Fundamental aspects of the dehydration of foodstuffs. New York, USA, Macmillan Co.

Saravacos, G.D. and Charm, S.E. 1962. A study of the mechanism of fruit and vegetable dehydration. Food Technology, 16(1), 78-81.

Van Arsdel, W.B. 1951. Principles of the drying process — with special reference to vegetable dehydration. U.S. Department of Agriculture, Bureau circulation, AIC-300.

Van Arsdel, W.B., Copley, M.J., and Morgan, A.I., Jr. 1973. Food dehydration (2nd ed.), vol. 1. Connecticut USA, AVI Publishing Co., Inc.

Drying of Paddy in Indonesia

Suahyadi¹

Abstract. Several studies have been carried out in Indonesia on the use of artificial dryers as an alternative to the traditional sun drying of rough rice (paddy). Compared to sun drying, artificial drying produces a better quality milled rice mainly because it has a lower percentage of broken rice and yellow or damaged grains. Other advantages of artificial drying that appear promising, but require further study, are a high mill recovery rate, an increase in resistance to pests or fungi, and an increase in storage life. However, from the farmer's point of view, the economic profitability of artificial dryers is still doubtful, but because of government interest, the use of these dryers has been encouraged. Artificial drying may offer some solution to the problems encountered in long-term storage of milled rice; however, efforts must be made to reduce drying costs.

Since 1970, the Indonesian government has promoted the use of mechanical dryers in the private sector to encourage small-scale industry. The drying cost of the different dryers was between Rp 742/t (Rp 630 = U.S.\$1.00) of rough rice to Rp 1648, and the cost of sun drying was Rp 300/t of rough rice. The use of artificial dryers at that time was very limited. In addition to being expensive, the dryers were relatively complicated and difficult to operate. However, artificial drying cannot always be replaced by sun drying. The possibilities of sun drying are limited under adverse weather conditions, and delays in drying generally lead to deterioration of the grain.

Advantages of a Proper Drying Process

When paddy is harvested, the moisture content (MC) is 20–22% when the weather is good, but after a rainfall the paddy could have 24–27% MC. Without aeration, grains with a high moisture content will deteriorate rapidly, sometimes within 24 hours. If the moisture content of the rough rice is reduced to 16% immediately after harvest, then the grain will be of good quality for 3–6 months (it is common practice for farmers to sun dry early to reach a 16% MC and then store the grain for several months).

If the farmers store paddy (rough rice) that has a high moisture content, the result will be discoloured grain — the high moisture grains will have a high degree of respiration that may result in heat-damaged grain and fungal damage.

Discoloured grain is the most evident sign of damage and may reduce the price 25–30% as compared with sound grain. The amount of rice classed as discoloured is difficult to estimate because the National Logistics Agency (BULOG), the only institution responsible for price stabilization, sets certain standards that include a prohibition on yellow grains, and rice that does not meet the standard requirements is rejected and put on the free market at reduced prices. Although BULOG sets the standard requirements, sometimes the agency experiences losses because of damaged grains that are mostly from the purchase of rough rice. (In 1981, a minimum of 16000 t decreased in price by at least 25% and, in the past, the decreased price has applied to close to 10⁵ t.) With appropriate drying processes the evidence of yellow or damaged grains may be avoided, and a large fraction of the postharvest problems may be eliminated.

With artificial drying, the dried rough rice may produce a higher quality of milled rice provided that excessive drying temperatures are not used. A comparison of milled rice dried by sun drying and by artificial drying is given in Table 1. Another advantage of artificial drying over sun drying is increased resistance to insect attacks and fungi. An increase in storability may also be possible but further studies are required.

¹National Logistics Agency (BULOG), P.O. Box 2345, Jakarta, Indonesia.

Table 1. Comparison of sun drying and artificial drying of milled rice.

	Sun drying ^a (%)	Artificial drying (%)
Moisture content	14	14
Head rice	65	85
Broken grains	35	13
Chips	2	2
Milling recovery	65	>65 ^b

^aRepresented by the standard of domestic procurement from BULOG.

^bThe milling recovery from artificial drying may be higher, but it is difficult to find an adequate sample.

Cost of Artificial Drying Compared to Sun Drying

In 1970-71, the Weitz-Hettelsater Company, Missouri, USA, studied the cost of several dryers, as well as sun drying, and found that the cost difference between sun drying and artificial drying is quite large (Rp 300/t of rough rice compared to Rp 742/t) and that there is a significant cost difference between dryers (Rp 742-1648/t).

The Department of Agriculture in 1976 did the same study and found that most of the flat-bed dryers had relatively low drying costs, because they were the lowest in energy consumption, and the labour requirements were inexpensive. Therefore, any type of dryer to be introduced in Indonesia should be technologically simple and low in energy consumption to maintain low drying costs.

In 1978, a study was also conducted by BULOG and IDRC on sun drying and on the flat-bed dryer developed in the BULOG/IDRC project. The relative results were similar to the earlier study. The cost of sun drying was Rp 1500/t of rough rice and the artificial drying cost (flat-bed dryer) was Rp 3500/t of rough rice.

Although sun drying is much cheaper than artificial drying, artificial dryers must be used when the weather conditions are unsatisfactory for sun drying. Therefore, BULOG has installed 71 dryers throughout the village cooperatives and will soon install another 40 units as well as 60 small, flat-bed dryers.

Problems in the Use of Artificial Dryers

Artificial dryers have several technological advantages, but there are still some economic problems to be solved. It is not economical to

use an artificial dryer at any other time than during the rainy season when sun drying is not possible. Otherwise, sun drying is a much cheaper method. Therefore, most of the dryers are only in operation for about 4 weeks. The use of an artificial dryer may only be economically feasible in areas where the incidence of harvesting in the rainy season is high such as in mountainous areas where rice cultivation is done continuously or in well-irrigated areas where, because of water rationing, harvesting has to be done in the rainy season.

A nontechnical condition that forced the use of artificial dryers, is the fact that rice is still a political commodity in the country. Rice accounts for about 30% of the average family expenditures in Indonesia, so the government uses rice price stabilization for rice as the mean for stabilization of the economy of the country.

Economic Analysis on the Use of Artificial Dryers

A study on the economic feasibility of the use of a small flat-bed dryer (capacity 1500 kg/batch) by the BULOG/IDRC project economists determined that: investment in artificial dryers does not substitute for investment in additional floor for sun drying, quantitative losses in the absence of artificial drying in the rainy season harvest are 4%, and fuel is costed at commercial prices. Analysis shows that the cost-benefit ratio for artificial drying (discount rate 18%) is unlikely to exceed +1 in the absence of a further government subsidy for paddy dried by artificial means. Another analysis by a Canadian University Service Overseas (CUSO) volunteer on the project concerned the possibilities of using a small flat-bed dryer, a vertical-bin dryer with a kerosine heater, and a vertical-bin dryer with a rice-hull burner. The model considered the following possibilities: three opportunity costs of labour (high, low, and zero wages), whether the use of artificial dryers can be considered as a substitute for additional investment in sun drying, and weather conditions observed for Jatisari (1970-80), a major paddy-producing region where the rainy season often presents serious problems for sun drying.

Among the conclusions of the analysis are: (1) mechanical dryers are unlikely to provide an efficient means of drying at the cooperative level if rice hulls are not used as fuel; (2) returns to artificial dryers are likely to fluctuate widely

from year to year because of the weather, which is a serious problem to businesses or cooperatives that do not have easy long-term credit; (3) returns to artificial dryers depend critically upon alternative investments when artificial dryers are absent and upon whether losses on the floor during sun drying can be lowered to about 1%. If artificial dryers are not intended to be substitutes for investment in additional sun-drying capacity or if losses on the floor in sun drying can be lowered substantially (as has been argued by other researchers in Indonesia) then investment in artificial dryers is not appropriate; (4) the Indonesian government has for a long time provided extremely large indirect subsidies for private sector investment in artificial dryers (fuel subsidies increase the internal rate of return to flat-bed and vertical-bin dryers, using kerosine fuel and operating in the rainy season, by about 1.0 points), yet, artificial dryers have only been used in the private sector or in cooperatives when the government fully subsidizes investment costs as well. From this information, it appears

that the use of artificial dryers is not yet economically viable, even though they do have some technological benefits.

Conclusions

(1) The use of artificial dryers improves the quality of milled rice.

(2) One benefit derived from the use of artificial dryers may be in improvements in long-term storability, etc., but this depends on changes in the demand for the quality of milled rice and requires further study.

(3) For now, the use of artificial dryers is still uneconomical or at least questionable, but in Indonesia, because of the government food policy, the use of artificial dryers has been encouraged.

(4) A further study should be carried out to find cheaper artificial drying processes or other drying processes, such as low-cost solar dryers that may overcome the drying problems encountered during periods of rain or supplement sun drying.

Effect of Drying on the Nutritive Value of Foods in Kenya

M.I. Gomez¹

Abstract. Vegetables were analyzed for vitamin C and carotene content. Four selected species were subjected to solar dehydration with and without photoprotection. Two pretreatments, steam blanching and sulfiting, were applied and carotene retention in the resulting dried products was evaluated. A control study was conducted with ambient temperature shade-dried material subjected to the same pretreatments. Mango and papaya were similarly subjected to blanching and citric acid and sucrose pretreatments, respectively, and retention of carotene and vitamin C in the dried products was observed.

Carotene retention in the ambient temperature-dried treatments was lower than in the solar-dried treatments with continued losses in storage. Light-protected drying resulted in higher retention than light-exposed drying and steam blanching improved retention significantly. Papaya showed appreciably higher retention of vitamin C on drying than did mango, while the latter showed significantly higher carotene retention. Steam blanching of mango prior to drying resulted in appreciable losses of both ascorbic acid and carotene.

Nutritional surveys in Kenya have identified a number of micronutrient deficiency problems, notably in vitamins A and C, riboflavin, folic acid, calcium, and iron (Bhodan et al. 1969; Keller et al. 1969; Burrows 1975; Steenberger et al. 1978). In the absence of an adequate animal protein intake, vegetables and fruits are the cheapest and most available sources of these micronutrients. Nutrient data on green leafy vegetables (GLV) indicate that they are good sources of β carotene, vitamin C, folic acid, riboflavin, calcium, and iron. Fruits are also a good source of vitamin C, carotene, and minerals. However, the availability of fruits and vegetables is seasonal, and they are particularly scarce during the long periods of drought. The application of simple solar-dehydration technologies at the rural level would not only ensure a year-round supply of these foods but would reduce waste of these highly perishable foods during the seasonal overabundance.

Because fruits and vegetables are a valuable micronutrient resource, dehydration technologies should also ensure maximum nutrient retention in the dehydrated products. Although the mineral content of fruits and vegetables is stable

to dehydration, the vitamins are highly labile and are destroyed through enzymes and oxidative and photodegradative mechanisms. The potential of solar-dehydration preservation of foods in countries such as Kenya is recognized, but the conservation of nutrient quality is an important consideration in relation to prevalent micronutrient deficiency problems. Therefore, solar dehydration of some local fruits and vegetables is studied in relation to nutrient and quality changes in dehydration and storage.

Green Leafy Vegetables

Green leafy vegetables, including a number of indigenous wild species, are popular when they are available (Fig. 1). However, they are subject to seasonal scarcity, disappearing entirely from the diet in the dry season. Sixteen species of green leafy vegetables were screened for vitamin C content and 18 species for β carotene content (Tables 1 and 2). Of these, four species (cassava leaf, cowpea leaf, kale, and amaranthus) were selected on the basis of nutrient content and acceptability for solar-dehydration studies. Initially, these species were studied for carotene retention in dehydration.

A conventional box-type solar dryer was used that consisted of a shallow wooden box with a

¹Department of Food Science and Technology, Faculty of Agriculture, University of Nairobi, P.O. Box 29053, Kabete, Nairobi, Kenya.



Fig. 1. In Kenya, a variety of leafy vegetables are marketed following the rainy season.

Table 1. Nutrient content of 16 Kenyan vegetables.

	Vitamin C (mg/100 g fresh weight)	
	Range	Mean
African spider herbs	171.8-212.0	158.4
Bean leaf	101.1-150.8	130.8
Cabbage	21.6-46.3	26.9
Cassava leaf	148.0-400.8	310.8
Cocoyam leaf	—	47.5
Coriander leaf	87.0-120.6	113.0
Cowpea leaf	56.4-123.0	91.9
E.A. spinach	116.3-293.0	169.0
Erucastrum arabicum	80.5-94.9	90.6
Fenugreek	114.0-140.5	133.0
Kale	122.3-260.2	200.2
Lettuce	2.0-10.4	8.6
Nightshade	109.6-158.6	141.5
Potato leaf	75.6-92.1	82.0
Pumpkin leaf	28.8-43.1	30.8
Swiss chard	64.2-90.0	71.4

cover and vents at the base and sides. The wooden frame lid was covered with a double layer of clear polyethylene sheet. The leaf material, after appropriate pretreatments, was placed on the screen-bottomed trays and loaded into the dryer. Dark- and light-exposed drying was achieved by interposing a sheet of black polyethylene at the base of the cover of one chamber while keeping the other clear.

Drying

Fresh, steam-blanching, and sulfited material was subjected to three drying treatments (ambient temperature, shade drying, and dark- and light-exposed solar drying). Optimum product quality, storage stability, and rehydration were observed in products dried to a final moisture content (MC_f) of 6-8%. Ambient temperature shade drying to reach this moisture content took 4-6 days, but solar drying was completed in 4-6 hours. Dried samples were packed in polyethylene bags and dark-stored at room temperature for 3 months.

Species differences in retention properties were observed based on physical heat and wilt stability and other intrinsic factors. Under all conditions cassava leaf showed exceptional retention properties, retaining 70-100% of its carotene, but the maximum observed retention in kale was only 58%. Cowpea leaf retained nearly 80% of its carotene in four of the treatments, but amaranthus showed comparable retention only in dark solar-dried, steam-blanching, and sulfited treatments. In direct dryers the colour of the product to be dried is important; if it is dark the dryer is more efficient.

Ambient Temperature Dehydration

Ambient temperature dehydration resulted in

Table 2. β carotene and moisture content of 18 varieties of green leafy vegetables.

	Moisture content (%) ^a	Carotene ($\mu\text{g}/100$ g fresh weight)	
		Range	Mean
<i>Amarantus hybridus</i>	88.3	6750-8750	7416
<i>Beta vulgaris</i>	90.9	4875-7375	6125
<i>Brassica oleracea</i> var. <i>acephala</i>	88.2	6625-8500	7312
<i>Brassica oleracea</i> var. <i>capitata</i>	91.6	1050-1163	1156
<i>Corchorus olitorius</i>	85.4	8250-9150	8750
<i>Colacasia esculentis</i>	79.8	9500-9952	9700
<i>Crotalaria brevidens</i>	84.8	6250-7750	7000
<i>Cucurbita pepo</i>	80.6	7750-9000	8375
<i>Cucurbita</i> sp.	87.4	7875-9125	8291
<i>Erucastrum arabica</i>	85.9	7750-7500	7625
<i>Galinsoga parviflora</i>	83.9	7250-7563	7375
<i>Gynandropsis gynandra</i>	81.8	8500-8900	8675
<i>Latuca sativa</i>	90.5	25-40	38.3
<i>Manihot utilissima</i>	66.3	12125-14675	12237
<i>Phaseolus vulgaris</i>	72.4	9500-11216	10650
<i>Solanum nigrum</i>	86.7	7500-7750	7625
<i>Solanum tuberosum</i>	90.5	10823-11520	10652
<i>Vigna unguiculata</i>	85.1	8250-10500	9416

^aMean of four samples.

the lowest carotene retentions in kale and in amaranthus of 20 and 40%, respectively, and slightly improved retention of 60% in cowpea. Cassava was least affected retaining over 90% of its original carotene. However, storage losses of carotene in ambient temperature-dried material were significant, presumably because of continued enzyme activity and consequent carotene destruction during storage.

Steam Blanching

Steam blanching (3 min), although causing some initial losses of carotene from heat degradation, improved retention appreciably in dehydration and storage in all dehydration treatments.

Sulfiting

The major effect of sulfiting was on improved storage retention of carotene in steam-blanching material. However, this improvement was significant only in the more wilt-susceptible species such as amaranthus.

Solar Dehydration

Significant carotene retention differences were observed between dark- and light-exposed material in all leaf species except cassava. The differences were greatest in the unblanching treatment and were considerably reduced by steam blanching and sulfiting. Photoprotection

of cassava did not significantly affect carotene retention in fresh, steam-blanching, and sulfited treatments indicating that its photodegradative mechanisms are minimal.

Conclusions

Cassava and cowpea leaf showed the most favourable response to dehydration in terms of carotene retention and quality of the dried product. Kale and amaranthus underwent extensive yellowing and fading even with dark solar drying and showed correspondingly poor retention properties.

Traditional methods of drying leaf vegetables in Africa involve direct sun and shade drying (Goode 1973; McDowell 1976). The results of these studies indicate that excessive losses of carotene occur with such drying techniques and in subsequent storage of the product. Steam blanching, though causing some initial losses of carotene from heat degradation, improved retention appreciably in dehydration and storage. In heat-sensitive, wilt-susceptible species such as amaranthus, sulfiting has a protective action. Photoprotected solar drying resulted in better carotene retention and storage stability of the product than ambient temperature or light-exposed drying. However, heat-stable species such as cowpea, dehydrate just as well under shade-drying conditions as in dark solar drying as long as the leaves are steam blanching first.

Organoleptic trials with dehydrated cowpea leaf showed excellent rehydration and acceptability of the product. Cowpea leaf, on the basis of nutrient retention properties, acceptability, and wide utilization, offers the best potential for development as a dried-leaf vegetable.

Nutrient Retention in Solar Dehydrated Mango and Papaya

Carotene and ascorbic acid retention were observed in solar dehydration of mango and papaya. The optimum degree of ripeness and other preparation, pretreatment, and drying variables were optimized in preliminary experiments. Papaya and mango were sliced 0.5–0.75 cm and 1–1.5 cm thick, respectively. Optimum pretreatment for product quality (organoleptic) consisted of a citric acid dip (0.1%) followed by

a sucrose dip (10%). The effect of omission of the citric acid dip on nutrient retention and quality and the effect of combining steam blanching with the chemical treatment were observed. The products were dark solar dried to a final moisture content of 15–20%.

Initial moisture, content (MC_i), vitamin C, and carotene content of mango and papaya are represented in Table 3. Papaya showed an increase in both ascorbic acid and carotene and with the degree of ripeness in conformity with observations by others (Arriola et al. 1975). This is an exception to what is generally found with other fruits that show decreasing levels of ascorbic acid with ripening.

However, the retention of ascorbic acid in mature papaya ranged from 81–87% and was significantly higher than in ripe fruit in which retention was about 40–50% (Table 4). When the

Table 3. Nutrient composition of mango and papaya.

Ripeness	Moisture content (%)	Vitamin C (mg/100 g)	β carotene (μg/100 g)
Papaya			
Ripe	86.00	53.78	343.75
Mature ^a	87.50	43.48	312.50
Undermature	86.75	37.57	250.00
Mature	86.40	45.56	552.00
Mango			
Mature	77.75	31.64	800.00
Mature	81.75	41.13	1578.00
Mature	81.00	34.31	1288.75

^aMature samples from different farms within the same area and possibly from different cultivars.

Table 4. Nutrient retention in solar-dried mango and papaya.

Ripeness	Colour	Texture	Treatment	% retention ^a	
				Vitamin C	β carotene
Papaya					
Mature ^b	Orange yellow	Firm	Citric acid and sucrose	81.27	50.62
Ripe	Bright orange yellow	Soft, disintegrates on slicing	Citric acid and sucrose	48.50	49.76
Mature	Orange yellow	Firm	Citric acid and sucrose	90.63	50.74
Mature	Orange yellow	Firm	Sucrose only	84.30	40.93
Mango (Boribo)					
Mature	Golden yellow	Firm	Citric acid and sucrose	57.22	81.15
Ripe	Orange yellow	Soft, spongy	Citric acid and sucrose	38.61	85.40
Mature	Golden yellow	Firm	Steam blanched citric and sucrose dipped	27.49	35.81

^aDry weight basis.

^bMature samples from different farms within the same area and possibly from different cultivars.

citric acid dip was omitted, no significant differences were observed in ascorbic acid and carotene retention immediately after dehydration. However, organoleptic and colour differences became evident after 2-weeks' storage at room temperature.

Mango retained only 30–57% of its ascorbic acid on dehydration as compared to papaya, although carotene retention was appreciably higher. The pattern of retention of ascorbic acid in relation to maturity was the same as in papaya, mature fruits retaining significantly higher levels than ripe ones. Carotene retention as in papaya did not show a distinct trend in variation with ripening.

Significant reductions were observed in ascorbic acid (19%) and carotene retention (50%) after steam blanching along with the accompanying loss of flavour and colour. Colour of the product, however, appeared to be more stable during storage with less tendency toward undesirable darkening.

-
- Arriola, M.C., Madrid, M.C., and Rolz, C. 1975. Some physical and chemical changes in papaya during storage. *Proceedings of the American Society of Horticultural Science*, 19, 97.
- Bhodal, M., Gibbs, N.E., and Simmons, W.K. 1969. Nutrition survey and campaign against malnutrition in Kenya. WHO/FAO/UNICEF, 170 p.
- Burrows, J. 1975. Kenya: into the second decade. Maryland, USA, The John Hopkins University Press, pp. 447–526.
- Goode, F.M. 1973. Some local vegetables and fruits of Uganda. Entebbe, Uganda, Department of Agriculture, 61 p.
- Keller, W.E., Muskat, E., and Valder, E. 1969. Investigations into health and nutrition in East Africa. München, DFR, Weltforum Verlag, 253 p.
- McDowell, J. 1976. Village technology in Eastern Africa. Nairobi, Kenya, Eastern Africa Regional Office, UNICEF, 32 p.
- Steenberger, W.M., Kuscin, J.A., and Onchere, S.R. 1978. *Tropical and Geographical Medicine*, 30.

Designing Cowpea Products for Northeastern Thailand

T. Ngarmsak,¹ M.D. Earle,² and A.M. Anderson²

Abstract. This paper illustrates the use of a product development system in designing cowpea food products for northeastern Thailand. The Home Processed Legumes Project at Khon Kaen University has developed acceptable, high-protein cowpea dishes and a 1-week menu for a balanced diet designed for use at the village level and selected from a combination of cowpea dishes and common northeastern food. A snack food made from a product from cowpea flour was also developed for marketing by food vendors throughout Thailand.

Over the years, researchers at Massey University, New Zealand, have built a system of product development designed to satisfy known or suspected consumer needs. The system varies in detail from project to project, but usually the structure is divided into different stages, each of which is followed by an evaluation.

The stages in designing a food product start with setting the aims for the project; ideas are put forward based on the aims. The product ideas are screened according to the potential marketability and technical feasibility of the product. The next stage is the detailed study of the market and of the processing involved. In a qualitative evaluation of the preliminary products, the most suitable products for development can be chosen. This is followed by the design of prototypes and preliminary testing. At this stage, it is possible to make a much more accurate economic evaluation of the project before the very expensive stages of factory production and market development are attempted. The next steps are to study the processing parameters, either in a pilot plant or on a small scale in a factory, to determine whether the product can be made easily, consistently, and economically while maintaining quality standards. At this stage, there is enough information to make a detailed analysis of the potential market and to draw up a complete plan to introduce and test the product and the

marketing methods in a consumer test or in a test market. If the product successfully passes the test market, it is then ready to be launched on the market.

The Design of Cowpea Products

In designing a food product for northeastern Thailand, the main considerations were to develop nutritional products and to create a market for a new raw material, cowpea. The evaluation of the development steps was based on the nutritional value of the products and the ready acceptance of the products by the northeastern villagers. The northeastern region is the poorest in Thailand. About one-third of the Thai population live in this region and rely for their livelihood on agriculture, with an income derived mainly from the production of rice, cassava, kenef, sugarcane, and legumes.

From several surveys (ICNND 1962; Chandrapanond et al. 1973; Kumazawa et al. 1974), it was concluded that in spite of the comparatively abundant supply of food in the country, Thailand still suffers from malnutrition. Scarcity of food in the semi-arid areas of the northeast result in a high proportion of the population suffering from malnutrition.

From a survey on northeastern eating habits by Ngarmsak et al. (1980) at Khon Kaen University, it was found that the diet included glutinous rice with small amounts of animal meat, mainly freshwater fish, and significant quantities of vegetables. Small amounts of legumes were also eaten. Food was obtained mainly from the area surrounding the village and varied with the season.

¹Department of Agricultural Products, Faculty of Agriculture, Khon Kaen University, Khon Kaen, Thailand.

²Department of Food Technology, Massey University, P.O. Box 63, Palmerston North, New Zealand.

Protein/energy malnutrition is due mainly to the unavailability of low-cost, high-quality food for the low-income family. Legumes have been suggested as a good source of cheap, high-quality protein. Soybean cannot be successfully grown for production in the northeast; mung beans, peanuts, and string beans are traditionally produced and utilized in some villages throughout the area but not in others. The multiple-cropping project at Khon Kaen University has encouraged cowpea as the legume for the northeast, because it can be grown well in the arid area where other legumes fail. A promising system of integrating cowpea in the cropping system has been established, but there is reluctance on the part of the farmers to grow cowpea until they are assured of its value either for home use or for cash income. Therefore, it is important that housewives, food vendors, and food shops in the rural northeast be encouraged to use cowpeas. The Home Processed Legumes Project at Khon Kaen University has encouraged the use of cowpea as a protein-rich source. The work to develop cowpea products at Khon Kaen University is divided into two levels.

Level 1: Improving the Diet of the Villagers

The utilization of cowpea was designed to improve the nutritional status of the villagers. The foods eaten most often could be supplemented with cowpea to improve the availability of nutrients at a reasonable cost. The use of cowpea either as a complement to existing raw materials or as a replacement for raw materials in commonly eaten foods might provide a better basis for selection of a nutritious and low-cost menu. It is imperative that the cowpea-supplemented dishes be readily acceptable to the villagers and should be incorporated into their normal diet. This led to the first step in the development work: the development of cowpea dishes and the menu planning of a balanced diet, selected from a combination of cowpea dishes and normal northeastern food.

A list of 50 dishes, including main dishes, snacks, and desserts was collected from the literature and local recipes and by brainstorming. Preliminary cooking trials were carried out to evaluate the suitability for inclusion of cowpeas in each dish. Taste panels were used to judge the acceptability of each dish. All dishes were then screened on the basis of protein and cost per serving, complexity of preparation, and raw material availability in the villages. The number of dishes was screened down to 14 main dishes

and 11 snacks and desserts. Each recipe was then readjusted so that the quantity of cowpea could be increased. The readjusted recipes were then tested for their acceptability and run through a series of taste panels for preference ranking. Further formulation research was used to maximize protein content by the application of linear programming and to calculate the 26 nutrients present in each dish. The maximized protein dishes were then tested again for consumer acceptability by a taste panel of northeastern Thais. The comments for the taste panel were used to select other more acceptable recipes from the parametric cost runs in the linear programming where improvement in palatability was considered necessary. Final computerized recipes were selected for menu planning and popularized by publication in pamphlet form and distributed through government agents and school teachers.

These dishes were then incorporated into a 7-day menu selected by use of mixed integer programming from common dishes eaten in northeastern Thailand. The cowpea dishes and the menu are now being introduced in six Thai villages through different methods of promotion to find which is the most suitable method for launching a new food raw material in northeastern Thailand.

Level 2: Encouraging Farmers to Grow Cowpea as a Cash Crop

To encourage the farmers to grow more cowpeas, not only for their own needs but also as a cash crop, a widespread utilization of cowpeas is needed. Cowpea flour would be the form most easily utilized as it could be used in food dishes or in snack foods. The snack food seemed to be the most appropriate method as it would be ready to eat, and the housewife would not need to learn any new recipes. It could be made and sold by food vendors throughout Thailand.

The aim was to widen the utilization of cowpea in the form of cowpea flour by making it into snack products. The products to be developed should be high in nutritional value, especially protein; low cost; require simple processing; be ready to eat or require simple cooking; easy to transport and store without refrigeration; highly acceptable products, e.g., products similar to the already well-known products; economical to make; and have a large market outlet.

The steps in developing snack products are:

a search for product ideas, systematic selection of product ideas, process selection, formulation and process testing, consumer testing, introduction of snack products to the food vendors and food processors, and launching of the products.

In the search for product ideas, ideas for cowpea were formulated by a search through Thai recipe books. The amount of cowpea flour was determined by a literature research and by trial recipes. The most suitable products were chosen by a systematic selection. Ideas were screened first by a "pass or fail" method. To satisfy the aim, the level of cowpea flour in the recipe was high. From past experience in developing cowpea dishes, literature searches, and the distribution of the level of cowpea flour in the product ideas, it was considered that the cowpea flour in the recipe must be greater than 12%. The original product ideas were screened to meet these requirements.

To select the suitable product ideas for further development, we used the checklist screening method. The method attempted to quantify the information so that the product ideas could be ranked against each other and the ideas with the highest rank were chosen for further development. The screening factors, which were related to the objective of the snack product, were given a score. Each product idea was numerically rated against the total of each factor; then the marks of all the factors were added to give a total score for the product idea. From the total it was possible to rank the product ideas and select the suitable product idea. The most suitable product idea was the cowpea puff.

The next step was to select the method of making puff products. Two possible processing methods were selected: hot-oil puffing and the village texturizer puffing machine. These two methods were considered to be simple enough that they could be carried out by the food vendor in the village. The hot-oil puffing is the most common method in which the gelatinized dried paste with a moisture content of about 10% will puff when deep fried in hot oil at a temperature between 195–205°C. The village texturizer is a machine developed by the Meals for Millions Foundation (MMF 1977). It is low cost and simple to make and is an intermediate technology machine designed to manufacture puff snack food at the village level.

Once the processing methods were selected, the next step was formulation and process testing. Work at this stage is now in progress. It was initially found that an acceptable hot-oil puff product can be made from dried gelatinized paste of a mixture of tapioca and cowpea flour

in the ratio of 1:1. An increase in the ratio of cowpea flour resulted in less volume in the puff product and a hard texture. At this stage it is planned to use a mixture incorporating the maximum amount of cowpea flour to give the right amount of puffing in the final product.

The village texturizer machine was made according to the instructions (MMF 1977). The machine was tested using rice flour and tapioca flour as the optimum conditions for these were published in the booklet provided by the Meals for Millions Foundation. A satisfactory product of moderate puffed volume was obtained from cowpea flour. It was found that the satisfactory range of moisture content (MC) in the flour mixture was between 20 and 30% and the optimum cooking condition was at 200°C at high pressure and 15–20 sec of processing time. It was also found in the early experiments that mixtures of pumpkin, sesame, and rice flour and cowpea flour could be made into a favourable puff product. A design of possible combinations of cowpea flour with these ingredients (pumpkin, sesame, and rice flour) will be tested to determine their effect on the flavour, appearance, and protein quality of the final product. The protein content and protein quality of the mixtures will be optimized by use of linear programming. The puff products from each mixture at their optimum puffing condition will be compared for their acceptability in a taste panel, and then the mixture that satisfies the nutritional specifications and is accepted by the consumer will be selected.

The next step is the consumer test. A sample of housewives in Khon Kaen villages and towns will be given the product to test at home. A week later they will be interviewed for their opinion about flavour, texture, and appearance of the product to gather some suggestions about improvement in the product and to learn about their intention to buy the product and frequency and quantity of buying. The result of the consumer test will be used to improve the product and help in estimating the future sale of the product.

Because the aim is to widen the utilization of cowpea flour, it is necessary that the food vendors, food processors, and food entrepreneurs be encouraged to produce the snack product for market. The product and the method of processing should be introduced to as many of these groups as possible with the aim that they will adopt the product and market it.

The plan of introduction is still to be developed and it is intended that a pilot introduction be analyzed before the large-scale introduction.

Two series of workshops will be held at Khon Kaen University. The first workshop will include a demonstration on how to process the snack products. The processing equipment and machines will be displayed and information will be given on how to build or purchase the components and the costs involved. Information will also be given on the costs and profits that can be made by making snack products for sale. The food vendors, small-scale food processors, and food entrepreneurs will be encouraged to try out the processing on their own premises. Ingredients, processing equipment, and machines will be supplied to help in the production of the product. At the same time, a test market of the product will be run in the villages or in the areas of small-scale food processors and entrepreneurs who have expressed an interest in the product. A second workshop will be conducted for a group of food vendors, food processors, and entrepreneurs who now intend to produce the product for market. This workshop will illustrate in more detail the techniques of making good products and how to maintain the equipment and machines. They will also learn about production control, quality control and plant sanitation, bookkeeping, and costing as well as other important areas of factory management. The university will help at the beginning with the

product promotion in the area where the product is planned to be launched.

Acknowledgment

This part of the research study received financial support from IDRC and the Thai government.

-
- Chandrapanond, A., Suttapreyasri, D., Tansuphasiri, S., and Harinasuta, P. 1973. Nutrition, growth and development of Thai village children. *Journal of the Medical Association of Thailand*, 56(1), 722-731.
- ICNND (Interdepartmental Committee on Nutrition for National Defence). 1962. Nutrition survey. Bangkok, Thailand, ICNND.
- Kumazawa, A., Ono, M., Takahashi, H., Vchijima, Y., and Hiyano, T. 1974. Investigations on nutritional anemia of the farmers in the north eastern part of Thailand, November-December 1972. Thailand, Ministry of Public Health, Division of Nutrition, Department of Public Health Promotion and Japan, Nogoya Womens University.
- MMF (Meals for Millions Foundation). 1977. The village texturiser: A low cost machine for preparing texturised food products at the village level. Meals for Millions Foundation, Mt. Rainier, VITA.
- Ngarmsak, T., Anderson, A.M., and Earle, M.D. 1980. Menu planning for northeast Thailand. In: A symposium — food product and process development in Pacific countries. 10-13 November 1980, Auckland, New Zealand.

Consumer Acceptance of Dehydrated Banana Weaning Food in Costa Rica

Celsa Lastreto G., Rodney Cooke, and Armando Campos S.¹

Abstract. An infant cereal using banana, rice, and soybean was developed to supply the needs of the Costa Rican Program for Food and Nutrition, which eventually will be introduced into the national market. This food, which uses principally nationally produced raw materials, is in the form of small flakes and can be consumed with either milk or water. The cereal was fortified with vitamins and minerals and was designed as a complementary food for weaning. The process for preparation of the cereal consists of cooking to destroy the inhibitors in the soybean to acceptable levels, gelatinization of the rice starch, inactivation of the banana enzymes, and dehydration of the mixture by drum drying to 5% MC.

Optimization studies of the ingredients, using the chemical score as a nutritional index with the banana content maintained at 40%, indicated that the best complement between rice and soybean proteins was achieved in mixtures with 10.5% and 16.5% soybean dry weight. The cereal, according to chemical and microbiological analyses and taste panels, was stable after 12 months' storage in a package of laminated paper, aluminum, and polyethylene. The cereal developed was produced on a commercial scale. The product has high caloric value and exhibits the functional characteristics (viscosity, dispersability, water absorption, and texture) recommended for this type of food. The acceptance of the cereal was evaluated in a study "Food for children under two years" during the first phase of the field experiment. For this evaluation a group of 50 families each with a child under age 2 was selected in an urban zone exposed to the risk of malnutrition. The results based on the information given by the mother or person in charge of feeding the child demonstrated a good acceptance of the product.

Faced with the need of the Costa Rican government's Food and Nutrition Programme for low-cost, easy-to-distribute, and nutritional foods that would be well accepted by the public, the Food Technology Research Centre (Centro de Investigaciones en Tecnología de Alimentos — CITA) has concentrated its efforts on developing food products of this kind. One example is banana-flavoured dehydrated infant cereal. The aim of this project was to develop a supplementary food for the weaning period, which might be taken with water or milk. In designing the product, locally produced raw materials were used: bananas, to make use of the nonexportable surplus from Costa Rica's banana crop; rice, which is grown locally; and whole soybeans, to improve the mixture's protein quality, supply the oil necessary for processing, and add calories. The use of other legumes (cowpeas and pigeon

peas) as alternatives to soybeans was also studied. With this product, the aim was to supplement the amino acids lysine, tryptophan, and threonine, in which cereals are deficient, and methionine, of which legumes and oilseeds often contain only limited amounts (Rosenberg and Culik 1957; Bressani et al. 1972 a, b). The project assessed the effect of varying the proportions of soybeans and rice on the nutritive value and functional characteristics of the final product. The banana content was kept constant at 40% thus ensuring that the banana flavour would be maintained in the product. The final formula, enriched with soybean oil to increase its caloric content and fortified with vitamins and minerals, was prepared on an industrial scale and yielded a cereal having the functional properties recommended for foods of this kind. The product's acceptability was assessed under a project entitled "Food for children under two years of age." The primary goal of this project was to further the development of high-calorie foods for use by children under age 2 during the

¹Centro de Investigaciones en Tecnología de Alimentos (CITA), Universidad de Costa Rica, San Jose, Costa Rica.

weaning period and in populations exposed to the risk of malnutrition. The specific objectives may be listed as follows:

(1) To evaluate the acceptability and nutritional impact of various food products that are potentially effective for preventing malnutrition in urban and rural populations exposed to the risk of malnutrition.

(2) To make progress in developing stronger hypotheses regarding the key factors and relationships that affect results when food products are introduced on a noncommercial basis to families resident in these areas.

(3) To consolidate a research methodology applicable to the social context of Costa Rica, and to other similar social contexts, to provide a basis for future studies in this field.

The acceptability of the product was assessed under a preliminary field trial in which three foods were administered experimentally: banana-flavoured dehydrated infant cereal, rice cereal, and a rice-and-bean cereal. Each cereal was given to a trial group of 50 families over a 2-month period. Another group of 50 families also took part as a control group, bringing the total population studied to 200. Each family had at least one child under age 2 who was being weaned or had already been weaned.

Method of Preparation

Basically, the method used to prepare the cereal consisted of precooking the ingredients and drying the resulting mash on a drum dryer. After being washed in running water, the whole soybeans were cooked at 121°C for 30 min; then the water used was drained off to remove the water-soluble carbohydrates, which are the main cause of flatulence (Rackis et al. 1970). Cooking the soybeans in this way reduced the concentration of inhibitors and flatulence-causing oligosaccharides (Shemer et al. 1973; Rackis et al. 1974). The rice and water were then added, and allowed to boil for 5 min to gelatinize the rice starch. At this point, the bananas were peeled and put in a tank with water and ascorbic acid (0.1% by weight) to prevent discoloration. The contents of this tank were then added to the soybeans and rice in the cooking pot and left to boil for 3 min to inactivate the banana's enzymes.

The cooked mixture was then transferred to a tank feeding into a Fitz mill. After milling, the mixture continued to another tank that in turn fed the drum dryer. The temperature of this tank was maintained at 70°C to keep the viscosity of

the mixture low, reduce the cost of drying, and ensure that the film formed in the dryer was uniform. This temperature also prevented the growth of microorganisms (Jay 1973; Frazier 1978).

The pressure and velocity at which the drum dryer was operated were chosen on the basis of specific output in grams per hour and the functional characteristics of the resulting product (Fig. 1).

Results

Nutritional Aspects

To optimize the relative proportions of the ingredients in the banana-rice-soybean mixture, a chemical score was used as a nutrition index. A system of linear equations was used to calculate the chemical score of various banana-rice-soybean mixtures. The banana content was kept constant at 40% while the protein content varied from 8 to 18%. For each of these mixtures, the chemical score and caloric content were calculated. The chemical score was calculated on the basis of 1976 Food and Agriculture Organization of the United Nations (FAO) data, and the 1973 FAO/World Health Organization (WHO) guideline on amino acids was used as a reference. The results obtained indicated the optimum protein level to be from 10 to 12%; in other words, the optimum mixtures were found to be those containing between 10.5 and 16.5% soybean. The caloric content of the various mixtures was found to be virtually the same (Table 1).

Mixtures containing 30 and 40% soybeans were sent to the Instituto de Nutrición de Centro América y Panamá (INCAP) and the Tropical Product Institute (TPI) for the following biological analyses: protein utilization index (PER), net protein utilization (NPU), and net protein ratio (NPR). The results showed the quality of the mixture's protein to be from 63 to 77% that of casein, indicating that the mixture's protein quality is good although not excellent. This is because, even though the rice-soybean mixture contains a good variety of amino acids, the addition of the banana reduces the protein quality, possibly owing to a Maillard-type non-enzymatic discoloration during the drying process.

Functional Characteristics

To evaluate the functional characteristics of the mixtures studied, the analytical tests and methods used by the infant-food industry for

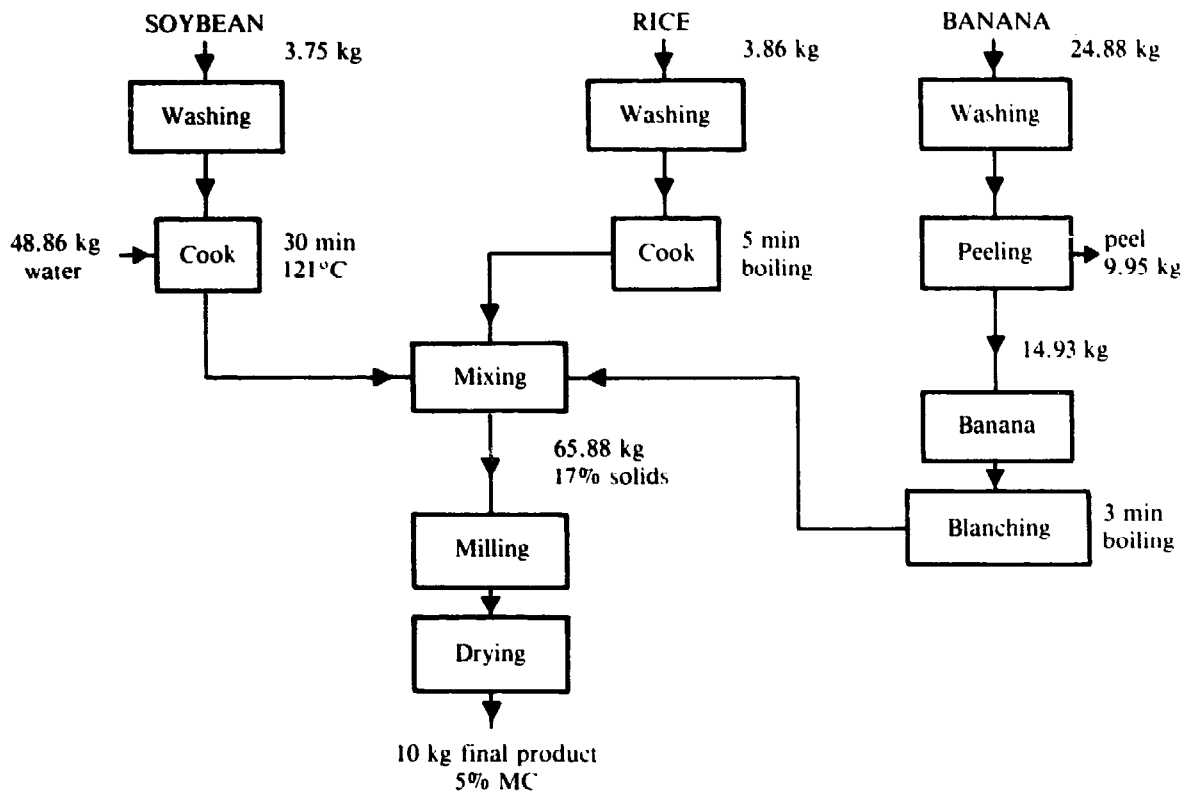

Fig. 1. Material balance for a mixture of 40% ripe bananas (70% MC), 30% rice (13% MC), and 30% whole soybean (10.4% MC).

quality control in this type of product were used, on the basis of information supplied by Productos Gerber de Centro América, S.A.

The various mixtures, containing different percentages of soybeans, and prepared on an industrial scale under different drying conditions, were rated for: density, solubility, water absorption, texture, tendency to form lumps, and viscosity. The findings indicated that the ingredients in the mixture have a greater influence on the final product, and particularly its level of quality, than do the drying conditions. As the mixture's rice content was increased, the final product's water-absorption rating was found to be adversely affected. Whether prepared on a small scale or on an industrial scale, the mixtures were found to have the recommended properties for this type of product (Table 2), similar to those for infant cereals produced by Productos Gerber de Centro América, S.A.

Sensory Evaluation of the Product and Storage Properties

The composition of the R_{40} , G_{40} , and S_{40} mixtures are: R_{40} = 40% cowpeas, 20% rice, and

40% bananas; G_{40} = 40% pigeon peas, 20% rice, and 40% bananas; and S_{40} = 40% soybeans, 20% rice, and 40% bananas. As an initial step, the three mixtures were studied for acceptability and storage properties.

Samples were stored for 12 weeks in three different commercially available packages. Chemical and microbiological analyses and sensory evaluations were carried out both before and after storage.

Differences Between Mixtures

The mixtures differed significantly as to colour, smell, texture, and flavour (Tukey test). The results showed the soybean mixture (S_{40}) to be superior to the cowpea and pigeon pea mixtures (R_{40} and G_{40}) in terms of flavour, colour, and smell. As regards texture, the data indicated that the R_{40} mixture, which yields a crunchier final product, was more highly rated.

Differences in Packaging and Storage Periods

There was no significant difference found between the types of packaging in any of the sensory characteristics analyzed for any of the mixtures. This confirms that the three kinds of

Table 1. Characteristics of different mixtures of soybean-rice-40% banana (S).

Mixture	% dry base	% protein	kcal/100 g	Chemical score	Limiting amino acid	
S ₅	Soybean Rice	5 55	8	390	82	Lysine
S _{7.5}	Soybean Rice	7.5 52.5	9	391	86	Lysine
S _{10.5}	Soybean Rice	10.5 49.5	10	392	90	Lysine
S _{13.5}	Soybean Rice	13.5 46.5	11	393	92	Sulfur-containing
S _{16.5}	Soybean Rice	16.5 43.5	12	393	90	Sulfur-containing
S ₂₂	Soybean Rice	22 38	14	395	86	Sulfur-containing
S ₂₅	Soybean Rice	25 35	15	395	85	Sulfur-containing
S ₃₀	Soybean Rice	30 30	17	396	84	Sulfur-containing
S ₄₀	Soybean Rice	40 20	20	399	81	Sulfur-containing

packaging used share similar characteristics. During the storage periods, there was no difference for flavour, colour, or texture. The only significant difference found was for smell, which deteriorates somewhat after 6 weeks storage, but was still within the acceptable range. During the 12-week storage period, no variations in moisture content occurred in any of the mixtures in the three types of packaging studied. Total count, coliform, and fungus analyses after storage indicated that the product presents no microbiological problems.

Batches of the S₃₀ mixture were stored for 1 year and then were analyzed for microbiological counts and moisture content. Comparison of the results of analyses conducted within 24 hours of processing and those of analyses conducted after 1 year's storage confirmed the good microbiological quality of the product, as no significant changes in the moisture level or number of microorganisms were found. It was also demonstrated that no large changes in moisture level took place in the packaging during the product's year in storage.

Industrial-Scale Production

The product was prepared on an industrial

scale using the facilities at the Productos Gerber de Centro América cereal plant in Costa Rica. It was fortified with vitamins and minerals and enriched with 10% soybean oil to increase its caloric content.

The industrial-scale preparation process is semicontinuous. First, the banana pulp is mixed with the rice and soybean meal, and then the rest of the ingredients are added, with water, to produce a mixture that has a total solids content of approximately 17% (Fig. 2).

After drum drying, the resulting product is in the form of small flakes that smell and taste of banana. Its chemical composition and caloric content are as follows: moisture, 4.90%; protein, 10.20%; fat, 13.85%; ash, 3.30%; carbohydrates, 67.50%; fibre, 0.70%; reducing sugars, 9.40%; caloric content, 463 kcal/100 g (dry); thiamine, 1.58 mg/100 g; riboflavin, 1.90 mg/100 g; niacin, 14.08 mg/100 g; calcium, 634 mg/100 g; phosphorus, 528 mg/100 g; and iron, 15-25 mg/100 g. The product meets Gerber's standards as regards functional characteristics and microbiological analyses. The prepared food product was packaged in aluminum/polyethylene laminate bags each containing 265 g, and then distributed to the households taking part in the study of acceptability and nutritional impact.

Table 2. Functional characteristics of the S₃₀, S₂₂, S_{16.5}, and S_{10.5} (S = soybean-rice-banana) mixtures processed according to seven different drying conditions.

Mixture	Drying conditions		Density (g/cm ³)	Solubility (%)	Water absorption level ^a	Texture (I)	Tendency to form lumps (II)	Viscosity (cP) ^a	Quality on basis of (I) and (II) ^b
	(psi)	(rpm)							
S ₃₀	50	2.25	0.19	27.0	1	Loose	None	1280	1-1
	80	2.25	0.17	31.0	1	Loose	None	1360	1-1
	80	3.25	0.19	33.0	1	Loose	None	1280	1-1
	80	4.50	0.21	37.0	1	Loose	None	1280	1-1
	100	3.25	0.16	33.0	1	Loose	None	1360	1-1
	100	4.50	0.20	32.0	1	Loose	None	1200	1-1
	100	5.50	0.19	39.0	1	Loose	None	1120	1-1
S ₂₂	50	2.25	0.21	27.4	1	Loose	Moderate	910	1-3
	80	2.25	0.19	35.6	1	Loose	Moderate	770	1-3
	80	3.25	0.22	24.5	2	Loose	Moderate	915	1-3
	80	4.50	0.15	27.4	3	Loose	Slight	1840	1-2
	100	3.25	0.14	31.6	2	Loose	None	1255	1-1
	100	4.50	0.20	36.0	2	Loose	Slight	1130	1-2
	100	5.50	0.15	33.5	1	Loose	Slight	940	1-2
S _{16.5}	50	2.25	0.18	34.6	3	Loose	Moderate	1180	1-1
	80	2.25	0.24	47.8	2	Loose	Moderate	1010	1-1
	80	3.25	0.23	38.9	2	Loose	None	1280	1-1
	80	4.50	0.23	37.2	2	Loose	Slight	880	1-2
	100	3.25	0.18	34.3	3	Loose	None	1450	1-1
	100	4.50	0.16	33.7	3	Loose	None	1215	1-1
	100	5.50	0.11	33.4	2	Loose	None	1170	1-1
S _{10.5}	50	2.25	0.18	38.3	3	Loose	None	1354	1-1
	80	2.25	0.12	36.3	3	Loose	Slight	1600	1-2
	80	3.25	0.18	38.6	3	Loose	None	1794	1-1
	80	4.50	0.17	37.8	3	Loose	None	No reading (over 100)	1-1
	100	3.25	0.16	36.3	3	Loose	None	1700	1-1
	100	4.50	0.17	43.7	3	Loose	None	1450	1-1
	100	5.50	0.12	32.8	3	Loose	None	1440	1-1

^aViscosity is determined with the Brookfield Spindle No. 4 using the amount of water corresponding to the water-absorption figure for the mixture in question.

^bLevel of quality according to the scale established by processors of infant foods: levels 1 and 2 are good, level 3 must be reported, and level 4 must be rejected.

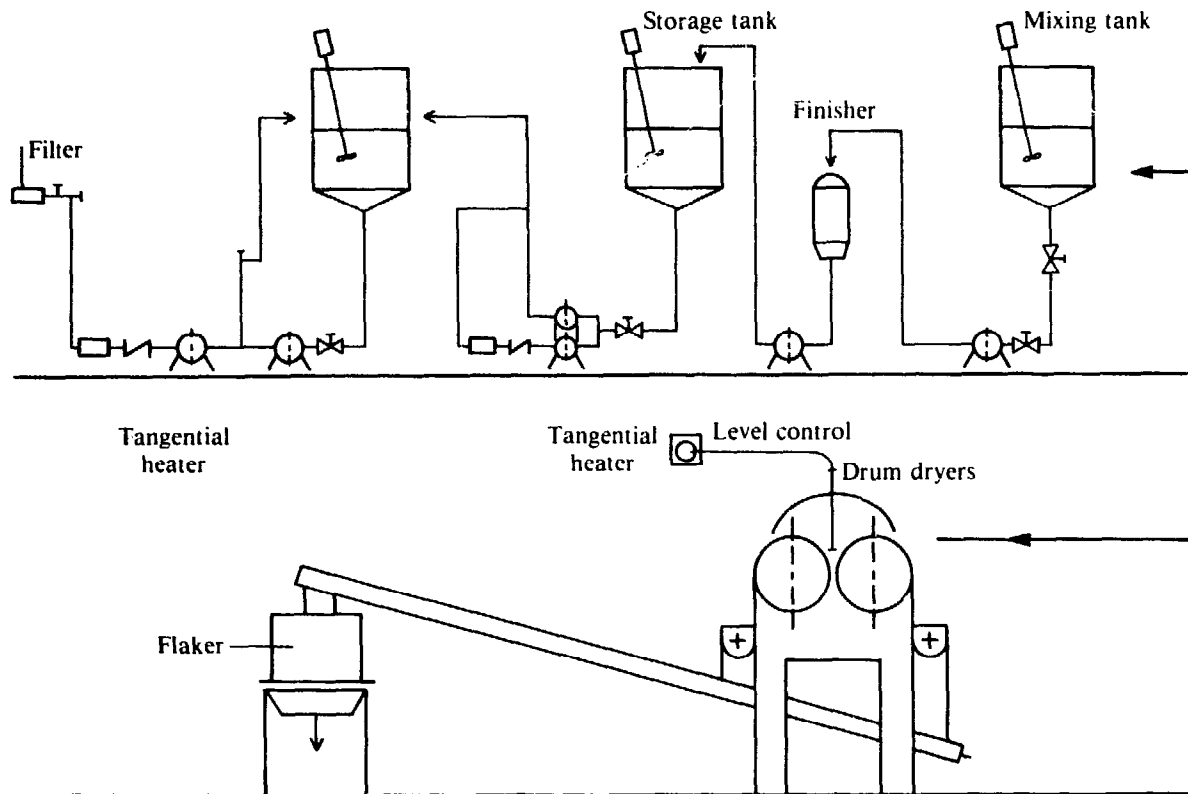

Fig. 2. Process line for industrial-level production.

Acceptability of the Product

The acceptability of the product was determined in the preliminary field trial mentioned earlier. The first step in this study was to conduct a survey to select 200 families living in four urban areas identified by Costa Rica's Nutrition Information Service as high malnutrition risk areas. Each of these families had at least one child under age 2 who either had been weaned or was being weaned and who became the central subject of the analysis unit. The families were split into four groups of 50 each, and were provided with food as follows: group 1, banana-flavoured dehydrated infant cereal; group 2, rice cereal; group 3, rice and beans; and group 4 was a control group that received no product.

Continuous records were kept on the provision and consumption of the banana and rice cereals, primarily to determine their acceptability and nutritional impact. The families in group 3 were provided with rice and beans to test a different hypothesis: that an increase in the availability of food for the adults in a family group would have a positive impact on the feeding of the infants in that group. For all four groups, the characteristics of each family's food intake,

health conditions, and socioeconomic position were measured extensively. The nutritional impact of the food provided was determined by anthropometric means, and trained interviewers surveyed the mothers or other individuals responsible for the child's feeding to determine acceptability.

Information was sought on a series of variables relating to acceptability: knowledge and prejudices with respect to infant foods, the type of food provided to the child, the actual availability of food, and so on. An effort was also made to determine whether basic nutrition education, which was given to all four groups, and the trial itself were changing these factors. Specific acceptability factors for the infant foods were divided into five groups: organoleptic factors, the child's reaction upon consuming the food, ingestion, the results obtained in preparing the cereal, and ratings for the digestive and nutritive properties of the product provided.

The surveys of these factors were administered twice, once at the start and once at the end of the period during which the food was provided, to reveal any changes taking place and to check the consistency of the information obtained. The food was provided over a period of 8 weeks.

Results

Organoleptic

Each mother tasted the products and then was asked her opinion of characteristics of flavour, colour, and smell. The results showed that between 70 and 90% of the mothers rated the products as good or very good on a hedonic scale for all factors.

Preparation of the Cereal

In her own words, the mother described the consistency achieved in preparing the product. At the first interview, it was found that 60% of the mothers felt the product to be smooth and 5% felt it was lumpy. In the second interview, after 8 weeks, more than 80% felt that it was of a smooth consistency on preparation.

Ratings for the Product's Digestive and Nutritive Properties

The mother was asked for her opinion of the nutritive value of the product and how well the child digested it. More than 90% in both the first and second interviews said the nutritive value was either good or very good, and the same was true for digestibility (Table 3).

The product was thus given a fairly high rating, which agrees with the sensory analyses carried out under laboratory conditions. The mothers' opinions seemed to be better defined in the second survey, and, therefore, it seems more reasonable to attach greater importance to the data from that survey than to those from the first. The information obtained is not at odds with the recorded consumption. Acceptability of the rice cereal was also shown to be high. The data obtained for this cereal are not included in this report, as the differences between localities were not entirely eliminated (owing to the research being conducted under nonartificial

Table 3. Behaviour of children at the moment of eating and amount of product consumed.

	First application	Second application	
Reaction			
Liked very much	52.5	40.5	} 78.6
Liked slightly	22.5	38.1	
Disliked slightly	12.5	19.0	
Disliked very much	5.0	—	
Uncertain	—	2.4	
Missing values	7.5	—	
Portion eaten			
All	65.0	69.0	} 78.5
Almost all	7.5	9.5	
About half	5.0	4.8	
Less than half	2.5	4.8	
Hardly tasted	12.5	7.1	
Missing values	7.5	—	

conditions); hence, the data cannot be considered wholly comparable.

Bresanni, R. et al. 1972a. Improvement of protein quality by amino acid and protein supplementation. Oxford, U.K., Pergamon Press, pp. 475-539.

1972b. The nutritional value of rice in comparison with that of other cereals in the human diet in Latin America. Reprinted from: Rice Policy in Latin America. Cali, Colombia, CIAT, 19 p.

Frazier, W.C. 1978. Food microbiology (3rd ed.). New York, USA, McGraw Hill, 540 p.

Jay, J.M. 1973. Modern food microbiology. Zaragoza, Acribia, 319 p.

Rackis, J.J. et al. 1970. Flavor and flatulence in soybean protein products. Journal of Agricultural and Food Chemistry, 18(6), 977-982.

1974. Biological and physiological factors in soybeans. Journal of the American Oil Chemist's Society, 51, 161A-174A.

Rosenberg, H.R. and Culik, R. 1957. The improvement of the protein quality of white rice by lysine supplementation. Journal of Nutrition, 63, 477-487.

Shemer, M., Wei, L.S., and Perkins, E.G. 1973. Nutritional and chemical studies of three processed soybean foods. Journal of Food Science, 38, 112-115.

Marketing Dried Fish in East Java, Indonesia

J.A. Sumardi, H. Purnomo, W.H. Susanto, Putiati, Darius, and I. Suryo¹

Abstract. A marketing survey was made in a rural processing village and an urban market to identify important characteristics for marketing of dried fish in East Java. Both merchants and consumers were interviewed. It was found that dried gutted fish with low salt content was preferred by both merchants and consumers, although this was dependent on the species preferred. Merchants were concerned, however, about storage life of the dried fish presently available and thus became more critical with the length of the market chain. This information will guide the development of improved processing and drying technology, being carried out at the fishing village, as products with minimum salt content, consistent with adequate storage life, are sought.

In 1979, 53% of Indonesia's total fish yield was produced in East Java. More than half of this was dried fish (33 856 t). Fish processing is not standardized and there is a wide variation in product quality. Consumption of processed fish varies from region to region and between the high and low socioeconomic classes. The availability of products on the market and their accessibility largely determine what the people will eat. Based on these facts, we undertook a survey of markets in East Java to determine, among other things, merchant and consumer preferences and perceptions. We felt the information would be valuable as a basis for the planning of improvements in processing methods.

Materials and Methods

We interviewed 34 merchants in dried fish stalls in the municipality of Malang (a consumer area) and in Muncar district (a producer area). About 25 consumers from each market area were also interviewed. Muncar has one market only, whereas Malang has one large market (Pasar Besar) and smaller markets in the districts around the city (Table 1). Merchants were asked to elaborate on the varieties of dried fish sold

¹Departemen Pendidikan Dan Kebudayaan, Universitas Brawijaya, Proyek Kerjasama Unibraw/IDRC, Jalan Mayjen Haryono 169, Malang, Jatim, Indonesia.

and their origin; buyers' preferences; the reasons for those preferences; the quality of the dried fish and their shelf life; constraints in selling; and suggestions for product quality improvements. Consumers were asked how often they ate dried fish, how they prepared and served it, what type they preferred and why, how long the fish were usually kept before being eaten, and what was the longest amount of time they could safely be kept. A sample of dried fish was obtained from the stalls and the amount of salt it contained was determined by the Volhard method at the Unibraw/IDRC laboratory. The results were compared with comments by merchants about the saltiness of the products they sold.

Results and Discussion

Our results indicated that there were marked differences between the production area and the consumer area. Presumably, these reflected the availability of fresh fish and eating habits in the region.

In the production area (Muncar), almost all dried fish sold at stalls in the market are produced by small processors using very simple methods and equipment (Fig. 1). Sometimes, the stall owner is also the processor. There are also medium- and large-scale processors, but they also sell their products to merchants in large cities throughout Java (Fig. 2).

All the merchants in Muncar noted that they sold unsalted and slightly salted fish, because

these products have a better storage life than do heavily salted ones. The local consumers prefer to buy small species like *teri* (*Stolephorus* spp.), *lemuru* (*Clupea* spp.), *tembang* (*Sardinella* spp.), and *cumi-cumi* (*Loligo* spp.) as these are quite cheap. According to the merchants, consumers differentiate between the slightly salted fish by appearance. The slightly salted fish were compact and similar in colour to fresh fish; they were softer than heavily salted fish and their condition was more stable in all weather conditions. The heavily salted fish were very hard, whitish, and stale, and their condition changed according to the weather. The merchants felt the high salt content perhaps caused fish to absorb moisture.

To prevent losses caused by changes in the weather, the merchants said they dry the fish in the sun and store them in large containers to obtain good air circulation. Fish too large to be handled in this manner are hung at the front of the stall. The products are kept in the stall until purchased, the length of time varying between species, salt content, and processing. *Tongkol* (*Euthynnus* spp.) was usually sold within 2-4 weeks, whereas *teri* sometimes took more than 2 months to be sold.

The amount of dried fish sold daily in Muncar was a minimum of 2 kg and a maximum of 30 kg, the local people being the only consumers. Sales dropped markedly during the fresh fish season. The prices differed considerably between

Table 1. Number of merchants, location, and name of markets surveyed.

Location and name of market	Total stalls	Merchants interviewed
Malang		
Blimbing	8	4
Sarangan	6	3
Klojen	4	2
Pasar Besar ^a	16	8
Oro-2 Dowo	8	4
Dinoyo	9	4
Tanjung	4	2
Sukun	6	3
Muncar		
Tembokrejo	7	4

^aPasar Besar is a wholesale market, the merchants selling their fish to retailers. Merchants in this market buy their fish directly from producers or other large dealers: 4 (2 of whom were interviewed) buy quantities of 2-25 t/week, and 12 (6 interviewed) buy about 100-300 kg/week. Other merchants in Malang operate on a small scale, 5-10 kg of each variety every 3-7 days.

species, and these differences were recorded during the survey (Table 2).

The merchants do not know the salt content of the products they sell. Our analysis showed that all the products contained salt, although the merchants distinguished between the fish as unsalted, half-salted, and fermented (Table 3).

In contrast with the production area, the consumer area (Malang) has several markets.

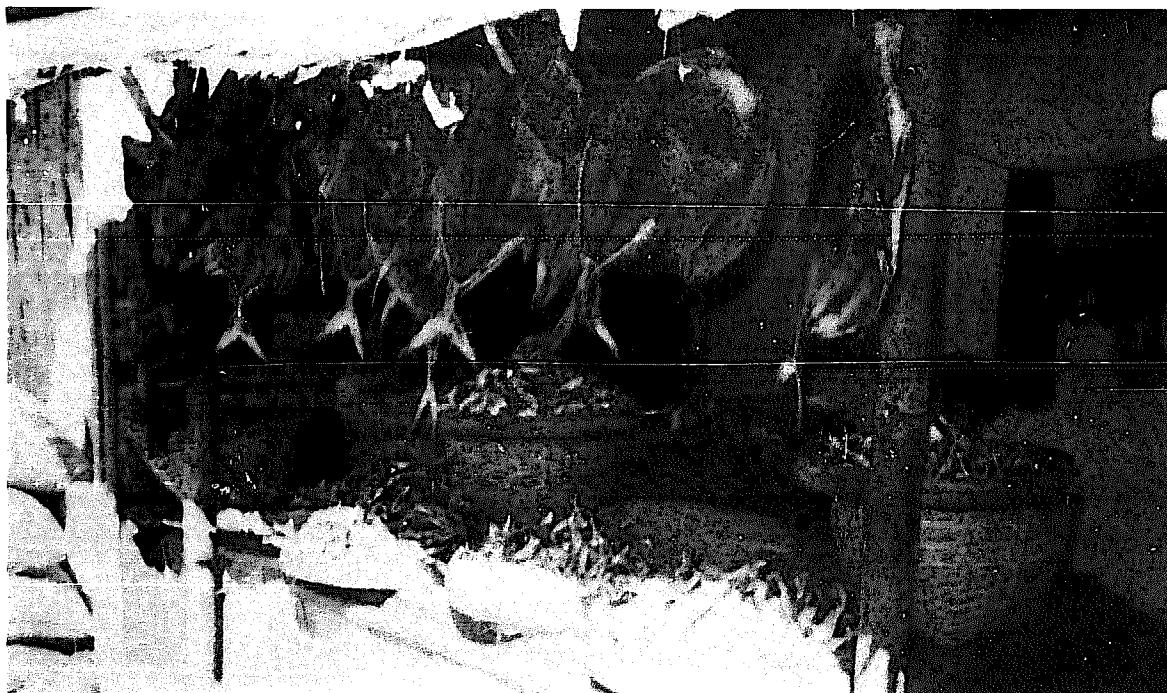

Fig. 1 A typical dried fish retail stall in the fishing village of Muncar, East Java.

Table 2. The price of different species of dried fish sold in a small stall in Muncar during the survey.

Species	Price (Rp/kg) ^a	
	Minimum	Maximum
Slightly salted		
Small sardine (<i>Clupea</i> spp.)	150	250
Cumi-2	650	2000
Teri	400	650
Pari (<i>Dasciatis</i> spp.)	300	350
Heavily salted		
Lemuru/sardine	125	150
Cumi-cumi	550	1750
Teri	300	600
Bawal	250	400
Tongkol	300	600
Sementi/small sardine (<i>Clupea</i> spp.)	75	250

^aRp 630 = U.S. \$1.00.

Dried fish marketing radiates from Pasar Besar, a large market where the merchants are primarily wholesalers who receive their products from outside and sell them to retailers operating in the smaller markets, named according to the districts in which they reside. The number of retailers varies in each market and depends on the main activities of the market. Most dried fish sold in Malang come from production areas in East Java, although a few come from Sumatra and Kalimantan (Table 4).

The processed fish *kurisi* (*Holocentrum* spp.) and *janggalak* (*Saurida* spp.) either unsalted or slightly salted are the favourites, according to the retailers who noted that the most popular fish had good flavour, were attractive, had good texture, were not too salty, were properly dried when the fish were split, and could be stored for a reasonable length of time. The retailers also indicated that small fish like anchovies (*Stolephorus* spp.) and small sardines (*Clupea* spp.) are also popular mainly because of their low cost.

Of the 98 consumers interviewed, 44 (45%) preferred *kurisi* and *janggalak*. The rest commented that they liked all the species if the fish were not too salty, attractive (similar in appearance to fresh fish), split (except small species), and properly dried.

Handling by merchants depended on the origin, species, size, and saltiness of the fish. Usually, fish come from Madura, Probolinggo, and Pasuruan, where the medium-sized fish are gutted and split, and from Muncar and some other regions, where they are processed whole. Small fish such as *teri*/small sardines and *tembang* (*Sardinella* spp.) are always dried whole. *Lemuru*/sardines (*Clupea* spp.) from Muncar are sometimes gutted and beheaded and, if the freshness declines, they are dried with heavy salt contents.

Retailers (9 of 22) maintained that consumers prefer gutted fish because they are clean; 12



Fig. 2. Dried fish stalls (subagent) in a large city market in Malang, East Java.

Table 3. Salt and moisture content of dried fish in Muncar.

Species	Handling	Classification	Salt content (%)	Moisture content (%)
Semenit	Whole fish	Unsalted	22.34	44.56
Kurisi	Gutting	Half salted	29.02	51.15
Tembang	Whole	Salted	30.89	48.04
Selar	Whole	Salted	32.91	45.85
Layang	Whole	Fermented	37.29	49.55
Selar	Whole	Fermented	37.59	48.78
Kurisi*	Whole	Salted	29.02	51.15
Kurisi	Gutting	Salted	31.67	48.57

**Holocentrum* spp.

Table 4. The variety of processed fish sold in Malang and their origin.

Species	Processing method	Origin of products
Lemuru/sardine (<i>Clupea</i> spp.)	Salted dried	Muncar
Tembang (<i>Sardinella</i> spp.)	Salted dried	Muncar
Layang (<i>Decapterus</i> spp.)	Salted dried	Muncar, Tuban, Brondong
Teri (<i>Stolephorus</i> spp.)	Unsalted dried/half salted	Muncar, Madura, Sumatera
Kurisi (<i>Holocentrum</i> spp.)	Salted dried	Gresik, Madura
Gulamah (<i>Otolithoides</i> spp.)	Unsalted/half salted dried	Pasuruan, Probolinggo
Janggalak (<i>Saurida</i> spp.)	Unsalted/half salted dried	Pasuruan, Probolinggo, Madura
Kerong-2 (<i>Therapon</i> spp.)	Salted dried	Madura
Banyar (<i>Rastrelliger</i> spp.)	Fermented dried	Madura, Tuban
Selar (<i>Caranx</i> spp.)	Salted dried	Kalimantan, Madura
Bang-2 an (<i>Lutjanus</i> spp.)	Half salted dried	Pasuruan, Probolinggo, Madura

noted that the gutted and split fish are preferred because they are clean, properly dried, not too salty, and have a reasonable storage life. Five of the six wholesalers who bought and sold 100–300 kg fish a week supported this information.

Of the 98 consumers surveyed, 46 preferred gutted fish, and 32 liked good quality whole fish better. Only 20% of the consumers preferred split fish. A majority (63%) noted that they prepared the dried fish by frying in hot oil, about 4% cooked the fish with pulpy vegetables, about 12% cooked them with coconut, and about 21% put them together with other items as side dishes. The frequency of consumption was about 11% daily, 74% more than 1 day/week, and about 15% only a few days per month. Amounts were 0.25–1 kg/week. Most of the consumers ate the fish the same day they were purchased, although some kept them for 2–5 days.

None of the fish was completely unsalted; all were processed with at least small amounts of salt. The fish classified as salted were considered to have high concentrations of salt. All of the retailers sell the “unsalted” and salted dried fish.

High salt concentrations according to the retailers result in the fish becoming moist during damp weather and exhibiting white spots during dry weather due to recrystallization of the salt

on the surface. The consumers do not like the very salty fish, and 3 of 22 retailers said they wipe the salt crystals off the fish using coconut husks moistened with water.

From the quality point of view, the retailers noted that *lemuru/sardines* (*Clupea* spp.) from Muncar suffer the most from rapid colour changes (red or brown). The coloration was presumed to be caused by high fat contents. The gutted and beheaded products also deteriorate rapidly.

The retailers mentioned that the price was stable for a couple of months. The marketing volume decreases when large amounts of *pindang* (boiled fish) come to market and during the fresh fish season. The dried products, however, are affordable to consumers, especially dried *teri* (*Stolephorus* spp.) at Rp 300/kg and *kurisi* at Rp 800/kg. Most of the consumers buy the small fish because there are more fish in a kilogram.

This study indicated the need to design a salting and drying process with minimum salt content consistent with adequate storage life for the marketing systems on East Java.

Acknowledgment

We appreciate the guidance and advice of Dr. William Edwardson during our work. This is part of the Indonesian fish processing supported by IDRC.

Drying of Cereal Grains in the Philippines

S.C. Andales¹

Abstract. The theory of drying is reviewed with emphasis on the composition and nature of the grain product and air drying. Different techniques of effecting the drying process are illustrated. Macroscopic and microscopic analyses of heat and mass transfer are treated. Thin-layer drying and deep-bed drying are also distinguished.

This paper reviews the principles and theory of grain drying, illustrates some typical drying methods, and presents the two established approaches of heat and mass transfer analysis. It must be made clear, however, that there are limitations in the equations and techniques presented. Hence, discrepancies are possible where these are applied in actual practice.

Theory of Drying

Drying is by convention the process of removing excess moisture from a product. Removal of all or most of the moisture is termed dehydration. To understand grain drying it is necessary to comprehend first the composition and nature of the grain product as well as the composition and nature of the conventional medium of moisture extraction, namely, the atmospheric air.

Composition and Nature of Atmospheric Air

The ambient atmosphere ordinarily surrounding the grain at any time is a mixture of dry air (dry air is in turn a mixture of oxygen, 20.95%; nitrogen, 78.09%; carbon dioxide, 0.03%; and argon 0.93%) and water vapour, hence, the term moist air. The amount of water vapour per unit weight of dry air is technically termed as the humidity ratio or absolute humidity.

Water vapour in the air exerts a pressure depending upon its quantity and in accordance

with Dalton's law of mixtures. The ratio of the actual vapour pressure in the air to that of the vapour pressure at saturation (the condition of air when carrying its maximum amount of moisture) is termed relative humidity (RH).

The properties of dry air and water vapour and their relationships are discussed in the study of psychrometry. Processes performed with air can be plotted on the psychrometric chart (Fig. 1).

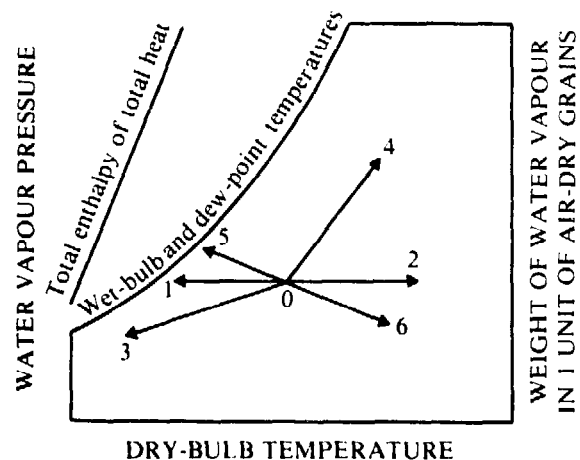

Fig. 1. Different possible processes of air in the psychrometric chart: 0-1 cooling, 0-2 heating, 0-3 cooling and dehumidification, 0-4 heating and humidification, 0-5 drying (adiabatic saturation), and 0-6 desiccating (chemical dehumidification).

Composition and Nature of Cereal Grains

Cereal grains are said to be composed of dry matter (essentially starch) and moisture. At harvest, cereal grain normally has excess moisture, which renders it unsafe for storage or unsuitable for milling. The amount of moisture in the product is normally expressed as moisture

¹Department of Agricultural Process Engineering, University of the Philippines at Los Baños, College, Laguna 3720, Philippines.

content (MC) percentage, either on a wet basis (wb) or dry basis (db).

Cereal grain is hygroscopic in nature. This means it may gain or lose moisture depending upon the ambient condition surrounding it. The movement of moisture into or from the grain is a function of the pressure differential between the vapour in the grain and the vapour in the surrounding atmosphere. If the vapour pressure in the grain is higher than the vapour pressure in the air, the transfer of moisture would be from grain to air, thus effecting drying. Conversely, if the vapour pressure in the air is higher than the vapour pressure in the product, the transfer of moisture would be from air to the grain, thus effecting adsorption of moisture by the grains.

A hygroscopic material may contain moisture in one of two forms: bound or unbound moisture. Bound moisture is the moisture content of the grain that has a vapour pressure less than the vapour pressure of free water at the grain temperature. A maximum amount of bound moisture is reached when the product is exposed to ambient air with 100% RH.

Unbound moisture refers to moisture in the product in excess of this maximum amount. Unbound moisture behaves like free water with vapour pressure equal to free-water vapour pressure.

Bound moisture content is a function of the relative humidity of the surrounding air. The bound moisture content in equilibrium with the air at a certain relative humidity is called equilibrium moisture content (MC_e). The relative humidity of the air at this condition is called equilibrium relative humidity (RH_e). Moisture in excess of the equilibrium moisture content (bound or unbound) is called free moisture and is the amount of moisture that can be removed from the grain with prolonged contact with air whose relative humidity is the equilibrium relative humidity (Table 1).

Techniques of Effecting the Drying Process in Cereal Grains

There are several ways of creating the pressure differentials between the vapour in the grain and the vapour in the air to effect drying. One can either increase the vapour in the grain or decrease the vapour pressure in the air or do both simultaneously. Techniques of increasing the grain vapour pressure are as follows:

Sun Drying The grains are spread over a floor area directly exposed to solar radiation. Solar

radiation heats the grain kernels and increases the vapour pressure of the moisture in the grain. Ambient air (wind breeze) with low RH picks up moisture from the grain. On the psychrometric chart this is shown in Fig. 2.

Infrared Drying The grain kernels are heated directly by infrared radiation from an infrared source, which increases the vapour pressure of the moisture in the grain. Ambient air in contact with the hot grain absorbs the moisture from the grain.

Conduction Drying The grain kernels are heated by a surface directly in contact with it. The hot surface, usually metal plates, is heated by burning fuel on the other side of the plate. The heat is thus transferred by conduction. The heating of the grains increases the vapour pressure of the moisture in it. Moving ambient air in contact with the grain picks up moisture from the grain.

Techniques of lowering the vapour pressure in the air relative to saturation (or lowering its relative humidity) are as follows:

Heated Air Drying The air is either directly or indirectly heated by a heat source (combustion of fuels, electric heaters, or collected solar energy). The heating of the air increases its temperature and decreases its relative humidity. As this hot air comes in contact with the colder grain, a convection mode of heat transfer results, simultaneously effecting a mass transfer from the grain to the air. On the psychrometric chart this is shown in Fig. 3.

Desiccated Air Drying The air is made to pass through an adsorbent material, like silica gel, which absorbs the moisture in the air. The desiccated air has a low relative humidity with a slightly increased temperature. Upon contact with wet grain, mass transfer proceeds from grain to air in a simultaneous process by convection heat transfer. On the psychrometric chart this is shown in Fig. 4.

Refrigerated Air Drying The air is made to pass through an evaporator of a refrigeration system during which air temperature is reduced and moisture in the air is condensed. This low temperature, low absolute humidity air, has a high relative humidity.

As this refrigerated air is made to pass through the condensing unit of the same refrigeration system, its relative humidity decreases. When this air is forced into a grain layer, a simultaneous transfer of heat by convection from air to grain and mass transfer from grain to air is effected. On the psychrometric chart this is shown in Fig. 5.

Table 1. Hygroscopic equilibria of rough rice^a

% moisture (wb)	Equilibrium relative humidity (%) at the following temperature, °F											
	40°	50°	60°	70°	80°	90°	100°	110°	120°	130°	140°	150°
1	0.1	0.2	0.3	0.5	0.8	1.3	2.0	3.1	4.6	6.8	9.8	14.0
2	0.4	0.6	0.9	1.3	1.9	2.8	4.0	5.6	7.7	10.5	14.2	18.9
3	1.1	1.5	2.1	2.9	3.9	5.3	7.0	9.2	11.9	15.3	19.4	24.5
4	2.5	3.3	4.3	5.5	7.0	8.9	11.2	13.9	17.2	21.0	25.5	30.7
5	5.0	6.2	7.7	9.4	11.5	13.9	16.6	19.8	23.4	27.5	32.1	37.3
6	8.8	10.6	12.5	14.8	17.3	20.1	23.2	26.6	30.4	34.6	39.1	44.0
7	14.2	16.4	18.7	21.3	24.2	27.2	30.5	34.0	37.8	41.9	46.1	50.7
8	21.0	23.5	26.1	28.9	31.9	35.0	38.3	41.8	45.4	49.1	53.1	57.1
9	28.8	31.5	34.2	37.1	40.0	43.1	46.2	49.4	52.8	56.2	59.6	63.2
10	37.3	40.0	42.6	45.4	48.2	51.0	53.9	56.8	59.8	62.7	65.8	68.8
11	46.0	48.5	51.0	53.5	56.0	58.6	61.1	63.7	66.2	68.8	71.3	73.8
12	54.4	56.6	58.9	61.1	63.3	65.5	67.7	69.8	72.0	74.1	76.2	78.3
13	62.2	64.1	66.0	68.0	69.8	71.7	73.5	75.3	77.1	78.8	80.5	82.2
14	69.1	70.8	72.4	74.0	75.6	77.1	78.6	80.0	81.4	82.8	84.2	85.5
15	75.2	76.6	77.9	79.2	80.4	81.7	82.9	84.0	85.1	86.2	87.3	88.3
16	80.4	81.5	82.5	83.5	84.5	85.5	86.4	87.3	88.2	89.1	89.9	90.7
17	84.7	85.5	86.3	87.1	87.9	88.7	89.4	90.1	90.8	91.4	92.0	92.7
18	88.2	88.8	89.4	90.1	90.6	91.2	91.8	92.3	92.8	93.3	93.8	94.2
19	91.0	91.5	91.9	92.4	92.8	93.3	93.7	94.1	94.5	94.8	95.2	95.5
20	93.2	93.5	93.9	94.2	94.6	94.9	95.2	95.5	95.8	96.0	96.3	96.6
21	94.9	95.2	95.4	95.7	95.9	96.1	96.4	96.6	96.8	97.0	97.2	97.4
22	96.2	96.4	96.6	96.8	97.0	97.1	97.3	97.4	97.6	97.7	97.9	98.0
23	97.2	97.4	97.5	97.6	97.7	97.9	98.0	98.1	98.2	98.3	98.4	98.5
24	98.0	98.1	98.2	98.3	98.4	98.4	98.5	98.6	98.7	98.7	98.8	98.9
25	98.5	98.6	98.7	98.7	98.8	98.9	98.9	99.0	99.0	99.1	99.1	99.2

^aAdapted from Houston (1972, p. 144). Accuracy of extrapolated data beyond the range of 77–111°F has not been verified experimentally.

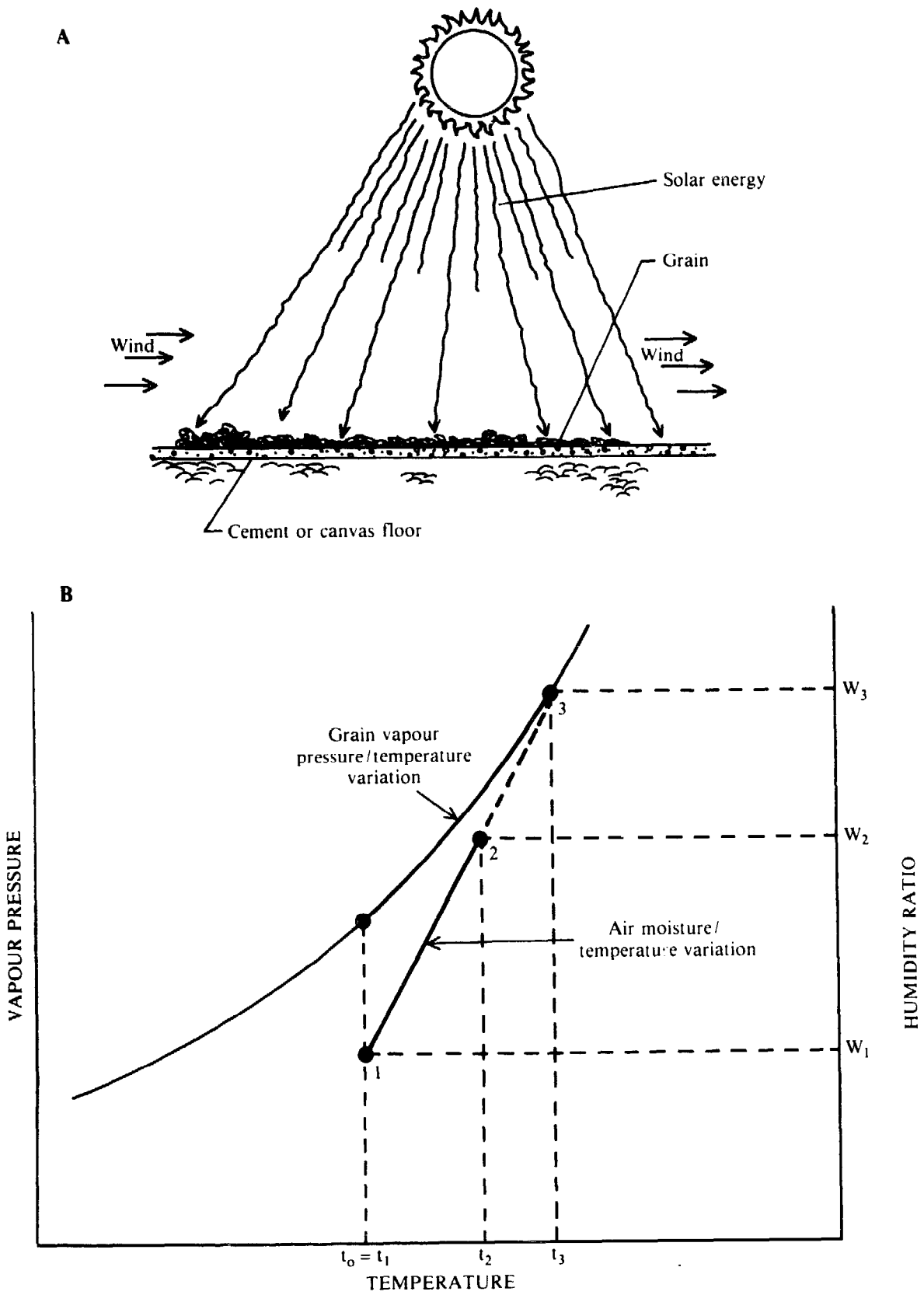

Fig. 2. Increasing the vapour pressure in the grain by solar heating: (A) schematic drying and (B) the drying process in the psychrometric chart.

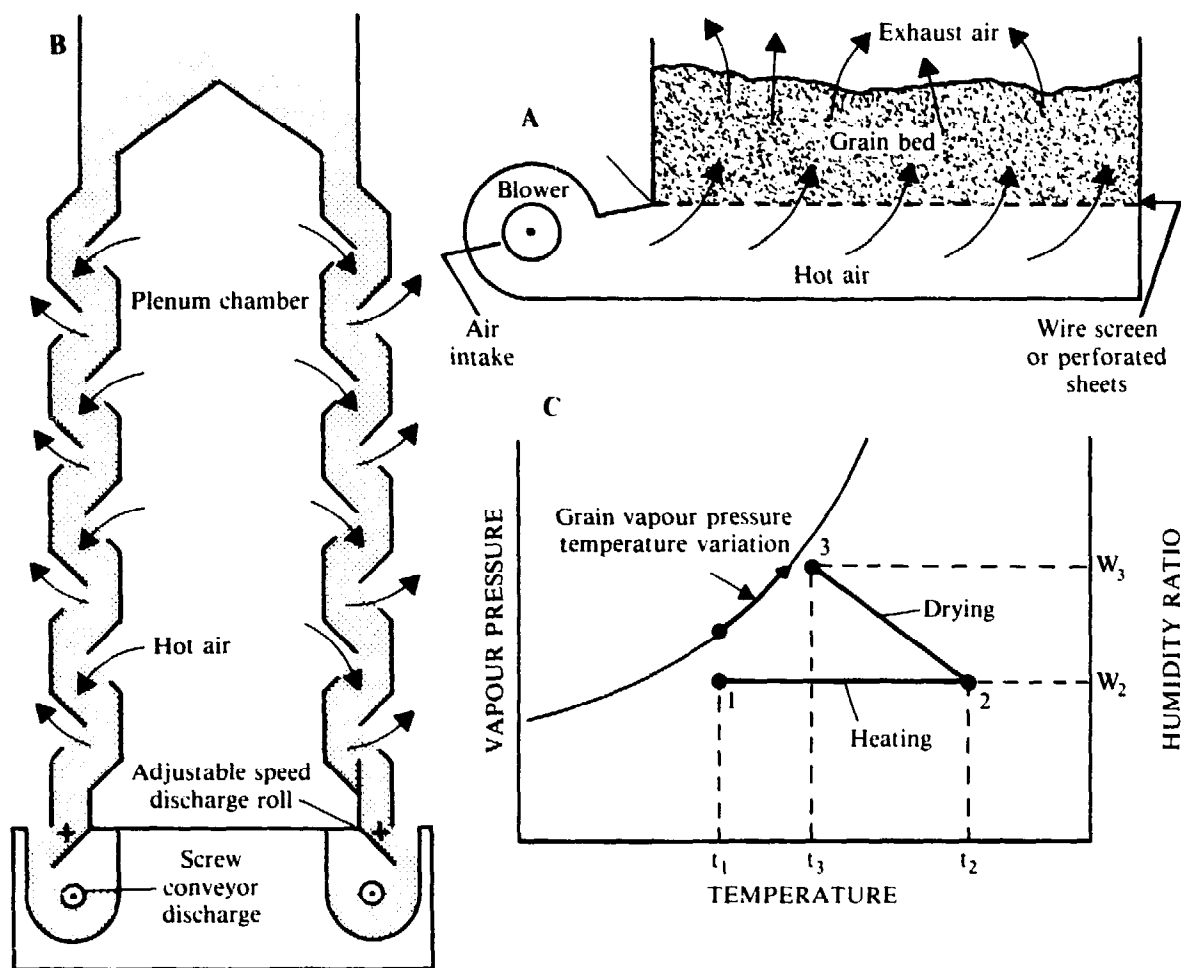

Fig. 3. Decreasing the relative humidity of air by heating: (A) flat-bed heated air drying, (B) continuous-flow heated air drying, and (C) the heating and drying process in the psychrometric chart.

Deep-Bed Drying

In locations where the ambient air condition is already suitable for drying, artificial means of creating vapour pressure differential between the grain and air may not be required; hence, the name natural air drying. In deep-bed drying the drying air moves from the bottom to the top of the bed. Exchange of moisture, from grain to air, takes place in a finite depth or zone of grain. At the start of the drying process the zone exists at the bottom of the bed. As drying continues the zone moves upward, and when the zone passes entirely through the grain the entire mass is dried to equilibrium with the drying air.

The grain below the drying zone has essentially reached equilibrium conditions with the incoming air and has a moisture content equal to the equilibrium moisture content corresponding to the air relative humidity. The grain below the drying zone is said to be dried grain.

The grain above the zone has not begun to dry and still has a moisture content equal to the initial moisture content (MC_i) — this is called wet grain.

Hot air of very low relative humidity is not suitable for use in this method of drying because it will cause an overdrying of grain at the bottom at the time when the top grains are dried to the desired moisture content. However, if the air has a high relative humidity, the drying zone may take an undesirably long time to reach the top of the bed allowing the top wet grains to be destroyed by moulds.

There is a pattern of moisture content distribution throughout the drying bed during the drying process. The moisture-time curves are functions of the height of the bed, air velocity, and air temperature and relative humidity. As a rule low height and high air velocity results in curves that are closer together. A decrease in air temperature will also bring

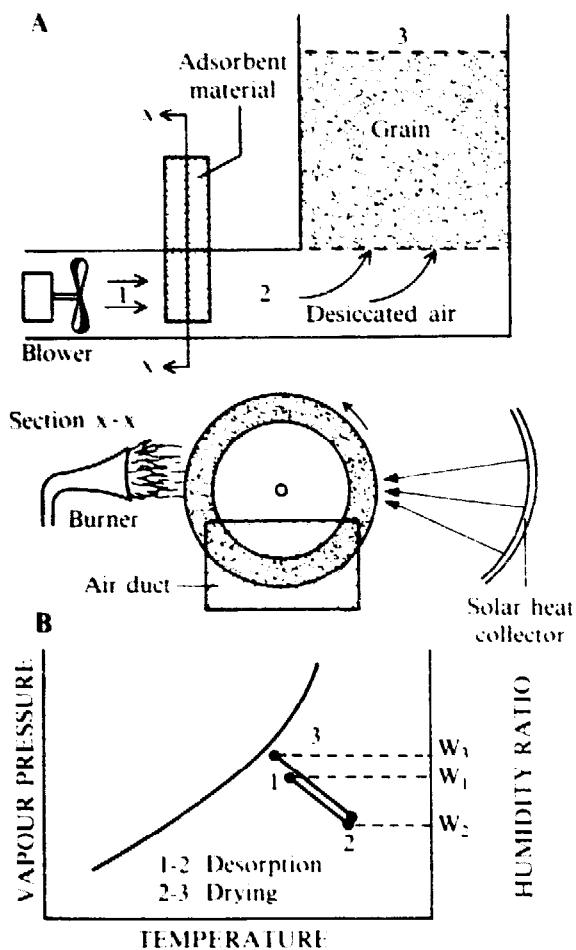

Fig. 4. Decreasing the relative humidity of air by desiccating it using adsorbent material, silica gel: (A) schematic of desiccated air drying, and (B) the desiccating and drying process in the psychrometric chart.

the curves closer together, but the drying time will be expanded. However, increased height and low air velocity results in curves that are farther apart. An increase in air temperature or low relative humidity will reduce the drying time but will cause the drying curves to be farther apart.

Macroscopic Analysis of Heat and Mass Transfer in Grain Drying

To the farmer or dryer operator the macro-analysis of drying is the most important factor to consider. Given the initial condition of the grain and the ambient air including other information, such as the desired purpose of the grain and the type of dryer to be used, the farmer or dryer operator will give more importance to such factors as the amount of water to be removed, amount of air to be used, amount

of fuel to be supplied, and power required for the drying system. The correlation of the results in the calculation of drying time between the gross (macroscopic) and the theoretical (microscopic) analyses depends on the accuracy of the instrumentation and should be within 10%.

Microscopic Analysis of Heat and Mass Transfer in Grain Drying

Farmers or dryer operators may not be concerned with the detailed mechanism of drying. However, scientists and engineers need to understand it so that they can manipulate the factors affecting the drying process, use it as a guide in the design of the drying system, and look for better alternatives in drying techniques.

Rates of Drying Periods

Previous investigators advanced the idea that the convection drying process can be divided into three periods (Threlkeld 1965). As indicated in Fig. 6, the drying rate is a function of the moisture content of the product. Period "A" is the zone of the "constant drying rate." During this period, the wet surface of the product behaves as a free-water surface. The period continues as long as water is supplied to the surface as rapidly as evaporation takes place. The constant rate period ends when the critical moisture content (MC_c) is reached. The critical moisture content is a function of the product and its thickness.

Period "B" is called the "first falling-rate period." This zone is characterized by a decreasing drying rate because of a decreasing area of wet surface. As drying proceeds, the fraction of wet surface decreases to zero. At this point period B ends.

Period "C" is called the "second falling-rate period" and is characterized by subsurface evaporation throughout. Under prolonged operation, the period continues until the equilibrium moisture content is reached.

Most of the drying of cereal grains takes place in the second falling rate period. Drying in this period involves two processes: movement of moisture within the material to the surface and removal of the moisture from the surface.

Brooker et al. (1974), listed six different physical mechanisms proposed by investigators to describe the movement of moisture inside a porous product during the drying process, namely: (1) capillary flow, (2) liquid diffusion, (3) surface diffusion, (4) vapour diffusion, (5) thermal diffusion, and (6) hydrodynamic flow. Henderson and Perry (1976) indicated that if the

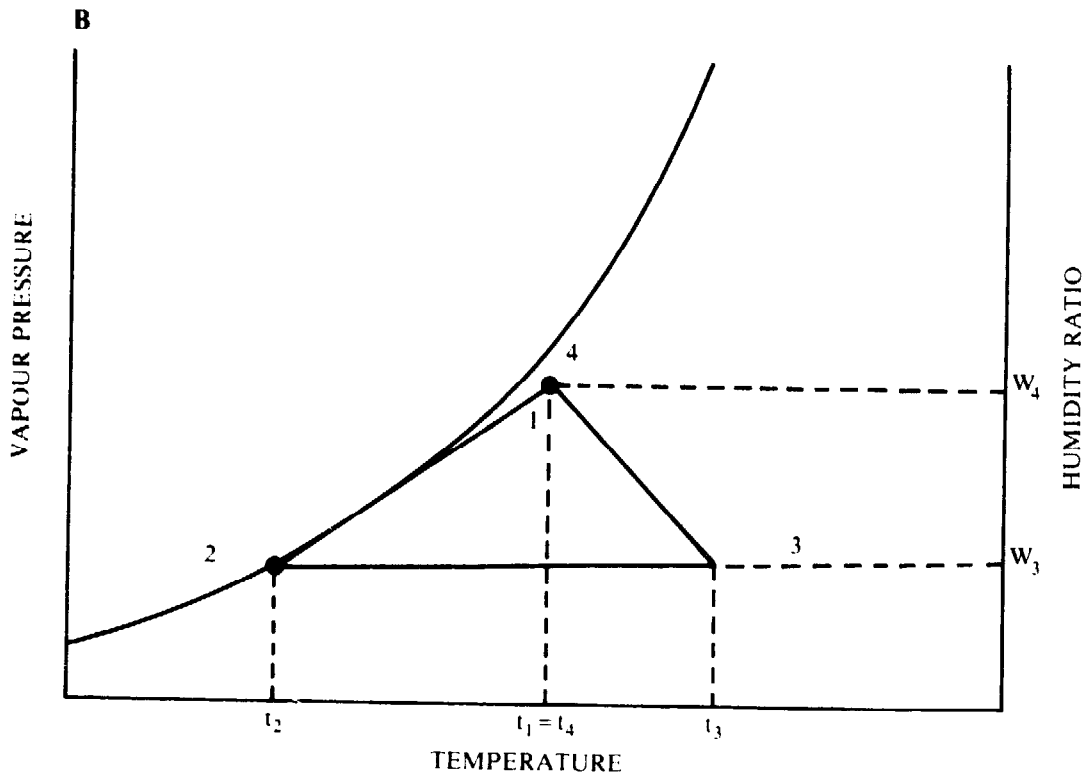
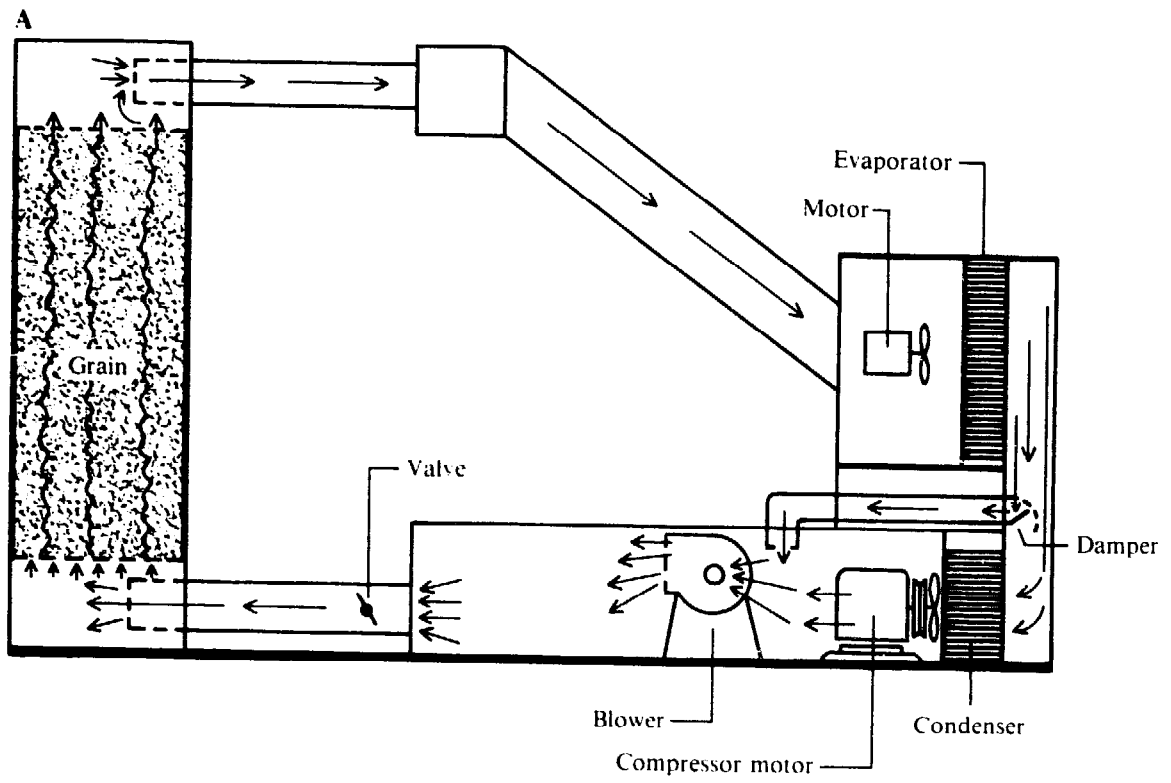

Fig. 5. Decreasing the relative humidity of air by using a refrigeration system: (A) schematic of refrigerated air drying, and (B) the cooling, heating, and drying process in the psychrometric chart.

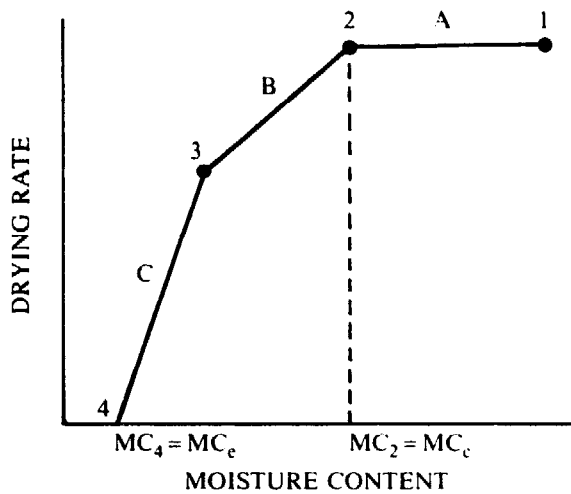

Fig. 6. Drying rate for a wet product.

moisture content is a bound moisture, diffusion is said to be the primary mechanism of moisture movement within the grain.

Mass Transfer Equation in Single-Kernel Drying

Within the solid, diffusion mass transfer is similar to heat conduction in solid, and the following equation applies:

$$(1) \quad (\delta G / \delta \theta) = -D_v \rho A (\delta MC / \delta X)$$

where G = quantity of water (kg), θ = time (hours), D_v = mass diffusivity (m^2/hour), ρ = dry solid density (kg/m^3), A = surface area (m^2), MC = moisture content in decimal (kg/kg), and X = distance from centre of the mass being dried (m).

At the surface the moisture movement is a function of the moisture concentration gradient between the drying air and the surface of the product and the following equations apply:

$$(2) \quad -D_v \rho (\delta MC / \delta X) = S (MC_s - MC_e) \rho$$

$$(3) \quad (\delta MC / \delta \theta) = D_v (\delta^2 MC / \delta X^2)$$

where S = surface conductance (m/hour), MC_s = moisture content at surface (% db), and MC_e = equilibrium moisture content at the relative humidity of the drying air (% db).

The solution of equations (1) and (3) determines a relationship indicating the variation of moisture content with time and product geometry. The differential equations (1) and (3) may be solved either by analytical or numerical methods.

Heat Transfer Equation in Grain Drying

Generally, the grain drying process includes four distinct heat flows between the grain and its surroundings: latent heat by virtue of moisture evaporation (q_l), sensible heat due to convection heat transfer (q_{sc}), sensible heat due to radiation heat transfer (q_{sr}), and sensible heat due to conduction heat transfer (q_{su}). These four heat flows are related by:

$$(4) \quad q_l = q_{sc} + q_{sr} + q_{su}$$

Schematic presentation of these different energy flows is shown in Fig. 7. Applying a heat balance for a unit area of grain surface yields the following equation:

$$(5) \quad h_d (W_s - W) h_{fg} = h_c (t - t_s) + h_r (t_r - t_s) + U (t_o - t_s)$$

where W_s = humidity ratio of the saturated air at the grain surface, W = humidity ratio of the drying air, t = drying air temperature, t_s = temperature of grain surface, t_r = temperature of the surrounding surface, t_o = temperature of environment below the supporting base, h_d = mass transfer coefficient, h_c = convection heat transfer coefficient, h_r = radiation heat transfer coefficient, U = overall heat transfer coefficient of the supporting base, and h_{fg} = latent heat of vaporization of water at t_s .

If the effects of radiation and conduction are negligible, as in ordinary convection drying, equation (5) becomes:

$$(6) \quad (W_s - W) h_{fg} = (h_c / h_d C_p) C_p (t - t_s) = L_e C_p (t - t_s)$$

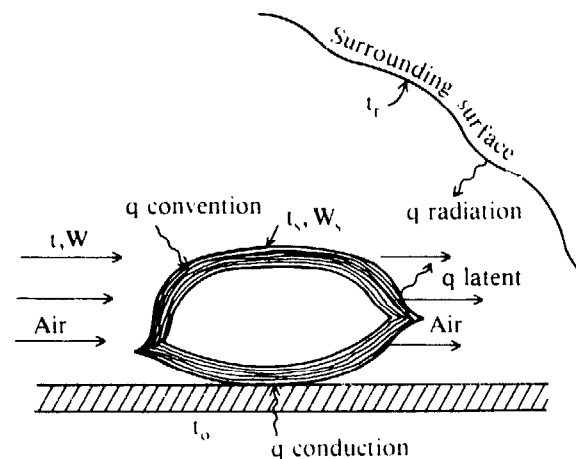

Fig. 7. Schematic diagram of heat flows between the grain and its surrounding area.

Note that if the Lewis Number (L_e) is a unity, the drying process is an adiabatic saturation process where t_s equals the wet-bulb temperature.

Mass and Heat Transfer Equations in Deep-Bed Drying

The discussions in the preceding sections were based on the assumption that drying is done with individual kernels or with a thin layer of grains. Although the analysis was informative, the practical importance of the resulting equations is limited because cereal grains are seldom dried as individual kernels or in a thin layer. Instead, grains are dried either in a stationary or moving deep bed.

Applying the basic laws of heat and mass transfer to a deep-bed drying system leads to a rather complicated system of partial differential equations. However, by adapting valid simplifying assumptions, by expressing the partial differential equations by use of finite differences, and with the help of large digital computers, an accurate prediction of the grain and air conditions at any time and location is possible.

Brooker et al. (1974), presented eight valid assumptions in the solution of four unknowns, namely: (1) the average grain temperature, t ; (2) the average grain kernel moisture content, MC_g ; (3) the air temperature, T ; and (4) the air humidity ratio, W . Four heat and mass balances were made to come up with the system of four differential equations (7-10) for a fixed-bed dryer (derivation of these equations are presented by Brooker et al. (1974)):

$$(7) \quad (\delta t / \delta \theta) = (h_a / \rho_p C_p + \rho_p C_w MC_g)(T - t) + [h_{fg} + C_v(T - t)] / [\rho_p C_p + \rho_p C_w MC_g] G_a (\delta W / \delta X)$$

$$(8) \quad (\delta MC_g / \delta \theta) = \text{an appropriate thin layer equation, say, } D_v (\delta^2 MC_g / \delta X^2)$$

$$(9) \quad (\delta T / \delta X) = -h_a (T - t) / (G_a C_a + G_a C_v W)$$

$$(10) \quad (\delta W / \delta X) = (-\rho_p / G_a) (\delta MC_g / \delta \theta)$$

where t = grain temperature, MC_g = grain moisture content, T = air temperature, W = air humidity ratio, h_a = convective heat transfer coefficient, ρ_p = density of product, C_p = specific heat of product, C_w = specific heat of water, C_v = specific heat of vapour, h_{fg} = heat of vaporization of water, G_a = mass flow rate, and X = drying bed coordinate.

Transformation of the above system of partial

differential equations into finite difference equations allows solution by use of large digital computers. A number of computer simulation programs for drying systems exist. For example, computer programs have been developed by Michigan State University for corn and by Kansas State University for corn and rice. A sample computer output is presented by Brooker et al. (1974) with corn and by Chang et al. (1978) with rice.

Through such simulation models as noted above, the different effects of the drying parameters could be readily studied without undergoing expensive and laborious experimentation.

Dryer Performance

The performance of dryers differ according to how well the drying system has been designed, engineered, and operated. The desired performance objectives of the drying systems are:

- (1) The grain equality must be preserved, and for paddy, the grain should not fissure or crack.
- (2) The entire batch of grain should be uniformly dried.
- (3) The grain should dry fast enough to arrest moulding and germination.
- (4) The dryer should be efficient in the utilization of energy. The utilization of the drying potential of the heated air should be maximized.

To evaluate the performance of a dryer, the design specifications should be known or deduced and compared with measured indicators such as:

- (1) Static pressure at the plenum — this gives an indication of air delivery of the fan and can be roughly cross-checked with an air-velometer.
- (2) The moisture content of the grain at the top and bottom layers, and at various points in the dryer bed area, to monitor drying progress and uniformity.
- (3) The temperature and relative humidity of the exhaust air as an indication of degree of utilization of the drying potential of the drying air.
- (4) The drying air temperature and, when feasible, the actual grain temperature, particularly the lower layers as it approaches 14%.
- (5) The fan rpm — this is useful if the fan characteristics are known.
- (6) The amount of fuel used by the burner — if a reasonably accurate airflow rate can be measured, the efficiency of fuel combustion can be inferred. This can also be inferred from the

moisture load if the heat of vaporization is known.

(7) The ambient air, dry bulb temperature, and relative humidity — the process can then be traced on the psychrometric chart.

(8) The actual drying time.

(9) The final proof is the milling quality of the dried grain sampled from the top and lower layers at various points in the dried bed. Milling quality is primarily the total milling yield and percentage of head rice. This may be compared with a control sample that is air dried or dried in a sample dryer.

The difference between a properly engineered drying system and that which has been put together without much concern for thermodynamics, fluid mechanics, and the physical properties of the grain, is reflected in the dryer performance.

Acknowledgment

The information provided by D. de Padua of the Southeast Asia Cooperative Post-Harvest Research and Development Programme, SEARCA, on certain portions of this paper is gratefully acknowledged.

-
- Brooker, D.B., Bakker-Arkema, F.W., and Hall, C.V. 1974. Drying cereal grains. Connecticut, USA, AVI Publishing Co., Inc.
- Chang, D.I., Chung, D.S., and Pfof, H.B. 1978. Simulation of natural air drying of rough rice. Kansas, USA, Food and Feed Grain Institute, Kansas State University, AID/ta-C-1162.
- Henderson, S.M. and Perry, R.L. 1976. Agricultural process engineering. Connecticut, USA, AVI Publishing Co., Inc.
- Houston, D.F., ed. 1972. Rice chemistry and technology, vol. IV. Minnesota, USA, American Association of Cereal Chemists, 517 p.
- Threlkeld, J.L. 1965. Thermal environmental engineering. New Jersey, USA, Prentice-Hall Inc.

Drying of Onions in Niger

A. Ba, Ch. Banzet, and J.M. Degbe¹

Abstract. This paper describes research to date on an indirect solar dryer using forced convection. The drying air was considered as a perfect gas, and relationships were developed that permitted the researchers to determine the heat and mass transfer in the collector, in the drying chamber, and, consequently, in the dryer as a whole. In addition, some design features of the dryer are given.

Onions are widely consumed in Niger in sauces or stews. Until now, the only drying method used has been direct sun drying. Traditionally, the nearly ripe onion is opened and the leaves are piled into a hole where they are allowed to ferment. This partially fermented product is then sun dried. The resulting product is often insect infested, sand covered, and micro-biologically unacceptable.

Much of the Niger is desert-like, which lends itself well to solar dehydration. With a relative humidity of less than 30% for most of the year, 3000–3500 hours of sunshine annually, and an average annual global radiation of 650 W/m², agricultural products can be dried in a relatively short time.

Onions are generally grown only in the Maggia or Niger Valley under irrigation on small plots of 300–1000 m² with an average yield of 25–30 t/ha. Three varieties are preferred: a white variety from Toumarana and white and violet varieties from Galni.

This study describes some of the design characteristics of the dryer as well as relationships that permitted the research team at the Office national de l'énergie solaire (ONERSOL) to determine the heat and mass transfer in the drying system.

Design Considerations

The team considered the importance of taste, colour, and general appearance of the dried onions. The maximum drying temperature was

¹Office national de l'énergie solaire (ONERSOL), B.P. 621, Niamey, Niger.

50–55°C. Final moisture content (MC) of the product was to be about 5%.

The collector was made of A5 aluminum. The collecting surface was 2.32 × 1.00 m with a cover glass thickness of 3 mm and insulation (6 cm of glass wool) on the sides and bottom of the collector. For global radiation of 600 ≤ G ≤ 900 W/m² and airflow rate of 190 ≤ V ≤ 225 m³/hour, exit temperatures from the collector were between 35 and 60°C.

The drying chamber, also made from A5 aluminum, consists of three trays 15 cm apart each 1.00 × 0.50 m. The trays are made from 1 × 1 cm wire mesh to allow easy flow of air.

Heat and Mass Transfer

Heat transfer occurs in both the drying chamber and the collector; mass transfer occurs primarily in the drying chamber. In the flat plate collector, it was assumed that heating of the moving air was achieved without an increase in humidity ratio. Based on well-known expressions for psychrometric processes involved, the team obtained a measure of the useful energy within the collector. Efficiency of the collector is given as the ratio of useful energy to the total global incident radiation received on the collector plate.

Heat and mass transfer in the tower takes place: (a) in the onions by diffusion (Fick's law) or conduction heat transfer (Fourier's law) and (b) in the wet air by convection. With an isenthalpic process in the drying chamber, it was possible to obtain the mass flow and its efficiency. Efficiency of the dryer is given as the product of the efficiencies of the collector and the drying chamber.

Measurements were taken every 6 min on temperatures of air entering and leaving the collector, on temperatures of the glass plates in the collector, collector plate temperature, temperatures of air entering and leaving the drying chamber, and global radiation with the

use of a Hewlett Packard data acquisition system.

The results obtained from a limited number of tests are encouraging. Further tests are now being planned to improve dryer efficiency and product quality.

Drying Fish in the Philippines

Ernesto V. Carpio¹

Abstract. Traditional sun drying in the Philippines is associated with several problems including losses through spoilage and uneven drying, fly infestation, and improper handling and inadequate storage facilities. Because sun drying is dependent upon the total surface area being exposed to sunlight, a large drying area is required, but most processors have limited land resources and can only dry a fraction of the catch during seasonal gluts. Therefore, controlled procedures and appropriate equipment are required to ensure that the maximum yield of dried fish with a satisfactory storage life can be produced quickly.

Drying of fish products, one of the simplest and earliest fish-preservation methods practiced, is a major traditional processing industry in the Philippines. The drying industry, being very flexible due to small and widespread units, is important because of the volume of fish being handled and the fact that fish surpluses can be processed at any landing prior to distribution thereby stabilizing prices to a certain extent. The annual tonnage is estimated to be more than 160 000 t dried weight, equivalent to 35% of the total Philippine catch, and provides a stable protein product that can be distributed over a wide area.

The traditional drying practice in the Philippines is to salt either whole or split-open fish, depending on their size, by dipping them in a 25% brine solution for 6-7 hours and then placing them on bamboo mats in the open air for sun drying. The resulting marketable product has a moisture content (MC) between 30 and 40% of total weight, but this varies widely. The most common species dried are anchovy, mackerel, slipmouth, sardines, nemipterids, and roundscad.

The general method of sun drying is associated with several problems aside from the fact that sunlight is unpredictable even during the dry season. Sun drying is relatively slow, and because fish is highly perishable, losses through

spoilage are high and the products are not uniformly dried. In the coastal areas of the Philippines where sun drying is widely practiced and where the relative humidity (RH) can fall as low as 40%, it takes an average of 1-2 days (8 hours/day) to dry herring and split-open mackerels to 35% MC wet basis (wb). Another major problem encountered with open-air sun drying is fly infestation. In the absence of intense sunlight as in the early and late part of the day, maggots develop and cause disintegration of the fish. Eggs laid on the exposed fish at the latter part of the day could hatch and cause damage to the products during subsequent storage. Sun drying is largely dependent on the total surface area being exposed to sunlight so that a very large area of drying operation is required. The fact that most processors have limited land resources means that during seasonal gluts, only a fraction of the catch can be dried. Handling the materials during unexpected rains presents another problem. Controlled procedures and appropriate equipment are required to ensure that the maximum yield of acceptable dried fish with satisfactory storage life can be produced quickly to cope with the seasonal landing.

Theory of Drying

Hall (1957) referred to drying in foods as the removal of moisture so that the environment is unfavourable for the development of moulds and bacteria. It is desirable to obtain dehydration in the shortest time possible to minimize the chances of spoilage by microbial action.

¹Department of Food Science and Technology, University of the Philippines at Los Baños, College, Laguna 3720, Philippines.

Equilibrium Moisture Content

Isotherms for anchovy, mackerel, and herring within the relative humidity range of 20–80% were studied at the University of the Philippines at Los Baños (UPLB 1979). Experiments showed that, at low relative humidity range such as that present in the dryer, only a small difference could be observed between the equilibrium moisture content (MC_c) of the different species tested (Fig. 1). This means that although the dryer can remove 25% of the free moisture in the products tested, the amount removed depends on the initial moisture content (MC_i).

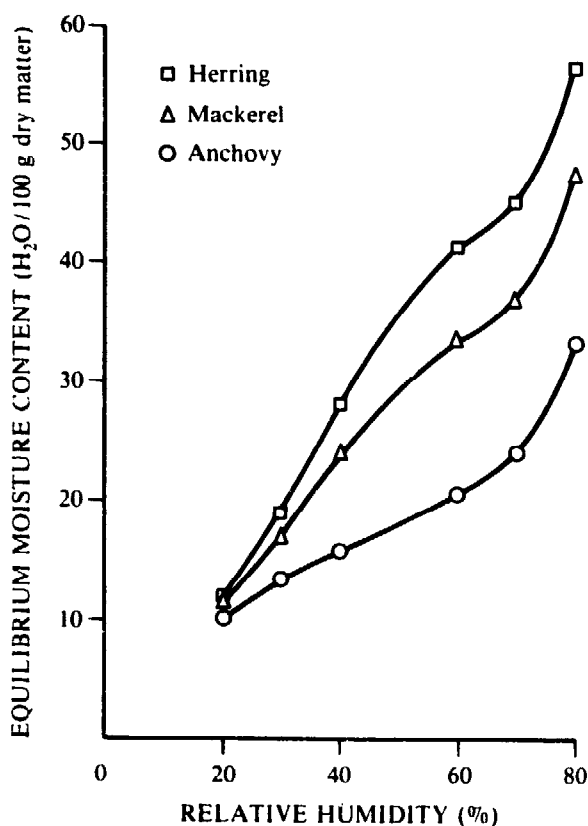

Fig. 1. Desorption isotherm of anchovy, mackerel, and herring at 43.5°C and relative humidities varying from 20 to 80%.

Rates of Drying

The rate at which the free moisture is removed from the product does not remain constant. Jason (1962) and Burgess et al. (1967) described the drying process as composed of the constant rate period where moisture is removed at a uniform rate until it reaches a critical moisture

content (MC_c), after which the rate of moisture removal decreases as the drying process enters a falling-rate period. In the case of fish muscles, which initially have a water content of about 4 g/g of dry weight, the moisture evaporates at a constant rate until it falls to about 1 g/g of dry weight (Jason 1962).

Henderson and Perry (1955) described the free surface evaporation of moisture during the constant-rate period in the equation:

$$(1) \quad (dW/d\theta) = 4.39 \times 10^{-5} f_v A (P_s - P_a)$$

$$(2) \quad = 0.4536 K_f A (t_s - t_a) / h_{fg}$$

where $(dW/d\theta)$ = drying rate, kg of water/hour; f_v = water vapour transfer coefficient $\text{kg}/(\text{m}^2 \cdot \text{m}^2 \cdot \text{kg}/\text{m}^2)$; A = water surface area, m^2 ; P_s = water vapour pressure at t_s , atm; P_a = water vapour pressure in the air, atm; K_f = thermal conductance of air film, $\text{kcal}/(\text{m}^2 \cdot \text{m}^2 \cdot ^\circ\text{C})$; t_a = air temperature, $^\circ\text{C}$; t_s = water temperature, wet bulb, $^\circ\text{C}$; and h_{fg} = latent heat of vaporization, kcal/kg .

The mass migration equation (equation 1) describes the rate of drying as being dependent on the vapour pressure difference between the product surface and the bulk of air and on the mass transfer coefficient. The constant rate of drying may also be evaluated in terms of the heat transferred to the product to evaporate the surface moisture (equation 2).

At the end of the constant drying rate, the hygroscopic material has reached the critical moisture content that can sustain a uniform rate of flow of free water to the surface, which is equal to the maximum rate of water vapour removal from the surface.

The moisture diffusion within the fish decreases below that needed to replenish the moisture at the surface, and the rate of moisture removal from the product slows. The falling-rate period is largely controlled by the movement of moisture within the material to the surface by liquid diffusion and removal of moisture from the surface (Hall 1957). The drying rate at this stage may be described by the Fick's law of diffusion:

$$(3) \quad (dMC/d\theta) = D_L (\delta^2 MC / \delta X^2)$$

where D_L = liquid phase diffusion coefficient applicable for movement through the solid phase, m^2/hour ; MC = moisture content, dry basis; θ = time; and X = distance along travel of moisture, m .

A solution to this differential equation (Newman 1931) requires that we take D to be constant, which is not always the case, and that drying would occur only at one face of the product. Equation 3 simplifies to:

$$(4) \quad (MC - MC_c)/(MC_i - MC_c) = \frac{8}{\pi^2} \left\{ e^{-D_L \theta \pi^2 / L} + (1/9)e^{-D_L \theta \pi^2 / L} + (1/25)e^{-D_L \theta \pi^2 / L} + \dots \right\}$$

where MC_c = equilibrium moisture content, dry basis; MC_c = critical moisture content at the start of the diffusion process, dry basis; and L = distance from face to centre of a slab drying from both faces or thickness of a slab drying from one face, m.

Equation 4 may also be solved graphically using the Gurney-Lurie charts that have been developed and used for unsteady state heat conduction. Henderson and Perry (1955) described the drying rate during the falling rate in the equation:

$$(5) \quad (dMC/d\theta) = -t(MC - MC_c)$$

where t is a drying constant. Integration of equation 5 gives:

$$(6) \quad MC - MC_c / MC_i - MC_c = e^{-\theta/t}$$

where MC_i = initial moisture content, dry basis.

Figure 2 shows the drying curves (log of available moisture vs time) of anchovy at various drying conditions. Each curve is closely fit to equation 6 of Henderson and Perry (1955) and

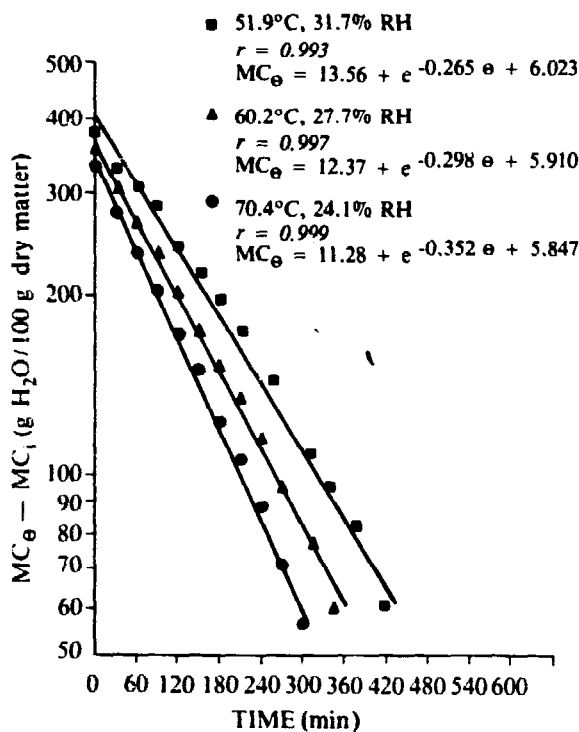

Fig. 2. Relationship of the available moisture (log scale) to time during the dehydration of anchovy at 173 m/min air velocity across the product surface.

may be used to determine the drying constant for the different species. Table 1 presents the different drying-time constants for anchovy, mackerel, and herring at various drying conditions. The table also presents the calculated drying time (θ), to obtain a final moisture content of 20% wb. The drying time, θ , calculations assume continuous drying with conditions kept constant.

Psychrometry

Psychrometrics of the Dryer Air

Psychrometry refers to the study of the "principle which governs the properties and behavior of the so-called fixed gases with condensable vapor" (Brown et al. 1950). A plot of the dry-bulb temperature of the air-water mixture and its water vapour pressure can be made under a particular pressure (normally at atmospheric) to obtain what is known as a psychrometric chart (Fig. 3).

If the physical properties of air such as the dry-bulb and the wet-bulb temperature are known, it is possible to identify the state point (A, B, or C) of air on the psychrometric chart. With the state point defined, other physical properties such as density, moisture content, and enthalpy may be obtained. For example, when air at state point A moves to a new condition B, it is said to have undergone a state process. The amount of energy absorbed by the air when being heated from state point A to B may be calculated as the difference in enthalpy ($h_B - h_A$) between points A and B.

Drying with heated air, particularly during the constant rate period, is a constant wet-bulb process and may be described by the path B to C on the psychrometric chart. The energy to evaporate the moisture from the product is supplied by the passing air, which decreases in temperature from T_B to T_C . Parker et al. (1954) mentioned that during this dehydration process, the wet-bulb temperature is rather constant and normally does not vary more than 1.1°C.

The water transport rate for the constant wet-bulb process is defined by Henderson and Perry (1955) in the equation:

$$W = 89.29V (H_C - H_B)/v$$

where W = water removal rate, kg/hour; V = air rate, $m^3/\text{hour} \cdot m^2$; H_C = absolute humidity of air at state C, kg water/kg dry air; H_B = absolute humidity of air at state B, kg water/kg dry air; and v = humid volume of air, m^3/kg .

Table 1. Drying time constants (t) and calculated drying time (θ) to reach 20% MC for anchovy, mackerel, and herring dried under different drying conditions.

Air velocity (m/min)	Average temperature (°C)	Average RH (%)	t (hours)	Drying time θ (hours)
Anchovy				
173	70.4	24.14	2.84	9.06
	60.2	27.7	3.36	11.25
	51.9	31.7	3.78	13.25
48	69.8	23.97	4.05	13.2
	58.4	27.1	4.8	16.27
	50.02	31.5	5.72	19.72
Mackerel				
173	69.6	23.87	3.69	10.45
	61.9	27.9	3.74	11.70
	49.5	31.6	4.23	14.31
48	69.59	26.9	4.45	13.08
	64.1	23.3	4.68	13.39
	49.83	30.7	6.07	20.11
173, skewered	69.6	23.9	2.67	7.59
Moderate sun dried	52.8	38.4	5.0	22.01
Herring				
173	69.6	28.4	4.15	14.25
	61.47	35.0	7.95	—
	52.8	32.2	6.39	24.68
	70.1	38.6	5.26	24.87
48	60.2	27.9	6.93	22.49
	50.27	31.5	8.79	33.20

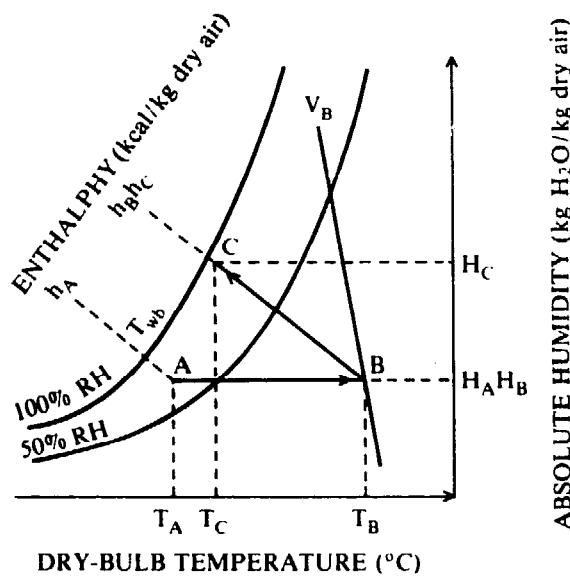

Fig. 3. The psychrometric chart showing state points and processes of air in a dryer.

The equation may also be defined as the maximum evaporation capacity of the dryer. In a design, however, it is never safe to approach too closely to the theoretical maximum, because drying becomes very slow as the drying limit is reached and hence takes a longer time to remove

all the free moisture. If the air is almost saturated at the cool end, as is expected in the above equation, condensation and dripping of water on the walls and roof will most likely occur. Van Arsdel (1942) and Parker et al. (1954) recommended that for design purposes, it is well to leave 8.3°C wet-bulb depression at the cool end.

Ambient air at A of the psychrometric chart (Fig. 3) must be heated to condition B before it enters the drying chamber. The amount of this heat energy is (Henderson and Perry 1955):

$$q = (60V/v)(h_B - h_A)$$

or

$$q = (0.252V/v)(h_B - h_A)$$

where q = heat rate, kcal/hour; h_A = enthalpy of air at state A, kcal/kg; and h_B = enthalpy of air at state B, kcal/kg.

The thermal efficiency of the system as a percentage is given by Hall (1957) as:

$$\text{Thermal efficiency} =$$

$$\frac{(\text{kg water evaporated}) (\text{latent heat, kcal/kg})}{(\text{kg fuel used}) (\text{heating value of fuel, kcal/kg})}$$

where the latent heat is taken as 555.56 kcal/kg of water evaporated.

Design of Hot-Air Dryers

Dehydration is defined as "drying under controlled conditions of temperature and humidity to a specific end point in a given time" (Parker et al. 1954). There are several means of artificially drying products, but the most common is air convection dryers, because they are relatively simple to operate and inexpensive (Fig. 4-5).

All hot-air dehydrators work essentially on the same principle: hot air is passed through the moist product and in the process evaporates and carries the moisture out of the dryer through an exhaust port. They may differ in the ways in which the air is heated and circulated.

Beavens (1944) described a typical cabinet dehydrator, which consists of (1) an insulated chamber with a suitable duct and baffle system to promote uniform air distribution through the product being dried, (2) a circulating fan that forces the air from the heat source and then to the product, (3) a heating system within the chamber, (4) product support within the chamber, and (5) a convenient control system to regulate the conditions within the dryer.

Systems of Heating the Drying Air

Hall (1957) described a direct method of

heating air whereby the primary air is allowed to pass directly through an open flame and in the process mixes with the product of combustion. Liquefied petroleum gas (LPG) has been extensively tested (UPLB 1979) and has been found to be one of the most convenient fuels for heating air. It is ideal for direct-fired devices, as it burns without producing odours that flavour the fish. Its relatively high cost and unsteady supply as compared with other energy sources make it unsuitable for low-cost fish dryers intended for small- to medium-scale processors. Thermostat-controlled nichrome wire heaters proved to be very manageable in terms of operation and temperature control. Electric heaters are not usually as bulky as other heat sources, and they have a wider range of application. These types of heaters and their operation, however, are often very costly. In most fishing villages of the Philippines, the supply of electricity is also unsteady if available at all.

Kerosine burners have also been tried (UPLB 1979) in the direct-fired heating system. Fuel was supplied through feed tubes from a pressurized container to two pressurized burners. The burners are enclosed in a protective shell to prevent the high discharge of air from putting out the flame. When properly operated, the burner produces a bluish flame that burns the



Fig. 4. A rice hull-fired dryer at a fishing village in Mercedes, Philippines.

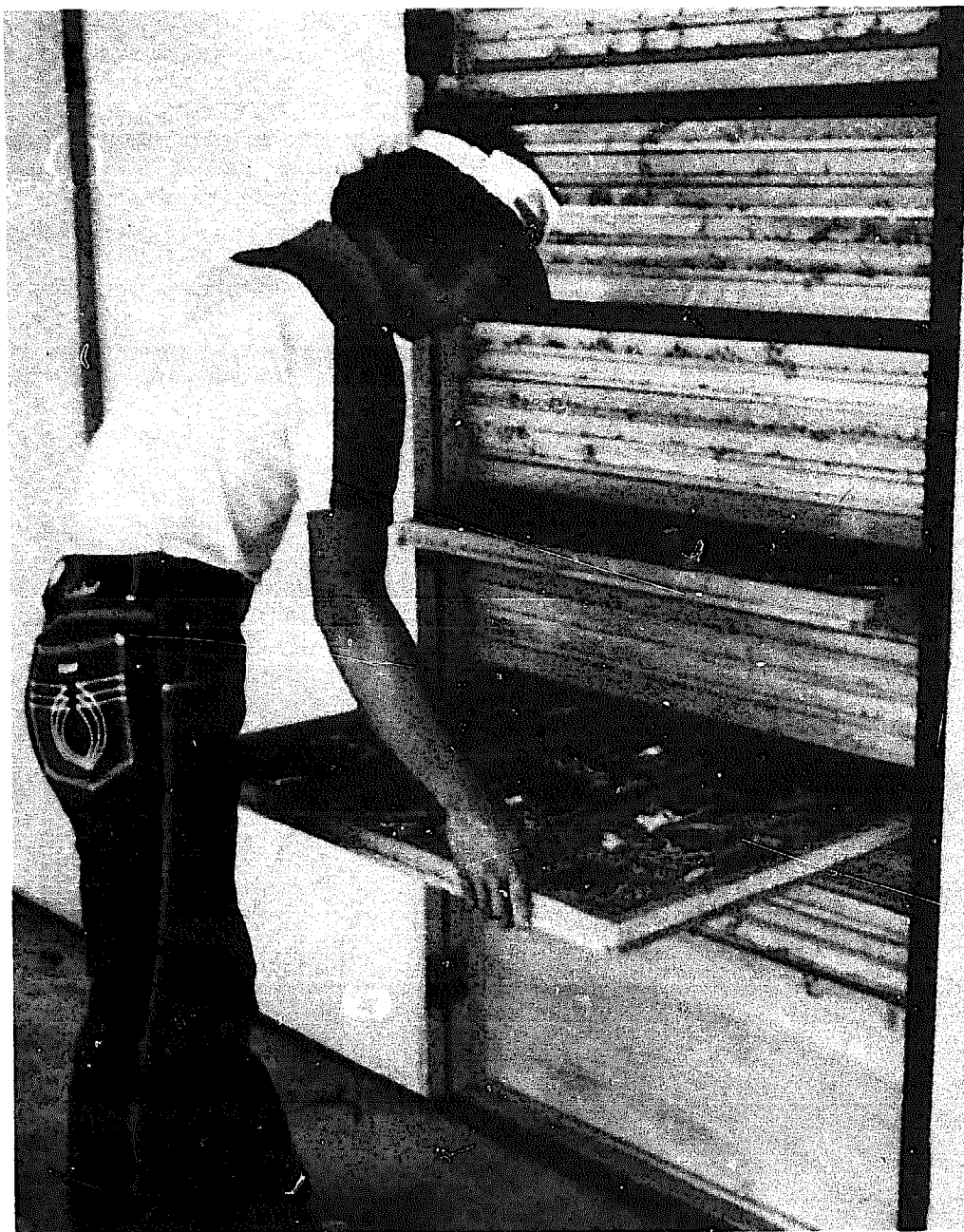

Fig. 5. Trays being loaded into the fish dryer at Mercedes, Philippines.

kerosine almost completely. Burner efficiencies greater than 84% have been obtained using this system.

Burners for heavy oils or furnaces that burn raw fuel have to use a heat-exchanger surface because heavy oils when burned produce soot that can undesirably come in contact with the product (de Padua 1970). A heat exchanger, which normally is made of high thermal conductivity materials such as metals, is heated with the burning oil and in turn heats up the air that is forced to come in contact with the

product. On the other hand, the air that supports the combustion of the burner, together with all the other products of combustion, such as smoke and soot, is exhausted through a chimney. Beavens (1944) stated that with this type of heating system, only 50-75% of the heating value of fuel is available as compared with the direct-flame method where almost all the heating value of fuel is utilized. Furnaces with heat exchangers may also be used to tap energy from unconventional sources such as agro wastes. A 1 t capacity fish dryer (Fig. 6), which uses rice

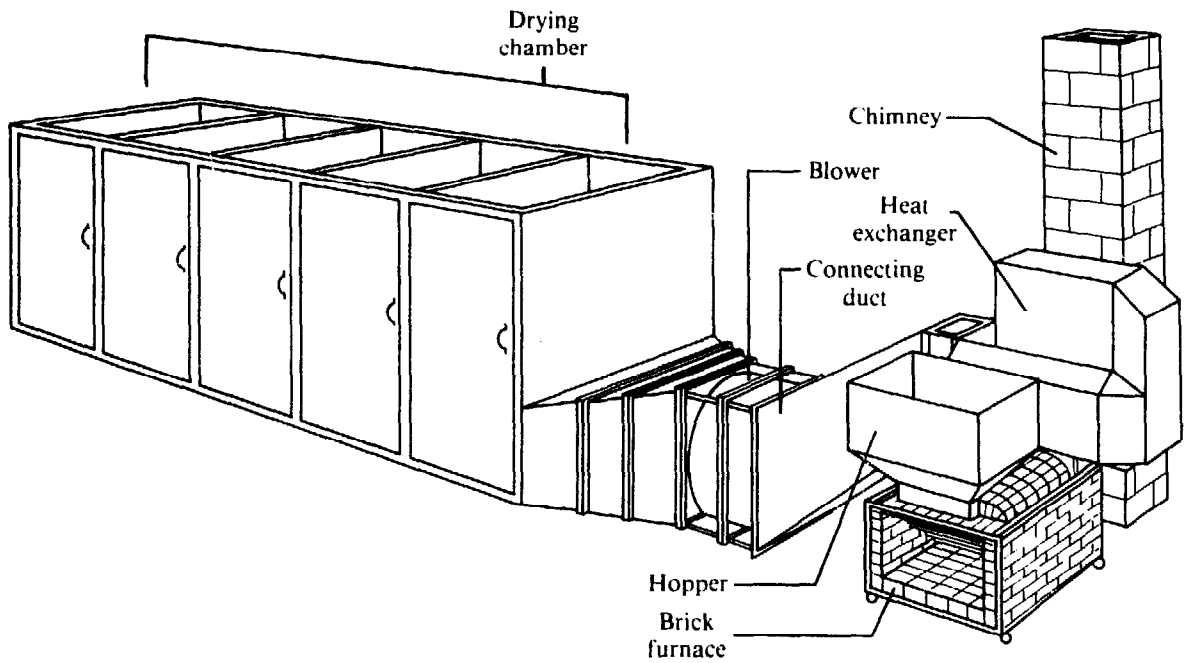

Fig. 6. A perspective view of the rice hull-fired fish dryer.

hulls as a source of heat, has been tested and proved to be practicable. Rice hulls are burned in a brick furnace that heats up air in a heat exchanger. The hot air produced is used to dry the fish located in a drying chamber (UPLB 1979).

Air Circulation

Systems to circulate heated air within the drying chamber aim to promote even or uniform air distribution throughout the chamber. This is normally accomplished through ducts, baffles, or guide vanes.

Hot air may be passed horizontally over and under the dehydrated material as in a cross-flow dehydrator. In a through-flow circulation dehydrator, however, hot air is allowed to move through the bed of fish and through the material supports such as perforated trays (Beavens 1944).

In most circulation systems, provisions are made to recirculate air where the heated air after passing through the product is reheated and again circulated in the dryer. In places where the ambient temperature is much lower than the operating dryer temperature, recirculation has been found to save a considerable amount of heat energy and, therefore, fuel (Williams-Gardner 1971). The humidity-temperature path of air, represented on a psychrometric chart, is shown in Fig. 7. With this process, the dryer operates at a higher humidity than one without

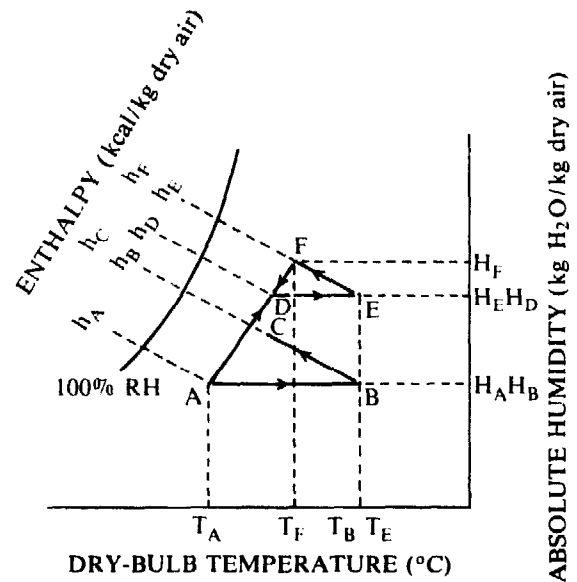

Fig. 7. Absolute humidity chart, showing state points of air during the recirculation process. The air mixture of fresh and recycled air enters the drying chamber at point E and passes through the product following a constant wet-bulb process EF resulting in a moisture-laden air at point F. A portion of this air (F) is exhausted while a certain amount is mixed with the incoming fresh air from point A resulting in a mixture at D. This mixture is reheated to E and again allowed to pass through the product to be dried.

recirculating air, and a longer time — proportionate to the energy saved — is required for drying. The percentage of recirculation of air may be calculated using the equation:

$$\% \text{ recirculation} = [(H_D - H_A)/(H_F - H_A)]100$$

where H_A , H_D , H_F = absolute humidities at points A, D, and F, respectively, in a psychrometric chart (Fig. 7), kg of water/kg of air.

Fans and Blowers

De Padua (1970) recommended centrifugal blowers especially in large drying installations as they can develop high-static pressures. Fish dryers, typical of tray dryers, however, do not need to develop high-static pressure due to the relatively low product resistance to airflow. Beavens (1944), however, stated that large volume flow of hot air across the product is needed to increase drying rates. For this purpose, axial flow fans may be used as they are designed to move large volumes of air usually at zero static pressure (McCabe and Smith 1956). Cutting (1942) suggested that for high rates of fish drying, dehydrators should be installed with fans or blowers that can deliver air at 182.9 m/min across the product. For most food products, Beavens (1944) recommended air velocities as high as 243.8–304.8 m/min.

Material Support

For the through-flow systems, perforated trays are preferred to allow passage of hot air through layers of materials. Amin and Bhatia (1962) found that drying time can be reduced substantially by the use of wire-mesh trays instead of stainless steel or aluminum trays; however, the use of wire-mesh trays presents a problem because raw fish stick to the mesh. Used fish nets have been found to be ideal as trays because the fish do not stick to them (UPLB 1979). With this type of tray, fish dry uniformly inside the chamber without being turned.

Amin, H.D. and Bhatia, B.S. 1962. Studies on dehydration of some tropical fruits — Part II:

drying rates as affected by various factors. *Food Science*, 2(3), 69.

Beavens, E.A. 1944. Cabinet dehydrators suited to small-scale operation — Part I. *Food Industries*, 16(2), 70–72.

Brown, G.G., Katz, D., Foust, A., and Scheidewind, R. 1950. *Unit operations*. New York, USA, John Wiley and Sons Inc., pp. 559–574.

Burgess, G.H., Cutting, C.L., Lovern, J.A., and Waterman, J.J. 1967. *Fish handling and processing*. New York, USA, Chemical Publishing Co., Inc., 389 p.

Cutting, C.L. 1942. Engineering problem of the smoke curing of fish. *Chemistry and Industry*, 61, 365.

de Padua, D. 1970. *Grain drying principles, practices and system*. Laguna, University of the Philippines at Los Baños, College of Agriculture, UNDP/FAO publication.

Hall, C.W. 1957. *Drying farm crops*. Michigan, USA, Edward Brothers Inc., pp. 245–278.

Henderson, S.M. and Perry, R.L. 1955. *Agricultural process engineering*. New York, USA, John Wiley and Sons, Inc., 402 p.

Jason, A.C. 1962. Drying and dehydration. In: Borgstrom, G., *Fish as food*, volume III: Processing — Part I. New York, USA, Academic Press, Inc., pp. 1–50.

McCabe, W. and Smith, J.C. 1956. *Unit operation in chemical engineering*. New York, USA, McGraw-Hill Book Co., Inc., pp. 162–182.

Newman, A.B. 1931. *Transactions of the American Institute of Chemical Engineers*, 27, 203.

Parker, M.E., Harvey, E.H., and Stateler, E.S. 1954. *Elements of food engineering*. New York, USA, Reinhold Publishing Corp.

UPLB (University of the Philippines at Los Baños). 1979. Terminal reports on IDRC-funded improvements of processing and handling of traditional fish products in the Philippines, Phase I and II, Laguna, Philippines, UPLB.

Van Arsdel, W.R. 1942. Tunnel dehydrators and their use in vegetable dehydration. *Food Industries*, 14(11), 47–50.

Williams-Gardner, A. 1971. *Industrial drying*. London, U.K., Leonard Hill, 310 p.

Drying Grapes in Northern Chile

J.M. Olhagaray¹

Abstract. This paper reports the results on the drying of Thompson seedless grapes in Northern Chile. The work was carried out during the summer of 1978 by the Institute of Technological Research (INTEC/CHILE). The Thompson seedless grape is grown in the Valley of Copiapo River and is used mainly for export purposes as a fresh product. For variety and quality reasons only 70% of the production is exported, which leaves about 800 t of usable grapes discarded.

Apart from exhibiting very good ecological conditions for sun-drying fruits, the area is economically depressed, with a high percentage of unemployment. An adaptation of the Australian method of sun-drying grapes was considered as a solution to the problem. A drying rack prototype was built with a capacity of 1 t of fresh grapes. Drying runs were conducted during the summer of 1978. Results show the technical feasibility of drying the grapes by this method. An economic study was carried out that considered a facility for drying 300 t of fresh product. Results show a moderate investment, a good return, and a high requirement of hand labour.

The Valley of Copiapo River where Thompson seedless grapes are grown is an economically depressed area with high unemployment. The availability of the raw material consists of about 800 t (fresh) corresponding to 3000 t of table grapes for export (Thompson seedless). The region has adequate conditions for sun drying, but a drying system is needed that would be labour intensive, capable of being operated within a small area, easily constructed, and would not require liquid or solid fuels.

Procedure for Drying Unsulfured Grapes

In the procedure for drying unsulfured grapes, grape bunches are first collected and washed in cold water to remove dust and contaminants. The grape bunches are then caustic dipped (0.3% boiling lye solution). The dipping time ranges between 3 and 4 sec producing cracks in the skin, which speeds up the dehydration process. The grapes are then washed in cold water to stop the chemical attack and to avoid cooking the product. Another cold water dip is used to eliminate traces of lye from the grape skin. The grapes then go through a sulfuring process to develop a clear colour and prevent deterioration.

The grapes are then placed in racks (load 15 kg/m²) and left to dry, starting by the upper

floors. Protection against insects and small animals must be provided. Once dry, grape bunches are removed from the rack and stored in the shade for about 20 days.

The system characteristics are a drying rack with a total capacity of 1 t of grapes, a sulfur chamber made with sun-dried bricks with an inner cover of coal tar, and ancillary equipment consisting of 200-L drums, steel baskets, and a brick fireplace for the hot-dip drum.

Results of Drying Runs

Results of the drying runs indicated an average drying time of 16 days. The product characteristics are as follows: the average moisture content is 14.4% (wet basis), the deviation is 0.6%, and the average size is 6.5 mm. In the colour evaluation 52% of the sample exhibits were of a pale yellow colour (uniform), 36.5% were not of uniform colour, and 11% were pink coloured with dark yellow spots. The major defects included 14.5% with scars and a remaining SO₂ of 460 ppm. Evidence of mechanical damage, burns, moulds, insect damage, and dust was not detected. From 4.4 kg of unprocessed grapes the yield was 1 kg of raisins.

Results of Feasibility Study

The results of the feasibility study showed a base capacity of 300 t of fresh grapes per season,

¹Institute of Technological Research (INTEC/CHILE), Casilla 667, Santiago de Chile, Chile.

raisin production of 70 t/season, and a land requirement of 2.5 ha. The total investment was U.S.\$180 000, working capital was U.S. \$20 000, the operation cost amounted to

U.S.\$41 700/season, the raisin price was an average of U.S.\$1150/t (70% of total production is exported), there was a rate of return at 18%, and a labour requirement of 50 people.

Solar Energy as a Heat Source in Crop Drying in Sierra Leone

Michael W. Bassey¹

Abstract. Solar energy as a heat source has been used in many applications pertaining to developing countries. One of the main applications, especially in rural areas, is crop drying. This paper examines various aspects of solar crop drying.

The evaluation of available solar energy and its utilization in various types of dryers are discussed. Factors affecting the design of these dryers, which are mainly for use in developing countries, are outlined. There is need for more research and development work on solar crop dryers appropriate to the needs of these countries.

The drying of crops using the sun's thermal energy has been carried out for centuries throughout the world. The methods used have not changed in most countries due to several factors, some of which are related to their level of technological development. Traditionally, the crops are spread out in the open air under the sun on the ground or on raised platforms. This method is cheap but has several drawbacks.

The disadvantages of open-air sun drying include: the intermittent nature of solar energy throughout the day and different times of the year; the possible contamination of the crops by dirt and rodents; the infestation of the crops by insects; the exposure of the crops to the elements such as rain and wind, which cause spoilage and losses; and the exposure of the crops to rats, chickens, and human beings.

Crops that have been dried using open-air drying methods include fruits, vegetables, meat, fish, grains, spices, tobacco, coffee, and cacao. Other drying activities have been used to process timber and hides. The quality of these products are in most cases quite acceptable although improvements are possible. These improvements can be achieved by applying certain modifications to existing methods or developing different systems for drying depending on the particular crop.

In many cases, it is possible to have sophisticated systems that give good quality dried

products. Their cost is high, however, most of them needing electricity to power a fan and fuel such as oil or gas to provide the heat needed for drying. In many developing countries electricity is unavailable in most rural areas and fossil fuel is imported, therefore, this alternative appears to be impractical at the present time. There may be possibilities for combining wind energy and solar energy in East Africa where it seems economically feasible, but in West Africa there are many places where there is no wind.

There has been an attempt over recent years to concentrate on the development of solar dryers that can be used in agricultural activities in the rural areas. These dryers have mainly been for small scale use in which the drying times are reduced and the quality of the final product improved, compared to the traditional methods.

The financial implications of improving traditional drying methods have greatly influenced the direction of the use of solar energy as a heat source for crop drying in developing countries. Many of the dryers used for dehydrating crops are relatively low cost compared to systems used in developed countries.

This paper discusses the use of solar energy for drying crops in developing countries. The interaction between solar energy and dryers is outlined, and some design considerations are made bearing in mind the existing technological and financial limitations. Some examples of various types of dryers using solar energy will be given to show the possibilities that exist for further developments.

¹Department of Mechanical Engineering, Fourah Bay College, University of Sierra Leone, Freetown, Sierra Leone.

Availability of Solar Energy

The solar radiation intensity, outside the earth's atmosphere, at the mean distance of the earth from the sun is 1.353 kW/m^2 . This amount of radiation is in turn reduced to values less than 1 kW/m^2 at the earth's surface by the presence of clouds, dust particles, and gases. The magnitude of the available radiation depends on the location, time of year, time of day, and general atmospheric conditions.

The solar radiation available at the earth's surface consists primarily of wavelengths ranging from 0.3 to $2.4 \mu\text{m}$. Most practical applications use solar radiation between 0.38 and $2 \mu\text{m}$, which covers the visible range (0.38 – $0.78 \mu\text{m}$) and the near infrared (0.78 – $2 \mu\text{m}$). The variation of solar radiation intensity with wavelength is shown in Fig. 1 as is the radiation intensity outside the atmosphere of the earth and at its surface. Also shown are the absorption of the radiation by various gases. It is noted that attenuation of solar radiation can be quite significant throughout the whole spectrum.

The total radiation incident on a horizontal surface is called global radiation or insolation. It includes the direct beam radiation, the diffuse radiation, and the reflected radiation. The direct radiation is received from the sun in a linear path. The diffuse radiation, however, is directed from all over the sky. It is radiation that is scattered by gases, particles, etc., in the air. The diffuse component of radiation may vary from 10% (on a very clear day) to 100% (on a very cloudy day) of the global radiation. The reflected radiation originates from surfaces such as walls of buildings, the ground, and other equipment.

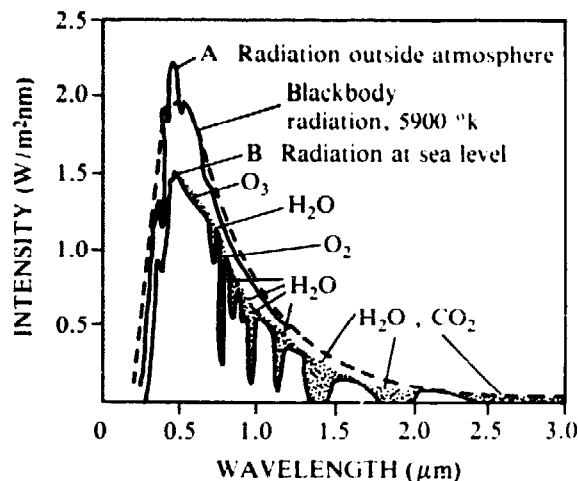

Fig. 1. Variation of the intensity of radiation with wavelength.

In practice, the amount of available solar radiation is measured with equipment specially designed for a particular component of the radiation. Pyranometers are used for measuring global radiation and pyreheliometers used for direct radiation. Various types are available (Coulson and Howell 1980). Diffuse radiation is obtained with the aid of a shadow ring, which prevents the direct component from reaching the pyranometer.

For solar drying applications, it is important to know the global radiation. Although this value can be obtained with a pyranometer, the lack of the appropriate infrastructure for acquiring such solar radiation data presents a problem in developing countries. Many of these countries have radiation data for a few years and only for limited locations. Funds are usually unavailable to buy equipment for obtaining solar radiation at, for example, experimental sites. These constraints make development work on dryers rather difficult.

Estimates of global solar radiation can be obtained using empirical equations that have been presented in the literature (Ånström 1924, Reddy 1971; Bassey 1978; Hoyt 1978; Notaridou and Lalas 1979). Meteorological data are used to estimate the global radiation.

One of the most common formulations was due to Ånström (1924) and it uses data on sunshine duration that can be obtained using a sunshine recorder. The equation is:

$$Q/Q_0 = a + b n/N$$

where Q is the global radiation received on a horizontal surface, Q_0 is the theoretical radiation on the surface assuming the absence of an atmosphere, n is the actual duration of sunshine, N is the maximum possible duration of sunshine, and a and b are constants. These constants, a and b , depend on location; a being relatively constant but b depending on latitude.

Climatological values of total precipitable water, turbidity, and surface albedo have been used by Hoyt (1978). Another study (Notaridou and Lalas 1979) used parameters such as elevation, absolute humidity, and cloud cover to predict global solar radiation. Work by Reddy (1971) used the mean length of day, the number of rainy days in the month, and mean humidity per month to estimate global radiation.

It has been observed (Bassey 1978) that the available radiation data at some locations are not reliable, which make the estimates referred to earlier quite useful. It is usually possible to obtain an idea of the accuracy of the predictions by comparison with reliable measurements

obtained in other locations having similar weather conditions and latitudes. The lack of measured solar radiation data at any place should, therefore, not prevent work on solar drying as estimates can be obtained that can serve as a basis for research and development studies.

Methods of Utilizing Solar Energy for Drying

Solar energy has been the oldest and most widely used method of drying crops in developing countries. The methods used to date have largely been based on open-air drying. However, to better utilize this abundant source of energy effectively, systems have to be developed based on specific needs.

Crop dryers can be designed to use solar energy in various ways. There are two main types of dryers that can be used: active dryers and passive dryers. Active dryers use an external device operated, for example, by means of a fan to circulate the air, but passive dryers do not.

Although passive systems tend to be more realistic for application in developing countries, because of the relatively low initial capital and operating costs, it is possible to use active systems for relatively large-scale applications. Their specific uses, therefore, depend on various factors such as availability of a power source, scale of application, location, design, and available materials. There are various modes in which solar energy can be used for drying.

Open-Air Drying

In this method, the dryers use solar insolation, wind velocities, ambient air temperatures, and the relative humidity of the air to reduce the moisture content of the crops. This method, which has many variations, has been used extensively because it is cheap to implement.

In one application, the crop is spread on the ground on an area that has been cleaned of leaves, stones, and grass. The solar energy incident on the thinly spread crops provides heat, which is required to evaporate water. The mechanisms by which this is achieved are well understood and have been reported in the literature. The mechanisms by which the moisture leaves the crop are: conduction, convection, and radiation.

Radiation from the sun heats the ground and the surrounding air. Heat is transferred to the

crop by conduction from the ground, by conduction and convection from the air close to the crop, and by radiation from the sun and the ambient air. The moisture at or near the surface of the crop is thus heated and is vaporized, which causes movement of moisture to the surface. The heat transferred to the crop may also be transmitted to the inner core by conduction, which will in turn liberate further vapour. Thus, the rate of drying depends on the available radiation and the ground temperature.

During open-air drying efforts must be made to ensure that the ground temperature is not so high that it will damage the crop. Sometimes crops are spread out on cement or asphalt pavement. This method is more expensive than ground drying because of the initial cost of constructing the pavement. It does, however, have the advantage of providing a higher surface temperature compared to the ground.

Because there is little or no vertical circulation of air through the crops, they have to be spread thinly when dried by the open-air method, which makes it necessary to have a large area of land. Although this method is relatively low cost, it has many disadvantages as mentioned earlier.

Another method of open-air drying involves raising the crop above the ground to dry by placing it in a tray and resting it on an open, raised platform. This arrangement reduces the problems encountered when drying on the ground. Rodents and insects, such as ants, find it more difficult to infest the crops. To better utilize the solar energy, the base of the tray should be made of wire mesh and the tray should be painted black to attain higher temperatures for heat transfer. The depth to which the crops are packed can in this instance be higher compared to when there is no wire mesh because of the increased circulation of air through the crops.

Open-air drying on trays or racks can be used for beans, coffee, and cacao, etc. For other crops such as grapes, the trays are stacked on top of each other with a roof overhead that protects the crops from dew or rain (this method is used in Australia). The method is cheap and can be used to process large quantities of grapes.

Direct Drying

The discussion on open-air drying has shown that the air used for taking moisture from the crops is effective at the ambient temperature and relative humidity (RH). However, it is well known that air at a given temperature and relative humidity when heated experiences a

decrease in relative humidity. Thus, heated air takes away more moisture from the crops than unheated air. This fact has been used in various solar crop dryers that use direct and indirect methods of heating the ambient air.

Direct dryers consist of an enclosure with a transparent cover. The crops are placed on trays in the enclosure and the solar energy is absorbed by both the crops and internal mass of the dryer. The elevated temperatures cause evaporation of water from the crops. The warm moist air escapes through vent holes usually located on the side of the dryer, and fresh air is drawn in through holes at its base. Therefore, there is a continuous flow of ambient air through the dryer.

A survey of these dryers has been done by the Brace Research Institute (BRI 1979). A typical dryer is shown in Fig. 2. Heat is accumulated by the greenhouse effect, and the moist air escapes through the vent holes. Many of these direct dryers are insulated on their sides and underneath. Their effectiveness depends on good insulation (proper sealing of the glass or plastic cover to prevent uncontrolled movement of air). The temperature in this type of dryer can rise to more than 100°C depending on the type and quantity of crops being dried. Care, therefore, has to be taken to ensure that the final product is not overdried.

Cheaper dryers, which use solar energy by the direct method, do not use insulation. The top and sides of the dryers are covered with a transparent cover that serves to collect solar radiation and protect the crops from dirt, bad weather, and insects.

The design of direct dryers is such that the crops are directly beneath the transparent top covers that are sloped at the appropriate angle to collect the optimum solar radiation. The magnitude of this angle can be calculated for various locations. However, because it changes throughout the year a recommended value is $\alpha = \text{latitude} + 10^\circ$. Although this inclination will

not give the best performance when the dryer is used on a year-round basis, it should be noted that tracking the sun would be an expensive exercise making the application very uneconomical.

The transparent cover can either be a single or double cover with a distance of about 1 cm between the covers. The effect of having the double glazing is to decrease the amount of heat lost to the ambient air by convection, which in turn increases the temperature in the drying chamber. An advantage of having higher temperatures is that the relative humidity of the moist air will be low enough to prevent water from being reabsorbed by the crops, a process that increases the drying time. It may be necessary to have two transparent covers if wind speeds are consistently high during drying periods. Cooling of the glass cover causes loss of heat and condensation on the transparent surface inside the chamber. As a result the crop increases in moisture content, and less radiation is transmitted through the cover material. Because of this problem, an adequate number of vent holes must be located at strategic points on the dryer through which the moisture can escape.

The regulation of the temperatures in direct dryers is achieved by opening or closing the vent holes. Their operation depends on the experience of the user and on the type of crop being dried. They have been used for drying okra, onions, apricots, grapes, garlic, prunes, peaches, cauliflower, etc., with good results (BRI 1979; Bassey 1980a).

Design considerations of direct heating systems involve maximizing the temperatures in the dryer as this determines the load. As mentioned earlier, the insulation must be effective and the materials used can be chosen from sawdust, wood shavings, fibreglass, coconut fibre, straw, and others. The thickness of insulation will depend on the material used and the temperature difference between the ambient air and that in the chamber. Wind speeds should also be considered in the design of the direct-heating dryer as this causes losses by convection.

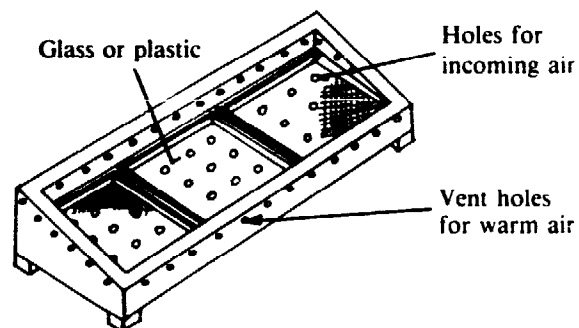

Fig. 2. Diagram of a typical direct dryer.

Indirect Drying

In indirect drying, solar energy does not come into direct contact with the crops. The air used for drying is heated in a solar air collector and then circulated through the crop to reduce its moisture content.

This type of dryer has been studied and reported in the literature (Akyurt and Selçuk

1973; Headly and Springer 1973; Satcunanathan 1973; Selçuk et al. 1974; BRI 1979; Bassey 1980a). It is possible to use a fan for circulating the air or just natural convection. The typical configuration of these dryers is shown in Fig. 3.

The solar energy is collected in the air heater by means of the greenhouse effect using the transparent cover and absorber. Because of buoyancy effects, the warm air rises through the sloped collector and into the drying chamber where the crops are placed. Many designs are possible depending on the mode of circulating the air.

Some designs (Akyurt and Selçuk 1973) have used a collector that has a glass cover, and the absorber consisted of metal chips. The air was blown over the hot metal chips by a fan and then allowed to circulate through trays stacked on top of each other.

Another indirect dryer has been reported by Headly and Springer (1973) and is shown in Fig. 4. The ambient air is heated in the double-glazed sloped collector and passes through the crops by natural convection. The warm air removes water from the crops and becomes cooler and falls to the bottom of the drying chamber. Because the air is enclosed in a continuous loop, the moist air is drawn into the collector through a duct where the water condenses. The following crops were dried: yam, sweet potato, sorrel, and grass.

A simple dryer using natural convection for air circulation has been reported by Bassey (1980a). This dryer shown in Fig. 5 is used for drying rice. Two types of collectors have been used; in the first one the air passes between the glass cover and the black absorber plate, but in the second dryer the air circulates on both sides of the absorber plate. Another dryer, using plastic as the transparent cover, makes use of

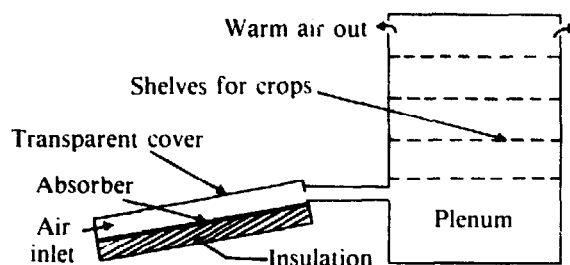

Fig. 3. Schematic diagram showing the typical features of an indirect crop dryer.

burnt rice husk as the absorber (Exell 1978). The side walls of the dryer are made of plastic and the air circulates without the use of a fan.

The main objective in the design of indirect dryers is to produce adequate air temperatures that can be used to dry the crops. The design of air heaters for developing countries must be aimed at minimizing the material requirements for the dryer to be economically attractive.

It is possible to obtain absorber plate temperatures of 140°C using single glazing and a well-insulated collector. Removal of heat from the absorber plate is achieved by causing air to flow over it. In some designs air flows over one of the surfaces of the plate, whereas the other surface is in contact with an insulating material to prevent heat loss through the back of the collector. In another design, the air removes heat from both sides of the plate (Fig. 6 and 7).

A collector can also be designed so that two glass covers are used. In this case the air flow may be made to flow as shown in Fig. 8. Heat is collected from the space between the double glazing and then from the under side of the absorber plate. In this design there is no need for insulation because the hot air passes through the crops immediately after it leaves the absorber plate (Satcunanathan 1973).

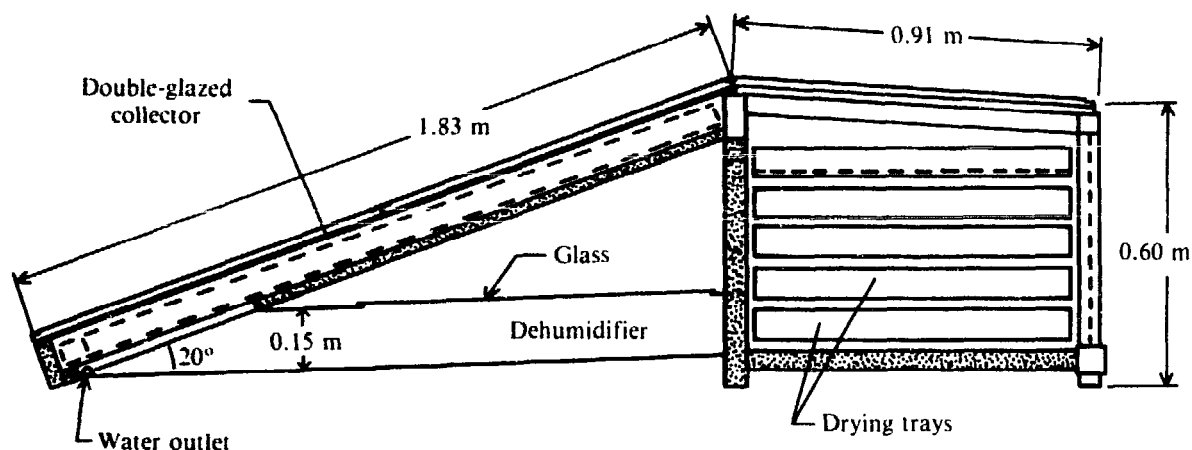

Fig. 4. Schematic diagram of an indirect crop dryer developed by Headly and Springer (1973).

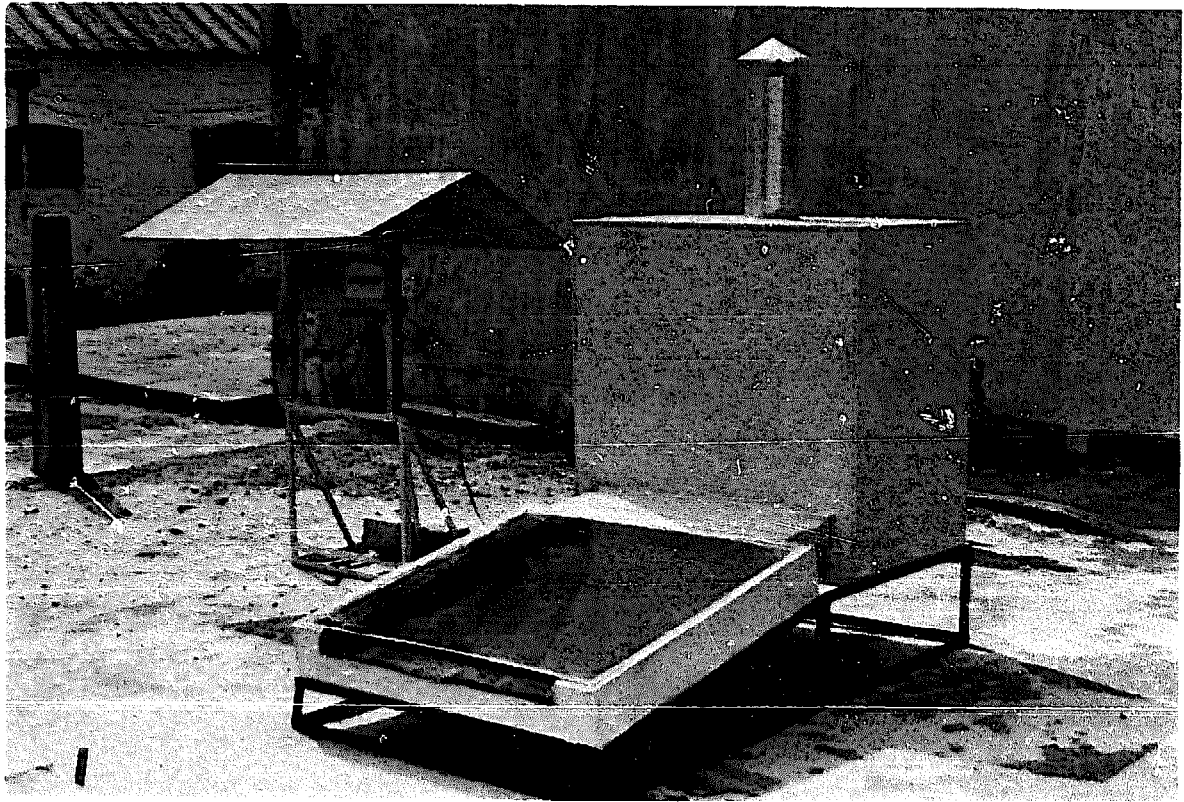

Fig. 5. A solar crop dryer with a chimney.

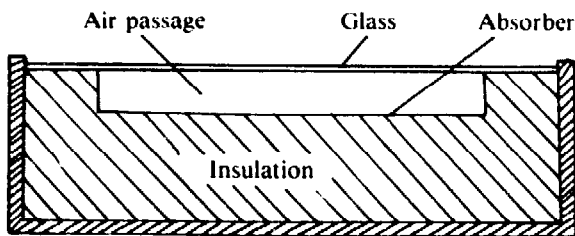

Fig. 6. Schematic diagram of an air heater in which heat is removed from one side of the absorber.

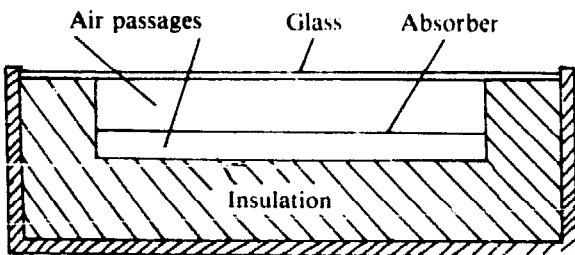

Fig. 7. Schematic diagram of an air heater in which heat is removed from both sides of the absorber.

The agent for moving the air in most of the designs available is mechanical, such as a fan. With the restrictions mentioned earlier that exist in developing countries, these designs may be expensive in many situations. The effect of

buoyancy can be used by incorporating a chimney shown in Fig. 5. This creates a draft that can cause an adequate mass flow rate of air to pass through the collector and then through the crops. There does not appear to be a great deal of interest in this method of circulating the air in crop dryers using solar energy, although it is very important in some parts of the world. There is, however, work in progress by some researchers, as previously mentioned, to use natural convection.

One such study, (Bassey 1980b) is presently looking at the methods of improving airflow rates by directly incorporating solar energy to heat up the chimney, which in turn produces higher air temperatures and increased buoyancy. Figure 9 shows the blackened chimney with a plastic glazing over it. Preliminary work has shown that higher temperatures are obtained in the chimney, and a reduction in the height of the chimney can be made using this method.

The application of indirect dryers in developing countries has been shown in many studies to be quite useful. The design of such systems is, however, dependent on local conditions and available facilities. The relative humidity and temperature of the ambient air, the maximum allowable temperature for the crop and its

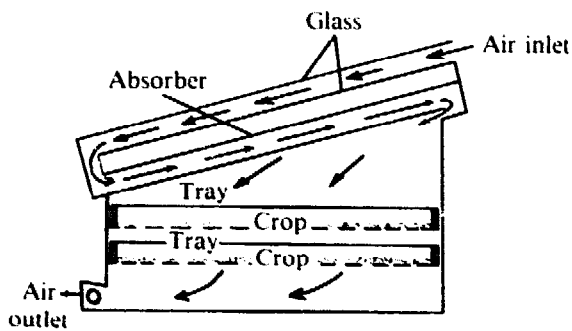

Fig. 8. A collector using double glazing.

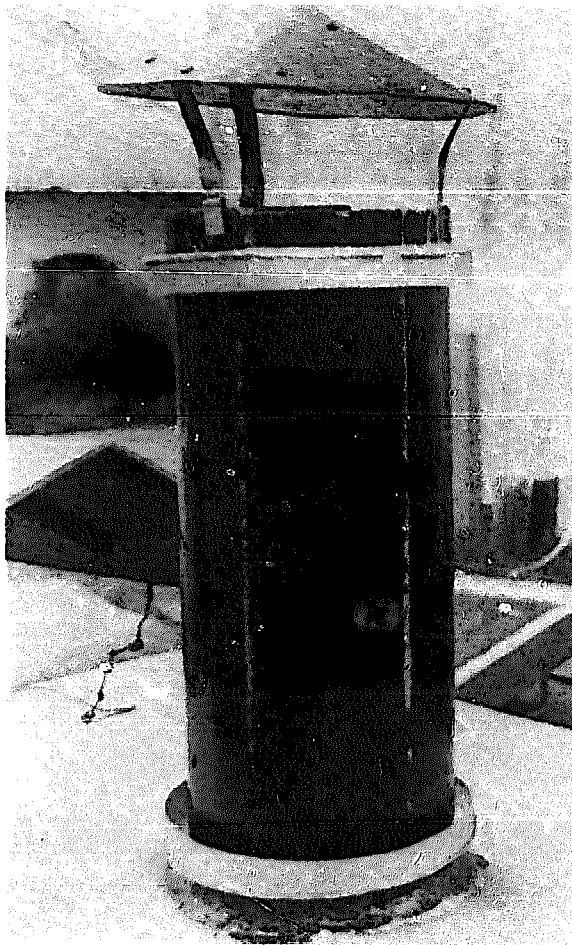

Fig. 9. In this chimney single plastic glazing is used to obtain elevated temperatures.

quantity, determine the best design of the system. The design of the chamber depends on whether grains or fruits, for example, are being dried. Another consideration is the versatility of a particular system. It is desirable, although not always feasible, to have a solar dryer that can process various types of crops as this is a more economical proposition.

Hybrid and Mixed-Mode Drying

The use of solar energy in a dryer, so that both indirect and direct heating can be carried out, is called mixed-mode drying. This method makes use of the greenhouse effect in both the drying chamber and in the collector. Although the influence of sunlight on the quality of the dried product is beyond the scope of this paper, it should be mentioned that mixed-mode dryers make use of the direct action of sunlight to improve the overall quality of some crops. These dryers are not substantially different from the other types mentioned except that the side walls or top use a transparent material such as glass or plastic.

Dryers that use solar energy as well as supplementary heating are called hybrid dryers. The heat source may be fossil fuel, electricity, agricultural waste material, etc. The design and operation of such systems is not considered in this paper, but it should be noted that in certain locations solar energy is not available to dry crops for a few months of the year. It is also not possible to use solar dryers at night. Therefore, systems that can utilize supplementary heat have possibilities for application in developing countries.

Materials for Constructing Solar Dryers

Construction of solar dryers for use in developing countries very often poses problems for various reasons. For example, the materials used must be available locally, and the cost of the materials would be another factor because this determines the investment that would have to be made by the owner. The expected life span of the dryer is another factor that must be taken into consideration.

The materials that can be used for the transparent cover are glass or plastics. Glass does not deteriorate with age, whereas plastic is affected by solar radiation. In many instances it may be wise to use plastic material if the risk of breakage of glass is high. It is also possible to use glass and plastic on double-glazed collectors. The arrangement should, however, be such that the plastic material can withstand the heat and it is advisable to use plastic as the outer covering. This arrangement can also act as a protection for the inner glass cover.

The collector can be made from materials such as wood, aluminum, or galvanized iron. The main objective is that there should be minimum air leakage from the collector, no possibility of

the insulation getting wet, easy to manufacture, and low cost. It is possible to use wood and galvanized iron sheets to make good air heaters. In fact, various designs have used these materials for small and large solar collectors. If wood is used it should be treated against attack by insects and painted as protection from wet conditions.

Methods of fixing the glazing to the collector depend on the materials used. For glass and wood, wood putty may be used and for plastics, strips of wood and nails are used to secure the glazing. Sealants such as silicon are good for some applications using glass, but they tend to be expensive when used in large quantities.

Insulating materials are numerous and some of them have been mentioned earlier. It should be noted that the use of a locally available thermal insulator does not necessarily imply cheaper equipment because the thickness needed is often greater compared to other materials such as foam or fibreglass wool. For example, if straw is used, a cavity of about 15 cm may be needed compared to 5 cm for fibreglass wool, and more building material is needed for the dryer using the straw.

The drying chamber may be made from plywood or sheet metal. Transparent materials such as glass or plastic are used for one or more of the walls in mixed-mode dryers. The shelves on which the crops are placed are made from simple wire mesh.

Materials that are needed for solar crop dryers are simple and available in most developing countries. There may be cost restrictions because of import taxes that cause prices to be high for some simple materials. This problem can, however, be minimized by finding alternatives in some instances.

Conclusion

This paper has attempted to evaluate the use of solar energy as a heat source in operating crop dryers. There is information in the literature that can be used to design workable solar crop dryers for various applications. But tests have to be carried out locally before the suitability of a

particular dryer can be established, and further research and development work is needed in this area of utilizing solar energy for crop drying.

Ånström, A.K. 1924. Solar and terrestrial radiation. Quarterly Journal of the Royal Meteorological Society, p. 121.

Akyurt, M. and Selçuk, M.K. 1973. A solar drier supplemental with auxiliary heating systems for continuous operation. Solar Energy Journal, 14, 313-320.

Bassey, M.W. 1978. A recommended formula for predicting total solar radiation in Sierra Leone. Presented at the 11th Biennial WASA Conference, 13-18 March 1978, Lomé, Togo.

1980a. Solar crop drying in Sierra Leone. Presented at International Symposium on Solar Energy Utilization, 10-20 August 1980, London, Ontario, Canada.

1980b. Development of solar dryers for agricultural use in Sierra Leone. Interim Report, IDRC Project 3-P-78-0113.

BRI (Brace Research Institute). 1979. A survey of solar agricultural dryers. Technical Report T99, Quebec, Canada, BRI.

Coulson, K.L. and Howell, Y. 1980. Solar radiation instruments. Sunworld, 4(3).

Excell, R.H.B. 1978. A low cost solar rice dryer. Presented at proceedings of the Workshop on Grain Post-Harvest Technology, 10-12 June 1978, Bangkok, Thailand.

Headly, O. St.C. and Springer, B.G.F. 1973. A natural convection crop drier. Presented at International Congress: the Sun in the Service of Mankind, 2-6 July 1973, Paris, France.

Hoyt, D. 1978. A model for the calculation of solar global radiation. Solar Energy Journal, 21(1).

Notaridou, V.A. and Lalas, D.P. 1979. The distribution of global and net radiation over Greece. Solar Energy Journal, 22(6).

Reddy, S.J. 1971. An empirical method for the determination of total solar radiation. Solar Energy Journal, 13, 289.

Satcunanathan, S. 1973. A crop drier utilizing a two pass solar air heater. Presented at International Congress: the Sun in the Service of Mankind, 2-6 July 1973, Paris, France.

Selçuk, M.K. et al. 1974. Development, theoretical analysis and performance evaluation of shelf type solar dryers. Solar Energy Journal, 16, 81.

Solar and Natural Air Drying of Rough Rice in Korea

Hak Kyun Koh and Chang Joo Chung¹

Abstract. An evaluation was made of the feasibility of the solar and natural air in-bin drying and storage system, and the weather conditions and some experimental results conducted in Korea from 1973 to 1980 were analyzed. The experimental results of solar natural air drying were discussed in terms of drying rate, moisture variation in the grain mass, and energy requirements per kg of water removed.

Solar collectors with and without heat storage units were used for drying of rough rice. Economic profitability for the system developed is also analyzed in this paper.

The traditional method of rough-rice drying in Korea consists of sun drying in the field before threshing and sun drying on mats after threshing, which is laborious and highly weather dependent. With this method, a considerable loss both in quality and quantity of rough rice is unavoidable. Early cutting and threshing in the field have been recommended to prevent field losses. Because a new high-yielding variety was introduced in Korea in 1969, an improved drying operation has been urgently required to reduce the shattering loss in the field. In accordance with the new harvesting system using a combine or binder harvester, a mass drying of high-moisture grain has been required. However, Korean farmers are facing difficulties in the drying of high-moisture grain with the traditional sun-drying method.

The concept of natural-air drying and the application of solar energy to grain has received considerable attention in the past few years mainly because of the favourable weather conditions during the harvesting season in Korea. Furthermore, the application of solar energy to grain drying seems best suited to low-temperature systems. In addition, an in-bin drying system developed in this study would have an additional advantage because of its extended use as an improved storage system.

It was intended to evaluate the feasibility of the solar and natural air in-bin drying and storage system that is to be used at the farm level. For this purpose, the weather conditions,

the average temperature and relative humidity, and some experimental results on solar and natural air drying conducted in Korea from 1973 to 1980 were summarized and reviewed.

Analysis of Weather Conditions for Natural Air Drying

In natural air-drying systems, the aeration method and the minimum amount of air flow are determined from the weather conditions and initial moisture content (MC) of grains, therefore, the feasibility of drying and storage using natural air must be studied on the basis of weather conditions over long periods. If weather conditions during the harvesting season have good drying potential, natural air drying is favourable, otherwise, heated air drying must be used. Drying potential of natural air can be measured by the dry-bulb temperature and relative humidity (RH) of natural air. To calculate a reasonable drying potential, weather data over a long period must be analyzed.

The investigators who conducted the natural air-drying experiments during 1973-80 also analyzed the weather data accumulated over 10 years to obtain the average temperature and relative humidity that determined the drying potential of natural air. Their analyses showed that the average temperature in October was in the range of 13.0-16.8°C and the relative humidity from 64 to 76%. Average temperature and relative humidity in October over 14 locations were 14.9°C and 69.4%, respectively.

From these analyses, the temperature and relative humidity in October provided high

¹Division of Agricultural Machinery and Process Engineering, Department of Agricultural Engineering, College of Agriculture, Seoul National University, Suwon, Korea 170.

drying potential because the equilibrium moisture content (MC_e) of grains was about 15% in this season. However, it must be noted that ideal weather conditions with high drying potential did not always occur during consecutive days. Sometimes, drying would be interrupted because of unsatisfactory weather conditions.

In the analysis of weather data, relative humidity was considered to be the most important weather factor for natural air drying. Kim (1974) assumed that the critical relative humidity (RH_c) for natural air drying was 75%. Based on this assumption, Kim analyzed the weather data and reported that an optimum daily drying time in Suweon area was 9 hours. During 9 hours, the average temperature was in the range of 13–17.4°C and the relative humidity was 66%. These weather conditions were reported to have such high drying potential that the moisture content of grains was reduced as much as 14.2% wet basis (wb). By assuming that any day that had a relative humidity of more than 75% continuously for 3 hours or more was a non-drying day, Kim also reported that the Suweon area had 4 nondrying days in October. In the analysis of Kim et al. (1980), the Taegu area was also found to have 4 days of nondrying in October. Consequently, the weather conditions during the harvesting season in Korea could be considered as having high drying potential for natural air drying.

Analysis of Natural Air-Drying Experiments

To determine whether or not a natural air in-bin drying and storage system is feasible in a particular farm area, continuous experimental studies on natural air drying must be made over many years, because the efficiency of natural air drying using a grain bin varies depending upon the annual weather conditions in that area. The technical evaluation of the natural air in-bin drying and storage system must also be made on the basis of these experimental results. Table 1 summarizes the results of the natural air-drying experiments analyzed in this study. As shown in Table 1, six natural air-drying experiments employed similar experimental methods and showed similar results. All the experiments were conducted in October, and the drying period was about 10–15 days.

In experiments B, D, E, and F, the moisture content of grains was reduced to 15%, which was within the moisture content required for safe storage. However, in experiments A and C,

moisture content could not reach 15% during the same drying period, because the amount of airflow in experiments A and C was less than those of the other experiments.

Average drying rate during the drying period was 0.03–0.11% per fan operation hour. This drying rate differed with fan operation methods such as continuous and intermittent operations. There were also significant differences in the drying rate between the beginning and final stages of drying.

Similar variations were observed in average moisture content during the drying period, although some differed depending on the area and time. The difference in the final moisture content (MC_f) between the upper and bottom layers of grain was only within 1.0%, and a uniform drying progressed from the bottom to upper layers. No moisture gradient was observed in the radial direction within the grain bin. Consequently, natural air drying using a grain bin could be a very efficient drying method, although it does require a long drying period.

Storage Experiment

As previously mentioned, the grain bin performs the functions of both the grain dryer and storage unit. A rough-rice storage experiment using a grain bin was conducted at three locations. In the three experiments, analyses were made on the variations of the grain temperature and moisture content, which were considered to be important factors that affect the safe storage of rough rice.

From March to July of 1979, the average temperature of rough rice during storage gradually increased from 3 to 30°C and was generally higher than the ambient temperature as shown in Fig. 1. This higher temperature was attributable to the respiration heat of rough rice and convective heat transfer from outside the grain bin. During this period, average moisture content gradually increased from 13.5 to 15.3%. In general, during winter, little variation was observed in the grain temperature and moisture content inside the grain bin, but a large variation was observed during summer. Kim (1974) pointed out the storage problem resulting from the increase in grain temperature in summer. However, Chung and Koh (1980) showed in their experiment that safe storage in summer was possible even without aeration.

The milling test was conducted after the storage experiments were completed. The results of the milling test showed that brown rice recovery, milled rice recovery, and head rice

Table 1. Summary of drying experiments using natural air.

	Experiment no.					
	A	B	C ^a	D	E	F
Cross section area of bin (m ²)	3.8 (ϕ 2.2 m)	3.14 (ϕ 2.0 m)	2.25 (1.5 × 1.5 m)	2.01 (ϕ 1.6 m)	4.33 (ϕ 2.35 m)	7.1 (ϕ 8.0 m)
Height of bin (m)	1.8	1.8	1.8	1.2	1.2	2.5
Bin material	steel	steel	plywood	steel	steel	steel
Rough rice quantity (t)	3.6	2.0	1.7	1.0	2.3	4.2
Rice variety	Tong-il	Milyang 23	Jinhung	Milyang 23	Suweon 264	Milyang 30
Rough rice depth	1.6	1.1	1.35	1.1	0.9	0.9
Amount of air-flow (cm/m ³)	2.8	4.0	1.64	3.60	3.60	4.81
Drying period	13/10/73– 02/11/73	30/09/78– 12/10/78	14/10/78– 03/11/78	01/10/79– 12/10/79	15/10/79– 24/10/79	15/10/80– 28/10/80
Initial moisture content (% wb)	22.2	20.0	24.8	19.8	20.0	24.4
Final moisture content (% wb)	16.7	14.0	15.1	13.7	13.0	15.0
Fan operation time (hours)	107	210	325	207	66	288
Average drying rate (%/hour)	0.05	0.03	0.03	0.03	0.11	0.03

^aRound steel bins were used for all the experiments except in experiment C where a rectangular plywood bin was installed.

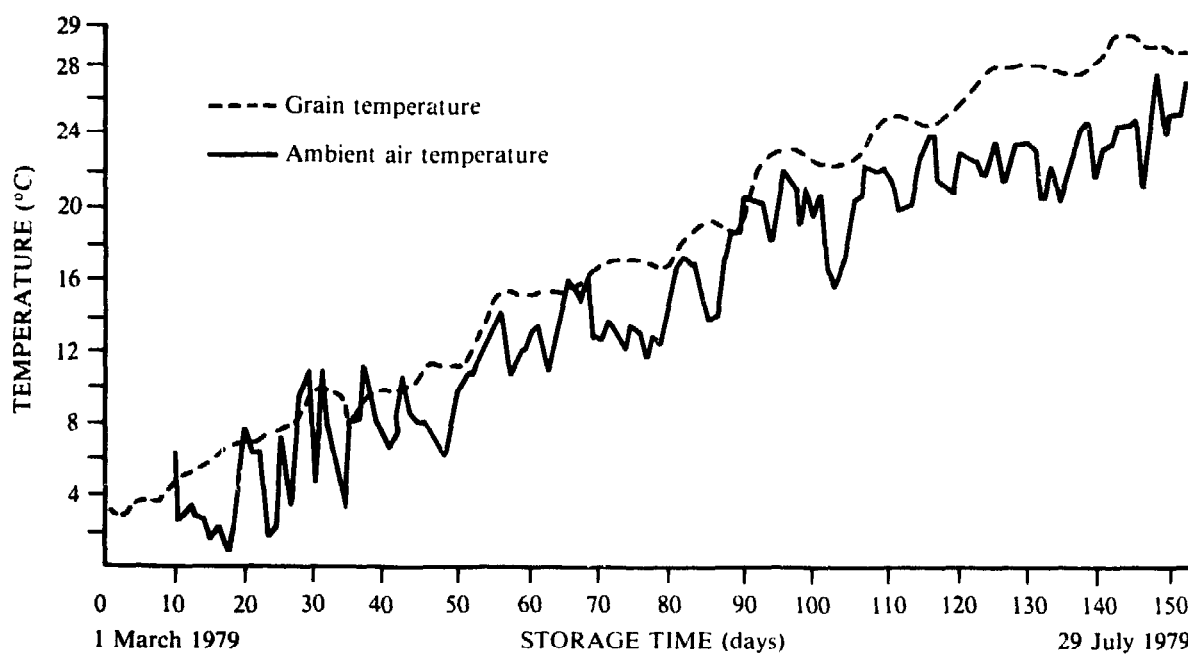

Fig. 1. Variation in average ambient air temperature and grain temperature during the storage period (experiment B).

recovery were 79.9, 72.8, and 63.63%, respectively. These values indicated that the quality of rough rice during the storage period was maintained within the first degree criterion.

After drying test B was completed, another storage experiment was conducted using the same grain bin and rough rice as used in drying test B. The average moisture content range of rough rice during the storage period from the middle of October of 1979 to the middle of May 1980 was maintained in the range of 12.5–13.7%, which was a safe moisture content to keep rough rice undamaged. The milling test after the storage experiment showed that brown rice recovery, milling recovery, and head rice recovery were 80, 73, and 64%, respectively. These values indicated that the quality of rough rice during the storage period was maintained within the first degree criterion. No damages due to moulds or insects were found.

Cost Analysis

As discussed in the previous sections, drying and storage of rough rice with the use of a grain bin were found to be highly practical in Korea. In addition to the technical advantages of a grain bin, the economic feasibility must also be considered. However, at present, there are no economically feasible methods that can be compared to drying and storage using a grain bin. The conventional sun drying being practiced in most farm areas, although economically less expensive, has problems of qualitative and quantitative grain damage, frequent operational interruptions because of unexpected bad weather, and difficulty in the mechanization of harvesting. These problems make it difficult for conventional sun drying to be compared to grain bin drying.

Batch or circular dryers were not considered, because only a limited number of them have been supplied. Therefore, in this study, only the drying costs for using a grain bin were calculated. In this experiment, total cost for drying 1 t of rough rice from the initial moisture content (MC_i) of 20 to 14% was 40 000 won (685 won = U.S.\$1.00). The fixed cost was 32 300 won (about 80%) and the variable cost was 7 700 won (about 20%). Because the fixed cost took a large portion of the drying cost, the total drying cost can be reduced to less than half when the capacity of the bin is increased to 2 t and the annual use to twice a year. If the price of a bin can be lowered by mass production, the drying cost will be reduced even more. The present drying cost for a circular type of dryer used in farm areas is 600 won per

sack of rough rice, which is equivalent to about 12 000 won/t. Therefore, if the additional advantages such as safe storage are considered, a grain bin may be economically reasonable.

Analysis of Solar-Drying Experiments

A solar-drying test of rough rice was conducted at three locations. The same grain bin used in the natural air-drying experiment was also used for solar-heated air-drying experiments. Table 2 shows the results of solar-drying experiments analyzed in this study.

Table 2. Summary of rough rice drying experiments using solar-heated air.

	Experiment no.		
	B	C	E
Quantity of rough rice (t)	2.0	1.7	2.3
Amount of air-flow (cm/m ³)	4.0	1.6	3.6
Test period	01/10/78– 11/10/78	10/10/78– 24/10/78	15/10/79– 31/10/79
Initial moisture content (% wb)	19.8	21.9	25.6
Average final moisture content (% wb)	13.3	13.7	11.2
Total fan operation time (hours)	140	130.4	96
Average drying rate (%/hour)	0.05	0.06	0.15
Energy consumed per 1% MC reduction (kWh) (natural air drying)	7.69 (9.70)	6.29 (13.64)	5.33 (7.54)
Final moisture content at top layer (% wb)	13.4	15.1	14.4
Final moisture content at bottom layer (% wb)	12.9	10.2	10.0
Daily fan operation (hours)	24 hours	8:00– 20:30	10:00– 17:00

Figure 2 shows the supplementary heating system that was used in Experiment B. It is composed of the flat-plate solar energy collector and heat-storage unit. In this system, the rocks with a volume of 7.2 m³, which were piled over a perforated duct inside the collector, were heated during the daytime, and the heat stored in the rocks was transferred to the drying air during the night. The collectors used in experiment C and E consisted of a clear film cover and a metal black absorber in which an oval cover and flat absorber collector were used in experiment C as shown in Fig. 3 and a flat cover and triangular absorber in experiment E. Because no heat storage unit was provided in these systems, the collectors were only used to heat the air during the daytime.

Performance of Solar Collectors

The performance of the solar collectors used in each experiment was analyzed in terms of temperature rise of drying air and solar collector efficiency. The drying air temperature variations obtained on a typical day with experiment B showed, in general, that the maximum temperature of the air drawn through the rocks occurred at about 14:00 hours and the minimum temperature at about 19:00 hours. Similar patterns of temperature variation appeared throughout the testing period. For the given system, the temperature of the air passing through the perforated duct was increased about 4°C on the

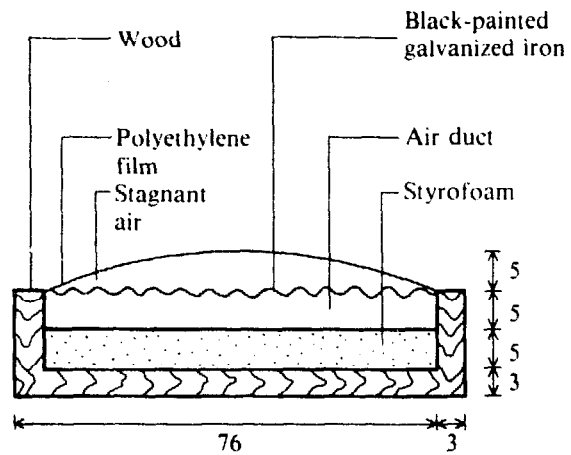

Fig. 3. Cross section of solar collector (experiment C) (dimensions in centimeters).

average above the ambient air temperature during the night and about 8°C during the daytime.

In experiment C, the temperature rise of air during the solar-drying experiment was in the range of 6.5–21.8°C, and the maximum temperature of drying air was 40.0°C and the minimum was 13.2°C. A similar result of temperature variation appeared in experiment E. The average temperature of air throughout the testing period was 15.3°C, which could reduce the relative humidity from 63.4 to about 40% on the average. The heated air, having such a high drying potential with high temperature and low relative humidity, however, may result in uneven

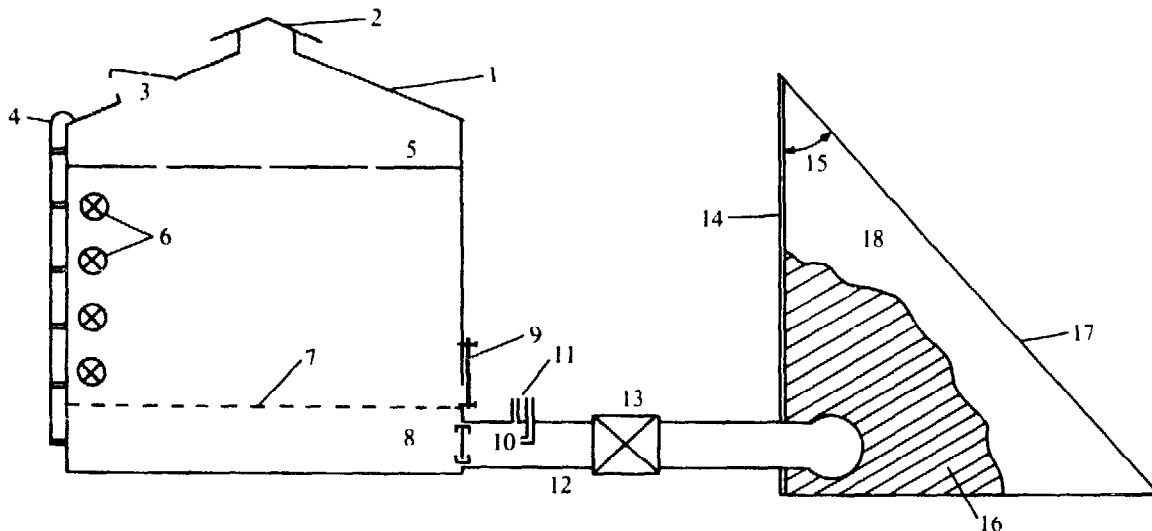

Fig. 2. Schematic diagram of the solar collector-heat storage system connected to the grain bin (experiment B): (1) grain bin, (2) ventilator, (3) manhole, (4) outside ladder, (5) grain surface, (6) sampling hole, (7) perforated floor, (8) anemometer, (9) outlet, (10) pilot-static tube, (11) manometer, (12) aeration duct, (13) fan and motor, (14) insulation wall, (15) tilted angle (48°), (16) rock pile, (17) plate covered with vinyl sheet, and (18) solar collector.

drying and overdrying for low-temperature, in-bin drying systems.

The collector efficiency on a typical day in each experiment was calculated from the ratio of the energy collected to the radiation available. The amount of energy collected was based on measurements of the quantity of air and the temperature rise in the air. Calculated efficiencies of the collectors were found to be about 35.0% in experiment B, 46.1% in experiment C, and 43.1% in experiment E.

Solar-Drying Analysis

In this section, moisture variation of grain with electric energy input in the solar-drying experiment is compared with natural air drying. Figure 4 shows the drying curves of grain located at the top, middle, and bottom layers when the heated air was supplied through the solar collector heat storage system in experiment B (Fig. 5 and 6). Throughout the drying period there existed some moisture gradients of the grain at each layer. However, the gradient decreased as drying continued, and the difference in moisture content between the top and bottom layers was less than 2.0% when the grain moisture content (MC_g) reached about 13.3% on the average after 5 days of drying.

The comparison of the average drying curves of natural air drying with and without supplementary heat showed that solar drying gave a much higher rate of drying and required a shorter period of drying to arrive at the desired final moisture content, although it also showed a

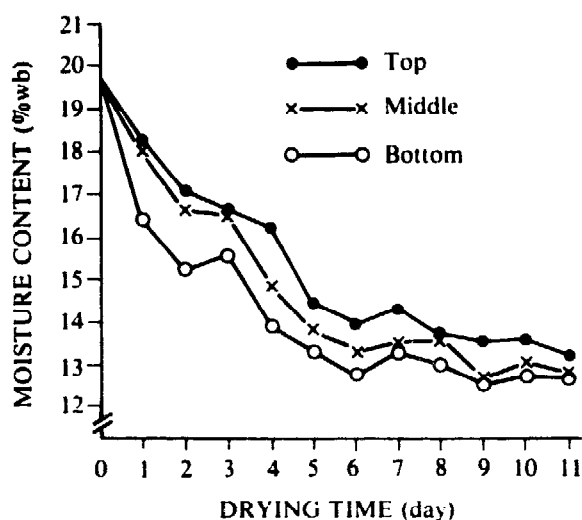

Fig. 4. Moisture content change of each layer of the rough rice dried with solar-heated air.

little greater moisture gradient between top and bottom layers throughout the testing period.

The results of the change in moisture content at each level of the grain mass in experiment E indicated that adding solar energy during the daytime increased the difference in moisture content between the grain at the air inlet and the grain at the air outlet as much as about 12.0%, even though the average grain moisture content reached about 15% after 69 hours of drying operation. It took 96 hours to dry the grain to a safe level for storage of 14.4% at the top layer, but the moisture difference was 4.4% after the completion of drying. The difference in the moisture content between individual layers resulted from high inlet air temperature and low airflow rate. Continued fan operation during the nighttime, when the relative humidity of the ambient air is high, may help in achieving uniform moisture content all over the grain mass.

A similar drying pattern appeared in experiment C in which the fan was operated from 08:00 hours to 20:30 hours, longer than in experiment E. The average moisture content was 13.7%, and the moisture difference between top and bottom layers was about 5.0% at the end of the drying operation. Uneven drying as well as overdrying of the grain was also observed in this experiment.

Energy Requirements

The electric energy requirements for each drying experiment are summarized in Table 3. In general, energy use per kilogram of water removed was lower by as much as 20–50% for solar-heated air drying than for natural air drying. More electric energy was consumed in experiment C when compared to the other two experiments because of its lower airflow rate.

From the analysis, it should be remembered that, under the operational and ambient air conditions examined in experiments B and E, not much saving in energy input as well as advantage in grain drying could be attained by the addition of the solar heating system. However, the need for the solar collector system for grain drying in unfavourable weather conditions should not be underestimated. Therefore, more research must be conducted in the future to develop a supplementary heating system that is applicable to a low-temperature in-storage drying system. There is also a need to decrease the solar collector costs and increase the durability of the collectors.

Table 3. Energy requirements per kilogram of water removed.

	Experiment B		Experiment C		Experiment E	
	Natural	Solar	Natural	Solar	Natural	Solar
Moisture content (% wb)						
Initial	20.2	19.8	24.8	21.9	20.0	25.6
Final (average)	13.6	13.3	15.1	13.7	13.0	11.2
Total energy consumed (kWh)	64	50	132.3	51.6	52.8	76.8
kWh/kg of moisture	0.418 (100)	0.333 (79.7)	0.678 (100)	0.320 (47.2)	0.285 (100)	0.206 (72.3)

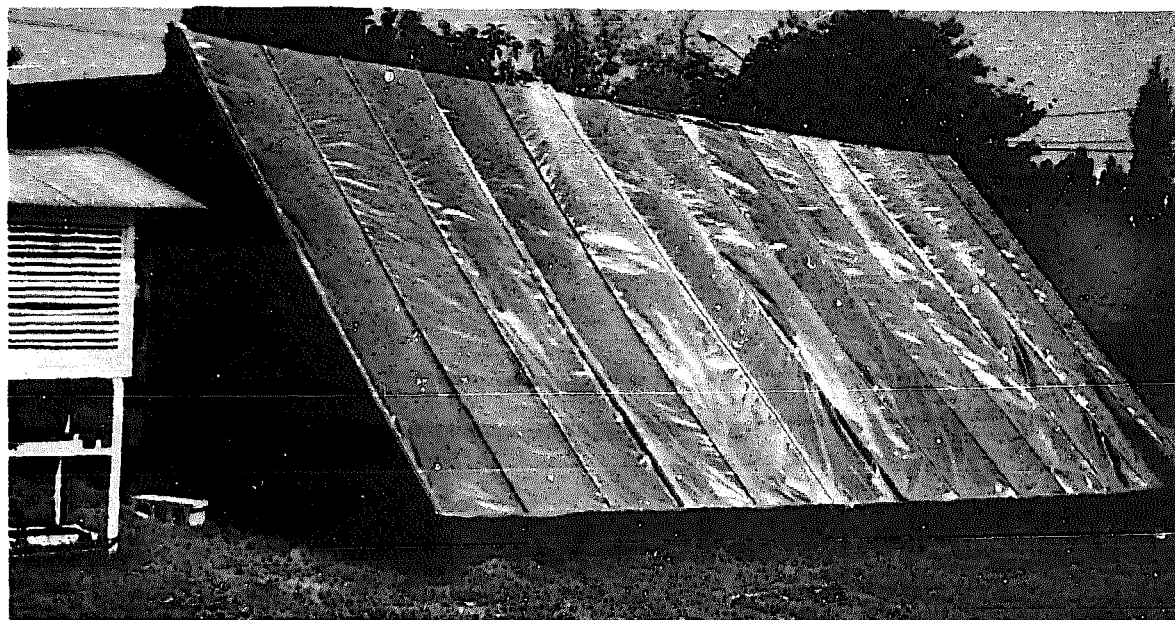

Fig. 5. A solar collector with a heat storage unit used for solar drying (experiment B).

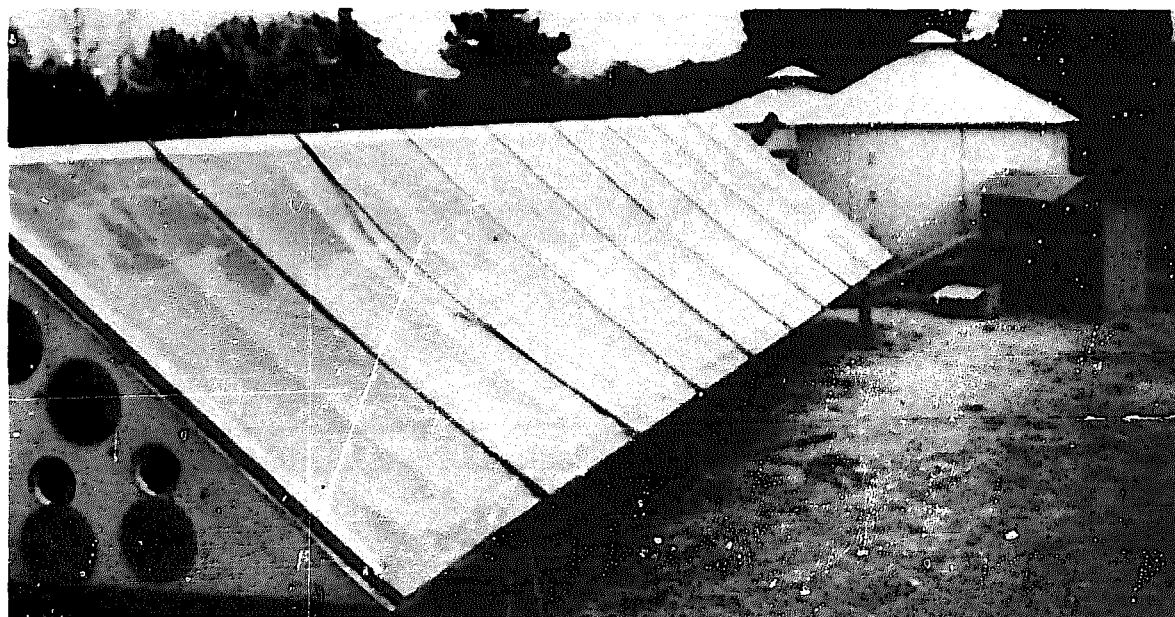

Fig. 6. A solar collector without a heat storage unit used for solar drying (experiment C).

Conclusion

In Korea, there is a great need to improve current grain drying and storage practices at the farm level. With shortages and high prices of fossil fuel, the reduction of energy consumption and the application of solar energy to grain drying are becoming more important.

This study was designed to evaluate the technical feasibility of an in-bin drying and storage system using natural and solar-heated air based on previous experimental results. The following conclusions can be drawn based on the analysis of the experimental results:

- The weather conditions during the drying period (October) of rough rice in Korea were found to have good potential for natural air drying.

- Through natural air drying using a grain bin it was possible to dry rough rice of 1-4 t within 3 weeks to the moisture content necessary for safe storage, and this method also achieved uniform drying.

- In the two storage experiments, the moisture content of rough rice was maintained within 14% wb during the storage period. There was no deterioration in rough rice quality.

- Solar-heated air drying helped in lowering the final moisture content of rough rice and in reducing the drying time and the energy require-

ments per unit of water removed, compared to natural air drying. Because a high temperature rise of drying air with the solar collectors results in uneven drying and overdrying of rough rice, a low-cost, durable solar collector heat-storage unit should be provided for a low-temperature, in-bin drying system.

- The cost of the in-bin drying system appeared to be higher than that for conventional sun drying. However, in-bin drying has advantages such as prevention from overdrying, preservation of good quality of rough rice, and safe storage. If these advantages are taken into account and the fixed costs of the in-bin drying system can be reduced with an increase in its capacity and the frequency of its annual use, in-bin drying may be economically feasible.

Chung, C.J. and Koh, H.K. 1980. Experimental study on the in-bin drying with natural and solar-heated air and storage of rough rice. *Journal of Solar Energy Society of Korea*, 3(2).

Kim, S.R. 1974. Study on the small grain bin for the improvement of grain drying and storage. *Journal of the Korean Society of Agricultural Engineers*, 16(1).

Kim, J.Y., Suh, S.D., Keum, D.H., and Lee, S.K. 1980. Investigation of natural air drying of rough rice based on the weather data in Taegu area. *Journal of the Korean Society of Agricultural Machinery*, 5(1).

Farm Grain Dryer — Thailand

Sriwai Singhagajen¹

Abstract. This paper discusses the work of the Agricultural Engineering Division, Department of Agriculture of the Government of Thailand, in postharvest technology, specifically in the development of a farm grain dryer to assist local farmers in the processing of a second harvest. The dryer helps to reduce losses and drying time and improve the quality of the final product. The work on this type of paddy dryer has already been completed, and design specifications and performance results are given. Further research is needed to determine appropriate design modifications and changes in methods of operation to meet the requirements of the farmers.

In 1976, the Agricultural Engineering Division, Department of Agriculture of the Government of Thailand, began work on postharvest technology with support from the International Development Research Centre (IDRC). The survey on postharvest practices of farms conducted in that year indicated that the introduction of a farm grain dryer was essential because of the government support for second cropping in various parts of the country. The second harvesting begins in May and ends in early August, which is during the wet season. The farmers have problems in drying because there are no sunny days in succession to dry paddy at one time. This causes quality loss because of mould infection and because paddy grain changes in colour and quality, which results in low milling yield. The dryer helps to reduce losses and drying time and to improve and stabilize the quality of the produce to increase the farmer's income.

Batch drying dries paddy down to 14% moisture content (MC) giving the paddy a longer storage life and a higher milling yield than sun drying. The Agricultural Engineering Division has designed, developed, and tested the performance of the dryer based on its simplicity of operation, and construction, and its ability to be constructed using local materials and labour. The work on this type of paddy dryer has already been completed and made available to both farmers and local manufacturers (Fig. 1).

¹Storage and Processing Section, Agricultural Engineering Division, Department of Agriculture, Ministry of Agriculture and Cooperatives, Bangkok, Bangkok 9, Thailand.

Components of the Dryer

The engine of the dryer is 6 kW minimum, and the engine from the power tiller can be converted for this purpose (Fig. 2). The rice-hull furnace (total size: 0.6 × 0.6 × 0.6 m) is made of ordinary bricks with an angle-iron bar frame. Rice husks can be burned, because ash does not come in contact with product. The ash is then used to make bricks. The furnace has a 45° inclined fire grate made of a series of 6 mm diameter iron rods with 1.5 mm spacing arranged vertically. The proper operation of this furnace would hold the desired temperature at ±3°C fluctuation. The diesel burner is used when the rice-hull furnace is not available. Kerosine is more expensive and not normally available in large quantities. The kerosine vaporizing-pot burner designed by the University of the Philippines at Los Baños (UPLB) was further modified by adding another perforated sheet to increase the vaporizing rate. The consumption rate of the diesel burner is 1.5–2.0 L/hour.

The cyclo fan has a 0.6-m diameter rotor with eight 0.15 × 0.3 m blades at a 70° pitch angle enclosed with a 0.6-m diameter metal sheet housing. The delivery rate is 0.5 m³/sec/m³ at 1600 rpm. The holding capacity of the grain-holding bin is 3.6 m³. It is composed of six pieces of plywood, 1.22 × 2.44 × 0.006 m, and wooden bars, 0.038 × 0.076 m. It takes four people about 40 min to assemble the bin.

Construction and Operation Costs

The 6 kW diesel engine at 1981 prices costs U.S.\$700. The materials for the rice-hull furnace

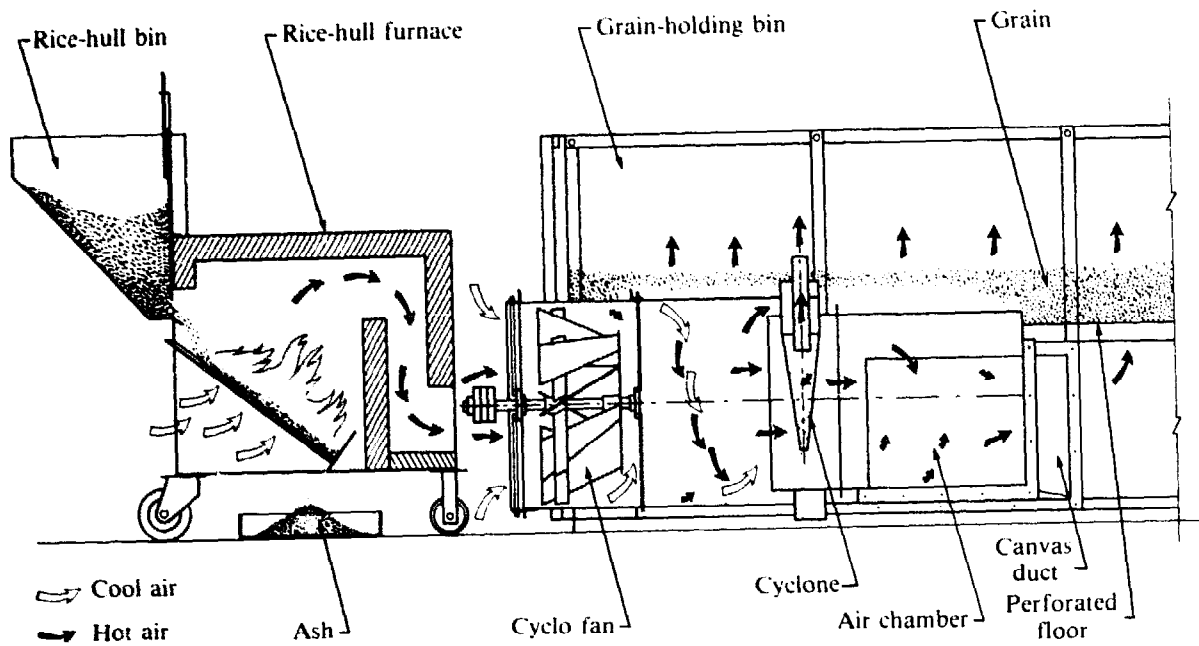

Fig. 1. Diagram of the farm grain dryer.

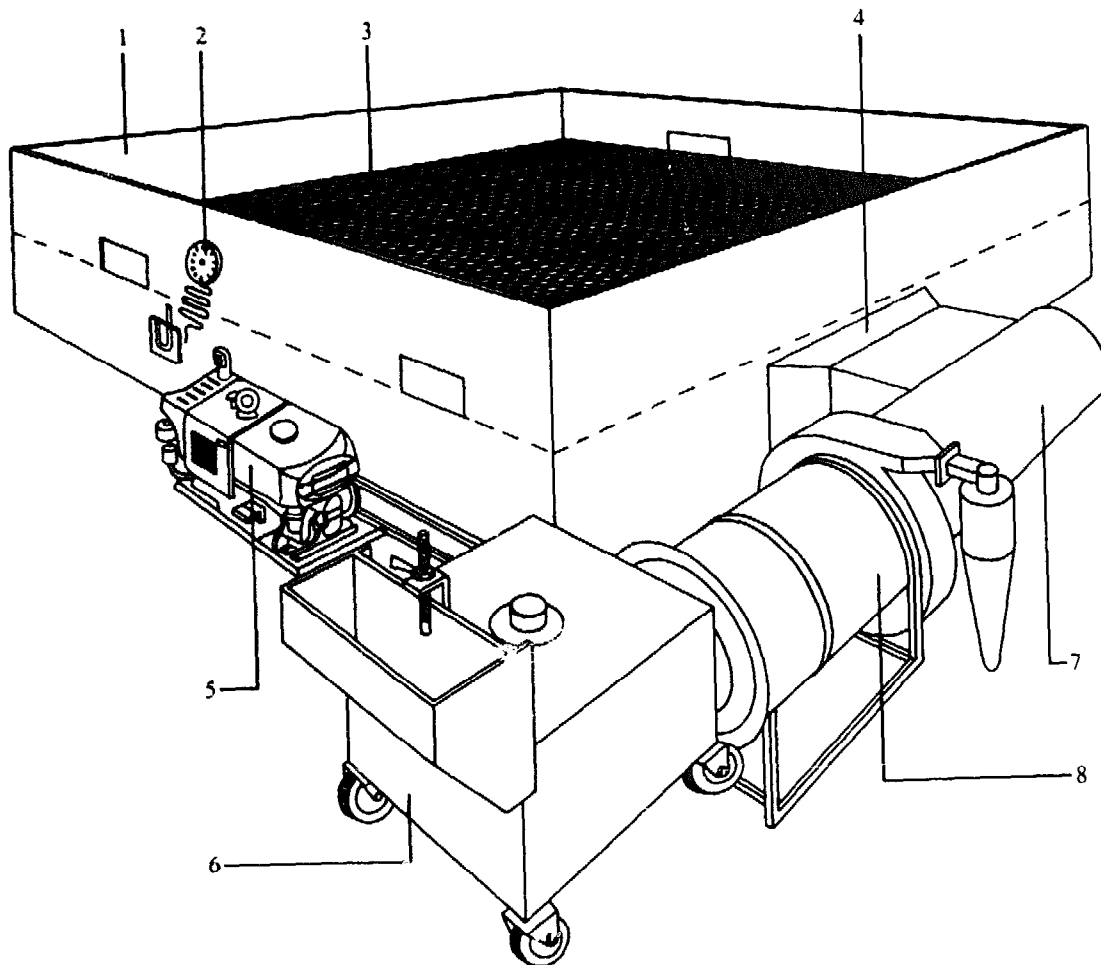

Fig. 2. Components of the paddy dryer: (1) grain bin (244 × 244 × 122 cm), (2) thermometer, (3) screen (no. 8½), (4) canvas air duct, (5) engine (6 kW), (6) rice-hull furnace, (7) air duct, and (8) cyclo fan.

total U.S.\$116; the diesel burner, U.S.\$84; the cyclo fan U.S.\$133; and the grain-holding bin, U.S.\$202. The total construction cost amounts to U.S.\$534, and the total cost of the dryer is U.S.\$1234.

The operation costs depend on the drying time, which is determined by the initial moisture content (MC_i), and the materials (fuel) used are: rice hulls, at a consumption rate of 8–10 kg/hour with a duration of 4–6 hours/operation — rice hulls are widely available at no cost; dieselene, at a consumption rate of 1.5–2.0 L/hour and a cost of U.S.\$0.50–\$0.75 — used if rice hulls are not available; and gasoline (power engine), at a consumption rate of 2.0–2.5 L/hour and a cost of U.S.\$1.15–\$1.40 — can be either gasoline or diesel engine.

Drying of Various Agricultural Products

Paddy

The capacity of the dryer is 2 t/lot of paddy. Generally, rice harvested from the field contains 20–26% MC and will take 3–6 hours to reduce to 14% MC. The rate of drying is about 2% of moisture reduction per hour. The temperature range is between 38 and 49°C, and static pressure is 50 mm of water. If the capacity is 1 t, the static pressure should be 10 mm of water obtained by adjusting the speed device on the engine.

The characteristics of the drying curves in drying paddy by using the diesel burner are shown in Fig. 3. The grain depth is 0.3 m, 22% MC_i , and final moisture content (MC_f), the average after 4 hours of drying, is 13.4%. The characteristics of the drying curves in drying paddy by using the rice-hull furnace are shown in Fig. 4. The grain depth is 0.46 m, 22% MC_i , and 12% MC_f , on an average of 4 hours drying. The curves indicate that the drying rate of the

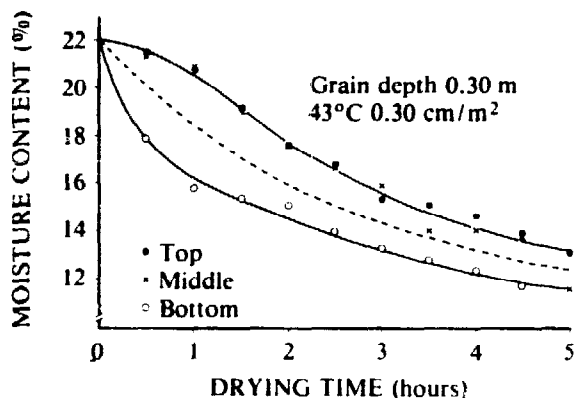

Fig. 3. Paddy drying curves (heat source: diesel).

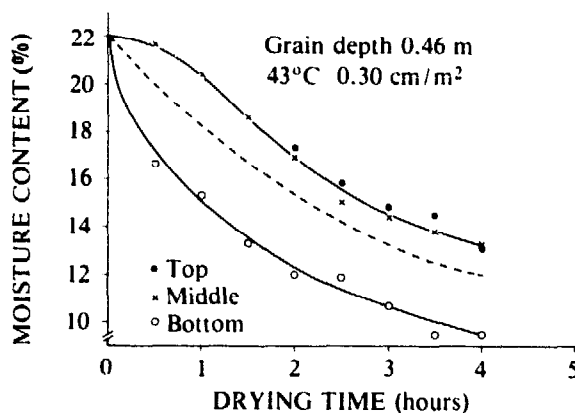

Fig. 4. Paddy drying curves (heat source: rice-hull furnace).

dryer using rice hulls as the heat source is greater than the diesel heat source.

Corn

The capacity of the dryer is 1.5 t. Figures 5–7 show the characteristics of the drying curves obtained from the three comparative tests on ear-corn drying. In drying by unheated air (Fig. 5) the drying time is 14 hours, the average initial moisture content is 15.9%, average final moisture content 14.4%, and the drying rate is 0.1%/hour. In drying by heated air from rice hulls (Fig. 6) the drying time is 9 hours, initial moisture content is 17.6%, average moisture content is 14.35%, and the drying rate is 0.4%/hour. Drying by heated air from diesel fuel (Fig. 7) involves a drying time of 13 hours, average initial moisture content is 16.4%, average final moisture content is 13.5%, and the drying rate 0.2%/hour. The general practices in ear-corn drying on the farm before marketing are: sun drying of newly harvested ear-corn containing 40% MC_i (the final moisture content is 20–22%), corn shelling, and sun redrying of

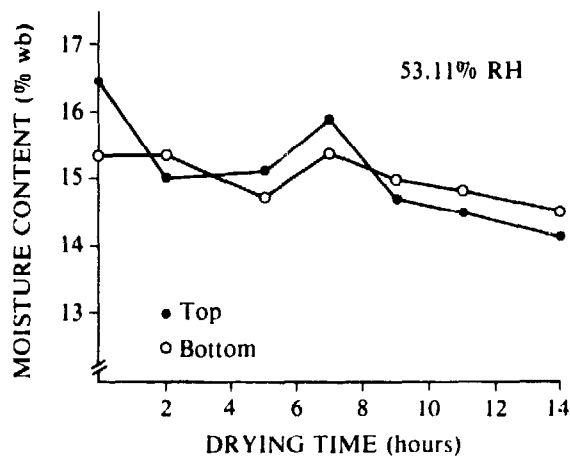

Fig. 5. Corn drying curves (unheated air).

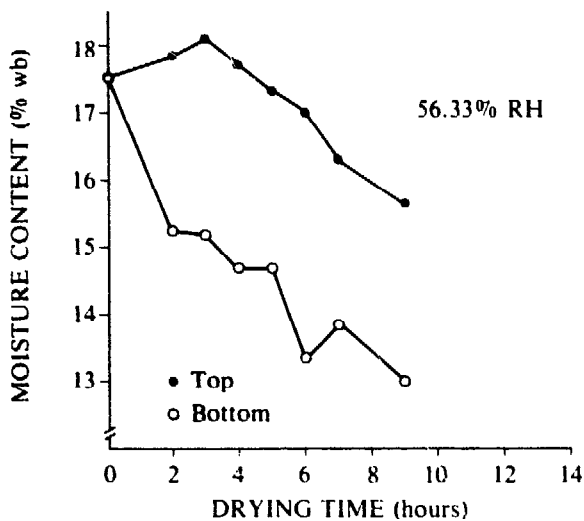

Fig. 6. Corn drying curves (heat source: rice-hull furnace).

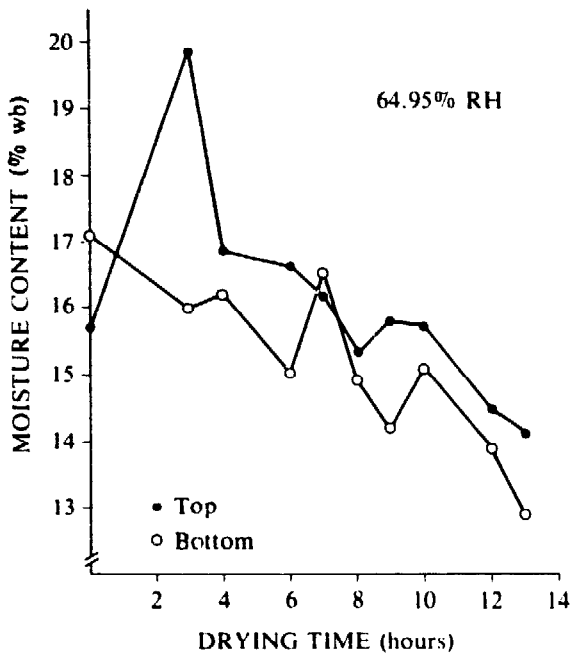

Fig. 7. Corn drying curves (heat source: diesel).

shelled corn until they are sufficiently dry.

It takes many days to reduce the moisture content from 20–22% to 8%. Procedures that may help to reduce the time used to complete the above steps are the artificial batch drying of ear corn and shelling after the drying has been completed. The time can be reduced to 1 day maximum.

Coffee

The capacity of the dryer for coffee berries is 140 kg. The general practice at present is sun drying, which usually takes 7–10 days. If there is rain during the drying period the farmers

will pile up the produce indoors and take it out again when the sun shines. This can cause fermentation and, therefore, reduce the quality and price. The tests on drying coffee berries by using the batch dryer have been reported as follows:

(1) The maximum temperature suitable for drying is about 93.3°C, because the berries are high-temperature tolerant.

(2) The higher the temperature is, the greater increase in heated air quantity. The quantity of air varied from 0.028 to 0.047 m³/sec, and the temperature also varied from 65.5 to 93.3°C. A flow of 0.028 m³/sec, however, was found not to be sufficient to go through the layer of berries.

(3) The batch dryer reduced the drying time from 7 to 10 days to 20 hours.

Figures 8 and 9 show the characteristics of the drying curves of coffee berries with an initial moisture content of 64%. The drying period was reduced to 15 hours to attain 8–10% MC.

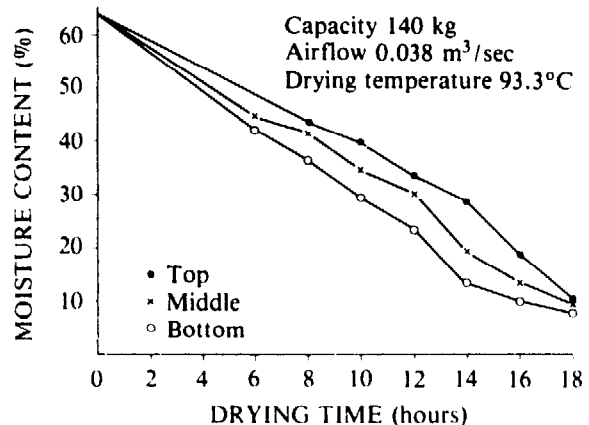

Fig. 8. Coffee berry drying curves with an initial moisture content of 64% and airflow rate of 0.038 m³/sec.

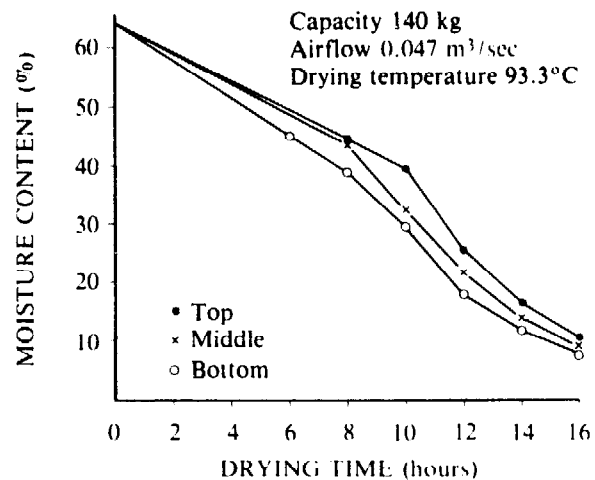

Fig. 9. Coffee berry drying curves with an initial moisture content of 64% and an airflow rate of 0.047 m³/sec.

Chilli

The capacity of the dryer is 200–720 kg. Sun drying is the general drying practice for chilli, which takes 2–3 days. Chilli becomes mouldy if exposed to rain, which affects the quality and lowers the cash income of the farmers. The dryer reduces the drying time of chillies (14% MC) by about one-third, and it reduces the risk in quality loss to nearly zero. The farmer's income will be higher if the dried chilli is at the market before the large supplies of lower-priced fresh chilli.

Conclusion

The batch-type dryer for farm grain (paddy)

has been successfully designed, tested, and introduced to the farmers to help in drying the second harvest. Some extensions have been made through the workshop service section, the Department of Agricultural Extension, and the Office of Accelerated Rural Development. The source of heat used depends on the availability of the fuel supply in each area, but rice hulls are available in most areas. Farmers also tried this type of dryer in drying other cash crops: corn, coffee berries, and chilli, as previously noted, but further research is needed to provide the appropriate design modifications and changes in methods of operation to suit the requirements of the farmers.

Economic Evaluation of Alternative Energy Sources for Coffee Bean Drying

R. García, C. Porres, J.F. Calzada, J.F. Menchú, and C. Rolz¹

Abstract. An economic evaluation was made of five energy sources for parchment coffee dehydration in static-bed mechanical dryers; base data were the conditions of an 18 160 kg/day peak capacity coffee processing plant (*beneficio*) located in the Guatemalan highlands. The energy sources evaluated were diesel oil, biogas generated from the anaerobic digestion of coffee waste (pulp), firewood, partially dried coffee pulp, and solar (forced convection). The cost of sun drying on concrete floors (patios) was also calculated. The minimum cost for the mechanical dryers was obtained when coffee pulp was used as fuel, followed in increasing order by firewood, solar, diesel oil, and biogas.

If the production of most coffee *beneficios* in Guatemala is plotted versus time in a graph, it will have a bell shape, with low production at the beginning and end of the coffee harvest season (about 4–6 months) and having a peak at mid season, which lasts from 2 to 5 weeks. Because wet coffee is perishable most of the equipment at the *beneficio* is usually designed for peak capacity and, thus, works below full capacity for about 40–80% of the time.

Washed parchment coffee is dried on flat concrete surfaces or patios in the sun, the process being supplemented by mechanical drying. At the beginning and end of the season only sun drying is used, whereas both systems are used at the peak.

During the years when fossil fuels were cheap, diesel oil was burned in most mechanical dryers for direct heating of air. Because of present diesel oil costs it is convenient to seek alternative energy sources. For the *beneficios* located on the slopes of the mountains in Central America and facing the Pacific coast, the annual trimming of the shade trees in the coffee plantations provides more than enough firewood to fuel the dryers when the use of the patios is limited because of frequent rain during the harvest season. For the *beneficios* located in the highlands like the one at San Lucas Tolimán, Atitlán, Guatemala,

firewood is scarce and expensive, and sun drying in patios is limited because flat terrain is seldom available.

The alternative energy sources selected for economic evaluation were firewood, dried coffee pulp, biogas from the anaerobic digestion of coffee pulp, solar energy (forced convection), and diesel oil. Other possible fuels like coffee hulls were not considered, because they are not generated in most of the wet processing *beneficios*, or like biogas from the digestion of sludge from an experimental water treatment plant in the *beneficio* at San Lucas Tolimán, which is still in the development stage. Figure 1 shows an outline of the alternative energy sources included in the economic evaluation.

Methodology

Firewood and Coffee Pulp

Base Data

Washed parchment coffee was to be dried from 45 to 25% moisture content (MC) (wet base) in 24 hours/batch. The investment cost for a dryer with a capacity of 2043 kg of dry (10% MC) parchment coffee per batch, with heat exchanger, like the prototype built by Instituto Centroamericano de Investigación y Tecnología Industrial (ICATI) in San Lucas Tolimán, is U.S.\$7900 (installed). Its firewood or dry coffee pulp consumption is about 27 kg/hour (from experimental tests). The cost of firewood varies

¹Applied Research Division, Instituto Centroamericano de Investigación y Tecnología Industrial (ICATI), Avenida La Reforma 4–47 Zone 10, Apartado Postal 1552, Guatemala, C.A.

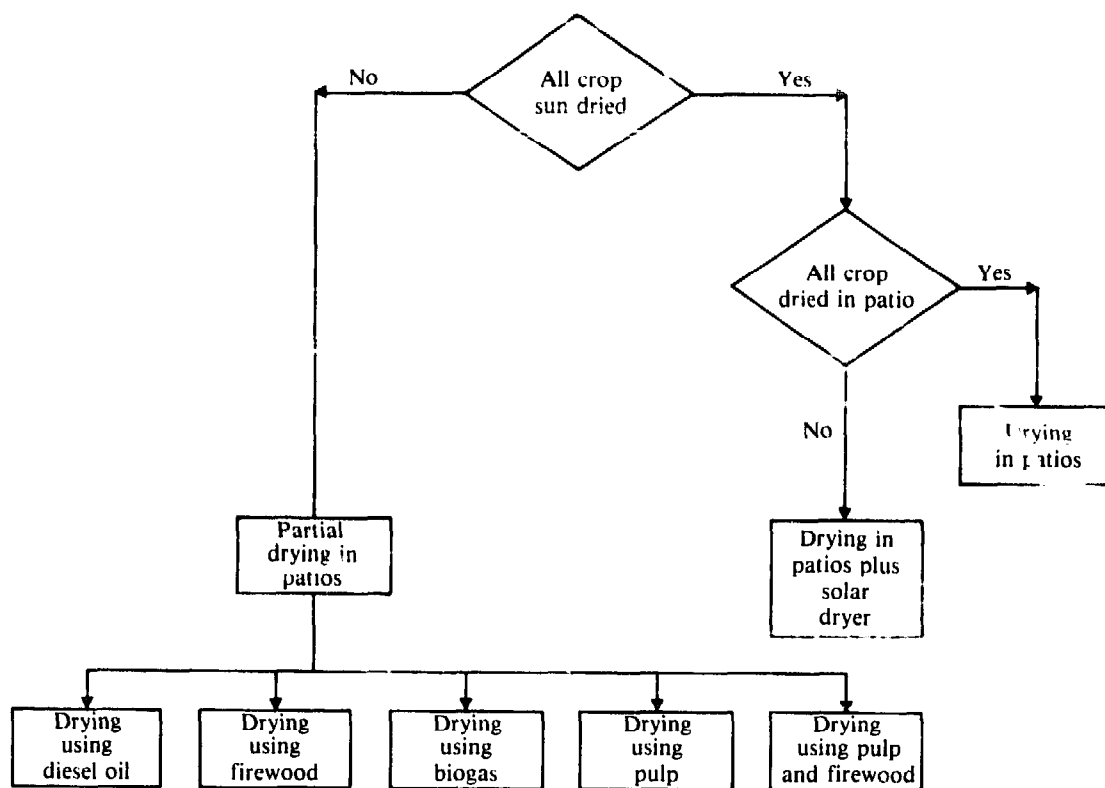

Fig. 1. Alternatives for drying coffee beans.

depending upon the region. In the Guatemalan highlands, it can be obtained for an average cost of U.S.\$0.25/kg. The cost of coffee pulp for fuel was estimated to be equal to its drying cost by sun drying (off-season) in patios, by which 36 000 kg of wet pulp (80% MC) could be dried using 1200 m² of patios and a 8-cm thick bed in 6 days and requiring 36 man-days at U.S.\$3.50/man-day. The "dry" pulp would have a 15% MC, and its calculated cost was U.S.\$0.015/kg dry pulp. Its heating value is shown in Table 1. The cost of electricity is U.S.\$0.12/kWh. All investment was assumed to be financed by loans at 13% interest for 7-year periods.

Table 1. Characterization of coffee pulp.

Analysis	Results
Moisture content of fresh pulp	82-71%
Moisture content of sun-dried pulp	11.16%
Bulk density of fresh pulp	250 kg/m ³
Bulk density of dried pulp	102 kg/m ³
Heating value on a dry base	14.61 × 10 ⁶ J/kg
Ash (at 575°C)	8.25%
Potassium as KO	3.40%
Phosphorus as PO	0.30%
Magnesium as MgO	0.29%

Capacity of the Mechanical Dryer

Because most coffee *beneficios* in the Guatemalan highlands have patios and mechanical dryers, it was of interest to study the influence of mechanical dryer capacity on drying cost, taking into consideration the special operating characteristics of the *beneficios* discussed earlier.

A *beneficio* with a peak capacity of 18 160 kg/day of coffee fruit (4040 kg/day of parchment coffee), like the one in San Lucas Tolimán, was selected for the economic study. Drying costs in U.S.\$/kg of water removed were calculated for three sizes of mechanical dryers: 50, 75, and 100% of the peak production of the *beneficio*, equivalent to 2043, 3042, and 4040 kg of dry parchment coffee per day. The 50% of peak production size was the smallest commercially available dryer.

It was assumed that the mechanical dryer operated at full capacity, and it was started only when the amount of coffee processed per day at the *beneficio* was enough to fill the bed of the dryer. When the mechanical dryer was not operating, coffee was dried in the patios. Under such conditions, the higher the capacity of the

mechanical dryer the shorter the time it operated and the more expensive it became. Table 2 summarizes the conditions assumed in this study.

Table 2. Conditions for the economical evaluation of alternative energy sources.

Dryer capacity		Amount of coffee dried by the mechanical dryer	
		% of total production	Operation time, days ^a
% of peak	kg/day		
50	2043	62	60
75	3042	56	36
100	4040	25	12

^aDays during which the mechanical dryer operated.

Cost Estimation

Labour cost per batch was estimated as 22 man-hours at U.S.\$0.55/man-hour for the furnace operator (constant for all dryer sizes) and 8 man-hours at U.S.\$0.44/man-hour for charging and discharging the dryer bed of the 2043 kg/day unit. This labour cost was increased linearly as a function of dryer capacity. Straight line depreciation was used, assuming a life of 10 years for electrical motors and 20 years for the rest of the dryer equipment, with no salvage value. Investment cost for the equipment was scaled-up using the six-tenths-factor rule from the known cost of the 2043 kg/day mechanical dryer built by ICAITI.

Annual maintenance cost was assumed to be 2.5% of the investment cost. The 2043 kg/day dryer has a 2.23 kW air blower and a 0.19 kW extractor for the stack gases, for a total power consumption of 2.42 kW, which was assumed to increase linearly as a function of capacity (kg/day) for the larger dryers. The same assumption was made for scaling up the consumption of firewood or dry coffee pulp (as fuel). Total cost per batch was divided by the amount of water removed per batch to obtain U.S.\$/kg water.

Diesel

Base Data

A 2043-kg/day diesel-fueled direct-heated dryer is commercially available for U.S.\$5700 (installed). It does not require a heat exchanger. Its diesel consumption is 5.03 L/hour and has a 3.73 kW blower. Diesel costs are U.S.\$0.32/L. All other base data are the same as for the firewood-fueled dryer mentioned earlier. The

capacity of the mechanical dryer is also the same as for the firewood-fueled dryer.

Cost Estimation

Labour cost per batch was estimated as 4 man-hours at U.S.\$0.55/man-hour for the operator (constant for all dryer sizes) and 8 man-hours for charging and discharging the dryer bed of the 2043 kg/day unit, which was incremented linearly as a function of dryer capacity.

Investment, depreciation, electricity, and fuel costs were calculated in the same way as for the firewood-fueled dryers. Annual maintenance cost was assumed to be 2.0% of the investment cost.

Solar (Forced Convection)

Base Data

It was assumed that inflated plastic solar collectors of the kind described by Baird et al. (1979) could be used to heat the air for a static-bed coffee dryer. ICAITI built an inflated plastic solar collector for a grain-drying research project in 1980, which cost U.S.\$10.06/m² (installed, air blower included). A 2043 kg/day dryer will require about 150 m² of collector area and a 1.49 kW air blower. Its installed cost was estimated at U.S.\$2716.

Solar radiation was assumed to be 508.8 W/m² (data for December–April in Guatemala City, 1500 m above sea level). All other base data are the same as for the firewood-fueled dryer. The capacity of the mechanical dryer is also the same as for the firewood-fueled dryer.

Cost Estimation

Labour cost per batch was assumed to be 16 man-hours at U.S.\$0.55/man-hours for the operator (constant for all dryer sizes) and 8 man-hours at U.S.\$0.44/man-hour for charging and discharging the dryer bed of the 2043 kg/day unit, which was increased linearly as a function of dryer capacity.

Straight line depreciation was used, assuming a life of 10 years for the air blower, 20 years for the dryer bed, and one season (4 months) for the plastic collector, which means that it has to be changed annually with no salvage value. Maintenance (excluding the collector) was assumed to be 1% of the investment cost. Scale-up of investment cost and electricity

consumption was calculated in the same way as for the firewood-fueled dryer.

Biogas

Base Data

An energy content of 24 MJ/m³ for biogas (65% v/v methane) from the anaerobic digestion of coffee pulp was used for the calculations. It was estimated that 1 L of diesel oil was equivalent to 1.61 m³ of biogas. A yield of one volume of biogas per volume of digester per day was known from experimental data, which means that 0.91 m³ of digester is needed to produce 1 m³ of biogas per day. ICAITI built several biogas digestors for another research project and gathered economical data from which a cost of U.S.\$23.80/m³ of biogas per year was estimated. The capacity of the mechanical dryer is the same as for the firewood-fueled dryer.

Cost Estimation

Biogas was substituted for diesel oil as fuel for the coffee dryer and then all the cost calculations were repeated following the same procedure used for the diesel-fueled dryer.

Drying in Patios

Base Data

Sun drying of washed coffee from 45 to 10% MC (wet base) takes about 8 days in the patios of the *beneficios* located in the Guatemalan highlands, where coffee processing is done in the dry season. The patios can yield approximately 13.8 kg of dry (10% moisture) coffee per m² of patio surface per 8-day drying batch.

Drying Capacity

It was assumed that the patios would function as a complement of the mechanical dryer; for example, when the mechanical dryer has a capacity of 75% for the peak production, the patio should dry 25% of the peak. It was also assumed that the mechanical units would dry the coffee only to 25% MC and that this partially dried coffee would be stored for several weeks and then dried to 10% MC in the patios at the end of the processing season when production is lower. The purpose of this drying schedule was to utilize the mechanical dryers at their maximum efficiency and leave the less efficient drying stage (from 25 to 10% MC) to the patios.

Cost Estimation

Because flat land is scarce in the Guatemalan highlands, it was assumed that the first 1200 m² of patio area had to be built on a terrain with a 10% slope, and any additional patio area would be built on a terrain with a 15% inclination. The higher the slope the higher the volume of soil that should be removed at U.S.\$1.25/m³. The cost of the concrete surface for the patios was U.S.\$4.00/m². Contention walls (to protect the patios from small landslides) were estimated at U.S.\$5.00/m². As with the mechanical dryers, it was assumed that the investment cost was financed by a bank loan at 13% interest for 7 years. Depreciation was straight-line for a 30-year period.

Annual maintenance cost was estimated at 1.5% of investment. Labour for patios with a capacity for drying 50% of the peak production was estimated as 50 man-hours/batch at U.S.\$0.44/man-hours, and was varied linearly as a function of drying capacity.

Results and Discussion

Drying costs expressed as U.S.\$/kg water removed for 3 sizes of mechanical dryers and for sun drying in patios are presented in Table 3. Part of the same information is also shown in Fig. 2, for which it should be noted that the percentage of peak production figures for the patios are the inverse of those for the mechanical dryers.

The drying time of 24 hours to reduce the moisture content of coffee from 45 to 25% was an average value taken after consultation with

Table 3. Washed parchment coffee drying costs (U.S.\$/kg water).

Type of energy utilized	Size of dryer as % of peak production		
	50	75	100
Biogas	0.130	0.190	0.500
Diesel oil	0.090	0.100	0.140
Solar (forced convection)	0.061	0.069	0.071
Firewood	0.066	0.071	0.129
75% firewood 25% pulp	0.064	0.069	0.128
50% firewood 50% pulp	0.062	0.068	0.126
Coffee pulp	0.059	0.064	0.123
Solar (patios)	0.020	— ^a	0.032

^aThis cost was not calculated because the complementary mechanical dryer would have been too small.

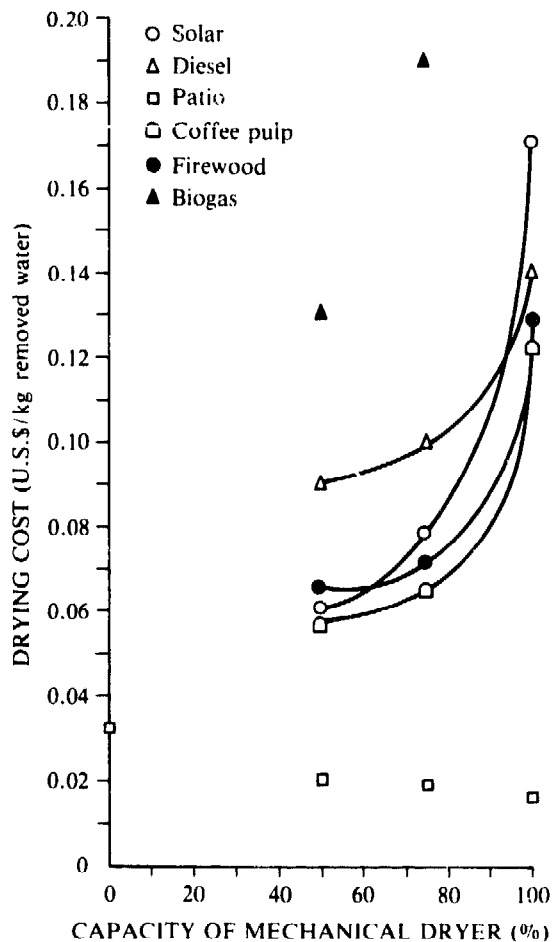

Fig. 2. Drying costs and capacity of mechanical dryers.

dryer operators from several *beneficios*. Actual drying tests done by ICAITI with a static-bed dryer at the San Lucas Tolimán *beneficio* showed that only 12–17 hours were required to dry coffee from 40 to 25% MC, but the 24-hour figure was used in the economical evaluation because it would give more conservative costs. However, using 12 hours instead of 24 hours drying time would only affect the total drying costs but not the relative values between the different systems, which are important for comparison purposes.

Conclusions

- Sun drying in patios is the least expensive method but its use is severely limited by the rugged topography of the highlands and by rain in the Pacific coasts.

- Burning locally available solid fuels for heating air through a heat exchanger for a static-bed dryer was the most economical method for drying coffee in a mechanical dryer.

- Partially dried coffee pulp was the least expensive of the fuels evaluated in this study.

- Biogas generated from the anaerobic digestion of coffee pulp is considered uneconomical for the conditions studied.

It was assumed that fresh pulp would be dried during off-season in the patios; however, this means that it needs proper storage while the *beneficio* is in operation (4–6 months). Although this is already common practice in Central America, it is also the main cause of air and water pollution associated with the *beneficios*. One technical alternative that is being studied is to press the pulp before storing it. If properly done the juice yield will be about 60% of the initial fresh weight of the pulp, extracting about 35% of the total solid present, which will probably be biodegraded during fresh pulp storage, and the final solid moisture being 70% (Rolz, C. et al. 1980). The lower solid moisture and good texture will be an asset for pulp drying in patios. The juice may be a much better substrate for biogas generation than whole pulp, and its throughput rate in an anaerobic digester could be rather high if new digester designs are employed like the upflow sludge-bed digester.

Baird, C.D., Chau, K.V., and Bagnall, L.O. 1979.

Final report on grain drying with solar energy in the humid south. Florida, USA, Agricultural Engineering Department, University of Florida.

Rolz, C. et al. 1980. Pressing of coffee pulp. *Agricultural wastes*, 2, 207–214.

Dryers for Cooperatives for Food Production in Indonesia

Sjachputra¹

Abstract. This paper examines the technical and economic aspects of using mechanical dryers in the Indonesian Cooperatives. The dryers used are flat-bed dryers, Lyster dryers, and tempering bin dryers. The specifications and operation of the dryers are mentioned. The important role of mechanical dryers for the Indonesian Cooperatives in the program of national stockpile and improving the living standard of the Cooperatives' members is explained.

In Indonesia sun drying can be done throughout the year and is a cheap method of preserving food. However, the rainy season, which lasts about 3-4 months, presents some problems, especially in recent years, as the use of early maturing paddy and corn has meant that some of the crops are harvested during the rainy season.

In Indonesia, cooperatives/KUD-s (unit village cooperatives) are actively involved in the national program for food, producing 91% of the national supplies. Although this amounts to a considerable contribution, there is room for increased production through the improvement of management personnel, and facilities. Much of the unhusked rice and secondary crops is sun dried on drying floors. When rain comes suddenly, the crop is at times completely spoiled. Also, the fluctuations in humidity adversely affect the quality of the product, and, because of the large surface and comparatively long time needed for sun drying, the capacity of the facilities cannot be increased quickly to handle bumper harvests. Moreover, cooperatives that have drying facilities are still few, and the majority still depend on private enterprise.

Since the first Five Year Plan, the government has felt that the food supply program suffers from the inefficiency of the drying floors. In fact, it has already introduced some mechanical drying equipment into large rice mills owned by private enterprises as well as cooperatives. Although this particular equipment has not

performed satisfactorily, the government is committed to finding mechanical means to deal with large harvests and crops during the rainy season.

Technical Aspects of the Use of Dryers

Some problems are specific to the mechanical drying of grain. For instance, fast drying can damage the grain: the high temperatures dry the surface of the crop bed faster than the interior so that the grain breaks easily. This can be overcome by using a tempering bin. Slow drying results in a better product but has the obvious disadvantage of taking a long time. The best temperature for mechanical dryers is between 43 and 49°C. Classified by the flow of crop to be dried, mechanical systems can be divided into batch (flat-bed) and continuous-flow.

In batch drying, the crop is kept stationary, whereas in continuous-flow drying the crop is conveyed, usually automatically. The capacity of continuous-flow dryers is larger than that for batch dryers. The batch dryers generally in use in Indonesia are two: flat-bed dryers, domestically produced, and Lyster dryers. The continuous-flow dryers are rarely used.

Flat-Bed Dryer

Flat-bed dryers are simple and relatively cheap. Kerosine is the source of heat energy. During operation, a fan draws the heated air and blows it through a steel screen into a drying box. The dryers are usually equipped with an oven to increase the air's capacity to absorb moisture from the crop. The temperature must

¹Departemen Perdagangan Dan Koperasi (Department of Trade and Cooperatives), P.O. Box 384, Jakarta, Indonesia.

value of the other advantages gained by using a mechanical dryer. For example, according to the data collected by the Directorate-General for Agriculture, in a survey conducted in East Java, the variable cost for drying rice using all types of mechanical dryers available was between Rp 0.80 and Rp 1.78 kg (Rp 630 = U.S.\$1.00) of rice ready for milling, which is 1-3.7 times more expensive than sun drying. In West Java the variable cost was between Rp 0.69 and Rp 1.69, which is 1-4 times the cost of sun drying (drying floor).

The comparisons made did not include other benefits gained by the use of mechanical dryers, such as (1) independence from weather conditions, the elimination of the risk of deterioration of the crop because of sudden rainfalls, and the possibility of both day and night usage; (2) the rice dried by a mechanical dryer results in a better quality product than rice dried in the sun, and, therefore, has a higher selling price; (3) mechanical drying does not encounter the unavoidable losses in sun drying due to spillage eaten by poultry and birds; (4) mechanical drying is faster than sun drying, which leads to a higher turnover in capital and an increase in rice trade; and (5) mechanical drying offers the possibility of drying several kinds of commodities, in addition to rice, to lower unit costs of dryer use.

The most important aspect of using a mechanical dryer is that it can assist in making the

program of food supply for the national stock a success, especially during the rainy season and when there is a big harvest.

At such times the price of rice and secondary crops are threatened and cooperatives that own a mechanical dryer are expected to be able to improve their performance and increase the standard of living of their members.

Conclusion

Mechanical dryers are essential for cooperatives in connection with the program of food supply for the national stock, especially in big harvest times that usually coincide with the rainy season. These dryers can help improve the quality of the crop produced. They can also assist in keeping prices stable of rice and secondary crops and increase the income and production of farmers. At this stage the mechanical dryers that can be used are the batch dryer and continuous-flow dryer.

For the sake of efficiency and effectiveness, whenever the crop to be dried exceeds 10 t/day, it is preferable to use Lyster dryers or tempering-bin dryers. If the crop to be dried is less than 10 t, then the flat-bed dryer is sufficient.

Although the operational cost of rice drying using mechanical dryers is relatively higher than sun drying, the additional benefits gained justify their use.

Commentary

G. Yaciuk¹

Drying of foods is carried out primarily to ensure stability of product quality for a given storage period or to ensure product availability on a year-round basis.

Traditional sun drying is still the most common drying method. The product is spread thinly over an unfinished area directly exposed to solar radiation. Solar radiation vaporizes the water in the product, and ambient moving air with a low relative humidity picks up this moisture and carries it away. Although the method is cheap, there are problems associated with sun drying, which often results in a poor quality dried product: no control over the drying process; possible contamination of the product by dirt, rodents, animals, etc.; infestation by insects or moulds (if dried too slowly); and exposure of the product to rain and wind, which causes repeated rewetting and redrying.

Improvements in the traditional method, however, are possible. Instead of drying on the ground, a drying floor can be made from concrete. Because the area of such a drying floor tends to be large, the cost is often prohibitive for all but high-priced food items. Another improvement is the use of drying mats or trays raised above ground level. This allows for air-flow through the product bed and eliminates many of the sources of contamination.

The only way to ensure that the product to be dried is not affected by constant rewetting and drying, is by use of dryers in which the product is enclosed in some type of chamber. Direct dryers consist of an enclosure with a transparent cover. The crops are placed on trays in the enclosure and the solar energy is absorbed by both the product crops and the internal mass of the dryer. The elevated temperatures cause

evaporation of water from the product. The warm moist air escapes through the vent holes and fresh air is drawn by natural convection through holes at the dryer base.

There are a number of operational considerations to be made when using a direct dryer:

(1) The temperature in the dryer chamber should be as high as possible to ensure low relative humidity and efficient moisture removal. At the same time, care must be taken to avoid overdrying the products. A higher temperature can be maintained by using two transparent covers, insulation to reduce heat loss through the chamber wall, and by controlling vent openings. Temperature in a direct dryer is often very hard to control.

(2) The efficiency of the dryer is related to the colour of the product to be dried. Products that are dark (acting as a black body) absorb more radiation, but they are also subject to colour changes (viewed as unappetizing by the consumer) due to a breakdown of plant pigments.

To eliminate the problem of quality losses and overdrying caused by using a direct dryer, an indirect dryer can be used in which air is heated in a solar air collector and circulated through the product to be dried, which is contained in a drying chamber (several designs exist). Indirect drying can be carried out by use of either forced convection (using a powered fan) or by natural convection. In most cases, however, the power necessary to drive a fan is either unavailable or too expensive. Mixed-mode dryers involve the use of both direct and indirect heating of the product.

In the introduction of either type of dryer, it should be ensured that they are: simple to construct, operate and maintain; made of local materials; acceptable to the users; cost-effective and capable of drying a variety of commodities (if possible).

¹Technical Coordinator for meeting, Program Officer, Agriculture, Food and Nutrition Sciences Division, International Development Research Centre, 10454 Whyte Avenue, Suite 304, Edmonton, Alberta, Canada.

The steps that should be followed in the development of a drying system are:

(1) The engineer and his colleagues should first determine the quantity and nature of the product to be dried and particular consumer requirements. By determining what the initial and final moisture content are and the maximum drying time and quantity to be dried per batch, the dryer bed size can be established, as well as the amount of moisture to be removed, heat required to remove this moisture, and required airflow rate. Although not necessary, but highly useful, these can be incorporated into a simulation model to verify if the design is suitable.

(2) The dryer can then be built and initial tests carried out. The home economist could begin consumer-acceptance testing while the food scientists look at product quality. Consumer-acceptance tests at this time will depend on whether the dried product to be introduced is a new food or just an improvement on the traditional sun-dried product and whether the product is being consumed by the processor's family or is being sold at the market. Several useful concepts to deal with these topics have been dealt with in section II.

(3) A team approach with interactive feedback is then used in prototype modification until the prototype is suitable for the drying of a high-quality product acceptable to the consumer.

(4) Suitable field testing involving government planners, policymakers, and extension workers should be carried out to ensure that the dryer prototype functions well under a variety of user conditions.

Recommendations for Future Work

The overall recommendations for future work that developed through discussions at the workshop were to:

- Ensure that a multidisciplinary approach to drying is used.
- Use dryer prototypes already tested for a particular commodity in a particular region: (1) for a different commodity in the same region, and (2) for the same commodity in a different region.
- Develop a "catalogue" of available known and tested dryer prototypes to help in determining the appropriate dryers and commodities to use.

Technical Editing: K. Kealey-Vallière