

AT MICROFICHE
REFERENCE
LIBRARY
A project of Volunteers in Asia

Reforestation in Arid Lands

By: Fred R. Weber with Carol Stoney

Published by: Volunteers in Technical Assistance
1815 North Lynn Street, Suite 200
Arlington VA 22209
U.S.A.

Available from: Volunteers in Technical Assistance
1815 North Lynn Street, Suite 200
Arlington VA 22209
U.S.A.

Reproduced with permission.

Reproduction of this microfiche document in any form is subject to the same restrictions as those of the original document.



REFORESTATION
IN
ARID
LANDS

Fred R. Weber

with
Carol Stacey

WILEY

REFORESTATION IN ARID LANDS

By
Fred R. Weber

With
Carol Stoney

Illustrated By
Frederick J. Holman

Edited By
Margaret Crouch

Volunteers in Technical Assistance
1815 North Lynn Street, Suite 200
Arlington, Virginia 22209
USA

Reforestation in Arid Lands

Copyright © 1986 Volunteers in Technical Assistance

All rights reserved. No part of this publication may be reproduced or transmitted in any form or by any means, electronic or mechanical, including photocopy, recording, or any information storage and retrieval system without the written permission of the publisher.

(This is the second edition of a manual first published in 1977 as a joint effort by the United States Peace Corps and Volunteers in Technical Assistance.)

Manufactured in the United States of America.

Published by Volunteers in Technical Assistance (VITA)
1815 North Lynn Street, Suite 200
Arlington, Virginia 22209 USA

Designed by Margaret Crouch.

Set in *Times* type on a Macintosh Plus computer, a gift to VITA from Apple® Computer Incorporated.

Cover art by Michael Okendo, produced by KENGO (Kenya Energy Non-Governmental Organizations Association).

10987654321

Library of Congress Cataloging-in-Publication Data

Weber, Fred R.
Reforestation in arid lands.

Bibliography: p. 326

1. Reforestation--Handbooks, manuals, etc. 2. Agroforestry--Handbooks, manuals, etc. 3. Arid regions--Handbooks, manuals, etc. II. Stoney, Carol, 1955- . II. Crouch, Margaret. III. Volunteers in Technical Assistance. IV. Title.

SD409.W34 1986 634.9'56 86-26720
ISBN 0-86619-264-6

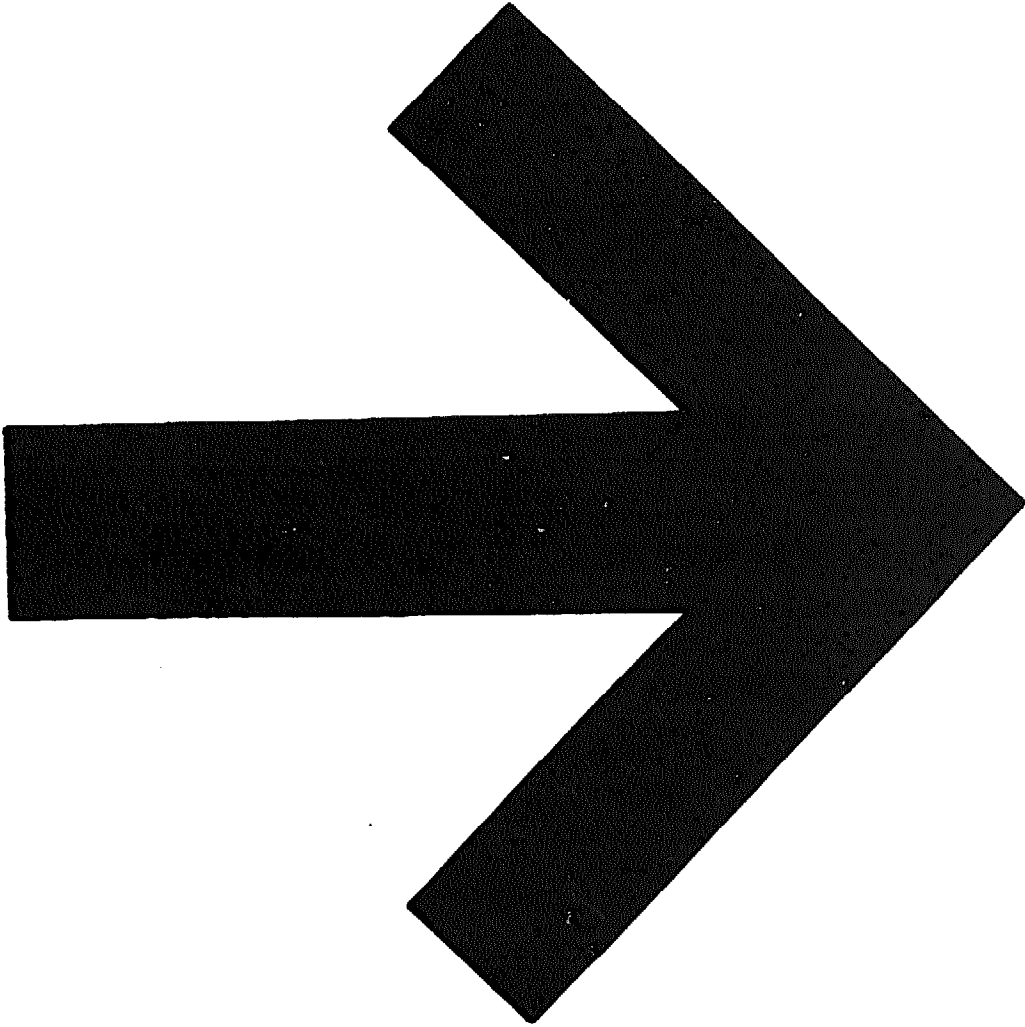

TABLE OF CONTENTS

CHAPTER		PAGE
	ACKNOWLEDGEMENTS	v
	FOREWORD by Edward C. Wolf	vii
1	INTRODUCTION	
2	PROJECT FRAMEWORK Preliminary Considerations; Project Goals; Community Involvement; The Conservation Community; Natural Resource Policies; Present Land Uses; Key Elements for Project Success	5
3	PROJECT DESIGN Regeneration Options; Water Supply; Seasonal Considerations; Site Use Planning; Protection; Personnel Management; Project Record Keeping	13
4	SOIL PROPERTIES Soil Texture; Water Holding Capacity; Soil Reaction (pH); Soil Depth; Erodibility of Soils; Soil Classification; Common Soil Problems	31
5	SITE/SPECIES SELECTION Site Selection; Species Selection	49
6	NURSERY MANAGEMENT Nursery Design and Layout; Ground and Soil Preparation; Determining Planting Sites; Determining Planting Dates; Seed Supply; Seeding; Tending and Protecting Seedlings in the Nursery; Preparing Seedlings for Transplanting	57
7	THE PLANTING SITE Site Management; Lifting Out and Transportation; Site Preparation; Transplanting; Coping with Delays; Preparations for Difficult Sites; Plantation Maintenance	93
8	AGROFORESTRY METHODS Agroforestry Systems in Africa; Agroforestry and Soil Conservation Techniques;	113
9	SPECIAL SUBJECTS Fire; More on Fencing; Propagation by Cuttings; Harvesting Methods	153
	APPENDIX A Species Identification	171

APPENDIX B A Field Guide to 30 Tree Species Commonly Found in Africa	239
APPENDIX C Climate, Vegetation, and Soils of Sub-Saharan Africa	301
APPENDIX D Information Sources; Suggested Reading	313

ACKNOWLEDGEMENTS

This second edition of *Reforestation in Arid Lands* is based on ten years of practical field experience in forestry programs around the world. VITA acknowledges with thanks the hard work of all the people who helped translate that experience into the reality of this new edition.

Reforestation author Fred R. Weber, a pioneer in the community forestry concepts presented here, has advised on such projects for over 20 years. He wrote the original edition in 1977 based on a training manual he prepared for Peace Corps volunteers in Niger. Carol Stoney collaborated with Mr. Weber on the revisions for the new edition. They have prepared some entirely new sections, revised and updated the original text, and substantially reorganized the material to make the manual easier to use. Frederick J. Holman, the landscape architect who provided the illustrations for the original, also contributed more than 50 new drawings for this edition. Both Mr. Weber and Mr. Holman are longtime VITA Volunteers, and provided their considerable expertise on a voluntary basis. Ms. Stoney is a more recent member of VITA's volunteer roster, and worked on this project as a VITA Fellow. VITA staff who participated in the preparation of the new edition were Margaret Crouch and Suzanne Brooks.

The first edition of *Reforestation in Arid Lands* was the third manual in a series of publications prepared jointly by the United States Peace Corps and VITA, Volunteers in Technical Assistance. These publications combined Peace Corps' practical field experiences with VITA's technical expertise in areas for which useful resource materials were severely lacking. Peace Corps has also assisted VITA in the preparation of this new edition by reviewing draft versions of the revised text and new material as they were being written, and by providing technical and editorial suggestions and recommendations. VITA would particularly like to acknowledge the help of Peace Corps specialists Jacob Fillion and George Mahaffey, Office of Training and Program Support (OTAPS), and Maureen Delaney, director, Information Collection and Exchange (ICE).

A special note of thanks to Tim Resch, Africa Coordinator, USAID/USDA Forestry Support Program, who reviewed the updated text and appendixes, and to Barney Popkin, Woodward-Clyde Consultants, who assisted with the section on salinity problems for the new edition. Both Mr. Resch and Mr. Popkin are longtime VITA Volunteers as well. VITA would also like to thank the numerous people who filled out and returned the reply form included in the first edition. Their comments were particularly helpful, and as many of their ideas as possible have been incorporated into the new edition.

Acknowledgement for their role in the creation of the first edition goes to Virginia Palmer, Editor, who has been a VITA Volunteer for almost 18 years; Laurel Druben, PC/VITA series editor and former VITA publications director; Brenda Gates, former director of ICE; and John Goodell, former VITA staff for research and layout of Appendix A.

Other people and organizations that provided information or assistance to the first edition include: John Camp, consulting forester, Rockefeller Brothers Fund, New York, and William R. Chapline, consulting forester, Washington, D.C., for technical review; J.W. Duffield, North Carolina State University, Raleigh, North Carolina; Jeffrey L. Wartluft, Department of Agriculture, Forest Service, Princeton, West Virginia; Lawrence R. Deede, Hopewell Junction, New York; National Agricultural Library of the Department of Agriculture; and the Botany Library, Smithsonian Institution, Washington, D.C.

About VITA

Volunteers in Technical Assistance is a private, nonprofit, international development organization that provides a variety of information and technical resources aimed at fostering self-sufficiency. These resources include needs assessment and program development support, by-mail and on-site consulting services, information systems training, and management of long-term field projects.

VITA places special emphasis on the areas of agriculture and food processing, renewable energy applications, water supply and sanitation, housing and construction, and small business development--areas in which self-sufficiency in the community is an essential step toward the well-being of a nation. VITA is also prepared to provide access to high-tech innovations that will help these communities and countries assume their roles in the modern world.

VITA Volunteers are located all over the world; many have lived and worked in developing countries. They are engineers, scientists, business people, agriculturalists, architects, educators, foresters, and specialists in many other fields. Through VITA they use their particular knowledge to help other people, and thanks to their contributions of time and expertise, VITA has been providing technical assistance to people in developing nations for more than 25 years.

This manual is one of more than 100 titles published by VITA to document and support development projects. VITA publications have been used successfully by villagers, students, teachers, field agents, and extension workers throughout the world. Relevance of subject matter, clarity of instructions, and easy-to-follow plans and illustrations make these materials invaluable resources. VITA also publishes *VITA News*, a quarterly magazine.

FOREWORD

The decade since *Reforestation in Arid Lands* was first published has not been kind to Africa's arid lands. From Senegal to Sudan, each season from the mid-seventies to 1984 brought less rain to nurture crops, water livestock, and sustain households than the average of the previous 70 years. By the early 1980s, food shortages and the threat of famine had followed drought across a vast crescent of savannas from the Sahel through eastern and southern Africa. Millions of people faced starvation; for hundreds of millions of others, the hardships of rural life steadily deepened.

Statistics on Africa sketch a troubled future. The continent's population, just over 400 million people in 1975, has expanded to 583 million in 1986, and will increase by an additional 16 million this year. The UN Food and Agriculture Organization estimates that 2.3 million hectares of Africa's open woodlands--an area nearly the size of Rwanda--are stripped for fuel or cleared to make way for new cropland each year. Much of this farmland, unsuited to sustained cultivation, produces less millet and sorghum per acre than more fertile areas tilled a generation ago. Despite the increase in cropland, harvests per person are declining.

The statistics don't measure the degradation of standing trees, the overcollection of branches for fuel and foliage for fodder, or the careless supervision of flocks of sheep and goats that nibble tree seedlings as they sprout. Savanna woodlands, the natural plant and animal diversity they once sustained, and the fertility of cropland are, like Africa's rural people, the victims of environmental deterioration that is difficult to quantify but impossible to escape.

Few circumstances could be more hostile to the success of reforestation efforts. And yet the last decade has been one of notable progress. Support for forestry has increased in both aid agencies and African governments, and tree planting projects today are better matched to the needs of rural communities. Early emphasis on plantation-based fuelwood production has given way to more centralized community forestry approaches that involve local people in project planning. Recognition that trees can enhance the fertility of agricultural land has prompted research on agroforestry. Native African trees ranging from *Acacia albida*, planted in millet fields to fix nitrogen and boost crop yields, to windbreaks and living fences of *Ziziphus spinachristi*, are today considered a key to restoring agricultural productivity on West Africa's degraded croplands. Prominent and well-publicized success stories, like CARE's windbreak project in the Majjia Valley in Niger, show that tree planting compatible with community needs can succeed even in harsh settings.

Reforestation has become a centerpiece of rural development in arid lands, a key to conserving soil and water supplies, securing food production, and reducing the hardships of rural life. Accordingly, the challenge of reforestation has grown more complex. Foresters must understand how tree species interact with their environments, match trees to the cultural needs, predispositions, and idiosyncracies of rural communities, and coordinate the agendas of development agencies with the limitations of local bureaucracies. It is no longer enough to know forestry alone; foresters must be advocates, lobbyists, accountants, fund raisers, negotiators, and diplomats as well, perhaps all in the same afternoon.

This new edition of *Reforestation in Arid Lands* is a comprehensive reference for people planting trees. Part field guide, part planting manual, part introduction to the legal and social context of reforestation, the book distills the lessons of forestry successes in dozens of countries. Few development activities confront so directly the fundamental human and environmental problems that undermine development and prolong impoverishment throughout Africa's arid lands. Few can match the lasting satisfaction derived from tree planting projects that become self sustaining.

Edward C. Wolf
Worldwatch Institute
Washington, D.C.

1 INTRODUCTION

Wherever people live, they make demands upon the earth. People need land and water to raise crops and livestock; they use wood to build houses and cook food. Trees provide a myriad of other products that are used as household necessities, as well as to add comfort, beauty and flavor to daily existence. The demands of human populations on forests, lakes, and agricultural land are increasing, while resources are decreasing. Fire, overgrazing, and uncontrolled use of already limited resources have added to the hardships caused by drought. Although natural resources are being rapidly used up throughout the world, the demand for them can be met if people plan for their continued, sustained use. More and more countries around the world are now trying to solve such problems and are taking steps to stop the depletion of their national resources. Reforestation and revegetation projects are among the most effective approaches to bringing about a restored, sustainable resource base.

The subject of this manual is reforestation in arid and semi-arid lands, specifically in Sub-Saharan Africa. The first edition of this manual, published jointly by Peace Corps and VITA, was an attempt to present current state-of-the-art examples of reforestation methods used in West Africa. This new edition has a broader geographic focus, drawing on experience in dry regions of eastern and southern Africa as well.

While the manual focuses on Africa, many of the problems that project planners face are similar throughout the world. The major obstacles to reforestation programs are usually caused by a lack of understanding of the social context within which the programs must be carried out, rather than by a lack of technical expertise, equipment, or funding. Local acceptance of a project is indispensable to widespread participation in project activities, which in turn is essential to ensure seedling protection and survival. Reforestation projects will be willingly accepted only if they address specific needs that are locally recognized as high priority problems within the community. This book deals with the broad subject of project design and implementation, and presents methods and planning guides useful in different cultural contexts.

Reforestation efforts are generally begun for three important reasons: 1) to conserve and protect soil and watersheds; 2) to increase the availability of

forest products; and 3) to enhance the physical environment of human habitations. Reforestation programs have been undertaken to provide:

- o erosion control -- trees and shrubs to keep water and wind from carrying away rich topsoils that contain the nutrients that make the land fertile.
- o production of adequate supplies of specific products--wood for fuel and construction, fruit and nuts for food, fodder for livestock, etc.
- o protection--trees to provide shade for people and animals.

But reforestation is only one component of larger land management endeavors. Increasingly projects are being designed with the understanding that it is unrealistic to separate reforestation from overall revegetation and conservation programs. Range and farm management, sand stabilization, agroforestry, and other similar activities are undertaken--ideally--as interdependent parts of an integrated land use system.

The tree planting techniques covered in the first edition dealt mainly with the establishment of small woodlots and community forestry projects. These small, isolated stands of trees, usually planted on communally owned land, have only a minimal effect on the environment. In the almost ten years that have elapsed since then, the importance of thinking more broadly in terms of revegetation is now apparent. More projects are now aimed at encouraging farmers to plant trees on their own property, as well as on public land. Establishment of shrubs, bushes, grasses, and other ground cover, as well as trees, is needed on many sites that do not have sufficient vegetative protection. Recognizing the evolution of this understanding, a new chapter on Agroforestry and Soil Conservation reflects the broader range of activities that comprise reforestation methods.

The first edition of this manual was based on the collective experience of project planners, foresters, nursery workers, and local farmers and herders. Additional information on nursery operation and seedling production has been included in this edition, and sections have been added covering propagation from cuttings, harvesting methods, and special procedures for tree planting on difficult sites. Chapter 4, Soil Properties, has also been rewritten to be more practical for actual field conditions.

The book has also been reorganized to give the material a more logical flow. Chapter 2 presents the environmental and political framework of an agroforestry project, and lists key elements for success. Subsequent chapters progress through the various steps involved in the start-up of a reforestation program. Project design and other aspects of planning are covered in Chapter 3. Chapter 4 provides some background on soil properties that influence site and species selection, which are discussed further in Chapter 5. Chapter 6 gives more detailed information on nursery planning and preparation, and Chapter 7 outlines the steps involved in the organization of tree-planting activities. Chapter 8 describes various methods used in the design of

agroforestry and soil conservation systems, and Chapter 9 covers some additional special subjects.

The appendixes are also worthy of special note:

- o Appendix A--a directory of 165 tree species found in arid Africa. Synonyms and common names are given as available. Brief pictorial views of each tree--a leaf, flower, branch, etc.--are provided for most of the species. Where possible, information is given on the uses of the tree (not a comprehensive listing, but an indicator of the value of that tree for certain purposes).
- o Appendix B--an expanded look at 30 of the trees highlighted in Appendix A. Each of the trees is treated individually in an attempt to show the value of having comprehensive data sheets that can be used to guide field activities. For example, the sheet has spaces for listing relevant nursery data (such as time needed in the nursery bed or pot) and for noting planting criteria (such as the soil and water requirements of each tree). Hopefully, as reforestation efforts continue and more project data are recorded, these information sheets will become a more complete and important data bank.
- o Appendix C--maps and charts explaining climate and rainfall, soil, vegetation, and characteristics of sub-Saharan Africa.
- o Appendix D--a listing--expanded for this edition--of other information sources and of bibliographic material which those who require further information and assistance will find extremely valuable.

The manual assumes basic familiarity with reforestation terms and methods. For example, it takes for granted that the reader will be familiar with laterite soils and with the use of such forestry tools as climate maps and vegetation charts.

The text uses only one Latin name for each tree. However, some trees are known by two or more Latin names; these synonyms are given in Appendix A. More than one name per tree can result from any of several causes: a tree may have been "discovered" and named by several different people; disagreement may exist among the experts as to whether a certain tree is a species or a variety of a species; the difference may simply be in spelling because of phonetic dissimilarities among the languages of forestry people.

2 PROJECT FRAMEWORK

This chapter presents some guidelines or characteristics of forestry and conservation programs that must be taken into consideration early on in the planning process. Some decisions must be made as early as possible, in order for the next phase in the project planning process to follow smoothly. This chapter discusses some of the issues that require careful consideration at the outset of project initiation. At all stages of a project, members of the affected community should be drawn into the decision-making process. Community participation is particularly important in project initiation, especially in the identification of specific problems that need to be solved and the setting of resource management goals and objectives.

Each individual project will require much more detailed planning as well. Selecting suitable sites, determining the best trees to plant for a given purpose, and making sure that equipment and materials are available are preparations that require good coordination and organization from the beginning. All of these decisions, which are discussed in detail in subsequent chapters, must be made in the context of the political, social, and environmental considerations presented here.

Preliminary Considerations

Among the many variables that must be considered early on, good land management involves:

- o taking into account social and cultural issues;
- o using resources only on a sustained yield basis, that is, replacement of resources at the same rate that they are being used;
- o producing the highest possible net income obtainable for any given area through the best use of land as determined by the local community;
- o improving, developing, and conserving natural resources for the future;
and

- o recognizing that conservation and production are interdependent, and that in the long run, neither is possible without the other.

All programs to conserve or develop natural resources--land, water, soil, trees, and other vegetation--must keep these factors in mind.

Project Goals

The primary conservation concern may be protection of the soil from erosion and loss of fertility, protection of watersheds, protection of the natural vegetation and wildlife, or all of the above. Production oriented projects often give priority to increasing the amount of wood available for fuel or construction; however, many other tree products have value to rural populations. In determining the objectives of a project, production and conservation goals are not necessarily incompatible. Agroforestry approaches are now receiving widespread attention, because they allow land to be used for a variety of mutually beneficial purposes (see Chapter 8).

The first step in planning, then, is to determine what specific problems exist *that the community wants to solve*. Once a problem has been identified, it is then possible to discuss what the project's goals should be. It is important to plan realistically in determining the project goals, the time frame within which they are to be accomplished, and how they can be achieved within an overall resource management framework. Some questions that should be asked are:

- o What problems will the project address? How will the project help to solve these problems?
- o Does the project have a predominant objective--either protection or production? Are there multiple objectives?
- o What will the social effects of the project be? Is the project oriented towards communal efforts or individual farmers and households? How will it affect different people's lives and incomes?
- o If the project is a community or cooperative effort, how are its benefits and responsibilities to be distributed? Will some people benefit more than others?

Community Involvement

Early input from local people is crucial to success. Foresters and other conservation personnel should encourage community members to take part in all aspects of project design, planning, and implementation. This is not always easy, because there are usually local, national, and international concerns that may conflict. Nonetheless, a conservation project must be supported by the people living in the area or it will not work.

Although land and resource use is largely controlled by government agencies, most communities have had some experience in managing their own environment. Strong traditions often exist to regulate use of natural resources, as well as procedures for allocating these resources among members of the community. There may also be customs regarding individual or cooperative efforts on projects, decision making, and distribution of benefits. It is up to project planners to find out what approaches will be acceptable within the local traditions and community structures.

Local people are often the ones who are asked to give land for a project, provide labor, or participate in other ways. Usually a reforestation effort will have to be supported by people for several years before results can be seen. A project should not be started, therefore, before communities are ready to sustain the effort. To make this commitment, residents must believe that 1) the project will address problems that they have identified and consider to be high priority needs; 2) the project will affect their environment and lives positively; and 3) the results will be worth the effort.

Ideally the impetus for starting a reforestation project should come from within the community itself. Sometimes erosion and wood shortages may be recognized as growing problems, but the community may not actively initiate efforts to counteract the problem for various reasons. Other problems or shortages may seem more urgent, or there may be a widespread belief that the environment is beyond the resources or power of the community to change. Environmental problems are closely linked, however, with other problems that most concern rural people, such as those affecting agricultural production and health. There is a growing awareness within conservation circles of the importance of these linkages to rural development programs.

Project planners, therefore, often try to create interest in projects that will control wind and water erosion, and which will also result in increased food, forage, and wood production. In such cases project planning should always be in line with what people can and want to do. If the results of such projects are likely to take years to show, local residents may look for more immediate benefits, such as individual potted trees they can plant for shade or fruit. The project should make every effort to respond to this level of need by providing the requested trees. This will lead to increased community support for the project, making it easier to convince the community of the necessity of the project over the long term.

The Conservation Community

The conservation community includes everyone. Particularly when projects are being carried out locally, foresters and extension agents often must act as the intermediaries between the people involved at various levels. They must contact farmers individually, work through such traditional authorities as village chiefs and elders, and involve representatives of various local, district, and national

government bureaus and agencies. They must also work cooperatively with representatives of all sectors of the local economy to ensure maximum cooperation between technical representatives and those concerned with social programs.

There is a lot of informal instruction to be done in order to sell a forestry or resource management project and plan for smooth program operation. This "teaching," when done well, lays a good foundation for the entire effort, and the project has a much better chance of success. Often it is necessary to explain, bring together, and reconcile a number of interest groups, some of which have widely differing ideas about the same project. Such cooperation sometimes means filling an advisory role to a certain agency or undertaking responsibility for a special project. Of course, coordinating the groups and interests involved in a forestry project is all part of project planning; it requires patience, diplomacy, and skill to resolve the potential conflicts between local populations' need to utilize the available resources and the national agencies' mandate to protect them.

Natural Resource Policies

Among the first issues to consider in initiating a new project are national policies, the laws and regulations that govern natural resource use. In most African countries, concern for natural resource management has led to the establishment of certain areas for special purposes. These areas, called forest reserves, classified forests, wildlife preserves, parks, or special reserves, can be identified on large-scale government maps. The use of these public lands is regulated by government agencies through national legislation. In areas that have not been set aside in this manner, land use and tenure are frequently controlled by the government as well. Regulations can be complex, and vary a great deal from country to country, according to national laws and local customs. These laws can have far-reaching effects on the lives of rural inhabitants. For example:

- o The setting of bush fires to clear fields may be controlled, limited to certain times of the year, or prohibited altogether.
- o Permits may be required to harvest certain species of trees, even if they are growing on private property or were planted by the person who wishes to use them. Obtaining a permit often involves payment of a fee to the regulating agency.
- o Other tree species may be protected by law. Cutting, grazing, or any destructive use of these trees may be forbidden under any circumstances.
- o Forest service agents may often be responsible for the enforcement of these laws as well as for the collection of fees and fines. Rural residents may tend to regard the foresters as police, rather than as extension agents, conservationists, or natural resource managers.

Most countries have at least one agency that is responsible for developing, managing, and protecting natural resources. Revenues raised from permits and fines may be used to pay administrative and operating costs of these and other government agencies, often through a specially established "forestry fund."

Project planners must determine why the land is being used or not used for a particular purpose. They must become aware of the policies and regulations regarding resource and land use if they are considering any change in the current pattern. One cannot begin a tree-planting program without thoroughly assessing the given location in terms of all the natural resources and the current land use situation.

Present Land Uses

What is the land suited for now? What could the land produce if changes were made? Would the new use be better than the old? Local customs, soils, topography, vegetation, and water supply all must be studied before these questions can be answered fully. Rural inhabitants who will participate in a forestry project or be affected by it in any way should be involved in all aspects of land use planning. Procedures for making these decisions at the local level should be agreed upon at an early stage in the project planning process.

Because the issues regarding distribution of benefits and responsibilities become so complicated in community projects, it is sometimes more effective to work with individual farmers or households. The individual project sites may be smaller, but they can serve as demonstrations for other members of the community. This often has the effect of motivating others to join the project on an individual basis as well.

An important aspect to consider when evaluating a location is whether or not land can be used for growing crops that allow people to support themselves. Above all else, the people living in that area must get enough from the land to live. For each tree that is planted, a certain amount of land is taken out of production for other agricultural purposes. Because trees take a comparatively long time to mature and be harvested, it is difficult for many farmers to take the risk of committing their land to forestry for so long. As a result, even if a staple crop they grow is not as valuable by itself as a cash crop might be in market terms, the land may already be serving its most important function.

First priority always is and must be given to agricultural products that are needed for food or for market. It probably would not be the best use of the land to plant a woodlot on a site where rice or bananas can be grown, and where there is a good market for such crops. What might be called secondary subsistence needs must also be kept in mind. These are uses of the land and trees that fill other needs--wood for fuel; grass for thatch; fruits and plants for medicine and food; material for cordage, detergents, tanning, and dyes.

If the area is now filling one or several important purposes certain questions should be raised. Would land use be improved by a forestry or conservation

project? Which conservation efforts would improve land use? Where should they be located? What special efforts--such as firebreaks, planting field trees, terracing, or planting an orchard--would increase the value and usefulness of the land?

Are wind erosion controls, such as windbreaks, or water erosion controls needed around farm lands? Are there places that are not now being farmed where crops could grow if they were protected? Gentle side slopes may be a good place to grow some farm crops if the field can be protected against erosion. Careful observation and detailed study of the project area provide answers to such questions.

Once the project planners have completed an initial assessment of land and resource use, have carefully evaluated the local situation in terms of needs and problems, and have agreed upon the project goals, it is necessary to begin a more detailed planning process: the project design.

Key Elements for Project Success

The following is a checklist of keys to successful forestry projects. These are particularly important to keep in mind during the planning stages. Some of these topics have already been mentioned in this chapter, while others are discussed in more detail elsewhere in the text.

- o **Start small.** Initial project efforts should be kept to a modest scale. If they are successful it will be easy to expand them later on.
- o **Encourage existing conservation activities.** Village level nurseries, woodlots, windbreaks, and other erosion control measures may already exist in the area. Concentrate efforts on improving and extending technologies that are already in place, rather than introducing new ones.
- o **Individual vs. communal activities** Projects that can be implemented only through communal efforts may not take into account the most effective means for extending reforestation efforts. Project planners should consider working with individuals on their own property as well.
- o **Local participation.** Rural inhabitants have a wealth of knowledge about their environment that they can contribute to project planning. Their participation is necessary to encourage that local needs and expectations are met.
- o **Soil and water studies.** It is vital to obtain all available data on soil and water quality. If possible, samples should be analyzed by a qualified laboratory. This should take place early so that the information can be used in species and site selection.

- o **Species selection.** Indigenous species should be considered as well as exotics. If possible, use a mixture of several species.
- o **Seed sources.** Select species and identify seed sources early. If seed is to be obtained locally it will be necessary to locate good quality parent trees and train seed collectors. The genetic quality of the planting stock can make the difference between success and failure.
- o **Land use.** The productivity of farming systems should be maximized through integration of conflicting land uses (agriculture, forestry, livestock).
- o **Protection.** Many planted trees die due to a lack of protection from pests, livestock, fire, and other threats. Prepare a protection package to deal with these problems.
- o **Benefits.** An equitable distribution of benefits will ensure continued interest in the project.
- o **Evaluation plan.** Once project goals have been decided, a set of criteria for ongoing project monitoring and future project evaluation will help ensure that goals are reached.

3 PROJECT DESIGN

Once the long-range goals of a project have been determined, community participation established, and alternative land uses carefully evaluated, the way in which the project will be implemented must be decided. The project design involves detailed technical planning and other considerations that must be integrated into the overall forestry or agroforestry project. One of the most complex aspects of project design is the choice of sites for reforestation efforts, and the matching of appropriate species to the site conditions. Because these decisions are so important, they are discussed in separate chapters. Chapter 4 provides an introduction to site evaluation in terms of soil properties and their influence on plant growth. Chapter 5 deals with the effect of other environmental factors on site and species selection, as well as considerations such as project purpose, human preferences, and legal constraints.

Other issues in project design involve options for regeneration of plantations or natural forests, seasonal considerations, water availability, site use planning, and protection of the growing stock. Project planning also includes preparations to direct activities and work effectively with crew members. In addition a successful project requires accurate record keeping. These issues and their implications for project design are discussed below.

Regeneration Options

One of the first steps in designing a forestry or conservation project is to examine various regeneration options. The key decision at this point is whether it is necessary to establish a nursery for selected species or whether revegetation can be accomplished in some other way. Some alternatives to raising seedlings in a nursery and transplanting them at the project include: direct seeding of the area, planting cuttings directly on the site, or simply protecting the area and leaving it alone so that it can regenerate naturally.

Most current reforestation efforts in dry lands use a nursery to produce seedlings, because these other methods are not considered feasible for one reason or another. Establishing and maintaining a sizable nursery can be expensive, however, and it may be worthwhile to try some of these alternative

techniques on an experimental basis to determine if they are practical. The principal consideration at this point is the type of reforestation or revegetation effort needed.

Natural Regeneration

Areas selected for reforestation are often marginal lands, unusable for intensive agriculture because of soil quality, topography, lack of water, or other factors. However, some trees will grow almost anywhere. If no examples of an indigenous species can be found on a site where it should be possible for it to grow, the forester tries to find out what is preventing it from occurring there.

Very often the major reason is a lack of seeds in that particular area. If there are no adult trees nearby producing seeds that can be carried by natural methods (for example by wind or water, or by animals depositing the seeds on the ground in their manure), the seeds will be scarce. Even if seeds are available, they may be unable to germinate or the newly sprouted seedlings may not survive, because of overgrazing, fires, or blowing sand in the area. If site conditions continue to deteriorate, the species will become even more sparsely distributed because new vegetation cannot become established.

Before any natural revegetation project can be undertaken, it is necessary to make sure that the factors preventing a species from growing on the site are not still present, or that they can be overcome in the course of the project. Nature can heal a barren area if given enough time, but in most cases, natural regeneration cannot occur unless special efforts are made to help it along. Such efforts might include fencing the area, protecting it from over-grazing, and setting up good local cooperation so that the residents realize the importance of leaving the area alone. Sometimes a certain area can be helped best simply by making arrangements to ensure that the area is left undisturbed for a number of years.

Direct Seeding

If the species chosen for planting in a given area responds well to direct seeding, this method is certainly worth trying. Obviously, it is cheaper to sow seeds directly on the planting site than it is to establish a nursery, maintain the seedlings for several months, and then transfer the young trees to the planting site. It is even possible to direct seed by feeding pods of certain trees to cattle or sheep that graze on the land. They deposit their manure, containing the seeds, on the ground, and sometimes this method achieves a high germination rate.

Some direct seeding results have been good in areas with rainfall as low as 700mm, but there is still much to be learned about direct seeding techniques on dry sites. One of the reasons this method has not been used more often in the past has undoubtedly been the scarcity of seeds. Direct seeding requires relatively large quantities of seed.

Good results from direct seeding have been obtained in sub-Saharan Africa with *Borassus aethiopum* and *Anacardium occidentale*. *Acacia albida* seeds have been sown in clumps in fenced-in areas and have started to grow. Good regeneration has also been obtained with seeds scattered in bushy areas where the young trees were at least partially protected by thorny branches and twigs.

Some trees simply cannot be grown using direct seeding techniques. One of the major constraints in dry areas is the irregularity of rainfall patterns. After a few rains have fallen, it is not uncommon for a dry spell to occur. When this happens, newly sprouted seedlings rarely survive. While the water supply of seedlings can be easily controlled in a nursery, it is usually impractical to water direct seeded plants in the field. Nursery raised seedlings are better able to withstand drought, because their root systems are more developed.

Cuttings

It is sometimes possible to take cuttings of trees and transfer them directly to a planting site. Successfully propagated cuttings sprout new roots and leaves, and develop into genetically identical replicas of the parent tree. *Commiphora africana* and several *Euphorbia* species are possible choices for this method of revegetation. However, use of cuttings is still only experimental on dry sites. This method has the advantage of being low-cost, because little is needed in the way of equipment, and cuttings are easy to transport. As with direct seeding, however, even brief dry spells can cause heavy losses if they occur before the cutting has established an adequate root system. A section on Propagation from Cuttings is included in chapter 9, Special Subjects. This section describes procedures for seedling production in the nursery, or direct on-site revegetation using cuttings.

Nursery Production

Although seedlings raised in a nursery may go through a short period of transplant shock, they already have well developed root systems when they are placed in the field. By the end of the first growing season, their roots should extend to deeper sources of soil moisture, enabling them to survive long periods of drought. An analysis of the regeneration options described above may indicate, therefore, that the best method for seedling production is a nursery.

If so, there are a number of decisions and plans to make before beginning. Is the nursery to be permanent or temporary? In other words, is there a need for one that can continue to supply trees even after the completion of a project? Is a large, centralized nursery needed, or would small, village-based nurseries be better? Moreover, the nursery should be designed to meet the specific requirements for the type of reforestation activities that are envisioned.

Other details regarding the nursery should be considered during the project design process. What type of soil does the nursery site have? Will fertilizers be needed? Should seeds be planted in plastic pots or other containers (clay jars,

leaves, cardboard, etc.) or directly into seedbeds (open-rooted)? These decisions depend in part on the species to be grown, the size seedlings that are needed, the amount of nursery space available, and the costs involved.

Obtaining seeds is often a major problem, and the question of seed supply should be addressed early in the planning process. Seeds must be ordered or collected locally, and they must be treated and prepared. What is the time-frame for the project? How long will it take to set up the nursery? When should seeds be planted? When is the best time to transplant? Is there an adequate water supply? Is the land cleared? Does a fence have to be built? Each of these important points is discussed in further detail in Chapter 6.

Water Supply

Water supply and costs are critical to nursery planning and operation. Much money and time could have been saved in some nurseries if the first year had been used only to test and observe the water supply and perhaps raise a few thousand trees on a trial basis. While this kind of testing may not be possible, one cannot be too careful when it comes to the subject of water supply. All too often what looks like a good water source turns into a dry, or nearly dry, hole just at the time the water is needed most. This is when the trees in the nursery are requiring the most water for growth, or when temperatures are highest, and the plants are losing more water through transpiration and evaporation.

Water Quantity

It is essential to be completely realistic about water supply, the project's need for water, and the costs involved. A method for calculating daily water requirements for the nursery is given in Chapter 6. It is important not to underestimate any of these factors. In sub-Saharan Africa it is usually not possible to get a steady water supply without 1) lifting the water from deep under the ground (as in a deep well), or 2) carrying it considerable distances from the source to the nursery. Both of these methods are expensive.

If the project has access to a deep well with a steady supply of water, it makes sense to include the cost of a pump in the project budget. While it is possible to handlift a few hundred liters of water a day from a deep, open well, pumps are necessary when quantities as much as 400 liters, twice a day, are called for. Large projects that use a well for a water source cannot rely on that well if it does not have an adequate water lifting or pumping system. These systems ensure that sufficient water is available at all times with the least possible effort. It is worth taking extra time and effort to plan a well and water-lifting system carefully.

Water Quality

Many water sources, whether they are wells or surface depressions, contain considerable amounts of salt. In fact, in some areas along coastlines, a well may contain mostly salt water with only a thin layer of fresh water floating on the surface. Even water that may not contain much salt originally can collect salt as it flows over the ground; salt remains after the water evaporates. Sometimes salt concentrations are so heavy that trees cannot be grown in the area.

Some trees and crops can stand more salt than others. Salt tolerance (the amount of salt a plant can take and still survive) of farm crops has been studied, and information is available for selecting crops that can live in water containing some salt. Unfortunately, however, relatively little is known about how much salt trees can absorb and still grow well. It does seem, however, that *Casuarina equisetifolia* (Australian pine), *Conocarpus lancifolius*, *Phoenix dactylifera* (date palm), and *Tamarix* spp. (Tamarisk) are all rather salt tolerant. As a general rule, however, water containing more than 550 parts per million of dissolved salt seems unfit for nursery use.

Sometimes there is no way to keep from using water that contains some salt. In a borderline situation--where it seems the trees might be able to live even if the water has some salt in it--the usual practice is to "over-irrigate." Over-irrigation is accomplished by putting on too much water so that any damaging substances in the water are likely to be washed down or leached and are less likely to build up and remain on the surface of the nursery beds. See Chapter 4 for a further discussion of salinity problems.

Water Sources

Ground Water and Wells

Water in the ground can be reached by constructing various types of wells using methods that have been studied extensively in Africa, for example, by local governments, international organizations, consultants, and engineering firms. Most nurseries use wells as their principal source of water.

Traditional wells in Africa are dug by hand. This is practical where the water under the earth's surface is only a few meters below ground level. In such cases, well construction is relatively easy and little more than a simple hole is needed. When the ground water is below 10-15 meters, well-digging becomes somewhat more complex, but still can be accomplished by hand-digging methods at reasonable costs.

In other areas, deeper wells are necessary, which require even more complicated construction procedures. In some places, it is necessary to dig 100 meters before reaching aquifers (water-bearing layers of the earth). And even when water is reached, the well may not give enough water to make the effort worthwhile.

One point cannot be stressed enough: when wells are dug, they must penetrate the water-bearing layers as deeply as possible so that the well will continue giving water even during the dry season when the water table in the aquifer drops. Failure to plan adequately in terms of any of these factors can lead to trouble for the project.

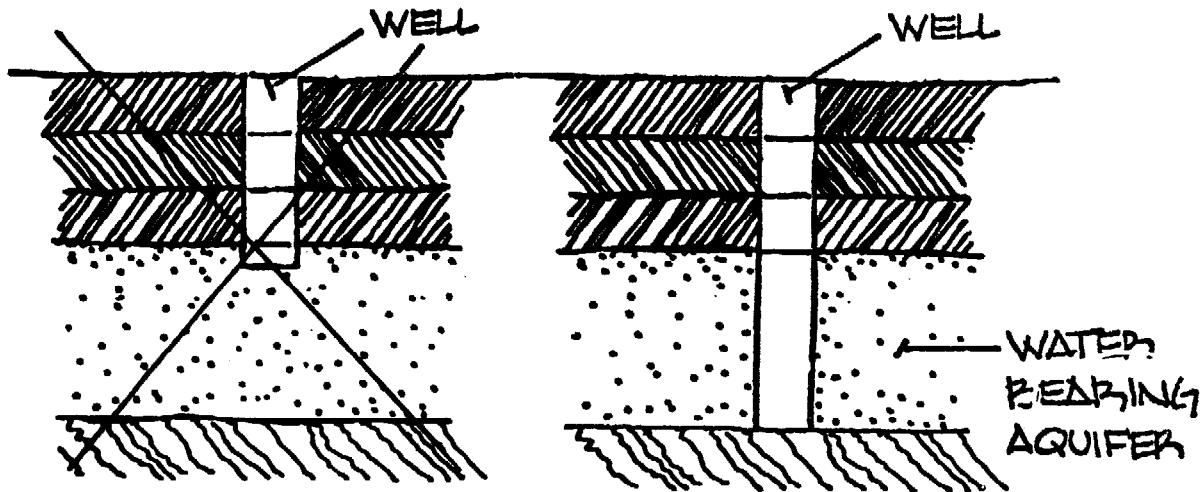

This well does not penetrate the aquifer completely, therefore, not enough water will be available during the dry season.

This well penetrates the aquifer and will give sufficient water during the dry season.

Surface Water Development

Reforestation programs in semi-arid regions can also benefit from surface water development. Catching the rainwater and storing it for later use is possible, and several methods involving micro-catchments and ridge construction are described in Chapter 7. However, using available water resources such as rivers, lakes, and streams is often difficult for a number of reasons.

In many dry areas of Africa, for example, the terrain is flat and the soils are often sandy. Even when water is available, the soil cannot hold it well enough to support vegetation. In places where running streams occur, the surrounding land is often so flat that there is not enough slope to make an effective diversion channel. Under these circumstances, gravity feed systems cannot carry the water effectively from the source to the nursery or plant site.

The typical flatness of the topography in many dry areas causes water to pool in large shallow depressions or basins. This water is difficult to use because it:

- o usually evaporates before it is needed most;

- o frequently contains large amounts of silt;
- o has to be lifted and transported to be used.

There are successful techniques for surface water development, although most methods require substantial investments of money, labor, tools, equipment, and maintenance. Some techniques involve reducing evaporation from water surfaces, reducing infiltration losses, and reusing water. These all are described in various texts listed in the bibliography at the end of this handbook.

Seasonal Considerations

Planting Schedule

The timing and duration of the rainy season are the principal factors that determine a reforestation project's planting schedule. In areas where there is one long dry season and a short rainy season, the period during which seedlings can be successfully established is fairly short. Some parts of the tropics have what is called a bi-modal rainy season. In these regions two separate rainy seasons occur each year, one usually longer than the other, alternating with several months of dry season.

Where bi-modal rains occur, it is possible to plan two planting seasons per year. During the longer rains, efforts are concentrated on the initial plantation establishment. Replacement planting is planned to take place during the short rainy season, to replace any seedlings that did not survive the initial planting. When there is only one rainy season per year, replacement planting usually has to wait until the year following the initial plantation.

Other seasonal changes also affect the nursery schedule. Seeds for different species mature and must be collected at different times of the year. Some species must be sown earlier than others so the trees will be large enough for transplanting at the beginning of the rainy season. These considerations are discussed in Chapter 6 and additional information is given for some species in Appendix B.

Labor Availability

In planning a project it is crucial to find out what other activities will be going on during the period you have scheduled for planting. The beginning of the rainy season is a very important time for farmers as well as foresters. For most of the rural population, planting and cultivation of crops will take precedence over any other activity during this period. If local labor will be needed to plant trees, there are some possible solutions to this potential conflict in the planting schedule. Alternatives should always be discussed well in advance with everyone involved to prevent misunderstandings. The following are some alternatives to consider:

- o Find out when farmers will be busiest. Sometimes there is a lull in farming activities during the first few weeks after the rains, when the crops have been sown, but weeding has not yet begun. It may be possible to plan on planting trees during this period.
- o In some projects most of the ground preparation is done before the rainy season begins. This involves digging the holes and doing any other micro-site improvements that are necessary such as individual water catchments, or ridge construction. This advance preparation reduces the actual planting time required after the rains begin. Pre-digging the holes may not be advisable on some dry sites however (see chapter 7 for more information).
- o If seedlings are produced in a centralized nursery, they can be lifted out early and transported to the planting site in advance. They should be kept in a temporary nursery until time for planting. Having the seedlings already at the site can save time, but this is only practical if they can be watered while there. This plan is particularly advantageous in areas where the roads become impassable during the rainy season.
- o Many villages have a traditional practice of setting aside one day a week for community projects, even during the rainy season. These community activity days can be used to support a wide variety of reforestation and conservation efforts.

Site Use Planning

Once it has been decided that a site is available for use as part of a reforestation effort, it is time to plan for the fullest use of the site. In other words, the area should be utilized as completely as possible. Incorporating other land uses, such as traditional or improved grazing or intensified agricultural practices (e.g., rotation from peanuts to cereal crops to fallow), must be taken into account during the planning process. This is particularly important if the site is located near relatively high density population centers.

Whenever possible, sites are chosen so that local residents receive some immediate benefits while the trees are growing, and so that the land is being put to optimal use. Some of the land uses that increase benefits during revegetation efforts are intercropping, grass cutting by hand, collection and gathering of forest products, and controlled grazing. These subjects are discussed briefly below and in more detail in Chapter 8, Agroforestry and Soil Conservation.

Intercropping

Intercropping is the practice of planting and growing agricultural crops between the rows of planted trees and shrubs. If left uncultivated, the area between the trees would soon be covered with grass and other vegetation.

This vegetation would compete with the seedlings for water, nutrients, and sunlight.

It has been found, however, that competition for growing space is not as severe when crops such as peanuts and beans are grown between the trees and the area is kept free from weeds.

At the few places where intercropping has been tried in the drier zones (500-700mm annual rainfall), excellent results have been obtained for the trees and the farmers. Even where results were poorer, intercropping may still be cheaper than hand-weeding grasses. This is especially true during the rains, when labor is short, because everyone is busy raising crops. Machine weeding and cultivation are expensive, particularly when maintenance and depreciation of the machines are included in the cost.

Successful intercropping benefits trees, crops, and farmers alike. It requires that farmers be aware of the special restrictions and conditions necessary for good plant growth. For example, the spacing of individual crops in relation to the young trees must provide enough room for both to grow without depriving either of sufficient water, light, or nutrients. Young trees that are hard to distinguish from other plants (such as *Acacia albida* or *Gmelina arborea*) can be marked with colored stakes or tape.

Of course, the choice of crop makes a big difference as to the success or failure of intercropping. Peanuts, cowpeas, and other legumes have worked well, but millet, sorghum, and corn have affected some trees badly. The decision about which crops to raise as part of an intercropping program must be based on information about the crops, the nature of the site, and the type of tree that will be planted there.

It is particularly useful to grow crops in firebreaks. These are spaces left between blocks of trees or other vegetation so that fires which may break out can be stopped before they burn down an entire plantation or nursery. Firebreaks in tree plantations are often quite wide, thus giving a lot of space for growing crops. For them to be effective, it is very important that they be kept free of weeds: planting and cultivating crops such as peanuts serves this purpose. When the area is completely cleaned after harvest, a relatively trouble-free firebreak is created that lasts until the next growing season. Of course, the need for a complete cleaning of the area after each harvest must be stressed and enforced.

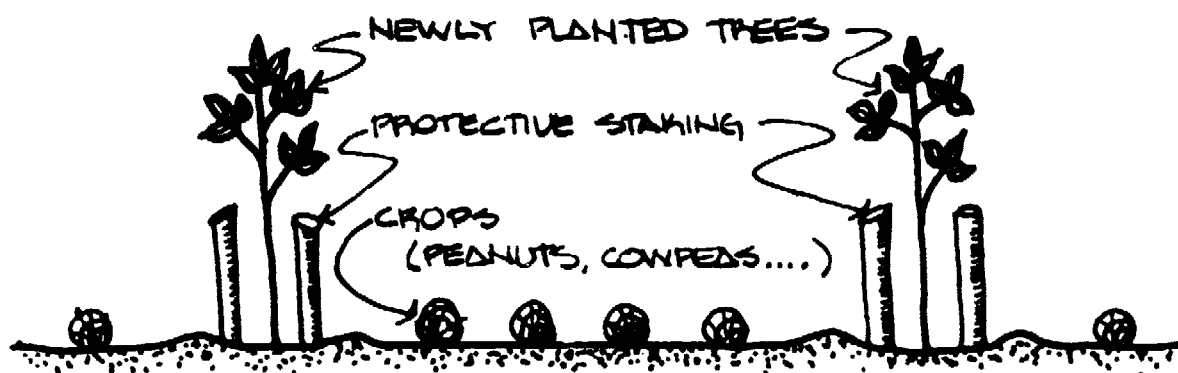

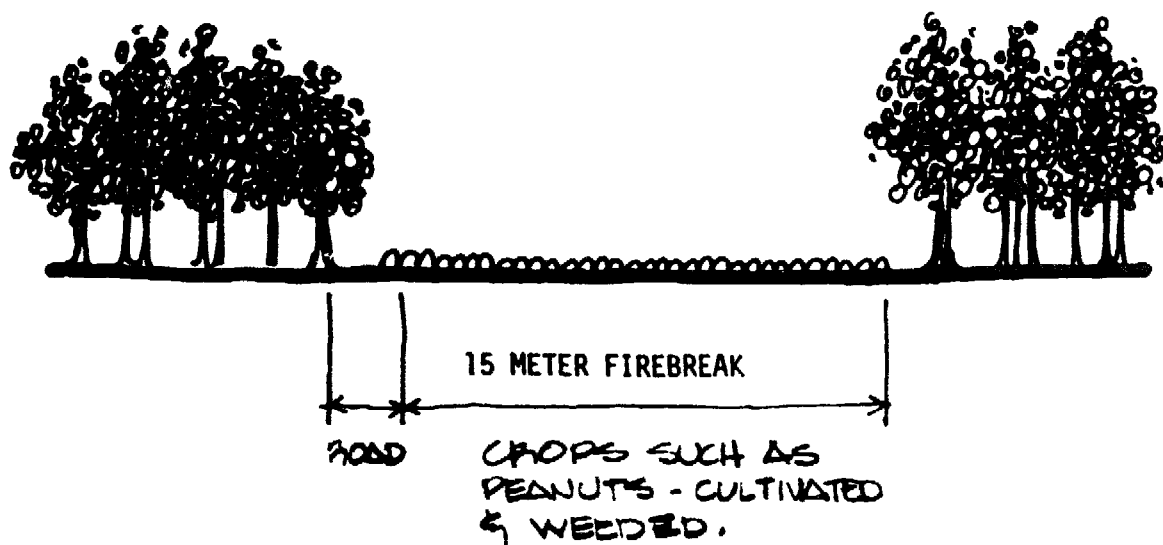

Cutting and Gathering

Strictly controlled cutting of grass for fodder, thatch, or mats may be feasible. Forest products such as leaves, nuts, fruits, gums, or resins may also be collected. These commodities often have an important place in the local economy which should not be overlooked, especially because they may be a significant source of income for rural women.

As a communally owned area becomes more and more attractive to individuals, it becomes increasingly important to be sure that any use of the land, even cutting grass for animal feed, is controlled by an authority that everyone recognizes. It may be necessary to charge a fee for such uses of the land. Land use fees will probably not bring in a lot of money, but they are important for laying a good and fair framework for the future of the area. Usually a national conservation agency is responsible for resource use and establishes limits for all cutting, grazing, or farming allowed on the land. Receipts can and should be used to sustain project efforts.

Grazing

Good land use projects may include introduction (planting, seeding, or natural) of vegetation that can be used for grazing in or near the same area where trees are planted. This kind of overall revegetation effort illustrates the fact that the divisions between forestry and range management programs are becoming less rigid than they once were.

Grazing is possible within the tree planting site as long as certain conditions are kept in mind:

- o The number and kind of animals, as well as the length of grazing time, must be controlled.
- o Grazing is not permitted until the trees are tall and strong enough to escape damage done to their foliage and bark by animals. A goat, for example, can stand on its hind legs and reach up to two meters. Donkeys also stand on their hind legs to reach leaves.
- o Grazing cannot be allowed to continue in one spot for too long. If grazing does continue there is a danger that the soil will become so compacted that air and water can penetrate the soil only with great difficulty.

If grazing can be controlled, the combination of forestry and range management programs can lead to good land use projects. Livestock will contribute to nutrient cycling, increasing soil productivity for both the grasses and the trees.

Protection

Whether in a nursery or planting site, trees have practically no chance to survive without protection from animals. Two possibilities exist to protect the trees: hiring people to keep animals or indiscriminate human users out of the area, or putting up fences. Some combination of both methods may be most effective.

Surveillance

This approach calls for protecting the trees by having people watch over the area to keep animals and other unwanted visitors from disturbing the trees. Surveillance may be possible and practical at one site, but not at another. Two of the factors that must be considered with respect to this method are 1) whether people are available who can and want to do the job, and 2) how much it would cost to have them do it. Experience shows that it is too much to ask villages or individuals to bear the burden of watching a planting site without some form of compensation. If the people protecting the site receive a return for their services, they are more likely to do the job well. Providing free seedlings may be a way to create additional incentives for the job.

Fencing

There are two important considerations in the use of fences in a project: custom or habit, and cost. A fence should be arranged so it requires the fewest possible changes in land use patterns. Fences can be social as well as physical barriers. If residents of the area are used to letting nomads graze their herds inside harvested fields, this practice must be considered before those same fields are fenced. Such grazing serves economic and social needs, as well as helping fertilize the land through the manure that is deposited. In order to take customs into account, it may be necessary to plan a different kind of fence, place it

differently, or even change the layout of the site before the land use problem can be solved satisfactorily.

No matter what type of fence is to be built, there are going to be materials, construction, and maintenance costs. The most expensive fences are those built to protect individual trees, although there are situations that justify such fences--as when establishing individual shade trees in fields, along roads, or in market places. The least expensive fences cover large blocks of land, for example, 50-100 hectares. Actual protection costs per tree are estimated for different materials, sites, and areas--from individual trees to areas of over 100 hectares.

It simply is not possible to generalize that a particular plot size is the most effective unit from either an economic or social point of view. It is a good thing to remember, however, that the larger the block of land, the more likely there is to be a problem with regulating its use. The two most important considerations in fencing operate in direct conflict with each other: the method requiring the fewest changes in land use patterns is the most expensive (fencing individual trees); the cheapest method of protection (fencing larger pieces of land) may require the most change in traditional habits.

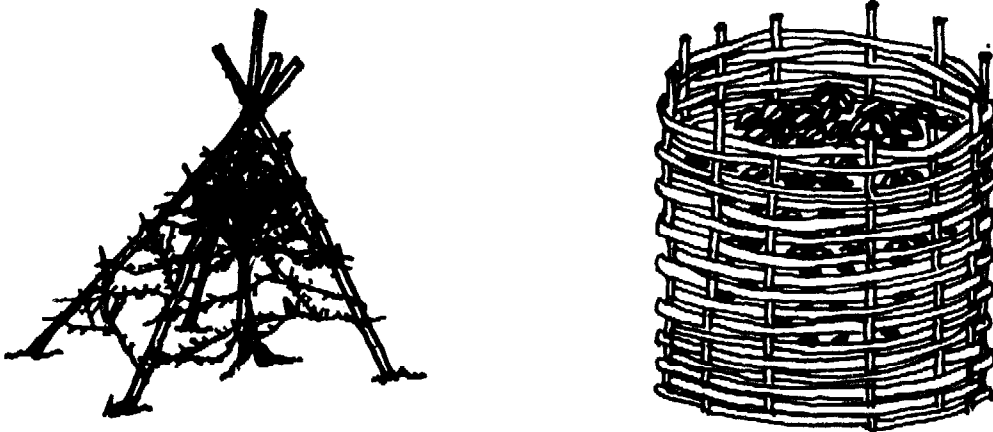

Individual Tree Protection

Maintenance must be included in the budgeted costs of a fence. Bitter experience shows that money spent on building expensive, strong fences is wasted if they are not kept repaired. Otherwise the fences become useless or disappear entirely long before the trees are ready to stand without protection. The fence around the nursery or permanent site can be constructed to demonstrate several kinds of fences and fencing material. It should be tight and sturdy, and the gates easy to open and close.

Fences may be built from imported or local materials or a combination of both. There are advantages and disadvantages to each of these approaches. Whatever materials are used, the fence should be designed to fit the needs of the project. For example, if grazing animals are cattle only, a four-stranded barbed wire fence is sufficient. This fence will not keep out goats and sheep, however. If there are goats and sheep in the area, either a different type fence must be built or the barbed wire fence must be improved.

Imported Materials

In many countries of arid Africa items such as metal posts, barbed wire, or wire mesh may have to be imported. Their major disadvantage is their extremely high cost. Salvaged materials, such as steel banding used for crating, are sometimes available, and, if used well, will produce sturdy, durable fences.

Traditional materials

Traditional materials for fencing include:

- o local woods for posts;
- o sticks and thorny branches from brush and bushes;
- o woven mats of bamboo or palm leaves;
- o stalks of millet or sorghum
- o banco (earthen) blocks

Fence posts are made from those local woods that are most resistant to rot and insect damage. *Borassus aethiopum*, for instance, is relatively resistant to termite damage. *Hyphaene thebaica* can be substituted, although it does not last as long and is much harder to split for posts.

It is possible to prune large branches from some species without killing the tree. *Azadirachta indica* responds particularly well to this method of harvesting. The tree will sprout new branches that can in turn be removed. This practice is called pollarding, and is often used to cut fence posts or firewood when it is not desirable to remove an entire tree.

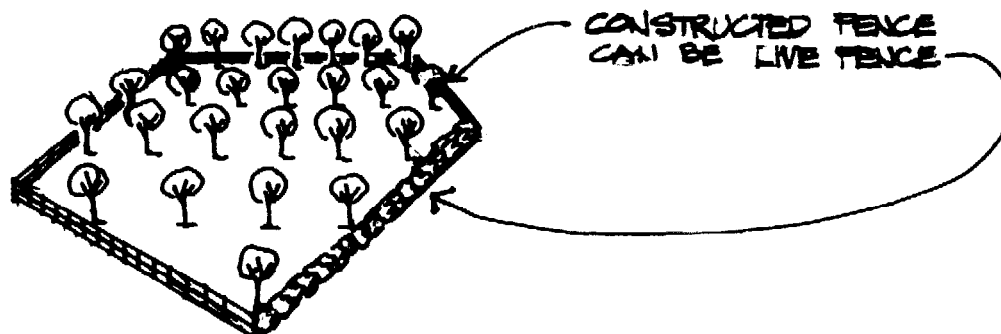

Combination live and constructed fence.

Most posts should be treated with insecticide before they are used. *Azadirachta indica* branches can be used, once they have been given the barrel treatment with an insecticide (as shown on the following page) to increase their resistance to termites. Limbs and branches should be at least about 10cm in diameter and about 2m long. The largest ones are used for corners, gateposts, and line braces.

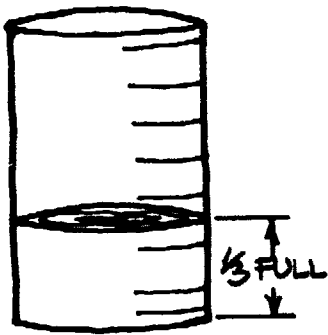

Fill 200 liter drum 1/3 full of insecticide solution

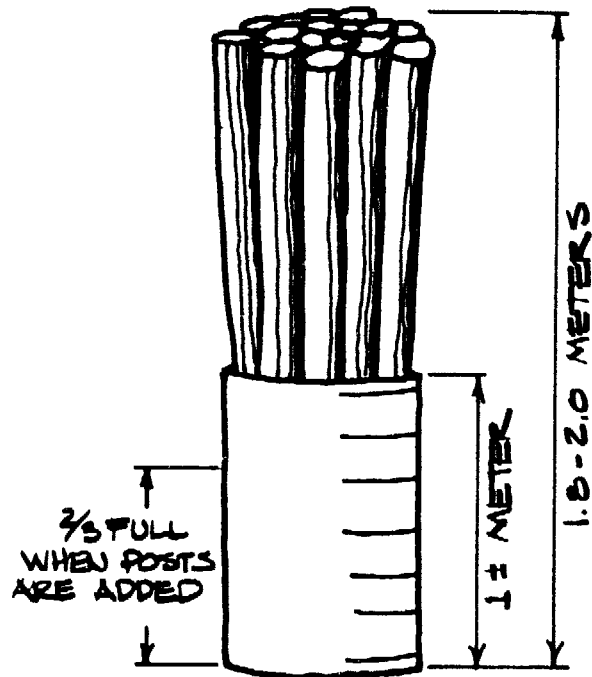

Set posts into drum and soak for 4 hours minimum

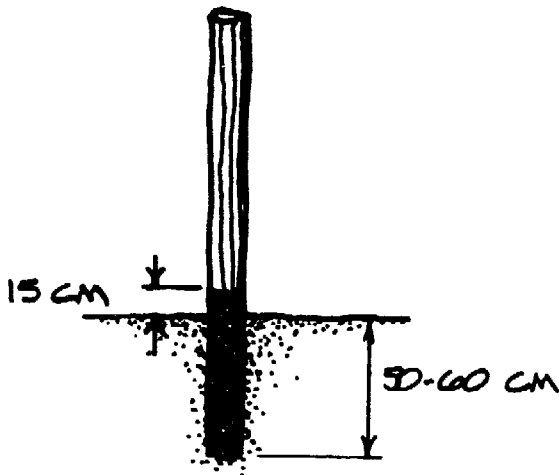

Posts should be immersed in solution to a level at least 15cm above anticipated ground line.

Treating Posts with Insecticide before Use

Any sort of thorny or sharp branch is useful and can be woven into fence wires. For example, although stems from palm trees cannot be used for fence posts, they make ideal staywires or pickets, because they are strong and durable, and some of them have sharp barbs.

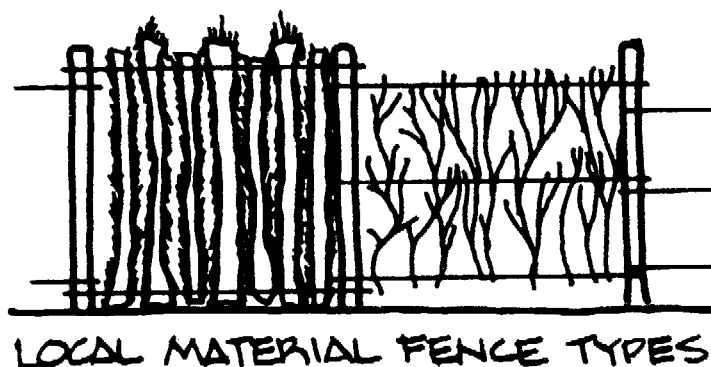

*Posts: Borassus aethiopum or
Down palm, Comiphora spp.
(treated)*

*Railing: Branches, sticks, Down
"lath"*

*Filler: Thorn limbs, millet
stalks (temporary),
palm-leaf stems*

LOCAL MATERIAL FENCE TYPES

More information on wire fencing is given in Chapter 9 Special Subjects. An alternative approach to building a fence though is to plant a live fence.

Live Fencing

Live fences are thickets or hedges that are planted to protect small areas like gardens or orchards. These fences are established entirely by growth of certain species rather than by constructions of wood and wire. The establishment of live fences is one of the agroforestry techniques discussed in greater detail in Chapter 8. Live fencing possibilities are interesting to foresters and conservationists, but there are practical problems that have not yet been solved.

In spite of extensive efforts to raise and transplant live fencing in a short period, no practical and rapid methods have been found. The fences, of course, are necessary from the beginning of the reforestation project, and one cannot wait ten years for them to grow. One practical solution may be to construct temporary fencing in front of the live fence while the latter is grown to an effective size. Then when the live fence is large enough, the other materials (posts, wires, etc.) can be moved to another site and reused.

Combined Protection

In most areas it is a good idea to use a combination of fencing and surveillance. Often fencing materials themselves are attractive for a number of other uses and may disappear unless the area is under regular surveillance.

There does not seem to be any one method of protection that is clearly the best. The decision must be based on such factors as local customs, willingness and ability of community residents to contribute to the protection of the trees, cost per tree, and effectiveness of the methods.

When possible, foresters often try several protection methods in one project. Then it becomes easy to see when one is working better than another. It is

sometimes the case that a method that did not work at one site is successful at another because of differences in the factors mentioned above.

Personnel Management

Dependable, well-trained work crews are essential to the success of a forestry project. Crew members should understand conservation and reforestation concepts, and should be trained to work independently to be most effective. Start training relatively early with small groups so that activities can be thoroughly explained and shown in detail. People who have more experience, and who are willing and able to accept responsibility, are natural candidates for leadership positions. As these people are identified, they can be given extra training and prepared to become supervisors or crew chiefs.

Having good crew chiefs means that during times of maximum effort, the routine work will be carried out competently and automatically. Project managers will have more time for dealing with urgent, special problems as they arise.

Project managers should teach by demonstration, as well as through discussion. During this teaching process, there will be an opportunity to watch different people and see how they master techniques. The manager will get a good idea of those who are the most capable. Activities and jobs may have to be explained more than once, but explanations must be done positively in order to provide encouragement and to build enthusiasm and support for the project.

High quality work and proper tool use and maintenance are far more important to the effort than is speed. The most effective means of teaching this is to provide the crew with a good model. If the project manager makes a point of maintaining the equipment by cleaning it and putting it away properly, the lesson will be effectively taught. Everything a project manager does, whether the crew members are watching or not, should be consistent with the techniques and values encouraged in the other personnel.

Project managers who are on time, plan well, and do what they say they are going to do will have more support and better projects. People enjoy working with someone who is in control of a situation and knows what to do. The ability to self-analyze and the willingness to accept suggestions from crew members are indicators of a good project manager.

All of these personnel development activities should be started well in advance. The goal is to establish a team of people used to working together, so that when the actual work arrives, each knows what to do without being told. The crew chiefs will work without being supervised all the time. Staff briefing sessions provide both information and encouragement, and can help to prevent problems and misunderstandings from arising.

Project Record Keeping

Record keeping procedures should be set up during the project planning phase. In addition to helping the project managers keep the project on track, accurate detailed nursery records make the project a valuable resource to others--whether the result was a success or failure. Some project managers find that keeping a diary is a good way to record important facts. Information that relates to the amount of labor and time spent on nursery activities goes into the diary. The project manager records what is done, by whom, and how many hours were spent by each person on which activity. This information can then be used to 1) fill out time sheets for payroll records; 2) calculate how many work-hours it took to build 100m of fence or to stack 1,000 pots; and 3) make cost and time estimates for future projects.

Other important data relate to the technical details of the project. For example: how were the seeds collected and pre-treated? When were the seeds planted? How many were planted in each bed or pot? How many of the seeds germinated and how long after they were planted? How much water did the seedlings receive? Were they treated with insecticides or any other chemicals? Appendix B is a start at gathering in one place relevant nursery and planting data for certain African species. This kind of information greatly facilitates planning of future projects.

Every funder or sponsoring agency wants to know how its projects are doing. Field personnel should be prepared to keep the following records, in addition to the diary mentioned above:

A Monthly Report should include:

- o A summary of the activities of the previous month, based on the more detailed accounts in the diary;
- o A basic plan of activities for the coming month;
- o A brief explanation whenever actual activities differ from those that had been planned for the month.

Such comparisons and explanations enable both the project manager and the sponsoring agency to understand and support the project better, and thus lead to fewer problems arising from lack of communication.

Special Project Reports, if necessary, such as separate reports of special project activities, can be prepared using material from the diary and monthly report.

Technical Notes are notes made of conclusions and specific observations. This kind of information can be sent to the funding agency, evaluated, and, where appropriate, incorporated into new projects and training programs.

4 SOIL PROPERTIES

Before selecting a project site, it is necessary to evaluate soil conditions as thoroughly as possible. The extent to which soil properties can be measured will depend on the availability of equipment in the field or access to laboratory facilities elsewhere. This chapter deals with on-site assessment of certain soil characteristics and their effects on plant growth, for use in situations where a complete soil analysis is unobtainable.

The chemical properties of soil layers near the surface, especially the amount of available nutrients, are not as important to trees and shrubs as they are to agricultural crops. Tree roots, particularly in arid areas, go much deeper and can extend laterally farther than those of crop plants. Therefore they can reach nutrients and water that plants with smaller root systems cannot. How well this takes place depends on *physical* soil properties rather than *chemical* ones. Without adequate soil moisture even an abundant supply of nutrients will be useless to the plant, unless sufficient water is available to act as a carrier for them.

The major soil characteristics that influence growth and health of trees and shrubs on arid sites are:

- o soil texture
- o water holding capacity
- o soil reaction (pH)
- o soil depth

Other factors can be important too, especially for younger, smaller trees. The organic content of the soil layers in the area of the root zones influences the physical properties of the soil as well as the pH and the availability of nutrients. Soils with a high organic content are better able to store rainwater that has filtered down to the areas where roots can absorb it. Another important factor is soil salinity, especially on very dry sites where runoff accumulates or groundwater tables are high.

Soil Texture

Certain soil types are best for trees and shrubs because of their texture. In analyzing soil texture, what counts is the relative proportion of the various sizes of soil particles (the individual grains of soil). Apart from gravel or pebbles, soil is made up of sand, silt, and/or clay particles. Soil particle classifications are shown in the box.

Soils with a high capacity for holding moisture that plants can absorb have a texture consisting of a blend of coarse and fine particles. Some tree and shrub species like *Acacia raddiana* and *A. senegal* grow well in loose, light, sandy soils. Others, like *Acacia nilotica* or *Bauhinia reticulata*, prefer heavy, clayey soils that may become waterlogged during the rainy season

Many species prefer a balanced soil texture. Based on current information, most species can be roughly grouped into three broad categories: heavy, medium, or light soil requirements. More data on different species are now becoming available that can be added to the existing knowledge base (see Von Maydell's *Arbres et Arbustes du Sahel*).

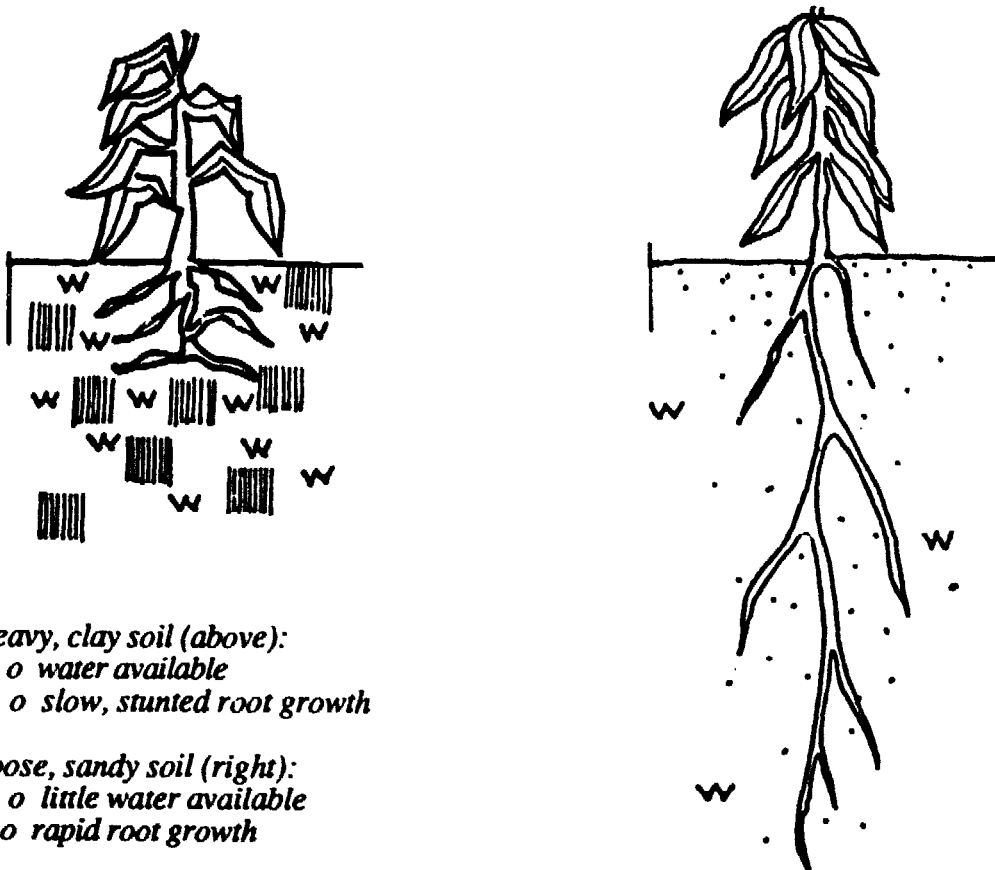

Heavy, clay soil (above):
 o water available
 o slow, stunted root growth

Loose, sandy soil (right):
 o little water available
 o rapid root growth

Soil Particle Diameter Range (in millimeters)

		USDA System	International System
Light Soils/ Coarse Particles ↓	Very coarse sand	2.0-1.0	
	Coarse sand	1.0-0.5	2.0-0.2
	Medium Sand*	0.5-0.25	
	Fine Sand*	0.25-0.1	0.2-0.02
	Very Fine sand	0.1-0.05	
Heavy Soils/ Coarse Particles	Silt	0.05-0.002	0.02-0.002
	Clay	Below 0.002	Below 0.002

* Particles in this range make up the largest portion of dunes in arid Africa.

Soil Structure

Soil structure should not be confused with soil texture. The concept of soil structure deals with the aggregation of primary soil particles, their size and their disparities. Four principal types of structure are recognized. They are mentioned for the purpose of acquainting the reader with the terms. It is important to keep the distinction between texture and structure in mind.

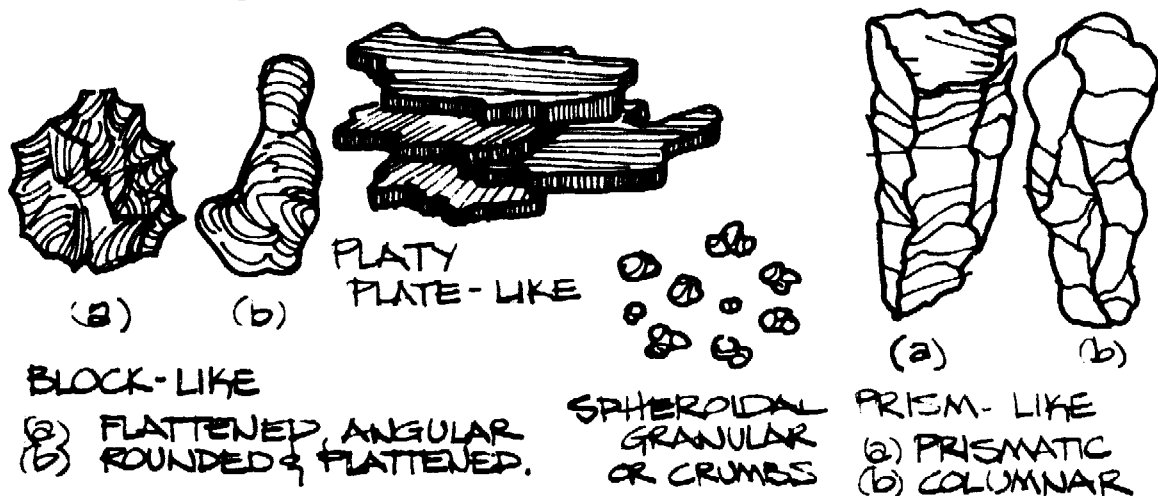

*The four principal structure types are illustrated above.
Soil particle aggregates are shown greatly enlarged.*

Water Holding Capacity

All soils can hold certain amounts of water. When a soil is saturated, some of the water will filter down through the open spaces around individual particles and will be lost to plant roots. This "drip-dry" process can take from several hours to several days. At the point when the downward movement of the water stops, the soil is at "field capacity." Some moisture stays behind after the excess water has moved through the soil. It is held in place by capillary forces. Plant roots have the ability to absorb this moisture and utilize it for growth and transpiration. The remaining moisture in the soil is held so tightly by individual soil particles that roots cannot absorb it. This is hygroscopic water, which is unusable by plants.

For a plant to grow, the soil moisture must be between field capacity and the wilting point (a low moisture level beyond which a plant cannot recover if additional moisture is not supplied). These two levels, field capacity and the wilting point, will vary from one soil to another.

The main factors that determine this range are:

- o **Soil Texture:** generally, the coarser the overall soil texture, the less water it will hold. Inversely, the finer the texture the more water it can retain; however, there will be a higher percentage of hygroscopic moisture.
- o **Organic Matter:** organic content is very important, because decomposed organic matter (humus) acts like a sponge. It soaks up excess water and stores it so that roots can absorb it later on.
- o **Other Factors:** porosity and surface conditions can influence soil moisture levels, but to a lesser degree.

In general terms, the heavier the soil, the more moisture it can hold after it has been soaked by infiltrating rainwater or excessive flooding. Sandy soils tend to dry out faster than soils consisting of finer particles. There are two soil types that contradict this general rule, and both have important implications for tree growing and reforestation activities.

Heavy clays (no sand and little silt) become hard when dry, severely hindering root development and killing young trees unless they are especially adapted to these conditions. In addition, the surface layers of clay soils, which show typical shrinkage cracks when dry, have a tendency to "slam shut" when wet. The upper soil layer expands when moist and keeps water from penetrating further down into the root zones of trees and shrubs. Even though the surfaces of these soils are waterlogged, the moisture is unable to descend to the lower horizons. Unless these soils are constantly loosened, this water is lost to surface runoff or evaporation. Organic matter will greatly help to create space for air and water in an otherwise compact soil medium. Termites can also excavate space in soils that are severely compacted.



Clay Cracking Patterns

The second type, dune sand, although very porous, can retain water relatively close to the surface (within 2-4m). Adequate levels of soil moisture can be maintained for a surprising length of time. Biological sand stabilization activities have had good success on dunes that appeared to be quite dry. Two-inch soil augers can be used to ascertain the presence of moisture near the surface on these sites.

As every farmer or gardener knows, plant growth can be greatly enhanced by increasing a soil's water holding capacity. While not much can be done to change the texture of a soil, organic matter can be added to help a soil retain moisture better. Apart from the additional nutrients it supplies, humus also helps keep soils crumbly and well aerated. This facilitates root development and plant growth in general.

Farmers as well as foresters increase the soil's water holding capacity in several other ways:

- o reducing wind velocities to slow down evaporation and transpiration;
- o reducing soil surface temperatures (using shade);
- o loosening and break up top layers to increase infiltration and produce a crumbly structure;
- o mulching to reduce surface drying;
- o practicing sub-soil plowing or "ripping" to break up compacted layers;
- o using green manure cover crops to provide additional organic matter and to protect the surface during dry seasons;

- o adding compost or animal manures, crop residues, or leaf litter from trees and shrubs;
- o practicing contour cultivation as well as other soil and water conservation techniques.

In some areas these approaches are practical only for crop or vegetable production because of the expense or labor involved. Those techniques that are applicable to reforestation involve breaking up soil layers (by preparing deep holes for planting seedlings), weeding and loosening the soil surfaces around newly planted trees, and the addition of leaf litter. Soil conservation techniques, such as windbreaks and mulching, can also be appropriate, depending on local conditions.

Emphasis in dryland reforestation is placed on conserving and retaining surface water that accumulates during the rains. Even in extremely arid areas rain often falls with high intensities. A water surplus builds up temporarily in the soils and on the surface that may be lost to runoff or evaporation. With some additional efforts much of this moisture could be stored and made available to trees and shrubs. Retaining and conserving water is one problem; getting it to and keeping it in the plants' root zone is another. In any case, a soil's water holding capacity remains one of the key factors in successful reforestation efforts in arid zones. Those techniques that have been given good results are covered in Chapter 8, Agroforestry and Soil Conservation.

Soil Reaction (pH)

Soil reaction is an important variable because it can limit or enhance survival and growth of trees and shrubs. The measurement of soil pH can also be a highly useful indicator of other soil characteristics that are more difficult to determine in the field, such as organic content and soil salinity. Inexpensive and reasonably accurate "pH kits" are becoming increasingly available, making pH tests feasible on almost any site. The information that can be derived from these tests makes them well worth the effort and investment.

The symbol pH stands for "potential of hydrogen." It measures the hydrogen ion concentration in a given soil sample, which indicates the intensity of soil acidity or alkalinity. A neutral substance has a pH level of 7. Values below 7 indicate acidity, and those above show alkalinity. The pH range of soils generally varies between 3.5 and 9.5.

A pH value of 7.5 or more indicates that some free carbonates of calcium or magnesium are present. Soils over 8.5 nearly always contain exchangeable sodium. Low pH values in tropical climates, on the other hand, indicate free aluminum levels, which can hinder plant growth considerably.

For a given soil, pH values can vary quite a bit, depending on the depth of the soil profile from which samples are taken. Soils that show high acidity close to the surface may be more alkaline at lower levels. The reverse can also be true, particularly in dry valleys subjected to an arid climate.

Tree and shrub species vary in their requirements for best or at least tolerable pH ranges. *Casuarina equisetifolia*, *Acacia auriculiformis*, *Tamarix* spp., and date palms are among those species that tolerate highly alkaline soils. Pines and mountain bamboos do better where soil acidity is relatively high and pH values therefore low (4.0-5.5). As a general guideline, trees and shrubs in arid zones will do well within pH ranges of 4.5 to 7.5. Proper choice of species is important, however, because some species are particularly sensitive to pH requirements.

Much time and effort has been lost when pH requirements of newly introduced species have not been properly checked against conditions at the planning site. A striking example is that of the many disappointing efforts to introduce *Leucaena leucocephala* in the Sahel. Poor survival rates and weak performance of most varieties of this species have been due to the fact that pH values of the soils were much lower (6 or below) than the ranges required (6.5 or higher). There are a few varieties of *Leucaena* that are better adapted to more acid soils, but most require a relatively alkaline soil reaction, such as limestone soils.

Anytime the pH is suspected of being as high as 7.7, caution is indicated, not only in choosing the appropriate species, but also for planting techniques and micro-site improvements. Furthermore, cultivation around young trees will be necessary to reduce alkalinity on the surface. At the other end of the scale, acidity levels of pH 5.3 and lower also require special planting techniques and soil restoration efforts. The addition of organic matter to the soil will affect pH levels, at least temporarily.

Soil Depth

Many of the soils in arid Africa are far shallower than one might expect. One reason is that in many instances the upper soil layers have been washed or blown away by erosion. Sometimes rock layers are covered with only a thin layer of soil, and lateritic rock outcroppings are common throughout these regions. The soils of the plateaus that exist in many areas of Africa are seldom really deep. In much of the African continent soils can be broadly categorized as being highly weathered, old soils. Erosive forces have had a particularly great impact over a long period of time.

It is unfortunate that in many instances trees are planted on sites where soils are too shallow to support the chosen species adequately. Reforestation should not be undertaken without first determining how deep the soil layers are. Tree roots can sometimes burrow into underlying rock and through cracks and fissures, but often they will become stunted and deformed, inhibiting growth and leading to early mortality.

DEEP TOPSOIL
GOOD GROWTH

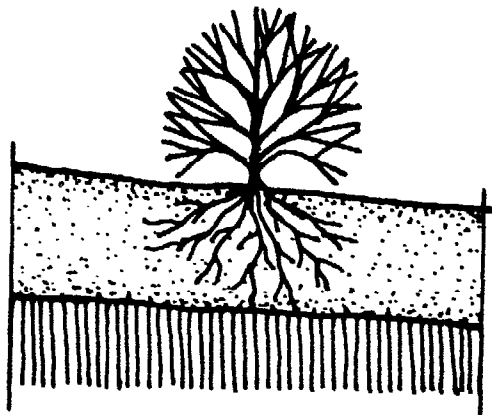

SHALLOW TOPSOIL
STUNTED GROWTH

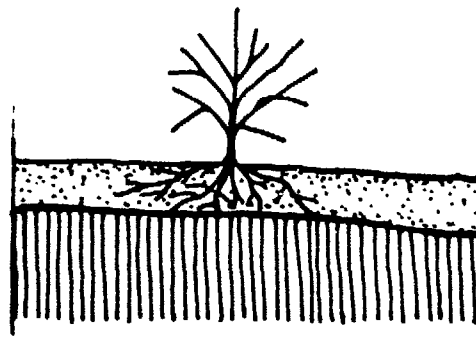

A general impression of soil depth can be gathered by looking at profiles along road cuts and at other construction sites. Hand dug wells provide a good source of information about sub-surface conditions. As a rule of thumb, trees will have difficulties if soils are less than three to five feet deep. If soils are less than 30 inches deep, problems will undoubtedly occur unless only those species are used that do not need deeper soils. Species selection becomes even more complicated under these conditions. As a first indicator one should always look at what is currently growing at the site, or what, according to the local people, grew there in the past.

Of all the recommendations that can be made on this subject, the single most important one is to dig before you plant. A soil pit can provide considerable preliminary information about soil conditions. A pit does not have to be deeper than about six feet. It will become readily apparent if hard crusty layers or "pans" are present. If no obstacles are met, most trees will have adequate room in which to develop their roots, although it is known that some indigeneous species send their roots to much greater depths. A three-year-old *Acacia albida* that was carefully excavated had a fine tap root that reached 30 feet into the ground before it broke and could not be traced any further.

In addition to the location of hard layers, a soil pit will reveal useful data about other soil characteristics. The color of a soil profile normally changes, sometimes abruptly, from darker tones to lighter ones below. Soil texture and pH can also change with depth. Where wind deposits occur, upper layers may vary considerably from lower ones. The same thing can happen where water-borne sediments have been deposited. As a rule, lower layers are less productive than those closer to the surface where organic content is usually higher. This is an important limitation when "deep planting" is being considered.

In summary, soil depth greatly influences tree and shrub growth, more so than in smaller plants. On soils less than three feet deep, only specially selected species will do reasonably well, particularly if impervious layers prevent the free movement of water. Three to six feet of soil are sufficient for tree growth, especially if the layers below can be penetrated by tree roots. Any soil deeper than six feet should pose no particular problem as far as adequate depth goes.

Erodibility of Soils

Soil erosion is caused by two major environmental forces: wind and water. Wind is an especially common factor affecting loss of topsoil in arid and semi-arid regions. Erosion by water is caused by surface runoff. Soil particles are loosened by the impact of the runoff, then carried down slope by the water. A similar process of detachment and transportation occurs in wind erosion. Several revegetation methods for use in erosion control are described in Chapter 8, Agroforestry and Soil Conservation.

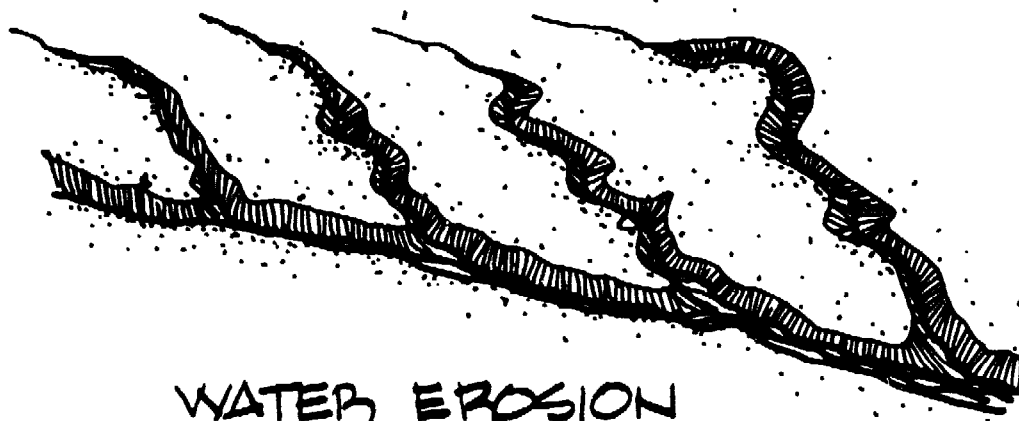

Water has carried topsoil away and left deep ditches or channels in the earth.

WIND
DIRECTION →

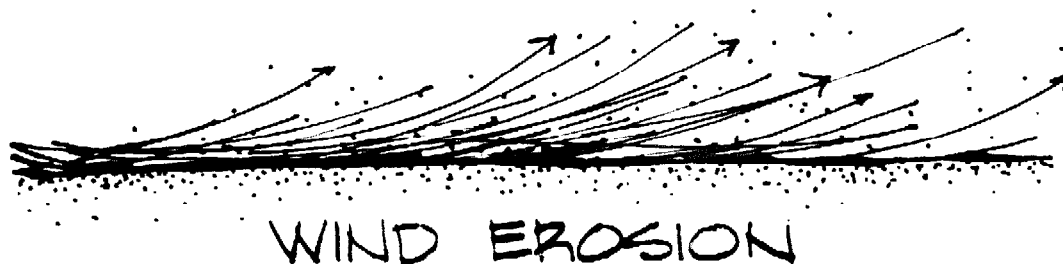

Fine, light dry sand, with no organic matter, being blown by the wind.

The rate of soil erosion is influenced by topography, climate, land use--particularly cultivation methods--and vegetation cover. The degree to which a particular soil type may be susceptible to erosion is also a function of various soil properties:

- o **Texture:** soils with a high percentage of silt and very fine sand particles (0.002-0.1mm) are more easily transported by wind and water than coarser material or finer particles, which tend to cling together more.
- o **Organic content:** all other things being equal, the higher the organic content, the less erodible the soil.
- o **Soil structure:** the particles in more stable soil structures are less likely to be dislodged from the aggregate.
- o **Permeability:** the ability of water to infiltrate through the soil can affect erodibility by decreasing surface runoff.

Soil Classification

Soils are classified in the United States according to a number of physical and chemical soil properties, including those discussed above. In some African countries other soil taxonomies may be used, however, and soils may be given different names under these classification systems. Soil type is determined by properties such as moisture, color, texture, structure, organic content, pH, presence of salts and other minerals, soil depth, and parent material. Many standard soil survey texts describe distinctions between the classes in much greater detail. An introductory overview is given here that explains terms that many forestry and conservation texts and project reports use.

Soil classification uses a special terminology to designate different *soil textural classes*, which are determined by the relative presence or absence of different particle size fractions. Soils rarely consist of only one fraction (dune sand is the major exception, but it frequently contains some finer particles). They usually consist of a mixture of sand, silt, and clay.

The basic soil textural classes, in order of increasing proportions of fine particles are: sand, loamy sand, sandy loam, loam, silt loam, silt, sandy clay loam, clay loam, silty clay loam, sandy clay, silty clay, and clay. "Loam" is an old English word sometimes applied to crumbly soils rich in humus. In soil classification terms, however, it is used to describe a soil that has about equal parts of sand, silt, and clay.

The following basic diagram gives the relative position of various soil classes to each other:

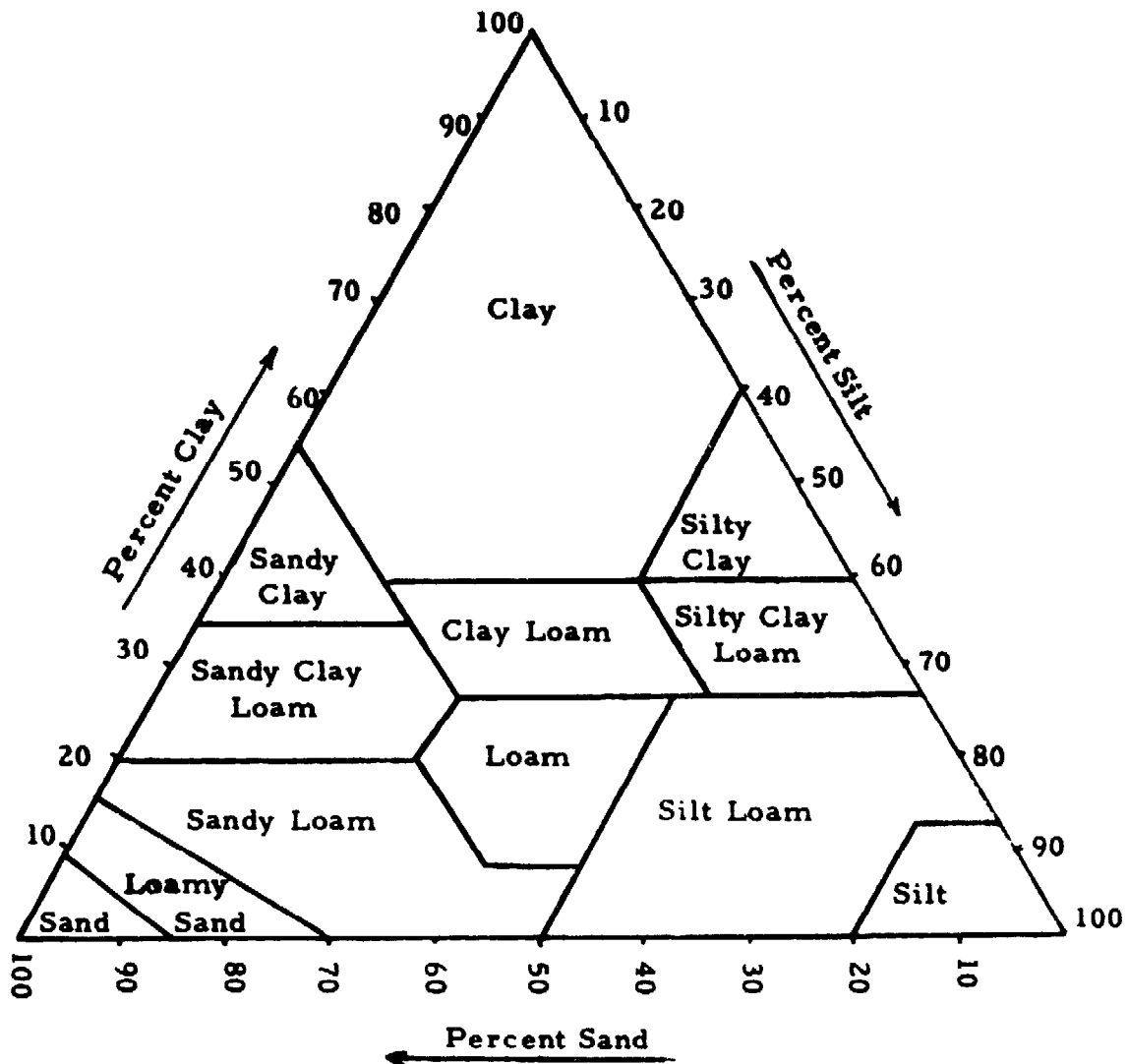

University of California Agricultural Extension Service

The particle distribution of a given soil can be measured using sieves to separate the grains into different size classes. Gradation of particle sizes can be determined this way only for fractions larger than about 0.05mm. To measure smaller particle sizes (silt and clay), other methods can be used that involve separation in water. These require laboratory equipment not normally available at project sites.

The different components of a soil sample can be separated by following the instructions in the box. This method gives a rough estimate of the proportions of sand to finer soil particles.

Estimating Soil Components

① START WITH CLEAR GLASS CONTAINER: WATER GLASS FOR INSTANCE.



② FILL 1/3 FULL WITH SOIL SAMPLE.

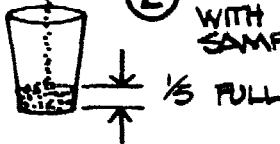

⑤ LET STAND FOR ONE HOUR.



⑥ DO NOT TOUCH

③ FILL 3/4 FULL WITH WATER.

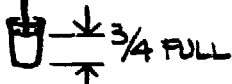

⑦ RESULTS

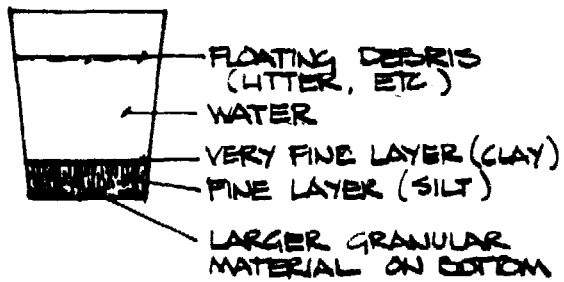

④ SHAKE LIKE MAD FOR AT LEAST 30 SECONDS.



⑧ OPTIONAL, IF WATER IS TURBID



ADD A FEW DROPS OF LEMON JUICE OR VINEGAR; WATCH SUSPENDED MATERIAL FORM FLAKES WHICH THEN SETTLE, CLEANING UP MURKY WATER.

RESULT: LOWERING PH WILL "FLOCCULATE" COLLOIDS.

Field assessment of soil texture, including the finer particles, involves the following method. It relies mainly on the feel of the soil and the observer's experience.

- o Sand: loose individual grains can be seen or felt. It forms a cast if squeezed when moist, but crumbles when touched.
- o Sandy loam: mainly sand, but contains enough silt and clay to make it somewhat cohesive. If squeezed when dry it forms a cast that readily falls apart. If squeezed when moist, the cast will bear careful handling.
- o Loam: a relatively even mixture of sand, silt, and clay. It feels slightly gritty, but is smooth and somewhat plastic. Squeezing when moist will produce a cast that can be handled quite freely.
- o Silt loam: when dry it appears cloddy, with lumps that can be broken easily. When pulverized it feels soft and floury like dry cement. It cannot be squeezed between thumb and finger to make "worms".
- o Clay loam: it breaks into clods or lumps that turn hard when dry. It can be rolled into "worms" when moist. If suspended the "worms" will barely keep from breaking apart under their own weight. Clay loam tends to turn into a compact mass when kneaded.
- o Clay: it forms very hard lumps when dry. When clay is wet it is plastic and sticky. It can be made into "worms" easily.

Common Soil Problems

Two common and troublesome soil characteristics, salinity and laterite, create particularly difficult conditions for reforestation. They are also problems that are frequently overlooked during site assessment because they are not always easy to recognize or diagnose in the field. If problems with salinity or laterite are suspected, additional soil sampling and laboratory analysis may be called for. For more information on these subjects, refer to the bibliography in Appendix D.

Soil Salinity

The soil properties that influence salinity are related to soil chemistry and mineralogy, soil-water movement, and soil pH. Saline soils occur frequently in arid zones, especially in depressions and basins where evaporation or evapotranspiration is high. The normal downward movement of water tends to wash or leach the upper soil layers, flushing salts out of the soil. In areas where evaporation is much higher than rainfall, moisture in the upper soil layers is transported upwards. The result of moisture rising to the surface is the appearance of sodium salt crystals, which can cover an entire valley bottom.

These "white alkali" soils are often, but not necessarily, found where intensive irrigation has been practiced.

"Black alkali" soils are formed when rains dissolve sodium and potassium carbonates, dispersing the organic matter that colors the soil brown or black. Sodium carbonate can also break down the structure of inorganic clay particles, forming a gel that becomes impervious and hard when dry. This impervious layer reduces infiltration of water through the soil, so that leaching cannot take place. Calcium should be added to the soil to counteract the effect of the sodium.

High concentrations of salts in the soil are toxic to most plants. A few species are tolerant of soil salinity to some extent. The concentration of salt in soil or water may be expressed or measured generally in one of three ways:

- o milliequivalent per liter (me/l)
- o parts per million (PPM)
- o electrical conductivity (EC_w) in millimhos per cm (mmho/cm)

A direct relationship between these values exists. Of the three measures, only conductivity can be readily measured in the field. It is the inverse (reciprocal) of electrical resistivity.

A second phenomenon greatly affects site conditions where salt problems occur. Even in soils where salt levels are relatively low (below 4 mmho/cm), strong concentrations of sodium salts can be a significant obstacle to reforestation efforts. This soil property is expressed in terms of the soil's Exchangeable Sodium Percentage (ESP). If the ESP value is above 15, reforestation efforts are likely to fail unless precautions are taken. Salt tolerant species must be selected and other site conditions must be favorable. Often on sites with high ESPs, pH values will also be high (around 8.5). This should be recognized as an indication of problems to come.

Frequently the soils at a proposed project site have not been analyzed to the extent that either pH, conductivity, or ESP are known. Reports from other projects on soils and soil resources of the region or country may provide some information. Local farmers should also be questioned about the productivity of local soils and site indicator plants.

Site Analysis

The obvious problem is to know what to ask and what to look for to avoid unsuitable sites. In terms of salinity problems in general, the following are specific situations that indicate potential trouble. Such sites require more thorough analysis, and it may be necessary to request assistance from a qualified soil scientist.

- o White alkali saline soils typically have high conductivity (over 4 mmho/cm), an ESP below 15, and a pH of 8.5 or above. Heavy leaching through over-irrigation can make them more productive.

- o Saline-alkali soils (over 4 mmho/cm, ESP above 15, and pH around 8.5) can also be made more productive through leaching. Nevertheless, the calcium concentration of the soil must be increased to prevent dispersion of soil particles and reduction of permeability so that leaching can take place. Obtain additional advice before planting on these sites.
- o Alkali "sodic" soils and "black alkali" soils show relatively low conductivity (below 4 mmho/cm), but ESP is over 15, and pH values are in the range of 8.5 to 10. Again calcium must be added for leaching to take place. Obtain additional advice before planting on these sites.
- o For sites with EC_w values of 6 mmho/cm, species must be selected with caution. At high levels of conductivity, fruit tree species such as citrus, plum, prune, and avocado are at their productive limits, even under otherwise favorable conditions.

Salinity Problems in the Nursery

The conductivity of water on irrigated sites should not be higher than 4mmho/cm, especially if species such as *Azadirachta indica* are to be planted. For all but the most salt tolerant species, problems with irrigation water will begin in the range of 2 mmho/cm. At higher EC_w values, a sandy mix in seedling containers and deliberate overwatering will still give reasonable results in the nursery, although at a higher cost. The germination medium must be well drained and regularly leached. In village nurseries in Senegal, well water with a conductivity of about 3 mmho/cm proved to be too saline for reliable seedling production, in spite of cautionary measures that were taken.

Laterite Soils

Laterite and lateritic soils in dryland Africa pose special problems for forestry and soil conservation in many areas. Often they restrict vegetation growth and limit the choice of species that can be used in reforestation efforts. As underlying parent material to soils that are often shallow and easily eroded, they can dominate the landscape where extensive formations occur.

The term laterite can be confusing because it is used for both:

- o the ongoing process of soil formation that takes place in semi-arid climates where temperatures are quite high, and
- o geologic rock formations that developed millions of years ago; for example, aluminum oxide, which is mined as bauxite.

Laterite and soils in the process of laterization can be described as zones rich in sesquioxides (Al_2O_3 and Fe_2O_3) that, when cut into bricks, become hard as they dry. This naturally occurring process of secondary cementation is used in making adobe blocks for construction materials.

Soils with these kinds of properties pose special challenges as a medium in which to grow trees and shrubs. Lateritic soils are deficient in basic plant nutrients, because typically most of the soluble iron, magnesium, sodium, potash, phosphorus, and nitrogen have been leached out of the surface horizons. In addition, these soils become extremely hard and impenetrable to plant roots during the dry part of the year. When rains fall, most of the water either runs off or evaporates at the surface. What moisture does infiltrate will contribute to further leaching of plant nutrients.

Certain vegetation types are productive on lateritic soils in spite of these drawbacks. These woodland and pasture resources can be utilized and developed as long as harvesting and access to grazing are limited to sustainable levels. Once trees or shrubs are removed, however, these soils will rapidly lose their ability to support plant life. The soil building and restoration process has to be tediously re-established, with substantially decreased productivity.

Physical site improvement is necessary for degraded lateritic soils, even to the extent of micro-site improvements for individual trees. Surface treatment is required to increase infiltration and water retention where runoff occurs even if slopes are minimal. Deep pits or trenches can be dug to loosen up the soil layers so that water can penetrate and roots have room to develop. Soil surfaces must be kept loose around young trees and as much organic matter as possible must be provided in the form of leaf litter and other plant residues. With careful ground preparation and maintenance, revegetation is possible on such sites.

In many areas throughout arid Africa, the sites that have been designated as communal lands for grazing and wood-cutting are typically those on which lateritic soils are encountered. These over-exploited, fragile sites form large areas of "useless brush," which nevertheless still constitute the major source of fuelwood for many rural communities. Many foresters in arid Africa have traditionally foregone natural forest management in favor of plantations and woodlots. Recent attention, however, has focused on the potential for silvicultural alternatives to the use of fast-growing, exotic species. Management of the existing vegetation of communal woodlands may be the best alternative on lateritic soils.

Experience has shown that many of the exotic species introduced for fuelwood production are totally out of their element under these harsh, demanding conditions. Naturally occurring species, on the other hand, have a remarkable potential for natural regeneration, provided that basic conservation techniques are adhered to. Some indigenous species have also shown much faster growth than traditional forestry lore would predict.

Of particular interest along these lines is the recent experience in the Sahel in the restoration and management of the shrub savanna, where local species of *Combretaceae* and *Acacia* make up the dominant vegetation. In the Bandia Forest in Senegal, management of existing stands of *Acacia seyal* may have

more potential for biomass production on lateritic sites than fuelwood plantations using *Eucalyptus camaldulensis*. In the Guesselbodi Forest in Niger, research into the management of natural stands of *Combretum nigricans*, *C. micranthum*, and *Guiera senegalensis* is also underway.

On sites where existing vegetation and soil resources are not severely depleted, natural forest management is not only preferable from a conservation point of view, but is also more cost effective than artificial reforestation projects. Silvicultural techniques that can be used in natural forest regeneration include promotion of stump and shoot sprouting, enrichment plantings, and soil preparation to increase natural seeding and germination.

5

SITE/SPECIES SELECTION

Site Selection

For the type of reforestation effort with which this manual is mainly concerned, it is usually necessary for the planner to think in terms of at least two locations: a site for the nursery (the place where young trees will be seeded and grown until they are large enough to have a good chance for continued growth in another place), and the location where the trees will finally be planted. This planting site may be known from the beginning, because, as a site in need of reforestation, it may have been the key element in determining the scope of the project. Planting sites may, however, be chosen at a later stage in the planning, after an analysis of land use and resource needs has been completed.

Nursery Site

The nature and scope of the project determines the type and size nursery that is necessary. State operated nurseries are usually permanent and are established at a centralized location within the region they serve. These nurseries produce trees on an ongoing basis for a variety of needs, such as forest plantings, shade trees, woodlots, or soil conservation projects. Such centralized nurseries are frequently maintained by government funds.

Temporary nurseries are used when seedlings are needed only for a project that will be completed within a relatively short time. These nurseries are set up near the planting site to minimize transportation costs. They may be maintained for several years or for only one planting season.

Small permanent nurseries that are locally owned and managed may be feasible. These nurseries can be operated by individuals, families, cooperatives, youth or women's groups, or as a community effort. They may be located within family compounds, in community garden areas, or wherever an adequate water source is available. The seedlings can be used for agroforestry efforts on private land holdings and for village reforestation projects, or they can be sold to raise money for other purposes. Fruit tree nurseries are particularly popular at the village level.

The best sites are those that are close to 1) a dependable source of water, 2) a road that is passable for heavy trucks during the rains, and 3) the nursery supervisor's or workers' living quarters.

If plastic pots or other containers (plant leaves, cardboard boxes, clay jars) are used, finding a good site is not difficult. Pots can be filled with soil brought in from elsewhere, and they can be stacked and tended in areas where nothing else will grow. If seeds are to be planted directly into the ground at the nursery site, that is, if the stock is to be open-rooted, the nursery soil must be rich, deep, and well drained. The best soil has a loamy texture and a loose crumbly structure.

A slight slope will help surface water drain away, and protection from prevailing winds is also desirable. Often a large shade tree in one corner of the nursery is useful to protect very young seedlings from extreme sunlight. It is a good idea as well to find out whether the land next to the nursery site would be suitable and available if the nursery had to expand.

The main factors to be considered when deciding upon a nursery site are:

- o availability of water year round
- o protection from prevailing winds
- o access to the planting site

Planting Site

The choice of a planting site is a complex decision. In selecting a site, it is essential that issues of ownership, tenure, risks and benefits be discussed in advance so that the expectations of government officials and local project participants are mutually understood. Officials and community members must meet to consider the following points when choosing a site:

- o Who owns the land? Who has the water rights, if anyone? Who will own the trees once they are planted? Who uses the land currently or has used it in the past? What are their claims to it now?
- o Who will be responsible for planting and maintaining the trees? Who will be allowed to harvest various products? If products are to be marketed, who will sell them and who will receive the proceeds from the sale?
- o Will permits or taxes be required by government agencies? Are there any resource use or management regulations that must be followed on this site?
- o How will grazing and other land uses be controlled on the site? Who will be responsible for enforcing the controls?

If protection of the land is the main goal, sites are selected to give the best possible conservation results. If production is the primary objective, issues

such as transportation and marketing become important. The site in turn determines which species and planting methods will be most successful. Forestry and conservation efforts are often undertaken to protect productive farmland against the adverse effects of flood and erosion damage. Frequently it is the area above the fields that requires treatment. In any drainage basin it is important to protect the upper portions of the slopes and hills.

Once a site has been decided upon, an agreement should be drawn up between the various parties involved. This should outline project goals, responsibilities, and a management plan for the site. The agreement is necessary to protect the participants, to ensure that everyone's expectations have been met, and to prevent future misunderstandings.

Species Selection

Foresters who are managing projects must analyze both tree species and sites before matching particular species to given sites. To do this successfully it is necessary to consider 1) environmental constraints, 2) purposes of the project, 3) human factors, and 4) legal constraints. For an additional discussion of species selection for agroforestry projects, see Chapter 8, Agroforestry and Soil Conservation.

Environmental Constraints

Performance of trees and shrubs is limited by the amount of moisture available to the plants, as well as certain other factors. Over time, different species have evolved that can exist where moisture is relatively scarce. Adaptations to arid site conditions can take on many forms. Some species develop roots that grow extremely fast or that spread out far beyond the radius of the trees' crowns. Others are able to store moisture and use it during the dry season. Some reduce their needs for moisture during the dry season by dropping their leaves or by closing them during the hottest part of the day to reduce transpiration. During an extreme drought many species have an unusual die-back/recovery capability: portions growing above the ground die back completely, but new shoots emerge from the root-stock when soil moisture conditions are again favorable.

The important question here, then, is which species can survive and grow well given the soil, water, and climatic characteristics of the site. To determine environmental constraints, foresters study climatic records for given areas.

Climate

In dry areas of Africa, the single most limiting climatic factor is rainfall. Before the project can be started, managers must find answers to a number of questions. How much rain falls during the rainy season (the period when young trees are planted)? How is the rainfall distributed during the rainy season? If the timing of the rains is wrong--for example, if the total rainfall occurs within two days instead of over several weeks--the project can be ruined.

There are other things about rainfall to consider. For example:

- o How hard does the rain fall? Gentle, spread-out rains are more likely to soak into the soil than heavy, torrential rains.
- o What is the temperature? If temperatures are very high, the moisture evaporates much more quickly.
- o When do the rainy seasons occur?

As noted earlier, some areas have two rainy seasons; others have only one, in the hot summer months. Still others have one rainy season in the cooler winter months. A tree species that grows well in a region where the rain falls during the winter usually does not adapt well to an area where it rains during the warmer weather—even though the amount of the rainfall is the same.

The single most useful rainfall measurement is the mean annual precipitation, measured in millimeters (mm) per year. In the tropics, however, annual rainfall tends to vary greatly, so it is necessary to consider the variation from year to year in determining the figures upon which to base a choice of species.

It is a good idea to make a list of tree species and the water needs of each in any area in which forestry projects are being implemented. If two species look good, but one requires less water and the project area is one where the supply of water is uncertain, choose the one requiring less water. The list on the following page was prepared for three rainfall zones in Africa.

Drought

No one can accurately predict when a drought will occur, but foresters should make use of previous records in drought prone areas to determine the suitability of a species for a given site. Unfortunately, the drier the area, the less reliable the average rainfall figures usually are, and the greater the range of averages will be. Furthermore, there are many areas where accurate rainfall records do not exist, and it is necessary for project managers to use very general information such as that presented on the maps in Appendix C, and upon the basis of information from local residents.

Project results also indicate that in a dry climate, local species will grow more slowly, but may survive better than exotics--species brought in from other areas or countries. Obviously, under arid conditions, plant growth is not as vigorous as it is if more moisture is available. Since native plant species in arid zones have adapted to withstand prolonged drought, it is natural that they have different, often slower, growth characteristics than plants that evolved in more humid climates.

Common African and Introduced Tree Species by Water Requirement

Dry Sites--200 to 500mm Mean Annual Precipitation

Acacia albida
Acacia radiana
Acacia senegal
Annona senegalensis
Balanites aegyptiaca
Boscia salicifolia
Commiphora africana

Conocarpus lancifolius
Dobera glabra
Euphorbia balsamifera
Maerva crassifolia
Parkinsonia aculeata
Prosopis juliflora
Ziziphus spp.

Medium Sites--500 to 900mm

Adansonia digitata
Anacardium occidentale
Azadirachta indica
Bauhinia spp.
Cassia siamea
Combretum spp.
Eucalyptus camaldulensis

Ficus sycomorus
Haxoxylon persicum
Parkia biglobosa
Salvadora persica
Sclerocarya birrea
Tamarix articulata
Terminalia spp.

Moist Sites--900 to 1200mm

Albizia lebbeck
Anoageissus leiocarpus
Borassus aethiopum
Butyrospermum parkii
Casuarina equisetifolia

Cordia abyssinica
Dalbergia melanoxyton
Erythrina abyssinica
Markhamia spp.
Tamarindus indica

On the other hand, species introduced from more favorable climatic zones may undergo severe stress when things get dry. They are often less able to survive than those species that occur naturally on dry sites. Even if these exotics are able to survive drought conditions, they may not grow normally or rapidly. In fact, their growth may be slower than the indigenous vegetation. This is the main problem in trying to introduce species from other areas into marginal sites.

In parts of Africa where the mean annual rainfall is less than 1,000mm, therefore, it is recommended that rapidly growing species such as *Eucalyptus camaldulensis* or *Leucaena leucocephala*, which originally came from other continents, be compared with other possibly more suitable species. If these species are used in low rainfall regions, they should be planted where the water table is near the surface, so that trees will have access to sufficient water.

Soil

Trees and shrubs need soils that have a high capacity for holding moisture, and a texture consisting of a blend of coarse and fine particles. They also should have a fair amount of organic matter that is renewed annually. Soil surfaces should be protected from strong, constant winds and they should not be

compacted. Preferably they should also be free draining, although this benefits some species more than others. Soil characteristics and their influence on species selection were discussed in the preceding chapter. Among the specific points to be considered are: What kind of texture does the soil have? Does it retain water well? How deep is the soil? Are there any potential problems with pH or salinity?

The presence of "indicator plants" on a site can provide clues as to the soil type that one can expect to find. *Calatropis procera*, for example, is often found on degraded soils where the nutrient pool has been depleted through intense cultivation. Close observation of the tree and shrub cover in specific landscapes will lead to a first feel for the type of soils that different species prefer. It is evident that *Mitrangina inermis*, *Anogeissus leiocarpus*, or *Borassus aethiopum* prefer low lying areas where soils contain a relatively large proportion of fine particles. What is already growing on the site can be the best clue as to which species will be compatible. On deforested sites, the most ecologically sound solution may be to restock the area with the original natural vegetation.

Other Environmental Factors

In addition to climate, soil, and water there are other factors in the environment that affect the choice of species:

- o Elevation - some species will thrive only above or below a certain altitude.
- o Slope - some species are especially useful for erosion control on steep slopes and unstable soils because they have lateral root systems (*Acacias*, *Balanites aegyptiaca*, *Anacardium occidentale*).
- o Topography - rough, broken terrain may have a great deal of variation in micro-site conditions. Species that can tolerate a wide range of site conditions are needed.
- o Fire history of the area - are there frequent or few fires? Some trees are more fire-resistant than others.
- o Pests - some trees are more affected by certain pests than others. A planting site that has several kinds of trees is less likely to be destroyed by insects or disease, because a pest that attacks one species of tree may not be attracted to another species.
- o Animals - do the livestock in the area prefer the leaves and bark of certain trees more than those of the other species being considered?

Project Purpose

While considering the species in terms of environmental constraints, it is necessary to keep in mind the purpose or objective of the project. What is the objective of the reforestation (or revegetation) effort? Is the project aim to

conserve resources, as in a sand stabilization program for an eroded area? Or does it seek to increase production of certain forest products, such as fuelwood or poles for construction?

Certain species can be used for one purpose and not the other, but some species can be used to fill a number of requirements. To meet several objectives, a plantation may also include more than one species. An example of a multiple-use species, *Anacardium occidentale*, is very valuable for soil reclamation and protection. It also produces fruits and nuts (cashews) that can be used for local consumption or as a cash crop. In addition, it can provide fuelwood, tannins, dyes, and medicines from different parts of the plant. The tree can tolerate a wide range of soil type, elevation, and rainfall variations.

Eucalyptus camaldulensis is a more limited species. Introduced to Africa for use in woodlots and large-scale plantations, it grows rapidly if conditions are favorable. It can produce large quantities of wood for fuel and construction in a short period of time. It is not particularly useful for soil conservation, however, because it produces little leaf litter, and there is evidence that it actually inhibits the establishment of other vegetation. The soil beneath a stand of *E. camaldulensis* is sometimes bare and thus is more susceptible to surface runoff and soil erosion. It also is not suited for use in intercropping or windbreaks and is fairly demanding in terms of site conditions.

In selecting species, therefore, it is important to weigh the production/conservation trade-offs, and determine priorities based on the project's purpose. Project goals should be formulated with consideration for local expectations and preferences.

Human Factors

The key is to discover what the residents of an area would like the project to do, and what is attractive to them. For example, if *Acacia albida* is highly thought of locally and can be grown on the site (i.e., it meets the environmental constraints), and it serves the project's purposes well, then it is a good choice of species: everyone takes better care of something that is highly valued. It is also important to investigate local preferences or prejudices towards certain species. The two species mentioned above, *A. occidentale* and *E. camaldulensis*, serve as examples to illustrate this point as well.

In parts of Senegal, the cashew tree is regarded with superstition because it is believed to attract ghosts (Hoskins, 1979). In other countries the cashew apple is thought to be poisonous if eaten with dairy products. In some areas where the trees have been planted, the cashews are not even harvested, because an oil in the nutshell causes skin irritations. In these cases the many beneficial characteristics of the tree may be outweighed by the negative perceptions of it.

The other example, *Eucalyptus*, has been widely promoted as a fuelwood species. But it tends to be smoky and it has a characteristic "cough drop" odor imparted by resins in the wood that are released when burned. In some areas

people have developed a taste for *Eucalyptus* and prefer it to other woods; but in other areas people object to the flavor the smoke gives to food--as well as to the smoke itself.

Legal Constraints

As mentioned earlier, many countries protect and regulate the use of natural resources and of certain tree species. In some cases, traditional laws give a specific tree special status. In West Africa, for example, *Acacia albida* was protected by local customs even before the national government protected it for ecological reasons.

It is impossible to give universally applicable information in this manual on such restrictions. Such information is readily available on a local basis, however, and foresters familiar with an area will know the restrictions that are enforced. Appendix B, which provides details for some of the common trees of arid lands in Africa, does note when a species has certain legal status.

A number of tree species of sub-Saharan Africa have been regulated by law (see box). This list can be referred to in considering the final choice of species. Species that are already protected by law may be more appropriate for a conservation project than species with no such restrictions. On the other hand, a species that requires special permits for use may be less desirable for a production oriented project.

Tree Species Regulated By Law in Africa

Use, cutting, and removal limited by law in at least one country:

<i>Acacia albida</i>	<i>Hyphaene thebaica</i>
<i>Acacia scorpiodes</i>	<i>Khaya senegalensis</i>
<i>Acacia senegal</i>	<i>Parinari macrophylla</i>
<i>Adansonia digitata</i>	<i>Parkia biglobosa</i> (Benth.)
<i>Balanites aegyptiaca</i>	<i>Pterocarpus erinaceus</i>
<i>Bombax costatum</i>	<i>Sclerocarya birrea</i>
<i>Borassus aethiopum</i>	<i>Tamarindus indica</i>
<i>Buyrospermum parkii</i>	

Classified as "Specially Useful" in at least one country:

<i>Acacia macrostachya</i>	<i>Landolphia heudelotti</i>
<i>Acacia scorpioides</i>	<i>Lannea microcarpa</i>
<i>Adansonia digitata</i>	<i>Prosopis africana</i>
<i>Anogeissus leiocarpus</i>	<i>Pseudoceadrela kotschyi</i>
<i>Balanites aegyptiaca</i>	<i>Pterocarpus erinaceus</i>
<i>Boswellia dalzielli</i>	<i>Pterocarpus lucens</i>
<i>Ceiba pentandra</i>	<i>Saba senegalensis</i>
<i>Dalbergia melanoxylon</i>	<i>Sterculia setigera</i>
<i>Detarium senegalense</i>	<i>Teclea sudanica</i>
<i>Elaeis guineensis</i>	<i>Vitex cuneata</i>
<i>Guiera senegalensis</i>	<i>Ziziphus mauritiaca</i>

6 NURSERY MANAGEMENT

Nursery Design and Layout

Sound nursery management begins with the design of the facility. Particularly in larger nurseries, a well thought out design is necessary to allow for rational traffic patterns and adequate work space.

A good way to begin planning the nursery design is to prepare a detailed sketch of its layout. Show the size and location of the beds and water storage facilities. Plan for irrigation during dry seasons and drainage during the rains. Allow room for walkways, driveways, and turnaround space as needed. Leave enough space for storage rooms and tool space. The storage area or construction shed should be large enough to provide shelter for the crew in times of intense heat and driving rain. Space is needed for research plots, germinating beds, compost bins, and safety or fire prevention strips (especially along the fences). The layout must also consider the special needs of open-rooted and potted seedlings.

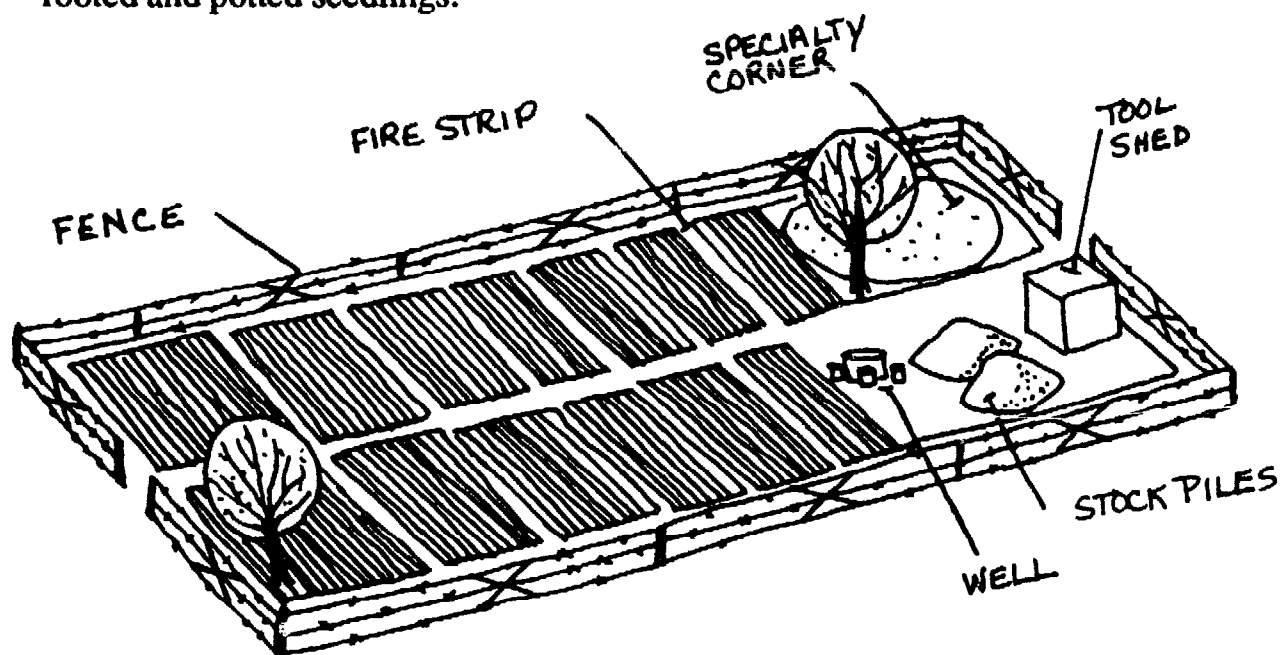

NURSERY LAYOUT

Open-Rooted or Potted Seedlings

Some species cannot be moved easily or transplanted safely from a nursery to a planting site unless they are grown and transported in pots; other species cannot grow well in pots. While the open-rooted stock method is cheaper to use, some species require the use of pots. If, however, a species will grow either in pots or as open-rooted stock, each method has advantages and disadvantages that should be considered.



In Africa, most of the *Azadirachta indica* (neem) trees are raised by the open-rooted method, and it is also used for *Cassia siamea*, *Khaya senegalensis*, *Sclerocarya birrea*, and some species of *Prosopis*.

Open-rooted Stock

The advantages of open-rooted stock are:

- o There is less weight to transport from the nursery to the permanent site--pots are heavy.
- o It takes less time to transplant open-rooted stock.
- o Less care of open-rooted seedlings is required in the nursery.
- o Seedlings are usually larger and so require less protection after transplanting.

The disadvantages of this method are:

- o Open-rooted seedlings need more space.
- o They need more time in the nursery.
- o The nursery location must have good soil conditions.
- o Roots are exposed to air when the plants are lifted out of the nursery soil and again when they are planted at the permanent site. This can damage the plants.

Potted Stock

The most commonly used containers in Africa are usually referred to as plastic pots, even though they are actually plastic bags. They are also sometimes called sleeves or tubes. Other types of containers may be used, and if they are made from locally available materials, they may be more affordable.

The advantages of using containers are:

- o Good soil is not required at the nursery site.
- o Seedlings can be placed closer together than in the open rooted method.
- o The time in the nursery is shorter, and although pots require expense at the beginning, the shorter nursery time cuts down on other expenses.
- o The pots can be easily moved to the permanent site well before outplanting starts, just as long as watering continues.
- o Root growth is contained in a package that is easy to transport, and there is little or no exposure of hair roots to the air during transporting and transplanting.
- o On difficult sites, potted plants may have better survival rates than open-rooted seedlings.
- o Soil diseases may not spread as rapidly to potted seedlings as in open-rooted beds.

The disadvantages of using containers are:

- o The seedlings require root pruning while in nursery pots.
- o Pots cannot be piled up for transport.
- o They are heavier and more difficult to transport.
- o Pots must usually be purchased, which may or may not be a problem (depending upon time saved in the nursery or on the expense of making certain soils ready for open-rooted planting).
- o Seedlings are normally smaller at the time of transplanting and require extra protection from grazing livestock until they are larger.

If pots are needed, they should be ordered well ahead of time. Only one size plastic pot is necessary for most species, which makes ordering easier. The plastic should not be too flimsy or the pots will collapse; a plastic that is 4 to 8 mils thick should be strong enough. Usually the pot is a standard 8cm (3 in.)

STANDARD PLASTIC POT

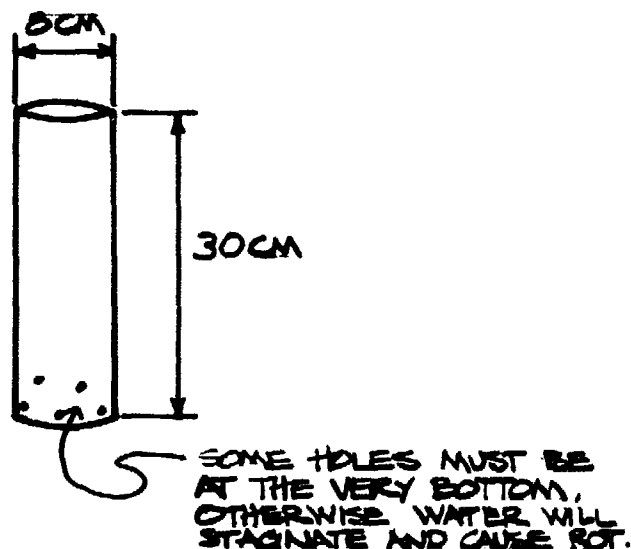

diameter by 30cm (9 in.) depth. Larger pots are needed for some species, particularly fruit trees, such as *Mangifera indica* (mango) and *Citrus* spp.

Some experiments have been done with much smaller seedling containers (2.5cm diameter by 5 to 30cm depth) in the United States and the Caribbean. These are made of styrofoam, cardboard, or plastic, and are much easier to transport than the larger pots. It is not clear, however, if they are appropriate for use on dry sites, and they are likely to be considerably more expensive than the widely used plastic sleeves.

Planning Nursery Beds

The amount of land needed for beds (the land within the nursery where the seeds will be sown) will depend on whether the seedlings will be grown in pots or will be open-rooted. If the open-rooted stock method is being used, figure that each group of 1,000 trees needs about 10 square meters. The same number of potted seedlings needs only about seven square meters. Add at least 20 percent to the figure calculated for the nursery beds. The 20 percent will be for additional space for roads, work areas, construction sheds, etc. Walkways between the beds must be wide enough to permit foot and wheelbarrow traffic, a minimum of 60cm (24 in.).

If at all possible, plan the beds so that their longer dimension is placed in an east-west direction and their narrower side faces north-south. Orienting the beds in this way gives trees on the inside the same exposure to the sun as those in the outside rows. Beds should not be wider than 1m so that weeding in the center can be done easily. A bed that is 1m wide and approximately 6 to 7m long can hold about 1,000 plastic pots in 12 rows of 83 pots.

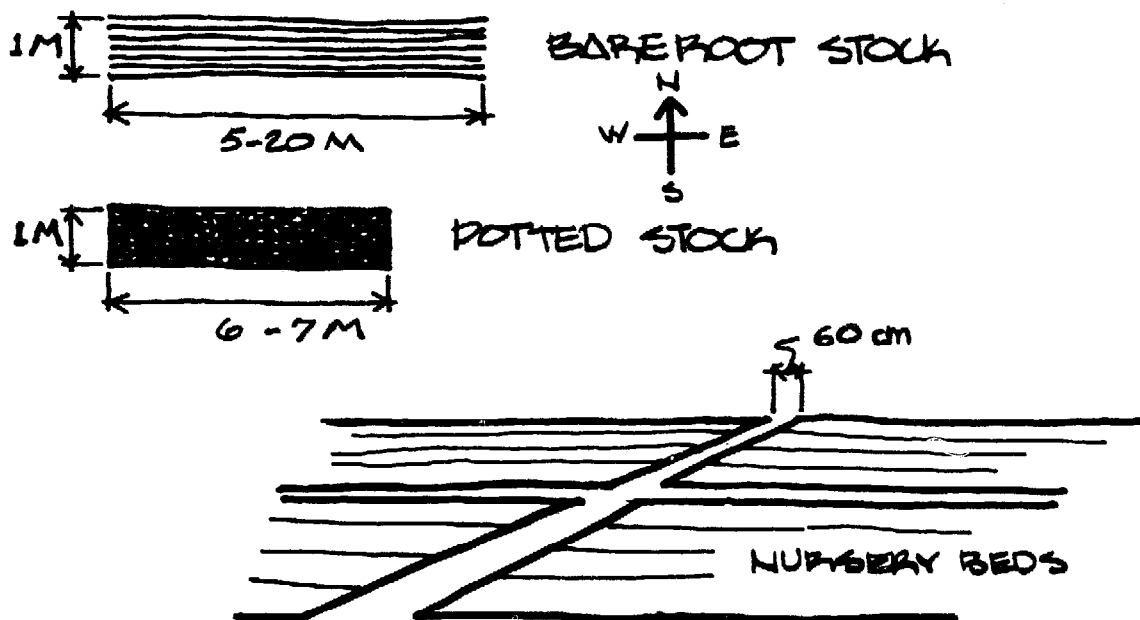

For open-rooted stock, standard sized beds contain five rows of trees and are approximately one meter wide. The length of the beds varies from 5 to 20 meters, depending partly on handling needs and the amount of labor and transportation available. Always allow room for extra beds.

Beds are usually either sunken or raised, depending on species and site conditions. Sunken beds retain moisture much in the same way that micro-catchments work, and thus are used where water availability is limited. Raised beds are prepared for open-rooted stock using the double-digging method. They provide seedlings with a well-drained and aerated rooting zone for optimal growth.

OPEN ROOTED STOCK

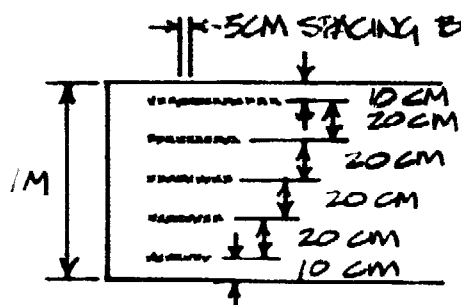

IN 1M^2 THERE ARE 5 ROWS OF TREES SPACED 50 CM APART =
 5×19 TREES = 95 TREES

A $1\text{M} \times 6\text{M}$ BED ($6 \times 95 = 570$ TREES)
 REQUIRES A TOTAL SPACE OF
 $(1.0 + 0.6) \times (6.0 + 2.0) = 12.8\text{M}^2$

$12.8\text{M}^2 + 10\% = 14\text{M}^2/\text{BED}$

570 TREES = 14M^2
 40.5 TREES / M^2

SPECIAL SUBJECT - NURSERIES

PLASTIC POTS

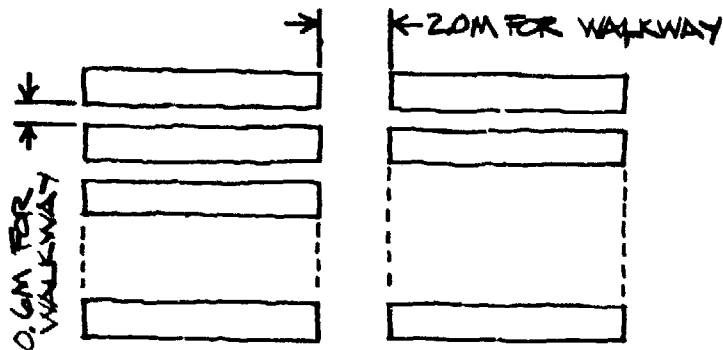
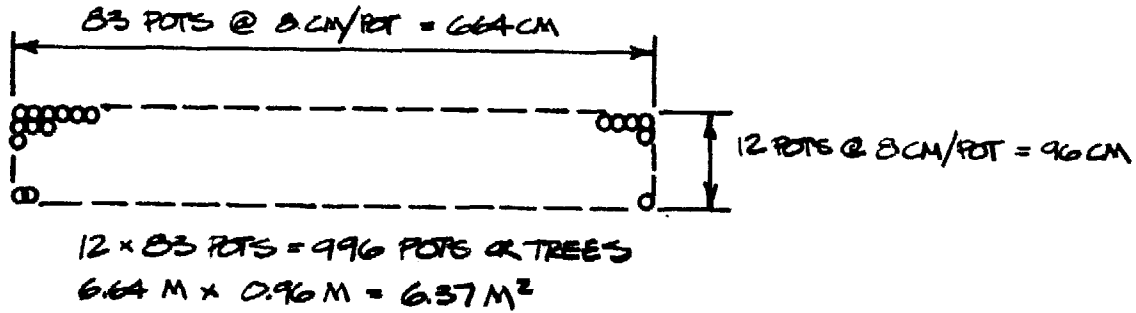

ONE BED REQUIRES:

$(0.96 + 0.6) \times (6.64 + 2.0) = 13.5 \text{ M}^2$
 13.5 M² BED AND WALKWAY
 + 1.5 M² 10% WORK AREA AND FENCE
 14.8 M² TOTAL AREA / BED

996 TREES = 14.8 M² =
 65 TREES / M²

TOTAL SURFACE AREA REQUIRED m ²	ILLUSTRATIVE DIMENSIONS m	NUMBER OF TREES THAT CAN BE RAISED AS EITHER	
		Plastic Pots	Open-Rooted (-10% LOSS OR REJECTS)
10	4 X 2.5	585	360
50	10 X 5	2,925	1,800
100	15 X 6.7	5,850	3,600
500	30 X 17	29,250	18,000
1,000	40 X 25	58,500	36,000
5,000	71 X 70	292,500	180,000
10,000	100 X 100	585,000	360,000

SPACE REQUIREMENTS CALCULATION

(Including walk space and work area)

ON THE BASIS OF:
 PLASTIC POT STOCK = 65 TREES/m²
 OPEN-ROOTED STOCK = 40 TREES/m²

TYPICAL LAYOUT FOR NURSERY PRODUCING APPROXIMATELY 20000 SEEDLINGS PER YEAR (BOTH POTTED AND OPEN ROOTED STOCK)

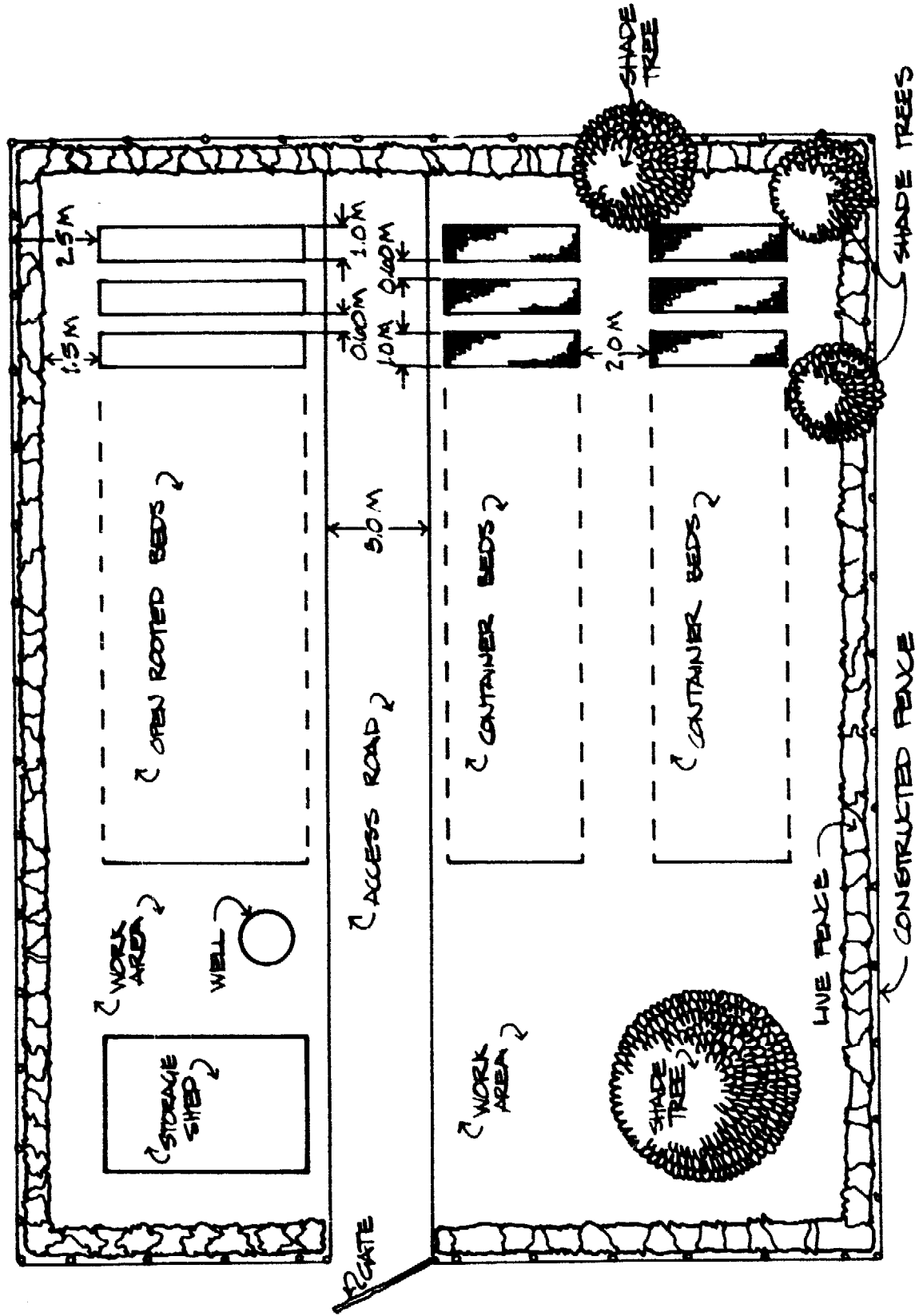

Other Nursery Design Considerations

Access

Long distances for hand carrying can be avoided by planning driveways in the layout. A small truck should be able to drive into the center of any nursery that holds 10,000 seedlings or more. It is even more useful if the nursery has a central access road that runs the full length of the nursery, with a turnaround or drive-through facility at the far end.

Research

Small research plots can be placed in a corner of the nursery. The location of these beds should be planned so that they do not interfere with the regular nursery efforts. Experimental plantations are also often located on a parcel adjacent to the nursery, for easy observation and to serve as a demonstration of new techniques for visitors to the nursery.

Shade

Young trees usually need some shade during their first weeks, especially when they have just been transplanted from a germination box into pots, or during the worst weeks of hot, dry weather. Shade can be used as a technique to cut down loss of plant moisture through transpiration if it is difficult to provide adequate water year round in the nursery through irrigation.

Too much shade, however, will cause seedlings to be spindly and weak. They should be protected from the sun only when necessary. Some seedlings are raised in full sunlight from the time they germinate. Usually shading is only necessary for a short time. Most species adapt themselves early and quite well to full sunlight.

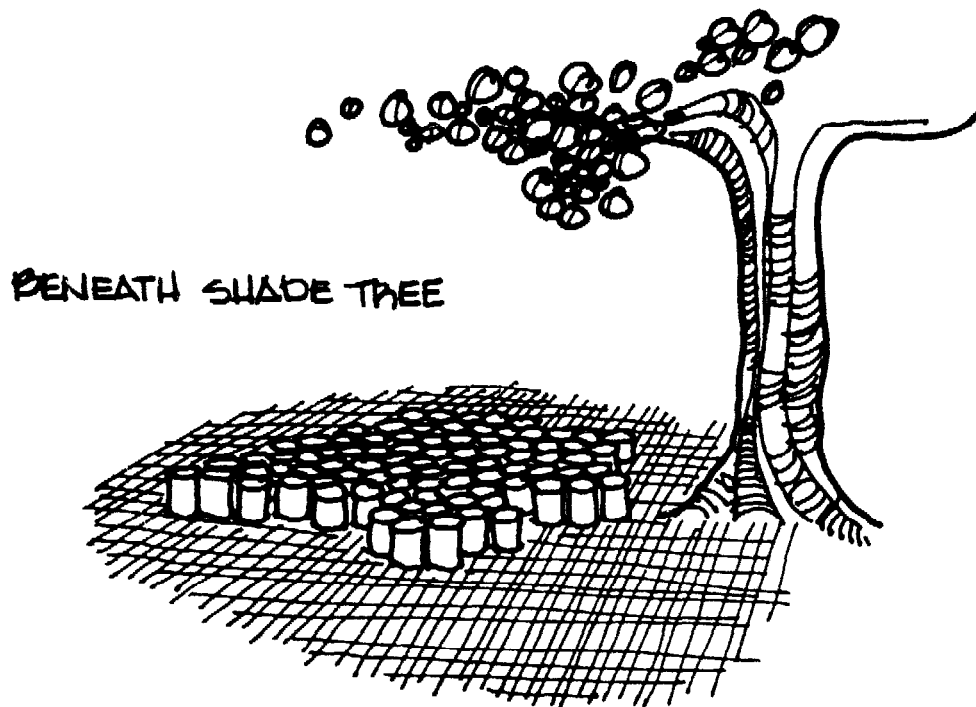

If a large shade tree is available in the nursery, seedlings in plastic pots can be started underneath it and later moved into partial or full sunlight. If there are no shade trees in the nursery or for open-rooted plants, another possibility is to rig straw or reed mats over some of the beds. The advantage of this method is that the screens can be adjusted to regulate the amount of sunlight at different times of the day.

SHADE

SCREENED CONSTANTLY

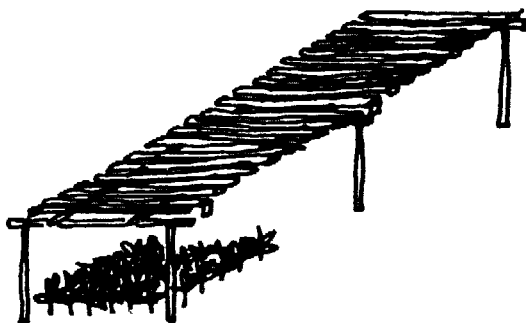

TOO MUCH SHADE WILL CAUSE
SEEDLINGS TO BE SPINDLY
AND GROW WEAK STEMS.
PROTECT ONLY WHEN
PROVEN NECESSARY

EXPOSE TO MORE DIRECT
SUN AS TREES GET OLDER

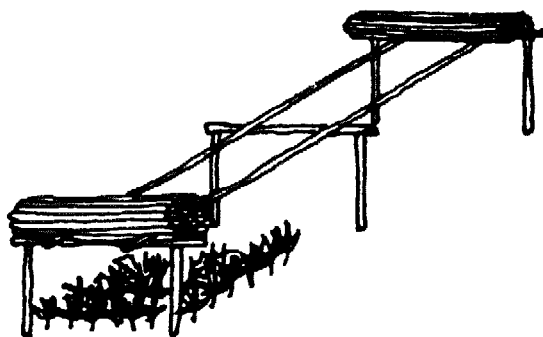

SOME TREES IN SAHEL
NURSERIES NEVER GET
SHADED AND DO WELL!

Gradually move the seedlings into the full sunlight: this will help prepare them to survive full exposure to the sun at the planting site. Seedlings should, however, be shaded when they have just been lifted out of the nursery, while

they are being transported, and during any delays prior to transplanting, to relieve the stress of moisture loss during the transplanting process.

Ground and Soil Preparation

Clearing the Site

The first step in preparing the nursery is to remove all but a few trees that may be there already. These trees are kept for shading young seedlings until they can stand full sunlight. Aside from these shade trees, old trees and quantities of young trees simply do not mix: the competition for light and water damages young trees. If it seems wrong to cut trees down, it is sometimes possible to move them elsewhere. All remaining roots, stumps, and other vegetation should be removed from the area.

Providing for Nutrients

If open-rooted stock is being raised, ideally the soil should be fertilized to add nutrients. Open-rooted seedlings draw large amounts of nutrients from the soil and special fertilizing efforts should be made, particularly when preparing the beds for a new crop. Nitrogen, potassium and phosphorus are nutrients of particular importance. Plants can take up these nutrients from organic compost, animal manure, and green manures, which also can help build or keep good soil structure. Commercially produced fertilizers are often needed to supply sufficient phosphorus. In many areas, however, these chemical fertilizers are not available, or are too expensive to purchase.

Beds for Open-Rooted Seedlings

Beds for open-rooted seedlings can be either raised or sunken. In either case the subsoil must be broken up and loosened to allow drainage and root development, and composted organic matter should be thoroughly mixed into the soil. There should be no large clumps of soil or organic matter. Sunken beds are usually about 15cm deep, although the sides of the beds may be built up above the surface. Their purpose is to retain additional moisture in areas where extreme aridity is a problem. In more humid zones sunken beds may retain too much water, causing stagnation and fungus problems.

Raised beds are prepared using the double-digging method (see box). This technique involves loosening the subsoil, turning the topsoil, and adding compost in a way that avoids compacting the soil and increases porosity for air and water infiltration and root development. Raised beds can be framed with side supports, such as bricks or boards, to keep the edges from eroding. Often these materials are scarce or too expensive, however, and the beds are simply maintained regularly.

Preparing Raised Beds

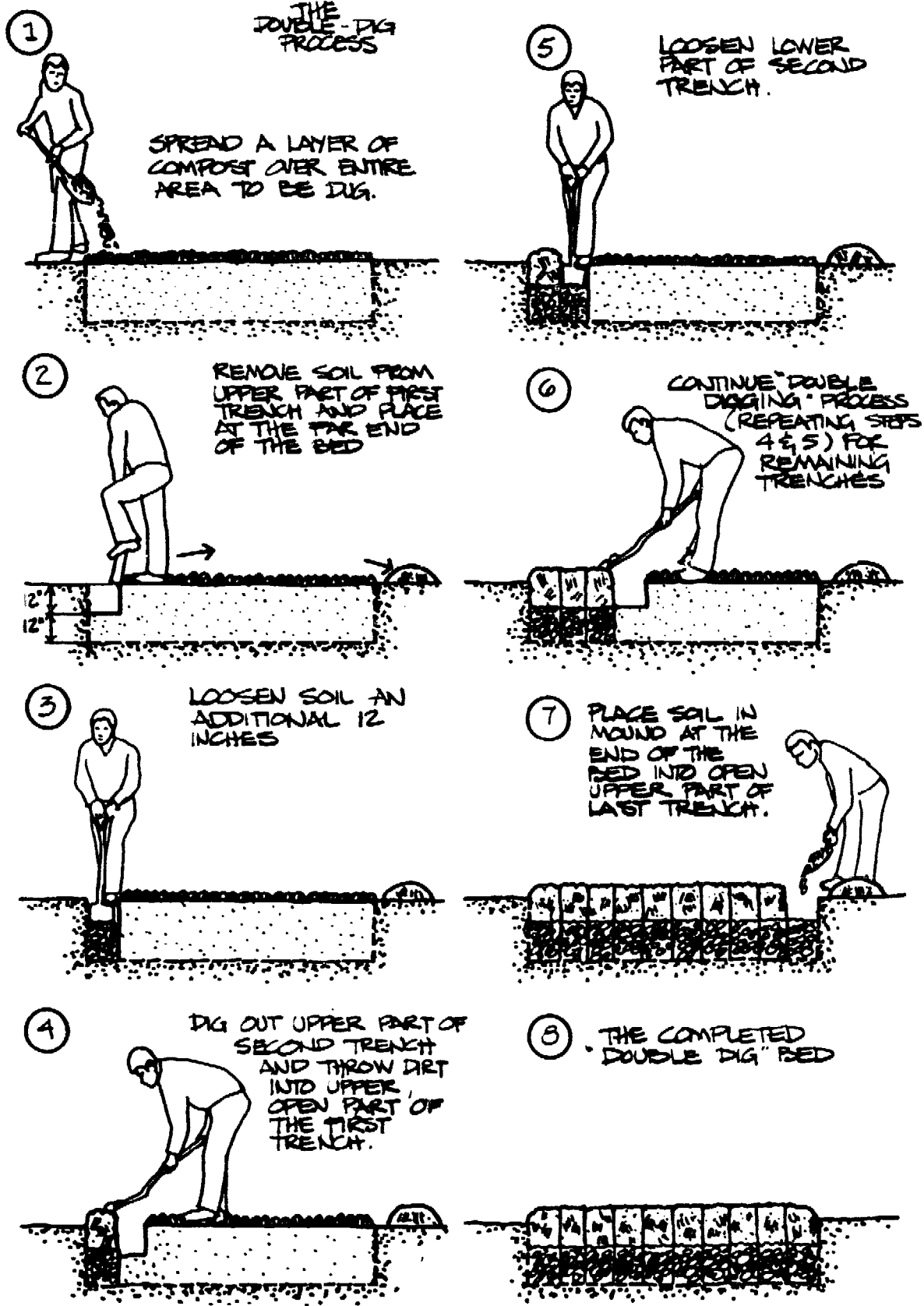

Procedures for Potted Seedlings

Potting Mixture

The potting mix should be loose and light to encourage good root development, but not so much so that the root ball crumbles when handled. Good results have been achieved by mixing plain sand with sieved cattle manure at a ratio of 1:1. It may also be desirable to include some clay in the mixture so that the root ball holds together well during transplanting. Old termite mounds are often a good source of clay. Other ingredients that may be included in the potting mix are charcoal dust, compost, insecticides or fungicides, and chemical fertilizers.

Clay and organic matter should always be sieved to get rid of any large clumps. Sand, on the other hand, normally does not need sifting unless it contains a lot of debris. A large screen can be constructed using a heavy wire mesh (1-cm openings) with a wooden frame for support. This is propped up at an angle, and the potting mixture is shoveled through it. Any clumps that are too big to pass through the screen can be dried and pounded to break them up.

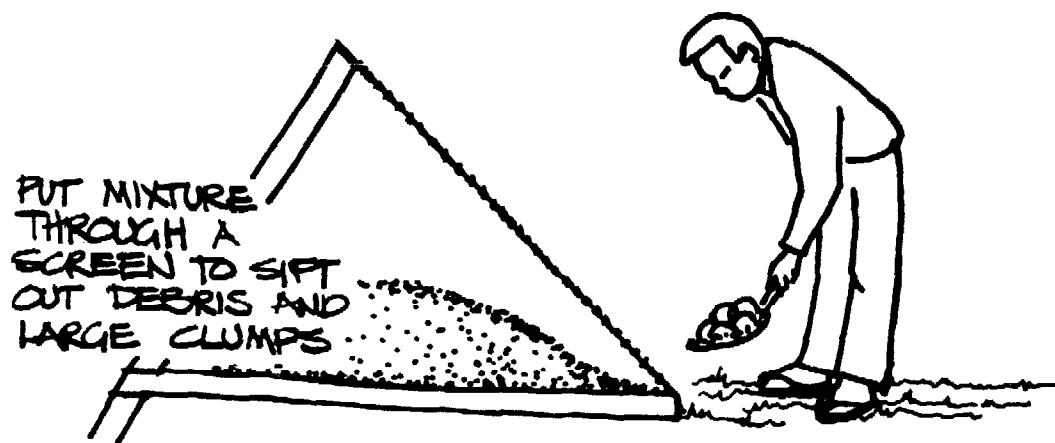

PUT MIXTURE
THROUGH A
SCREEN TO SIFT
OUT DEBRIS AND
LARGE CLUMPS

Manure should be sifted before it is used to make the potting mixture

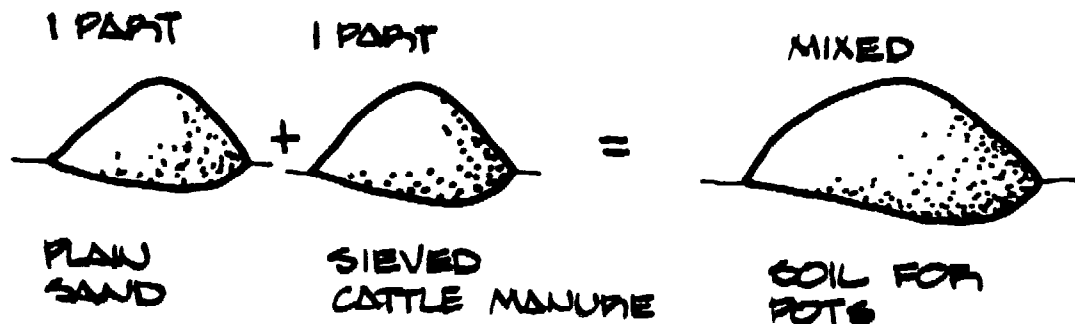

Heap the mixture in sizable piles in the nursery work area

Filling Pots

Once the ingredients have been thoroughly combined the pots are filled. It is important to teach nursery workers to fill the pots properly in order to ensure efficiency as well as good quality seedlings. The following pages illustrate how to fill and sink pots for the best results.

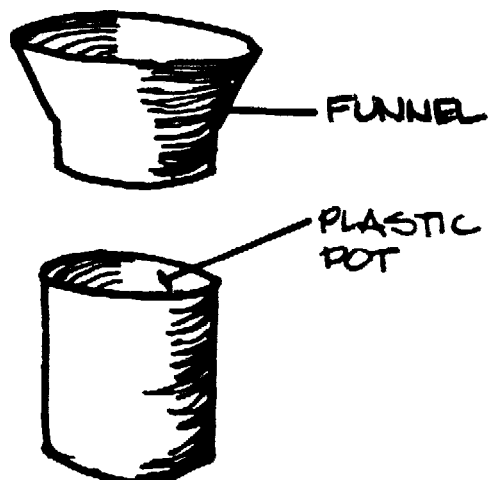

Fill the pots using a metal or plastic funnel just large enough to fit the top of the pot.

Fill the pots full. Watering will cause the mixture to settle to about 1/2cm below the top of the pot.

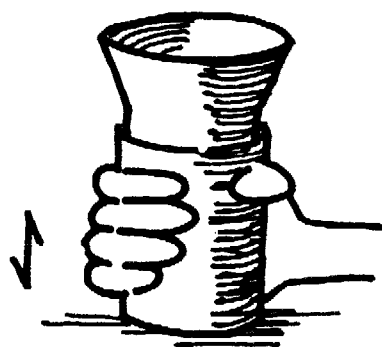

Scoop the mix into the funnel. The soil is lightly packed as the pot is being filled by tapping the pot on the ground with the funnel held in place.

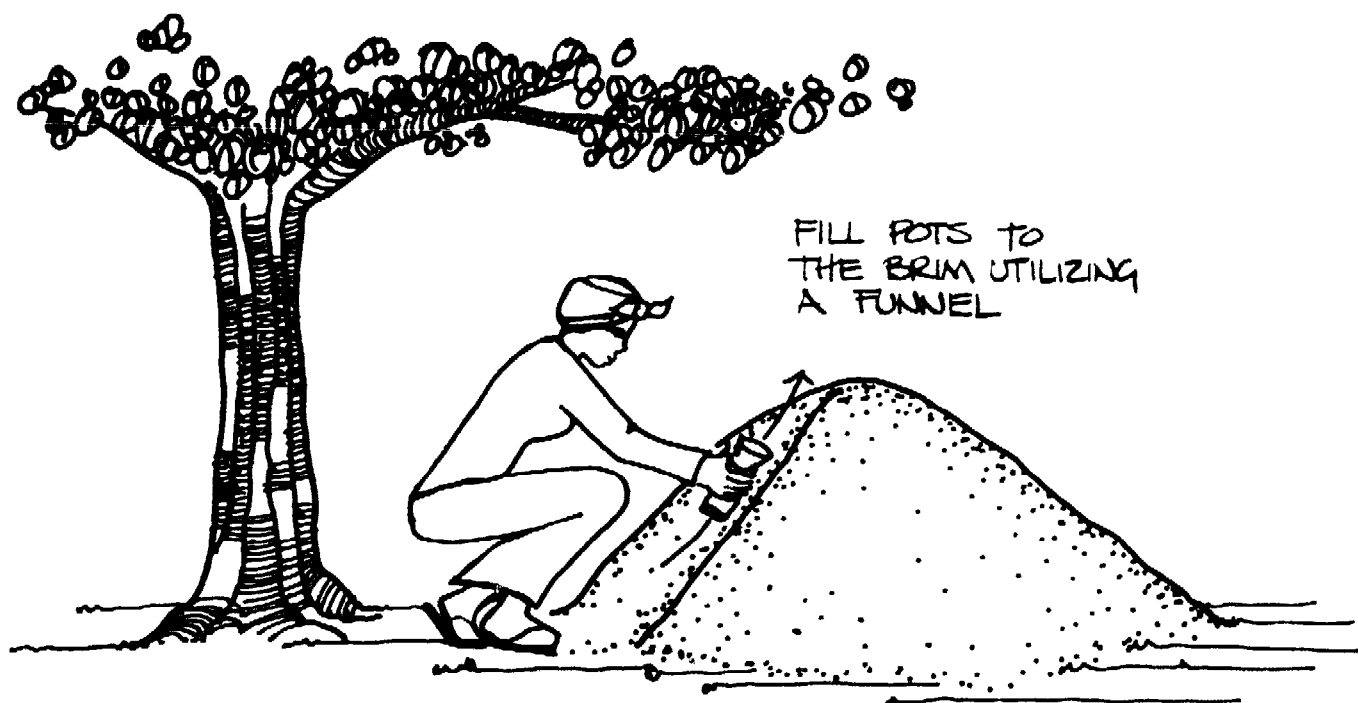

POTS SHOULD BE FILLED TO THE TOP

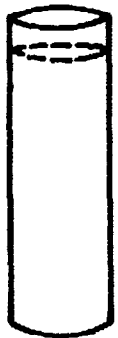

NOT PROPERLY FILLED TO THE TOP



PROPERLY FILLED



PART OF POT WALL FALLS IN. TREE WILL NOT GET ALL THE WATER.

SURFACE WILL SETTLE WITH WATERING



WHEN "COLLAR" BECOMES GREATER THAN 1.5 CM, REFILL WITH SCREENED SOIL OR SAND.

PROPER COMPACTION

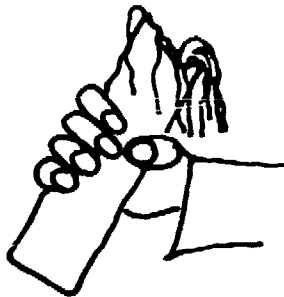

BAD

SOIL WILL RUN OVER TOP WHEN SQUEEZED.

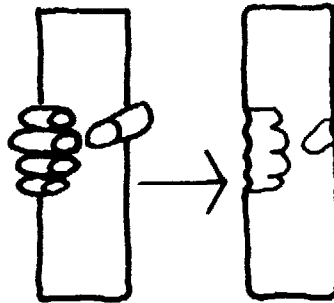

SLIGHT IMPRINT OF FINGERS LEFT AFTER POT WAS FIRMLY SQUEEZED.

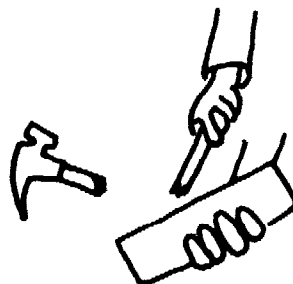

BAD TOO HARD

Sinking Pots

As some workers fill the pots, others set them in neat lines and rows. Although lining the pots up perfectly is extra work, it greatly reduces the effort required during the rest of the nursery operations. Seedlings planted in the outside row of pots should be protected against sunburn and excessive heat. Slightly countersinking or burying the rows of pots helps. Use the earth dug out from this operation to build a wedge against the outside pots to protect them.

POT LEVELS : GROUND LEVEL

AT DRY SITES

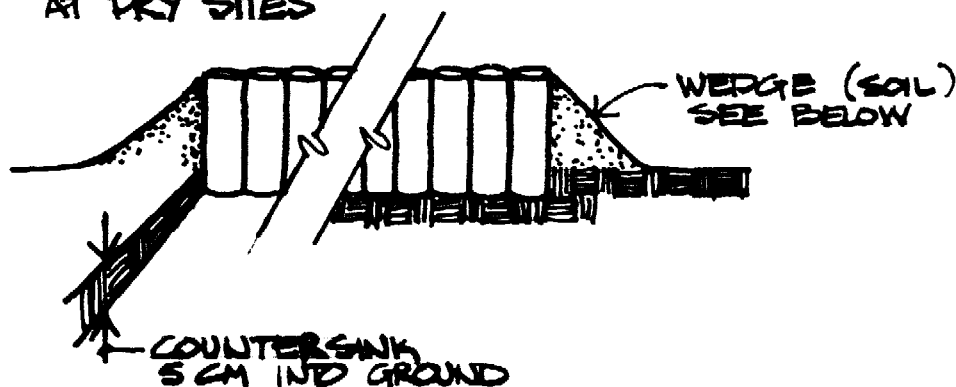

AT MORE HUMID SITES

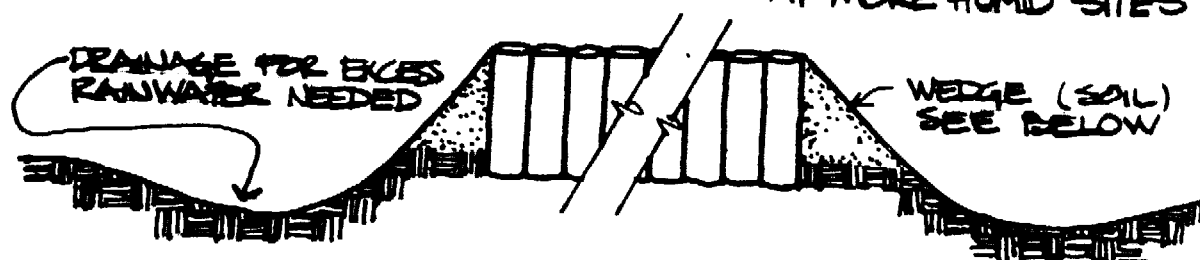

PROTECT OUTSIDE ROWS PROPERLY

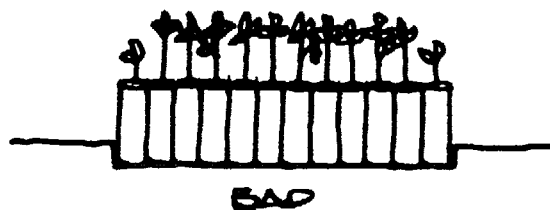

IF POT WALLS ARE NOT PROTECTED FROM SUN, TREES IN OUTSIDE ROWS WILL BE STUNTED.

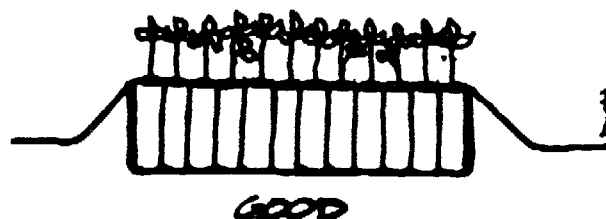

PUSH SOIL INTO OUTSIDE WEDGE ALONG OUTSIDE ROWS

It is very important that the beds be level and smooth. Stack the pots in straight even rows so that they do not lean. Separating the pots into units of 100 or 1,000 makes it easy to keep track of how many seedlings are in the nursery.



BED SHOULD BE LEVEL
TO AVOID LEANING

BAD

NO ROWS AND LINES,
SURFACES UNEVEN,
LEANING INSTEAD OF
STRAIGHT

RESULTS:

UNEVEN WATERING
DIFFICULT TO ORGANIZE WORK
LOW PRODUCTION
POOR QUALITY SEEDLINGS



ALL WALLS
VERTICAL

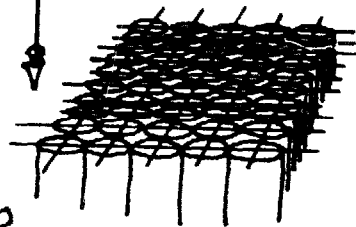

ROWS AND LINES



EVEN
SURFACE
HEIGHTS

GOOD

PLUMB BOBS AND LEVELS ARE
NOT NORMALLY USED IN STACKING
POTS, BUT BEDS SHOULD LOOK
AS IF THEY WERE.

Determining Planting Dates

Survival chances of the young trees depend directly upon their size when they are transplanted and upon planting them at exactly the right time of year. Therefore, the timing of the seeding operation must be carefully planned. Ideally, a tree should have as large a root system as possible before transplanting--this increases its survival chances. But trees must also be reasonably light and small so that transportation and transplanting can be done more easily.

Location, soil, the amount of sunlight and water, and other factors can affect the time needed in nursery beds. These differences make exact scheduling difficult, but much good information is often available from local experience and carefully kept records of other projects. For some species, it is important that seedlings be past the early emergent stage to survive the extreme dry heat and winds occurring in sub-Saharan Africa during dry season months. This kind of information must be considered when deciding the seeding dates.

The planting schedule is set up so that the trees will be strong and well-developed for transplanting to their permanent sites immediately after the first rains. To time the planting correctly, foresters determine how long each species to be grown has to remain in the nursery. Then they calculate the dates for seeding by subtracting the estimated time in the nursery from the number of weeks left before the predicted start of the rains. Thus if *Acacia albida* is to be seeded in plastic pots (see chart on following page) and if the rains are due to start in 24 weeks, it can be figured that the pots must be seeded in nine or ten weeks, thus:

$$\begin{array}{r} 24 \text{ weeks left before rains} \\ -14 \text{ weeks necessary in nursery} \\ \hline 10 \text{ weeks} = \text{time for planting} \end{array}$$

The following chart lists some species commonly found in Africa and classifies them according to the time needed in nursery beds with controlled irrigation and shade. If these conditions are not well controlled, more time in the nursery may have to be scheduled.

PLASTIC POTS

6-10 Weeks	10-14 wks.	14-18 wks.	18-24 wks.
<i>Parkinsonia aculeata</i>	<i>Acacia albida</i> <i>Acacia radiana</i>	<i>Acacia nilotica</i> <i>Acacia senegal</i> <i>Anacardium occidentale</i> <i>Azadirachta indica</i> <i>Eucalyptus spp. (1)</i> <i>Prosopis spp.</i>	<i>Balanites aegyptiaca</i> <i>Butyrospermum parkii</i> <i>Casuarina equisetifolia</i> <i>Eucalyptus spp. (2)</i> <i>Parkia biglobosa</i> <i>Tamarindus indica</i> <i>Tamarix spp. (3)</i> <i>Ziziphus spp.</i>

OPEN-ROOTED STOCK

30-35 Wks.	35-40 wks.
<i>Cassia siamea</i> <i>Sclerocarya birrea</i>	<i>Azadirachta indica</i> <i>Gmelina arborea</i>

- (1) Transplanted into pots
- (2) Seeded directly into pots
- (3) Propagated from cuttings

Seed Supply

Some seeds may have to be ordered, and this should be done early. Sometimes seeds are purchased locally in the market, but it is difficult to guarantee good genetic quality. The buyer has no control over the parent tree selection. Often it is necessary to gather seeds from trees in the area, and prepare them for use. Seed tree selection and seed collection should be supervised by trained personnel.

Seed Collection

The best seeds come from strong, healthy parent trees. Fully ripened fruits are picked directly from the trees or collected at least daily as they fall. If fruits are being picked, long handled pruning shears can be used to reach higher branches. Collection can be made more efficient by spreading large pieces of cloth, mats, or tarpaulins under the trees to catch the seeds as they fall. Whenever possible, seeds are collected as soon as they are ripe, otherwise many of them may be eaten or damaged by birds, animals, or insects. Damaged seeds are less likely to germinate. Seeds should be fresh and reasonably dry, without being dried out.

The timing of the rainy season also has an effect on flowering and fruiting of trees. If the seeds are to be collected locally, information on when the seeds will be ripe is needed to plan seeding operations. The fruits of many species in Africa mature during the dry season. If the timing of the fruiting season does not correspond with the planting schedule, seed must be collected in advance and stored for use during the following year. The seed of such species as *Azadirachta indica* cannot be stored for more than a few weeks, so collection and seeding in the nursery must be planned to take place as soon as possible after the seeds become ripe.

Appendix B has additional information on seed collection for certain species. Another good source is Von Maydell's *Arbres et Arbustes du Sahel*.

Seed Tree Selection

Seed trees should not be selected at random or on the basis of proximity or convenience to the seed collectors. The genetic quality of the parent tree is an important consideration in seed collection because characteristics such as fast growth, tree form, and resistance to diseases and insects can be passed on from one generation to the next. It may be difficult to determine which parent trees will produce superior offspring, however, because environmental variables can complicate the picture. A tree with high genetic potential, for instance, may appear to have slow growth because it is growing on a poor site.

In selecting a seed tree, the project's purpose will also determine the characteristics that are sought. Trees with straight, clear trunks are preferable for production of poles for construction, but bushy trees and shrubs that coppice easily are appropriate for firewood or live fencing. If foliage or food production are the primary project goals, then the amount of leaf or fruit production a specimen is capable of is more important than its form. In soil conservation projects, the longevity of a potential seed tree should be considered as well as rapid growth.

These characteristics are usually difficult to measure when comparing individual trees. Furthermore, the combination of traits that are sought can rarely all be found in one specimen. Generally, several seed trees for each species are selected. In selecting seed trees, look for places where site conditions do not limit the trees' growth. Try to find a stand with several individuals of the same species growing together and choose the healthiest, most vigorous representative that typifies the characteristics that are being selected. Seed trees should be marked so that they can be easily identified from year to year.

Extraction

Seeds must be removed from the fruits and pods that contain them, and there are various ways to do this.



Fruit containing seed

Dry fruits can be pounded carefully in mortars or bowls or on clean, hard surfaces to separate the fruit from the seed. Then the seeds are cleaned by hand or by winnowing them through the air (mortar and wind separation). Most of the *Acacias* and *Cassia simea* seeds can be extracted by this method.

The fruit of pulpy species, like *Balanites aegyptiaca* and *Azadirachta indica*, must be soaked before the pulp can be removed and the seeds extracted and dried. Some seeds, like *Ziziphus spina-christi* must be soaked to soften the pulp, and only then can the remaining hard shell be cracked with a hammer to remove the seeds.

Others, like *Parkinsonia aculeata*, can be easily shelled by hand.

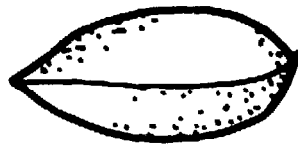

Extracted Seed

Drying and Storing Seeds

The two most important factors in good seed storage are keeping the seeds dry and keeping them cool. Wet seeds spoil and rot in storage, so they must be dried in the air first. Then they can be stored in dry containers such as jars, boxes, or bags. Care must be taken to keep the containers off floors and away from walls. This practice helps keep insects and dampness away from the seed containers.

Store the containers so that air can circulate around them. This helps keep the seeds drier and cooler. Extreme heat can destroy the seed's ability to germinate.

Seeds should not be left to dry under a hot sun for the same reason. For example, the viability of seeds like *Eucalyptus* spp. is destroyed at temperatures above 40 degrees Celsius.

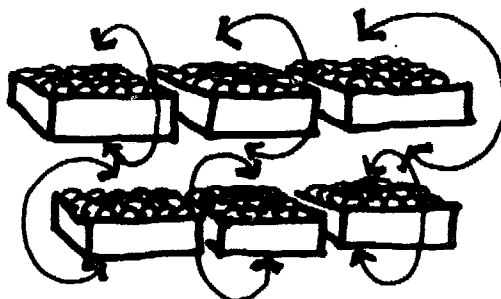

Seeds should be stored so that air can circulate around them

If at all possible, the seeds should be treated with a general pesticide to keep weevils and worms away. The containers should be checked frequently for damage to the seeds; the seeds should be turned over in their containers at that time.

Each container of seeds should be labeled with the following information:

Species:	Name
Collection:	Date Location Name of Collector
Storage:	Beginning date treatment
Quantity:	Number of seeds in the container

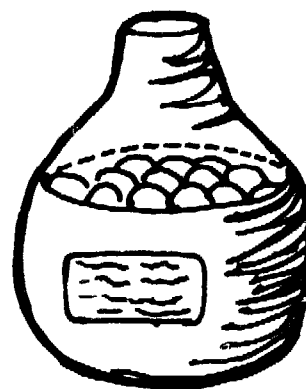

JAPS

Seeding

Prewatering and Weeding

The beds or pots should be watered daily beginning two weeks before sowing the seeds. Regular and gradual prewatering in small amounts (rather than adding a lot of water at the last moment) allows the water to mix evenly and thoroughly with the soil. The top 20cm of soil should be moist. Water

penetration of the soil can be checked by opening some of the pots to check the moisture levels inside.

Prewatering will cause weed seeds already in the soil to germinate and become visible before the tree seeds are planted. Then all the newly emerged weeds can be removed before sowing. Weeding at this point saves time later and increases the young trees' chances for survival.

Pretreatment of the Seeds

Most seeds must be treated in some way to give reliable germination results. Some seed coats are impermeable to water and will not germinate without help. Pretreating the seeds also causes them to germinate faster. This is important because if some seeds do not germinate, the beds or pots can be reseeded without too much loss of valuable time.

As a rule any seed that has a glossy, hard cover (for example, most of the *Acacias*) must be treated before it is planted. Usually, treatment involves soaking the seed (stratification) and/or scratching or nicking the hull (scarification). Different species respond best to certain treatments or a combination of treatments. Some seeds like *Azadirachta indica* do not need any pretreatment once they have been extracted from the fruit. The following are some examples of pretreatment methods:

Warm stratification process:

- o Bring water to a boil in a suitable container.
- o Remove from heat and let stand for five minutes.
- o Add the seeds and let them soak overnight.
- o Plant the seeds next day.

Scarification methods:

- o Use sand paper to scratch the hull (this can be time consuming).
- o Mix the seeds in a container with wet coarse sand and shake the container.
- o Use fingernail clippers to crack or nick the seed coat, being careful not to clip the seed germ.
- o Immerse the seeds in an acid bath for a few seconds (be careful to store acid solutions very securely).

Sowing

Seeds are planted in either pots or open beds according to the steps in the illustration below. This seeding method is used for most species.

STEP 1

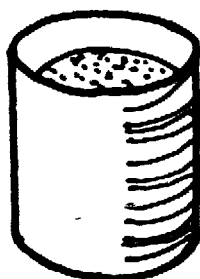

FILL WITH
SOIL
WATER 2
WEEKS BEFORE
SEEDING

STEP 2

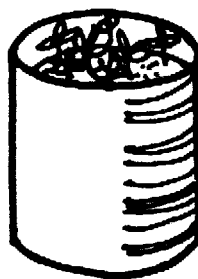

REMOVE ALL
GERMINATED
WEEDS PRIOR
TO SEEDING

STEP 3

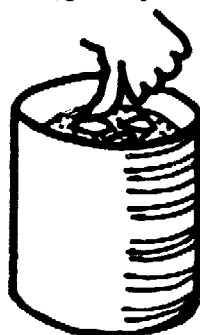

LAY SEED
FLAT & PUSH
INTO SOIL
WITH THUMB

STEP 4

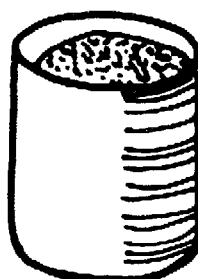

COVER SEEDS
ABOUT 3 TIMES
THEIR SMALLEST
DIAMETER WITH
FINE SOIL

Planting seeds

One notable exception is *Anacardium occidentale*, which is planted upright rather than flat. *Eucalyptus* seeds are also an exception, because they are very small and must be planted and watered using special methods (see following pages).

Seeds are spaced according to their predicted germination rates. In other words, if germination results are expected to be high, fewer seeds are planted. Generally one or two seeds are placed in a pot, depending upon the germination rate. In open-rooted seeding, extra seeds are planted. The seedlings are thinned to the desired spacing later. String can be used to lay out straight lines in the open beds. Planting the seeds in straight lines makes weeding and cultivating much easier.

Seeding *Eucalyptus*

Eucalyptus seeds can be started in a separate germination box and later pricked out and transplanted into pots, or they can be seeded directly into pots, using the method illustrated below.

SEEDING EUCALYPTUS

STEP 1



PUT 3-5 MM OF WATER INTO A CUP

STEP 2



MOISTEN NEEDLE OR THIN SLIVER OF WOOD TO A HEIGHT NOT MORE THAN 3 MM

STEP 3



PLUNGE THE NEEDLE INTO EUCALYPTUS SEEDS.

YOU WILL FIND SEEDS STICKING TO THE POINT

STEP 4



PUT THE PIN INTO THE SOIL AT A 45° ANGLE TO A DEPTH NO GREATER THAN 10 MM

NOTE: ANY WATERING METHOD MAY BE USED.

STEP 5



TRANSPLANT SEEDLING INTO EMPTY POT WHEN THE PLANTS ARE BETWEEN 25 & 50 MM HIGH.

If *Eucalyptus* seeds are sown directly into pots, they should be watered using a fine mist sprayer. Large droplets of water will wash the seeds to the edge of the pot, and will break the stems of the newly emerged seedlings. If a mist sprayer is not available, the Nobila method, illustrated on the following pages, can be used.

Nobila Method

In the Nobila method, capillary action in a special sand germinating mix is used to provide constant moisture around the seeds without having to use elaborate spraying or watering arrangements. Normal watering methods cannot be used because the seeds are so small that they would be washed away by large droplets of water.

Nobila Method for Germinating Seeds

STEP 1

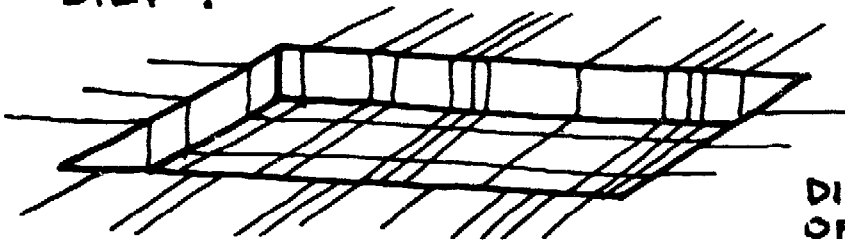

DIG A PIT 3/4 HEIGHT OF POTS USED

STEP 2

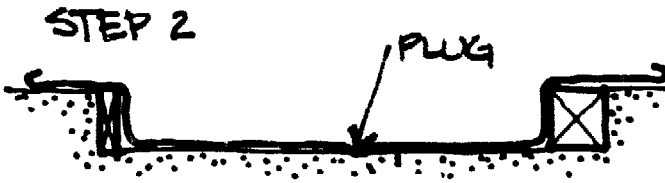

LINE SIDES WITH WOOD OR CEMENT BLOCKS OR SOMETHING SOLID TO FORM A FRAME. MAKE WATER PROOF "BASIN" WITH PLASTIC SHEET.

STEP 3

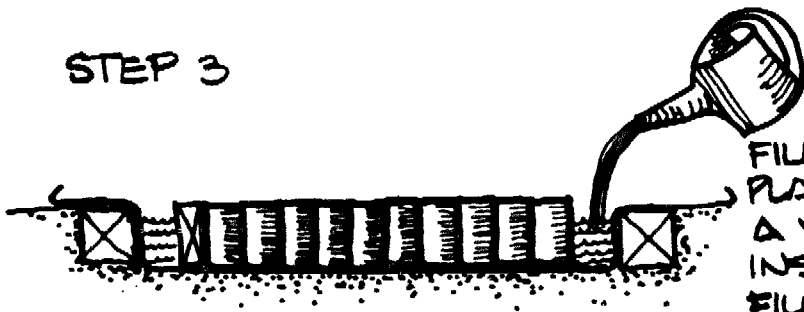

FILL BASIN WITH EITHER PLASTIC POTS OR BUILD A WOODEN FRAME INSIDE DEPRESSION; FILL FRAME WITH SOIL.

WATER SOIL & FILL BASIN WITH WATER TO WITHIN 5-10 CM OF TOP OF SOIL. LEAVE TO DRAIN OVER NIGHT.

STEP 4

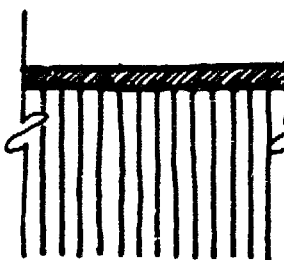

MIX SEEDS WITH FINE SAND & SPRINKLE OVER TOP. PUT 1MM LAYER OF FINE SAND/ MANURE MIX OVER SEEDS.

NOTE:

KEEP SEEDLINGS MOIST BY FILLING

STEP 5



COVER SEEDS WITH ANOTHER 2-4 MM SAND

BASIN WITH WATER

Transplanting Eucalyptus Seedlings into Pots

Eucalyptus seedlings started in germination boxes should be transplanted into pots when they are about 25-50mm tall and have several leaves. In transplanting the tiny seedlings, grasp them by their leaves and not by the stem, because the stem is too fragile to be handled. Also make sure that they are placed in the center of the pot and that there are no large air spaces around the roots. Keep them in the shade after transplanting them into pots until they have completely revived from the transplanting shock.

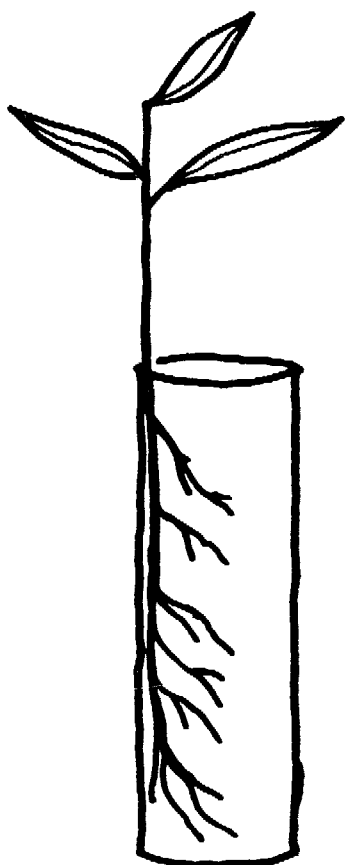

DIRECT SEEDING INTO POTS CAN RESULT IN OFF-CENTER GERMINATION. IF THE SEEDS ARE WASHED TO THE SIDE OF THE POT ROOTS ARE THEN EXPOSED TO THE WALLS OF THE POT RATHER THAN SURROUNDED BY SOIL.

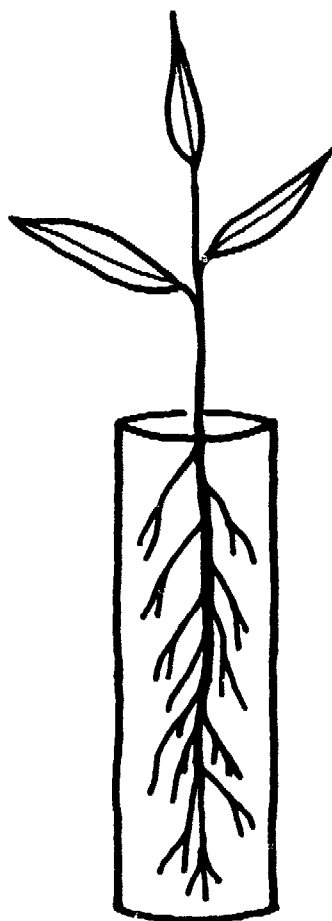

TRANSPLANTING FROM A GERMINATION BOX INTO A POT WILL ENSURE GOOD ROOT DEVELOPMENT.

Tending Seedlings in the Nursery

Mulch

If it is possible, the seed beds should be mulched. Mulch is the term for materials (for example, decayed leaves) laid on the seed bed to keep down soil temperature, inhibit weed growth, lessen erosion damage, and help the topsoil remain loose and crumbly. Some ideas for mulch materials include shredded newspaper, plastic sheeting, straw, and bark. Rodent damage to young plants can be reduced further by covering the mulch with small branches. One problem that mulch might actually encourage is termites. If there are termites in the area, the seedlings should be checked often for damage and insecticide applied if necessary.

Watering

Watering is relatively easy if plans have been made carefully. Even such improvements as water storage tanks beside the nursery beds are useful. The general rule for watering is simple: adequate amounts of water are needed at regular intervals. The water must be added gradually so that it does not form puddles or run off before it has a chance to soak in. The plants should be watered every day, including holidays. A strictly followed watering schedule will promote germination and seedling survival.

The seeds should be watered as soon as they are planted. For at least the first month, watering should be done twice a day (of course, it is often necessary to make allowances for soil types and locations that make more or less water necessary). Watering should take place in the early morning and late afternoon or evening. The plants should receive about 5mm of water each time. The top 20cm of soil in the pot or bed must be kept moist. Checking the pots or beds regularly will show whether the soil is sufficiently moist. Moisture levels should never be allowed to drop near the wilting point.

Water Need Calculation

DAILY REQUIREMENT:

$$10 \times 50 \times 0.02 = 0.1 \text{ M}^3$$

$$= 100 \text{ L OR}$$

$$\text{APPROX. 25 GAL.}$$

AT 5 ROWS & 5 CM
INTERVALS, THIS BED
CONTAINS 500 TREES.

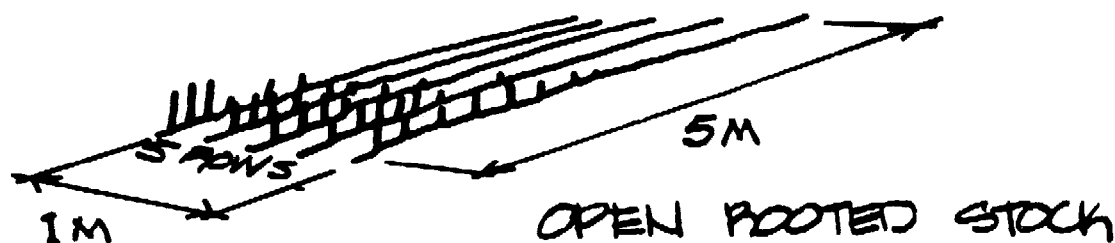

If this calculation is used and followed, there will be enough water even under the most demanding circumstances. If all the conditions in the nursery remain good during the project--if there is enough shade, protection from the wind, effective watering during the coolest part of the day, and good water retention by the soil or nursery mix--the amount of water needed will be less than this. In fact, if all of these conditions remain good, only half the amount of water calculated may be needed. However, experienced project managers plan for maximum need. It is far better to have the problem of not using all the water than it is to plan poorly and risk losing the entire stock.

PLASTIC POTS

THIS BED CONTAINS
500 TREES.

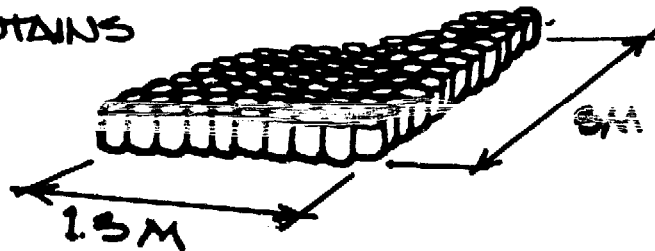

DAILY REQUIREMENT: $1.5 \times 30 \times 0.02 = 75 \text{ L OR}$
APPROX 20 GAL.

Cultivating

Young nursery plants should be weeded about once every ten days. No fancier techniques are needed than those used in a vegetable garden. The object is to get rid of weeds and to keep the surface of the soil loose and crumbly. Sticks or hand weeding tools are all that is necessary.

Thinning and Root Pruning

Thinning Open-Rooted Stock

Young trees must be thinned out: the single most frequently made mistake in raising open-rooted stock is failure to thin the young plants. When there are too many young plants in crowded conditions, the resulting trees are of uneven size and have poor root development. Many trees will die if thinning is not done at the proper time.

Seedlings should be thinned before root competition becomes severe. The best time is usually when the plants are between 10 and 15 cm tall. Thinning is done by removing enough seedlings from the bed to result in an approximate spacing of 5cm between each stem. The seedlings that are chosen to remain should be the ones growing the most vigorously.

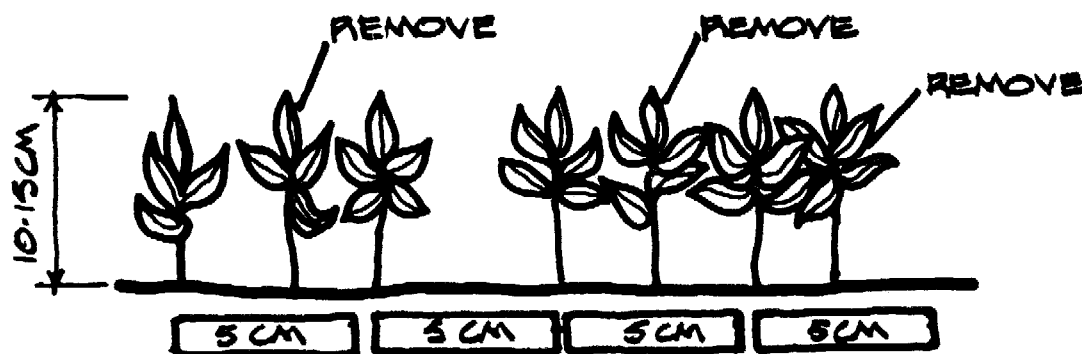

THINNING OPENROOTED STOCK

Sometimes empty spaces in beds can be filled with plants that become available as a result of a thinning operation that took place in nearby beds. This has been done successfully with *Azardichta indica*, *Parkinsonia aculeata*, and even with some *Acacias*. Such an operation will succeed if the following precautions are taken:

- o Roots of trees being transplanted do not exceed 5cm in length.
- o Dirt is left around the roots when the seedling is lifted out.
- o Plants are handled carefully to avoid injury.
- o Roots are exposed to air as little as possible.
- o Experienced workers with proper tools do the work.
- o Air pockets around roots are eliminated by gentle pressure--earth must not be packed too hard.
- o Trees are planted at the proper collar height.
- o Freshly transplanted roots are kept moist.
- o Plants are kept shaded until they are growing well in their new location.

If there is enough seed available and time is not a problem, it is probably better, in the long run, to reseed empty beds or pots than it is to transplant young plants from the thinning operation.

Root Pruning

Plastic pots must have some drainage, and thus are perforated in the bottom. Small roots will grow out of the holes into the soil below, and if nothing is done to prevent it, the tree will develop a second root system below and outside the pot. Consequently, those roots that grow below the pot and which are the major part of the root system will be destroyed when the pots are moved. This kind of situation defeats the main objective of using pots, which is to allow trees to be moved and planted with the least disturbance of the root structure.

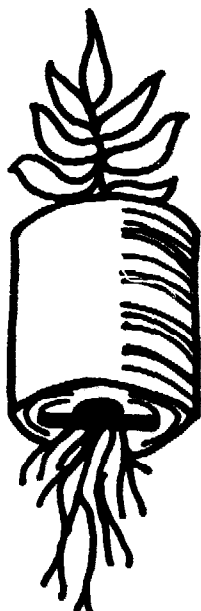

CUT ALL ROOTS
WHICH ARE GROWING
OUT OF THE BOTTOM
OF THE POT

Root pruning prevents the development of a root system outside the pots. Generally, after the first 6 to 8 weeks (it is earlier for *Acacia*), all trees in plastic pots must be moved twice a month, the outside roots cut off, and the pots set back in place.

To reduce work, each block of pots can be shifted, pot by pot, a convenient arm's length distance. To do this a worker picks up a pot with one hand, prunes the roots with pruning shears, transfers the pot to the other hand and puts the pot down on the other side. When pruning is finished, the entire block of pots will have been moved.

Pest Management

The nursery manager and other project personnel must watch constantly for signs of disease or insect attack and be prepared to respond immediately when problems are first noticed. Pests can spread quite rapidly in the nursery, and delay in treating the seedlings has been known to result in loss of much of the stock.

The Integrated Pest Management (IPM) approach involves the use of chemical, biological, and cultural practices for economical and environmentally sound plant protection. Although the dangers of chemical pesticides are now

recognized, they are still widely used in situations where other pest control methods are ineffective. Biological controls are being researched and introduced to take the place of pesticides where possible.

Biological methods involve the introduction of a new species into the agroecosystem that acts as a predator, disease, or repellent of the pest species. Insects are preyed on by birds, lizards, snakes, frogs, spiders, and other insect species. Diseases can kill insect pests or affect their growth and reproduction cycles. Repellent species are often other plants that produce substances that discourage certain insects from remaining in the vicinity. The Neem trees (*Azadirachta indica*) are believed to have this property of repelling a wide variety of insects. Compounds made from various parts of the Neem are being tested as organic insecticides.

Possibly the most effective approach to prevent pest incursions in the nursery is through sound cultural practices. Maintaining healthy seedlings is the best means of reducing losses due to pests. Plants that have not been properly tended and watered, or that are deficient in some nutrient, will be more susceptible to insect and disease attack than will well cared for seedlings.

Insects

In dry tropical regions, insects are most active and numerous during the rainy season. The life cycles of many insect species have adapted to the climate so that they do not hatch out until after the first rains have fallen. Because seedling production takes place during the dry season for the most part, insects may not be as great a problem in the nursery as they can be later, when seedlings are moved to the planting site. Nevertheless, insect pest outbreaks can occur in the nursery.

Often the most commonly found insects in the nursery are termites. While they can do extensive damage to seedlings, not all species of termites are pests. Some species consume manure and other compost, thereby aiding in the decomposition of organic matter, but do not bother live plants. Termites can also improve the soil structure by breaking up hard layers and increasing porosity, through their tunnel-building activities. Some termite species will, however, eat seedlings. In addition there are numerous other insect pests that can cause problems in the nursery.

Many tropical plants produce secondary compounds that poison or discourage herbivores. In spite of this natural immunity, however, a given plant species may be highly susceptible to certain insect species that are not affected by these compounds. Thus it is not uncommon for one tree species to be under attack in the nursery, even though the other seedlings are unaffected. Before beginning any sort of treatment, it is very important to assess the extent of the damage and whether or not it is confined to one plant species. This can help in the identification of the insect and in the evaluation of various control methods.

The first step in dealing with an insect attack is to try to identify the pest species. Insect identification is not always easy, particularly in the tropics where many species have yet to be classified. If the insect cannot be identified without expert assistance, collect samples in as many stages of its life-cycle as possible.

The next step is to determine what control measures can be used. Because so little is known about many of these insect species, the use of non-specific insecticides is far more widespread than the use of biological controls. More research into insect ecology is needed to identify natural predators and diseases that can regulate insect pest populations. It may be possible to remove and destroy the insects by hand, however, rather than resorting to chemical extermination, if:

- o the insect outbreak is caught early enough,
- o the insects are easy to see and grasp,
- o the insects will not bite or sting nursery workers, and
- o sufficient labor is available.

If other insect eradication methods cannot be used, most insect problems can be controlled by insecticides. Their application is discussed below under Pesticide Use.

Disease

The most common disease problem in the nursery is caused by fungi. This disease, which can be caused by many different varieties of fungus, is generically referred to as "damping off." The fungi occur in the soil of seedbeds and pots and attack the roots or stems of the young plants. Often the first noticeable symptom of damping off is a discolored, "pinched" stem. Sometimes, however, the leaves of the seedling seem to be drying out, although the stem still appears to be healthy. Shortly thereafter the seedling begins to wilt and die. Fungal diseases can spread rapidly, and there is little that can be done to revive the plants once they have been infected.

Beds and potting mixtures can be treated with fungicides before seeding, but this will destroy the beneficial fungi in the soil as well as the disease varieties. Damping off can be prevented to some extent by avoiding overwatering and stagnation in the beds and pots. Soils with high pH (6.0 or above) are less susceptible to infection, and some species, such as *Eucalyptus* and pines, are more vulnerable to fungal attack than others. *Eucalyptus* seedlings can be started in germination boxes containing soil that has been sterilized, then transplanted into pots when they are 25-50mm tall, and more resistant to the disease.

Other diseases in the nursery can be caused by bacteria and viruses. Viruses are usually transmitted to the host plant by some other organism, which is called the vector. Vectors can be either animals or plants, and they are often

normally aimed at eliminating the vector. Bacteria can be transmitted by vectors, as well as spread by water. Some fungicides are also used to combat bacterial diseases, but chemical applications do not work against viruses.

If the disease causing agent is not known, use of non-specific chemicals may destroy many organisms in the soil that are beneficial to plants. Preventive measures include removal of weeds that may be host to the parasites, turning the soil in the beds after each planting, and using resistant tree species.

Pesticide Use

It is best to be prepared for insect attack by having certain pesticides on hand, or by knowing where they can be found quickly. A number of products are available in the bigger towns throughout sub-Saharan Africa. Pesticides kept at the nursery site must be stored with extreme care and handled only by trained personnel.

Dieldrin (also called Aldrin) is one of the most widely used chemicals in nurseries and plantations in Africa, although its use has been suspended or controlled in some countries because it causes cancer. It is also highly persistent, that is, it does not break down quickly into less toxic chemicals, but rather remains in the environment for a long time. Dieldrin is very effective against termites, maggots, and other soil insects when it is used according to directions. It is important to follow the warnings given on the label, however, because it is also extremely toxic. Improper use of dieldrin can cause severe illness and even death. In addition, Dieldrin must be applied so that none of the insecticide gets on the foliage of the trees--even small quantities will burn holes in the leaves. See box for usage precautions.

In many countries, pesticides are sold in containers that are not adequately labeled. Pesticide labels should always include the following information:

- o Trade name (with name and address of manufacturer)
- o Common names of the product
- o Chemical ingredients of the product
- o Type of formulation (dust, water soluble powder, etc.)
- o Registration or license number
- o Pests for which the product is intended
- o Net contents of the container (by weight or volume)
- o Instructions for mixing and applying the product
- o Instructions for storage or disposal of the product and container
- o Warnings and precautions (of health or environmental hazards)
- o Emergency treatment

Do not use a pesticide if you are uncertain about any of the criteria listed above. Lack of information about the concentration of the chemical or the amount needed for a given area can lead to harmful consequences. Wear protective clothing such as gloves, boots, face masks, and goggles, when mixing or applying chemicals. Two good sources of information about pesticides for

DIELDRIN

Other names: Aldrin

Type: Contact insecticide

Formulations: Emulsion concentrate (EC), wettable powder (WP), dust, and granules.

Warning: Do not touch. Dieldrin can be absorbed through the skin. It is extremely dangerous to man if not used correctly.

Do not apply directly to animals or let animals eat treated crops.

Do not dump extra solution into lakes, streams, or ponds. It will kill fish, and it can kill people who eat the fish.

It is poisonous to bees.

Do not use to treat grain or any product to be used for food, animal feed or oil purposes.

Helping someone who has been poisoned by Dieldrin

1. These are signs of poisoning:

HEADACHE	WEAKNESS
NAUSEA	SWEATING
DIZZINESS	VOMITING
2. If the person feels sick while using Dieldrin or soon afterward:
 - o Get the poisoned person to the doctor, dispensary, or health officer as soon as possible.
 - o Bring the insecticide container or label so the doctor will know what poisoned the person.
3. If the person swallowed Dieldrin and is awake, and cannot see a doctor **RIGHT AWAY:**
 - o Mix a tablespoon of salt in a glass of warm water and make the victim vomit, or stick your finger down the person's throat. Make him vomit!
 - o Make the victim lie down. Keep him warm, and do not let him move until help comes.
4. If the person spilled Dieldrin on either skin or clothing:
 - o Get the clothing off and wash the skin with soap and plenty of water.
 - o Get medical attention as soon as possible.

project planners include *34 Pesticides: Is Safe Use Possible*, published by the National Wildlife Federation and *Agro-pesticides: Their Management and Application*, by Jan H. Oudejans.

Preparing Seedlings for Transplanting

The general rule of thumb for judging whether a tree is the right size for transplanting is that the above-ground growth of potted stock should not be less than 0.2m and no more than 1m tall. Open-rooted stock can have between 1.5m and 2m of growth above ground.

Great variations exist among species in the ratio of above-ground growth to root systems. For example, *Acacias* have very long root systems compared with their growth above ground; *Azadirachta indica* develop rather tall, single shoots over a limited root growth. The only way to find out the relationship of above-ground growth to root system is to expose the root systems of a few sample trees of each species.

When lifting out open-rooted stock, it is usually the case that no more than 20cm of the root depth can be excavated without damage. Obviously a tree that has a major portion of its roots below this level cannot be transplanted safely, therefore the seedlings must be checked periodically so that they may be transplanted on time.

Hardening Off

Hardening off is the gradual reduction in watering rates during the last few weeks in the nursery. This lessening of water intake helps prepare trees for the less steady water supplies they are likely to receive at the planting site. About four to six weeks before removal, watering is reduced to once per day. After about a week at that rate, the young trees should be watered every other day. If the trees do not begin to wilt, the amount of water can be reduced further. If the trees do wilt, however, additional water must be applied immediately to prevent permanent damage.

Culling

It is a standard nursery management practice to cull the seedlings before transplanting. The seedlings are graded in terms of their size and vigor, and any that are not within acceptable limits are rejected or culled. Generally about 15 percent of the nursery stock is culled before a planting operation. Some of the culls can be kept in the nursery until they are larger and stronger, but often it is better to start over with new stock.

Seedlings should be rejected on the basis of size either if they are too small or if they are too large. Potted plants that have been kept in the nursery for too long often outgrow their pots, causing their root systems to be deformed. Overgrown seedlings will have a higher chance of mortality than smaller

Preparing Seedlings for Transplanting

The general rule of thumb for judging whether a tree is the right size for transplanting is that the above-ground growth of potted stock should not be less than 0.2m and no more than 1m tall. Open-rooted stock can have between 1.5m and 2m of growth above ground.

Great variations exist among species in the ratio of above-ground growth to root systems. For example, *Acacias* have very long root systems compared with their growth above ground; *Azadirachta indica* develop rather tall, single shoots over a limited root growth. The only way to find out the relationship of above-ground growth to root system is to expose the root systems of a few sample trees of each species.

When lifting out open-rooted stock, it is usually the case that no more than 20cm of the root depth can be excavated without damage. Obviously a tree that has a major portion of its roots below this level cannot be transplanted safely, therefore the seedlings must be checked periodically so that they may be transplanted on time.

Hardening Off

Hardening off is the gradual reduction in watering rates during the last few weeks in the nursery. This lessening of water intake helps prepare trees for the less steady water supplies they are likely to receive at the planting site. About four to six weeks before removal, watering is reduced to once per day. After about a week at that rate, the young trees should be watered every other day. If the trees do not begin to wilt, the amount of water can be reduced further. If the trees do wilt, however, additional water must be applied immediately to prevent permanent damage.

Culling

It is a standard nursery management practice to cull the seedlings before transplanting. The seedlings are graded in terms of their size and vigor, and any that are not within acceptable limits are rejected or culled. Generally about 15 percent of the nursery stock is culled before a planting operation. Some of the culls can be kept in the nursery until they are larger and stronger, but often it is better to start over with new stock.

Seedlings should be rejected on the basis of size either if they are too small or if they are too large. Potted plants that have been kept in the nursery for too long often outgrow their pots, causing their root systems to be deformed. Overgrown seedlings will have a higher chance of mortality than smaller seedlings with normal root development. Any seedling that looks unhealthy or diseased should be culled. It is better not to plant poor quality seedlings than to expend a lot of energy on trees that are unlikely to survive.

7

THE PLANTING SITE

Site Management

Planning and Organization

The planting site should be completely ready well before the first rains are due, because the trees must be transplanted as soon as sufficient rain has fallen to moisten the top 20cm of soil. The tree roots cannot be placed into dry ground if they are to survive.

When planting is delayed, survival rates decrease greatly. Transplanted trees need the entire rainy season to get a good start. Therefore, nothing can be gained by planting in the second half of the rainy season even if there is more cloudy, wet weather than usual. The limited time span during which successful planting takes place requires proper planning and advance preparation, which should include alternative plans for action and substitute resources in case difficulties occur.

While it is difficult to give specific guidelines for organizing planting work because each project is distinctly different, foresters often find the following pointers helpful:

- o Make contingency plans, especially for transportation and labor. It is very important that no delays occur. Planting is the time where careful planning and good relationships with the workers and the community pay off.
- o Plan realistically and attempt only what can be accomplished. A small, solid job, well done, is worth more than a marginal performance on a larger scale. Goals should not be set so high that they cannot be achieved.
- o Each planting effort is worthwhile, and is worthy of the same degree of personal commitment.
- o Weather factors can, perhaps, be planned for, but not controlled. There is a limit to the project manager's ability to guide the project, and it is important to realize that the impossible cannot be done.

Site Preparation

Site preparation includes delineating the site, clearing the ground, marking the space for each tree, and digging the holes.

Site Delineation

Well before the trees arrive, the fence or other protection should be in place. The control of land use at the site and the lines of authority should be clear to everyone in the area.

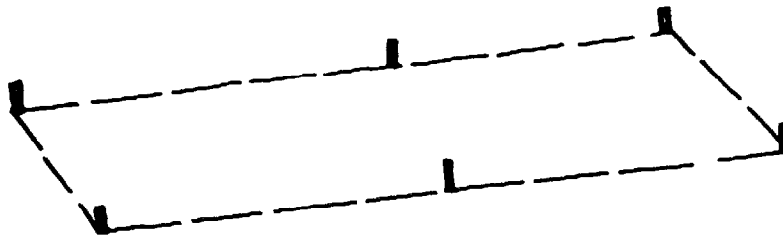

Planting area staked out.

Access routes to large sites should be established, and road work completed, if necessary. In large plantations, a four meter strip should be left just inside the fence so that a truck can pass, and the fence can be repaired easily. If the site is large enough to have firebreaks in addition to space left for the roadway, firebreak areas at least 6m wide should be planned and completely cleared.

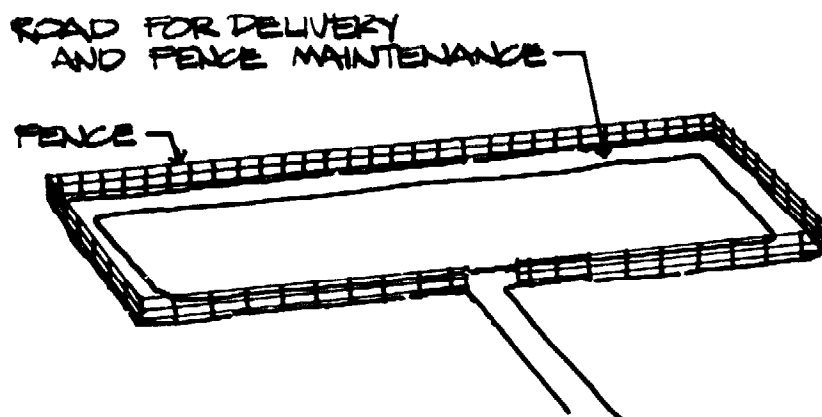

Roads and fences in place.

Clearing

The area around each tree's location should be cleared of all vegetation, including roots. Each tree should have a cleared area of at least 1 square meter in which to grow. This spacing eliminates competition for food and water and gives the tree a better chance for a good start in the new location. If the planting site already has some trees on it, space the transplanted seedlings so that they will not be in the shade of the existing trees.

Spacing

Based on experience relating to ground water tables, most trees in dryland Africa are now planted with an average of 3-4m between the trees. This of course differs depending upon the kind of tree and its needs. The following figures can be used as a guide in determining the number of trees that can be planted on a site according to the area needed by the tree:

Area Per Tree	Trees per Hectare
2m x 2m	2,500 per hectare
3m x 3m	1,100 per hectare
4m x 4m	600 per hectare
10m x 10m	100 per hectare

Some, if not most, of the large trees of Africa seem to be loners. *Acacia albida* and *Tamarindus indica*, for example, are rarely found growing naturally in dense stands. Plant these and other similar species in small clumps to ensure that one plant will survive.

Sometimes a lot of time is spent spacing trees very exactly. This is often done in areas where cultivation will be practiced using tractors and other vehicles. This use of vehicles is not as likely in a village situation, however, nor where the ground is very rough. In these cases, precision spacing is not called for, and it is better not to waste time trying to space the trees exactly. Spacing can be done very simply and easily by determining how many shovel lengths or steps must be left between each of the trees being planted. The first line of trees is planted along a boundary line such as a firebreak or road. The second line is then oriented parallel with the first.

Digging

In areas with less than 1,200mm mean annual precipitation, holes should not be dug before they are to be used. The purpose of pre-digging holes is to save time once the rains have begun, and to allow rain to fall directly into the hole, thus supplying extra moisture.

However, this technique may not work in dry areas for two reasons:

- o Rains are usually driven by the wind so that the drops hit the sides of the hole, rather than reaching the bottom.

- o As soon as the showers stop, the sun and wind dry out the holes and piles of excavated dirt. This drying process leaves the soil drier than it was before digging.

Each hole should be approximately 40cm wide and 40cm deep. This size should hold either open-rooted or potted seedlings easily. When digging, the soil is placed in two equal piles, one on each side of the hole. This technique greatly speeds backfilling.

Transplanting

Lifting Out and Transportation

Throughout the operations of uprooting, transporting, and planting, the workers must have plenty of room. It is a good idea to set up a number of small deposit points for unloading trees so that hand carrying can be kept to a minimum. Each team should know in advance the exact area in which it will be working. As soon as the work plan is ready, it should be discussed at staff meetings. The crew chiefs will know what is expected of them and their assistants. If everyone is sure of their job, the work will go much more smoothly.

REMOVE & TRANSPORT
MATERIAL FROM
NURSERY

START AT EXIT GATE FIRST

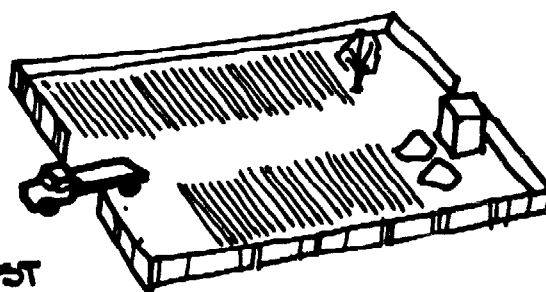

Moving Potted Stock

Transporting plants in plastic pots is relatively easy for the plants, but is more difficult in other ways (the pots are heavy, for example). However, since well-watered pots can be loaded and transported to the site at any time, it is possible to start moving potted stock beforehand in smaller batches.

Moving Open-Rooted Stock

The young stock must be dug up slowly and carefully using shovels or other strong tools to dig carefully around the roots.

Even during careful digging, the majority of roots break. These breaks sometimes leave long, tearing wounds through which the tree loses moisture, and disease can enter. Therefore, as soon as open-rooted seedlings are lifted out of the ground, the roots, especially the big ones, must be cut off neatly. Lifting out and root pruning must be done as quickly as possible.

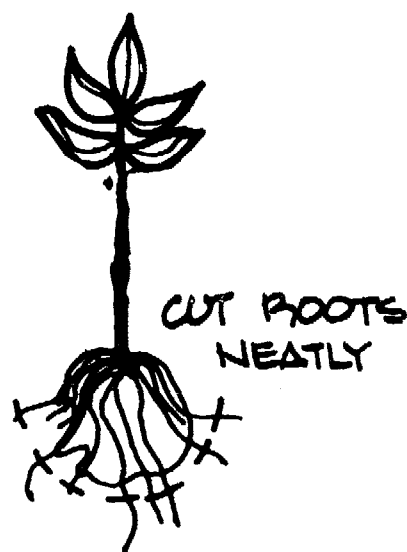

After the roots are pruned, the trees are bunched in groups of 20 to 50. Wet mud is packed around the bunched roots. A layer of wet grass or leaves is then placed over the mud, and the entire bundle is tied together well. Water should be poured over the bundle before it is loaded and taken to the site.

Some special preparations are used to reduce transpiration (loss of moisture through the leaves) when lifting out open-rooted stock. These preparations help maintain the balance between root and leaf functions until the roots have a chance to re-establish their supply functions. Otherwise, the fluids in the plant are used up faster than the newly transplanted roots can take in a new supply.

Some trees, such as *Azadirachta indica* and *Khaya senegalensis*, should be stripped of all leaves, except for the terminal bud and the last two or three leaves near it. The plant must not be ripped and torn, so stripping has to be done carefully. The terminal bud must not be damaged. The leaves are stripped as soon as the tree is lifted out and before bundles are made. The stripped leaves can be used for packing and wrapping material to protect the roots during transport.

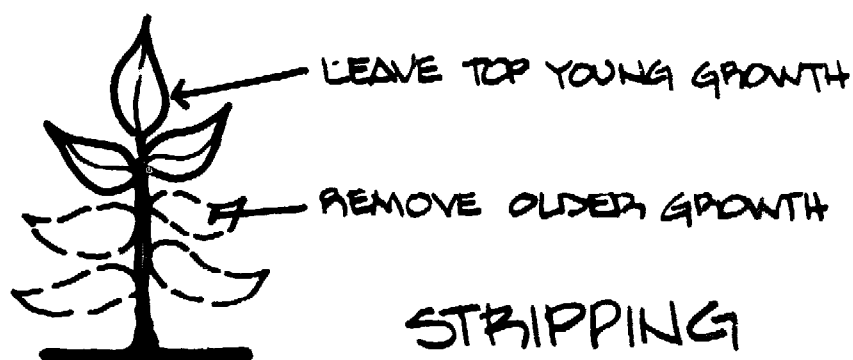

Other trees, *Cassia siamea* and *Gmelina arborea*, for example, can stand even more extensive cutting. In fact, they seem to recover best if the entire top portion of the tree is cut back to 5-15cm above the ground line. The result is a rather odd-looking short stem, attached to the first 15cm of its roots. This is called the stump method. Many stumps can be transported in very little space. In both the stump and stripping methods, roots must be kept moist.

Remove entire top from *Cassia siamea*
and *Gmelina arborea*.

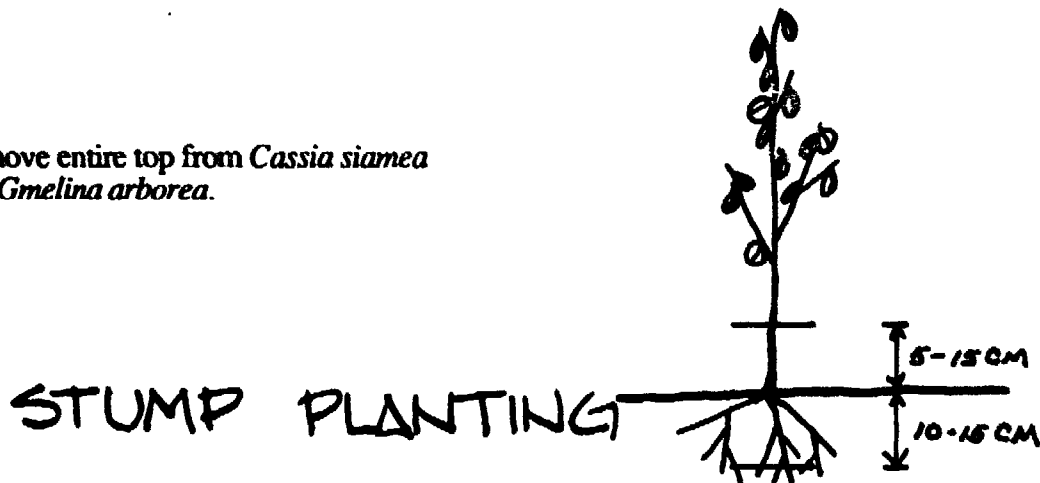

It is, of course, vital to know which species respond to which treatment; some will die if cut back to stumps. Workers must be carefully instructed to avoid loss.

Replanting

Plant the tree so that its root collar is even with the ground. The collar is the point where the tree's stem came through the surface of the soil in the pot or the nursery bed. This is an important step. If the collar is misplaced by as little as 1cm, the chances of survival for some species can be much poorer. The first small roots often start right under the collar, and must be carefully covered if the tree is to grow well.

Finding the collar of open-rooted stock is more difficult, because the collar of the potted stock is right at the top of the soil in the pot, and the soil remains around the plant. It is worth taking time to be sure that everyone handling the plants knows where to look for the collar.

Backfilling is done carefully by hand. The soil from the top of the piles is put around the bottom root structure of the open-rooted stock or the bottom soil of the potted stock. The person doing the planting should tamp the soil with the heel to get rid of the air pockets. Tamping is done diagonally against the bottom of the roots.

PLANTING OPEN ROOTED STOCK

STEP 1

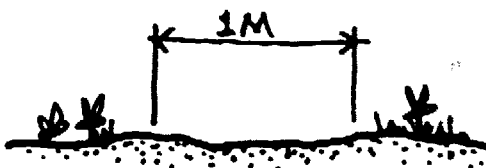

CLEAR THE GROUND OF ALL VEGETATION AT THE TREE LOCATION

STEP 2

DIG HOLE PLACING SUBSOIL ON TOP

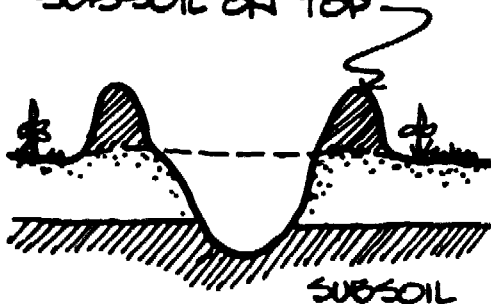

STEP 3

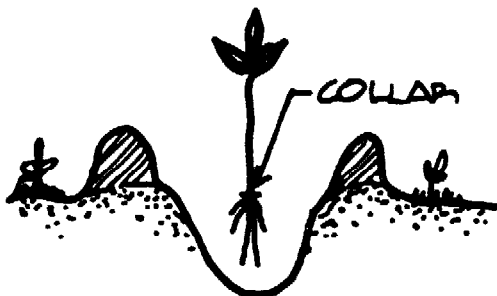

HOLD TREE ABOUT 3CM BELOW ITS FINAL POSITION

STEP 4

RAISE TREE TO FINAL POSITION AFTER SOME SOIL HAS BEEN PLACED AROUND ROOTS

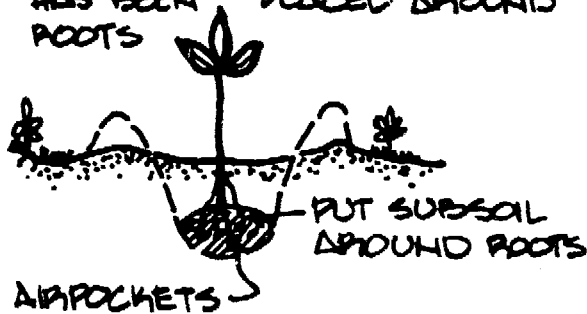

STEP 5

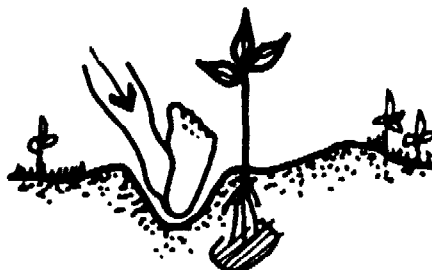

REMOVE AIR POCKETS

STEP 6

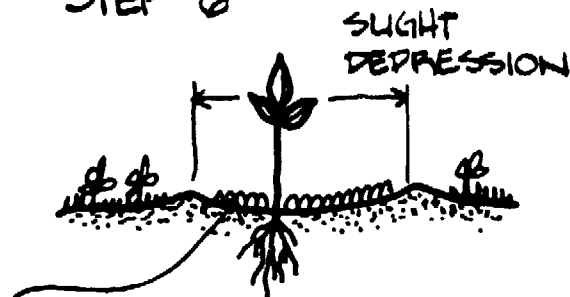

PLACE MULCH WHERE POSSIBLE

NOTE:

PACK SOIL WITH HEEL (AS SHOWN, STEP 5) FROM 2 OR 3 DIFFERENT DIRECTIONS

PLANTING POTTED STOCK

STEP 1
DIG HOLE PLACING SUBSOIL ON TOP (AS FOR OPEN ROOT)

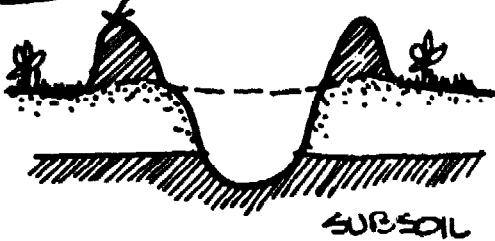

STEP 2
CUT BOTTOM FROM POT

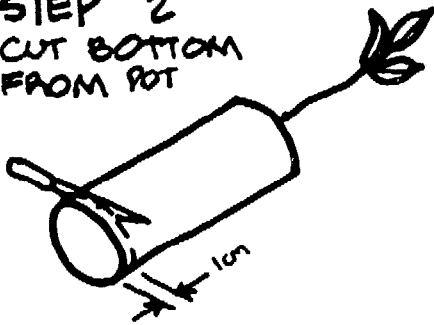

STEP 3
CUT POT LENGTHWISE

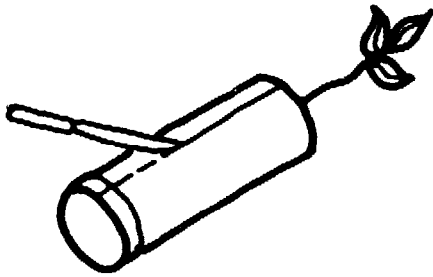

STEP 4
PLACE POT IN HOLE (HOLD POT TOGETHER WITH HANDS)

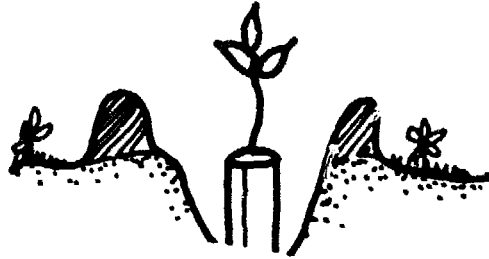

STEP 5

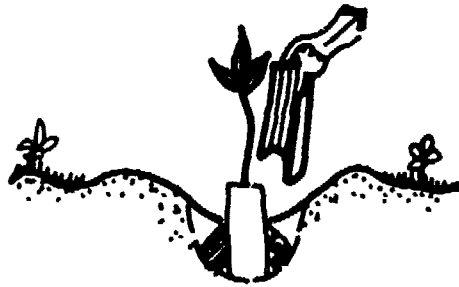

BACKFILL, THEN REMOVE POT

STEP 6

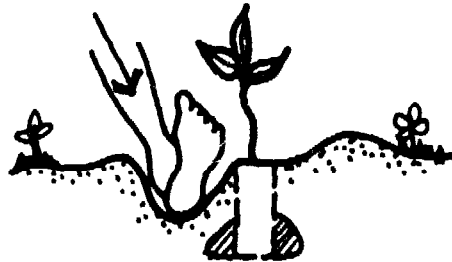

REMOVE AIR POCKETS.
PACK SOIL FROM 2 OR 3
DIRECTIONS

AS SHOWN.

STEP 7

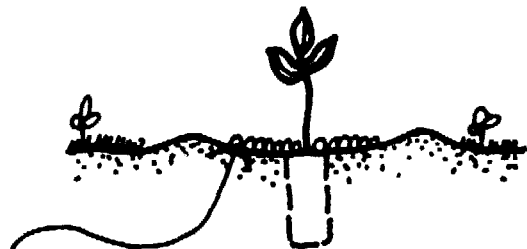

MAKE SLIGHT DEPRESSION
AND MULCH WHERE
POSSIBLE

After the hole is filled, a layer of loose soil is left around the tree. This loose soil is shaped into a shallow depression that acts as a basin to catch additional water. These depressions are called micro-catchments. Their construction is described further on in this chapter under Preparations for Difficult Sites.

Decayed organic matter (mulch) can be put around the newly planted trees if such material can be found. Again, it is necessary to watch for termites when mulch is used. The illustrations on this and the next page note the steps involved in planting open-rooted and potted stock.

Coping with Delays

Delays in planting the seedlings after they have been lifted out of the nursery can be a major cause of losses. This is particularly true of open-rooted seedlings, but delays can also have an adverse effect on potted plants. The trees must be watered abundantly the moment they arrive at the site. If delays in planting are unavoidable (whether overnight or longer, and at either the nursery or the planting site), special techniques are called for.

Potted seedlings that cannot be transplanted immediately after they are lifted from the nursery should be placed in sunken beds at the planting site.

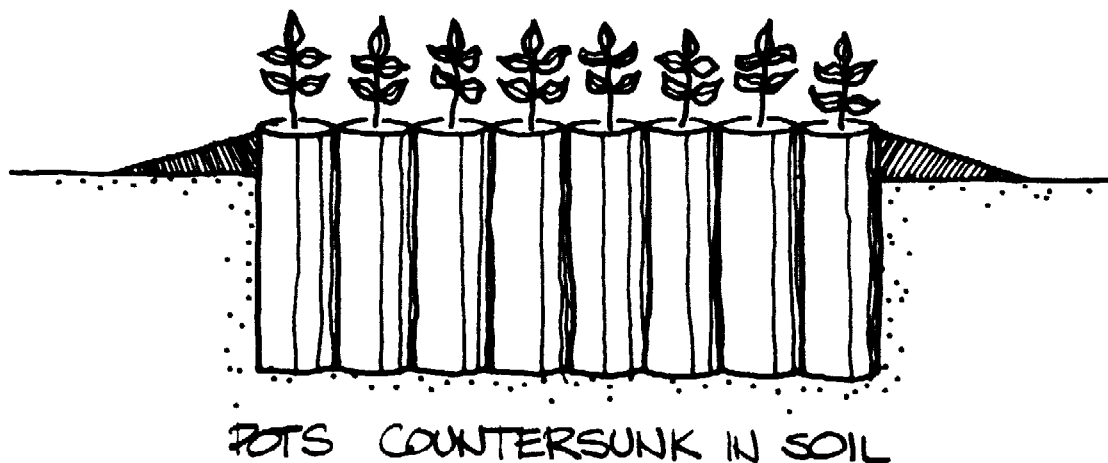

Open-rooted stock must be "heeled-in" to keep the roots from drying out. The seedlings are temporarily laid in trenches at the planting site until they can be transplanted.

HEELING IN OPEN ROOTED STOCK

STEP 1

DIG TRENCH
EAST TO WEST

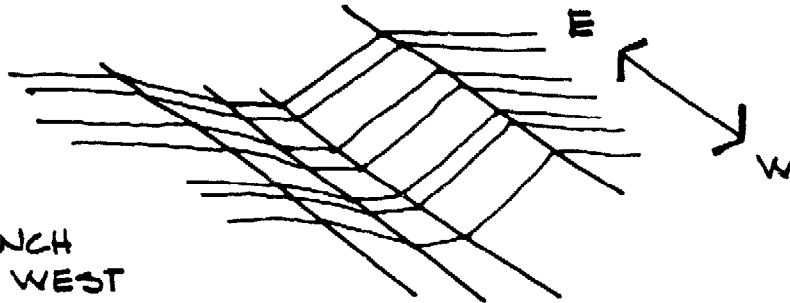

STEP 2

LAY PLANTS
IN ROWS ALONG
THE SIDE OF THE
DITCH

REMOVE ANY WRAPPINGS



STEP 3

COVER WITH
SOIL ALMOST
TO THE TOP OF
THE BRANCHES

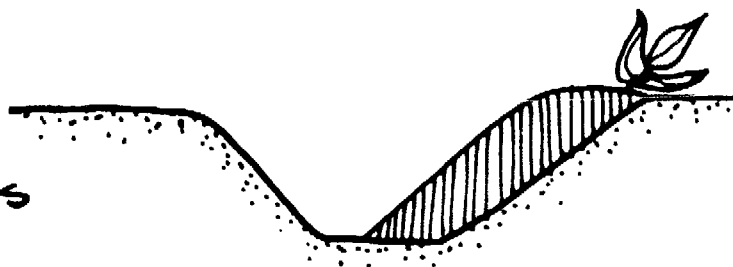

STEP 5

LAY IN NEXT
ROW OF PLANTS
& COVER THEM AS
BEFORE

REPEAT PROCEDURE UNTIL ALL PLANTS ARE HEeled IN.

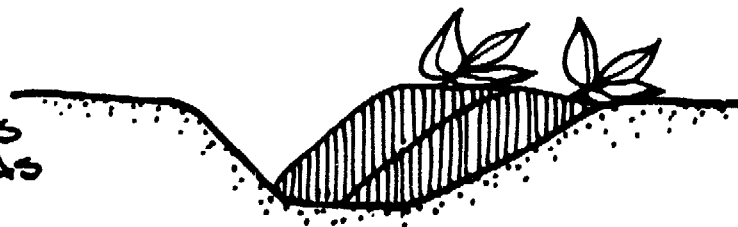

Preparations for Difficult Sites

Sometimes it may be cost-effective to try special procedures at very dry sites. These procedures may include water jar reservoirs, micro-catchments, or contour ridges.

Water Jar Reservoir

A special planting technique, primarily used at present for planting shade trees around villages, should be considered. In this method an unglazed clay jar is buried in the ground, with neck exposed, close by the seedling. The jar is filled with water, which seeps through the clay to provide the young tree with a steady supply of moisture. The clay jar reservoir method has a number of advantages and disadvantages.

The advantages are:

- o The soil does not become hard and crusty around the base of the tree.
- o The roots are kept evenly moist, not being subjected to alternate wetting and drying.
- o The roots will grow down around the base of the clay jar in search of moisture.
- o The amount of water needed is reduced (from one to two-thirds) because evaporation from the soil does not take place.
- o The growth rate of the tree can be doubled in the first year or two and its heartiness is greatly increased.
- o The survival rate is increased.

The disadvantages of the clay jar method are:

- o Initial planting is more expensive and time consuming.
- o The clay jars must be protected from breaking and from becoming filled with sand or trash.

In most African markets, clay jars 40-50cm deep and 25-30cm in diameter are available. Make a hole in the jar about 4cm up from the bottom. The size of the holes depends on the soil and the planting site. In sandy locations a small hole (half the diameter of a pencil) should be sufficient; in a site with very heavy soils, two or more (pencil sized) holes located side-by-side may be needed.

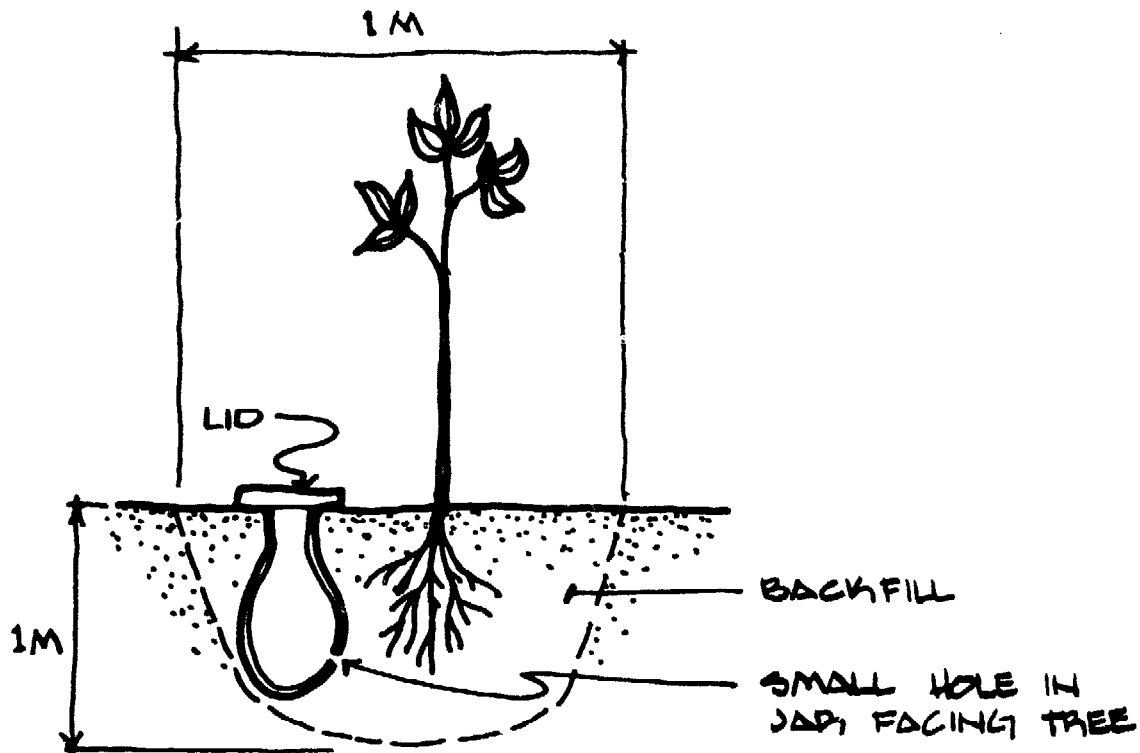

To plant the jar:

- o Dig a large hole about one meter square and one meter deep.
- o Partly refill the hole with soil and some organic fertilizer (if available).
- o Place the clay jar to one side of the dug-out space with the holes in its bottom facing the center of the area where the tree will be planted. The mouth of the jar should show above ground level only a few centimeters.
- o Plant the tree in the center of the hole about 20cm from the clay jar.
- o Continue refilling the hole in the ground with the mixture of soil and fertilizer.
- o Fill the jar with water and cover the top to keep the water clean and prevent evaporation.

For the first three or four weeks after planting, the tree roots grow toward the moist soil at the bottom of the jar. During this time keep the jar full, but also water the tree by pouring water around its base.

After this time, the tree is watered only by filling the jar with water. If the hole has been correctly matched to the soil consistency, a jar of water should take about one week to flow through the hole into the ground. Keep the level of the water in the jar high by adding water every two or three days. The holes can be made larger, if necessary:

- o Dig out entire jar, enlarge holes, and replace. This must be done very carefully, or the tree may be injured.
- o If the mouth of the jar is large, reach in with a sharp nail or drill bit and carefully enlarge the existing holes or add another.

Remember: keep the level of water high by adding water every two or three days. However, just a trickle of water is necessary to keep the tree watered. Do not make the holes too large.

Micro-catchments

On marginal sites, it is better to plant fewer trees and to concentrate efforts on micro-site improvement, than to plant a large quantity of trees without consideration for the area immediately around them. Reshaping the terrain around each individual tree ensures that as much moisture as possible is available to the roots. A micro-catchment is, in effect, a small basin around each tree that is planted.

Micro-catchments can make the difference between survival and mortality. This means an extra, often substantial, investment of energy in the location on which the tree will be planted, but it may also mean a chance for trees to grow in areas where they otherwise could not. Over-excavation is necessary where the sub-surface is hard or rocky. The root zone must be loose enough to allow root growth, and to let scarce water infiltrate. Although it is necessary to encourage normal drainage so that water does not stagnate, the micro-catchments are designed to reshape the area around the tree, so that excess runoff will collect around the base of the seedling and accumulate in the root zone.

Several shapes and construction methods have been tried. The most common are a series of "half moon" or "fish scale" shaped low dikes on the downslope side of the seedlings. An area of about two to four square meters around each plant is reshaped to provide a slight depression that catches water falling immediately around and up-slope from the tree.

Micro-catchments can be surprisingly effective even on sites with little slope. Some have been so successful that trees can survive on the water from only one rainfall each year. One site where this has been demonstrated well is located in Northern Kenya, west of Lake Turkana. A key element to success lies in providing a large enough catchment volume so that runoff from a 7mm

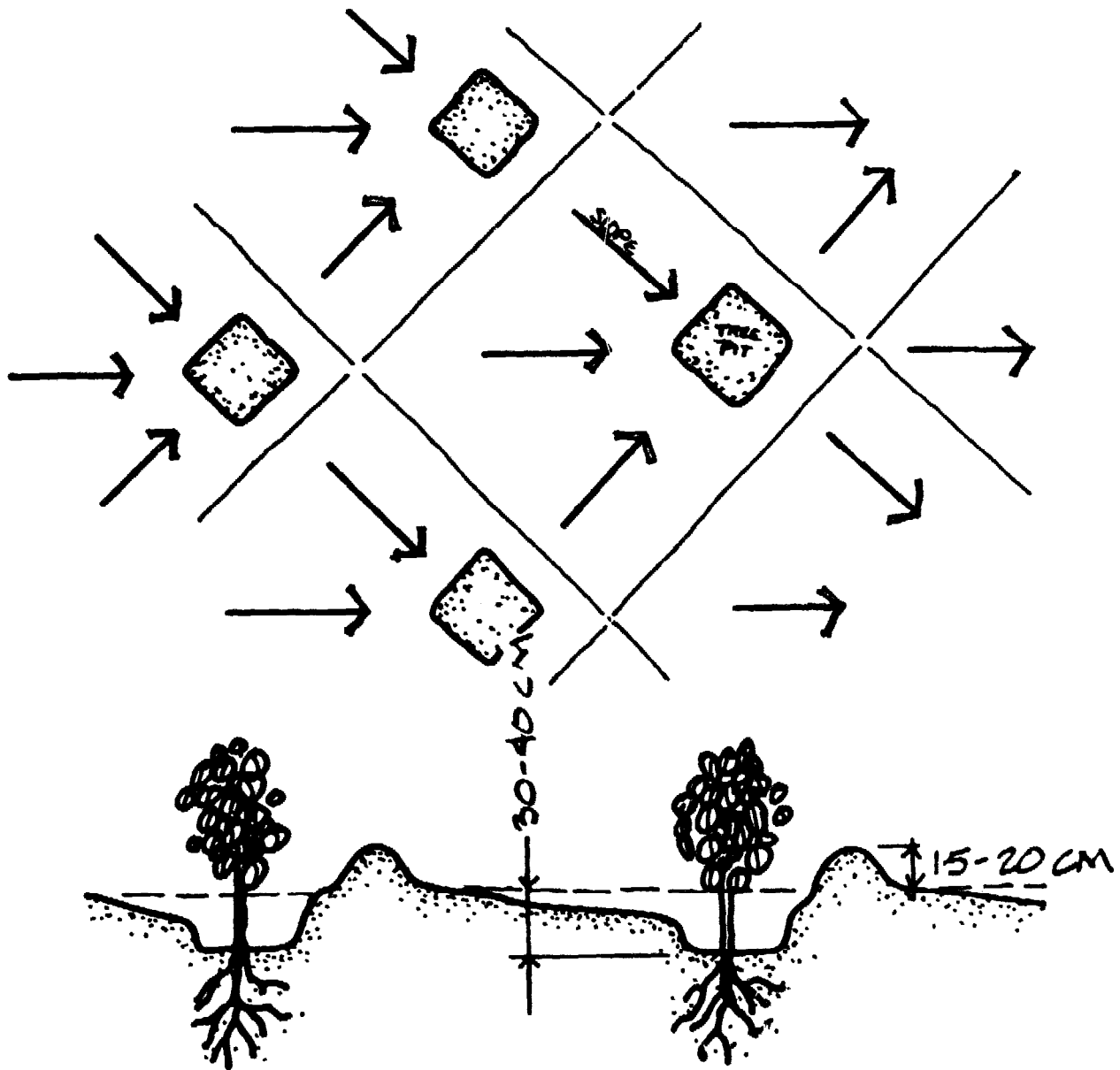

MICROCATCHMENT

LENGTH CAN BE FROM 2 METERS TO 50 METERS DEPENDING ON TERRAIN, SOIL, RAINFALL, TREE SPECIES, ETC.

Note: Dimensions of surface areas, as well as excavation and fills, vary according to slope and infiltration.

rain can be stored without overflowing the banks of the catchment. This requires a trial and error approach, as well as calculation of simple volumes based on more or less regular geometric figures.

A second key element is proper construction of the dikes. Their contours and grades must be geometrically correct, without low points or wavy crowns. The dike must also be keyed into the existing ground, and great care must be taken to compact the soil in the dike walls. Compaction works best if the soil is moist. Clay must be tamped thoroughly, in thin layers, so that no voids exist between the lumps of soil. If properly constructed, individual basins will hold and collect the runoff from rains and increase growth and survival where only marginal results would be obtainable under ordinary circumstances. *Prosopis* species particularly benefit from this method. In addition to the trees, grasses, which are harvested for forage, and in favorable cases even sorghum, can be grown in the moist area of the lowest portion of each basin.

Contour Ridges

A method similar in concept and purpose to micro-catchments, but on a larger scale, has been used on agricultural sites and is also appropriate for tree plantations or agroforestry projects. This method involves the construction of contour ridges, or *diguettes*, using rock or tamped earth walls built along the contour line. The ridges help prevent soil erosion as well as increase infiltration of moisture into the soil. They do, however, require substantial investments in terms of tools, labor, and maintenance.

Like micro-catchments, contour ridges can significantly increase survival and growth rates even on relatively flat land. The distance between ridges depends on the degree of slope--on steep hillsides they should be constructed closer together than on flatter sites. It is important to follow the contour closely in laying out the ridges. Once the ridges are in place, farmers should use contour plowing and cultivating techniques, if they are not doing so already.

The first step is to mark the contour using a level. In areas where there is an adequate supply of rock to use as a building material, the ridges are constructed by digging a furrow in which the boulders are lodged. Smaller rocks and soil are used to fill in gaps between the boulders. If rock is not available, the ridges are constructed using tamped earth. A shallow trench is excavated along the contour, and the earth is shaped into a ridge on the downhill side of the trench. The soil is packed using a wooden tamp. The soil must have a clay texture to retain water. Soils with a high sand content will not work.

After heavy rainfalls, some water normally passes over or through the ridges. Occasionally a channel of water will break through the ridges. These breaks must be repaired promptly to prevent gully formation.

Although contour ridges are usually constructed with the idea of using the increased soil moisture retention to improve crop production, trees and shrubs can also be planted at intervals along the contour ridge. Chapter 8, Agroforestry and Soil Conservation, gives a more complete description of this technique.

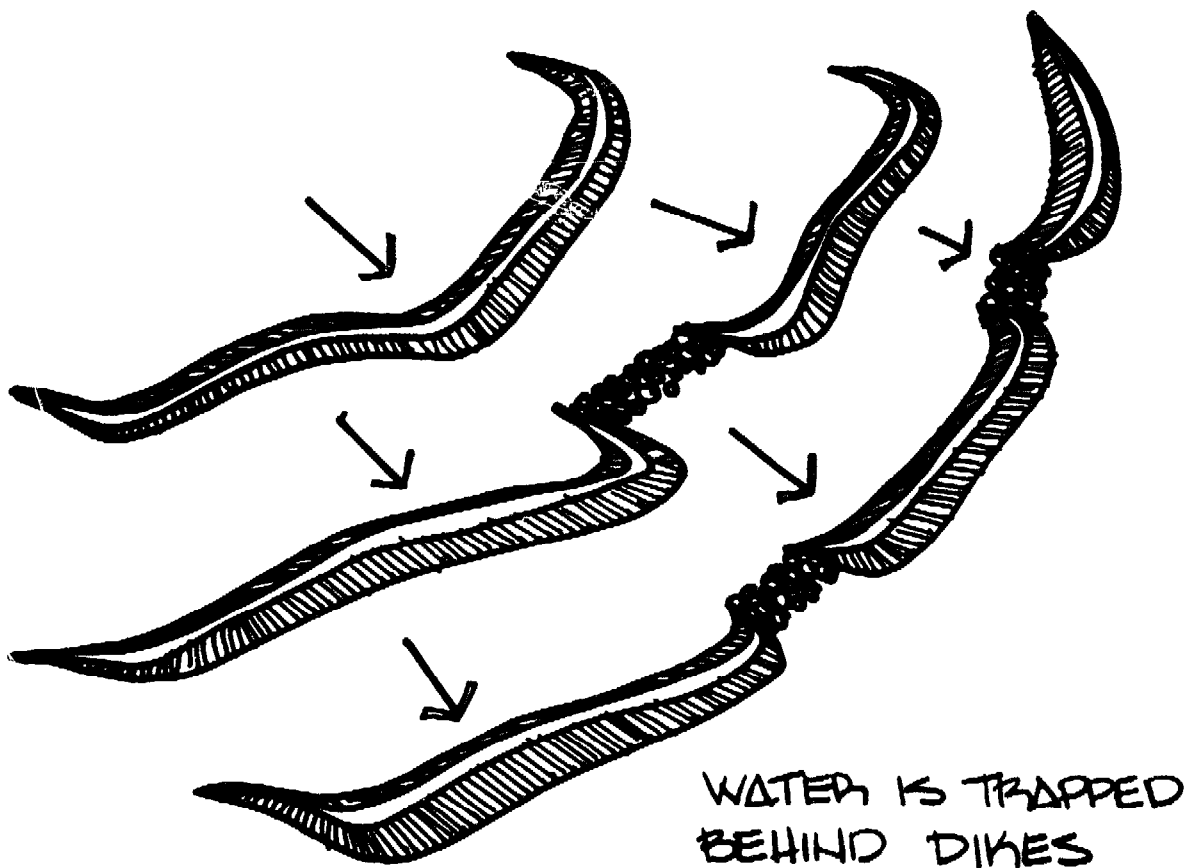

DIGUETTES

Contour ridges like these in use in Burkina Faso allow the growth of rice where rice was not previously able to grow .

Plantation Maintenance

Watering

General Considerations

Normally tree plantations in drylands Africa are rainfed; that is, they depend on rain and groundwater to supply all their moisture needs, rather than being watered or irrigated. The cost of irrigating a large area is usually too large for a forestry or conservation project. This holds true for most forest tree species and planting configurations, but there are some exceptions.

Shade trees are generally watered frequently because they are often located near enough to a water source that watering does not require much effort. Fruit tree orchards are also sometimes irrigated, because the crop is considered valuable enough to make the cost worthwhile. Research plots may be watered, if it will not interfere with the results of the experiment. Sometimes demonstration parcels are watered to ensure that the trees survive, in the hope of encouraging people to adopt the technique being demonstrated. This is misleading if the technique does not ordinarily involve watering.

Watering Trees At Extremely Arid Sites

In areas of less than 250mm mean annual precipitation, the survival chances of seedlings planted at the onset of rains are low at best. If sufficient rains do not materialize, seedlings must be watered. As long as provisions for watering must be made, it may be just as well to *plant trees during the cool, dry period*. This is a major deviation from the basic principle of planting during the rainy season. Experience in Mauritania has shown that planting and watering of trees during the cool season requires much less water to get them started.

Always provide water where it is needed, in the root zone rather than at the surface. Also, provide sufficient water to bring soils in root zone to field capacity in one application. The special procedure for watering trees at extremely arid sites is as follows:

- o Dig a hole or test the soil with an auger to determine the existing moisture conditions. Dune sands may contain capillary water at 1-2m below the surface. If that is the case, only the dry layer above these areas need be watered.
- o Apply the correct amount of water to each tree through a tube or pipe attached to a metal container placed on a stand. The container can be removed for refilling.

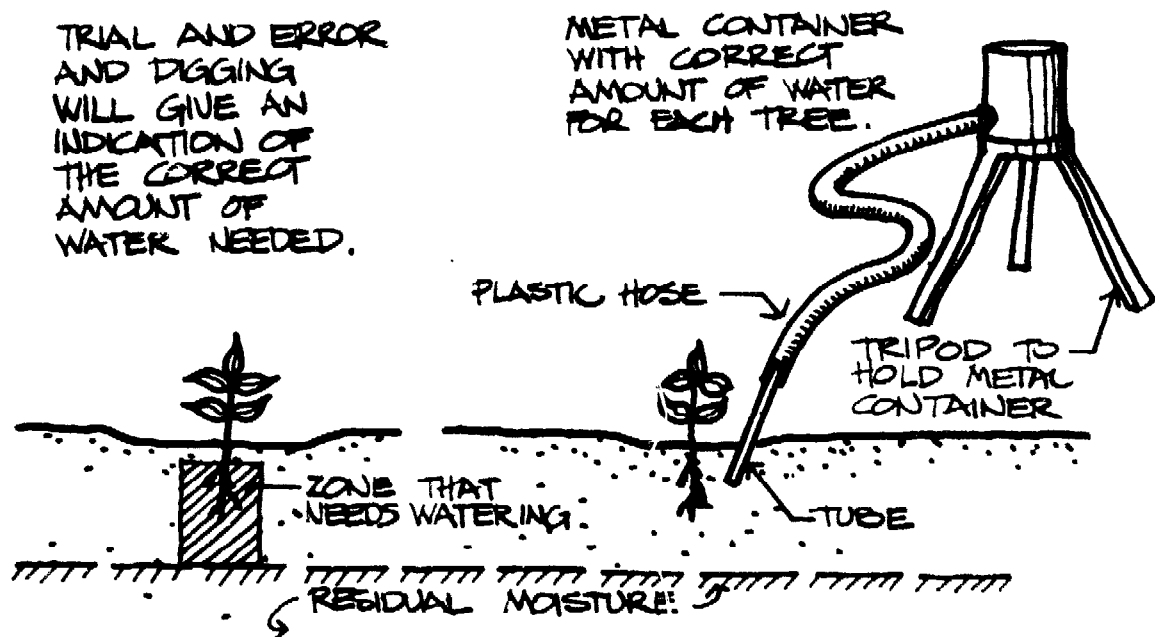

Weeding

There are two reasons why it is important to weed around young trees: 1) to reduce competition for moisture and growing space; and 2) to reduce the risk of damage from brush fires. Climbing vines can also strangle a seedling if they are not quickly removed. It is not necessary to weed the entire area of a plantation; clearing a radius of about 1m around each tree is sufficient.

Weeding is most necessary during the rainy season. If the trees have been properly tended during the rains when the weeds are most prolific, additional weeding operations should not be necessary during the dry season. If there is a considerable amount of dry vegetation on the ground surrounding the trees, however, fire becomes a major concern once the rains have ended.

The grasses and other vegetation removed from the plantation during weeding operations can be used as animal fodder or as mulch around the young plants. Weeding may be necessary for several years after the seedlings are planted--at least until they are taller than the other vegetation, and their root systems are deep enough so that they are not competing for surface moisture and nutrients.

Survival

If the trees have been properly cared for, if no animals get into the planting area, and if there are no serious attacks by insects or rodents, survival of the trees depends directly on the weather immediately after planting. Cloudy weather with frequent showers for the first three or four days after planting can mean that up to 90 percent of the trees will survive. A dry spell lasting several

days after planting can reduce the survival percentage to 30 percent. Abundant precipitation during the rainy season helps plants to build up reserves and roots that are long enough to reach down to lower water tables during the dry season.

Generally only those trees that are weak, diseased, or slow starting are affected by insects, rodents, and disease. Sometimes trees that look dead above the surface may resprout from the ground up the following year if conditions are good. While they may always be stunted, they can add to the ground cover.

A survival count should be undertaken during the planning stages for the next year's planting season, to determine how many seedlings will be needed to replace trees that have died. A site assessment is sometimes necessary to determine if high mortality rates are due to an inherent problem in site conditions. If a problem is identified that cannot be easily corrected, it may not be worthwhile to replant on that site the following year. In areas where there are two rainy seasons per year, replacement planting can take place during the second, shorter rains, if site conditions are favorable.

Because mortality losses may be due to more than one cause, it may be necessary to plan several survival counts at intervals during the dry season. The first count, taken shortly after the end of the rainy season, indicates losses due to transplanting shock, or to spotty, inadequate rainfall. Survival counts taken later in the year may show a higher overall mortality due to the cumulative effects of drought combined with other factors.

It is unrealistic for project managers to expect to maintain 100 percent survival even under the most favorable conditions. Although reasonable efforts should be made to reduce mortality as much as possible, a total survival rate of 60 percent of the nursery stock one year after planting should not be considered disappointing under arid land conditions. Total survival includes the seedlings still living after counting losses in the nursery, seedlings that are culled during grading, and seedlings that die following transplanting.

8 AGROFORESTRY METHODS

Agroforestry Systems in Africa

Agroforestry is a topic that has received considerable attention since the first edition of this book. This interest is largely due to evidence that trees and shrubs can be managed to enhance significantly and, to some extent, guarantee the *sustainability* of agricultural systems. Moreover, trees of appropriate species in suitable locations can *increase agricultural productivity*. Agroforestry offers an alternative approach to intensive agricultural "development" schemes that in the past have often resulted in decreased soil fertility and loss of soil restoration potential.

Even the widespread adoption of the term agroforestry indicates that development specialists now recognize the validity of indigenous farming systems. Farmers and pastoralists in dryland Africa have over a long period of time evolved complex strategies that utilize trees and shrubs as essential components of natural resource use systems (land, water, natural vegetation, etc.). In many parts of Africa, a form of shifting cultivation known as fallow or slash and burn agriculture has traditionally been practiced.

Under this farming system, small parcels of land are cleared. Fire is often used to clear the vegetation, releasing plant nutrients into the soil. The plots are intensively cultivated for a few years until soil nutrients are depleted. They are then left fallow (unplanted) for as long as several decades, allowing the regrowth of the natural vegetation. Soil fertility is gradually restored, and after a sufficient interval the land can be cleared and farmed in another rotation. Because of population pressures and recurring food shortages in Africa, however, many farmers find it difficult to practice traditional fallow agriculture. They are forced to lengthen cropping periods, while reducing the number of years the land is in fallow. This results in a loss of soil fertility and consequent reductions in crop yields. Wind and water erosion also increase.

Agroforestry or soil conservation techniques, often combined, can help to stabilize cultivation on a given piece of land. Certain of these methods help prevent or reverse environmental damage in areas where fallow cropping is no longer practical. Adding trees and shrubs as permanent features in the

landscape in the form of field trees, border and alignment plantings, windbreaks, and live fencing can protect the soil against erosion and improve nutrient cycling. Proper maintenance of trees in agroforestry or soil conservation systems may allow permanent cultivation of farm fields, that previously could only be fallow cropped. Many of the techniques described in this chapter are based on farming systems that evolved in Africa to allow long-term sustainable production systems to take the place of shifting cultivation.

An attempt to describe the role that trees and shrubs play in the overall management of natural resources is condensed in the following definition of agroforestry by the International Council for Research on Agroforestry:

"A land use system that integrates trees with agricultural crops and/or animals, simultaneously or sequentially, to get higher productivity, more economic returns, and better social and ecological benefits on a sustained yield basis, than are obtainable from monoculture on the same unit of land, especially under conditions of low levels of technological inputs and on marginal sites." (ICRAF, 1982)

This means that trees and shrubs are deliberately managed (that is, established, tended, protected, harvested, etc.) and considered as one of the resource elements used by the people or their livestock, even though the trees may appear to be randomly dispersed in the landscape. Trees and shrubs need not be forests, woodlots, orchards, or other discrete stands, especially set aside for a single purpose or product. Rather, they are planted wherever people have not allocated the space to some other use.

Forestry specialists in the past have paid too little, if any, attention to trees and shrubs outside of specifically designated forest areas. Throughout arid Africa, governments have established areas of land set aside to be managed by technical services for forest (wood products) or wildlife resources: gazetted forests, classified forests, various types of reserves, parks, etc. Agroforestry takes place outside of these boundaries and includes trees that have regenerated naturally as well as those that are intentionally planted. The goals of land and resource management for agroforestry systems can vary greatly as long as trees and shrubs are integrated with crops and/or animals. This definition of agroforestry includes a broad range of activities from hunting-gathering systems involving minimal technological input, to intensive intercropping patterns where trees are established, pruned, and harvested according to carefully controlled production schedules.

It has also become evident that, from the local people's point of view, integrating trees into traditional operations and land use patterns makes much more sense than setting aside specific areas of usable farm land for woodlots. In many areas the most acute problem is lack of food, not lack of wood. Certain tree species may provide food (fruit, leaves, edible seeds, etc.) not only for people but also for livestock, particularly during seasons when food supplies from other sources are low.

In addition to producing wood for fuel, construction, implements, tools, and art objects, other important and locally appreciated by-products of agroforestry include fiber for mats, baskets, and rope, or plant materials for medicines, dyes, tanning, cosmetics, and glue. These raw materials were easily obtainable a few generations ago when extensive woodlands still existed throughout the dry regions of Africa. Today they are scarce because much of the "useless brush" has been converted to farm fields or plantations of rapid growth species, the use of which is usually limited to only a single product.

Trees, Soil, and Farming Systems

Trees and shrubs play a critically important conservation role. They can reduce soil surface temperatures, increase infiltration and retention of soil moisture, provide organic matter, pump nutrients, fix nitrogen, reduce erosion from water and wind, form live fences, and provide shade, all of which create better growing conditions for crops and grasses.

Some methods currently being promoted as agroforestry interventions--windbreaks, for example--can be equally well categorized as soil conservation methods. For the purposes of this text, it is not necessary to classify techniques into one discipline or the other. By its definition, agroforestry attempts to achieve "higher productivity, more economic returns, and better social and ecological benefits on a sustainable basis...." These objectives should be compatible with the goals of soil conservation and sound farm or range management programs, and should also be in line with efforts focusing on response farming or farming systems research.

It is natural to ask which of these interventions, agroforestry, soil conservation, or farm management, will yield the best results. Experience shows that any one of the three, used alone, can produce significant results. It is becoming even more obvious, however, that better and more balanced effects can be achieved if the three systems are used in combination. Research shows that in many instances soil conservation efforts can have a synergistic effect when combined with agroforestry systems. This holds true for modifications of farm or range management practices. In fact, the three types of activities often complement and reinforce each other, to produce better results than could be achieved through the separate use of any one approach. Agroforestry systems should be designed, then, with careful consideration of methods that traditionally fall into the realm of soil conservation and farm or range management.

The table on the following page illustrates how the three technical fields relate to each other. Pilot projects should test different combinations of techniques, using a farming systems research approach, before introducing an agroforestry package to a rural area on a large scale.

Factors Affecting Sustainability and Productivity	AGROFORESTRY	FARM/RANGE MANAGEMENT		SOIL CONSERVATION
Soil Moisture Retention		FARM	RANGE	
Soil Fertility	<ul style="list-style-type: none"> - Alley cropping, line plantations and dispersed trees to provide: <ul style="list-style-type: none"> • Organic matter • Shade to reduce surface temperature - Nutrient cycling and Nitrogen fixation 	<ul style="list-style-type: none"> - Use of compost, cover-crops - Crop-residue left in fields - Mulch 	<ul style="list-style-type: none"> - Controlled grazing - Rotational grazing - Fire Management 	<ul style="list-style-type: none"> - Incorporating organic matter into the soil - Preparing micro-catchments, contour ridges or other micro-site improvements.
Water Erosion Control	<ul style="list-style-type: none"> - Surface Runoff reduction through: <ul style="list-style-type: none"> • Establishment of trees/shrubs along physical conservation features • Trees along canals and waterways 	<ul style="list-style-type: none"> - Crop rotation, (including legumes) - Contour farming - Maintaining soil tilth - Maintaining maximum plant cover 	<ul style="list-style-type: none"> - Use of Animal Manure - Range rotation - "Grazing reserves" 	<ul style="list-style-type: none"> - Contour vegetation strips - Berms, ditches, ridges - Benches or terraces - Waterway and gully control - Protection of stream banks
Wind Erosion Control	<ul style="list-style-type: none"> - Wind reduction through: <ul style="list-style-type: none"> • Dispersed Trees • Borderline Trees 	<ul style="list-style-type: none"> - Maintaining maximum plant cover - Natural vegetation strips left when clearing new land - Minimum till cultivation 	<ul style="list-style-type: none"> - Contract grazing linked to vegetation rehabilitation or protection. - Controlled lopping for fodder 	<ul style="list-style-type: none"> - Windbreaks - Palisades, other physical treatment in extreme cases - Dune stabilization
Access Control	<ul style="list-style-type: none"> - Live fencing - Alignment of livestock trails 	<ul style="list-style-type: none"> - Stock driveways left when laying out fields. - Borderline Trees 	<ul style="list-style-type: none"> - Herding as opposed to letting animals roam freely - Tethering or corralling livestock 	<ul style="list-style-type: none"> - Layout of soil conservation plantings to reinforce fencelines and livestock trails.

LINKAGES BETWEEN AGROFORESTRY, LAND MANAGEMENT, AND SOIL CONSERVATION

Species Selection

Sustainability is the key feature that agroforestry offers to people who depend on a limited and fragile resource base for their daily subsistence. An appropriate, properly managed species mix will result in sustainable land use systems that *produce as well as conserve*.

No other single issue is as important as species selection in planning an agroforestry intervention. In some instances, the choice is not hard to make. In the Sahel, *Acacia albida* is frequently identified as the species that is most appropriate for a given site. *Moringa oleifera* is a good candidate for intercropping with vegetable gardens in areas where people are familiar with it, but it may be more difficult to introduce to new areas. Another "classic" agroforestry species in dryland East Africa is *Dobera glabra*, which is very much appreciated and in demand from Lake Nyanza to Saudi Arabia.

The task of recommending species for windbreaks can become controversial. Many windbreaks established in Africa are composed of a single species, most frequently the Neem tree. It is widely agreed that a more diverse species mix would be preferable, but few data exist to indicate which species can be combined to achieve the desired effect. Fast-growing species are needed for windbreaks because they can begin to reduce wind erosion a few years after their establishment. The more slow-growing species, however, are often longer-lived, and provide protection for the crops and soil long after the fast-growing species have died. An ideal windbreak species mix should also contain multiple-use trees.

The same problem exists for many other experimental techniques such as live fencing and contour strips. The decision is complicated by the question of specific site requirements and conditions, but aspects such as resistance to browsing, or local preference (not to mention taboos, prejudices, and unfamiliarity with a new species) often severely limit the choice.

Much can be said for experimentation and trials, but research takes time, and project funding organizations are often in a hurry for results. They want and need short-term successes. Consequently, they tend to select from a limited number of key species, based on the best information available at the moment. This tendency to depend on the same few species for almost every application has resulted in a concentration of knowledge and experience with a few exotics at the expense of a number of other, potentially more valuable, species.

Agroforestry project planning should not take a cookbook approach. Rather, the project design should be adapted to specific site conditions and current land use patterns. Species trials are required to meet site requirements. Demonstration plantations using more varied species, including more indigenous species, are needed throughout dryland Africa so that future selection can be made on the basis of what has worked.

Species Selection Based On Rainfall

Rainfall	Below 500mm	500-1000mm
West Africa	<i>Acacia albida</i> <i>Acacia nilotica</i> <i>Acacia raddiana</i> <i>Acacia scorpiodes</i> <i>Acacia senegal</i> <i>Acacia seyal</i> <i>Azadirachta indica</i> <i>Balanites aegyptiaca</i> <i>Bauhinia reticulata</i> <i>Combretum spp.</i> <i>Commiphora africana</i> <i>Hyphaene thebaica</i> <i>Mitragina inermis</i> <i>Moringa oleifera</i> <i>Prosopis juliflora</i> <i>Pterocarpus lucens</i> <i>Salvadora persica</i> <i>Tamarindus indica</i> <i>Tamarix spp.</i> <i>Ziziphus spp.</i>	<i>Acacia albida</i> <i>Acacia nilotica</i> <i>Acacia scorpiodes</i> <i>Adansonia digitata</i> <i>Anogeissus leiocarpus</i> <i>Azadirachta indica</i> <i>Balanites aegyptiaca</i> <i>Borassus aethiopicum</i> <i>Butyrospermum parkii</i> <i>Carica papaya</i> <i>Citrus spp.</i> <i>Diospyros mespiliformis</i> <i>Eucalyptus camaldulensis</i> <i>Leucaena leucocephala</i> <i>Mangifera indica</i> <i>Moringa oleifera</i> <i>Parkia biglobosa</i> <i>Prosopis africana</i> <i>Prosopis juliflora</i> <i>Psidium guava</i> <i>Pterocarpus erinaceus</i> <i>Sclerocarya birrea</i> <i>Tamarindus indica</i>
East Africa	<i>Acacia melifera</i> <i>Acacia nilotica</i> <i>Acacia tortilis</i> <i>Azadirachta indica</i> <i>Balanites aegyptiaca</i> <i>Cassia spp.</i> <i>Commiphora ellenbeckii</i> <i>Conocarpus lancifolia</i> <i>Cordia abyssinica</i> <i>Dobera glabra</i> <i>Grewia tenax</i> <i>Jatropha dichter</i> <i>Leucaena leucocephala</i> <i>Moringa oleifera</i> <i>Prosopis chilensis</i> <i>Prosopis juliflora</i> <i>Salvadora persica</i> <i>Schinus molle</i> <i>Sesbania sesban</i>	<i>Acacia polyacantha</i> <i>Acacia senegal</i> <i>Azadirachta indica</i> <i>Balanites aegyptiaca</i> <i>Calliandra calothyrsus</i> <i>Calodendrum capense</i> <i>Carica papaya</i> <i>Casuarina equisetifolia</i> <i>Citrus spp.</i> <i>Cordia abyssinica</i> <i>Croton megalocarpus</i> <i>Eucalyptus spp.</i> <i>Gliricidia sepium</i> <i>Gmelina arborea</i> <i>Grevillea robusta</i> <i>Leucaena leucocephala</i> <i>Mangifera indica</i> <i>Psidium guava</i> <i>Schinus molle</i> <i>Sesbania grandiflora</i> <i>Sesbania sesban</i>

This list should be used as a guideline, a basis for further discussion and observation in the field and at the specific project sites.

Agroforestry and Soil Conservation Techniques

A wide assortment of different agroforestry techniques is being used today, based on traditional practices that have been carried out by local people for generations. Others are relatively new, "invented" by technicians working with local farmers or pastoralists and still being adapted to varying site conditions. The methods described here are presented in "tech-sheet" format. They provide a practical guide for use in the field, rather than extensive coverage of background information, theory, and reference sources. The bibliography and Information Source List in Appendix "E" should be consulted for further documentation.

Many of the technical requirements, design, and field work details that are used in agroforestry systems are similar to or the same as those of standard forestry and conservation activities. The information regarding establishment and maintenance techniques for reforestation efforts that has been discussed in the preceding chapters is also generally applicable for agroforestry applications. Several points, however, deserve special attention when implementing agroforestry-related projects. Additional information is provided in the following pages for specific factors that should be considered, such as spacing requirements, intercropping, plant protection, pruning, and harvesting.

Particular emphasis should be placed on extension of the agroforestry techniques presented here so that local people are encouraged to try them on their own land. Traditional plantation forestry methods often involve recruitment of a large labor force to carry out work on publicly owned land with high levels of technological and material inputs. Although some projects of this sort may fall within the broad definition of agroforestry, most of the techniques shown here are specially selected and modified to be implemented by rural households or communities using locally available materials.

Agroforestry and soil conservation techniques can be grouped or classified in different ways. Some of the techniques described in this chapter, therefore, could be equally well categorized as soil conservation or farm/range management measures. They are all grouped here, nevertheless, because they can contribute to the increased productivity and sustainability of land use systems. All of the techniques included involve the establishment of vegetation cover, primarily trees and shrubs. Some also involve physical soil conservation methods as well, such as contour ridges, terraces, or walls. This approach is intended to increase awareness of ways in which vegetative methods can be used interactively with physical methods.

The following outline shows the format that has been followed in organizing the information in this text. The main categories and sub-categories distinguish the various techniques according to their functions and the spatial arrangements in which trees appear in a rural landscape. The techniques are illustrated on the following pages and described in detail in the sections that follow.

Outline of Individual Techniques

On-farm

- Dispersed Trees (1)
- Alley Cropping (2)
- Line Plantations (3)
- Borderline Trees (4)
- Live Fencing (5)

Off-farm

- Roads and Trails (6)
- Water Courses (7)
- Shade Trees (8)

Soil Conservation

- Windbreaks (9)
- Sand Stabilization (10)
- Contour Strips (11)
- Trees Along Contour Ridging (12)
- Gully Reclamation (13)

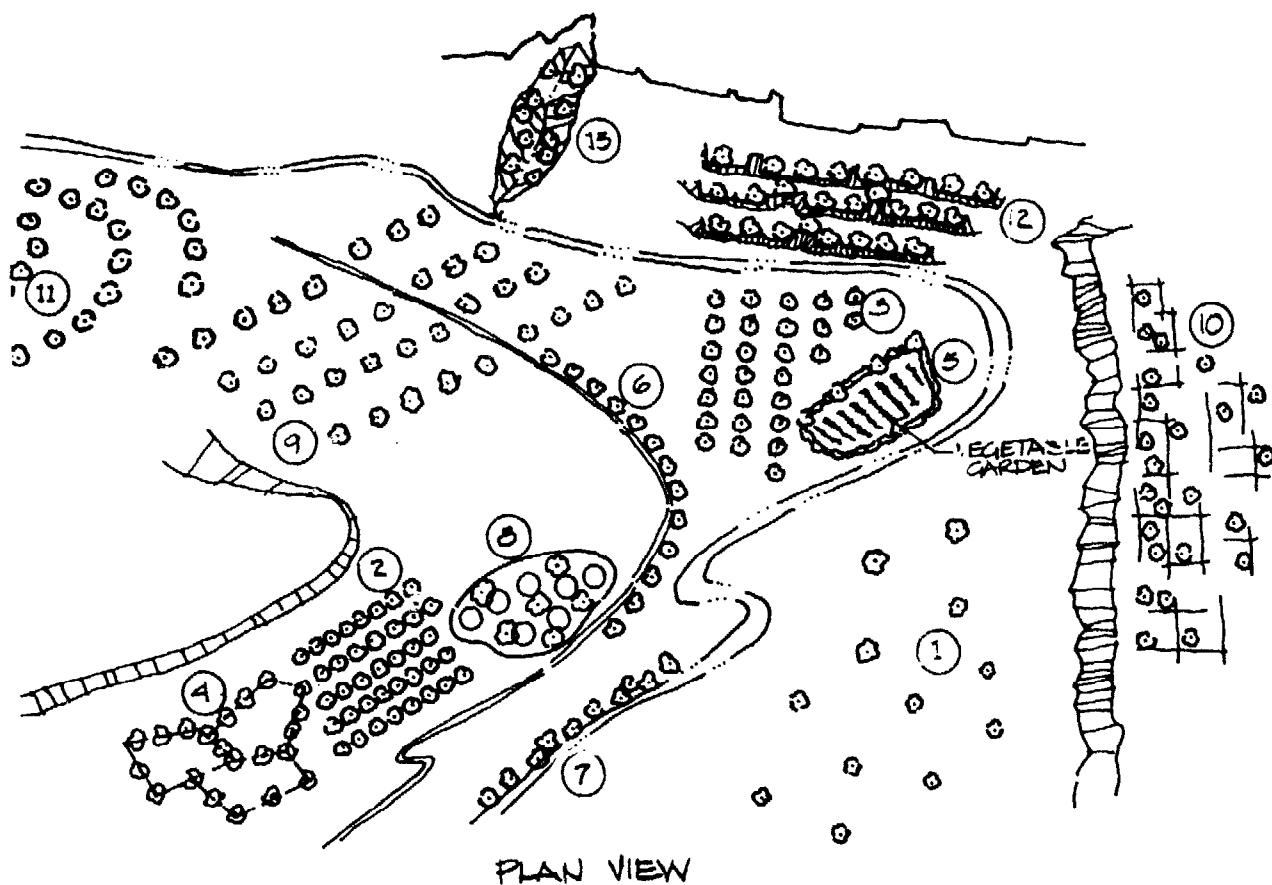

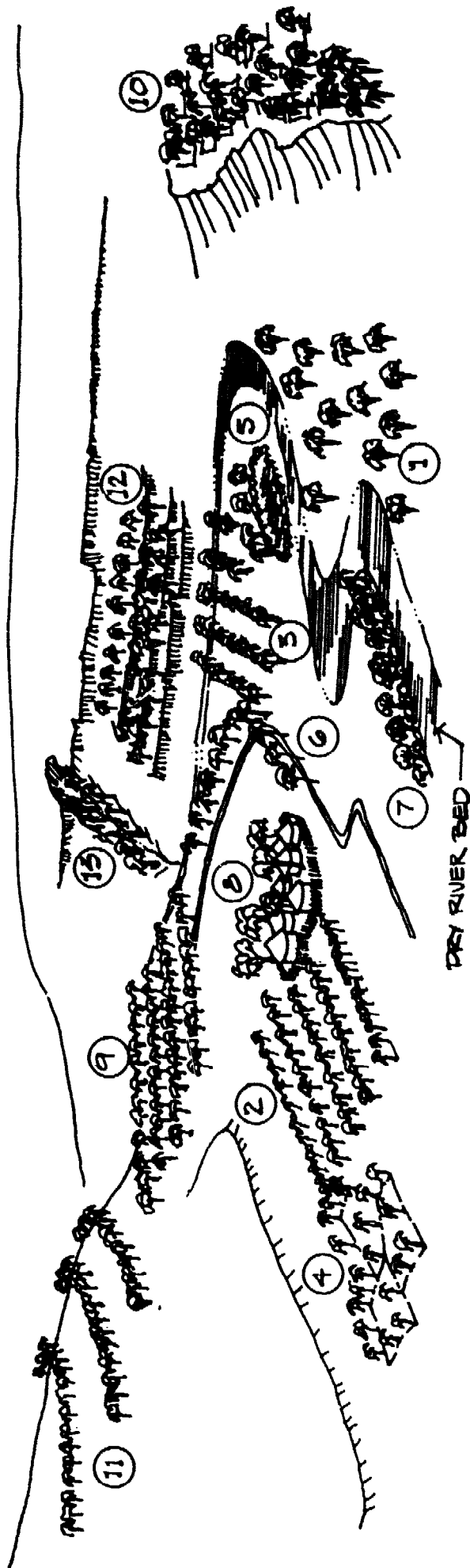

DELICUE VIEW

KEY

- 1. DISPERSED
- 2. ALLEY CROPPING
- 3. LINE PLANTATIONS
- 4. BOARDERLINES
- 5. LIVE FENCING
- 6. ROADS, TRAILS
- 7. WATER COURSES

- 8. SHADE BREAKS
- 9. WIND BREAKS
- 10. VINE STABILIZATION
- 11. CONTOUR STRIPS
- 12. TREES ALONG CONTOUR RIDGING
- 13. GULLY RECLAMATION

On-Farm Techniques

Trees can be integrated with crops in a number of ways. They may be dispersed randomly across a field, planted in careful rows between rows of other plants, or planted as separate stands for orchards or woodlots. Trees may also be used to mark borders or as live fencing.

1. *Dispersed Trees (On-Farm)*

Intensive interaction between crops and trees occurs when they are grown together. The classic farm/park landscape that covers large parts of the Sahel is a perfect example of a traditional agroforestry arrangement where trees dispersed in farm fields form an integral part of a cropping system. Different species are found in these dispersed, park-like stands, depending on site conditions. The best known are *Acacia albida*, *Butyrospermum parkii*, *Parkia biglobosa*, and *Borassus aethiopum*.

In traditional systems these trees regenerate naturally, and so they are more or less homogeneously distributed across fields in random patterns. Where they have been regenerated through human efforts they are planted in lines (normally 10m x 10m). Regular spacing is particularly important if mechanized cultivation, such as animal traction, is practiced. The main feature of this approach is that the trees are more or less uniformly dispersed either in a natural, irregular pattern or more systematically in a grid pattern.

There are some problems that have arisen in the use of this technique. The seedlings are difficult to protect from grazing when they are young (up to five years). Brush fences or woven baskets can be placed around individual trees, as described in Chapter 3, but this is expensive. Birds are also attracted to the trees, especially when they are established near rivers and lakes. The birds can cause problems for farmers if they eat crops and seed.

Efforts to introduce *Acacia albida* in farm fields in the Sahel have been particularly successful, however, because of a unique property of this species. During the rainy season it drops its leaves, and it does not leaf out again until well into the dry season. Cereal crops can be grown under the leafless trees during the rainy season. The crowns of almost all other tree species compete with light-demanding crops for space, thus the areas shaded by the trees cannot be used for crop production. Even small trees can create enough shade during the rainy season to take a significant part of a farmer's land-holding out of production.

During the dry season the *Acacia albida* leaves and pods provide a welcome source of food for livestock. The trees also seem to have a remarkable effect on soil fertility, and dramatically increased crop yields have been noted on a number of sites. Especially in Senegal, Niger, and Chad, some fairly old stands of *A. albida* can be found that were established in farm fields. In spite of little or no government or donor follow-up beyond the first two to three years, these 10 to 50-year-old plantations of *A. albida* are doing well. Their survival is probably due to the high value placed on the trees by local farmers.

Contrary to traditional forestry lore, which often describes *A. albida* as a slow-growing species, it can grow quite rapidly. The crowns of some stands, planted at a 10m x 10m spacing in 1972, are beginning to close. These trees are 5-7m tall and have begun to produce flowers and fruits as well.



Dispersed Trees

2. Alley Cropping (On-Farm)

Small trees or shrubs, pruned frequently to prevent them from producing too much shade, are grown in relatively compact rows (between 2 and 4m, never more than 6m apart). Crops are grown in the space--the "alley"--between the rows of trees. This method was developed in more humid areas of the tropics, and it is being tried in drier regions of Africa, Asia and Latin America. The International Institute of Tropical Agriculture (IITA) has been experimenting with alley cropping in Nigeria for a number of years. Arid lands versions of this approach are still in the trial stages, however, and experience in these zones has been much more limited. Most research is focused on obtaining the right species combination, but the question as to which crops respond best to which tree species also varies according to site conditions.

Fast growing tree species such as *Leucaena leucocephala*, *Gliricidia sepium*, and *Gmelina arborea* have been used in various research efforts. Other species that can be used for alley cropping include *Calliandra calothyrsus* and *Sesbania grandiflora*, but these also have high moisture requirements. They should be tried in arid regions in vegetable gardens that are irrigated during the dry season. Acidic soils are also not suitable for alley cropping with the species that have been suggested above. Species that would be more appropriate for dry sites and low pH soils need to be identified. Such diverse crops as corn, millet, cowpeas, yams, and manioc can be grown in the alleys.

The trees/shrubs are pruned as often as five times per year. The clippings are laid down as a mulch around both trees and crops, gradually decomposing and becoming incorporated into the soil as organic matter. The shade and mulch

from the tree rows also reduce weed growth. Yields of some crops are higher between the mulched rows than in comparable fields that are not being alley cropped. The IITA found that yields from maize were three times greater after four years of mulching with *Leucaena leucocephala* clippings (IITA, 1986).

In addition to the increased complexity of matching compatible crop and tree species to specific site conditions, several other problems may limit the widespread adoption of alley cropping in Africa. A major consideration to farmers who are considering various intercropping schemes is the amount of arable land that the trees will take up. Farmers tend to favor methods that will take as little land out of crop production as possible. Alley cropping requires fairly close placement of tree rows, which can substantially reduce the amount of land left for the crop rows. Where land scarcity is a problem, therefore, alley cropping is probably not the best method to use.

ALLEY CROPPING

1

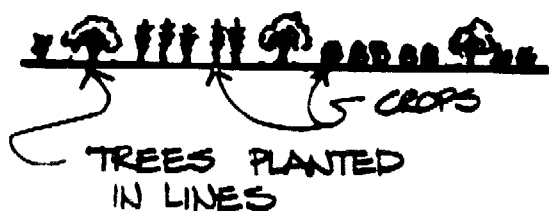
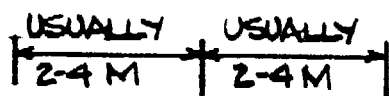

2

CROPS ARE HARVESTED



3

WHEN SHADE BEGINS TO INTERFERE WITH CROPS TREES ARE COPPICED OR POLLARED.

4. BRANCHES ARE PLACED BETWEEN TREE ROWS. LEAVES WILL FALL TO GROUND THE BRANCHES AND TWIGS CAN ALSO BE USED AS FUEL WOOD, FOR CONSTRUCTION OR OTHER PURPOSES.



5

TREES MEANWHILE WILL BEGIN TO RESPROUT.

6

CYCLE IS REPEATED:



DEPENDING ON SPECIES, SPACING & GROWING CONDITIONS, INTERVAL OF COMPLETE CYCLE VARIES FROM 6 MONTHS TO 1 YEAR RARELY MORE.

Alley cropping also requires fairly strict adherence to planting and pruning schedules in order for the technique to give good results. If the trees are not cut back at regular intervals, they will create too much shade for the intercropped plants. For light sensitive crops like corn, too much shade over a period of just a few days can interrupt flowering and fruiting processes. Other crops simply do not thrive in excess shade. Trained extension personnel are needed to work closely with farmers on crop and tree species selection and on setting up planting and pruning schedules.

Farmers may want to use the pruned branches for poles or firewood. The clippings can also be used as fodder for livestock. If the leaves and branches are not used to mulch the crops, alley cropping may not have the effect of increasing crop yields, but it will still be an effective technique for controlling soil erosion, increasing the availability of tree products, and maintaining agricultural sustainability.

3. *Line Plantations (On-Farm)*

Another alternating row arrangement involves planting larger trees at a wider spacing (7 to 10m) with crops planted between the rows. In this system, species that provide fuelwood and timber, such as *Grevillea robusta*, or fruit trees like avocado and citrus, are often used. As much as 60 percent of the species composition of the line plantations may be shrubs. Other possibilities such as *Markhamia platycalyx* or *Maesopsis eminii* are being studied on trial sites, where they serve as shade trees for coffee plantations. Several species of *Acacia* can also contribute to honey production. The species mix should include trees that provide different products as well as nitrogen fixing plants.

As in the case of alley cropping, this system has not yet reached full-scale production in the drier parts of Africa. It has, however, been tried at higher elevations in East Africa and its basic principle may some day prove of value in drier areas as well. The trees and shrubs are planted in rows with 1m-2m spacing between trees in the row. The rows are 7m-10m apart. The trees are not as intensively pruned as in alley cropping, although branches may be lopped to let more light through to the crops below.

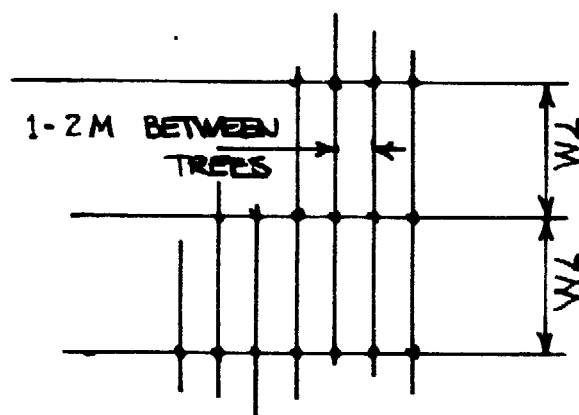

Line Plantation Spacing

It was found in Rwanda that as few as 70 trees (depending on species mix and the frequency of harvesting) will supply all the wood needed by a family of six for a year. Harvesting is done by lopping branches, and roots are also sometimes cut if they encroach too far into cultivated fields. An average tree provides about 20kg of dry fuelwood per year on a sustained yield basis under this agroforestry system.

TREE-LINES IN FIELD

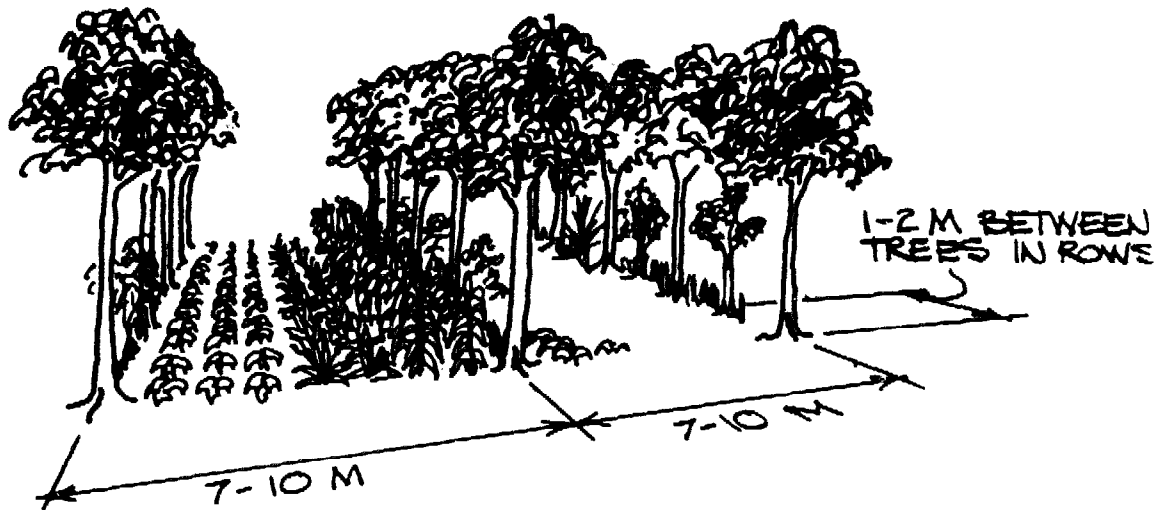

PROFILE OF A TYPICAL TREE-ROW IN RWANDA

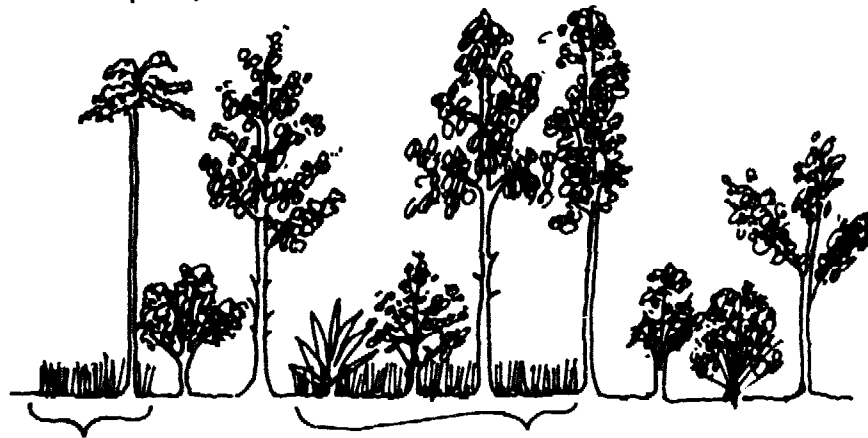

- FODDER GRASS
- CEPHELLA
- GLIRICIDIA
- GREVILLEA
- SEBANIA
- GUAVA
- AVOCADO
- FODDER GRASS
- CASUARINA
- LEUCAENA
- LEUCAENA
- MAESOPSIS

4. *Borderline Trees (On-Farm)*

Borderlines consist of trees, shrubs, and grasses established to delineate individual farm fields. They serve as property markers while they provide wood and other products for various purposes. They do not occupy too much space, nor do they shade large areas of the fields. Because the tree rows are not actually in the fields, they do not interfere with regular farming operations. As in line plantations, wood and other products can be harvested from the trees.

Grasses such as *Andropogon guiana* are traditionally used to mark property boundaries, especially around farm fields. In dry areas, *Calatropis procera* and *Euphorbia* and *Commifera* shrub species are also used for this purpose. Sometimes trees, particularly fruit-bearing species such as *Tamarindus indica*, *Annona senegalensis*, and *Borassus aethiopum*, are grown in borderlines or to mark the corners of fields.

The promotion of additional species for borderline plantation has potential, if species selection takes into consideration local preferences. Protection of young trees is necessary unless the species being used are unpalatable to livestock. *Euphorbia* and *Prosopis* species have proven somewhat resistant to grazing in Somalia, Kenya, and Niger.

Issues of land and tree tenure should be carefully researched and discussed with a community before this technique is tried. If the trees are planted on a borderline between two farmers' property, to whom do the trees and the harvesting rights belong? There may be several alternative approaches to resolve this question, but all parties involved should agree in advance as to how the situation will be handled.

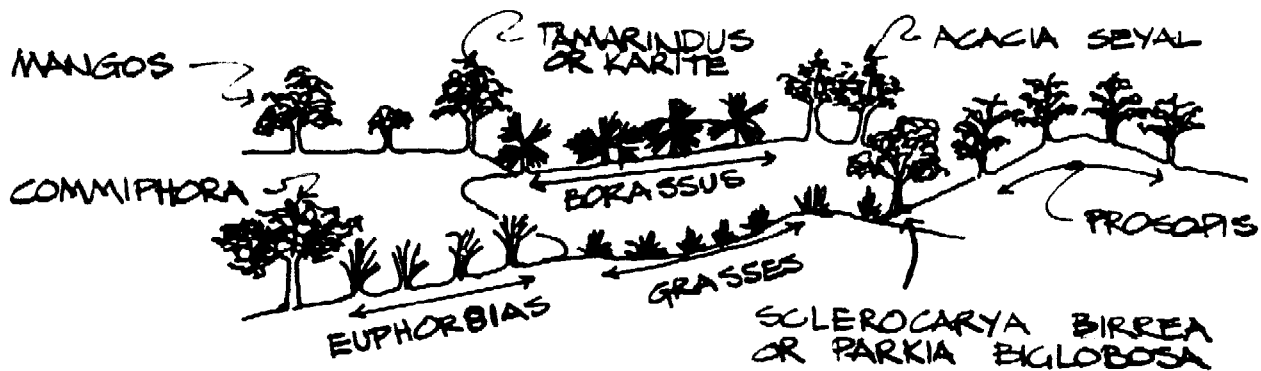

Borderline Trees

5. Live Fencing (On-Farm)

Live fencing consists of dense hedges or thickets usually planted around a garden or farm field to protect it from free ranging livestock. They are also planted around family compounds and other buildings. This technique differs from borderline plantations in that shrubbier species are used, the shrubs or trees are tightly spaced (0.5-1m), and they are intensively pruned to maintain a compact, dense barrier. This is a very important alternative to traditional fences that are constructed and annually repaired using interwoven thorny branches.

A number of species have shown that they adapt well to use as live fences. Members of the *Euphorbia* family are especially good because animals will not eat them (people too must be careful--when *Euphorbias* are cut, the milky sap can cause severe irritation if it touches the skin). Other species that are suitable for live fencing include *Acacia ataxacantha*, *Acacia machrostachya*, *Acacia nilotica*, *Acacia pennata*, *Acacia senegal*, *Acacia seyal*, *Balanites aegyptiaca*, *Calatropis procera*, *Comiphora africana* (mainly for posts), *Euphorbia balsamifera*, *Leucaena leucocephala*, *Parkinsonia acculeata*, *Prosopis juliflora*, and *Zyziphus* spp.

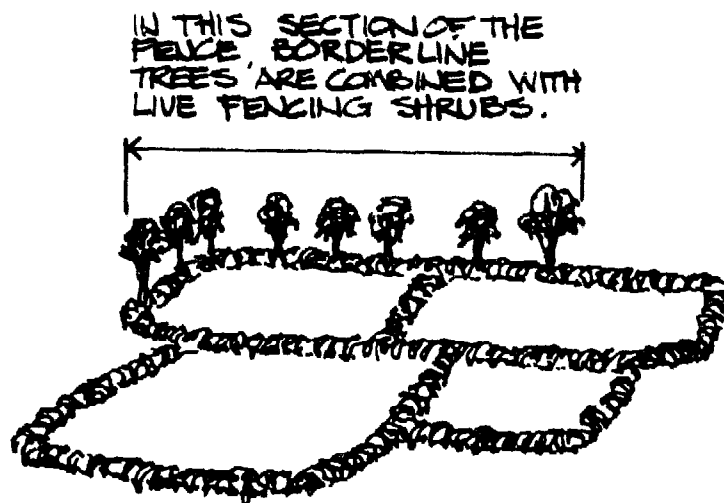
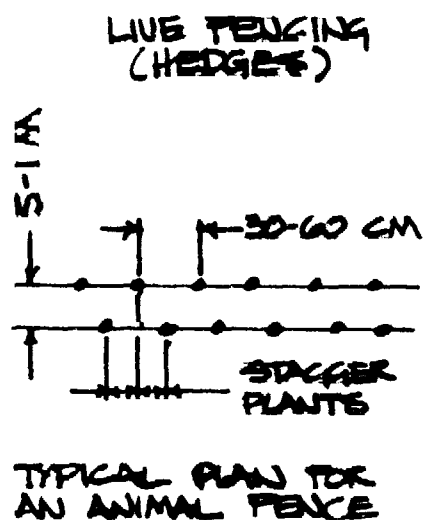

Spacing

Frequently, the main function of a hedge is to keep animals out. If this is the case, plants must be spaced tightly and kept well pruned. Select species that are:

- o Thorny
- o Easily coppiced (sprout back)
- o Relatively unpalatable
- o Fast growing

No one species will meet all these requirements. Trade-offs are inevitable although a mixture of species may provide the most protection. Final choice

depends much on specific site conditions. If protection from animals is not a primary concern, the spacing between plants can be wider. Hedges can have many other advantages and functions besides keeping out animals:

- o Demarcation of property boundaries
- o Protection against wind
- o Addition of organic matter from leaf litter
- o Fruit and forage, when combined with borderline trees
- o Privacy

As garden fences, or wherever irrigation is possible, trees for a live fence can be started by direct seeding. The seeds should be planted in furrows or in small pockets placed at intervals along the fence row.

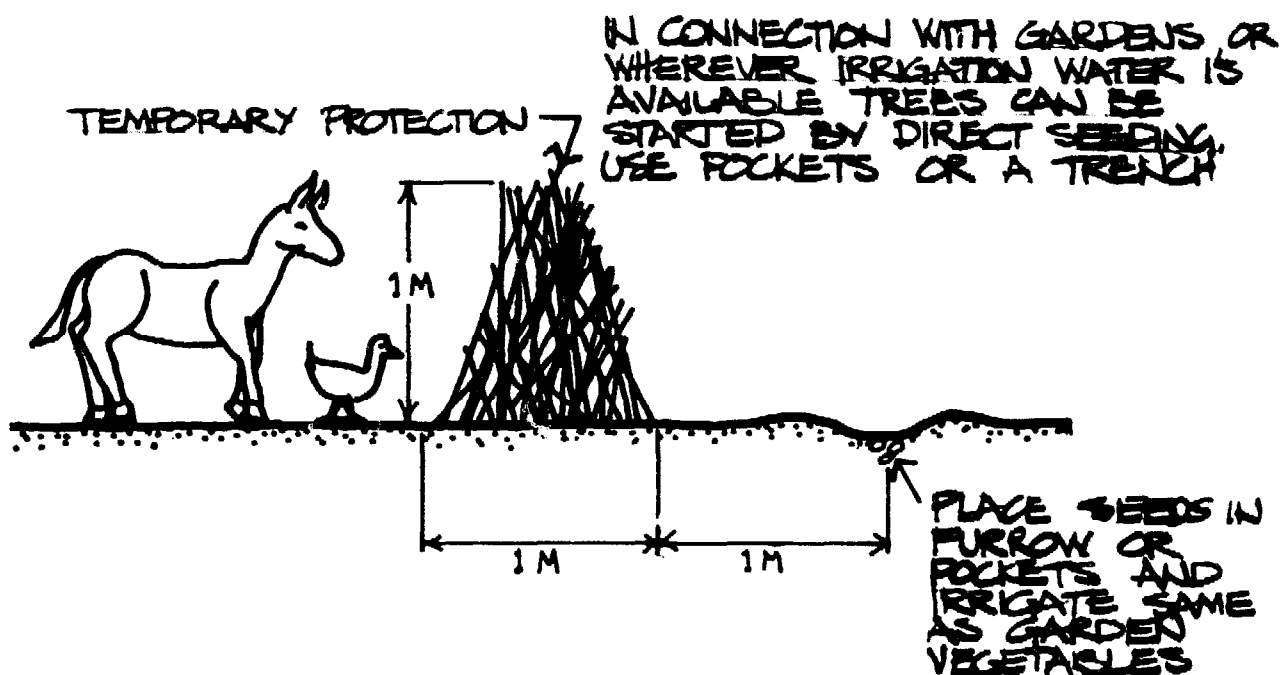

Direct Seeding Live Fences

Live fences can also be established from cuttings, especially from some species such as members of the *Euphorbia* and *Commiphora* genera and some perennial legumes. Freshly cut branches from these species are likely to take root and sprout if they are planted at the beginning of the rains. These species are therefore, particularly useful for establishing live fences. Normally, one would not wait until the beginning of the rainy season to build fences, but this might be done when using post materials that may take root. Care should be taken not to damage the bark or wood when attaching wire for the fence. See Chapter 9 for more information on propagation by cuttings.

ALTERNATE DESIGNS

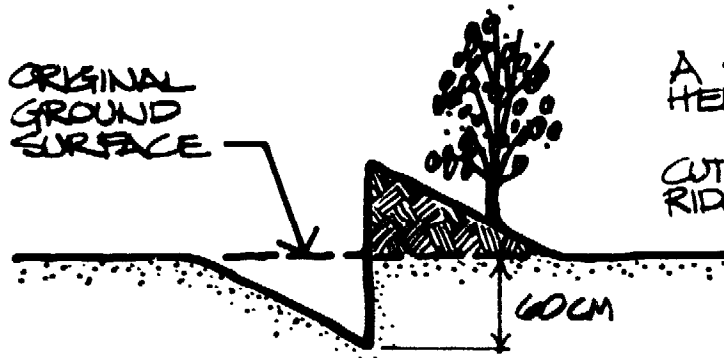

A STEP-OFF (LEDGE) WILL HELP DISCOURAGE ANIMALS.

CUT 60 CM TRENCH, MAKE RIDGE WITH EXCAVATED MATERIAL

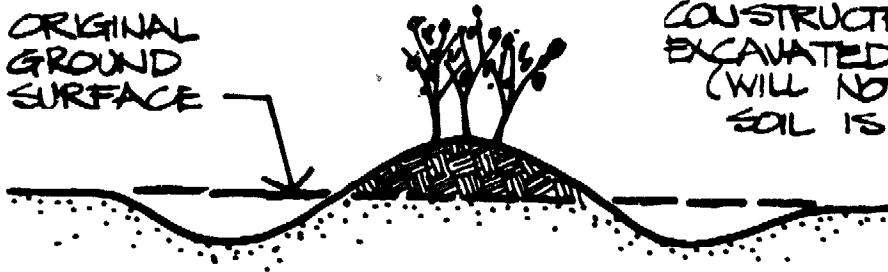

PLANT CUTTINGS ON RIDGE CONSTRUCTED FROM EXCAVATED MATERIAL. (WILL NOT WORK WHERE SOIL IS TOO SANDY)

PROPER FENCE PRUNING (ONLY ONE ROW IS SHOWN)



TREES IN FENCE LINE ARE GETTING ESTABLISHED. AT THIS STAGE, THEY MAY WELL NEED PROTECTION UNTIL THEY BECOME STRONGER



READY FOR PRUNING. CUT ALL BRANCHES ABOVE DESIRED HEIGHT. USE CUT BRANCHES TO PLUG HOLES BETWEEN PLANTS.



AFTER PRUNING, THE FENCE LOOKS LIKE THIS. FURTHER GROWTH WILL FILL IN REMAINING VOIDS.



FROM THIS STAGE ON, HEDGE ONLY NEEDS PERIODIC TRIMMING.

Off-Farm Techniques

In most rural areas as well as in towns and urban areas, there are unused spaces along roads and water courses, and around houses and public buildings. While they may traverse agricultural land, these open spaces are not used for agricultural production. Trees planted in these spaces can enhance the environment by providing erosion control and shelter from the sun and wind for both people and animals.

6. Road and Trail Alignment (Off-Farm)

A long standing tradition throughout Africa is to line roads with trees, mainly for shade, but also for wood and other tree products. This practice can be extended to include foot paths and trails. Certain species (*Eucalyptus* spp. or *Grevillea robusta*, for example) can be pollarded extensively every three to five years, yielding considerable amounts of fuelwood and poles for construction.

A frequently made mistake has been to plant trees too close to the road. On major roadways, enough room must be left for two vehicles to pass with additional space on the roadside for vehicles to pull over in an emergency. Less than six meters of space between tree rows creates traffic hazards. Additional width is needed around curves, because the trees reduce the distance ahead that drivers can see.

Trees are also established along livestock and bicycle trails and footpaths, sometimes in combination with live fencing or rock walls to control access to adjacent fields. Shade and fruit trees are favored for footpaths.

ALIGNMENT

TREES AND LIVE-FENCING (HEDGES)
ARE PLANTED ALONG A TRAIL IN
COMBINATION WITH EACH OTHER



TRAIL, FOOTPATH
TREES PLANTED AT REGULAR INTERVALS
2-5 M, OFTEN IN COMBINATION WITH
ROCK WALLS OR FENCE (LIVE) TO CONTROL
ACCESS TO ADJACENT FIELDS. USE
SHADE OR FRUIT TREES OR A
COMBINATION

Alignment Plantings

ROADS & TRAILS

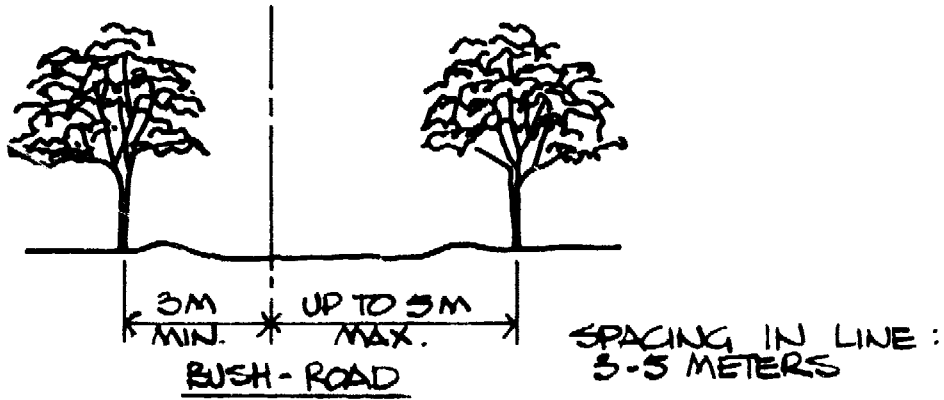

COMMON MISTAKE IN THE PAST: TREES WERE PLANTED TOO CLOSE TO THE ROAD. ENOUGH ROOM MUST BE LEFT FOR TWO CARS TO PASS PLUS SOME EXTRA SPACE: LESS THAN 6M BETWEEN TREES CREATES HAZARDS TO TRAFFIC. EXTRA WIDTH IS NEEDED ON CURVES.

TREES DO REDUCE SIGHT DISTANCE IN CURVES.

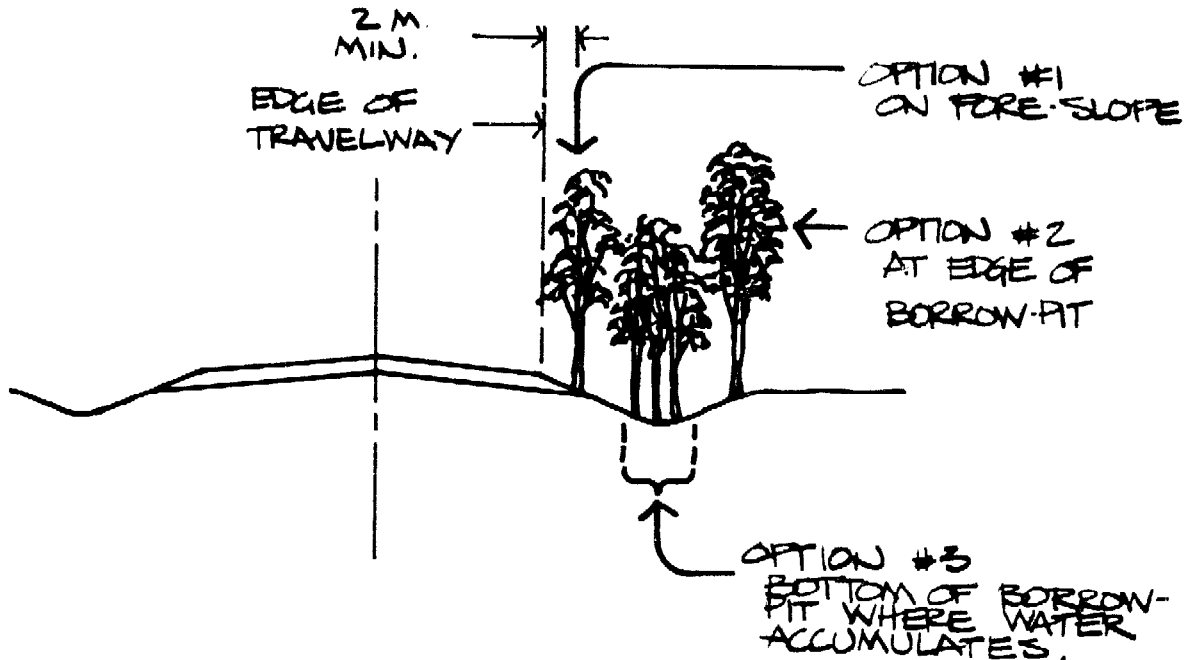

7. Water Course Alignment (Off-Farm)

The banks of streams are frequently cleared for cultivation of cereal crops or irrigated gardens. They are extremely susceptible to erosion once the natural vegetation has been removed. These areas can be protected by restoring tree and shrub cover along the stream banks. Water course alignments also create good habitats for wildlife.

Trees and shrubs can be established around water sources in much the same way as alignment plantings along roads. Rivers, ponds, or drainage canals in irrigation schemes provide excellent growing conditions for trees. Exotics like *Eucalyptus* spp., *Casuarina equisetifolia*, or *Cassia siamea* will grow rapidly on these sites. Fruit trees (mangoes, citrus) should be given special consideration because of their value as food sources. Dry river beds (*wadis*) provide a suitable site for species such as *Tamarix*, *Anogeissus leiocarpus*, *Prosopis* spp., or other more drought-resistant varieties.

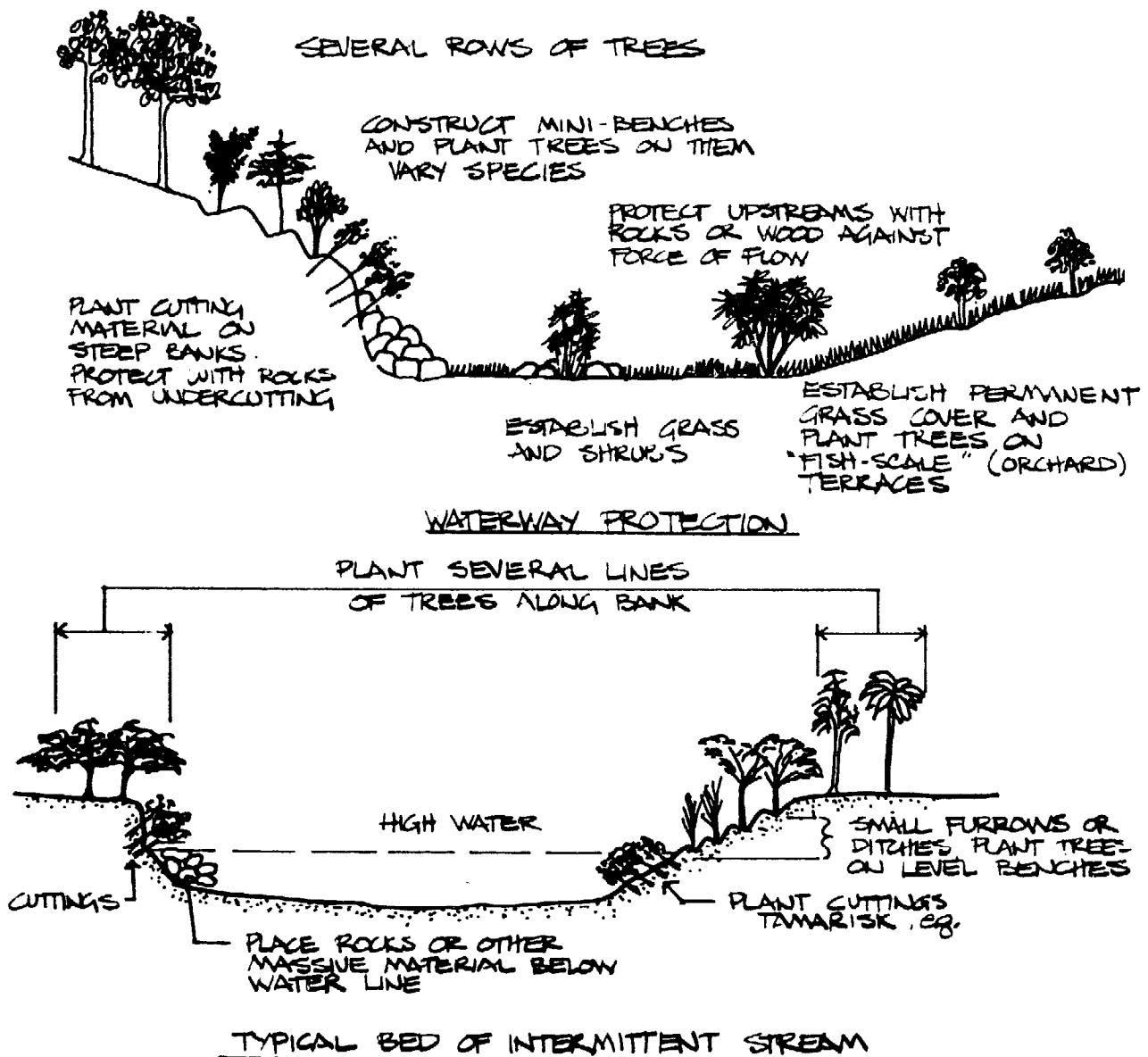

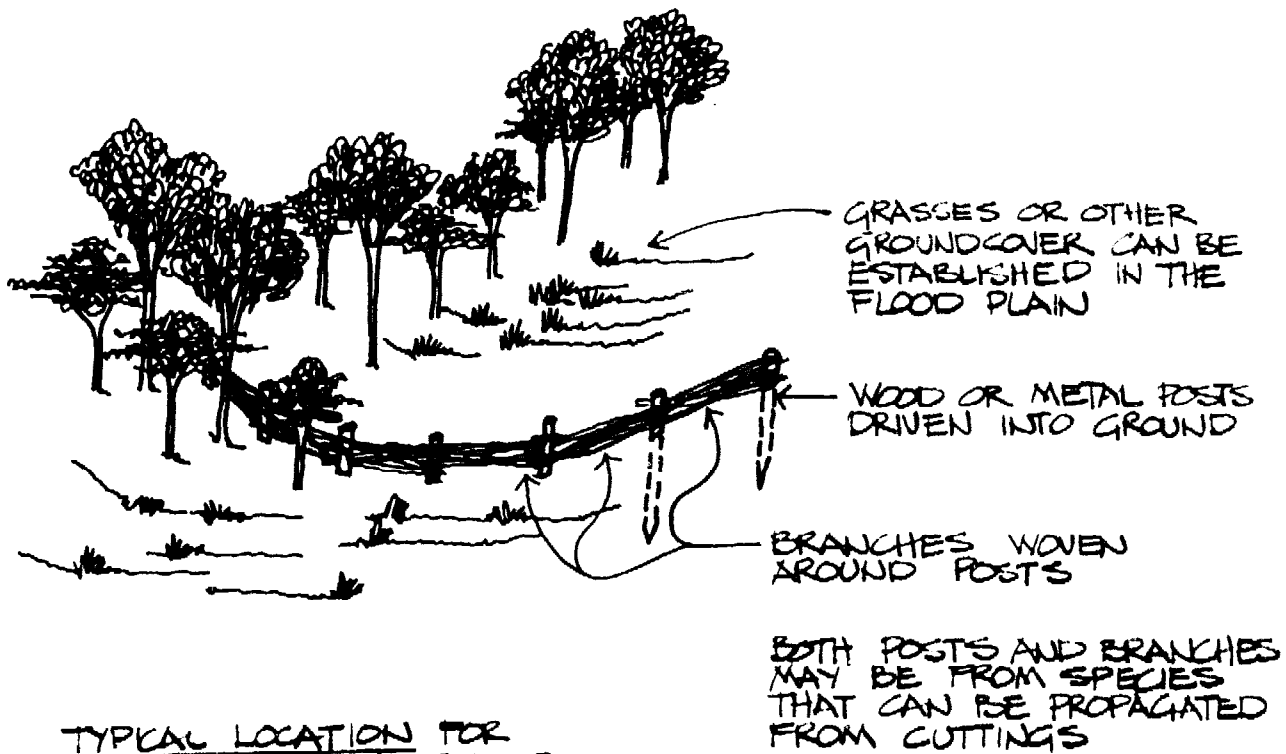

TYPICAL LOCATION FOR ESTABLISHING TREES OR SHRUBS ALONG WATERWAYS

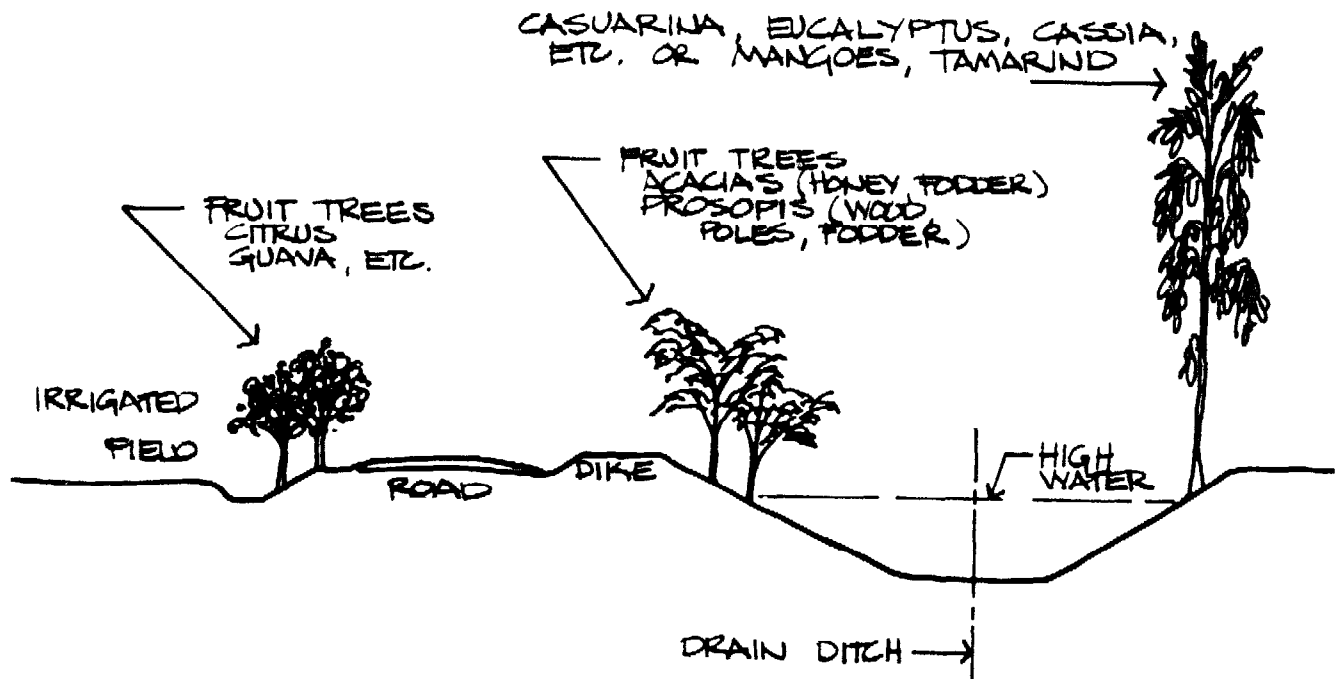

TREES ALONG DRAINAGE STRUCTURE

8. *Shade Trees (Off-Farm)*

In many parts of dryland Africa, the most striking impact of tree planting programs can be observed near houses, in compounds where people live. Protection is easier and questions of ownership arise less where trees are growing inside family compounds. A great diversity of species is found at such locations, particularly introduced species and ornamentals. The neem (*Azadirachta indica*), for instance, has found rapid and wide acceptance throughout Africa as a shade tree.

The pollarding method can be used to harvest wood from shade trees, particularly the neem (see Chapter 9, Harvesting Methods). The branches are cut at a point about two meters above the ground. They sprout back quickly forming a new crown, so that the tree continues to provide shade where needed.

Shade trees planted in public places around government buildings, schools, market places, churches, and mosques serve an important function. These are areas where people congregate during the day, and shade is an essential part of the environment. These are also places where trees can be established and maintained quite easily by local people themselves with minimal assistance from outside.

Trees planted in public places usually need individual tree fences to protect them until their branches are out of reach of free-ranging animals. Even after they are no longer threatened by livestock, good local cooperation is needed to keep people from over-harvesting the trees. For example, the twigs of the neem tree are very popular in Africa for toothpicks. A seemingly harmless practice like breaking off an occasional twig can, however, stunt the growth of young neems if the stems are continuously stripped by passers-by.

Although farmers generally try to restrict the amount of shade in areas where crops are grown, shade trees are used to protect livestock from intense heat during the day. Shade trees are particularly necessary wherever animals are corraled or fenced in, and around watering spots.

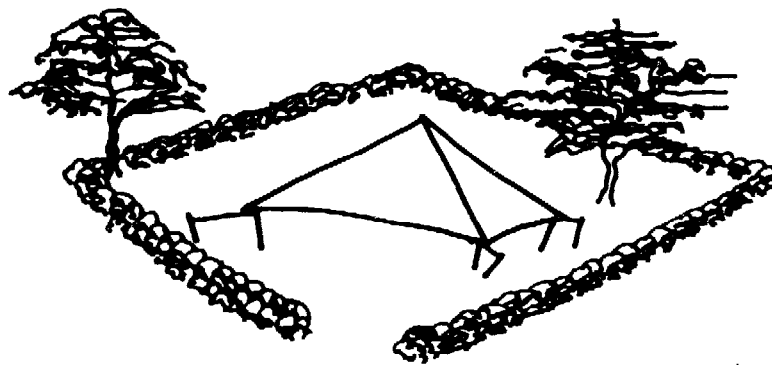

INDIVIDUAL
PERMANENT
ENCAMPMENT
(PASTORALIST
AREAS)

EUPHORBIA HEDGE:
AROUND A COMPOUND
IN MALIKITANIA
WITH INDIVIDUAL
TREES INSIDE

SHADE TREE
(NEEM FOR EXAMPLE)

TREES FOR WOOD &
POLES (CANIA FOR EXAMPLE)

SMALLER TREE PLANTED ALONG
WALL (PARKINSONIA FOR EXAMPLE)

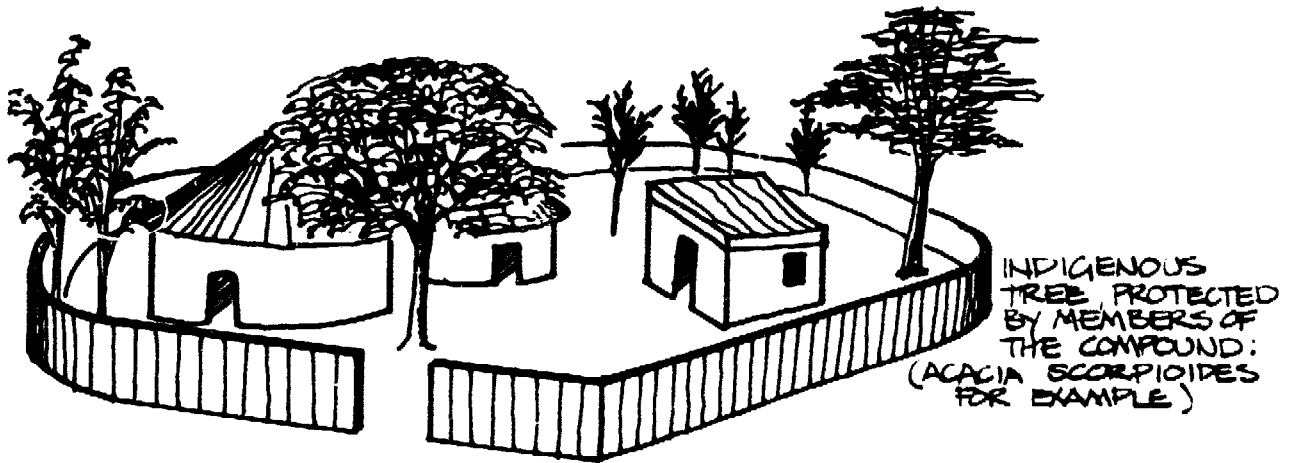

INDIGENOUS
TREE PROTECTED
BY MEMBERS OF
THE COMPOUND:
(ACACIA SCORPIOIDES
FOR EXAMPLE)

NOTE: WALLS IN MANY PLACES
ARE TRADITIONALLY
MADE OF ADOBE BRICK
IN SOME PLACES THEY
CONSIST OF LIVE FENCES
OR HEDGES

INDIVIDUAL COMPOUND
SEDENTARY FARM AREA

GOVERNMENT COMPOUND
(SCHOOL, DISPENSARY, ETC)

WITH LIVE FENCE AND
TREES PLANTED INSIDE

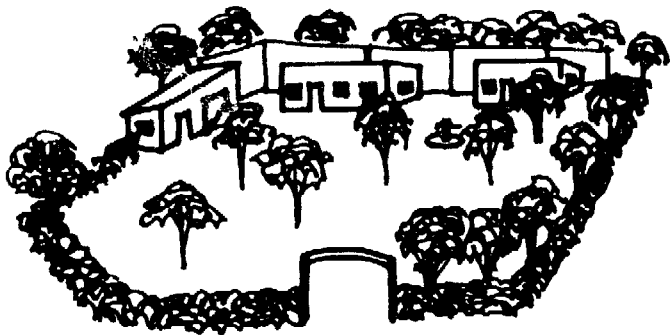

Soil Conservation Techniques

Soil conservation efforts protect the soil from the two primary forces of erosion, wind and water. Windbreaks and dune stabilization are effective methods of halting wind erosion. Planting trees and other vegetation in contour strips or along contour ridges and gully control plantings are techniques used in combination with physical control measures to reduce soil erosion from water.

9. Windbreaks (Soil Conservation)

Windbreaks are strips of trees and other vegetation that slow the flow of the wind, reducing wind erosion, evaporation, and wind damage to crops. They are sometimes referred to as shelterbelts, although this term usually implies a wider strip of vegetation, which incorporates more rows of trees and shrubs than are usually found in a windbreak.

The most successful windbreak projects to date are those found on enclosed farm lands and in some demonstration or pilot projects under government or private control. The major obstacle to windbreak establishment in other areas has been the difficulty and high cost of protecting the trees against animal grazing. Some large-scale successes have been achieved in areas where donors, government agencies, and local people have worked closely together.

Highly impressive results have been observed in Niger, where crop yields from fields protected by windbreaks are consistently higher than those from unprotected fields. Studies conducted at a CARE project in the Majjia Valley indicate that total yields are approximately 20 percent higher, even after accounting for losses from land that has been taken out of crop production to provide space for the windbreaks (Dennison, 1986).

Windbreaks have an especially high potential in farming areas where cereal crops such as millet and sorghum are grown. The windbreak trees, if properly harvested, can also provide significant quantities of fuelwood and poles without jeopardizing their primary function.

The effectiveness of a windbreak depends on how efficiently the wall of vegetation blocks the wind and confines the wind's turbulence to the zones close to the windbreak. A vegetation density of 60 to 80 percent seems to work best in arid zones. A barrier dense enough to block wind passage completely will cause turbulence close to the ground, loosening soil particles that can then be picked up by the wind. As well as removing needed topsoil, wind that is carrying soil particles causes damage to crops through the abrasive effect of the sediment load on plant tissues.

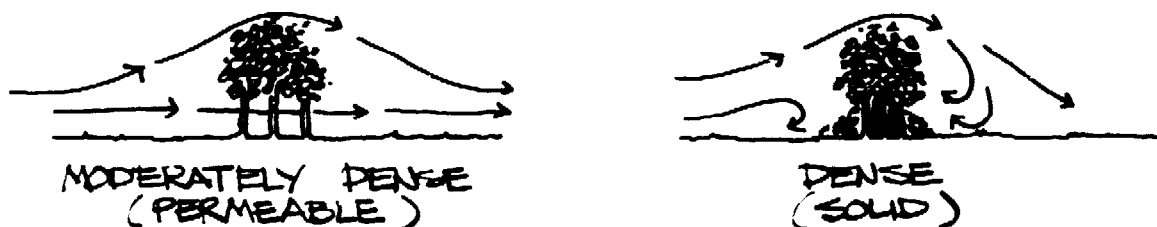

A row of trees that provides less complete wind reduction will also ensure that the effects of the wind are felt further away. Gaps or openings in the windbreak should be avoided as much as possible. Wind is funneled through gaps in the tree rows, concentrating its force and speed, so that the final effect can be very damaging.

Windbreaks can furnish protection for downwind areas up to 10 times the height of the trees, provided the windbreak consists of at least two rows of plants of different heights. Large trees should be chosen for one row (see A, below). Fast-growing species can be mixed with slower growing, longer-lived trees, depending on local preference. Row B should be composed of shorter species, chosen if possible for their by-products, and rows C and D are auxillary rows. These are planted with lower, bushier trees, shrubs, and grasses. A well chosen vegetation mix for windbreak composition will not only provide protection from the wind, but will yield secondary products as well.

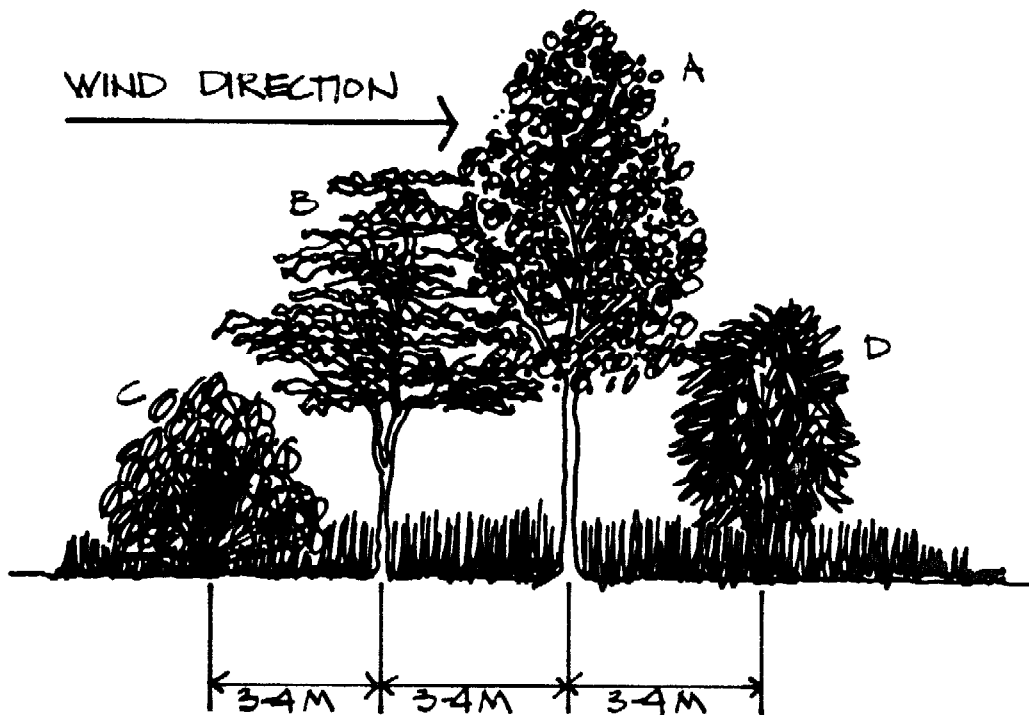

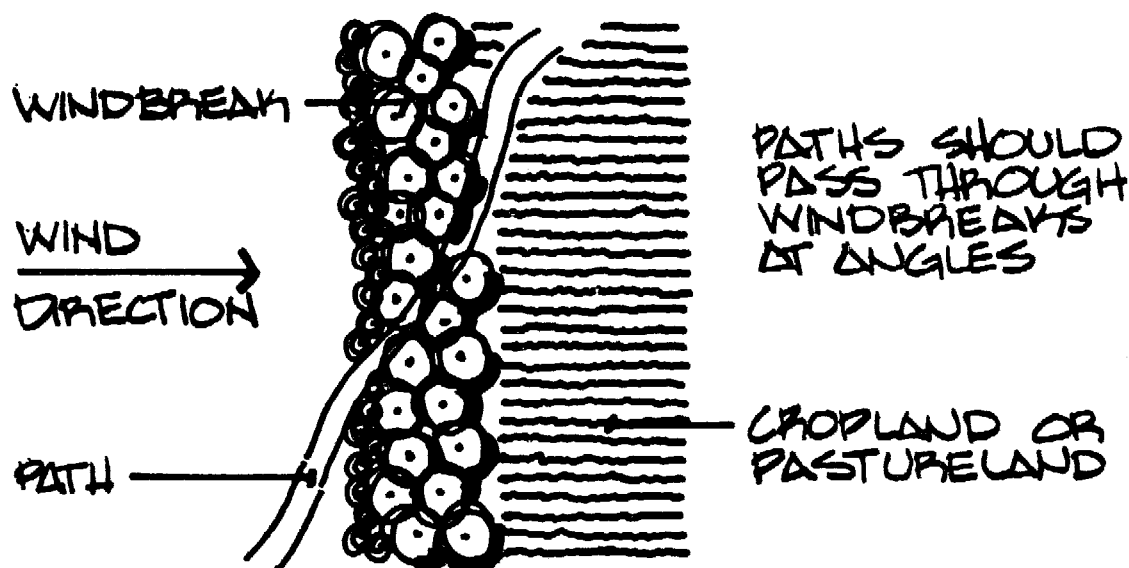

This windbreak is protecting the cropland from high winds, which would carry away topsoil and make the land useless for farming.

Windbreaks and shelterbelts can be laid out to include roads, trails, or driveways for livestock. In this way, animals and people can benefit from a shaded passageway that otherwise would be very hot. Any path through the windbreak should be at an oblique angle rather than perpendicular to the tree rows. This will allow people and livestock to move through the windbreak without opening a gap for the wind to roar through.

Some other points to consider about windbreaks:

- o The selection of species for the windbreak should follow the general guidelines given for the different rainfall zones. Good selections can be made from species protected by law. Use only species that local residents themselves have chosen and value.
- o Although double lines of *Azadirachta indica* have been used with satisfactory results, a strip three or five lines wide is better. Low growing bushes like *Bauhinia*, *Combretaceae*, and *Salvadora* should also be considered. The most efficient windbreaks are those with one or two rows of low-growing shrubs or trees on the outside and two or three rows of taller trees on the inside.
- o The utility of the wider shelterbelts can be enhanced by the selection of multiple use species for the middle rows. *Acacia senegal* has been used in some areas, and species that provide locally consumed fruits and medicines, such as *Tamarindus indica*, should definitely be considered.
- o Frequently a combination of planting methods is highly practical when establishing windbreaks. In other words, a combination of nursery

transplants, live fencing, cuttings, and stumps can be used (depending on the best time of the year for planting in the area).

- o Preparation and protection of the site involved are possibly more important for windbreaks than for regular plantations. During the rainy season when crops are being cultivated, the fields are effectively protected from livestock; however, after the harvest the animals are usually allowed to browse the crop residues left in the fields. Keeping the animals away from the windbreaks during this time is difficult, and fencing in a long narrow strip of land is costly.
- o Where complex land ownership patterns exist, it may not be possible to establish continuous straight tree rows across individual fields and parcels. In this case windbreaks may be staggered so that they conform with established boundaries such as borders of fields, roads, trails, streams, and other natural or man-made features. Staggered windbreaks can also provide the most effective protection around towns and villages, where they are laid out in a pattern of overlapping blocks.

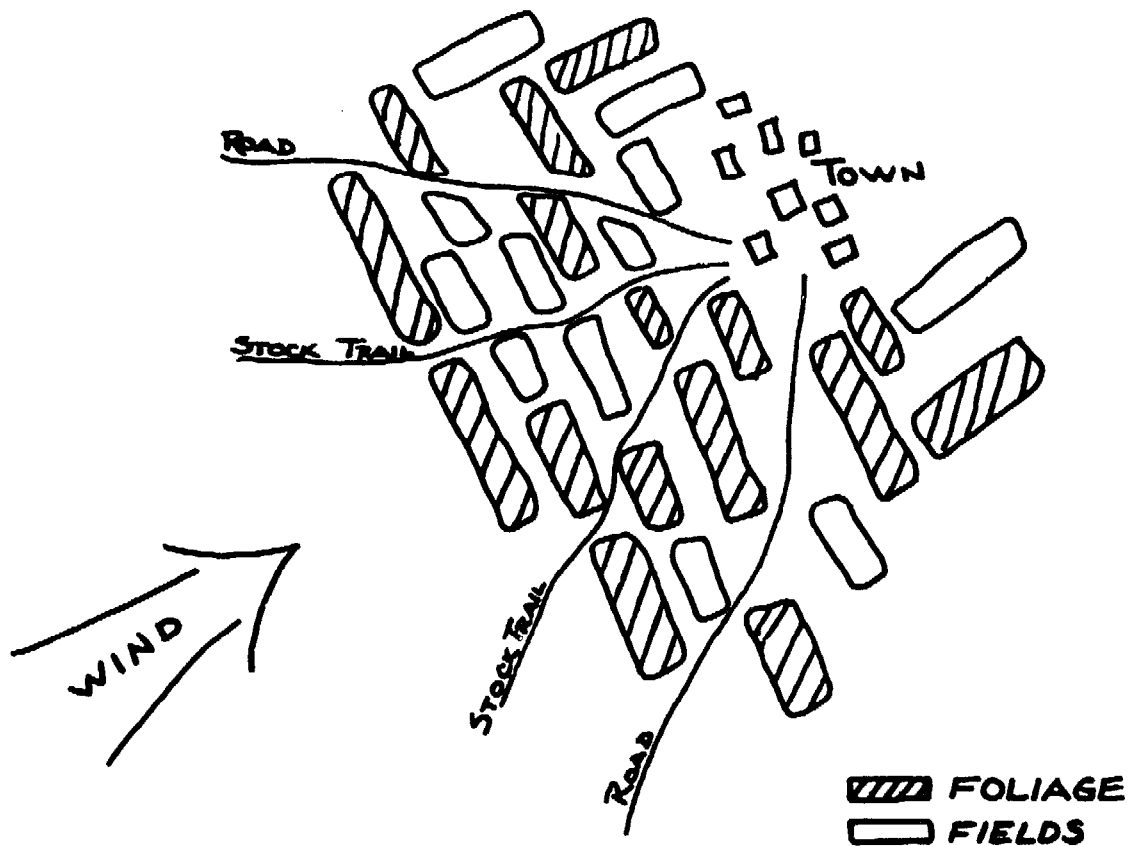

Shelterbelts

- o Another possible planting pattern is to line farm fields with wide windbreaks and to plant dispersed trees such as *Acacia albida* inside the field.

- o Many nurseries in arid zones could benefit from the establishment of a windbreak to protect the seedlings from drying winds. The nursery windbreak also serves as a demonstration to visitors to the nursery. If the nursery is very small, however, a tall windbreak might cast too much shade on the seedlings.

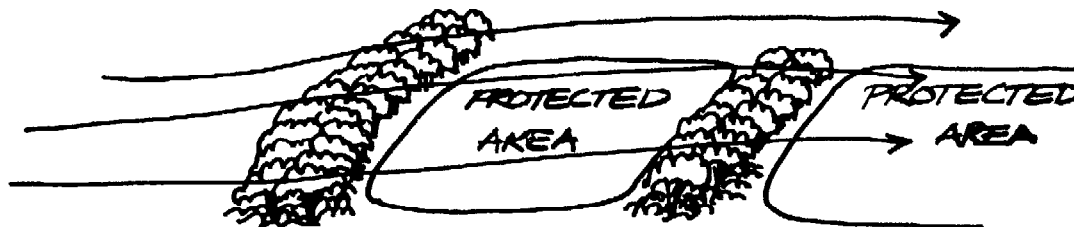

10. Sand Stabilization (Soil Conservation)

Shifting and blowing sand causes great damage to farmland, buildings, installations, and roads. Entire settlements can be threatened by the movement of shifting dunes. Sand stabilization is an important aspect of revegetation and conservation activities in many arid areas. Some of the most successful examples of erosion control efforts have resulted from reforestation projects.

The best protection against drifting or blowing sand is to prevent the sand from being picked up by the wind and becoming airborne. Conservation of existing grass and other vegetation cover is necessary to hold the sand in place. Even a small disturbance such as a footpath can start the process of erosion on fragile dunes. Once airborne, drifting sand can be made to settle, nevertheless, and can be kept from further shifting.

The first step is to determine why the natural vegetation has not recolonized the area that is being eroded. Various options that will remove any constraints to natural vegetation should then be considered. Often the problem is being caused by animals. Under these circumstances, little if anything will be gained by planting trees, unless access is first controlled.

There are basically two approaches to dune fixation: biological and physical. The best ultimate results are obtained when the open area where sand is picked up can be permanently covered by vegetation. Biological methods include:

- o Fencing off the area to protect it from animals, so that the vegetation can regenerate naturally
- o Establishing hedge rows of species such as *Euphorbia balsamifera*, which can be successfully regenerated from cuttings even in areas where annual rainfall does not exceed 300-400mm. Freshly cut branches of *Euphorbia balsamifera* are partially buried in rows of shallow trenches. For further details on propagation from cuttings, see Chapter 9.
- o Direct seeding, particularly of grasses, but also of woody plants such as vines, shrubs, and trees.

- o Transplanting seedlings from a nursery onto the site.

Certain vines and creeping plants are well adapted to grow in almost pure sand, covering the ground with runners and shoots. With the sand thus held in place, site conditions improve enough to permit the introduction of grasses and other small plants. Eventually seedlings raised in the nursery can be transplanted onto the site. This method of sequential revegetation gradually builds up the soil and improves growing conditions for other plants.

Often before grasses and other ground cover can be reestablished, however, the movement of the sand must be halted. Physical dune stabilization measures include:

- o Wind-baffles (palisades), which are constructed of a variety of materials, generally whatever is locally available.
- o "Fore-dunes," which consist of sand or soil ridges set at right angles to the major winds. They can be 1-5m high and stretch over hundreds of meters in length. Heavy construction equipment is required for large-scale efforts.
- o Mechanical surface stabilization, which is accomplished by covering exposed areas to reduce further erosion. Plastic sheeting, nets, cloth or some other fiber is used.
- o Chemical surface stabilization, which involves spraying a binder (rubber, oil, or plastic base) on the surface to bind particles together. Grass seeds and mulch can also be mixed with the binder and sprayed on the area to be protected.

Preference should be given to biological control measures whenever possible because of the high continuous maintenance costs of the physical methods. In exposed situations where plant survival is limited, however, some physical construction is needed for initial plant establishment. The construction of wind-baffles or palisades can be justified if low-cost materials are locally available. This barrier can take many forms and be made of a variety of materials.

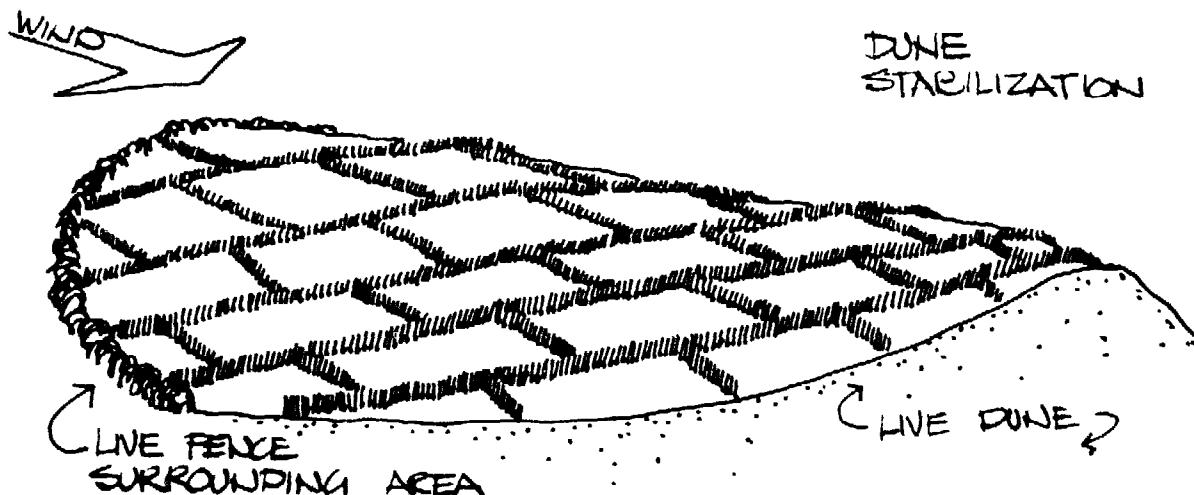

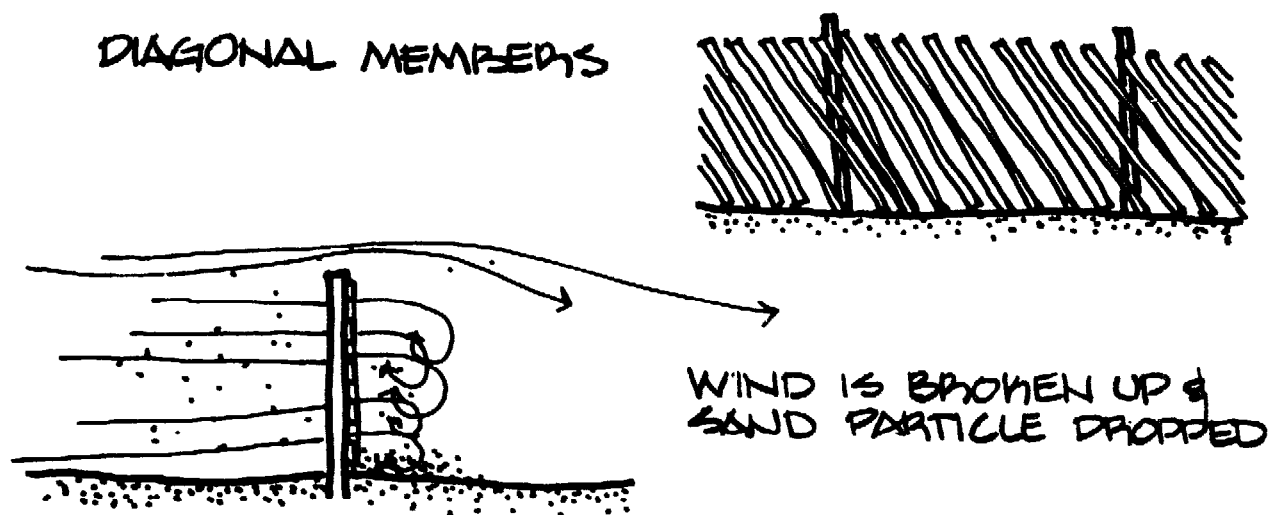

Windbreak fences used for sand stabilization

Stems and poles (3-8cm in diameter and up to 2m long) can be used to construct a diamond pattern of criss-cross rows across areas of open sand. Branches of tamarisk can be staked out in dense rows, or fences can be woven from branches of species such as *Guiera senegalensis* to construct the palisade. By breaking the force of the wind, the palisades keep the exposed sand from being picked up, and the sediment load already carried by the wind is deposited in or behind the barrier. Sand will become entrapped in such rows, and ridges will gradually form. Plant growth then becomes possible in the protected areas behind the ridges.

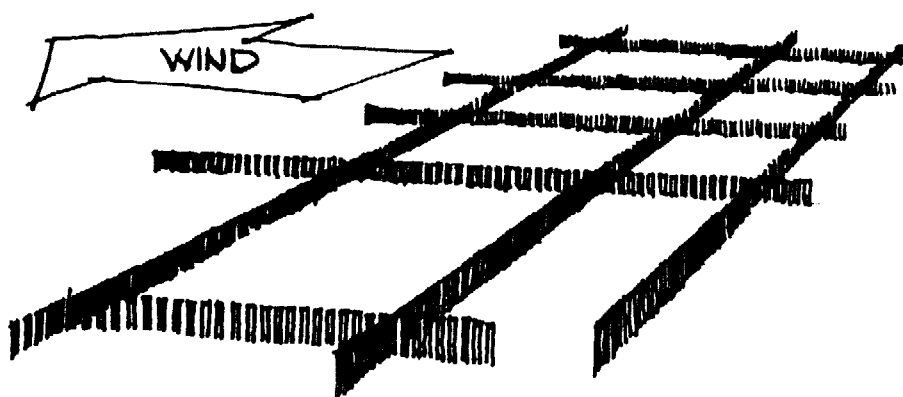

TYPICAL WIND BARRIER PATTERN

Fenced in squares and other sand traps can also be constructed of materials as basic as bundles of millet stalks or other crop residues. Additional possibilities include palm fronds, sticks, branches, cardboard, or any material that is reasonably sturdy, easily available, and low cost. Some of the problems that may be encountered in maintaining the barriers include damage from animals and termites that are attracted to them for food. Where sand accumulations are heavy, the barriers may have to be raised or added to periodically.

The following steps are followed in implementing a dune fixation project:

- 1) Establish a perimeter around the area to be treated, either with fencing material or by establishing a live fence.
- 2) Construct a network of palisades to prevent sand movement by cross currents. The primary gridlines should be perpendicular to the direction of the major prevailing winds, and the secondary lines should be at right angles to the principle lines.
- 3) Once the grid of palisades has been established and the movement of sand has been effectively reduced, vegetation can be introduced into the protected areas. Use methods described under biological control.
- 4) Begin protection and maintenance efforts. Voluntary participation, cooperation, and commitment to the project objectives on the part of the local inhabitants is essential.

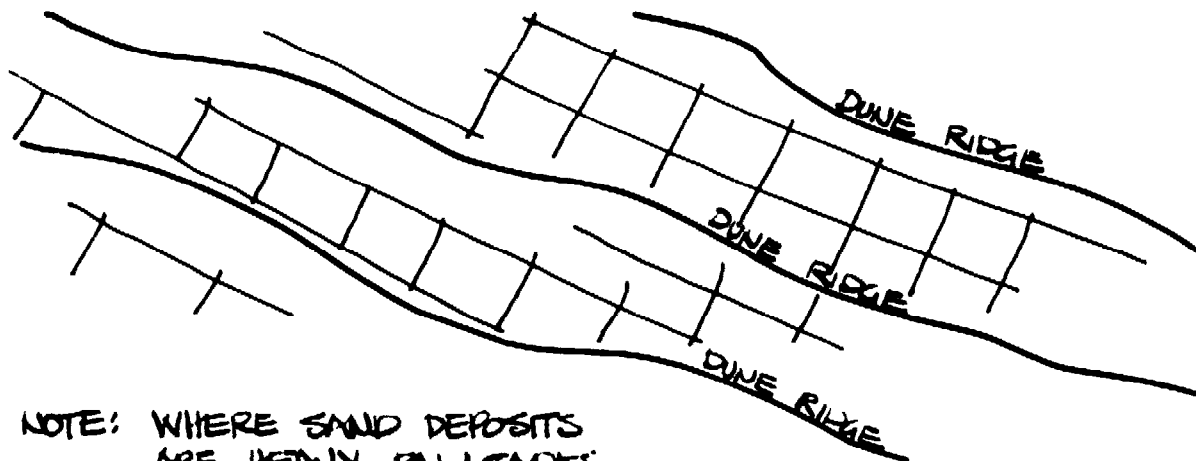

NOTE: WHERE SAND DEPOSITS ARE HEAVY, PALISADES HAVE TO BE RAISED OR EXTENDED VERTICALLY, SOMETIMES TWICE A YEAR

DETAILS OF PALISADE
NET-WORK

DUNE STABILIZATION PALISADE LAYOUT AND SPACING

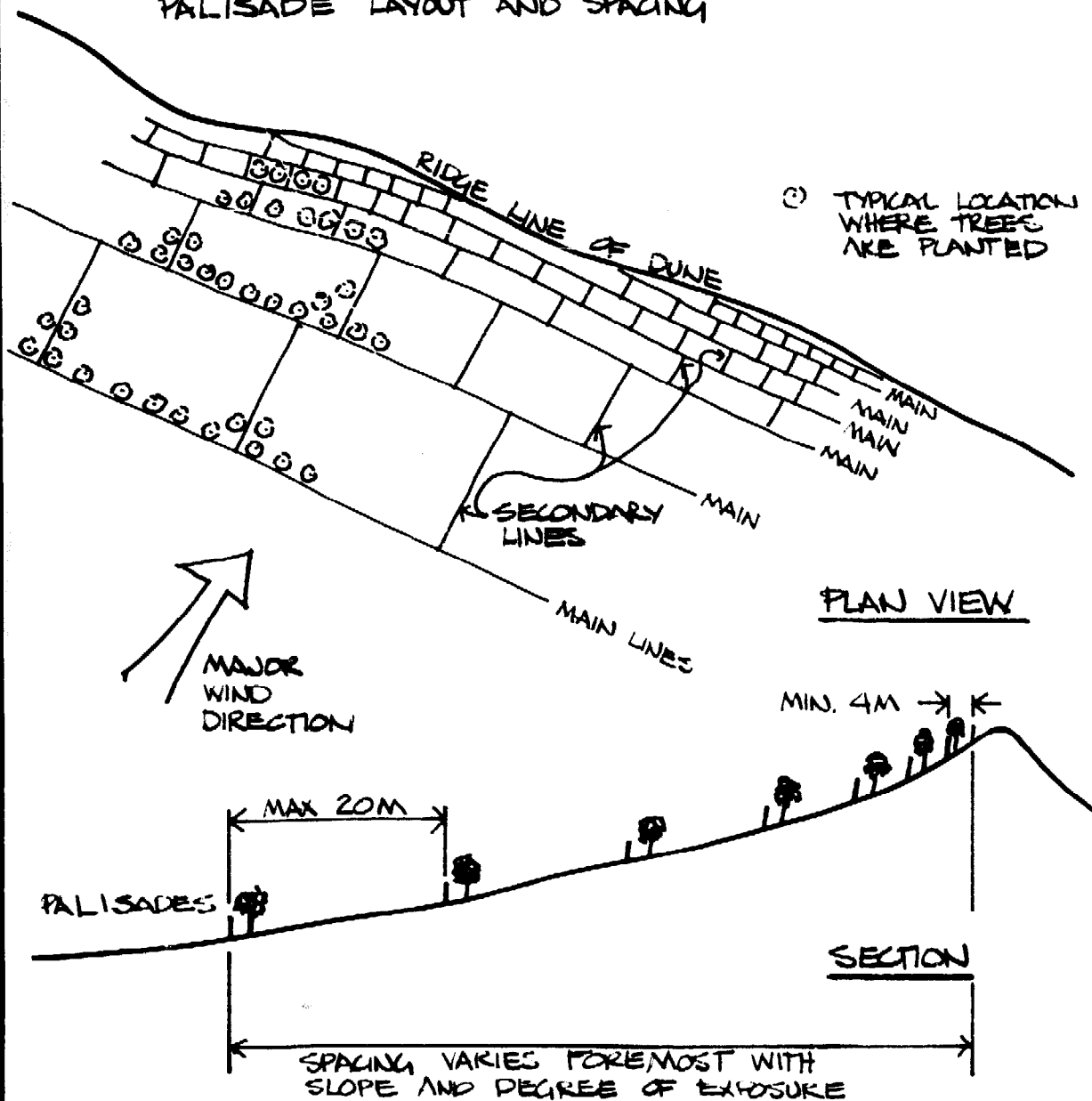

Before beginning a sand or dune stabilization project, planners should consider the following:

- o Dune fixation is not an appropriate conservation investment if the area that is being threatened by shifting sands has no inherent value. Unless some benefit will accrue in terms of protection of farmland, homes, or other property, the cost is prohibitive. Furthermore, those who will gain the most from the project should also be willing to exert the most effort, particularly in terms of sustaining and protecting the vegetation cover.

- o Dune fixation projects should not be undertaken without first carefully evaluating traditional and current land use attitudes, especially those governing grazing and wood cutting. If these are incompatible with the restrictions needed to protect the vegetation, then changes in land use policies must take place before dune fixation activities are initiated.
- o The shifting of live dunes is influenced by a complex set of variables, and may change with the seasons. It is worthwhile to observe and measure dune movements for a period of 12 months before starting stabilization activities.
- o Except under extreme desert conditions, it is more effective to stabilize the zone of origin of the shifting sand, rather than concentrating efforts on the areas where the sand is being deposited. It is important, therefore, to determine the location from which the sand is being removed by the wind.
- o Project sites that are close to or within actual desert zones will require more intensive efforts to stabilize shifting dunes. Maintenance inputs will also be higher.
- o The more exposed a specific location is to the wind (near the crest of large dunes, or in saddles between ridges), the more difficult it is to establish vegetation. Physical protection is often needed. If it is not possible to use physical control measures, however, the area can still sometimes be stabilized after the top has been lost to wind erosion.
- o Locally occurring trees and shrubs have great resiliency. In species selection, the indigenous vegetation should receive priority over exotics, particularly for large-scale projects.
- o A few outstanding examples are on record of communities that have controlled sand encroachment for generations, alone and unassisted by outside organizations. Local approaches may be more appropriate for a particular site than imported techniques that rely on heavy investments and foreign equipment.

11. Contour Strips (Soil Conservation)

The most likely, logical place to use trees and shrubs to halt erosion caused by water is across slopes, particularly where hillside cultivation is practiced. Properly maintained trees and shrubs, planted in combination with grasses and other vegetation, can effectively control surface runoff, thereby reducing soil losses. One successful technique involves establishing parallel vegetation bands along contour lines.

These contour strips will reduce runoff from the slopes above if they are designed and maintained to ensure a dense, multi-layered permanent ground cover. The ground surface is protected by successive layers of litter, grasses, other ground plants, bushes, and trees. A dense vegetation belt will not only

CONTOUR STRIPS (WATER EROSION)

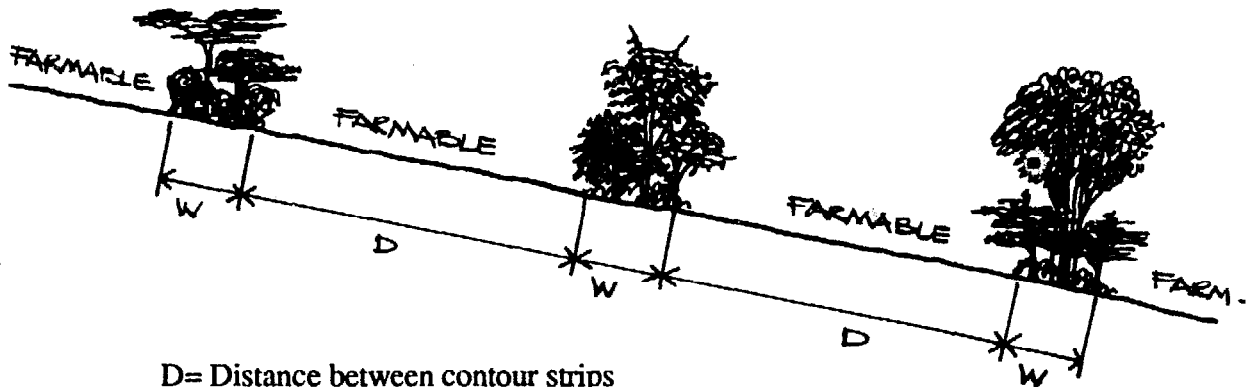

D= Distance between contour strips

W= Width of the band of vegetation in the contour strip

stop or slow down runoff, but will also trap soil particles suspended in the water that have been removed from the more exposed areas between the strips.

Correct dimensioning of the D and W variables indicated in the illustration above is important. Many factors affect the spacing of the strips, but the degree of slope is the most important. If previous efforts to establish contour strips in the area are available for study, these sites should be observed for evidence of erosion to determine if the dimensions are in proportion. Conservation services may also have tables or formulas appropriate for local site conditions. If no information of this kind is available, dimensions can be calculated using the following table as a rough indication of spacing.

Slope	W(meters)	D(meters)
0	2	50
5	4	47
10	5	43
20	8	38
30	10	33
40	13	28
50	17	24
60	20	20

Basis: 0-600mm mean annual precipitation

In areas with rainfall between 600-1,000mm: increase W by 20%
decrease D by 10%

In areas with rainfall greater than 1,000mm: increase W by 50%
decrease D by 20%

Revegetation efforts on these strips can be approached in many ways. To simply establish some groundcover, scarification of the ground along the contour may be sufficient site preparation. Furrows can be dug by hand or using a harrow or disc blade. More intensive effort may consist of additional seedbed preparation, for instance, loosening up the soil surface and raking along the contour. Direct seeding of desirable trees and shrubs may be feasible for such species as *Leucaena leucocephala*. Some trees can be established by cuttings. The most direct, but also most costly, method of establishing contour strips is by planting nursery raised seedlings.

The primary consideration for species selection should be local preference, because the contour strips take a certain percentage of the land out of cultivation, even though they are intended to increase productivity of the total area. Many different species can be used, some in combination with each other. Fruit trees are often a high priority on farmland. In other areas, trees that produce poles for construction, rafters, and fences may be preferred, such as *Casuarina equisetifolia* or *Tectona grandis*.

Particular attention should be given to vegetation layers nearer the ground surface. Fodder plants, such as Guinea, napier, or elephant grasses, may be of interest for feeding to penned livestock. Perennial bean species, produced on small woody shrubs for human consumption, may appeal to the local inhabitants. Contour strips can be a good location for introducing new species on a small-scale, experimental basis as well.

12. Trees Along Contour Ridges (Soil Conservation)

For information on the various applicable soil conservation measures that involve construction of contour ridges, or terraces, or excavation of infiltration ditches, a number of texts are available for arid areas in the tropics. The *Centre Technique Forestier Tropical* (CTFT), the *Centro Agronomico Tropical de Investigacion y Enseñanza* (CATIE), the International Council for Research in

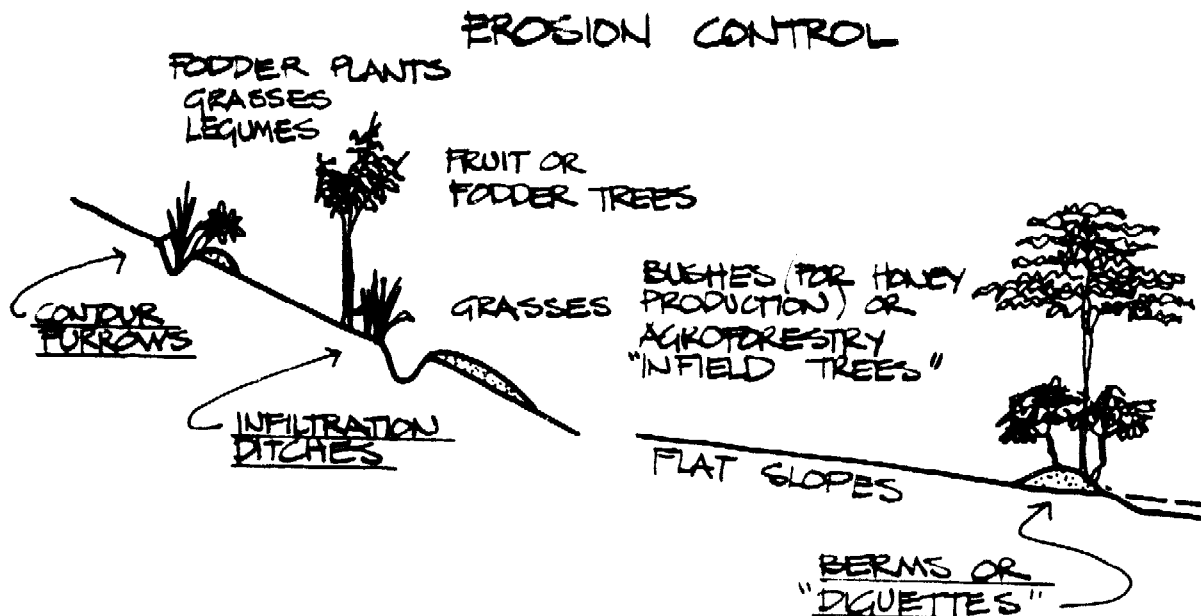

Agroforestry (ICRAF), and the United Nations Food and Agriculture Organization (FAO) have all published handbooks and technical materials on the subject. In addition, many of the bilateral donor organizations have developed standard texts on the subject during the past decade. Construction designs and extension materials have been developed specifically for certain countries, among them Honduras, Kenya, Burkina Faso, and the Philippines. See Appendix E for a list of information sources and bibliography for related materials. See also Chapter 7 for discussion of micro-catchments and contour ridges.

There is still relatively little information available, however, that deals with the effective combination of biological and physical erosion control measures. Vegetation, especially trees and shrubs, can play a vital role in increasing the effectiveness of soil and water conservation efforts. Properly established and managed woody plants can reduce maintenance and costs on hillside erosion control projects as well.

The following sketches show some specific, typical cases where trees and shrubs can make an important contribution to physical ridge or ditch formations along the contour lines of sloping surfaces.

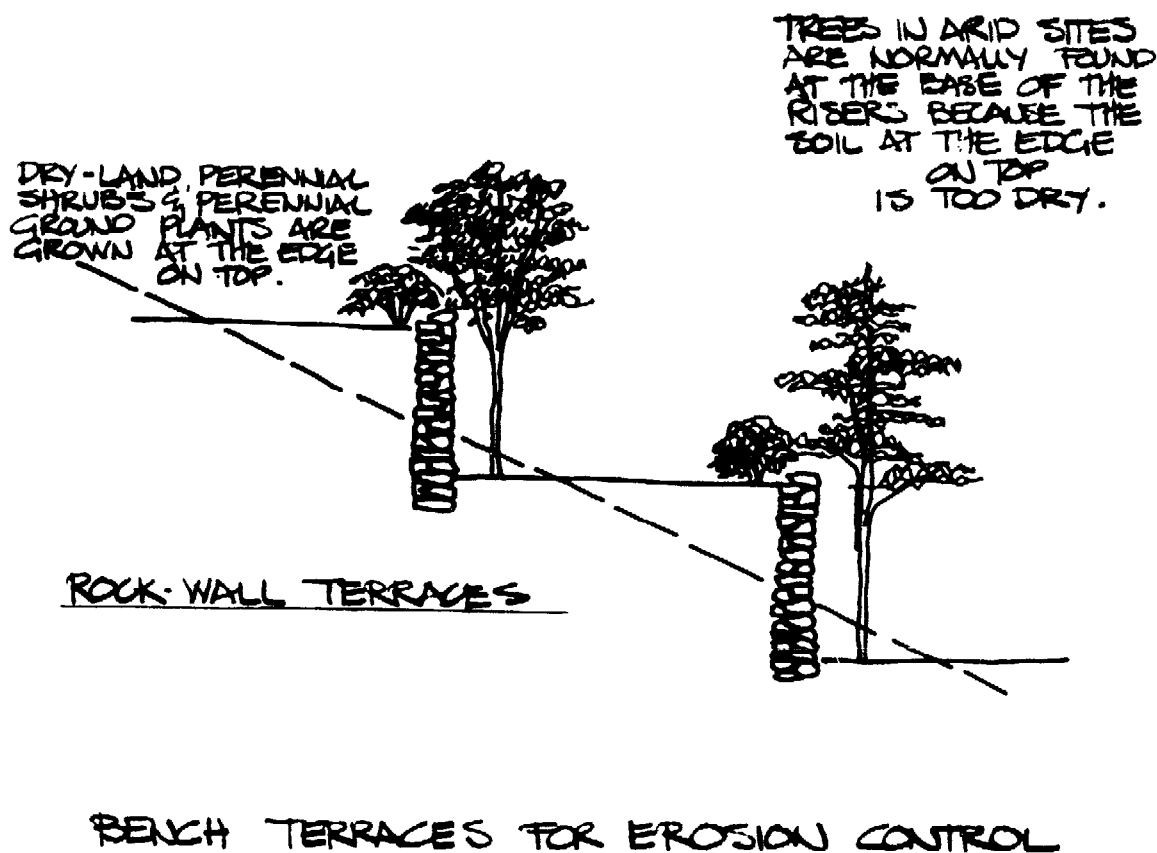

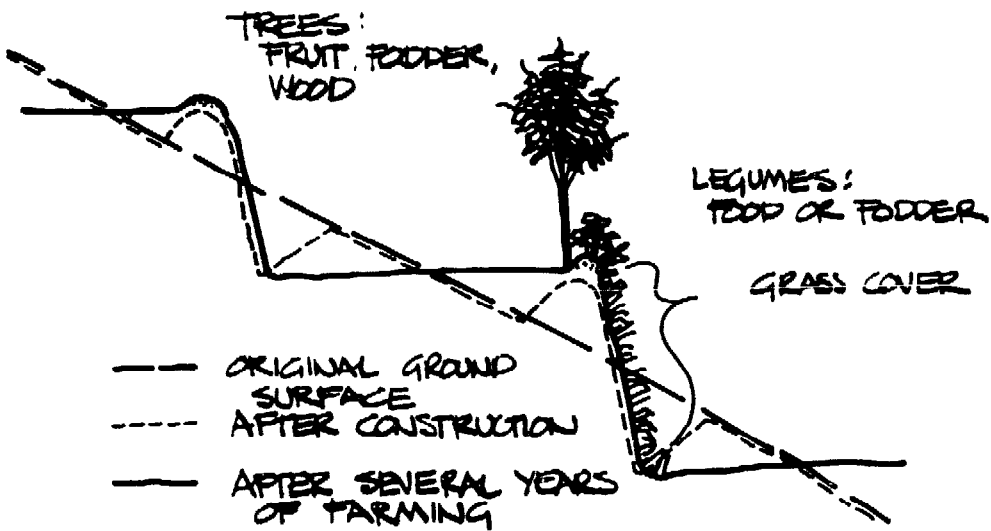
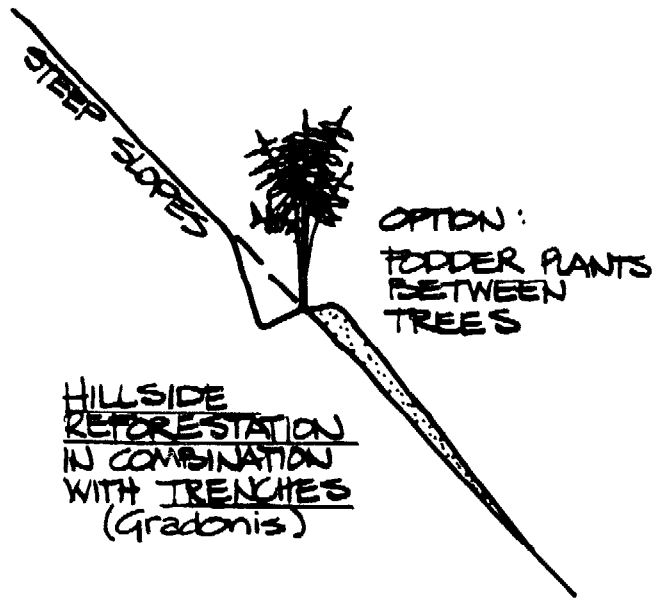
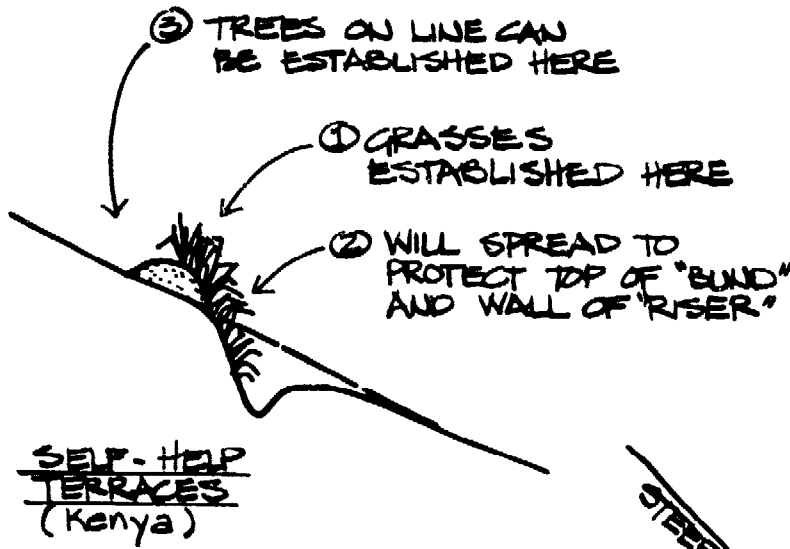

GRADUALLY DEVELOPING BENCH TERRACES

13. Gully Reclamation (Soil Conservation)

Permanent vegetation, especially shrubs and trees, can reduce bank or channel bottom erosion as long as the flow of water is not too powerful. Vegetation can also help stabilize mechanical protection materials, such as large rocks positioned along banks or bottom (rip-rap), wire mesh boxes filled with rocks (gabions), or bales of straw or branches staked in place to reduce water velocities.

Gullies present special problems, because they occur on steep slopes, and even brief peak flows can cause serious damage. Gully erosion is difficult to reverse once it has gotten started, and it can quickly destroy valuable agricultural land.

To prevent the formation of gullies along waterways, line the banks with trees and shrubs, as has been described above under Water Course Alignment (7). Trees, shrubs, and other vegetation can be established within the gullies to control further erosion and to help rebuild the soil layers that have been removed. Improperly placed trees can, however, have the undesired effect of narrowing the channel and increasing the speed of steam flow. The following sketches show how to combine vegetation with mechanical gully erosion control methods for optimal results.

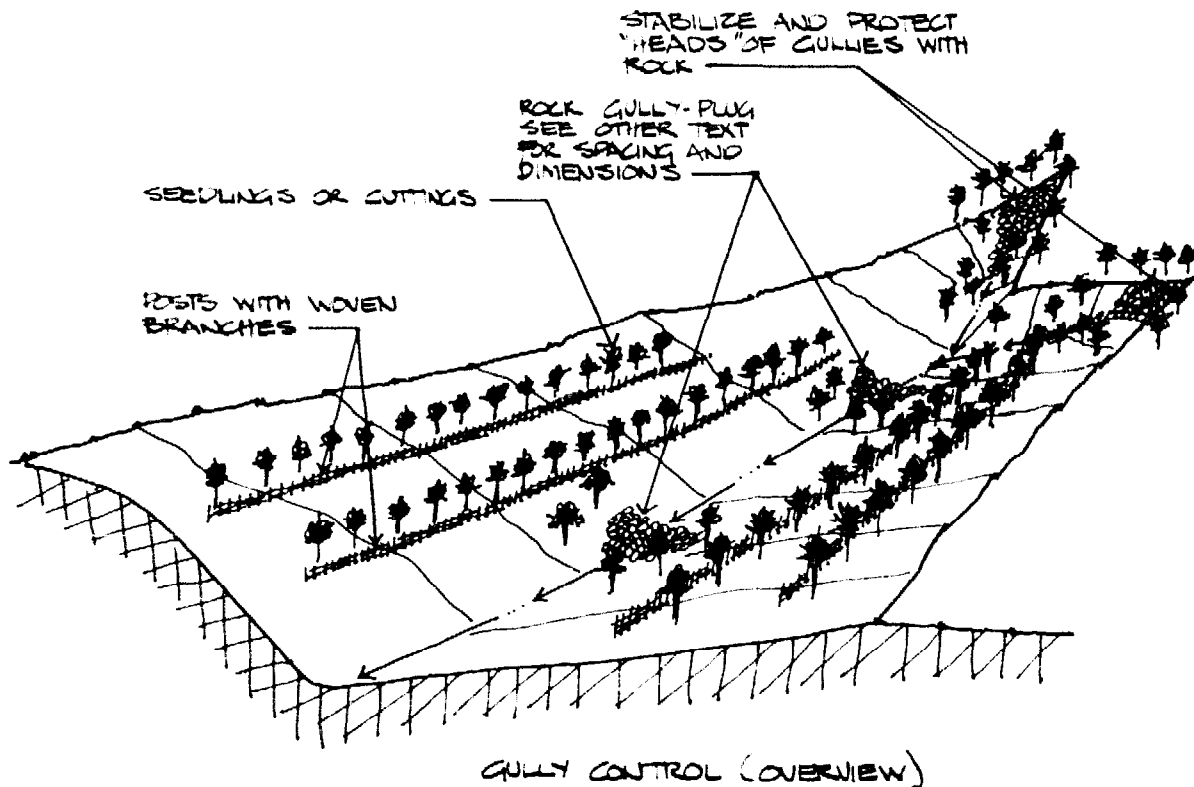

IMPORTANT DIFFERENCES BETWEEN:

ALLEY CROPPING (2)
 CONTOUR STRIPS (11) AND
 TREES ALONG CONTOUR RIDGING (12)

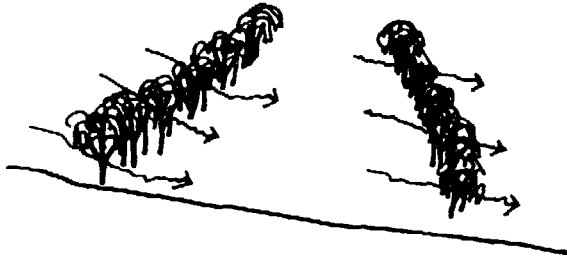

ALLEY CROPPING:
 ONE OR TWO ROWS OF TREES,
 FREQUENTLY TRIMMED. FEW
 PLANTS (WEEDS) COVERING
 GROUND SURFACE. TOO MUCH
 SHADE, GROUND OFTEN
 CULTIVATED. RUNOFF FLOWS
 AROUND STEMS. LESS
 EROSION PROTECTION.



CONTOUR STRIP:
 SOLID BAND OF MULTI-
 LAYERED PERMANENT
 VEGETATION, SEVERAL
 METERS WIDE. SLOWS
 RUNOFF AND TRAPS
 SEDIMENT.



TREES ALONG CONTOUR RIDGING:
 HERE, VEGETATION (CAN BE GRASS, SHRUBS
 OR TREES) IS INTEGRATED INTO SURFACES
 WHICH HAVE BEEN MECHANICALLY CHANGED.
 EROSION IS REDUCED MAINLY BY CHANGING
 SURFACE FEATURES TO WHICH VEGETATION
 HAS BEEN ADDED TO INCREASE THEIR
 EFFECTIVENESS AND REDUCE
 MAINTENANCE WORK.

9

SPECIAL SUBJECTS

Fire

Uses and Prevention

Mention has already been made of the need for firebreaks around both the nursery and the permanent planting site. These serve as protection from fire. Fire does, however, have some important positive uses.

In arid zones, fires are used to burn off old grass. Once that growth is gone, fresh tender grass is more likely to sprout. This happens quite quickly and can help bring relief to starving herd animals. It also limits the tendency of scrub trees and bushes to take over the grass range.

Where vegetation is plentiful, methodical burning is a traditional method of clearing land before planting, keeping snakes and insects in check, ridding the soil of crop diseases, and driving wildlife into traps or within range so that they can be killed for food.

Fire requires oxygen and fuel; if either is eliminated, the fire will not burn. Fire prevention and control consist of removing one of these elements. Normally, the easiest to remove is fuel.

Firebreaks

Prevailing winds in sub-Saharan Africa tend to be high and constant. Thus the spread of a fire can be reasonably well predicted, and the necessary width and direction of firebreaks fairly accurately calculated. Firebreaks should be constructed at right angles to the direction of prevailing winds, with secondary lanes dividing the resulting strips of land or trees.

The high winds dictate wide fire lanes in order to minimize the danger of a fire jumping the lane. Inside planting areas, maintenance and access roads can be combined with strips of cultivated land, adding additional width to the firelanes. As previously mentioned, good protection has been achieved by clearing strips of land 15m wide of all vegetative matter and allowing the land

to be used for cultivating beans or as roadways--either use guaranteeing elimination of dry grasses and weeds.

Plowing the natural vegetation under provides only temporary relief; in the long run, the area becomes a greater fire hazard. Disking and plowing eliminate perennial plants, but make more room for annuals, which tend to become dense and dry. When this happens, the fire spreads more rapidly in the firebreak than on the adjacent land.

Firefighting

Most firefighting efforts are limited to what materials can be found on the spot. Provided the fire is not yet large or too hot, the front of the fire can be attacked directly with branches, brooms, and mats. This is an effort to beat out the flames and kill the fire by shutting down its supply of oxygen.

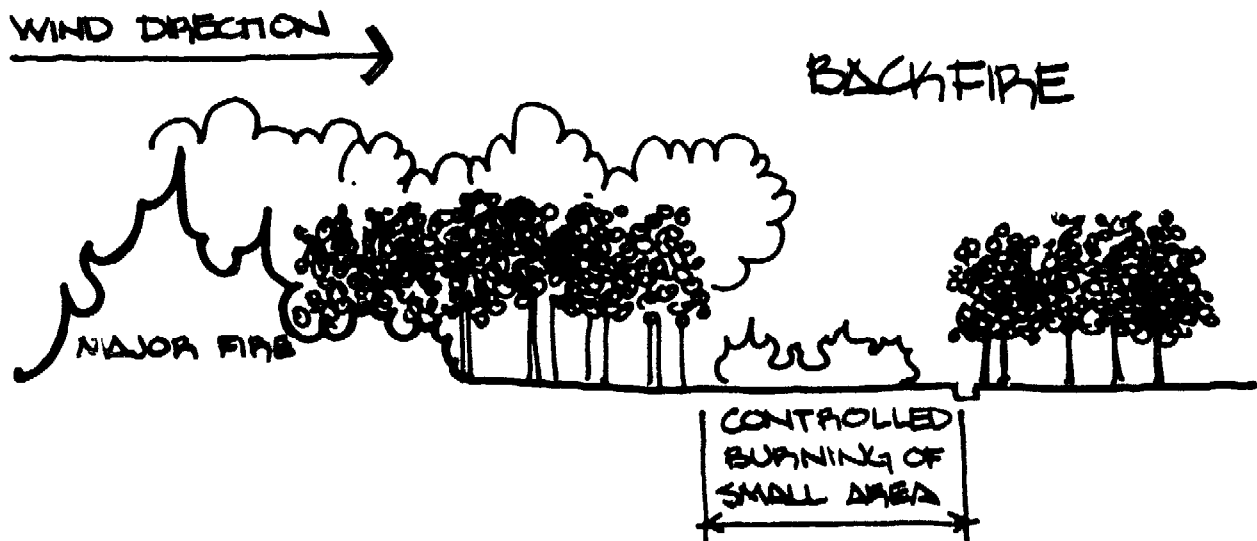

Backfires can be quite effective, particularly in areas where the normal vegetative cover is sparse, the prevailing winds are constant, and necessary control lines can be constructed quickly and easily. A backfire is simply a small controlled fire started in the path of a larger fire. The backfire destroys fuel, and thus halts the larger fire, which has no new fuel to burn.

More on Fencing

The following illustrations show ways of constructing fences to keep out the widest possible number of animals.

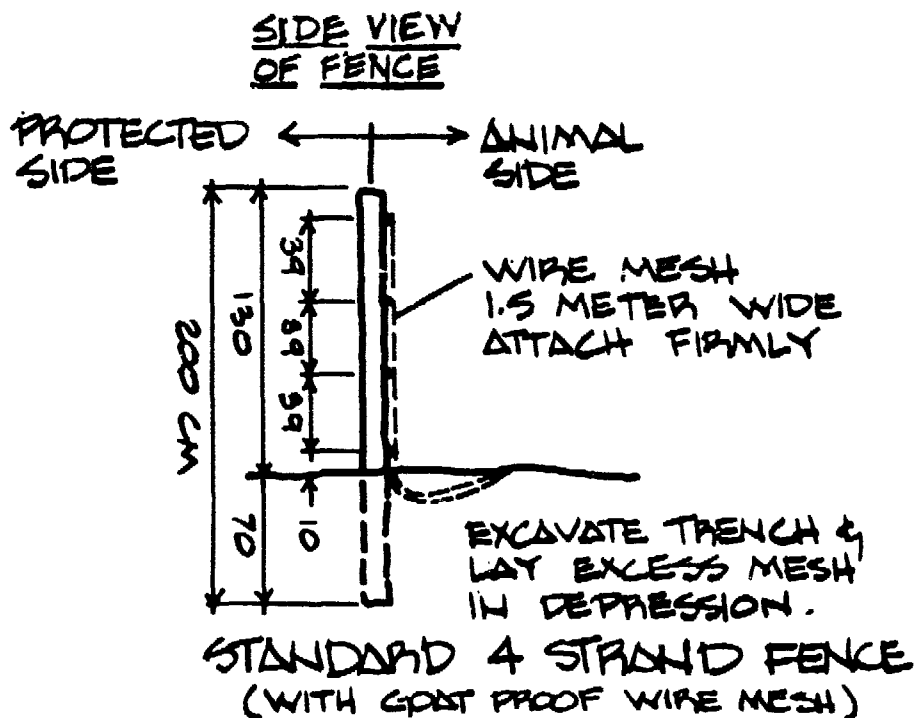

THORN LIMBS INTERWOVEN IN WIRE MESH

WOOD OR METAL POSTS

2 STAY WIRES BETWEEN POSTS

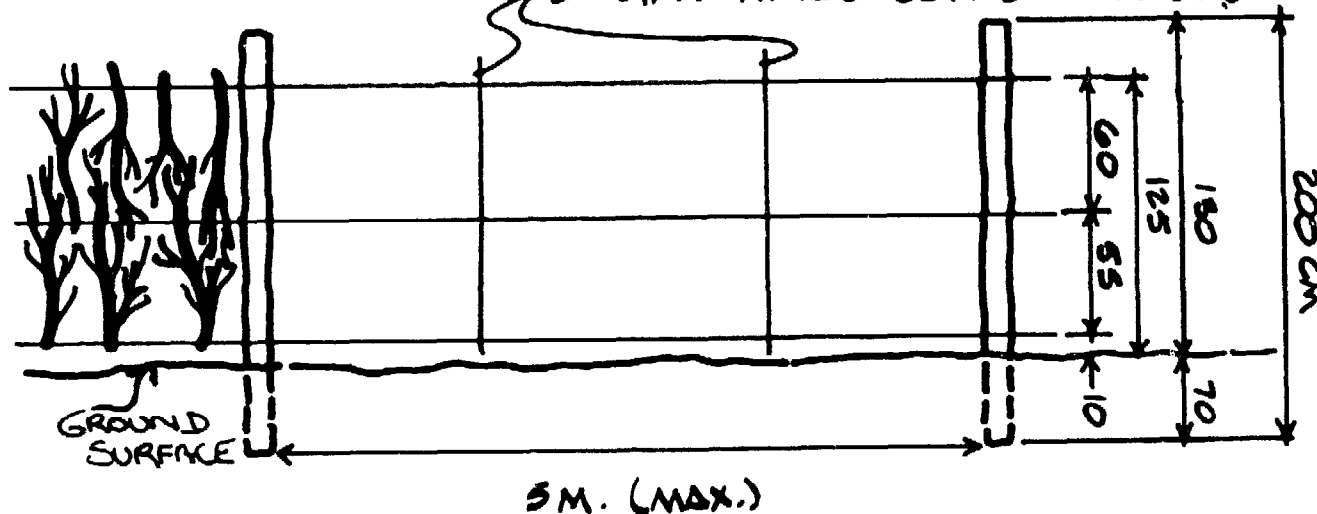

STANDARD 3 STRAND FENCE

(NOTE: MINIMUM IMPORTED MATERIALS)

When using wire for fences, the wire must be stretched tightly between the fence posts if the fence is to remain strong. Tension can be maintained along the fence by making sure that the wire is stretched tightly between posts, and that it cannot slip out of place. When the wire is placed correctly, each post exerts an equal pull against the next post, and this equal pressure creates a tension that keeps the fence posts strong and in place. However, if the tension on one section of the fence is lessened, the posts in this section will begin to lean toward that part of the fence having the stronger pull, and the fence will become weaker and weaker.

Tension becomes harder to maintain as fences get longer or when there are larger spaces between posts. It is generally a good idea to use a line brace every 120-150m. A line brace is pictured below. Sticks are inserted into loops in the wire as shown. These sticks can be twisted to tighten the wire and thereby increase tension.

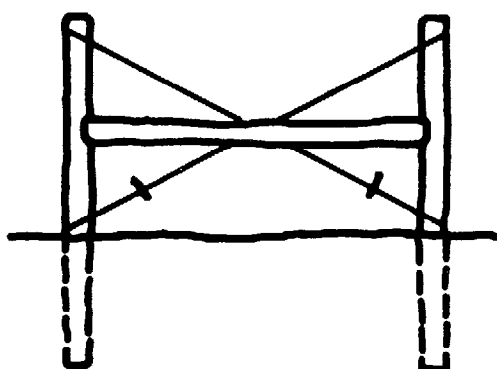

LINE BRACE EVERY 120-150M

Using a Deadman

Corners and openings (for roads, gates) require additional bracing for strength. One such way of providing extra support is by using a deadman. A deadman is simply a heavy stone or block of cement or piece of metal used as an anchor. One end of the fence wire is wrapped securely around the deadman, which is then buried in the ground where it can serve as a permanent anchor. The illustrations following give a clearer idea of the use of the deadman.

A sloping trench is dug as shown. The fence wire is placed around a rock or piece of metal. About midway along the wire, between the top of the post and the deadman, a stick is inserted into a loop of the wire. This stick can then be

POSTS ARE NOTCHED FOR
WOODEN BRACE & DIAGONAL
WIRE.

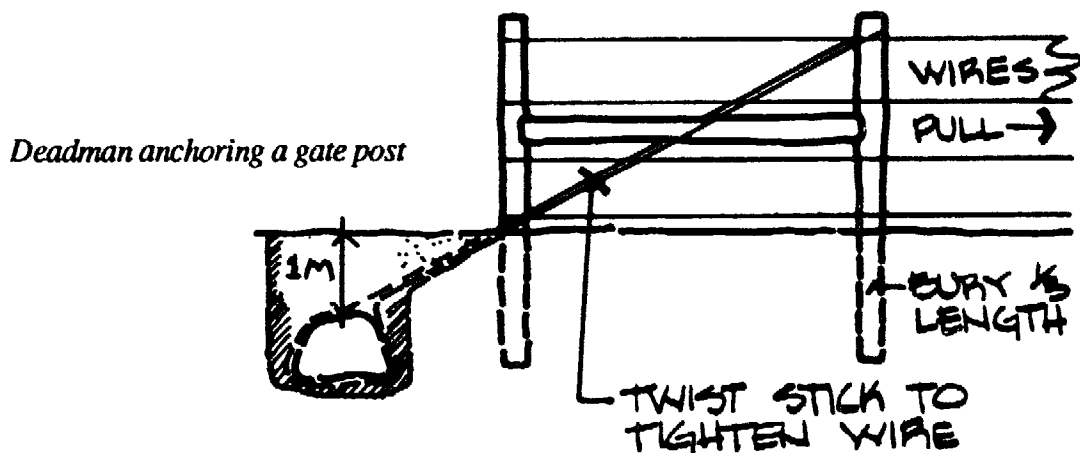

twisted as necessary to tighten the wire and maintain tension. The deadman is placed in the hole so that the wire is tight, and there is a strong diagonal pull. The dirt is piled back into the hole and packed down tightly around the deadman.

The following figure shows one deadman being used to support two posts. The deadman is creating a pull on the posts equal to that being created by the tension of the wire being stretched in the opposite direction.

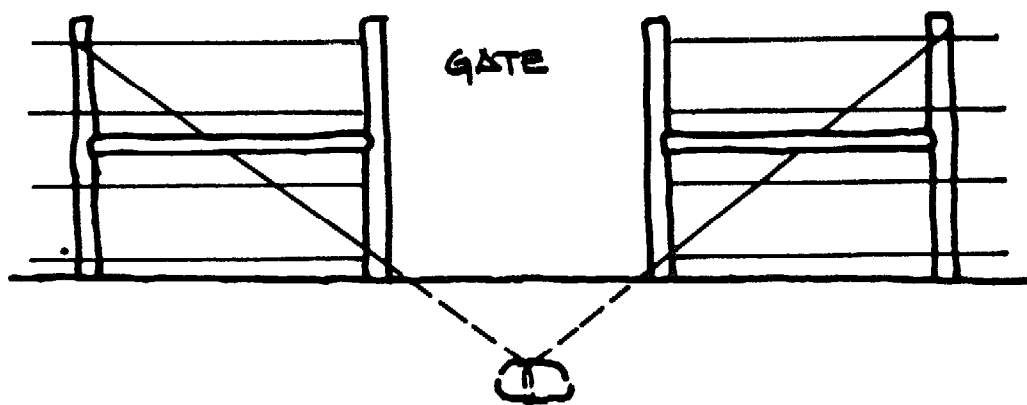

Single deadman anchoring two posts.

DOUBLE DEADMAN

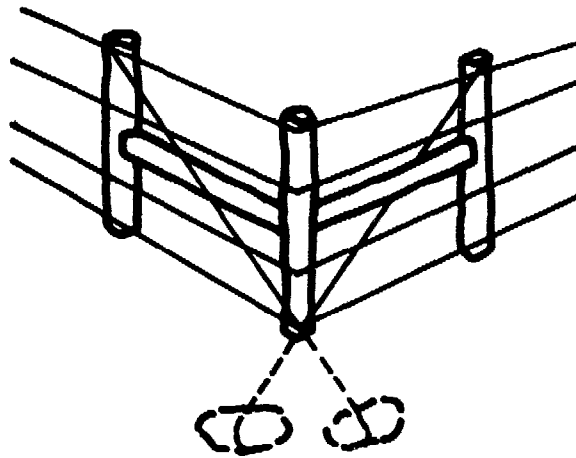

AT CORNERS

A deadman is not the only way to support a corner. The illustration presented here shows how rocks can be used to strengthen corner posts and help maintain tension on the wires.

4 POSTS WRAPPED WITH WIRE MESH / BARBED WIRE, AND THEN FILLED WITH ROCK.

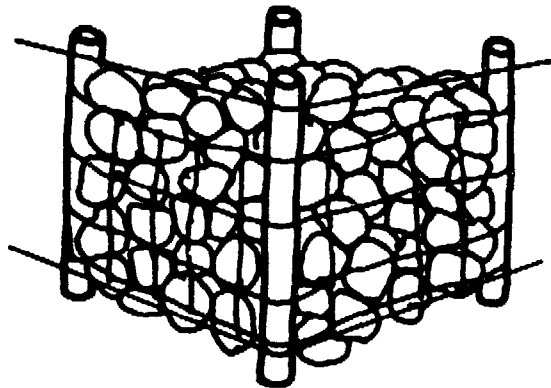

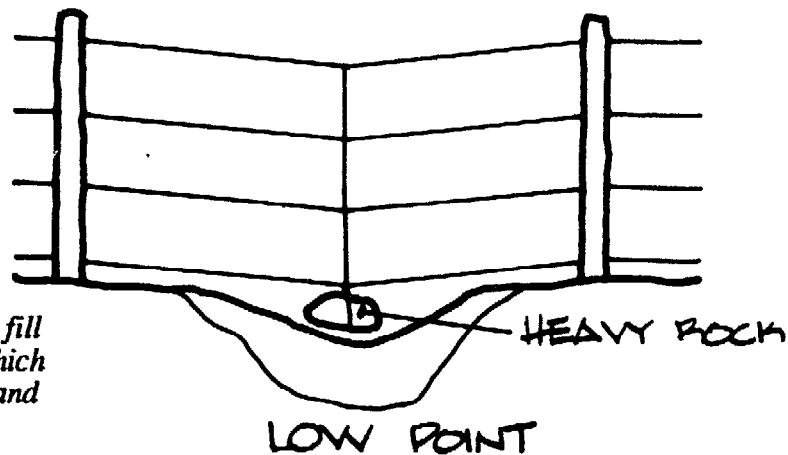

A heavy rock used to fill in a space through which animals might crawl and to maintain tension.

A Self-Closing Gate

Any strong gate that closes tightly is fine. A self-closing gate, however, is even better. People passing through do not have to stop, put down their loads, close the gate, and pick up the load again before going on. Most important, the gate cannot be left open to let animals through by accident.

The gate shown on the following page consists of a strong frame with a diagonal base. Wire fencing material is stretched between the pieces of the frame. The gate is supported by a pair of heavy, well-greased strap hinges. The gate operates very simply: when the gate opens, wood piece "C" swings away from post "F" and pulls the rope through the pulley. The gate closes when the weight on the end of the rope pulls wood piece "C" back into position.

To Make This Gate:

- o Wood piece "C" attaches to the gate at the hinge side. "C" should be about one third of the length between posts "A" and "B" (length "AB").
- o "C" is braced by pieces "D" and "E."
- o Strong cord or rope is attached to the end of "C" and passed through a pulley. The end of the cord is attached to a large rock or other weight.
- o Post "F" prevents the gate from opening too far. Allow room for the pulley and knot for attaching rope to "C."
- o Hinges, pulley, and weight must work easily for the gate to close properly.

- o Gate opens outward from the protected area so animals cannot push it open. No latch is necessary.
- o Gate posts are braced to prevent the pull of the wire fencing from tilting them.
- o Although pieces "C," "D," and "E" can be made of wood, it is better to use iron if at all possible.

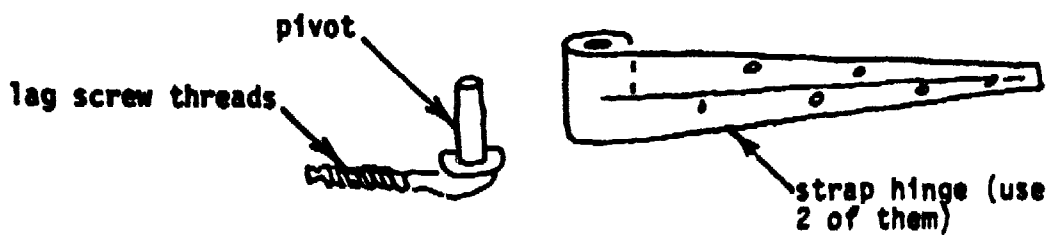
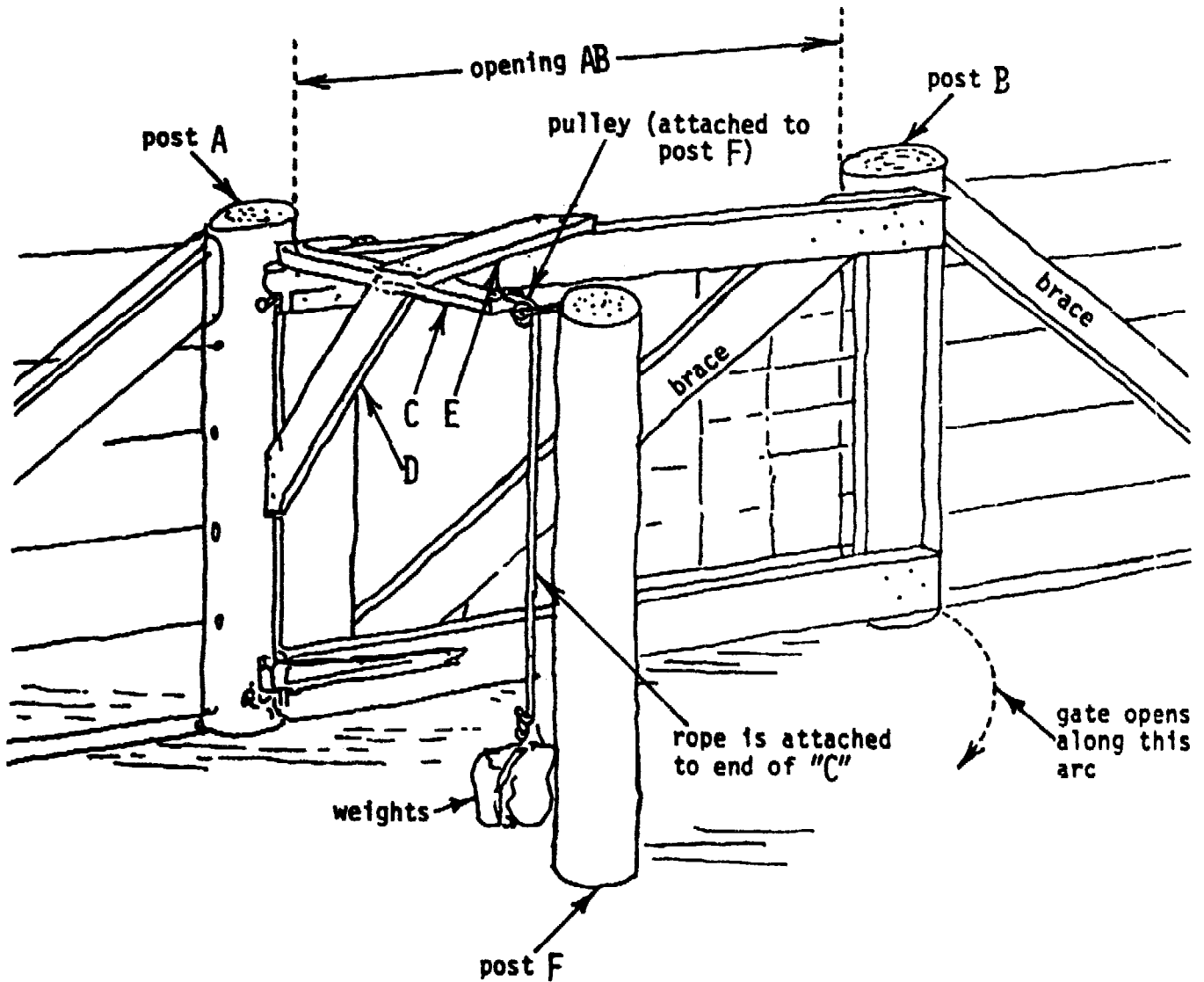

Propagation by Cuttings

Vegetative propagation is the asexual reproduction of individual plants, as opposed to reproduction from seeds. Various methods include grafting, budding, layering, tissue culture, and cuttings; these can be used for different purposes. There are numerous advantages to using vegetative propagation methods; among these the most important are that:

- o Seedlings develop rapidly.
- o Genetic origin can be controlled.
- o Some plant species can only be reproduced asexually. For other species, vegetative methods may be preferred because seed supplies are unavailable or unreliable.

Of the several possible vegetative propagation techniques, one of the fastest and easiest ways to reproduce seedlings is through cuttings. This technique can be used both in the nursery and directly in the field, although only certain species lend themselves readily to this process.

A few species, such as members of the *Euphorbia*, *Commiphora*, and *Tamarix* genera, which can be established on site from cuttings, also respond well to vegetative propagation in the nursery. Other species, which can be rooted in the nursery and transplanted to the site once the root system is fully developed, include: *Albizia lebbek*, *Azadirachta indica*, *Cassia siamea*, *Erythrina senegalensis*, *Ficus gnaphalocarpa*, *Guiera senegalensis*, *Moringa oleifera*, *Prosopis juliflora*, *Tamarindus indica*, and *Ziziphus mauritiana*.

An important feature of some tree and shrub species is that cuttings can be established directly at the site where they are to be permanently located. This saves time and expense by bypassing the need for initial propagation in the nursery. Of particular importance to arid areas are species that require relatively little rainfall and soil moisture. *Euphorbias* and *Tamarix* can be propagated this way on very dry sites that receive no more than 200mm per year.

For species that must be produced in the nursery, plastic pots or specially prepared cutting beds are used to start the new plants. The cuttings must not be allowed to dry out, or their ability to regenerate new roots will be diminished, if not destroyed. The pots or beds must have both good water retention capacity and good drainage. The rooting medium should have a high organic matter content; chaff from grain husks can be added to the soil mixture for this purpose. Cuttings started in the nursery are often initially shaded to reduce moisture loss as well.

It is important to adhere to specific procedures for selecting the plant material, and preparing the cuttings. If the prescribed methods are not followed, survival results may be disappointingly low.

Plant Material Collection

The age of the plant material is a primary consideration in collecting cuttings. Rooting responses in plants are controlled by hormones and auxins. The juvenile tissues of some plant species show more active rooting responses than those of older stems. New growth should not be used for cuttings, however, as only wood that has one full year's growth will have buds that will develop during the rooting process. The optimal diameter for plant material selection will vary with different species, but is generally within the range of 1-2cm. Stems that are less than 1cm in diameter will not usually give good regeneration results.

Healthy, vigorously growing specimens should be selected. The criteria described in Chapter 6 under the heading of Seed Tree Selection, can also be applied to the choice of genetically appropriate parent trees for cuttings. The genetic origin of the plant material is even more important in vegetative reproduction than in propagation from seeds, because the individual parent trees are cloned. The reproduced seedlings have the identical genetic makeup as the plant from which the cuttings are taken, unlike offspring from seeds, which will inherit only some of the characteristics of the seed tree.

Cuttings should be taken from dormant plants, so collection of plant material normally takes place during the dry season. The stems should have several buds that have not yet begun to swell or open. A sharp blade should be used to get a clean cut. It is often a good idea to mark the root end of the cutting in some manner, so that it will not be accidentally inserted in the ground upside-down. To prevent cuttings from drying out, store them in plastic bags and protect them from the sun until they can be planted, preferably as soon after collection as possible.

Sometimes cuttings are treated with synthetic substances that stimulate root formation. This is done by dipping the end of the cutting into the rooting solution before placing it into the ground. Although rooting solutions can improve overall plant response, they are not required for many species.

Preparing Cuttings

Just before placing the cuttings in pots or beds, remove about 1cm of stem from the root end of the cutting by making a clean diagonal cut. This is done to remove the tissues that have been exposed to the air, and that consequently are less likely to regenerate. The freshly cut stem can then be placed in the ground or in pots, with 5-10cm above ground. It is important to make sure that the cuttings are completely surrounded by soil, with no air pockets.

Preparing Cuttings for Planting

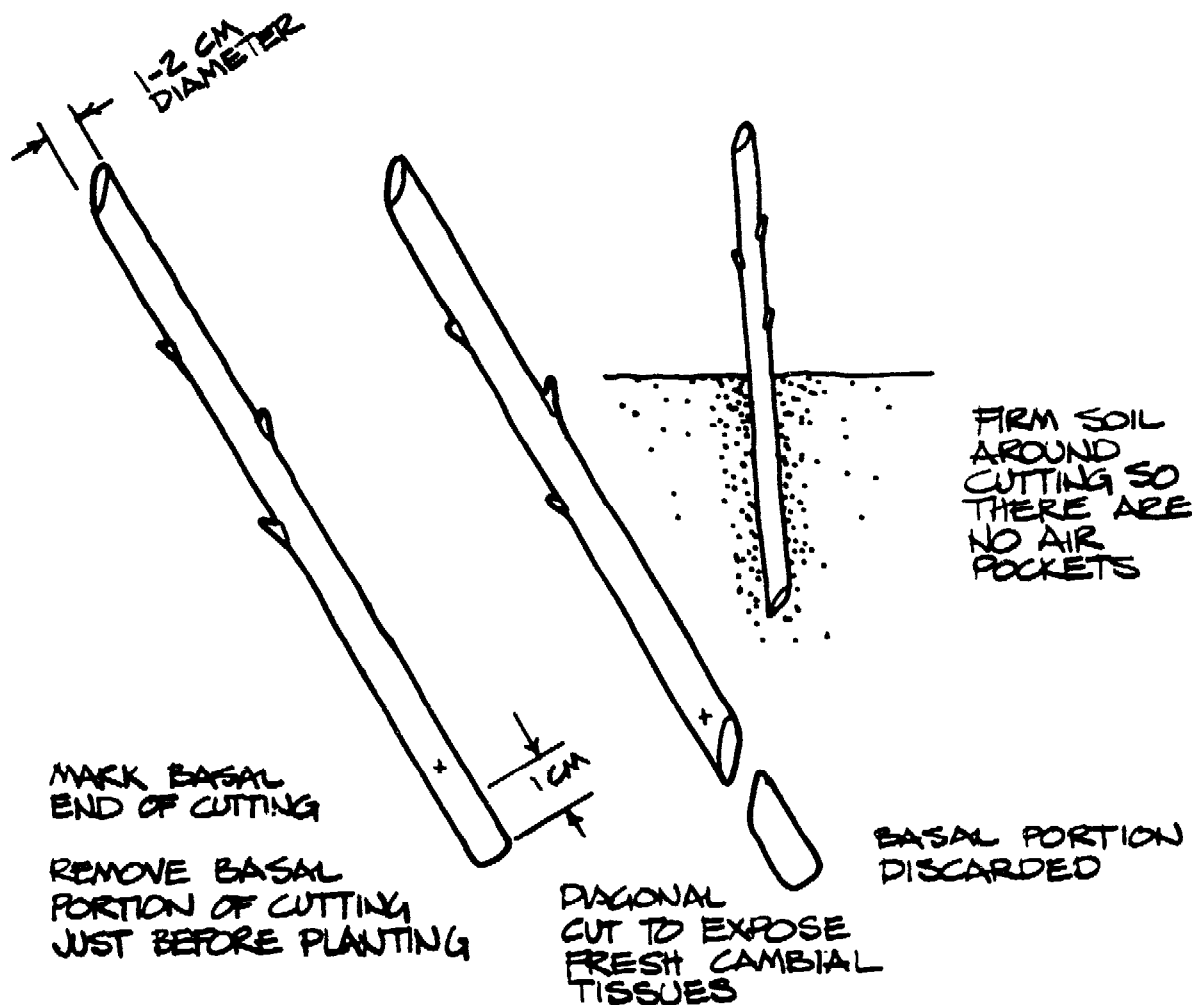

Planting Cuttings

Shallow Planting

The following procedure was developed under a project in Niger for on-site propagation of *Euphorbia balsamifera* cuttings. (Government of Niger, Project PAF, 1985):

- o Length of cuttings: 50-100cm
- o Diameter of cuttings: 1-2cm (although thicker stems can give satisfactory results, provided they are started during the cool season).
- o Provenance/Variety: The natural vegetation found on dune soils will be the best source of plant material for dune stabilization efforts.

- o Depth of hole: 30cm (minimum depth: 20cm)
- o Other important requirements: Cuttings must be planted at their final location no later than 24 hours after they have been cut from the parent plants. To stimulate latex flow, cut a few centimeters of the base of the stem with a sharp blade *immediately* before placing it into the ground.
- o Seasonal limitations: There are two periods during the year in Niger during which the best response to propagation from cuttings was observed:
 - November to February (coolest months) for all cuttings;
 - May to mid-June (hot period before rainy season) for young stems only.
- o Spacing: For complete area coverage, a grid pattern of 2m x 2m (shown below) has given good results at several sites. For establishment of live fencing or for the construction of wind-baffles for dune fixation, single or multiple rows of cuttings are laid out according to the diagrams below:

SPACING

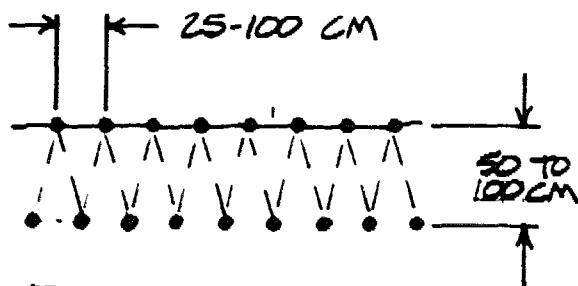

FOR AN EXTRA DENSE FENCE-ROW, PLANT A SECOND ROW

NOTE: STAGGERED LAYOUTS

SINGLE ROW
PALISADES OR
LIVE FENCE

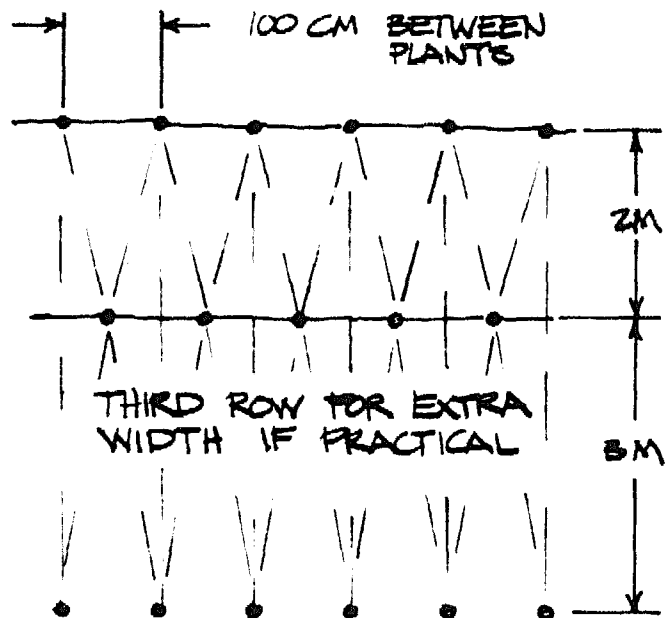

MULTIPLE ROWS
ALONG ROADS, STOCK
DRIVEWAYS ETC.

Deep Planting

Another technique for establishing plants from cuttings directly on the site is the deep planting method. Dune afforestation with tamarix cuttings has been quite successful where the following procedures have been used:

- o Using a 2-inch soil auger, carefully bore a hole through the dune sand to a depth of two meters. If the sand at the bottom of the hole is dry, choose another spot and try again.
- o In the bore holes where moist sand is encountered, insert a tamarix cutting deeply in the hole. Cuttings up to 2m in length have been tried using this method and early rooting and survival results have been over 80 percent.
- o Backfill the hole with the cutting in place. This can be done by first pouring 2-4 liters of water down the hole, which will settle the sand at the bottom. Then refill the remaining hole space by hand.

The deep planting technique described above has been successfully used in propagation of other tree species as well. Sometimes a deep pit is dug rather than a bore hole. Deep planting may also provide a solution to problems of establishing trees in soils high in salinity.

NORMAL PLANTING PROCEDURE



TREES PLANTED BY USUAL TECHNIQUES ARE KILLED BY SALINITY ON THE SURFACE

DEEP PLANTING

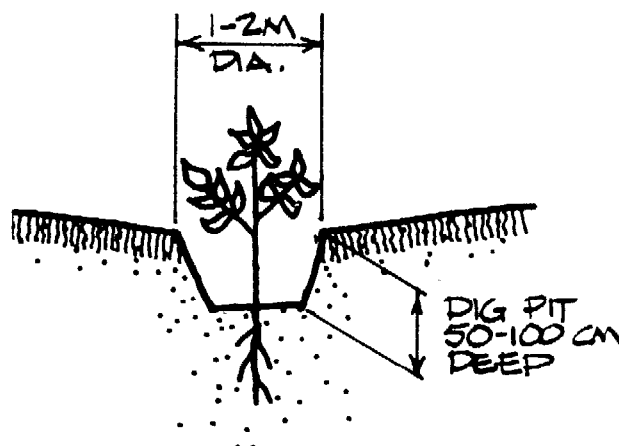

COUNTER-SINK PLANTING - SURFACE 50-100 CM BELOW GROUND.
NOTE: HOLE WILL OCCASIONALLY HAVE TO BE CLEANED OUT.

Organizing Planting Operations Using Cuttings

A well organized plan of operation is necessary to ensure that the work can be carried out efficiently, following the correct procedures for vegetative propagation. This plan should include the following elements:

- o Coordination of crew assignments, vehicle and equipment needs, collection of planting material, and planting operations
- o Training of work crews in how to collect and prepare the cuttings, planting methods, and proper spacing. Work crews should be familiar with the planting site and should be instructed in the plan of operation.
- o Location, size, and extent of the natural occurrence of the planting stock must be surveyed.
- o Once the stems have been cut, they should be planted with as little delay as possible, at least within 24 hours.
- o Although the actual planting process is simple, quality controls are necessary for good survival. In the case of *Euphorbias*, for example, failure to make fresh cuts at the base of the stem, to dig deeply enough, and to backfill properly, can result in high mortality rates.
- o Initial efforts should not be overly ambitious, especially when working with a crew that is not highly experienced in propagation techniques.

Other vegetation can be introduced along with the cuttings, to achieve as close to complete vegetation cover as possible. The following species and methods are suggested:

- o *Panicum turgidum*: this drought tolerant grass can be direct seeded using the same methods as for millet or sorghum.
- o *Cassia occidentalis*: this sturdy plant is sown in pockets or broadcast.
- o *Balanites aegyptiaca*, *Acacia raddiana*, *Leptadenia pyrotechnica*, and *L. hastata*: these and other indigenous trees and shrubs can be seeded directly or raised in pots and transplanted at the site.

Harvesting Methods

Many of the tree and shrub species mentioned in this text have the capacity to regenerate new growth from stumps, roots, or branches after being cut. This survival mechanism probably evolved in response to fires and drought. In arid areas where it is sometimes difficult to re-establish trees once they have been cut, this adaptation is a particularly valuable characteristic. Wood products can

be repeatedly harvested from such trees and shrubs without destroying the plant.

The time of year that cutting or harvesting occurs can influence the sprouting response. Generally it should take place while the plant is dormant. Species of *Eucalyptus* seem to be fairly flexible as to the time of harvest, but more research is needed to determine the optimal cutting period for these and other species.

The tools that are used to harvest the stems and branches may also affect the plants' ability to send out new shoots. There are some indications that saws, especially chain saws, may damage the cambial tissues to the extent that sprouting is inhibited. Machetes or axes, which may give a cleaner cut, and which are in any case more widely available in rural Africa than saws, may be the best tool for harvesting if regeneration from sprouts is desired. More research is needed on this subject as well.

Several different harvesting methods allow the plant to regenerate through sprouting. The ones that are described here include coppicing, pollarding, lopping, and pruning. Because these terms have been mentioned elsewhere in the text without being defined, short descriptions of each technique are provided below.

Coppicing

This is one of the most widely used harvesting methods for arid land species. When the main stem has reached the desired dimensions, it is cut at the base of the trunk. New shoots develop from the stump or roots. These shoots are sometimes referred to as suckers or sprouts. Only three to four of the most vigorous shoots should be allowed to continue to grow to full size; the others should be cut back to prevent competition for growing space. In subsequent harvests the sprouted stems are removed.

Several rotations of coppicing are usually possible with most species. The length of the rotation depends on the size of the specific wood products that are needed. Some species, such as *Leucaena leucocephala* can be coppiced on a yearly rotation for more than 30 years in more humid zones. Eventually, after several harvests, sprouting vigor will diminish, although this period of viability varies for different species.

Coppice harvesting is a particularly suitable method for production of fuelwood. Coppicing can also be used to increase the density of windbreaks. Most *Eucalyptus* species and many members of the legume family as well as most naturally occurring shrubs (*Combretaceae*, *Terminaliae*, etc.), can be harvested by coppicing.

Pollarding

With this harvesting system, all of the branches--including the top of the tree--are removed, while the main trunk is left standing. After the branches are cut, new shoots are allowed to sprout from the main stem to form a new crown. The main stem continues to increase in diameter, although not in height. When the tree loses its sprouting vigor, the main stem can also be cut for use as large diameter poles. An advantage of this method over coppicing is that the new shoots are high enough off the ground that they are out of reach of most grazing livestock.

The neem tree, *Azadirachta indica*, is usually harvested in this manner, and its branches can be used for poles, fuelwood, and toothbrushes. Because it is widely planted as a shade tree, pollarding is usually more appropriate for neems than coppicing. Neem trees can be pollarded as often as twice a year; however, it is important to allow the tree to become well established before the first cut. Some other species that also respond well to pollarding include *Eucalyptus* spp. and *Grevillea robusta*.

Lopping

Lopping is a form of harvesting in which only some of the branches are removed. Usually the lower branches are cut, while the upper part of the crown is allowed to continue to grow. New branches then resprout along the lower portion of the stem. This harvesting method can be used to reduce shading when trees are intercropped with other species. As with pollarding, the cut branches are used for a variety of products.

Lopping can also be used to shape a main trunk with a long, clear bole, if the purpose is to produce wood that can be sawn into planks. In this case any new shoots that sprout from the trunk should be removed to prevent the formation of knots in the wood. Branches and shoots should be trimmed as close to the main stem as possible.

Pruning

Pruning, as a harvesting system, usually involves the removal of smaller branches and stems, but these clippings can constitute a major source of wood for fuel and other purposes. Pruned branches are also used as a mulch between tree rows in alley cropping systems.

Pruning is often required for the maintenance of fruit and forage trees, alley cropping, and live fences. For fruit trees, pruning is undertaken to stimulate fruit production and to open up space in the center of the crown, thus facilitating harvesting of the fruit. The same principles can be applied to encourage leaf formation for production of forage. Pruning can also increase the bushiness of trees and shrubs when they are planted for live fencing.

HARVESTING METHODS

COPPICING

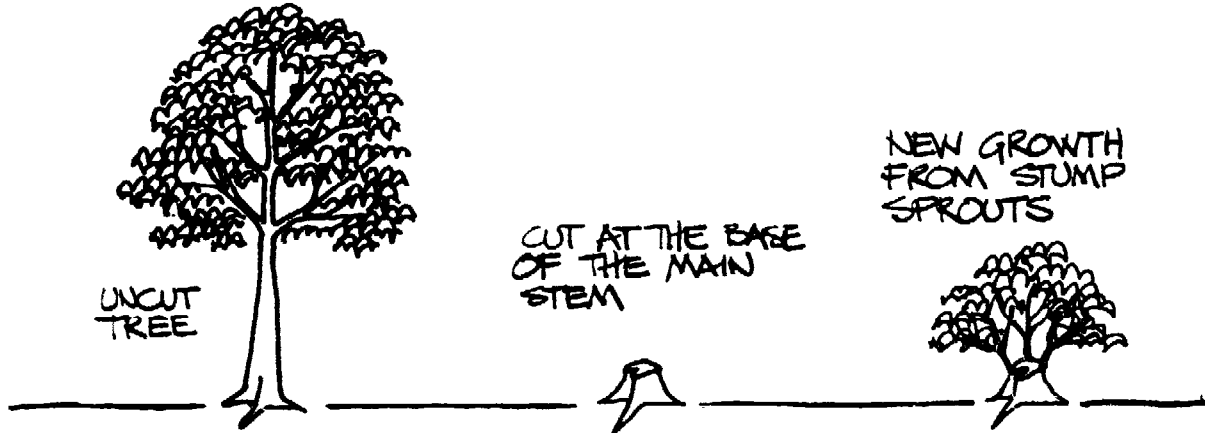

FOLLARDING

ALL BRANCHES ARE CUT AT A HEIGHT OF APPROXIMATELY 2 METERS ABOVE GROUND.



LOPPING

ONLY LOWER BRANCHES ARE CUT.

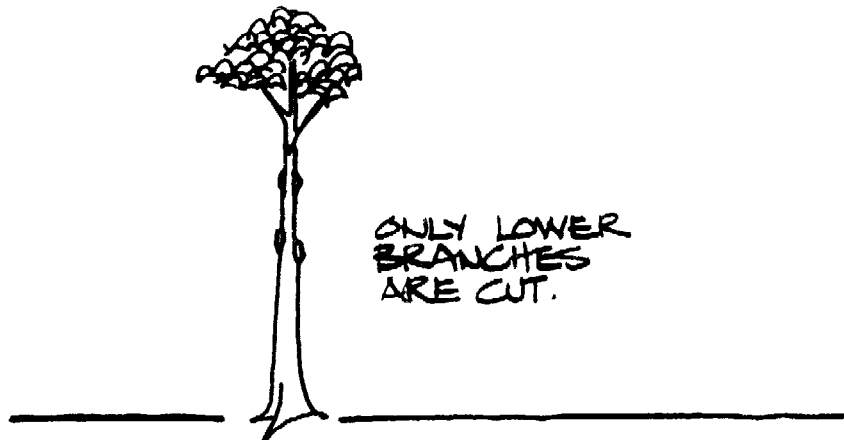

PRUNING

SMALLER BRANCHES ARE TRIMMED TO STIMULATE NEW SHOOT GROWTH.

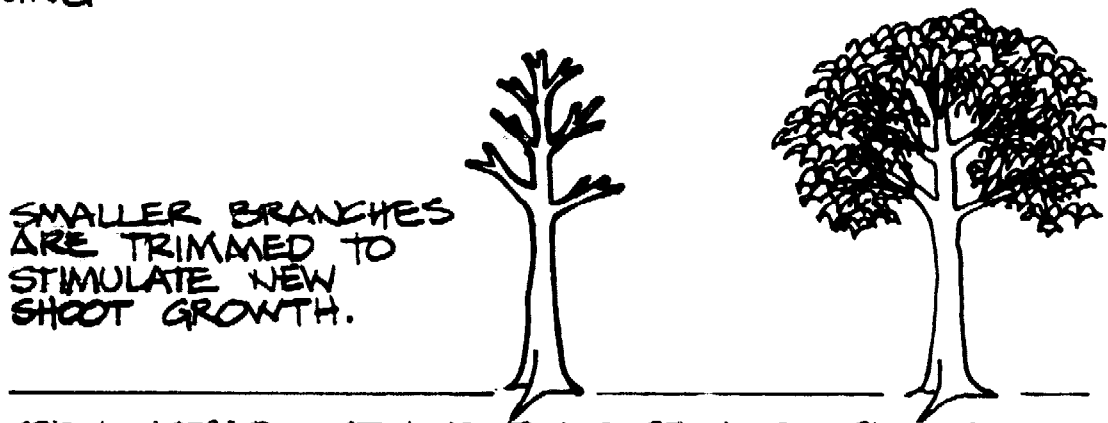

SEE ILLUSTRATION OF LIVE FENCE PRUNING, PAGE 130

Appendix A

Species Identification

Appendix A

SPECIES IDENTIFICATIONS

This appendix identifies 165 of the species found in West African lands by pictures, Latin names, and common names. Synonyms (other Latin names) for a species, common names in up to 12 languages, and some very brief notations on uses of a species are given where this information is available; it is not intended to be definitive. All the species which appear in Appendix B, where further information is given, are included here, with the notation "Also see APPENDIX B."

Pictures include leaves, branch configurations, fruits, flowers, and inflorescences (arrangement of flowering branches and the flowers on them). They are not labelled individually, but the different items should be recognizable. There is no consistent scale relative to life-size. Illustrations are drawn from Flore Forestiere Soudano-Guineenne by A. Aubreville, Flore Illustree du Senegal and Flore du Senegal by Jean Berhaut, West African Trees by Dr. D. Gledhill, and Trees for Vana Mahotsava by S. K. Seth, M. B. Raizada, and M. A. Waheed Khan. The artists are J. Adams, M. J. Vesque, Jean Berhaut, Douglas E. Woodall, and P. Sharma.

A NOTE ON LATIN NAMES

- The genus and species of each tree appear in boldface type (genus first, species second).
- An abbreviation of the name of the author of the tree name follows the boldface type in lighter faced type.
- "var." means variety. The name of the variety appears in boldface immediately following the abbreviation "var."
- An abbreviation of the name of the author of the variety name follows the name of the variety in lighter faced type.
- "L." is an abbreviation for "Linnaeus," a Swedish botanist who initiated the development of this present, widely used system of nomenclature.

Drawings in this appendix are reprinted, with permission, from the following sources:

Aubreville, A., *Flore Forestiere Soudano-Guinéene*, Paris, Société d'Editions Géographiques, Maritimes et Coloniales, 1950.

Artists: J. Adams, M. J. Vesque

Berhaut, J., *Flore Illustrée du Sénégal*, Direction des Eaux et Forêts, Government du Sénégal, 1975.

Artist: J. Berhaut

Gledhill, D., *West African Trees*, London, Longman Group Ltd., 1972.

Artist: Douglas E. Woodall

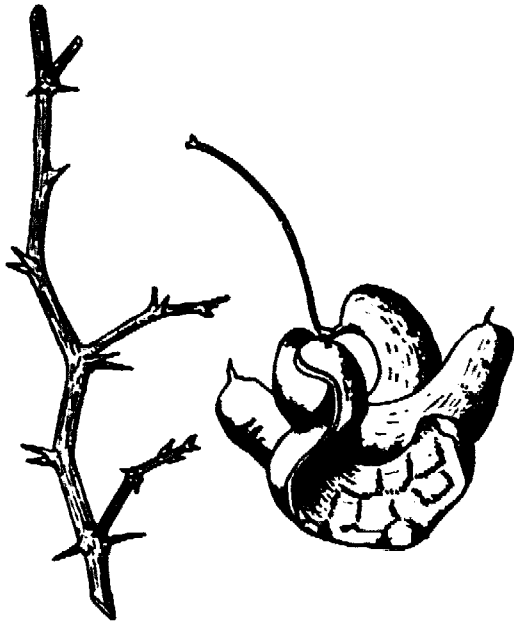

1. *Acacia albida* Del.

Also see APPENDIX B

SYNONYMS:

Faidherbia albida (Del.) Chev.
Acacia gyrocarpa Hochst.
Acacia saccharata Benth.

ENGLISH	geo	FULANI	tiaki
FRENCH	geo	HAUSA	geo
ARABIC	harraz	KANOURI	haragu
CHAD ARABIC	araza	MORE	zanga
BAMBARA	balanzen	SONGHAI	geo
DJERMA	geo	WOLOF	cadde

2. *Acacia ataxacantha* D.C.

BAMBARA	bonsoni	DJERMA	kougou
	sofakueni	HAUSA	goumbi
	korr		

Use for live fences, posts, firewood, fodder (valuable), branch fencing



3. *Acacia caffra* Willd. var. *campylacantha* Aubr.

Also see APPENDIX B

SYNONYMS:

Acacia campylacantha Hochst., ex A. Rich.
Acacia catechu W.
Acacia polycantha Willd. subsp. *campylacantha*
 (Hochst.) Prenah

CHAD ARABIC	ai guetter	HAUSA	karo
BAMBARA	kuroko		tsarkakia
FULANI	faterlahi	KANOURI	golawai
		MORE	guara

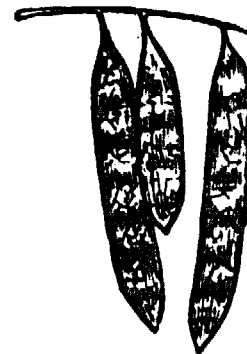

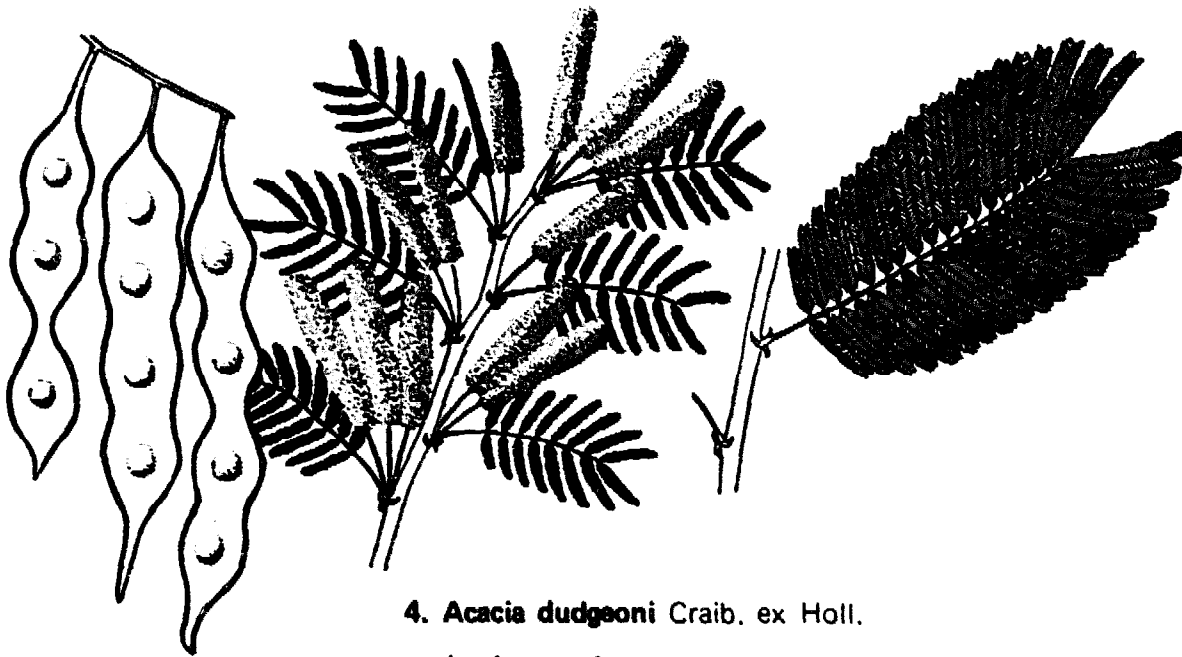

4. **Acacia dudgeoni** Craib, ex Holl.

Acacia senegal var. *samoryana* Rob.
Acacia sandry

5. **Acacia farnesiana** Willd.

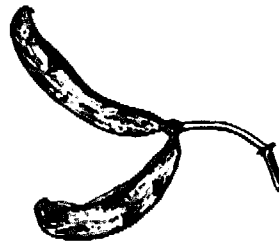

6. **Acacia flava** (Forsk.) Schwth.

SYNONYMS:

Acacia flava var. *atacorensis*
Acacia atacorensis

DJERMA	tanat	HAUSA	tanat
	mnno		

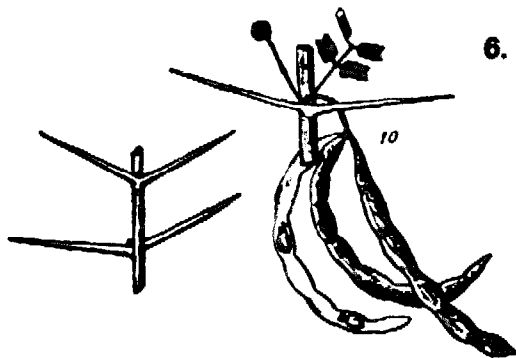

7. *Acacia gourmaensis* A. Chev.

not illustrated

MORE gonponlali
gonsablega

Like *Acacia mellifera* In East Africa

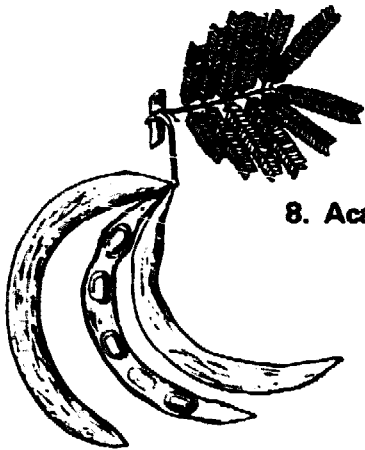

8. *Acacia hebecladoides* Harms.

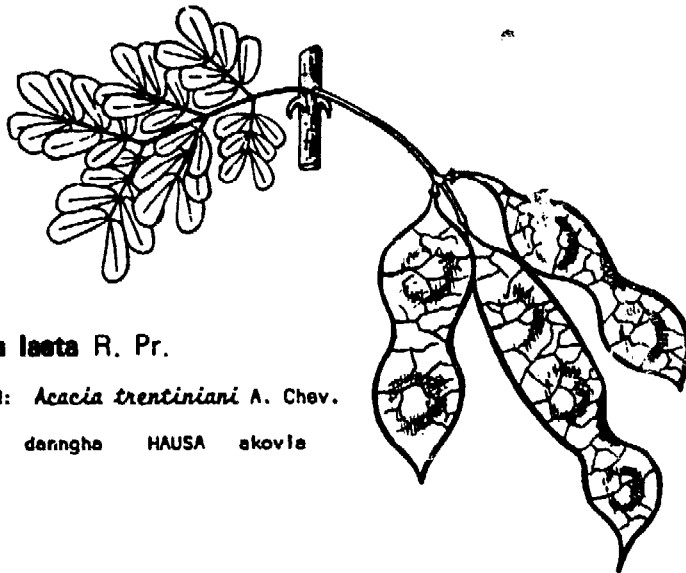

9. *Acacia laeta* R. Pr.

SYNONYM: *Acacia trentiniana* A. Chev.

DJERMA darrnha HAUSA akovia

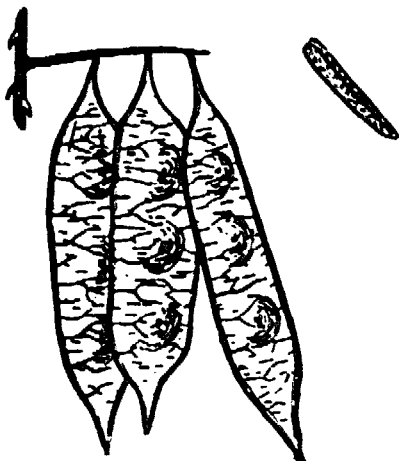

10. *Acacia macrostachya* Reichenb.

BAMBARA	ouenidie	FULANI	chidi,
	kordontinlo		patarhami
	mbourcur	MORE	karedega
DJERMA	goumbi		guembaogo

Use for edible seeds, leaves to graze, live fences, posts, firewood, fodder (valuable), branch fencing

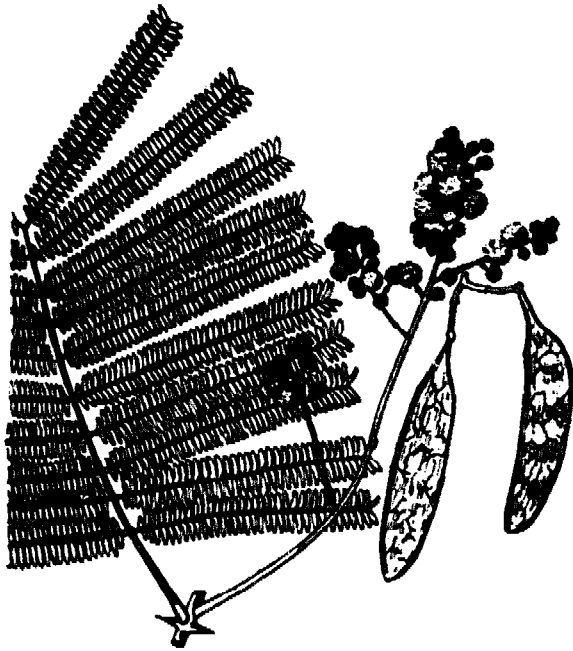

11. *Acacia macrothrysa* Harms.

SYNONYMS:

Acacia dalzielii Craib.
Acacia prorsispinnata Stapf.
Acacia bucharanii Harms

KANOURI gardaye



12. *Acacia pennata* Willd.

13. *Acacia raddiana* Savi.

SYNONYMS:

Acacia tortilis Hayne
Acacia fasciculata Guill. & Perr.

CHAD ARABIC	salale	FULANI	chilukl
BAMBARA	sayele	HAUSA	kendil
DJERMA	bissau	KANOURI	kandil

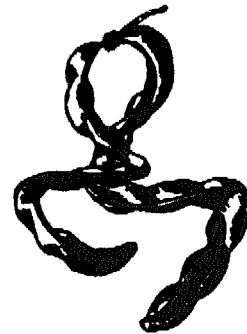
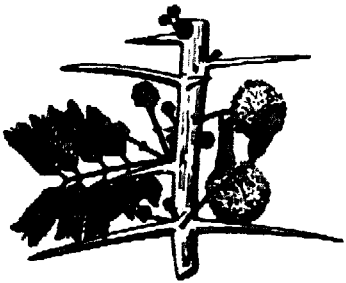

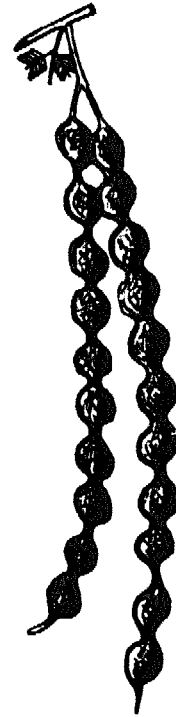
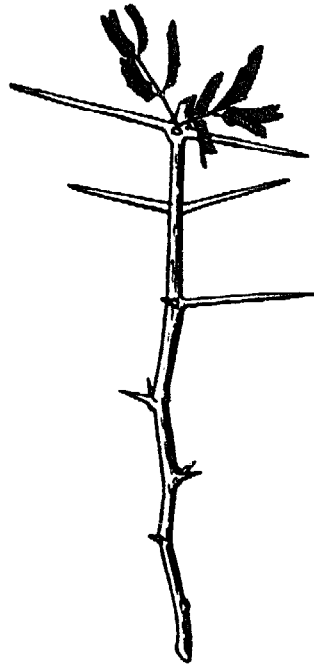

14. *Acacia scorpioides* (L.) var. *nilotica* (L.) A. Chev.

Also see APPENDIX B

SYNONYMS: *Acacia nilotica* (L.) Willd.
Mimosa nilotica L.
Acacia arabica (Lam.) var. *nilotica* (L.) Benth.

FRENCH	gonakler	DJERMA	bani
CHAD ARABIC	sunta, charat, senet, sunt	FULANI	gaudi
BAMBARA	barana diabe boina	HAUSA	bagarua
		MORE	peguenega

Found in lowlands; near water or in moist soils

15. *Acacia scorpioides* (L.) var. *adstringens* Bak.

SYNONYM: *Acacia adansonii* Guill. & Perr.



FRENCH	gonakler	DJERMA	bani
CHAD ARABIC	sunta, charat, senet, sunt	FULANI	gaudi
BAMBARA	barana diabe boina	HAUSA	bagarua
		KANOURI	kangar kissau
		MORE	peranenge

Found in highlands, in drier environments



15.

Acacia scorpioides
var.
adstringens



16. *Acacia senegal* (L.) Willd.

Also see APPENDIX B

SYNONYM: *Acacia verec* Guill. & Perr.

ENGLISH	gum arabic	FULANI	dibehi
FRENCH	gomnier	HAUSA	patuki
CHAD ARABIC	asharat	KANOURI	dakworo
	kitr al ablod	MORE	koloi
BAMBARA	donkori		goniminiga
DJERMA	danya		

Source of gum arabic

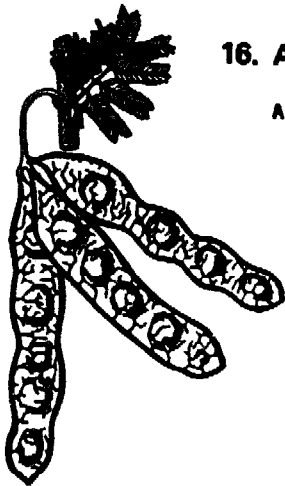

17. *Acacia seyal* Del.

SYNONYMS: *Acacia stenocarpa* Hochst.
Acacia boboensis Aubr.

CHAD ARABIC	talhaye	HAUSA	farin kaya
BAMBARA	sagnie	KANOURI	karamga
DJERMA	saykire	MORE	gompelaga
FULANI	bulki		

Use for firewood, fodder

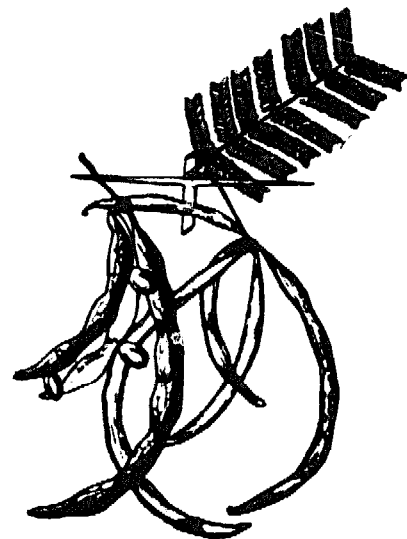



18. *Acacia sieberiana* D.C.

Also see APPENDIX B

SYNONYMS:

Acacia verugera Schweinf.
Acacia sanguinea Guill. & Perr.
Acacia rehmanniana
Acacia villosa
Acacia fischerii
Acacia monga
Acacia verhoensis
Acacia nefasia Schweinf.

CHAD ARABIC	kuk
BAMBARA	bakl
FULANI	gle daneji
HAUSA	boudji
	dushe
KANOURI	katalogu
MORE	goiponso



**19. *Acacia stanocarpa* Hochst.
 var. *chariensis* A. Chev.**



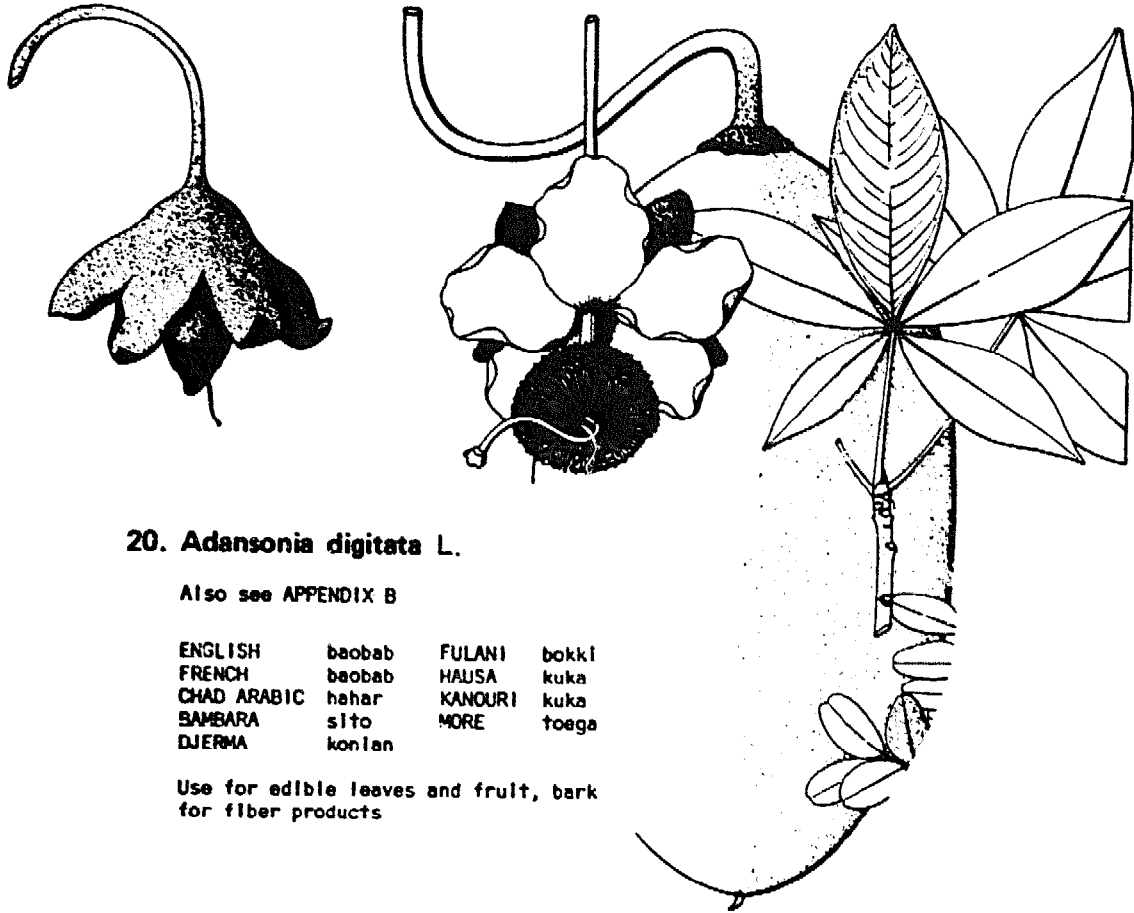

20. Adansonia digitata L.

Also see APPENDIX B

ENGLISH	baobab	FULANI	bokki
FRENCH	baobab	HAUSA	kuka
CHAD ARABIC	hehar	KANOURI	kuka
BAMBARA	sito	MORE	toega
DJERMA	konlan		

Use for edible leaves and fruit, bark for fiber products

**21. Adenium obesum (Forsk.)
Roem. et Schult.**

SYNONYMS: *Adenium arabicum* Palf. f.
Adenium coetaneum Stapf.
Adenium hongkel A. x.

CHAD ARABIC	kuka meru
BAMBARA	
& MORE	foukala sitandi
	kongosita
FULANI	leki peouri
HAUSA	karya

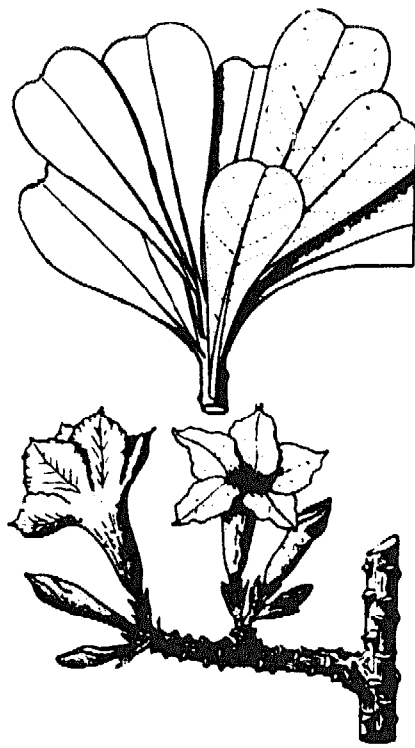
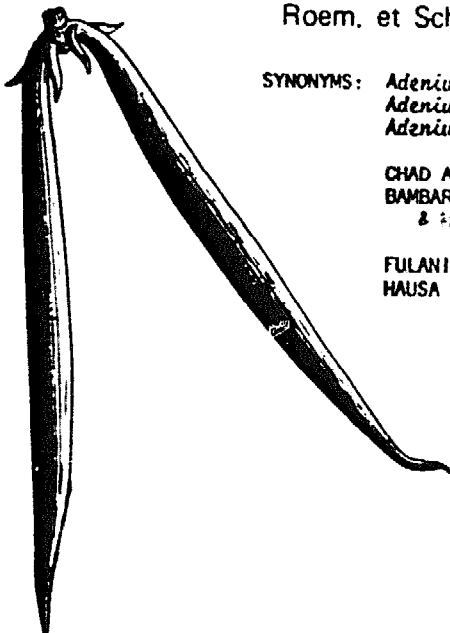



22. *Adina microcephala* (Del.) Hiern.

HAUSA kandyarrafi

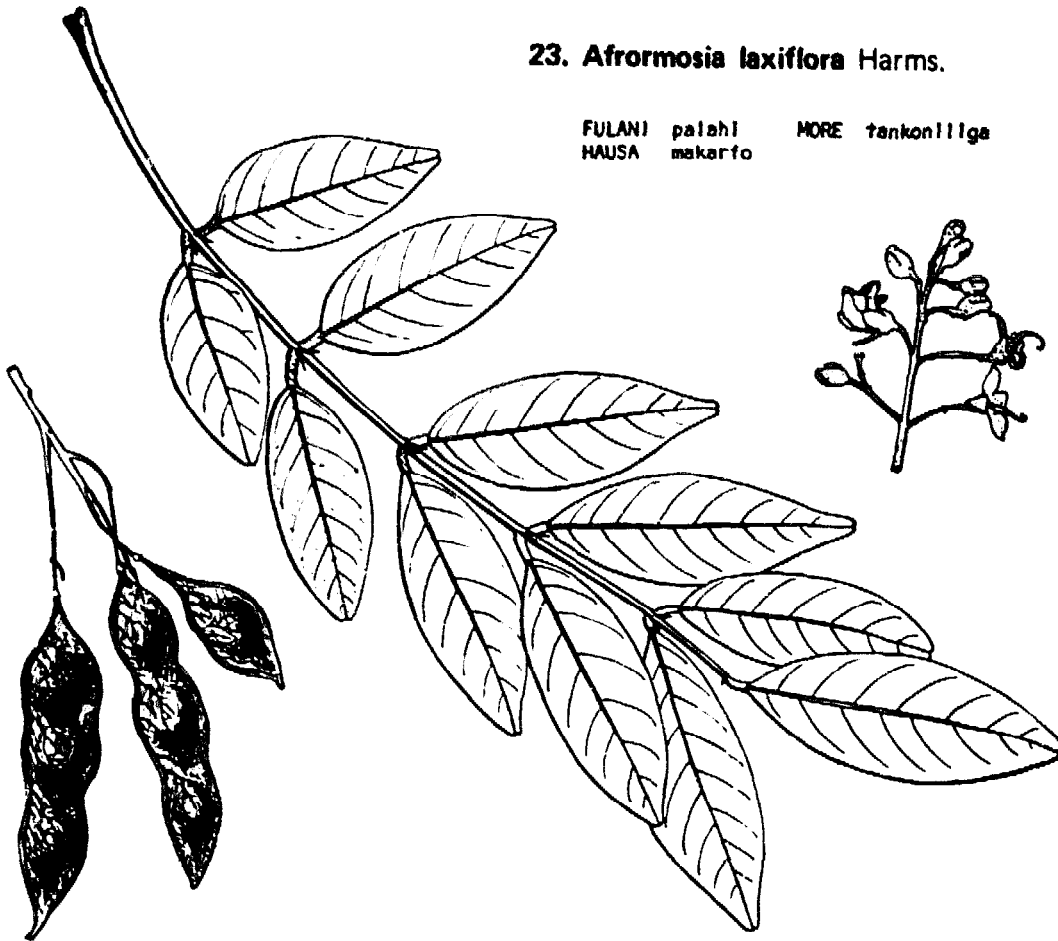

23. *Afrormosia laxiflora* Harms.

FULANI palahi MORE tankonliga
HAUSA makarfo

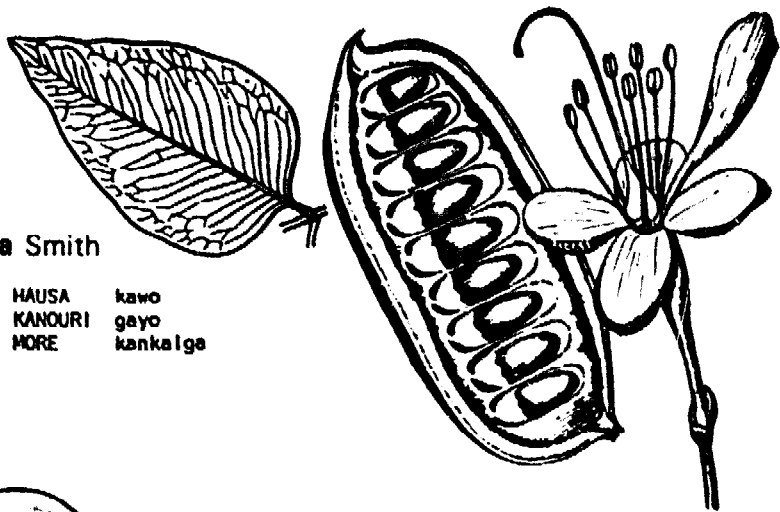

24. Afzelia africana Smith

FRENCH	linguo	HAUSA	kawo
DJERMA	kao	KANOURI	gayo
FULANI	gayohi	MORE	kankalga

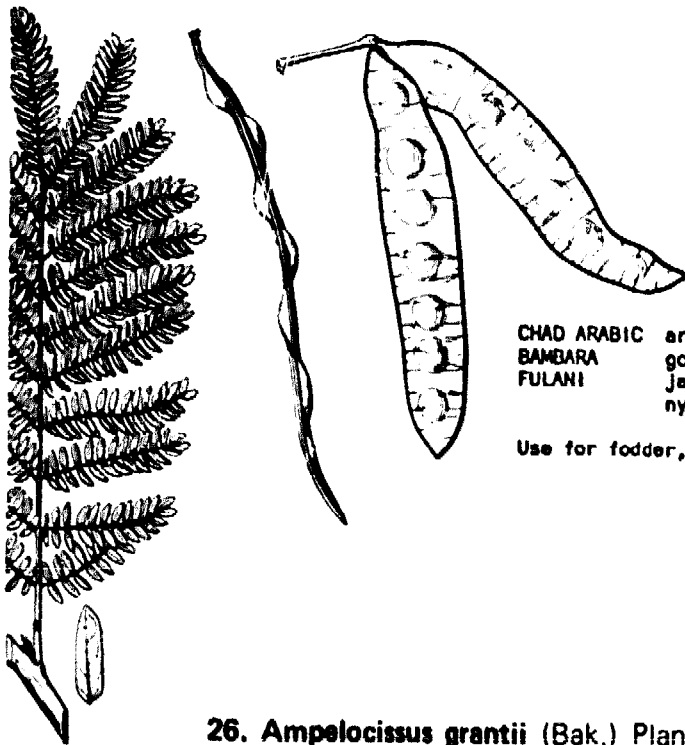

25. Albizzia chevalieri Harms.

Also see APPENDIX B

CHAD ARABIC	ared	HAUSA	katsari
BAMBARA	golo lri	KANOURI	tsag'e
FULANI	jarichi	MORE	ronsedonga
	nyebel		

Use for fodder, construction, roots to repair gourds

26. Ampelocissus grantii (Bak.) Planch.

HAUSA	rogon daji
FULANI	gufugafal

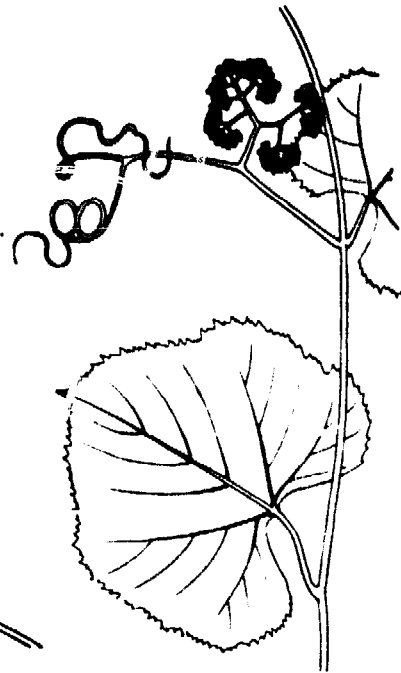
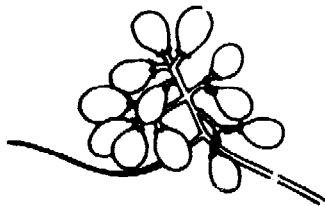
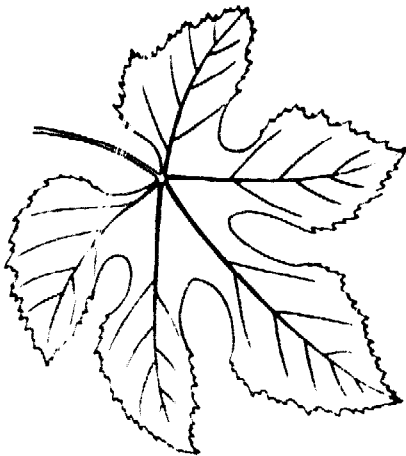



27. Anacardium occidentale L.

Also see APPENDIX B

Use for edible nut (valuable),
firewood, construction, soil
regeneration

28. Anclomanes difformis not illustrated

HAUSA cakara KANOURI gazamanga!

29. Andira inermis H.P. & K.

FULANI	deluhi
HAUSA	madobla
MORE	gwaska
	ouenlebende

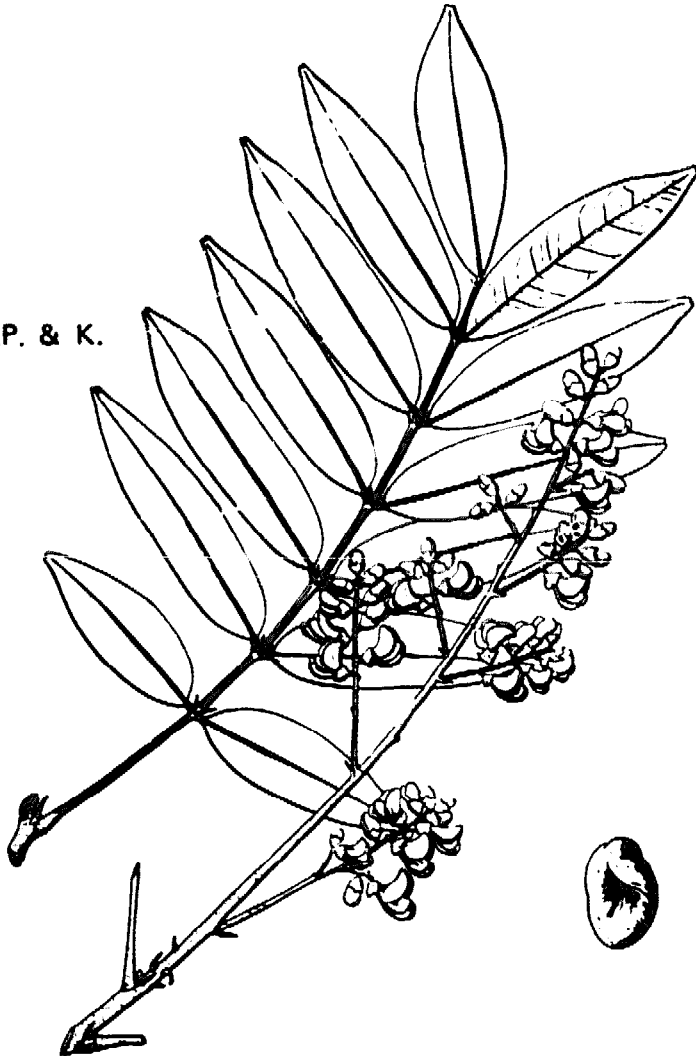
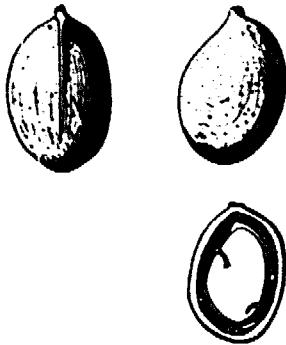

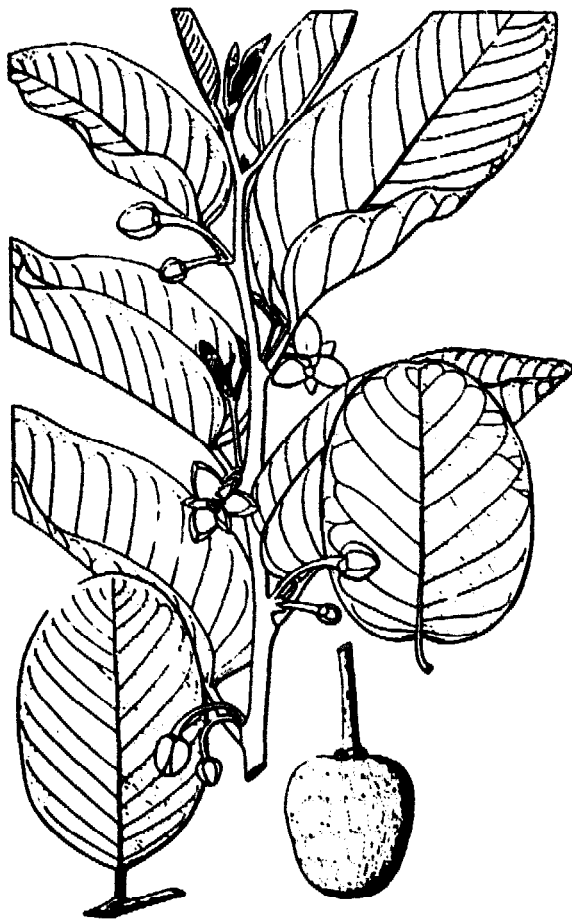

30. *Annona senegalensis* Pers.

CHAD ARABIC	um boro
BAMBARA	sunsun
DJERMA	moupa
FULANI	dukuhl
HAUSA	gouanda
KANOURI	tissa
	ngonowo
MORE	bakikudiga

**31. *Anogeissus leiocarpus*
Guill. & Perr.**

Also see APPENDIX B

SYNONYM:

Anogeissus schimperii Hochst. ex
Hutch & Dalz.

CHAD ARABIC	sahab
BAMBARA	kreketo
DJERMA	gonge
FULANI	kojoli
HAUSA	marika
KANOURI	annum
MORE	sigha plega



32. Azadirachta indica A. Juss.

Also see APPENDIX B

ENGLISH Neem FRENCH Neem

Use for firewood, poles,
construction, brush your
teeth with the bark

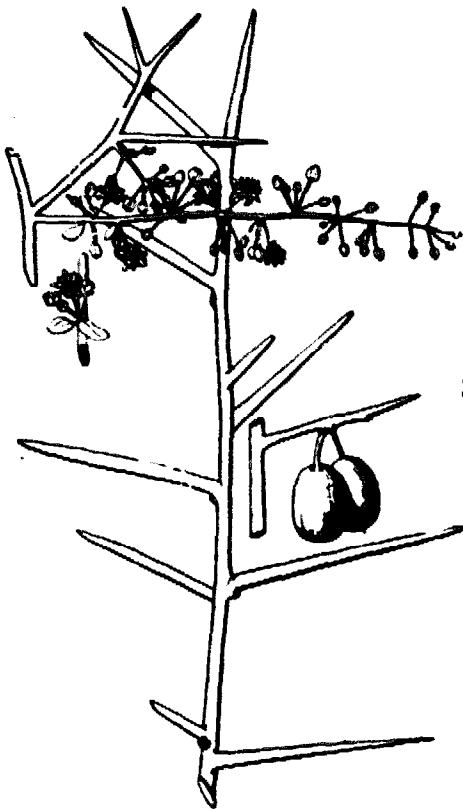

33. Balanites aegyptiaca (L.) Del.

Also see APPENDIX B

CHAD ARABIC	hajlij	KANOURI	chingo
BAMBARA	seguene		bito
DJERMA	garbey	MORE	tiagallga
FULANI	Tanni		
HAUSA	edoua		

Use for edible fruits,
firewood, tool handles,
soap, poison

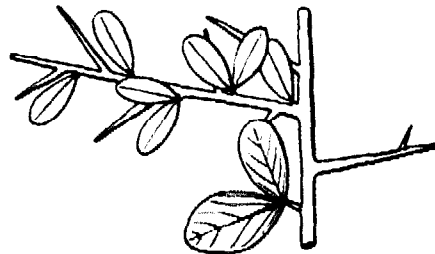

34. Bauhinia reticulata D.C.

Also see APPENDIX B

SYNONYMS: *Bauhinia glabra* A. Chev.
Bauhinia glauca A. Chev.
Ptilostigma reticulatum (D.C.) Hochst.

CHAD ARABIC	harum	HAUSA	calgo
BAMBARA	niameba	KANOURI	kaldul
DJERMA	kosseye	MORE	barani
FULANI	barkevi		

Use for smoking wood

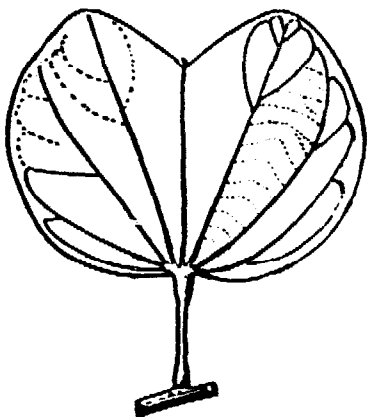

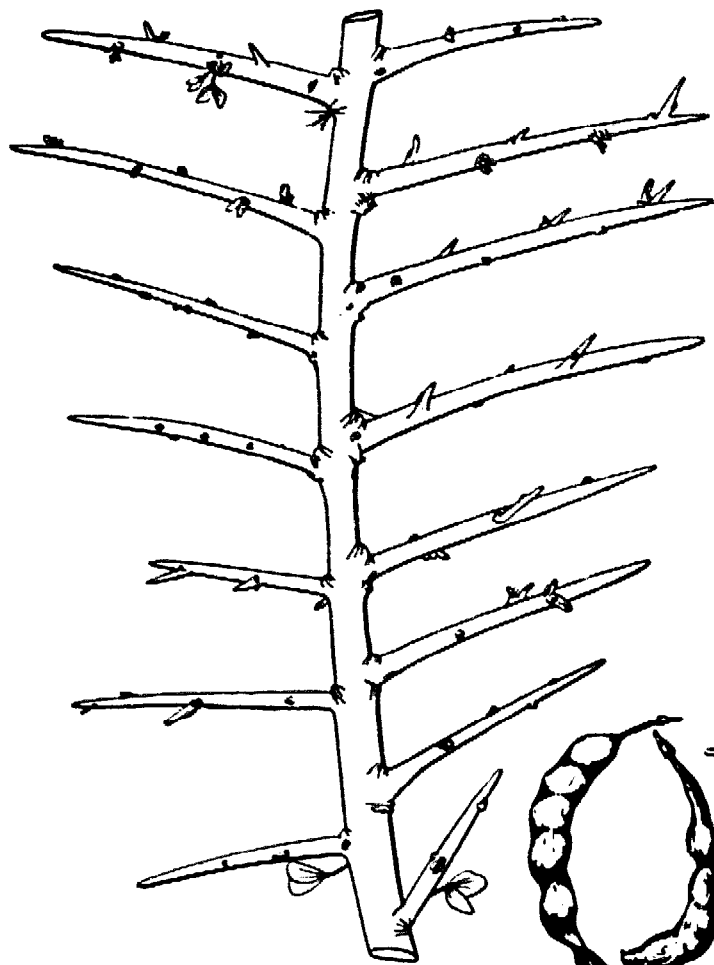

35. Bauhinia rufescens Lam.

SYNONYMS:

Bauhinia adansoniana Guill. & Perr.
Bauhinia parvifolia Hochst.

CHAD ARABIC	kule kule
BAMBARA	guesembr
DJERMA	namari
FULANI	namai
HAUSA	dirga
KANOURI	sisl
MORE	tipoega

Use for firewood,
 medicine

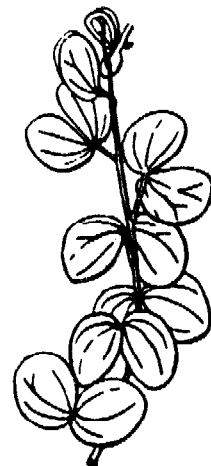

**36. Berlinia grandiflora (Vahl)
 Hutch. & Dalz.**

SYNONYM:

Berlinia auriculata

HAUSA raff

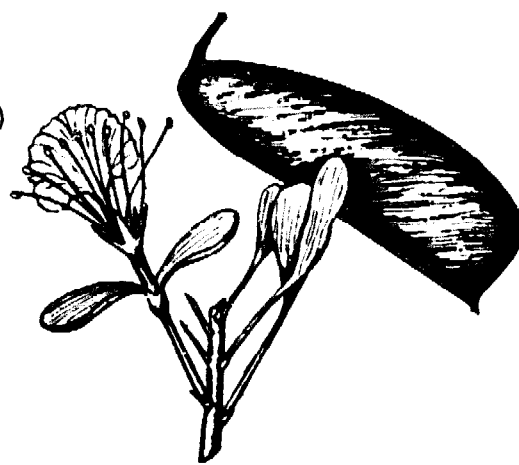



37. *Bombax buonopozense* Beauv.

ENGLISH kapok tree
FRENCH kapokier

Use for kapok
fiber - not as
fine as *Ceiba*
petandra (see
#54, this ap-
pendix, and
appendix B)

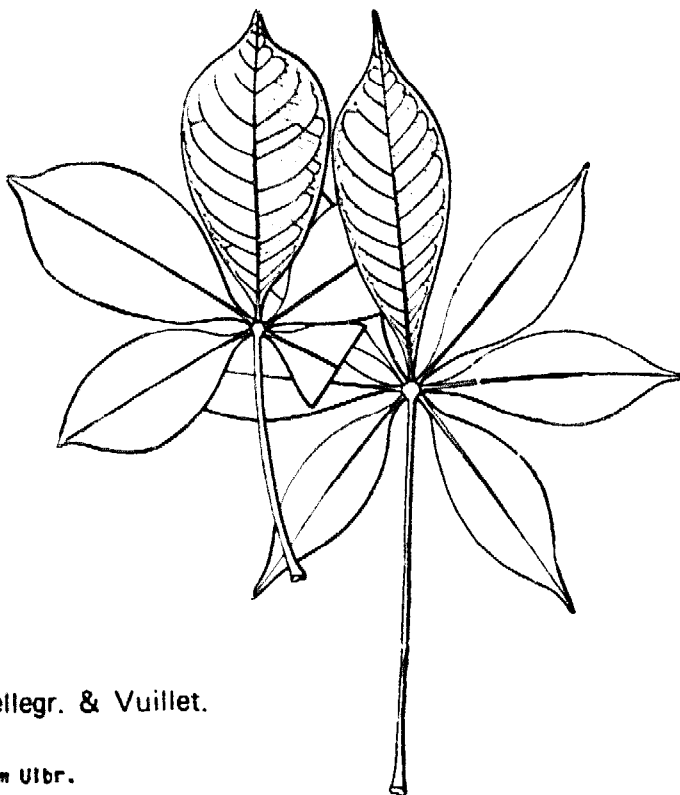
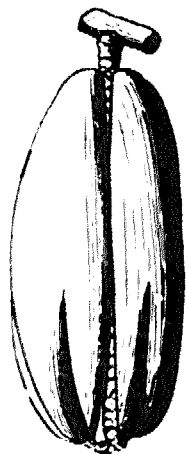
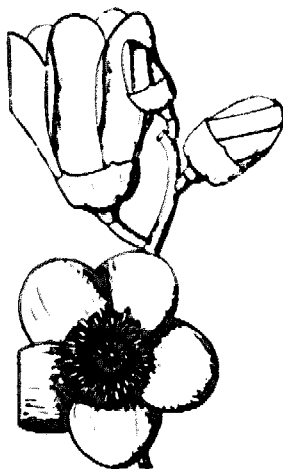
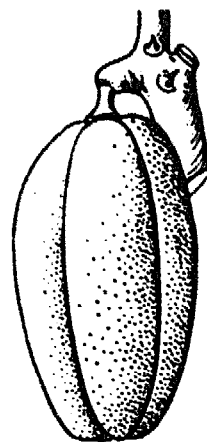

38. *Bombax costatum* Pellegr. & Vuillet.

SYNONYM: *Bombax flammeum* Uibr.

ENGLISH	kapok tree	DJERMA	forogo
FRENCH	kapokier	FULANI	kuruhl
CHAD ARABIC	johe	HAUSA	kuria
BAMBARA	zombou	KANOURI	yelte
		MORE	ouaka

Use for kapok,
edible leaves



39. Borassus aethiopum Mart.

Also see APPENDIX B

SYNONYM:

Borassus flabellifer L. var.
aethiopum (Mart.) Warb.

FRENCH	ronier
CHAD ARABIC	deleb
DJERMA	sabouze
FULANI	dubbi
HAUSA	gigunia
KANOURI	ganga
	kemelutu

Use for termite-proof posts for construction, fences, etc., leaves and "stems" for fencing reinforcement. Slow growing.

40. Boscia angustifolia A. Rich.

BAMBARA	diaba
	guinadiou
	toutigul
FULANI	anzagi
HAUSA	agajini
KANOURI	marga
MORE	kisinkinde



41. *Boscia salicifolia* Oliv.

CHAD ARABIC mahkei
HAUSA zoure

Use for edible leaves

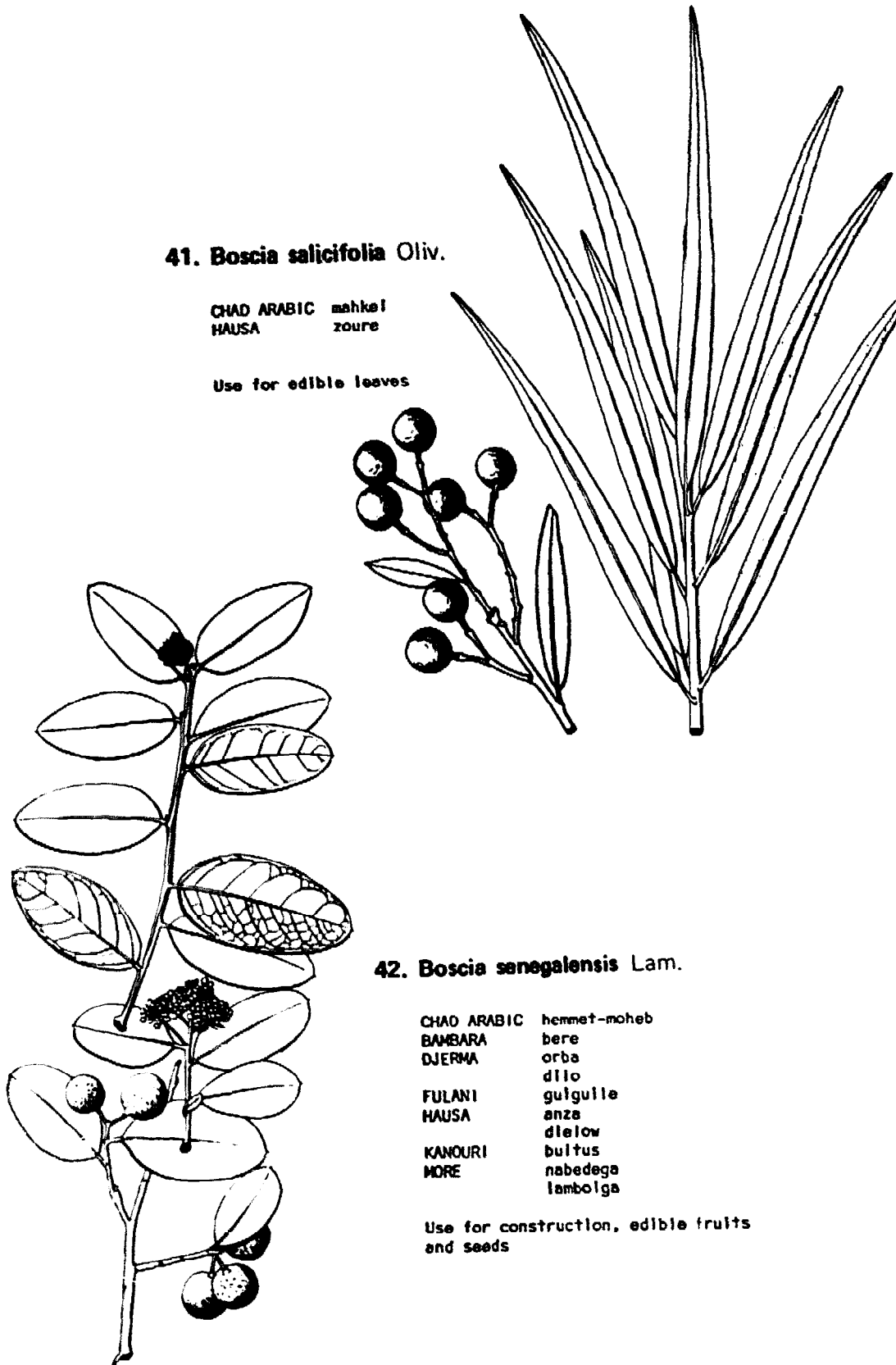

42. *Boscia senegalensis* Lam.

CHAD ARABIC hemmet-mohab
BAMBARA bere
DJERMA orba
 dlio
FULANI guiguile
HAUSA anza
 dielew
KANOURI bultus
MORE nabadega
 lambolga

Use for construction, edible fruits
and seeds

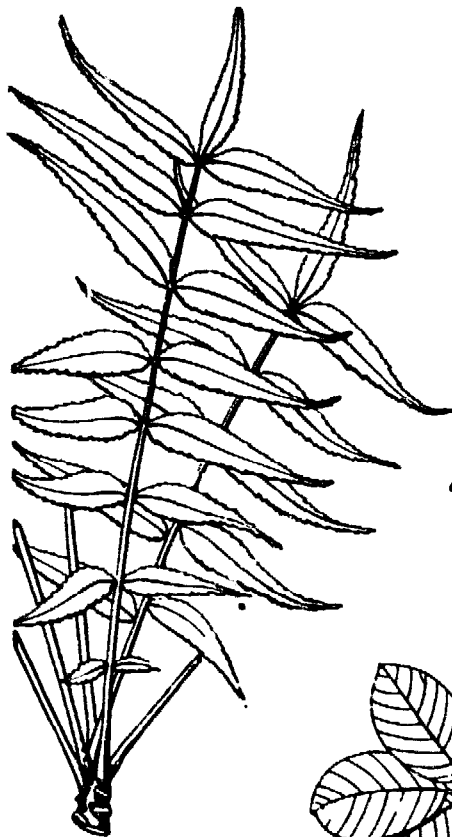

43. *Boswellia dalzielli* Hutch.

FULANI	andekahi	KANOURI	kafi dukan
HAUSA	hano		

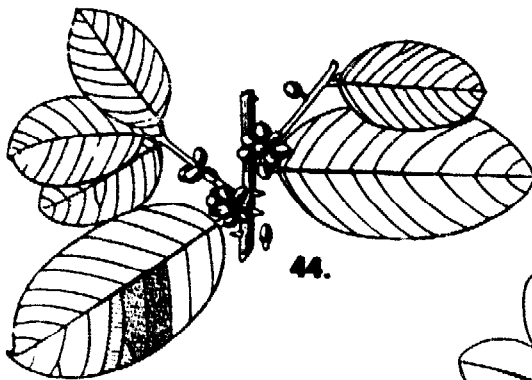

44.

44. *Bridelia ferruginea* Benth.

BAMBARA	beboni	HAUSA	kirni
	segue	KANOURI	zindi
FULANI	marani	MORE	tensaloga
	dafi		

Use for firewood, fodder



45. *Burkea africana* Hook.

CHAO ARABIC	azrak ana
FULANI	kokobi
HAUSA	bakin-makarfo
MORE	sienra

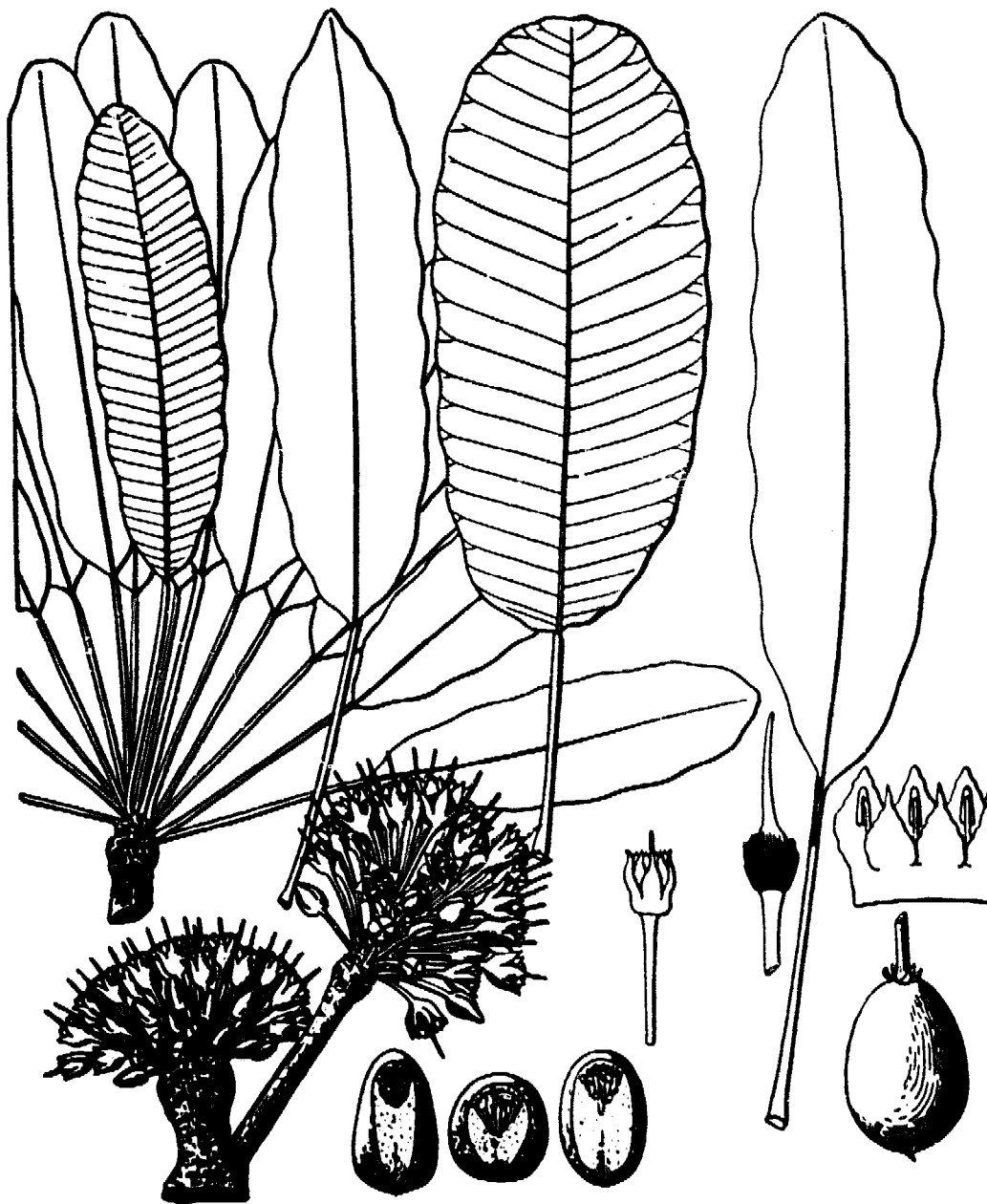

46. *Butyrospermum parkii* Kotschy

Also see APPENDIX B

SYNONYM: *Butyrospermum paradoxum* (Gaertn. f.) Hepper

ENGLISH	shea nut tree	FULANI	karehi
FRENCH	karite	HAUSA	kandanya
CHAD ARABIC	um kurum	KANOURI	toso
DJERMA	boulanga	MORE	tanga

Use for shea butter, hard wood for mortar



47. Cadaba farinosa Forsk.

CHAD ARABIC	sirreh
BAMBARA	berekunan
	tamba
HAUSA	bagey
KANOURI	marga

48. Calotropis procera (Ait.) Dryand

CHAD ARABIC	rhalga
BAMBARA	fugolri
	ngounyo
FULANI	bambani
HAUSA	tumfafa
KANOURI	kayo

Use for construction

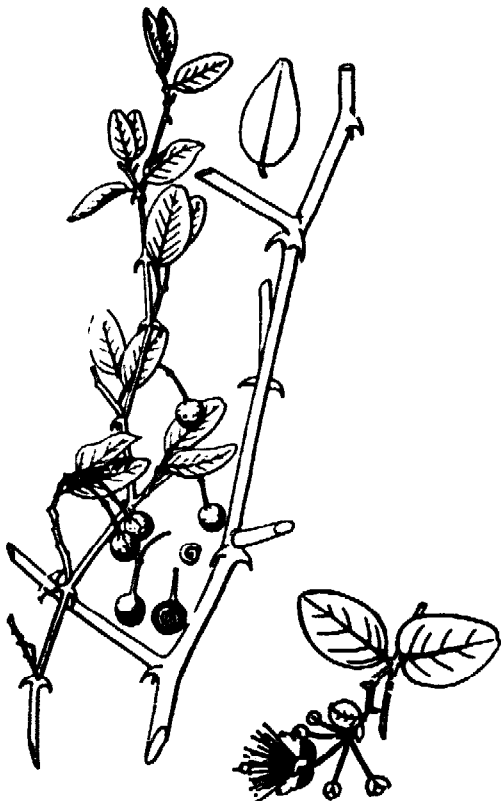
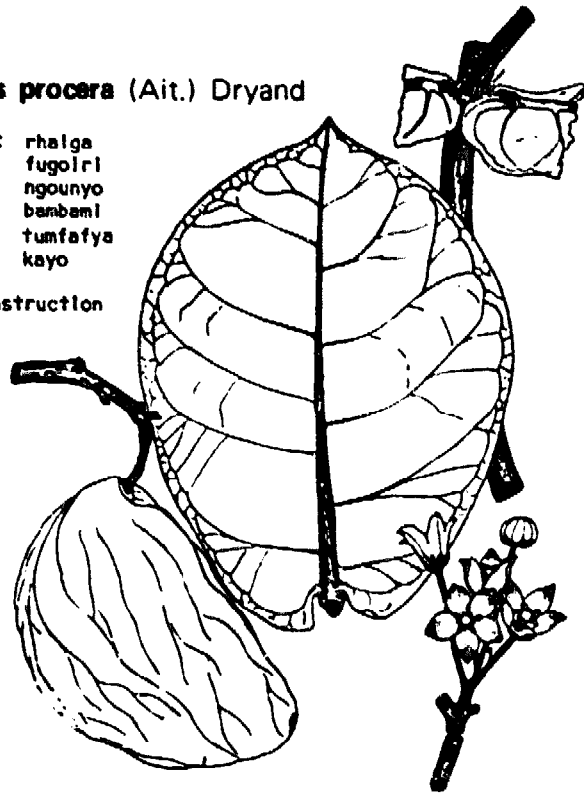

49. Capparis corymbosa Lam.

CHAD ARABIC	mardo
HAUSA	houjari-mutane
KANOURI	pido
	dansa

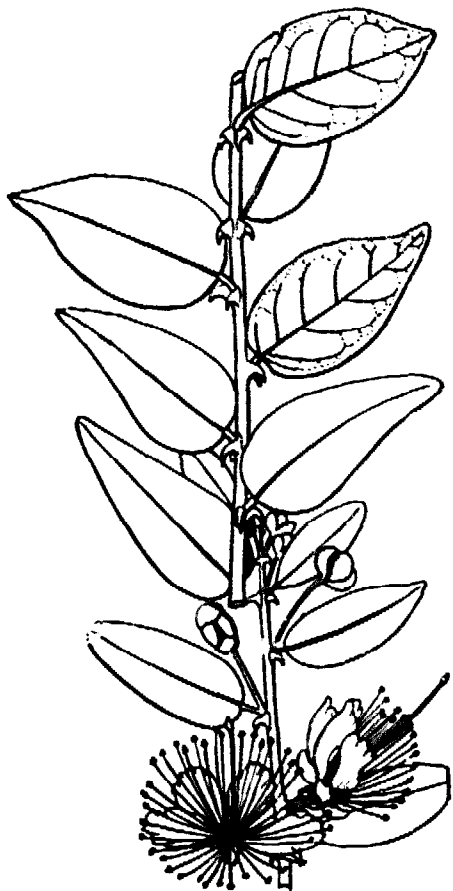

50. Capparis tomentosa Lam.

SYNONYM:

Capparis polymorpha A. Rich.

CHAD ARABIC gulum
HAUSA haujari
KANOURI zaJI

Use for fodder

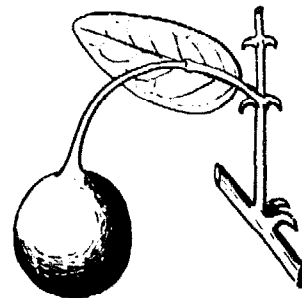

51. Cassia siamea Lam.

Also see APPENDIX B

FRENCH cassia

Use for construction,
firewood, windbreaks



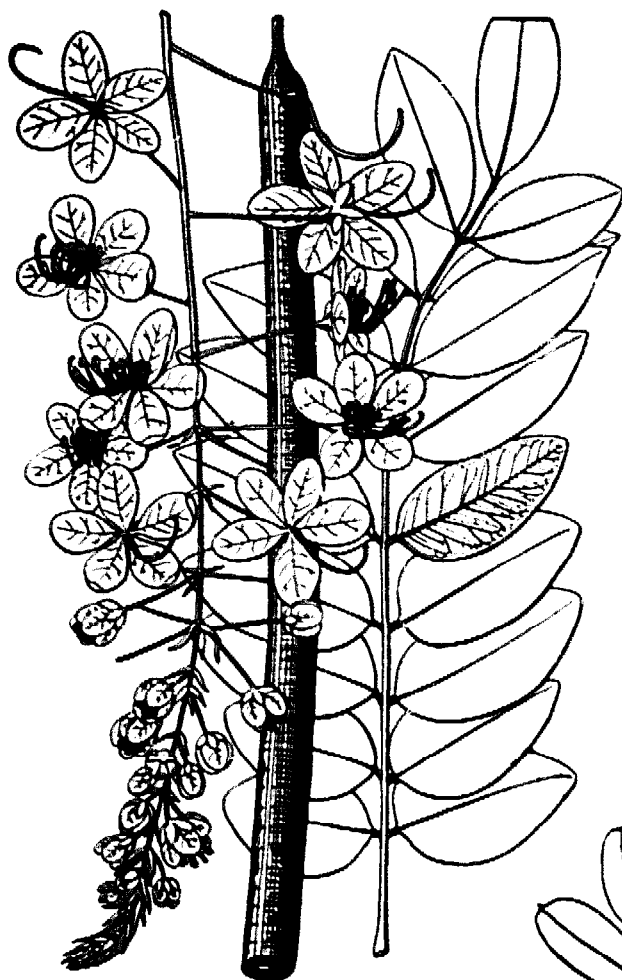

52. Cassia sieberiana D.C.

CHAD ARABIC	sireth
BAMBARA	sinia
	sinedian
DJERMA	senturi
FULANI	malagahi
HAUSA	malga
KANOURI	badin zikki
	marga
MORE	kombissaka

Use for hard firewood

53. Cassia singuana Del.

SYNONYM:
Cassia gonatensis Fres.

CHAD ARABIC	shaderat- ai bashima
FULANI	rumfuhl wabilihi
HAUSA	rumfu
KANOURI	tuguleia
MORE	gueleponsgo

Use for fodder, firewood



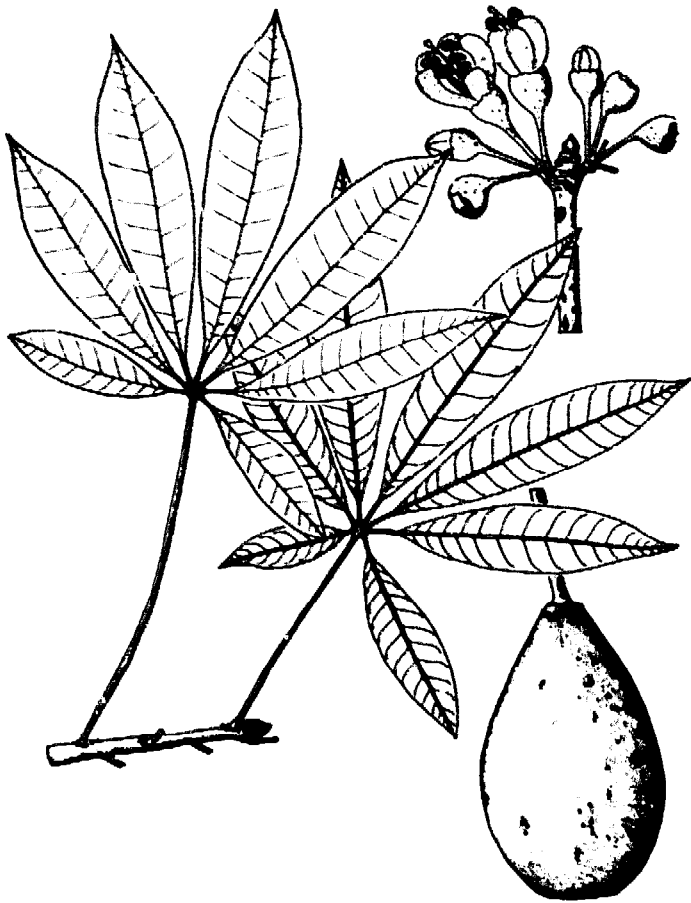

54. Ceiba petandra (L.) Gaertn.

Also see APPENDIX B

SYNONYM:
Eriodendron orientale

ENGLISH	silk cotton tree
FRENCH	fromeger
CHAD ARABIC	rum
FULANI	bantahl
HAUSA	rimi
KANOURI	tom
MORE	gunga

Best source of kapok fiber

55. Celtis integrifolia Lam.



CHAD ARABIC	abun gate
BAMBARA	gous
	kameguan
FULANI	genki
HAUSA	dikki
	zuwo
	kouka
KANOURI	nguso
MORE	tintigella

Use for fodder, firewood

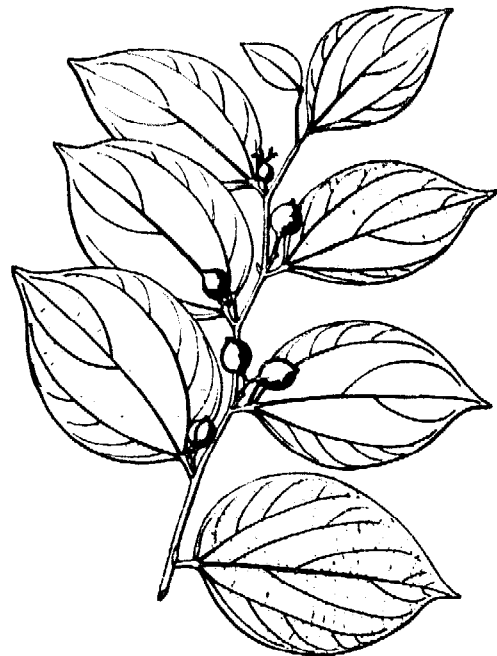



56. *Ceratotheca sesamoides* Endl.

FULANI wanko
 HAUSA karkashi
 KANOURI kembulubul

57. *Cochlospermum tinctorium* Perr.

CHAD ARABIC maghr
 FULANI Jarundal
 HAUSA rawaya
 KANOURI maseune

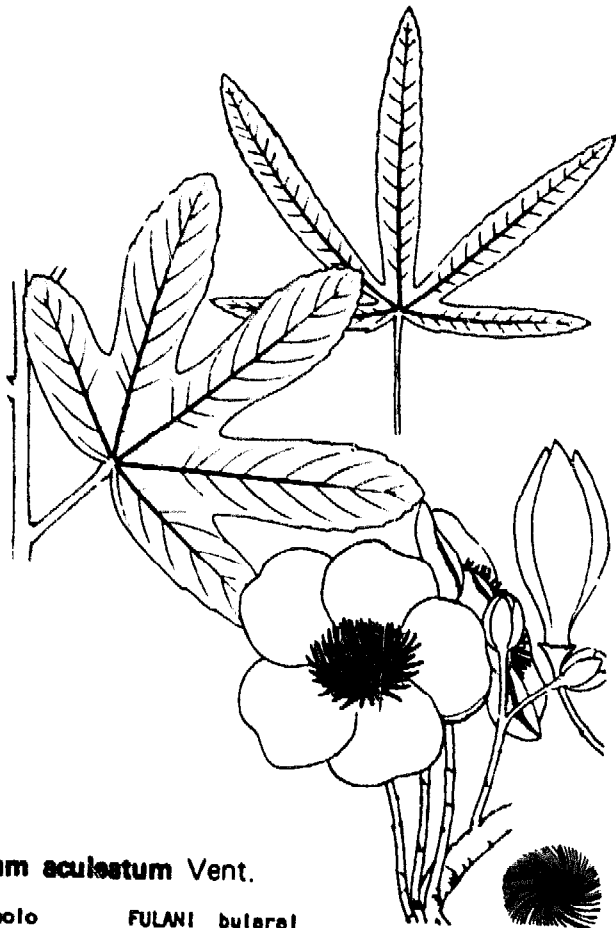

58. *Combretum aculeatum* Vent.

BAMBARA	oulo	FULANI	bularal
DJERMA	kotfi	HAUSA	oulo
	bouboure	HAUSA	bubukya
		MORE	koditambiga

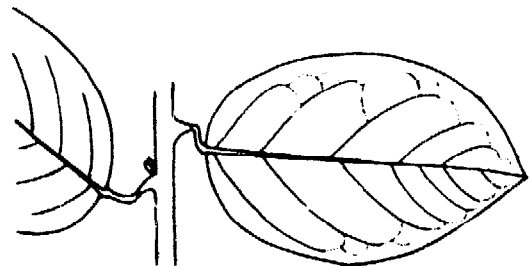

59. *Combretum binderianum* Kotschy

HAUSA fara geza

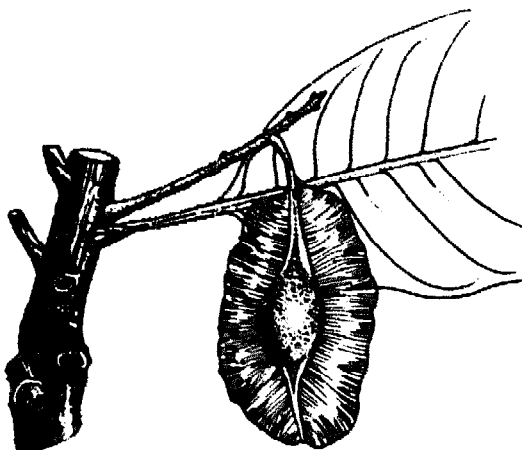

60. *Combretum ghasalense* Engl. & Diels

SYNONYM:
Combretum dalzielii

HAUSA bakin
taramnya
KANOURI zindi

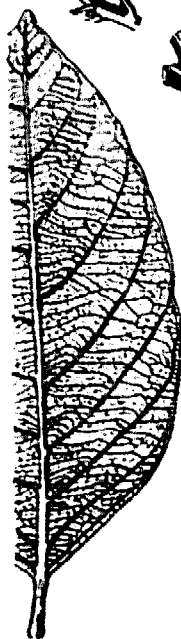

61. *Combretum glutinosum* Perr.

CHAD ARABIC	hebli	HAUSA	taramnya
BAMBARA	demba	KANOURI	katagar
DJERMA	kokorbe	MORE	kwenga
FULANI	buski		

Use for gum, firewood, charcoal

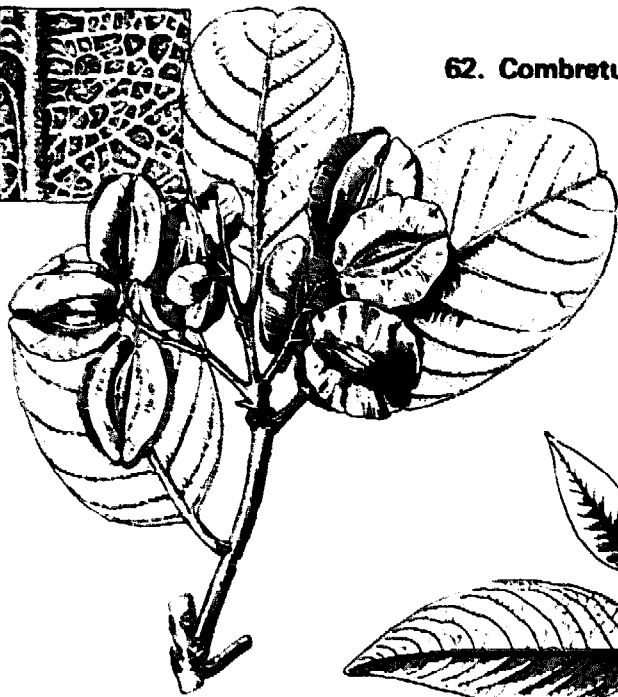
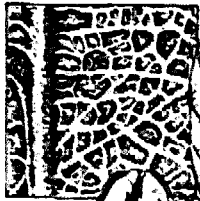

62. *Combretum glutinosum* var. *passargai* Aubr.

HAUSA taramnya

Use for firewood

63. *Combretum hypopilinum* Diels

HAUSA Jan
taramnya



64. *Combretum lamprocarpum* Diels

SYNONYM: *Combretum verticillatum*

HAUSA taramnya



65. *Combretum micranthum* G. Don.

BAMBARA	kolobe	HAUSA	gleza
DJERMA	koubou	MORE	landaga
FULANI	taii		
	gugumi		

Use for hut sticks, medicine,
gum, firewood

**66. *Combretum molle* R. Br.
ex G. Don**

SYNONYMS:
Combretum velutinum D.C.
Combretum akodense
Combretum leonense

FULANI danoruhl
HAUSA wuyan daho

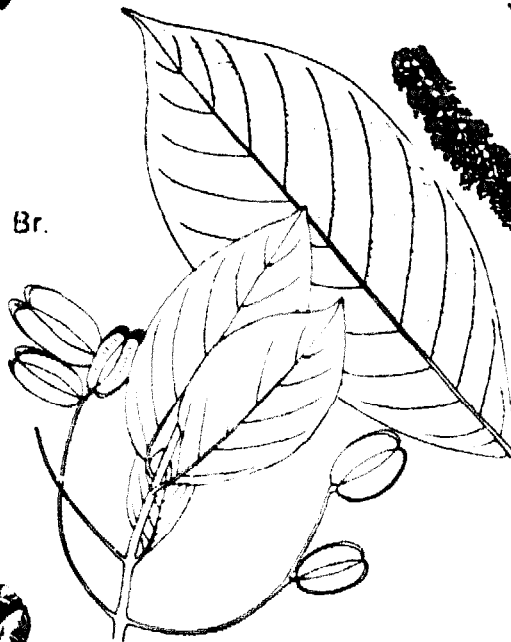

66.



67. *Combretum nigricans* Leprieur var. *elliotii* Aubr.

SYNONYM:
Combretum lecananthum Engl. & Diels.

BAMBARA	diangara
DJERMA	delligne
FULANI	dokigori
HAUSA	dagera
MORE	kuerehtuaga

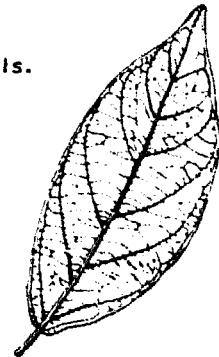

68. *Cosmiphora africana* (Rich.) Engl.

SYNONYMS: *Palaquandron africanum* Arn.
Heudelotia africana Rich.

CHAD ARABIC	hbarkat	HAUSA	dashi
	gafal	KANOURI	kabi
FULANI	bsdadi	MORE	kocartabega

Use for live fences



69. *Cordia abyssinica* R. Br.

SYNONYMS: *Cordia africana* Lam.
Cordia ubanghensis Chev.

CHAD ARABIC	birjjuk	HAUSA	alilba
	ngirli	KANOURI	aluba
FULANI	lilbeni		

Use for edible fruit

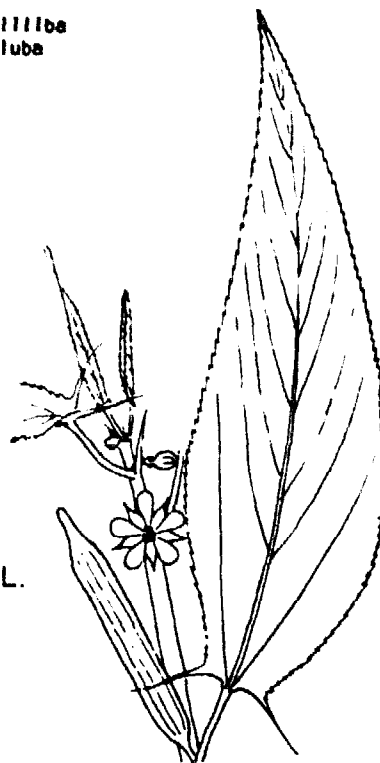
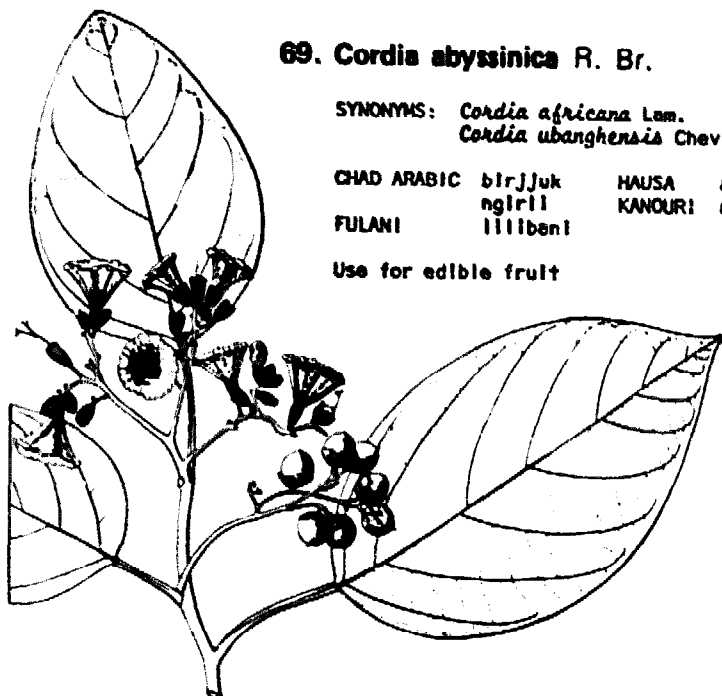

70. *Corchorus olitorius* L.

CHAD ARABIC	muickhiye
HAUSA	malafya
KANOURI	ganzaino



71. Courbonia virgata Brongn.

SYNONYMS:
Courbonia pseudopetalosa Gilg. & Ben.
Marcia pseudopetalosa (Gilg.) de Wolf

HAUSA Ielo
 KANOURI kumkum

72. Crataeva religiosa Forsk.

SYNONYM: *Crataeva adansonii* D.C.

CHAD ARABIC dabkar
 FULANI Iandam bani
 HAUSA ungodudu
 goude
 KANOURI ngulido
 MORE kaelegain-tohiga

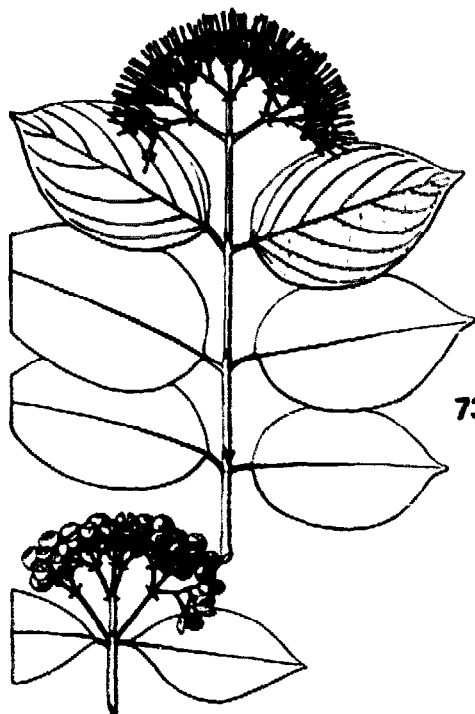
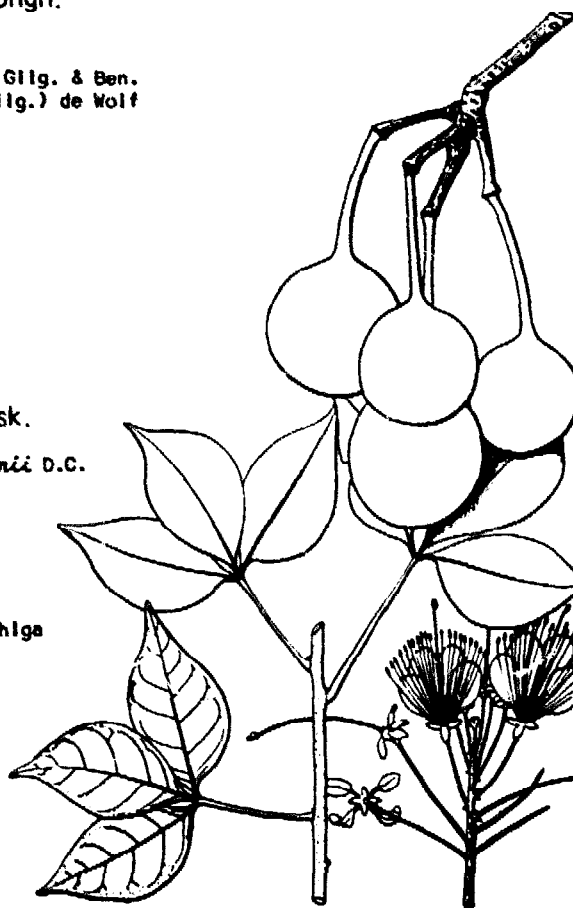

73. Crossopteryx febrifuga Benth.

SYNONYMS:
Crossopteryx africana Belli.
Crossopteryx kotschyana Fenzl.

BAMBARA belimba HAUSA kas'ya
 klenke MORE kumronanga
 FULANI brakoll

74. *Croton macrostachys* Hochst. ex A. Rich.

SYNONYM: *Croton amabilis* Muell.

CHAD ARABIC	deapa
HAUSA	koribe
KANOURI	moromoro

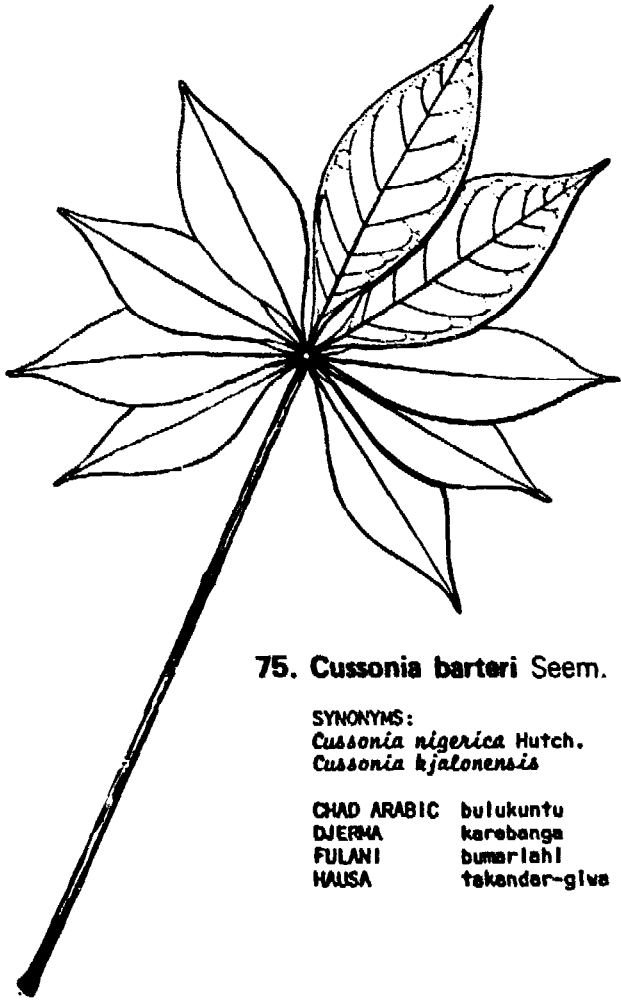
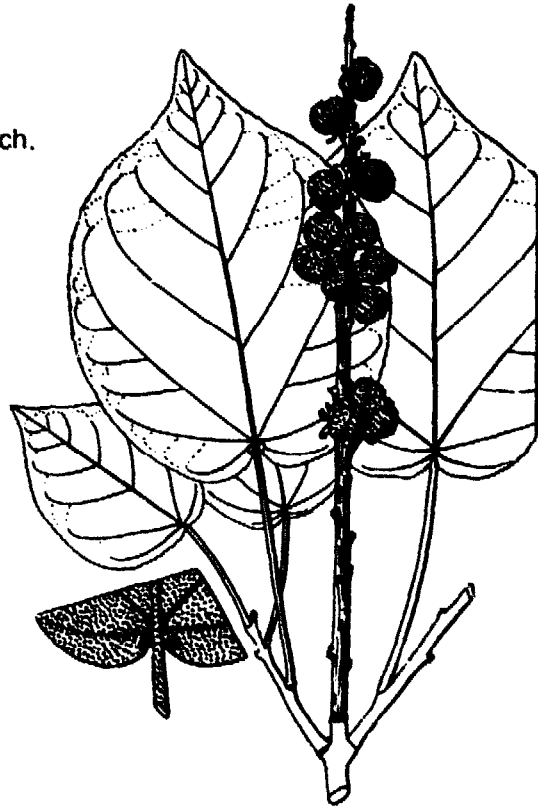

75. *Cussonia barteri* Seem.

SYNONYMS:
Cussonia nigerica Hutch.
Cussonia kjalonensis

CHAD ARABIC	bulukuntu
DJERMA	karebanga
FULANI	bumriahi
HAUSA	takender-giwa

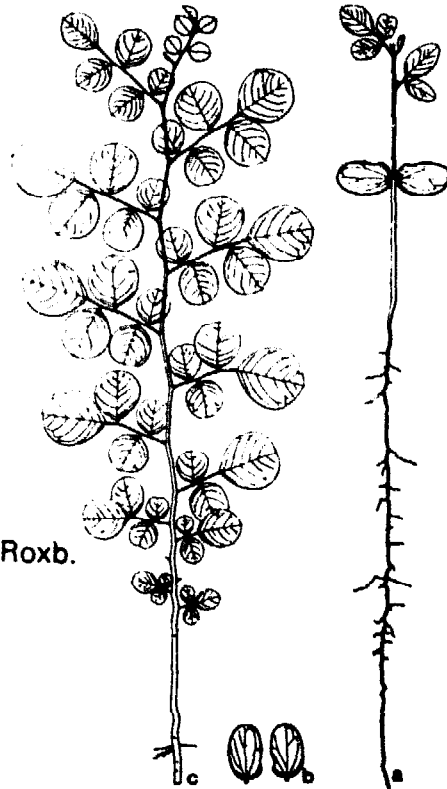

76. *Dalbergia sissoo* Roxb.

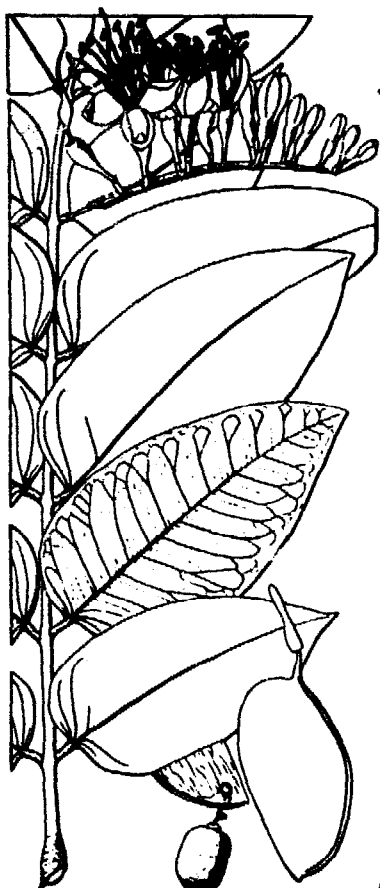

77. Daniella oliverii (Rolfe) Hutch. & Dalz.

SYNONYM: *Paradaniellia oliveri* Rolfe.

FRENCH	senten
CHAD ARABIC	sameim
DJERMA	farmey
FULANI	kaharleh
HAUSA	maje
KANOURI	majo
MORE	honge

78. Detarium microcarpum
Guill. & Perr.

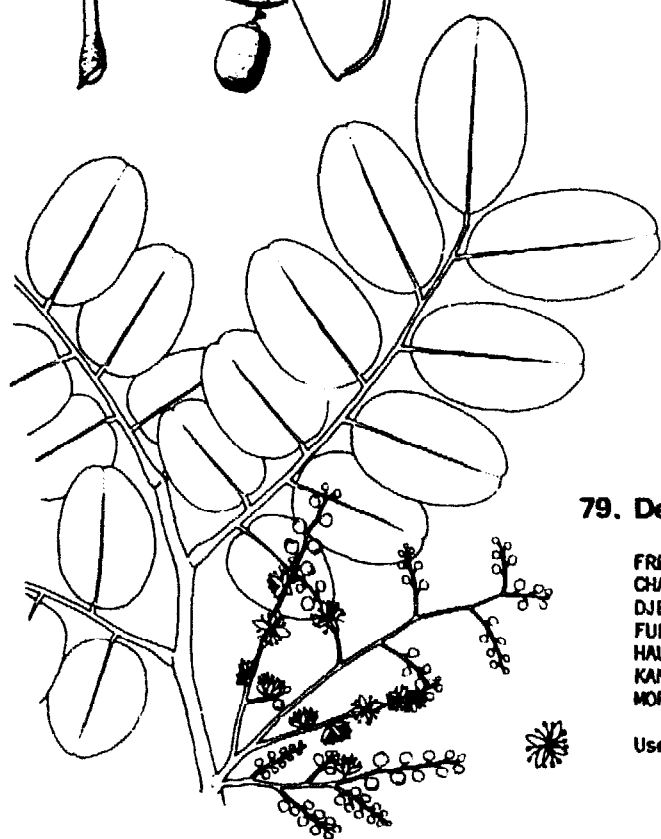
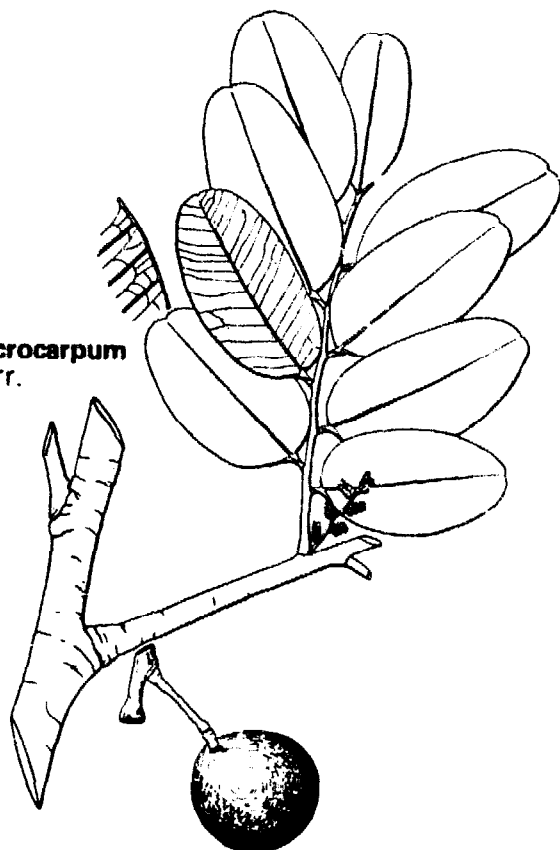

79. Detarium senegalense Gmel.

FRENCH	moroda
CHAD ARABIC	abuielle
DJERMA	fantou
FULANI	konkeh
HAUSA	taura
KANOURI	getapo
MORE	kagtega

Use for drum-wood

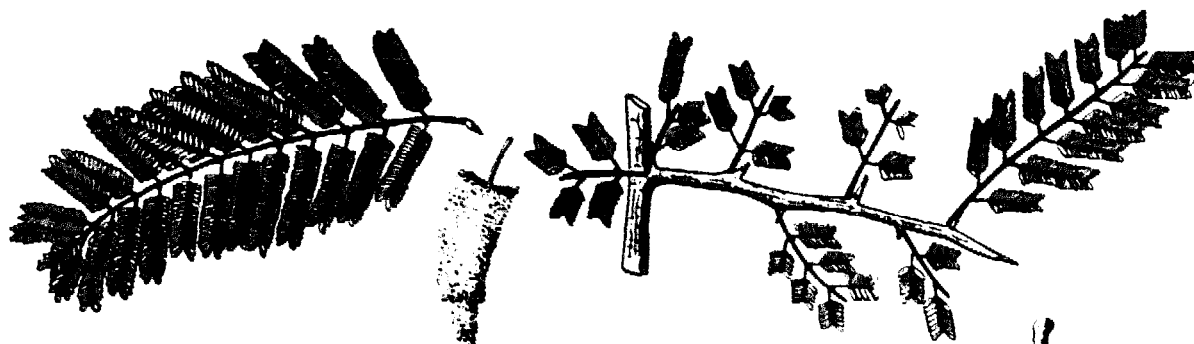

80. *Dichrostachys glomerata* (Forsk.) Hutch. & Dalz.

SYNONYMS: *Dichrostachys arborea* N.E. Br.
Dichrostachys cinerea (L.) Nees & Arn.
Dichrostachys nutans Benth.
Dichrostachys platycarpa Welw.
Gaillia dichrostachys Guill. & Perr.

CHAD ARABIC	dhigingap	HAUSA	dundu
BAMBAFA	gliki-goro	KANOURI	gerbinna
	ntiligi	MORE	sunsutiga
FULANI	burii		
	patrulaki		

Use for thorn fencing, medicine, root fibers

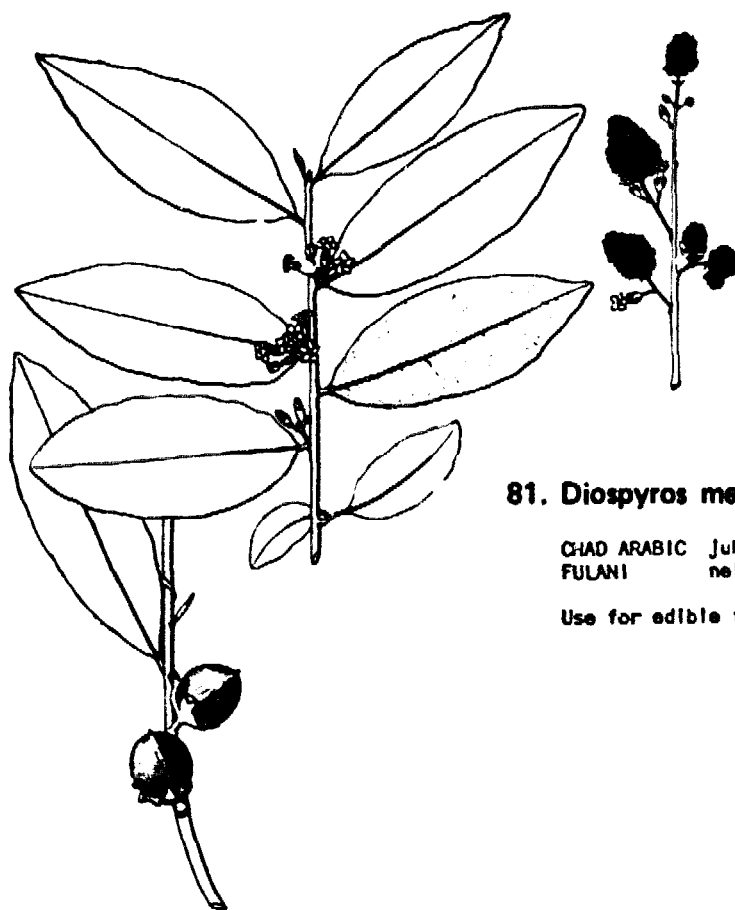

81. *Diospyros mespiliformis* Hochst.

CHAD ARABIC	Jukhan	HAUSA	kanyan
FULANI	nei'bi	KANOURI	burgum

Use for edible fruit, firewood

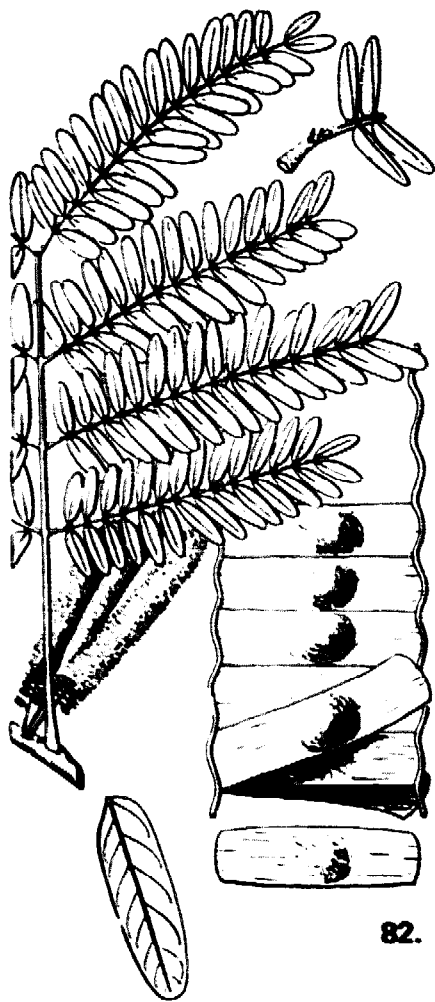

82.

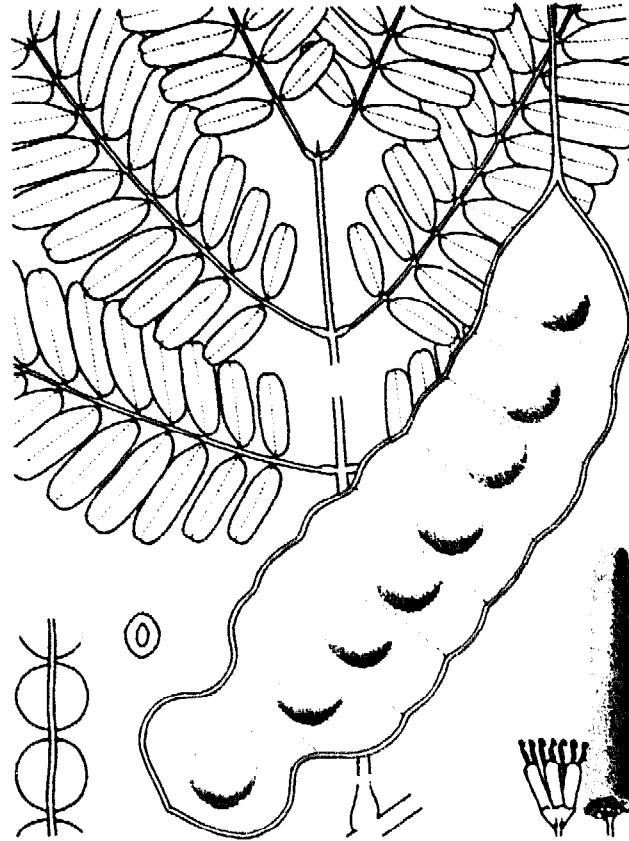

83.

82. *Entada africana* Guill. & Perr.

83. *Entada sudanica* Schweinf.

Also see APPENDIX B

CHAD ARABIC	dorot	HAUSA	tawatsa
BARBARA	diamba	KANOURI	falofala
	samenere	MORE	slanlogo
FULANI	fa'o-wanduhl		

Use for firewood, medicine

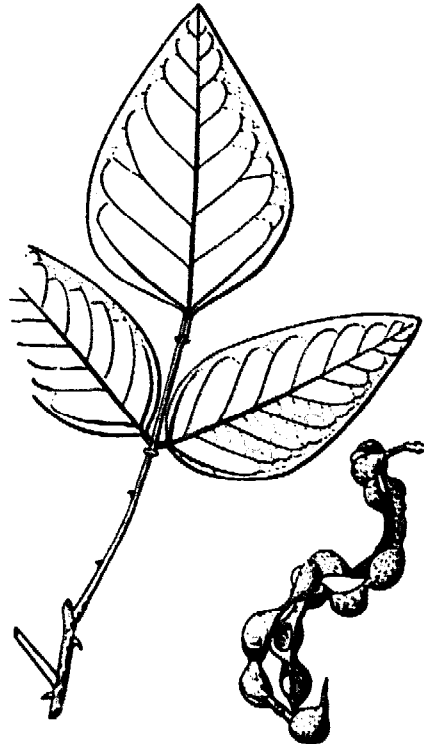

84. Erythrina senegalensis D.C.

BAMBARA †imeba
 lerung
 HAUSA madjirya



85. Eucalyptus camaldulensis Dehnh.

Also see APPENDIX B

SYNONYM:
Eucalyptus rostrata Schlecht.



86. Euphorbia balsamifera Ait.

SYNONYMS: *Euphorbia rogeri* N.E. Br.
Euphorbia sepium N.E. Br.

DJERMA berre
 FULANI yero
 megara
 HAUSA agoua
 KANOURI yaro
 megara

Use for live hedges

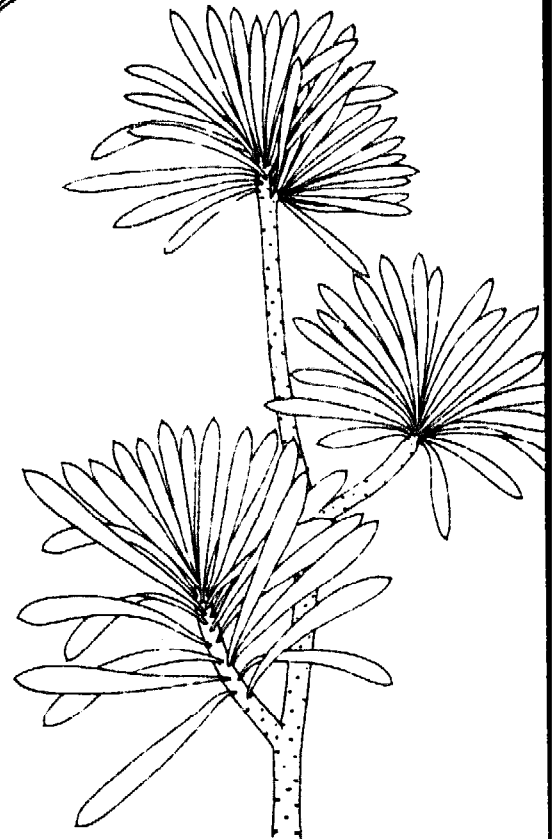
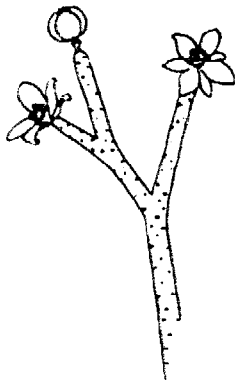

87. Ficus gnaphalocarpa A. Rich.

SYNONYMS:
Ficus sycomorua L.
Ficus trachyphylla Fenzl.
Grosse crenata Warb.

CHAD ARABIC	Jameiz al ablad	HAUSA	baoure
BAMBARA	nituro toro n'toro	KANOURI	farmu obbo
FULANI	yibe obbi	MORE	jivi kankanga

Use for edible fruit, medicine, bark

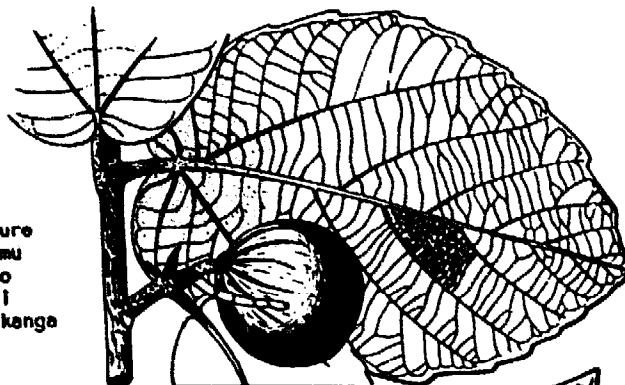

88. Ficus ingens Miq.

SYNONYMS:
Ficus kawuri Hutch.
Ficus lutea Voh.

BAMBARA	turu
HAUSA	kawuri
KANOURI	busugu
MORE	kampsera-manga

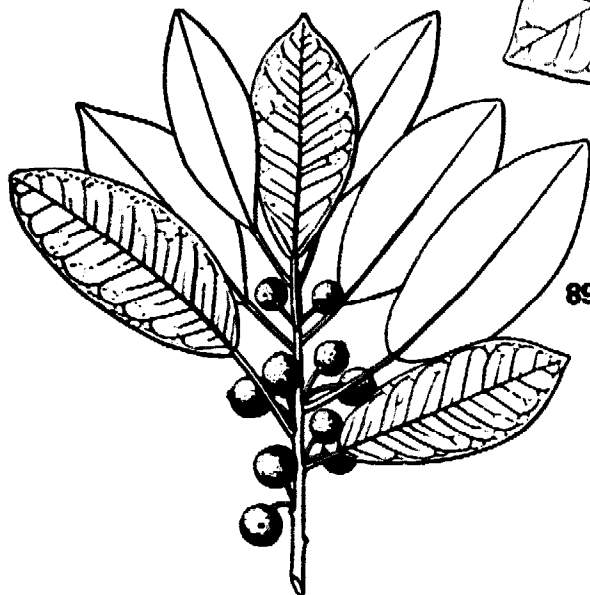
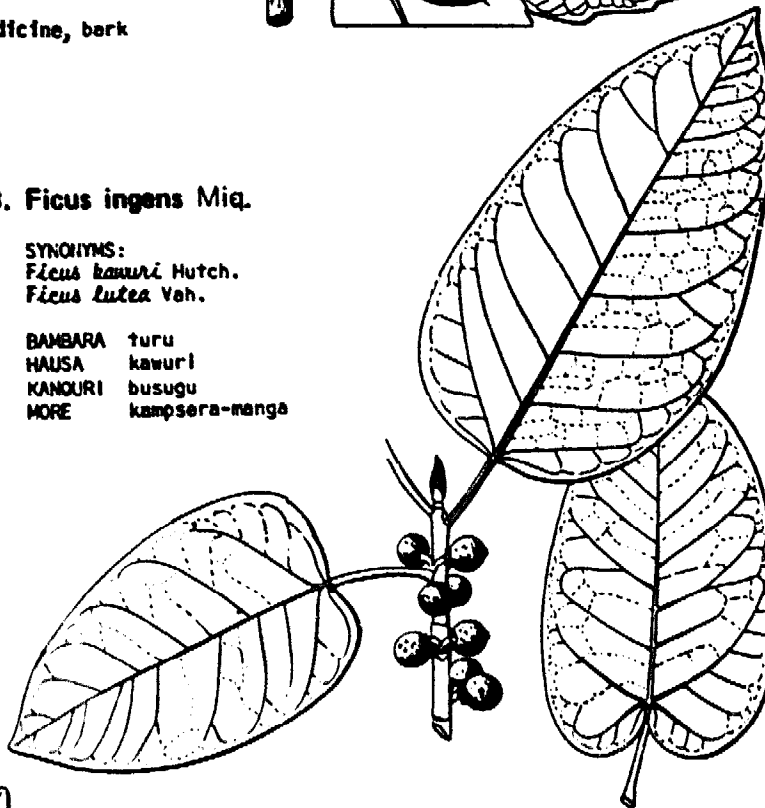

89. Ficus iteophylla Miq.

SYNONYMS:
Ficus bongoensis Warb.
Ficus spragueana

FULANI	sekehi
HAUSA	shirya
KANOURI	nje-nja

Use for firewood

90. *Ficus platyphylla* Del.

SYNONYMS:

Ficus bibracteata Warb.
Ficus umbrosa Warb.

CHAD ARABIC	jameiz el ahmahar
BAMBARA	n'kobo
FULANI	dundehi
HAUSA	gamji
KANOURI	ngabare
MORE	kemsaogo

Use for shade, medicine

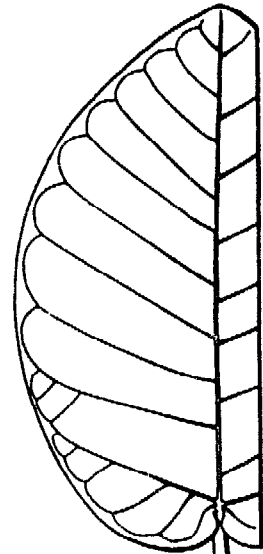

91. *Ficus polita* Vahl

SYNONYMS: *Ficus niarniamensis* Warb.
Ficus stenosiphon Warb.
Ficus syringifolia Warb.
Ficus syringoides Warb.

CHAD ARABIC	djimeimb azrak	HAUSA	durumi
FULANI	ilitahi	KANOURI	rita
		MORE	pampanga

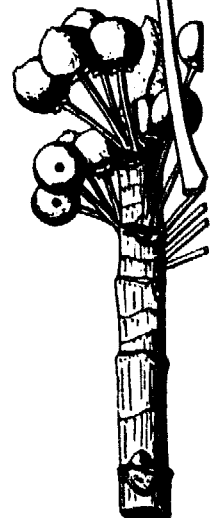
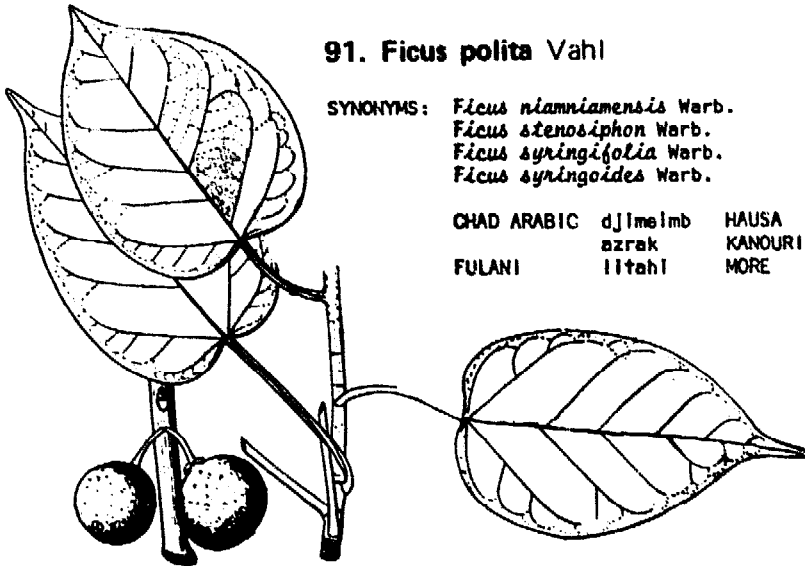

92. *Ficus thonningii* Blume

CHAD ARABIC	jameiz el abled	HAUSA	tchedia
BAMBARA	dubale	KANOURI	jeja
FULANI	biskehi	MORE	kusga

Use for medicine

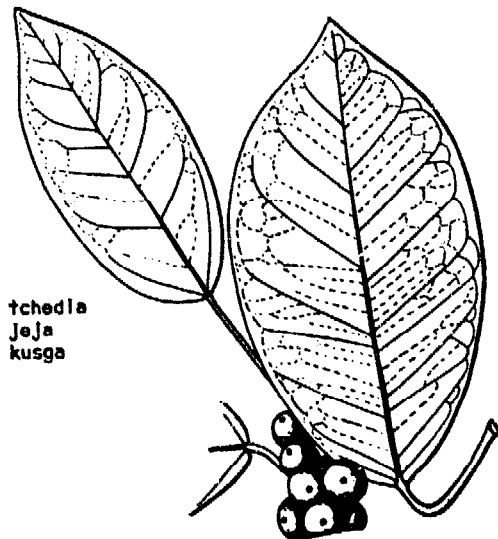

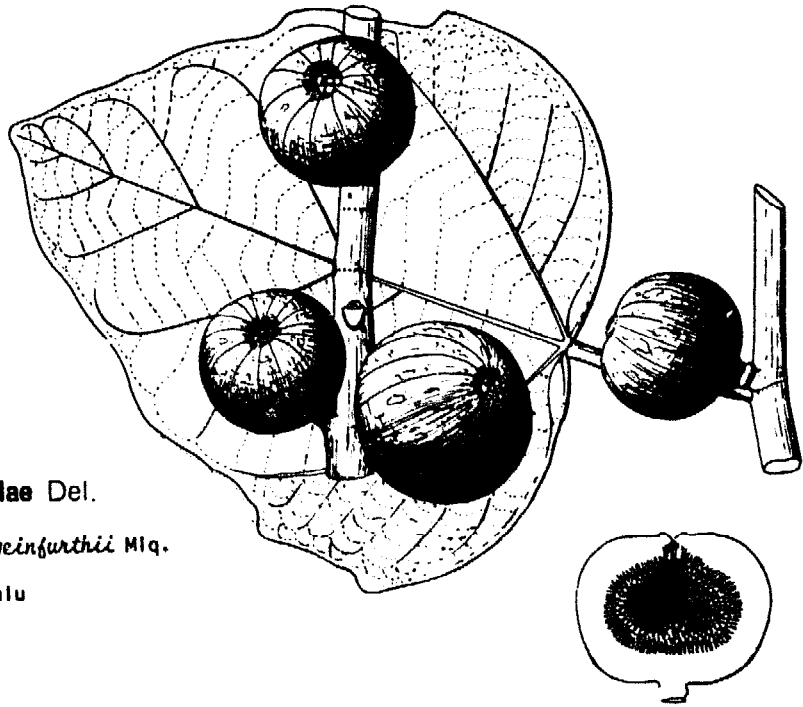

93. *Ficus vallis choudae* Del.

SYNONYM: *Ficus schweinfurthii* Miq.

HAUSA dulu

94. *Fluggea virosa* (Roxb. ex Willd.) Bail.

SYNONYMS:

Fluggea microcarpa Blume
Fluggea virosa Buch.-Ham. ex Wall.
Securinea microcarpa (Blume)
 Pax & Hoffm
Phyllanthus virosus Roxb.

HAUSA daghirto
 tsa
 KANOURI shim shim

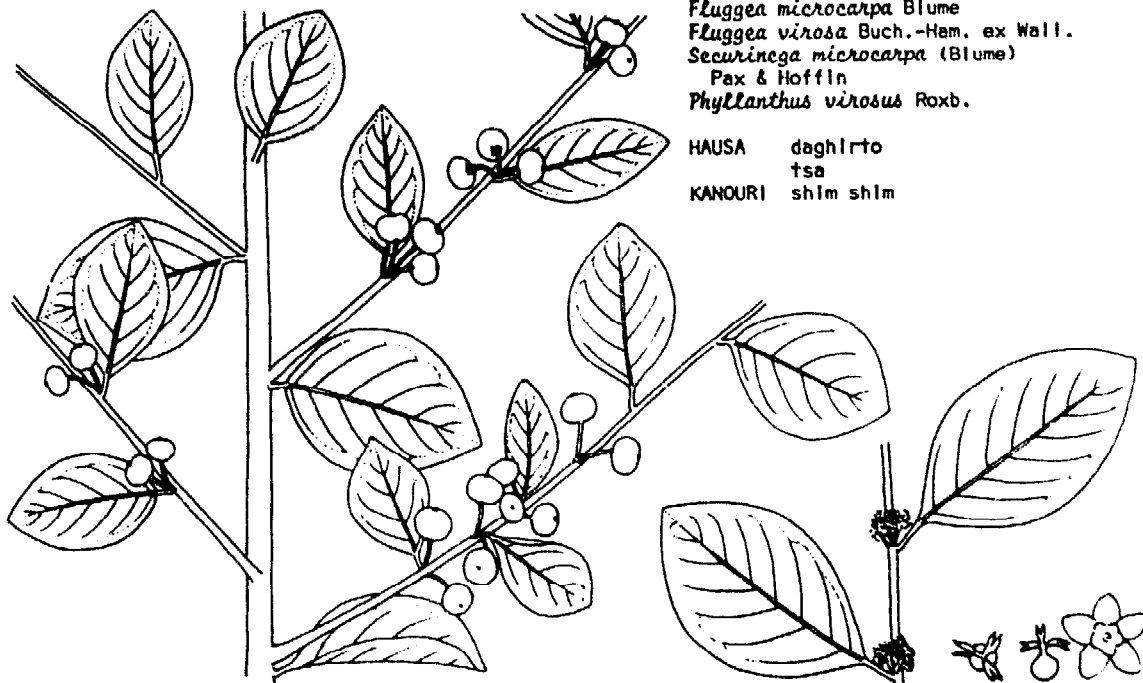

95. *Gardenia erubescens*
Stapf. & Hutch.

CHAD ARABIC	am mififene
BAMBARA	m'bure
	mussema
DJERMA	sinesan
FULANI	dingell
HAUSA	gaoude
KANOURI	gursime
	gogut
MORE	tankorah-gonga

Use for dye

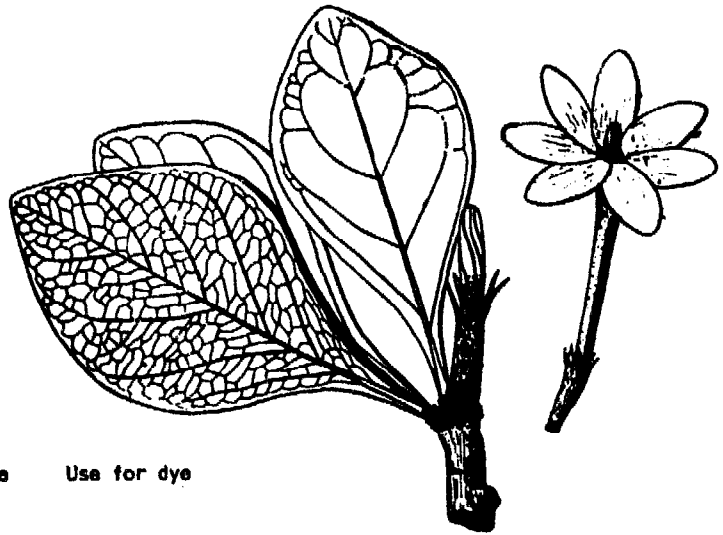

96. *Gmelina arborea* Roxb. not illustrated

Also see APPENDIX B

ENGLISH melina

Use for soft wood (for matches, boxes, etc.)



97. *Grewia bicolor* Juss.

CHAD ARABIC	abesh
FULANI	leloko
KANOURI	djimdjime
MORE	toniaga

Use for edible fruit



98. *Grewia flavescens* Juss.

CHAD ARABIC	gueddeb
HAUSA	kamanmoe
KANOURI	karnai
MORE	somkondo



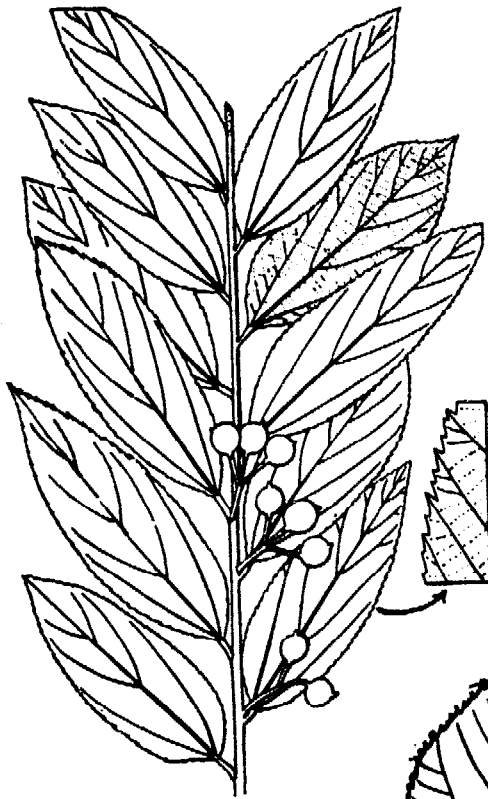

99. Grewia mollis Juss.

CHAD ARABIC	ghebbesh	HAUSA	dergaza
BAMBARA	nogo nogo	KANOURI	karno
FULANI	keili	MORE	mumuka

Use for salt from ashes

100. Grewia villosa Willd.

SYNONYM:
Grewia corylifolia
Gill. & Perr.

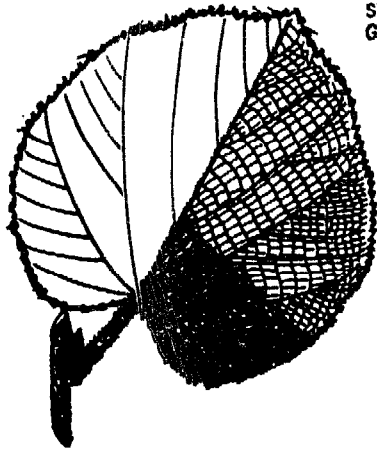

101. Guiera senegalensis Lam.

Also see APPENDIX B

CHAD ARABIC	kabeah
BAMBARA	kudlengbe
DJERMA	sabara
FULANI	gelloki
HAUSA	sabara
KANOURI	kasasai
MORE	unulga

Use for firewood, seeds for
dysentery medicine

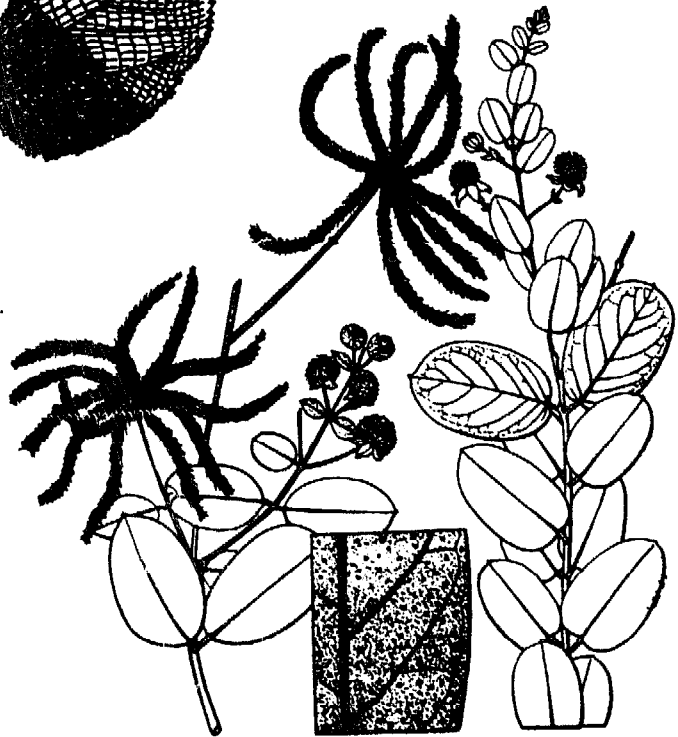

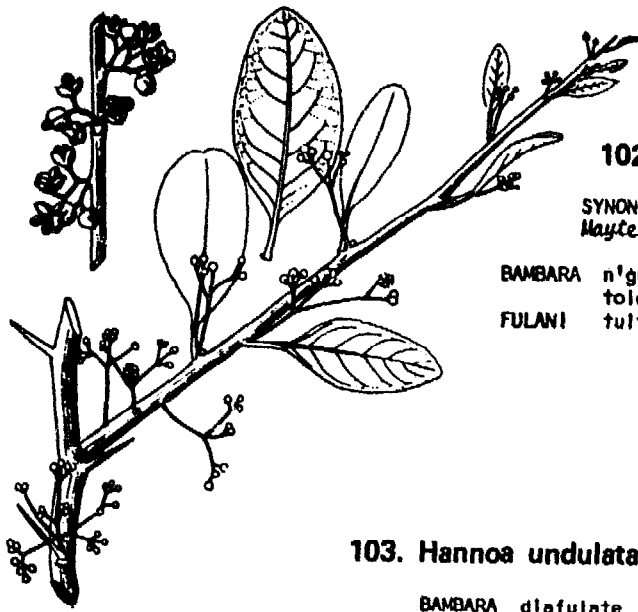

102. *Gymnosporia senegalensis* Loes.

SYNONYM:
Maytenus senegalensis (Lam.) Excell

BAMBARA	n'guigue	HAUSA	namijin-tsada
	tole	MORE	tokuvuguri
FULANI	tultulde		

103. *Hannoa undulata* Planch.

BAMBARA	diafulate
FULANI	bumere
	badl
HAUSA	takandar
	giwa

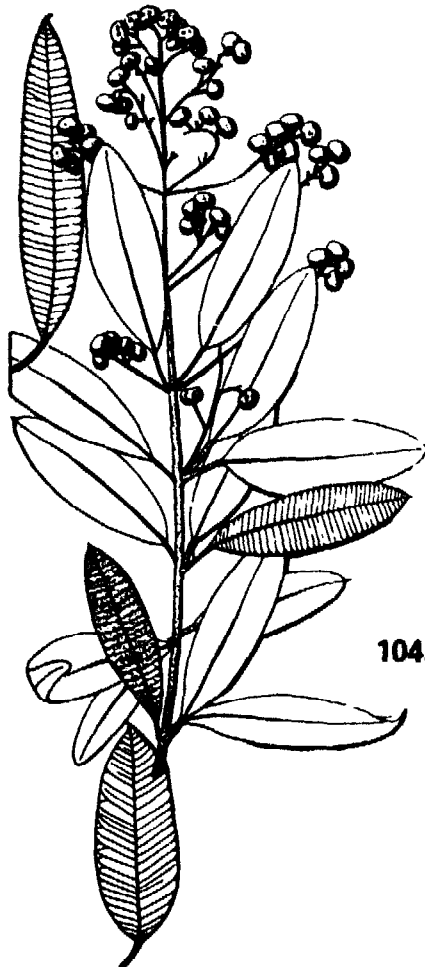
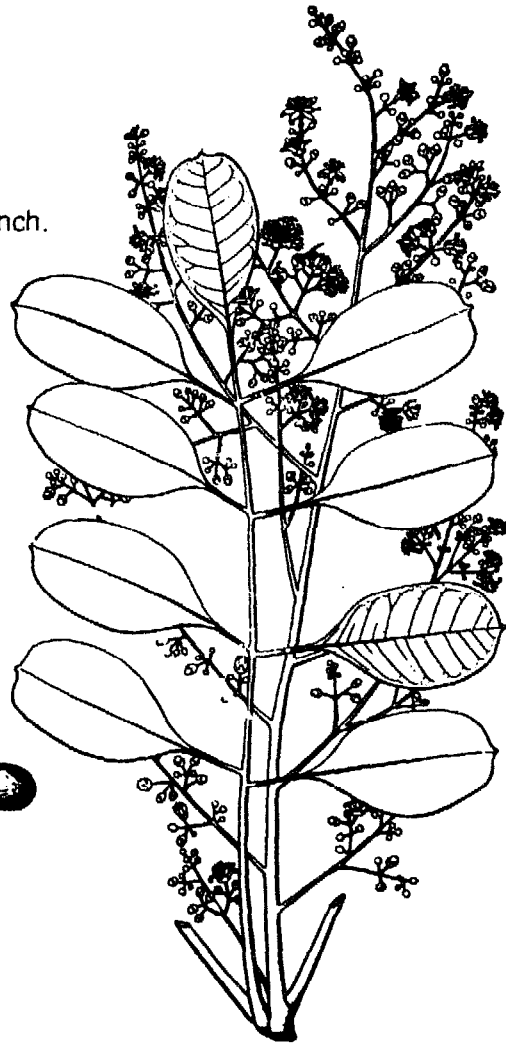

104. *Heeria insignis* (Del.) O. Ktze.

SYNONYMS:
Anaphrenium abyssinicum Hochst.
Rhus insignis Del.

BAMBARA	kalakarl	HAUSA	kasheshe
FULANI	badl	MORE	nilnore

105. Hibiscus asper Hook.

not illustrated

FULANI follere
HAUSA yakuwar
daji
KANOURI karesu

106. Hibiscus cannabinus L.

CHAD ARABIC tii
libe
FULANI gabal
HAUSA rama
KANOURI ngalal

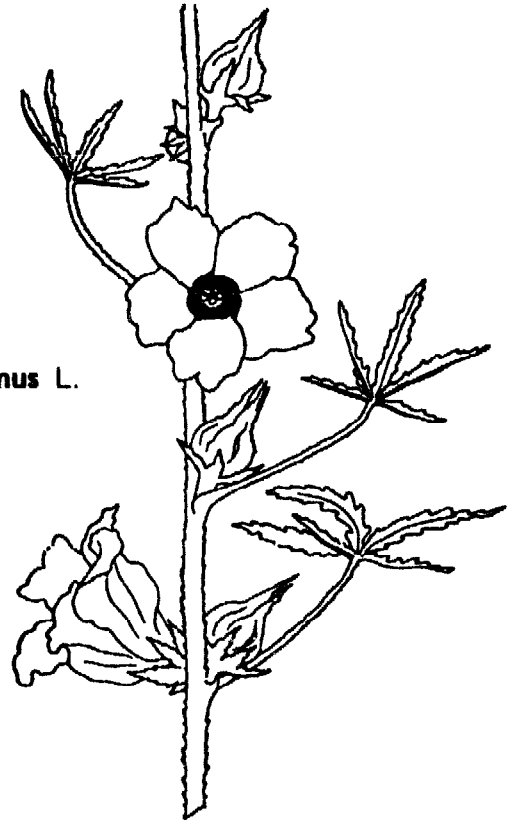

107. Hibiscus esculentus L.

not illustrated

CHAD ARABIC bamiya
FULANI takeyi
HAUSA kubewa
KANOUPI nubalto

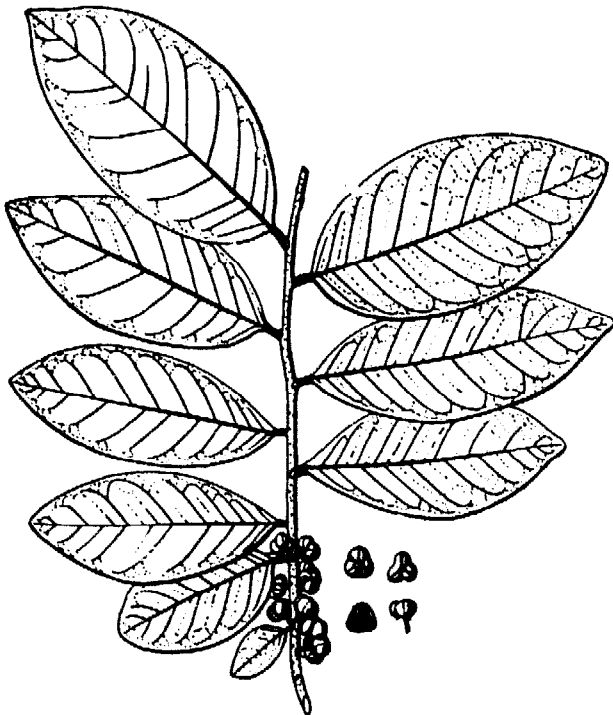

108. Hymenocardia acida Tul.

BAMBARA tanloro
FULANI yawa sotoje
bodehi
HAUSA Jan-yero
dJan-ltche

Use for red-colored
wood



109. *Hyphaene thebaica* (L.) Mart.

FRENCH	doum	FULANI	gellohi
CHAD ARABIC	dom	HAUSA	goriba
DJERMA	kangau	KANOURI	kerzun

Use for construction, edible fruit

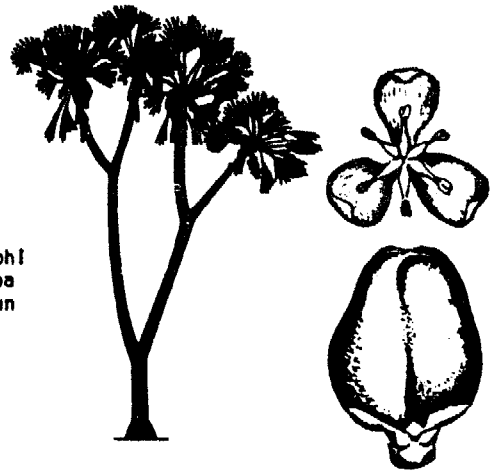

110. *Isoberlinia dalzielii* Craib & Stapf. not illustrated

SYNONYM: *Isoberlinia tomentosa* (Harms.) Craib. & Stapf.

BAMBARA	seu	HAUSA	fara doka
	slo	MORE	kalsaka
FULANI	kubahi		



**111. *Isoberlinia doka*
Craib & Stapf**

HAUSA doka



112. *Khaya senegalensis* Juss.

ENGLISH	African "mahogany"
FRENCH	calicedrat
CHAD ARABIC	muray
BAMBARA	diala
DJERMA	farel
FULANI	dalehi
	call
HAUSA	madadji
KANOURI	kagam
MORE	kuga

Use for fodder

113. *Kigelia africana* Benth.

SYNONYMS:
Kigelia aethiopica Decne.
Kigelia africana var.
aethiopica Aubr.

CHAD ARABIC	kouk
FULANI	girlahi
HAUSA	rahma
	baounia
KANOURI	bulungu
MORE	dindon
	limbi

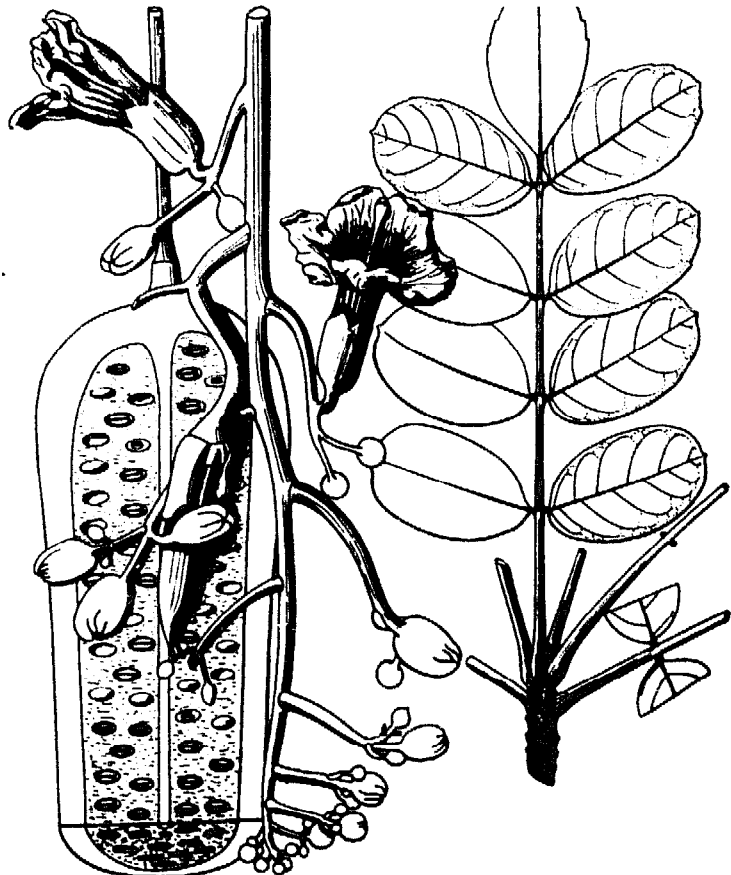

114. *Lannea acida* A. Rich.

Also see APPENDIX B

FULANI	faruhl
HAUSA	farou
KANOURI	adarazagai
MORE	pekunl sabga

Use for edible fruit



115. *Lannea afzelii* Engl.

SYNONYMS:

Lannea glaberrima Engl. & Krause
Lannea grossularia A. Chev.
Lannea nigritana (Sc. Ell.) Keay

HAUSA daoya

Use for medicine



116. *Lannea humilis* (Oliv.) Engl.

SYNONYMS: *Lannea bagirmonsii* Engl.
Odina humilis Oliv.

KANOURI kurubulul

117. *Lannea oleosa* not illustrated

SYNONYM: *Odina acida*

118. *Leptadenia lancifolia* Decne.

SYNONYMS:
Leptadenia hastata (Pers.) Decne.
Cynanchum hastatum Pers.

CHAD ARABIC	sha'elob
FULANI	yehi
HAUSA	yadiya
KANOURI	njara

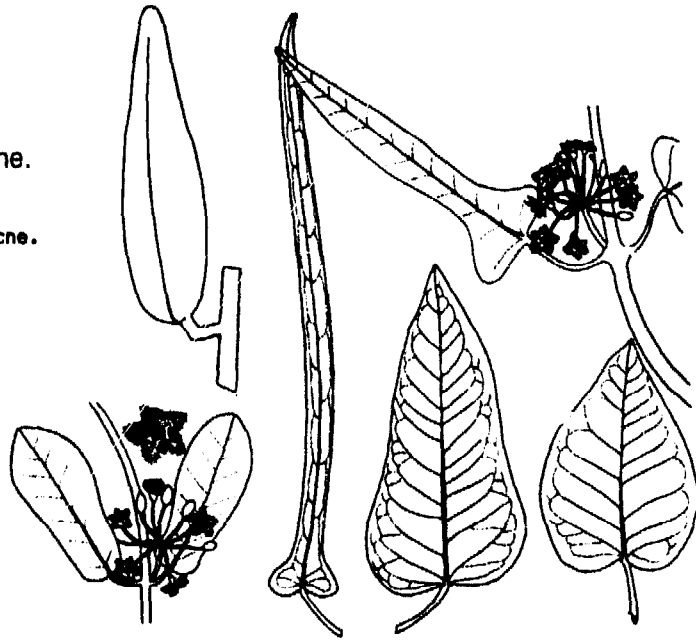

119. *Leptadenia spartium* Wright

SYNONYM:
Leptadenia pyrotechnica (Forsk.) Dec.

CHAD ARABIC	marakh
FULANI	sebale
HAUSA	kalumbo
KANOURI	karimabo

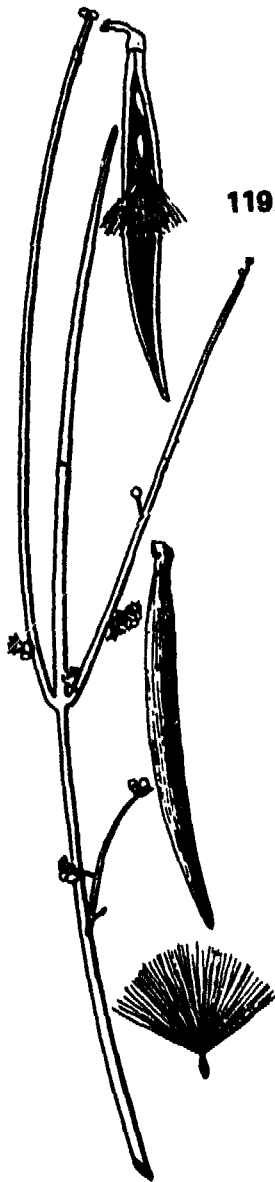

120. *Lophira alata* Banks

SYNONYM:
Lophira lanceolata
 Van Tiegh. ex Keay

BAMBARA	mane
FULANI	karehi gori
HAUSA	nanijin
	kadal

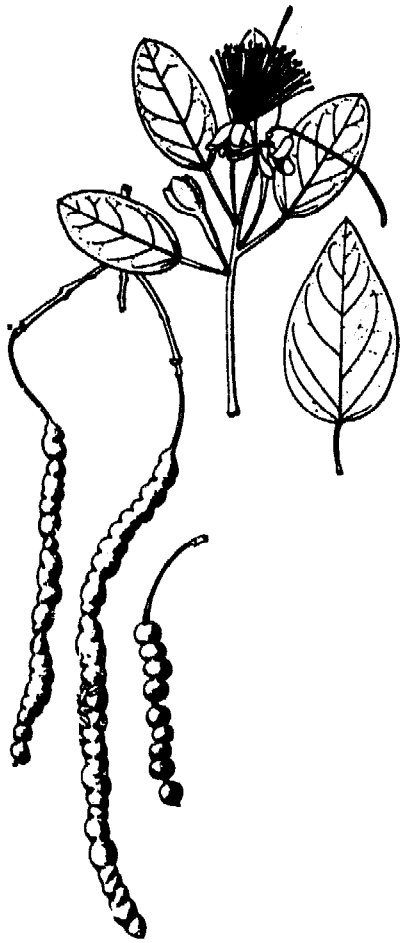

121. Maerua angolensis D.C.

CHAD ARABIC	shagara el zeraf
BAMBARA	bre-bre kokali
FULANI	leggal ball
HAUSA	ciciwa
KANOURI	abchi
MORE	kessiga

Use for fodder

122. Maerua crassifolia Forsk.

CHAD ARABIC	zorhale sarah
BAMBARA	beredlou
FULANI	sogul
HAUSA	jiga
KANOURI	jiga
MORE	kessiga

Use for tool handles,
firewood, fodder



123. Menotes keratingii

FULANI	jangi
HAUSA	farin rua

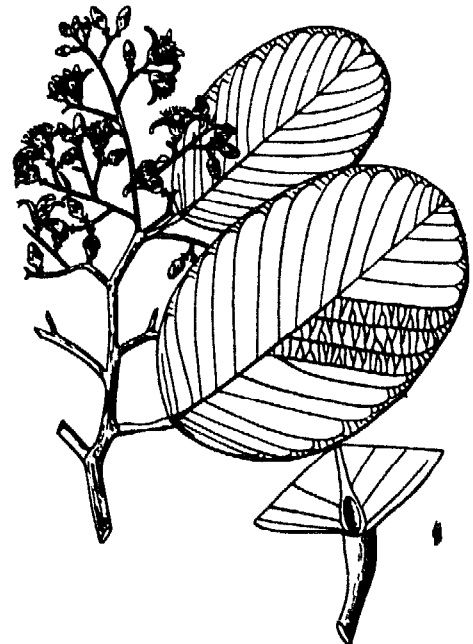
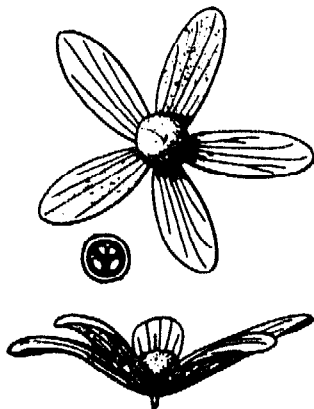

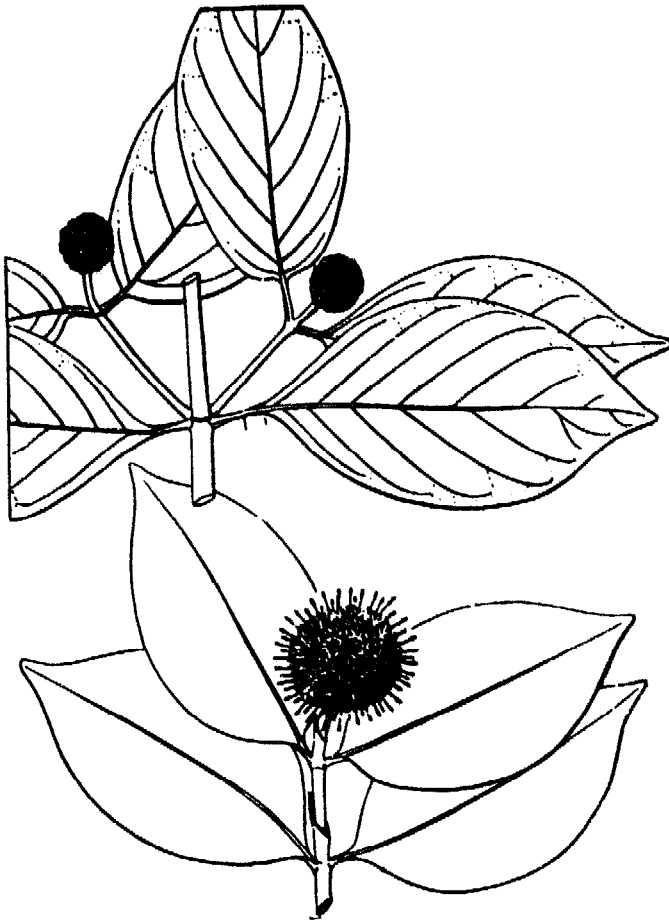

124. *Mitragyna inermis* O. Kuntze

SYNONYM:
Mitragyna africana Korth.

CHAD ARABIC	ngato
BAMBARA	dioun
FULANI	koli
HAUSA	guljeje
KANOURI	kawul
MORE	lioga

Use for firewood, medicine,
fish baskets

125. *Momordica balsamina* L.

HAUSA	garafuni
KANOURI	dugdoge

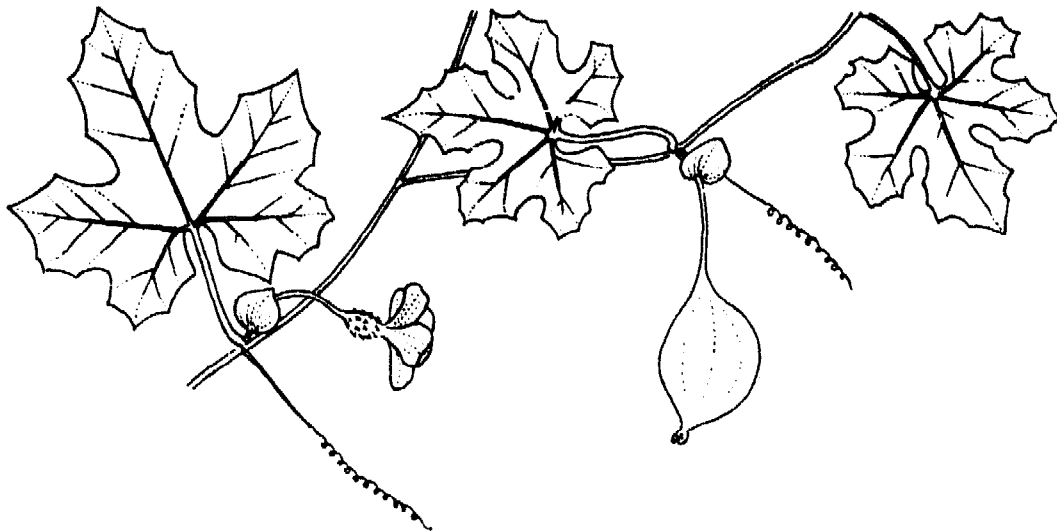

126. *Moringa pterygosperma* Gaertn.

SYNONYM: *Moringa oleifera* Lam.

CHAD ARABIC	ailm
FULANI	gulligandani
HAUSA	zogolangandi
KANCURI	ailum
MORE	argentiga

Use for edible leaves

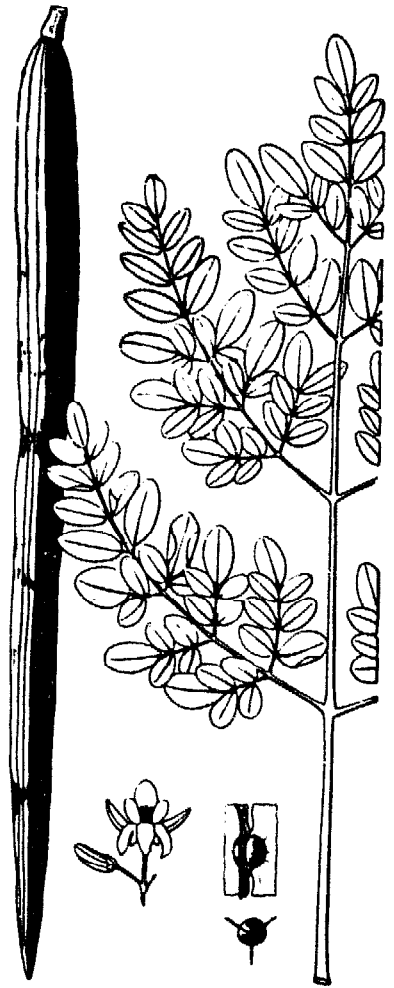

127. *Nauclea esculanta*

not illustrated

FULANI	bakurehi
HAUSA	tafeshiya

128. *Nauclea latifolia* Smith

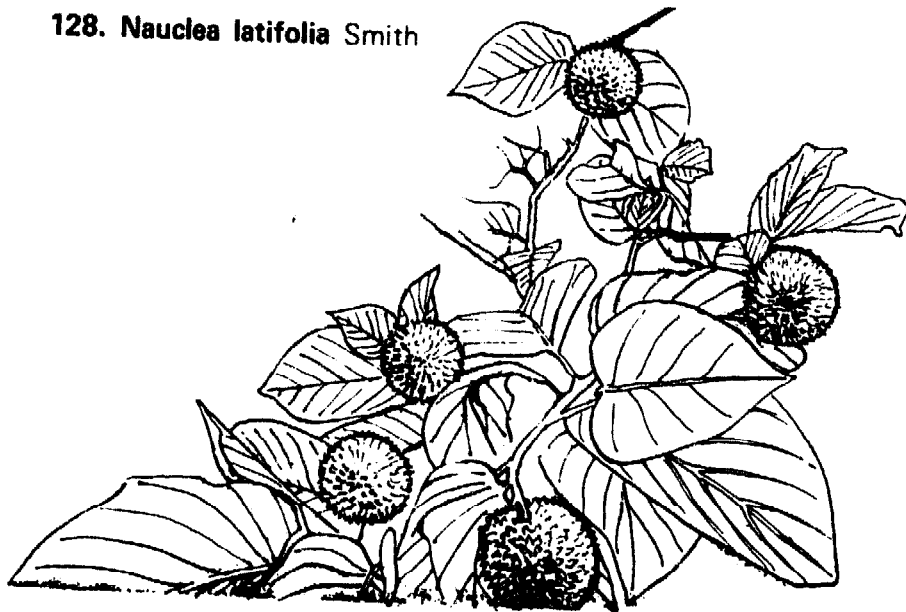



129. *Nymphaea lotus* L.

CHAD ARABIC	sitteib
FULANI	tabbera
HAUSA	bado
KANOURI	dzmbi

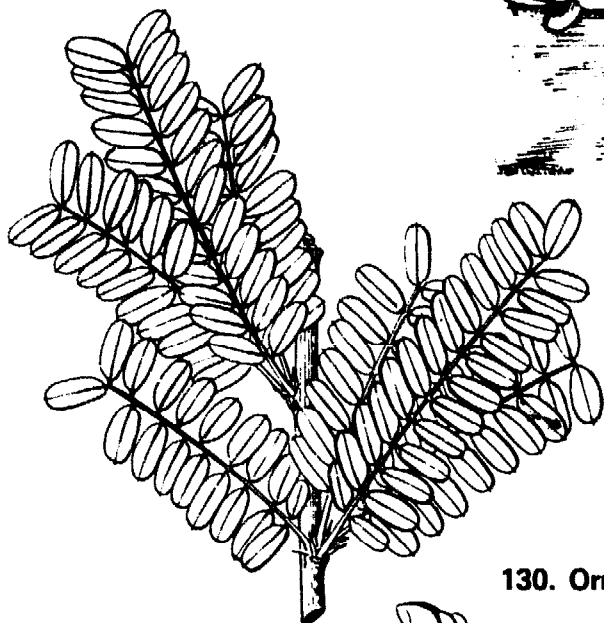

130. *Ormocarpum bibracteatum* Bak.

HAUSA	fashkara
	giwa
KANOURI	sabrem

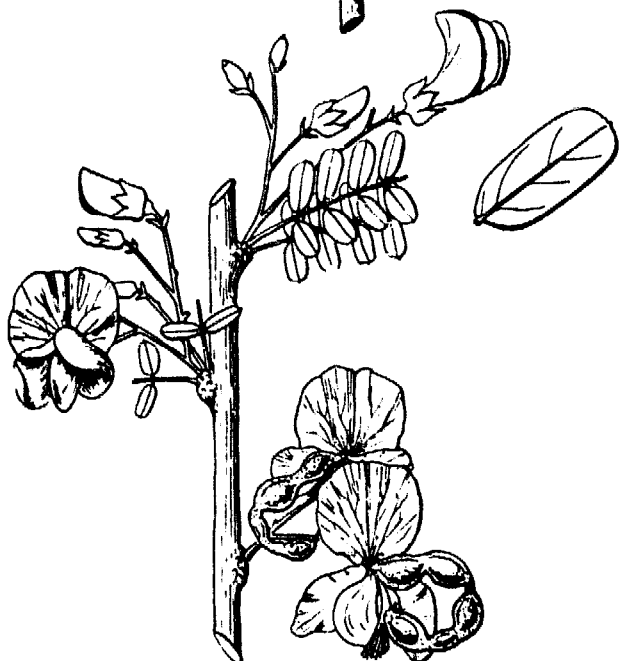

131. *Oryza barthii*

not illustrated
HAUSA shinkafa

132. *Ostryoderris chevalieri* Dunn

SYNONYM: *Ostryoderris stuhlmannii*
(Taub.) Dunn ex Harms.

BAMBARA mussa sana
 fugu
HAUSA burdi
MORE baombanko

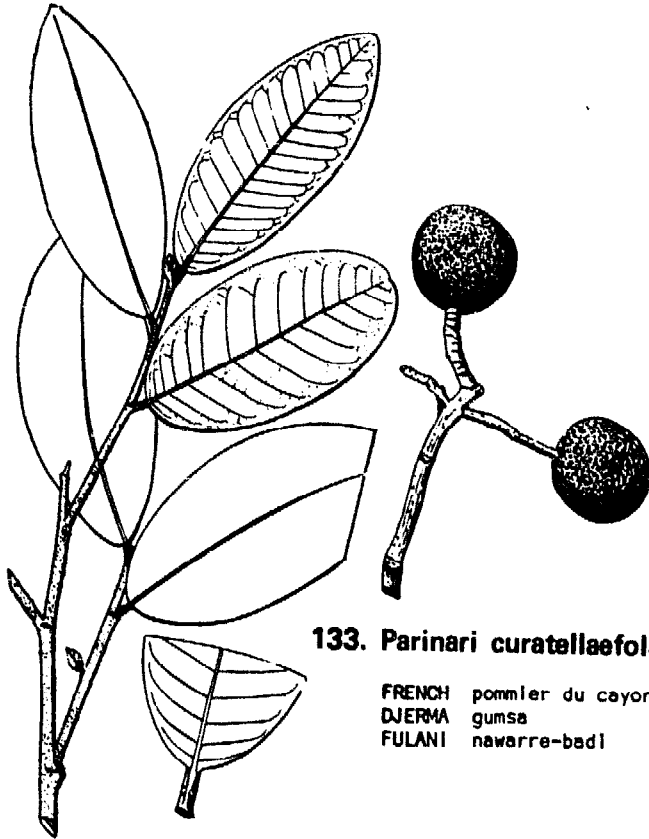
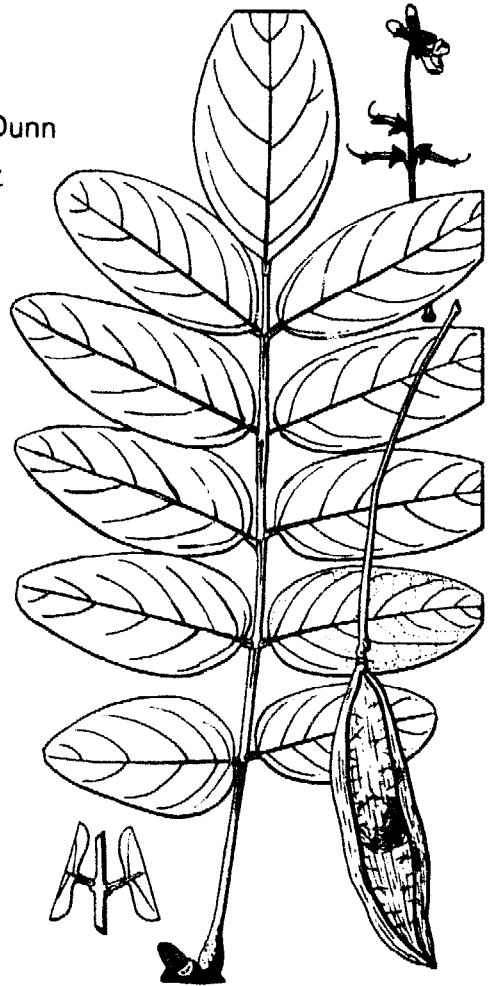

133. *Parinari curatellaefolia* Planck.

FRENCH	pommier du cayor	HAUSA	rura
DJERMA	gumsa		gawassa
FULANI	nawarre-badi	KANOURI	mande

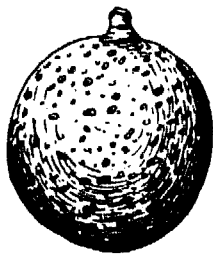

134. *Parinari macrophylla* Sabine

FULANI nawarre
HAUSA gawasa
MORE ouamtanga

Use for edible fruit

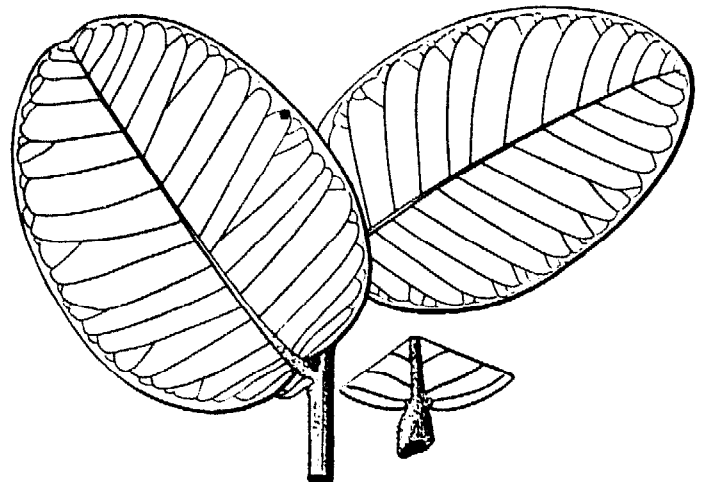

135. *Parkia biglobosa* Benth.

Also see APPENDIX B

SYNONYMS:
Parkia clappertonia Keay
Mimosa biglobosa Jacq.

FRENCH	nere
CHAD ARABIC	malto
BAMBARA	nere
DJERMA	dosso
FULANI	narghi
HAUSA	dorowa
KANOURI	runo
MORE	rouaga

Use for edible fruit

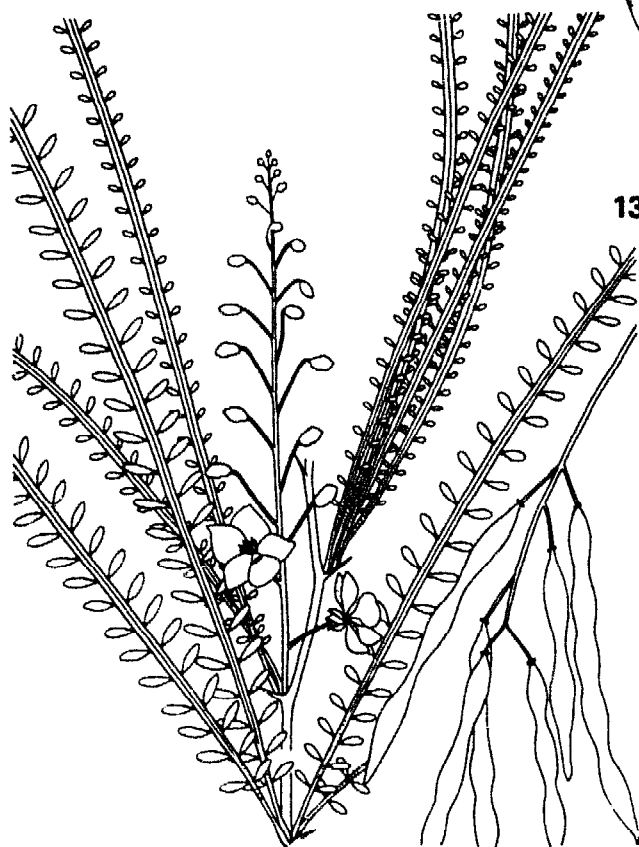
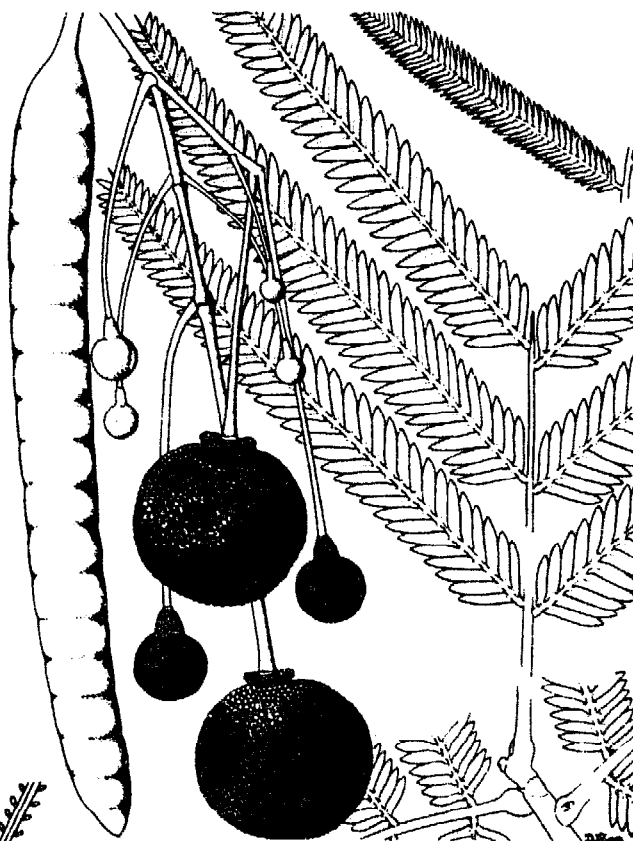

136. *Parkinsonia aculeata* L.

Also see APPENDIX B

DJERMA	sassa bani
HAUSA	sharan abi
KANOURI	sharan labi

Use for firewood, live
 fencing, windbreaks,
 soil cover

137. *Phoenix dactylifera* L.

not illustrated

ENGLISH	date palm
FRENCH	palmier dattier
CHAD ARABIC	tamrei
FULANI	bukki
	dibinobi
HAUSA	dabino
KANOURI	difono

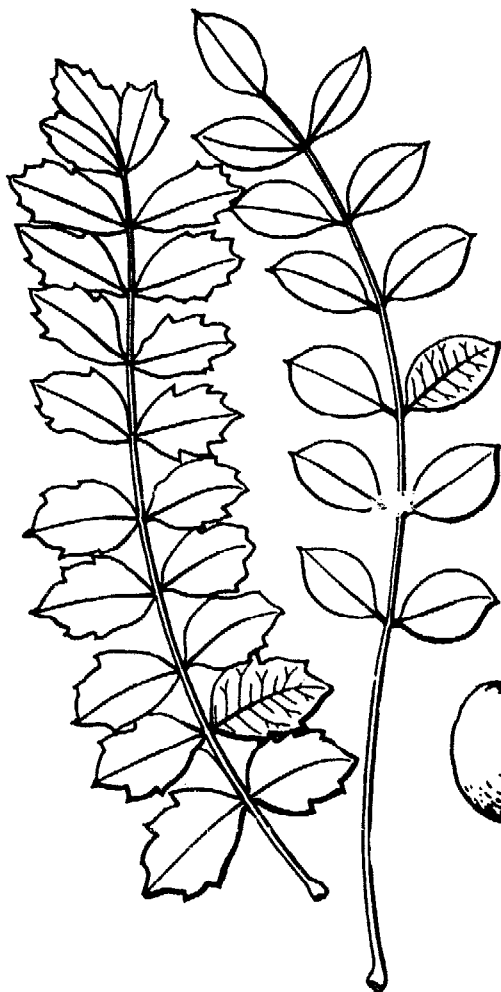

138. Poupartia birrea (Hochst.) Aubr.

Also see APPENDIX B

SYNONYM: *Sclerocarya birrea* Hochst.

FRENCH	dine	HAUSA	danya
CHAD ARABIC	homeld	KANOURI	kumagu
BAMBARA	kuntza	MORE	nobega
FULANI	ho: i		

Use for edible fruit,
light woodworking

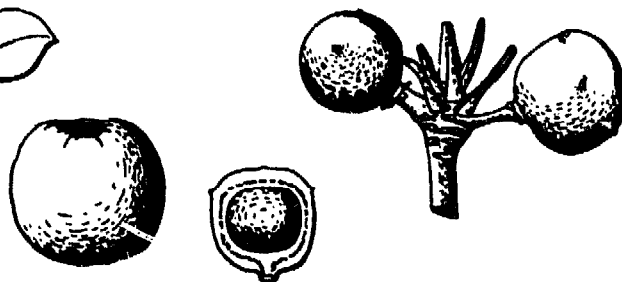

139. Prosopis africana Taub.

Also see APPENDIX B

SYNONYM:
Prosopis oblonga Benth.

BAMBARA	guele
FULANI	kohi
HAUSA	kirlya
KANOURI	simain
MORE	niuri-segue

Use for construction,
woodworking, charcoal,
tanning

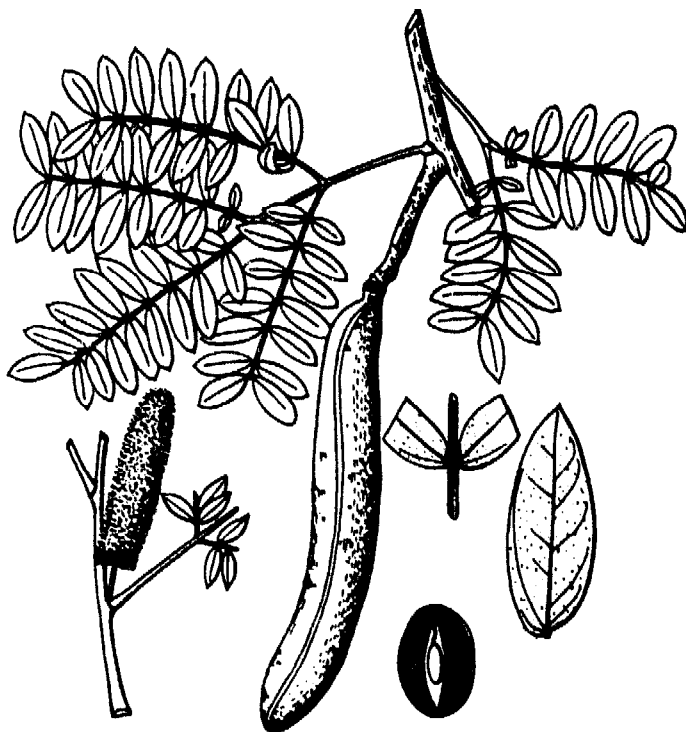

140. *Prosopis juliflora* (Sw.) D.C.

Also see APPENDIX B

SYNONYMS:
Prosopis chilensis (Mol.) Stuntz
Ceratonia chilensis Mol.

ENGLISH (USA) mesquite

Use for fence posts, firewood,
live fencing, windbreaks,
fodder

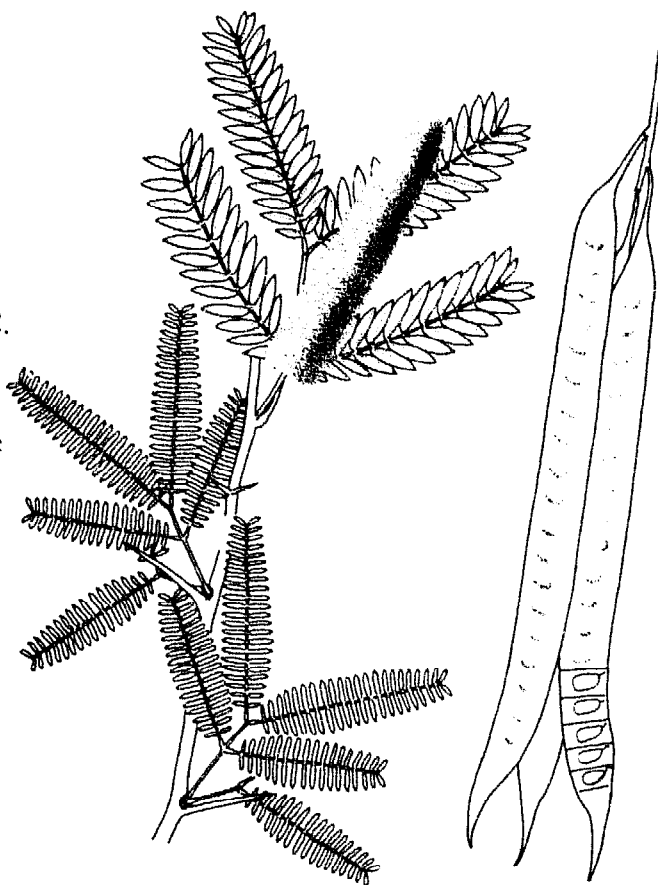

141. *Pseudocedrales kotschy* Harms.

SYNONYM:
Cedrales kotschy Schweinf.

FULANI	bodo
HAUSA	tuna
KANOURI	kagarakagum
MORE	seguedere

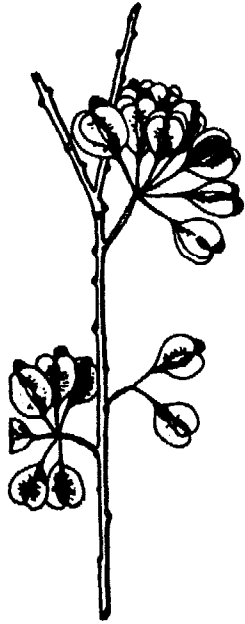

142. *Pteleopsis suberosa*
Engl. & Diels.

SYNONYM:
Pteleopsis keratingil Gilg.

HAUSA wyan demo

Use for fodder

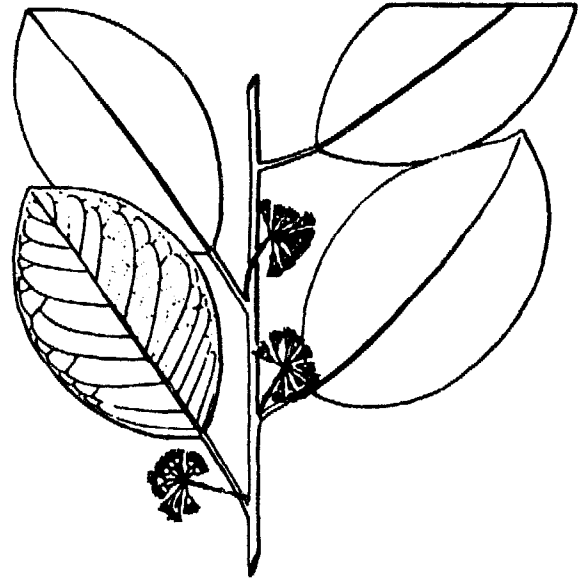

143. *Pterocarpus erinaceus* Poir.

FRENCH	vene
BAMBARA	diabe
DJERMA	tolo
FULANI	banuhi
	geodi
HAUSA	madobla
KANDURI	buwa
MORE	pempelaga

Use for firewood, flowers
for sauce, & construction

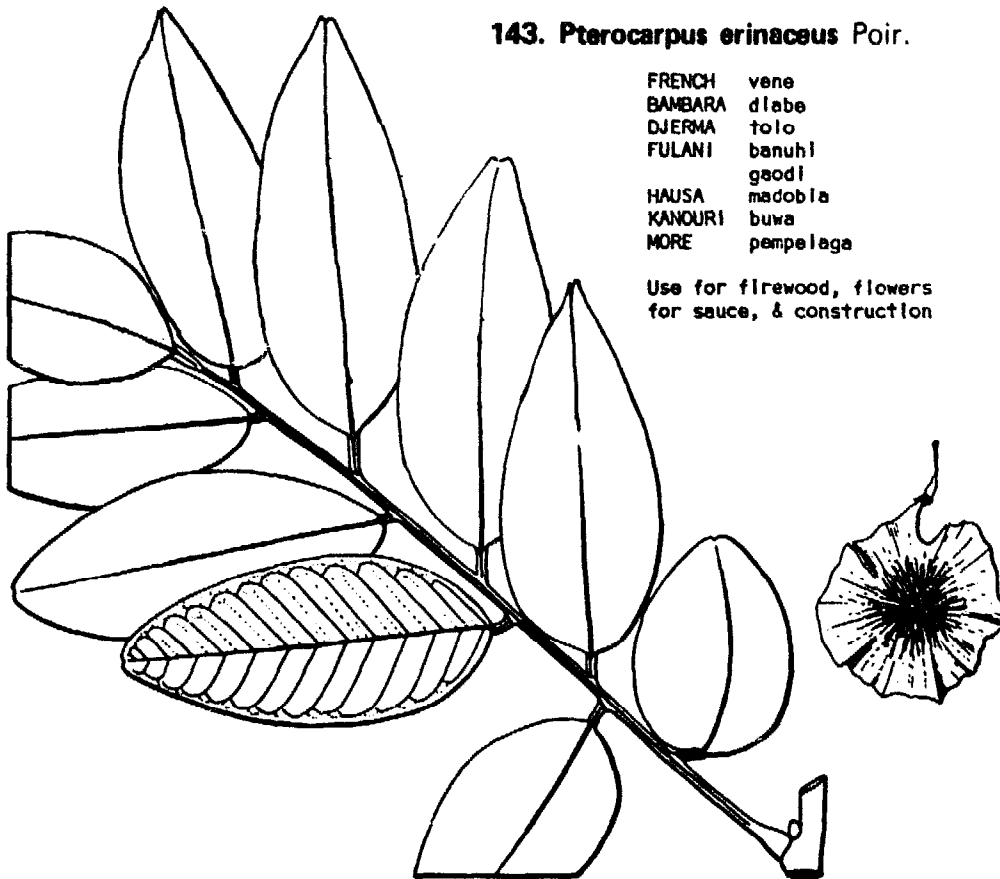

144. *Raphionacme brownii* Sc. Elliot

FULANI fugore
HAUSA rujiya
KANOURI gadagar

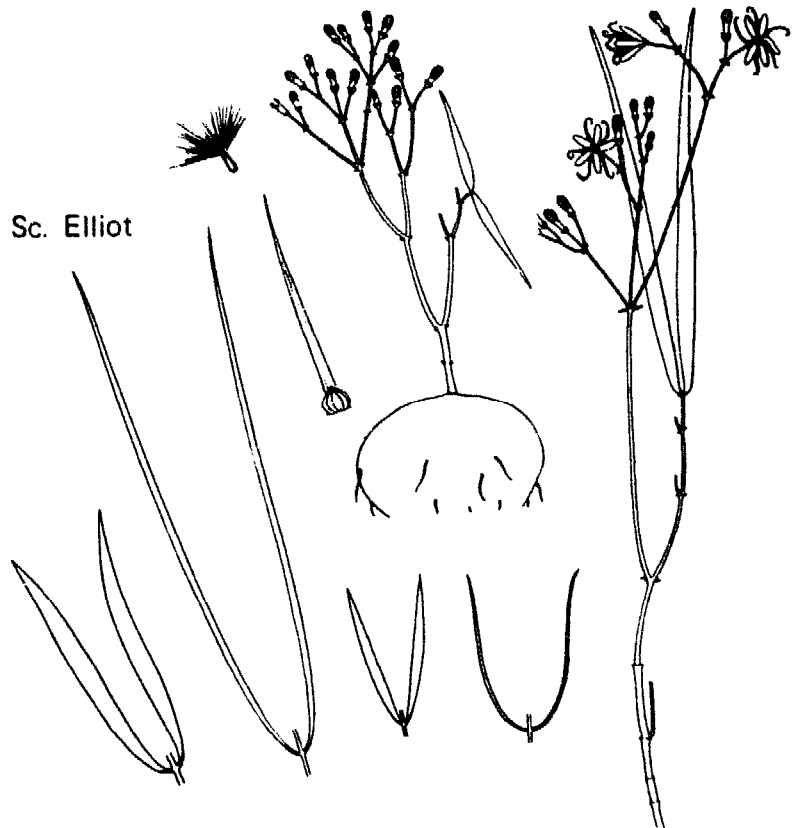
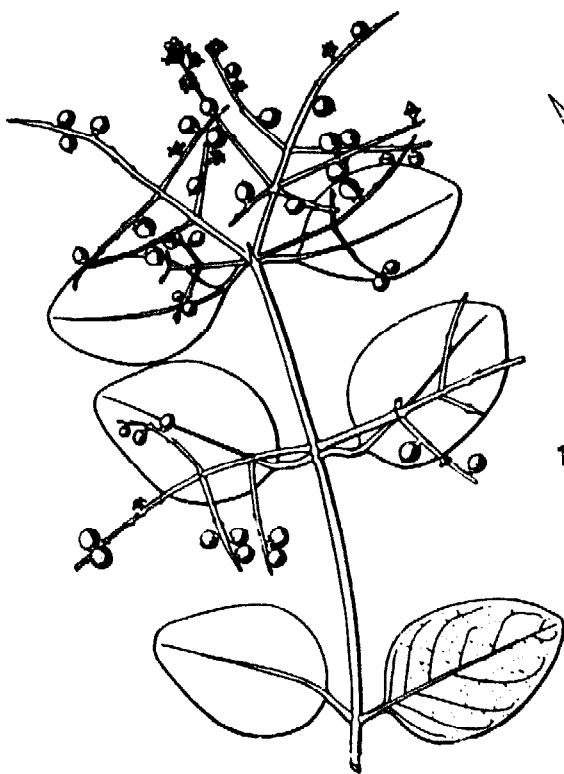

145. *Salvadora persica* L.

CHAD ARABIC	arak	FULANI	hirohi
	siwak	HAUSA	talakia
BAMBARA	hiriguesse	KANOURI	babul
DJERMA	hiro	MORE	irak

Use leaves for stocksalt

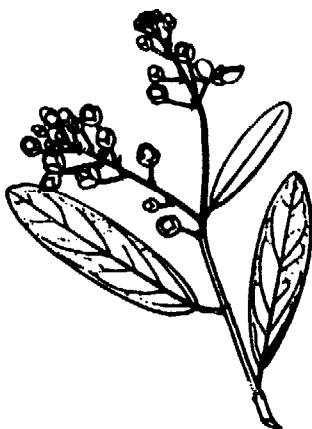

146. *Securidaca longipedunculata* Fres.

CHAD ARABIC	alali
BAMBARA	diota
FULANI	alali
HAUSA	magunguna
KANOURI	gazaboro
MORE	pelaga

Use for firewood



147. *Sterculia setigera* Del.

SYNONYM:
Sterculia tomentosa Guill. & Perr.

CHAD ARABIC shadarat
ai damn
BAMBARA koko
konguranl
FULANI bo'boil
HAUSA kukukl
KANOURI sugubo
MORE pupunga

Use for gum



148. *Stereospermum kunthianum* Cham.

CHAD ARABIC ess
arad
BAMBARA mogo kolo
FULANI golombi
HAUSA sansam
KANOURI golombi
MORE vulga
nihlienga

Use for firewood

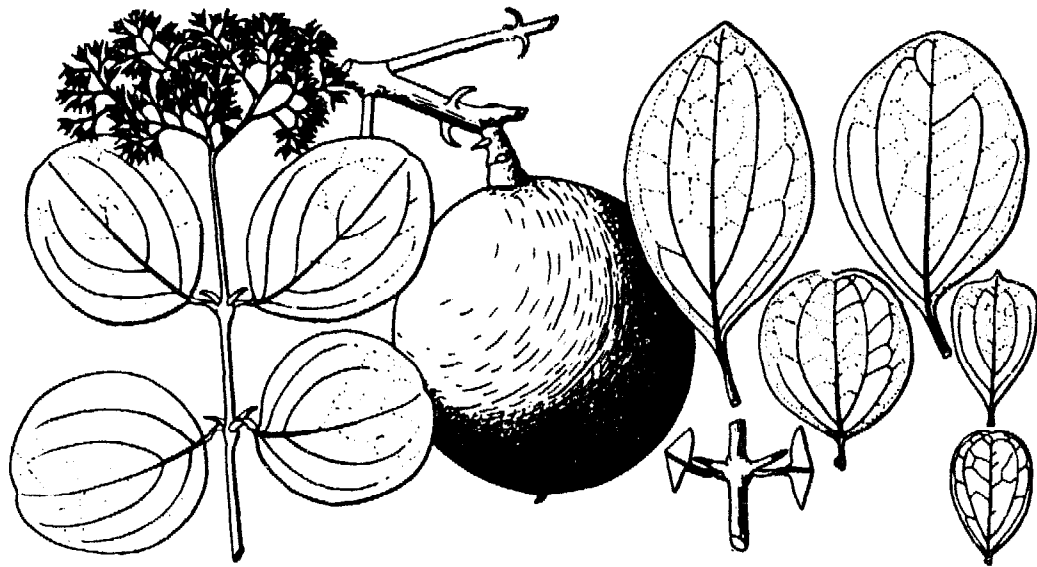

149. Strychnos spinosa Lam.

SYNONYMS:

Strychnos courteti Chev.

Strychnos dulcis Chev.

Strychnos emarginata Bök.

Strychnos gracillima Glig.

Strychnos lokua A. Rich.

Strychnos volkensii Glig.

BAMBARA kankoro HAUSA kokliya
FULANI kumbija KANOURI toria

Use for edible fruit



150. Stylochiton warneckii Engl.

not illustrated

HAUSA gwanda
KANOURI ngura

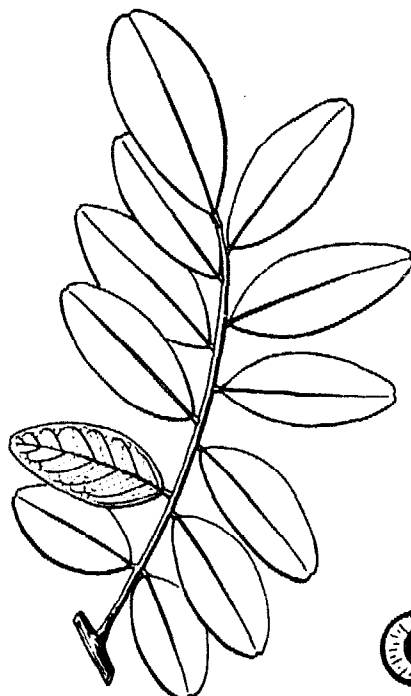

151. Swartzia madagascaraensis Desv.

HAUSA gwaskia
game fada



152. *Syzygium guineense* D.C.

BAMBARA kisse
FULANI asurahi
HAUSA maimo
KANOURI kunar



153. *Tamarindus indica* L.

Also see APPENDIX B

ENGLISH	tamarind tree
FRENCH	tamarinier
CHAD ARABIC	tamr hindi
BAMBARA	tombi
DJERMA	bossaye
FULANI	jtatami
HAUSA	tsamiya
KANOURI	tamsugu
MORE	pousiga

Use for juice from fruit,
woodworking, charcoal

154. Terminalia avicennioides Guill. & Perr.

SYNONYMS:
Terminalia dictyonera Diels.
Terminalia lecardii Engl. & Diels.

BAMBARA	oudlotleni	HAUSA	bauchi
DJERMA	farkahanga	KANOURI	kumanda
FULANI	bodeyi	MORE	barbar
			kutruageia

Use for fodder, firewood, roots
 for dye

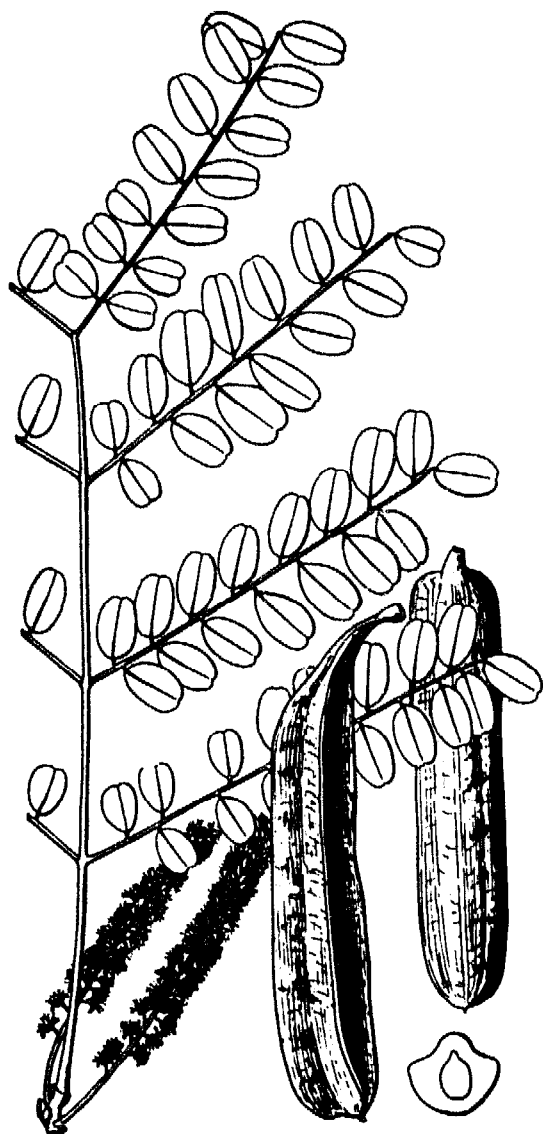
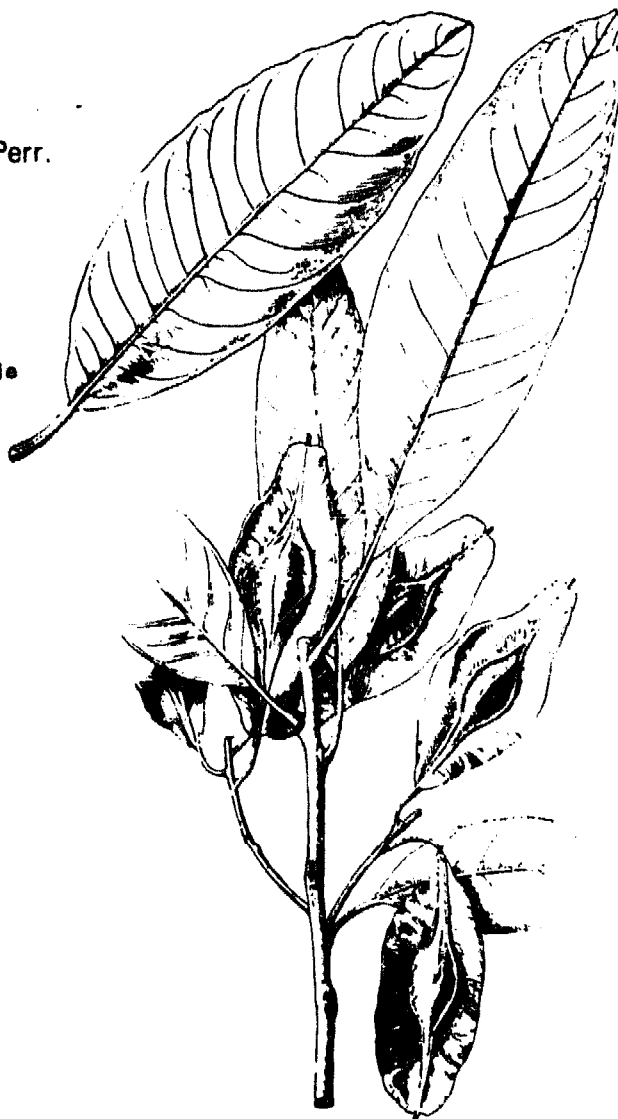

**155. Tetrapleura andongensis Weiw.
 var. schweinfurthii Aubr.**

SYNONYMS:
Tetrapleura obtusangala Weiw.
Tetrapleura nilotica Taub.
Tetrapleura schweinfurthii Taub.
Amblygonocarpus andongensis Weiw. ex Oliv.
Amblygonocarpus schweinfurthii

FULANI	Jigarehi	HAUSA	kirya te mata tsage
--------	----------	-------	------------------------

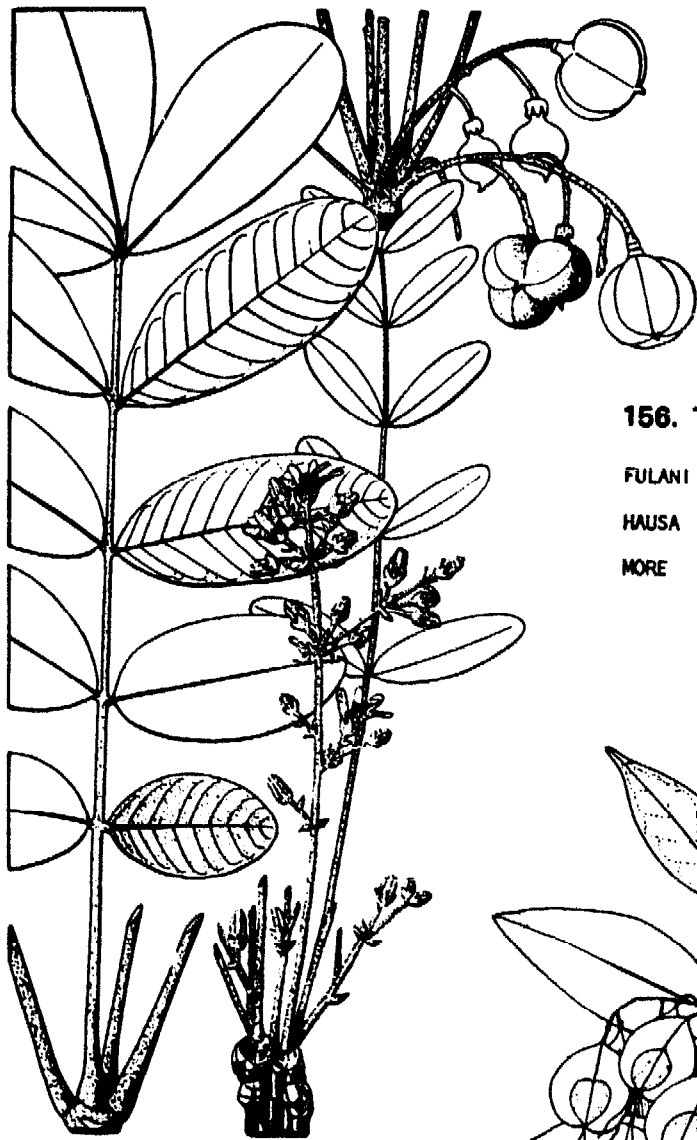

156. *Trichilia emetica* Valh.

FULANI	beszi
	bakurchi
HAUSA	kusa
	jansaaye
MORE	kiklramtango



157. *Uapaca somon* Aubr. & Leandri

SYNONYM: *Uapaca logoensis* Pax

BAMBARA	somon
FULANI	bakurghi
HAUSA	kafafago
KANOURI	goramfi

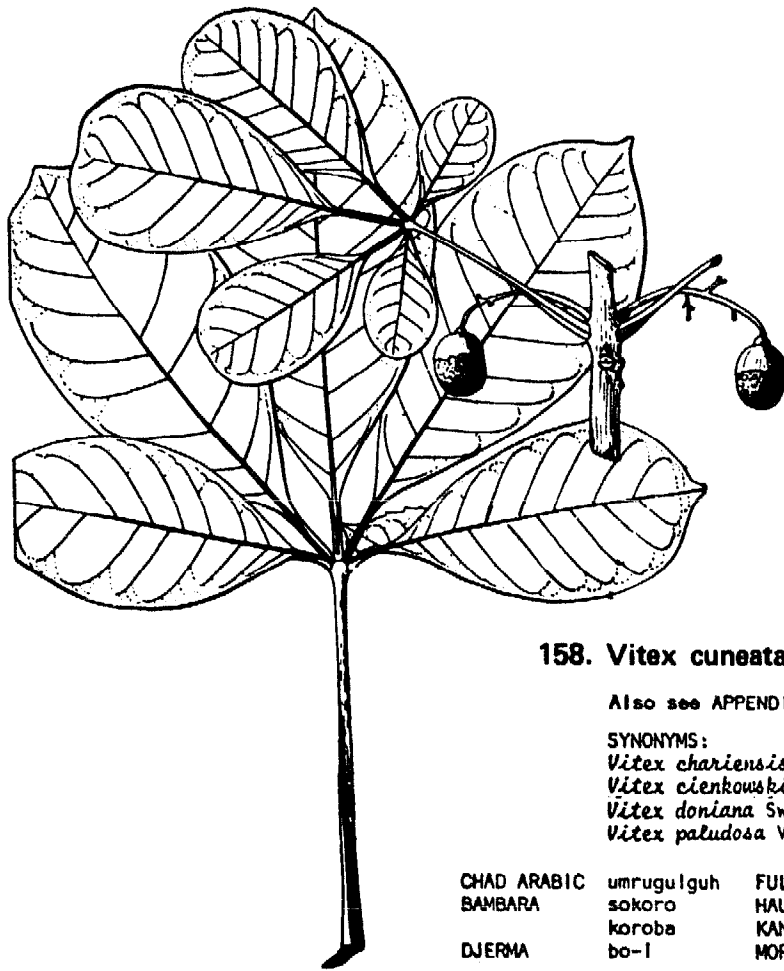

158. *Vitex cuneata* Schum. & Thonn.

Also see APPENDIX B

SYNONYMS:

Vitex chariensis Chev.
Vitex cienkowskii Kotschy & Perr.
Vitex doniana Sweet
Vitex paludosa Vatke

CHAD ARABIC	umrugulguh	FULANI	galbli
BAMBARA	sokoro	HAUSA	dumjaa
	koroba	KANOURI	ngaribi
DJERMA	bo-l	MORE	andega

Use for edible fruit, light
 woodworking, leaves for
 dysentery medicine

159. *Vitex diversifolia* Bak.

SYNONYM:

Vitex simplicifolia Oliv.

BAMBARA	kotoni
FULANI	bummehi
HAUSA	dinyar

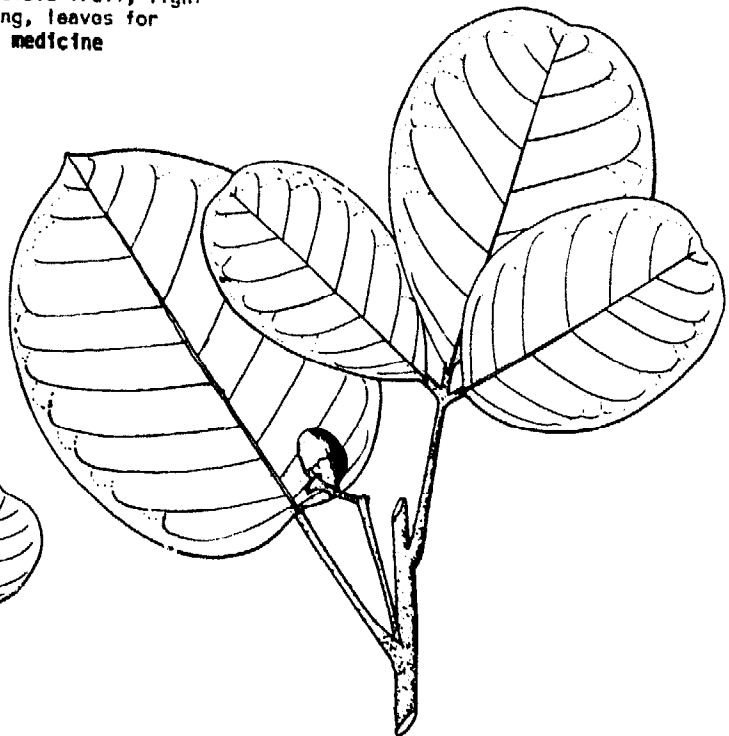
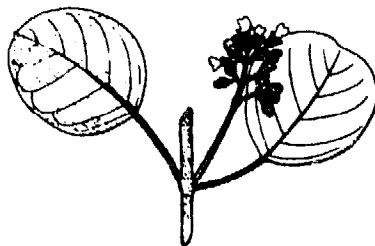

160. Xeromphis nilotica (Stapf.) Keay

not illustrated

SYNONYMS:

Randia nilotica Stapf.
Lachnosiphonium niloticum (Stapf.) Dandy

FULANI glogoti
HAUSA kwenaria
KANOURI bantatai

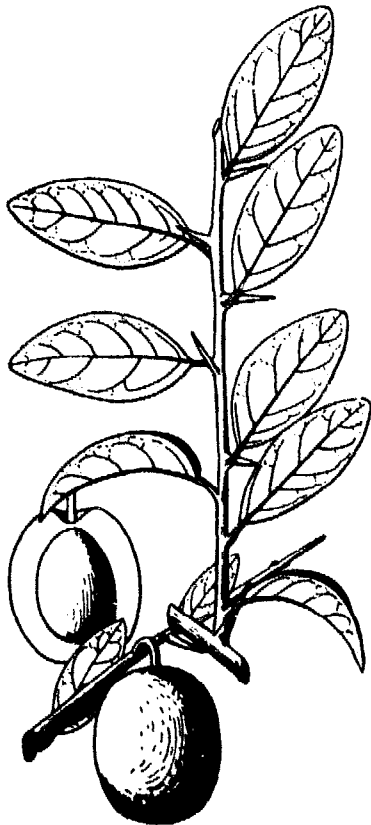

161. Ximenia americana L.

SYNONYM:

Ximenia nilotica

CHAD ARABIC kalto
BAMBARA tonkain
 gani
FULANI chebull
 sene
HAUSA tsada
KANOURI dadin
MORE leanga

Use for edible fruit

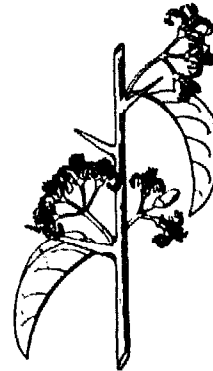

162. Ziziphus abyssinicus Hochst. ex A. Rich.

not illustrated

SYNONYMS:

Ziziphus atacorensis Chev.
Ziziphus baguirmiae Chev.

CHAD ARABIC nabaga
DJERMA dare
FULANI gulum Jabl
HAUSA magari-kura
KANOURI kululu bina

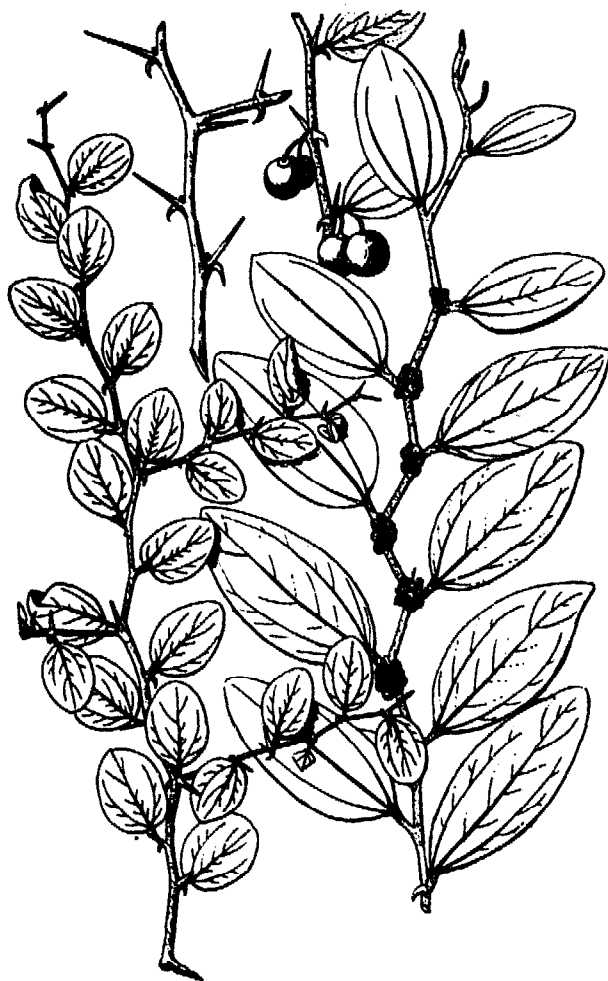

163. Ziziphus mauritiana Lam.

SYNONYMS:

Ziziphus mauritiana Lam.
Ziziphus orthacantha D.C.
Ziziphus jujuba (L.) Lam.

CHAD ARABIC	nabagale
BAMBARA	tomboron niame ba
FULANI	Jell barkevi
HAUSA	mageria
KANOURI	kusulu
MORE	mugunuga bagandre

Use for sweet edible fruit,
 & leaves

164. Ziziphus sieberiana

not illustrated

HAUSA mageria-kura

165. Ziziphus spina christi (L.) Willd.

Also see APPENDIX B

CHAD ARABIC	karno
FULANI	kurnahl
HAUSA	kurna
KANOURI	korna

Use for edible fruit (bitter)



Appendix B

**A Field Guide to 30 Tree Species
Commonly Found in Africa**

Acacia albida Del.

Synonyms: *Faidherbia albida* (Del.) Chev.
Acacia gyrocarpa Hochst.
Acacia saccharata Benth.

Common Names:	ENGLISH	gao	FULANI	tiaiki
	FRENCH	gao	HAUSA	gao
	ARABIC	harraz	KANOURI	haragu
	CHAD ARABIC	araza	MORE	zanga
	BAMBARA	balanzan	SONGHAI	gao
	DJERMA	gao	WOLOF	cadde

Legal Restrictions: Cutting and Removal

GENERAL DESCRIPTION

Large tree, growing as tall as 10m with a large spread-out crown. The bark is dull grey, fissured and scaly. Branchlets are white; spines are thick, white, straight and point downward. Leaves are grey-green; 3-10 pairs pinnules and 6-23 pairs leaflets. A. albida flowers with creamy white blossoms. Seeds are dark brown inside yellow pods which are 8-15cm long. A. albida is highly valued in conservation efforts. It is the only species which loses its leaves during the rainy season; therefore, farming under these trees is not only possible but profitable.

SEEDS

Source: Strong, healthy parent trees.
Collection: Collect pods from ground; seeds ripen January - February (Upper Volta).
Watch for small-size worm holes -- worms destroy the seeds.
Extraction: Mortar/wind separation.
Storage: Stores well.
Pre-Treatment: Necessary; soak in hot water or scarify hull.

NURSERY

Pots/Open-rooted: Only grow in pots because of long tap root.
Time: 10-14 weeks for good size plants. Earlier seeding may be required so plants get somewhat larger before hot weather.
Other Notes: Attempts to collect young plants in the wild not successful because of long tap root. Frequent root pruning required because of tap root. Watch for caterpillar and locust attacks which destroy young leaves. Spray with ordinary insecticide.

PLANTING/SITE REQUIREMENTS

- Soil: Sandy soil; grows well in same type of ground where millet grows (ask farmers). Also can be grown in heavier soils and will stand occasional flooding.
- Water: 350-500mm mean annual precipitation; may be necessary to water newly planted trees in areas where precipitation is at the low end of the scale.
- Direct Seeding: Can be tried under good conditions. Seeds can be fed to livestock. Livestock then graze over the desired area and eliminate seeds with their manure. Leads to natural regeneration.
- Other Notes: Do not disturb potted mix more than necessary when transplanting. Wide spacing of plants (10m X 10m) is required.

USES

- . Good soil conservation tree (can lead to higher yields of crops planted underneath).
- . Pods good food for cattle.
- . Branches useful for fences.
- . Leaves used for animal feed.
- . Wood -- for carving.
- . Bark contains tannin.

SPECIAL NOTES

- Introduction of Acacia albida is considered important and worthwhile by many farmers, a fact which helps gain acceptance of a project using this tree.
- A. albida trees have reached heights of 2 to 4m after only three and four years of growth (Niger and Upper Volta).
- It is not clear yet just how much Acacia albida does enrich the ground around the tree.
- Young trees are hard to protect. The young branches and leaves are enjoyed by animals; young trees are small and hard to see and may be lost during hoeing if not marked. It is usually necessary to protect these trees for 5 - 8 years depending upon area and site conditions.
- The benefits of planting Acacia albida in terms of initial investment, are not clear. Thus, it may be hard to justify a project when seeking funds from certain agencies. However, to eliminate

grazing so that the tree can regenerate naturally is harder to do than to raise the young plants in protected areas.

- A. albida until recently was able to regenerate naturally because the seeds were eaten by and passed from the bodies of animals. Now land and grazing pressures have increased so much that the young trees are being destroyed by browsing animals and cleaning operations.

Acacia caffra Willd. var. **campylacantha** Aubr.

Synonyms: *Acacia campylacantha* Hochst., ex A. Rich.
Acacia catechu W.
Acacia polycantha Willd. subsp. *campylacantha*
(Hochst.) Prenah

Common Names: CHAD ARABIC al guetter HAUSA karo
BAMBARA kuroko tserkafia
FULANI fatariahi KANOURI golawai
MORE guara

Legal Restrictions:

GENERAL DESCRIPTION

Tall, slender tree. Short, curved spines. Seed pods are flat and thin and hang in clusters. Brown seeds are small, flat, and thin.

SEEDS

Source: Strong, healthy trees.
Collection: Pods mature January and February.
Extraction:
Storage:
Pre-Treatment: Put in hot water and soak overnight.

NURSERY

Pots/Open-rooted: One project planted 50 pots with 3 seeds each.
41% of seeds germinated.
Time:
Other Notes: Good germination; grows rapidly.

PLANTING/SITE REQUIREMENTS

Soil: Heavy soil, has adapted to variety of conditions.
Water: Along water courses.
Direct Seeding:

Other Notes:

USES

- . Localized use for construction purposes. Heartwood very hard and resistant to insects.
- . Leaves used for fodder.
- . Bark yields tannin.

SPECIAL NOTES

Acacia scorpioides (L.) var. **nilotica** (L.) A. Chev.

Synonyms: *Acacia nilotica* (L.) Willd.
Mimosa nilotica L.
Acacia arabica (Lam.) var. *nilotica* (L.) Benth.

Common Names: FRENCH gonakier DJERMA bani
CHAD ARABIC sunta, charat, FULANI gaudi
senet, sunt HAUSA bagarua
BAMBARA barana MORE peguenega
diabe
boina

Legal Restrictions: Classified as "Specially Useful"; Cutting and Removal.

GENERAL DESCRIPTION

Small or medium tree 3-8m with long white or grey spines and very dark, almost black, fissured bark. It grows rapidly. Balls of yellow flowers, narrow whitish grey flattened pods.

SEEDS

Source: Strong, healthy trees.
Collection: Seeds ripen in November-December, Upper Volta, and December-January, Niger.
Extraction:
Storage:
Pre-Treatment: Soak overnight.

NURSERY

Pot/Open-rooted: Pots
Time: 14-18 weeks
Other Notes:

PLANTING/SITE REQUIREMENTS

Soil: Heavy soil
Water: Likes a lot of water. Plant where water table is close to surface. Will do well even in areas where periodic flooding occurs.
Direct Seeding:

USES

Live fences and windbreaks. Pods and bark provide natural tanning material.

SPECIAL NOTES

Acacia senegal (L.) Willd.

Synonyms: *Acacia vereh* Guill. & Perr.

Common Names:	ENGLISH	gum arabic	FULANI	dibehi
	FRENCH	gommier		patuki
	CHAD ARABIC	asharat	HAUSA	dakworo
		kitr al abiod	KANOURI	kolol
	BAMBARA	donkori	MORE	goniminiga
DJERMA	danya			

Source of gum arabic

Legal Restrictions: Cutting and removal. The nature, site, and propagation requirements of this species place its development, protection, and production under control of forest services.

GENERAL DESCRIPTION

Bush or small tree usually less than 5m high, but sometimes is as tall as 9m. Bushes are low-branched with flat crowns and form thickets. Pale brown or grey bark. Branches have short, curved thorns or spines in groups of 3. Grey-green leaves, 3-6 pairs of pinnules and 8-18 pairs of leaflets. *A. senegal* has creamy white flowers; brown seed pods which are flat and papery. Each pod contains 1-5 greenish brown seeds. *A. senegal* produces gum arabic between ages of 4 and 18.

SEEDS

Source: Strong, healthy parent trees.
Collection: Seeds ripen in November-December, South-central Niger, and January, Upper Volta.
Extraction:
Storage:
Pre-Treatment: Put seeds in hot water and soak overnight.

NURSERY

Pot/Open-rooted: Pots or open-root. One project planted 50 pots with 3 seeds per pot. 27% germination.
Time: 14-18 weeks in pots.
Other Notes: Only fair germination.

PLANTING/SITE REQUIREMENTS

- Soil:** Sandy soils, dry savanna, abandoned fields or dunes stabilized by grasses.
- Water:** Driest sites; 350mm mean annual rainfall.
- Direct Seeding:** Can be directly seeded easily. Watch for insect and rodent damage.
- Other Notes:**

USES

- . Produces gum arabic, a money crop on world market.
- . Live fencing.
- . Source of tannin.
- . Browse for animals.
- . Firewood and charcoal.

SPECIAL NOTES

- It is not known how this tree will grow in regions of heavier rainfall.
- Because this tree produces a special product (gum arabic), it is being studied in many ways. Extension activities are underway to advise people on how to get higher yields from tapping procedures and how to market the product. Countries are seeking ways to increase output of gum arabic for world markets.
- It may be more feasible to protect and encourage natural regeneration than to start extensive planting efforts.

Acacia sieberiana D.C.

Synonyms: *Acacia verugera* Schweinf.
Acacia sanguinea Guill. & Perr.
Acacia rehmanniana
Acacia villosa
Acacia fischerii
Acacia monga
Acacia verhoensis
Acacia nefasia Schweinf.

Common Names: CHAD ARABIC kuk
BAMBARA baki
FULANI gie daneji
HAUSA boudji
 dushe
KANOURI katalogu
MORE golponsgo

Legal Restrictions:

GENERAL DESCRIPTION

Acacia sieberiana is a large acacia, up to 15m tall. It has long white, straight spines and fairly smooth, light olive or yellowish-colored bark. Crown is flat-topped, umbrella-shaped or irregular. 10-25 pinnules; 20-40 folioles. Seed pods are brown and thick-skinned. The wood is semi-hard and termite resistant.

SEEDS

Source:
Collection:
Extraction:
Storage:
Pre-Treatment: Put in hot water and soak seeds overnight.

NURSERY

Pots/Open-rooted: Pots; one project planted 50 pots, 3 seeds per pot. 8.7% germination.
Time:
Other Notes: Varying germination results.

PLANTING/SITE REQUIREMENTS

Soil: Prefers low-lying, heavy soil, but grows in a variety of soils.

Water: Grows well in areas with higher rainfall.

Direct Seeding:

Other Notes:

USES

- . Wood is easy to work with and is used to make tool handles and other light objects.
- . Good firewood and charcoal.
- . Bark is a source of tannin.
- . Some value in live fencing and windbreaks.
- . Produces a type of gum arabic.

SPECIAL NOTES

Adansonia digitata L.

Synonyms:

Common Names:	ENGLISH	baobab	FULANI	bokki
	FRENCH	baobab	HAUSA	kuka
	CHAD ARABIC	hahar	KANOURI	kuka
	BAMBARA	sito	MORE	toega
	DJERMA	konfan		

Legal Restrictions: "Specially Useful"; Cutting and Removal;

GENERAL DESCRIPTION

Large tree up to 18m tall with an enormous trunk. Roots which extend far from base of tree. Seeds do not germinate well; therefore, young trees in wild are hard to find. Adult tree flowers with white blossoms; fruit hangs from long stem and is good to eat. Seeds are acid and may be cooked or eaten fresh. Leaves are palmately divided into 5-7 segments.

SEEDS

Source:
Collection: Seeds ripen December-February, Upper Volta.
Extraction:
Storage:
Pre-Treatment:

NURSERY

Pots/Open-rooted: Good results with open-rooted stock.
Time:
Other Notes: In pot culture, some seeds can take up to a year to germinate.

PLANTING/SITE REQUIREMENTS

Soil:
Water:
Direct Seeding:

Other Notes:

USES

- . A major food tree of Hausas -- leaves dried and used for flavoring sauces.
- . Bark used to make mats, paper

SPECIAL NOTES

Albizzia chevalieri Harms.

Synonyms:

Common Names:	CHAD ARABIC	ared	HAUSA	katsari
	BAMBARA	golo iri	KANOURI	tsagle
	FULANI	jarichi	MORE	ronsedonga
		nyebal		

Legal Restrictions:

GENERAL DESCRIPTION

Small to medium tree with a branching crown. Leaves contain 8-12 pinnules and 20-40 folioles. Pods are thin and oblong and contain flat round seeds. It is found throughout the region.

SEEDS

Source:
Collection:
Extraction:
Storage:
Pre-Treatment: Put in hot water and soak overnight.

NURSERY

Pots/Open-rooted: Pots planted in one test -- 40 pots with 3 seeds each -- showed 61% germination.
Time:
Other Notes:

PLANTING/SITE REQUIREMENTS

Soil: Sahel and Sudan zones.
Water:
Direct Seeding:
Other Notes:

USES

- . Primarily firewood.
- . Some uses for root fiber.

SPECIAL NOTES

Anacardium occidentale L.

Synonyms:

Common Names:

Legal Restrictions: The nature of the tree places its development and production under protection of forestry service programs.

GENERAL DESCRIPTION

Small spreading evergreen tree which grows to about 9m. Bark is rough; flowers are small. Fruit is a kidney-shaped nut with a hard covering which contains bitter black juice. Stalk of the flower swells into a juicy pear-shaped body. A hardy tree for planting in poor soil and dry areas.

SEEDS

Source: Ripe fruit.
Collection: Pick fruit from trees in late February, Southwest Niger.
Extraction: Separate hull from fruit.
Storage: Leave in hull and dry; stores well.
Pre-Treatment: None necessary.

NURSERY

Pots/Open-rooted: Plant only in pots; open-rooted stock almost impossible to transplant without root damage.
Time: 14-18 weeks in pots.
Other Notes: Plant seed with convex side up. Cover with 3cm of dirt. Watch for termite problems during germination and again when transplanting. Spray with Dieldrin or Chlordane.

PLANTING/SITE REQUIREMENTS

Soil: Will grow in many types of soil; grows well in sandy soil, low country up to 150m; grows well on eroded and other poor sites.
Water: At least 500-700mm annual precipitation.
Direct Seeding: Possible; some projects have had good results; many seeds are needed.
Other Notes:

USES

- . Tree produces the cashew nut -- a valuable product in foreign markets.
- . Construction - packing cases; boat-building; firewood.

SPECIAL NOTES

- Ideal tree for soil cover and conservation purposes.
- Seems to grow in all soils, except for rock, down to about 500mm mean annual precipitation. However, in areas of lower rainfall, the tree produces less fruit.
- Bark contains up to 10% tannin.

Anogeissus leiocarpus Guill. & Perr.

Synonyms:	<i>Anogeissus schimperi</i> Hochst. ex Hutch & Dalz.
Common Names:	CHAD ARABIC sahab BAMBARA krekete DJERMA gonga FULANI kojoli HAUSA marike KANOURI annum MORE sigha piega

Legal Restrictions: Classified as "Specially Useful."

GENERAL DESCRIPTION

Anogeissus leiocarpus is a medium to large tree which often gets very tall. Leaves are small and lanced; fruits are small, yellowish-brown colored cones containing many seeds. The wood is heavy and hard.

SEEDS

Source:
Collection:
Extraction:
Storage:
Pre-Treatment: None necessary.

NURSERY

Pots/Open-rooted: Experiments with growth in pots proved non-successful.
Time:
Other Notes: Slow growth discourages artificial propagation. There has been little success in germinating.

PLANTING/SITE REQUIREMENTS

Soil: Moist, low-lying soil along water courses.
Water: 900-1,200mm mean annual precipitation.
Direct Seeding:
Other Notes:

USES

- . Hard wood useful for fence posts. Construction and woodworking.
- . Ashes of the wood used for potash in soap-making and dyeing.

SPECIAL NOTES

- This is an impressive tree because of its large size. But growth is very slow, and discouraging nursery results make its potential doubtful at the moment. More research is needed.

Azadirachta indica A. Juss.

Synonyms:

Common Names: ENGLISH Neem FRENCH Neem

Legal Restrictions:

GENERAL DESCRIPTION

Moderate-sized to large evergreen tree (11m tall) with dense, rounded crown. Grows fairly rapidly. Bark is thick and dark grey. Flowers with bunches of small white blossoms, from March to May; fruit ripens from mid-May.

SEEDS

Source: Local trees; use fresh seeds only.
Collection: For best harvest, clean area under tree and collect freshly fallen seeds only.
Extraction: Soak seeds and pulp in water. Separate by hand while under water; spread seeds out to dry.
Storage: Seeds do not store well; viability drops near zero within a few weeks unless special storage is possible.
Pre-Treatment: None required, but pre-germinating in moist sand helps reduce empty space in nursery. Bury seeds in sand and keep wet for one week. Plant only seeds which are swollen.

NURSERY

Pots/Open-rooted: Can be planted in pots -- good-sized trees in 3 months. Usually planted as open-rooted stock.
Time: Leave open-rooted stock 8-11 months (trees average 1m high).
Other Notes: Plant seeds in horizontal position in beds or pots.
When transporting open-rooted stock, strip to terminal bud and wrap roots. Keep roots moist.

PLANTING/SITE REQUIREMENTS

Soil: Grows on most kinds of soil, even clay; will grow on rocky ground with good drainage; not suitable for laterite outcrops.

Water: Plant in areas having 500-700mm mean annual precipitation. Grows well where groundwater is available within 9-12m of the surface.

Direct Seeding: Works well in good locations; best to plant as individual trees or in lines

Other Notes: Needs rain within 4-6 days after planting or survival is doubtful.

USES

- . Firewood
- . Construction wood
- . Fence posts, when treated with pesticide
- . Reforestation purposes
- . Seeds yield oil for soap and burning

SPECIAL NOTES

Balanites aegyptiaca (L.) Del.

Synonyms:

Common Names:	CHAD ARABIC	hajijj	KANOURI	chingo
	BAMBARA	seguene		bito
	DJERMA	garbey	MORE	tiegaliga
	FULANI	tanni		
	HAUSA	adoua		

Legal Restrictions: Classified as "Specially Useful"; cutting and removal.

GENERAL DESCRIPTION

Small or medium tree, up to 10m high, with small, oval, grey-green leaves and long, straight, green spines. Bark is greyish green to brown and is fissured. Fruits resemble dates and are yellow when ripe. The wood is hard and heavy and has a fine texture. This tree is fairly resistant to termites.

SEEDS

Source:

Collection: Seeds ripen in September-October, Upper Volta; October-December, Niger;

Extraction: Soak fruit in water and separate seeds from pulp.

Storage:

Pre-Treatment: Soak in lukewarm water overnight.

NURSERY

Pots/Open-rooted: Seeds planted in pots -- 50 pots, 2 seeds per pot -- showed 61% germination.

Time: 18-24 weeks in pots.

Other Notes:

PLANTING/SITE REQUIREMENTS

Soil: Dry sites, prefers sandy soil which occasionally floods.

Water: 350-500mm mean annual precipitation.

Direct Seeding: Possible and worth doing.

Other Notes:

USES

- . Construction from light woodworking to heavy carpentry
- . Fruit is sweet and is a favorite food
- . Animals, particularly camels, use for browse
- . Strong emulsions of fruits may be used to poison fish

SPECIAL NOTES

- An excellent, all-around species well worth propagating, either in plastic pots or by direct seeding.
- The wood is fine-grained, easy to work, durable, and resistant to insects.

Bauhinia reticulata D.C.

Synonyms: *Bauhinia glabra* A. Chev.
Bauhinia glauca A. Chev.
Piliostigma reticulatum (D.C.) Hochst.

Common Names: CHAD ARABIC harum HAUSA calgo
BAMBARA niamaba KANOURI kaldu
DJERMA kosseye MORE barani
FULANI barkevi

Legal Restrictions:

GENERAL DESCRIPTION

Bush or small tree up to 6m with spherical crown. Leaves are large grey-green color and consist of two distinct symmetrical lobes. Bark is dark brown to grey or nearly black. Seed pods hang and are large, thick and reddish-brown in color.

SEEDS

Source: Local trees.
Collection: Seeds ripen December-January; as early as October, November in some areas (parts of Upper Volta, for example).
Extraction:
Storage:
Pre-Treatment: Hot water overnight.

NURSERY

Pots/Open-rooted: Pots; 3 seeds per pot.
Time:
Other Notes: Poor germination results in nursery.

PLANTING/SITE REQUIREMENTS

Soil: Wide variety of soil, including sand, laterite and heavy clay.

Water:

Direct Seeding: Possible.

Other Notes:

USES

- . Firewood.
- . Local medical purposes.
- . Shade tree because of large crown.
- . Bark contains tannin.

SPECIAL NOTES

- This is an abundant tree, and this fact makes it of questionable value for a nursery project. Nevertheless, it should be encouraged in fallow areas by direct seeding or cuttings.

Borassus aethiopum Mart.

- Synonyms:** *Borassus flabellifer* L. var. *aethiopum* (Mart.) Warb.
- Common Names:**
- | | | | |
|-------------|---------|---------|-----------------|
| FRENCH | ronier | FULANI | dubbi |
| CHAD ARABIC | deleb | HAUSA | gigunia |
| DJERMA | sabouze | KANOURI | ganga, kemeiutu |
- Legal Restrictions:** Cutting and Removal; the nature, site, and propagation requirements of this species place its development, protection, and production under control of forest services.

GENERAL DESCRIPTION

Tall palm up to 25m. Stem is straight and smooth in old trees. Bark is dark grey; fan-shaped leaves up to 4m long. Orange fruit about 15cm long and 12cm wide. Each fruit contains 3 hard-coated edible seeds surrounded by edible flesh. Hard, heavy wood very resistant to termites.

SEEDS

Source: Local trees.
Collection: Pick from ground.
Extraction: Not applicable.
Storage:
Pre-Treatment: None required.

NURSERY

Pots/Open-rooted:
Time:
Other Notes: Not raised in nursery.

PLANTING/SITE REQUIREMENTS

Soil: Moist, low spots.
Water: Over 800mm annual precipitation; lowland areas with high watertable; swamp grass sites.
Direct Seeding: Any method possible. Good results in likely sites.
Other Notes:

USES

Construction -- housing, fencing, etc. It is especially useful as rafters in mudwall housing. It is rarely attacked by termites and natural oils make it one of the most durable natural post materials known.

SPECIAL NOTES

- Tree grows slowly. May take 10 years for good crown to develop.
- Borassus brings prices on the construction market almost equal to imported structural steel.
- Regeneration attempts have shown good results.

Butyrospermum parkii Kotschy

Synonyms:

Common Names: CHAD ARABIC sirreh HAUSA bagay
BAMBARA berekunan KANOURI marga
tamba

Legal Restrictions: Cutting and Removal.

GENERAL DESCRIPTION

Small tree with thick, dark-grey, deeply fissured bark and long strap-like leaves. Flowers with white blossoms between May and August. Mature fruit is green and about 5cm long. Each fruit contains one seed (shea nut); collected in July.

SEEDS

Source: Strong, healthy trees.
Collection: Find newly fallen seeds.
Extraction: Shells easily.
Storage:
Pre-Treatment: None required.

NURSERY

Pots/Open-rooted: Pots.
Time: 14-24 weeks in pots.
Other Notes: Plant with the point of the white part of the seed down.

PLANTING/SITE REQUIREMENTS

Soil: Moist, medium-to-heavy soil;
Water: Above 700mm mean annual precipitation or along mares and low spots.
Direct Seeding: Possibilities unknown.
Other Notes:

USES

- . Hard wood used for mortar.
- . Hard to work but accepts a polish.
- . Nut produces butter -- useful for cooking, lamp burning and cosmetic purposes -- both for local and export use.

SPECIAL NOTES

-- Tree is tolerant of annual burning.

Cassia siamea Lam.

Synonyms:

Common Names: FRENCH cassia

Legal Restrictions:

GENERAL DESCRIPTION

Moderate-sized evergreen with dense crown and smooth grey bark. Yellow flowers in large bunches. Pods 10-25cm long hanging in clusters. Foliage is especially attractive to pigs. However, the leaves are poisonous and animals must not be allowed to browse on these trees. Tree grows fairly rapidly.

SEEDS

Source: Strong, healthy trees.
Collection: December and January collect unopened pods.
Extraction: Dry in sun and beat with stick. Mortar and wind separation.
Storage:
Pre-Treatment: Cut; soak in warm water.

NURSERY

Pots/Open-rooted: Pots only in special situations. Most seeds are open-rooted.
Time: 4-5 months in pots; 30 weeks to one year open-rooted.
Other Notes: Potted plants require pruning; plant as a "stump."

PLANTING/SITE REQUIREMENTS

Soil: Moist soil with good drainage.
Water: 500-700mm minimum annual precipitation; trees do better with more rainfall.
Direct Seeding: Possible, but not done extensively.
Other Notes: Plant a stump 10cm above ground; cut roots to 20cm.

USES

- . Firewood, but is smokey.
- . Construction.
- . Good, dense windbreaks with no undergrowth.
- . Reforestation purposes.

SPECIAL NOTES

Ceiba petandra (L.) Gaertn.

Synonyms:	<i>Eriodendron orientale</i>
Common Names:	ENGLISH silk cotton tree
	FRENCH fromager
	CHAD ARABIC rum
	FULANI bantahi
	HAUSA rimf
	KANOURI tom
	MORE gunga

Legal Restrictions: Classified as "Specially Useful."

GENERAL DESCRIPTION

Ceiba petandra is an impressive tree up to 60m with a wide trunk and large base roots. The trunk gradually tapers to a narrow tip. Bark is smooth and grey; it is valued for beauty, shade and cotton-like material yielded from seed pods. This is an important plantation crop tree.

SEEDS

Source: Healthy trees.
Collection:
Extraction:
Storage:
Pre-Treatment:

NURSERY

Pots/Open-rooted: Open-rooted.
Time:
Other Notes:

PLANTING/SITE REQUIREMENTS

Soil: Forest conditions, low elevations.
Water: Prefers sites where water is near or on the surface or areas having heavy rainfall.
Direct Seeding:
Other Notes:

USES

- . Shade tree.
- . Cotton-like fiber (kapok) used for stuffing.
- . Canoes from wood.
- . Cuttings used as living fence posts.
- . Seeds edible fresh, germinated or after extracting oil for cattle feed.
- . Leaves yield hair lotion and medicine.

SPECIAL NOTES

Entada sudanica Schweinf.

Synonyms:

Common Names:	CHAD ARABIC	dorot	HAUSA	tawatsa
	BAMBARA	diamba	KANOURI	falofala
		samanere	MORE	sianlogo
	FULANI	fado-wanduhi		

Legal Restrictions:

GENERAL DESCRIPTION

Small tree with leaves containing 5-7 pairs of pinnules and 14-24 pairs of folioles. Pods are shaped like large, flat plates.

SEEDS

Source:
Collection:
Extraction:
Storage:
Pre-Treatment: Hot water overnight.

NURSERY

Pots/Open-rooted: Pots.
Time:
Other Notes: 10 pots planted with 3 seeds per pot showed 67% germination.

PLANTING/SITE REQUIREMENTS

Soil: Sudan savanna.
Water:
Direct Seeding:
Other Notes:

USES

- . Firewood (fair).
- . Bark used for rope.
- . Medical purposes.

SPECIAL NOTES

Eucalyptus camaldulensis Dehnh.

Synonyms: *Eucalyptus rostrata* Schlecht.

Common Names:

Legal Restrictions:

GENERAL DESCRIPTION

A fast-growing, tall (18-45m) tree. Bark of older tree rose-pink; flowers profusely; seed germinates well. Moderately heavy, hard wood.

SEEDS

Source: Nearest seeds available in Northern Nigeria (*Eucalyptus camaldulensis*, Australian origin). There are, however, reports of the first fruit-bearing by some of the oldest trees planted in Niger. Seeds can be ordered direct from Australia. Israel also has seeds available and so does the French Tropical Forestry Research Agency (C.T.F.T.). Considerable lead time is needed. Varieties selected must be drought resistant and termite proof in both green and dead stage.

Collection:

Extraction:

Storage:

Pre-Treatment:

NURSERY

Pots/Open-rooted: Pots.

Time: 18-24 weeks in plastic pots.

Other Notes: Seeds are very, very small and can be germinated by Nobile Method (See SPECIAL NOTES) or planted directly into plastic pots.

PLANTING/SITE REQUIREMENTS

Soil: Heavy or rocky soils at altitudes under 610m.

Water: At least 800mm of rain or access to plentiful groundwater. Where mean annual rainfall is 1,00mm or less, plant only along water courses.

Direct Seeding:

Other Notes: May require additional care and watering during first year.

USES

- . Reforestation -- root system useful in protecting banks of water courses from erosion.
- . Bark yields tannin.

SPECIAL NOTES

Nobila Method: (see Section 6, "Nursery Management", page 63)

- Prepare germination beds.
- Screen materials (sand and manure) for top 4 inches.
- Treat with Dieldrin solution, 0.5% to 1% concentration.
- Mix seeds with fine sand and spread over bed.
- Cover lightly with screened sand.
- Keep top layer moist at all times.
- Apply water as fine spray.
- Transplant into plastic pots after trees have developed 3 or 4 primary leaves.
- Water frequently with fine spray.
- Keep in complete shade for first week.

Direct seeding into pots:

- Prepare soil mixture for the pots by adding HCH or Dieldrin -- 1 kilogram/2500 pots.
- Fill pots as usual.
- Put seeds into soil.
- Put 3-5mm of water into a cup.
- Moisten needle with the water to a height not exceeding 3mm.
- Plunge the needle into the eucalyptus seeds (you will find several seeds clinging to the point of the needle).
- Pierce the surface of the soil in the pots with the needle at an angle of 45° and to a depth of not over 10mm.
- Any sort of watering method may now be used.
- When transplanting seedlings into empty pots, one should only use seedlings which are between 25mm and 50mm high.

Gmelina arborea Roxb.

Synonyms:

Common Names: ENGLISH melina

Legal Restrictions:

GENERAL DESCRIPTION

Rapidly growing species, up to 15-80m. Many wonderfully scented yellow and brown flowers and yellow fruits. Wood lasts well under water. Introduced as a firewood tree from tropical Asia; suffers from infection in certain areas.

SEEDS

Source: Old trees (scarce); import from other countries.
Collection: Seeds ripen in March-April, Upper Volta.
Extraction:
Storage:
Pre-Treatment: Soak overnight.

NURSERY

Pots/Open-rooted: Not planted in pots. Open-rooted.
Time:
Other Notes:

PLANTING/SITE REQUIREMENTS

Soil: Good, well-drained soils.
Water: Where mean annual rainfall is 1,000mm or less, plant only along water courses or in irrigated areas.
Direct Seeding: Possible in tropical forests.
Other Notes: Plant as a stump.

USES

- . Wood for match sticks.
- . Boxes.

SPECIAL NOTES

Guiera senegalensis Lam.

Synonyms:

Common Names:	CHAD ARABIC	kabeah
	BAMBARA	kudiengbe
	DJERMA	sabara
	FULANI	gelloki
	HAUSA	sabara
	KANOURI	kasasai
	MORE	unuiga

Legal Restrictions: Classified as "Specially Useful."

GENERAL DESCRIPTION

Bush or small tree. Small grey-green leaves opposite one another on the branches. Fruits are long, narrow capsules covered with large hairs.

SEEDS

Source:
Collection:
Extraction:
Storage:
Pre-Treatment: None necessary.

NURSERY

Pots/Open-rooted: Pots.
Time:
Other Notes: Project which planted 10 pots, 3 seeds per pot, showed 10% germination. Poor germinator.

PLANTING/SITE REQUIREMENTS

Soil: Sandy areas, particularly fields in fallow.
Water:
Direct Seeding: Probably best method; reproduces rapidly.
Other Notes: Worthwhile to plant cuttings.

USES

- . Firewood -- a principal firewood species.
- . Browse for camels.
- . Local medicine against dysentery.

SPECIAL NOTES

Lannea acida A. Rich.

Synonyms:

Common Names:

FULANI	faruhi
HAUSA	farou
KANOURI	adarazagai
MORE	pekuni
	sabga

Legal Restrictions:

GENERAL DESCRIPTION

Small-to-medium tree with scaly, fissured, dark-colored bark on a red trunk. Leaves consist of 3-6 pairs elliptical folioles. Fruits look like cherries.

SEEDS

Source:
Collection:
Extraction: Soak fruit to separate seed and pulp. Dry seeds.
Storage:
Pre-Treatment: Soak in lukewarm water overnight.

NURSERY

Pots/Open-rooted: Good germination in pots.
Time:
Other Notes: 10 pots planted with 2 seeds per pot showed 80% germination.

PLANTING/SITE REQUIREMENTS

Soil: Sudan zone.

Water:

Direct Seeding:

Other Notes:

USES

- . Firewood -- high quality.
- . Rope from bark.
- . Food -- fruits widely eaten.

SPECIAL NOTES

- A valuable tree for firewood and food whose propagation should be encouraged.

Parkia biglobosa Benth.

Synonyms: *Parkia clappertoniana* Keay
Mimosa biglobosa Jacq.

Common Names: FRENCH nere FULANI narghi
CHAD ARABIC maïto HAUSA dorowa
BAMBARA nere KANOURI runo
DJERMA dosso MORE rouaga

Legal Restrictions: Cutting and Removal.

GENERAL DESCRIPTION

Medium-to-large tree, up to 15m, with dense, spreading crown. Leaves consist of 14-30 pairs of pinnules and 50-70 pairs of small leaflets. Tree has hanging red flowers; seeds develop in long, narrow pods. Bark is thick and deeply fissured. The wood is hard and heavy but is easily attacked by termites.

SEEDS

Source: Strong, healthy trees; local market.
Collection: Pick the largest, freshly fallen seeds.
Extraction: Remove from pod.
Storage: Viability better when used right away.
Pre-Treatment: Soak overnight in hot water.

NURSERY

Pots/Open-rooted: Pots only.
Time: 10-14 weeks.
Other Notes: Special care; germination results variable depending upon age of seeds.

PLANTING/SITE REQUIREMENTS

Soil: Deep, heavy sand (type where sorghum grows well); known to survive on poor, rocky sites as well.

Water: 500-700mm mean annual precipitation.

Direct Seeding: Worth trying.

Other Notes:

USES

- . Light woodworking.
- . Pulp of seed dried and used as flour.
- . Seeds produce flavoring for sauces.
- . Bark yields tannin for tanning and dyeing.

SPECIAL NOTES

- Parkia is often left standing in millet fields for its shade and fruits. It is one of the few species farmers will actually plant themselves.
- There is great demand for this tree. Given the demand and the ease of raising the tree, it may be good to consider as a cash crop. In some areas, there is enough market for the seeds to warrant establishing special plantations.

Parkinsonia acculeata L.

Synonyms:

Common Names: DJERMA sassa bani
HAUSA sharan abi
KANGURE sharan labi

Legal Restrictions:

GENERAL DESCRIPTION

Tree grows to about 10m. Long branches which are covered with 3cm-long spines and which droop. Many bright-yellow flowers.

SEEDS

Source: Local trees.
Collection: Seeds ripen in December-January, Upper Volta. Pods containing viable seeds often remain on tree for several months. Pick dry pods only.
Extraction: Shell by hand; shells come off easily.
Storage:
Pre-Treatment: Soak overnight in hot water, or clip end for faster germination (few days only).

NURSERY

Pots/Open-rooted: Pots.
Time: 6-10 weeks in pots.
Other Notes: Easy to raise, but roots need pruning.

PLANTING/SITE REQUIREMENTS

Soil: Dry sites.
Water: 350-400mm mean annual precipitation.
Direct Seeding: Worth trying.
Other Notes:

USES

- . Firewood.
- . Live fences.
- . Windbreaks and soil cover for conservation.

SPECIAL NOTES

Poupartia birrea (Hochst.) Aubr.

Synonyms: *Sclerocarya birrea* Hochst.

Common Names:

Legal Restrictions:

GENERAL DESCRIPTION

Small tree with well-developed crown. Leaves contain 7-8 pairs of folioles. Fruits are large, round, and yellow when ripe.

SEEDS

Source:

Collection: Seeds ripen in April-May, Niger.

Extraction:

Storage:

Pre-Treatment: Lukewarm water overnight.

NURSERY

Pots/Open-rooted: Pots.

Time:

Other Notes: 10 pots, 2 seeds per pot, had germination rate of 90%.

PLANTING/SITE REQUIREMENTS

Soil: Throughout Sahel and Sudan zones.

Water:

Direct Seeding:

Other Notes:

USES

- . Light woodworking, particularly in manufacture of mortars.
- . Pulp of fruit is a popular food and is used to produce a kind of beer.
- . Local value for medical purposes.

SPECIAL NOTES

The tree's high germination rate and the value of its wood and fruit seem to justify propagation in the nursery.

Prosopis africana Taub.

Synonyms: *Prosopis oblonga* Benth.

Common Names:
BAMBARA guele
FULANI koki
HAUSA kiriya
KANOURI simain
MORE niuri-segue

Legal Restrictions: Classified as "Specially Useful."

GENERAL DESCRIPTION

Medium tree with light-colored foliage. It grows rapidly. Leaves have 2-4 pinnules and 6-12 folioles. There is a gland between each pair of pinnules and folioles. Pods are dark-brown cylinders which are thick and hard. Wood is hard and semi-heavy and has fine texture.

SEEDS

Source:
Collection: Seeds ripen in February-March, Niger.
Extraction:
Storage:
Pre-Treatment: Warm stratification. Hot water overnight.

NURSERY

Pots/Open-rooted: Pots.
Time: 14-18 weeks.
Other Notes:

PLANTING/SITE REQUIREMENTS

Soil: Usually grows in abandoned fields or where forest has been replaced by savanna.

Water:

Direct Seeding:

Other Notes: Grows singly, not in clusters.

USES

- . Heavy carpentry and light woodworking uses.
- . Charcoal for blacksmithing.
- . Bark of the roots used for tanning hides.

SPECIAL NOTES

- Should be encouraged in the nursery because of rapid growth and high-quality of wood.

Prosopis juliflora (Sw.) D.C.

Synonyms: *Prosopis chilensis* (Mol.) Stuntz
Ceratonia chilensis Mol.

Common Names: ENGLISH (USA) mesquite

Legal Restrictions:

GENERAL DESCRIPTION

SEEDS

Source: Order trees.
Collection: Pick when yellowish and partly dry.
Extraction: Messy. Mortar and wind, or hand separation; powder is sticky.
Storage:
Pre-Treatment: Hot water; clipping is possible but difficult.

NURSERY

Pots/Open-rooted: Pots. Open-root possible, but needs special lifting-out care.
Time: 12-14 weeks.
Other Notes:

PLANTING/SITE REQUIREMENTS

Soil: Rich, heavy soil; prefers some clay.
Water: Areas under 600mm mean precipitation.
Direct Seeding: Should be encouraged on a trial basis.
Other Notes:

USES

- . Wood useful for fence posts.
- . Firewood.
- . Live fencing and windbreaks.
- . Food for animals.

SPECIAL NOTES

Tamarindus indica L.

Synonyms:

Common Names:	ENGLISH	tamarind tree
	FRENCH	tamarinier
	CHAD ARABIC	tamr hindi
	BAMBARA	tombi
	DJERMA	bossaye
	FULANI	jtatami
	HAUSA	tsamiya
	KANOURI	tamsugu
	MORE	pousiga

Legal Restrictions: Cutting and Removal.

GENERAL DESCRIPTION

Tree of medium-to-large size up to 15m recognized by its dense, well-rounded crown. Bark is reddish-grey and is fissured. Leaves consist of 10-15 pairs of folioles. Seed pods are reddish-brown and cylindrical. Pale yellow wood bends well and is strong.

SEEDS

Source:
Collection: January-March, depending upon location.
Extraction: Soak fruit to remove pulp; dry the seeds.
Storage:
Pre-Treatment: None required.

NURSERY

Pots/Open-rooted: Pots.
Time: 18-24 weeks.
Other Notes: Project planted 50 pots, 3 seeds per pot; 63% germination. Germinates well and grows rapidly in pots.

PLANTING/SITE REQUIREMENTS

Soil: Grows best in sandy soil along coasts.
Water: More than 800mm annual precipitation or along mares and low spots.
Direct Seeding:

Other Notes:

USES

- . Wood for furniture and boatbuilding.
- . Excellent charcoal.
- . Produces tamarind fruit, which is used to make drinks and soups.
- . Shade.
- . An herb/spice to add flavor to main dishes.

SPECIAL NOTES

- In some areas, there is sufficient demand for the fruit to justify special plantations.
- Some countries export the fruit.

Vitex cuneata Schum. & Thonn.

Synonyms: *Vitex chariensis* Chev.
Vitex cienkowskii Kotschy & Perr.
Vitex doniana Sweet
Vitex paludosa Vatke

Common Names: CHAD ARABIC unrugulguh FULANI galbihi
BAMBARA sokoro HAUSA dumnjaa
koroba KANOURI ngaribi
DJERMA bo-i MORE andega

Legal Restrictions: Classified as "Specially Useful."

GENERAL DESCRIPTION

Small or medium savanna tree, 10-12m high. Dark green, rounded crown. Bark is pale brown to greyish white with fissures. Leaves are large with oblong folioles. Fruits are large, black, and good to eat. Wood is semi-hard and susceptible to insect attack.

SEEDS

Source:
Collection: October in Niger.
Extraction: Soak fruit to remove pulp; dry seeds.
Storage:
Pre-Treatment: Soak seeds in lukewarm water overnight.

NURSERY

Pots/Open-rooted: Pots.
Time:
Other Notes: Project planted 50 pots, 3 seeds per pot; germination of 2%.

PLANTING/SITE REQUIREMENTS

Soil: Dense forest, wooded savanna, river borders, and cultivated fields.
Water: Needs access to water for good growth.
Direct Seeding:
Other Notes: Widely distributed throughout Africa.

USES

- . Wood used for light woodworking and building small boats.
- . Fruits are popular food.
- . Leaves used in sauces and as medicine against dysentery.

SPECIAL NOTES

- This is a popular tree mainly because of its fruits. Unfortunately, it is a slow and poor germinator and propagation is difficult.

Tamarindus indica L.

Synonyms:

Common Names:	ENGLISH	tamarind tree
	FRENCH	tamarinier
	CHAD ARABIC	tamr hindi
	BAMBARA	tombi
	DJERMA	bossaye
	FULANI	jtatami
	HAUSA	tsamiya
	KANOURI	tamsugu
	MORE	pousiga

Legal Restrictions: Cutting and Removal.

GENERAL DESCRIPTION

Tree of medium-to-large size up to 15m recognized by its dense, well-rounded crown. Bark is reddish-grey and is fissured. Leaves consist of 10-15 pairs of folioles. Seed pods are reddish-brown and cylindrical. Pale yellow wood bends well and is strong.

SEEDS

Source:
Collection: January-March, depending upon location.
Extraction: Soak fruit to remove pulp; dry the seeds.
Storage:
Pre-Treatment: None required.

NURSERY

Pots/Open-rooted: Pots.
Time: 18-24 weeks.
Other Notes: Project planted 50 pots, 3 seeds per pot; 63% germination. Germinates well and grows rapidly in pots.

PLANTING/SITE REQUIREMENTS

Soil: Grows best in sandy soil along coasts.
Water: More than 800mm annual precipitation or along mares and low spots.
Direct Seeding:

Other Notes:

USES

- . Wood for furniture and boatbuilding.
- . Excellent charcoal.
- . Produces tamarind fruit, which is used to make drinks and soups.
- . Shade.
- . An herb/spice to add flavor to main dishes.

SPECIAL NOTES

- In some areas, there is sufficient demand for the fruit to justify special plantations.
- Some countries export the fruit.

Vitex cuneata Schum. & Thonn.

Synonyms: *Vitex chariensis* Chev.
Vitex cienkowskii Kotschy & Perr.
Vitex doniana Sweet
Vitex paludosa Vatke

Common Names: CHAD ARABIC unrugulguh FULANI galbihi
BAMBARA sokoro HAUSA dumnjaa
koroba KANOURI ngaribi
DJERMA bo-i MORE andega

Legal Restrictions: Classified as "Specially Useful."

GENERAL DESCRIPTION

Small or medium savanna tree, 10-12m high. Dark green, rounded crown. Bark is pale brown to greyish white with fissures. Leaves are large with oblong folioles. Fruits are large, black, and good to eat. Wood is semi-hard and susceptible to insect attack.

SEEDS

Source:
Collection: October in Niger.
Extraction: Soak fruit to remove pulp; dry seeds.
Storage:
Pre-Treatment: Soak seeds in lukewarm water overnight.

NURSERY

Pots/Open-rooted: Pots.
Time:
Other Notes: Project planted 50 pots, 3 seeds per pot; germination of 2%.

PLANTING/SITE REQUIREMENTS

Soil: Dense forest, wooded savanna, river borders, and cultivated fields.
Water: Needs access to water for good growth.
Direct Seeding:
Other Notes: Widely distributed throughout Africa.

USES

- . Wood used for light woodworking and building small boats.
- . Fruits are popular food.
- . Leaves used in sauces and as medicine against dysentery.

SPECIAL NOTES

- This is a popular tree mainly because of its fruits. Unfortunately, it is a slow and poor germinator and propagation is difficult.

Ziziphus spina christi (L.) Willd.

Synonyms:

Common Names:

CHAD ARABIC	karno
FULANI	kurnahi
HAUSA	kurna
KANOURI	korna

Legal Restrictions:

GENERAL DESCRIPTION

Medium-sized tree which lives a long time. Small, elliptical leaves on slender branches with short, curved spines.

SEEDS

Source: Strong, healthy trees.
Collection: October-January, depending on location.
Extraction: Soak fruit to remove pulp; crack shell with hammer to extract seeds.
Storage:
Pre-Treatment: Soak in lukewarm water overnight.

NURSERY

Pots/Open-rooted: Pots.
Time:
Other Notes: Project planted 50 pots, 2 seeds per pot; 35% germination. Grows fairly rapidly in pots.

PLANTING/SITE REQUIREMENTS

Soil: Extends into dry, desert areas but prefers alluvial plains with deep soils.
Water: Likes sites where some ground water is available; has long tap root.
Direct Seeding:
Other Notes: Strong regenerative powers and is resistant to heat and drought.

USES

- . Conservation uses for erosion control: windbreaks, shelterbelts and dune fixation.
- . Wood used for fuel, tools and charcoal.
- . Branches and leaves weed for animal browse.

SPECIAL NOTES





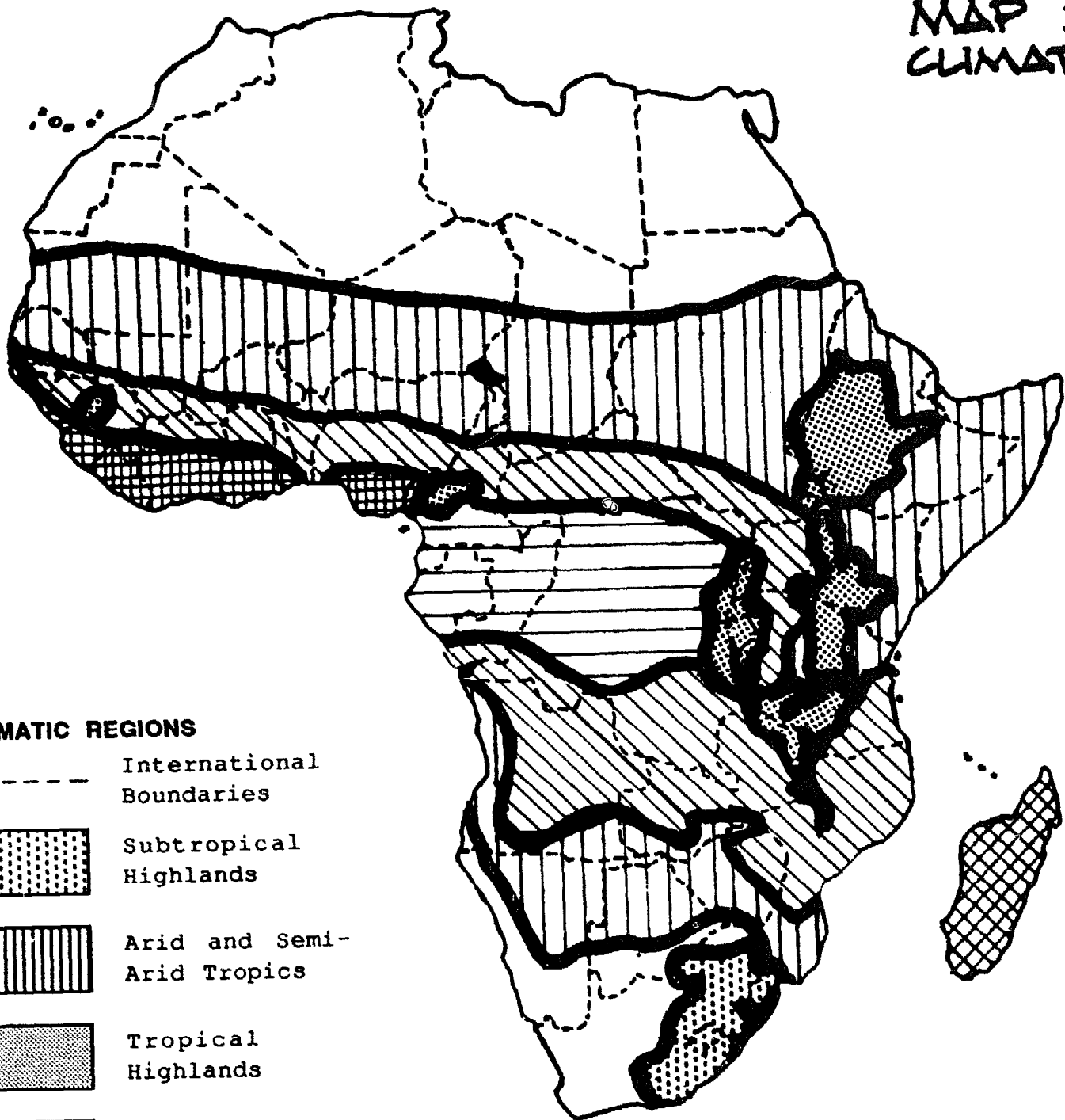

Appendix C

Climate, Vegetation, and Soils Of Sub-Saharan Africa

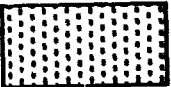
MAP 1 CLIMATE

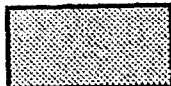

CLIMATIC REGIONS

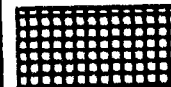
- International Boundaries
-  Subtropical Highlands
-  Arid and Semi-Arid Tropics
-  Tropical Highlands
-  Subhumid Tropical Uplands
-  Humid Equatorial Lowlands
-  Madagascar and Indian Ocean Islands
-  Humid Coastal Lowlands

MAP 2 MEAN ANNUAL PRECIPITATION

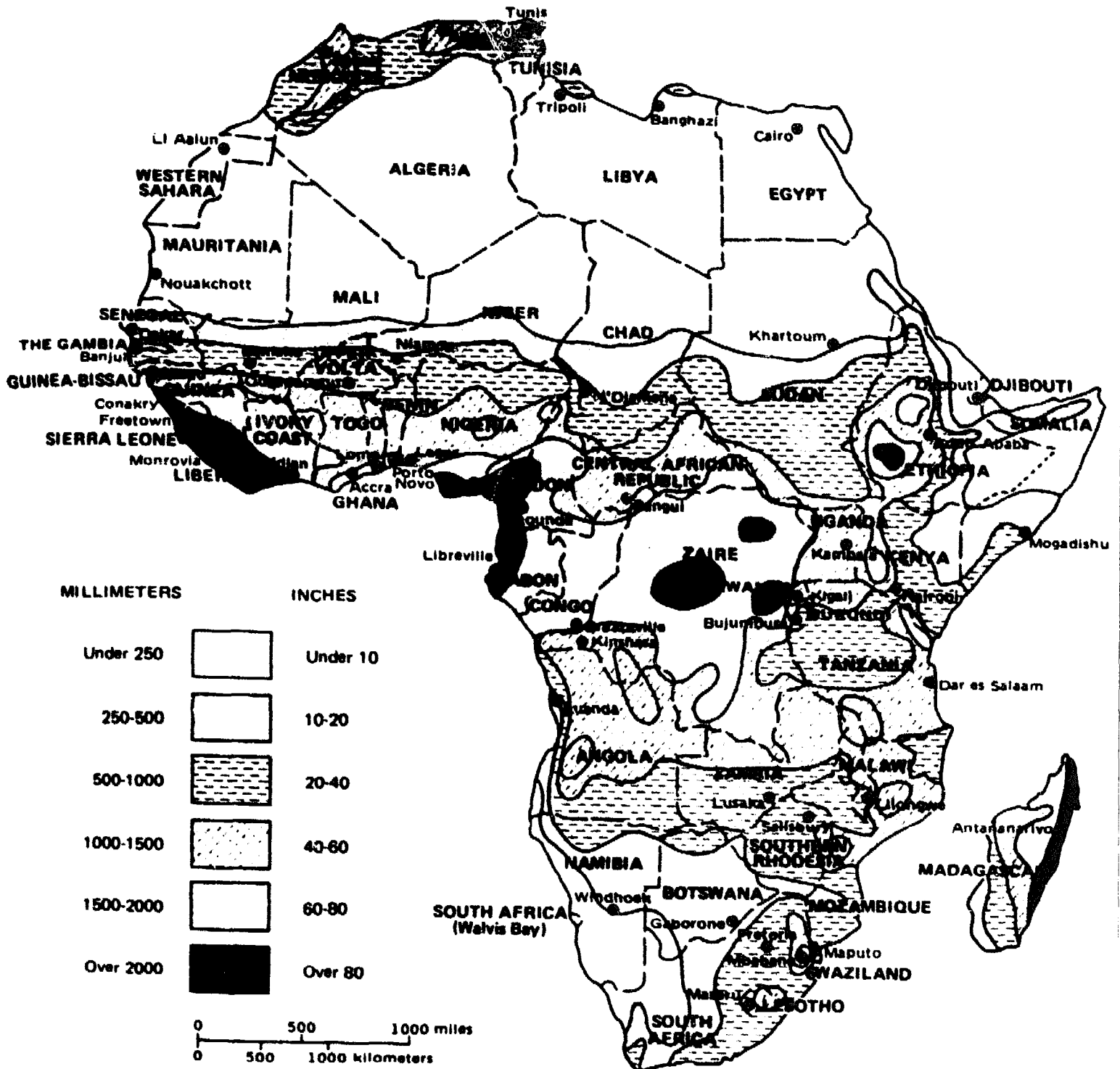

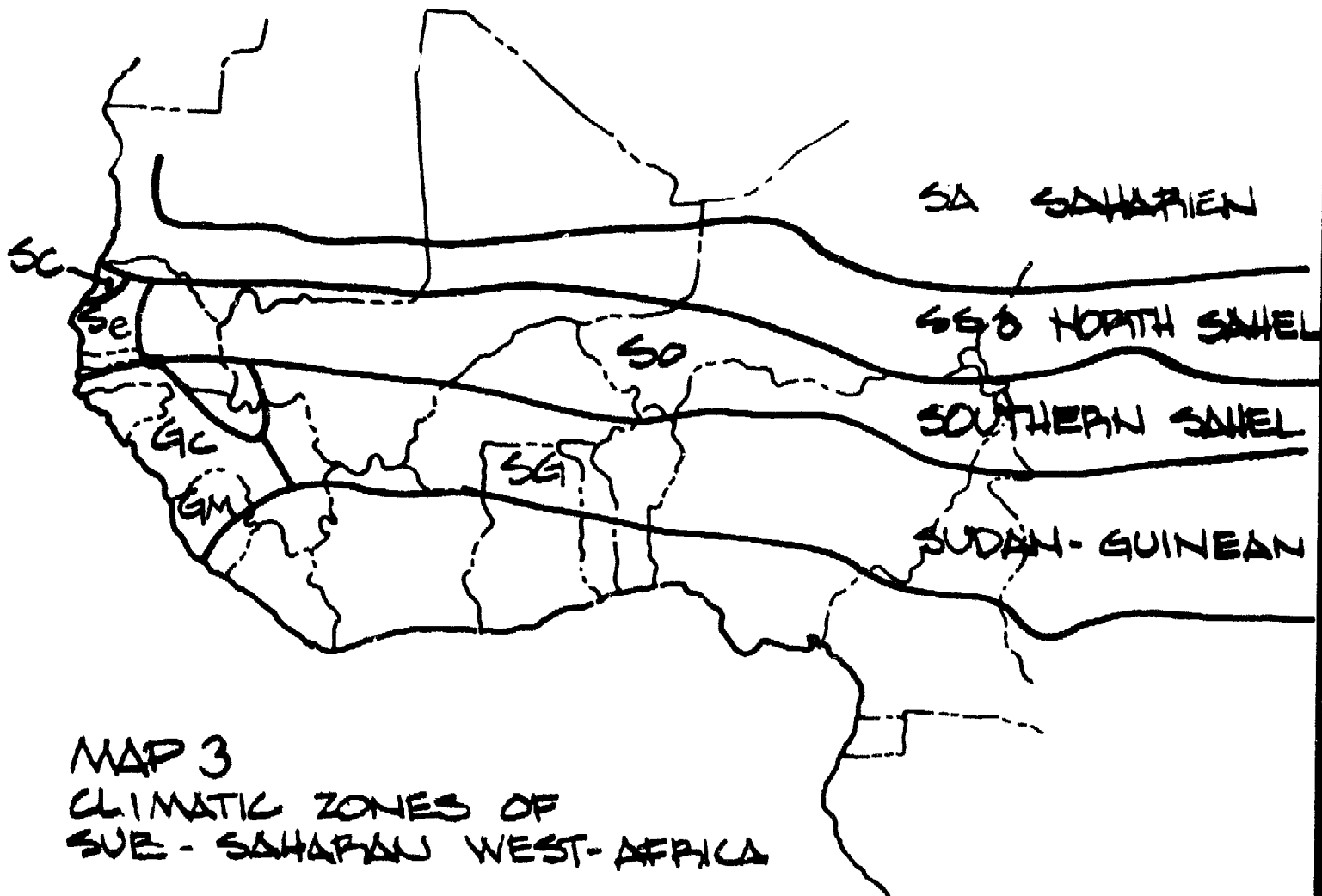

MAP 3
CLIMATIC ZONES OF
SUB-SAHARAN WEST-AFRICA

<u>SYMBOL</u>	<u>DESCRIPTION FRENCH</u>	<u>DESCRIPTION ENGLISH</u>	<u>MEAN ANNUAL PRECIPITATION</u>	<u>MEAN ANNUAL SATURATION DEFICIT</u>
SA	Saharien	Saharan	less than 200	20mm
SSa	Sahélo-saharien	Northern Sahel	200 to 400	15mm
Sc	Sahélo-Côte sénégalais	Senegal Coastal Sahel	400 to 500	5.3-7mm
Se	Sahélo-sénégalais	Senegal Sahel	500 to 900	9-12mm
So	Sahélo-soudanais	Southern Sahel	400 to 1200	11.5-22mm
SG	Soudano-Guinéen	Sudan-Guinean	950 to 1750	7-12mm
Gc	Guinéen basse Casamance	Casamance Guinean	1200 to 1750	6.5-7mm
Gm	Guinéen-maritime	Costal Guinean	1950 to 4500	4.4-5.5mm
Gf	Guinéen - foutanien	Fouta Guinean	1800 to 2050	6-7mm

Source "Flore forestière Soudano-Guinéene"

This terminology used here is commonly used in sub-Saharan West Africa and is based on the work of Aubreville. (As such it came into use prior to the creation of the Yangambi classification of African vegetation types.)

MAP 4 VEGETATION ZONES

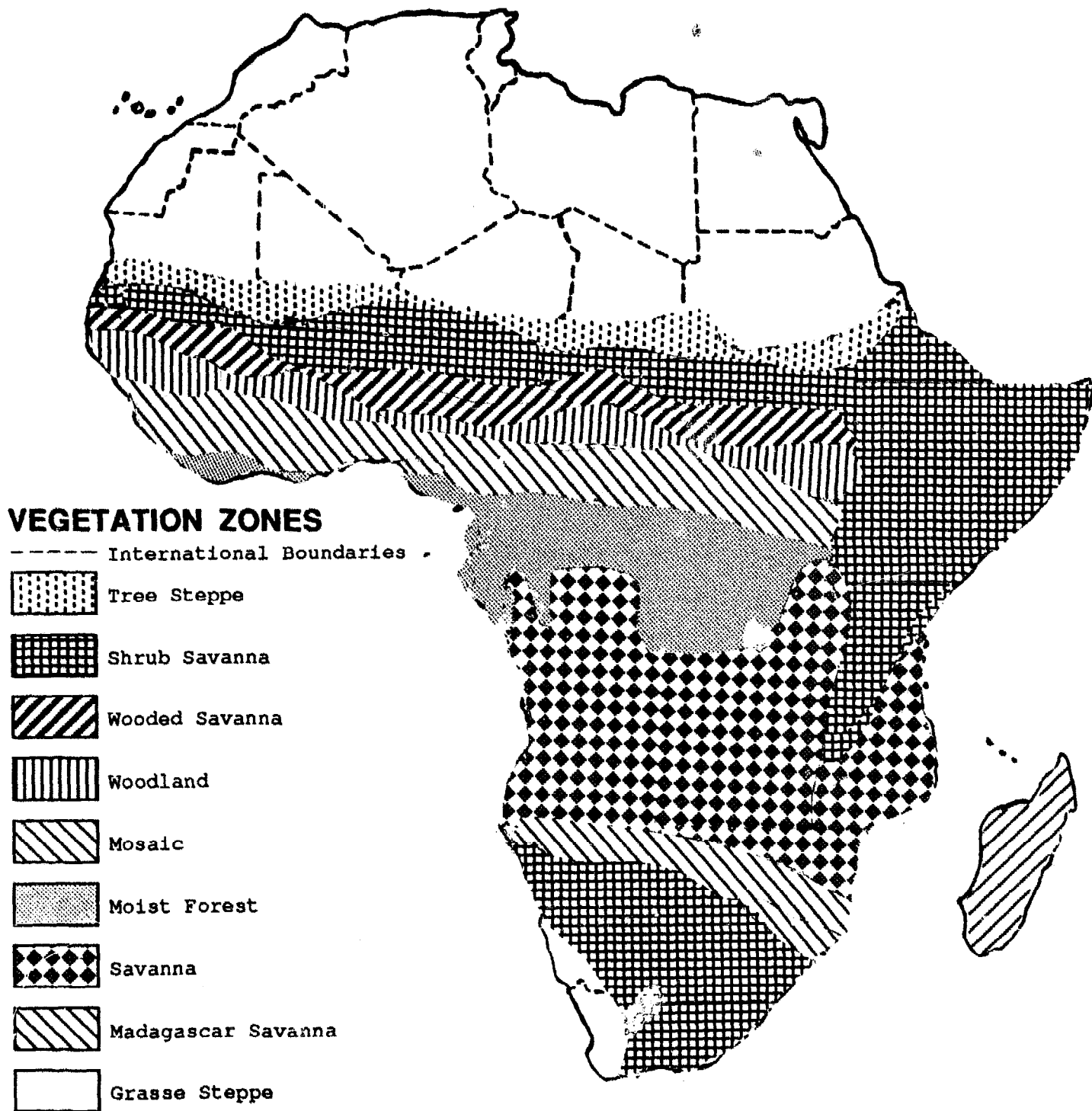

Vegetation zones in this map are based on the Yangambi classification created by a 1950 meeting of the Commission for Technical Cooperation in Africa South of the Sahara and used in the U.N. Food and Agriculture Organization publication, *Tree Planting Practice in African Savannas*.

SOUTH

1750 mm
TROPICAL
RAIN
FOREST

1600 mm
MOOSAIC

1200 mm
WOODLAND

900 mm
WOODED
SAVANNA

500 mm
SHRUB
SAVANNA

200 mm
TREE
STEPPE

NORTH

200 mm
GRASS
STEPPE



VEGETATION PROFILE

NORTH - SOUTH

* SEE CHART BEGINNING
NEXT PAGE FOR MORE
INFORMATION

ZONE _____ SUB-AREA _____ MEAN ANNUAL RAINFALL (in millimeters) _____ GRASSES _____ BUSHES & TREES _____ SOILS _____

Ferruginous Soils: See "Shrub Savanna".

Terminalia
Butyrospermum
Parkia
Borassus

Thick, tall grasses

900-1200mm



SAVANNA

WOODED SAVANNA

1200-1600mm

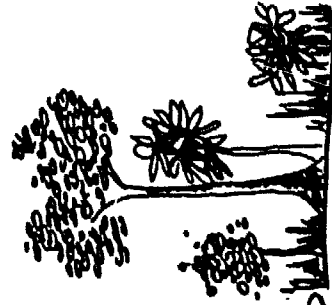

SAVANNA

WOODLAND

soberlinia doka
Khaya
Hyparrhenia
Andropogon
gayanus

Ferralitic Soils: Begin over 1200mm rainfall. Cation exchange capacity very poor. SiO_2/Al_2O_3 ratio less than 2. Often, these soils are very deep. (Oxisols USDA). Similar to laterized* red earth soils of East Africa. Sometimes layers of iron oxides but not as common as in ferruginous soils.

Low Fertility

* The term "laterite" is frequently used especially in connection with tropical soils. In spite of voluminous writings it is not possible to define this term to everyone's satisfaction. In its purest sense the following description is given: "zone(s) rich in sesquioxides (Al_2O_3 and Fe_2O_3) that, when cut into bricks, become hard as they dry."

Geologists, on the other hand, frequently use the term to describe ferruginous layers, already hard and cellular or clin-kerlike, including concretionary coatings of iron oxides.

As a given parent material is slowly transformed into laterite under the influence of its exposure to a certain climate, great chemical changes take place to considerable depths. Much of the original silica is removed. Aluminum oxide (Al_2O_3) leading -- in its purest form -- to commercially exploitable accumulations of bauxite.

ZONE SUB-AREA MEAN ANNUAL RAINFALL (in millimeters) GRASSES BUSHES & TREES SOILS



SAVANNA

Patches of moist forest surround areas of dense, coarse savanna grass.

1600-1750mm

Ferrallitic Soils: Ferrisols, Kaolinite and oxides in clay complex. See also "Woodland".

Hymenocardia acida
Lophira lanceolata



SAVANNA

TROPICAL RAIN FOREST

over 1750mm

Appendix D

**Information Sources
Suggested Reading**

INFORMATION SOURCES

The following organizations work in arid forestry, range management, or agriculture, and can be contacted for information on specific problems:

RESEARCH ORGANIZATIONS

Centro Agronomico Tropical de Investigacion y
Ensenanza (CATIE)
Dept. de Recursos Naturales
Turrialba
Costa Rica

Centre Technique Forestier Tropical (CTFT)
45 Bis Avenue de la Belle Gabrielle
94 Nogent Sur Marne
France
(Regional Offices in Dakar; Stations in Ndjamena
Niamey, and Ouagadougou)

Commonwealth Forestry Institute (CFI)
University of Oxford
South Parks Rd.
P.O. 13 RD
Oxford, England OX1 3RB

Consultive Group on International Agriculture
Research (CGIAR)
1818 H Street
Washington, D.C. 20433 USA

Environment and Policy Institute
East-West Center
1777 East-West Road
Honolulu, HI 96848 USA

Institute for Development Anthropology
99 Collier St., Suite 302
P.O. Box 818
Binghamton, N.Y. 13902 USA

Institute of Tropical Forestry
Post Office Box AQ
Rio Piedras, PR 00928

International Council for Research in Agroforestry
(ICRAF)
P.O. Box 30677
Nairobi, Kenya

International Crops Research Institute for the
Semi-Arid Tropics (ICRISAT)
Patancheru P.O.
Andhra Pradesh 502 324
India
(Offices in Mali and Niger)

International Development Research Centre
(IDRC)
60 Queen St.
P.O. Box 8500
Ottawa, Canada

International Institute for Environment and
Development (IIED)
1717 Massachusetts Ave., N.W. , Suite 302
Washington, D.C. 20004 USA

International Institute of Tropical Agriculture
(IITA)
PMB 5320
Ibadan, Nigeria

International Livestock Centre for Africa (ILCA)
P.O. Box 5689
Addis Ababa, Ethiopia

International Tree Crops Institute
P.O. Box 888
Winters, CA 95694 USA

National Academy of Sciences
Board on Science and Technology for
International Development (BOSTID)
2101 Constitution Ave., N.W.
Washington, D.C. 20418 USA

Nitrogen Fixation by Tropical Agricultural Legumes (NifTAL)
Project
P.O. Box 0
Paia, Hawaii 96779 USA

Office of Arid Lands Studies
University of Arizona
Tucson, AZ 85719 USA

Tropical Products Institute
56/62 Gray's Inn Rd.
London WC1 X8LU
England

Tropical Resources Institute
Yale School of Forestry and Environmental Studies
205 Prospect St.
New Haven, CT 06511 USA

U. S. GOVERNMENT AGENCIES

Forestry Support Program
FSP Room 1208 RPE
USFS P.O. Box 2417
Washington, D.C. 20013 USA

Office of International Development and Cooperation
(OICD)
U.S. Dept. of Agriculture
Room 4405 Auditors Building
Washington, D.C. 20250 USA

Office of Technology Assessment (OTA)
600 Pennsylvania Ave. S.E.
Washington, D.C. 20510 USA

Peace Corps
OTAPS/Forestry and Natural Resources
806 Connecticut Ave., N.W.
Washington, D.C. 20526 USA

Smithsonian Tropical Research Institute
1000 Jefferson Dr.
Washington, D.C. USA

Soil Management Support Services
Soil Conservation Service
P.O. Box 2890
Washington, D.C. USA

USAID (Agency for International Development)
Department of State
Washington, D.C. 20520 USA
(AID field offices can be contacted through
the respective U.S. Embassies)

USAID
Science and Technology/FENR
Dept. of State
Washington, D.C. 20520 USA

International Forestry Staff
Room 1208 RPE
USDA/FS
P.O. Box 2419
Washington, D.C. 20013 USA

**AGENCIES RESPONSIBLE FOR NATURAL
RESOURCE MANAGEMENT IN ARID LANDS**

Conservator of Forests
Ministry of Animal and Forest Resources
Private Mail Bag #3022
Kano, Nigeria

Direction des Eaux et Forets/Burkina Faso
B.P. 7044
Ouagadougou, Burkina Faso

Direction des Eaux de Forets/Mali
B.P. 275
Bamako, Mali

Direction des Eaux de Forets/Niger
B.P. 578
Niamey, Niger

Direction des Eaux de Forets/Senegal
B.P. 1831
Dakar, Senegal

Direction des Forets des Chasses
et de L'Environnement
Lome, Togo

DNAREF
B.P. 1341
Yaounde, Cameroon

Forestry Association of Botswana
Box 2008
Gaborone, Botswana

Forestry Office
Box 30048
Lilongwe 3, Malawi

Forestry Research Center
P.O.Box 658
Khartoum, Sudan

Forest Research Institute
P.O. New Forest
Dehra Dun
U.P. India

Forestry Research Institute of Nigeria
P.M.B. 5054
Ibadan, Nigeria

Land Utilization Division
Private Bag 003
Gaborone, Botswana

Ministry of Ag and Natural Resources
Box 596
Yundum, Gambia

Ministry of Energy
PO Box 30582
Nairobi, Kenya

Ministry of Forestry
Box 426
Dar es Salaam, Tanzania

Ministry of Water Resources and Environment
5 Marina Parade
Banjul, Gambia

Ministere pro Nature
B.P. 4055
Dakar, Senegal

National Range Agency
PO Box 1759
Mogadishu, Somalia

Proection de la Nature
B.P. 170
Nouakchott, Mauritania

Reforestation Service
Keren Kayemet
BP 45 Kiryat Haim
Haifa, Israel

INTERNATIONAL ORGANIZATIONS

CBLT (Lake Chad Basin Commission)
Forestry Division
B.P. 727
N'Djamena, Chad

CIEH (Interafrican Committee for Hydraulic Studies)
B.P. 369
Ouagadougou, Burkina Faso

Comittee Inter-Etat pour la Lutte Contre
la Secheresse du Sahel (CILSS)
Projects and Programs Division
B.P. 7049
Ouagadougou, Burkina Faso

Environmental Liaison Centre
P.O. Box 72461
Nairobi, Kenya

International Society of Tropical Foresters
5400 Grosvenor Lane
Bethesda, MD 20814 USA

International Tree Project Clearinghouse (ITPC)
Non-governmental Liaison Service
2 UN Plaza
DC-2-RM 1103
New York, NY 10017 USA

International Union for Conservation of Nature and
Natural Resources
Avenue de Mont Blanc
CH - 1196 Gland
Switzerland

UN Development Programme (UNDP)
1 United Nations Plaza
New York, NY 10017 USA

UN Environment Programme (UNEP)
Ecosystems Natural Resource Division
P.O. Box 30552
Nairobi, Kenya

UN Food and Agriculture Organization (FAO)
Forest Resources Division
Via delle Terme di Caracalla
00100
Rome, Italy

UN Sahelo-Soudanian Office
1 United Nations Plaza
New York, NY 10017 USA

World Bank
Africa - Forestry Division
1818 H Street, N.W.
Washington, D.C. 20433 USA

PRIVATE VOLUNTARY AND NONGOVERNMENTAL ORGANIZATIONS

Arid Lands Information Center
845 N. Park Ave.
Tucson, AZ 85719 USA

Africare
1601 Connecticut Ave. N.W.
Suite 600
Washington, D.C. 20009 USA
CODEL
79 Madison Ave.
New York, NY 10016 USA

CARE International
Agriculture and Natural Resources Program
660 First Avenue
New York, NY 10016 USA

Chambre D' Agriculture, De L'Elevage et Des Forets
du Cameroun
B.P. 287
Yaounde, Cameroon

Conseil Des Organisations Non Gouvernementales
D'Appui Au Developpement Du Senegal (CONGAD)
Rue 41 X Boulevard General De Gaulle
B.P.4109
Dakar, Senegal

Environnement Et Developpement du Tiers Monde
(ENDA)
B.P. 3370
Dakar, Senegal

IUCN Bulletin
International Union for Conservation of Nature and
Natural Resources
CH-1196 Gland
Switzerland

Joint Energy and Environment Projects (JEEP)
Plot 14 A Main Street Jinja
Opposite Upper Bata
P.O.Box 1684
Jinja, Uganda

Kenya Energy Non-Governmental Organizations
(KENGO)
Westlands, Karuna Road
P.O. Box 48197
Nairobi, Kenya

Kweneng Rural Development Association
Private Bag 7
Molepolole, Botswana

Lutheran World Relief
360 Park Ave. South
New York, NY 10016 USA

Mazingira Institute
P.O.Box 14550
Nairobi, Kenya

National Wildlife Federation
International Program
1412 16th Street, N.W.
Washington, D.C. 20036 USA

Natural Resources Defense Council
International Project
1350 New York Ave., N.W., Suite 300
Washington, D.C. 20005 USA

Resources for the Future
1755 Massachusetts Ave., N.W.
Washington, D.C. 20036 USA

Sierra Club
228 East 45th St.
New York, NY 10017 USA

Sierra Leone Environment and Nature Conservation
Association (SLENCA)
P/M.B. 376
Freetown, Sierra Leone

Sudan Council of Churches
P.O.Box 469
Khartoum, Sudan

Tanzania Environment Society
P.O.Box 1309
Dar Es Salaam, Tanzania

Volunteers in Technical Assistance (VITA)
1815 North Lynn St., Suite 200
Arlington, VA 22209 USA

Winrock International Institute for Agricultural
Development
Rt. 3
Morrilton, AR 72110 USA

World Resources Institute
1735 New York Ave., N.W.
Washington, D.C. 20006 USA

Worldwatch Institute
1776 Massachusetts Ave.
Washington, D.C. 20036 USA

ARBORETUMS AND HERBARIUMS

Arnold Arboretum
Cambridge, Mass. USA

Boyce Thompson Southwestern Arboretum
P.O. Box AB
Superior, Arizona 85273 USA

KICPAL
Royal Botanical Gardens
Kew, Richmond, Surry
TW9 2AE, U.K.

Missouri Botanical Garden
St. Louis, MO USA

New York Botanical Gardens
Bronx, NY 10458 USA

University of Hawaii Instructional Arboretum
Waimanalo, Hawaii 96795 USA

JOURNALS AND BULLETINS

Agroforestry Review
International Tree Crops Institute USA
Route 1
Gravel Switch, Kentucky 40328 USA

Agroforestry Systems
Martinus Nijhoff
Kluwer Academic Publishers
101 Philip Drive
Assinippi Park
Norwell, Mass. 02061 USA

AMBIO
Royal Swedish Academy of Sciences
Box 50005
S - 104 05
Stockholm, Sweden

Arid Lands Newsletter
University of Arizona
845 No. Park Ave.
Tucson, AZ 85719 USA

Farm Forestry News
Winrock International Institute for Agricultural
Development
1611 North Kent Street
Arlington, VA 22209 USA

FSSP Newsletter
Farming Systems Support Project
3028 McCarty Hall
University of Florida
Gainesville, FL 32611 USA

ISTF Newsletter
International Society of Tropical Foresters
5400 Grosvenor Lane
Bethesda, MD 20814 USA

ICRAF Newsletter
International Council for Research in Agroforestry
P.O. Box 30677
Nairobi, Kenya

IITA Research Briefs
International Institute of Tropical Agriculture
PMB 5320
Oyo Road
Ibadan, Nigeria

International Tree Crops Journal
A.B. Academic Publishers
P.O. 97
Berkhampstead, Herts.
HP4 2PX, England

IUSF Newsletter
International Union of Societies of Foresters
Canadian Institute of Forestry
151 Slater Street, Suite 815
Ottawa, Ontario
Canada K1P5H3

Leucaena Research Reports
Nitrogen Fixing Tree Association
P.O. Box 680
Waimanalo, Hawaii 96795 USA

Nitrogen Fixing Tree Research Reports (NFTRR)
Nitrogen Fixing Tree Association
P.O. Box 680
Waimanalo, Hawaii 96795 USA

NFTA News
Nitrogen Fixing Tree Association
P.O. Box 680
Waimanalo, Hawaii 96795 USA

New Forests
Martinus Nijhoff
Kluwer Academic Publishers
101 Philip Drive
Assinippi Park
Norwell, Mass. 02061 USA

Social Forestry Network Newsletter
Overseas Development Institute (ODI)
Agricultural Administrative Unit
Regent's College
Inner Circle, Regent's Park
London
NW1 4NS England

The Tree Project News
International Tree Project Clearinghouse
Non-governmental Liaison Service
2 UN Plaza
DC-2-RM 1103
New York, NY 10017 USA

UNASYLVA
UNIFUB
P.O. Box 1222
Ann Arbor, MI 48106 USA

SUGGESTED READING

CHAPTER 1

- Aubreville, A. 1950. Climats, Forêts et Désertification de l'Afrique Tropicale. Paris: Societe d'Editions Geographiques, Maritimes et Coloniales. 351 p.
- Brown, L.R. 1980. Food or Fuel: New Competition for the world's cropland. Washington, D.C.: Worldwatch Institute, Worldwatch Paper No. 35, 43 p.
- Catinot, R. 1974. "Contribution du Forestiere a la Lutte Contre la Désertification en Zones Seches". Paris: Revue Bois et Forêts des Tropiques, No. 155, May-June.
- Catterson, T.M.; F.A. Gulick and T. Resch. 1985. Desertification - Rethinking Forestry Strategy in Africa: Experience Drawn from USAID Activities Paper prepared for Expert Consultation on the Role of Forestry in Combatting Desertification, Saltillo, Mexico, 16 p.
- Delwaulle, J.C. 1976. Le Role de la Foresterie dans la Lutte Contre la Désertification. Ouagadougou: CILSS, Consultation CILSS/UNSO/FAO, 21 p.
- Eckholm, E.P. 1975. The Other Energy Crisis: Firewood. Washington, D.C.: Worldwatch Institute, Worldwatch Paper No. 1, 22 p.
- Eckholm, E.P. 1976. Losing Ground: Environmental Stress and World Food Prospects. New York: W.W. Norton, 223 p.
- Eckholm, E.P. 1979. Planting for the Future: Forestry for human needs. Washington, D.C.: Worldwatch Institute, Worldwatch Paper No. 26, 64 p.
- Eckholm, E.P. and L.R. Brown. 1977. Spreading Deserts: the hand of man. Washington, D.C.: Worldwatch Institute, Worldwatch Paper No. 13, 40 p.
- Glantz, M.H. 1977. Desertification: Environmental Degradation in and Around Arid Lands. Boulder, Colorado: Westview Press, 346 p.
- National Academy of Sciences. 1983. Environmental Change in the West African Sahel. Washington, D.C.: NAS/Advisory committee on the Sahel, 96 p.
- Office of Technology Assessment. 1984. Technologies to Sustain Tropical Forest Resources. Washington, D.C.: U.S. Congress OTA-F-214, 344 p.

UNESCO. 1973. The Sahel: Ecological Approaches to Land Use UNESCO Press: MAB Technical Notes

USAID. 1982. Proceedings of a Workshop on Energy, Forestry and Environment (I. Workshop Summary; II. Discussion Papers/Case Studies; III. Country Energy Papers). Washington, D.C.: USAID/Bureau for Africa, 565 p.

USAID/SDPT. 1984. Sahel Development Strategy Statement Annex: Forestry. Bamako: USAID/SDPT, 60 p.

World Bank. 1985. Desertification in the Sahelian and Sudanian Zones of West Africa Washington, D.C.: The World Bank, 60 p.

CHAPTER 2

Brechin, S.R. and P.C. West. 1982. "Social barriers in implementing appropriate technology: the case of community forestry in Niger, West Africa." Humboldt Journal of Social Relations. Vol. 9, No. 2, p. 81-94.

CILSS/Club du Sahel. 1979. Ecological Guidelines for Development Projects. Part I: Impact Analysis. Part II: Background Information. Ouagadougou/Paris: CILSS/Club du Sahel, 90 p.

FAO. 1978. Forestry for Local Community Development. Rome: FAO, 56 p. (Also Available in French).

Ffolliot, P.F. and J.L. Thames. 1983. Environmentally Sound Small-Scale Forestry Projects. Washington, D.C.: CODEL/VITA, 109 p.

Foley, G. and G. Barnard. 1984. Farm and Community Forestry. London: Earthscan, 236 p.

GRAAP. Vivre dans un Environnement Vert: Premiere Recherche (I. Les changements dans notre environnement; II. Nous avons besoins des arbres pour vivre; III. Etres maitres de notre terroir). Ouagadougou: MET/GRAAP, 13 p.

Hoskins, M.W. 1979. Community Participation in African Fuelwood Production: transformation and utilization. Washington, D.C.: Overseas Development Council/USAID, 63 p.

Hoskins, M.W. 1979. Women in Forestry for Local Community Development: A Programming Guide. Washington, D.C.: USAID/Office of Women in Development, 58 p.

Hoskins, M.W. 1982. Social Forestry in West Africa: Myths and Realities. Paper presented at American Association for the Advancement of Science (AAAS) meeting in Washington, D.C.

Peace Corps. 1982. Forestry Case Studies. Washington, D.C.: Peace Corps ICE, 102 p.

- Romm, J. 1982. "A Research Agenda for Social Forestry." International Tree Crops Journal. Vol. 2, No. 1, p. 25-59.
- Skutsch, M. 1983. Why People Don't Plant Trees: Village Case Studies, Tanzania. Washington, D.C.: Resources for the Future, 99 p.
- Thomson, J.T. 1983. Participation, Local Organization, Land and Tree Tenure: Future Directions for Sahelian Forestry. Ouagadougou/Paris: CILSS/Club du Sahel, 34 p.
- USAID. 1984. Report of the Forestry Program Evaluation Workshop, Lome, Togo. Washington, D.C.: USAID/Bureau for Africa, 30 p. and Appendices.
- Wood, D.H. et al. 1980. The Socio-economic Context of Fuelwood Use in Small Rural Communities. Washington, D.C.: U.S.A.I.D. Evaluation Publications.

CHAPTER 3

- Ayers, R.S. and D.W. Westcot. 1985. Water Quality for Agriculture. Rome: FAO, 174 p.
- Bene, J.G.; H.W. Beall; and A. Cote. 1977. Trees, Food and People: Land Management in the Tropics. Ottawa: International Development Research Centre. 52 p.
- Bernstein, C. et al. 1974. More Water for Arid Lands. Washington: National Academy of Sciences, Resume Francais, 137 p.
- Boudet, G. 1975. Manuel sur les Paturages Tropicaux et les Cultures Fourrageres. Paris, I.E.M.V.T.
- Child, R.D. et al. 1984. Arid and Semiarid Lands: Sustainable Use and Management in Developing Countries. Morrilton, Arkansas: Winrock International, 205 pp.
- Fortmann, L. 1983. "Land Tenure, Tree Tenure and the Design of Agro-forestry Projects." Dept. of Forestry and Natural Resources, University of California, Berkley, CA.
- Norman, D.W.; E.B. Simmons and H.M. Hays. 1982. Farming Systems in the Nigerian Savanna: research and strategies for development. Boulder, Colorado: Westview Press, 275 p.
- Shaik, A and P. Larson. 1981. The Economics of Village-Level Forestry: a methodological framework. Washington, D.C.: USAID, 73 p.
- Shaner, W.W.; P.F. Philipp; and W.R. Schmehl. 1981. Farming Systems Research: Guidelines for Developing Countries. Boulder, Colorado: Westview Press, 414 p.

Yaron, B. et al. (eds.). 1973. Arid Zone Irrigation. New York: Springer-Verlag, Ecological Studies Volume 5.

CHAPTER 4

Brady, N.C. 1974. The Nature and Properties of Soil. New York: MacMillan Publishing Co., Inc., 639 p.

Development and Resources Corp./Development Planning and Research Assoc. 1983. Irrigation Principles and Practices. Washington, D.C.: Peace Corps ICE, 112 p.

Dewis, J. and F. Freitas. 1970. Physical and Chemical Methods of Soil and Water Analysis. Rome: FAO Soils Bulletin 10, 275 p.

FAO/UNESCO. 1973. Irrigation, Drainage and Salinity: An International Sourcebook. Paris: UNESCO/Hutchinson Publishers, 510 P.

Hamel, O. and C.R. Bailey. 1981. Afforestation des Terres Salees. (Paper prepared for the XVII Congres Mondial de l'IUFRO) Dakar: ISRA/CNRF, 10 p.

Israelson, O.W. and V.E. Hansen. 1962. Irrigation Principles and Practices. John Wiley and Sons, Inc., 368 p.

USDA/US Salinity Staff. 1954. Diagnosis and Improvement of Saline and Alkali Soils. USDA Handbook 60.

CHAPTER 5

Burley, J. 1980. "Selection of Species for fuelwood plantations." Commonwealth Forestry Review, Vol. 59, No. 2, p. 133-148.

Cocheme, J. and Franquin, P. 1967. An Agroclimatic Survey of a Semiarid Area in West Africa. Geneva, WMO No. 210, T.P. 110.

Delwaulle, J.C. 1979. Plantations Forestieres en Afrique Tropicale Seche. Techniques et especes a utiliser. Nogent sur Marne: CTFT, 1979. 178 p.

Huxley, P.A. 1984. A Manual of Methodology for the Exploration and Assessment of Multipurpose Trees (MPT's). Nairobi: ICRAF.

Little, E.L. 1983. Common Fuelwood Crops: a handbook for their identification. Morgantown, W.V.: Communi-Tech Associates, 354 p.

National Academy of Sciences. 1980. Firewood Crops: Shrub and Tree Species for Energy Production, Vol. 1. Washington, D.C.: National Academy Press, 237 p.

- National Academy of Sciences. 1983. Firewood Crops: Shrub and Tree Species for Energy Production, Vol. 2. Washington, D.C.: National Academy Press, 92 p.
- Rugh, D. 1972. Guide des Onze Arbres Proteges du Niger. Maradi (Niger): Atelier Inter-Service.
- Teel, W. 1984. A Pocket Directory of Trees and Seeds in Kenya. Nairobi: KENGO, 151 p.
- Von Maydell, H.J. 1983. Arbres et Arbustes du Sahel: leur caracteristiques et leurs utilisations. Eschborn: GTZ, 531 p.

CHAPTER 6

- Doran, J.C.; D.J. Boland; J.W. Turnbull; B.V. Gunn. 1983. Guide des Semences d'Acacias des Zones Seches: recolte, extraction, nettoyage, conservation, et traitement des graines d'Acacias des zones seches. Rome: FAO, 116 p. (Also available in English).
- Evans, J. 1982. Plantation Forestry in the Tropics. Oxford: Oxford University Press, 460 p.
- FAO. 1963. Tree Planting Practices for Arid Zones. Rome: FAO.
- FAO. 1975. A Forest Tree Seed Directory. Rome: FAO.
- FAO. 1977. Savanna Afforestation in Africa. FAO/DANIDA Training course and Symposium Kaduna, Nigeria. Rome: FAO, 312 p.
- Ffolliot, P.F. and J.L. Thames. 1983. Collection, Handling, Storage and Pre-Treatment of Prosopis Seeds in Latin America. Rome:FAO, 45 p.
- France, Ministere de la Cooperation. 1978. Memento du Forestier. Paris: Ministere de la Cooperation, 2nd Edition, 894 p.
- Goor, A.Y. and C.W. Barney. 1976. Forest Tree Planting in Arid Zones. New York: Ronald Press, 2nd Edition, 504 p.
- Kamwet, D. 1982. Tree Planting in Africa South of the Sahara. Nairobi: The Environmental Liaison Centre, 75 p.
- Konde, B.A. 1981. Guide Pratique d'Amenagement d'une Pepiniere. Ouagadougou: Ministere de l'Environnement et du Tourisme, 19 p.
- Laurie, M.V. 1974. Tree Planting Practices in African Savannas. Rome: FAO, 185 p.
- Mali, DNEF. 1983. Note Technique sur Quelques Principes de Base Concernant les Pepinieres Villageoises. Bamako: DNEF, 5 p.
- National Wildlife Federation. 1984. 34 Pesticides: Is Safe Use Possible? Washington, D.C.: NWF International Programs, 68 p.

- Oudejans, J.H. 1982. Agro-pesticides. Bangkok: ARSAP/FADINAP, 205 p.
- Schmutterer, H.; K.R.S. Ascher; and H. Rembold. 1981. Natural Pesticides from the Neem Tree (Azadirachta indica A. Juss): Proceedings of the First International Neem Conference. Eschborn, W. Germany: GTZ, 297 p.
- Southgate, B.J. Handbook on Seed Insects of Acacia Species. Rome: FAO, 30 p. (Also Available in French)

CHAPTER 7

- CESAO. 1980. Des Paysans Plantent des Arbres (Echanges No. 20) Bobo Dioulasso: CESAO/GRAAP, 41 p.
- CESAO: 1981. Des Villageois Font des Diquettes Pour Ameliorer leur Terres. (Echanges No. 22) Bobo Dioulasso: CESAO/GRAAP, 48 p.
- Chapman, G.W. and T.F. Allan. 1978. Establishment Techniques for Forest Plantations. Rome: FAO, FAO Forestry Paper No. 8, 1978, 183 p.
- Evans, J. 1982. Plantation Forestry in the Tropics. Oxford: Oxford University Press, 460 p.
- FAO. 1963. Tree Planting Practices for Arid Zones. Rome: FAO.
- FAO. 1977. Savanna Afforestation in Africa. FAO/DANIDA Training course and Symposium Kaduna, Nigeria. Rome: FAO, 312 p.
- France, Ministere de la Cooperation. 1978. Memento du Forestier. Paris: Ministere de la Cooperation, 2nd Edition, 894 p.
- Goor, A.Y. and C.W. Barney. 1976. Forest Tree Planting in Arid Zones. New York: Ronald Press, 2nd Edition, 504 p.
- Laurie, M.V. 1974. Tree Planting Practices in African Savannas. Rome: FAO, 185 p.

CHAPTER 8

- Bognettau-Verlinden, E. 1980. Study on the Impact of Windbreaks in Majjia Valley, Niger. Niamey/Wageningen, Holland: CARE/Agricultural University, Wageningen, Holland.
- Buck, L.E. (ed.). 1983. Proceedings of the Kenya National Seminar on Agroforestry, Nov. 1980. Nairobi: ICRAF and the University of Nairobi.
- Delehanty, J.; J. Thomson, and M. Hoskins. 1985. Majjia Valley Evaluation Study: Sociology Report. Niamey: CARE International Report.

- Dennison, S. 1986. Project Review of the Majjia Valley Windbreak Evaluation Study. Niamey: CARE International Report.
- FAO. 1977. Guidelines for Watershed Management. Rome: FAO Conservation Guide Series No. 1., 298 p.
- FAO. 1977. Conservation in Arid and Semi-Arid Zones. Rome: FAO Conservation Guide Series No. 3.
- FAO. 1977. Special Readings in Conservation Techniques. Rome: FAO Conservation Guide Series No. 4.
- FAO. 1983. Management of Upland Watersheds: Participation of the Mountain Communities. Rome: FAO Conservation Guide Series No. 8.
- FAO. 1985. Sand Dune Stabilization: Shelterbelts and Afforestation in Dry Zones. Rome: FAO Conservation Guide Series No. 10.
- FAO. 1985. FAO Watershed Management Field Manual: Vegetative and Soil Treatment Methods. Rome: FAO Conservation Guide Series No. 13.
- Felker, P. 1978. State of the Art: Acacia alba as a complementary permanent intercrop with annual crops. Riverside California: University of California, 133 p.
- Flannery, R.D. 1981. Gully Control and Reclamation. VITA Publications, 26 p.
- Gulick, F.A. 1984. Increasing Agricultural Food Production through Selected Tree Planting Techniques: A summary memorandum with selected references. Washington, D.C.: U.S.A.I.D./ Bureau for Africa, 149 p.
- Hagedorn, H. et al. 1977. Dune Stabilisation: a survey of literature on dune formation and dune stabilization. Eschborn, W. Germany: GTZ, 193 p.
- Hoekstra, D.A. and F.M. Kuguru (eds.) Agroforestry Systems for Small-Scale Farmers: Proceedings of an ICRAF Workshop. Nairobi: ICRAF, 283 p.
- IITA. 1986. Alley Cropping. Ibaden: IITA Research Report.
- ILCA. 1983. Pastoral Systems Research in Sub-Saharan Africa: Proceedings of the IDRC/ILCA Workshop held at ILCA, Addis Ababa, Ethiopia. Addis Ababa: ILCA, 480 p.
- Kunkle, S.H. 1978. Forestry Support for Agriculture Through Watershed Management, Windbreaks and Other Conservation Actions. Position Paper, Eighth World Forestry Congress, Jakarta, Indonesia, 28 p.
- Le Houerou, H.N. (ed.). 1980. Browse in Africa: The Current State of Knowledge. Addis Ababa: ILCA, 491 p.

- McGahuey, M. 1986. Impact of Forestry Initiatives in the Sahel on Production of Food, Fodder and Wood. Washington, D.C.: Chemonics International, 25 p.
- Nair, P.K.F. 1980. Agroforestry Species: A Crop Sheets Manual. Nairobi: ICRAF, 336 p.
- Nair, P.K.R. 1982. Soil Productivity Aspects of Agroforestry. Nairobi: ICRAF, 83 p.
- National Academy of Sciences. 1983. Agroforestry in the West African Sahel. Washington, D.C.: NAS/Advisory committee on the Sahel, 86 p.
- USDA/SCS. 1962. Soil Conservation Manual. Paris: USAID/Centre Regional d'Editions Techniques, 359 p. (Also Available in French)
- Vergera, N.T. (ed.). 1982. New Directions for Agroforestry: The Potential of Tropical Legume Trees. Honolulu: Environment and Policy Institute, East-West Center.
- Weber, F. and M.W. Hoskins. 1983. Soil Conservation Technical Sheets (Fiches Techniques de Conservation du Sol). Moscow, Idaho: University of Idaho for USDA (OICD), 112 p.
- Weber, F. and M.W. Hoskins. 1983. Agroforestry in the Sahel. Blacksburg, VA: VPI, Dept. of Sociology.

CHAPTER 9

- Giffard, P.L. 1974. L'Arbre dans le Paysage Senegalais: Sylviculture en Zone tropicale seche. Dakar: CTFT, 431 p.
- Government of Niger/Projet PAF. 1985. "Guide Pratique de Multiplication par Bouturage de Euphorbia balsamifera." Niamey: Direction Forets et Faune.

GENERAL BACKGROUND READING

- Berhaut, J. 1975. Flore Illustree du Senegal. Direction des Eaux et Forets, Gouvernement du Senegal.
- Brenon, J.P.M. 1983. Manual on Taxonomy of Acacia Species: present taxonomy of four species of Acacias (A. albida, A. senegal, A. nilotica, A. tortilis). Rome: FAO, 47 p. (Also available in French).
- De Vries, P.F.W.T. and M.A. Djiteye (eds.) La Productivite des Paturages Saheliens: une etude des sols, des vegetations et de l'exploitation de cette ressource naturelle. Wageningen, Netherlands: Centre for Agricultural Publishing and Documentation (PUDOC), 525 p.

- Earl, D.E. 1975. Forest Energy and Economic Development Oxford: Clarendon Press, 128 p.
- FAO. 1965. Crop Ecologic Survey in West Africa. Rome: FAO.
- FAO. 1981. Forest Resources of Tropical Africa (Part I: Regional Synthesis; Part II: Country Briefs; Map of the Fuelwood Situation in Developing Countries and Explanatory Note). Rome: FAO.
- FAO. 1982. Environmental Impact of Forestry: Guidelines for its Assessment in Developing Countries. Rome: FAO Conservation Guide Series No. 7.
- Geerling, C. 1982. Guide de Terrain des Ligneux Saheliens et Soudano-Guineens. Wageningen: H. Veerman & Sons, 340 p.
- Gledhill, D. 1972. West African Trees. London: Longmans, 72 p.
- Gorse, J. 1984. Forestry Terms - Terminology Forestiere (English-French, French-English): A World Bank Glossary. World Bank: Washington, D.C., 48 p.
- Griffiths, J.F. 1972. World Survey of Climatology. Amsterdam: H.E. Landsberg Elsevier Publ. Co.
- Grove, A.T. 1971. Africa South of the Sahara. Oxford: University Press.
- Hopkins, B. D.P. Stanfield. 1966. A Field Key to the Savanna Trees of Nigeria. Ibaden, Nigeria: Ibadan University Press, 39 p.
- Hradsky, J. et al. 1982. Fuelwood: an appraisal of energy, ecology, and forest cover in West Africa (unpublished discussion paper). Abidjan: USAID/REDSO/West Africa, 65 p.
- Keay, R.W.J. 1959. Vegetation Map of Africa South of the Tropic of Cancer. Oxford: Oxford University Press, 24 p.
- Keay, R.W.J; C.F.A. Onachie; & D.P. Stanfield. 1960. Nigerian Trees. Lagos: Federal Government Printer.
- McGahuey, M. and R. Kirmse. 1977. Acacia albida: a field manual. N'Djamena: CARE-Chad, 121 p.
- National Academy of Sciences. 1979. Tropical Legumes: Resources for the Future. Washington, D.C.: NAS, 331 p.
- Pagot, J. 1975. Manuel sur les Paturages Tropicaux. Paris: I.E.M.V.T.
- Phillips, J. 1959. Agriculture and Ecology in Africa. London, Faber and Faber.
- Rattray, J.M. 1960. The Grass Cover of Africa. Rome: FAO.
- Riou, G. 1971. Quelques Arbres Utiles de Haute-Volta. Ouagadougou: C.V.R.S.

- Sen, K.M.; K. Updegraff; and L. Vitelli. 1984. Arbres et Arbustes: Burkina Faso. Ouagadougou: KAYA, 35 p.
- Sholto Douglas, J. and Robert de J. Hart. 1984. Forest Farming. London: Intermediate Technology Publications, 197 p.
- Swami, K. 1973. Moisture Conditions in the Savanna Region of West Africa. Ottawa: McGill University Series No. 18.
- Taylor, G.F. and B.A. Taylor. 1984. Forests and Forestry in the West African Sahel: A Selected Bibliography For: CILSS/Institute du Sahel and USAID, 207 p.
- Terrible, M. 1984. Essai sur l'Ecologie et la Sociologie d'Arbres et Arbustes de Haute-Volta. Bobo-Dioulasso: Libraire de la Savane, 257 p.