

pair trawling with small boats

PAIR TRAWLING with small boats

Text: H.S. Noel and M. Ben-Yami

Illustrations: S. Maugeri, M. Carlesi and A. Barcali

Notice: The designations employed and the presentation of material in this publication do not imply the expression of any opinion whatsoever by the Food and Agriculture Organization of the United Nations concerning the legal status of any country, territory, city or area or of its authorities, or concerning the delimitation of its frontiers or boundaries. The views expressed are those of the authors.

P-41

ISBN 92-5-100627-X

The copyright in this book is vested in the Food and Agriculture Organization of the United Nations. The book may not be reproduced in whole or in part, by any method or process, without written permission from the copyright holder. Applications for such permission, with a statement of the purpose and extent of the reproduction required, should be addressed to the Director Publications Division, Food and Agriculture Organization of the United Nations, Via delle Terme di Caracalla, Rome, Italy.

FAO 1980

Printed in Italy

PREFACE

This booklet has been written for artisanal and small-scale fishermen to help them learn a new kind of fishing: pair trawling, that is, trawling with two boats. It may also teach fishermen who have been pair trawling before a few new tricks and how to make trawlnets all by themselves.

This booklet may be used by fishermen who cannot read. But somebody who can read must help them. That "somebody" does not have to be a fisherman himself. He can be the fisherman's young son who has learned to read at school, the local schoolteacher, an extension worker, or anybody else who can read the words in this booklet. The fisherman himself will listen to the words and look at the pictures and, if he is a fisherman, he should be able to do all the things explained in the booklet.

When we speak here of fishermen, we are thinking of people who have fished before with lines or, better, nets such as gillnets or beach seines. People who know how

to work with a fishermen's needle to mend a hole in netting, to hang a sheet of netting on rope, and to join two pieces of netting. People who go in boats and canoes to a sea or lake and who have, or hope to have, engines in their boats. For them this booklet has been written most of all.

But we believe that this booklet may also be useful for fishery schools and for such village and town schools where fishing is taught. It should also be helpful in training practical fishing technologists and extension workers for village fisheries.

FAO would very much like to know what the readers think of this booklet: the language, style, and pictures. The comments, criticism, and opinions of the readers will help us to make future books better. So please write to the Fisheries Technology Service, Fishery Industries Division, Food and Agriculture Organization of the United Nations, Via delle Terme di Caracalla, 00100 Rome, Italy.

WHAT IS TRAWLING?

There are two ways to catch fish. A *passive* way is to wait for them to come to your hook, trap or gillnet. For these kinds of fishing you do not need a motor in the boat; you can sail or paddle to the fishing place, catch your fish and sail or paddle home.

If you put an outboard motor on your boat you can go further and find new and better places to fish, but then you need to catch more fish to pay for the fuel. You must also save money for repairs and to buy a new motor when the present one is worn out. In order to earn this extra money, you may need to go after the fish and hunt them down. This is the *active* way. If you do it with a net pulled along behind your boat you are trawling. Sometimes you can catch more fish by trawling and this can be done with one boat that has a motor — or with two boats with motors, working together. Trawling with two boats is called *pair trawling* and that is what this book is about.

If you look at the picture on this page you will see how men can pull small trawls to catch fish or shrimps in shallow water. These nets are very small and they would not catch much being pulled so slowly and so close to the shore.

What is needed is a bigger trawl net that can be pulled along the bottom in deeper water (a *bottom trawl*). To do

this one or two boats are needed to pull the net. The speed at which the net is pulled may be from 3 to 5 km/h (or 1.6 to 2.7 knots), so in one day it travels a long way catching fish. This method may bring more money than sitting and waiting for the fish to come to the net.

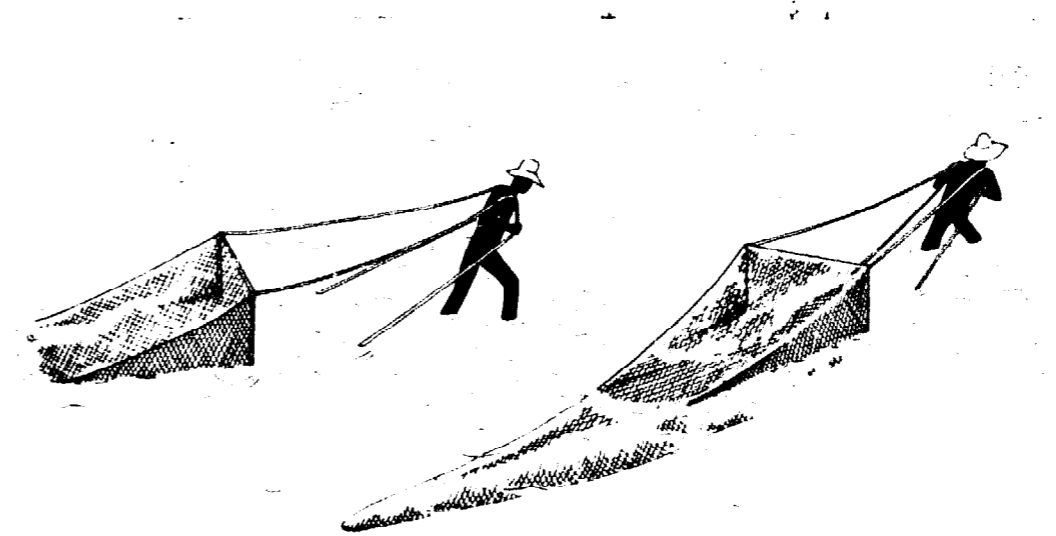

These fishermen are dragging small trawls in shallow water.

PAIR TRAWLING

In many countries there are very big boats for pulling a trawl. These are called *trawlers*, and the big ones are 120 m (400 ft) long, with engines of up to 6 000 horsepower (hp). They can catch many tons of fish every hour.

These big boats can pull a net with a mouth 25 or more metres wide — it is called an *otter trawl*, because the two

sides of the trawl net are held open by *otter boards*. These look like the top of a table and they have an iron or steel bottom edge. Because they are set in a special way they try to 'fly' sideways as they are pulled through the water, just as a paddle will go to one side if you hold it at the wrong angle. You can see how they hold the net open by looking at the picture of a trawl.

A lot of engine power is needed to pull otter boards through the water — sometimes up to half as much as is

needed to pull the trawl net. Because the boats we are going to write about in this book do not have very strong engines, they would not use otter boards.

Instead, two boats pull the trawl, one on each side. By pulling the trawl in this way the boats do not need otter boards to hold the net open and, if each boat has a 5-hp engine we shall have twice that power — 10 hp — to pull, or tow our net. If a single boat towed the same net it would have to use otter boards and this would need much more

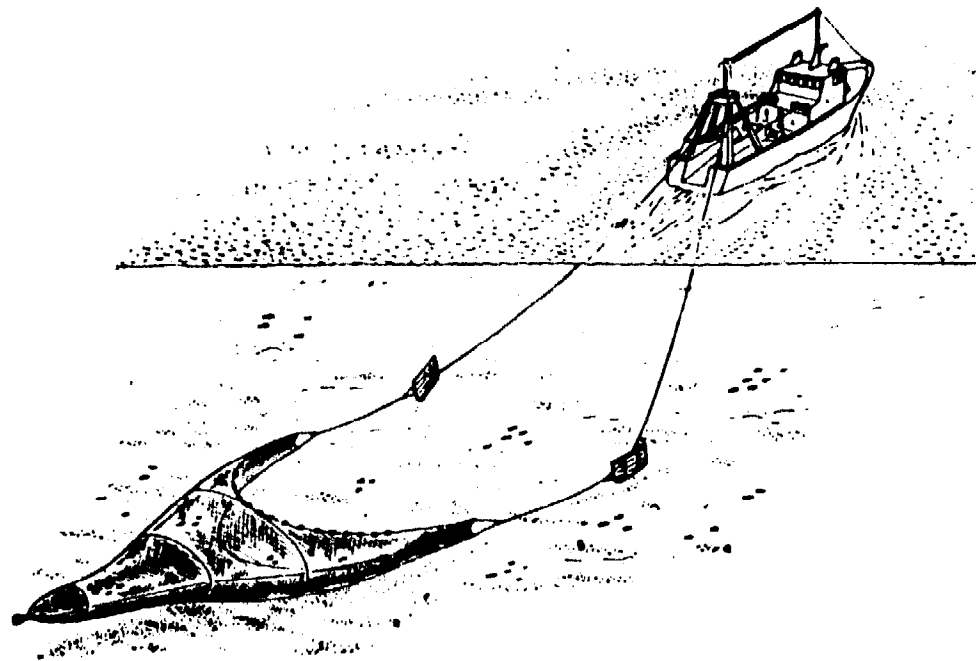

This is a big trawling ship fishing with an otter trawl on the high seas.

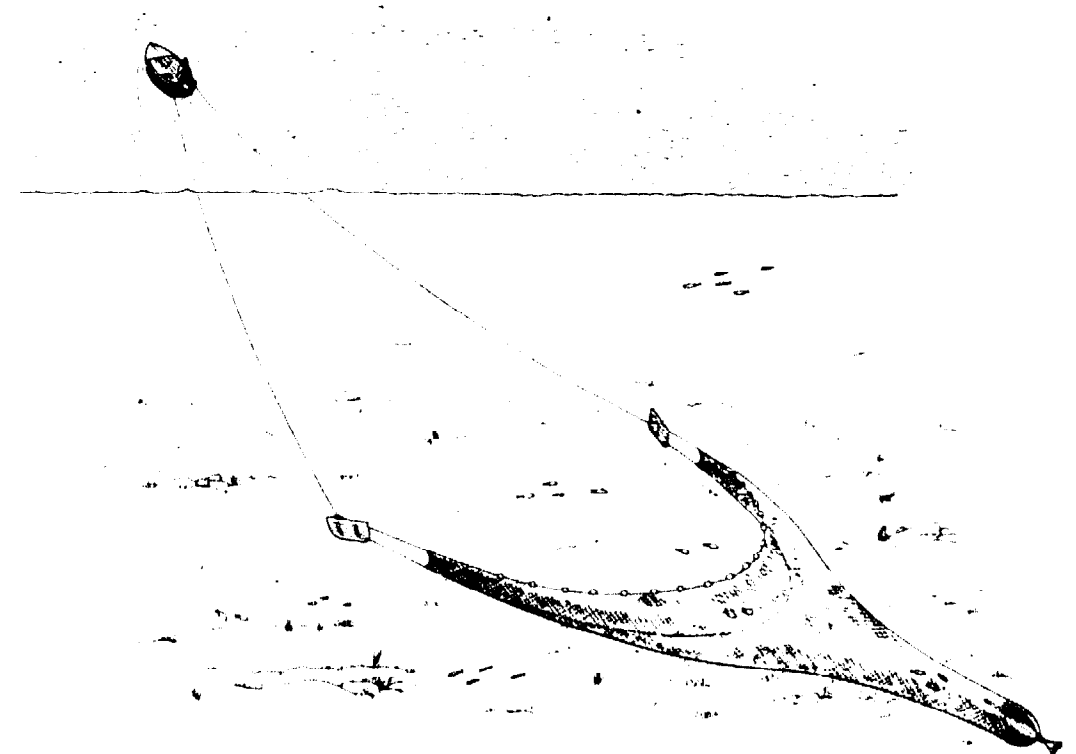

Otter trawl.

than a 10-hp engine — maybe a 15-hp one. So you see that we can go pair trawling with smaller engines, and at the same time, use less fuel.

There is one more good thing about pair trawling when compared with otter trawling with one boat: for the same size of net you may catch more fish. Why? Because a single boat towing in front and at the centre of a trawl net may frighten some of the fish away with the noise of its engine, propeller and towing ropes, while two boats

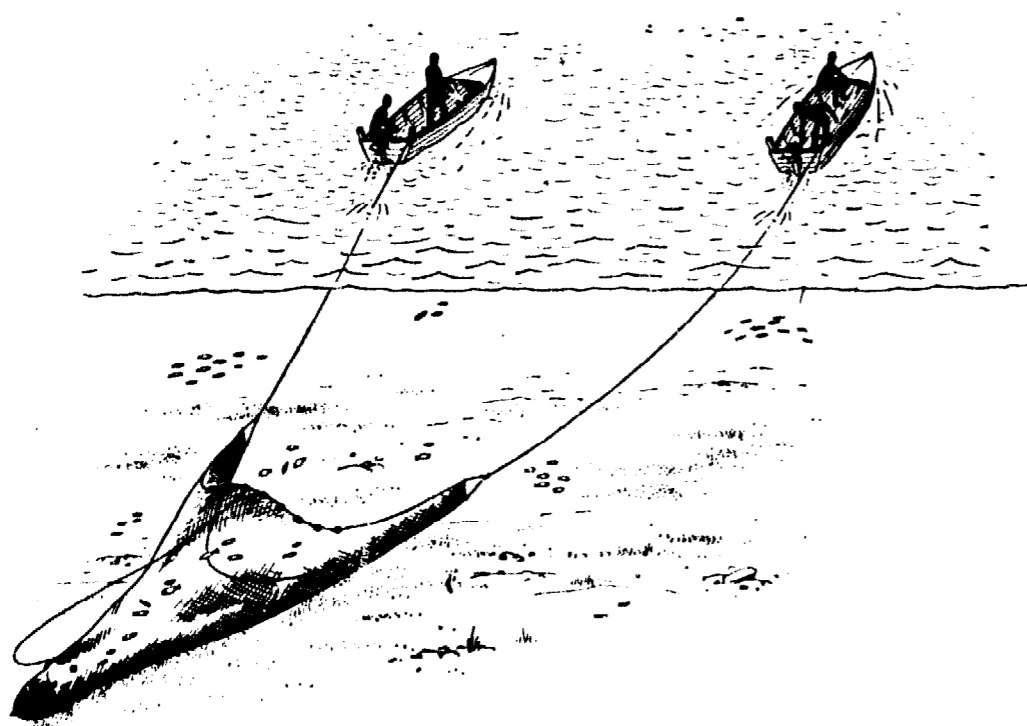

Pair trawling can be done with small boats and engines, and without otter boards.

towing in front and at the sides of the net will be making noises which will scare some of the fish toward the centre and straight into the net (see picture on next page).

IS PAIR TRAWLING GOOD FOR YOU?

Before we can decide whether to go pair trawling or not we need to know the good things and the bad things about this way of fishing. First we shall look at the good things, or the advantages:

- You may catch more fish;
- You may catch many different sorts of fish;
- You may catch prawns, shrimps or crayfish, which are worth much money;
- You may catch the sort of fish that you could not catch on a hook or in a gillnet or in a trap.

Now let us look at the not-so-good things, or the disadvantages:

- Two boats must work together and take orders from one man;
- Because you are using two boats, you must catch at least double what one boat could catch alone *in order to pay the extra cost of the second boat and its crew*;
- You have to pay for fuel and repairs to the motors;
- The trawl may get caught on a wreck or a rock and be damaged or even lost;

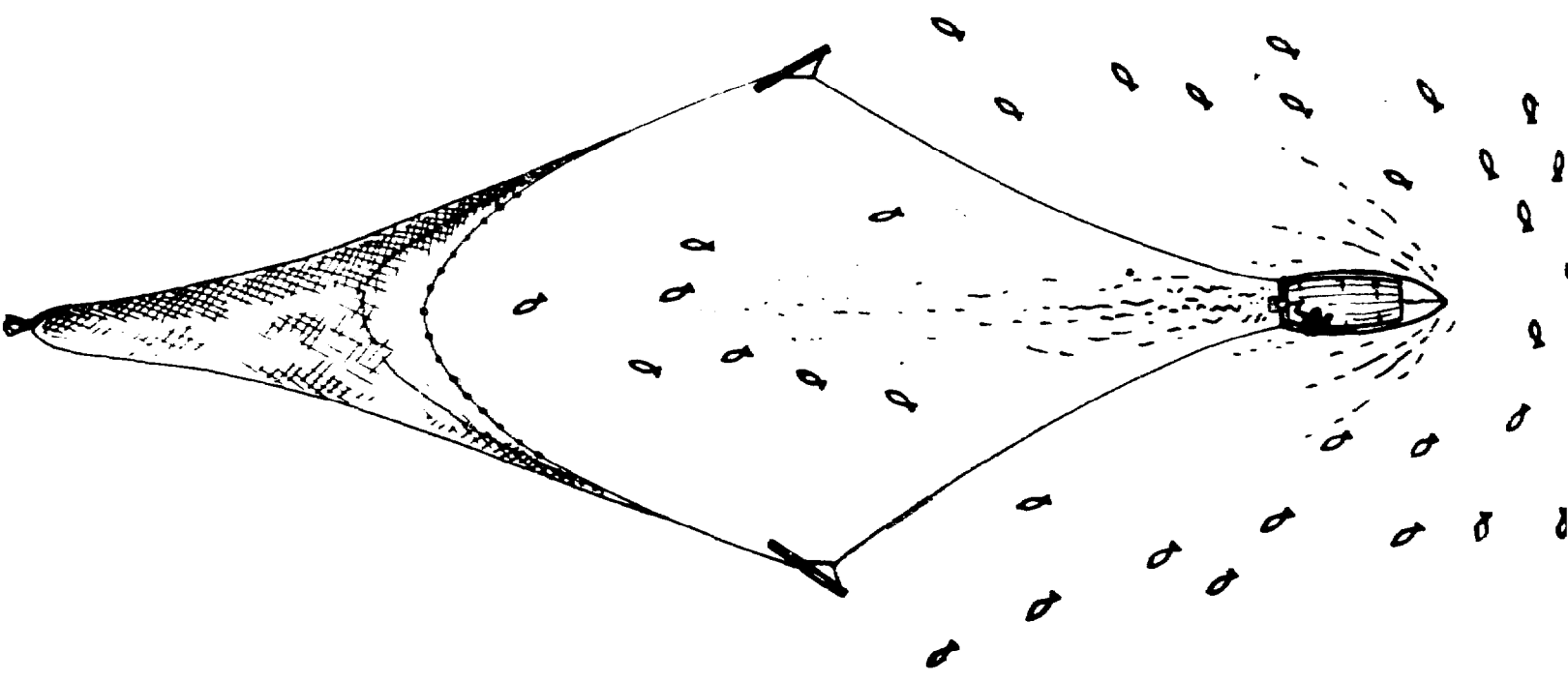

Pair trawling offers you a chance of catching more fish because you cover a bigger area and make noise not at the centre but at the sides of the trawl.

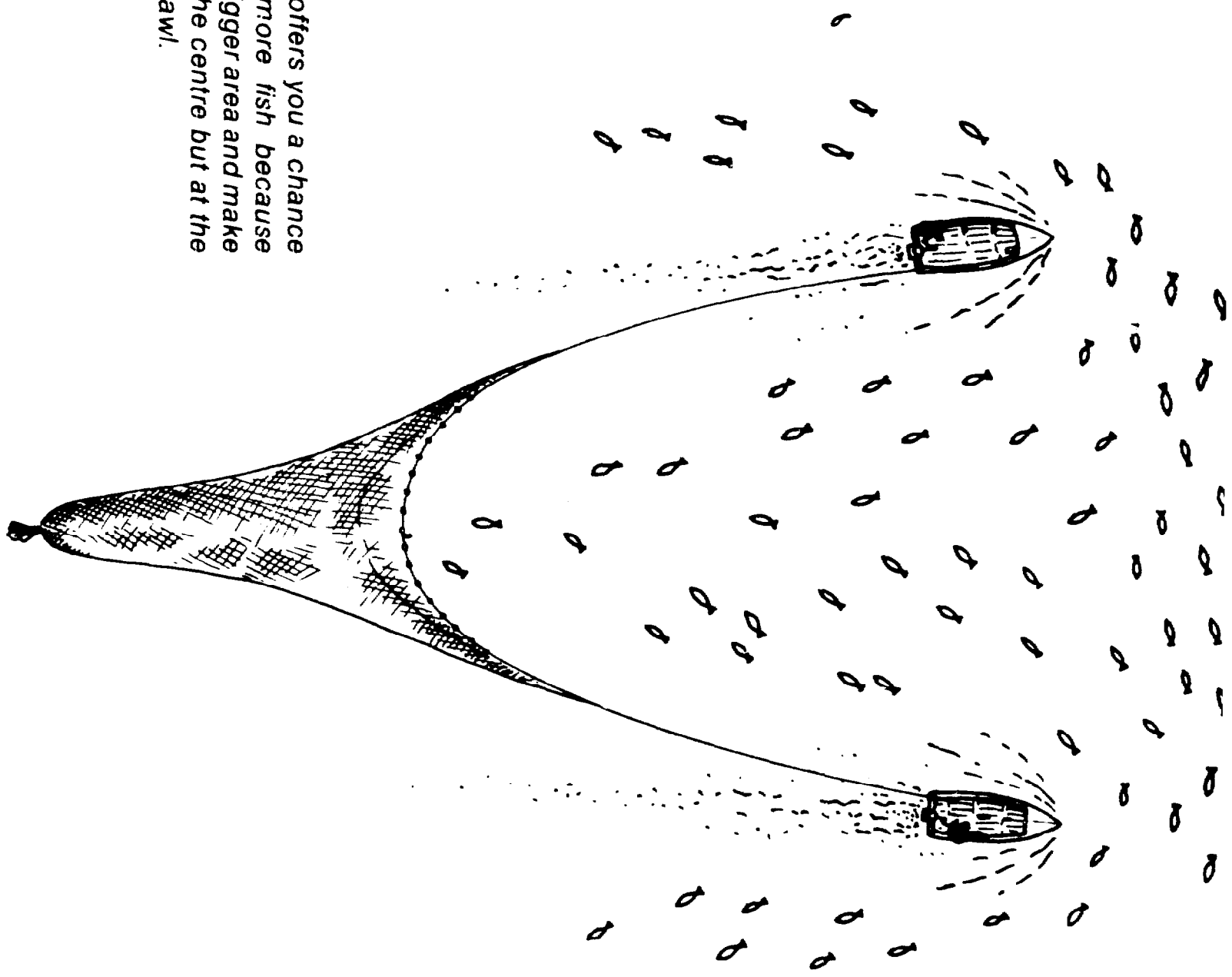

- You can only go trawling where the bottom is smooth enough;
- If one boat is laid up, or the engine will not start, the other boat cannot go trawling alone.

The important thing, of course, is that you hope to make more money, which is what every fisherman wants to do.

WHICH BOATS SHOULD YOU USE?

You can use almost any boat that has an engine for pair trawling in shallow water. We said that two 5-hp outboards would pull a small trawl, but, of course, a larger motor is better as it does not have to be driven so hard for the same pull. Whatever the size of the motor, it is best to have a large, low-pitch propeller for trawling. It is also best to get the propeller as deep as possible, to get a good 'grip' on the water, so an outboard motor with a long shaft is usually better than one with a short shaft.

Have your propeller as deep as possible for good pull. For this purpose you need a long-shaft outboard motor.

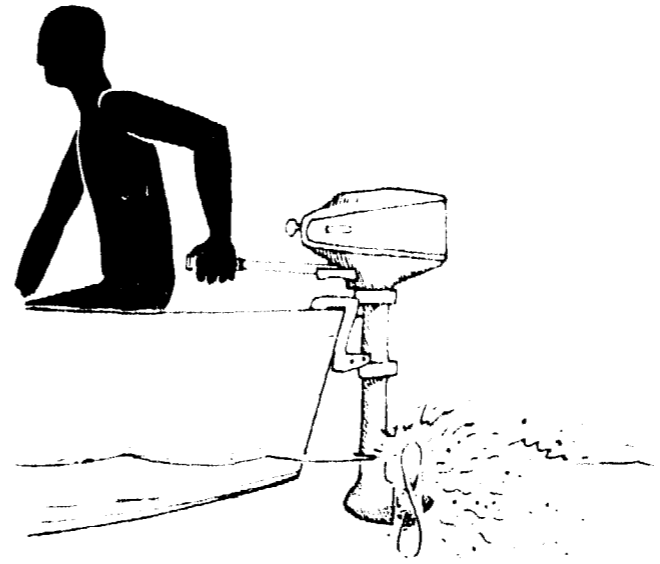

WRONG

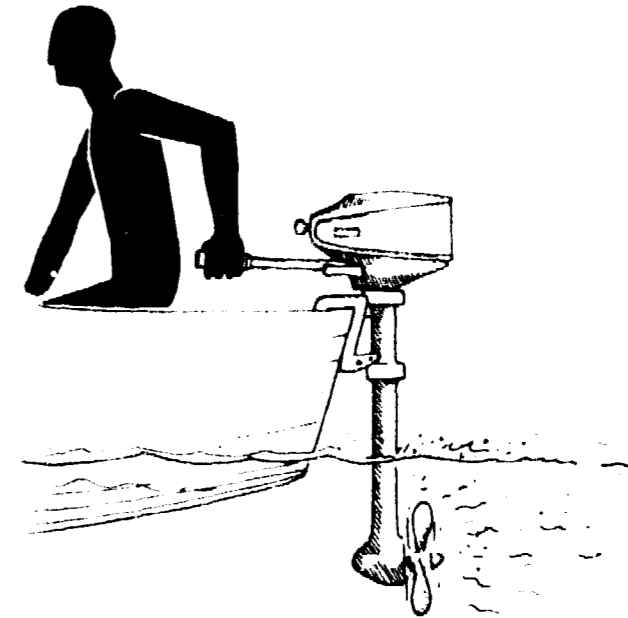

CORRECT

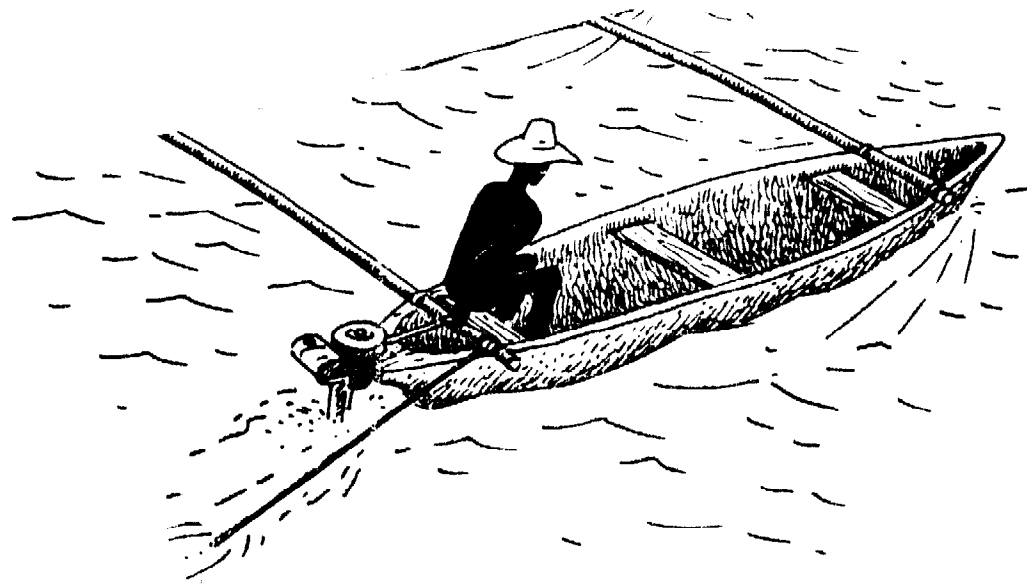

For trawling from canoes use outrigger floats ...

... or this may happen to you.

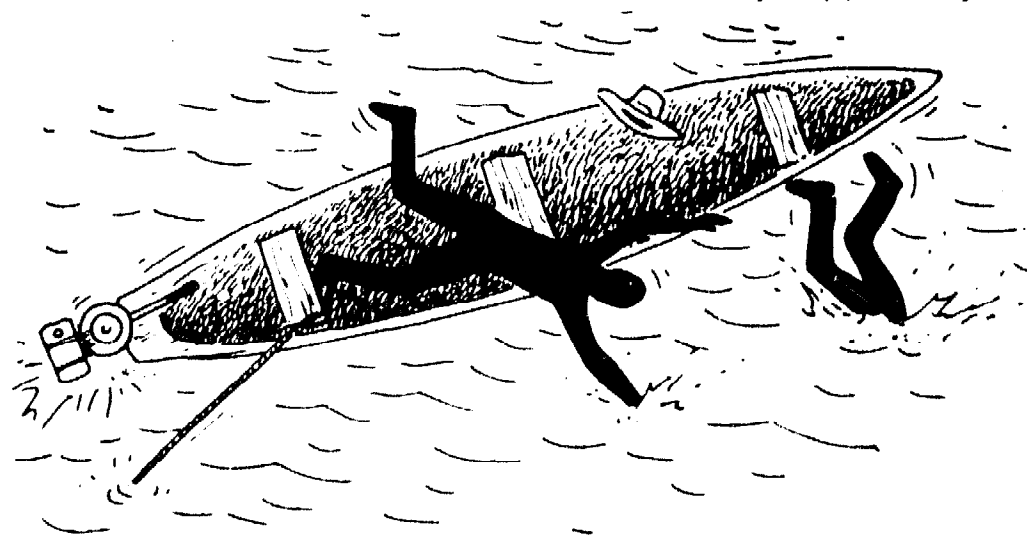

If you are going to use two canoes to pull your trawl, then it is safest to use outriggers on the canoes, like those in the picture. This is because the net sometimes gets caught on a rock or sunken tree which makes the towing ropes (the *warps*) get very tight. This can turn an ordinary canoe over.

At the end of each tow the trawl has to be pulled up and into the boat (*hauled*). A small pair-trawl can be hauled by hand, but bigger boats that use a big trawl and steel wire for the warps must have a winch driven from the engine.

Bigger boats with big trawls and steel-wire ropes for warps need a winch driven from the engine.

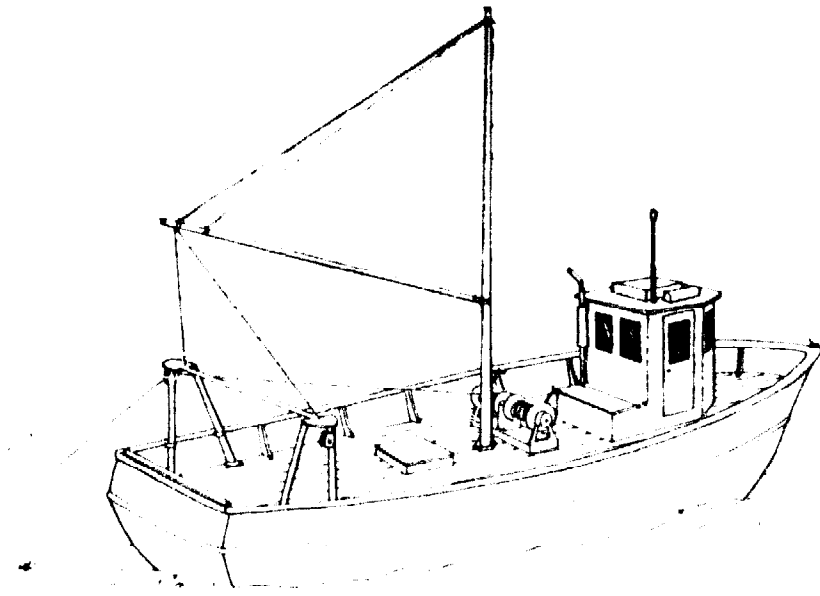

It is easier to go trawling with an open boat of 4 to 5 m than with a canoe. A boat has more *freeboard* than a canoe — that means that the sides are higher and the waves do not come over so easily. Another good thing about a boat is that, being wider, it has no need for an outrigger, so that the net can be used from both sides. Best of all, a boat can have a small diesel engine instead of an outboard motor, and this is better for trawling because it uses diesel fuel, which, in most countries, is cheaper than petrol.

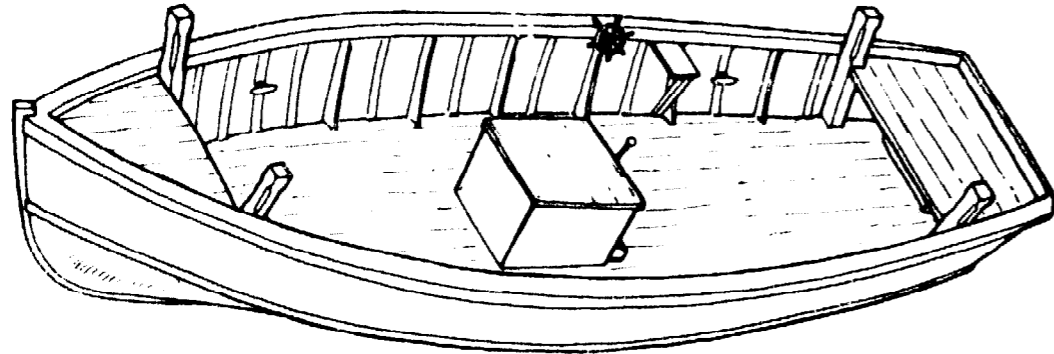

This small boat with an inboard engine is good for pair trawling.

An *inboard* diesel (inboard means inside the boat) can also be used to drive a small capstan or winch to pull in the warps. Providing there is enough room in the boat, even a simple hand-capstan or winch is a big help, especially when the net is heavy with weeds, stones or fish.

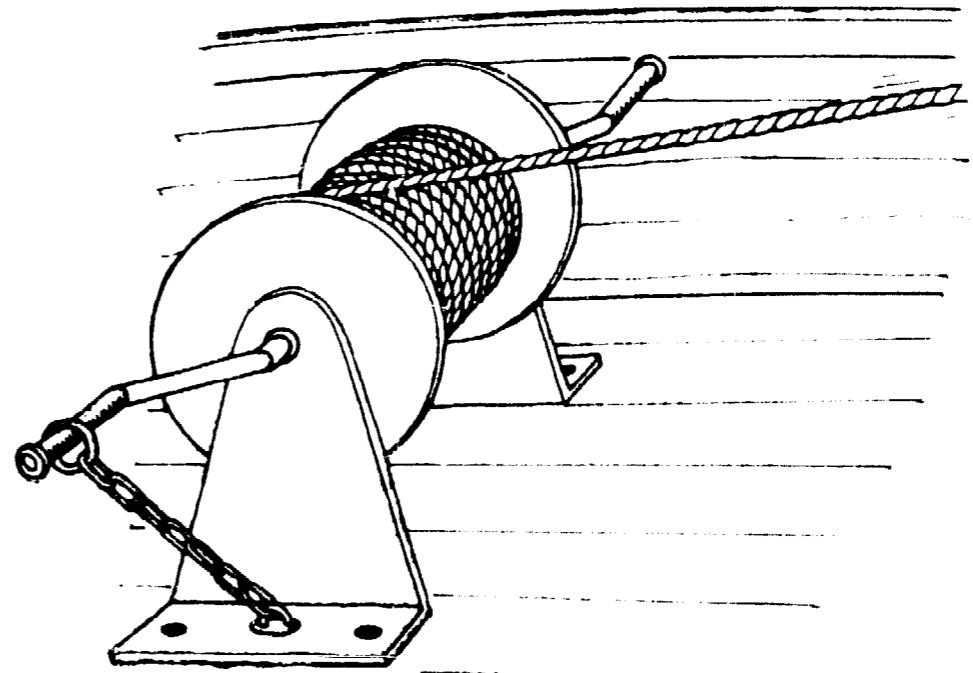

A good and simple hand winch may help a lot ...

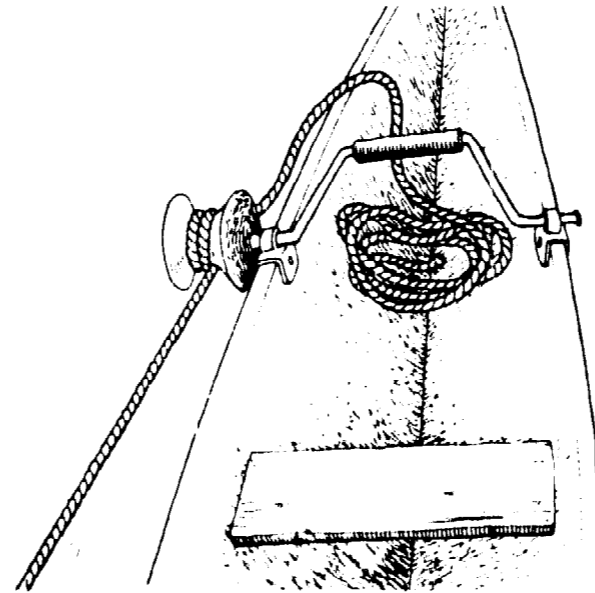

... or a hand-driven winch head.

Fishermen who live by a river or lake, or those who can fish from a harbour, are able to use all sorts of boats; but fishermen who work from a beach must use a canoe or a boat that is built to be beached when work is finished for the day. Whatever kind of boat you use, pair trawling is easier if you have plenty of power in the engine. Two small engines can tow the trawl in good weather, but in a strong wind you will need more power to stop the boats being blown off course, or turning into the wind when towing the trawl. Of course, where possible, you should tow with the wind, tide or current. If you tow against it, the boats will tow too slowly.

It is best if the two boats are the same size and power, because each side of the trawl (each *wing*) must be pulled with the same force, or the net may be pulled out of shape. It is easier to keep the two boats level if they both have the same kind of engine and propeller.

This is what may happen with one boat pulling more strongly than the other.

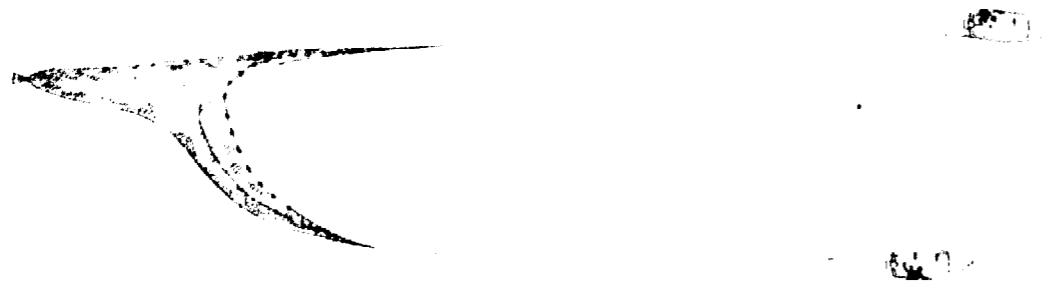

If you are not able to build a special boat for trawling, here are some ways to make your boat safer and easier to trawl with:

- Check for sharp corners, nails or rough wood on which the net can catch when putting out the trawl (*setting or shooting* the trawl);
- The boats or canoes must have strong towing posts and cleats to which the towing ropes can be fastened at each side of the boats' sterns. This gives you two places to fasten the towing rope or *warp*, according to which way the wind is blowing. Cleats in the middle (*midship*) and in front (*forward*) of the boat are also useful (see picture on p. 20);
- Controls for an inboard engine should be close to the tiller (the piece of wood or iron used to turn the rudder) so that one man can control the boat;
- Fasten a piece of thin rope to each side of the boat at the back (*aft*). These can be used to tie the tiller while the man who is steering does something else;
- Even on a lake, strong winds can make waves that can put water in your boat. A small foredeck helps to keep the boat dry and it provides a place shaded from the sun where the fish can be kept cool;
- If the propeller is not deep enough in the water try putting some stones in the stern as ballast. A big propeller with a low pitch is better than a small one with a high pitch. Also it is better to have a slow-turning engine because bigger propellers can be used. A fast-turning engine should have a re-

duction gearbox that makes the propeller turn more slowly, so that a bigger propeller can be used.

WHERE CAN YOU TRAWL?

If you have fished with traps or with a line you know that you catch more fish around rocks and wrecks. Trawling is different, for we need a clear, smooth bottom where a trawl will not catch on rocks, old tree-stumps or old fish weirs. When it does this we say that it has *come fast* on a *fastener* and if we can remember or mark that spot, we will not catch that fastener again.

Before we can say whether a place is good for trawling there are some things we must find out:

- Are there any laws or regulations against trawling in that place?
- Is the bottom level, smooth, and clear enough of rocks and rubbish?
- Is the current too strong?
- Is the water too deep (more than 15 to 20 m (8 to 11 fath))?
- Can you sell the fish or shrimp you will be able to catch with a trawl?

If the area in which you hope to go trawling has been surveyed for fishing by the Government, then your Fishery Officer will have the answers to many of these

questions. Perhaps bigger trawlers are fishing over this area. Or maybe you already know these waters well because you fish them in some other way. If not, you will have to make a survey yourself.

Echosounder

If you are making a survey yourself, it will save time if you can get a small echosounder. Perhaps you can borrow one from your Fisheries Department or the Extension Service. You need a small one that can record on paper the depth and type of bottom and it should be worked by batteries — if possible a 12-volt motor-car battery that can be recharged each night. The part of the echosounder that is underwater (the *transducer*) can be put over the side on a pole at the front half of your boat and must be level with or below its deepest part.

A small recording echosounder will tell you how deep the water is and whether there are any deep holes, reefs or very rough ground, and it will also give you some idea whether the bottom is hard or soft. If it is a 'white line' echosounder, it can show fish on the bottom — other recording echosounders will only show fish above the bottom.

A recording echosounder measures water depth by sending short, strong noises, but which you cannot hear,

down to the bottom; then it listens with a kind of ' electric ear ' for the echo of the noise to come back. When it does, a special pen called a *stylus* makes a mark on paper inside the glass window of the echosounder. The stylus is always moving across the paper, so when the water is shallow, the stylus has not moved far before the echo comes back and the paper is marked. If the water is deep, the stylus travels further before making a mark. The paper or the glass window is marked off in metres or fathoms and the position of the stylus mark or *trace* tells you how many metres or fathoms it is to the bottom. If a wreck, a reef or even a school of fish sticks up above the bottom, then this will be shown too as a mark by the stylus. There

are also simpler and cheaper echosounders that do not record the depth or fish on paper but instead show it by flashes of light against a marked scale. This type of echosounder may serve you later on, but the recording type is better for finding out how smooth the bottom is.

Look at the picture of an echosounder recording on this page and you can see the surface of the water, the bottom, and some fish in between. Some of these would probably be swimming too high to catch with your bottom trawl; such fish, if they do not swim too fast, can be caught with a *midwater trawl*, which is towed above the bottom.

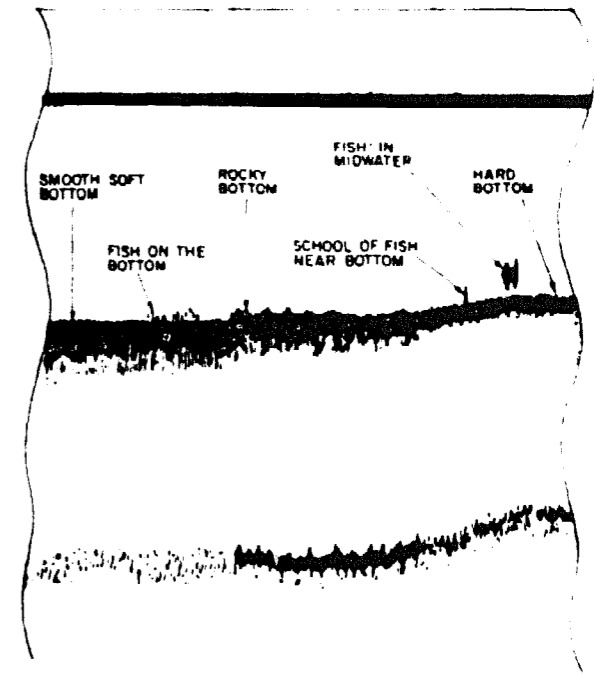

An echosounder

Leadline

If you cannot get an echosounder, you can still learn a lot about the bottom by using a *leadline*. This is simply a weight (or *lead*) fixed to a line which is marked off in metres (or fathoms). By dropping it over the side and letting the line run out until the weight hits the bottom you can see how many metres or fathoms have run out. This is the depth. The weight has a hollow end that picks up sand or mud from the bottom so that you can see whether it is hard or soft. It helps if you smear it with grease, tallow or any other sticky stuff. When using the leadline (we call this *taking soundings*) when the boat is going ahead (*under way*), we must throw the lead in front of the boat to give it time to sink to the bottom. The depth is measured when the line is straight up and down.

You can make a good leadline yourself. The weight can be an old piece of iron pipe about 35 mm (1 3/8 in) across, and filled with cement, except for 20 mm (3/4 in) at the bottom. An old chain-link is set in the cement at the top to take the line. This is 6 mm (1/4 in) in diameter, and made of any material, natural or synthetic, that coils easily. It is marked every metre (or fathom) by weaving canvas or plastic sheet through the twists or *lays* of the line — one for 1 m, two for 2 m, three for 3 m and so on up to, say, 5 m and then start again with one. In very shallow water you may be able to use a long pole instead of a leadline, and this can be marked with notches. With a pole you can feel if the bottom is hard or soft.

You can also mark your leadline by using marks of different colours.

TAKING SOUNDINGS

Throw the leadline far ahead.

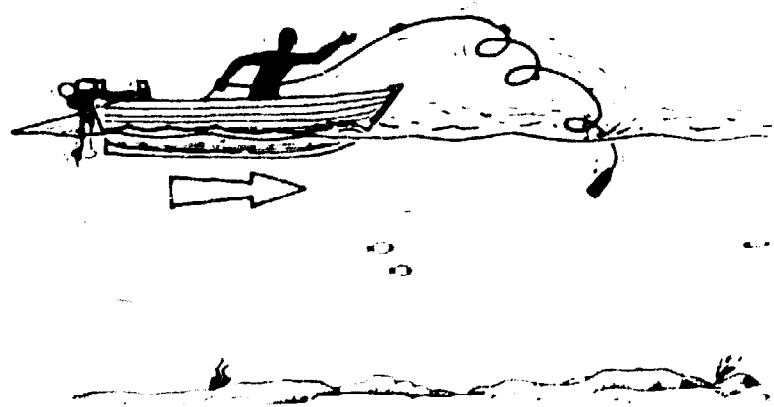

Let out enough line so that the lead can get to the bottom quickly.

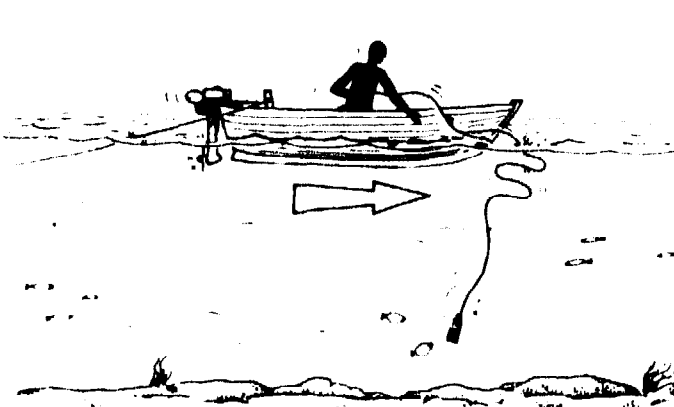

The line is straight up and down and the lead touches the bottom; this is your depth.

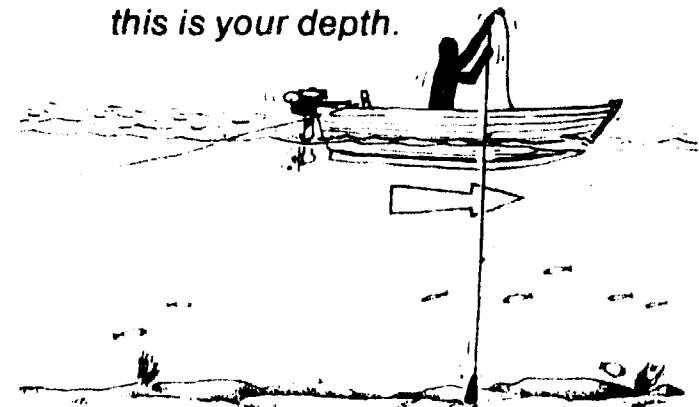

A marker buoy.

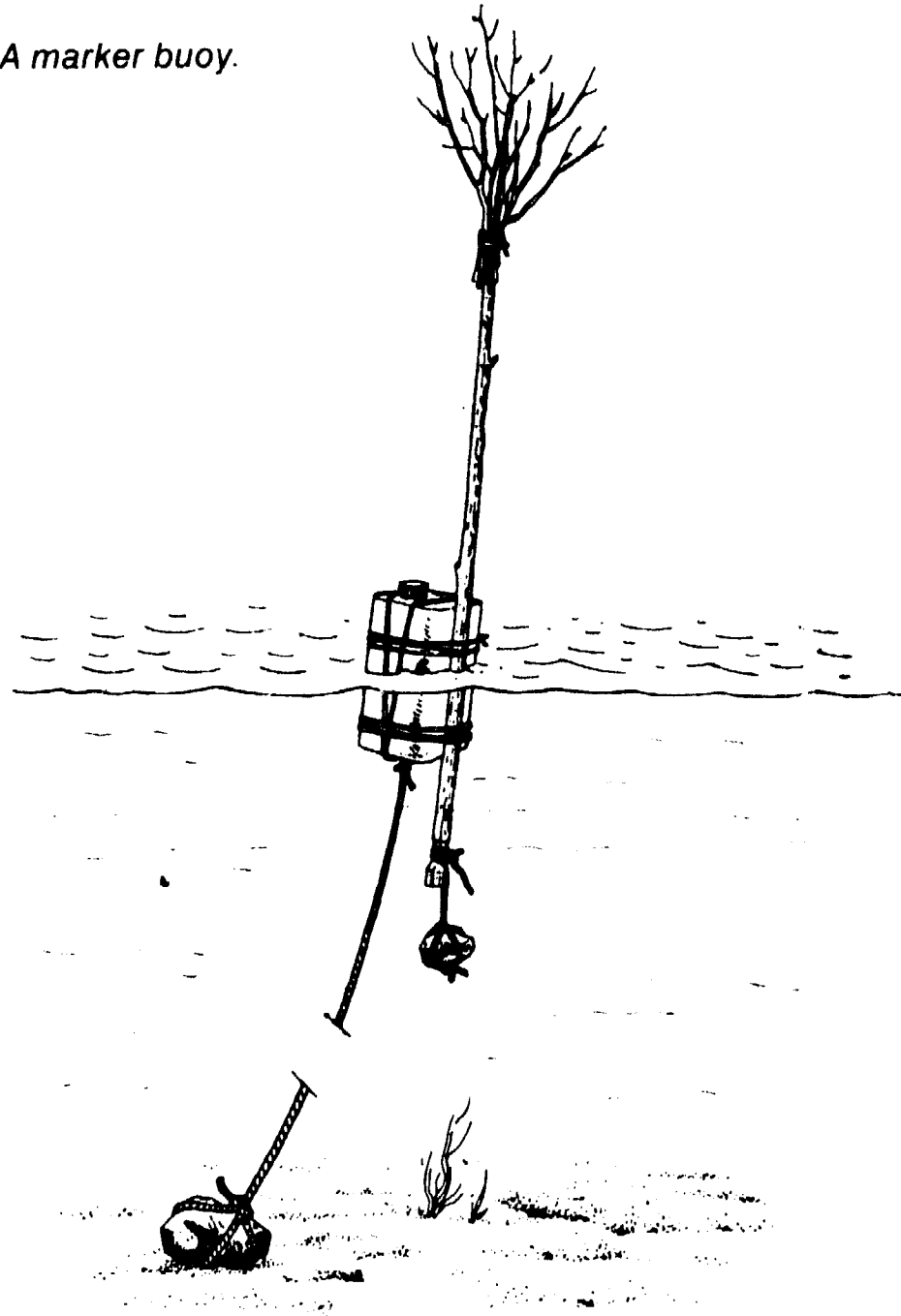

Checking the bottom

It is best to begin your survey up-tide and up-wind of the stretch of water you want to check so that the current or the wind is pushing you in the right direction. Choose the point where you want to begin and push a long pole into the bottom if the water is shallow; if not, use a simple buoy made with a float such as an old oil-drum, a piece of rope longer than the depth of water and an ' anchor ' of scrap iron or rock. Do the same at the other end of your survey run.

While you are measuring the depth and checking the hardness of the bottom you can also check for ' fasteners '. We do not want to put an expensive new net in the water until we have checked to see if the bottom is clear.

Two ways of learning things about the sea bed.

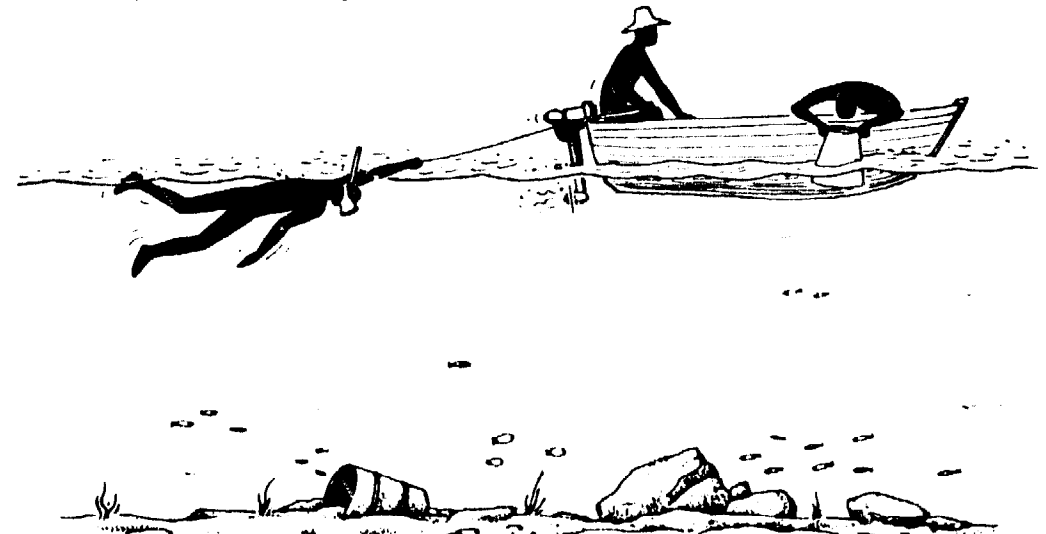

Looking at the bottom

If the water is clear and shallow we can learn a lot about the bottom by just looking at it. This can be done by putting on a diving mask or diving goggles and following the boat on a safety rope. Or you can fit a piece of glass into the bottom of a box or bucket so that it is watertight; by pushing this into the water as you lean over the side you will be able to see into the water and look for rocks and rubbish on the bottom.

Combing the bottom

In most cases it will be necessary to check the bottom with combing gear, towed between our two boats.

We do this with a cable towed between the two boats like a trawl. While we are combing we can also be measuring water depth with our echosounder or leadline and taking samples of the bottom. This is good practice for pair trawling. If the combing gear catches on something, the glass box or diving mask can be used to see what it is. Sometimes an old anchor or sunken dugout-canoe can be moved out of the way. If the area seems to be good for trawling with only one or a few of such fasteners, you may try to remove them. If you cannot remove them then remember the place or mark it on a simple map by using cross-bearings of shore marks; if possible, attach a buoy

or set a pole on the fastener so that you can see it from far away.

How to make combing gear

The combing gear can be towed by the two towing ropes or *warps* which we shall use to pull our trawl later on. Between the warps we fix a strong 'combing rope', 100-150 m long, on which are tied pieces of old chain to keep the rope on the bottom. Wire cannot be used for combing unless it is 'soft' enough to lie flat on the bottom, without kinks.

Each end of the combing rope is held down (*ballasted*) by a heavy piece of scrap iron, a piece of old chain or a heavy stone with a hole through it and this should weigh as many kilograms as the horsepower of the engine in the towing boat. In the middle of the combing rope are two loops or eye splices and these are joined by thin rope (see next page). If the combing gear catches on a fastener this thin rope, or 'weak link', should break. The two pieces of combing rope can then be pulled up and joined again, ready for more work.

The warps have to be from 4 to 10 times longer than the depth of the water you will trawl in, plus more warp in the boat as a reserve. The following table shows you the length of the warps for the different depths.

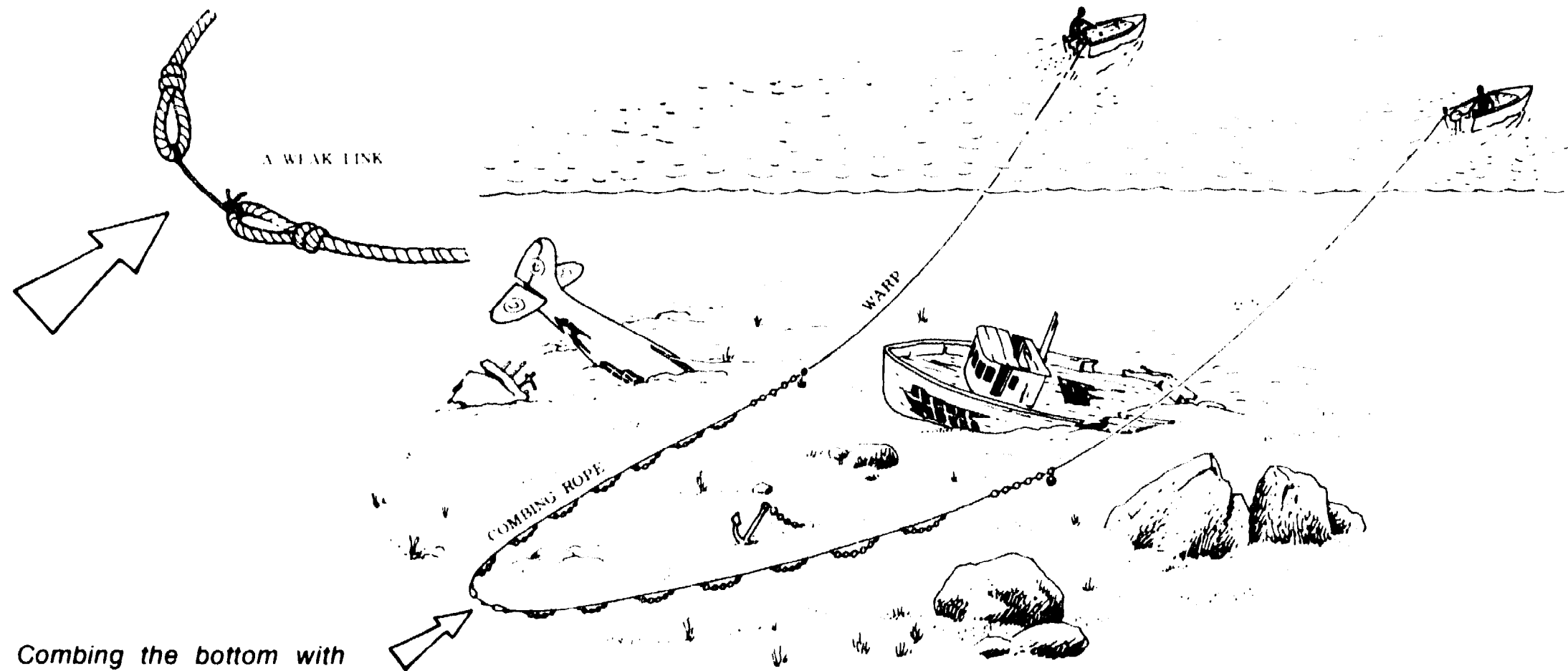

Combing the bottom with
combing gear.

How long should the warps be? See the depth at the left side of each column of the table on the next page and the length of the warp at the right side. You may choose metres, feet or fathoms, whichever unit you are used to.

14 For faster towing, for example, with wind or current, use

the bigger length of the two shown in the table. The warp must be thick enough and soft enough to be easily pulled by hand. It can be natural rope, such as sisal or manila, or it can be a *synthetic* rope of *man-made* fibres such as nylon, polyethylene or polypropylene. Some ropes get very stiff

when they are wet and become hard to work with. Ropes made of polyvinyl alcohol (Kuralon) are like this. Some synthetic ropes are so light that they will float up if not ballasted. Polyethylene and polypropylene ropes are like this. If they are used for warps, it is advisable to fit pieces of light chain 2-6 m long at the ends of the warps.

Remember these warps may be used later for fishing with your two-boat trawl and the work you are doing to prepare them is not only for the 'combing' survey.

Depth and length of warp

| Metres | | Feet | | Fathoms | |
|--------|---------------------|-------|---------------------|---------|---------------------|
| Depth | Length of the warps | Depth | Length of the warps | Depth | Length of the warps |
| 2 | 15-20 | 5 | 35-50 | 1 | 7-10 |
| 3 | 25-30 | 10 | 80-100 | 1 ½ | 12-15 |
| 4 | 30-40 | 15 | 120-145 | 2 | 15-20 |
| 5 | 35-45 | 20 | 150-170 | 2 ½ | 20-25 |
| 6 | 40-50 | 25 | 180-195 | 3 | 20-25 |
| 8 | 45-55 | 30 | 190-205 | 4 | 25-30 |
| 10 | 50-60 | 35 | 195-210 | 5 | 30-35 |
| 12 | 55-65 | 40 | 200-215 | 6 | 30-35 |
| 14 | 60-70 | 45 | 205-220 | 7 | 35-40 |
| 16 | 65-75 | 50 | 210-225 | 8 | 35-40 |
| 18 | 70-80 | 60 | 230-250 | 9 | 40-45 |
| 20 | 75-85 | 70 | 250-270 | 10 | 40-45 |
| | | | | 11 | 45-50 |

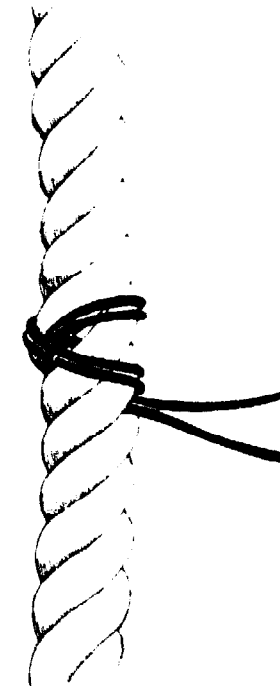

A mark on a warp.

Before you use the warps they must be marked off in metres, fathoms or feet, so that both boats can let out the same length of warp when they are trawling. Stretch the two warps out on the ground beside one another and mark every 5 or 10 m, exactly level on both ropes. Start

measuring and marking from the end that will be fixed to the trawl (the trawl end) — this is very important. Make the marks with the netting twine passed through and around the lays of the rope. Use a long mark for 10 m and a short one for 5 m, and have one, two and three 10-m marks at 10, 20 and 30 m from the end. Then start again. If you are making marks every 10 m, use one mark for 10 m, two for 20 m and so on until five for 50 m and then start again with one for 60 m and so on. Usually it is enough to start the marking from 15 m onward. Measurements can be made in feet or fathoms if you use them instead of metres.

Shrimp trynet

It is also a good idea to have a simple trynet with which at the same time as you are doing the combing survey you can look for shrimp. The trynet is made by bending 1 m of 12-mm thick (diameter) iron rod into a triangle and fitting it with a 'bag' of 20-mm (3/4-in) stretched mesh netting, like a small trawl. It is pulled by a light rope about 8 mm diameter to which it is fixed by a three-line bridle, as shown in the picture. The trynet is put over every 10 minutes and the towing line let out until you can feel the net bumping on the bottom. After two or three minutes it is pulled in and checked for shrimps. Two or three shrimps in the trynet is a good sign and if you find small crabs or other animals, then this could be a good feeding ground for fish.

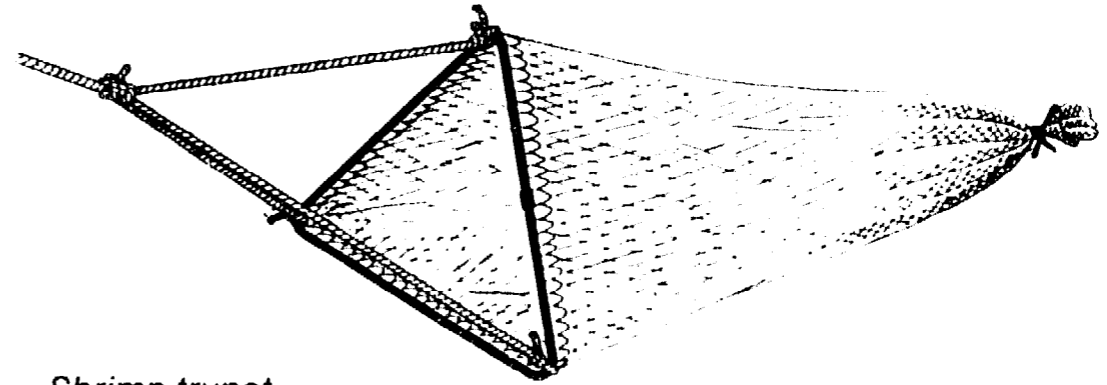

Shrimp trynet.

How to use the combing gear

The combing gear is carried in the boat of the chief fisherman, and we will call this Number One boat. To put the combing gear on board, you make the boat-end of one warp fast to a cleat on the boat then coil the warp with the boat-end down and the trawl-end on the top aft or on the net platform if you have one. Now attach the first ballast weight to the trawl-end, and put it in such a place that it will not be in the way of the combing rope as it runs off the boat. Now tie the end of the combing rope to the weight. If you are using a chain for the weight, attach the combing rope to the other end of the chain; that is, not to the same end to which you tied the warp.

Now, still on Number One boat, coil down the combing rope in such a way that it can run freely off the boat

without entangling with other ropes and things. If it does, you may have a big mess to clear. Finally, leave the end of the combing rope on the top of the rest and ready to be passed to the Number Two boat.

On the Number Two boat you coil down the warp and the ballast weight as you did on the Number One boat.

Now you are ready to go to the starting place you have chosen, which, if possible, you have marked with a buoy. Check the depth of water, so that Number One can tell Number Two how many metres of warp to let out. Both boats must, of course, let out (*pay out*) the same length of warp.

Number One passes the end of the combing rope to Number Two, who will tie it to the chain weight.

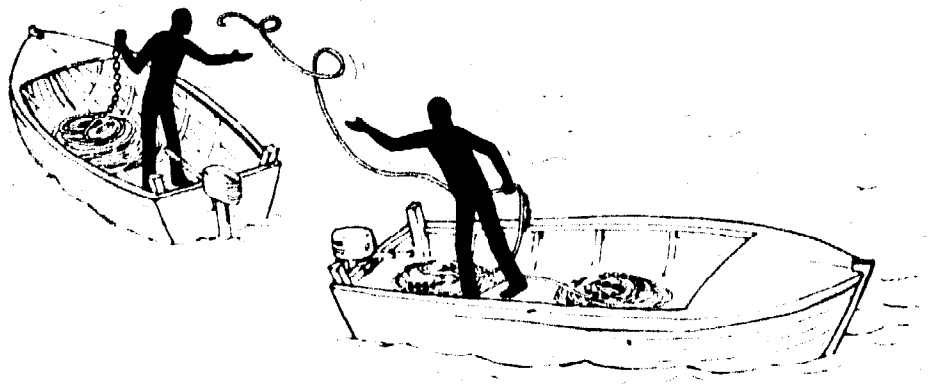

The two boats now come together so that Number One can give the free end of the combing rope to Number Two, who makes it fast at the weight. Both boats then move slowly ahead and away from each other paying out first the combing rope (Number One) and then the weight and warps until the agreed number of metres is reached. On each boat the warps are then made fast by a special turn on the towing post which will be explained later.

Look at the picture on page 18 to see how to set the combing gear, in what direction Number One pays out the combing rope and how, later on, both Number One and Number Two boats pay out or shoot the warps.

Now the boats begin, as you see in the picture, towing *down-wind* (with the wind) or *down-tide*, whichever is the strongest. It is important that the boats are the right distance apart when combing or trawling. Later in this book you will read about choosing the right distance when trawling and keeping it by means of a *distance rope*. When combing, keep the distance between the boats the same as, or a little less than, the length of one warp plus half of the length of the combing rope. So, if your combing rope is 100 m (55 fath) long, and you have paid out 50 m (27.5 fath) of warps, the distance between the boats should be $50 + 25 = 75$ m (41 fath) or a bit less, say, 70 m (38 fath).

Both boats must tow at the same speed and they must keep level with each other. You can check your towing

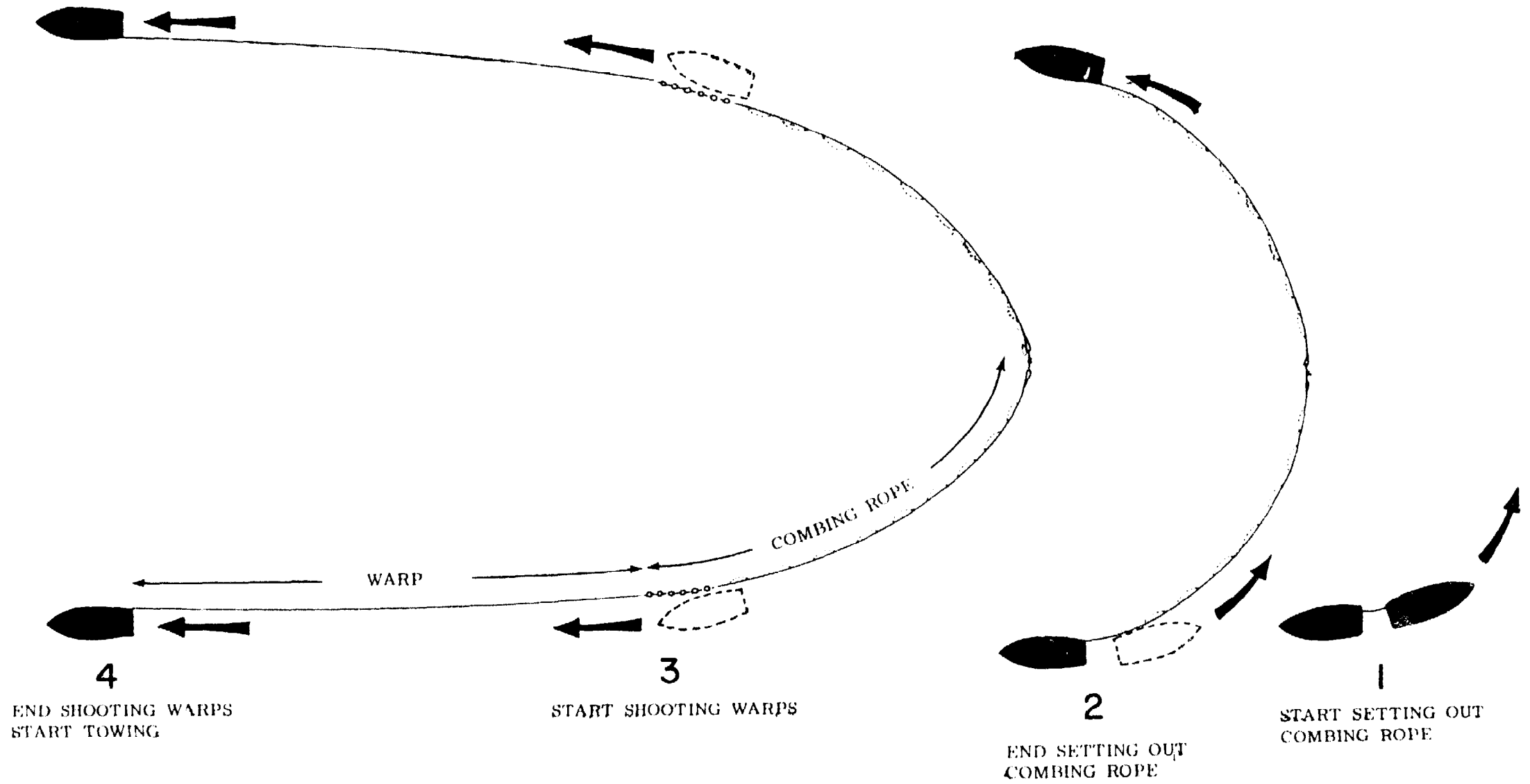

speed (speed over the bottom) by throwing the lead (the weight on the leadline) ahead of you. When it reaches the bottom, watch how fast the boat moves compared to the lead, which is not moving.

When combing keep a hand on the warp, to feel if the gear is bumping on the bottom. If you feel nothing, this may mean that the gear is not touching the bottom, and you must let out more warp or slow down. It can also

mean that the gear is caught on a fastener and the ' weak link ' has not parted. In such a case, you will feel that the warp is very tight and the boats have stopped. If this happens, stop the engines of both boats, or put them into neutral gear. Pull in the warps until the boats are over the fastener with the warps ' up and down '. Now the combing rope will usually pull clear. If not, tow the warps back the way you came because the gear will often come off the way it went on. If one of the boats can pull in and the

Checking the towing speed using a lead (this boat is moving over the bottom).

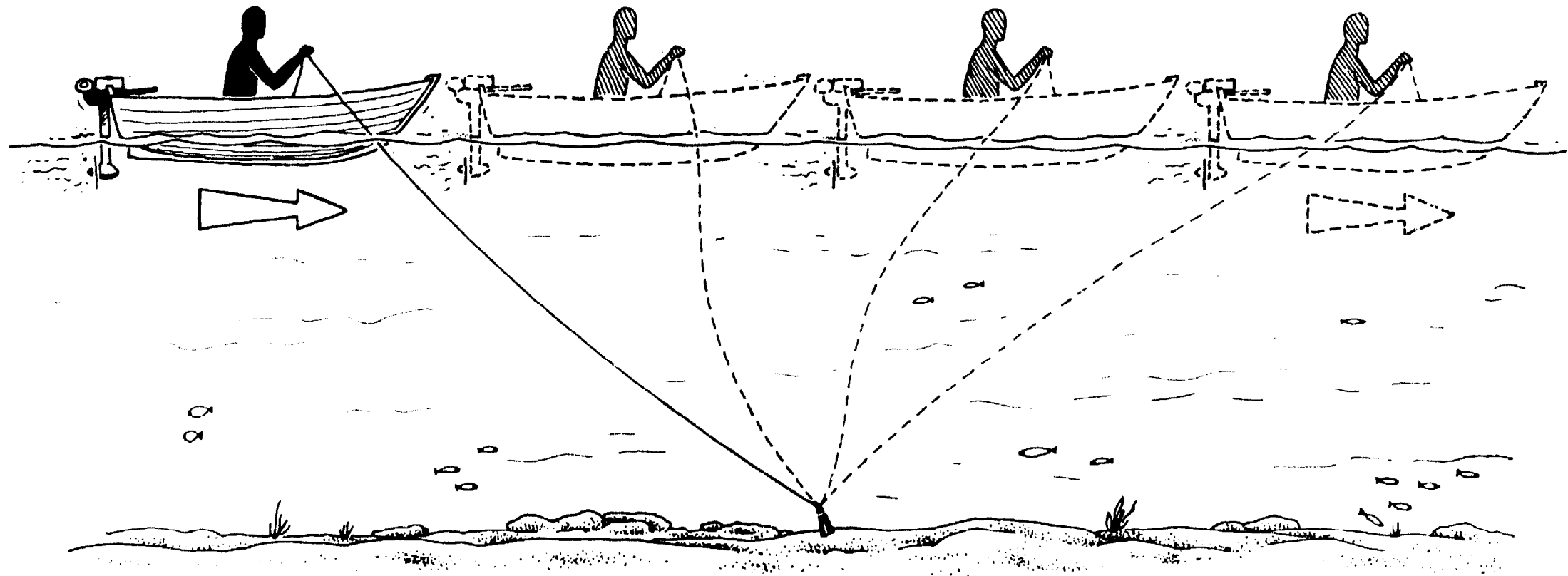

other cannot, then pull from the first and let go from the second. If none of these ways gets you clear, you will have to put the engines full ahead and try again to break the 'weak link'.

Sometimes you will want to let the warps go quickly — in a strong wind perhaps. If you have fastened them tightly around the towing post, the rope may be jammed, so that it is very difficult to untie it and especially in bad weather even dangerous. Always put two turns around the towing post and make the rope fast on a separate cleat, then you will never have this trouble. Never put the rope on the towing post with a clove hitch. And always carry a good knife in the boat to cut a rope in an emergency.

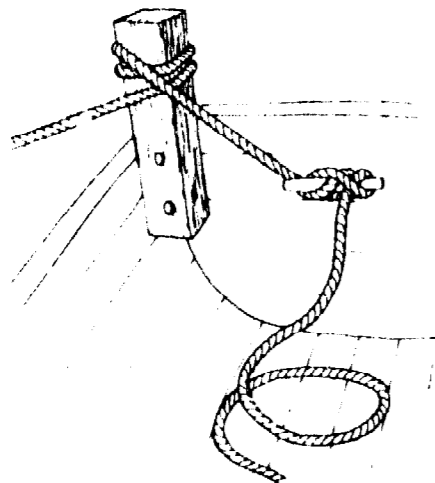

CORRECT

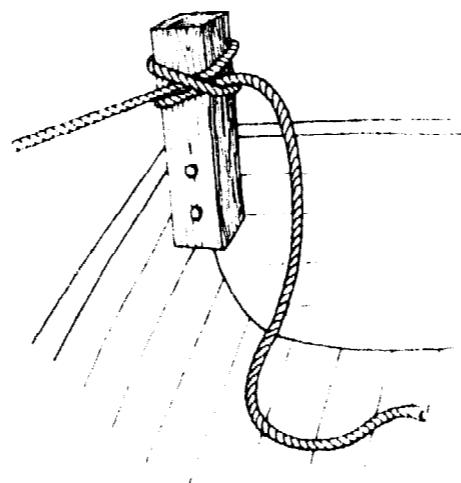

WRONG

If you find that the ground is clear for trawling you may want to know if there are enough of the right kind of fish to make good money. You can get some idea by fishing the ground with gillnet or line, but the only real way is to try with the trawl.

The next thing, then, is to decide what is the right kind of trawl to use. To do this you must know how trawls are made and how they work.

HOW TRAWLS CATCH FISH

The shape of the trawl

When water flows through a trawl it blows it up into shape, just as wind fills a sail. And, as is the case in many sails, a trawl has ropes around its edges to make it strong and keep it in shape.

The shape of a trawl is very important, and every fisherman likes to fix his net the way he wants it. Divers who have gone down to look at trawls fishing have told us that more fish escape from a trawl that is pulled out of shape by a bad repair, or from one that was badly made, than from a well-made and well-kept trawl. They have also seen how important it is to use the correct length of warps and the correct number of floats and sinkers, so that the groundrope is firmly on the sea bed.

A trawl is not just a bag of net which is big at one end and small at the other. Each part of the net is there for a purpose and each part has its special name. Fishermen have been making their trawls better and better for a hundred years — but they are still not satisfied.

There are different kinds of trawls for different kinds of fishing, and the kind you should be using is for catching fish that live and feed on the bottom. We call it a *ground trawl* or *bottom trawl* and, as you will use two boats to tow

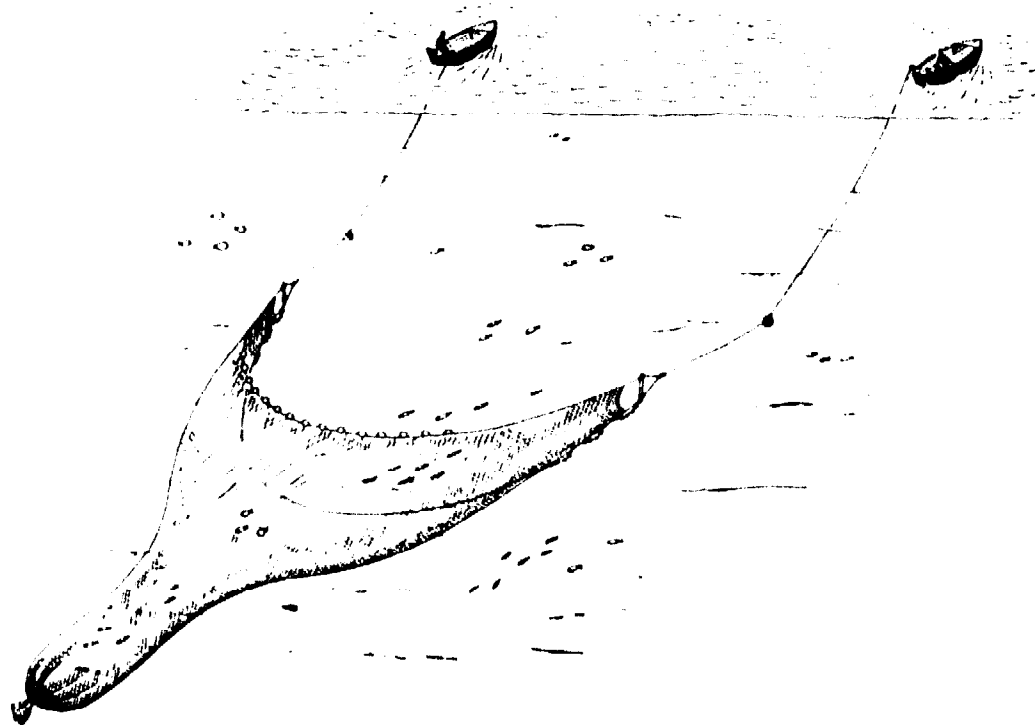

it, it will be a two-boat or pair bottom-trawl. Such trawls come in many different types and sizes, because pair trawling is being done not only with small boats, but also with medium and even with quite large fishing vessels of several hundreds of tons. Later in this book we tell you how to make a 'four-seam' or 'box' type of trawl for two 4- to 5-hp boats. Here we want you to look at another very common kind — a 'two-seam' trawl.

The picture on page 22 shows a trawl net split up into the parts from which it was made. The picture on this page shows how a trawl net looks when it is being towed in pair trawling. You can see how the weights keep the trawl on the bottom and how the floats keep the mouth open. You can also see how the ropes keep the net in shape and why you must keep the wings level when you are towing a trawl.

How fish are caught

Fish may be frightened by noise and swim away from it. But noise may also scare fish into our net. The strongest noise they hear is the noise of the engine and propeller of the boat nearest to them. This scares them to either side of the boat, so that some go toward the net. Next, the fish hear the drumming of the warps, sweep lines and bridles and, if the water is clear, they see the clouds of sand or mud stirred up by the lower bridles, the weights and

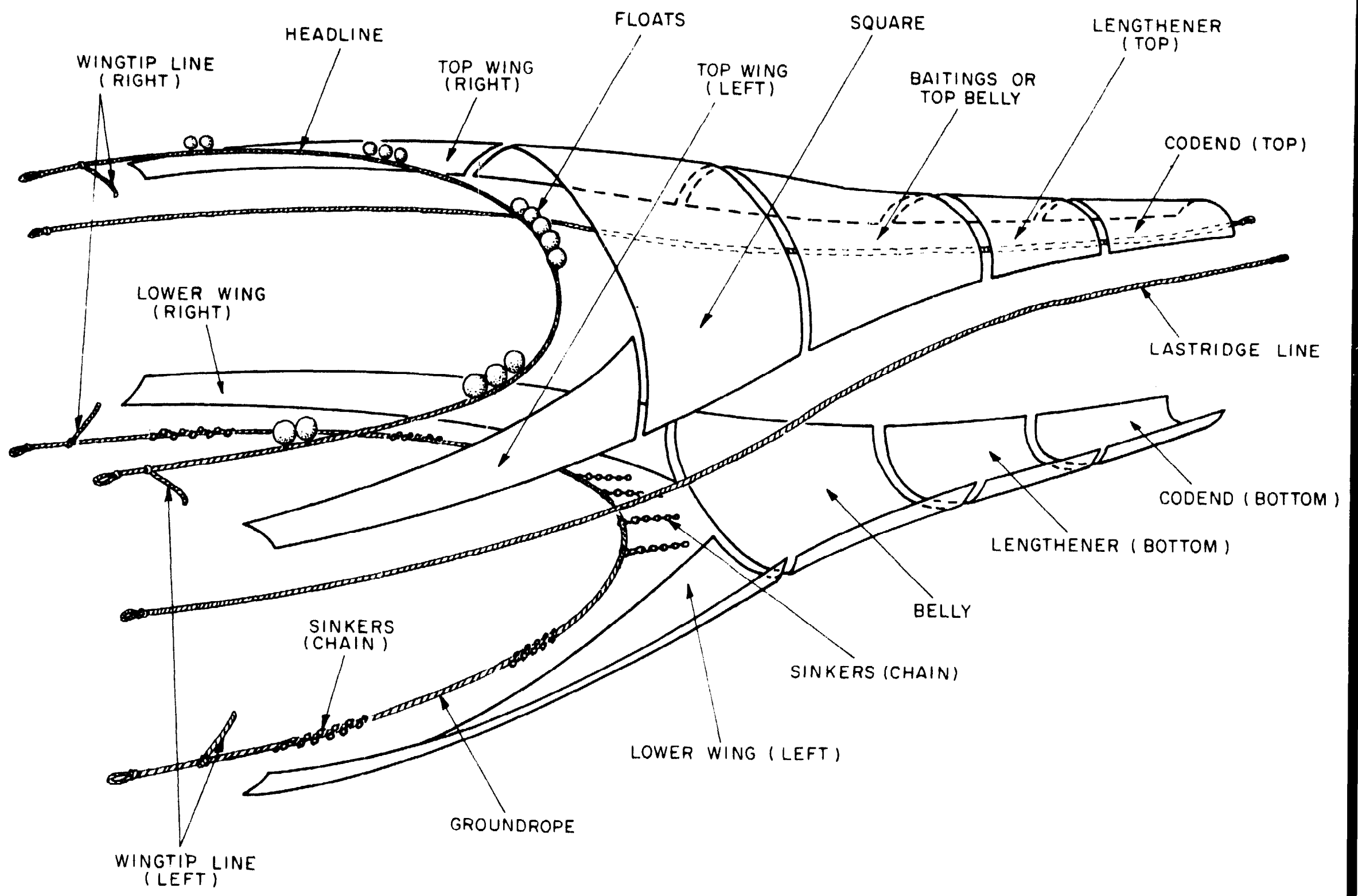

wings of the net. They try to swim away, but find that they are trapped between the wings. If they try to swim up in front of the groundrope they are stopped by the netting of the square behind the floats, so they soon get tired and drift back into the trawl. Divers have seen this happen many times. You can see now why we use weights to make the groundrope stay on the bottom, for if it lifts, the fish will escape underneath it. (Take another look at p. 4.)

Even the best trawl does not catch all the fish that are in its path. Some always escape over or through the large meshes in the wings and the forward part of the belly. Some may also escape because they can swim faster than the trawl is being towed. To tow the right trawl at the right speed and direction, knowledge of the way the current is flowing and its speed are most important for success. We cannot tell you here what are the best speed and direction to tow the trawl, for they differ from place to place. You will have to find it out yourself from your own experience.

Do not let the fish escape from the codend

After the fish are inside the net you must keep them there. They will not escape while you are towing (unless there is a hole in the net), but if you slow down or stop, which you must do when hauling your net, they may swim out. You can do very little to stop this with fish that are in

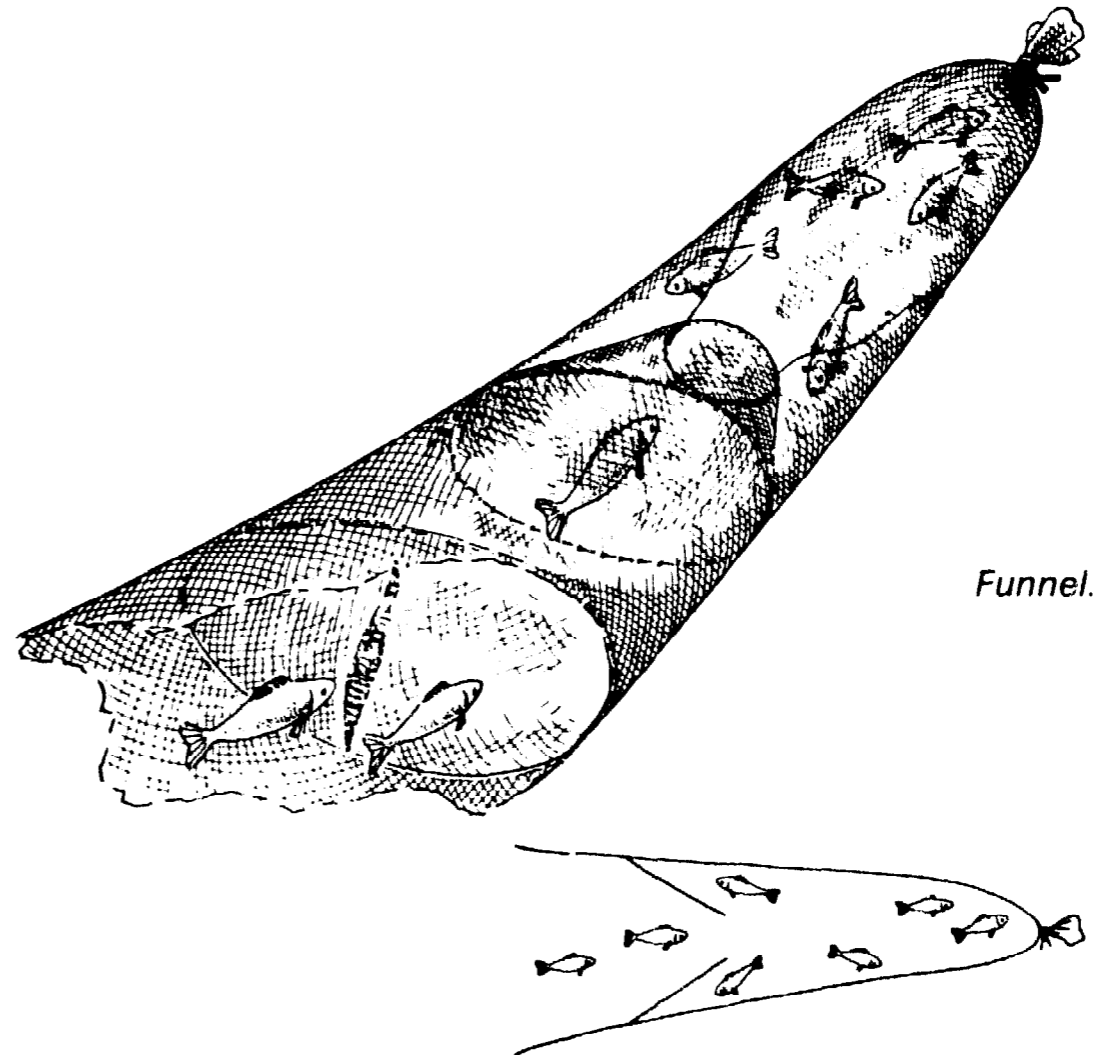

the front part of the net, but you can stop those which have entered the *codend*, that is the sack at the end of the net. To do this, trawl fishermen have sewn in, in the front part of the codend of their trawlnets, trapping 'non-return valves', called a flapper or funnel, which let the fish in but

do not let them out. A funnel is sewn into the net all-round, while a flapper is a kind of curtain or veil and sewn to the net only at the top and sides and left hanging free at the bottom. This veil is kept open by the flow of the water when the trawl is towed, but hangs down and closes the codend when the trawl is stopped. You can see both types in the pictures.

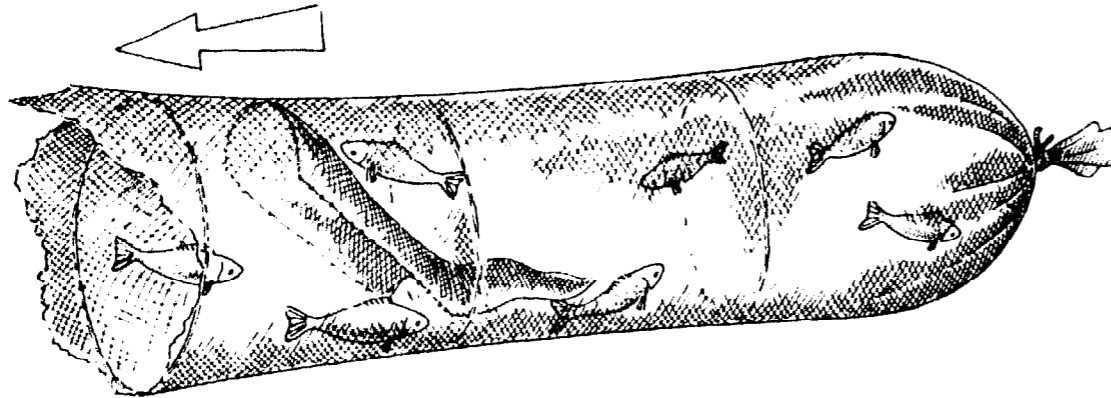

Flapper.

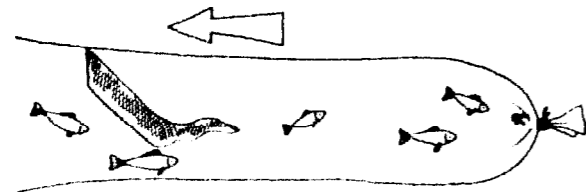

When fishing the net moves ahead.

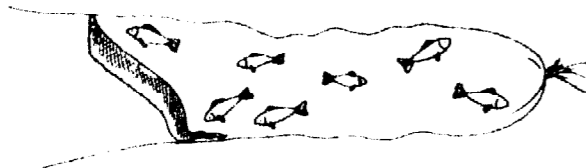

When hauling the net stops.

MESH SIZE

The size of the meshes in the codend is very important. They must be small enough to keep all the fish we can sell, but large enough to let the young and unwanted small ones escape. By letting the young fish escape, you give them a chance to grow big enough to breed more fish. When you catch them again, they are bigger and heavier and you get a better price for them. In some places the Fishery Officer will tell you what is the smallest size of codend meshes that you are allowed to use.

A net made of thick twine, with small meshes, will be harder to pull through the water than a light net of thin twine and big meshes. Since we shall be trawling with small engines we shall use a light trawl made of thin twines with big meshes in the wings, getting smaller toward the codend. Most fish do not try to swim through the big meshes in the wings as the trawl moves through the water but are scared by them into the mouth of the net.

GROUNDROPE

The groundrope (*footrope*) is the rope attached to the lower edges of the wings and the forward edge of the belly of the trawl net between the wings (*bosom*). It is weighted so that it keeps close to the bottom. The picture shows how short lengths of old chain are tied or wired to

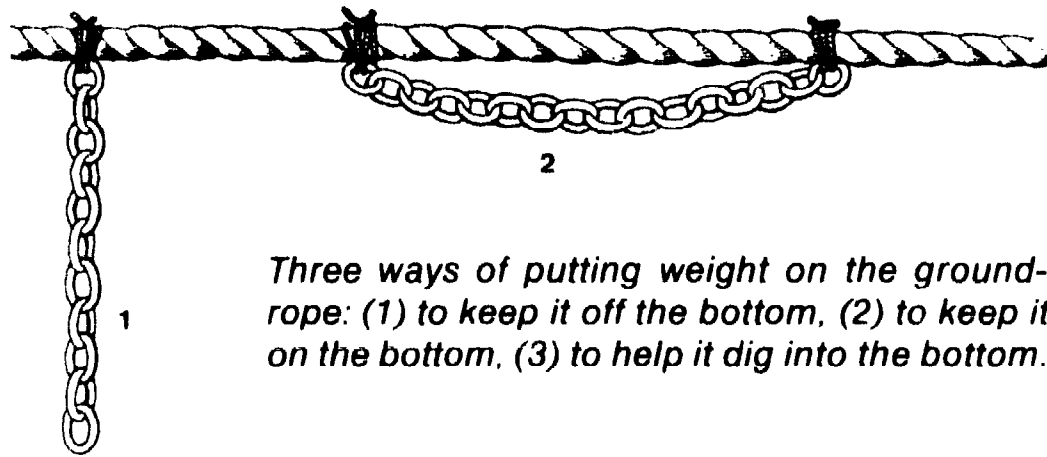

Three ways of putting weight on the ground-
 rope: (1) to keep it off the bottom, (2) to keep it
 on the bottom, (3) to help it dig into the bottom.

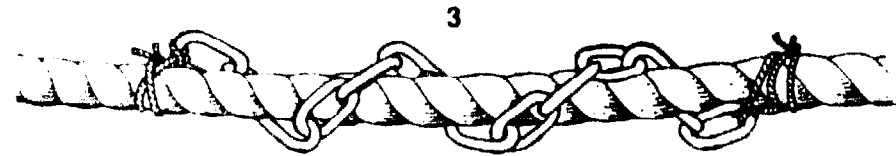

you use pounds (lb), take 2 lb for every hp.) At the be-
 ginning, make your tows short to see if you need to take
 away or add sinkers.

If the groundrope is made of natural fibres such as
 manila or sisal which become heavy after they soak up
 water, it needs fewer sinkers than if made of synthetic
 fibres.

On a very soft sea bed, even a properly made ground-
 rope digs into the mud. If this happens we can use a
 thicker, lighter groundrope. It may be easier to *seize*
 (fasten with twine) an old, thick rope to the groundrope of
 your trawl or to serve it with (wrap around it) another rope
 to help it slide over the mud.

the groundrope as sinkers. Chains may also be wound
 round the groundrope so that it may dig slightly into a soft
 bottom to catch flatfish and shrimp. But if it digs too deep,
 the trawl net may fill with mud, stones and other rubbish
 and be damaged. Therefore, always adjust the number
 and weight of the chain section and the manner of their
 attachment to the type of bottom.

A good way at the beginning is to have the weight of
 your sinkers in kilograms more or less equal to the joint
 horsepower of both boats. So, if you have two boats each
 with a 5-hp engine, use about 10 kg (22 lb) of sinkers. (If

HEADLINE

This is the rope attached to the upper edges of the
 wings and to the top bosom (forward edge of the square
 between the wings).

The headline is fitted with floats to keep it high above
 the bottom and in this way to keep the trawl mouth open.
 As long as you do not trawl in deep water (more than
 20 m), the floats can be made of anything that floats on
 water, even light wood or bark dipped in hot tar will do. Of
 course, cork is better and floats made of plastic foam are

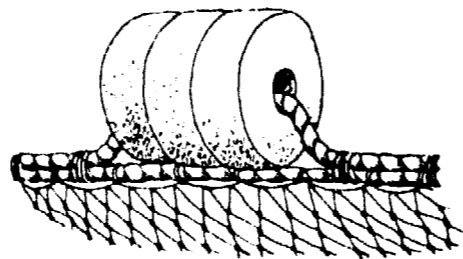
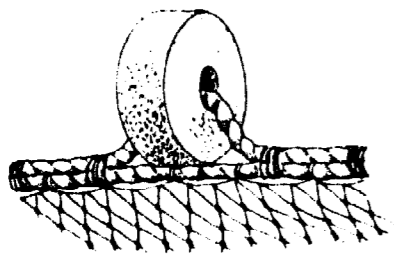

The various types of floats you can use on your headline in shallow water. If you fish in water deeper than 30 metres (18 fathom) you may need to buy special trawling floats that will neither break nor take up water.

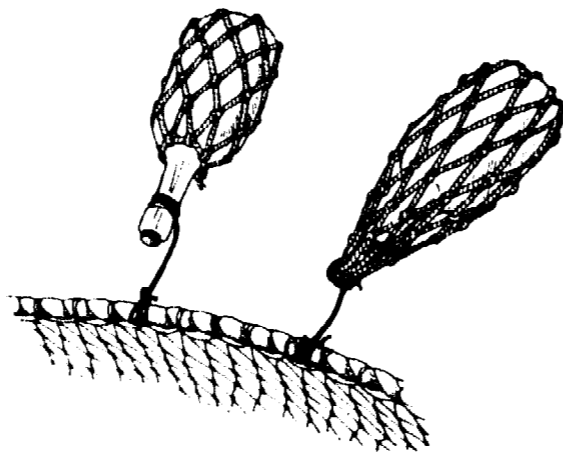
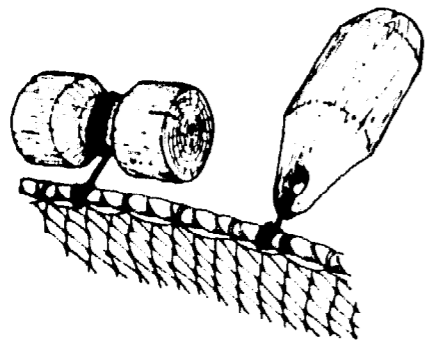

Too many floats will lift the wings, or even the whole net off the bottom. Therefore, the floats you attach to the headline should be able to lift only *half* of the sinkers on the groundrope.

How many floats you will need for your sinkers you can find out for yourself by attaching sinkers to floats and putting them in water.

This float can lift two or perhaps two and a half sinkers. You can therefore use one float for every five sinkers.

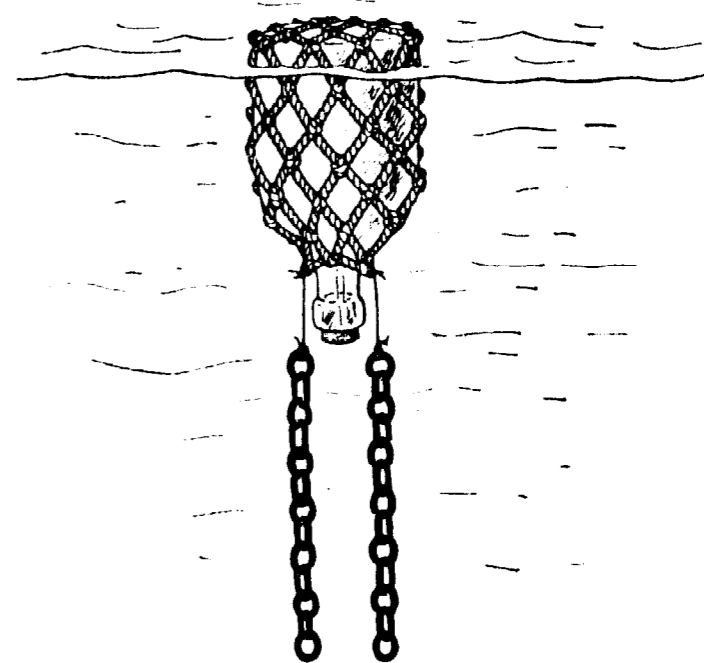

excellent. But you can also use well-sealed wine or beer bottles. These, however, must be sewn into protective coverings of thick netting.

A headline of manila, sisal or other natural fibre will need slightly more floats than a headline made of light synthetic fibre.

TOWING GEAR

You tow your trawlnet by two warps attached to its wings. To hold down the wing ends you will need front weights, and these are best made of old chain. They should weigh as many kilograms on each side as the horsepower of each boat (if the ground is sandy and no mud or stones are getting into the net, their weight can be up to 50 percent more). Where you have a lot of space for trawling on smooth and clear bottoms, you can make your towing gear better by fitting pieces of rope 10 to 50 m (6 to 30 fath) long (*sweep*lines) between the wing ends and the warps. Sweep

lines are generally thicker than warps. If you use sweep

lines then you fit the front weights between the sweep

lines and the warps so that during towing they will not lift from the bottom like the warps, but scare fish and herd them into the net as the wings do.

Which ropes should you use?

This depends on the power of your engines. If it is less than about 5 hp it may be better if you do not use sweep

lines. Your warps can be 8 mm (5/16 in) in diameter if made of synthetic rope such as nylon, polyethylene or polypropylene, which is enough for strength. For better grip, however, you may prefer slightly thicker rope. Natural fibre ropes should be at least 11-12 mm (7/16 to 1/2 in) in diameter, for they rot and become weaker much

faster than synthetic ones.

The warps for boats of 6-15 hp can be of 10-12 mm (7/16 to 1/2 in), and for stronger boats of 12-14 mm (1/2 to 9/16 in) in diameter. Boats over 30 hp can use 16-mm (5/8-in) warps. Again, all these measures are given for synthetic ropes, and natural fibre ropes should be a bit thicker.

Boats that have engines stronger than about 8 hp are strong enough also to tow sweep

lines. The length of each sweep

line in metres can be equal to or up to 50 percent more than the horsepower of each engine. (If you measure in feet it would be 3-4 times your horsepower and if you measure in fathoms it would be 1/2 to 2/3 of your horsepower.)

Sweep

lines go on the bottom in front of the wings of your trawl, and help to scare the fish into the trawl from a wider area. They also make the distance between the boats greater, as shown in the picture on the next page.

The sweep

lines may be made of either natural or synthetic ropes, but not of polyethylene or polypropylene because they are so light that they float in water, and you want the sweep

lines always to be on the bottom. They may be 12-14 mm (1/2 to 9/16 in) in diameter for 8-20 hp and 16-20 mm (5/8 to 3/4 in) in diameter for stronger engines.

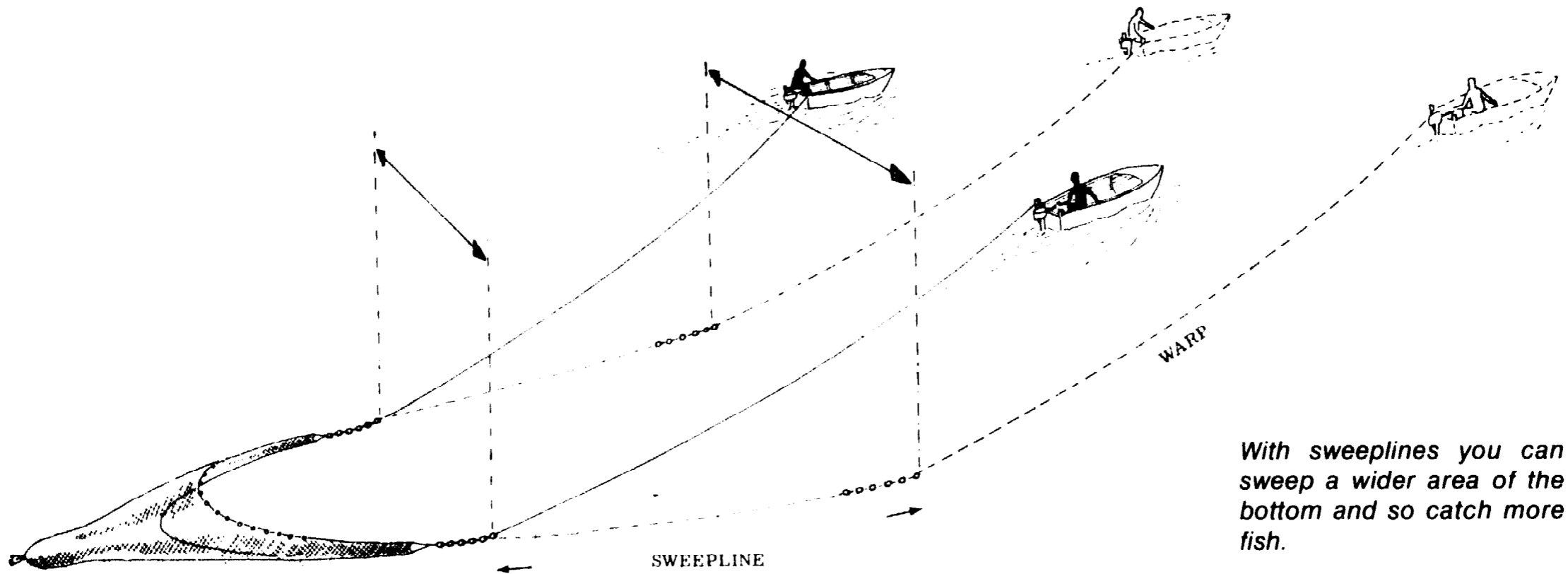

With sweeplines you can sweep a wider area of the bottom and so catch more fish.

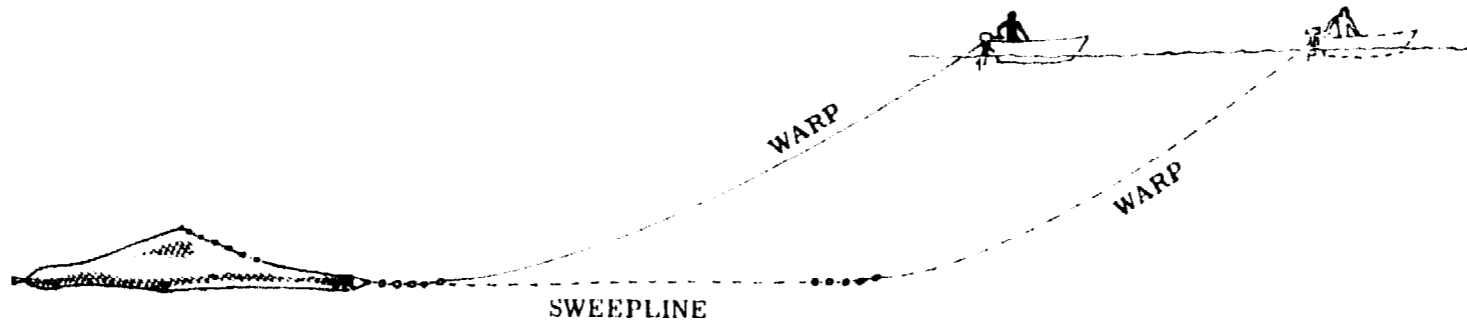

If you have a little trawl winch on board, you may use steel-wire rope 8-10 mm (5/16 to 7/16 in) in diameter for the warps. Although the sweep lines can also be of steel-wire rope, we think that the thicker synthetic or natural fibre rope will fish better..

CHAFERS

A codend *chafer* protects the end of the codend from sharp stones, coral or sand. Chafers can be made of old netting, strips of old inner tubes or similar material.

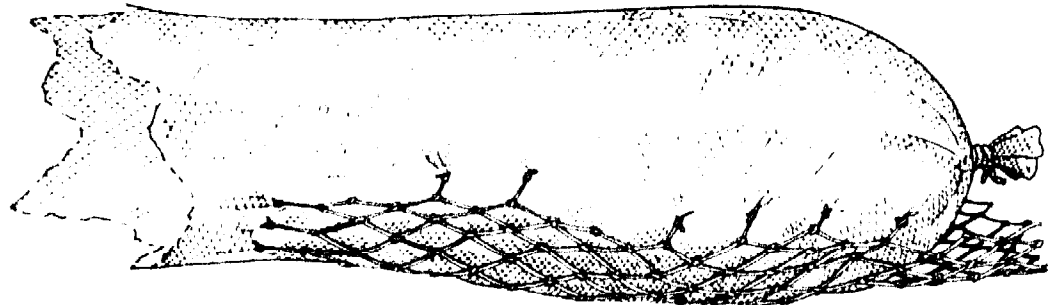

This chafer protects the bottom part of the codend.

TRAWL SIZE DEPENDS ON ENGINE POWER

Our two boats now have a lot to pull through the water and over the ground. There is the net, the chafer, the sweep lines, the weights, the warps and maybe some fish in the codend.

All this adds up to a big load that must be pulled along by the boats and lifted out of the water by the crew. Be sure that the trawl is not too big, or the boats will not be able to tow it fast enough. If it is too small it will not catch as many fish as you could get and you may find that you tow it too fast, which may lift it off the bottom.

We know now what types of boat we can use to go pair trawling. We also know that a boat which is right for trawling in a river or lake may not be right for working

This boat and its Number Two trawled with 3 1/2-horsepower outboard motors.



from a beach on the open sea. Up to now, pair trawling with very small boats has mostly been done on lakes and rivers. On some African lakes open boats 4-6 m (13-19 ft) long are used. Sometimes they have an outboard motor of only about 5 hp and sometimes an inboard diesel engine of 10 to 15 hp or more.

To choose the correct size trawl for the fish you want to catch you have to ask yourself how much power you have in the two boats' engines, because trawls are made in different sizes according to how many horsepower are needed to pull them. Remember that a slow-running 10-hp diesel has more pulling power than a fast-running 10-hp outboard, and that you can pull a bigger net if the twine is thin and the meshes are big. Then, you can either

tow a smaller trawl faster or a bigger one slower. With time you will know which is best for your fishing ground.

WHAT KIND OF TRAWL SHOULD YOU USE?

Now you have to decide what kinds of fish you want to catch. Some fish stay close to the bottom; some even bury themselves. These fish need a trawl which really 'scrapes' the bottom. For fish that swim a metre or two above the bottom you need a high-opening trawl, which is made so that the headline is high, giving a big mouth. For fast-swimming fish the net must be towed faster, or they will escape, and for this purpose the trawl must be small and light with meshsize as big as possible.



Midwater pair trawl.

For shrimp the meshsize must be very small in all parts of the trawl; even in the wings and square it is only 40 mm (1 1/2 in) stretched and in the codend it is 20 mm (3/4 in) stretched. Because of such small mesh in the trawl it cannot be towed fast. Fortunately, for shrimp this does not matter because they cannot move fast. For pelagic fish — which swim in *midwater* (this is off the bottom and up to the surface of the water) — another kind of trawl is used. Where they are found in great numbers and close to each other or where they swim in dense *schools*, they can be caught with a *pelagic* or *midwater* trawl. From this type of trawl fish can escape upward, downward or sideways so that it has to be larger and the towing speed faster to stop fish escaping. For midwater trawling you need more powerful boats, at least 50 hp each boat, so that you can lift your net while towing by using some extra speed.

In the next chapter we will explain two pair bottomtrawls: one for 4- to 7-hp boats and one for 15- to 20-hp boats. For other boats and trawls you should ask the fishing technologist in your area or the Fisheries Department of your country or write to us at the FAO Fishery Industries Division, Via delle Terme di Caracalla, 00100 Rome, Italy.

HOW TO MEASURE THE MESH SIZE

You can measure the meshsize in several different ways. In this book we use *meshsize stretched* in mea-

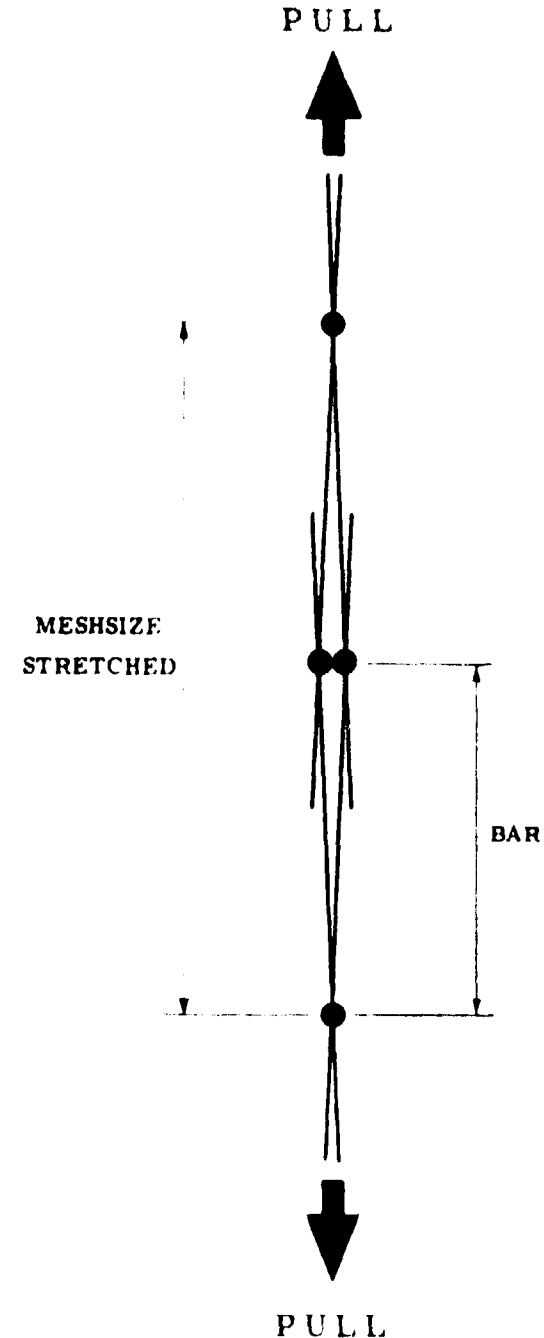

surements. By this we mean the distance between the centres of two opposite knots in a mesh measured while the mesh is pulled tight as shown in the picture on the page before this one.

A very good way to measure the meshsize is to measure not one but, say, 10 stretched meshes and divide the result by 10. You can use either millimetres or inches, but always say that you mean *meshsize stretched*, because some people use half meshes (bars) and may misunderstand you.

MAKING THE TRAWLNETS

The first trawl we are going to look at is made of four netting panels sewn or *laced* together along their sides, and of two wings. We call it a *four-seam* or *four-panel* trawl. It was made for muddy ground and it has fished well on Lake Chilwa in Malawi. There it was towed by two flat-bottomed boats, each 4 m long with 2 1/2- and 5-hp outboard motors.

As you can see, this net does not have a square overhanging in front of the groundrope, as both top and bottom panels are the same. We say that such a trawl net has no overhang, and many pair trawls are made like this. It has four sections: the wings, the belly, the lengthener and the codend.

The wings are very long, which makes the net opening wider (more *spread*). To make your own trawl you need sections of netting which you may have to cut yourself.

In this chapter we will tell you how to cut these sections using as little netting as possible and how to put them together into the trawl sections and then how to make these into a complete trawl net.

The netting

The first thing to do is to prepare the netting sheets (see page 34). All the netting used for this trawl is made of the same nylon (PA or polyamide) twine. The thickness of this twine (its "twine number") is R 230 tex. This means that 1 000 m of twine weigh 230 grams so that there is 4 350 m to each kilogram (? 100 yd/lb, approximately), which is the *runnage* of this twine. Some people call this twine number also: 210 D/9.

You will need three sizes of netting:

- stretched meshsize 50 mm (2 in);
- stretched meshsize 25 mm (1 in);
- stretched meshsize 12.5 mm (1/2 in).

This last size is a very small mesh that you will only need for the codend if you are going to fish for the very small fish like sardine, anchovy, *dagaa*, *kapenta*, bleak, or

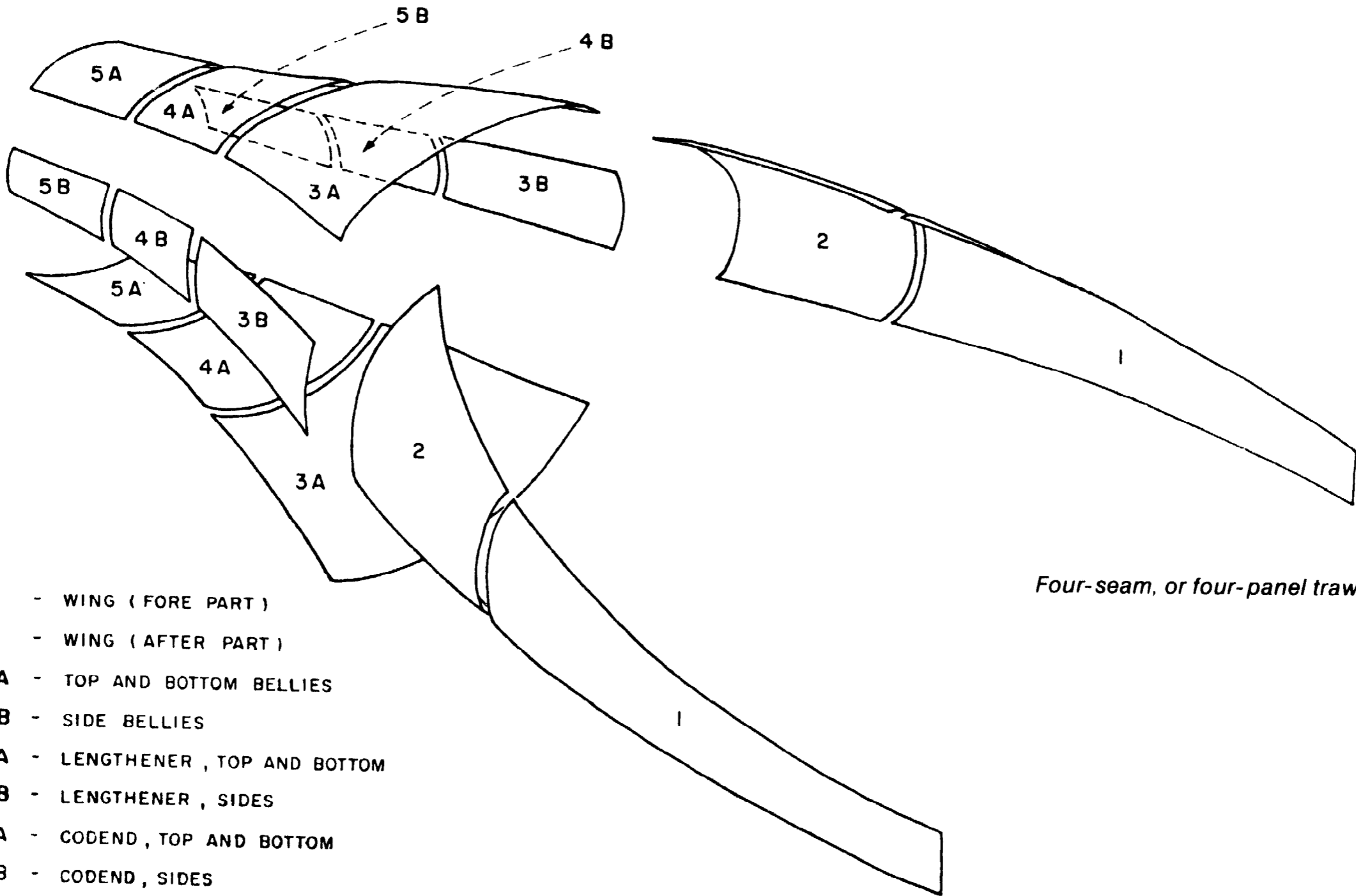

Four-seam, or four-panel trawl.

- 1 - WING (FORE PART)
- 2 - WING (AFTER PART)
- 3A - TOP AND BOTTOM BELLIES
- 3B - SIDE BELLIES
- 4A - LENGTHENER , TOP AND BOTTOM
- 4B - LENGTHENER , SIDES
- 5A - CODEND , TOP AND BOTTOM
- 5B - CODEND , SIDES

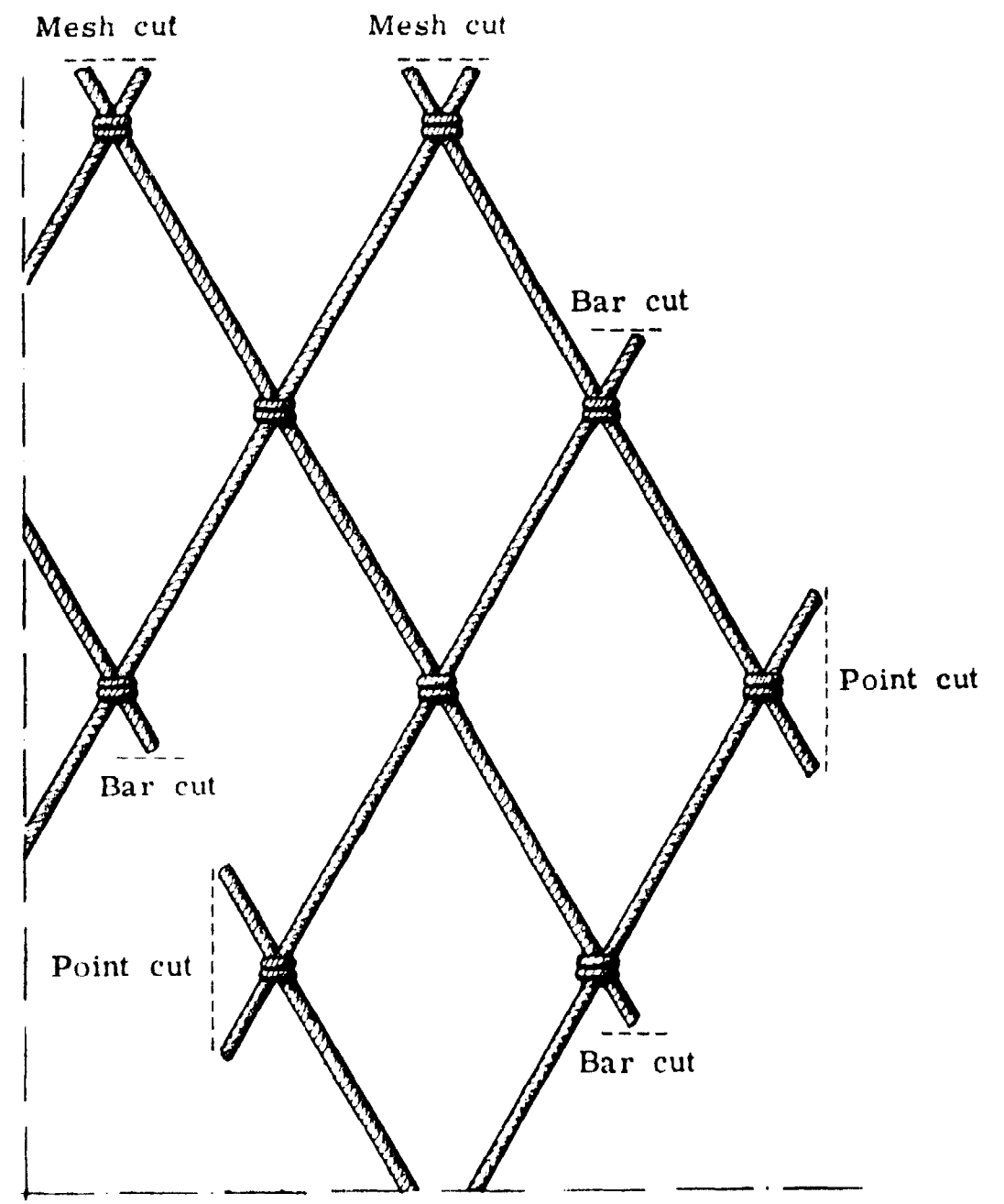
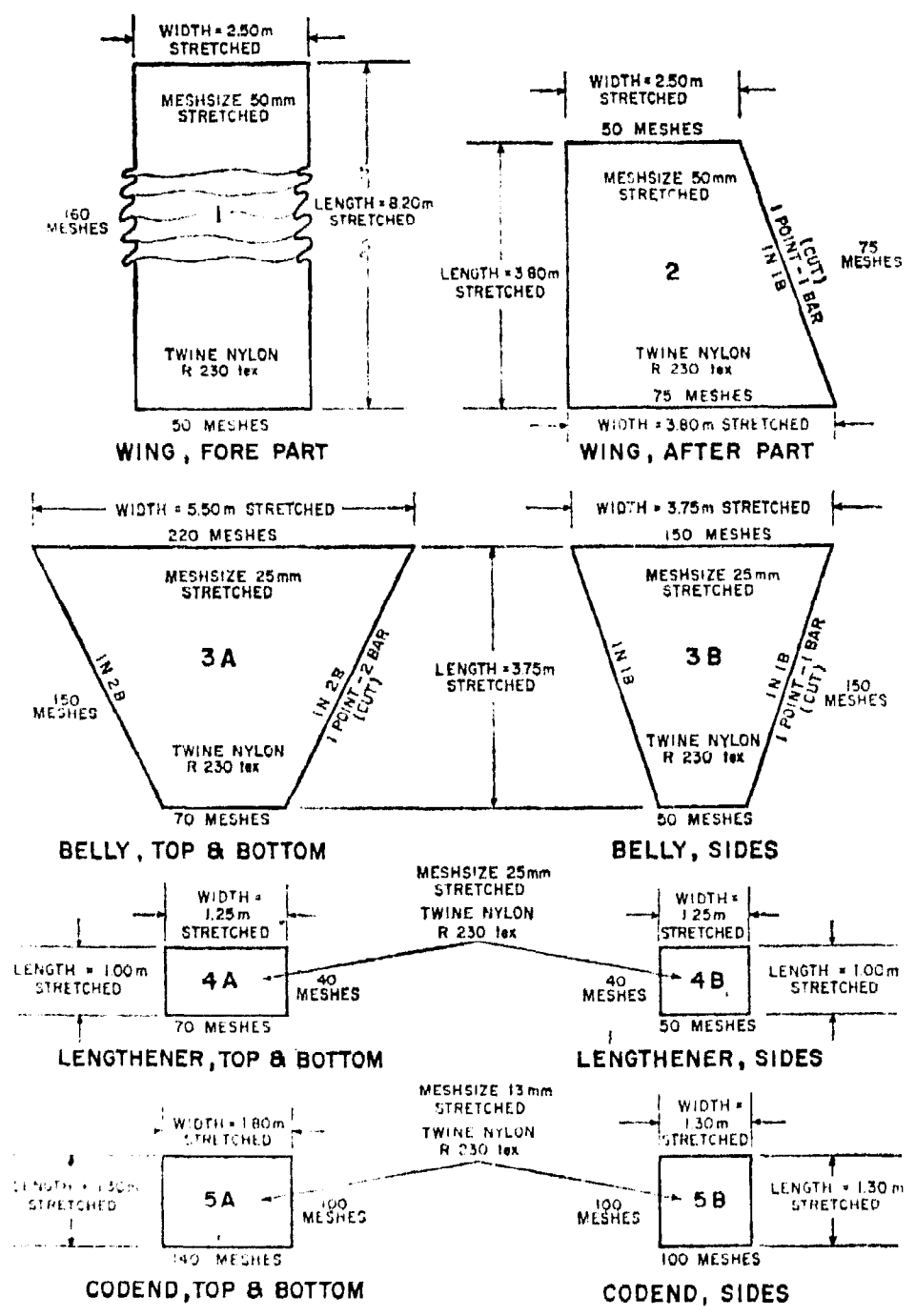

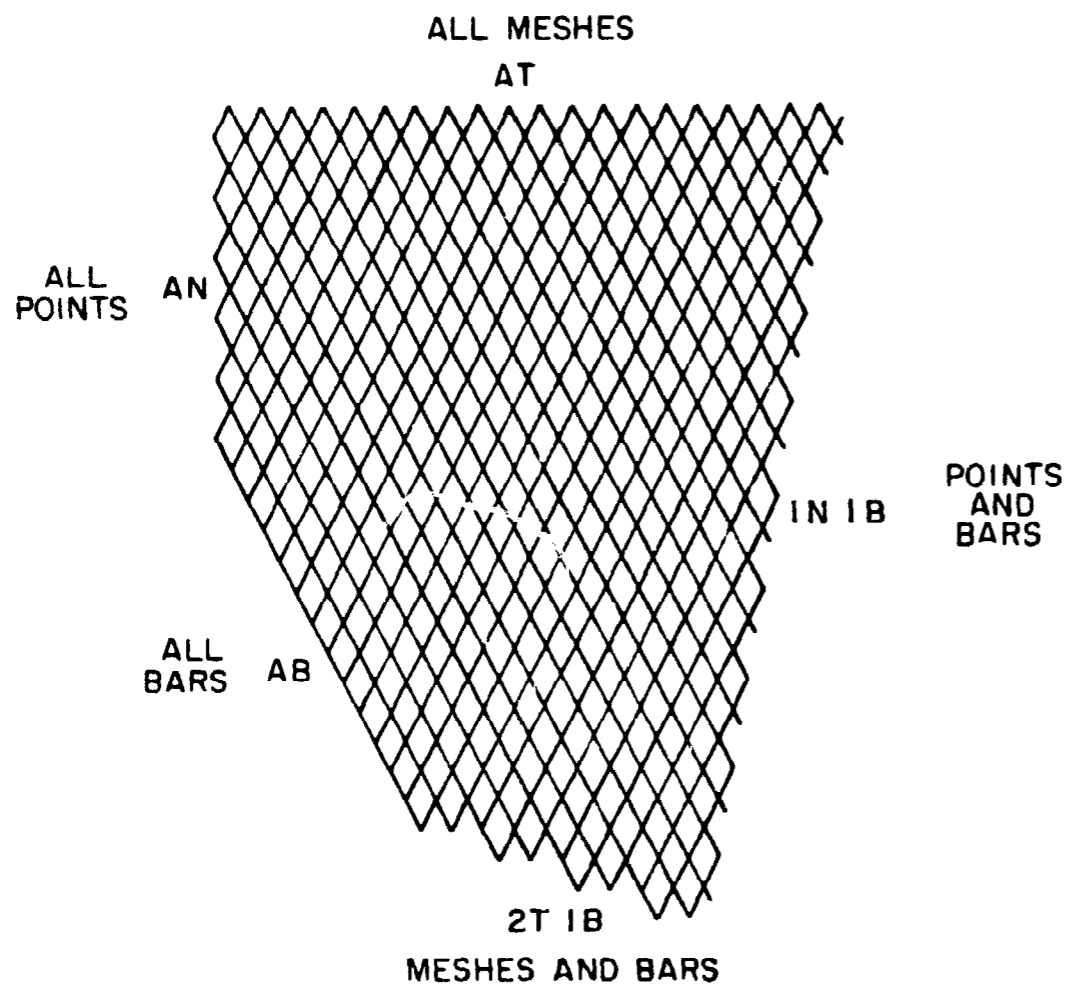

Five different cuts.

small shrimp. If you are after bigger fish it is better to use bigger mesh in the codend.

The cutting of the netting

You can cut the sections you need from the sheets of netting. You cut, depending on the pictures or *plans of panels or sections, lengthwise*, that is, along the netting panel, *widthwise*, that is, across the netting panel, or *obliquely*, that is, when you want a section of netting to be wider at one end than at the other.

This picture shows five different cuts: lengthwise (all points or *AN*), widthwise (all meshes or *AT*), oblique (all bars or *AB*), and two other oblique cuts which combine either points (*N*) and bars (*B*) or meshes (*T*) and bars. In this picture we see *AT*, *AN*, *AB*, *1N 1B* and *2T 1B* cuts. The points-and-bars and the meshes-and-bars cuts can be made in many different combinations or *cutting rates*, a few of which we shall use in the trawlnets you will read about in this book.

The codend

Now you can start with the codend. It is made of 2 side sections, each 100 meshes wide and 100 meshes deep, and of 2 top and bottom sections each 140 meshes wide

and 100 meshes deep. So we need a netting sheet which is 100 meshes deep and $100 + 100 + 140 + 140 = 480$ meshes wide. With such sheet of netting, no cutting is needed. You can fold it and lace it along its 100 meshes sides.

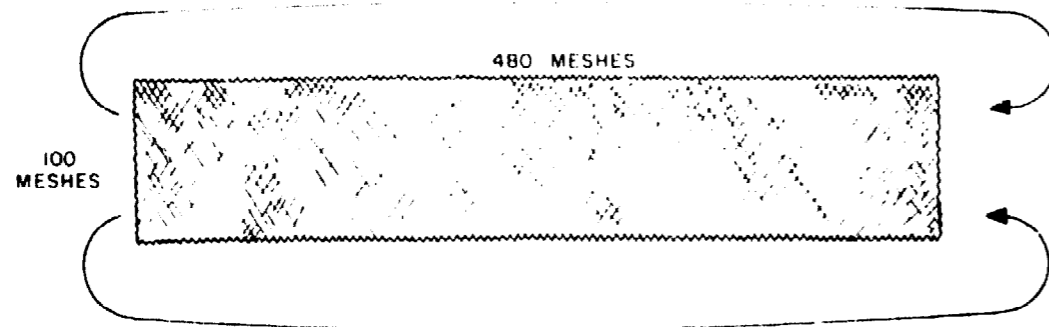

But mark off the top, bottom and sides by counting (and marking) the meshes 140, 100, 140 at one edge as shown in this picture.

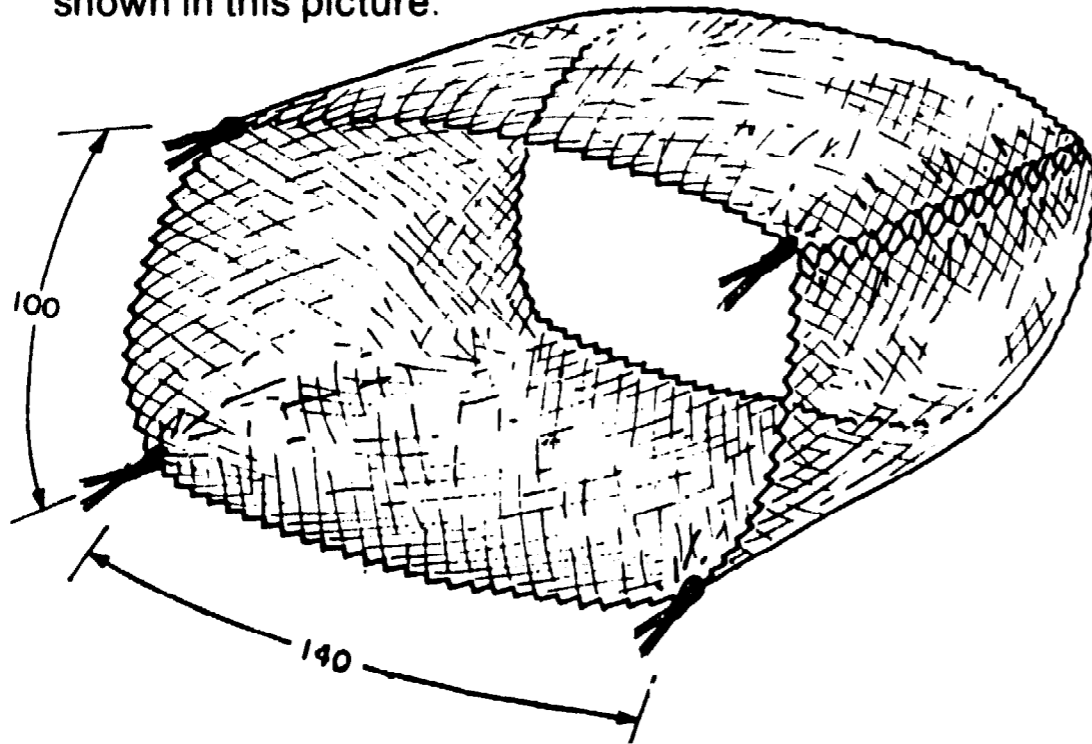

If the netting is sold only in sections longer than the 100 meshes you need, you may have to buy longer sections. If the netting sold is, say, twice as long as needed, it need only be half as wide as the section you want. For example, if the netting for the codend is sold in sections 200 meshes long, you can buy a piece 240 meshes wide and cut it in half to give two pieces 100 meshes in length.

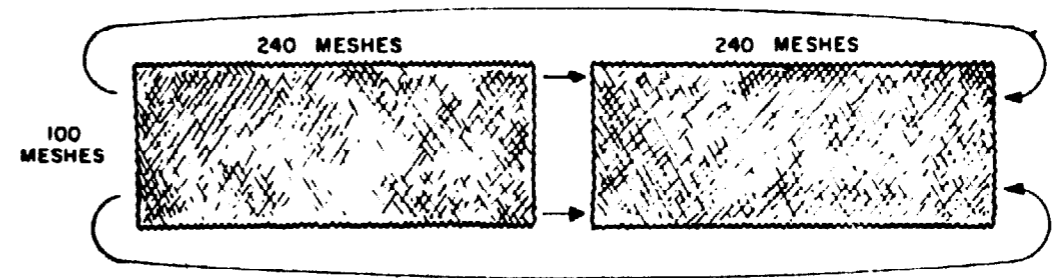

Now, lace them together as shown in the picture to make the 100 x 480-meshes codend.

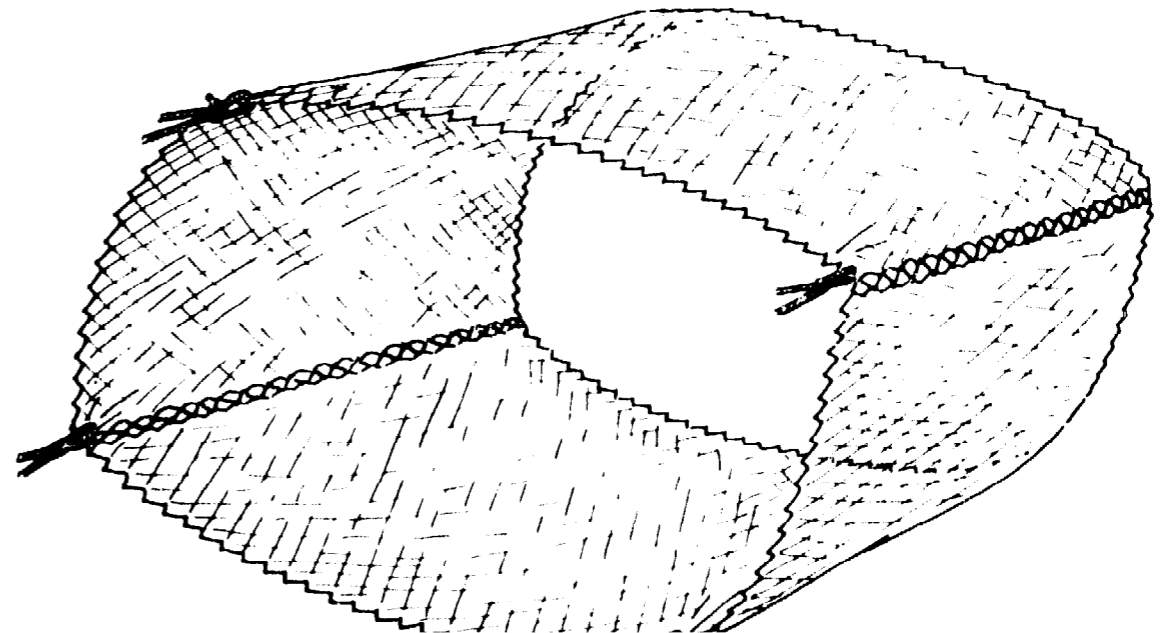

Then, mark off as before the top, the bottom and the sides.

If the netting is sold in sheets 300 meshes long, buy a piece that is 160 meshes wide, cut it into 3 pieces 100 meshes in length

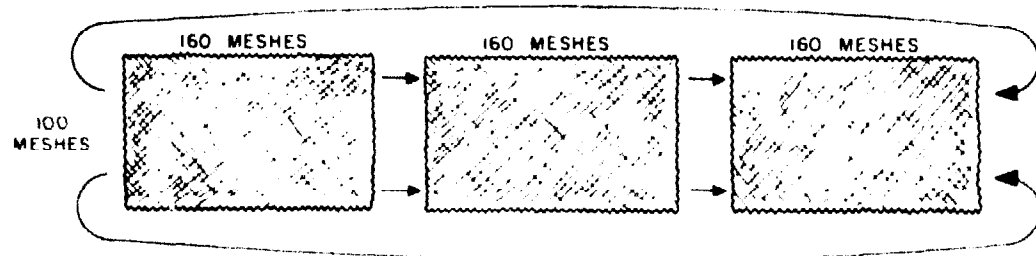

and lace them together to get 480 meshes around the codend, as shown in this picture:

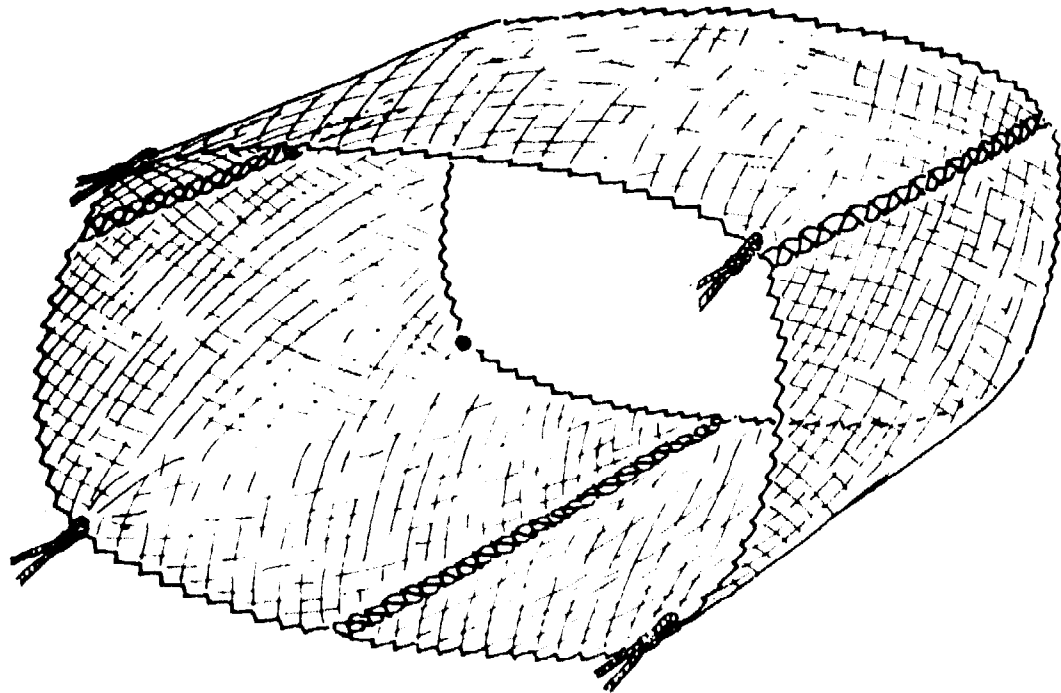

In this way, by cutting and lacing properly, the codend and other sections of a trawl net can be made from sheets of netting of different lengths.

The lengthener

The next part is the lengthener. You make it in the same way you made the codend. The only difference is the number of meshes, for here the depth is 40 meshes, the width of the top and the bottom 70 meshes and of the sides 50 meshes each. You can see that the meshes of the lengthener are twice as big as those of the codend, but their number widthwise is half the number of the meshes in the codend. Thus, the total stretched width of the lengthener is the same as that of the codend.

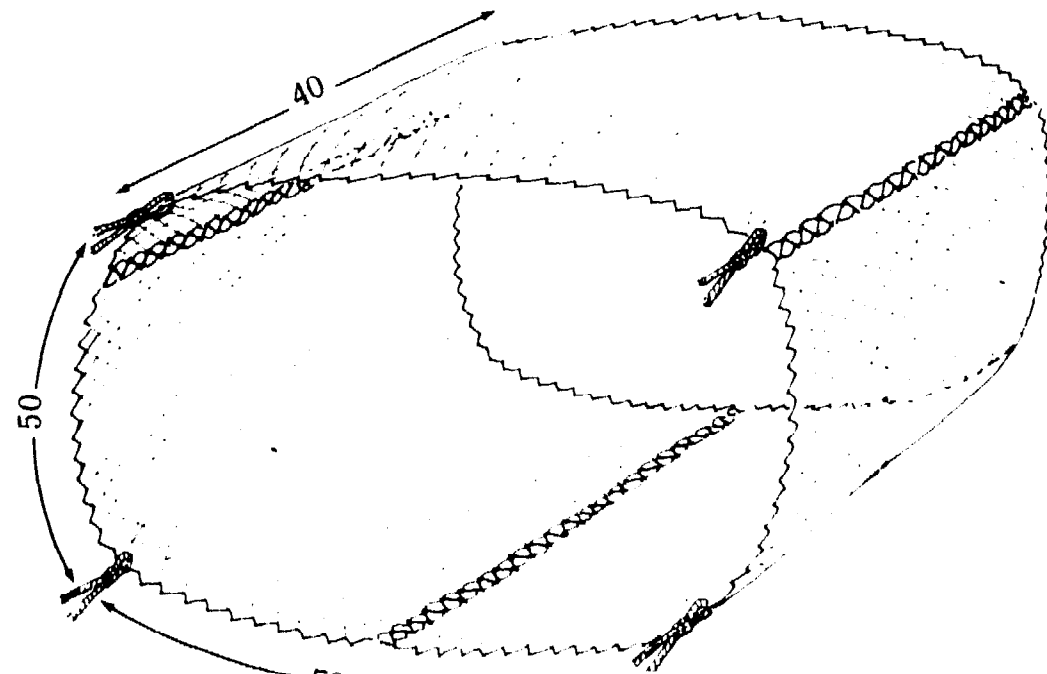

The bellies

The bellies are wide at the mouth of the net and narrow at the lengthener. Therefore, they must be cut obliquely.

First let us see how much netting you need to make the bellies. You need two pairs of sections:

BELLIES

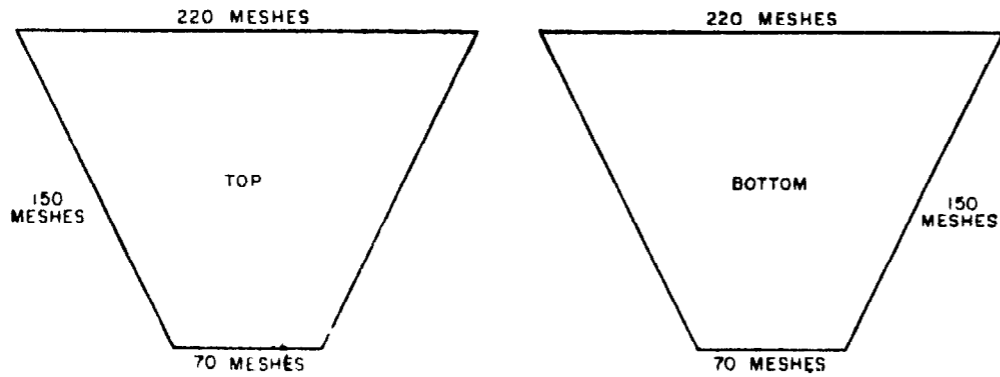

Now look at them this way:

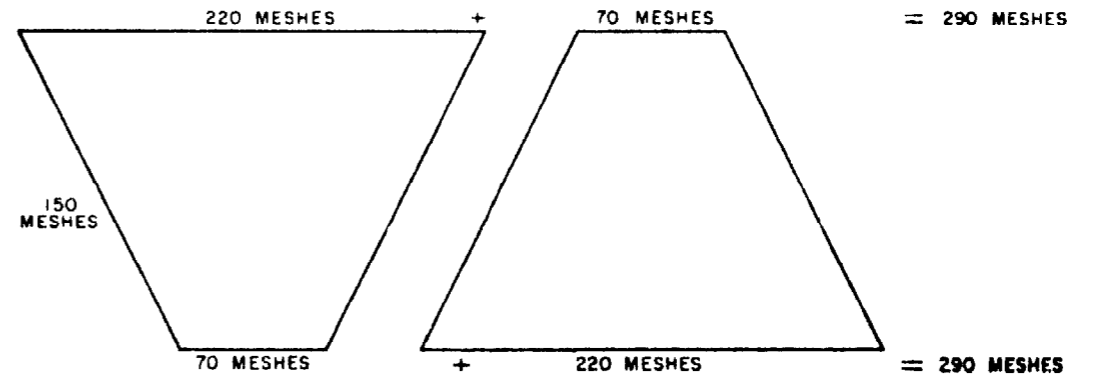

SIDE BELLIES

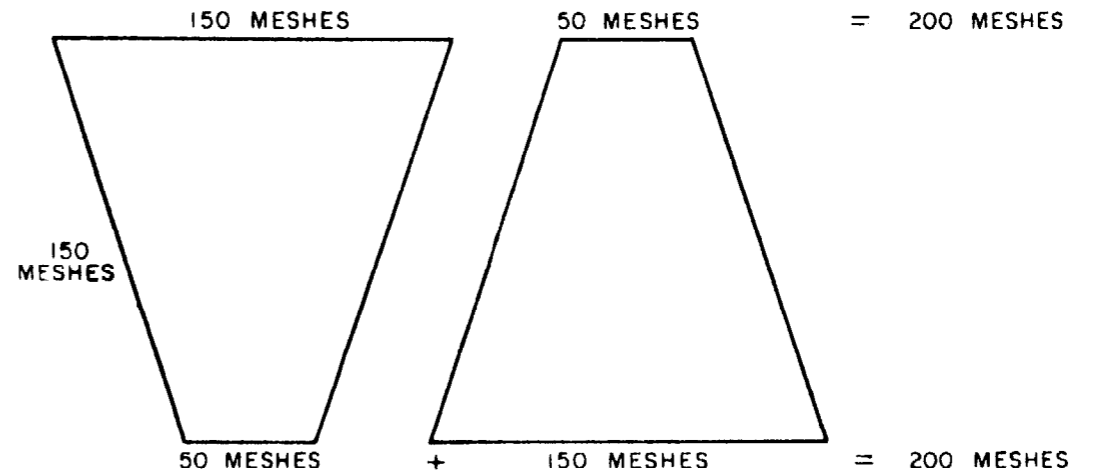
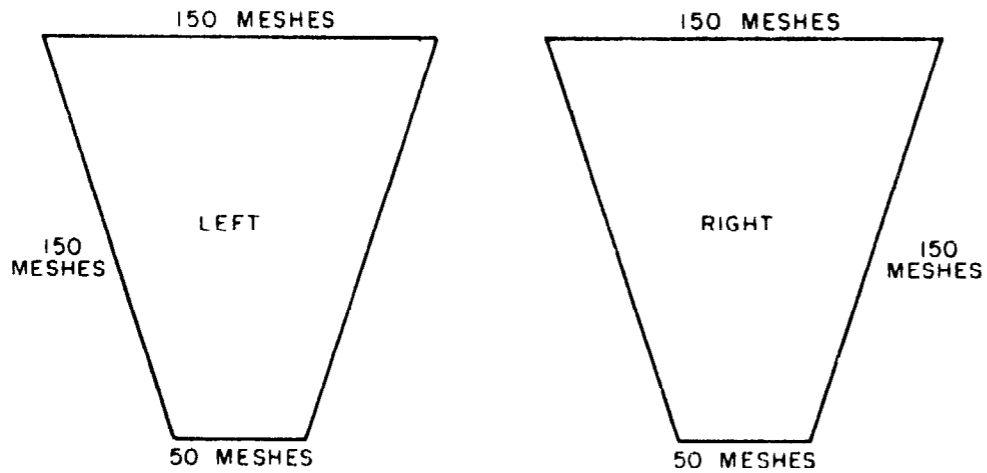

If you cut along one section of each pair, that is all points (AN), starting from one corner of the narrower edge, and put both sections and the cut-off triangular wedge together (as shown in the picture), you will see that each pair becomes a rectangular sheet of netting. By cutting and lacing such sheets you can make the bellies.

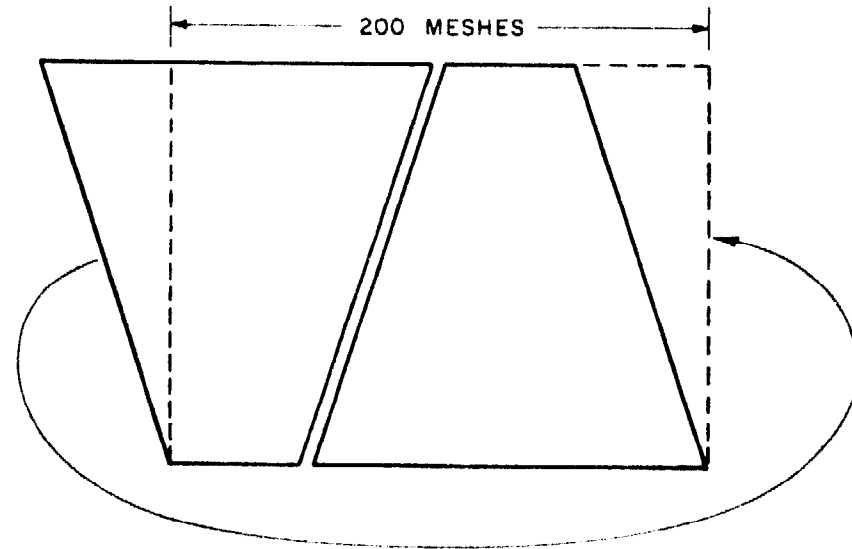
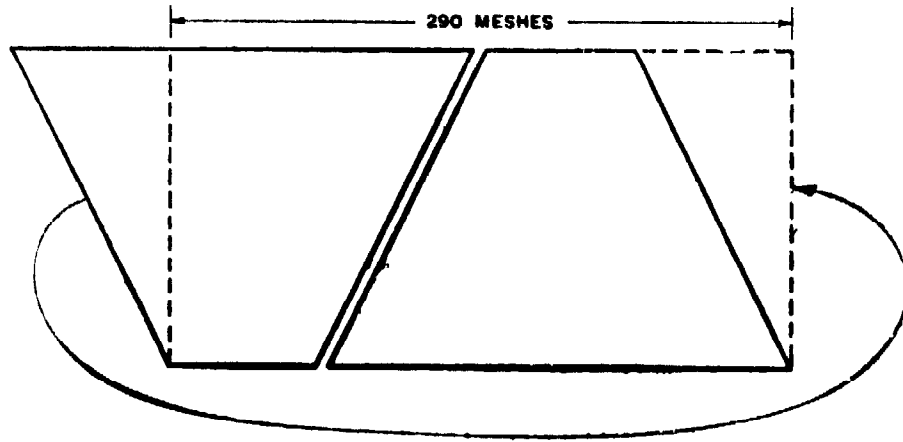

So, to make the two pairs of sections you need for the bellies, you need two sheets 150 meshes deep; one 200 and the other 290 meshes wide. This means that, together, you need a sheet 490 meshes wide. Since you are going to lose a couple of meshes when cutting the sections to shape, better take a few meshes more, say, 492.

You can see in this series of pictures how you can cut the two pairs of bellies from this one sheet of netting:

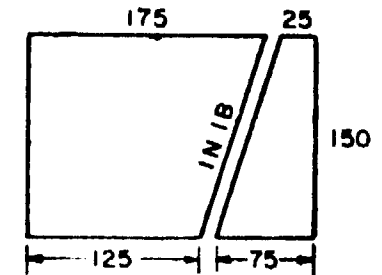
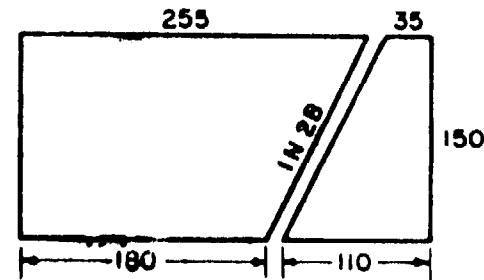
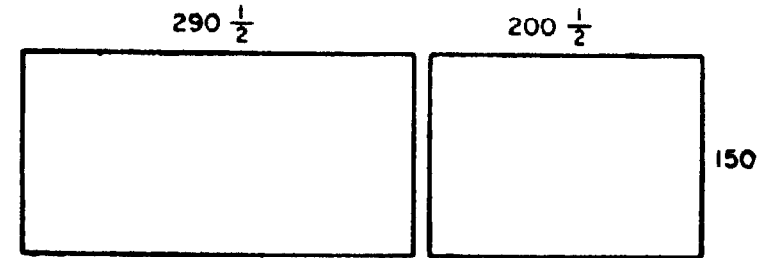
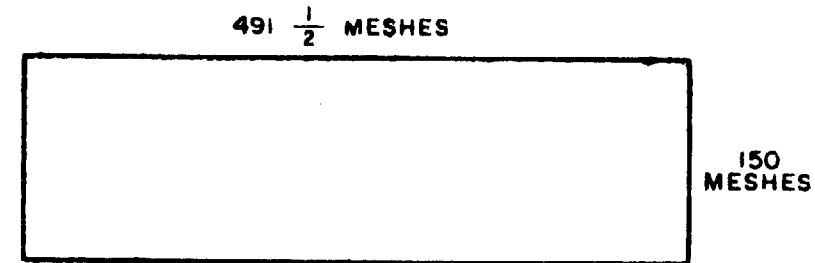

Now you must join them like this:

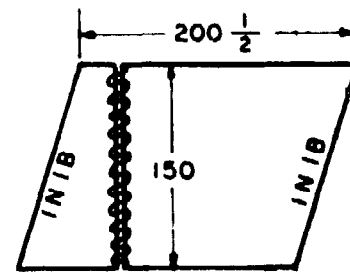
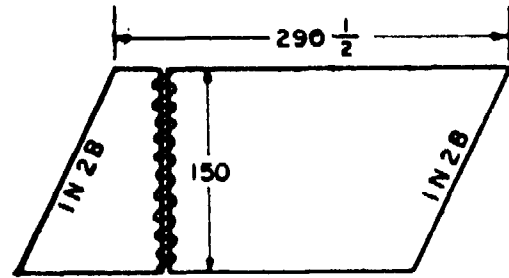

Depending on how you put the pieces together, you can either gain half a mesh or lose a mesh or two.

Finally, you cut:

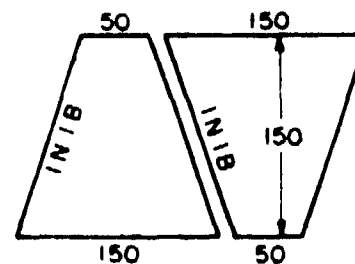
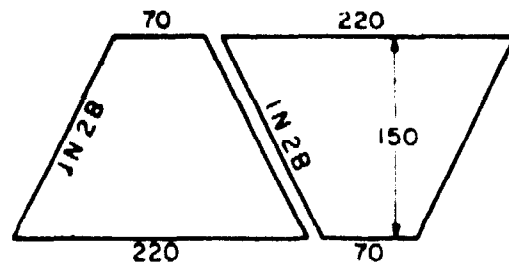

and your sections are ready.

The plans of the sections on page 34 tell you how to cut each edge to get the correct shaping. A mesh can be cut to leave a *point* or a *bar* at the end of a row. This is best seen by looking at the plans.

1 POINT - 1 BAR

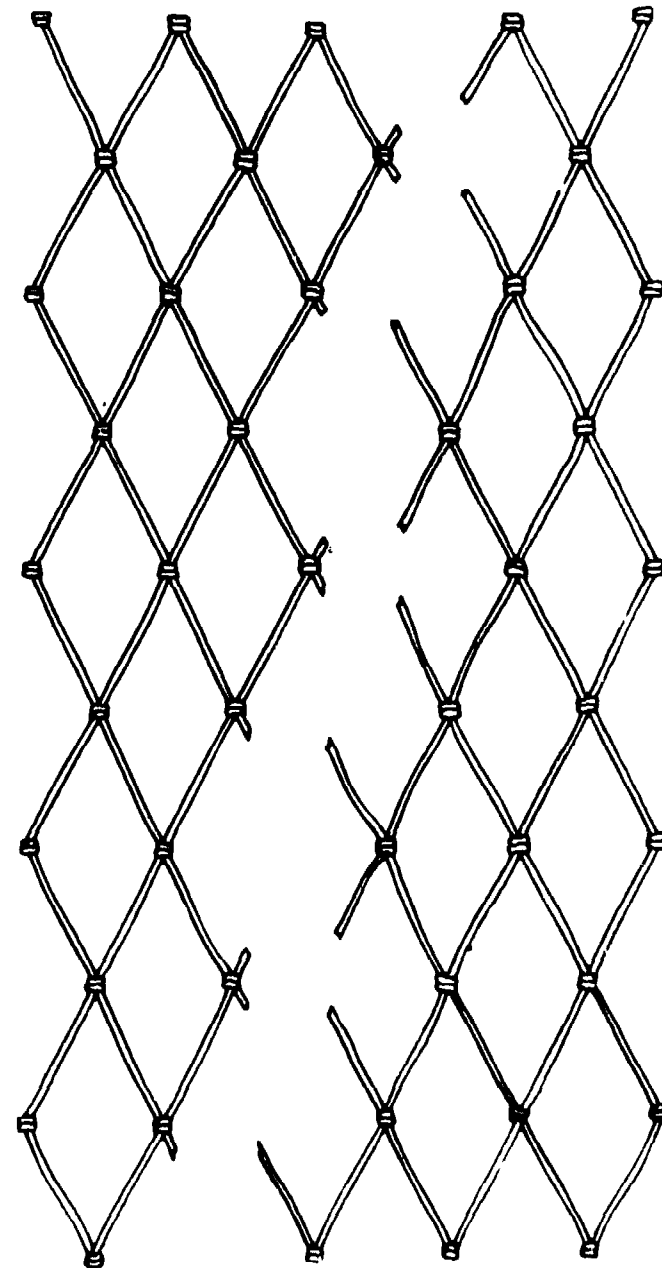

1 POINT - 2 BARS

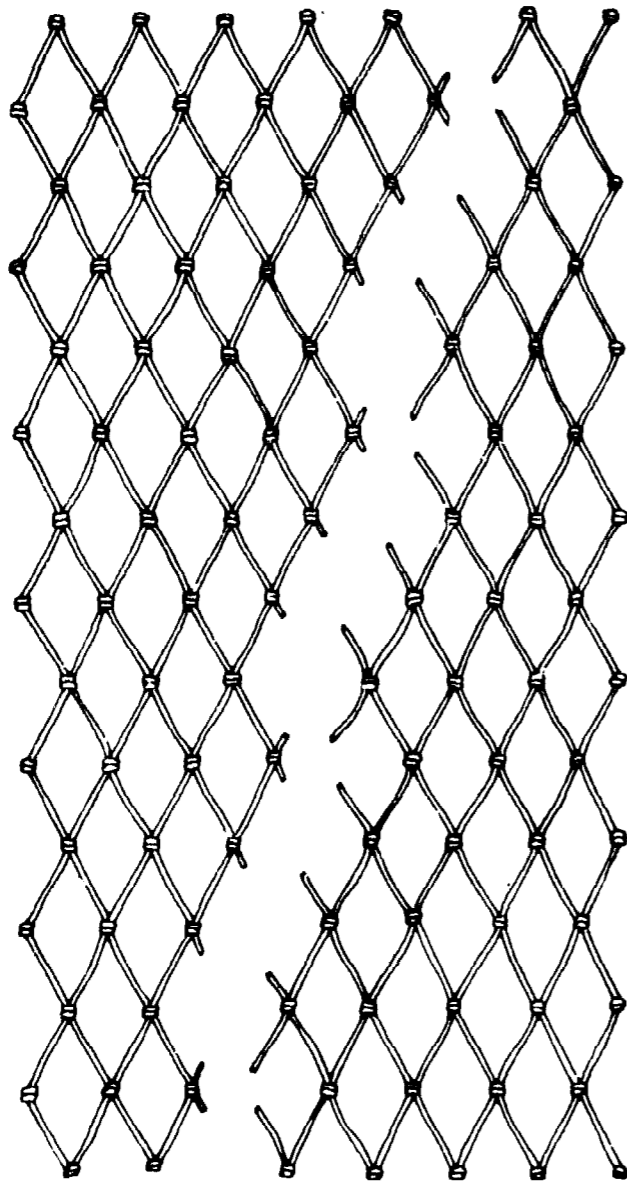

Two different *cutting rates* are used: 1 point 1 bar (1N 1B) for the panels marked 2 and 3B, and 1 point 2 bars (1N 2B) used for those marked 3A.

Of course, if you cannot get a sheet of netting which is 150 meshes deep, you will have to make one yourself. How this is done we have explained already when talking about the making of the codend.

The wings

Each wing is made of two sections: the *fore part*, which is 160 meshes deep and 50 meshes wide and the *after part*, which is 75 meshes deep and 75 meshes wide at the rear and 50 meshes wide at the front.

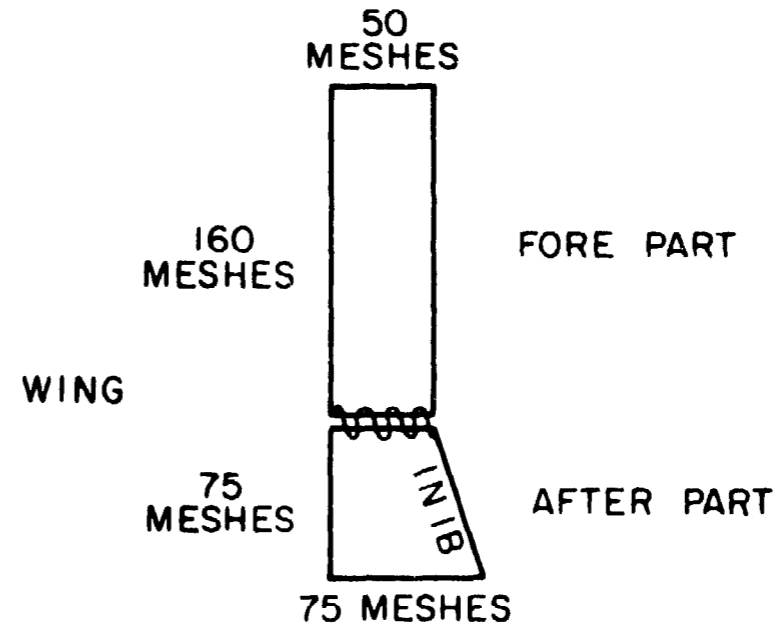

You need a sheet of netting which is 160 meshes deep and 164 meshes wide.

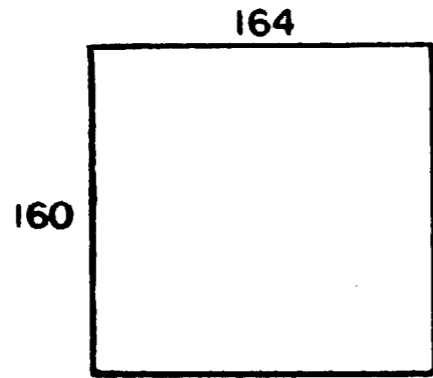

Now take the remaining piece and cut 9 meshes off its length.

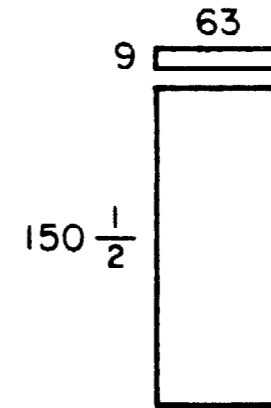

First cut off the two fore parts, each 50 meshes wide.

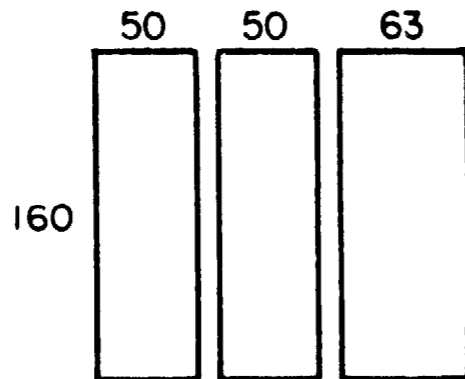

The 9 meshes strip is a left-over piece not needed for this net.

Next count 75 meshes, cut the piece of netting into two halves and put them together depthwise like this:

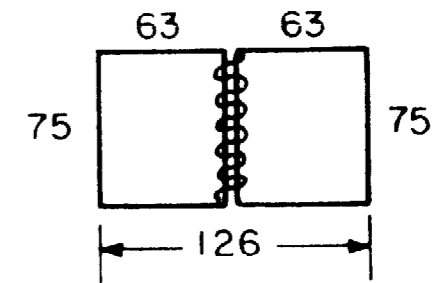
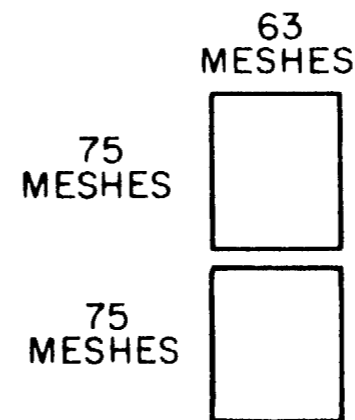

Now you make the oblique cut, cutting 1 point-1 bar, like this:

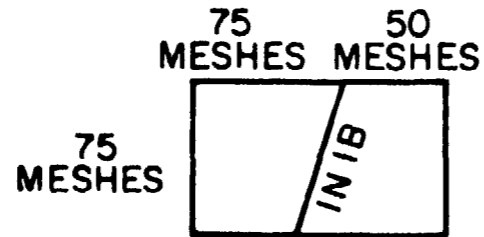
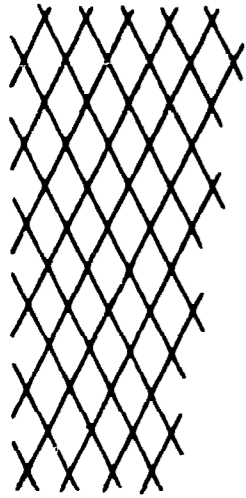

Finally, join the after and the fore parts to make a pair of wings.

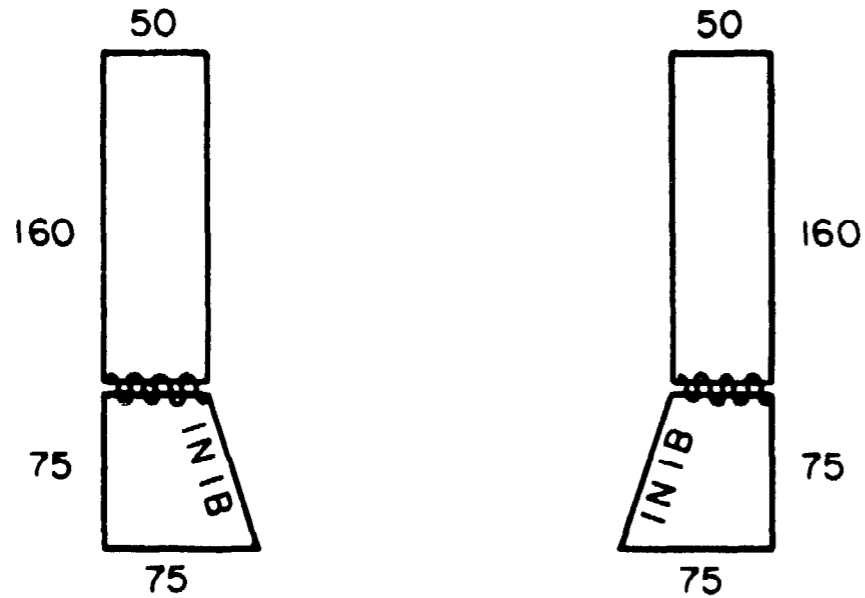

Joining the netting sections

The netting sections can now be joined to make up the whole net. If possible, use a different colour twine to show where sections are joined. This may help you later when mending the trawlnet. Start with the codend and join it to the lengthener, taking one mesh from the lengthener rear edge to two meshes from the front edge of the codend, like this:

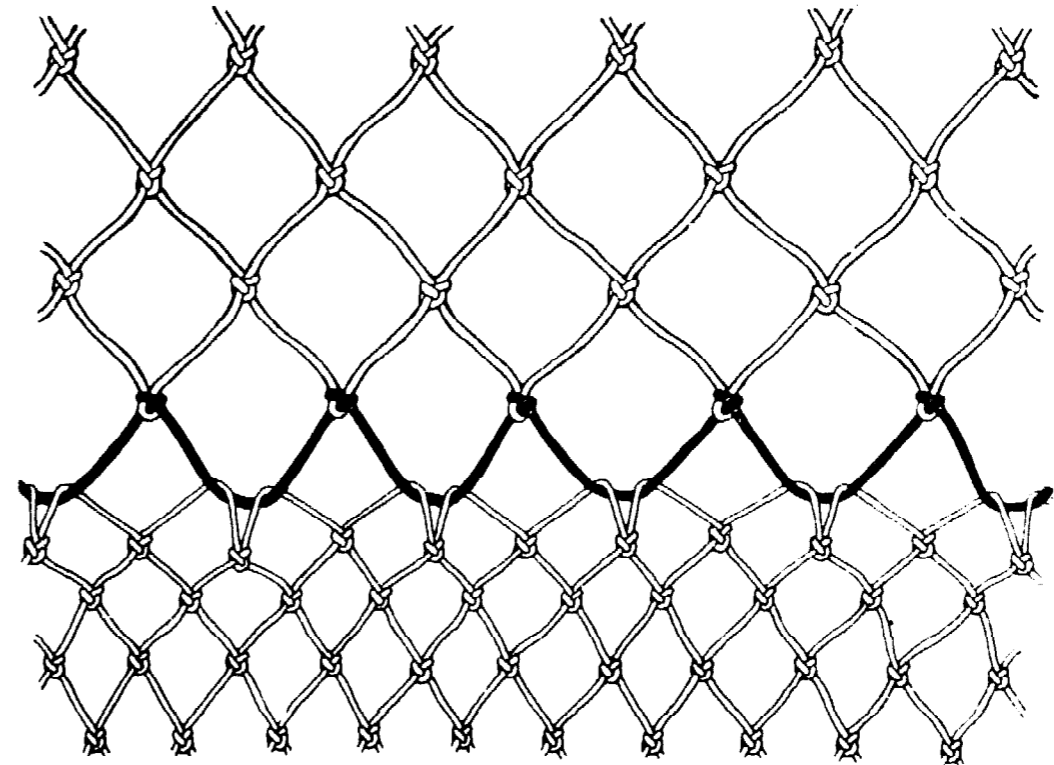

A 2/1 joining.

And this is what you have got:

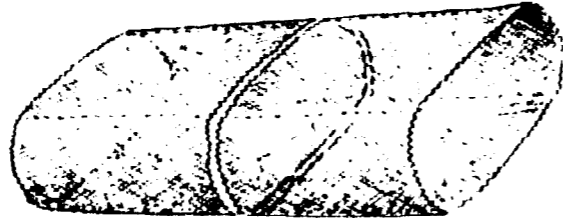

Take the *side belly* panels and join them with their rear 50-meshes ends to the 50-meshes-wide spaces you marked on the front edge of the lengthener, mesh against mesh.

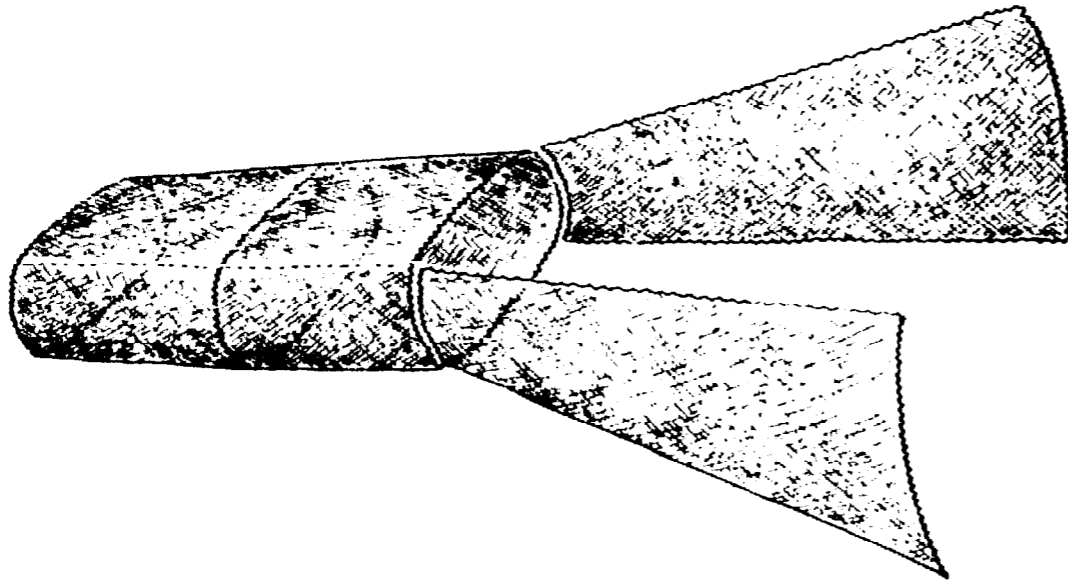

Now join in the same manner the *top and bottom* belly panels to the lengthener. Lace the panels together and you have the body of the trawlnet.

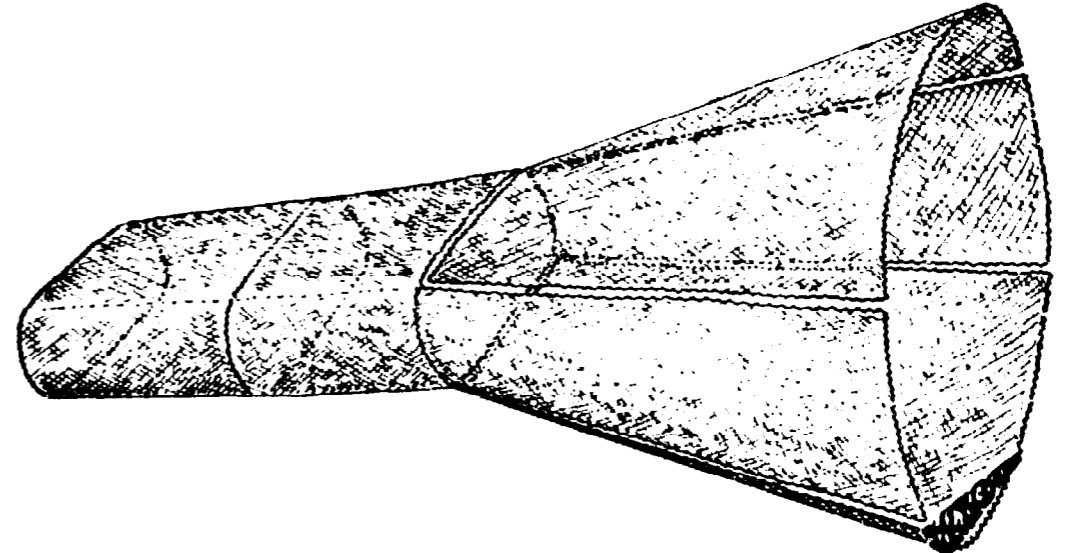

The wings can now be joined to the body. You do this by joining the 75-meshes-wide rear edges of the wings to the 150-meshes-wide front edges of the side bellies, taking two meshes from the belly to one mesh of the wings; be careful to do it so that the oblique edges of the wings that you have cut 1 point 1 bar both face in the same direction (where the headline will be).

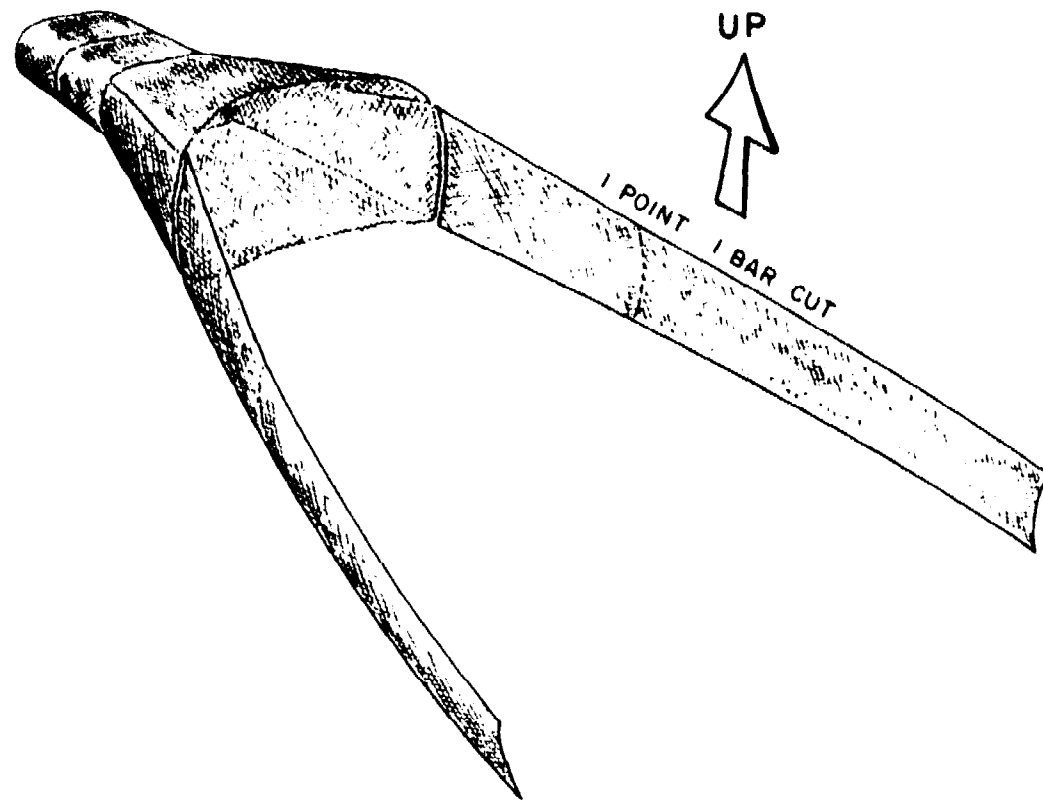

The ropes

This trawl has three lines: the headline, the groundrope and two wingtip lines, one for each wing.

The headline and the groundrope are of the same length and can be made of the same material. It does not really matter whether you use nylon, polyethylene or polypropylene and whether the diameter of the rope is 8, 10, 12 or even 14 mm (5/16 to 9/16 in).

If the rope is of the twisted type you should stretch it out by a hard pull to take the extra twists out (see the picture on the next page). You do not need to do this if the rope is braided.



TWISTED ROPE



BRAIDED ROPE

You need 44 m (or 24 fath) of rope. Cut it in two halves and find and mark the centre of each half.

Measure 137.5 cm in each direction from the centres so that you have marked out a 275-cm-long section at the centre of each rope.

One centre section should be attached to the *top bosom*, that is, to the front edge of the top belly between the wings, and the other to the *lower bosom*, that is, to the front edge of the lower belly between the wings.

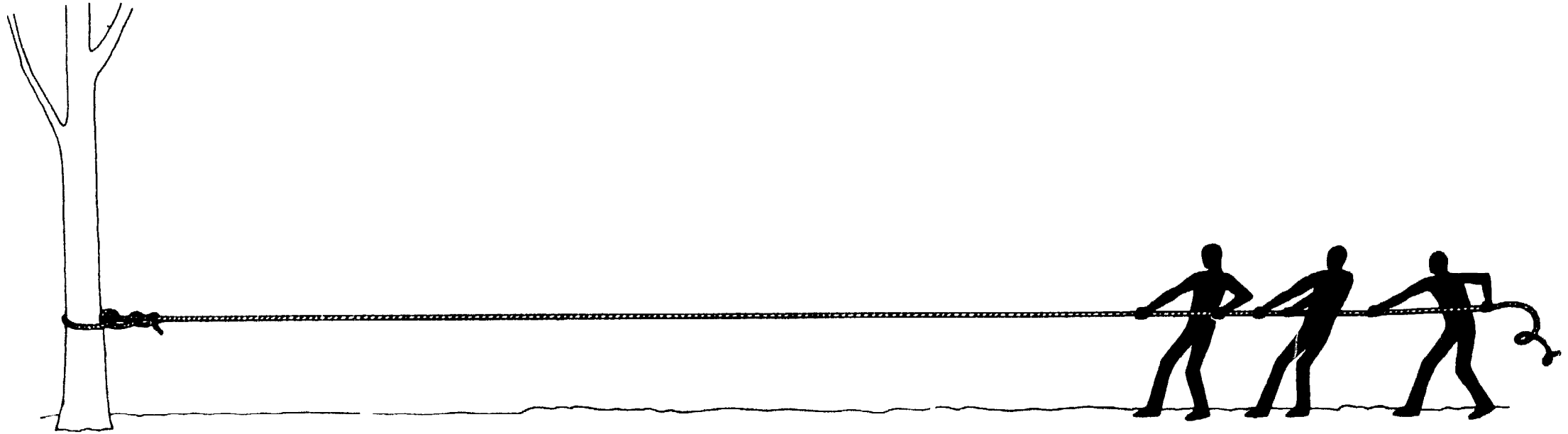

Stretching the rope is very easy if you have a swivel and use it like this:

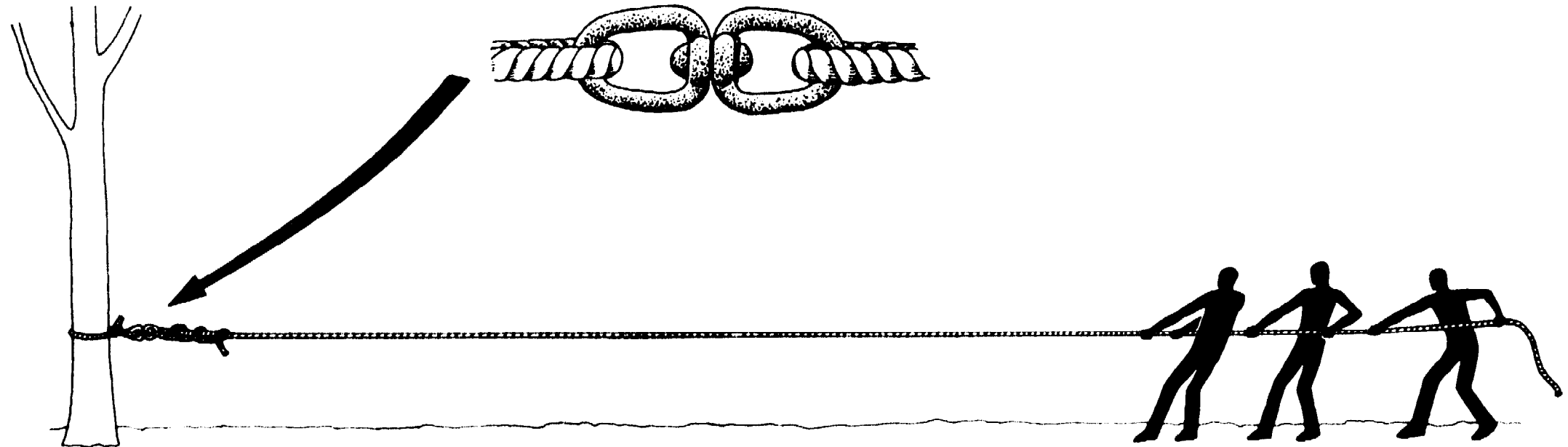

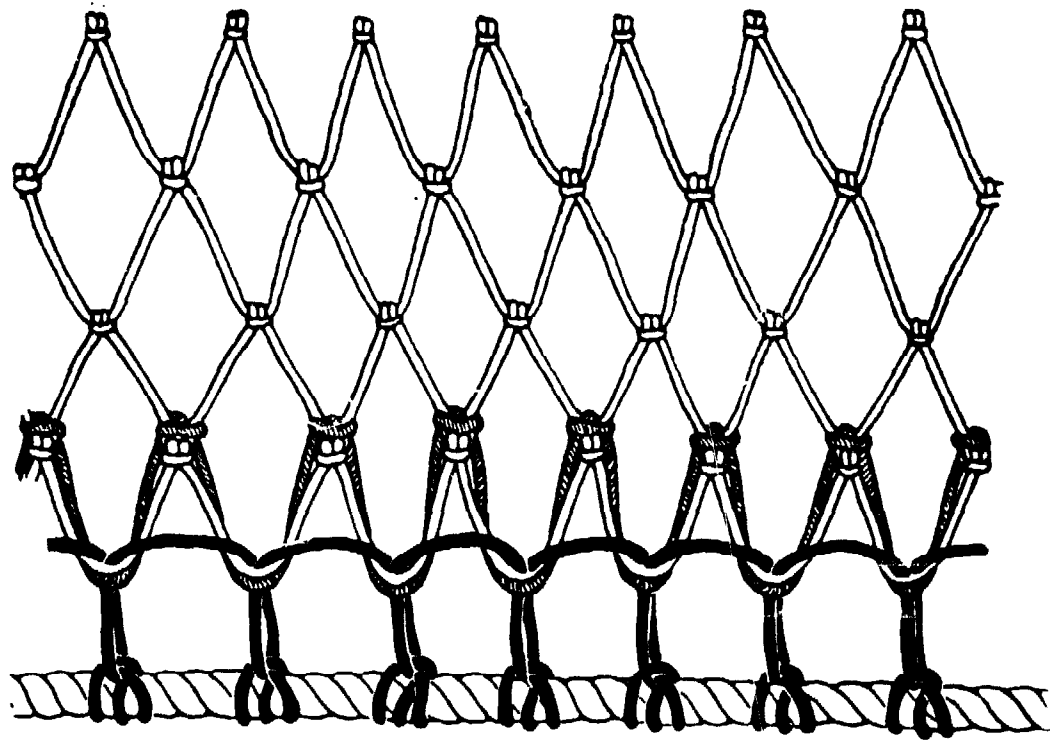

The first rope is the headline and the other the groundrope of the trawl.

The rope should be shorter than the netting hung to it. This makes sure that the rope takes most of the pull. Attaching of netting to rope is called *hanging* and there are several ways to do this.

The picture shows how the bosom can be hung to the headline and the groundrope.

The bosom has 220 meshes of 25 mm each. So, if it is stretched it will become 550 cm (18 ft) wide. The central section of each rope to which you are hanging the bosom is 275 cm long. So you have to attach 550 cm of stretched

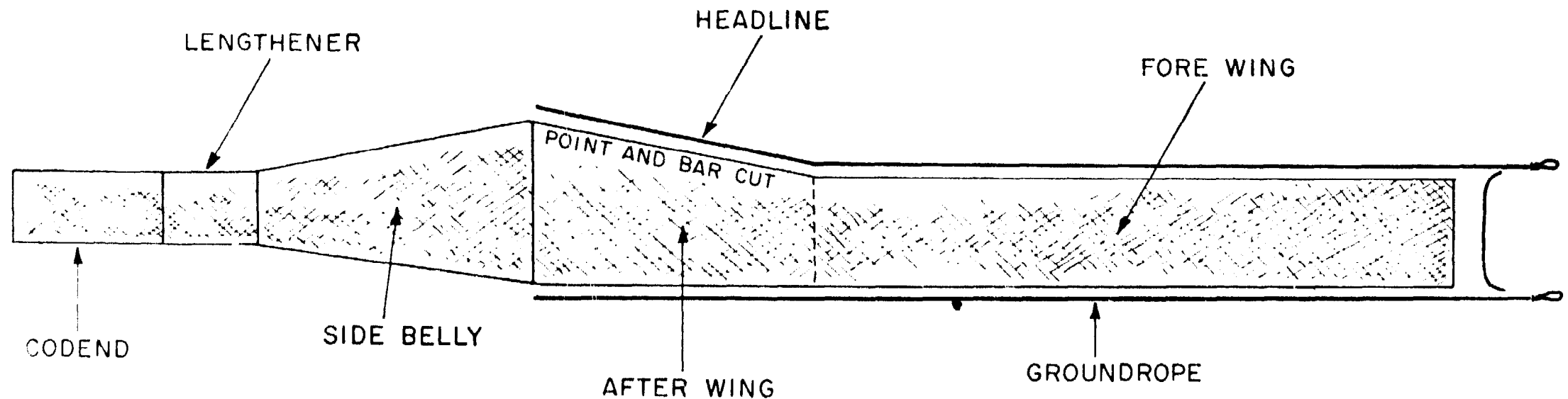

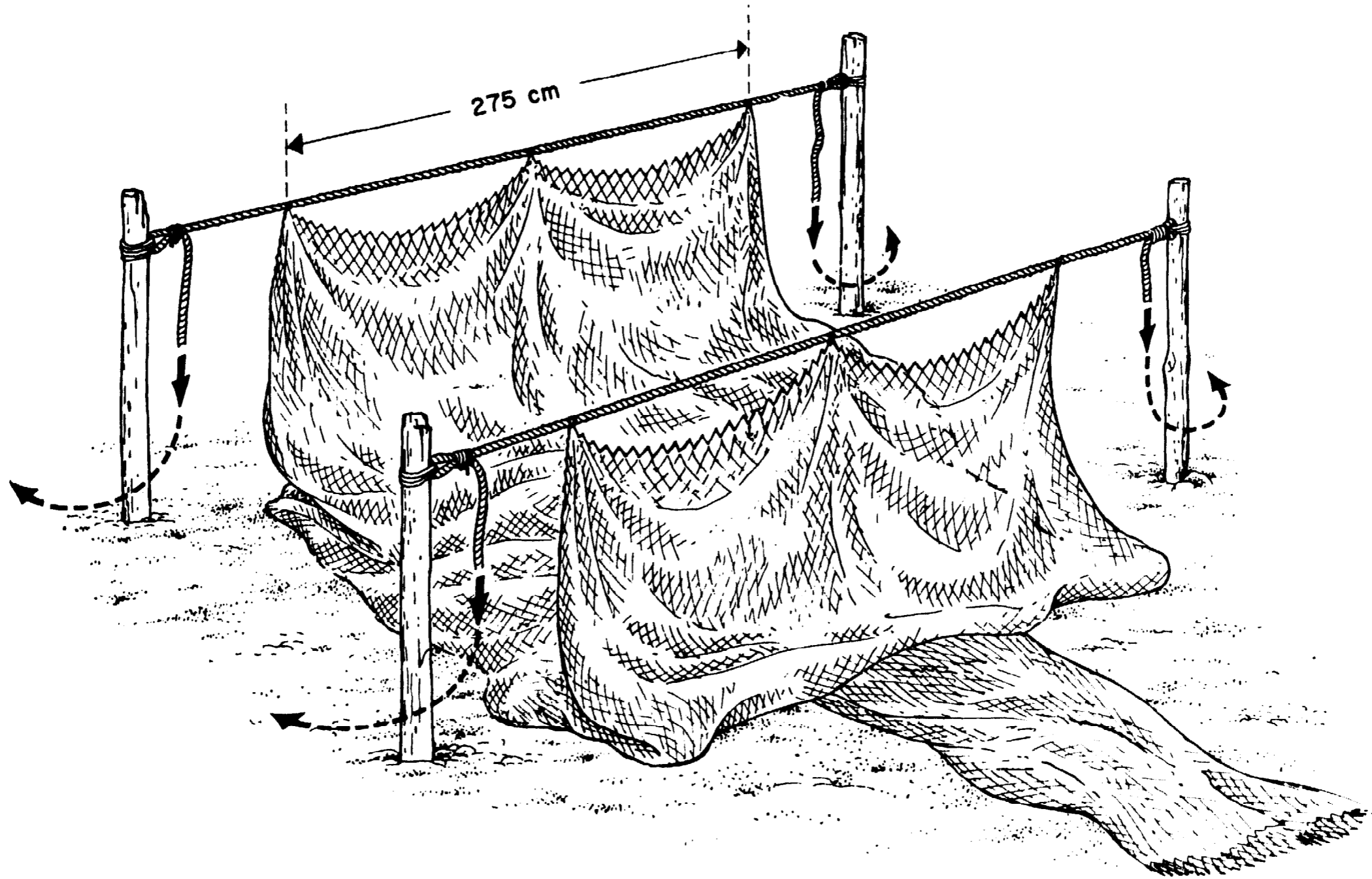

netting to 275 cm of rope. We call this a *hanging ratio* of 1/2 or 0.5. With a hanging ratio 0.5, the stretched netting is twice as long as the rope ($2 \times 275 = 550$).

Don't forget the headline is the rope attached to the point-and-bar cut wing-edges. You should mark the headline when attaching it to the netting so that later you can easily see which rope is which.

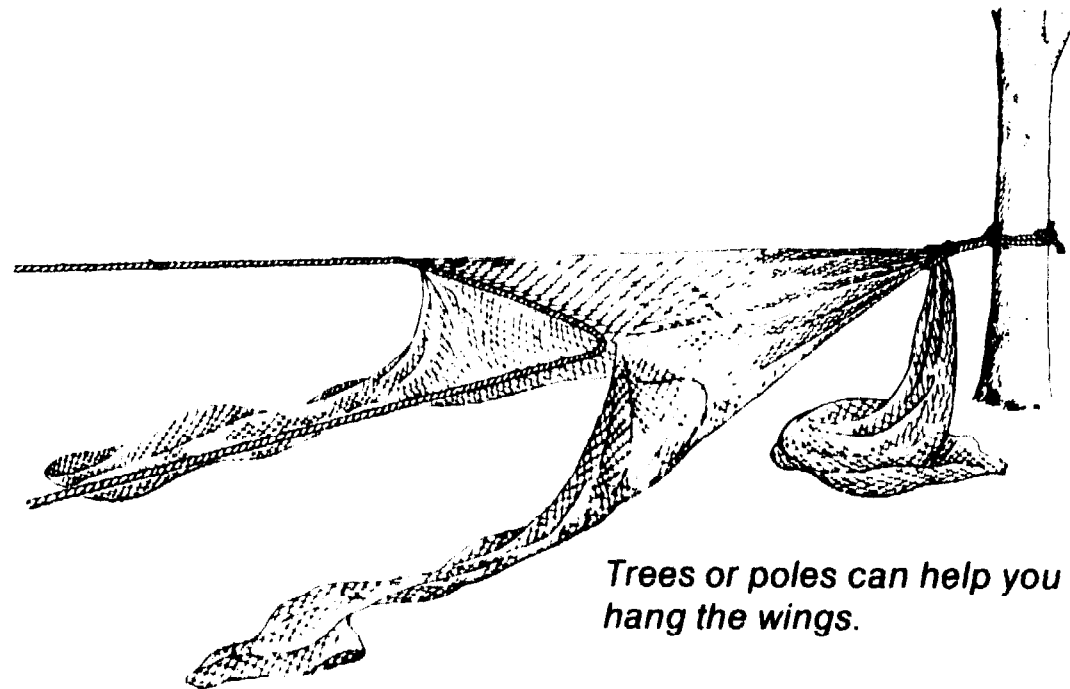

Trees or poles can help you hang the wings.

Next, you hang the wings to the headline and the groundrope. You can do it as shown on the picture. Along the wings the hanging ratio is 0.75, that is, that you take 3 lengths of rope for 4 lengths of stretched netting.

Mark off each rope 8.85 m from the corners of the bosom, see that all four rope lengths are exactly equal and hang the netting, as shown in the picture:

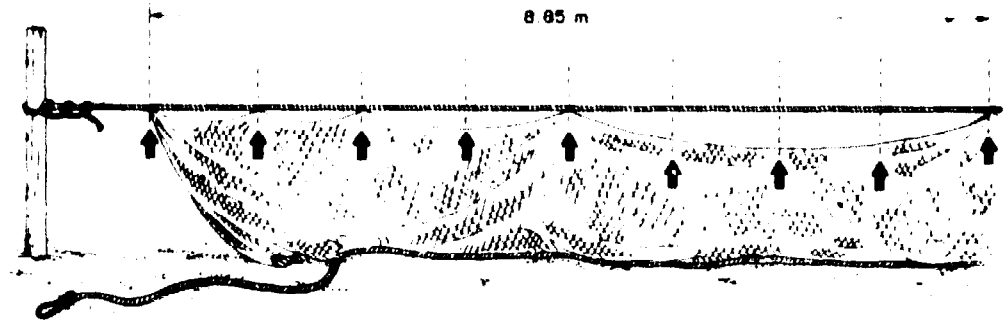

Divide the rope length and the netting length into equal parts and "catch" them with marks. This makes the hanging work easier.

You finish the trawl net by hanging the front edge of the fore wing (the wingtip) on the wingtip line. For each wing you need 1.25 m (4 ft) to be attached to the netting at a hanging ratio of 0.5 (50 meshes of 50 mm each make 2.50 m of stretched netting) and, say, 20 cm (4 in) more at each end to splice the wingtip line into the headline and the groundrope, altogether 1.65 m of line.

The wingtip line can be thinner than the headline and groundrope, say, about 6 mm (1/4 in) diameter.

The extra rope at each end is needed to splice in the wingtip line and to make a knot or an eye splice to attach the *danleno*, or *spreader stick*.

RIGGING THE TRAWL

Once the trawl net is finished it has to be *rigged* ready for fishing. Start with the floats that hold up the headline in the right shape with the headline highest in the middle. In the chapter on the headline (page 25), we told you about floats that are easy to make and how they are fixed to the headline. We also told you how to find out how many floats you need. On the headline bosom along the 2.75-m length you may fix a group of three or four floats for stronger lift, for example, one float at either side of the centre and group of two at each corner where the bosom and the wings meet. Each wing may have five single floats spaced equally along it. Fix more or fewer

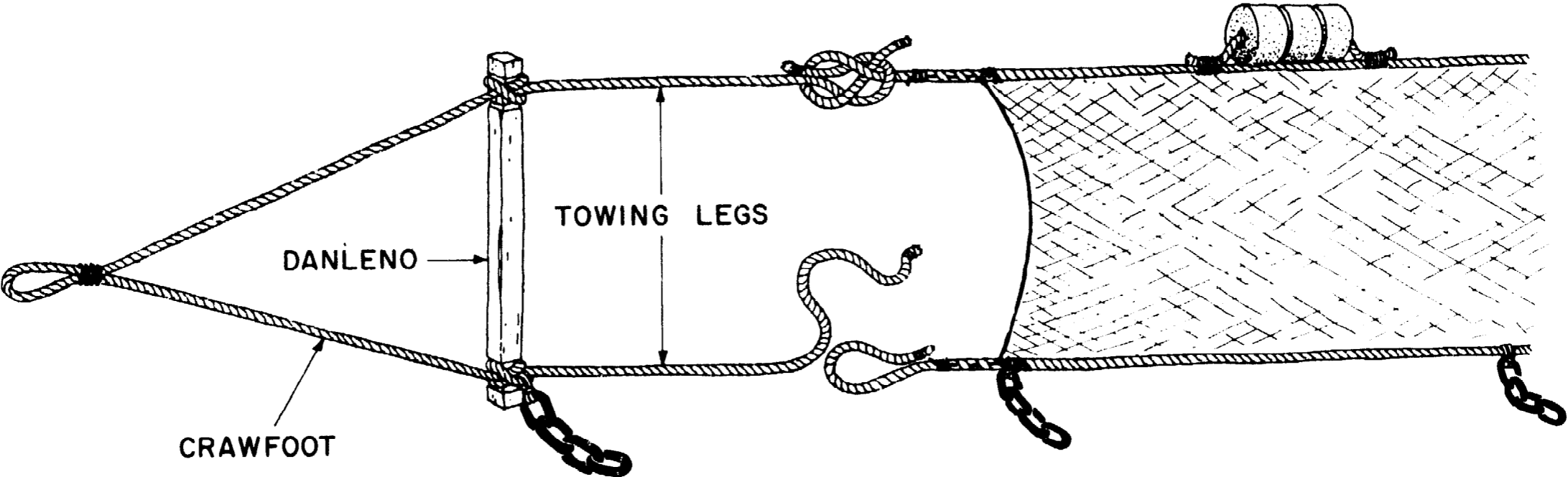
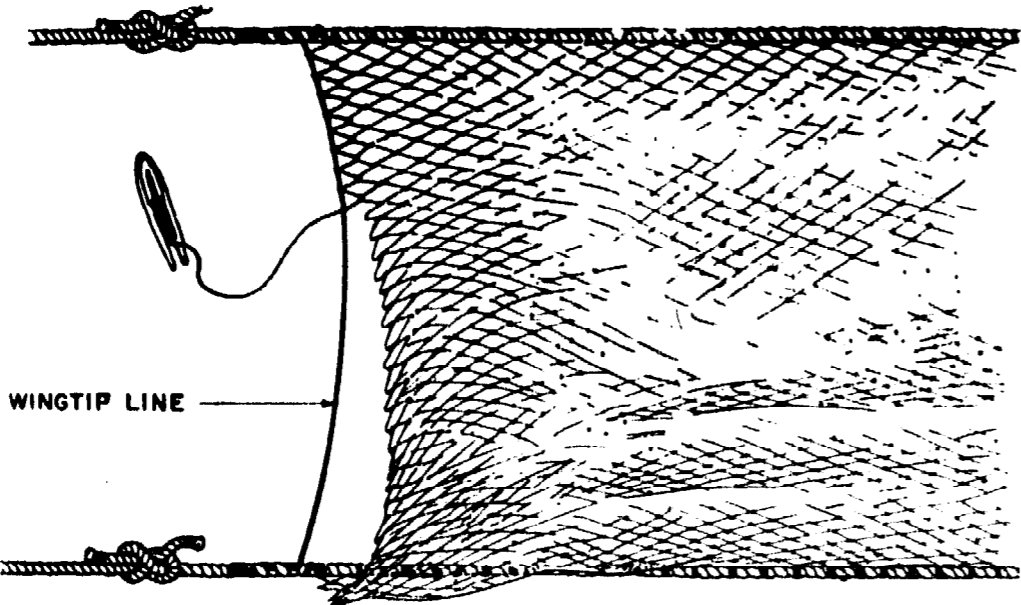

floats as needed, but remember to have an equal number at each side of the trawl.

The groundrope can best be weighted by short pieces of old 25-mm or 50-mm chain of 0.3 to 0.5 kg each. The number of kilograms all the chain sinkers weigh should be equal to the number of horsepower of one boat, or a little more. Between 1/4 to 1/3 of the chain sinkers should be tied at the bosom, and the rest equally spaced along each wing.

At the end of each wing there is 0.75 m (2.5 ft) of rope left spare. This is used to tie the wing end to the *danleno* or *spreader stick* made of square or round hardwood about 75 mm in diameter and 1.20 m long, with all the edges rounded off. It is weighted at the bottom end with a piece of old 2- to 4-kg (4.5- to 9-lb) pipe or chain. The picture shows how it is rigged.

The towing legs are short ends of the headline and the groundrope between the ends of the wing netting and the *danleno*. In this trawl you can make them of a single, separate piece of rope, which will run from the headline to the upper end of the *danleno*, from there to the loop or eye where the sweepline or the warp will be attached, back to the *danleno* and to the groundrope end. This is shown in the picture. The V-shaped section of this rope, between the loop and the *danleno*, is sometimes called a *crowfoot*. To make all this, you need 15 m (49 ft) of the

same kind of rope which you used for the headline and groundrope. You need 30 m (16 fath 2 ft) for both *danlenos* and for the whole trawl you need 74 m (40.5 fath) of the rope altogether.

A TRAWL FOR BIGGER BOATS

The next trawl we shall look at is larger than the last one, with bigger meshes and of slightly different shape. It is for two boats, each 15-20 hp (see picture on page 52) and more suitable for fish than for shrimp.

The wings of this net are shorter, with a " V " or forked end and three ropes on each side. The middle rope takes some strain off the headline and groundrope, so that the mouth of this trawlnet opens higher. It is also a two-seam trawl, as there are no side panels, just top and bottom panels locked together.

You can see on page 54 that this trawl has a square that overhangs the groundrope to stop fish escaping upward. The headline is 11.70 m (about 38.5 ft) long, which is shorter than the groundrope, which is 14.20 m (46 ft) long, to allow for the square 30 meshes deep.

Note also that braided rope is used to prevent kinking; also that there is a "funnel" in the codend.

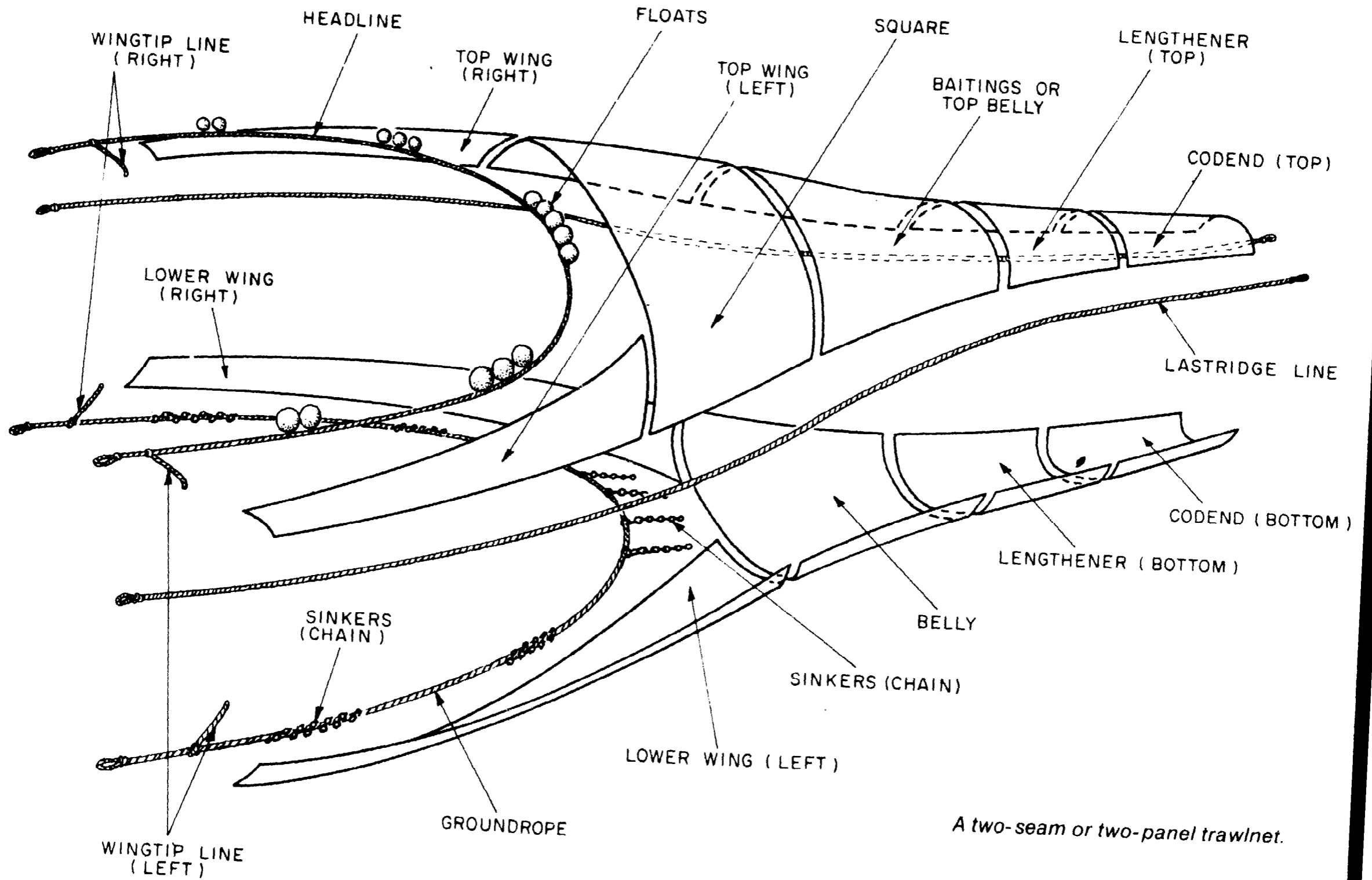

A two-seam or two-panel trawl net.

To make up for the short wings, bridles 11 m (36 ft) long are used to guide the fish into the net. To keep the foot-rope of this net on the bottom, a leadline with about 8 kg (18 lb) of lead sinkers, as shown in this picture, may be used.

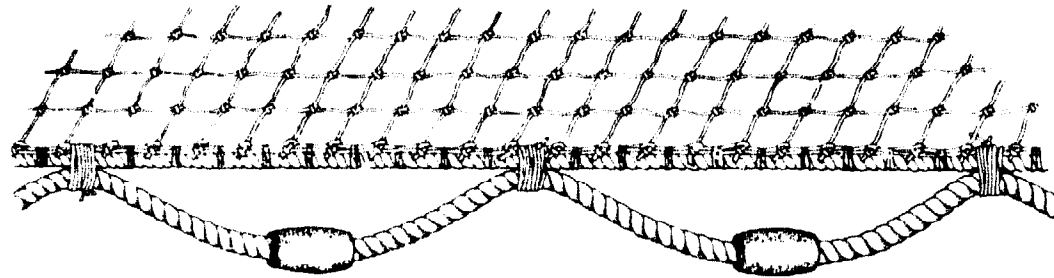

If you cannot get such lead sinkers then use short lengths of chain as we did on our first trawl. A bunch of old chain weighing about 7 kg (16 lb) is fixed to each warp, about 2 m (6.5 ft) in front of the spreader to keep the whole trawl close to the bottom.

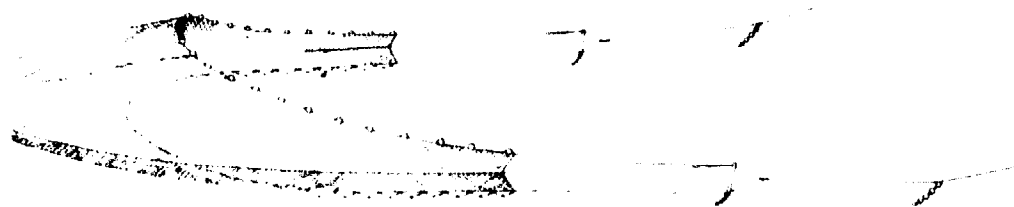

The sort of footrope shown for this trawl may not be right for fishing where the bottom is of sharp sand or small coral, with shells and even small rocks half covered by sand. In this case, you can fit the footrope of the net

with an additional thick groundrope, so that it rides better over rough ground. The picture shows how old rope can be wound round a section of light chain a few metres long to make a length of such a groundrope. This

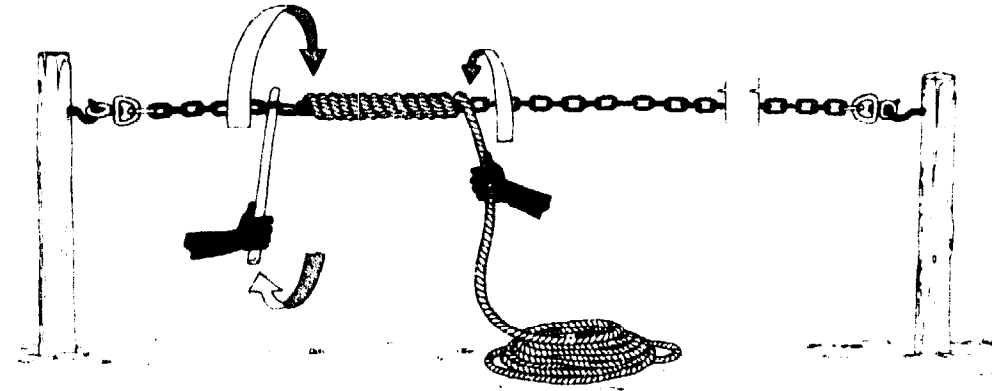

is fixed to the trawl's footrope by *stoppings* of twine, as you can see in the next picture. This type of groundrope takes a while to soak up water and sink properly when fishing begins.

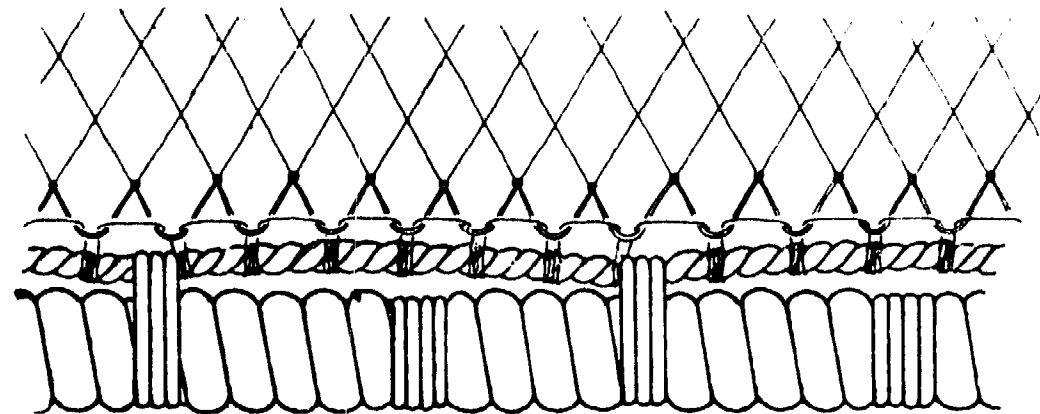

You can also protect the net by fixing wooden *bobbins* on to the footrope, as the picture shows. The wood must be hard and should be well soaked or it may tend to float when first used. If this happens, tie the pieces of chain around the bobbins to sink them until the wood has become soaked. You can use 2, 4, 6, or more of such bobbins, depending on how rough the bottom is. The bobbins should be about 25 cm (10 in) long and 15 cm (6 in) in diameter and you can make them yourself or have a local carpenter do it for you.

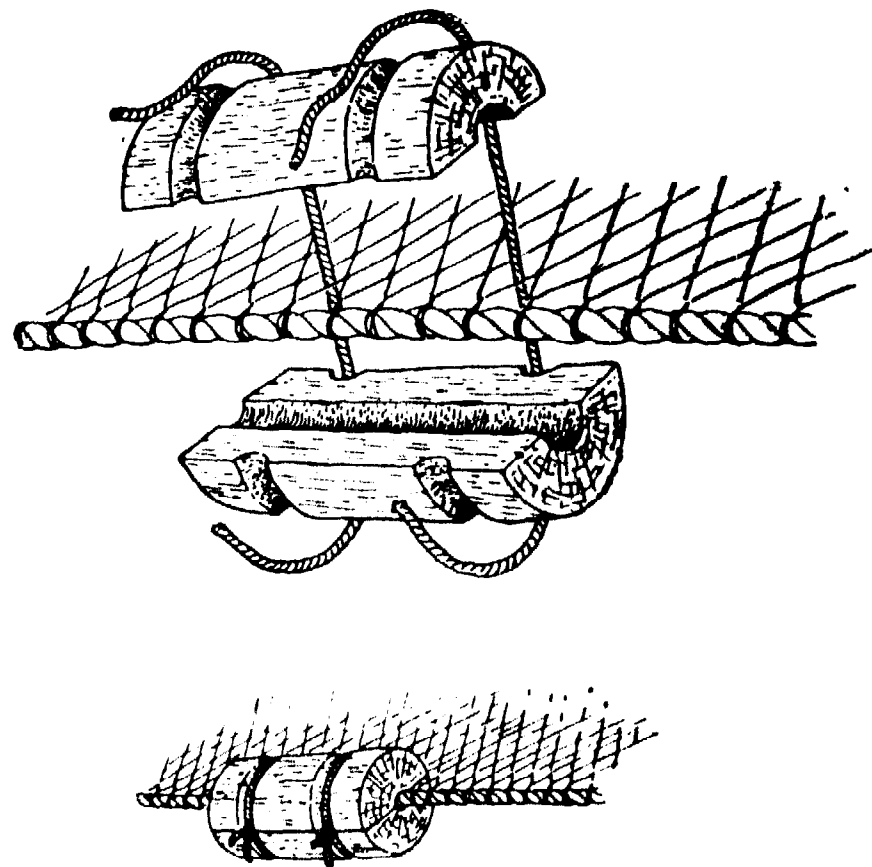

The twine used for this trawl is thicker than for the first one we looked at. This twine is (PA) R 550 tex, which means nylon with a runnage of 1 820 m to the kilogram or 890 yd/lb.

The detailed plan for this trawl for larger fish (with stretched meshsize in the codend of 50 mm) was taken from the *FAO Catalogue of Small-Scale Fishing Gear*, page 78. In the same book, on page 79, the same trawl is shown, but for smaller fish (with stretched meshes in the codend of 24 mm). You will find, however, that some of the cutting rates are different from those used in the trawl we described before.

The inner edges of the wings are cut all bars (AB).

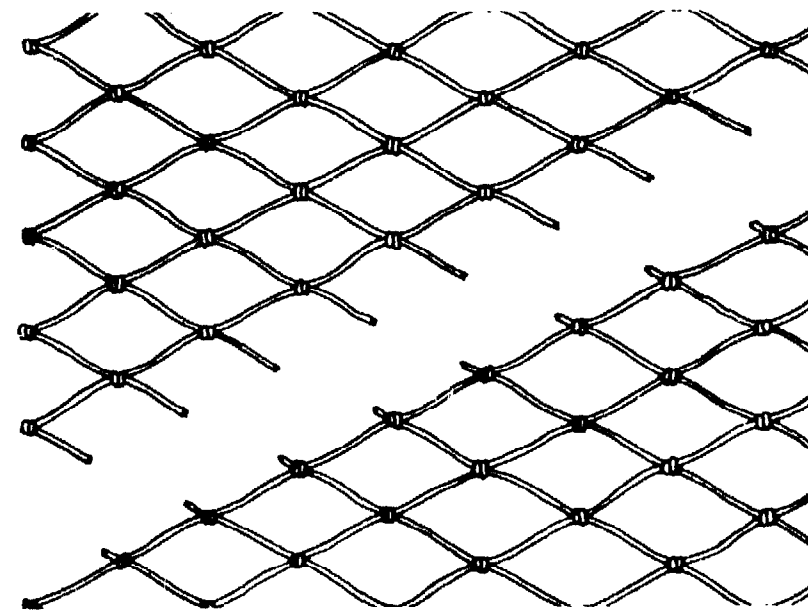

They can be hung to headline and footrope like this:

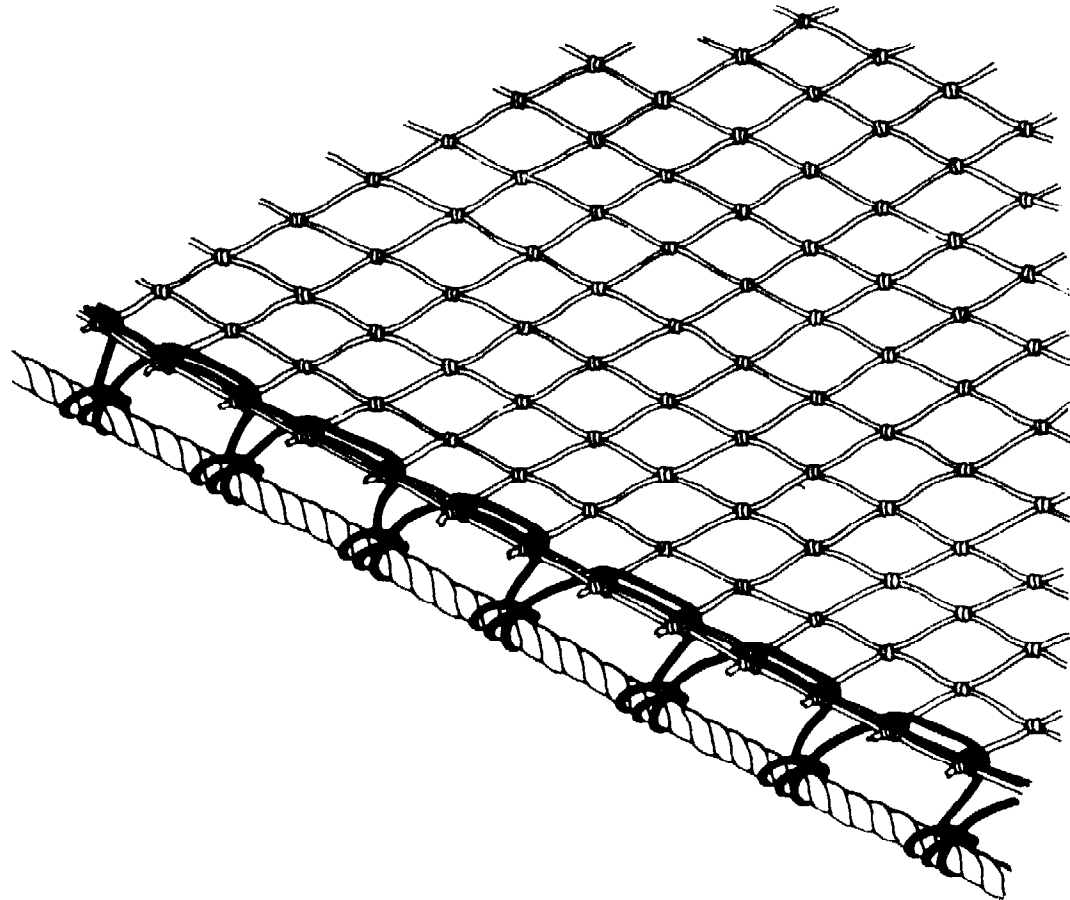

A cutting ratio of 3 points 8 bars (3N 8B) is used in the upper wing of the small fish trawl. This can be cut in series:

1 point 2 bars + 1 point 3 bars + 1 point 3 bars and then start again with 1 point 2 bars, like this:

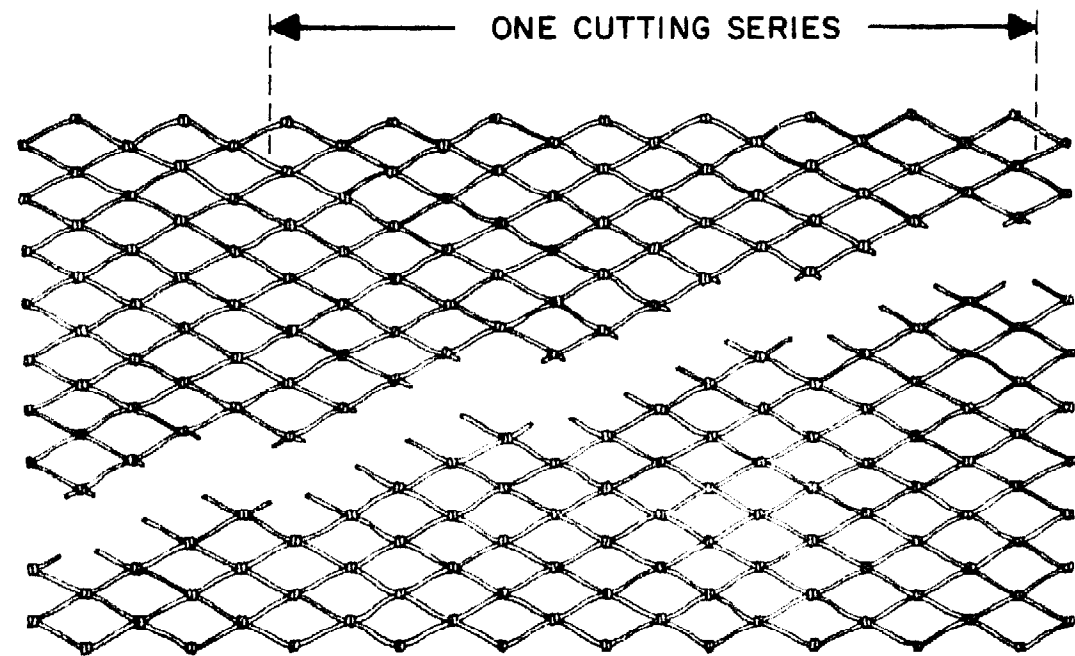

In the lower lengthener there is a cutting ratio of 5 points 6 bars (5N 6B) which you do by cutting 1 point 1 bar four times and 1 point 2 bars the fifth time.

Sections cut all bars are easy to make. The fore part of the lower wings is cut all bars (AB) at both edges, and the picture shows you how to make a pair:

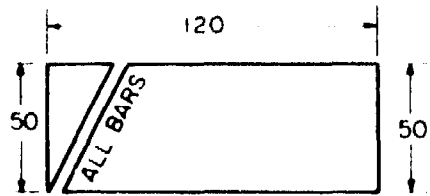

1. Cut all bars starting from the corner.

2. Join the 50-mesh edges.

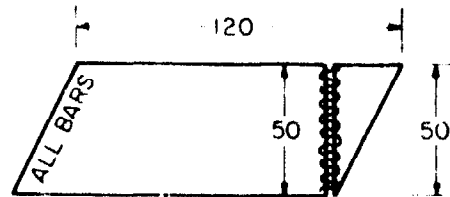

3. Count 60 meshes and cut all bars.

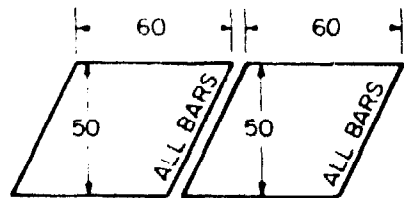

And this is how you make the two wingtip sections of 42 meshes cut all bars for the upper wings of the larger fish trawl from a square piece of netting:

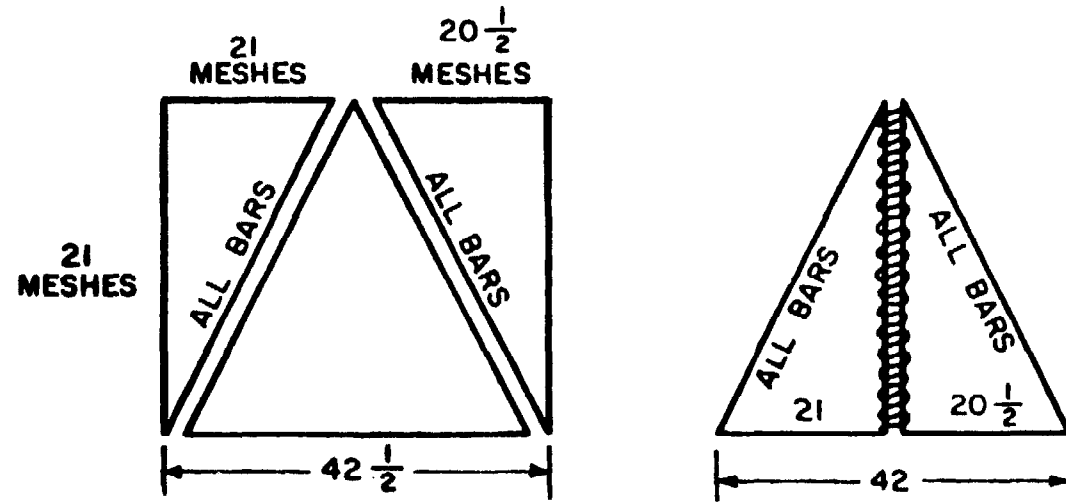

After the two cuts are made as shown, one wingtip is ready, while the other can be made up by lacing the two remaining wedges along the all-point edges.

GOING TRAWLING

You have your trawl rigged and ready for fishing. You have found some good, clear trawling ground. Now you have to learn the best way to go pair trawling.

Pair trawling only works well if the two boats can work together as a team. If one boat goes one way and the other goes another, then you will not catch many fish. You can only have one boss and we call his boat *Number One*. *Number Two* boat must do what the boss says.

Number One boat carries the net that is shot and hauled from this boat. Some fishermen build a small platform on the stern of Number One boat to carry the trawl. This helps to avoid the net getting tangled and caught up in the boat when shooting, and also keeps it clear of the propeller.

You will remember that we shoot the combing gear by starting with the combing rope. When we shoot our trawl, we shall start in the middle of the whole gear — that is to say, with the codend.

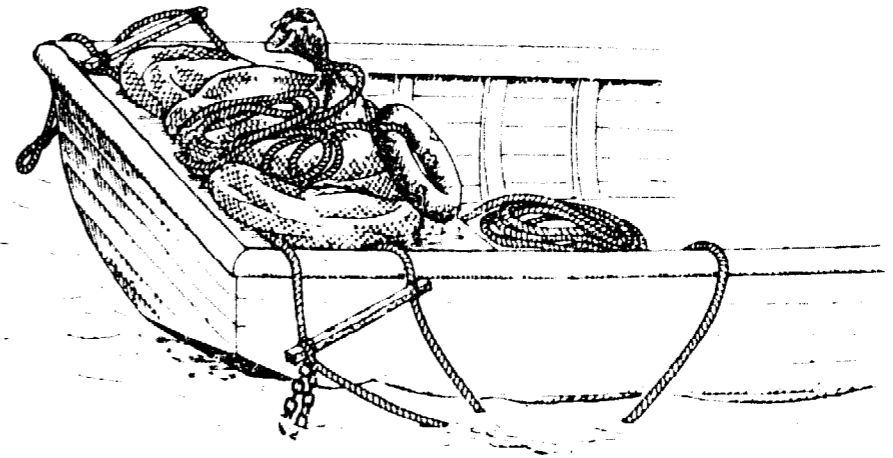

Trawl gear ready for shooting on the Number One boat.

If you coil your rope better than this fisherman ...

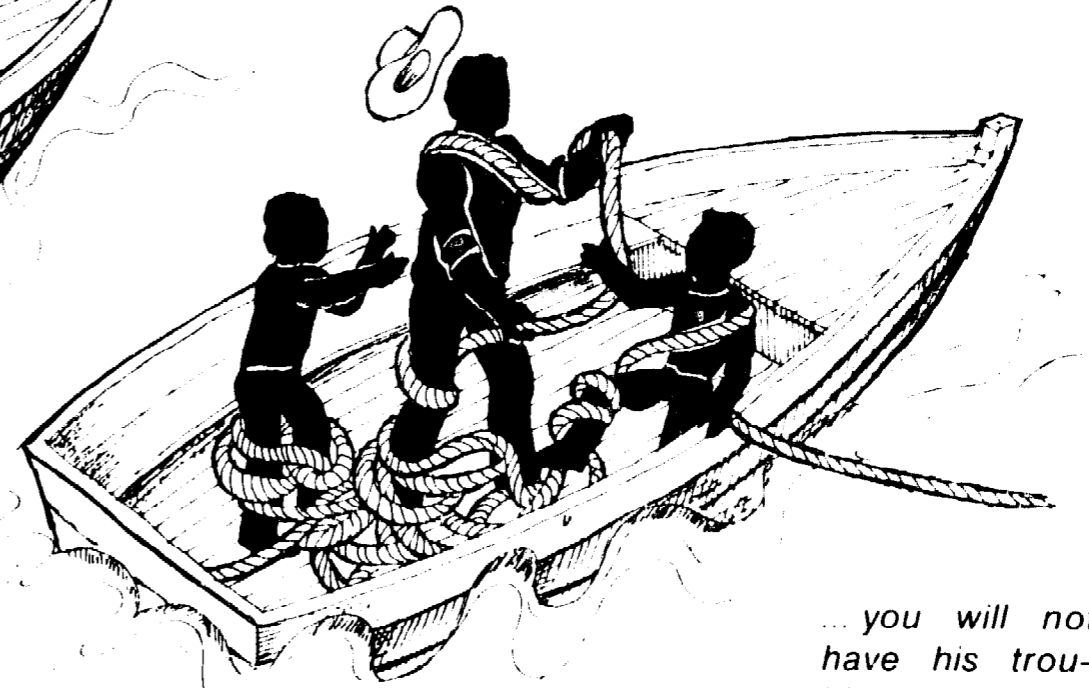
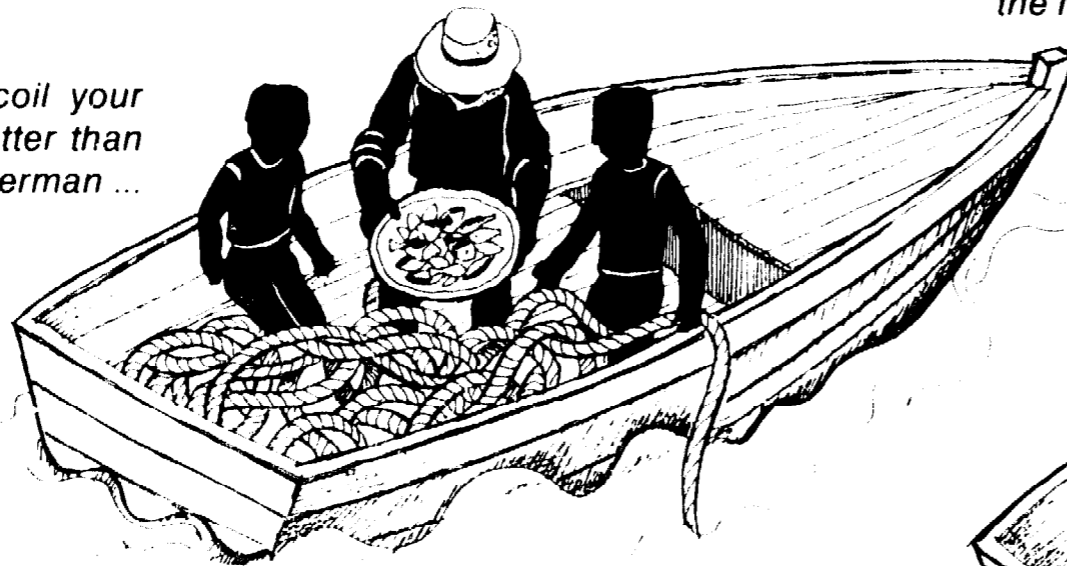

... you will not have his troubles.

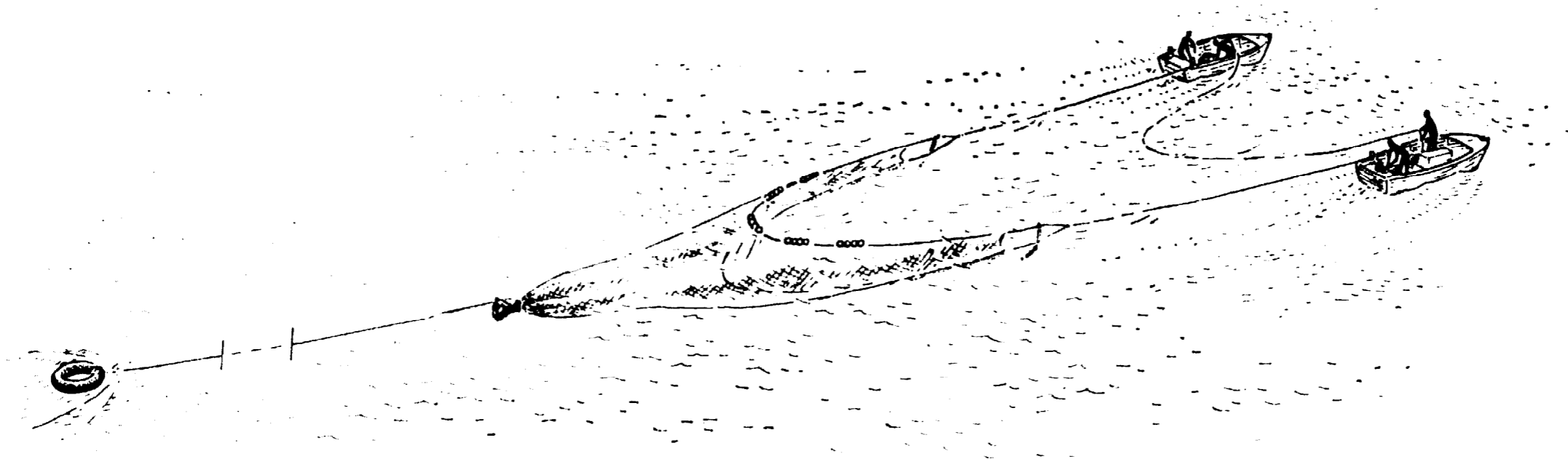

The codend buoy

When fishing in water which is not too deep it is a good idea to use a codend buoy. A codend buoy is a big float or old car inner tube and it is connected to the codend by a light but strong rope. The length of this rope must be nearly twice the depth of water. You can attach the buoy rope to the codend using a " running bowline " knot.

The codend buoy has several uses. It helps to pull the net clear of the boat when shooting the trawl; it tells you where your net is when you are towing; you can use it to

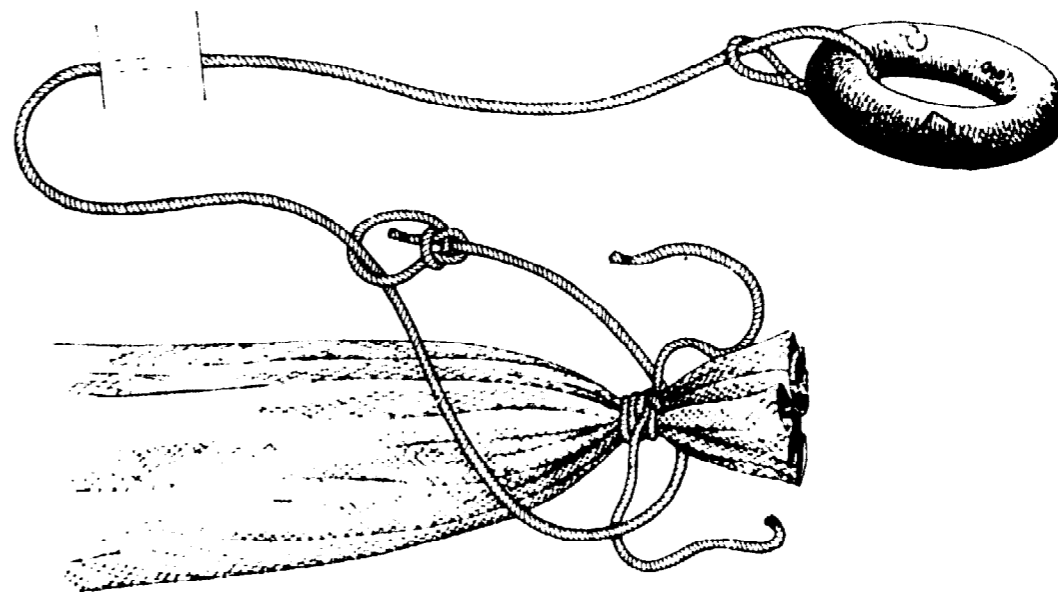

pull the trawl off a fastener, by slacking off the warps and pulling the codend buoy, and finally, if you pick up a heavy stone or a lot of sponges or mud in the trawlnet you can slack off the warps, pick up the buoy and by hauling the buoy rope up, empty the codend on the bottom.

Connecting warps

When fishing with a pair trawl, the Number Two warp is constantly being fastened to and unfastened from the danleno or spreader. If we tie the warp on, we must use a knot that does not jam up tight. A bowline or an "eye splice and a round turn and two half hitches" are best and you can see from the picture how to tie these.

This knot has a long name:

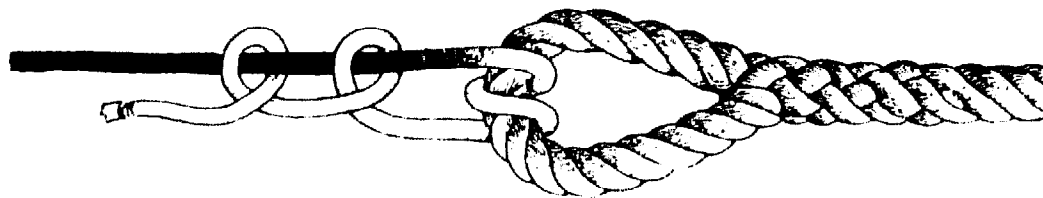

Round turn and two half-hitches.

And this is how to tie a bowline knot.

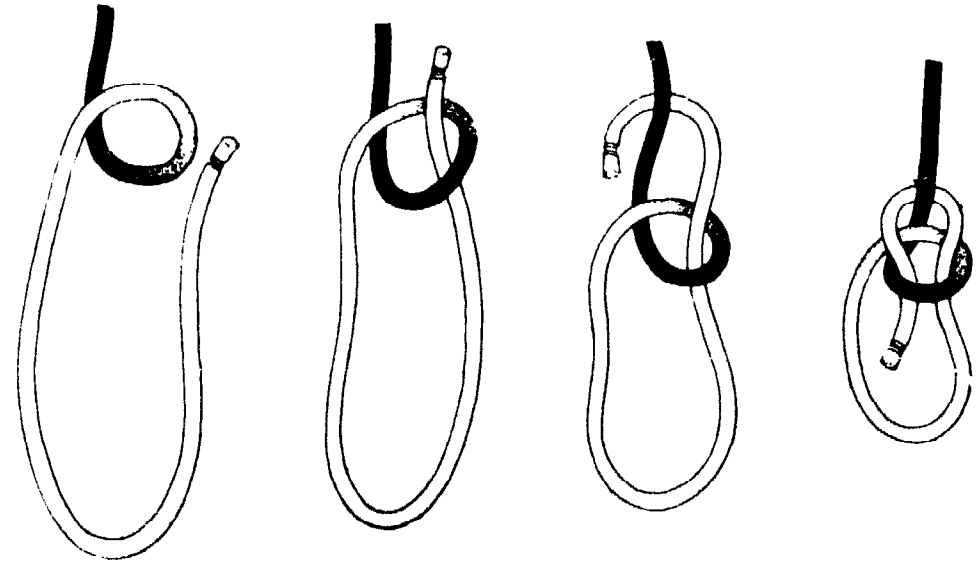

If the end of the warp has a metal *thimble* spliced into it the rope will not wear out so quickly. You can also use a shackle to connect the warp and danleno crowfoot, but shackles take time to fix (and you might drop the pin), so a quick-release hook from a safety harness or a quick-release purse-seine ring will do the job even better. Another way is to use G-links such as are common on otter trawls, provided the links are not too heavy. The picture shows how they look and work — and they do save time.

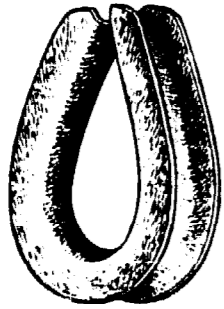

THIMBLE

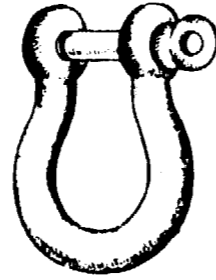

SHACKLE

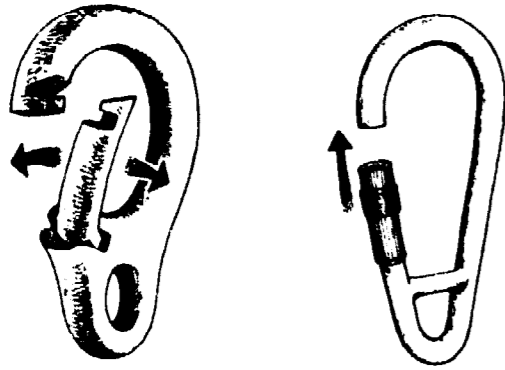

QUICK-RELEASE
LINKS

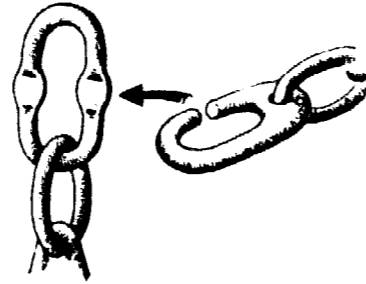

G-LINKS

of the rope. The fish then spill on the deck or straight into a hold because the weight of the catch forces the hanging codend open.

Here, however, we will show you another knot, because you probably will not have a boom or derrick to haul up your codend.

First you arrange your codend correctly and pass around it about 30 cm (1 ft) from the end a doubled 1- to 1.5-m (3- to 5-ft) long, 6- to 10-mm (1/4- to 1/2-in) diameter line, threading its end through the loop.

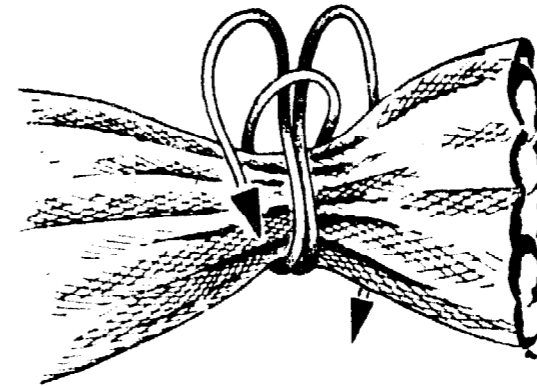

Tying the codend

There are several knots used by trawl fishermen to tie their codends. On big trawlers, heavy codends are hauled on board using booms, derricks or gantries. For such cases there are knots that open when pulled by one end

Next, you make a turn with each of the ends but in opposite directions around the codend, tighten strongly, and make a regular flat (square) knot.

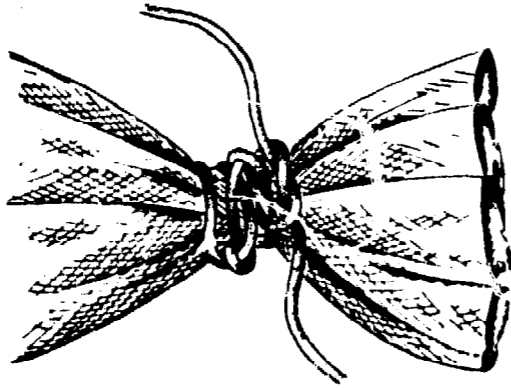
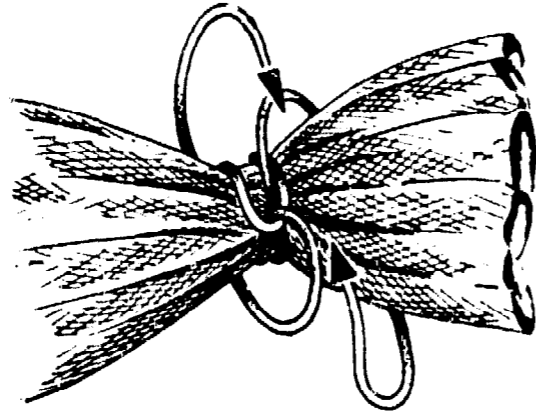

Shooting the gear

The net is laid up with a wing on each side and the rest of the net piled in the centre, with the codend (tied securely, of course) on top. If the codend buoy is used, this is already tied to the codend with a running bowline and the buoy rope coiled down, ready to shoot. This arrangement is good whatever method is used to shoot the gear because the codend is always the first to go over. Now you can steer for the starting point of your tow. It is best to make your first tows with the current or with the wind, whichever is the strongest.

These are lucky fishermen — they have the wind and the current in the same direction.

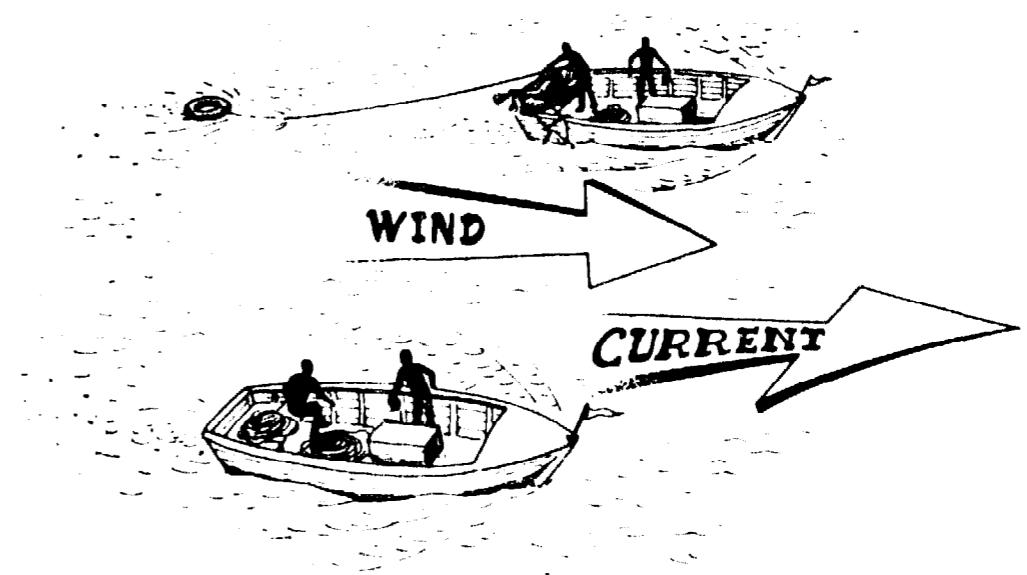

This is easy enough to untie by pulling one of the ends in a reverse direction to loosen the knot. Its ends may also be used to fasten the bowline of the buoy rope (see picture on page 59).

Next, you check the depth of water so that you know how much warp to pay out. Both boats now move slowly in the direction of the tow. On board Number One boat make the warp fast to the towing post, close to the net, to stop it from running out when the net goes over. The shooting starts when you throw over the codend buoy (if one is used) and the codend, followed by the body of the net as the boats go slowly ahead.

In the meantime, Number Two boat comes alongside and you pass the end of its warp to boat Number One. One of the men in Number One fastens this warp to the free danleno. While the two boats are close, the Number One skipper tells the Number Two skipper how much warp should be let out, what the distance should be between boats, and what course to steer.

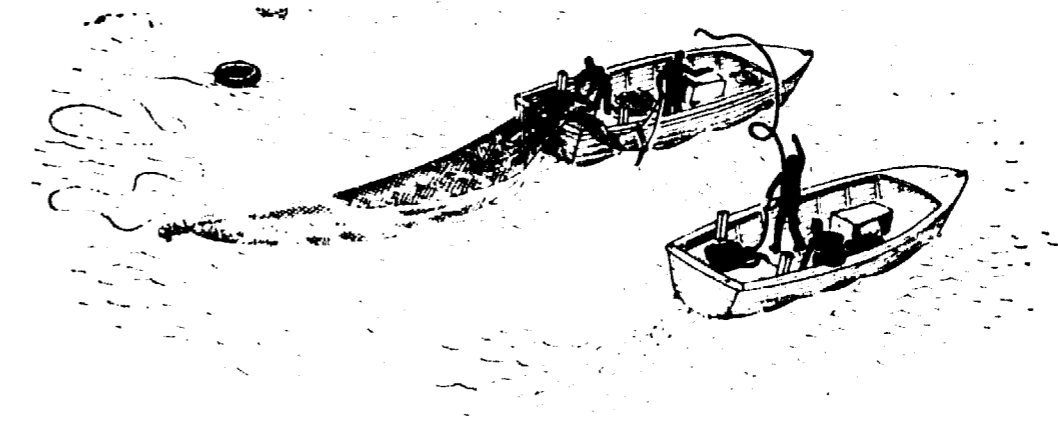

Now you can let go the rest of the trawl. For a while, both warps are held by a turn on the towing posts. The Number One skipper can now check that the net is not twisted or caught up.

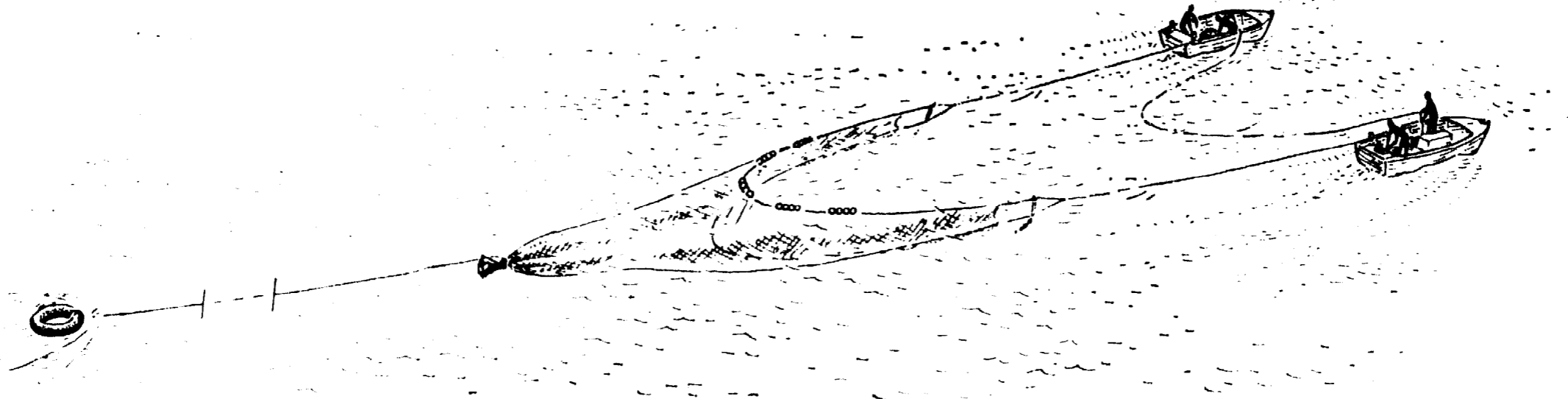

As soon as he gives the " OK " the warps are paid out slowly and evenly, braking with one turn round the towing posts. This keeps pull on the warps and keeps the net flowing out clear.

When the correct warp mark is reached, the warps are made fast as shown on page 20. The engines of the two boats can now be speeded up until proper towing speed is reached. Number Two may then have to play a bit with the speed of his boat until the two boats are towing level.

For shooting a trawl with sweeplines, Number One boat pays out all the trawl until it is streaming behind the boat with the crowfeet held by a turn around the towing

posts. Each boat has its ballast weight ready, fixed near the end of the sweeplines.

Now Number Two boat comes alongside and passes to Number One the end of his sweepline, which is quickly fixed to the Number Two crowfoot. Number One now releases both crowfeet from the towing posts and they are slacked away followed by the weights and the sweep-lines as before.

Once fishing has started it is easier to leave the weights just outside the boats, hanging on the warps when shooting and hauling. This saves lifting them in and out of the boats each time.

In windy weather when the boats cannot get too close, the warp end or the end of the sweepline can be passed across using a heaving line, that is, a rope that is easy to throw 15-20 m (9-12 fath) long. One end is tied to the warp or sweepline end and the other thrown from Number Two to Number One boat.

A distance rope between the danlenos may scare fish away.

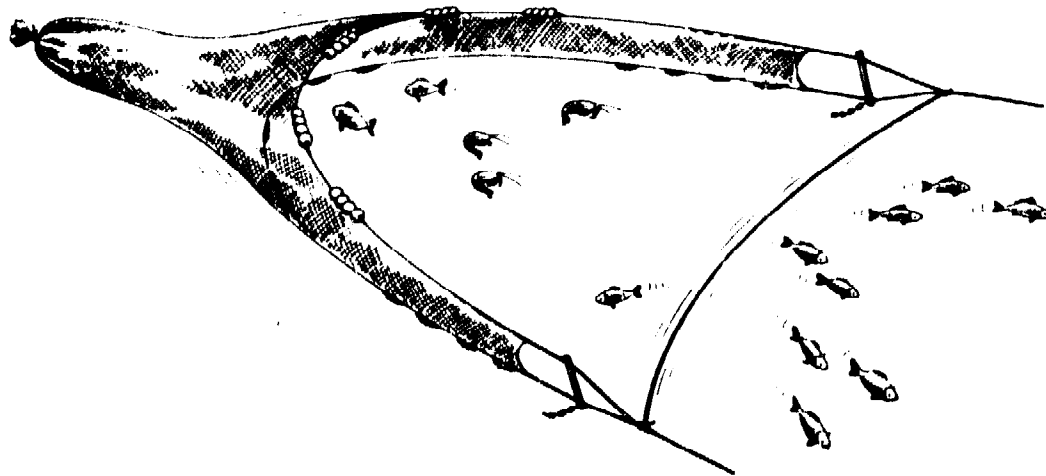

Distance keeping

It is the job of the Number Two skipper to keep the correct distance between the two boats. If they are too close, the trawl is not open wide enough. If they are too far apart, the trawl is pulled out of shape. Some fishermen

use a light rope between the danlenos to keep them at the correct distance, but, although this rope between the wings may not disturb shrimp, it could frighten fish away. After some practice, when you have become used to trawling with two boats, you will not need a *distance rope*, but it may be useful in the beginning until you learn to judge your distances.

The best place for a distance rope is between the boats. Don't forget that the boats need to get further apart as more warp is paid out, so for every length of warp there is a different length of distance rope. The distance between the boats (and the length of the distance rope) should be half the total length of the headline including the towing legs and crowfeet plus half the length of one sweep line; to this you add half of the length of the warp paid out. So for every 20 metres of warp paid out, you need 10 metres more distance between the boats.

For example, with a headline + towing legs + crowfeet length = 30 m, and sweep lines 20 m long, distances between boats should be as shown in the picture.

For the distance rope try to use 8-mm diameter polypropylene or polyethylene rope, as this will float and be less likely to catch up in the propeller. The rope should be marked every 5 m, starting at 20 m. While shooting, fasten one end to Number One boat when the warp is passed across. The crew of Number Two pay out the distance

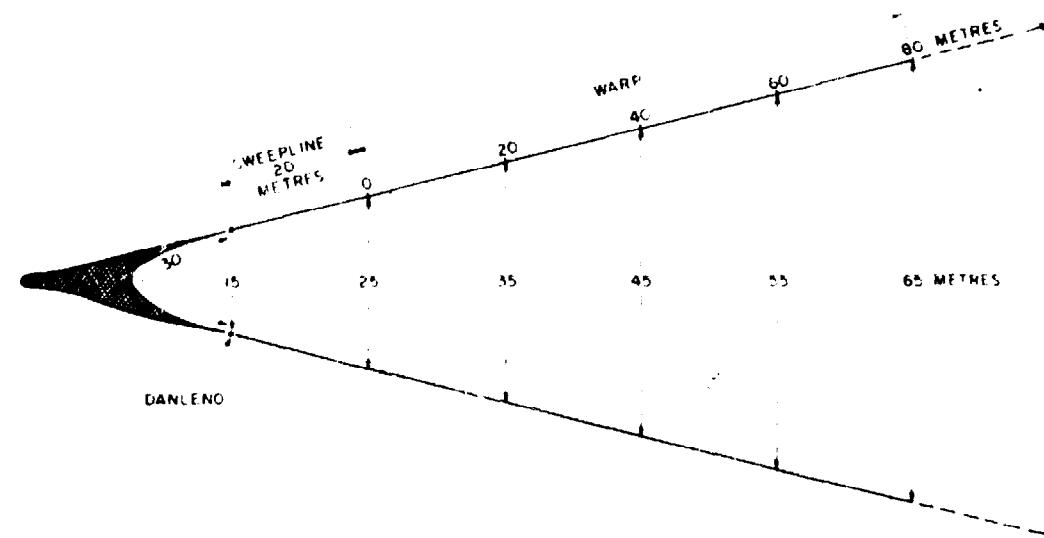

rope as the boats move apart, making fast when the correct mark is reached and steering their boat to keep it tight during towing. Make the distance rope fast to the boats, not too near the stern or the bow so that the pull of the rope does not make your steering difficult.

Talking with the other boat

When two boats are pair trawling they often need to "talk to each other", that is, to communicate. You may be too far apart to shout so have a "code" of hand signs and learn them well. These are the kind of things you will need to say: "Let out another...metres of warp"; "Get

ready to haul "; " You are too close "; " You are too far astern (or ahead) "; " I am opening my throttle "; " Waves are going to turn left (or right)"; and so on. Some examples of such sign language you can see in this picture:

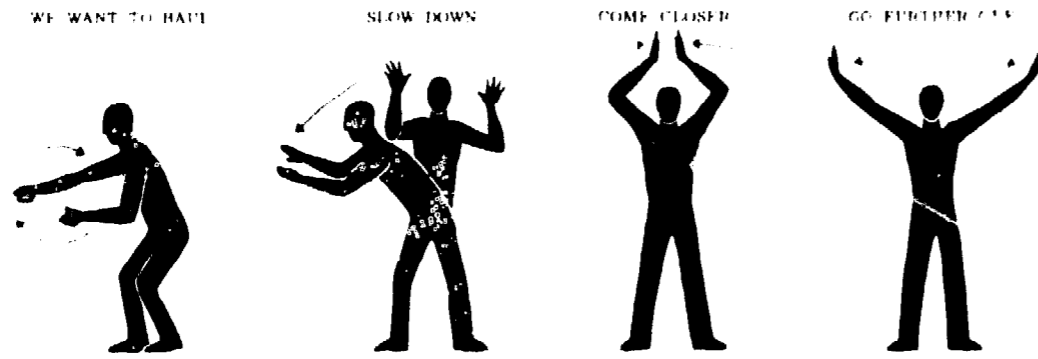

Radio, of course, is the best way to communicate and even small boats could use Citizens Band " walkie-talkie " radio-telephone sets. Some of those on the market are quite reliable and not too expensive.

While towing

Feeling the warp. A good trawler skipper will often put his hand on the warp while he is towing. This is because you can feel the trawl bumping gently over the bottom as the boats tow it along. With time and experience, you will

learn to feel if the water has gone deep and the trawl is swimming above the bottom (if this happens more warp has to be let out). If you feel strong jerks it could be because of rough bottom. In the case of a fastener, that is when the trawl has got caught on an obstacle on the bottom, the warp becomes very tense and your hand will stop feeling the trawl going over the bottom. Also, the boats will stop. If they are still going ahead, but slowly, you may have your trawl full with mud, sponges or stones. The warp is like a telephone -- but you must learn to understand the language it speaks.

The trawling depth. On most trawling grounds the depth of the water tells you where you are. If you trawl in a bay or close to the shore you will learn with time how to know your position on the ground by various landmarks (mountains, trees, towers, houses) on shore. Until you know the ground, it is a good idea to check the depth often with the leadline — or with the echosounder if you have one (see picture on page 10). There are some good reasons for knowing your depth. Very often fish prefer certain depths to others so that you catch them only if you are towing in the right depth. You should know at what depths the ground is bad for trawling so that you can steer your boats away from them or haul immediately if the depth is wrong.

Turning with the trawl. Sometimes when you are trawling you will have to change directions or even turn

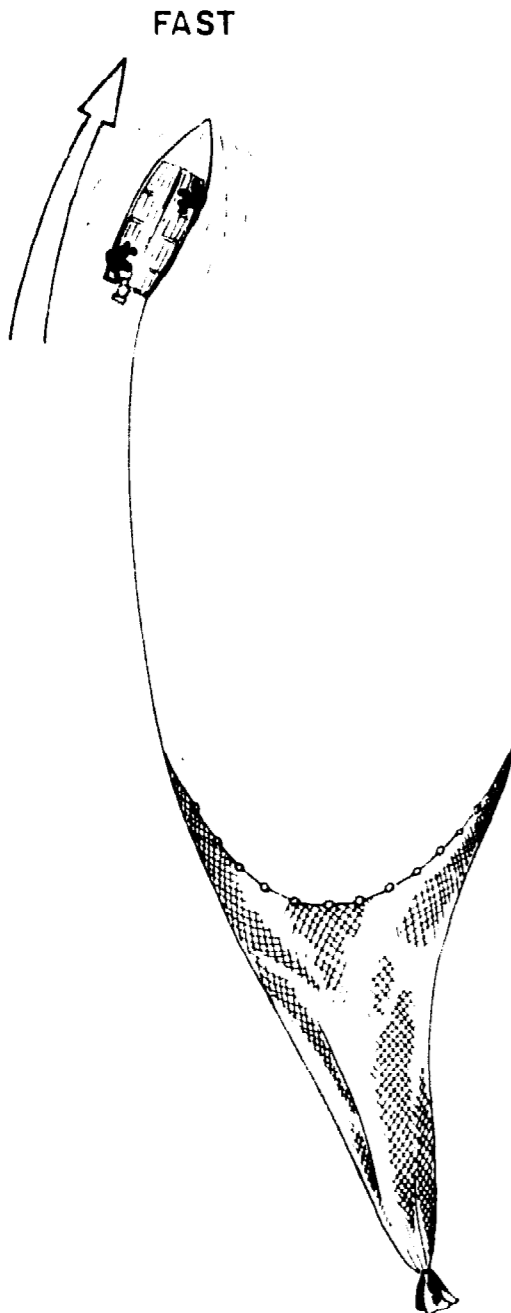

CORRECT

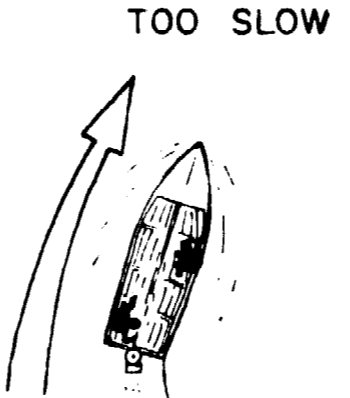
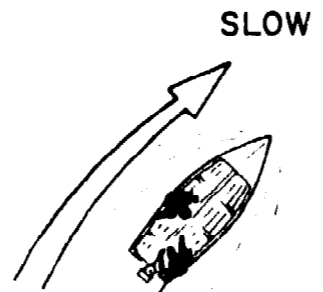

Turning with the trawl.

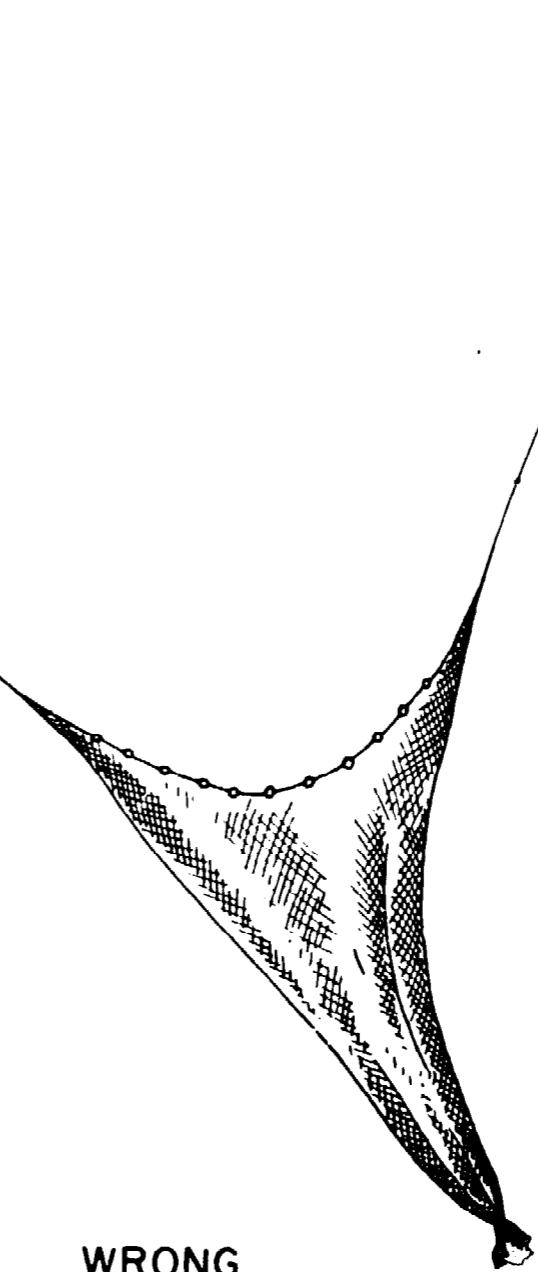

WRONG

TOO FAST

right around and go back the way you came. To turn to the right, the left side boat has to go faster and make a wide sweep round the right side boat, which slows down without letting the warp go completely slack. If this happens to you, it means you are turning too tight. Don't make sharp turns. Change course slowly.

Hauling

You haul in the gear with wind or current taking the boats away from the net. Try to keep the net moving as you haul, for if the warps go slack the net stops, its headline goes up, opening the mouth of the net, and you may lose fish. If you have a winch you can pull in with the propellers working slowly ahead. If you are hauling by hand you will have to stop the motors and pull net and boat toward one another. Try to be quick. If you use a distance rope, Number Two crew should haul it in completely so that it cannot foul the propeller.

At the same time you may start hauling the warps. As you can see from the pictures, you can haul the warps from the stern or from the bow. If you haul in by hand, it may be better to haul from the bow because that way the boat makes less resistance and the work goes more easily and faster. Less fish escape, too.

68 The boats in the picture have special blocks installed at

Warp-leading block, or "mol-gogger".

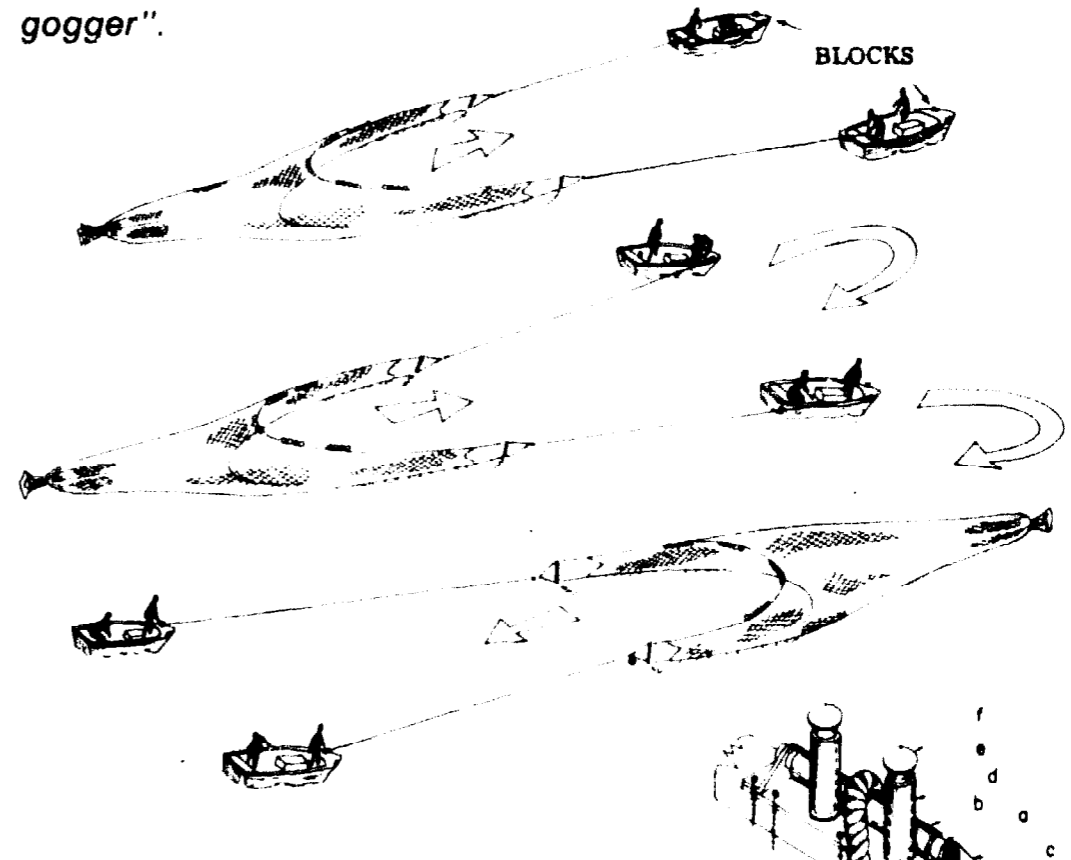

KEY

- a - piece of iron bar or tubing for the horizontal roller
- b - piece of tubing larger than bar (a), such that it can turn around it
- c - bracket made of flat steel plate to which (a) is welded
- d - piece of the same tubing that was used for (b), here used for an upright roller
- e - piece of the same tubing that was used for (a)
- f - steel cap welded onto (e) to prevent (d) from slipping off
- g - flat steel plate to which the brackets (c) and the bars (e) are welded
- h - gunwale of the boat to which the plate (g) is bolted

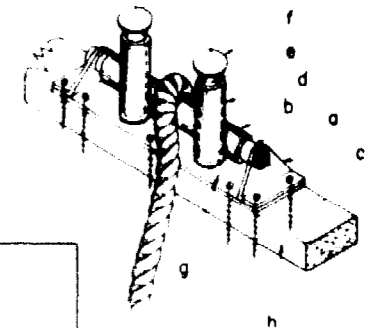

the bow (marked on the picture) which help to lead the warp and to keep the boat heading with the bow to the trawl. As you pull them in, the boats come closer until Number Two's wing or bridle can be passed across to Number One (using a heaving line in bad weather). Usually one or several men from Number Two boat will go aboard Number One to help in hauling or repairing the net, and with the catch.

In smooth water it is possible to haul the gear without taking off the Number Two warp. This is done by tying the two boats together so that they shoot and haul as one

A method of hauling in calm waters.

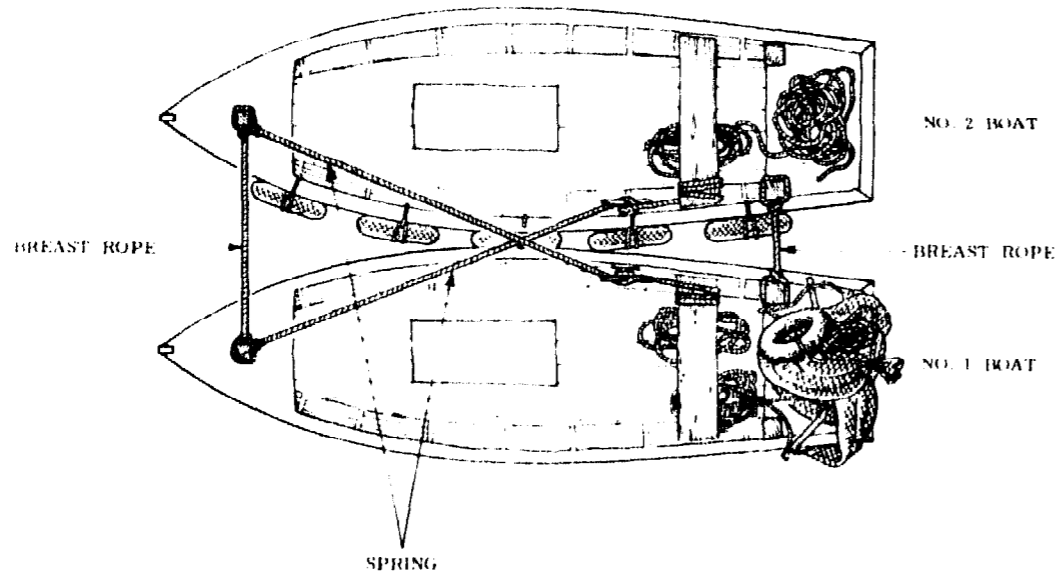

boat. Each boat pulls in its own wing, but the rest of the net is pulled in by Number One. To work like this, one boat must be fitted with good fenders such as old car tyres. The boats are tied together with *breast ropes* and *springs*, which are kept ready to drop over the cleats. It is best for these ropes to be kept on Number Two, as the other boat has to carry the net.

When the time comes to haul, the two boats steer toward each other and make fast with the springs and breast ropes. The warps are hauled in — if possible with the engine of Number Two going very slowly ahead. As soon as the wings are in, the mate (and other men) of Number Two can go aboard Number One to help with the trawl and catch. Number Two uses engine and rudder to keep the boats into the wind.

The next tow

When the codend has been emptied and re-tied, the trawl is shot again. If the catch has been a good one (a *good haul*), you may want to go back over the same ground again. Of course, if the current or wind is slight or has reversed since the last tow, you can trawl straight back in the opposite direction. But if the wind or current is the same and too strong to tow against, you may have to go back to your starting point, which is easy if you have put down a marker buoy or taken good shore marks. If the

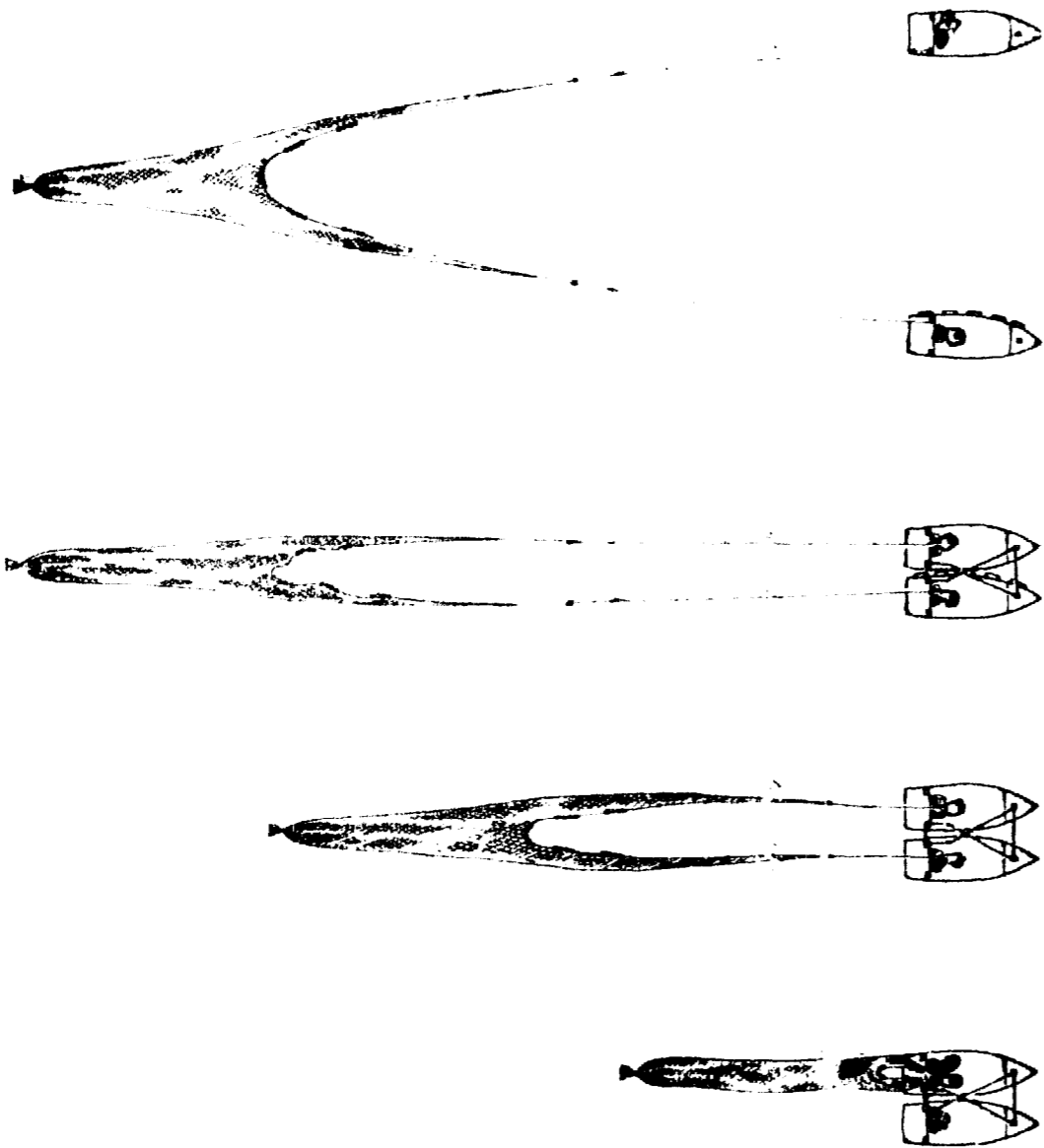

catch is poor, you should try another place or another depth. But, first, check if your trawl has worked properly. Are there any holes in your codend? Had the groundrope been on the bottom? Look at the chains and other sinkers for marks. Where the bottom is sandy they would be getting a nice " polish ". See if there is no twist in any of the wings. Have you kept the correct distance? Were you and your Number Two towing side by side?

WHERE AND WHEN TO FISH

How long each tow lasts is decided by Number One skipper. For example, you must not keep towing if the ground gets rough; and you may tear the net. You may think there is more fish at one end or in the middle. If so, you may make short tows along the whole length of the ground to find the best places. These are then marked on the chart or on your own map of the trawling ground, or if you have no maps just remember those places (depth, landmarks). Also remember, many fish do not stay in a place for a long time. With time you will learn to follow them.

After a while you will notice that you catch more fish at some times than others. This may depend on whether the moon is full or not. If the water is tidal, you may find that fishing is better when the tide goes out or at slack water between tides.

Trawling sometimes works better in the dark or in muddy water when the fish cannot see the net. Trawling for shrimp is often better at night.

Catches may be better after bad weather or just before it, depending on the kind of fish and the nature of your fishing grounds. If so, try to be on the trawling ground when the fishing is best.

FASTENERS AND HOW TO GET OFF THEM

If you think that the net is caught on a fastener, first lower the leadline and find out if the boat is still moving; if not, haul the gear and check for damage.

If the trawl is held fast on the bottom, try towing it off in the opposite direction to your previous tow.

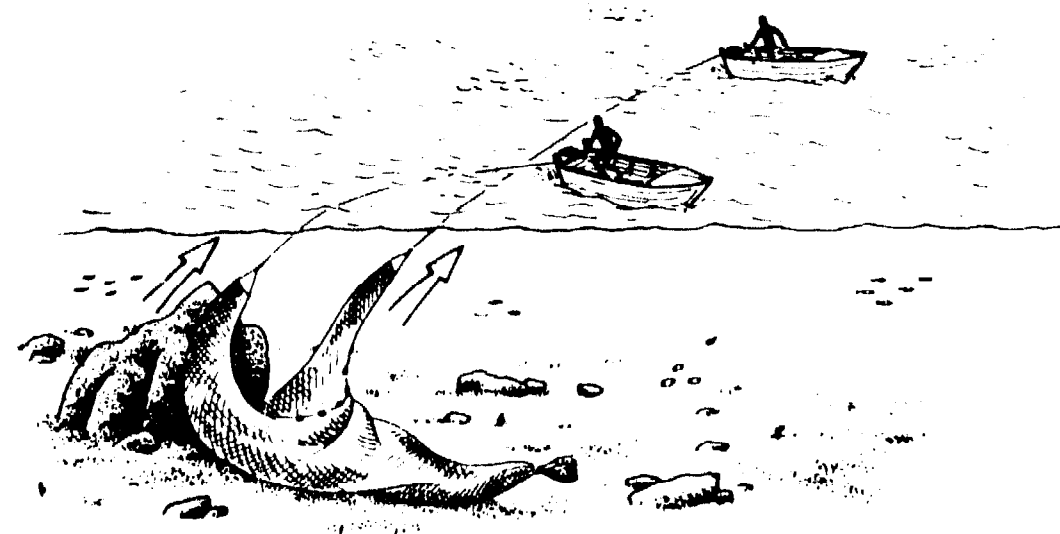
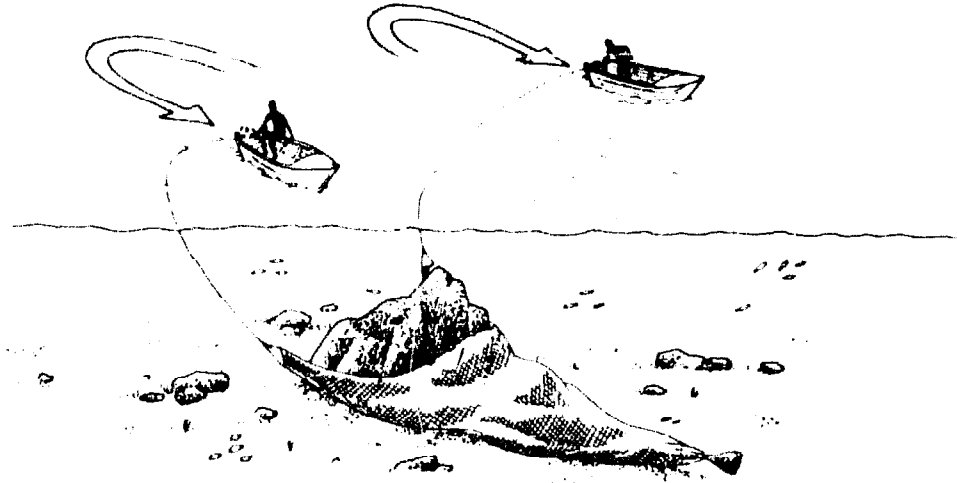

If the net is still fast, try hauling on each warp in turn — it may pull off one way but not another.

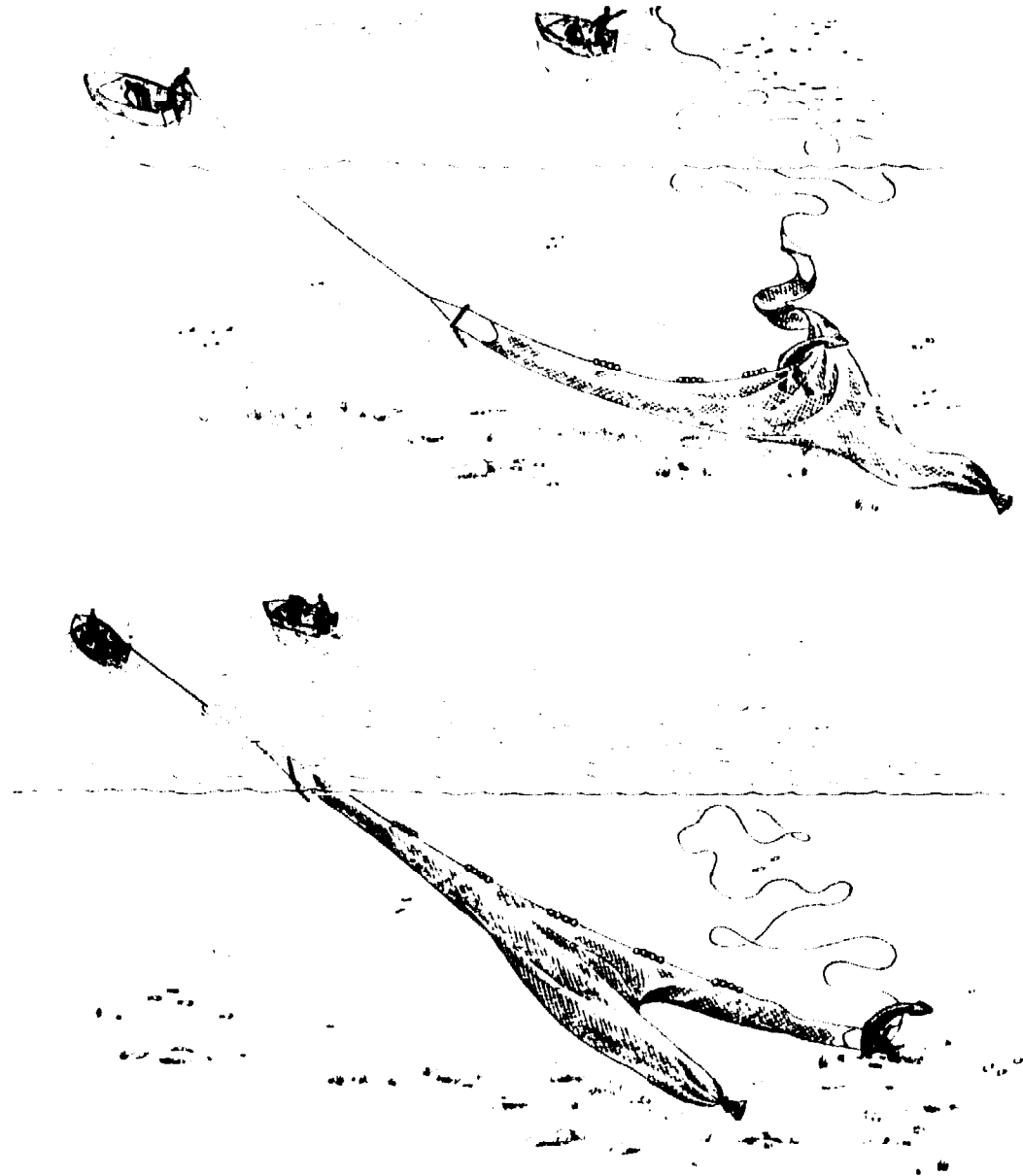

If this does not work and you have a codend buoy, release one or both warps (better fit them with floats) and haul the trawl gear codend first.

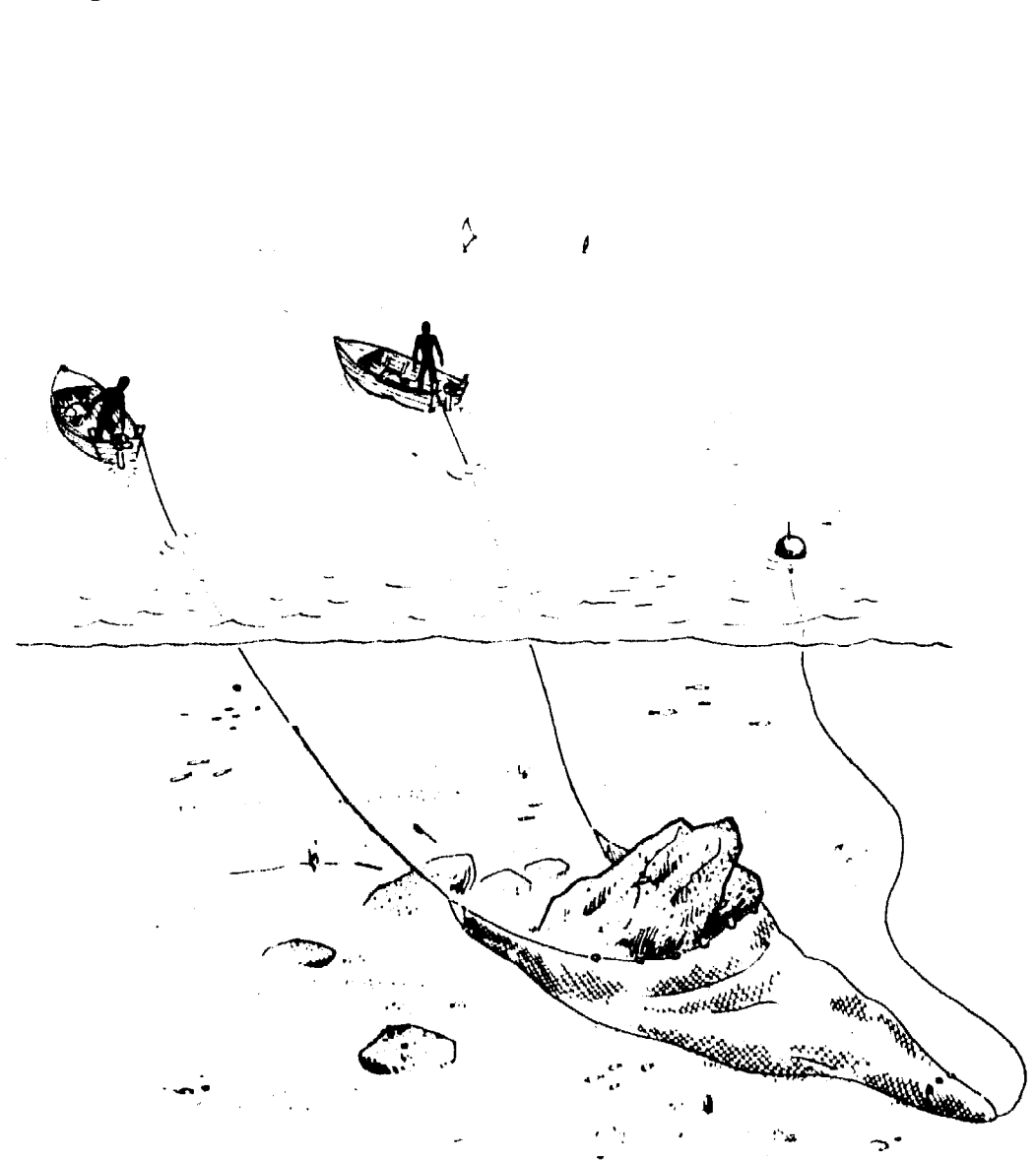

LOOKING AFTER YOUR GEAR

Sooner or later your trawl will have to be repaired or *mended*, because it is torn or *chafed* (rubbed through on the bottom). The quicker and better you mend it the quicker it can be fishing again. Lost time and holes in the net mean lost fish, so mending is important. It must often be done in the boat between tows, or while towing with a spare net.

Both boats should carry mending twine of the same size and type as the trawl twine. There should also be two or three needles, a knife, and some rope similar to that used in the trawl; also some spare pieces of netting about one metre wide, known as *shooters*. If you use shackles, take a few spares and if you use splices in your ropes, take a marlin spike.

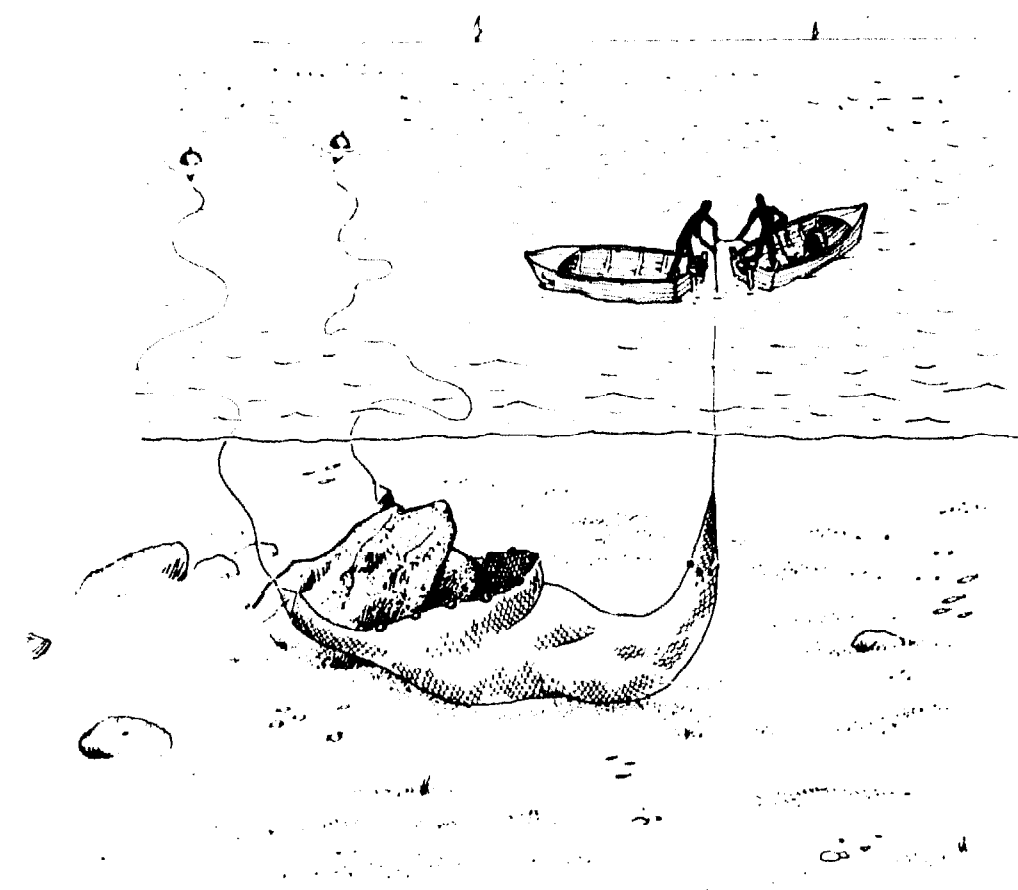

If none of these ways work and you cannot pull it off with the codend buoy, or you have not got one, fix a buoy on the warps and let them go. You may be able to clear the net at low tide or you can ask other boats to come and help you. If the water is not too deep you may also try to dive and release the net from the fastener by hand.

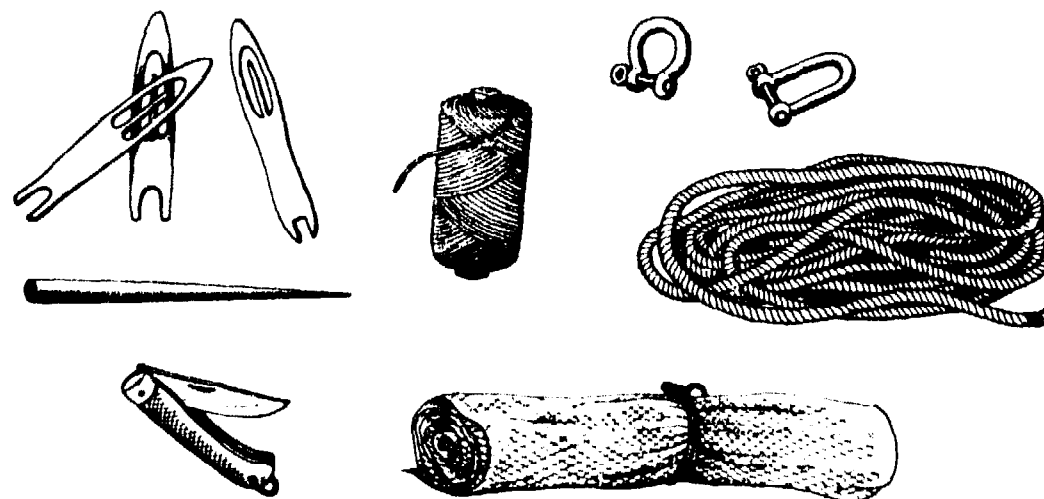

Every time you pull in the trawlnet, check it for damage, especially in the codend, lower belly and wings. You can mend a tear in the wings or near the mouth of the trawl by rough lacing and carry on fishing. But do a proper repair when you get ashore. Take care when making a quick repair not to pull the net out of shape, and remember: holes in the codend must always be closed properly or you will lose most or all of your fish.

If a wing, square or baiting is damaged too badly for repair, a whole new section is "shot in". This is a job usually done ashore. Now you see why the sections of the trawl should be joined with twine of a different colour. This makes it easy to take out a section completely and to put in a new one. Spare sections can be made and kept ready.

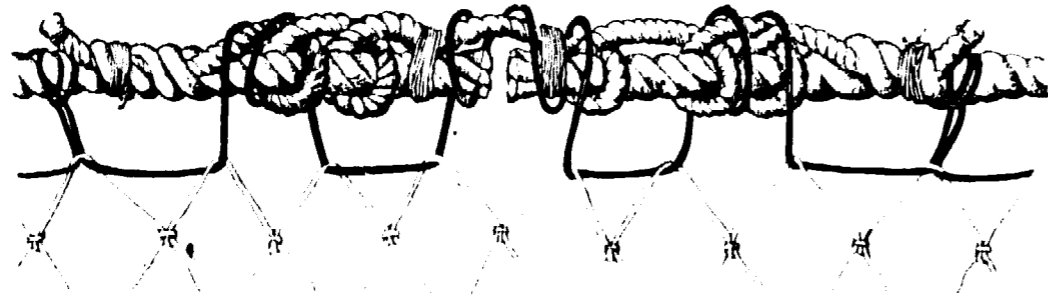

A temporary repair.

Not all damage is in the meshes; sometimes a rope is cut or broken on a fastener. If this happens, netting near the rope may also be torn but first we must repair the

rope. A good temporary repair can be made by tying on new rope — or even twine — using one or two half hitches. The ends are tucked through the twists (or *lays*) of the broken rope, as you can see in the picture. Of course, it is better if a piece can be spliced in right away, but if not, it should be done as soon as possible. Make sure that the length of the rope after repair is the same as before.

You can also mend a rope using the netting twine. This is not as strong as using rope with hitches or better a splice, but may be strong enough until you have the time to make a proper repair or to put a new rope in the net.

A weak link ...

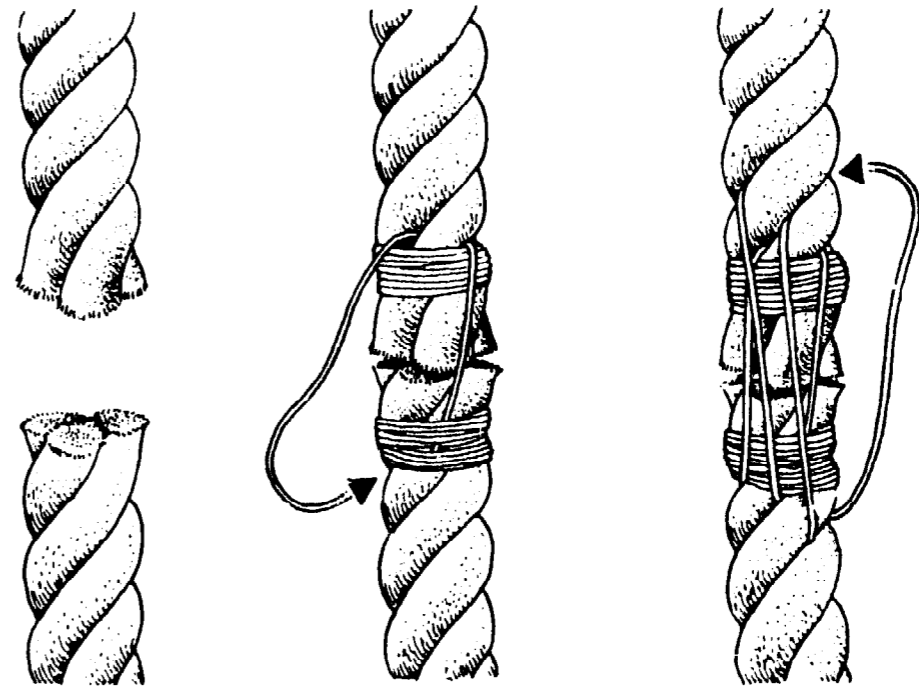

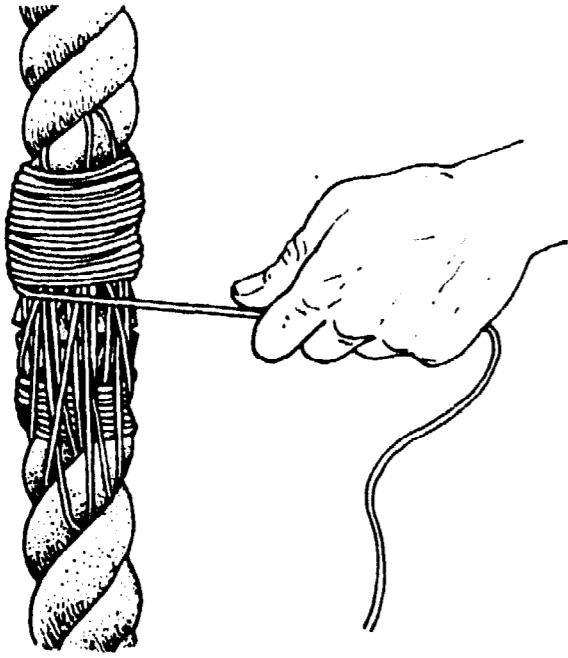

... or a temporary connection.

The ends of the warps that are joined to the net will wear out first. They spend more time in the water and are worn by stones, mud and sand. If you see this end getting



worn, cut it off. This is better than waiting for it to break. You can also change the ends of the warps so that the end which was in the boat is now at the net and the marks are reversed, but you may have to move the marks to new places on the warps starting from the end which is now on the net. The cut-off pieces of warp can now be used for other things, such as distance rope or heaving line.

If one warp breaks and has to be knotted or spliced together, the marks will be wrong, as the warp is now shorter. That means that the marks have to be re-measured starting with the last mark before the splice. One can also splice in, or tie in, a new piece of rope of the correct length so that the mark remains at the same length (but this means two splices). If a warp, headline or footrope becomes frayed, it can be made strong again by "bridging" the weak section with light rope or twine until a new piece is spliced in. You can see how this is done in the picture:

Another way of repairing a rope: "bridging".



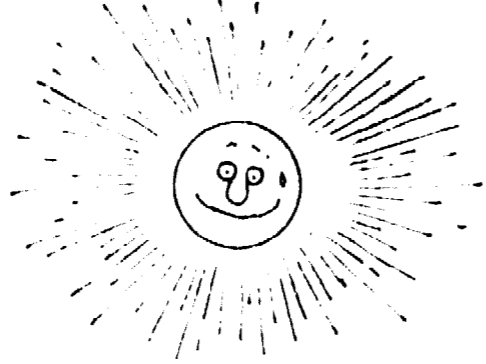

Protect your fish from the sun.

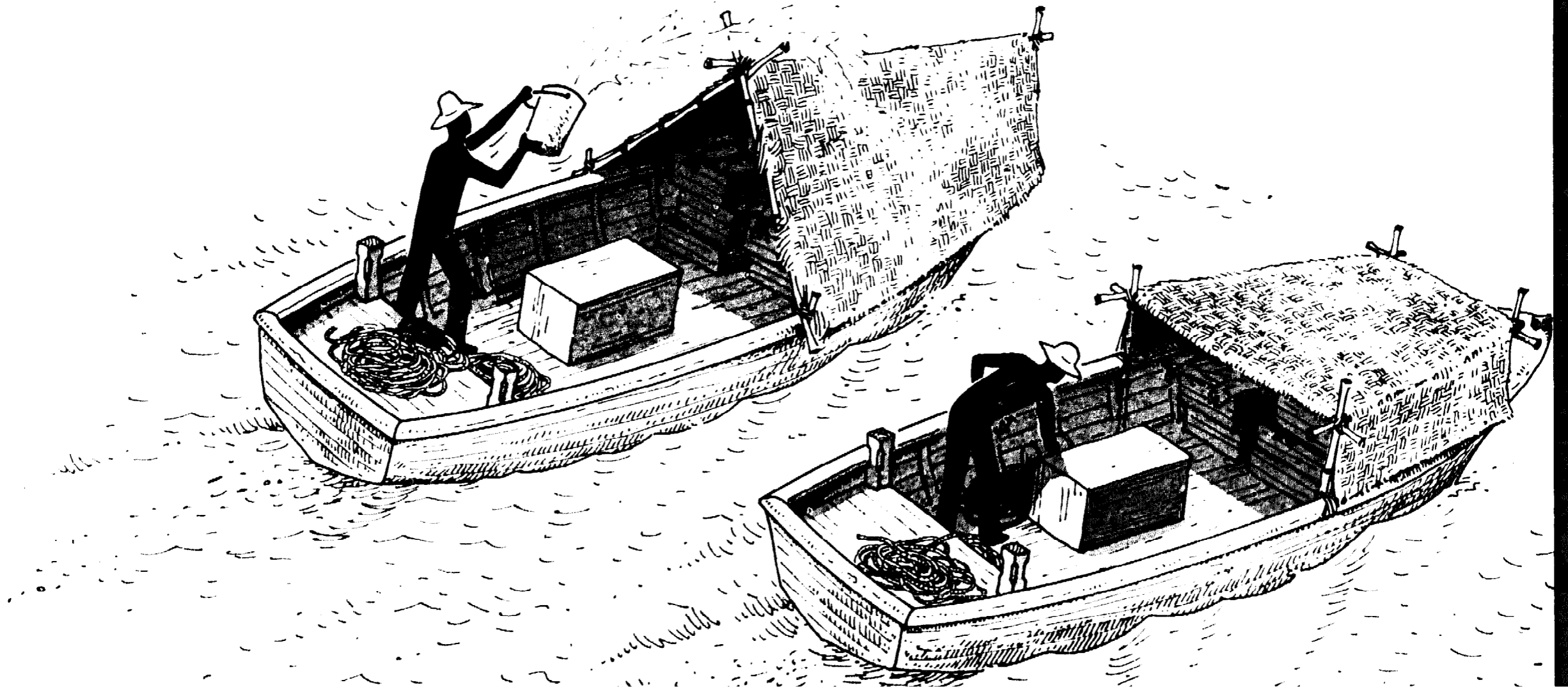

When the trawling season has ended, put the trawl and warps away, having first dried them and carried out any repairs which may be necessary, so that they are ready for use again. Always store synthetic netting and ropes in the shade so that air gets round them. Taking care of your gear saves money and means that you are ready to go trawling when the new season begins.

HANDLING THE CATCH

When you begin trawling, you may catch more fish than before and you may have to keep the fish in the boat for many hours during the day. Some of them may have to

be sent away to be sold, so it could be still longer before the fish come to the market. Sun heats the fish, and warm fish spoil faster, so keep the fish out of the sun and as cool as possible when fishing. If you can get ice, use it. Crush it into little pieces and cover the fish well with the crushed ice. Do not put too many fish one on top of another, so that the fish on the bottom are not pressed too much. Pressed fish become soft and soft fish spoil faster and make a smaller price on the market. Keep fish in the shade — under the foredeck or under a " roof " of matting. If possible, keep the iced fish in boxes or baskets, which should be well washed after use with clean water. Dry the boxes or baskets in the sun because sunlight kills the little microbes that spoil your fish.

HAPPY FISHING!

FAO SALES AGENTS AND BOOKSELLERS

| | |
|------------------------------|--|
| Algeria | Société nationale d'édition et de diffusion, 3, boulevard Zirout-Youcef, Algiers. |
| Antilles, Netherlands | St. Augustinus Boekhandel, Abraham de Veerstraat 12, Willemstad, Curaçao. |
| Argentina | Editorial Hemisferio Sur S.R.L., Librería Agropecuaria, Pasteur 743, Buenos Aires. |
| Australia | Hunter Publications, 58A Gipps Street, Collingwood, Vic 3066; The Assistant Director, Sales and Distribution, Australian Government Publishing Service, P.O. Box 84, Canberra, A.C.T. 2600, and Australian Government Publications and Inquiry Centres in Canberra, Melbourne, Sydney, Perth, Adelaide and Hobart. |
| Austria | Gerold & Co., Buchhandlung und Verlag, Graben 31, 1011 Vienna. |
| Bangladesh | Agricultural Development Agencies in Bangladesh, P.O. Box 5045, Dacca 5. |
| Belgium | Service des publications de la FAO, M.J. De Lannoy, 202, avenue du Roi, 1060 Brussels. CCP 000-0608993-13. |
| Belize | The Belize Bookshop, P.O. Box 147, Belize. |
| Bolivia | Los Amigos del Libro, Perú 3712, Casilla 450, Cochabamba; Mercado 1315, La Paz; René Moreno 26, Santa Cruz; Junin esq. 6 de Octubre, Oruro. |
| Brazil | Livraria Mestre Jou, Rua Guaipá 518, São Paulo 10; Rua Senador Dantas 19-5205-206, Rio de Janeiro; PRODIL, Promoção e Dist. de Livros Ltda., Av. Venâncio Aires 196, Caixa Postal 4005, Porto Alegre, RS; Livraria Dom Bosco, Rua 14 de Julho 2818, Caixa Postal 962, Campo Grande, MT; A NOSSA LIVRARIA, CLS 103, Bloco C, Lojas 2-6, Brasília, D.F.; FIMAC, Distribuidora de Livros Ltda., Rua de Bahia 478, Loja 10, Belo Horizonte, ME; METRO CUBICO, Livros e Revistas Técnicas Ltda., Praça São Sebastião, Rua 10 de Julho 613, Caixa Postal 199, Manaus, Amazonas; Distribuidora Luso Mercantil, Rua 13 de Maio 524, Caixa Postal 1124, Belém, Pará; G Lisboa Livros Ltda., Rua Princesa Isabel 129, Recife, PE; Livraria Cometa Distribuidora Ltda., Rua da Independência 46, Salvador, Bahia. |
| Canada | Renouf Publishing Co. Ltd., 2182 Catherine St. West, Montreal, Que. H3H 1M7. |
| Chile | Tecnolibro S.A., Merced 753, entrepiso 15, Santiago. |
| China | China National Publications Import Corporation, P.O. Box 88, Peking. |
| Colombia | Litexsa Colombiana Ltda., Calle 55, N° 16-44, Apartado Aéreo 51340, Bogotá. |
| Costa Rica | Librería, Imprenta y Litografía Lehmann S.A., Apartado 10011, San José. |
| Cuba | Empresa de Comercio Exterior de Publicaciones, O'Reiley 407, Havana. |
| Cyprus | MAM, P.O. Box 1722, Nicosia. |
| Denmark | Ejnar Munksgaard, Noregade 6, Copenhagen 5. |
| Dominican Rep. | Fundación Dominicana de Desarrollo, Casa de las Gárgolas, Mercedes 4, Santo Domingo. |
| Ecuador | Su Librería Cia. Ltda., García Moreno 1172, Apartado 2556, Quito; Calle Chimborazo 416, Guayaquil. |
| El Salvador | Librería Cultural Salvadoreña S.A., Calle Arce 423, Apartado Postal 2296, San Salvador. |
| Finland | Akateeminen Kirjakauppa, 1 Keskuskatu, Helsinki. |
| France | Editions A. Pedone, 13, rue Soufflot, 75005 Paris. |
| Germany, F.R. | Alexander Horn Internationale Buchhandlung, Spiegelgasse 9, Postfach 3360, Wiesbaden. |
| Ghana | Fides Enterprises, P.O. Box 1628, Accra; Ghana Publishing Corporation, P.O. Box 3632, Accra. |
| Greece | "Eleftheroudakis", 4 Nikis Street, Athens. |
| Guatemala | Distribuciones Culturales y Técnicas «Artemis», Quinta Avenida 12-11, Zona 1, Guatemala City. |
| Guinea-Bissau | Conselho Nacional da Cultura, Avenida da Unidade Africana, C.P. 294, Bissau. |
| Guyana | Guyana National Trading Corporation Ltd., 45-47 Water Street, Georgetown. |
| Haiti | Max Bouchereau, Librairie «A la Caravelle», B.P. 111, Port-au-Prince. |
| Honduras | The Bookstore, Apartado Postal 167-C, Tegucigalpa. |
| Hong Kong | Swindon Book Co., 13-15 Lock Road, Kowloon. |
| Iceland | Snaebjörn Jónsson and Co. hf., Hafnarstraeti 9, P.O. Box 1131, Reykjavik. |
| India | Oxford Book and Stationery Co., Scindia House, New Delhi; 17 Park Street, Calcutta. |
| Indonesia | P.T. Gunung Agung, 6 Kwitang, Djakarta. |
| Iran | Iran Book Co. Ltd., 127 Nadershah Avenue, P.O. Box 14-1532, Tehran. |
| Iraq | National House for Publishing, Distributing and Advertising, Rashid Street, Baghdad. |
| Ireland | The Controller, Stationery Office, Dublin. |
| Israel | Emanuel Brown, P.O. Box 4101, 35 Allenby Road and Nachlat Benyamin Street, Tel Aviv; 9 Shlomzion Hamalka Street, Jerusalem. |
| Italy | Distribution and Sales Section, Food and Agriculture Organization of the United Nations, Via delle Terme di Caracalla, 00100 Rome; Libreria Scientifica Dott. L. De Biasio "Aeiou", Via Meravigli 16, 20123 Milan; Libreria Commissionaria Sansoni "Licosa", Via Lamarmora 45, C.P. 552, 50121 Florence. |
| Jamaica | Teacher Book Centre Ltd., 95 Church Street, Kingston. |

FAO SALES AGENTS AND BOOKSELLERS

| | |
|---------------------------------|--|
| Japan | Maruzen Company Ltd., P.O. Box 5050, Tokyo Central 100-31. |
| Kenya | Text Book Centre Ltd., P.O. Box 47540, Nairobi. |
| Korea, Rep. of | The Eul-Yoo Publishing Co. Ltd., 5-2 Ka, Chong-ro, Seoul. |
| Kuwait | Saeed & Samir Bookstore Co. Ltd., P.O. Box 5445, Kuwait. |
| Luxembourg | Service des publications de la FAO, M.J. De Lannoy, 202, avenue du Roi, 1060 Brussels (Belgium). |
| Mauritius | Nalanda Company Limited, 30 Bourbon Street, Port Louis. |
| Mexico | Dilitsa S.A., Puebla 182-D, Apartado 24-448, Mexico City 7, D.F. |
| Morocco | Librairie «Aux Belles Images», 281, avenue Mohammed V, Rabat. |
| Netherlands | N.V. Martinus Nijhoff, Lange Voorhout 9, The Hague. |
| New Zealand | Government Printing Office, Government Bookshops at Rutland Street, P.O. Box 5344 Auckland; Alma Street, P.O. Box 857, Hamilton; Mulgrave Street, Private Bag, Wellington, 130 Oxford Terrace, P.O. Box 1721, Christchurch; Princes Street, P.O. Box 1104, Dunedin. |
| Nicaragua | Librería Interamericana Nicaraguense S.A., Apartado 2206, Managua. |
| Nigeria | University Bookshop (Nigeria) Ltd., University of Ibadan, Ibadan. |
| Norway | Johan Grundt Tanum Bokhandel, Karl Johansgt. GT 41 43, Oslo 1. |
| Pakistan | Mirza Book Agency, 65 The Mall, Lahore 3. |
| Panama | Distribuidora Lewis S.A., Edificio Dorasol, Calle 25 y Avenida Balboa, Apartado 1634, Panama 1. |
| Paraguay | Agencia de Librerías Nieza S.A., Paraguari 144, Asunción. |
| Peru | Librería Distribuidora Santa Rosa, Jiron Apurimar 375, Casilla 4937, Lima. |
| Philippines | The Modern Book Company 928 Rizal Avenue, Manila. |
| Poland | Art Polona Ruch, Krakowskie Przedmiescie 7, Warsaw. |
| Portugal | Livraria Bertrand, S.A.R.L., Apartado 37, Amadora; Livreria Portugal, Dias y Andrade Ltda., Apartado 2681, Rua do Carmo 70-74, Lisbon 2; Edições ITAU, Avda. Republica 46A c/v-E, Lisbon 1. |
| Romania | Hoxim, Calea Grivitei N° 64-66, B.P. 2001, Bucarest. |
| Saudi Arabia | University Bookshop, Airport Road, P.O. Box 394, Riyadh. |
| Senegal | Librairie Africa, 58, avenue Georges Pompidou, B.P. 1240, Dakar. |
| Somalia | "Samateris", P.O. Box 936, Mogadishu. |
| Spain | Mundi Prensa Libros S.A., Castello 37, Madrid-1; Librería Agrícola, Fernando VI 2, Madrid-4. |
| Sri Lanka | M.D. Gunasena and Co. Ltd., 217 Norris Road, Colombo 11. |
| Switzerland | Librairie Payot S.A., Lausanne et Genève; Buchhandlung und Antiquariat, Heimann & Co., Kirchgasse 17, 8001 Zurich. |
| Suriname | VACO nv in Suriname, P.O. Box 1841, Domineenstraat 26-32, Paramaribo. |
| Sweden | C.E. Fritzes Kungl. Hovbokhandel, Fredsgatan 2, 103 27 Stockholm 16. |
| Tanzania | Dar es Salaam Bookshop, P.O. Box #030, Dar es Salaam. |
| Thailand | Suksapan Panit, Mansion 9, Rajadamnern Avenue, Bangkok. |
| Togo | Librairie du Bon Pasteur, B.P. 1164, Lomé. |
| Trinidad and Tobago | The Book Shop, 111 Frederick Street, Port of Spain. |
| Tunisia | Société tunisienne de diffusion, 5, avenue de Carthage, Tunis. |
| Turkey | Guven Bookstores, Guven Bldg., P.O. Box 145, Mudafaa Cad. 12-5, Kizilay-Ankara; Guven Ari Bookstores, Ankara Cad. No. 45, Cagaloğlu Istanbul; Guven Bookstore, 5-5 K. Konak Tesitleri P.18, Konak Izmir. |
| United Kingdom | Her Majesty's Stationery Office, 49 High Holborn, London WC1V 6HB (callers only); P.O. Box 569, London SE1 9NH (trade and London area mail orders); 13a Castle Street, Edinburgh EH2 3AR; 41 The Hayes, Cardiff CF1 1JW; 80 Chichester Street, Belfast BT1 4JY; Brazenrose Street, Manchester M60 8AS; 248 Broad Street, Birmingham B1 2HE; Southey House, Wine Street, Bristol BS1 2BQ. |
| United States of America | UNIPUB, 345 Park Avenue South, New York, N.Y. 10010, mailing address P.O. Box 433, Murray Hill Station, New York, N.Y. 10016. |
| Uruguay | Librería Editorial Juan Angel Peri, Alzibar 1328, Casilla de Correos 1755, Montevideo. |
| Venezuela | Blume Distribuidora S.A., Av. Romulo Gallegos esq. 2a Avenida, Centro Residencial «Los Almendros», Torre 3, Mezzanina, Ofc. 6, Urbanización Montecristo, Caracas. |
| Yugoslavia | Jugoslovenska Knjiga, Terazije 27/11, Belgrade; Cankarjeva Založba, P.O. Box 201-IV, Ljubljana; Prosveta Terazije 16, P.O. Box 555, 11001 Belgrade. |
| Other countries | Requests from countries where sales agents have not yet been appointed may be sent to Distribution and Sales Section, Food and Agriculture Organization of the United Nations, Via delle Terme di Caracalla, 00100 Rome, Italy. |

This booklet has been written for artisanal and small-scale fishermen to help them learn a new kind of fishing: pair trawling, that is, trawling with two boats. It may also teach fishermen who have been pair trawling a few new tricks and how to make trawlnets by themselves.