

Residential and Non-Residential Drinking Water
Installations and Drainage Requirements in Nepal

By: Andreas Bachmann & Heinz Waldvogel

Published by: The Mechanical Training Centre (MTC)
Balaju
Kathmandu
Nepal

Swiss Center for Appropriate Technology (SKAT)
St. Gallen
SWITZERLAND

Available from: SKAT
Varnbuelstrasse 14
CH-900 St. Gallen
SWITZERLAND

Reproduced with permission.

Reproduction of this microfiche document in any form is subject to the same restrictions as those of the original document.

SIAT

Residential and Non - Residential

**DRINKING WATER INSTALLATIONS
AND DRAINAGE REQUIREMENTS IN NEPAL**

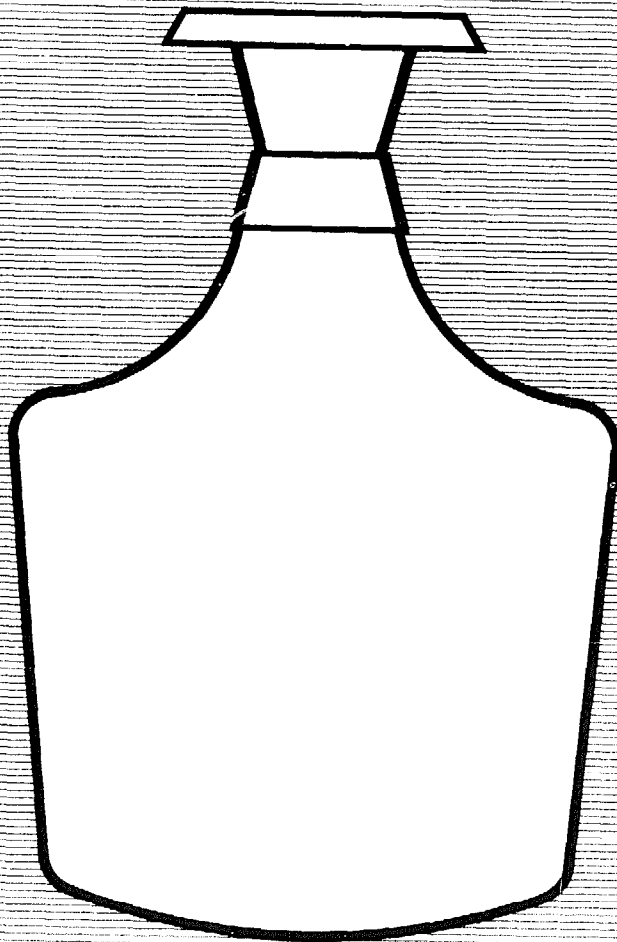

SRAT

Residential and Non - Residential

**DRINKING WATER INSTALLATIONS
AND DRAINAGE REQUIREMENTS IN NEPAL**



The Mechanical Training Centre (MTC) is a vocational training centre run jointly by His Majesty's Government of Nepal and the Government of Switzerland through the Directorate for Technical and Vocational Education (Nepal) and Helvetas Nepal.

SKAT, Swiss Center for Appropriate Technology, is a documentation centre and consultancy group which is engaged in promoting Appropriate Technology in the Third World. Its mail-order bookshop with more than 1200 publications in stock and its publishing help to fulfill this aim.

First Edition	1976
Second Edition	1979, expanded content
Third Edition	1982, slightly revised
Fourth edition	1988, revised and expanded, co-published by MTC and SKAT
Authors	Andreas Bachmann & Heinz Waldvogel
Editor	MTC (Mechanical Training Centre, Balaju, Kathmandu/Nepal)
Publishers	MTC, Balaju, Kathmandu/Nepal SKAT, St. Gallen/Switzerland
Copyright	Material of this publication may be freely quoted, translated or otherwise used. Acknowledgement is requested.
Comments	Questions and comments are welcome at MTC
Distributors	in Nepal: Mechanical Training Centre P.O. Box 4897 Kathmandu / Nepal outside Nepal: SKAT, Varnbuelstrasse 14 CH- 9000 St. Gallen/Switzerland and KODIS, Wartstrasse 6 CH- 8400 Winterthur/Switzerland
ISBN	3 908001 12 9

The Mechanical Training Centre (MTC) is a vocational training centre run jointly by His Majesty's Government of Nepal and the Government of Switzerland through the Directorate for Technical and Vocational Education (Nepal) and Helvetas Nepal.

SKAT, Swiss Center for Appropriate Technology, is a documentation centre and consultancy group which is engaged in promoting Appropriate Technology in the Third World. Its mail-order bookshop with more than 1200 publications in stock and its publishing help to fulfill this aim.

First Edition	1976
Second Edition	1979, expanded content
Third Edition	1982, slightly revised
Fourth edition	1988, revised and expanded, co-published by MTC and SKAT
Authors	Andreas Bachmann & Heinz Waldvogel
Editor	MTC (Mechanical Training Centre, Balaju, Kathmandu/Nepal)
Publishers	MTC, Balaju, Kathmandu/Nepal SKAT, St. Gallen/Switzerland
Copyright	Material of this publication may be freely quoted, translated or otherwise used. Acknowledgement is requested.
Comments	Questions and comments are welcome at MTC
Distributors	in Nepal: Mechanical Training Centre P.O. Box 4897 Kathmandu / Nepal outside Nepal: SKAT, Varnbuelstrasse 14 CH- 9000 St. Gallen/Switzerland and KODIS, Wartstrasse 6 CH- 8400 Winterthur/Switzerland
ISBN	3 908001 12 9

INTRODUCTION

Urbanization is profoundly changing the face of many nations. Rapidly growing cities bring new possibilities, but also new challenges. One of the most vital of these challenges is the provision of piped water and of efficient sanitation for an ever-growing urban population.

In Nepal, as in many other countries, sanitary installation represents a new trade. It was with the intention of giving useful hints and guidelines to the practitioners of this trade that the first edition of this book was published.

This fourth edition is the result of a steady demand for the book in many countries. The opportunity has been taken to review and improve the entire text. Drawings have been redone and the section on drainage has been considerably enlarged. As in earlier editions, more than one solution is given for certain problems because some norms differ from country to country. In all cases, however, care was taken to use standard terminology.

In preparation of this edition, special thanks are due to Mr. Laxmi Bahadur Manandhar, Principal of M.T.C. and Mr. A. Wiederkehr of Helvetas, Zurich. Thanks are also due to Mr. Ram Prasad Shah, Draftman; Mr. Ram Kumar Thapa, Office Asst.; Mr. Purna Man Shrestha, Office Incharge. Grateful acknowledgement is owed to SSIV (Schweiz. Spenglermeister und Installateur Verband) for much additional information on soil and waste water drainage. The English language was checked and corrected by Mr. Nick Gregory.

This book is intended to be used as manual and reference work by practising sanitary engineers. We hope that it will continue to be a valuable and trusted companion to many planners and practitioners in Nepal and abroad.

**Ben Dolf / Programme Director
Helvetas Nepal**

**Patrick Leu / Co-Principal
MTC, Balaju**

FOREWORD

These guidelines were prepared in accordance with international and regional standards. Much attention was also given to the local conditions to ensure acceptable and troublefree installations.

This is the fourth edition, and has a wider coverage on drainage requirements in buildings. In this we have tried to give a proper blend of different types of modern installation technologies, suitable for actual needs. The manual includes essential details of technologies of different countries. Expressions vary from one region and language to another and this book aims to use internationally acceptable expressions without creating new words or definitions.

As the Mechanical Training Center has a Sanitary Section, updated schooling materials were required. These guidelines were collected to give essential knowledge on sanitary installations in buildings in Nepal. Although the guidelines are quite complete they are not intended for self-teaching. This manual cannot and shall not be used in place of methodologically introduced teaching materials nor should it be used in place of school lessons.

We are grateful to the concerned authorities in Nepal and to Helvetas for having supported this new edition. Thanks also to Mr. R.P. Shah, Draftsman at MTC, for his many drawings included in this book.

Andreas Bachmann & Heinz Waldvogel

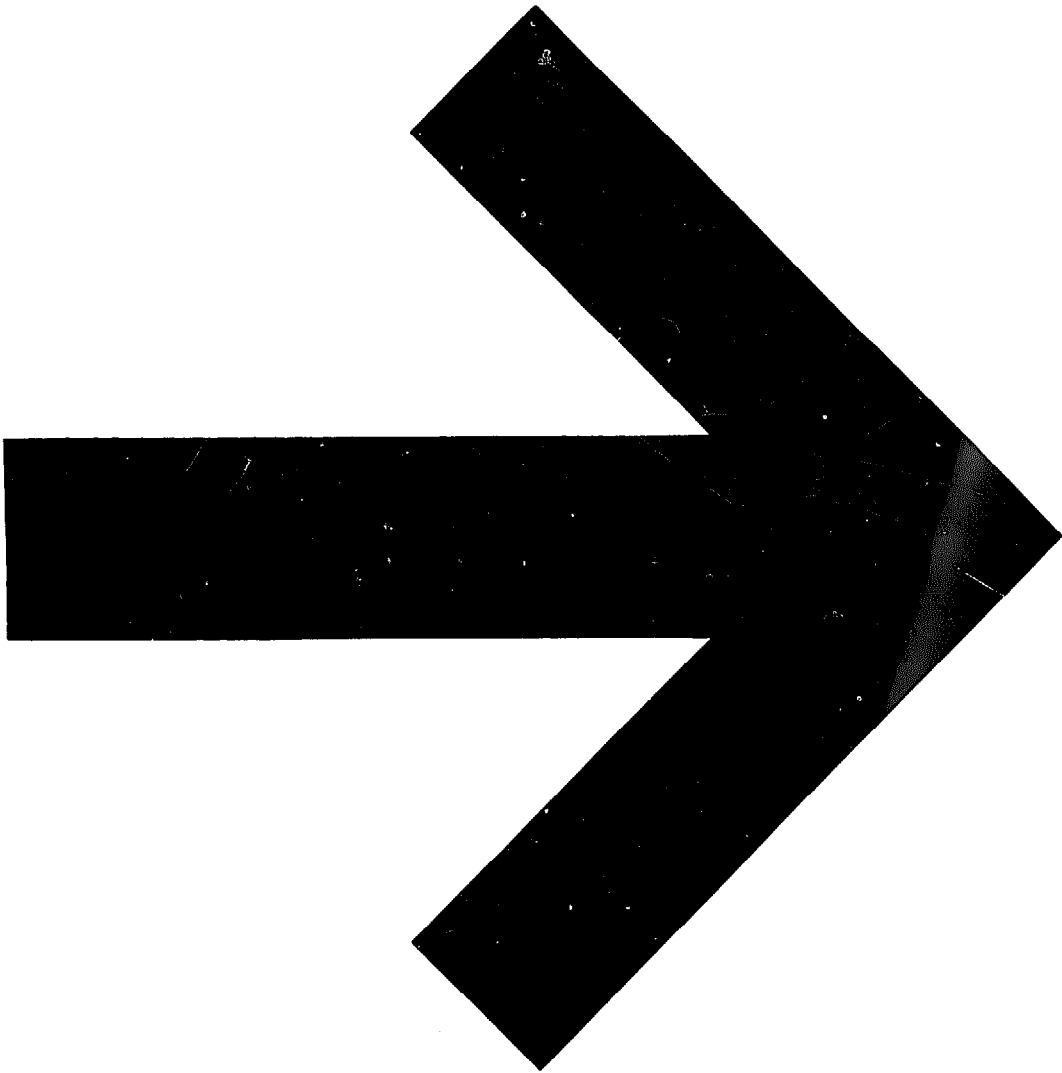

Residential and Non - Residential

**DRINKING WATER INSTALLATIONS
AND DRAINAGE REQUIREMENTS IN NEPAL**

PART 1

DRINKING WATER INSTALLATIONS

DRINKING WATER INSTALLATIONS

		page
1	OBJECTIVES	1
2	FIELD OF APPLICATIONS	1
3	TERMS AND DEFINITIONS	1
4	PRINCIPLES OF INSTALLATIONS	2
5	PARTS OF PIPELINES	4
6	WATER METER	5
7	STORAGE TANKS	6
8	PROTECTION AGAINST CORROSION	9
9	MATERIALS AND CONNECTIONS OF PIPELINES	9
10	POSITIONING OF PIPELINES	11
11	INSTALLATIONS IN BUILDINGS	12
12	APPARATUS AND VALVES	17
13	FIRE HYDRANT LINES	18
14	FREEZING PROTECTION	18
15	DIMENSIONING	19
16	TESTING OF A NEW INSTALLATION	21

1. OBJECTIVES

This manual explains how to supply and distribute pure water, free of impurities and in sufficient quantity to the consumers. All connections to the main pipelines must be technically sound, so that the water will remain uncontaminated.

2. FIELD OF APPLICATION

This manual deals with drinking water installations from the town main supply to the tapping places, including the connected apparatus, as follows:

- communication and service pipes
- domestic installations (house installations)
- cold and hot water supply

2.100 REQUIREMENTS

Installations between the distribution pipes and the water consumer must fulfill the following requirements in order to maintain a pure and high quality water supply.

2.110 Hygienic requirements - The water must stay free of pollution or anything else harmful to health. Examples:

- Absorbing dirty substances,
- re-infections (through bad or wrong installation)

Also to be avoided are:

- the heating of water from the pipes (sun, fire, etc.)
- noise transfers.

2.120 Technical requirements - The installation and all connected apparatus must be adapted to the existing mains and flow pressure (from the distribution pipes) to guarantee an adequate quantity of water.

3. TERMS AND DEFINITIONS

3.101 **Main** - means a pipe laid by the water authority for the purpose of giving a general supply of water but does not include a communication or service pipe.

3.102 **Communication pipe** - means that part of a service pipe which lies between the main and the boundary of the street in which the main is laid.

3.103 **Consumer** - means a person supplied with water by the water authority.

3.104 **Meter** - includes an appliance or device used to measure or ascertain amounts of water taken or used from the water authority's waterworks.

3.105 **Service pipe** - means any portion of any pipe or any fittings from the water authority's mains to any premises which conveys or is capable of conveying water under pressure.

3.106 **Supply pipe** - means any portion of any pipe which is not a communication pipe.

3.107 **Storage tank** - means any tank for containing water supplied by the water authority or by the consumer, other than a flushing tank or hot water tank.

3.108 **Flushing tank**- means a tank with a discharging apparatus for flushing a water closet, sink, urinal or drain.

- 3.109 **Cylinder**- means a cylindrical closed vessel capable of holding water under pressure.
- 3.110 **Water fittings**- includes pipes and parts to change direction, branches, etc., (other than mains) taps, cocks, valves, etc.
- 3.111 **Apparatus**- includes water closets, wash basins, bath tubs, kitchen sinks, machines, tanks and other similar devices. Usually they have a drain for connection to the waste water system.
- 3.112 **Stop cock** - includes stop tap, stop valve, angle valve and any other device for stopping the flow of water in a line of pipes.
- 3.113 **Ball cock** - means flow operated valve for controlling the inflow of water to a tank.
- 3.114 **Overflow pipe** - means a pipe so fixed that the discharge of water may readily be seen.
- 3.115 **Waterworks**- includes all catchment areas, reservoirs, wells, boreholes, dams, weirs, tanks, cisterns, tunnels, filter beds, conduits, aqueducts, fountains, standposts, sluices, valves, hydrants, pumps, prime movers and all other structures or appliances used or constructed for the collection, storage, conveyance, supply, measurement or regulation of water, and which have been constructed by or on behalf of the water authority and are the property thereof or which shall hereafter be used or constructed by the water authority.
- 3.116 **Premises** - includes dwellings, buildings, lands and leaseholds whether open or enclosed, and whether public or private.
- 3.117 **Catchment area** - means any surface of land or other area which collects rainfall for the purpose of the waterworks.

4. PRINCIPLES OF INSTALLATIONS

4.100 FUNDAMENTAL RULES

- 4.101 **Continuous supply from the mains** - the water authority will endeavour to maintain continuous supply of potable water to consumers but will not be liable for compensation in respect of loss or damage caused by or attributable to any failure or disruption or supply.
- 4.102 **Security** - The quality of the water supplied must remain uncontaminated. And the installations made by the plumber must be carried out with greatest care, according to this manual.
- 4.103 **Skill and supervision** - Practical work should be done only by specially trained persons. To attain this manual's standard, the installation should be supervised during construction and in operating conditions.
- 4.104 **Materials** - all materials installed should be of good quality to guarantee proper, trouble-free function and long life for the installation.
- 4.105 **Apparatus** - The sanitary apparatus supplied must be of standard make and connected with the septic or sewer systems. Protection against the exit of the poisonous and bad smelling gases must be ensured by means of siphon or trap.
- 4.106 **Existing installations** - Should also conform to the rules of this manual. If safety is not guaranteed, repairs should be done immediately.

4.200 PROTECTION FROM DAMAGE FROM FROST

Every water fitting, whether inside or outside a building, should be placed so as to

reduce the risk of damage by frost.

4.300 **SUPPORT OF PIPES**

Every pipe shall be properly supported and so arranged as to avoid air locks or reverberation.

4.400 **PROTECTION AGAINST WATER HAMMER**

Both in choice of apparatus and design of the installation, consideration should be given to the avoidance of water hammer.

4.410 **Plug valves** - should not be used, except for draining purposes.

4.420 **Spring loaded flushing systems** - (as for closets, urinals) should be avoided, instead cisterns should be utilized. If a spring loaded flushing system is necessary then it should be installed so that there is no possibility of a cross connection between the drinking water and the waste water system.

4.500 **PROTECTION FROM DAMAGE FROM OTHER CAUSES**

Every water fitting should be so placed as to be readily accessible for purposes of examination and repair.

4.510 **Dissimilar metals** - water fittings of unlike metals should not be used unless effective measures are taken to prevent deterioration.

4.600 **DIRECT CONNECTION OF TOWN SUPPLY**

With pipes from private water supplies is not allowed.

4.700 **PREVENTION OF WATER POLLUTION**

4.710 Principles

4.720 The entire installation has to be assembled so that there is no possibility of **back siphonage** or back-flow of foul water or sewage or any form of pollution to the installed water system.

4.730 **Pipes are not to be laid through sewers**, - etc: No pipe shall pass into or through any ashpit, manure pit, sewer drain, cesspool, trash chute or through any manhole.

4.740 **Cross connections** - from the drinking water with the waste water system are prohibited.

4.750 **Waterworks have to be kept clean**. It is not permissible to deposit any earth, material, liquid or any dead creature in such manner or place that it may be washed, fall or be carried into the waterworks. However, nothing in this section shall be analysed as prohibiting or restricting:

- a) any method of cultivation of land which is in accordance with the principle of good husbandry; or
- b) the reasonable use of oil or tar on any highway maintainable at the public expense, so long as all reasonable steps are taken for preventing the pollution of any part or any water of the waterworks.

4.800 **APPROVED MANUFACTURE**

All pipes and fittings which carry water supplied by the water authority must comply with their regulations and be of approved manufacture.

4.810 Costs of replacement - All water installations have to be of good quality. It is required that water is kept clean and is not contaminated in any way, also including through defective installation. Consumption has to be within reasonable limits and must be measured properly. Although water is supplied by the water authority, alteration or renewal of pipelines and fittings may be charged to the consumer.

4.820 Entry into premises - The water authority may enter into premises into which pipes have been laid for the supply of water:

- a) to inspect any supply pipe
- b) to regulate and repair any supply pipe or meter as circumstances may require
- c) to ascertain consumption
- d) to disconnect the supply pipe to any premises or to suspend, stop, turn off or divert the supply of water to any premises or to suspend, stop, turn off or divert the supply of water to any premises.

4.900 DISTRIBUTION OF WATER FROM OTHER SOURCES

The concerned person should apply to the water authority for a licence if the water has to be supplied from under ground or from a river, lake or pond lying within the distribution area of the water authority.

However, a license may not be required for the under mentioned conditions which should be checked for approval with the concerned water authority:

- a) If somebody wishes to take water supply of up to 5,000 liters (or the proper quantity approved by the water authority) for household purposes.
- b) If some land owner wishes to take the water supply for cultivation of his own land from the nearest source attached to his land.

4.910 Responsibilities of waterworks - Waterworks are under the responsibility of the water authority for the following:

- a) operation of waterworks
- b) maintain the quality of water supply
- c) grant permission to draw off, divert or take water from any stream or waters by which the waterworks are supplied, or
- d) arrange to open or shut any valve, hydrant or stopcock belonging to the water authority
- e) arrange for measurement of water consumption.

5. PARTS OF PIPELINES

5.100 COMMUNICATION AND SERVICE PIPES (water authority)

All communication pipes at present existing or here-after constructed should vest in the water authority and the water authority should at it's own expense, carry out any necessary works of maintenance, repair or renewal of such pipes.

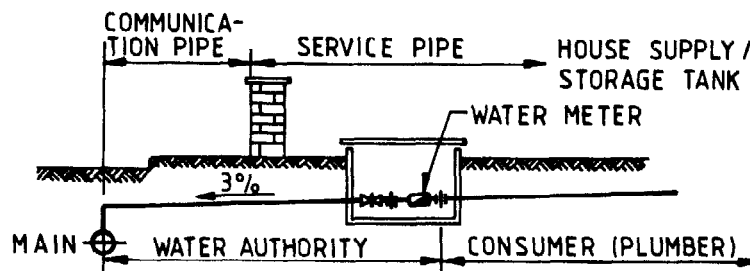

- 5.110 **Provision and maintenance of fittings** - The water authority may provide and sell or hire any water fittings and may install, repair or alter any water fitting, whether supplied by it or not and may provide any materials and do any work required in connection with the installation, repair or alteration of water fittings, making reasonable charge therefore.
- 5.120 **Stopcocks on pipe lines** - every pipe supplying water to a building shall be fitted with a stopcock adjacent to the water meter; near to the ground tank; or inside and as near as possible to the point where it enters the building.
- 5.130 **Water authority regulations prohibit the installation of a suction pump directly into the main supply pipe lines.**

PROHIBITED:

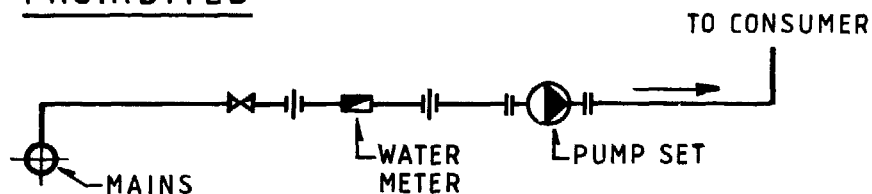

5.200 **SERVICE AND SUPPLY PIPES (Consumer)**

- 5.210 **Costs relating to supply pipes** - The cost of constructing, altering or repairing all supply pipes shall be borne by the consumer.
- 5.220 **Stand posts** - No person should erect a standpost for conveying water (supplied by the water authority) for the occupants of more than one building or of separately occupied parts of a building unless the pipe is provided with a non-concussive self-closing tap.
- 5.230 **Drinking troughs** - Every pipe supplying water to a drinking trough or drinking bowl for animals and poultry should be fitted with an approved ball cock for controlling the inflow of water so as to prevent overflow.
- 5.240 **Tap and stop cock pressure requirements** - Every draw-off tap and every stop cock not of the ordinary screwdown pattern shall be capable of withstanding a hydraulic test pressure of at least 20 kgs/cm² and shall be of approved manufacture.
- 5.250 **Location of stop cock** - every stop cock should be so placed that it can be readily operated by the means by which it is designed to be operated.

6. WATER METER

6.100 **PRINCIPLES**

The provision, size and the placement of all water meters, both for domestic and industrial premises should be approved by the water authority.

6.200 **POSITION**

A water meter should, in general, be installed inside the consumer's boundry wall in a secure and readily accessible position.

6.300 **INSTALLATION**

Water meters, in general, are to be supplied by the water authority. A stop cock should be fitted on the supply side of the meter and the meter itself should be

fitted between unions or flanges for easy replacement.

6.400 **ACCURACY OF METERS**

The accuracy of water meters has always to be maintained. No person is permitted to:

- a) alter or cause or permit to be altered any supply pipe with intent to avoid the accurate measurement of water;
- b) willfully or negligently interfere with or injure any meter;
- c) dishonestly alter the index of any meter used by the water authority; or
- d) dishonestly prevent any meter used by the water authority from registering correctly the quantity of water supplied.

Handling of water meters, including repairs and replacements, are under the rules and regulations of the water authority.

7. **STORAGE TANKS**

7.100 **PRINCIPLES**

7.110 **Materials for storage tanks** - Every storage tank should be watertight and of adequate strength and should be constructed of galvanized iron or steel, copper, ferro-cement, concrete or other approved materials, and should be provided with a cover of an approved pattern.

7.120 **Protection from corrosion of storage tank** - Every tank should be suitably protected from corrosion.

7.130 **Capacity of storage tanks**- Every storage tank should have a capacity of not less than 100 liters and if used for hot water systems of not less than 200 liters.

7.140 **Placing of storage tanks** - Every storage tank should be so placed and equipped that it can be readily inspected and cleansed, and not be liable to any contamination.

7.150 **Storage tank support** - Every storage tank should be adequately supported and suitably covered.

7.160 **Every storage tank should be provided with a:**

- a) **Manhole**, having a diameter of at least 50 cm, the edge of which is at least 20 cm above the tank top. The manhole should be provided with a cover which can be securely fastened;
- b) **Device**, for the control of the inflow of water, so designed as to prevent overflow (e.g. ball cock or electrical pump-switch);
- c) **Overflow**, which should be of a larger diameter than the inlet pipe and be at least 2 cm below the inlet level;
- d) **Ventilation pipe**;
- e) **Drain valve**, if possible
- f) **Stopcock**, to be fitted to each draw-off pipe, as near to the storage tank as possible (on tanks exceeding 100 liters capacity).

7.170 **Ball cocks**

7.171 Every ball cock shall be **securely and rigidly fixed** to the tank it serves.

7.172 The ball cock should be fitted in such a **position** that:

- a) It discharges at a level higher than the level of the overflow;
- b) can easily be checked and repaired from the top, and without necessarily draining the water tank.

7.173 Every ball cock should be of **approved manufacture** and comply with the following requirements:

- a) Working pressure of 15 kg/cm² with every medium pressure valve of 10 kg/cm² and every low pressure valve of 5 kg/cm².
- b) Every ball cock of the piston type should have a suitable washer of approved materials.

7.200 **LOW LEVEL STORAGE TANKS**

7.210 Principles

No storage tank should be buried or sunk in the ground unless there is sufficient space around for the purposes of maintenance and the detection of leaks. This shall not apply to a concrete tank designed and constructed to an approved standard.

When possible, tanks should be installed above ground level.

In the case of sunken tanks special precautions should be taken to avoid flooding. In particular, the manhole should be above any possible flood level.

Low level tanks should be secured with fastened manholes, having inlets with a control device (ball cock) and an overflow. Where possible, a drain-out system should be fitted which should include a drain cock or plug.

7.300 **ROOF TANKS**

7.310 **Placement** - Roof tanks shall be securely placed on top of the house installation, taking into account the structural requirements to carry the heavy weight. Tanks have to remain easily accessible for inspection and maintenance. They shall be placed on adequate battens, leaving gaps for air circulation beneath.

7.320 **Tanks inside the building** - roof tanks inside the building require a safety tray made of watertight design, having side walls of not less than 10 cm in height. Such trays need to be of greater surface area in order to securely collect overflowing water from the tank. A separate drain is required for the safety tray. Such tanks also require to be on battens leaving gaps for air circulation and prevention of condensed water accumulation.

7.330 The inlet requires a **control device**

- a) A ball cock when connected directly to a pressurized system (town supply).
- b) A cut-out switch at low level to be provided for the pump, arranged to operate when the tank is completely filled. Alternatively the tank should be fitted with a water level indicator.

7.340 The **supply outlet** should be positioned 5 to 10 cm above the bottom of the tank.

7.350 A **drain out** should be provided and arranged so that there is no direct connection with the waste water system.

7.360 Roof tanks require an **overflow**, the diameter to be larger than that of the inflow. The level of the overflow to be at least 2 cm below the level of inlet.

7.400 **PUMPS**

7.410 For installations in buildings **pumps** are normally used to move the drinking water from the ground tank to the roof tank, i.e., where the pressure from the mains is insufficient.

- 7.420 Alternatively **pressure boosters**, with cylinder and pump could be used, where there is continuous electricity supply.
- 7.430 The most common type of centrifugal pump used in such small installations is of the "monobloc" type, powered by electricity.
- 7.440 **Pumps and motors should be securely mounted** on concrete blocks, preferably higher than the surrounding floor or ground level. Pumps should also be provided with a roofing, in order to protect the electric motor and it's connection from rain water.
- 7.450 Pumps, as other devices fitted to the pipeworks, should always **remain easily accessible** for maintenance, and always be fitted with flanges or unions for easy removal.
- 7.460 **Pump connections.** These can be divided in two groups:

- a) Suction or inlet pipework
- b) Delivery or discharge pipework

Further there are differences in:

- c) Gravity-fed installation (= efficient and trouble-free) (Ref: table no 1/11)
- d) Suction-fed installation (Ref: table No 1/12)

- 7.470 **Suction pipe** - This pipework should be kept as short as possible and have a gradual rise towards the pump (to avoid air locks in the suction line). Diameters of such suction pipework should be the same as of the pump inlet connection or preferably be of the next larger diameter.

It is suggested to install a tee-piece near to the entrance of the pump, fitted with a valve and a funnel to enable initial priming, when required.

- 7.471 **Foot valve, strainer** - Suction pipes require a foot valve. It maintains water in the suction line on completion of pumping, reducing the need to prime the pump when pumping is recommenced. A swing type valve is recommended. A strainer is often incorporated in this type of foot valve.
- 7.480 **Delivery pipework.** The diameter of such pipes should be the same as of the pump exit connection. The pipes should be fitted in a straight line and where bends are required use those with a long radius to minimize frictional losses.

Pipes should be arranged so that there is a **gradual rise** from the pumps towards to the roof tank to enable automatic air release at the highest point, i.e. at the tank inlet.

- 7.490 Adjacent to the pump a **non-return valve** is to be fitted. This valve prevents the water of the delivery pipe from draining back through the pump casing when the pump is turned off.

Non-return valves: A swing type valve is the most suitable, since it offers less restriction to the flow as compared to the under-and-over type.

7.500 **DOUBLE-PUMP INSTALLATION**

For larger buildings at least two pumps should be fitted, having the necessary bypass pipeworks and valves. These pumps should be run alternately, giving security for continuous water supply.

8. PROTECTION AGAINST CORROSION

8.100 PRINCIPLES

The pipelines (pipes and connections) should be protected against corrosion.

8.200 PIPES IN THE GROUND/SOIL

Pipes, fittings and valves should be protected with an inert insulation.

Before the corrosion protector is applied to the pipes, all rust, tinder, dirt and all other impurities have to be removed.

The protection of pipes should be ensured by providing a suitable pipe cover.

Possibilities:

- a) **Steel pipes, galvanized pipes** - galvanization is not sufficient as outer protection, it tends to be damaged during installation. Bitumen paint and a layer of hessian can protect the pipes.
- b) **Cast-Iron** - in a very aggressive soil even cast-iron pipes have to be protected against corrosion. (clay soil, pipes in refill of building rubbish).
- c) **Plastic pipes** need no protection against corrosion, but they should be well protected against mechanical destruction and if necessary should be laid in sand. No stone or rock should be used in the first stage of refilling.

8.300 PIPES IN BUILDINGS:

If the pipes are visible, galvanized pipes will be used. Copper and stainless steel need no additional protection.

- 8.310 **Pipes in the walls (under plaster):** galvanized steel pipes must be protected with an anti-rust paint and with a wrapping or bandage, which must remain completely dry.

9. MATERIALS AND CONNECTIONS OF PIPELINES

9.100 MATERIALS

9.110 a) Laying in soils:

- welded or seamless steel pipes, galvanized, (called G.I. pipes)
- jointless steel pipes, internally coated
- cast-iron pipes (called G.I. pipes)
- H.D.Pe (only best quality and made specially for water pressure pipelines to be used).
- Ductile iron pipes

Prohibited:

- Plastic pipes as used in conduits for electrical installations.
- the use of lead pipes (poisonous)

9.120 b) Installation in buildings:

- welded or seamless steel pipes, galvanized (G.I. pipes)
- copper

Prohibited: lead pipes

9.200 **PIPE CONNECTIONS**

9.210 **The pipe connections** should be made in such a way that the strength of the pipe material should not be weakened connections as follows:

- Thread connections, welding connections
- hard soldering, compression joints
- screw socket connections
- connections with flanges and gaskets
- connections with sockets and lead.

9.220 **Thread connections** - fittings of good quality are necessary for thread connections with steel pipes (G.I. pipes).

9.230 **The fittings have to be leak-proof.** The thread must be cut exactly at right angles to all branch directions. They must also have full threads without much space. After cutting the pipes, the inside burr (spin) must be removed.

9.240 **Thread cutting** - lubrication oil of acceptable quality shall be used for thread cutters (No old mobil oil!)

9.250 **Thread joint** - non-poisonous materials shall be used, such as hemp and joining paste (compound) or teflon tape. No putty: **the use of putty is prohibited.**

Cautions: Red and white lead jointing compounds should not be used in pipe joints for health reasons (white lead was very often used, but it is a health risk).

Connections with flanges - Flange connections shall be used for pipes of 2" diameter and above. Flanges are often also used on pumps and other machines. The flange surface shall be parallel.

Other pipe connections - Caulked socket connections (lead joints). Lead joints should contain, after finishing the connection, jute rope in 2/3 of the socket, and lead in 1/3 of the socket.

Before caulking the rope inside the sockets, ensure that the pipes are well pushed together into the sockets, so that the rope does not enter into the pipes. Also check that the ring-type joint has been properly centered (centric-placement).

The joint should be poured in one casting as fast as possible.

Characteristics of G.I. pipes

Nominal	Diameter		Approx. weight' per meter in kg	Useful length of thread in mm
	i.d.*	o.d.		
1/2	16	21.3	1.2	13
3/4	21.6	26.9	1.5	15
1"	27.2	33.7	2.4	17
1 1/4"	35.9	42.4	3.1	19
1 1/2"	41.8	48.3	3.6	19
2"	53.0	60.3	5.0	24
2 1/2"	68.8	76.1	6.5	27
3"	80.8	88.9	8.4	30

* i.d. = nominal width, as of ISO standards

10. POSITIONING OF PIPELINES

10.100 LAYING IN SOILS

Pipelines must be placed as deep in the ground as possible so that they do not get damaged through mechanical forces, e.g. traffic. The covering should be, if possible, at least 1 meter deep.

Pipelines underground should be installed on a rising alignment so that the pipeline can be drained and air be released from the water system.

If the soil is yielding, the pipes must be protected, e.g. cast iron pipes break easily through settlement of poorly consolidated soil.

Water pipelines must be at a higher level than the sewerage systems (waste water lines), so that leakage from foul water may never enter the drinking water system.

Cast iron pipes are vulnerable to any movement and must be protected by being surrounded with an elastic substance when passing through walls.

If there are valves outside the building, they must be protected, have a waterproof signboard, and be indicated with marker plates.

For pipelines laid in the ground: bends should be used in preference to elbows.

10.200 PIPELINES INSIDE THE BUILDING

10.210 **Layout** - The pipelines should be laid as straight as possible, and change of direction made by means of elbows with a small radius.

10.220 **No bending** - G.I. pipes must not be bent (by bending the galvanization may split off and cause corrosion).

10.230 **Drainage** - A drain valve must be installed at the lowest point of the whole installation.

10.240 **Pipe closure** - Pipe covers have to be made of pressure resistant and watertight materials, such as: metal, plastic or other suitable materials. A cover can be a plug, cap, blind flange, etc., however, other stoppings (as for example wooden plugs) are not permissible. Completed installations, but not connected inside pipelines, must be closed with such covers.

10.250 **Building strength** - The building must not be weakened through the installation of pipelines and other sanitary requirements, (slits, openings, cutting of reinforcement iron, etc.). Therefore, care must be taken to avoid weakening the structure when breaking holes. Particular care must be taken not to cut reinforcing material.

10.260 Exposed pipelines

10.261 Water pipelines must be installed **beneath the electric** installations, where possible. (Condensed water may cause danger to the electric installations).

10.262 Pipelines passing **through floors** exposed to high moisture (kitchens, bathrooms) must be protected by waterproofing fitted closely to the pipe (Ref: Table 1/8)

10.263 **Pipes should be firmly fixed with clamps**, pipe carriers or suspension fixtures. In general these should be spaced at 1.5 m intervals, but account should be taken of the diameter and weight of the pipe.

10.270 Concealed pipelines (under plaster)

- 10.271 G.I. pipes and fittings (in protective wrapping) may only be covered with non-corrosive material such as cement plaster.
- 10.272 Any water connection liable to leakage (e.g. union, flange connection, valve) should not be concealed.
- 10.273 Hot water pipes require special attention for reasons of expansion and contraction, and also for reduction of heat losses (insulation).

11. INSTALLATIONS IN BUILDINGS

11.100 COLD WATER

- 110 **Distribution lines:** Each house should have at least two separate lines, each having a gate valve. They should be connected near to the water meter or adjacent to the roof tank. One line to be for the kitchens and the other for the bathrooms, so as to allow separate sections to be cut off without interrupting the supply to the other section.

Example: Distribution lines

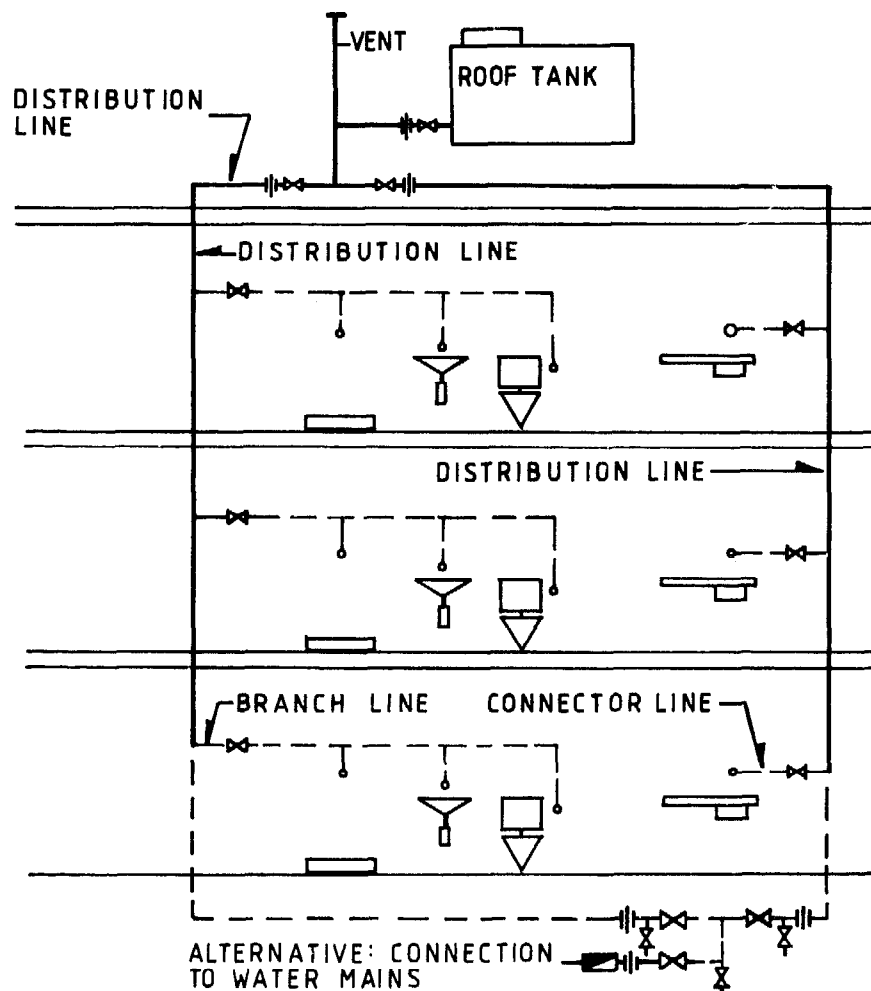

- 11.111 Additionally, in low pressure systems, there may be another separate distribution line with a valve for the **hot water system**. Fitted also near to the roof tank or adjacent to the water meter.
- 11.120 **Branch lines** - Houses designed for more than one family, and apartments, as well as hotels, hospitals, laboratories, etc., require a separate service valve for each unit (e.g. per one bathroom in a hotel), so as to allow convenient repairs, without interrupting the others' water supply.

Example: Branch lines (in a hotel)

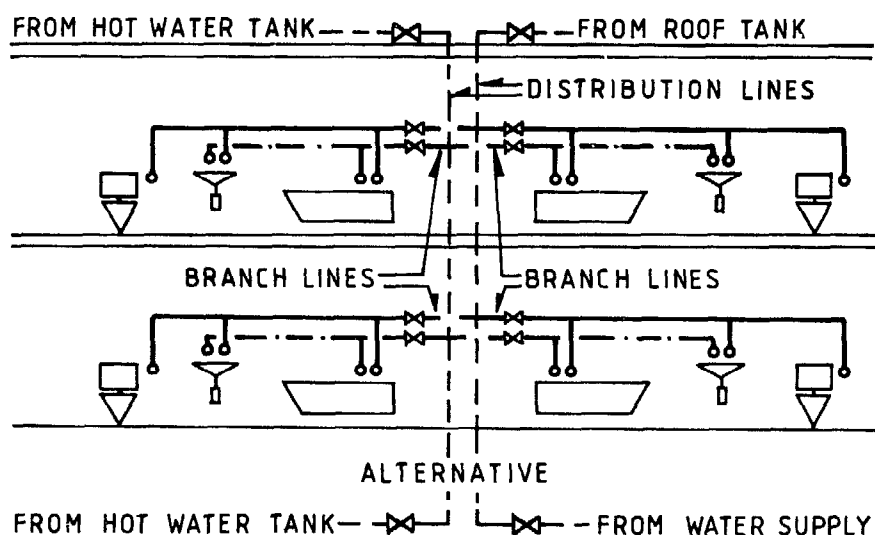

- 11.200 **HOT WATER SYSTEMS**
- 11.210 Hot water systems, in general, should be installed in the same way as cold water systems. However, more attention is required to the change of length through temperature variation (expansion, contraction), as well as for proper insulation.
- 11.211 Hot water systems are more liable to corrosion than cold water systems.
- 11.212 Hot water heaters should operate at temperatures of approx. 60° Centigrade, but not exceeding 70° C.
- 11.230 **Domestic installations:** The water is heated in water heaters (by electricity, gas, solar, etc.). They should be centrally positioned, so that the hot water is quickly available at the users' taps. These direct systems supply bath, kitchen sink, wash basin, etc. This system is commonly used in Nepal for domestic requirements and in hotels, hospitals, etc.
- 11.240 **Centralized systems:** Water is heated and stored centrally and distributed throughout the building by means of pipework with good insulation. In order to quickly receive hot water at the users' places these systems require constant circulation by means of a circulation pump, (or probably through thermosyphon, provided the hot tank is placed in the ground floor). These systems require much attention to good insulation to reduce heavy heat losses in the pipelines.

11.250 Hot water tanks should be positioned so that:

- the hot water reaches the taps within 20 to 30 seconds;
- they remain easily accessible for maintenance and repairs;
- heat loss is reduced, therefore tanks are fitted inside the building only.

11.260 Hot water taps should always be fitted in **mixing arrangements**, i.e. to have one spout outlet for both, cold and hot water. Such mixing taps require attention to guarantee proper function and safety to the house installation:

- a) Hot water connections to mixing taps should always be on the left side (and with vertical mixers the hot tap below).
- b) Mixing taps must always have one open outlet in order to avoid internal hot water circulation into the cold water line, i.e. without intervening valve between the mixing valve and the outlet.

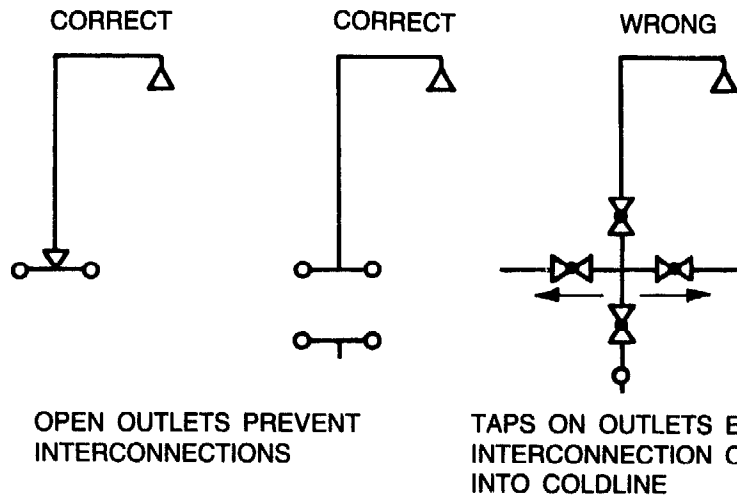

- c) For successful shower installations it is required that the **pressure must be adequate**. Note that telephonic showers have large losses in pressure and should be installed only where pressure is above 5 meters head, otherwise a metal pipe should be fitted.

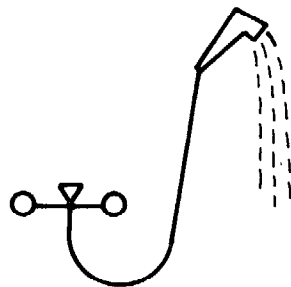
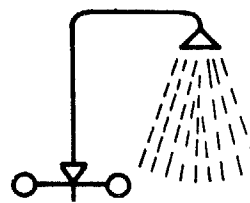
LOW PRESSURE INSTALLATION:**TELEPHONIC SHOWER****(INSUFFICIENT FLOW)****METAL PIPE INSTALLATION****(SATISFACTORY FLOW)**11.300 **HOT WATER TANK CONNECTIONS**

- 11.310 Hot water tanks may be connected to the supply lines **only if adequate security measures** are taken into consideration (non-return valve, safety valve, pressure reducer, etc.). The source of energy (electricity, solar, gas, etc.), makes no difference for the above requirements.

- 11.320 A hot water tank must **always remain filled with water**; i.e. not to be drained when cold water pipelines are without water.

- 11.330 Pressure of supply line and **limits of tank operation** pressure are to be checked prior to installation. Where the pressure in the cold water line exceeds 30 kg/cm², and where the heater is not designed to operate at high pressure, a pressure reducing valve or a separate feed tank (with ball valve) has to be fitted in the cold water system.
- 11.340 A **stop valve** must be fitted in the cold water line adjacent to the heater to allow it to be removed for repair without draining the entire line.
- 11.350 **Inlet and supply connections** to heaters must be fitted with unions, and the cold water inlet must lead to the bottom of the heater.
- 11.360 A **drain branch** should be fitted between the stop valve and the apparatus (or the non-return valve, if such is installed), which should be provided with a drain cock operated with an open-end spanner or a stop valve or plug.
Note: drain outlets may not be connected directly to the waste water system.
- 11.370 **Non return valve** - A non-return valve is to be fitted in the cold water line, adjacent to the stop cock valve.
- 11.380 A **safety valve** is to be fitted between the non-return valve and the heater (and not having under any circumstances any stop valve fitted between!)
- 11.381 **Safety valves** should be provided with a **drain outlet**, which must not be connected directly to the waste water system.
Safety valves should release pressure if there is an increase in pressure of 0.5 to 1 kg/cm² above normal working pressure in the line.
- 11.390 For smaller heaters up to 7 kW/hr one safety valve of 1/2" diameter is sufficient. Larger capacity heaters require larger safety valves (note: lever-arm safety devices are not permissible).
- 11.400 **HOT WATER TANK CONNECTIONS TO ROOF TANKS**
- 11.410 It is recommended to have **separate cold water lines** from the roof tank to each water heater. This system does not require a non-return valve (which often leaks and/or reduces an easy flow of water). The hot water tank will remain filled with water, even when the roof tank is empty (safety of electric heating element). A separate stop cock is required, adjacent to roof tank.
- 11.420 **Over-pressure** is to be released by means of a **safety valve**. Instead of a safety valve, a vent pipe can be fitted to allow excess pressure to escape. A vent pipe also acts as a anti-vacuum and so ensures an easy flow of hot water. This has its importance, especially in low pressure systems.
- 11.430 In buildings having more than two storeys or where it is not practical to provide separate water supply piping from the roof tank to each hot water tank, there must be fitted between the stop valve and the heater in a readily accessible position: a **non-return valve** and a safety valve between the non-return valve and the heater.
- 11.440 Hot water tanks must be **fitted with unions**, and have a **drain branch** in the cold water inlet pipeline. Drain outlets **must never be connected directly to the waste water systems!**
- 11.500 **ECONOMICAL HOT WATER INSTALLATIONS**
- 11.510 In order to achieve **economical utilization** of hot water systems great care is required at the planning phase. It is essential to reduce heat losses to the minimum. When installing hot water tanks and pipe-lines the following points should therefore be observed:

- a) Use **well-insulated** hot water tanks only, having a minimum of 50 mm thickness (or preferably 75 mm) of good quality insulating material.
- b) Where possible, keep the **hot water tank inside the building**, especially in areas where freezing can happen.
- c) Keep the **hot water supply pipes as short** as possible, especially to the kitchen sink. The sink is used more frequently than other apparatus and a near-by water heater is therefore an energy-saving and economical solution.

When having a **solar water heater system** at a distance from the kitchen sink, an additional small water heater fitted near the sink could prove economical by using preheated water from the solar system.

- d) Instead of using one pipeline of larger diameter it **might be better to have several lines** of smaller diameters, leading from the hot water tank to the various hot water taps.
- e) **Insulation** of hot water pipes is required especially where the exit is directly from the top of the hot water tank. To reduce the heat losses at least the first vertical pipe and part of the horizontal pipe require an insulating cover (This situation often occurs with solar water heater installations).

11.600 SAFETY

11.610 **Electric hot water tanks** must be fitted properly to guarantee complete safety.

- a) Installation away from direct water sprinkling: shower, bath tubs, rain, etc.
- b) Electric connections (earth, fuse, switch, etc.) as per rules and regulations through specialized persons only.
- c) Water heater not to be damaged when pipe system is without water supply. (Water tank always to remain filled with water - and draining possible only by opening of special valves).

Guiding principles for hot water requirements

Purpose	medium consumption / day Liter / person at 60-65 °C	maximum consumption / day Liter / person at 60-65 °C
modest domestic	20 - 40	30 - 60
comfortable standard	40 - 60	60 - 90
high standard	60 - 120	90 - 180
children hostel	40 - 60	60 - 80
hospital (town)	70 - 100	100 - 150
hostel (luxury)	upto 200	upto 300

Consumption	Quantity in ltrs.	Temperature °C
bathtub	150 - 200	40
shower (ca. 5-6 min.)	40 - 60 (20 - 30)	40
bidet (for 1 filling)	25	40
washbasin (1 filling)	6 - 8	40
kitchen (1 filling)	25 - 30	50 - 60
dish washing machine	15 - 25	55

12 APPARATUS AND VALVES

- 12.110 Each individual piece of apparatus in the installation must be controlled by its own stop valve (angle valve, etc.). The connection between the stop valve and the apparatus should enable easy repair of the apparatus and valves, or easy removal for replacement.
- 12.120 Every draw off point (wash basin, closet, floor drain, etc.) must be connected to the waste water system with trapped outlets.
- 12.130 Open containers with direct connection to the drinking water system and without automatic inflow regulation must have the lower edge of the drinking water outlet to be at least 2 cm higher than the overflow, (Ref: Table: 1/7). If the inlet must be introduced under water level (fishbasin, swimming pool, etc.) a special interruption system must be introduced to obtain 2 cm space in order to prevent back-siphoning.
- 12.140 Closet / Urinal Flushing in principle, water closets and urinals shall be flushed by means of cisterns only. Where in special cases valves for direct flushing are fitted, it is absolutely essential that a back-flow prevention is included in the flushing pipe (e.g. vacuum breaker), to make any siphoning from the pan into the drinking water pipelines impossible. Note that such a flushing system requires pipes with large diameter, and could be troublesome when flushing in low-pressure systems.
- 12.150 No pipe other than flushing pipe leading from a flushing tank shall be connected so that it can deliver water to any water closet pan or urinal.
- 12.160 Volume of flush no flushing tank or other flushing apparatus serving a water closet pan shall give a flush of more than 10 liters (or of more than 5 liters per stall of a urinal).
- 12.170 Fixing of non-return valves these valves are fitted to prevent return flow of drinking water (i.e. opposite direction of supply). They are required with: hot water systems, pumps, foot valves, machines, thermo-regulated valves, pressure boosters, water treatment plants, etc.
Note: direct connections with other mediums than drinking water are prohibited by any means. Direct connections are not permitted by use of non-return valves!
- 12.180 Connections of machines are to be made of high-pressure resistant flexible tubes, and preferably in rooms only having a floor drain (for prevention of damage by water flooding). A stop cock must be fitted before such a flexible tube.
- 12.190 Concealed fixtures - valves shall preferably be fitted in the open, and remain accessible for repair and easy replacement. Where concealed installations are required only specially designed valves for these purposes shall be utilized.

13 FIRE HYDRANT LINES

13.110 FIRE HYDRANTS SHOULD BE SITED IN A BUILDING ON ADVICE OF THE FIRE AUTHORITY

- 13.120 Installations of fire hydrant pipelines require **separate distribution lines**, to ensure an adequate supply of water for the fire hydrants. In case of low pressure systems adequate roof tank capacity and pipelines of larger diameters must be provided.
- 13.130 **A connection from the fire hydrant** to regularly used sanitary apparatus (water closet) should be made in order to provide for water renewal. For pressure lines this should be at the highest point of the building and for low pressure systems at the lowest point.
- 13.140 **A minimum of 3" diameter pipe** should be installed for fire hydrants.
- 13.150 **The fire hose** (e.g canvas) has to be long enough to be able to cover the entire area with water.
- 13.160 **The hydrant locations have to be near doors** and stairs. in order to secure operation and escape.
- 13.170 **The hydrants must be accessible to all people** in the building (for 24 hours a day): no locks on cabinets. The fire hydrants need a large "F" sign on doors of cabinets.

14. FREEZING PROTECTION

- 14.100 To secure regular water supply and avoid damage, pipelines fitted in places with sub-zero temperatures **require special attention**. Security can partly be achieved by proper installation, however, when systems inside the buildings are left without room heating they need to be drained.

The following should be observed:

- a) Feed line from mains to be underground (1 meter deep) Pipelines have to be **inside the building** as much as possible.
- b) **Main valve to be inside the house**, having a drain valve at the lowest point. The drain valve has to be operated before freezing conditions occur, and must be left open until system is refilled.
- c) All pipes to be fitted with **constant slope** towards either the taps or the lowest drain point. A proper **ventilation** is also required to guarantee a through drainage (top-most valve or ventilation pipe).
- d) Pipelines **not to be concealed** in outer walls.
- e) Consider whether pipes could be fitted on **walls or in ducts** - keeping distance from walls by means of clamps - and insulation added where required.
- f) Pipelines **not to pass through shafts, chimneys, etc.**, and to remain accessible as much as possible.
- g) **Hot water tanks to be fitted inside the house**, with easy draining facility.
- h) Pipelines and valves **exposed to outside temperatures** (pump line, pipeline in roof, vent pipe) probably **require good pipe insulation**.
- i) **The use of G.I. pipes in the house is recommended**, they could be thawed by flame heat. (HDPE pipes have the advantages as they will not crack in normal circumstances, but if they freeze they cannot be thawed by flame heat).

- k) **Water storage tanks and pipelines** may require lagging to prevent freezing of the water, especially when fitted in cold roofs. The insulation shall be of inorganic materials.

15. DIMENSIONING

15.100 Proper dimensioning is essential to guarantee a trouble-free supply of water, in sufficient quantity and with sound controls.

15.200 **THE DIMENSIONS CAN BE CALCULATED IN TWO WAYS:**

- 1) With tables (see table 15.460) for procedure for normal house installations,
- 2) Through calculation.

15.300 **FOR NORMAL INSTALLATIONS THE FOLLOWING LOSSES OF HEAD CAN BE ACCEPTED:**

- The flow-pressure (dynamic pressure) may **not** be less than approx. 0.5 kg/cm² (7 lb/in²) and the total loss of head in the entire installation may not be more than 1 kg/cm² (14 lb/in²).
- For pressure over 5 kg/cm² (70 lb/in²), the pressure loss on the longest distance may not be more than max. 20 percent.

15.400 **NORMAL HOUSE INSTALLATIONS**

15.410 Loading values of taps and apparatus

Utility	valve diameter	units
Washbasin, hand washbasin, bidet, flushing cistern, single tap	1/2"	0.5
Kitchen sink, service sink, dish washing machine, laundry trough, wash sink	1/2"	1.0
Bath mixer, shower mixer, wash fountain, washing machine (up to 6 kg)	1/2"	2.0

15.420 **Hot and cold water connections** must be taken into account separately for calculating the connection value even though they may be at a joint mixer.

For example: 1 washbasin 1/2"

Coldwater	0.5 U
Warmwater	0.5 U
Total Units	1.0 U

15.430 **Water heater connection-dimensions** will be according to the loading unit of the apparatus, i.e. the total of all units connected to the hot water system.

For example: 4.0. U = 3/4", or 8.0. U = 1"





15.440 **One loading unit (1.0.U)** corresponds to a medium water consumption of 10 liters/minute. In respect to quantities of 5 liters/minute, or less, the unit is taken as 0.5 U.

15.450 For installations with high **simultaneous draw-off** (schools, canteens, hotels, etc.), a higher consumption must be considered, e.g. by doubling the value of the units.

15.460 TABLE FOR DIMENSIONING WITH UNITS

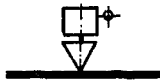
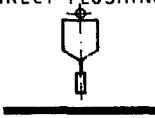
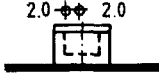
- 15.461 A) For systems with roof tanks
-
- (Head less than 40 meters)

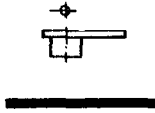
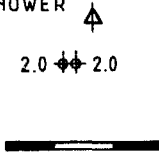
LOADING VALUES AND DIAMETERS (G.I. PIPES)	
PIPE DIAMETER IN INCHES	MAX. LOADING IN UNITS
1/2	0.5 - 2.0
3/4	2.5 - 4.0
1	4.5 - 10.0
1 1/4	10.5 - 20.0
1 1/2	20.5 - 40.0
2	40.5 - 100.0

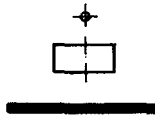
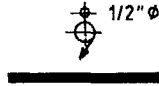
0.5 UNIT	1.0 UNIT	2.0 UNITS
WATER CLOSET (CISTERN) 	URINAL (DIRECT FLUSHING) 	BATHTUB 
WASHBASIN 	KITCHEN SINK 	SHOWER 
FLOOR PAN (CISTERN) 	SINK / TROUGH 	GARDEN VALVE 

- 15.462 B) For systems with pressure
-
- (Head above 40 meters)

LOADING VALUES AND DIAMETERS (G.I. PIPES)	
PIPE DIAMETER IN INCHES	MAX. LOADING IN UNITS
1/2	0.5 - 2.5
3/4	3.0 - 5.0
1	5.5 - 12.0
1 1/4	12.5 - 25.0
1 1/2	25.5 - 50.0
2	50.5 - 125.0

15.500 CALCULATION OF DIMENSIONS

For special conditions and in doubtful situations it is necessary to calculate the pipeline-diameters. For example:

- pipelines longer than 30 meters in length (measured from the tap farthest away from the tank)
- where there is simultaneous demand on the installations
- industrial districts
- fire hydrant lines

15.510 Basis for the exact calculations are:

- the acceptable loss of head
- the connected load of apparatus (unit) considering also the likelihood of the simultaneous use of the installations (Ref: table 1/39)
- the length and diameter of the pipes considering the loss due to friction (Ref: table 1/37)

15.520 Procedure for calculation

- Fixing of the acceptable loss of head
- Assessing the simultaneous demand of the installation according to the table.
- For industries, schools, etc., the fact that most of the taps might be used simultaneously must be taken into consideration.
- Working out the dimensioning, considering the probability of **simultaneous use** and the disposal loss of head.
- **Comparing calculated loss of head**, and acceptable loss of head. The results of both values should be about the same.
- If there is a big difference between the acceptable and the calculated loss of head, a **new assessment must be worked out**. The calculated loss of head has to be checked again as before using different pipe dimensions.

16. TESTING OF A NEW INSTALLATION

16.100 A TEST MUST BE CARRIED OUT ON ALL PIPELINES PRIOR TO THEIR BEING COVERED.

The procedure for the test should be as follows:

- a) Pipelines should be closed off from all apparatus such as basins, water closets, hot water storage tanks, etc.
- b) The system should be filled with water and be thoroughly ventilated to secure the release of all trapped air.
- c) The system should be closed, and a pressure of 1 1/2 times the working pressure applied by means of a hand pump.
- d) The system should remain under pressure for at least one hour. During this testing period the loss of pressure should not be more than 0.1 kg/cm².

16.110 **After the pressure test** is completed satisfactorily all apparatus should be connected and the system refilled and checked for leaks.

16.120 **Before handover the system** should be filled and drained at least 2 times to ensure that it is properly cleansed of sand, cutting oil, or other material.

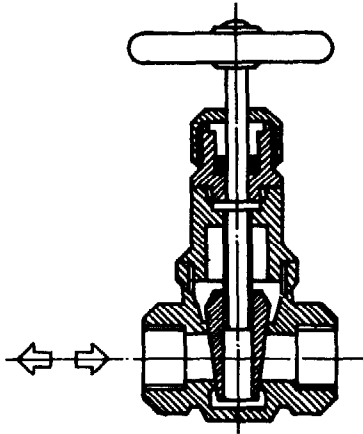
**GATE VALVE (STOP VALVE)**

The seat openings are usually of the same diameter as the inside of the pipes. They have very little loss of head, when the valve is completely opened.

Application: In main pipelines, before the taps. Where watertightness is not so important.

Don't use: As out-flush valve (too high speed in the pipeline, and not really watertight) instead, use a suitable tap.

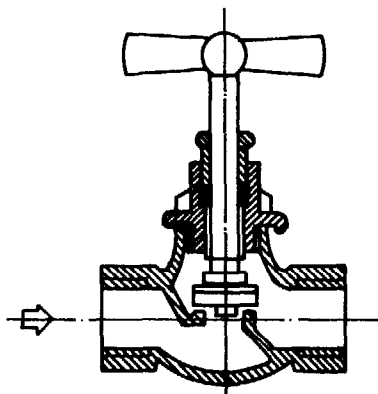
**GLOBE VALVE (STOP COCK)**

This valve has to be installed with the water pressure under the valve seat.

A globe valve can be repaired and is watertight, however, it has a quite high loss of head.

Application: for smaller diameters.

Don't use: as outflush (drain valve at water reservoirs).

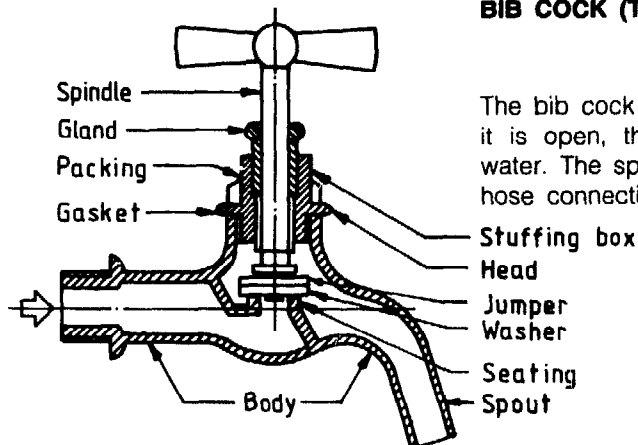
**BIB COCK (TAP; FAUCET)**

The bib cock closes against water pressure. When it is open, the passage is relatively free for the water. The spout may or may not be threaded (for hose connection).

C.P. VALVES, EXAMPLES

TABLE 1/2

BIB COCK
(Tap. faucet)

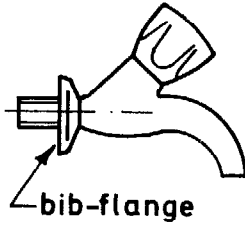

BIB COCK WITH HOSE CONNECTION

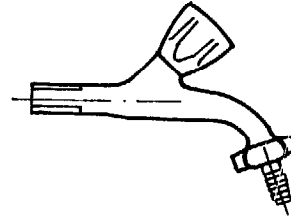

PILLAR COCK

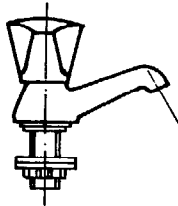

PILLAR COCK SWIVEL

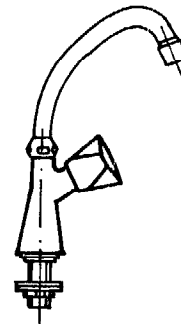

ANGLE STOP COCK
(Angle valve)

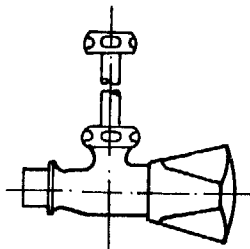

GLOBE VALVE
(Stop cock, female)

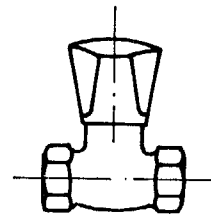

UP-VALVE (Under plaster)
(Concealed stop cock)

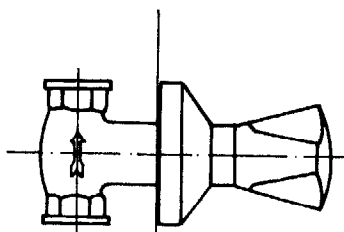

This is the only stop cock type which may be fixed for concealed pipes (under plaster).

C.P. = CHROME PLATED

C.P. VALVES, EXAMPLES

TABLE 1/3

BASIN, ONE HOLE MIXER

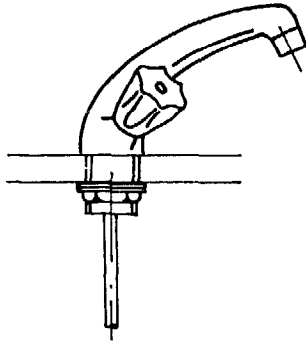

BASIN, THREE HOLE MIXER

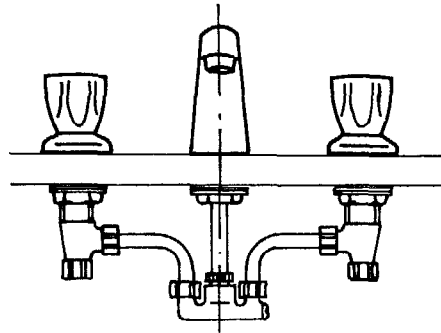

BASIN / SINK

WALL MIXER

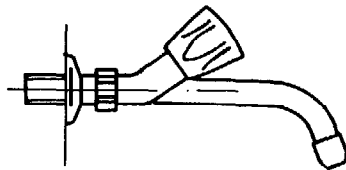

SIDE

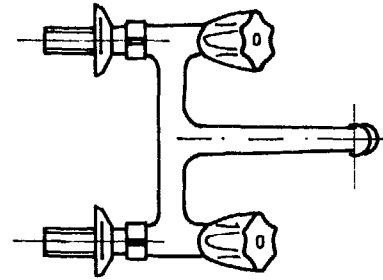

TOP

BATH WALL MIXER

With eg. telephonic shower
(Waterhead min. 5m)

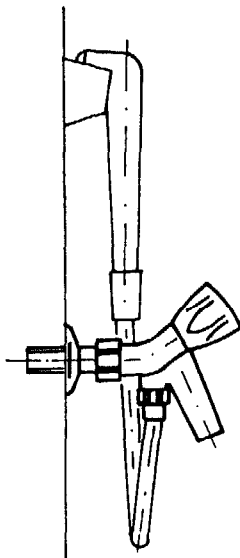

SIDE

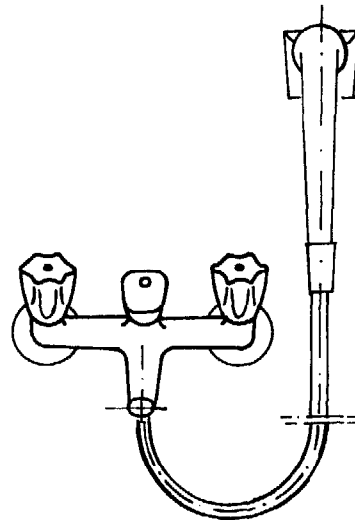

FRONT

C.P. = CHROME PLATED

VALVES, EXAMPLES

TABLE 1/4

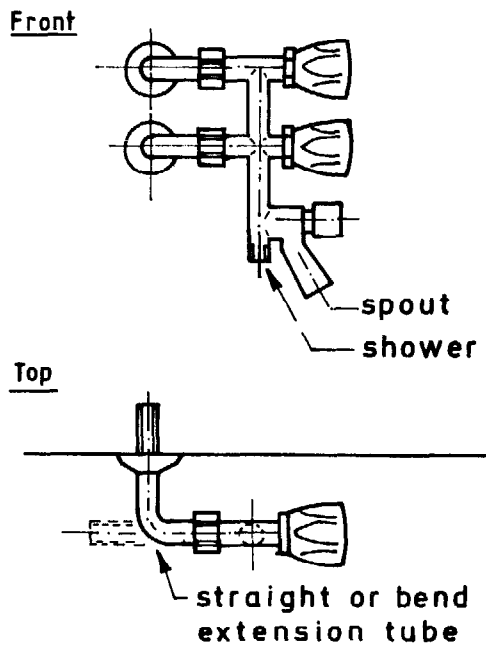

VERTICAL BATH MIXER

In many situations this rather unusual mixer might be the adequate solution, eg. if bathtub or shower is in a niche or corner. In addition it can be the more economical installation. (Soma Plumbing Fixtures Ltd, India Similor, Switzerland).

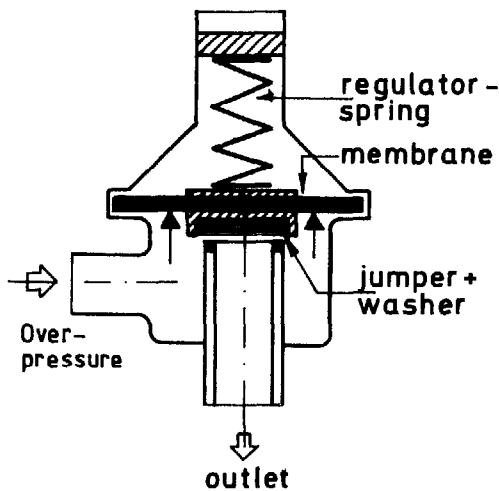

SAFETY VALVE (PRESSURE RELEASE)

Application: Must be fitted in pressure systems with hot water tanks (low pressure vent pipe will also do).

Caution: Verify the flush direction of the water.

Danger: Never install any valve between the hot water tank and the non return or any other valve !

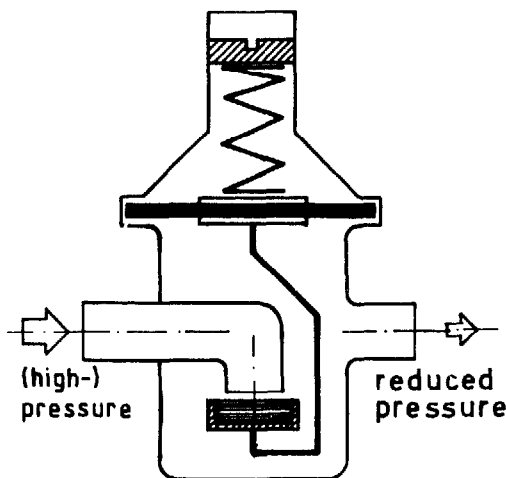

PRESSURE REDUCER VALVE

This valve is applied where a lower pressure is required.

Pipelines for domestic use should not be over a pressure of 4 kg/cm² (= 40 m Head).

Note: Hot water tanks are normally built to resist a maximum head of 30 m. Where the water supply has more pressure a reducing device (pressure reducer valve, cistern) is required.

VALVES, EXAMPLES

TABLE 1/5

FOOT VALVES

Application: On inlets of suction pipes in pumped systems

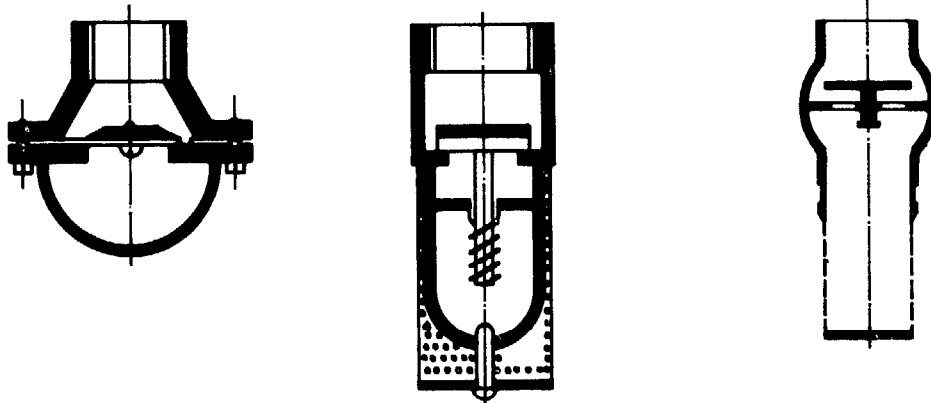

Note: A swing check valve is most suitable since it offers easier flow

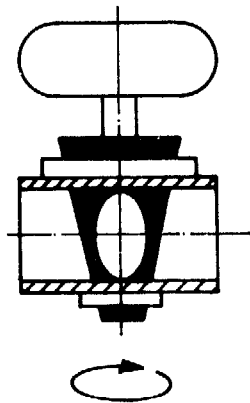

TAPERING PLUG (GAS COCK)

Applications: for gas installations and drain valves only.

Note: these valves are made for low pressure application only: since the water flow would be stopped too fast in pressure systems they would produce water hammers and damage the pipeline.

NON-RETURN VALVES

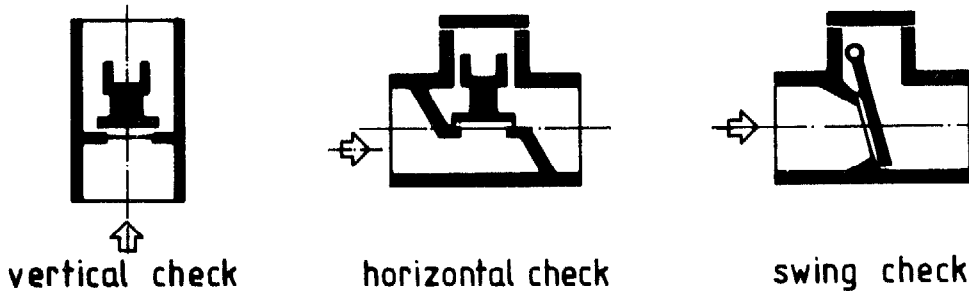

vertical check

horizontal check

swing check

Non return valves are fitted in pipe systems to secure the flow direction and to prevent any flow back.

For application in systems with hot water tanks, solar water heaters, pumps, pressure boosters, washing machines, etc.











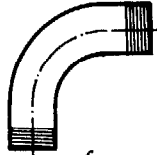



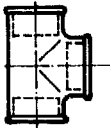
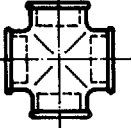

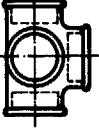
Swing checks are recommended (flap type), since there is full passage and less friction loss.

Caution: Attention has to be given to the flow direction. Non return valves have to be fitted in that way that the water pressure (incoming) remains under the valve seat.

G.I. FITTINGS

TABLE 1/6

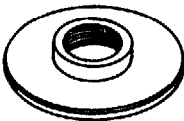
EXAMPLE

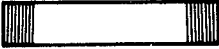
<p>BEND 90° (made out of steel tubes)</p>  <p>6</p>	<p>BEND 45° (made out of steel tubes)</p>  <p>8</p>	<p>ELBOW 90° female equal + reducing</p>  <p>90</p>	<p>ELBOW 90° male + female equal + reducing</p>  <p>92</p>
<p>TEE female</p>  <p>130</p>	<p>CROSS female</p>  <p>180</p>	<p>SIDE OUTLET ELBOW female</p>  <p>221</p>	<p>SIDE OUTLET TEE female</p>  <p>223</p>
<p>REDUCING SOCKET female</p>  <p>240</p>	<p>REDUCING BUSH female + male</p>  <p>241</p>	<p>RED. HEXAGON male</p>  <p>245</p>	<p>RED. SOCKET male + female</p>  <p>246</p>
<p>SOCKET</p>  <p>270</p>	<p>PLUG</p>  <p>291</p>	<p>BACKNUT</p>  <p>310</p>	<p>CAP</p>  <p>300</p>
<p>FLANGE</p>  <p>321</p>	<p>UNION flat sheet female</p>  <p>330</p>	<p>NIPPLE</p>  <p>530</p>	

WATER SUPPLY TO BATHTUBS AND BASINS

TABLE 1/7

PREVENTION OF BACK-SIPHONING

Bathtub, mixing - tap

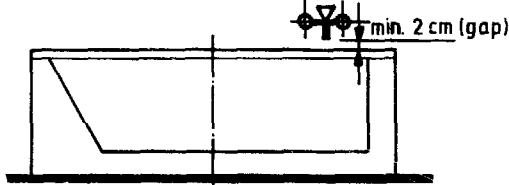

Safety valve

means of safe drainage

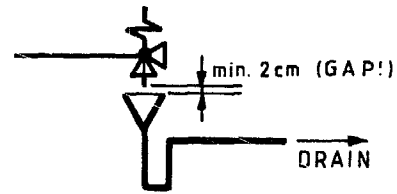

Correct

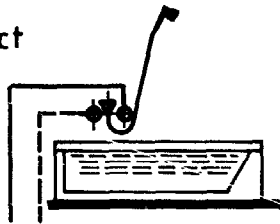

Keep telephonic showers out of bath tubs

Wrong

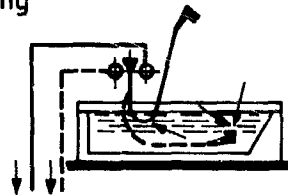

It is dangerous to have telephonic showers in used water : with empty feed lines, the water can be sucked into the drinking water.

DIRECT WATER SUPPLIES FOR BASINS

Basin / Inlet above water level

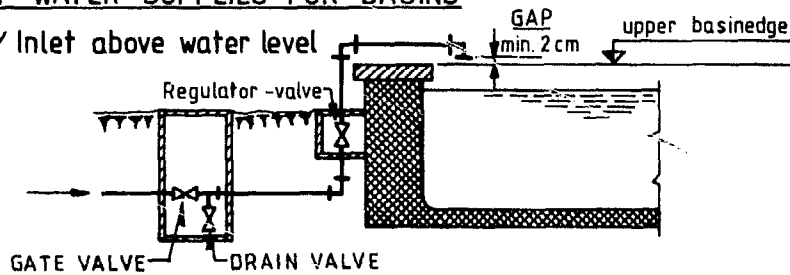

Inlet under water level

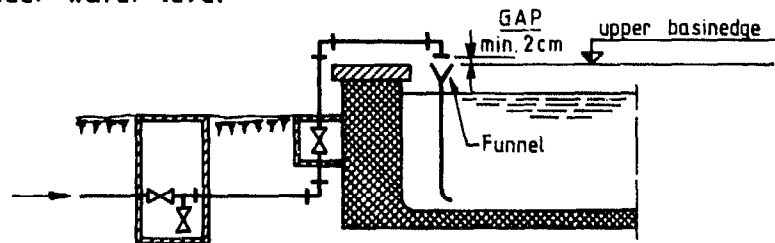

Wrong

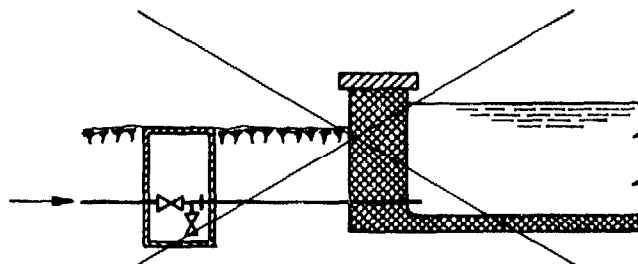

**PASSAGES OF PIPES
THROUGH WALLS AND CEILINGS**

TABLE 1/8

Galvanized pipe through the outside - wall

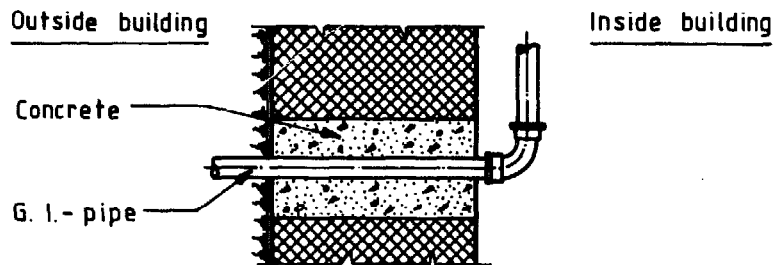

Cast iron pipe through the outside - wall

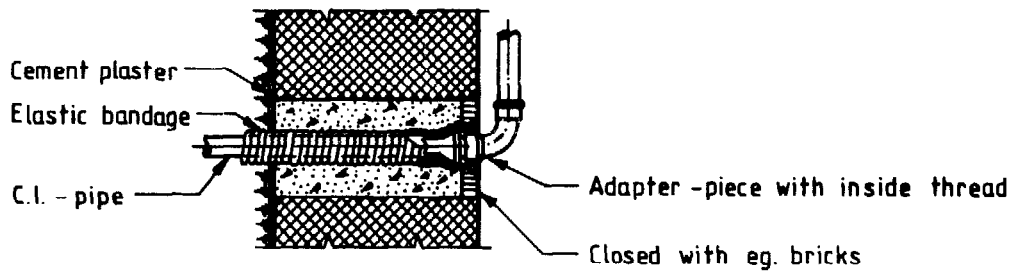

Galvanized pipe through 2 walls with expansion joint

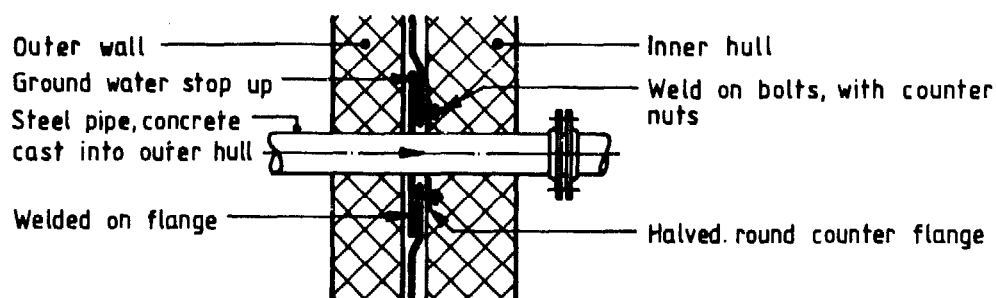

Pipe passage through ceiling (for rooms with high moisture)

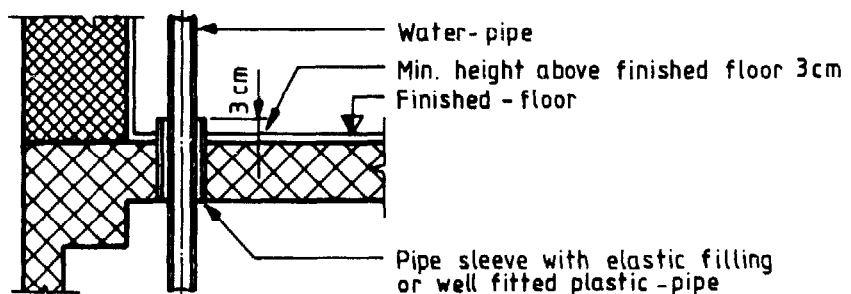

ROOF TANK PRINCIPLE REQUIREMENTS

TABLE 1/9

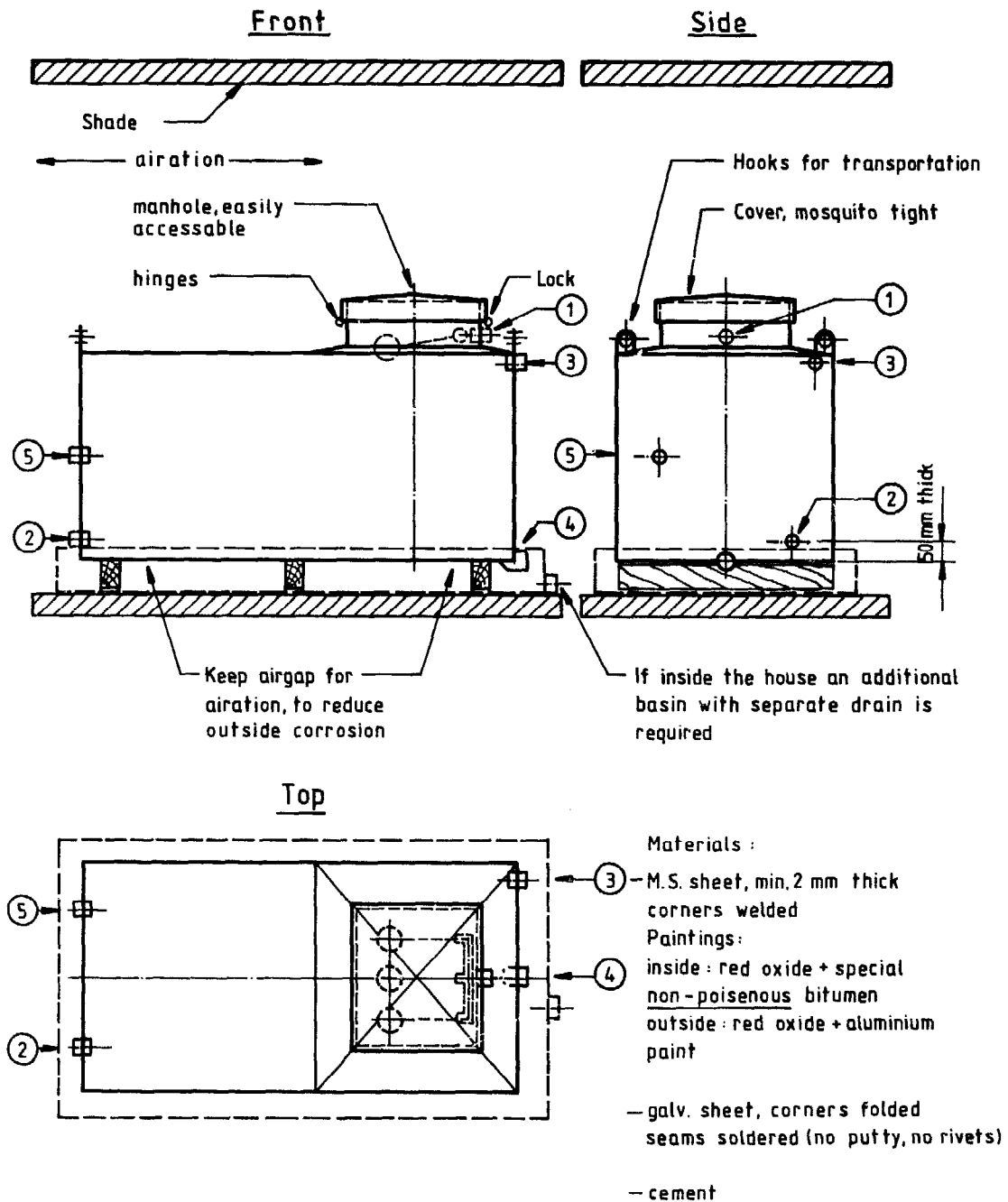

- 1 Inlet, with one or more ball valves, or open inlet, when filled with pump or with electric automatic control system.
- 2 Outlet, min. 5/4" Ø G.I. socket, and after fixing of main gate valve.
- 3 Overflow, min. 5/4" Ø G.I. socket.
- 4 Drain, min. 2" Ø G.I. socket with plug.
- 5 Interconnection, min. 5/4" Ø G.I. socket for possible extensions.

Note: A water level indicator is useful (clear plastic pipe) size of tank: Water consumption per one person approx. 165 l/day, suggested minimal size: 1000 liters.

PARTS OF WATER INSTALLATIONS

TABLE 1/10

- 1 WATER MAIN
- 2 MAIN CONNECTION (FERRULE OR CONTROL VALVE)
- 3 COMMUNICATION PIPE
- 4 METER CONTROL VALVE
- 5 WATER METER
- 6 SERVICE PIPE
- 7 SUCTION PIPE WITH FOOT VALVE
- 8 PUMP
- 9 CHECK VALVE (NON RETURN)
- 10 DELIVERY PIPE (PUMP LINE; DISCHARGE)
- 11 OVERFLOW
- 12 DISTRIBUTION LINE
- 13 BRANCH LINE
- 14 APPARATUS CONNECTOR
- 15 TAP
- 16 WATER HEATER
- 17 HOT WATER SUPPLY LINE

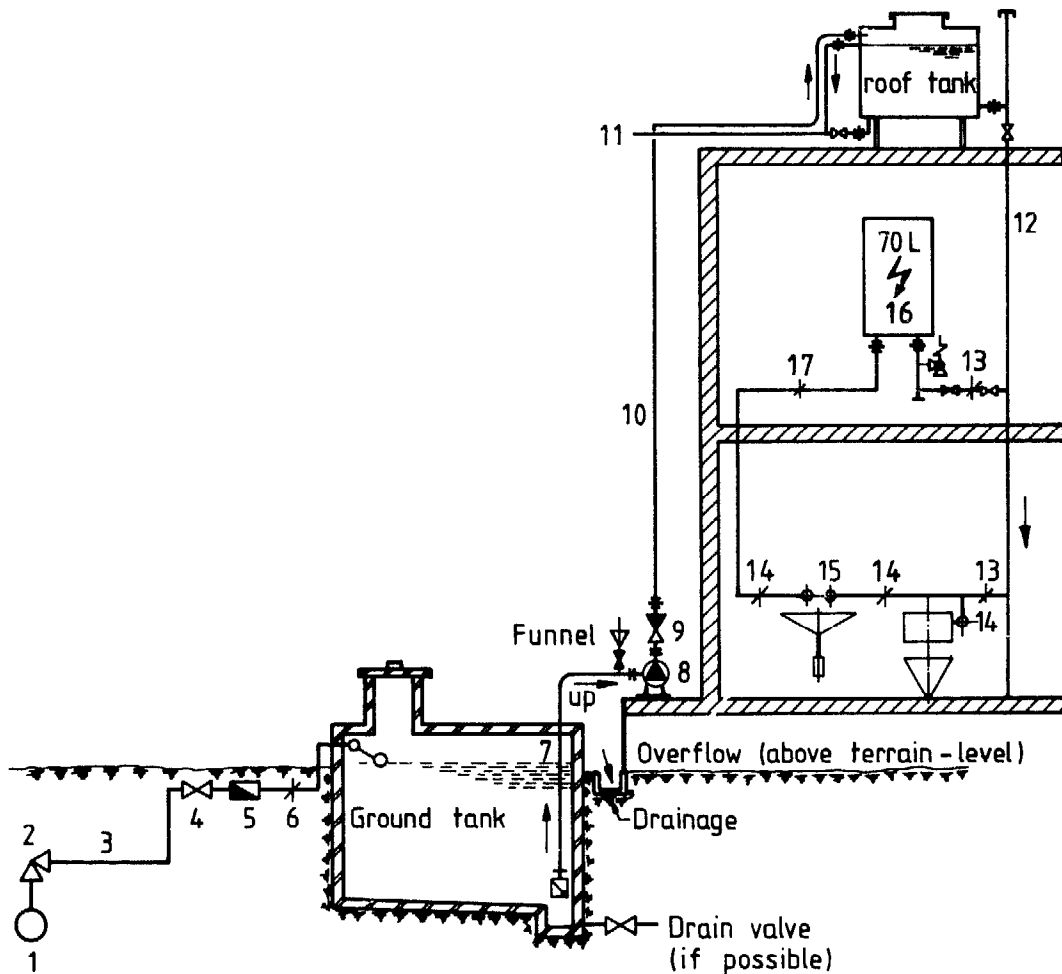

ROOF TANK CONNECTION, EXAMPLE

TABLE 1/11

- 1 MAIN VALVE
- 2 WATER METER
- 3 BALL VALVE
- 4 OVERFLOW
- 5 DRAIN-OUT
- 6 PUMP
- 7 NON-RETURN VALVE
- 8 ELECTRIC-PUMP SWITCH-OUT
- 9 WATER TO THE APPARATUS

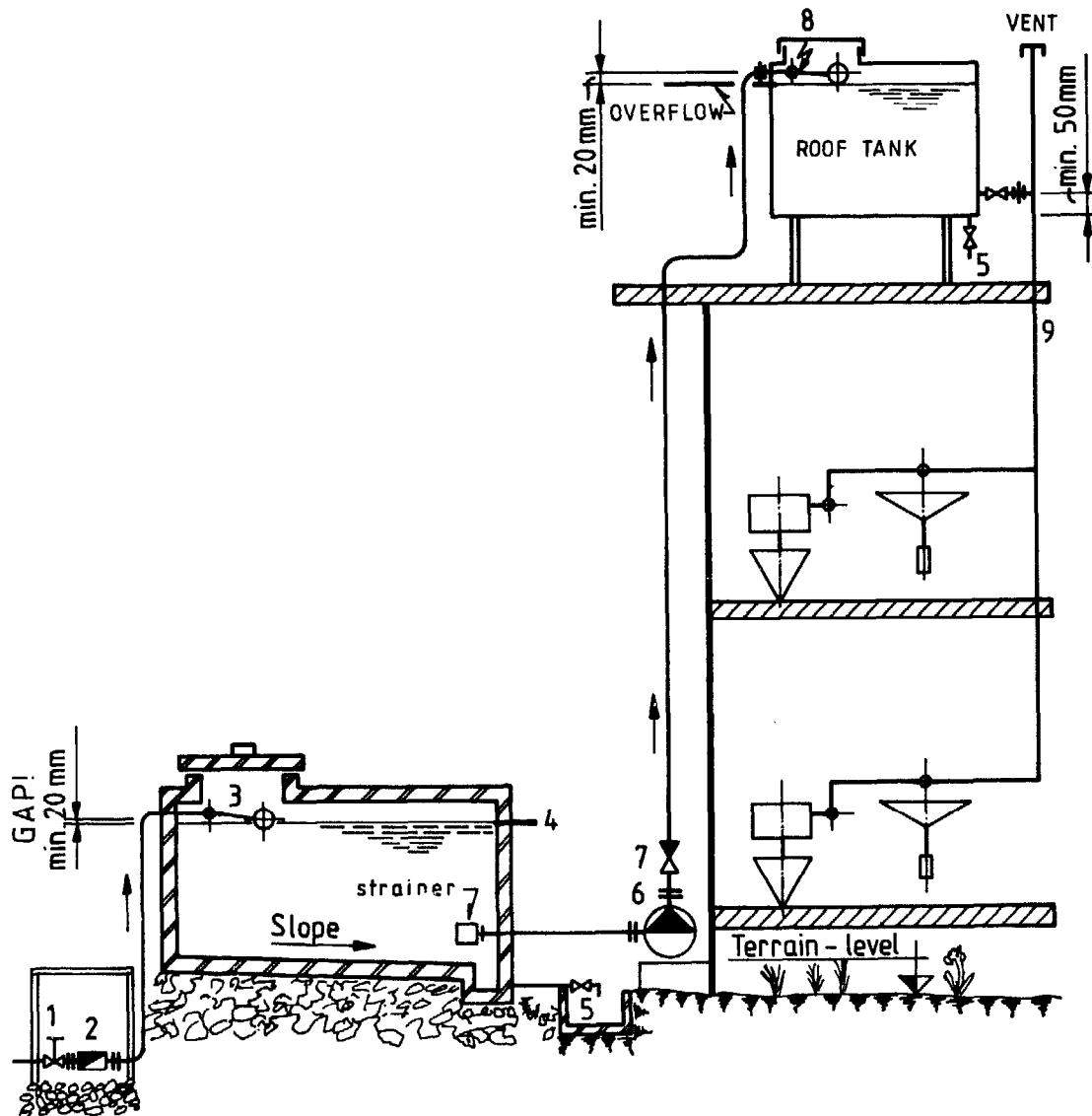

ROOF TANK CONNECTION, EXAMPLE

TABLE 1/12

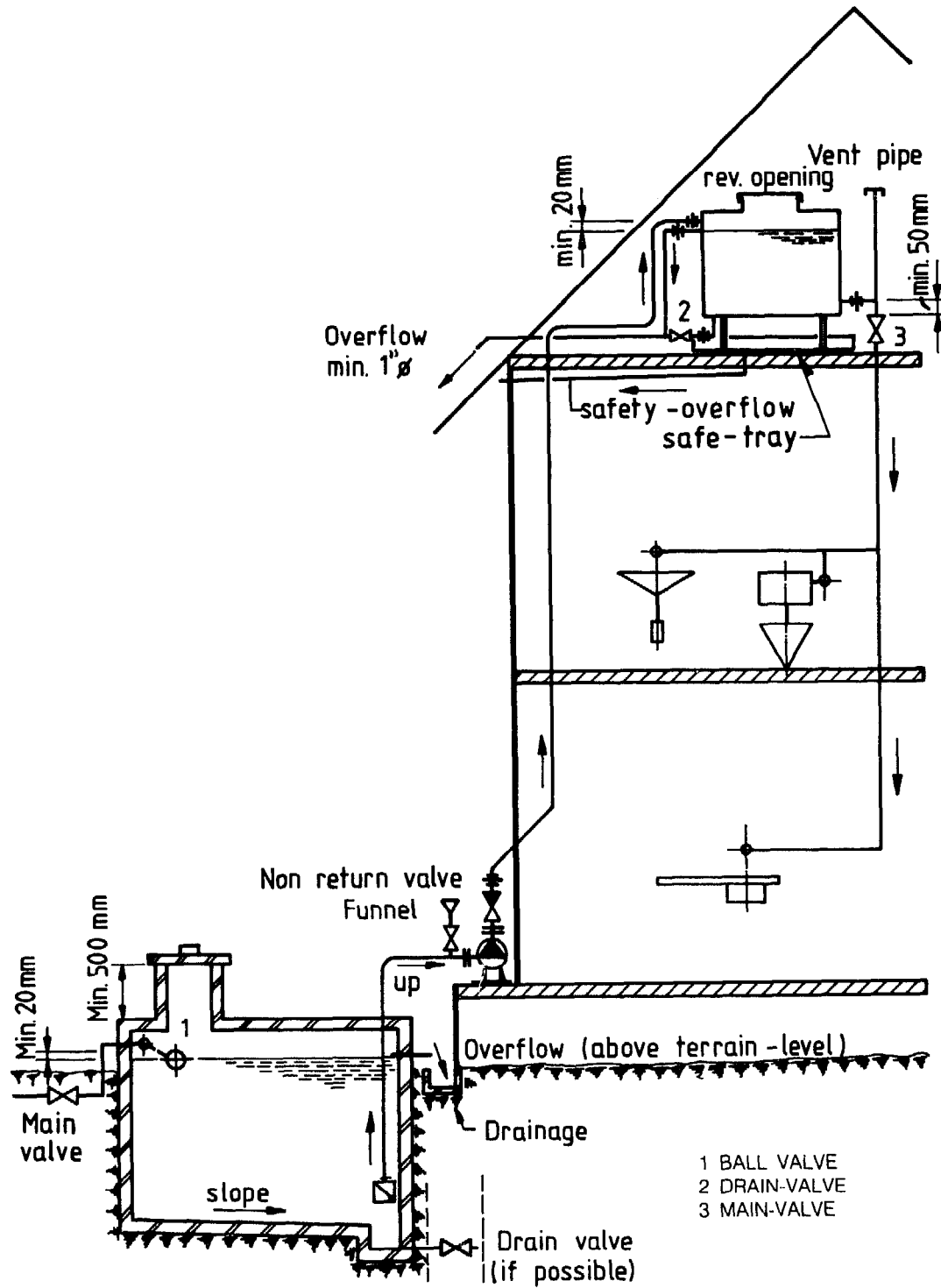

Note: Drinking water tanks should be above the ground

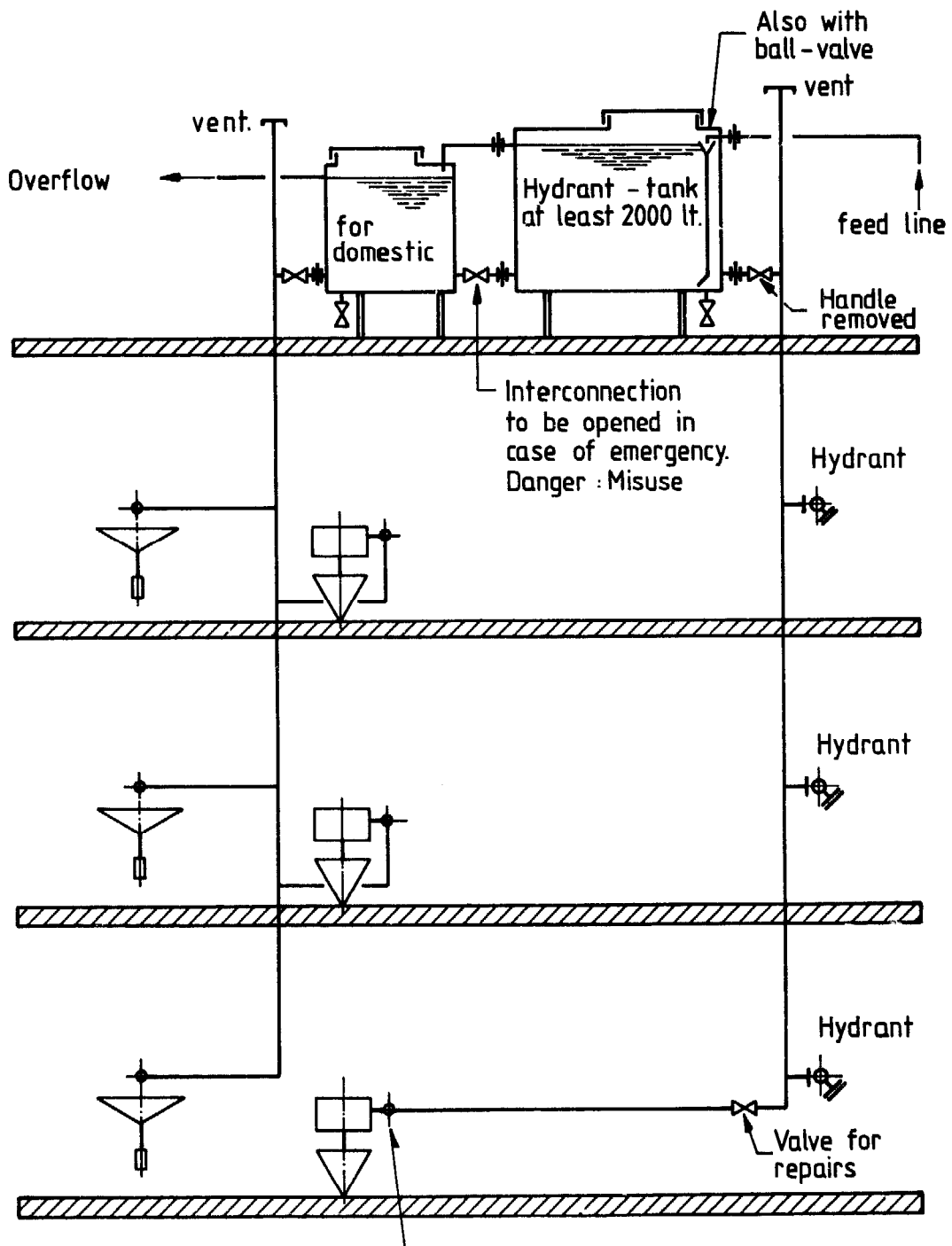

Note: Regular replacement of water in pipes and roof tank is maintained by having a cistern connected, at furthest distance from tank, i.e. at lowest point.

PRESSURE INCREASE WITH BOOSTER

TABLE 1/14

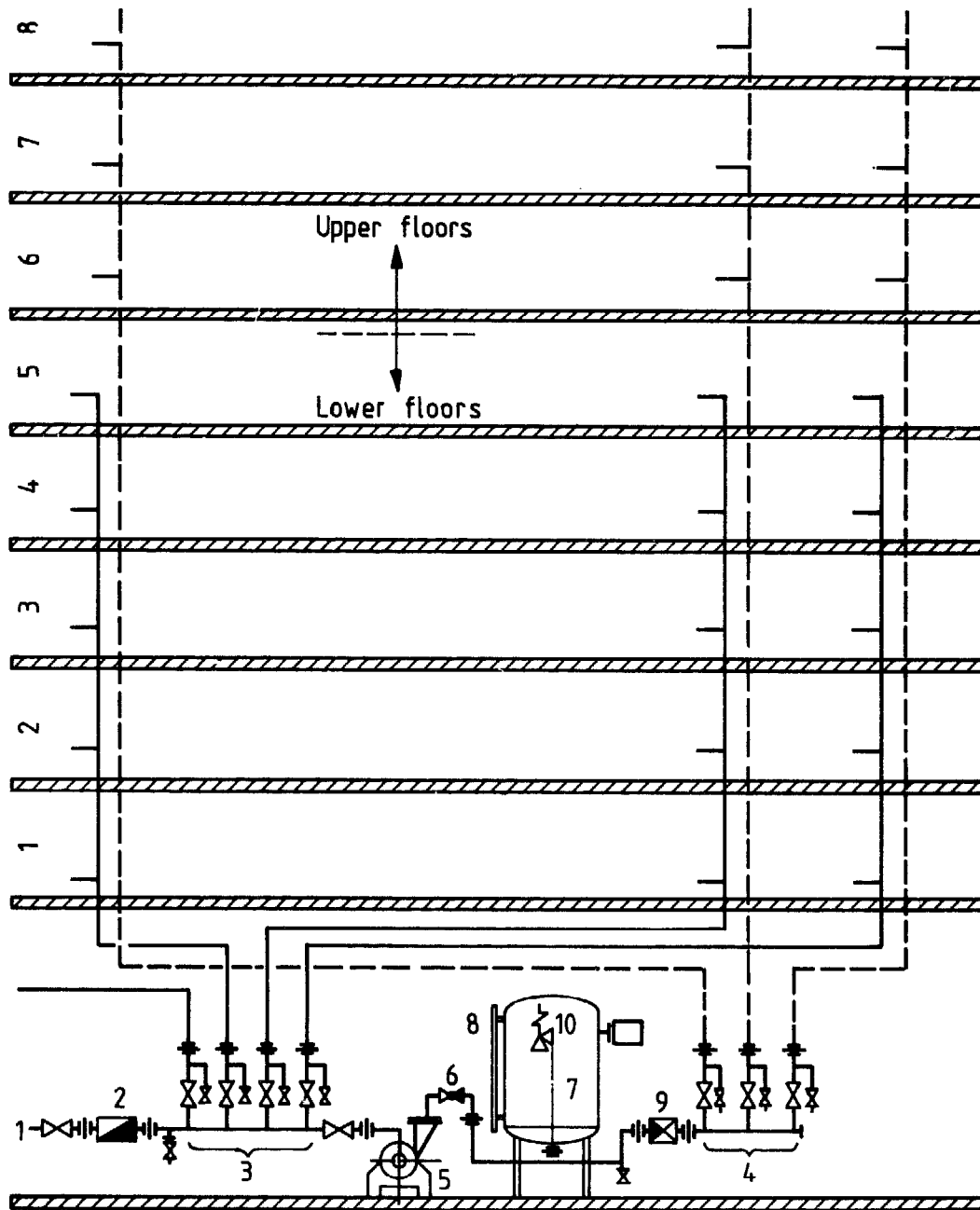

- 1 TOWN SUPPLY LINE
- 2 WATER SUPPLY LINE
- 3 DISTRIBUTION, LOWER FLOORS
- 4 DISTRIBUTION, UPPER FLOORS
- 5 PUMP FOR PRESSURE-INCREASE

- 6 NON RETURN VALVE
- 7 PRESSURE-BOOSTER
- 8 WATER LEVEL INDICATION
- 9 PRESSURE-REDUCER VALVE
- 10 SAFETY-VALVE

HOUSE INSTALLATION IN FREEZING CLIMATE

TABLE 1/15

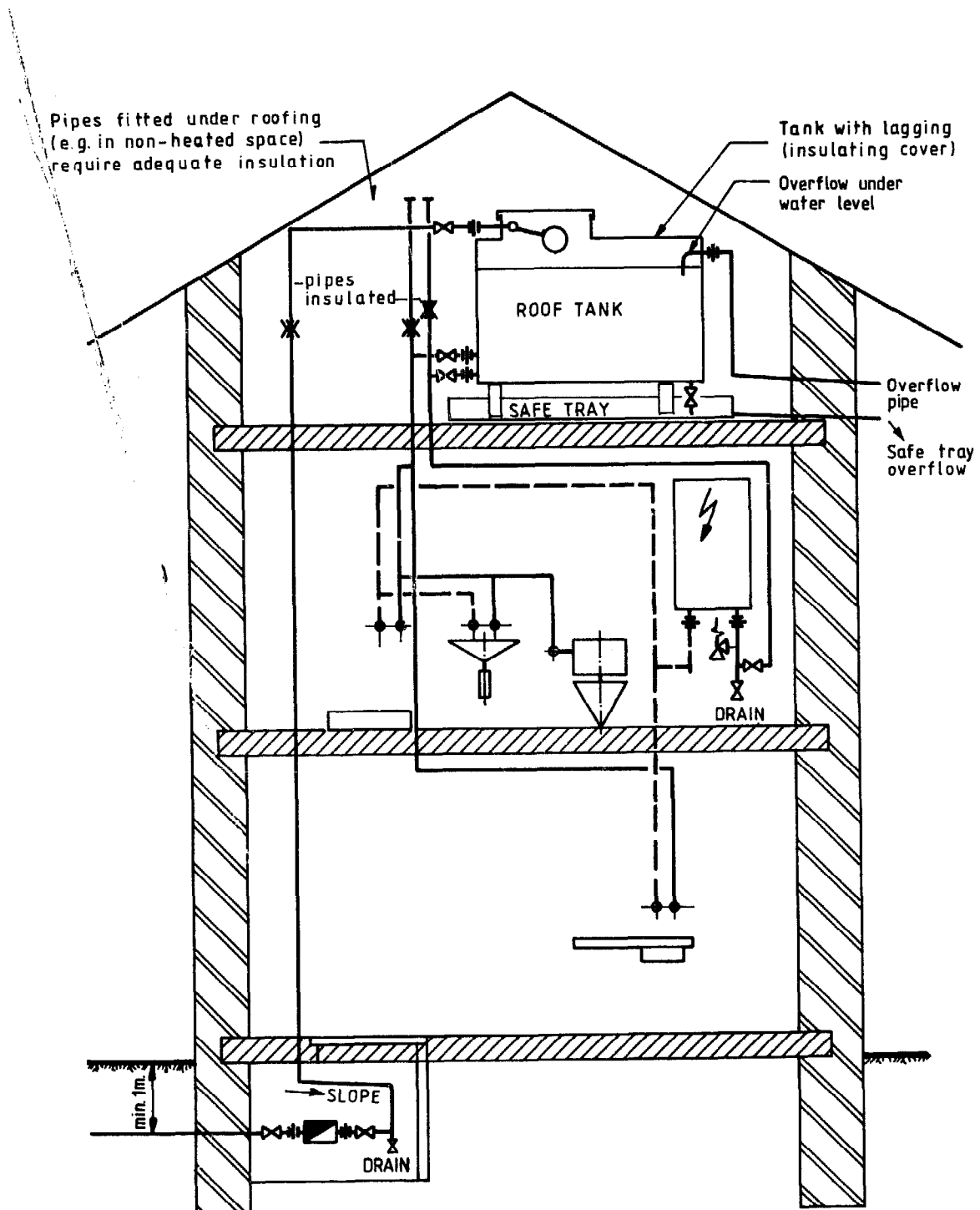

Notes: Pipes not to be fitted into outside walls pipes to fitted with slopes (no siphons!) to enable through drainage.

WATER HEATER CONNECTION

TABLE 1/16

Note: All installed water heaters must have a pressure-release possibility: by safety valve or by an air pipe.

Caution: The maximum head for water heaters is given by the factory and is indicated on the water heaters. (Normally for max. 30 m head = 3kg/cm²).

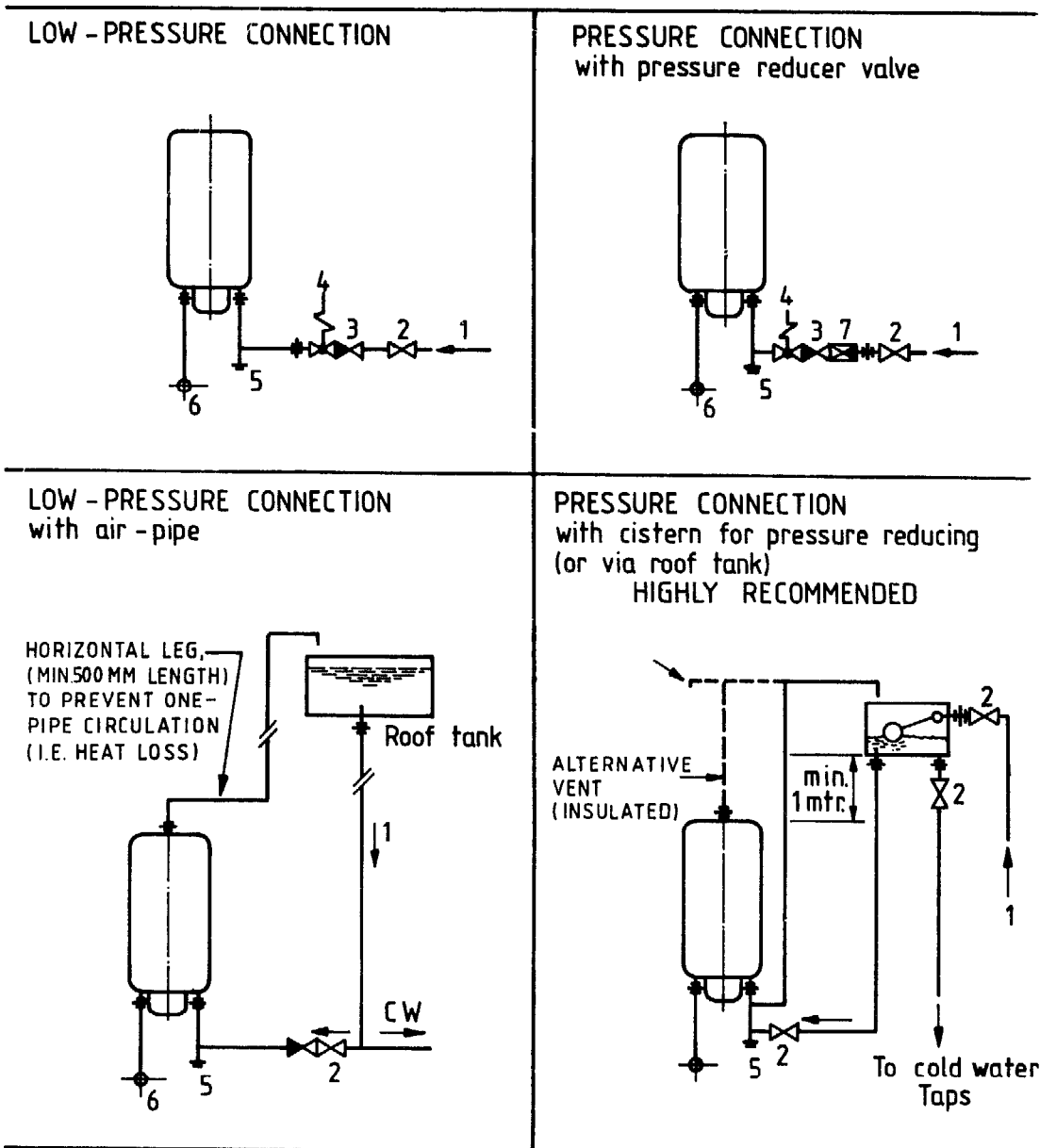

- 1 FEED PIPE
- 2 MAIN VALVE
- 3 NON RETURN VALVE
- 4 SAFETY VALVE

- 5 DRAIN (PLUG OR VALVE)
- 6 HOT WATER TAP
- 7 PRESSURE REDUCER VALVE

HOT WATER SUPPLY SYSTEMS

TABLE 1/17

Series - connection

Parallel - connection

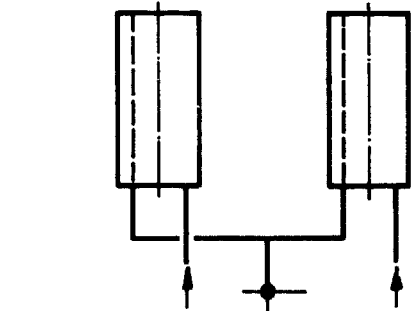
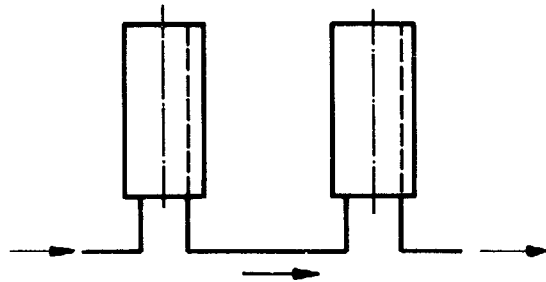

Single - supply

Group - supply (for nearby taps)

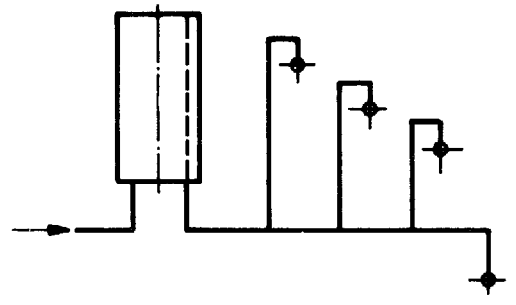
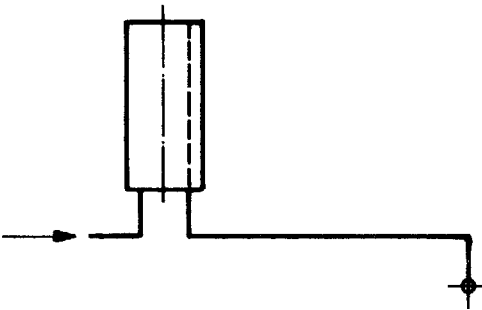

Single - tap system (effective and economical; fast hot water availability)

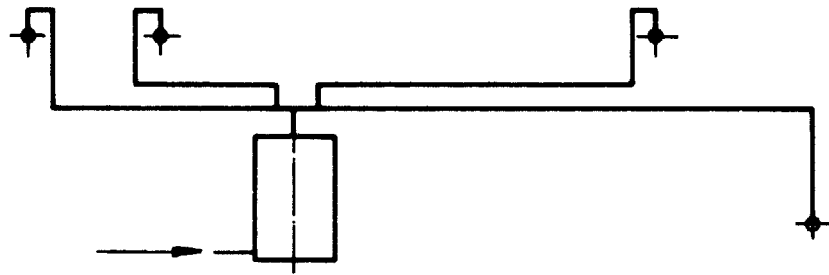

Distribution line with circulation

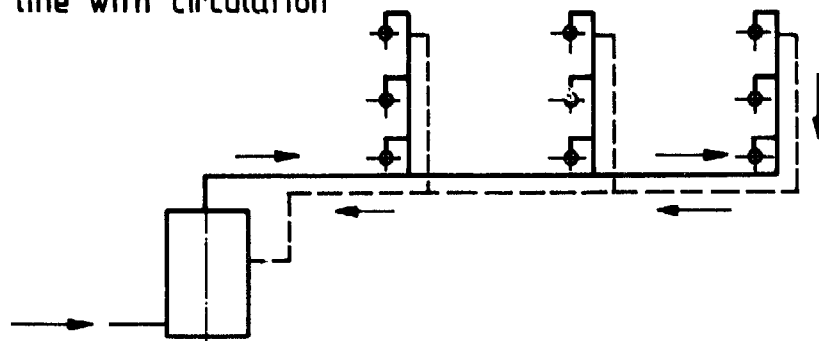

HOTWATER SUPPLY**TABLE 1/18**

EXAMPLE No 1: ONE FAMILY HOUSE
SEPARATE FEED LINE TO HOT WATER TANK (=NO NON-RETURN VALVE)
HOT WATER TANK LOWER THAN TAPS

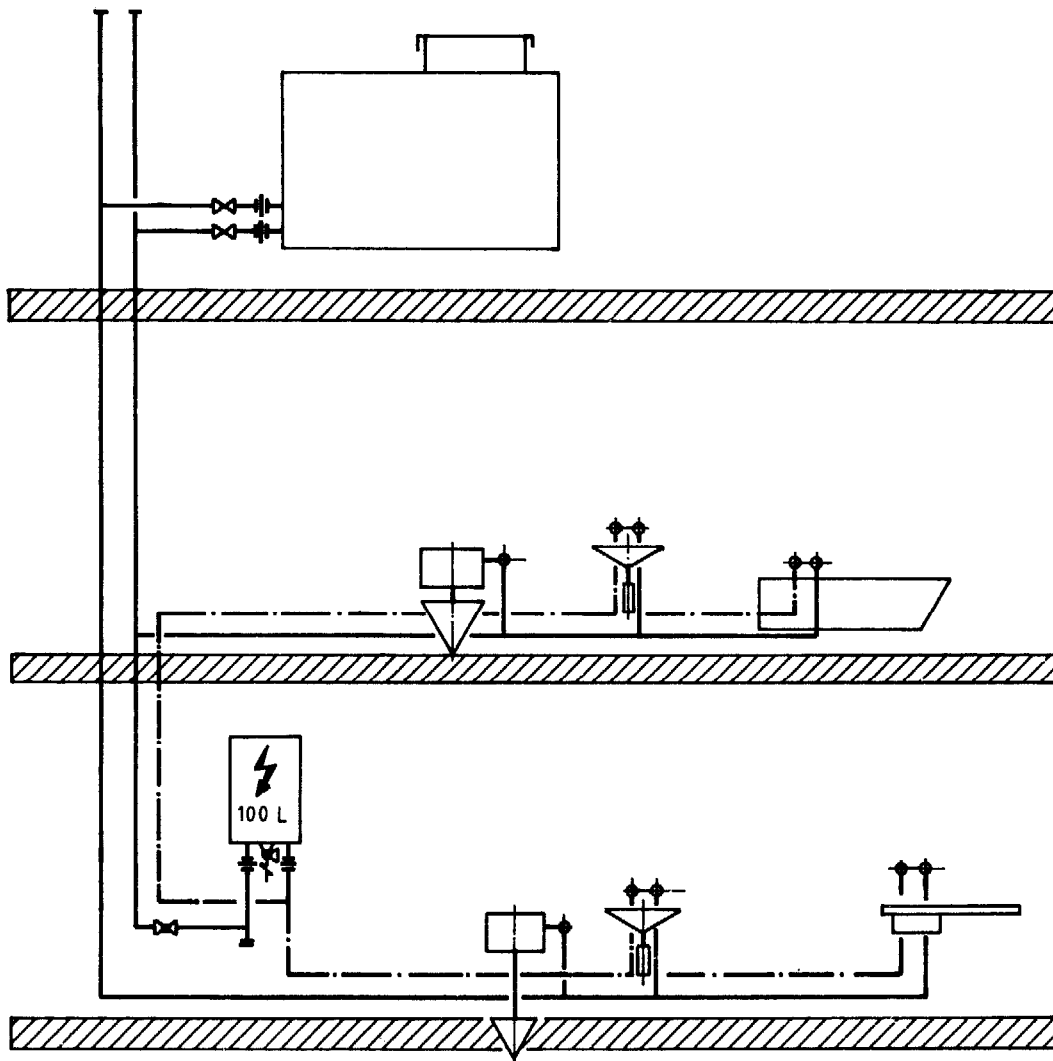

HOTWATER SUPPLY

TABLE 1/19

EXAMPLE No. 2: LARGE ONE FAMILY HOUSE
 SEPARATE FEED LINE TO HOT WATER TANK
 (= NO NON-RETURN VALVE)
 DIVIDED CONNECTIONS FROM HOTWATER TANK TO TAPS
 FOR SPEEDY AND ECONOMICAL HOTWATER SUPPLY.

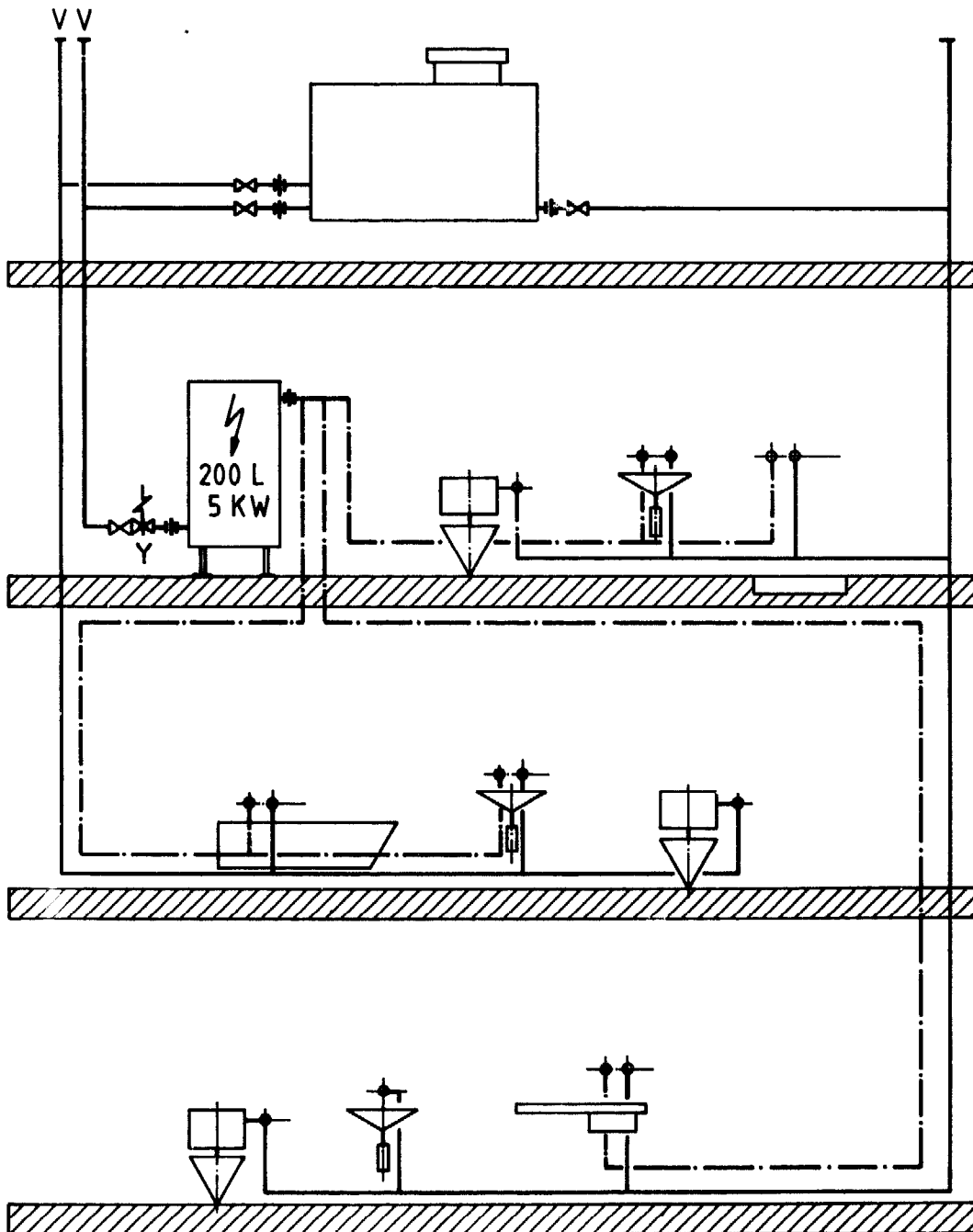

HOTWATER SUPPLY

TABLE 1/20

EXAMPLE No 3: TWO FLAT HOUSE, WITH SEPARATE HOTWATER TANK
WITH SEPARATE FEED LINES TO HOT TANK (= NO NON-RETURN VALVE)

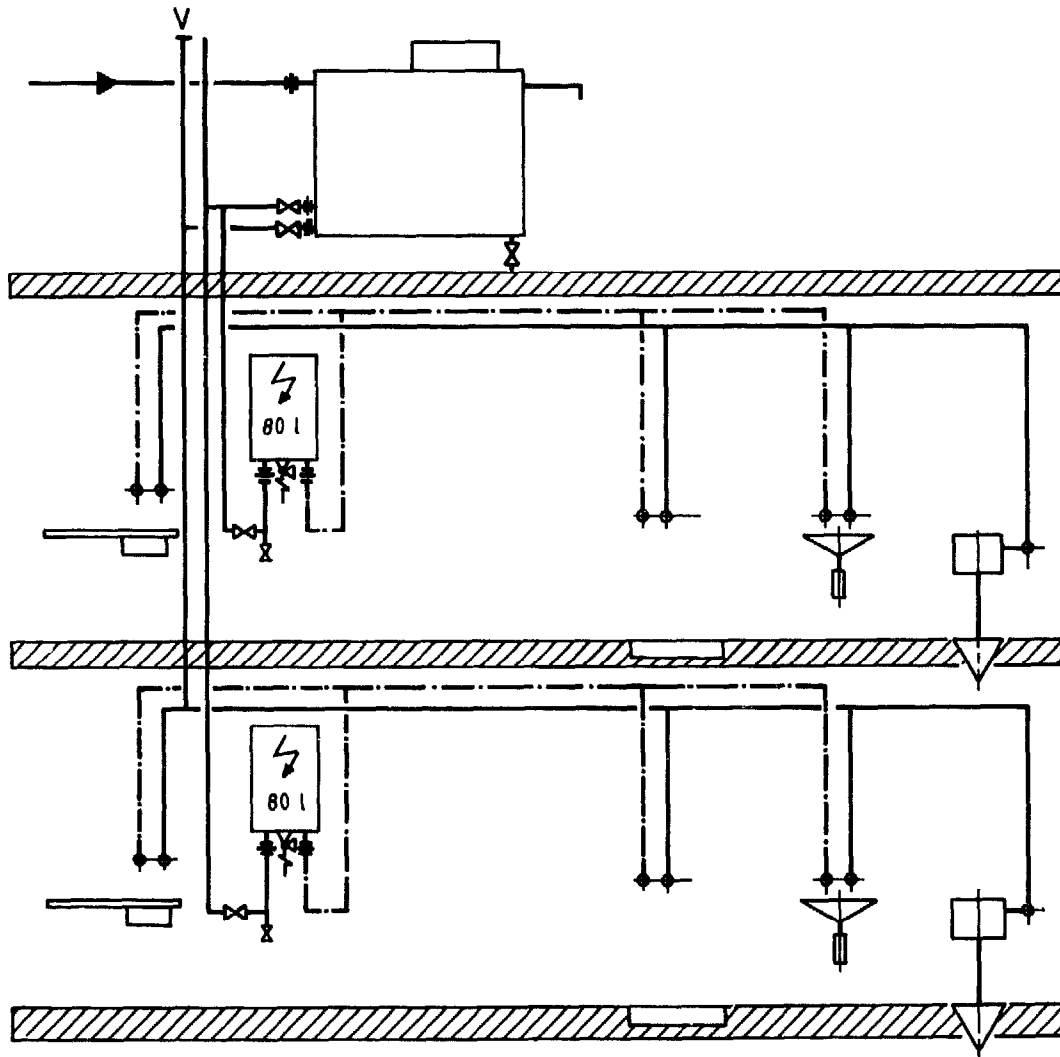

HOTWATER SUPPLY

TABLE 1/21

EXAMPLE No 4: MULTISTORY BUILDING
WITH SEPARATE FEED LINES TO HOTWATER TANKS
EACH HOTWATER TANK HAVING 1 VALVE, 1 NON-RETURN VALVE
AND 1 SAFETY VALVE.

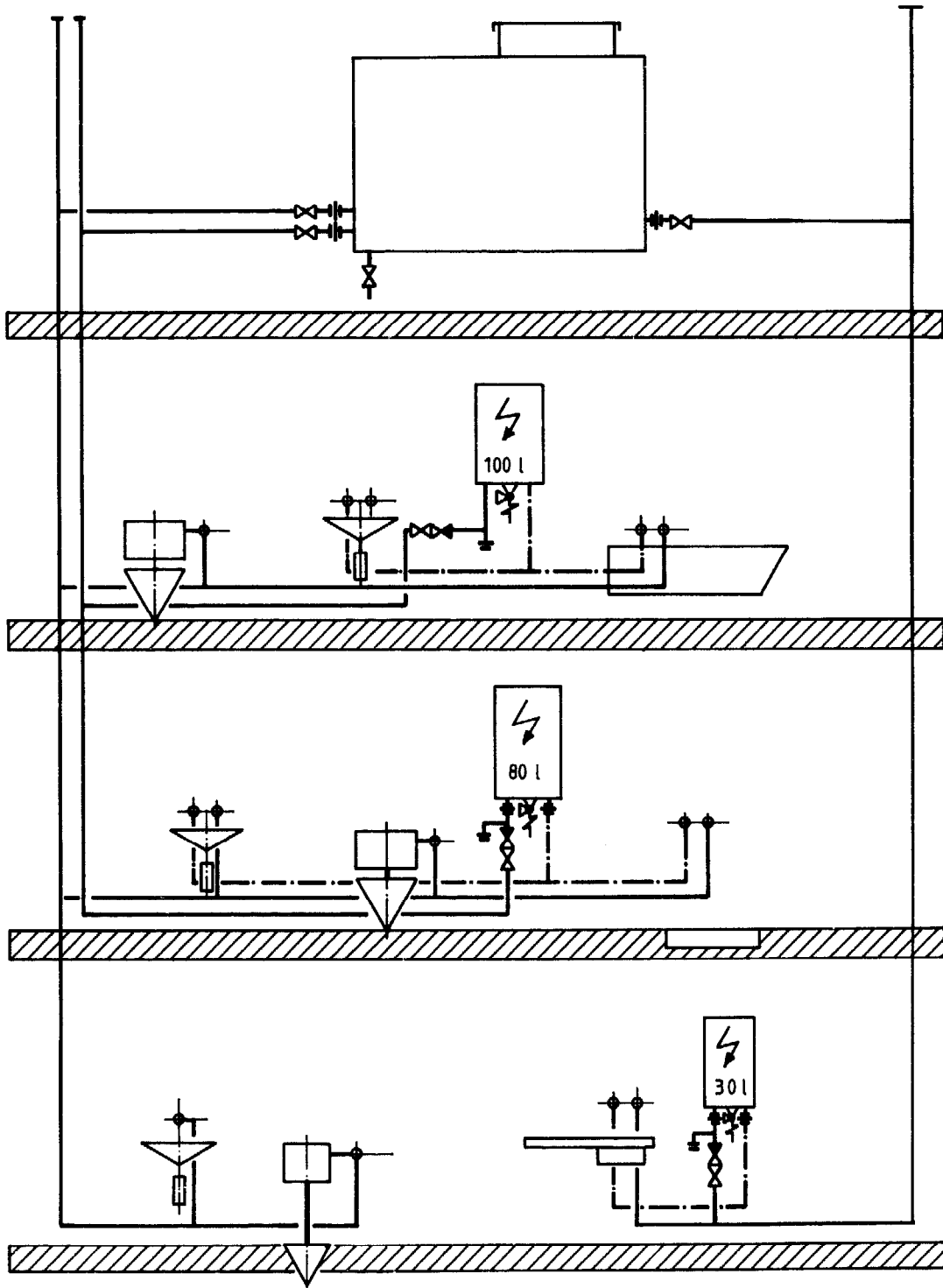

SOLAR WATER HEATER INSTALLATION**TABLE 1/23**

INSTALLATION EXAMPLE No 1: ROOF TANK, WITH SEPARATE COLDWATER PIPELINE TO THE SWH-SYSTEM, WITHOUT REQUIREMENT OF SPECIAL VALVES

CIRCULATION SYSTEM
(WITH HEAT STORAGE)

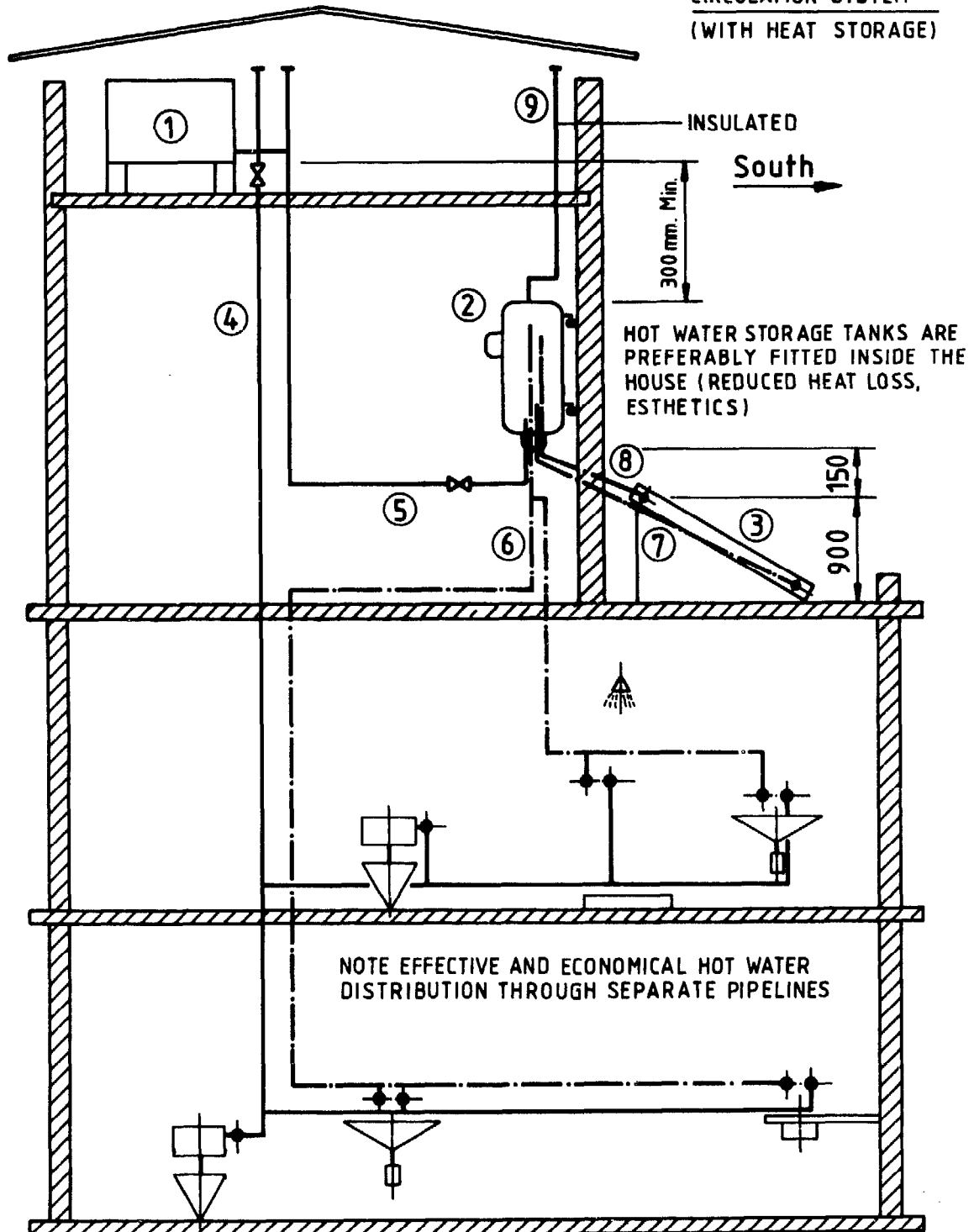

- 1 COLDWATER STORAGE TANK
- 2 HOTWATER STORAGE TANK
- 3 COLLECTOR
- 4 COLDWATER PIPELINE
- 5 COLDWATER TO HOT TANK

- 6 HOTWATER TO THE TAPS
- 7 CIRCULATION PIPE TO COLLECTOR
- 8 CIRCULATION PIPE TO HOT TANK
- 9 VENT PIPE

SOLAR WATER HEATER INSTALLATION**TABLE 1/24**

INSTALLATION EXAMPLE No 2: ROOF TANK WITH BRANCH IN MAIN COLDWATER PIPELINE CONNECTING THE SWH-SYSTEM
REQUIRES: 1 NON-RETURN VALVE

CIRCULATION SYSTEM
(WITH HEAT STORAGE)

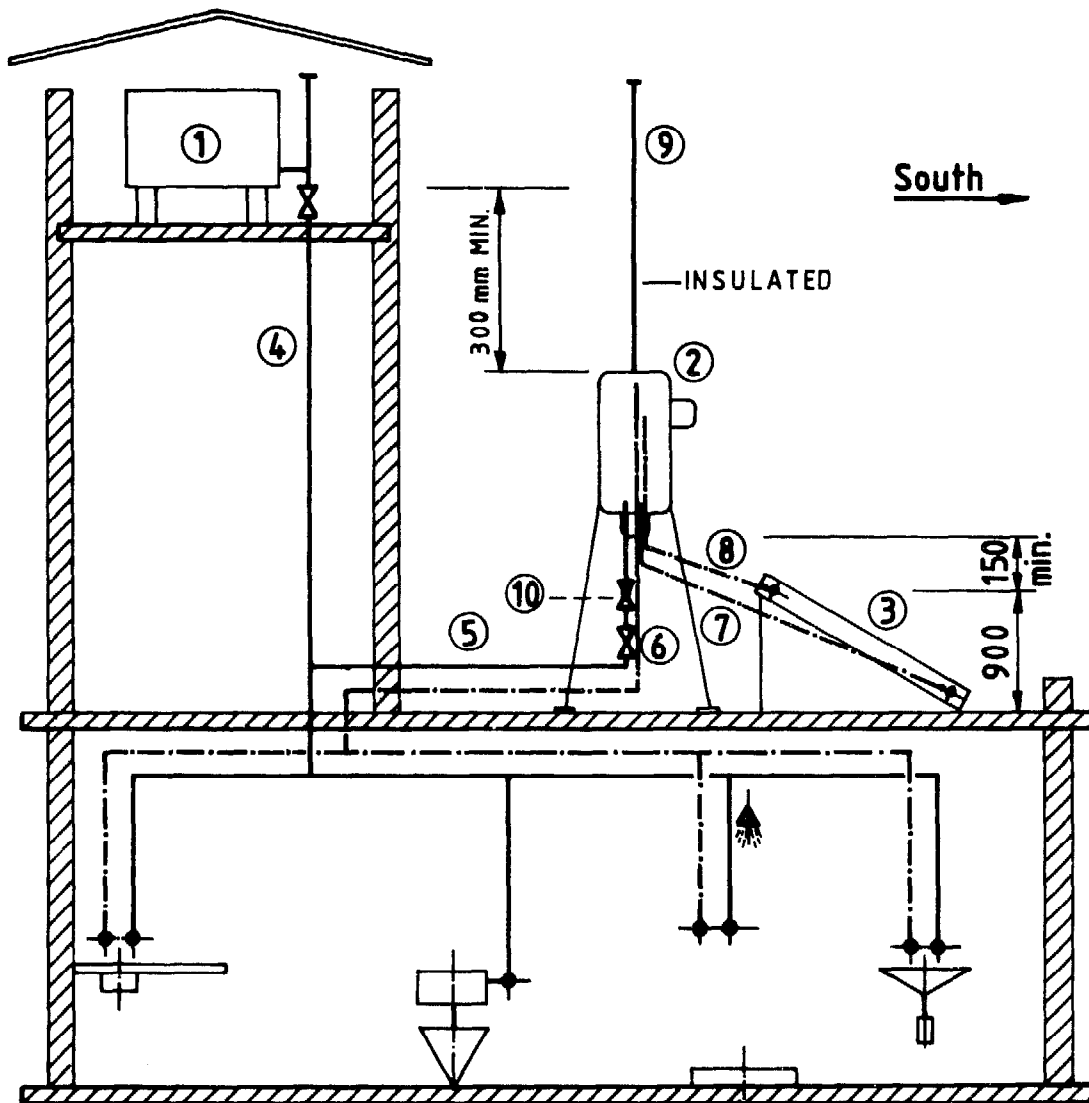

- 1 COLDWATER STORAGE TANK
- 2 HOTWATER STORAGE TANK
- 3 COLLECTOR
- 4 COLDWATER PIPELINE
- 5 COLDWATER TO HOT TANK

- 6 HOTWATER TO THE TAPS
- 7 CIRCULATION PIPE TO COLLECTOR
- 8 CIRCULATION PIPE TO HOT TANK
- 9 VENT PIPE, INSULATED
- 10 CHECK (NON RETURN VALVE)

Note: A book "solar water heaters in Nepal-manufacturing and installation" with relevant information, was prepared through the same publishers.

SOLAR WATER HEATER INSTALLATION**TABLE 1/25**

INSTALLATION EXAMPLE NO 3: TOWN SUPPLY (24 HOURS/DAY) WITH LOW-PRESSURE CONDITION

REQUIRES: 1 NON-RETURN AND 1 SAFETY VALVE

**CIRCULATION SYSTEM
(WITH HEAT STORAGE)**

South →

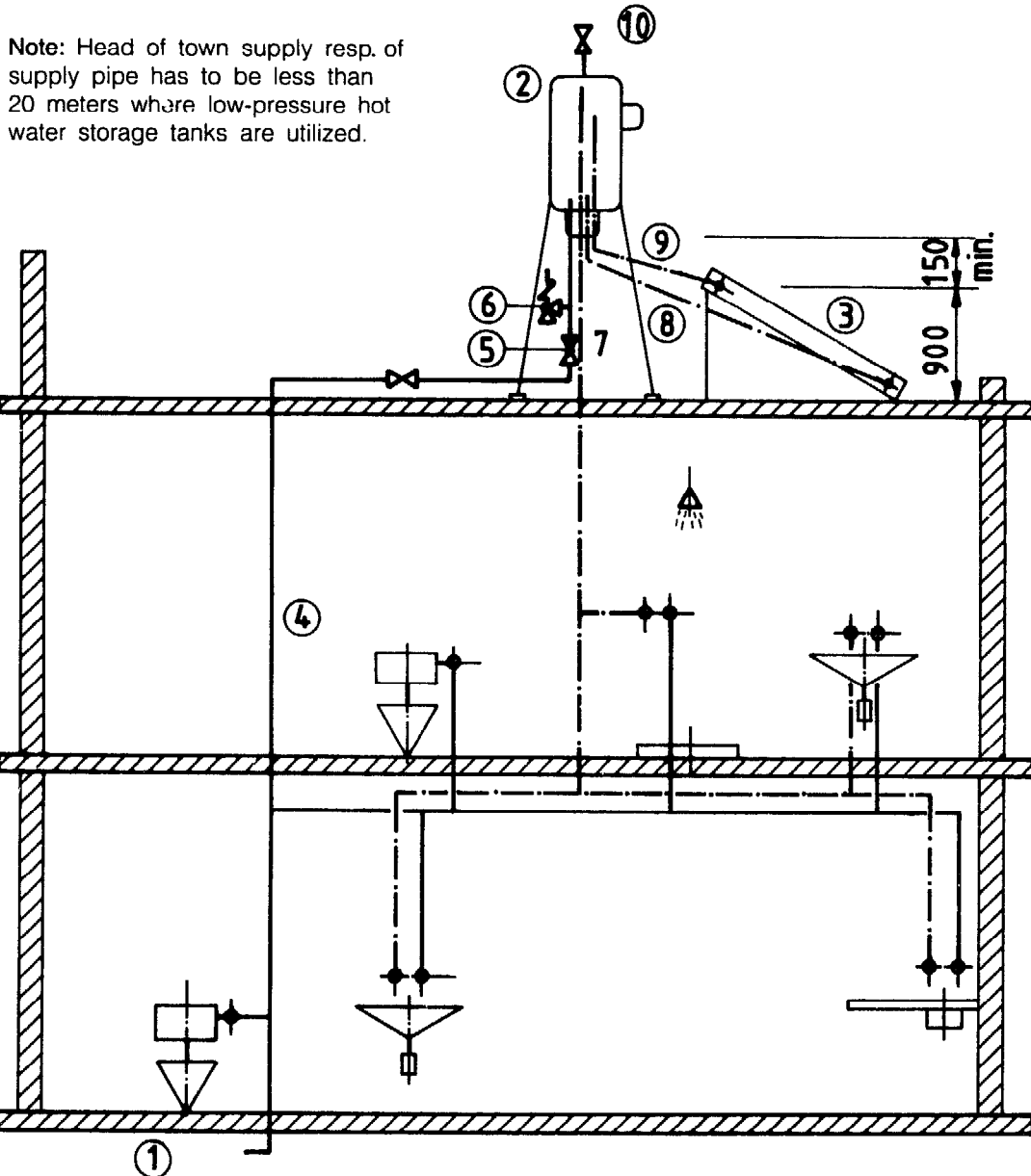

- 1 COLDWATER, TOWNSUPPLY
- 2 HOTWATER STORAGE TANK
- 3 COLLECTOR
- 4 COLDWATER TO HOT TANK
- 5 CHECK (NON-RETURN VALVE)

- 6 SAFETY VALVE
- 7 HOTWATER TO THE TAPS
- 8 CIRCULATION PIPE TO COLLECTOR
- 9 CIRCULATION PIPE TO HOT TANK
- 10 AIR VALVE

SOLAR WATER HEATER INSTALLATION

TABLE 1/26

INSTALLATION EXAMPLE NO 4: OPEN HOTWATER OUTLET SIMPLE AND LOW-COST INSTALLATION, BUT FOR ONE (OR TWO) HOTWATER OUTLETS ONLY.

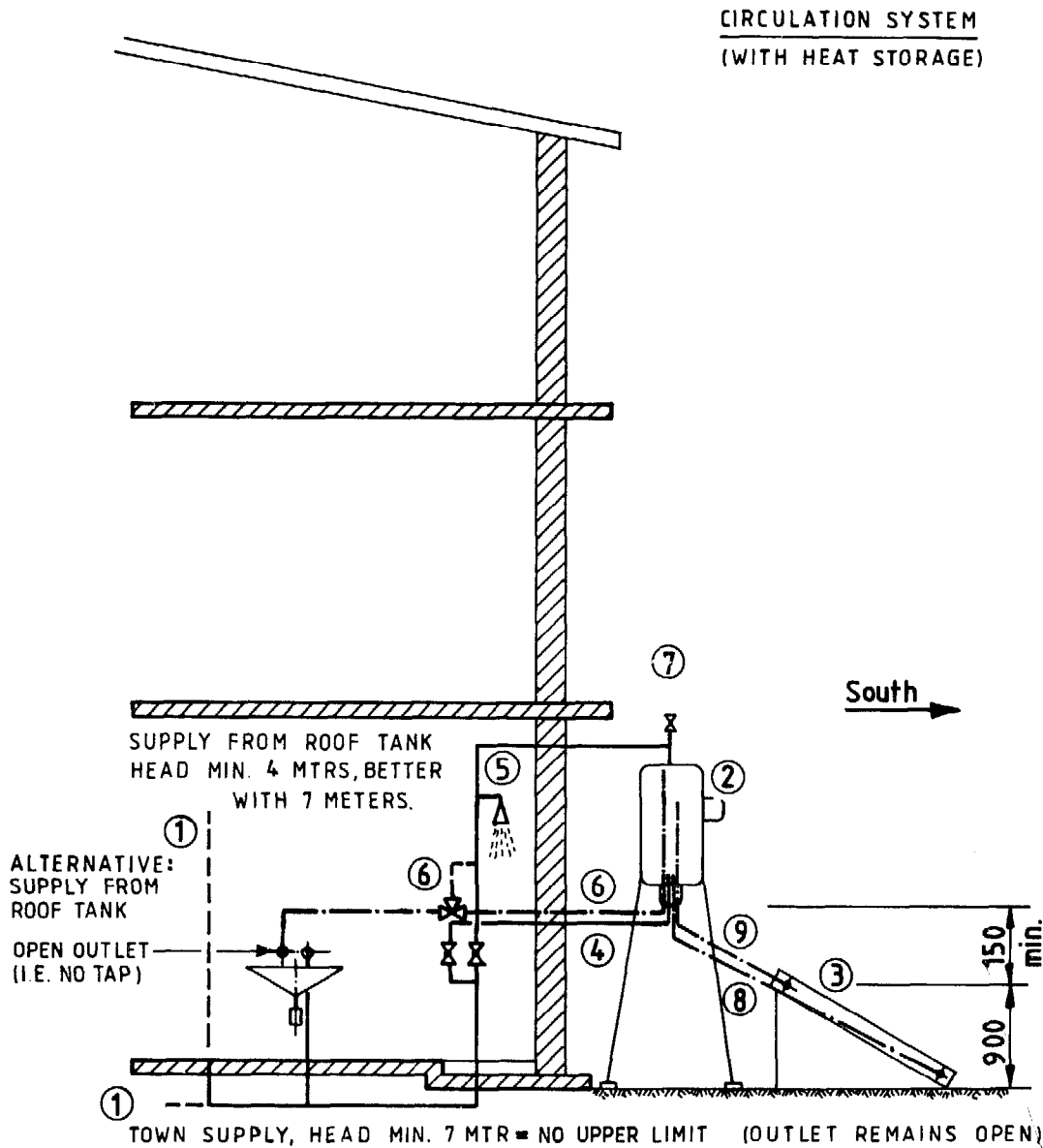

- 1 COLDWATER SUPPLY
- 2 HOTWATER STORAGE TANK
- 3 COLLECTOR
- 4 COLDWATER TO HOT TANK
- 5 HOTWATER TO SHOWER

- 6 TWO-WAY VALVE, IF FOR TWO HOTWATER OUTLETS
- 7 EVENTUALLY: AIR VALVE
- 8 CIRCULATION PIPE TO COLLECTOR
- 9 CIRCULATION PIPE TO HOT TANK

Note: For hotwater on shower only: Install pipe No 5, but not pipe No 6 and without a 2-way valve/for double use, i.e. shower or washbasin install pipe No 6 incl. 2-way valve, but not pipe No 5.

SOLAR WATER HEATER INSTALLATION**TABLE 1/27**

INSTALLATION EXAMPLE NO 5: ROOF TANK, WITH SEPARATE COLDWATER PIPE TO THE FLAT TANK COLLECTOR, REQUIRES NO SPECIAL VALVES.

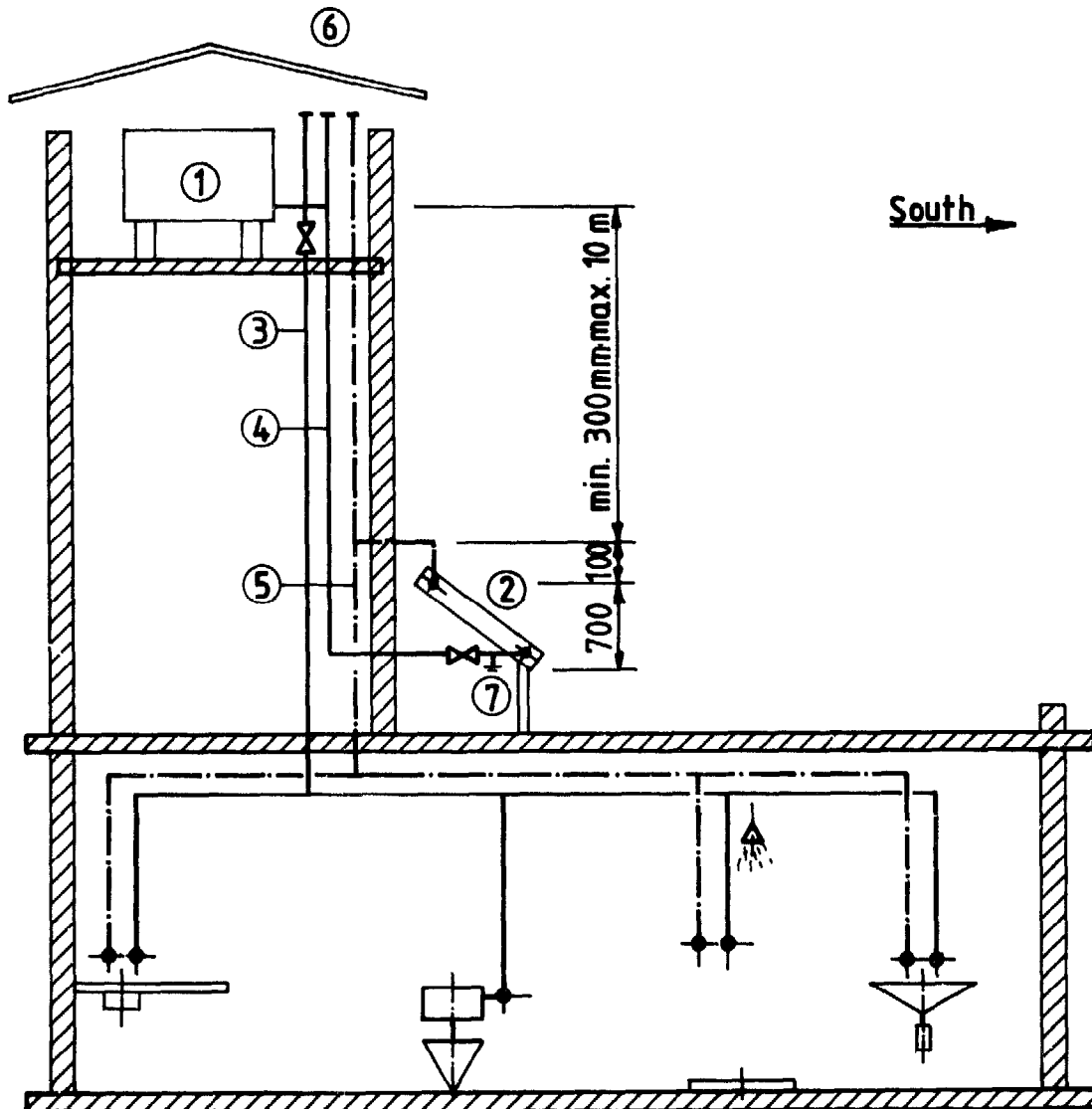
FLAT TANK COLLECTOR

1 COLDWATER STORAGE TANK
2 FLAT TANK COLLECTOR
3 COLDWATER PIPELINE

4 COLDWATER TO FLAT TANK COLLECTOR
5 HOTWATER TO THE TAPS
6 VENT PIPE
7 DRAIN (TEE WITH PLUG OR VALVE)

SOLAR WATER HEATER INSTALLATION

TABLE 1/28

INSTALLATION EXAMPLE NO 6: ROOF TANK WITH BRANCH IN THE MAIN COLDWATER PIPE TO THE FLAT TANK COLLECTOR
REQUIRES: 1 NON-RETURN VALVE

FLAT TANK COLLECTOR

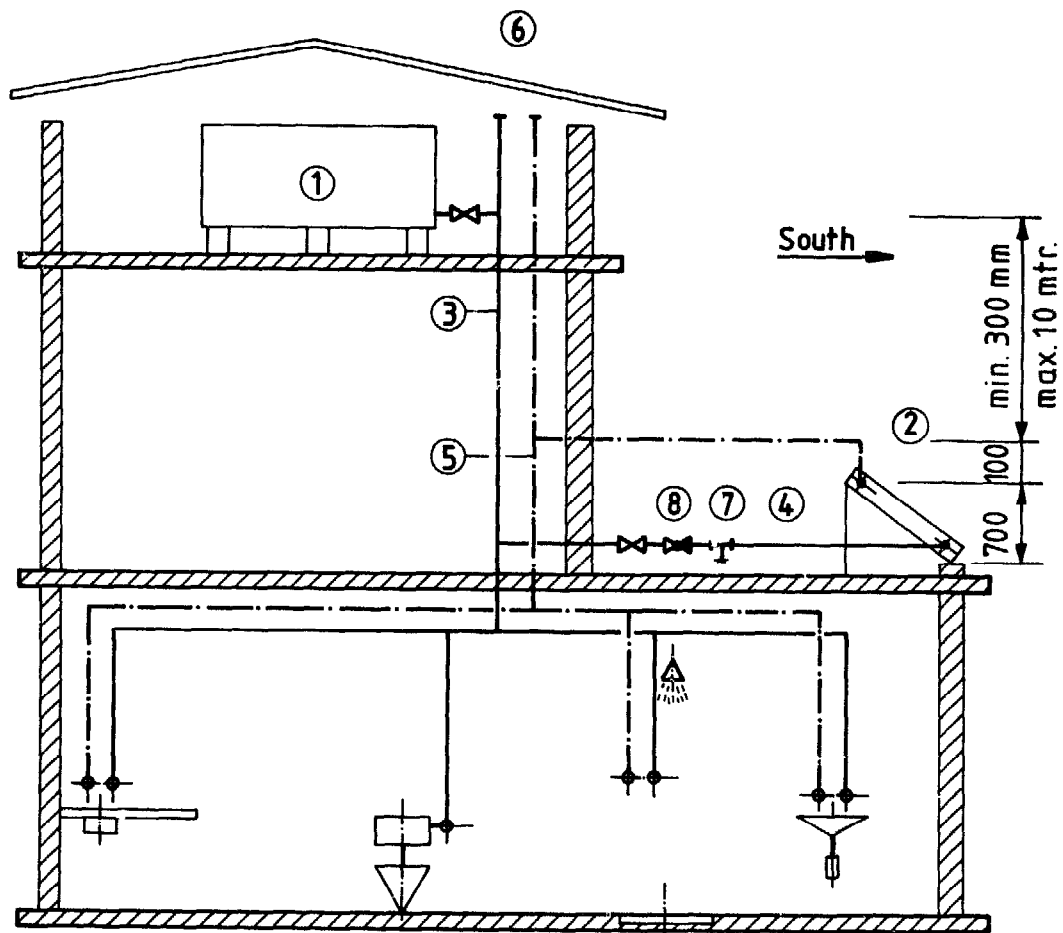

- 1 COLDWATER STORAGE TANK
- 2 FLAT TANK COLLECTOR
- 3 COLDWATER PIPE
- 4 COLDWATER TO FLAT TANK

- 5 HOTWATER TO THE TAPS
- 6 VENT PIPES
- 7 DRAIN TEE WITH PLUG OR VALVE
- 8 CHECK (NON-RETURN VALVE)

SOLAR WATER HEATER INSTALLATION**TABLE 1/29**

INSTALLATION EXAMPLE NO 7: PREHEATER TO ELECTRIC HOT WATER TANK, INCREASES THE HOTWATER CAPACITY, REDUCES ELECTRICITY CONSUMPTION

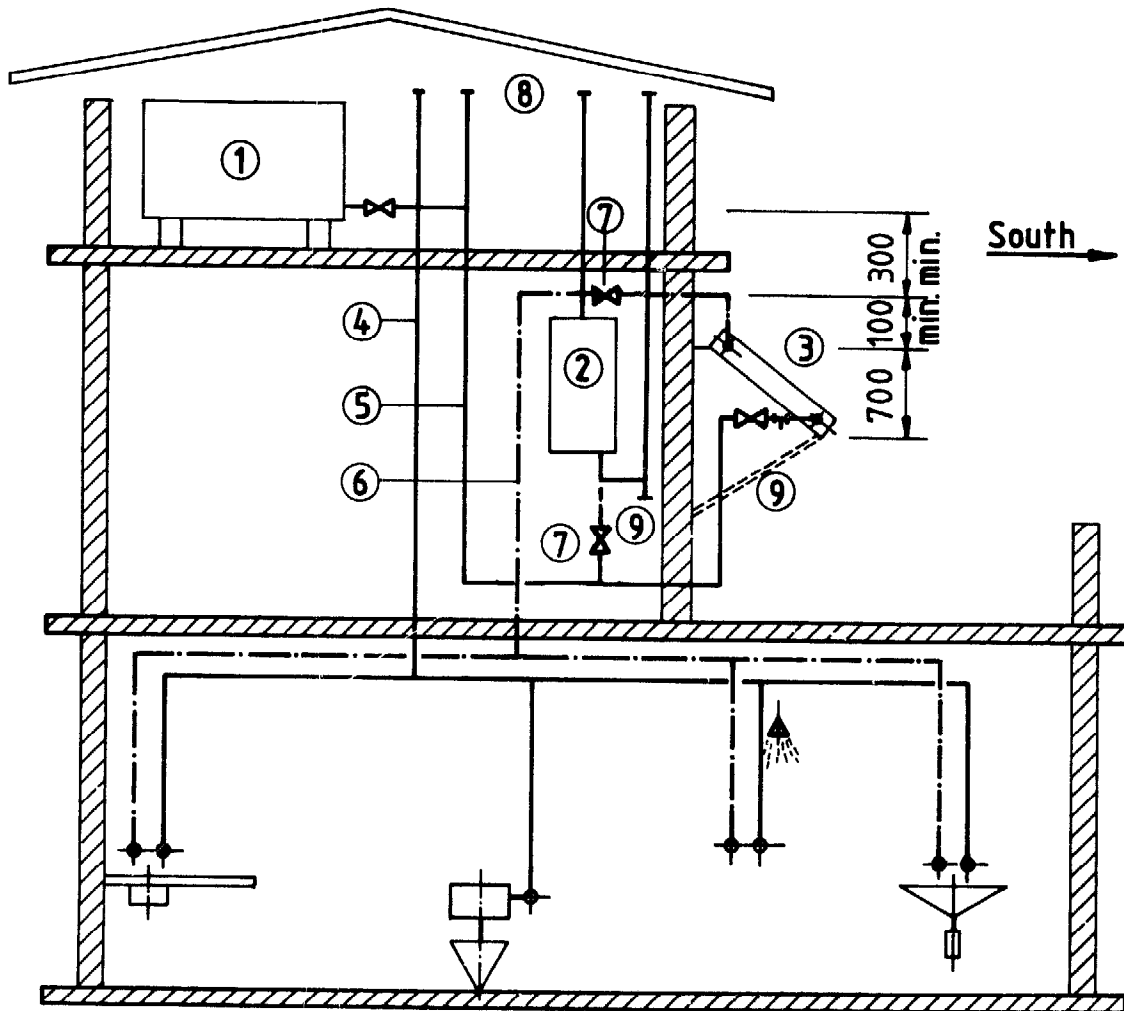
FLAT TANK COLLECTOR

- 1 COLDWATER STORAGE TANK
- 2 ELECTRO-OR GAS HOT TANK
- 3 FLAT TANK COLLECTOR
- 4 COLDWATER PIPE
- 5 COLDWATER PIPE TO FLAT TANK COLLECTOR (AND TO ELECTRO-OR GAS HOT TANK)

- 6 HOTWATER TO THE TAPS
- 7 BYPASSES (TO ENABLE DIRECT USE OF ELECTRO HOT TANK ONLY)
- 8 VENT PIPES
- 9 DRAIN (TEE WITH PLUG OR VALVE)

DIMENSIONING, EXAMPLES

TABLE 1/30

LOW PRESSURE (ROOF TANK)

DIMENSIONS ACCORDING UNITS, TABLE A

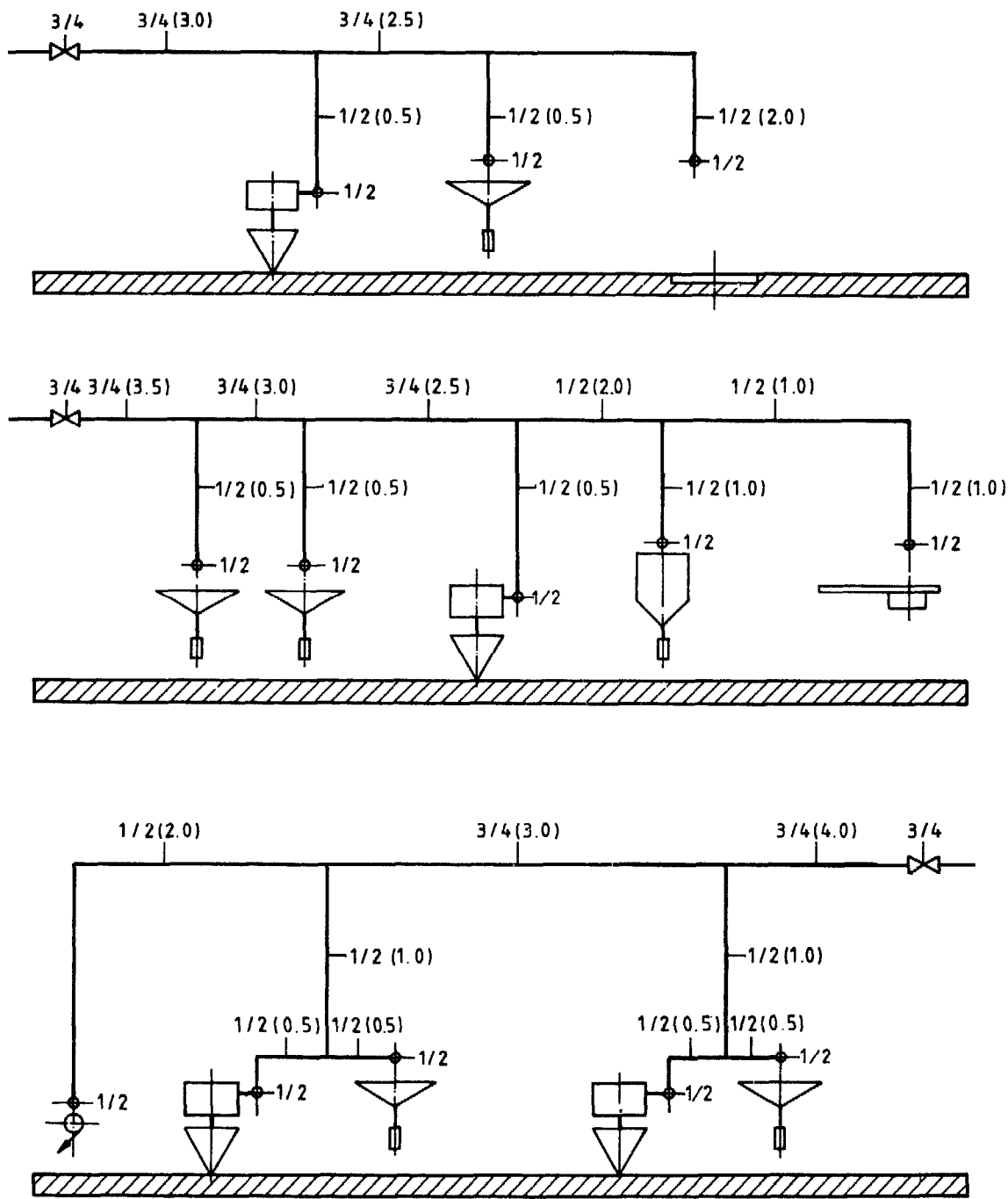

DIMENSIONING, EXAMPLE

TABLE 1/31

LOW PRESSURE (ROOF TANK)

DIMENSIONING ACCORDING UNITS, TABLE A

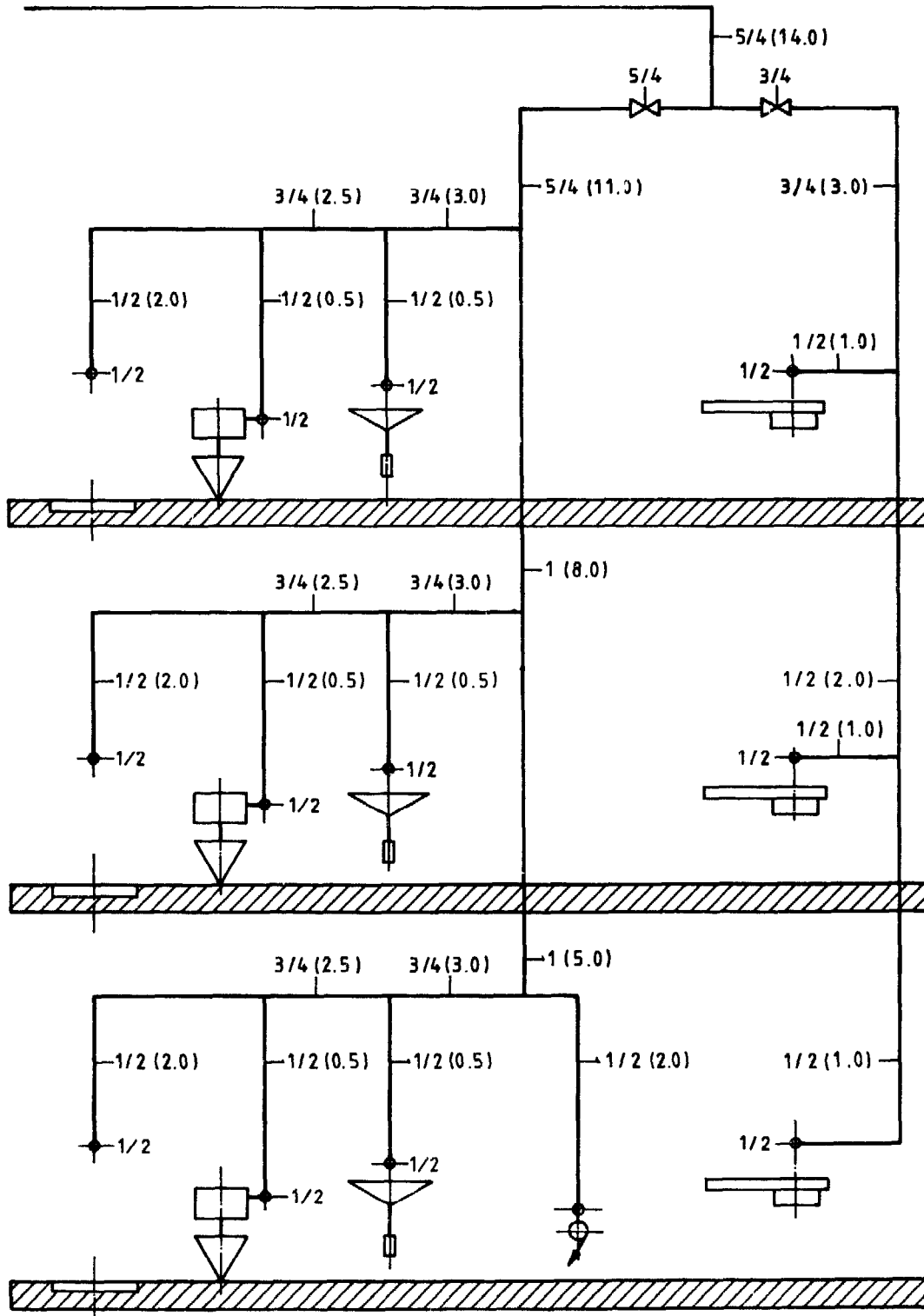

DIMENSIONING, EXAMPLES

TABLE 1/32

LOW PRESSURE (ROOF TANK)

DIMENSIONS ACCORDING UNITS, TABLE A

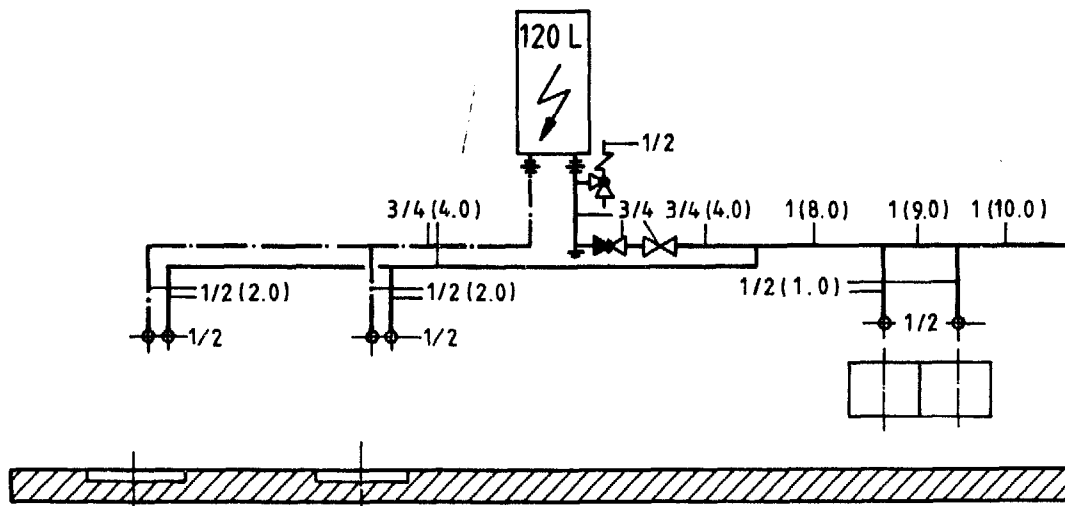
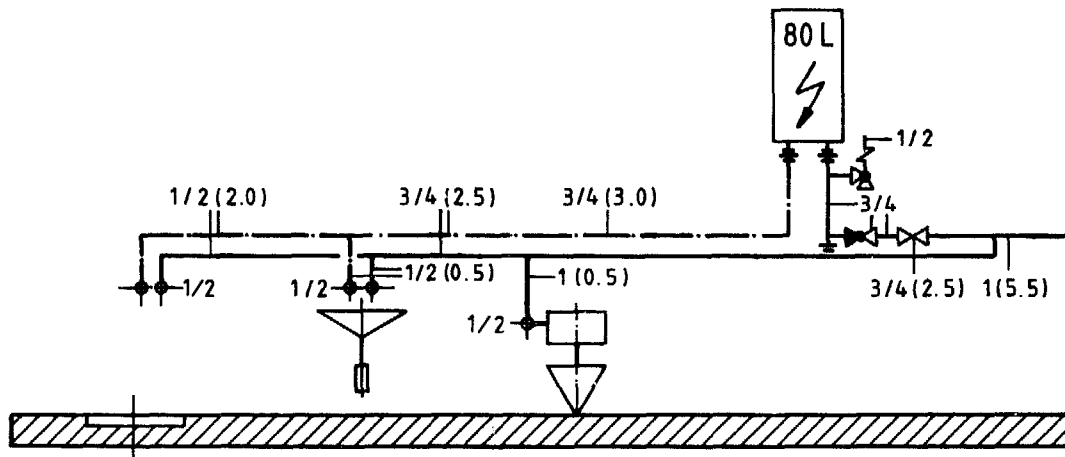
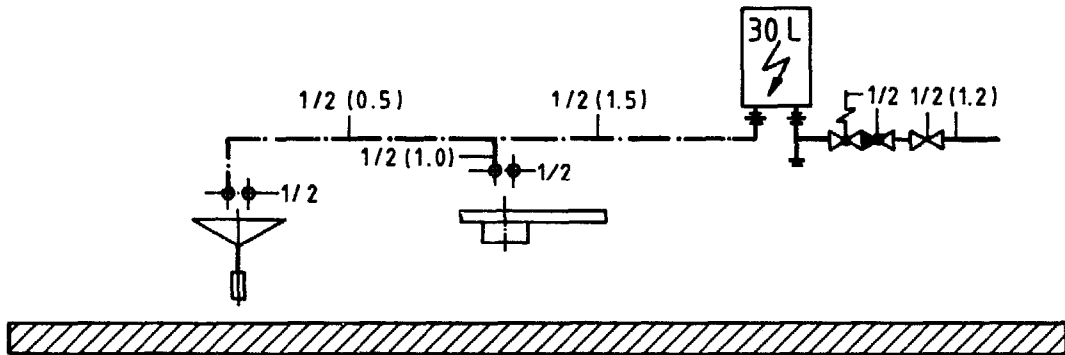

PRESSURE, TOWN SUPPLY

DIMENSIONS ACCORDING UNITS/TABLE B

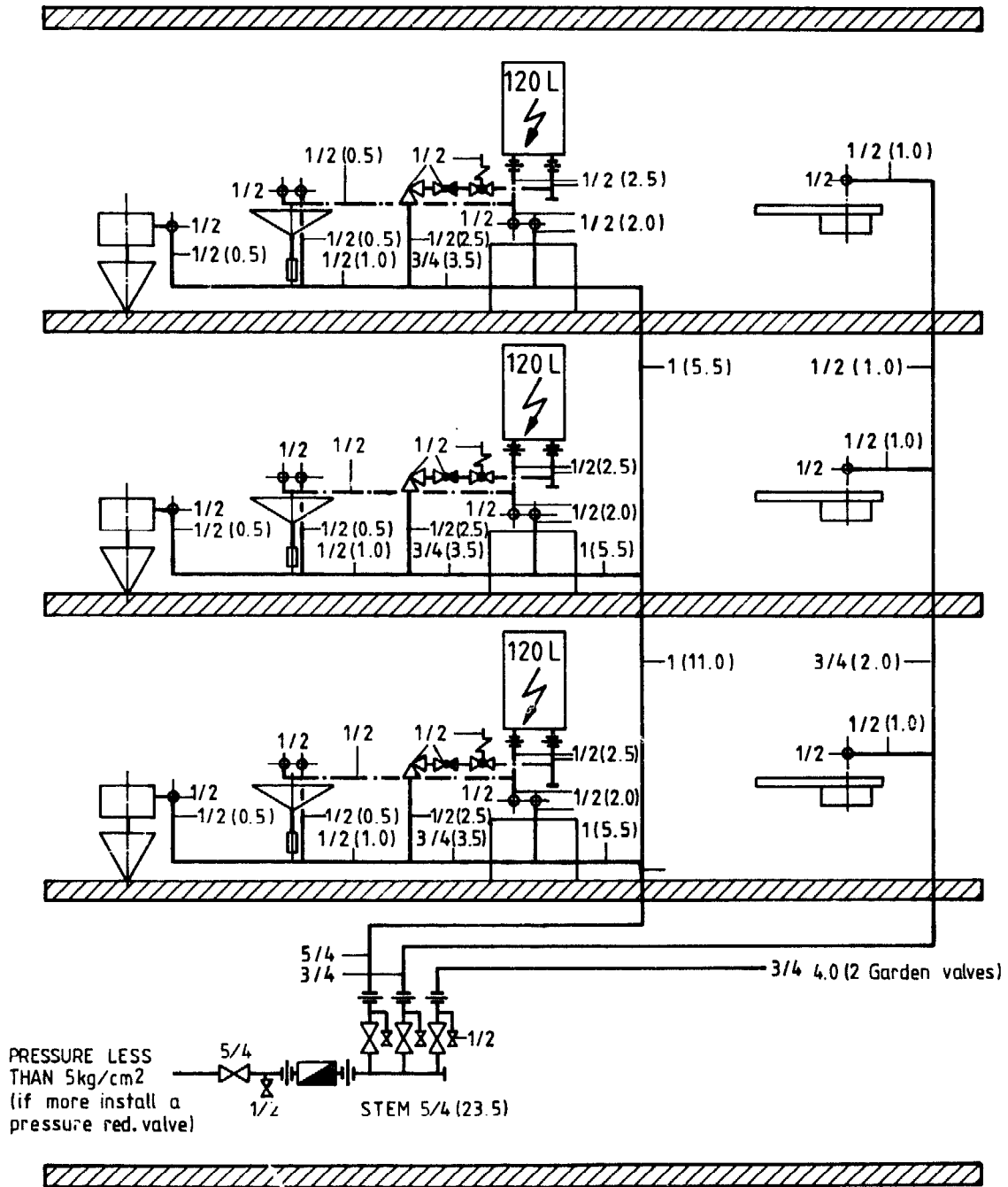

DIMENSIONING, EXAMPLE

TABLE 1/34

PRESSURE, TOWNSUPPLY, ACCORDING UNITS/TABLE B

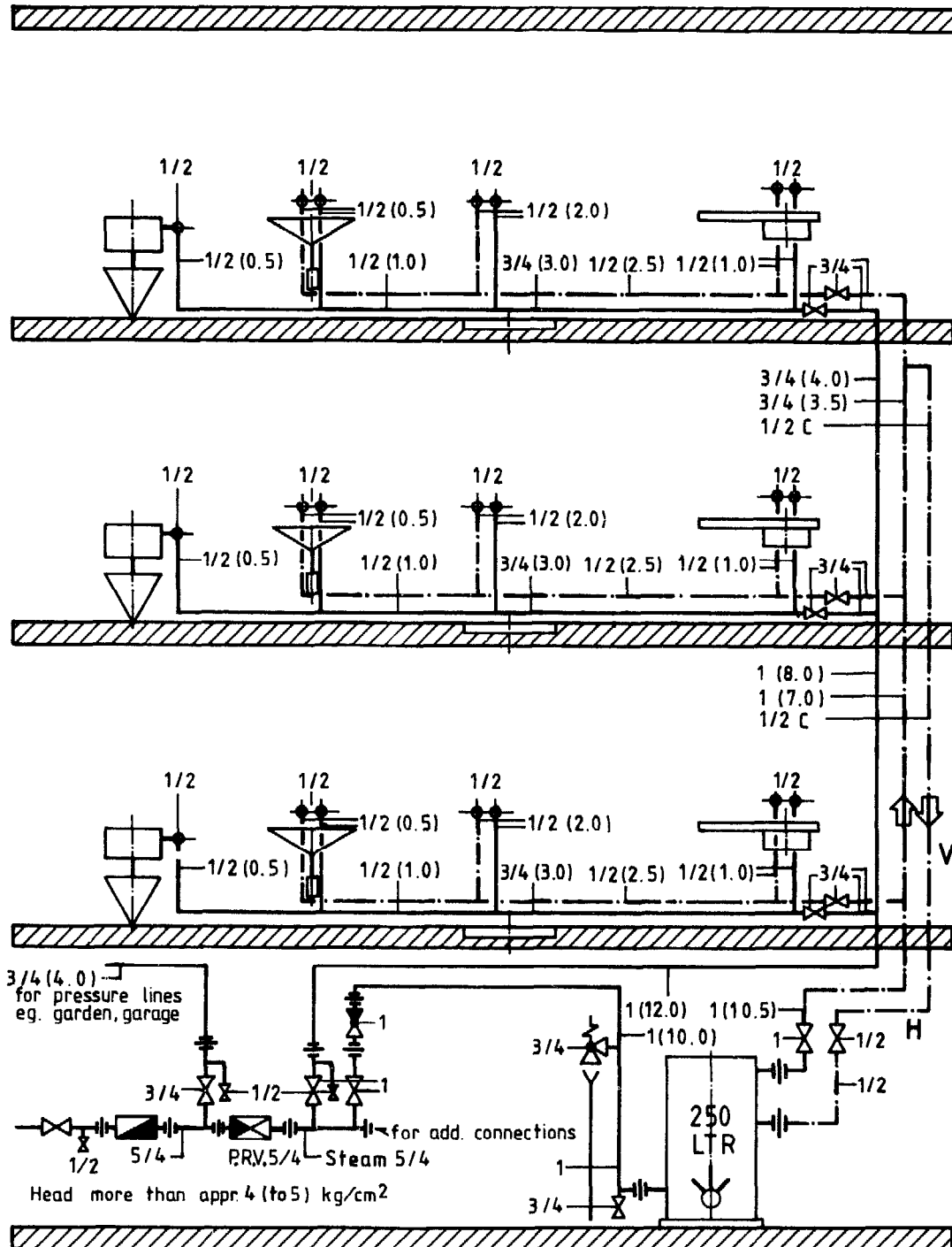

Note: All circulation pipes have to be insulated !

Gravity circulation system (without pump) rule of thumb: The horizontal (H) may not be longer than the vertical length (V). The diameter of the circulation (backflow) pipe to be appr. two dimensions smaller than the forward pipe (but at least 1/2" Ø).

DIMENSION-CALCULATION EXAMPLE

TABLE 1/35

PIPELINE - SCHEME

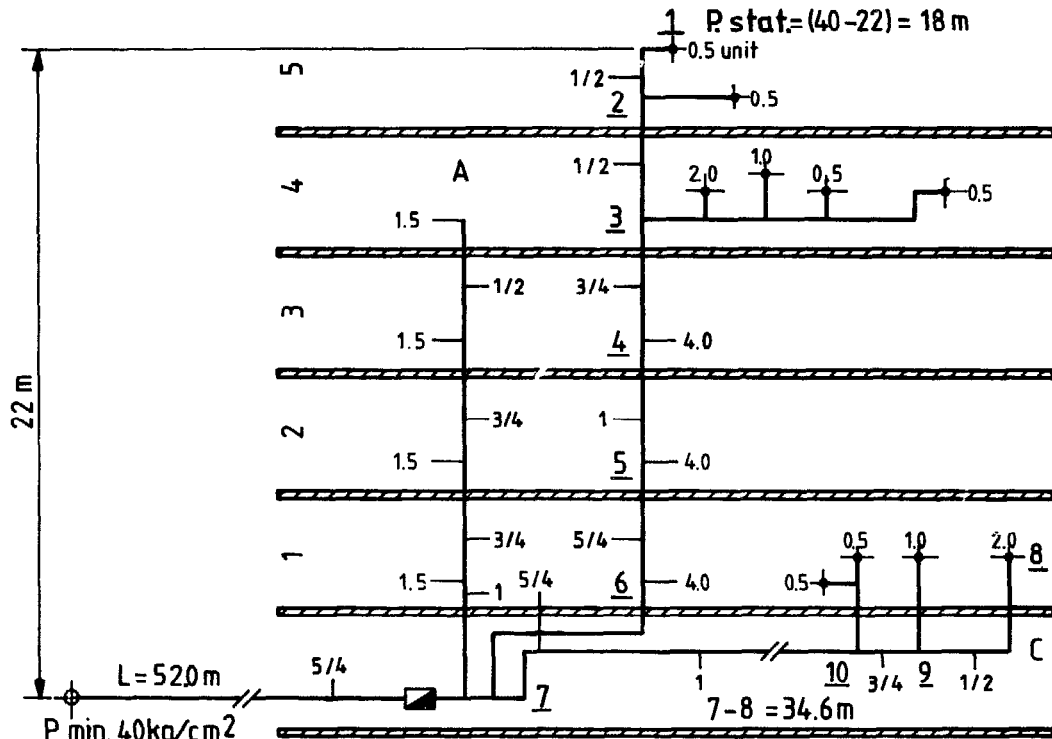

CALCULATION FOR THE LOSS OF HEAD:

pipe	section	units	max. load ltrs/min.	ø inches	length meter	addition %	total length m.	loss of head	
								mm/m	total mm
B	1 - 2	0.5	5	1/2	1.80	100	3.60	25	90
	2 - 3	1.0	10	1/2	3.20	100	6.40	85	544
	3 - 4	5.0	30	3/4	3.00	100	6.00	170	1020
	4 - 5	9.0	38	1"	3.00	100	6.00	80	480
	5 - 6	13.0	44	5/4	3.00	100	6.00	28	168
	6 - 7	17.0	48	5/4	6.80	100	13.60	33	448
	1 - 7				20.80				2750
Water meter connection		27.0	60	1"	-	-	-	-	2650
		27.0	60	5/4	52.00	50	73.00	50	3650
								9050mm	(9.05 m)
C	8 - 9	2.0	20	1/2	2.70	100	5.40	290	1566
	9 - 10	3.0	24	3/4	3.50	100	7.00	120	840
	7 - 10	4.0	27	1"	28.40	70	48.30	47	2270
	7 - 8				34.60				4676
	Water meter connection		27.0	60	1"	-	-	-	-
		27.0	60	5/4	52.00	50	73.00	50	3650
								10976mm	(10.976 m)

DIMENSION-CALCULATION EXAMPLE

Explanations to the example table 1/35

In most cases it will be sufficient to check the dimensions after using the simplified method (unit, dimensioning table)

The calculation-bases are the following:

- a) Lowest dynamic pressure of 0.5 kg/cm² on the highest fixed tap. This pressure is absolutely necessary to guarantee a normal water-flow and to prevent any re-suction from waste-water into the drinking water pipeline.
- b) Highest loss of head of 1.0 kg/cm² in the whole installation (including the feeding-pipeline and the water meter).
- c) Consumption of water according to the probable maximum load in domestic and office buildings (according to table). For industries, fire-hydrants etc. the highest load has to be calculated according to the actual consumption in L/S.
- d) Effective length of the pipelines has to be measured at the building sites or from the plans. The effective length must be increased to include also the losses of head in the fittings.

feeding - lines + appr.	50% (to the effective length).
house-installations appr.	100% (to the effective length).

Example for the control of the measurements from an installation indications:

- Lowest pressure on the connection	40 m	watercolumn
- Height-difference between the connection and the highest-placed tap	22 m	WC
- Static-pressure on the highest tap	18 m	WC
- Length of the connection line	52 m	
- Inside-pipeline according to the scheme		

Calculation of the pipeline 'B'

Make provisional statement of the consumer units and diameter according to the pressure table.

Calculate the loss of head in the separate pipeline-sections 'B', beginning from the water meter and from the connection.

DIMENSION-CALCULATION EXAMPLE

Total loss of head of the installation 9.76 m water-column, that is less than 10 m.

Dynamic-pressure on the highest placed tap 3.24 m, that means more than 5 m.

Final Conclusion: The dimensions according to the easy method are sufficient (unit, dimensioning table).

Calculation of the pipeline 'C'

Length, beginning from the water-meter 34.6 m

To consider this pipe length, there is the adjustment from the section 7-10: The diameter is changed into 1" Ø (instead 3/4"Ø for 4 units).

Calculation for the loss of head in the pipeline 'B'

Total loss of head: 11.99 m, that means 20% more than the admissible loss of head from 10 m. But this difference is tolerable, because the connection is for adjoining rooms, and because pipeline has little influence on the feeding of the main-building.

Water Meter

The produced loss of head in a water meter may determined with diagrams or with a calculation. Therefore take the waterflow with a loss of head 10 m.

Water meter 25 mm \varnothing = 7 m³ h with a loss of head of 10 m. For the waterflow of 60 litre/minute, that means 3.6 m³ h, result in a loss of head in the water meter of:

$$\frac{10 \times 3.6 \times 3.6}{7 \times 7} = 2.65 \text{ m}$$

Connection

For the calculation of the loss of head in the connection pipeline, it may be assumed to take 10% of the net (town-line). An additional charge of 50% on the length of the pipeline will be sufficient, to consider the armatures and other special pieces. That is because they will be less numerous than the inside installations.

Assumable loss of head 10/%	=	4 m
Calculated loss of head	=	3.65 m

Also in this case the easy method is sufficient to determine the diameter, even when the connection-line is longer than 30 m.

GUIDING PRINCIPLES FOR WATER REQUIREMENTS

TABLE 1/36

Purpose	Unit		Requirement		
	Consumer/Time		Min.	Medium	max.
Domestic Purposes: drinking, cooking, cleaning laundry (washing) bathing, douche WC-cistern, flush cleaning of a car	person	day	50	80	120
	person	day	10	20	40
	person	day	50	100	180
	person	day	40	50	60
	car		150	250	400
Domestic Buildings: modest conditions medium comfort higher standard	inhabitant	day	100	150	200
	inhabitant	day	150	200	300
	inhabitant	day	250	400	600
Public: schools hospitals bathing establishment restaurants (for meals) barracks (army) covered market slaughter houses slaughter houses wash institution open yard (grass field) road sprinklers car workshop bakery (bread) hair-dresser photo-studio administration-building	student	day	10	12	15
	patient	day	300	450	600
	500 - 600 bath		500	550	600
	guest	day	60	100	150
	man	day	50	100	150
	m ²	day	3	4	5
	cattle/big		400	450	500
	livestock, small		300	350	400
	kg (dry wash)		50	60	70
	m ² surface		1	1.5	2
	m ² surface		1	1.25	1.5
	employee	day	30	40	50
	employee	day	120	130	140
	employee	day	160	170	180
	employee	day	280	300	320
	employee	day	30	40	50
Industries: brewery (without cooling) (with cooling) dairy paper factory	100 ltr. beer		600	700	800
	100 ltr. beer		1400	1700	2000
	100 ltr. milk		400	500	600
	kg, fine paper		1500	2200	3000
Farming Purposes: horses cows young cattle pig sheep goats	1 pc.	day	60	70	80
	1 pc.	day	60	65	70
	1 pc.	day	40	45	50
	1 pc.	day	15	20	25
	1 pc.	day	5	6	7
* According international standards					

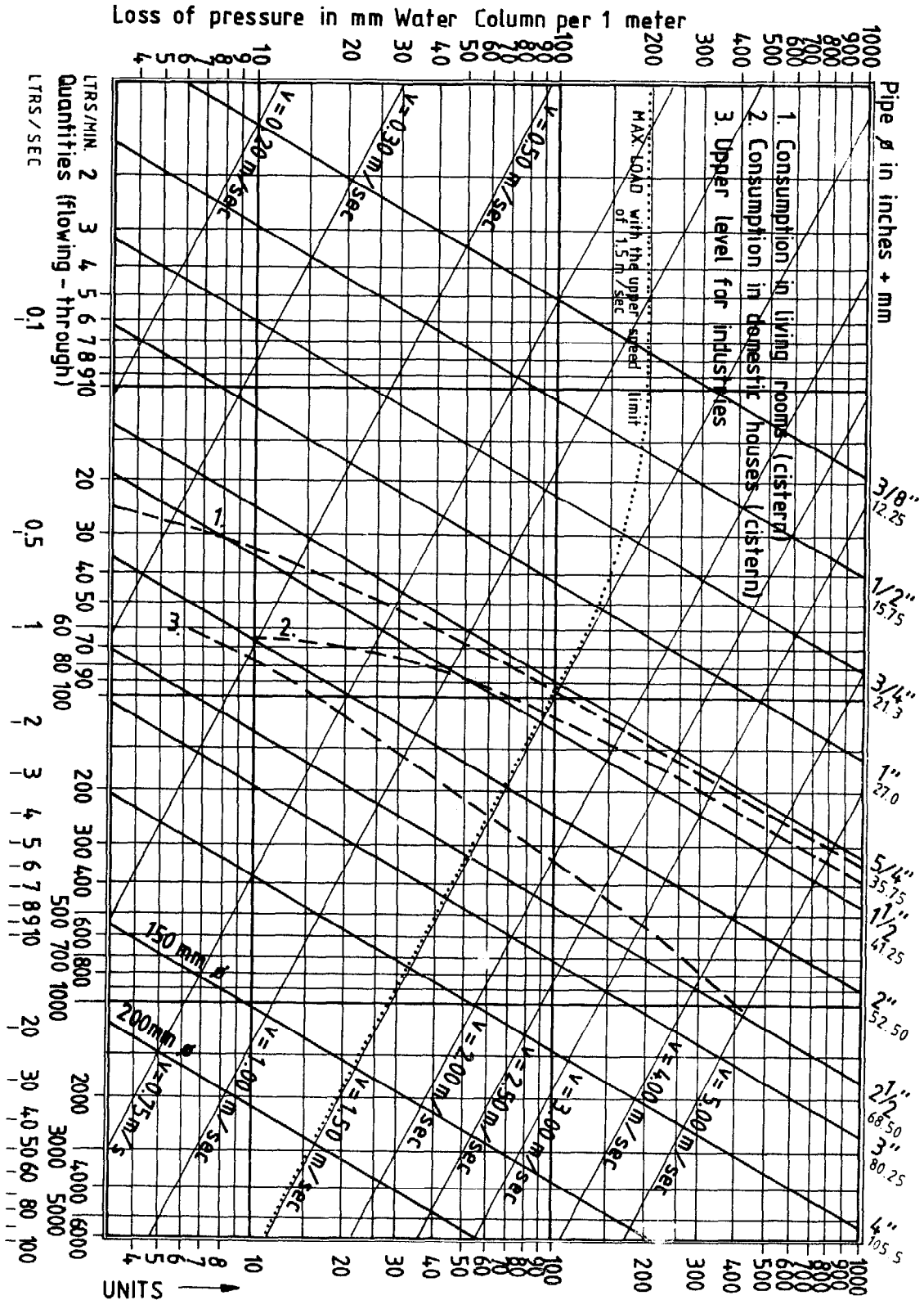

LOSS OF HEAD - CHART

TABLE 1/38

LOSS OF HEAD IN POLYETHYLENE PIPES (WATER AT 10°C)

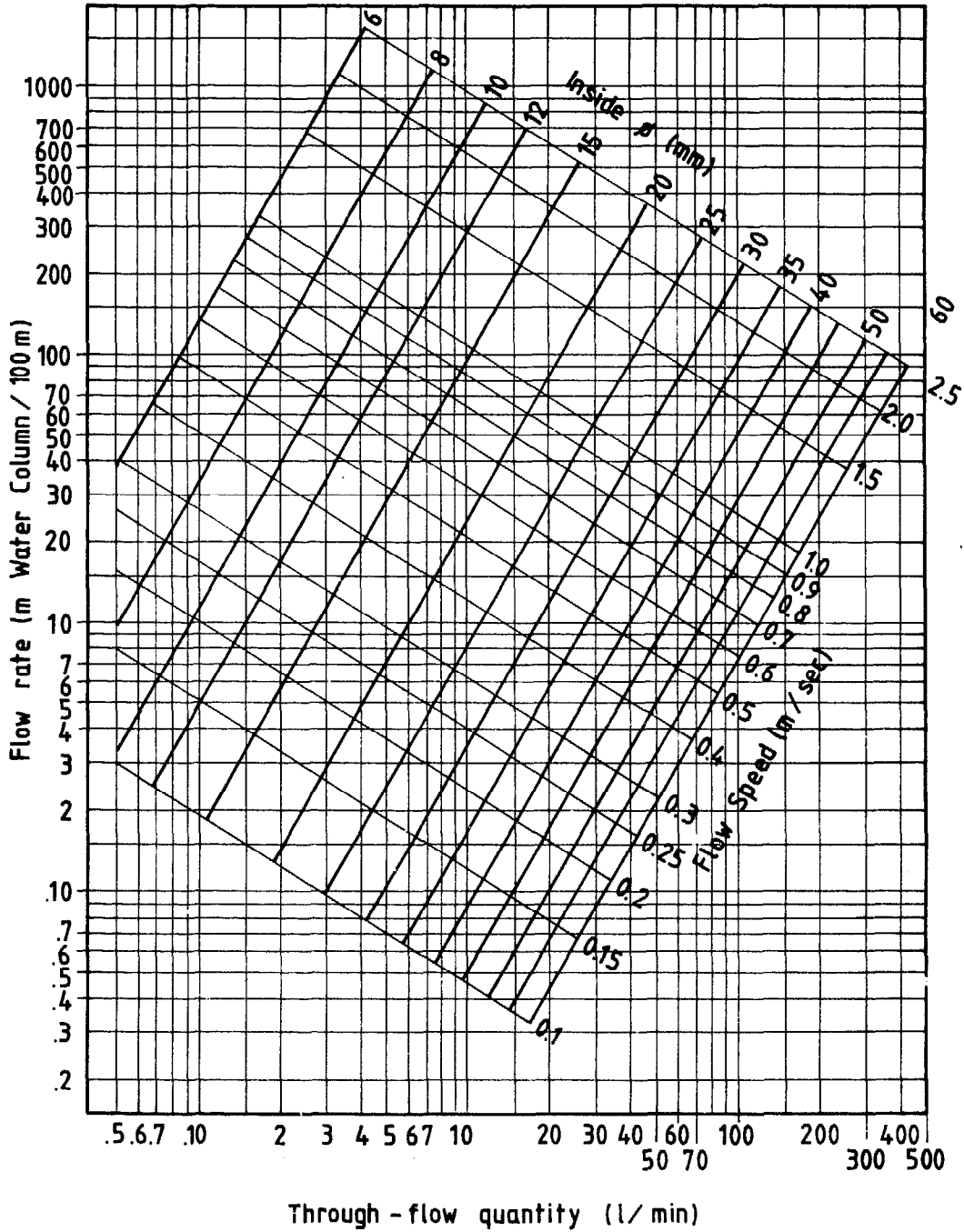

MAXIMUM LOAD CHART - UNITS INTO LTR/MIN

TABLE 1/39

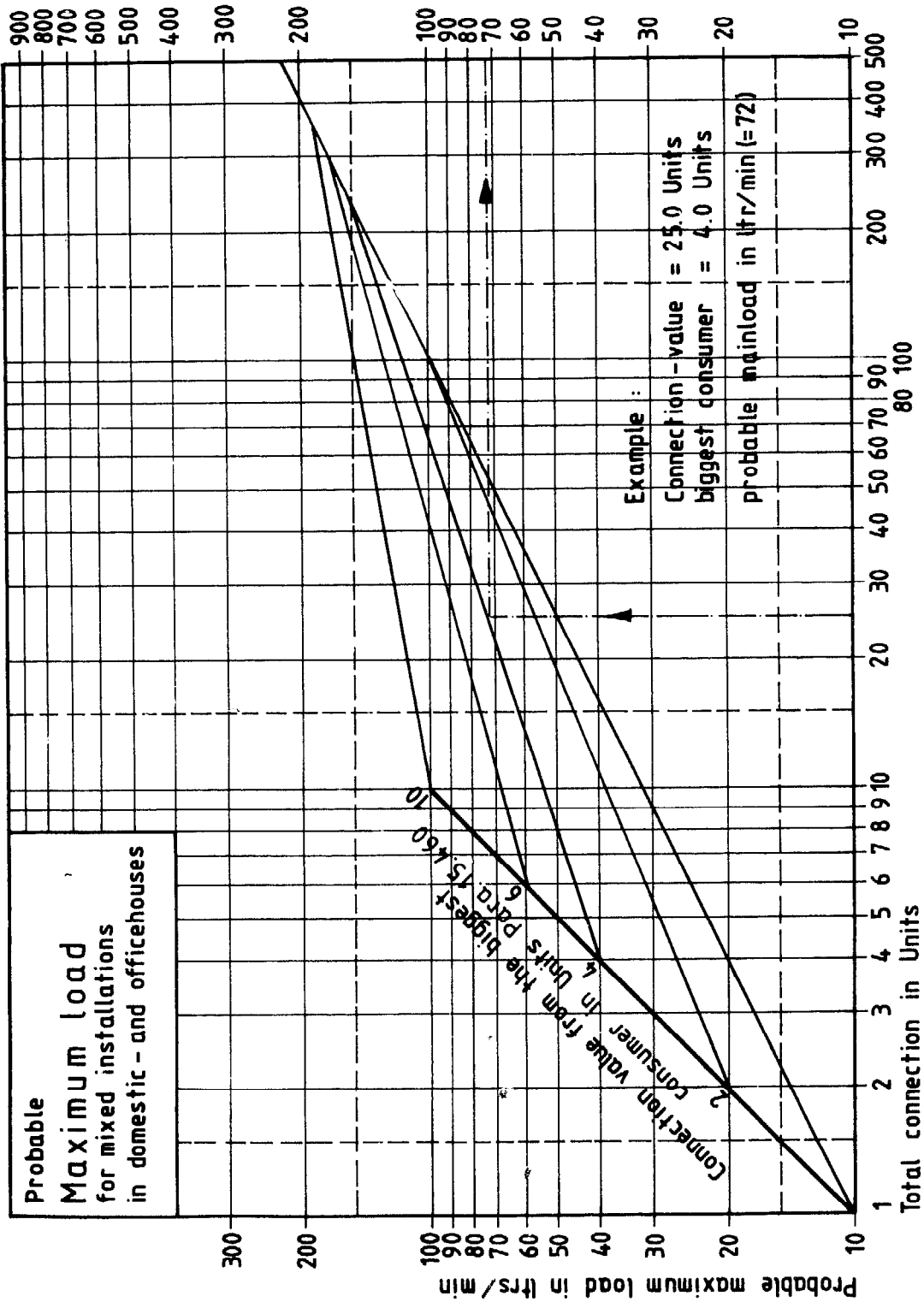

Residential and Non - Residential

**DRINKING WATER INSTALLATIONS
AND DRAINAGE REQUIREMENTS IN NEPAL**

PART 2

DRAINAGE REQUIREMENTS

DRAINAGE REQUIREMENTS

		page
1	SCOPE	69
2	FIELD OF APPLICATION	69
3	TERMS AND DEFINITIONS	74
4	PRINCIPLES OF INSTALLATION	79
5	PRINCIPAL REQUIREMENTS FOR PARTS OF PIPELINES	81
6	PRINCIPAL REQUIREMENTS FOR DRAINAGE APPLIANCES	82
7	PRINCIPAL FOR THE PLANNING AND FITTING OF DRAINAGE PIPES	84
8	SANITARY APPARATUS	101
9	VENTILATION	104
10	RAIN WATER	106
11	MATERIALS	108
12	PRINCIPLES OF CALCULATION	111
13	DIMENSIONING	113
14	INSPECTION AND TESTING	118

1 SCOPE

This section deals with the design and installation of soil, waste and ventilating pipes where they occur above ground both inside and outside the building.

The establishment of unobjectionable sewerage system and the safety of the community have been taken into account.

2 FIELD OF APPLICATION

These guidelines are applicable for:

- Domestic house drainage systems (soil and waste waters)
- Partly covered: Rain water pipes

2.100 PRINCIPLES

This manual covers modern methods of plumbing, namely, the single stack system, the divided stack system and the one-pipe system. However, in view of the simplicity and economy of the single stack system, it is recommended that for all new construction this system may be adopted in preference to other systems.

2.200 DESIGN CONSIDERATIONS

The system to be adopted will depend on the type and design of the building in which it is to be installed and will be one of the following:

- a) Single stack system
- b) Divided stack system
- c) One-pipe system

2.300 STACK SYSTEMS

This is the name given to a simplified system, wherein all separate ventilation pipes are omitted. The stack itself is made to cater (or provide) for all vent requirements by restricting the flow into the stack to certain predetermined limits.

A stack is a pipeline for main vertical discharge, extending more than one storey in height, and where all fixtures connected to it require a trap.

Note: rain water pipes are not to be fitted to stacks for soil and/or waste water pipelines. Usually they are not connected to the ground pipelines but drained through separate systems.

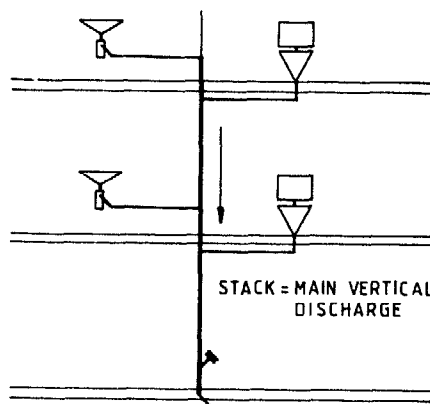

- 2.310 **Single Stack System (Standard Installation)** -In this mixed system, the pipe conveys discharges from all waste water appliances (e.g. soil and waste appliances) such as water closets, urinals, bath tubs, wash basins, kitchen sinks, etc.).

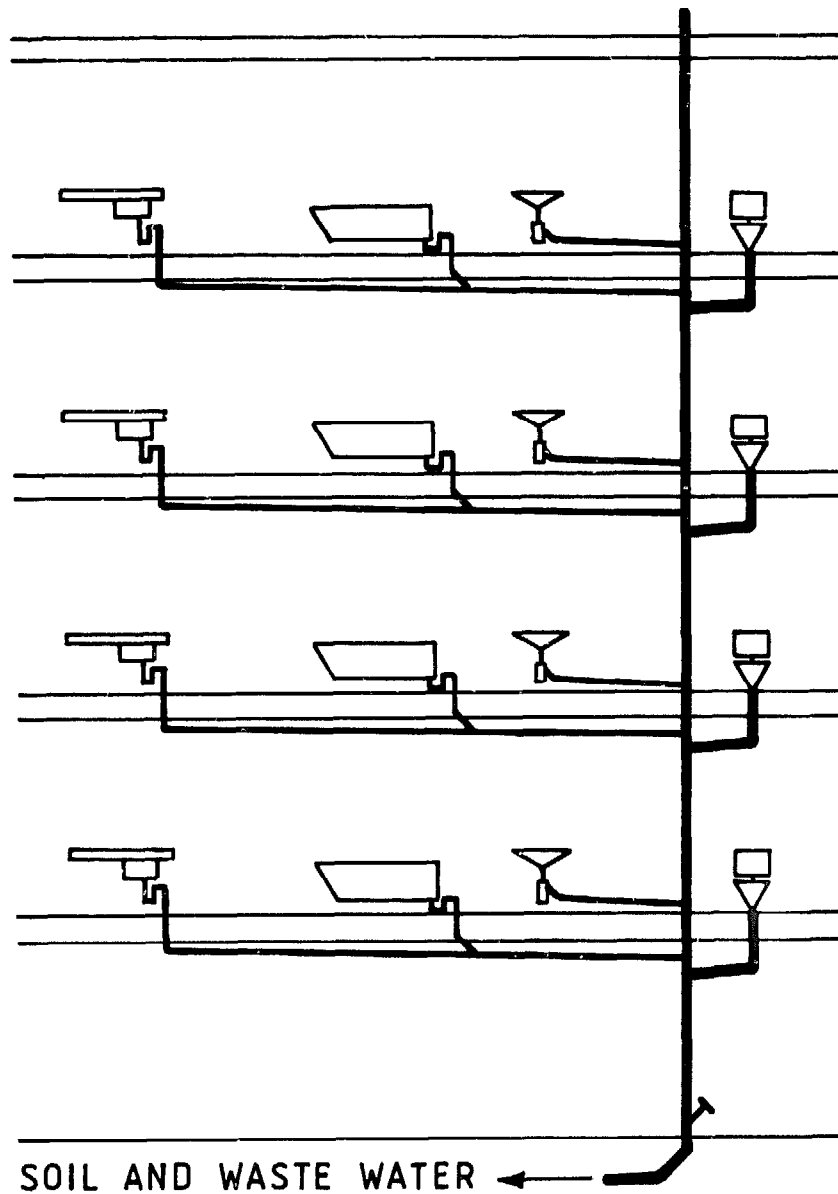

CONNECTED DIRECTLY TO THE TOWN SEWER
OR TO SEPTIC TANK OF ADEQUATE SIZE.

These pipelines convey waste water directly to the canalization main pipelines or into individual septic tanks of adequate size.

2.320 **Divided Stack System (Individual Installation)** - In this divided system there are two (or more) separate separate stacks:

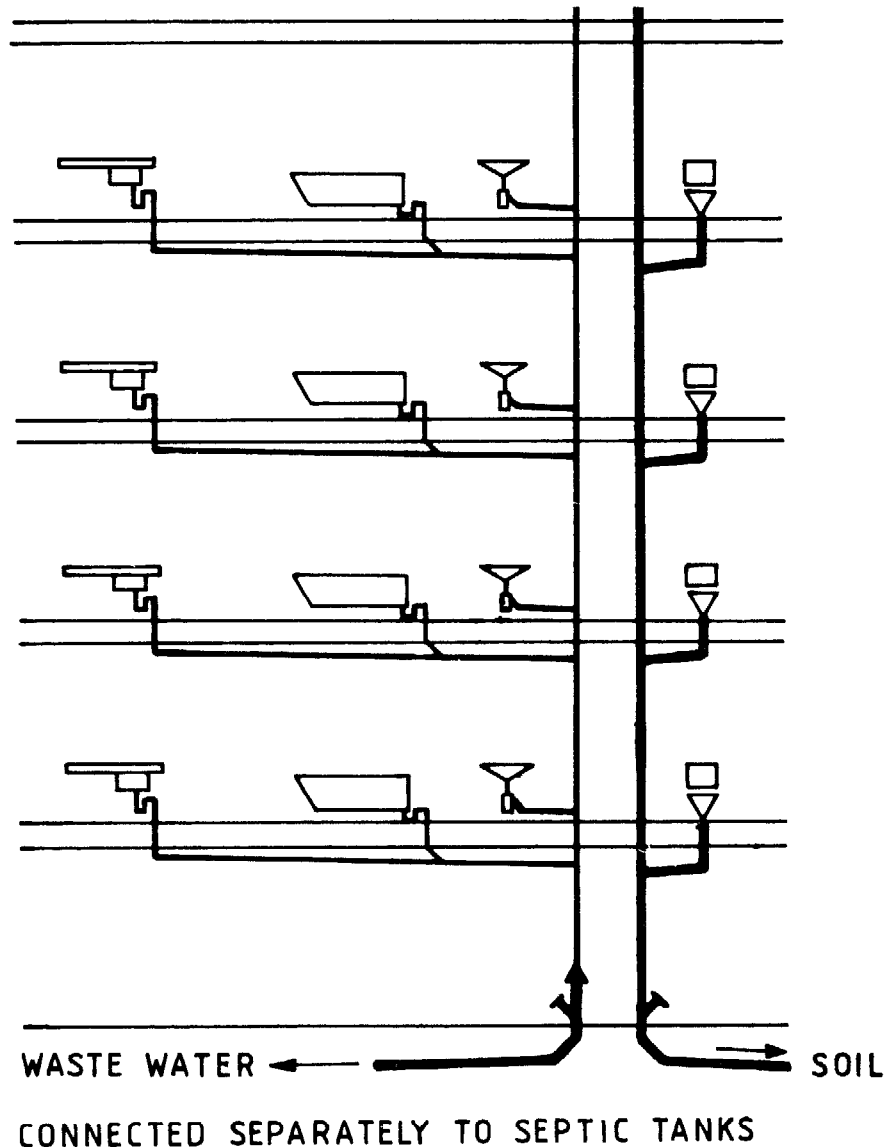

- i) The soil stack conveys discharges from water closets, urinals and similar soil appliances directly to the septic tank.
- ii) The waste stack conveys wastes from ablutionary (washing, washing-off) and culinary appliances (food), such as wash basins, bath tubs, kitchen sinks, shower trays, etc., either to a separate septic tank, or to the last chamber of the septic tank.

Divided stacks are to be ventilated above roof level in the same way as single stacks. If required, a waste stack ventilation, instead of being led straight through the roofing, could be joined to a nearby soil stack ventilation by use of 88° to 45° bends, with the branch at least 0.5 m above the upper level of the top-most apparatus.

Note: Divided stack systems might be useful in places with individual, small septic tanks. It is not required for mixed systems, e.g. when led into the town mains, or where septic tanks of sufficient capacity are provided.

2.340 Note: Previously a "Two-Pipe System" was applied in building installations. In this separate pipelines conveyed discharges:

- The soil pipes from water closets, urinals and similar appliances discharged directly to the drainage system (e.g. septic tank). Thorough ventilation was maintained by an extensive pipe-work of additional branch and main ventilation pipes.
- The waste pipes from ablutionary and culinary appliances were conveyed to the drainage systems directly or through a trapped gully, where desired. In these pipelines also the ventilation was maintained by an extensive pipework of additional branch and main ventilation pipes.

As mentioned earlier, in view of modernization and consideration of economy this "Two-Pipe System" is not now applied in new buildings.

DIAGRAM OF TWO-PIPE SYSTEM

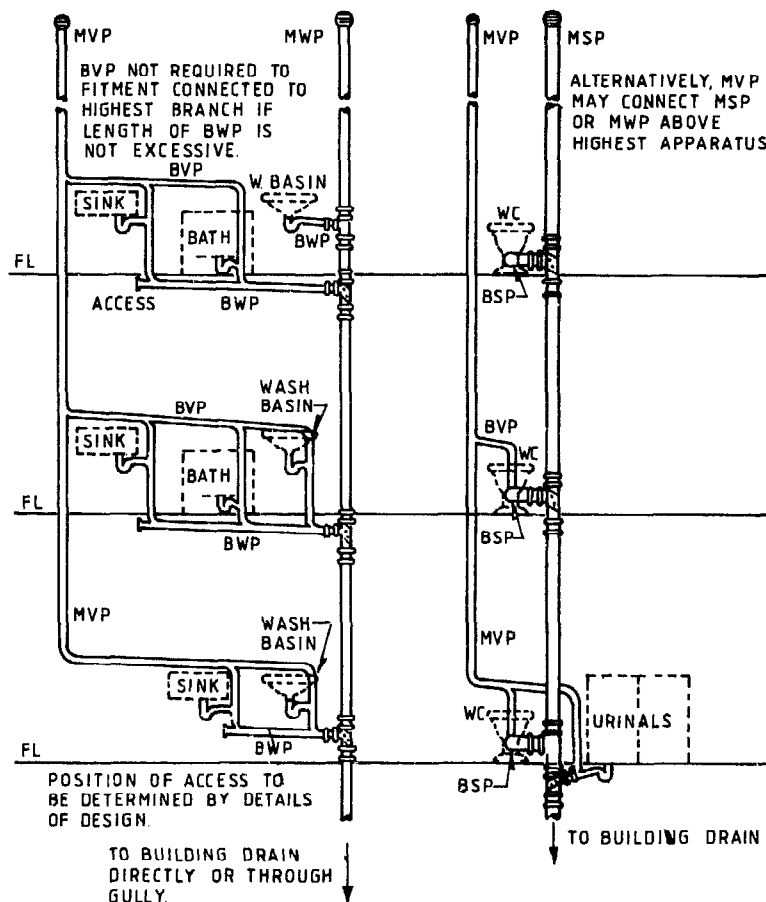

Main Soil Pipe (M.S.P.): A pipe connecting one or more branch soil pipes to the drain.

Main Waste Pipe (M.W.P.): A pipe connecting one or more branch waste pipes to the drain.

Main Soil Waste Pipe (M.S.W.P.): A pipe connecting one or more branch soil waste pipes to the drain.

Branch Soil Pipe (B.S.P.): A pipe connecting waste appliances to the main soil pipe, (stack).

Branch Waste Pipe (B.W.P.): A pipe connecting waste appliances to the main waste pipe, (stack)

Branch Soil Waste Pipe (B.S.W.P.): A pipe connecting soil and/or waste appliances to the main soil waste pipe (stack).

2.400 DRAINAGE REQUIREMENTS FOR BUILDINGS

Principles of system

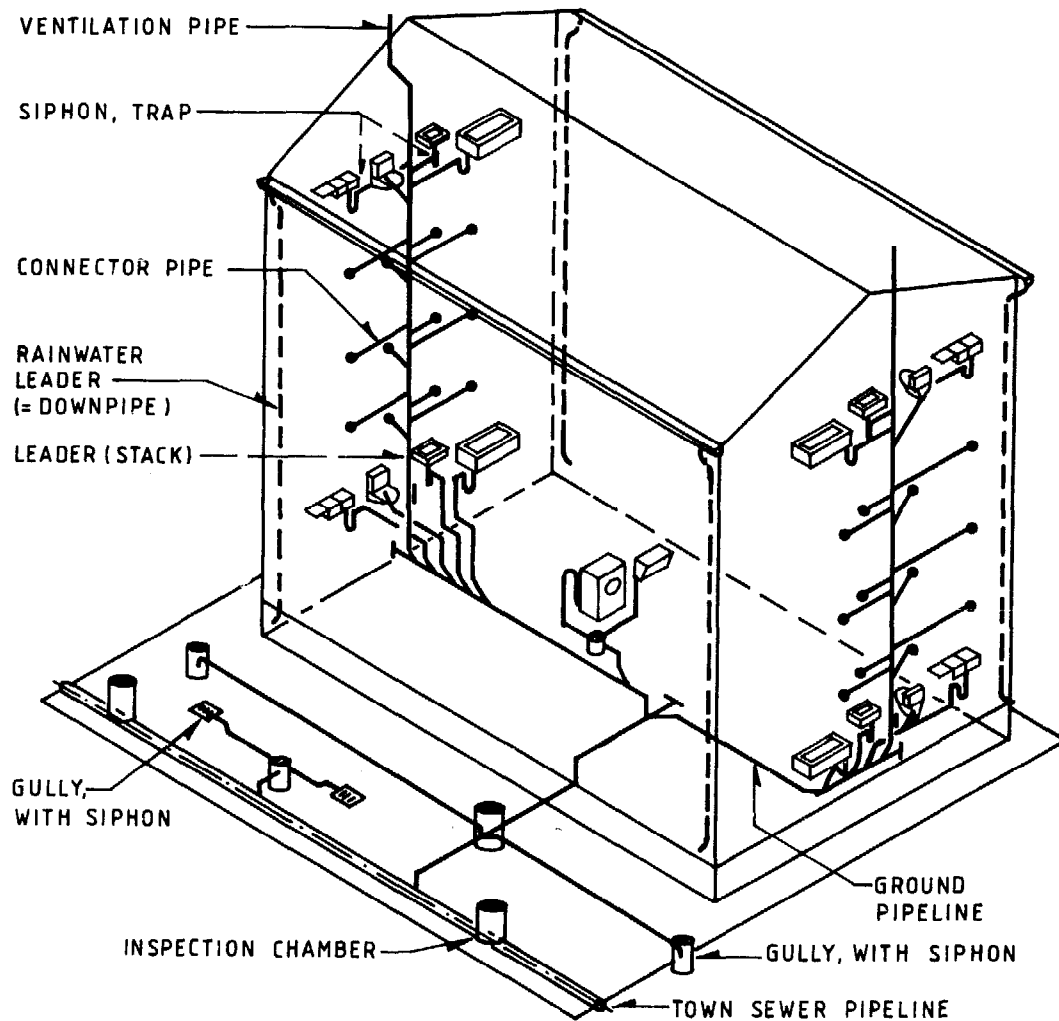

Notes:

- Rain water drains may only be connected to combined or single sewer systems in which the sewer pipe is designed to take both sewage and rain water.
- Rain water drains must be properly trapped before entry into soil drainage system (town sewer).
- Written permission must first be obtained from the concerned government authorities before rainwater drains can be connected to the sewerage systems.

3 TERMS AND DEFINITIONS

3.100 WASTE WATER

(WA) - General term for all types of waste water.

3.110 **Waste Water Clear (WAC)** - Waste water that can be led directly to the outfall ditch, e.g. led without any treatment to an open drain (river, lake, etc.) WAC includes:

- Storm drain (WAC-R) (=Rainwater)
- Water from cooling tower (WAC-C)
- Waste water approved by the water and sewerage authority (WAC-A)
- Ground water approved by the water and sewerage authority (WAC-G)
- Treated waste water (WAC-T)
- Drainage water (WAC-D)

3.120 **Soil Water** - Contaminated waste water which requires treatment, such as:

- Domestic waste water (Soil waste water = WAS-H)
- Heavily contaminated rain water (WAS-R)
- Pretreated industrial waste water (WAS-I)

3.130 **Industrial Drain** - Water which needs treatment by specialized plants before being led into the main sewerage line.

3.140 **Drain** - Any pipe which conveys discharges from sanitary appliances into a drainage system.

3.141 **Building Drain** - The building (house) drain is that part of the lowest horizontal piping of a drainage system which receives the discharge from soil, waste and other drainage pipes inside the walls of the building and conveys it to the building (house, sewer beginning outside the building wall.

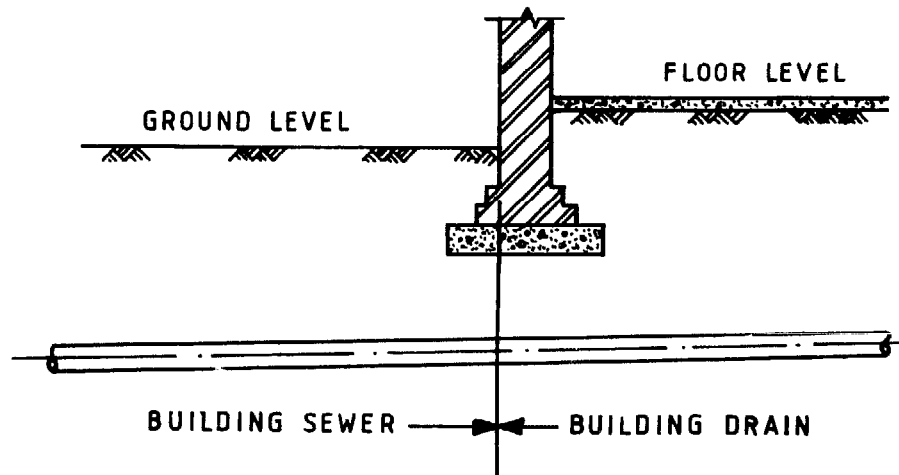

3.142 **Building Sewer** - The building (house) sewer is that part of the horizontal piping of a drainage system which extends from the end of the building drain and which receives the discharge of the building drain and conveys it to a public sewer, private sewer, individual sewage-disposal system, or other point of disposal.

3.143 **Soil Connections** - Connections to the drainage system of water closets, urinals and similar appliances (which contains human or animal excreta, but not water with soap).

3.144 **Waste Connections** - Connections to the drainage system of wash basins, bath tubs, shower trays, bidets, kitchen sinks and similar appliances (which does not contain excreta, but probably contains soapy water).

- 3.145 **Soil and Waste Water Pipelines (Combination Drain)** - A pipe which conveys to a drain the discharges from a water closet or urinal as well as the discharges from baths, wash basins, sinks and similar appliances.
- 3.146 **Divided Drains** - Pipes which convey discharges in separate pipes to the drainage systems: one system for the soil connections and the other system for the waste connections.
- 3.150 **Soil and/or Waste Water Accumulation** - Discharge of water quantity.
- 3.151 **S-Value** (Soil and Waste Water Flow Value - SV, also called fixture unit) - Calculated value of nominal soil and/or waste water flow rate of any drainage appliance per unit time through proper waste outlet. The basic outlet unit 1 SV corresponds with the discharge in time unit of 1 liter/sec.
- 3.152 **Volume flow rate** (loading) - Soil and/or waste water accumulation per unit time:
 - V_s (Volume flow) of several drainage appliances
 - V_r Flow rate per unit time of rain water.
 - V_m Flow rate per unit time of mixed soil and/or waste water with rain water (inground pipes only).
- 3.153 **Loading Capacity** - Permissible load in (l/s) of a pipelines, drainage appliance or drainage system.
- 3.154 **Inside Diameter** (i.d.) - Inside diameter of round pipes.
- 3.155 **Width of pipe** - Nominal inside (light) diameter of round pipes, i.e. bore.
- 3.156 **Soffit** - The highest portion of the interior of a sewer pipe at any cross section.
- 3.157 **Invert** - The lowest point of the interior of a sewer or rain pipe at any cross section. In a manhole chamber, the channel in the floor of the chamber which carries the flow of sewage through the manhole.
- 3.160 **Ground pipeline** - Horizontal installed pipeline for intake of a soil and waste water (building drain) below floor level or below basement.
- 3.161 **Collector pipe** - Horizontal, openly installed pipeline for intake of soil and/or waste water from leaders, branch and connector pipelines.
- 3.162 **Leader** - Vertical pipeline (eventually with loop), leading through one or several storeys, ventilated over roofing and led into a ground pipeline or into a collector pipeline.
- 3.163 **Stack** - A main vertical discharge or ventilating pipe, extending more than one storey in height, and where all fixtures connected to it require a siphon.
- 3.164 **Connector pipe** - Pipeline from an apparatus connector joint of a drainage appliance to a branch, leader (stack), collector or ground pipeline.
- 3.165 **Branch Pipeline** - Joining pipeline of several connector pipelines to the leader, collector or ground pipeline.
- 3.170 **Fall line**- Part of vertical distance of a connector or branch pipeline above 0.2 m.
- 3.171 **Tilt line** - Part of distance of a connector or branch pipeline having more than 10 percent slope and above 0.2 m height.

- 3.172 **Offset** - Installed vertical pipeline having a shifted axis, made of one fitting or of two bends up to 45°, which does not require any technical drainage measures.
- 3.173 **Loop** - Horizontal connection of two parts of a leader up to max. 10 m length.
- 3.174 **Bypass** - Side pipeline to the leader in the range of a loop with connection of drainage appliances which are connected below or above this leader.
- 3.175 **Special Fitting** - Fitting which reduces the over-pressure or vacuum in a leader (required at extended heights).

3.200 **DRAINAGE APPLIANCES**

Collective term for all drainage places, i.e: Appliances which serve as containers for the intake of water after its use in domestic ranges, enterprises or industries and disposes this water as soil and/or waste water, (e.g: water closet, bath tub, inlet funnel, etc.).

- 3.210 **Sanitary Apparatus (Fixture)**, such as - Bath tubs, shower trays, wash basins, bidets, water closets, urinals, service sinks, sinks, kitchen sinks, domestic kitchen and wash-kitchen apparatus, etc.
- 3.220 **Special Sanitary Apparatus (Special Fixture)**, such as-commercial kitchen and washing-kitchen apparatus, laboratory and hydrotherapy, etc.
- 3.230 **Drain funnels** - Open conical inlet with drain outlet.
- 3.240 **Floor Drain Inlets** - Appliances with drain outlets, without siphon, for collecting and draining of floor water.
- 3.250 **Rain Water Inlet** - Appliances with drain outlet, without siphon, for collecting and draining of rain water.
- 3.260 **Floor Drains** - Appliances with drain outlet and siphon for the collection and drainage of waste water inside buildings.
- 3.270 **Manhole (Inspection Chamber)** - Any chamber constructed on a sewer pipe, with access for inspection, maintenance and clearance of obstruction. Used for both soil and waste waters. They are placed on branches to the main sewer pipe, at a change in grade, diameter, direction and in straight length at appropriate intervals. They are so located to provide access.
Note: Manholes inside buildings are to be fitted with an airtight and removable cover.
- 3.280 **Siphon (Trap)** - A fitting or part of an appliance or pipe which contains water to prevent the passage of air. An integral trap is one formed in an appliance during manufacture. An "attached siphon" is a separate fitting which is connected to the waste outlet of the appliance.
- 3.281 **Water Seal** - The depth of water which should be removed from a fully charged siphon before air can pass through the siphon.
- 3.282 **Self-Siphonage**- It is the action by which the wastes from individual appliances suck out their own seals at the end of their discharge.
- 3.283 **Induced Siphonage** - The siphonage of a siphon due to the discharge of other appliances in the system.
- 3.284 **Back Pressure** - Air or waste water from pipes being forced up through siphons.

3.285 **Back-Siphoning** - Suction of used waters (e.g. from filled bath tubs) into the drinking water pipes. A situation which must absolutely be prevented through professional installations!

3.300 **SPECIAL ARRANGEMENTS**

3.310 **Floor Trap** - Small container with siphon (dive bend), with a inlet for waste water and the exit connected to the drainage pipe, by which heavy particals remain in the trap.

3.320 **Sludge Trap** - Appliance with a cover perforated with holes (above 150 cm² with slots) and having a sludge sack, which receives incoming waste water, separates the heavy particals and solid matter, then leads the waste water into the drainage pipes. As of local regulations it requires a dive bend (or a dividing wall), which can be removed for cleaning purposes.

3.330 **Silt Trap** - Container or appliance without siphon, which receives incoming waste water. Heavy particals, (sand, gravel, etc.) are retained and waste water is led to an arrestor (separator).

3.340 **Arrestor (Separator)** - Appliance with siphon (dive bend, dividing wall), which separates and retains from waste waters matters such as mineral oils, greases, perchloride-ethylene, etc.

3.350 **Drainage Pump (for Sewer)** - Arrangement for lifting of waste water.

3.360 **Back-flow Prevention** - Arrangement which should prevent a possible back-flow from the canalization into rooms.

3.400 **VENTILATION PIPES**

3.410 **Vent Pipes** - Pipelines which serve for the circulation of air, but do not dispose of any waste water.

3.420 **Stack Vent (Main Ventilating Pipe)** - Continuation of a leader, without reduction of the inner diameter. It is the primary vent, beginning from the top-most inlet and passing above roof level.

3.430 **Connector Vent** - Ventilation of a connector pipeline.

3.440 **Branch Vent** - Ventilation of a branch pipeline.

3.450 **Pit Vent - (Drain Ventilating Pipe - D.V.P.)** A pipe installed to provide flow of air to or from a pit (e.g: pump sump, arrestor, etc.) which is extended to above roof level or fitted into a leader.

3.460 **End Vent** - Ventilation of a ground or collector pipeline above roof level or into a leader.

3.470 **Collector Vent** - Collector pipeline of two or several vertical pipe vents or side (branch) vents.

- 3.530 **Indirect Side Vent System** - Parallel to the leader (stack) lead vent pipe, which in each floor is connected with a branch pipeline to the leader.

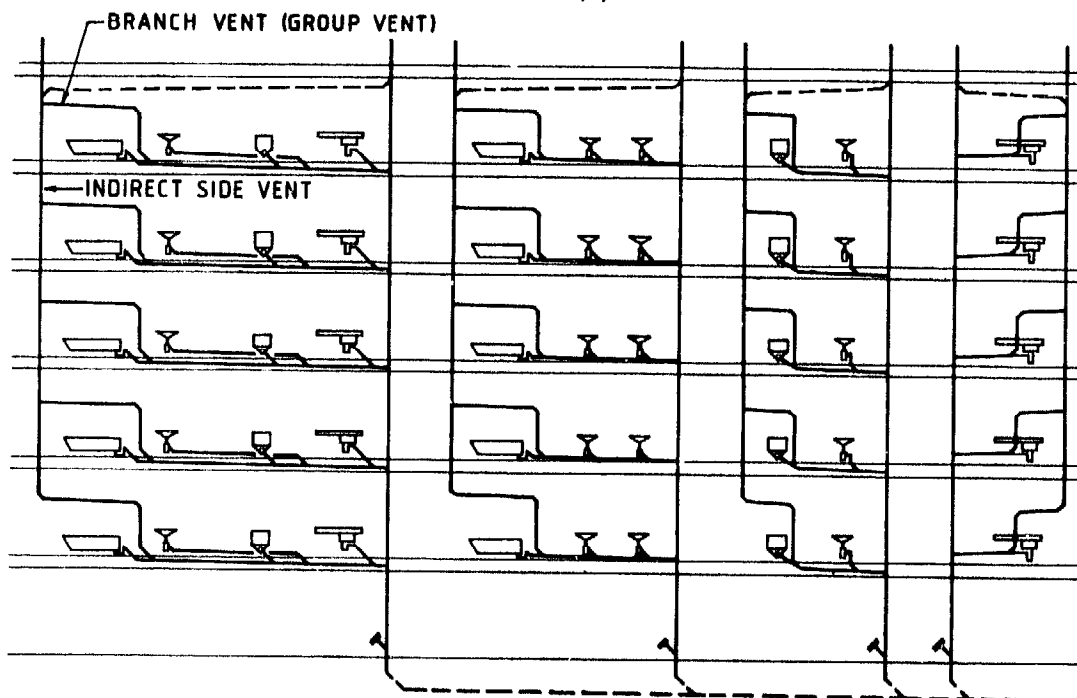

- 3.540 **Secondary Vent System (modified One-Pipe System)** - Ventilation of single connector pipelines with a side vent leading above the roof or connected to a leader at a minimum of 0.1 m above top-most apparatus.

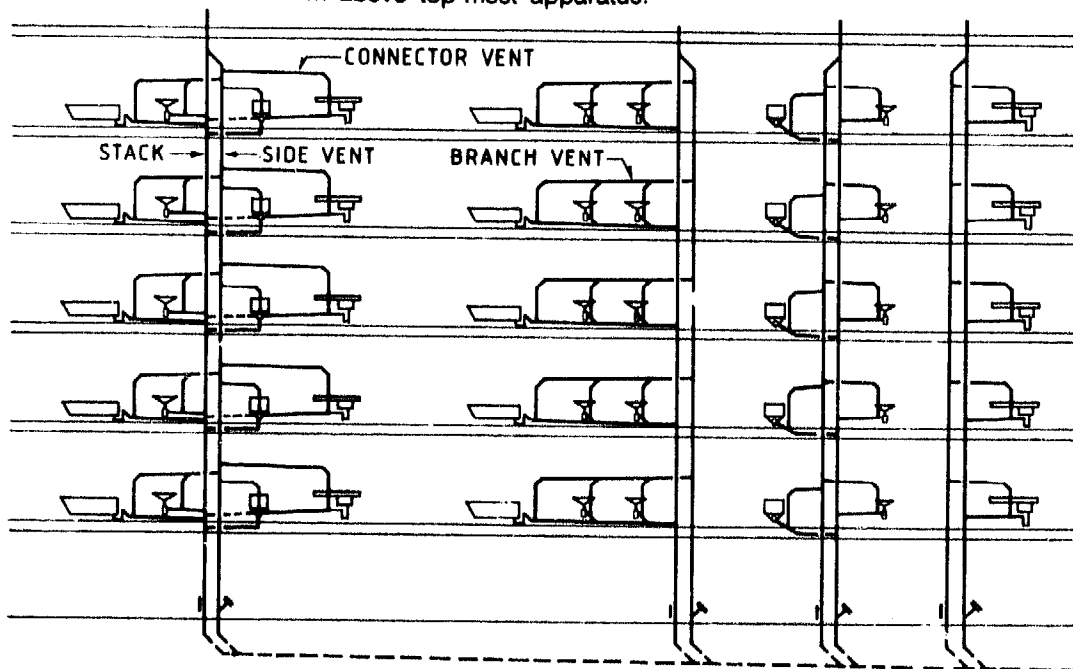

4. PRINCIPLES OF INSTALLATION

4.100 HYGIENE AND FUNCTION

The buildings are to be fitted with drainage installations which should follow these guidelines in view of hygiene and function.

The waste waters have to flow as fast as possible into the plot's sewerage system without leaving sediments in the pipelines (i.e. to be self-cleaning).

4.200 SAFETY

The drainage system has to be planned and to be installed so that the following conditions are fulfilled:

- Resistant to domestic soil and waste waters and gases
- To absorb the soil waste waters

Protection provided against:

- Exit of any soil and waste waters and gases
- Mechanical influences of all kinds
- Outside influences of temperatures
- Back-flow
- Corrosion and erosion

4.300 NOISE CONTROL

Drainage installations are to be collected and reasonably fitted in those rooms where normally no noise control is required. (e.g: bathrooms, kitchens, etc.).

4.400 PROHIBITION OF DIRECT CONNECTION WITH THE WASTE WATER PIPELINE

Drinking water (and overflows and drainages of containers and appliances, which are fed from a drinking water pipeline) must never be connected directly to the drainage pipes, (prevention of back-siphoning)!

4.500 SEPARATION OF RAIN WATER AND WASTE WATERS

Rainwater and soil/or waste waters have to be drained separately, and (if permitted) may only be joined outside the building into the ground pipeline.

4.600 CHEMICALLY LOADED WASTE WATER

Chemically loaded waste waters are to be led separately to a pre-processing plant.

Waste waters require a special pre-processing plant, especially when they contain:

- a) Floating matter and heavy sediments;
- b) Oils and greases in large quantities or on demand of the concerned authorities;
- c) Strong poisons;
- d) Acids
- e) Strong alkalinous reacting substances
- f) Radiation exposure

The damaging effects of these substances are opposed by means of:

- a) Silt traps, filters or sieve plants
- b) Oil or grease arrestors
- c) Detoxication
- d & e) Neutralization
- f) Decontamination plants

- Processing plants are to be established and to be operated according to the Government's laws.

- The achievement of determined limiting values by means of dilution is prohibited.

4.700 SECURING OF AERATION AND VENTILATION

Sewerage plants are to be constructed so that the air can circulate, also during the drainage of waste waters.

4.800 **MAINTAINING OF FLOW SECTION**

Soil and/or waste water pipes are not to be reduced in their sections in the direction of drainage.

4.900 **CLEANING**

The cleaning of drainage systems is to be secured by means of relevant cleaning openings (clean out, cleaning eye, manhole, etc.)

4.910 **Siphon (Traps)** - The entry of foul air to the building should be prevented by suitable siphons, properly sited. Each drainage appliance is to be fitted with such a siphon, which needs to be installed at the place of the outflow of water, e.g. waste coupling. Out of use drainage appliances are to be removed and the apparatus connector pipeline must be closed tightly by professional skills.

4.920 **Back-flow** - Where a back-flow from the public canalization is to be expected, an overflowing of endangered basement rooms is to be avoided by means of a suitable precaution (e.g. pump). The level of the back-flow is to be asked from the concerned authorities.

4.930 **Gravity flow** - All drainage appliances situated above the back-flow level are to be drained directly through gravity flow.

4.940 **Drainage of rainwater (storm water)** - Roofs, balconies and other building annexes are to be drained by means of rain gutters, roof drains and through leaders, provided they are projecting over accessible surfaces (walk ways, forward squares, side walks, etc.).

5 **PRINCIPAL REQUIREMENTS FOR PARTS OF PIPELINE**

5.100 **PIPES, FITTINGS AND CONNECTOR PIECES**

5.110 **Choice of material** - The choice of suitable materials (e.g. reinforced cement, cast-iron or plastic pipes and steel with corrosion protection), is dependent on the range of application, the local conditions and the loading factors.

5.120 **Tightness** - All pipes and joints in pipework and connector pieces to appliances should be made in such a manner as to be air-tight and water-tight and to remain so during use. Care should be taken to ensure that no jointing material may enter the pipe. Some flexibility is desirable where there is a possibility of movement between the pipes or between the pipes and the appliances.

They have to withstand the following pressures within the surrounding temperatures:

- Accessible, open fitted connections of waste water appliances and apparatus connectors 0 up to 0.1 bar (0 up to 1 m water column).
- All other connections and soil and waste water pipelines 0 up to 3 bar (0 up to 30 m water column).

5.130 **Mechanical stress and resistance** - All soil and waste water pipelines and their parts have to be of proven quality in order to remain stable, hit proof, shock resistant, abrasive and scratch resistant and corrosion resistant.

The surface condition of the pipes, fittings and connectors must not favour blockages.

5.140 **Cleaning devices** - All apparatus and pipelines shall be easily cleaned and shall resist normal commercially used cleaning devices.

- 5.150 **Temperature resistance** - Waste water pipelines and their parts have to resist changes of temperature. Appropriate measures are to be taken, where required, to safeguard stability (e.g. expansion joints, halved shells under horizontally placed plastic pipes).
- 5.170 **Installation** - The connection of pipes and fittings, and all appliances (apparatus) must be easily made and be safe.
- 5.180 **Colour** - Non-transparent materials are to be utilized. Non-compatibility with specific coatings (paints) have to be indicated.
- 5.200 **Water proofing compound for connections**
- 5.210 **Requirements for compounds** - Materials for connections of pipes, fittings and apparatus must correspond, with regard to mechanical, chemical and thermal resistance, to the same requirements as for the materials of pipes.

They must not endanger the functioning of the connections.

6 PRINCIPAL REQUIREMENTS FOR DRAINAGE APPLIANCES

6.100 PRINCIPLE

To each water tap in buildings there belongs a drainage appliance (Exception: fire fighting equipment).

6.200 DISCHARGE VALUE

The discharge value of soil and/or waste water of any drainage appliance depends on its function.

6.300 OVERFLOW

Drainage appliances having outlets with stoppers (e.g. washbasins, kitchen sinks, bath tubs, etc.) require an overflow.

6.400 BACK FLOW PREVENTION

Drainage appliances have to be above the level of back-flow or are to be secured against exit of waste water by means of appropriate measures.

6.500 PREVENTION OF EXIT OF GASES

- 6.510 **Siphon drainage appliance** - Each drainage appliance (with exception of inlets, e.g. drain inlets) has to be fitted with a siphon to prevent the exit of gases. This siphon can be an integral part of an appliance or be directly attached to the outlet of the appliance. The pipe bore should be uniform throughout and have a smooth surface.

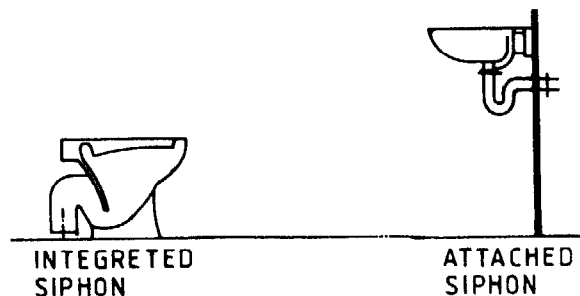

- 6.520 **Siphon rainwater** - Rainwater pipelines, from which disturbing odours may occur, are to be fitted with a siphon, fitted in a frost-secured place.

6.600 REQUIREMENTS OF SIPHONS (traps)

6.610 **Water Seal** - The siphon prevents the exit of gases by means of it's water seal.

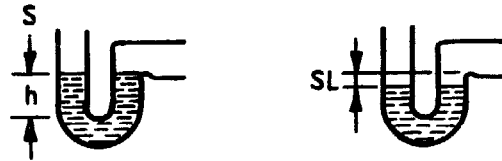

- h = height of water seal (odour lockage)
 for water closets, min.50 mm
 for all other siphons, min. 70 mm
- S = level of water seal
- SL = (partial) loss of water seal (e.g. trough siphonage)

6.620 **Self-cleansing** - Siphons should always be of a self-cleansing pattern, by means of the discharged waste and/or soil water.

Anyhow, a cleaning opening must be provided.

6.630 **Placement of siphon** - Siphons for use in domestic waste installations and all other siphons should be accessible. A siphon has to be directly attached to the outlet of the appliance, or to be an integral part of the appliance (e.g. water closets).

6.640 **Removable connection** - Where openly fitted, such a siphon has to be easily fitted and removed.

6.650 **Concealed siphons** - The construction and fitting of siphons must guarantee an easy removal of parts of the siphon and therefore enable easy access to the connector pipeline.

Where the siphon is an integral part of the appliance, the connector pipeline has to be accessible through either easy removal of the drainage appliance (closet, urinal, etc.), or by means of reasonably placed cleaning openings. The cleaning opening has to be adjacent to the siphon or be directly part of it (e.g. floor drain with siphon).

Where the siphon is concealed in the building construction, with the exception of shower tray and bathtub, the possibility for cleaning is to be secured by means of a manhole or a cleaning opening.

6.660 **Guarantee of water level** - To maintain the minimal required water level at each siphon, a permanent guarantee has to be provided by appropriate means.

6.670 **Water replacement** - Closets and urinals with self-siphoning flushing systems have to be fitted with a device which replaces the water in the siphon automatically after each flushing.

6.680 **Mechanical odour barriers and aeration valves** - both are prohibited for installation in domestic waste systems.

- 6.700 **Prohibition of direct connection with soil and/or waste water pipelines** - Appliances, refrigerators, refrigerator plants, fish cabinets, food cabinets and other containers for food may only be connected to the soil and/or waste water pipeline by means of an inlet funnel. This same is also valid for drains of safety valves and other devices of the drinking water system.

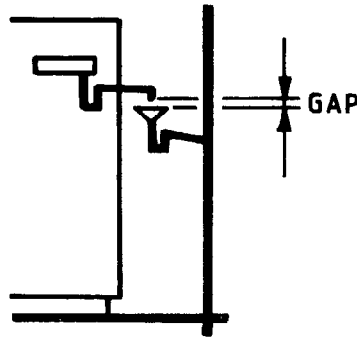

gap to be of min. 2 cm,
or of same diameter as
inlet.

6.800 **PROTECTION AGAINST POLLUTION OF PIPELINES**

- 6.810 **Protection from solid matter** - no solid matter, such as sand, garbage, textiles, vegetable wastes, etc., may be fed into a drainage system.
- 6.820 **Protection from gross pollution** - The outlet of a drainage appliance has to be constructed in such a way that no blocking solid matter may reach the siphon. The fitting of a kitchen waste chopper is prohibited.
- 6.830 **Closet arrangements** - They have to be fitted with flushing cisterns, in order to guarantee the self-cleansing of the soil water system.

7 **PRINCIPLES FOR THE PLANNING AND FITTING OF DRAINAGE PIPES**

7.100 **PRINCIPLES FOR PLANNING**

For planning and execution of building drains (domestic house drainage system) the following marginal requirements are valid. The drainage of premises is as of separate, governmental rule.

- 7.110 **Method of connection** - Each plot shall be drained separately and led into the canalization by the shortest way and without using the neighbour's plot.

Where the above is not feasible or not appropriate the drainage of several buildings can be realized by means of a collecting or ground pipe, provided the approval of the concerned government authority has been given.

Where the approval of the authority has been given for such cases of joint sewerage pipes it is suggested that the legality be secured by entering the agreement into the land registry.

- 7.120 **Later extension** - Where plots are only partially covered with buildings, attention is required that at extension stages the sewer can also be drained by gravity flow.
- 7.130 **Direct drainage in public waters** - where premises are situated near public waters the tendency should be for their direct connection to these waters, provided the authorities give their require approval.
- 7.140 **Seepage water** - Seepage water shall, if possible, be led to the outfall ditch or in any possible way to the ground water.

7.150 **Slope or ground water** - Slope or ground water may only be connected into the canalization where permission of the concerned authorities has been granted.

7.160 **Seepage of stormwater** - where soil conditions are acceptable, a seepage of rainwater can be led directly to the underground, provided permission has been given.

7.200 **PRINCIPLES FOR THE LAYING OF PIPES**

7.210 **Change of direction** - Pipe connections may not be utilized for change of direction.

7.220 **Reducer fittings** - Centric reducers are permissible for connector pipes and branch pipelines, as well as for vertical pipelines (e.g. stacks).

For collector and ground pipelines, as well as in loops, the various diameters may preferably be connected by means of excentric reducers and at parting alignment.

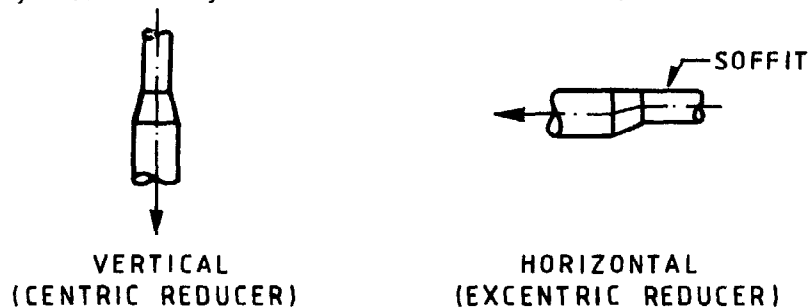

7.230 **Manhole / Inspection Chamber** - At each exit of pipes from the house to the pipeline fixed in the ground, there should be a inspection opening, preferably a manhole or a clean out (i.e. branch with tight cover).

On collecting pipes accessible clean outs are required at:

- exit of buildings
- at straight lines after each 40 meters length
- change of direction

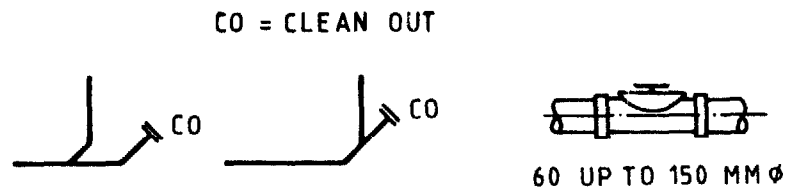

7.300 **BUILDING SEWER** - as of special governmental rules.

7.400 **HORIZONTAL PIPELINES** (Ground pipelines).

7.410 **Principles** - All drains and private sewers have to be of sufficient strength and must be bedded and supported so as not to be damaged by the maximum loads to which they may be subjected. They must be constructed of materials of adequate durability in relation to matter being carried by the drain in relation to the ground and subsoil water outside. Joints must be formed in materials appropriate to the drain itself and in such a way that they remain watertight in all working conditions, including any differential movement that may occur between the pipe and the ground or the structure under which it passes. Joints must not form any obstruction in the interior of the drain.

7.420 **Design of pipelines** - Drains must be laid in a straight line between points where changes of direction occur. Horizontal pipelines shall be fitted in parallel to the walls of the buildings. The drains have to be of such size and gradient (slope) as to ensure that they are self cleaning and can carry the maximum volume of matter which can be discharged.

- 7.430 **Sizes** - The size and method of construction for pipes which carry soil and waste water, including their ventilation system, must be appropriate to their function. In the direction of flow, pipes are to be of the same or larger diameters, and must not be reduced.
- 7.431 **Minimal diameter** - For ground pipelines the internal diameter at any point must not be less than the outlet diameter of any appliance, pipe or drain discharging its contents through it, and in any case should never be less than 100 mm i.d.
- 7.440 **Water seals** - Provision has to be made in the system to ensure that in normal working conditions the water seal in any siphon (trap) in the system is maintained.
- 7.450 **Ventilation** - Each house connected to a drainage system requires at least one main ventilation of not less than 100 mm \varnothing (whether connected to a septic tank or to the canalization mains).
- 7.460 **Means of access** - All drains and private sewers shall have such means of access as may be necessary for inspection and cleaning, as indicated below. Inspection chambers etc., may be of brickwork, concrete or other suitable materials so as to properly sustain any loads imposed, to exclude subsoil water, and to remain water tight.

MEANS OF ACCESS

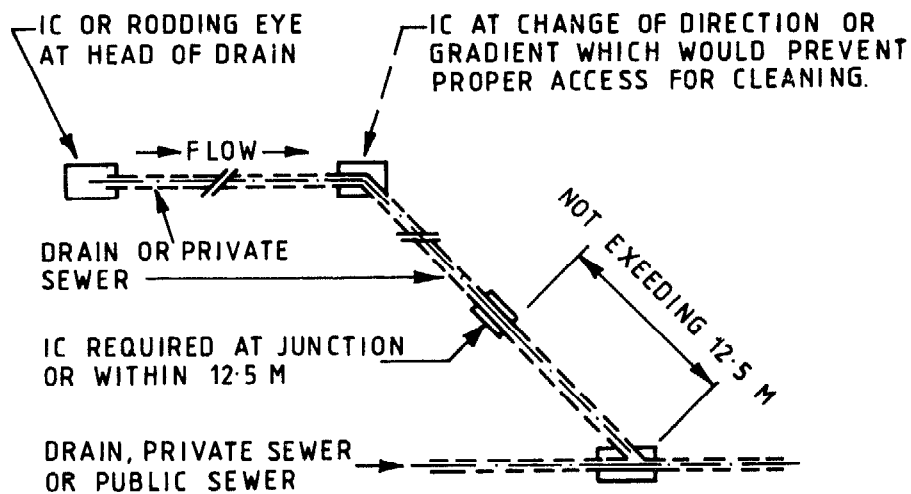

MAXIMUM SPACING OF INSPECTION CHAMBERS ON STRAIGHT RUNS

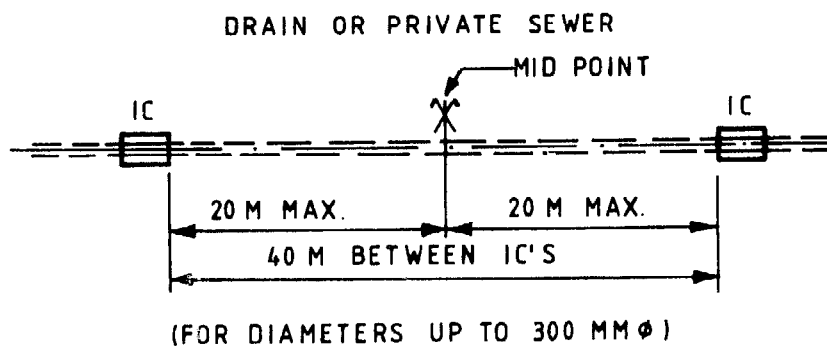

7.470 **Manholes/outside buildings** - at every change of alignment, gradient or diameter of drain, there shall be a manhole or inspection chamber. Bends and junctions in the drains shall be grouped together in manholes as far as possible. The maximum spacing of manholes in any ground pipelines, for diameters up to 300 mm, may not exceed 40 m.

7.471 **Sizes of manholes** - Chambers shall be of such size as will allow necessary examination or clearance of drains. Size of manholes shall be adjusted to take into account any increase in the number of entries to the manhole. The minimal internal sizes of chambers (between brick faces) shall be as follows:

- a) for depth of 1 m or less 0.8 × 0.8 m
- b) for depths between 1 m and 1.5 m 1.2 × 0.9 m

In adopting the above sizes of chambers, it should be ensured that these sizes accord with full or half bricks and with standard thickness of mortar joints so as to avoid wasteful cutting of bricks.

7.473 **Manholes/Inside buildings** - Inspection chambers on drains (= manhole on sewers) inside buildings are to comply with the following construction requirements:

- a) to be fitted with cover having an airtight seal, fixed down with bolts of non-corrodible material. The chamber is to be watertight under the maximum pressure which could be created by a blockage at a point below the chamber, or
- b) contain a drain equipped with fittings having water-tight inspection covers.

7.474 **Sample of a manhole, inside building:**

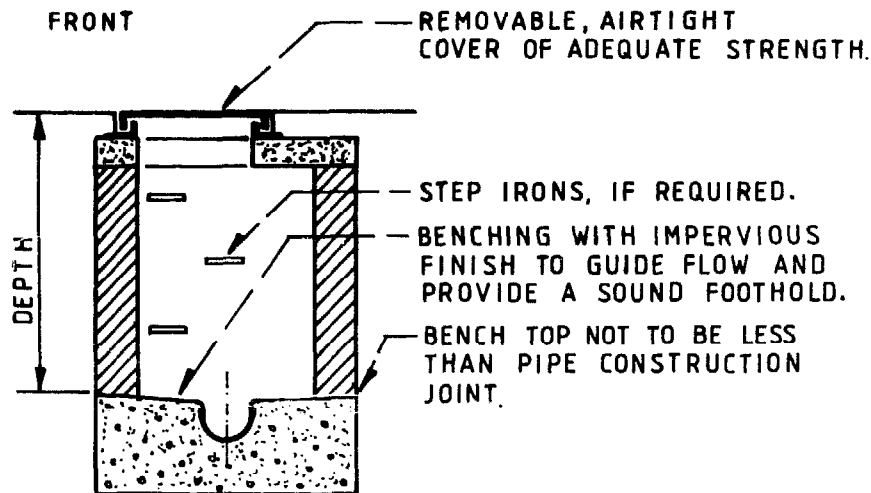

NOTE THAT CHAMBER SHOULD BE OF ADEQUATE SIZE TO PERMIT READY ACCESS TO DRAINS FOR CLEANING AND RODDING.

COVER SIZE	DEPTH
60 × 60 CM	60 CM
80 × 80 CM	80 CM
80 × 80 CM OR 100 × 100	100 CM

7.475 **Separate Manholes** - For drainages with divided systems joint manholes for any kind of waste waters are not permissible, except where passages are fully enclosed and incorporate approved cleaning openings.

- 7.510 **Slopes of pipelines** - Horizontal pipelines shall be fitted with an even slope gradient. The optimal slope for soil and/or waste water pipes is 3%. The acceptable minimal slopes are shown in the following table.

Minimal slope	in %
Storm sewer	1
Soil / waste water drainage Ground pipelines and collecting pipes	
- up to i.d. 200 mm Ø	2
- above i.d. 250 mm Ø	1.5
Branch- and connecting pipelines	2
Vent pipes	1

7.520 **Connections to collection and ground pipelines**

- Connections to the collecting pipes have to be made with a fitting of up to 60° (e.g. open installation on ceilings).
- Connections to the ground pipeline have to be made with a fitting of up to 45°.
- As a rule the connection in ground pipelines and collector pipes must be made in the upper half of the pipe (e.g. above horizontal axis).

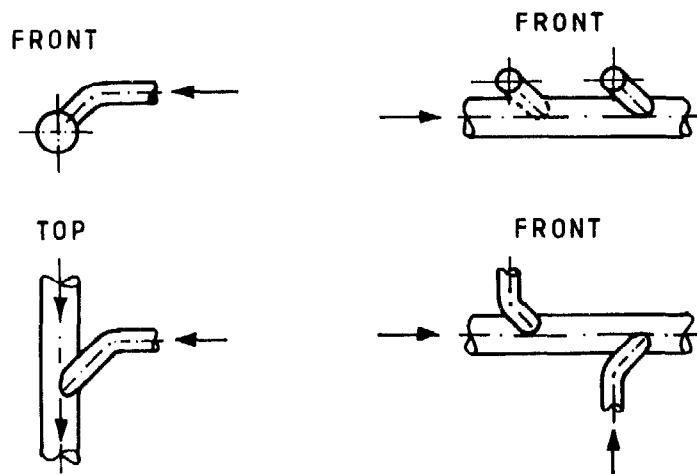

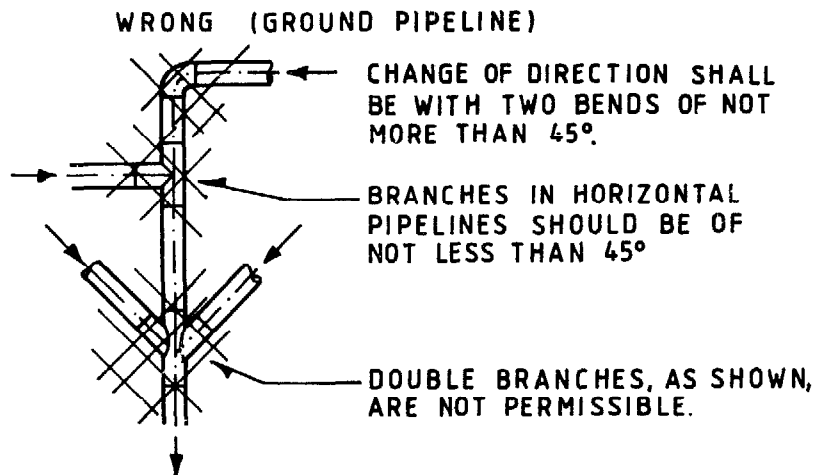

7.521 Change of direction - Ground pipelines and collecting pipes shall be fitted with bends up to 45°.

7.522 Example of 90 degree change of direction

90° TURNING (TOP)

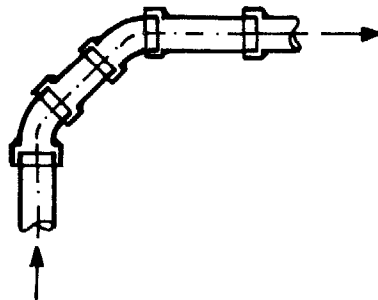

7.530 Trenches for drains - Where trenches for drains are constructed adjacent to the foundations of a building, precautions must be taken to ensure that the drainage trench in no way impairs the stability of the building. Therefore sufficient distance from the building foundation to the sewer pipes and trenches is required.

7.531 Trenches for drains near a building

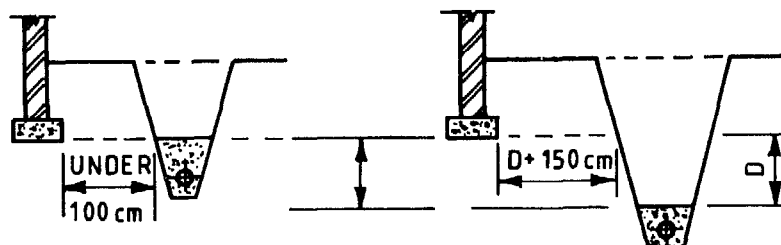

trenches filled with concrete to levels shown, expansion joints at spacing not exceeding 9 m centres along trench.

7.540 **Drains passing through outer walls** - Where a drain passes through a wall (including the wall of an inspection chamber or septic tank) precautions must be taken to prevent damage or loss of watertightness by differential movement. This also applies if a drain passes under any other structure which may exert stress. Note: Where within the range of the ground-water table, a watertight passage is indispensable.

7.550 **Inlets to drain** - Inlets to ground pipelines and collector lines are to be made as indicated below.

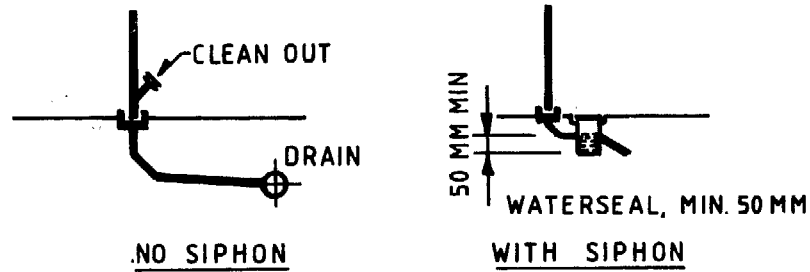

7.560 **Series of rainwater pipes** - Collected, with siphon and with connection to sewer, as indicated below.

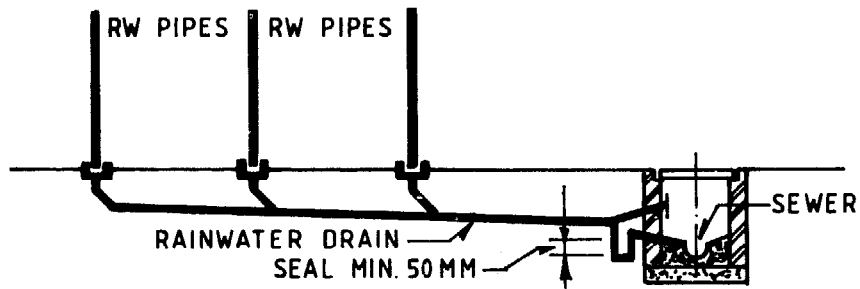

7.570 **Waste connection to gully** - In divided drainage systems, where waste waters are discharged separately from soil waters, there exists the possibility of joined drainages by use of a gully.

Such waste water pipes in a building can be taken through an external wall of the building by the shortest practicable line, and shall discharge below the grating or surface box of the chamber but above the grating of a properly trapped gully.

The waste pipes shall be brought to the gully without any reduction in diameter. A straight pipeline with few bends is preferable.

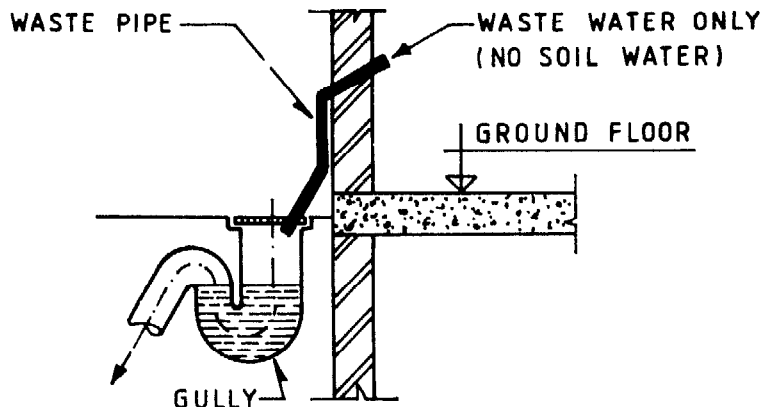

Note: The outlet of a gully (floor drain with siphon) may be led into a soil and/or waste water sewer system.

- 7.580 **Connections of appliances into horizontal pipelines near to (vertical) stacks - Where stacks are over 10 m in height, connections of appliances for drainage are to be inserted into collector or ground pipeline no closer than 1.5 m from the vertical stack.**

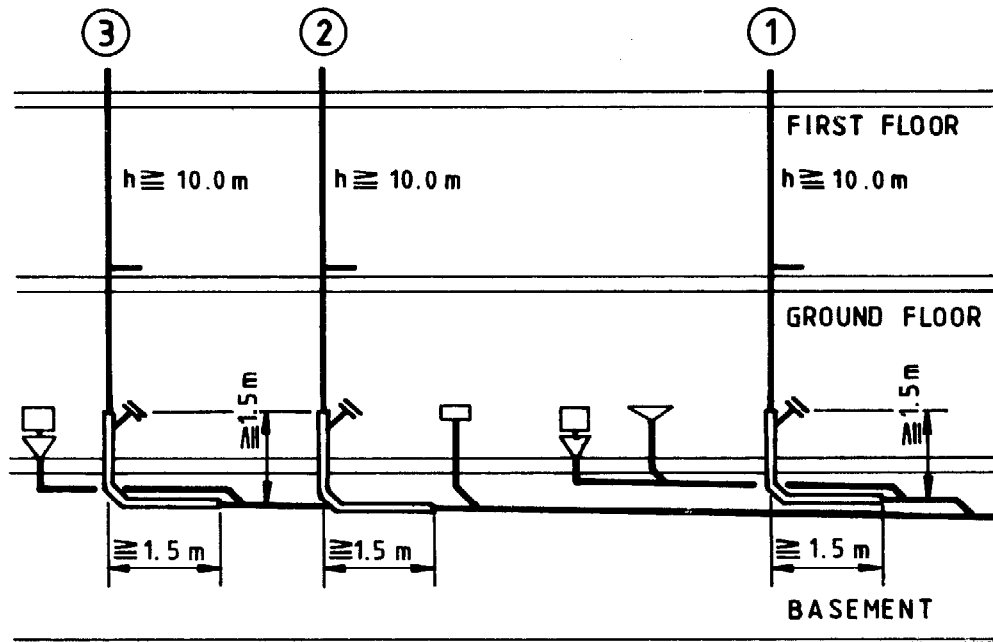

- 7.590 **Septic Tank design** - The principal factors to be considered in deciding on the capacity of a septic tank are the average daily flow of sewage, the retention period and adequate sludge storage to suit the frequency of cleaning (desludging).
- 7.591 It is important that the tank capacity be sufficient to permit reasonably long periods of trouble-free service and prevent frequent progressive damage to the effluent absorption systems due to discharge of sludge by overloaded tanks.
- 7.592 Depending on local circumstances preferred methods of disposal of septic tank effluent are:
- by dilution, if there is adequate flow in the receiving watercourse,
 - by a soakpit, if the ground is sufficiently porous and the water table is sufficient low,
 - by sub-surface irrigation where the ground is less porous,
 - by surface irrigation over a grass plot where ground conditions are unsuitable for sub-soil irrigation. An area of about 1 m² per person is required, or
 - by evapo-transpiration up to 100 m² per person may be required where the ground is of heavy clay.

In connection with (c) above, the WHO publication "Excreta Disposal for Rural Areas and Small Communities" sets out the percolation test procedure and, based on the results, the size and minimum spacing requirements for disposal trenches.

- 7.593 **Note:** In principle septic tank designs are to be provided by civil engineers/ architects, as they are not part of sanitary building installations.

7.594 Example of a septic tank design

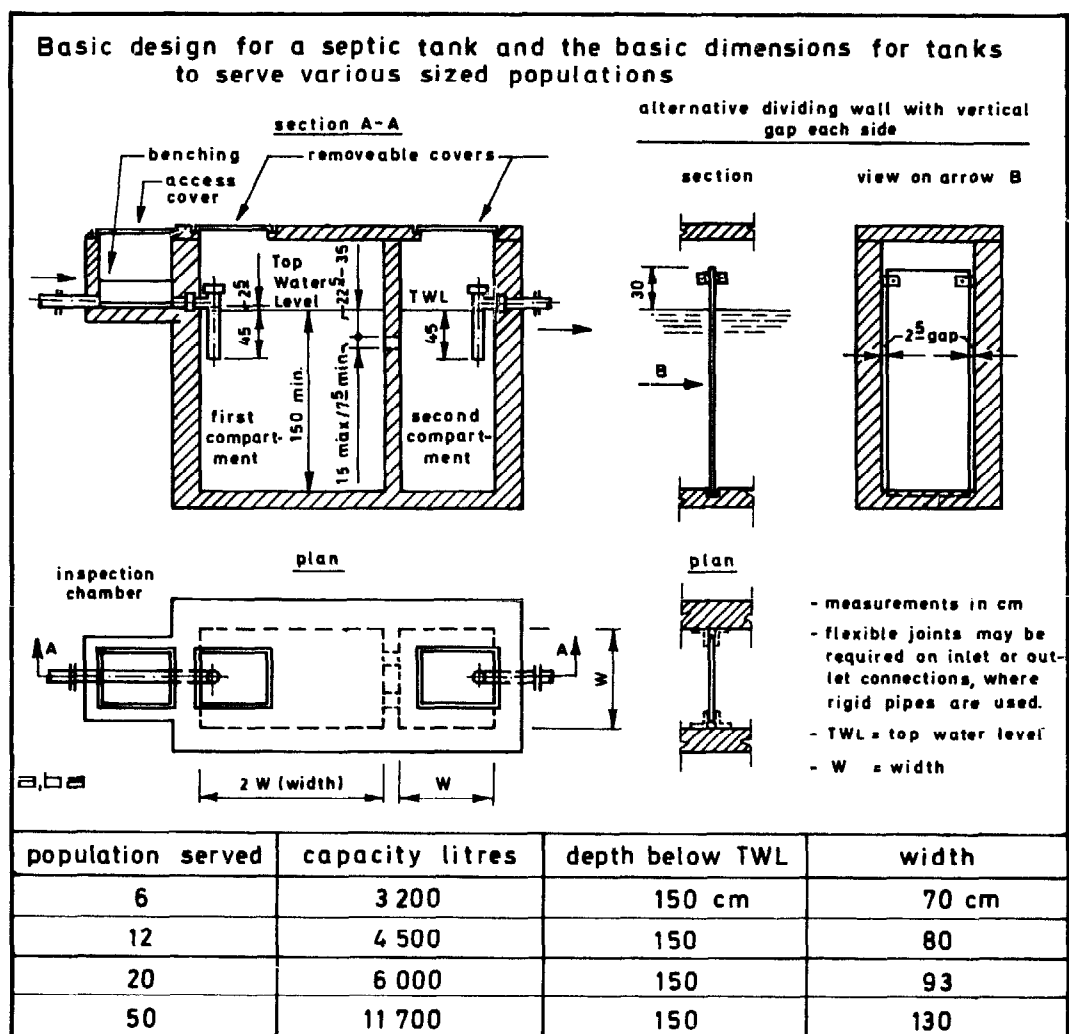

7.595 **Kitchen connections** - In certain cases it might be advisable to have a simple grease arrestor fitted near to the kitchen sink (e.g. covered gully). This helps to avoid blockages in the drainage pipe, leading from the house to the mains or to the septic tank.

7.600 **LEADERS (Stacks)**

7.610 **Principles** - drainage pipes, such as leaders, branch and connector pipelines, etc., shall be situated inside the building. If this is not possible then they can be situated outside the building, provided easy access is maintained after completion of construction works.

7.611 **Leaders (Stacks)** - shall have the approved diameter and be continued upwards without any reduction in diameter, without any bends or angle being formed (except where this is unavoidable), to such a height and position as to afford by means of the open end a safe outlet for foul air.

7.612 **Layout of pipes** - Pipe work and appliances should be so arranged as to allow close grouping of connections preferably with the water closet near to the leader.

7.613 **Siphon** - All appliances directly connected to leaders (stacks) are to be fitted with a siphon.

- 7.614 **Placing of pipes** - Pipes should be placed, fixed and jointed so as to avoid risk of damage through variations in temperature. Unless suitable precautions are taken, the jointing of pipes exposed to unduly high temperatures may become unsatisfactory. Small drainage pipes are particularly liable to damage caused by the freezing of water from a leaking tap in places where freezing normally occurs.
- 7.615 **Access** - Sufficient provision should be made for access to all pipework. The embedding of joints in walls should be avoided as far as possible. Pipes should remain readily accessible for the complete height of the building both during erection and after completion for maintenance works. Where fitted inside the house and in shafts access must be possible from each floor. Where fitted on to the outside wall, permanent platforms are to be provided for access.

LEADER (STACK) FITTED
INSIDE HOUSE CONSTRUC-
TION.

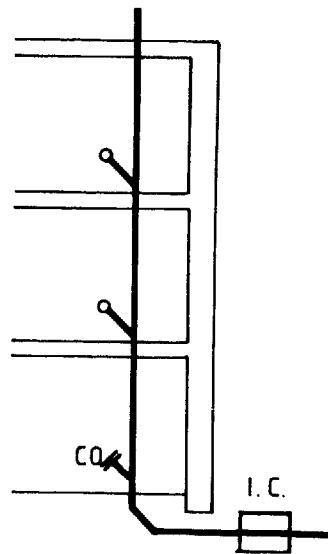

LEADER (STACK) FITTED
OUTSIDE THE WALL
CONSTRUCTION.

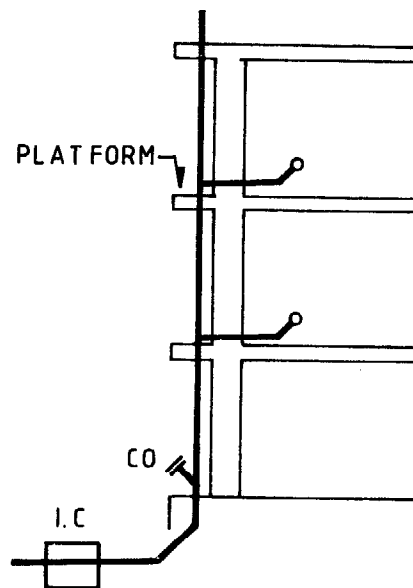

I.C. = INSPECTION CHAMBER

CO = CLEAN OUT

It is recommended that leaders and branch and connector pipelines remain accessible, where possible, and are not concealed in masonry (to be fitted in shafts, ducts, etc.).

- 7.616 **Clean out** - At the footing of each leader and at easily accessible sites, installation of lockable, airtight gastight "clean outs" is required. This is in order to secure cleaning of these pipelines. However, they may not be situated in living rooms, and if possible also not in workshops.

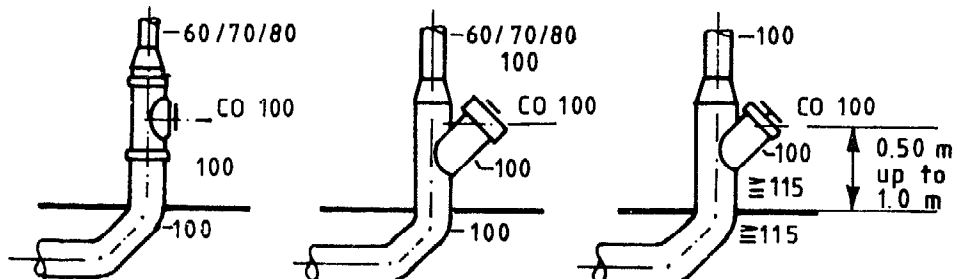

Note: clean-out's to be the same dimension as the horizontal ground pipeline (min. 100 mm i.d.); reduction only above the clean out.

- 7.617 **Change of direction** - The transition of the leaders into the horizontal pipeline or into a loop, and the transition of the horizontal pipeline into the leader is to be made with two bends of between 30° and 60° (max.) and with a straight piece of pipe between ($M \geq 2d$).

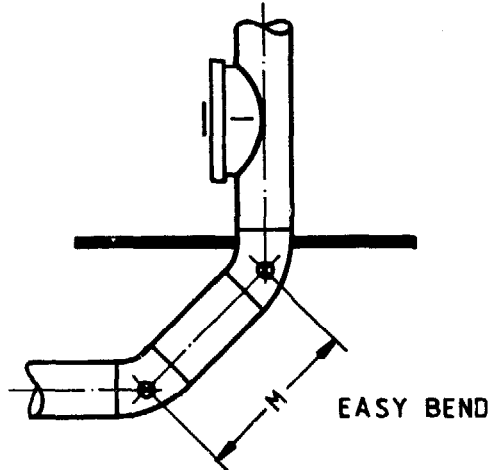

- 7.618 **Offset** - To shift the fall line of leaders up to 1 m distance offset bends with pointed edges from 15° up to 45° shall be utilized.

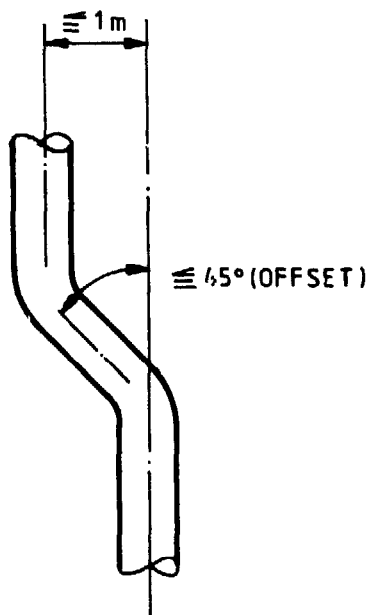

- 7.620 **Loops** - Where loops of leaders are unavoidable the influence on the drainage function shall be compensated by appropriate measures.

- 7.621 **Loop with bypass** - Where the leaders have a height of over 10 m the drainage appliances in the storey above the loop have to be connected to a bypass. Where there are no drainage appliances in the storey above the loop, a vent pipe shall be made.

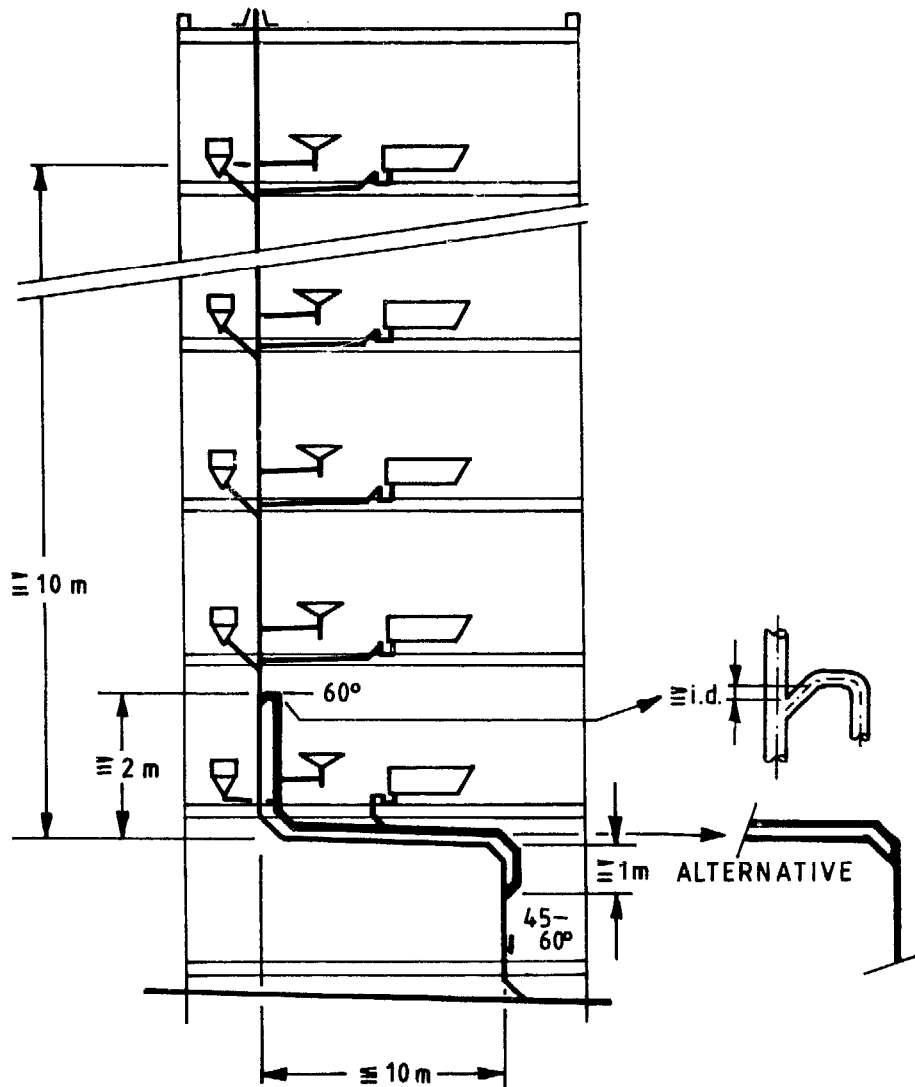

- 7.622 **Connections of bypass loop to stack** - The connections to the stack must be made at least 2 m above and 1 m below the stack loop. Connections must be made using fittings having angles of between 45° (min.) and 60° (max.), as shown above.
- 7.623 **Dimensioning of loop pipes** - The diameter has at least to correspond to the connected S-values. The loop can be made one dimension smaller than the corresponding leader.

- 7.624 **Loop without bypass** - No stalk bypass is required where the height of the leader between the top-most inlet and loop is less than 10 m. In such a case there may be no insertion of a connector or branch line into the leader within 1 m either side of the loop bend.

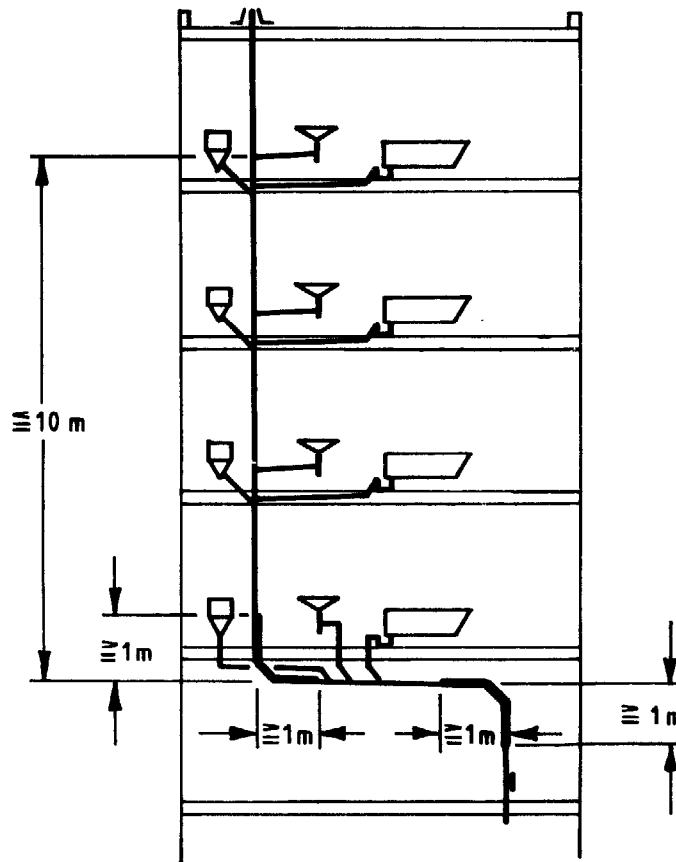

- 7.630 **Connection of appliances into horizontal pipelines near to vertical stacks** - Where leaders are less than 10 m in height (Height between the top-most inlet and the collection pipe or ground pipeline) no apparatus may be connected within 1 m either side of the easy bend (as shown above)
- 7.640 **Pipe fixings** - All drainage pipes need to be securely fasted to the building structure in order to remain in their proper place and not to change shape or direction (e.g. plastic pipes). A proper, open installation has pipes fixed approx. 5 cm clear of the finished surface of the wall by means of suitable clamps.
- 7.641 **Brackets/Clamps** - Pipe clamps are to be appropriately designed so as to withstand applied loads. They are to be coated to resist corrosion.

Note that branches from leaders are not to be regarded as fixings, since such "clamping" could harm the branch fittings (especially on plastic pipes) and therefore clamps are still required. There are principally two types of brackets:

- Guide bracket and hangers: they serve as pipe guides and enable contraction and expansion in the desired directions.
- Anchor bracket: A strong bracket fitted firmly to the building structure and the pipe. It serves to hold the pipes and to resist possible movement of pipes (i.e. fixpoint). All sockets normally should be secured with such a strong bracket.

7.642 **Number of brackets** - Leaders shall be secured with a minimum of two brackets in each floor. One anchor bracket just below the socket, and one guide bracket at the middle point.

7.700 **BRANCH AND CONNECTOR PIPELINES**

7.710 **Principles** - The pipework in branch and connector pipes should always be arranged to allow free drainage of the system. Connections to main or branch pipes should be so arranged as to prevent cross flow from one appliance to another.

Self-siphonage of traps through drainage in the branch and/or connector pipeline shall be avoided by means of the following installation technologies.

7.720 **Horizontal Connection** - The appliances should be grouped as closely as possible round the main stack so as to keep the branch and/or connector pipes short and reduce noise.

7.721 **Gradual slope** - Pipes should have a gradual and continuous slope in the direction of flow.

7.722 **Minimal distance** - In order to prevent siphonage, the distance of the leader's fall line and the angle of the next 88.5° bend may not be less than 0.25 m.

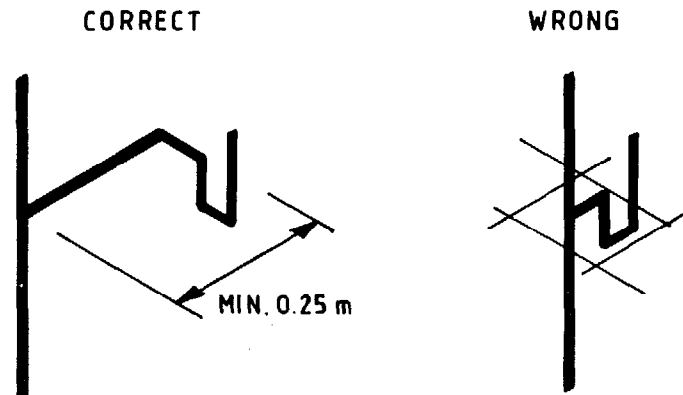

Note: A direct horizontal connection between the siphon exit and leader is prohibited.

7.723 **Minimal slope of connector- and branch pipelines** - The minimal slope has to be equal to the measurement of the internal diameter of the connector or branch pipeline, as shown below.

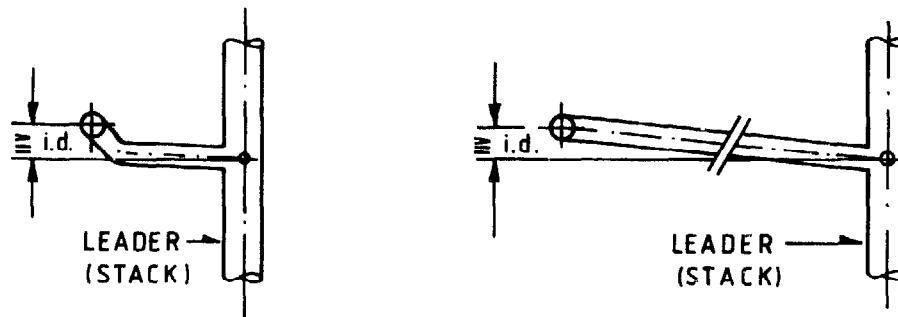

7.730 **Branches from the leader** - The branch of a horizontal connector pipeline from the leader has to be made at an angle of between 87° and 88.5° . In the case of a connector pipeline with secondary ventilation the connection to a leader can be between 45° and 88.5° .

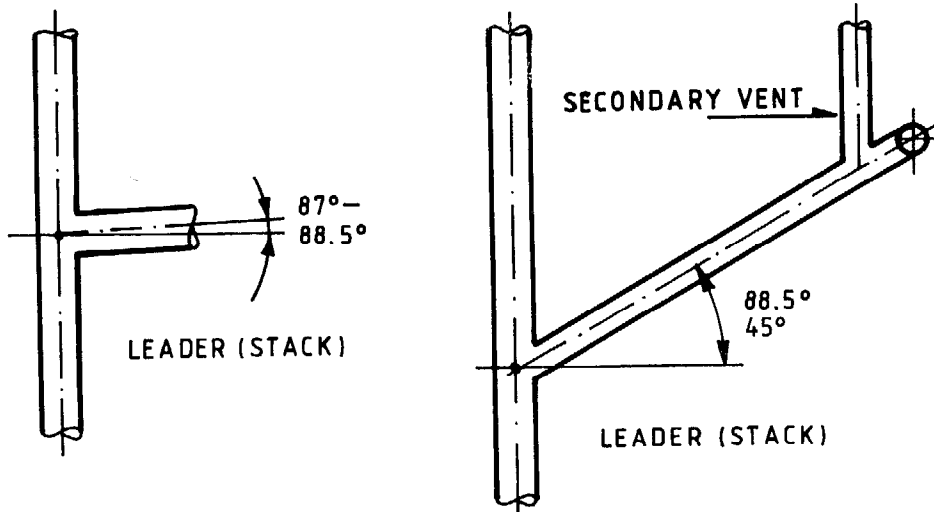

7.731 **Connector tilt-line** - Single devices for drainage can be connected to a leader with a straight tilt-line of between 45° and 60° (max.).

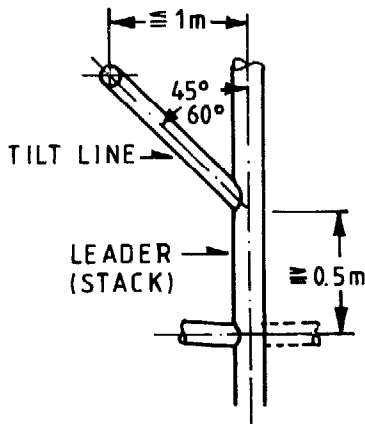

7.732 **Adapters and connections** - The adapter to a connector on to a branch pipeline or collector pipe, has to be made with a fitting of up to 60° .

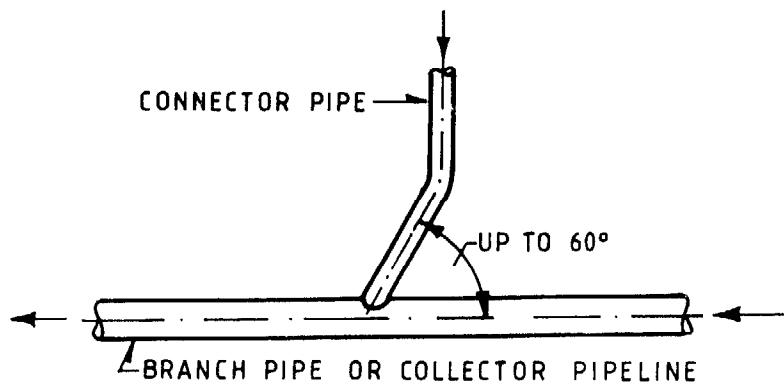

7.740 Cross flow - The insertion of a connector pipeline into a leader has to be made so that no disturbing cross-flow may occur into another connector pipeline. The following shows some examples of this.

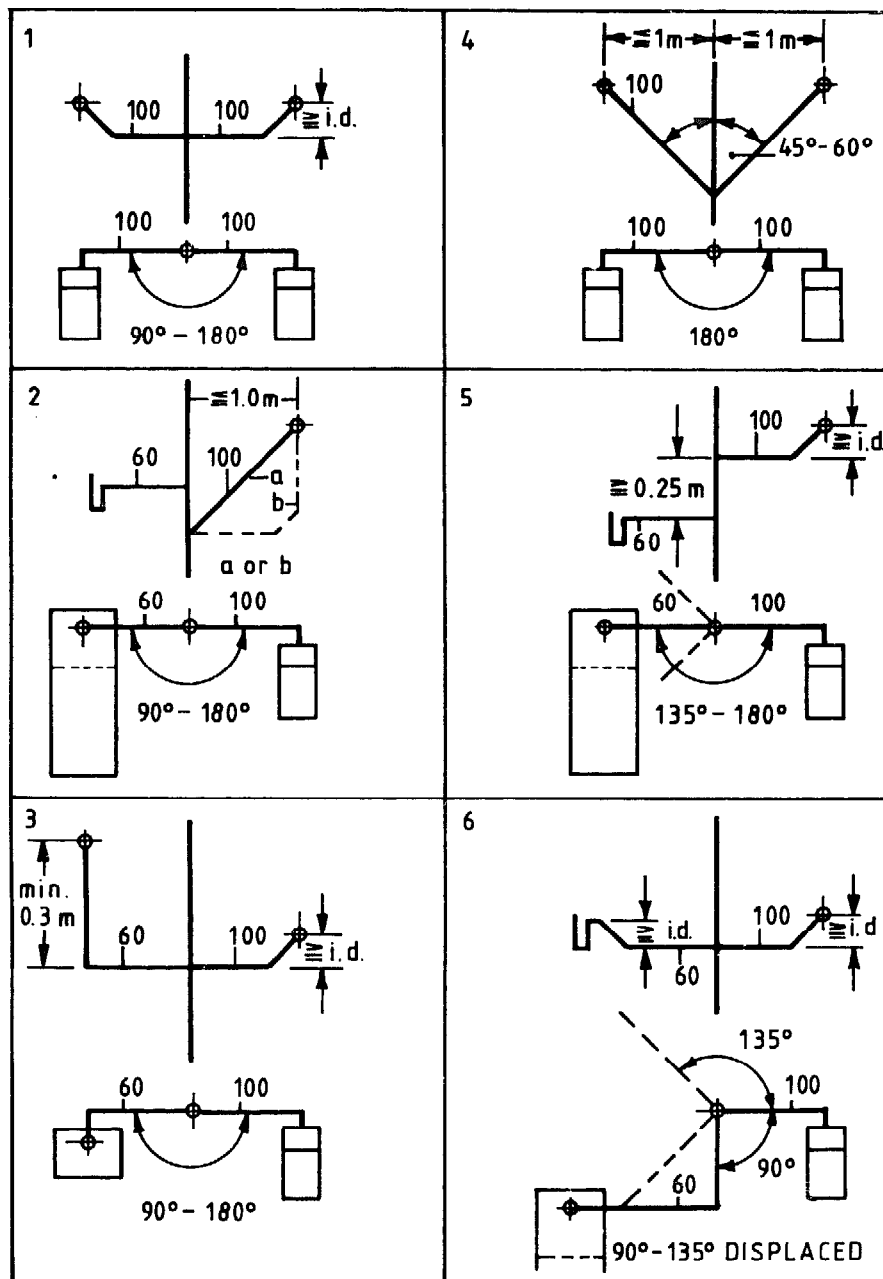

- 7.741 **Opposite drainage appliances** - Connector pipelines of opposite, equally loaded drainage appliances may be joined by the use of permitted special fittings, provided they are located in the same apartment or where it is possible to have a round-the-clock access to the drainage appliances (e.g. in hotels, schools, etc.). Opposite WC-arrangements are to be connected vertically.

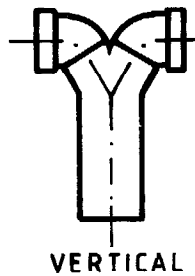

- 7.742 **Dimensioning** - Branch and connector pipelines of max. 4 m effective length, having max. 1 fall line or tilt line in a branch pipeline of max. 1.5 m in height are to be dimensioned according to the table: "Branch and connector pipelines without vent." (Fig. 13.420)
- 7.743 **Increased loadings with secondary vent** - Where the above conditions may not be realized, a branch- or connector pipeline can be ventilated at its end. Such pipes with secondary vent. pipes may have increased loadings, as of table: "Branch and connector pipelines with ventilation." (Fig. 13.430)
- 7.760 **Principle of installation for connector and branch pipelines** - Variant 1: The connector pipeline with an effective length of up to 4 meters, may have only one tilt-line or fall line up to max 1.5 m measured after the elbow of the apparatus connector. The dimensioning follows the table: "SV-values" (13.300)

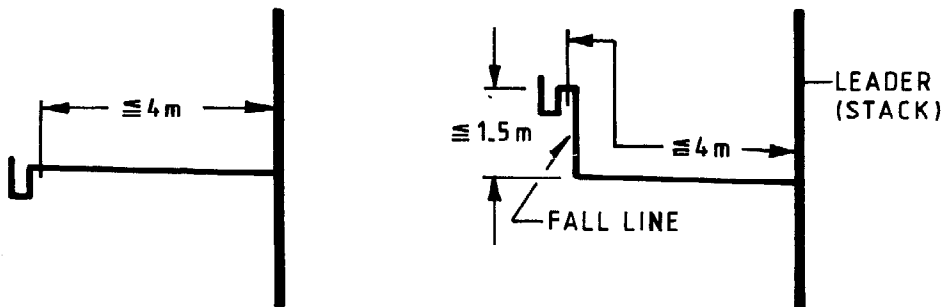

Variant 2: The connector or branch pipeline of the SV-groups 0.5 and 1.0, with an effective length of between 4 and 8 meters, may have only one fall line or one tilt-line of up to 1.5 m if adjacent to the elbow of the apparatus connector, provided the diameter of the pipeline is made larger by one dimension as in table: "SV-values", Fig. 13.300 (i.e. to increase indicated SV-values by one dimension).

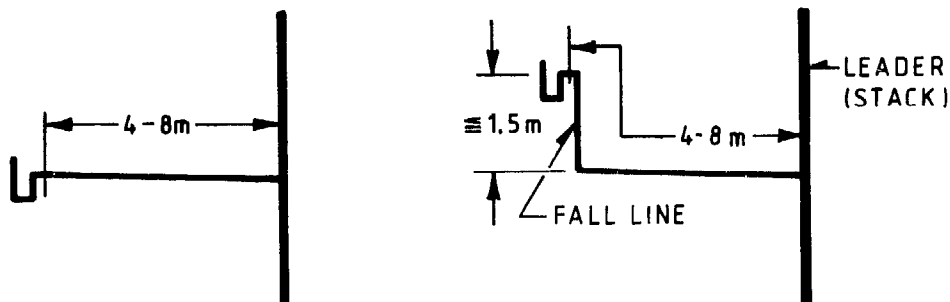

Variant 3: The connector or branch pipeline, with an effective length of up to 4 meters and with one or several tilt-lines or fall lines within 4 meters, has to be made one dimension larger as indicated in table: **SV-value** (= increase indicated diameter of table by one dimension), except for WC

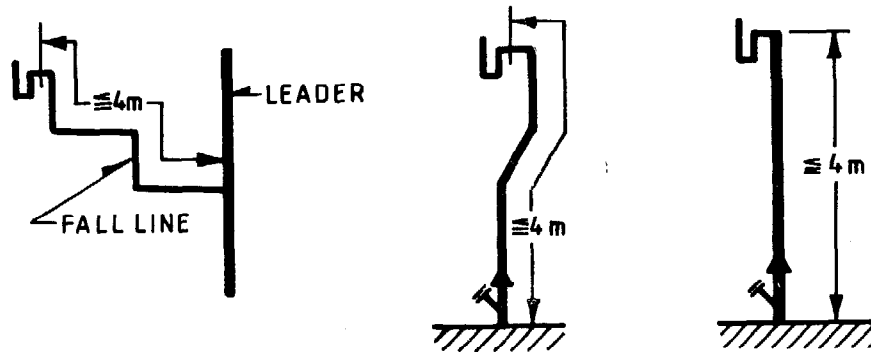

Variant 4: All other connector or branch pipelines are to be made with a connector or branch vent, as mentioned in table: **SV-values**.

- 7.770 **Branch pipeline with ventilation** - Stacks normally require a ventilation pipe to be of the same dimension as the stack. Provided there is at least one ventilation pipe of 100 mm \varnothing within the house installation, the following exception for reduced ventilation is applicable.

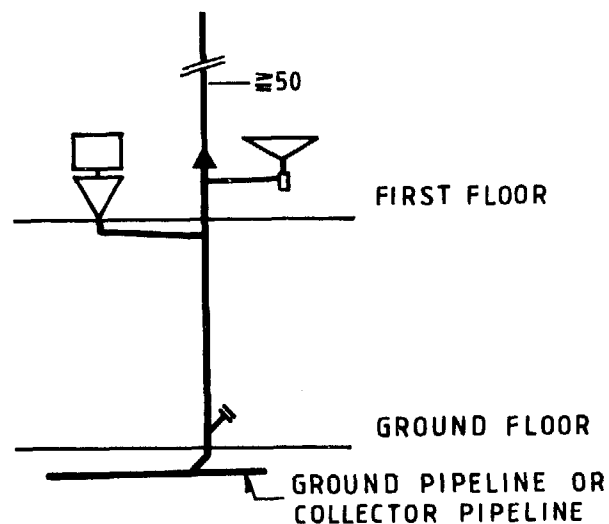

Both of the drainage appliances closet and service sink or wash basin fitted in the first floor may be connected as a joint pipeline to a ventilated collector pipeline or ground pipeline. The dimension of the corresponding vent pipe above roof level may be reduced to i.d. 50 mm.

8. SANITARY APPARATUS (Fixture, Appliance)

8.100 PRINCIPLE

All apparatus must be fixed securely to the building structure. They have to withstand the loads of the appliance itself as well as additional load (e.g. wall water closets and person; washbasin with children on it, etc.) Ceramic items are to be fitted on finished walls or finished floors, with screws, in order to enable easy removal and replacement when required.

8.110 **Apparatus connections-** All connected apparatus shall always be easy removeable and accessible for maintenance. This can be through the fixing with back-nuts (raccords), for water closets, resp. ceramic connections with a rubber-ring seal or ropes with putty (mastic). No cement shall be used, as the whole apparatus might be damaged if it has to be removed at later stage.

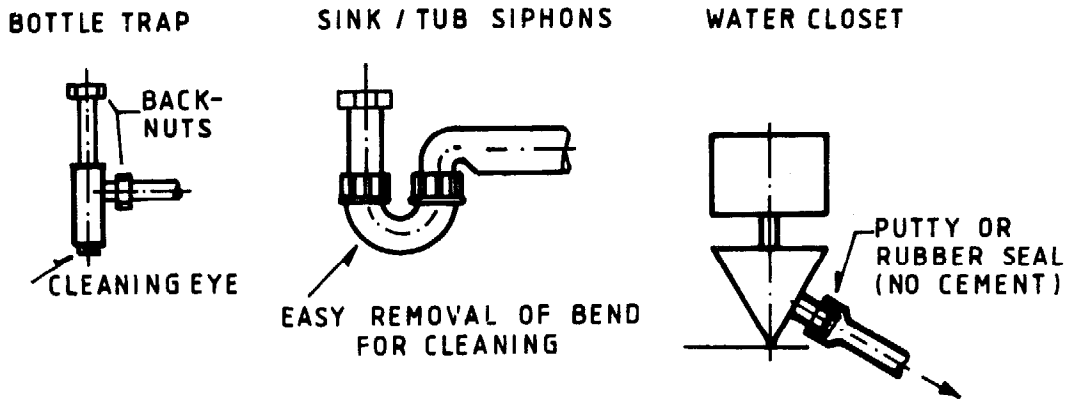

8.200 **WASTE COUPLING AND SIPHON**

The waste outlet and siphon of a sanitary apparatus can consist of the following parts:

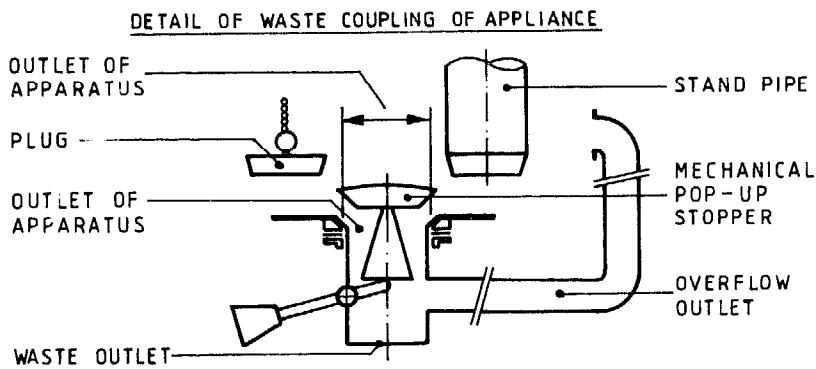
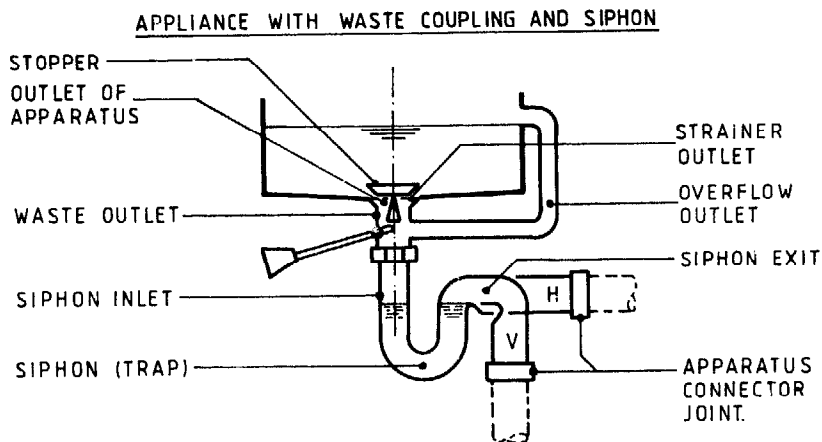

- 8.210 **Outlet of apparatus** - Removeable or fixed connection on outlet for the connection of the drainage appliance with the siphon or with the connector line respectively.
- 8.211 **Waste coupling** - Removable (flanged) or fixed projection at outlet for the connection of the drainage appliance with the siphon or the connector pipeline respectively.
- 8.212 **Stopper** - for the watertight closing of the waste outlet, such as:
- Standpipe (for kitchen sinks)
 - plug (rubber, with chain)
 - mechanical pop-up stopper (washbasin)
- 8.220 **Overflow outlet** - Device which when outlet closed, prevents an overflowing of the drainage appliance up to the maximal permitted inlet volume.
- 8.230 **Siphon (Traps)** - A siphon is a device which prevents the exit of gases from soil and/or waste water pipelines, canals and of septic tanks.
- 8.231 **Siphon inlet** - Connector piece between outlet of drainage appliance and of siphon.
- 8.232 **Siphon exit** - Connector piece from siphon to connector pipeline.
- 8.233 **Apparatus Connector Joint**- Connector between siphon exit and connector pipeline with collar, ring seal socket, H-nipple, siphon, joint socket, etc.
- 8.234 **Cleaning of siphons** - Siphons should always be of a self-cleansing pattern. They are to be situated so as to be conveniently accessible and provided with cleaning eyes, or other easy means of cleaning, e.g. removal of entire siphon.
- 8.235 **Placement of siphons** - Close to each appliance there must always be a siphon of adequate diameter and appropriate seal. A siphon which is not an integral part of an appliance should be directly attached to its outlet, and the pipe bore should be uniform throughout and have a smooth surface.
- Note: In any situation (including where the appliance itself has a siphon) more than one siphon in the pipeline is not permissible.
- 8.236 **Single siphons** - In certain conditions ranges of appliances need not have a separate siphon for each apparatus, for example:
- Single trap for range of basins

RANGE OF LAVATORY BASINS OR BATHS

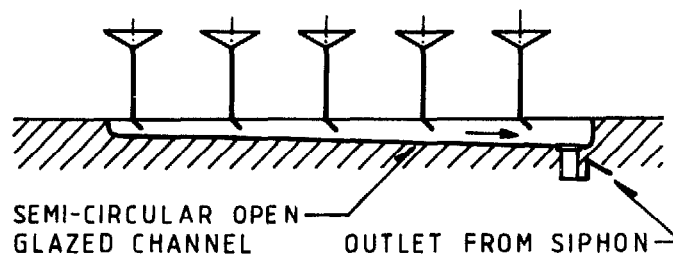

- b) Range of lavatory basins or showers

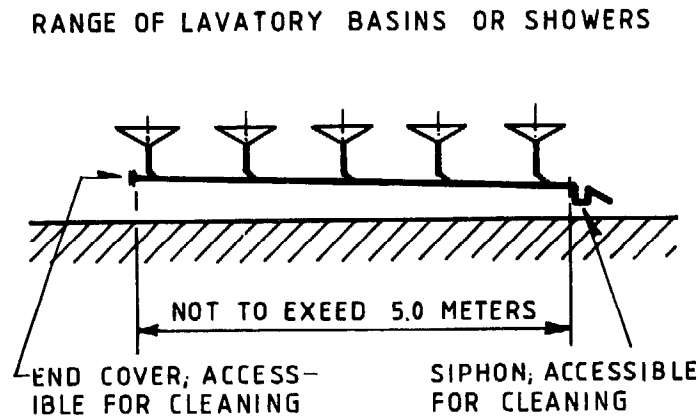

9. VENTILATION

9.100 PRINCIPLES

The main purposes of a drain-ventilating pipe are to prevent undue concentrations of foul air and to provide sufficient ventilation. Ventilation is required to avoid loss of water in a siphon seal caused by siphoning and to prevent admission of foul air to the building caused by back-pressure. Ventilation pipes have to be so installed that water cannot be retained in them. They should be fixed vertically, and whenever possible horizontal runs should be avoided.

9.200 CORROSION RESISTANCE

In principle the same requirements apply as for drainage pipes, however, more attention is required to corrosion resistance. Note: galv. sheet metal pipes are not permissible.

9.300 MINIMAL REQUIREMENT

A building requires at least one ventilation pipe, with a diameter of not less than 100 mm i.d.

9.310 **Leader/Stack vent** - The upper end of a leader or stack is to be continued (with a pipe having the same diameter as the drainage pipe), to the open air above roof level.

9.320 **Branch and connector pipes** - Normally sufficient ventilation is provided from the leader. However, where the installation is not within the range of the leader's ventilation, additional vent pipes (e.g. secondary vents) are to be installed to secure sufficient air flow.

9.400 TERMINATION OF VENT PIPES

The ventilation pipe has always to be taken above the level of the flat roof or of the eaves or terrace parapet, whichever is higher, or the top of any window.

- 9.410 **Flat roofs** - Vents of leaders are to be fitted separately to a leader and to be of the same diameter as the leader, to a height of 0.3 m above roof level. In regions with heavy snowfalls the vent should be correspondingly higher.

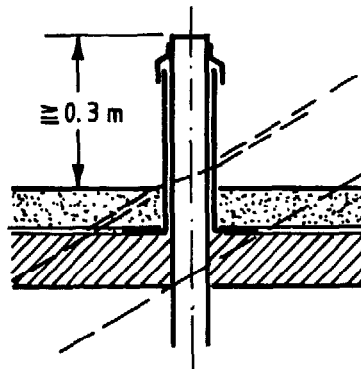

- 9.420 **End of vent pipes** - Caps on vent pipes (vapour pipe) and end pieces with cross-sectional narrowing of diameter should not be fitted, since they may endanger the proper functioning of the drainage system.
- 9.430 **Layout** - The vent pipes led to the outside and above the building have to be so arranged that there may be no occurrence of odour annoyance. (Facades, windows, terraces, air conditioning plants, ventilations, etc.)

9.500 **DISTANCES**

Vent pipes having an exit nearer than 2 m to a window of inhabited rooms, have to be led to a minimum of 0.1 m above the lintel.

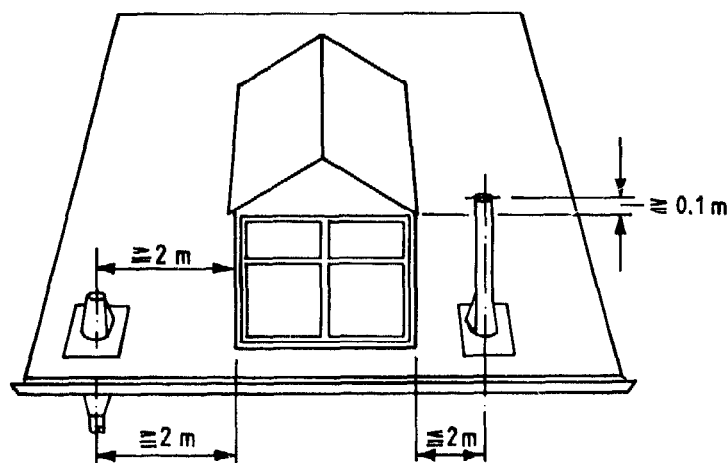

In districts with mixed drainage systems, storm drains having inlets without siphons, require to have a distance of 2 m from windows of inhabited rooms.

9.600 **VENT LOOPS**

Vent pipes require a minimum slope of 1%, for the drainage of the expected condensed water.

10 RAIN WATER

10.100 PRINCIPLES

The drainage of rainwater from roofs, terraces, etc., has to be according to the climatic conditions and must follow the rules of the building inspectorate. Spouts are to be applied only beyond walkways. Rain water drainage requires separate pipe-work for the entire building installation. Any possible joining with a drainage system are to be made **outside the building only!**

10.200 LEADERS

The rain water leader shall be situated outside the building, where possible, and shall be continued upwards without diminution of it's diameter to the roof outlet. Pipes are preferably to be in a vertical line, and except where it is unavoidable bends should be utilized. Changes of directions to be made with bends having larger radius, and approx. 15° up to 45° (no elbows!)

10.300 TERRACES

Where terraces are connected to the drainage system, this must be made with a separate leader and with a siphoned device and situated in a frost-protected place.

10.400 ACCESSIBLE ROOFS

On accessible roofs (as for example Penthouses) the rain waterleader requires a siphon or mud trap (with siphon). Exception: Divided systems, i.e. rainwater drainage led into an outfall ditch.

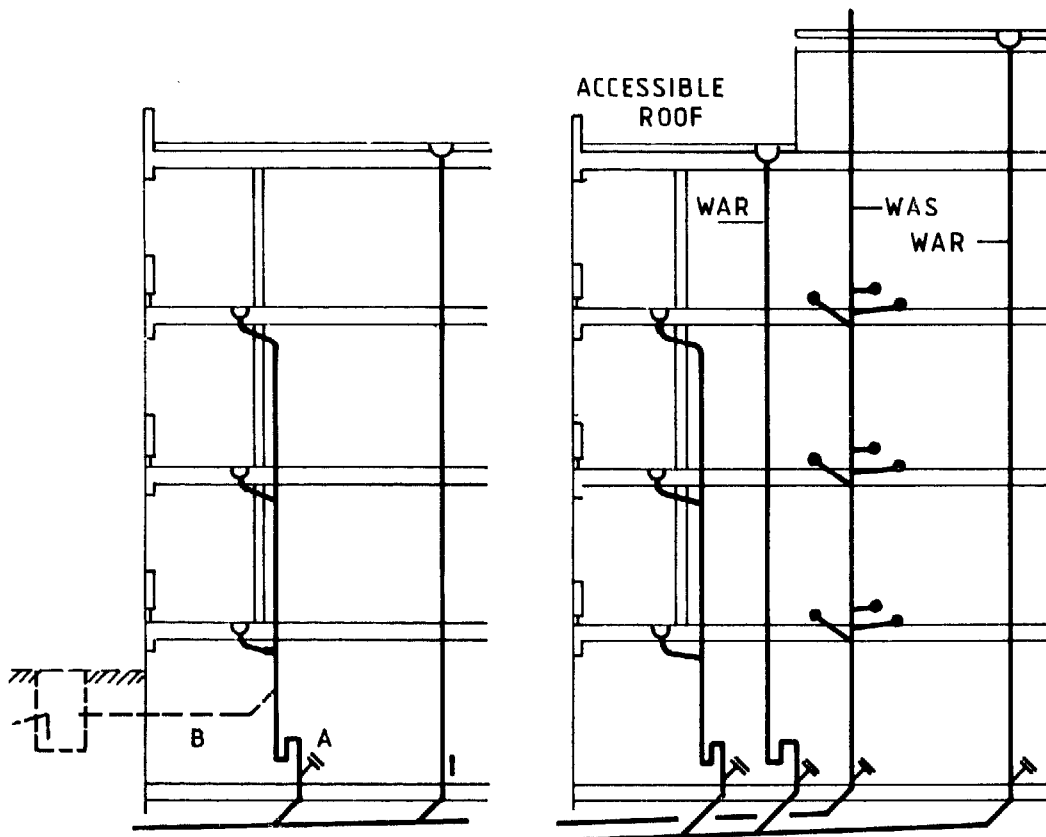

10.500 ROOF SURFACES AT DIFFERENT LEVELS

On buildings with roof surfaces at different levels it is suggested to design separate rain water leaders. Where this suggestion is not followed, the installation has to be made in such a way that no damage may occur due to back-flow.

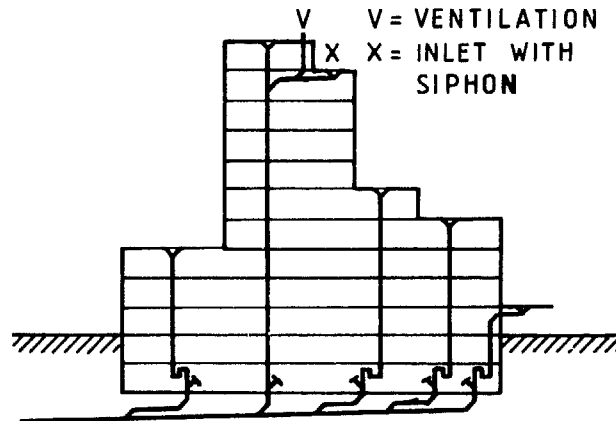

10.600 OUTSIDE RAIN WATER LEADERS (=DOWNPIPES)

Are to be made of mechanical resistant (impact-strengthened) material up to a height of min. 1m, measured from above terrain level, and to have a sliding piece (for easy removal of downpipe when required).

10.700 PROTECTION OF RAINWATER PIPES AT ROAD SIDES

Rain pipes adjoining public pavements or roads should be recessed up to a height of 3 m into the building facade.

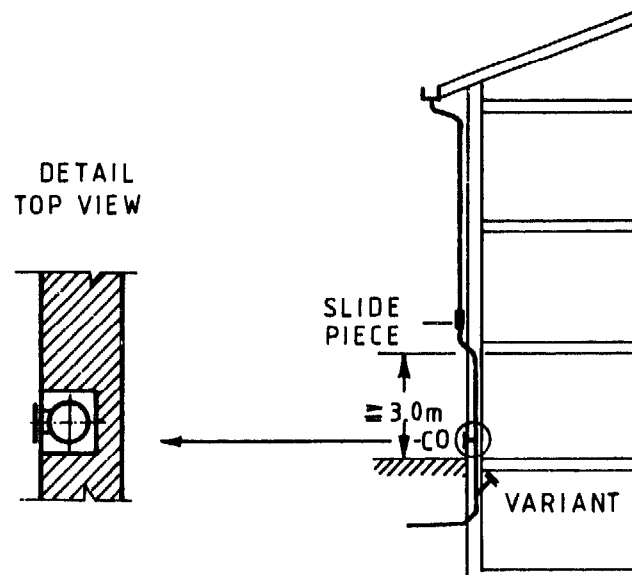

10.800 RAINWATER OUTLETS

The funnel and gutter outlets have to be conical, in order to ensure proper swallowing of rain water.

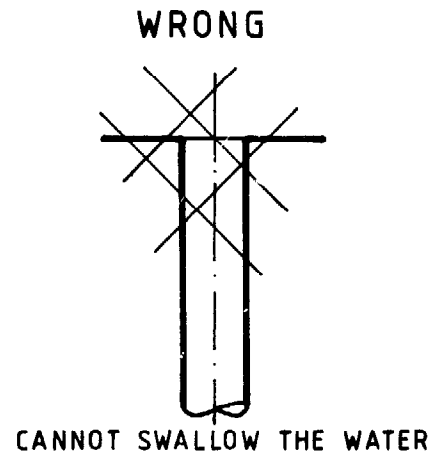
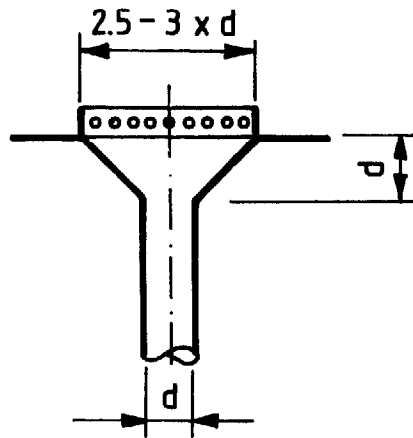

10.900 SAFETY OVERFLOW

Flat roofs are to be provided with a safety overflow!

11 MATERIALS

11.100 **PLASTIC PIPES, PRINCIPLES** - Plastic pipes require special attention:

- Contraction/expansion to be taken care of by including special sockets, and by clamps which provide longitudinal movement.
- Horizontal pipelines to be fitted with galv. M.S. half-shells, in order to provide required strength.

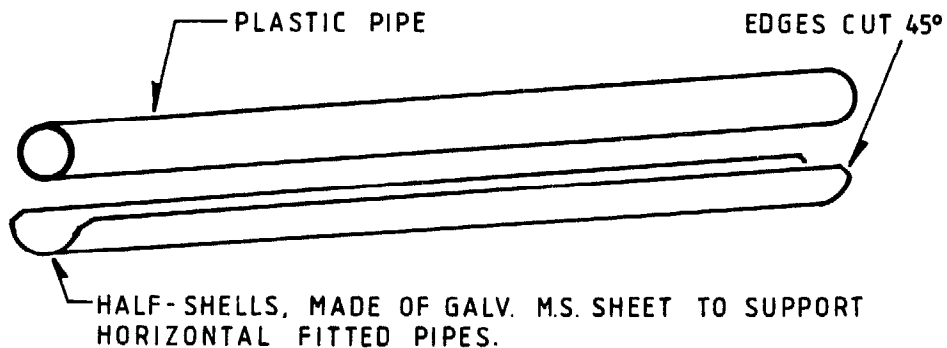

11.200 FIXED JOINTS

Fixed joints of plastic pipes are achieved by welding (e.g. butt welding with a hot plate for HDPE, or by solvent weld joint using solvent cement on to uPVC pipes).

11.130 **Ring seal sockets** - Are joints having a neoprene ring seal and allow easy fitting on site. They have a limited capability to absorb little changes in length. Protection of sensitive sealing parts from any ingress of dirt is to be maintained, especially at the building site (wrapping of joints with pieces of cloth and securing it with adhesive tape).

- 11.140 **Preparation of pipe ends** - The end to be inserted should be bevelled all around to an even angle of approx. 15°

Before joining: sockets and spigot ends are to be cleaned from any impurities.

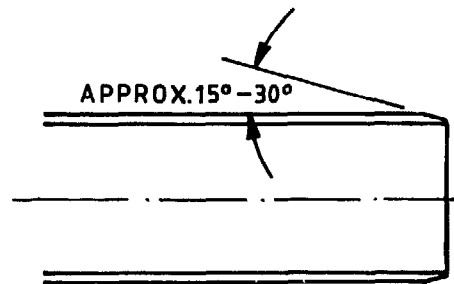

- 11.150 **Insertion depth** - It is required to mark the depth of insertion on the spigot end, prior to joining. When using flexible joints (e.g. ring seal sockets), in winter at lower temperature, insert to approx. 5 mm less than entire insertion length.

Summer = full depth

Winter = minus 5 mm
of full depth

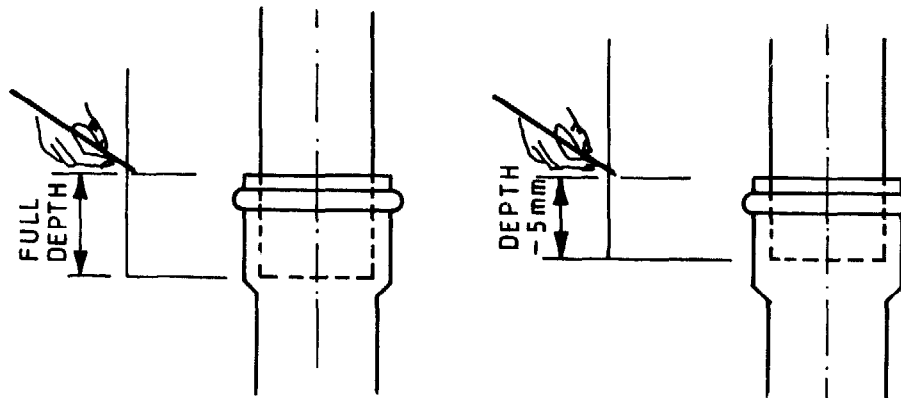

- 11.160 **Fixation of horizontal pipelines** - Exposed lay-outs require attention to physical strength and changes in length. Satisfactory fixings can be achieved partly by using appropriate sealing sockets, and with a pipe lay-out allowing flexibility for limited movement. (Prevention of movement is possible when having a fixed lay-out by embedding the pipe in concrete or by having strongly fixed pipes).

It is recommended to have horizontal pipelines fitted with half-shells, as follows:

WITH SUPPORT SHELL

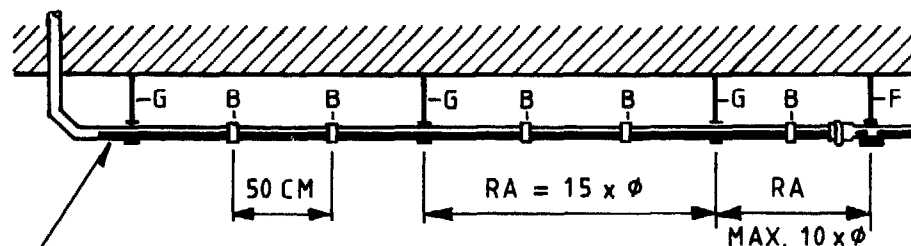

SUPPORT SHELL

B = PIPE BAND

F = ANCHOR HANGER

G = GUIDE HANGER

RA = SPACING OF HANGERS

Alternatively, instead of having half-shells, one could provide a greater number of appropriate clamps.

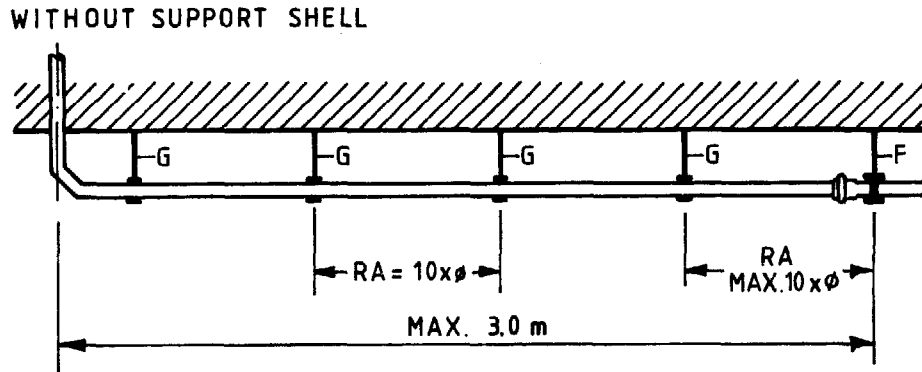

11.200 CAST-IRON PIPES, PRINCIPLES

C.I. pipes can be used for soil and/or waste waters and also for ventilation pipes.

11.210 **Quality** - C.I. pipes shall be sand cast iron or centrifugally cast (spun) iron pipes as per accepted standards.

11.220 **Application** - C.I. pipes can be used:

- a) in unstable ground where limited soil movement is expected;
- b) in made-up or tipped ground;
- c) To provide for increased strength where a sewer is laid at insufficient depth, where it is exposed or where it has to be carried on piers or above ground;
- d) under buildings and where pipes are suspended in basements and similar situations;
- e) In reaches where the velocity is more than 2.4 m/s;
- f) For crossing of watercourses.

11.230 **Corrosion of C.I. pipes** - It shall be noted that cast iron pipes even when given a protective paint are liable to severe external corrosion in certain soils. Among such soils are:

- soils affected by peaty waters, and
- soils in which the subsoil contains appreciable concentrations of sulphates.

11.300 REINFORCED CEMENT PIPES

Are commonly used for house drainage systems and they shall conform to accepted standards. They are not recommended for underground situations. If used underground the life of reinforced cement pipes may be increased by lining the inside of the pipes with suitable coatings like epoxy/polyester resins, etc.

11.400 SALT GLAZED STONEWARE PIPES

For all sewers and drains in all soils, except where supports are required as in made-up ground, glazed stoneware pipes may be used. They are suitable particularly where acid effluents or acid subsoil conditions are likely to be encountered. Salt glazed stoneware pipes shall conform to accepted standards.

12 PRINCIPLES OF CALCULATION

12.100 GENERAL PRINCIPLES

The dimensioning of a drainage system is based on the following factors:

- 12.110 **Sewer Value (SV)** - Sewer accumulation per time unit in l/s of the drainage appliance.
- 12.120 **Duration of drainage** - Duration of discharge in seconds (s) of the drainage appliance.
- 12.130 **Probable maximum load** - Maximum expected discharge of soil and/or waste water per time unit in simultaneous use of sanitary drainage appliances.
- 12.140 **Loading Capacity** - For those under section: "Dimensioning" fixed and permissible loadings are based on following preconditions:
- trouble-free drainage of the waste waters
 - warranty of ventilation of the drainage systems and of the ventilation system respectively
 - water seal (of siphon) may neither break through by vacuum, nor be pushed out of the siphon due to over-pressure

Note: Larger inner diameters than indicated are not to be used.

- 12.150 **Classification of groups for drainage appliances**- All places of discharges of soil and/or waste water (from drainage appliances) are classified in four SV-groups, ref. table: "Nominal sewerage values." (13.300) The smallest SV is 0.5.
- 12.160 **Soil and/or waste discharges over 2.5 l/s** - Drainage appliances with an S-Value larger than 2.5 l/s, as well as continuous discharges (pumped soil and/or waste water plants) are to be treated as special arrangements and their effective drainage capacity to be added to the findings of maximum loading under diagram 1.
- 12.170 **Dish washing machine** - The S-value of domestic dish washing machines connected to a siphon of a single or double sink is not to be considered.
- 12.180 **Duration of the discharges of drainage devices** - When determining the possible maximum-loading and the dimensioning of drainage arrangements, the following are to be differentiated:
- a) short term drainage as for closets, washbasins, etc., which are marked for residential buildings.
 - b) long term drainage, as for example in industries, trades and in laboratories.

12.200 PRINCIPLES OF DIMENSIONING

- 12.210 **Determination of the possible maximum loading** - for the determination of the possible maximum loading serves, above 60 SV, the approximation formula is used:

$$V_{s \text{ max.}} = \sqrt{0.5 \times \sum SV \text{ (L/s)}}$$

this takes into consideration the differentiation of connected drainage appliances of a domestic system.

Below 60 SV the maximum loading is not to be calculated, but determined according to the dimensioning tables.

- 12.220 **Filling ratio** : The ratio for filling for ground pipelines or collector pipelines will be assumed, as follows:

Sewer, rain and mixed waste water

$$\frac{h}{d_i} = 0.8$$

12.230 **Simultaneous Discharges:-** When dimensioning leaders (stacks, collector and ground pipelines), the possibility of simultaneous discharge must be considered. Maximum loading is determined by adding connected discharges in l/s of connecting pipes, as of diagram 1.

12.300 **DIMENSIONING**

12.310 **Connector - and branch pipelines -** The dimensioning of the connector line results from table: "Nominal Sewerage values" (Fig. 13.300). The following tables serve for the dimensioning of branch and connector pipelines.

Up to 60 SV determination of the expected probable maximum load is not required.

12.320 **Diagram 1 -** This diagram serves to determine the expected maximal loadings of a soil and waste water system in a domestic building. The graph converts total S-Values into liters per seconds.

For the calculation of the probable maximum loading with connecting values above 60 SV, the following equation is valid:

$$V_s \text{ max. } 0.5 \times \sqrt{\sum SV} \text{ (l/s)}$$

(Vs max. = Volume flow of all drainage appliances)

**DIAGRAM 1: PROBABLE MAXIMUM LOADINGS (SV INTO l/s)
FOR DOMESTIC BUILDINGS (APPLICABLE ABOVE 60SV ONLY)**

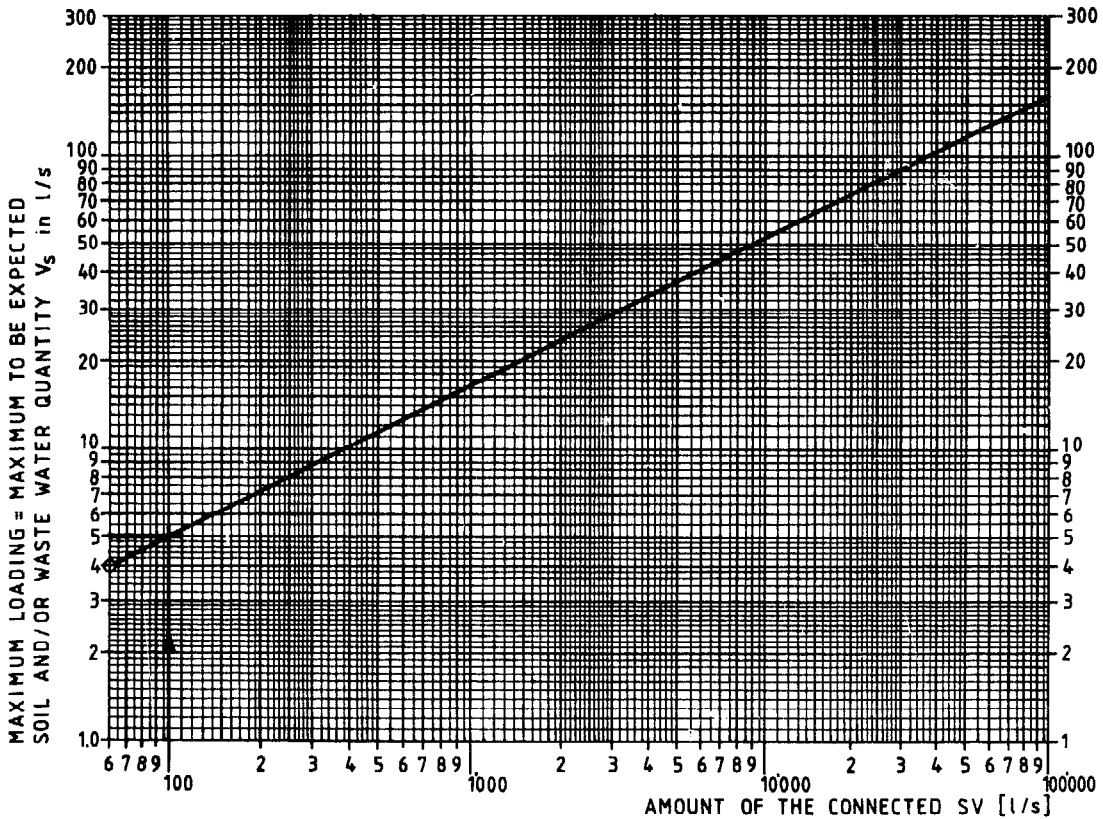

Reading example:

known: 20 flats at 5 SV = 100 SV
 wanted: Probable Maximum Load
 solution: $V_s = 0.5 \times \sqrt{100} \text{ (l/s)} = 5 \text{ l/s}$

12.330 **Leaders** - The permissible loading (V_s) of the leader is variable depending of the ventilation system and assessed in the tables: "dimensioning of leaders" (Fig. 13.500)

12.340 **Ground pipelines and collector pipes** - Relevant for the determination of the inner diameter (i.d.) for ground pipelines and collector pipes is the maximum expected loading, V_s max. in l/s.

- For soil and/or waste water pipelines the i.d. is determined based on the maximum expected loading (V_s max.), under consideration of the total simultaneous amount of the SV before this point, according to diagram 1.
- For rain water the effective loading of rain water, V_r , is decisive for the determination of the i.d.
- Roof surfaces - The horizontal projection is the base for the calculation of roof surfaces (A in m^2)

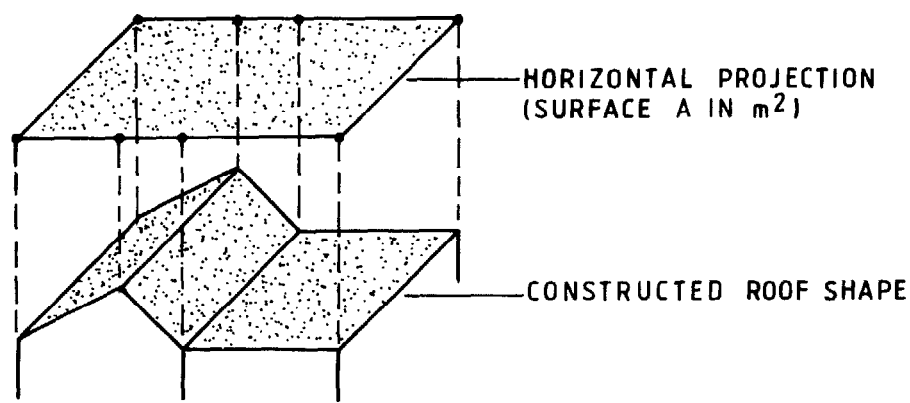

- For ground pipelines in mixed systems the maximum expected loading, V_m , results from the amount of V_s max. + V_r .
- V_s = Volume flow of several drainage appliances
- V_r = Flow rate per unit time of rain water
- V_m = Flow rate per unit time of mixed soil, waste water and rain water (in ground pipelines only).

13 DIMENSIONING

13.100 PRINCIPLES

Decisive for the dimensioning of parts of arrangements and systems are the principles explained in the chapter: "Principles of Calculation",



13.200 ARRANGEMENTS OF PARTS AND SYSTEMS

Systems and arrangements of parts are separately treated according to their dimensions as follows:

- connector pipes
- branch pipes
- leader with leader vent (stack with stack vent)
- leader with leader vent and indirect side vent
- leader with secondary vent
- vent pipe
- ground pipelines and collector pipelines

13.300 **NOMINAL SEWERAGE VALUE (SV).**

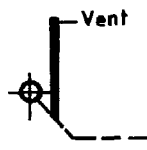
Of drainage appliances and for the dimensioning of their connector pipes.

SV		Minimal inner diameter in mm		
		Connector pipe	Connector and branch pipe, 2)	Sipt.on exit & connection (excl. self- siphonage apparatus)
	Drainage device with relevant siphon			
0.5	Handwashbasin i.d. 44 Washbasin Bidet	44		
	Service sink, at schools Washesink, up to 3 taps Domestic centrifuge Shower tray, without stopper	57	44 or 50	32 outside 40
1.0	Bathtub Combitub Feet sink, up to 5 taps Shower tray, with stopper Washesink, 4 to 10 taps Urinals (connector 40/45 mm) Kitchen sink (cement, metal) Double kitchen sink (cement, metal) Dish washing machine Wash fountain, 6 - 10 taps Laundry sink Washing machine, up to 6 kg Floor drain, i.d. 60 mm	57	44 or 50	50 57
105	Large-sized bathtub Laboratory tub Washing machine, 7 - 12 kg Dish washing machine for commercial use, 1) Floor drain, i.d. 70 mm	69	50	57
2.5	Water closets, all types Service sink / wall types (faeces, scrub/floor water) Service sink / standing type (faeces, scrub/floor water) Floor drain, i.d. 80 to 100 mm Washing machine, 13 to 40 kg Bed pan cleaning device (hospital)	100	50	80

- 1) For the definitive decision of the S-value the effective pump drainage accumulation respectively, is decisive.
- 2) The vertical pipelines of collected connector vent pipelines and branch vent pipelines are dimensioned as of table: "side vent".
- 3) Exceptions are siphons of ceramic make.
- 4) Horizontal connector pipelines, i.d. 44 up to max. 2 meters, with maximum one change in direction up to 45°, excl. apparatus connector elbow.

13.400 Dimensioning tables for soil and/or waste water system

13.410 Leaders (stacks), Main vent system.

stack	max. permitted numbers				permitted loading Vs (1/s)
	SV		WC		
i.d. in mm	Total	largest single SV	Total	per storey	
57	3-1)	1.0	--	--	1.3
69	7	1.0	--	--	2.0
80	20	1.5	--	--	3.0
100	70	2.5	14	6	4.2
118	100	2.5	20	7	5.0
125	150	-	30	10	6.1
150	400	-	80	22	10.0

1) max. 2 apparatus at 1 SV.

0.5 S-VALUE	1.0 S-VALUE	2.5 S-VALUES
<p>WASHBASIN</p>	<p>SHOWER</p>	<p>WATER CLOSET</p>
<p>URINAL (DIRECT FLUSHING)</p> <p>WITH CISTERN = 1.0 SV</p>	<p>KITCHEN-SINK</p>	<p>FLOOR PAN</p>
<p>BIDET</p>	<p>BATHTUB</p>	<p>WALL CLOSET</p>

1) HORIZONTAL CONNECTOR PIPE, I.D 44 φ UP TO MAX. 2.0 M

13.420 Branch- and connector pipes, without secondary vent.

i.d. in mm	max. permitted numbers SV	largest single SV
50	1	0.5
57	2	1.0
69	3-1)	1.5
80	6	1.5
100	15	2.5

1) max. 1 apparatus at 1.5 SV.

13.430 Branch- and connector pipes, with secondary vent.

i.d. in mm	max. permitted numbers SV	largest single SV	vent pipe in mm
50	2	0.5	44 or 50
57	3-1)	1.0	44 or 50
69	4.5	1.5	50
80	9	1.5	50
100	25	2.5	50

1) max. 2 apparatus at 1 SV.

13.500 Soil and/or waste water leaders (stacks) with direct and indirect side vent system.

i.d. in mm	max. permitted numbers			Vs -1) permitted [1/s]	side vent i.d. in mm
	Total	WC			
		Total	per storey		
80	64	---	---	4.2	57
100	150	30	6	5.9	80
118	200	40	7	7.0	80
125	300	60	10	8.5	80
150	800	160	20	14.0	100

- 1) Vs permissible values as compared to 13.410 increased by 80%
- 2) The connection of the side vent with the stack is to be made of the same dimension as the side vent.

13.600 Soil and/or waste water leaders (stacks) having secondary vents connected.

i.d. in mm	max. permitted numbers		per storey	Vs -1) permitted [1/s]	side vent i.d. in mm
	SV Total	WC Total			
80	100	--	--	5.4	57
100	240	50	8	7.6	80
118	300	75	10	9.0	80
125	500	100	15	11.0	80
150	1200	260	30	18.0	100

1) Vs permissible values as compared 13.410 increased by 80%

13.700 Collector pipeline and ground pipeline

V permitted in l/s (as of Prandtl-Colebrook) -1)							
i.d. in mm	slope in						i.d. in mm
	1	% -3)	2	3	4	5	
80	2.8	3.4	4.0	4.9	5.6	6.3	80
100-2)	5.0	6.2	7.2	8.9	10.2	11.5	100-2)
118-2)	8.0	9.8	11.3	13.9	16.0	17.9	118-2)
125	9.2	11.3	13.1	16.0	18.6	20.8	125
150	15.0	18.4	21.3	26.1	30.2	33.8	150
187	27.0	33.1	38.1	47.0	54.3	60.8	187
200	32.3	39.7	45.8	56.2	64.9	72.6	200
250	58.4	71.7	82.8	101.6	117.3	131.2	250
300	94.7	116.2	134.2	164.6	190.6	212.6	300

- 1) For all pipe materials; after Prandtl-Colebrook:
 Operation roughness $k_b = 1.0$ mm
 Kinetic velocity γ (ny) = 1.3×10^6 m²/s
 Filling relation $h/d_i = 0.8$
- 2) Minimal inner diameter of ground pipelines = 100 mm \varnothing
 Where WC are connected, suggested to be min. = 118 mm \varnothing
- 3) Optimal slope is 3% - to be maintained where possible.

13.800 DIMENSIONING OF VENT PIPES

13.810 Maximum length - Maximum effective length of a loop pipe from the axis of the first bend over the top-most apparatus connector: 100 times i.d.

Deductions for:

- Bends 15° - 60° 5 times i.d.
- Bends 75° - 88.5° & branches 10 times i.d.

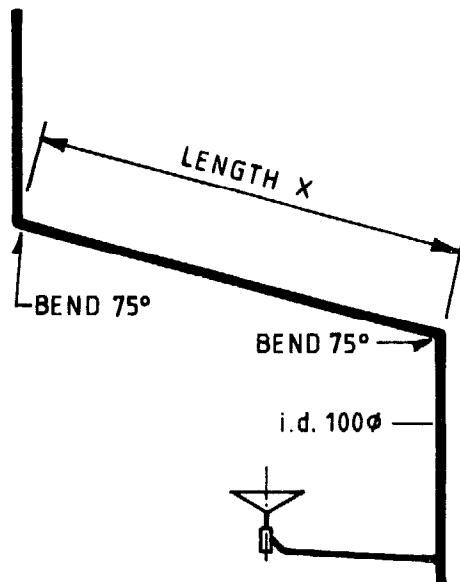

LENGTH X:

MAX. LENGTH (100 x i.d.) = 10.0 m

DEDUCTIONS FOR 2^{Nº}

BENDS 75°,

2 x (10 x i.d.) 1.0 m = -2.0 m

MAX. LENGTH X = 8.0 m

13.820 Collector vent pipes - Where for compelling reasons a collector vent pipe cannot be avoided, it will be equally dimensioned as leaders with relevant total loadings (table 13.410), and with the reservations mentioned in fig. 13.810.

- 13.830 **Connection of pumped pressure pipelines** - When connecting pumped pressure pipelines to collector pipelines or to ground pipelines, the following regulations apply: The dimension of the collector or ground pipelines will be determined by calculating the total of $V_s + V_p$, after the table 13.700.

V_s = Volume flow of several drainage appliances
 V_p = Volume of pumped water

The inlet of a pumped pressure pipeline normally requires an enlargement of the collector or ground pipeline by one dimension up to max. i.d. 150 mm.

14 INSPECTION AND TESTING

14.100 INSPECTION

Work should be inspected during installation and tests applied on completion, care being taken that all work to be encased or concealed is tested before it is finally enclosed.

- 14.110 **Range of inspection** - Pipe systems should be tested for tightness and for hydraulic performance. Inspection should be carried out to ensure the following:

- a) Work accords with the drawings and specifications;
- b) All pipe brackets, clips, etc., are securely fixed;
- c) Fixings are correctly spaced;
- d) Pipe is protected where necessary by insulation;
- e) Embedded pipework is properly protected before sealing-in;
- f) All access covers, caps or plugs:
 - are accessible,
 - are so made that the internal faces truly complete the internal bore,
 - cause no obstruction in the pipe bore, and
 - are well jointed.

14.200 TESTING OF THE SYSTEM

The water test must be applied before the appliances are connected and prior to concealing of pipes.

- 14.210 **Hydraulic performance** - Discharge tests should be made from all the appliances, singly and collectively. Obstruction in any of the pipelines should be traced and the whole system examined for proper hydraulic performance, including the retention of an adequate water seal in each trap.

- 14.230 **Defects** - Any defects revealed by the tests should be repaired, and the tests repeated until a satisfactory result is obtained.

- 14.300 **Efficiency** - When testing the efficiency of the design of soil and waste water pipe systems they should withstand any condition of discharge of appliances which may occur in practice. The discharge from one appliance must not be forced up into another, and every siphon should retain at least 25 mm of its seal under these conditions. The tests should be designed to make full allowance for the maximum suction and pressure effects which may occur as given below:

- a) in small installations when all the appliances are discharged together, and
- b) in large installations when sufficient appliances are simultaneously discharged to simulate peak conditions.

- 14.310 **Testing of siphons** - When testing the seals of siphons fitted to appliances, they should be filled to overflow level (where applicable, e.g. wash basins, kitchen sinks, etc., and allowed to discharge in the normal way.

- 14.320 **Similar tests** - Tests similar to the above should also be carried out by discharging some appliances, while others are empty with plugs out.

PARTS OF SOIL AND WASTE WATER SYSTEMS

TABLE 2/1

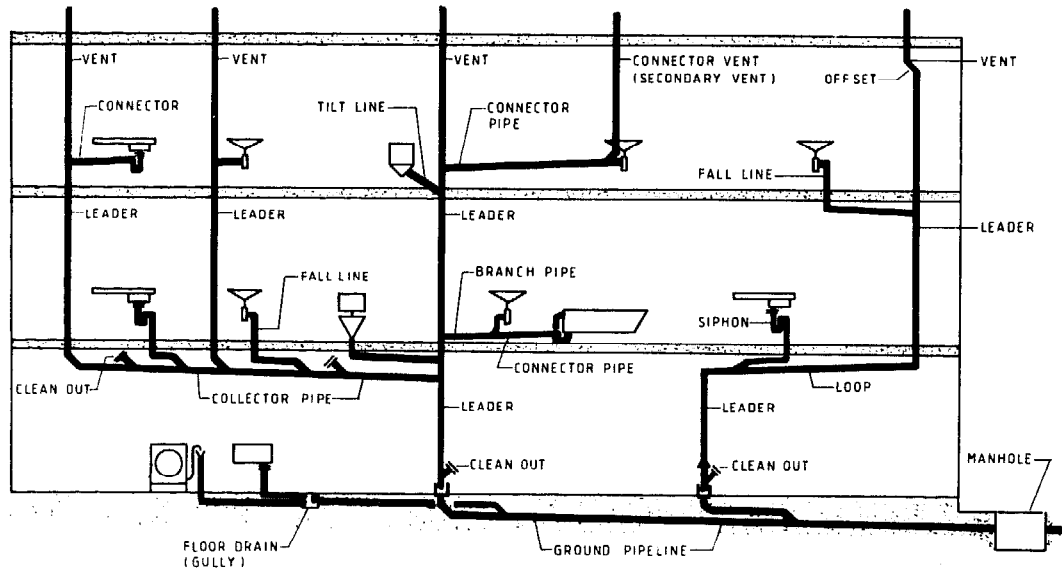

PARTS OF SINGLE STACK SYSTEM

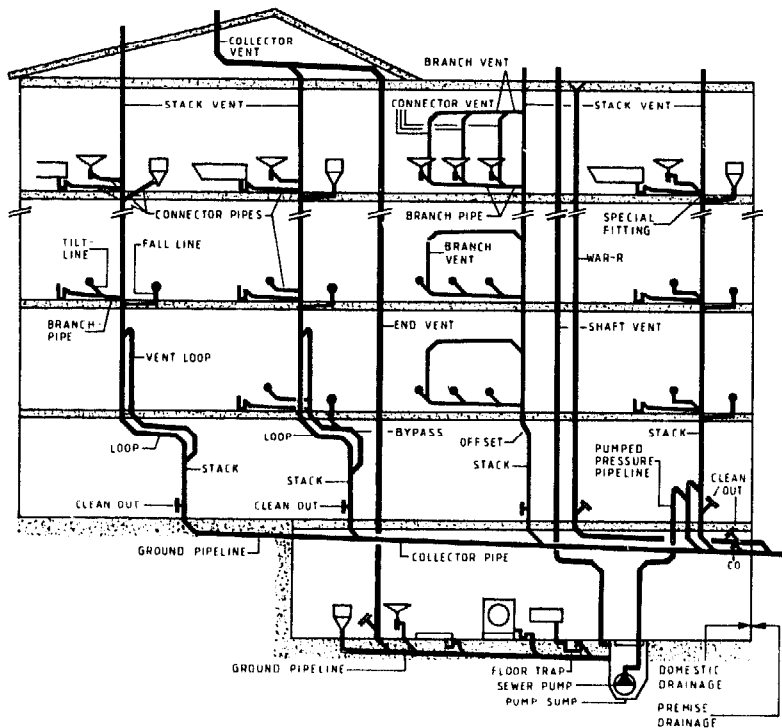

PRINCIPAL REQUIREMENTS ON STACK SYSTEMS

TABLE 2/2

ALL APPARATUS (INCLUDING FLOOR DRAINS, FUNNEL OF SAFETY VALVE, ETC) CONNECTED TO A STACK DRAINAGE SYSTEM MUST HAVE A SIPHON.

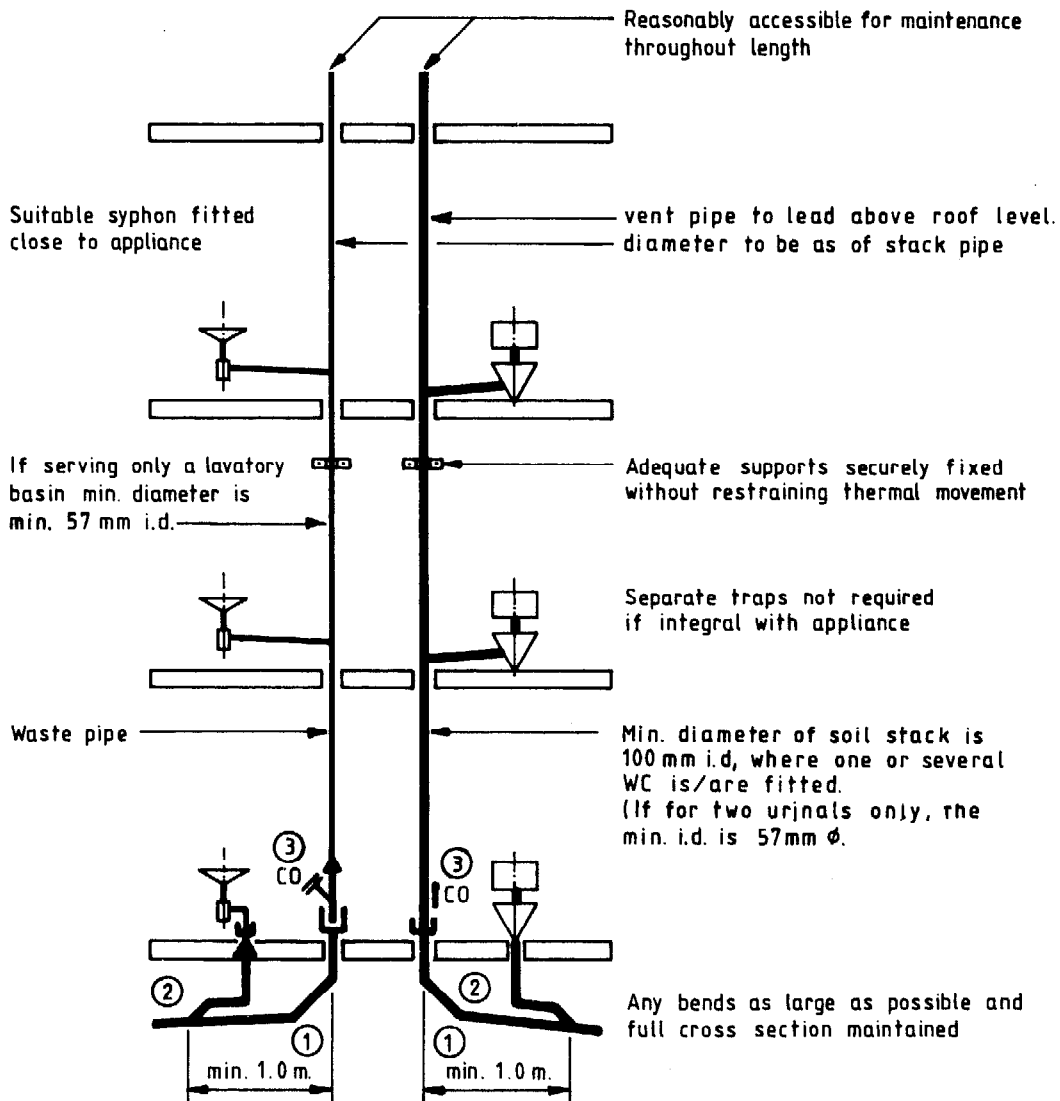

- Note:**
- 1 For a height up to 10m, a min. distance of 1.0m is required for buildings above 10.0m a min. distance of 1.5m is necessary.
 - 2 Ground pipelines to be of min. 100 mm i.d.
 - 3 Diameters of clean-outs to be of min. 100 mm ϕ

GROUND FLOOR CONNECTION OF APPARATUS

TABLE 2/3

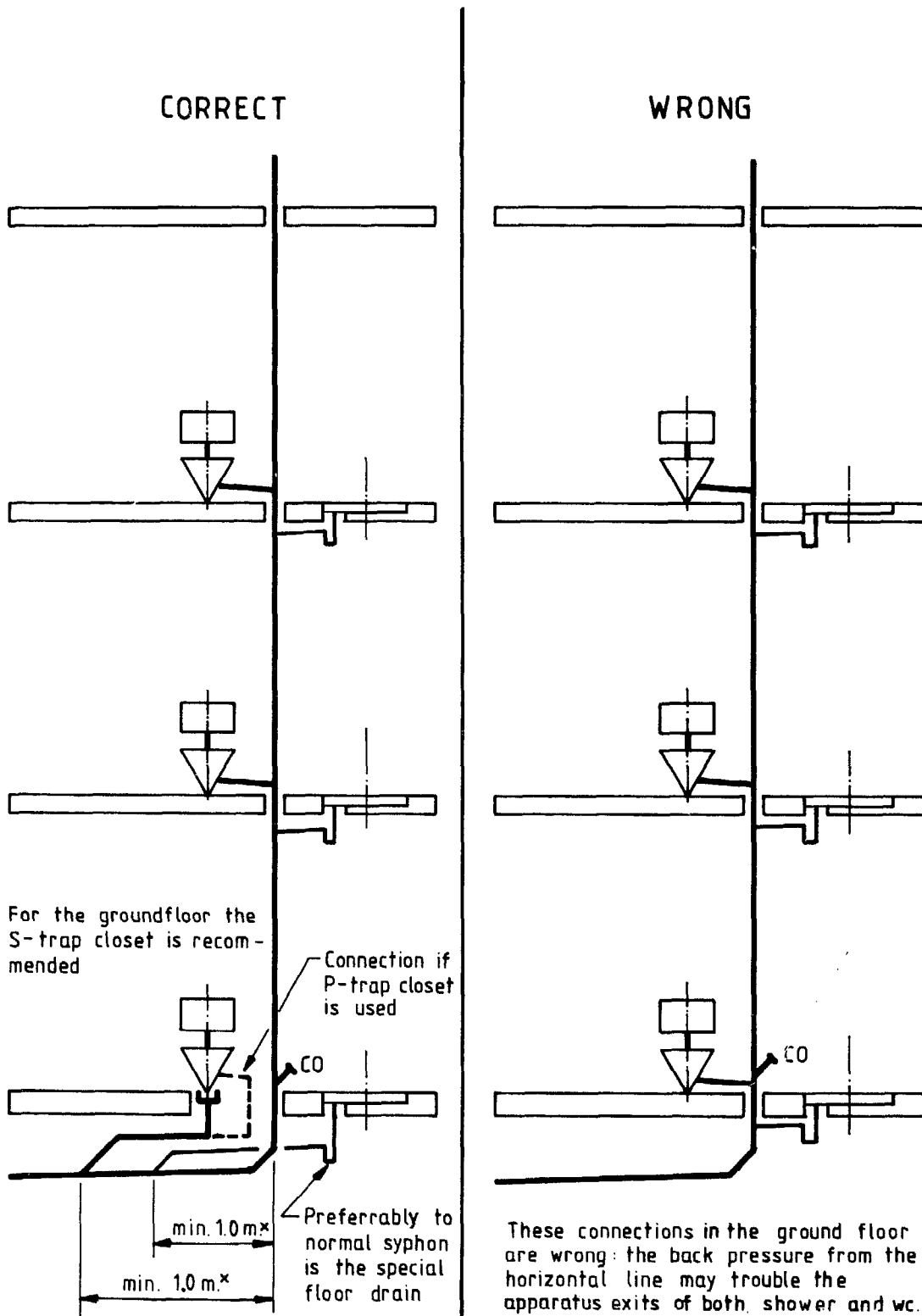

* FOR A HEIGHT UP TO 10.0 m
A DISTANCE OF 1.0 m IS REQUIRED.
FOR BUILDINGS ABOVE 10.0 m THE
DISTANCE HAS TO BE AT LEAST 15 m.

DIMENSIONING EXAMPLE

TABLE 2/4

SINGLE STACK SYSTEM: SOIL AND WASTE WATER DRAINAGE

VENT PIPE ABOVE ROOF LEVEL: EACH HOUSE MUST HAVE AT LEAST ONE VENT PIPE OF 100 mm iØ. WHETHER FOR SINGLE OR MULTISTORY BUILDINGS

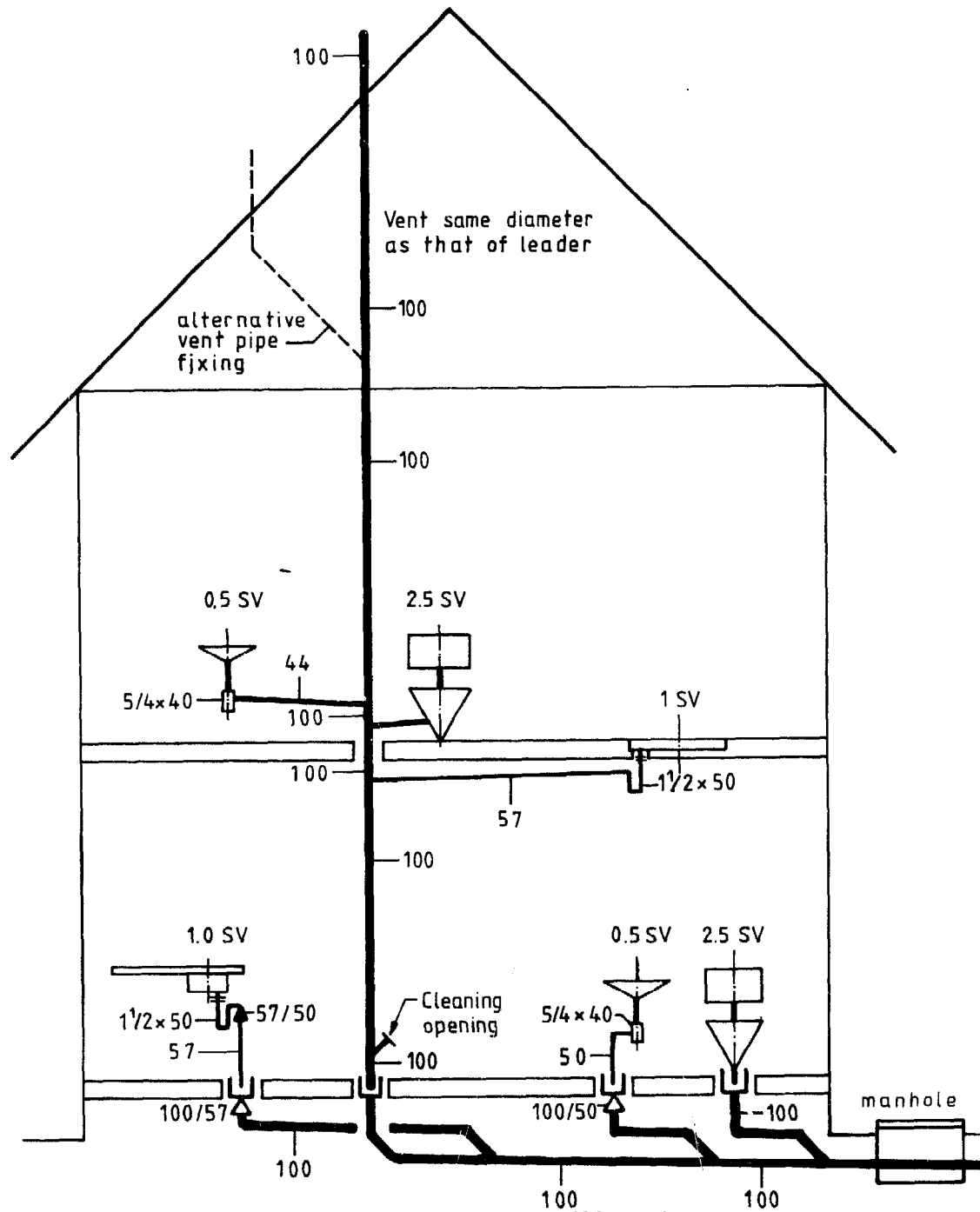

ALL GROUND PIPELINES TO BE OF MIN. 100 mm ϕ

STACK DIMENSIONING:		
1 SHOWER	1 SV	
1 WASHBASIN	0.5 SV	
1 WC	2.5 SV (= MIN ϕ 100 mm)	
TOTAL	3.5 SV = 100 mm ϕ	

DIMENSIONING EXAMPLE

TABLE 2/5

SINGLE STACK SYSTEM: SOIL AND WASTE WATER DRAINAGE

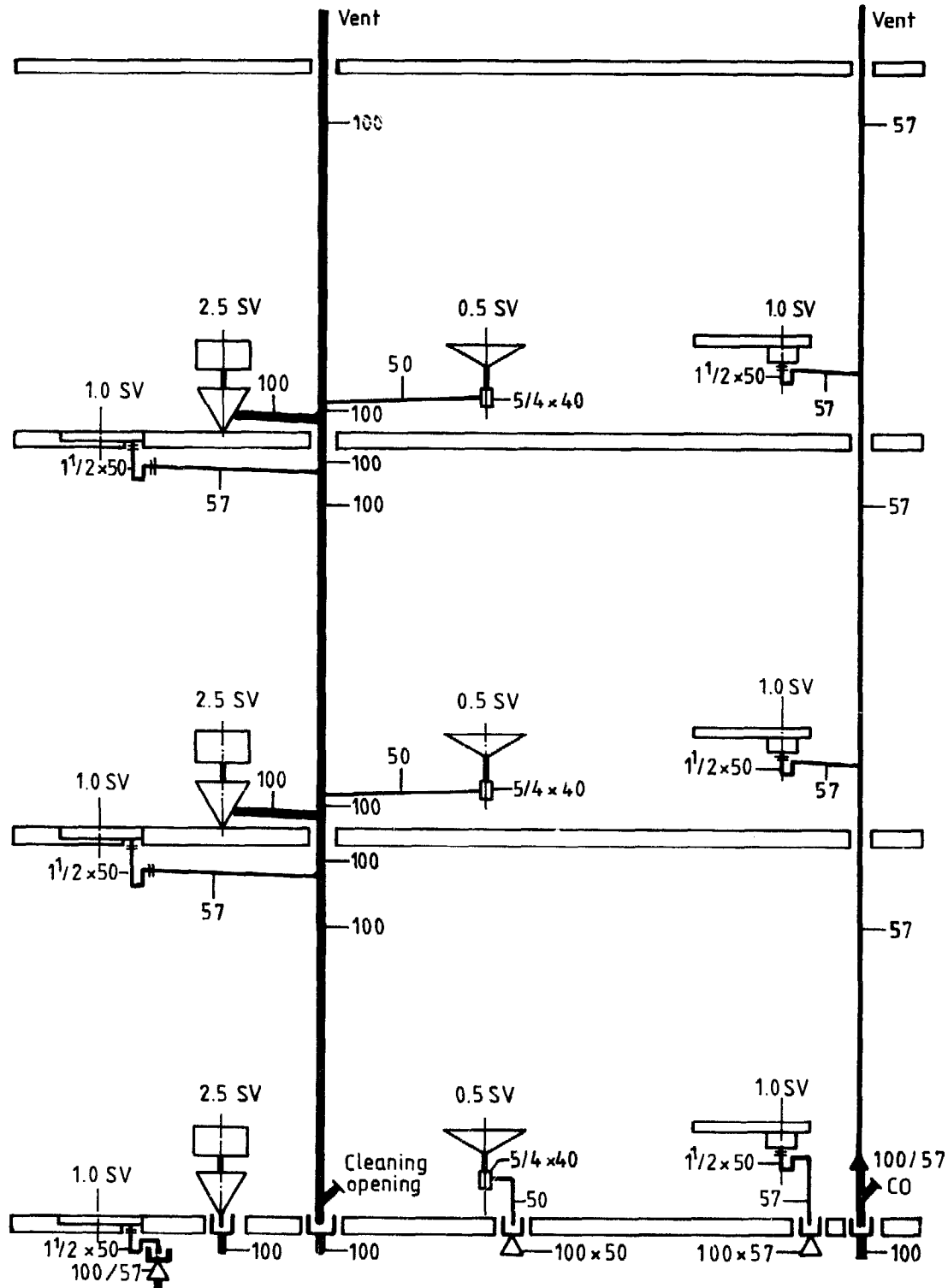

STACK N°1: 2 Washbasin a 0.5 SV = 1 SV
 2 Shower a 1.0 SV = 2 SV
 2 WC a 2.5 SV = 5 SV
 Total for leader pipe 8 SV=100 φ

STACK N° 2: 2 kitchen at 1.0 SV =
 Total 2 SV = 57 mm i.d.

DIMENSIONING EXAMPLE

TABLE 2/6

Dimensions of leader pipes depends on the numbers of connected apparatus resp. their S-values, but at least 57 mm Ø (when without WC)
 When with WC diameter is at least 100 mm Ø (upto max. 14 WC and/or max. 70 SV) (Single stack system)

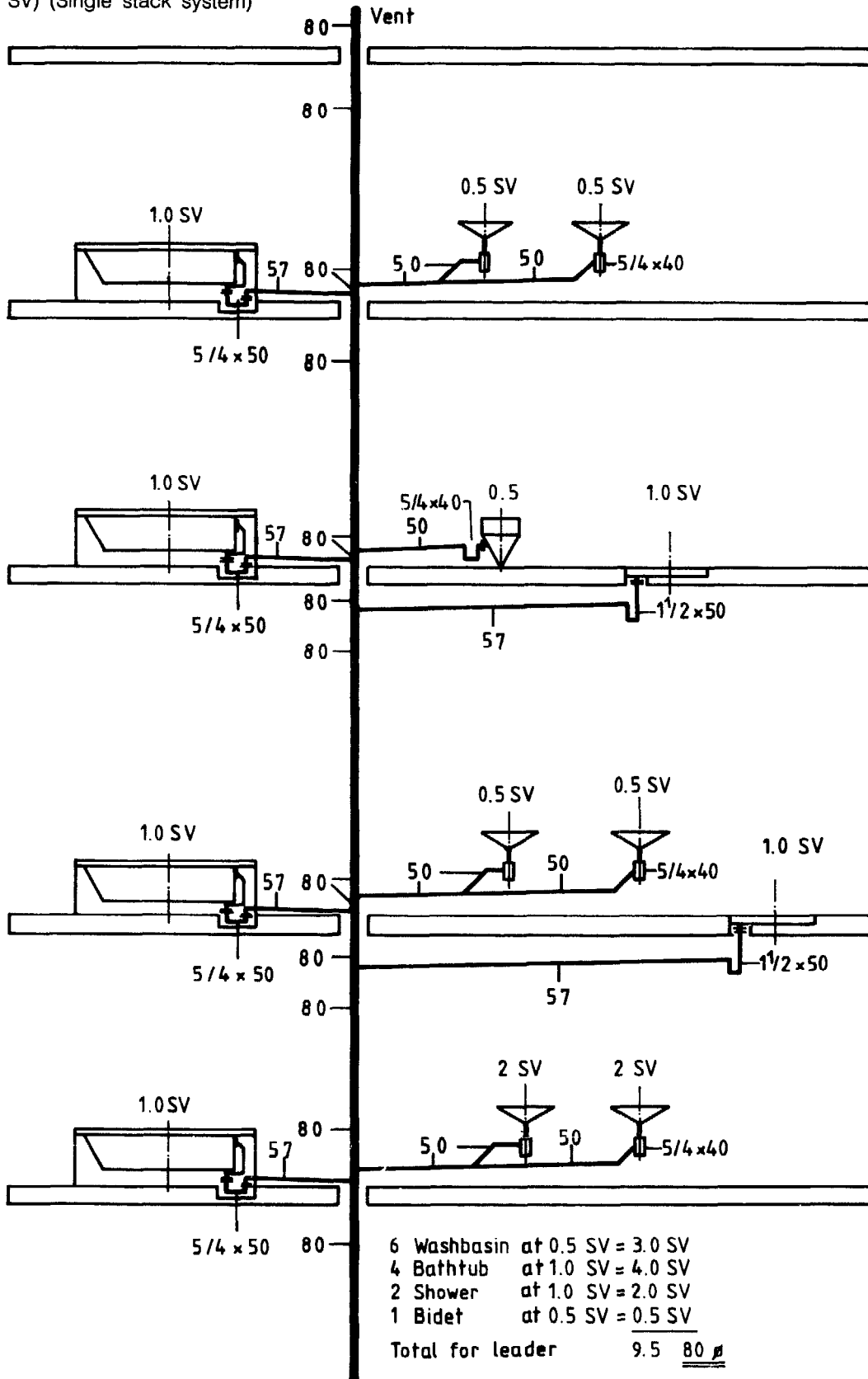

PRINCIPLES ON STACK VENTILATION

TABLE 2/7

SINGLE STACK SYSTEM: SOIL AND WASTE WATER DRAINAGE

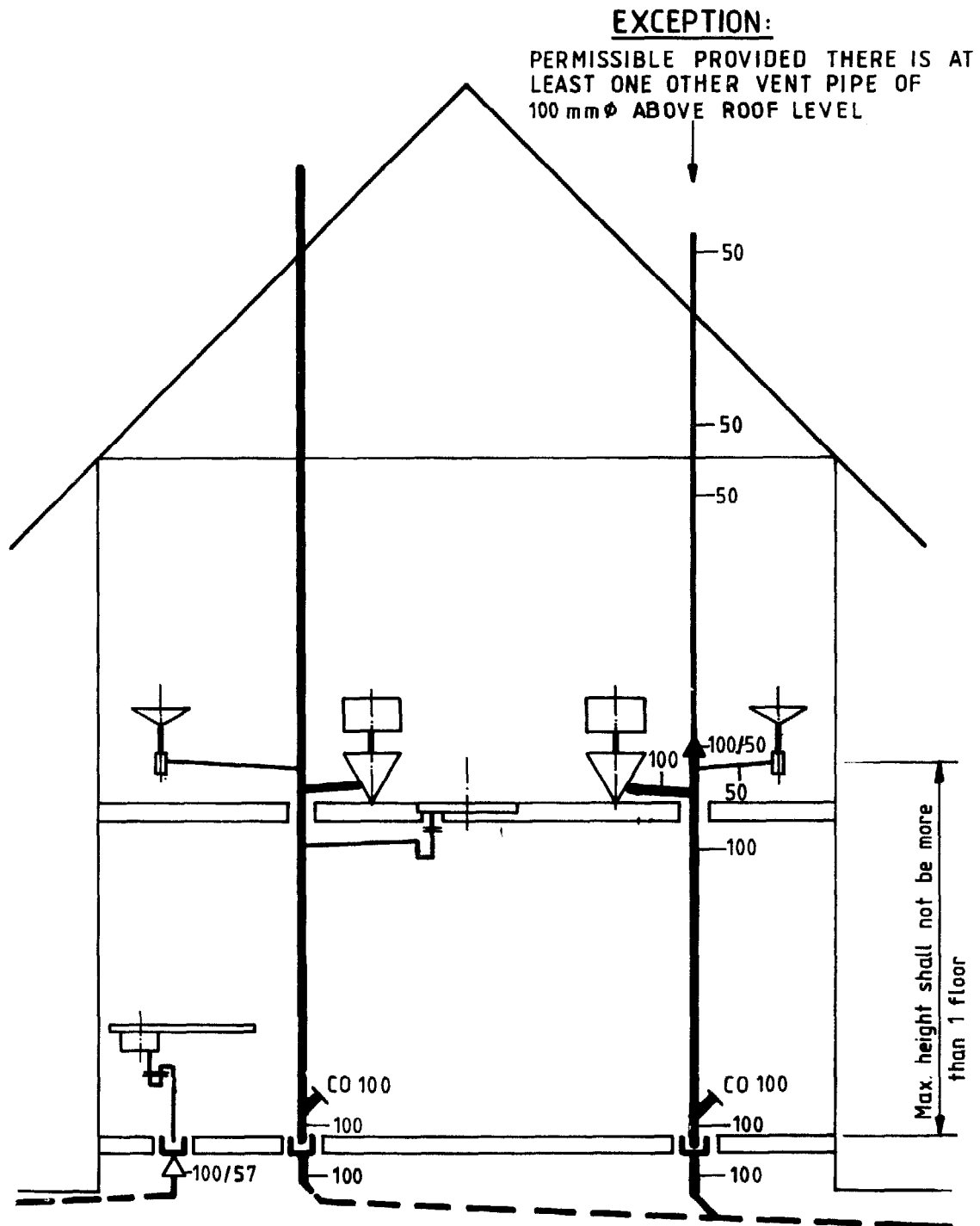

Each house shall have at least one main vent of 100mm ϕ . However additional single connections may be used for example:

Watercloset and washbasin can be fixed to an existing sewerage system and there dimension of the vent pipe can in this case be (not less than) 50 mm ϕ

DIMENSIONING EXAMPLE

TABLE 2/8

Divided Stack System:

- a) Soil Stack: The water closet is led to the septic tank
- b) Waste Stack: Other apparatus, free from human faeces, are led into a separate septic tank

Note:

- It might be advisable to incorporate a grease arrester, in order to retain the kitchen wastes from the drainage pipes.
- Ventilation: each house requires at least one ventilation pipe (100 Ø)
- All ground pipelines to be of min. 100 mm inner diameter

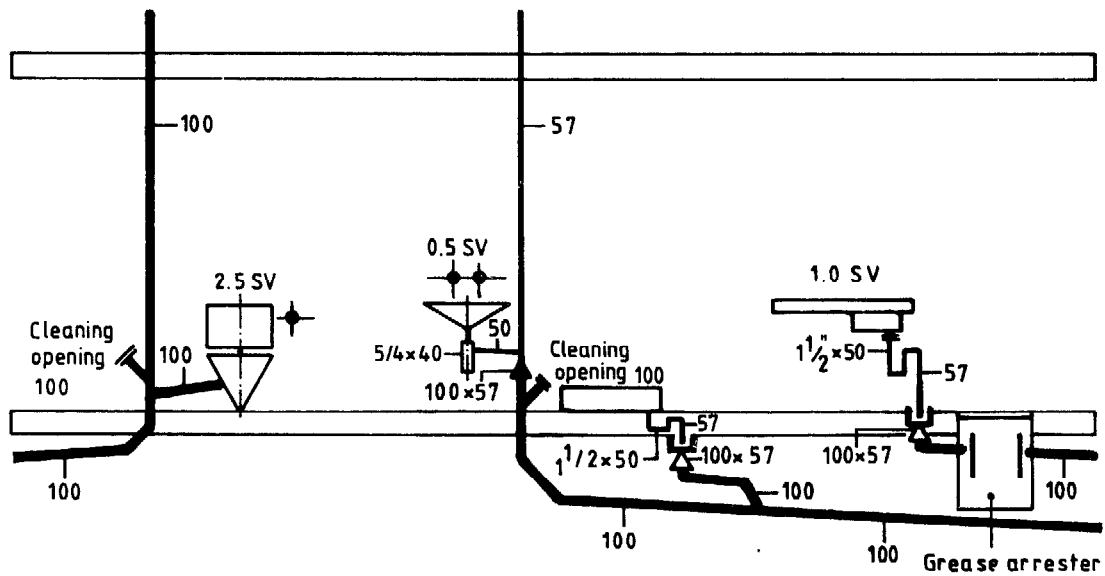

DIMENSIONING EXAMPLE

TABLE 2/9

Divided Stack Drainage System:

- a) Soil Stack: Pipe line to which water closets are fitted and led to the septic tank with straight ventilation above roof
- b) Waste Stack: Washbasin, bathtub and kitchen, having a separate stack, which is led to a separate septic tank it requires a vent pipe above roof level.

Note: This system is optional e.g. where houseowner asks for the same - however, single stack systems are similar in function.

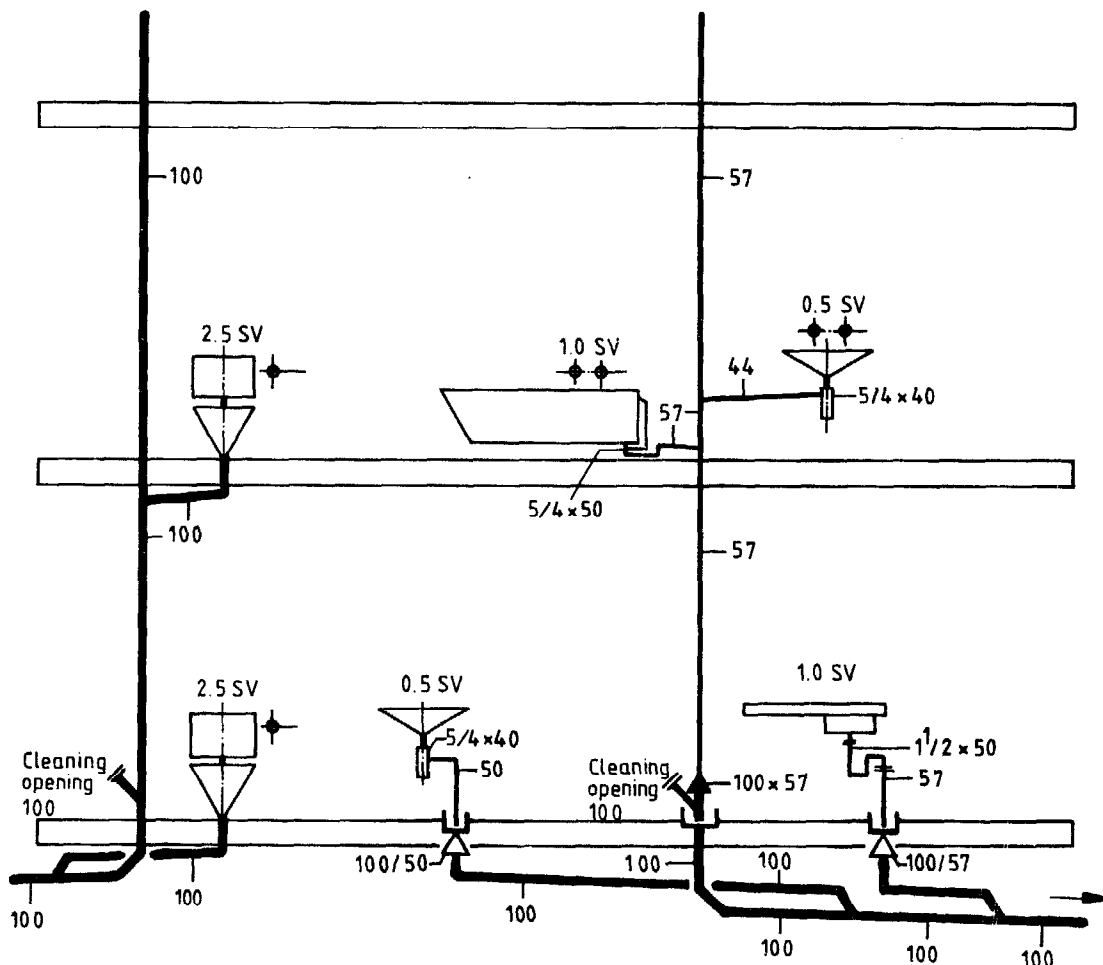

Soil Stack:
1 WC at 2.5 SV = 100 mm ϕ

Waste Stack:
1 WASHBASIN 0.5 SV
1 BATH TUB 1.0 SV
TOTAL 1.5 SV = 57 mm ϕ

ALL GROUND PIPELINES TO BE OF MIN. 100 mm INNER DIAMETER

DIMENSIONING EXAMPLE

TABLE 2/10

Divided Stack Drainage System:

- a) Soil Stack: all water closets, to be lead into septic tank
- b) Waste stack: washbasins and bathtubs into waste stack, to be lead into separate septic tank
alternatively vent pipe could lead into soil stack

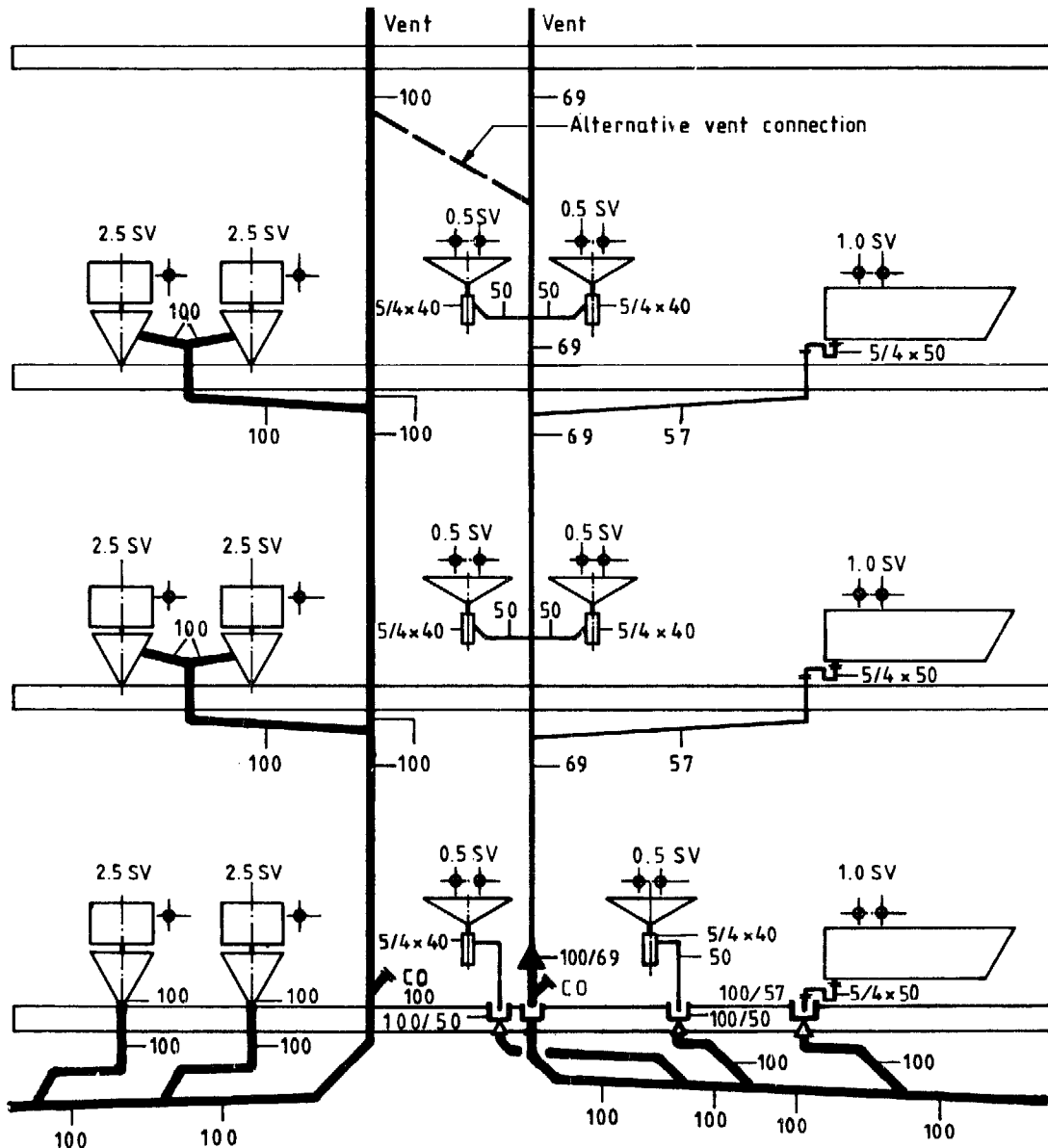

Soil stack
 4 WC at 2.5 SV = 10 SV = 100 Ø

Waste stack:
 4 Washbasin at 0.5 = 2 SV
 2 Bathtub at 1.0 = 2 SV
 4 SV = 69 Ø

MANHOLE EXAMPLE (EXTERIOR)

TABLE 2/11

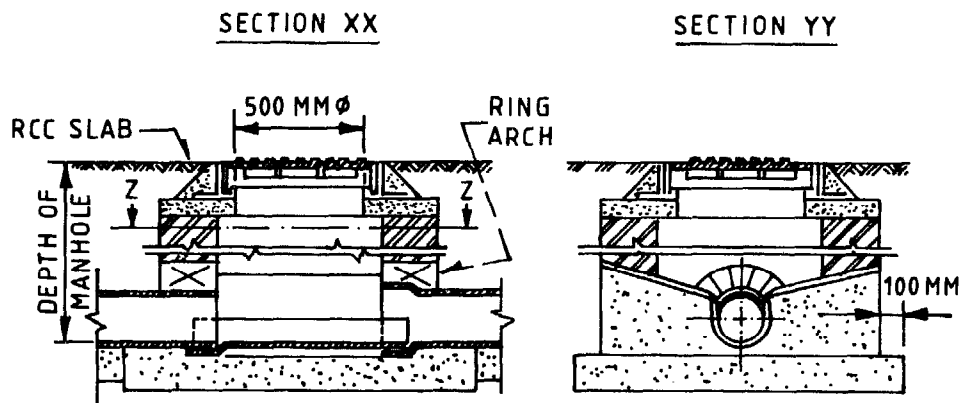

SECTIONAL PLAN AT Z-Z

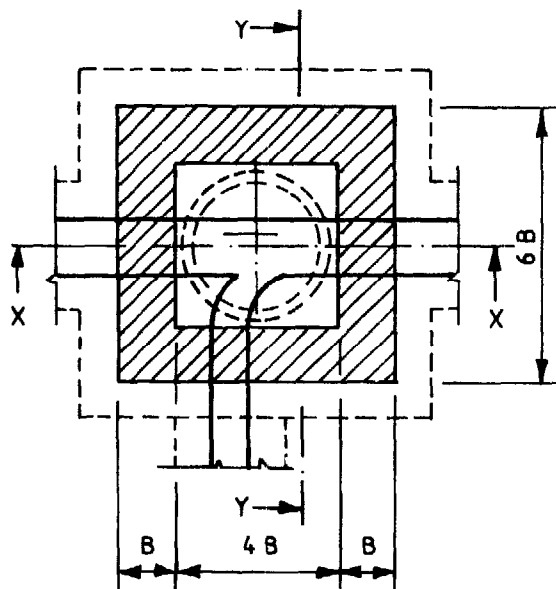



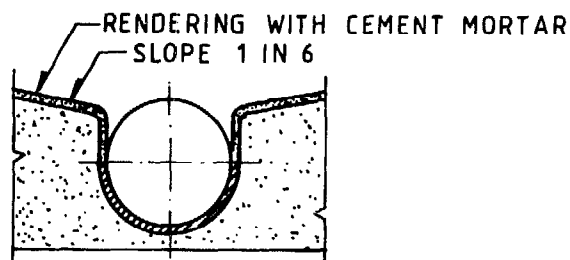





















DETAIL OF BENCHING



Note: Wall thickness have been indicated in brick lengths to provide for use of modular bricks or traditional bricks in the figure, B = one brick length, 6 B = six bricks

H.D.P.E. PIPES MATERIAL LIST

TABLE 2/12

BUILDING SITE: _____		DATE: _____			
SECTION: _____					
SIG.	ARTICLE	i.d. 44φ 44/50	57φ 57/63	83φ 83/90	100φ 100/110
	PIPES HDPE				
	PIPES TOTAL				
	BRANCH 90°				
	BRANCH 60°				
	BRANCH 45°				
	BRANCH 90°	100/44	100/57	100/83	
	RED 100φ -				
	BRANCH 90°	83/44	83/57		
	RED 83φ -				
	BRANCH 90°	57/44			
	RED 57-44φ				
	BEND 90°				
	BEND 45°				
	BEND RED. 90°	57-44			
	Y-TEE				
	REDUCER 100φ -	100/44	100/57	100/83	
	REDUCER 83φ -	83/44	83/57		
	REDUCER 57/44	57/44			
	HDPE WASTE COUPLING	44 x 5/4"	44 x 1 1/2"		
	WASHBASIN SIPHON SOCKET	44			
	WC SOCKET W. RUBBER SEAL				
	RING SEAL SOCKET				
	SCREW-THREADED SOCKETS				
	CLAMPS				
	CEMENT FIXATION SADDLE CLAMP				
	SCREW / DOWEL				

Residential and Non - Residential

**DRINKING WATER INSTALLATIONS
AND DRAINAGE REQUIREMENTS IN NEPAL**

**PART 3
DRAWINGS / DESIGN**

APPARATUS REQUIREMENTS**TABLE 3/1**

GUIDELINES FOR THE DETERMINATION OF REQUIRED APPARATUS IN BUILDINGS

Object	unit	take graph for				
		WC (commode)		urinals	showers	
		ladies	gents	gents	ladies	gents
1. schools	students	3 - 4	4 - 5	3 - 4	2 - 3	2 - 3
2. offices	employees	2 - 3	3 - 4	2 - 3	-	-
3. industries	employees	2 - 3	3 -	2 - 3	6 - 7	6 - 7
4. hotel / rest.	seats	3 - 4	4 - 5	3 - 4	-	-
5. restaurants	seats	4 - 5	5 - 6	4 - 5	-	-
6. swimmingpool	locked boxes	5 - 6	6 -	6 -	5 - 6	5 - 6
7. theatres	visitors	6	6 - 7	5 - 6	-	-
8. barracks	persons	5	3 - 4	3 - 4	5 - 6	5 - 6

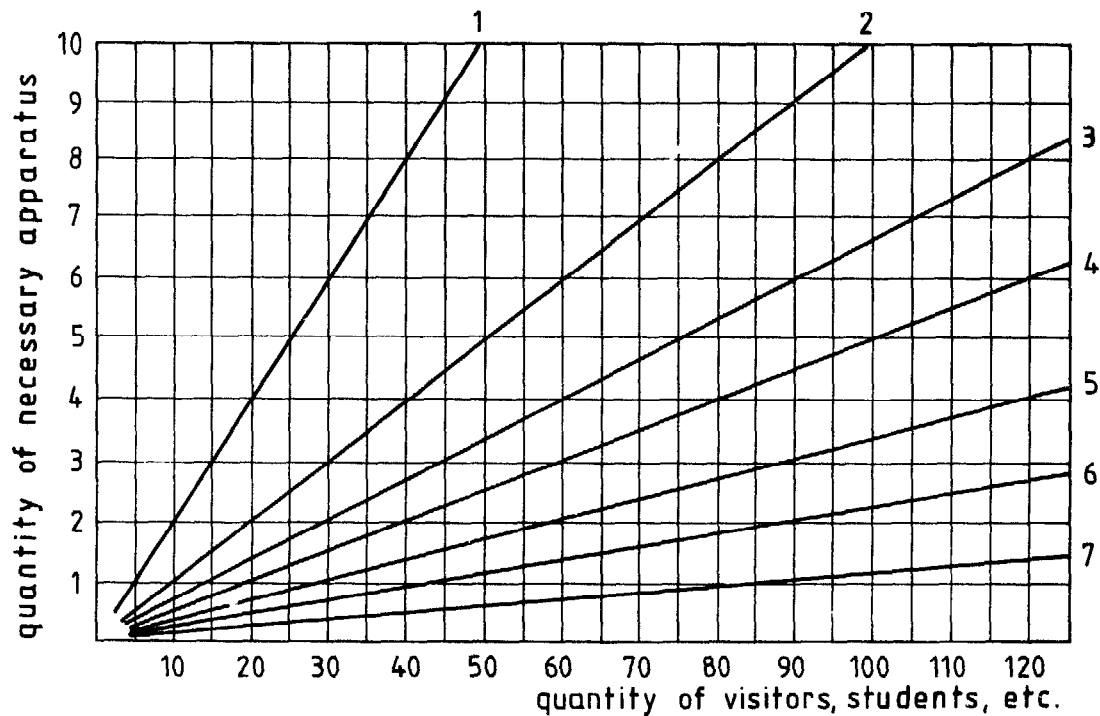

The above indications are in accordance with international directions.

WATER CLOSET (COMMUNE)

TABLE 3/2

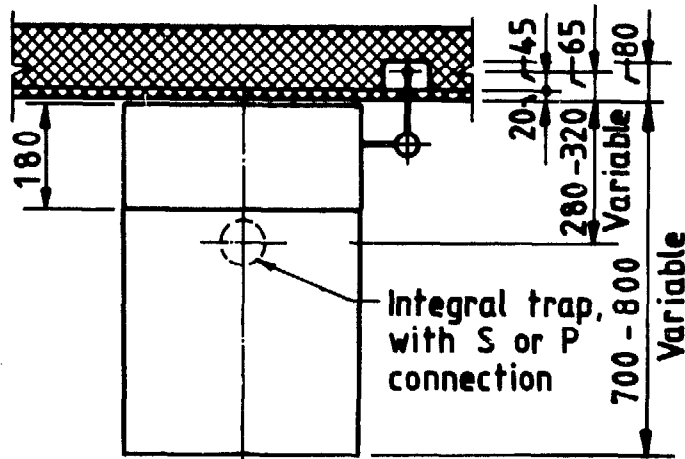
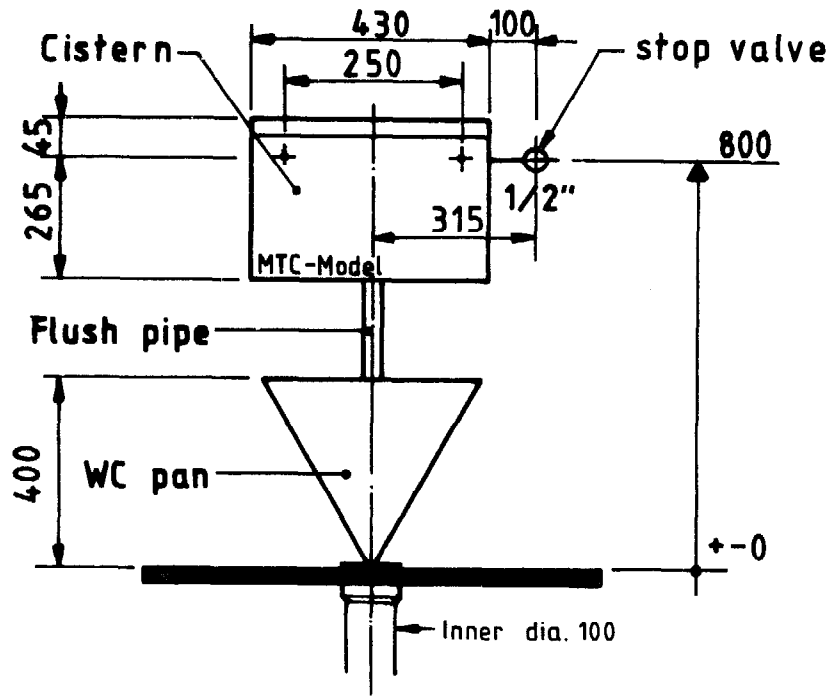

Example of Apparatus. Note: There are many different types and designs available on the market. The indications above are proposals. Actual dimensions of the apparatus and appliances (height, diameters, connecting accessories, etc.) have to be measured from the very apparatus to be fixed at the site, prior to fixing of pipes into the walls or floors.

WC FLOOR PAN

TABLE 3/3

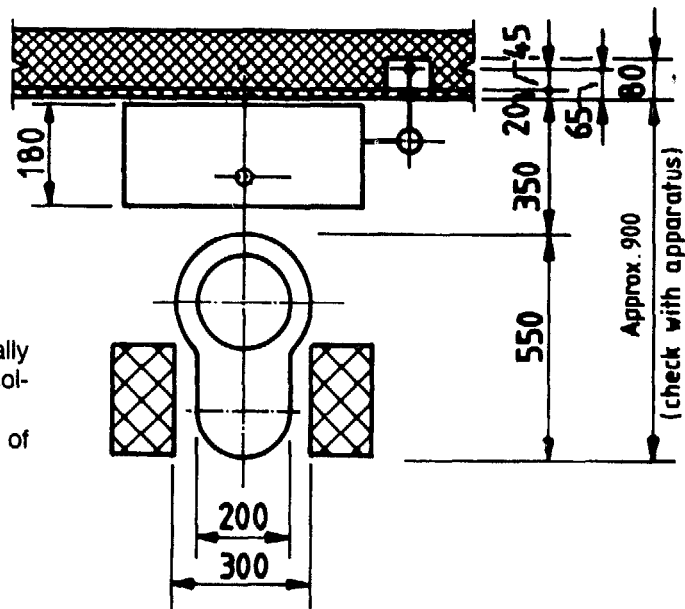
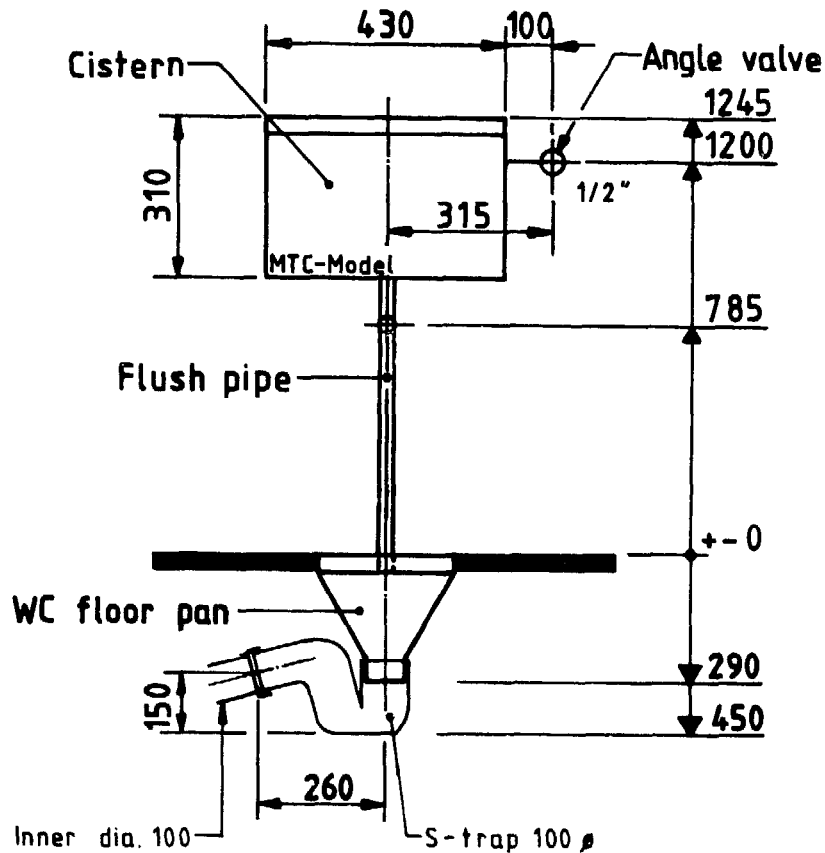

Note: This type of WC usually requires one additional coldwater tap (1/2") fitted nearby at a height of approx. 400 mm.

Example of Apparatus. Note: There are many different types and designs available on the market. The indications above are proposals. Actual dimensions of the apparatus and appliances (height, diameters, connecting accessories, etc.) have to be measured from the very apparatus to be fixed at the site, prior to fixing of pipes into the walls or floors.

WASHBASIN (LAVATORY)

TABLE 3/4

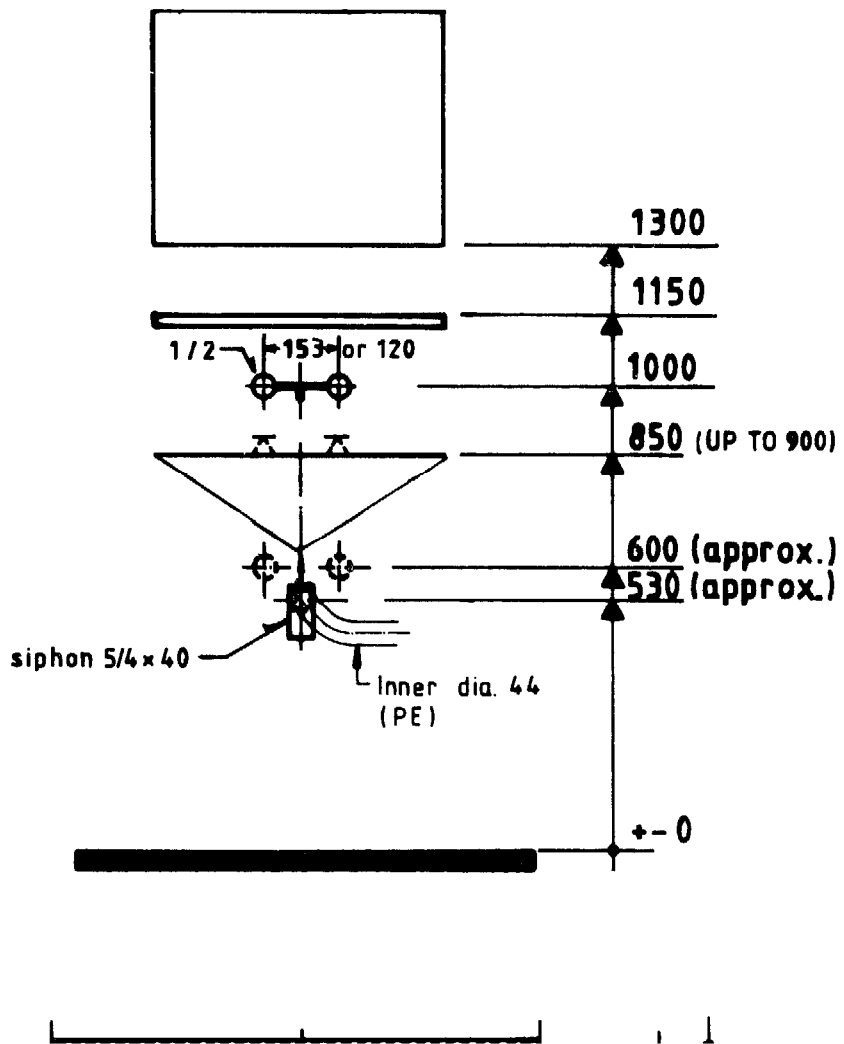

BATHTUB

TABLE 3/5

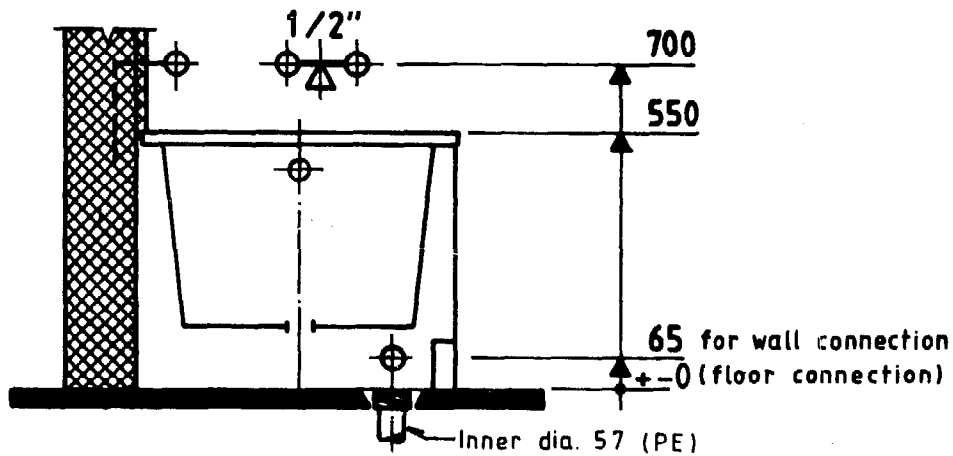

waste coupling 5/4" ϕ
 overflow min. 1" ϕ
 siphon 5/4" x 50 or 57

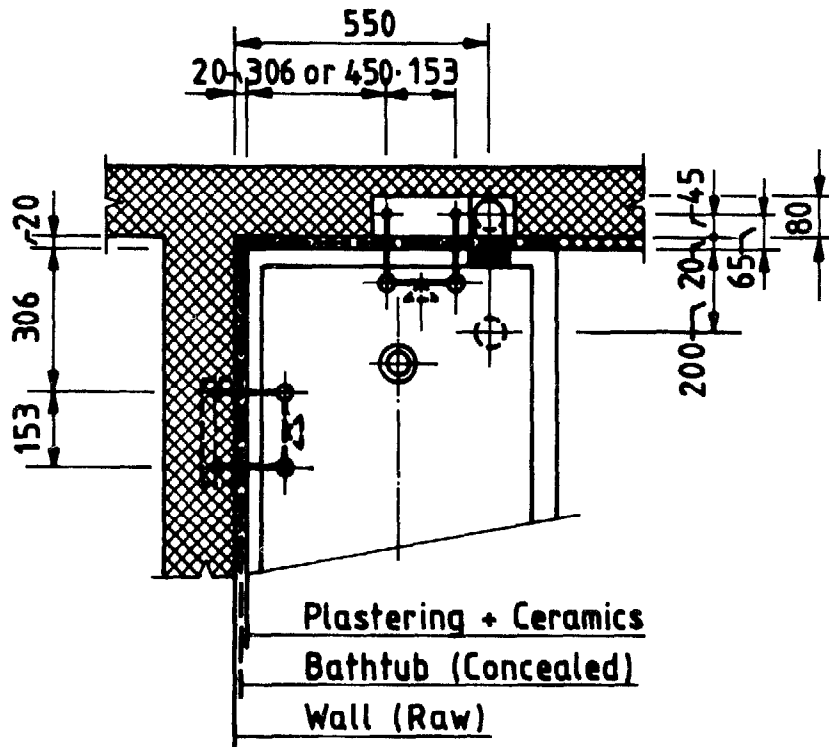

Example of Apparatus. Note: There are many different types and designs available on the market. The indications above are proposals. Actual dimensions of the apparatus and appliances (height, diameters, connecting accessories, etc.) have to be measured from the very apparatus to be fixed at the site, prior to fixing of pipes into the walls or floors.

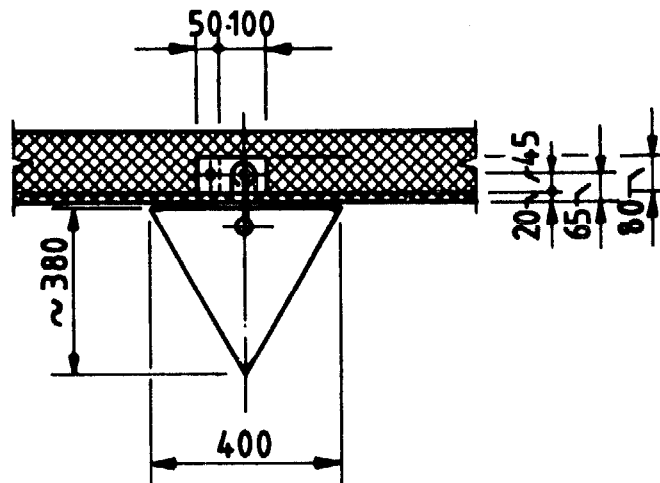
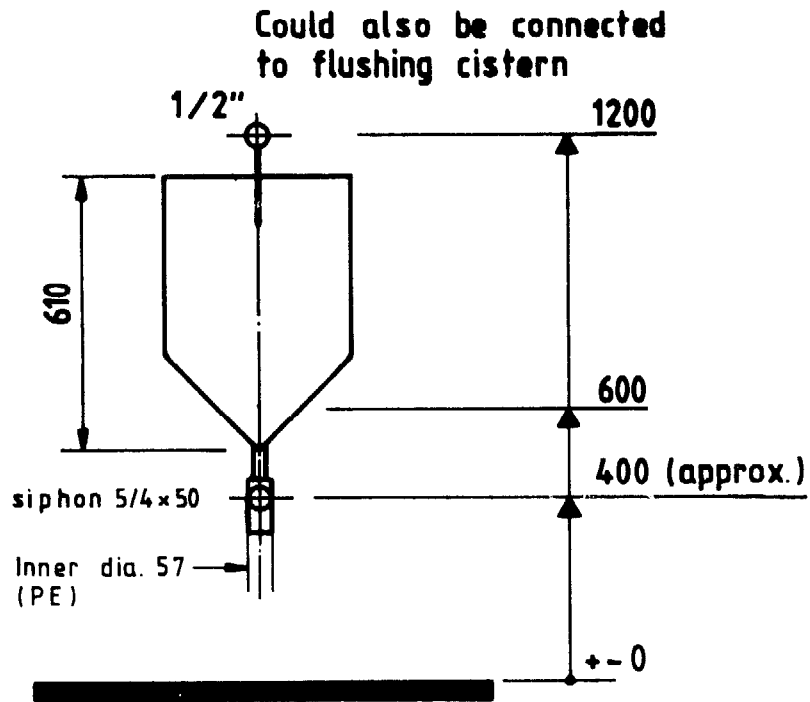

Example of Apparatus. Note: There are many different types and designs available on the market. The indications above are proposals. Actual dimensions of the apparatus and appliances (height, diameters, connecting accessories, etc.) have to be measured from the very apparatus to be fixed at the site, prior to fixing of pipes into the walls or floors.

URINAL (SMALL TYPE)

TABLE 3/7

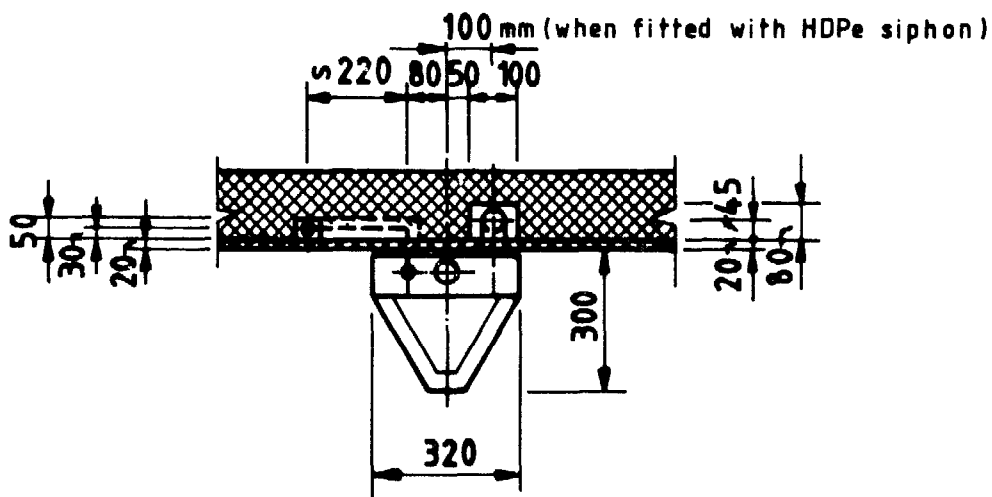
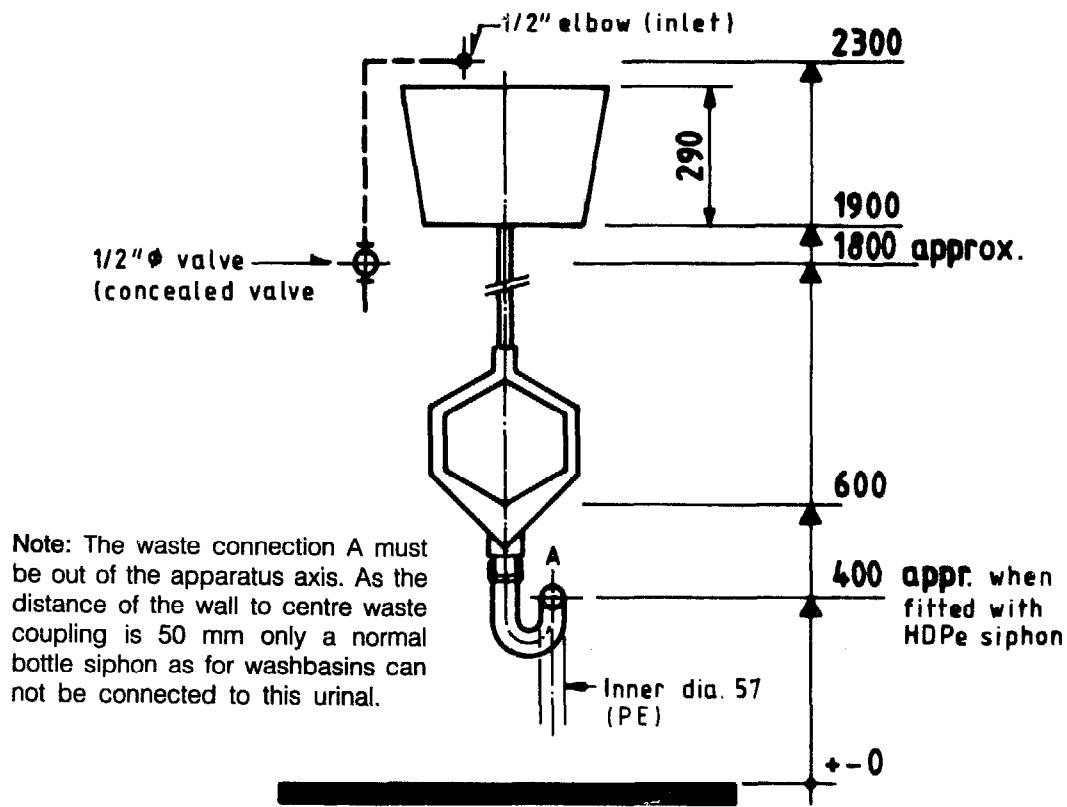

Example of Apparatus. Note: There are many different types and designs available on the market. The indications above are proposals. Actual dimensions of the apparatus and appliances (height, diameters, connecting accessories, etc.) have to be measured from the very apparatus to be fixed at the site, prior to fixing of pipes into the walls or floors.

KITCHEN SINK

TABLE 3/8

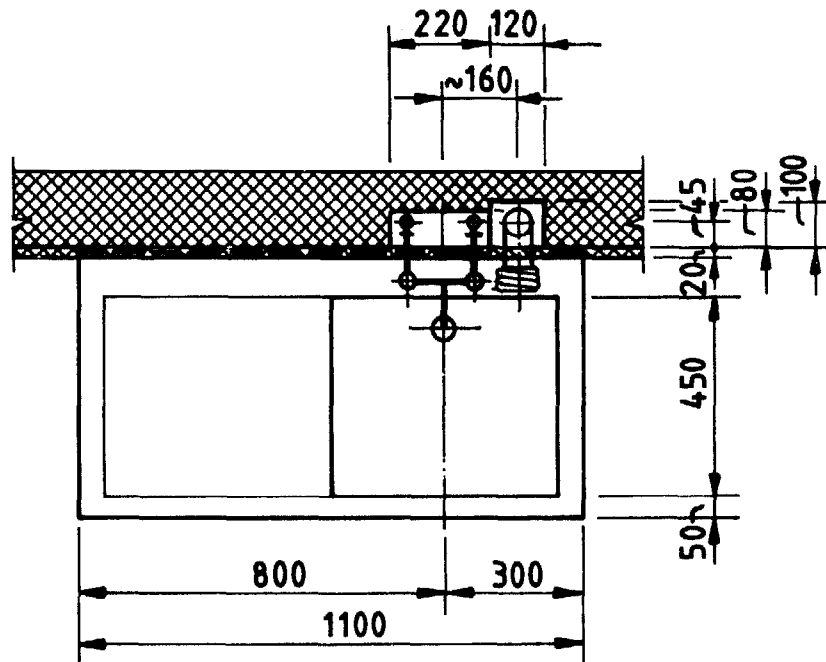
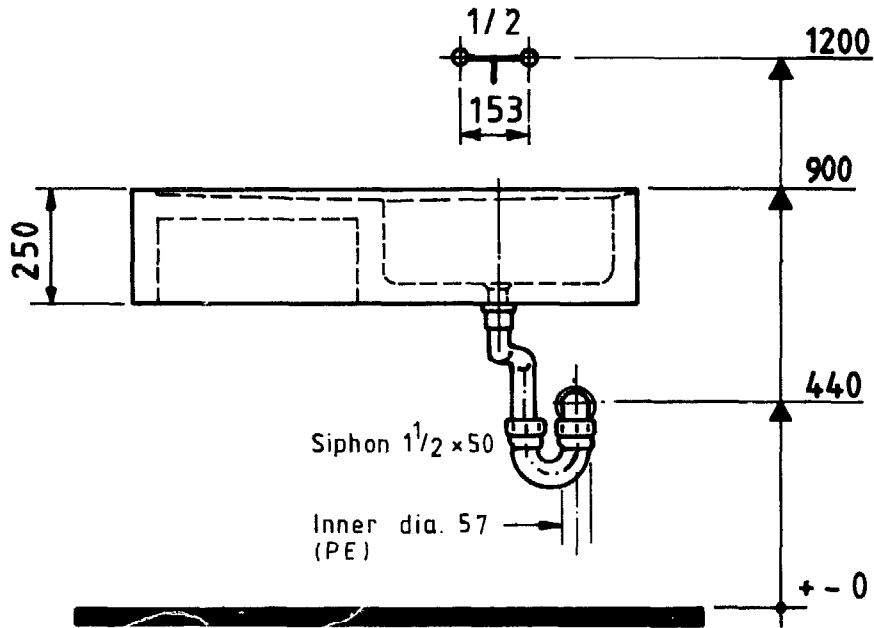

Example of Apparatus. Note: There are many different types and designs available in the market. The indications above are proposals. Actual dimensions of the apparatus and appliances (height, diameters, connecting accessories, etc.) have to be measured from the very apparatus to be fixed at the site, prior to fixing of pipes into the walls or floors.

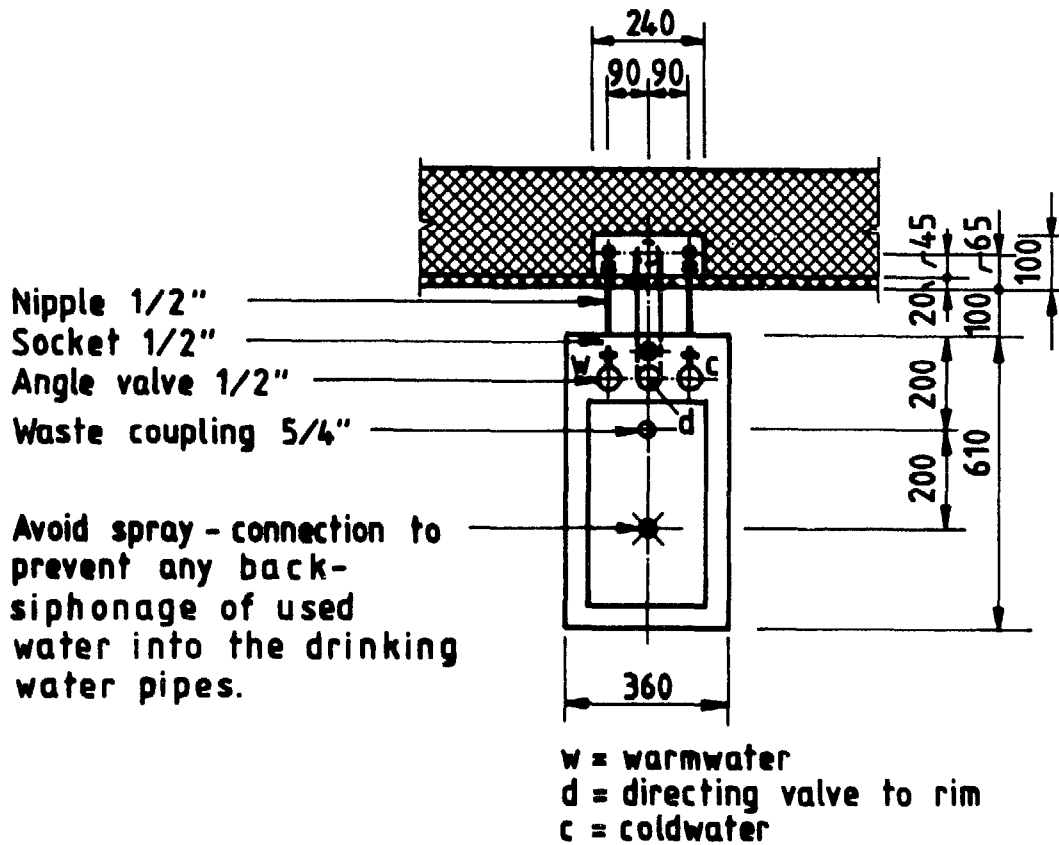
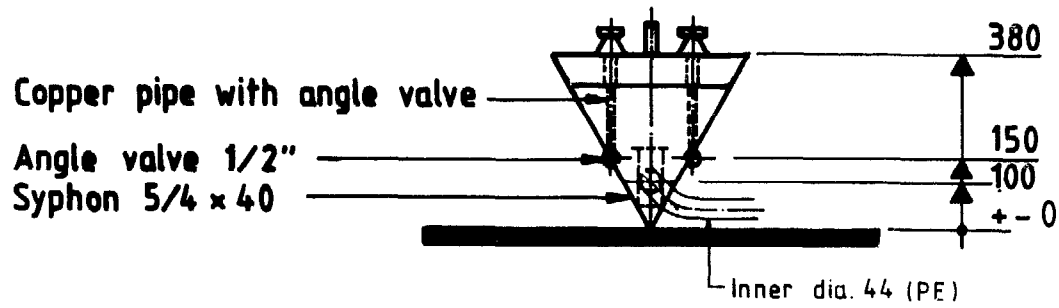

Example of Apparatus. Note: There are many different types and designs available on the market. The indications above are proposals. Actual dimensions of the apparatus and appliances (height, diameters, connecting accessories, etc.) have to be measured from the very apparatus to be fixed at the site, prior to fixing of pipes into the walls or floors.

ROOM MEASUREMENTS

TABLE 3/11

MINIMAL SPACE REQUIREMENTS FOR APPARATUS AND PERSON

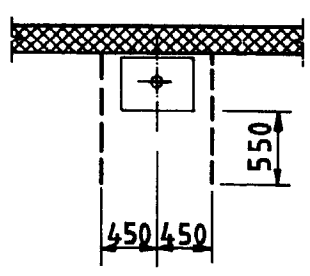
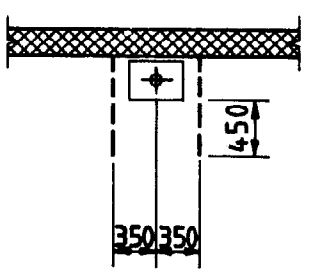
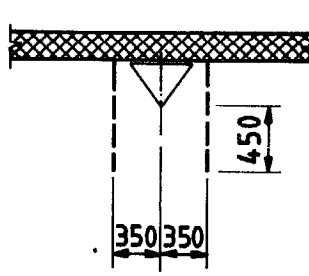
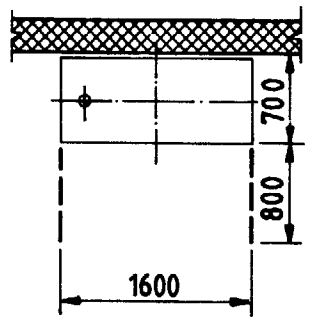
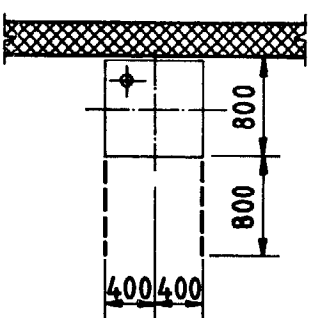
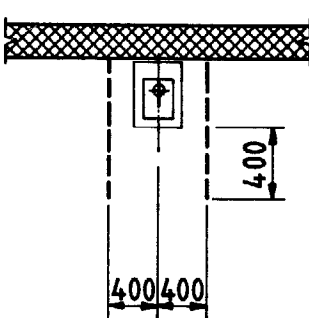
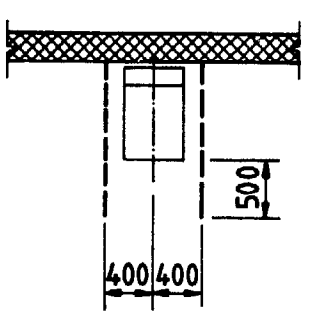
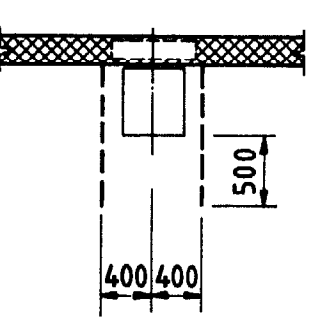
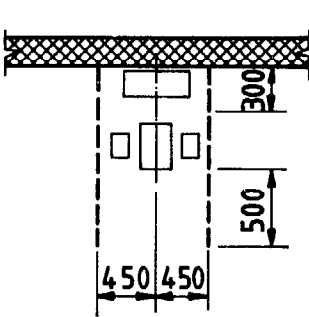
<p>1 Washbasin</p> 	<p>2 Hand-Washbasin</p> 	<p>3 Urinal</p> 
<p>4 Bathtub</p> 	<p>5 Showertray</p> 	<p>6 Bidet</p> 
<p>7 Water-Closet</p> 	<p>8 Water-Closet with Tank</p> 	<p>9 Floor-Pan</p> 

ROOM MEASUREMENTS

TABLE 3/12

MINIMAL SPACE REQUIREMENTS FOR APPARATUS AND PERSON

1 WC + Handwashbasin

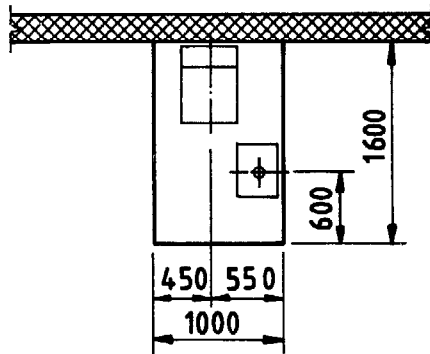

2 WC + Washbasin

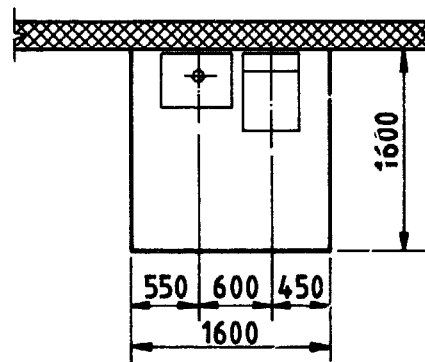

3 Floor -Pan + Handwashbasin

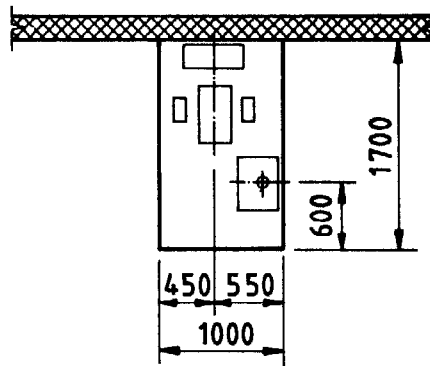

4 Floor -Pan + Washbasin

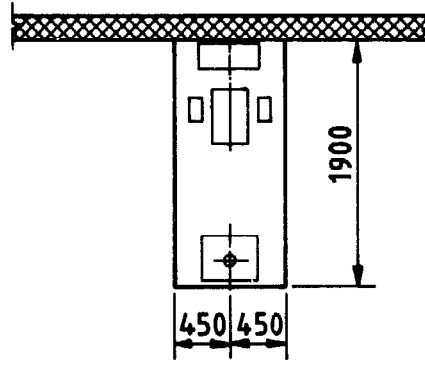

5 Shower + Washbasin

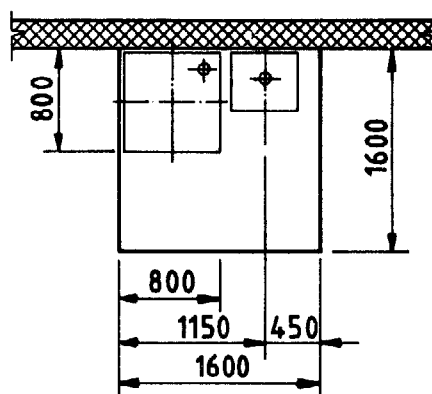

6 Shower, Washbasin + WC

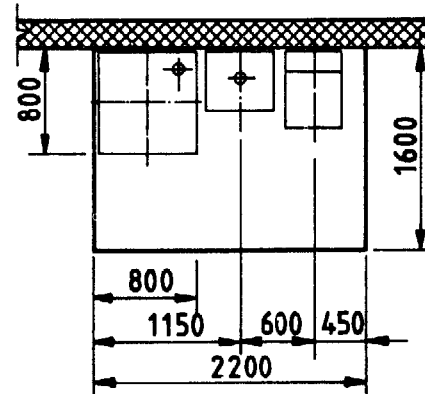

ROOM MEASUREMENTS

TABLE 3/13

MINIMAL SPACE REQUIREMENTS FOR APPARATUS AND PERSON

1 Bathroom with 2 apparatus

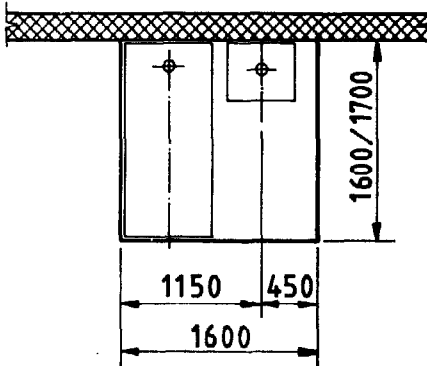

2 Bathroom with 3 apparatus

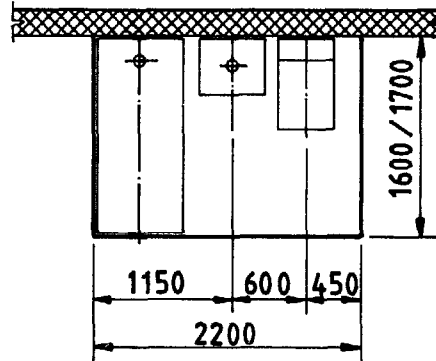

3 Bathroom with 3 apparatus

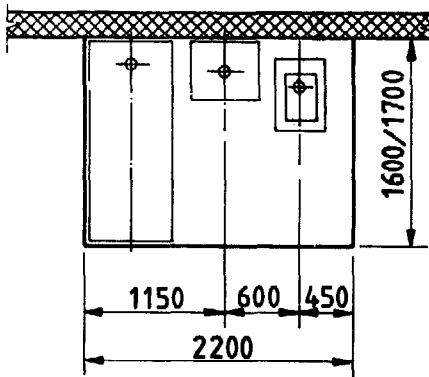

4 Bathroom with 3 apparatus

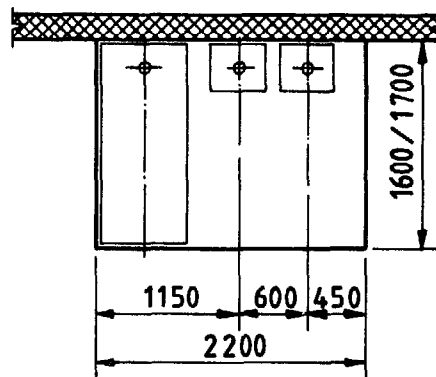

5 Bathroom with 4 apparatus

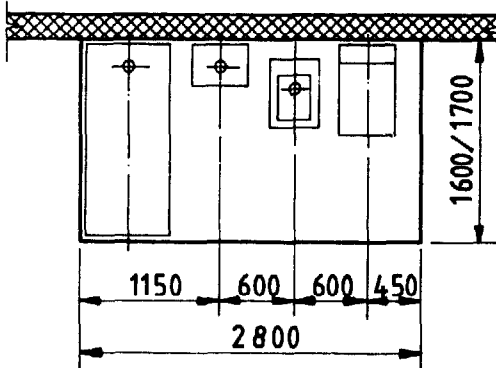

6 Bathroom with 4 apparatus

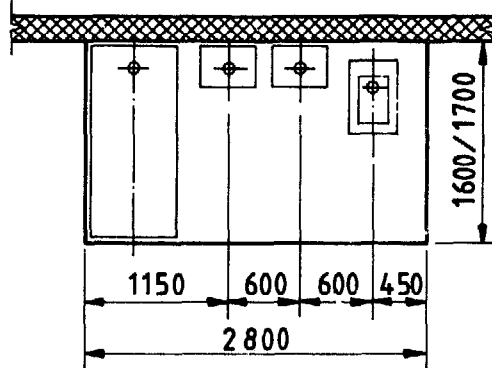

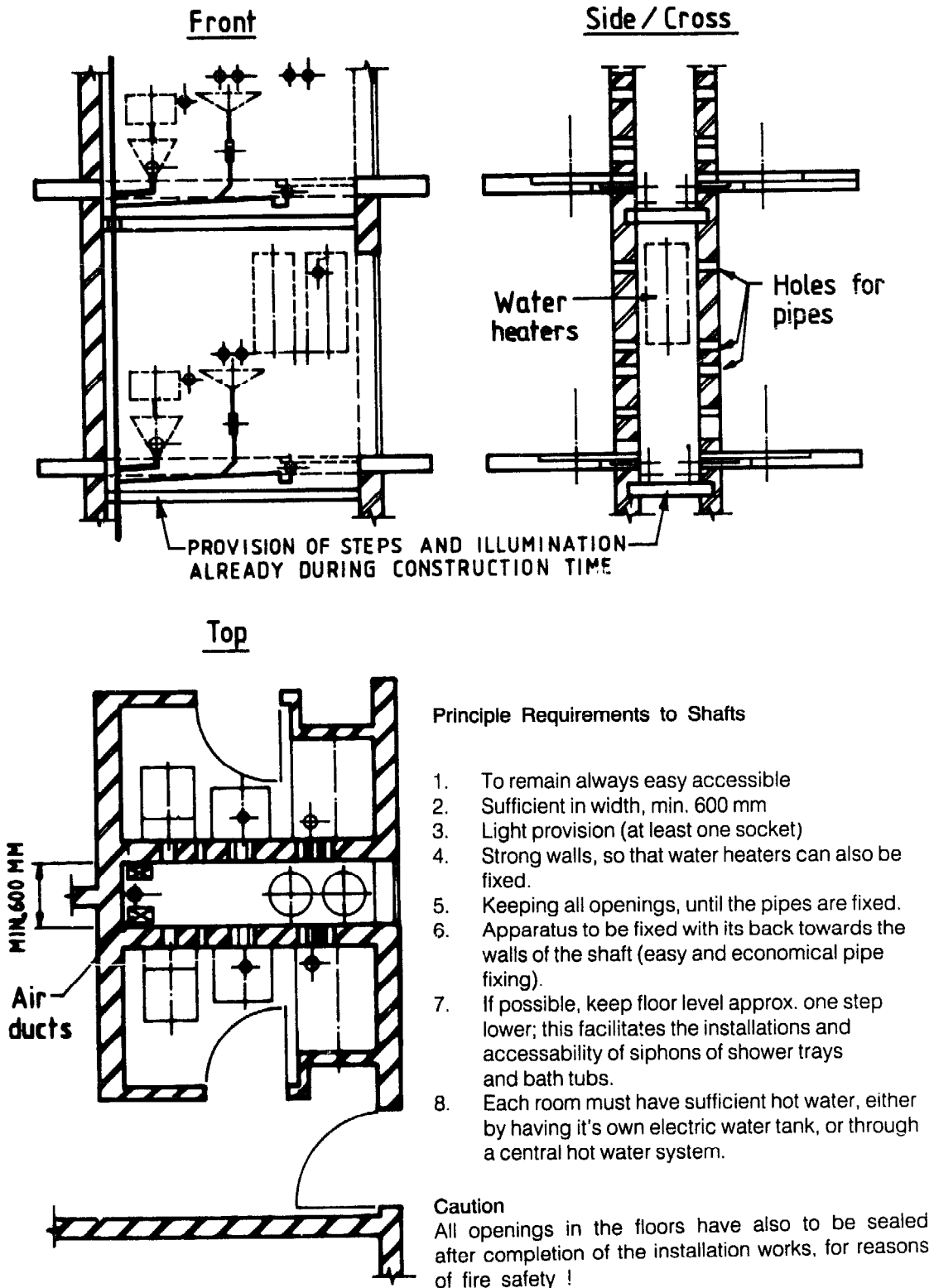

LAYOUT, EXAMPLE**TABLE 3/15**

LAYOUT AS REALIZED IN A HOTEL. INSTALLATION IN SHAFTS FACILITATES WORKS AND MAINTAINS EASY ACCESS FOR REPAIRS.

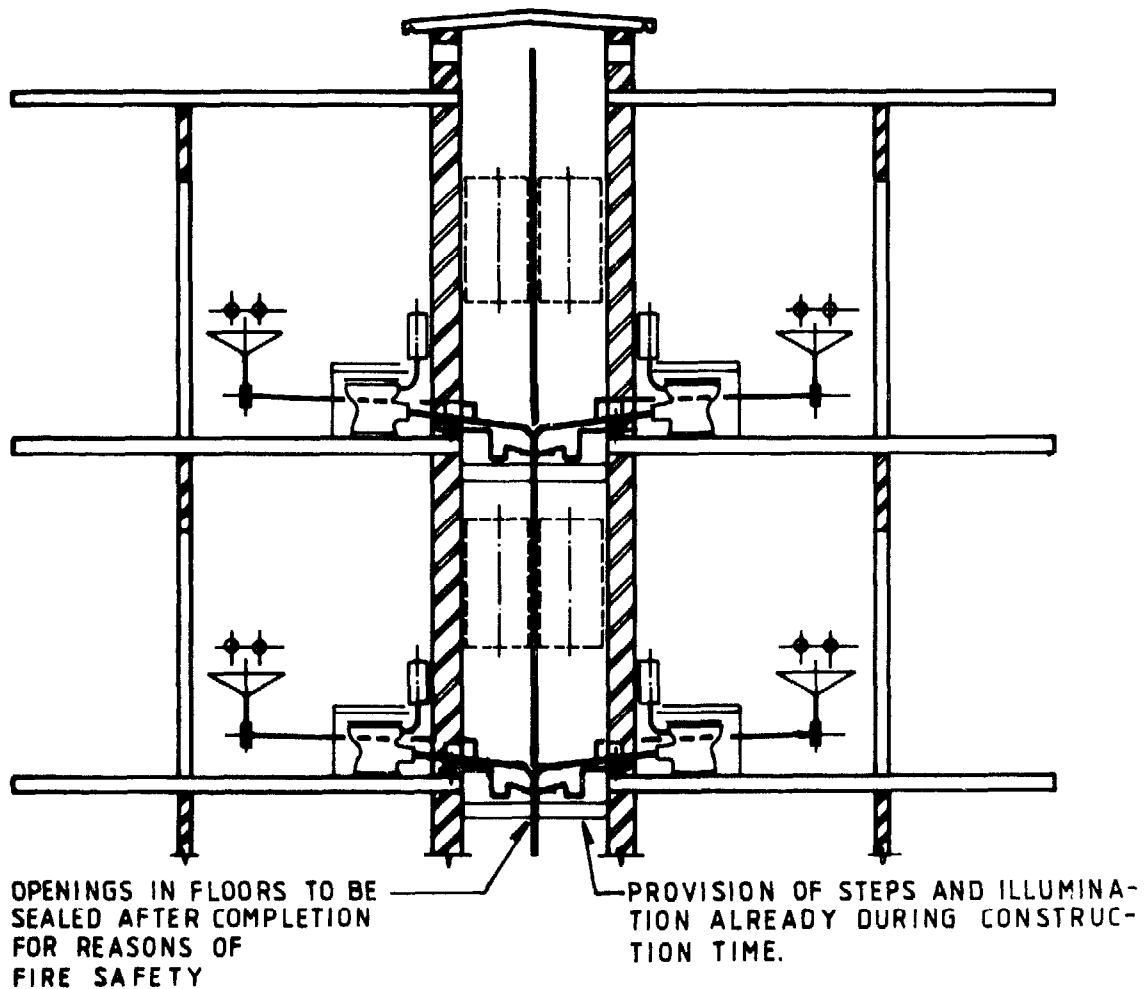
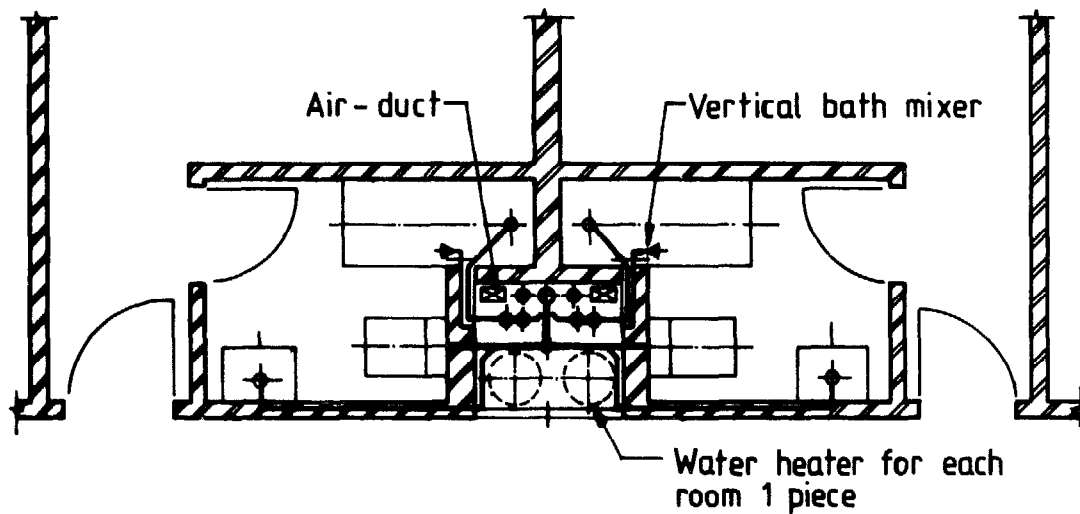

LAYOUT, EXAMPLE

TABLE 3/16

TYPICAL BATHROOM REQUIREMENTS IN A HOTEL PIPELINES ARE FITTED IN A SHAFT AND REMAIN EASILY ACCESSIBLE FOR REPAIRS AND MAINTENANCE.

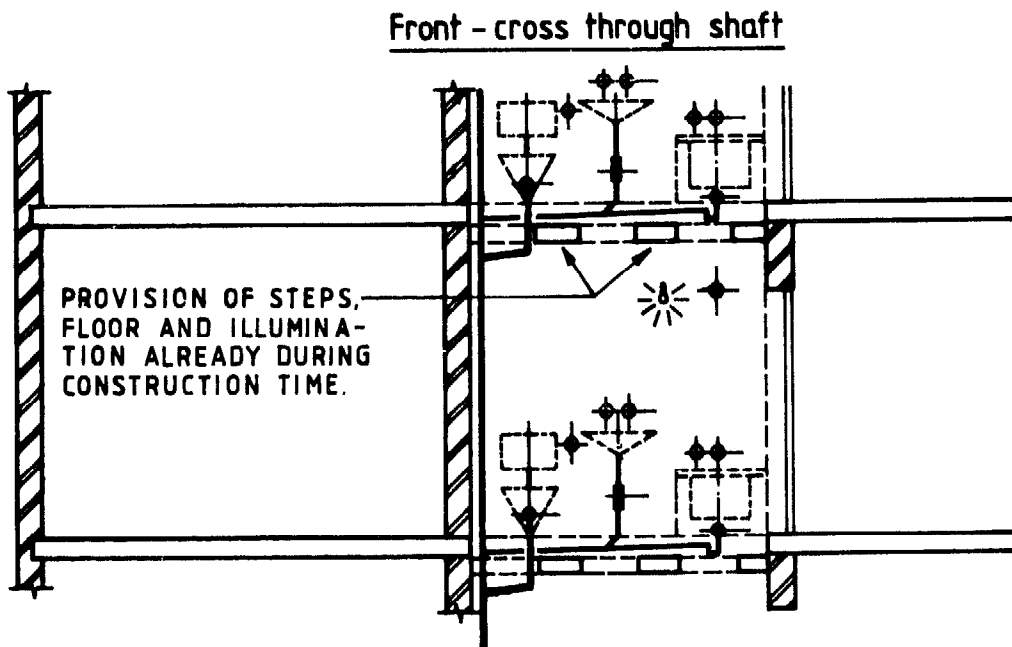
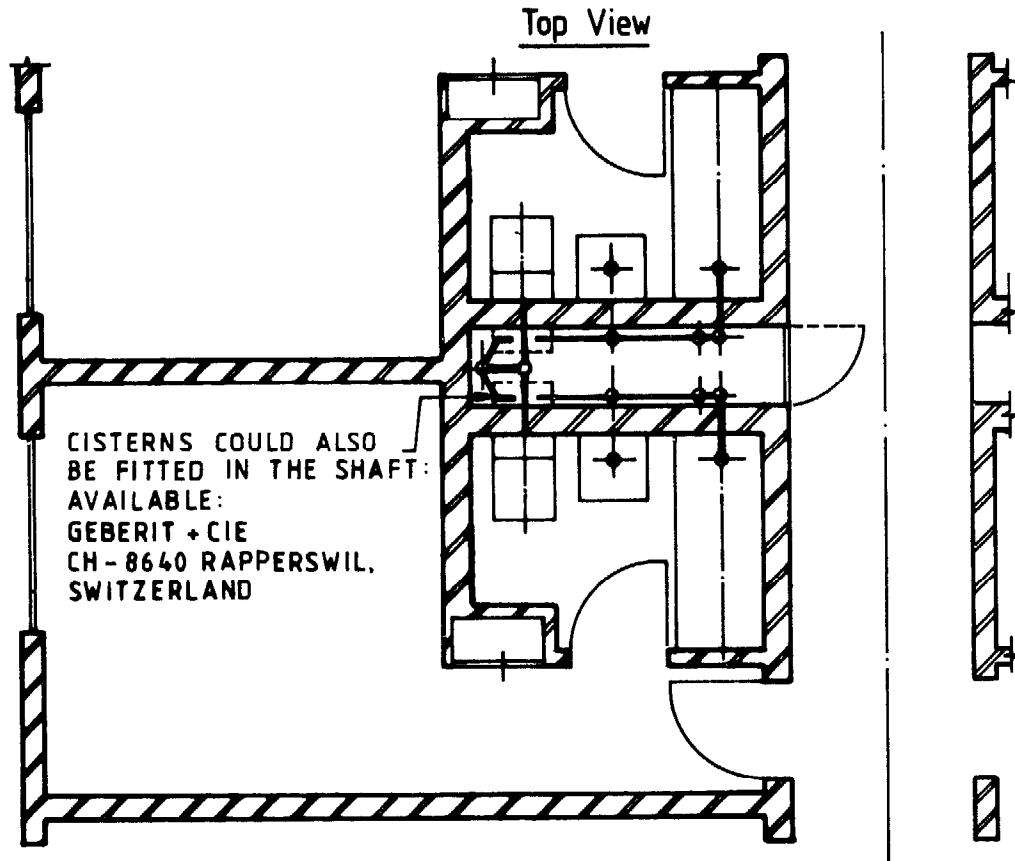

SYMBOLS

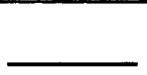
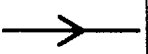



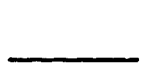
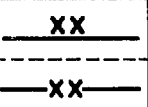
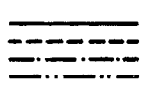

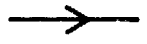
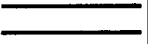
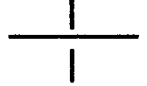

TABLE 3/17

FOR MECHANICAL INSTALLATIONS IN BUILDINGS

Scope: These symbols are valid for the following installations in buildings:











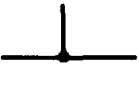





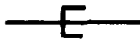
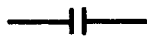

- Plumbing
- Heating
- Ventilating
- Air conditioning
- Refrigeration

SYMBOLS ARE DETERMINED ON THE BASE OF I S O STANDARDS. FOR UNIFORM PRESENTATION OF DRAWINGS OF INSTALLATIONS IN BUILDINGS.

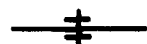
1 BASIC + GENERAL SYMBOLS					
1 1 Basic Symbols					
1 11		Pipes	1 12		Direction of flow of pipe content (arrow)
1 13		Control valves Stop valves (i.e. gate valves, butterfly valves)	1 14		Apparatus (without rotating parts)
1 15		Apparatus (without rotating parts)	1 16		Indicating and recording instruments
1 2 General Symbols					
1 201 Pipes					
1		Pipe	2		Contents of pipe : Method A : Designation by printing the nature of contents above or in the line
3		Contents of pipe : Method B : Designation by different lines (example on the left)	4		Contents of pipe : Method C : Designation by coloured * lines according to the colour code used in the industries
5		Direction of flow of pipe content (arrow)	6		Duct
7		Crossing of two pipes without connection	8		Crossing of two pipes with connection























SYMBOLS

TABLE 3/18

1 201		Continuation (General symbols)			
9		Branching pipe (Tee)	10		Pipe with slope
11		Flexible pipe	12		Insulated pipe
13		Heated pipe	14		Pipe with heating or cooling jacket
1 202		Pipe shown in plan			
1		Change of level in the same level	2		Pipe going through
3		Pipe going down	4		Pipe going up
5		Indication of levels / = highest level			
1 203		Pipe connections			
1		Pipe socket	2		Flanged connection
3		Screwed connection union	4		Pipe coupling
5		Centric reduction	6		Excentric reduction (above)
7		Excentric reduction (below)			
1 204		Expansion joints			
1		Expansion joint (general)	2		U - bend

SYMBOLS

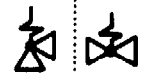
TABLE 3/19

1 204		Continuation (Expansion joints)		
3		Slip joint	4 	Bellow expansion joint (axial)
5		Bellow expansion joint (lateral)		
1 205		Supports		
1		Anchor point	2 	Sliding support
3		Pipe support	4 	Pipe hanger
5		Pipe hanger with spring	6 	Sliding pipe hanger
7		Sliding pipe, hanger with guides	8 	Rolling pipe support
1 206		Stop valves		
1		Valve (general)	2 	Angle valve
3		3 Way valve	4 	4 Way valve
5		Valve	6 	Gate valve
7		Stop cock	8 	Pressure reducing valve
9		Non return valve (check valve)	10 	Spring operated safety valve
11		Weight operated safety valve	12 	Butterfly safety valve



















SYMBOLS

TABLE 3/20

1 206 Continuation (Stop valves)					
13		Butterfly stop valve	14		Butterfly check valve
15		Butterfly throttling valve	16		Pipe vent
17		Funnel	18		Sight glass
19		Steam trap	20		Strainer
21		Water meter			
1 207 Apparatus					
1		Apparatus without rotating parts (with exact description)	2		Apparatus with rotating parts (with exact description)
3		Pump	4		Fan
5		Compressor	6		Motor
1 208 Measuring and sensing element					
1		Measuring point	2		Temperature sensing element
3		Pressure sensing element	4		Flow sensing element
5		Humidity sensing element	6		Level sensing element
7		Built-in measuring device	8		Measuring orifice (measuring nozzle)

SYMBOLS

TABLE 3/21

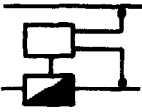
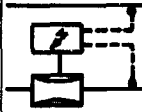
1 208		Continuation (Measuring and sensing element)			
9		Flow limiting device	10		Indicating device
11		Recorder			
1 209		Transmitters and controllers			
1		Transmitter	2		Controller
1 210		Drives			
1		Manual drive	2		Automatic drive (with auxiliary energy)
3		Direct drive	4		Weight operated drive
5		Float operated drive	6		Spring drive - operated
7		Piston drive operated	8		Diaphragm drive operated
9		Solenoid drive operated	10		Motor drive
1 211		Sources of energy			
1		Solid fuel	2		Liquid fuel
3		Gaseous fuel	4		Electric power
1 212		Heat meter			
1		Mechanical heat meter			Heat meter with electronic integration

SYMBOLS

TABLE 3/22

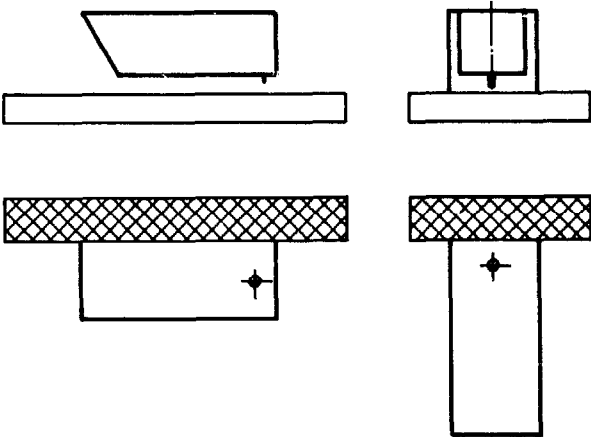
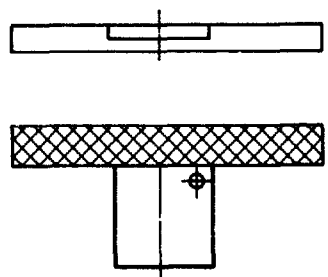
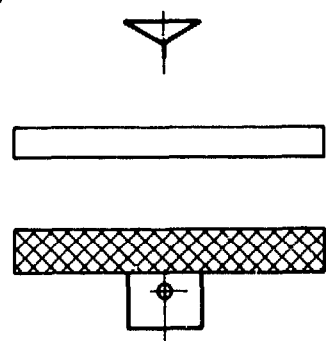
2 PLUMBING SYMBOLS	Connecting Values			
	Soil+waste water		Drinking water	
	Siphon	S- value	Valve	Units
<p>2.1 Sanitary Fixtures</p> <p>1 Bath tub</p> 	5/4 x 50 (or 57)	1	1/2"	2.0
<p>2 Shower</p> 	1 1/2" x 50 (or 57)	1	1/2"	2.0
<p>3 Lavatory (wash basin)</p> 	5/4 x 40 (or 32)	0.5	1/2"	0.5

SYMBOLS

TABLE 3/23

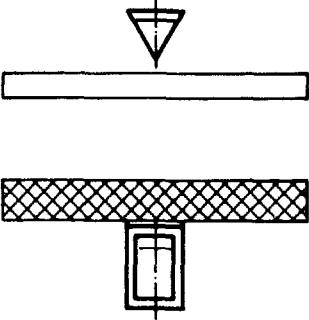
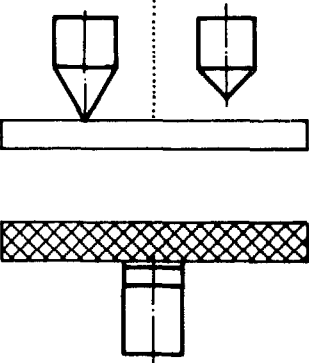
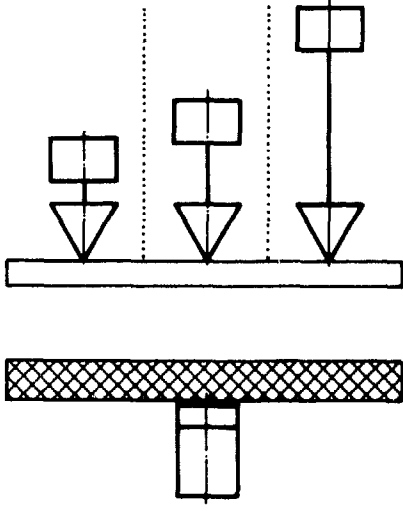
2 PLUMBING SYMBOLS (CONTINUED)	Connecting Values			
	Soil+waste water		Drinking water	
	Siphon	S- value	Valve	Units
2.1 Sanitary Fixtures 4 Bidet 	5/4 x 40 (or 32)	0.5	1/2	0.5
5 Water closet, low tank 	100 mm	2.5	1/2	0.5
6 Water closet, high tank 	100 mm	2.5	1/2	0.5

SYMBOLS

TABLE 3/24

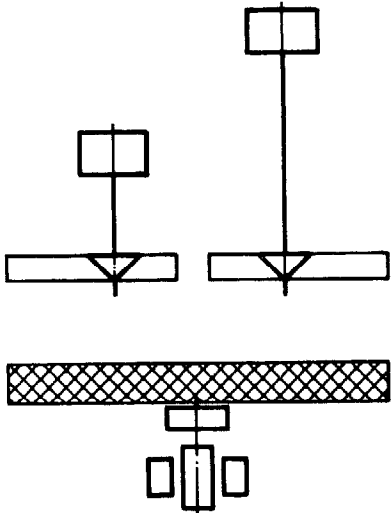
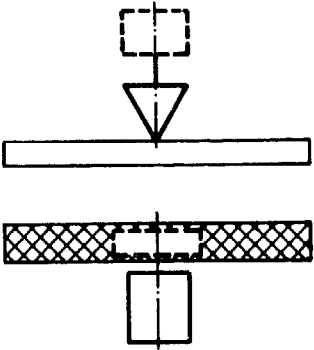
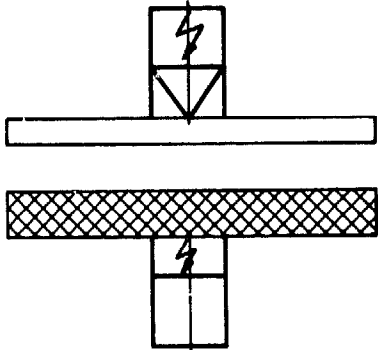
2 PLUMBING SYMBOLS 2.1 Sanitary Fixtures	Connecting Values			
	Soil + waste water		Drinking water	
	Siphon	S - value	Valve	Units
<p>6a Water closet floor pan</p> 	100 mm	2.5	1/2 Cleaning 1/2	0.5 tap: 0.5
<p>7 Water closet with tank built into wall</p> 	100 mm	2.5	1/2	0.5
<p>8 Automatic water closet</p> 	100 mm	2.5	1/2	0.5

SYMBOLS

TABLE 3/25

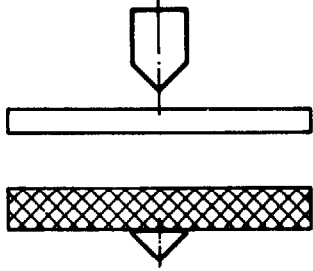
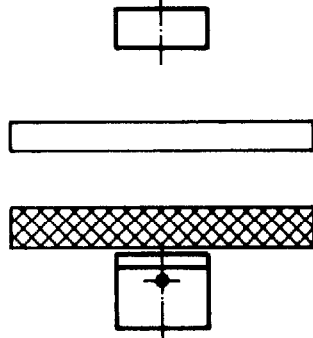
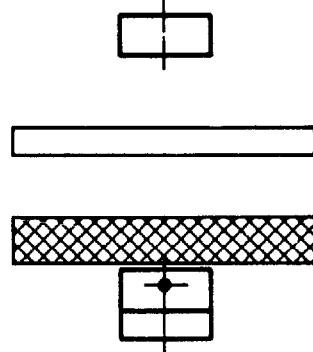
2 PLUMBING SYMBOLS 2.1 Sanitary Fixtures	Connecting Values			
	Soil + waste water		Drinking water	
	Siphon	S-value	Valve	Units
<p>9 Urinal, wall type</p> 	5/4 x 50 (or 57)	1.0	1/2	1.0
<p>10 Service sink</p> 	1 1/2 x 50 (or 57)	1.0	1/2	1.0
<p>11 Laundry trough</p> 	1 1/2 x 50 (or 57)	1.0	1/2	1.0

SYMBOLS

TABLE 3/26

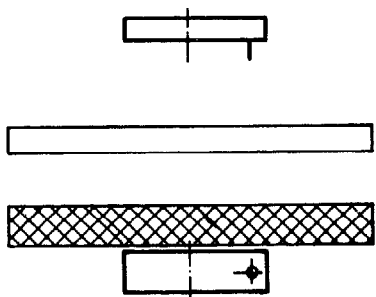
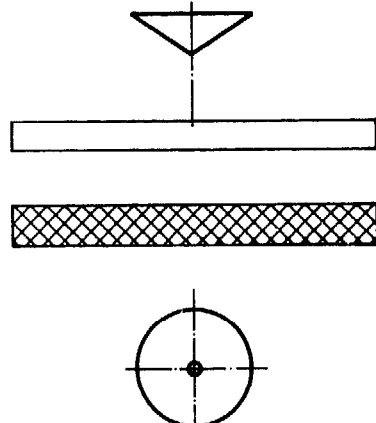
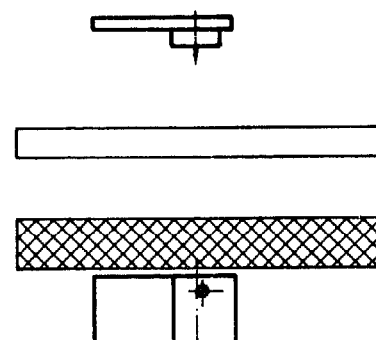
2 PLUMBING SYMBOLS (CONTINUED) 2.1 Sanitary Fixtures	Connecting Values			
	Soil+waste water		Drinking water	
	Siphon	S- value	Valve	Units
<p>12 Wash sink</p> 	<p>1 1/2 x 50 (or 57)</p>	<p>1.0</p>	<p>1/2</p>	<p>1.0</p>
<p>13 Wash fountain</p> 	<p>1 1/2 x 50 (or 57)</p>	<p>1.0</p>	<p>1/2</p>	<p>1.0</p>
<p>14 Single kitchen sink with drain board</p> 	<p>1 1/2 x 50 (or 57)</p>	<p>1.0</p>	<p>1/2</p>	<p>1.0</p>

SYMBOLS

TABLE 3/27

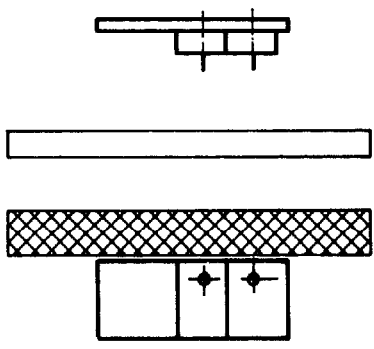
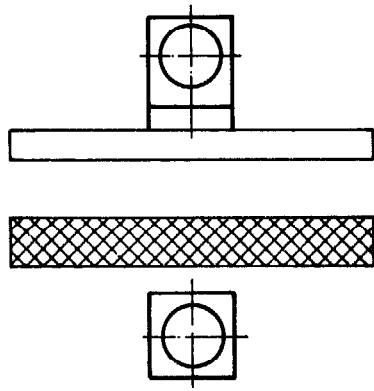
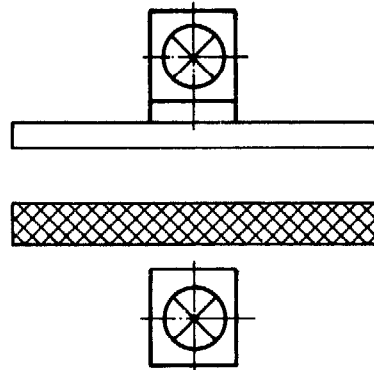
2 PLUMBING SYMBOLS (CONTINUED) 2.1 Sanitary Fixtures	Connecting Values			
	Soil + waste water		Drinking water	
	S phon	S - value	Valve	Units
<p>15 Double kitchen sink with drain board</p> 	1 1/2 x 50 (or 57)	1.0	1/2	1.0
<p>16 Washing machine</p> 	1 1/2 x 50 (or 57)	1.0 up to 6kg	1/2	2.0
<p>17 Clothes dryer (tumbler)</p> 	N. A.	N. A.	N. A.	N. A.

SYMBOLS

TABLE 3/28

2 PLUMBING SYMBOLS (CONTINUED) 2.1 Sanitary Fixtures	Connecting Values									
	Soil + waste water		Drinking water							
	Siphon	S - value	Valve	Units						
<p>18 Centrifugal dryer (electric)</p>	5/4 x 40 (or 32)	0.5								
<p>19 Water heater</p>	Probably safety valve drainage	nil	As per total connected units of hot water taps							
<p>20 Gas water heater</p>	N.A.	N.A.	<table border="1"> <thead> <tr> <th colspan="2">Gas</th> </tr> <tr> <th>Valve</th> <th>m³/h</th> </tr> </thead> <tbody> <tr> <td colspan="2">As of indications on apparatus.</td> </tr> </tbody> </table>		Gas		Valve	m ³ /h	As of indications on apparatus.	
Gas										
Valve	m ³ /h									
As of indications on apparatus.										





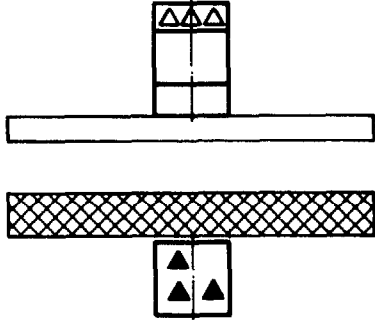
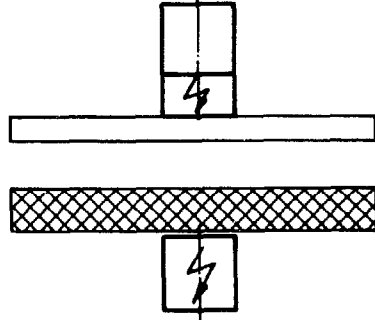

















SYMBOLS

TABLE 3/29

2 PLUMBING SYMBOLS (CONTINUED) 2.1 Sanitary Fixtures	Connecting Values			
	Soil+waste water		Gas	
	Siphon	S-value	Valve	m ³ /h
<p>21 Gas cooker</p> 	N.A.	N.A.	1/2	as of indication on apparatus.
<p>22 Automatic dish washer</p> 	by hose pipe into kitchen sink siphon	not to be counted for, if fitted into sink siphon otherwise: 1 1/2 x 50 (or 57)	1/2	1.0
			Drinking water	
			Valve	Units

SYMBOLS

TABLE 3/30

2 2		Valves			
1		Bib cock	2		Mixing valve
3		Compact mixing valve	4		Mixing valve with regulator
5		Hose bib	6		Bib cock with bypass and hose connection
7		Twin regulator valve	8		Mixing valve with bypass
9		Pillar tap	10		Mechanical mixer
11		Thermostatic mixer	12		Mechanical mixer with manual valves
13		Thermostatic mixer with manual valves	14		Mechanical mixer with regulator and manual valves
15		Thermostatic mixer with regulator and manual valves	16		Mechanical mixer with bypass
17		Thermostatic mixer with bypass	18		Shower
2 3		Drainage elements			
2 31		Pipes			
	Plan	Elevation			
1			Clear waste water		
2			Storm sewer		











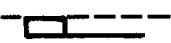
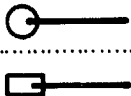





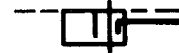

SYMBOLS

TABLE 3/31

2 31		Continuation (Pipes)	
	Plan	Elevation	
3			Sanitary sewer
4			Industrial sewer
5			Vent pipe
2 32		Pipe fittings	
1			Pipe socket Pipe coupling
2			Pipe end with clean out
3			Clean out
4			Reduction; centric
5			Reduction; excentric
7			S - Trap
8			Bottle trap
9			Horizontal trap



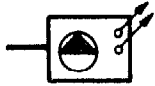

SYMBOLS

TABLE 3/32

2 32		Continuation (Pipe fittings)	
	Plan	Elevation	
10			Floor sink without bottle trap
11			Floor sink with bottle trap
2 33		Collector, separators, wells, pumps	
1			Collector (sludge separator)
2			Grease trap
3			Mineral oil separator
4			Fuel oil lock
5			Double non - return lock
6			Control well (open system)
7			Control well (closed system)
8			Sump pump (not for raw sewage)
9			Pump for sanitary waste, vented

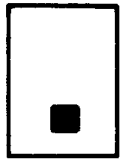
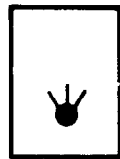
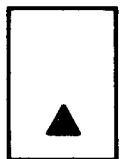
SYMBOLS

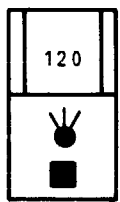
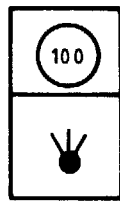
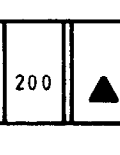
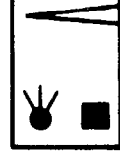
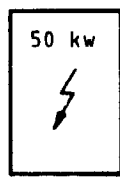
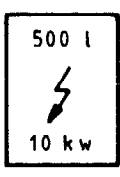
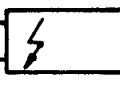
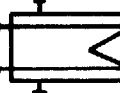
TABLE 3/33

SYMBOLS FOR HEATING INSTALLATIONS					
3 1		Boilers			
1		Boiler for solid fuel	2		Boiler for liquid fuel
3		Boiler with fan assisted gas burner	4		Gas fuelled flow-heater with atmospheric burner
5		Dual fuel boiler vertical hot water storage tank mounted on top (capacity e.g. 120 litres)	6		Oil fired boiler with hot water storage tank (horizontal) mounted on top (capacity e.g. 100 litres)
7		Gas fired boiler with hot water storage tank (vertical) mounted on side (capacity e.g. 200 litres)	8		Dual fuel boiler with hot water flow-heater
3 2		Storage heaters and heat exchangers			
1		Electric storage heater with ceramic core power : e.g. 50 kw	2		Electric storage heater for water capacity : e.g. 500 litres power : e.g. 10 kw
3		Electrically heated flow type water heater power : e.g. 5 kw	4		Horizontal water to water heat exchanger
5		Heat exchanger cooling the secondary circuit	6		Heat exchanger with co-axial tubes

SYMBOLS

TABLE 3/34

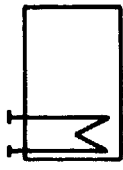
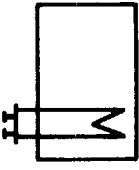
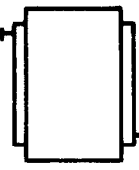
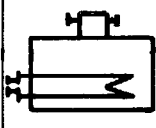
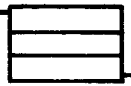
3 2		Continuation (Storage heater and heat exchangers)			
7		Vertical hot water tank with fixed heating coil at bottom	8		Vertical hot water tank with removable heating coil
9		Vertical hot water tank with double jacket	10		Horizontal water heated steam generator with removable heating coil
11		Water heater in several segments			

BASIC PRINCIPLES OF PLANNING AND DESIGN

The following rules are general guidelines which may be altered when necessary to suit particular circumstances.

Additional basic principles will arise out of practical experience.

1. For representation in the drawings use only official and common symbols.
2. Consider always that lines in a drawing represent pipe lines and that the space required for pipes must be allowed for.
3. The sanitary installations of a building are a complete functional unit made up of supply and waste disposal pipe lines (water, waste water etc.). For correct installation, pipelines and apparatus must be shown in their proper relationship to each other in all drawings (top view, schemata and detail drawing).
4. Drawings should be complete, containing sufficient information for making the material list and for execution on the site. There should be no need for further inquiry at the design office.

TOP VIEW DRAWING

1. The scale for top view drawings, is normally 1:50.
2. The dividing line of stories (floors) for drawing in pipelines is top of floor level up to top of ceiling level.

DIVIDING LINE OF STORIES

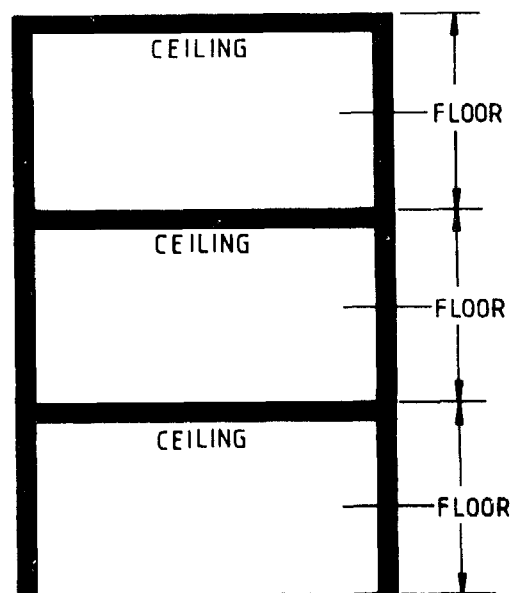

3. Before starting to draw in pipelines, study carefully all top view plans and all building cross section drawings. A better knowledge of the building and of all its constructional details results in a faster execution and conformation of the pipe layout.

4. Preferably start the design from top to bottom (top floor to basement) and prepare a separate layout for each different apparatus group.
5. After the draft is completed the final design of the pipelines should be made in coordination with other installations (e.g. electrical, air condition etc.).

TOP VIEW

EXAMPLE 1

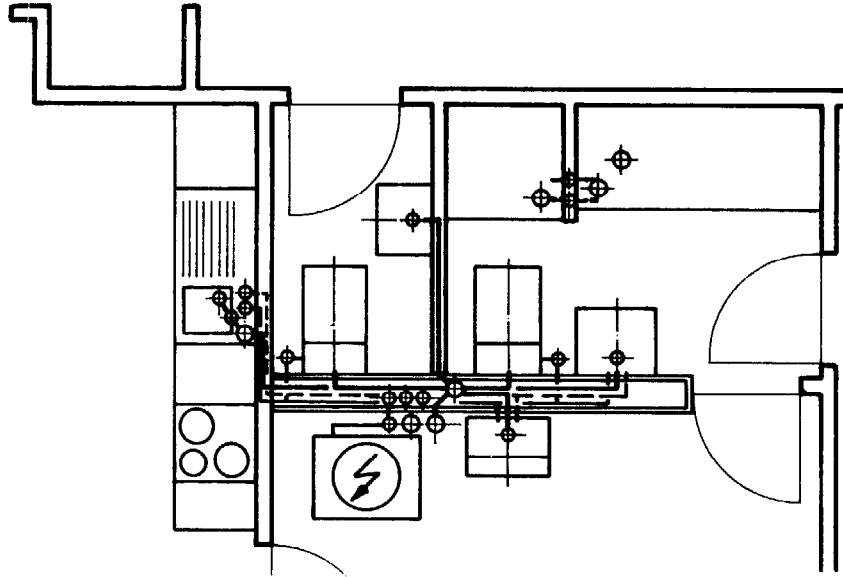

EXAMPLE 2

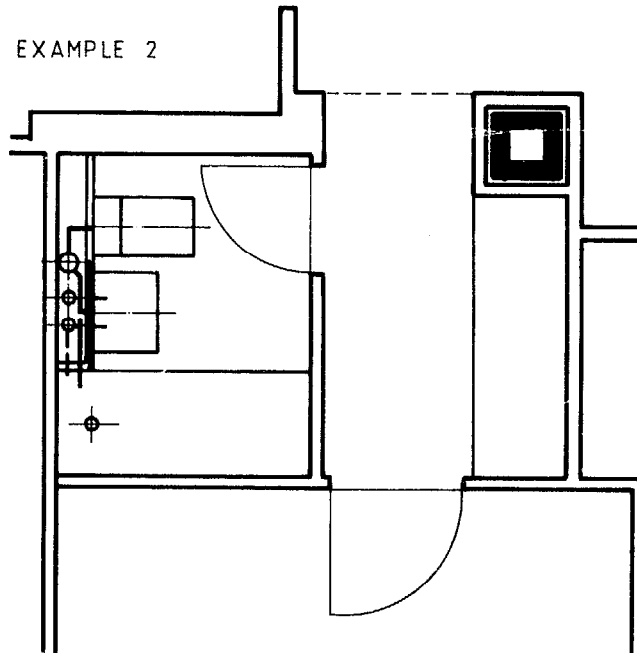

SCHEMATIC DRAWING

1. A representation of all installation parts in a three dimensional room is not possible on a 2-dimensional drawing therefore the best possible solution should be chosen.
2. A schematical drawing is made primarily to show the pipelines. Items of apparatus are of secondary importance and show for what purpose at which height, and how the pipes are connected to them.

4. In all drawings pipelines should be represented in the same way as they later will be installed on the site. This applies for individual rooms as well as for the branches and tees.
5. In cases where apparatus is fitted on both sides of a wall, the development of the schematic drawing starts from the point where the pipes will be fitted. The view should, therefore, be from the wall on which the pipes are fitted (regardless of which wall has most apparatus).
6. The items of apparatus must be shown in order of their pipe connections (as they will be fitted at the building site). Apparatus fitted on the back of the wall will be drawn as it would be seen from the front. The same applies to the water connection pipelines. For mixing taps the cold water connection shall always be drawn on the right side, and the warm water connection on the left side.

SCHEMATIC DRAWING

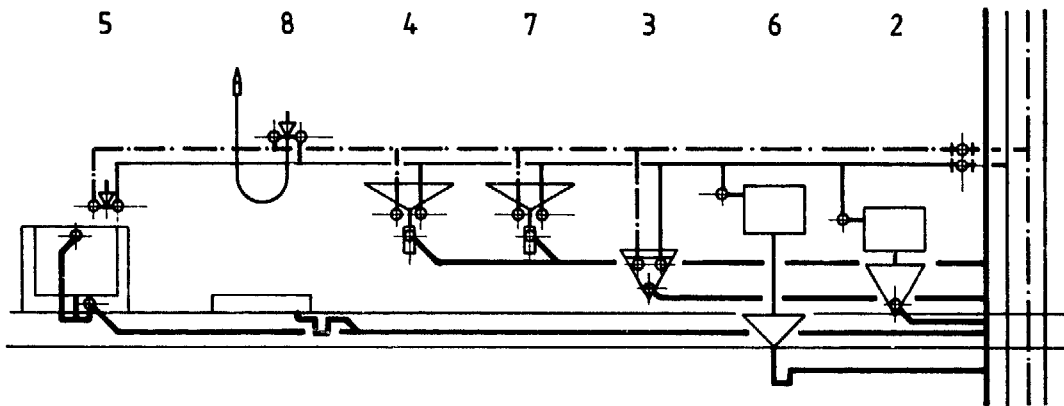

TOP VIEW

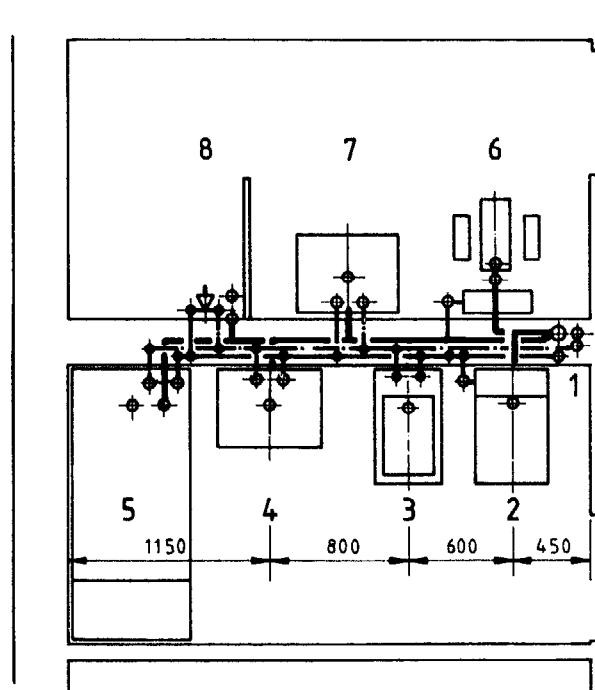

7. The order of branches (waste water) and of tees (cold-, hot water), in the schematic drawing has to correspond with the order shown in the top view.
8. The height for fixing of apparatus, valves (armatures) and connecting places shall be to scale 1:50. The drawing of increased heights of storys should be avoided if possible (especially in cases where a greater concentration of pipes in basements may occur).

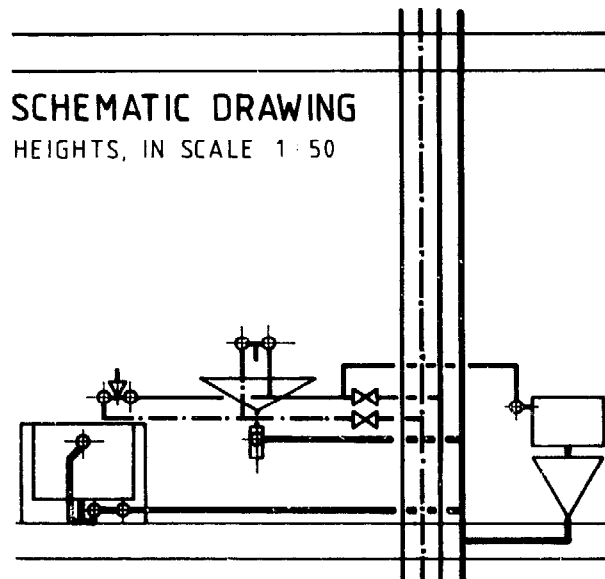

9. The sizes of all parts of valves and parts of water and gas pipelines must be given. When the connector pipe for the tap has the same dimension as the tap itself, it is not necessary to mention separately the dimension of this pipe.

Indications of dimensions shall be made in letters of sufficient height. Lines of reference to pipes should be of short distance.

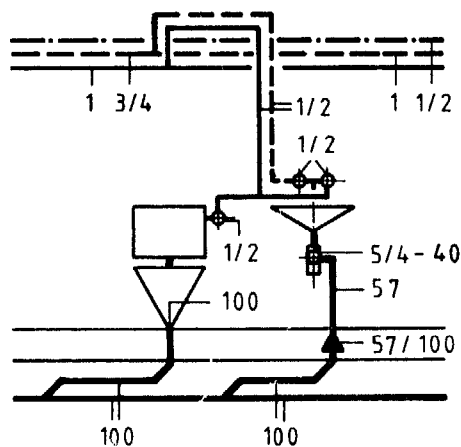

For soil and waste water pipelines sizes must be given for :-

- all pieces of pipe between each branch,
- apparatus connectors, siphons, cleaning openings, reducers and connections to the ground pipeline.

The minimal inside diameter in mm (e.g. 100, 57, 44) or both inside/outside dia. (e.g. 100/110, 57/63, 44/50) should be indicated in letters of sufficient height.

Shifting of the axis (offsets) of leaders must be shown in the schematic drawing.

SCHEMATIC DRAWING

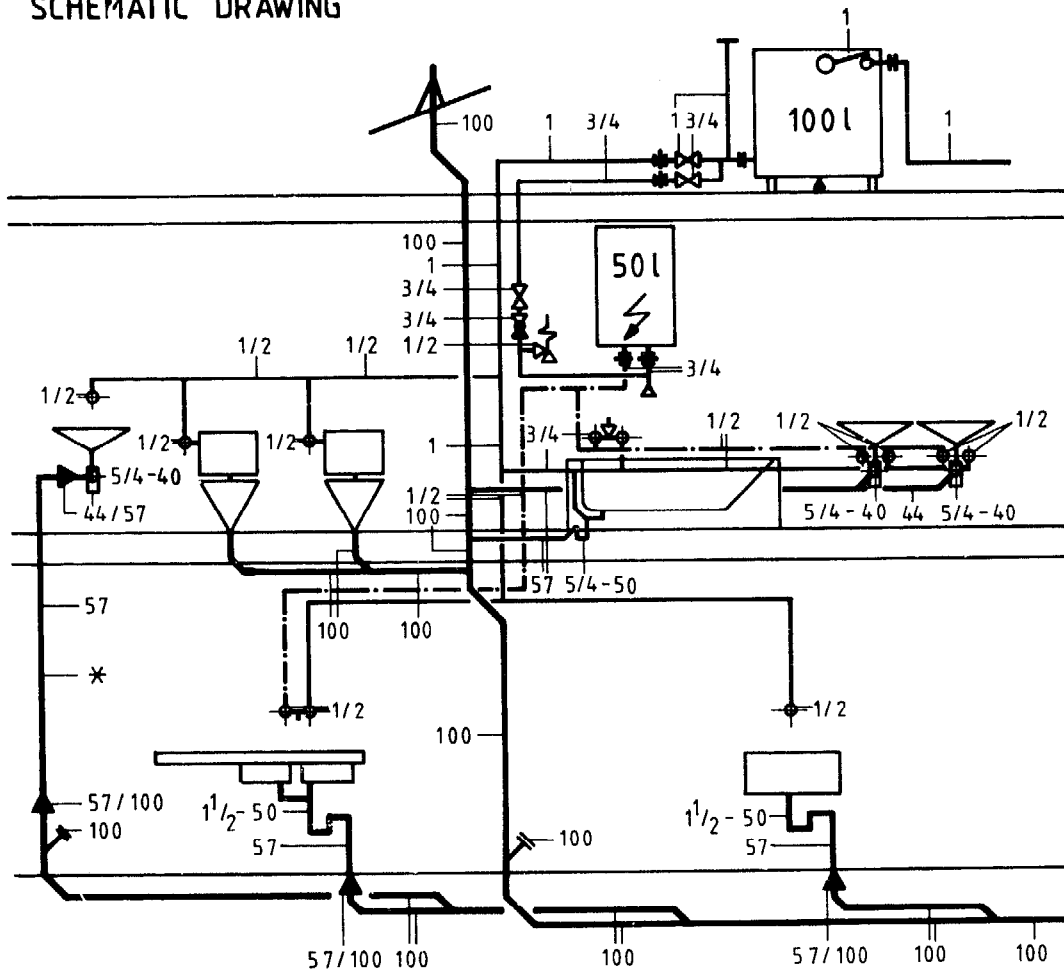

LEGEND:

- COLD WATER
- · - · - · HOT WATER
- SOIL / WASTE WATER

* SEE PARA 7.760 VAR 3

DIMENSION OF WASTE WATER PIPES = MINIMAL INSIDE DIA.

DETAIL DRAWING

There are many different stages of planning, from the very first thoughts up to the execution of an installation. One part of the planning is the detailed drawing which itself can have also different levels of detail.

A bathroom drawing can refer to :

- Level 1: Roomsize, items of apparatus and their center to center distance.
- Level 2: As above plus front view with the heights of the apparatus and the connections to the water and waste water system. The minimal space requirements of each individual item of apparatus may also be shown.
- Level 3: Top and front view of a bathroom in scale 1:10, using symbolic design for the apparatus and pipelines. The pipelines should be drawn in a single pencil or ink line with all necessary information about material and dimensions of the pipes. Further it should include the center to center dimensions and (in the elevation) all measurements of the different levels (heights of the apparatus, pipes, etc.).
(N.B. one measurement line only for one apparatus)

Only absolutely necessary measurements should be shown in the drawing. With all this information, it should be possible to prepare a pre-assembly drawing and a detailed material list.

1. All dimensions (measurements) of the pipelines and apparatus in the top view drawing should be given from one side only and never from both sides of the walls.
2. All measurements, including the center to center distance of the apparatus and the stack (vertical waste water pipe) take their reference measurement from the same wall (as do all others risers and connections to the apparatus).

DETAIL DRAWING

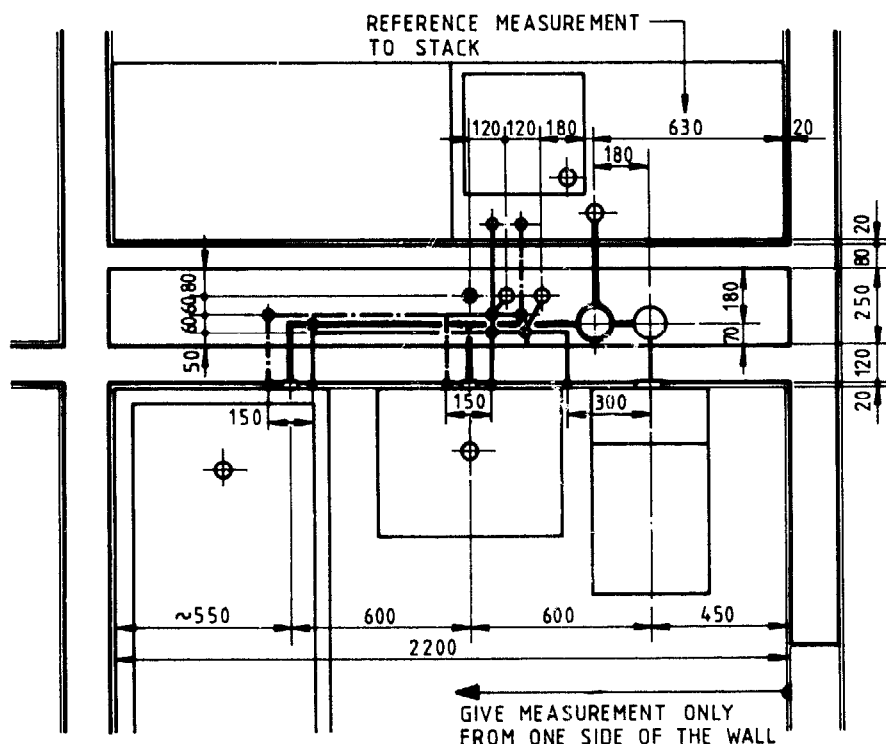

3. Consider when working out the disposition of the pipelines, that the execution at site must be possible with standard available fittings.
4. For the center to center distance of apparatus and for pipe connections use only standard measurements with consideration for minimal space requirements (see Table 3/11 - 3/13).

DETAIL DRAWING

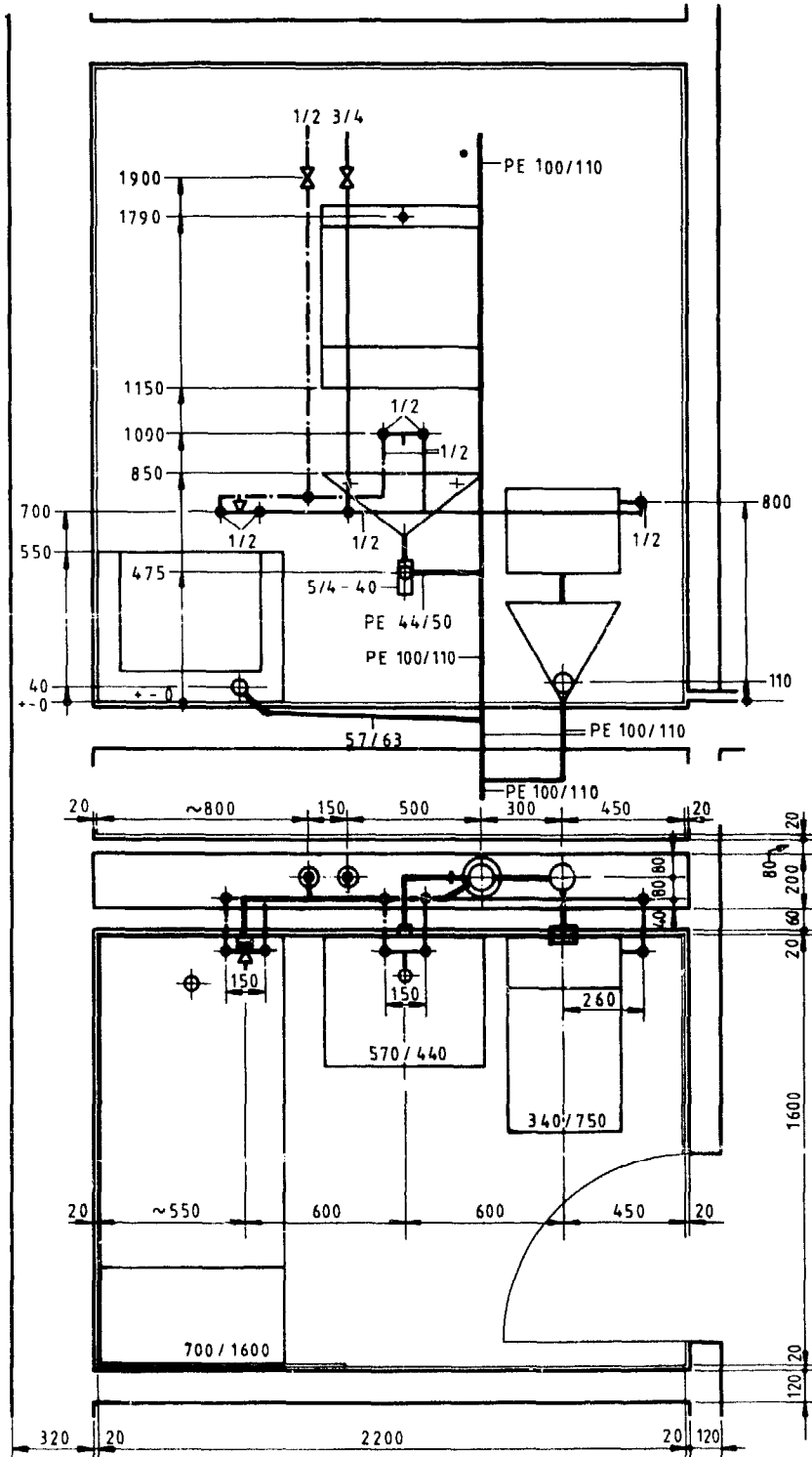

FIXATION OF PIPES EXAMPLES

All pipelines have to be fixed with adequate clamps, to hold the weights very well, (also when waste - lines are filled with water)
 Materials: mild steel 2 - 3mm thick, galv or painted

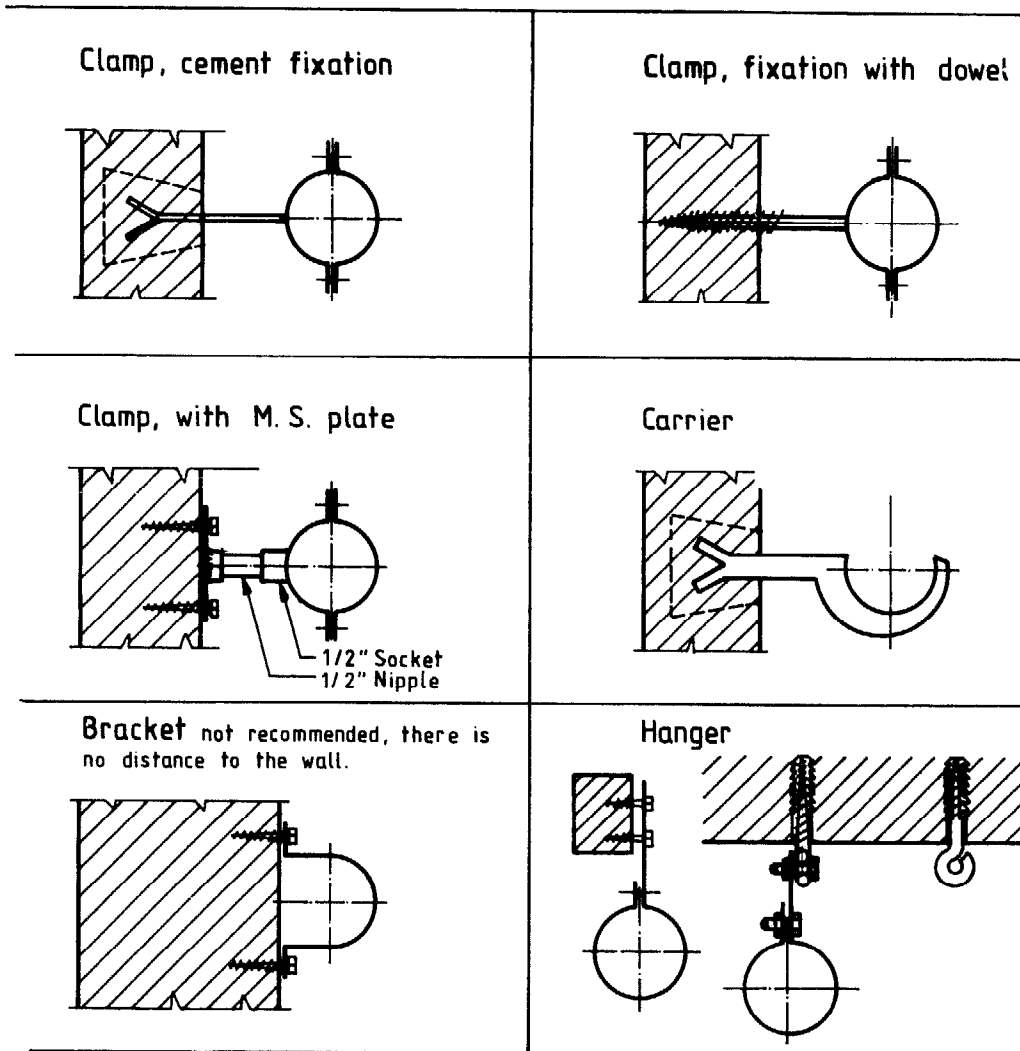

Front

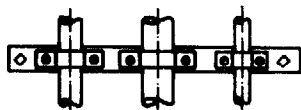

Top

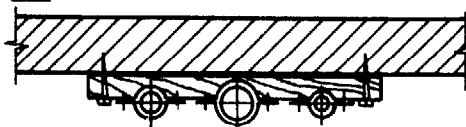

Combined system

might be useful in installation shafts, but only where not exposed to outside conditions.

ABBREVIATIONS

i.d.	inner diameter
∅	diameter
N.D.	Nominal diameter
mm	millimeter
cm	centimeter
m	meter
l	length
h	height
x x2	square
x x3	cubic
A	surface
"	inch
'	foot
I.S.	Indian Standard
I.S.O.	Intl. Standard Org.
C.O.	Clean out
C.P.	chrome plated
WC	Water closet
Vent	Ventilation
U	Unit/used for dimensioning of drinking water
SV	S-Value (Sewer value) used for dimensioning of sewer and waste water
l/s	liters per seconds
N.A.	Not applicable
>	larger than
<	smaller than
≥	larger or same
≤	smaller or same
Σ	sum, total

Conversion table sheet metal

Thickness in I.S.W.G.	Thickness in mm
30	0.314
29	0.345
28	0.376
27	0.416
26	0.457
25	0.507
24	0.558
23	0.609
22	0.711
21	0.812
20	0.914
19	1.015
18	1.218
17	1.422
16	1.625
15	1.828
14	2.040
13	2.337
12	2.641
11	2.946
10	3.250







I.S.W.G = Imperial Standard
Wire Gauge

DRINKING WATER DIMENSIONING

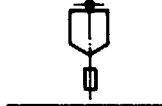
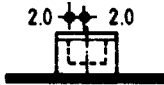
Table for dimensioning with units

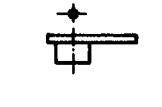
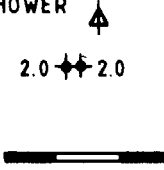
A) For systems with roof tanks
(Head less than 40 meters)

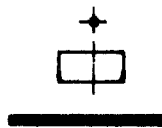
LOADING VALUES AND DIAMETERS (G.I. PIPES)	
PIPE DIAMETER IN INCHES	MAX. LOADING IN UNITS
1/2	0.5 - 2.0
3/4	2.5 - 4.0
1	4.5 - 10.0
1 1/4	10.5 - 20.0
1 1/2	20.5 - 40.0
2	40.5 - 100.0

0.5 UNIT	1.0 UNIT	2.0 UNITS
WATER CLOSET (CISTERN) 	URINAL (DIRECT FLUSHING) 	BATHTUB 
WASHBASIN 	KITCHEN SINK 	SHOWER 
FLOOR PAN (CISTERN) 	SINK / TROUGH 	GARDEN VALVE 

B) For systems with pressure
(Head above 40 meters)

LOADING VALUES AND DIAMETERS (G.I. PIPES)	
PIPE DIAMETER IN INCHES	MAX. LOADING IN UNITS
1/2	0.5 - 2.5
3/4	3.0 - 5.0
1	5.5 - 12.0
1 1/4	12.5 - 25.0
1 1/2	25.5 - 50.0
2	50.5 - 125.0

SOIL AND WASTE WATER DIMENSIONING

Leaders (stacks), Main vent system

stack	max. permitted numbers				permitted loading
	SV		WC		
i.d. in mm	Total	largest single SV	Total	per storey	Vs (1/s)
57	3-1)	1.0	--	--	1.3
69	7	1.0	--	--	2.0
80	20	1.5	--	--	3.0
100	70	2.5	14	6	4.2
118	100	2.5	20	7	5.0
125	150	-	30	10	6.1
150	400	-	80	22	10.0

1) max. 2 apparatus at 1 SV.

0.5 S-VALUE	1.0 S-VALUE	2.5 S-VALUES
<p>WASHBASIN</p>	<p>SHOWER</p>	<p>WATER CLOSET</p>
<p>URINAL (DIRECT FLUSHING)</p> <p>WITH CISTERN = 1.0 SV</p>	<p>KITCHEN-SINK</p>	<p>FLOOR PAN</p>
<p>BIDET</p>	<p>BATHTUB</p>	<p>WALL CLOSET</p>

1) HORIZONTAL CONNECTOR PIPE, I.D 44 mm UP TO MAX. 2.0 M

Branch- and connector pipes, without secondary vent.

i.d. in mm	max. permitted numbers SV	largest single SV
50	1	0.5
57	2	1.0
69	3-1)	1.5
80	6	1.5
100	15	2.5

1) max. 1 apparatus at 1.5 SV

FURTHER READINGS

1) Code of practice for Plumbing

Royal Government of Bhutan (NUDC/004/1984) issued under the authority of Chairman, National Urban Development Corporation, Thimphu, Bhutan (78 pages)

2) Code of Practice for sanitary pipe work above ground for buildings. (Indian Standard, 15:5329-1969)

Indian Standards Institution, Manak Bhava, 9 Bahadur Shah Zafar Marg, New Delhi -110 002

3) "Plumbing" - Periodical

The Institute of Plumbing,
64 Station Lane, Hornchurch / Essex RM12 1BR, U.K.

4) Symbols for mechanical installations in buildings

(German, French, Italian, English)
Schweiz. Ing.- und Architekten-Verein
Postfach, 8039 Zurich, Switzerland

5) Water Installation and Drainage System

by F. Hall, 1978
The Construction Press (Longman Group)
Lancaster, England

6) Solar Water Heaters in Nepal / Manufacturing and Installations

by A. Bachmann and H. Waldvogel
a publication by MTC/Nepal and SKAT/Switzerland
SKAT, Varnbuelstrasse 14, CH- 9000 St. Gallen, Switzerland

7) PLUMBING SERVICES:

Volume I	1982	Basic Skills, Water Supply
Volume II	1982	Waste Disposal, Roof Plumbing
Volume III	1986	Gasfitting
Volume IV	1986	Mechanical Services. Air Conditioning

by: R.J. Puffet and L.J. Hossack
McGraw-Hill Book company, Sidney
4 Barcoo Street, Roseville, NSW 2069, Australia

8) MATHEMATICS - PLUMBERS AND PIPEFITTERS

by: Bartholomew D'Arcangelo, et al.
DELMAR PUBLISHERS INC., USA, 1968
(Library of congress Catalog Card No: 68-29997)

9) PLUMBING AND HEATING

by: F. Hall (reprinted 1981)
The Macmillan Press, Ltd, London and Basingstoke

10) HOME PLUMBING

by: F. Hall (reprinted 1983)
David and Charles (Publishers) Newton Abbot, London

11) PLUMBING - HOT WATER SUPPLY AND HEATING SYSTEMS

by: F. Hall
Longman Scientific & Technical, Longman House, Burnt Mill, Harlow, Essex CM20
2JE, England

FURTHER PUBLICATIONS ON THIS SUBJECT IN SKAT'S BOOKSHOP

ENVIRONMENTAL HEALTH ENGINEERING IN THE TROPICS: AN INTRODUCTORY TEXT, S. Cairncross and R. Feacham

1983, 283 pp., SFr. 49.- (Bookshop 36048e)
Handbook dealing extensively with a large number of infectious diseases which can be controlled by environmental intervention. Covers: health and pollution; water supply; excreta treatment: etc.

A HANDBOOK OF GRAVITY-FLOW WATER SYSTEMS, T.D. Jordan JR.

1984, 250 pp., SFr. 18.- (Bookshop 34008e)
Originally written for systems in Nepal, most principles presented are applicable in locations all around the world. The material is organized for quick reference.

DRINKING WATER SUPPLY - TECHNICAL ASPECTS, K. Wehrle

1985, 177 pp., SFr. 20.- (Bookshop 34030e)
Description of all technical aspects of drinking water supply and sanitation projects.

VILLAGE WATER SUPPLY IN THE DECADE, LESSONS FROM FIELD EXPERIENCE, C. Glennie,

1983, 152 pp., SFr. 43.- (Bookshop 34031e)
Gives a detailed account of a successful rural water supply programme in East Africa over a period of 10 years. Emphasises the role of management, organization and community participation.

GUIDELINES FOR DRINKING-WATER QUALITY, VOLUME I: RECOMMENDATIONS, WHO

1984, 130 pp., SFr. 38.- (Bookshop 32010e)
Provides a basis for the development of standards. May also be of assistance in developing alternative control procedures where the implementation of drinking water supply is not feasible (also available VOLUME II: Health Criteria and other supporting information and VOLUME III: Drinking Water Quality Control in Small Community)

SIMPLE METHODS FOR THE TREATMENT OF DRINKING WATER, GATE

1985, 78 pp., SFr. 18.50 (Bookshop 36046e)
Manual with basic technical information on equipment, procedures and hints for planning and implementing water treatment projects.

HAND DUG WELLS AND THEIR CONSTRUCTION, S. Watt and W. Wood

1977, 253 pp., SFr. 15.- (Bookshop 32001e)
Provides practical step-by-step guidance in the techniques of digging and constructing a well: principles of groundwater storage, the actual construction, the materials required and details on additional sources of information.

GUIDELINES FOR PLANNING COMMUNITY PARTICIPATION IN WATER SUPPLY AND SANITATION, A.

Whyte
1983, 60 pp., SFr. 5.- (Bookshop 34022)
Guidelines for planners on how to establish community participation in projects concerned with water supply and sanitation.

MANUAL FOR RURAL WATER SUPPLY, HELVETAS

1985, 175 pp., SFr. 34.- (Bookshop 34003e)
A guide on how to identify, plan, organise, and execute drinking water projects. With many elaborate scale drawings. Specially written for engineers and construction supervisors but serves also as a comprehensive introduction for non-technical readers (also available in french and spanish).

SLOW SAND FILTRATION FOR COMMUNITY WATER SUPPLY PLANNING, DESIGN, CONSTRUCTION, OPERATION AND MAINTENANCE, J.T. Visscher et al

1987, 149 pp., SFr. 20.-
Describes the principles and applicability of slow-sand filtration. Provides guidelines resulting from demonstration projects in developing countries.

HORIZONTAL-FLOW ROUGHING FILTRATION (HRF), A DESIGN, CONSTRUCTION AND OPERATION MANUAL, M. Wegelin

1986, 142 pp., SFr. 15 (Bookshop 35007e)
Technical manual addressed primarily to design engineers. Covers design, construction, operation and maintenance aspects. The content is based on laboratory tests and field experiences.

COMMUNITY WATER SUPPLY, THE HANDPUMP OPTION, S. Arlosoroff et al

1987, 202 pp., SFr. 26.40 (Bookshop 34034e)
Reference manual for policy makers and professionals. The critical elements of a handpump-based community water supply systems are discussed and analysed.

If you are interested in further publications on water supply or on appropriate technology please ask for our free bookshop catalogue; it lists all our titles for sale. Our Address: SKAT, Varnbühlstr. 14, CH-9000 St. Gallen, Switzerland