

AT MICROFICHE
REFERENCE
LIBRARY

A project of Volunteers in Asia

Rural Water Supply in Nepal: Pipe and Fittings
Course Technical Training Manual No. 4

Published by:

Local Development Department, Ministry of Home
and Panchayat, Government of Nepal/
Swiss Association for Technical Assistance/
United Nations Children's Fund
Kathmandu, Nepal

Available from:

United Nations Children's Fund
Lazimpat
P.O. Box 1187
Kathmandu
Nepal

Reproduced by permission of UNICEF/Nepal.

Reproduction of this microfiche document in any
form is subject to the same restrictions as those
of the original document.

RURAL WATER SUPPLY NEPAL

**TECHNICAL TRAINING
MANUAL no. 4**

PIPE AND FITTINGS COURSE

*Prepared and Published by
Local Development Department, Ministry of Home and Panchayat
SATA - Swiss Association for Technical Assistance
UNICEF - United Nations Children's Fund*

Katmandu 1978

PIPE AND FITTINGS COURSE

<u>Table of contents</u>	<u>Page</u>
1. <u>Preface</u>	1
2. <u>HDP Pipe and fittings</u>	
2.1 <u>Introduction</u>	1
2.1.1 Materials	
2.1.2 Advantages of HDP pipe	
2.1.3 Disadvantages of HDP pipe	
2.2 <u>Standard supplies of HDP pipe and fittings</u>	2
2.2.1 General	
2.2.2 Pipe	
2.2.3 Fittings	
2.3 <u>Handling of HDP pipe</u>	5
2.3.1 Transport	
2.3.2 Storage	
2.3.3 Pipe coils	
2.4 <u>Joining HDP to HDP</u>	5
2.4.1 General	
2.4.2 Tools for "Butt-Welding"	
2.4.3 Welding procedure	
2.4.4 Making fittings locally	
2.5 <u>Joining HDP pipe to G.I. pipe or G.I. fittings</u> 15	15
2.5.1 General	
2.5.2 Using flanges	
2.5.3 Using brass unions	
Appendix 1: Operating a blow torch	17
Appendix 2: Mould and mitre box	18
3. <u>G.I. Pipe and fittings</u>	
3.1 <u>Introduction</u>	19
3.1.1 General	
3.1.2 Advantages of G.I. pipe and fittings	
3.1.3 Disadvantages of G.I. pipe and fittings	

<u>Table of contents (contd.)</u>	<u>Page</u>
3.2 <u>Standard supplies of G.I. pipe and fittings</u> ...	19
3.2.1 General	
3.2.2 Pipe	
3.2.3 Fittings	
3.3 <u>Handling of G.I. Pipe</u>	24
3.3.1 Transport	
3.3.2 Storage	
3.4 <u>Joining of G.I. Pipe</u>	24
3.4.1 Tools	
3.4.2 Thread cutting	
3.4.3 Water-tight joints	
4. <u>Miscellaneous valves</u>	
4.1 Gate valve:.....	26
4.2 Globe valve or stop cock (corporation cock) ..	26
4.3 Tap (faucet)	27

PIPE AND FITTINGS COURSE

1. Preface

The purpose of this course is to give foremen a brief introduction to the types of pipe and fittings most commonly used in the construction of community water supply systems in Nepal. The following types of pipe are presently used:

- HDP (plastic) pipe for distribution pipelines
- GI for service pipes in tanks and for stand pipes

Pipe and fittings made from several other types of materials, for example asbestos and PVC, are available on the world market but these are not described here as their use in Nepal is at present limited.

2. HDP pipe and fittings

2.1 Introduction

2.1.1 Materials

HDP is an abbreviation for high density polyethylene. The liquid gas ethylene is the basic material for the production of polyethylene. Ethylene is produced from either petroleum or coal.

Density: 0.95 gm/cc (lighter than water)
Colour : Black
Permissible temperature range: -30°C to + 50°C

2.1.2 Advantages of HDP pipe

- Simple joining procedure (see chapter 2.4).
- It is possible to make fittings, such as tees and bends, out of pipe.
- Low transport cost due to light weight. Compared to GI pipe, HDP is about seven times lighter in weight.
- The fact that HDP pipe is flexible reduces the cost of installation in difficult hilly areas.
- HDP pipes have a smooth internal surface which means low pressure loss due to friction.
- Polyethylene is exceptionally resistant to inorganic chemicals and to many organic chemicals as well.

2.1.3 Disadvantages of HDP pipe

- HDP cannot be joined to metal by welding. This means the need for special fittings.
- HDP can easily be damaged, so it is recommended that HDP pipe be used only when the pipe is not exposed to the open air. Connecting HDP directly to a masonry or concrete wall should be avoided.
- Coils of larger pipe are difficult to carry because of their size.

2.2 Standard supplies of HDP pipe and fittings

2.2.1 General

HDP pipe and fittings are available in various sizes and types. From time to time it is necessary to change or substitute one or more of the items provided in order to suit changing conditions. For further information on materials described under this section please refer to the booklet entitled "UNICEF Standard Supplies, Rural Water Supply Programme, Nepal". This booklet is updated from time to time to include any changes made.

Firms which manufacture HDP pipe and fittings use the outer diameter to indicate size. Inner diameter is used to indicate GI pipe size. The following table gives the equivalent GI and HDP pipe sizes:

GI (in inches)	HDP (in millimetres)
$\frac{1}{2}$	20
1	32
$1\frac{1}{2}$	50
2	63
3	90

2.2.2 Pipe

The dimensions and technical specifications of the pipe can differ depending on the supplier's country. To date, all HDP pipe used in Nepal has been manufactured according to DIN (German) specifications, but in future pipe purchased in India will be according to ISI (Indian Standard Specifications). The only major difference between them is that the pipe wall thickness is greater for ISI than for DIN.

Normally, only four sizes of HDP pipe are used in Nepal. These are 20mm. (outer diameter); 32mm; 50mm and 63mm. The usual pressure ratings are 10 kg/sq.cm. for 20mm pipe and 6 kg/sq.cm. for the other three sizes. (A pipe with a 10 kg/sq.cm. rating can withstand water head pressures of up to 100 metres; 6 kg/sq.cm. represents a water head pressure of 60 metres).

When required, however, it is possible to obtain HDP pipe in other sizes (e.g. 90mm). It is also possible to obtain the larger sizes suitable for 10 kg/sq.cm. pressure ratings.

Pressure ratings show the maximum pressure the pipe can withstand. In designing a water system, care should be taken to ensure that the water pressure inside the pipe will never exceed the pressure rating for that particular size of pipe.

2.2.3 Fittings

Fittings are used to join the pipe. Different types of fittings are used to suit different needs. Fittings now available are:

- A - Flange sets
- B - Brass unions
- C - Equal tees
- D - Reducers
- E - Pipe caps

Elbows can be manufactured in Nepal from pipe, and reducing tees can be made by welding reducers to equal tees.

A. Flange sets

A flange set consists of five parts:

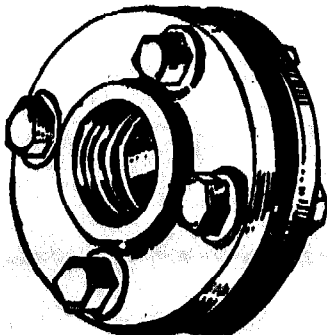

- 1 - Threaded flange
 - 2 - Unthreaded (plain) flange
 - 3 - Flange adaptor
 - 4 - Rubber gasket
 - 5 - Nuts, bolts and washers.
- Flange sets are used as described under section 2.5.2

The threaded flange is for joining to the GI pipe; the flange adaptor is for joining to the HDP pipe.

B. Brass unions

A brass union of this type consists of five parts:

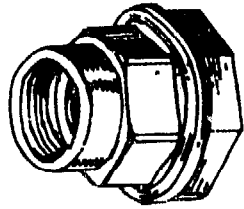

- 1 - The union body
- 2 - Brass ring
- 3 - Brass expansion plug
- 4 - Neoprene ring
- 5 - Neoprene gasket. Brass unions are used as described under section 2.5.3

The female-threaded socket is for joining to the GI pipe. The male-threaded socket is for joining to the HDP pipe.

C. HDP Equal tees

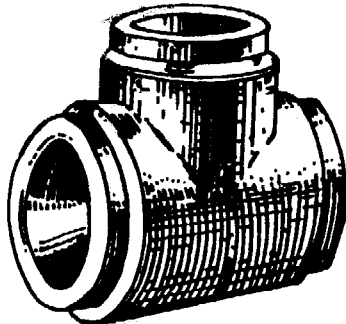

Three equal diameter openings at 90° to each other. These are used in adding branch lines to the main line. Where a reducing tee is required, one or more reducers are welded to one of the tee openings.

D. HDP Reducers

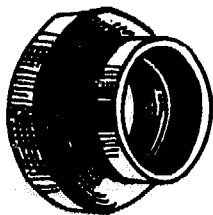

Used in joining two lengths of pipe of different sizes. The larger pipe is welded to the larger reducer end; the smaller pipe to the smaller reducer end.

E. HDP Pipe caps

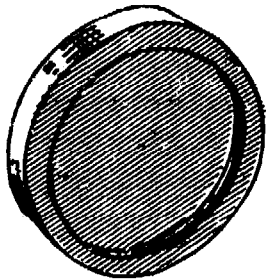

Where a 90° elbow is required, a cap can be welded to one of the ends of an equal tee. Caps can also be used in blocking lines, when required, and in manufacturing HDP screens for tank outlets.

2.3 Handling of HDP pipe

2.3.1 Transport

HDP pipes are normally transported in coils. Any possibility of external damage, for example from sharp stones or glass, should be avoided.

2.3.2 Storage

HDP pipe coils should be laid horizontally, and stored in the shade. Polyethylene pipes should not be stored near fertilizers, insecticides or other strong chemicals. The pipe should never be exposed to fire or excessive heat.

2.3.3 Pipe coils

The pipe which is extruded in a straight length is mechanically wrapped around a coil former and bound together into a rigid transportable coil. When the binding is cut from the coil, the pipe will tend to revert to a straight pipe. Care should be taken to control this movement for 50mm diameter pipe and above, as the uncoiling force can be of a considerable magnitude. (HDP pipe can also be provided uncoiled and cut into lengths if so required).

2.4 Joining HDP to HDP

2.4.1 General

HDP pipes are joined by a process called "Butt-Welding". When HDP plastic is heated to the correct temperature it becomes molten and solidifies again after cooling. A properly welded joint is as strong as the pipe itself. This joint has the same life expectancy and corrosion resisting properties as unwelded pipe.

2.4.2 Tools for "Butt-Welding".

The following tools are required:

- Heating plate
- Blow torch or other source of heat
(see appendix 1)
- Thermochrome crayon
- Hacksaw (with blades)
- Scraper or knife

Other very helpful tools are:

- Mould)
- Mitre box) - see appendix 2
- Hand mitre saw)

2.4.3 Welding procedure

- a) Hold the pipe in the mitre box and cut it to the desired angle. Care should be taken to prevent movement of the pipe while cutting so as to prevent any change in the profile of the surface.
- b) Remove fibrous material with a scraper or knife to obtain a smooth surface. Care should be taken that the trimming of the pipe ends is complete over the entire pipe circumference. After trimming nothing should be allowed to touch the newly exposed faces.
- c) Check the joint for neat contact and true alignment. At no point of the joint should there be a gap of more than 0.5mm.
- d) Heat the clean plate a short time. Put marks with the thermochrome crayon on it and continue with heating. During the heating the colour of the marks will change from white to brown. When the marks are dry and brown, the plate has the right temperature of 220°C and the heating plate must be removed immediately from the blowtorch. It is very important to weld with the correct heating plate temperature. Every new joint needs the same procedure.
- e) Hold the pipe ends on the two sides of the hot plate and press them gently until a low rim of melted material is formed.

- f) Remove the heating plate and without delay bring the pipe ends into contact under light but firm pressure. At no time should excessive pressure be applied. Keep pressure on the joint until it has cooled. It is recommended that contact with cold water not be used in speeding up joint cooling.
- g) Every joint has to be checked by bending and good visual control. An internal water pressure test will be carried out after the pipe has been welded into a line. (See water supply construction course).

Summary of Butt-Welding

1. Rules

Clean straight cut (pipe end)
Clean welding plate
Heating plate temperature 220°C

2. Form of the Butt-Weld under various welding conditions

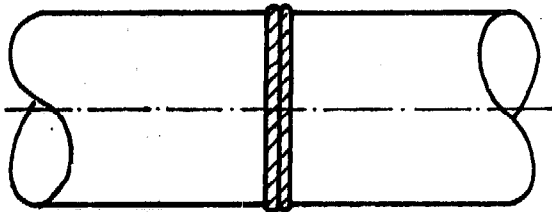

Correct

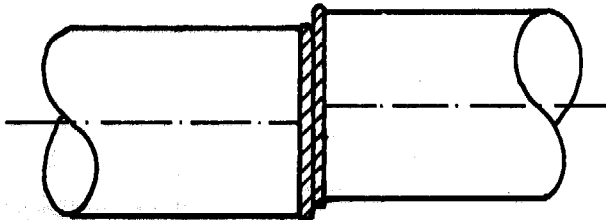

Wrong: Out of axial alignment

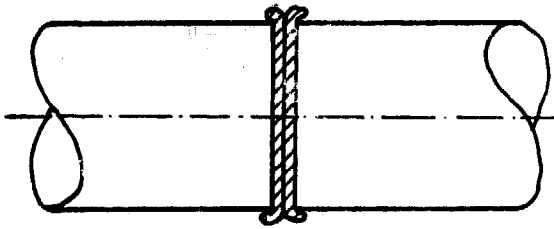

Excessive pressure at
the start of the welding
procedure

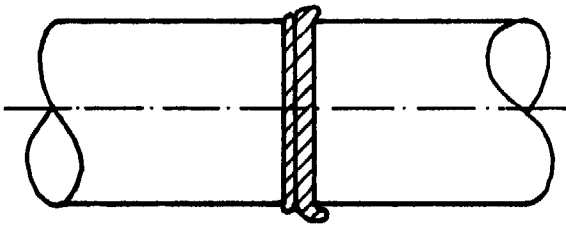

Uneven heating of the
two pipe ends

2.4.4 Making fittings locally

Usually the HDP fittings are prefabricated but in certain cases, for instance repairs, some fittings can be produced at the site.

On the following pages the procedures for making different fittings are illustrated.

1. BRANCH 90°

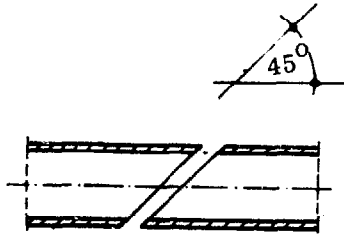

1. cut

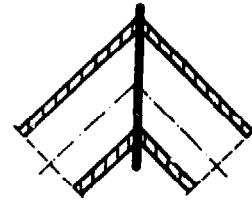

2. check

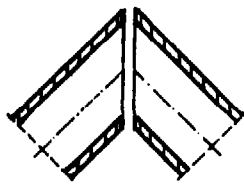

3. file and check

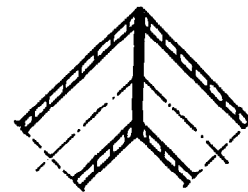

4. Weld

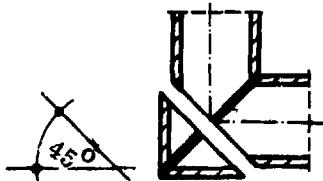

5. Cut



6. Cut another piece

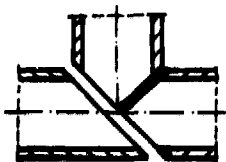

7. File and Check



8. Weld

2. BRANCH 60°

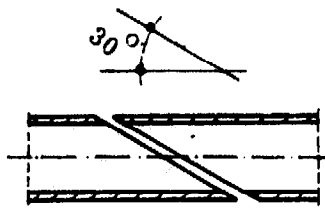

1. Cut

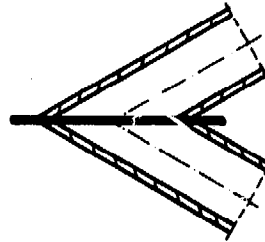

2. Check

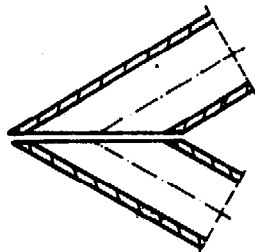

3. File and Check

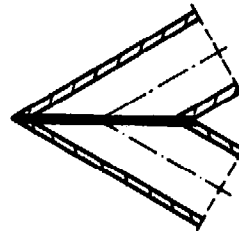

4. Weld

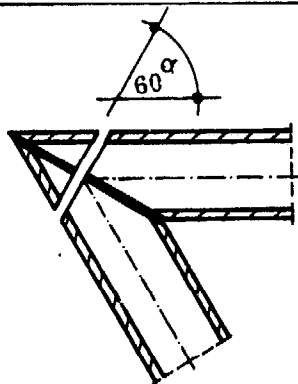

5. Cut

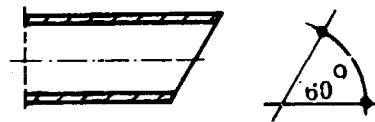

6. Cut another piece

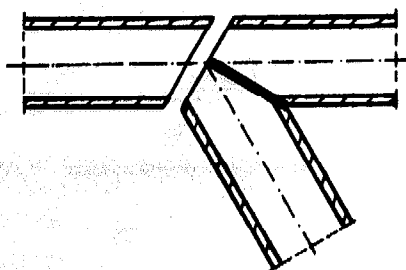

7. File and Check

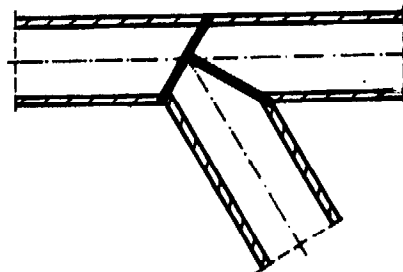

8. Weld

3. BRANCH 45°

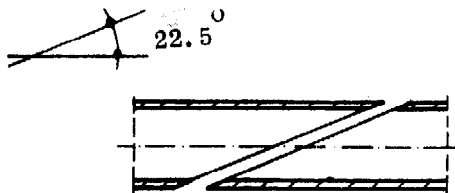

1. Cut

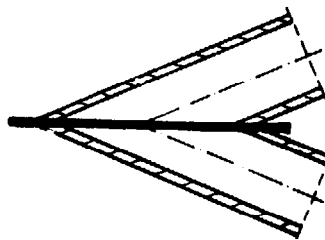

2. Check

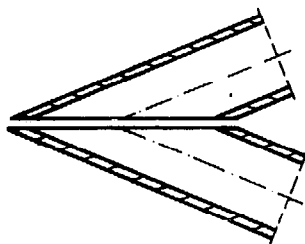

3. File and Check

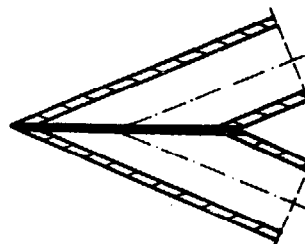

4. Weld

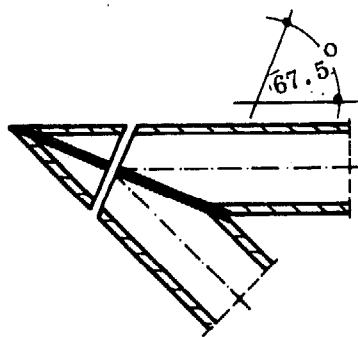

5. Cut

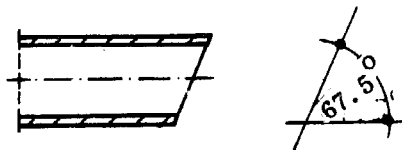

6. Cut another piece

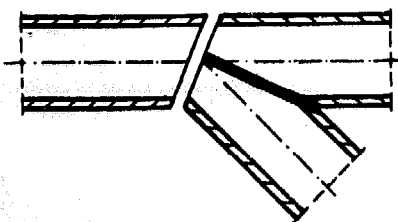

7. File and Check

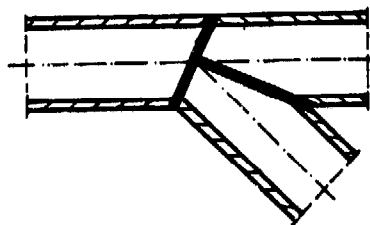

8. Weld

4. ELBOWS AND BENDS

Elbow 45°

2 pieces with 11.25° cut
1 segment piece 2 x 11.25° cut

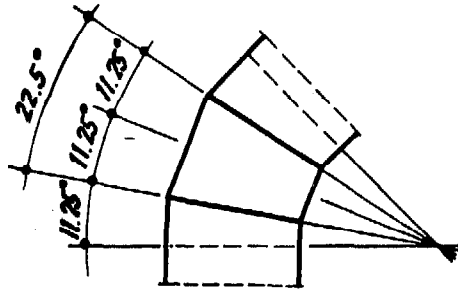

Elbow 90°

2 pieces with 15° cut

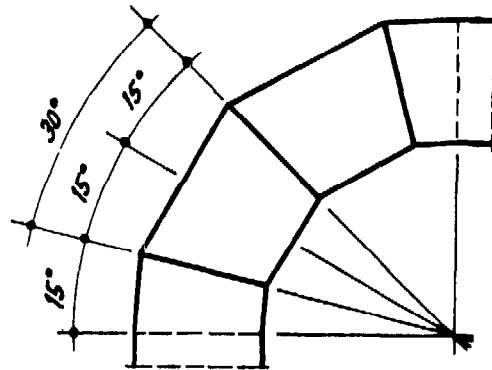

2 segment pieces 2 x 15° cut

Bend 45°

2 pieces with 5.6°
3 segment pieces 2 x 5.6°

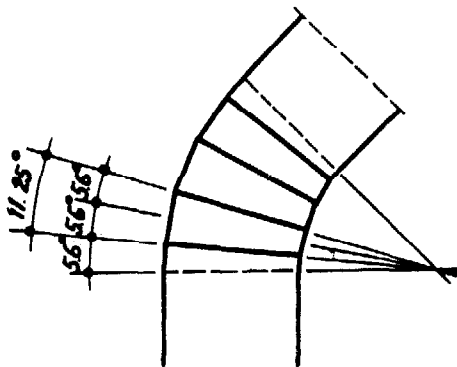

Bend 90°

2 pieces with 7.5°
5 segment pieces 2 x 7.5°

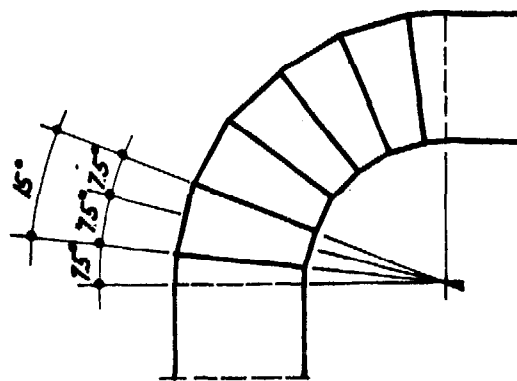

Not recommended

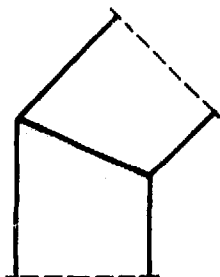

Wrong

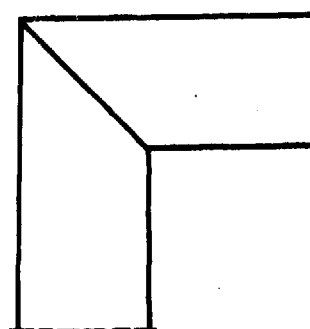

5. ENDCAP

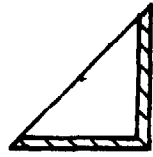

Take the left-over segment of a 90° branch of the same diameter as the pipeline

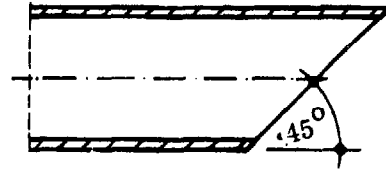

Cut a 45° angle on the pipe line

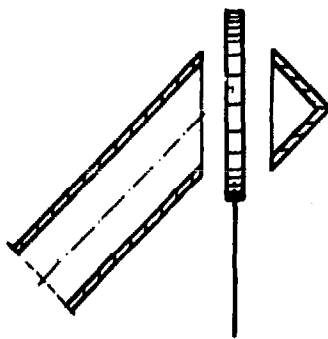

Heat both pieces on the welding plate

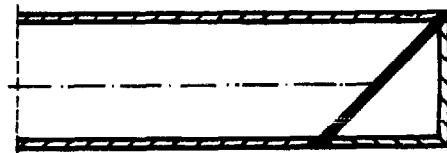

Weld them together

6. CONICAL REDUCER

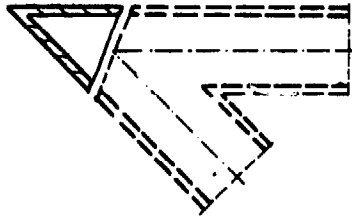

1. Take a segment of a 45° branch

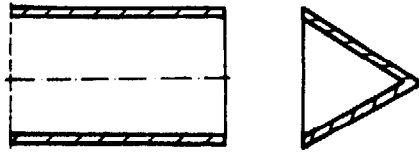

2. Check to ensure that the diameter of the segment is the same as that of the larger diameter pipeline



3. Weld the conical piece to the pipe with the larger diameter
Cut off the pointed end; this small segment has to be smaller than the diameter of the smaller pipe to be joined.

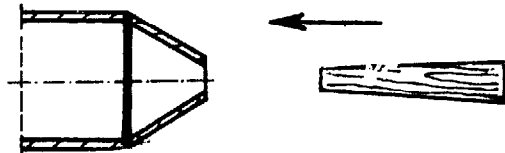

4. Heat the end lightly and push a conical piece into it.

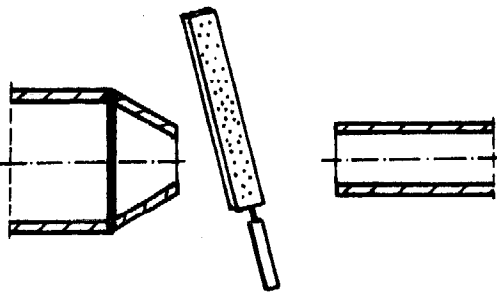

5. After cooling file the end of the reducer down to the diameter of the smaller sized pipe

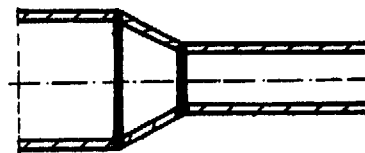

6. Heat both pieces on the welding plate and weld them together

2.5 Joining HDP pipe to GI pipe or GI fittings

2.5.1 General

HDP cannot be joined to metal by butt-welding, but there are several other methods of making such a joint. The two methods for which fittings are provided are joining with flanges and joining with unions.

2.5.2 Using flanges

In making a flanged joint a flange set is used (see 2.2.3). A flange set has one threaded flange, one flange which is not threaded, a plastic flange adaptor, a rubber gasket and nuts and bolts to hold these together. First, the set is disassembled by removing the bolts. Second, the threaded flange is screwed onto the GI pipe. Third, the unthreaded flange is slid onto the HDP pipe. Fourth, the HDP pipe is welded to the flange-adaptor. Fifth, the gasket is replaced and the flanges are bolted together again.

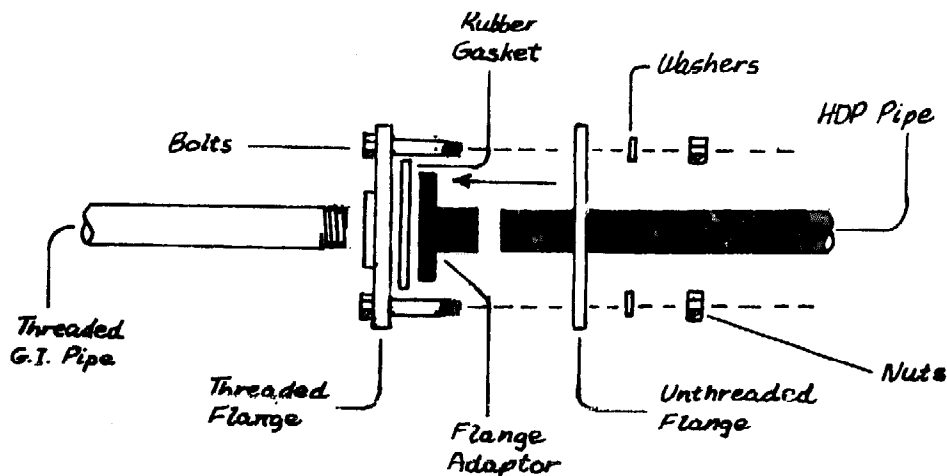

2.5.3 Using brass union.

For making a union joint a brass union is provided (see 2.2.3). A brass union of this type consists of 5 parts:

- a) The union body which has female threads on one end and male threads on the other
- b) A brass ring, with female threads
- c) A brass expansion plug
- d) A neoprene ring
- e) A neoprene gasket

First, the female-threaded end of the union is screwed onto the GI pipe. Second, the brass ring is unscrewed and slid over the HDP pipe. Third, the neoprene ring is also slid over the pipe. Fourth, the end of the HDP pipe is heated until it becomes soft. The most practical way of doing this is to place the pipe end directly in a flame, but in using this method care must be taken to ensure that the pipe is not over-heated or made to burn.

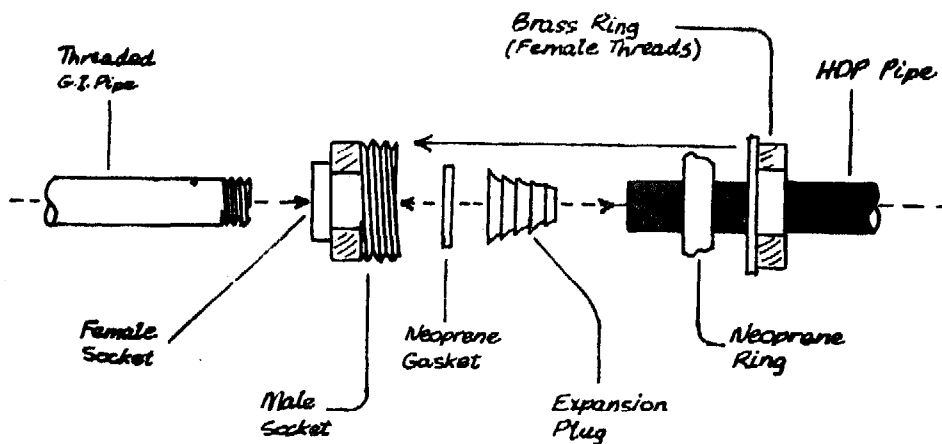

Fifth, the expansion plug is inserted into the HDP pipe, small end first. The nozzle should be pushed in until its large end is even with the pipe end, but not further. This must be done while the pipe end is still warm. Sixth, the neoprene gasket is placed in the union socket which has male threads. (Note that with certain types of brass unions a gasket is not necessary). Seventh, the brass ring is screwed tightly onto the union. With a union joint no butt-welding is necessary.

APPENDIX 1:

OPERATING A BLOW TORCH!

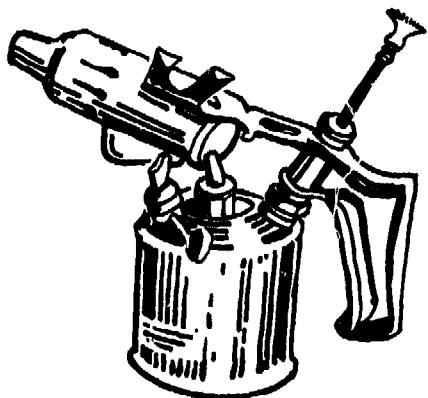

The blow lamp is a portable kerosene torch used to produce intense local heat, for melting metals, heating metals and soldering. The blow torch can also be used in welding HDP pipe and fittings.

Operating a blow torch

1. Fill the tank to 3/4 with kerosene. Use a funnel with a filter so that dirt will not flow into the tank and block the outlet.
2. Open the air valve.
3. Fill the oil cup with kerosene.
4. Light the kerosene in the oil cup. Leave the burning match in the cup.
5. Let the kerosene almost burn out.
6. Close the air valve.
7. Pump the air pump 15 to 20 times.
8. After pumping the torch should start burning. If it goes out, repeat the above operation.
9. Pump more if a more intense flame is required.
10. To decrease flame intensity open the air valve slightly to lower the air pressure.
11. If the flame smokes or fluctuates, clean the outlet with a cleaning needle.
12. To put out the flame open the air valve all the way.

APPENDIX 2 : Mould and Mitre Box

MOULD FOR STRAIGHT PIPE WELDING

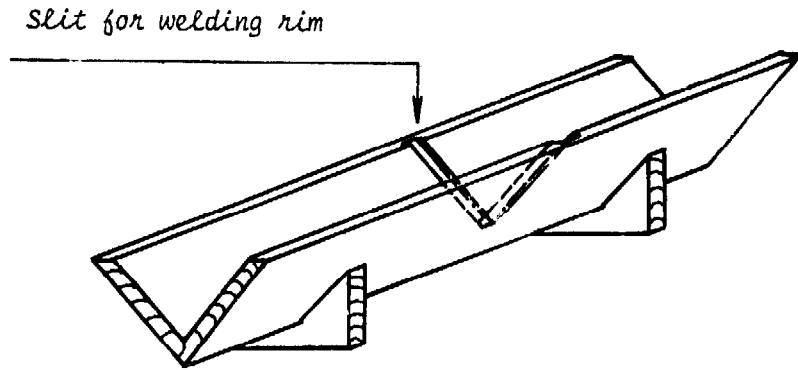

MITRE BOX

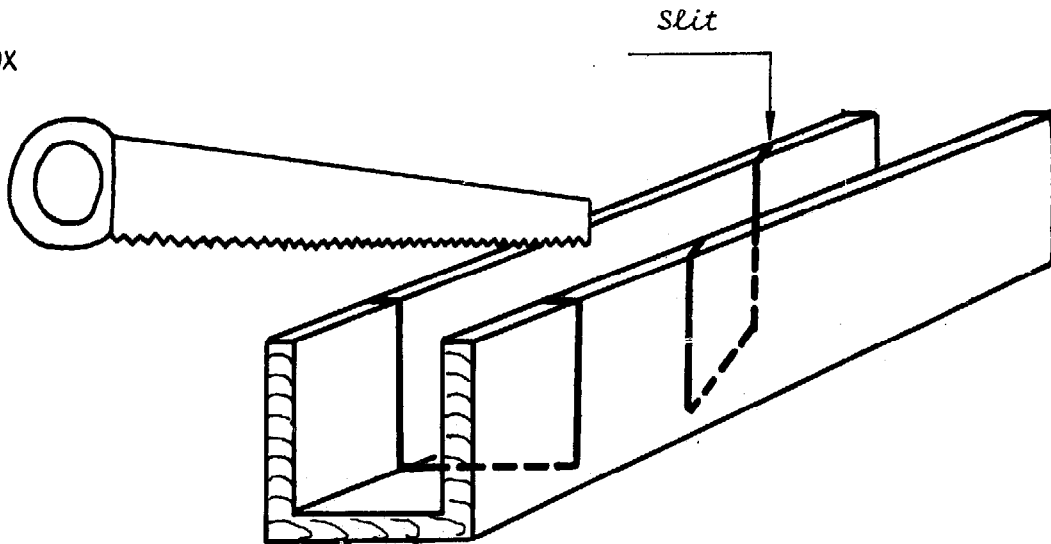

MOULD FOR BRANCH (WELDING AND CUTTING)

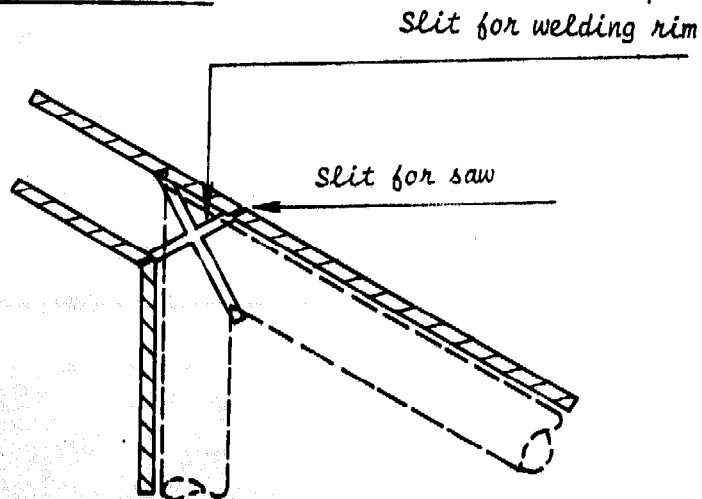

3. GI pipe and fittings

3.1 Introduction

3.1.1 General

Galvanised iron pipes are used as service pipes in crossing rivers, in tank installations and pressure reducers. This is possible because of the rigidity and high pressure rating of GI pipe. GI pipe and most of the fittings are usually locally available in the bazaar. The abbreviation GI is short for "Galvanised Iron".

Density : 7.85 gm/cc.
Colour : Grey-galvanized.

3.1.2 Advantages of GI pipe and fittings

- Mechanical strength and high pressure rating.
- Locally available.
- Cement will adhere to the metal after the galvanisation has been removed. This makes it possible to use the pipe in concrete structures such as reservoirs.

3.1.3 Disadvantages of GI pipe and fittings

- No possibility of making fittings locally.
- High loss of water pressure due to internal friction.
- Low resistance to chemical corrosion as compared with HDP or other plastic pipe.
- Higher cost than HDP or other plastic pipe.
- Heavy weight.

3.2 Standard supply of GI pipe and fittings

3.2.1 General

The following sections give a brief description of each GI item normally used in constructing water supply systems of the gravity-flow type. (Refer to section 2.2.1 for pipe size description).

3.2.2 Pipe

GI is an abbreviation of "Galvanised Iron", a term broadly used to describe metal pipe of the type commonly utilised in the installation of gas, water and steam conduits. Although such pipe is normally made of mild steel, it is nevertheless widely referred to as GI.

It is possible to procure such pipe without the galvanisation, but it is usually galvanised (coated with a thin layer of zinc) to prevent otherwise rapid rusting of the pipe. For this reason, GI pipe should not be bent. If this is done the galvanisation will crack and the pipe will begin to rust at that point. If a bend is required, an appropriate fittings (e.g. an elbow) should be used.

GI pipe is normally delivered in single lengths of 6 metres each. Each length should have a socket screwed to one end.

The pipe is manufactured in three categories according to its weight and pressure-bearing capacity. The categories are: 1-light (formerly Class A); 2-medium (formerly Class B); 3-heavy (formerly Class C). The category most readily available in hardware stores in Nepal is of the light grade. Medium and heavy grades can also be purchased but for those grades an advance order is generally required.

The three tables given below described the basic characteristics of each grade of pipe.

a) Light grade

INSIDE DIAMETER (INCHES)	OUTSIDE DIAMETER (mm)	WALL THICKNESS (mm)	WEIGHT (kg/m)	RECOMMENDED WORKING PRESSURE (kg/sq.cm.)
½	21.2	2.0	0.95	10.6
1	33.5	2.7	2.01	10.6
1½	48.1	2.9	3.25	8.8
2	59.9	2.9	4.11	7.0
3	88.3	3.3	6.81	7.0

b) Medium grade

INSIDE DIAMETER (INCHES)	OUTSIDE DIAMETER (mm)	WALL THICKNESS (mm)	WEIGHT (kg/m)	RECOMMENDED WORKING PRESSURE (kg/sq.cm)
½	21.4	2.7	1.22	21.1
1	33.8	3.3	2.44	21.1
1½	48.4	3.3	3.61	17.6
2	60.2	3.7	5.10	14.1
3	88.8	4.1	8.47	14.1

c) Heavy grade

INSIDE DIAMETER (INCHES)	OUTSIDE DIAMETER (mm)	WALL THICKNESS (mm)	WEIGHT (kg/m)	RECOMMENDED WORKING PRESSURE (kg/sq.cm)
½	21.4	3.3	1.45	24.6
1	33.8	4.1	2.97	24.6
1½	48.4	4.1	4.43	22.1
2	60.2	4.5	6.17	17.6
3	88.8	4.9	10.10	17.6

Important note: In calculating the recommended working pressure, a safety factor of 4 is included in order to allow for occasionally high water pressure which results from surge pressure, water hammer etc. within the pipe. Under working conditions which are generally free of exceptionally high pressures which result from surging, or other such causes, the pipe can be used under pressure conditions up to 4 times the recommended working pressure. This applies to all three grades. For example, this could mean that 1" light grade pipe could be safely used under pressures of up to 42.4kg/sq.cm.; 2" heavy grade pipe could be used under pressures of up to 70.4kg/sq.cm. provided that intermittently very high pressures as described above are not expected.

3.2.3 Fittings

Most GI fittings are normally made of either medium or heavy grade mild steel. Certain types, such as sockets, are sometimes made of light grade mild steel, and this should be kept in mind while designing a system as such fittings are not as durable as those of medium or heavy grade mild steel. One way of getting around this would be to bring spare fittings to the village. For example, if 10 elbows are required for a certain system, 15 could be brought to the work site. This would allow for spares and for replacements in case some of the parts were found to be defective.

On the following pages, the most commonly used GI fittings are described.

BEND

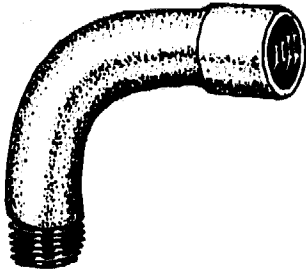

BEND

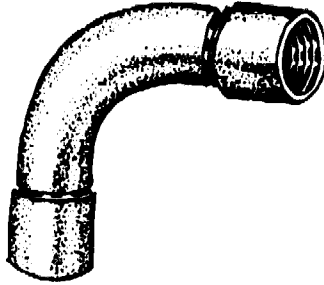

BEND

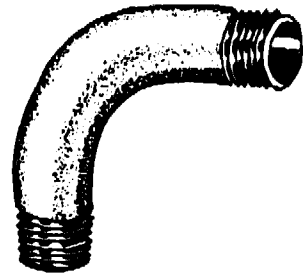

ELBOW

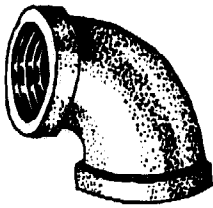

ELBOW

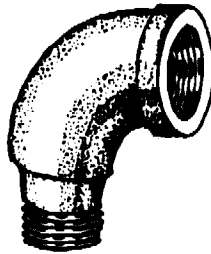

TEE

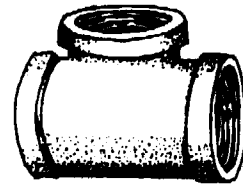

CROSSES

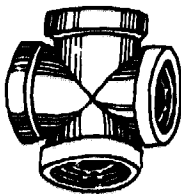

REDUCING SOCKETS



REDUCING BUSHES

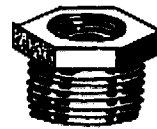

SOCKET

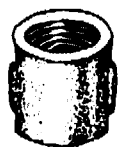

HEXAGON NIPPLES

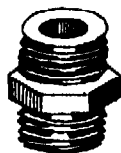

PLUGS

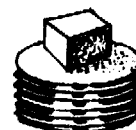

CAPS

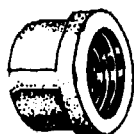

BACK NUTS



FLANGE OVAL

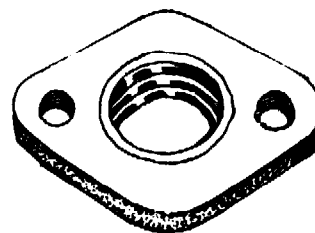

FLANGE ROUND

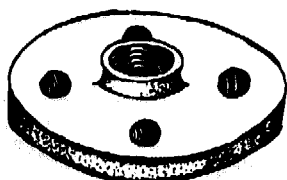

UNION

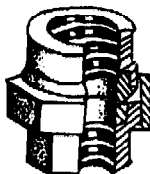

NIPPLE



3.3 Handling of GI pipe

3.3.1 Transport

GI pipes are heavy. They should be treated carefully. If the galvanisation is damaged, the pipe will start to rust.

3.3.2 Storage

GI pipes have low resistance to chemical corrosion, so it is better to store them above ground level by using supports or other means.

3.4 Joining of GI pipe

3.4.1 Tools

To work with GI pipes, the following tools are required:

- Pipe wrench
- Shifting spanner
- File
- Hacksaw (with baldes)
- Die set
- Plumber's table with vice
- Hammer
- Chisel
- Tape and pencil
- Spirit level

3.4.2 Thread cutting

Measure and mark the length of pipe to be threaded and cut the pipe with the hacksaw. In cutting the pipe, even strokes should be used as hasty, irregular strokes rapidly wear out the teeth. The saw blade must be kept straight. After the pipe has been cut, a die set is used to thread the end of the pipe. A properly cut pipe-end makes the pipe easier to thread.

- a) Use the set of teeth which corresponds to the diameter of the pipe to be threaded.
- b) Put oil on the end of the pipe which is to be threaded.
- c) Fix the machine in such a way as to place the guiding teeth on the pipe.
- d) Begin the thread cutting. There has to be a sufficient quantity of oil on the surface to be threaded during the entire cutting operation.
- e) The length of thread to be cut varies with the diameter of the pipe according to the table given below. The threads have to be cut in three working operations.
- f) Clean the thread and test it by fitting a socket on the threaded pipe end.

Internal pipe diameter (inches)	Length of thread to be cut (mm)
$\frac{1}{2}$	13
1	17
$1\frac{1}{2}$	19
2	24
3	30

Many of the locally available die sets are of low quality, and added care should be taken in using such sets. These sets have no guiding teeth, no fixed point for the cutting teeth and they are difficult to use in threading large diameter pipe.

3.4.3 Water-tight joints

Although several types of materials can be placed on threads to make the joint water-tight, only dry hemp and non-poisonous joint paste (putty or animal grease) should be used. Because paint becomes very hard when it dries, it is not recommended as joint paste.

- a) To guarantee water-tightness the threads have to be roughened with an old hacksaw blade so that the hemp will remain in the thread.
- b) Turn the hemp in a clockwise direction, starting at the beginning of the thread (end of the pipe), covering the entire thread with hemp.
- c) Put joint paste on the thread hemp. Ensure that no hemp, oil or joint paste remains inside the pipe.
- d) Fix the fitting on the pipe by hand and tighten with a pipe wrench until reasonably tight. If turned too tight, the fitting may stretch or crack.
- e) Cut off the visible hemp with an old hacksaw blade by moving it counter-clockwise.

The conical form of threads contributes to water-tightness. If a lot of hemp comes out of screwed fittings, it means that the hemp was not fixed correctly.

Tools must always be kept clean, especially the teeth of pipe wrenches.

4. Miscellaneous valves

4.1 Gate valve

Gate valves are normally used in situations where a full pipe flow is required but where it is occasionally necessary to shut off the flow completely. Gate valves should not be used in controlling flow. In other words, gate valves should not be left partially open - they should either be completely open or completely closed. The gate of the valve is wedge shaped and this gate cuts off the flow when the valve is closed and the gate is lowered into a groove cast in the body of the valve.

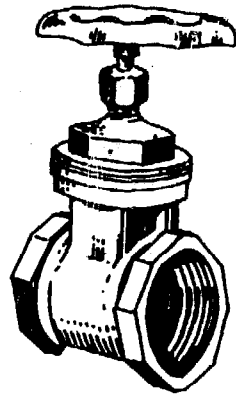

The valve opening is usually of the same diameter as the inside of the pipe to which it is fitted and the valve, when completely open, offers very little resistance to water flow. Gate valves which are left shut for a long time tend to stick shut, after which great force is required to get the gate off the sealing. Similarly, valves which have been left open for a long time may not close properly because of

dirt collected in the gate groove which prevents proper lowering of the gate. If a gate valve has not been opened or closed for years after that time it may not be possible to operate it at all.

These problems can be avoided by regularly opening and closing the valves.

4.2 Globe valve or stop cock (corporation cock)

These valves derive their name from the valve body which is globe-shaped. Globe valves are normally made only in smaller sizes. The body of the valve is cast so that the water must pass through a horizontal opening in the valve seat. A plug, a diaphragm or a jumper can then be forced down into this opening by a screwed handle for shutting off or controlling flow.

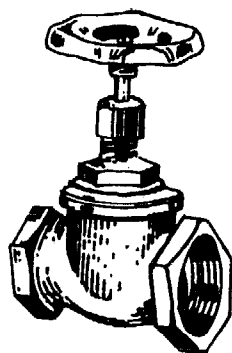

Globe valves have to be installed in such a way that the force of the incoming water is pressing upwards on the valve seat.

The friction loss of water flowing through such valves is quite high.

4.3 Tap (faucet)

Taps are used at the water collecting point to fully open, partially open or completely shut off the flow of water. Many types of taps are available (automatic control, manual control, etc.) and all of those can be made of a variety of materials (brass, iron, steel, etc.).

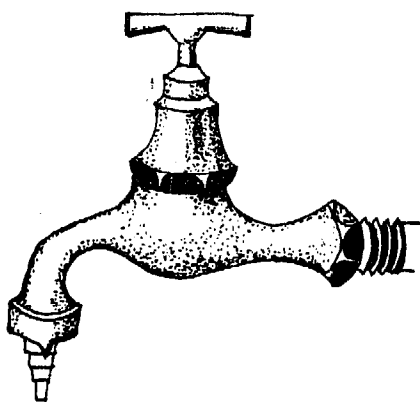

The tap most commonly used in rural areas of Nepal is a manually operated, brass tap with male threads suitable for fitting to a 1/2" socket. Another type, called the "Jayson Waste-Not" tap, closes automatically when water is no longer required. The Jayson tap can be purchased in local hardware shops.